

AL028 ALPHA ACER TENDL-2021 LIBRARY; T=0.K
Principal cross sections

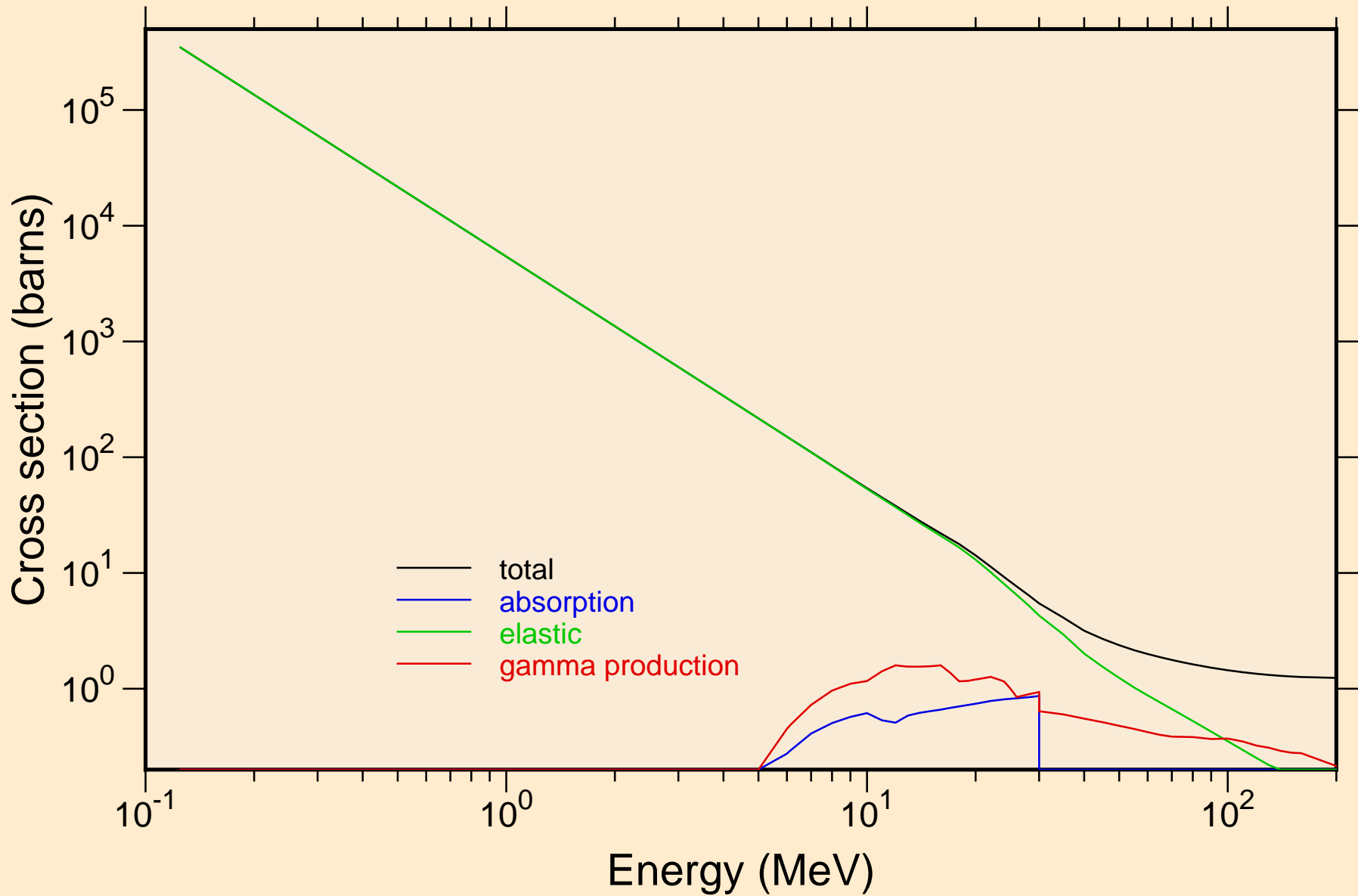

AL028 ALPHA ACER TENDL-2021 LIBRARY; T=0.K

Heating

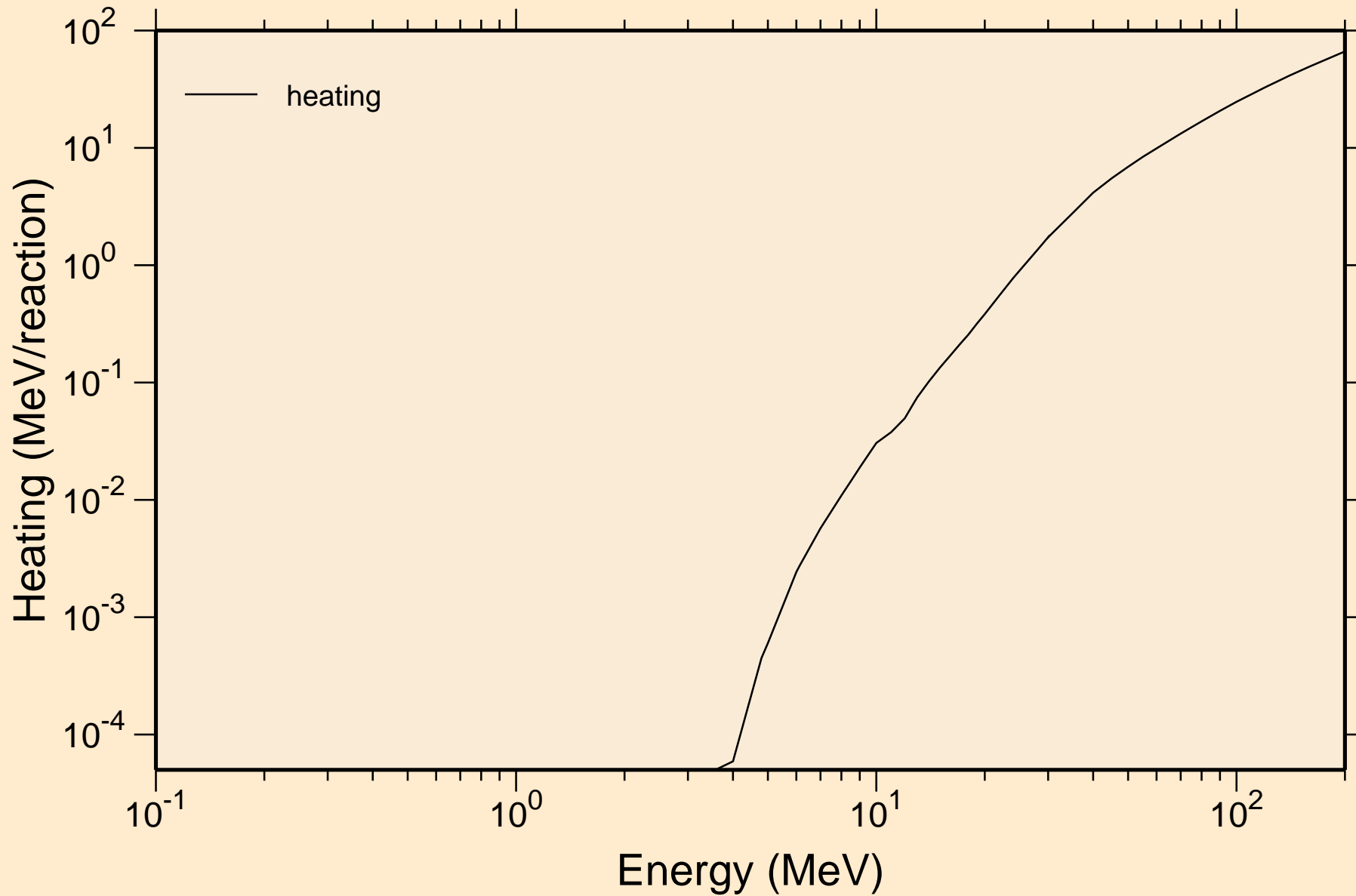

AL028 ALPHA ACER TENDL-2021 LIBRARY; T=0.K

Principal cross sections

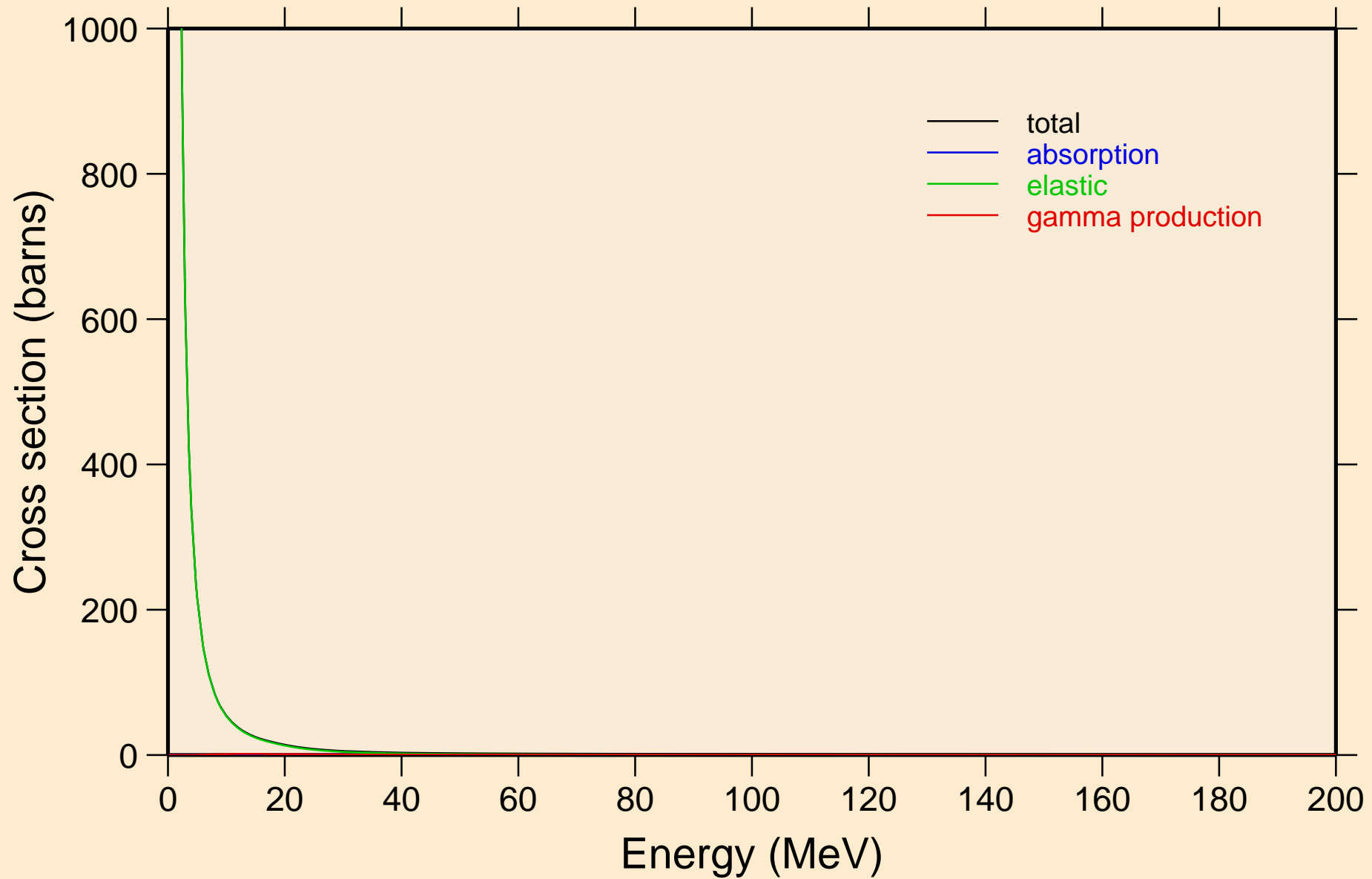

AL028 ALPHA ACER TENDL-2021 LIBRARY; T=0.K

Heating

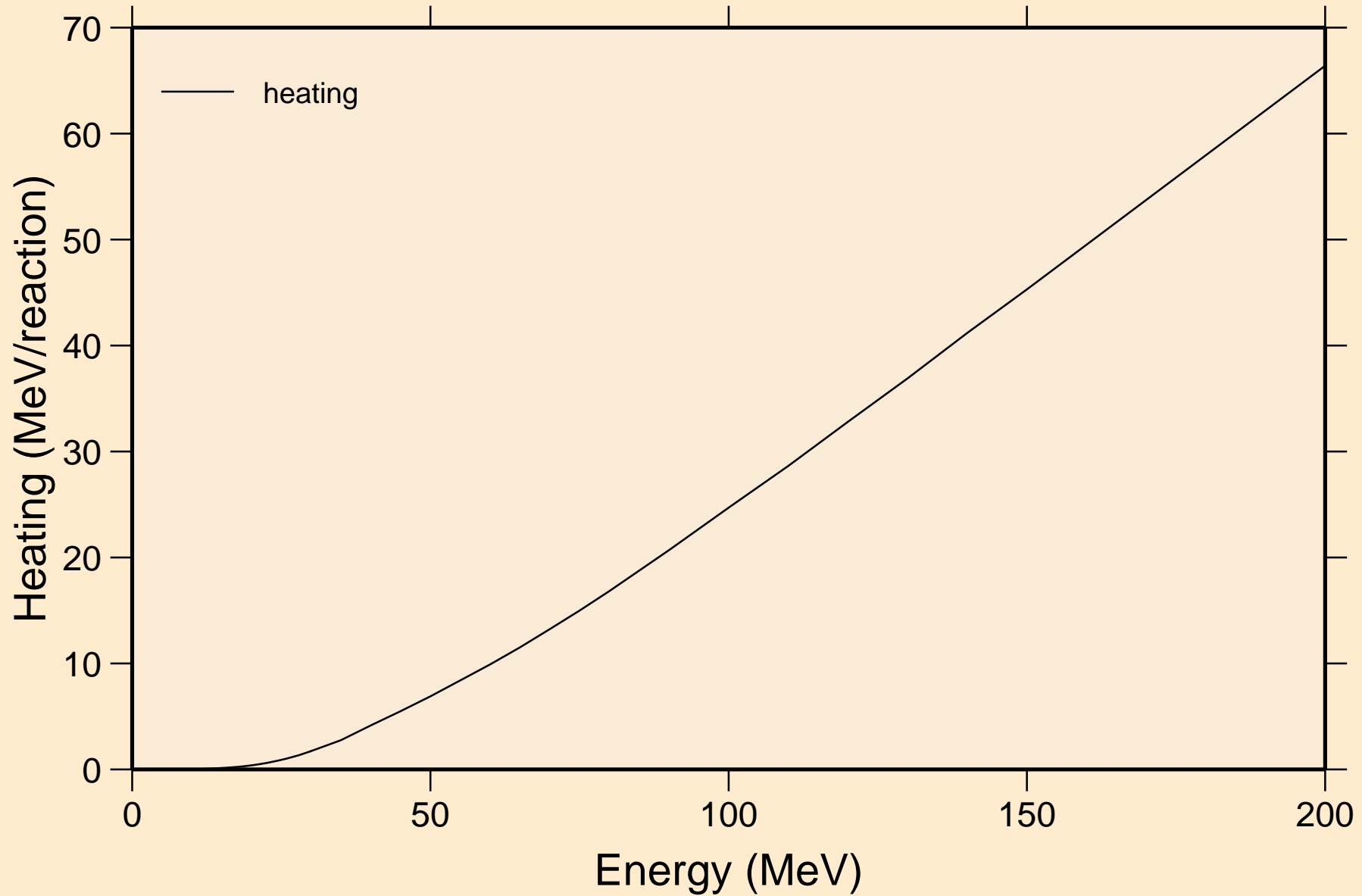

AL028 ALPHA ACER TENDL-2021 LIBRARY; T=0.K
Threshold reactions

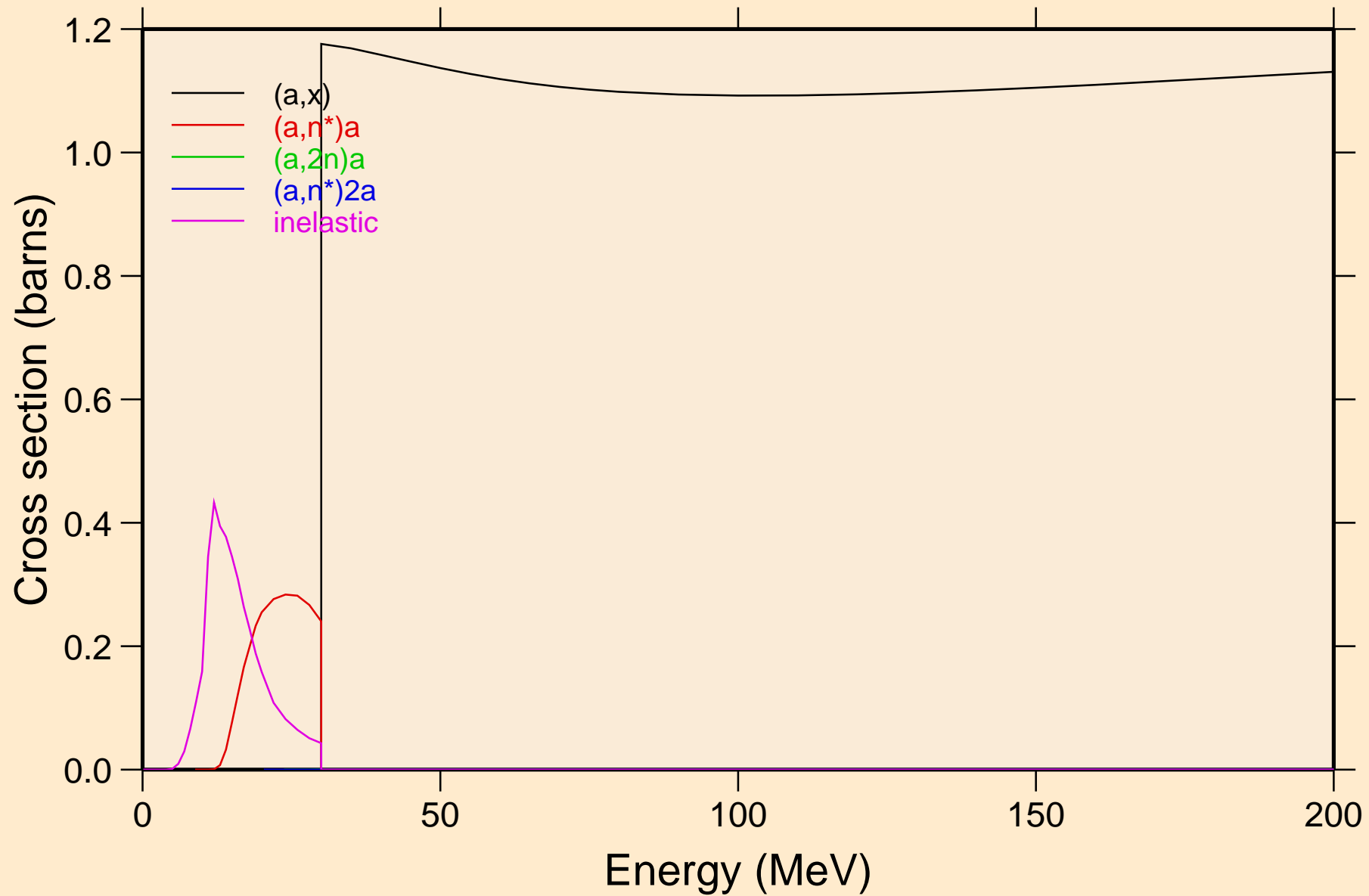

AL028 ALPHA ACER TENDL-2021 LIBRARY; T=0.K
Threshold reactions

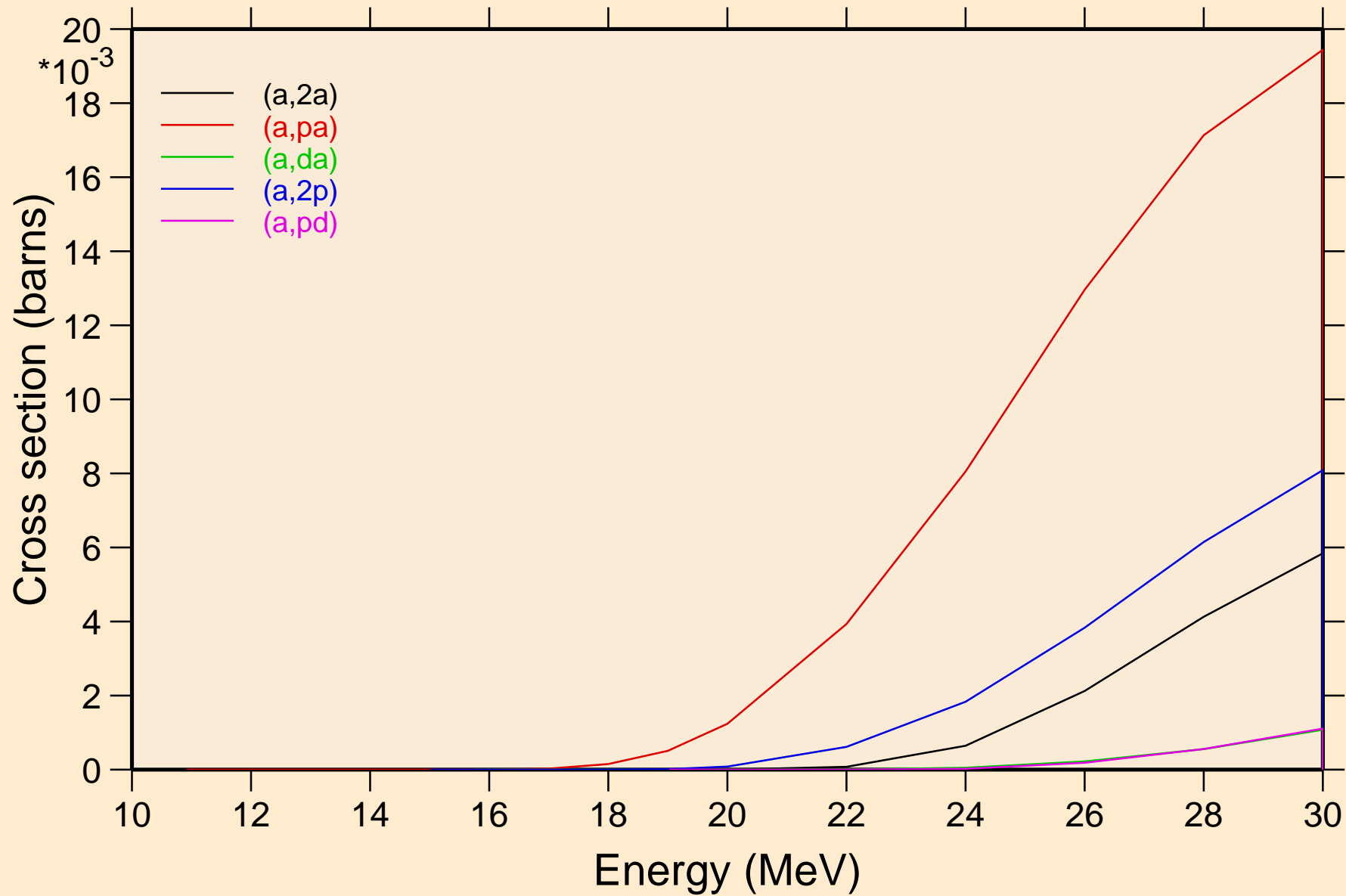

AL028 ALPHA ACER TENDL-2021 LIBRARY; T=0.K
Threshold reactions

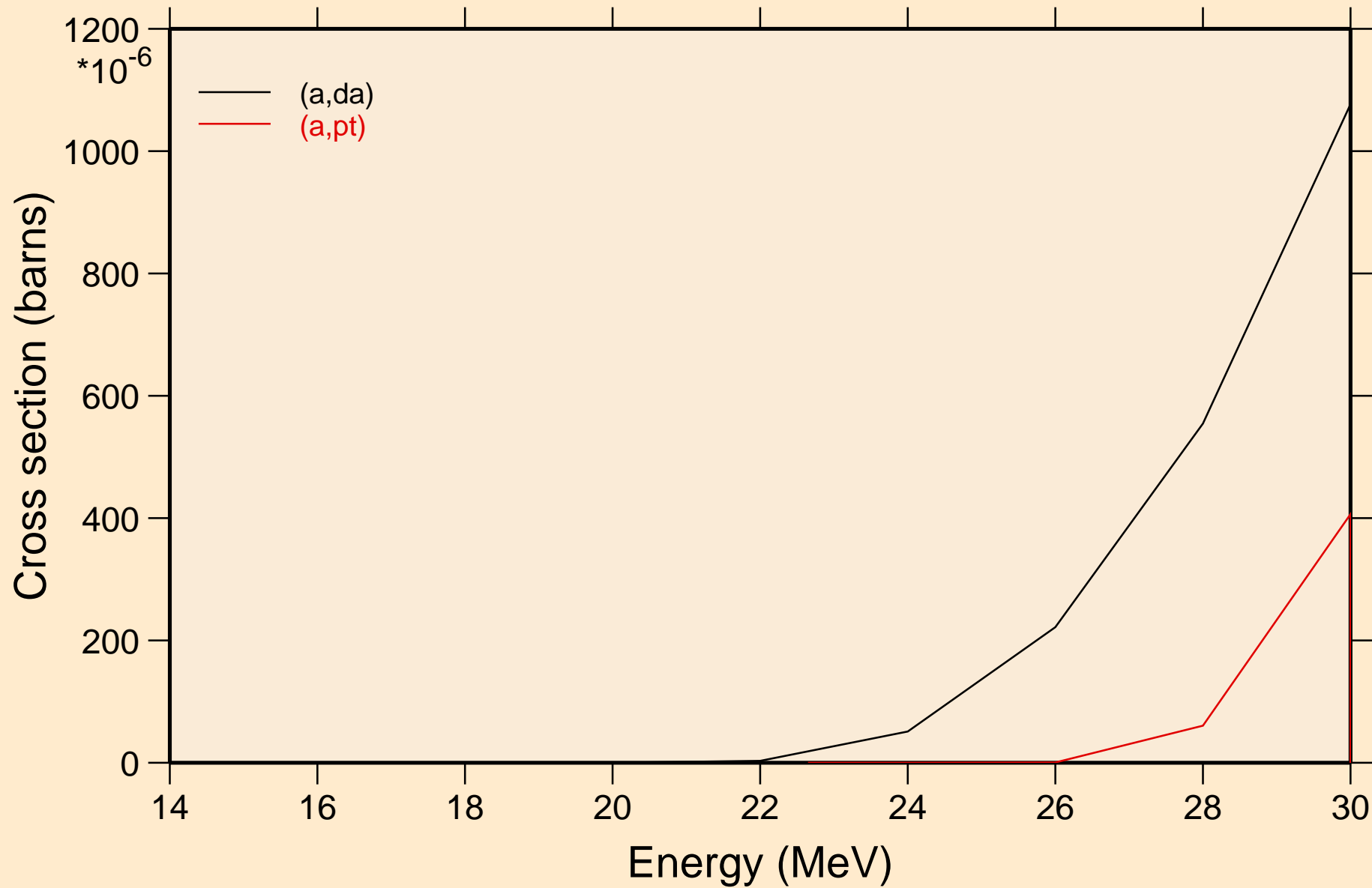

AL028 ALPHA ACER TENDL-2021 LIBRARY; T=0.K
Threshold reactions

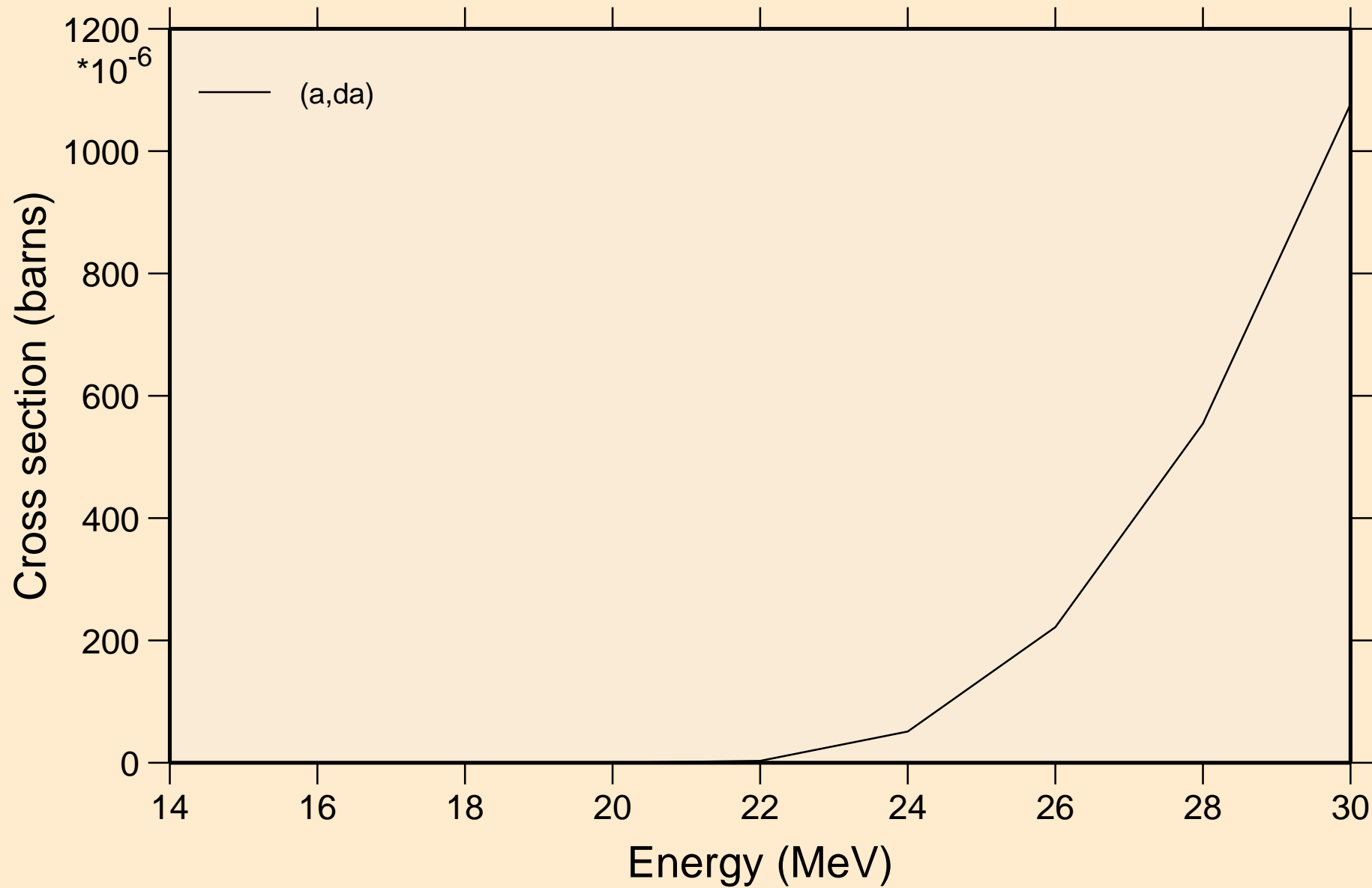

AL028 ALPHA ACER TENDL-2021 LIBRARY; T=0.K
angular distribution for elastic

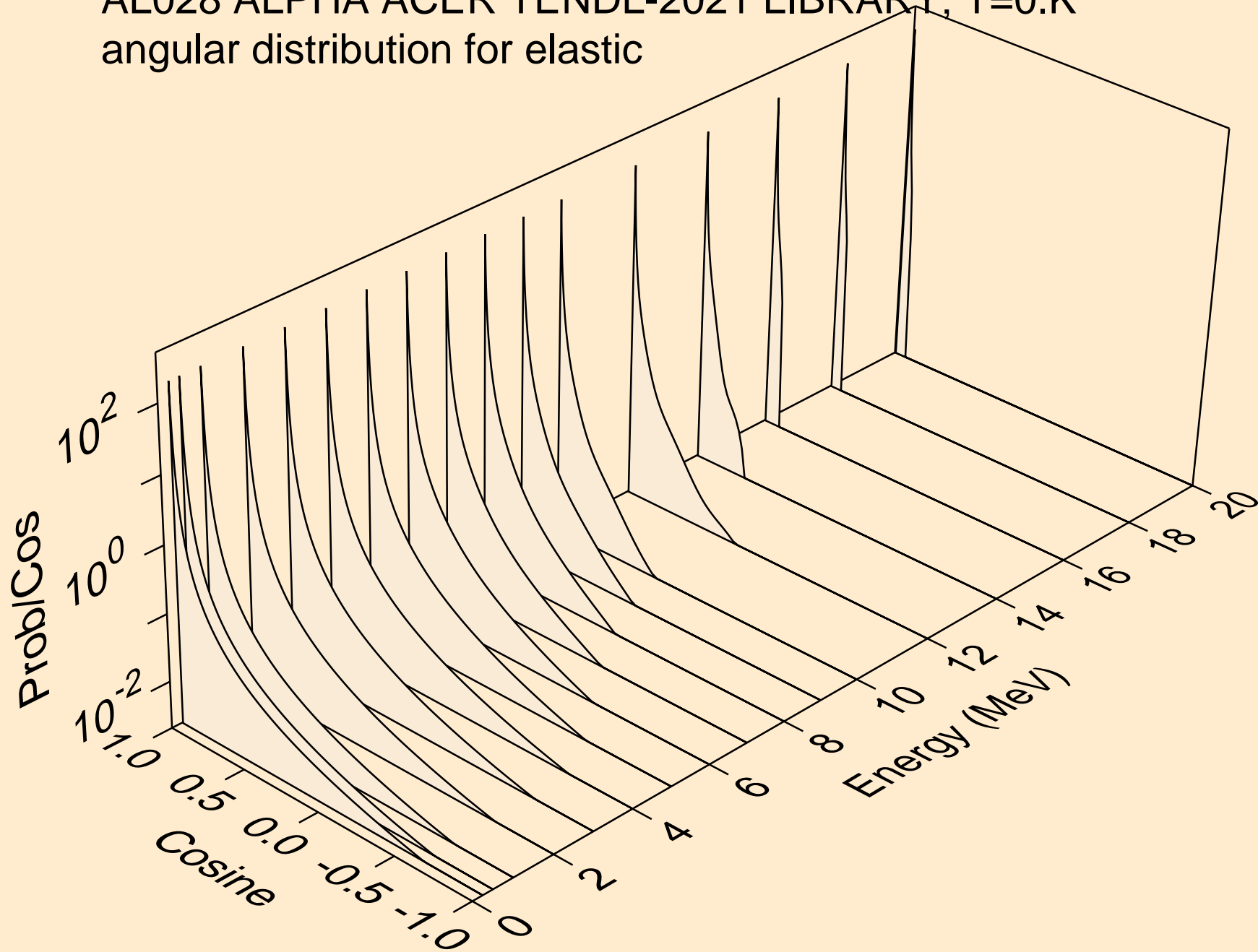

AL028 ALPHA ACER TENDL-2021 LIBRARY; T=0.K
angular distribution for elastic

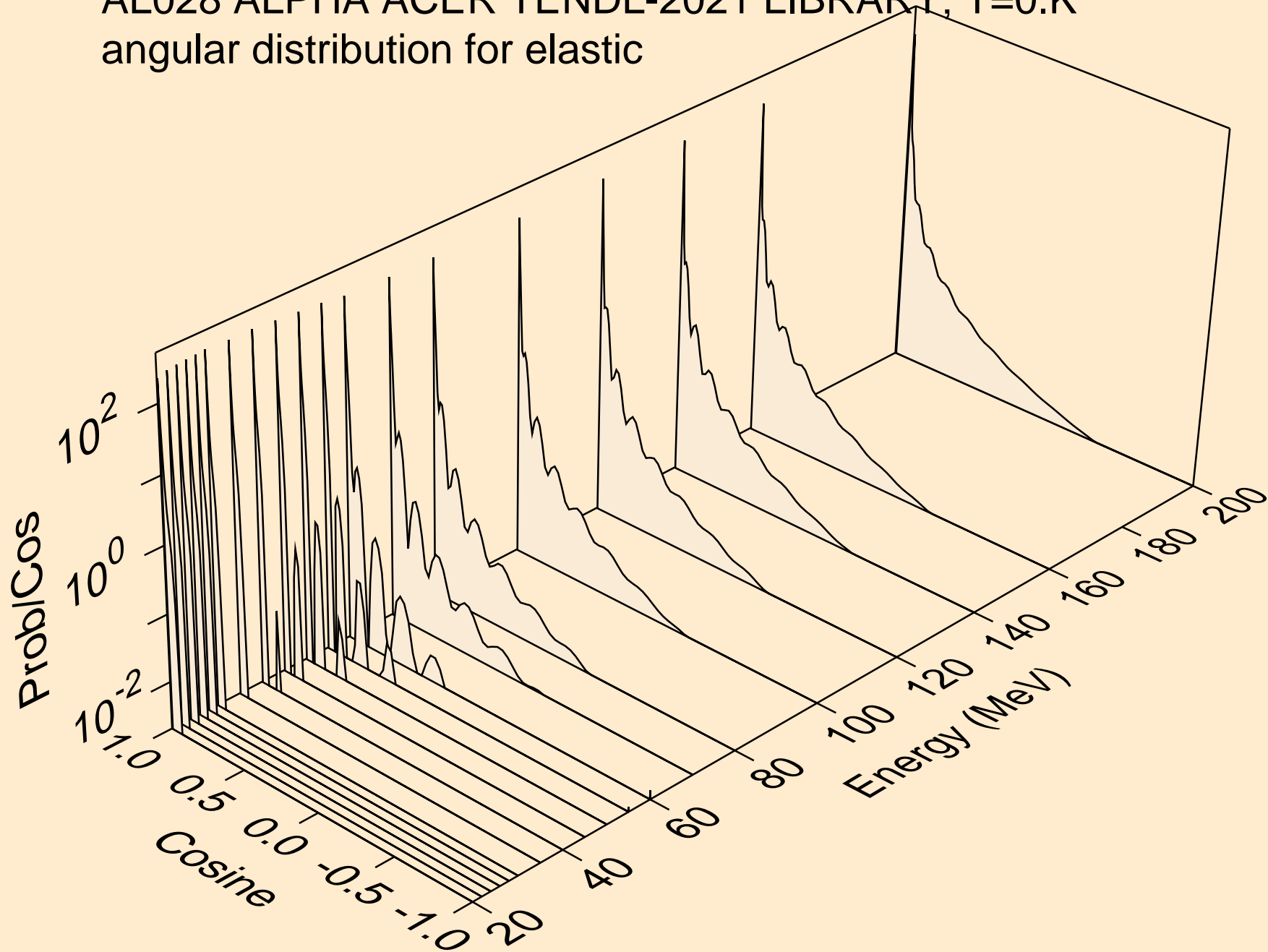

AL028 ALPHA ACER TENDL-2021 LIBRARY; T=0.K

Alpha emission for (a,x)

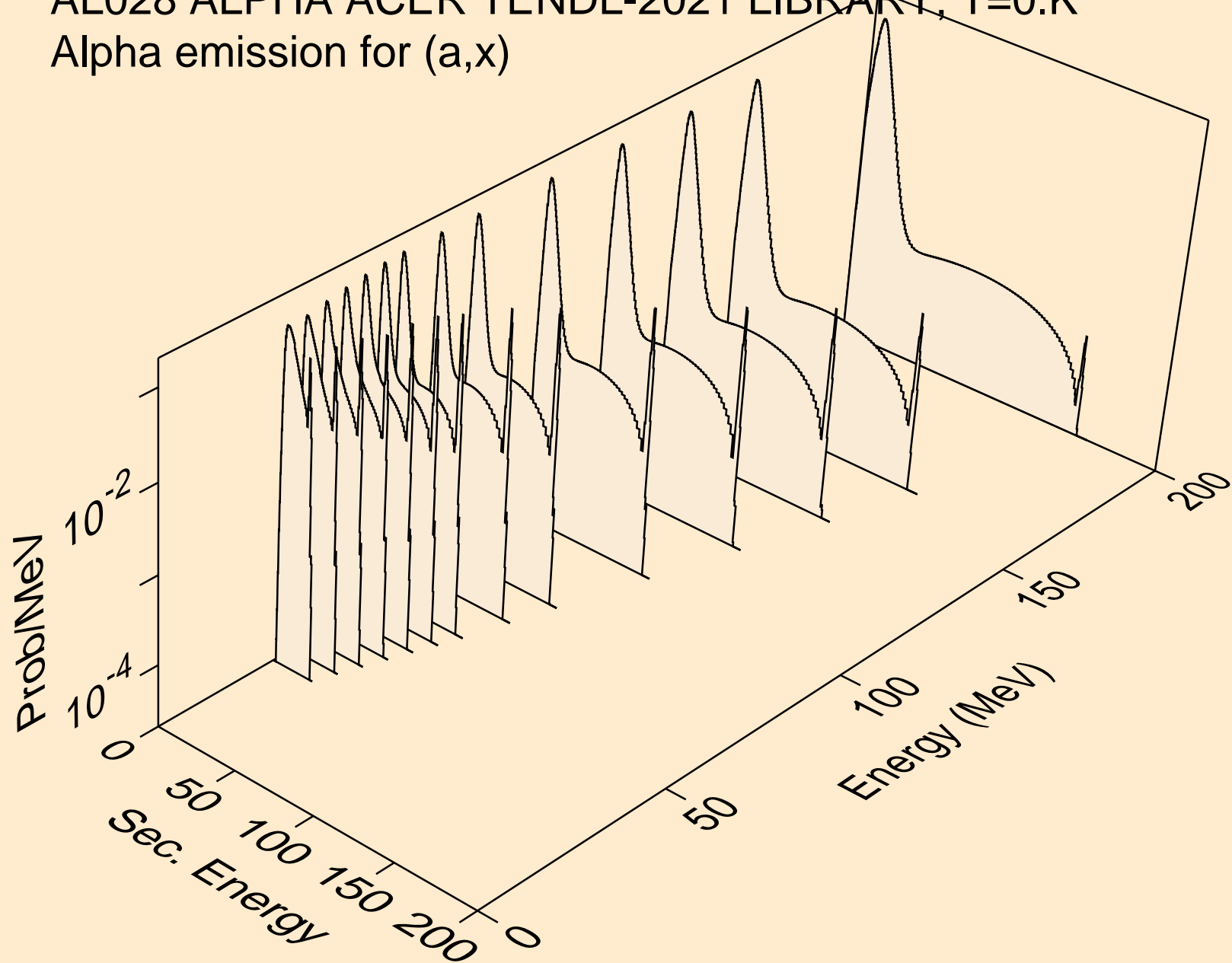

AL028 ALPHA ACER TENDL-2021 LIBRARY; T=0.K
Alpha emission for (a,n*)a

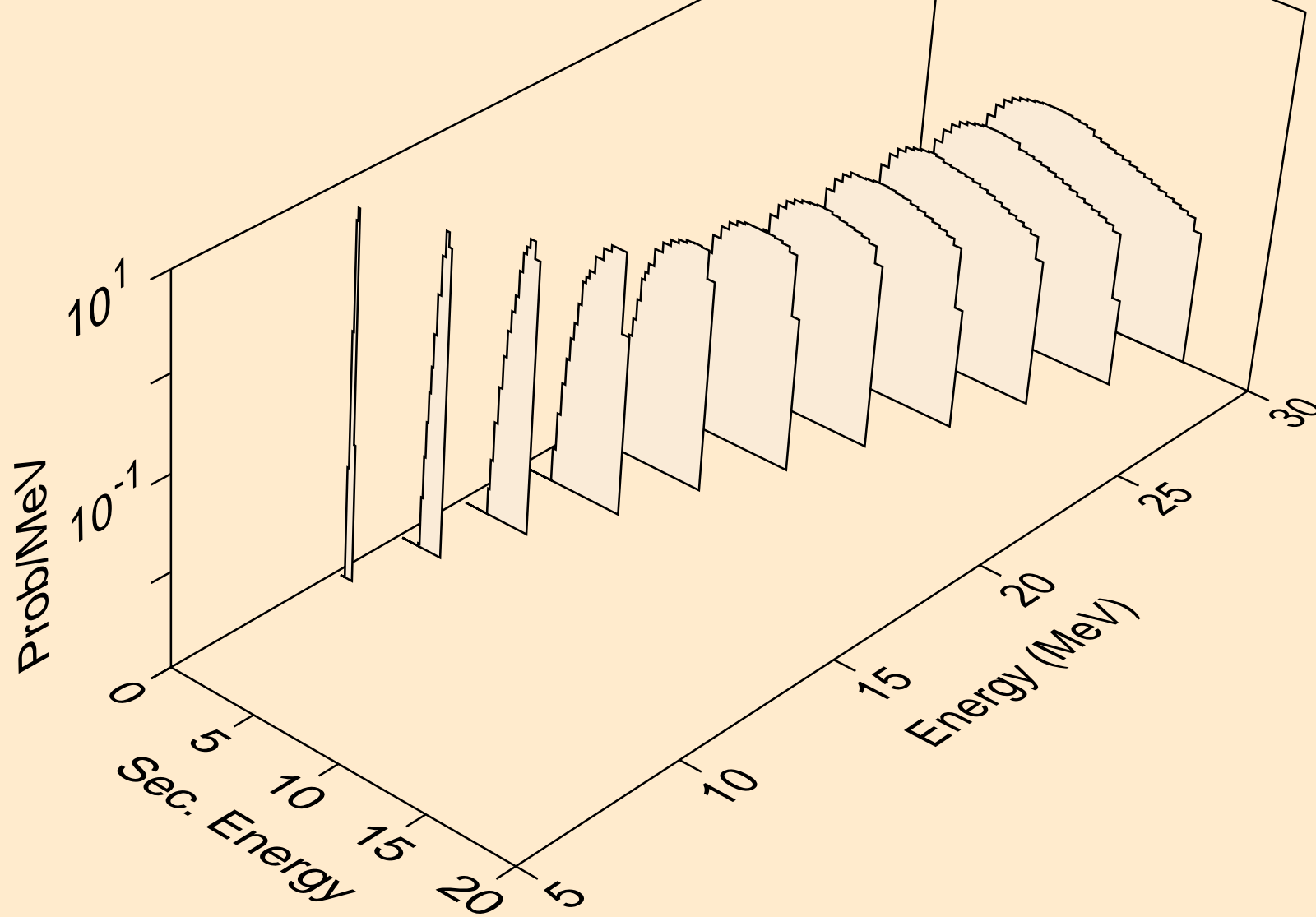

AL028 ALPHA ACER TENDL-2021 LIBRARY; T=0.K
Alpha emission for (a,2n)a

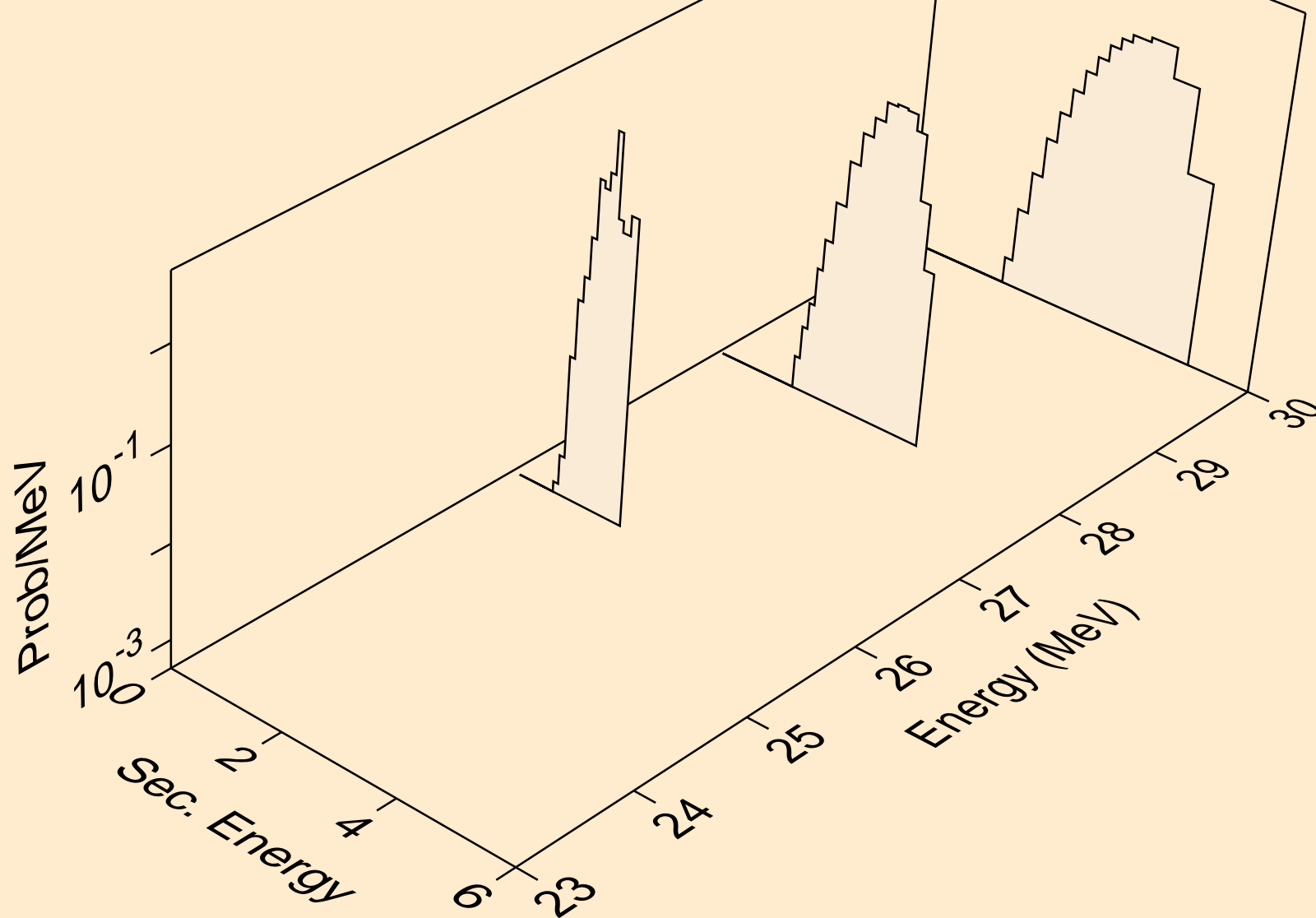

AL028 ALPHA ACER TENDL-2021 LIBRARY; T=0.K
Alpha emission for (a,n*)2a

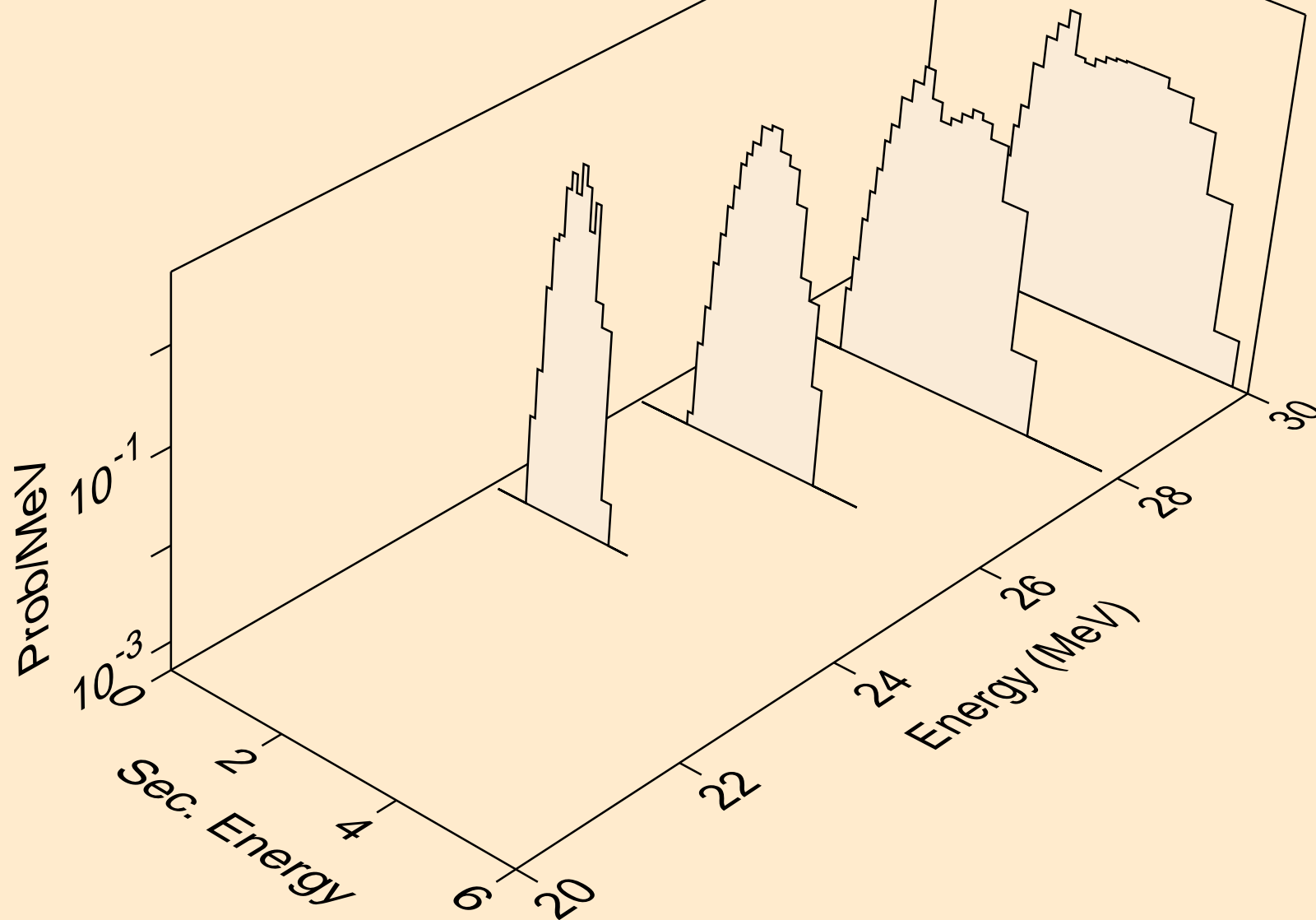

AL028 ALPHA ACER TENDL-2021 LIBRARY; T=0.K
Alpha emission for inelastic

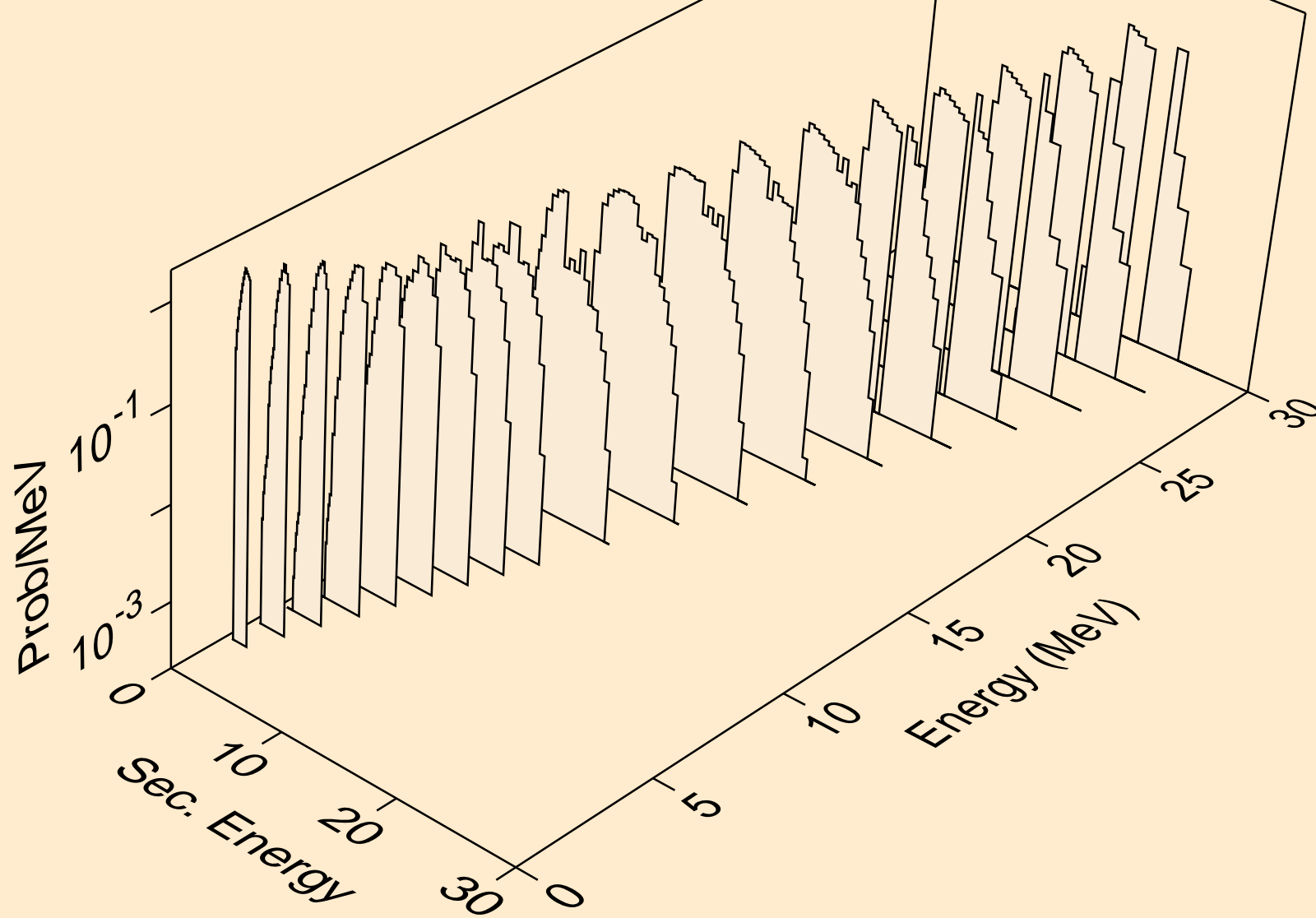

AL028 ALPHA ACER TENDL-2021 LIBRARY; T=0.K

Alpha emission for (a,2a)

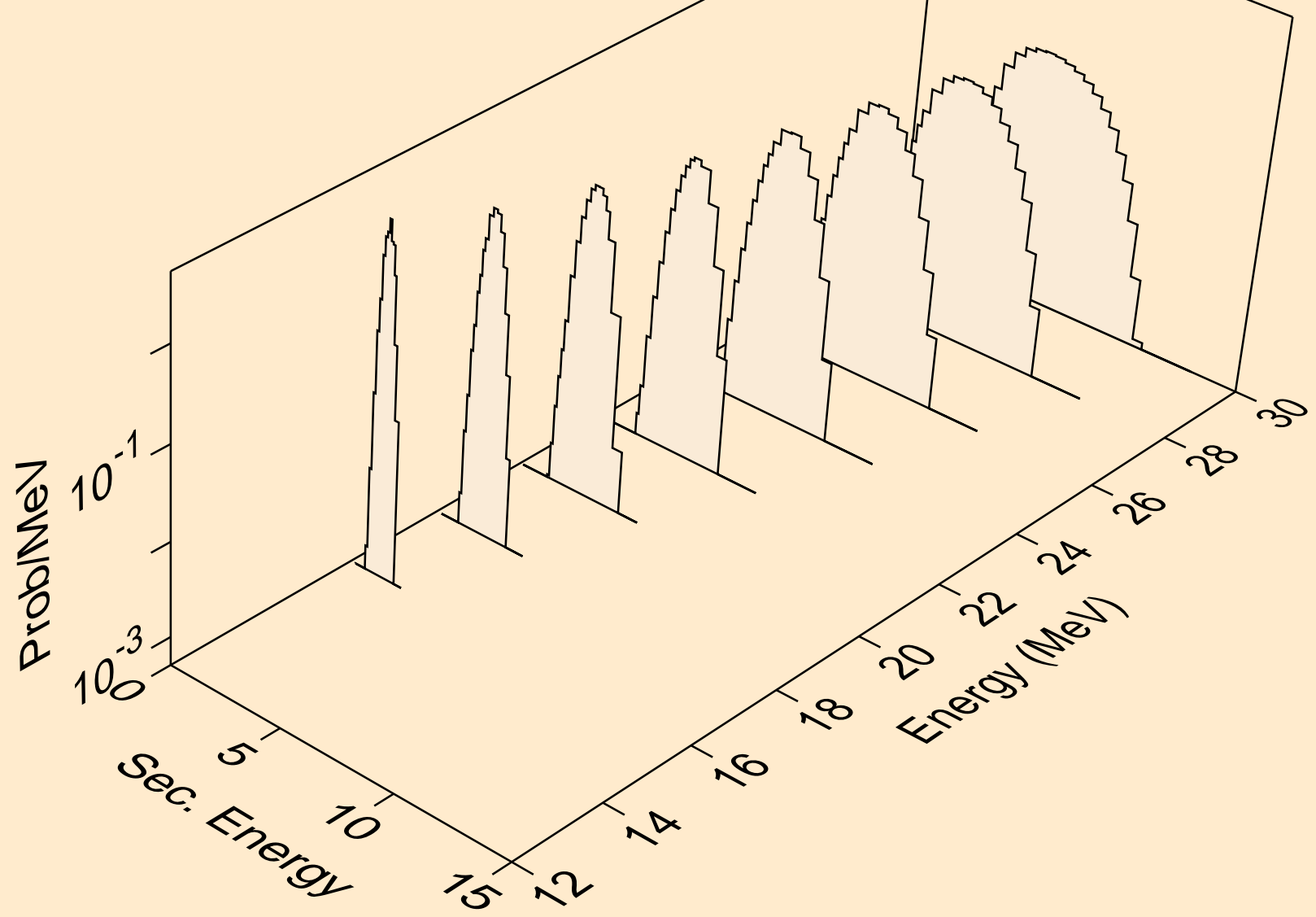

AL028 ALPHA ACER TENDL-2021 LIBRARY; T=0.K

Alpha emission for (a,pa)

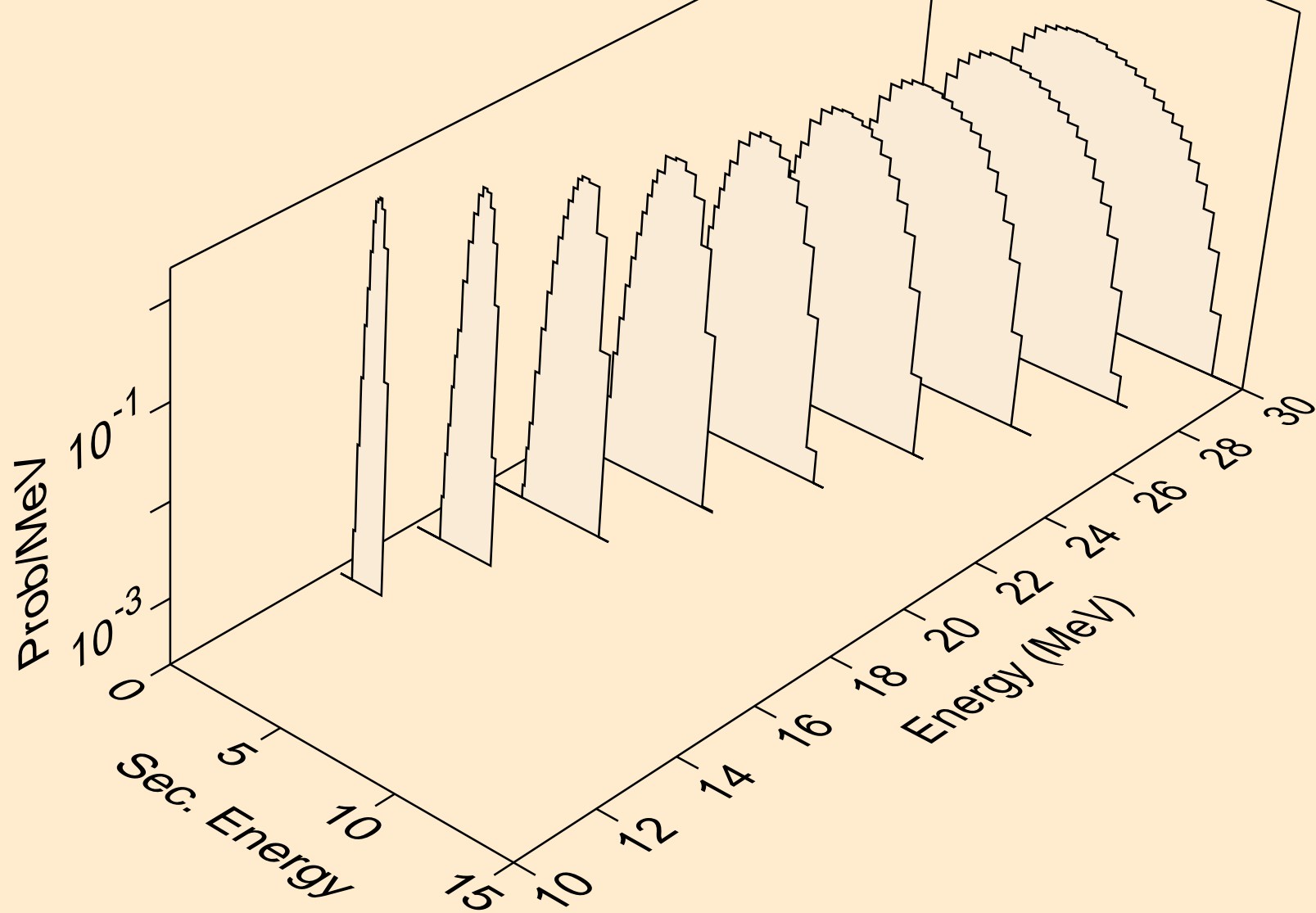

AL028 ALPHA ACER TENDL-2021 LIBRARY; T=0.K
Alpha emission for (a,da)

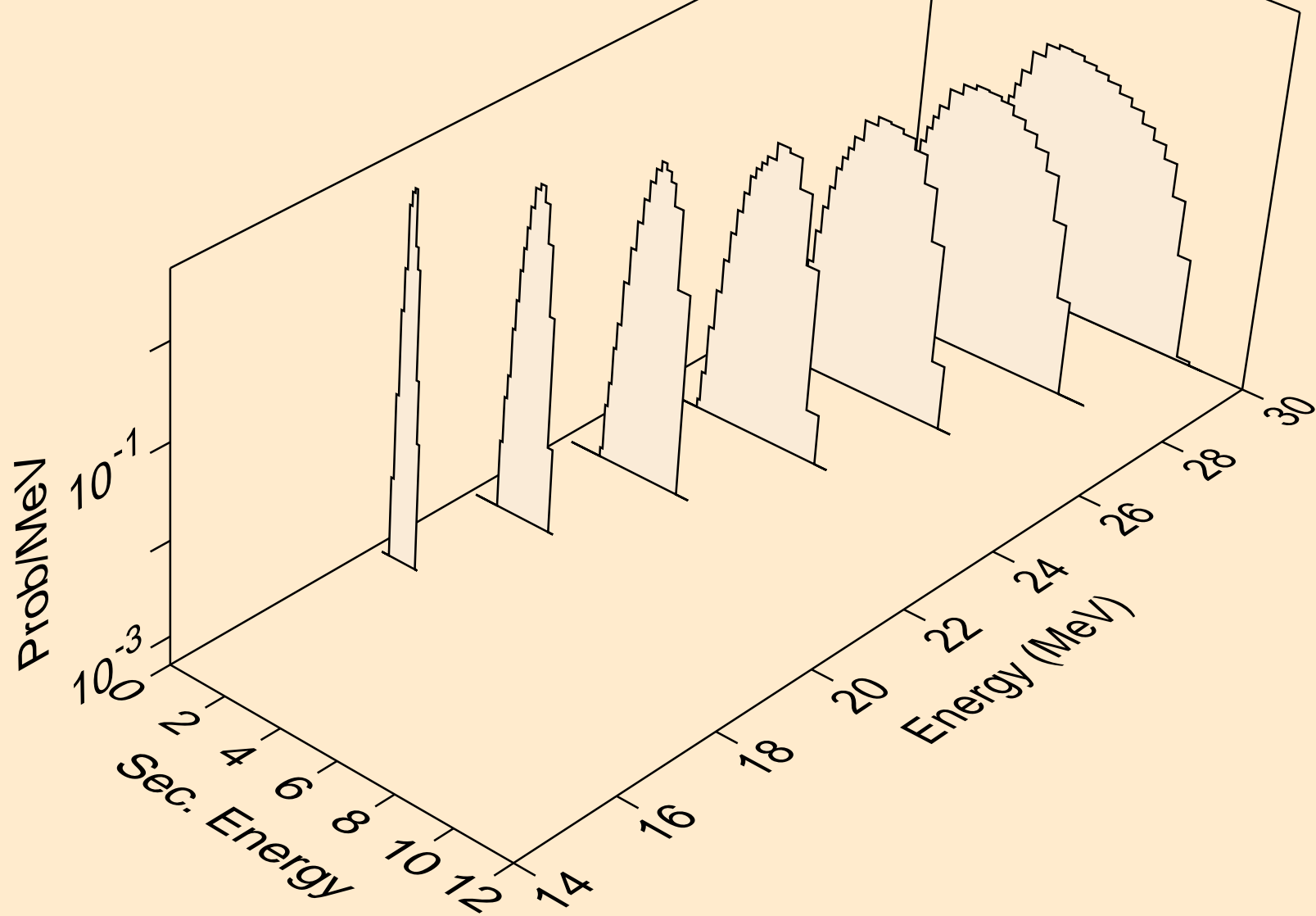

AL028 ALPHA ACER TENDL-2021 LIBRARY; T=0.K
Photon emission for (z,n)

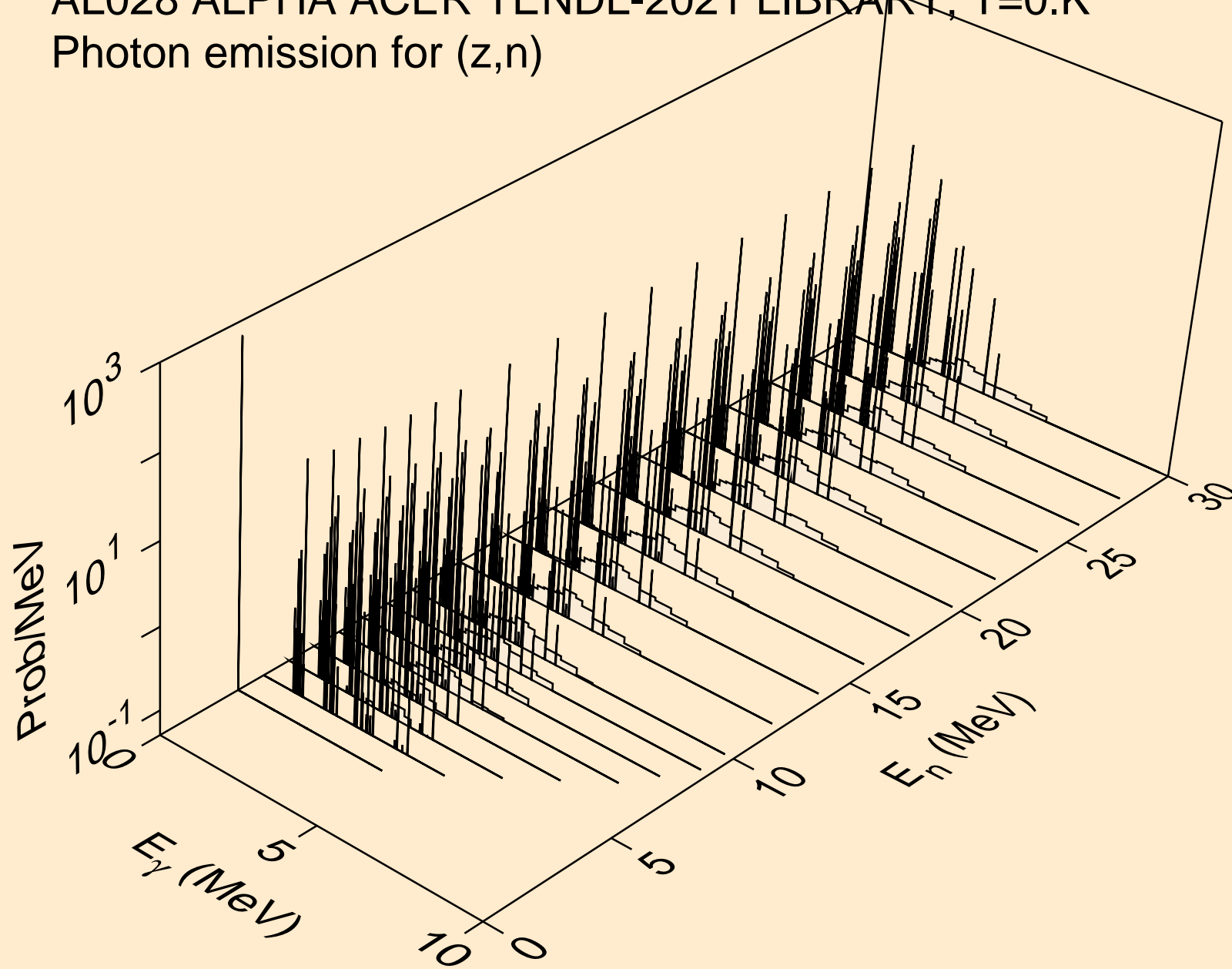

AL028 ALPHA ACER TENDL-2021 LIBRARY; T=0.K
Photon emission for (n,x)

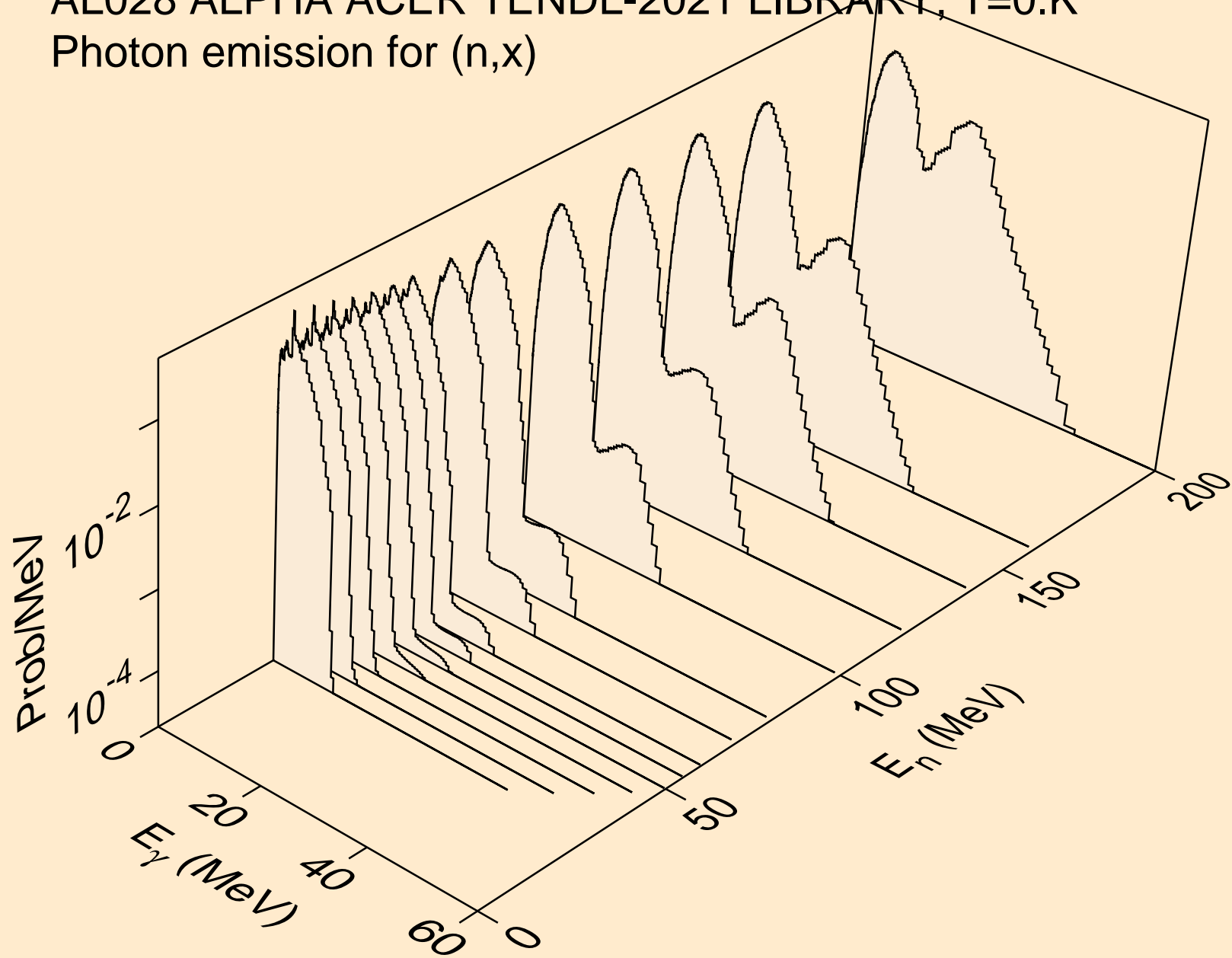

AL028 ALPHA ACER TENDL-2021 LIBRARY; T=0.K
Photon emission for (n,2nd)

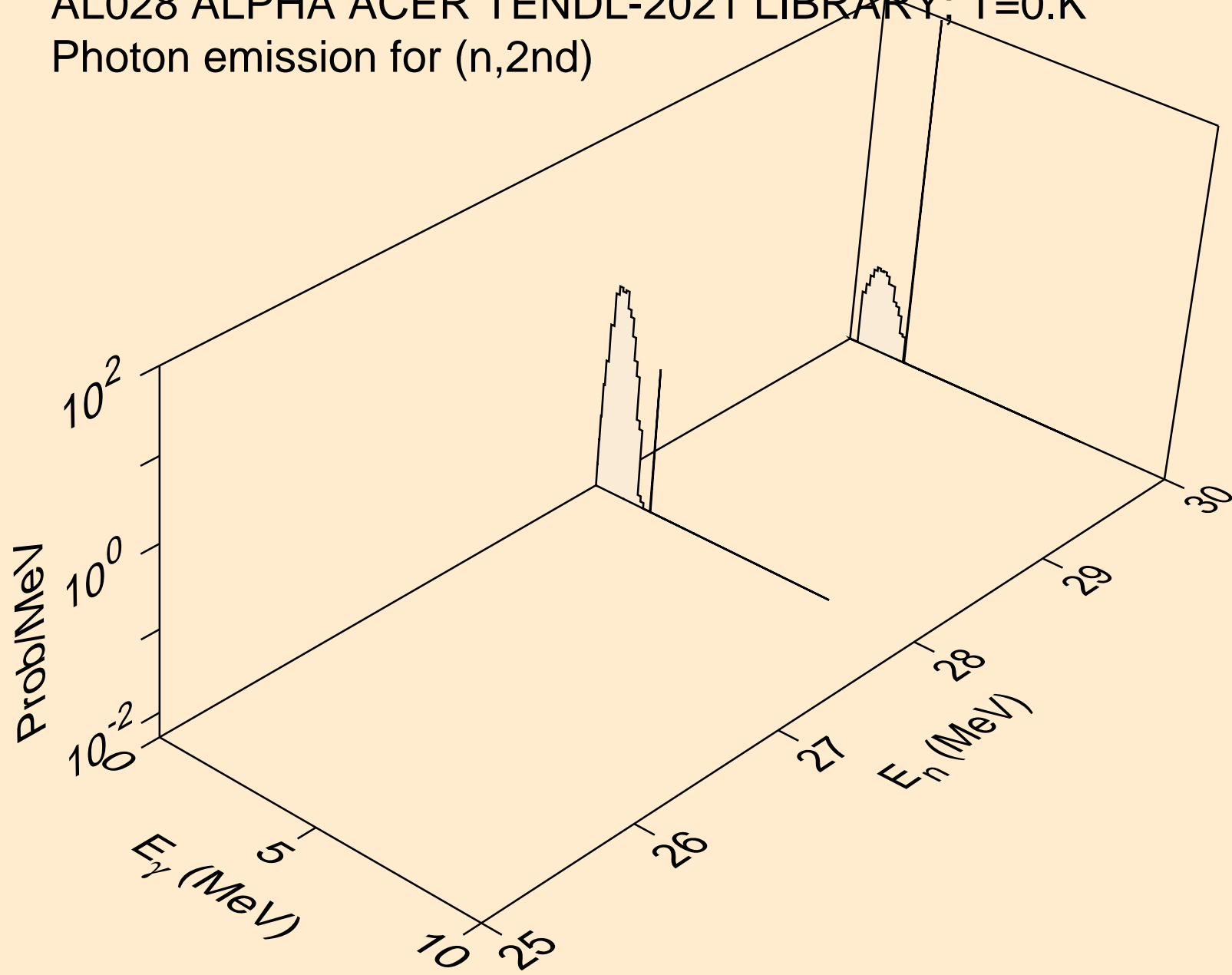

AL028 ALPHA ACER TENDL-2021 LIBRARY; T=0.K
Photon emission for (n,2n)

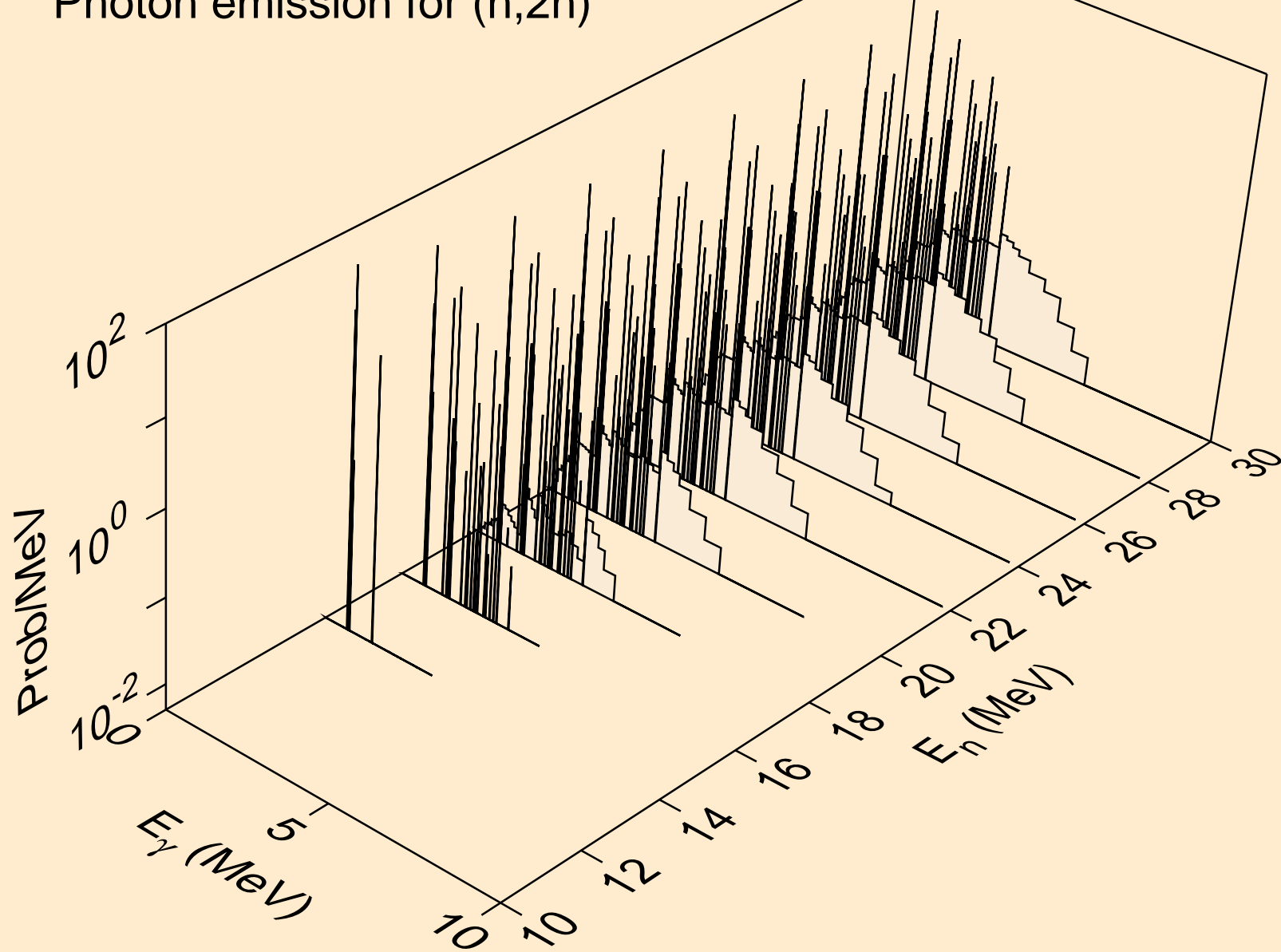

AL028 ALPHA ACER TENDL-2021 LIBRARY; T=0.K
Photon emission for (n,3n)

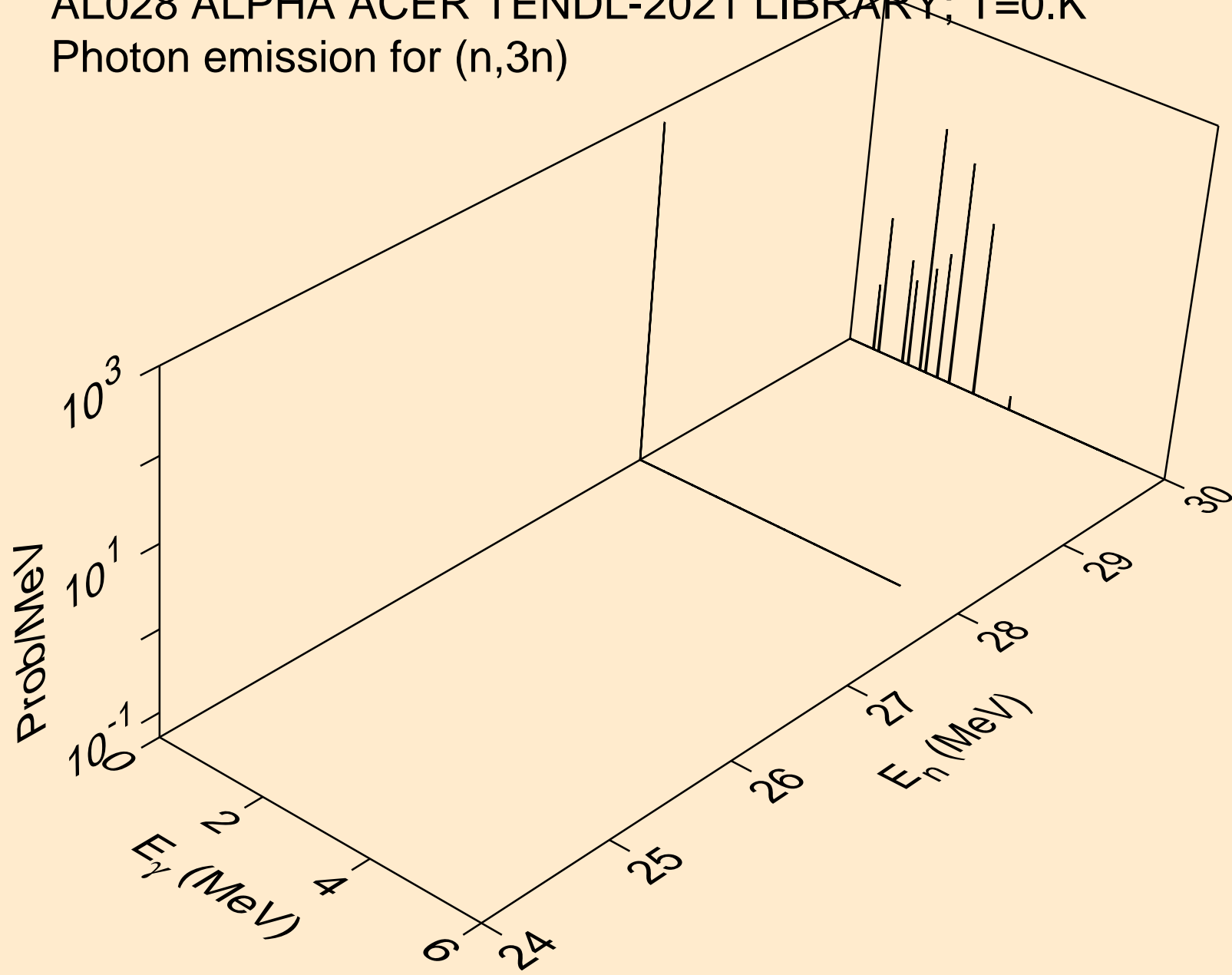

AL028 ALPHA ACER TENDL-2021 LIBRARY; T=0.K
Photon emission for (n,n*)a

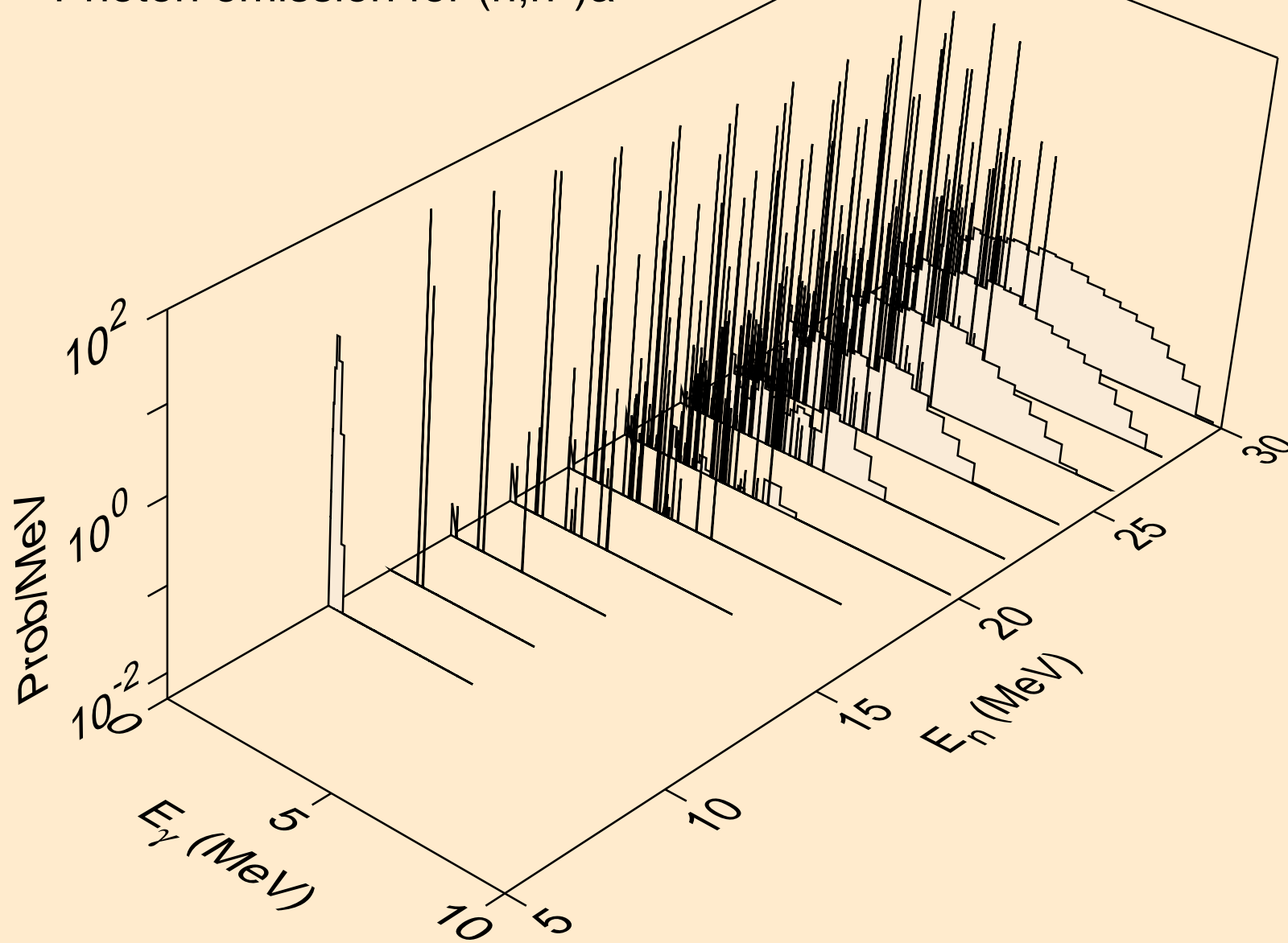

AL028 ALPHA ACER TENDL-2021 LIBRARY; T=0.K
Photon emission for (n,2n)a

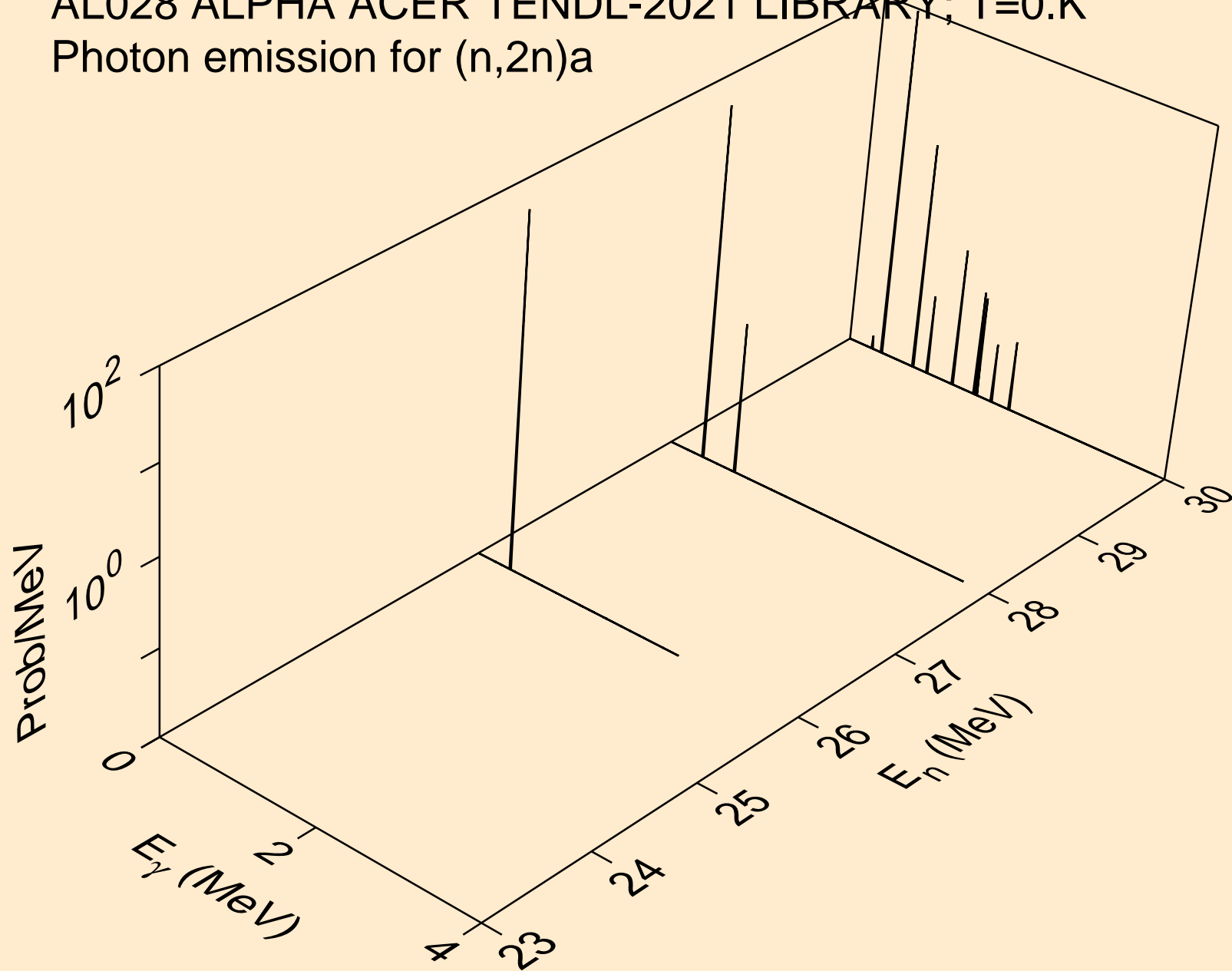

AL028 ALPHA ACER TENDL-2021 LIBRARY; T=0.K
Photon emission for (n,n*)p

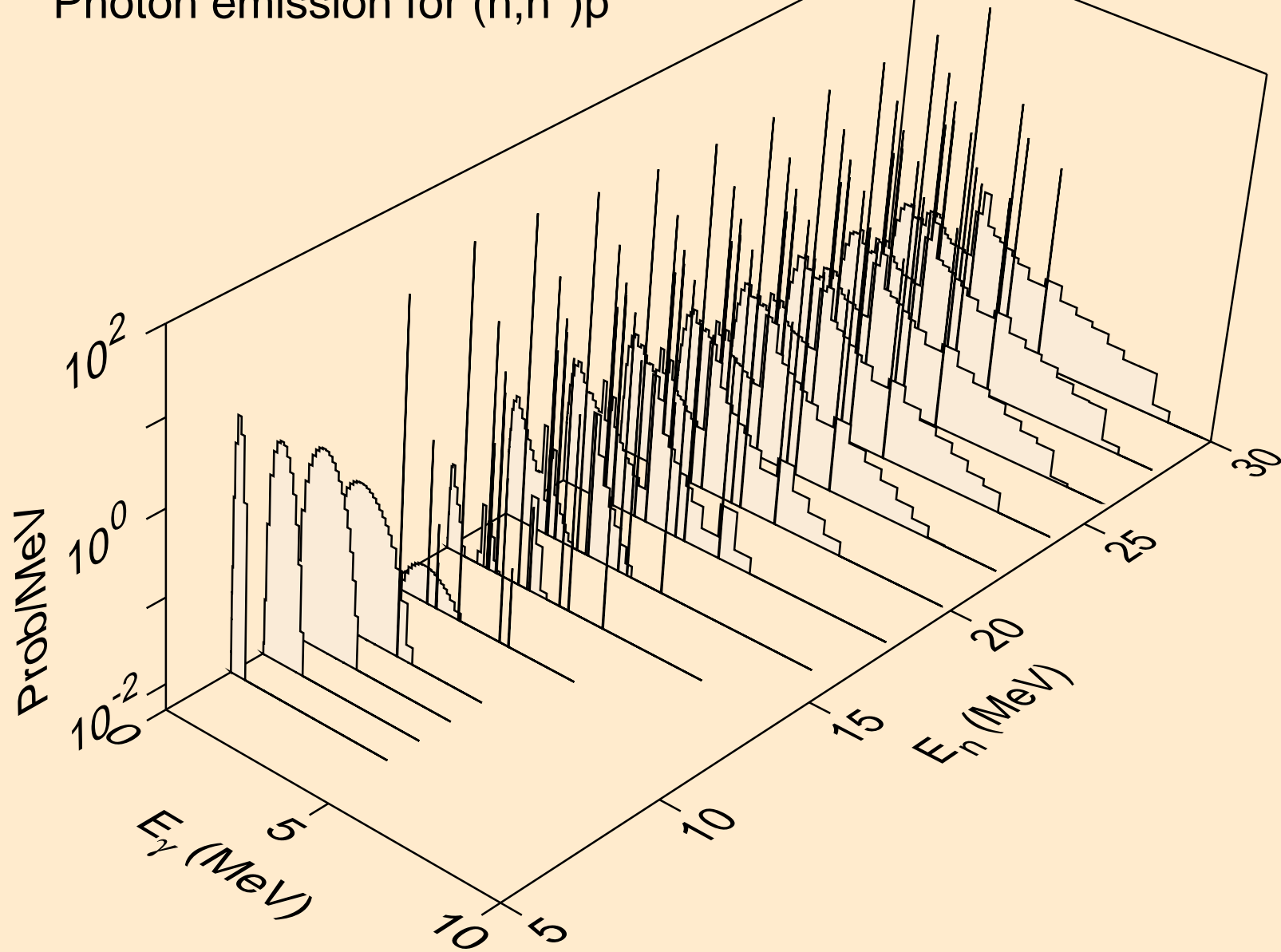

AL028 ALPHA ACER TENDL-2021 LIBRARY; T=0.K
Photon emission for (n,n*)2a

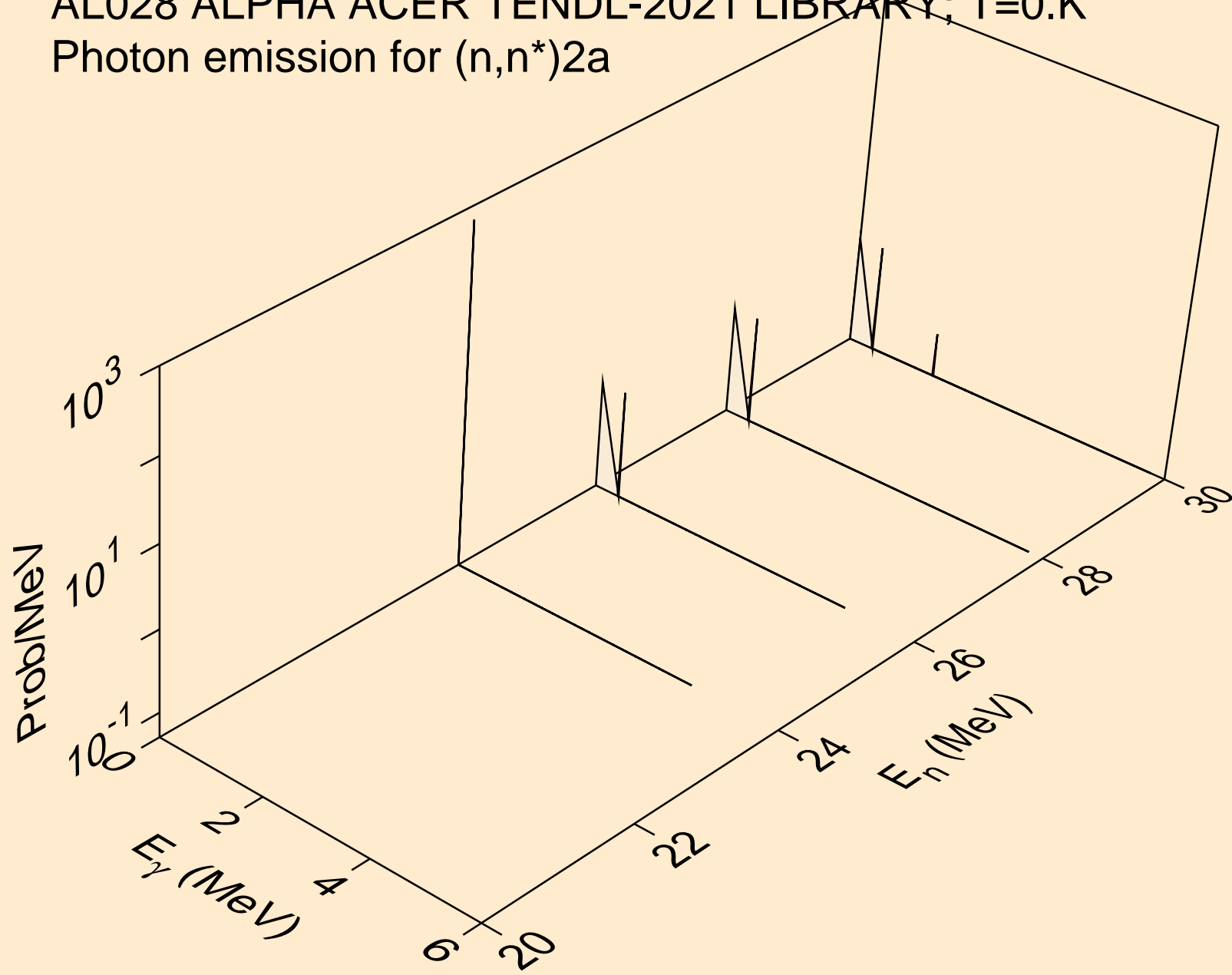

AL028 ALPHA ACER TENDL-2021 LIBRARY; T=0.K
Photon emission for (n,n*)d

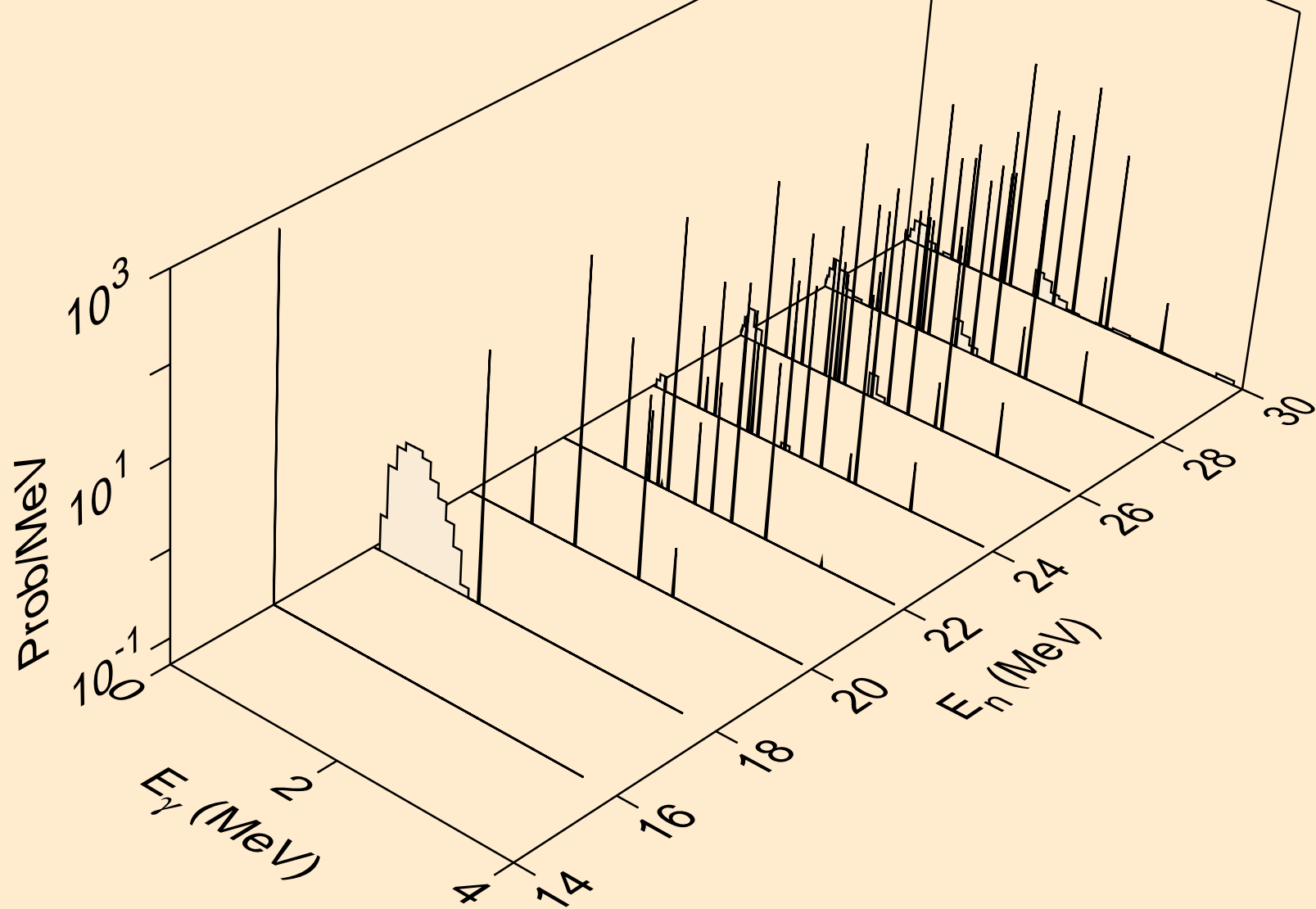

AL028 ALPHA ACER TENDL-2021 LIBRARY; T=0.K
Photon emission for (n,n*)t

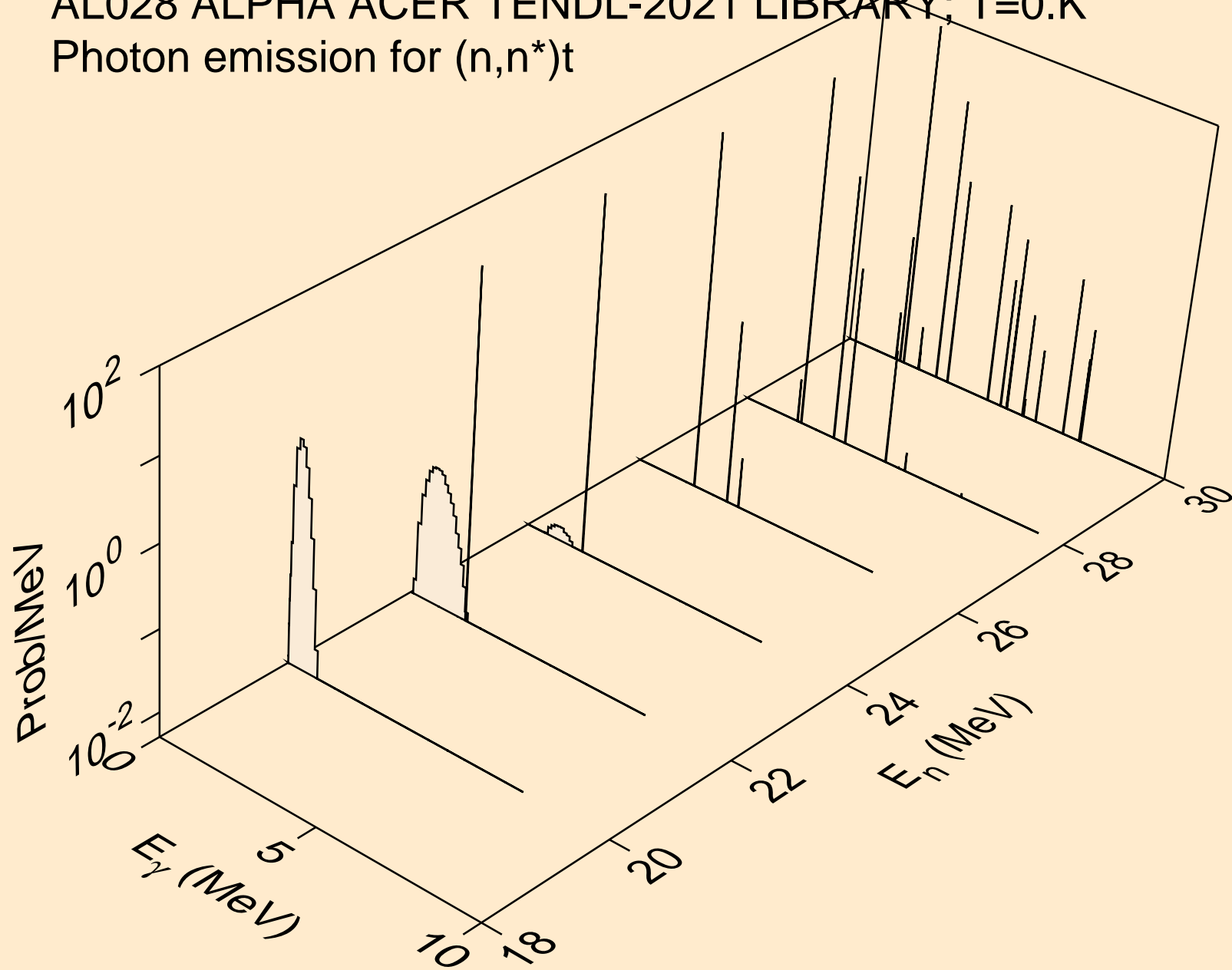

AL028 ALPHA ACER TENDL-2021 LIBRARY; T=0.K
Photon emission for (n,n*)he3

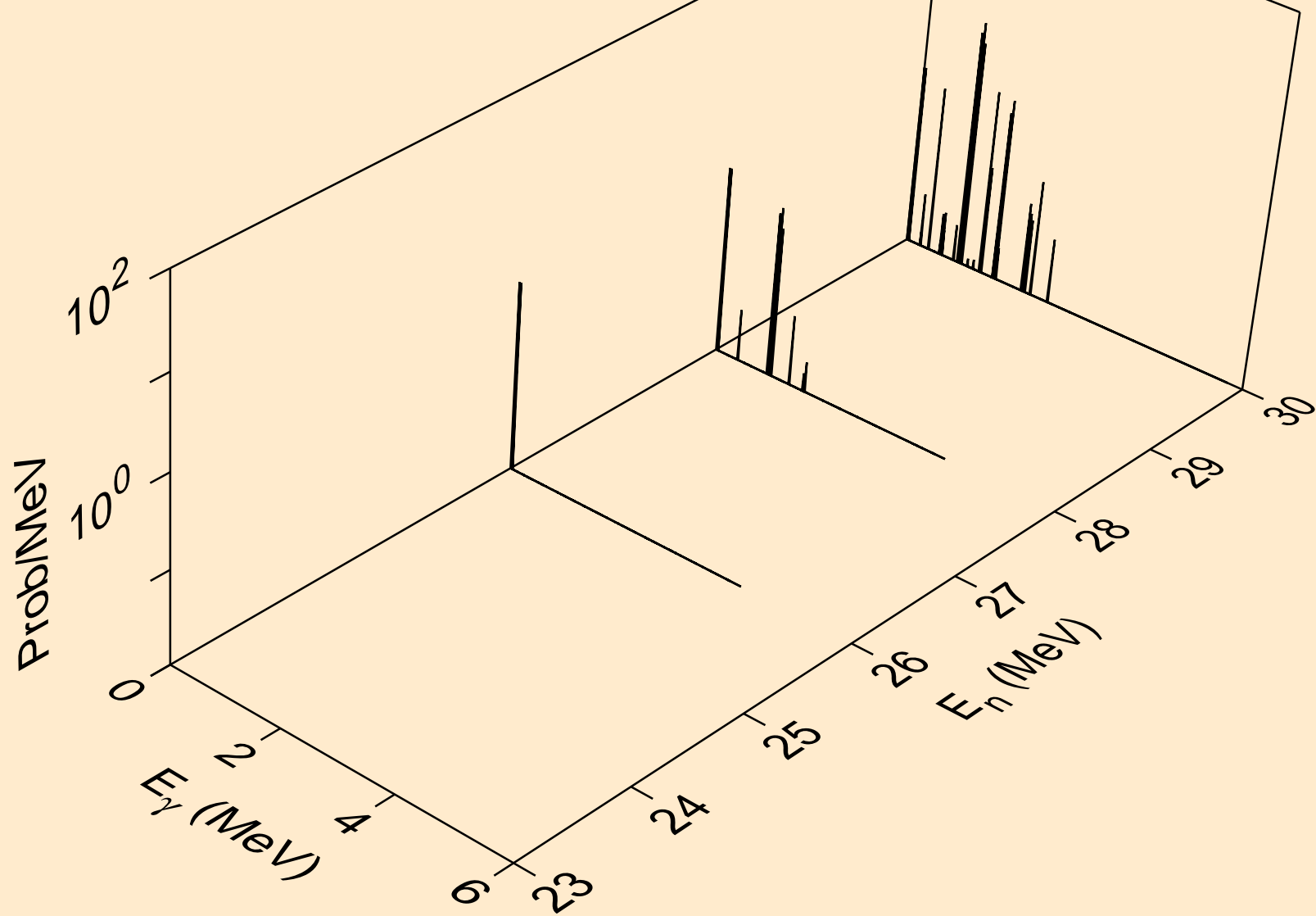

AL028 ALPHA ACER TENDL-2021 LIBRARY; T=0.K
Photon emission for (n,2np)

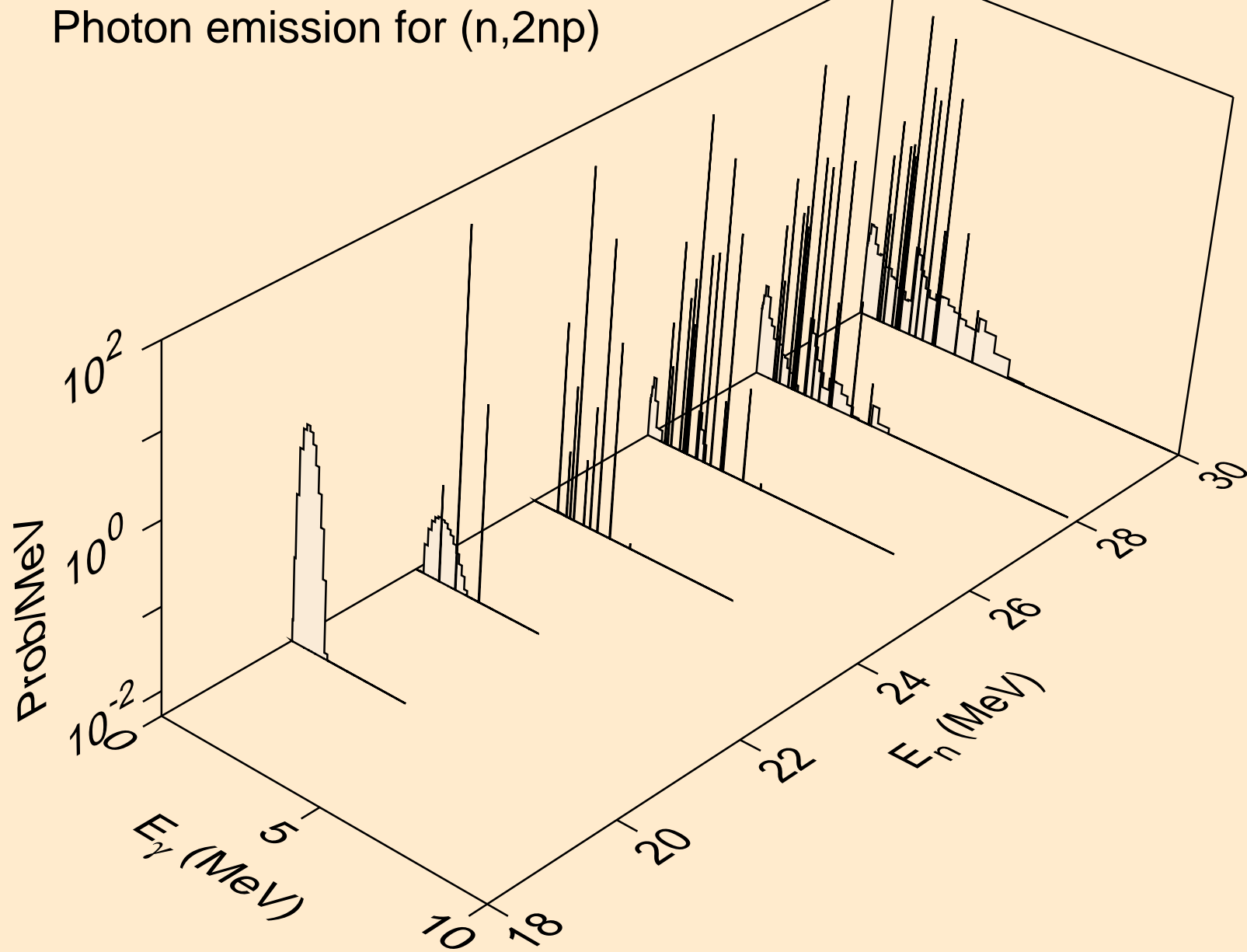

AL028 ALPHA ACER TENDL-2021 LIBRARY; T=0.K
Photon emission for (n,3np)

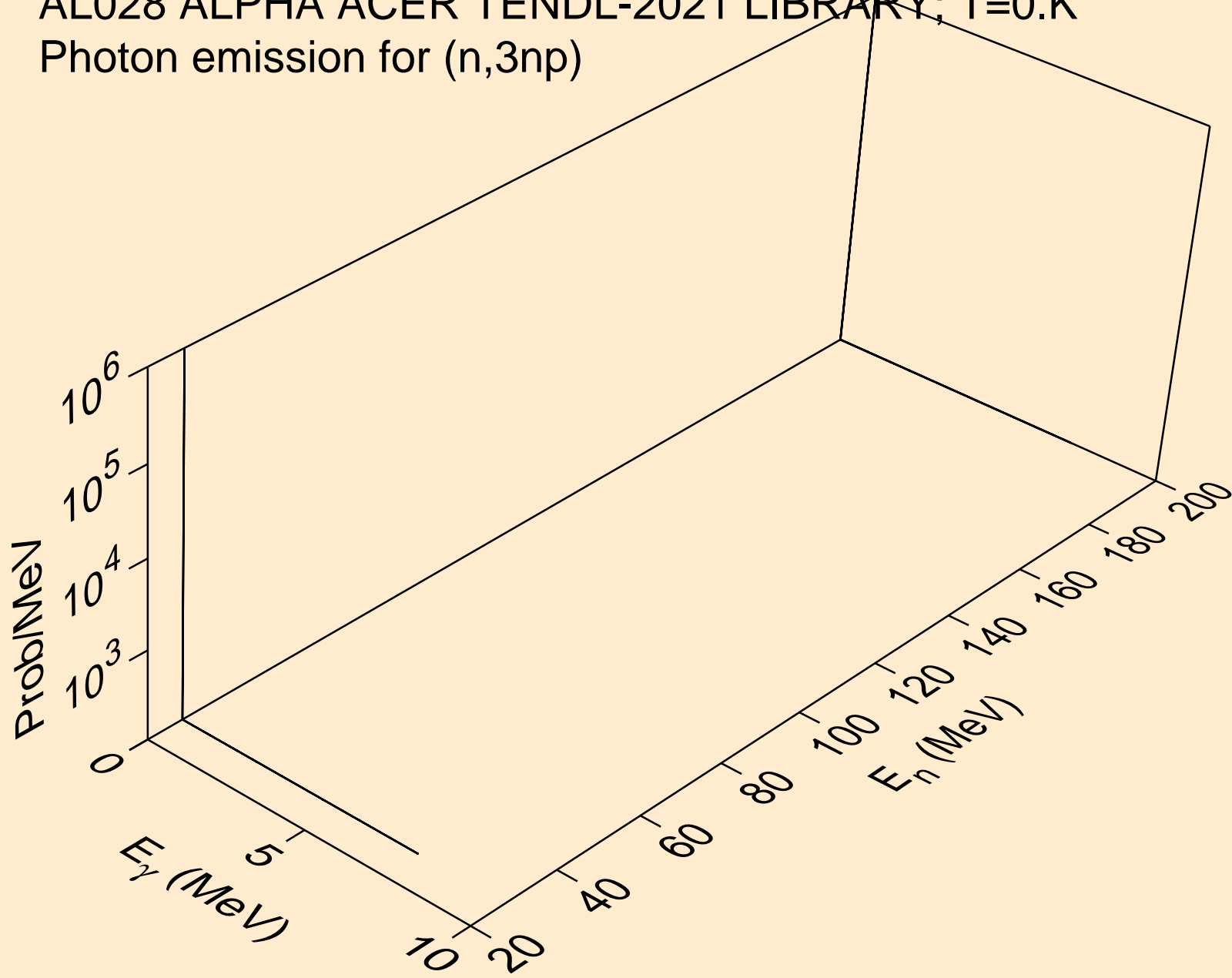

AL028 ALPHA ACER TENDL-2021 LIBRARY; T=0.K
Photon emission for (n,2np)

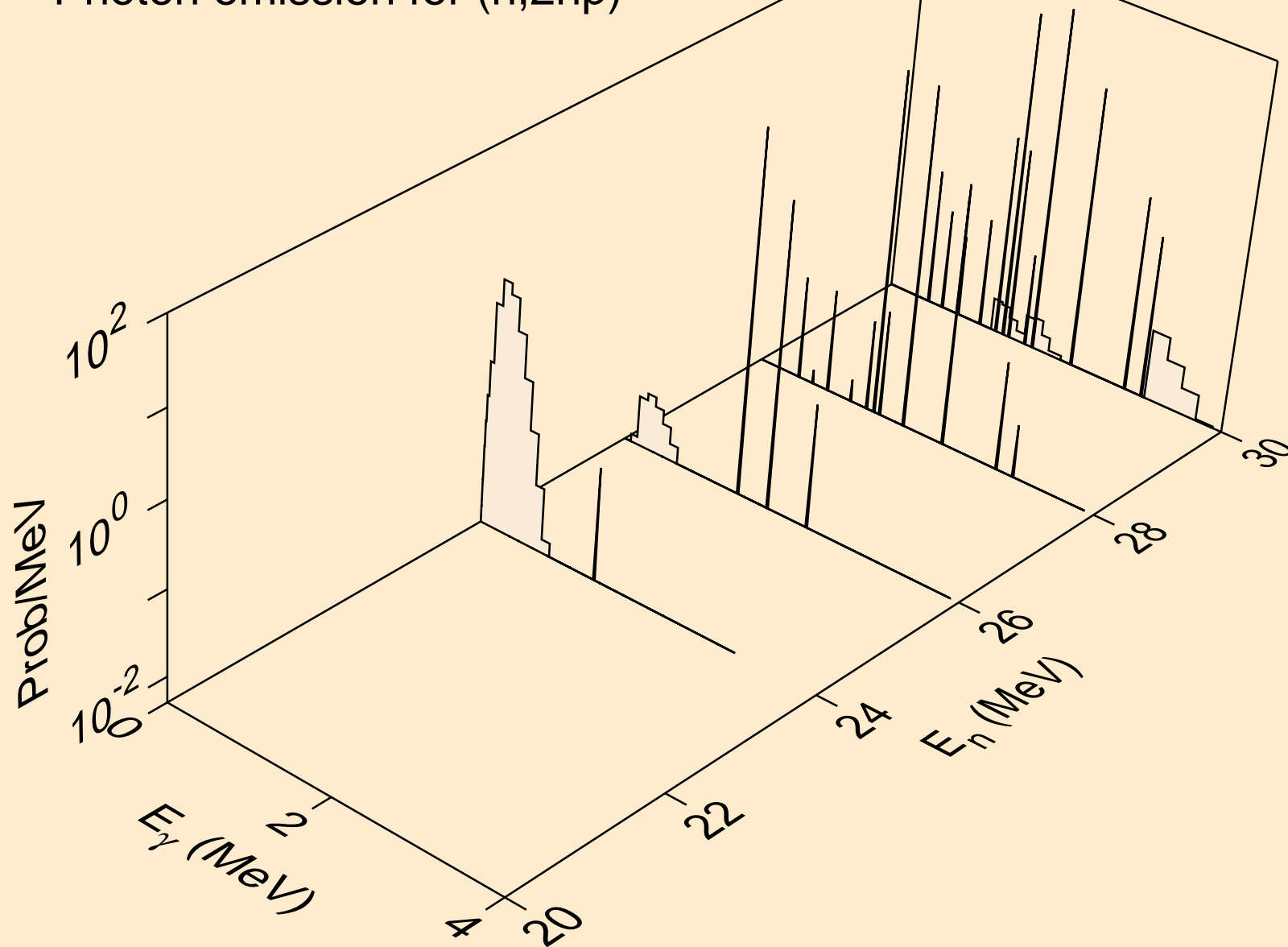

AL028 ALPHA ACER TENDL-2021 LIBRARY; T=0.K
Photon emission for (n,npa)

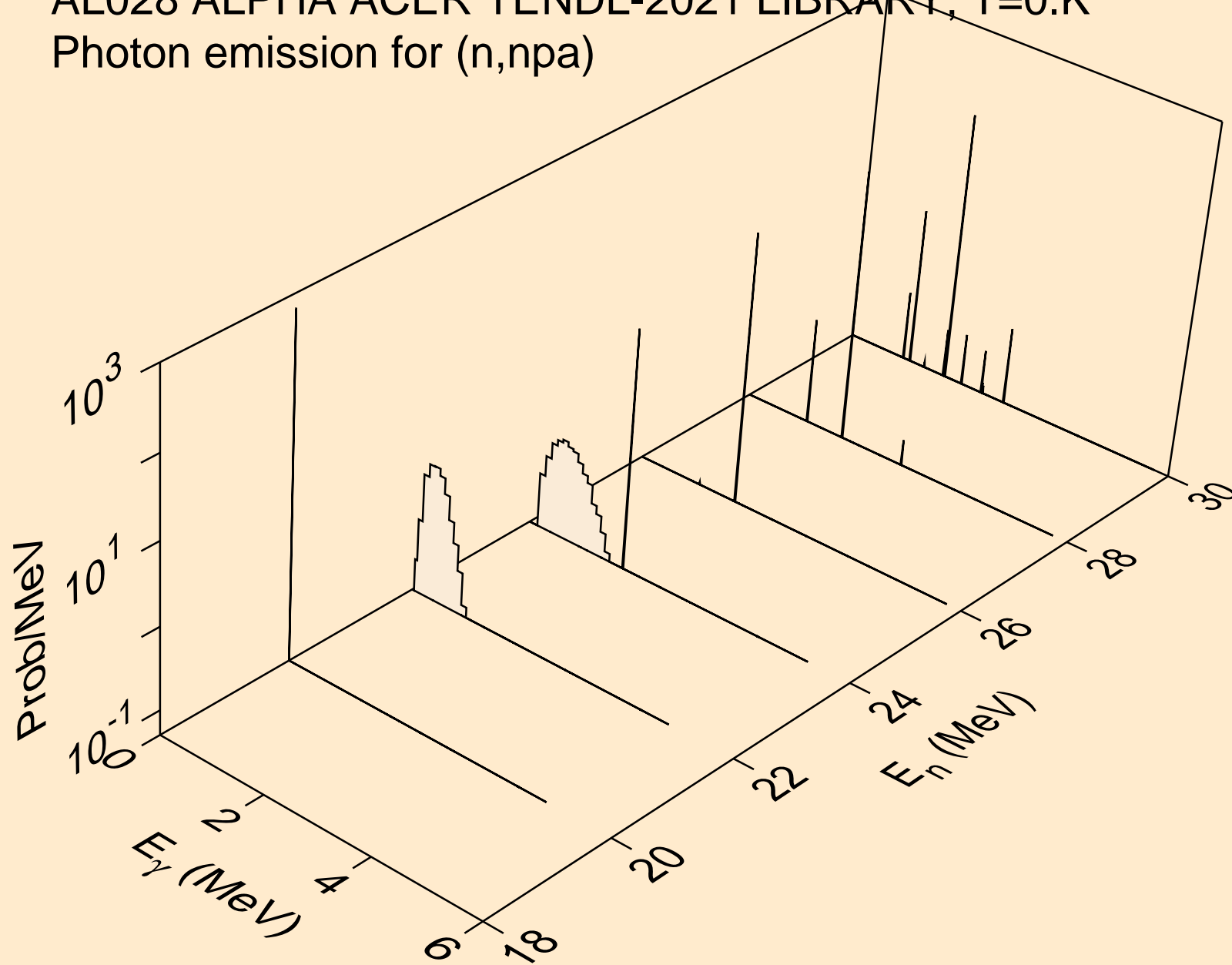

AL028 ALPHA ACER TENDL-2021 LIBRARY; T=0.K
Photon emission for (n,gma)

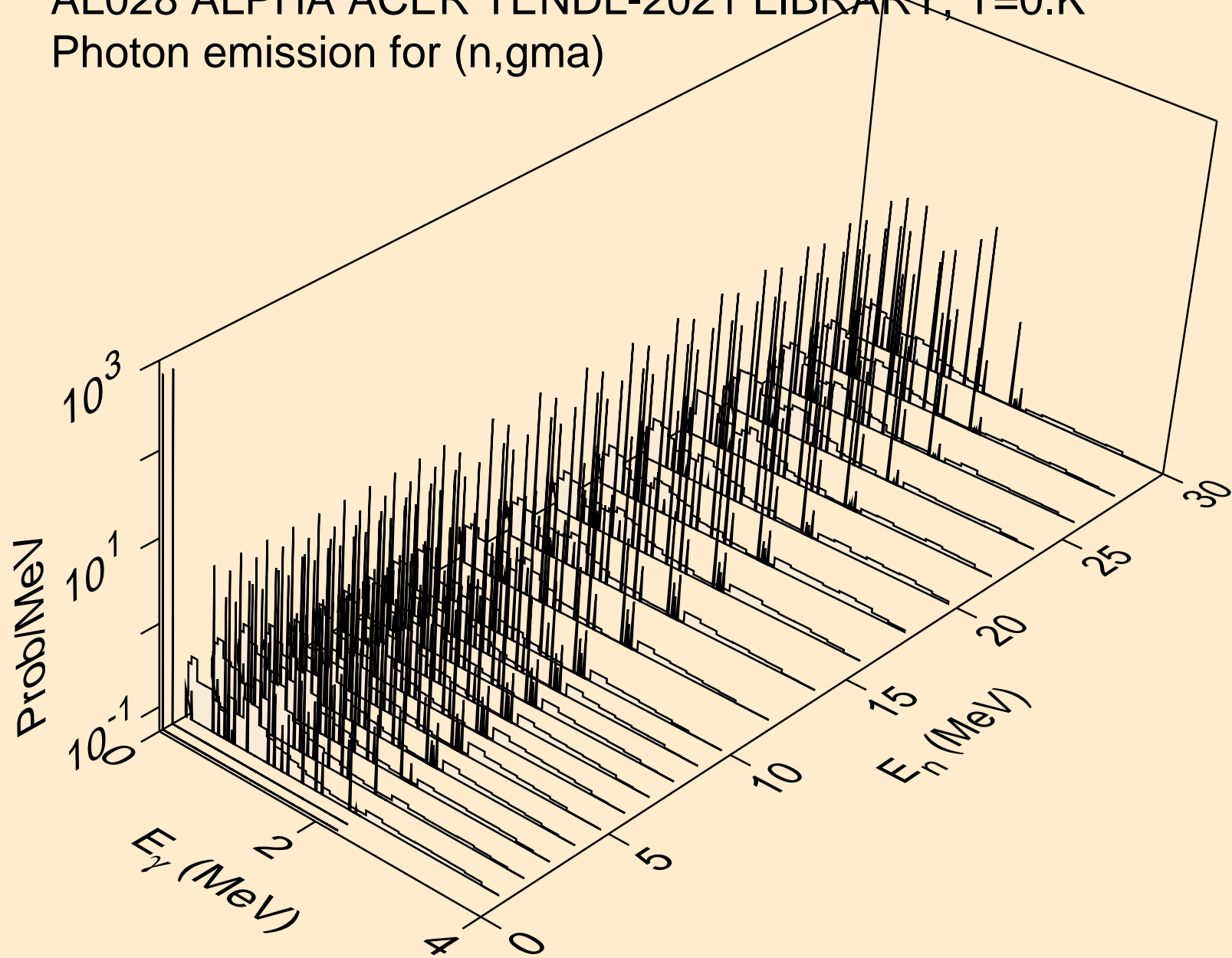

AL028 ALPHA ACER TENDL-2021 LIBRARY; T=0.K
Photon emission for (n,p)

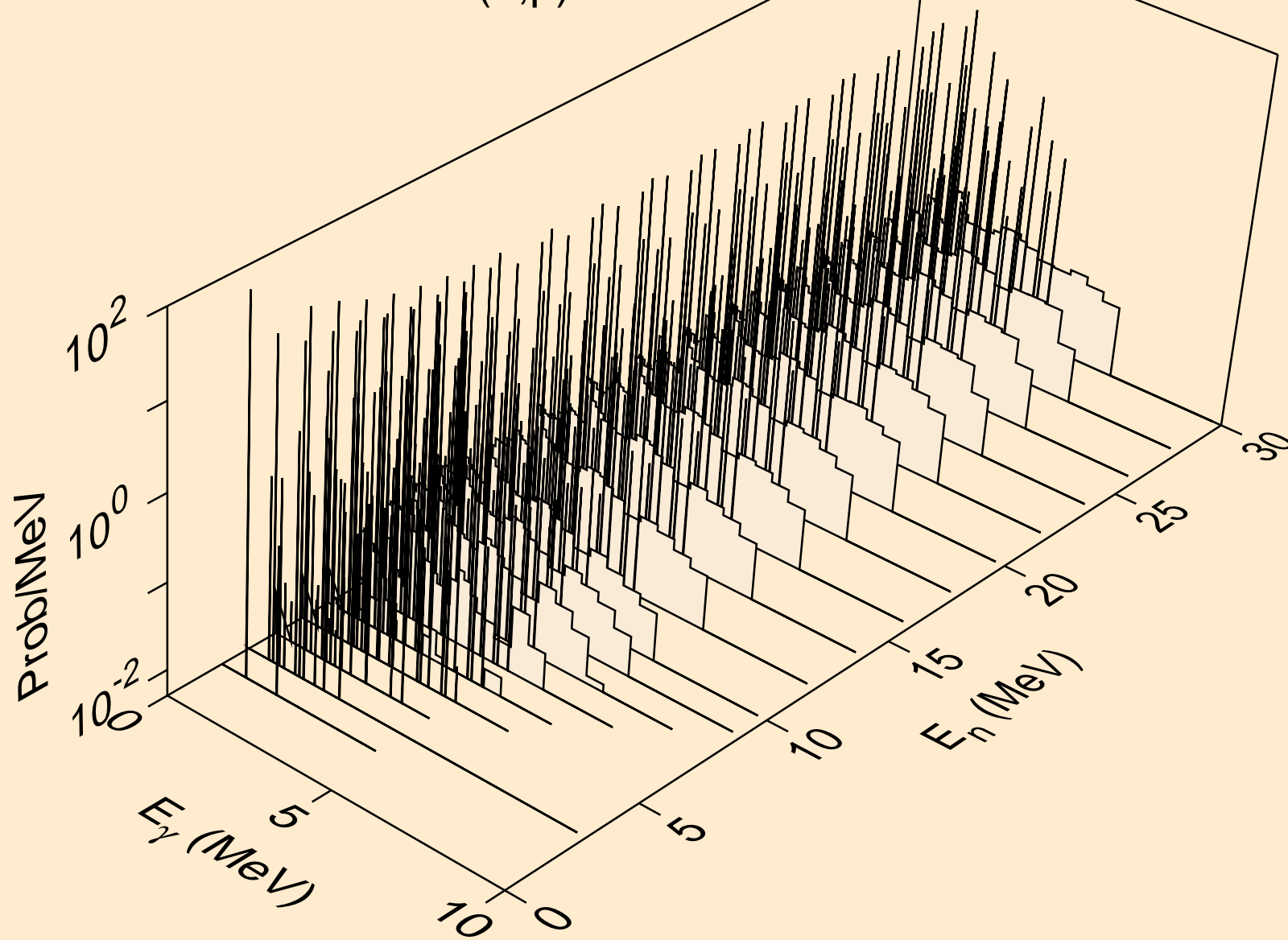

AL028 ALPHA ACER TENDL-2021 LIBRARY; T=0.K
Photon emission for (n,d)

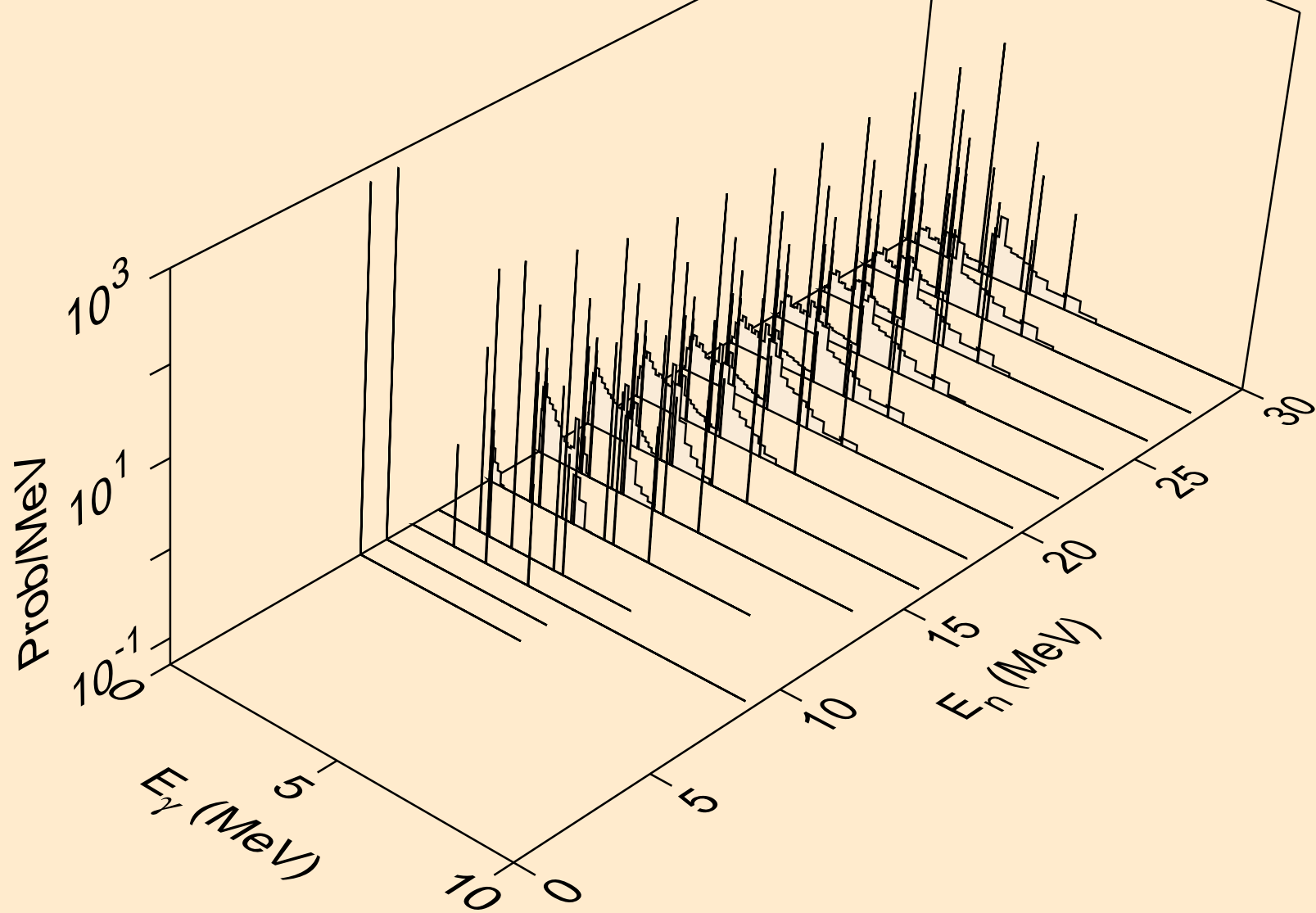

AL028 ALPHA ACER TENDL-2021 LIBRARY; T=0.K
Photon emission for (n,t)

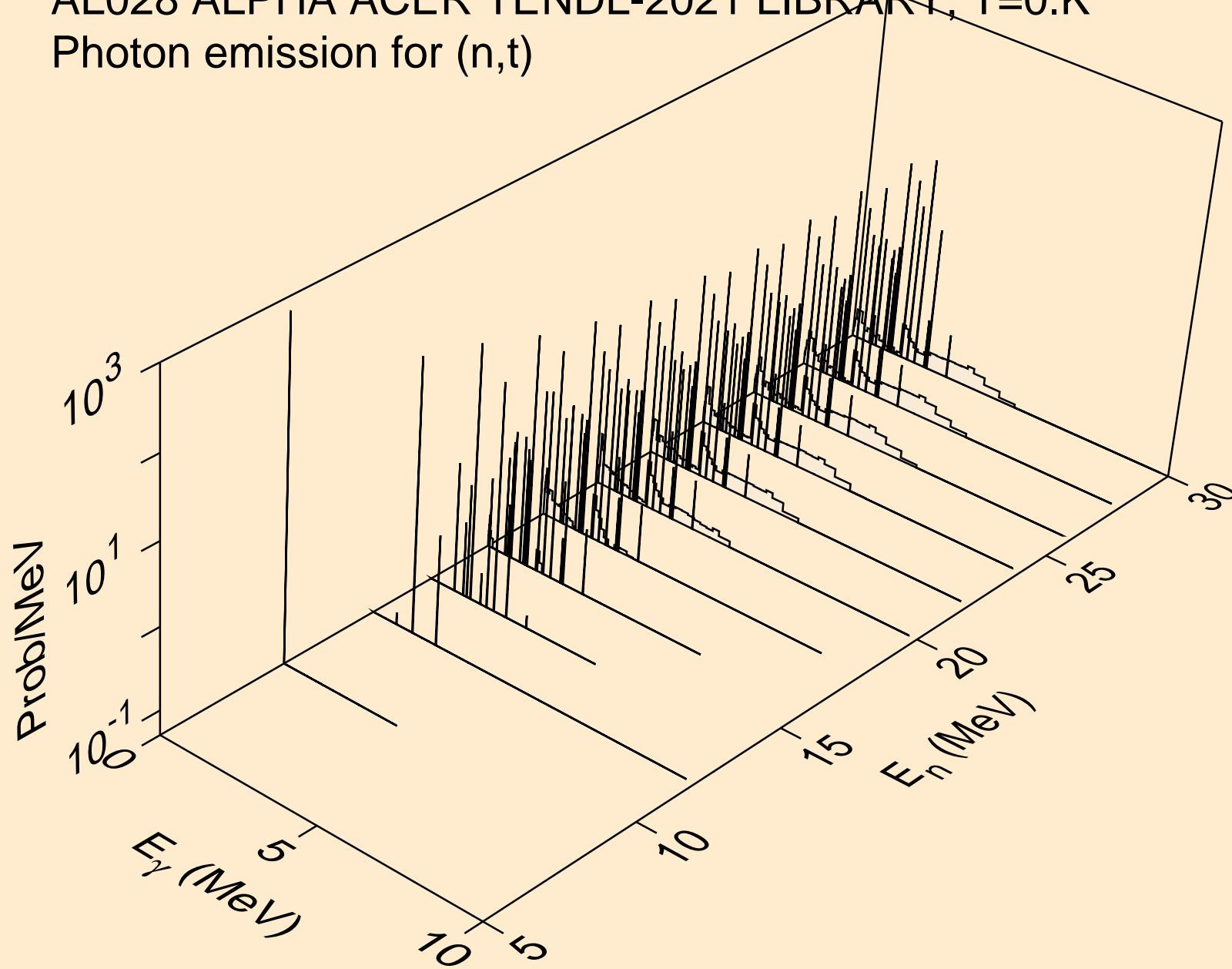

AL028 ALPHA ACER TENDL-2021 LIBRARY; T=0.K
Photon emission for (n,he3)

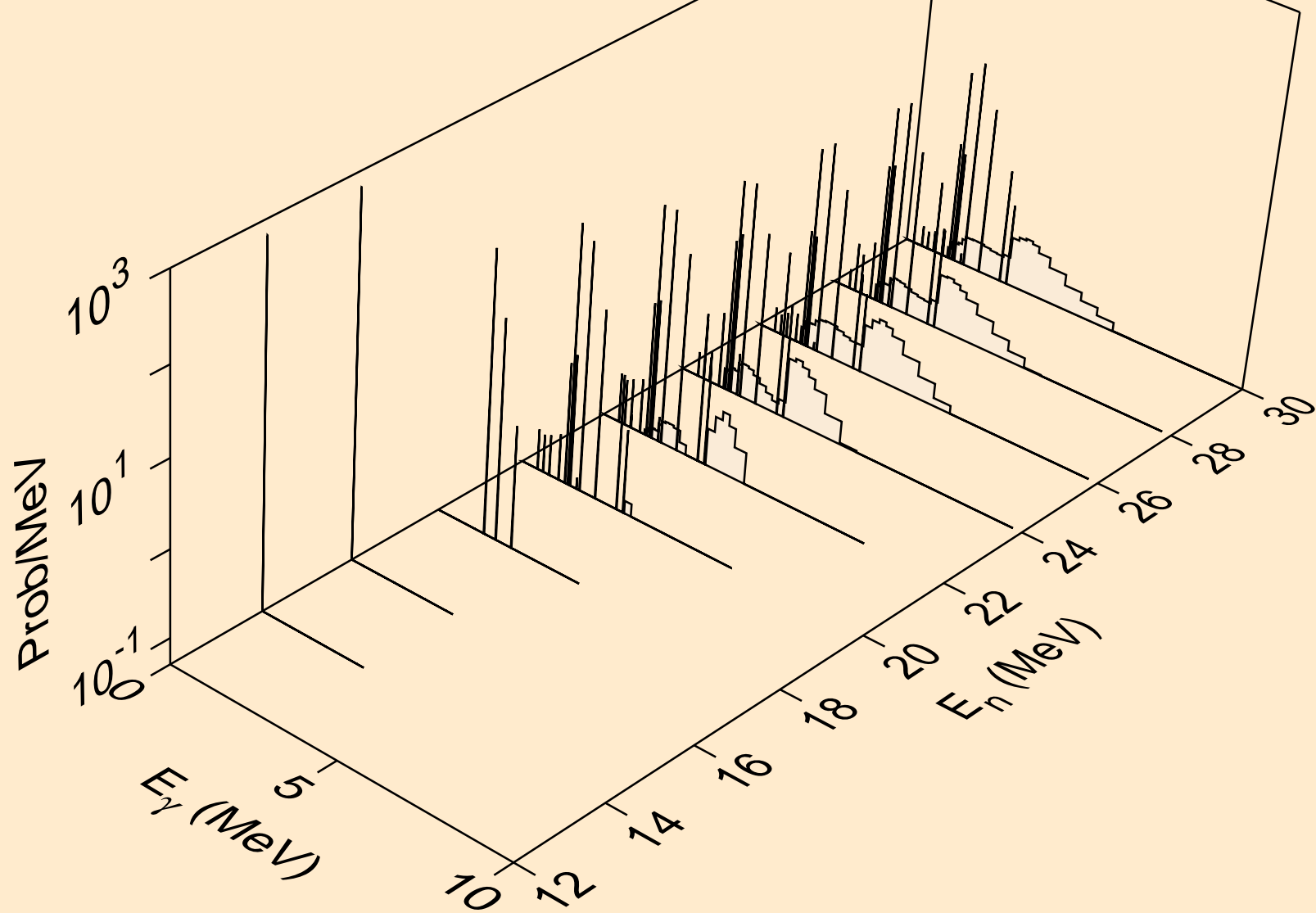

AL028 ALPHA ACER TENDL-2021 LIBRARY; T=0.K
Photon emission for inelastic

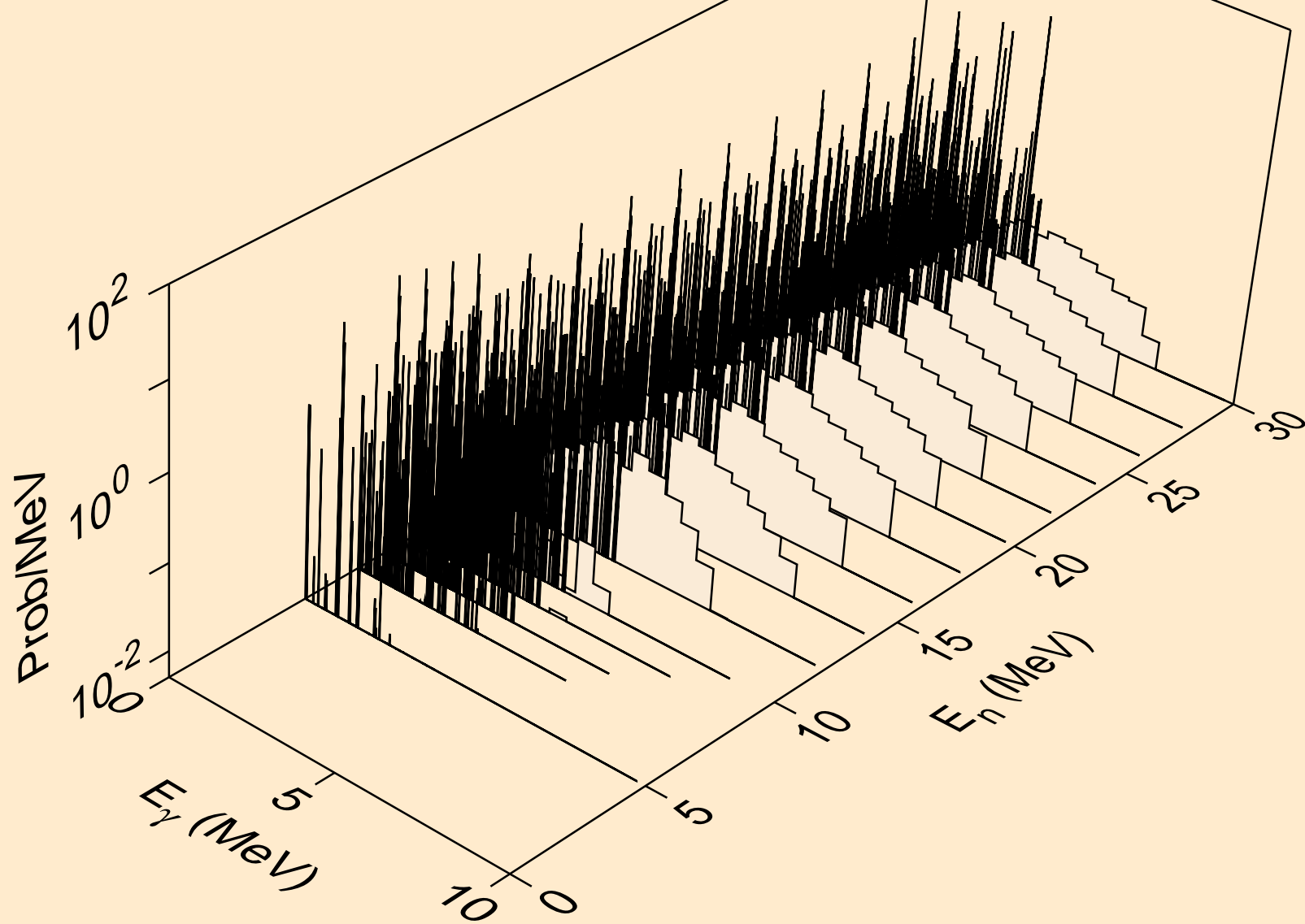

AL028 ALPHA ACER TENDL-2021 LIBRARY; T=0.K
Photon emission for (n,2a)

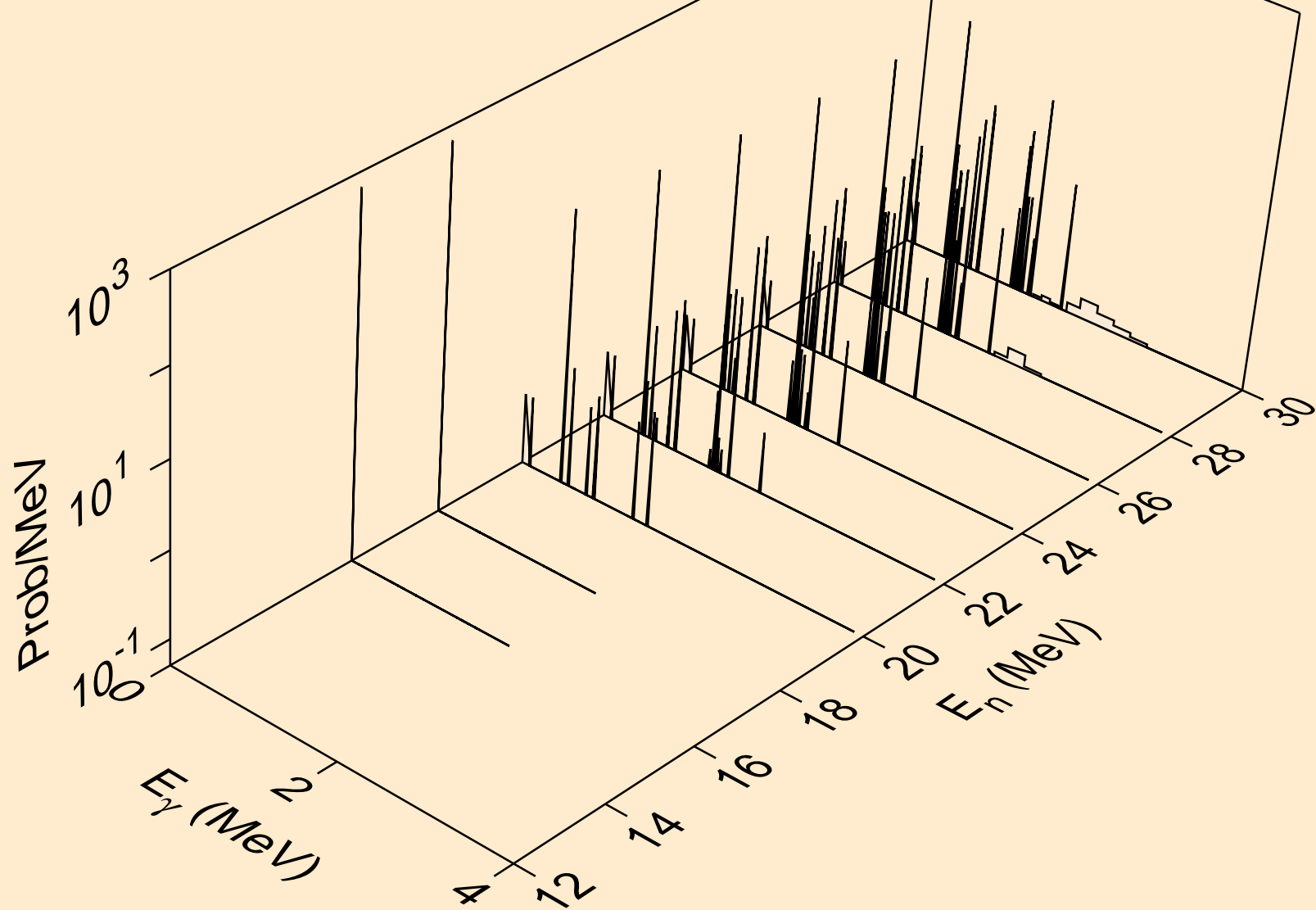

AL028 ALPHA ACER TENDL-2021 LIBRARY; T=0.K
Photon emission for (n,2p)

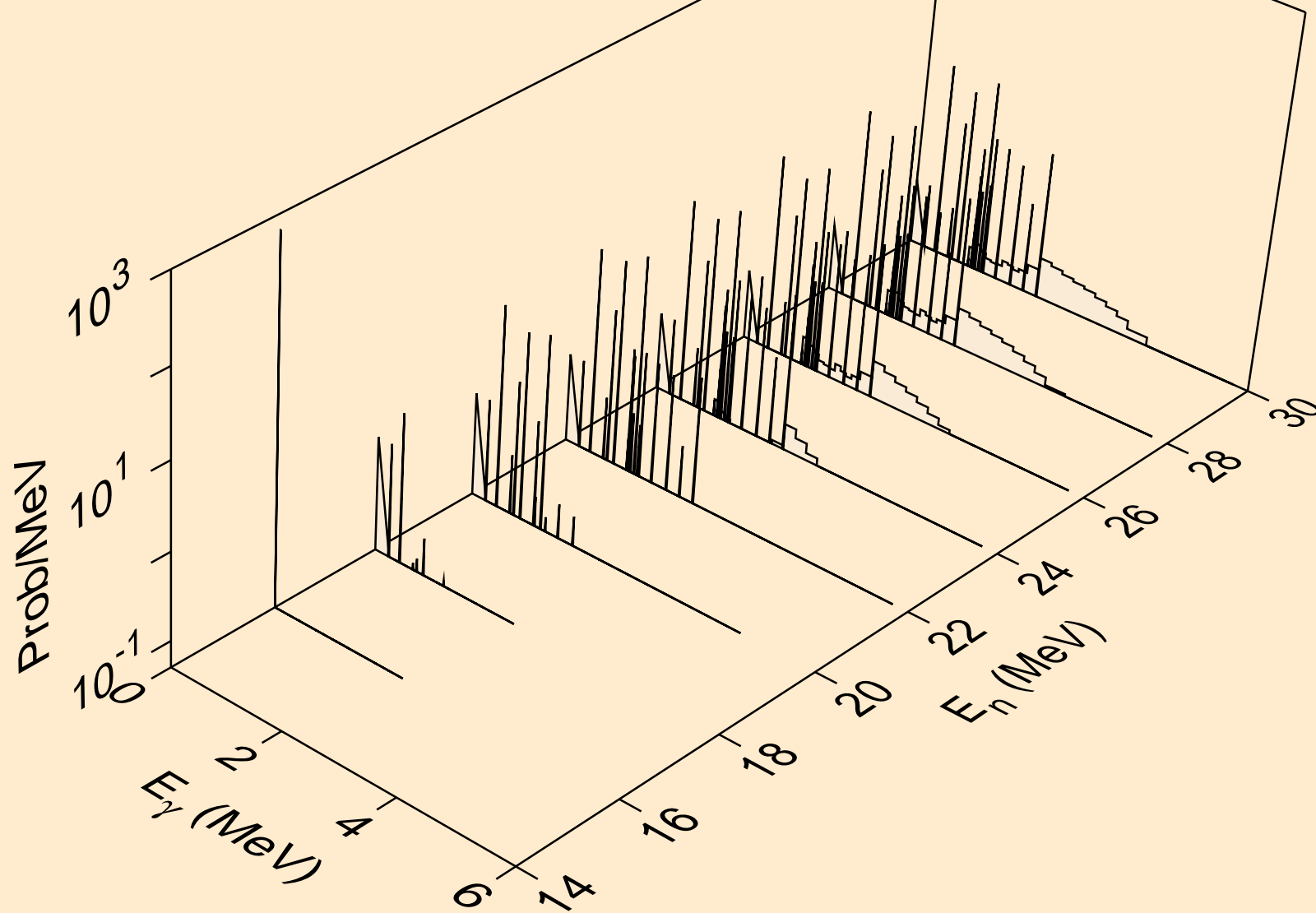

AL028 ALPHA ACER TENDL-2021 LIBRARY; T=0.K
Photon emission for (n,pa)

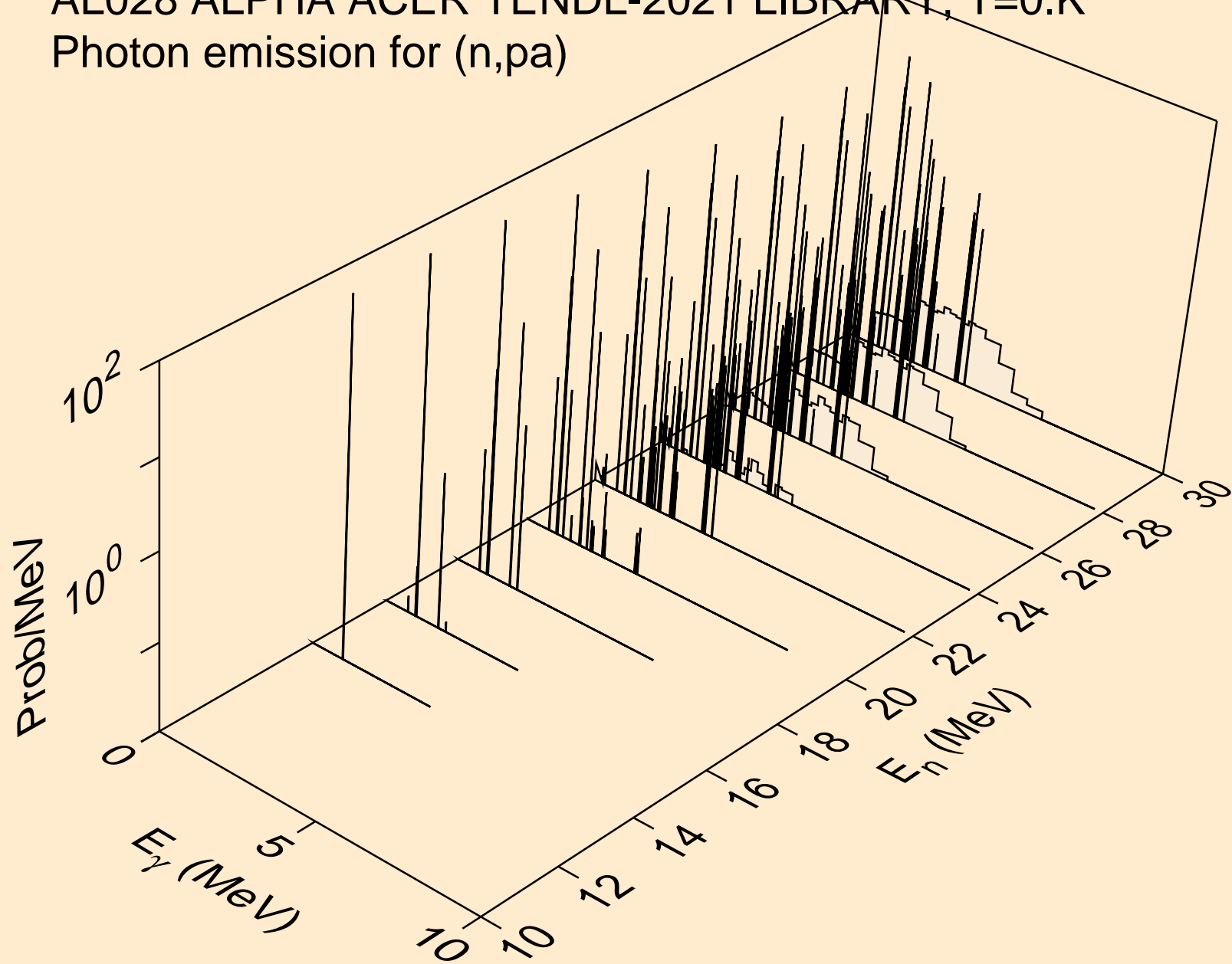

AL028 ALPHA ACER TENDL-2021 LIBRARY; T=0.K
Photon emission for (n,pd)

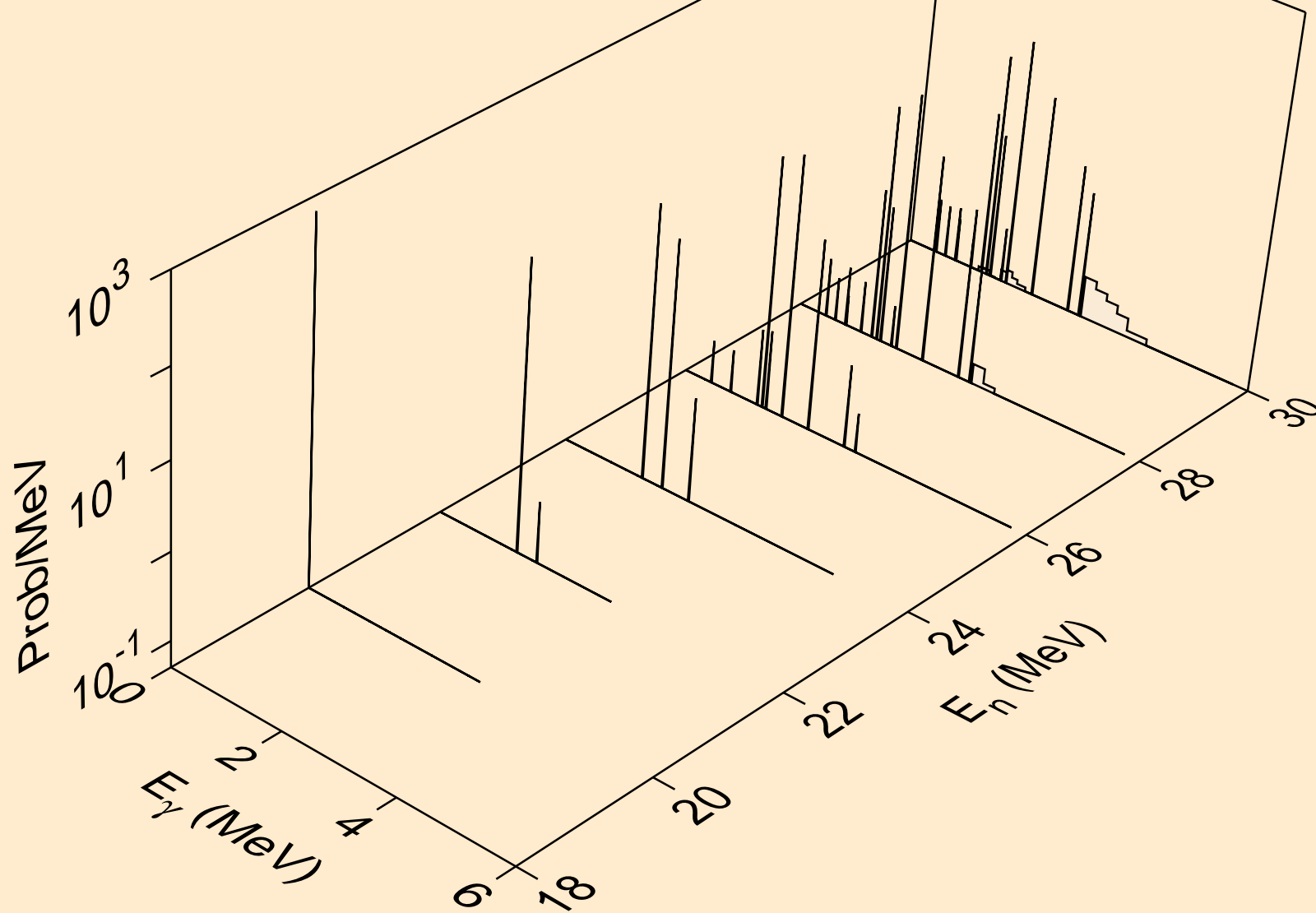

AL028 ALPHA ACER TENDL-2021 LIBRARY; T=0.K
Photon emission for (n,pt)

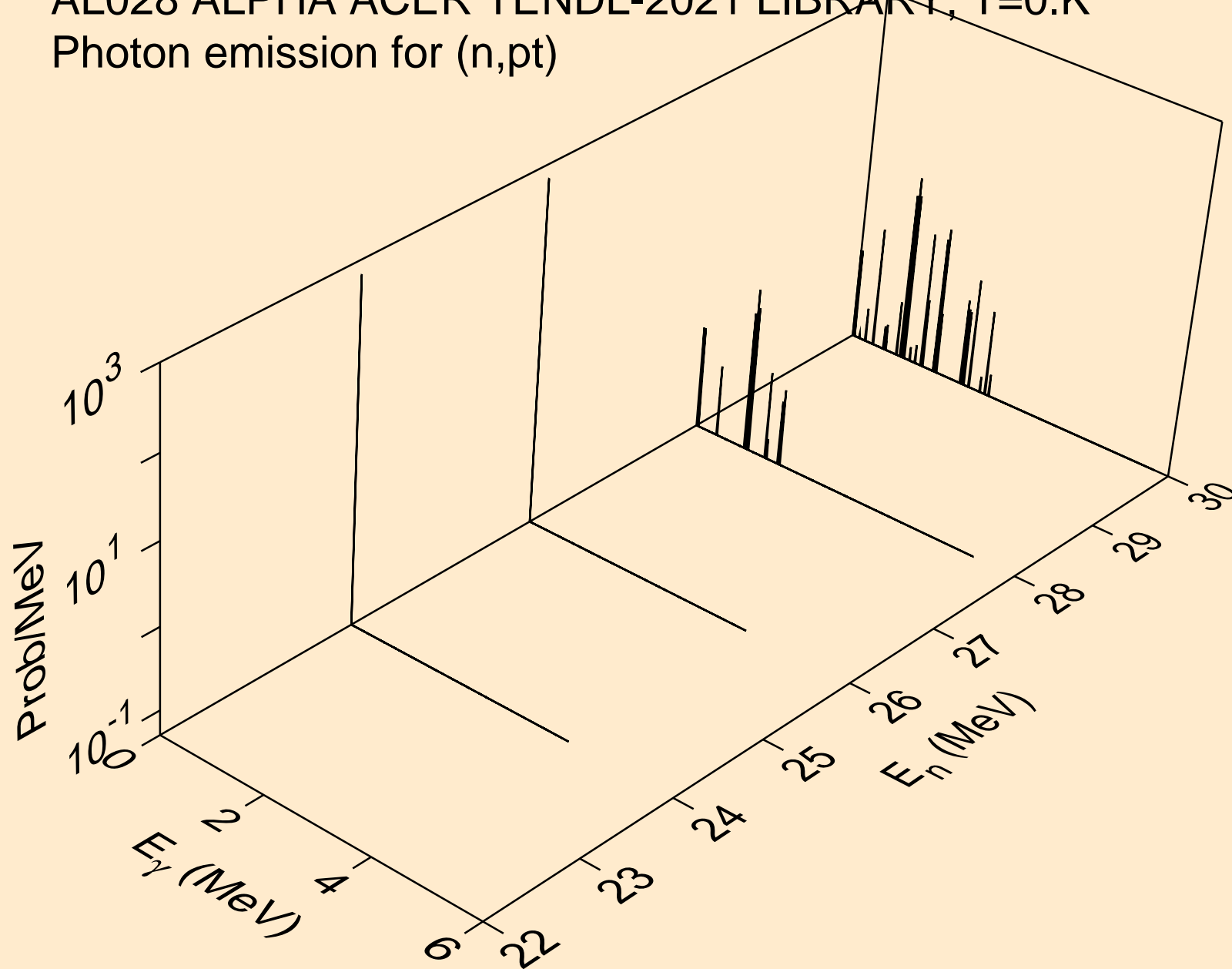

AL028 ALPHA ACER TENDL-2021 LIBRARY; T=0.K
Photon emission for (n,da)

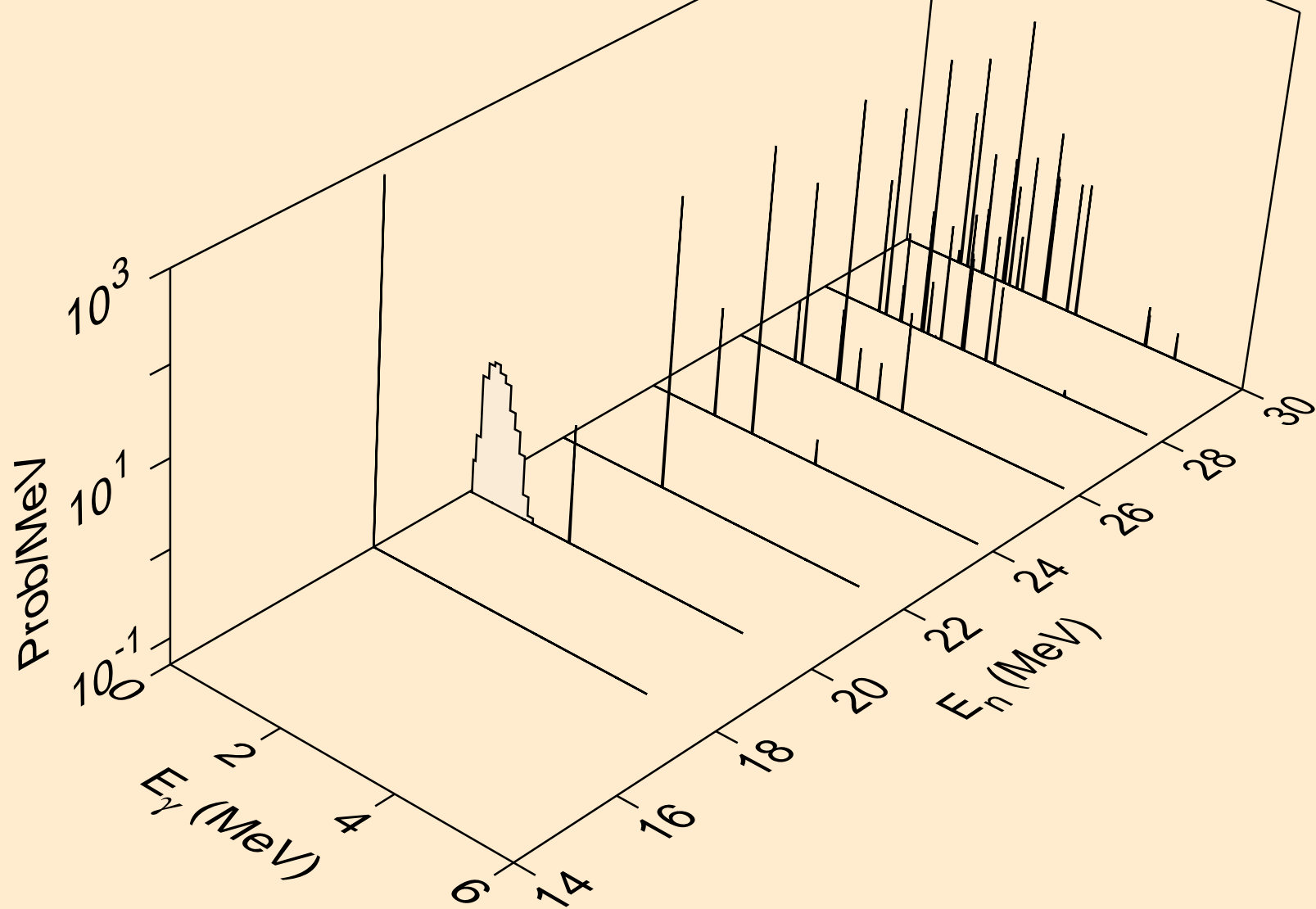

AL028 ALPHA ACER TENDL-2021 LIBRARY; T=0.K
Particle heating contributions

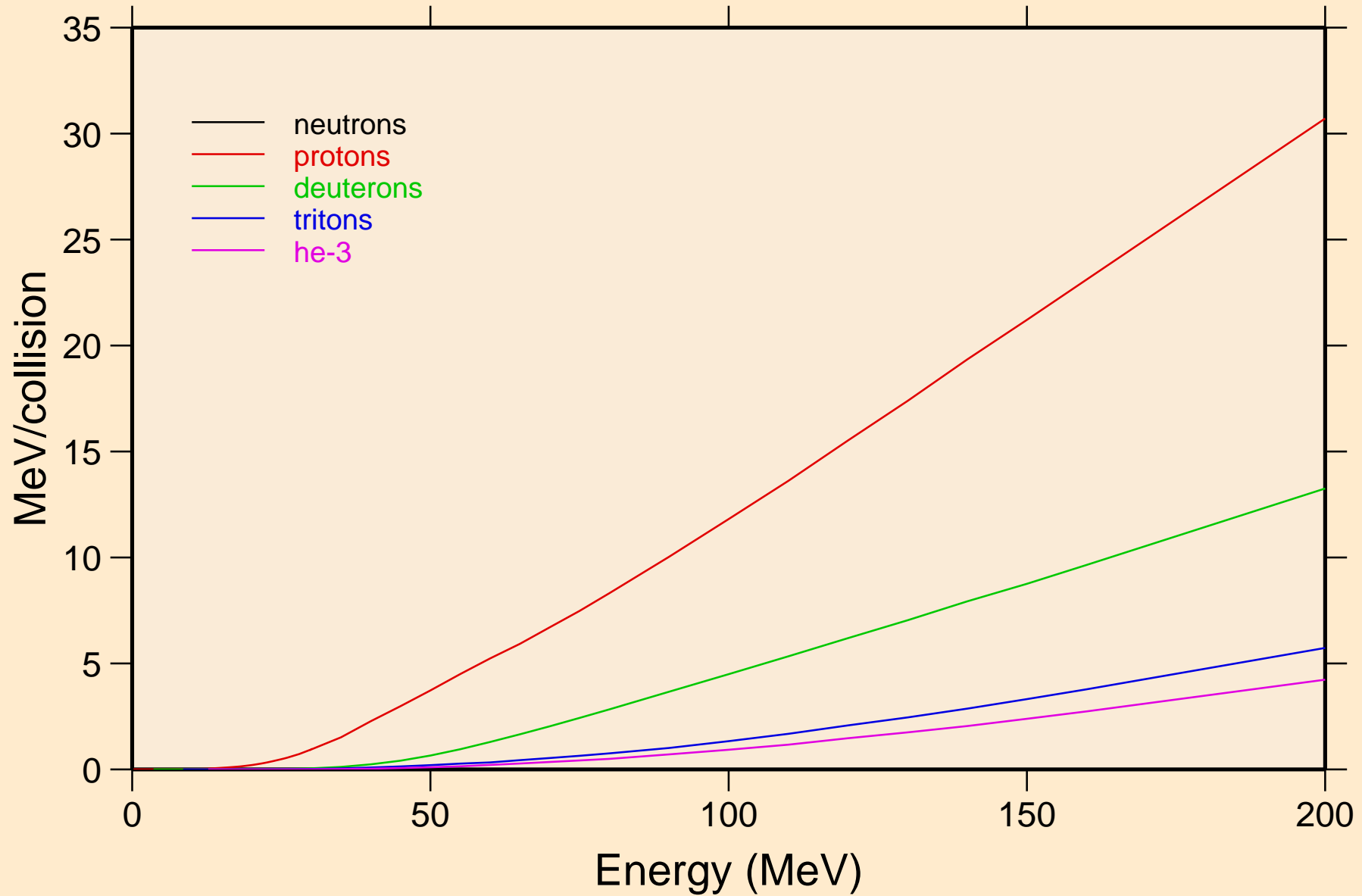

AL028 ALPHA ACER TENDL-2021 LIBRARY; T=0.K
Recoil Heating

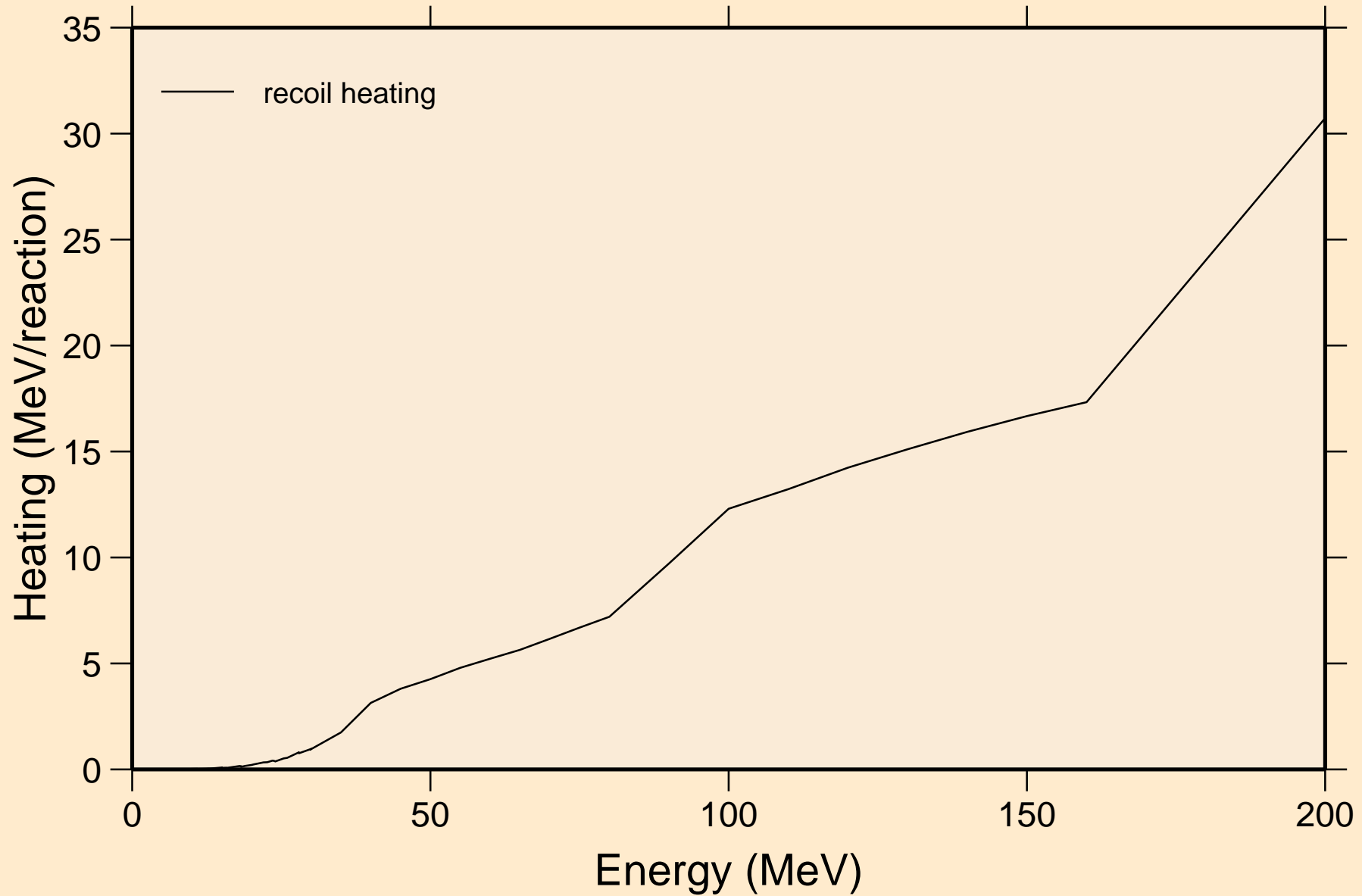

AL028 ALPHA ACER TENDL-2021 LIBRARY; T=0.K
Particle production cross sections

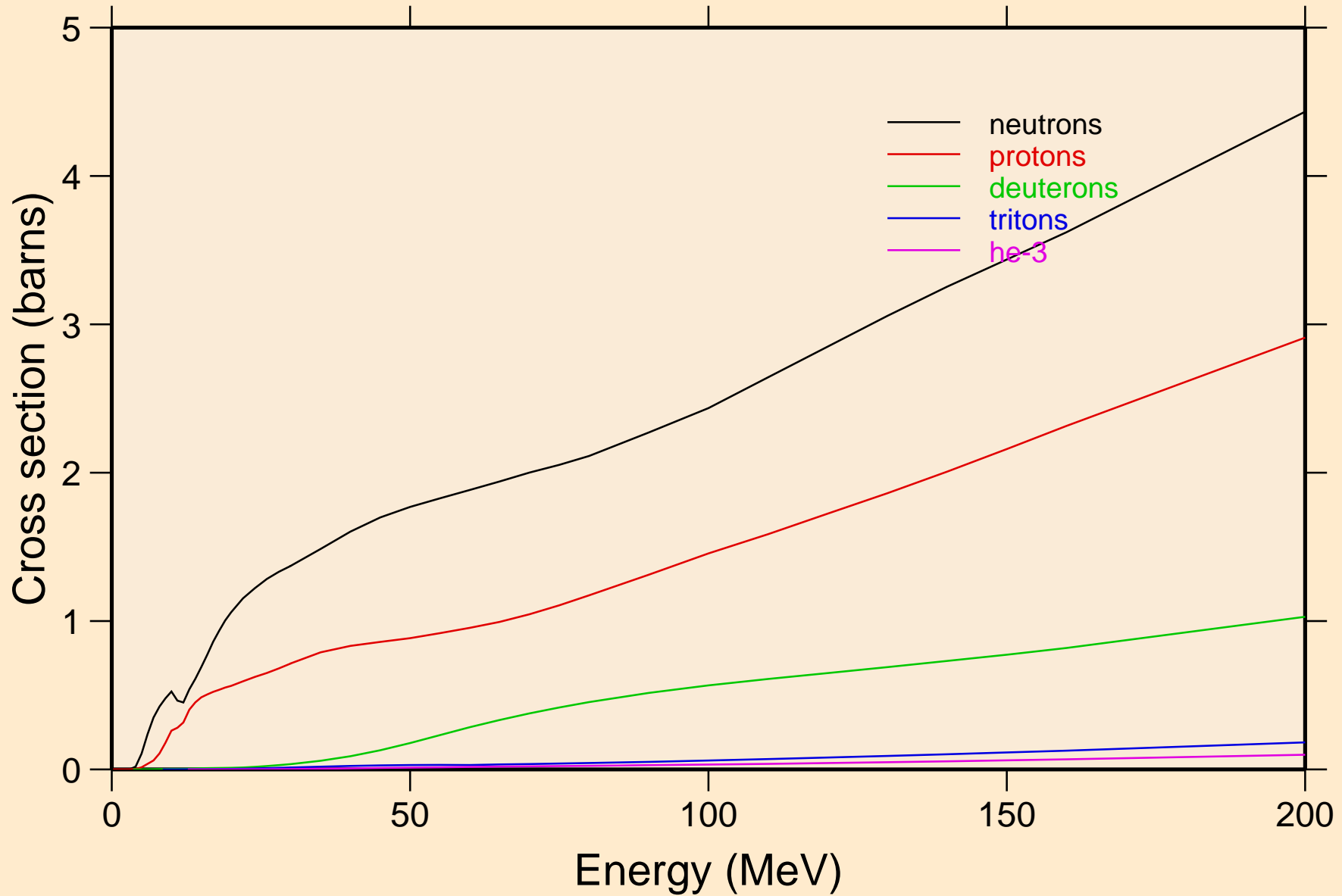

AL028 ALPHA ACER TENDL-2021 LIBRARY; T=0.K
neutrons from (a,n)

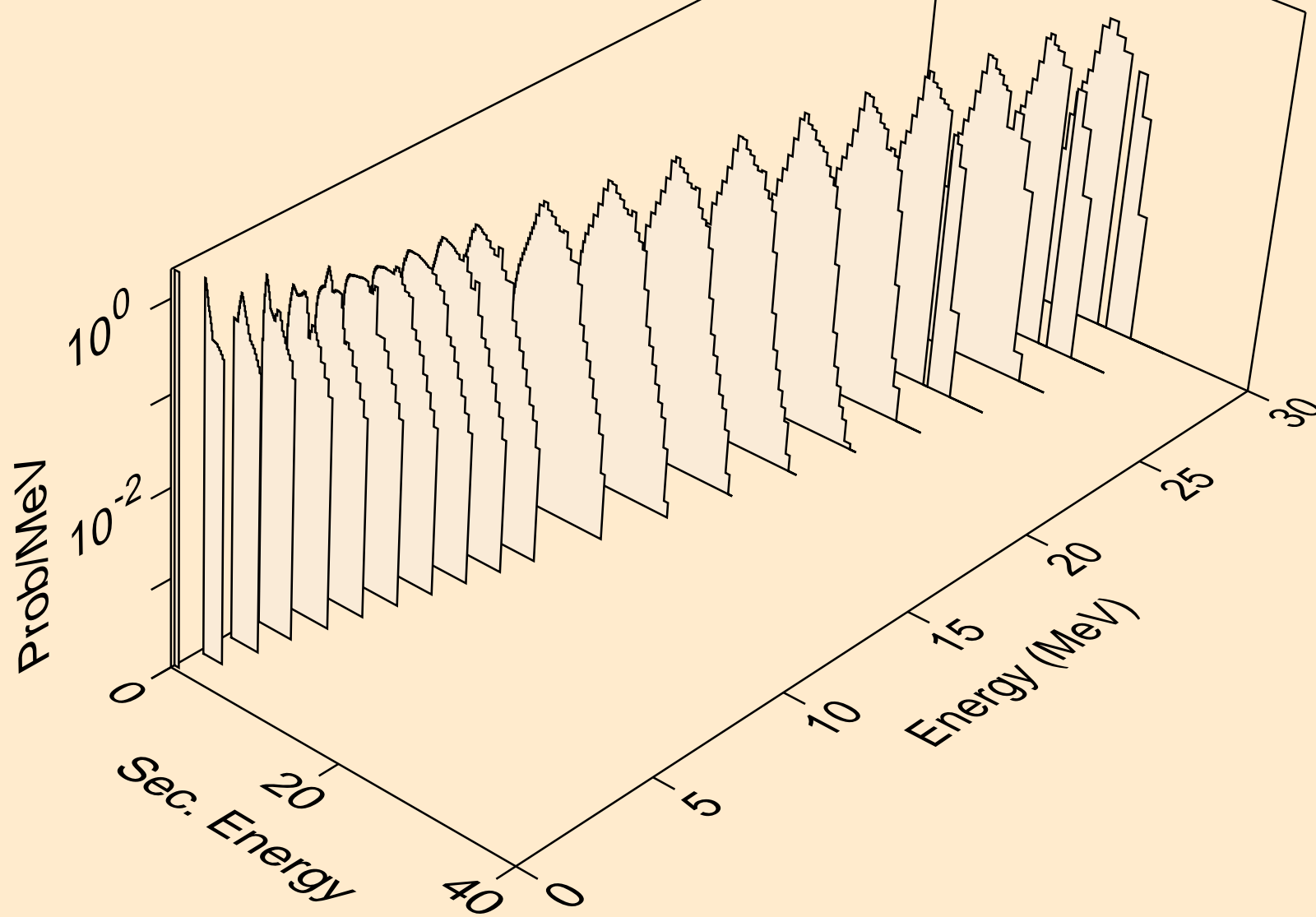

AL028 ALPHA ACER TENDL-2021 LIBRARY; T=0.K
neutrons from (a,x)

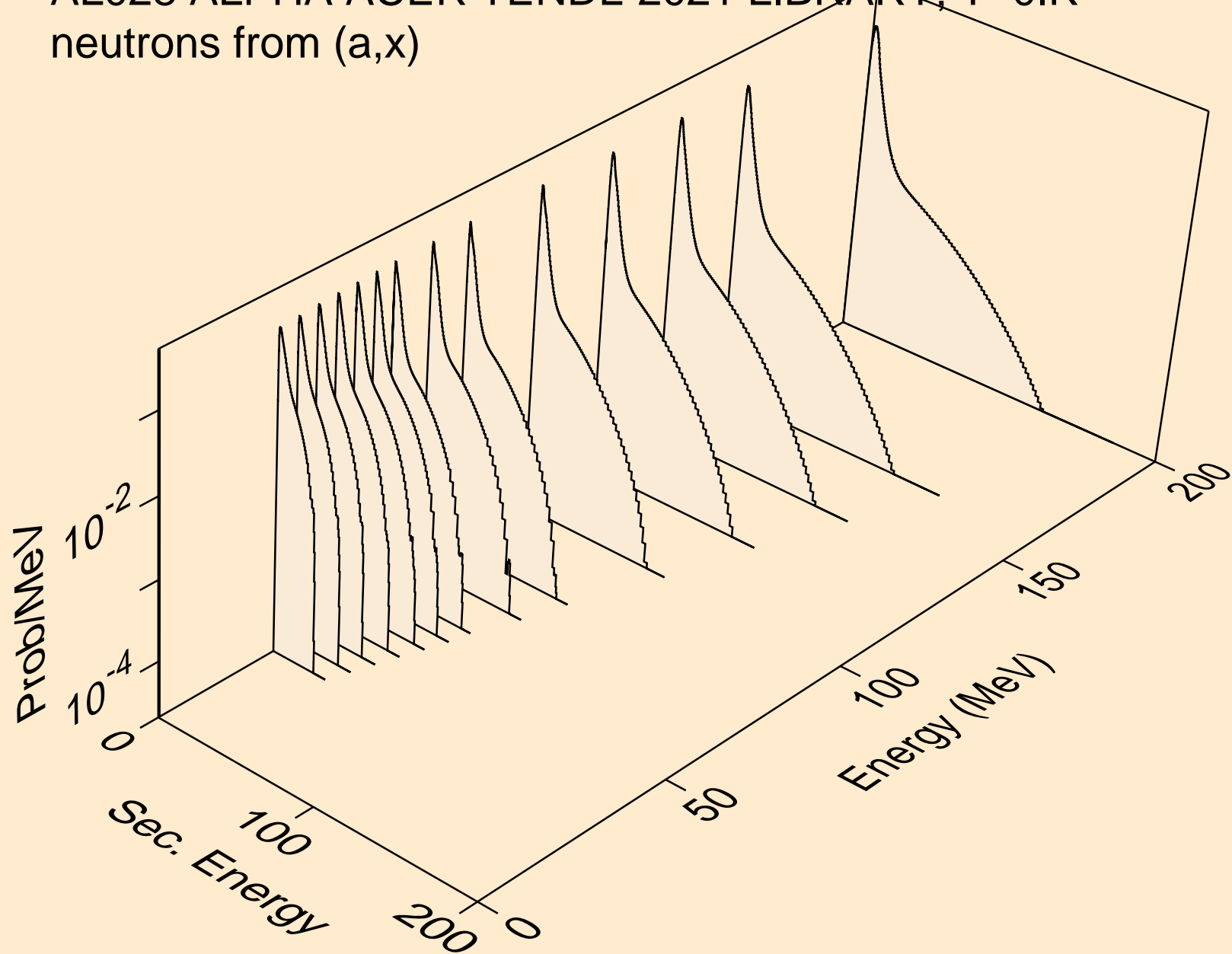

AL028 ALPHA ACER TENDL-2021 LIBRARY; T=0.K
neutrons from (a,2nd)

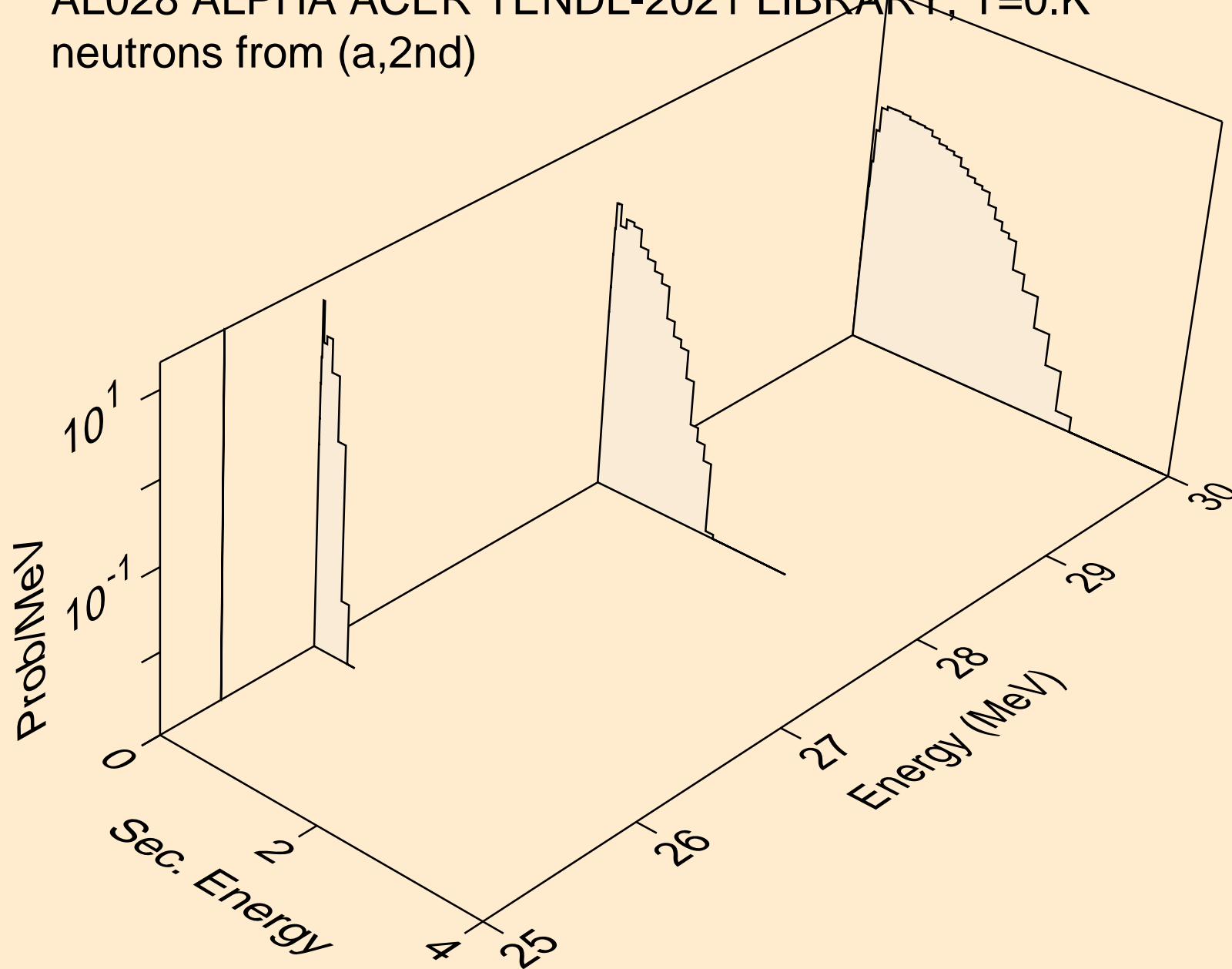

AL028 ALPHA ACER TENDL-2021 LIBRARY; T=0.K
neutrons from (a,2n)

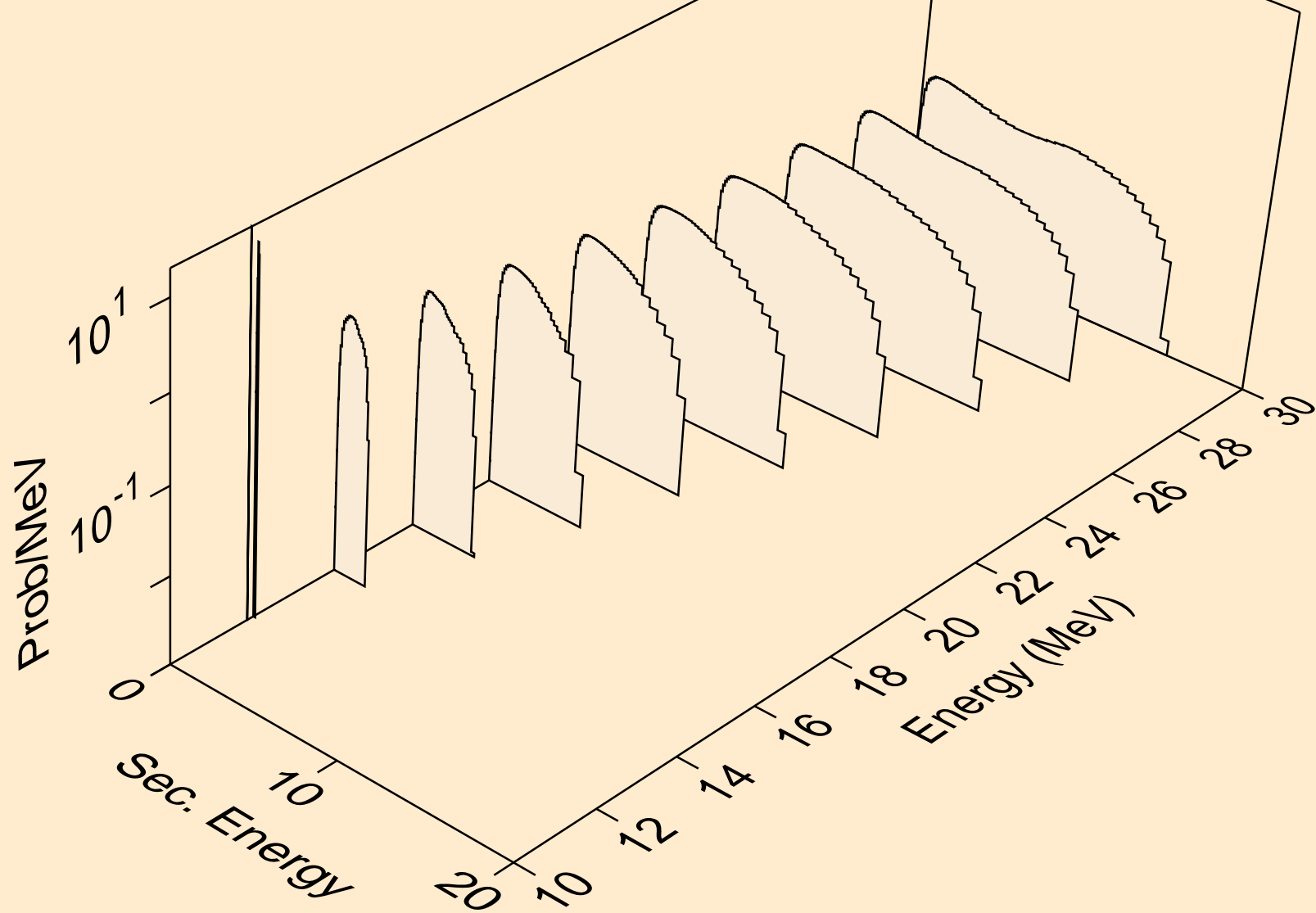

AL028 ALPHA ACER TENDL-2021 LIBRARY; T=0.K
neutrons from (a,3n)

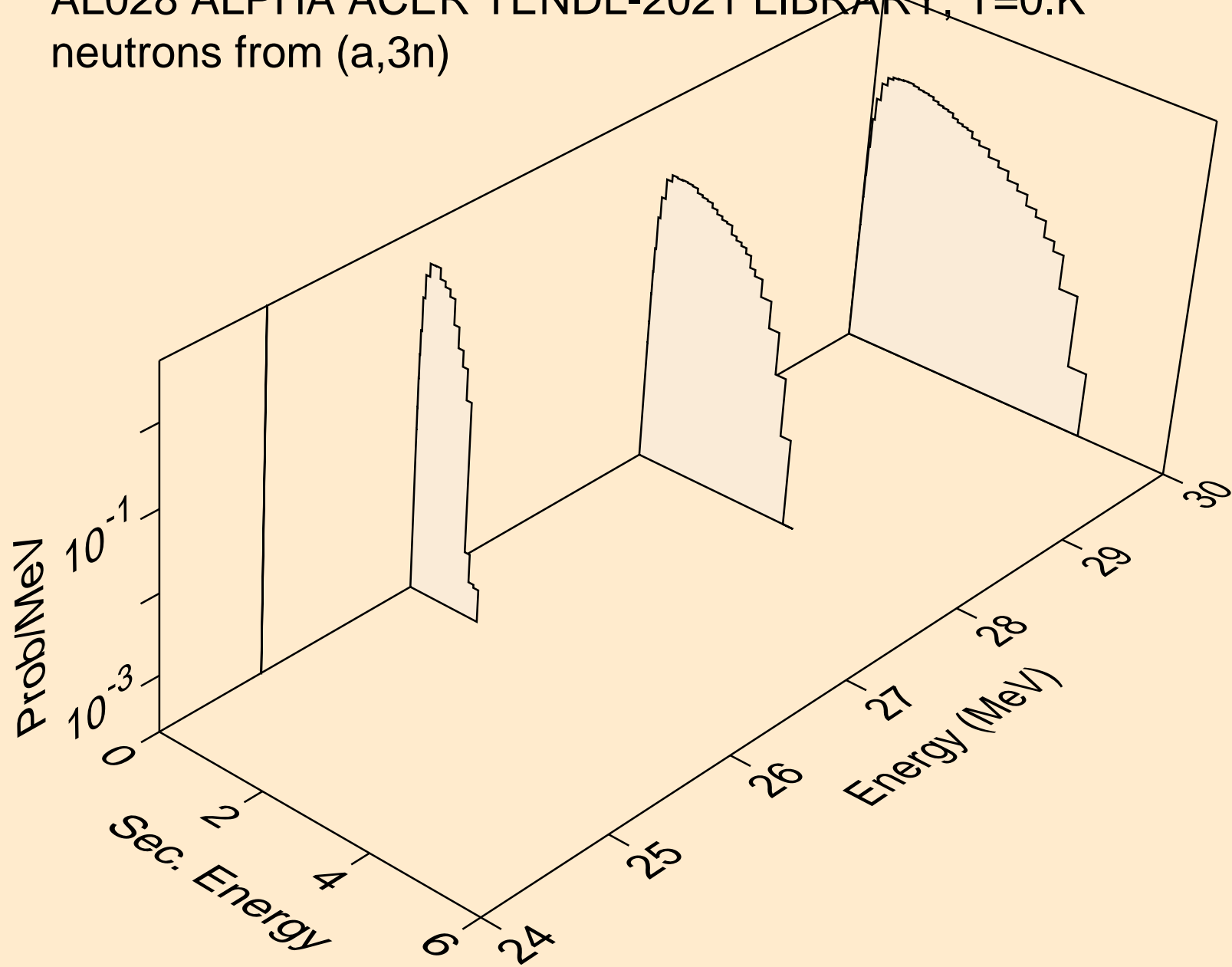

AL028 ALPHA ACER TENDL-2021 LIBRARY; T=0.K
neutrons from (a,n*)a

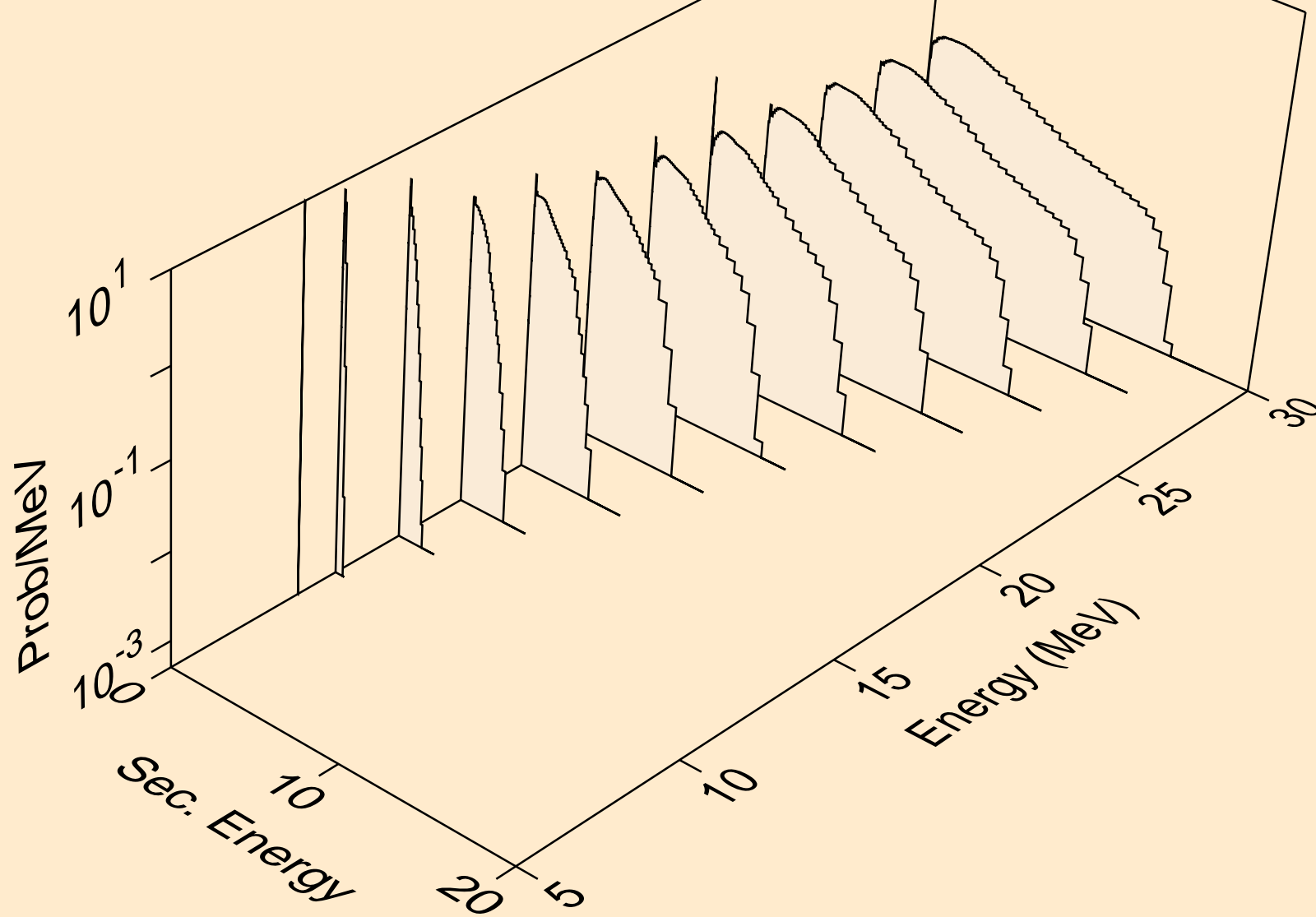

AL028 ALPHA ACER TENDL-2021 LIBRARY; T=0.K
neutrons from (a,2n)a

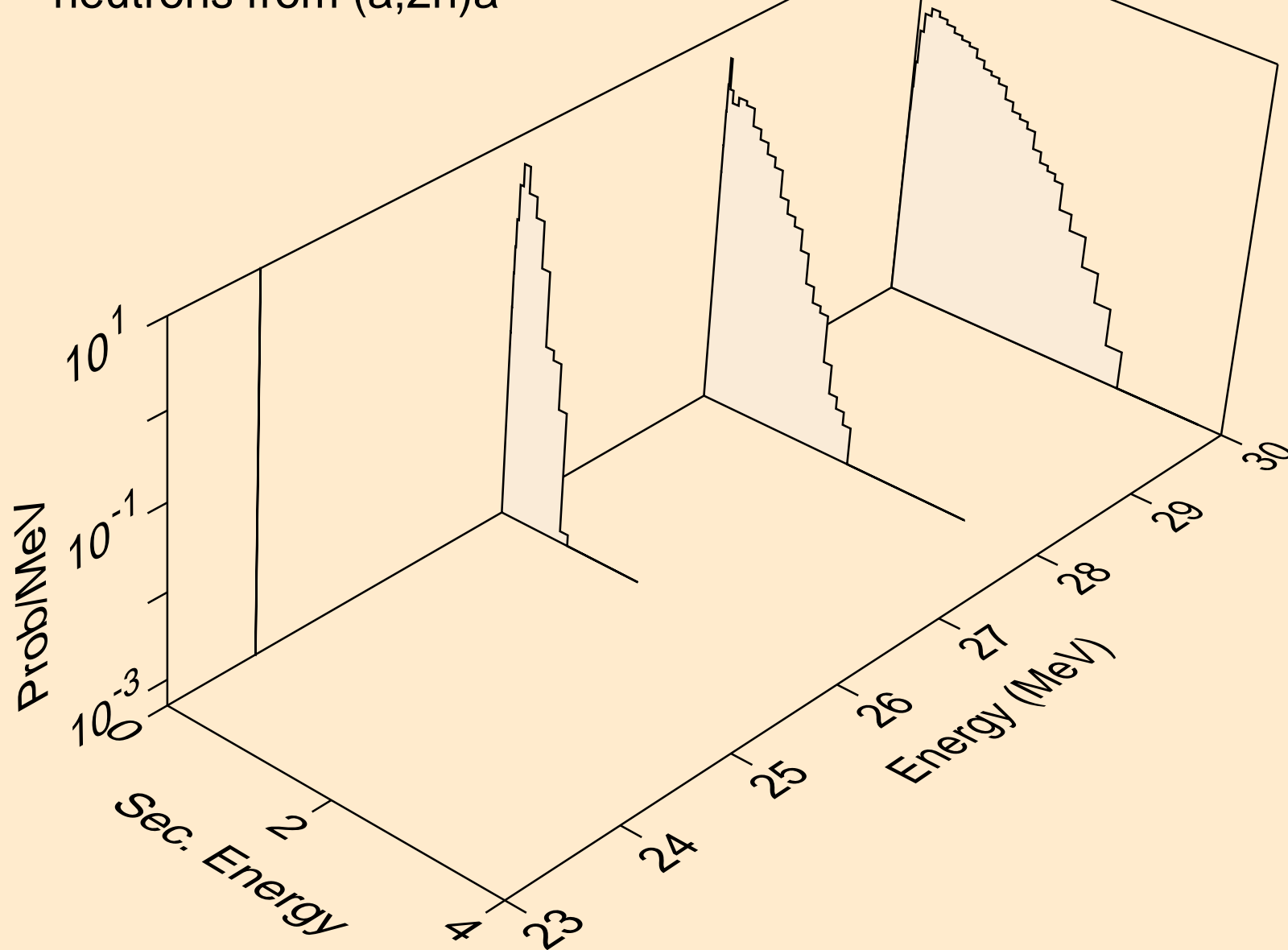

AL028 ALPHA ACER TENDL-2021 LIBRARY; T=0.K
neutrons from (a,n*)p

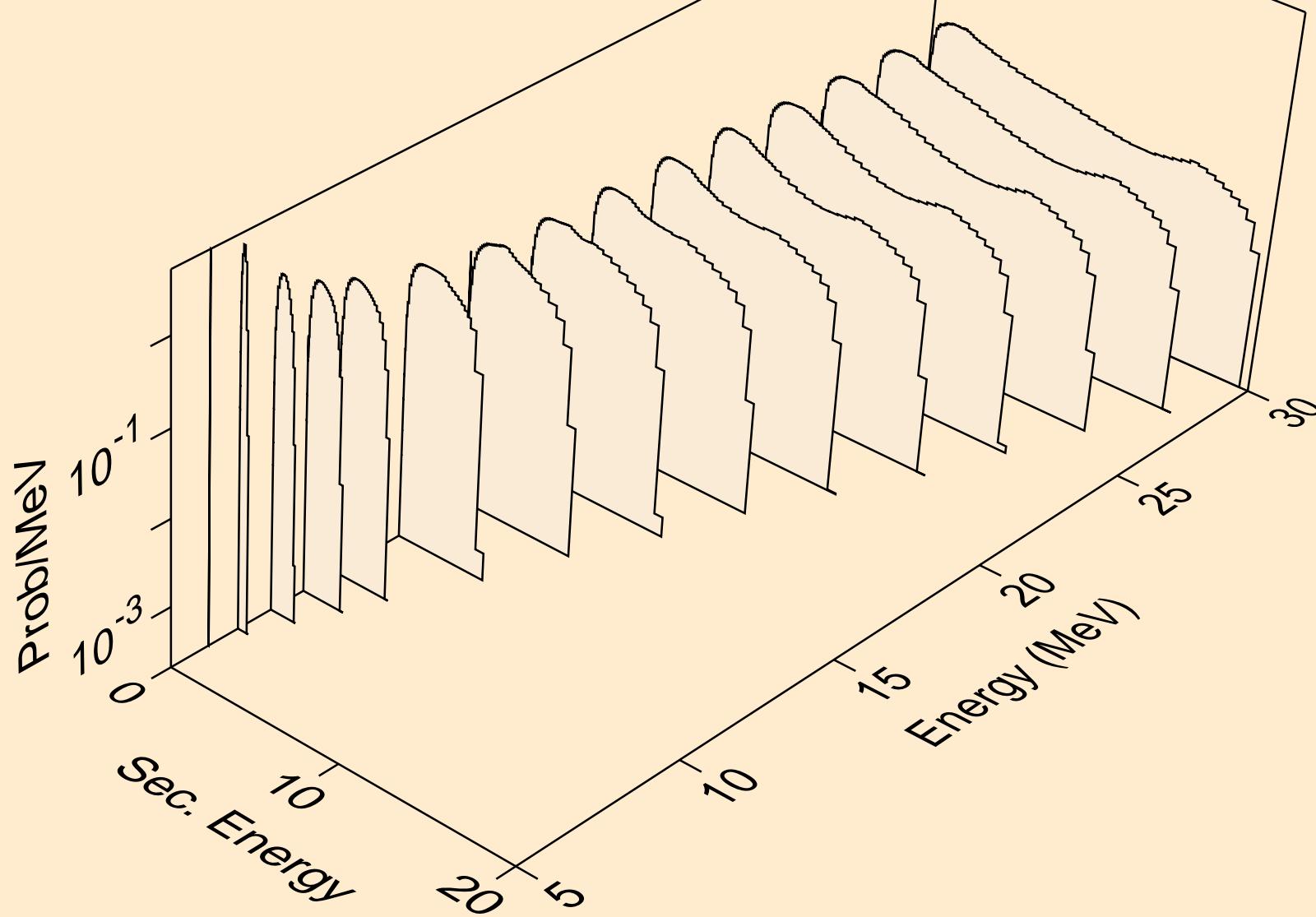

AL028 ALPHA ACER TENDL-2021 LIBRARY; T=0.K
neutrons from (a,n*)2a

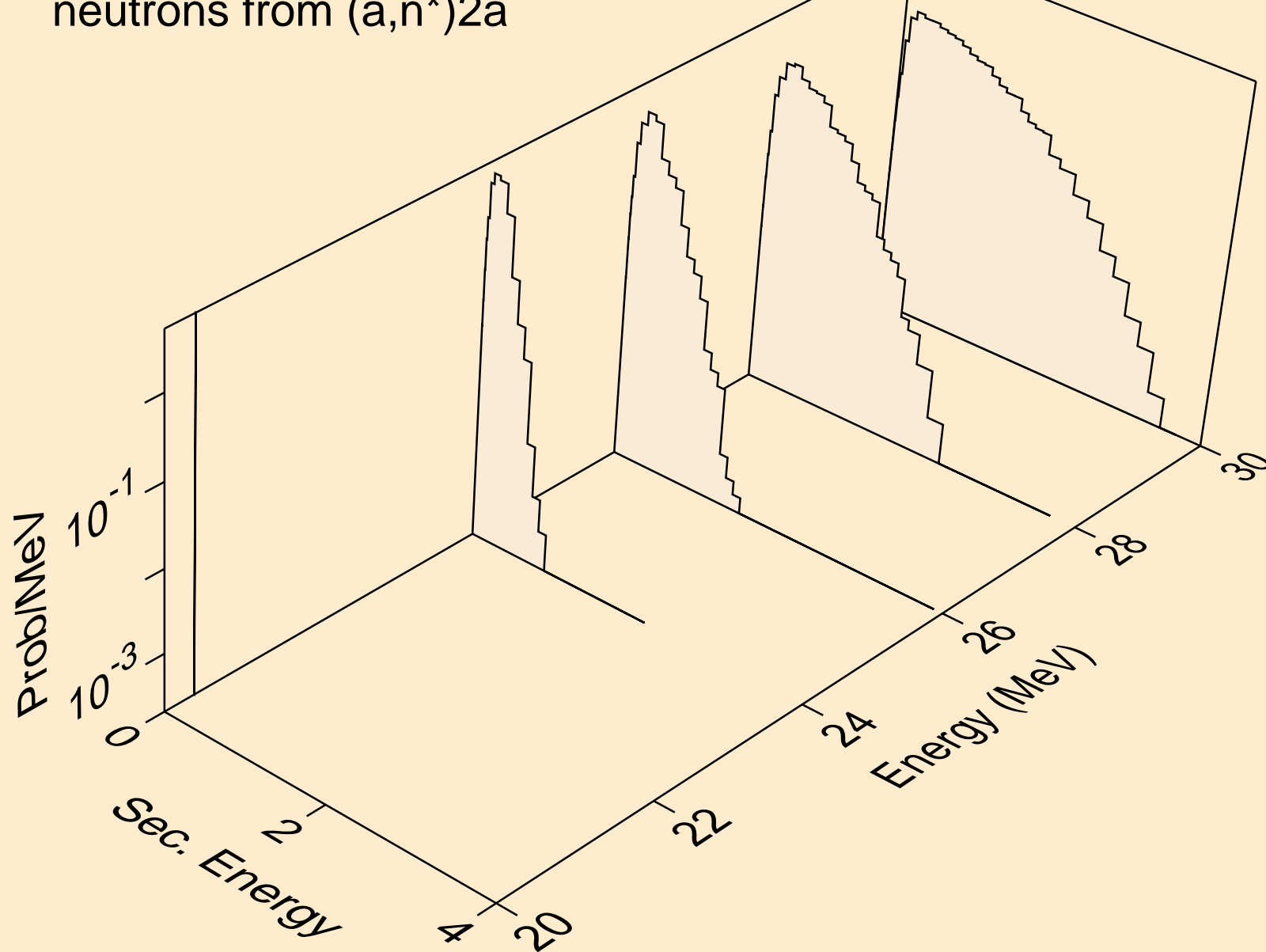

AL028 ALPHA ACER TENDL-2021 LIBRARY; T=0.K
neutrons from (a,n*)d

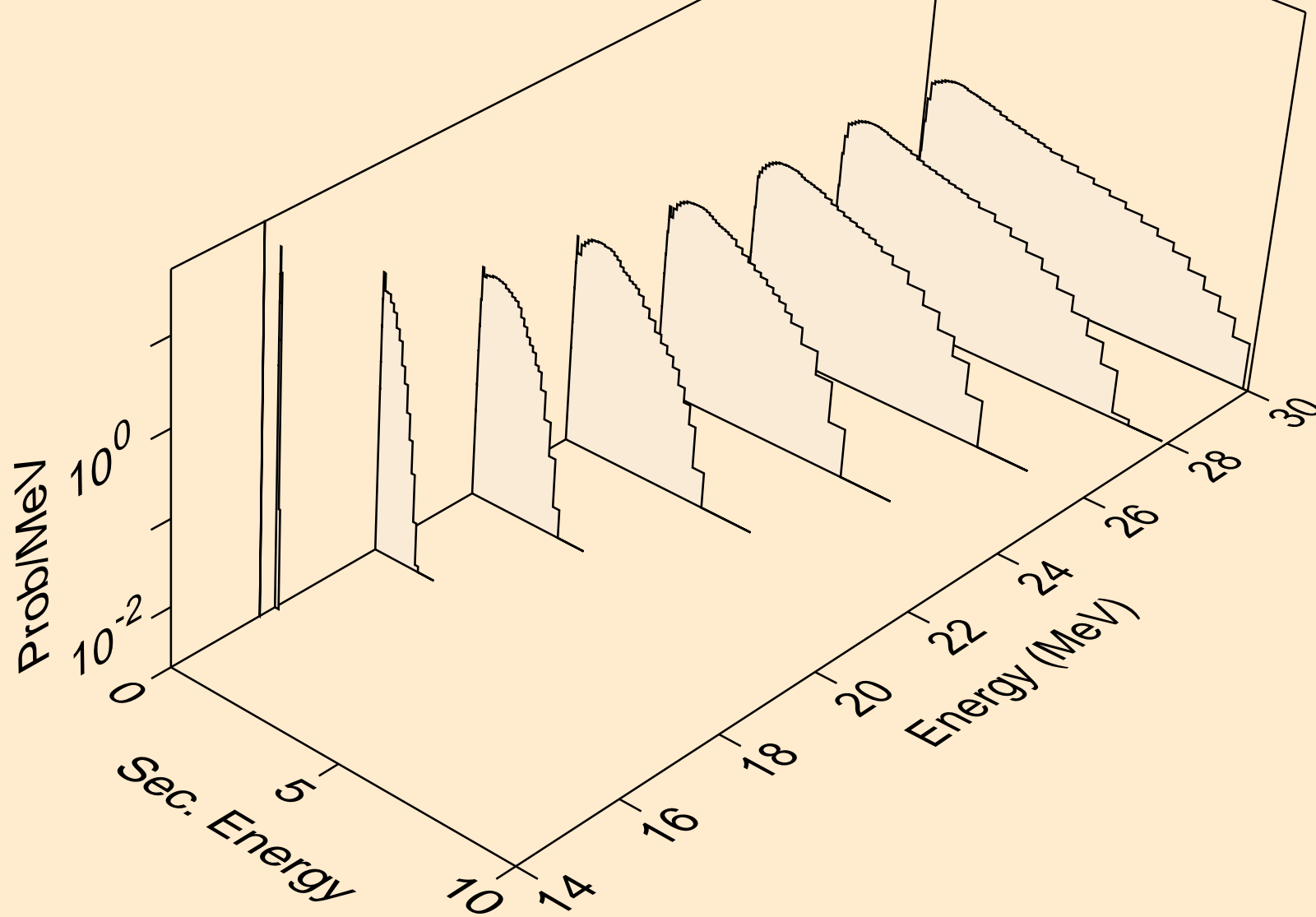

AL028 ALPHA ACER TENDL-2021 LIBRARY; T=0.K
neutrons from (a,n*)t

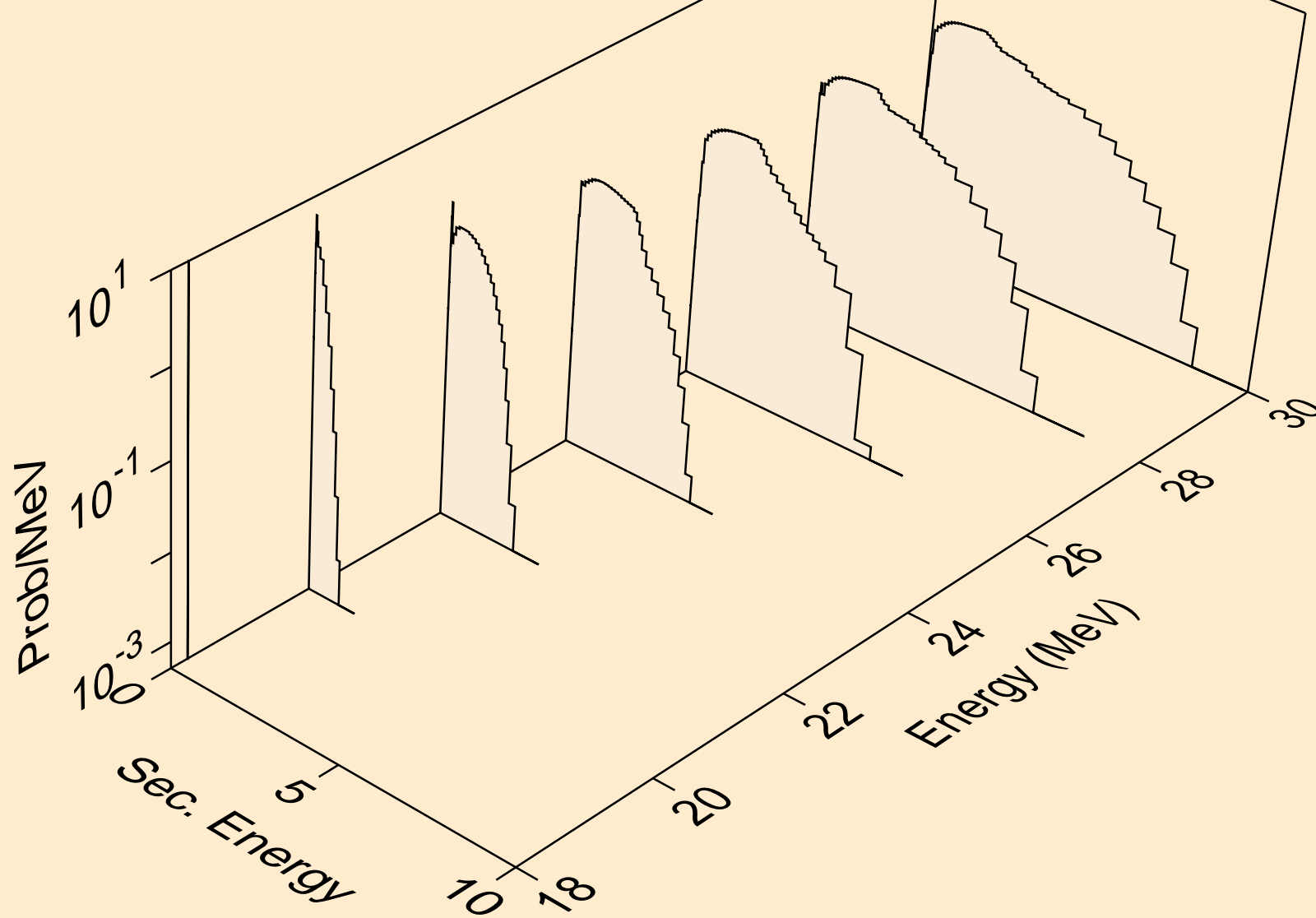

AL028 ALPHA ACER TENDL-2021 LIBRARY; T=0.K
neutrons from (a,n*)he3

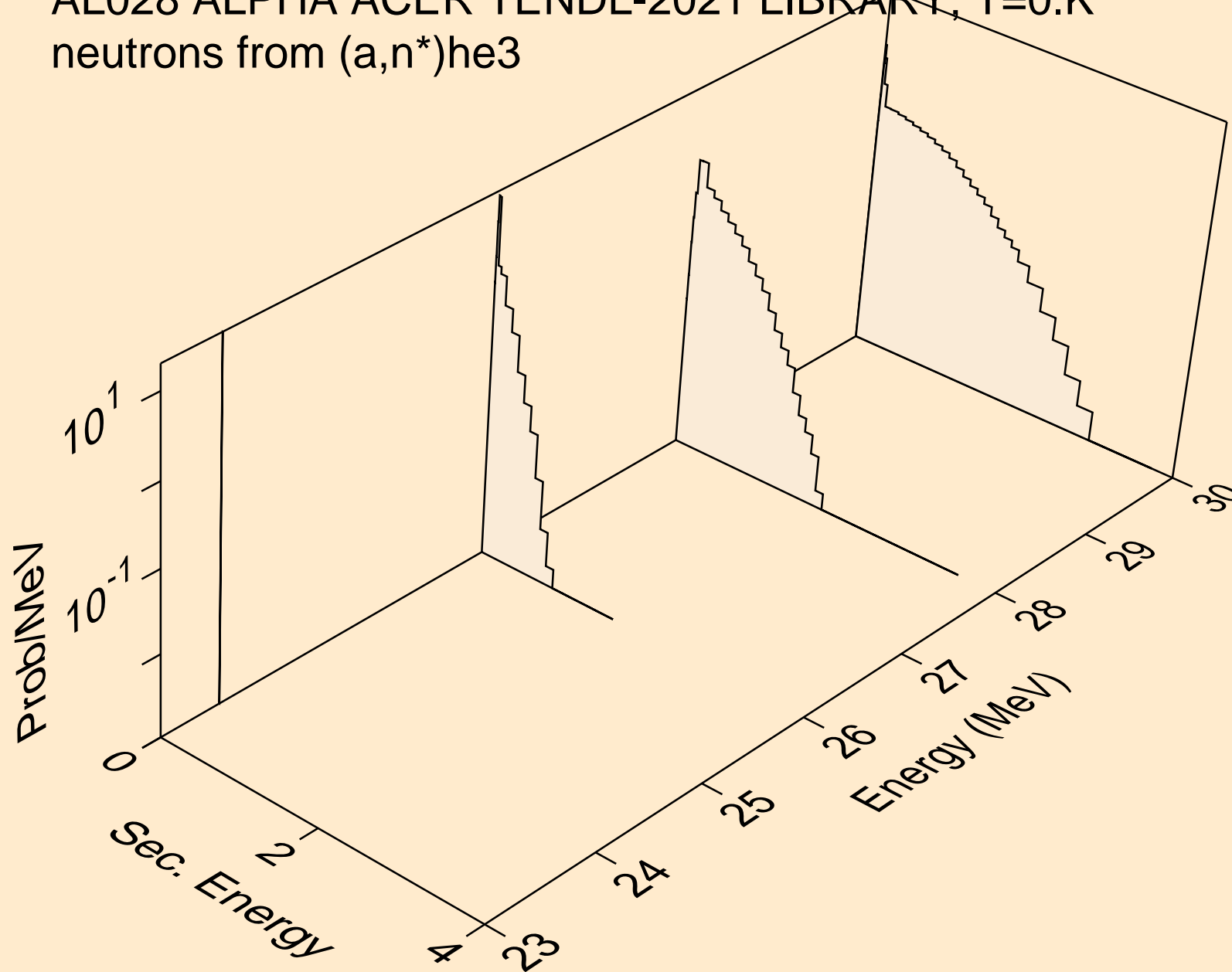

AL028 ALPHA ACER TENDL-2021 LIBRARY; T=0.K
neutrons from (a,2np)

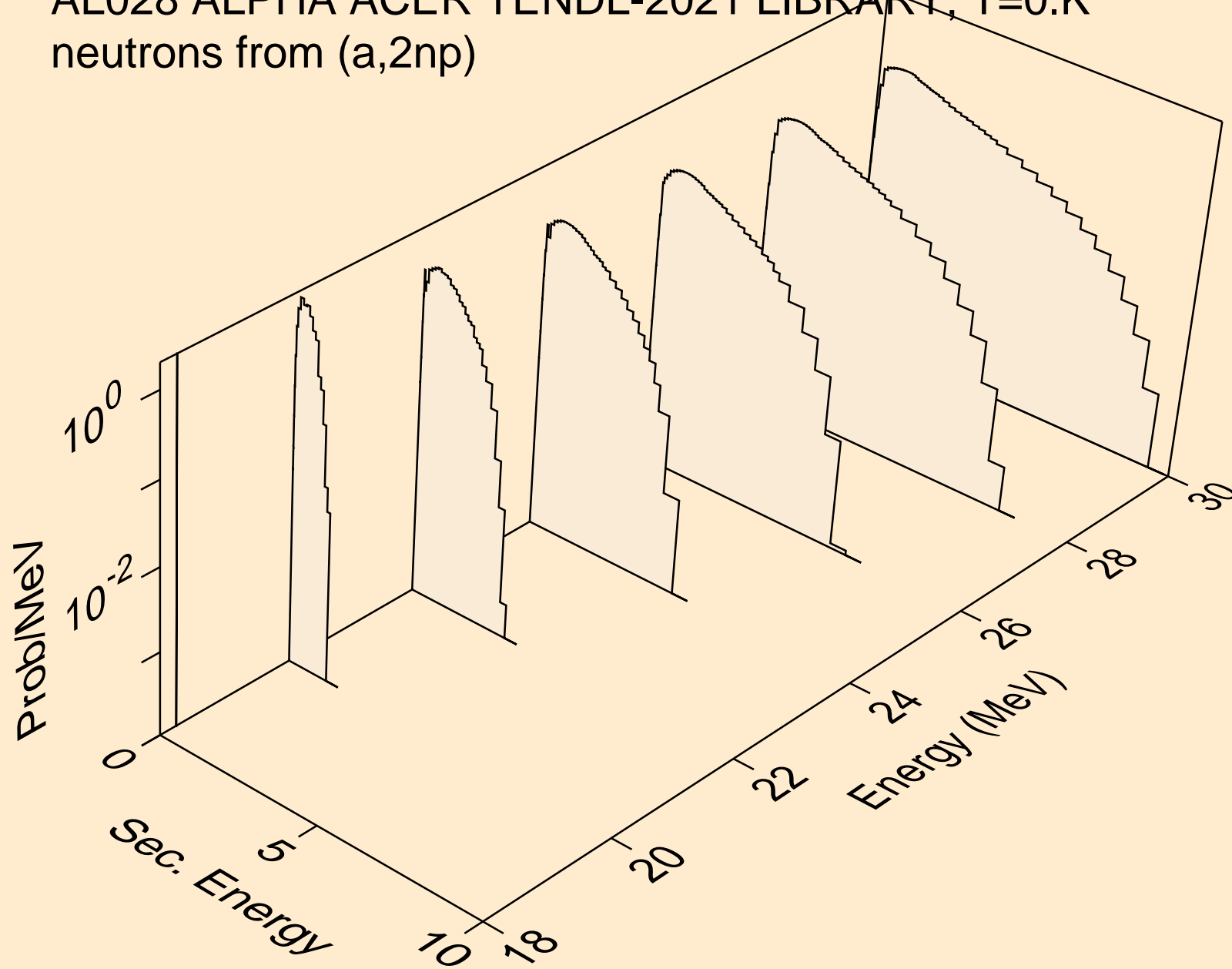

AL028 ALPHA ACER TENDL-2021 LIBRARY; T=0.K
neutrons from (a,3np)

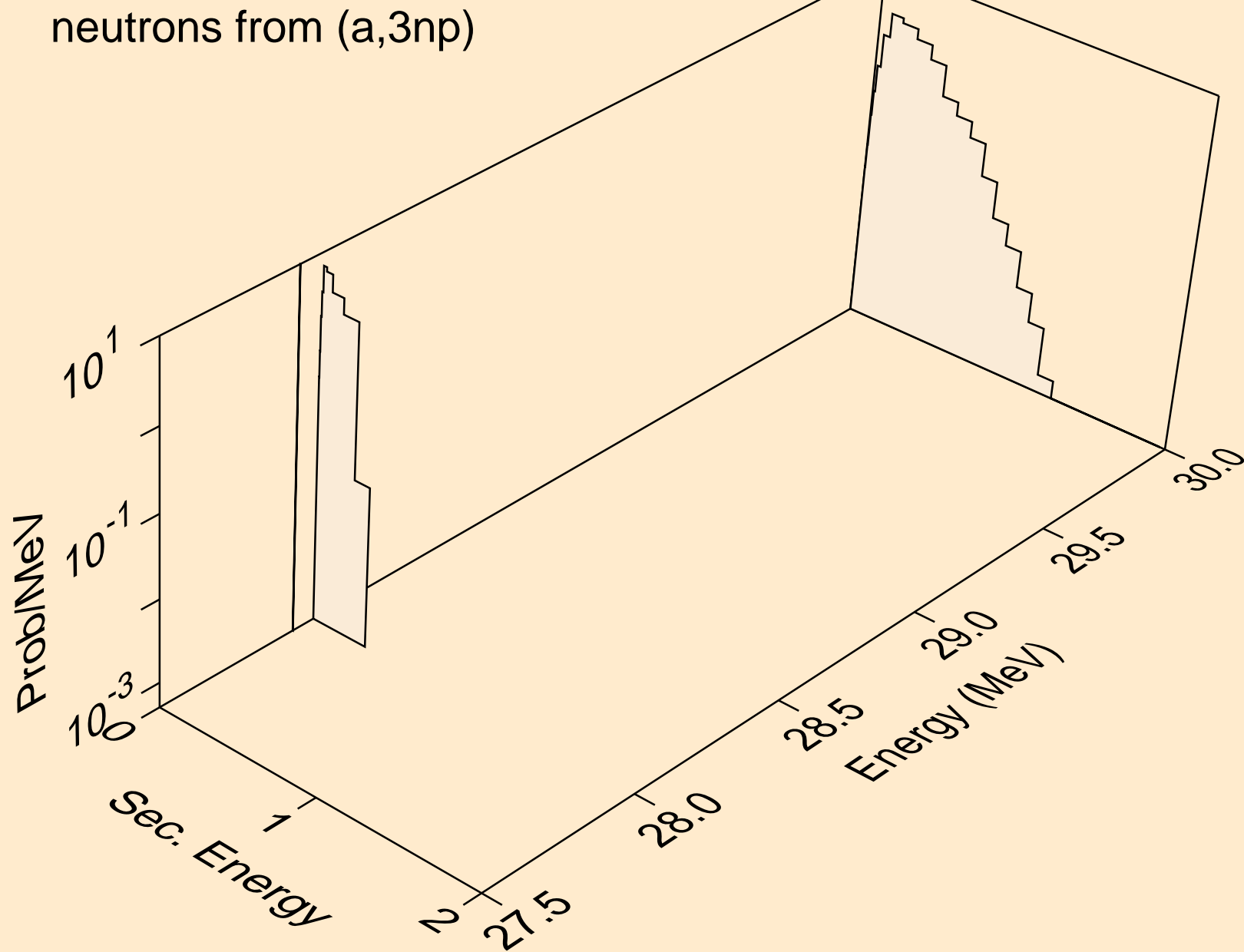

AL028 ALPHA ACER TENDL-2021 LIBRARY; T=0.K
neutrons from (a,2np)

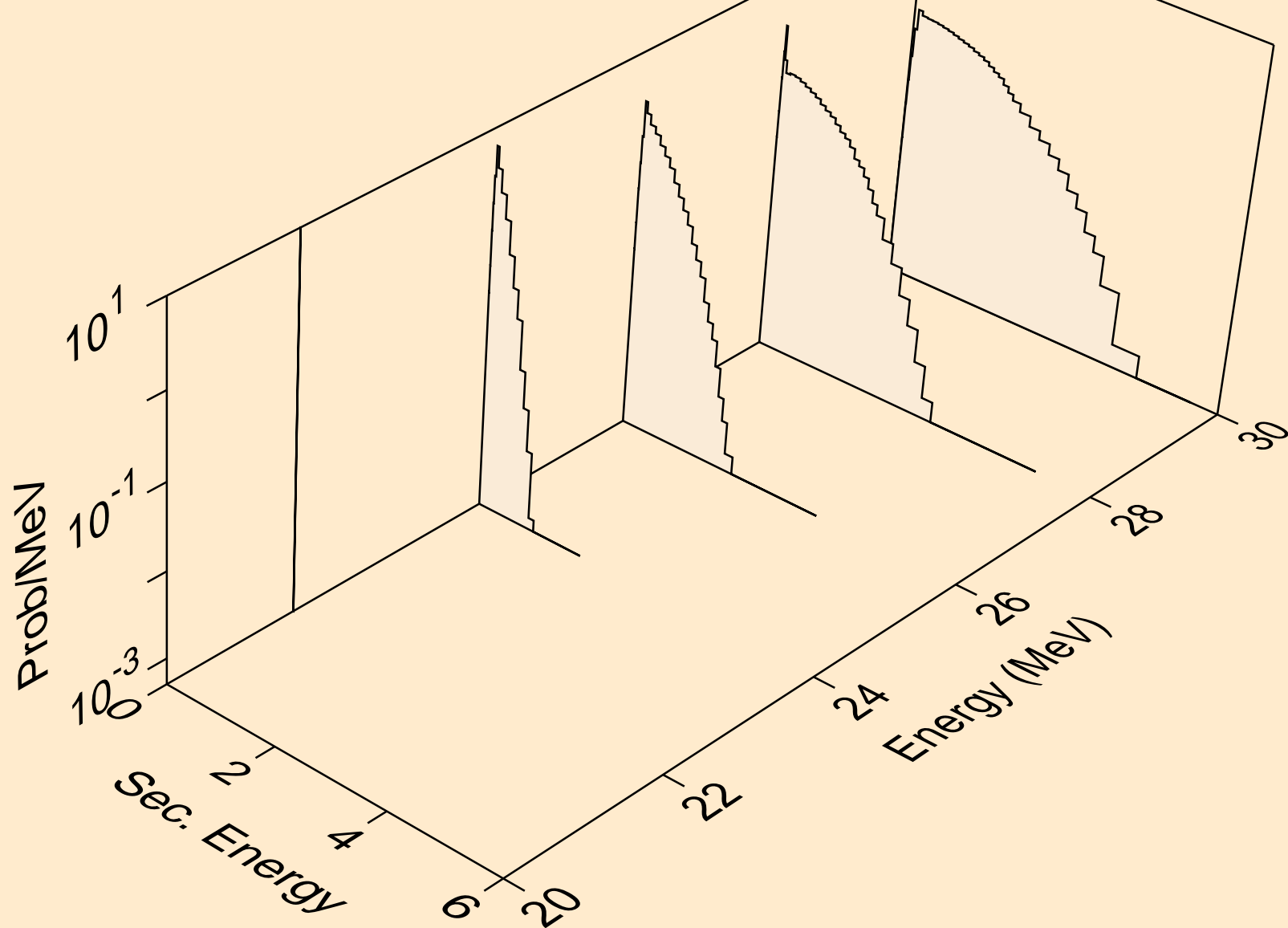

AL028 ALPHA ACER TENDL-2021 LIBRARY; T=0.K
neutrons from (a,npa)

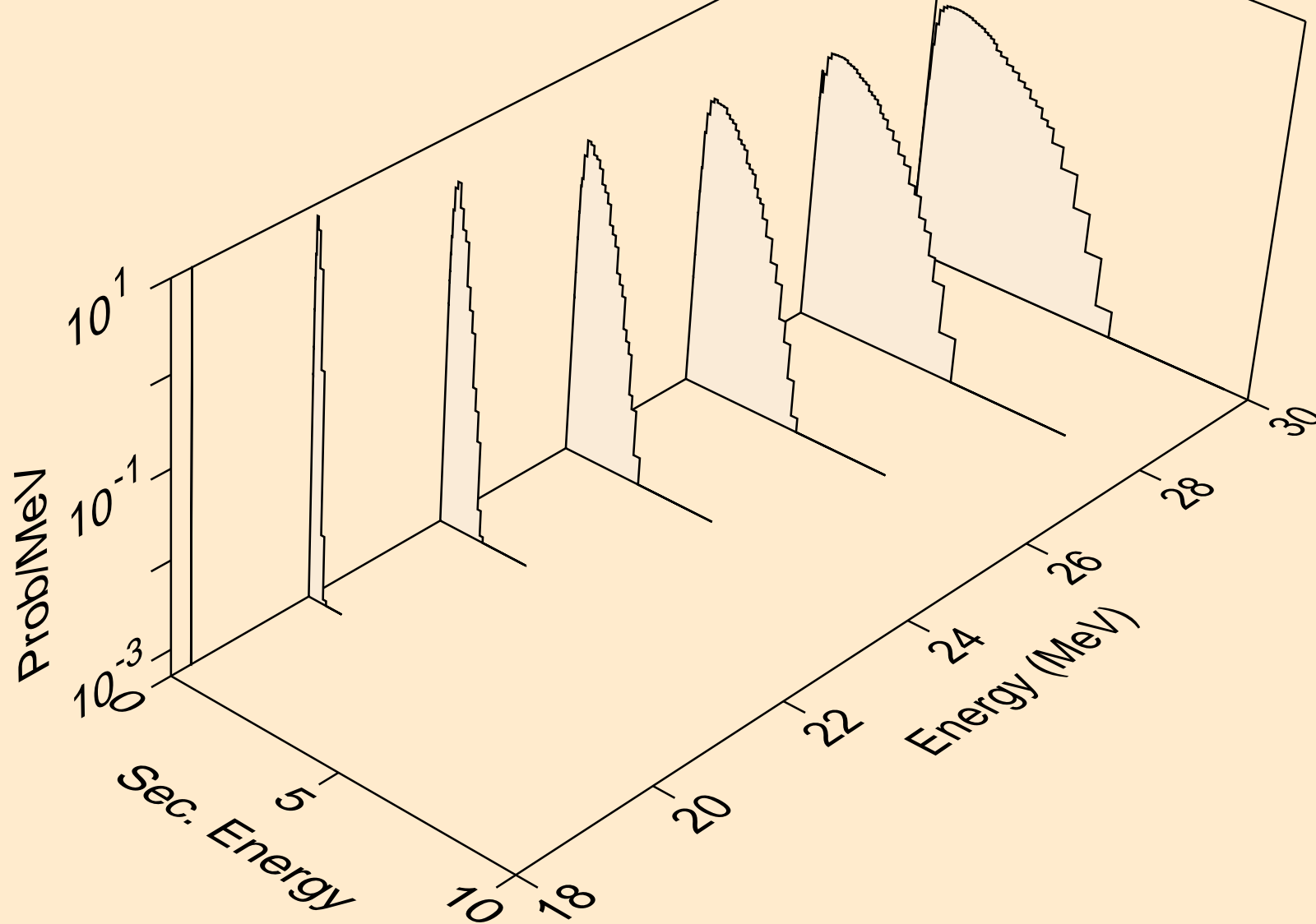

AL028 ALPHA ACER TENDL-2021 LIBRARY; T=0.K
protons from (a,x)

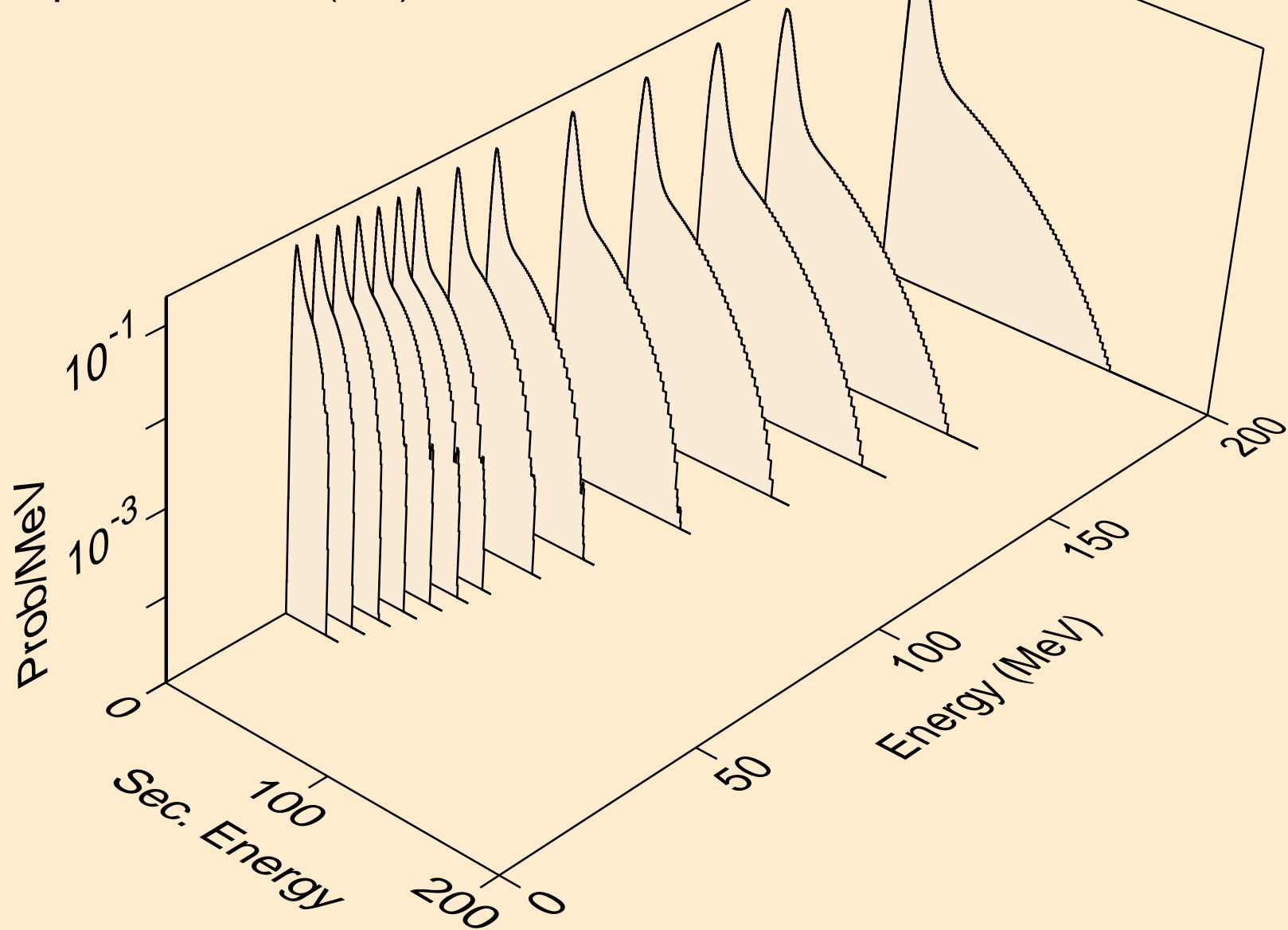

AL028 ALPHA ACER TENDL-2021 LIBRARY; T=0.K
protons from (a,n*)p

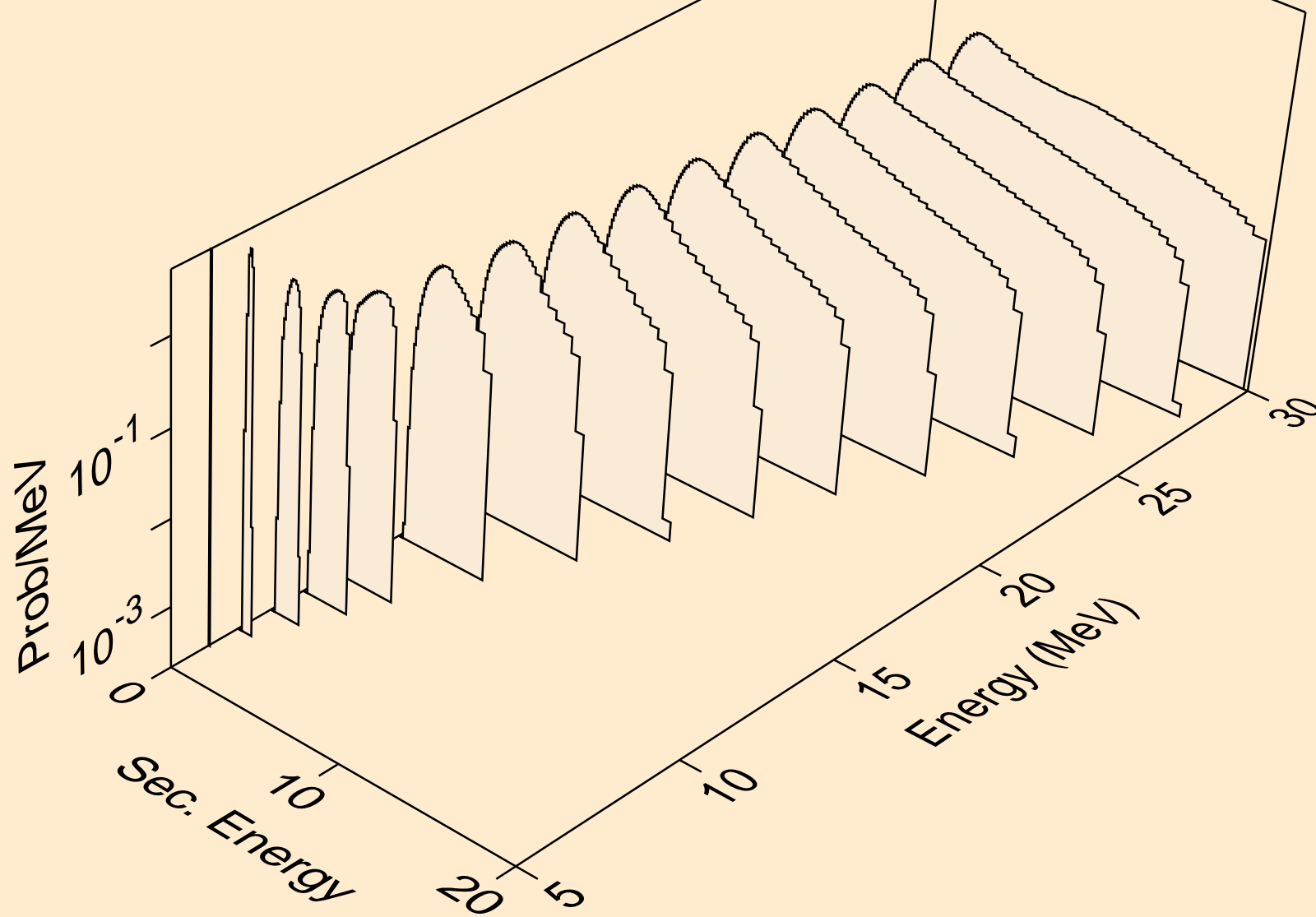

AL028 ALPHA ACER TENDL-2021 LIBRARY; T=0.K
protons from (a,2np)

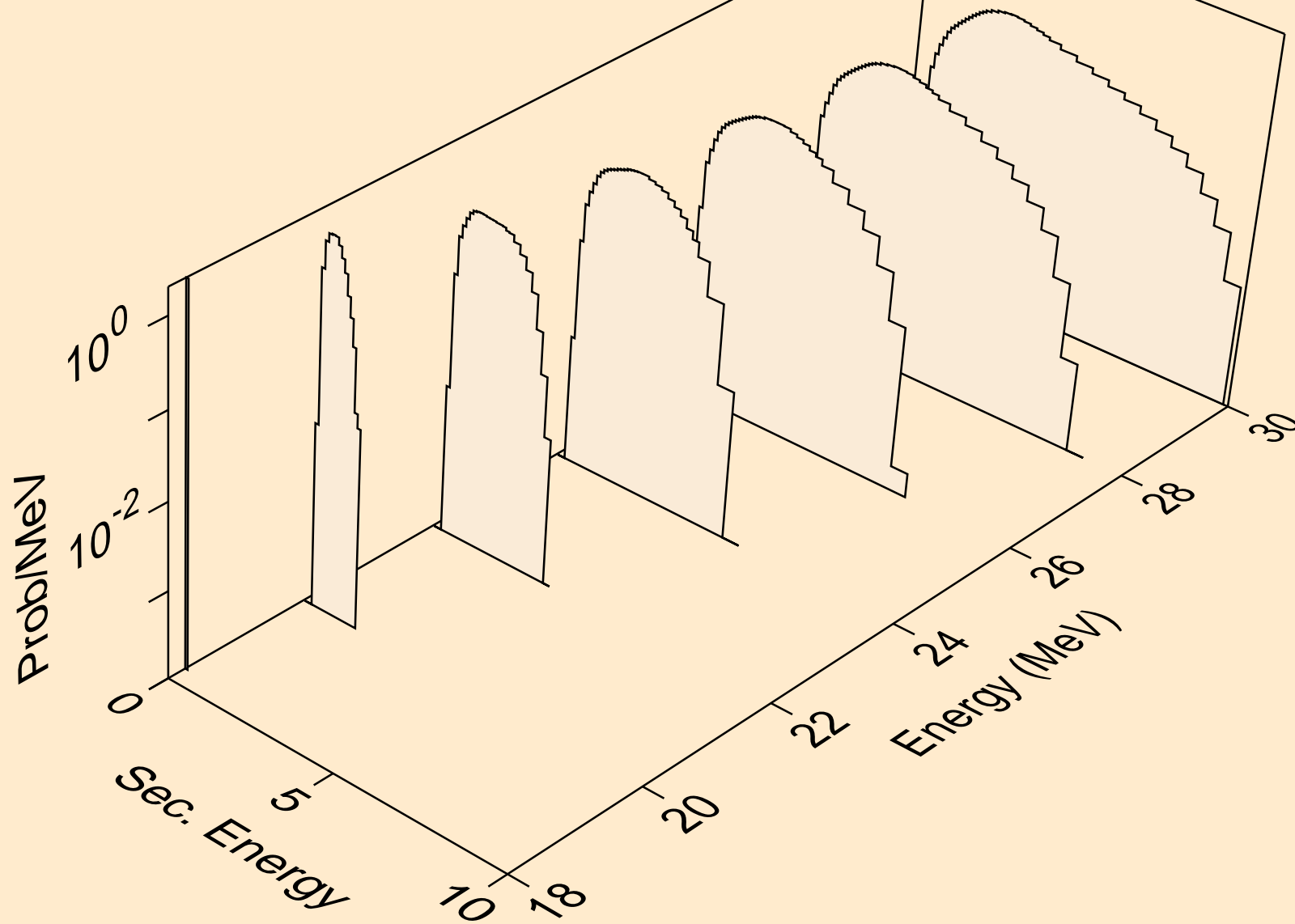

AL028 ALPHA ACER TENDL-2021 LIBRARY; T=0.K
protons from (a,3np)

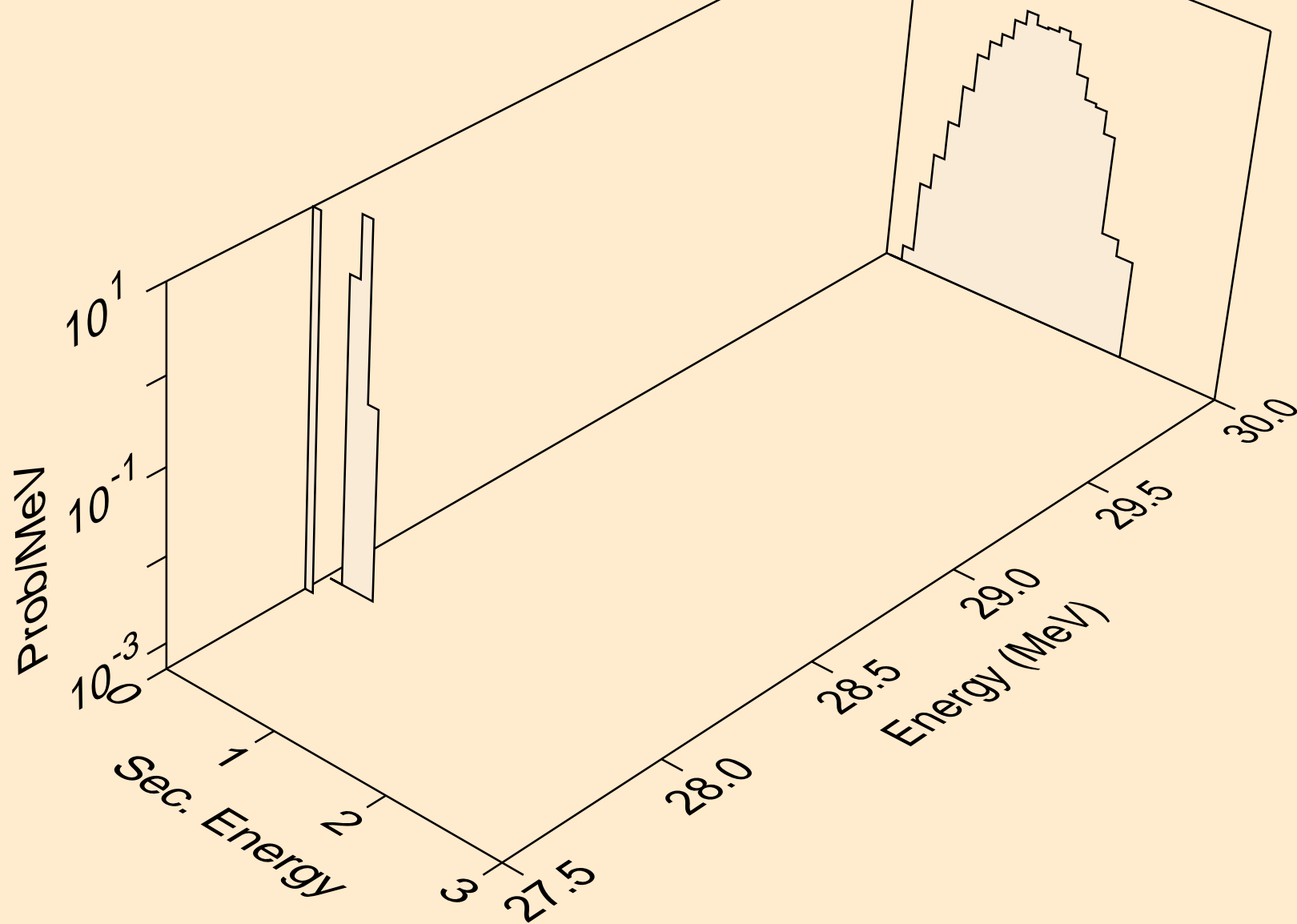

AL028 ALPHA ACER TENDL-2021 LIBRARY; T=0.K
protons from (a,2np)

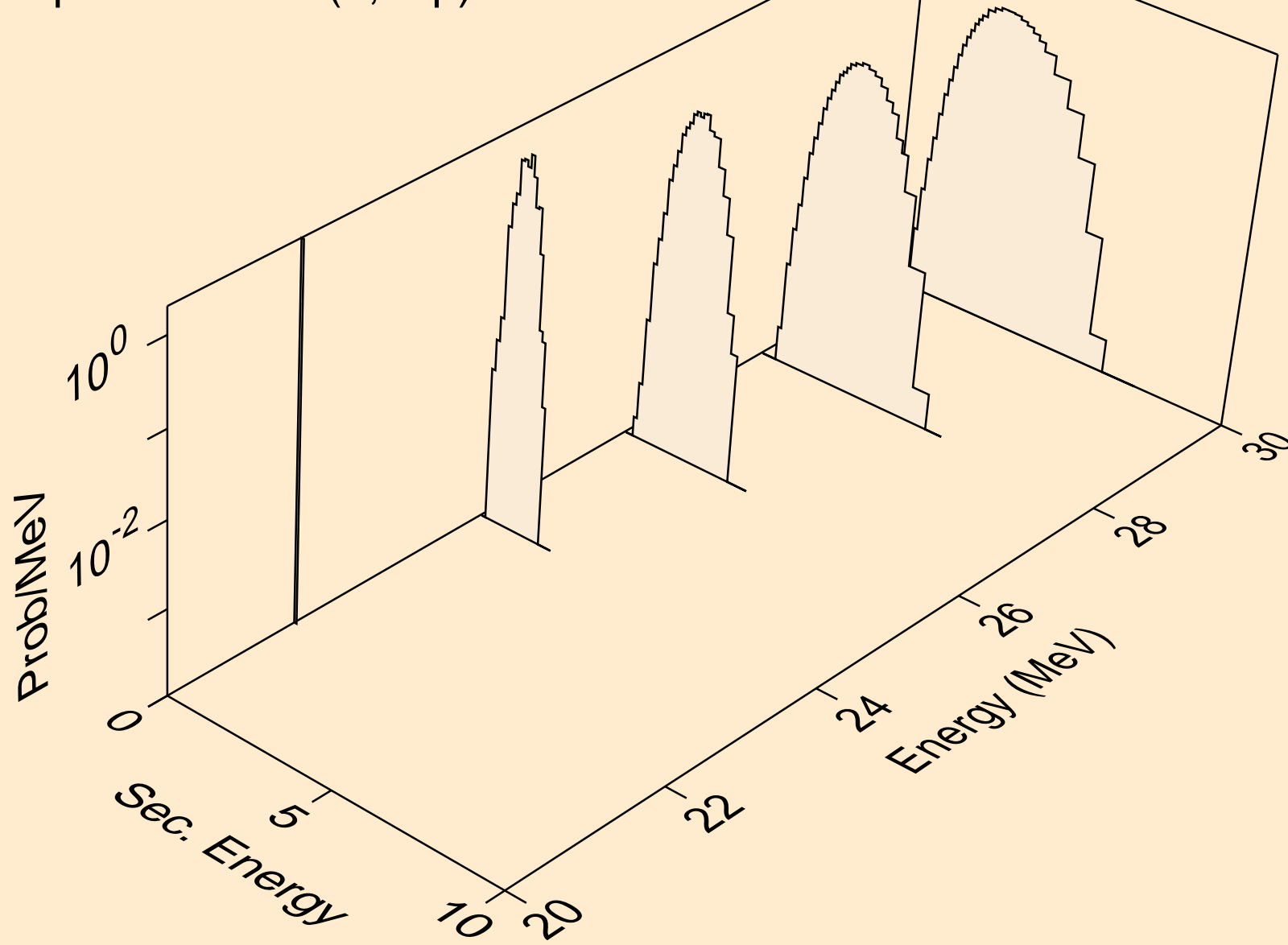

AL028 ALPHA ACER TENDL-2021 LIBRARY; T=0.K
protons from (a,npa)

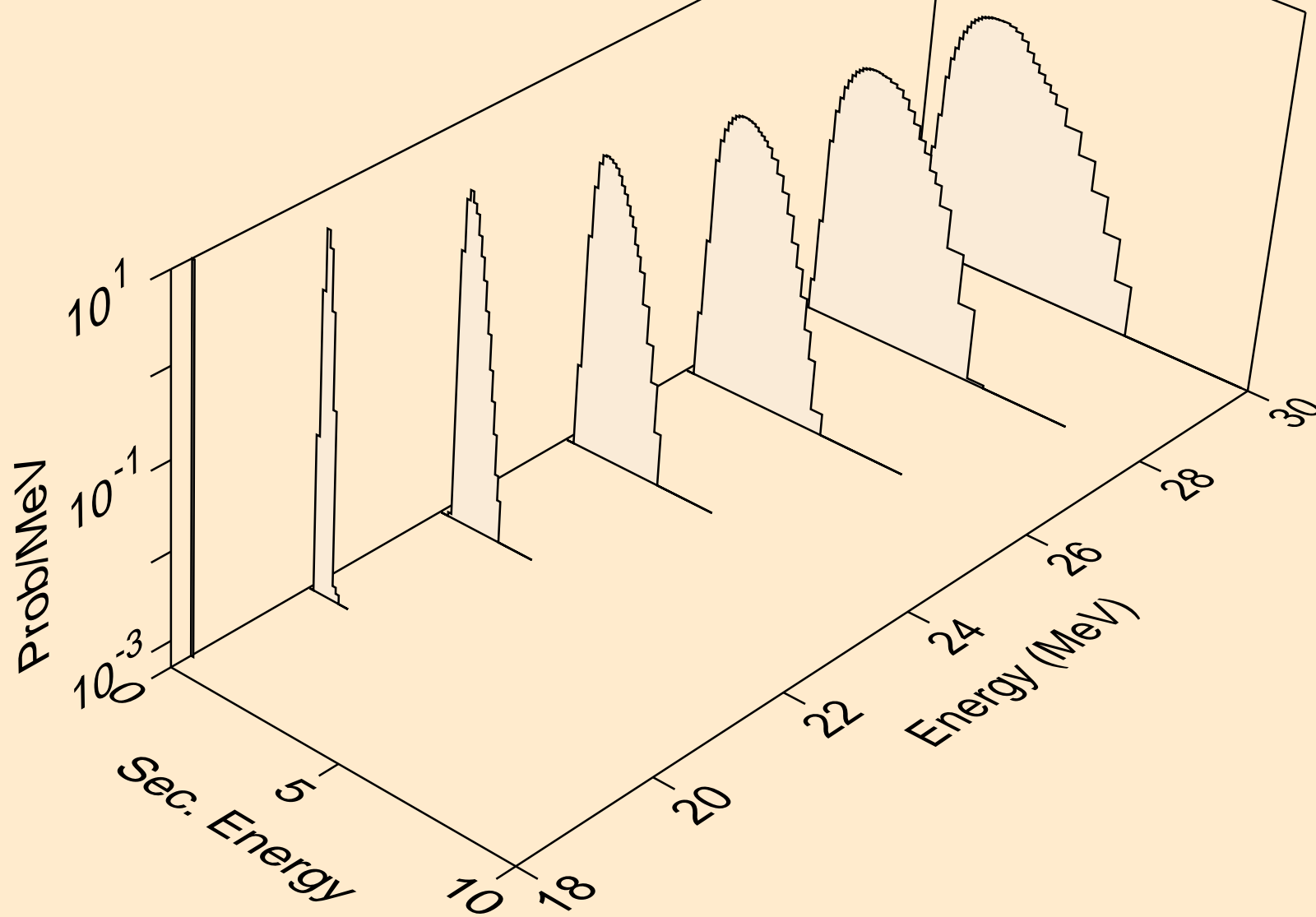

AL028 ALPHA ACER TENDL-2021 LIBRARY; T=0.K
protons from (a,p)

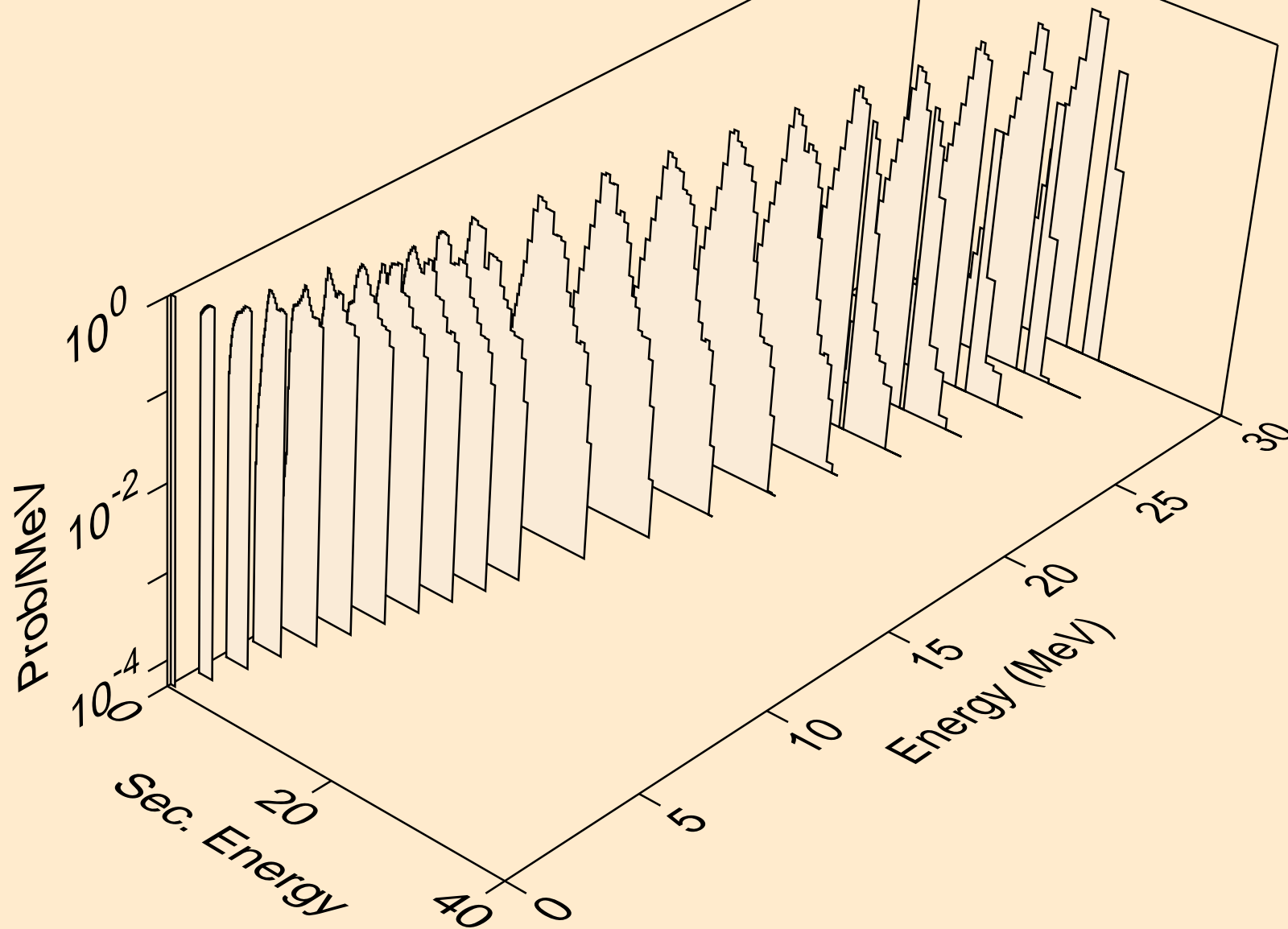

AL028 ALPHA ACER TENDL-2021 LIBRARY; T=0.K
protons from (a,2p)

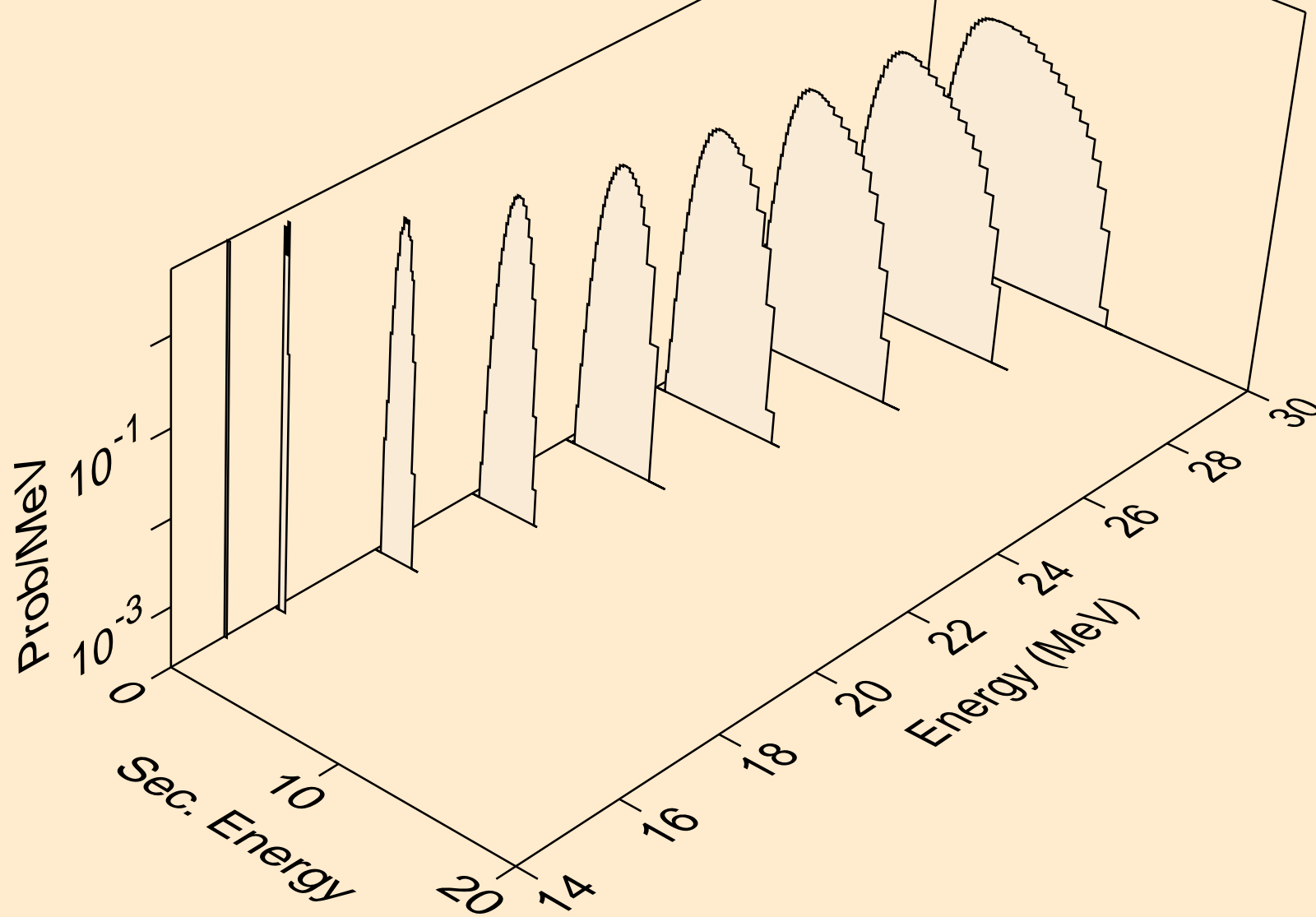

AL028 ALPHA ACER TENDL-2021 LIBRARY; T=0.K
protons from (a,pa)

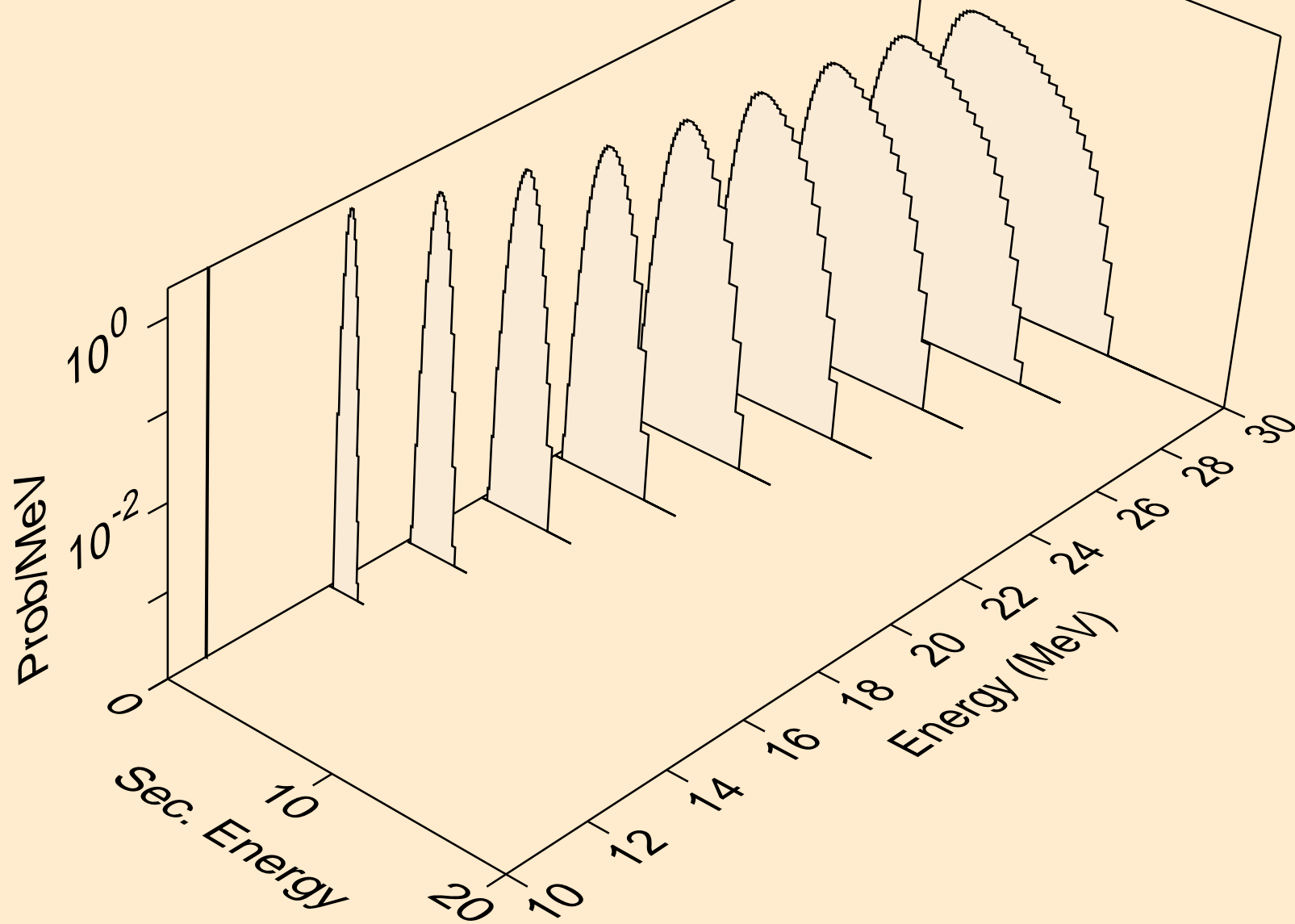

AL028 ALPHA ACER TENDL-2021 LIBRARY; T=0.K
protons from (a,pd)

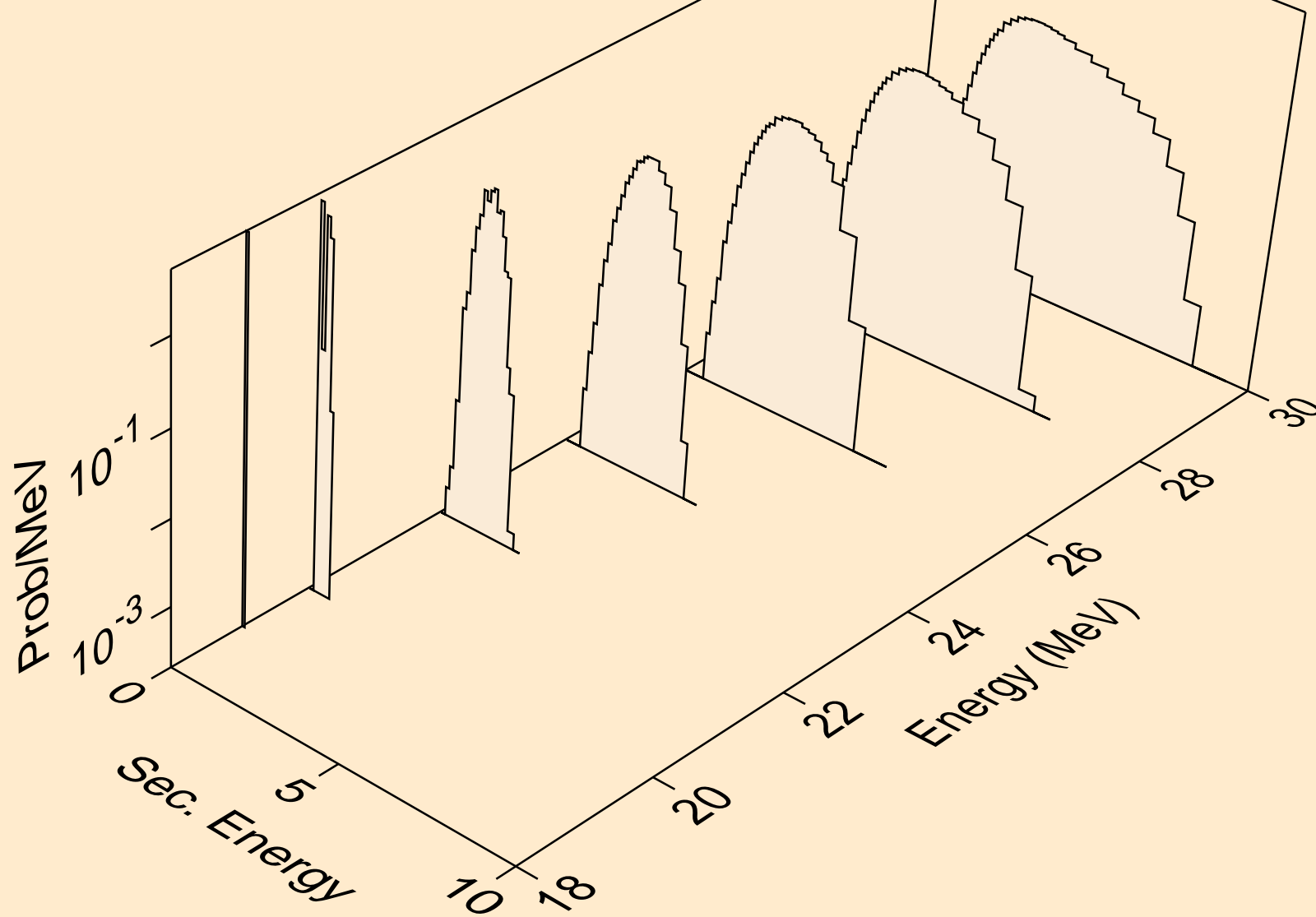

AL028 ALPHA ACER TENDL-2021 LIBRARY; T=0.K
protons from (a,pt)

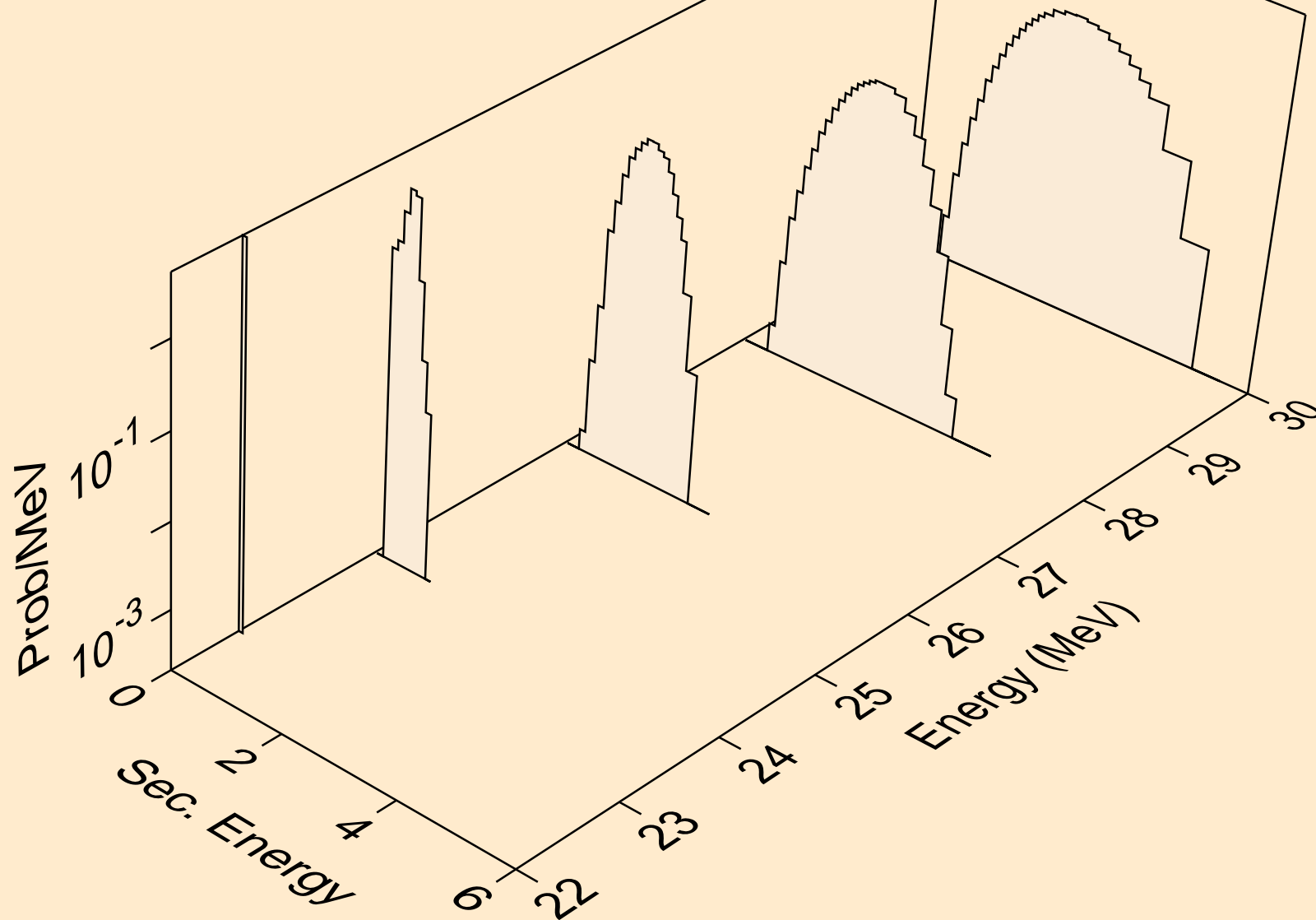

AL028 ALPHA ACER TENDL-2021 LIBRARY; T=0.K
deuterons from (a,x)

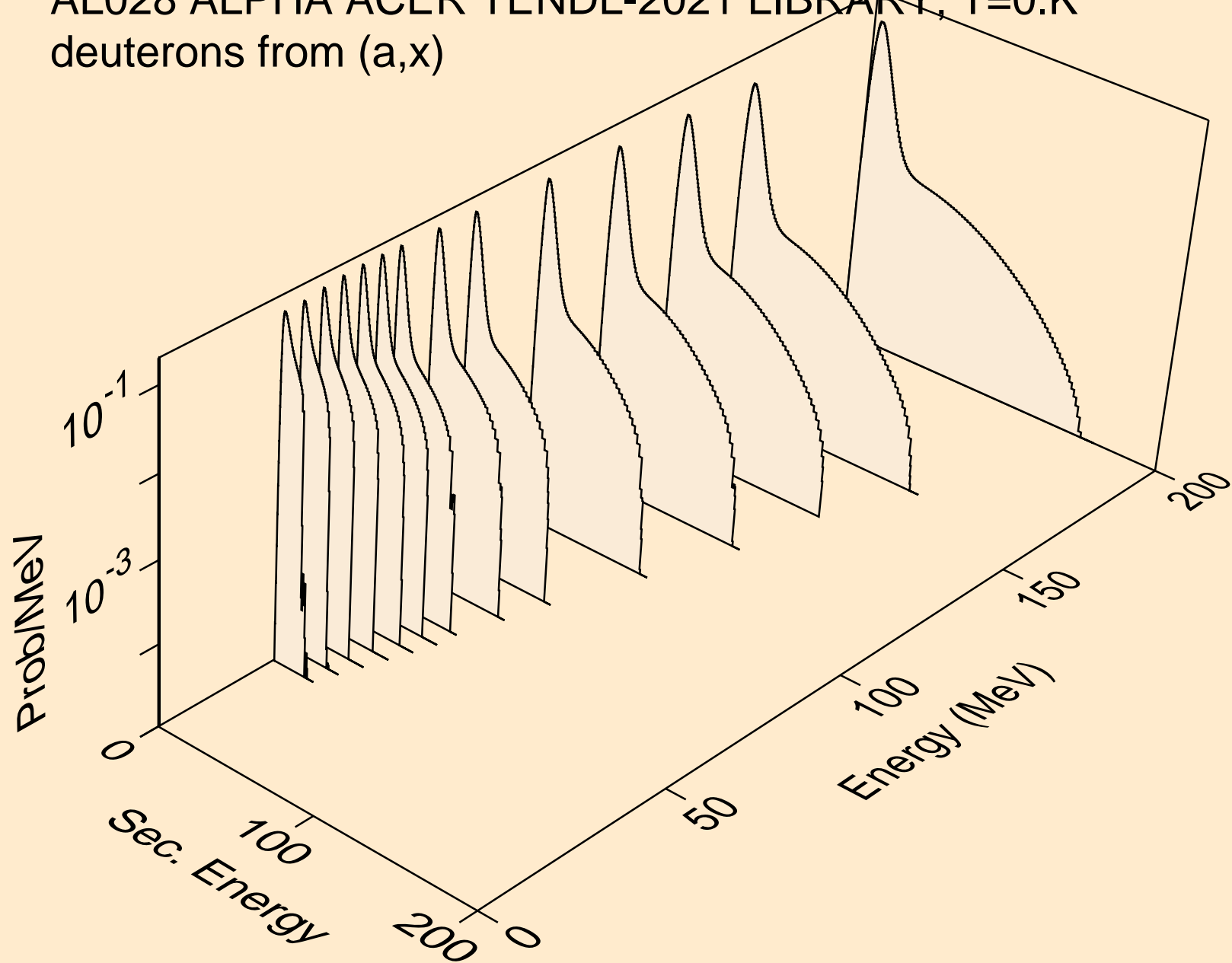

AL028 ALPHA ACER TENDL-2021 LIBRARY; T=0.K
deuterons from (a,2nd)

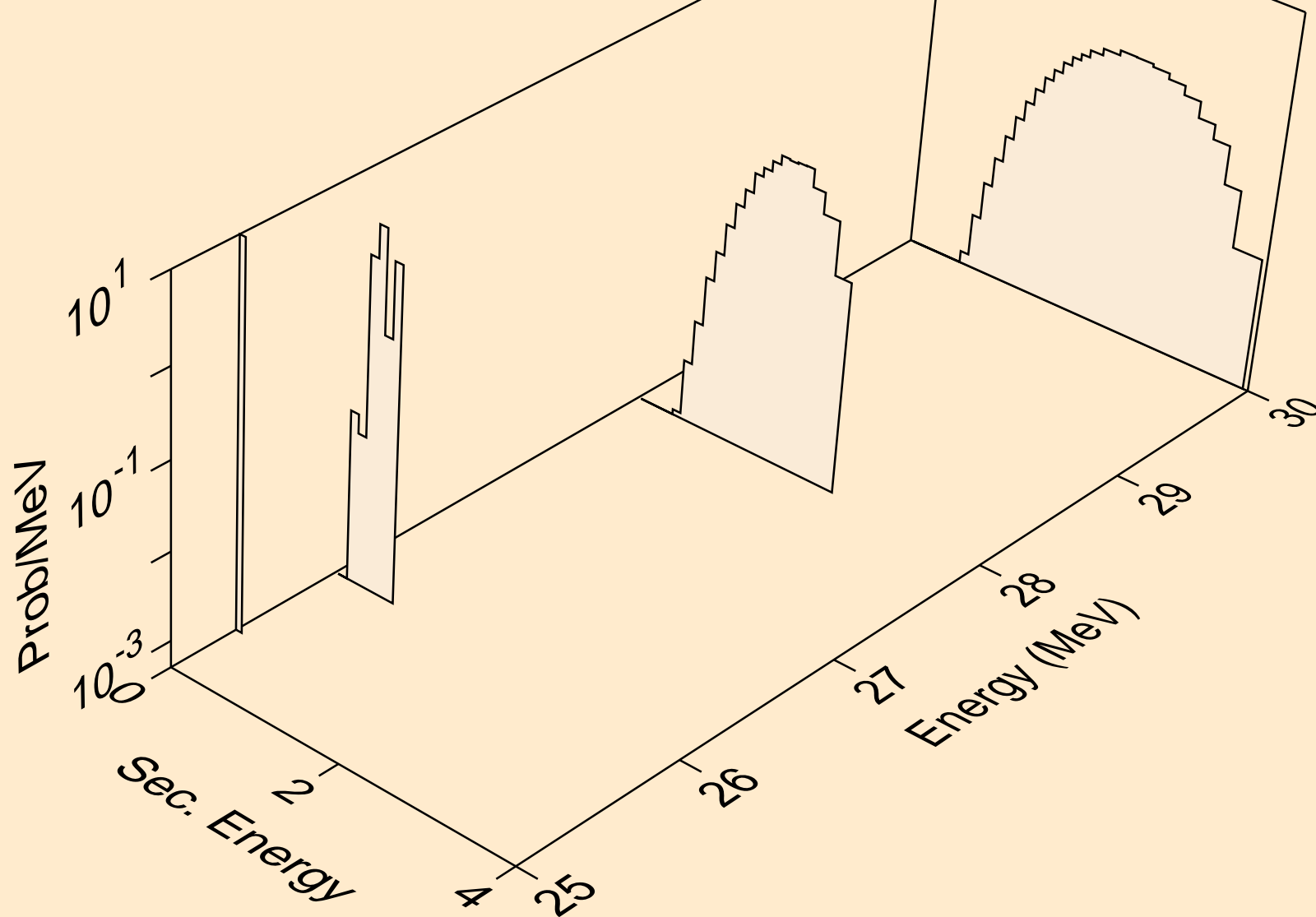

AL028 ALPHA ACER TENDL-2021 LIBRARY; T=0.K
deuterons from (a,n*)d

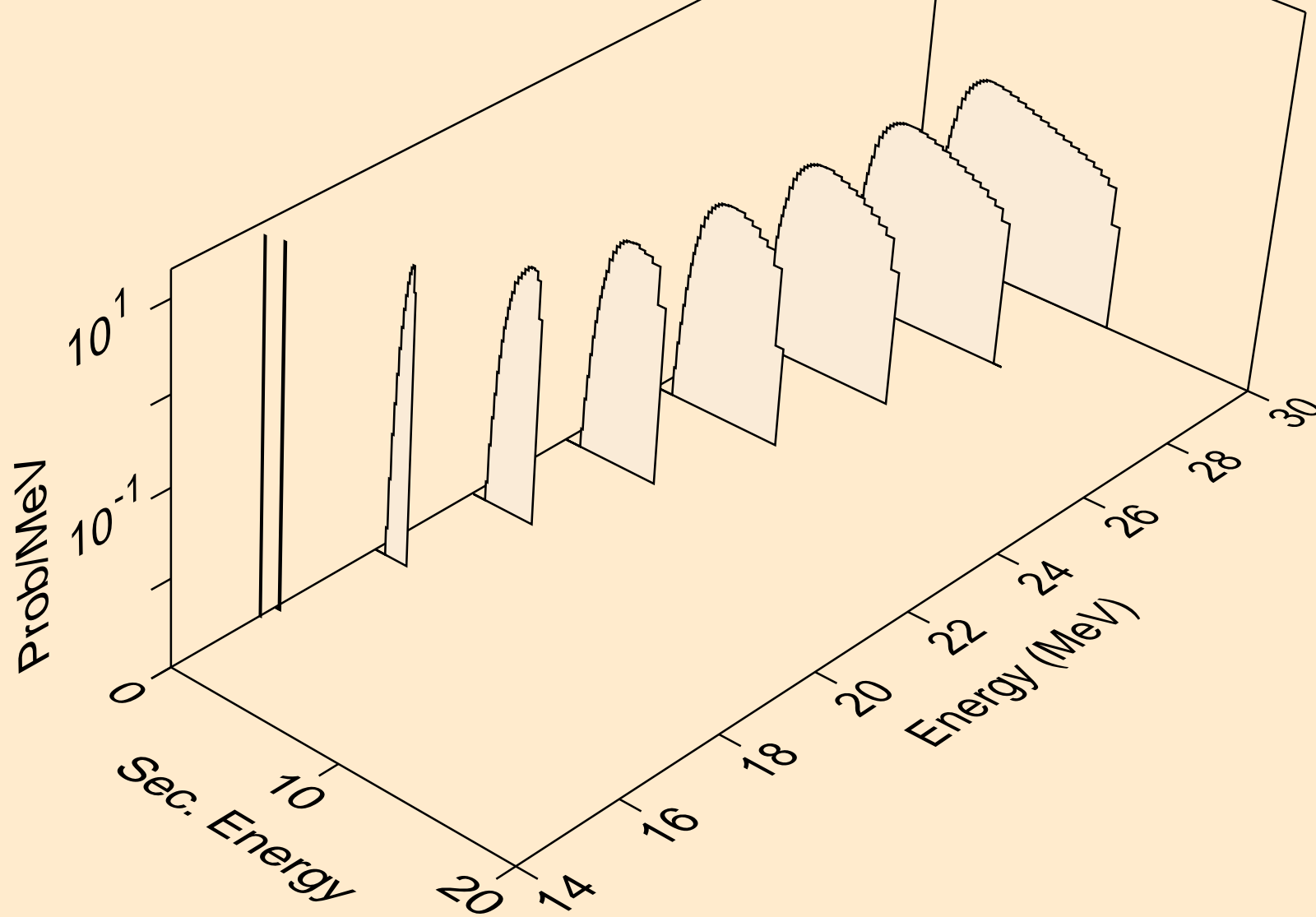

AL028 ALPHA ACER TENDL-2021 LIBRARY; T=0.K
deuterons from (a,d)

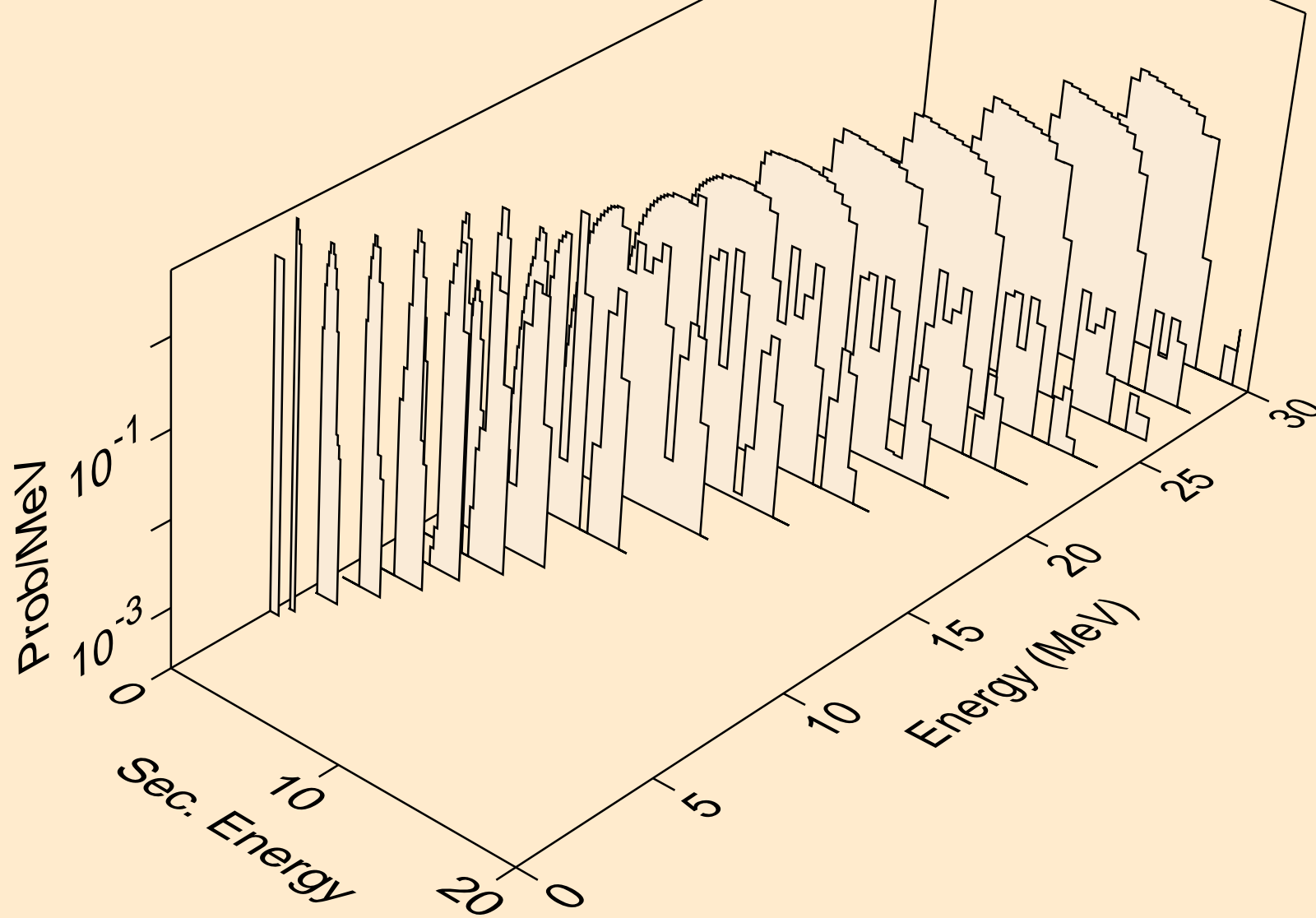

AL028 ALPHA ACER TENDL-2021 LIBRARY; T=0.K
deuterons from (a,pd)

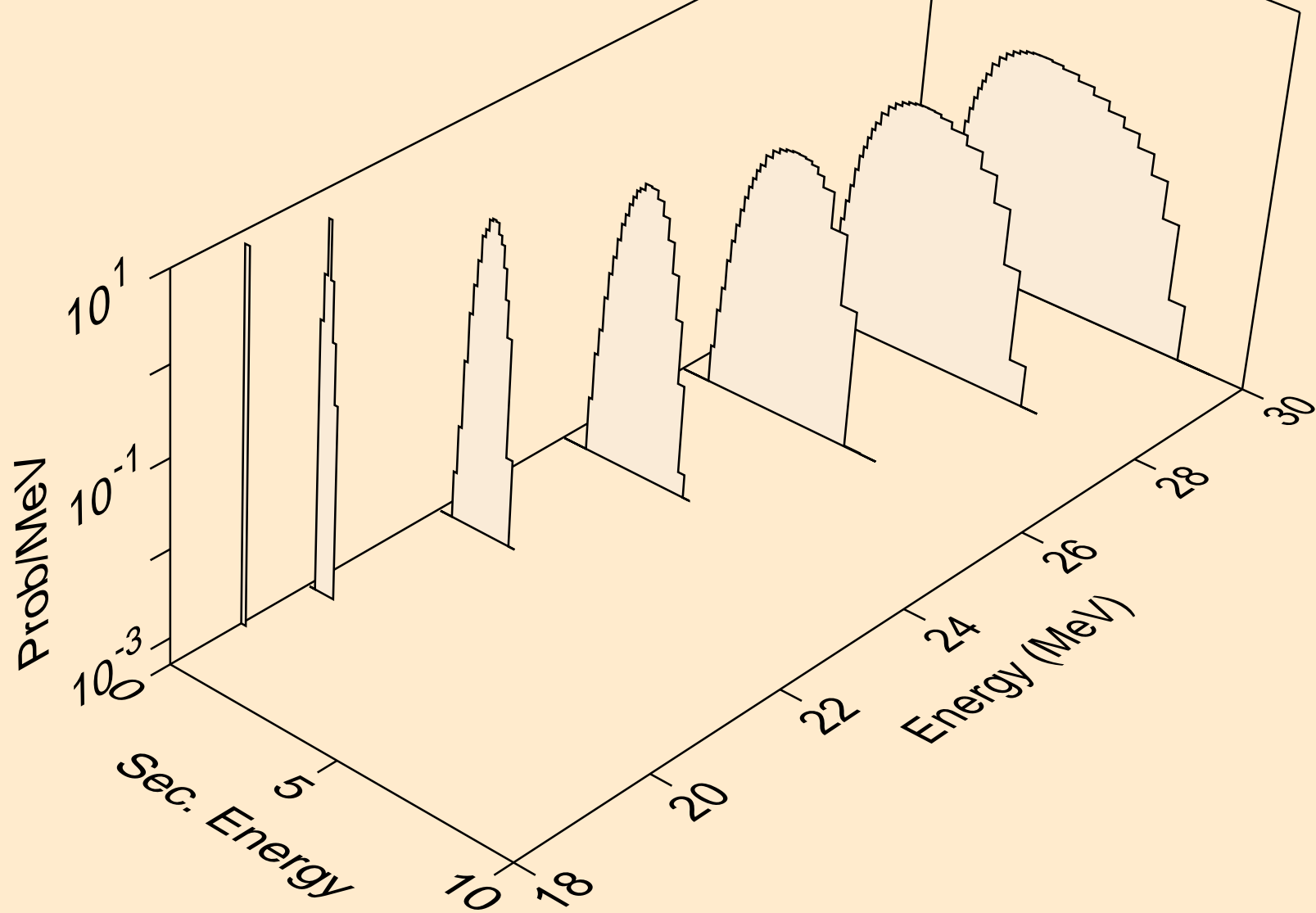

AL028 ALPHA ACER TENDL-2021 LIBRARY; T=0.K
deuterons from (a,da)

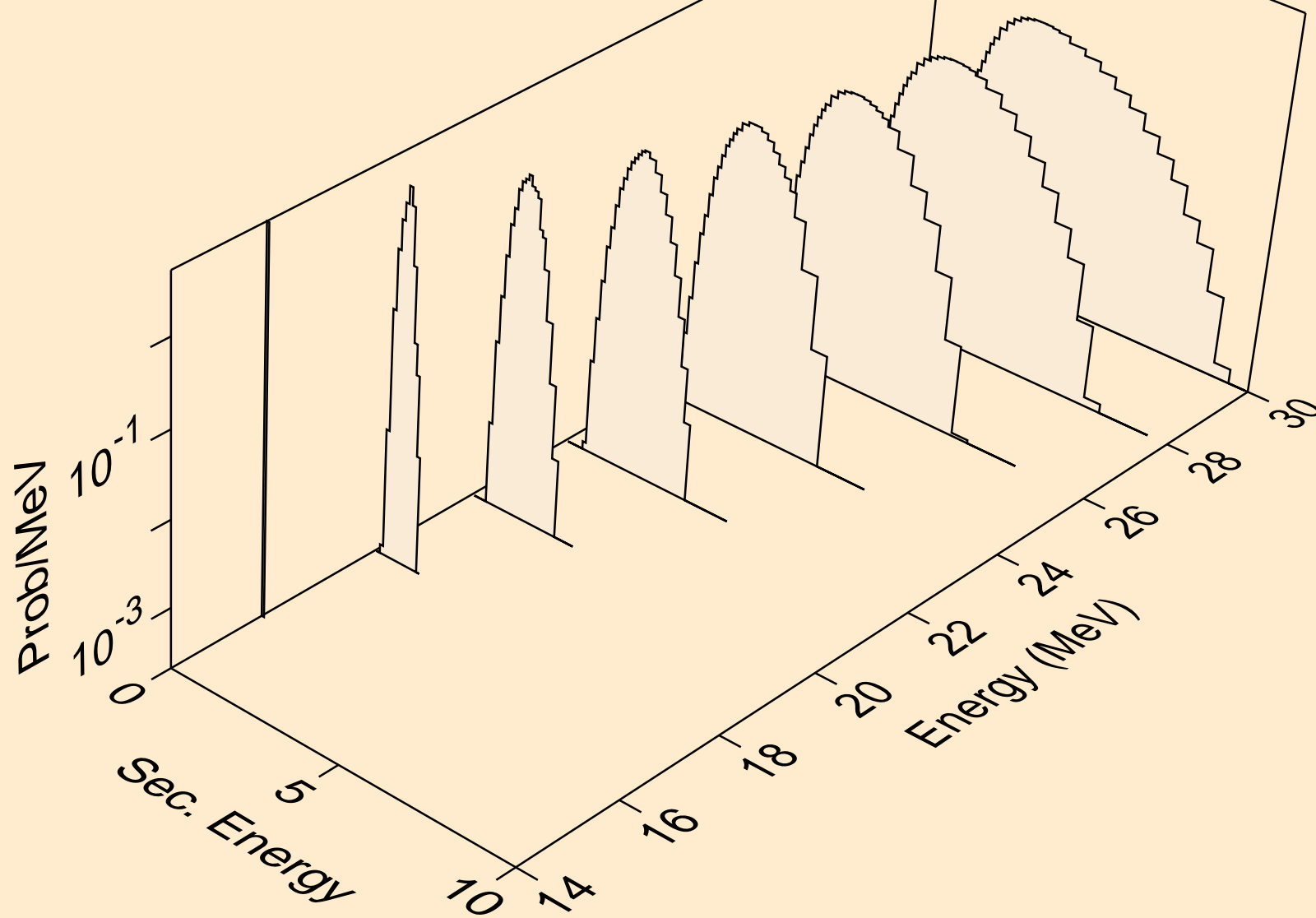

AL028 ALPHA ACER TENDL-2021 LIBRARY; T=0.K
tritons from (a,x)

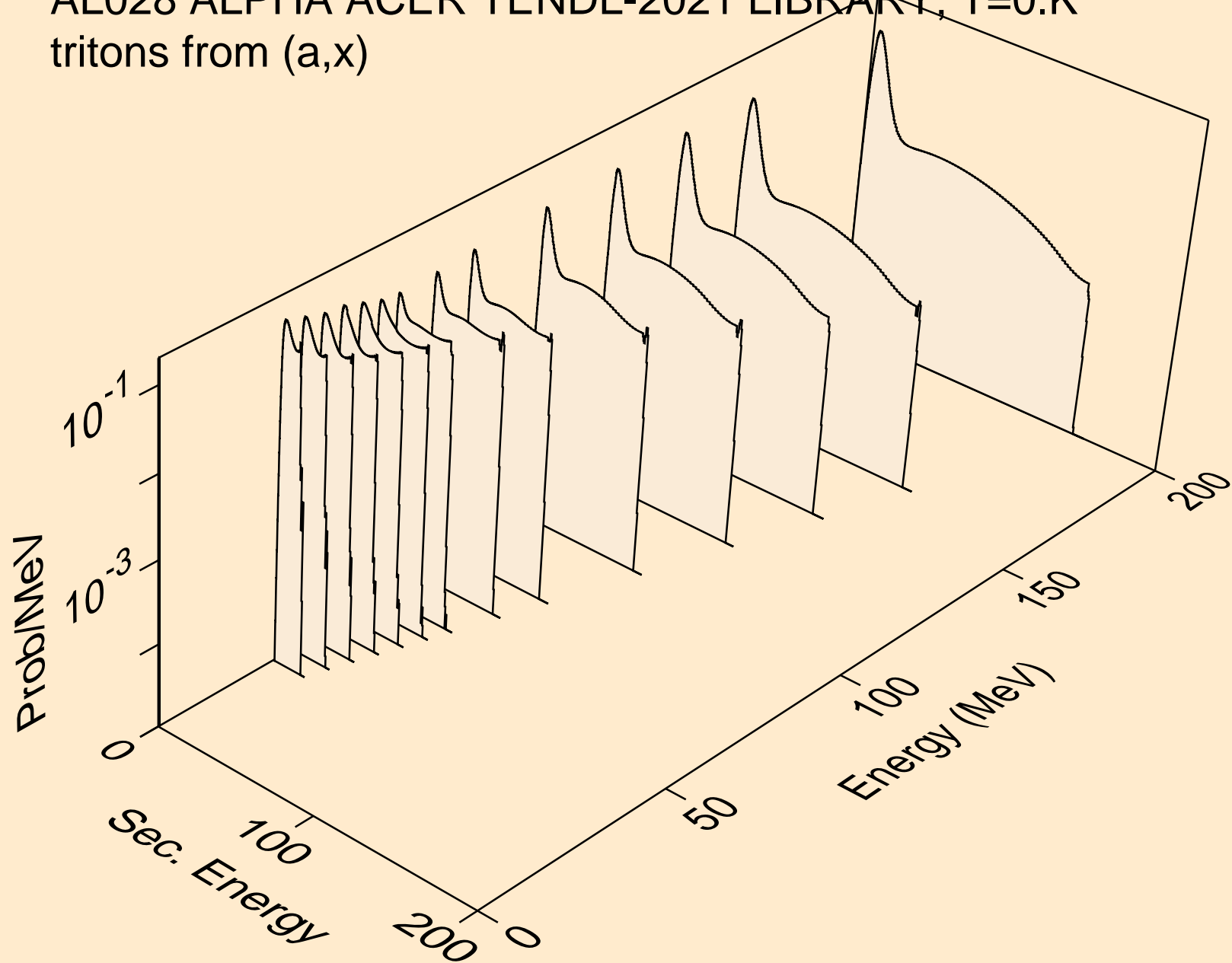

AL028 ALPHA ACER TENDL-2021 LIBRARY; T=0.K
tritons from (a,n*)t

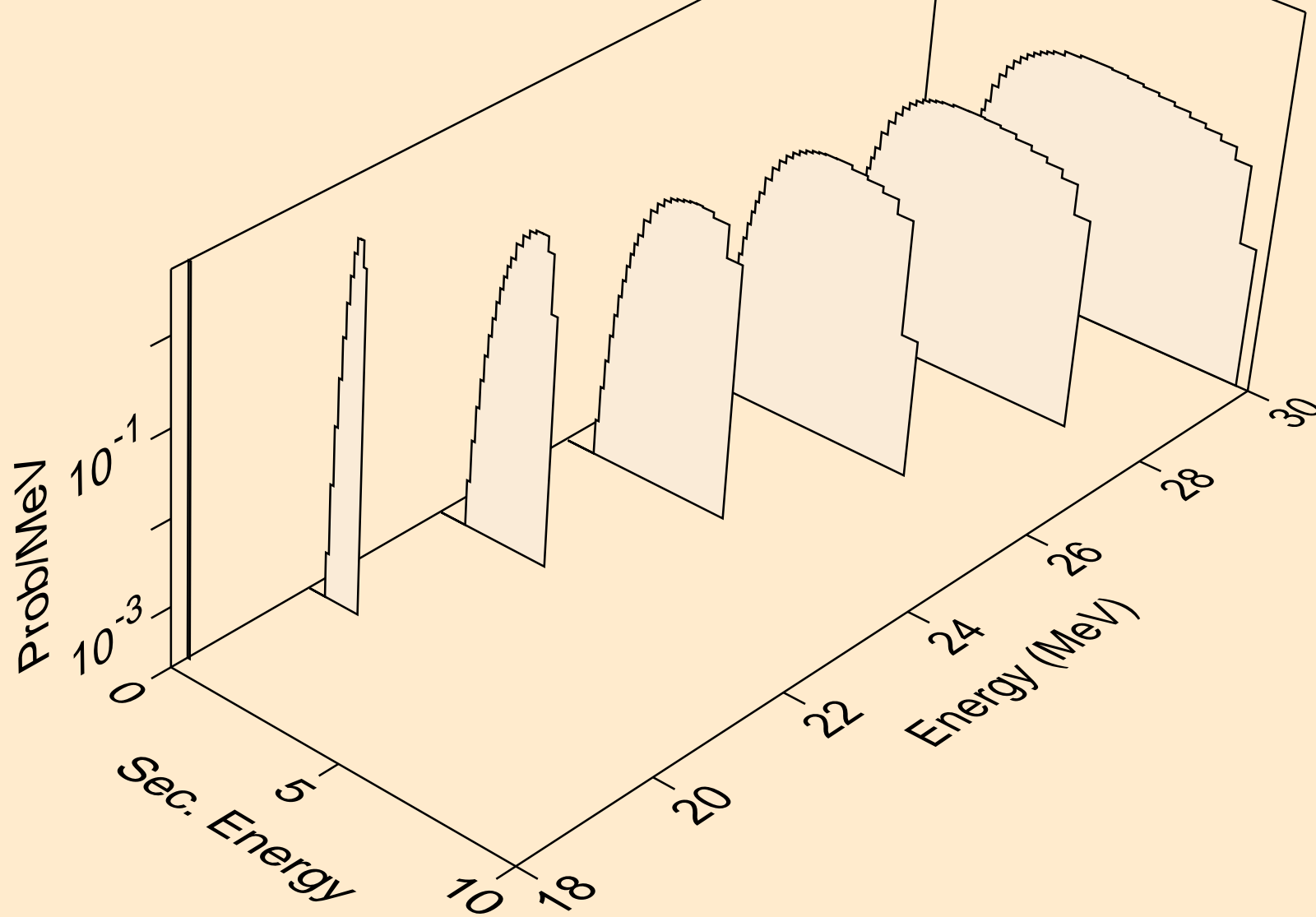

AL028 ALPHA ACER TENDL-2021 LIBRARY; T=0.K
tritons from (a,t)

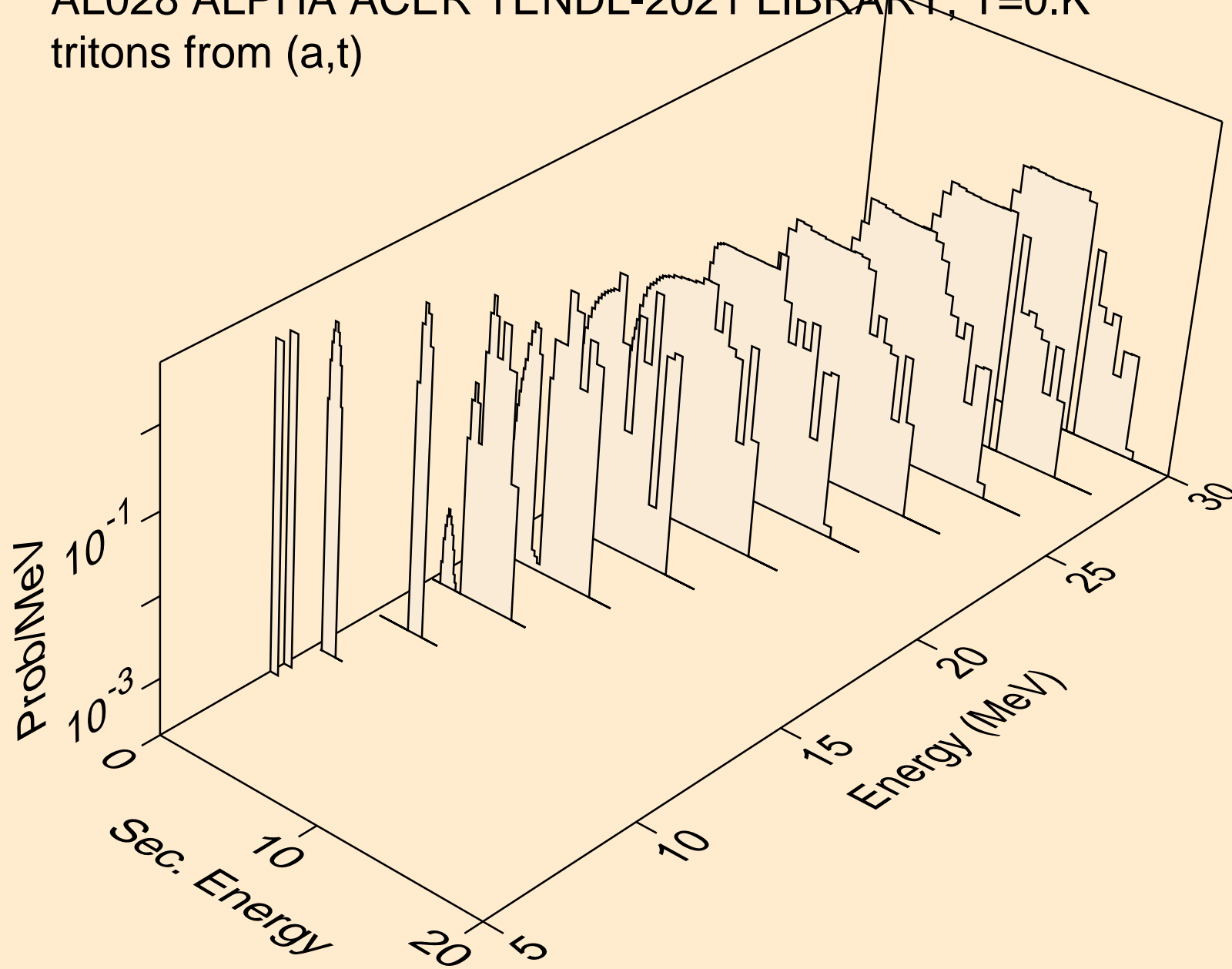

AL028 ALPHA ACER TENDL-2021 LIBRARY; T=0.K
tritons from (a,pt)

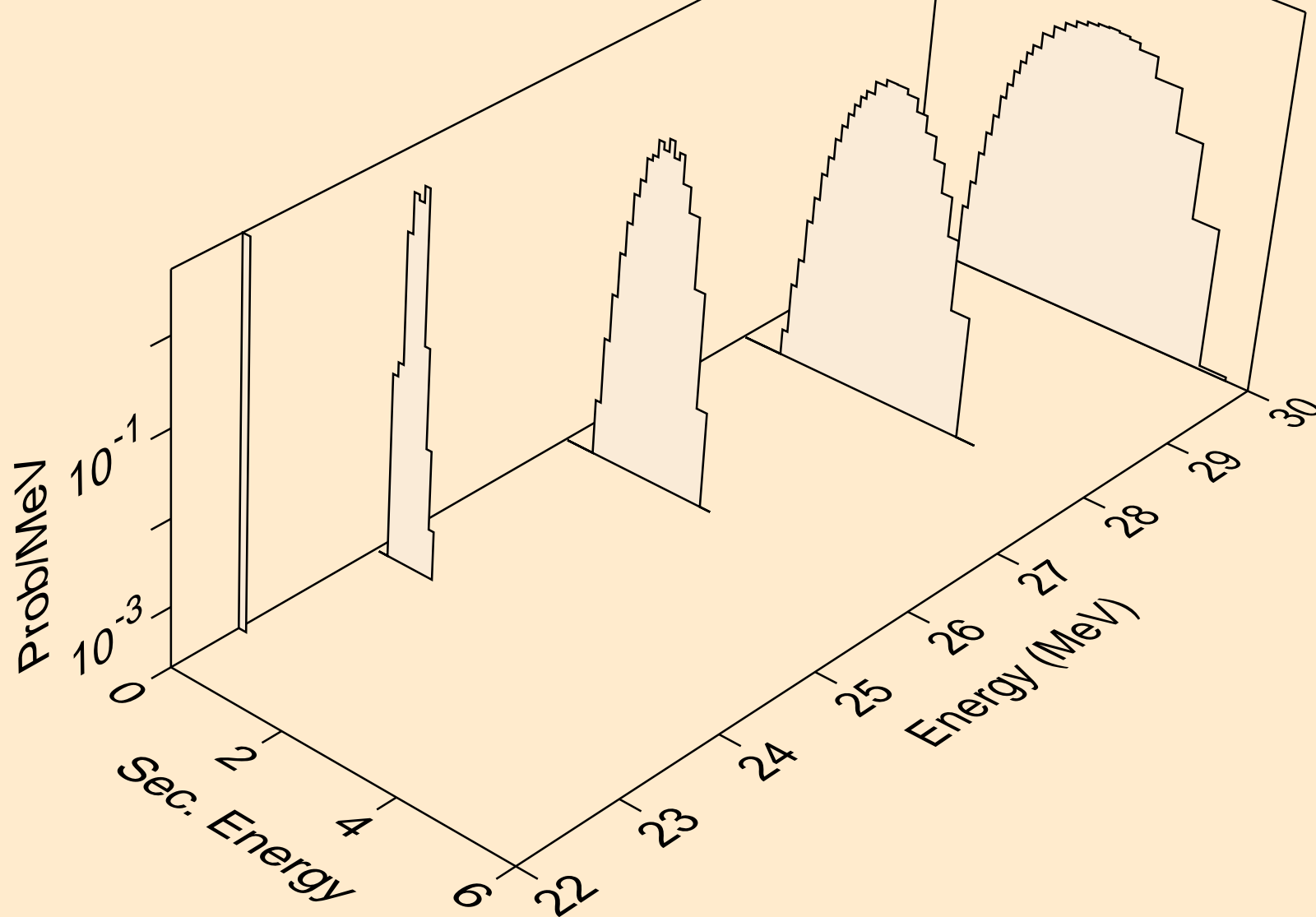

AL028 ALPHA ACER TENDL-2021 LIBRARY; T=0.K
he3s from (a,x)

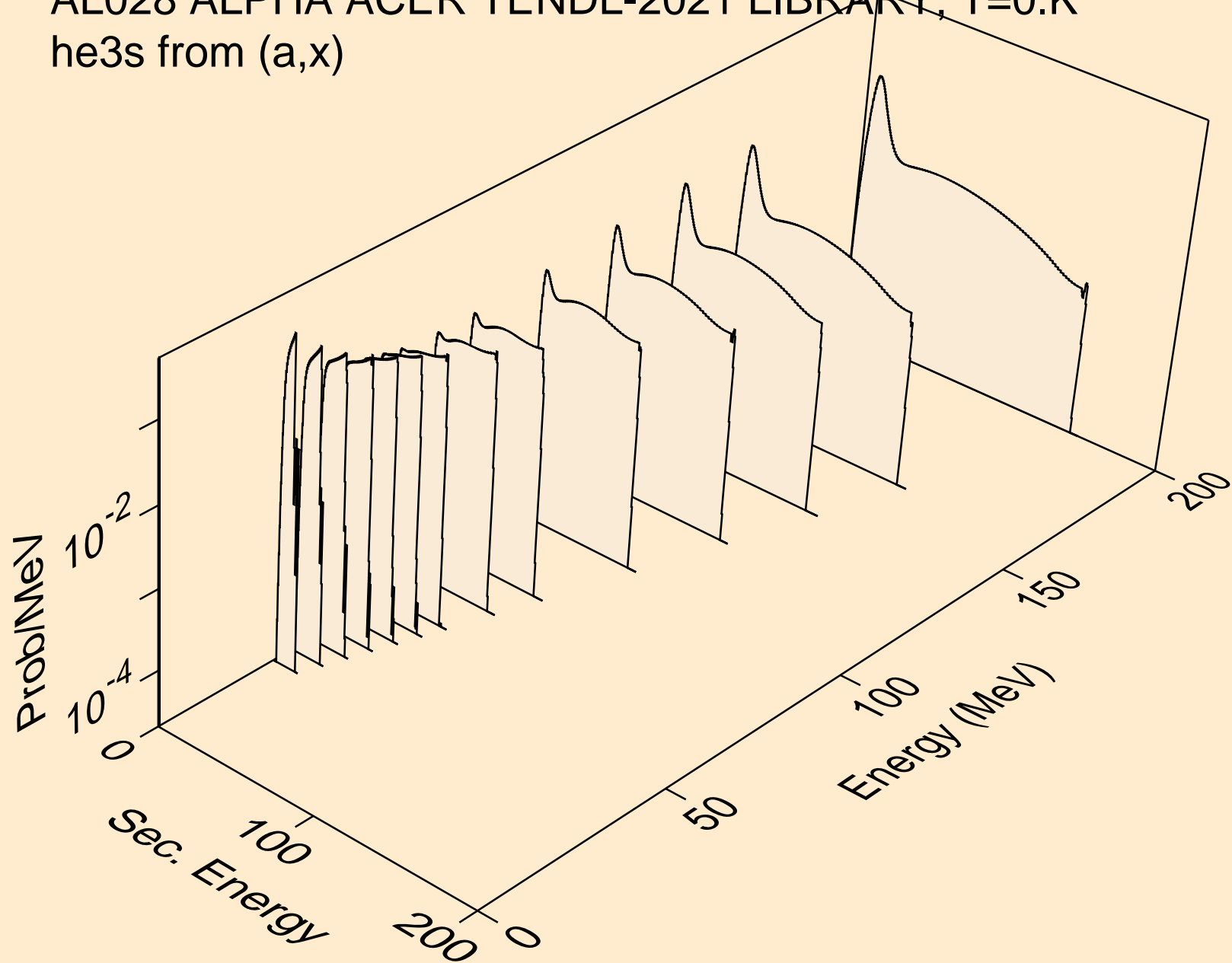

AL028 ALPHA ACER TENDL-2021 LIBRARY; T=0.K
he3s from (a,n*)he3

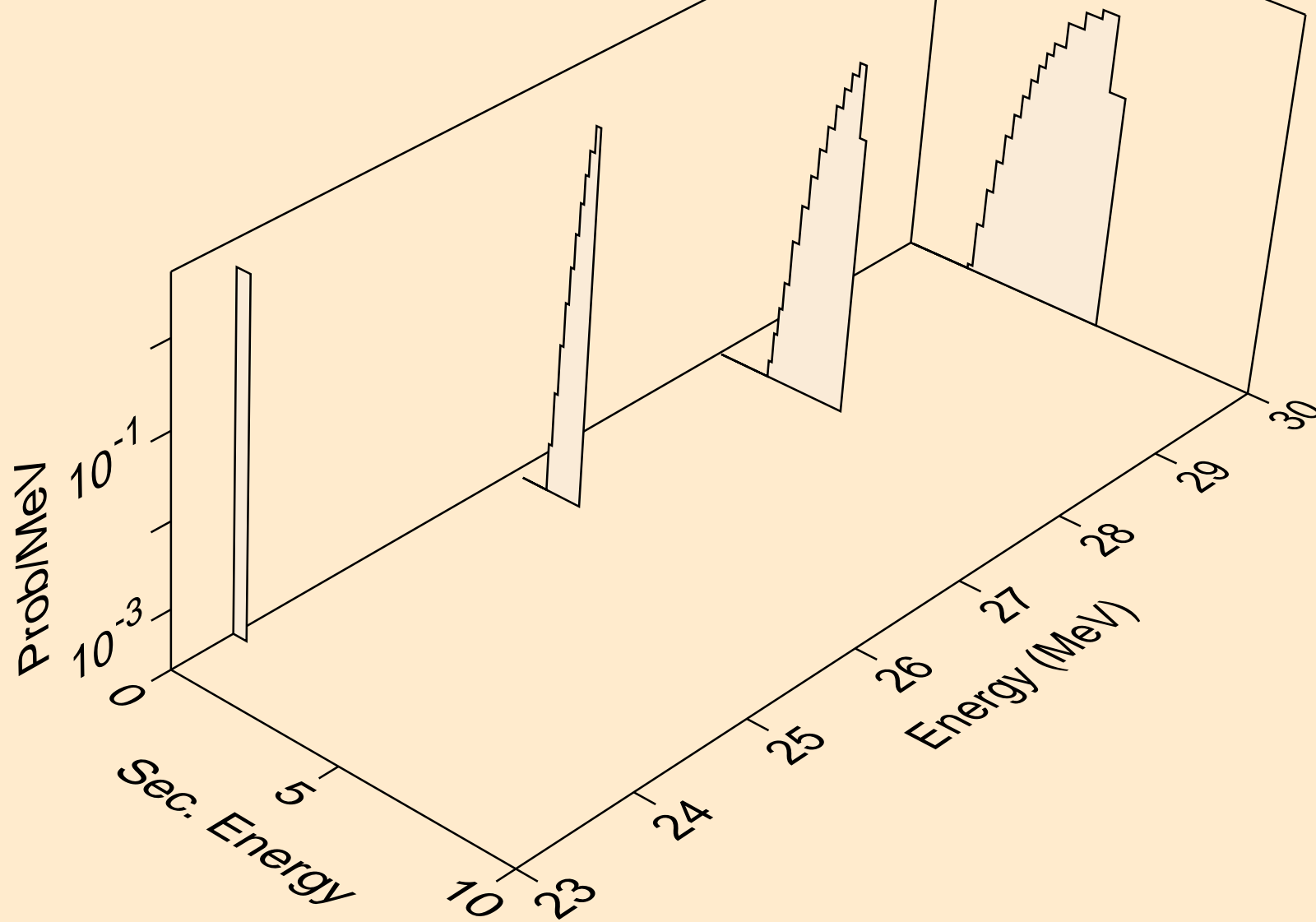

AL028 ALPHA ACER TENDL-2021 LIBRARY; T=0.K
he3s from (a,he3)

