

BR079 ALPHA ACER TENDL-2021 LIBRARY; T=0.K  
Principal cross sections

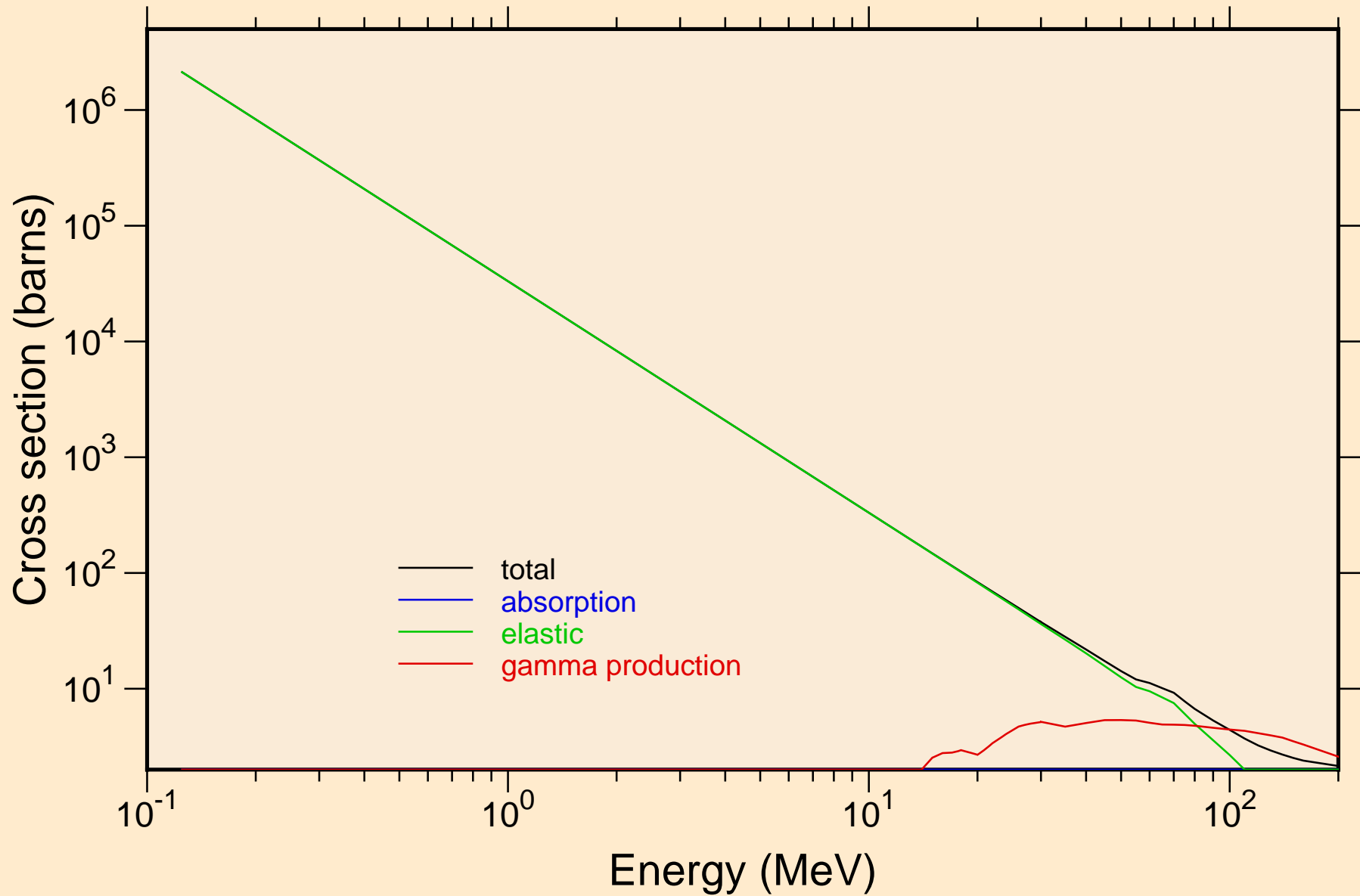

BR079 ALPHA ACER TENDL-2021 LIBRARY; T=0.K

Heating

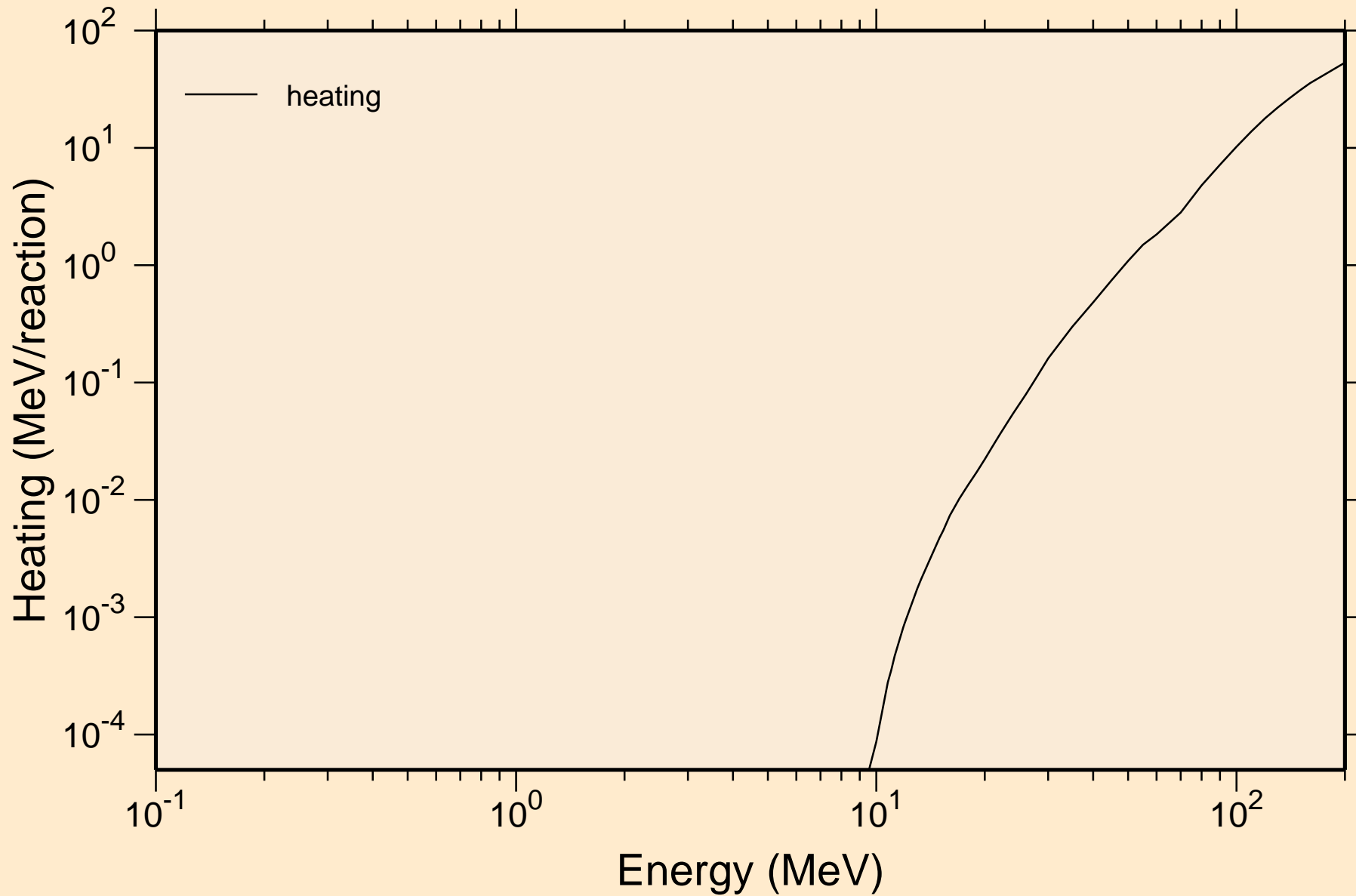

BR079 ALPHA ACER TENDL-2021 LIBRARY; T=0.K

Principal cross sections

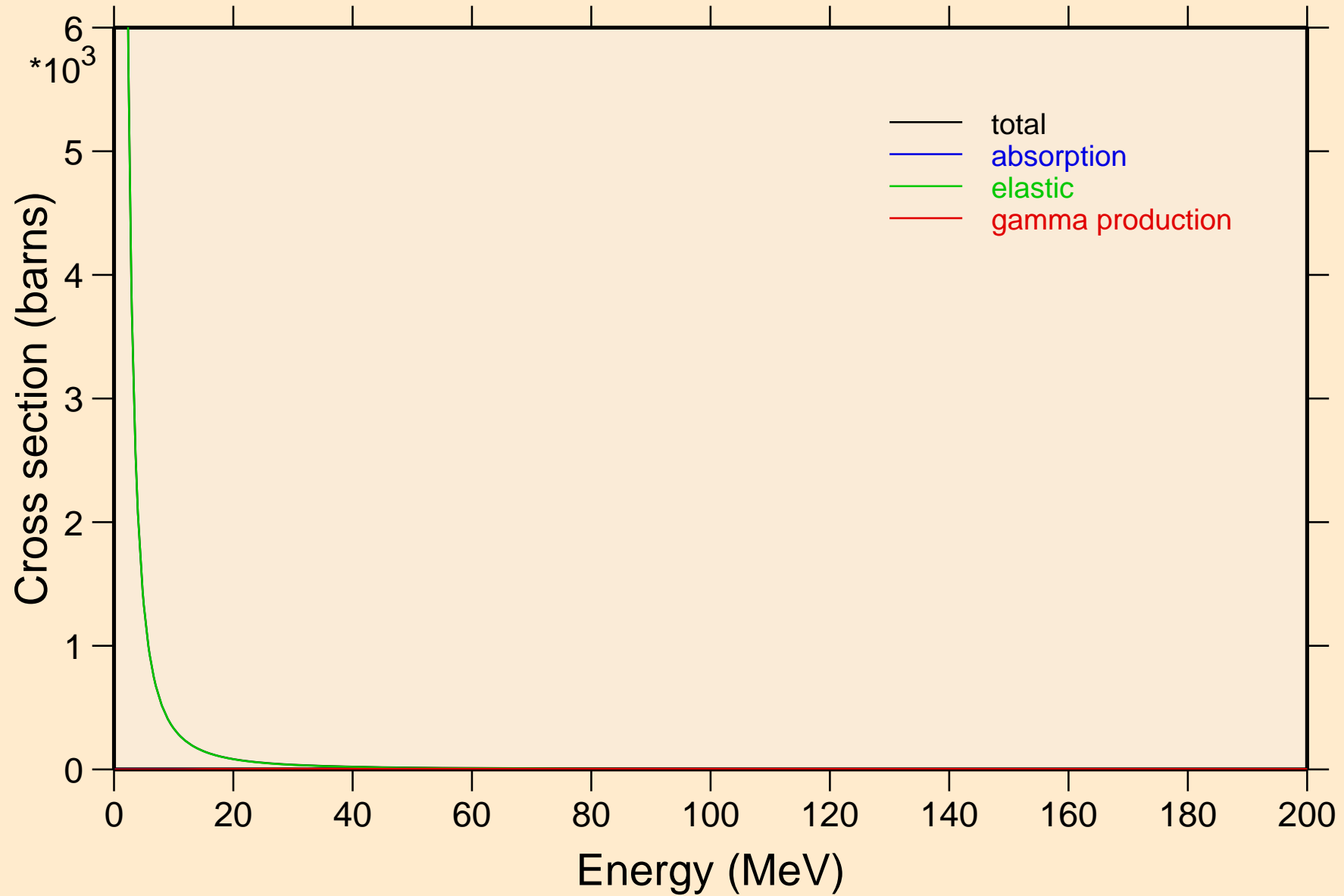

BR079 ALPHA ACER TENDL-2021 LIBRARY; T=0.K

Heating

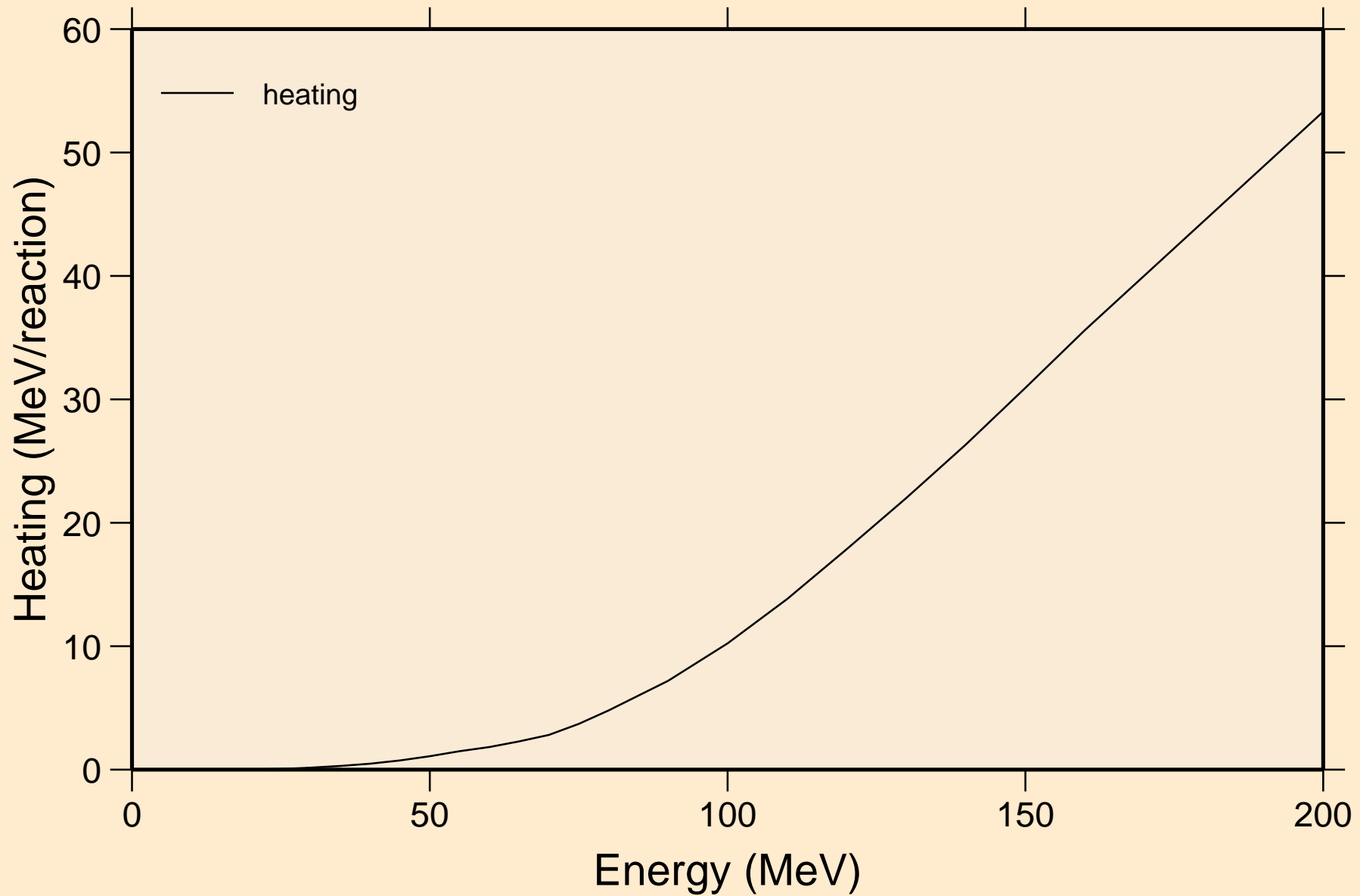

BR079 ALPHA ACER TENDL-2021 LIBRARY; T=0.K  
Threshold reactions

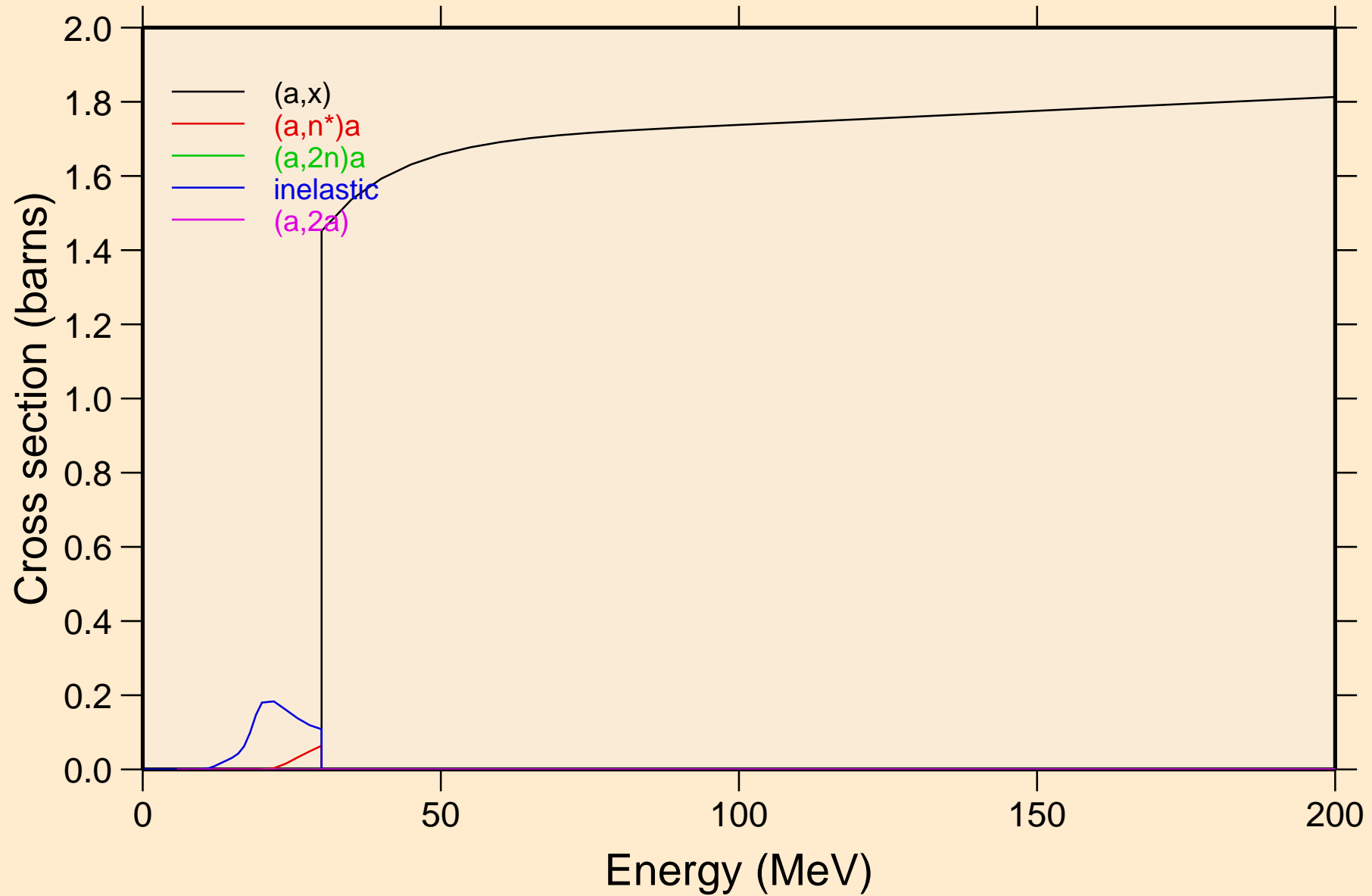

BR079 ALPHA ACER TENDL-2021 LIBRARY; T=0.K  
Threshold reactions

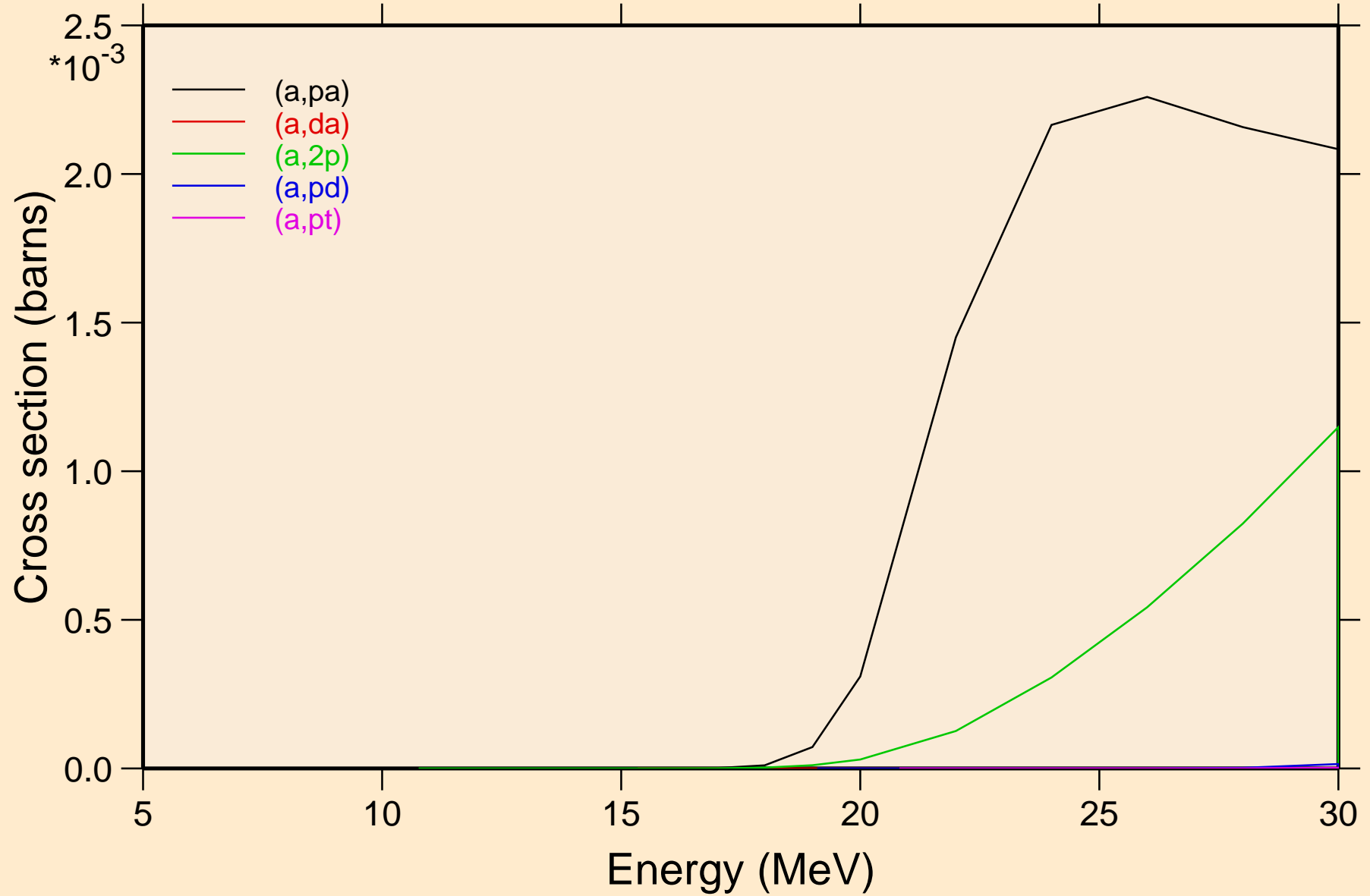

BR079 ALPHA ACER TENDL-2021 LIBRARY; T=0.K  
Threshold reactions

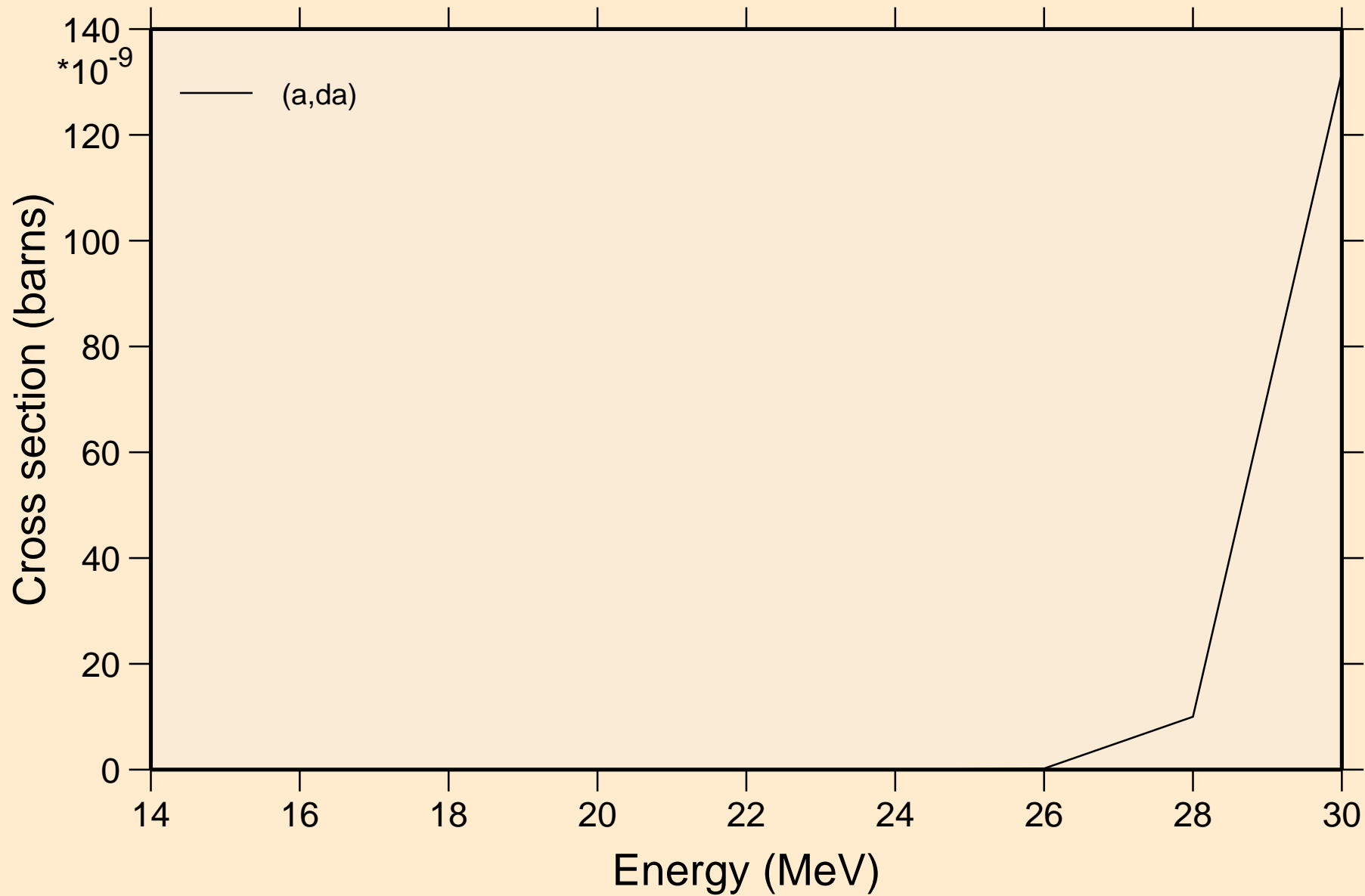

BR079 ALPHA ACER TENDL-2021 LIBRARY; T=0.K  
angular distribution for elastic

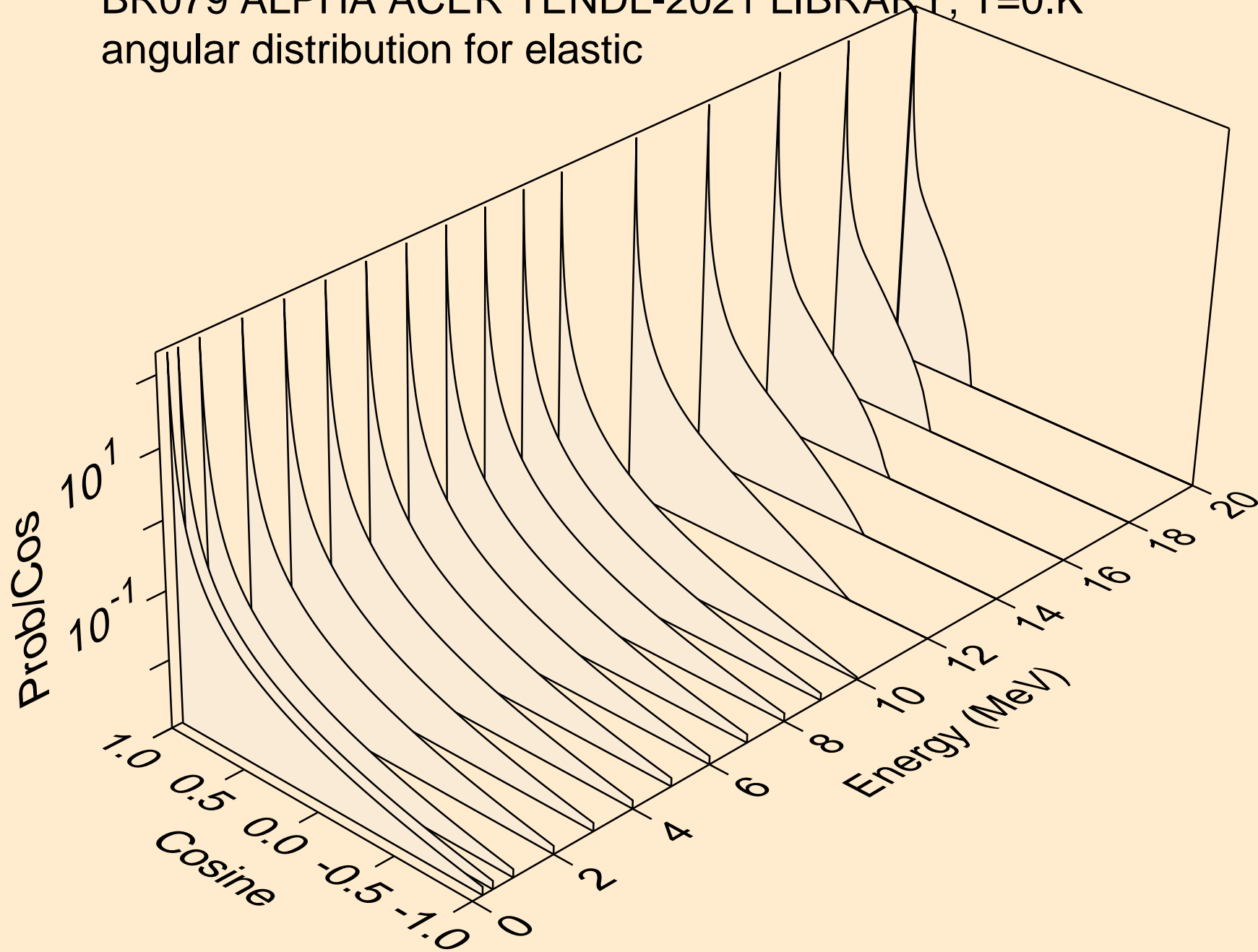



BR079 ALPHA ACER TENDL-2021 LIBRARY; T=0.K  
angular distribution for elastic

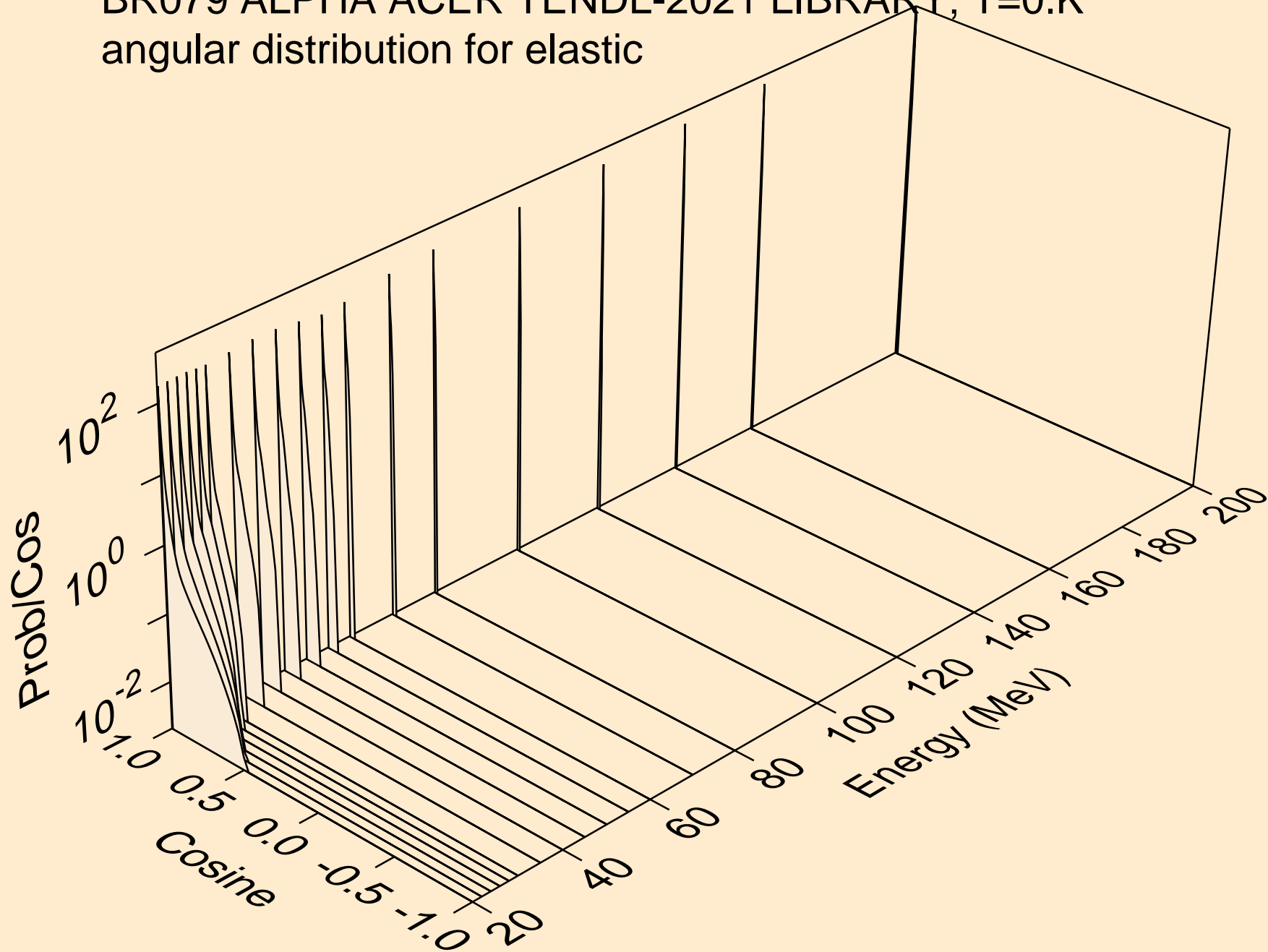

BR079 ALPHA ACER TENDL-2021 LIBRARY; T=0.K  
Alpha emission for (a,x)

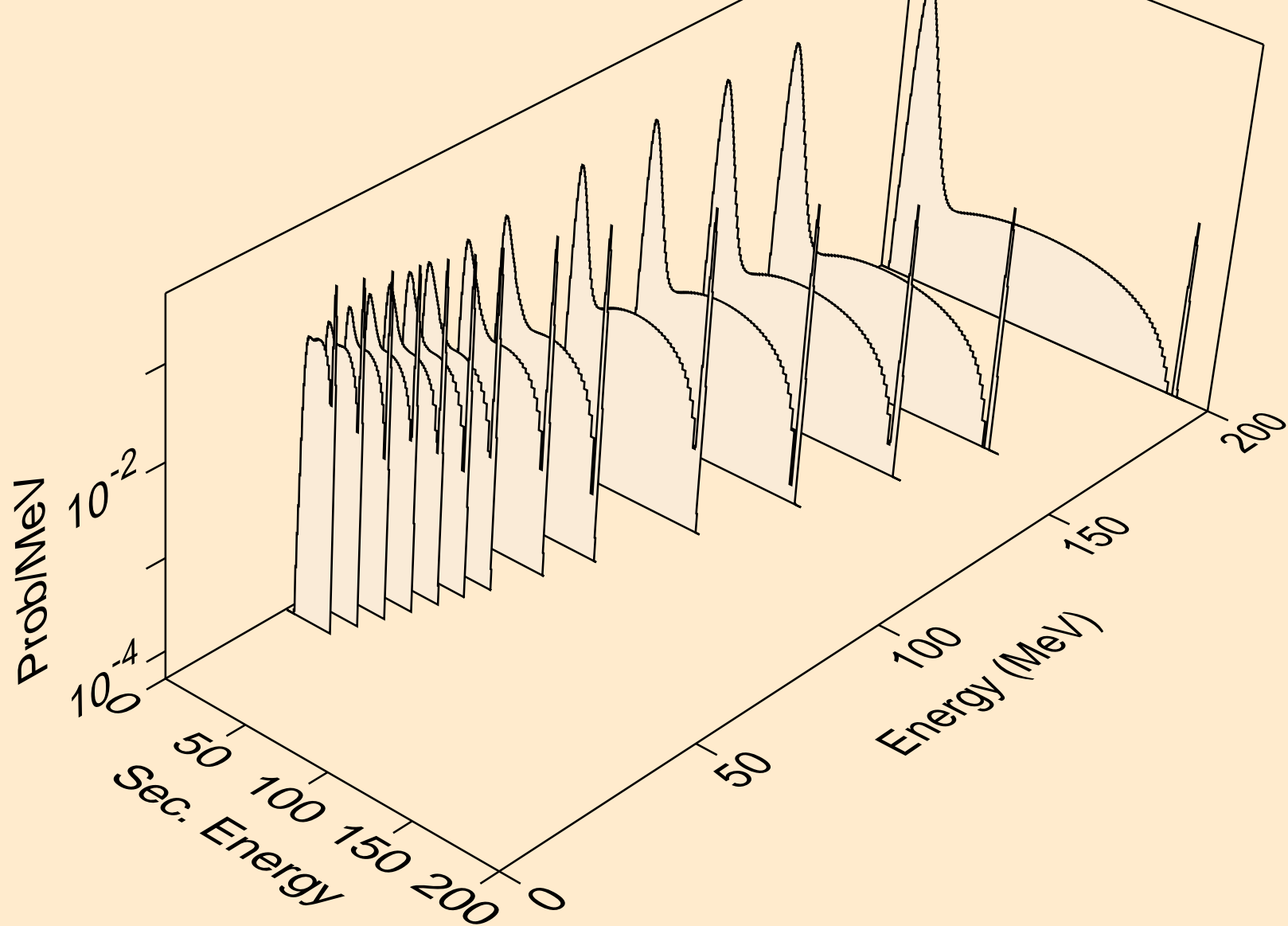

BR079 ALPHA ACER TENDL-2021 LIBRARY; T=0.K  
Alpha emission for (a,n\*)a

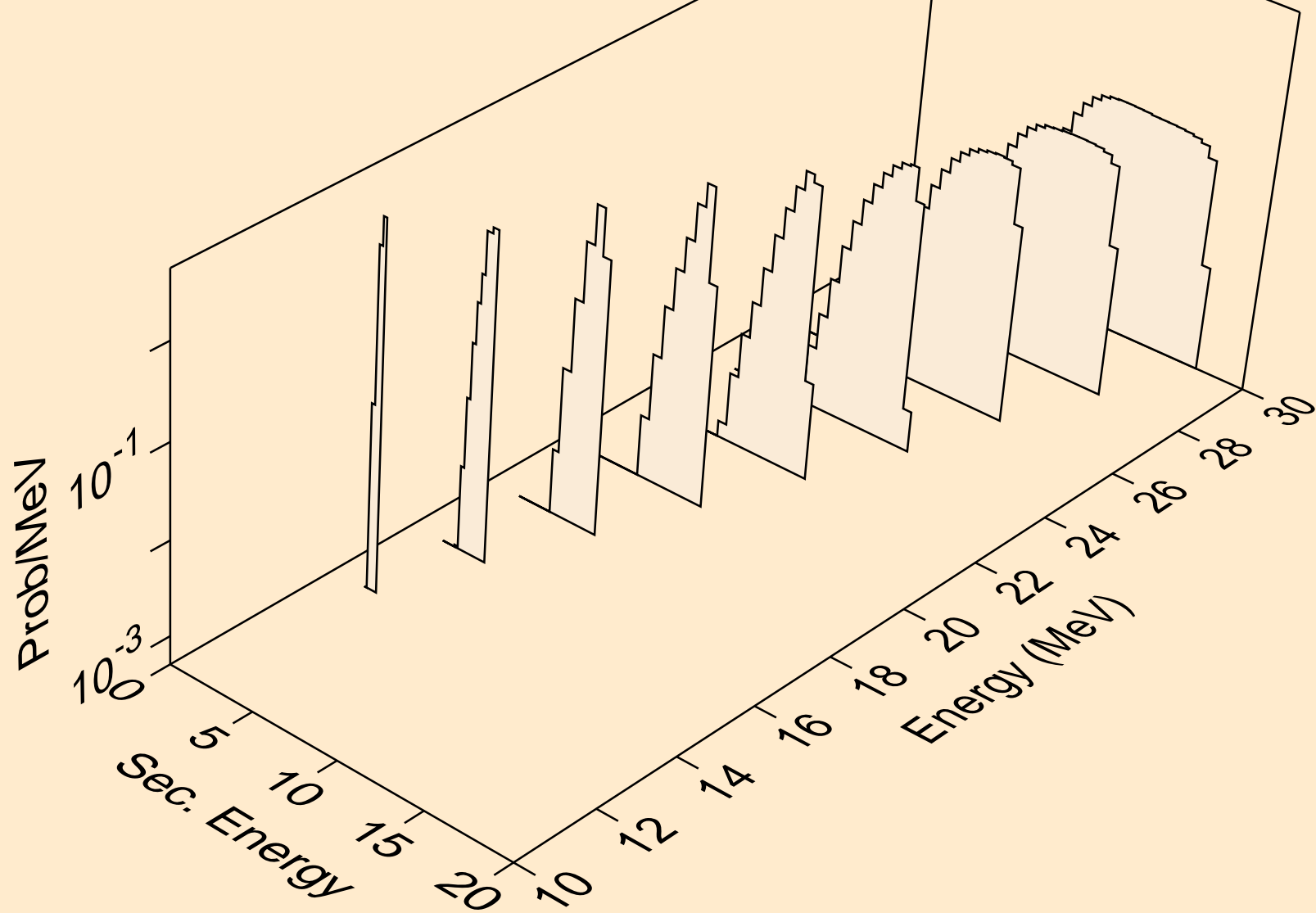

BR079 ALPHA ACER TENDL-2021 LIBRARY; T=0.K  
Alpha emission for (a,2n)a

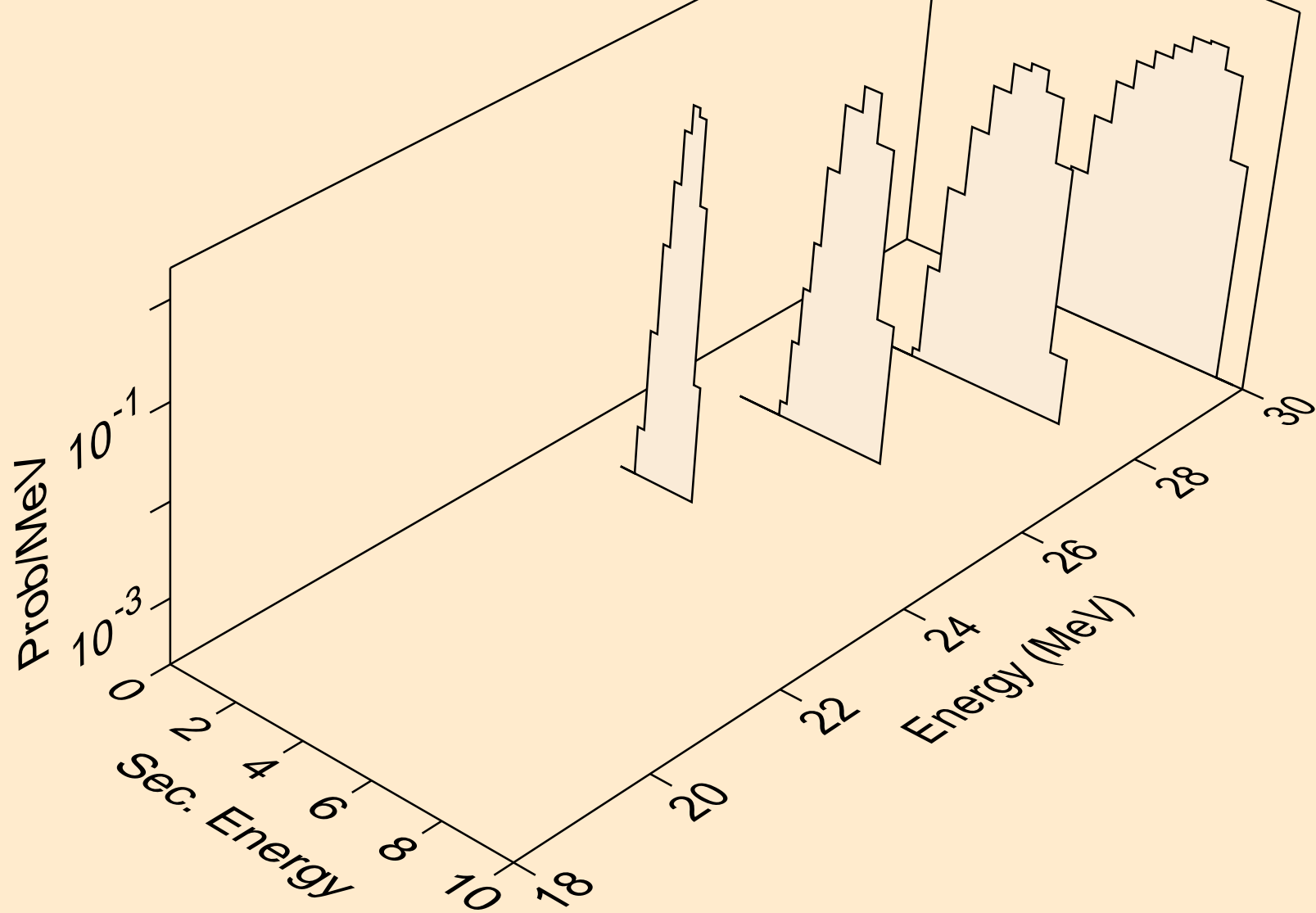

BR079 ALPHA ACER TENDL-2021 LIBRARY; T=0.K  
Alpha emission for inelastic

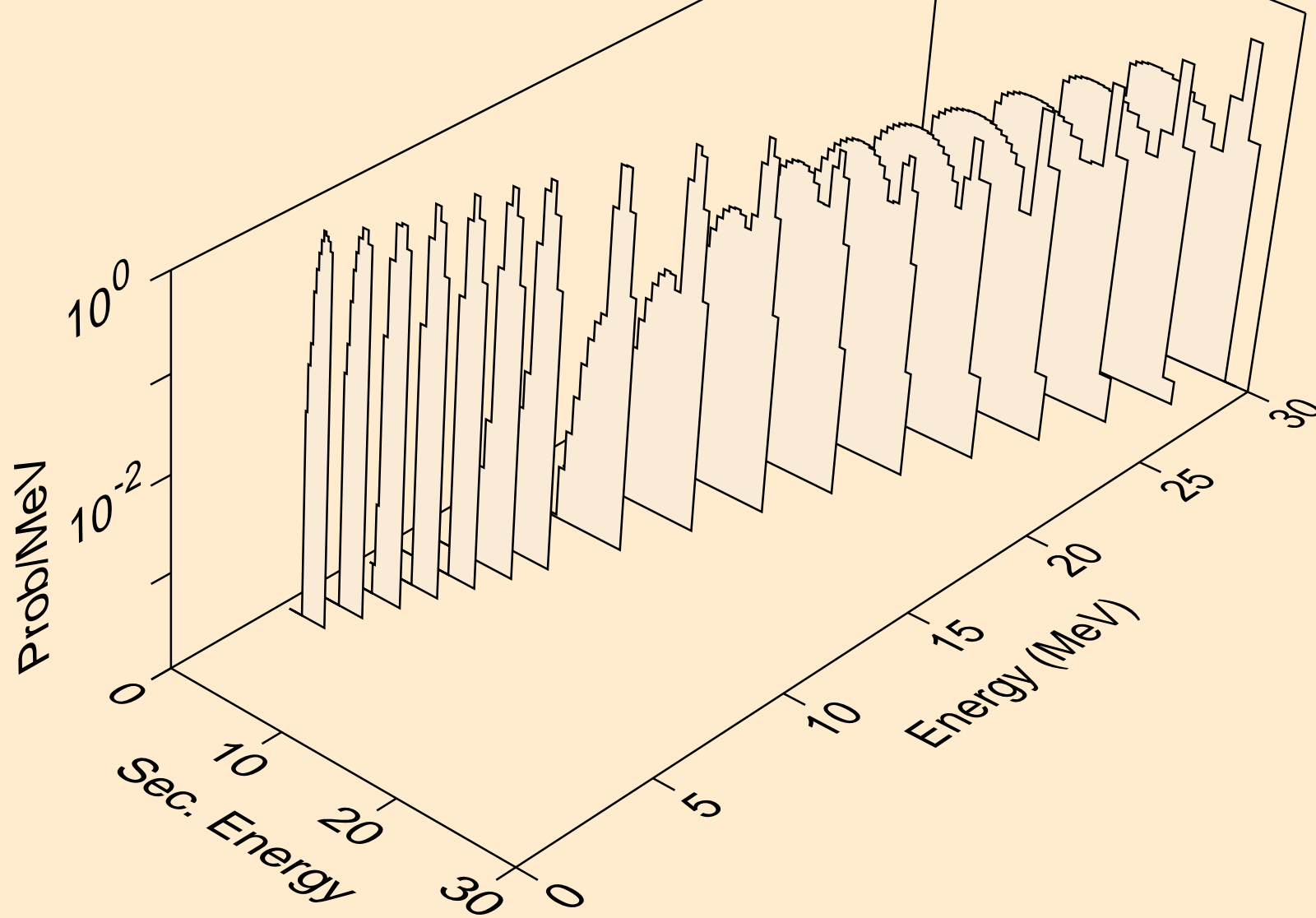

BR079 ALPHA ACER TENDL-2021 LIBRARY; T=0.K  
Alpha emission for (a,2a)

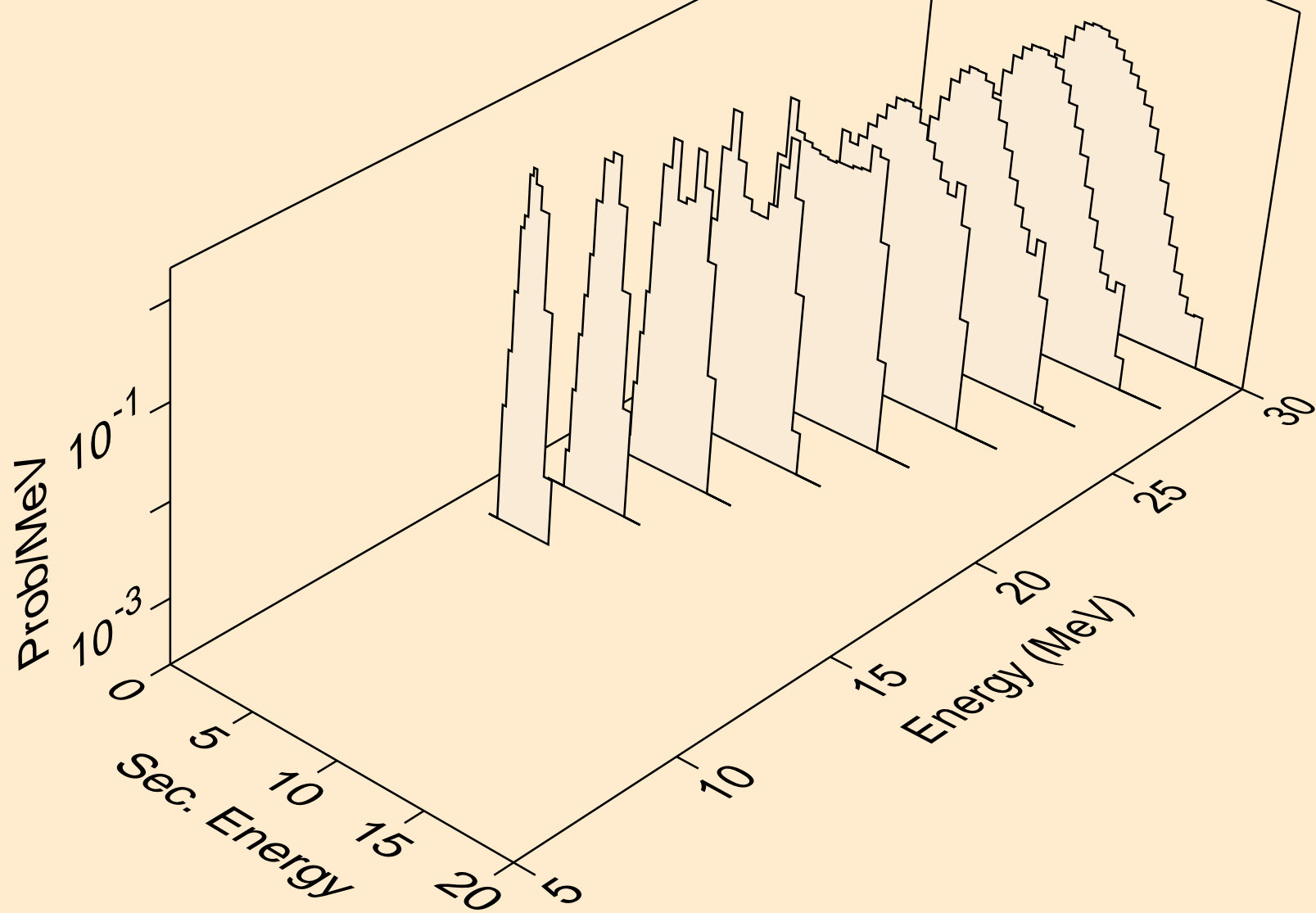

BR079 ALPHA ACER TENDL-2021 LIBRARY; T=0.K  
Alpha emission for (a,pa)

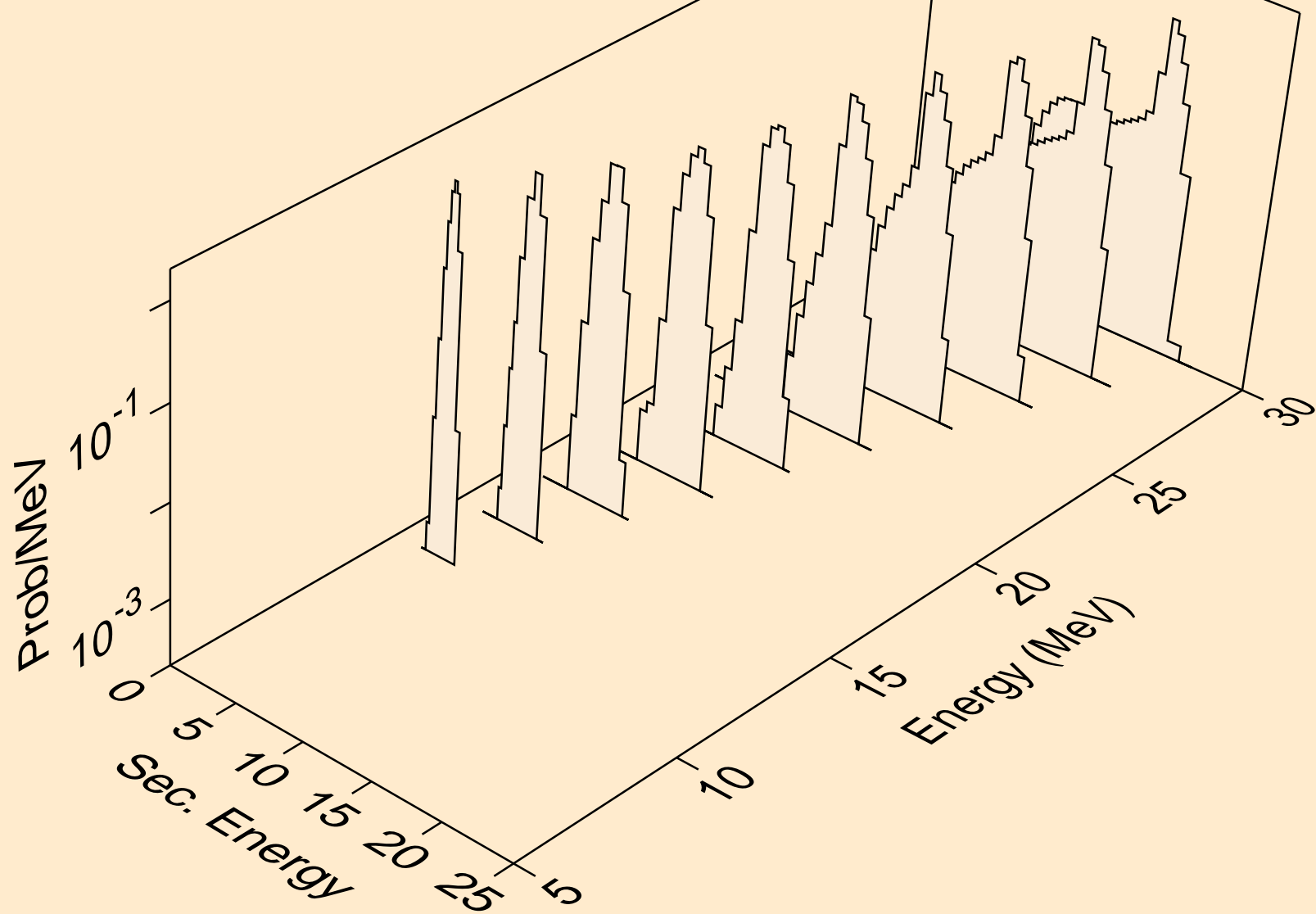

BR079 ALPHA ACER TENDL-2021 LIBRARY; T=0.K  
Alpha emission for (a,da)

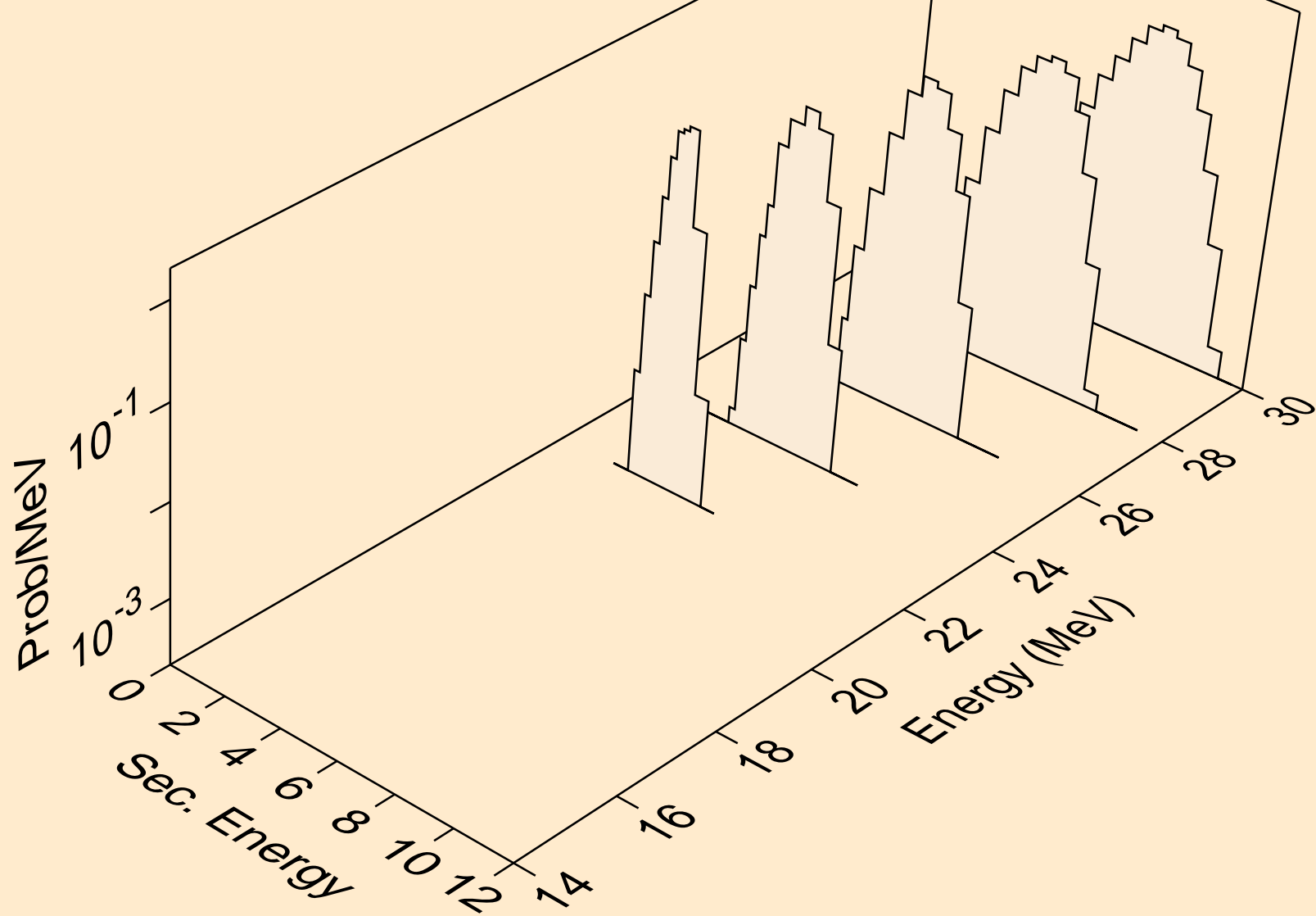



BR079 ALPHA ACER TENDL-2021 LIBRARY; T=0.K  
Photon emission for (z,n)

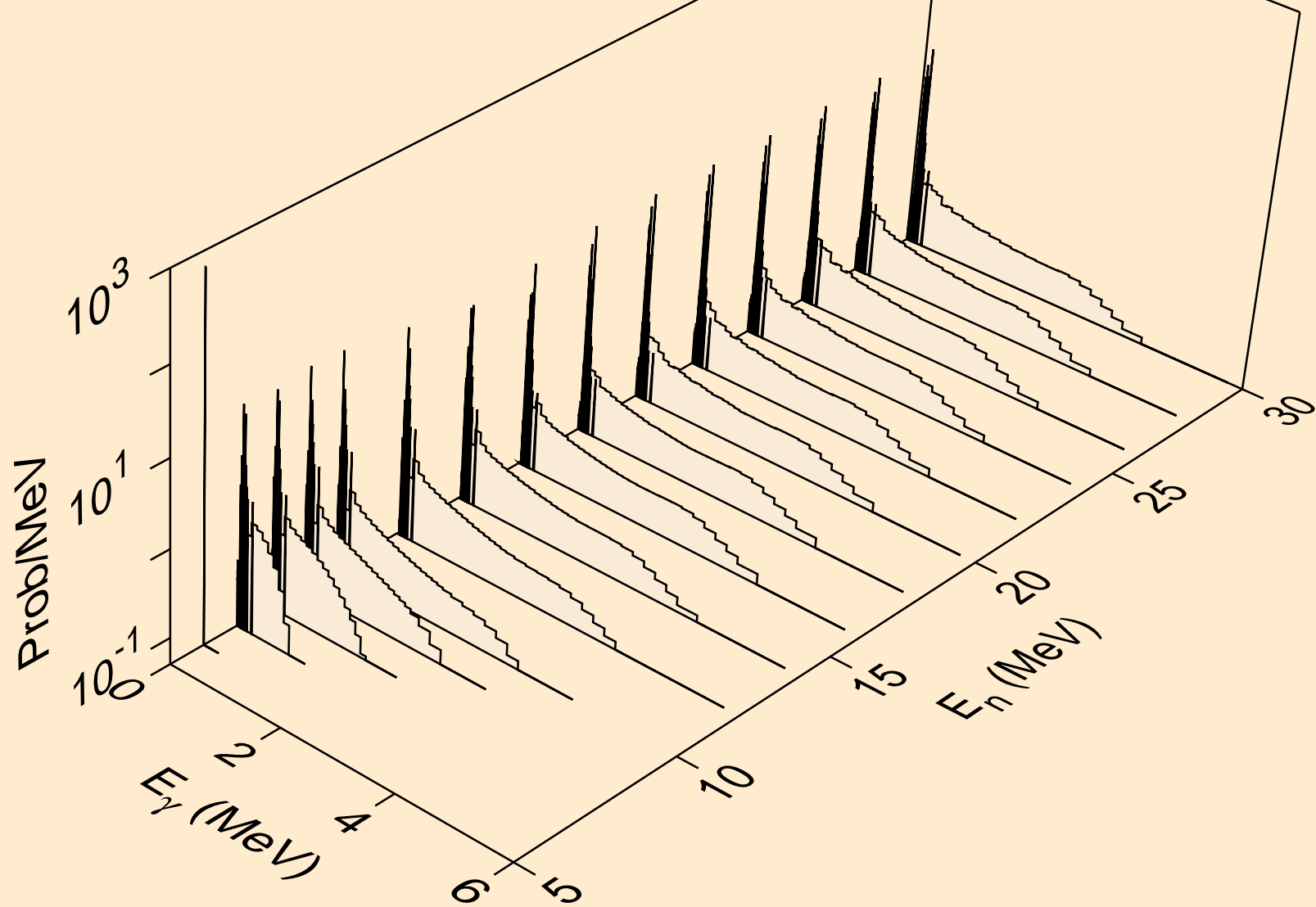

BR079 ALPHA ACER TENDL-2021 LIBRARY; T=0.K  
Photon emission for (n,x)

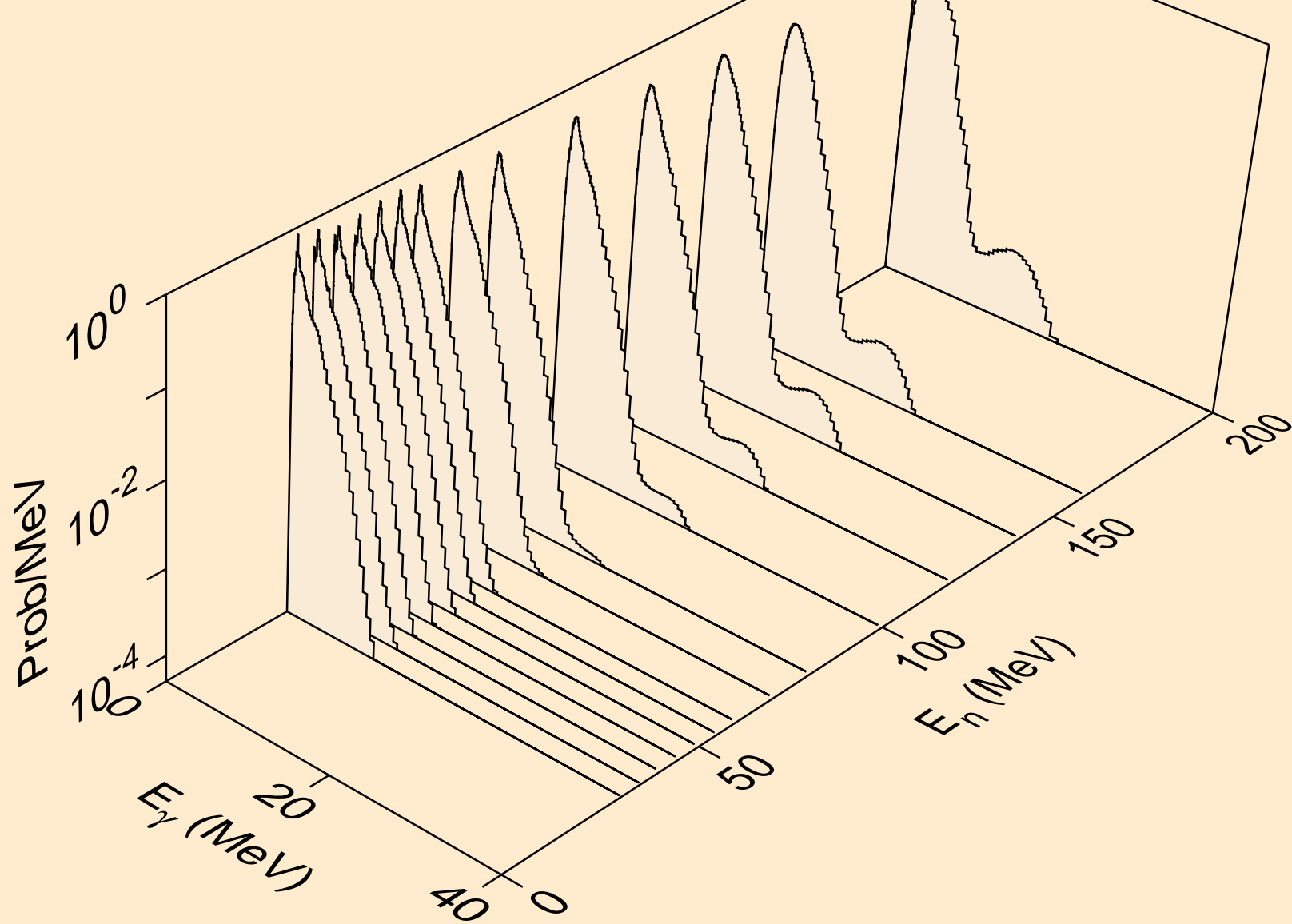

BR079 ALPHA ACER TENDL-2021 LIBRARY; T=0.K  
Photon emission for (n,2n)

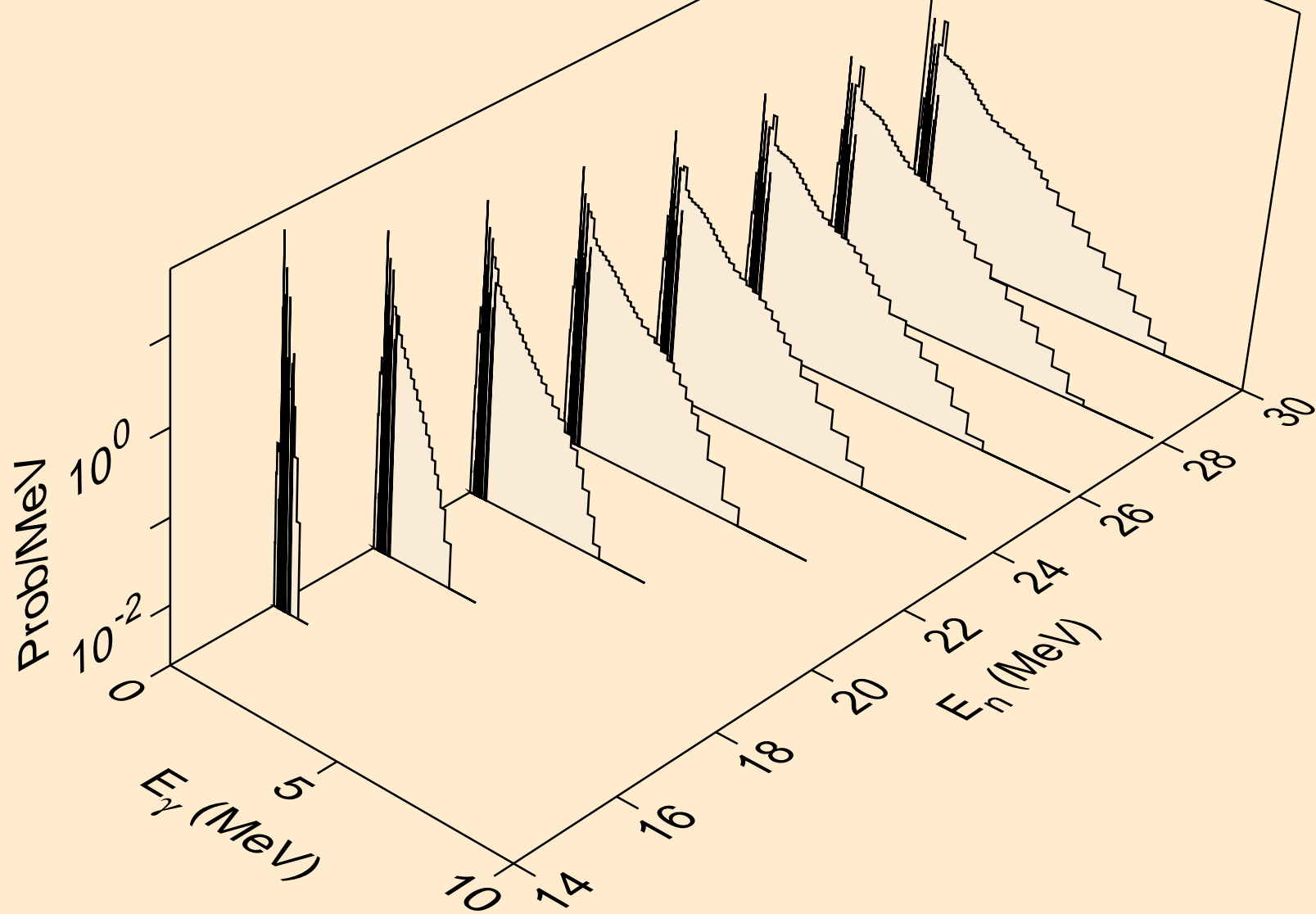

BR079 ALPHA ACER TENDL-2021 LIBRARY; T=0.K  
Photon emission for (n,3n)

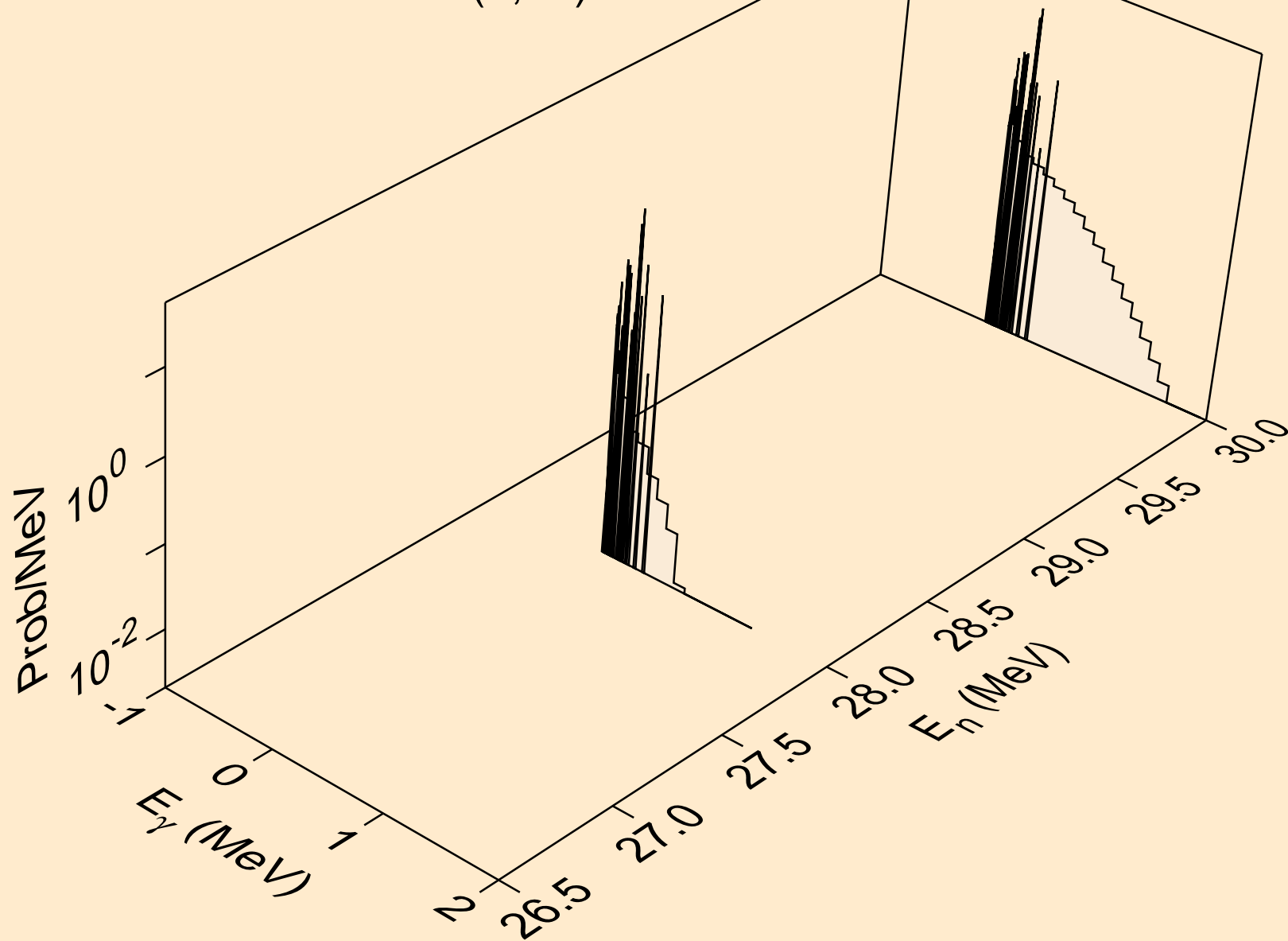

BR079 ALPHA ACER TENDL-2021 LIBRARY; T=0.K  
Photon emission for (n,n\*)a

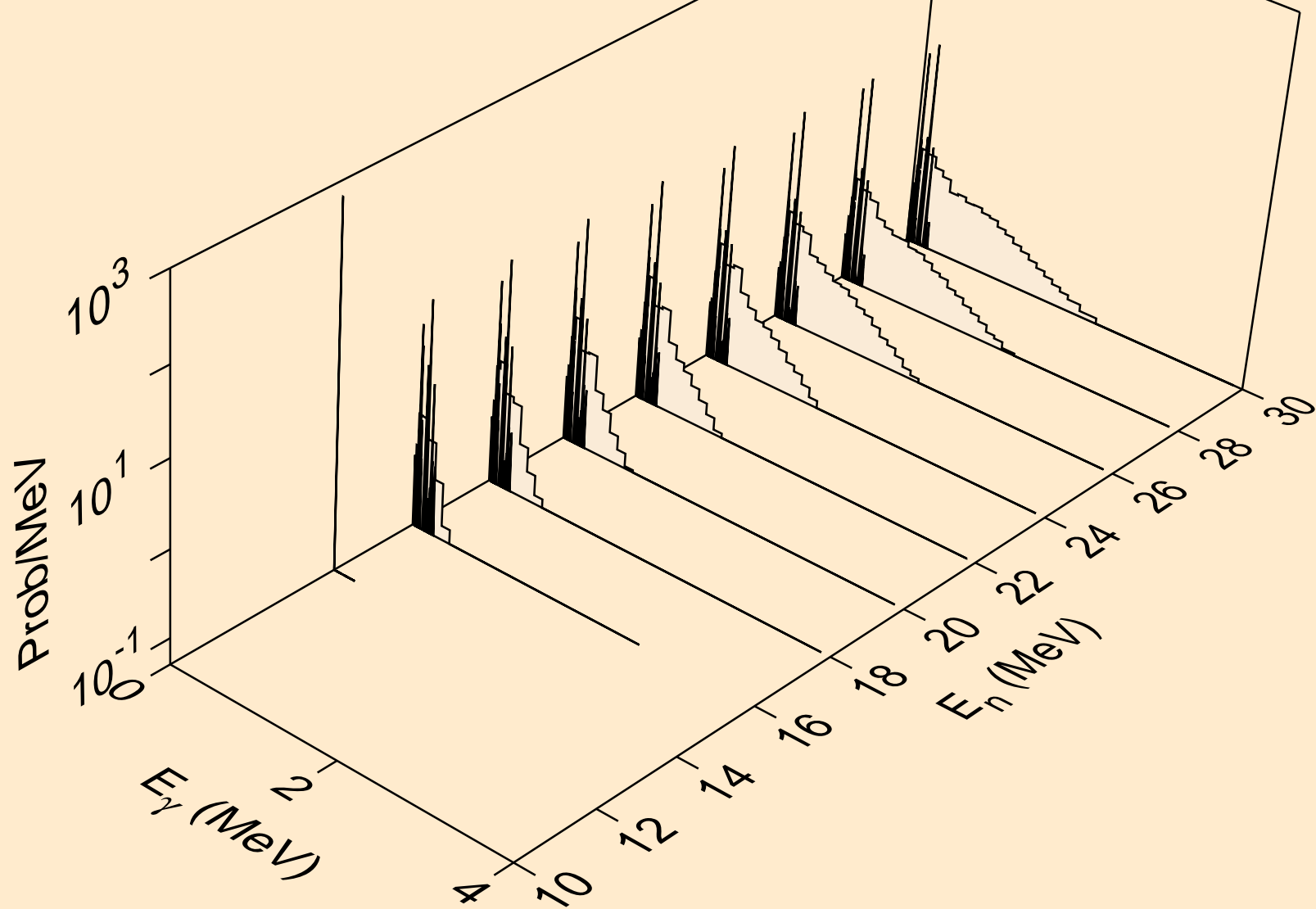

BR079 ALPHA ACER TENDL-2021 LIBRARY; T=0.K  
Photon emission for (n,2n)a

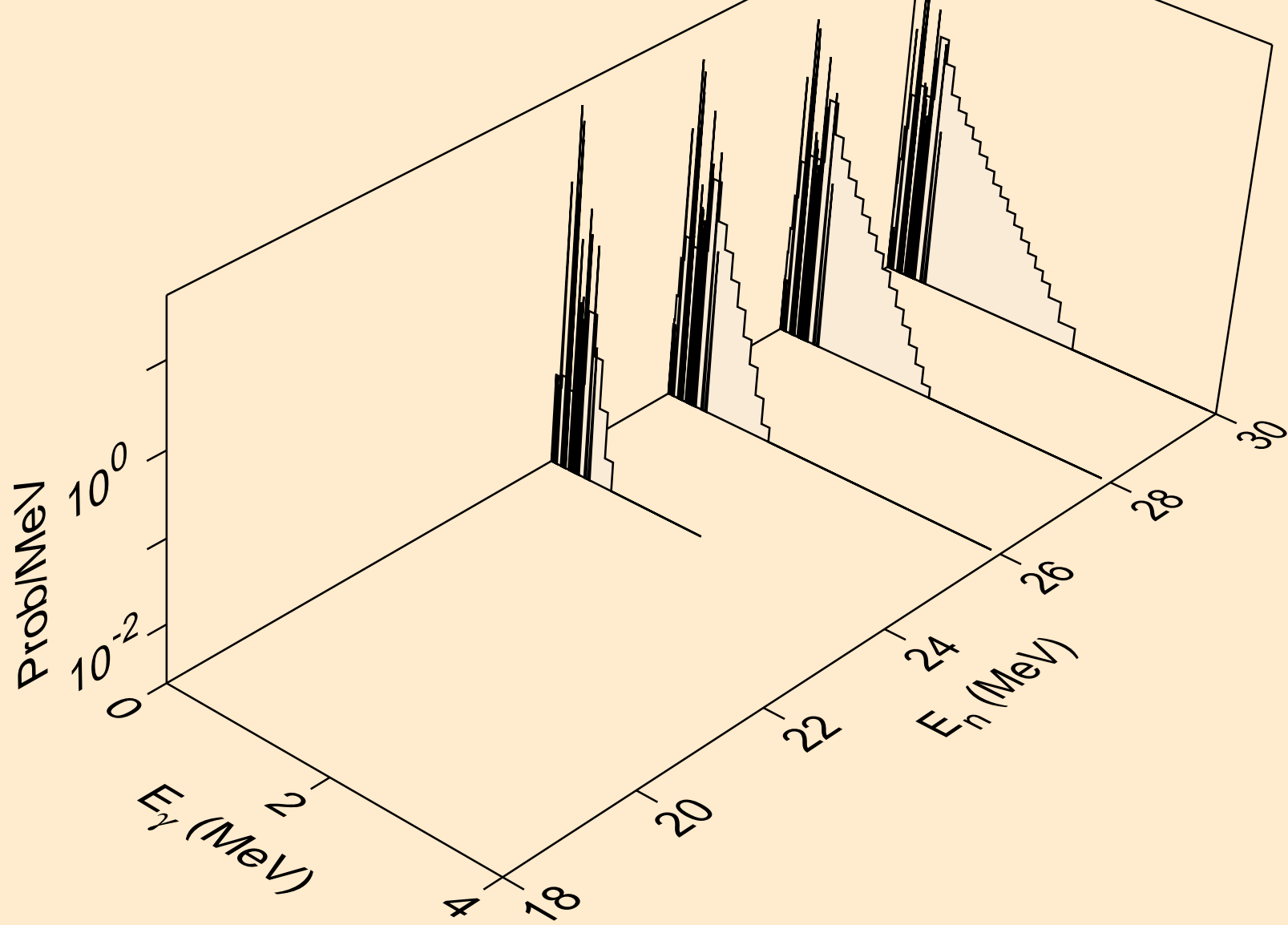

BR079 ALPHA ACER TENDL-2021 LIBRARY; T=0.K  
Photon emission for (n,n\*)p

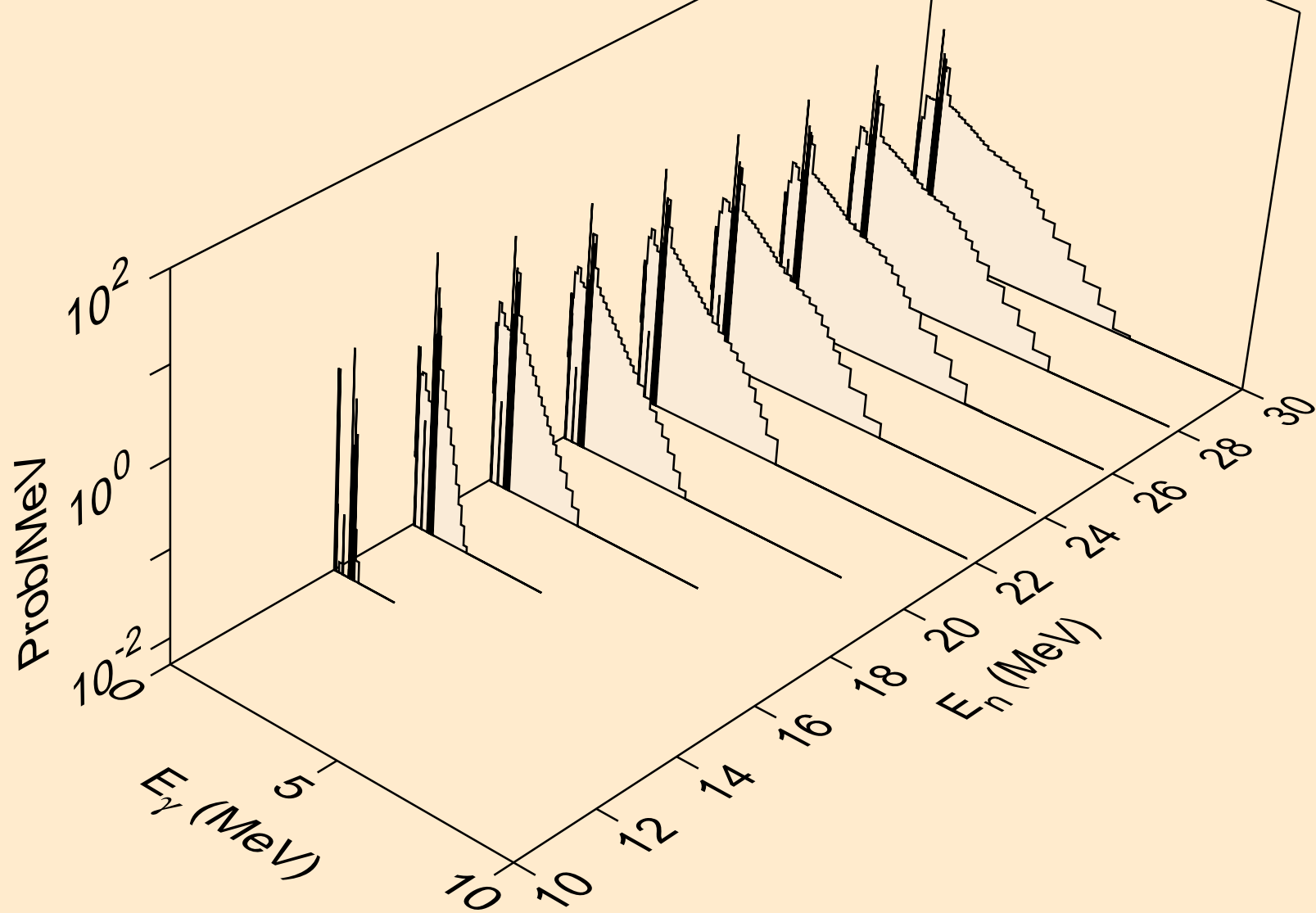

BR079 ALPHA ACER TENDL-2021 LIBRARY; T=0.K  
Photon emission for (n,n\*)d

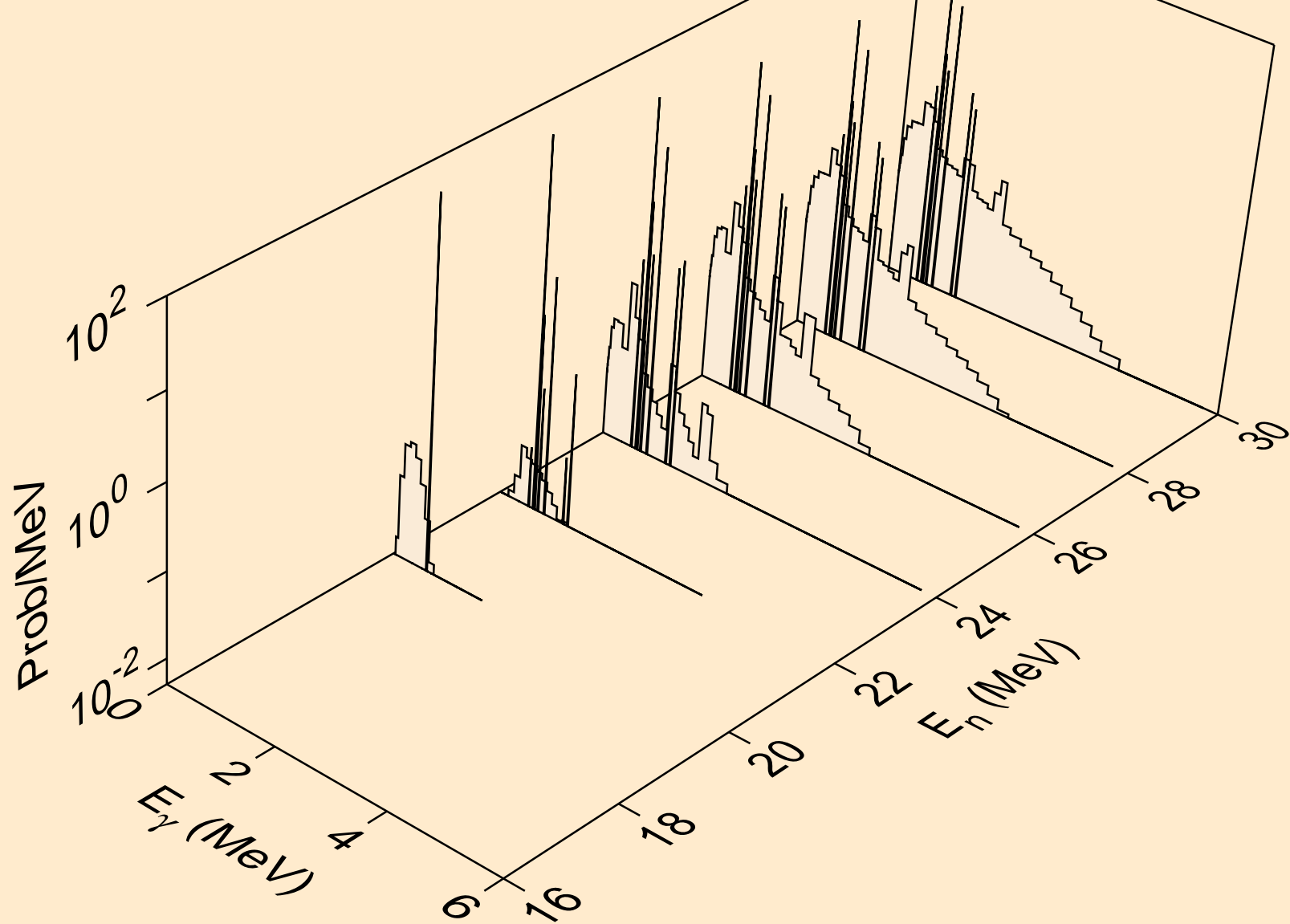



BR079 ALPHA ACER TENDL-2021 LIBRARY; T=0.K  
Photon emission for (n,n\*)t

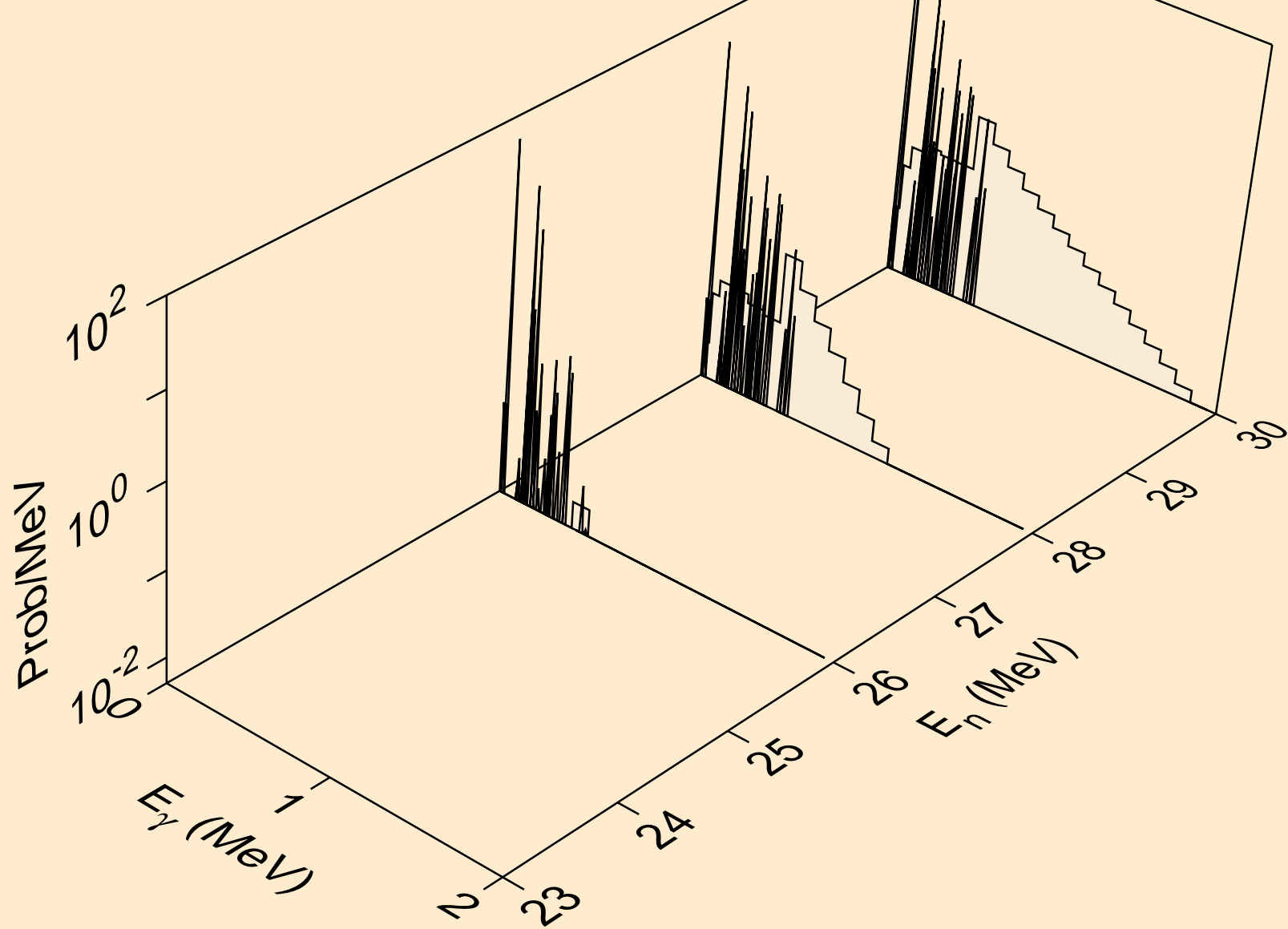

BR079 ALPHA ACER TENDL-2021 LIBRARY; T=0.K  
Photon emission for (n,n\*)he3

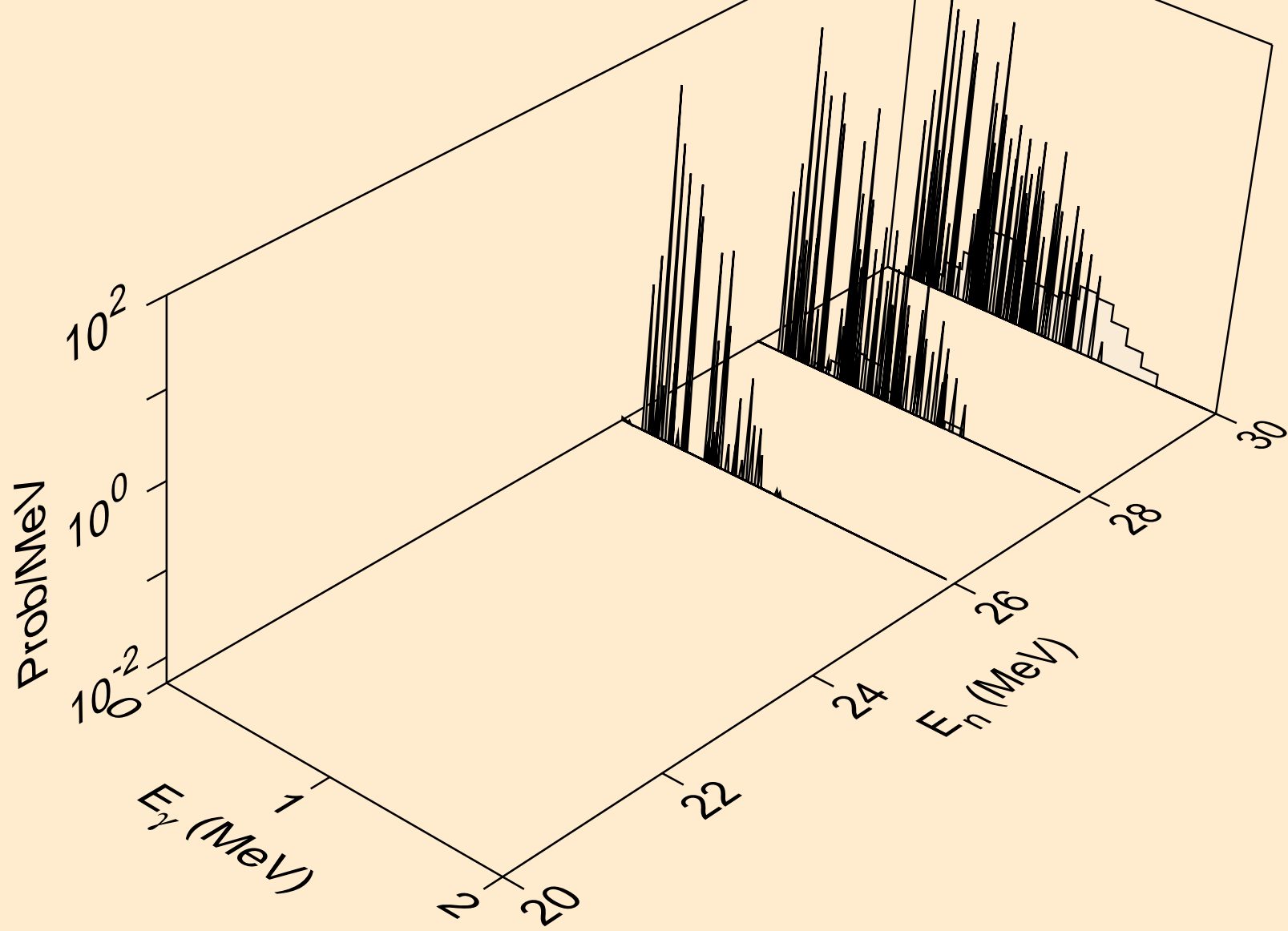

BR079 ALPHA ACER TENDL-2021 LIBRARY; T=0.K  
Photon emission for (n,2np)

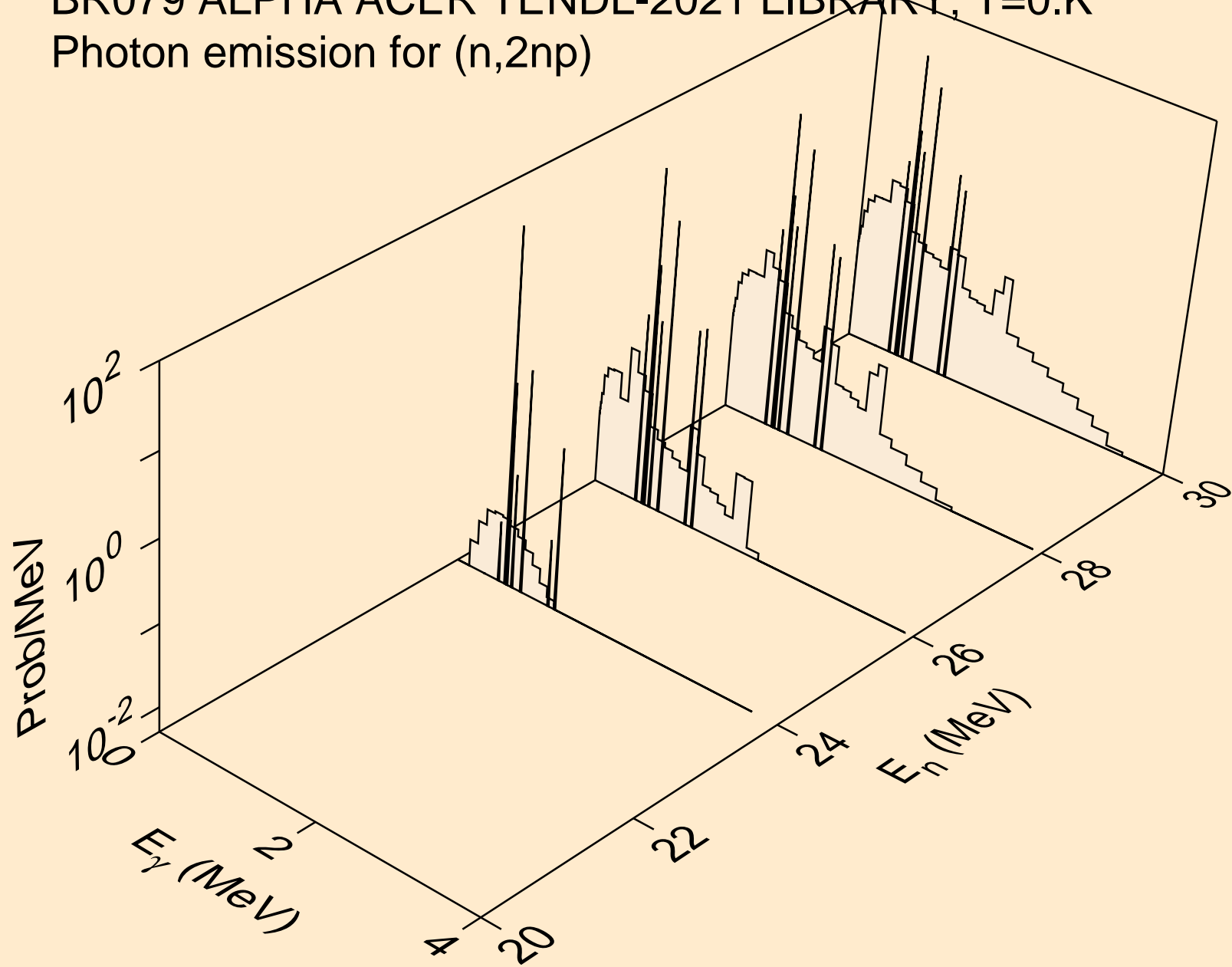

BR079 ALPHA ACER TENDL-2021 LIBRARY; T=0.K  
Photon emission for (n,2np)

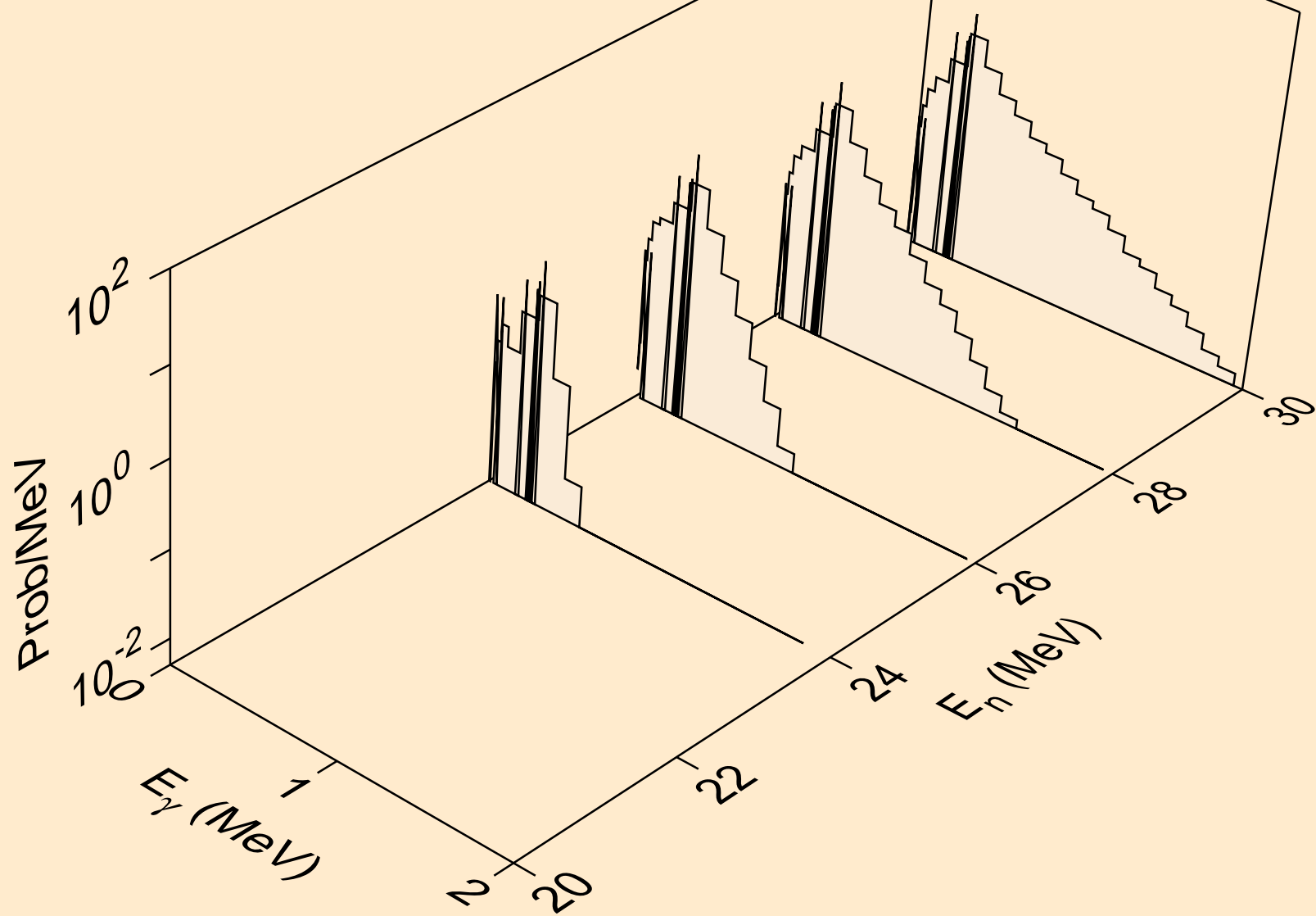

BR079 ALPHA ACER TENDL-2021 LIBRARY; T=0.K  
Photon emission for (n,npa)

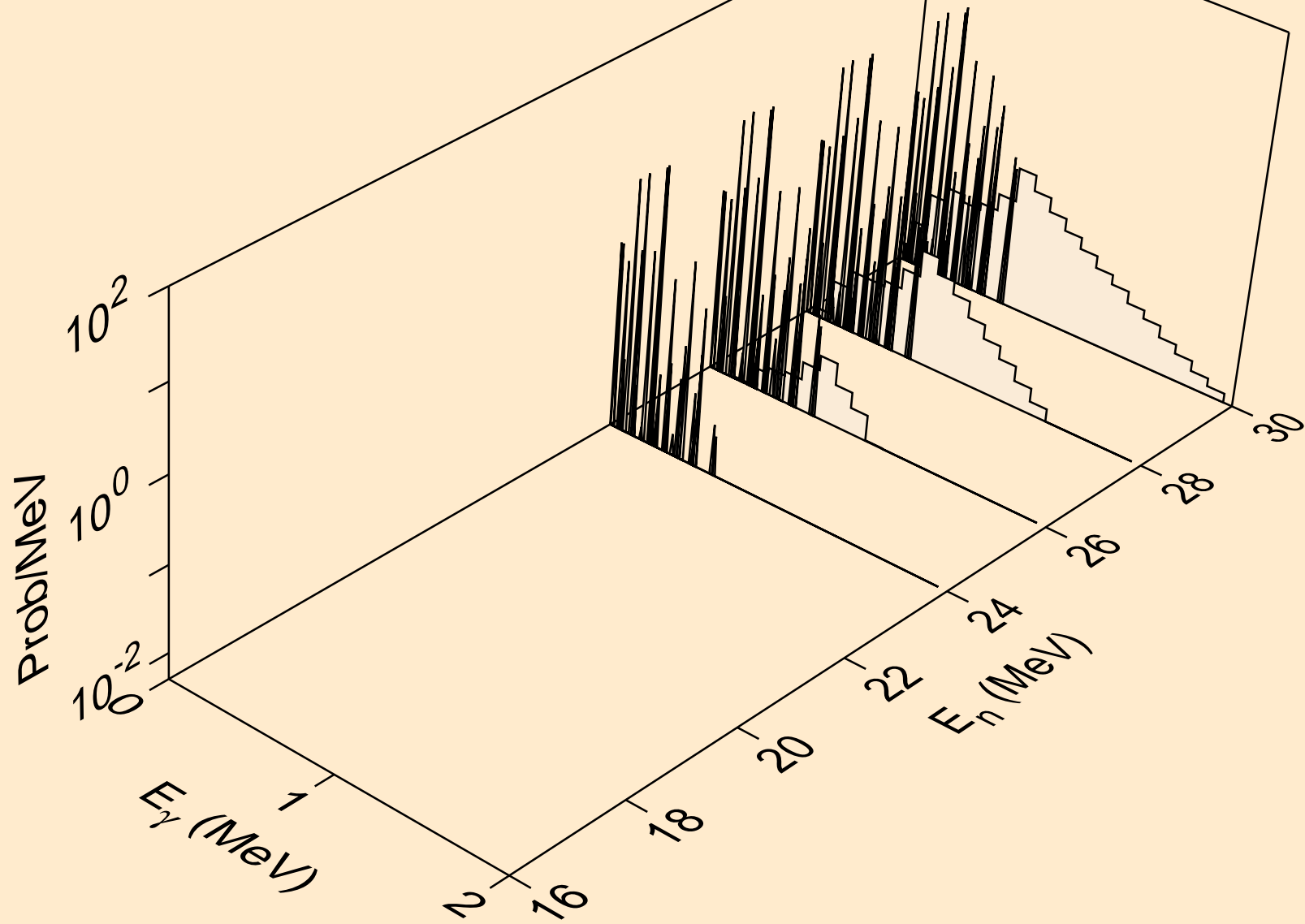

BR079 ALPHA ACER TENDL-2021 LIBRARY; T=0.K  
Photon emission for (n,gma)

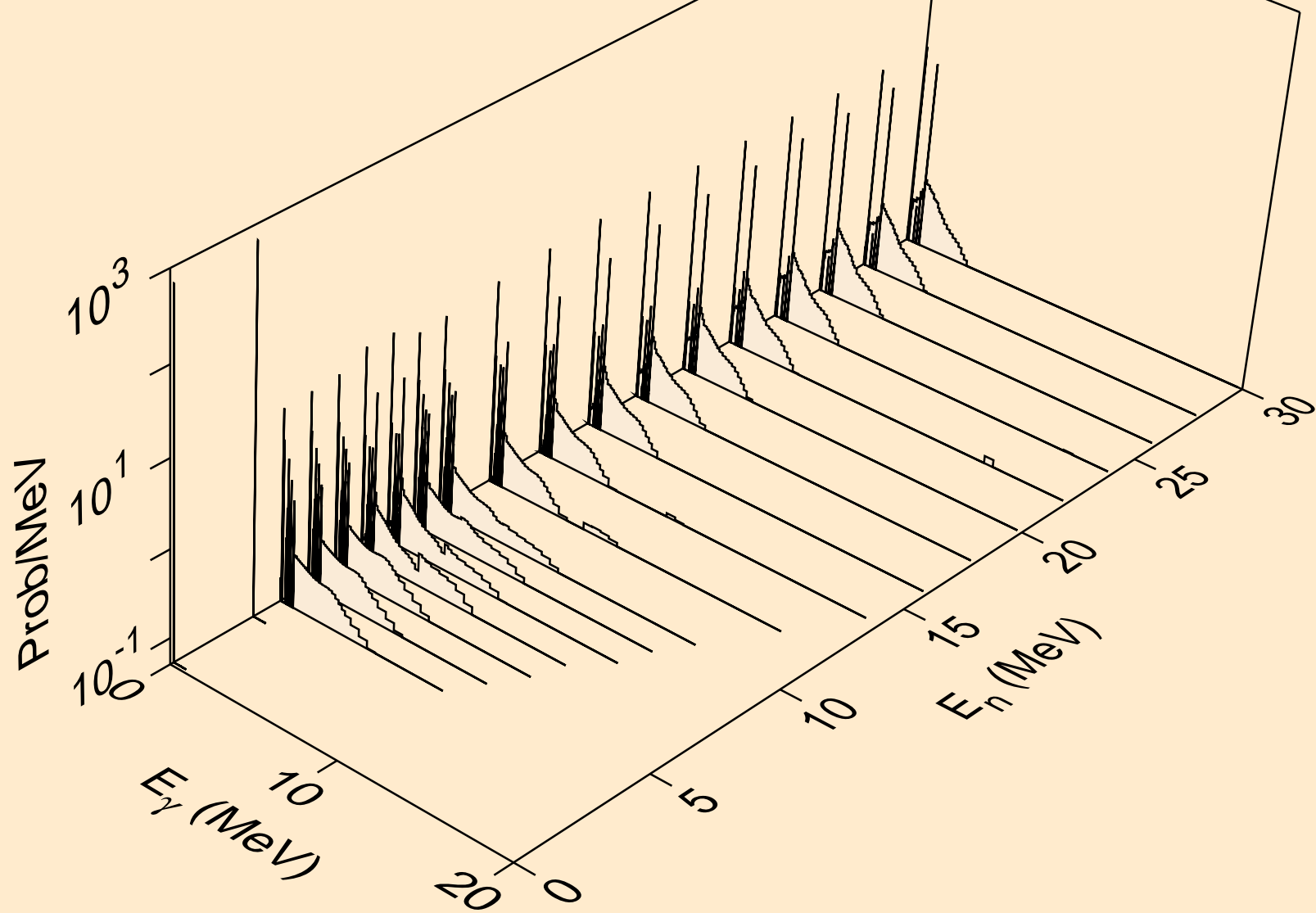

BR079 ALPHA ACER TENDL-2021 LIBRARY; T=0.K  
Photon emission for (n,p)

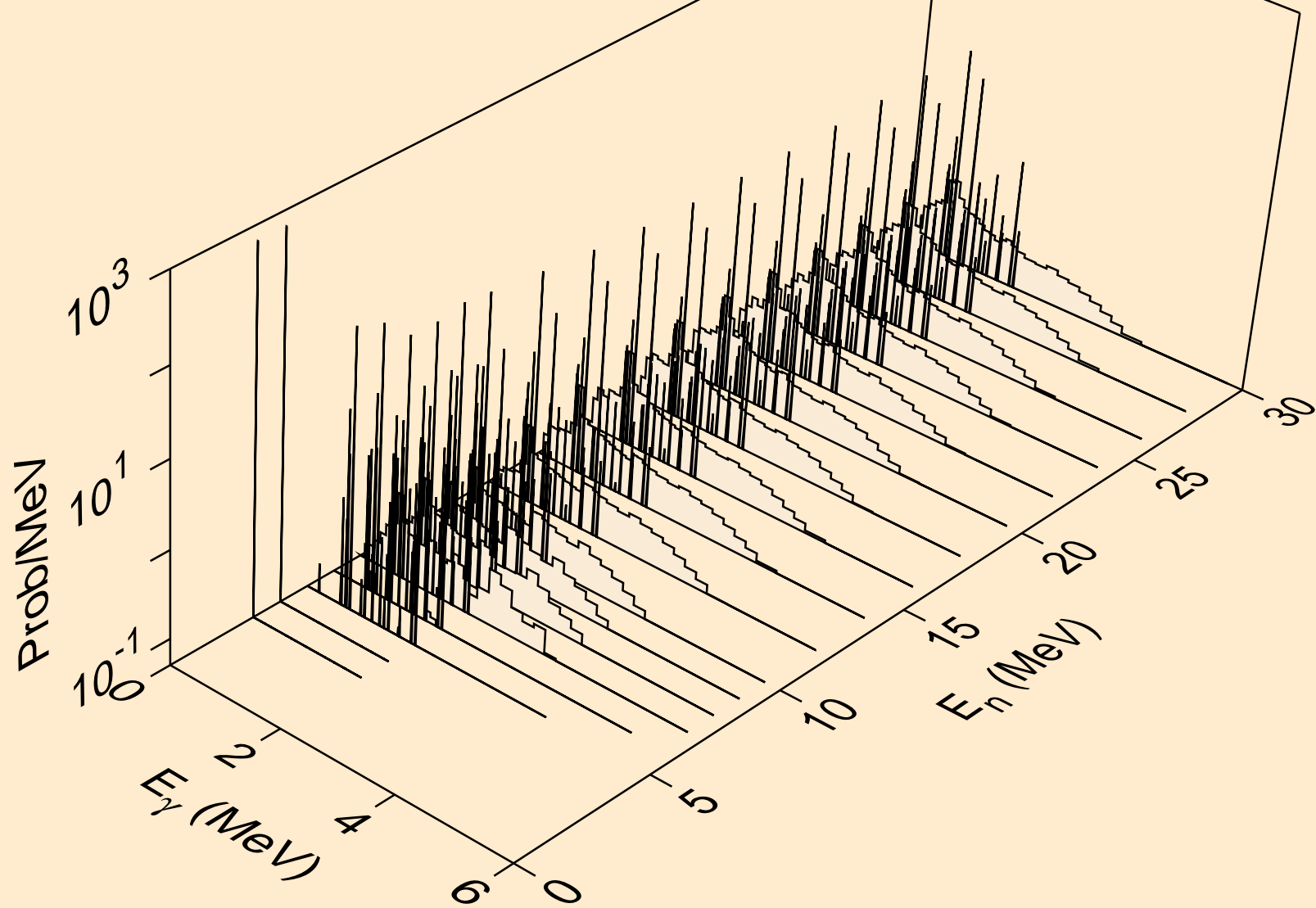

BR079 ALPHA ACER TENDL-2021 LIBRARY; T=0.K  
Photon emission for (n,d)

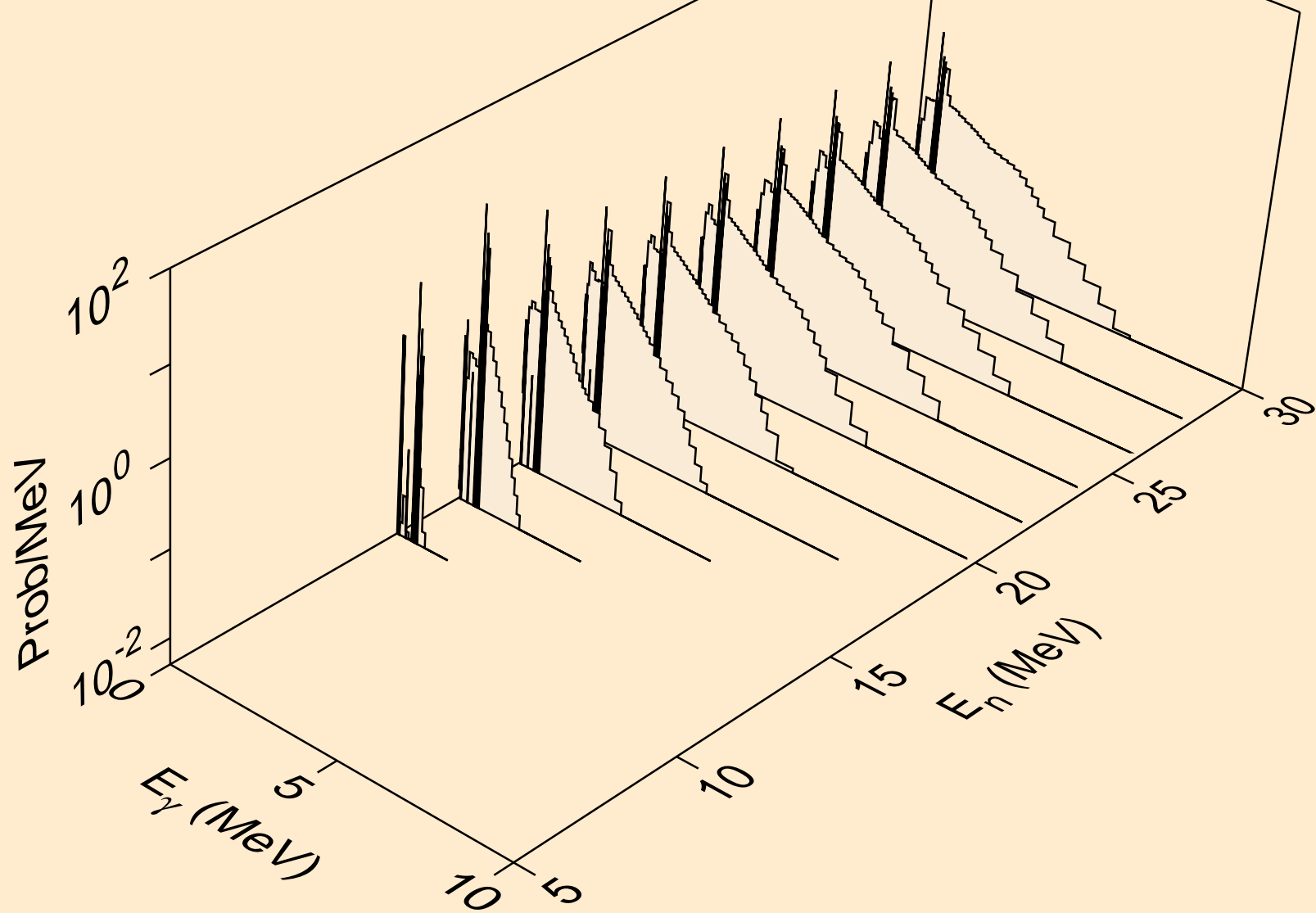



BR079 ALPHA ACER TENDL-2021 LIBRARY; T=0.K  
Photon emission for (n,t)

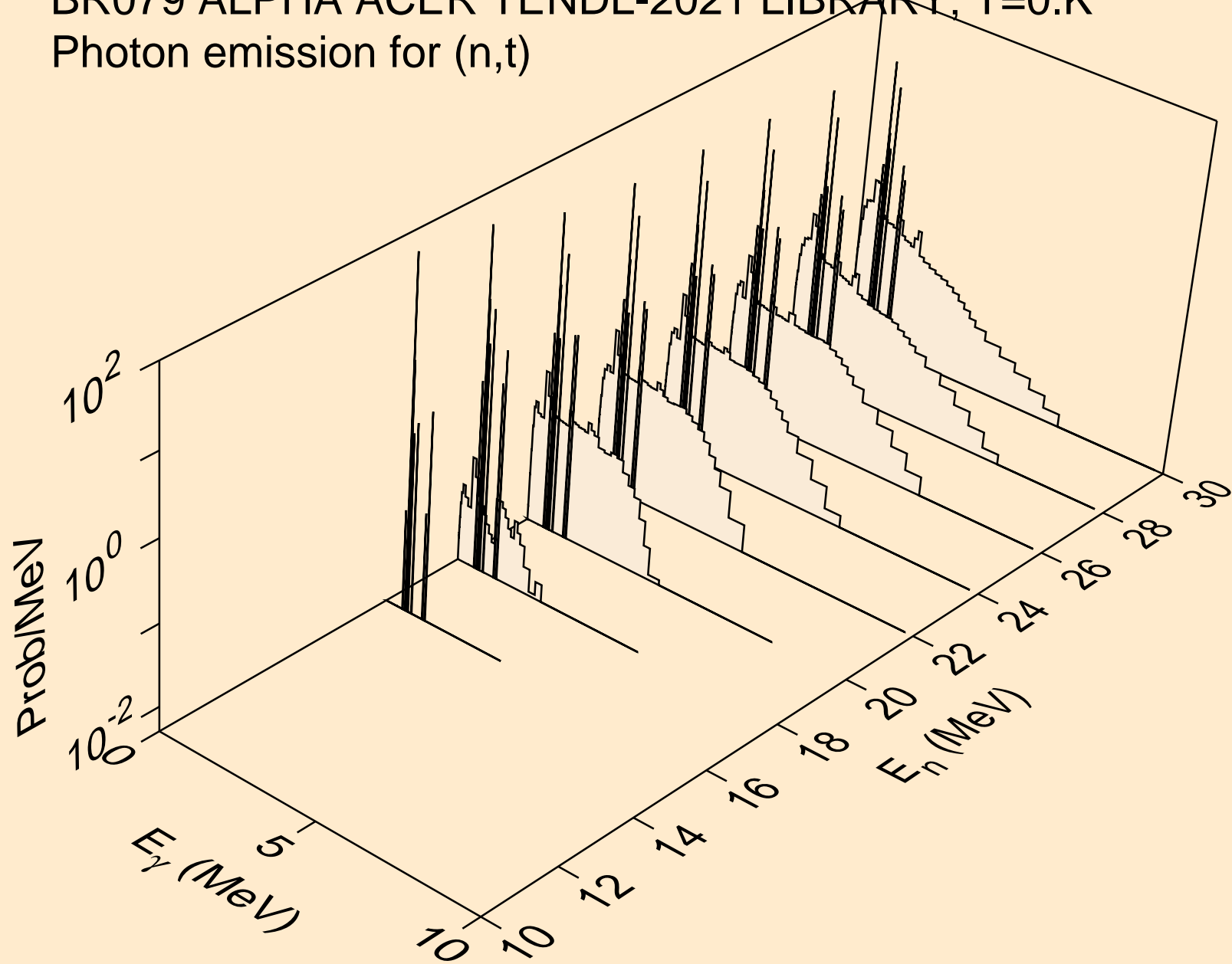

BR079 ALPHA ACER TENDL-2021 LIBRARY; T=0.K  
Photon emission for (n,he3)

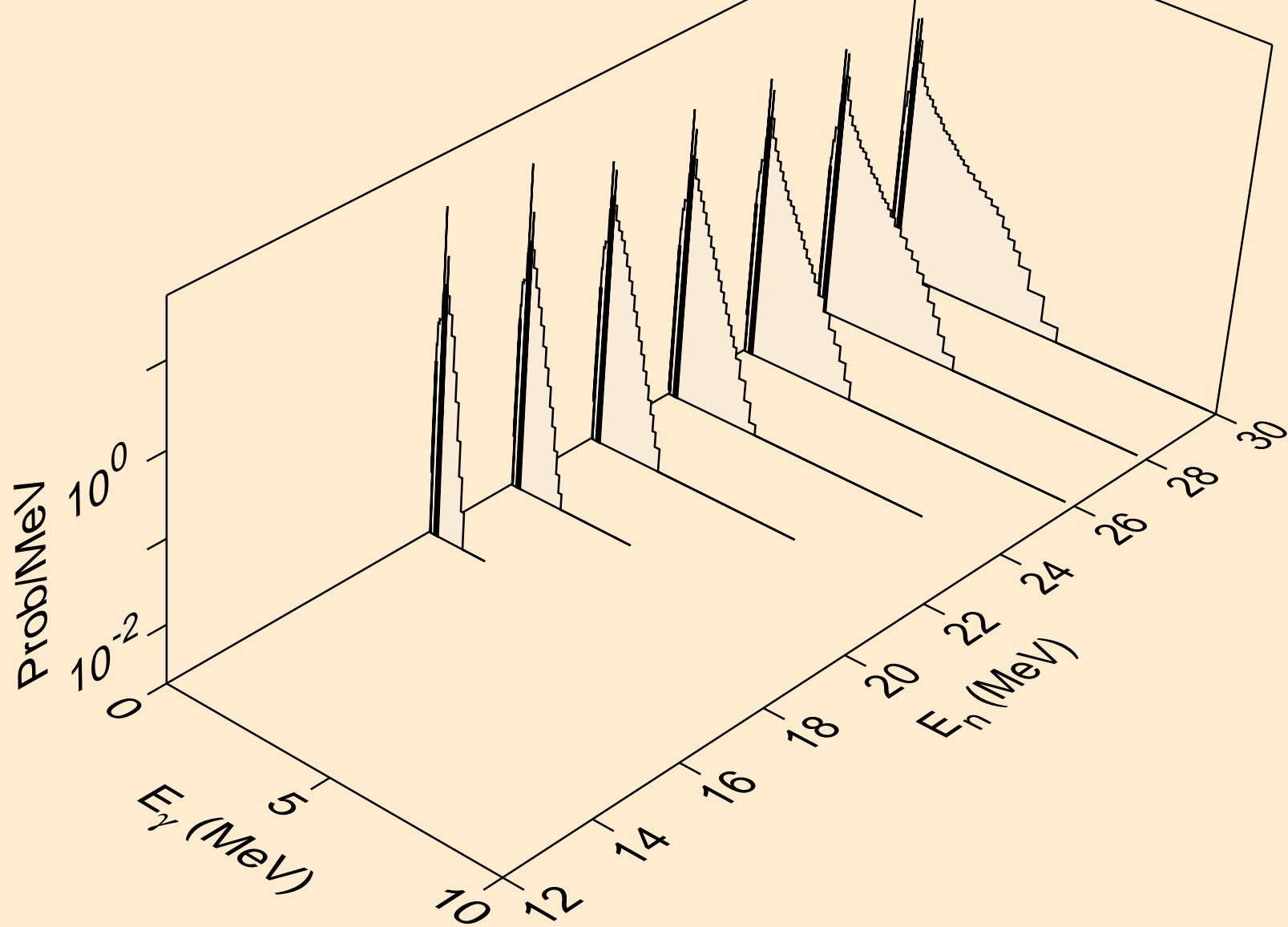

BR079 ALPHA ACER TENDL-2021 LIBRARY; T=0.K  
Photon emission for inelastic

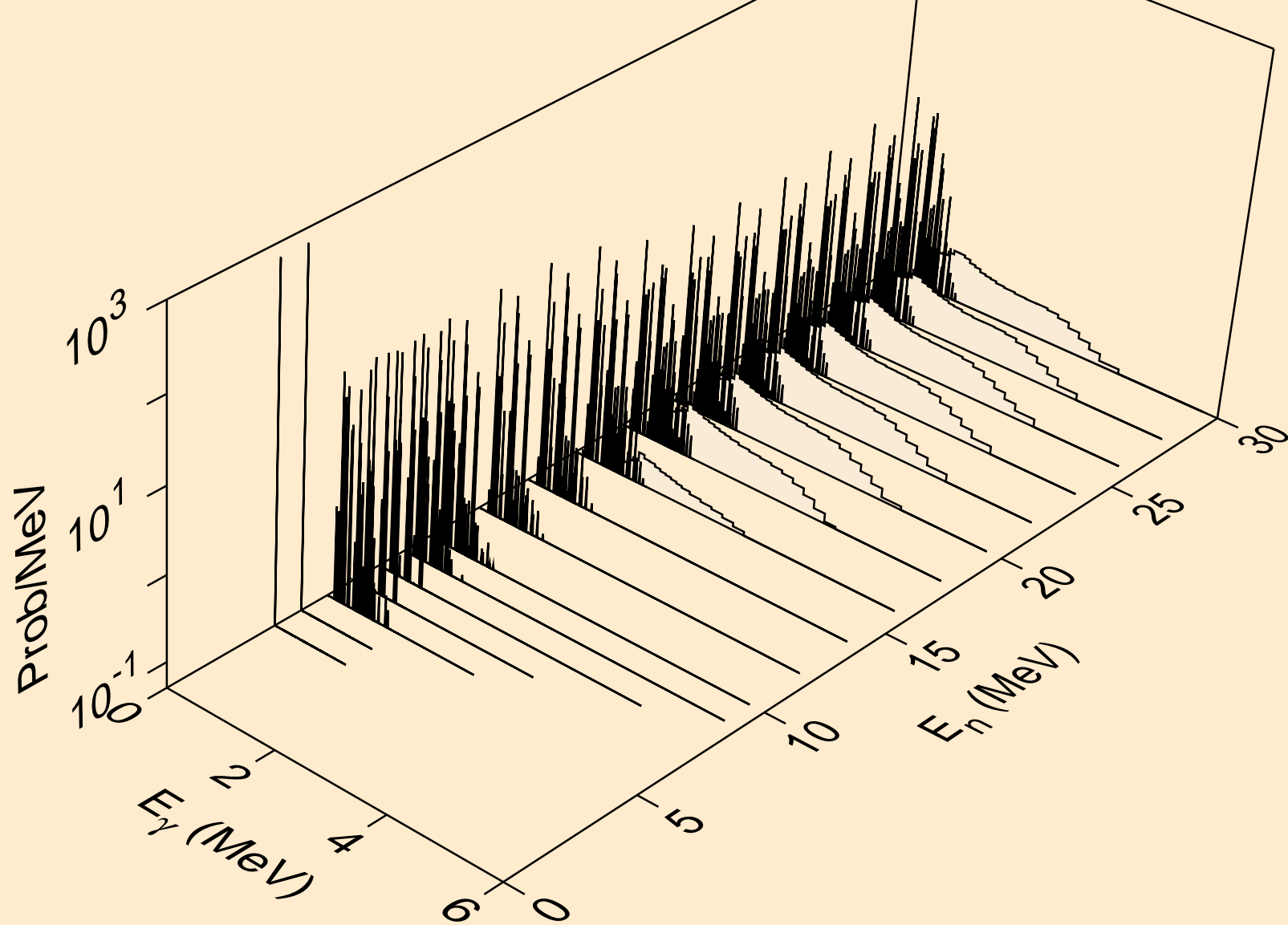

BR079 ALPHA ACER TENDL-2021 LIBRARY; T=0.K  
Photon emission for (n,2a)

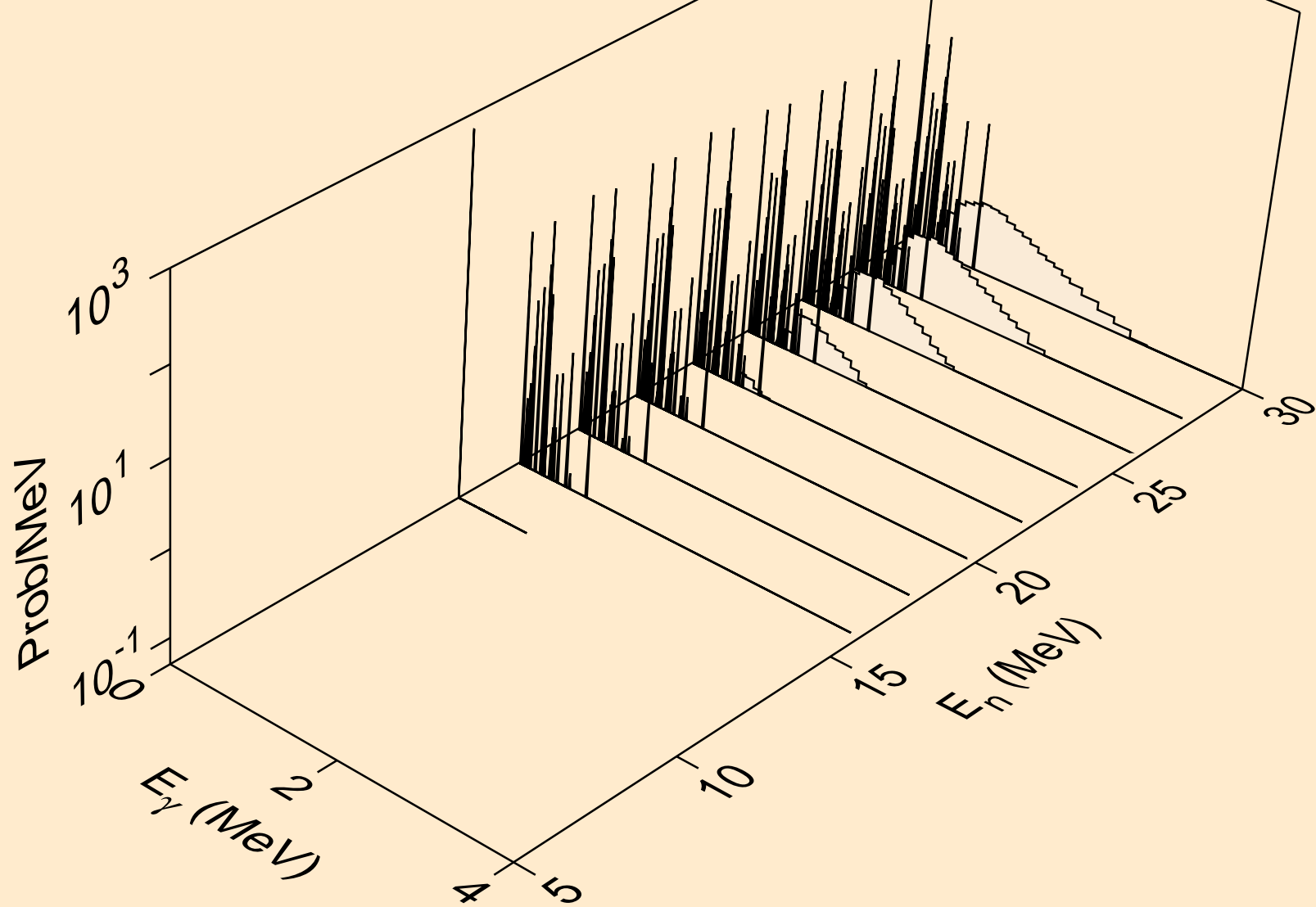

BR079 ALPHA ACER TENDL-2021 LIBRARY; T=0.K  
Photon emission for (n,2p)

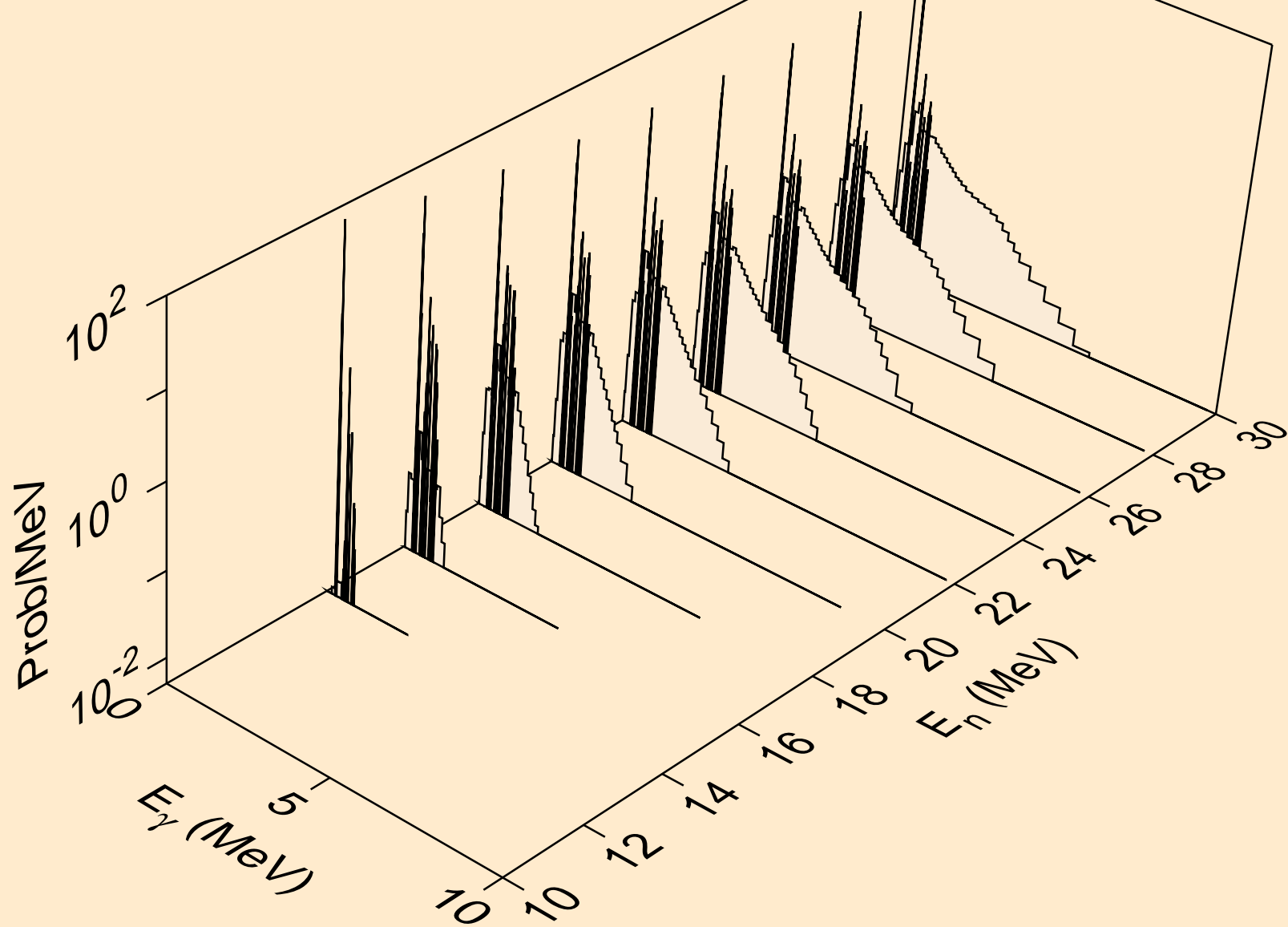

BR079 ALPHA ACER TENDL-2021 LIBRARY; T=0.K  
Photon emission for (n,pa)

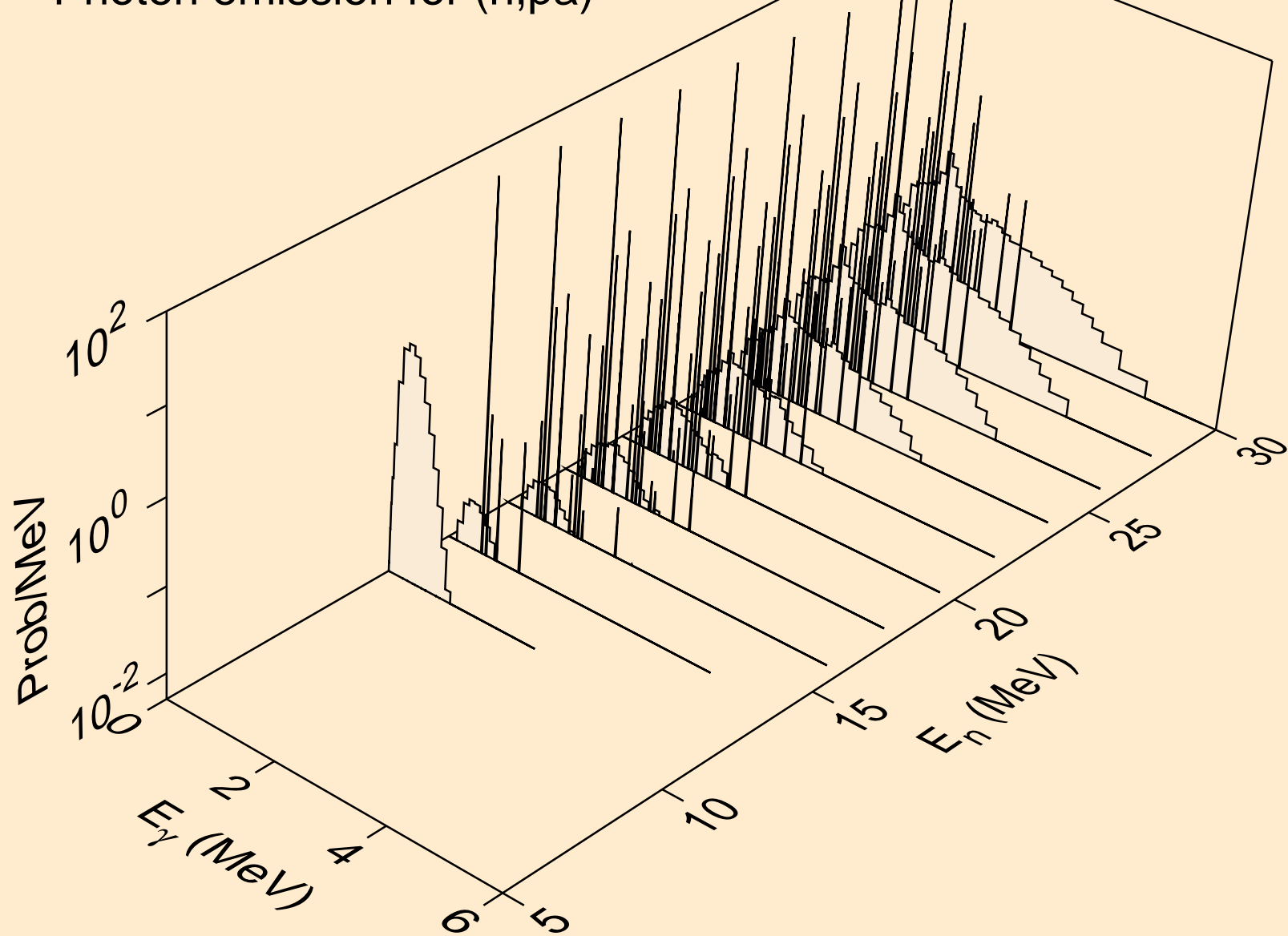

BR079 ALPHA ACER TENDL-2021 LIBRARY; T=0.K  
Photon emission for (n,pd)

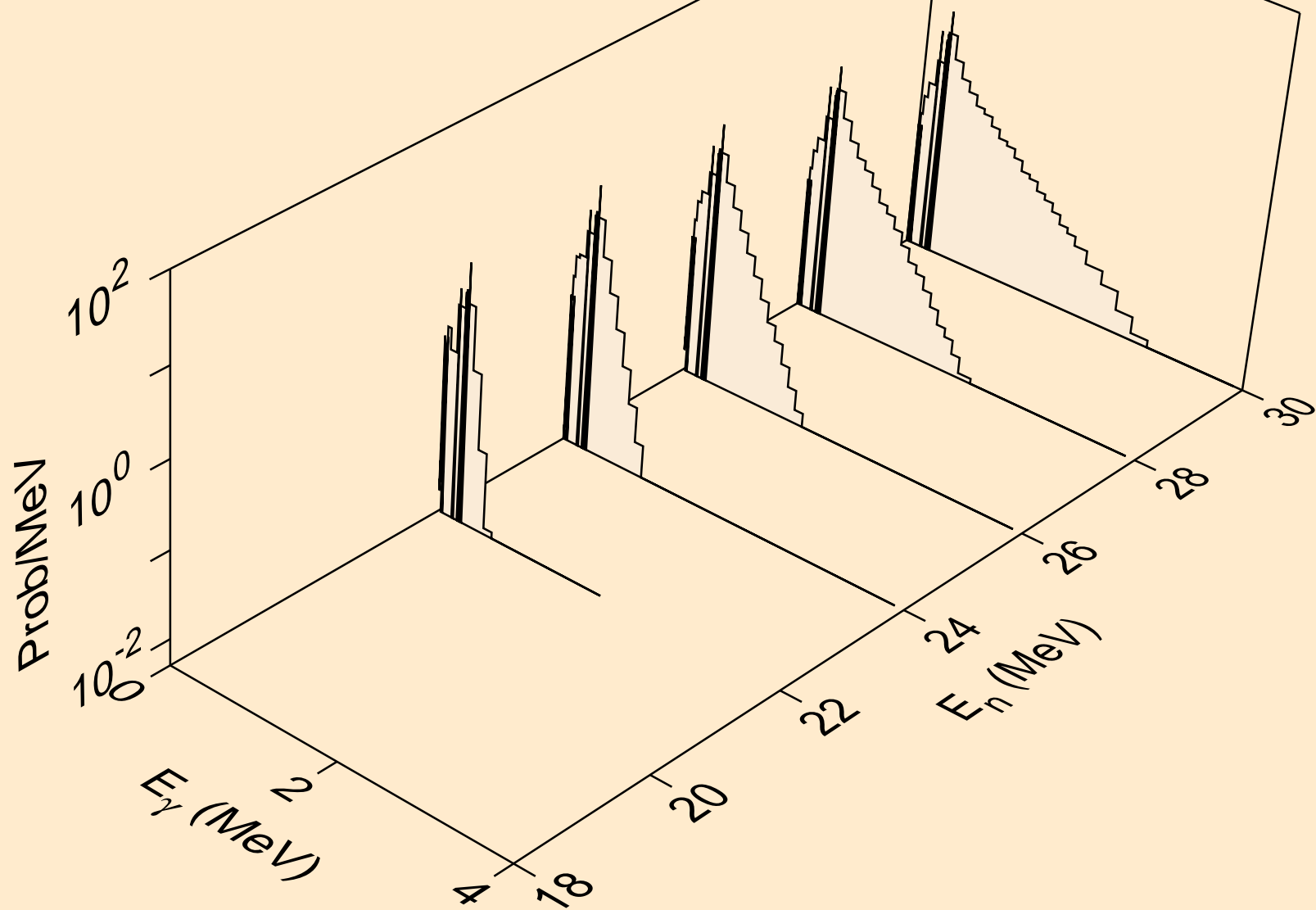

BR079 ALPHA ACER TENDL-2021 LIBRARY; T=0.K  
Photon emission for (n,pt)

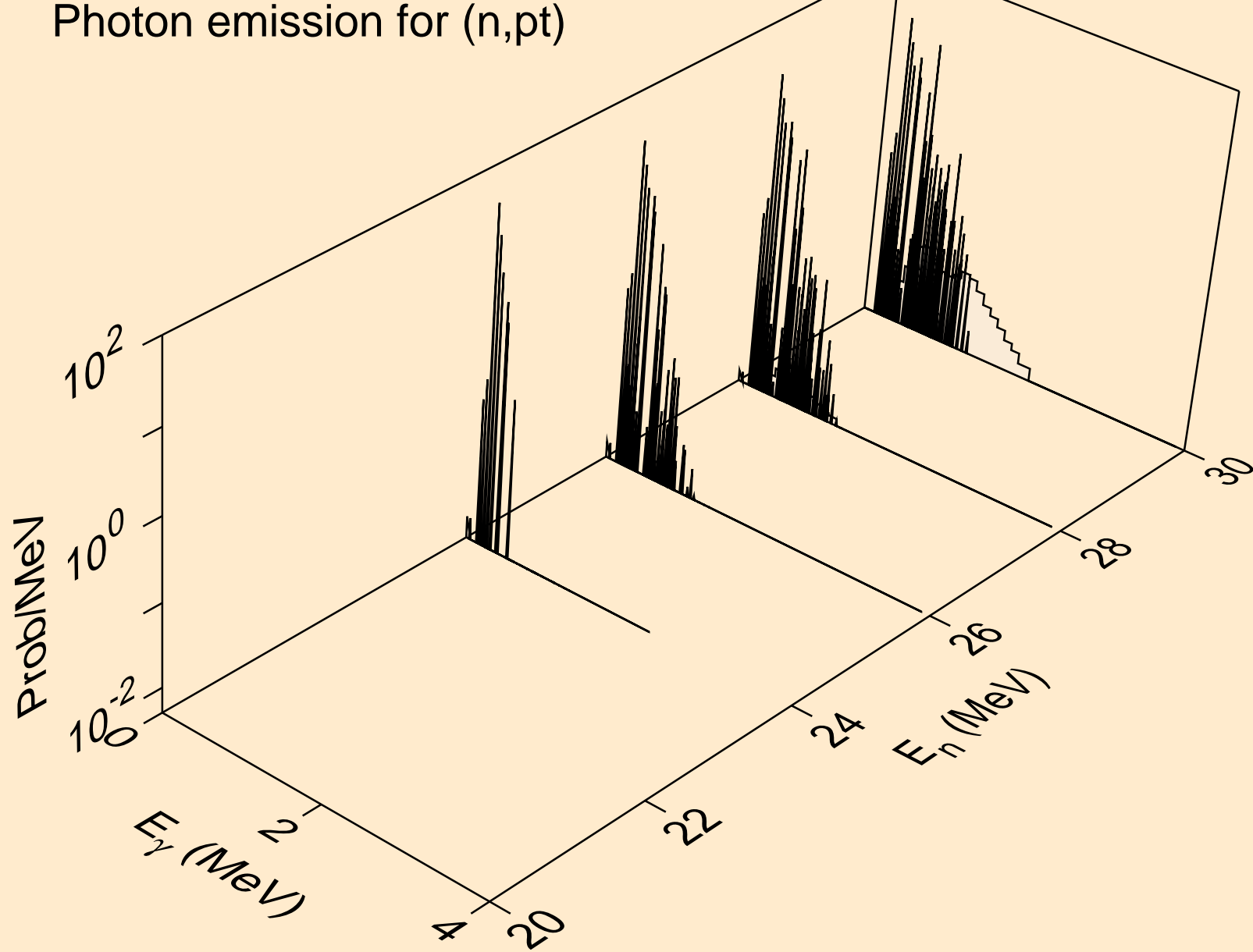



BR079 ALPHA ACER TENDL-2021 LIBRARY; T=0.K  
Photon emission for (n,da)

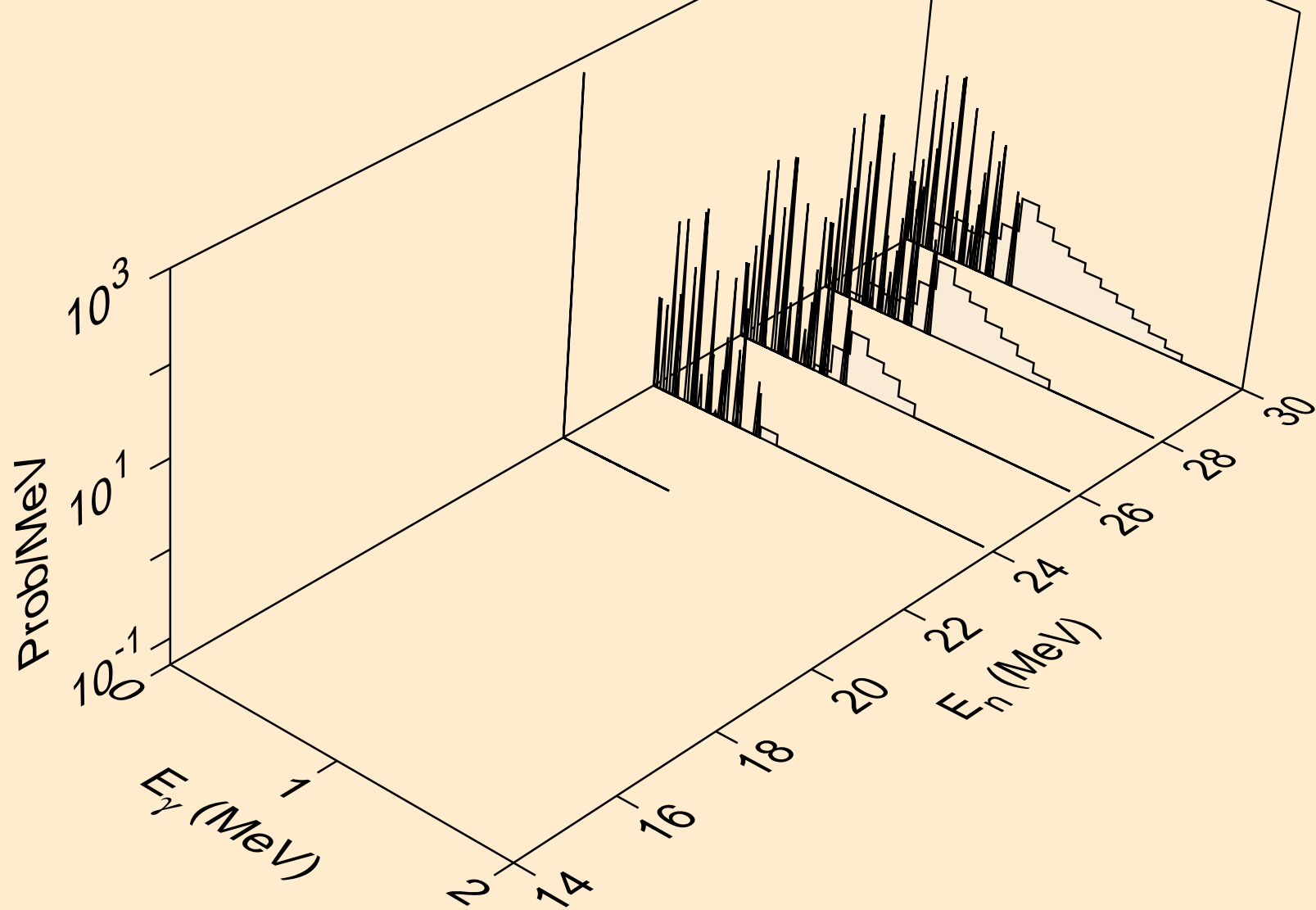

BR079 ALPHA ACER TENDL-2021 LIBRARY; T=0.K  
Particle heating contributions

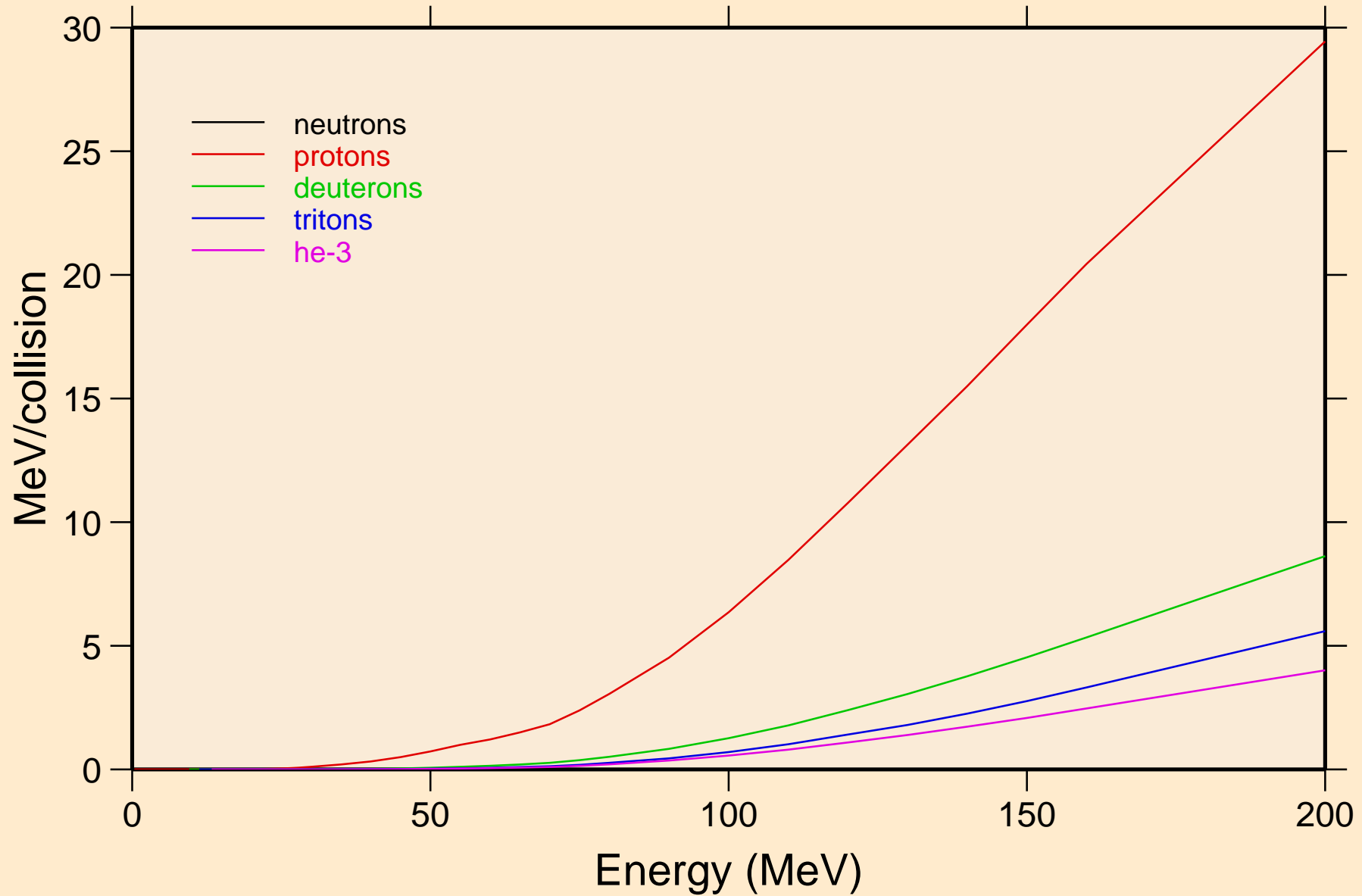

BR079 ALPHA ACER TENDL-2021 LIBRARY; T=0.K  
Recoil Heating

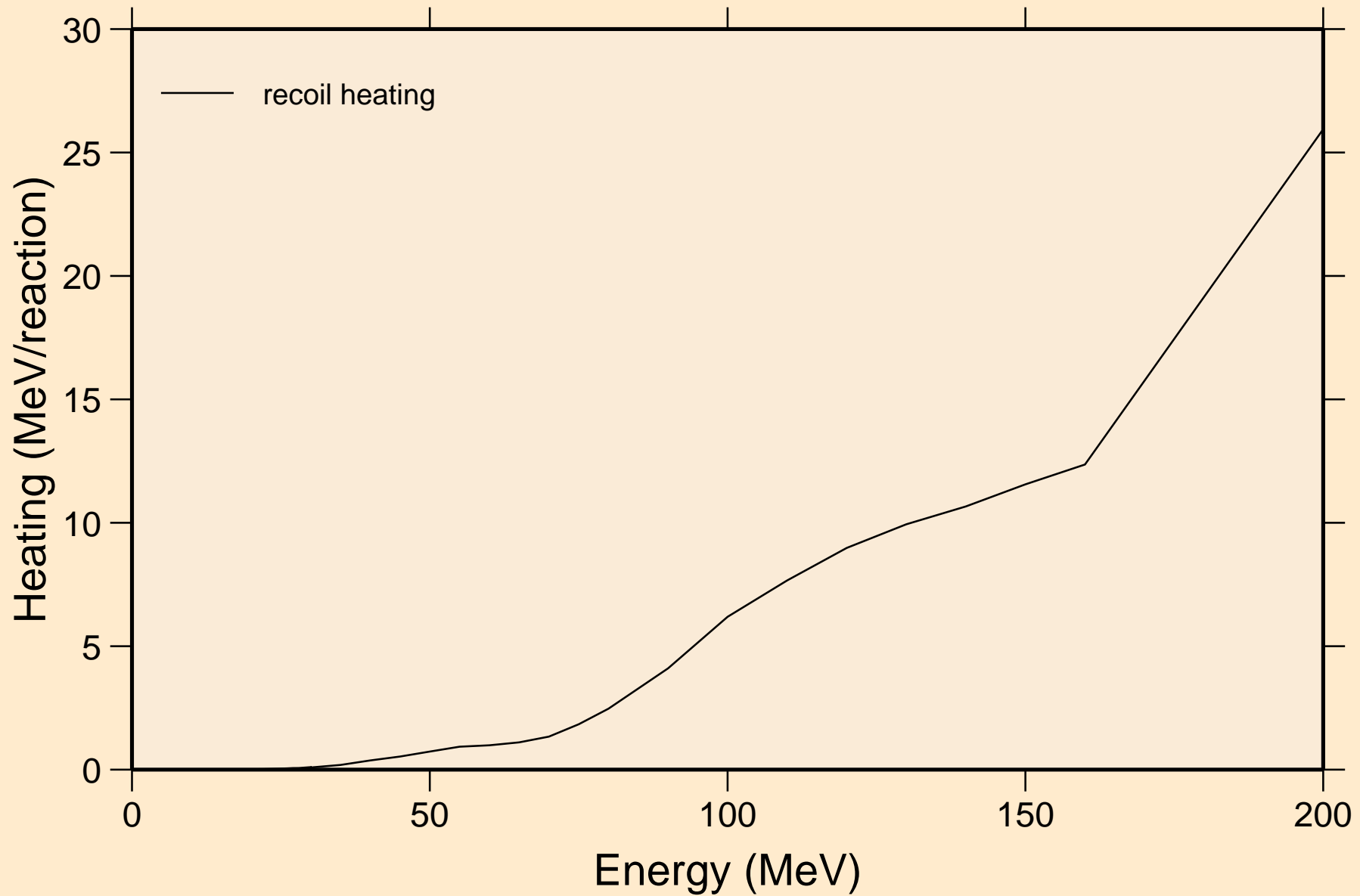

BR079 ALPHA ACER TENDL-2021 LIBRARY; T=0.K  
Particle production cross sections

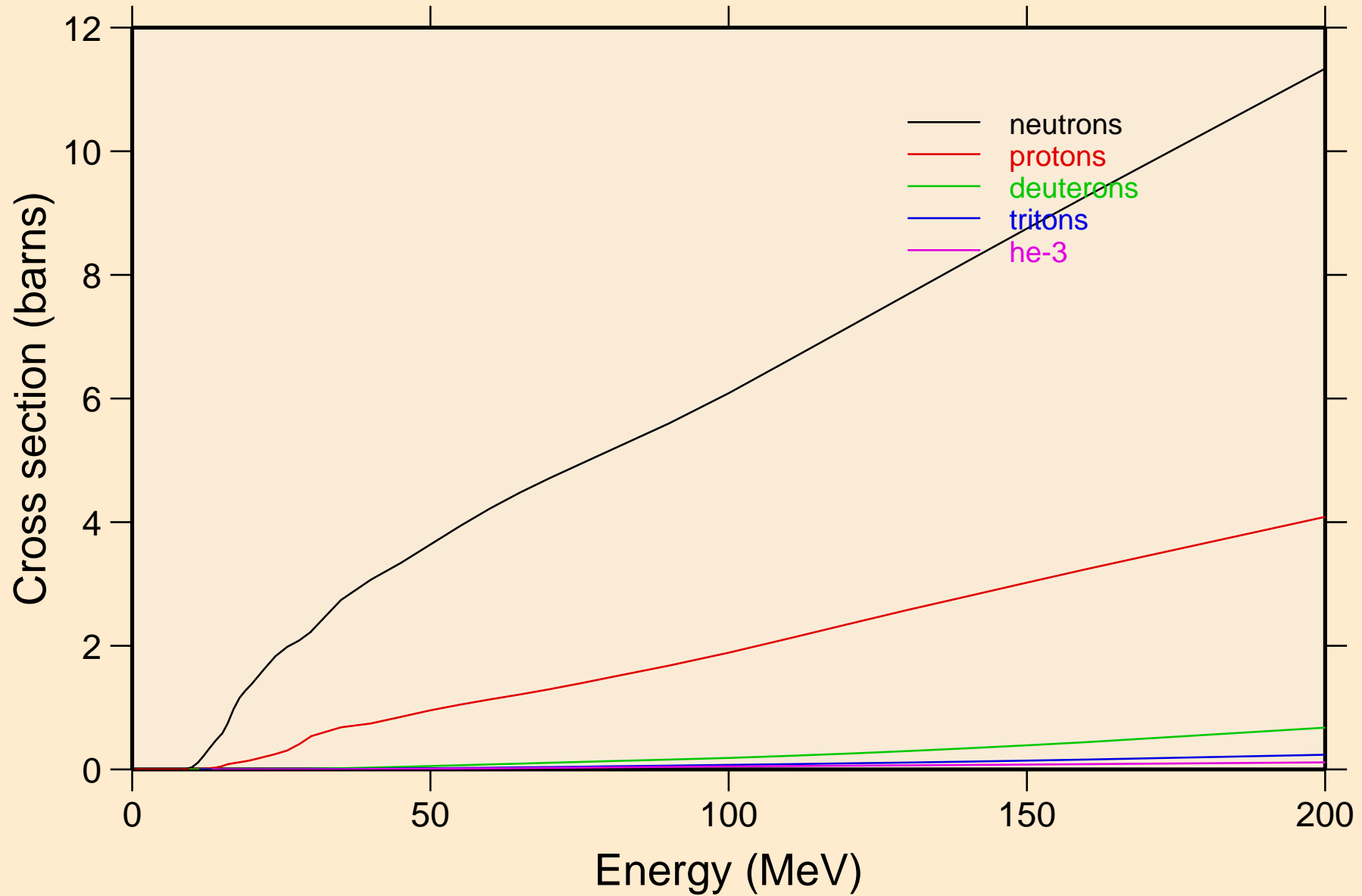

BR079 ALPHA ACER TENDL-2021 LIBRARY; T=0.K  
neutrons from (a,n)

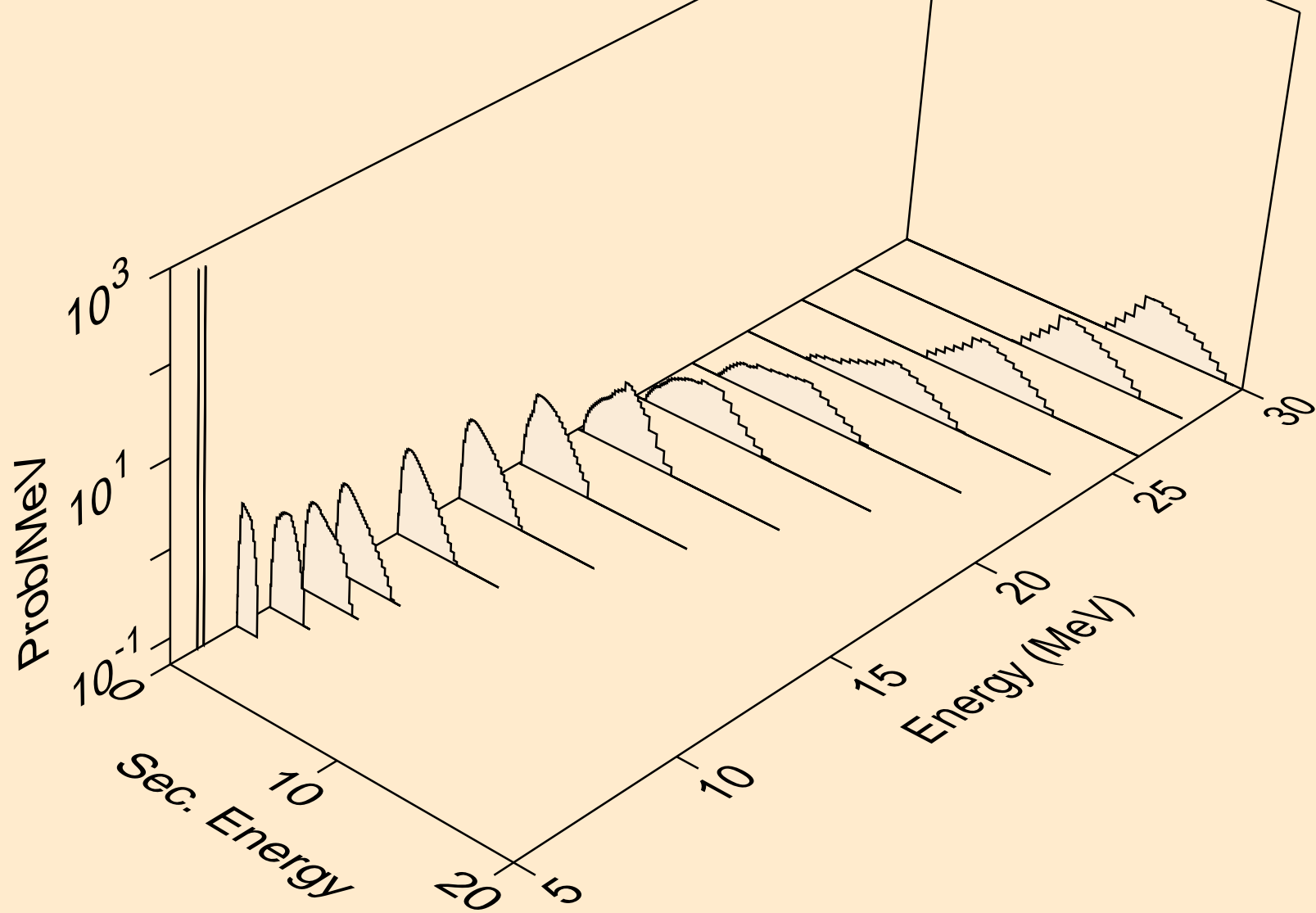

BR079 ALPHA ACER TENDL-2021 LIBRARY; T=0.K  
neutrons from (a,x)

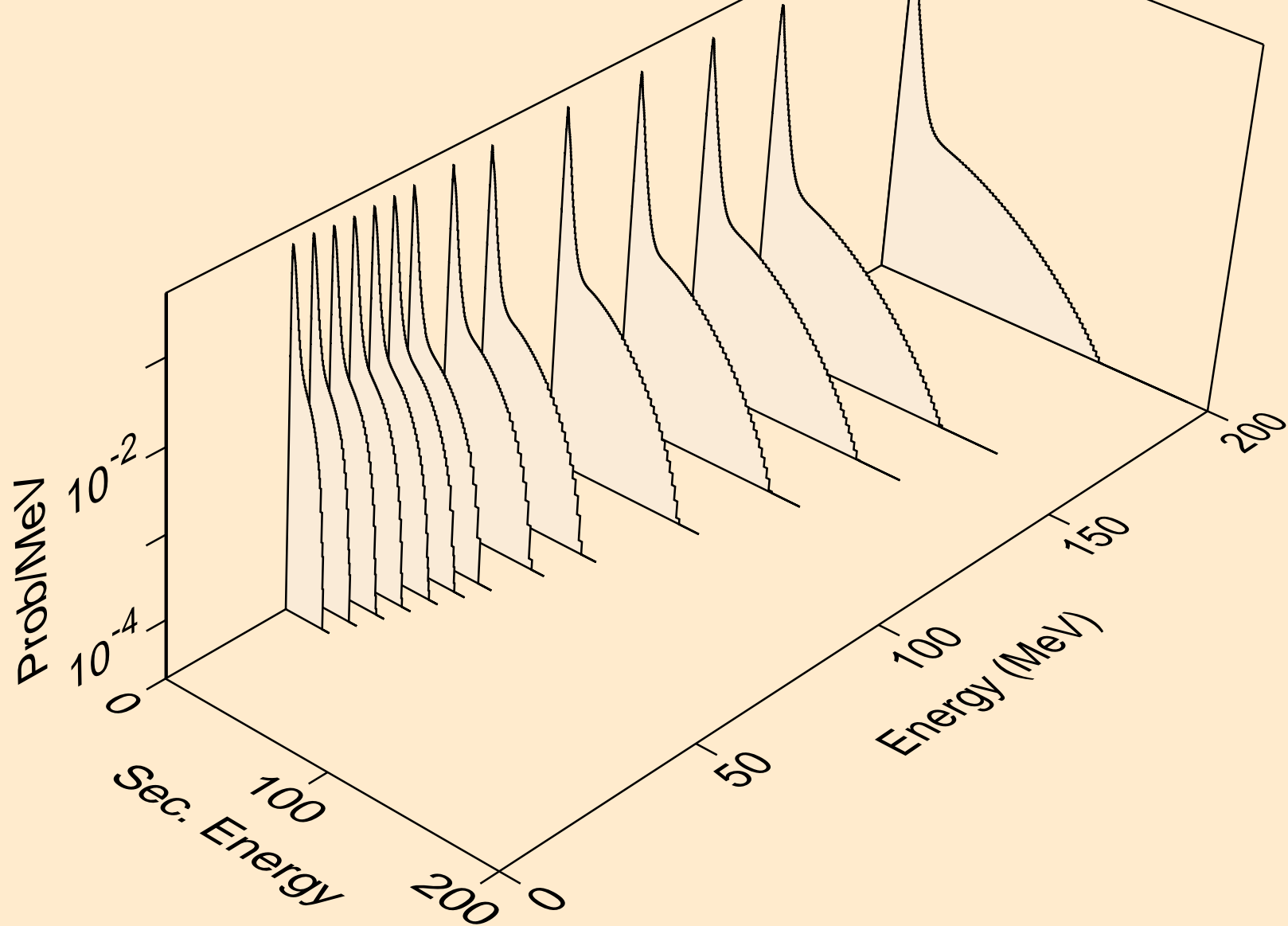

BR079 ALPHA ACER TENDL-2021 LIBRARY; T=0.K  
neutrons from (a,2n)

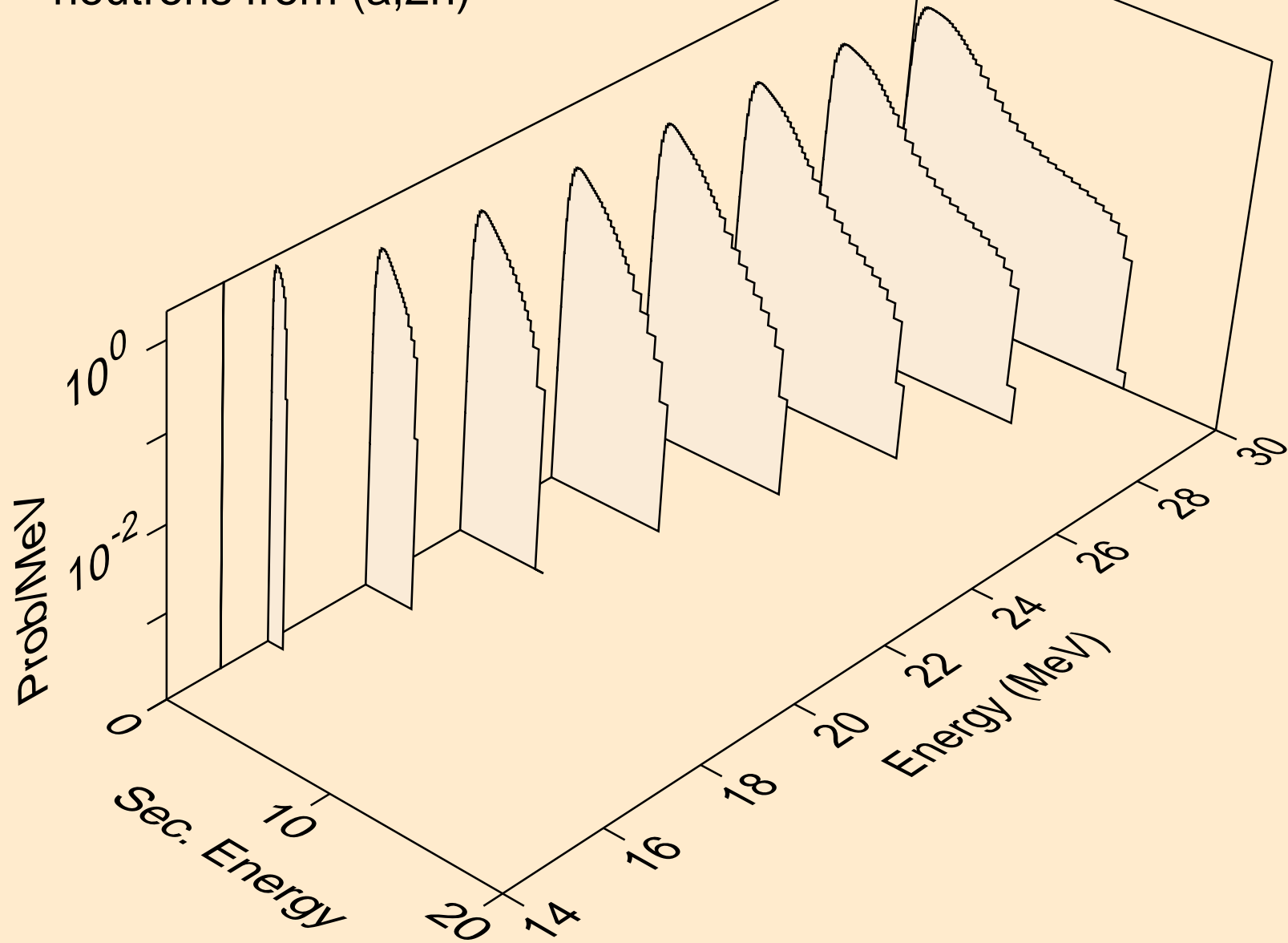

BR079 ALPHA ACER TENDL-2021 LIBRARY; T=0.K  
neutrons from (a,3n)

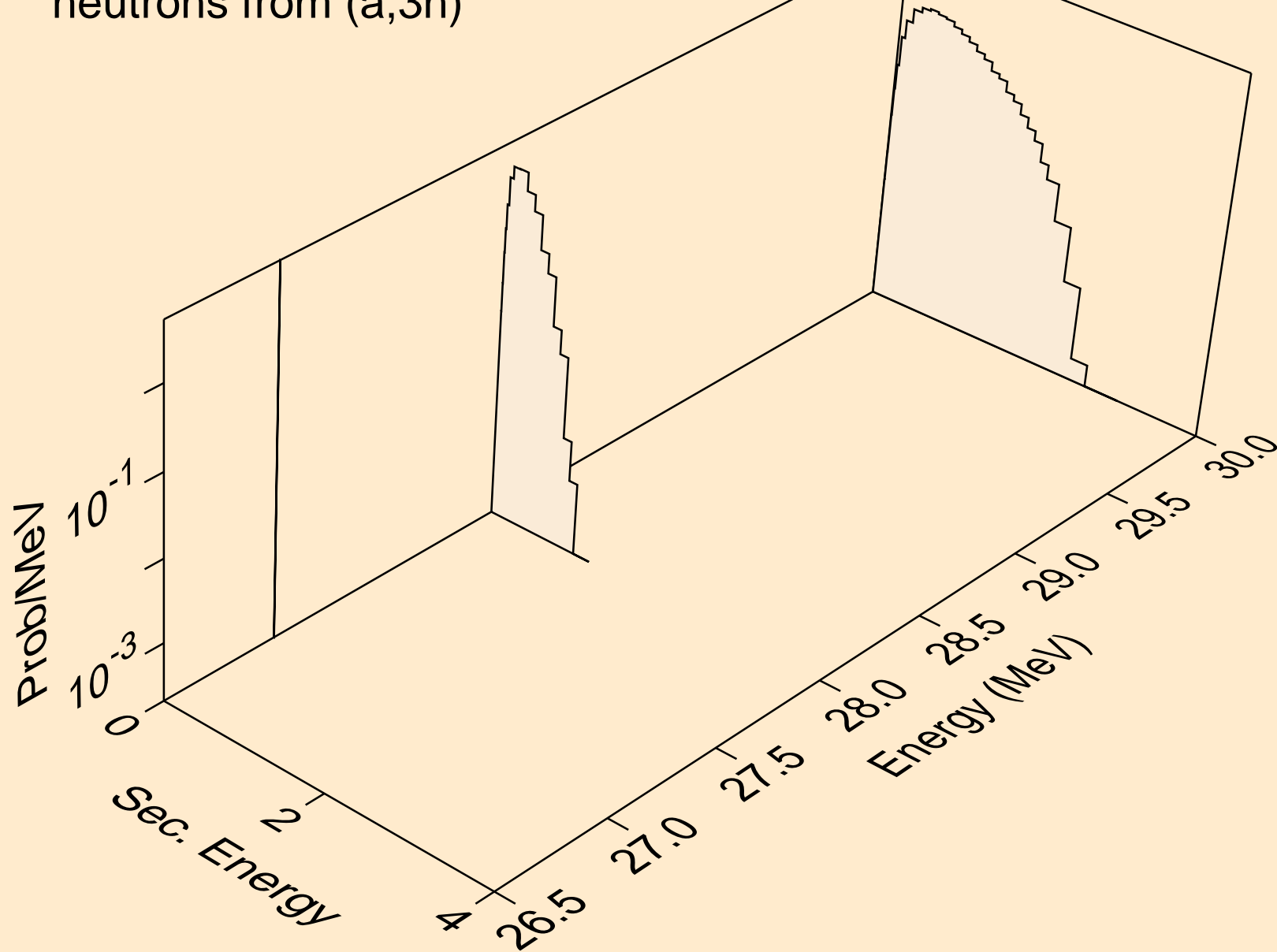



BR079 ALPHA ACER TENDL-2021 LIBRARY; T=0.K  
neutrons from (a,n\*)a

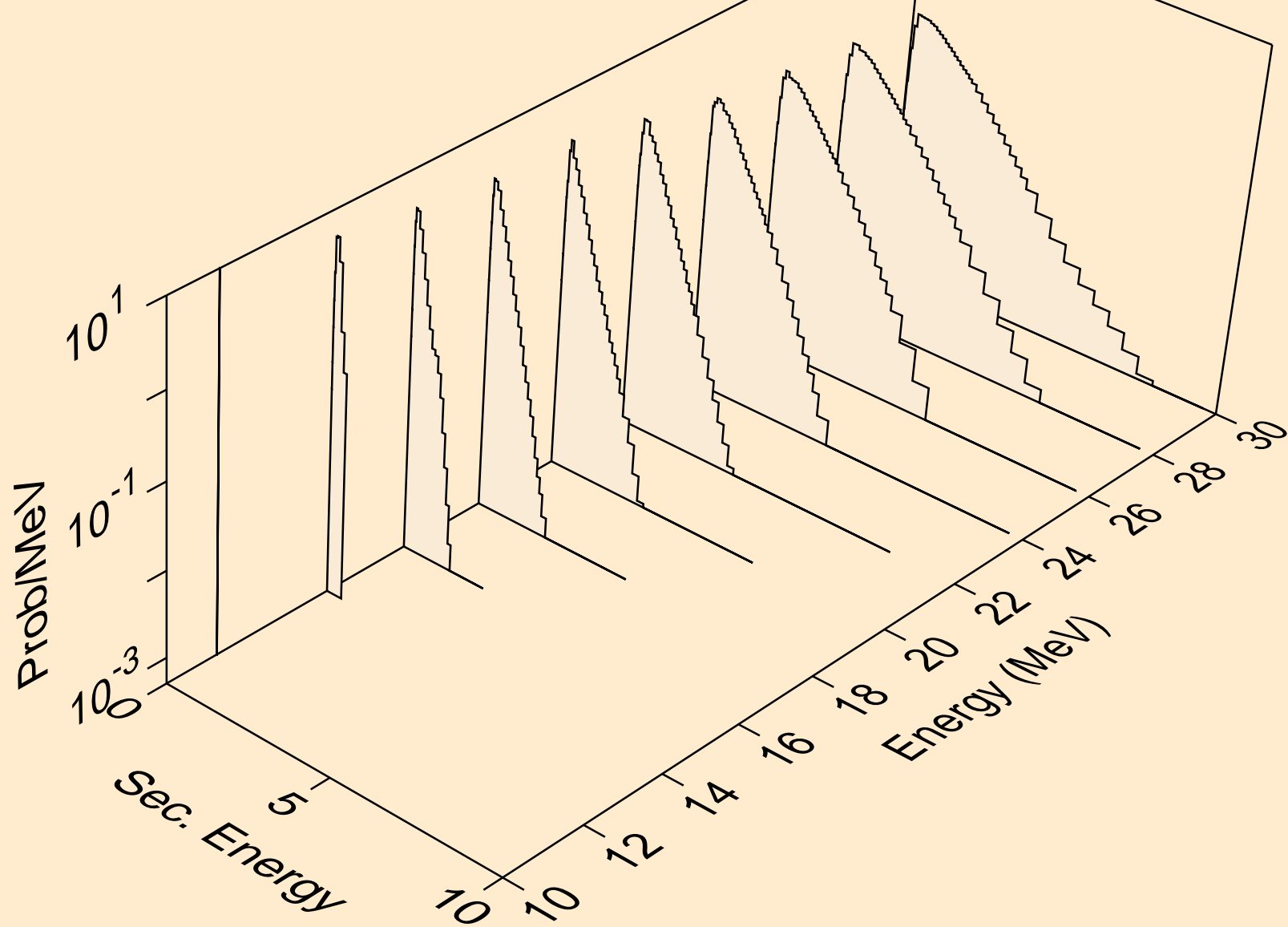

BR079 ALPHA ACER TENDL-2021 LIBRARY; T=0.K  
neutrons from (a,2n)a

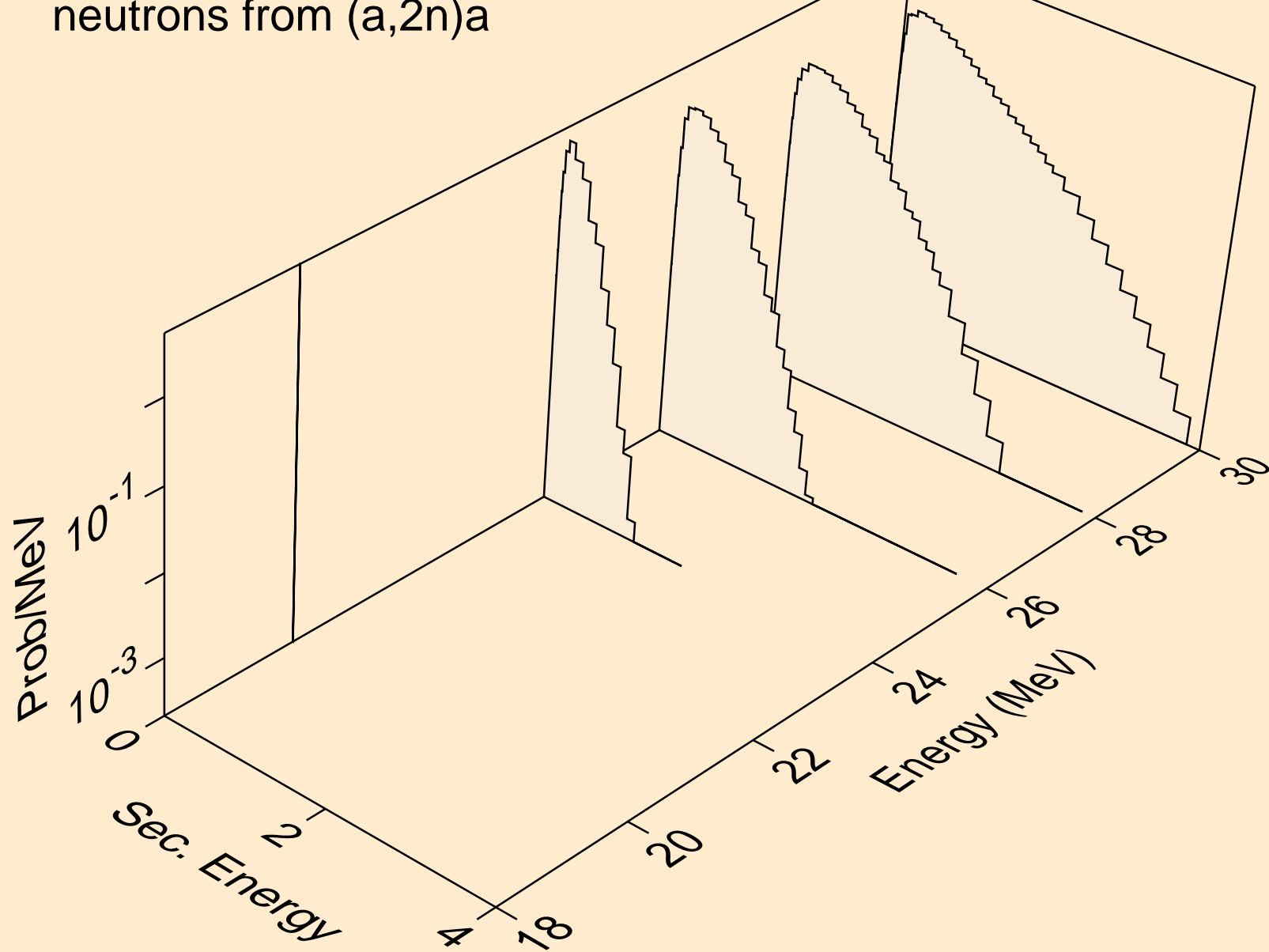

BR079 ALPHA ACER TENDL-2021 LIBRARY; T=0.K  
neutrons from (a,n\*)p

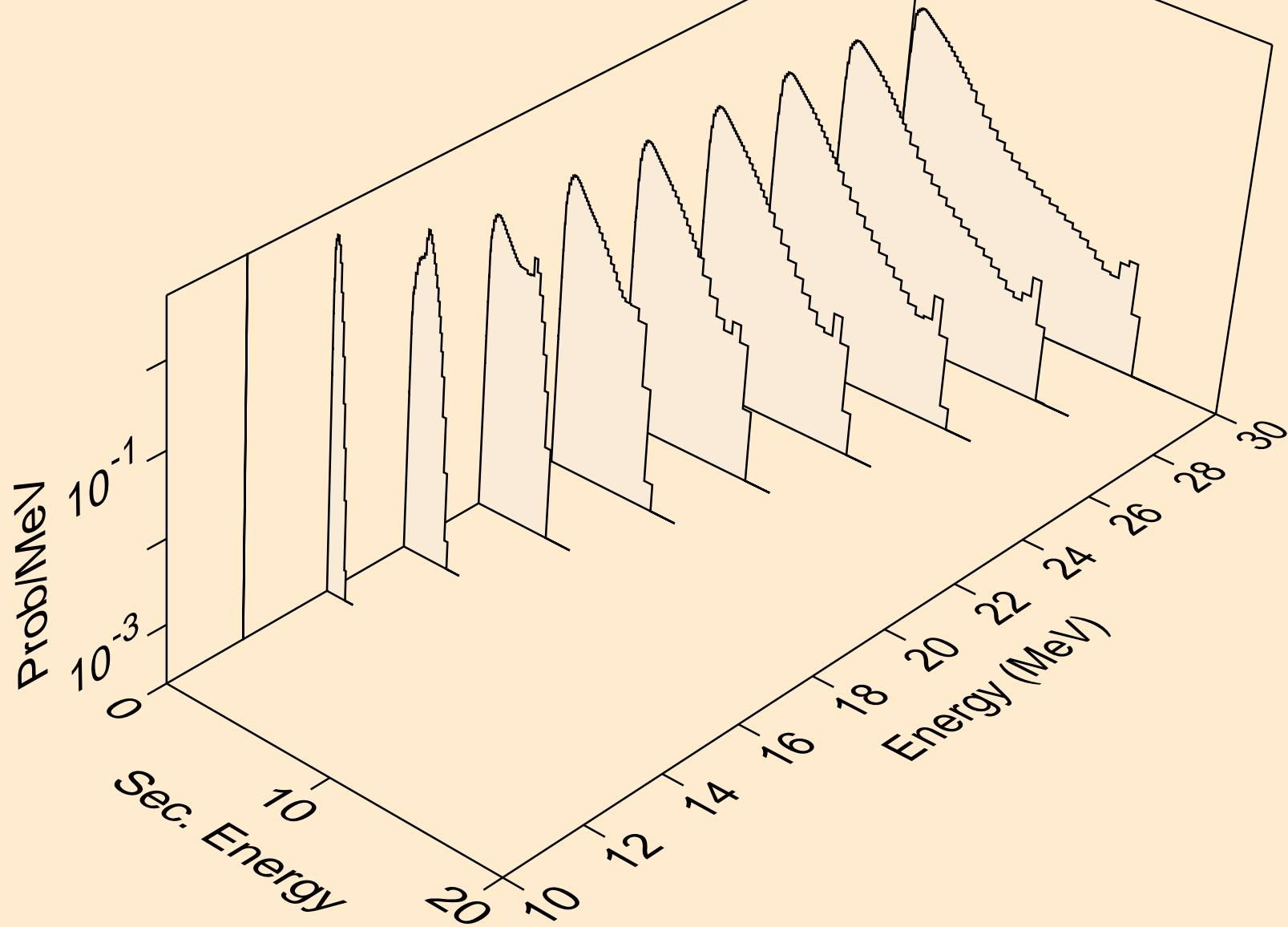

BR079 ALPHA ACER TENDL-2021 LIBRARY; T=0.K  
neutrons from (a,n\*)d

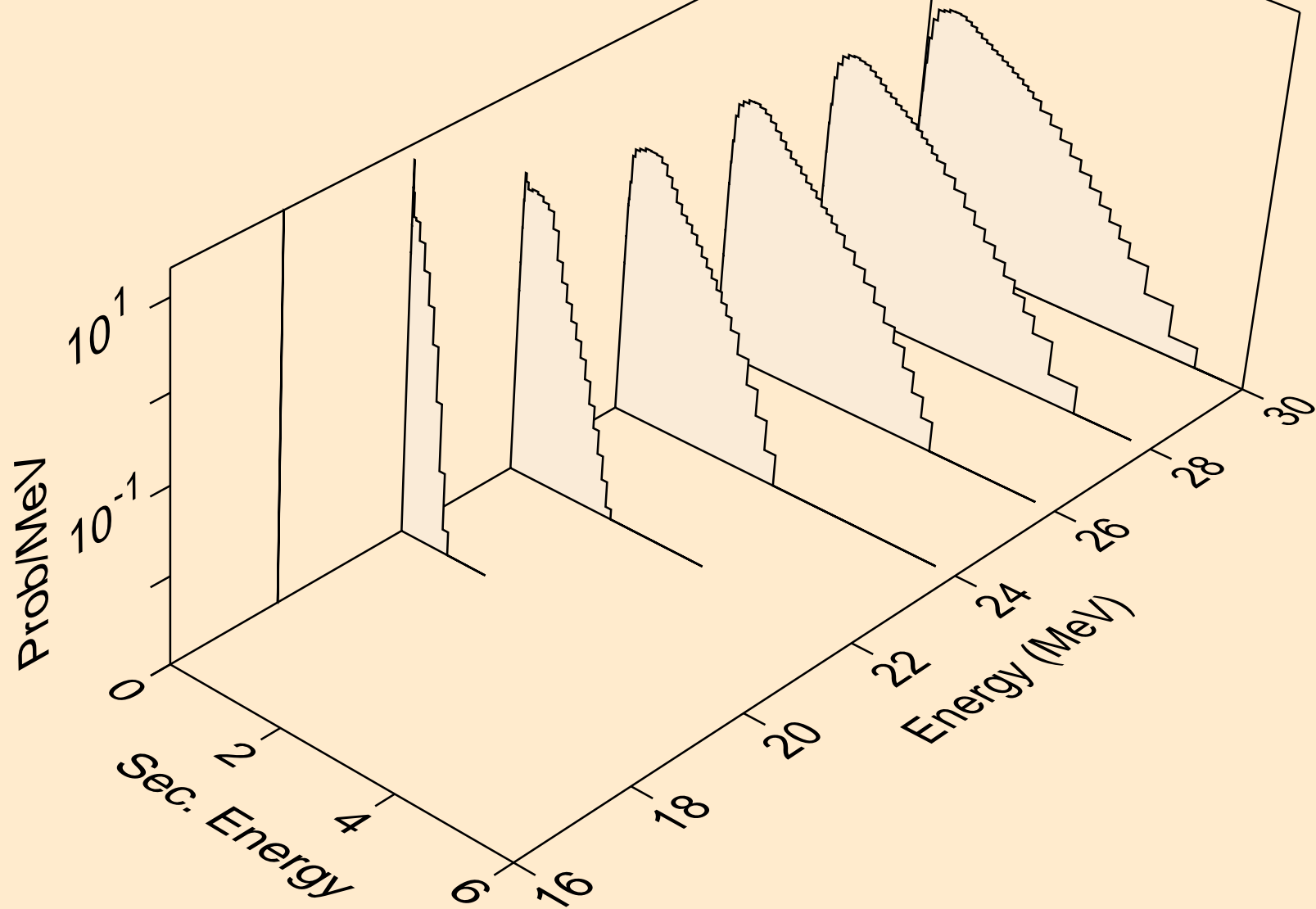

BR079 ALPHA ACER TENDL-2021 LIBRARY; T=0.K  
neutrons from (a,n\*)t

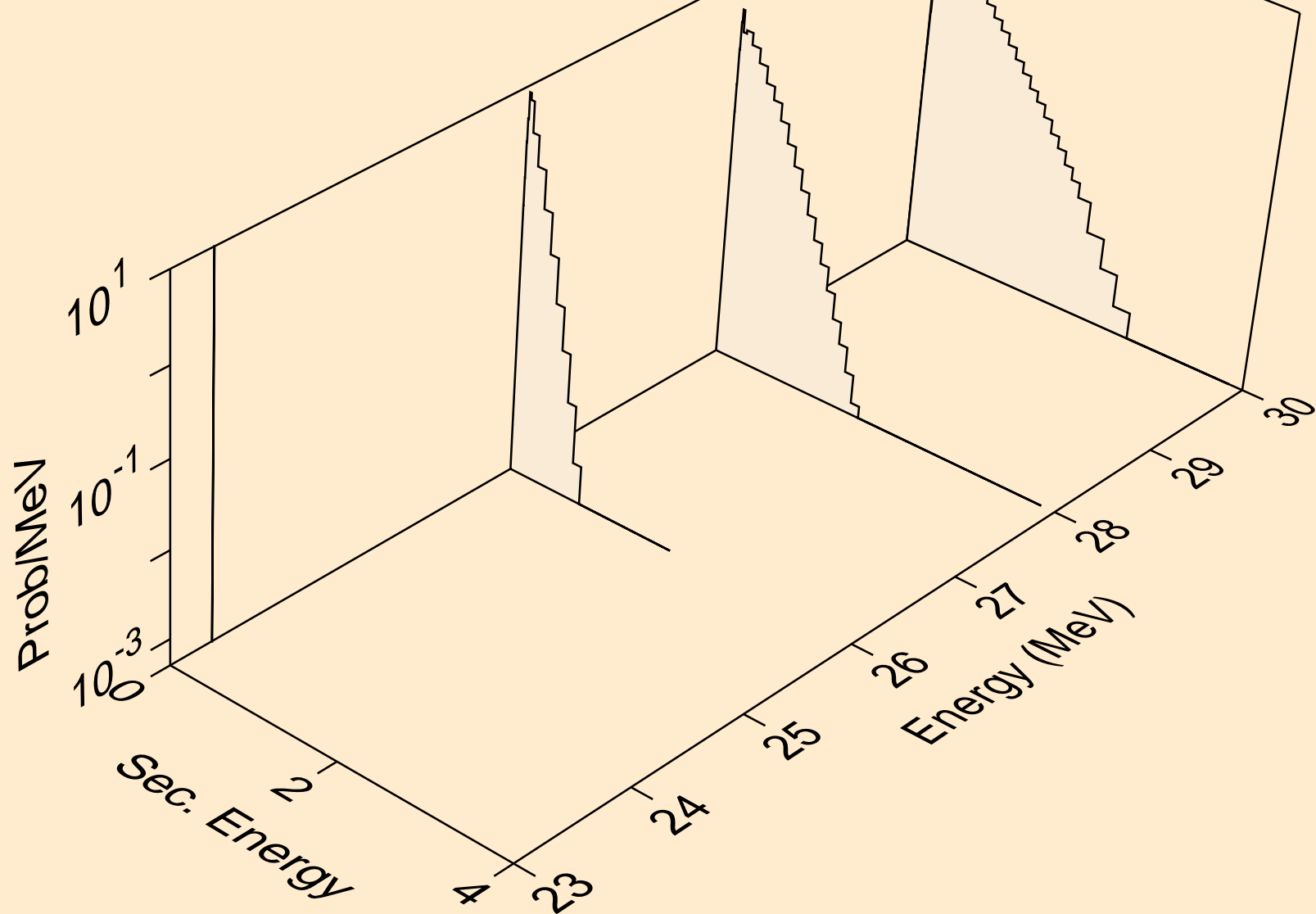

BR079 ALPHA ACER TENDL-2021 LIBRARY; T=0.K  
neutrons from (a,n\*)he3

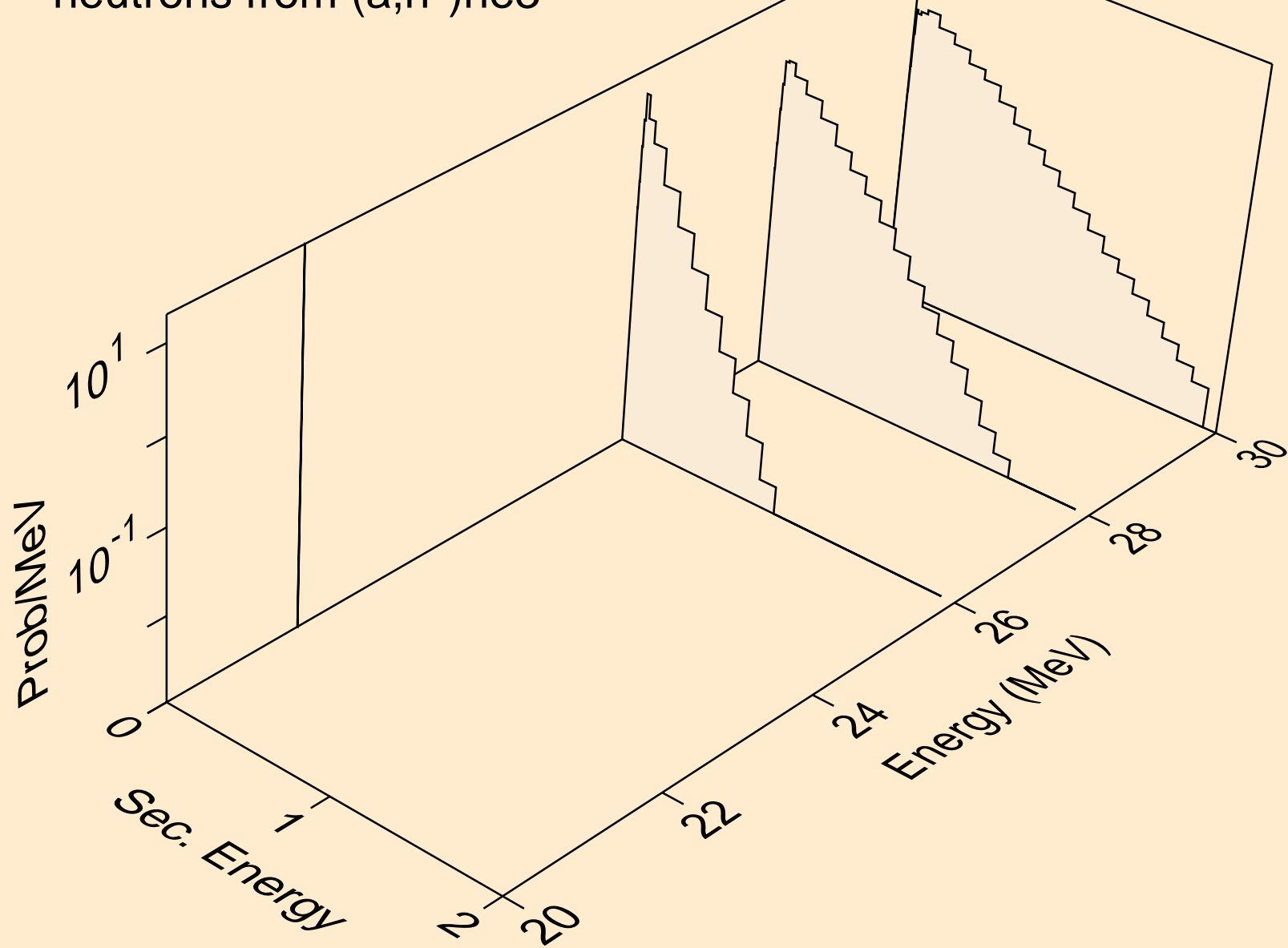

BR079 ALPHA ACER TENDL-2021 LIBRARY; T=0.K  
neutrons from (a,2np)

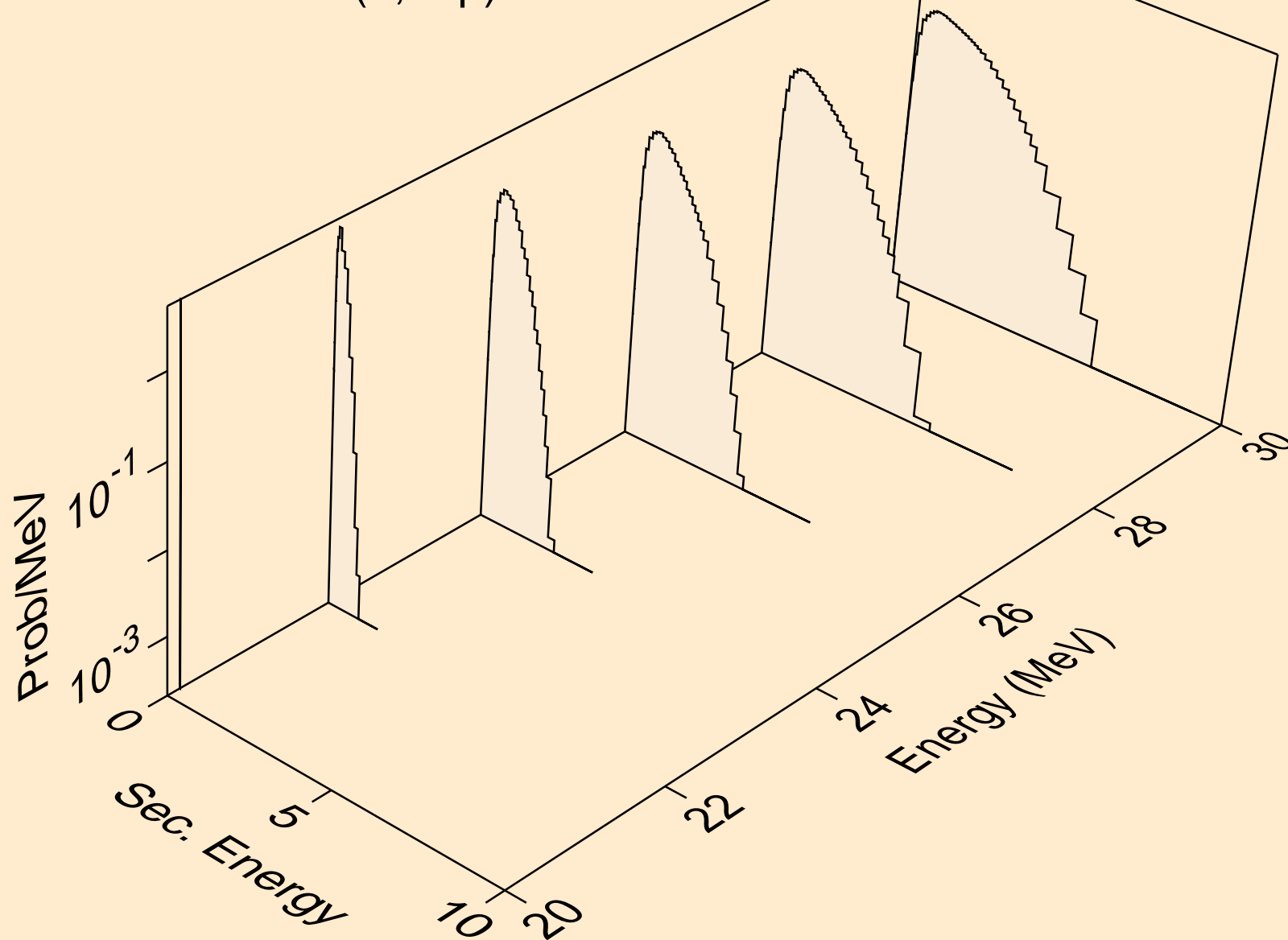

BR079 ALPHA ACER TENDL-2021 LIBRARY; T=0.K  
neutrons from (a,2np)

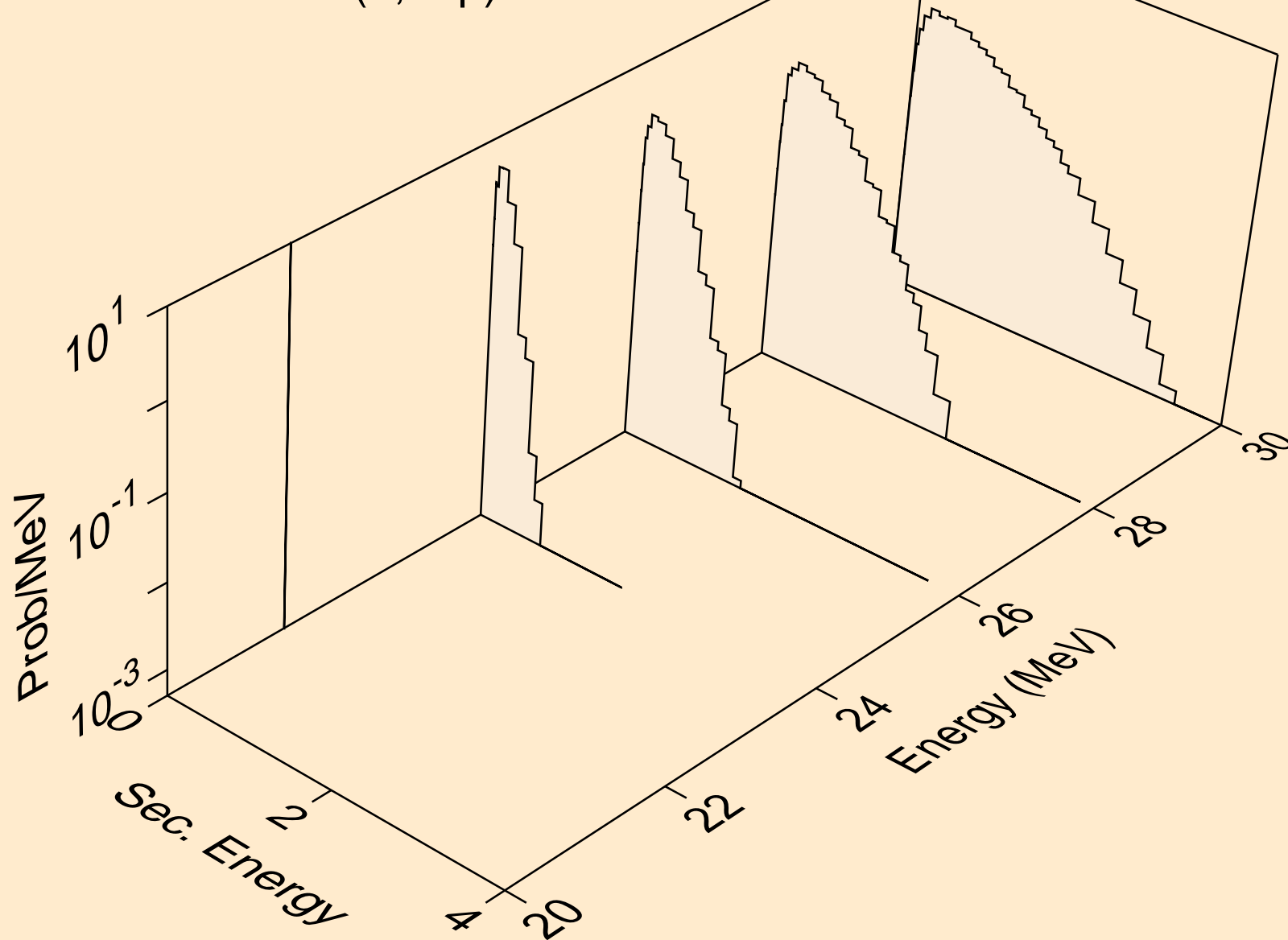



BR079 ALPHA ACER TENDL-2021 LIBRARY; T=0.K  
neutrons from (a,npa)

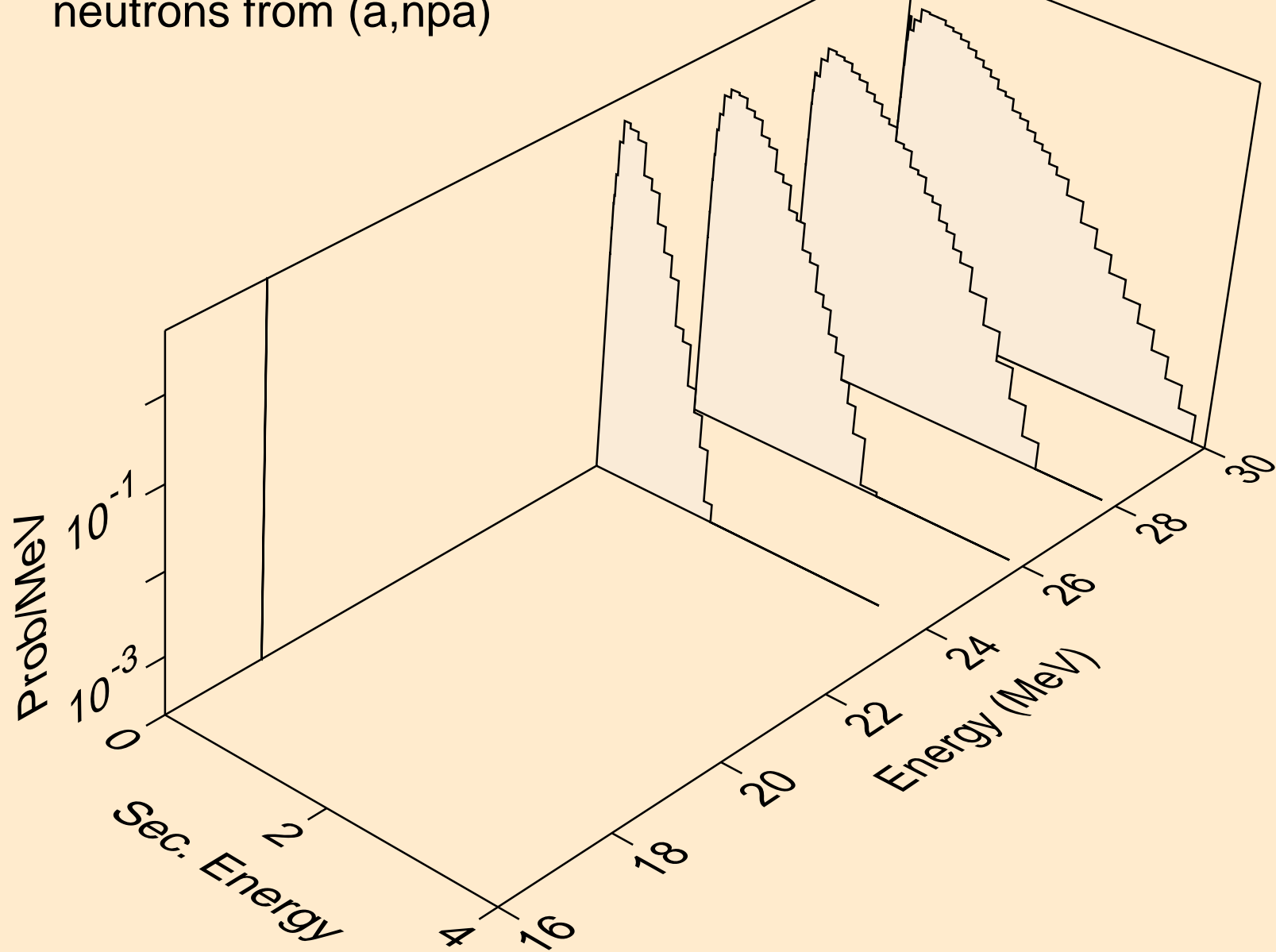

BR079 ALPHA ACER TENDL-2021 LIBRARY; T=0.K  
protons from (a,x)

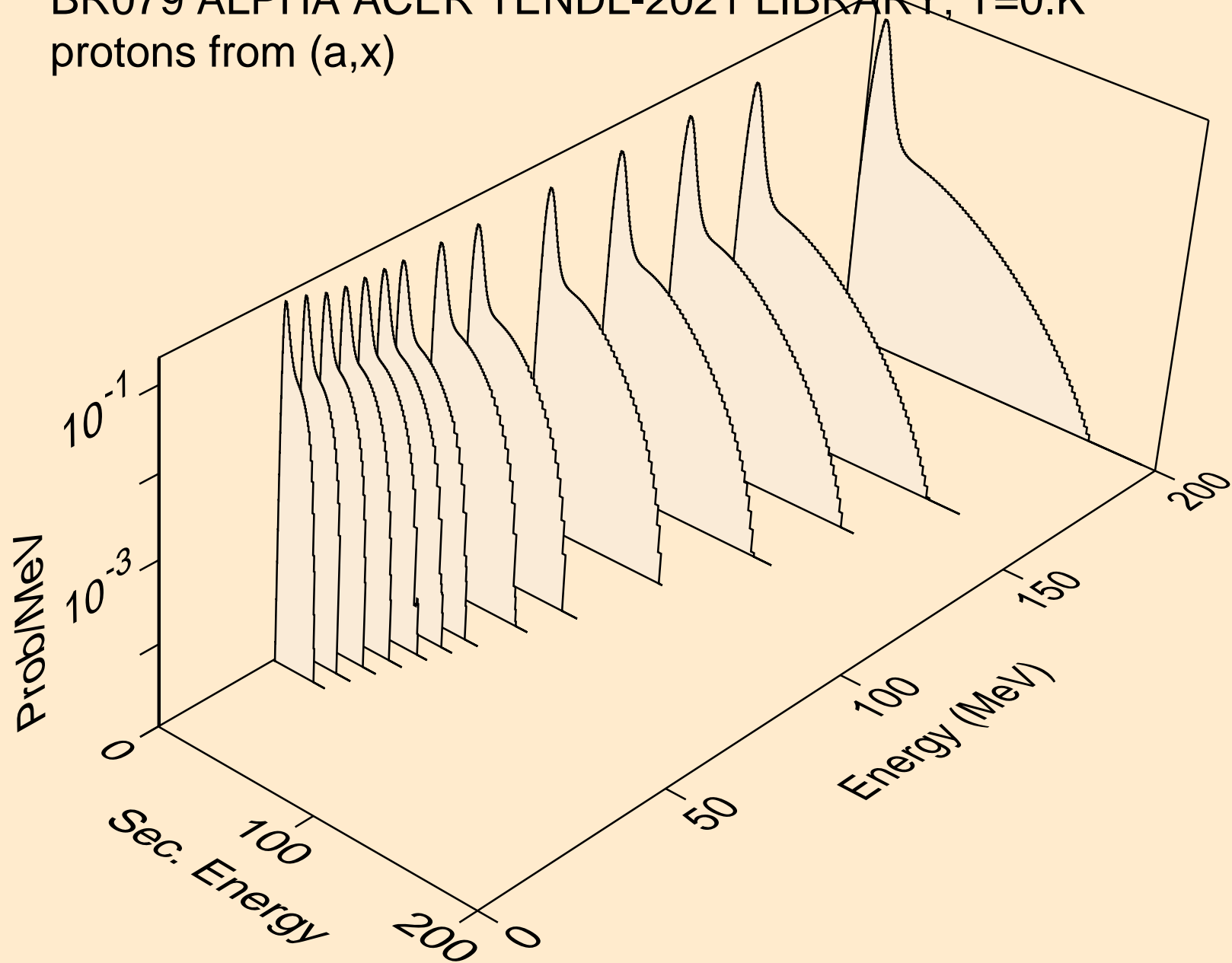

BR079 ALPHA ACER TENDL-2021 LIBRARY; T=0.K  
protons from (a,n\*)p

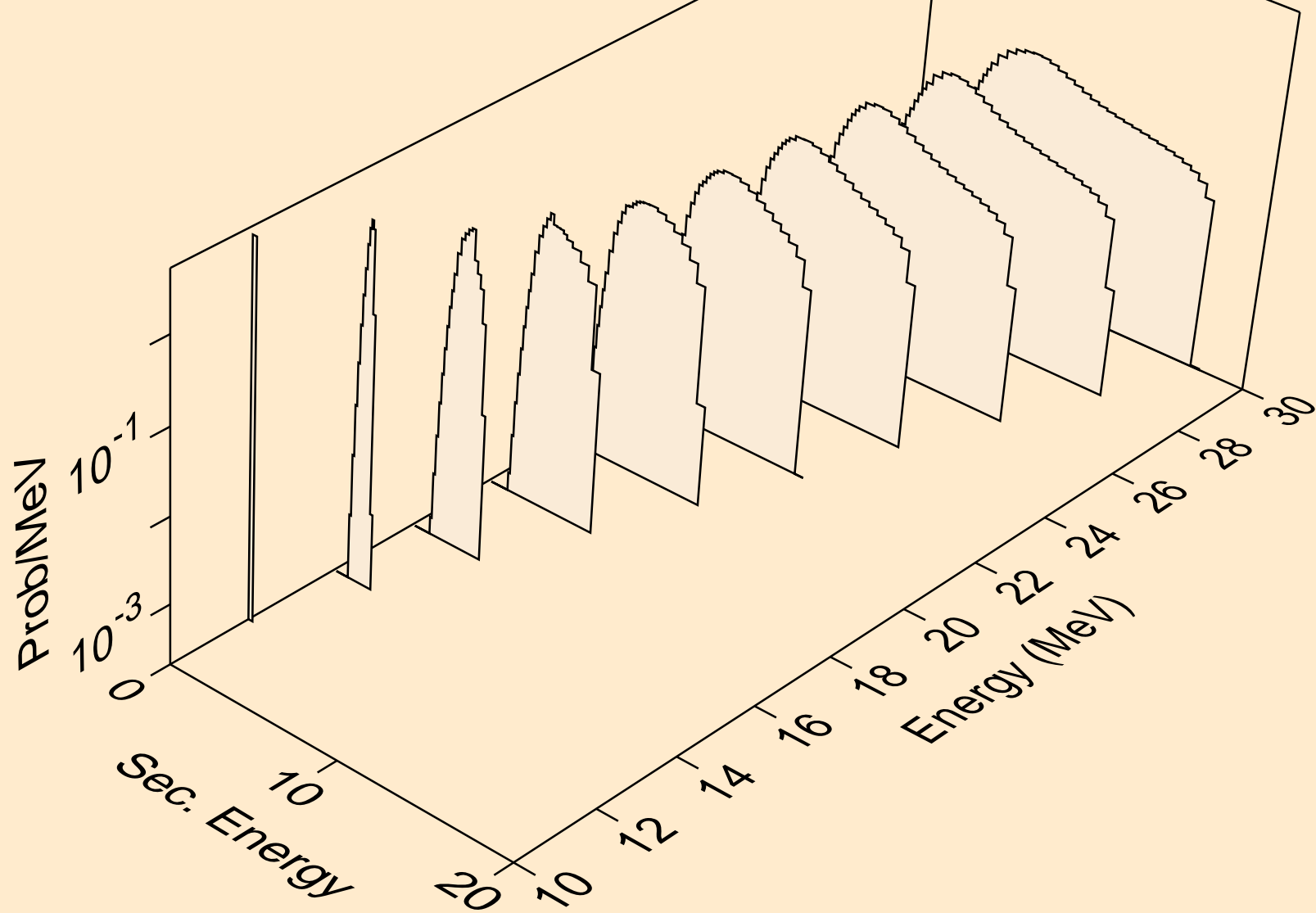

BR079 ALPHA ACER TENDL-2021 LIBRARY; T=0.K  
protons from (a,2np)

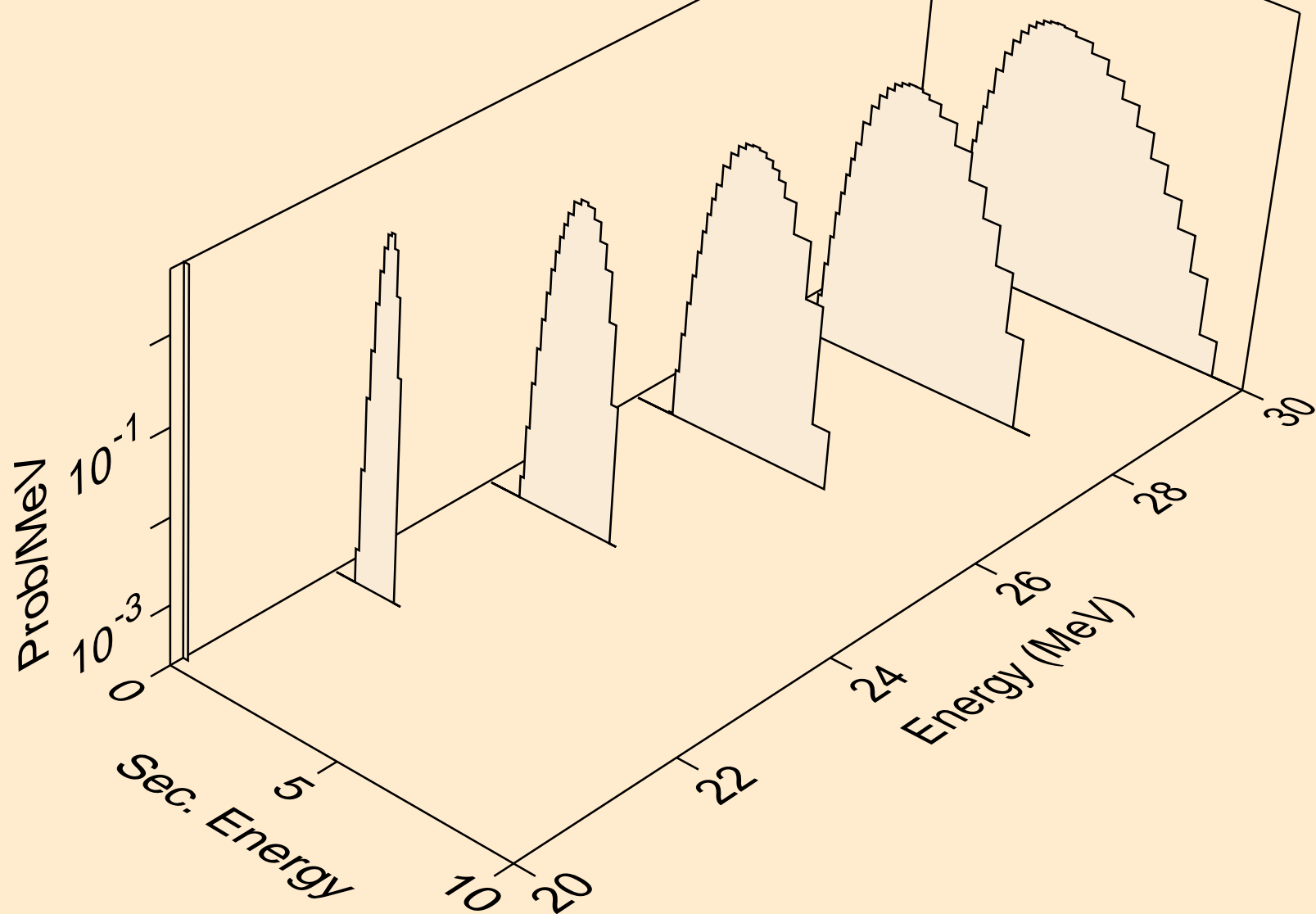

BR079 ALPHA ACER TENDL-2021 LIBRARY; T=0.K  
protons from (a,2np)

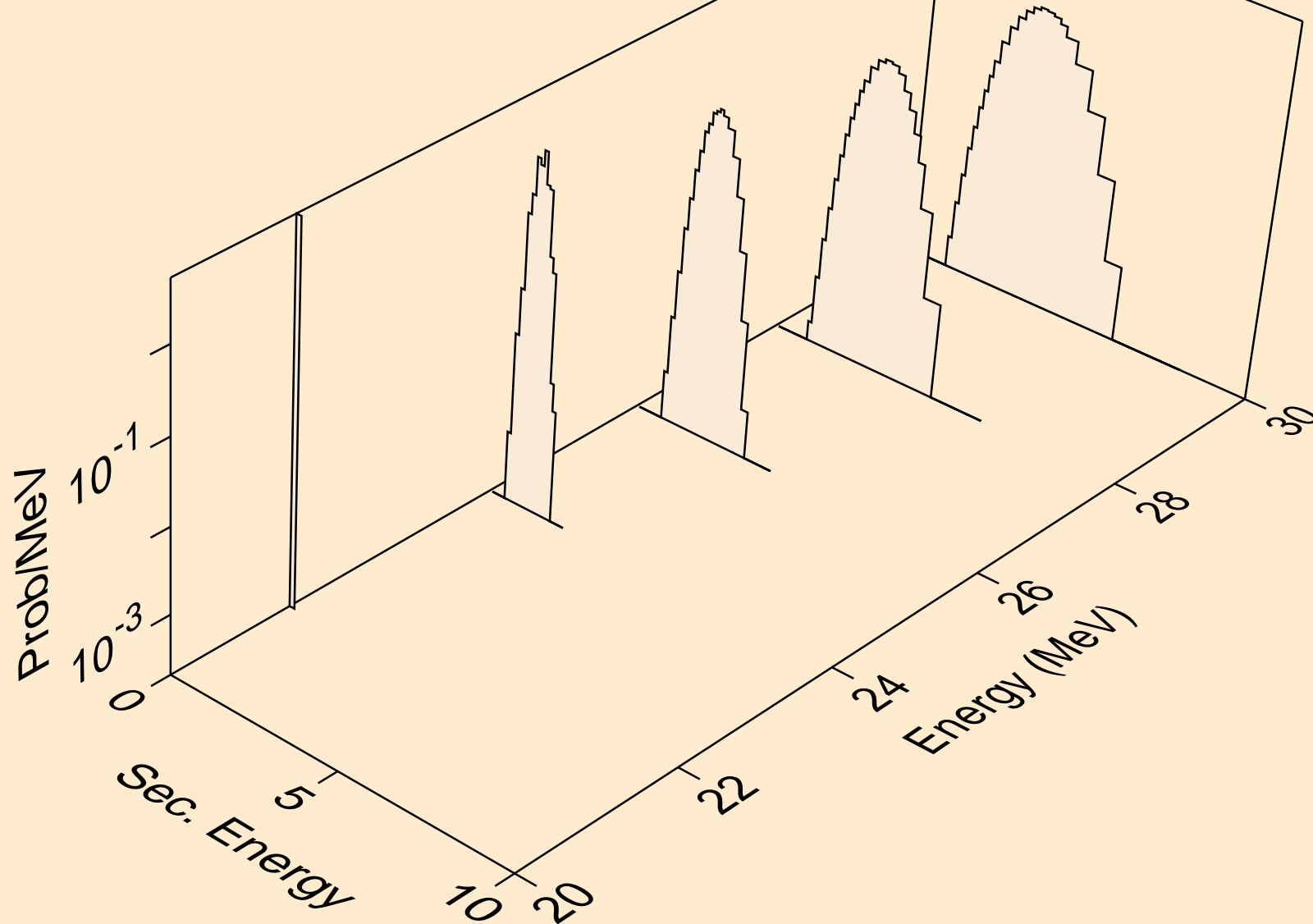

BR079 ALPHA ACER TENDL-2021 LIBRARY; T=0.K  
protons from (a,npa)

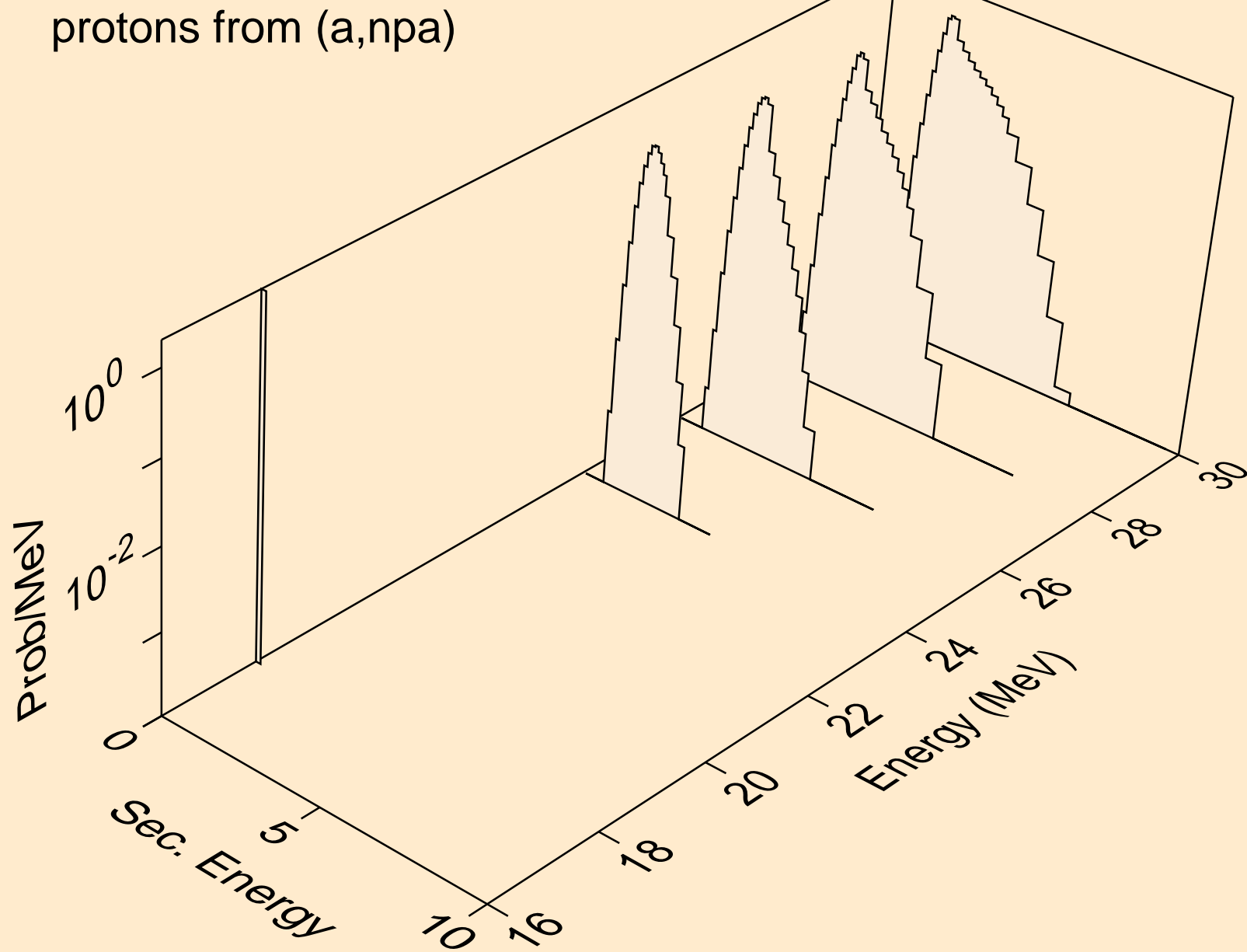

BR079 ALPHA ACER TENDL-2021 LIBRARY; T=0.K  
protons from (a,p)

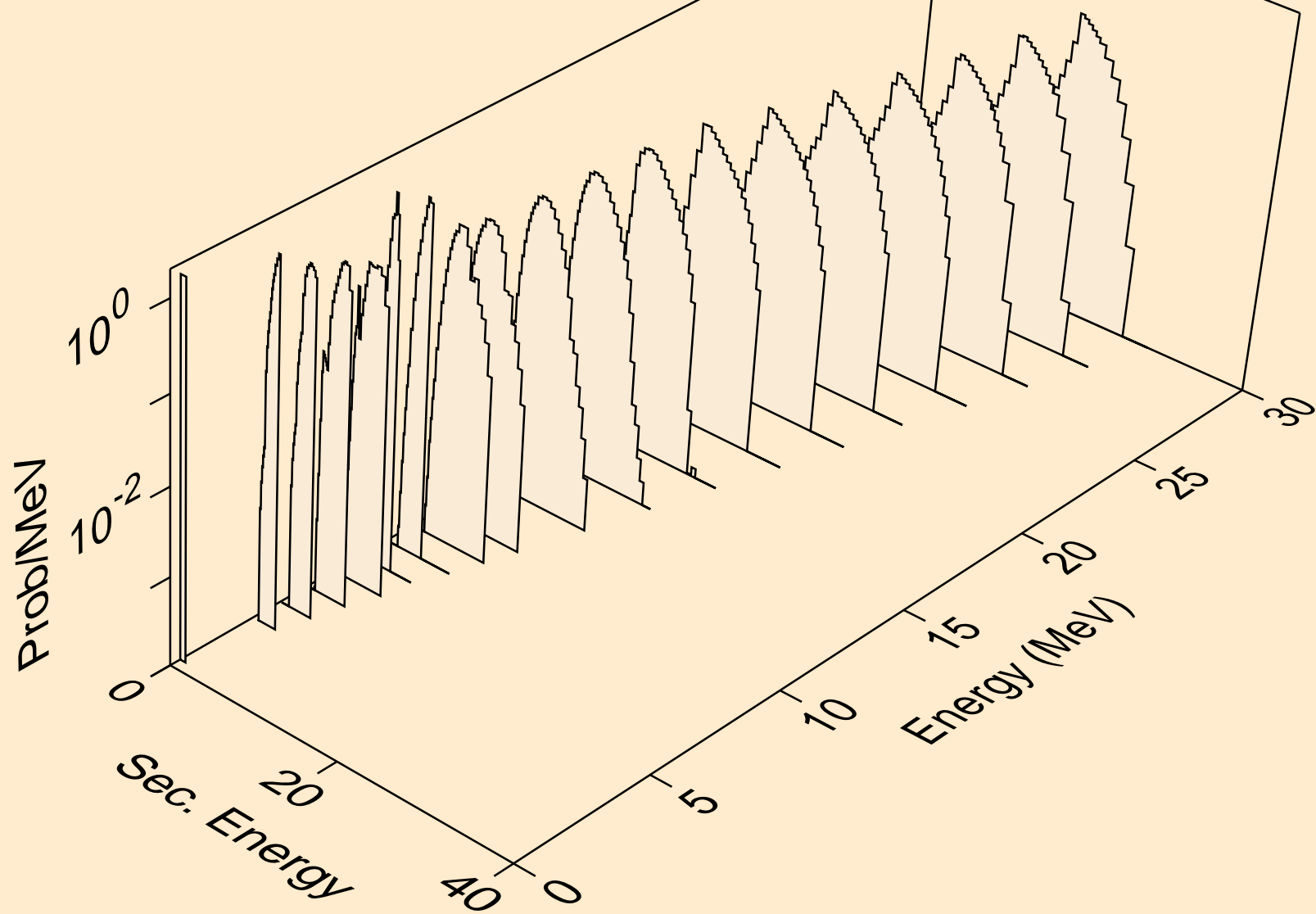

BR079 ALPHA ACER TENDL-2021 LIBRARY; T=0.K  
protons from (a,2p)

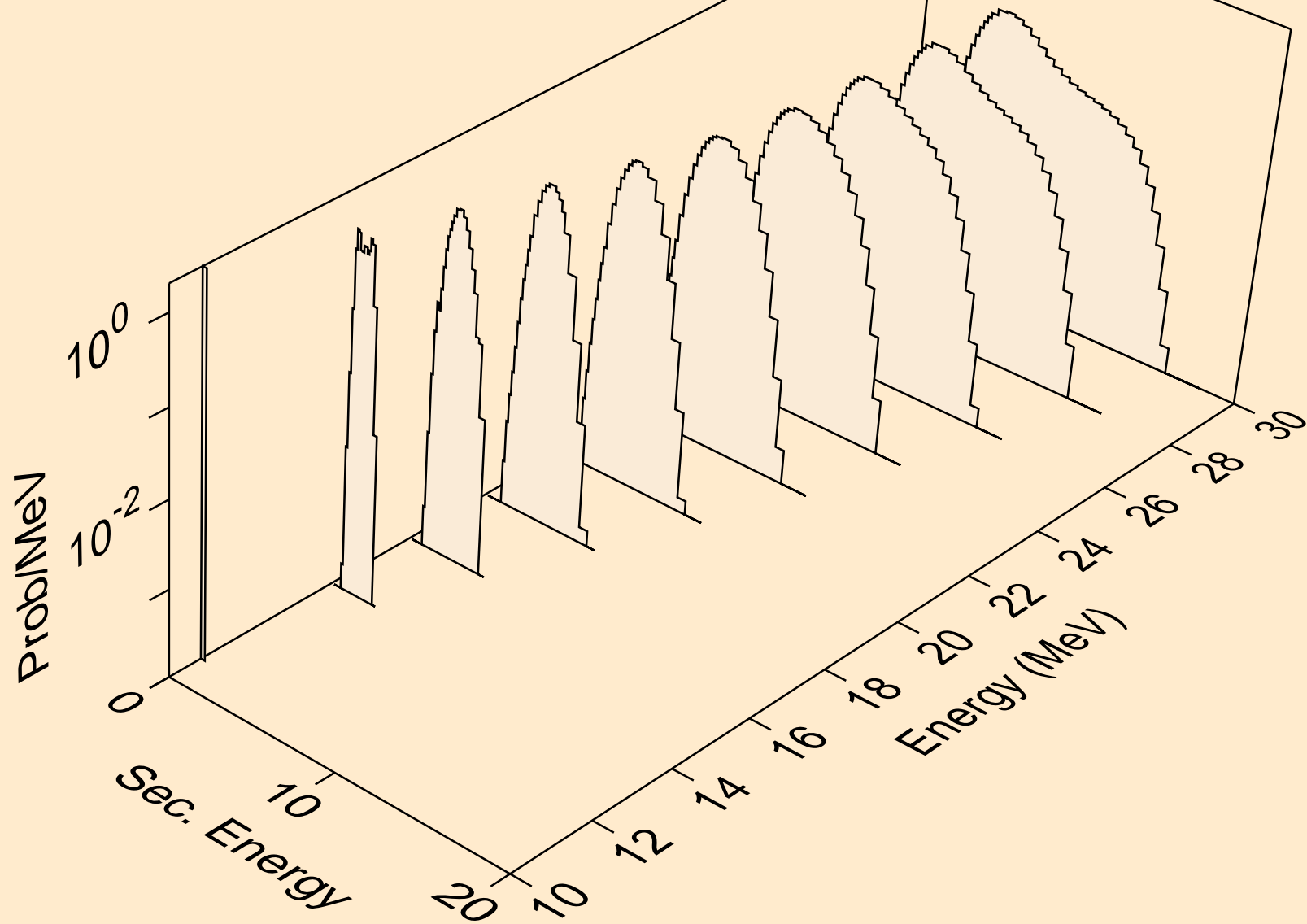



BR079 ALPHA ACER TENDL-2021 LIBRARY; T=0.K  
protons from (a,pa)

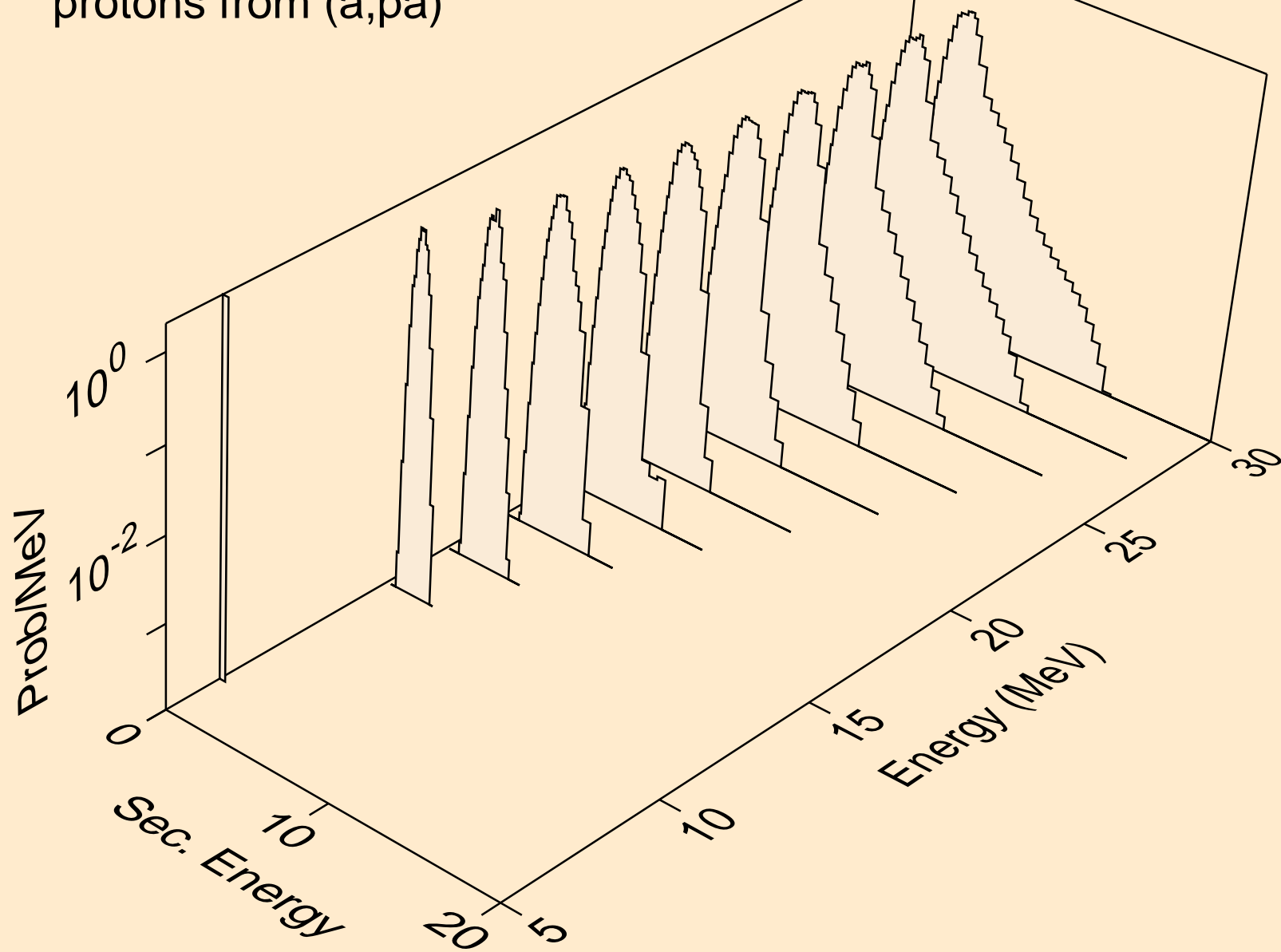

BR079 ALPHA ACER TENDL-2021 LIBRARY; T=0.K  
protons from (a,pd)

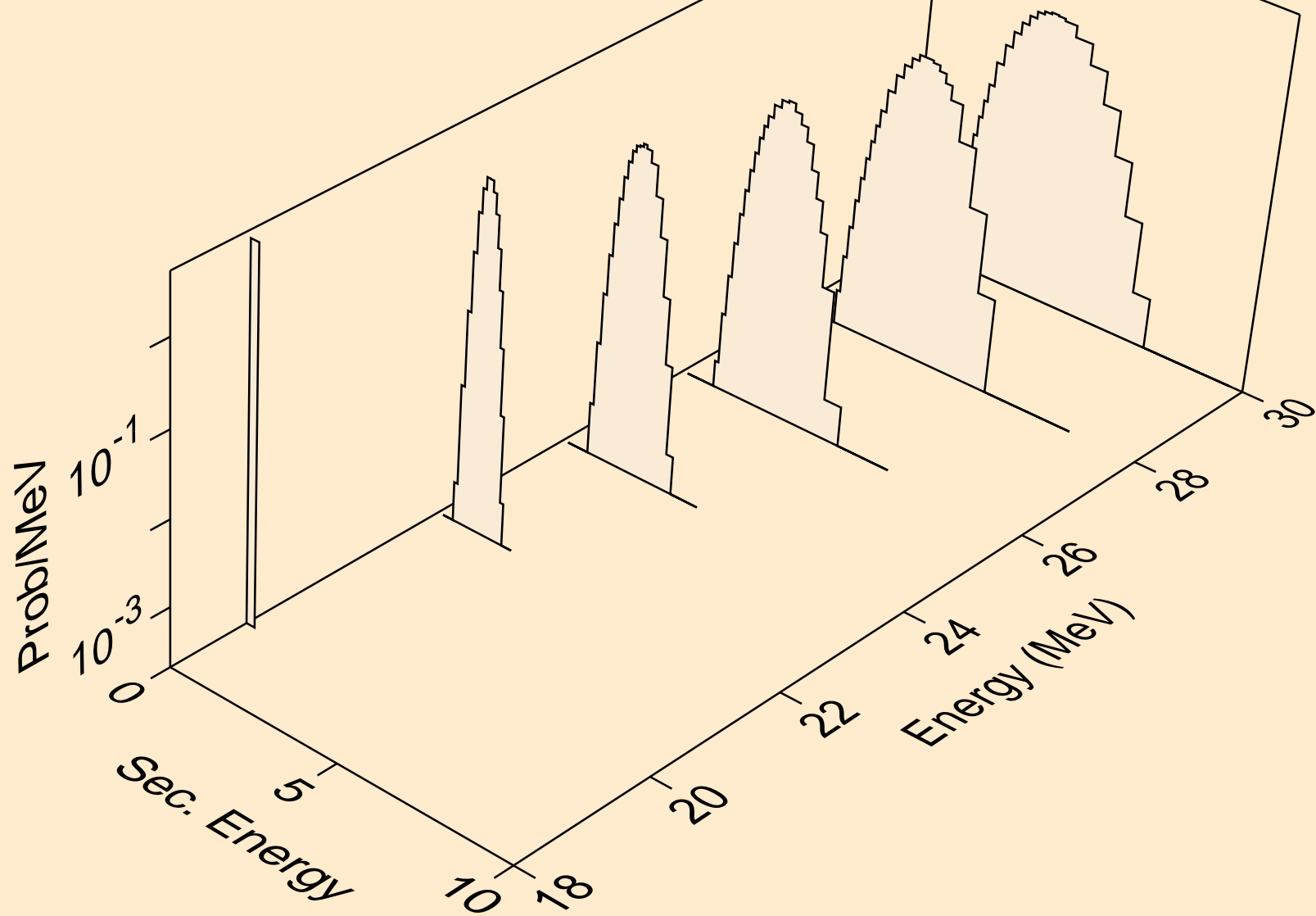

BR079 ALPHA ACER TENDL-2021 LIBRARY; T=0.K  
protons from (a,pt)

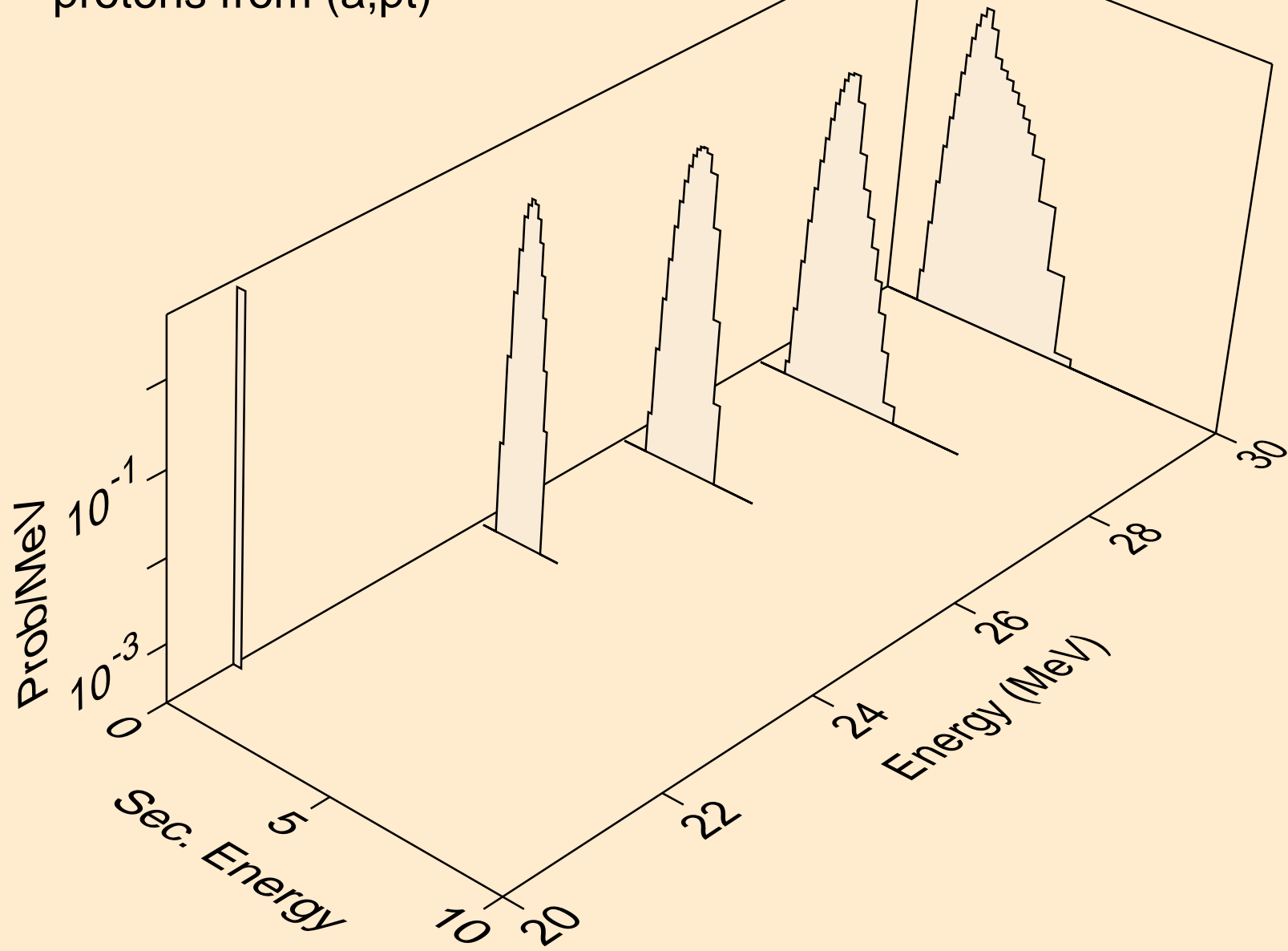

BR079 ALPHA ACER TENDL-2021 LIBRARY; T=0.K  
deuterons from (a,x)

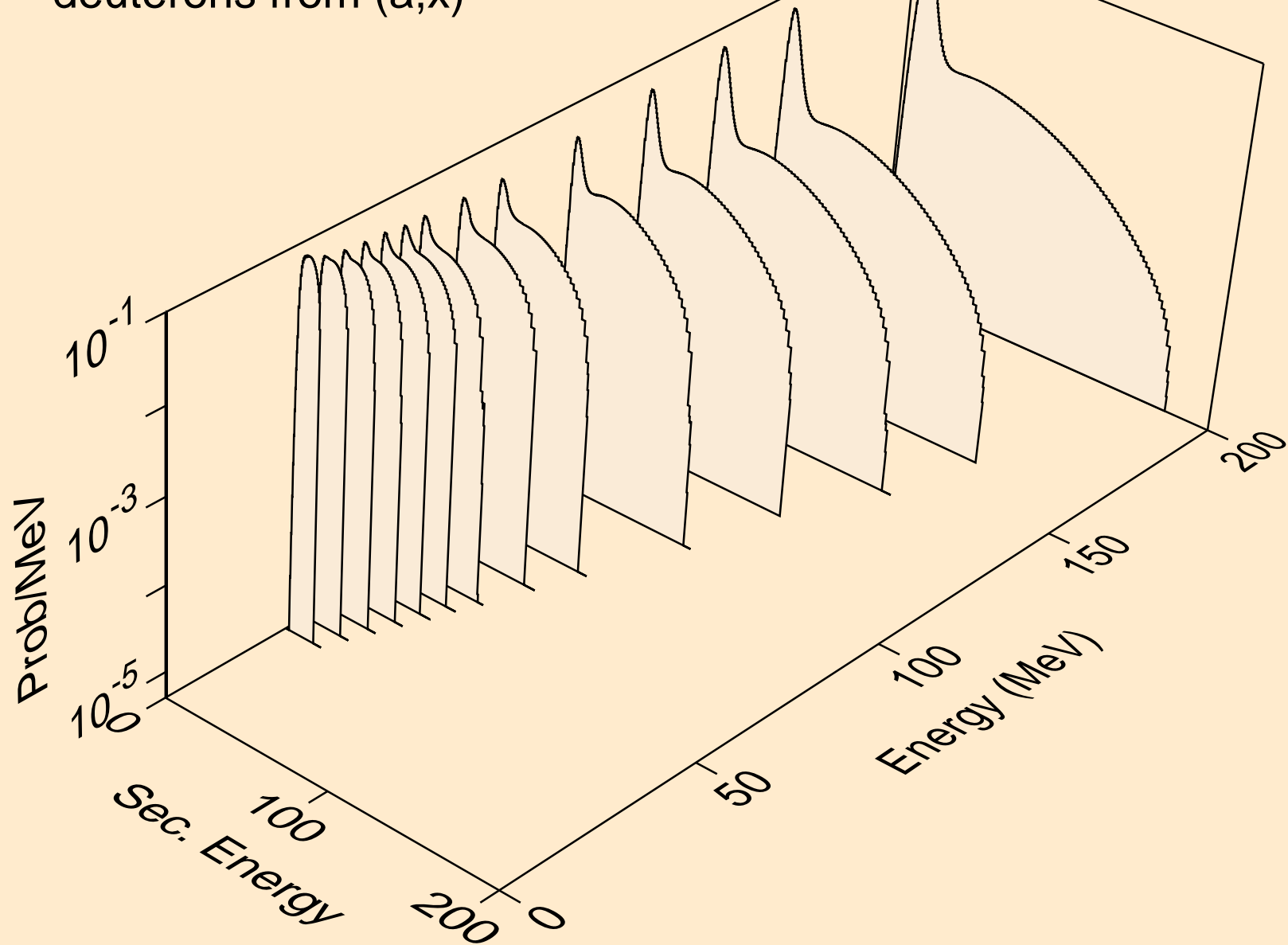

BR079 ALPHA ACER TENDL-2021 LIBRARY; T=0.K  
deuterons from (a,n\*)d

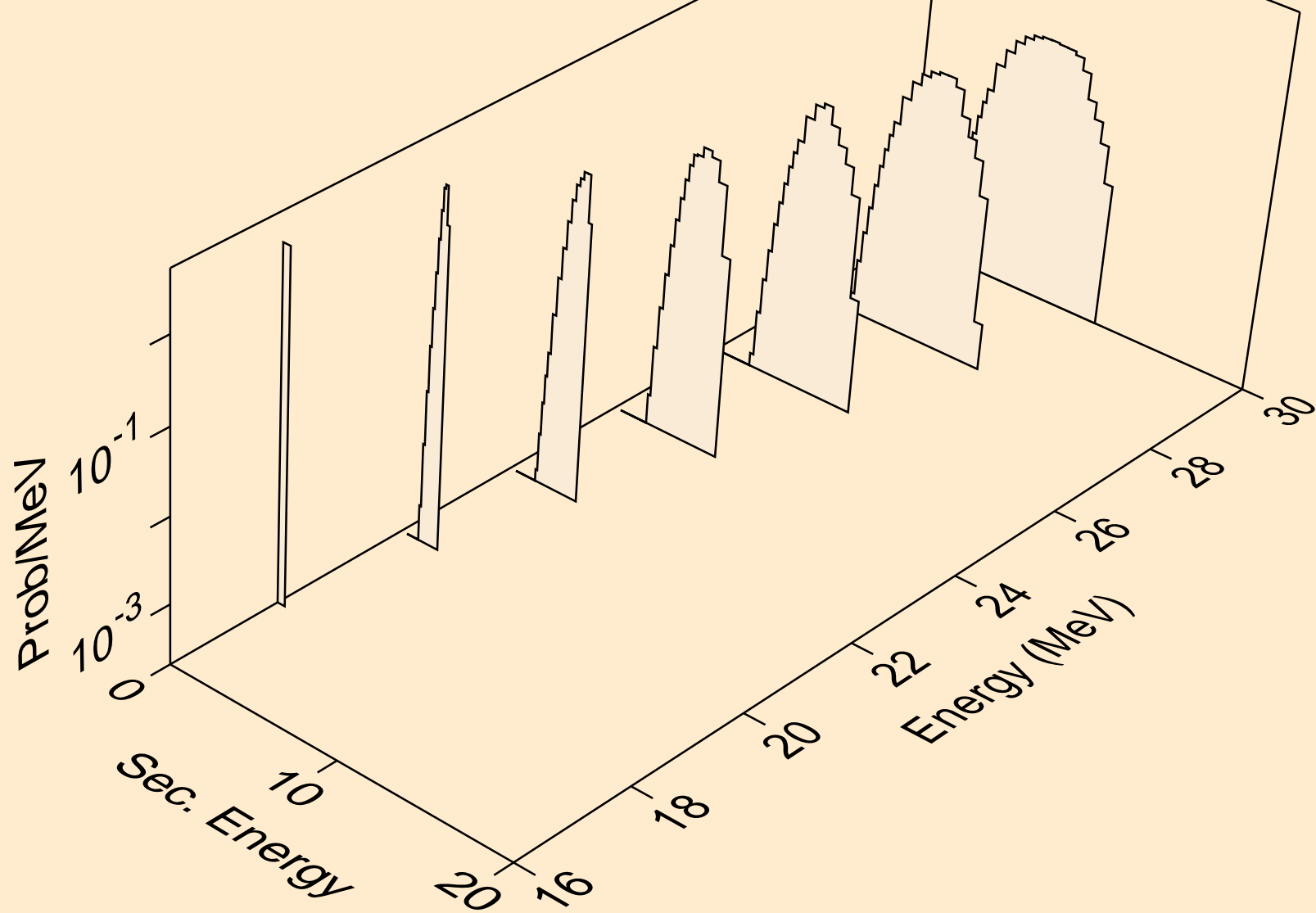

BR079 ALPHA ACER TENDL-2021 LIBRARY; T=0.K  
deuterons from (a,d)

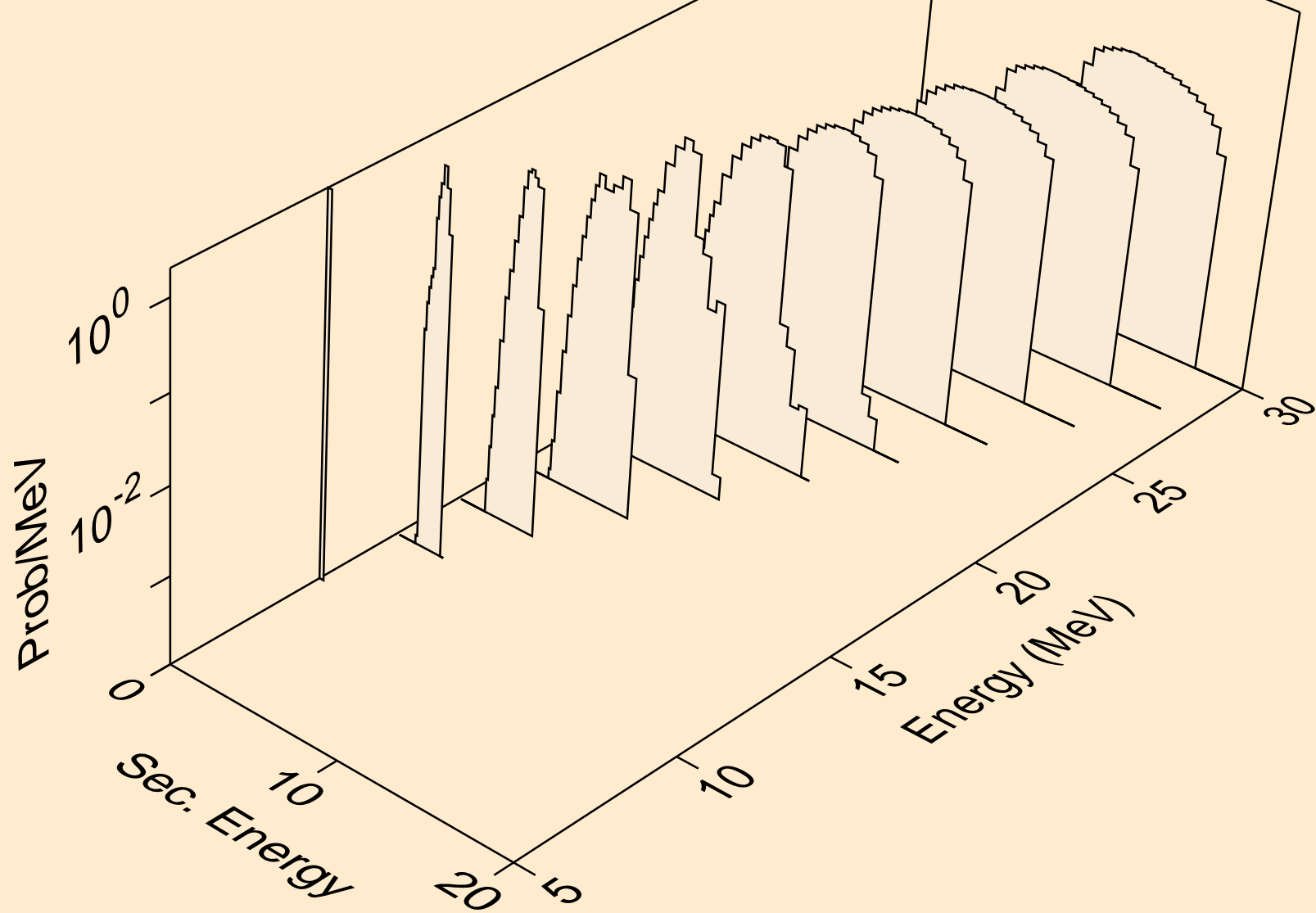

BR079 ALPHA ACER TENDL-2021 LIBRARY; T=0.K  
deuterons from (a,pd)

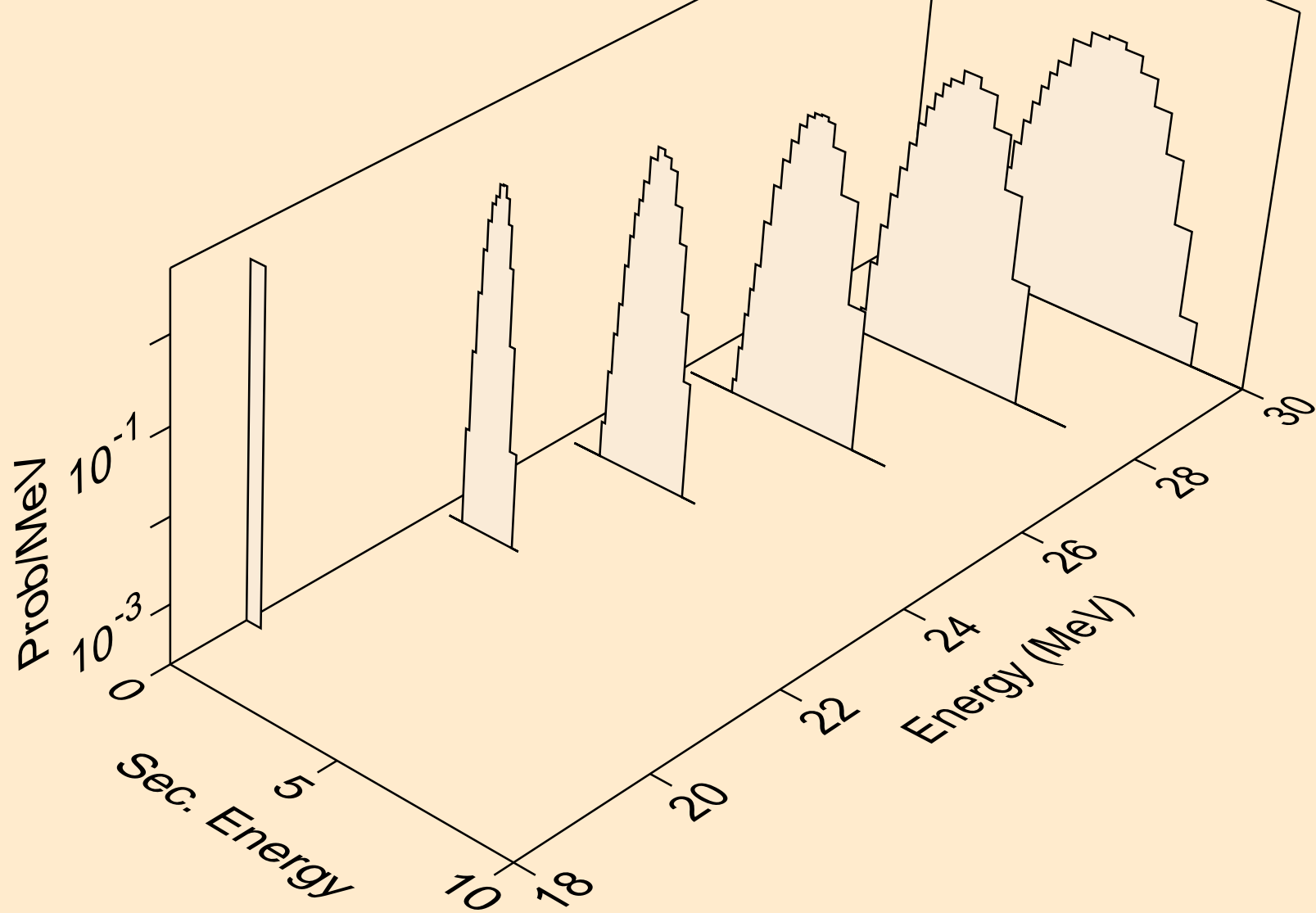

BR079 ALPHA ACER TENDL-2021 LIBRARY; T=0.K  
deuterons from (a,da)

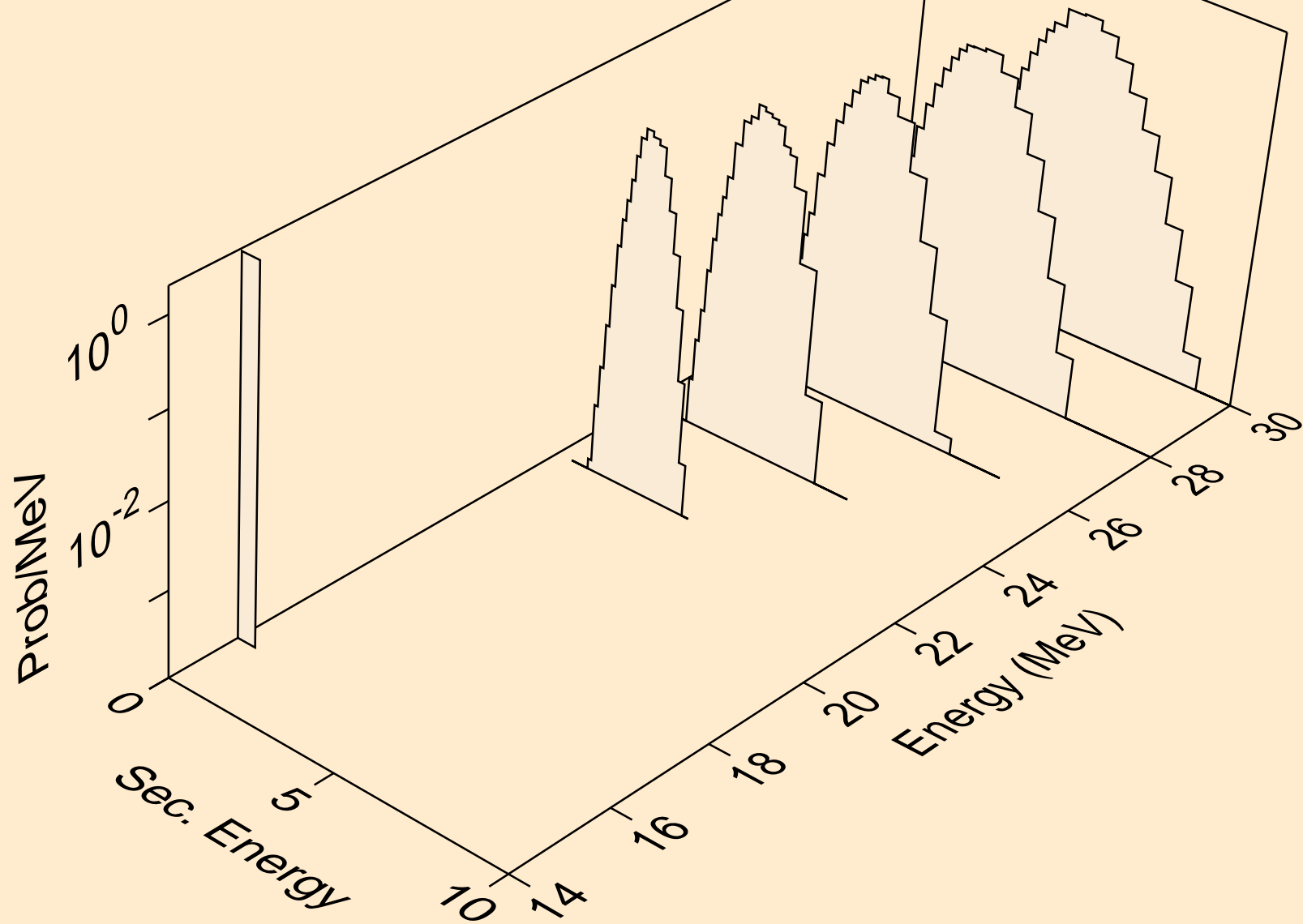



BR079 ALPHA ACER TENDL-2021 LIBRARY; T=0.K  
tritons from (a,x)

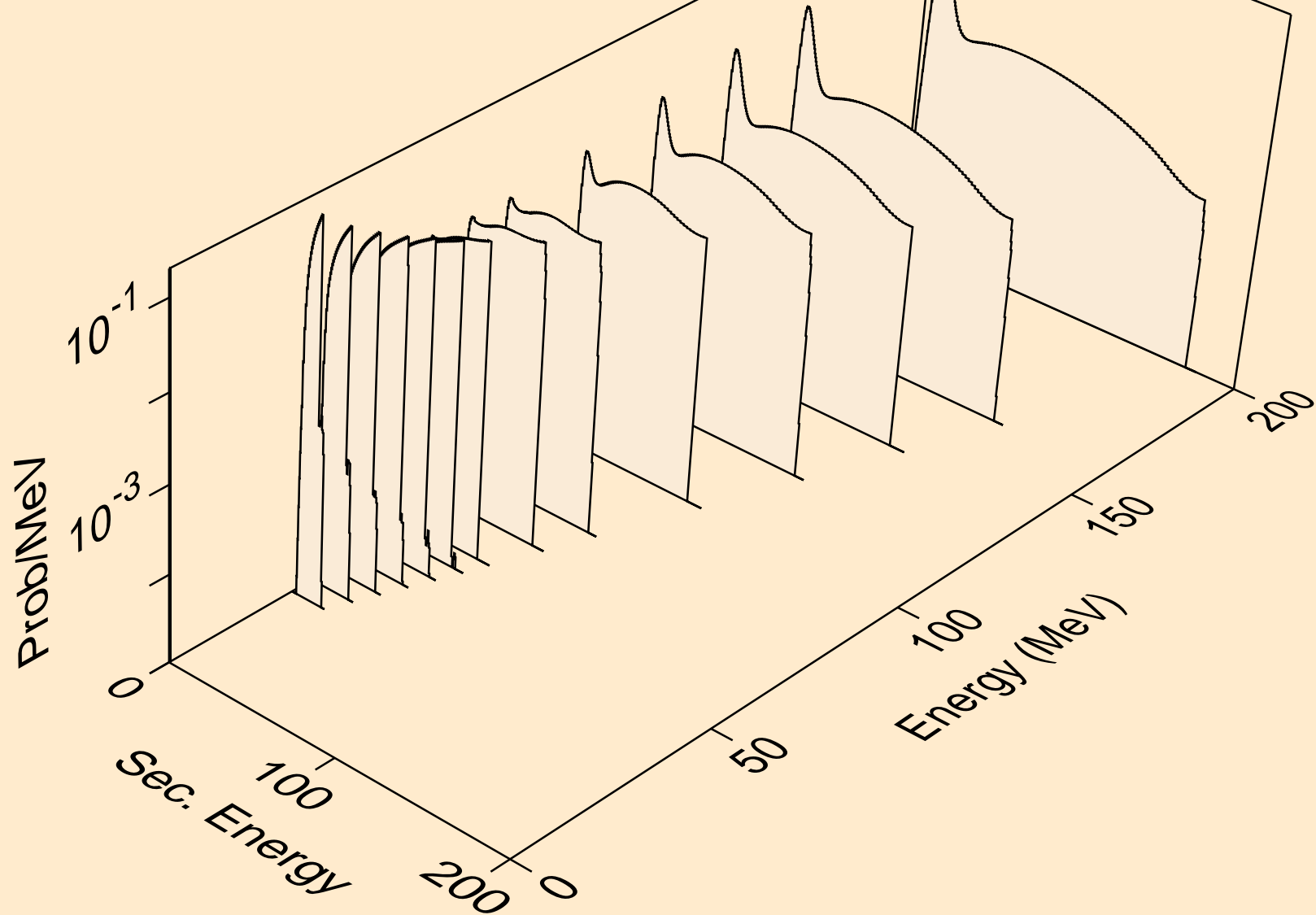

BR079 ALPHA ACER TENDL-2021 LIBRARY; T=0.K  
tritons from (a,n\*)t

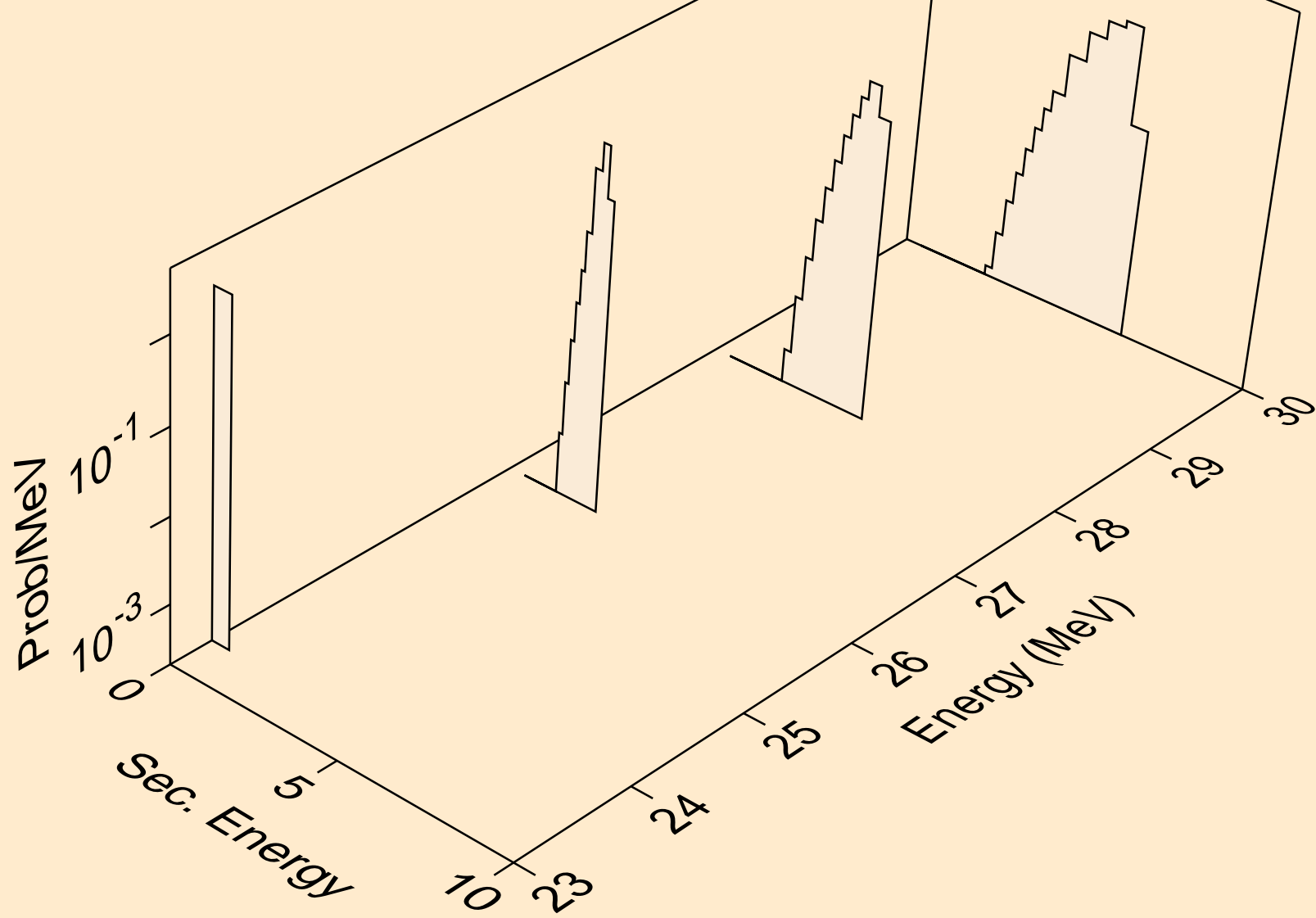

BR079 ALPHA ACER TENDL-2021 LIBRARY; T=0.K  
tritons from (a,t)

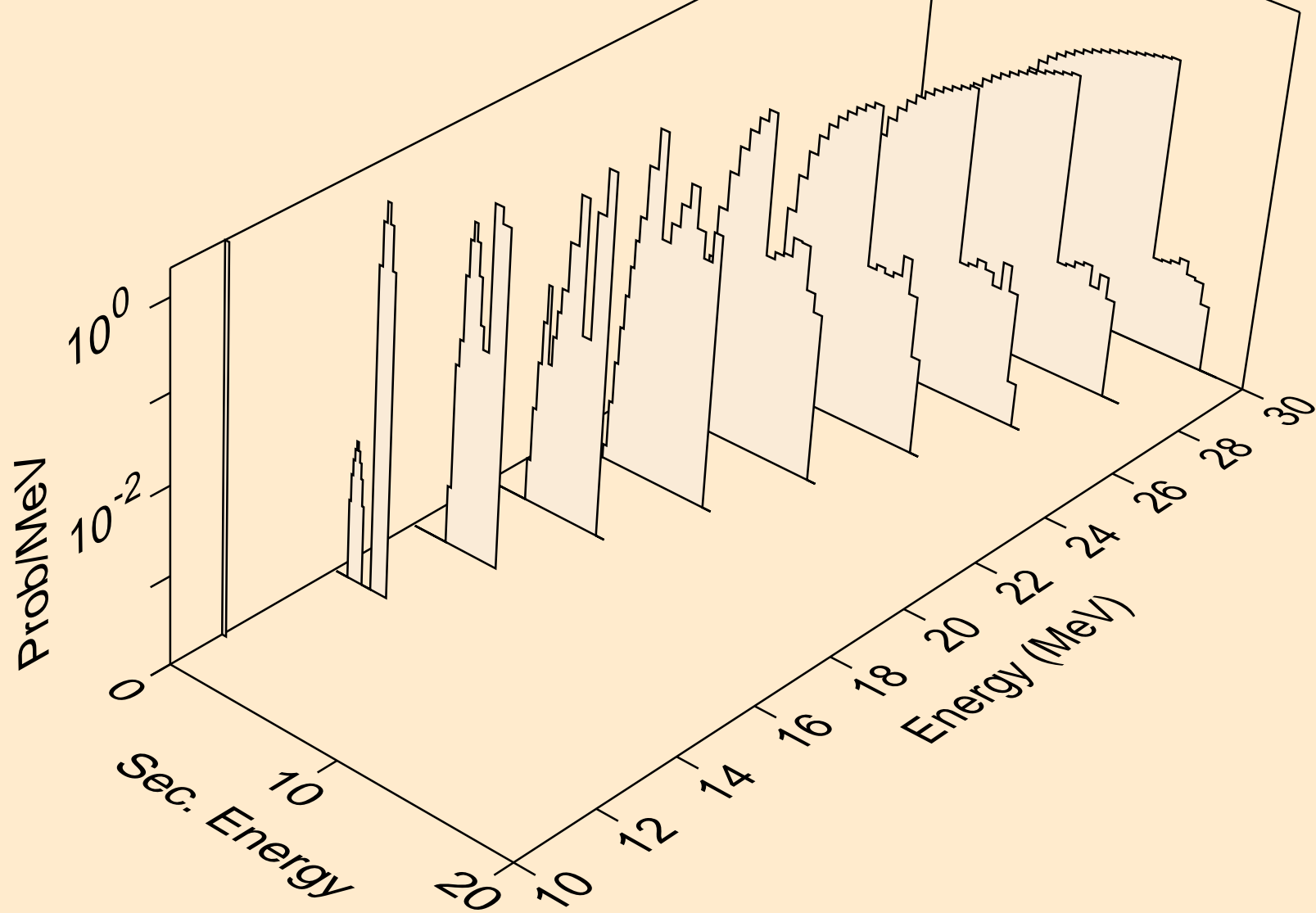

BR079 ALPHA ACER TENDL-2021 LIBRARY; T=0.K  
tritons from (a,pt)

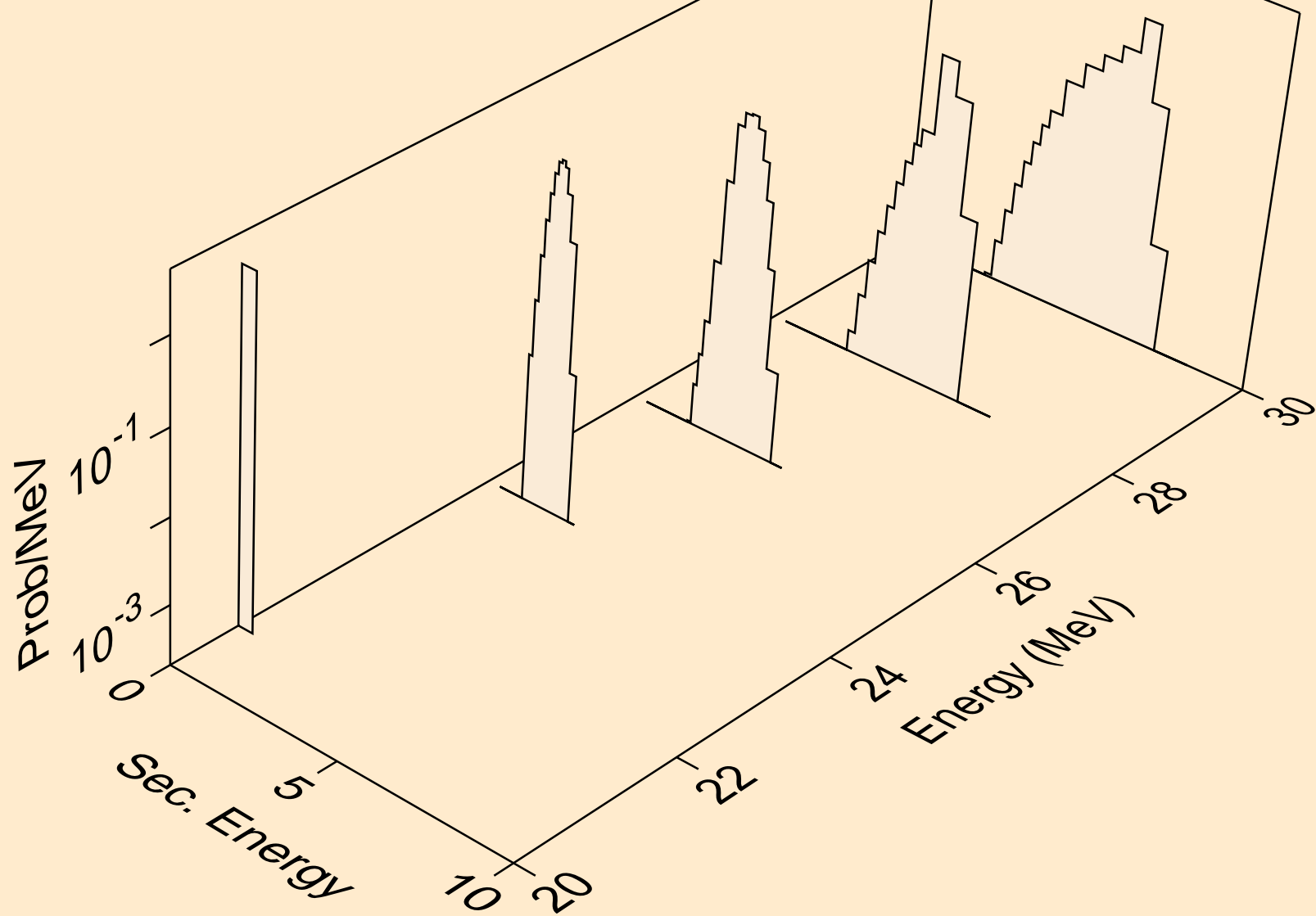

BR079 ALPHA ACER TENDL-2021 LIBRARY; T=0.K  
he3s from (a,x)

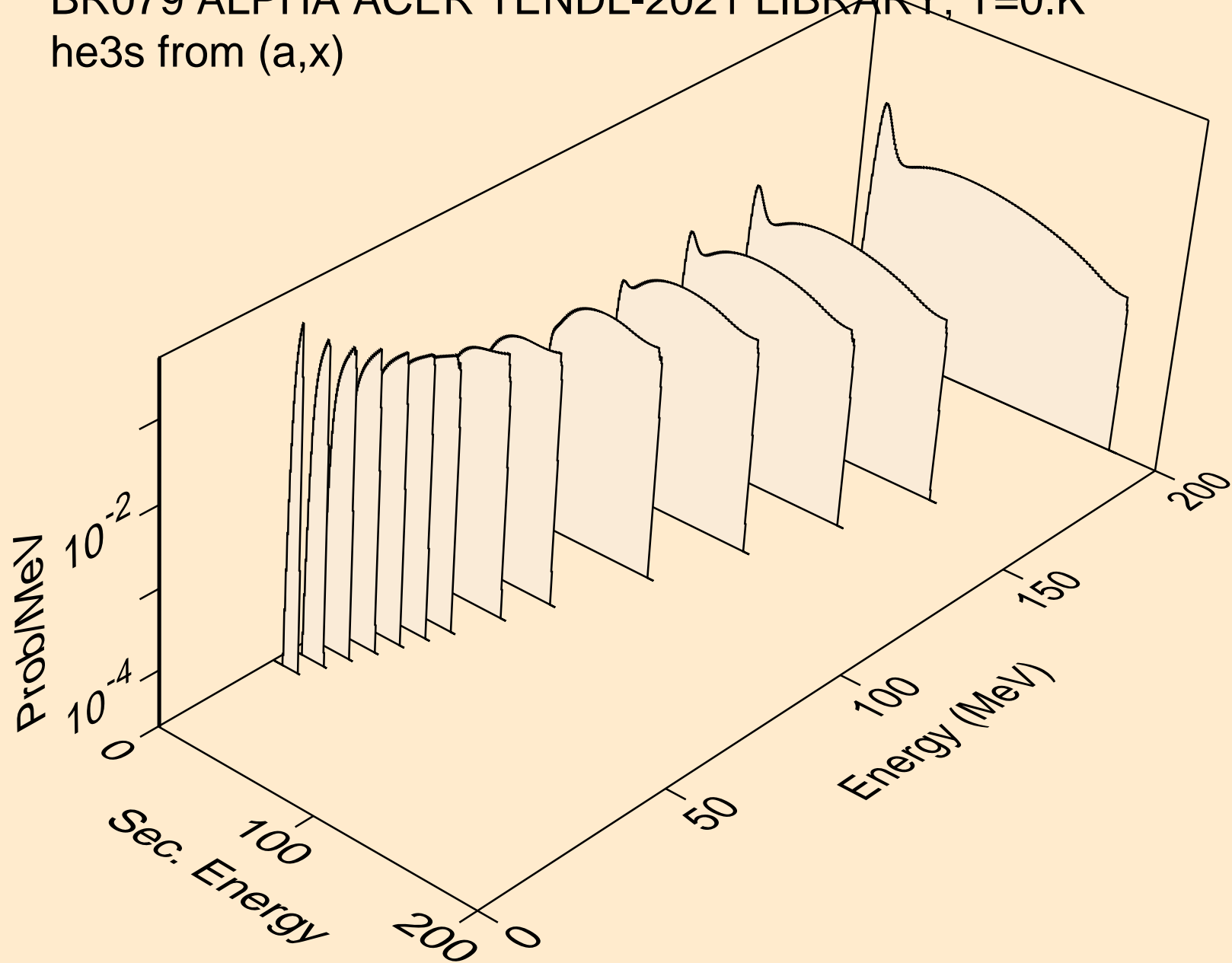

BR079 ALPHA ACER TENDL-2021 LIBRARY; T=0.K  
he3s from (a,n\*)he3

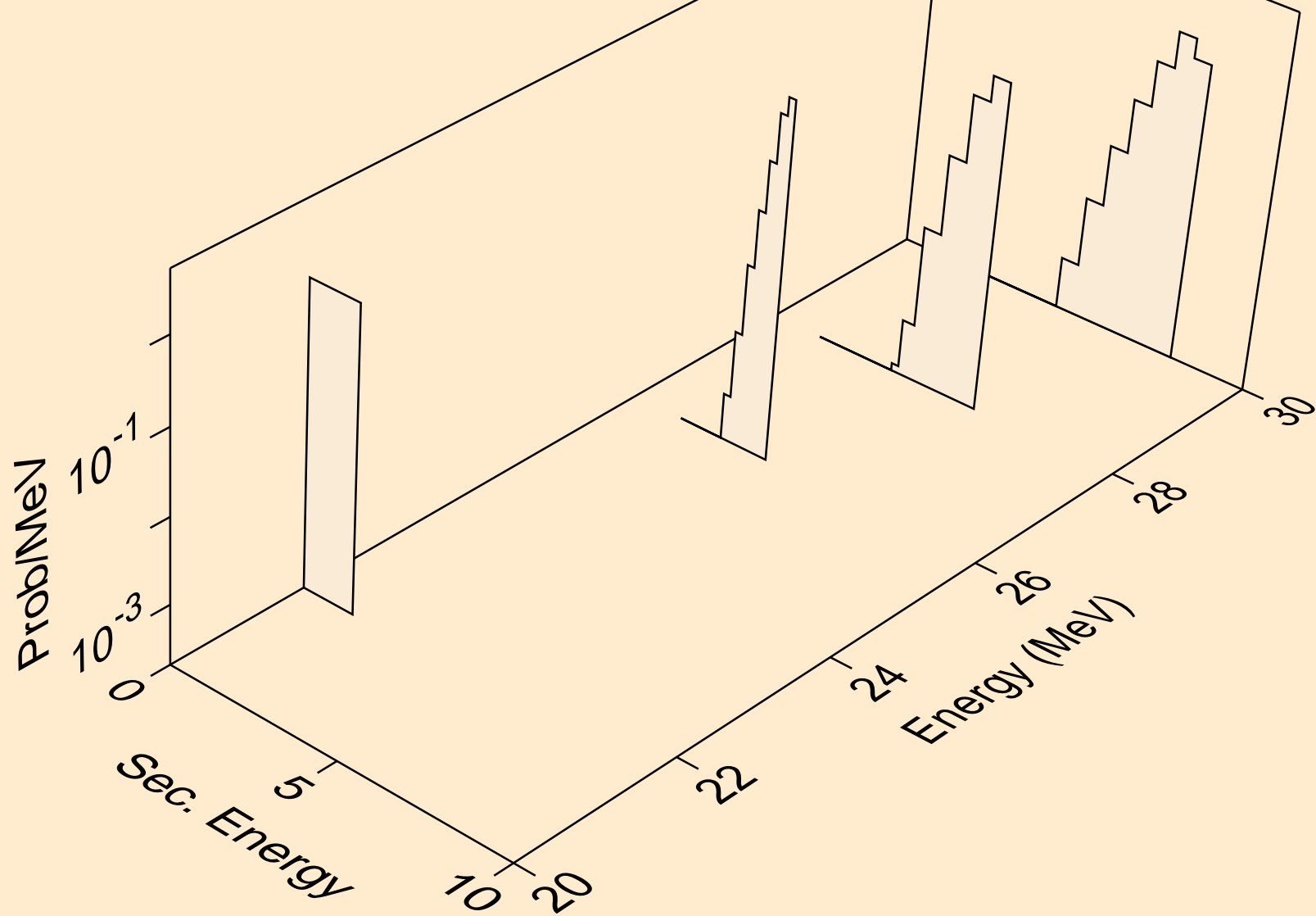

BR079 ALPHA ACER TENDL-2021 LIBRARY; T=0.K  
he3s from (a,he3)

