

EU153 ALPHA ACER TENDL-2021 LIBRARY; T=0.K

Principal cross sections

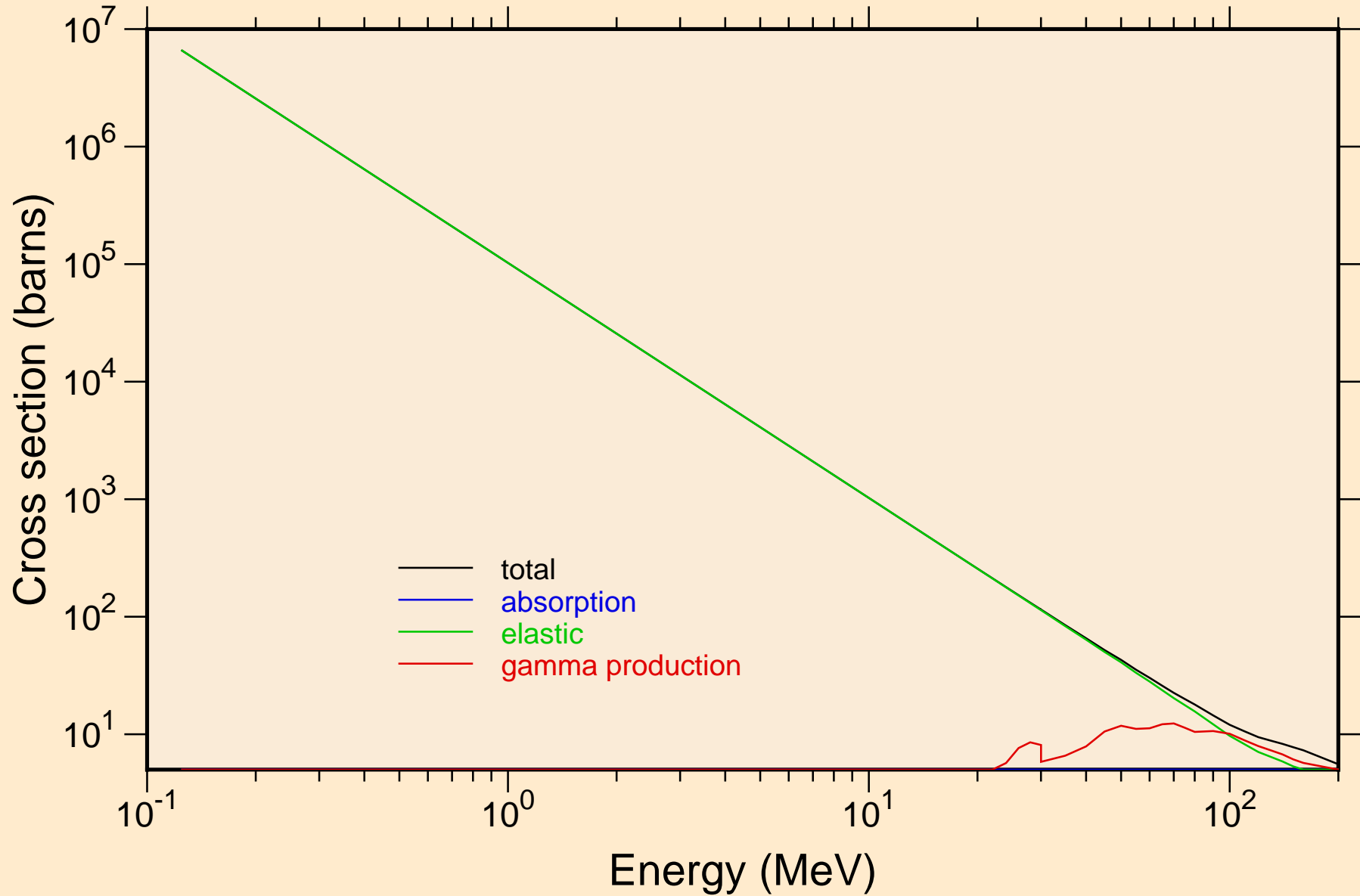

EU153 ALPHA ACER TENDL-2021 LIBRARY; T=0.K

Heating

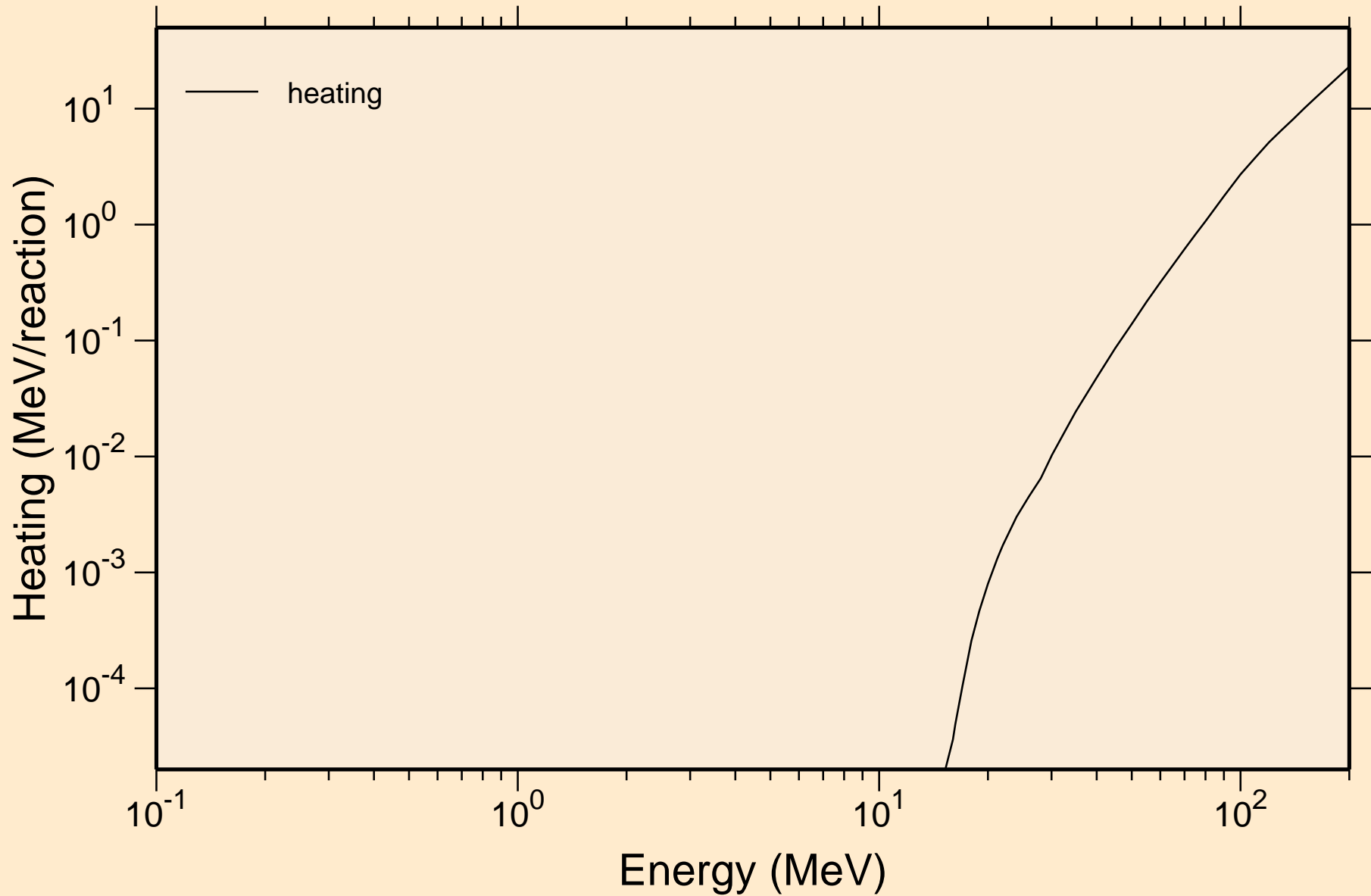

EU153 ALPHA ACER TENDL-2021 LIBRARY; T=0.K

Principal cross sections

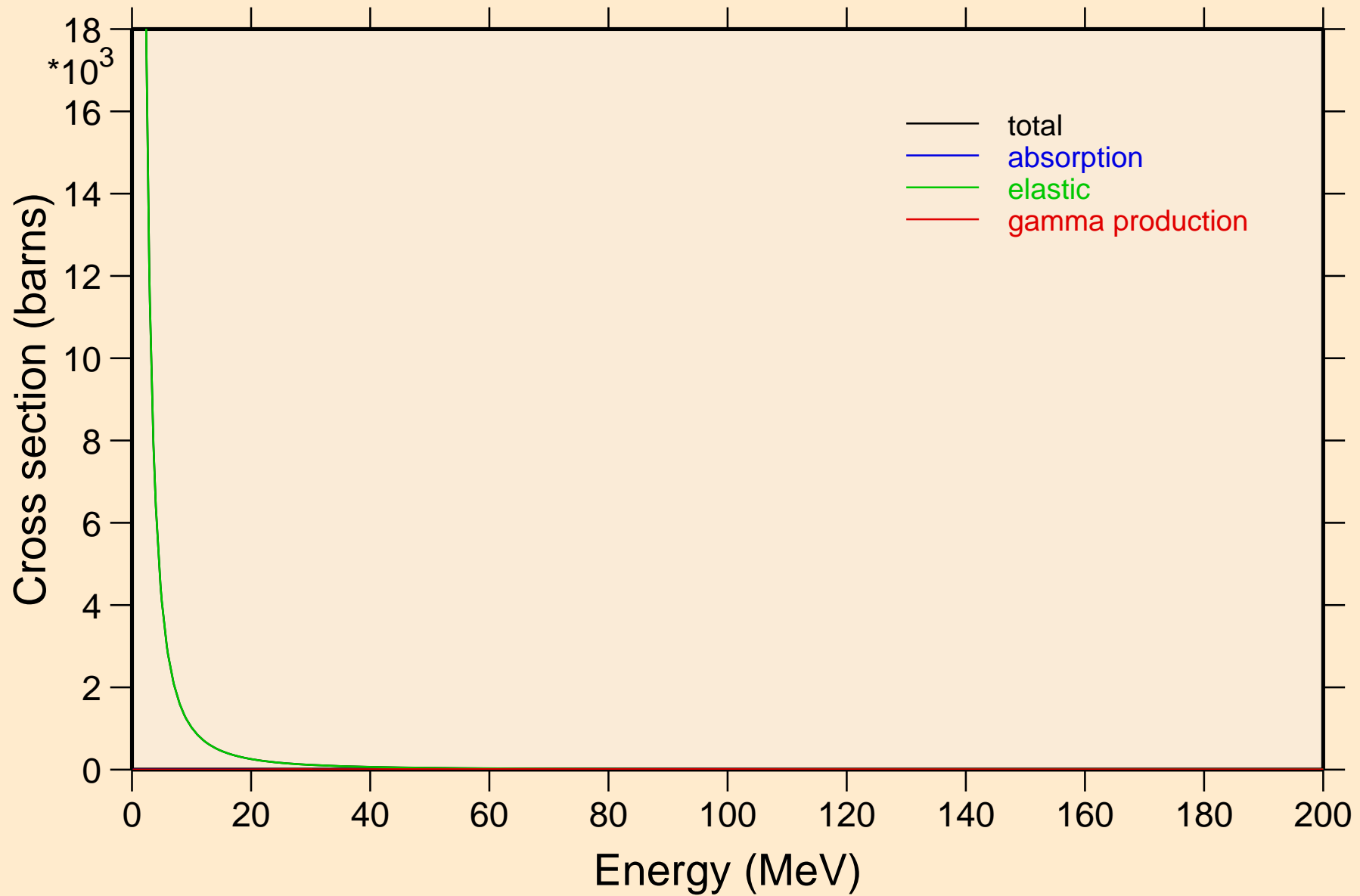

EU153 ALPHA ACER TENDL-2021 LIBRARY; T=0.K

Heating

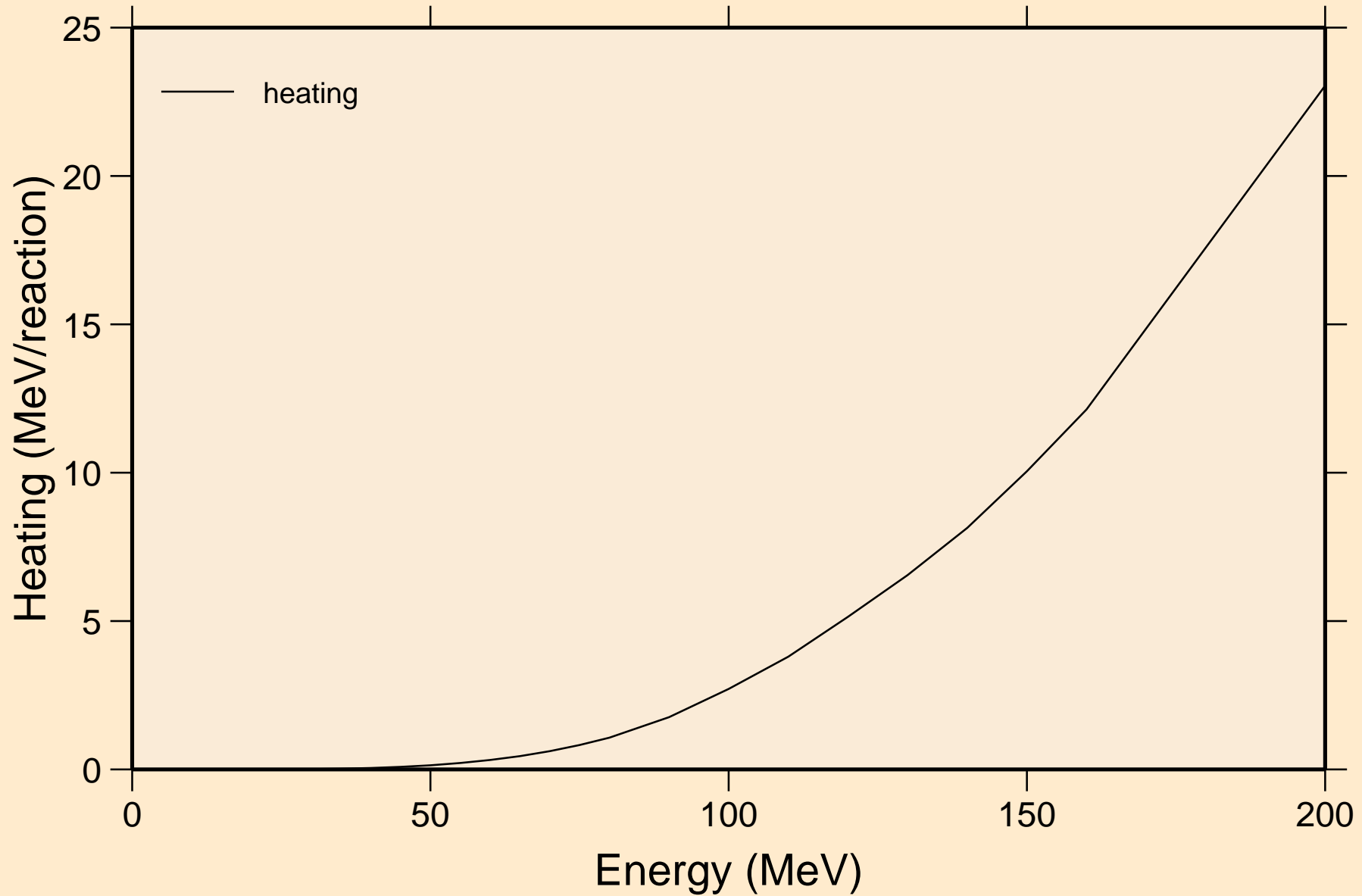

EU153 ALPHA ACER TENDL-2021 LIBRARY; T=0.K
Threshold reactions

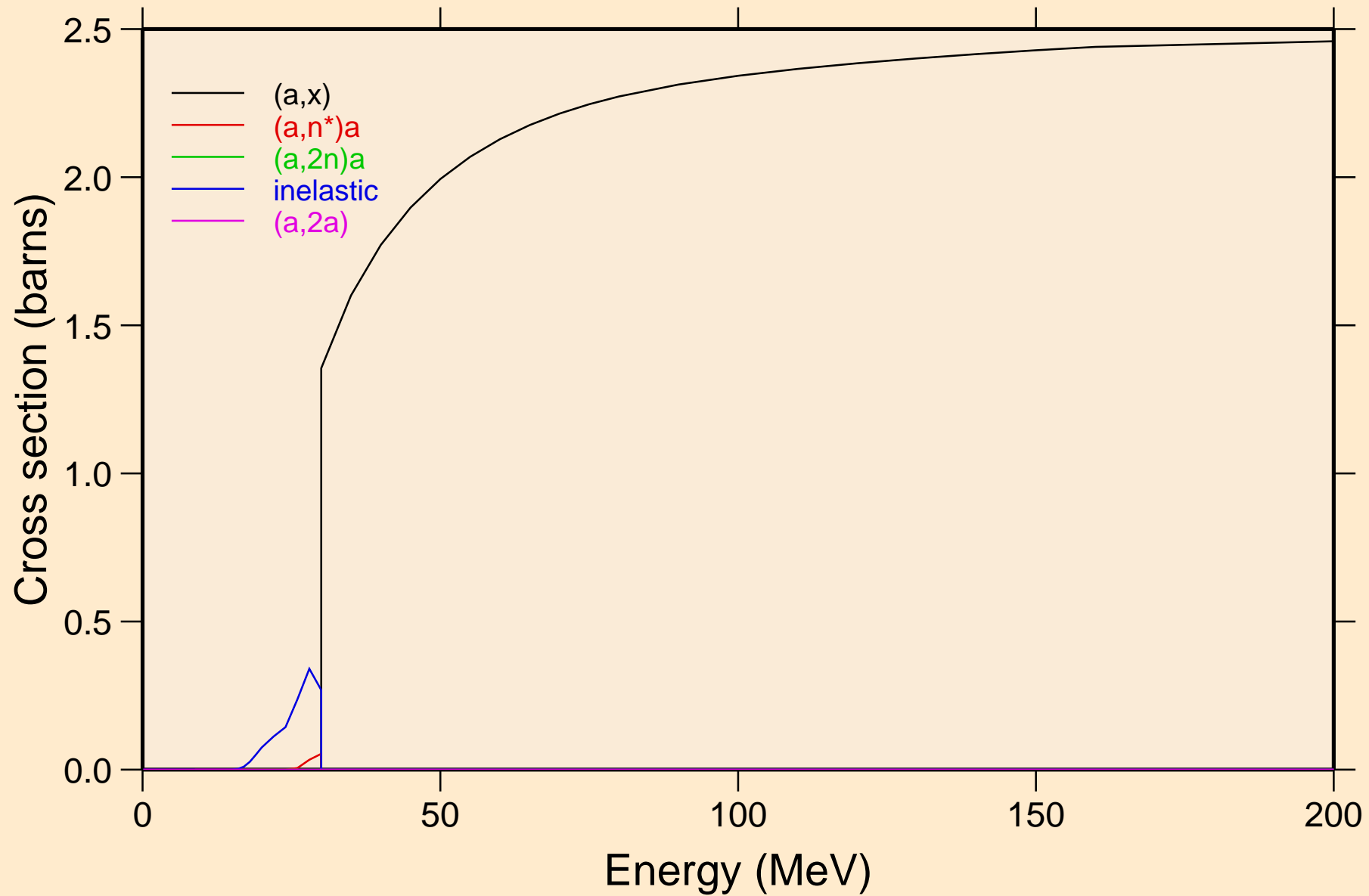

EU153 ALPHA ACER TENDL-2021 LIBRARY; T=0.K
Threshold reactions

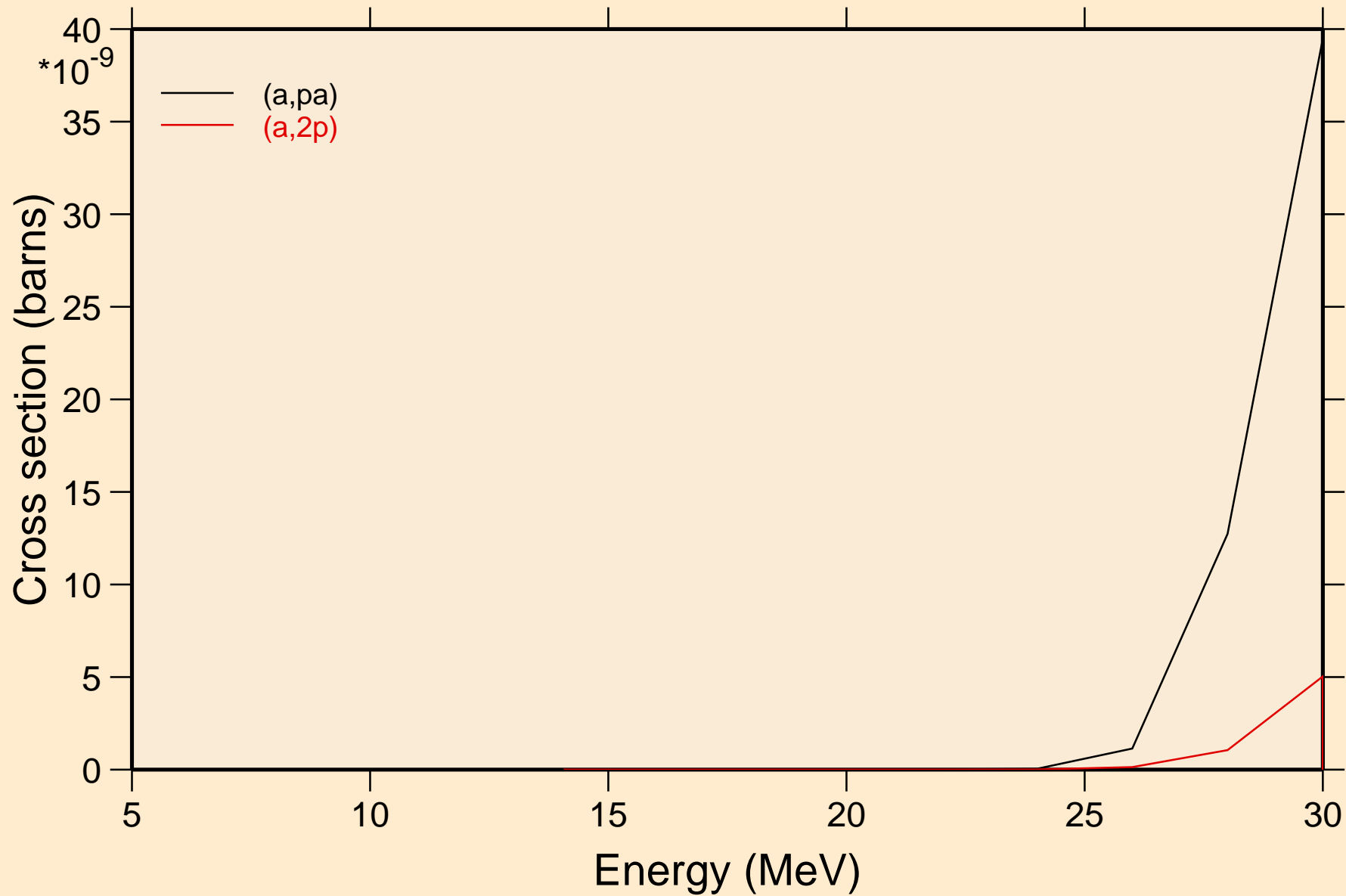

EU153 ALPHA ACER TENDL-2021 LIBRARY; T=0.K
Threshold reactions

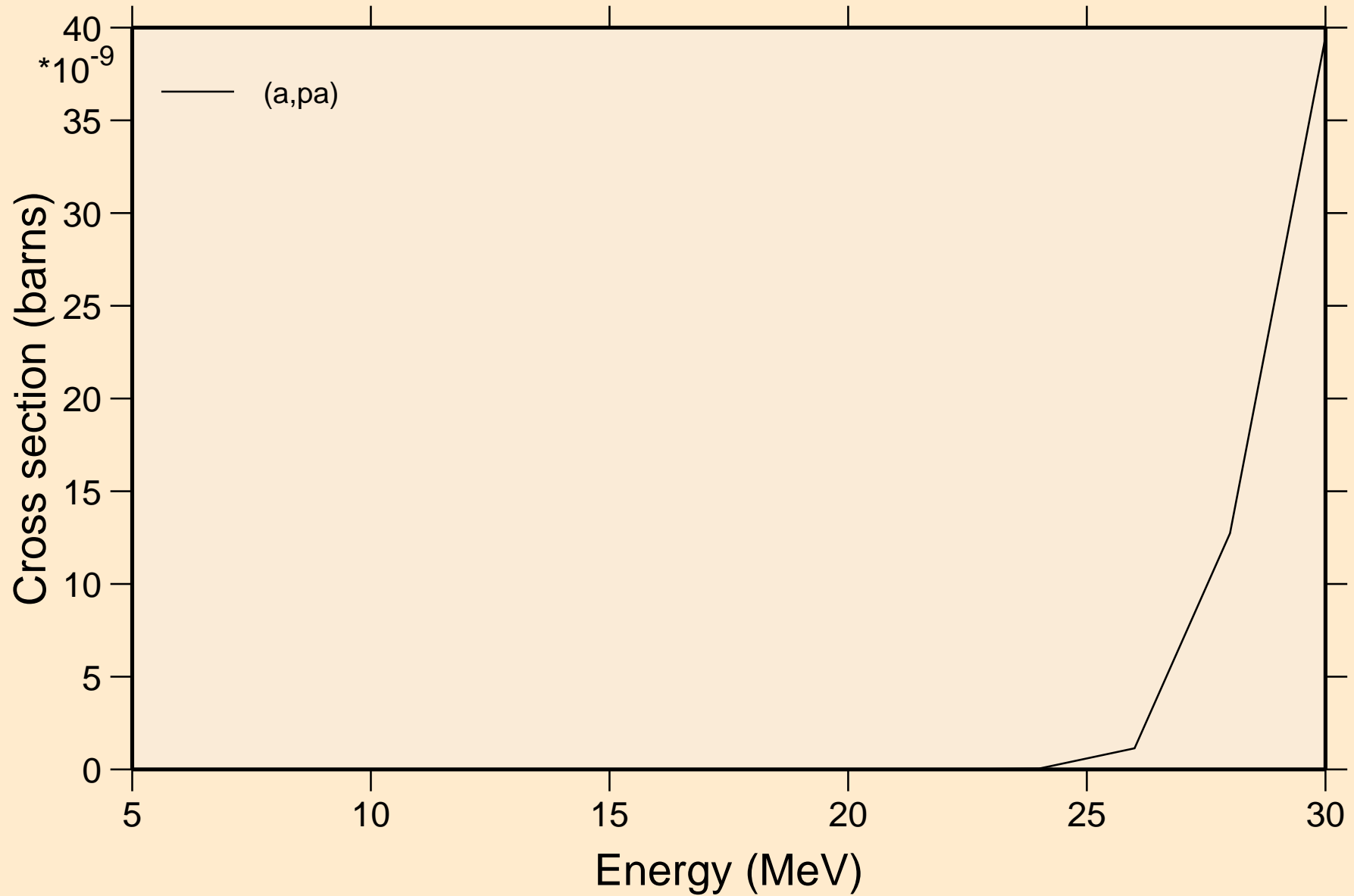

EU153 ALPHA ACER TENDL-2021 LIBRARY; T=0.K
angular distribution for elastic

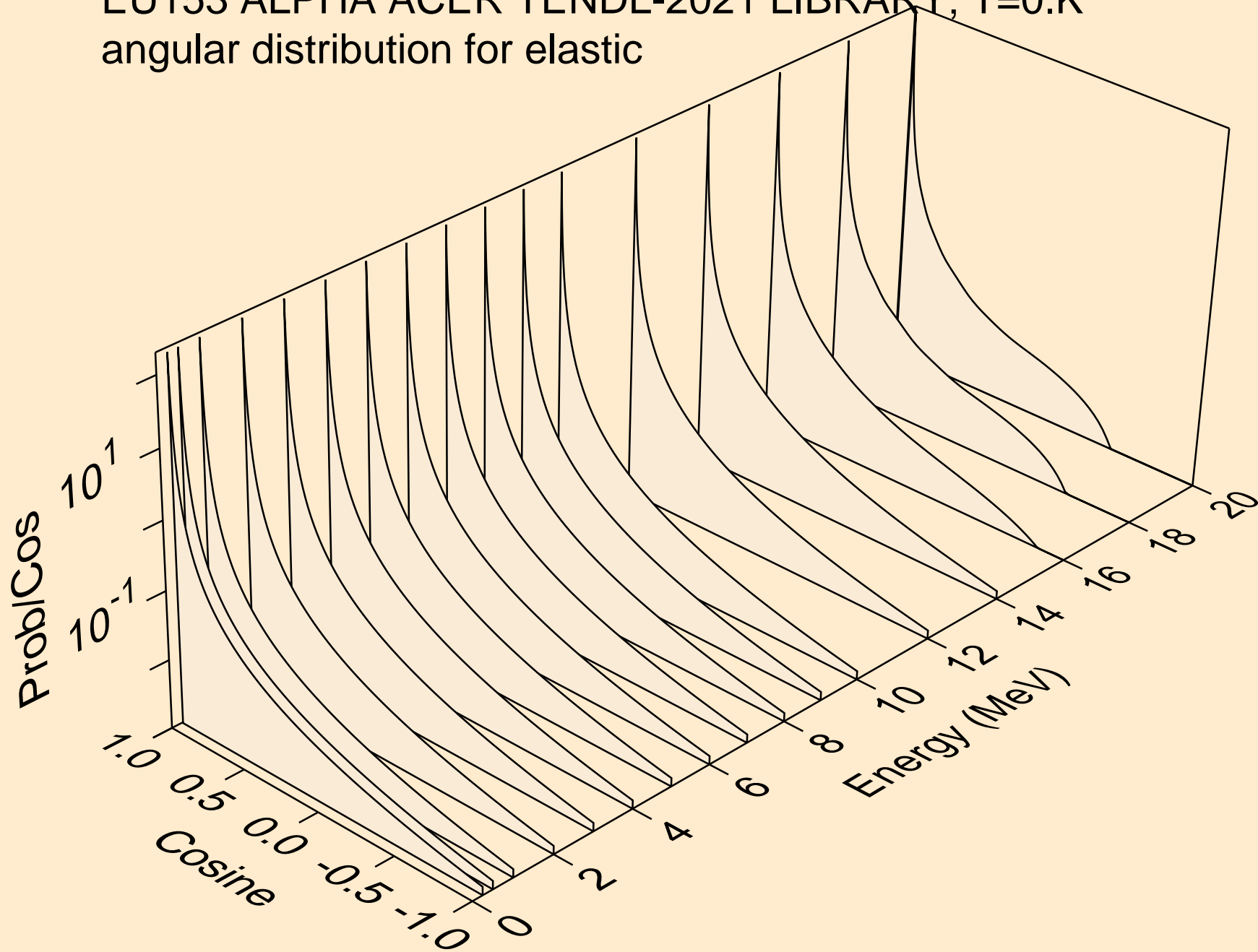

EU153 ALPHA ACER TENDL-2021 LIBRARY; T=0.K
angular distribution for elastic

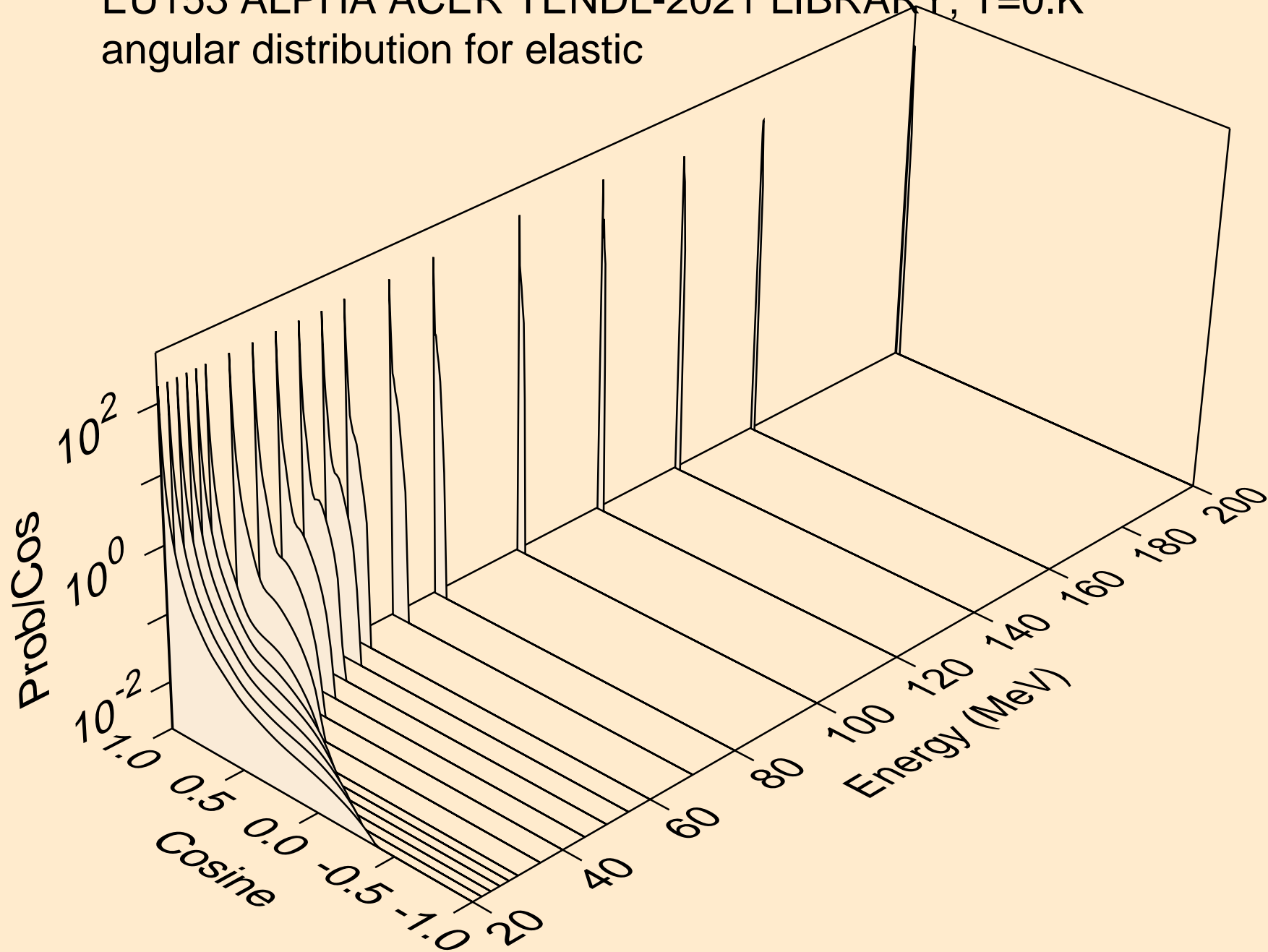

EU153 ALPHA ACER TENDL-2021 LIBRARY; T=0.K
Alpha emission for (a,x)

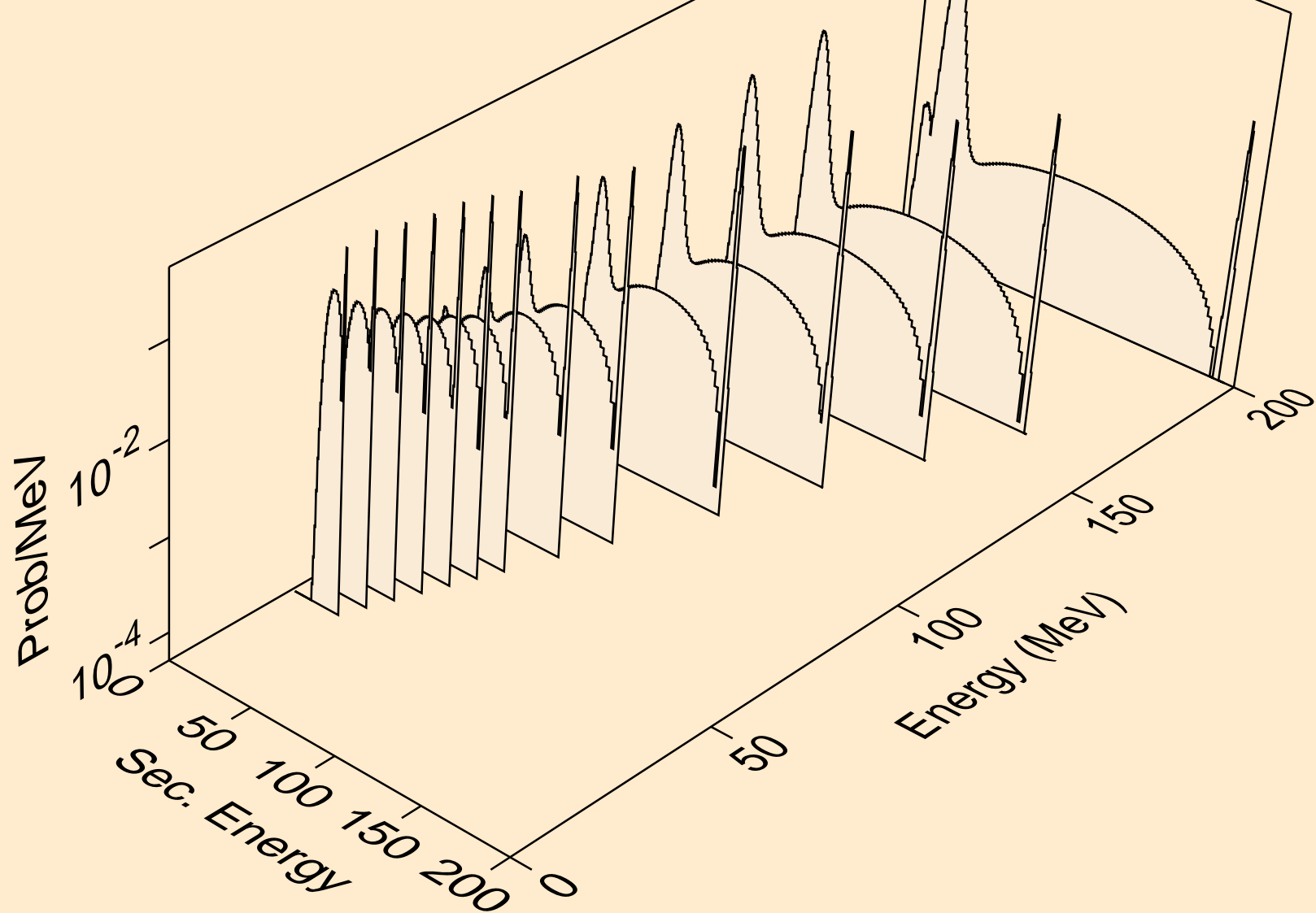

EU153 ALPHA ACER TENDL-2021 LIBRARY; T=0.K
Alpha emission for (a,n*)a

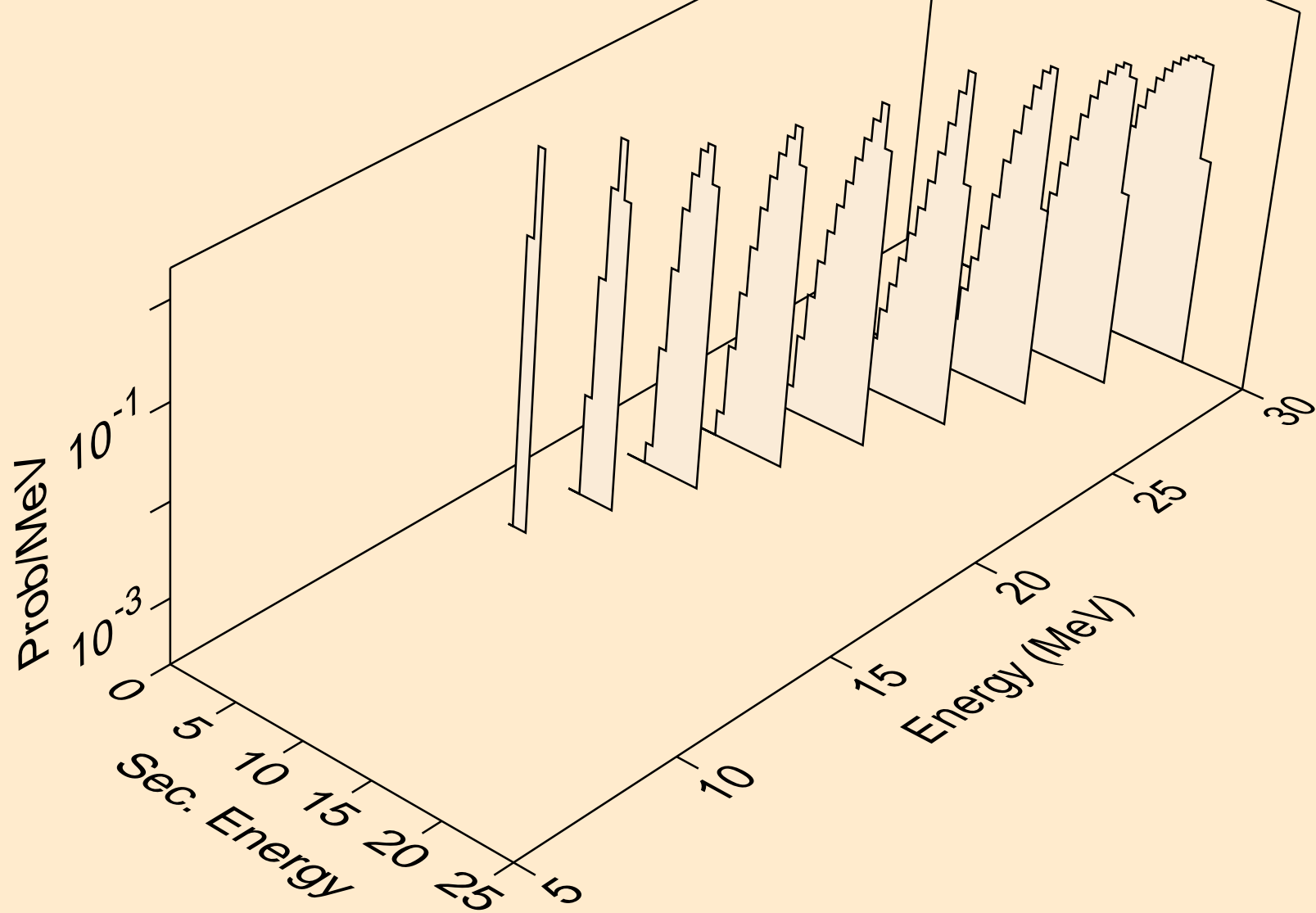

EU153 ALPHA ACER TENDL-2021 LIBRARY; T=0.K
Alpha emission for (a,2n)a

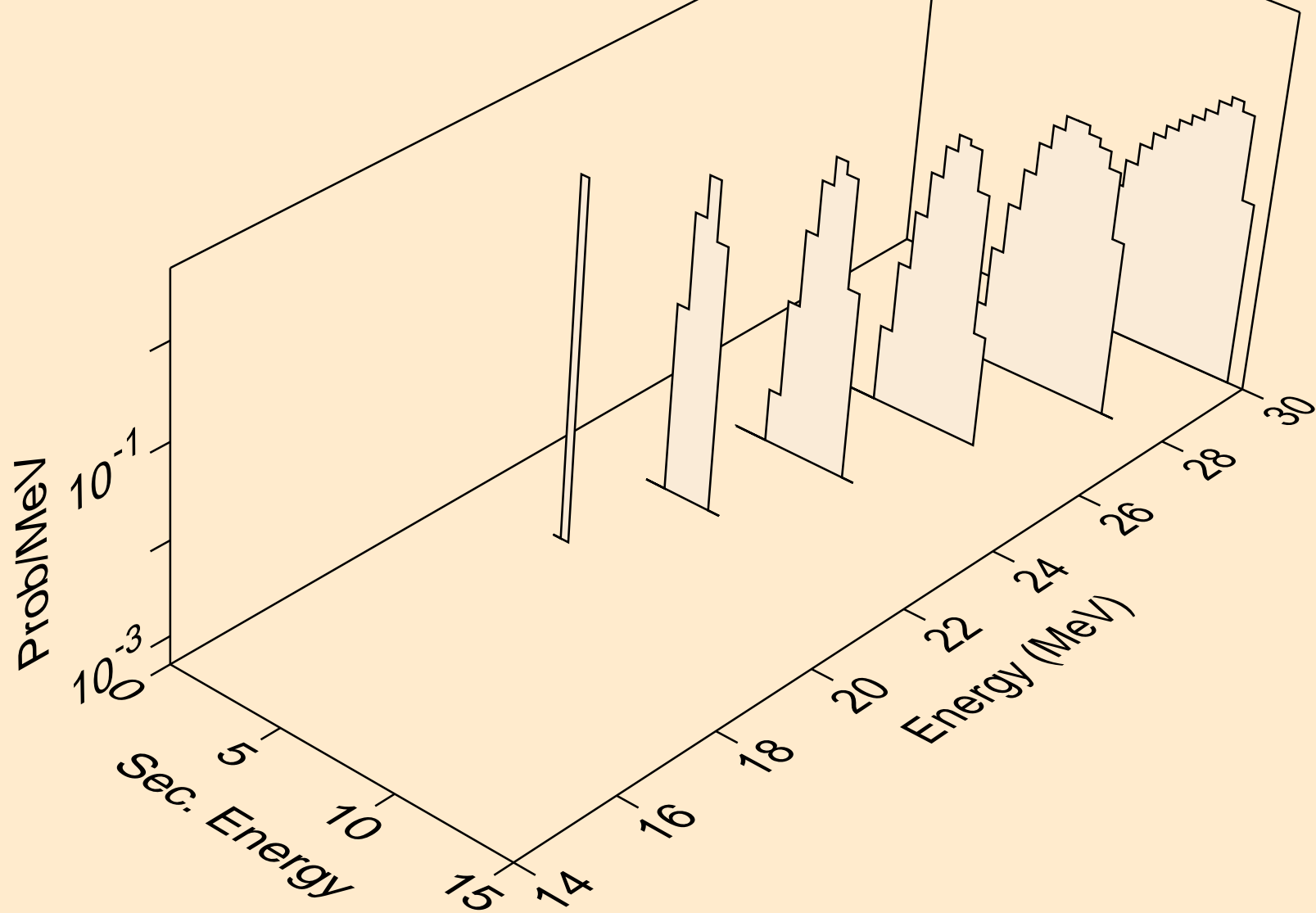

EU153 ALPHA ACER TENDL-2021 LIBRARY; T=0.K
Alpha emission for inelastic

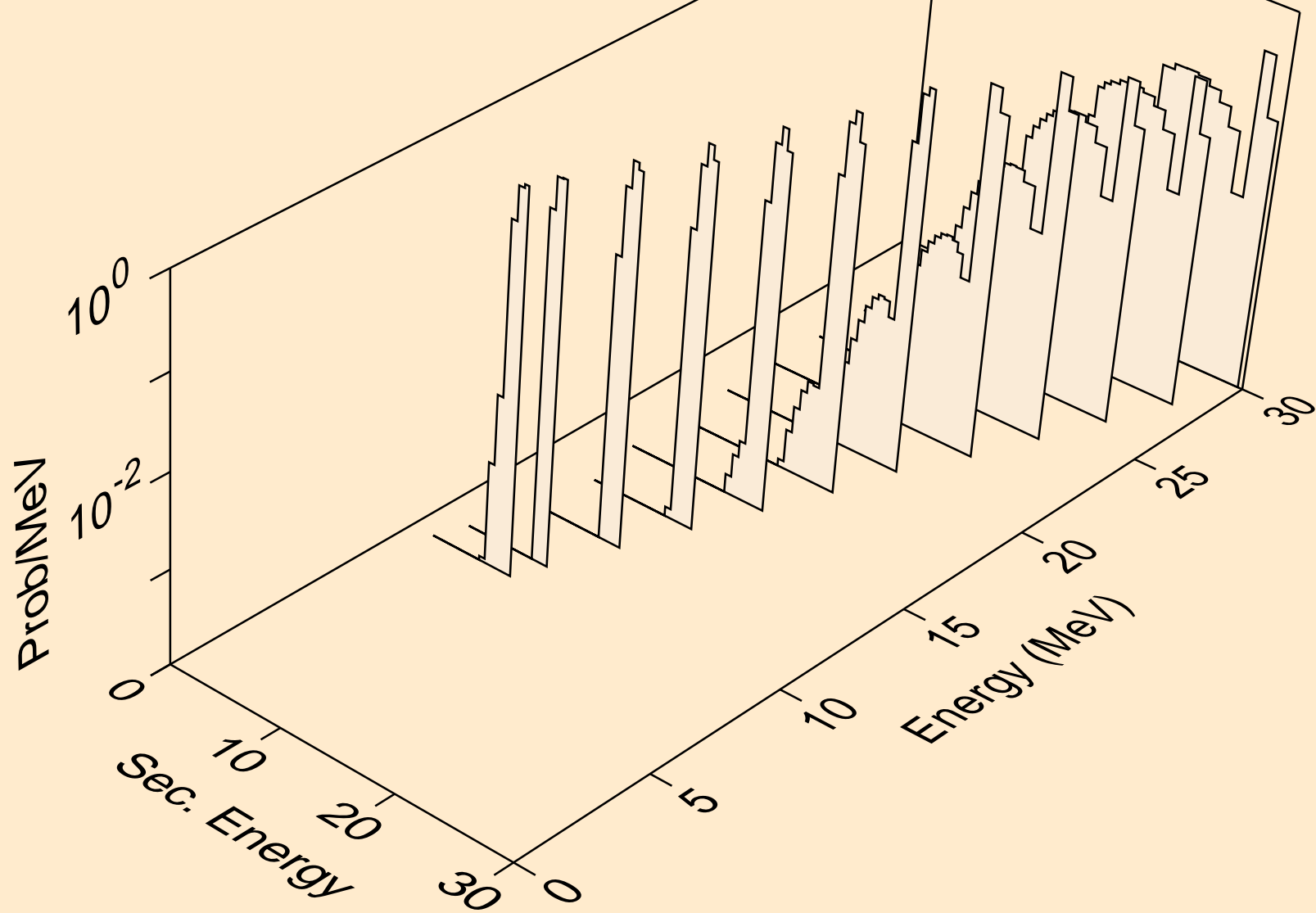

EU153 ALPHA ACER TENDL-2021 LIBRARY; T=0.K
Alpha emission for (a,2a)

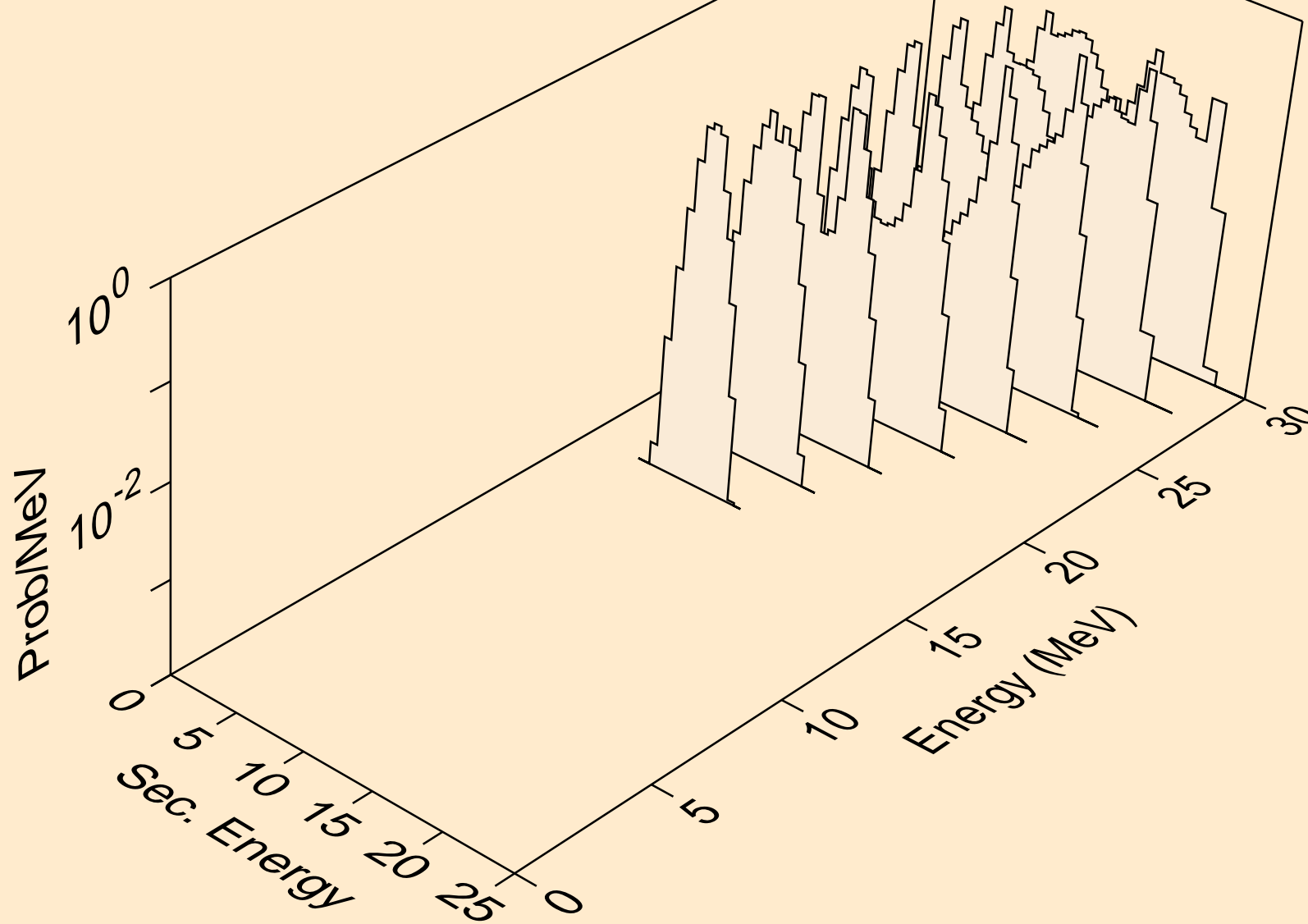

EU153 ALPHA ACER TENDL-2021 LIBRARY; T=0.K
Alpha emission for (a,pa)

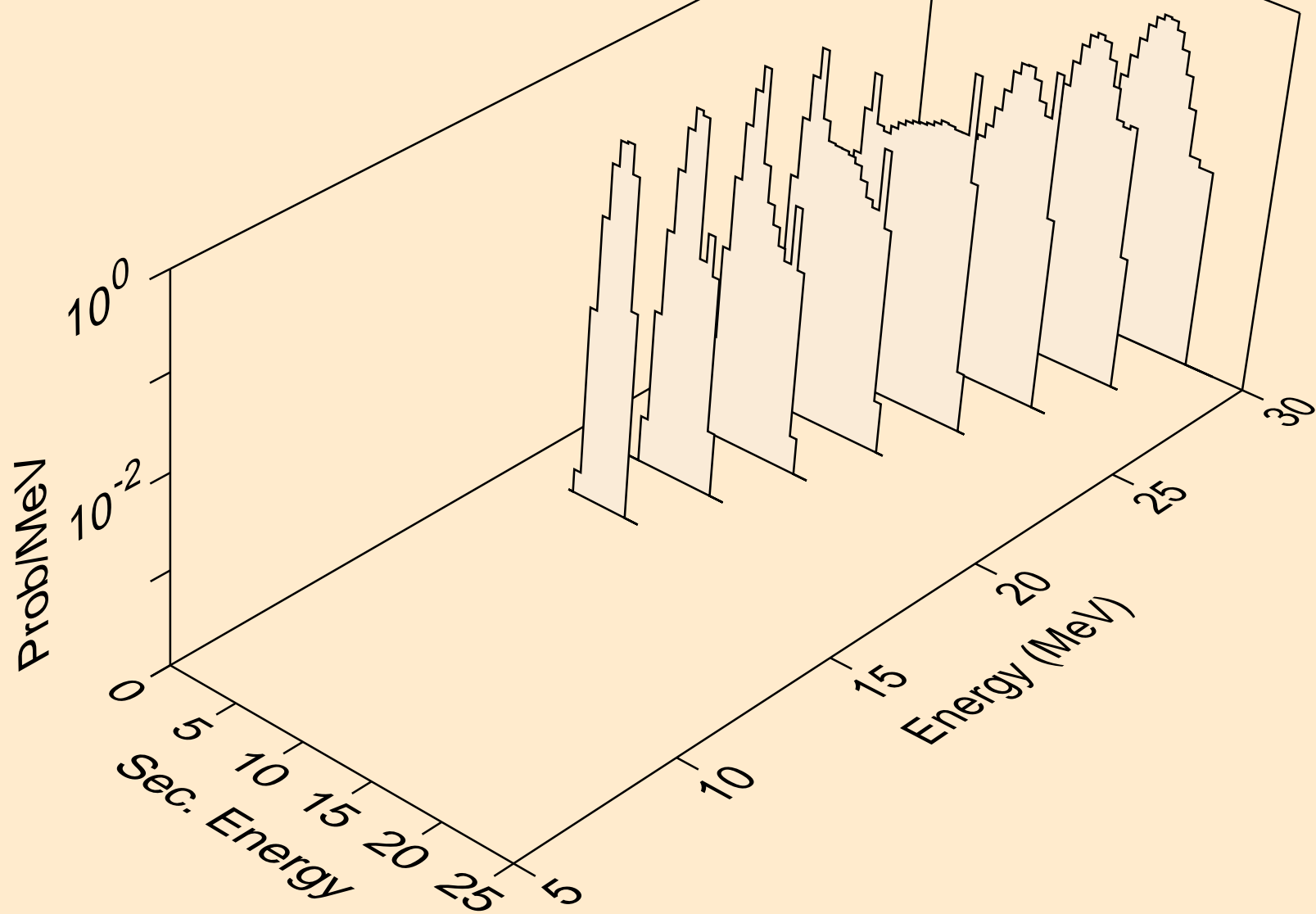

EU153 ALPHA ACER TENDL-2021 LIBRARY; T=0.K
Photon emission for (z,n)

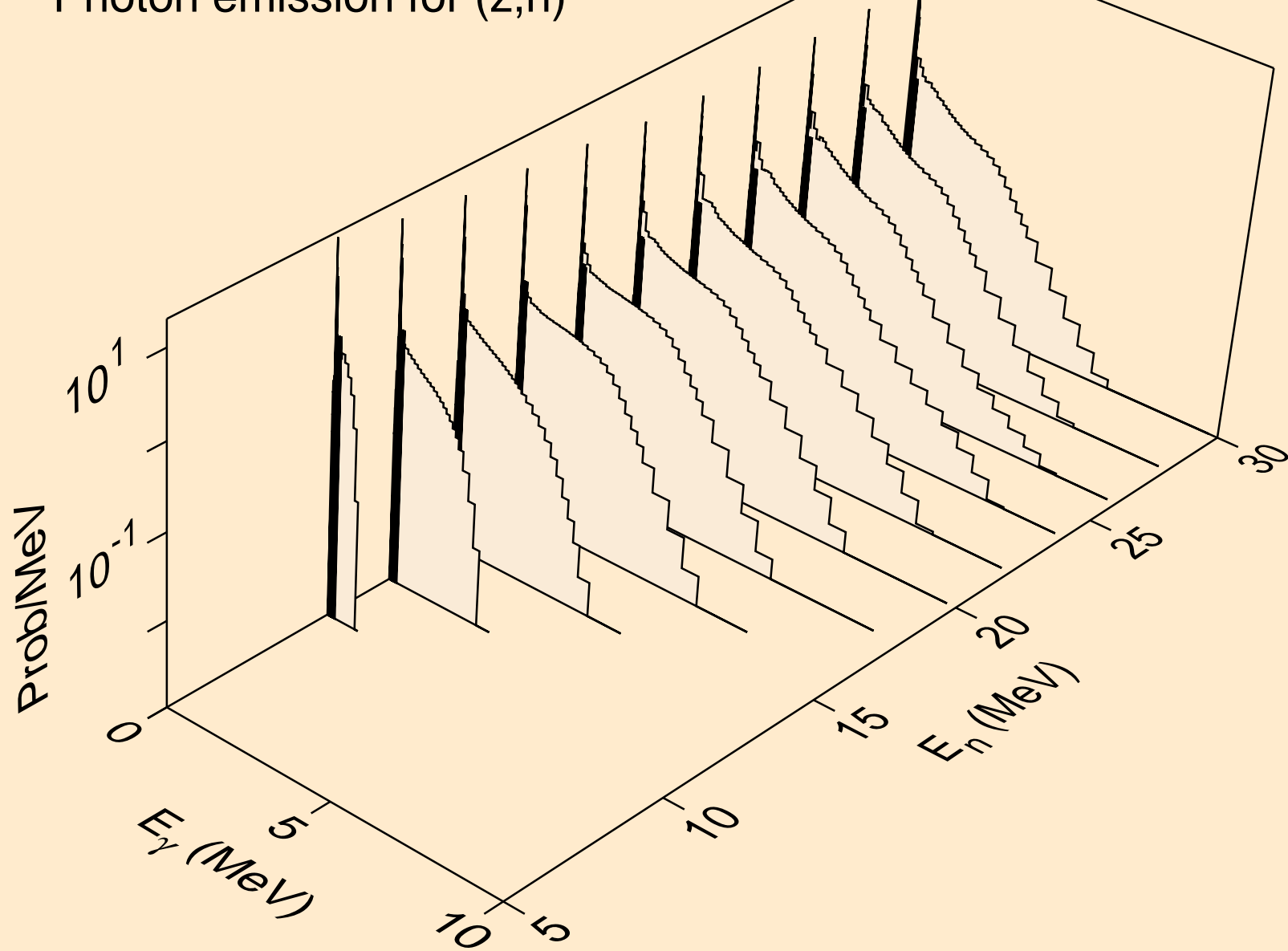

EU153 ALPHA ACER TENDL-2021 LIBRARY; T=0.K
Photon emission for (n,x)

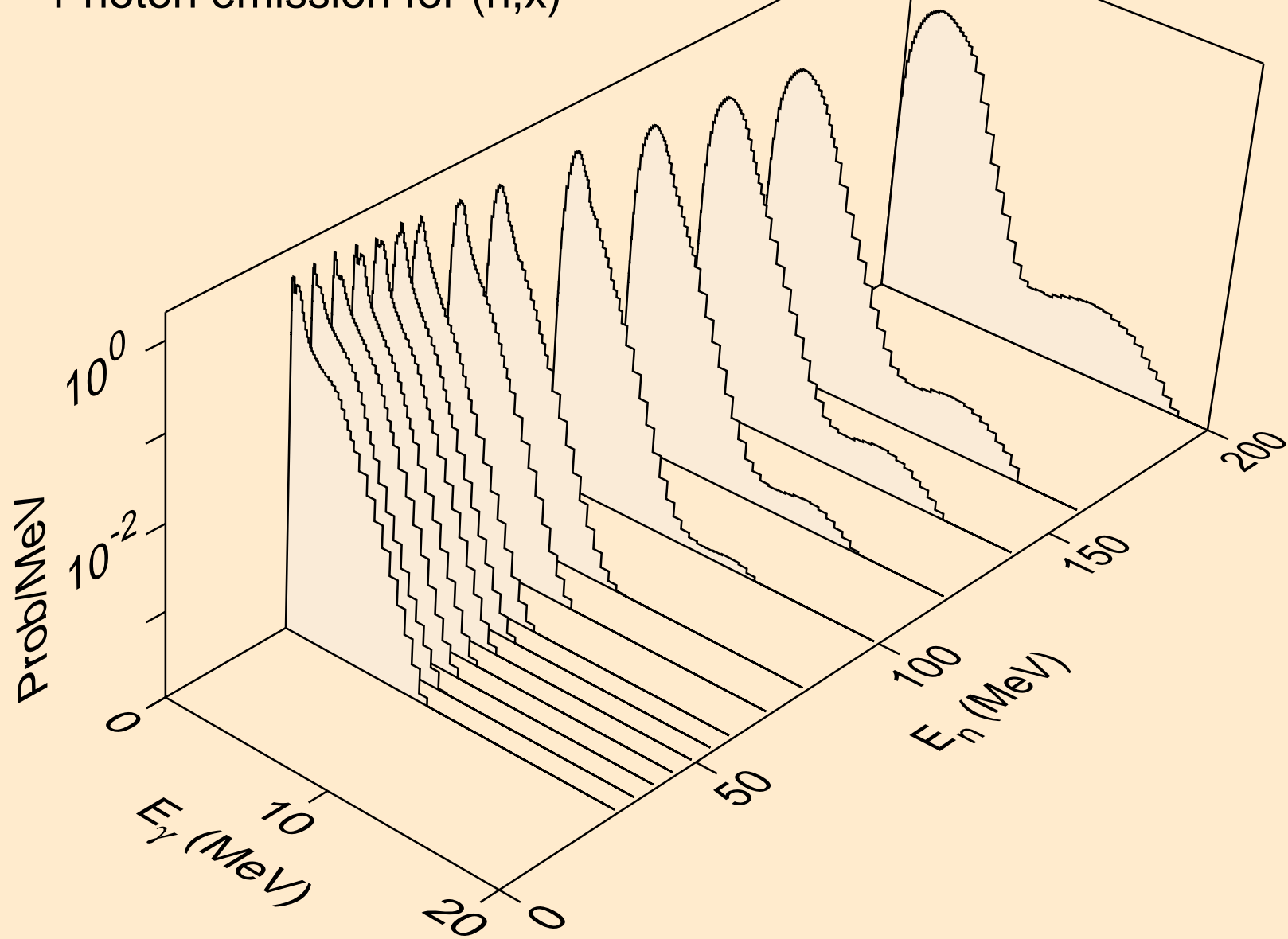

EU153 ALPHA ACER TENDL-2021 LIBRARY; T=0.K
Photon emission for (n,2n)

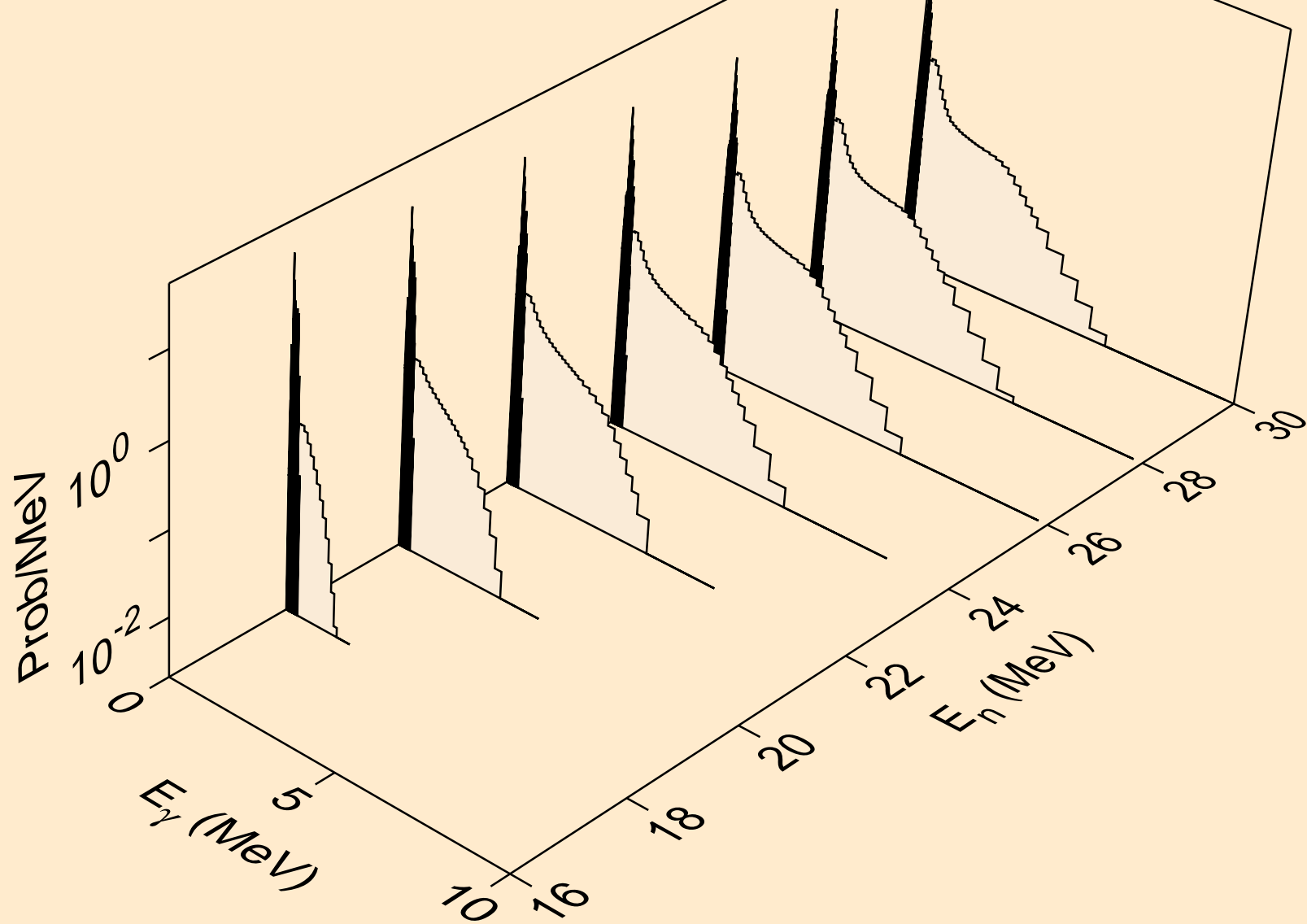

EU153 ALPHA ACER TENDL-2021 LIBRARY; T=0.K
Photon emission for (n,3n)

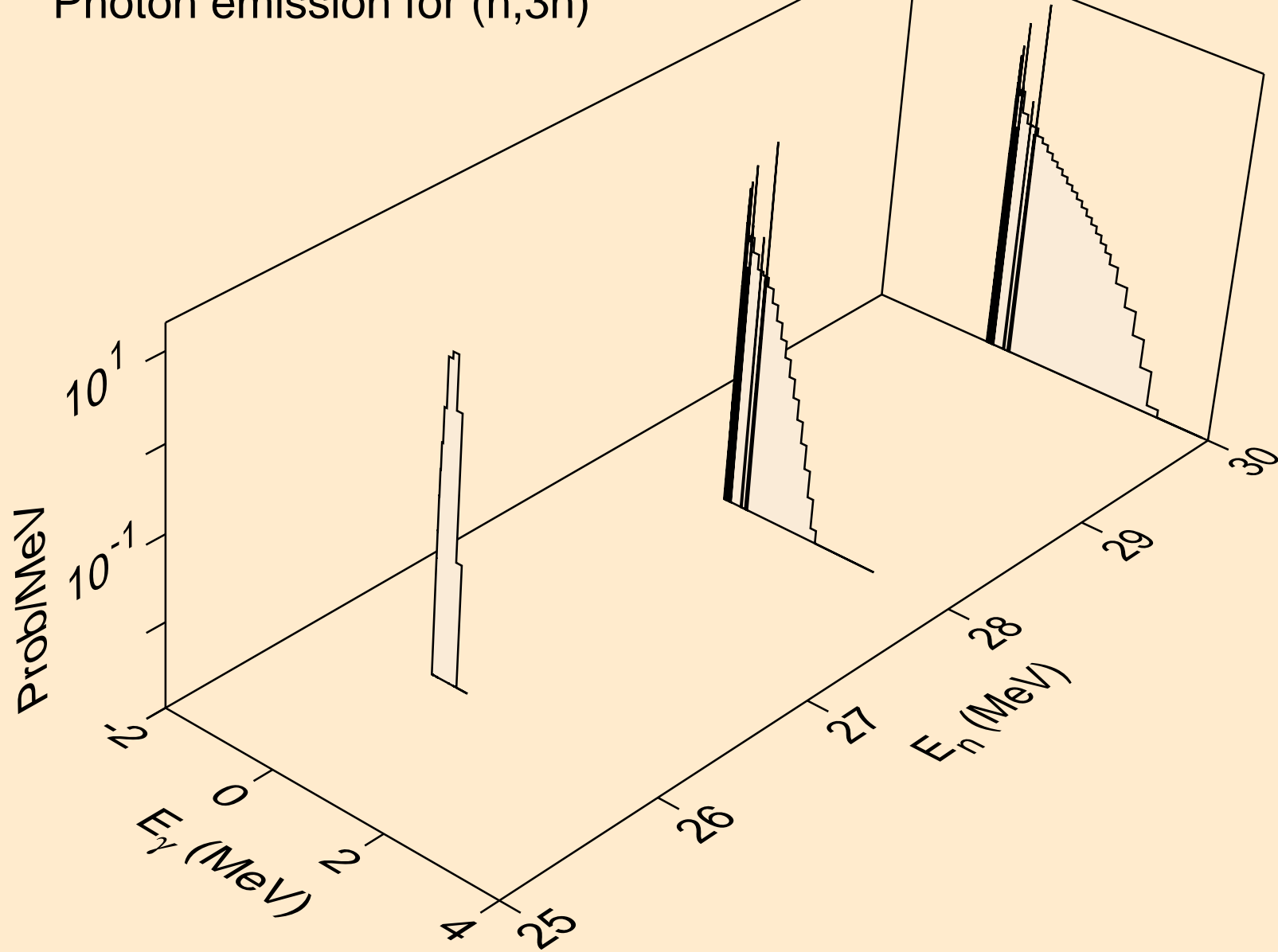

EU153 ALPHA ACER TENDL-2021 LIBRARY; T=0.K
Photon emission for (n,n*)a

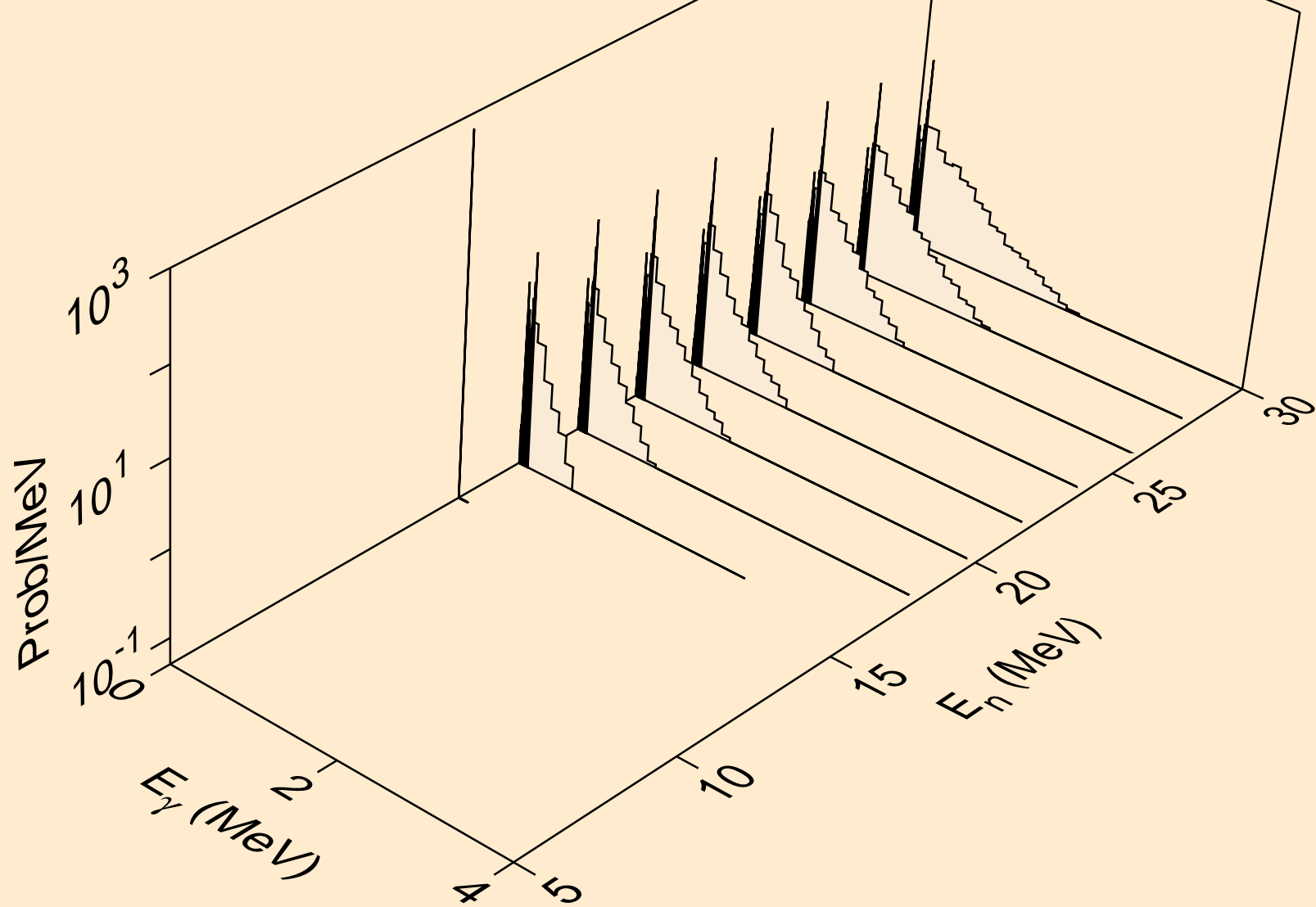

EU153 ALPHA ACER TENDL-2021 LIBRARY; T=0.K
Photon emission for (n,2n)a

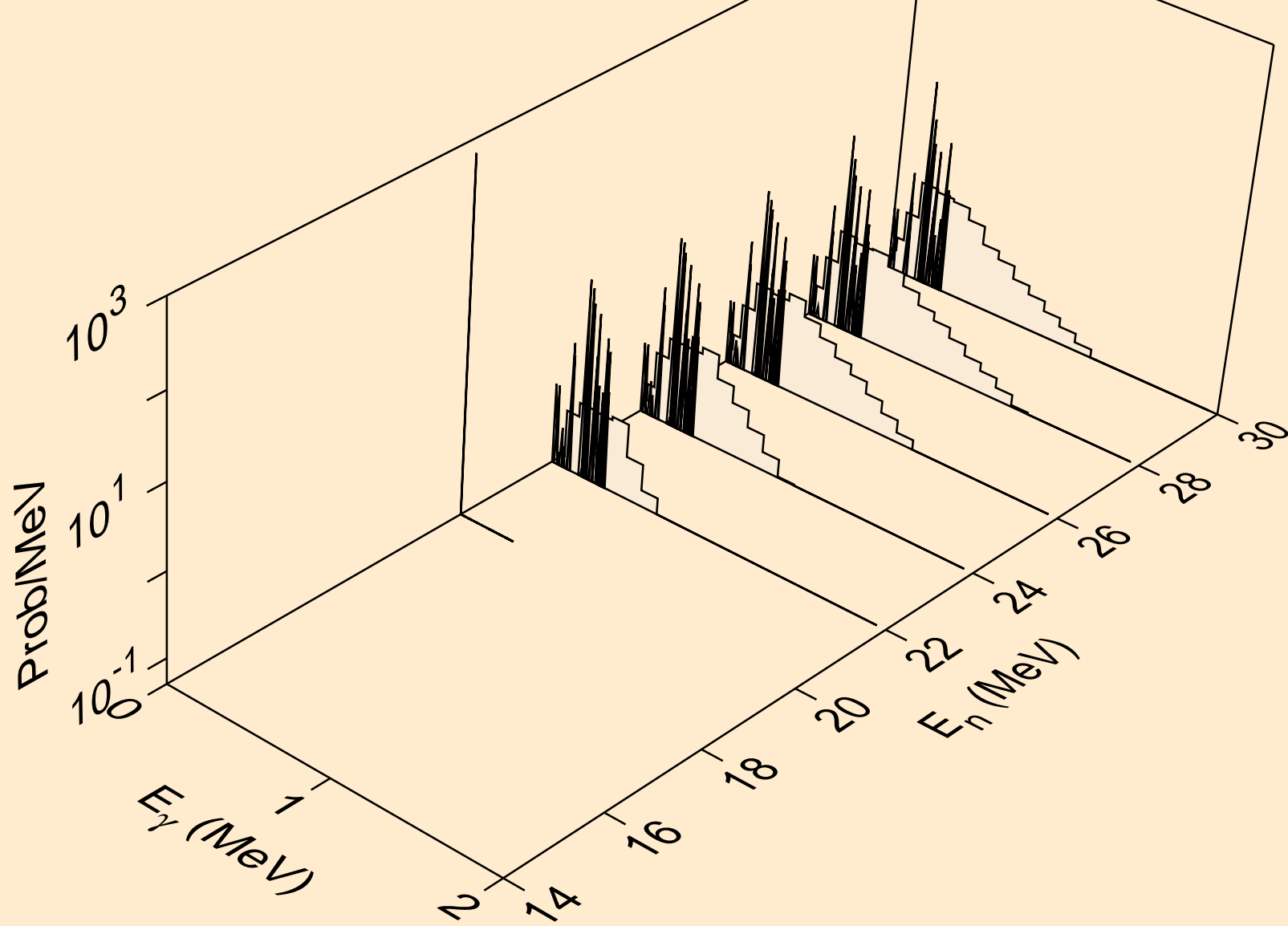

EU153 ALPHA ACER TENDL-2021 LIBRARY; T=0.K
Photon emission for (n,n*)p

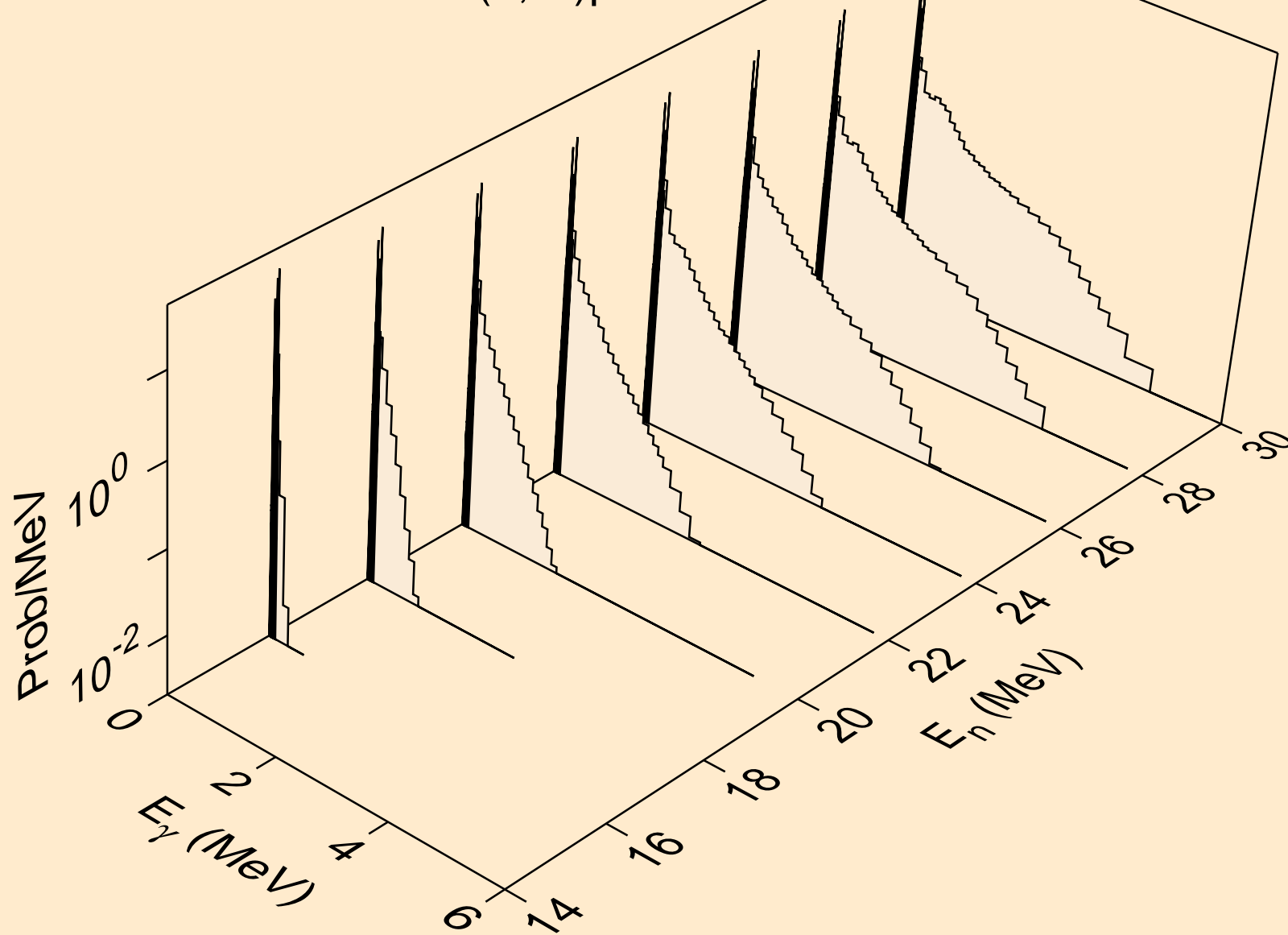

EU153 ALPHA ACER TENDL-2021 LIBRARY; T=0.K
Photon emission for (n,n*)d

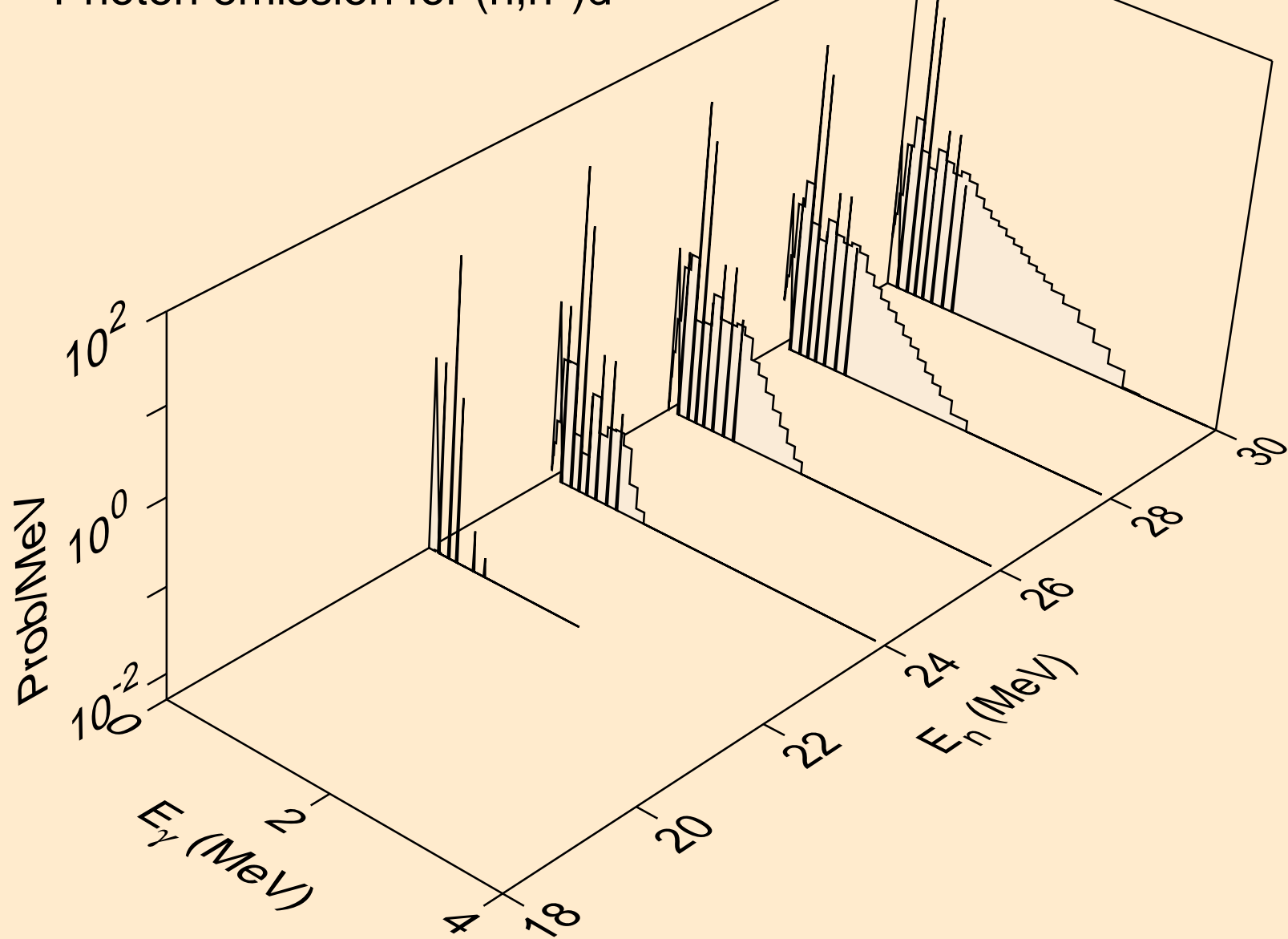

EU153 ALPHA ACER TENDL-2021 LIBRARY; T=0.K
Photon emission for (n,n*)t

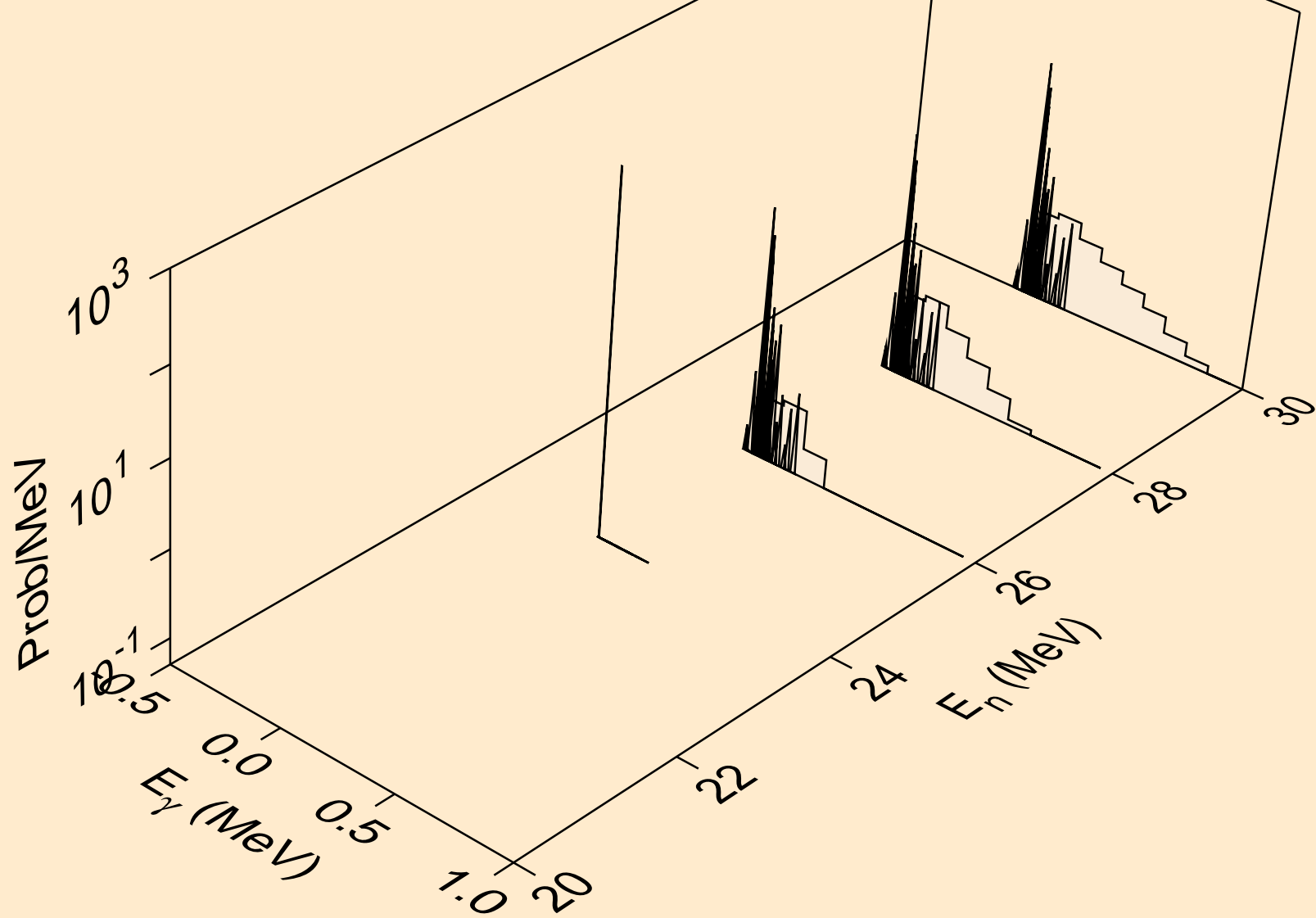

EU153 ALPHA ACER TENDL-2021 LIBRARY; T=0.K
Photon emission for (n,2np)

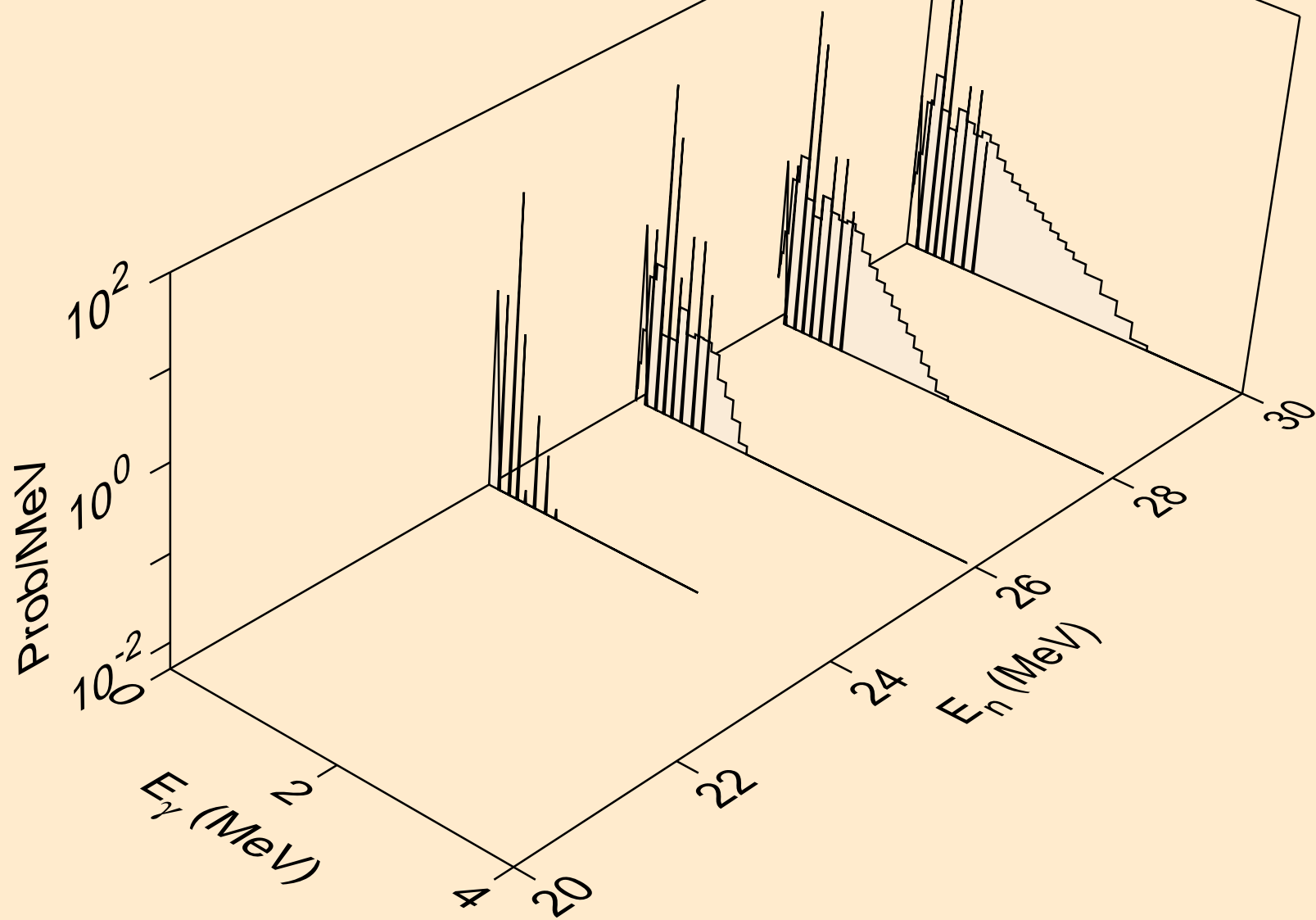

EU153 ALPHA ACER TENDL-2021 LIBRARY; T=0.K
Photon emission for (n,gma)

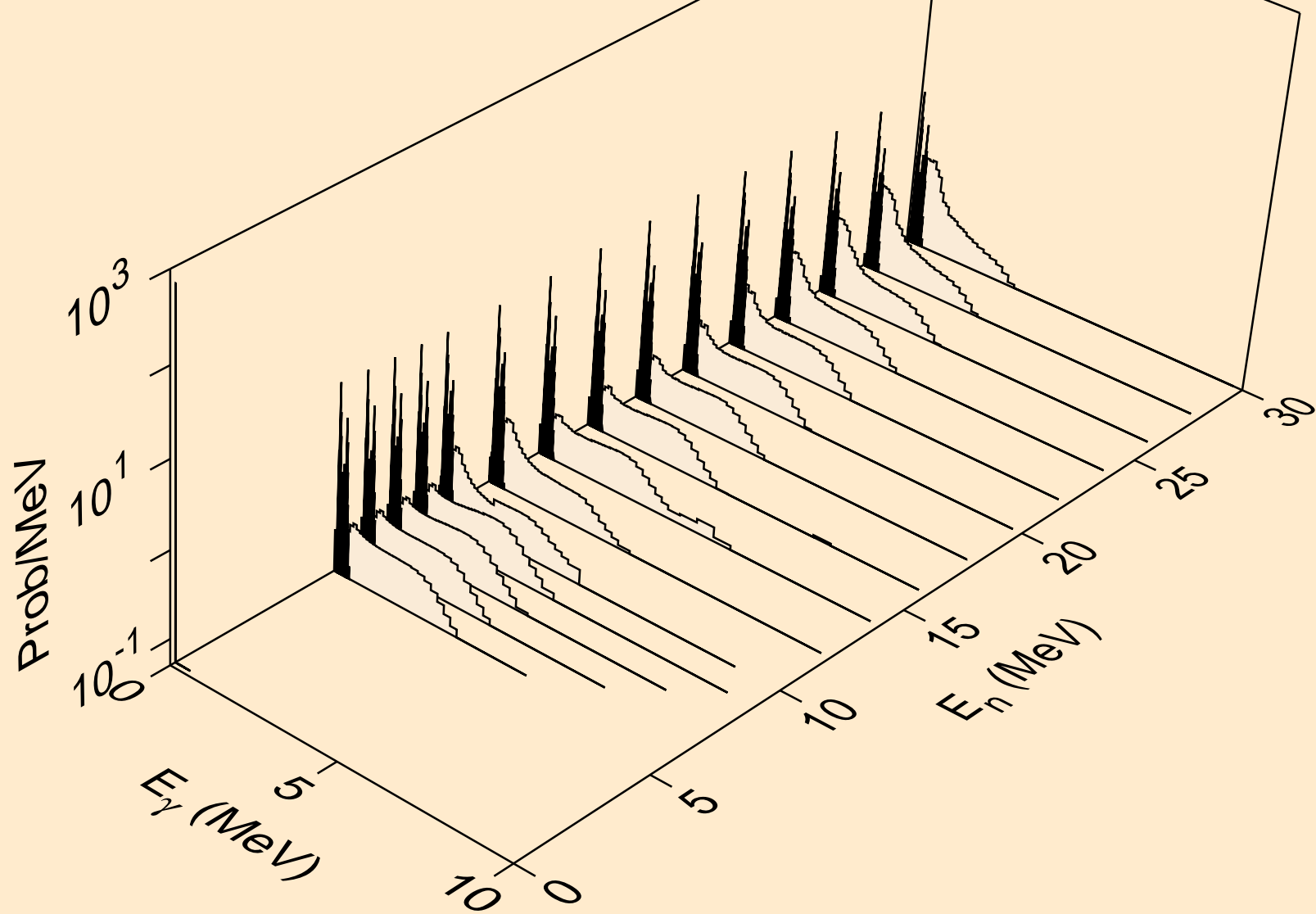

EU153 ALPHA ACER TENDL-2021 LIBRARY; T=0.K
Photon emission for (n,p)

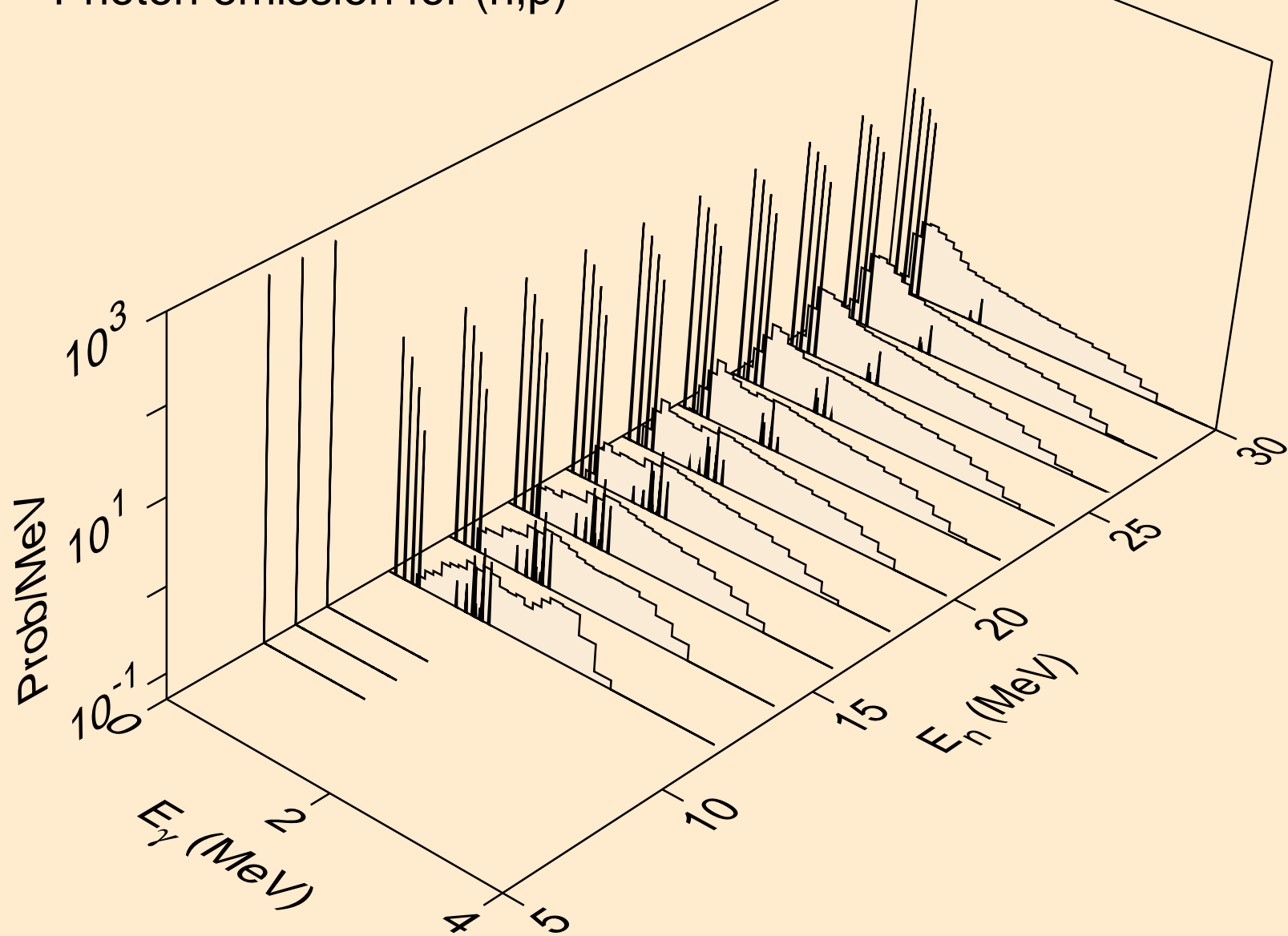

EU153 ALPHA ACER TENDL-2021 LIBRARY; T=0.K
Photon emission for (n,d)

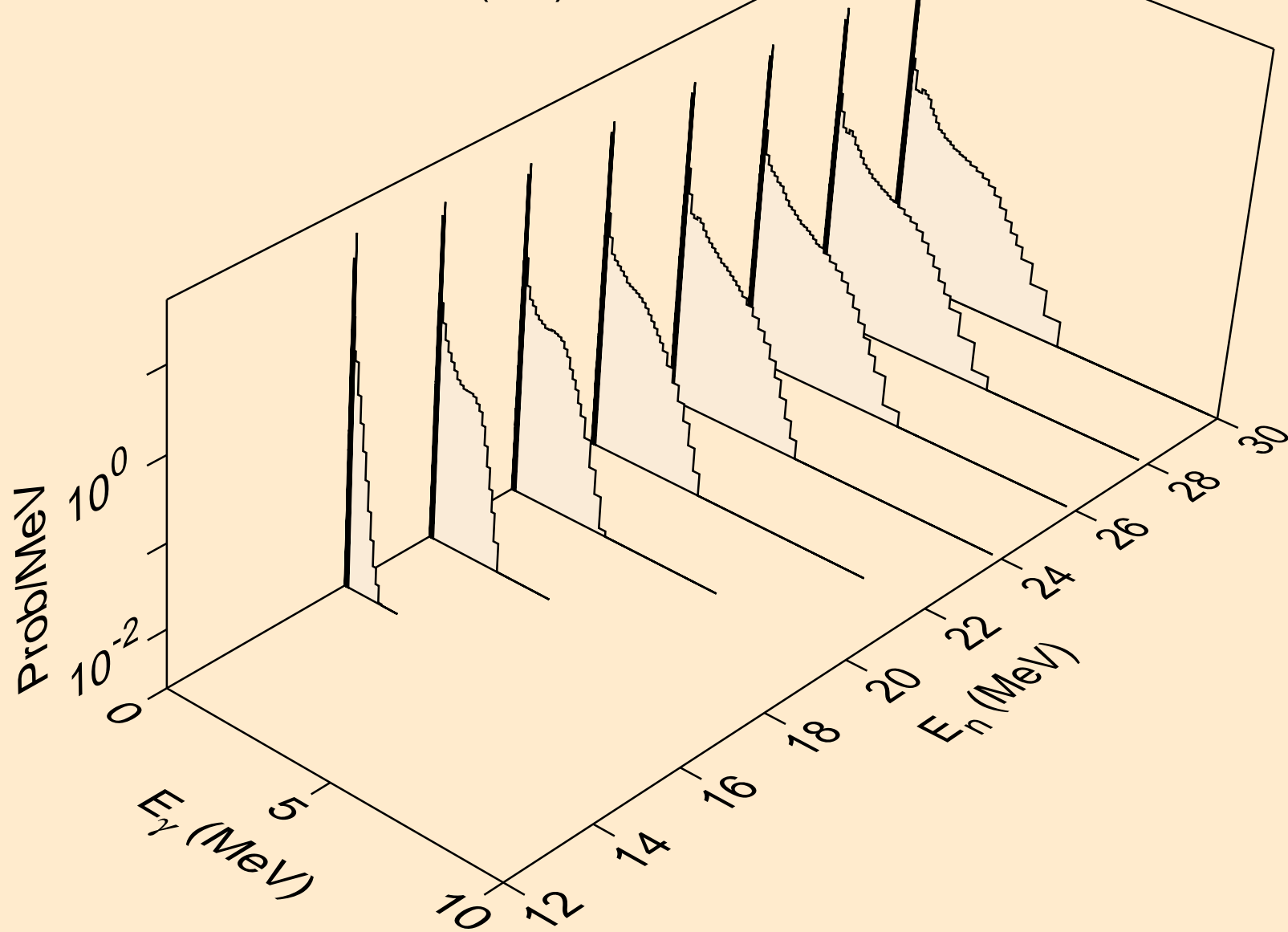

EU153 ALPHA ACER TENDL-2021 LIBRARY; T=0.K
Photon emission for (n,t)

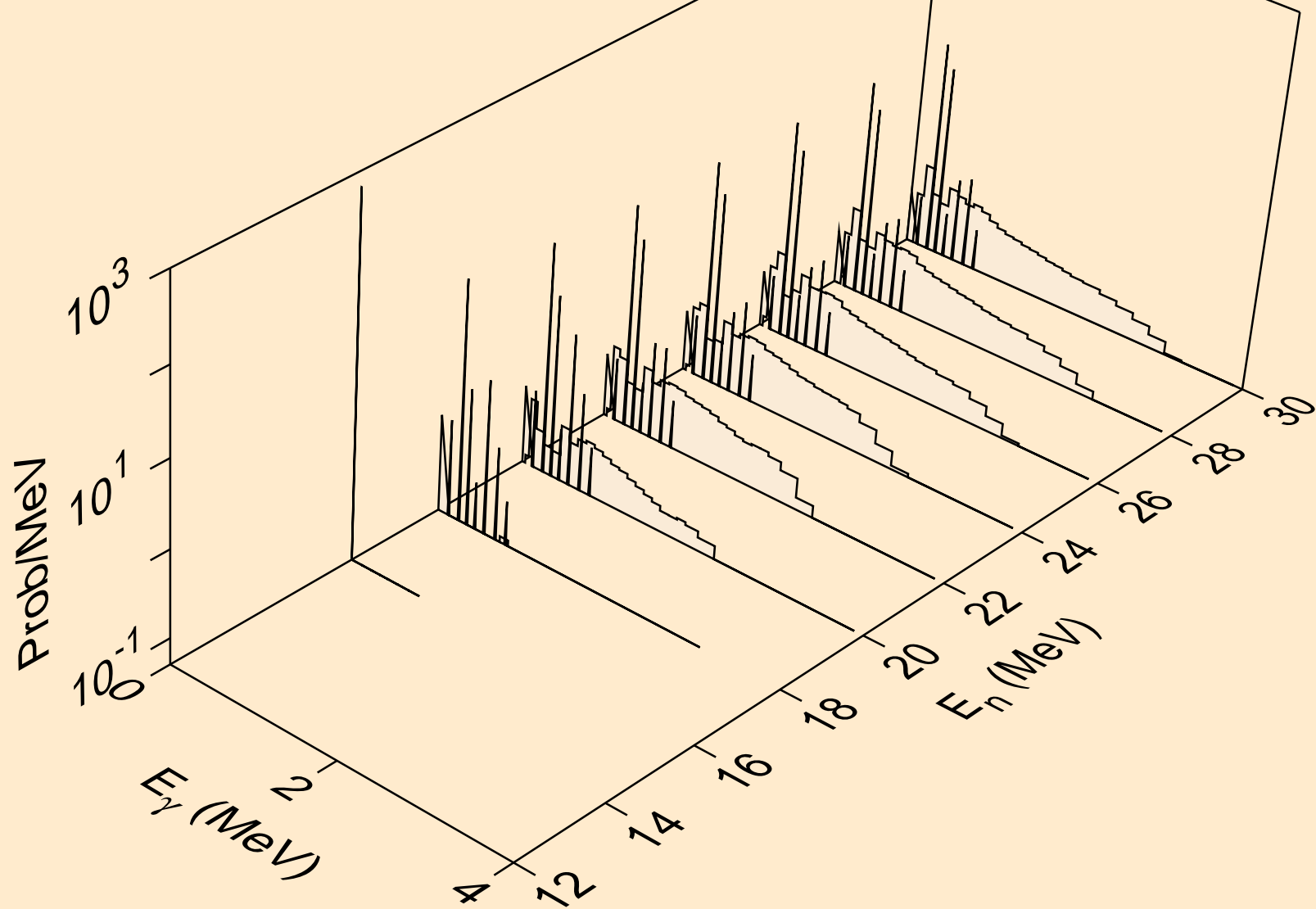

EU153 ALPHA ACER TENDL-2021 LIBRARY; T=0.K
Photon emission for (n,he3)

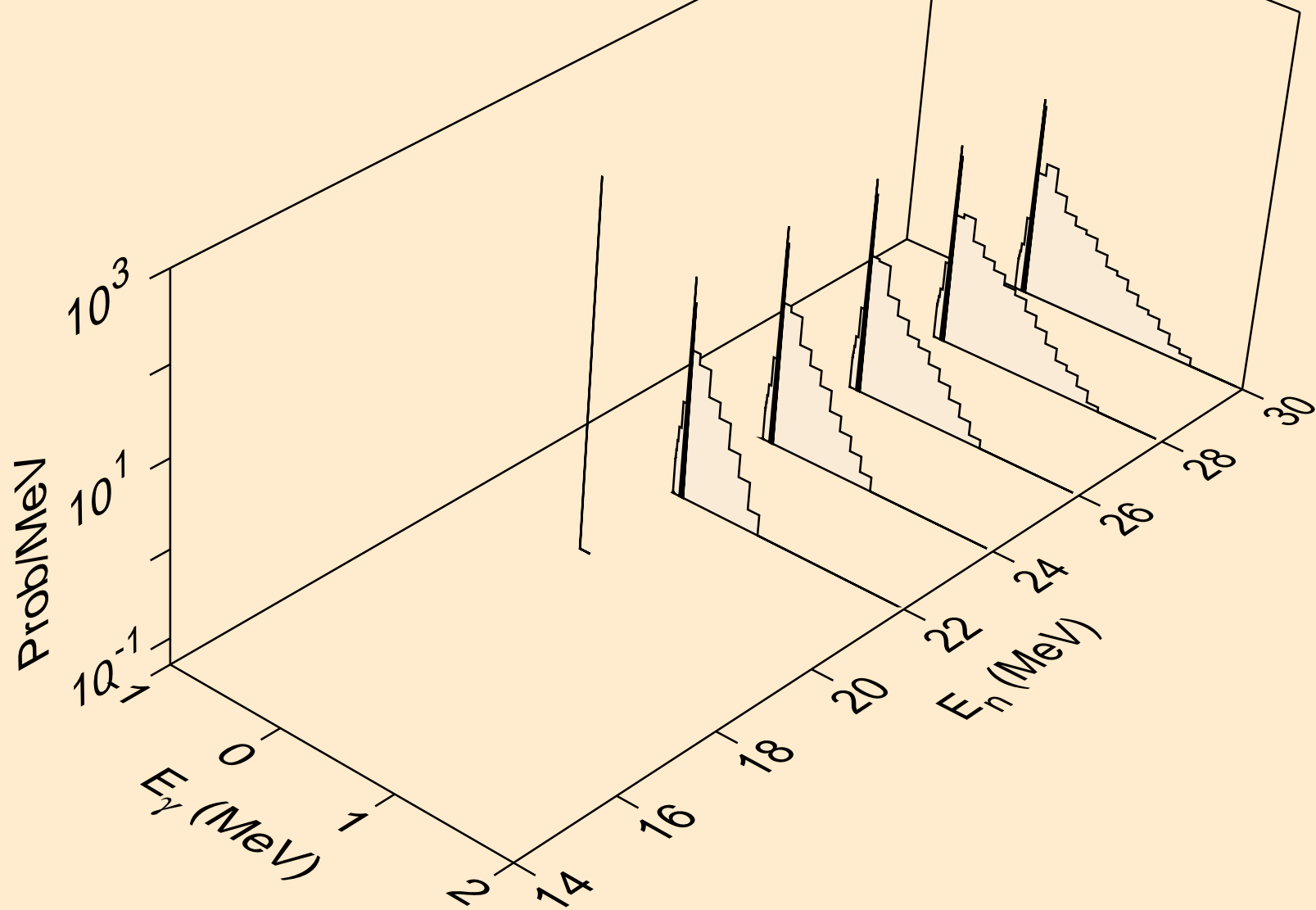

EU153 ALPHA ACER TENDL-2021 LIBRARY; T=0.K
Photon emission for inelastic

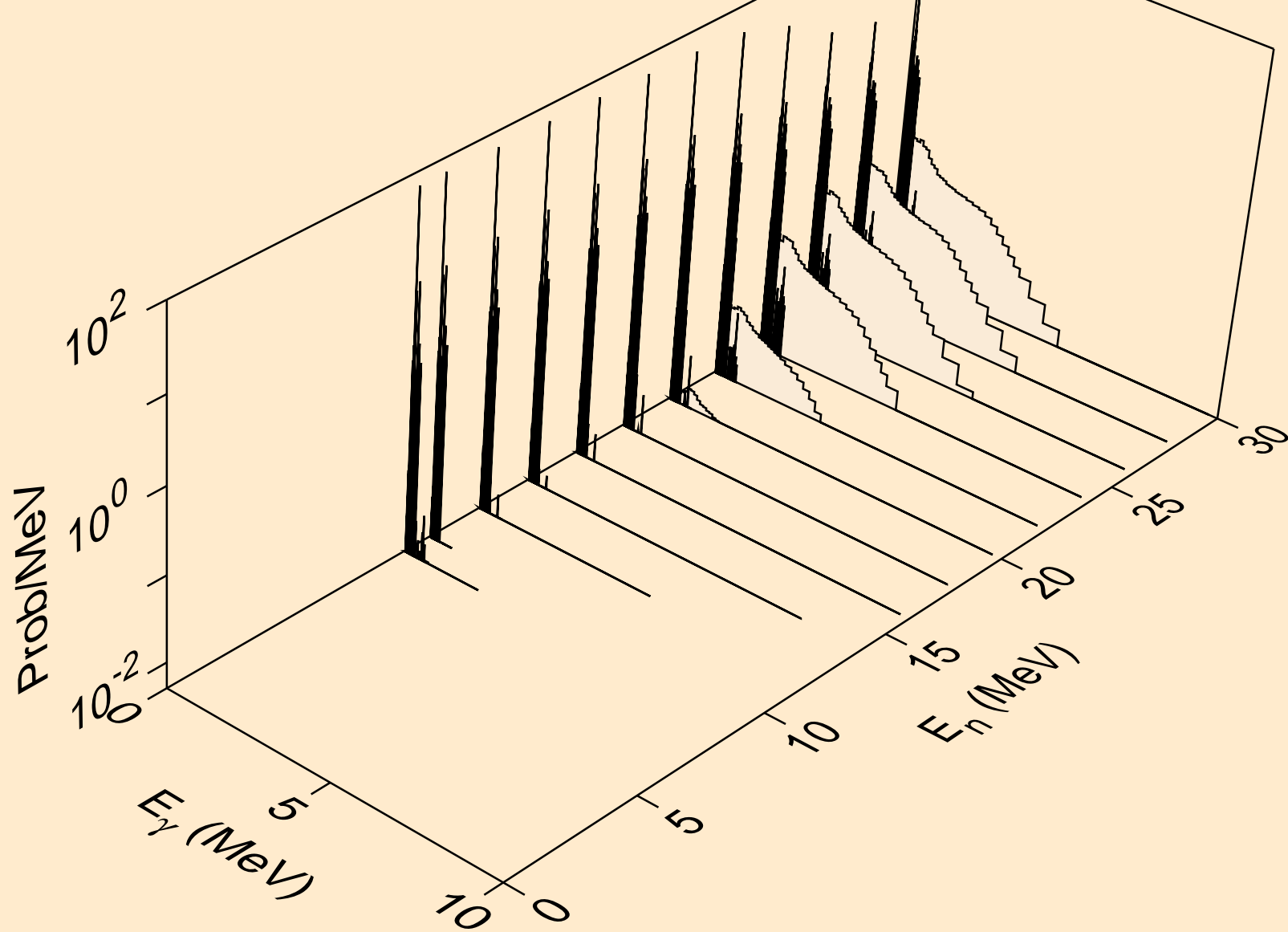

EU153 ALPHA ACER TENDL-2021 LIBRARY; T=0.K
Photon emission for (n,2a)

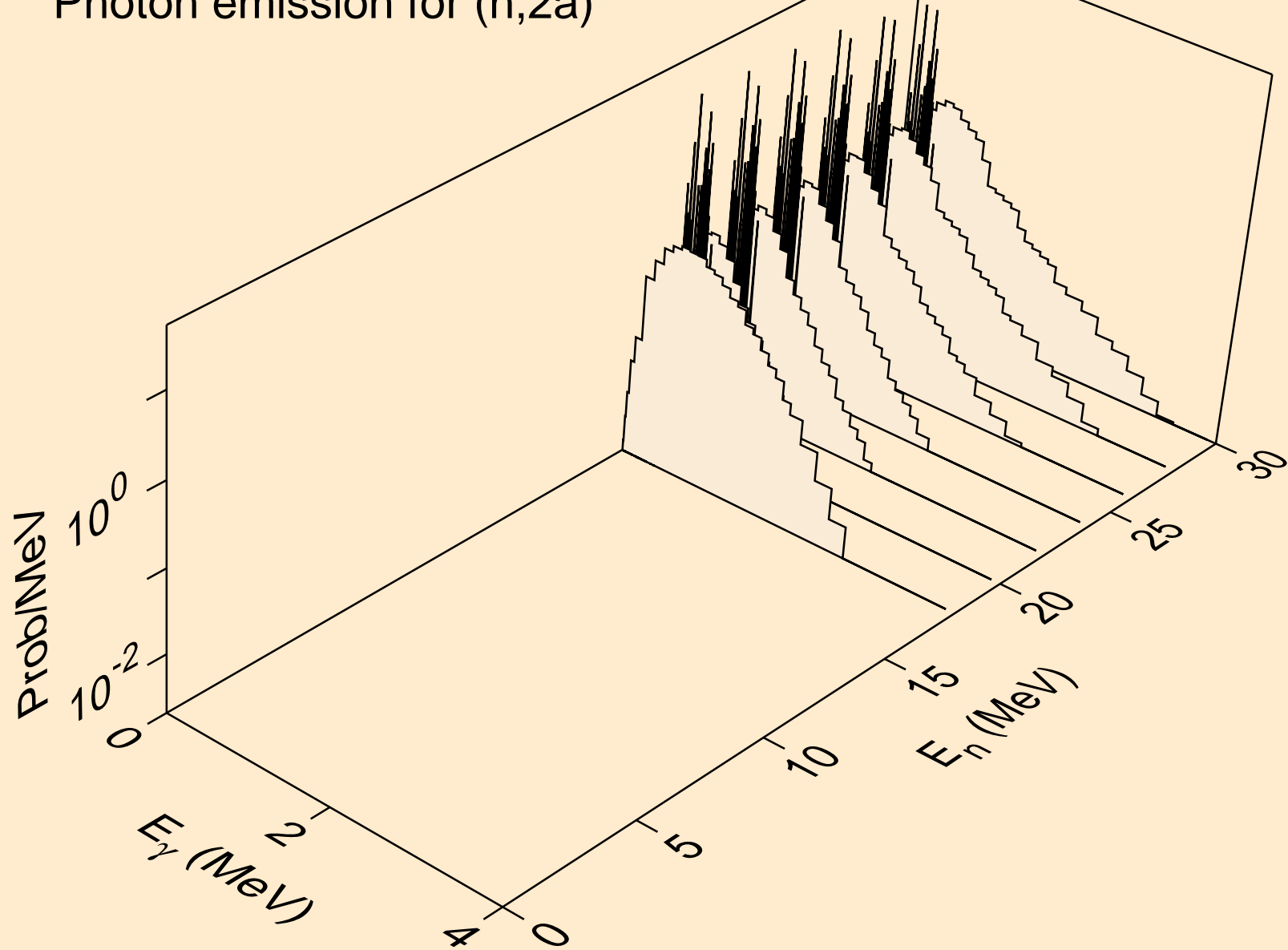

EU153 ALPHA ACER TENDL-2021 LIBRARY; T=0.K
Photon emission for (n,2p)

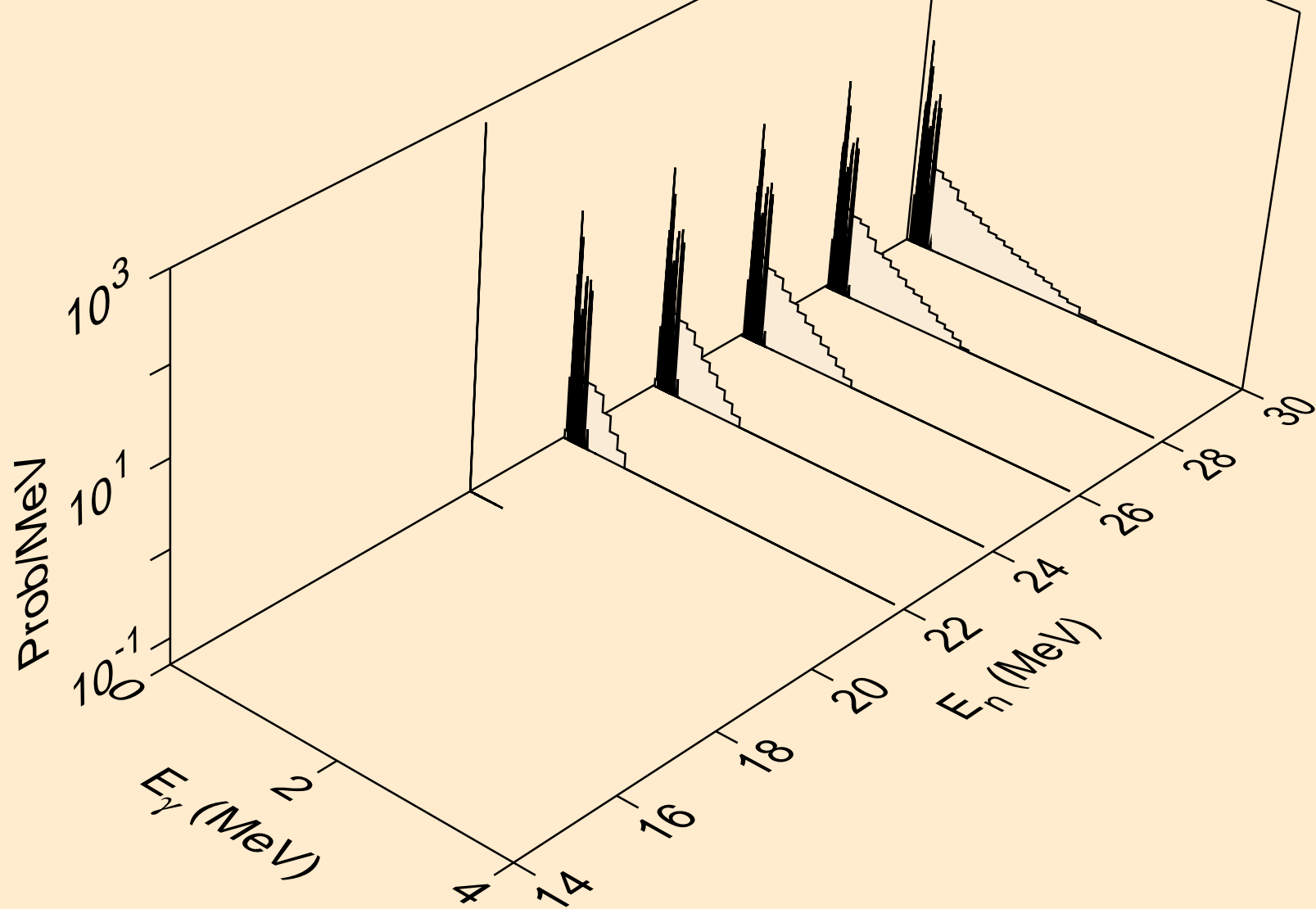

EU153 ALPHA ACER TENDL-2021 LIBRARY; T=0.K
Photon emission for (n,pa)

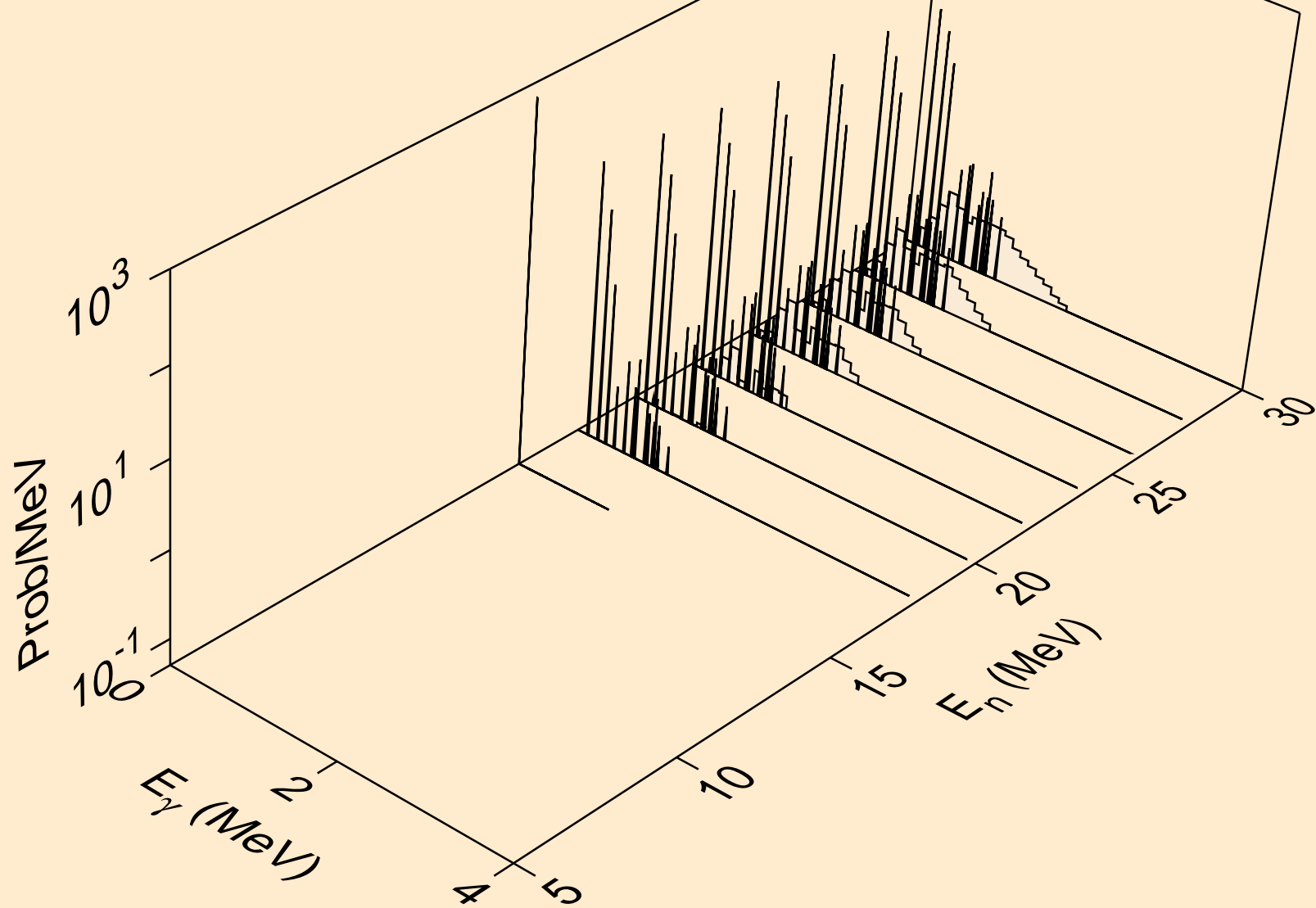

EU153 ALPHA ACER TENDL-2021 LIBRARY; T=0.K
Particle heating contributions

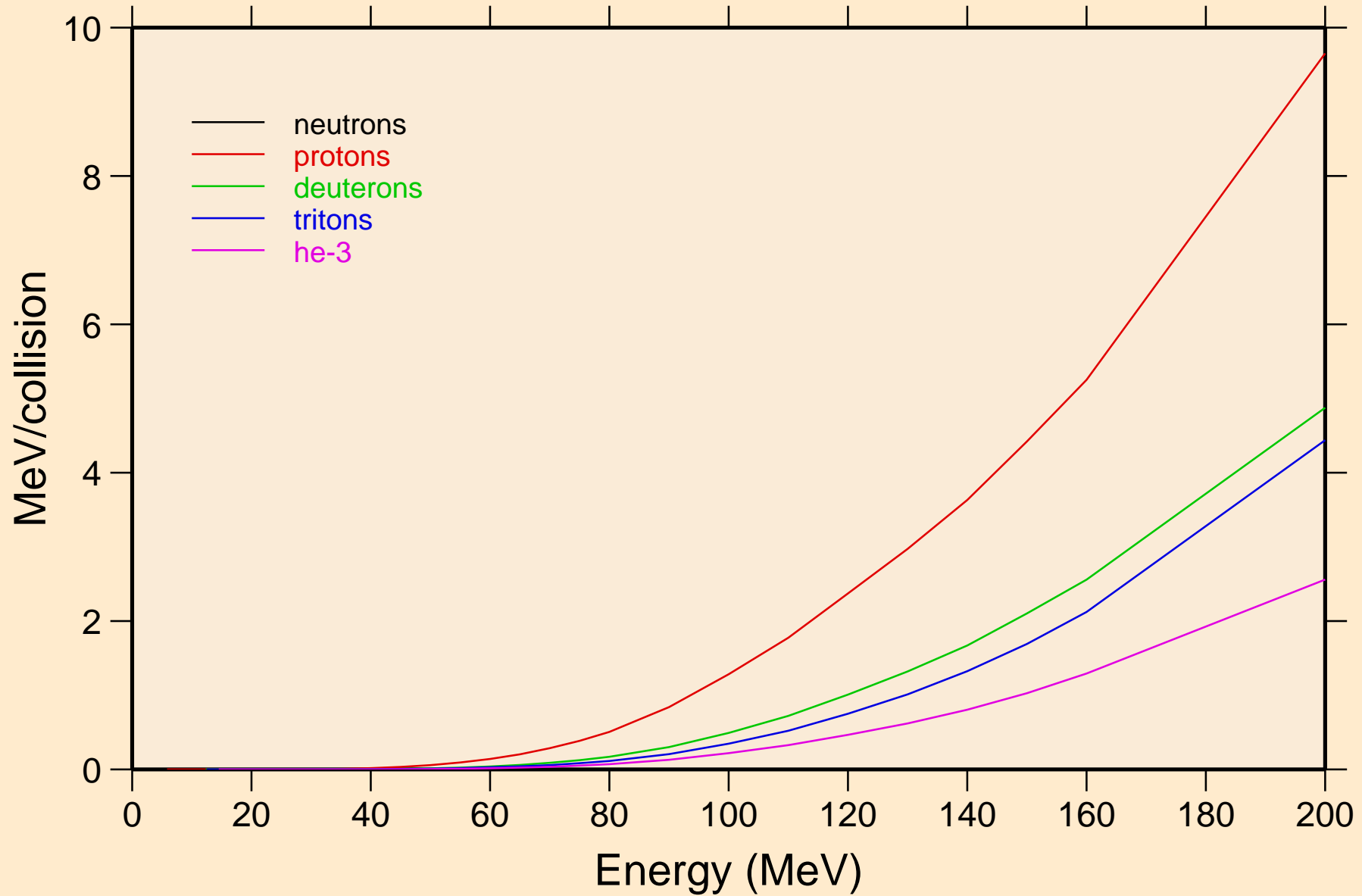

EU153 ALPHA ACER TENDL-2021 LIBRARY; T=0.K
Recoil Heating

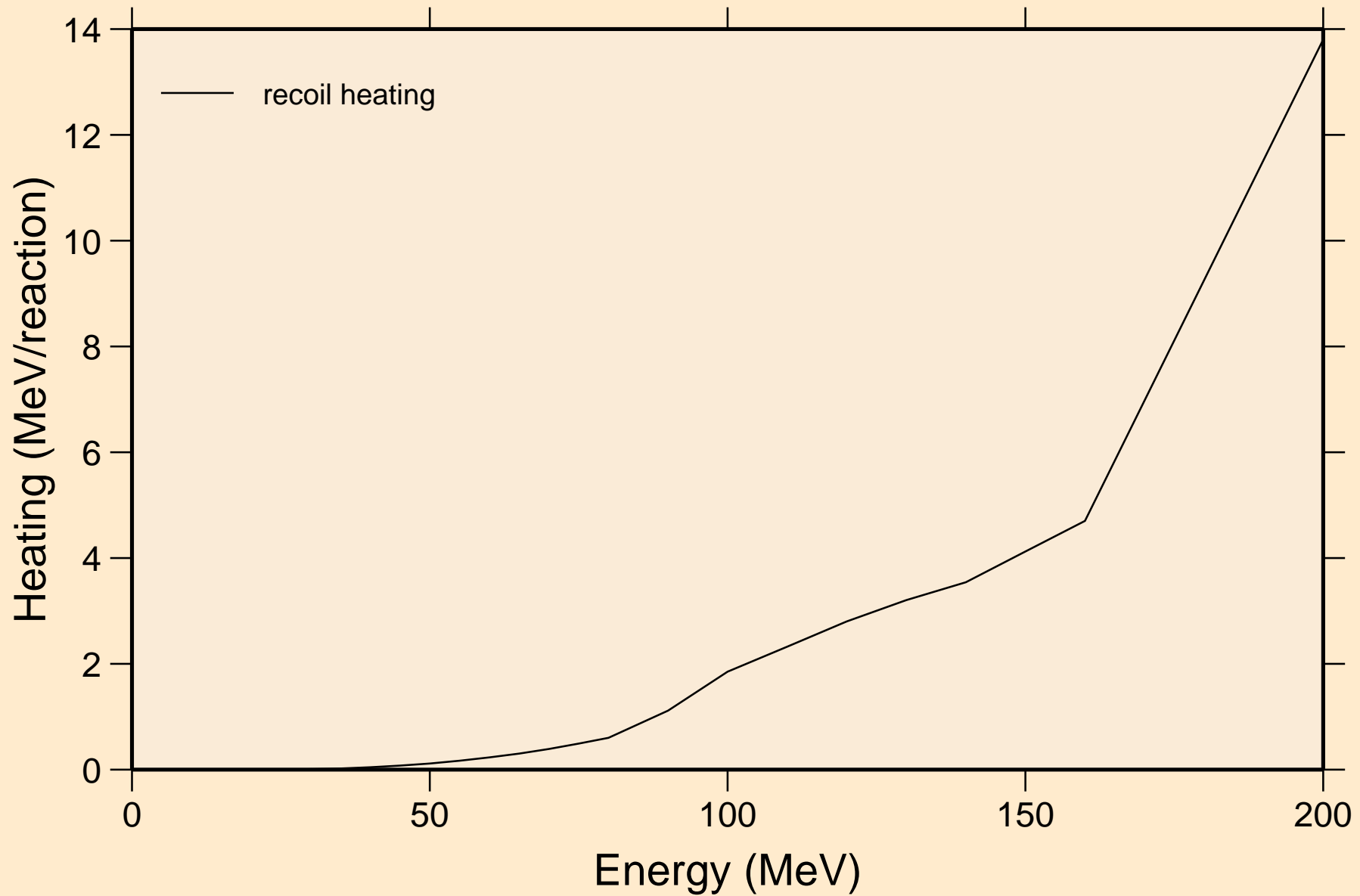

EU153 ALPHA ACER TENDL-2021 LIBRARY; T=0.K
Particle production cross sections

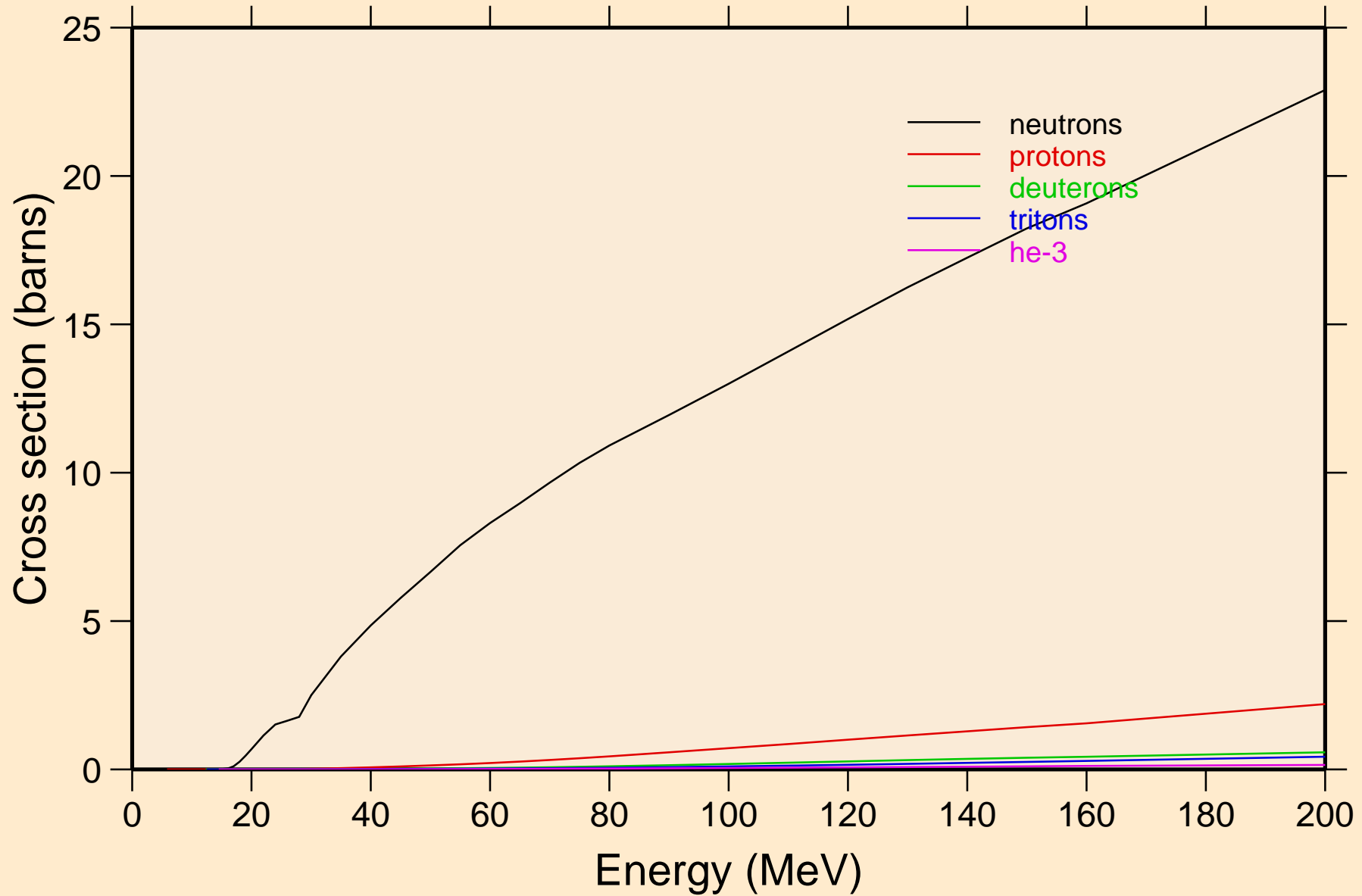

EU153 ALPHA ACER TENDL-2021 LIBRARY; T=0.K
neutrons from (a,n)

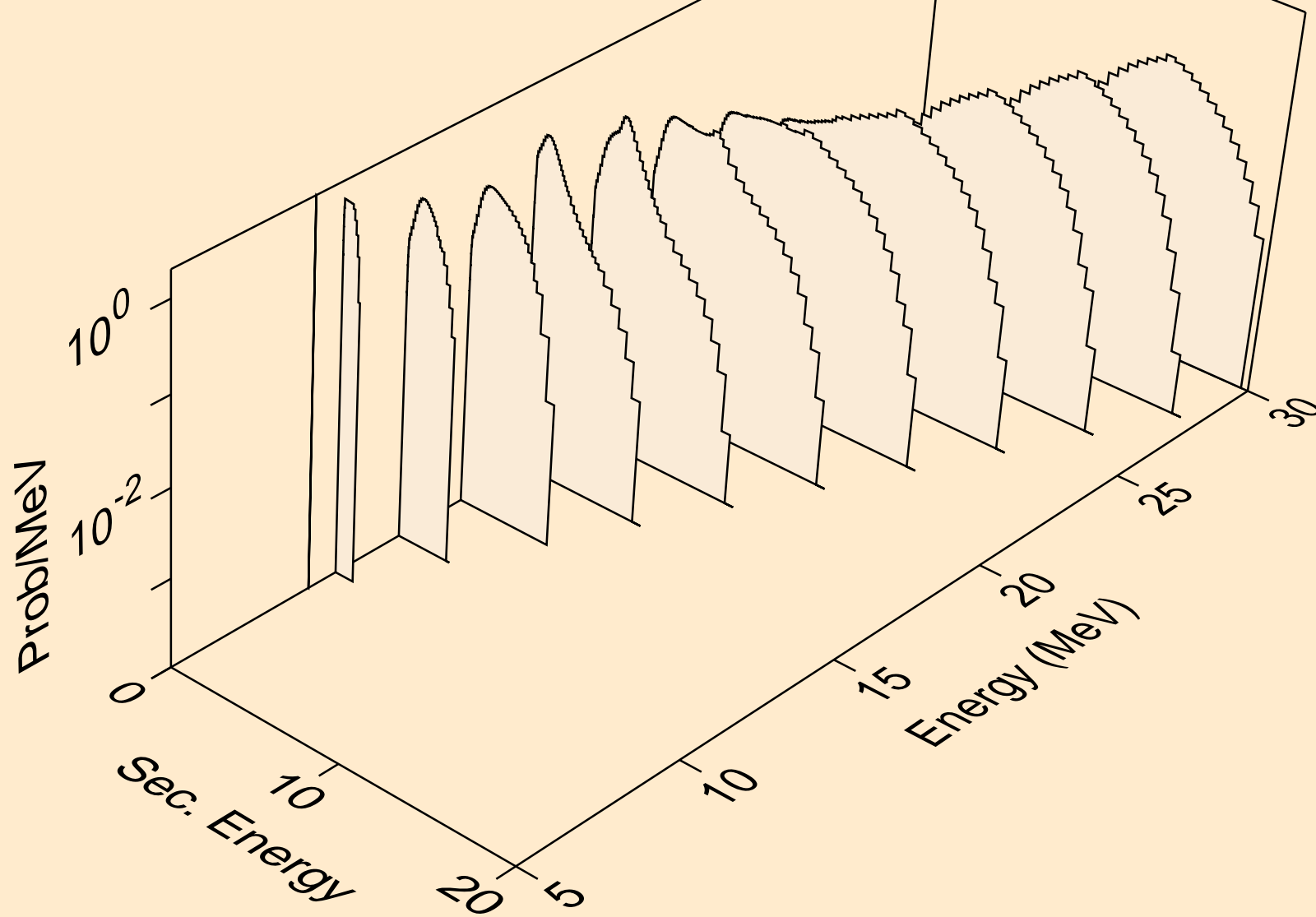

EU153 ALPHA ACER TENDL-2021 LIBRARY; T=0.K
neutrons from (a,x)

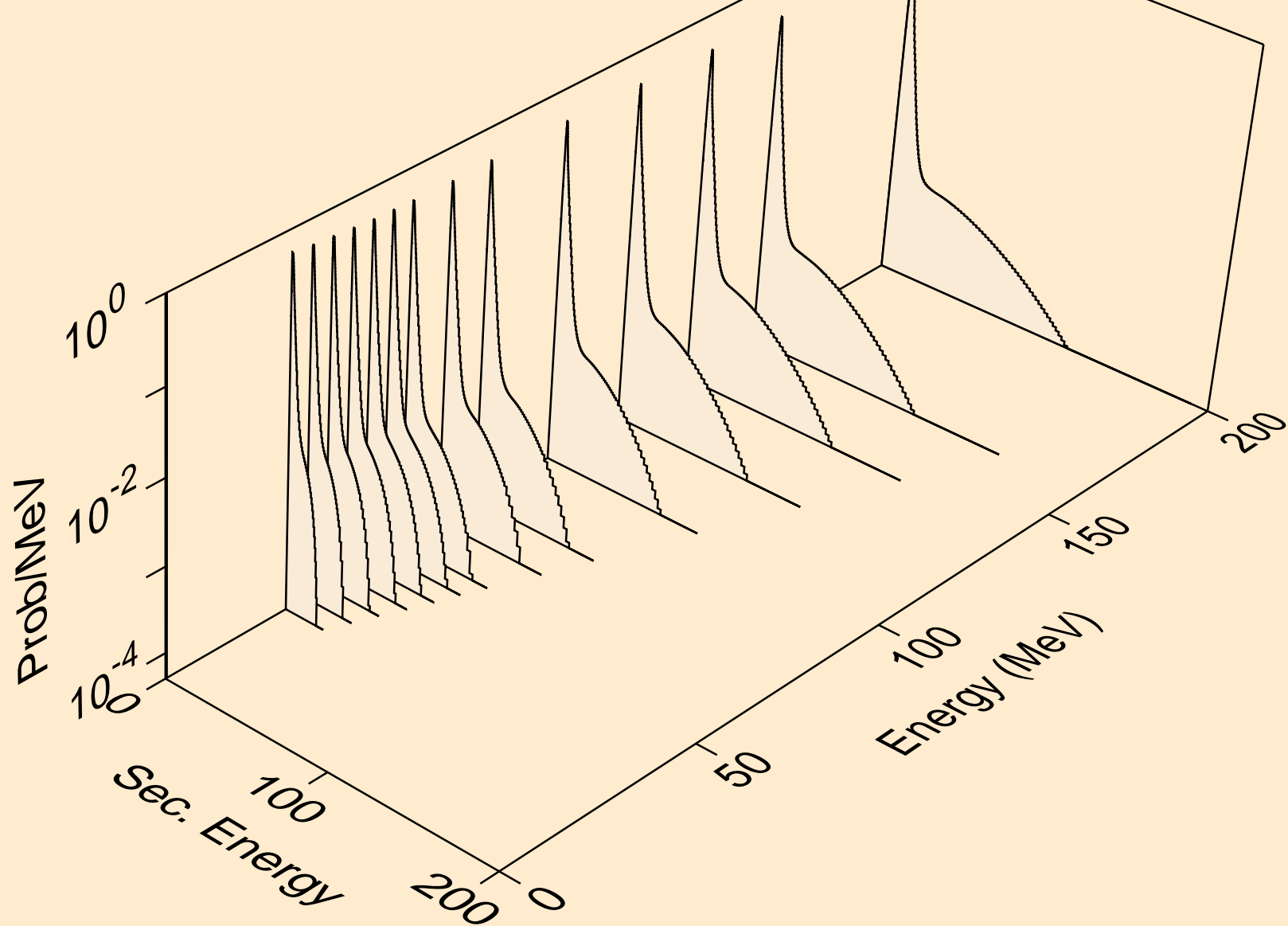

EU153 ALPHA ACER TENDL-2021 LIBRARY; T=0.K
neutrons from (a,2n)

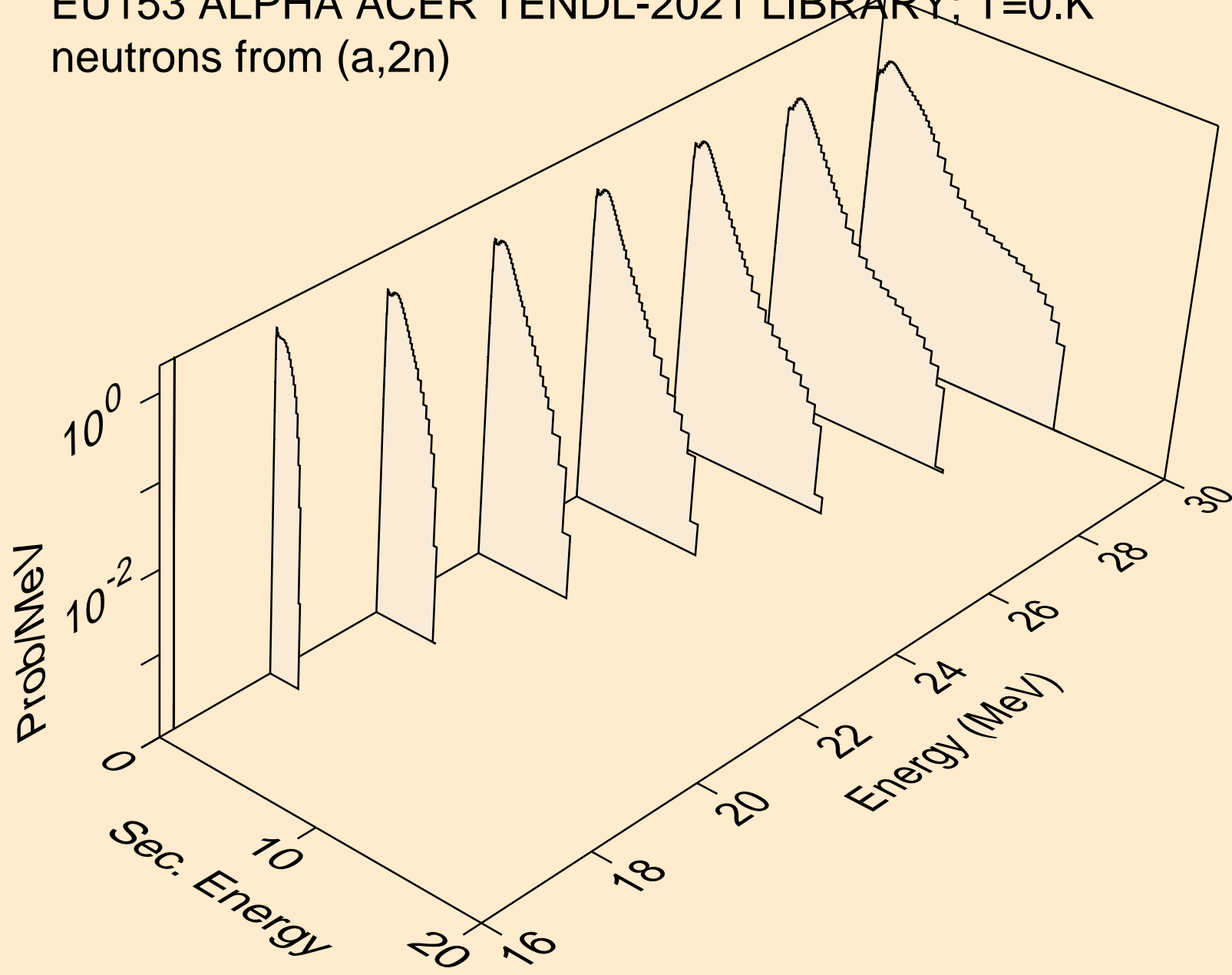

EU153 ALPHA ACER TENDL-2021 LIBRARY; T=0.K
neutrons from (a,3n)

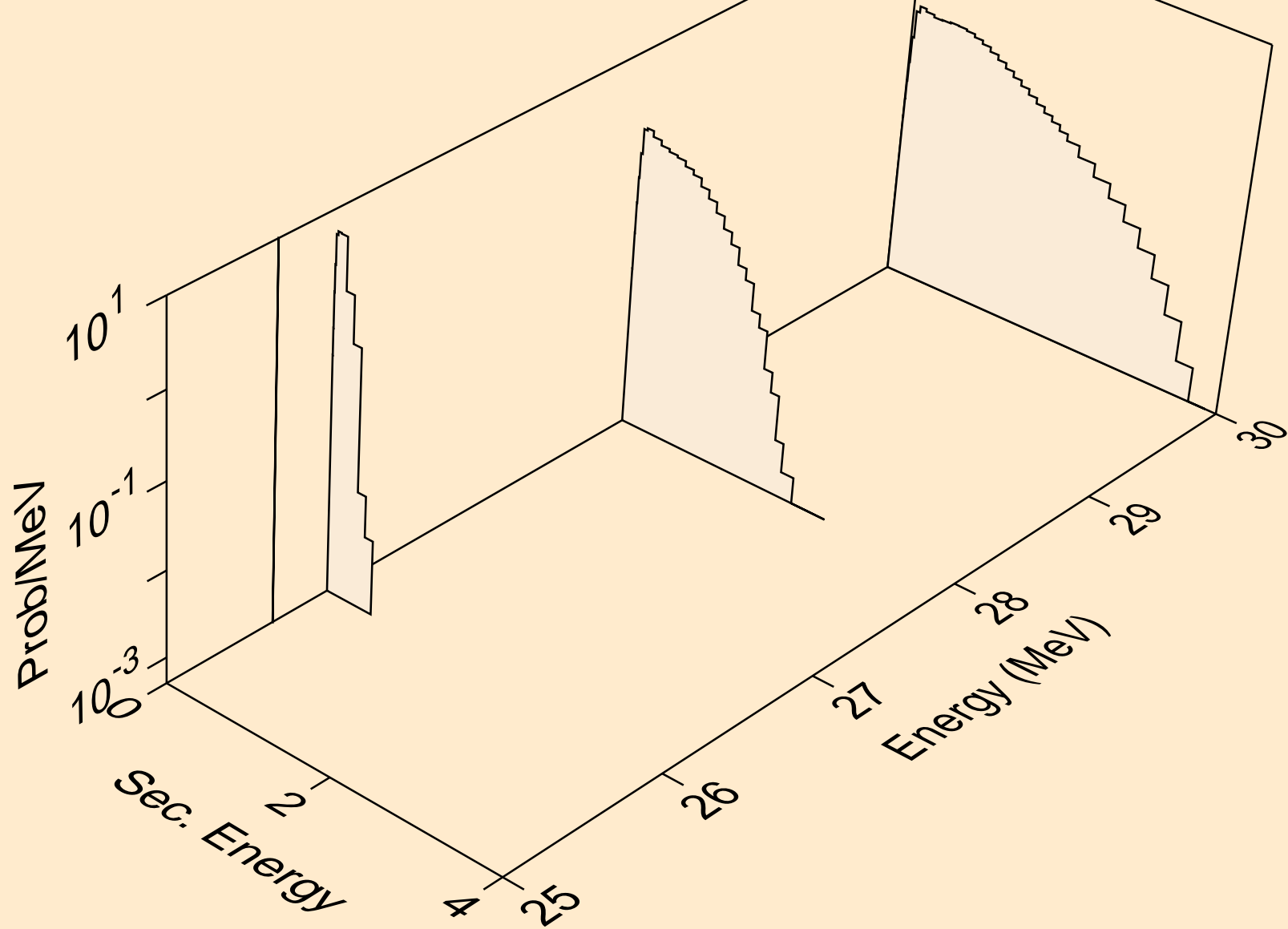

EU153 ALPHA ACER TENDL-2021 LIBRARY; T=0.K
neutrons from (a,n*)a

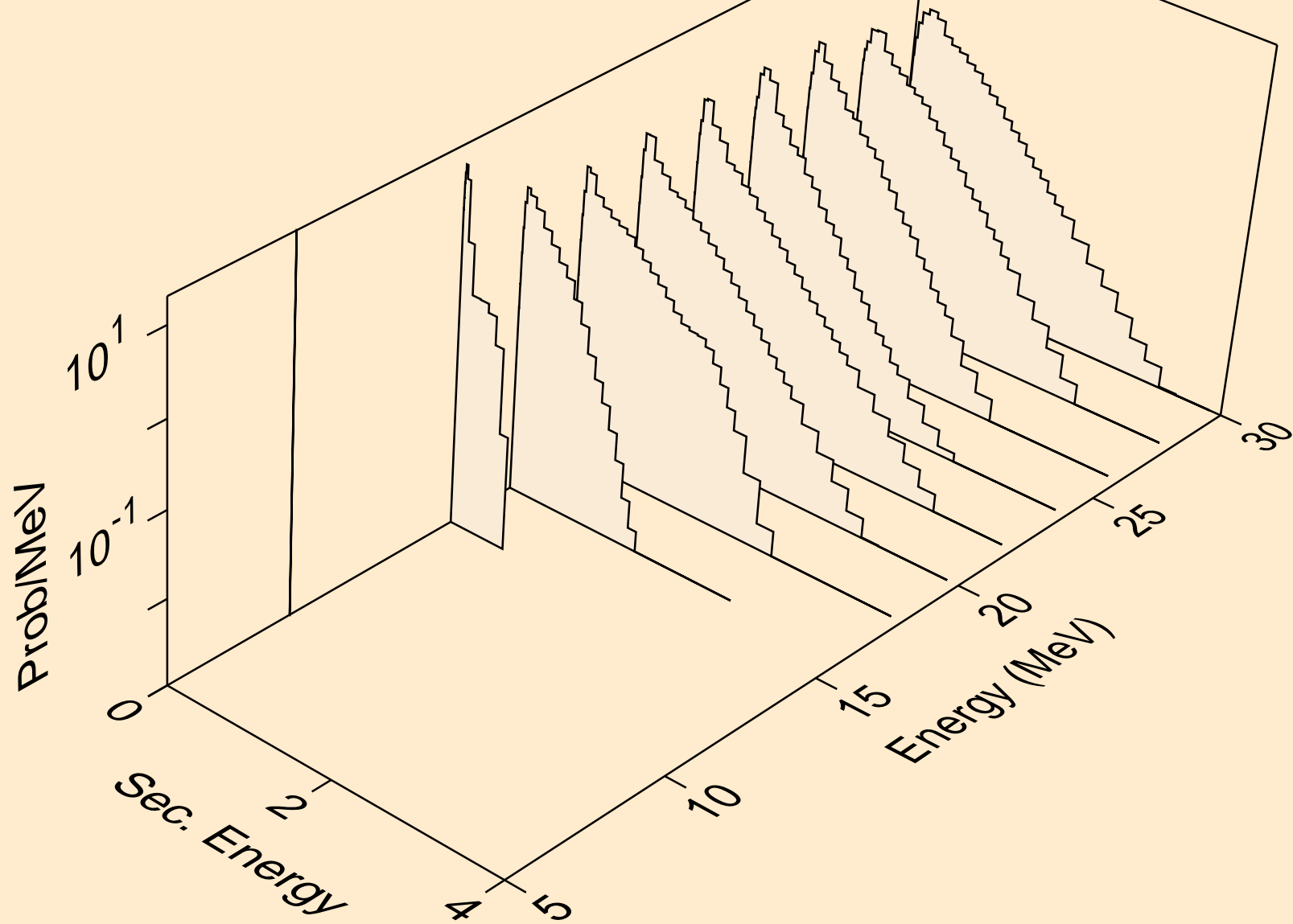

EU153 ALPHA ACER TENDL-2021 LIBRARY; T=0.K
neutrons from (a,2n)a

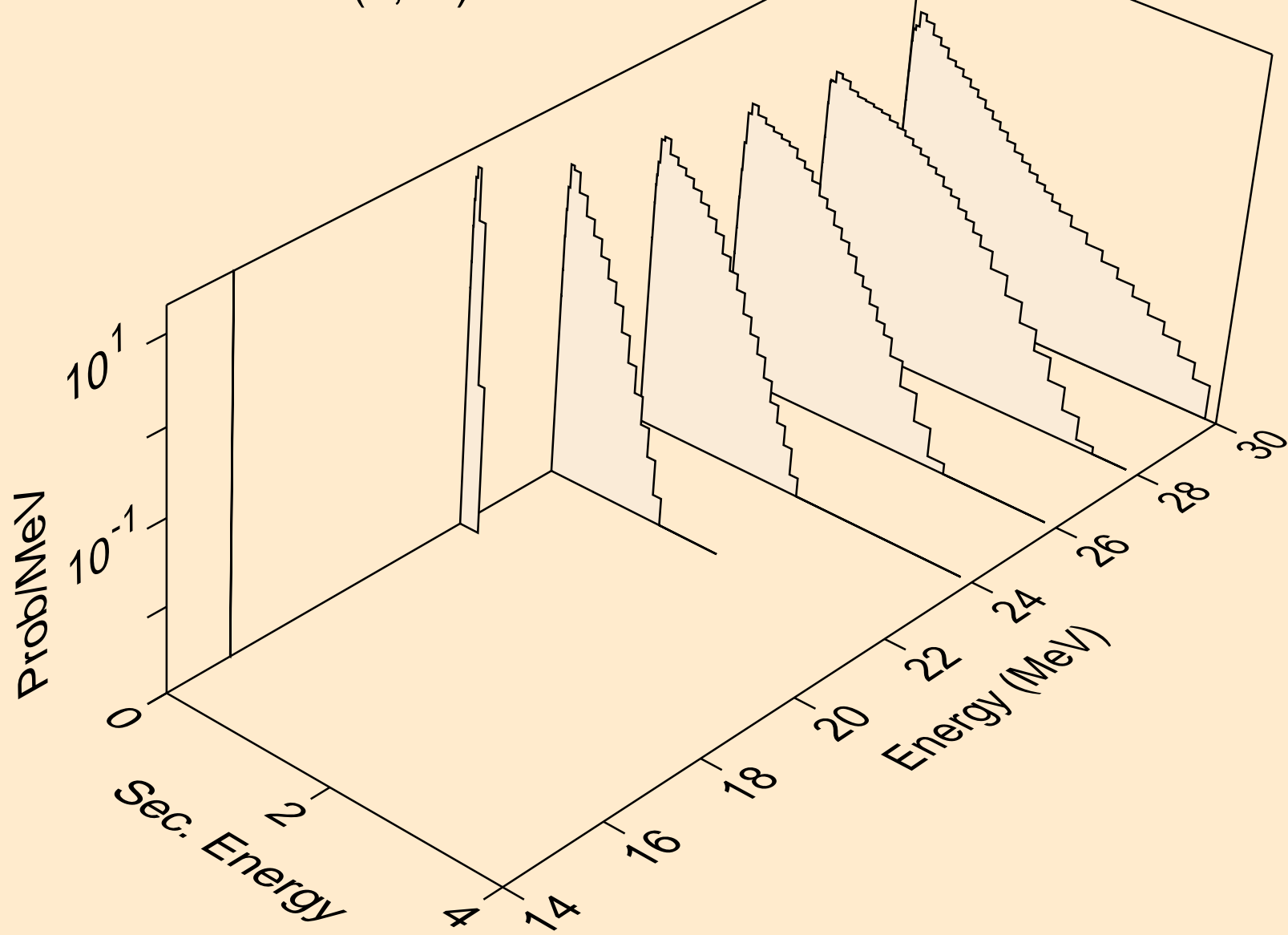

EU153 ALPHA ACER TENDL-2021 LIBRARY; T=0.K
neutrons from (a,n*)p

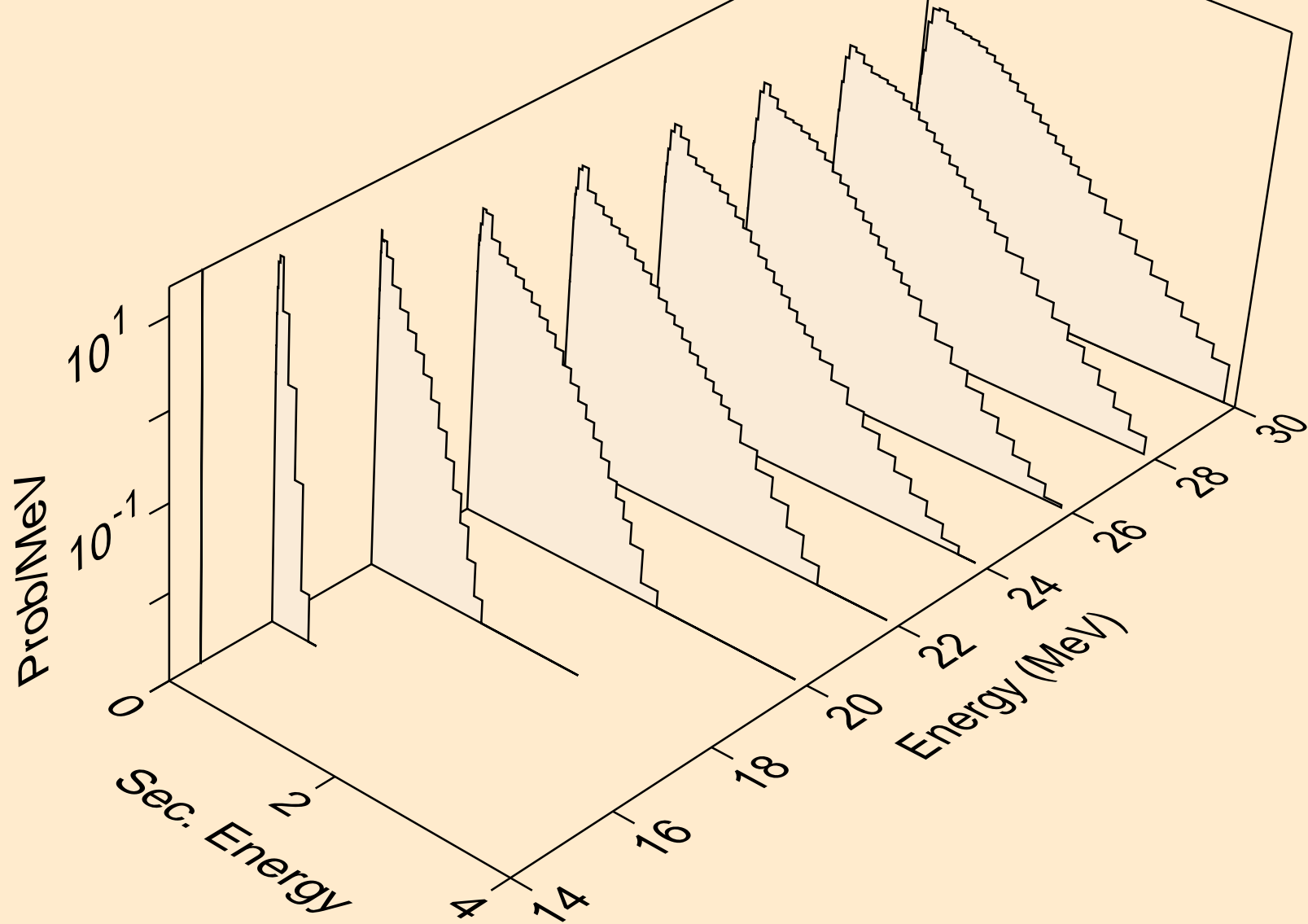

EU153 ALPHA ACER TENDL-2021 LIBRARY; T=0.K
neutrons from (a,n*)d

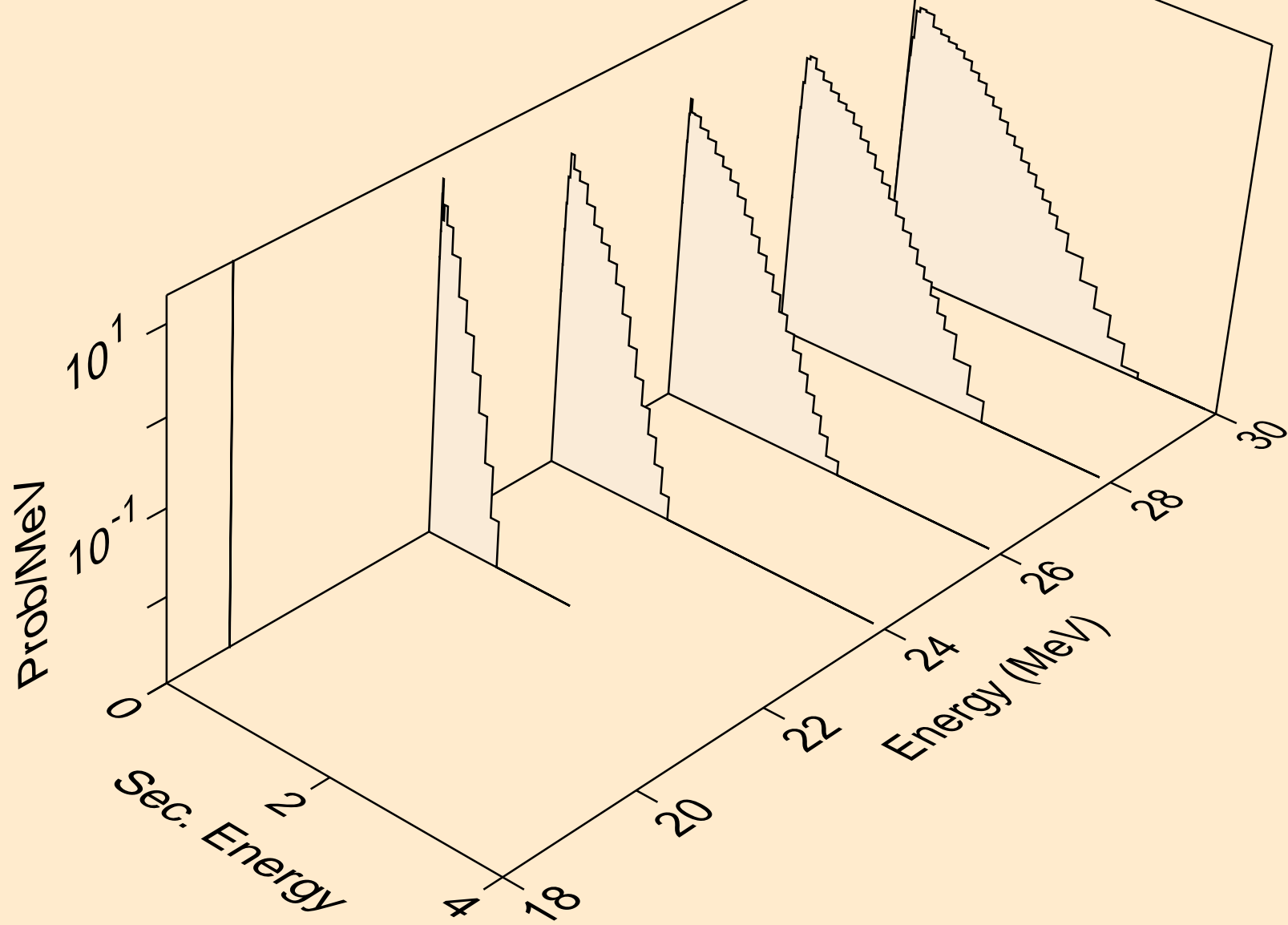

EU153 ALPHA ACER TENDL-2021 LIBRARY; T=0.K
neutrons from (a,n*)t

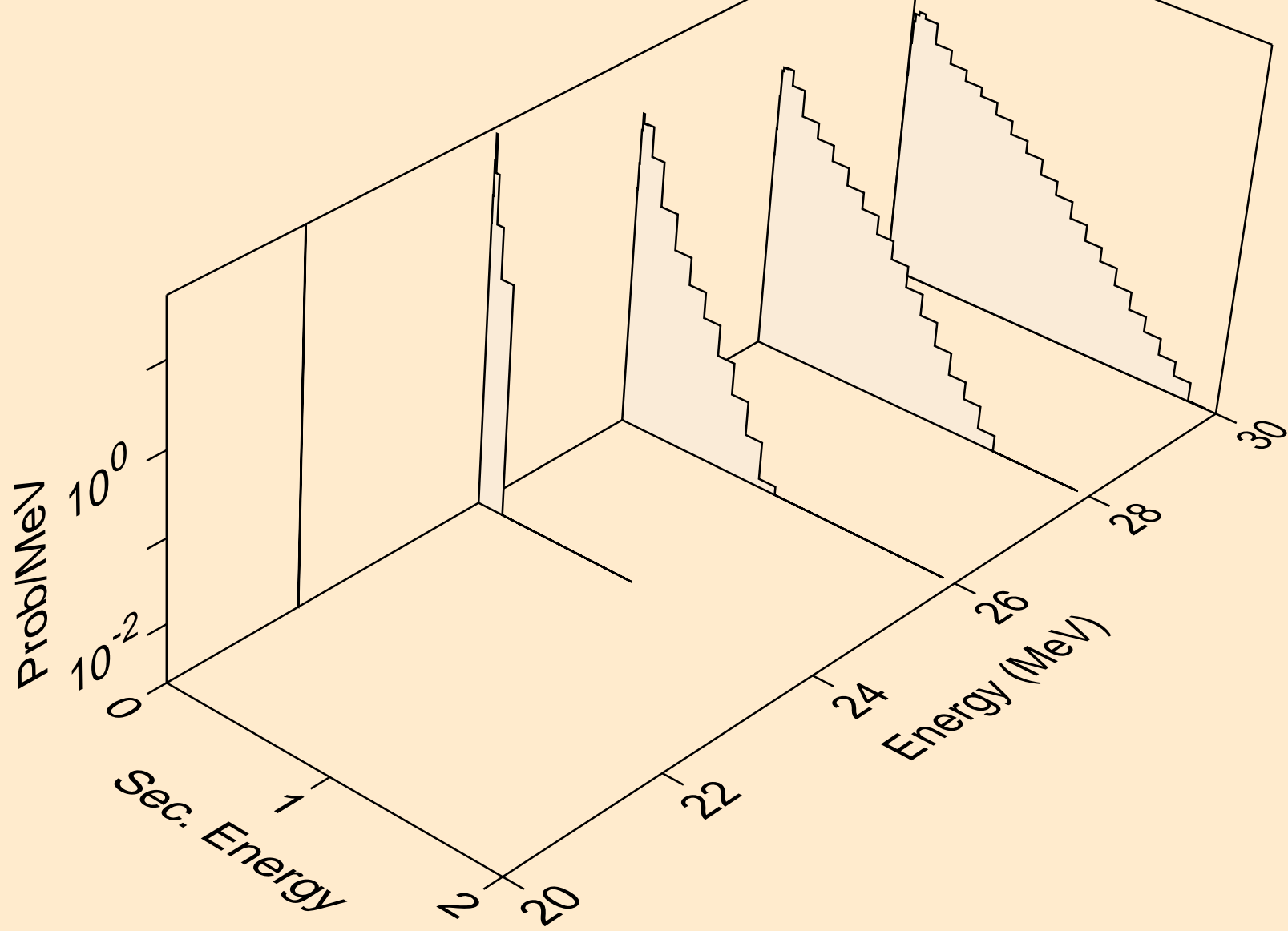

EU153 ALPHA ACER TENDL-2021 LIBRARY; T=0.K
neutrons from (a,2np)

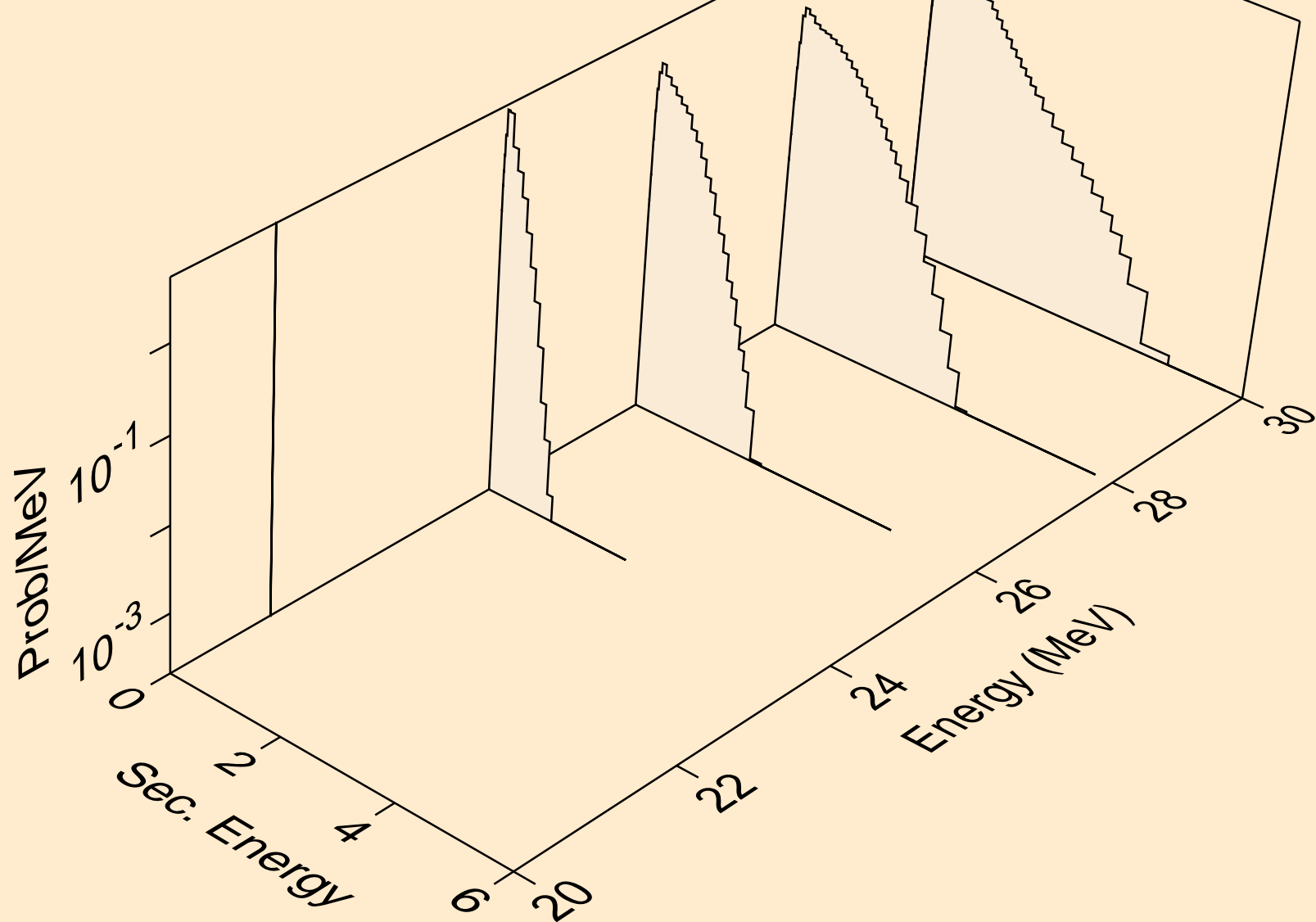

EU153 ALPHA ACER TENDL-2021 LIBRARY; T=0.K
protons from (a,x)

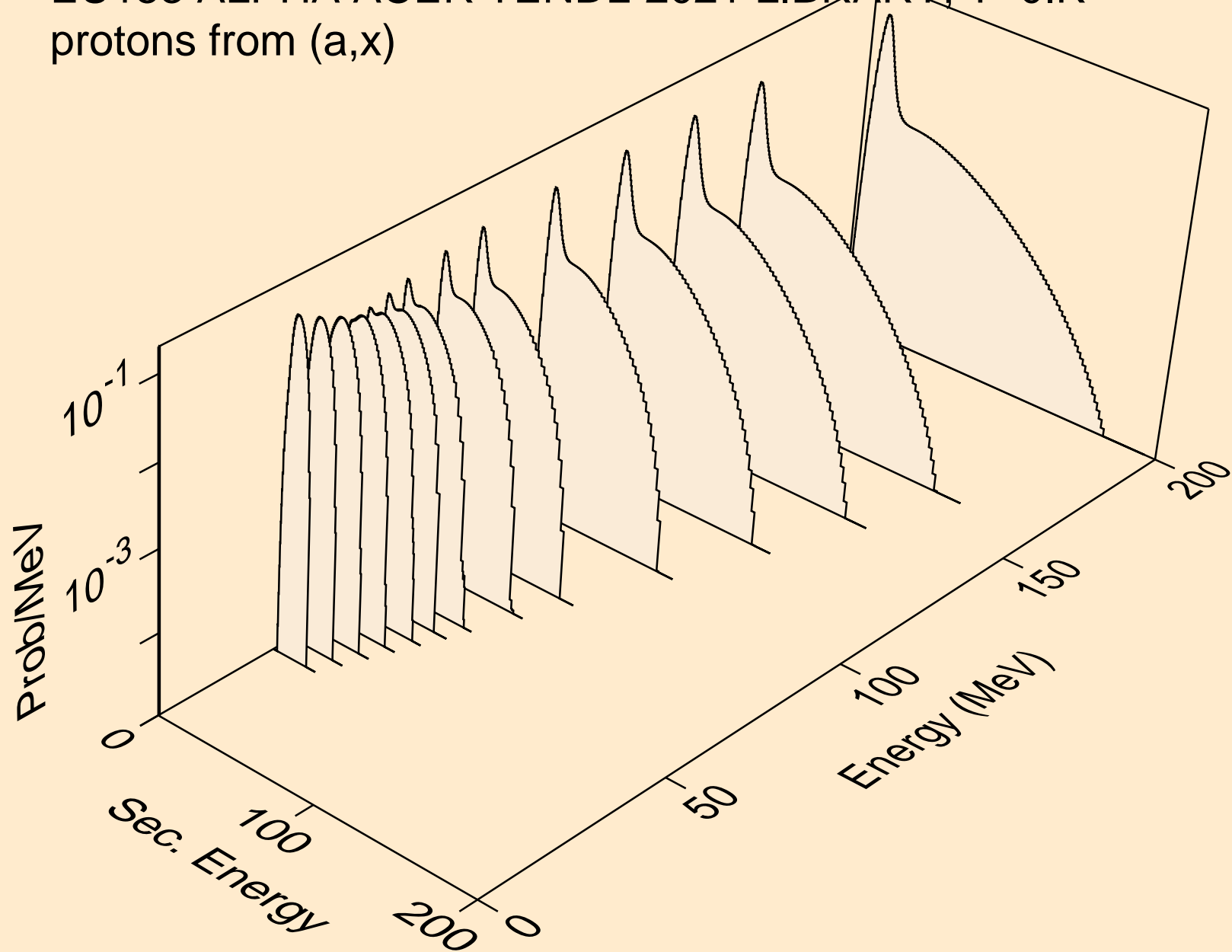

EU153 ALPHA ACER TENDL-2021 LIBRARY; T=0.K
protons from (a,n*)p

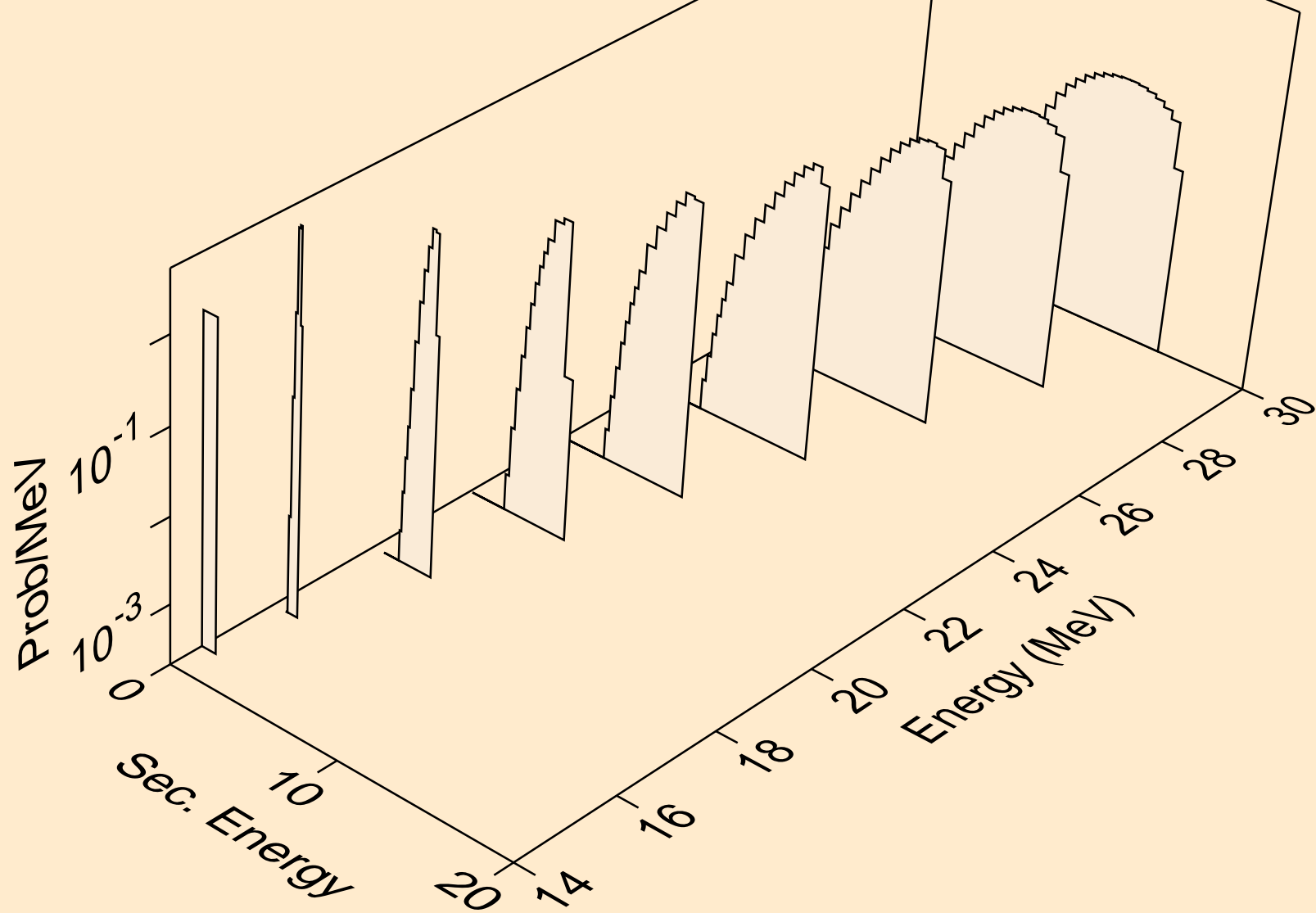

EU153 ALPHA ACER TENDL-2021 LIBRARY; T=0.K
protons from (a,2np)

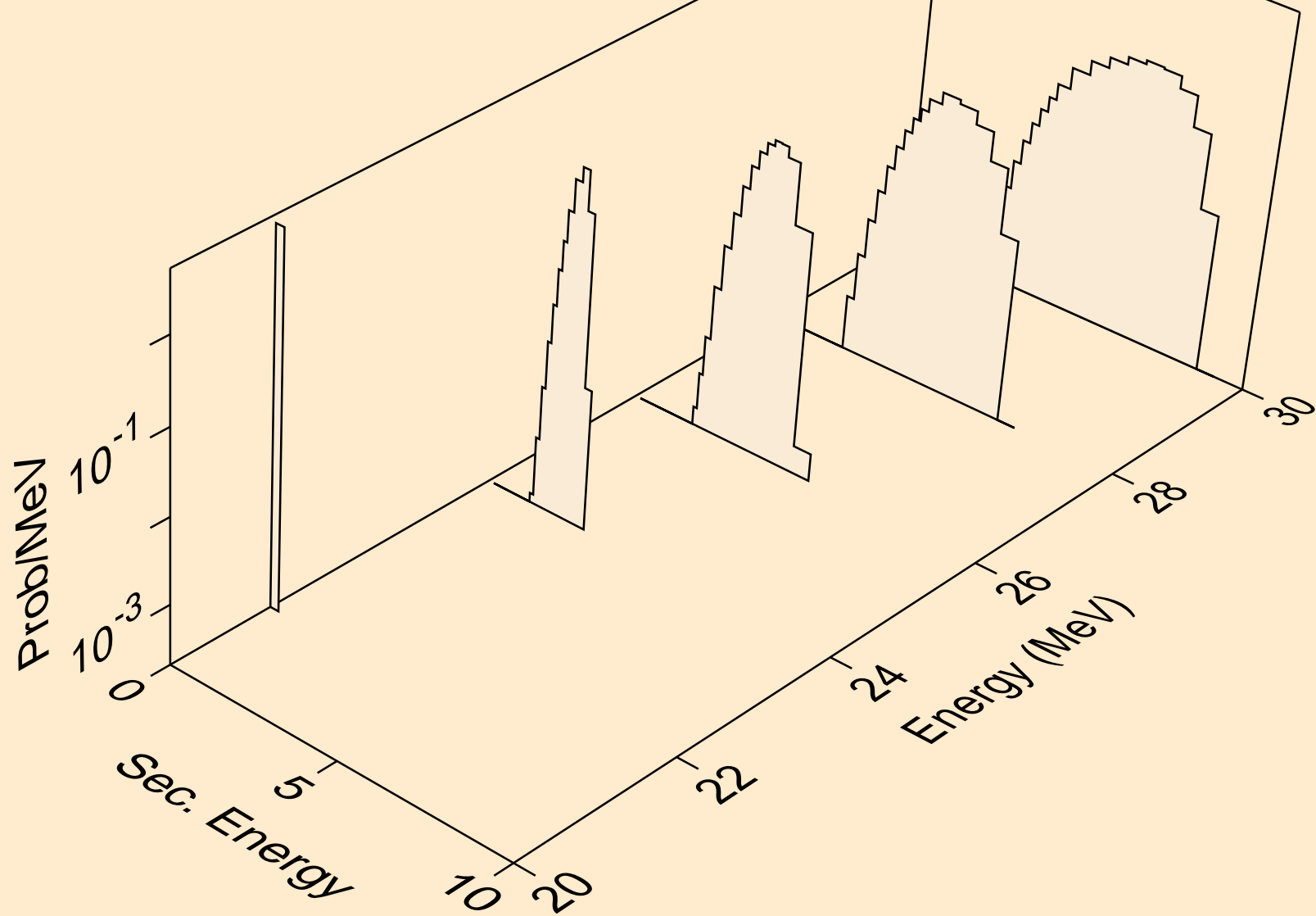

EU153 ALPHA ACER TENDL-2021 LIBRARY; T=0.K
protons from (a,p)

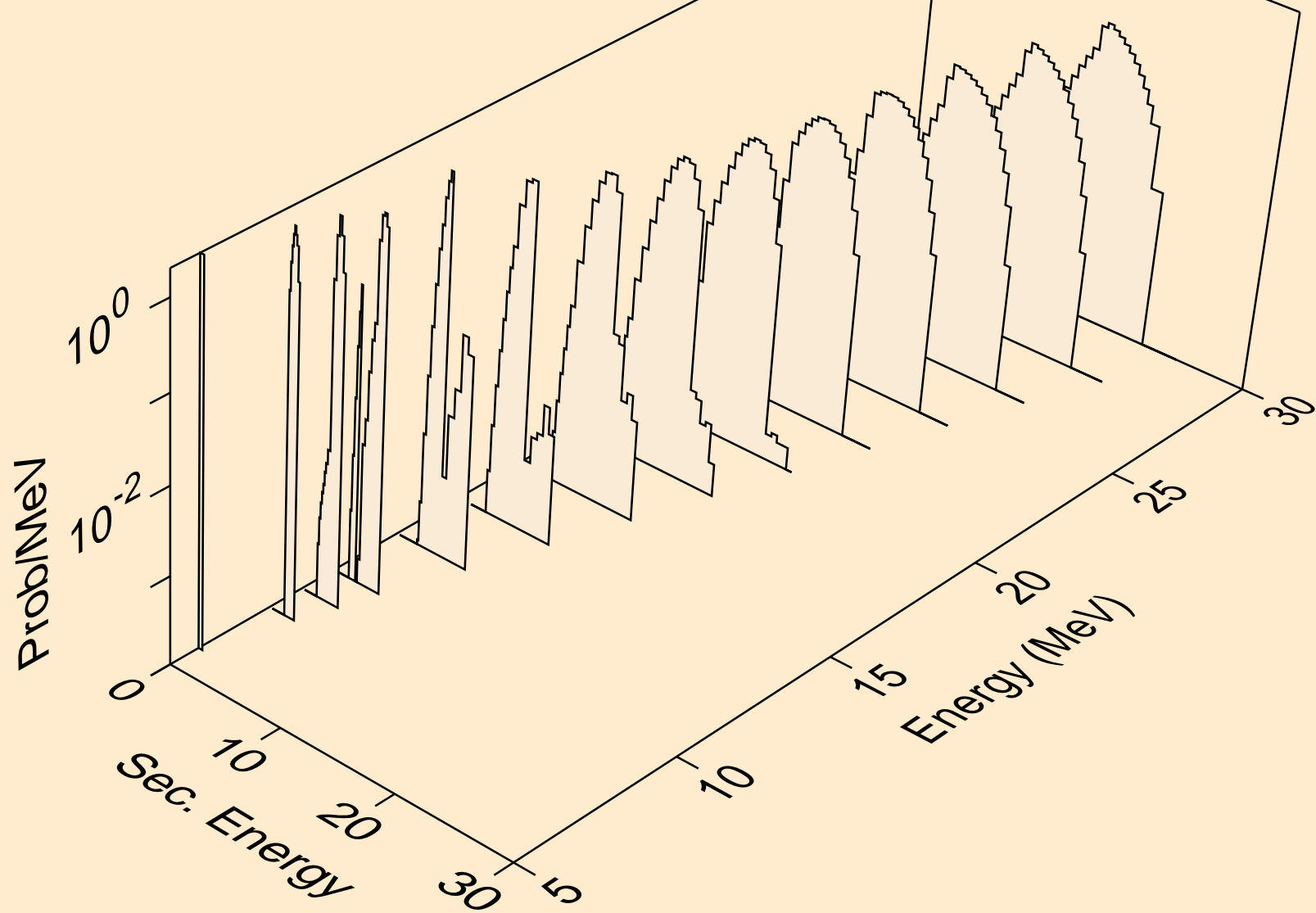

EU153 ALPHA ACER TENDL-2021 LIBRARY; T=0.K
protons from (a,2p)

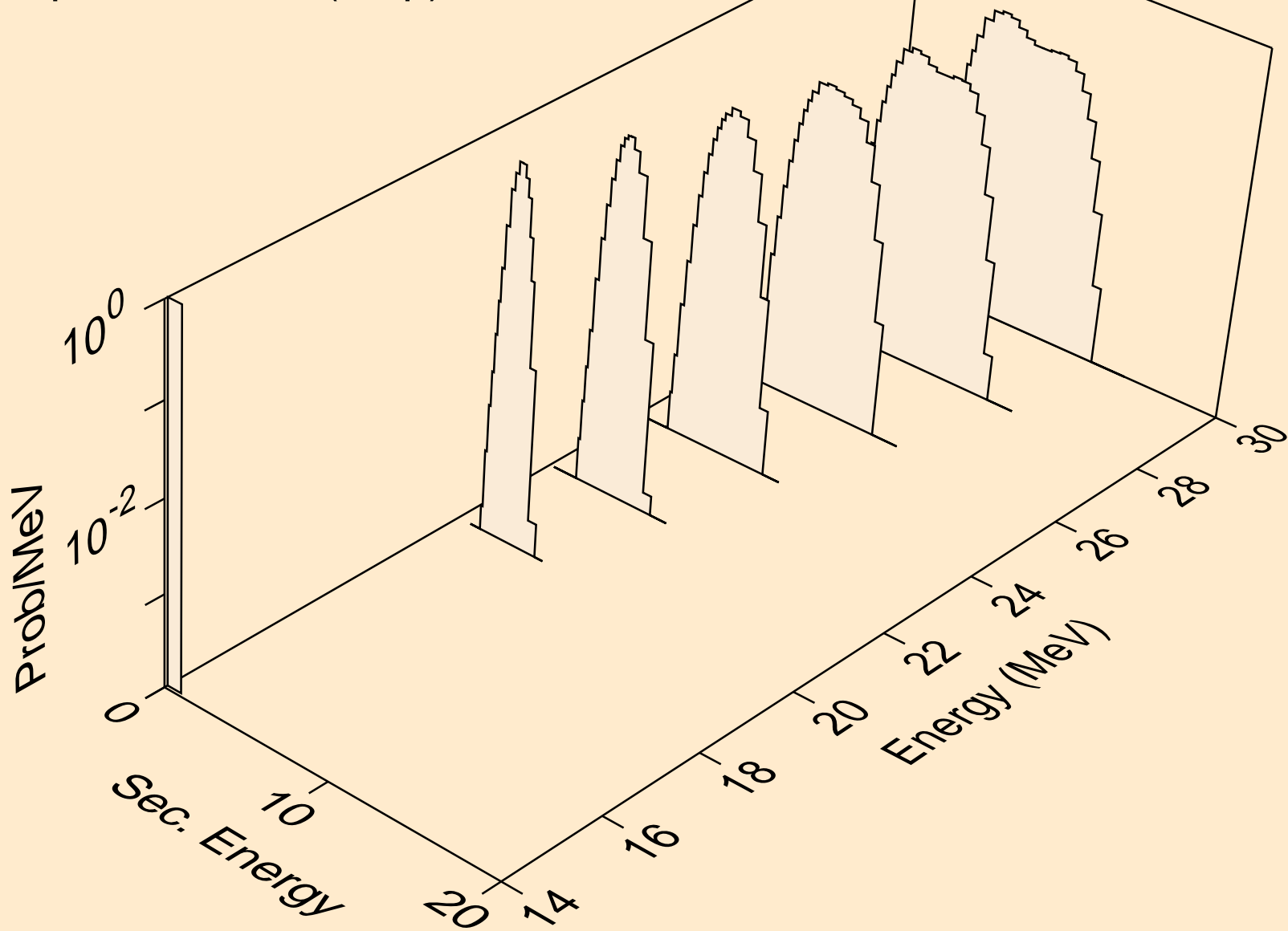

EU153 ALPHA ACER TENDL-2021 LIBRARY; T=0.K
protons from (a,pa)

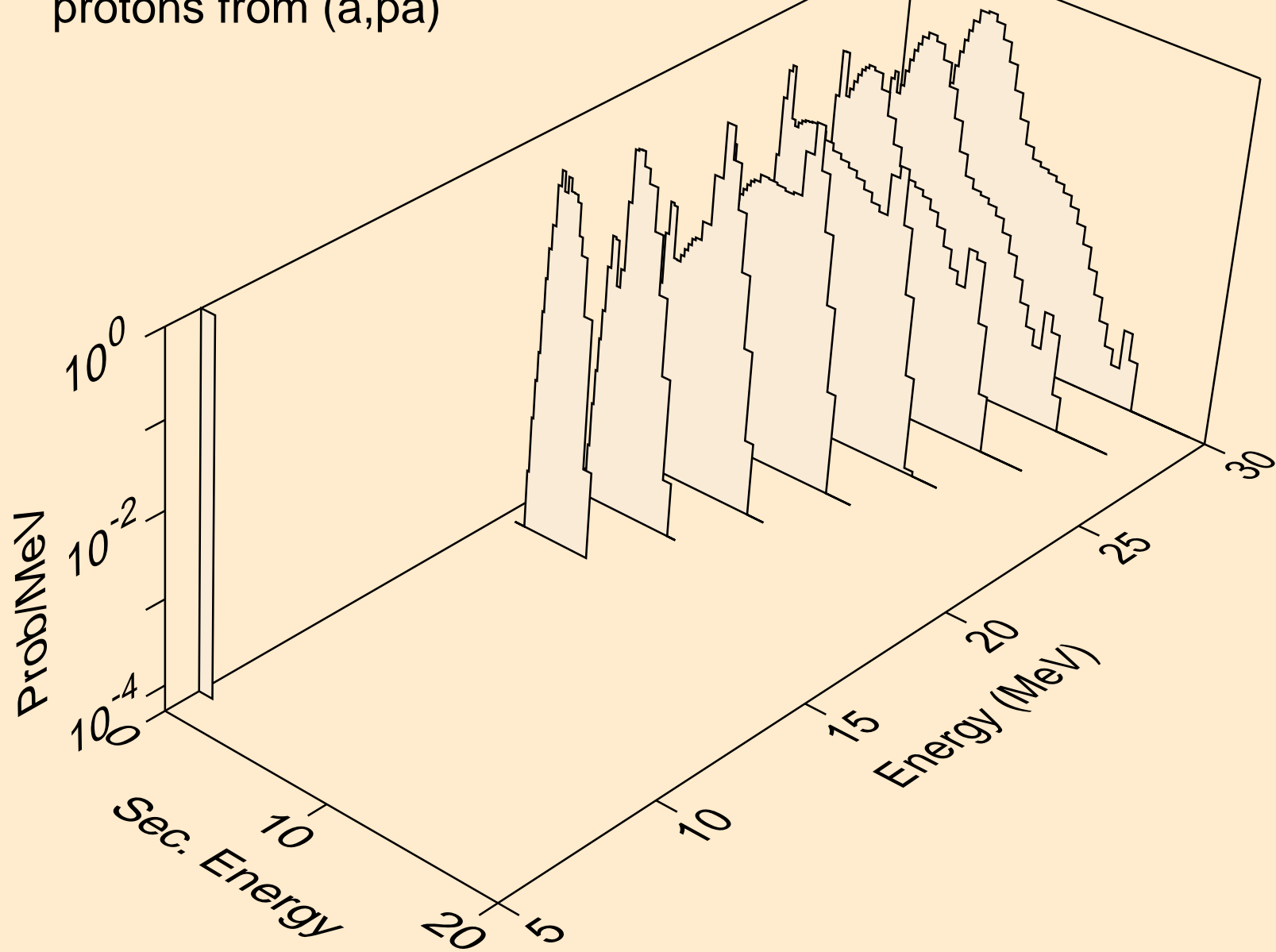

EU153 ALPHA ACER TENDL-2021 LIBRARY; T=0.K
deuterons from (a,x)

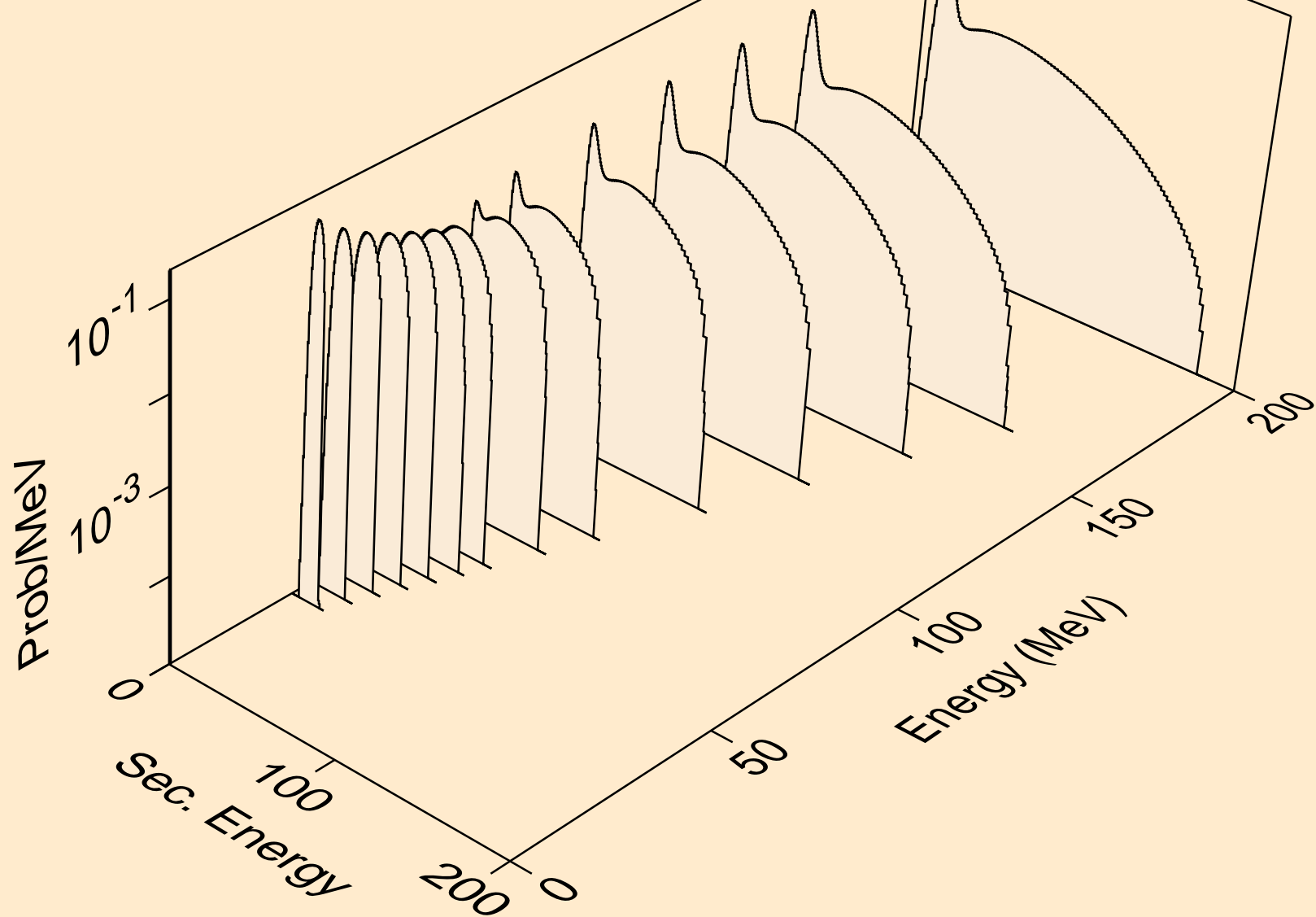

EU153 ALPHA ACER TENDL-2021 LIBRARY; T=0.K
deuterons from (a,n*)d

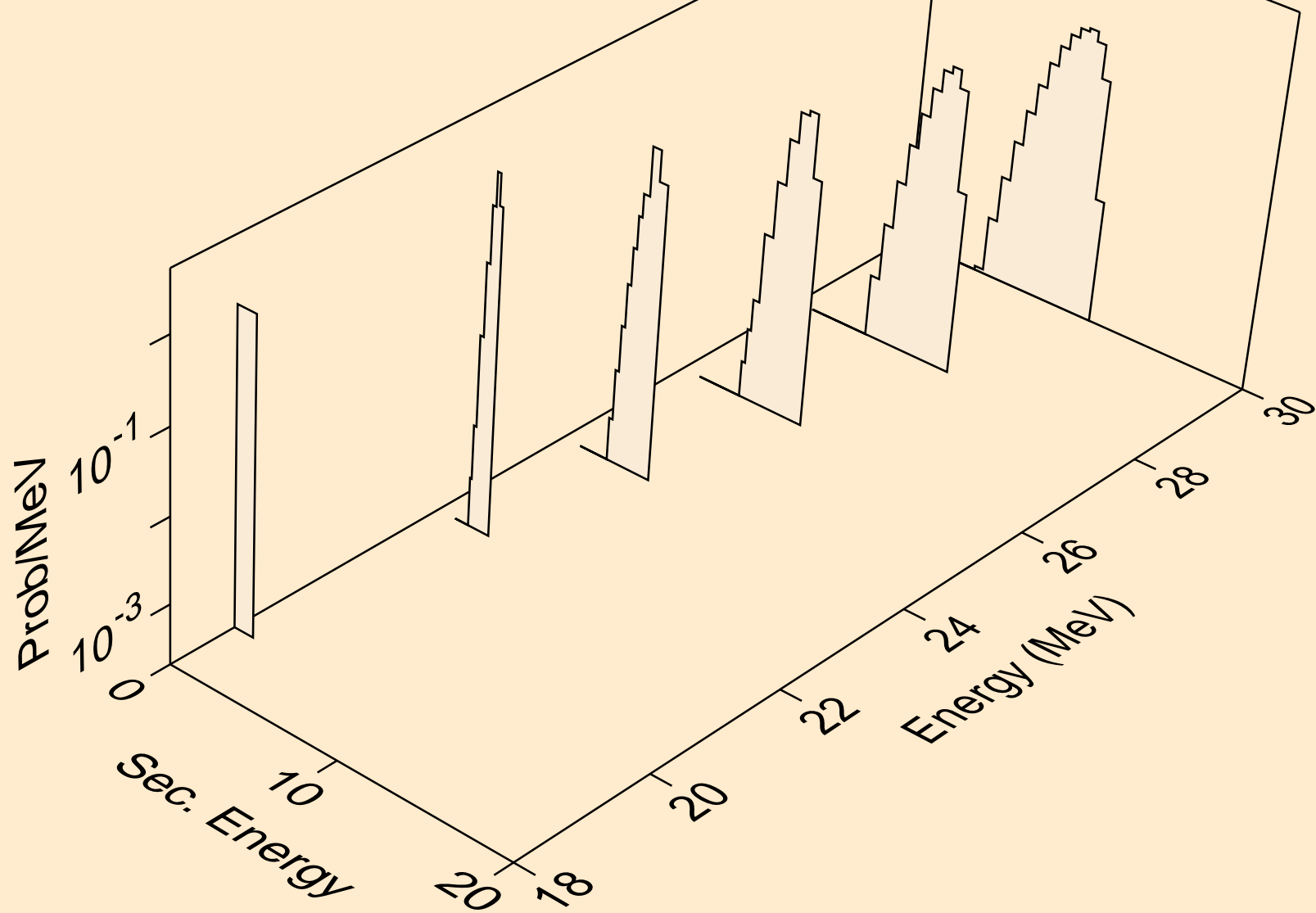

EU153 ALPHA ACER TENDL-2021 LIBRARY; T=0.K
deuterons from (a,d)

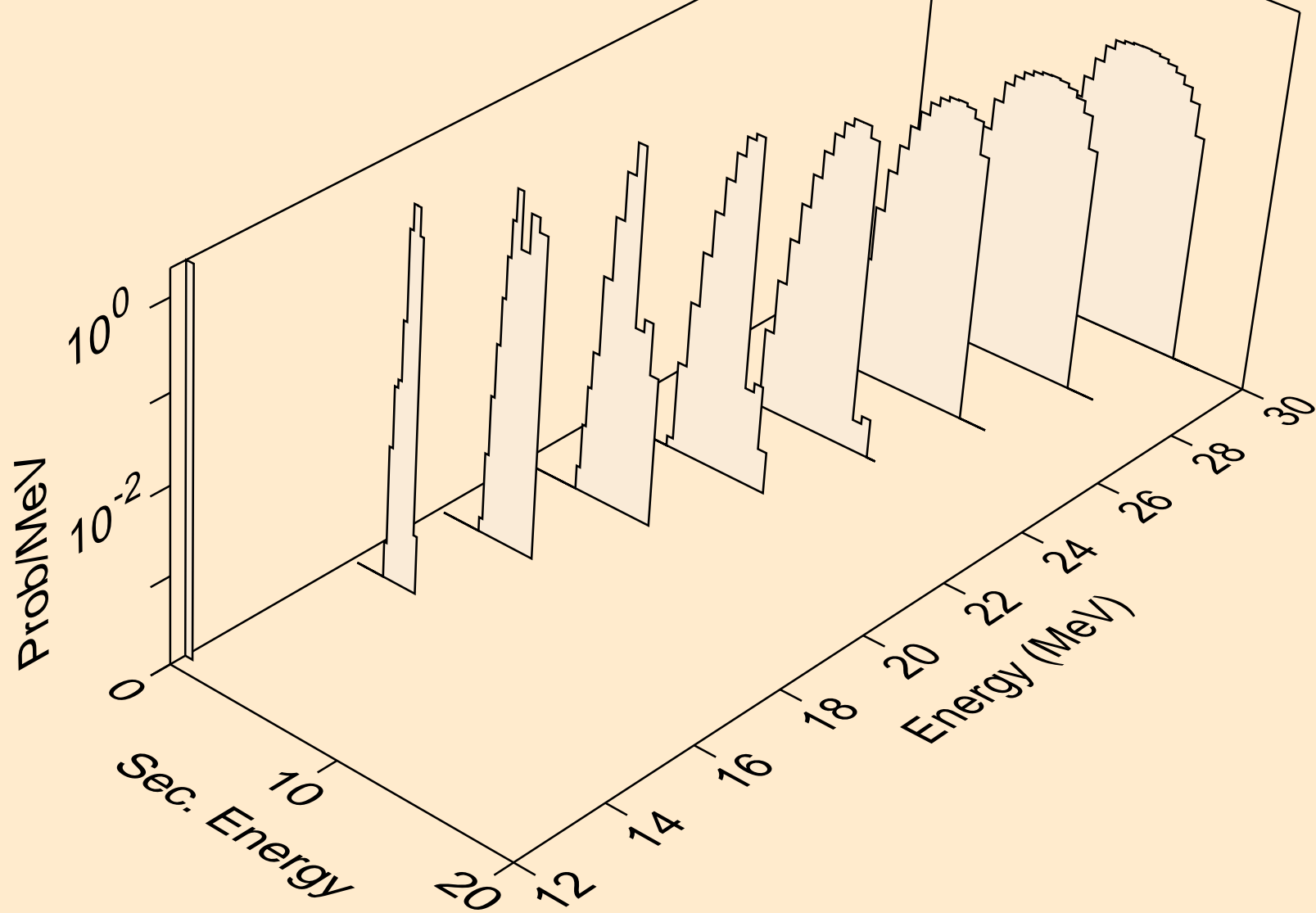

EU153 ALPHA ACER TENDL-2021 LIBRARY; T=0.K
tritons from (a,x)

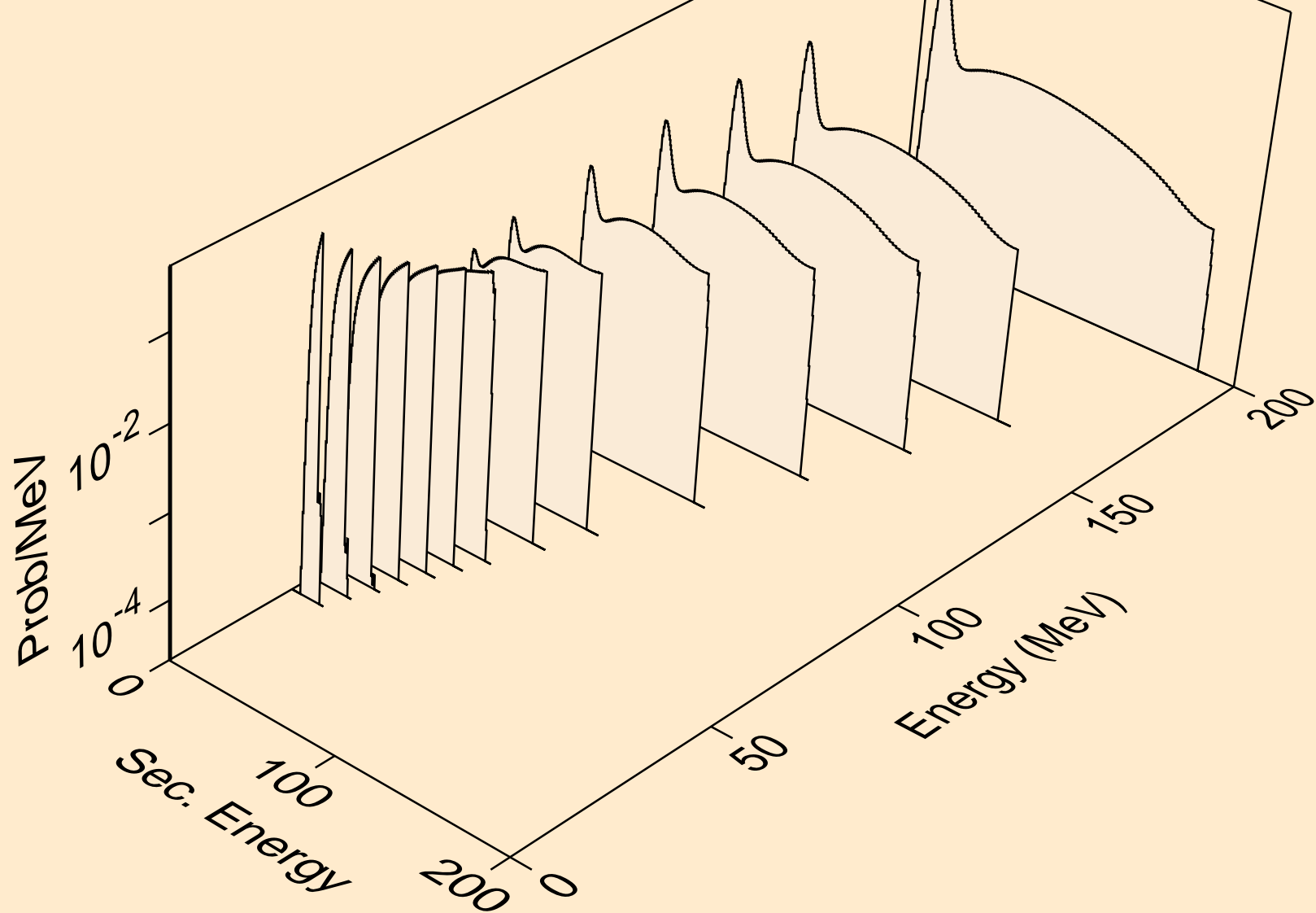

EU153 ALPHA ACER TENDL-2021 LIBRARY; T=0.K
tritons from (a,n*)t

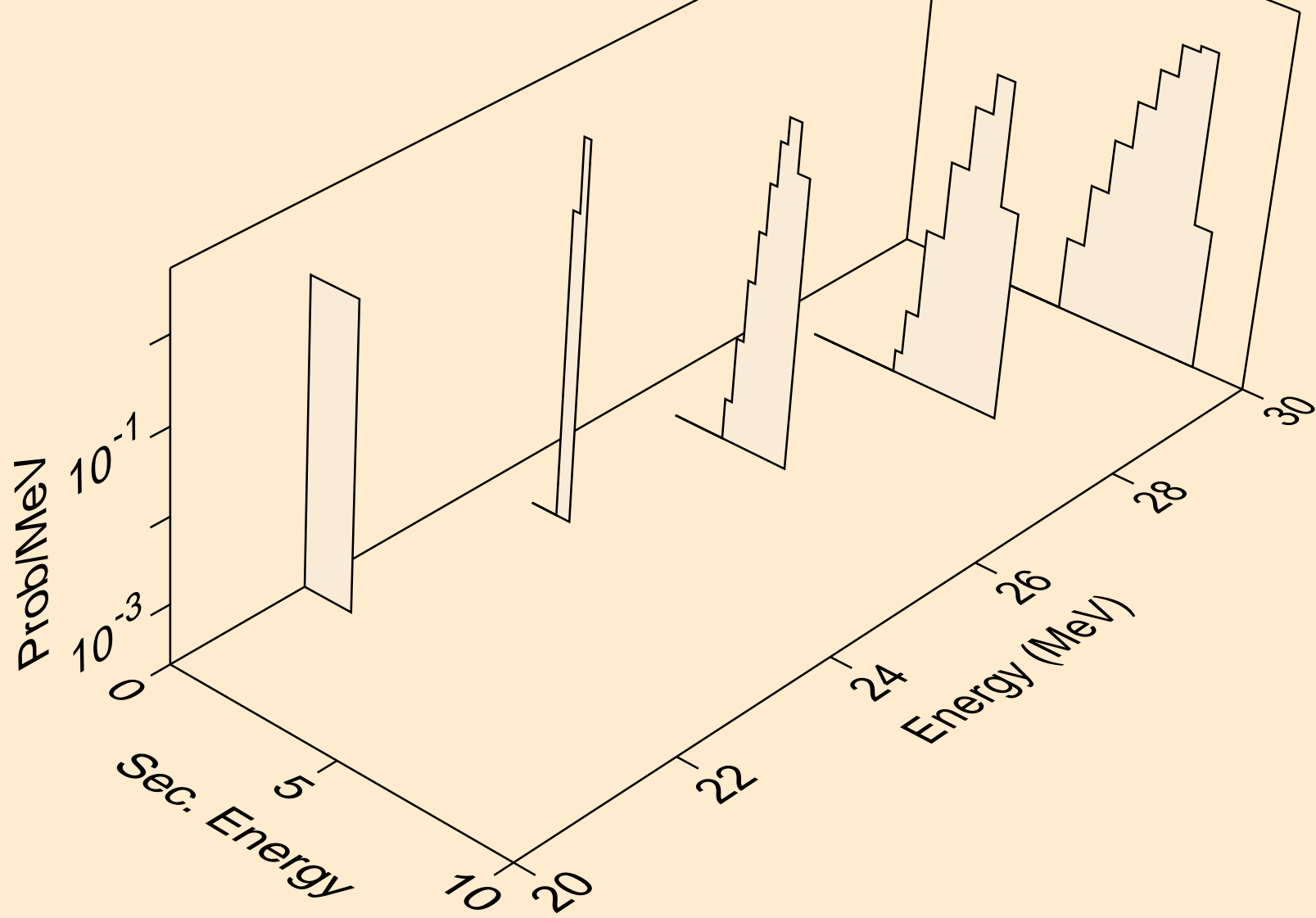

EU153 ALPHA ACER TENDL-2021 LIBRARY; T=0.K
tritons from (a,t)

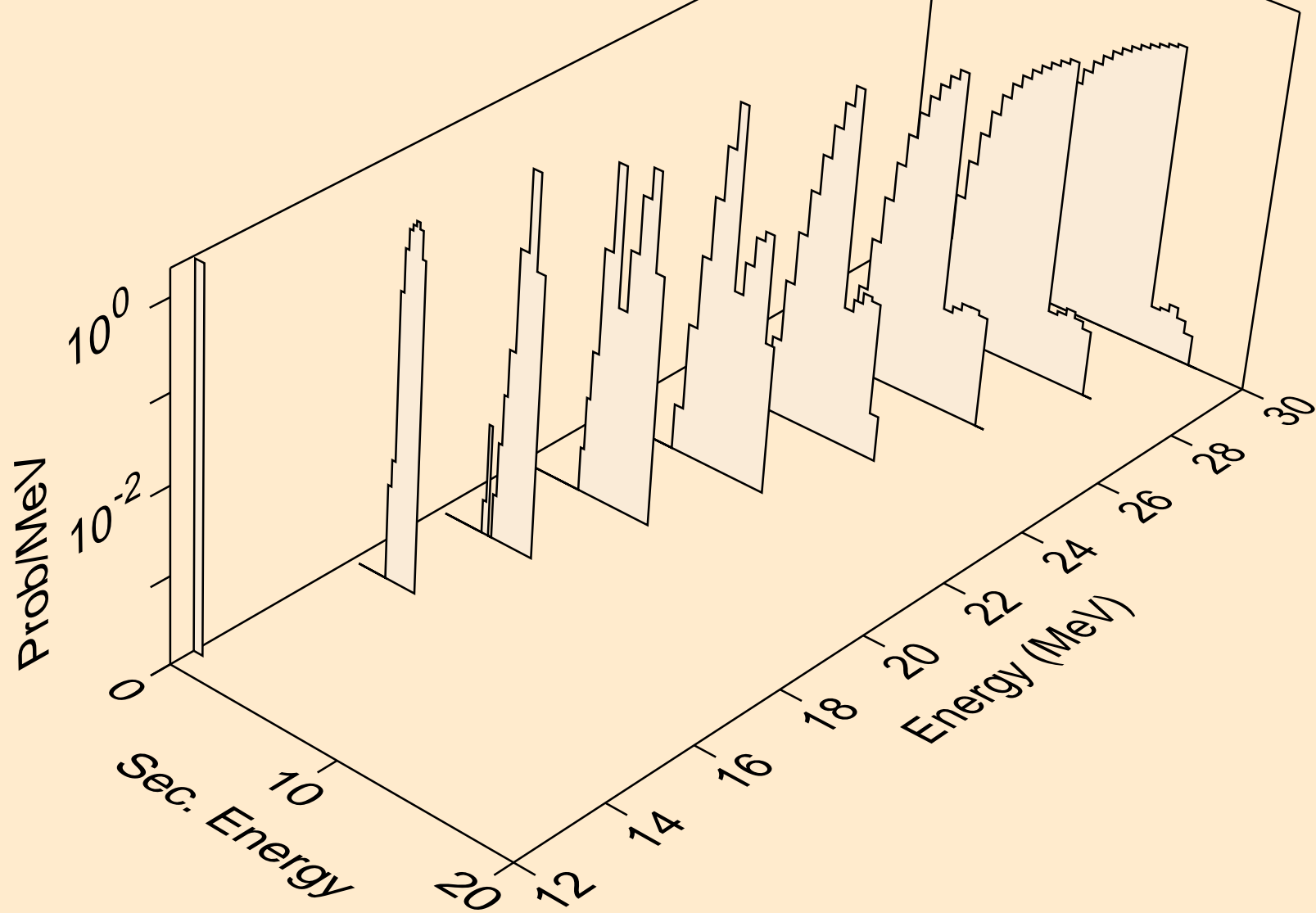

EU153 ALPHA ACER TENDL-2021 LIBRARY; T=0.K
he3s from (a,x)

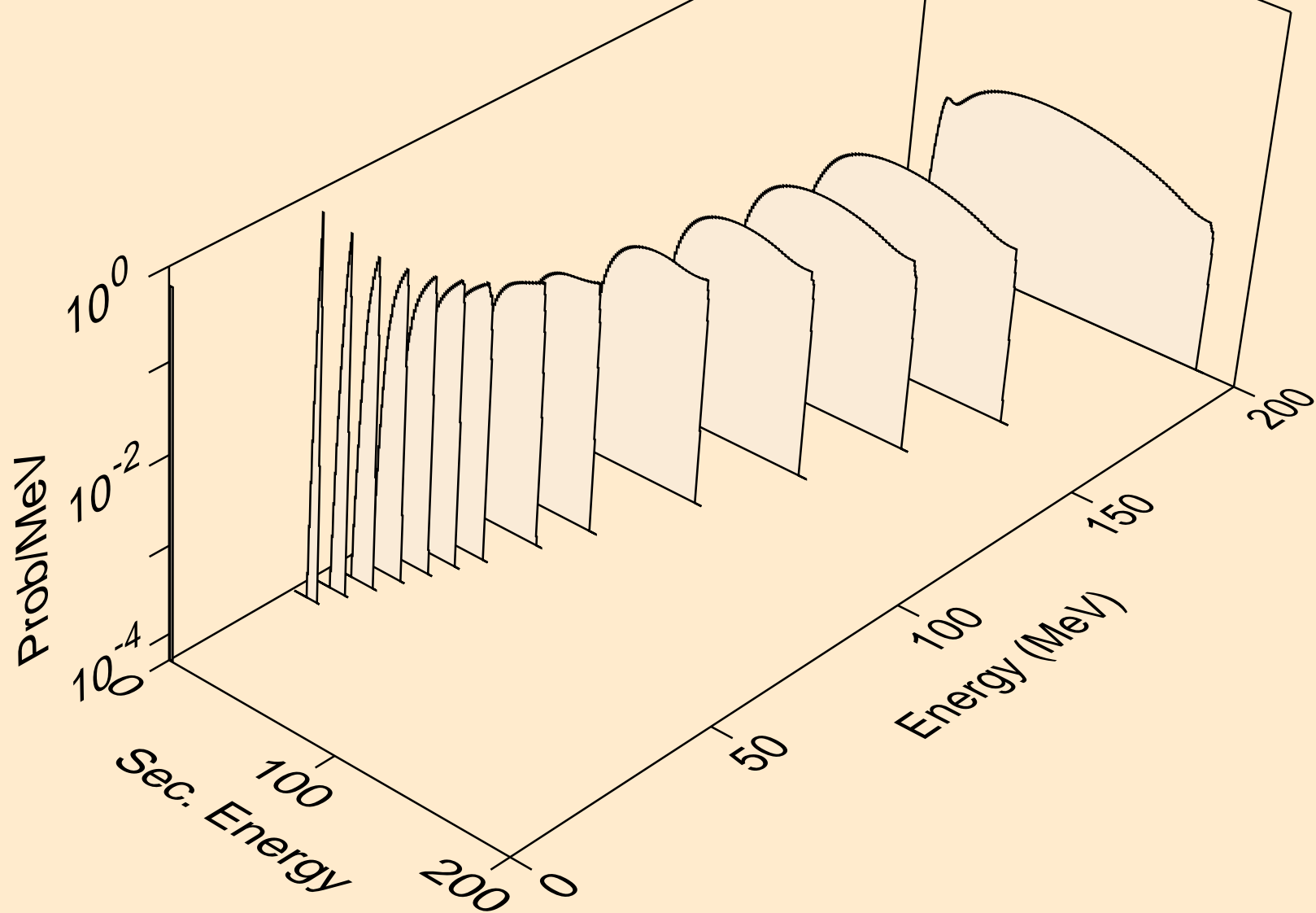

EU153 ALPHA ACER TENDL-2021 LIBRARY; T=0.K
he3s from (a,he3)

