

HS269 ALPHA ACER TENDL-2021 LIBRARY; T=0.K
Principal cross sections

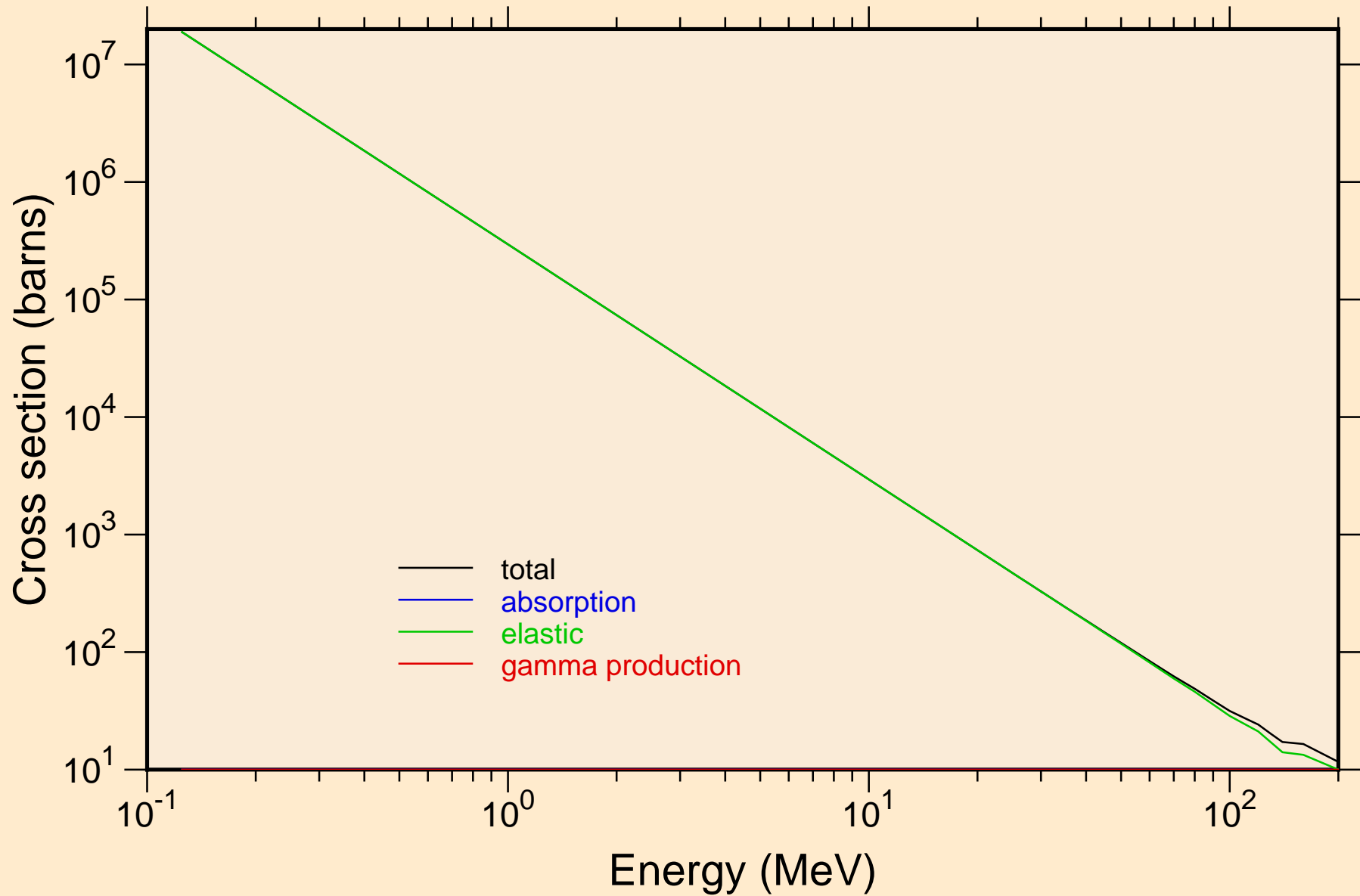

HS269 ALPHA ACER TENDL-2021 LIBRARY; T=0.K
Heating

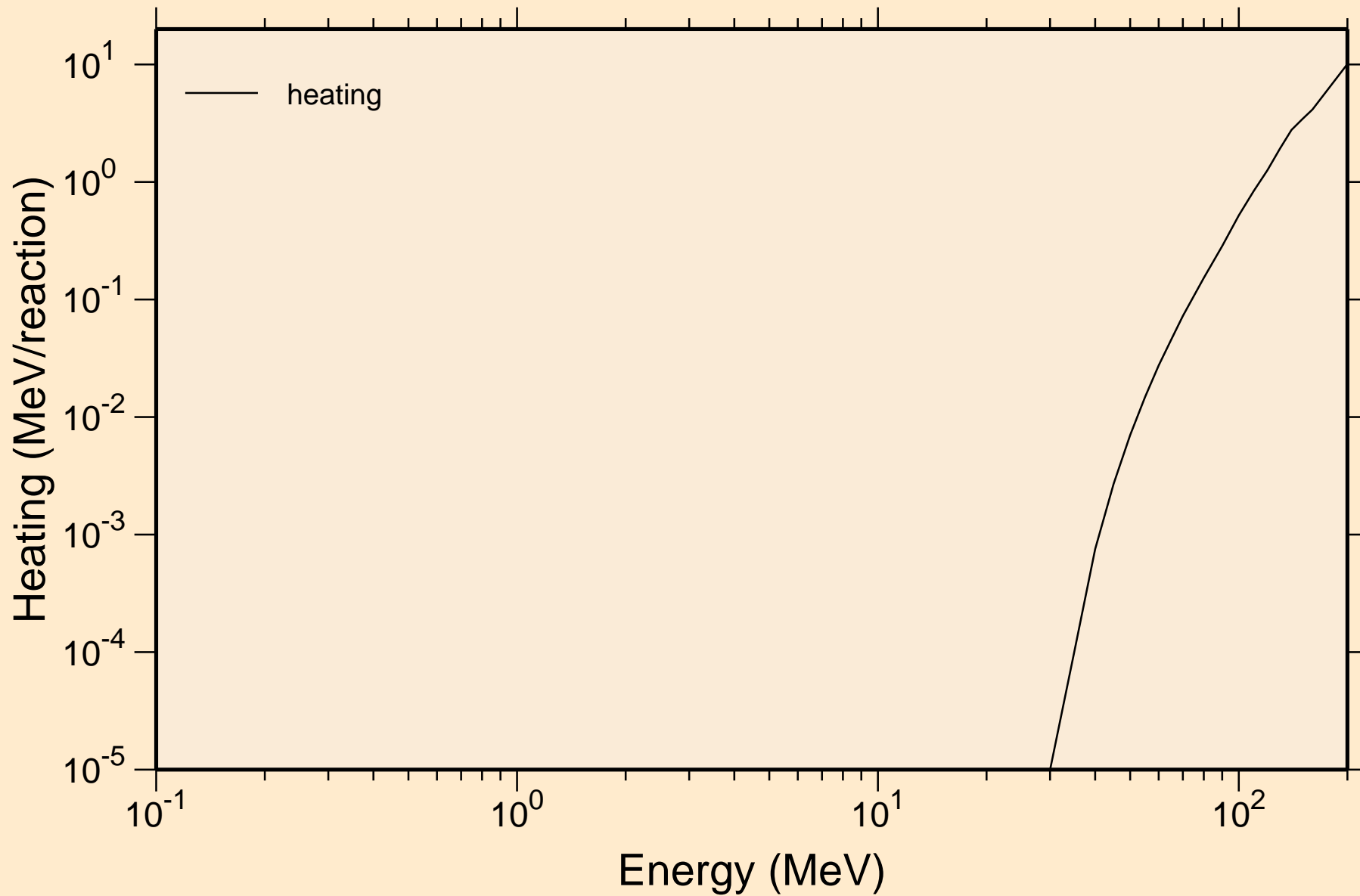

HS269 ALPHA ACER TENDL-2021 LIBRARY; T=0.K

Principal cross sections

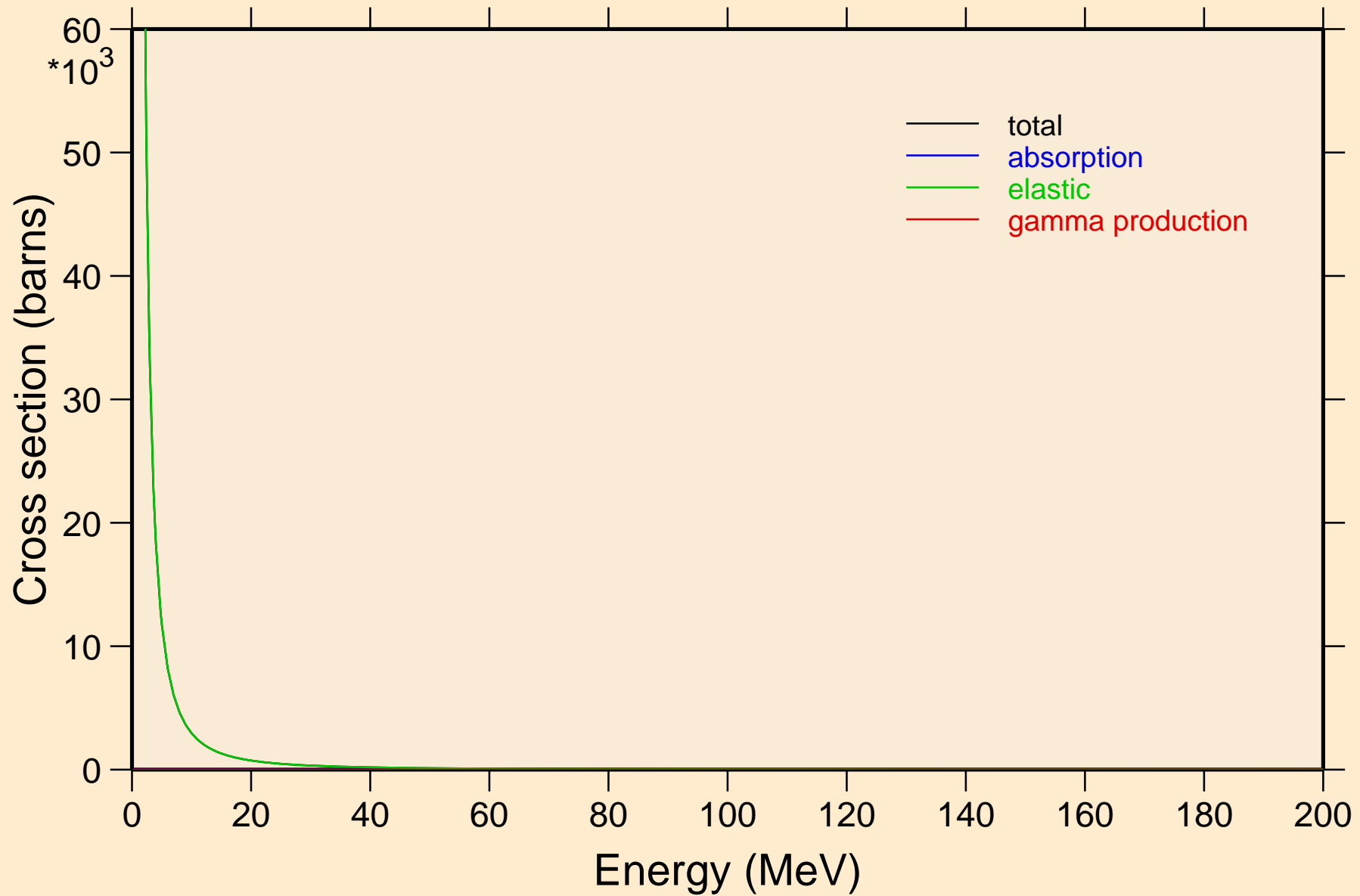

HS269 ALPHA ACER TENDL-2021 LIBRARY; T=0.K

Heating

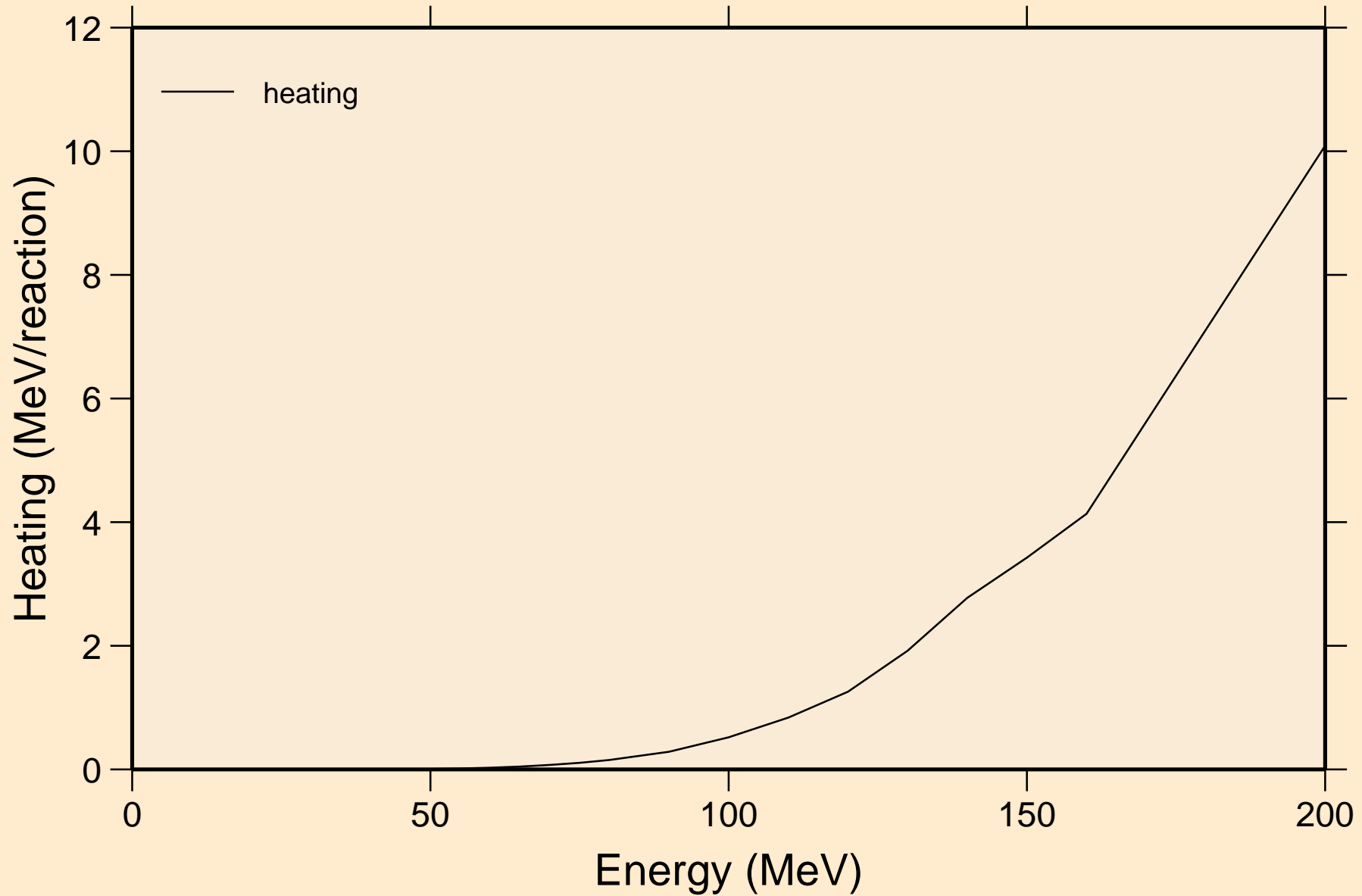

HS269 ALPHA ACER TENDL-2021 LIBRARY; T=0.K
Threshold reactions

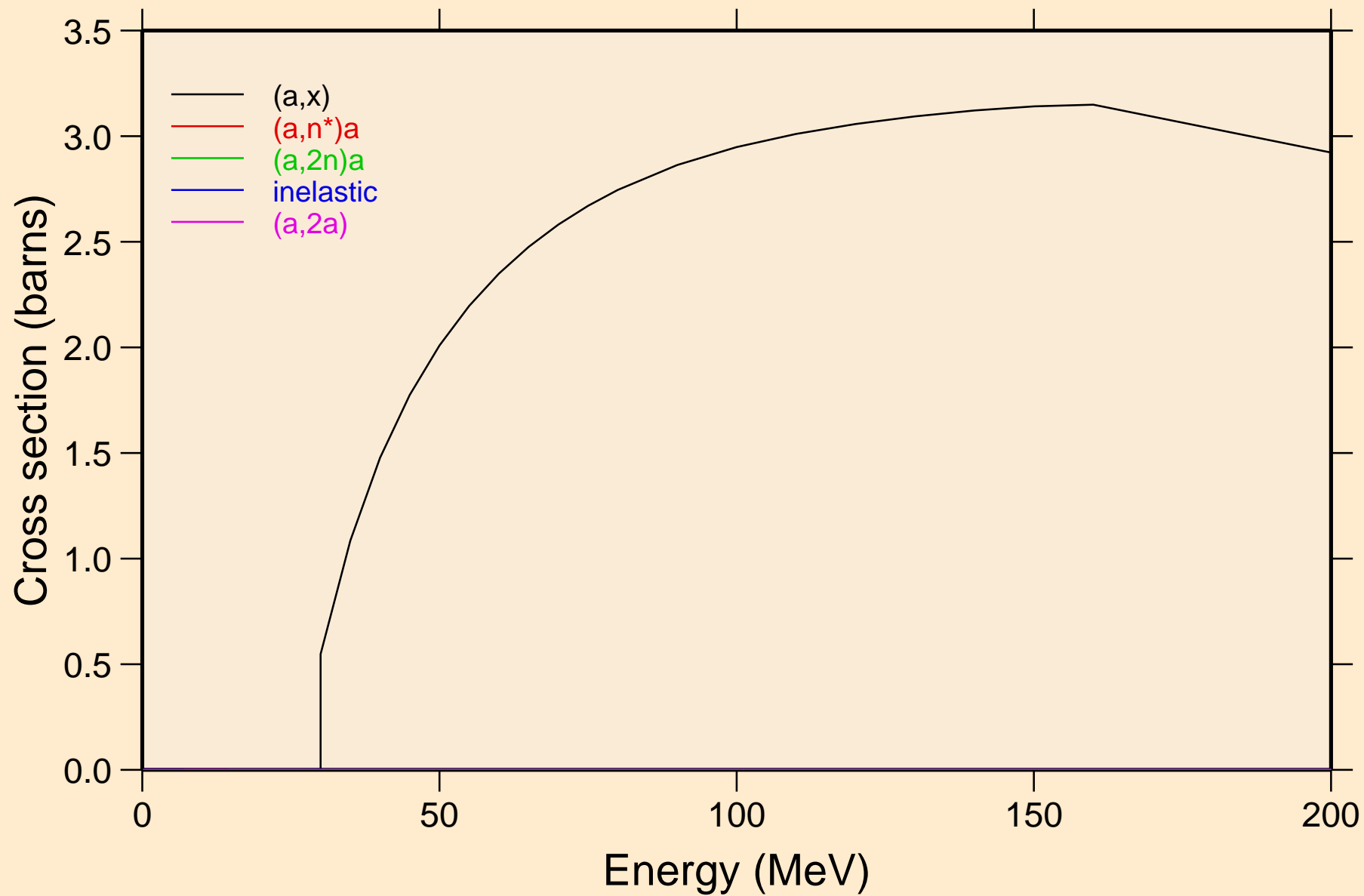

HS269 ALPHA ACER TENDL-2021 LIBRARY; T=0.K
Threshold reactions

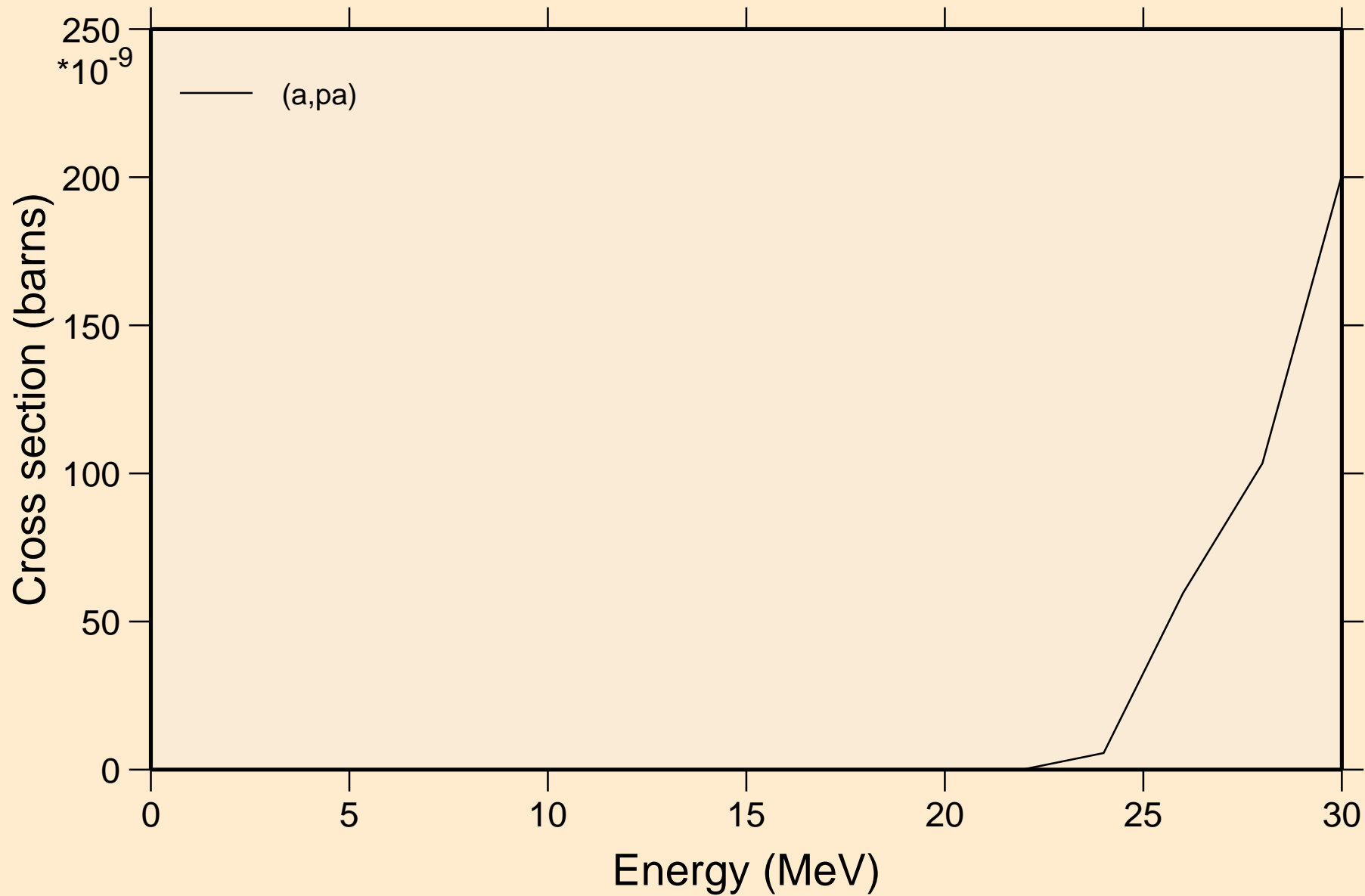

HS269 ALPHA ACER TENDL-2021 LIBRARY; T=0.K
angular distribution for elastic

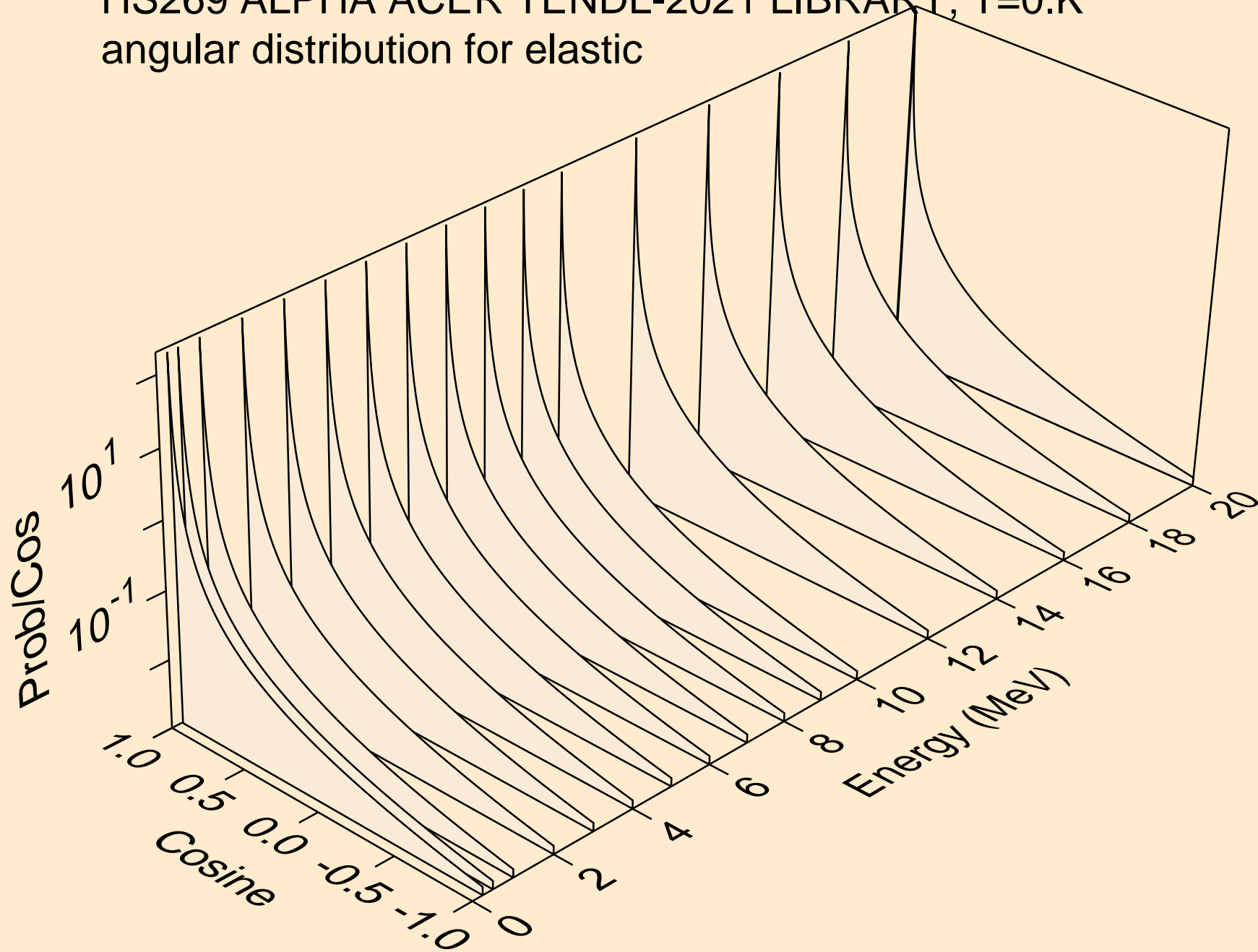

HS269 ALPHA ACER TENDL-2021 LIBRARY; T=0.K
angular distribution for elastic

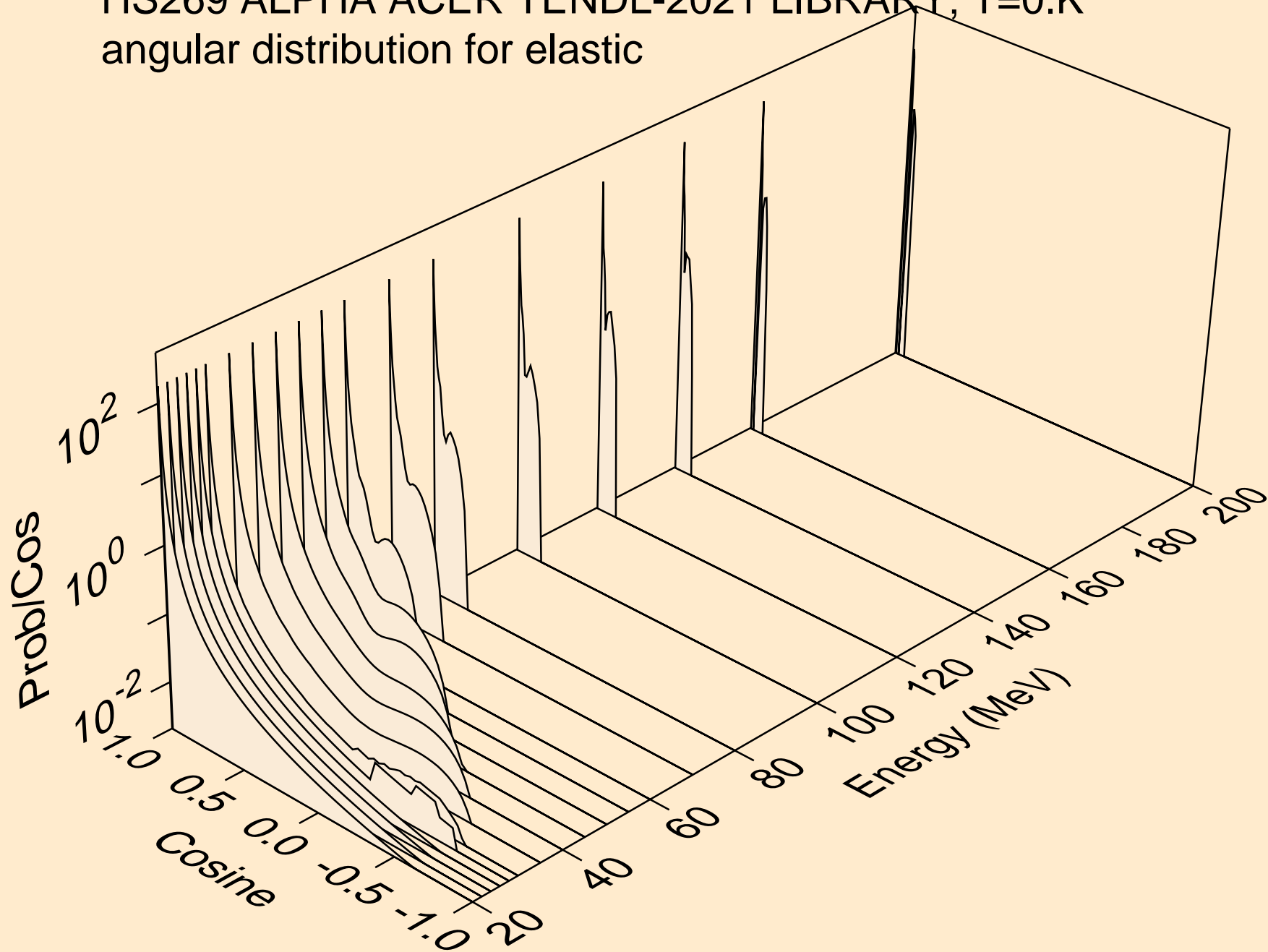

HS269 ALPHA ACER TENDL-2021 LIBRARY; T=0.K
Alpha emission for (a,x)

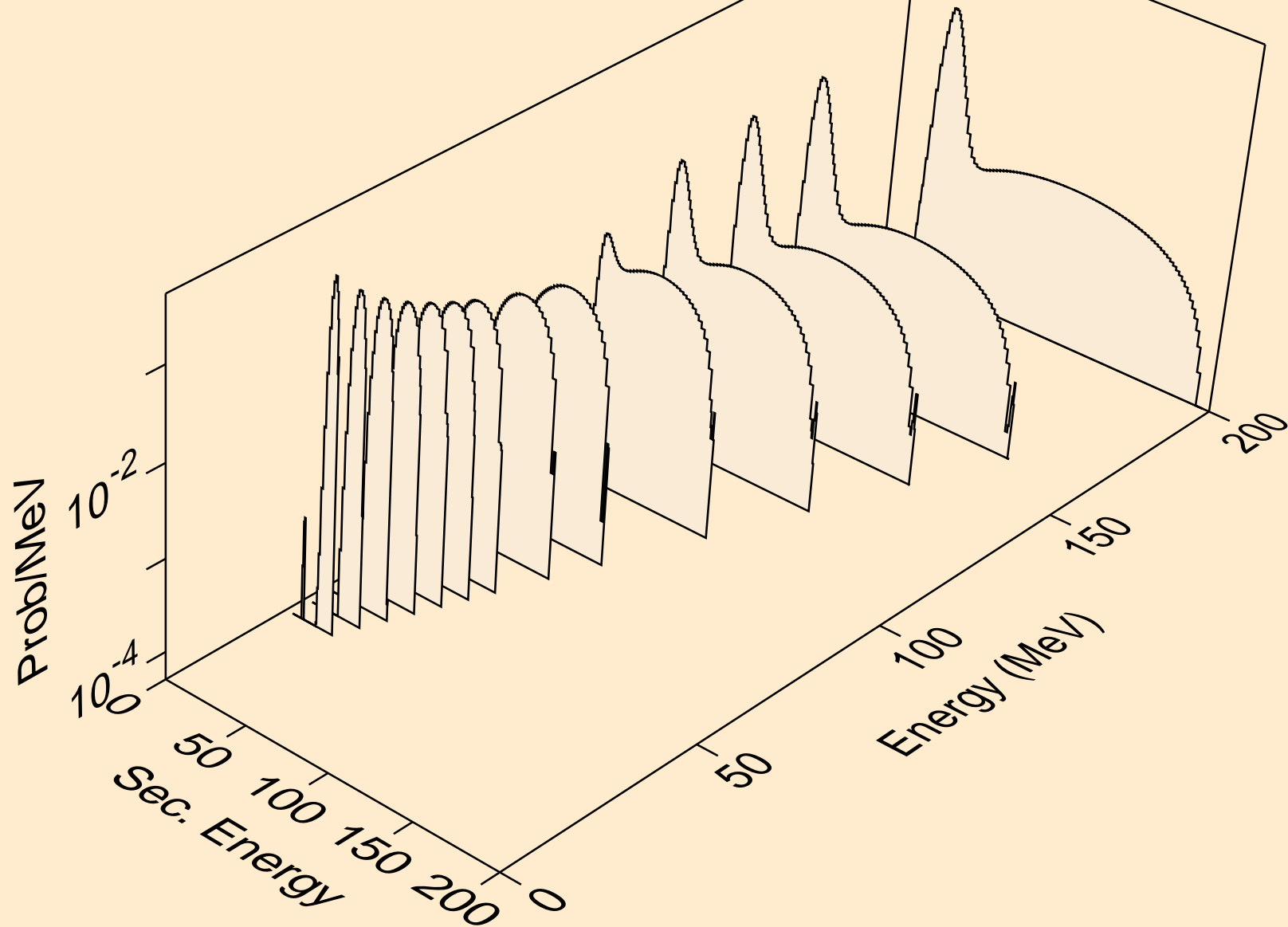

HS269 ALPHA ACER TENDL-2021 LIBRARY; T=0.K
Alpha emission for (a,n*)a

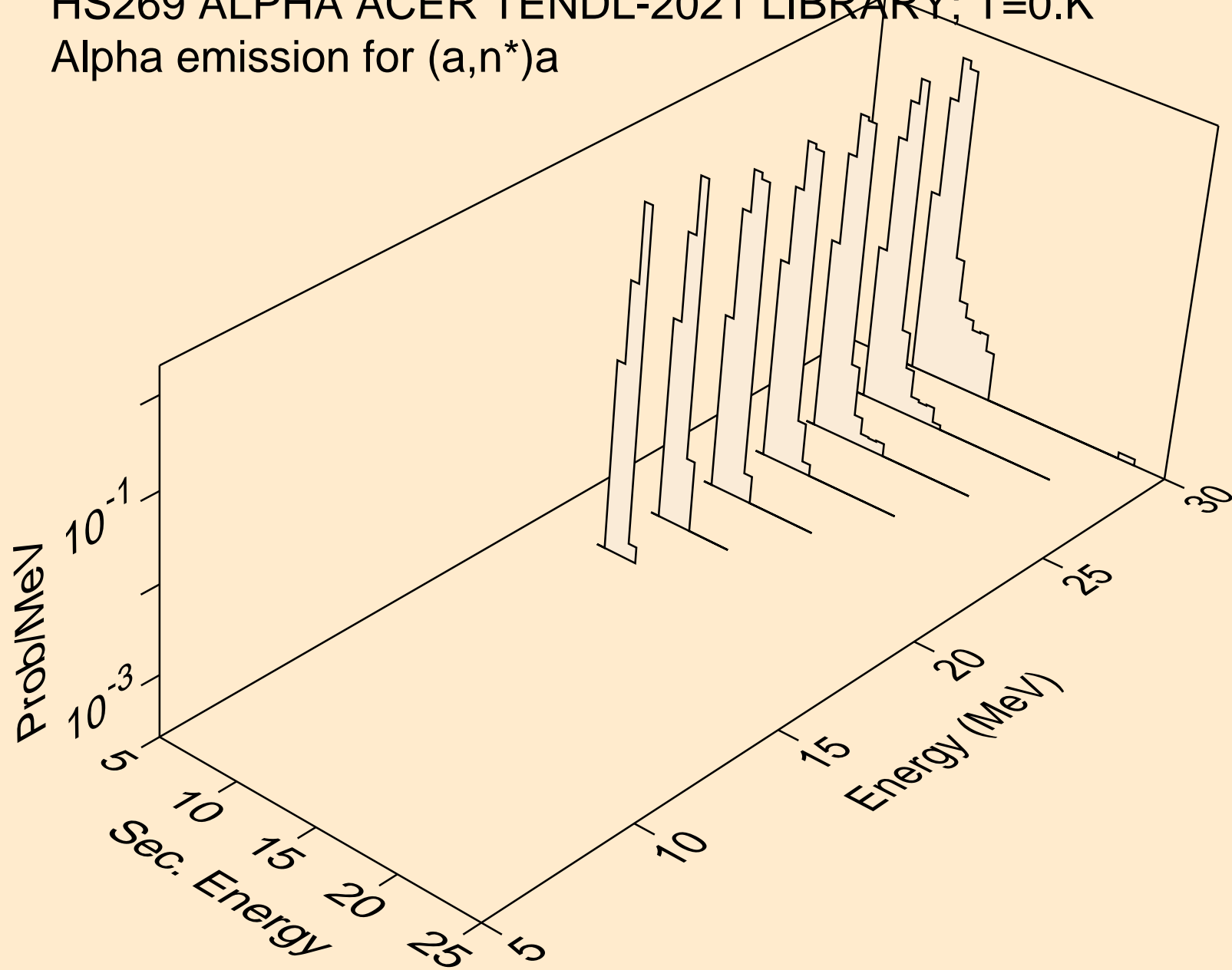

HS269 ALPHA ACER TENDL-2021 LIBRARY; T=0.K
Alpha emission for (a,2n)a

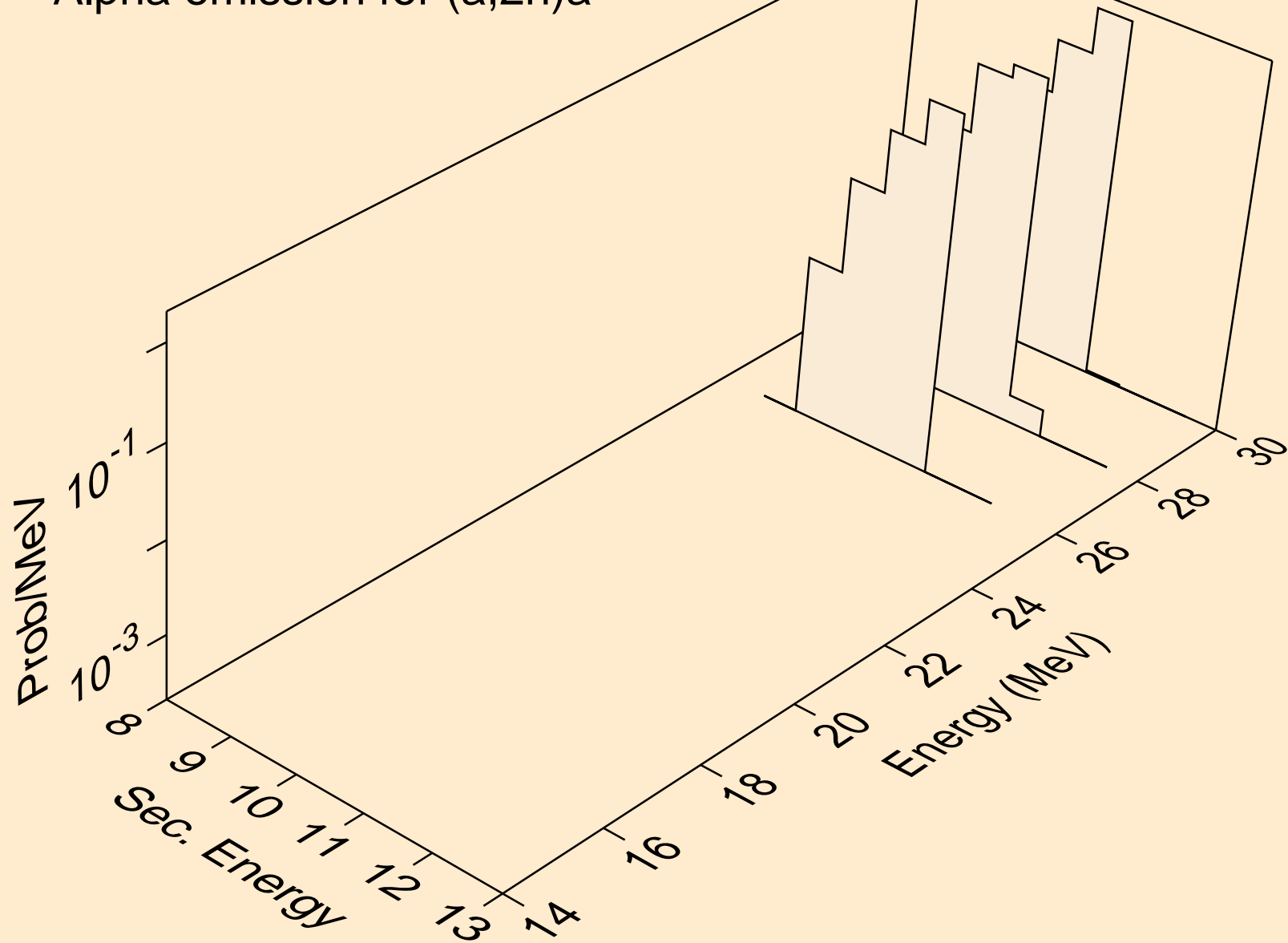

HS269 ALPHA ACER TENDL-2021 LIBRARY; T=0.K
Alpha emission for inelastic

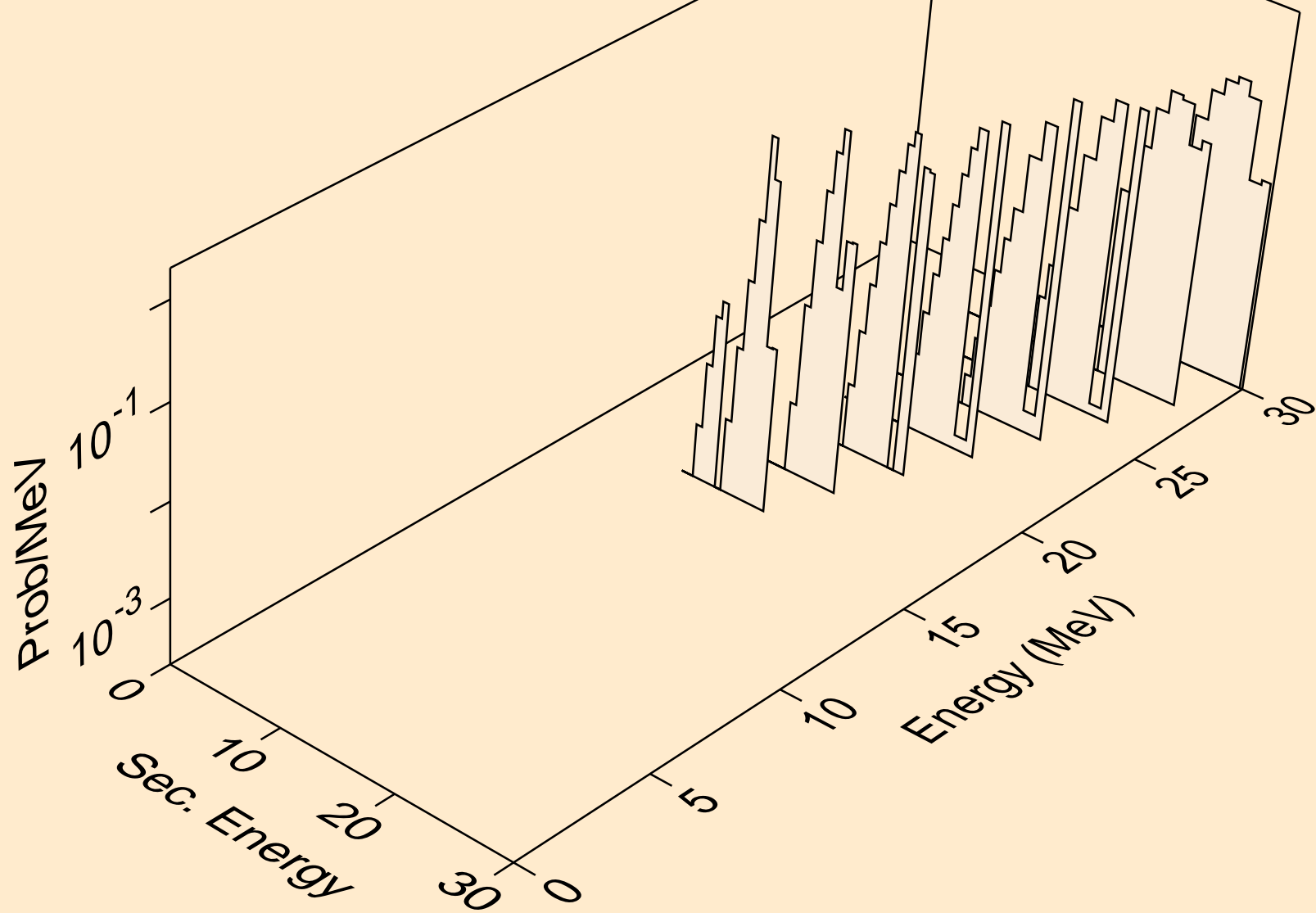

HS269 ALPHA ACER TENDL-2021 LIBRARY; T=0.K
Alpha emission for (a,2a)

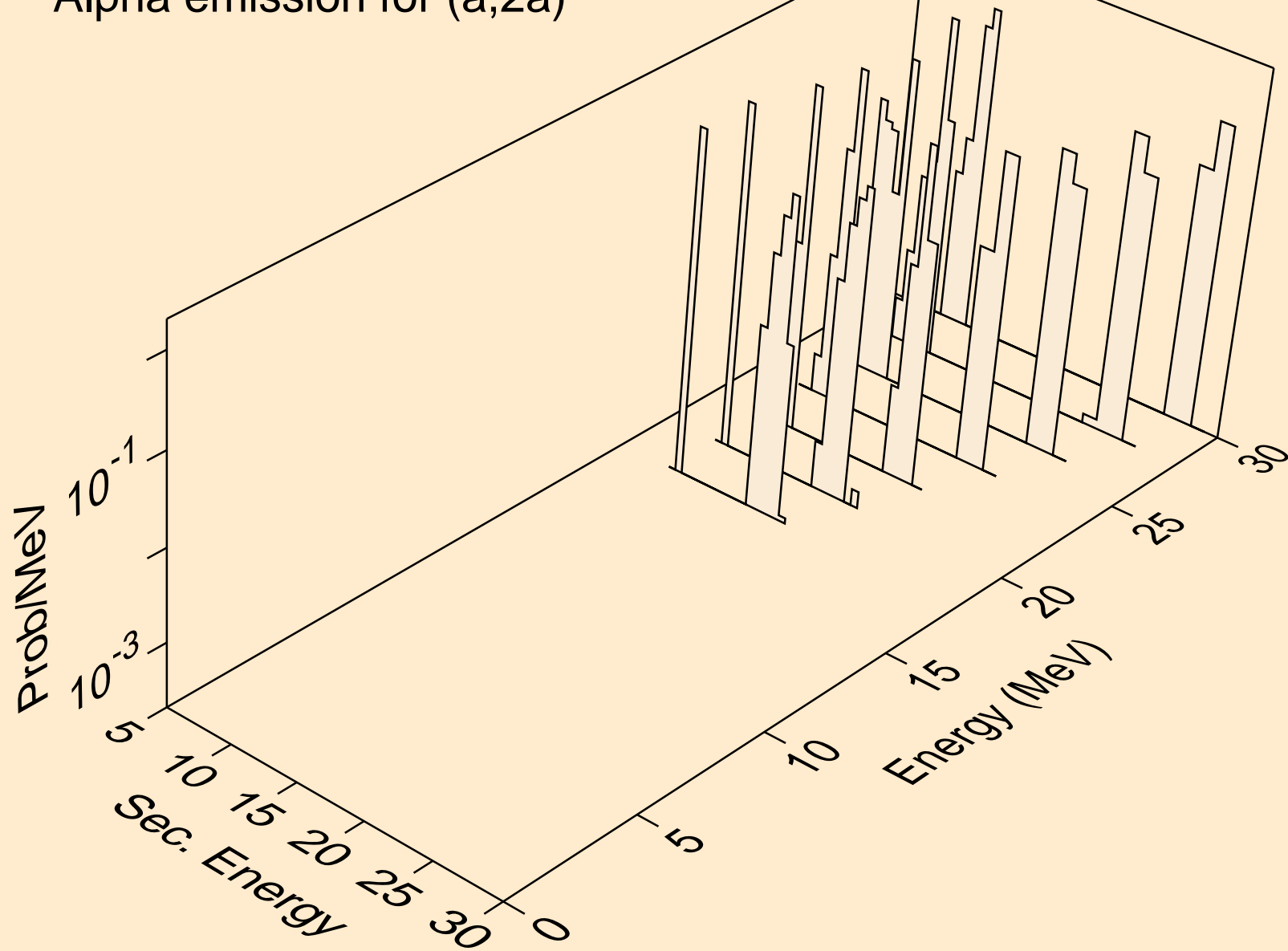

HS269 ALPHA ACER TENDL-2021 LIBRARY; T=0.K
Alpha emission for (a,pa)

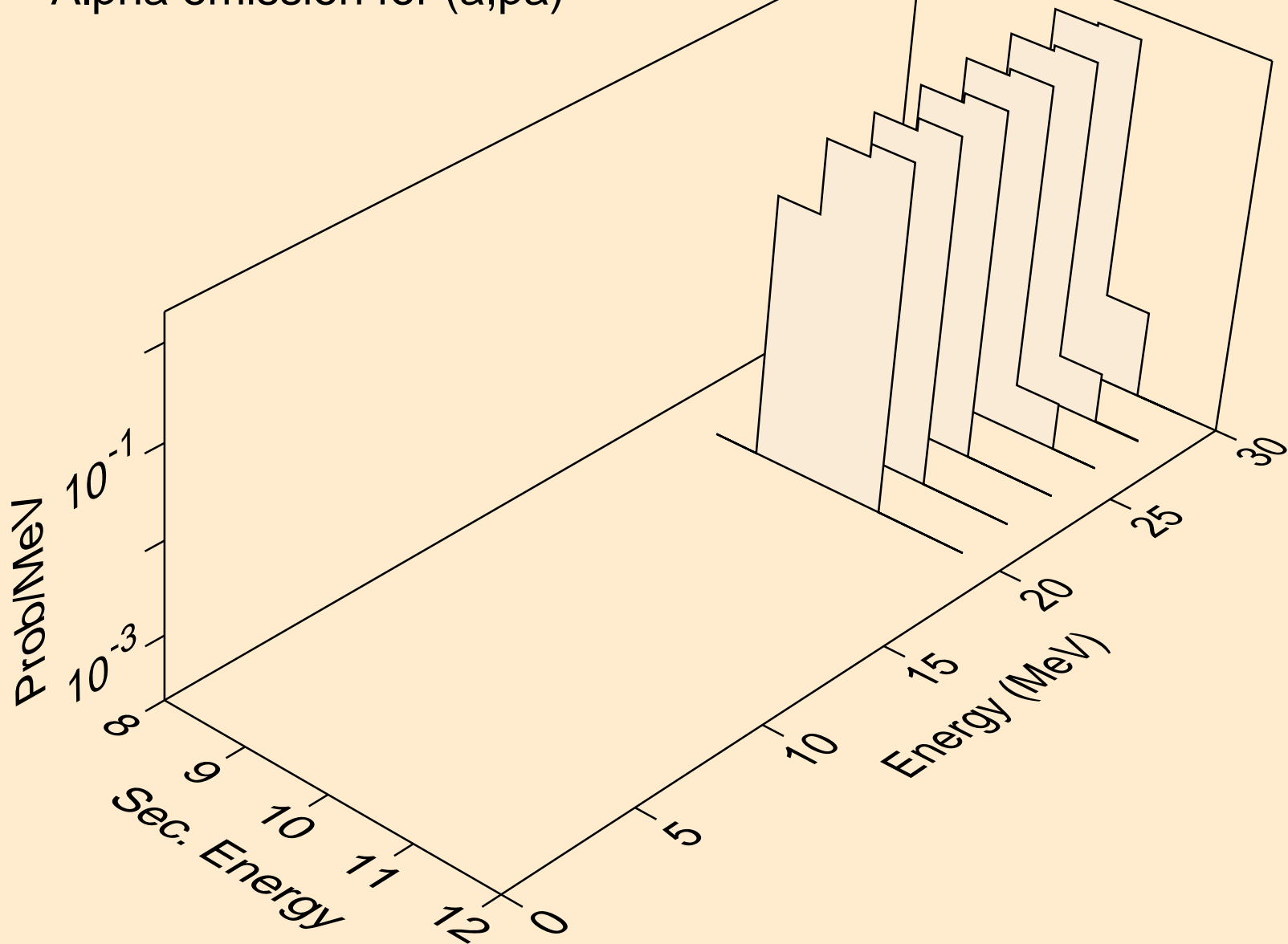

HS269 ALPHA ACER TENDL-2021 LIBRARY; T=0.K
Photon emission for (z,n)

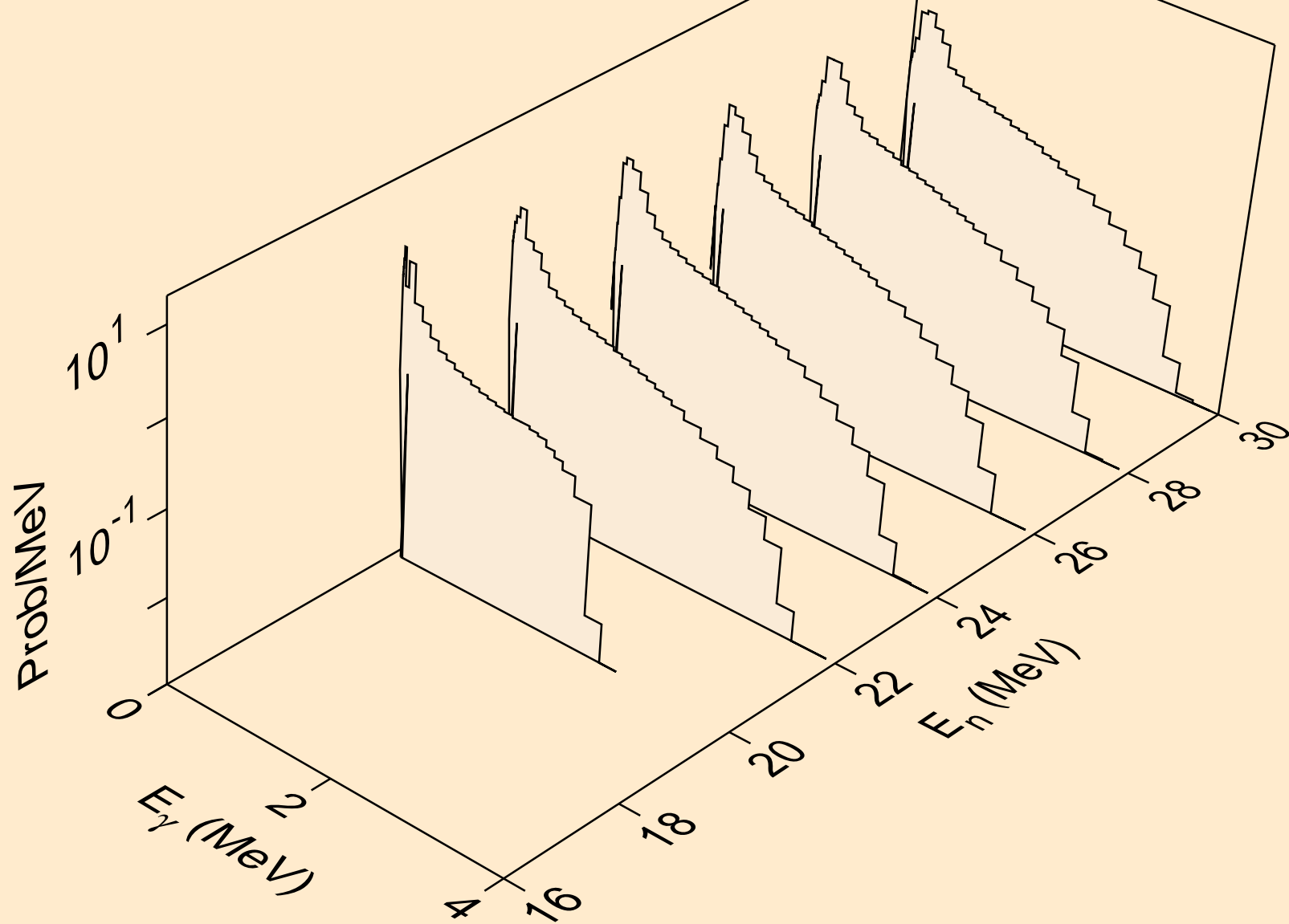

HS269 ALPHA ACER TENDL-2021 LIBRARY; T=0.K
Photon emission for (n,x)

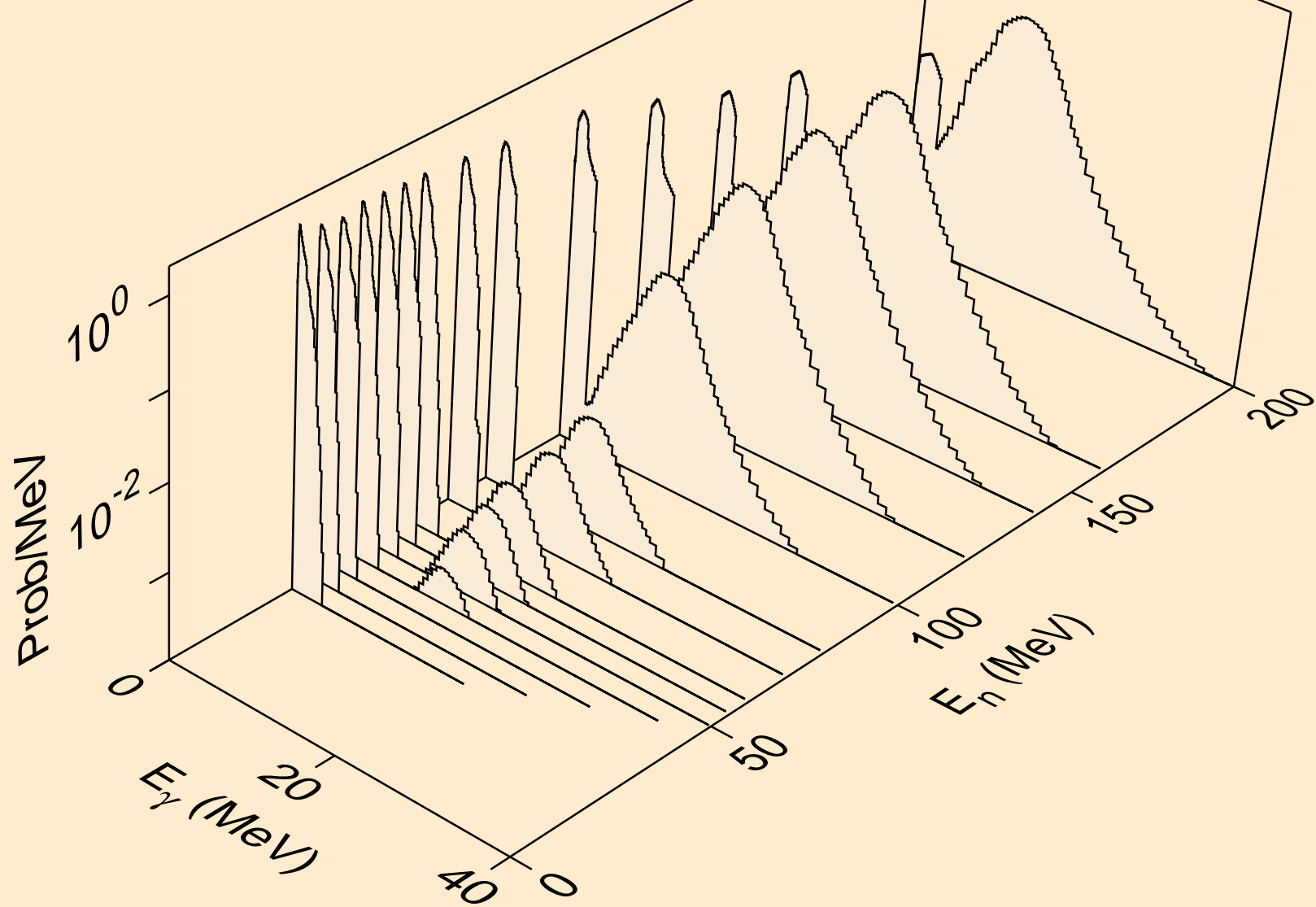

HS269 ALPHA ACER TENDL-2021 LIBRARY; T=0.K
Photon emission for (n,2n)

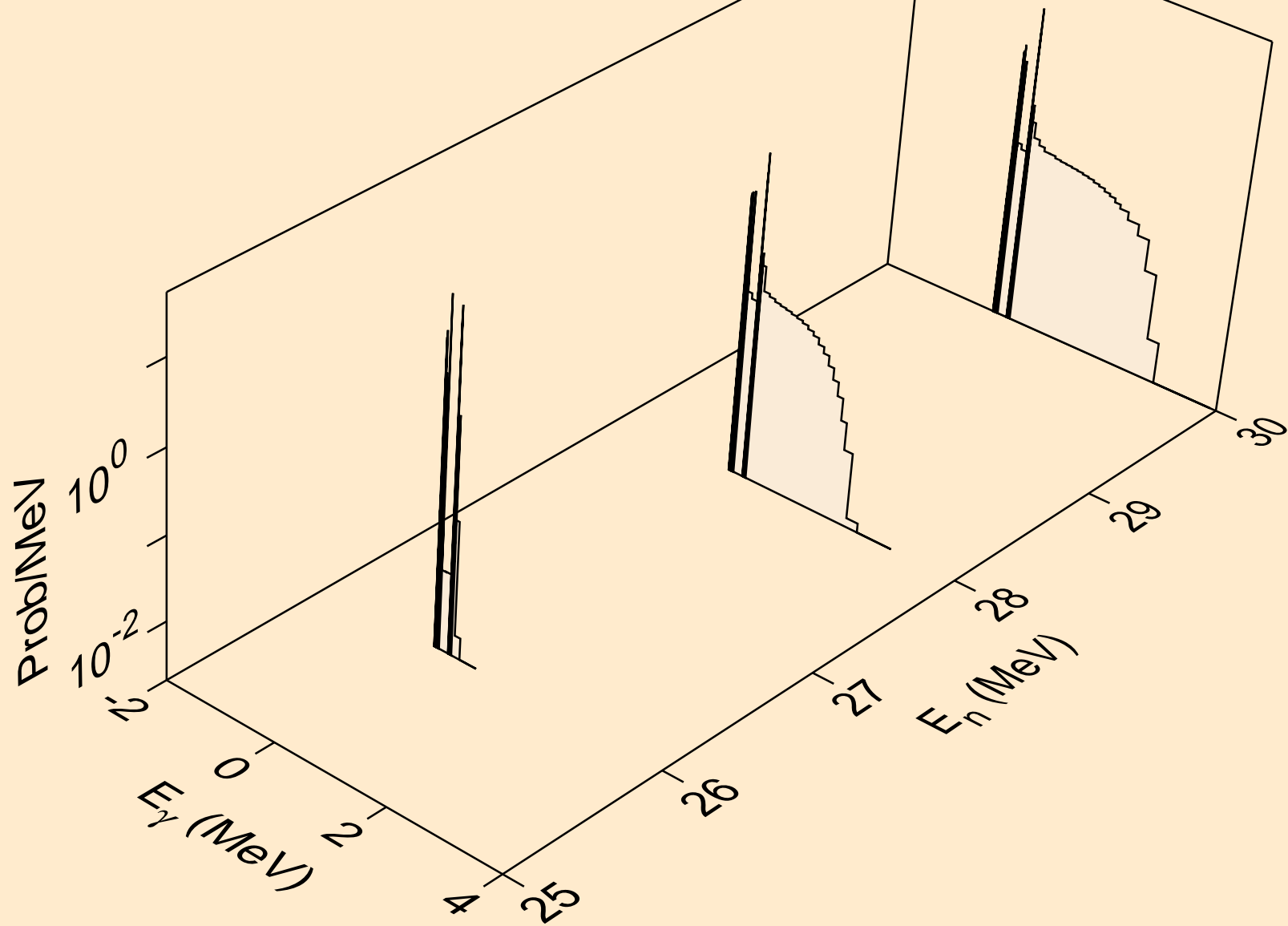

HS269 ALPHA ACER TENDL-2021 LIBRARY; T=0.K
Photon emission for (n,n*)a

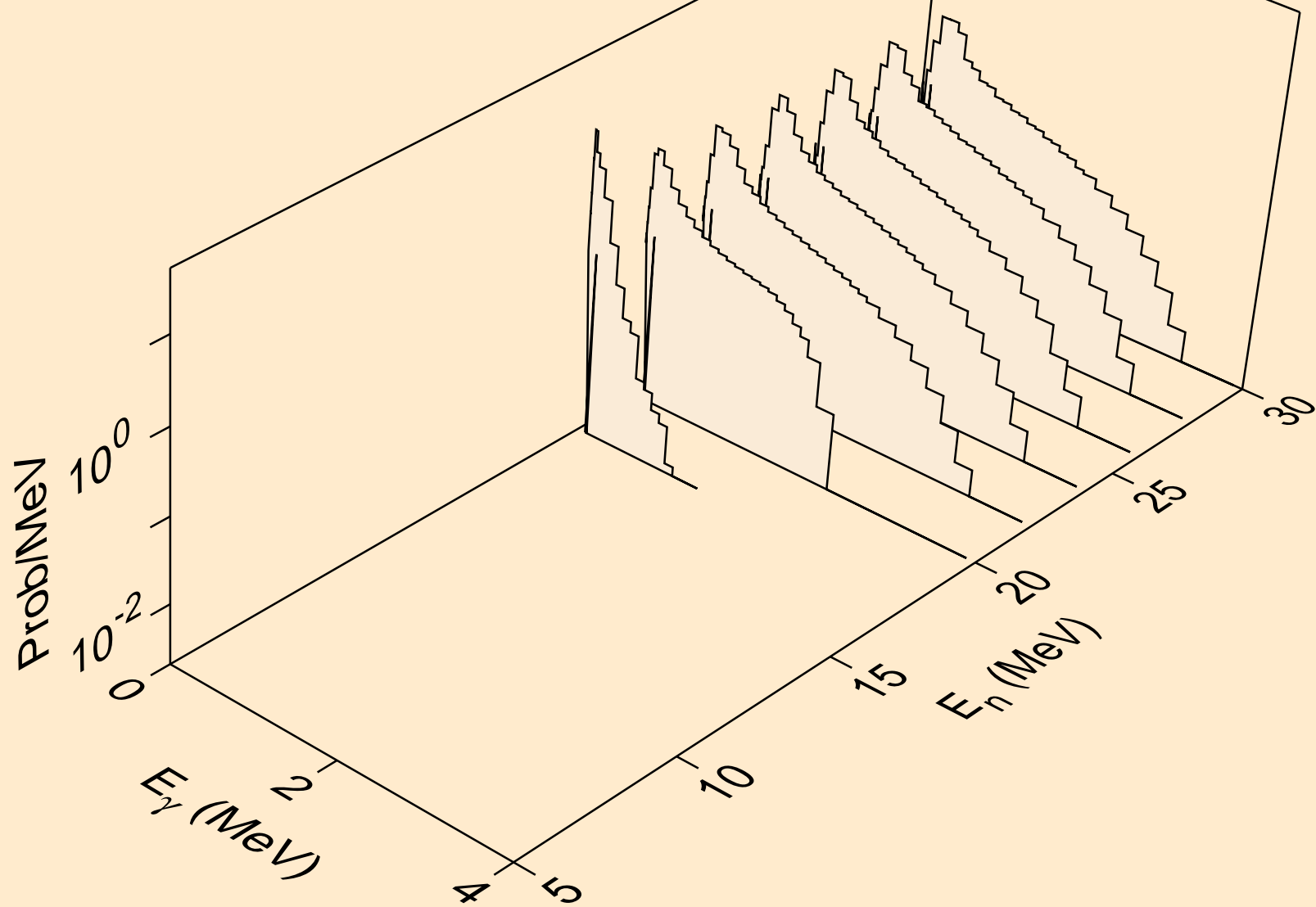

HS269 ALPHA ACER TENDL-2021 LIBRARY; T=0.K
Photon emission for (n,2n)a

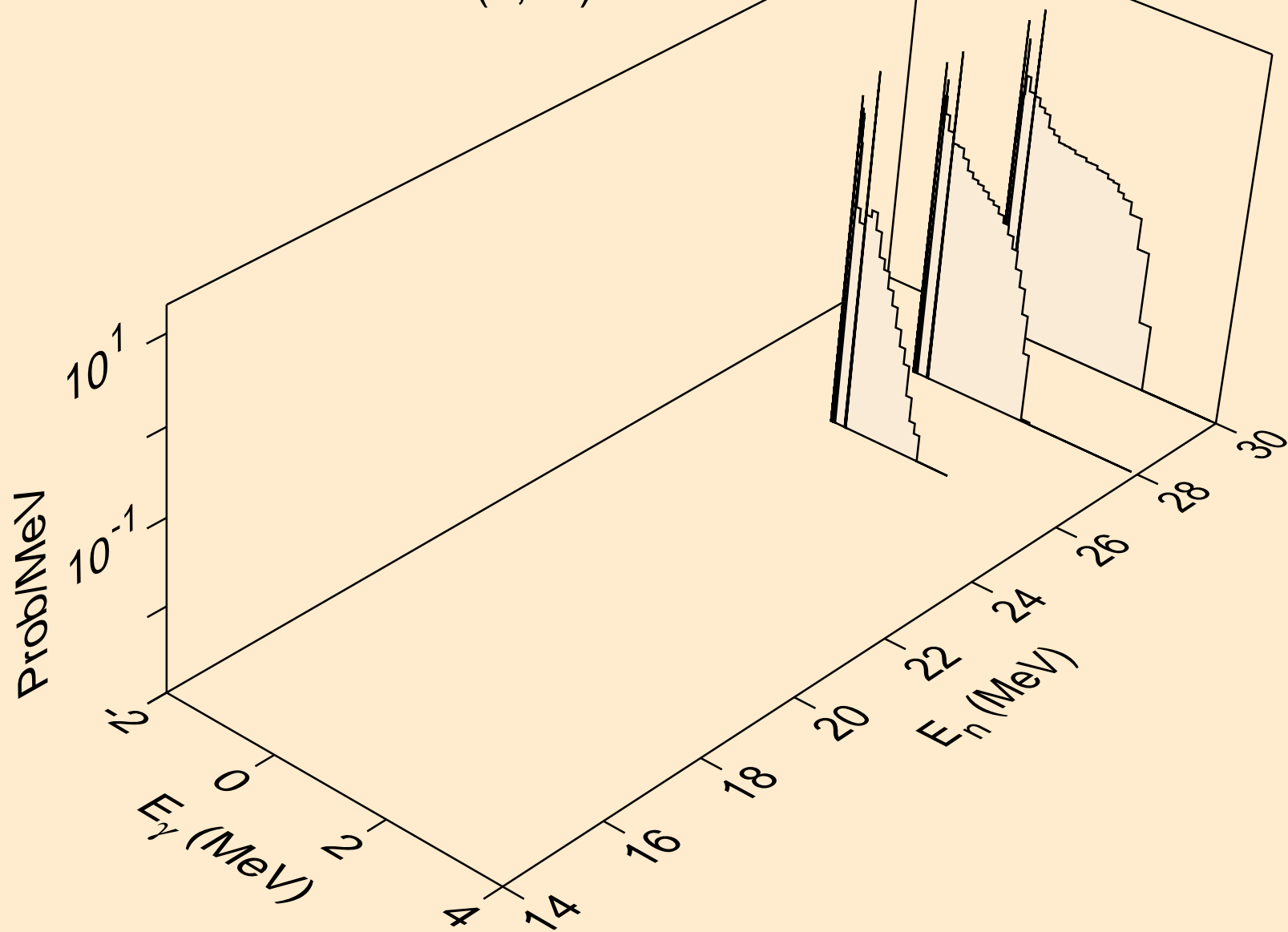

HS269 ALPHA ACER TENDL-2021 LIBRARY; T=0.K
Photon emission for (n,p)

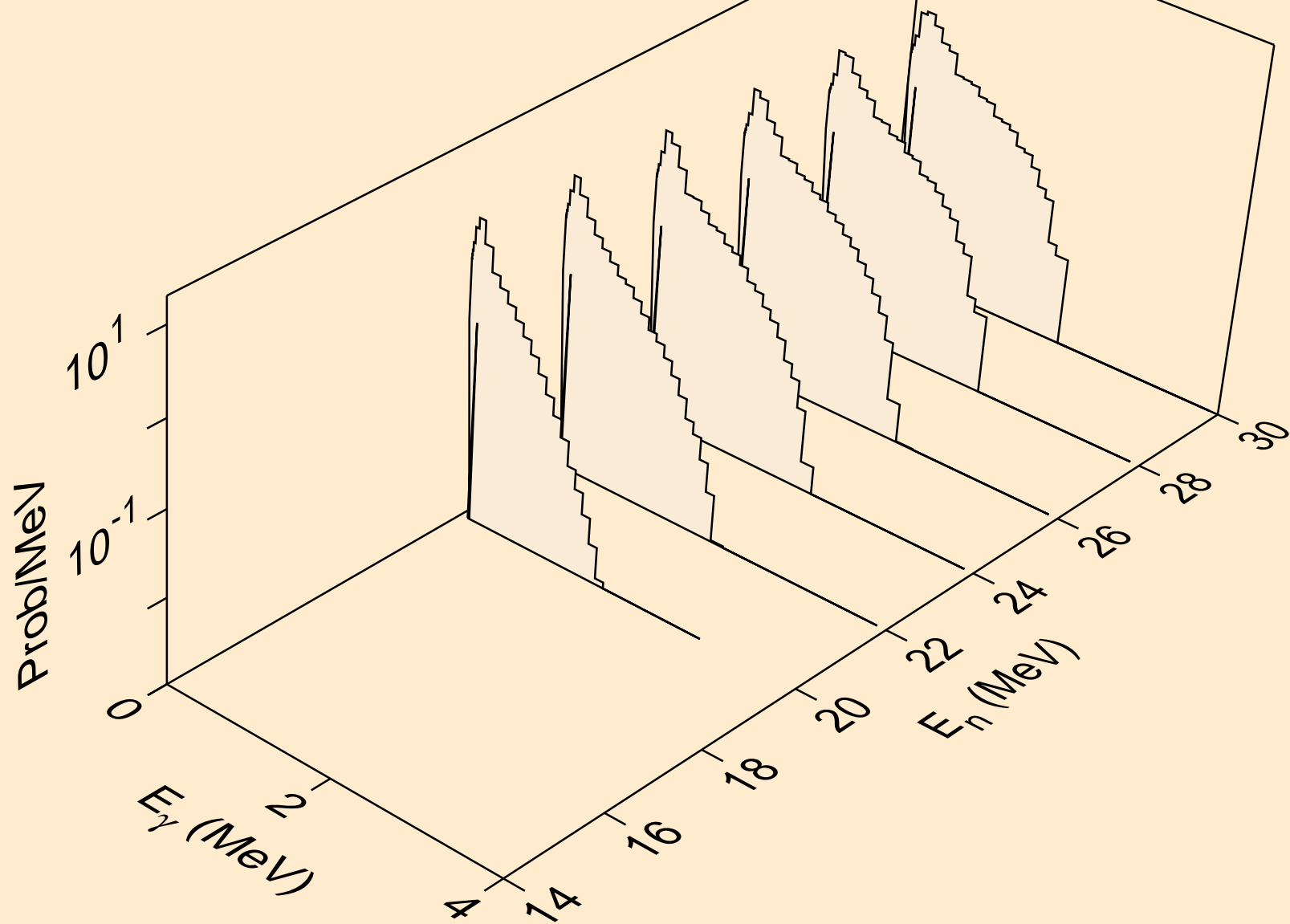

HS269 ALPHA ACER TENDL-2021 LIBRARY; T=0.K
Photon emission for (n,d)

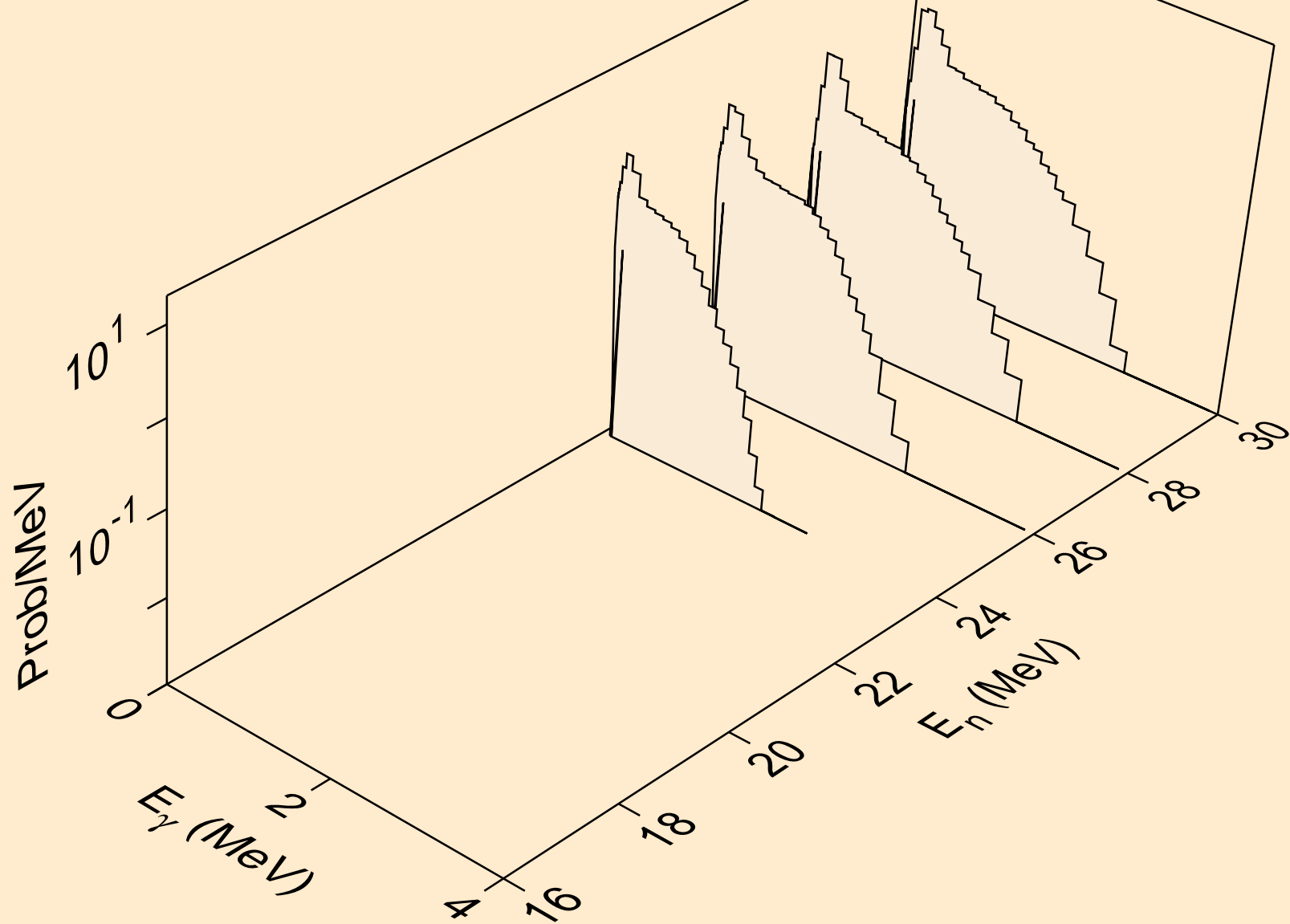

HS269 ALPHA ACER TENDL-2021 LIBRARY; T=0.K
Photon emission for (n,t)

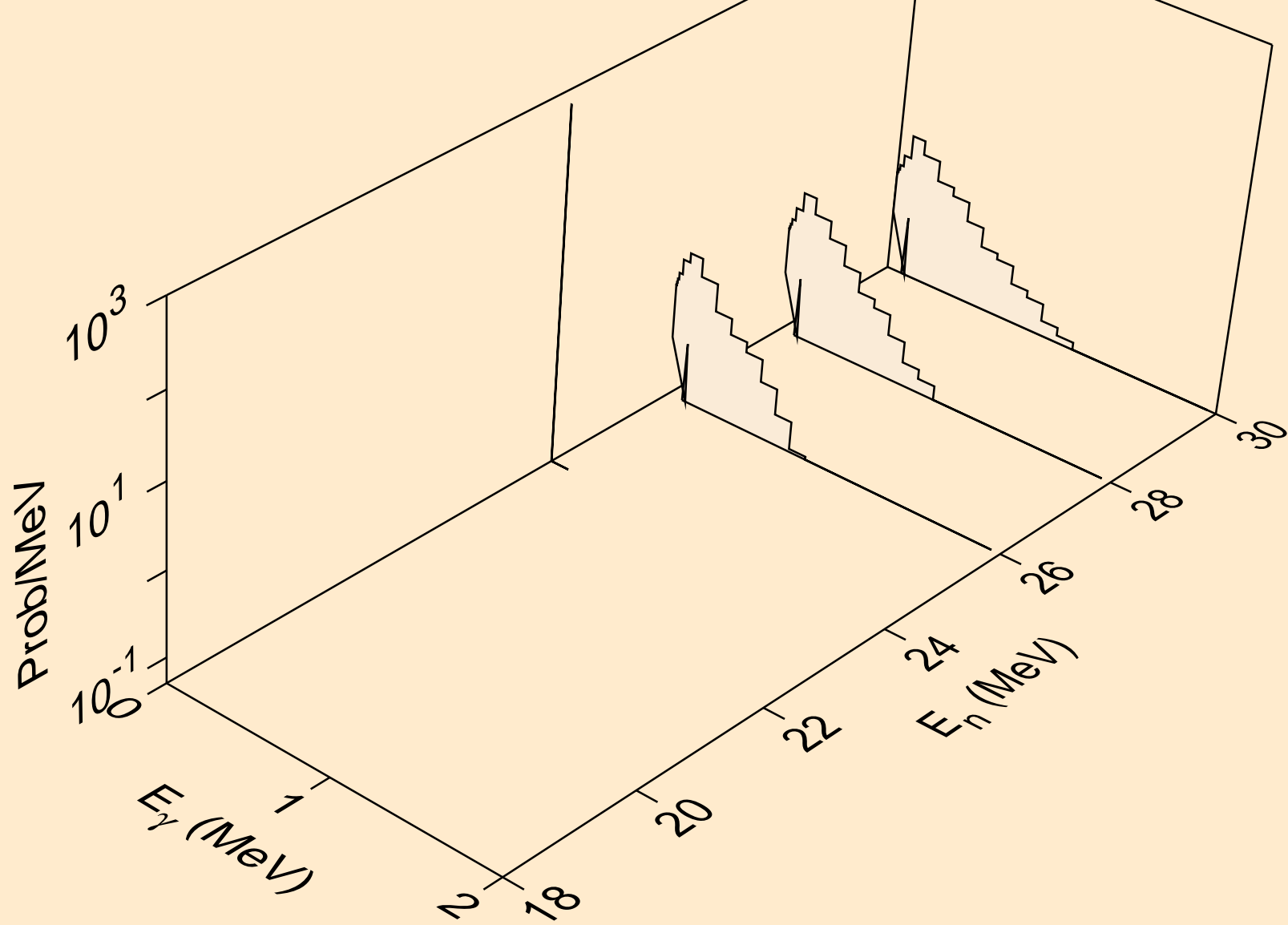

HS269 ALPHA ACER TENDL-2021 LIBRARY; T=0.K
Photon emission for inelastic

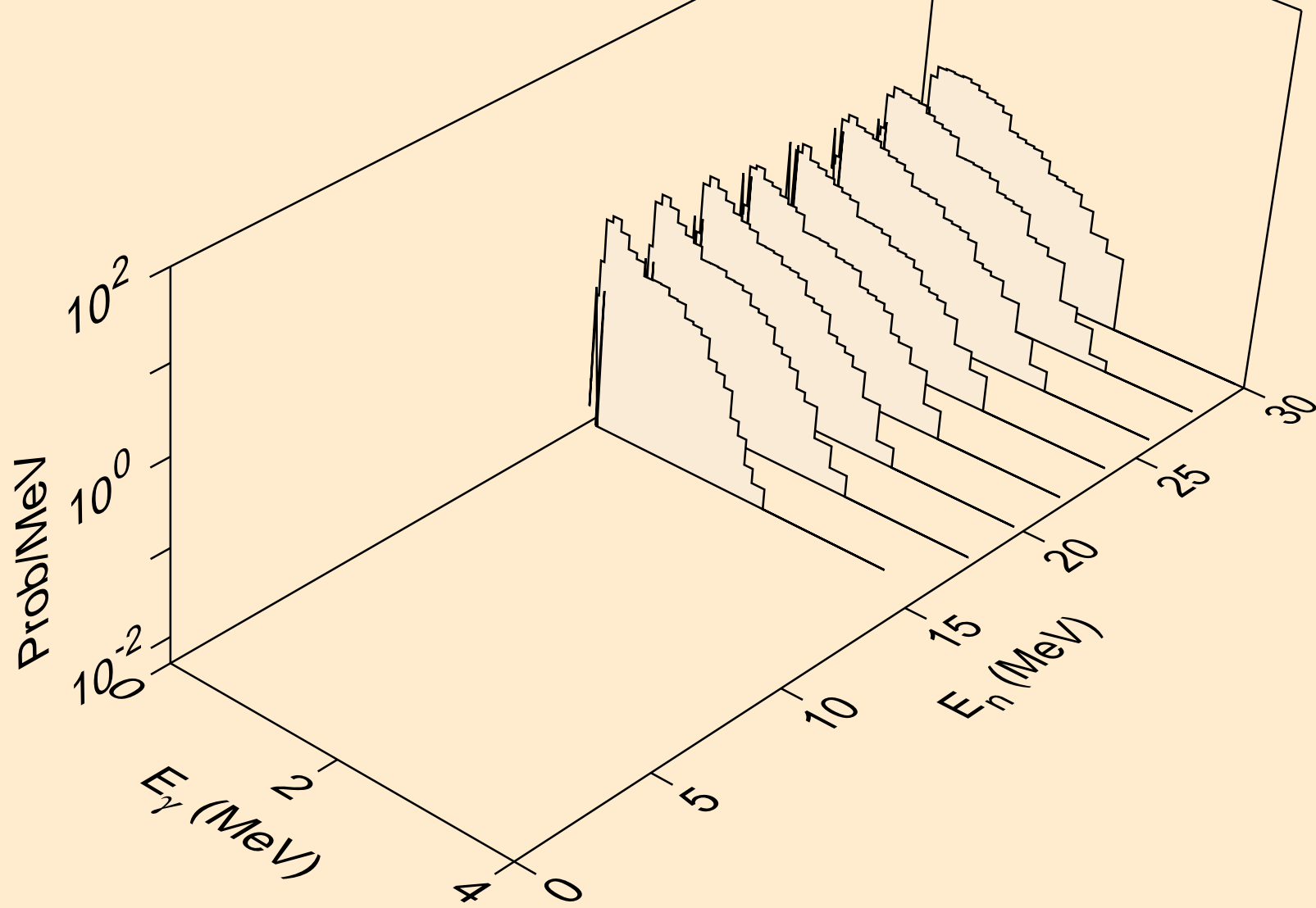

HS269 ALPHA ACER TENDL-2021 LIBRARY; T=0.K
Photon emission for (n,2a)

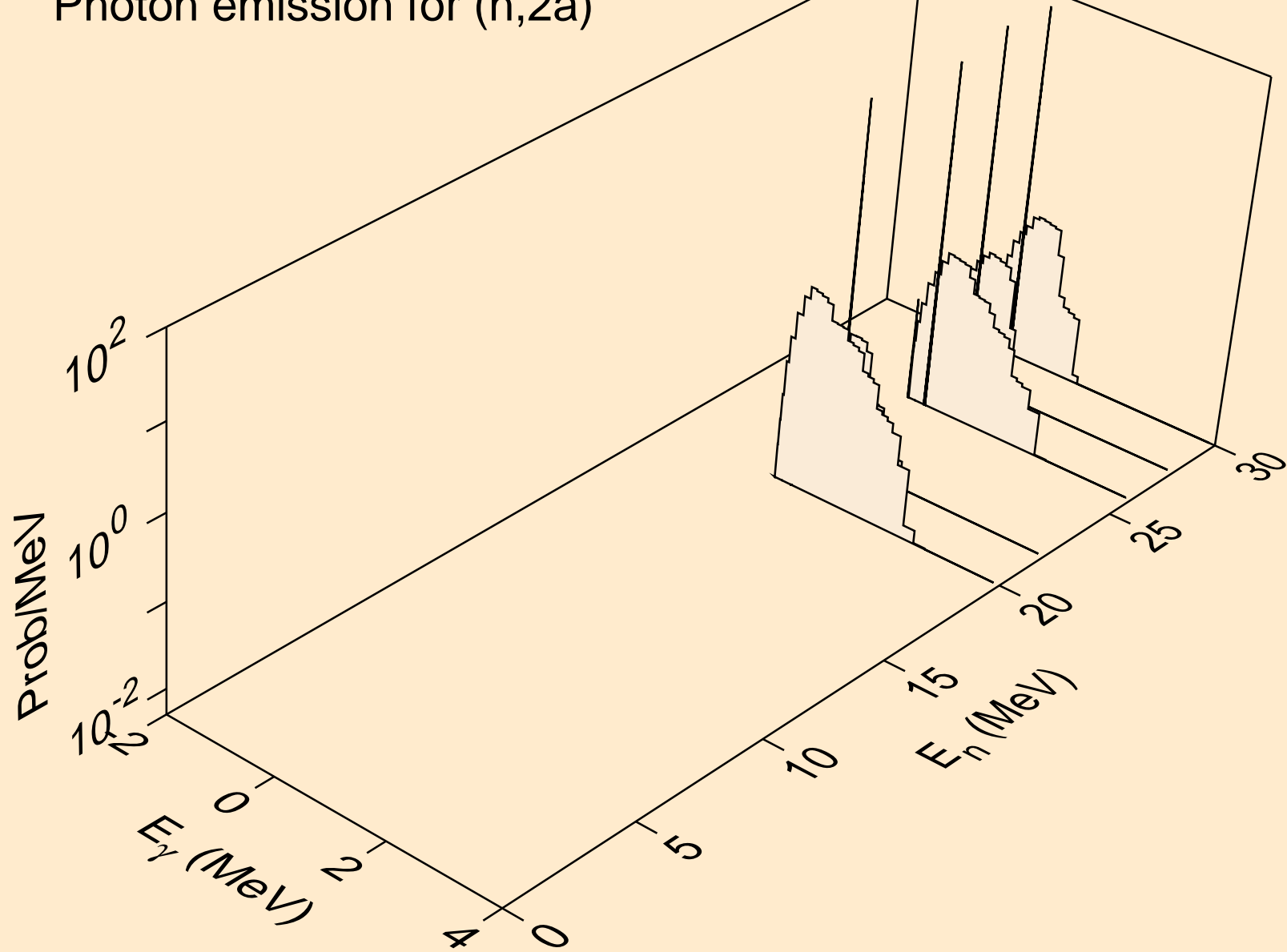

HS269 ALPHA ACER TENDL-2021 LIBRARY; T=0.K
Photon emission for (n,pa)

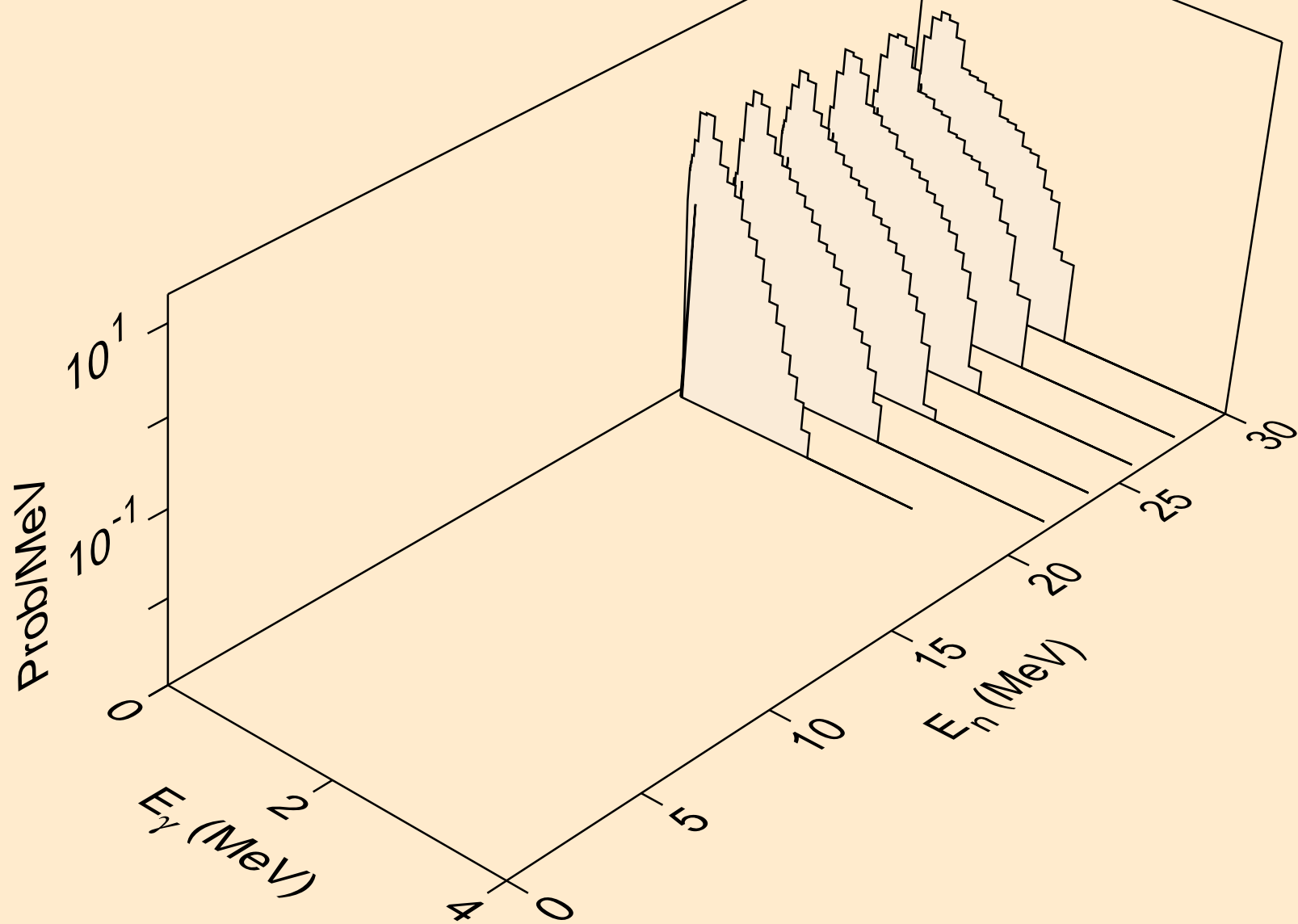

HS269 ALPHA ACER TENDL-2021 LIBRARY; T=0.K
Particle heating contributions

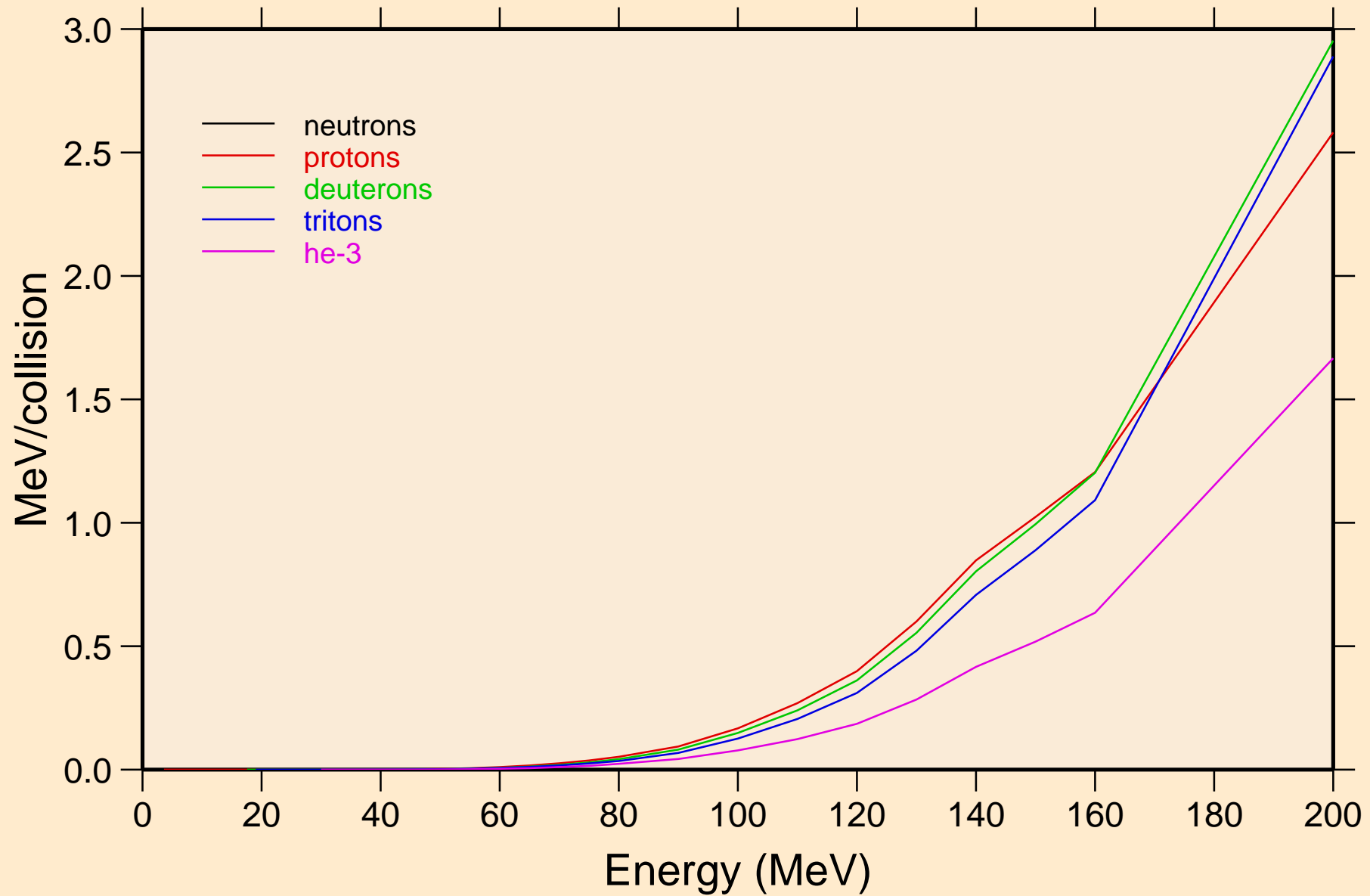

HS269 ALPHA ACER TENDL-2021 LIBRARY; T=0.K
Recoil Heating

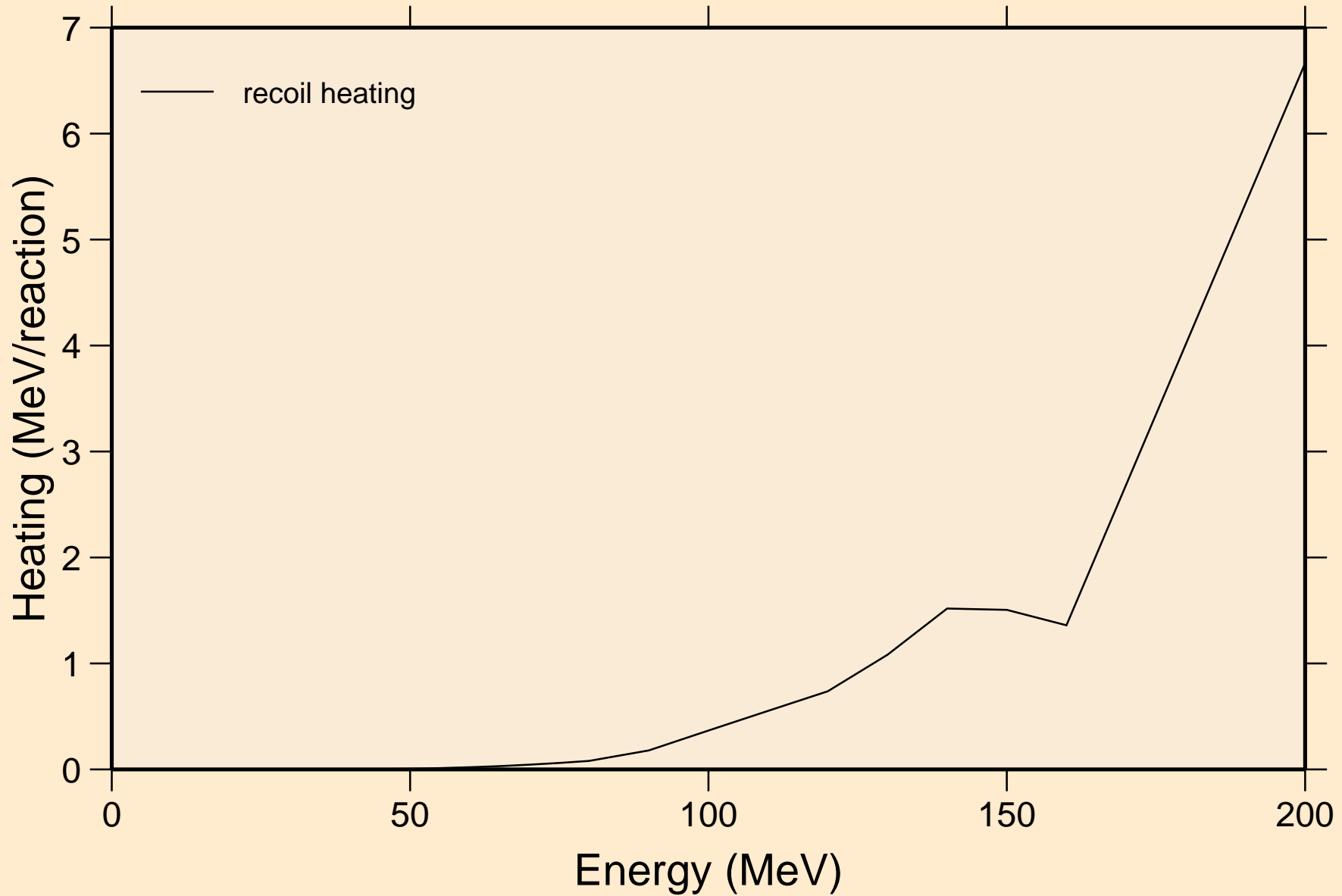

HS269 ALPHA ACER TENDL-2021 LIBRARY; T=0.K
Particle production cross sections

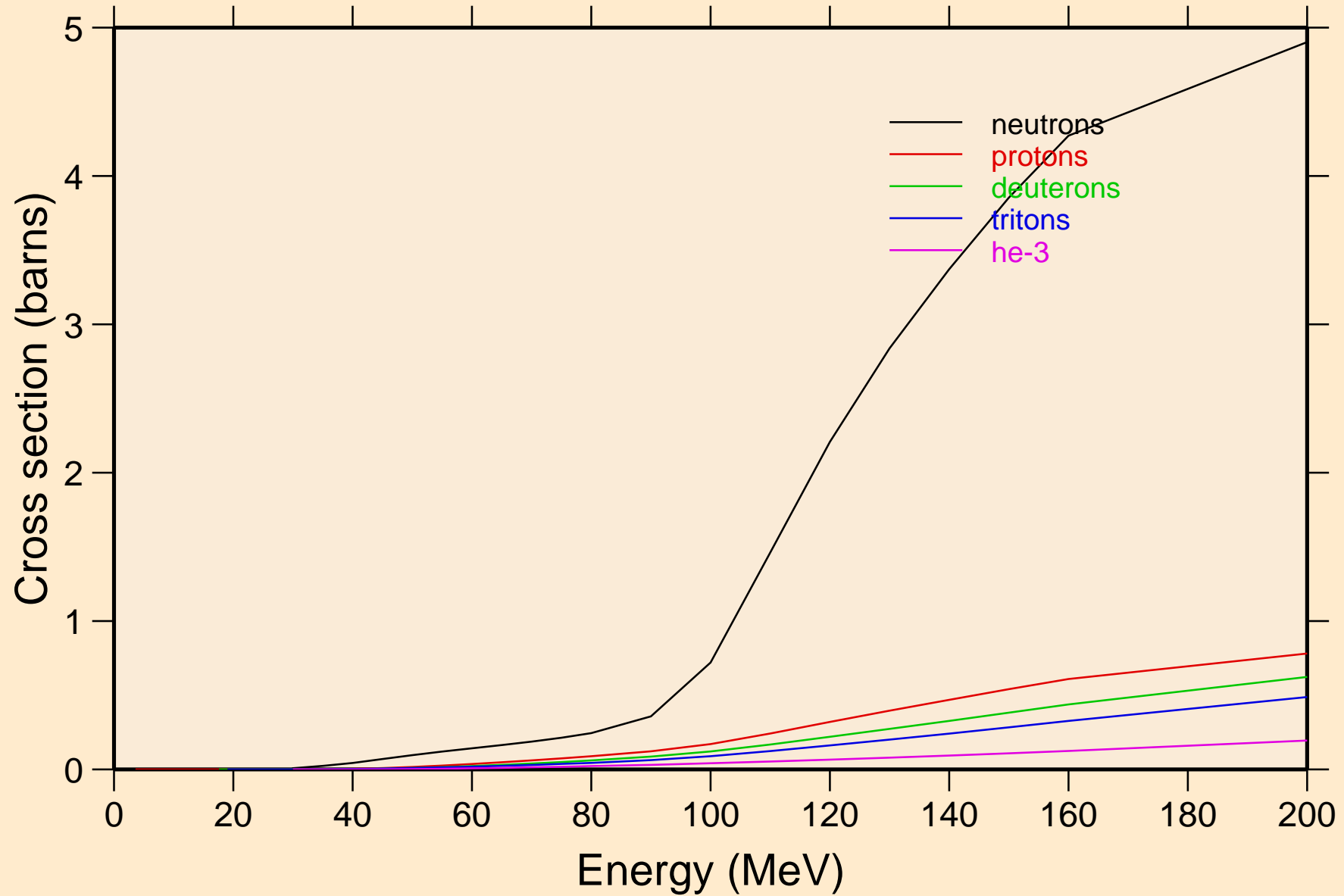

HS269 ALPHA ACER TENDL-2021 LIBRARY; T=0.K
neutrons from (a,n)

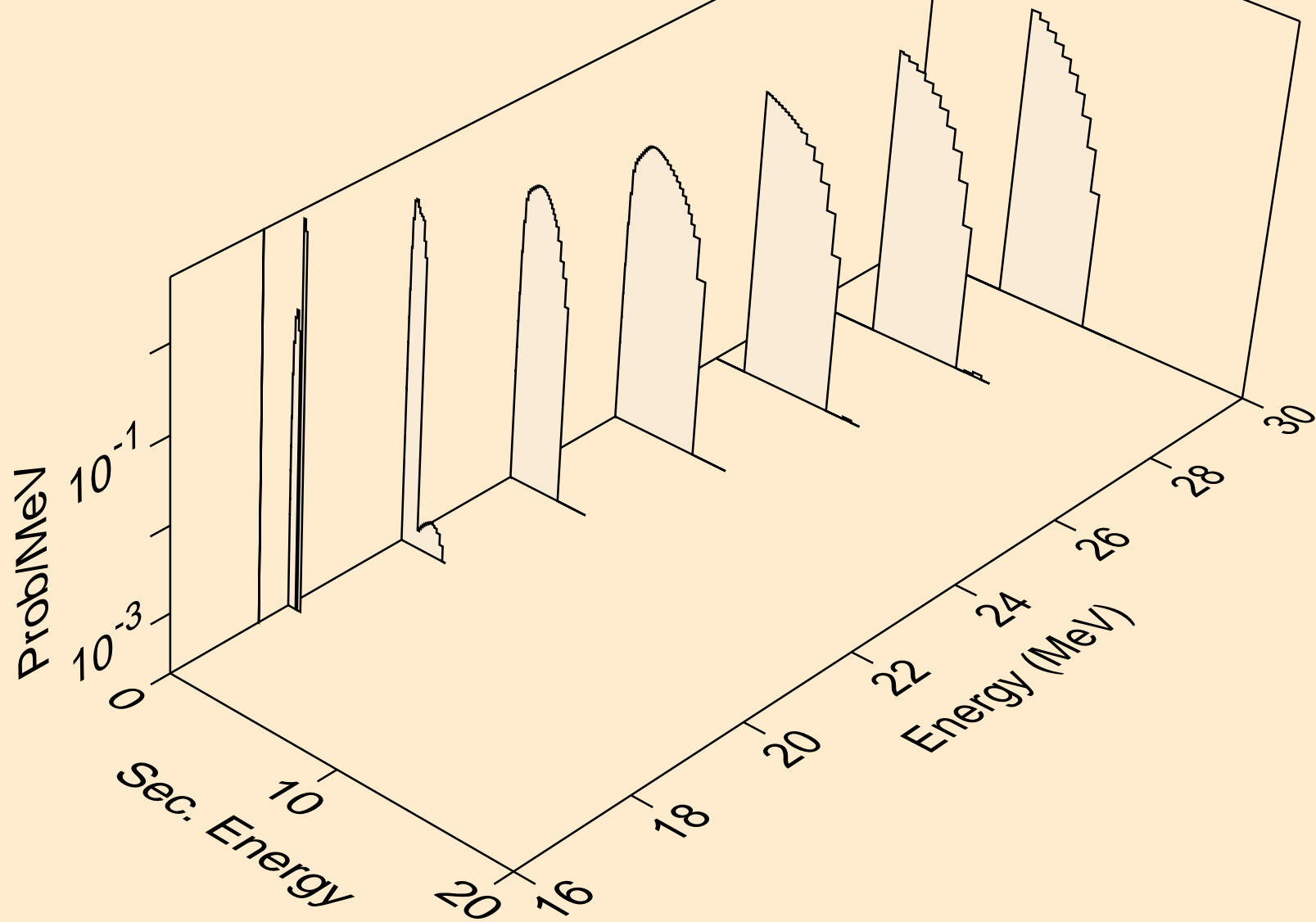

HS269 ALPHA ACER TENDL-2021 LIBRARY; T=0.K
neutrons from (a,x)

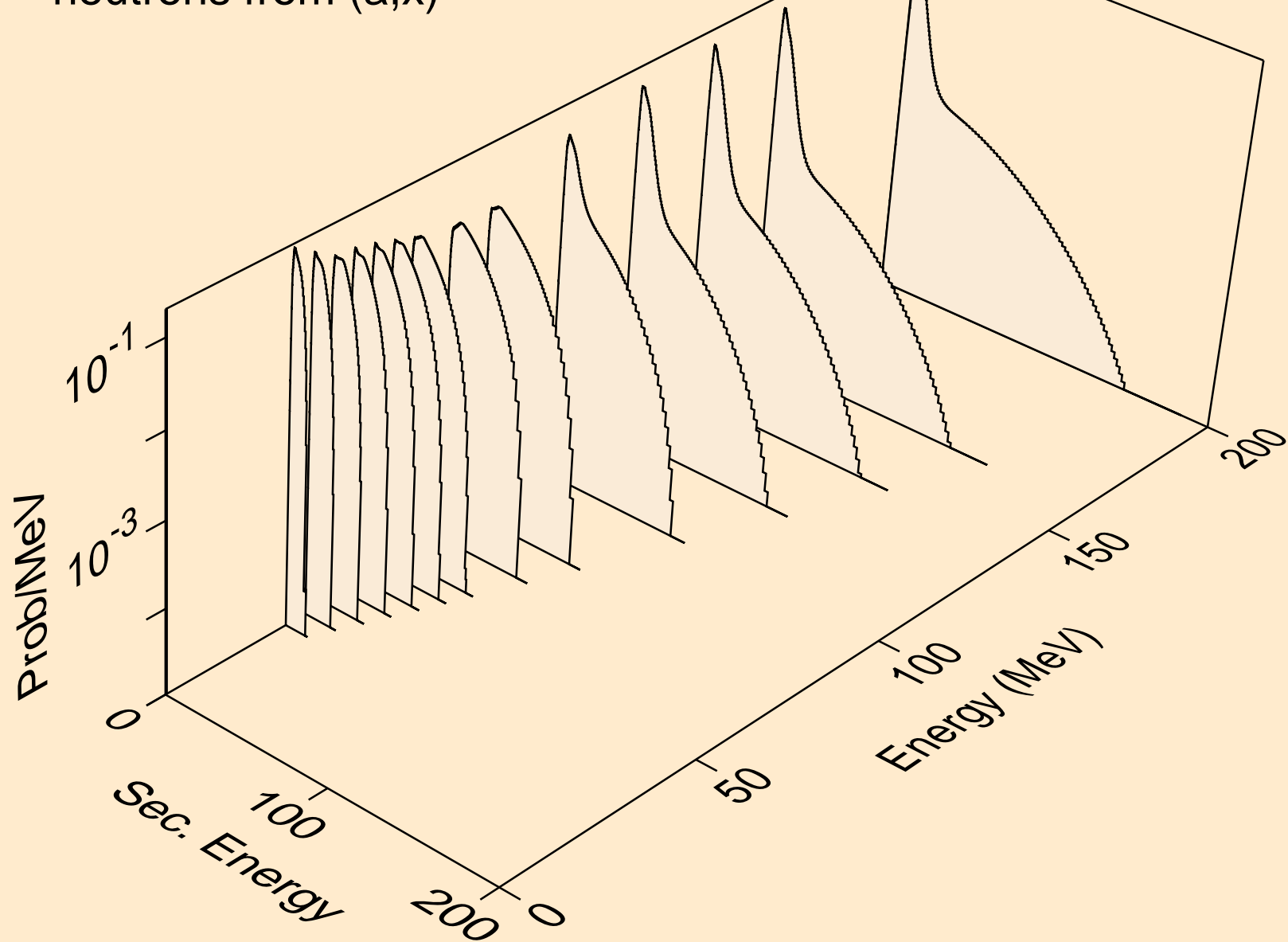

HS269 ALPHA ACER TENDL-2021 LIBRARY; T=0.K
neutrons from (a,2n)

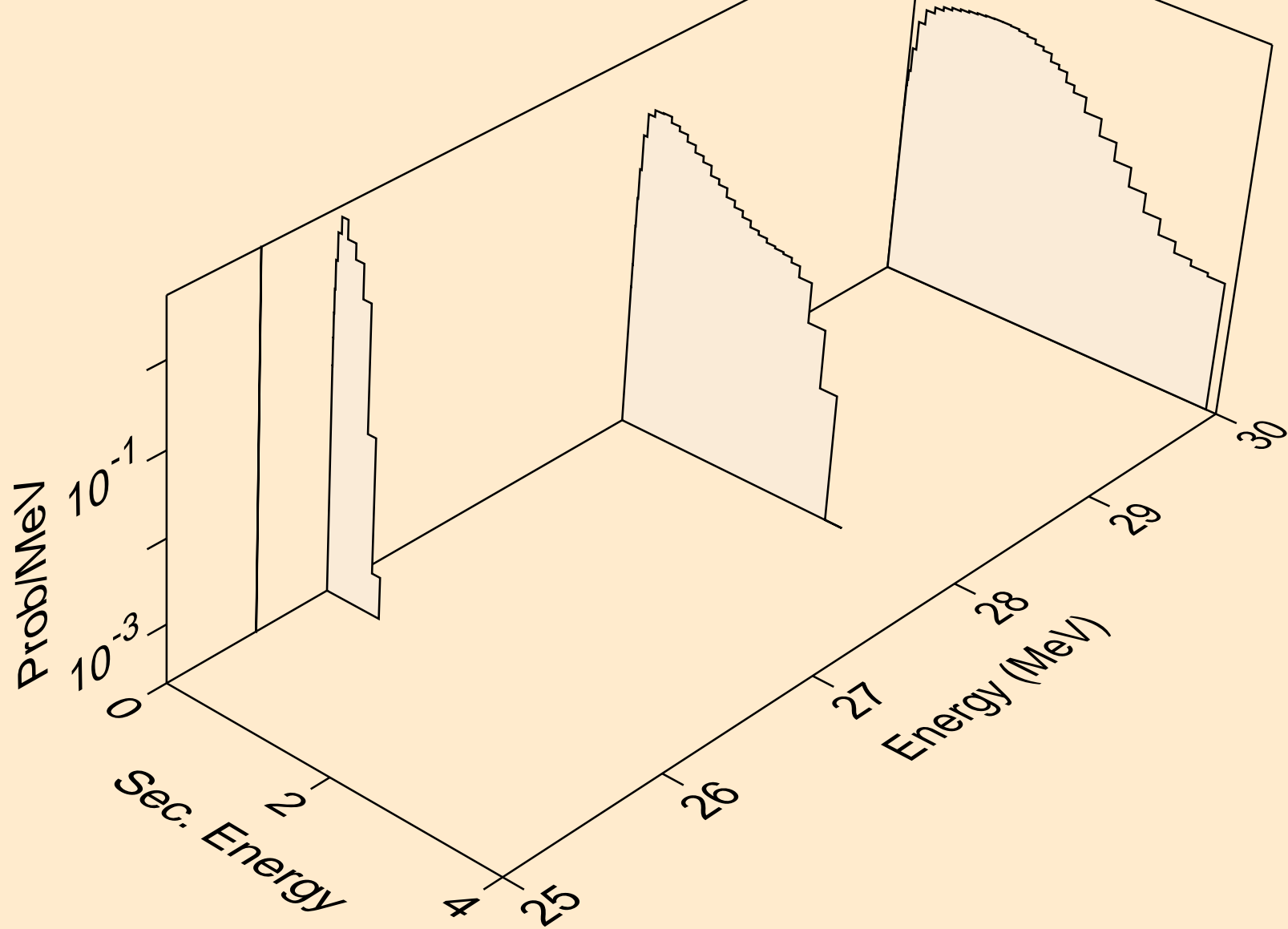

HS269 ALPHA ACER TENDL-2021 LIBRARY; T=0.K
neutrons from (a,n*)a

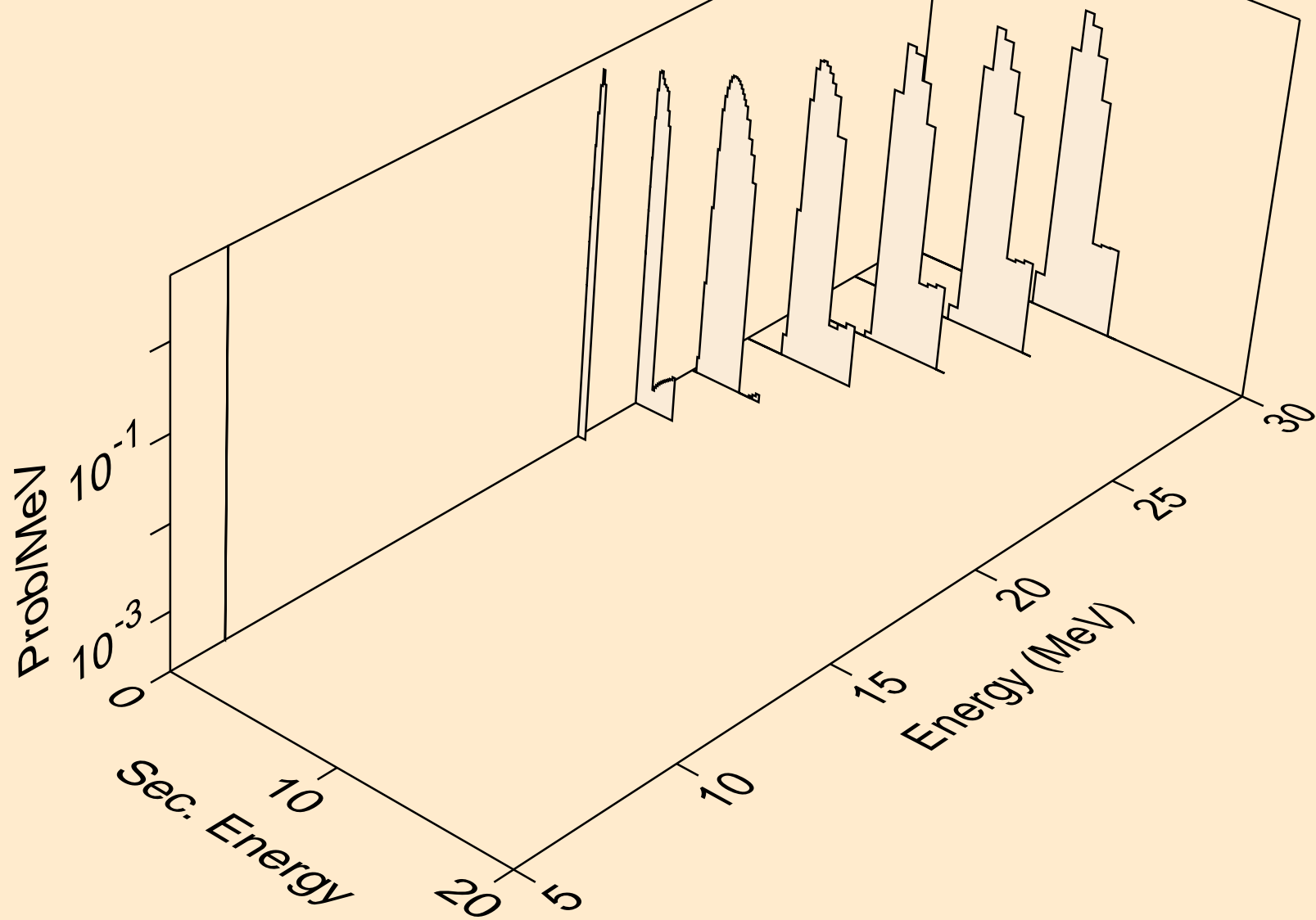

HS269 ALPHA ACER TENDL-2021 LIBRARY; T=0.K
neutrons from (a,2n)a

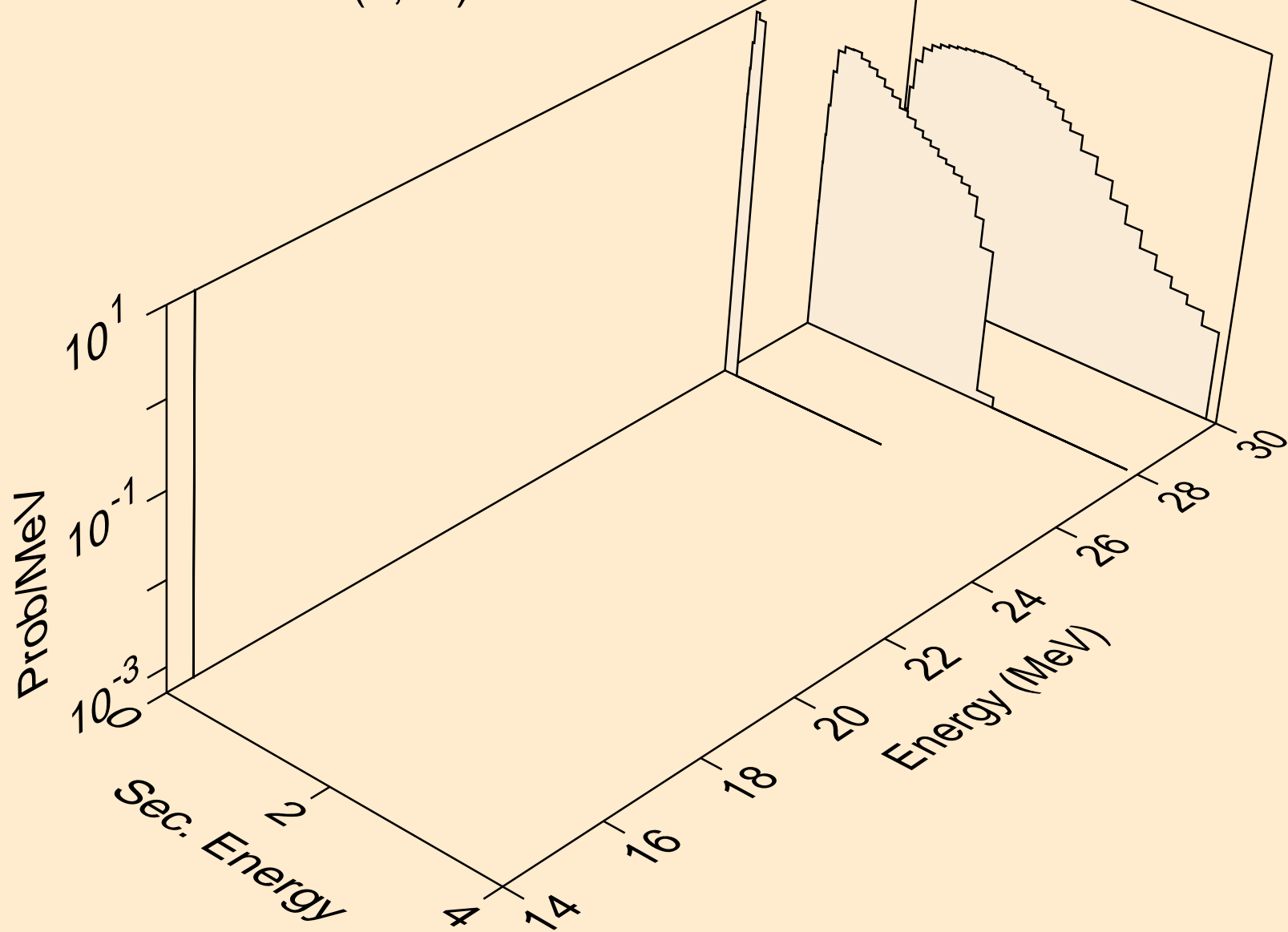

HS269 ALPHA ACER TENDL-2021 LIBRARY; T=0.K
protons from (a,x)

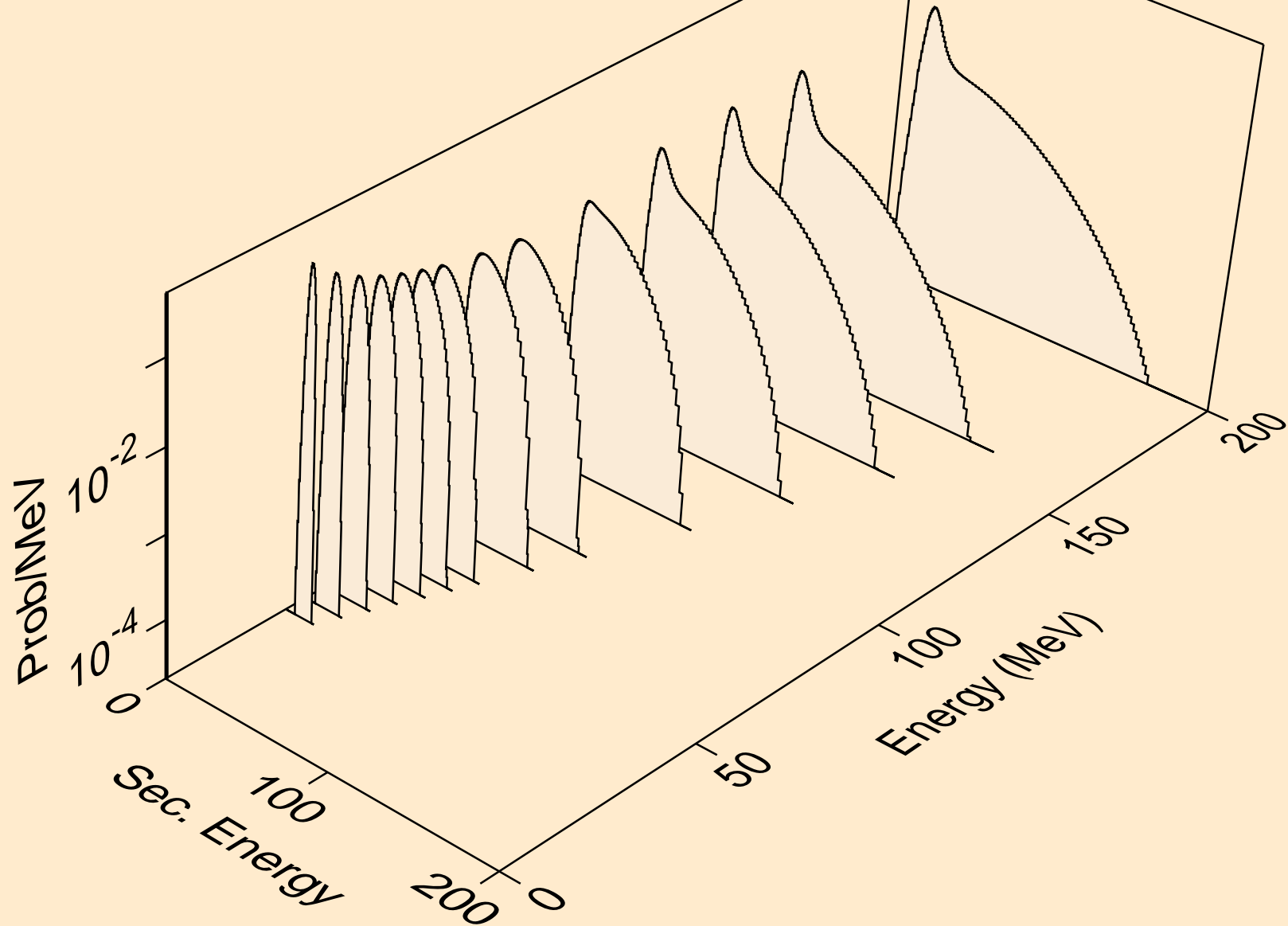

HS269 ALPHA ACER TENDL-2021 LIBRARY; T=0.K
protons from (a,p)

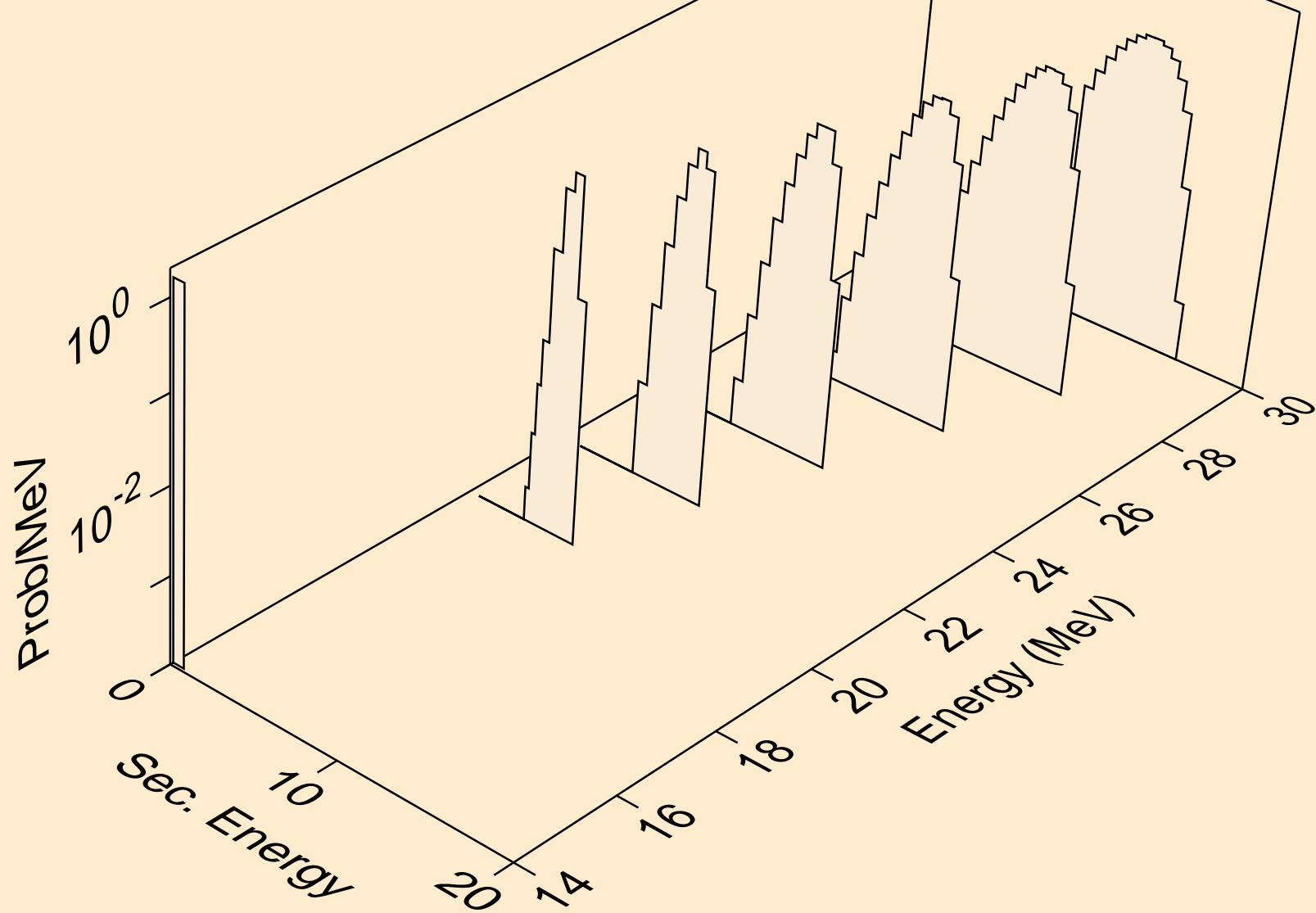

HS269 ALPHA ACER TENDL-2021 LIBRARY; T=0.K
protons from (a,pa)

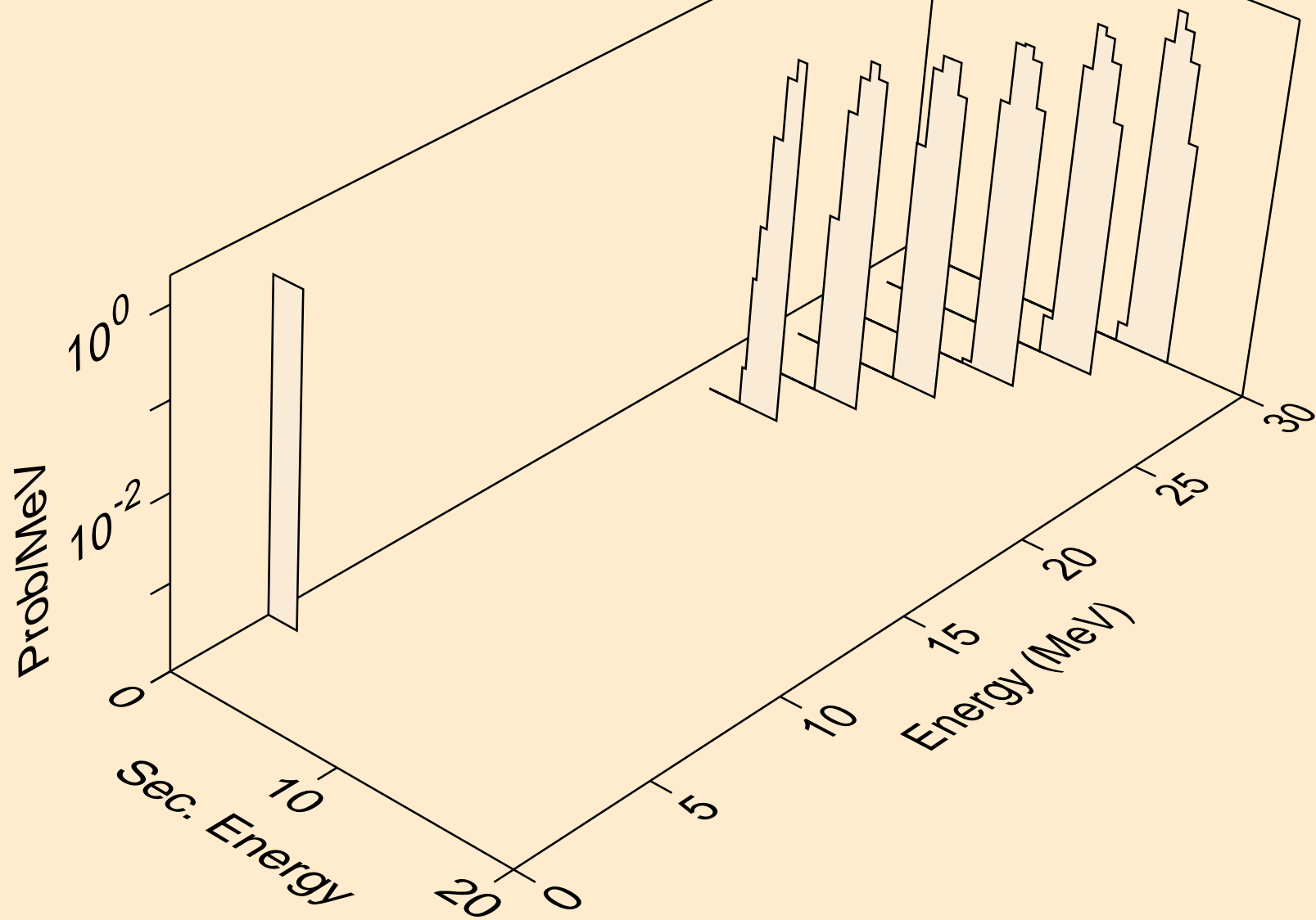

HS269 ALPHA ACER TENDL-2021 LIBRARY; T=0.K
deuterons from (a,x)

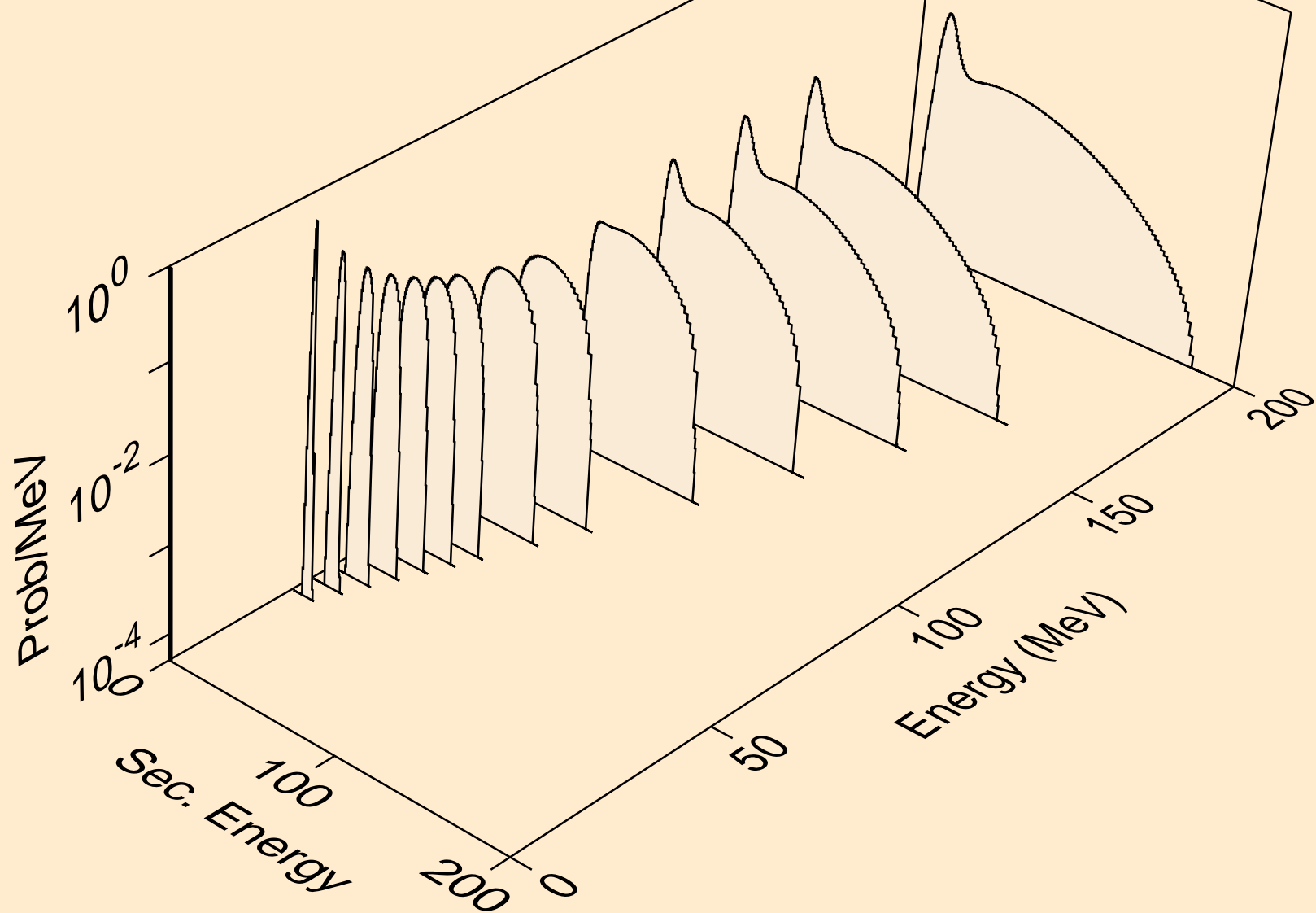

HS269 ALPHA ACER TENDL-2021 LIBRARY; T=0.K
deuterons from (a,d)

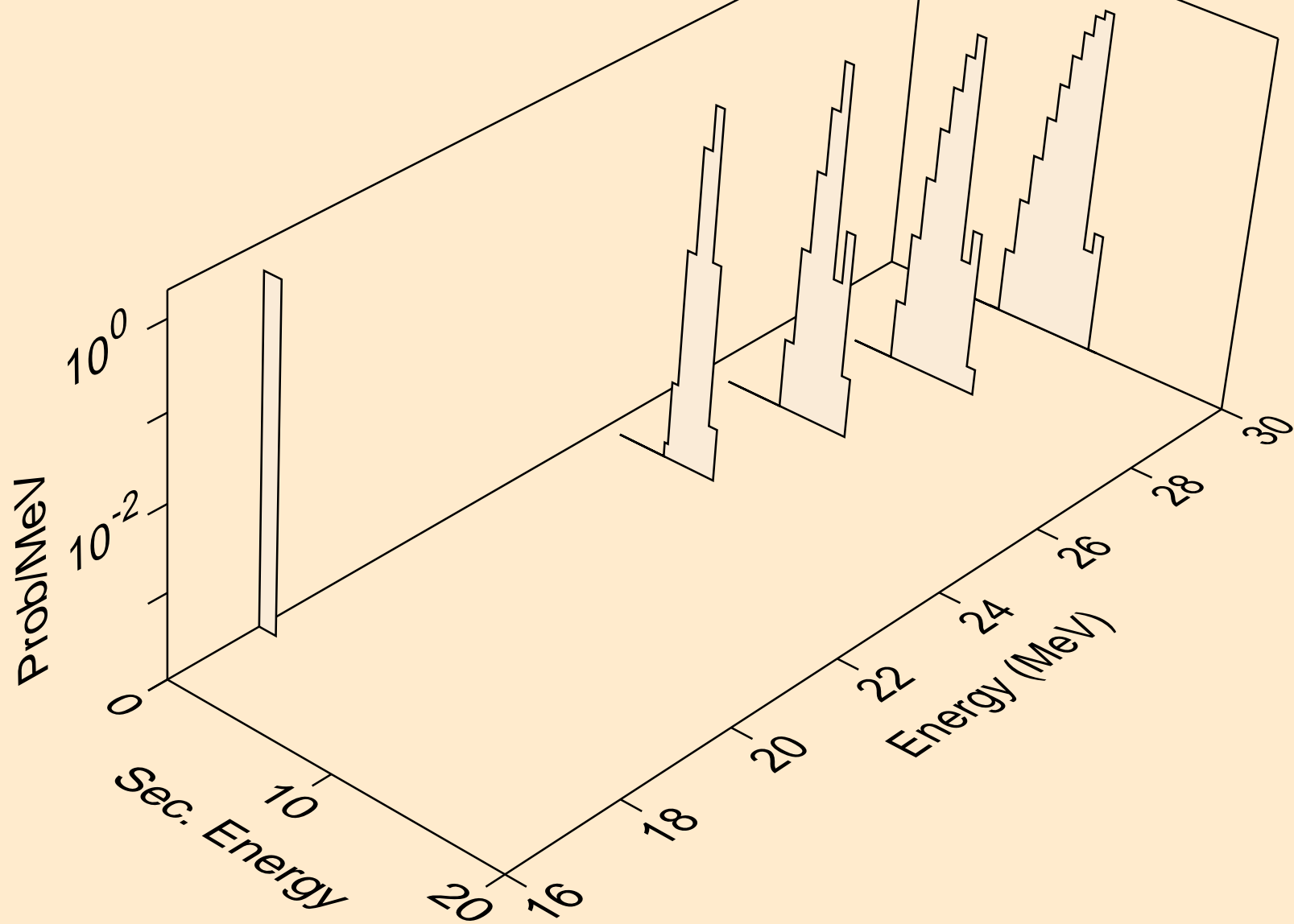

HS269 ALPHA ACER TENDL-2021 LIBRARY; T=0.K
tritons from (a,x)

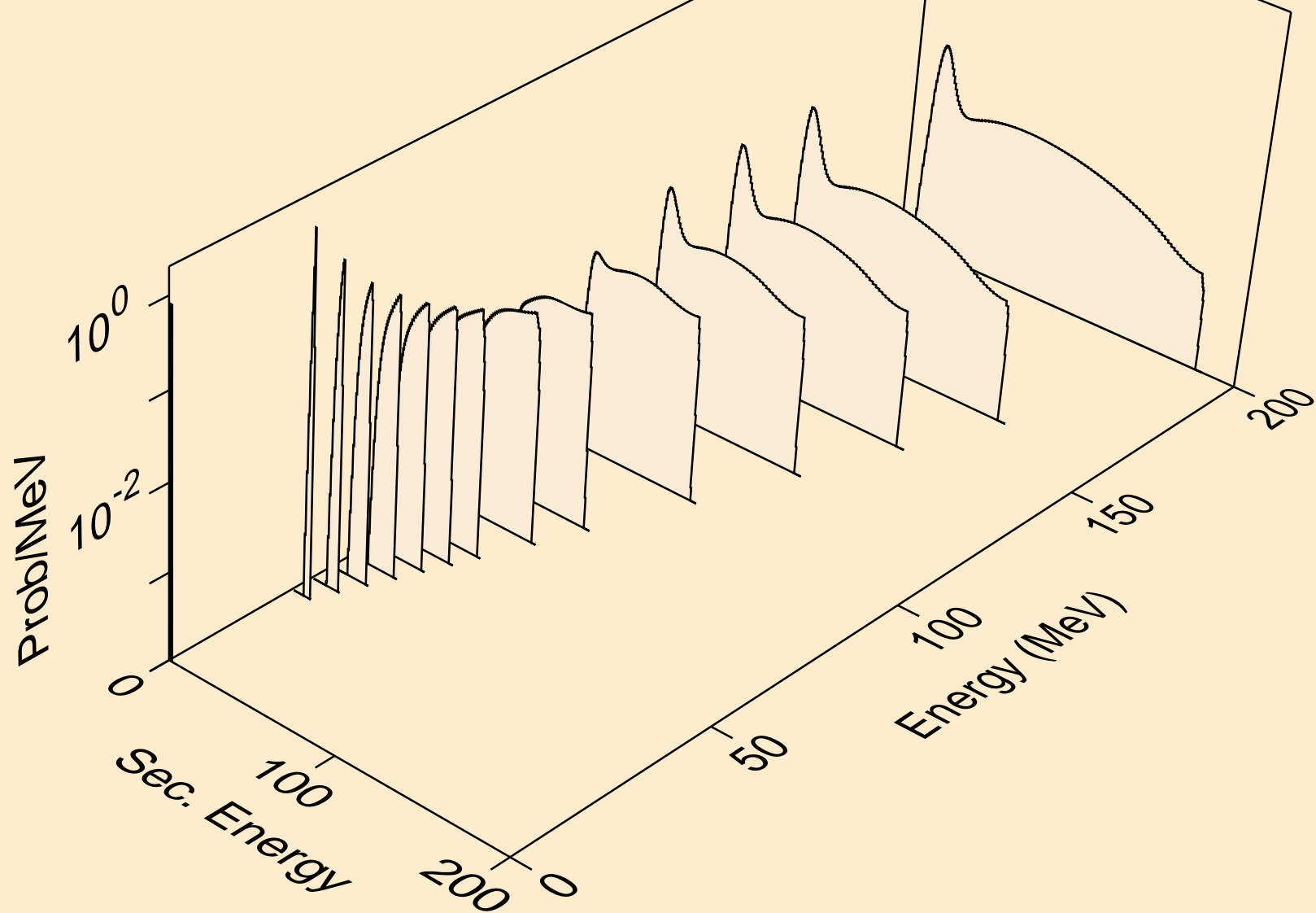

HS269 ALPHA ACER TENDL-2021 LIBRARY; T=0.K
tritons from (a,t)

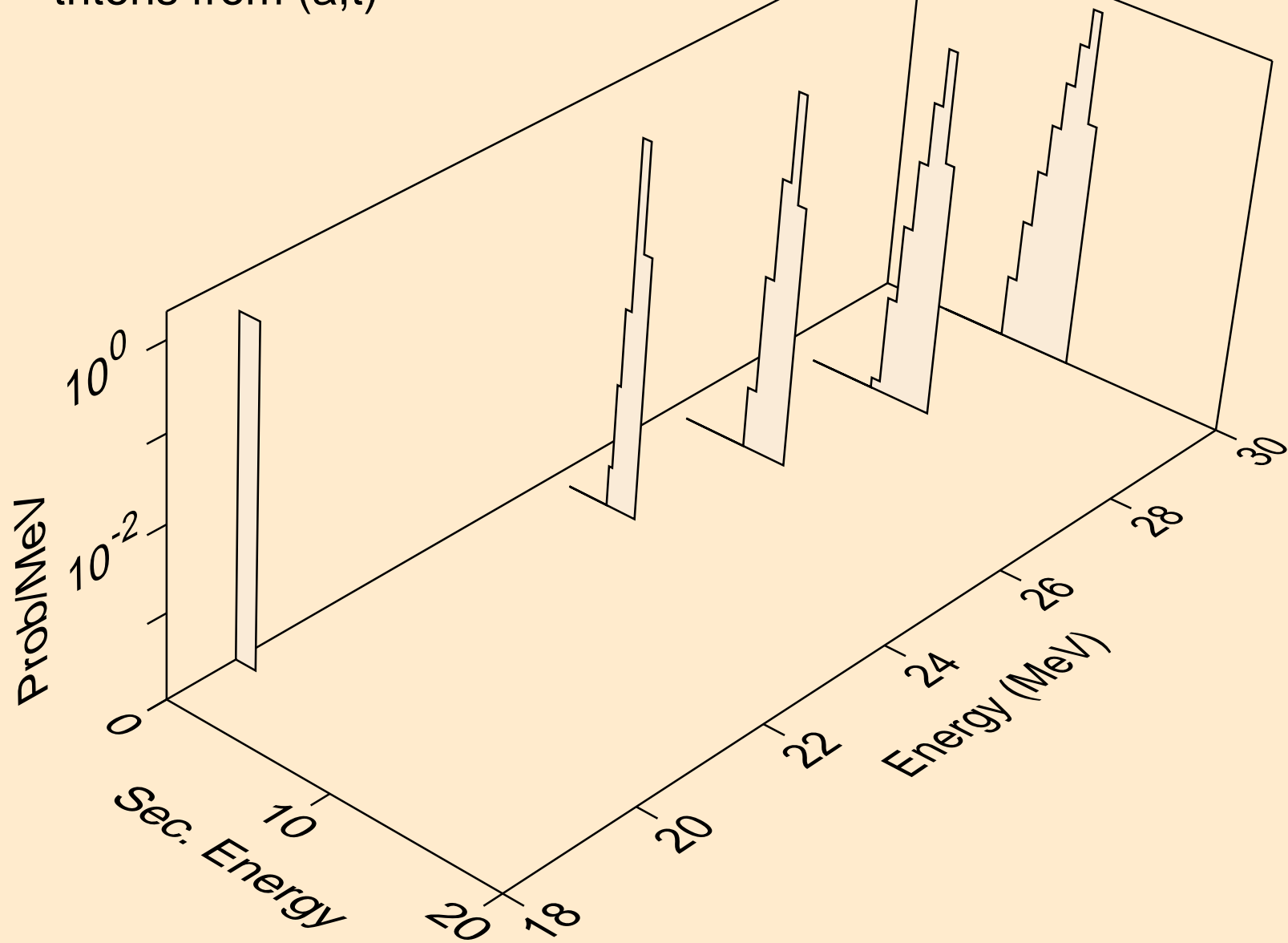

HS269 ALPHA ACER TENDL-2021 LIBRARY; T=0.K
he3s from (a,x)

