

IR172M ALPHA ACER TENDL-2021 LIBRARY; T=0.K
Principal cross sections

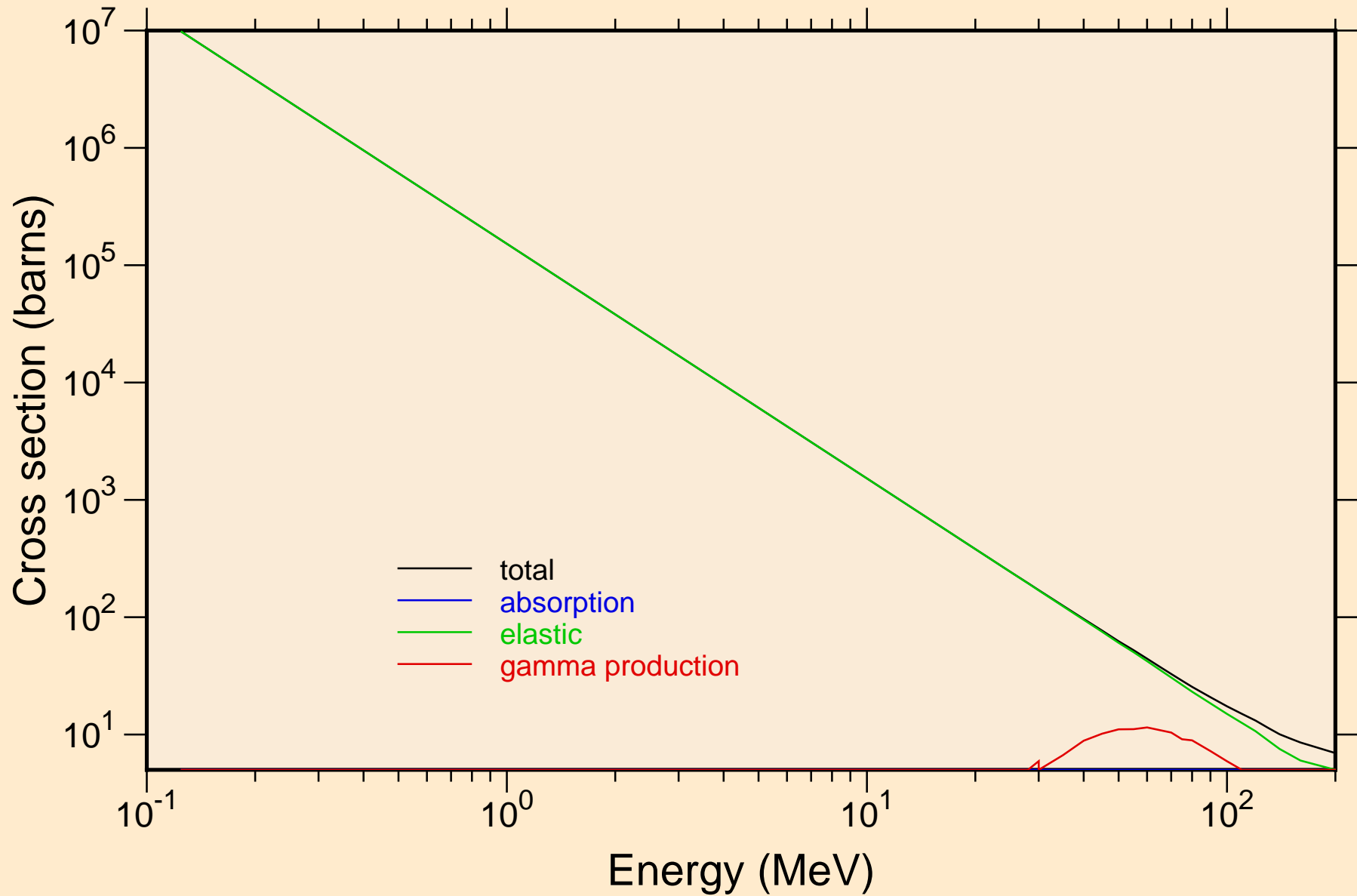

IR172M ALPHA ACER TENDL-2021 LIBRARY; T=0.K

Heating

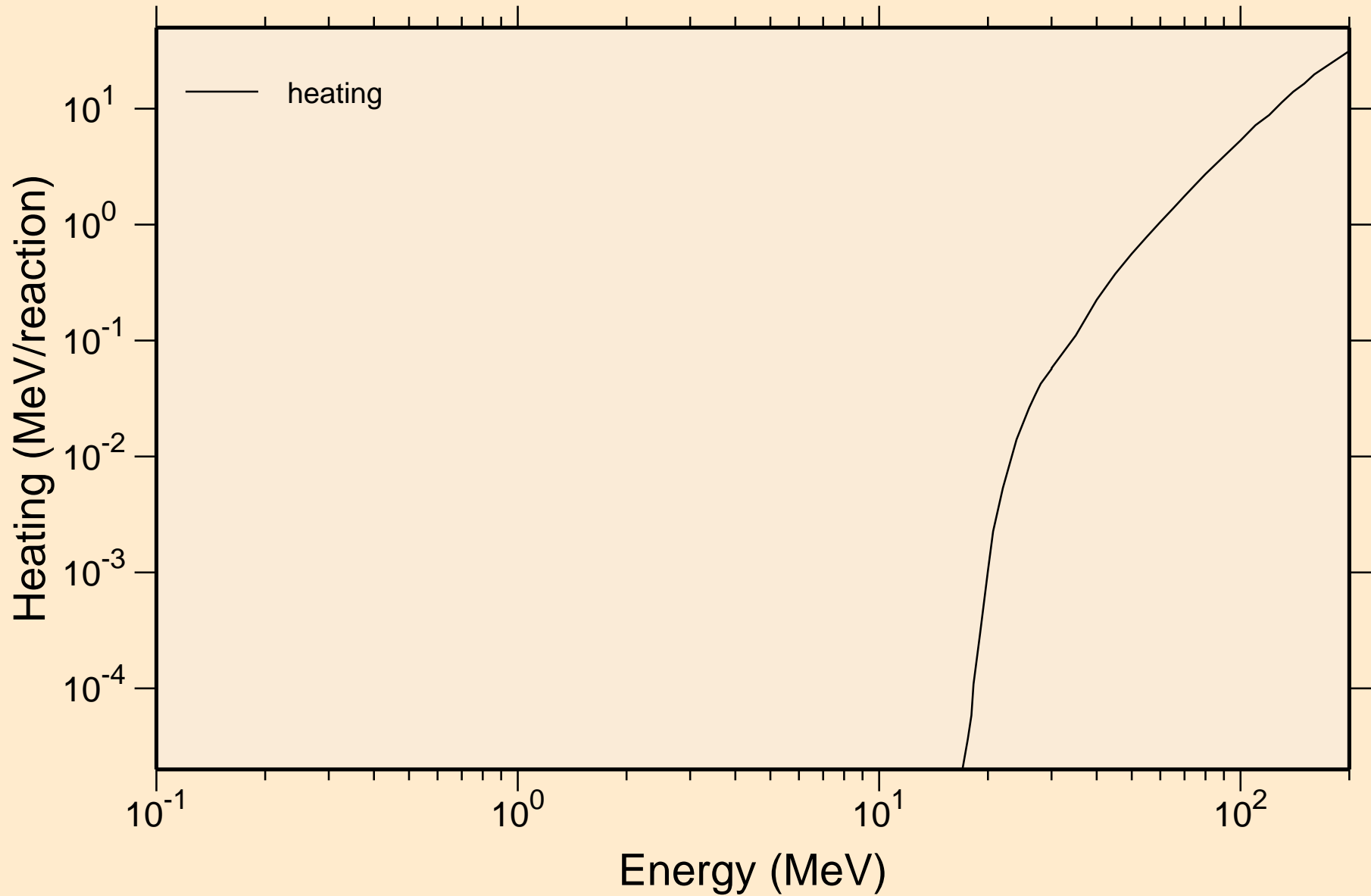

IR172M ALPHA ACER TENDL-2021 LIBRARY; T=0.K

Principal cross sections

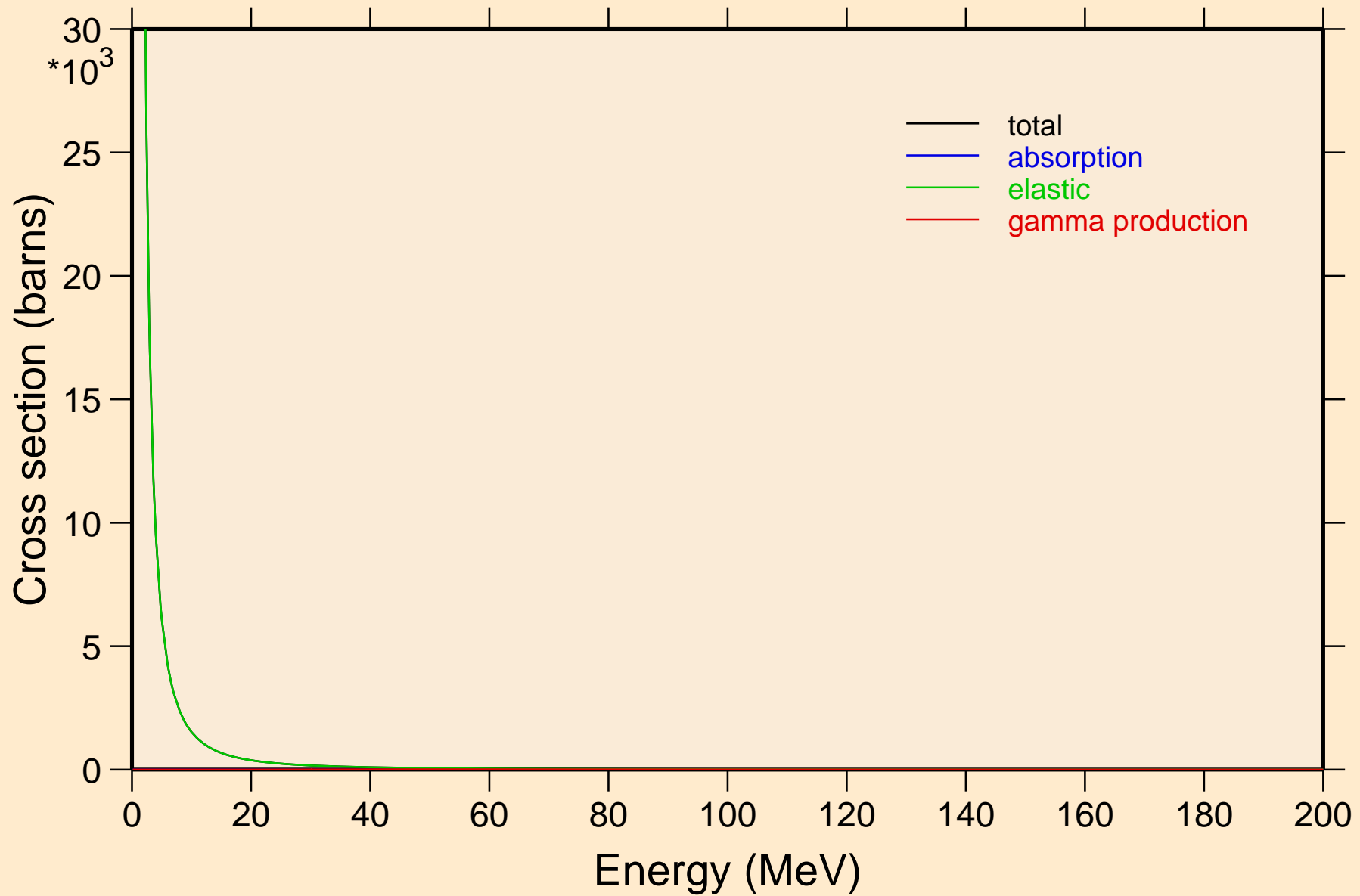

IR172M ALPHA ACER TENDL-2021 LIBRARY; T=0.K

Heating

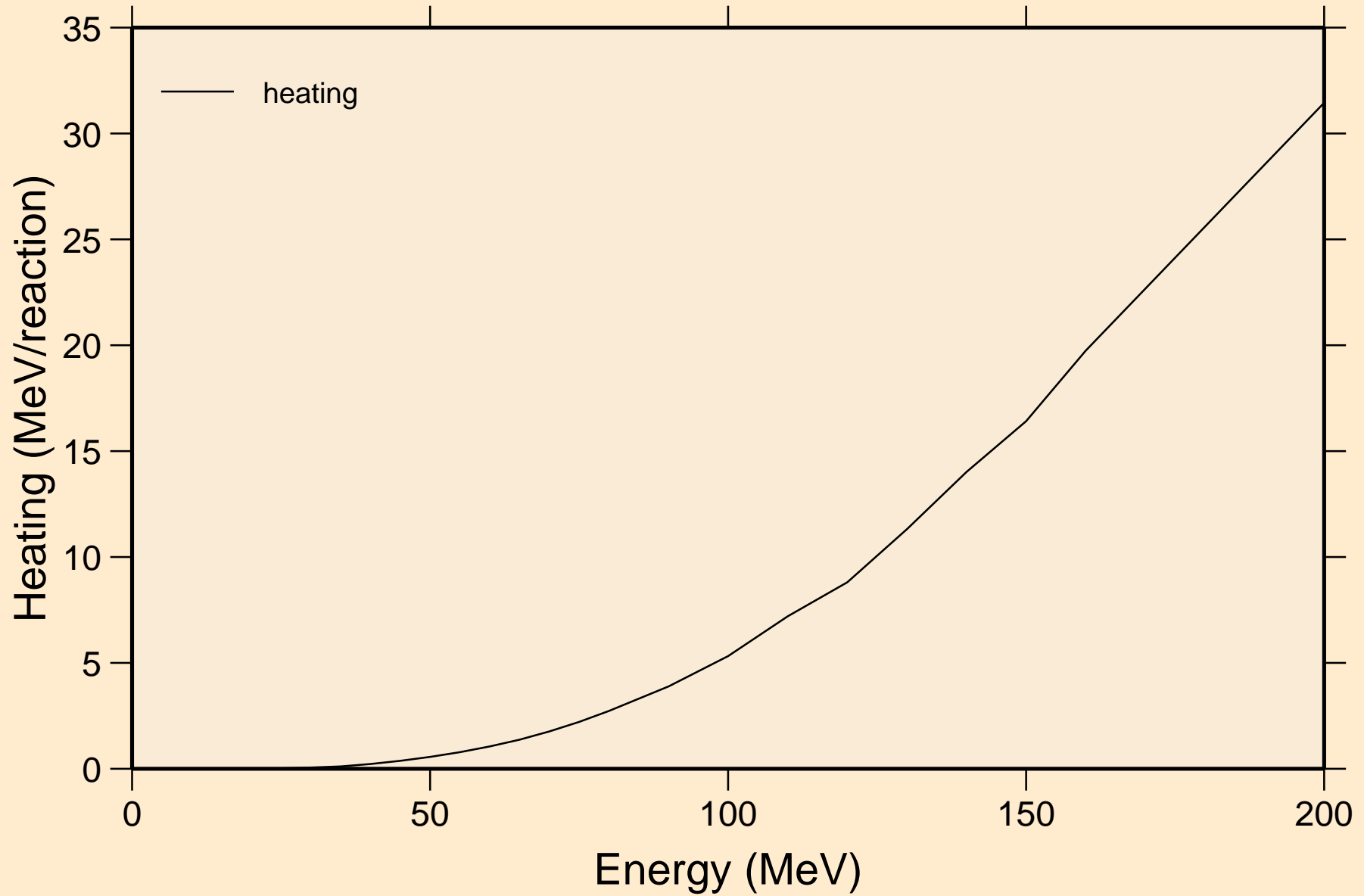

IR172M ALPHA ACER TENDL-2021 LIBRARY; T=0.K
Threshold reactions

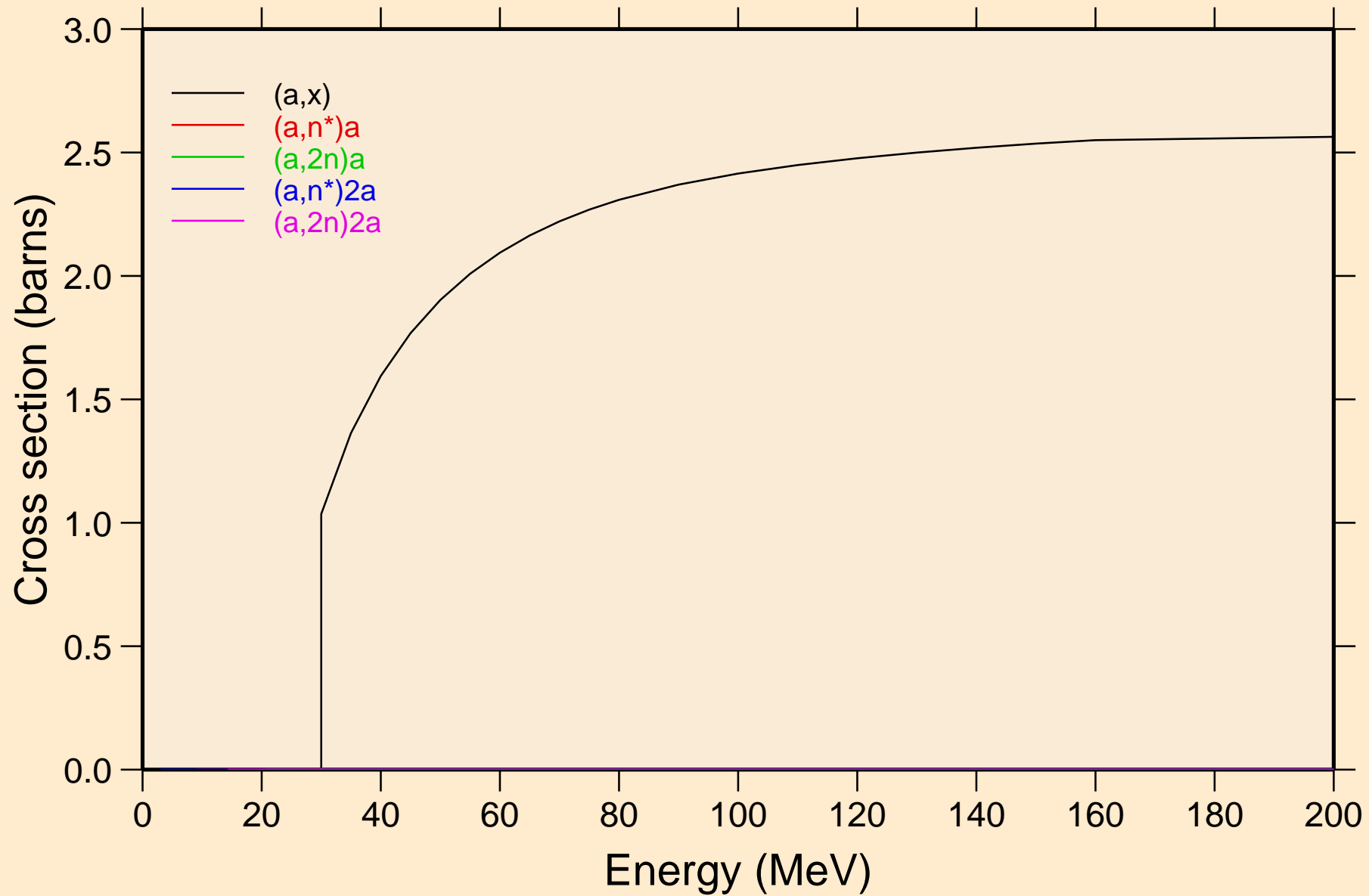

IR172M ALPHA ACER TENDL-2021 LIBRARY; T=0.K
Threshold reactions

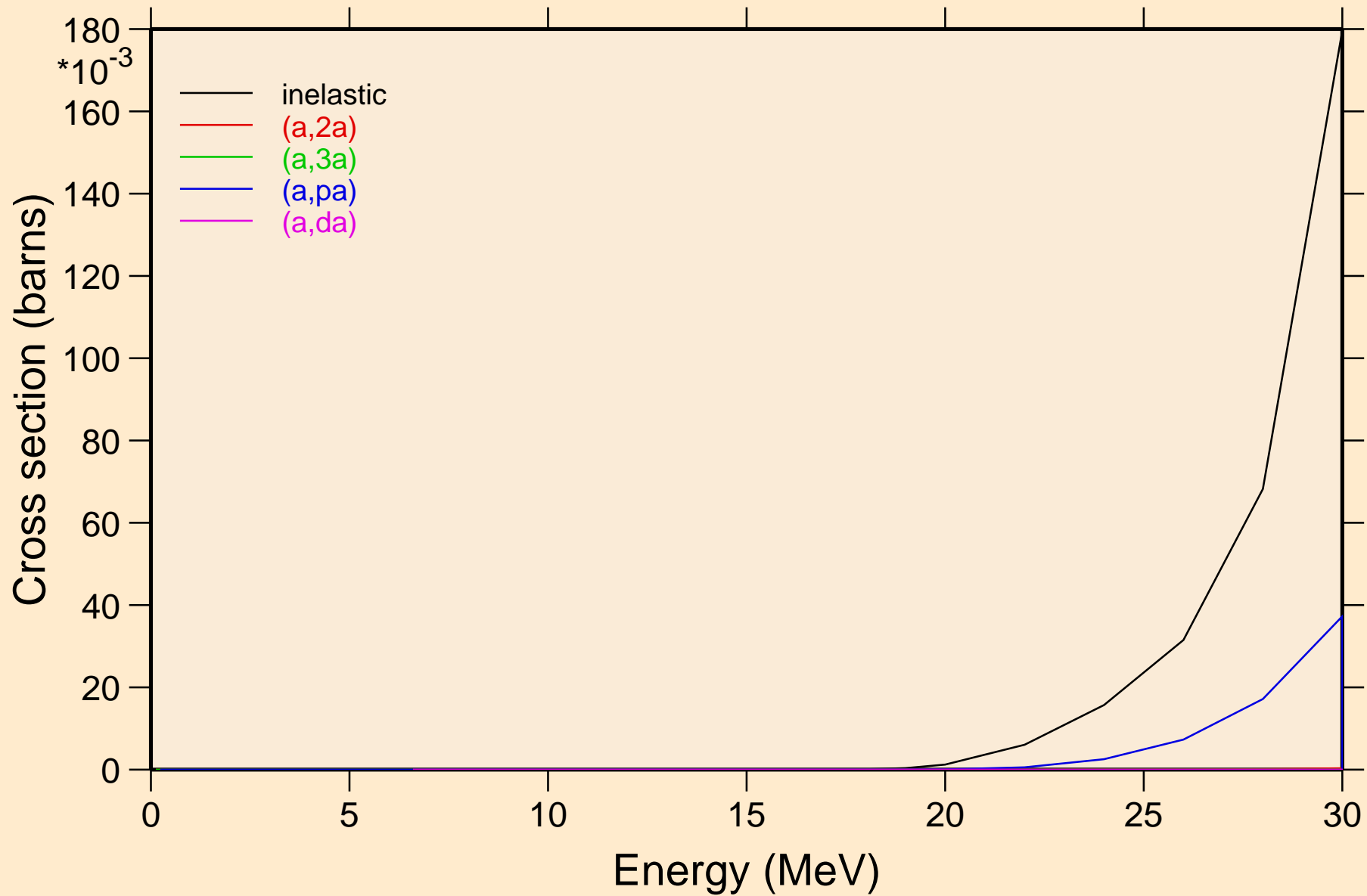

IR172M ALPHA ACER TENDL-2021 LIBRARY; T=0.K
angular distribution for elastic

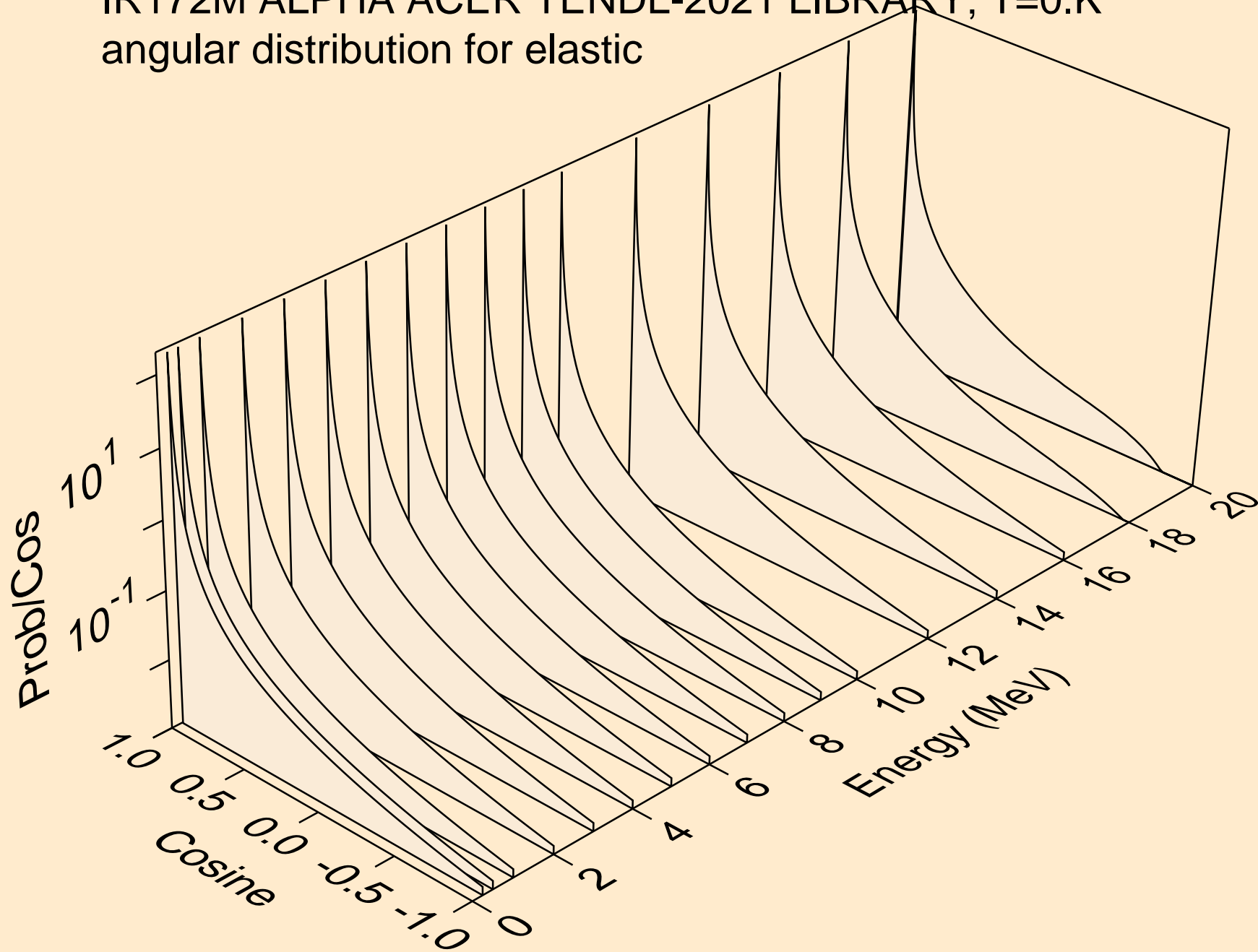

IR172M ALPHA ACER TENDL-2021 LIBRARY; T=0.K
angular distribution for elastic

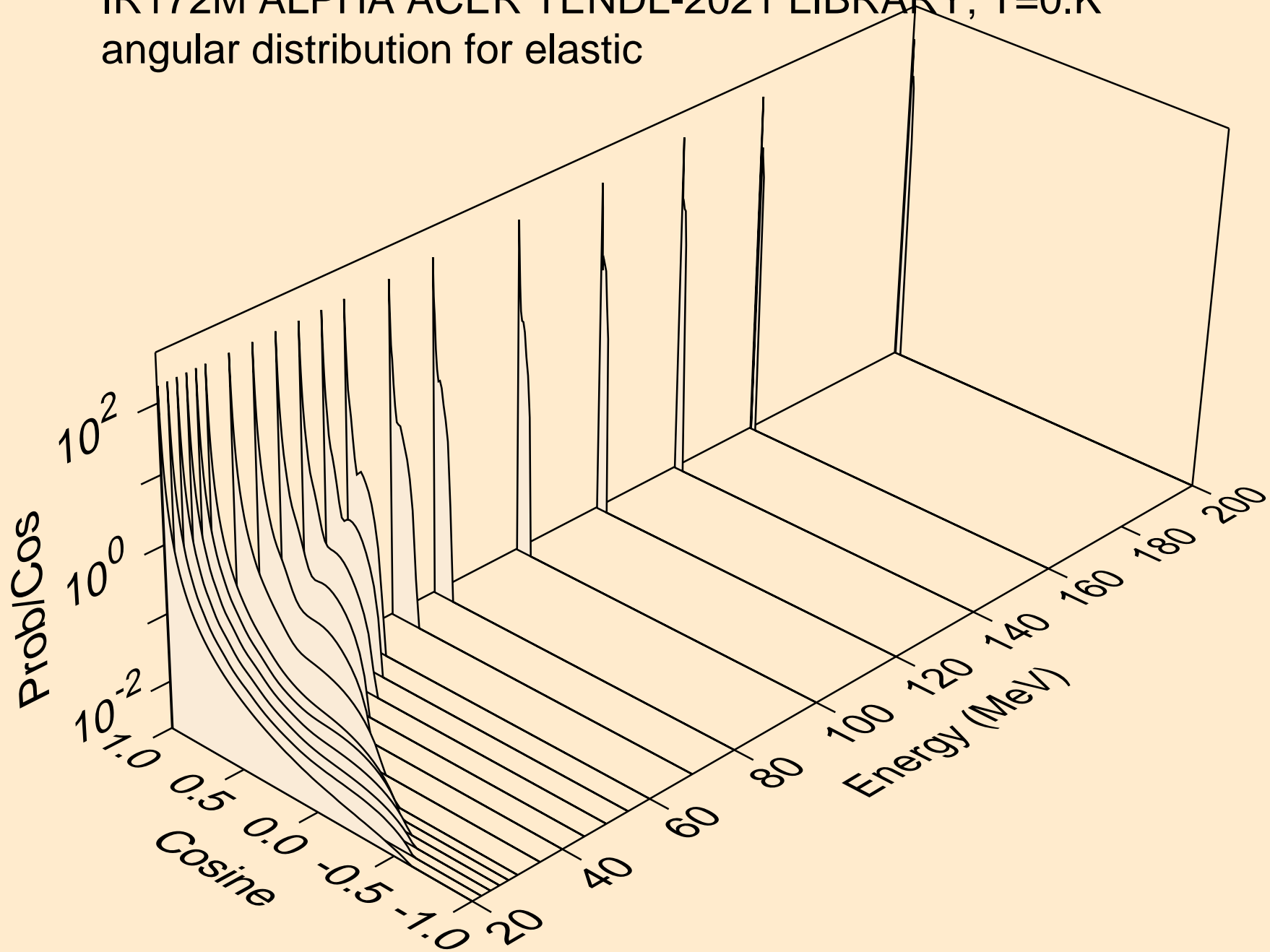

IR172M ALPHA ACER TENDL-2021 LIBRARY; T=0.K
Alpha emission for (a,x)

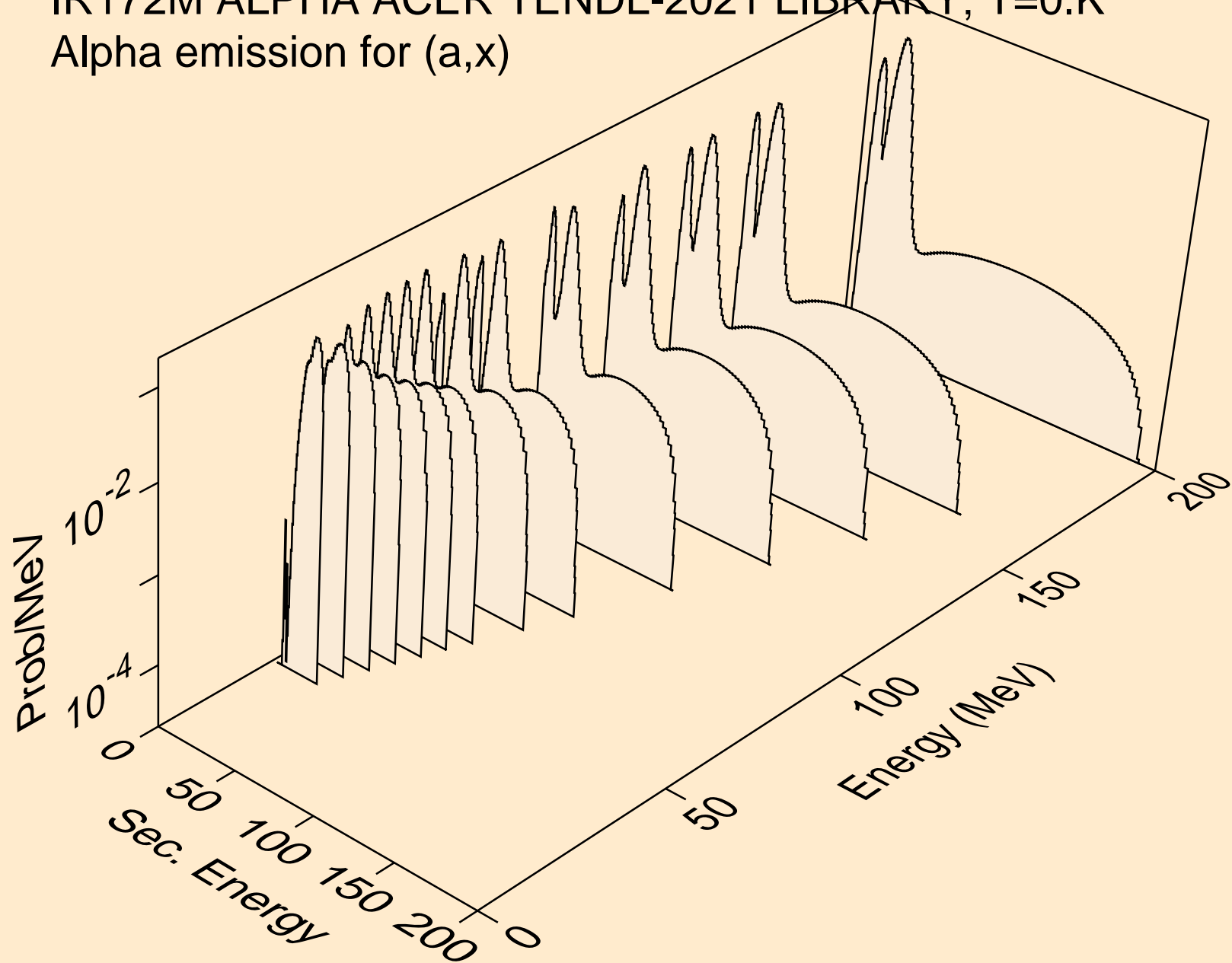

IR172M ALPHA ACER TENDL-2021 LIBRARY; T=0.K
Alpha emission for (a,n*)a

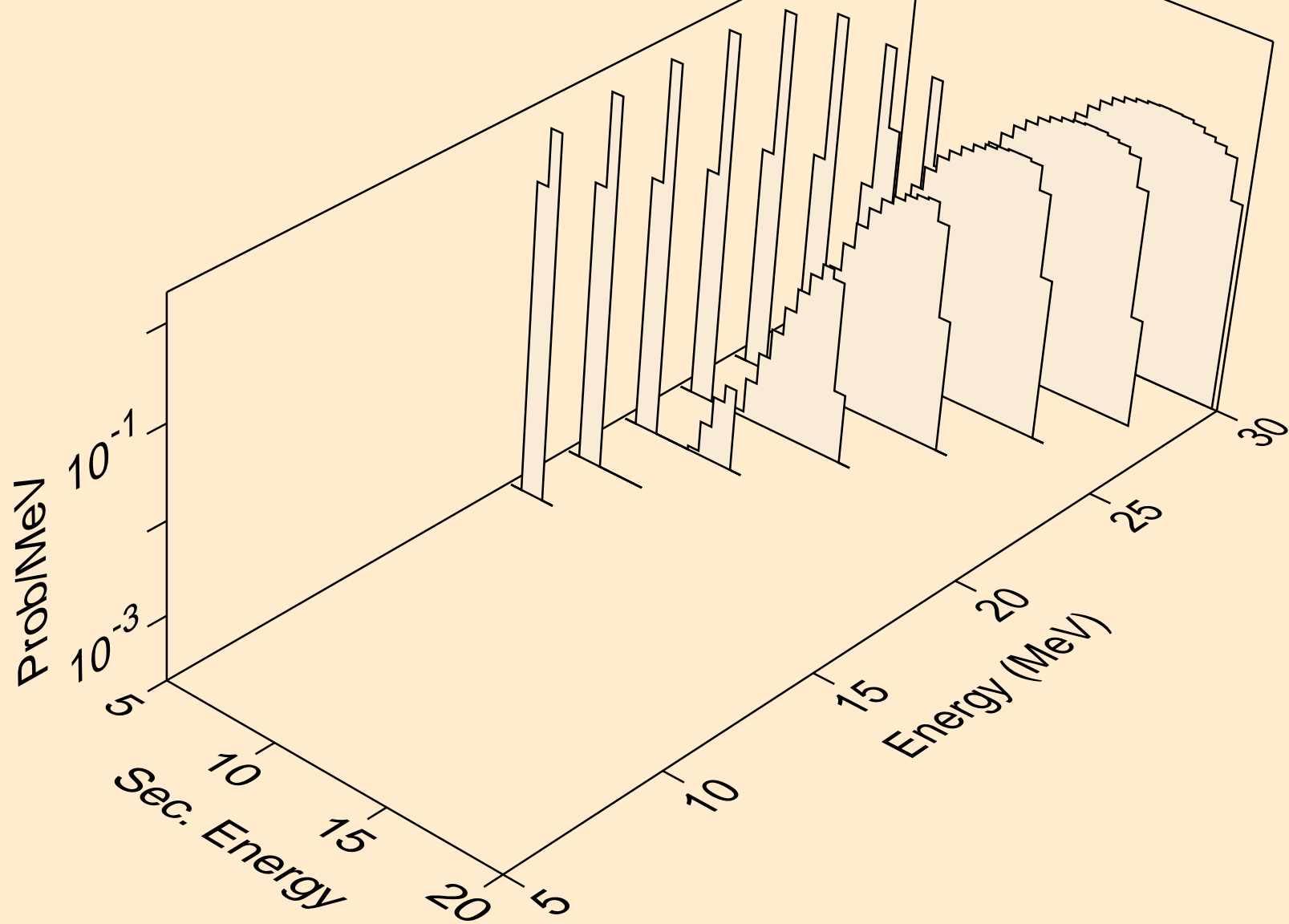

IR172M ALPHA ACER TENDL-2021 LIBRARY; T=0.K
Alpha emission for (a,2n)a

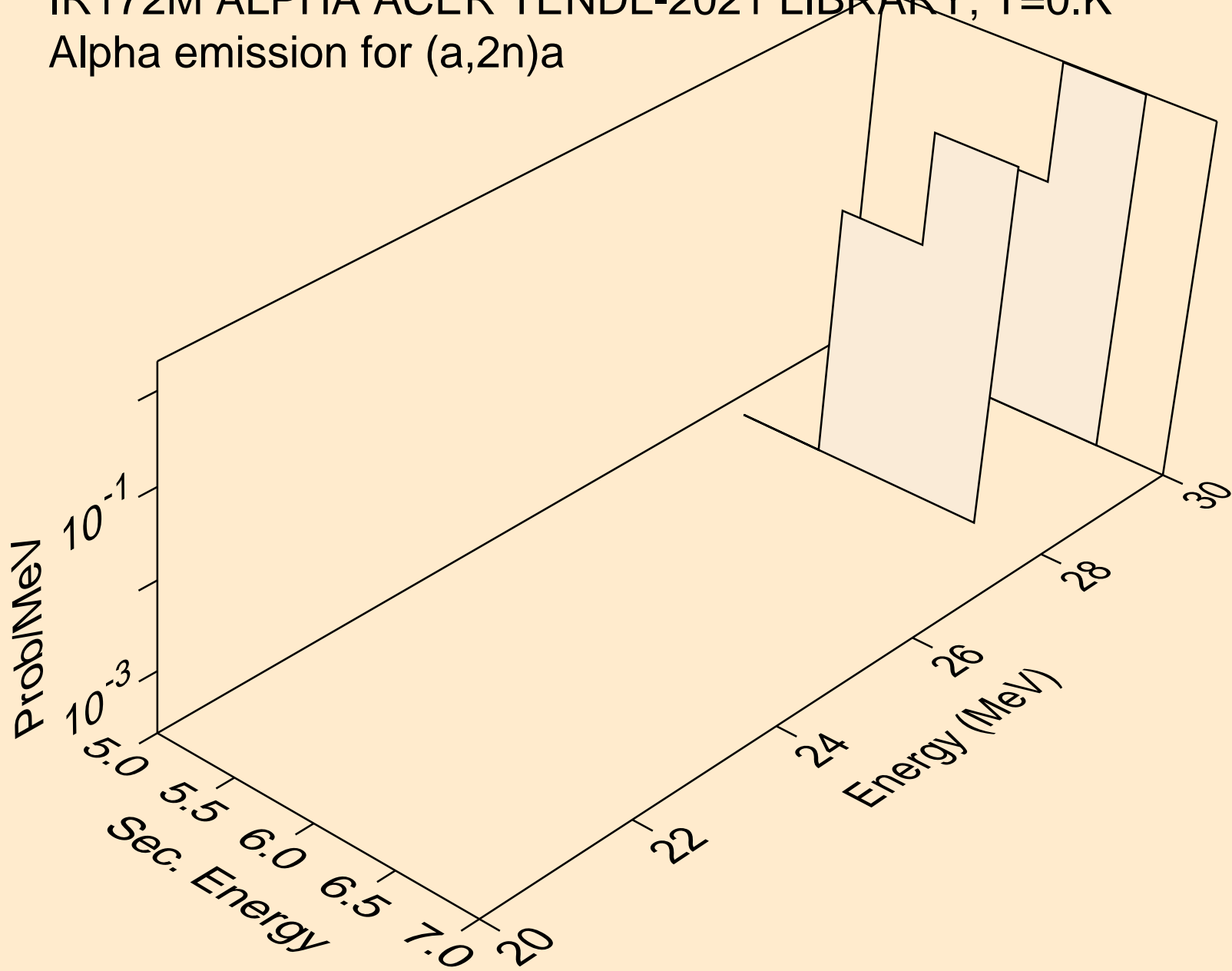

IR172M ALPHA ACER TENDL-2021 LIBRARY; T=0.K
Alpha emission for (a,n*)2a

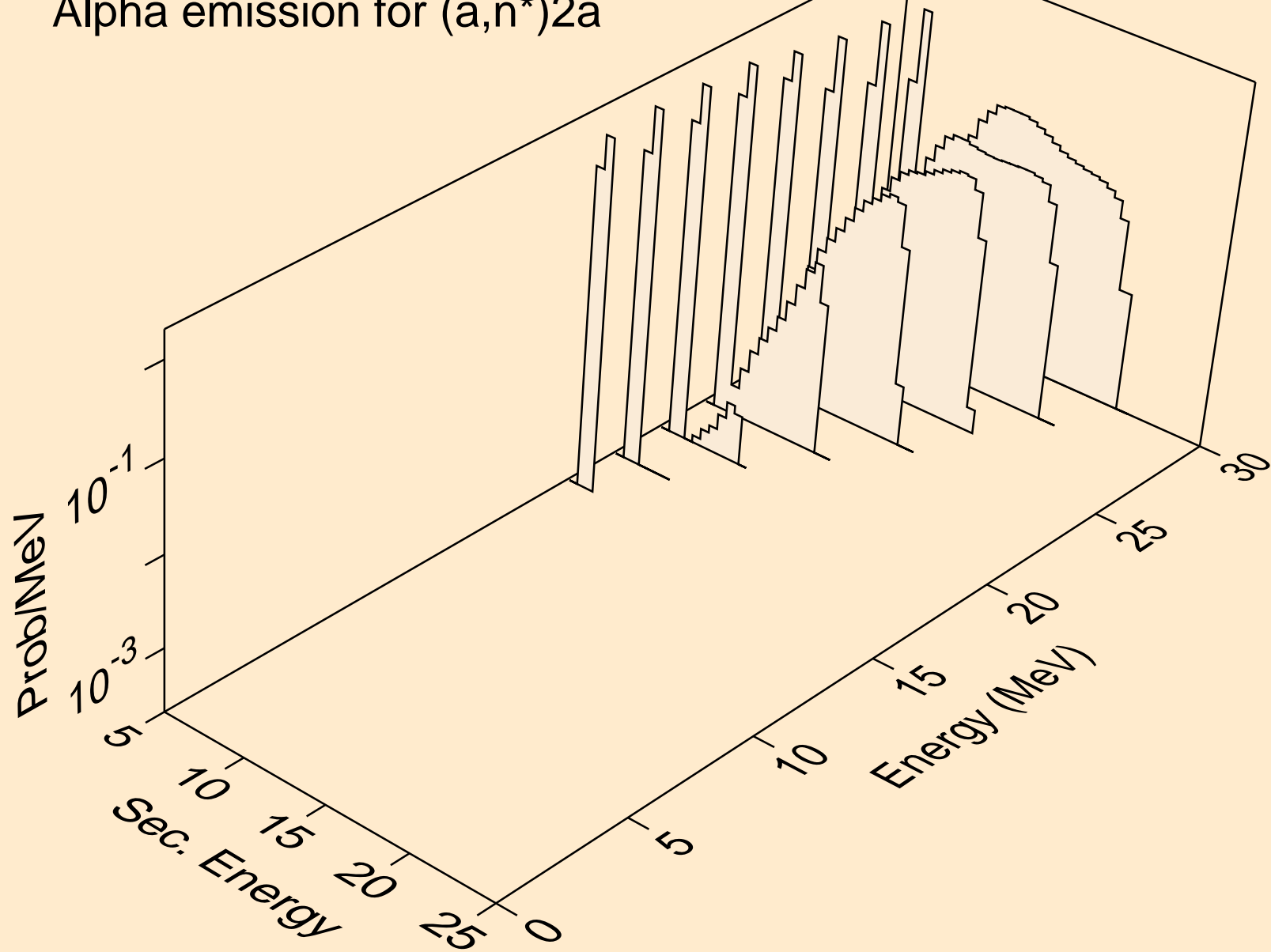

IR172M ALPHA ACER TENDL-2021 LIBRARY; T=0.K
Alpha emission for (a,2n)2a

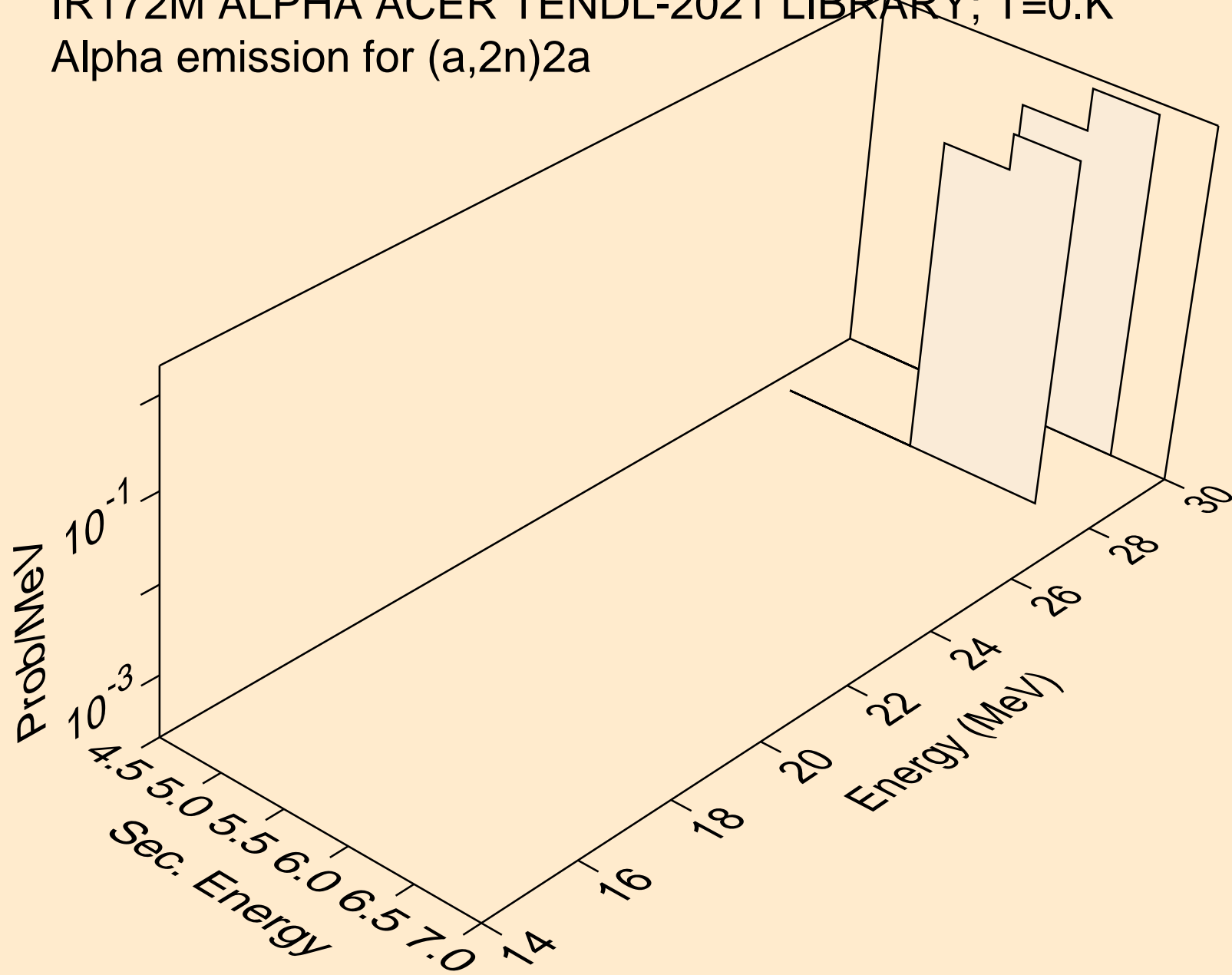

IR172M ALPHA ACER TENDL-2021 LIBRARY; T=0.K
Alpha emission for inelastic

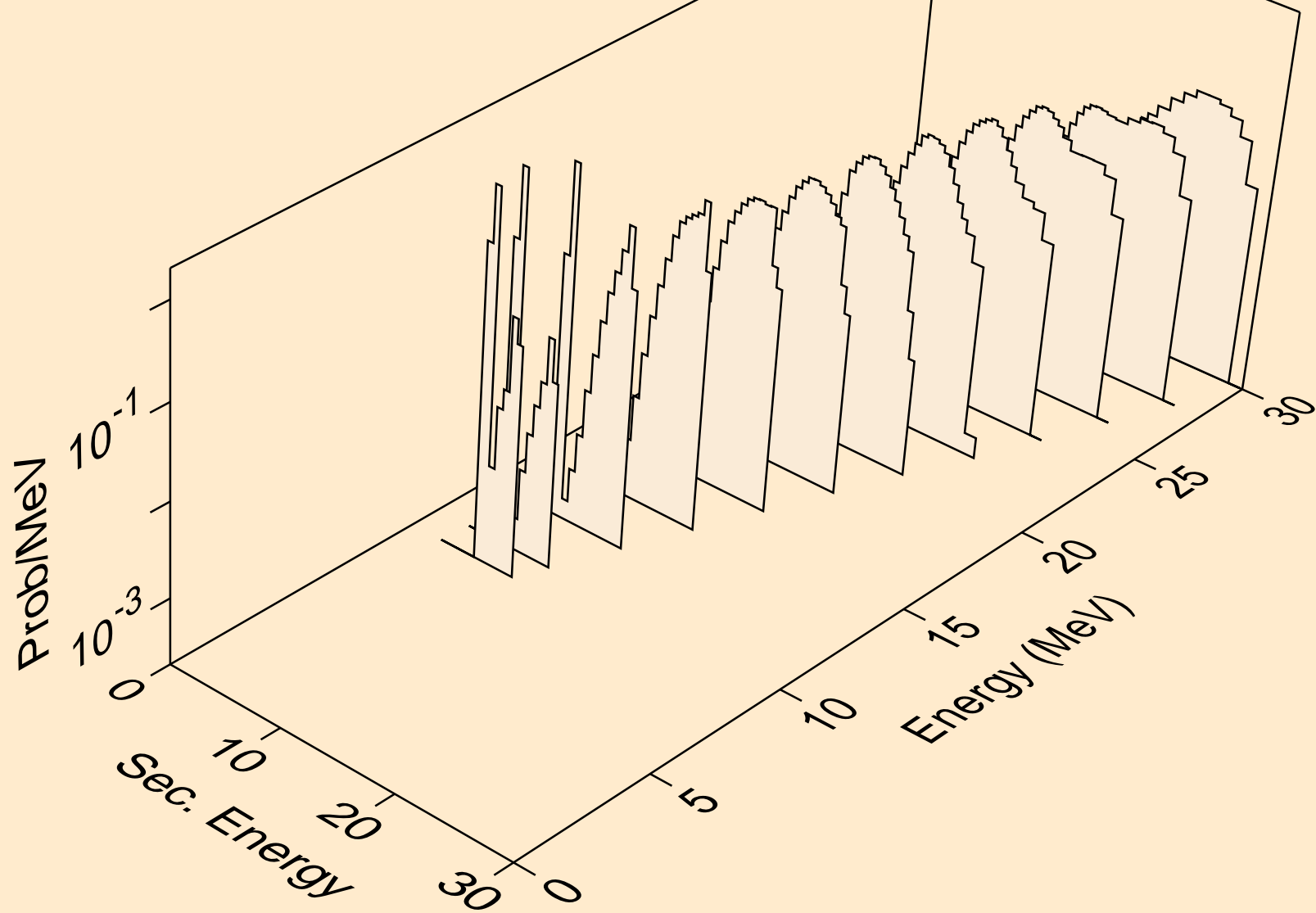

IR172M ALPHA ACER TENDL-2021 LIBRARY; T=0.K
Alpha emission for (a,2a)

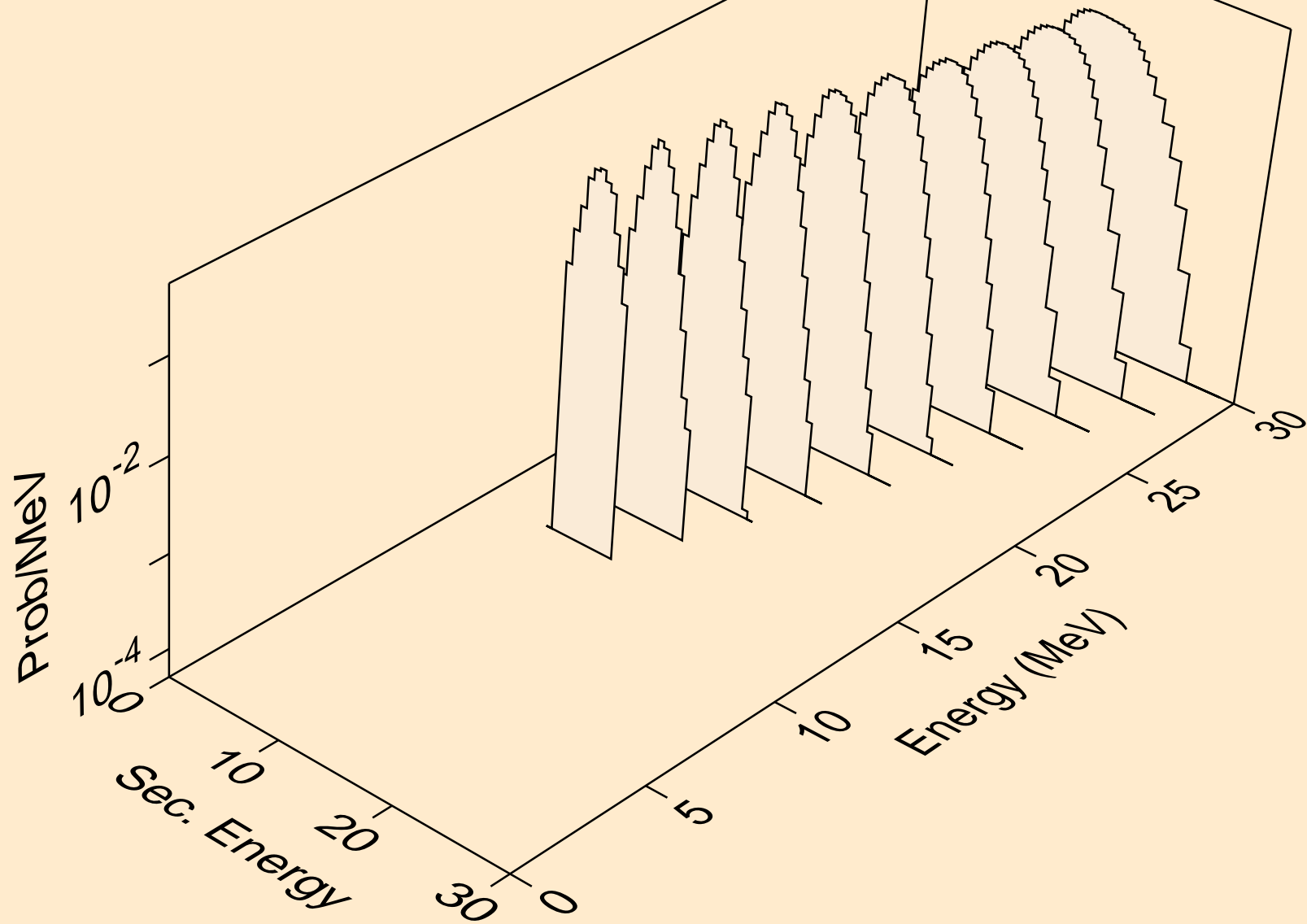

IR172M ALPHA ACER TENDL-2021 LIBRARY; T=0.K
Alpha emission for (a,3a)

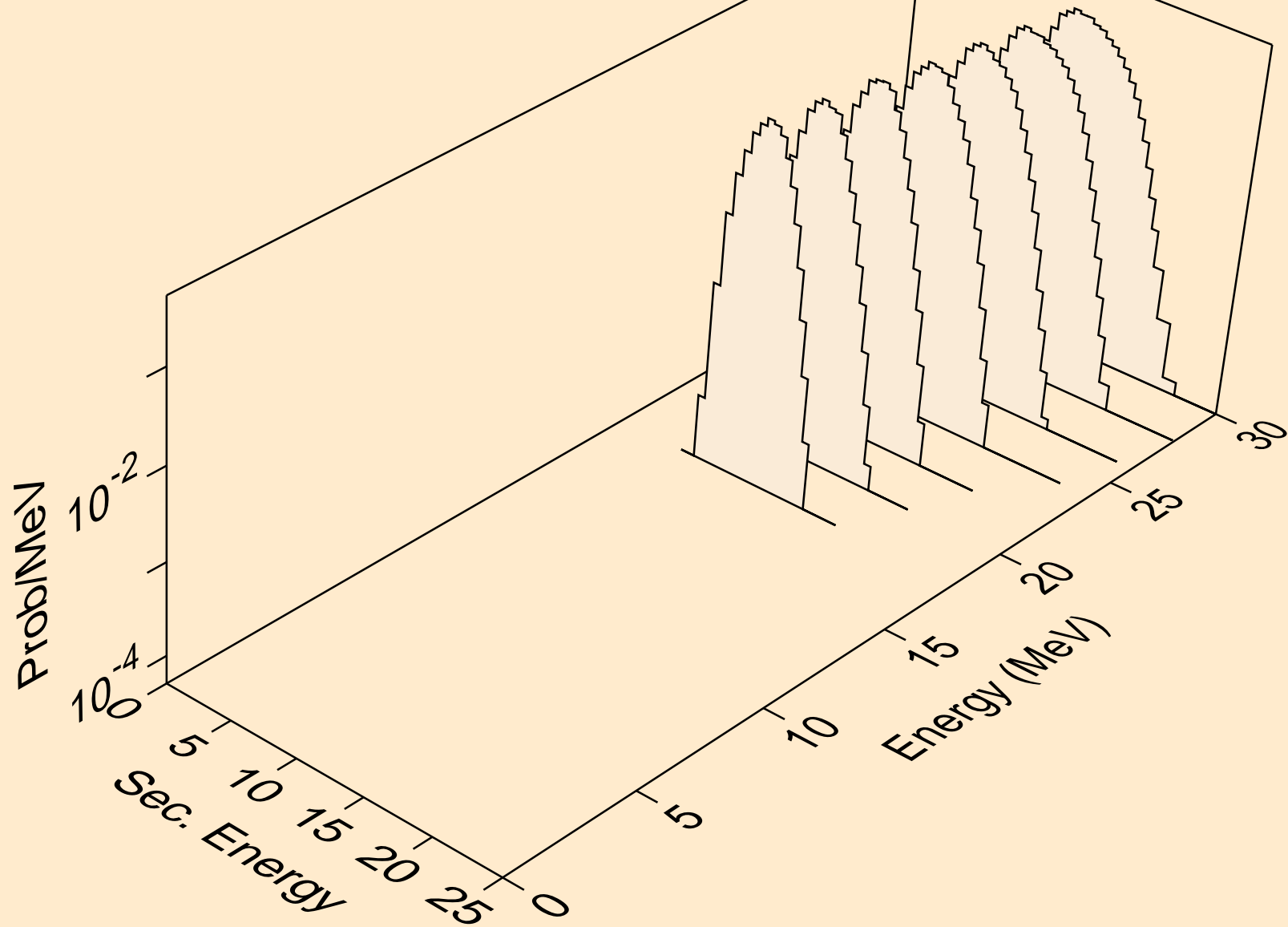

IR172M ALPHA ACER TENDL-2021 LIBRARY; T=0.K
Alpha emission for (a,pa)

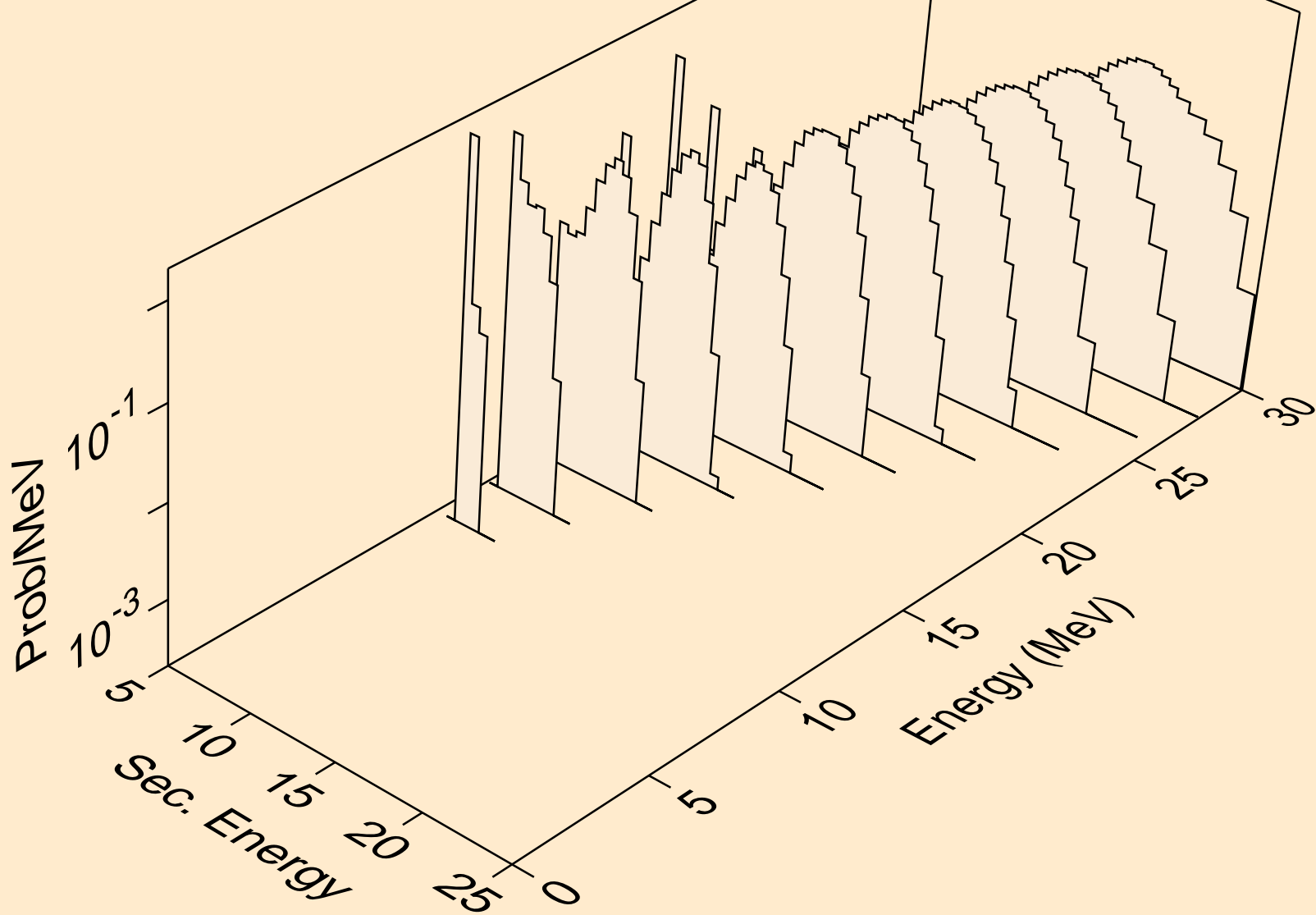

IR172M ALPHA ACER TENDL-2021 LIBRARY; T=0.K
Alpha emission for (a,da)

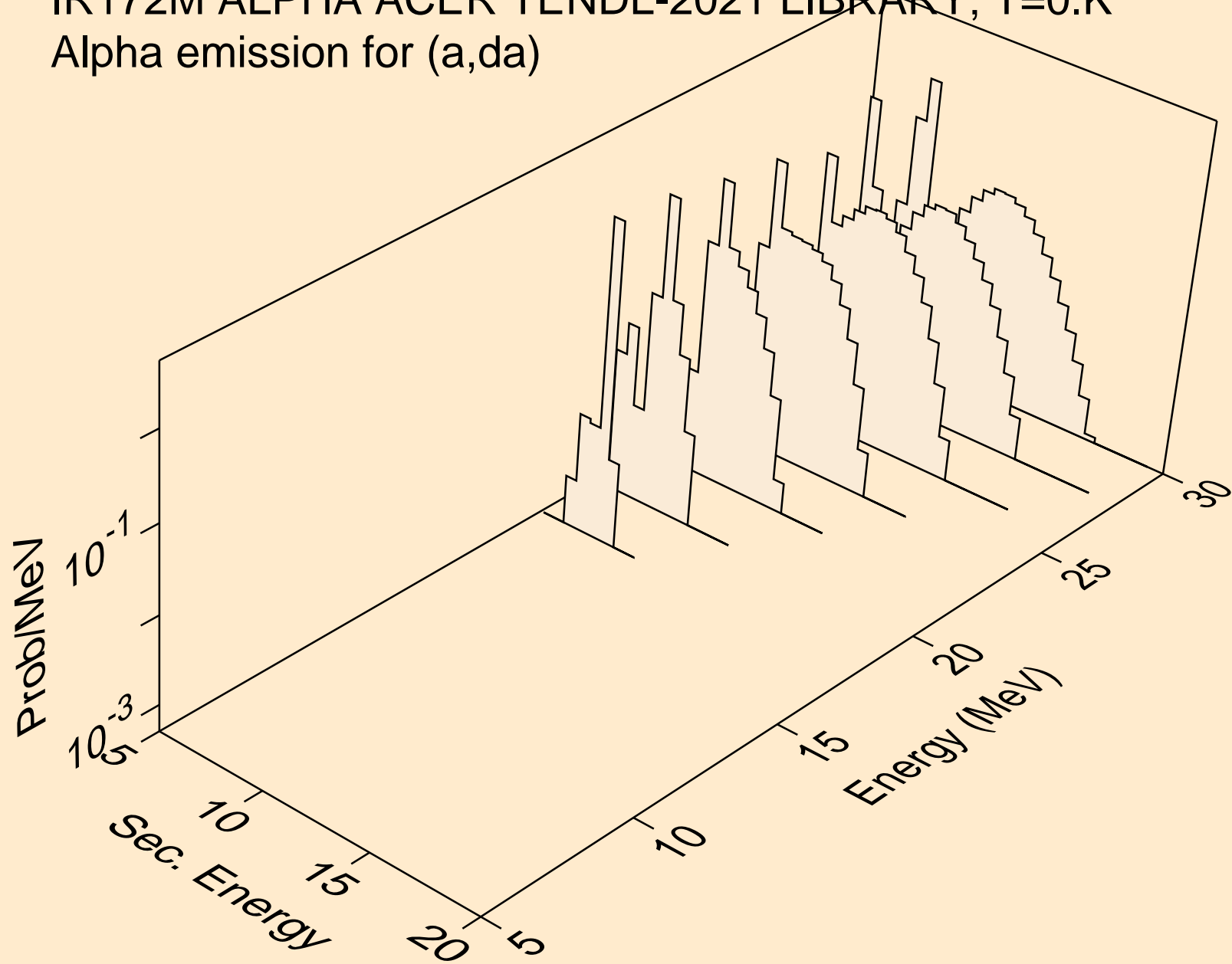

IR172M ALPHA ACER TENDL-2021 LIBRARY; T=0.K
Photon emission for (z,n)

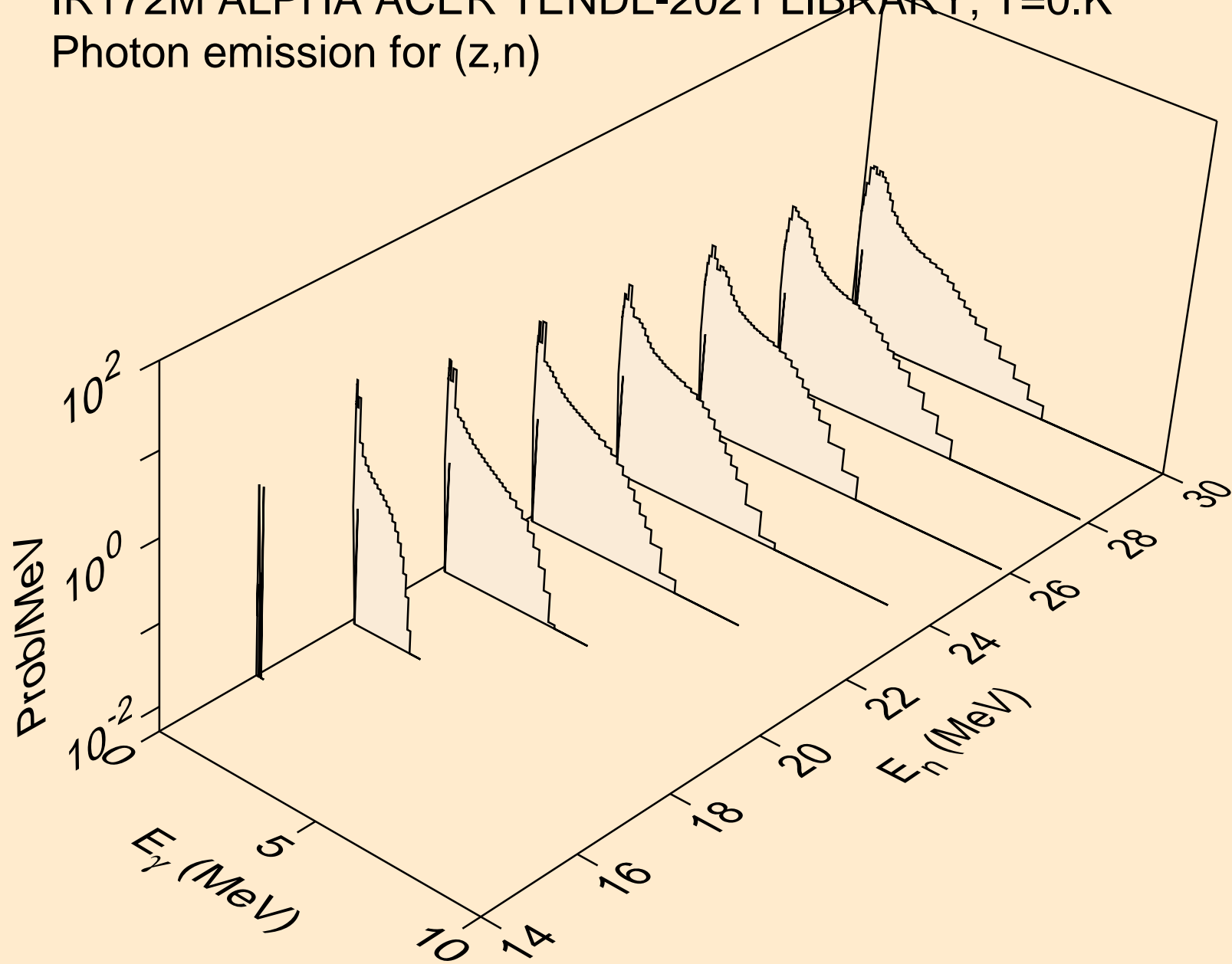

IR172M ALPHA ACER TENDL-2021 LIBRARY; T=0.K
Photon emission for (n,x)

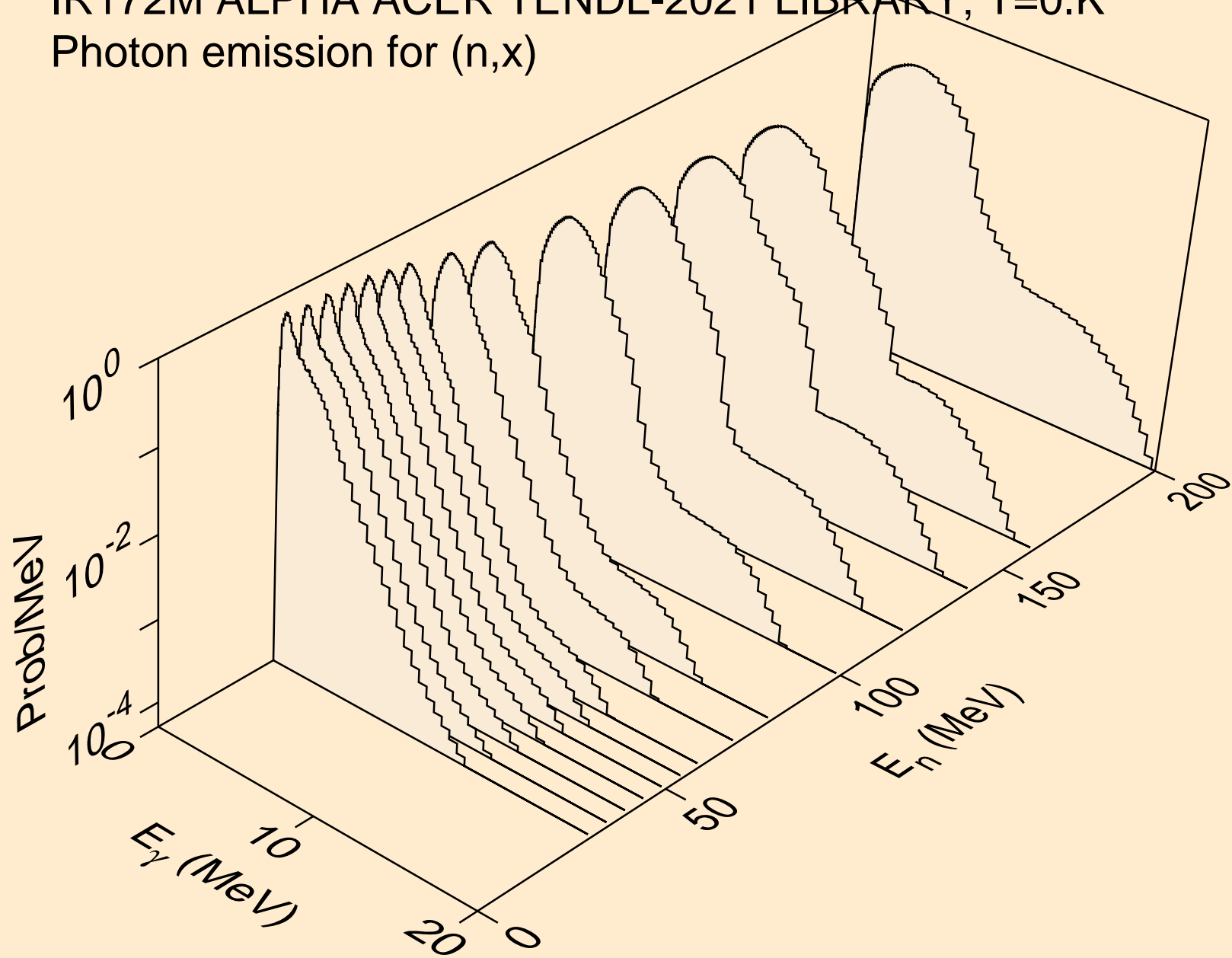

IR172M ALPHA ACER TENDL-2021 LIBRARY; T=0.K
Photon emission for (n,2n)

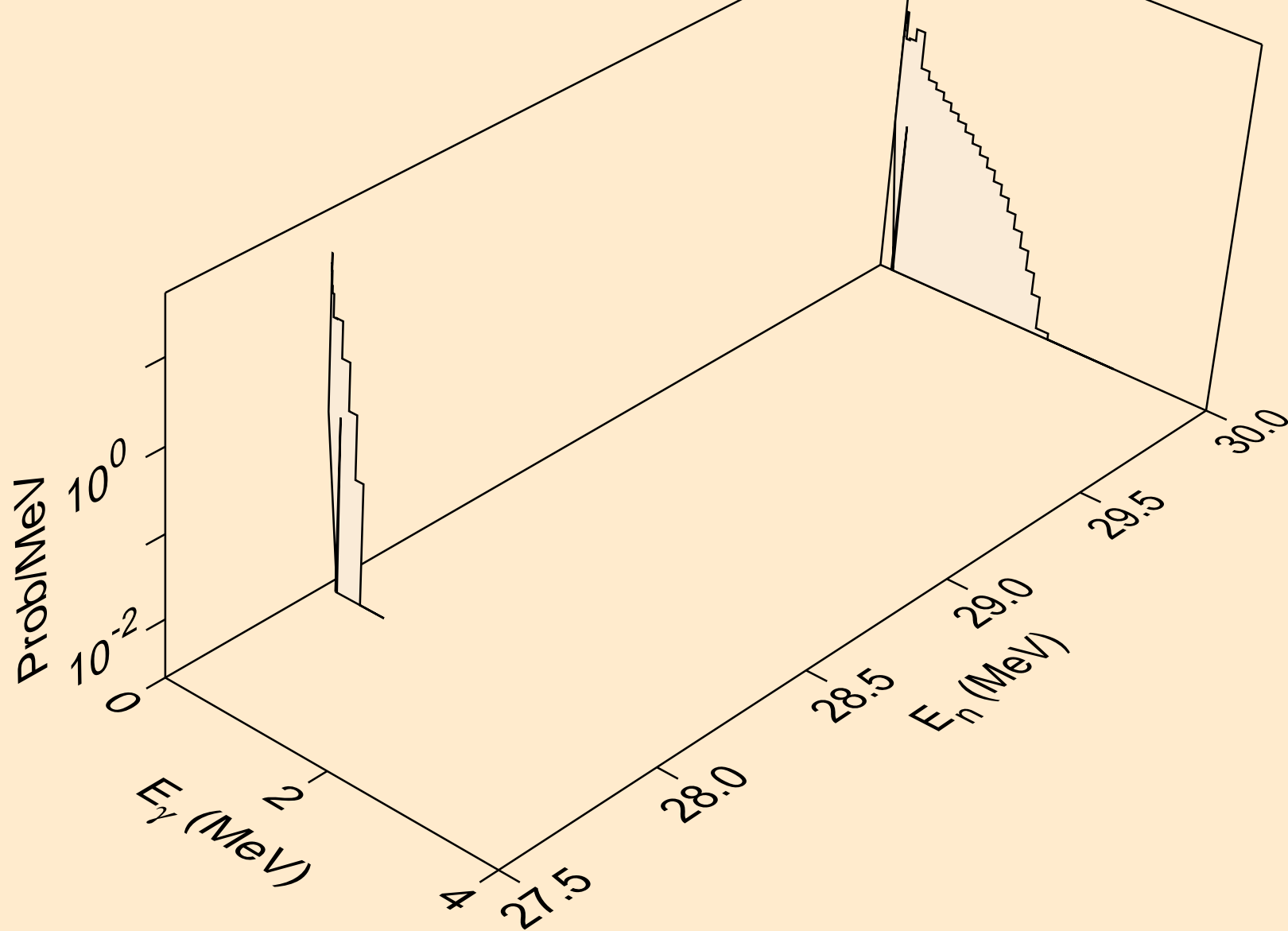

IR172M ALPHA ACER TENDL-2021 LIBRARY; T=0.K
Photon emission for (n,n*)a

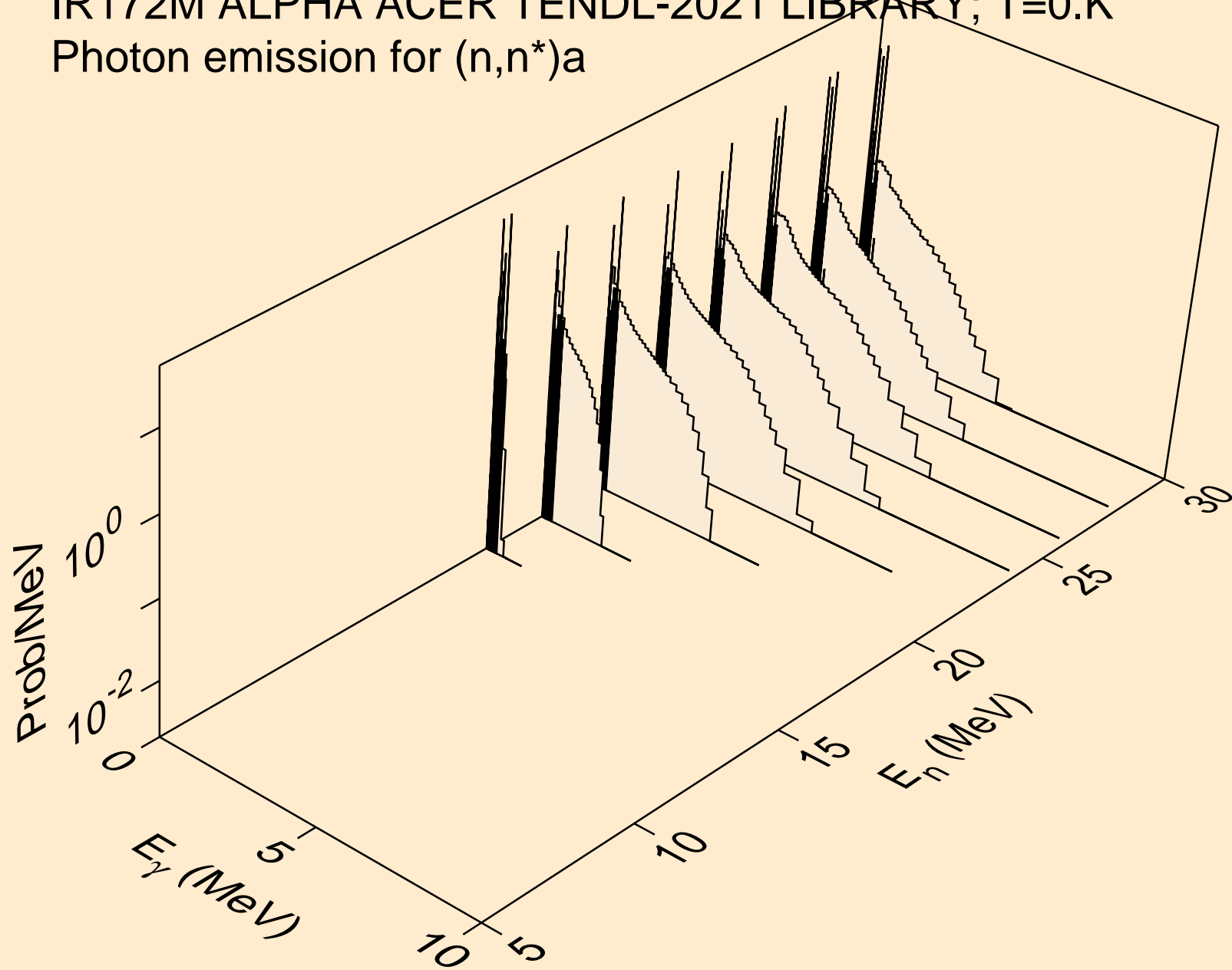

IR172M ALPHA ACER TENDL-2021 LIBRARY; T=0.K
Photon emission for (n,2n)a

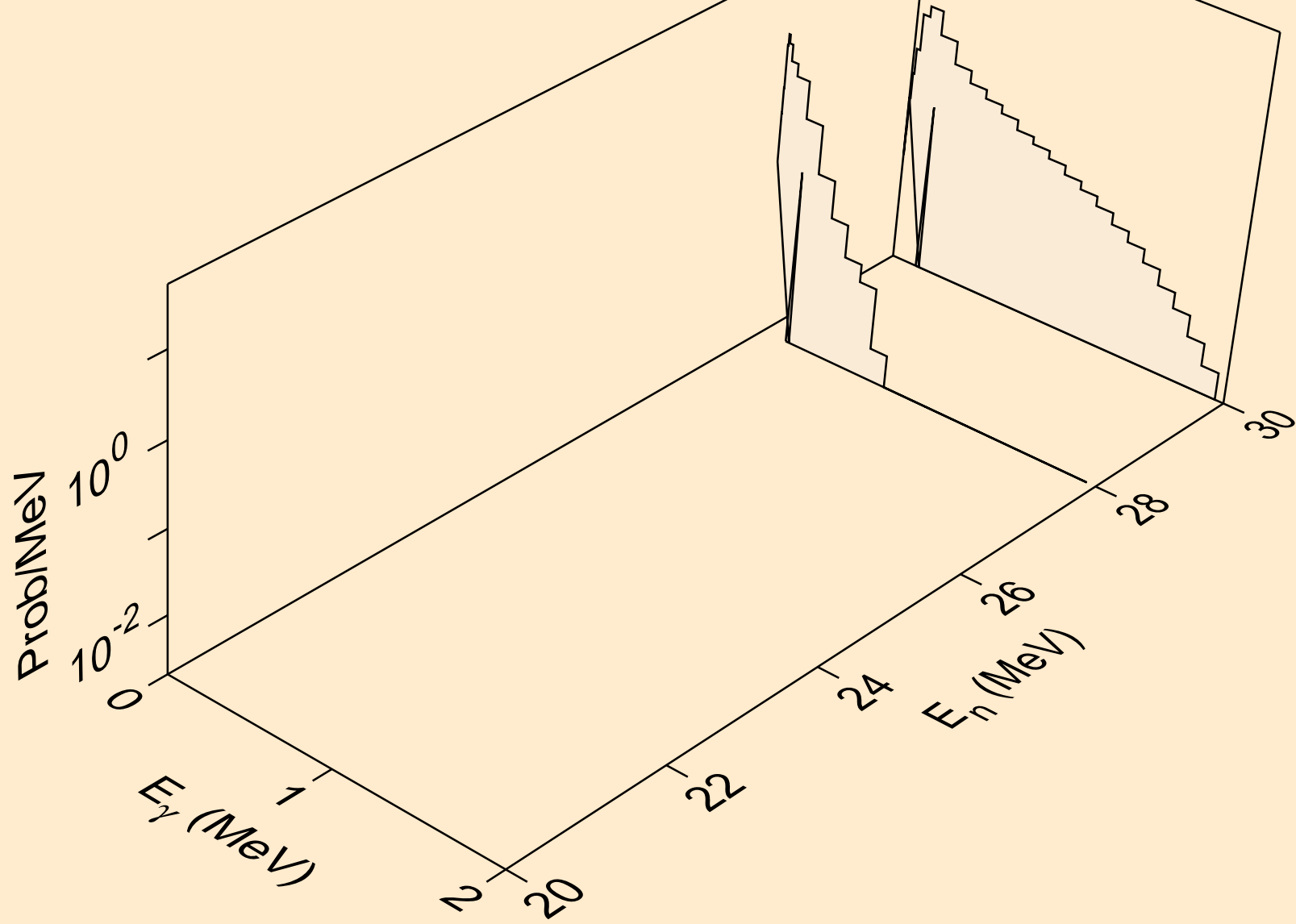

IR172M ALPHA ACER TENDL-2021 LIBRARY; T=0.K
Photon emission for (n,n*)p

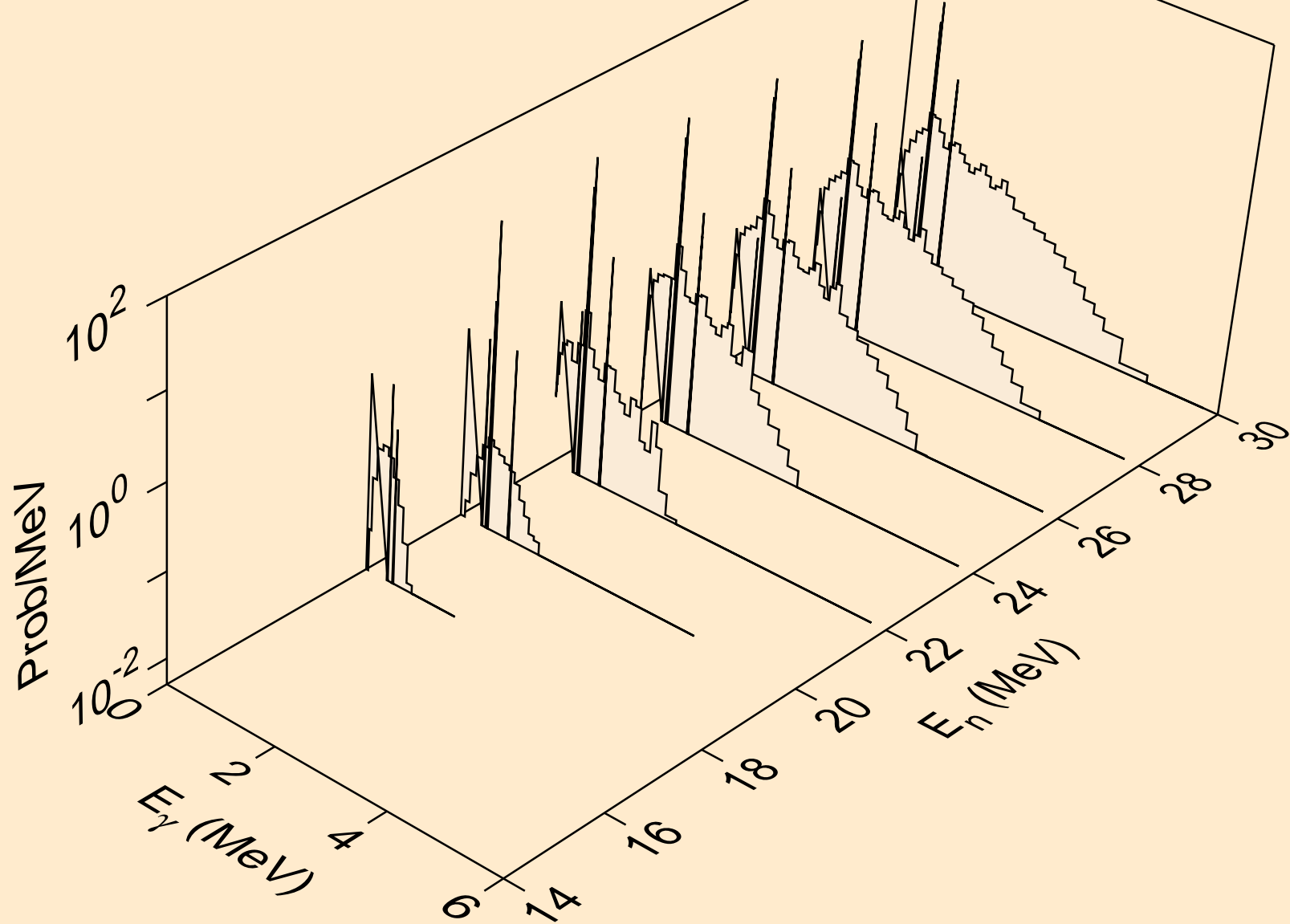

IR172M ALPHA ACER TENDL-2021 LIBRARY; T=0.K
Photon emission for (n,n*)2a

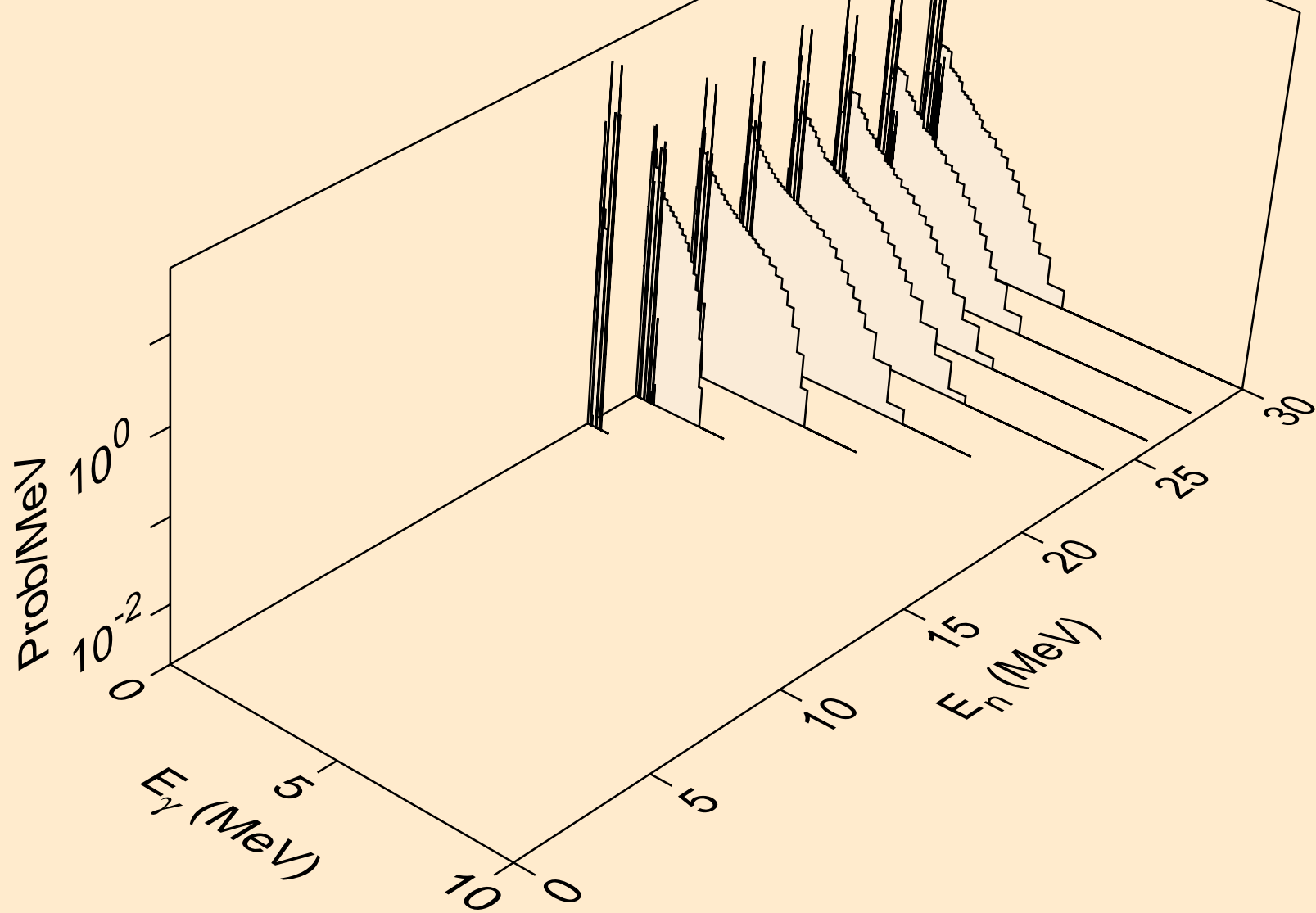

IR172M ALPHA ACER TENDL-2021 LIBRARY; T=0.K
Photon emission for (n,2n)2a

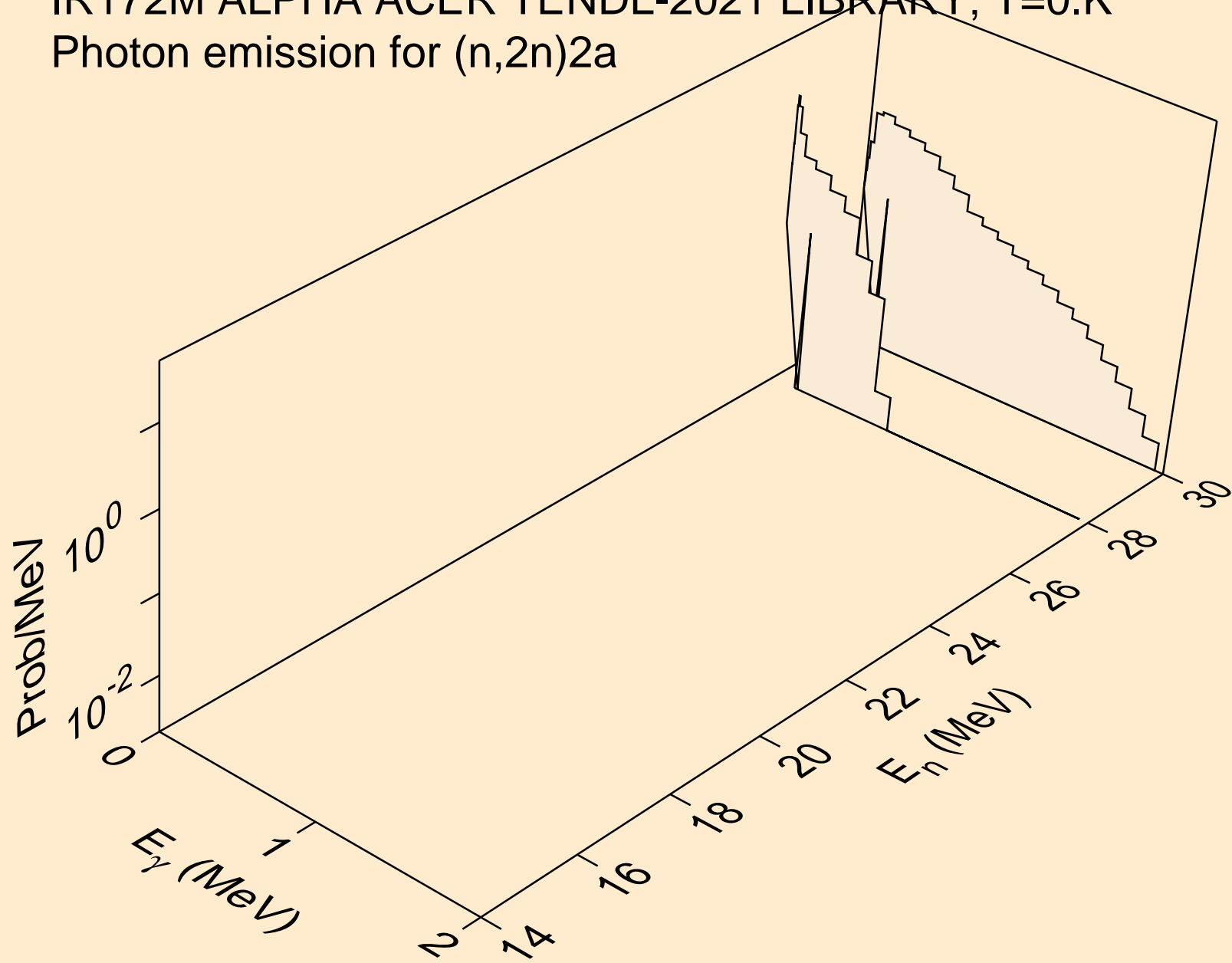

IR172M ALPHA ACER TENDL-2021 LIBRARY; T=0.K
Photon emission for (n,2np)

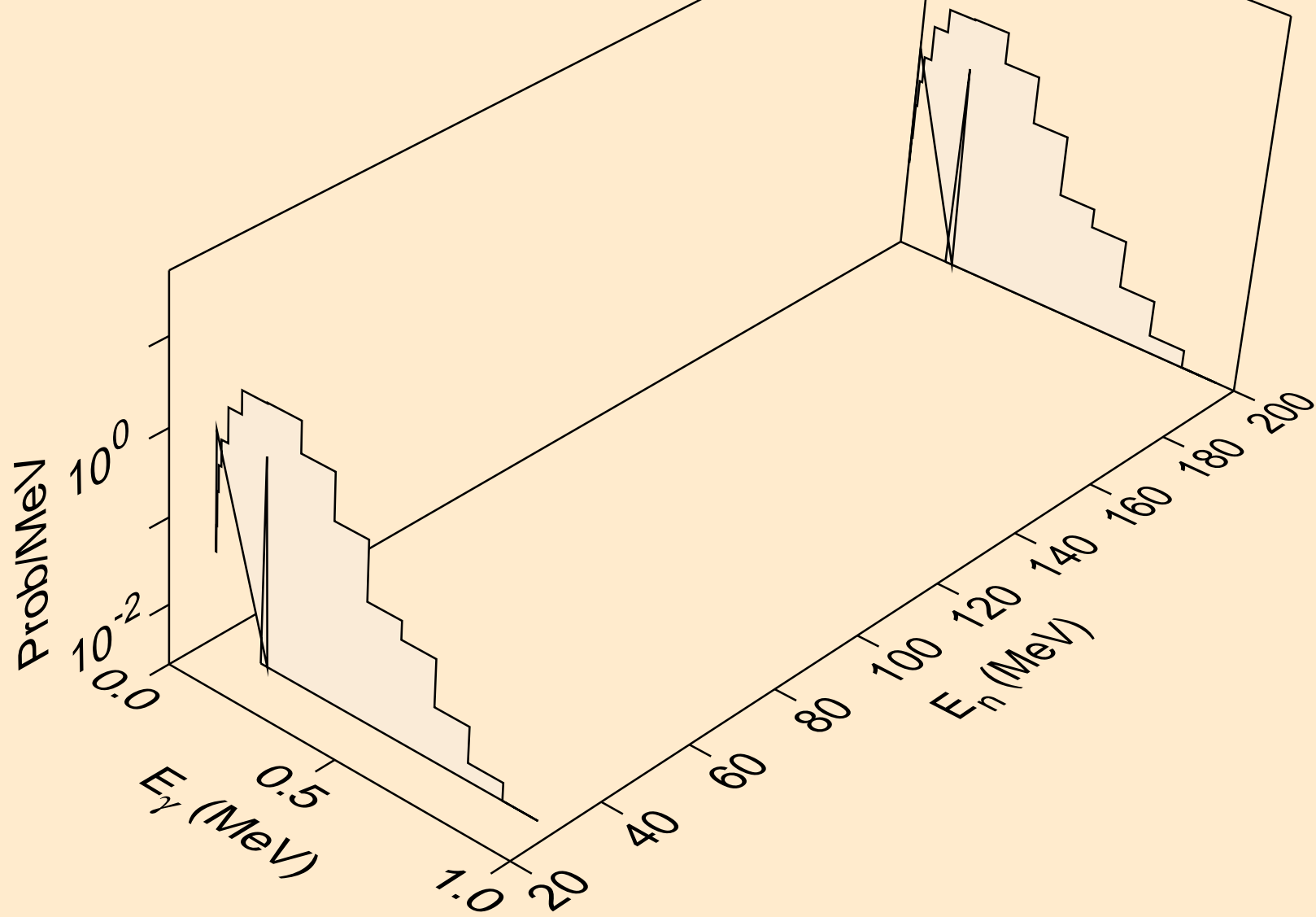

IR172M ALPHA ACER TENDL-2021 LIBRARY; T=0.K
Photon emission for (n,2np)

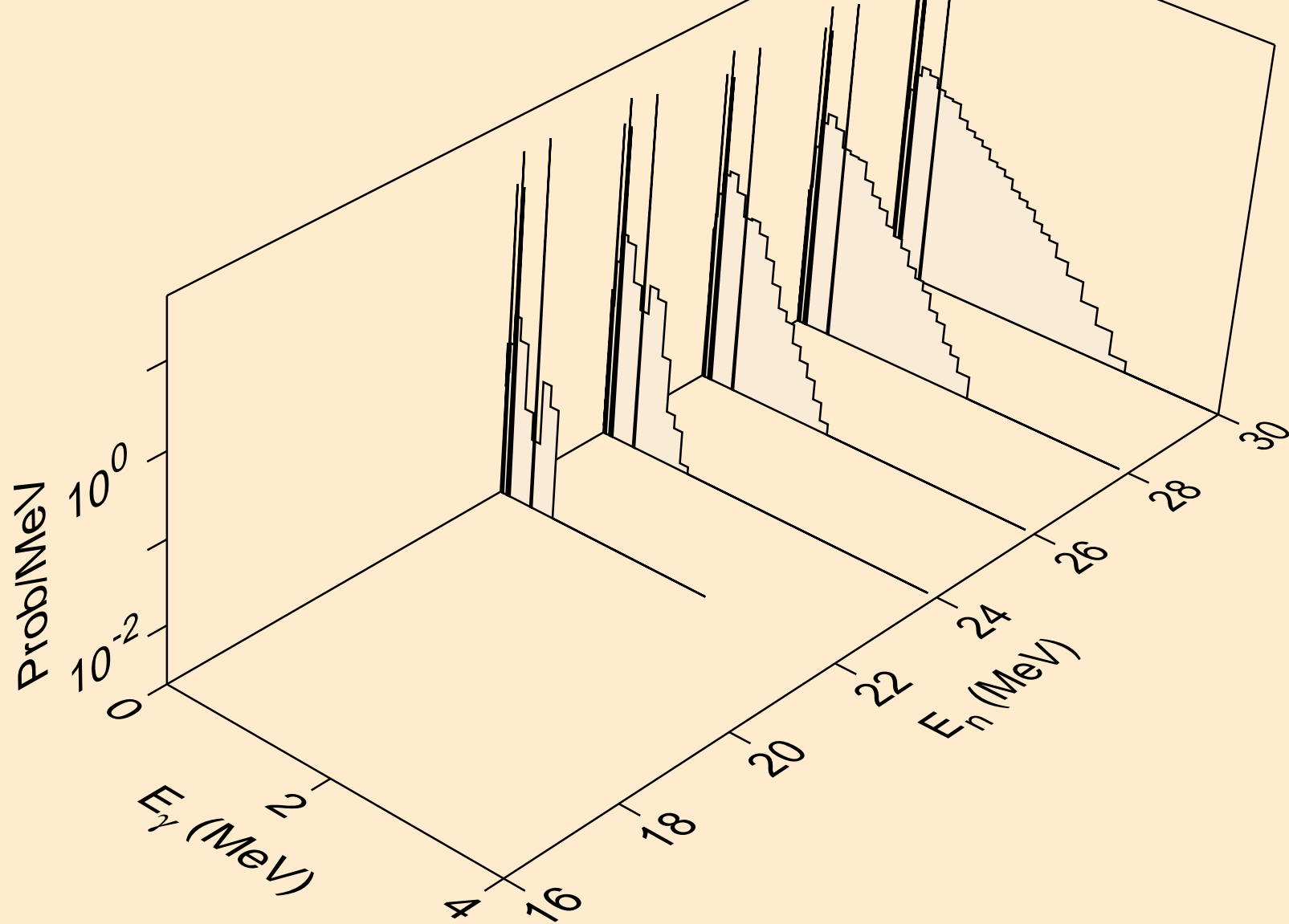

IR172M ALPHA ACER TENDL-2021 LIBRARY; T=0.K
Photon emission for (n,npa)

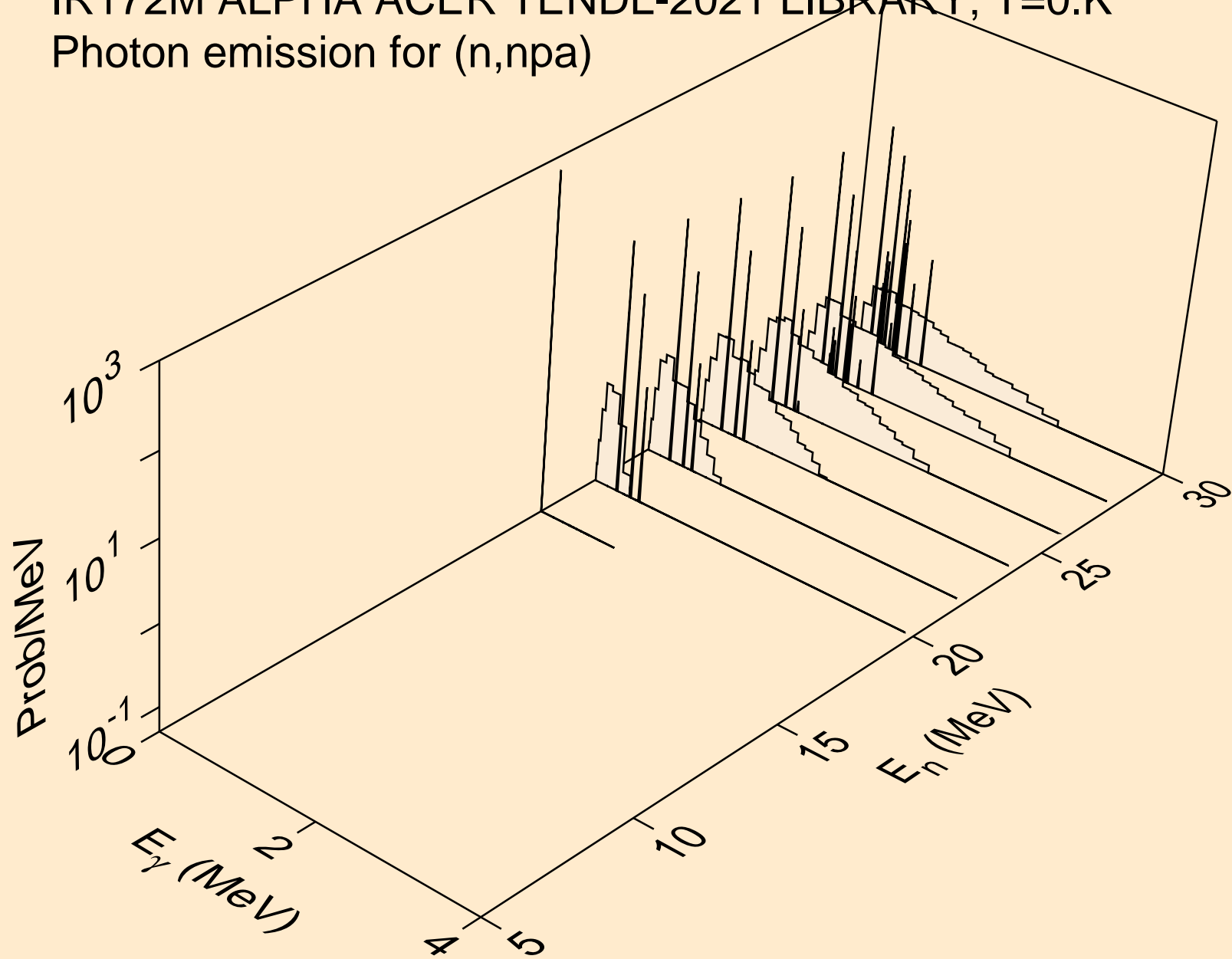

IR172M ALPHA ACER TENDL-2021 LIBRARY; T=0.K
Photon emission for (n,gma)

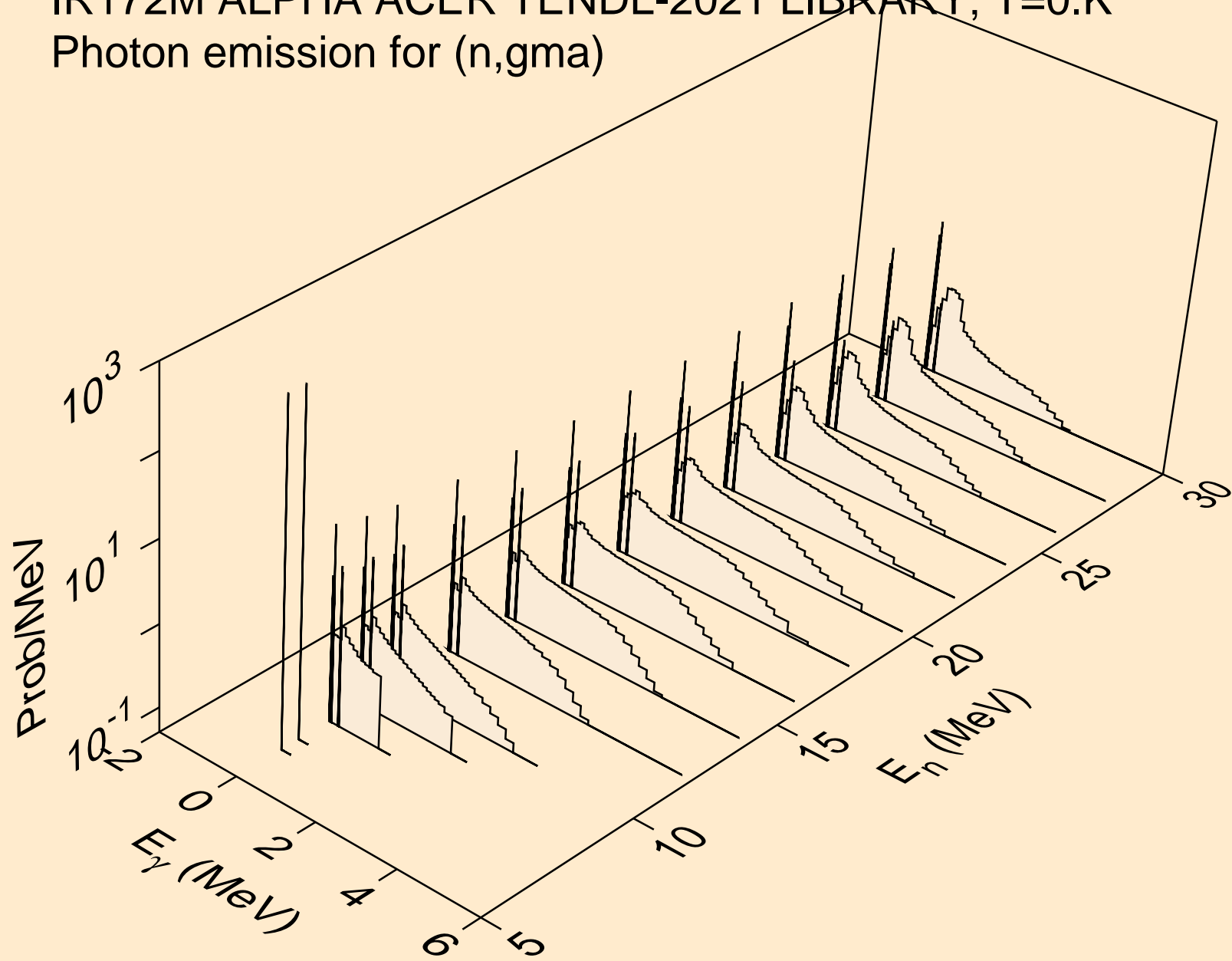

IR172M ALPHA ACER TENDL-2021 LIBRARY; T=0.K
Photon emission for (n,p)

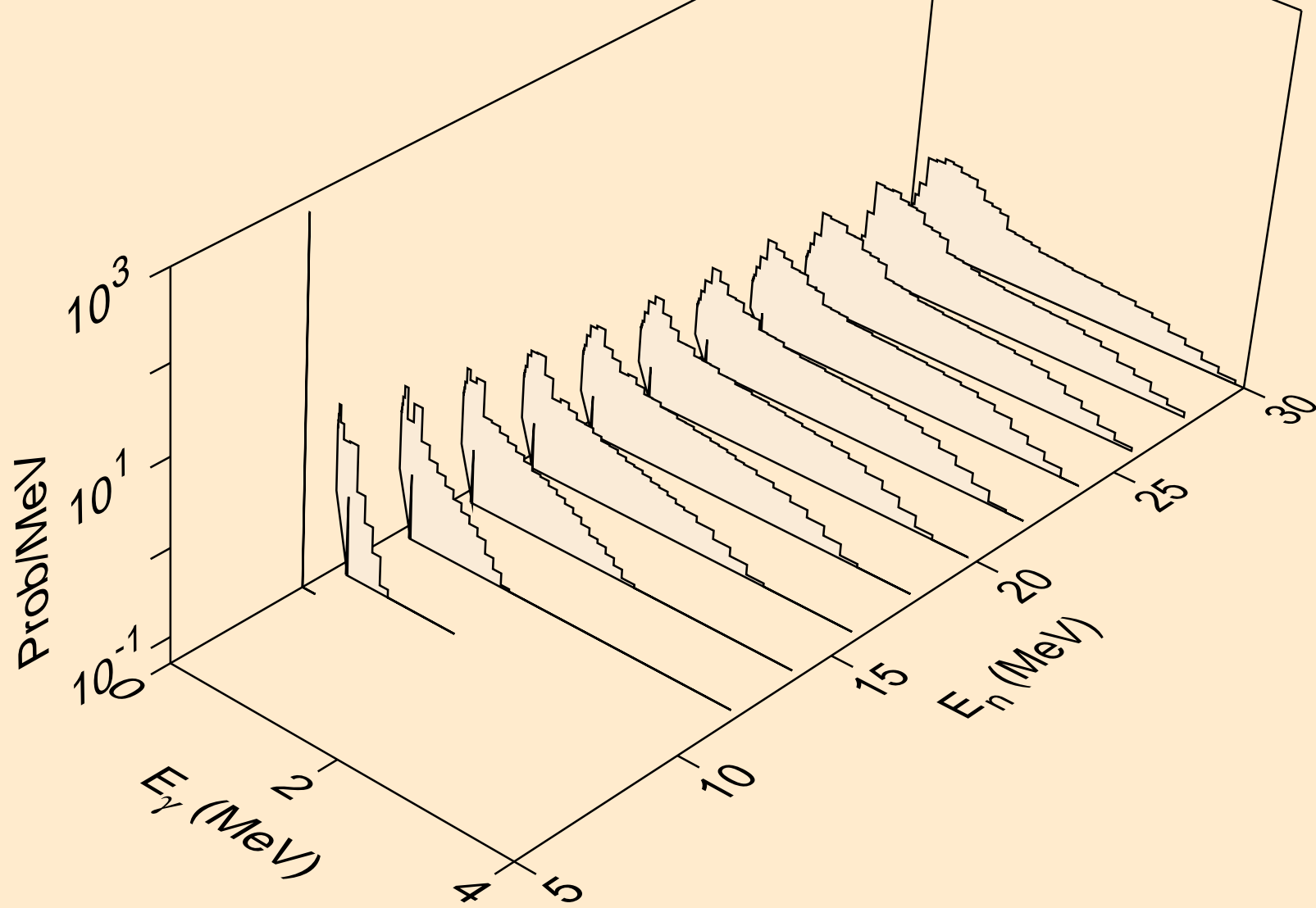

IR172M ALPHA ACER TENDL-2021 LIBRARY; T=0.K
Photon emission for (n,d)

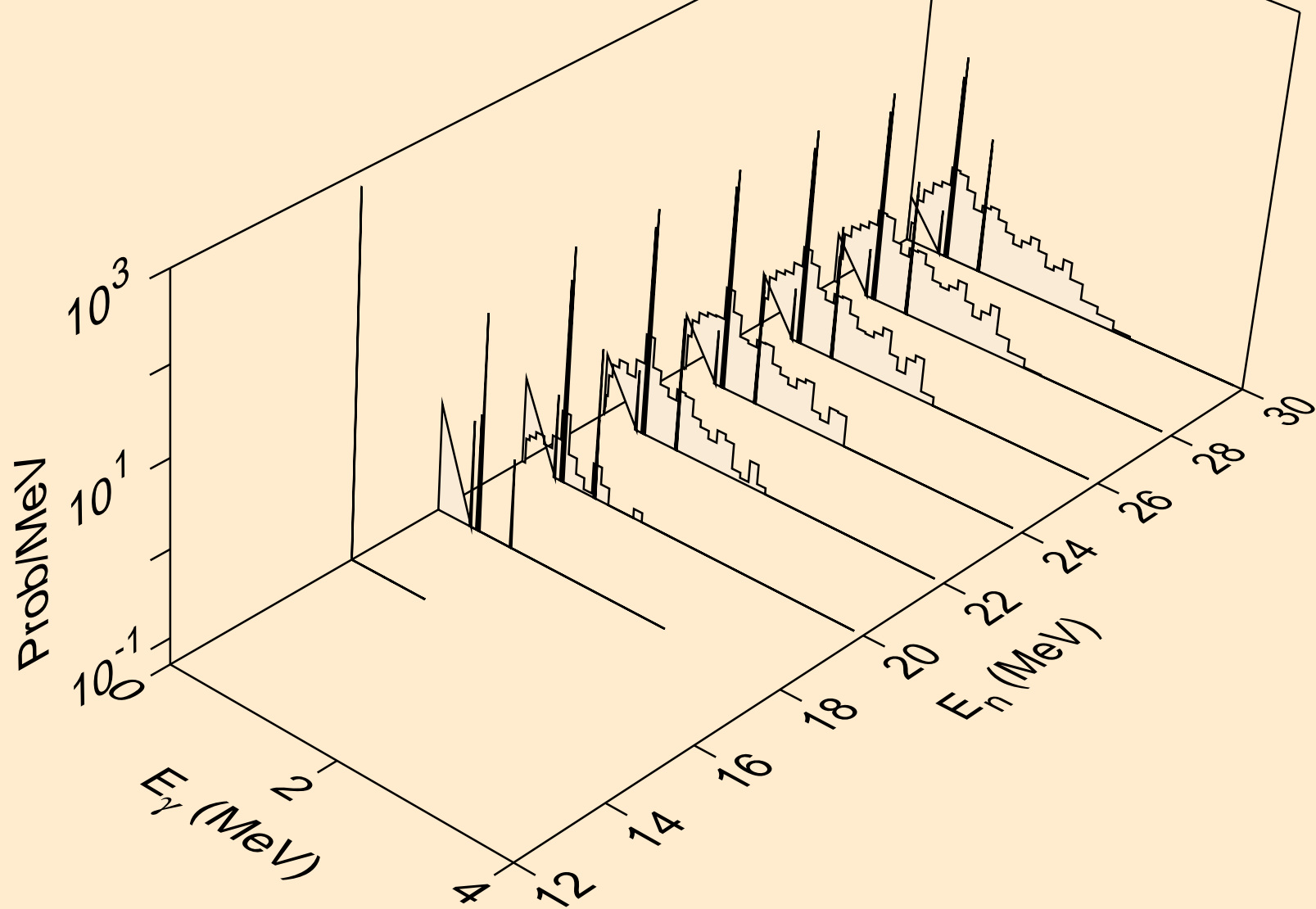

IR172M ALPHA ACER TENDL-2021 LIBRARY; T=0.K
Photon emission for (n,t)

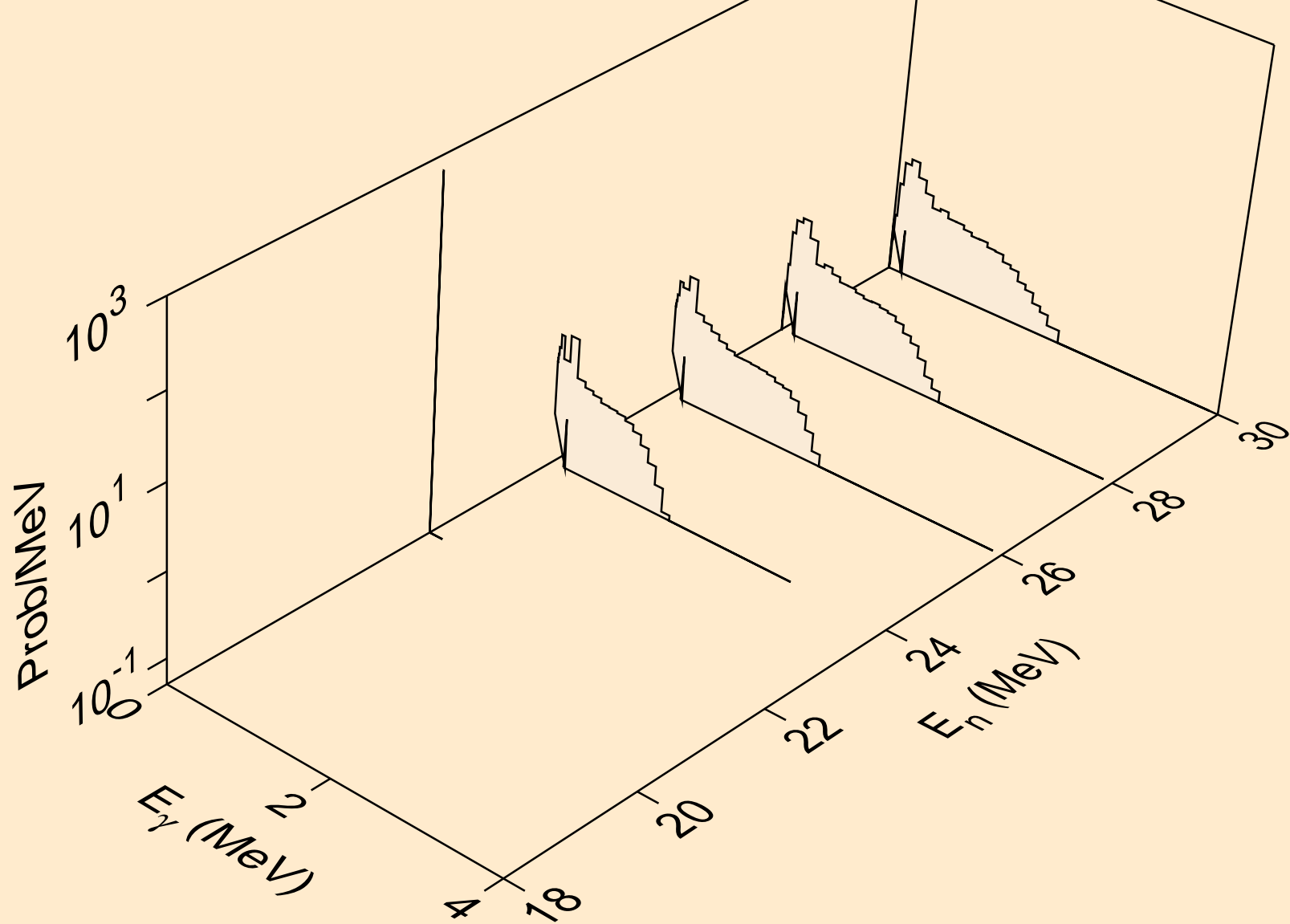

IR172M ALPHA ACER TENDL-2021 LIBRARY; T=0.K
Photon emission for (n,he3)

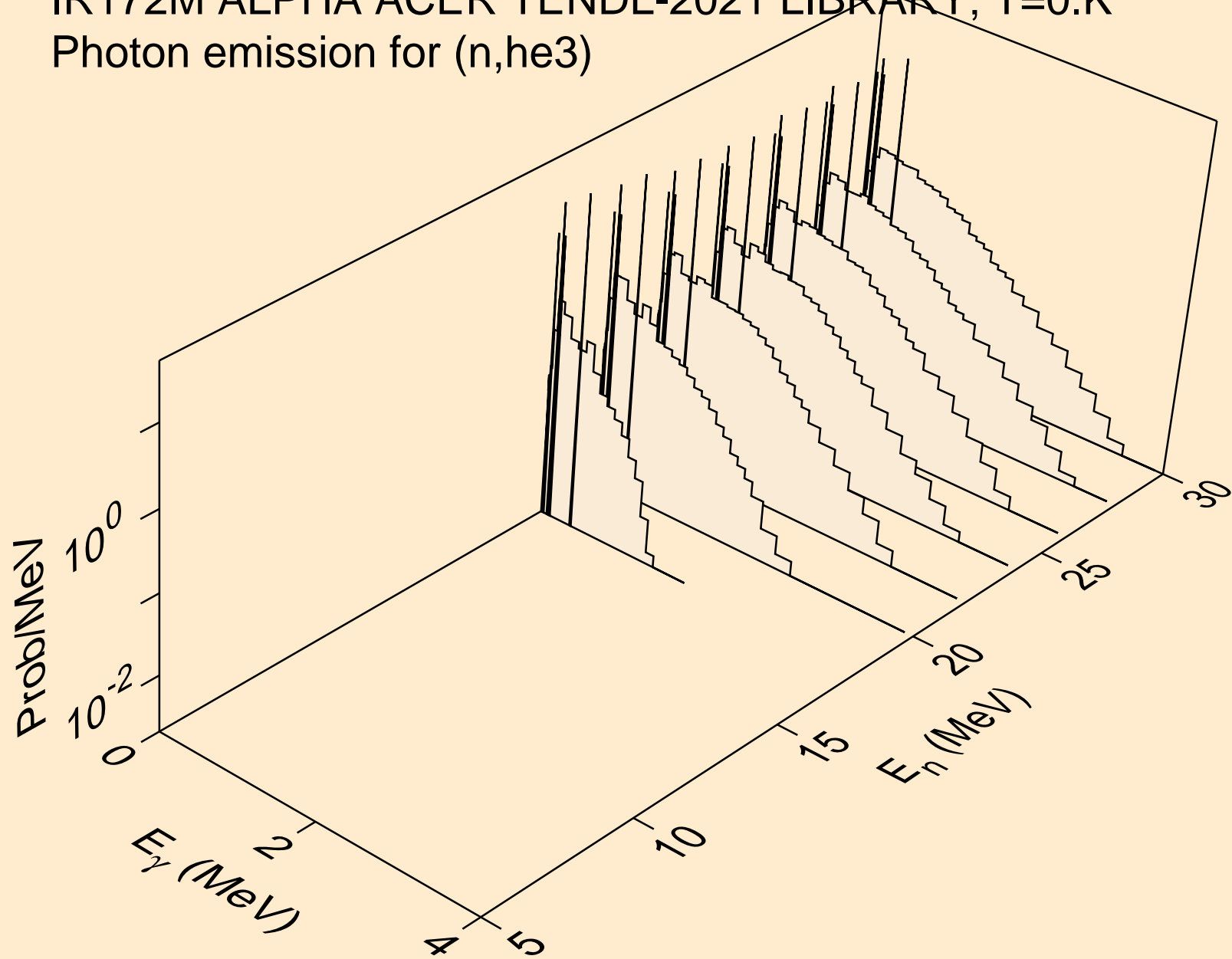

IR172M ALPHA ACER TENDL-2021 LIBRARY; T=0.K
Photon emission for inelastic

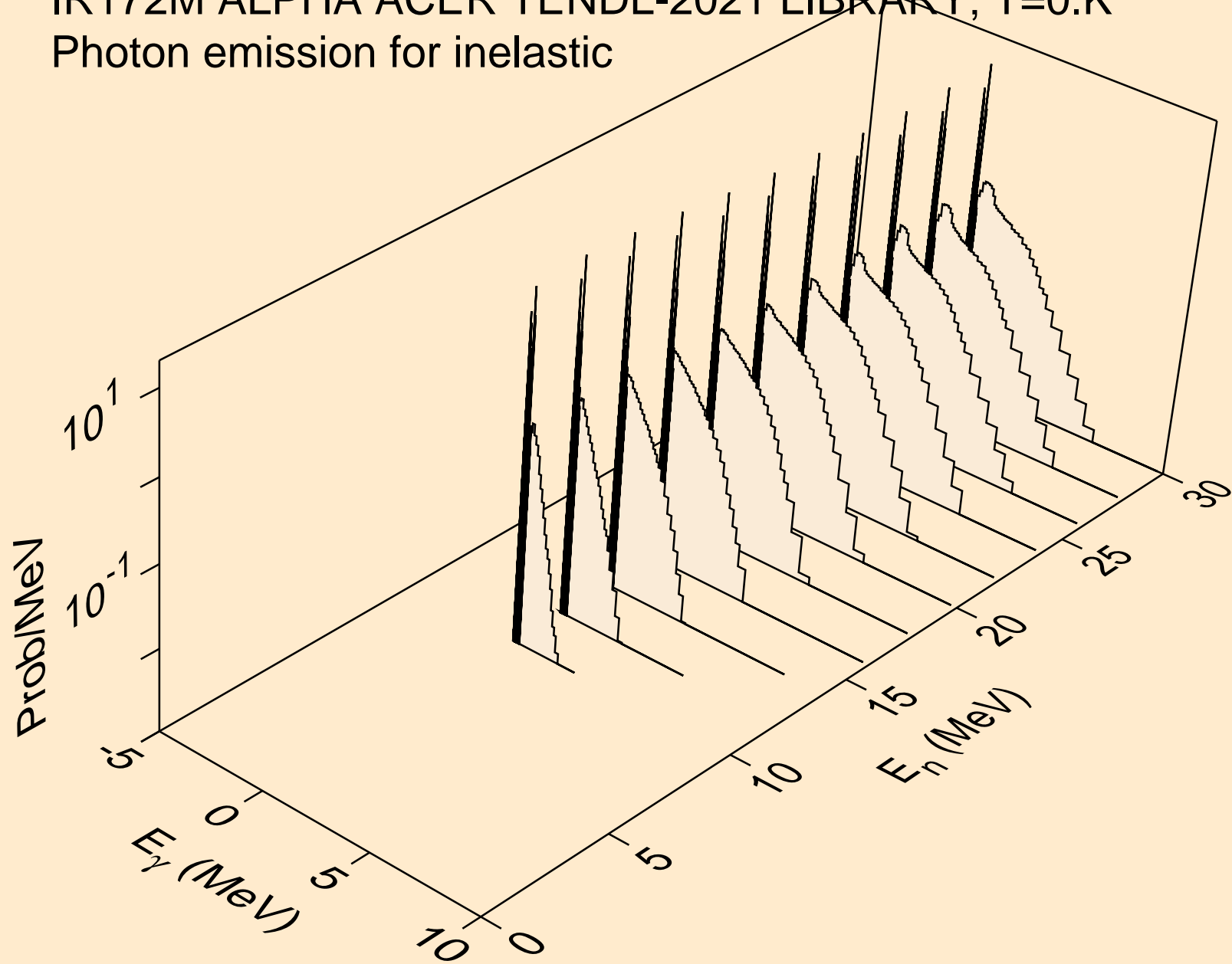

IR172M ALPHA ACER TENDL-2021 LIBRARY; T=0.K
Photon emission for (n,2a)

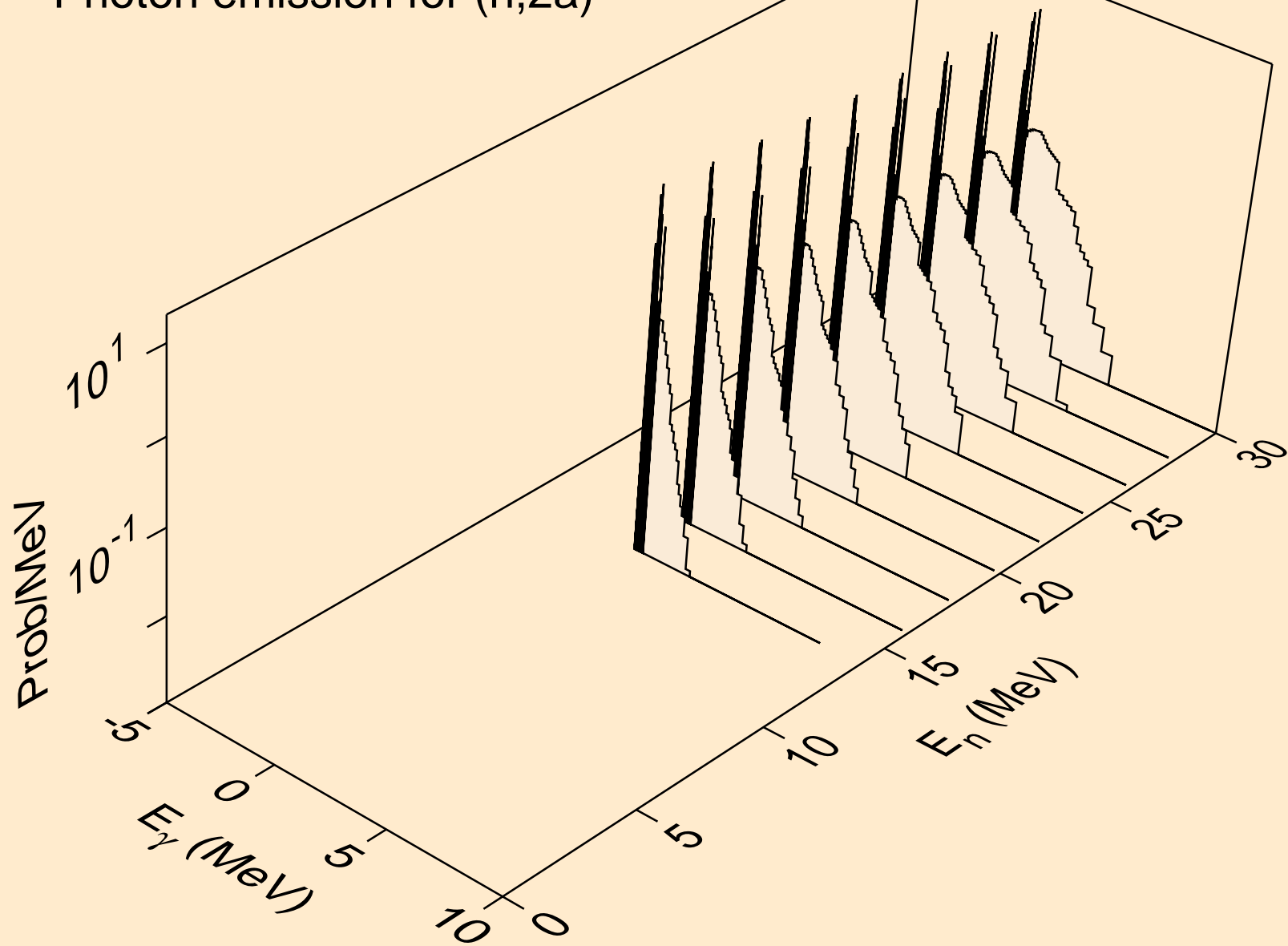

IR172M ALPHA ACER TENDL-2021 LIBRARY; T=0.K
Photon emission for (n,3a)

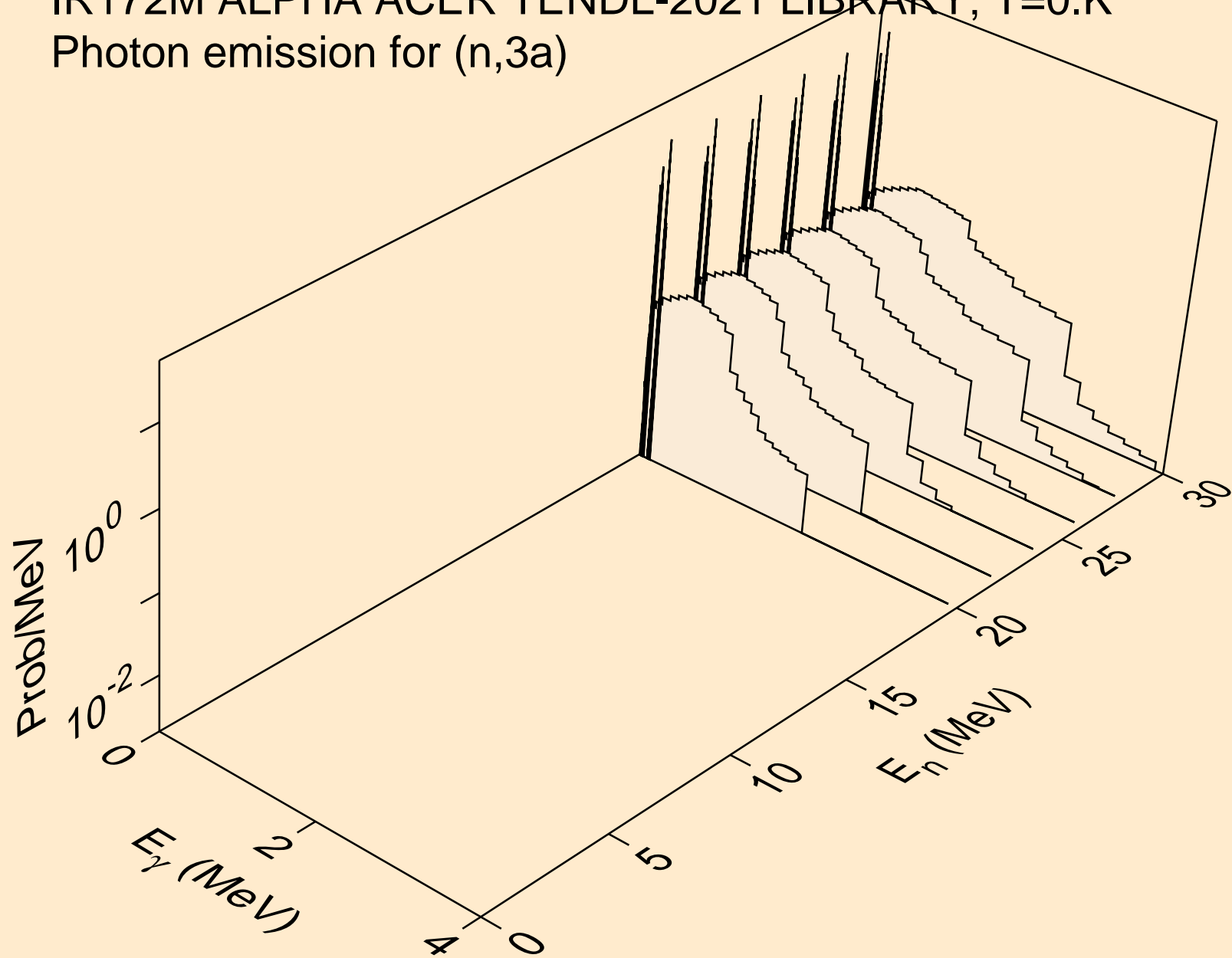

IR172M ALPHA ACER TENDL-2021 LIBRARY; T=0.K
Photon emission for (n,2p)

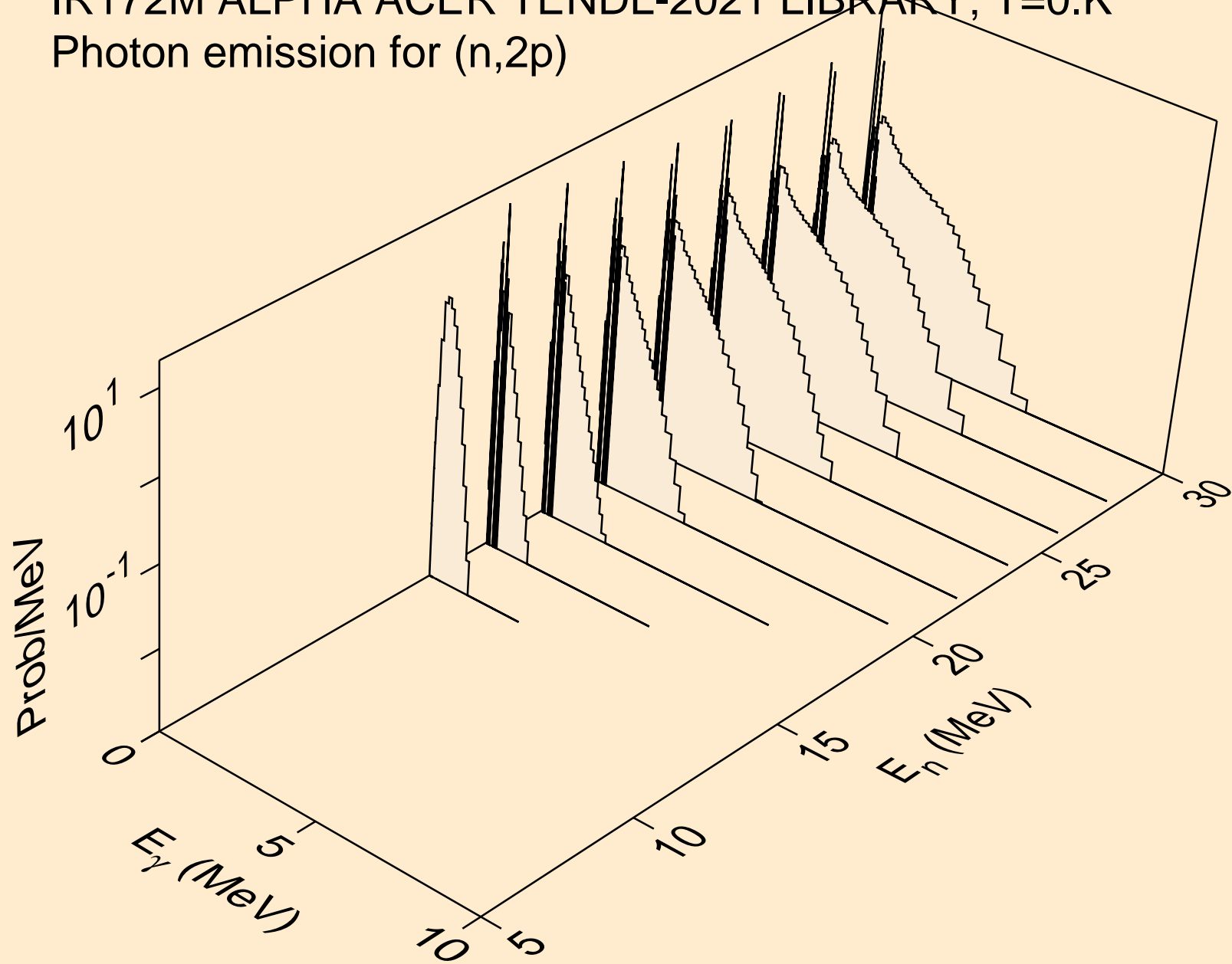

IR172M ALPHA ACER TENDL-2021 LIBRARY; T=0.K
Photon emission for (n,pa)

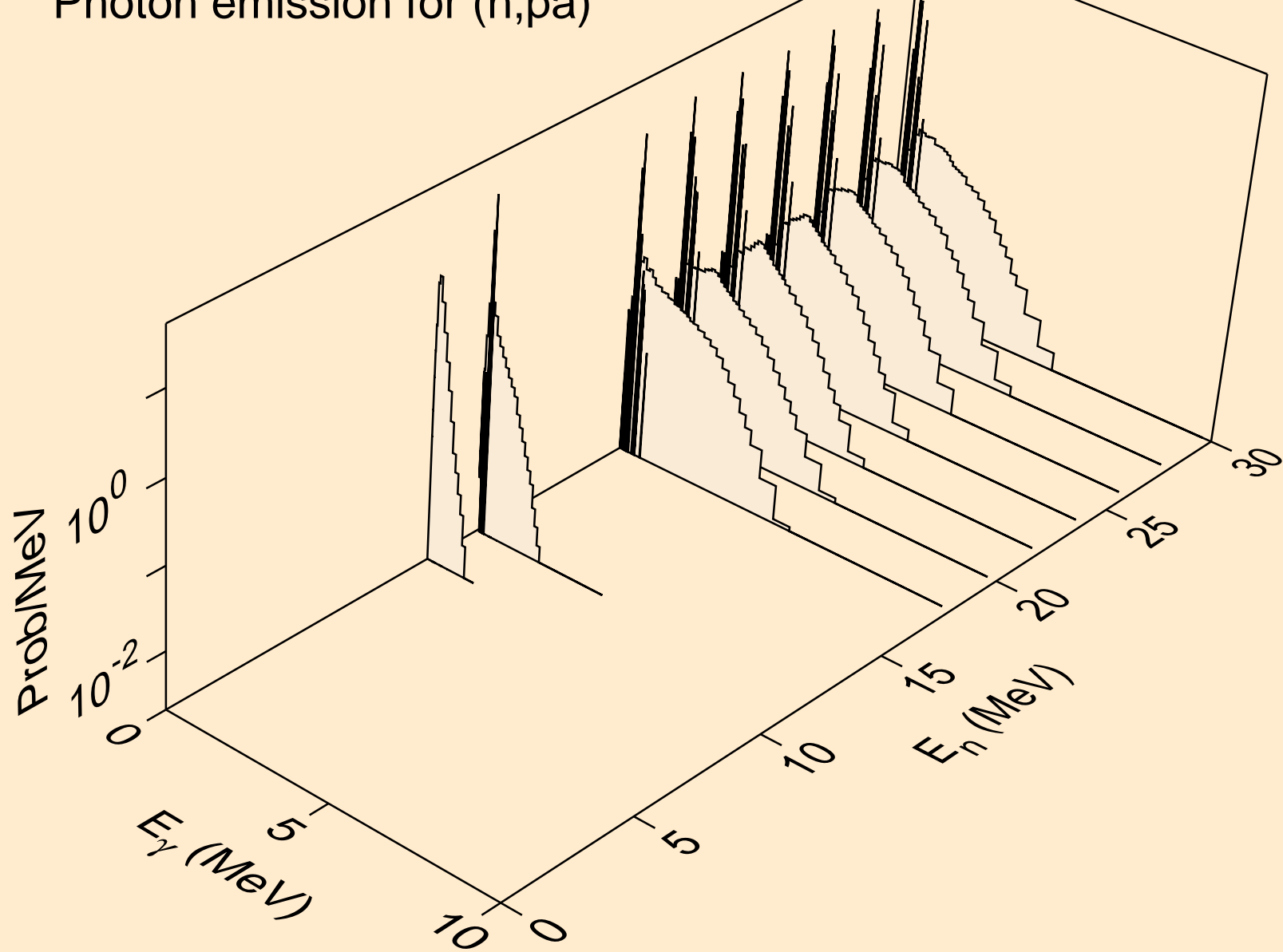

IR172M ALPHA ACER TENDL-2021 LIBRARY; T=0.K
Photon emission for (n,pd)

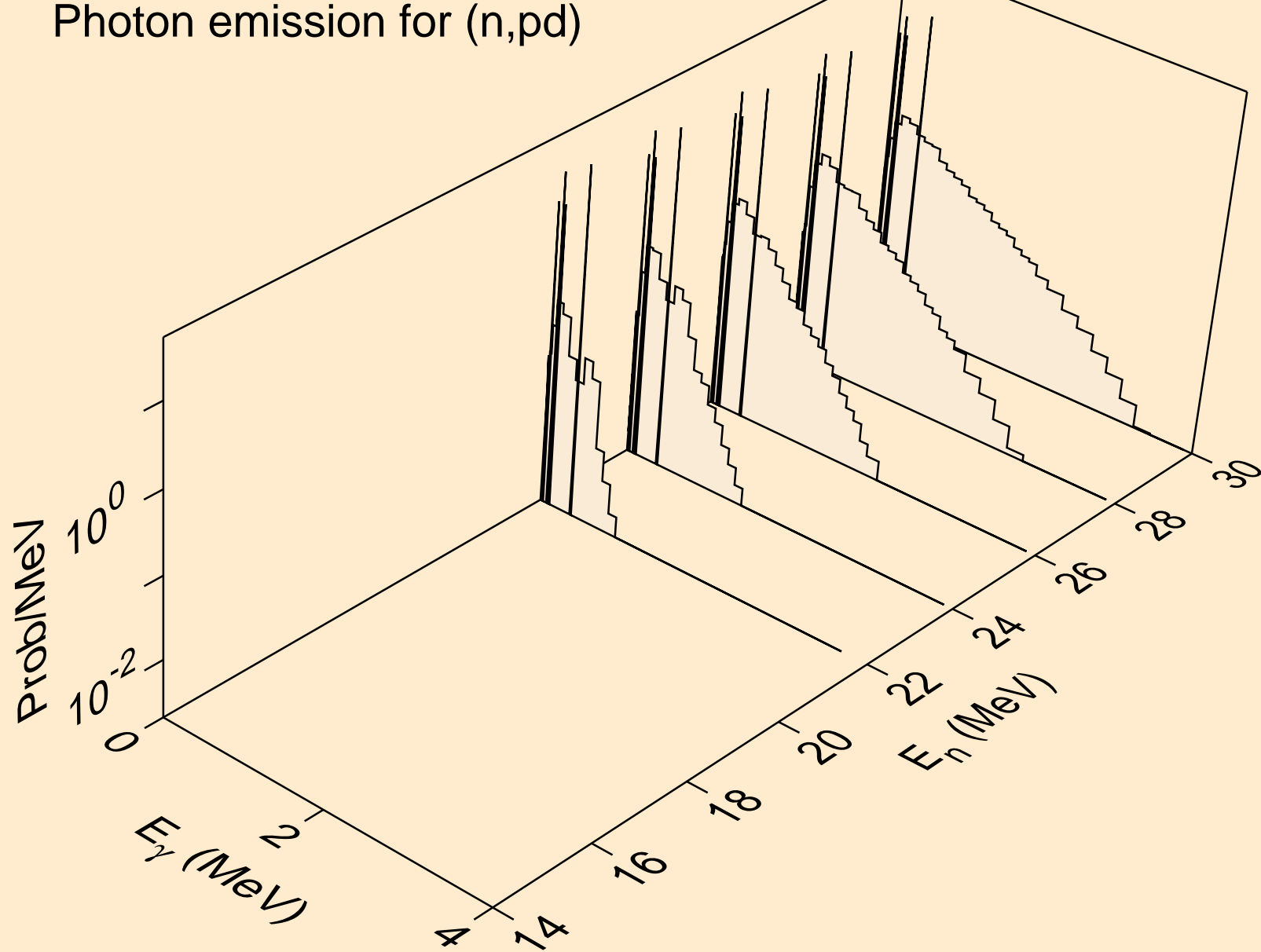

IR172M ALPHA ACER TENDL-2021 LIBRARY; T=0.K
Photon emission for (n,da)

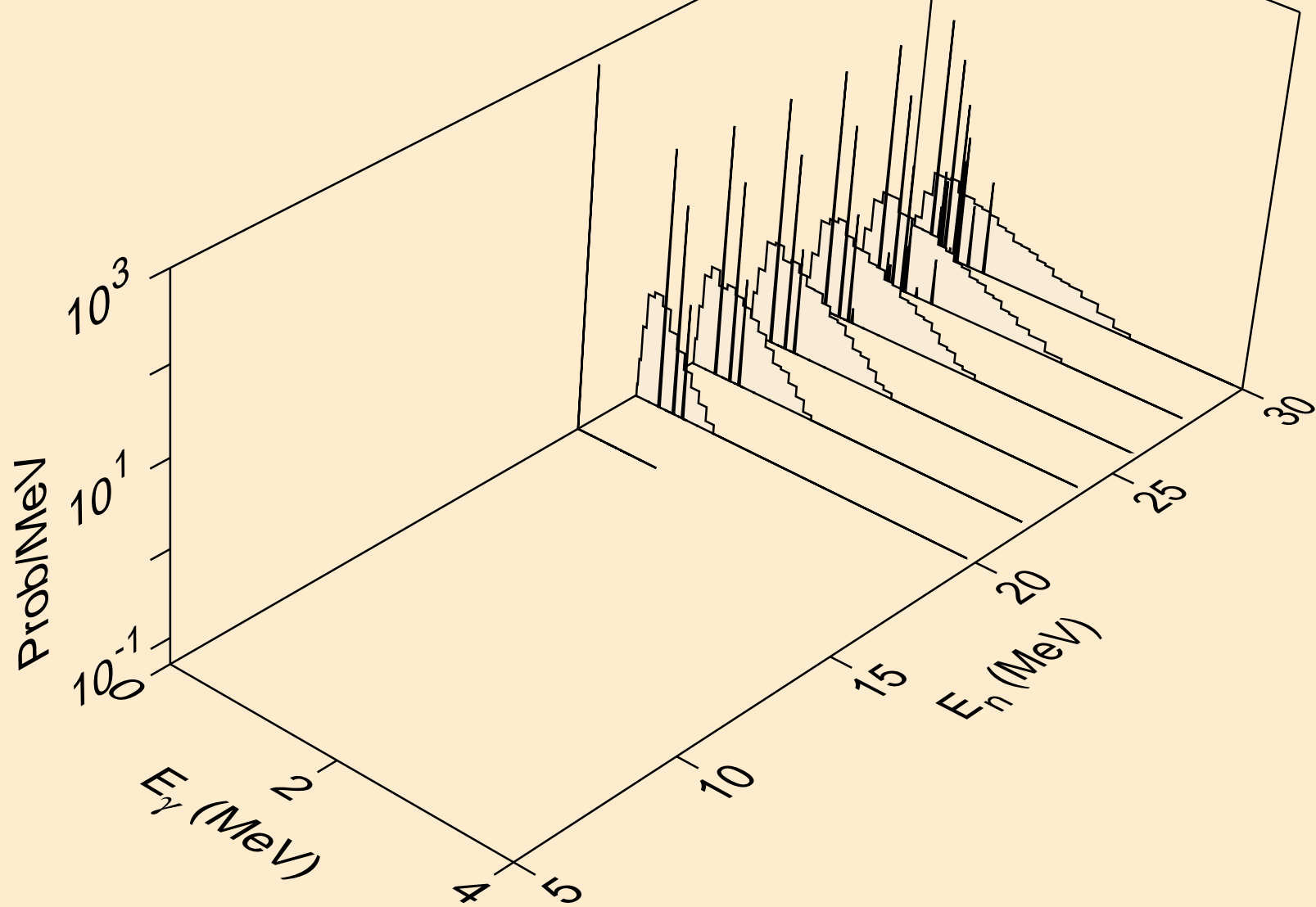

IR172M ALPHA ACER TENDL-2021 LIBRARY; T=0.K
Particle heating contributions

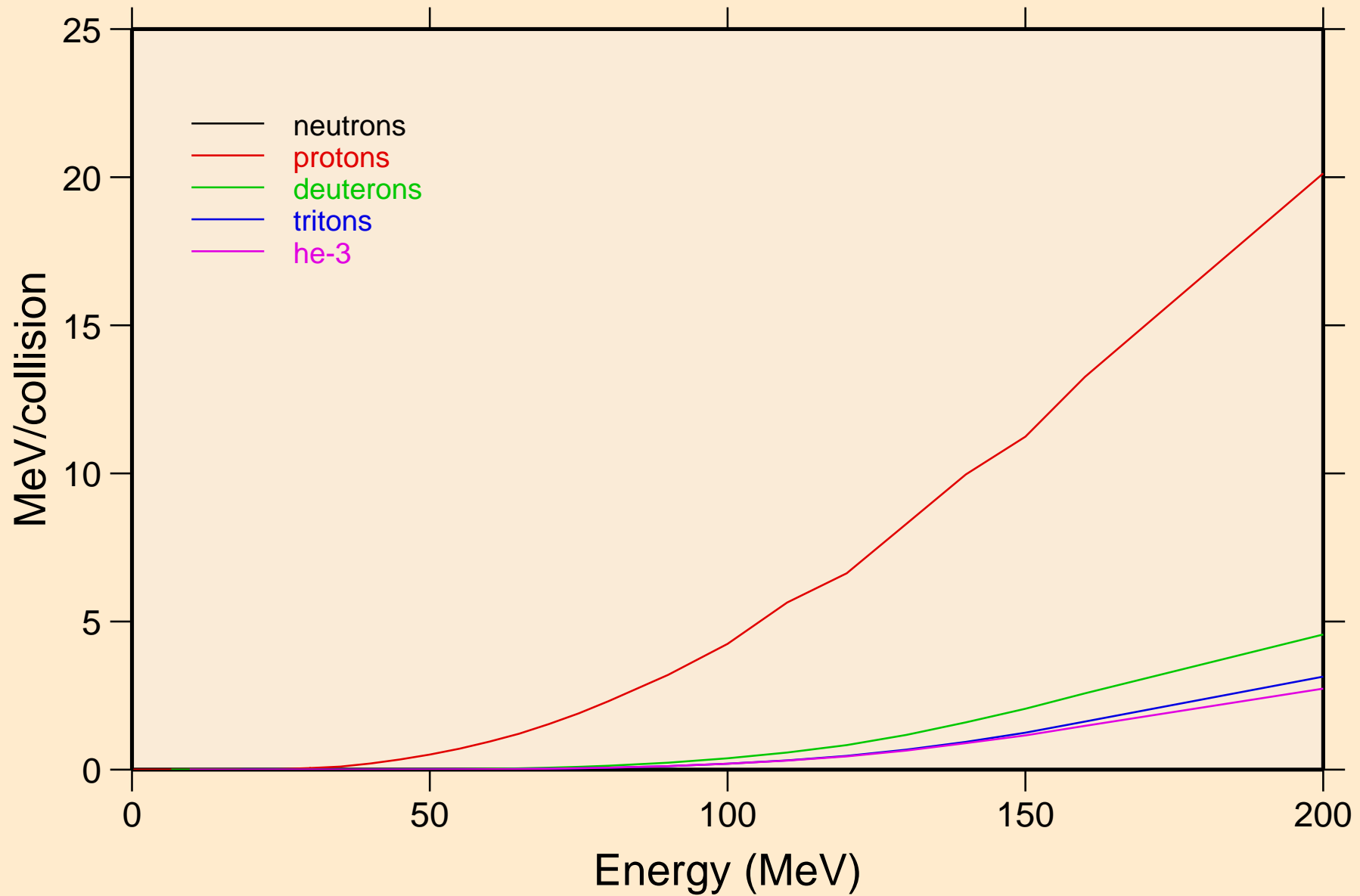

IR172M ALPHA ACER TENDL-2021 LIBRARY; T=0.K
Recoil Heating

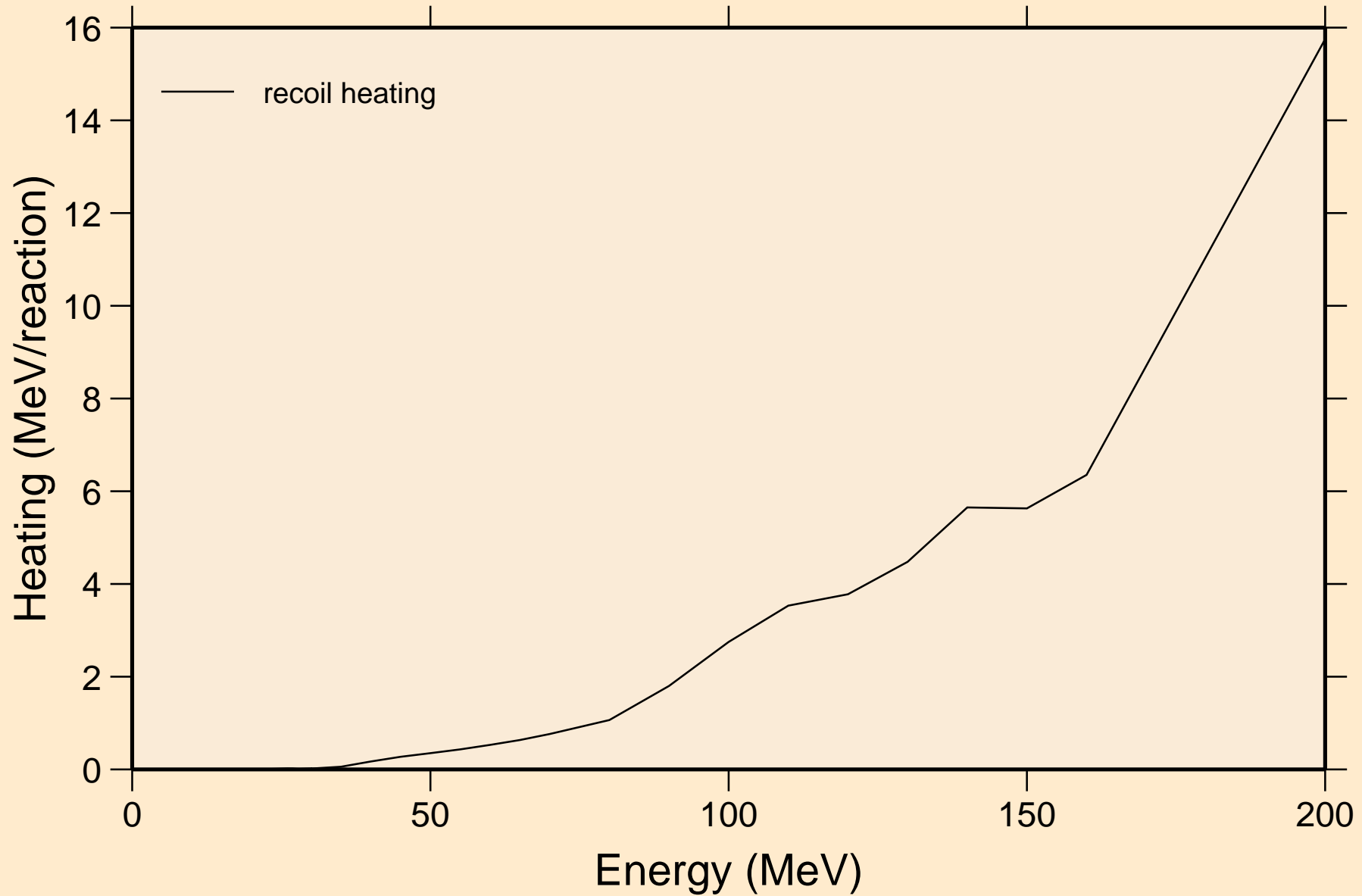

IR172M ALPHA ACER TENDL-2021 LIBRARY; T=0.K
Particle production cross sections

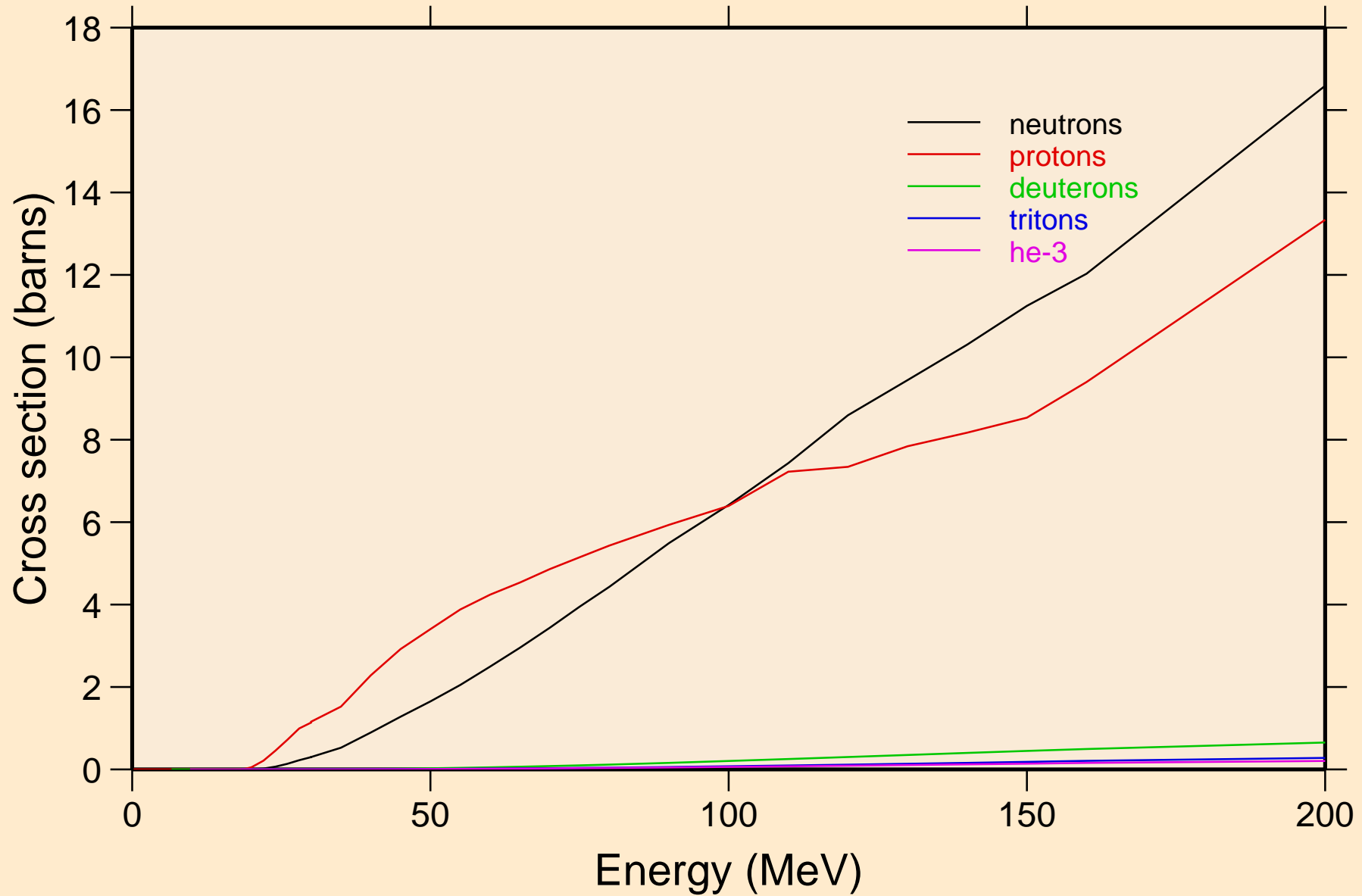

IR172M ALPHA ACER TENDL-2021 LIBRARY; T=0.K
neutrons from (a,n)

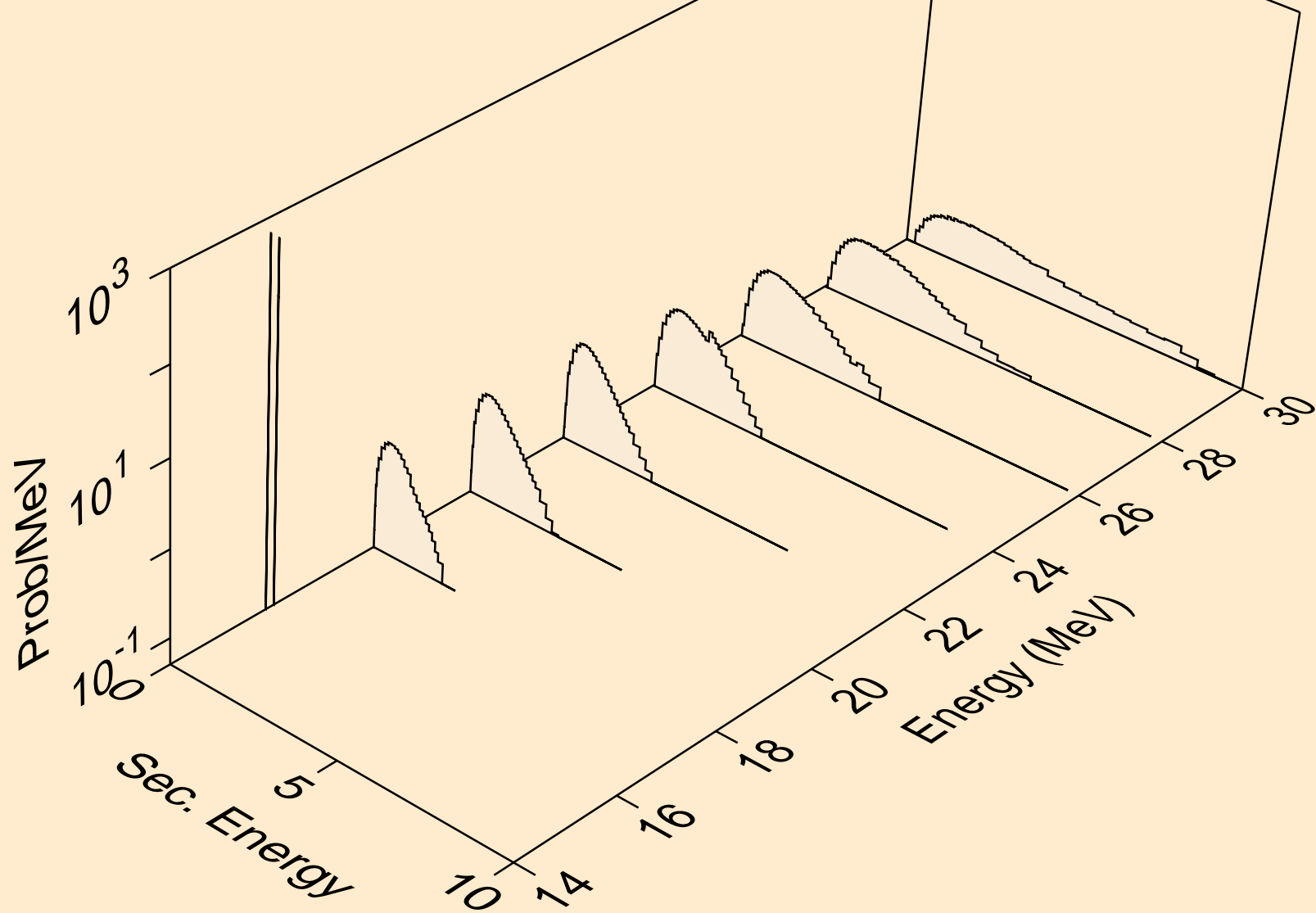

IR172M ALPHA ACER TENDL-2021 LIBRARY; T=0.K
neutrons from (a,x)

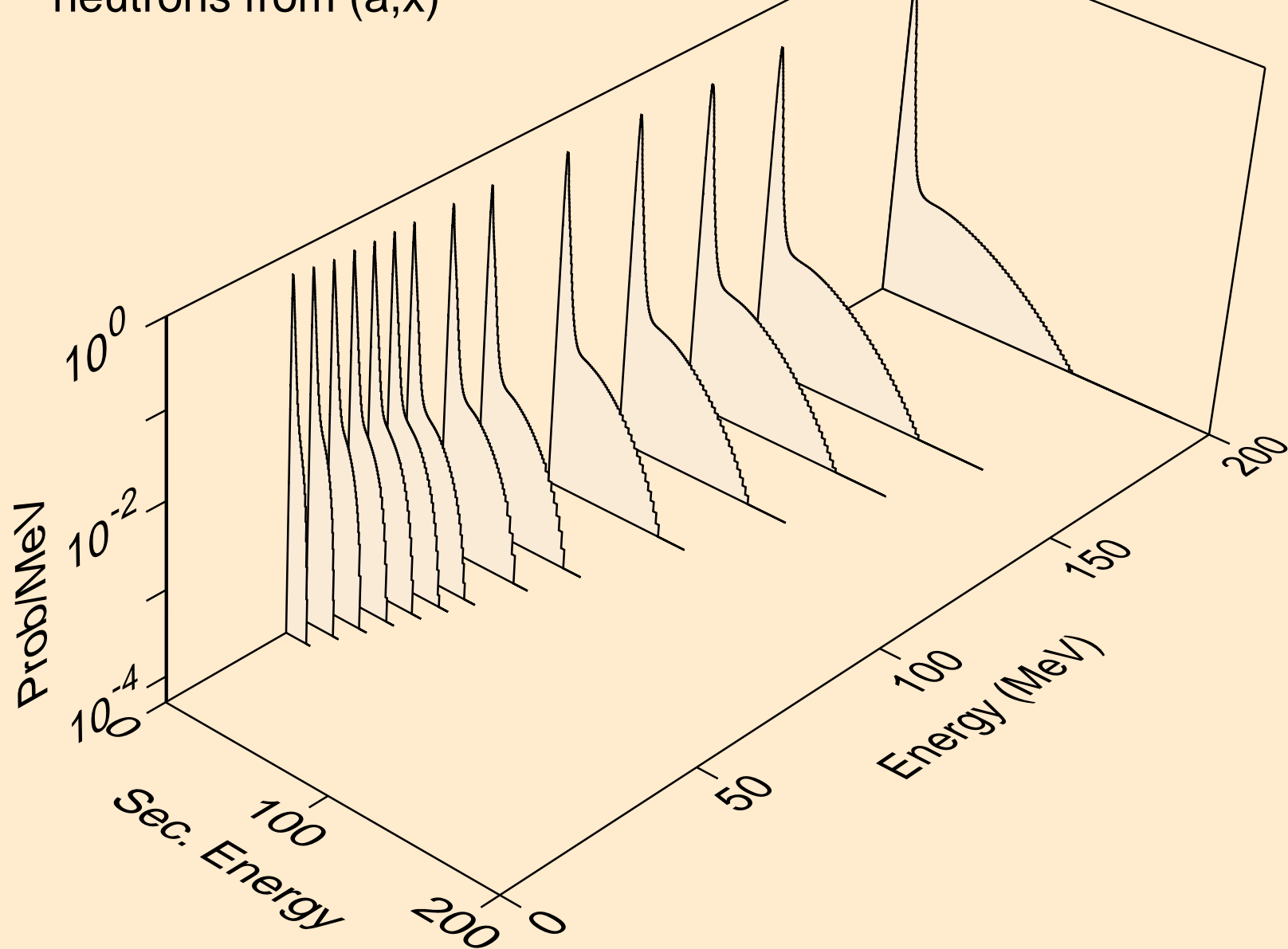

IR172M ALPHA ACER TENDL-2021 LIBRARY; T=0.K
neutrons from (a,2n)

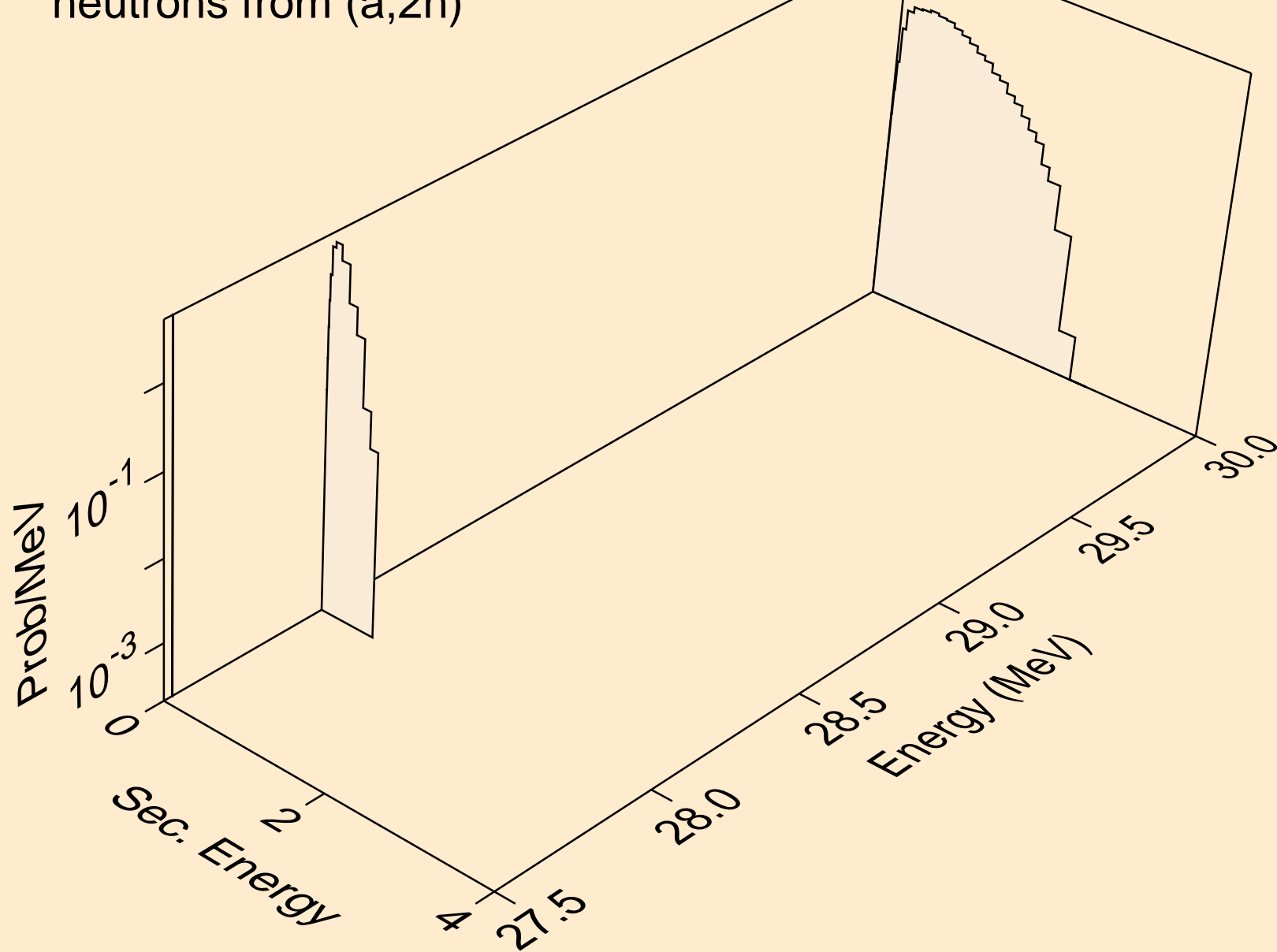

IR172M ALPHA ACER TENDL-2021 LIBRARY; T=0.K
neutrons from (a,n*)a

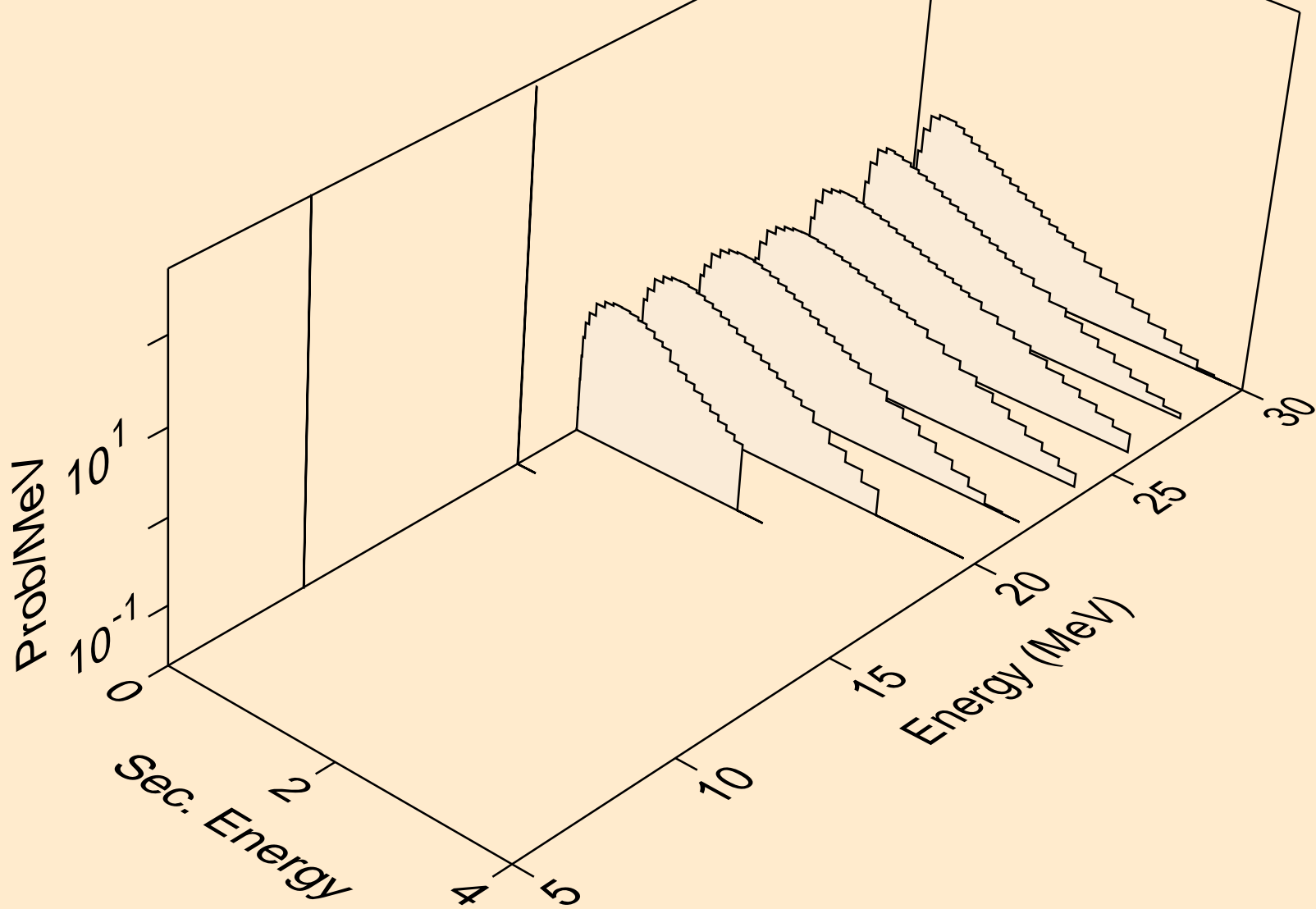

IR172M ALPHA ACER TENDL-2021 LIBRARY; T=0.K
neutrons from (a,2n)a

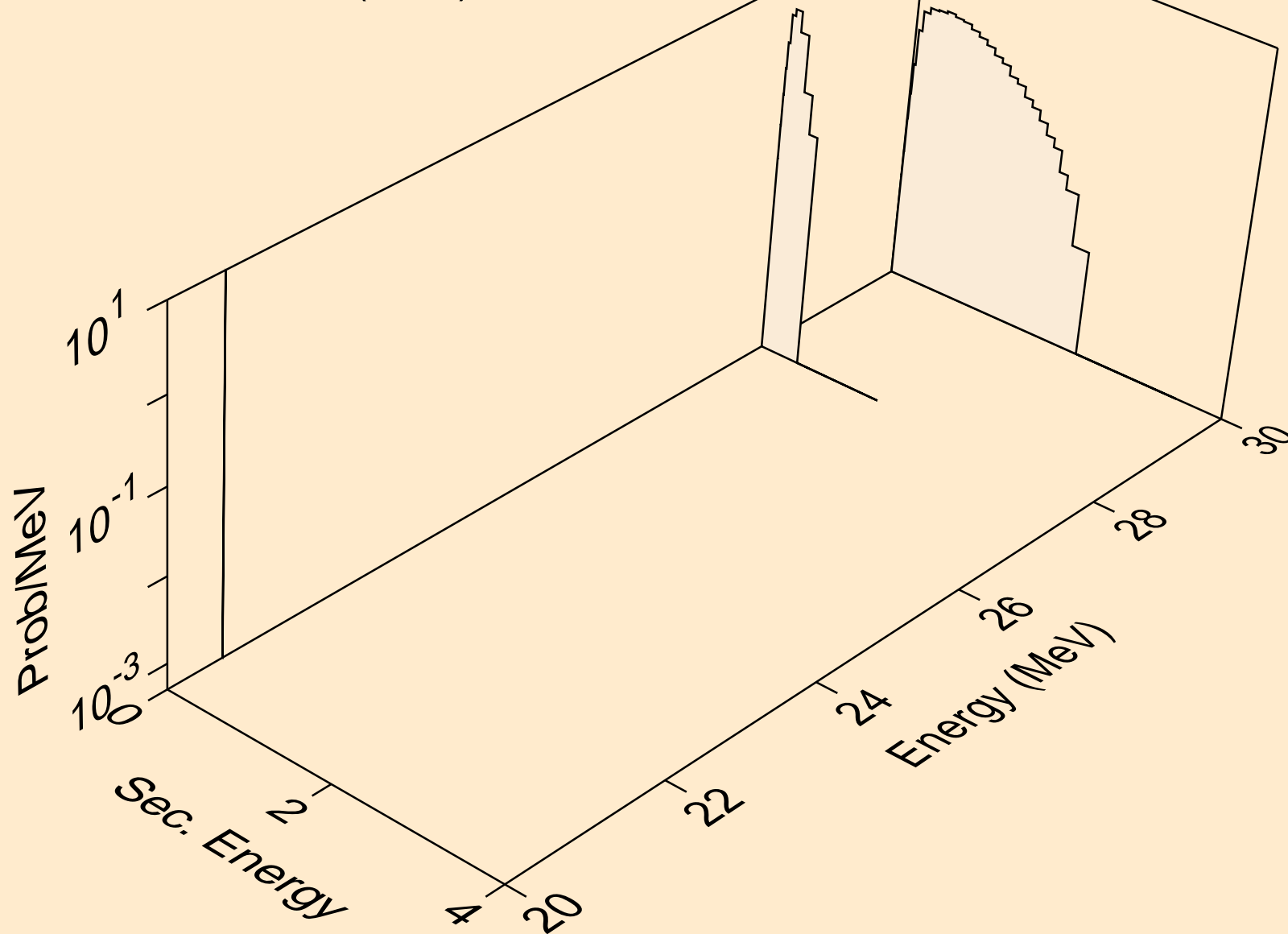

IR172M ALPHA ACER TENDL-2021 LIBRARY; T=0.K
neutrons from (a,n*)p

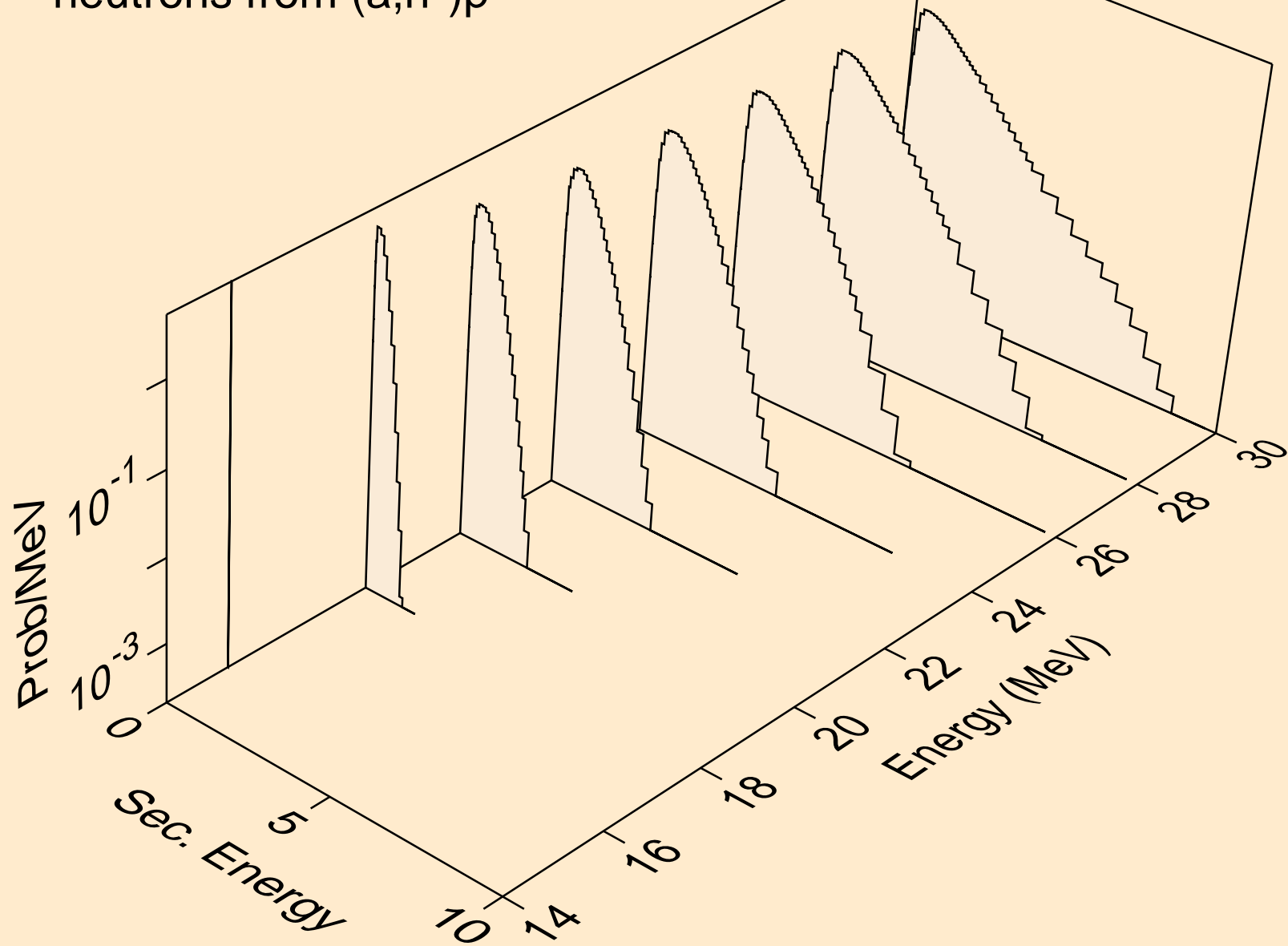

IR172M ALPHA ACER TENDL-2021 LIBRARY; T=0.K
neutrons from (a,n*)2a

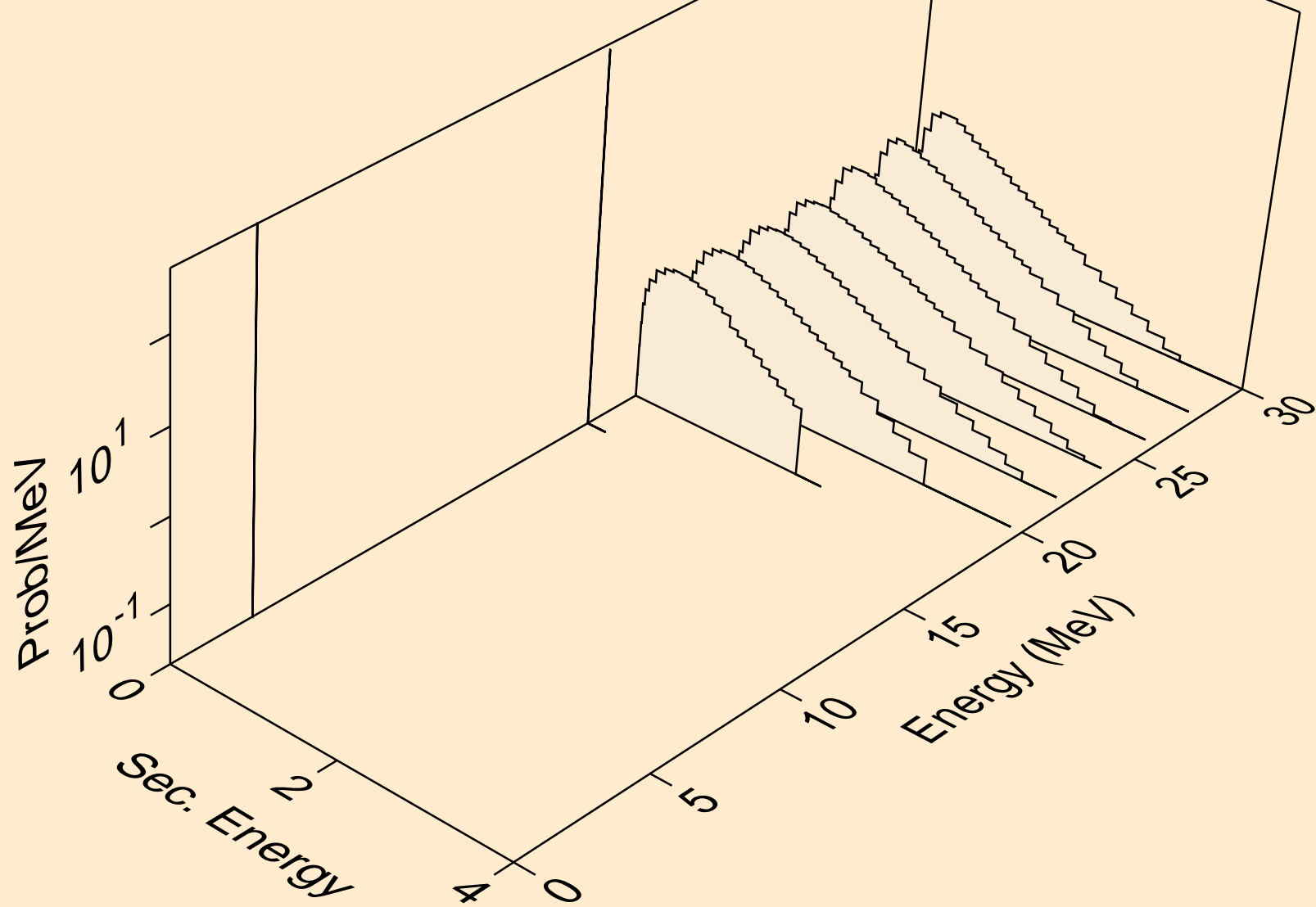

IR172M ALPHA ACER TENDL-2021 LIBRARY; T=0.K
neutrons from (a,2n)2a

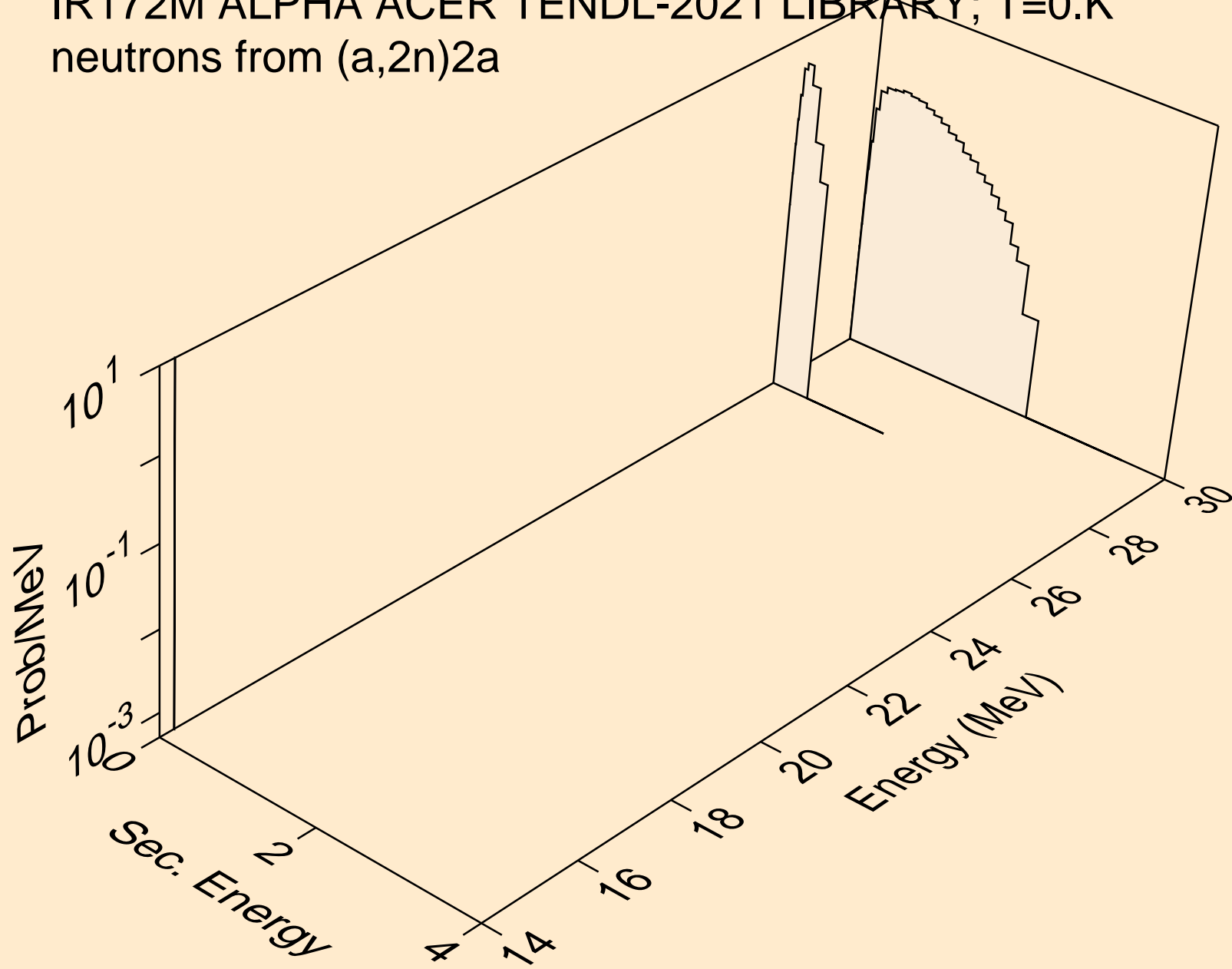

IR172M ALPHA ACER TENDL-2021 LIBRARY; T=0.K
neutrons from (a,2np)

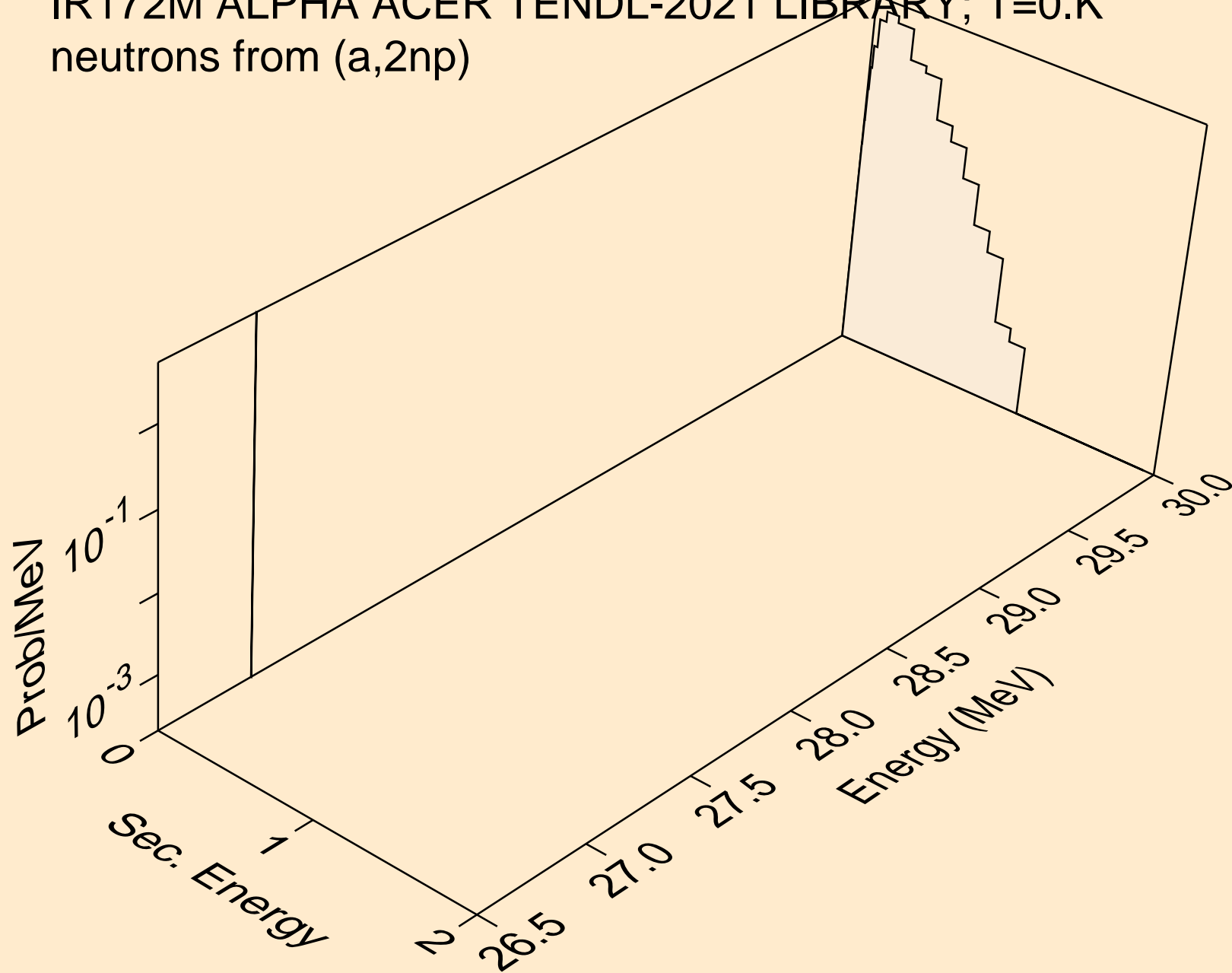

IR172M ALPHA ACER TENDL-2021 LIBRARY; T=0.K
neutrons from (a,2np)

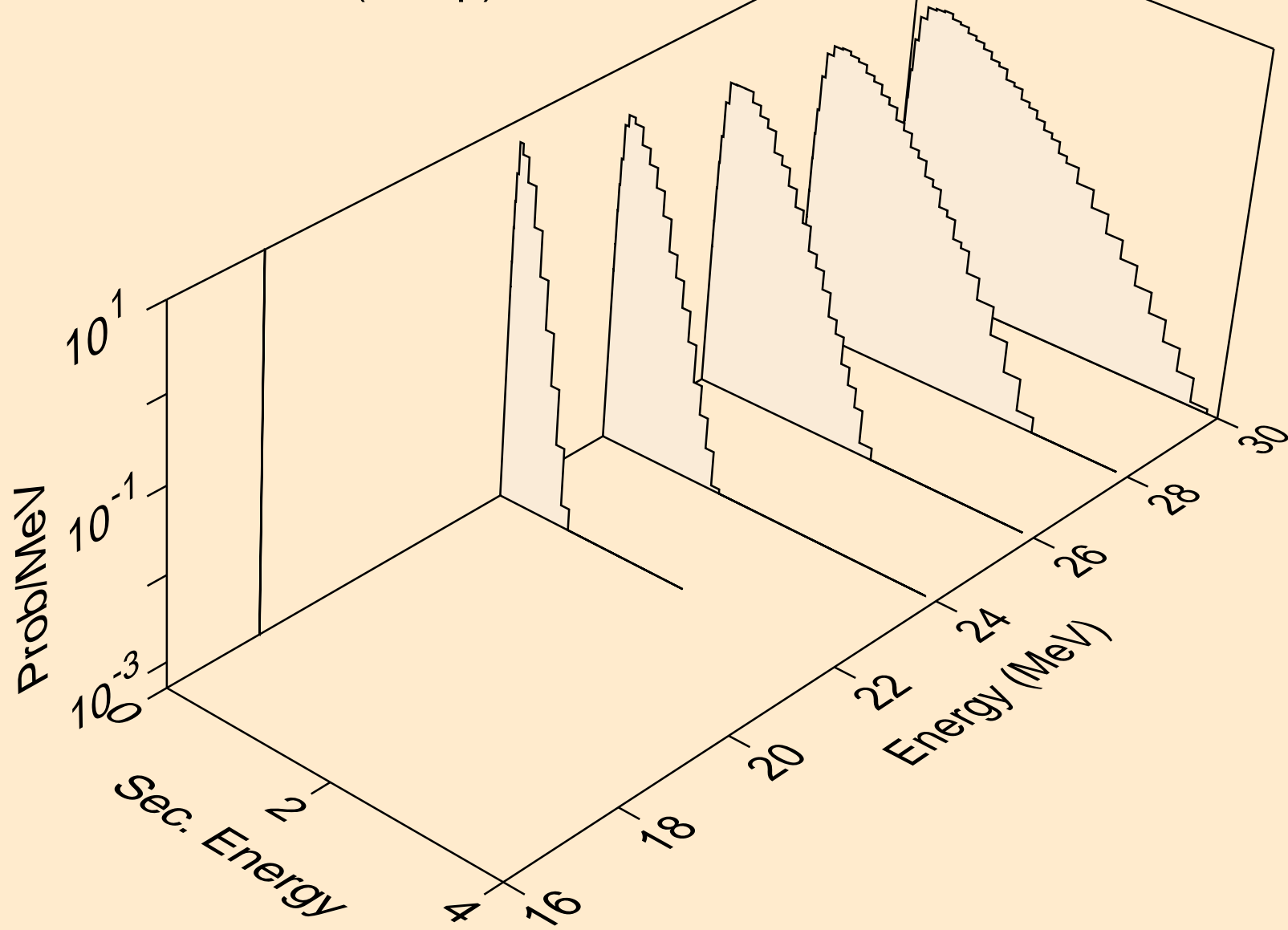

IR172M ALPHA ACER TENDL-2021 LIBRARY; T=0.K
neutrons from (a,npa)

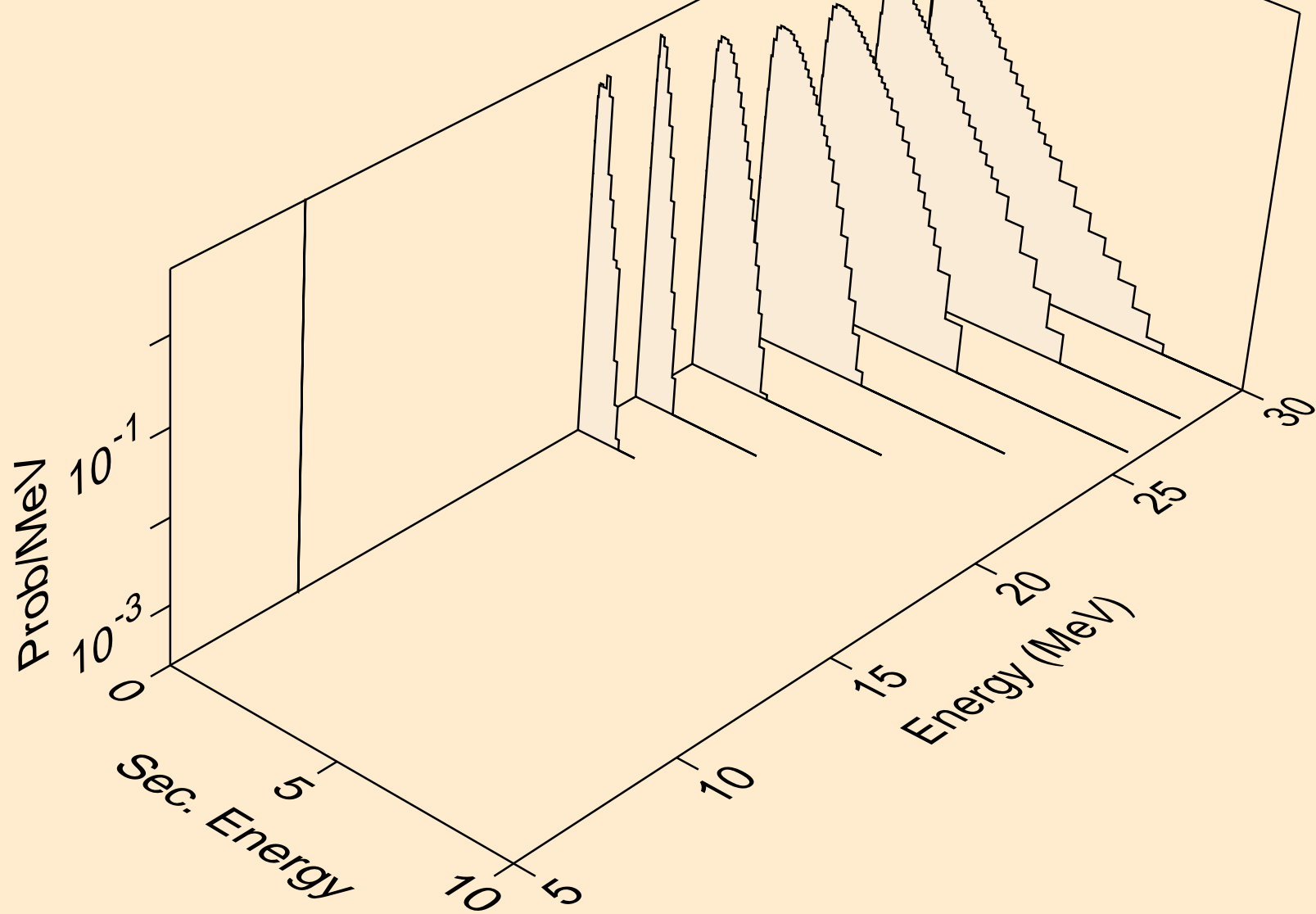

IR172M ALPHA ACER TENDL-2021 LIBRARY; T=0.K
protons from (a,x)

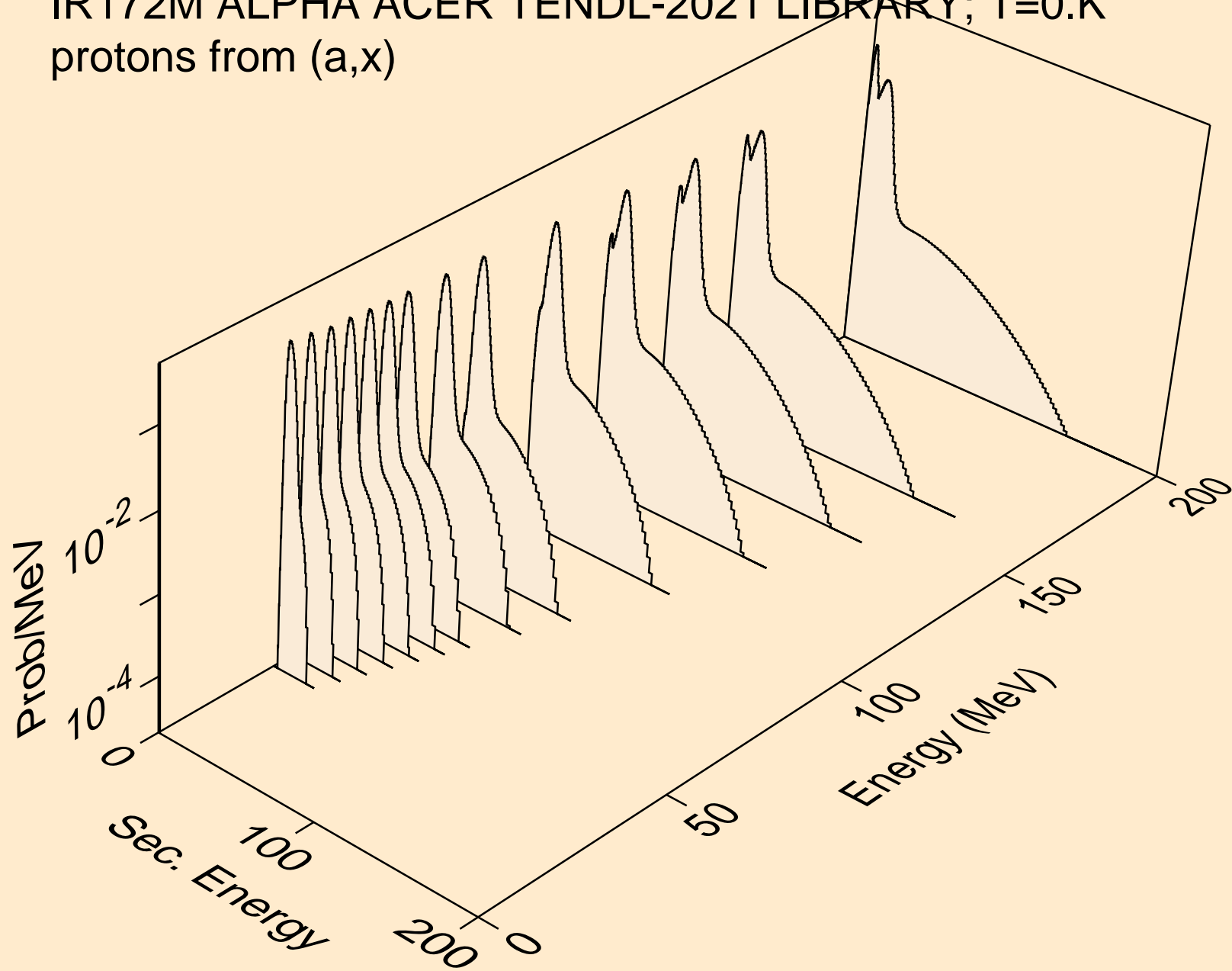

IR172M ALPHA ACER TENDL-2021 LIBRARY; T=0.K
protons from (a,n*)p

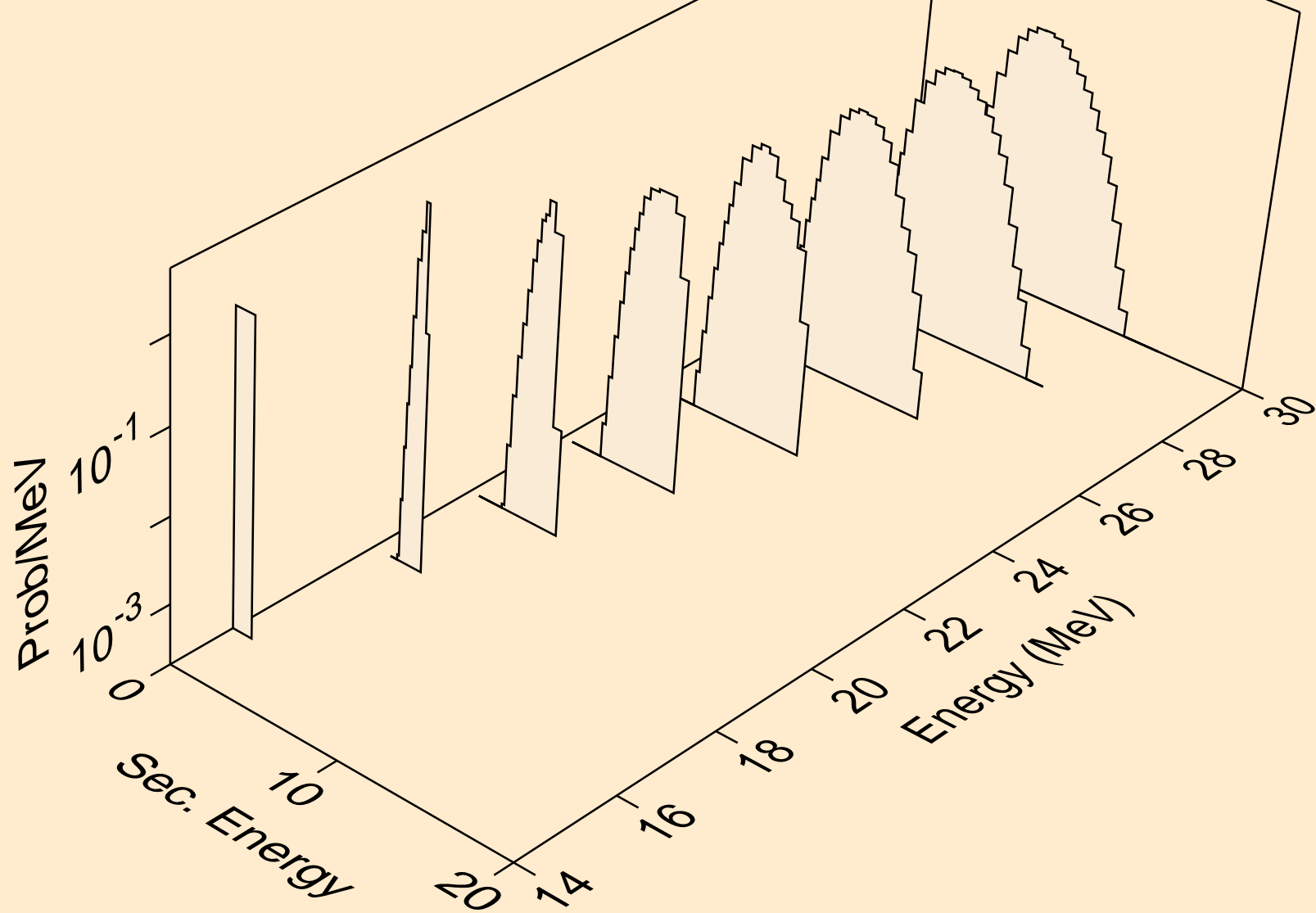

IR172M ALPHA ACER TENDL-2021 LIBRARY; T=0.K
protons from (a,2np)

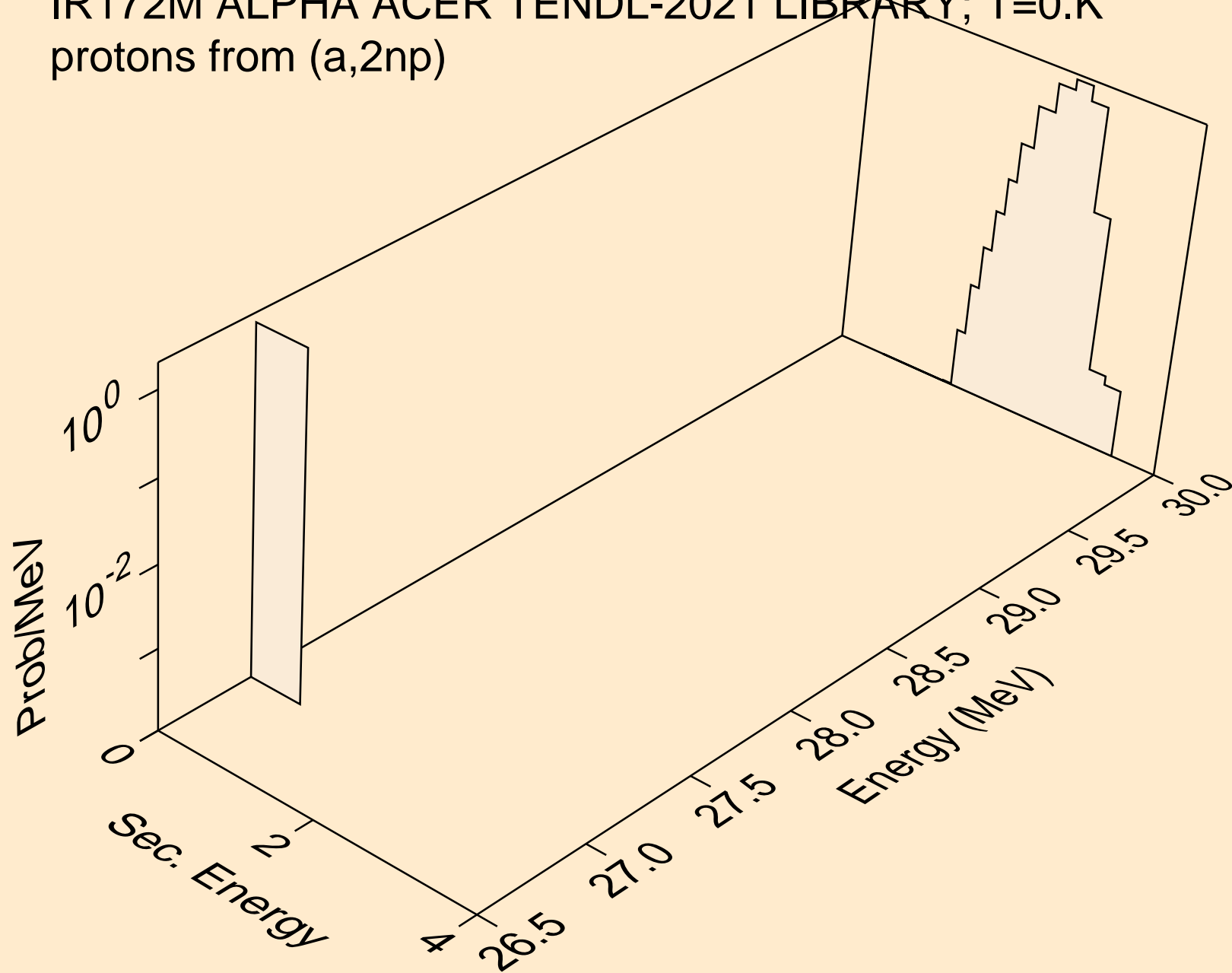

IR172M ALPHA ACER TENDL-2021 LIBRARY; T=0.K
protons from (a,2np)

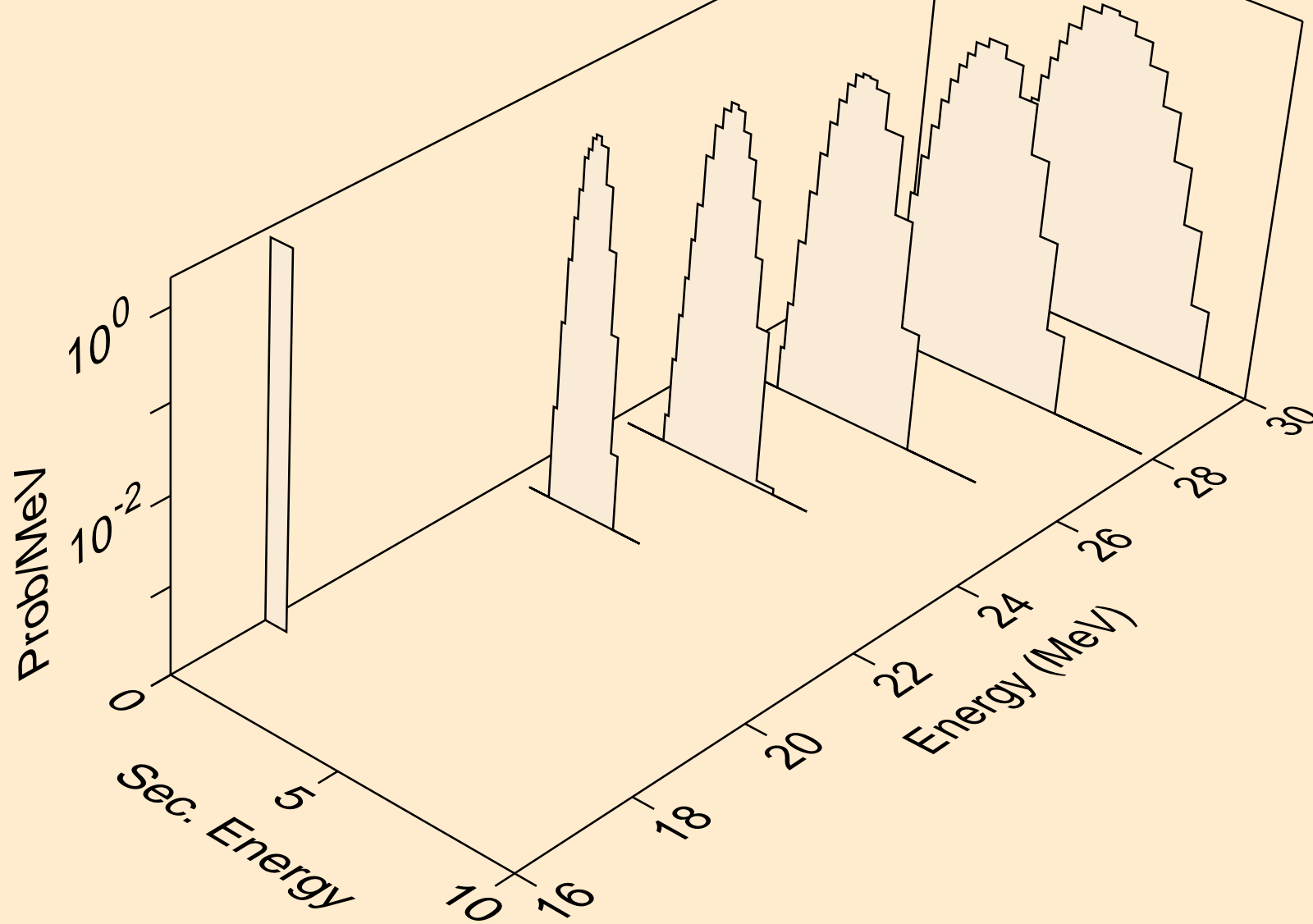

IR172M ALPHA ACER TENDL-2021 LIBRARY; T=0.K
protons from (a,npa)

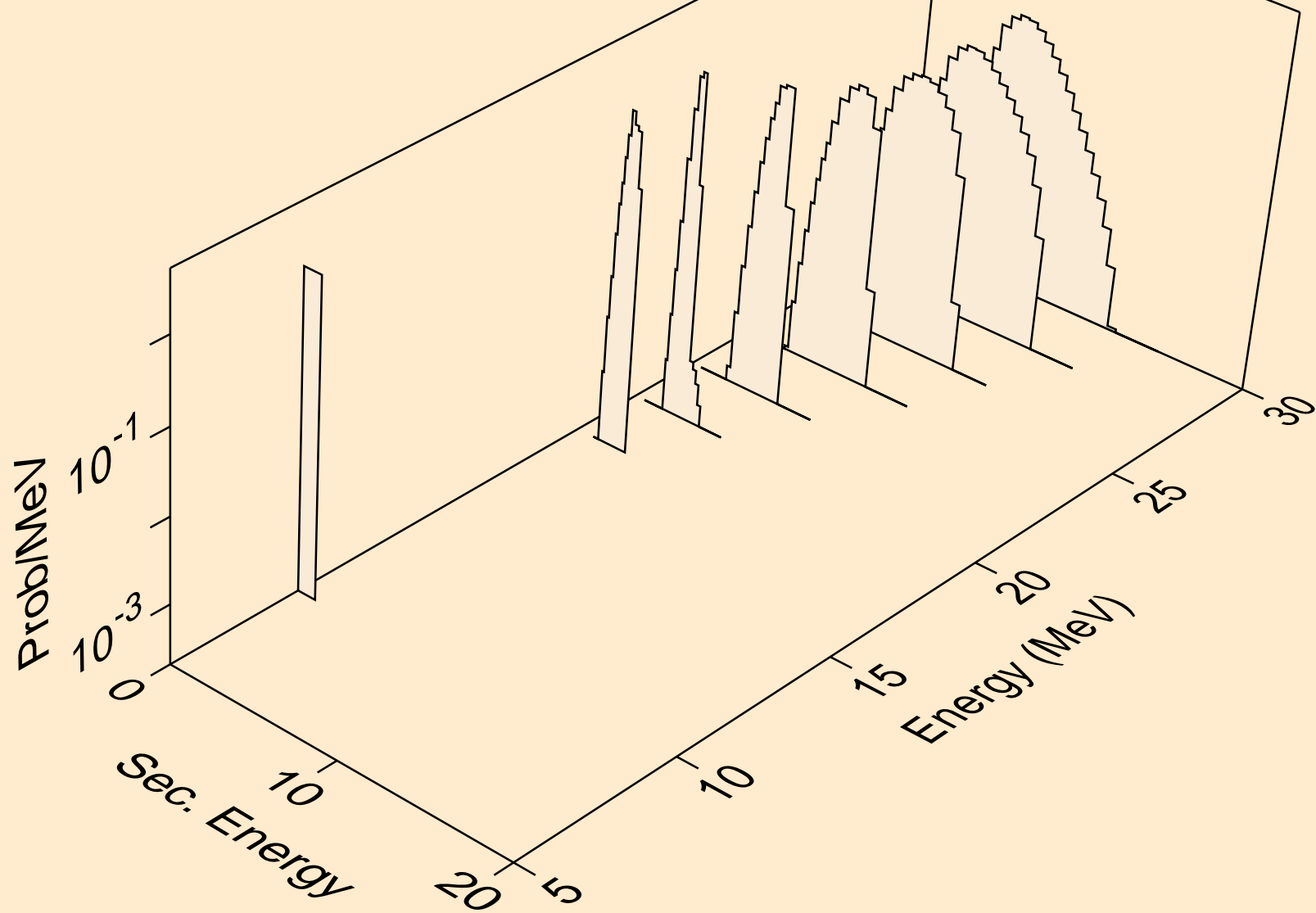

IR172M ALPHA ACER TENDL-2021 LIBRARY; T=0.K
protons from (a,p)

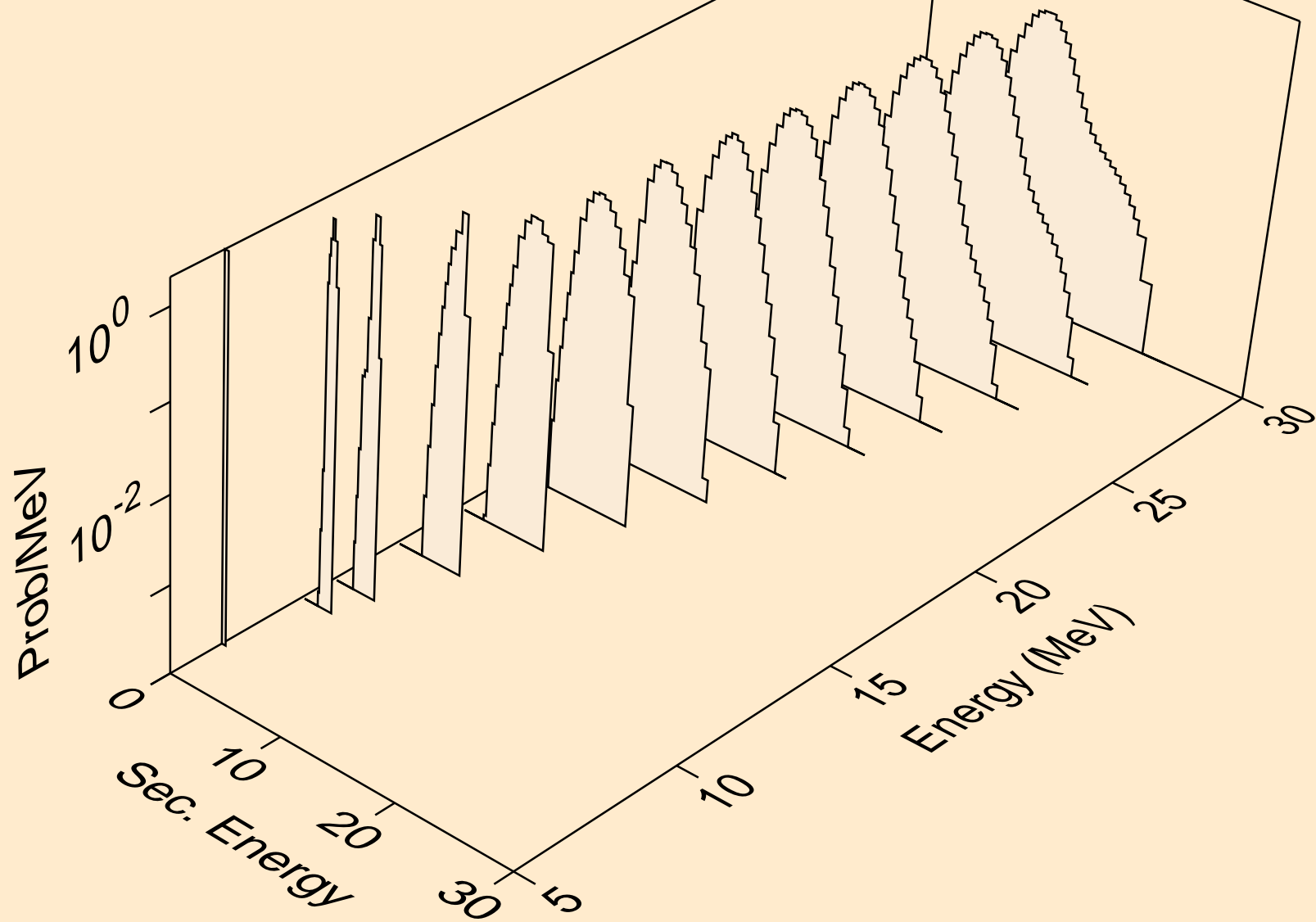

IR172M ALPHA ACER TENDL-2021 LIBRARY; T=0.K
protons from (a,2p)

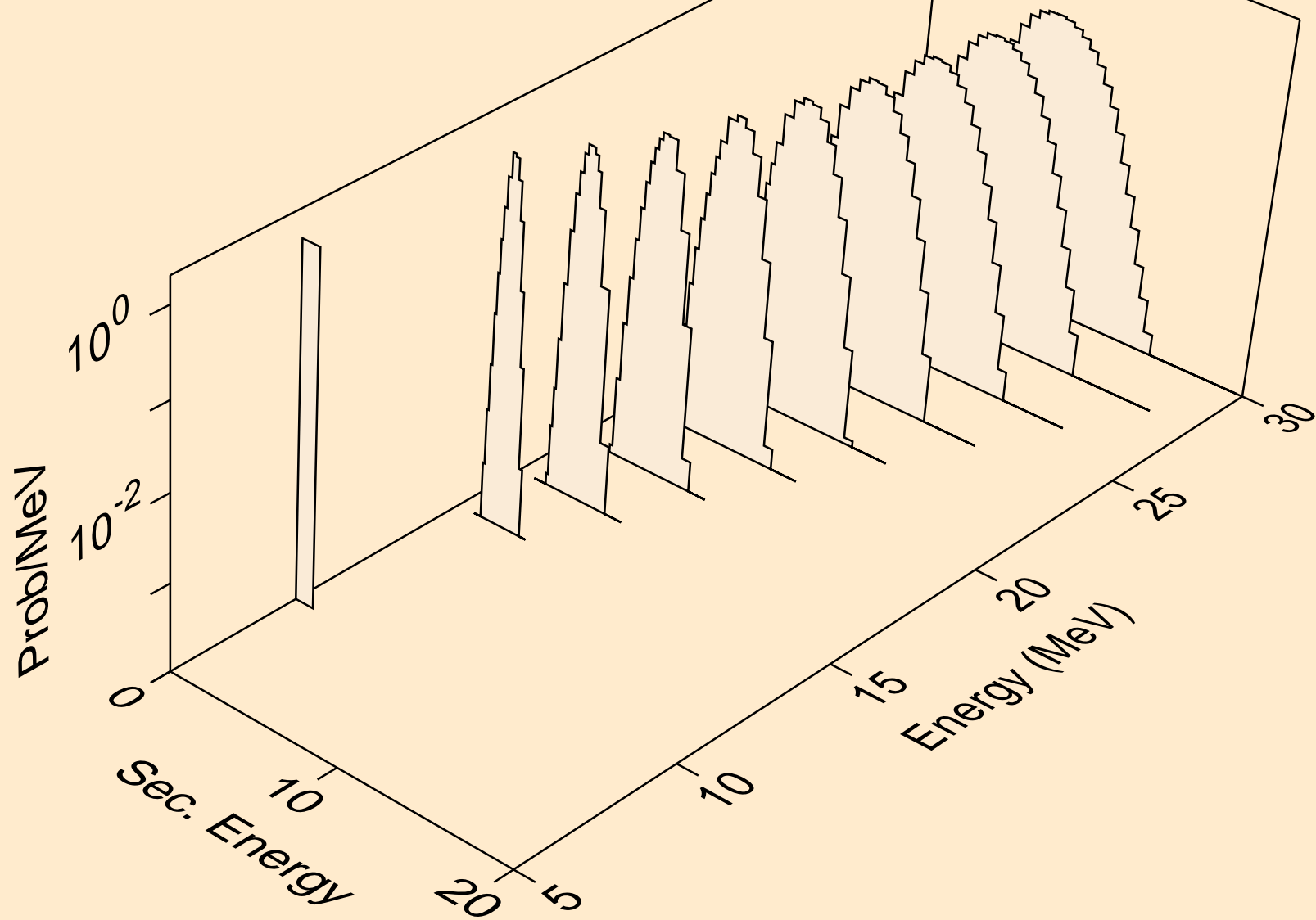

IR172M ALPHA ACER TENDL-2021 LIBRARY; T=0.K
protons from (a,pa)

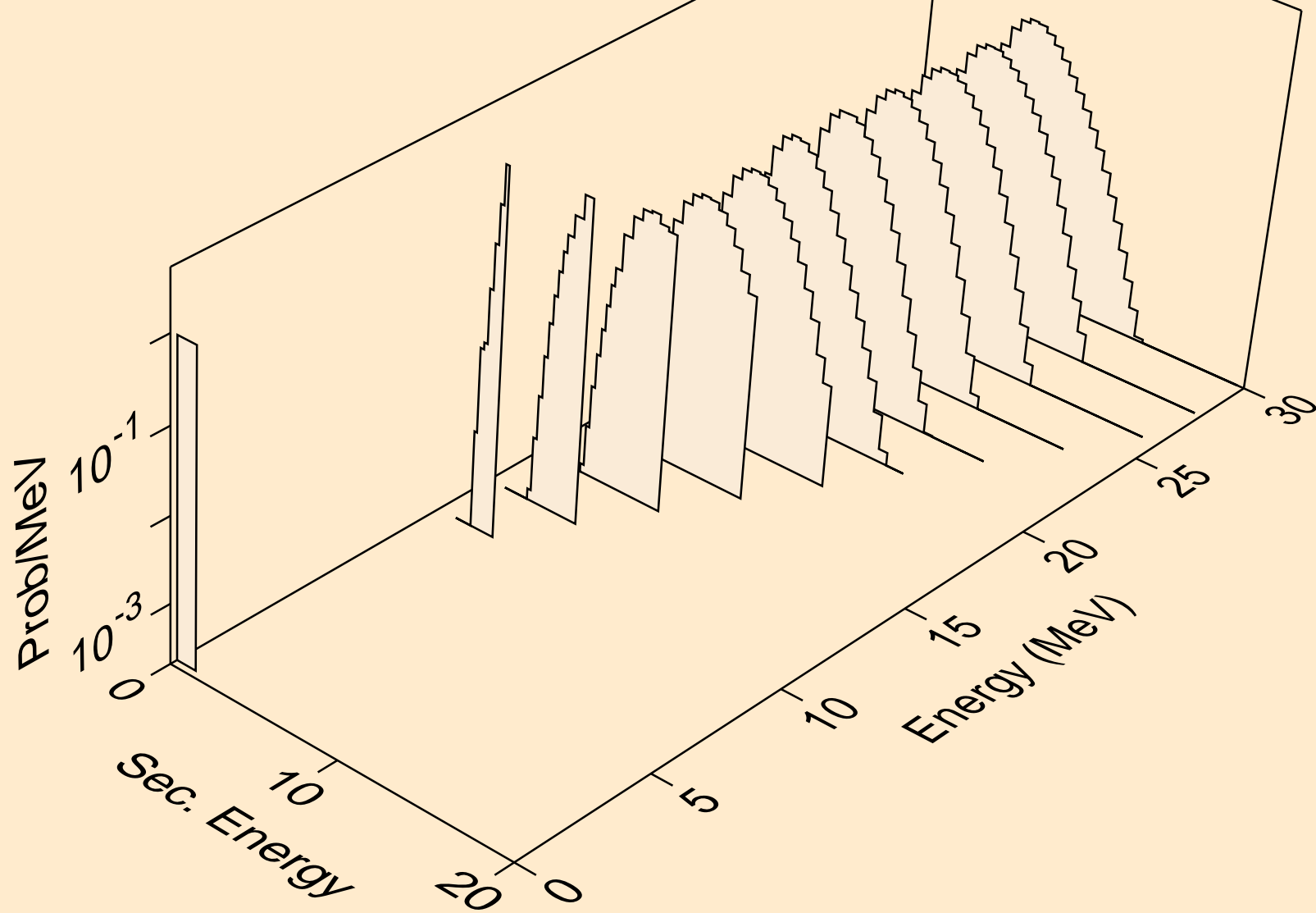

IR172M ALPHA ACER TENDL-2021 LIBRARY; T=0.K
protons from (a,pd)

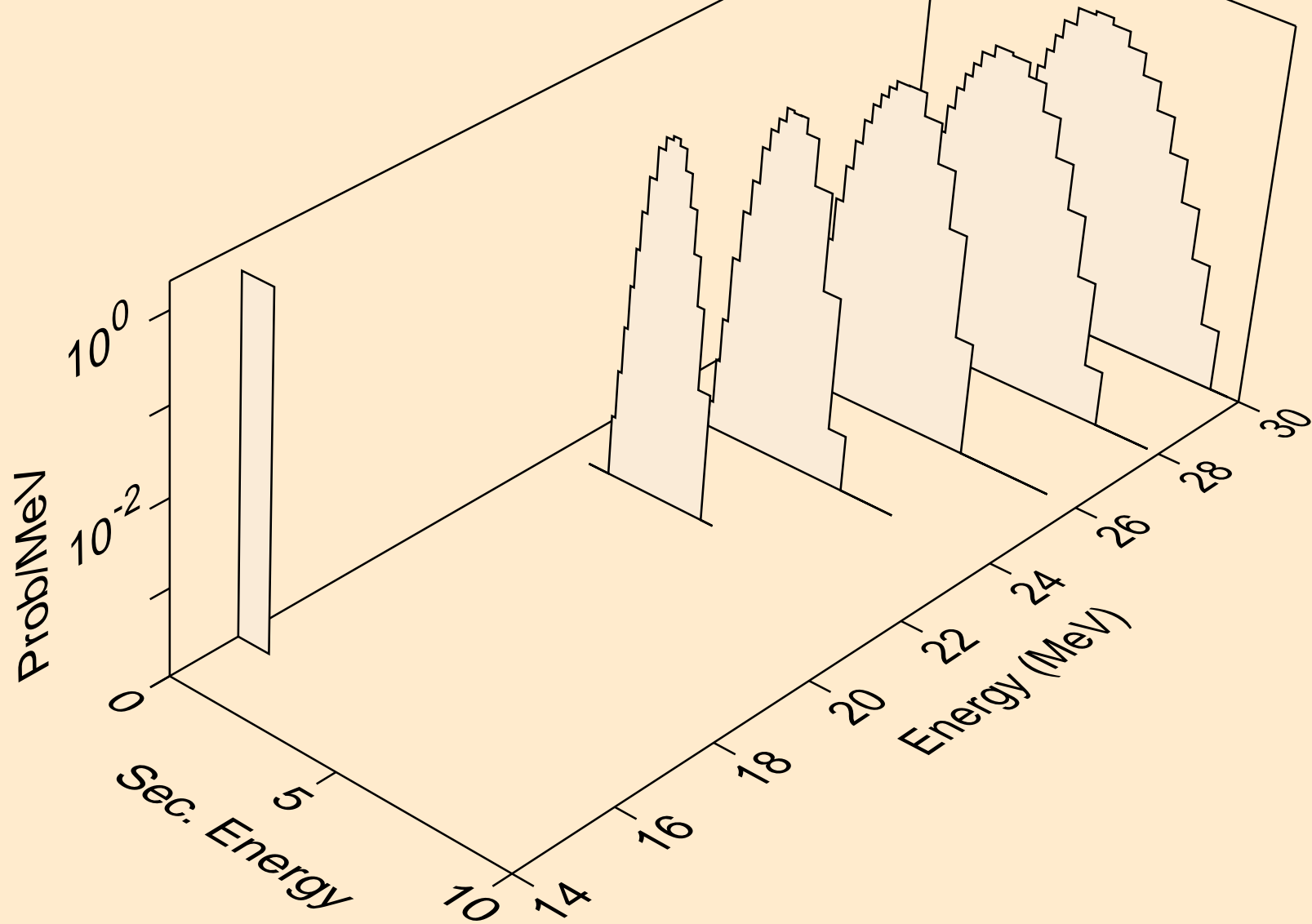

IR172M ALPHA ACER TENDL-2021 LIBRARY; T=0.K
deuterons from (a,x)

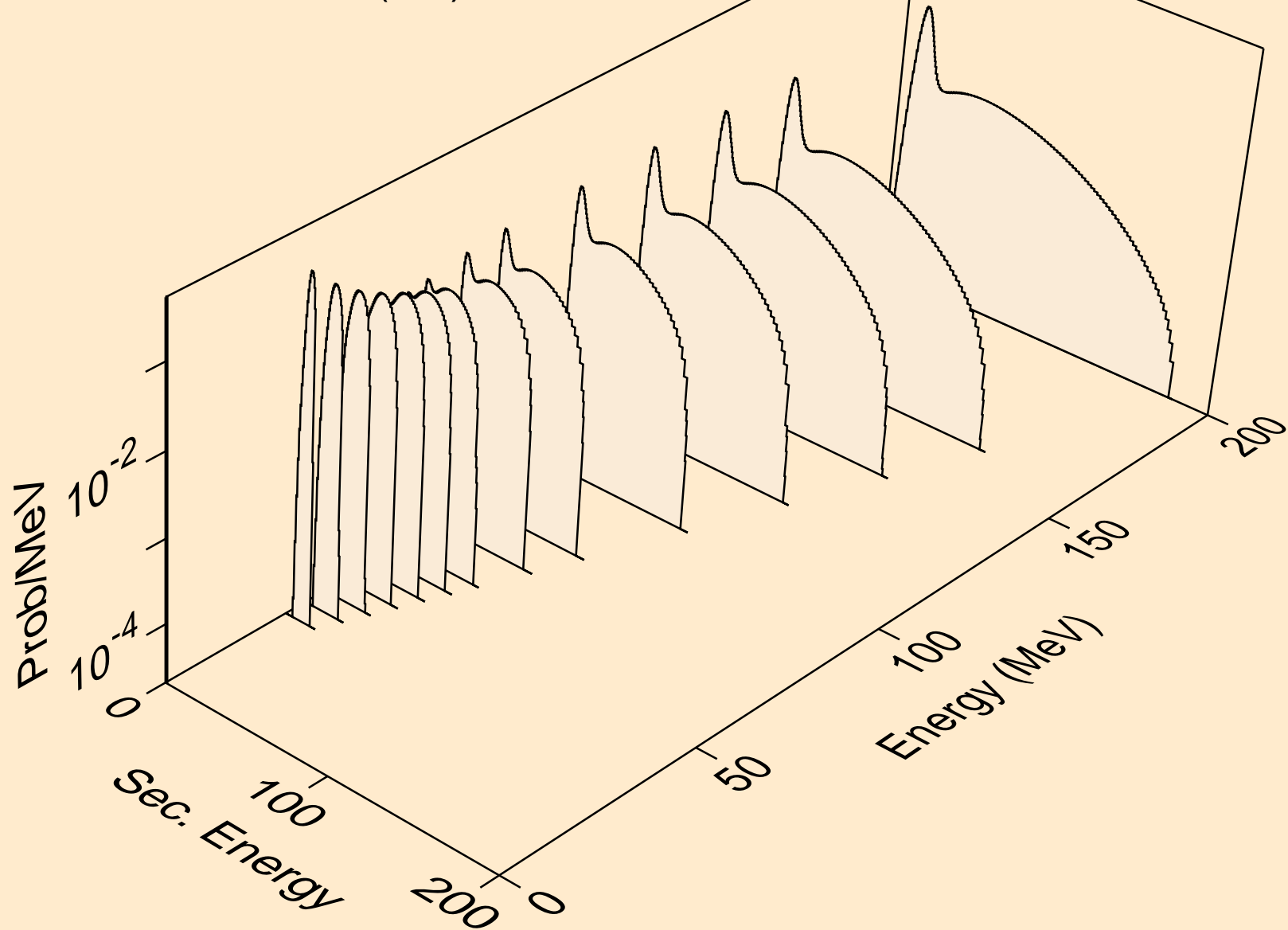

IR172M ALPHA ACER TENDL-2021 LIBRARY; T=0.K
deuterons from (a,d)

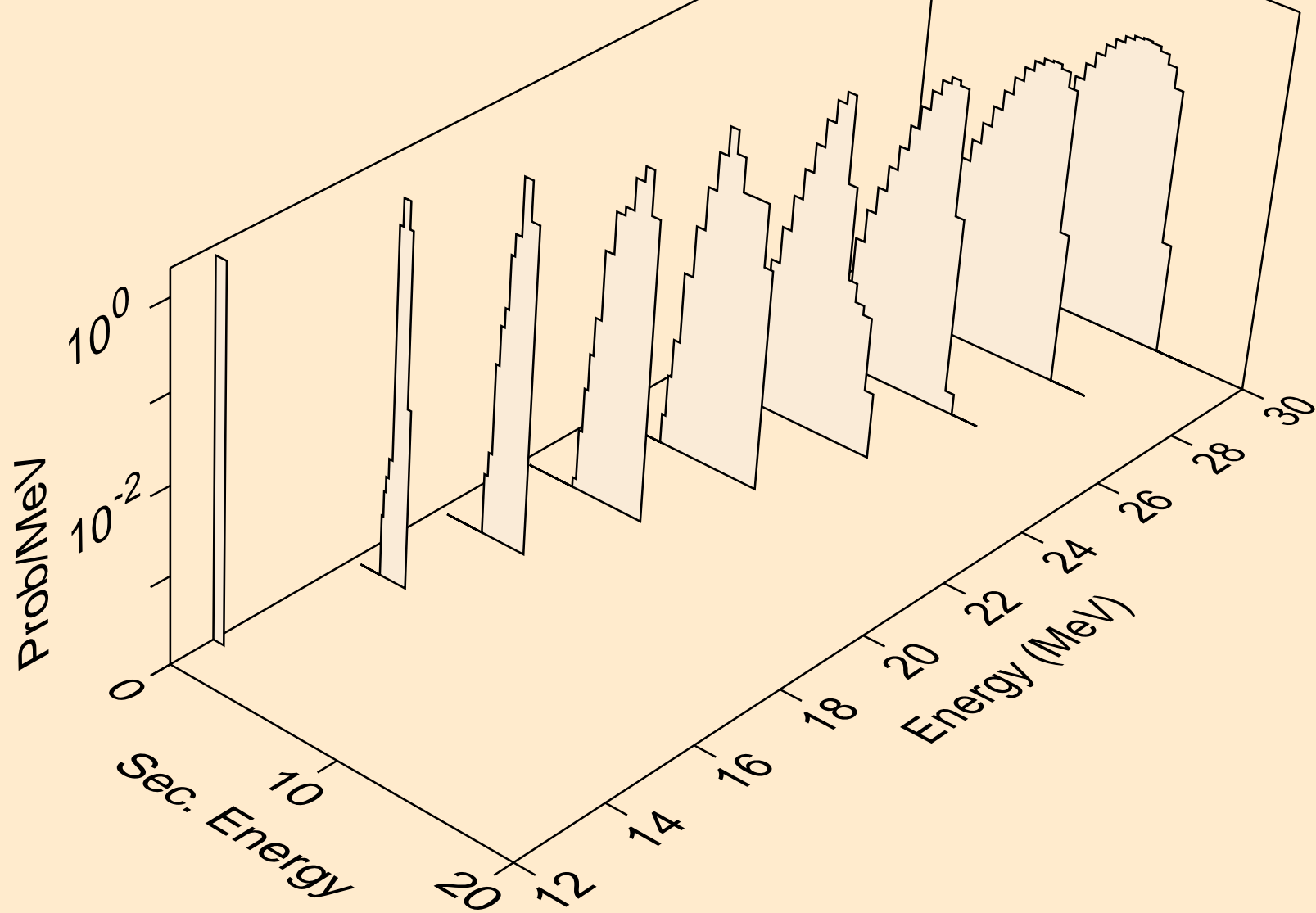

IR172M ALPHA ACER TENDL-2021 LIBRARY; T=0.K
deuterons from (a,pd)

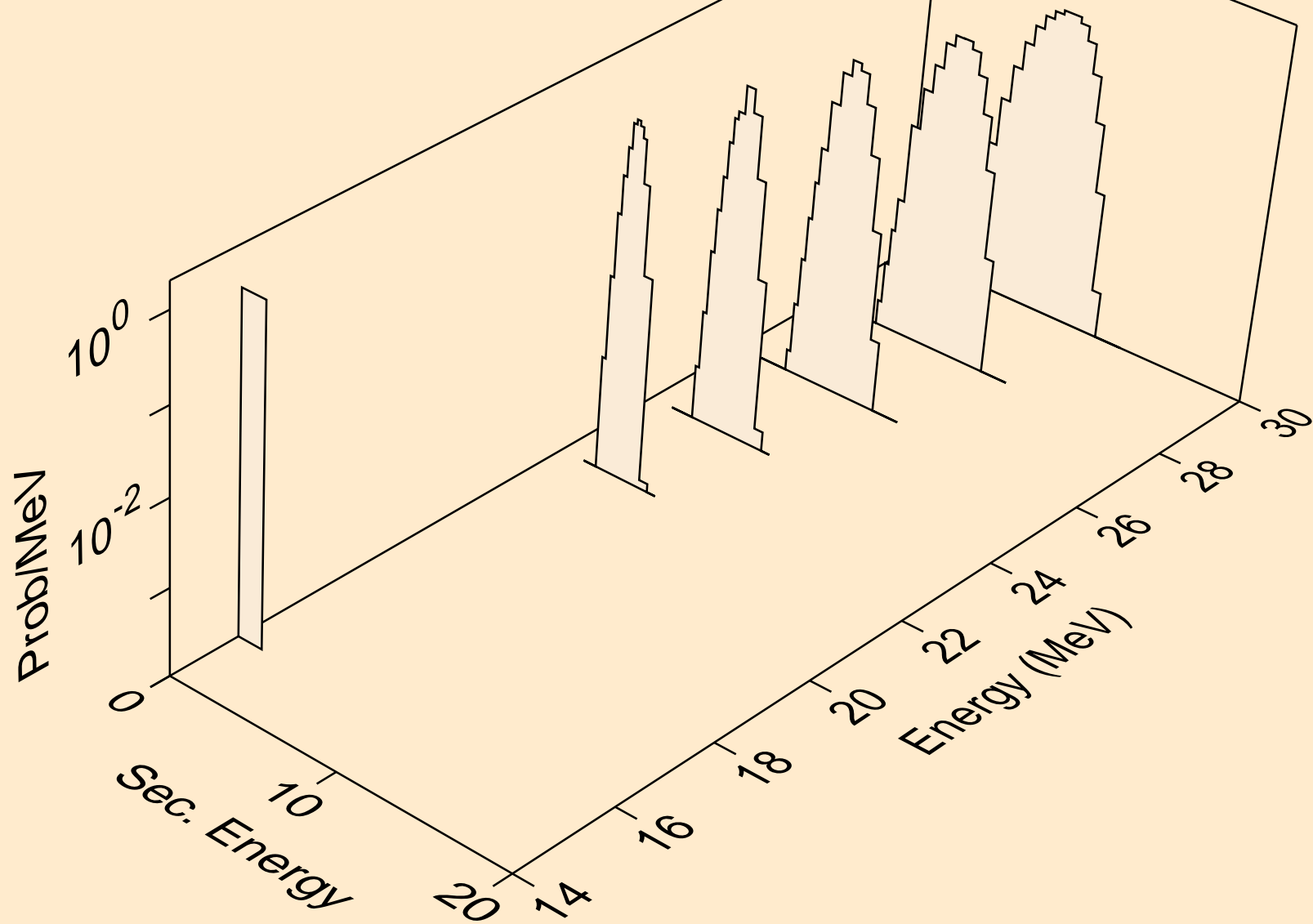

IR172M ALPHA ACER TENDL-2021 LIBRARY; T=0.K
deuterons from (a,da)

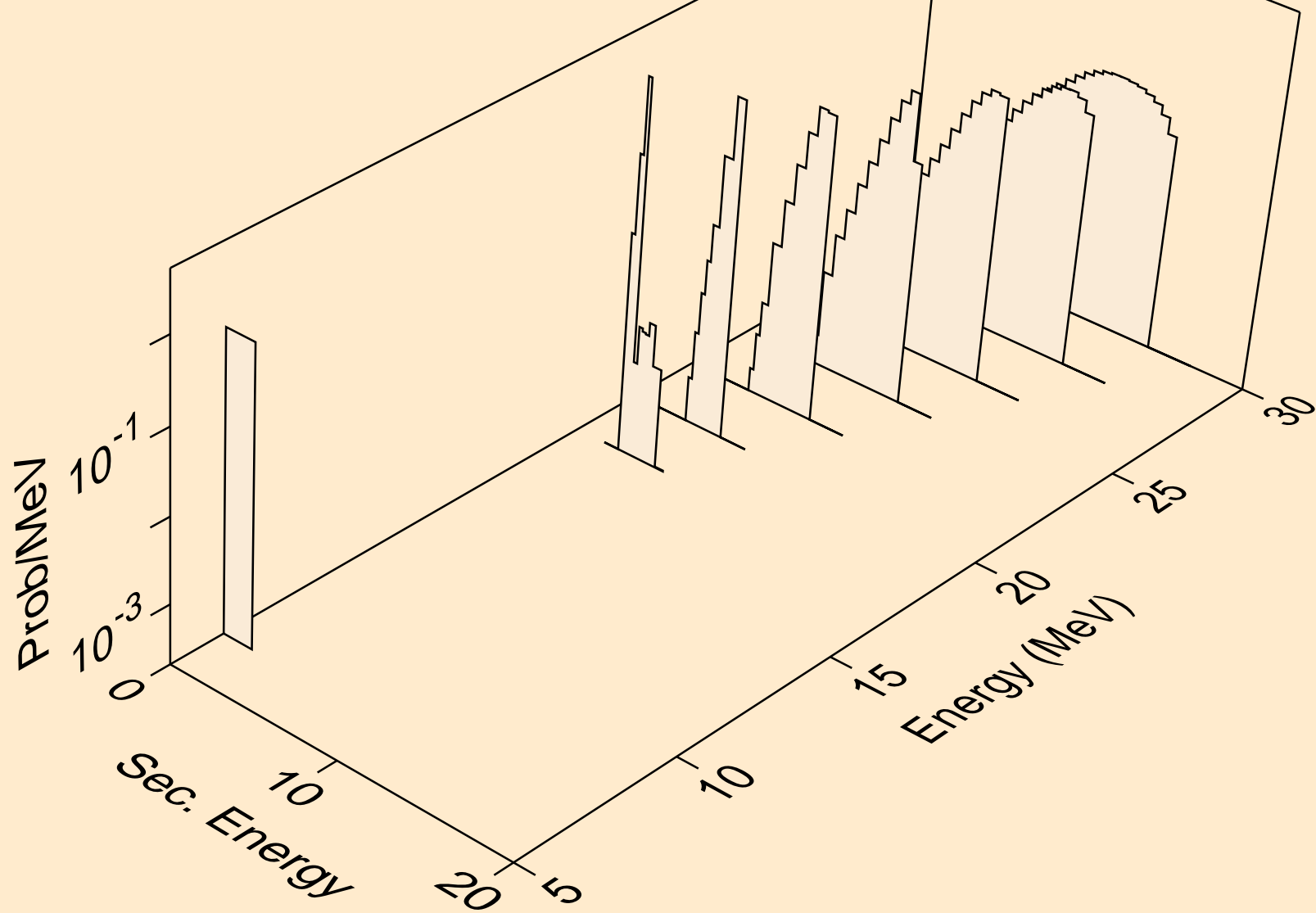

IR172M ALPHA ACER TENDL-2021 LIBRARY; T=0.K
tritons from (a,x)

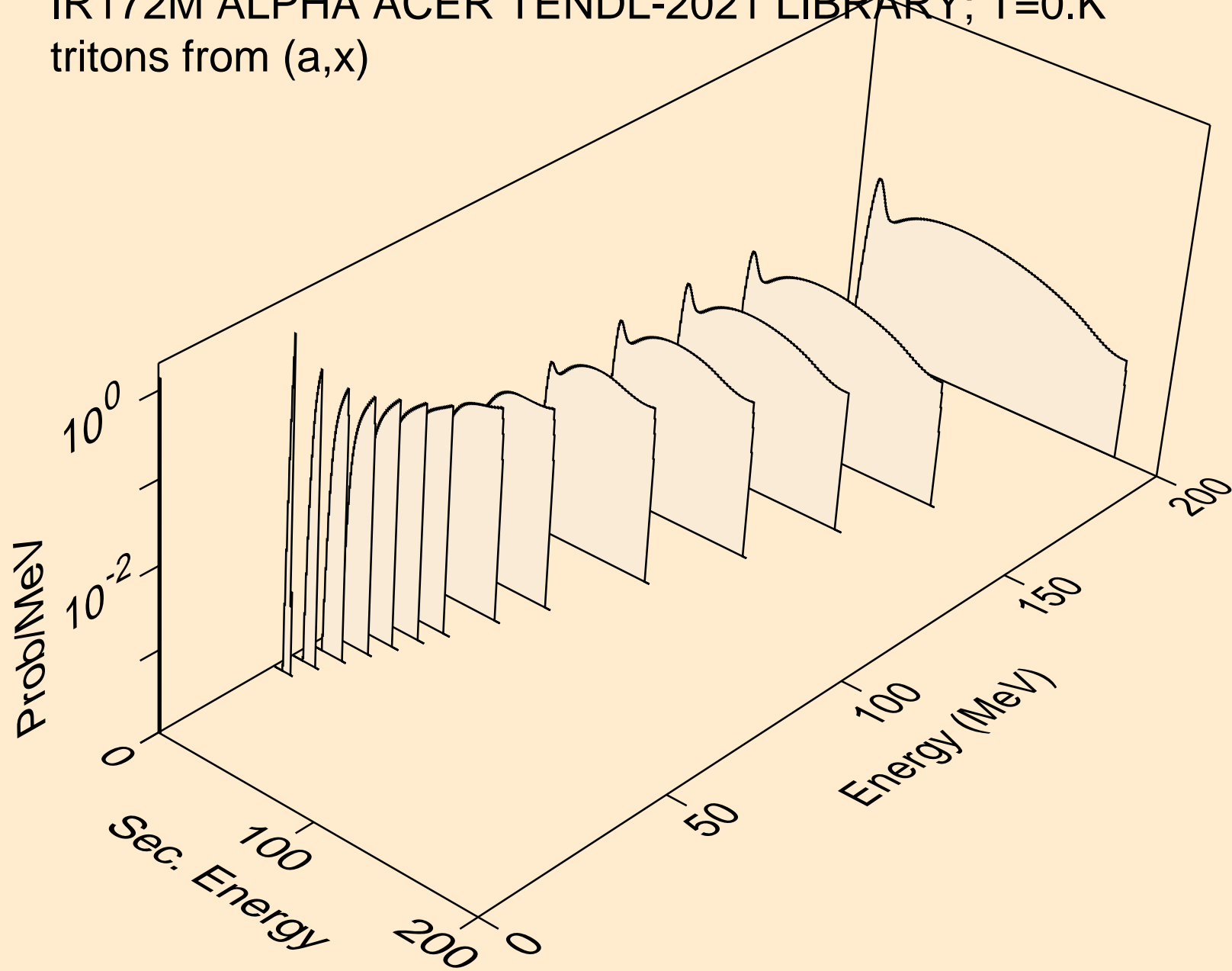

IR172M ALPHA ACER TENDL-2021 LIBRARY; T=0.K
tritons from (a,t)

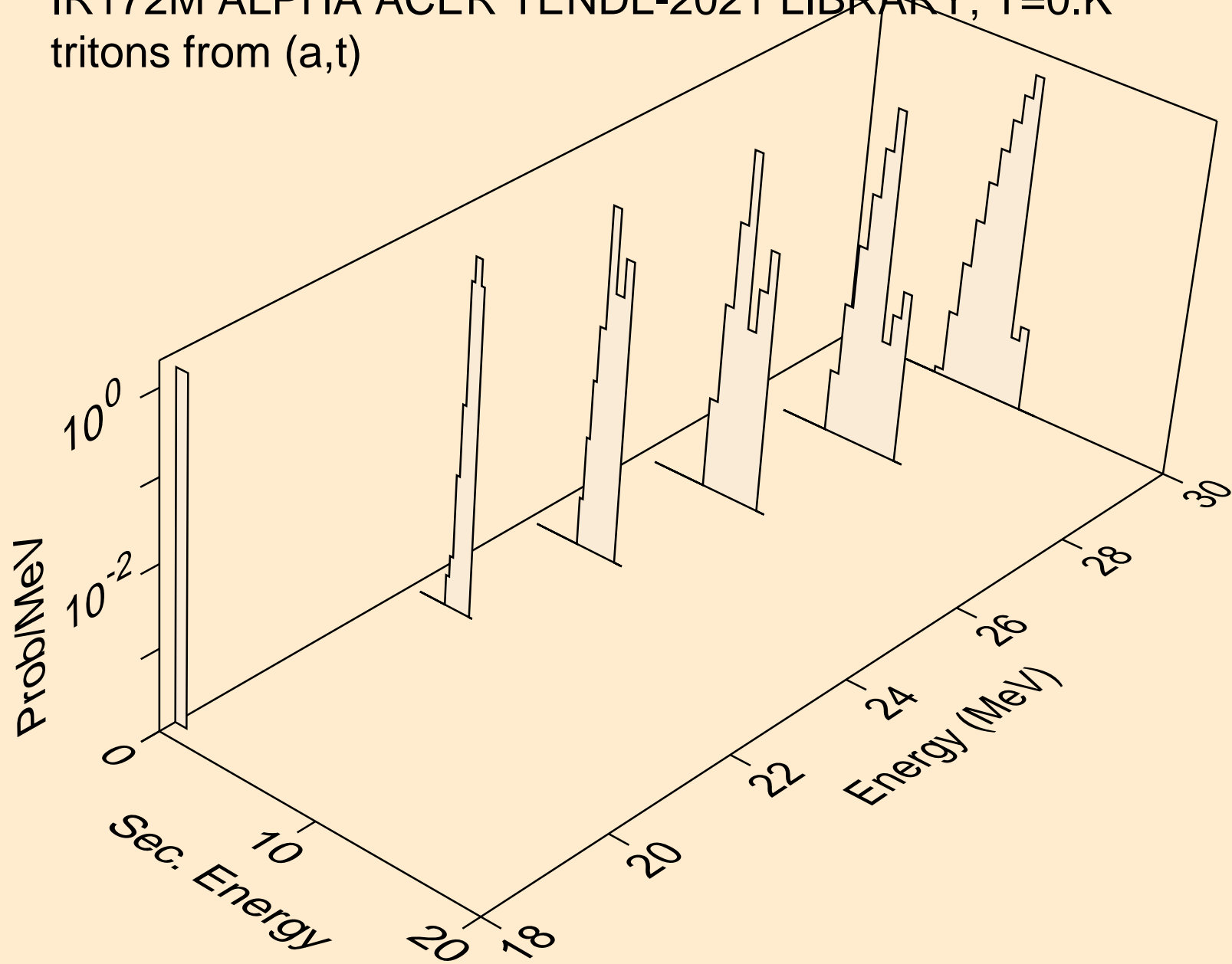

IR172M ALPHA ACER TENDL-2021 LIBRARY; T=0.K
he3s from (a,x)

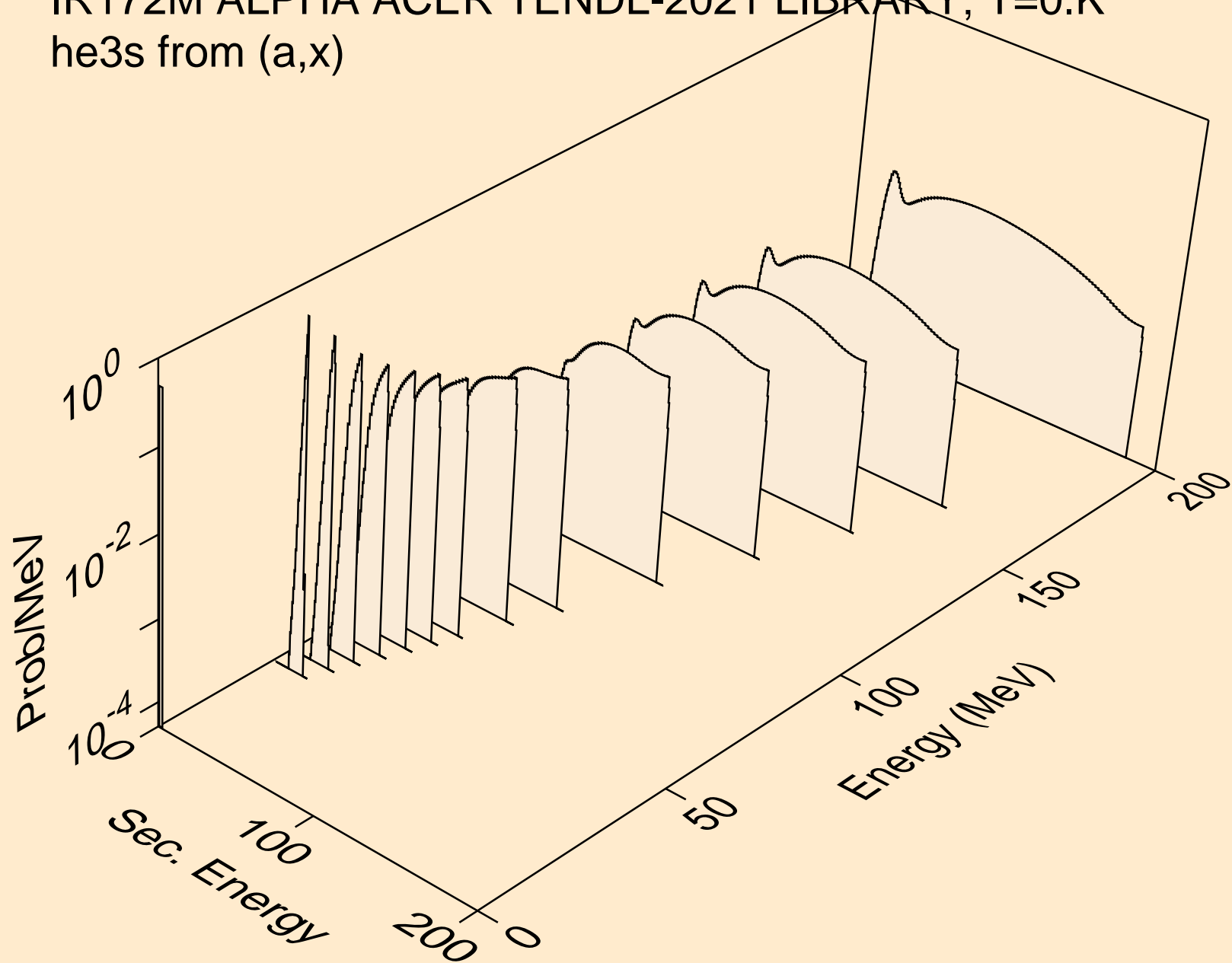

IR172M ALPHA ACER TENDL-2021 LIBRARY; T=0.K
he3s from (a,he3)

