

LA119 ALPHA ACER TENDL-2021 LIBRARY; T=0.K

Principal cross sections

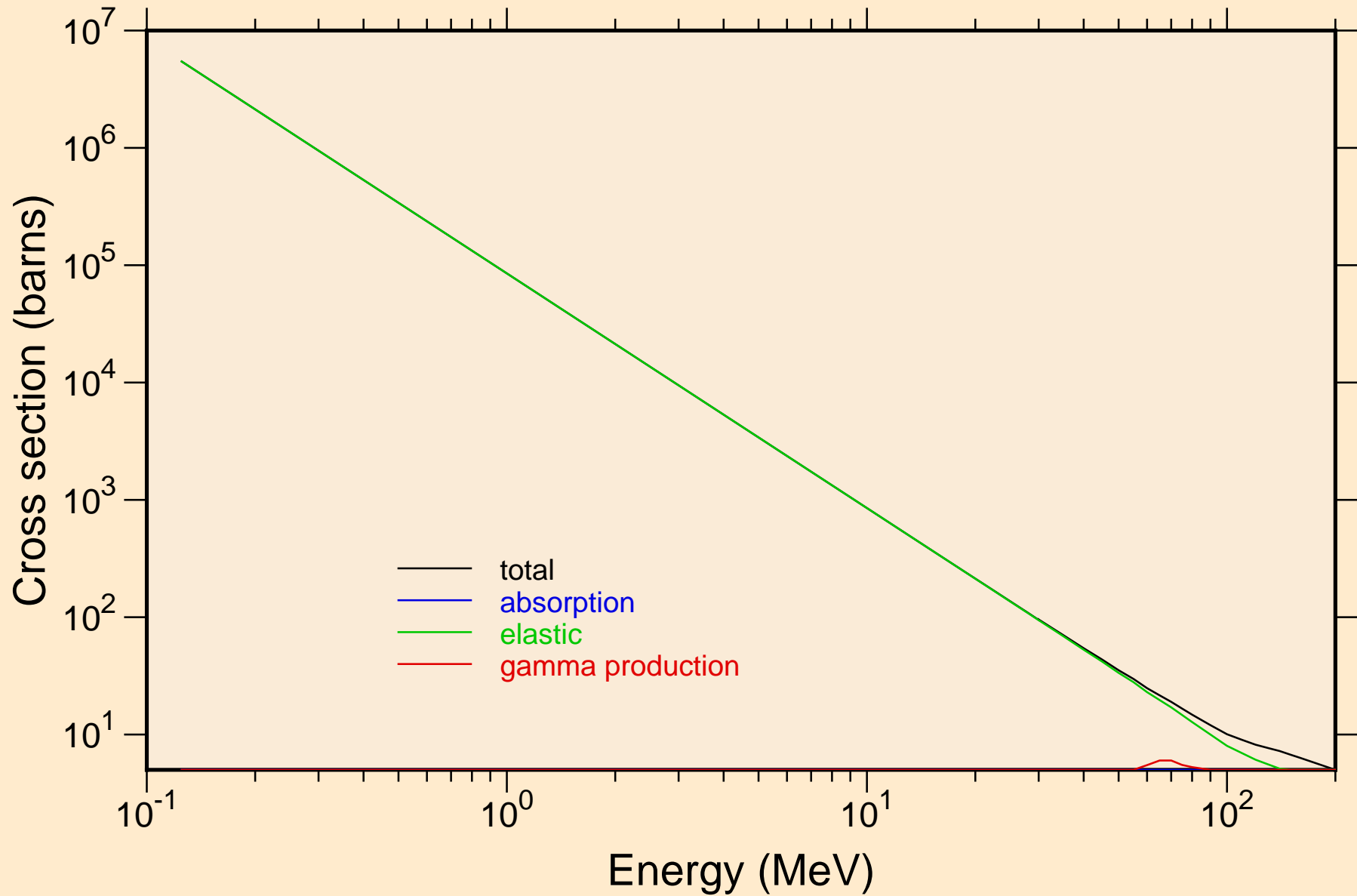

LA119 ALPHA ACER TENDL-2021 LIBRARY; T=0.K

Heating

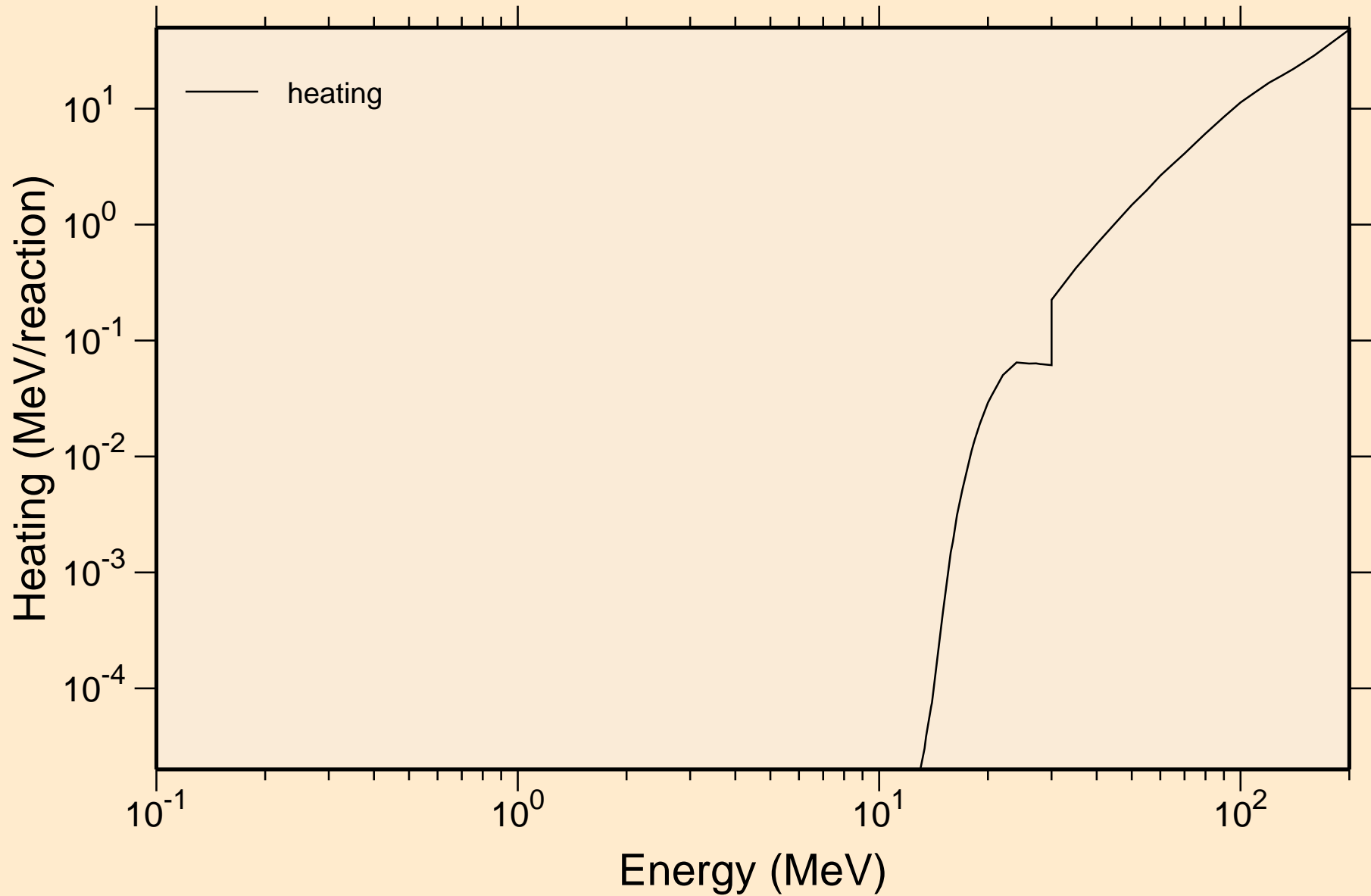

LA119 ALPHA ACER TENDL-2021 LIBRARY; T=0.K

Principal cross sections

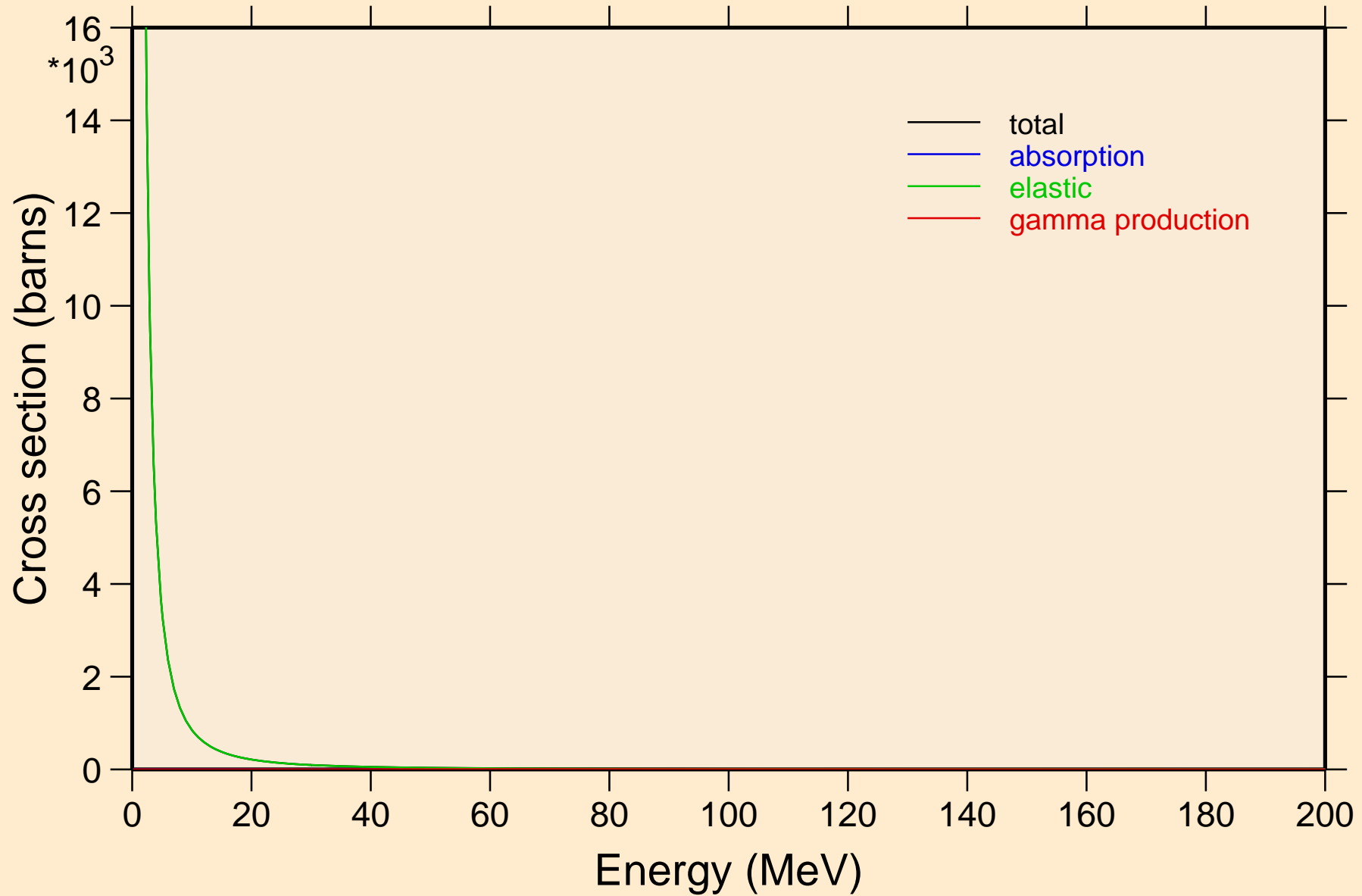

LA119 ALPHA ACER TENDL-2021 LIBRARY; T=0.K

Heating

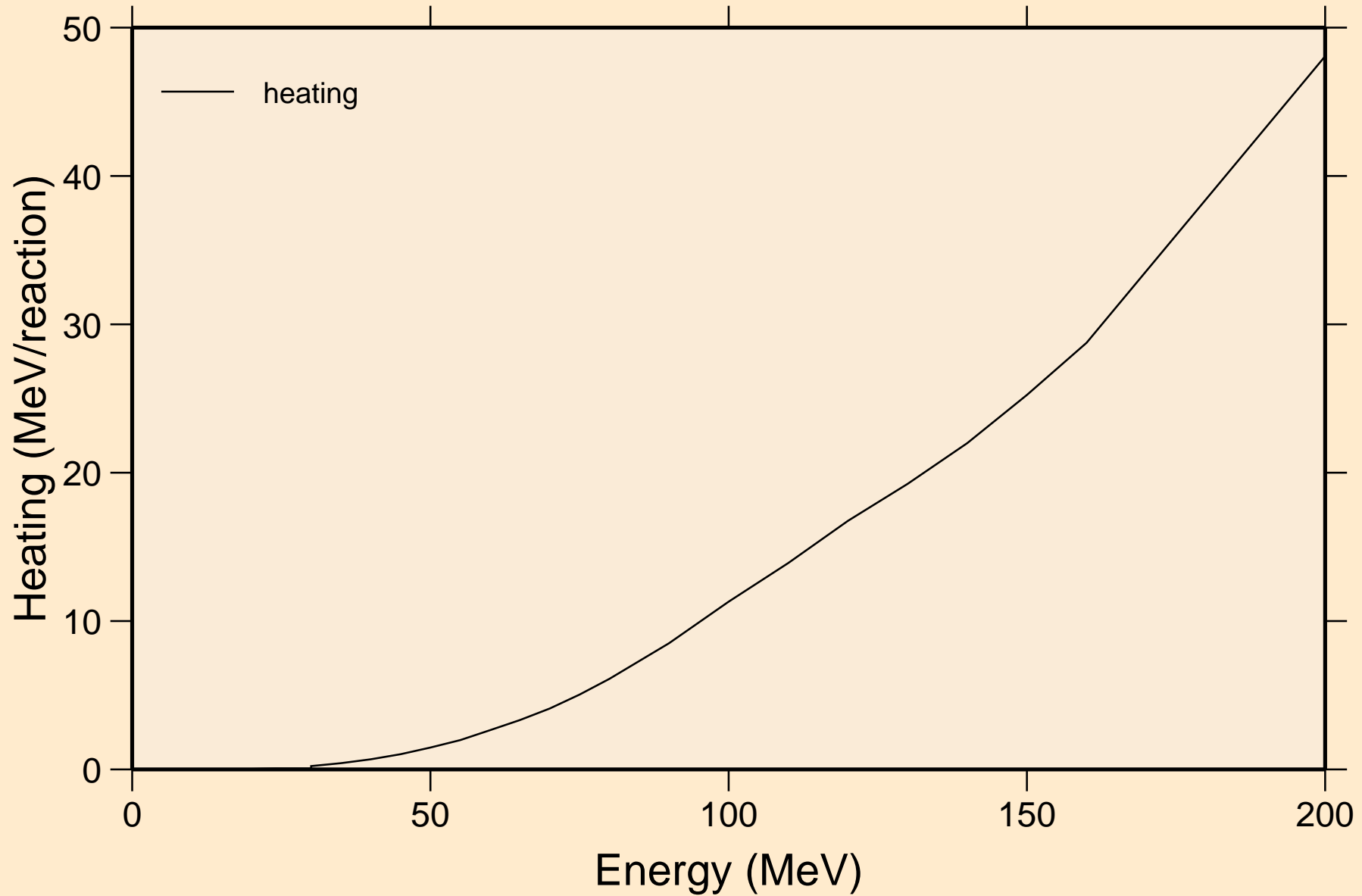

LA119 ALPHA ACER TENDL-2021 LIBRARY; T=0.K
Threshold reactions

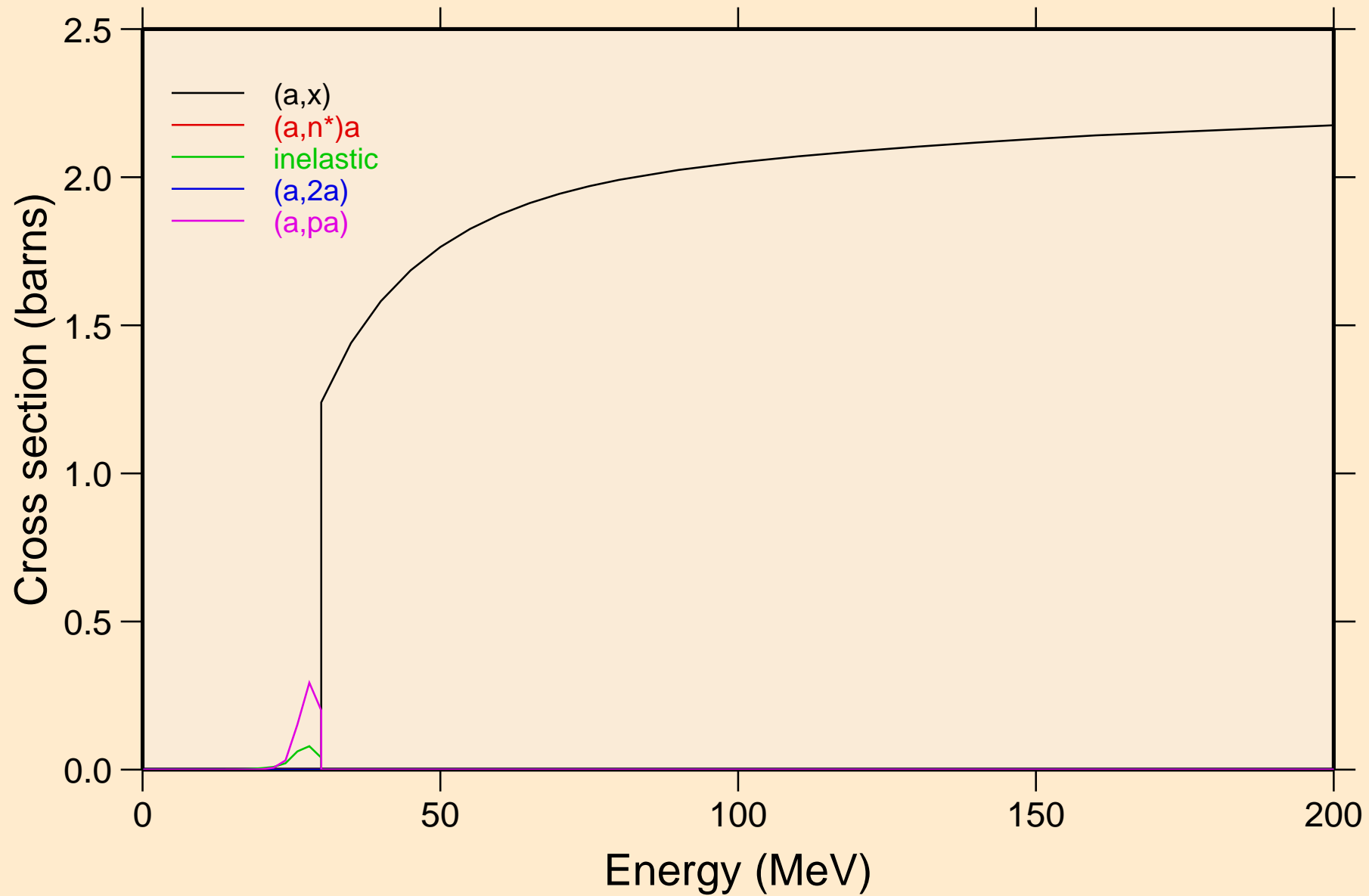

LA119 ALPHA ACER TENDL-2021 LIBRARY; T=0.K
Threshold reactions

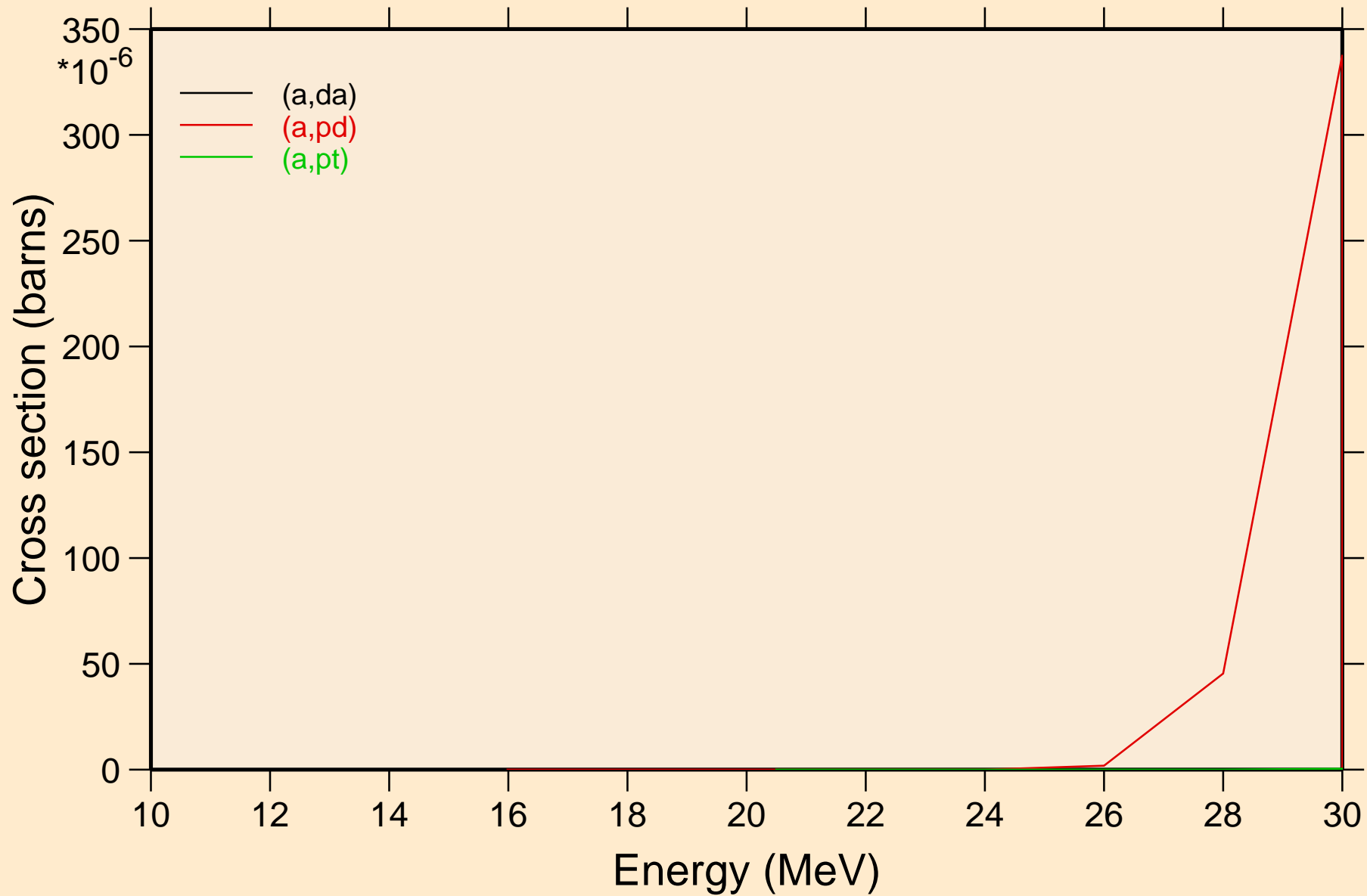

LA119 ALPHA ACER TENDL-2021 LIBRARY; T=0.K
Threshold reactions

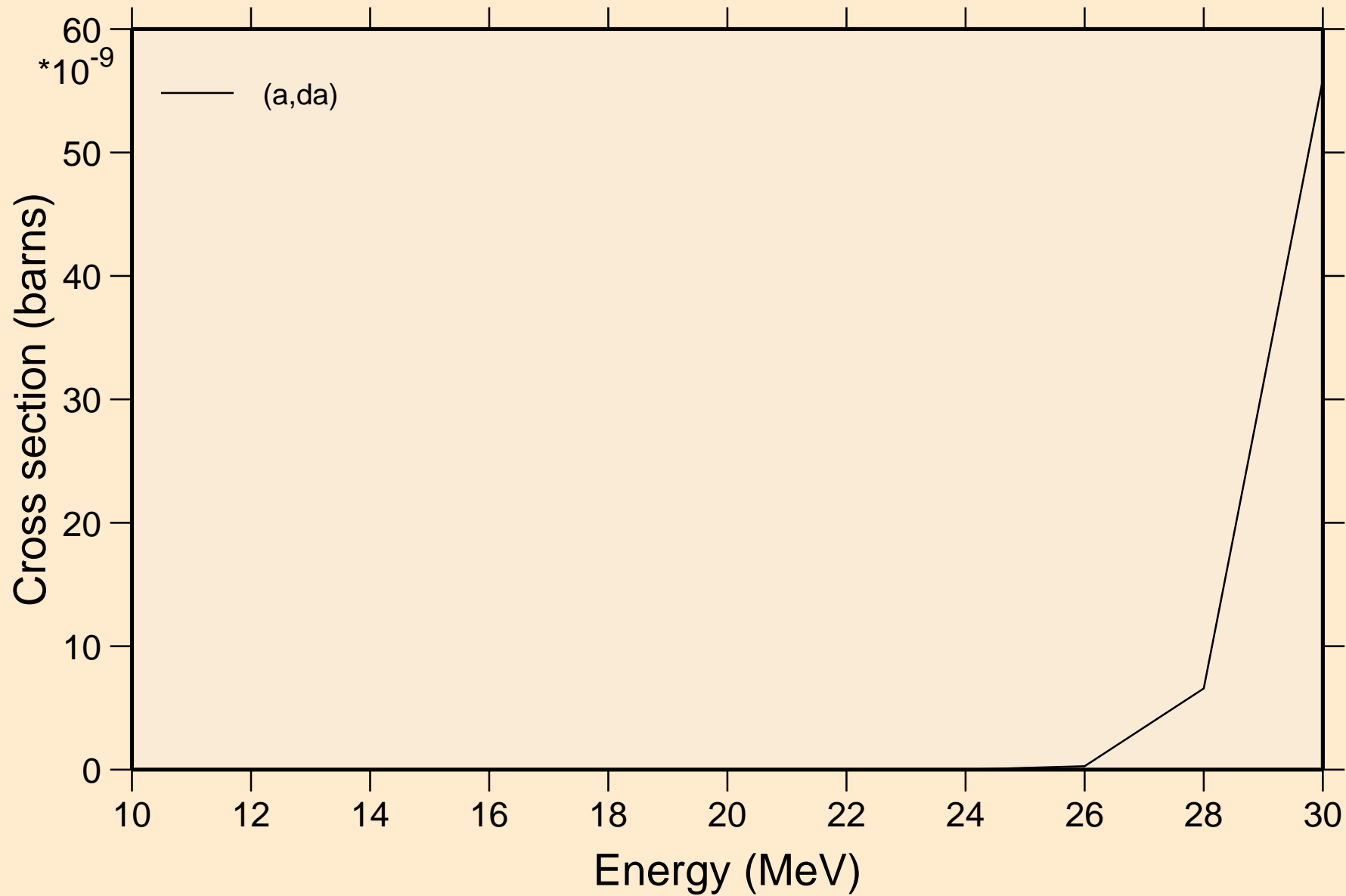

LA119 ALPHA ACER TENDL-2021 LIBRARY; T=0.K
angular distribution for elastic

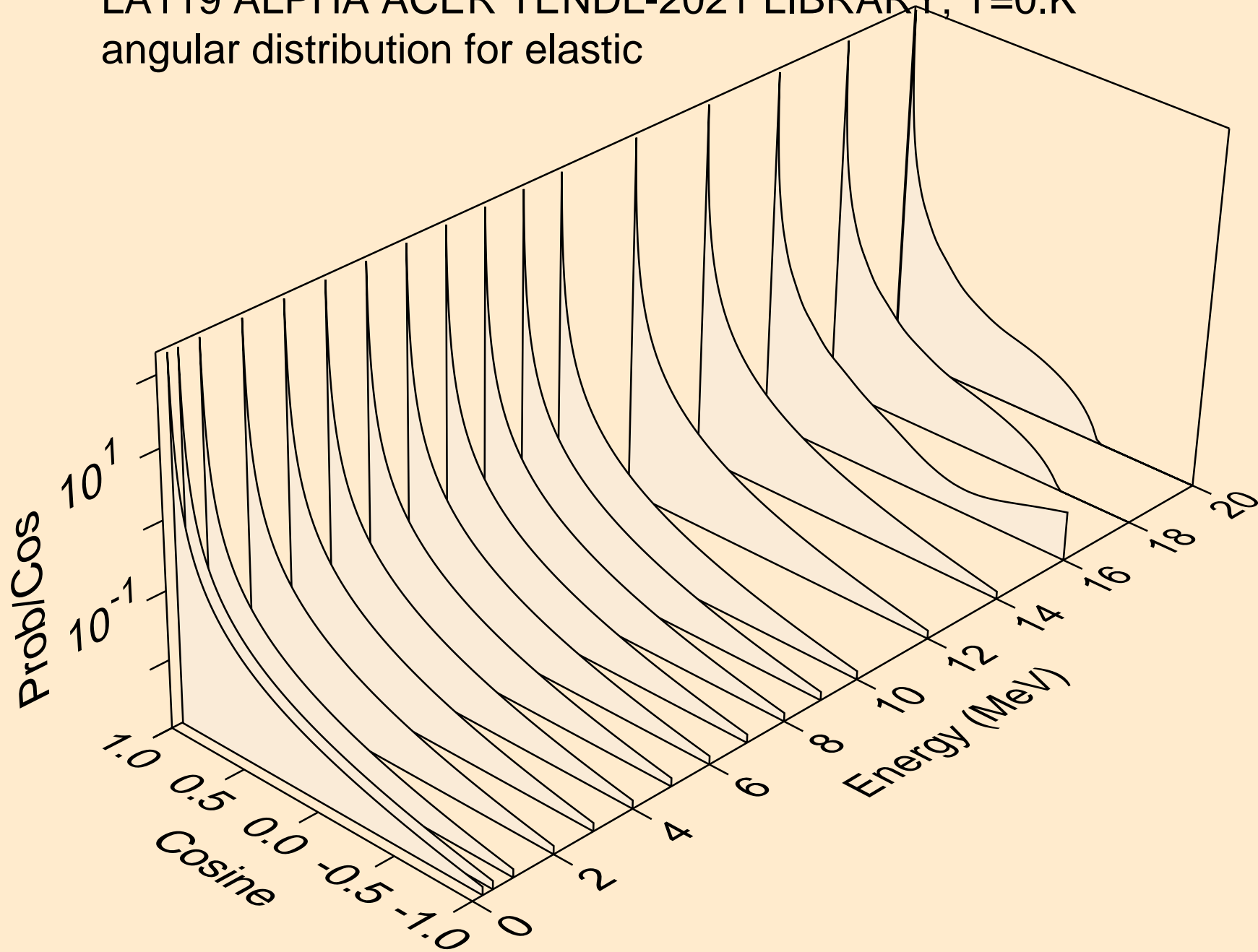

LA119 ALPHA ACER TENDL-2021 LIBRARY; T=0.K
angular distribution for elastic

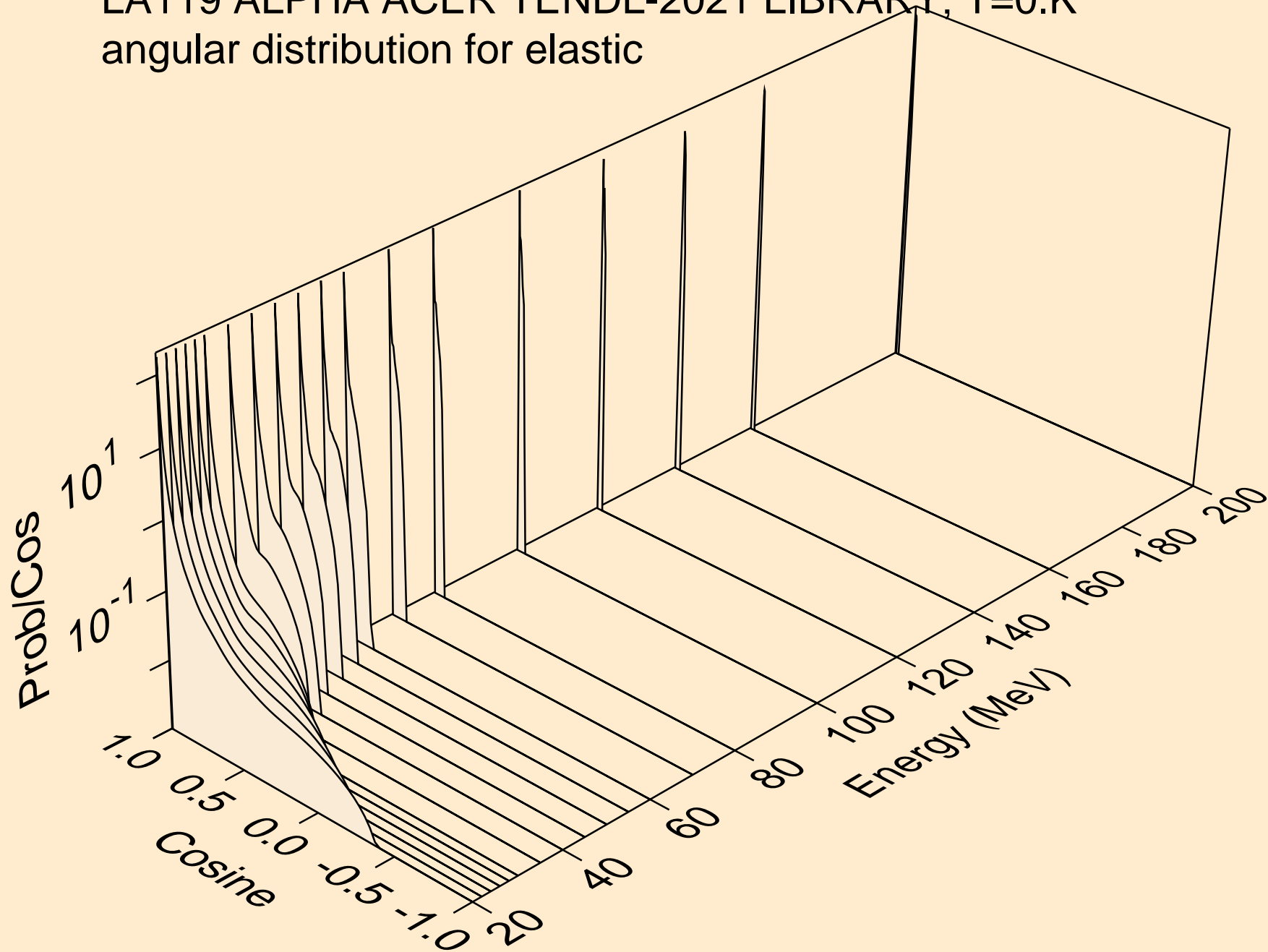

LA119 ALPHA ACER TENDL-2021 LIBRARY; T=0.K

Alpha emission for (a,x)

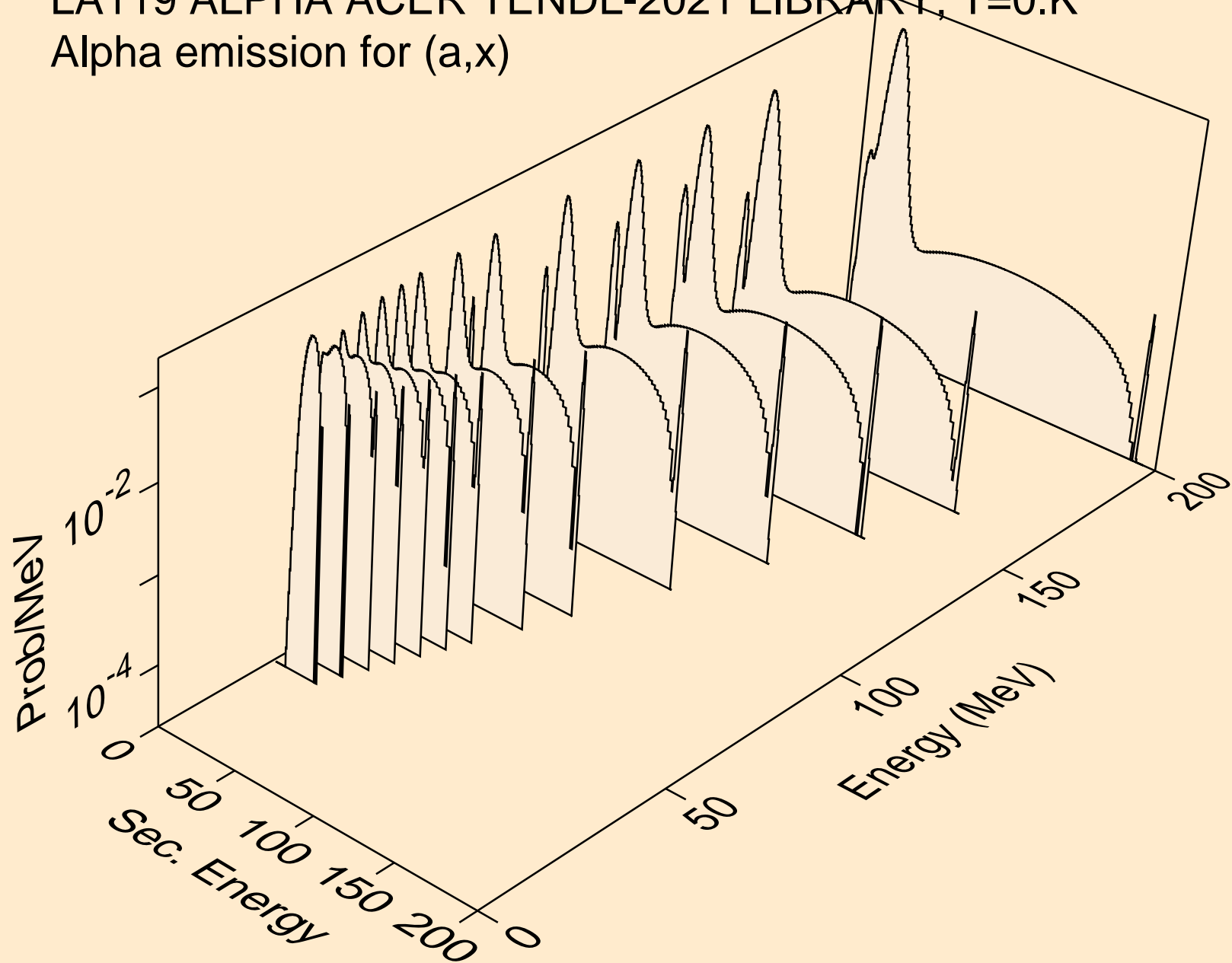

LA119 ALPHA ACER TENDL-2021 LIBRARY; T=0.K

Alpha emission for (a,n*)a

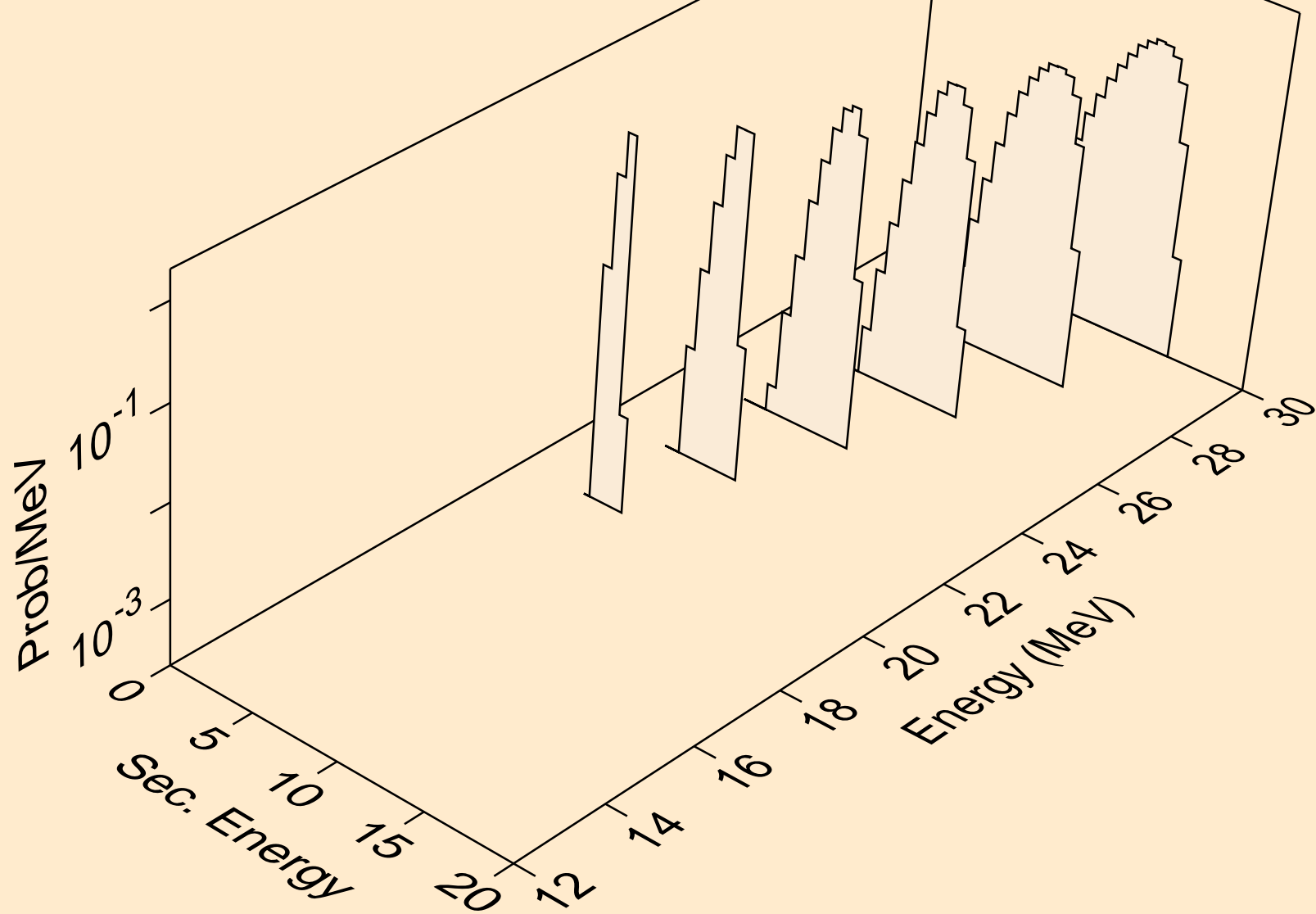

LA119 ALPHA ACER TENDL-2021 LIBRARY; T=0.K
Alpha emission for inelastic

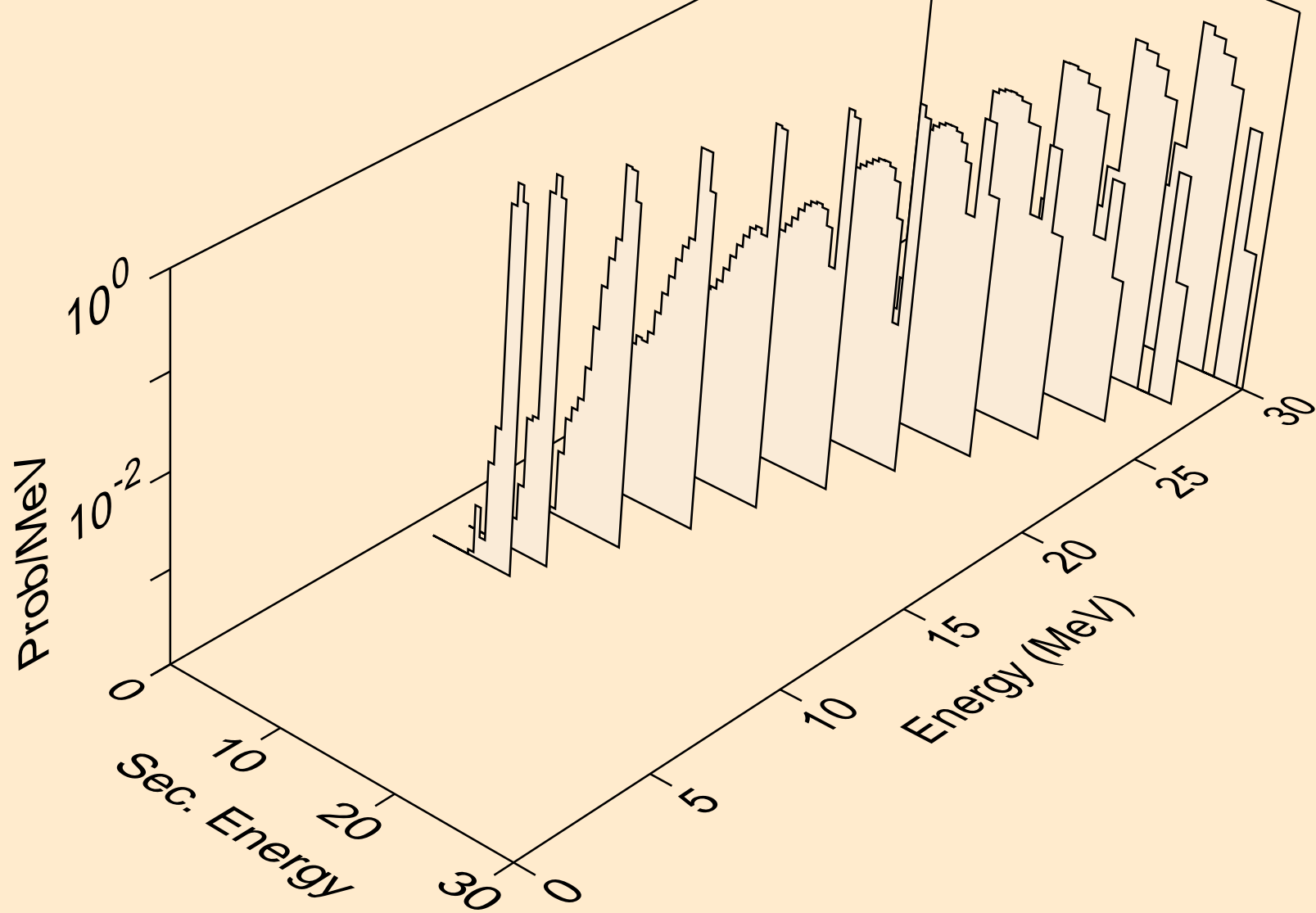

LA119 ALPHA ACER TENDL-2021 LIBRARY; T=0.K

Alpha emission for (a,2a)

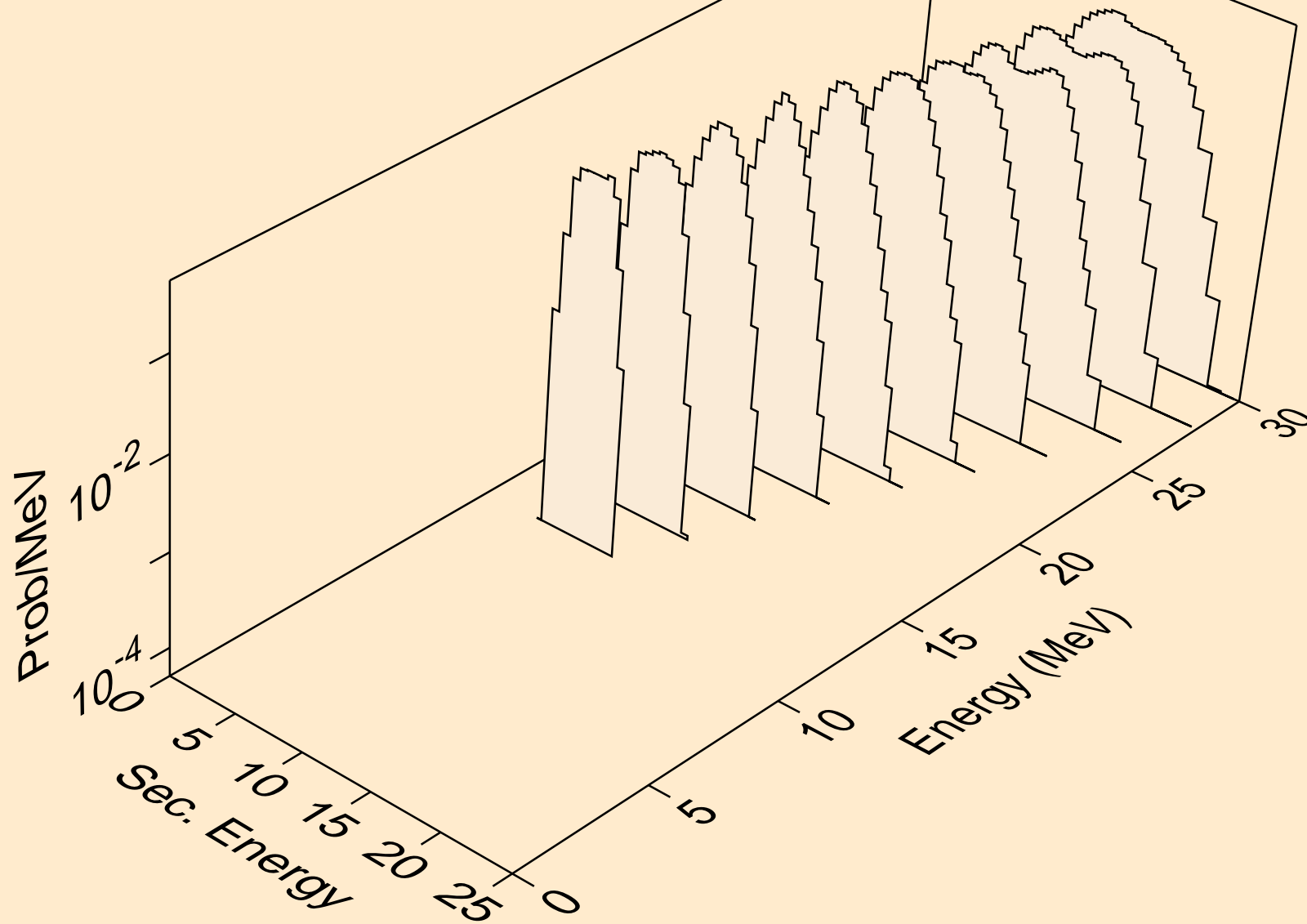

LA119 ALPHA ACER TENDL-2021 LIBRARY; T=0.K

Alpha emission for (a,pa)

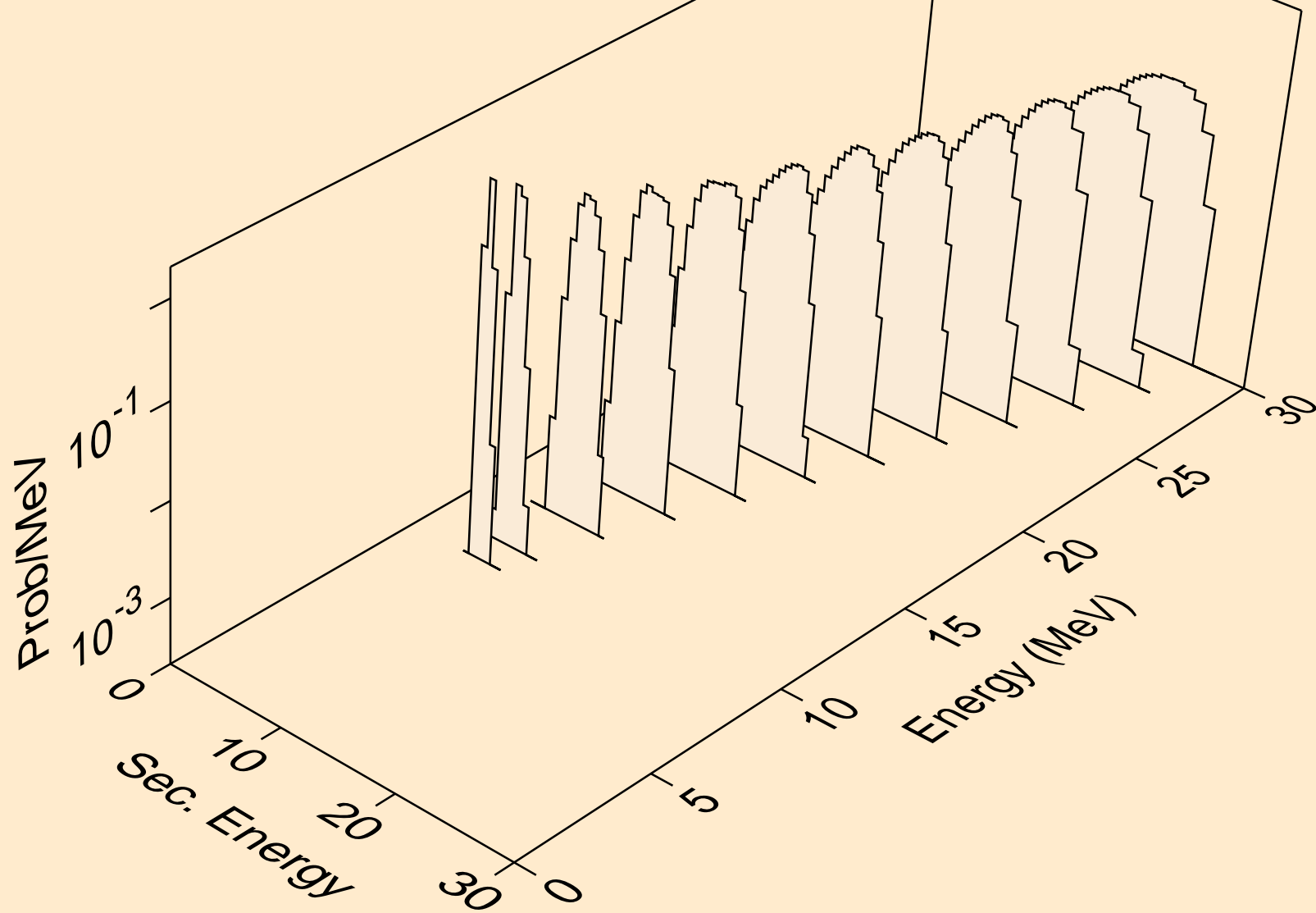

LA119 ALPHA ACER TENDL-2021 LIBRARY; T=0.K

Alpha emission for (a,da)

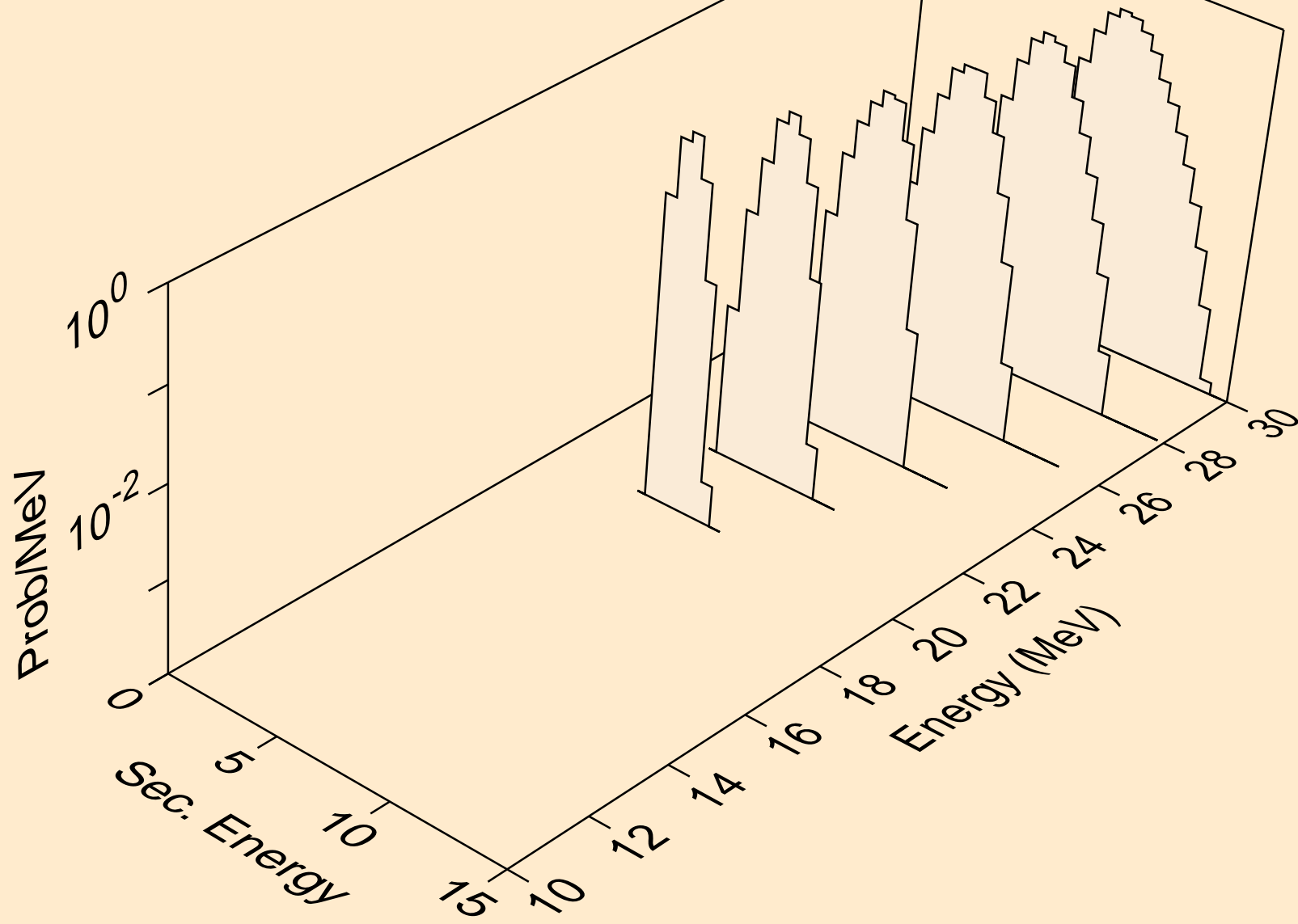

LA119 ALPHA ACER TENDL-2021 LIBRARY; T=0.K
Photon emission for (z,n)

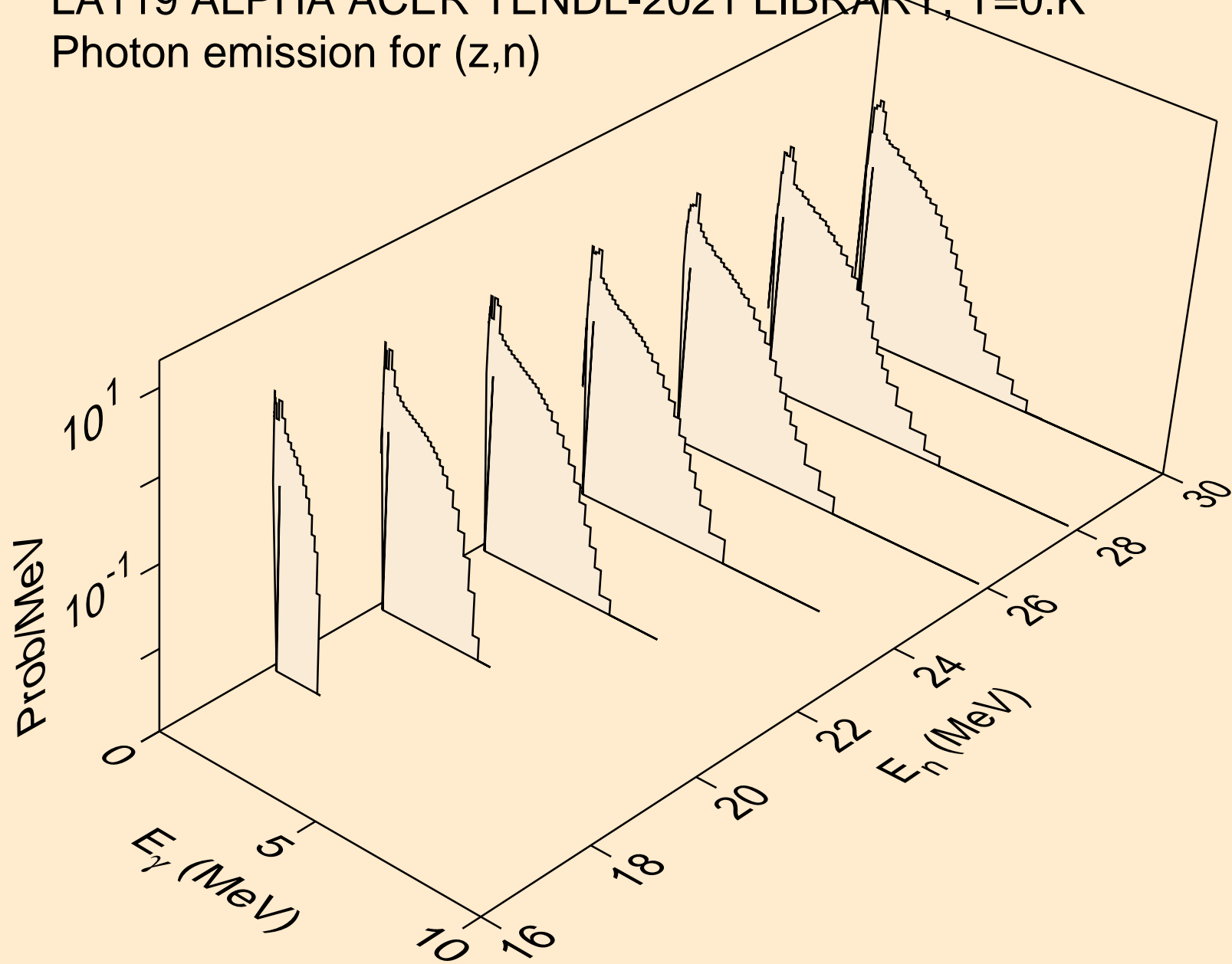

LA119 ALPHA ACER TENDL-2021 LIBRARY; T=0.K

Photon emission for (n,x)

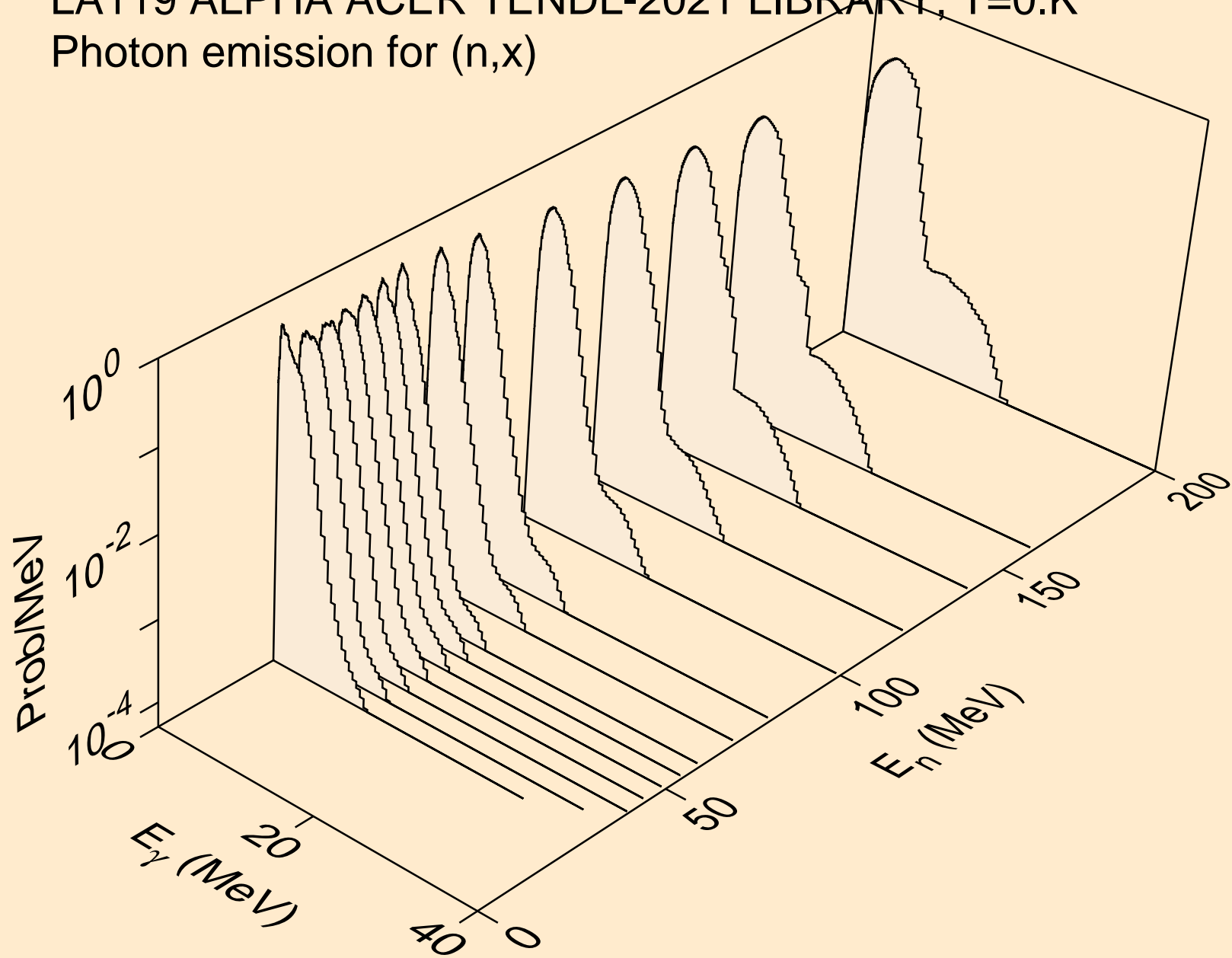

LA119 ALPHA ACER TENDL-2021 LIBRARY; T=0.K
Photon emission for (n,2n)

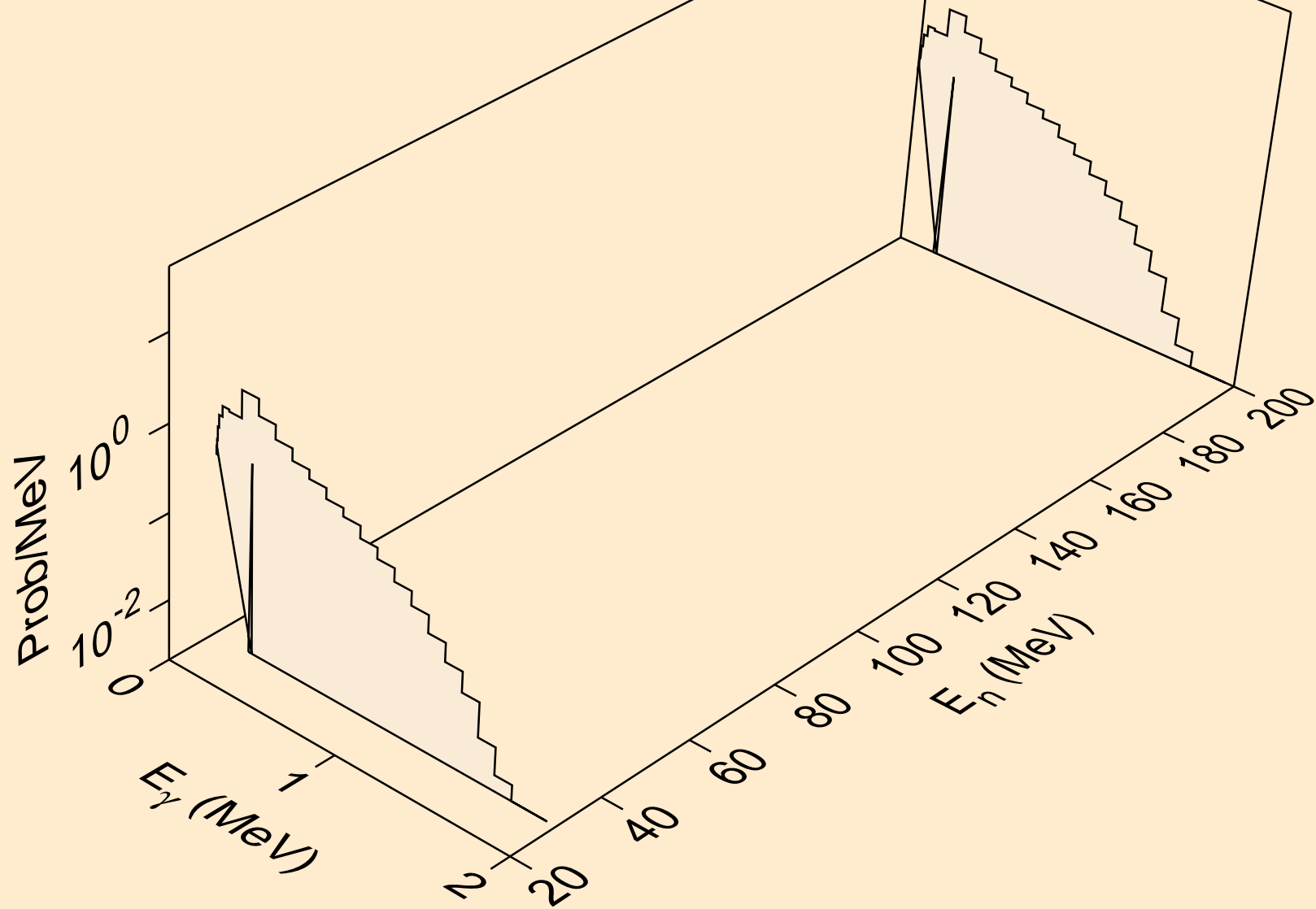

LA119 ALPHA ACER TENDL-2021 LIBRARY; T=0.K
Photon emission for (n,n*)a

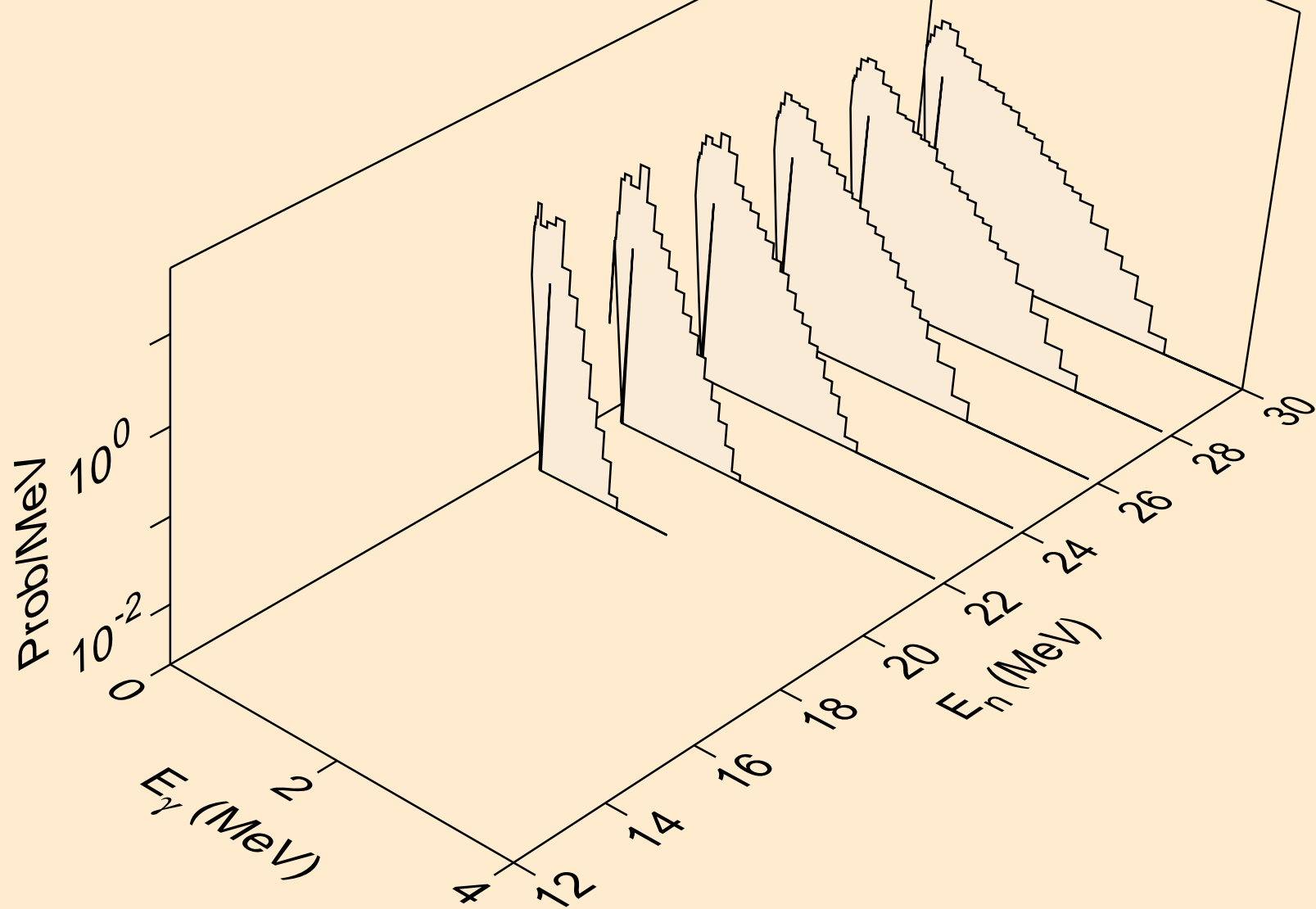

LA119 ALPHA ACER TENDL-2021 LIBRARY; T=0.K

Photon emission for (n,n*)p

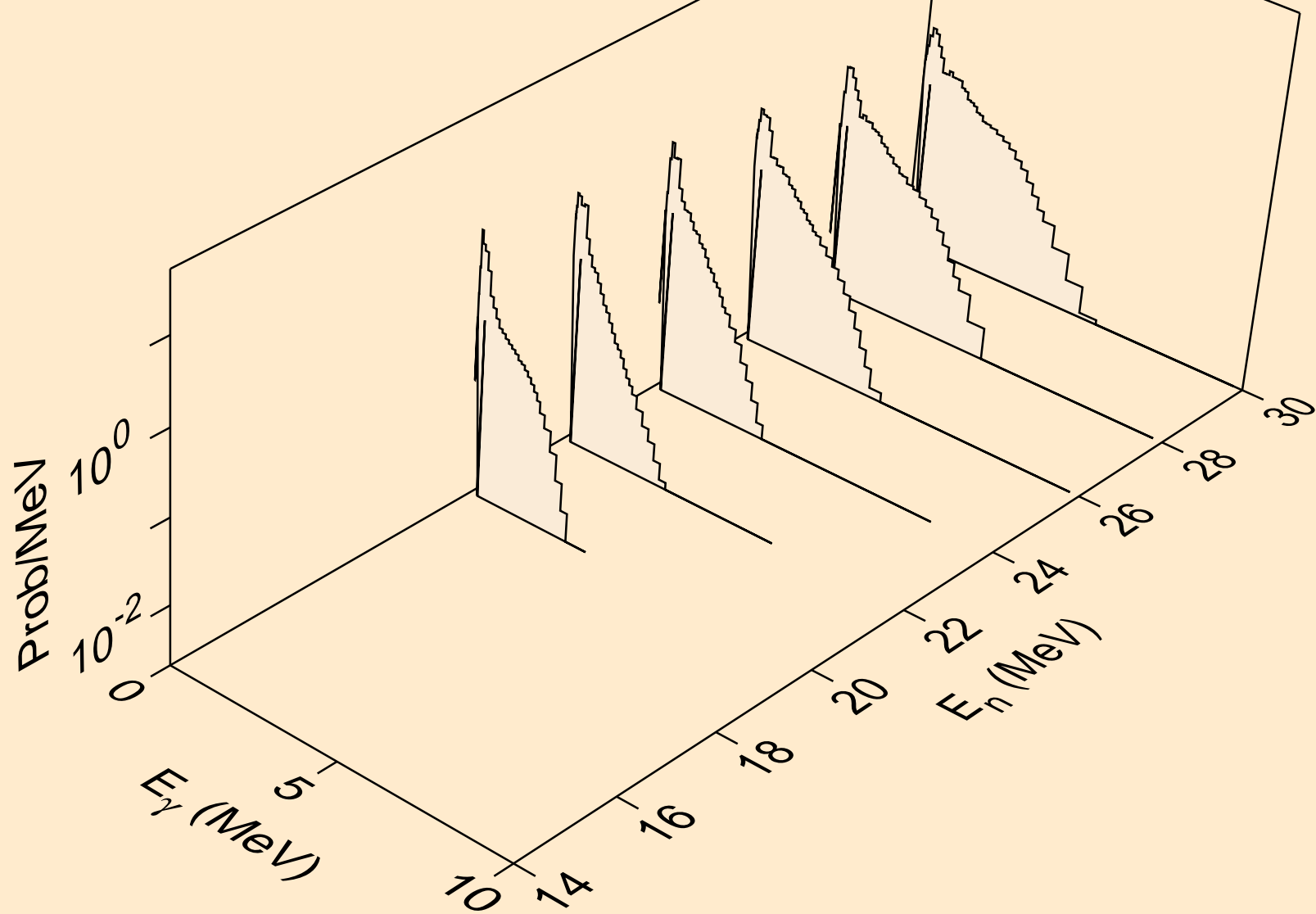

LA119 ALPHA ACER TENDL-2021 LIBRARY; T=0.K
Photon emission for (n,2np)

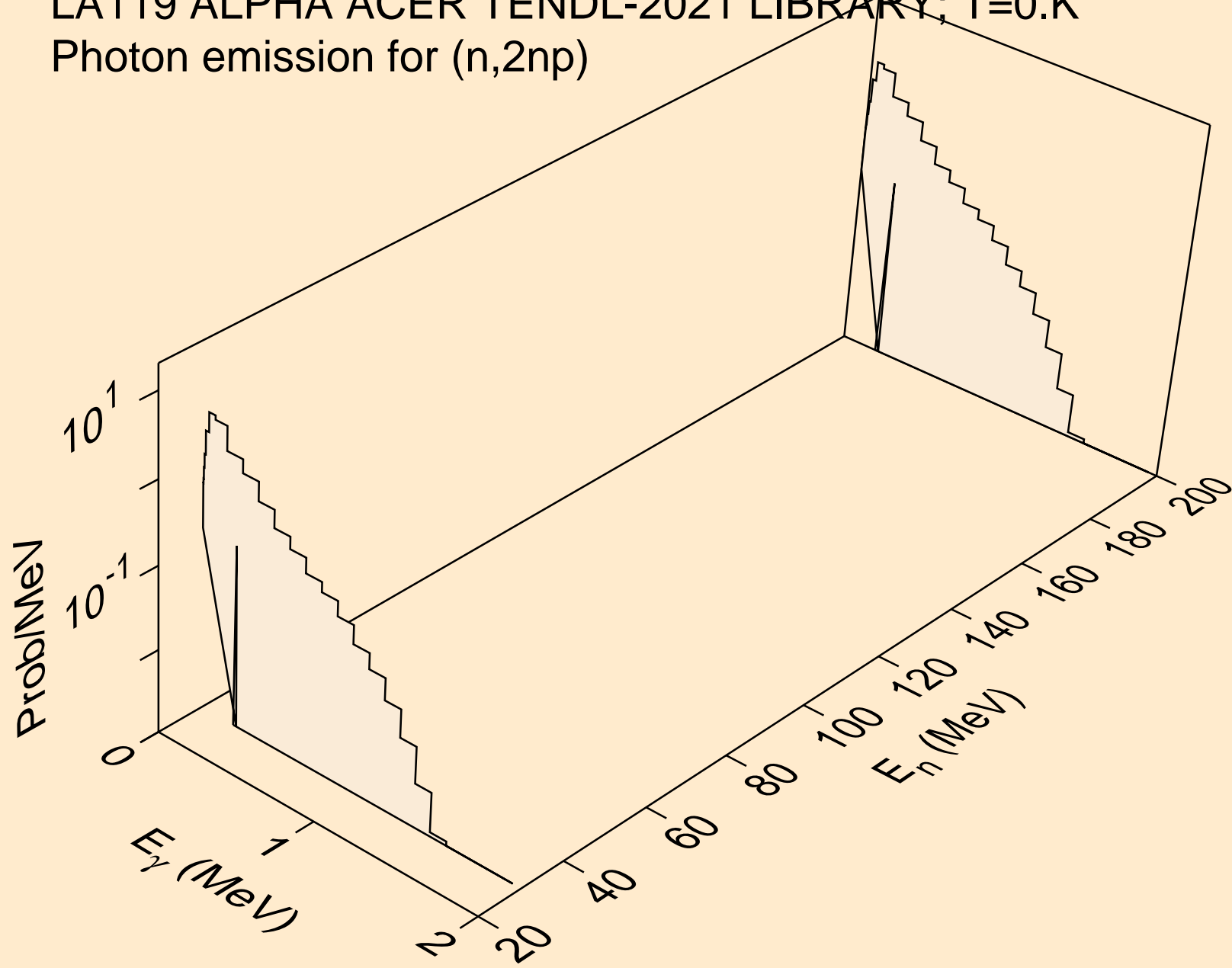

LA119 ALPHA ACER TENDL-2021 LIBRARY; T=0.K
Photon emission for (n,2np)

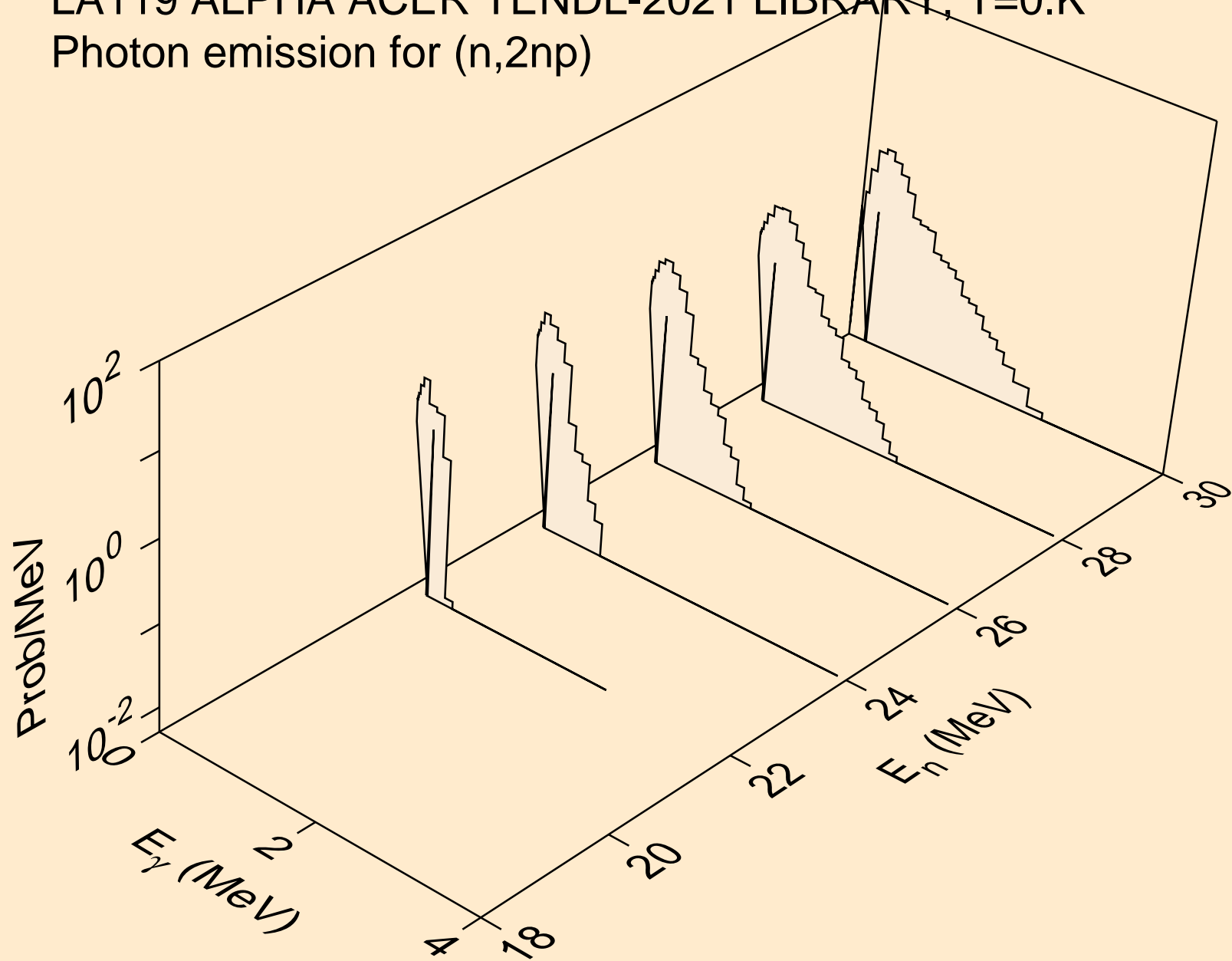

LA119 ALPHA ACER TENDL-2021 LIBRARY; T=0.K
Photon emission for (n,npa)

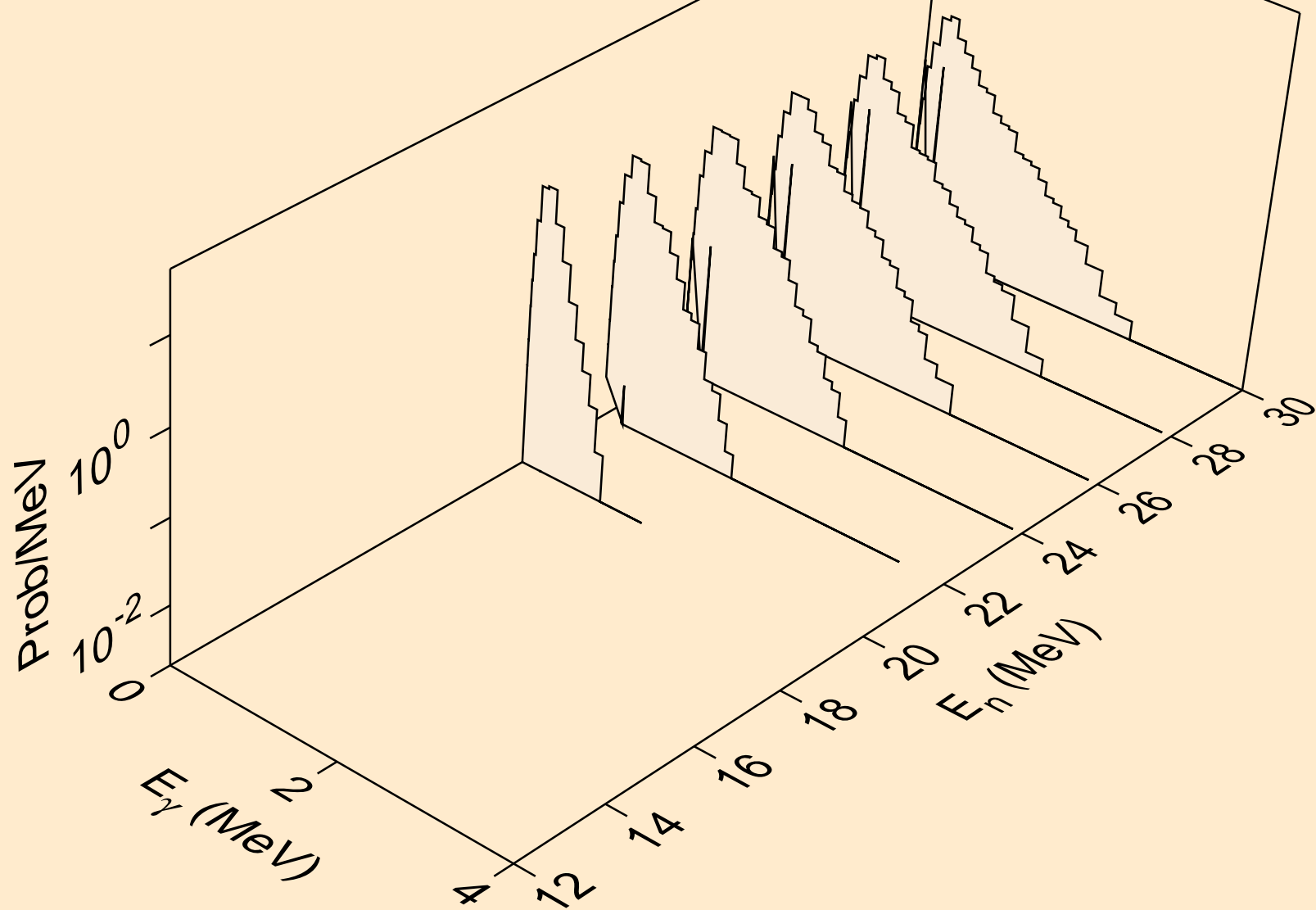

LA119 ALPHA ACER TENDL-2021 LIBRARY; T=0.K
Photon emission for (n,gma)

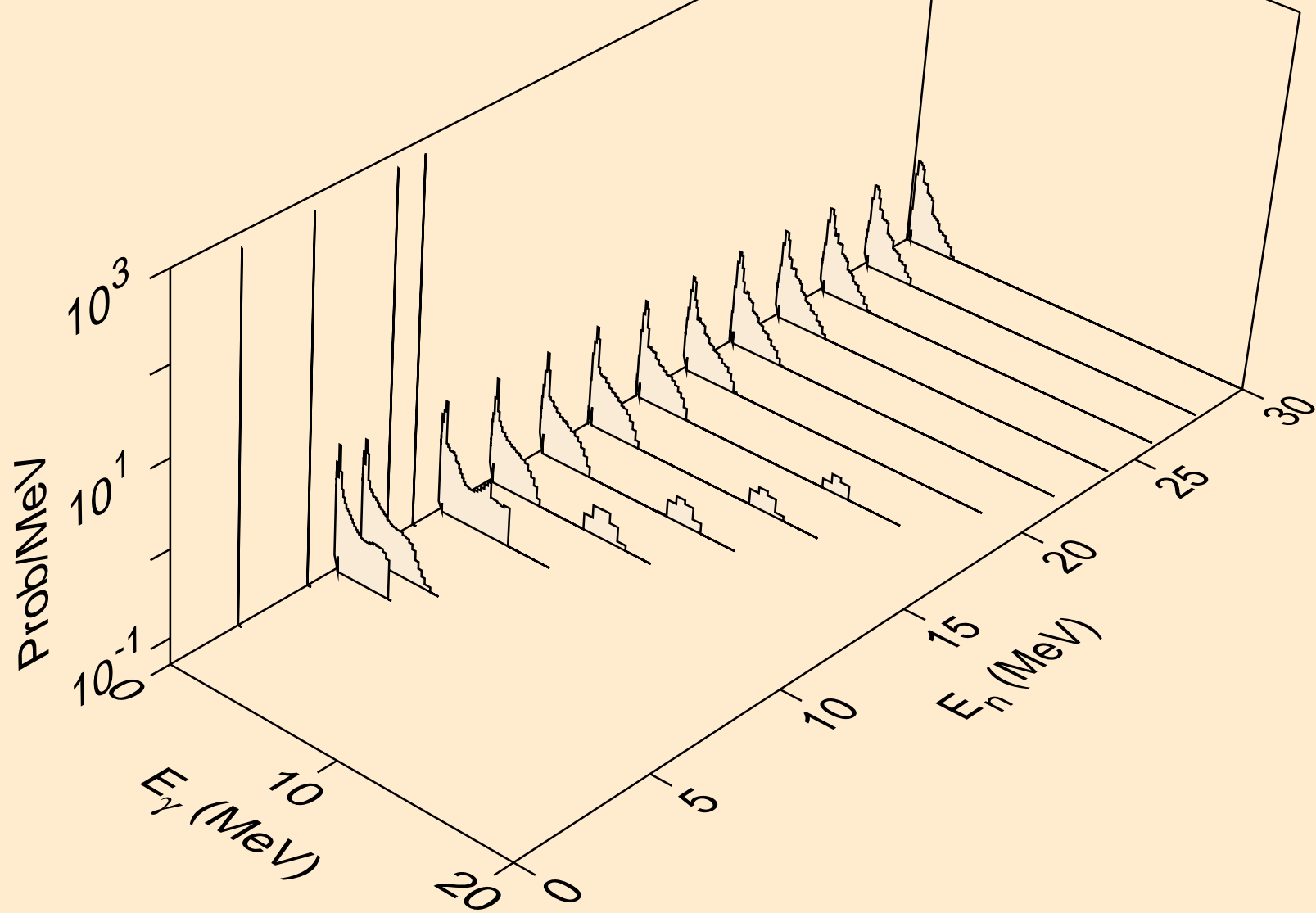

LA119 ALPHA ACER TENDL-2021 LIBRARY; T=0.K
Photon emission for (n,p)

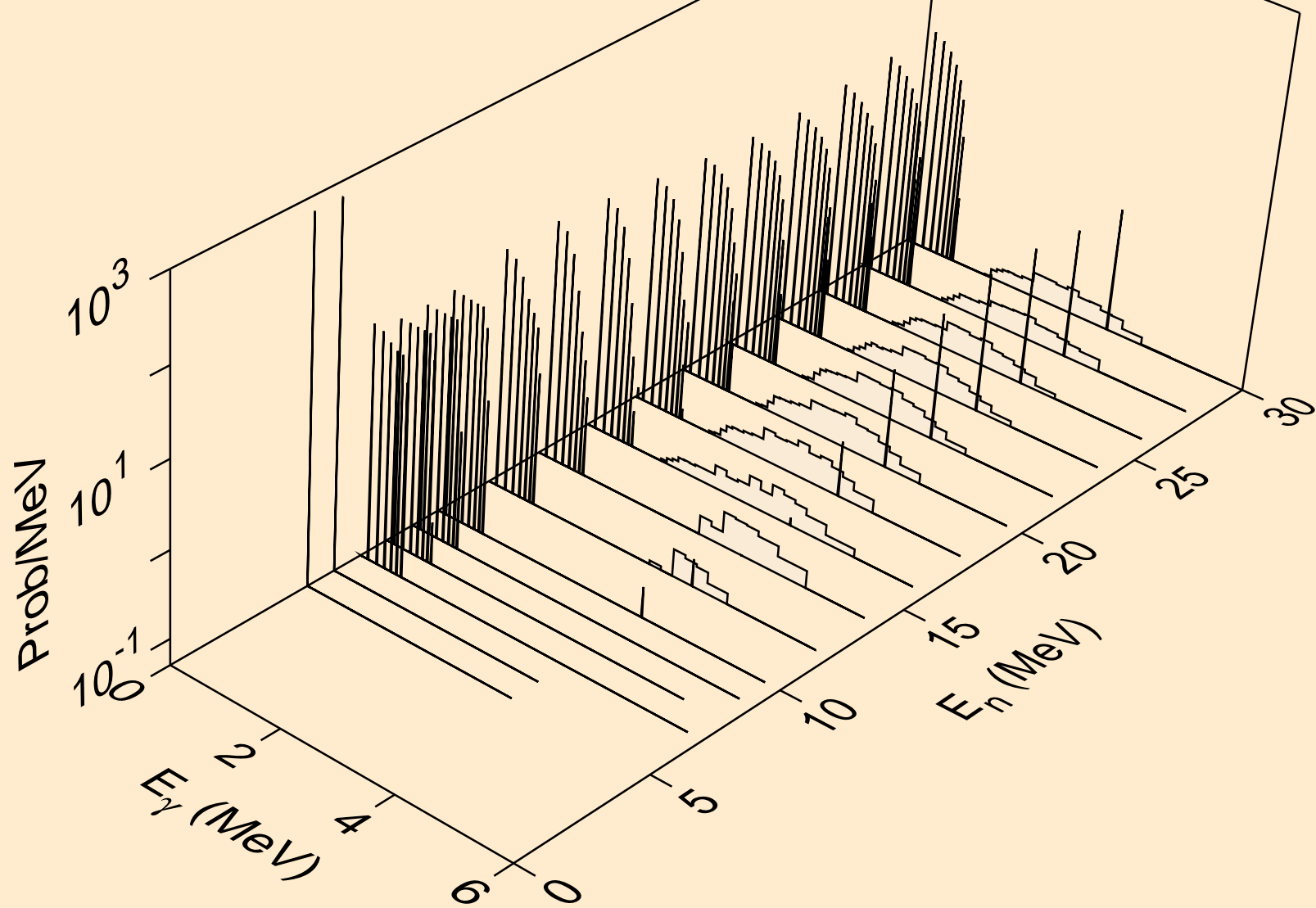

LA119 ALPHA ACER TENDL-2021 LIBRARY; T=0.K
Photon emission for (n,d)

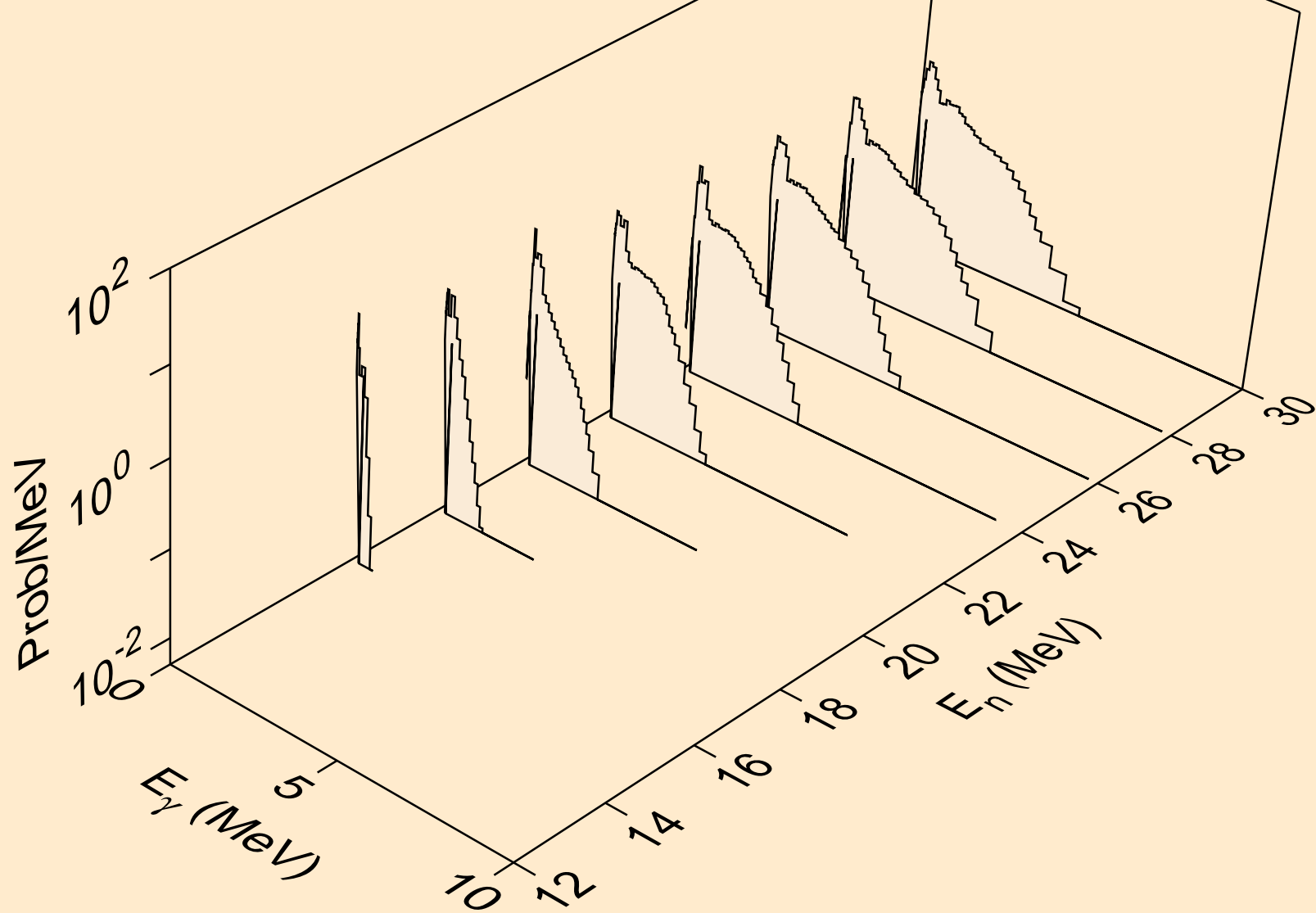

LA119 ALPHA ACER TENDL-2021 LIBRARY; T=0.K
Photon emission for (n,t)

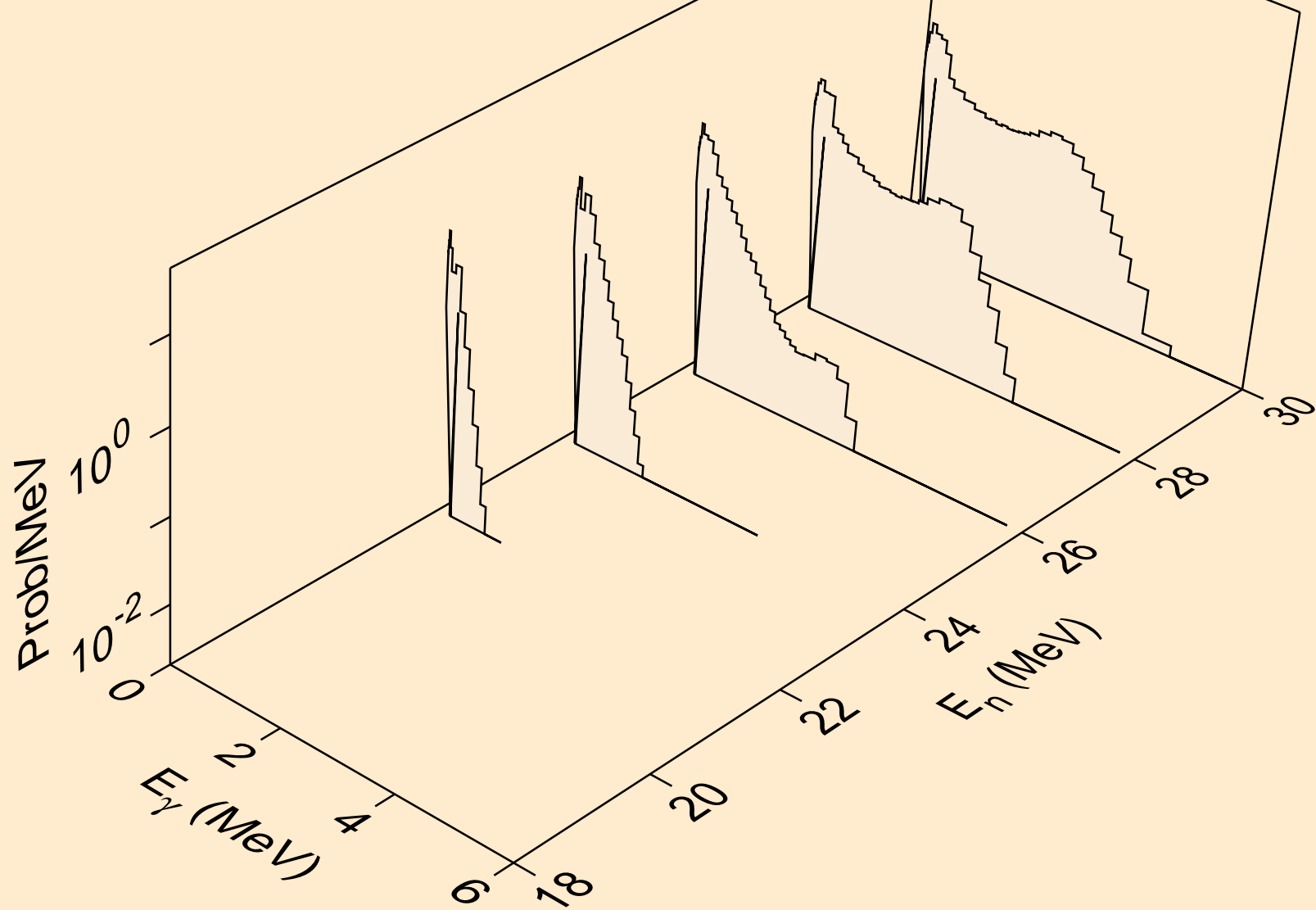

LA119 ALPHA ACER TENDL-2021 LIBRARY; T=0.K
Photon emission for (n,he3)

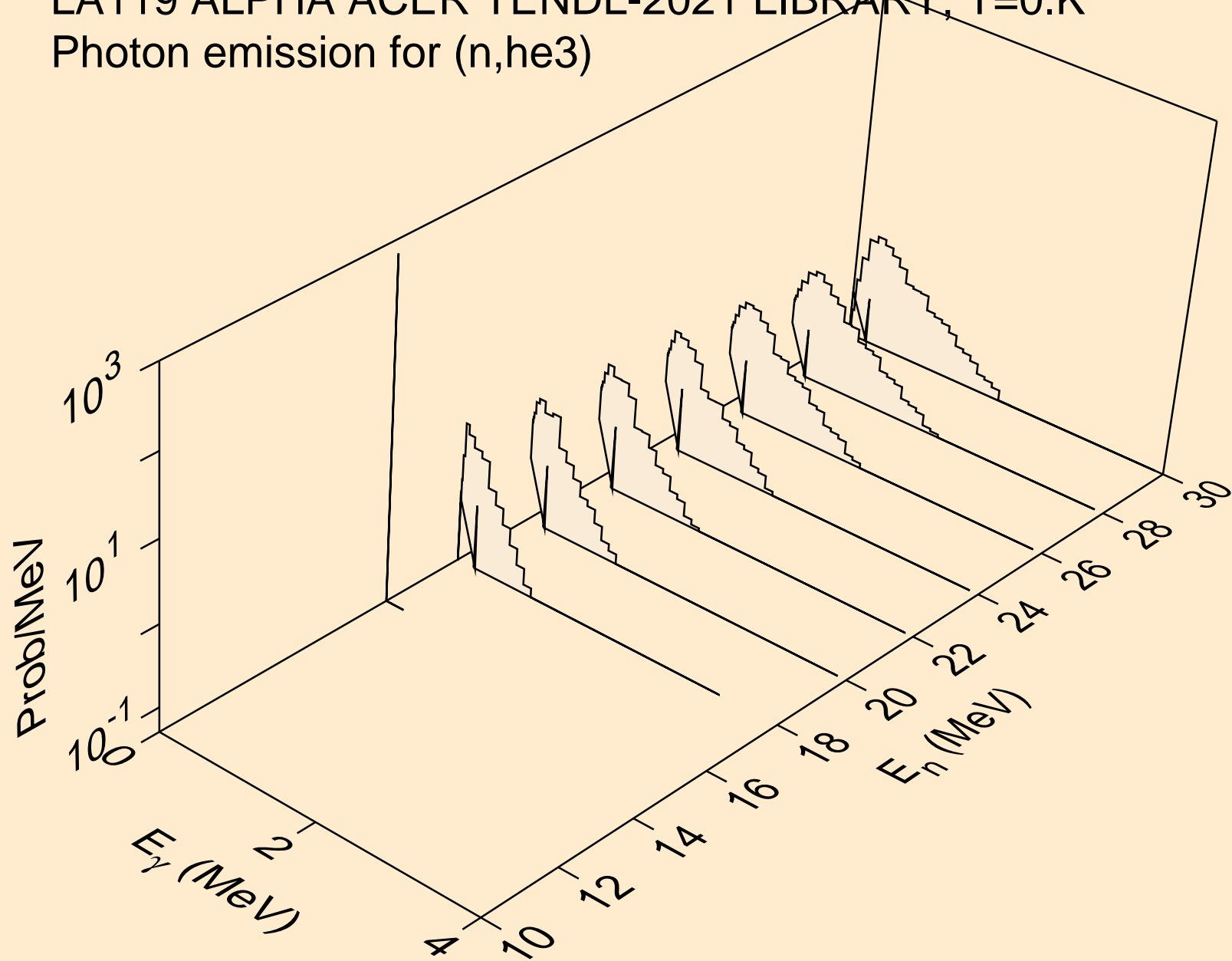

LA119 ALPHA ACER TENDL-2021 LIBRARY; T=0.K
Photon emission for inelastic

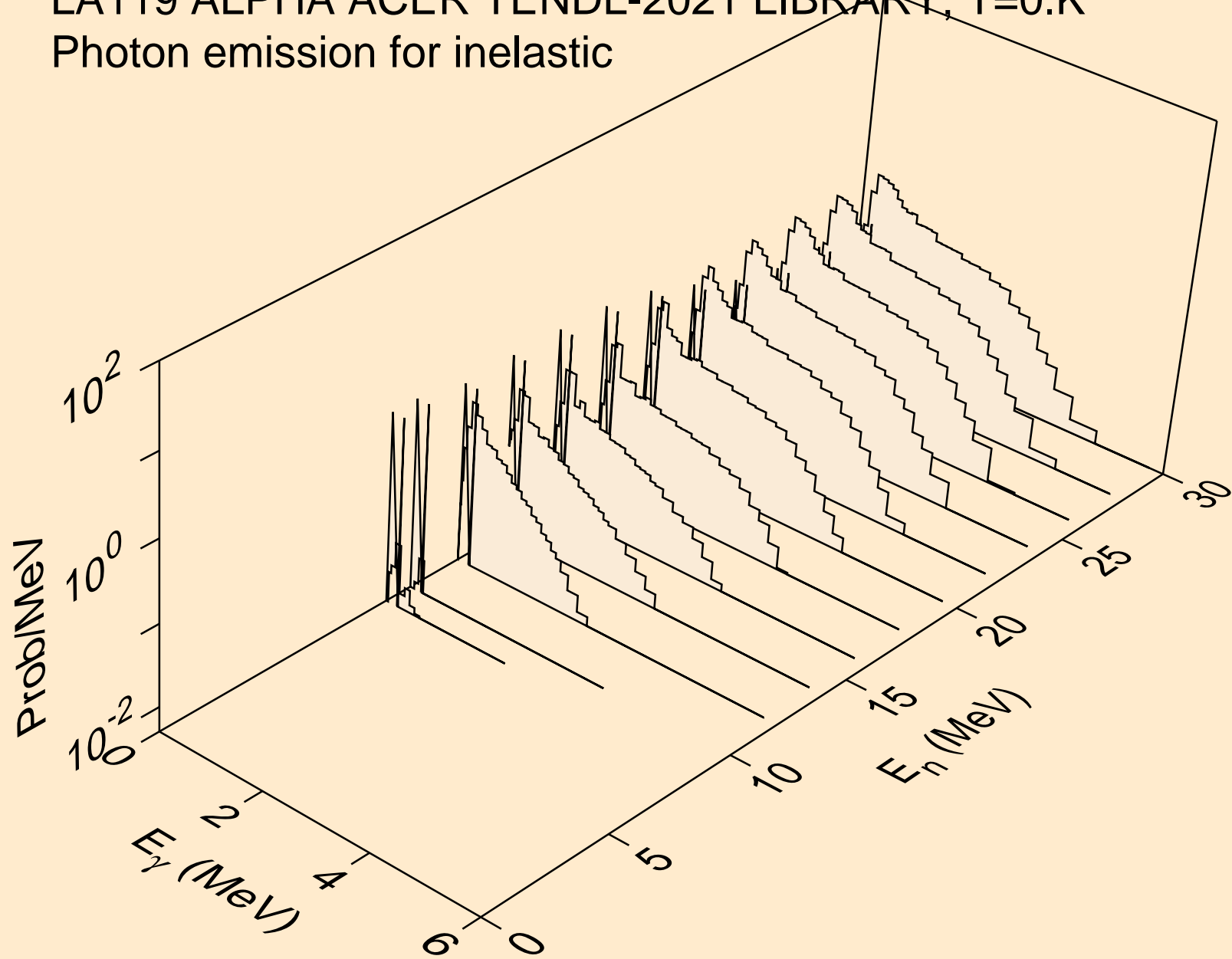

LA119 ALPHA ACER TENDL-2021 LIBRARY; T=0.K
Photon emission for (n,2a)

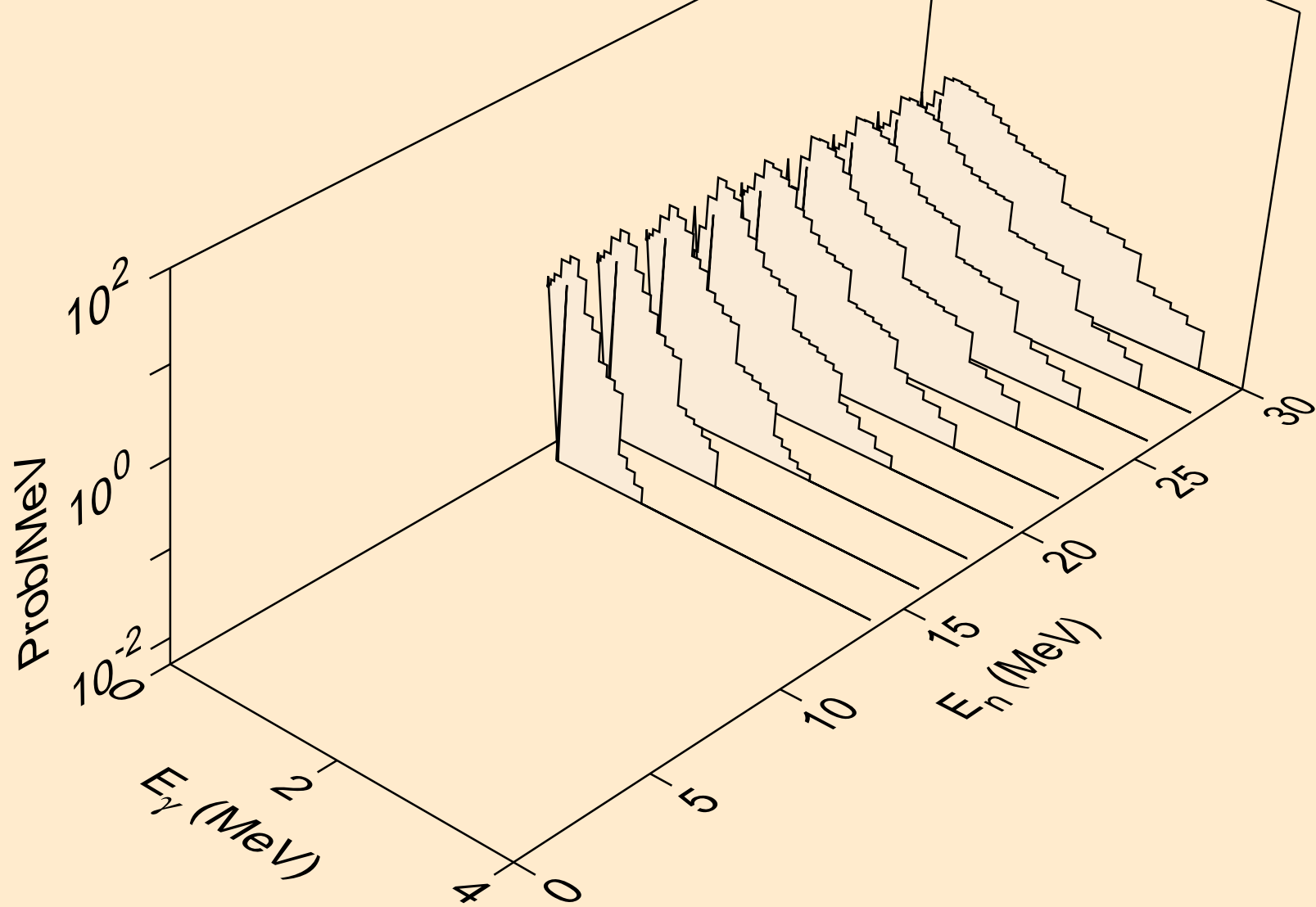

LA119 ALPHA ACER TENDL-2021 LIBRARY; T=0.K
Photon emission for (n,2p)

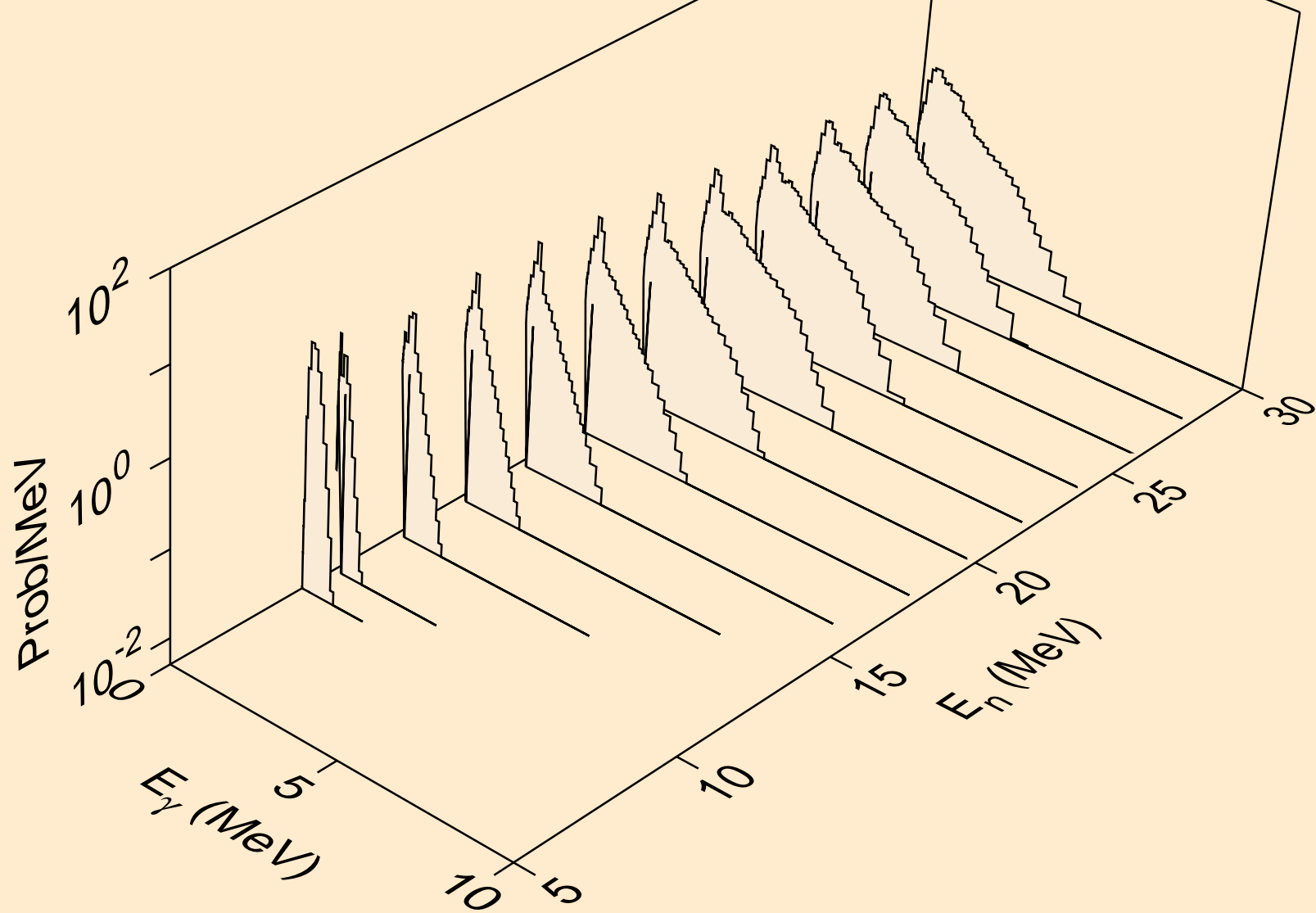

LA119 ALPHA ACER TENDL-2021 LIBRARY; T=0.K
Photon emission for (n,pa)

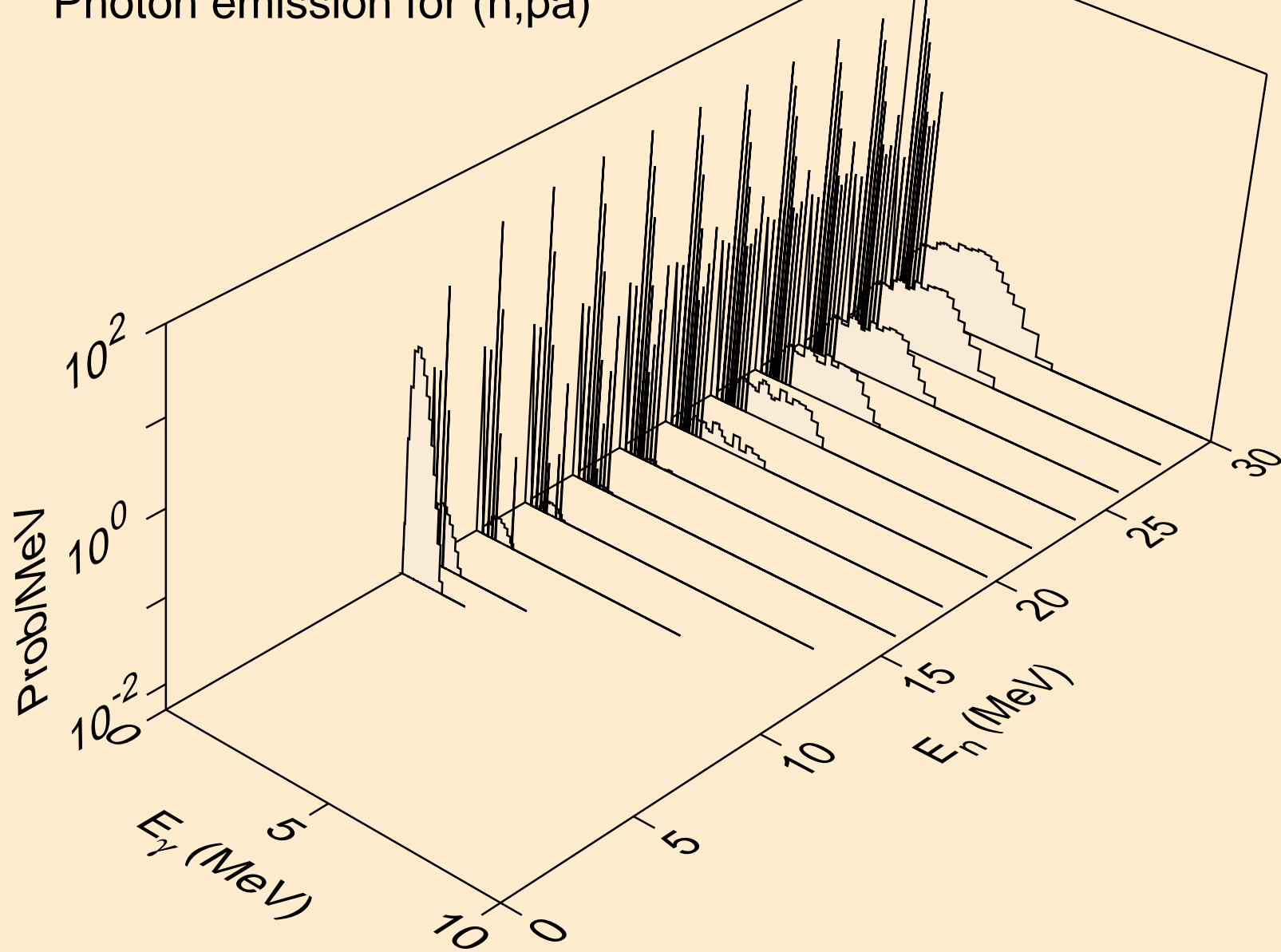

LA119 ALPHA ACER TENDL-2021 LIBRARY; T=0.K
Photon emission for (n,pd)

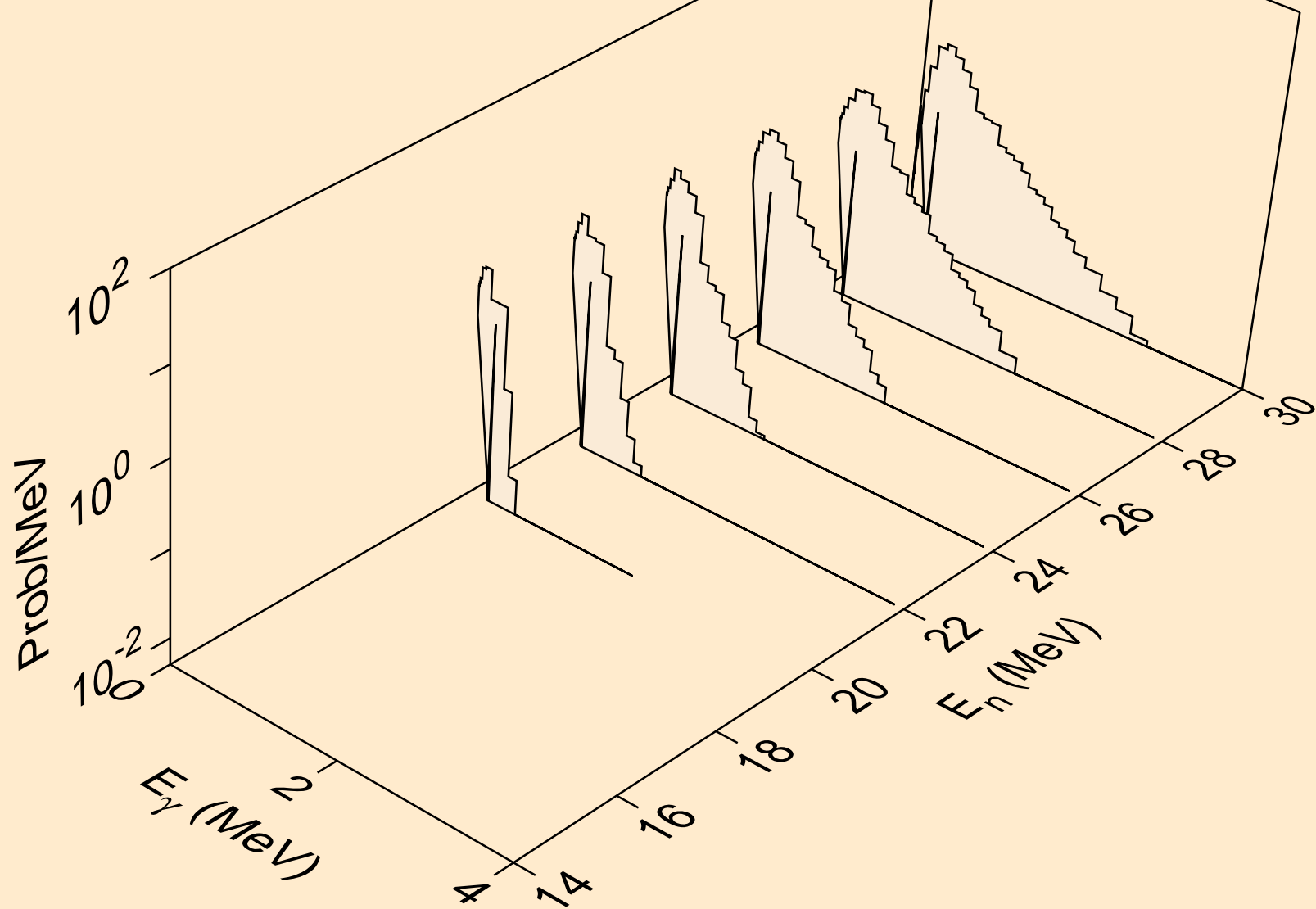

LA119 ALPHA ACER TENDL-2021 LIBRARY; T=0.K
Photon emission for (n,pt)

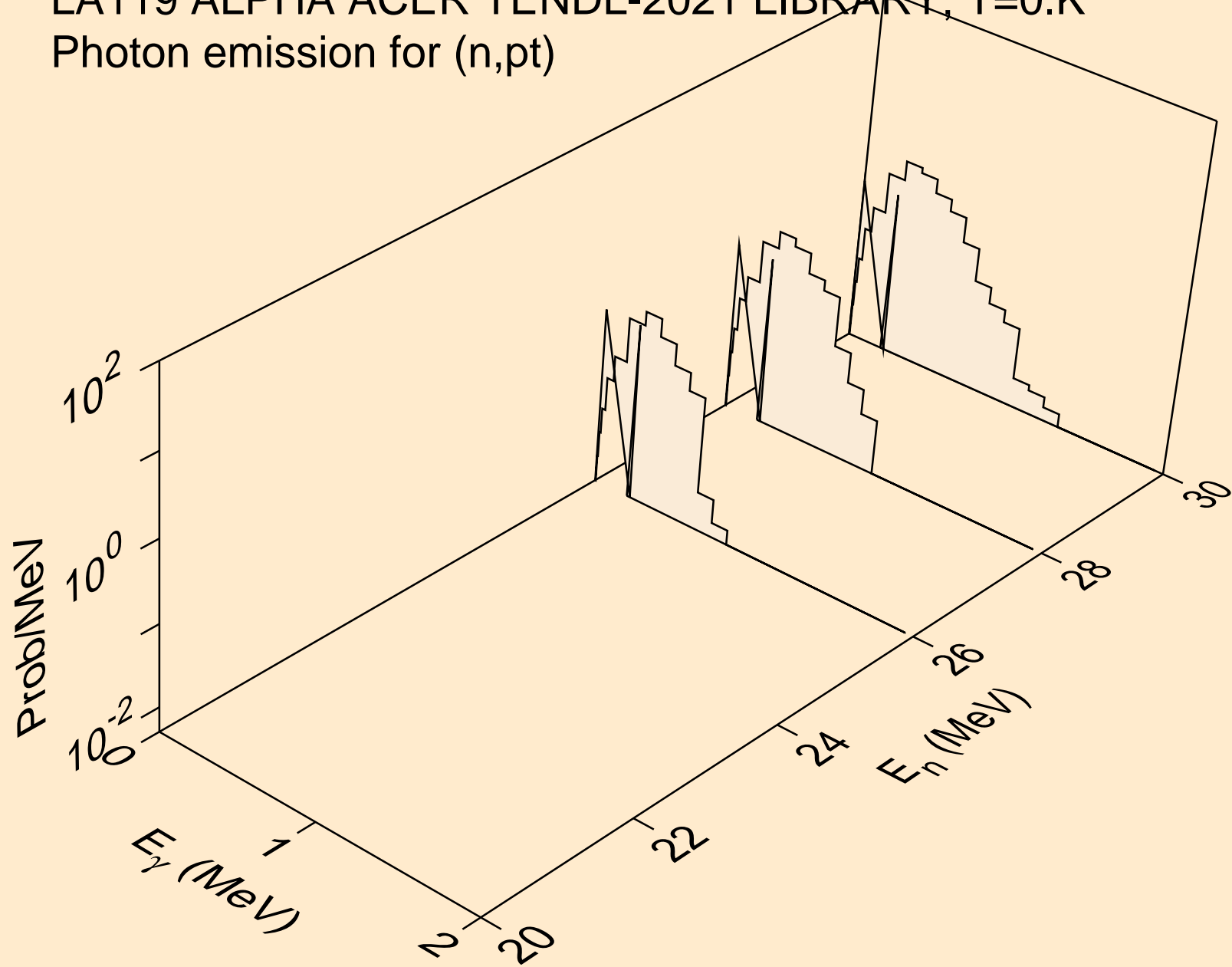

LA119 ALPHA ACER TENDL-2021 LIBRARY; T=0.K
Photon emission for (n,da)

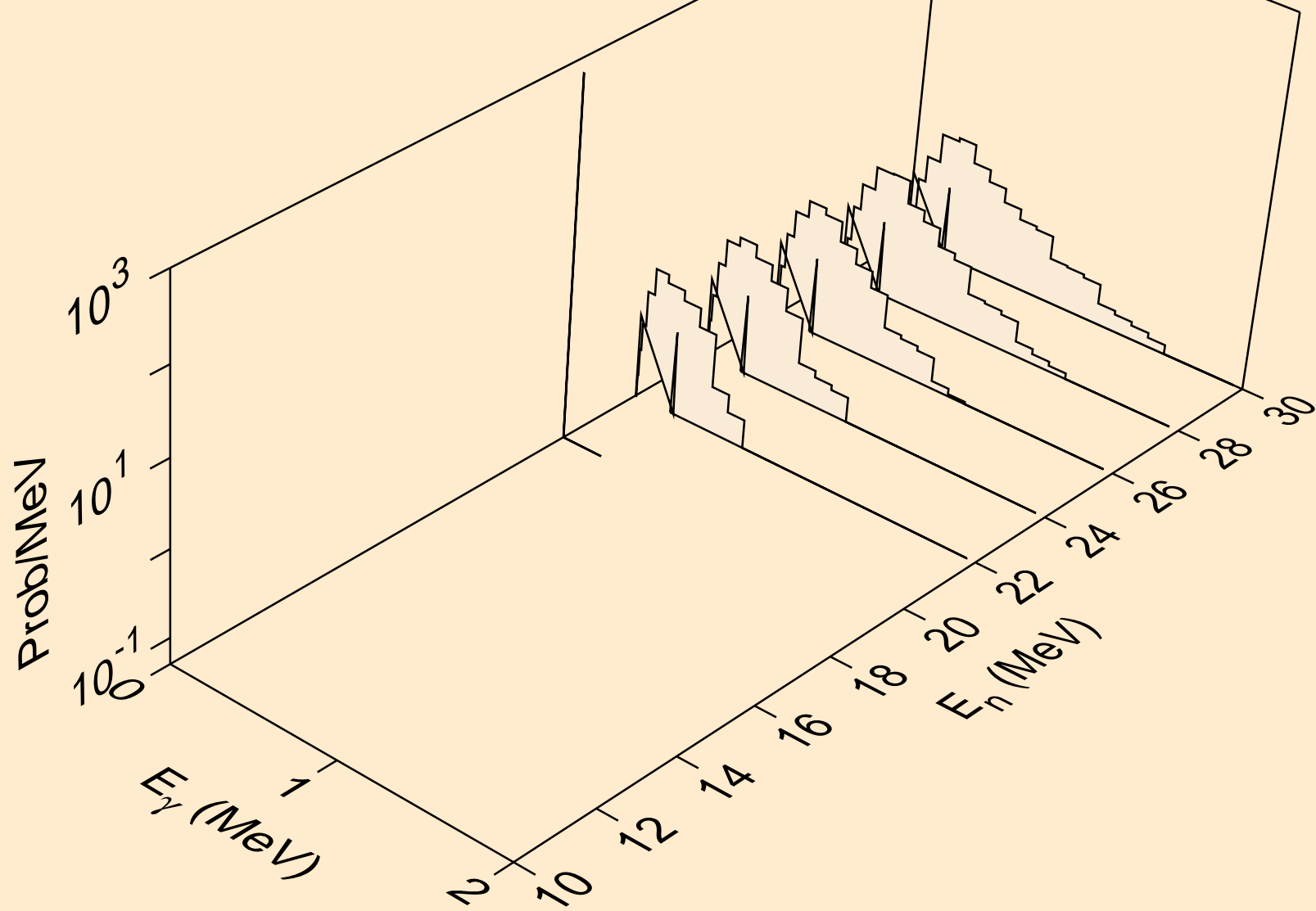

LA119 ALPHA ACER TENDL-2021 LIBRARY; T=0.K
Particle heating contributions

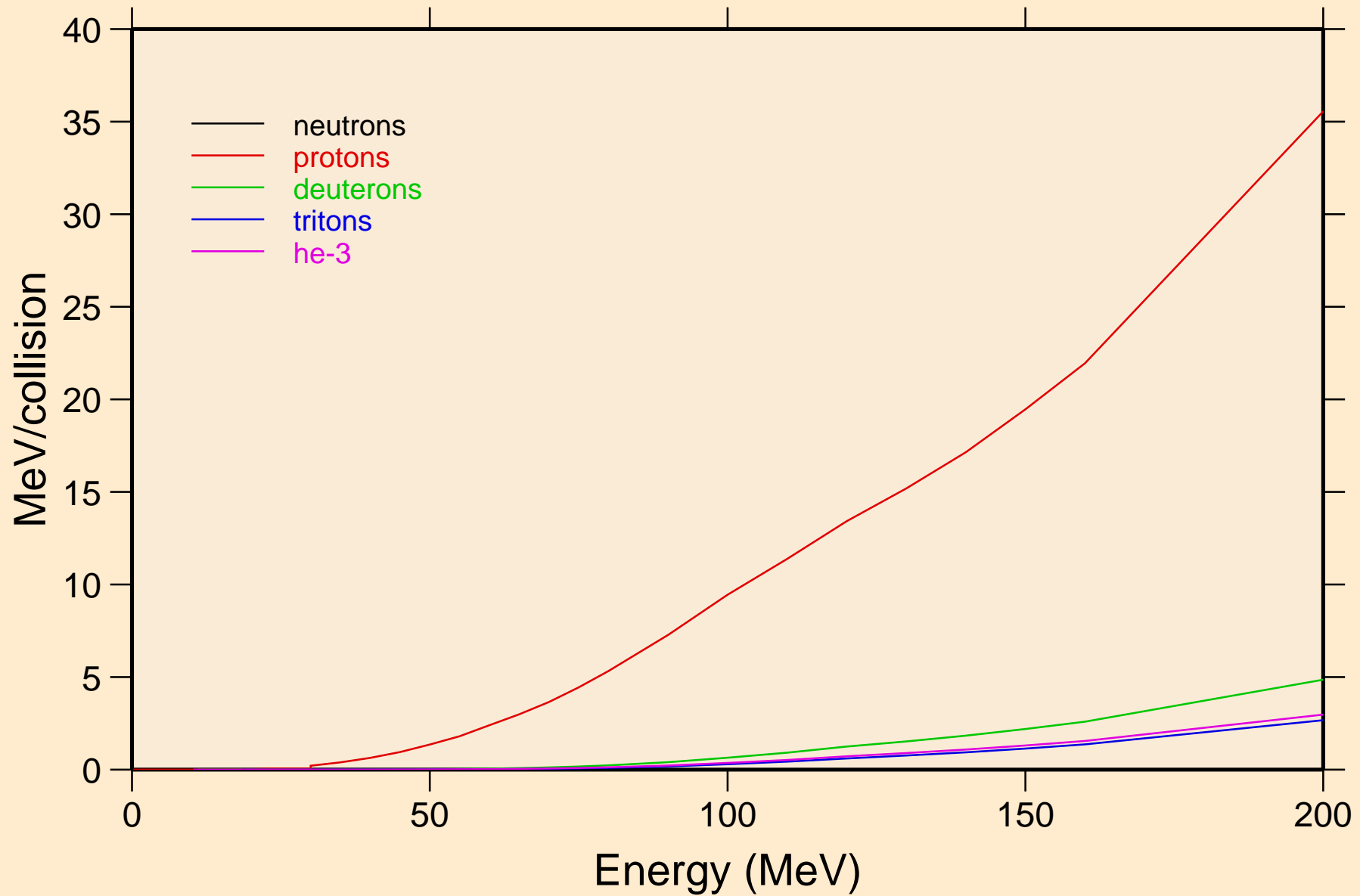

LA119 ALPHA ACER TENDL-2021 LIBRARY; T=0.K

Recoil Heating

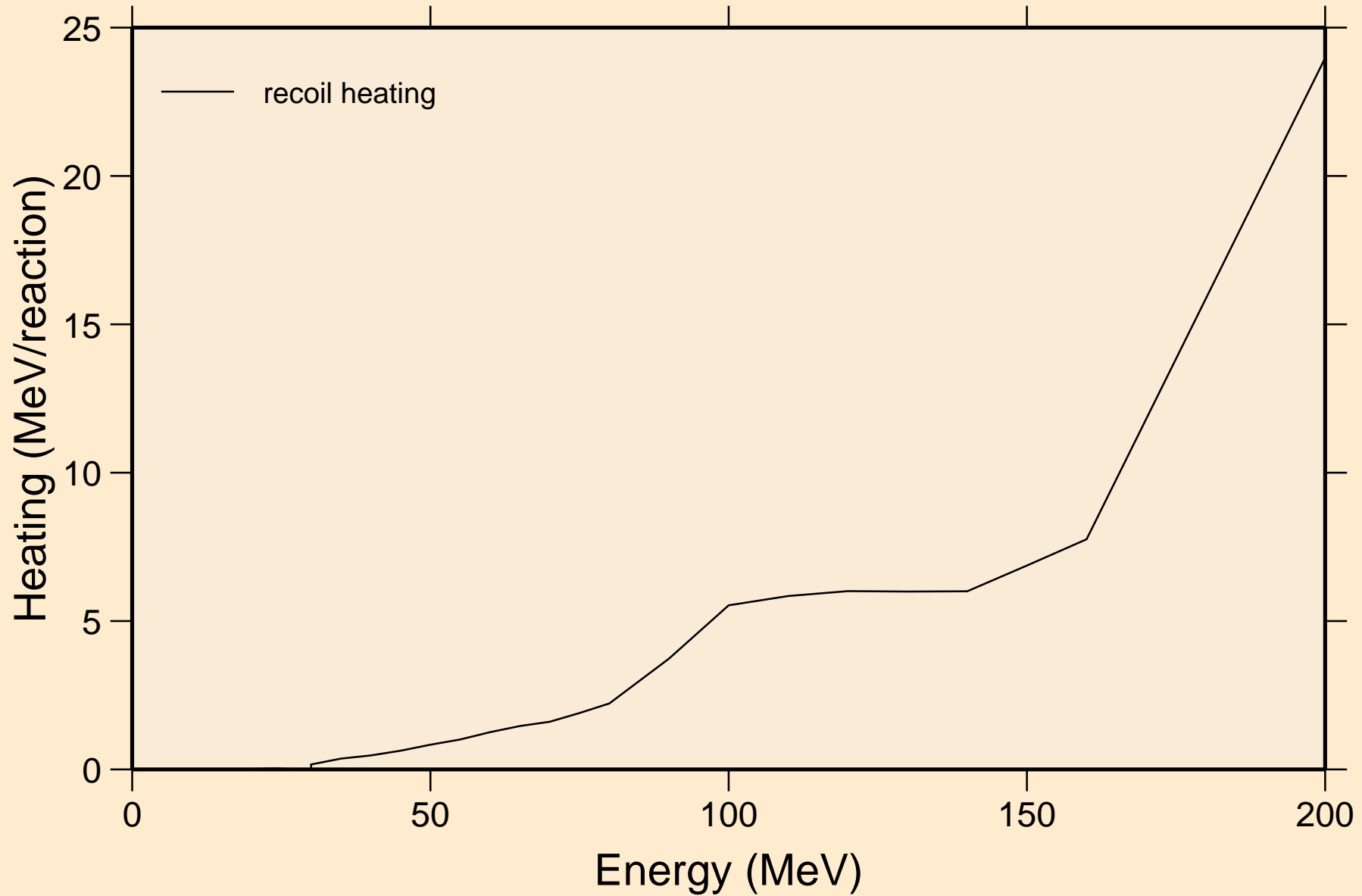

LA119 ALPHA ACER TENDL-2021 LIBRARY; T=0.K
Particle production cross sections

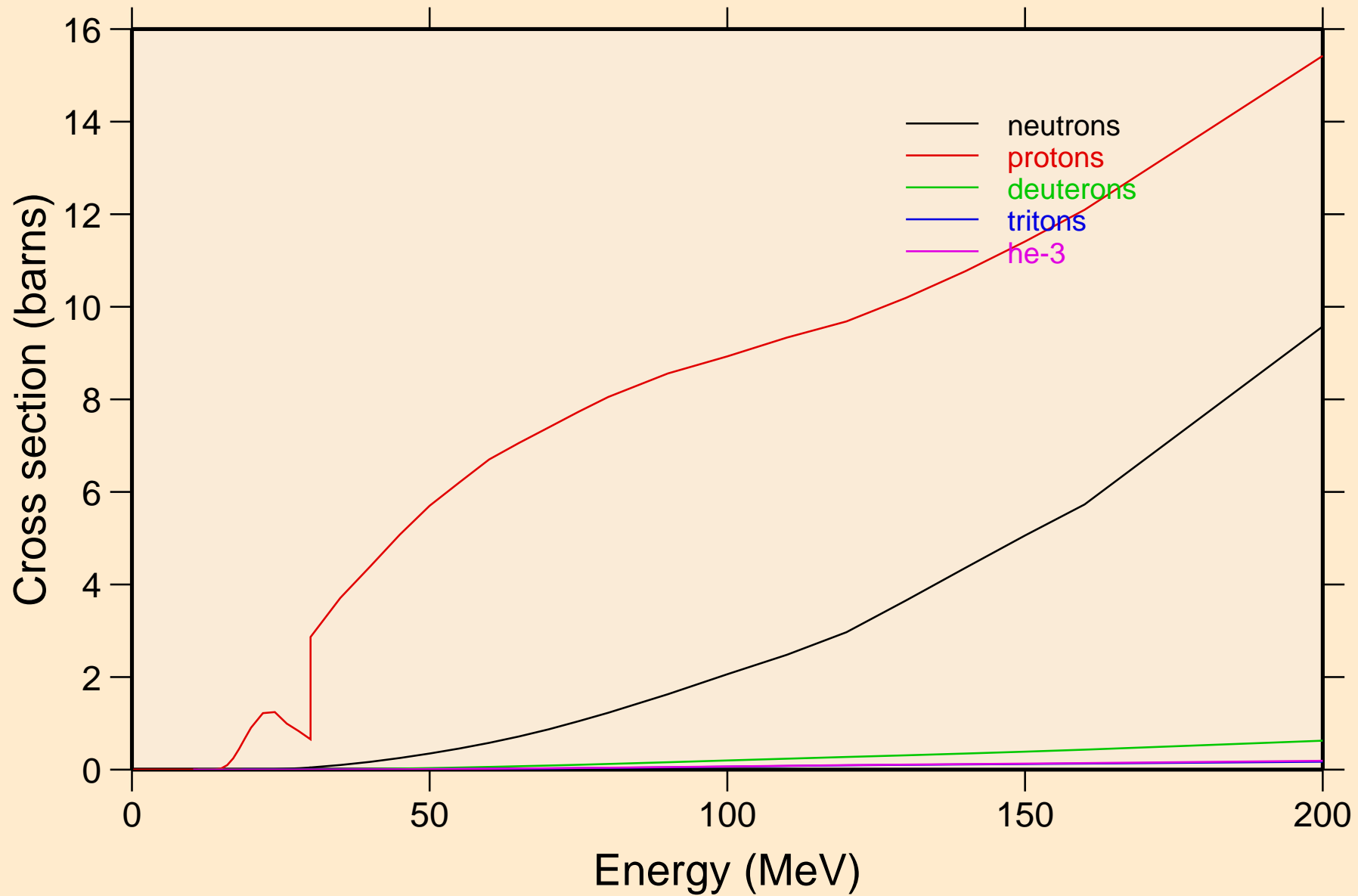

LA119 ALPHA ACER TENDL-2021 LIBRARY; T=0.K
neutrons from (a,n)

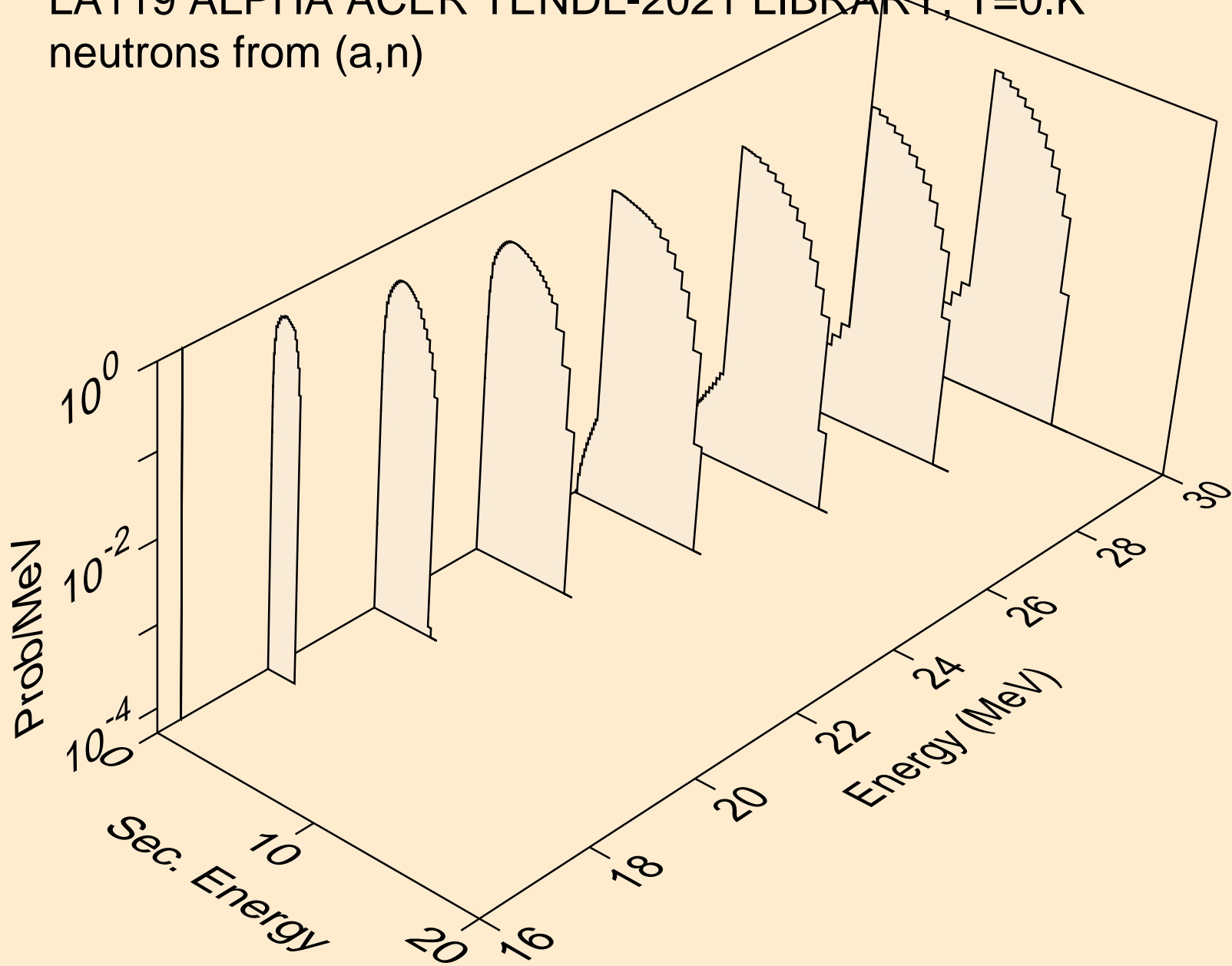

LA119 ALPHA ACER TENDL-2021 LIBRARY; T=0.K
neutrons from (a,x)

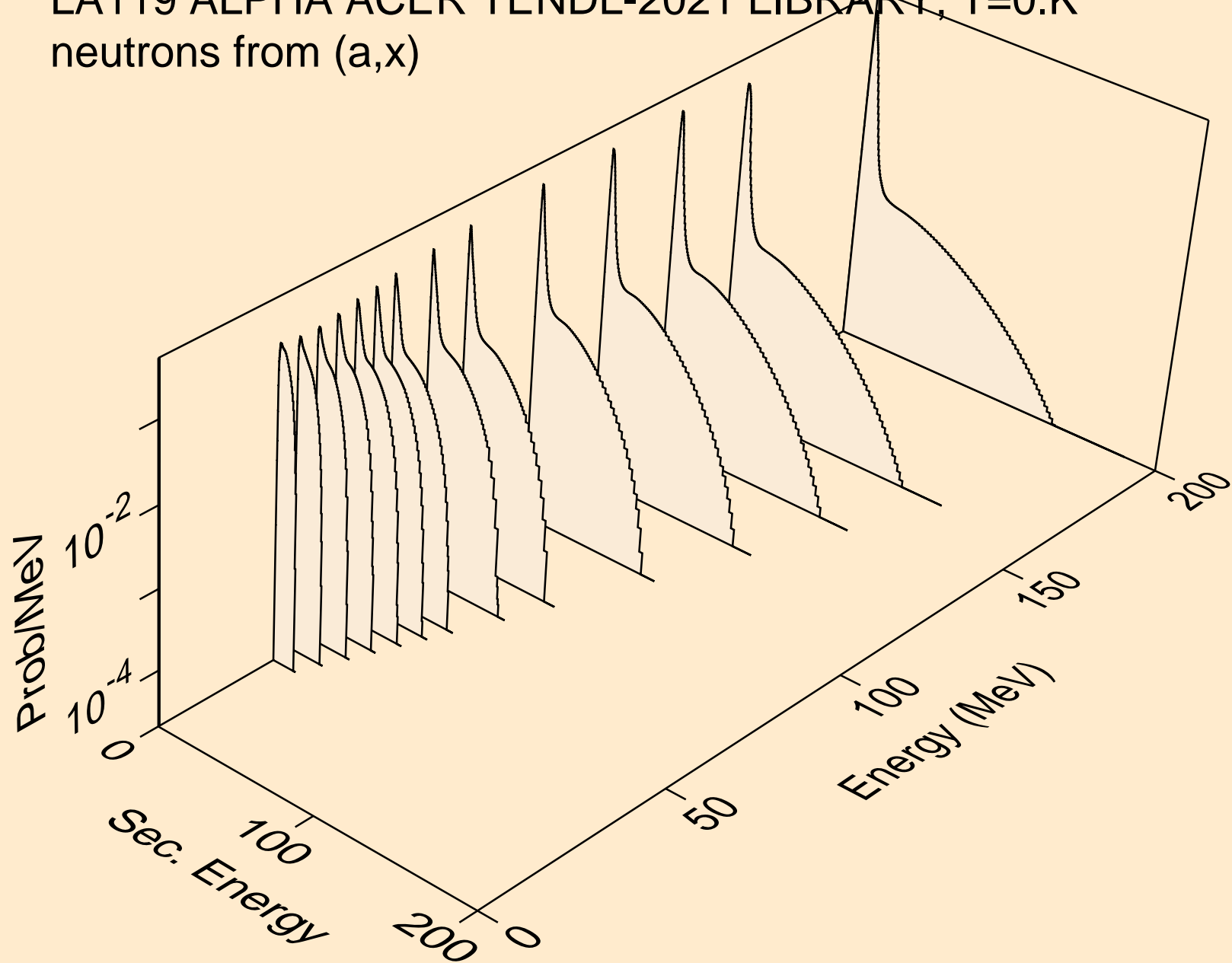

LA119 ALPHA ACER TENDL-2021 LIBRARY; T=0.K
neutrons from (a,2n)

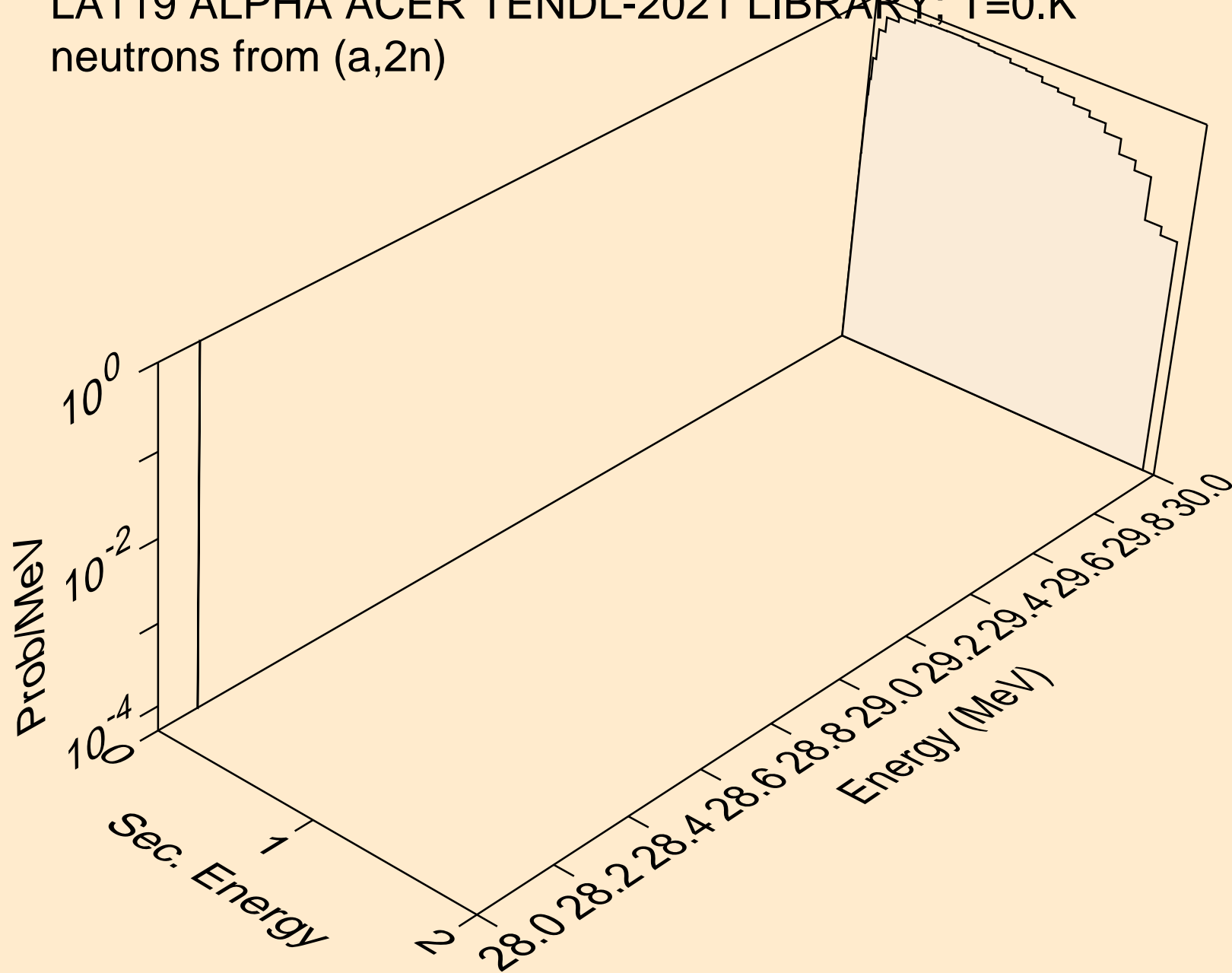

LA119 ALPHA ACER TENDL-2021 LIBRARY; T=0.K
neutrons from (a,n*)a

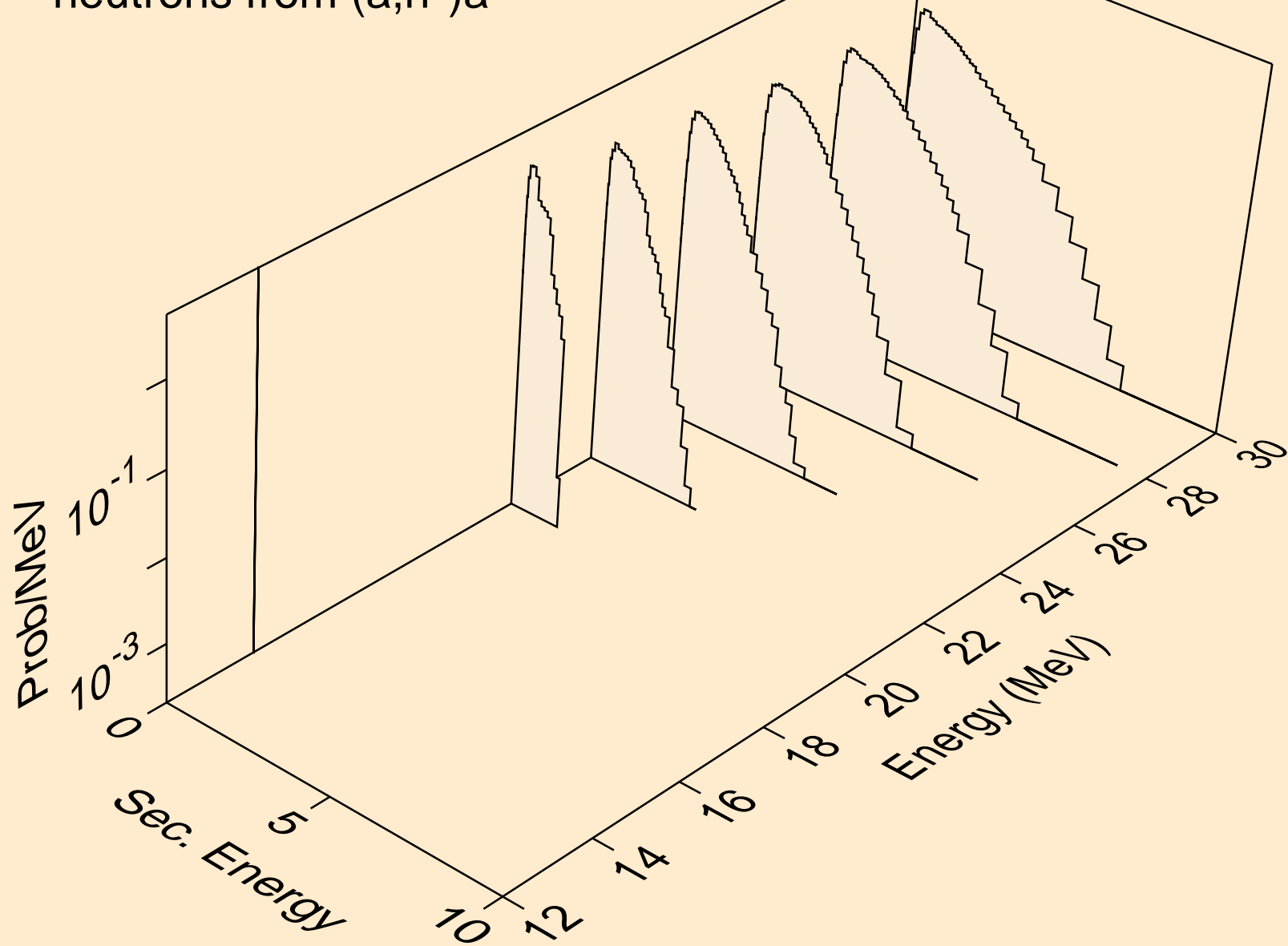

LA119 ALPHA ACER TENDL-2021 LIBRARY; T=0.K
neutrons from (a,n*)p

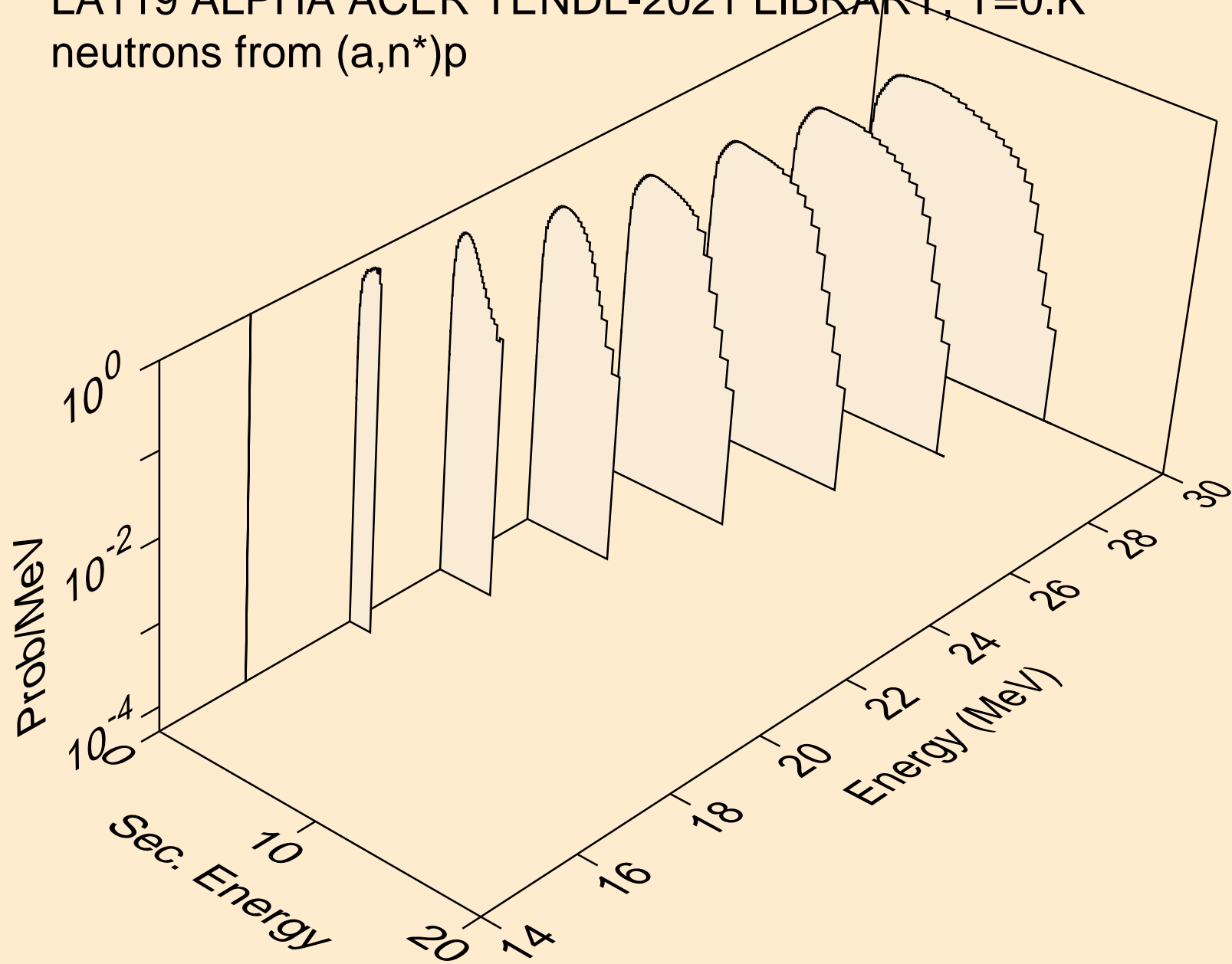

LA119 ALPHA ACER TENDL-2021 LIBRARY; T=0.K
neutrons from (a,2np)

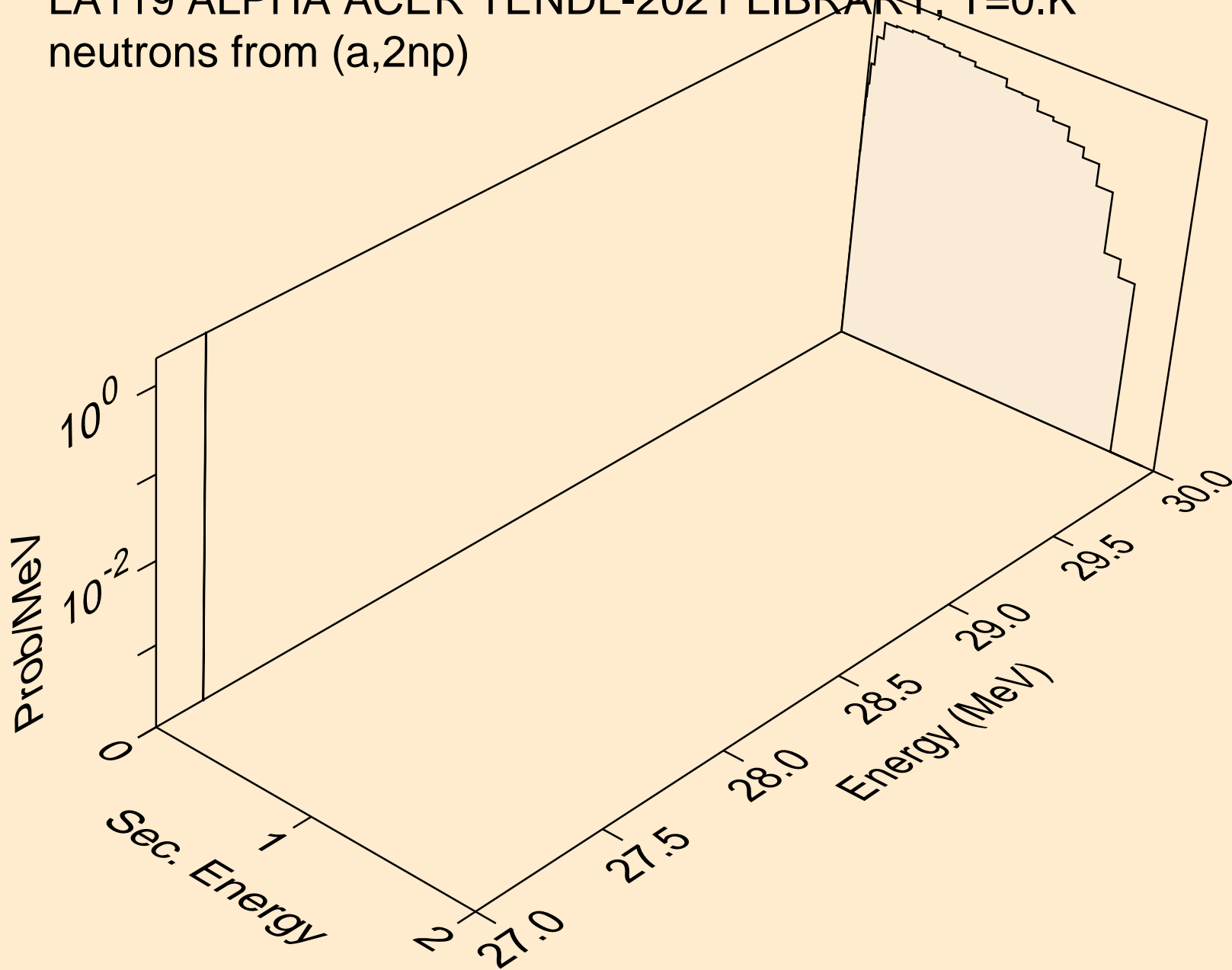

LA119 ALPHA ACER TENDL-2021 LIBRARY; T=0.K
neutrons from (a,2np)

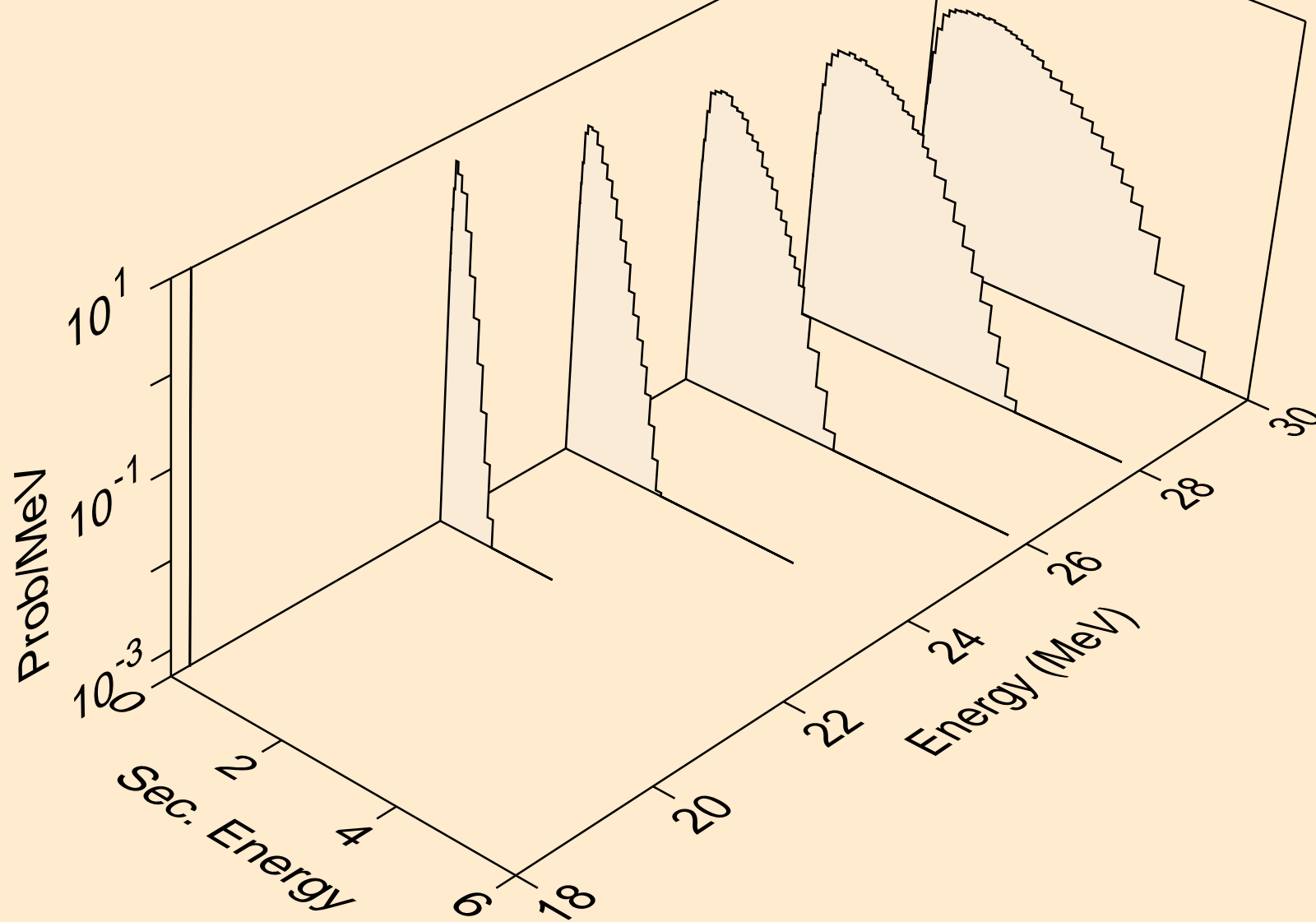

LA119 ALPHA ACER TENDL-2021 LIBRARY; T=0.K
neutrons from (a,npa)

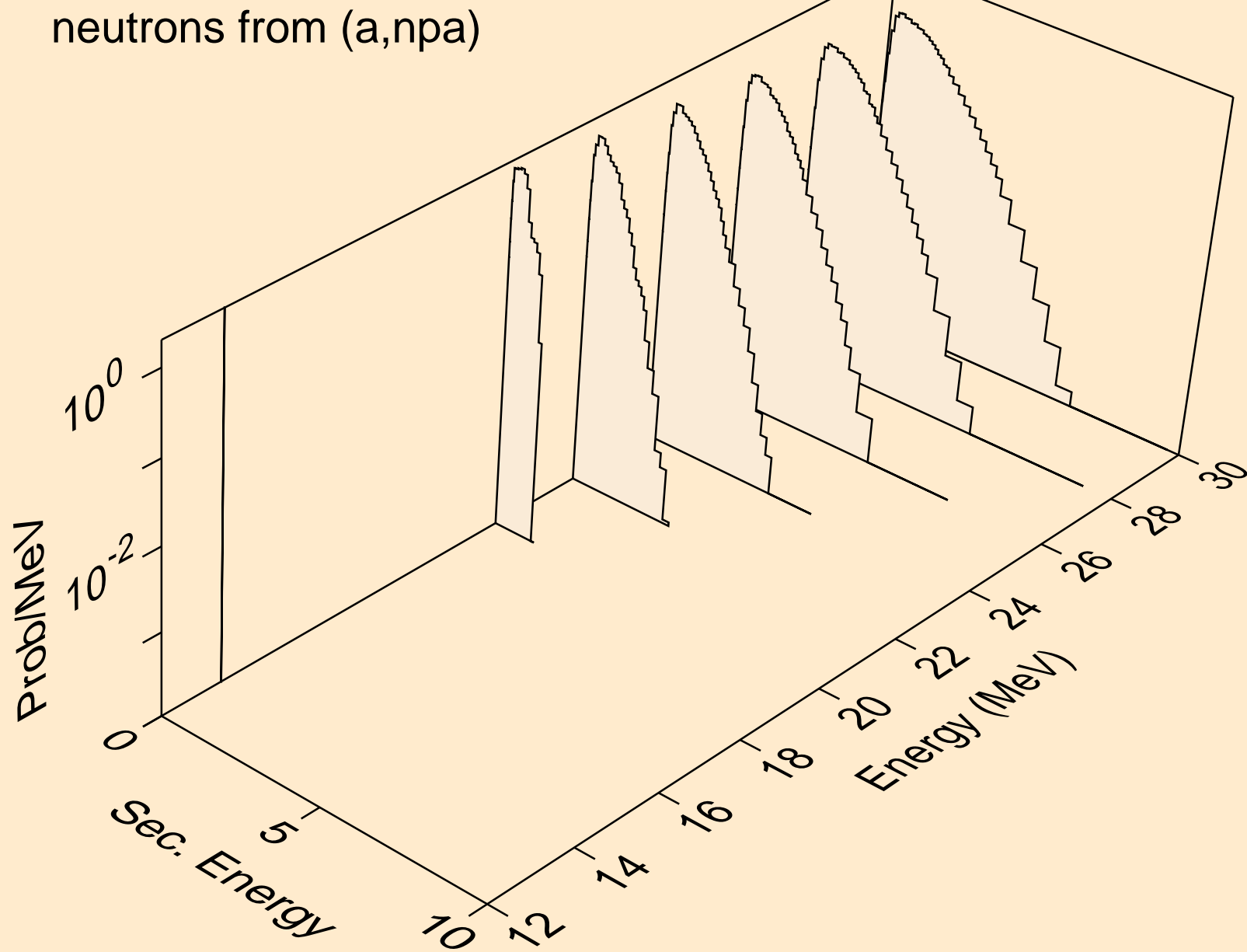

LA119 ALPHA ACER TENDL-2021 LIBRARY; T=0.K
protons from (a,x)

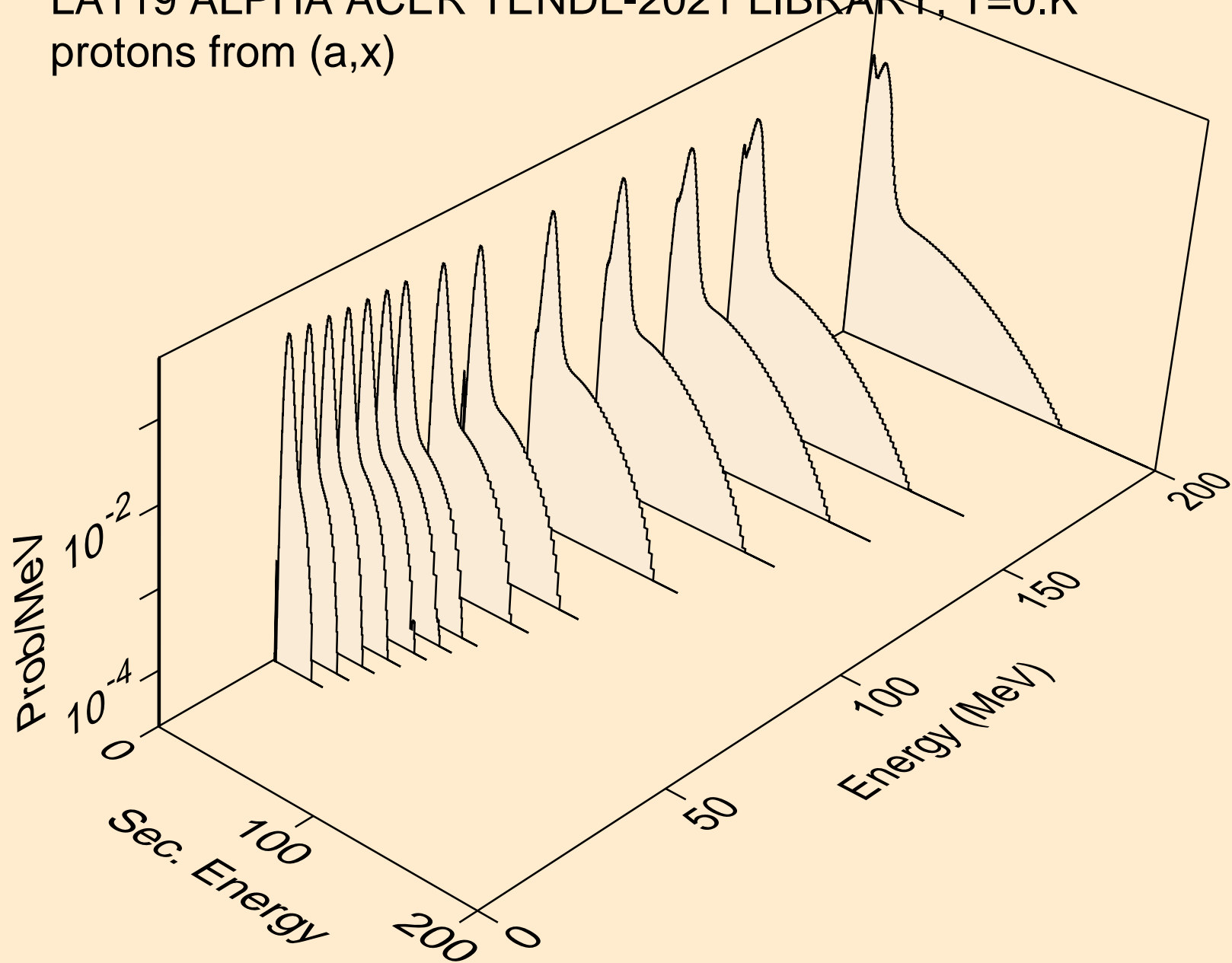

LA119 ALPHA ACER TENDL-2021 LIBRARY; T=0.K
protons from (a,n*)p

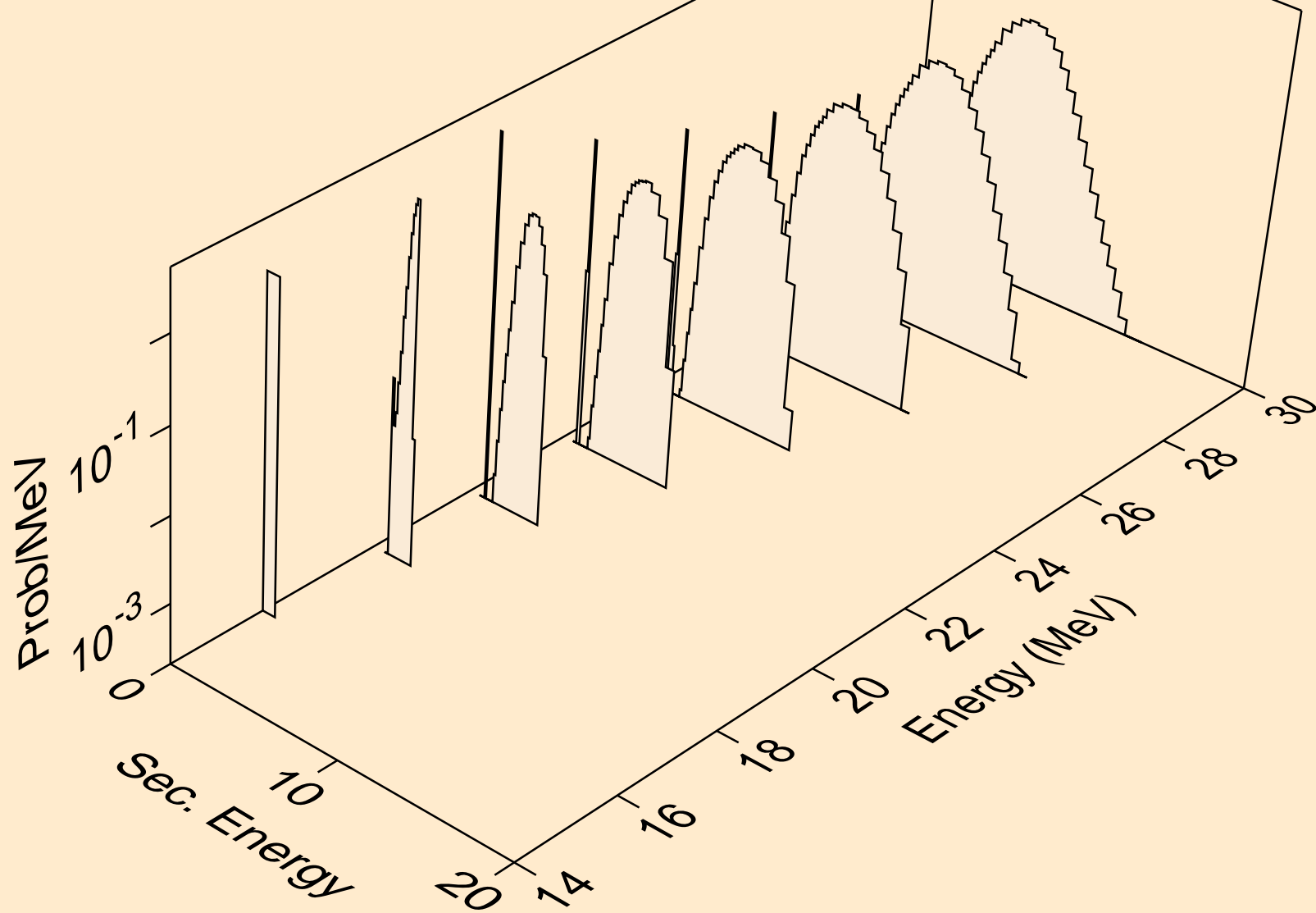

LA119 ALPHA ACER TENDL-2021 LIBRARY; T=0.K
protons from (a,2np)

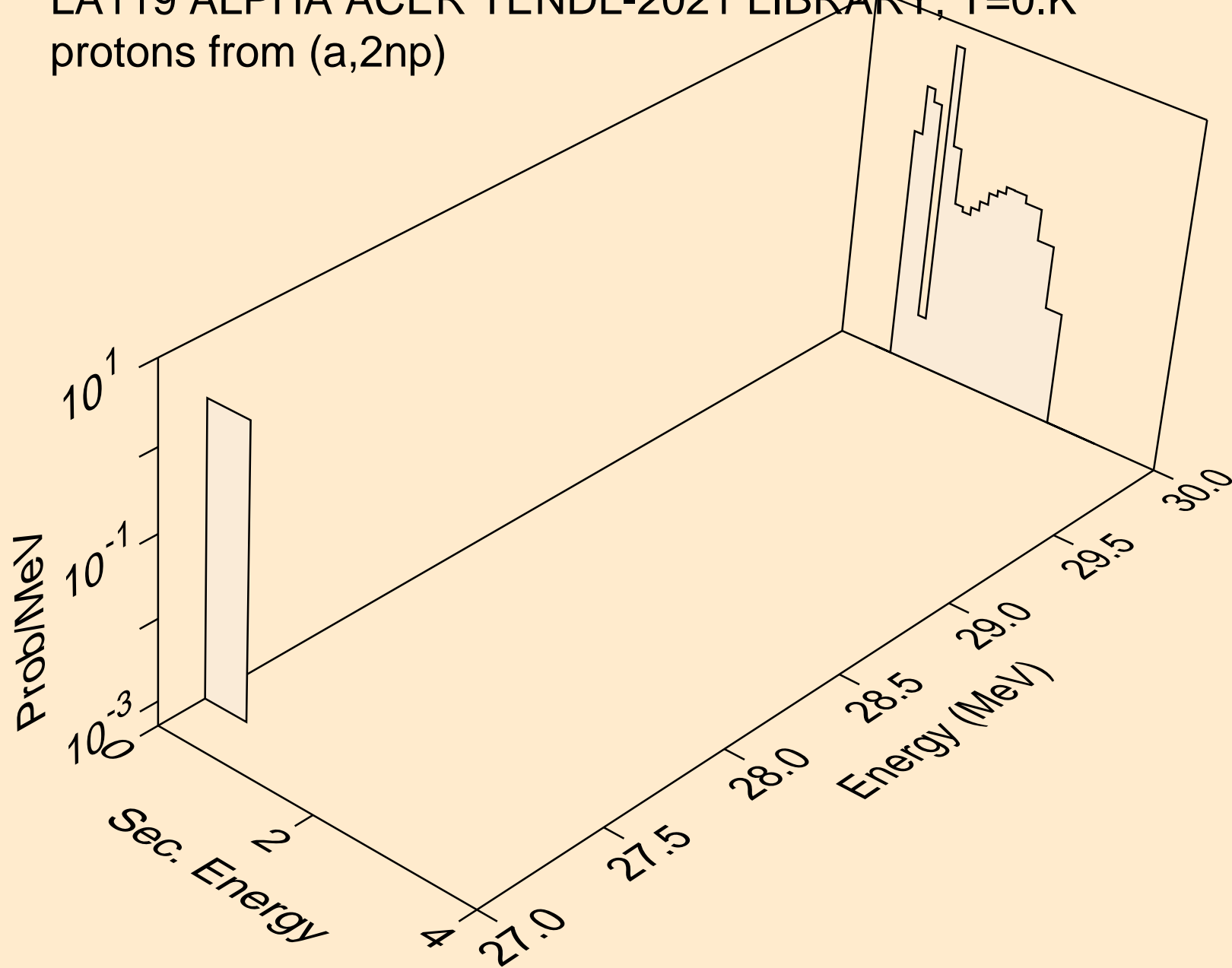

LA119 ALPHA ACER TENDL-2021 LIBRARY; T=0.K
protons from (a,2np)

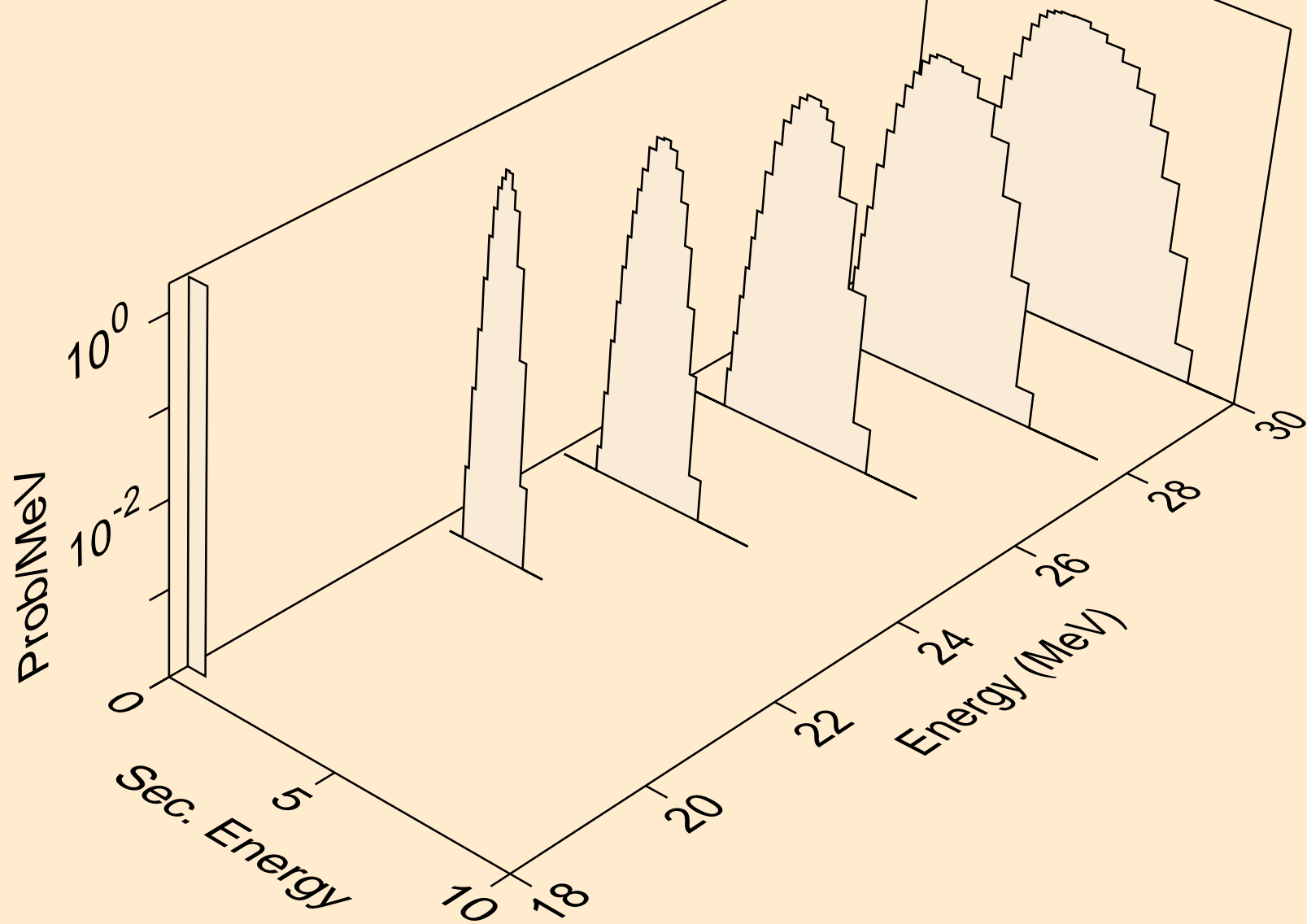

LA119 ALPHA ACER TENDL-2021 LIBRARY; T=0.K
protons from (a,npa)

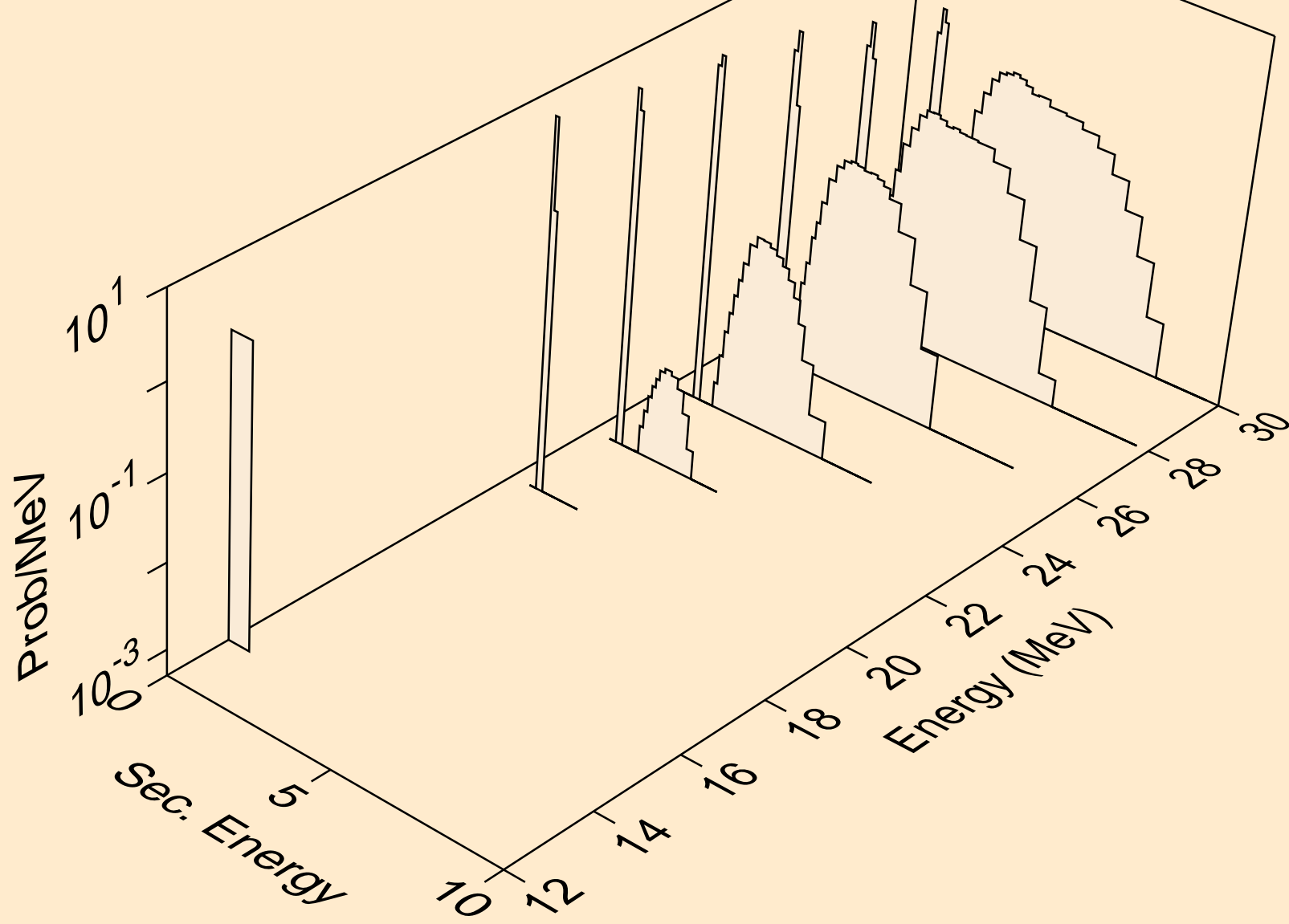

LA119 ALPHA ACER TENDL-2021 LIBRARY; T=0.K
protons from (a,p)

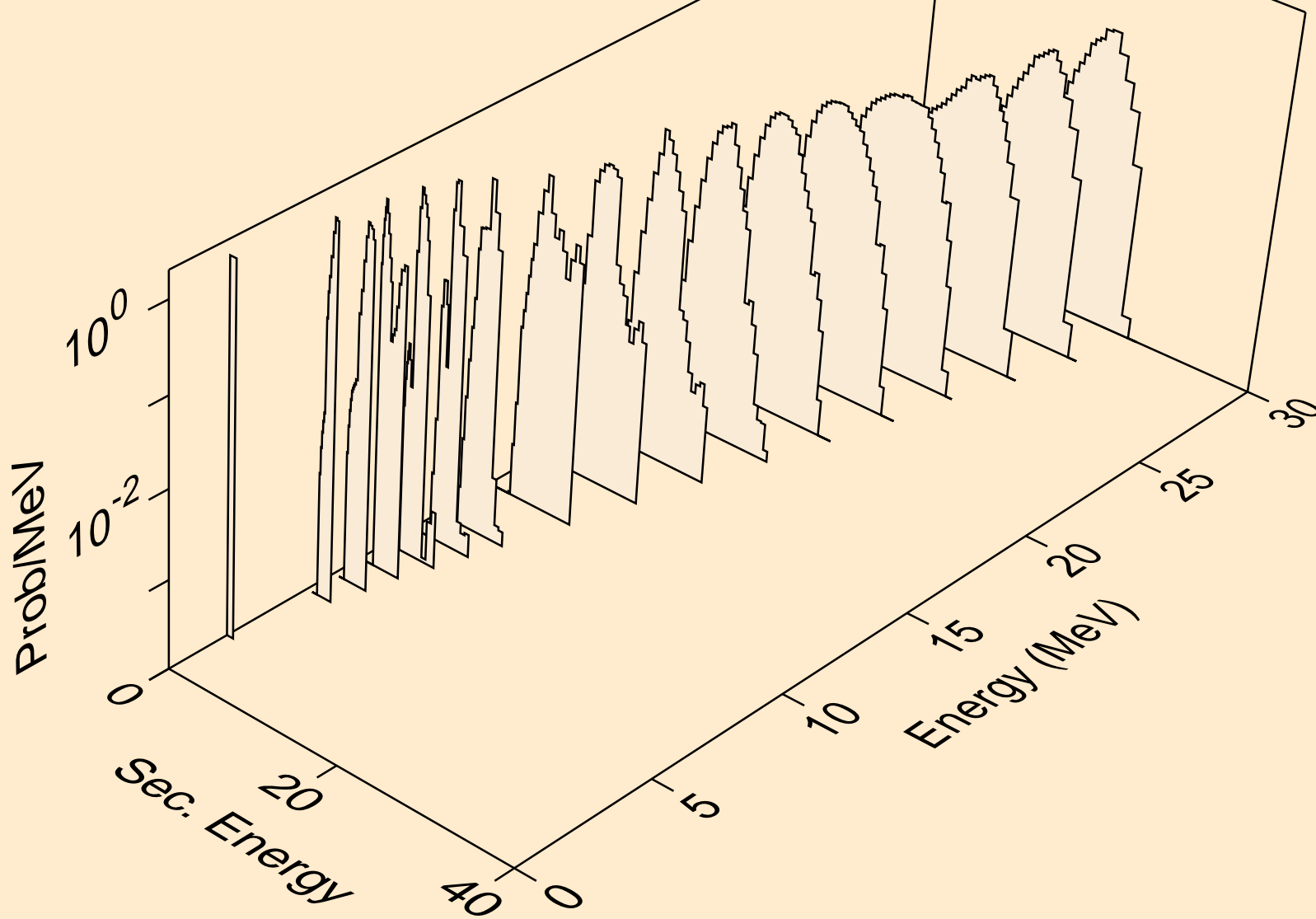

LA119 ALPHA ACER TENDL-2021 LIBRARY; T=0.K
protons from (a,2p)

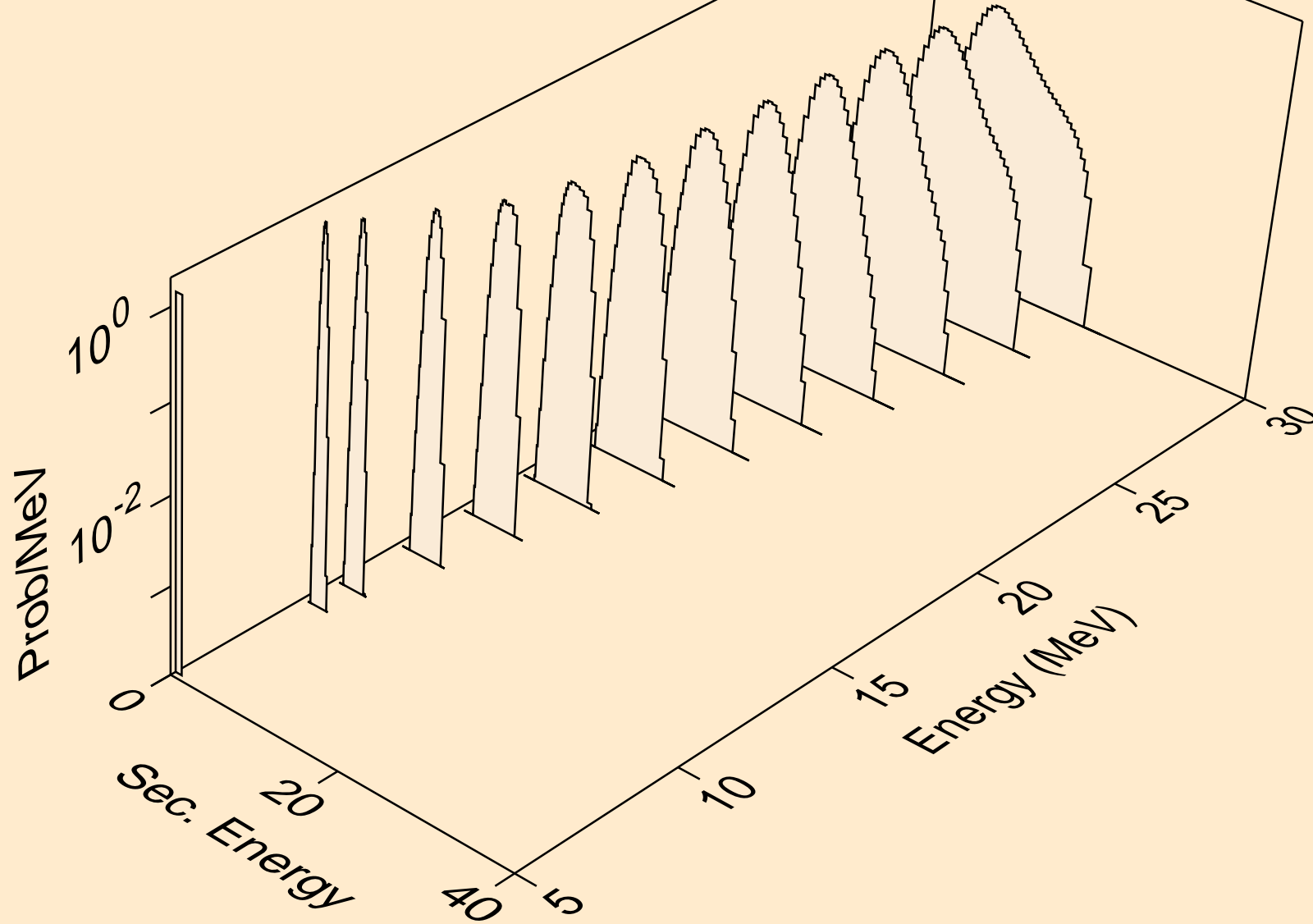

LA119 ALPHA ACER TENDL-2021 LIBRARY; T=0.K
protons from (a,pa)

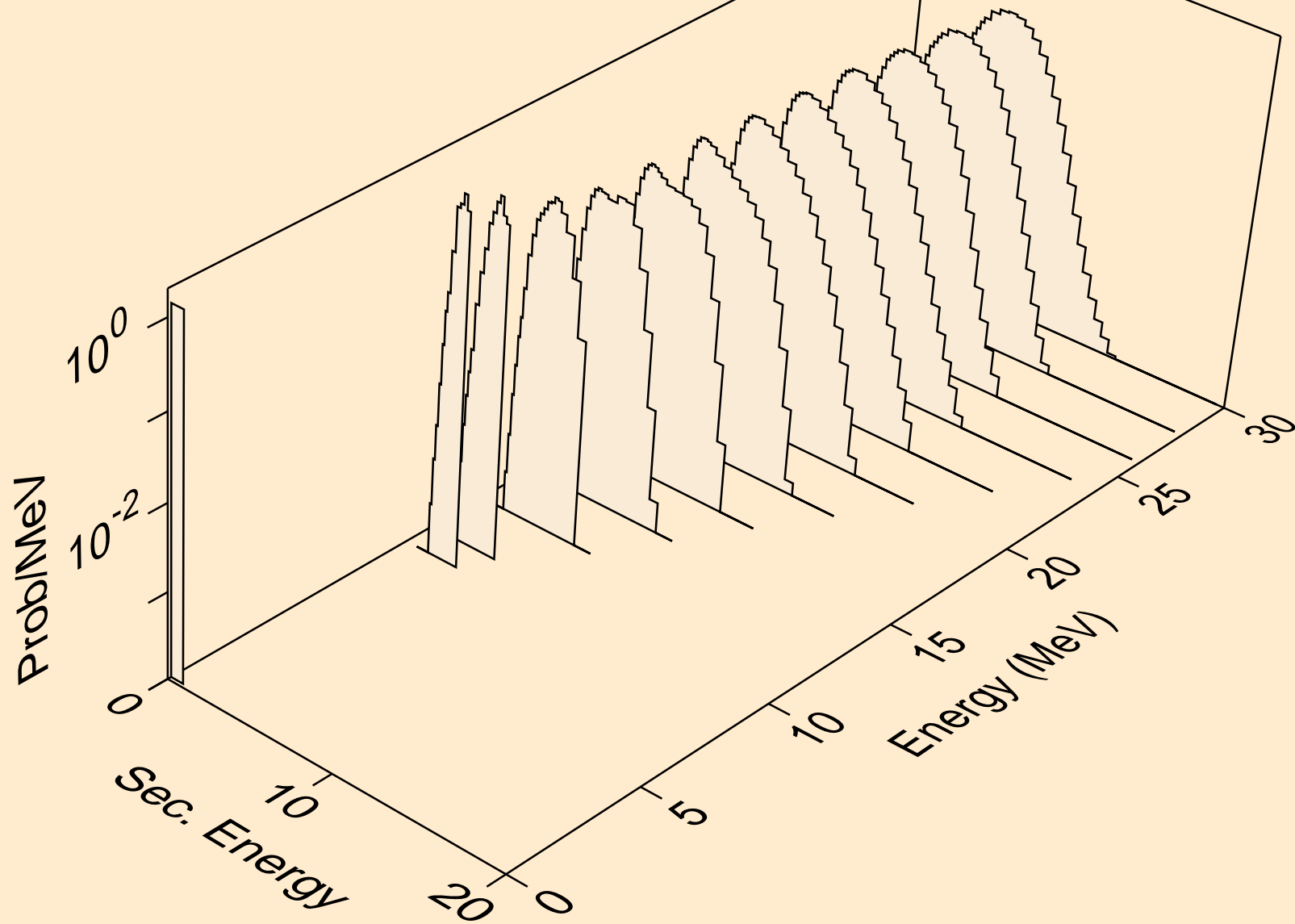

LA119 ALPHA ACER TENDL-2021 LIBRARY; T=0.K
protons from (a,pd)

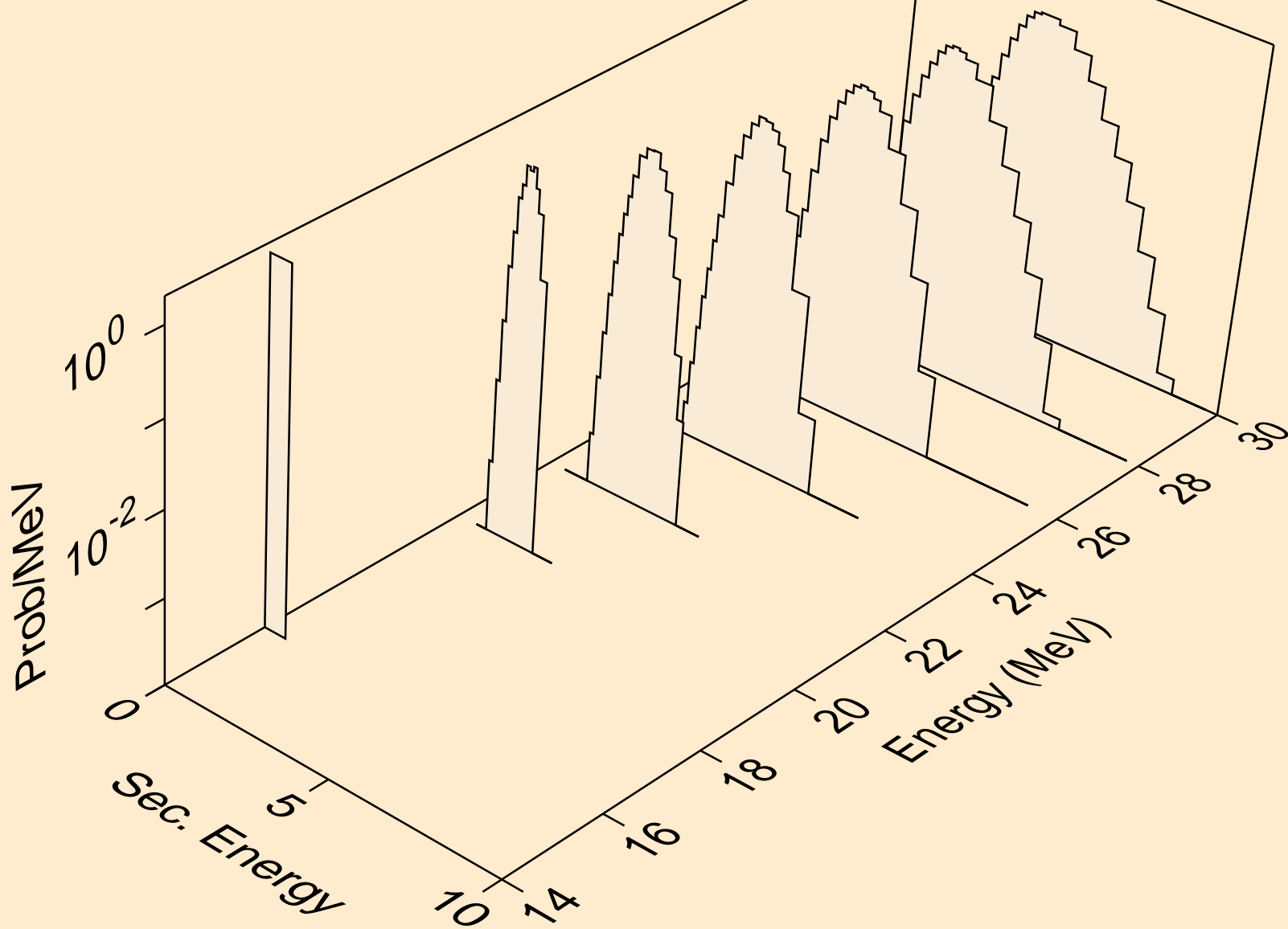

LA119 ALPHA ACER TENDL-2021 LIBRARY; T=0.K
protons from (a,pt)

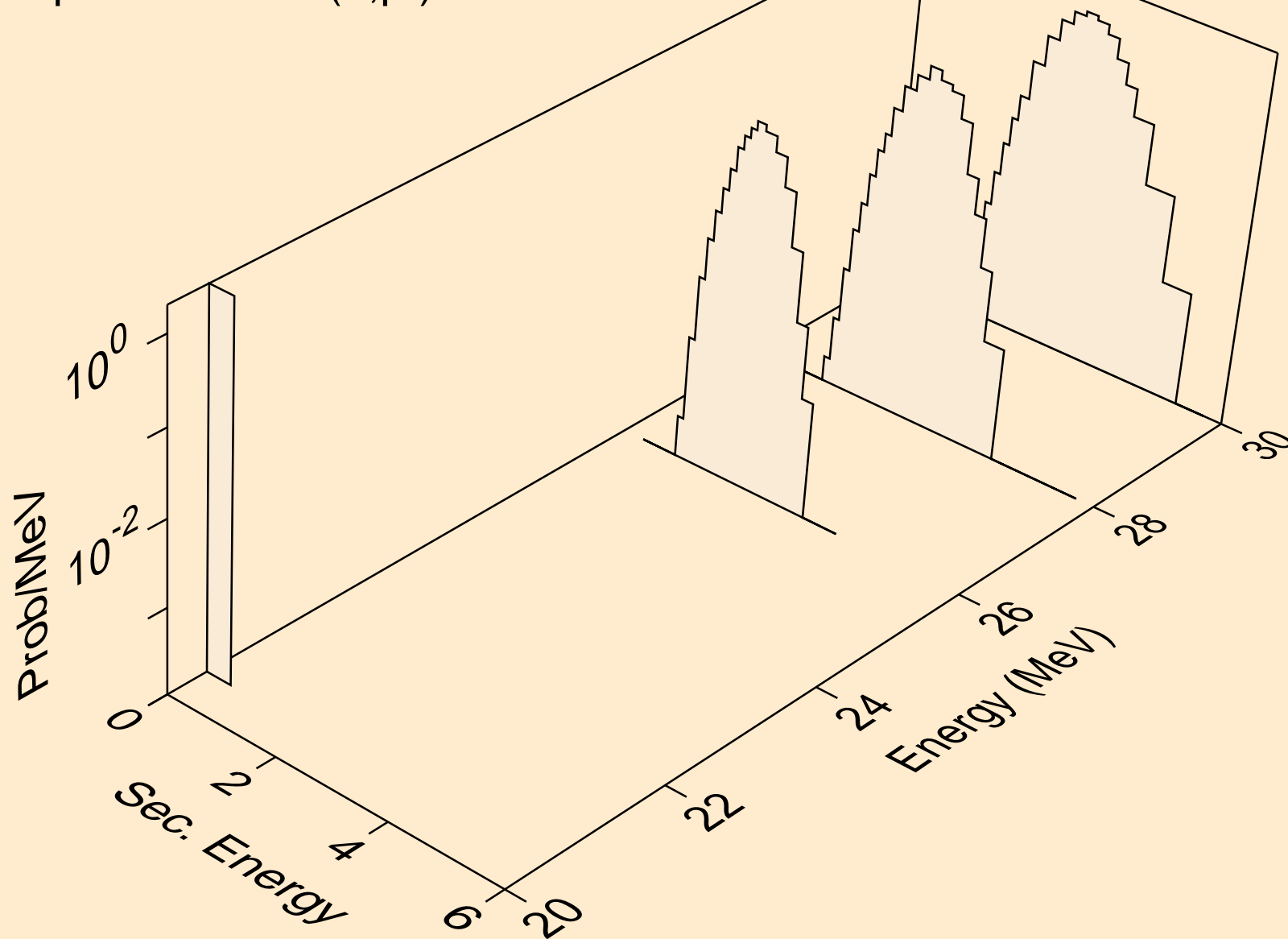

LA119 ALPHA ACER TENDL-2021 LIBRARY; T=0.K
deuterons from (a,x)

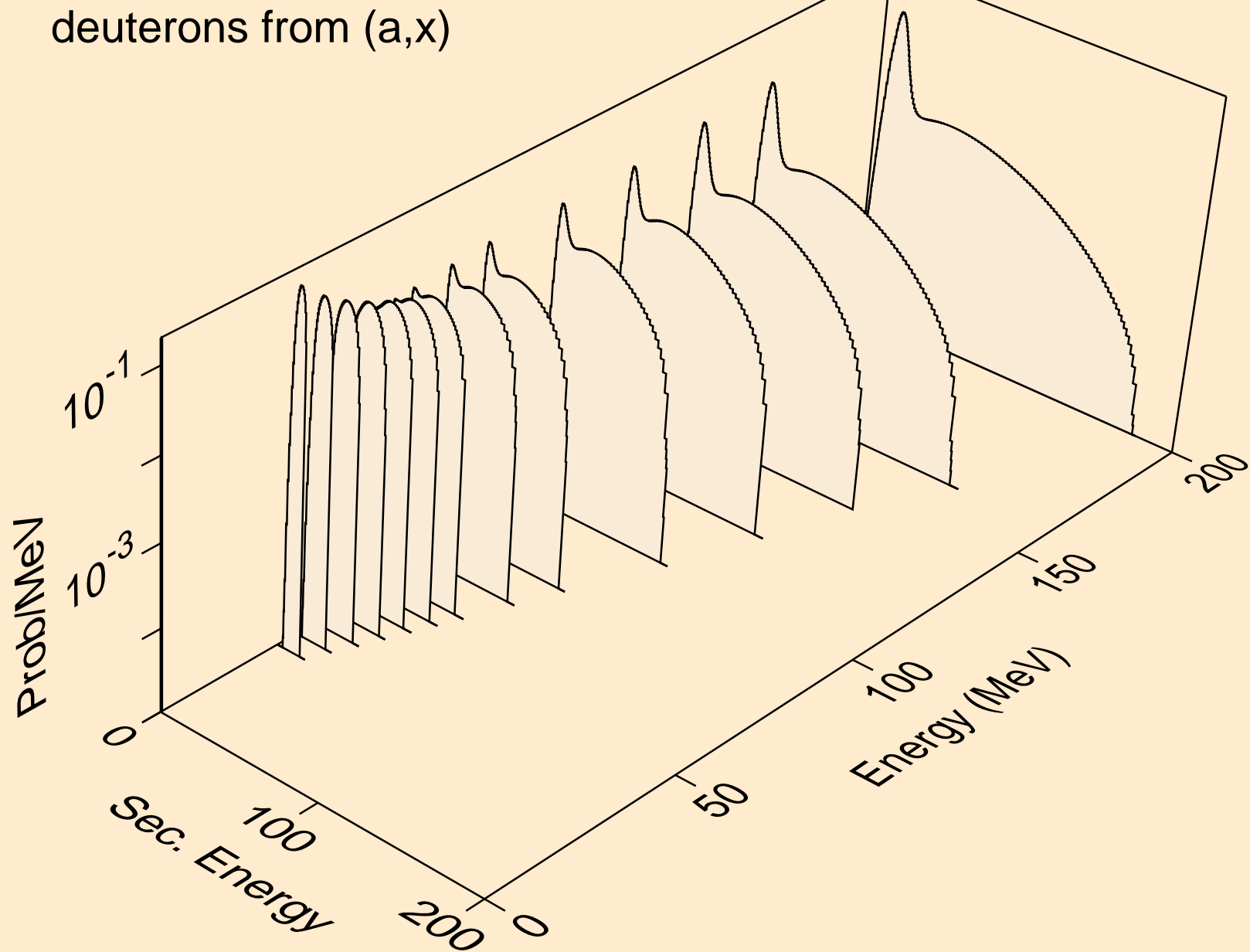

LA119 ALPHA ACER TENDL-2021 LIBRARY; T=0.K
deuterons from (a,d)

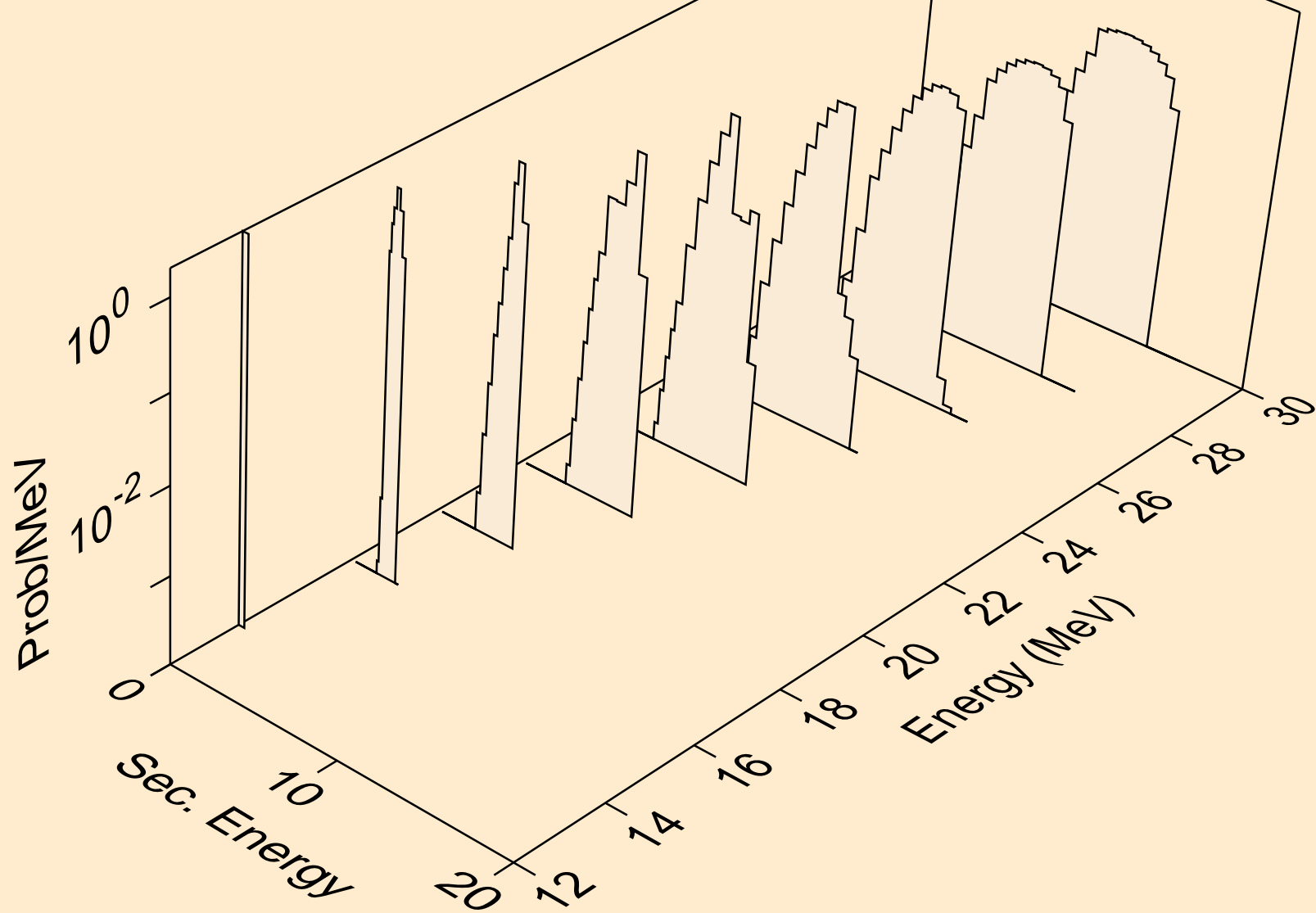

LA119 ALPHA ACER TENDL-2021 LIBRARY; T=0.K
deuterons from (a,pd)

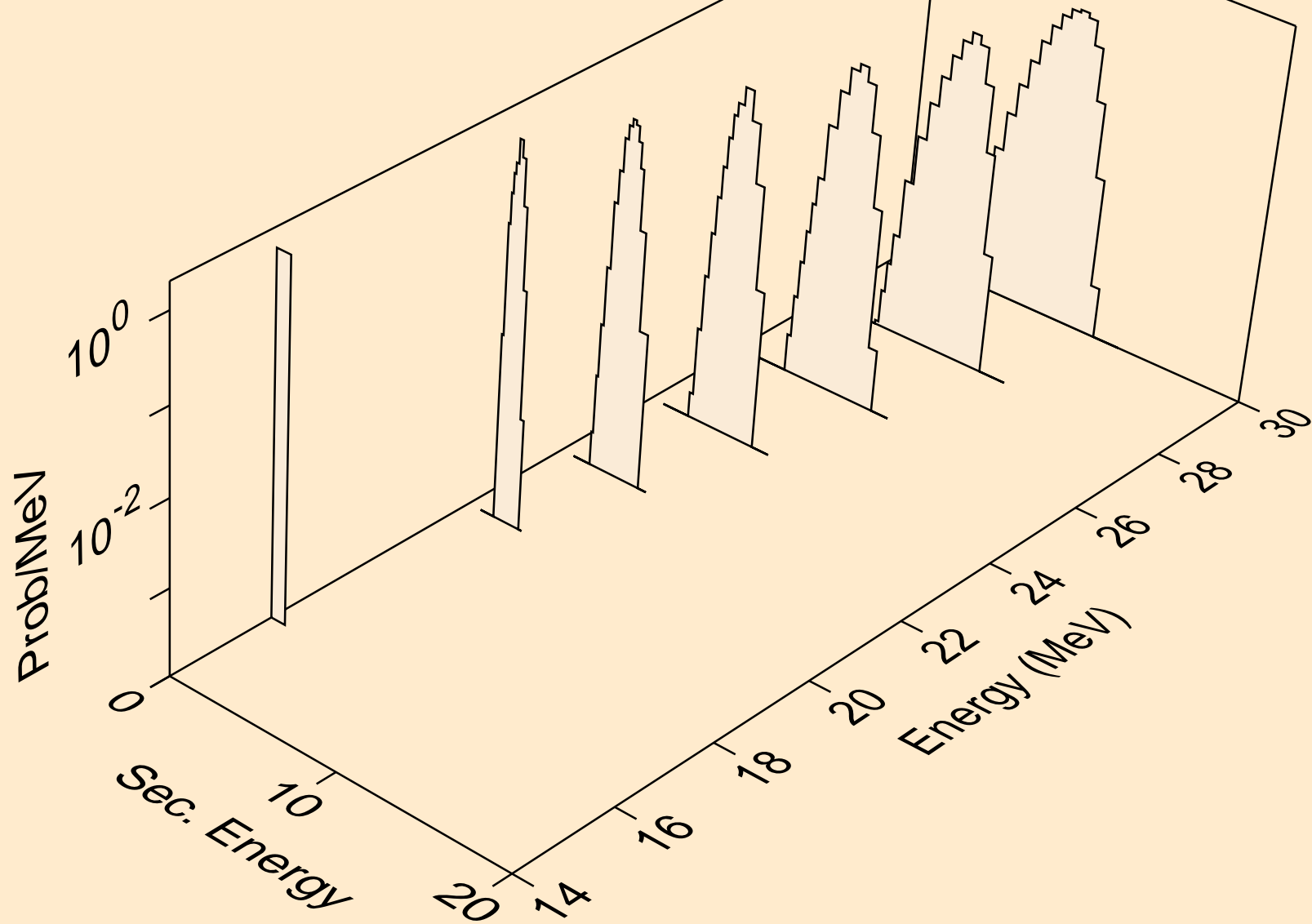

LA119 ALPHA ACER TENDL-2021 LIBRARY; T=0.K
deuterons from (a,da)

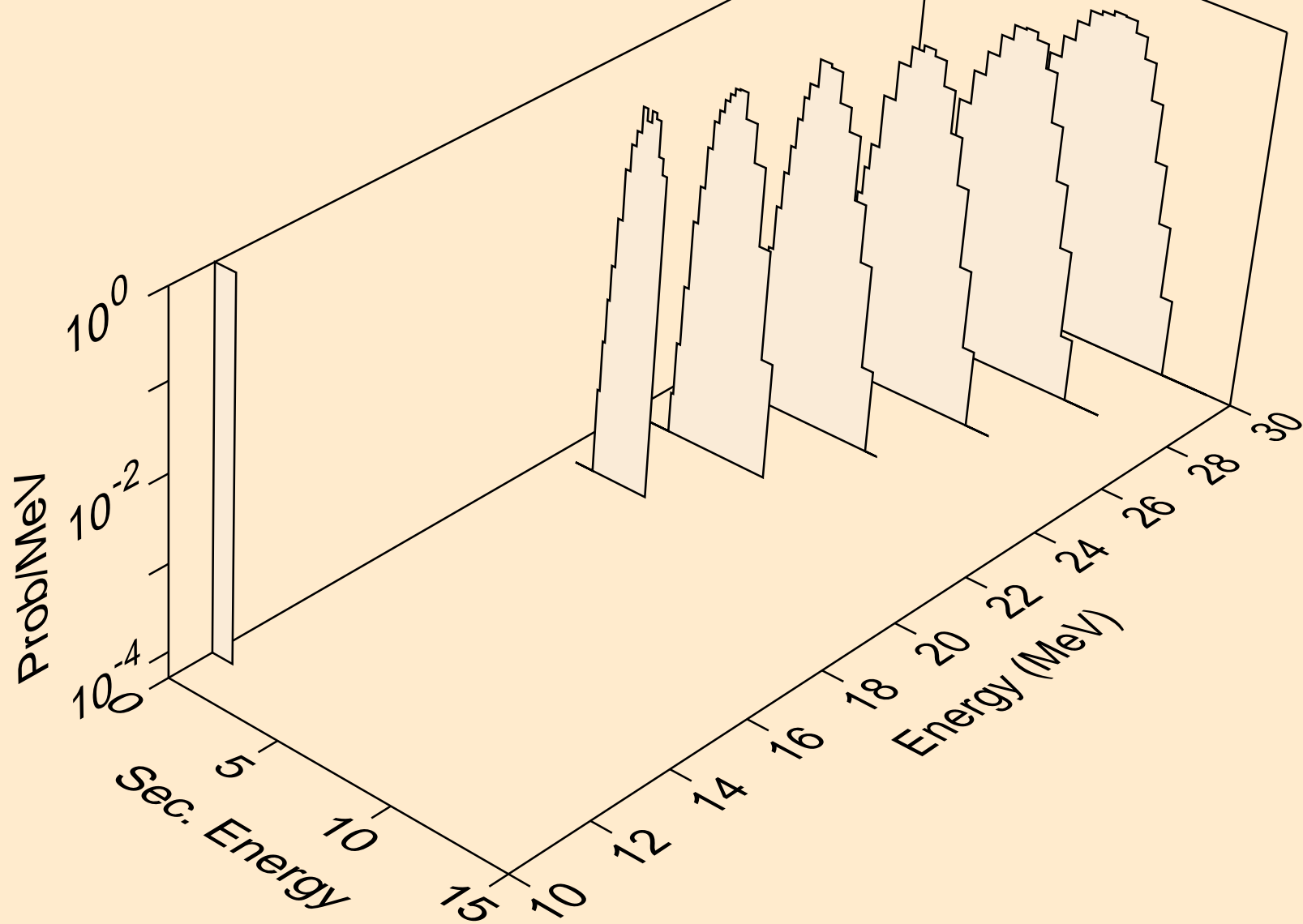

LA119 ALPHA ACER TENDL-2021 LIBRARY; T=0.K
tritons from (a,x)

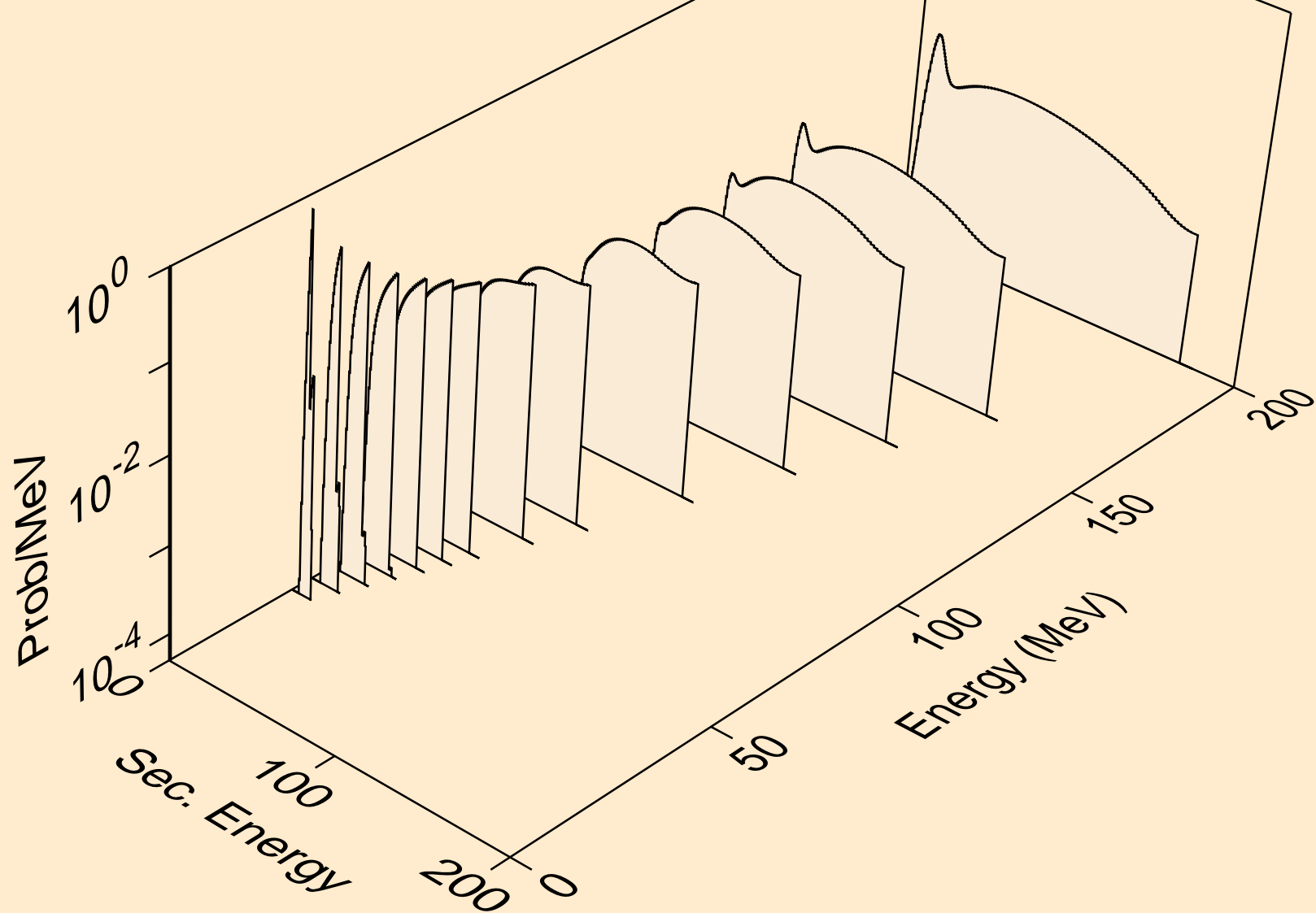

LA119 ALPHA ACER TENDL-2021 LIBRARY; T=0.K
tritons from (a,t)

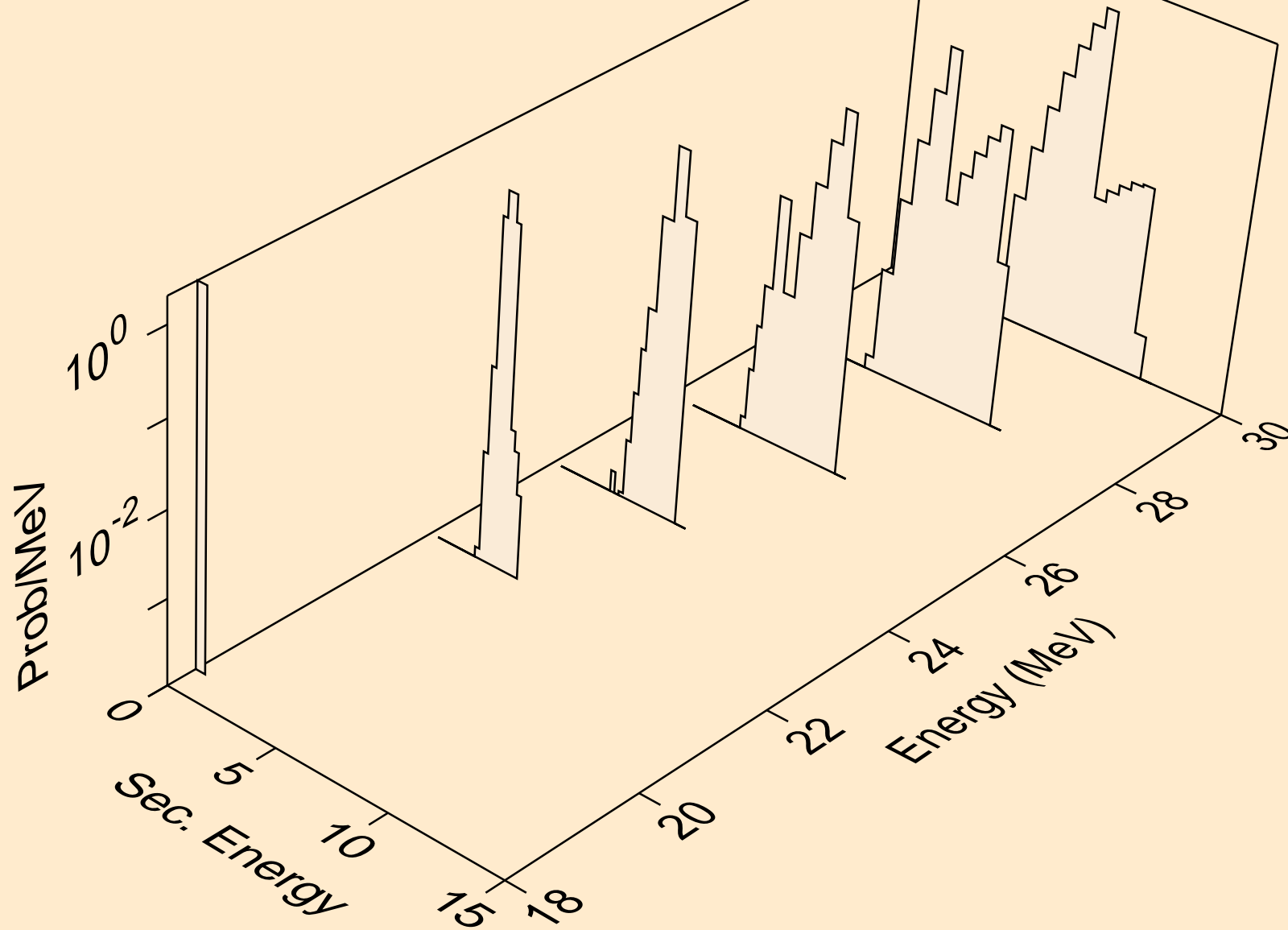

LA119 ALPHA ACER TENDL-2021 LIBRARY; T=0.K
tritons from (a,pt)

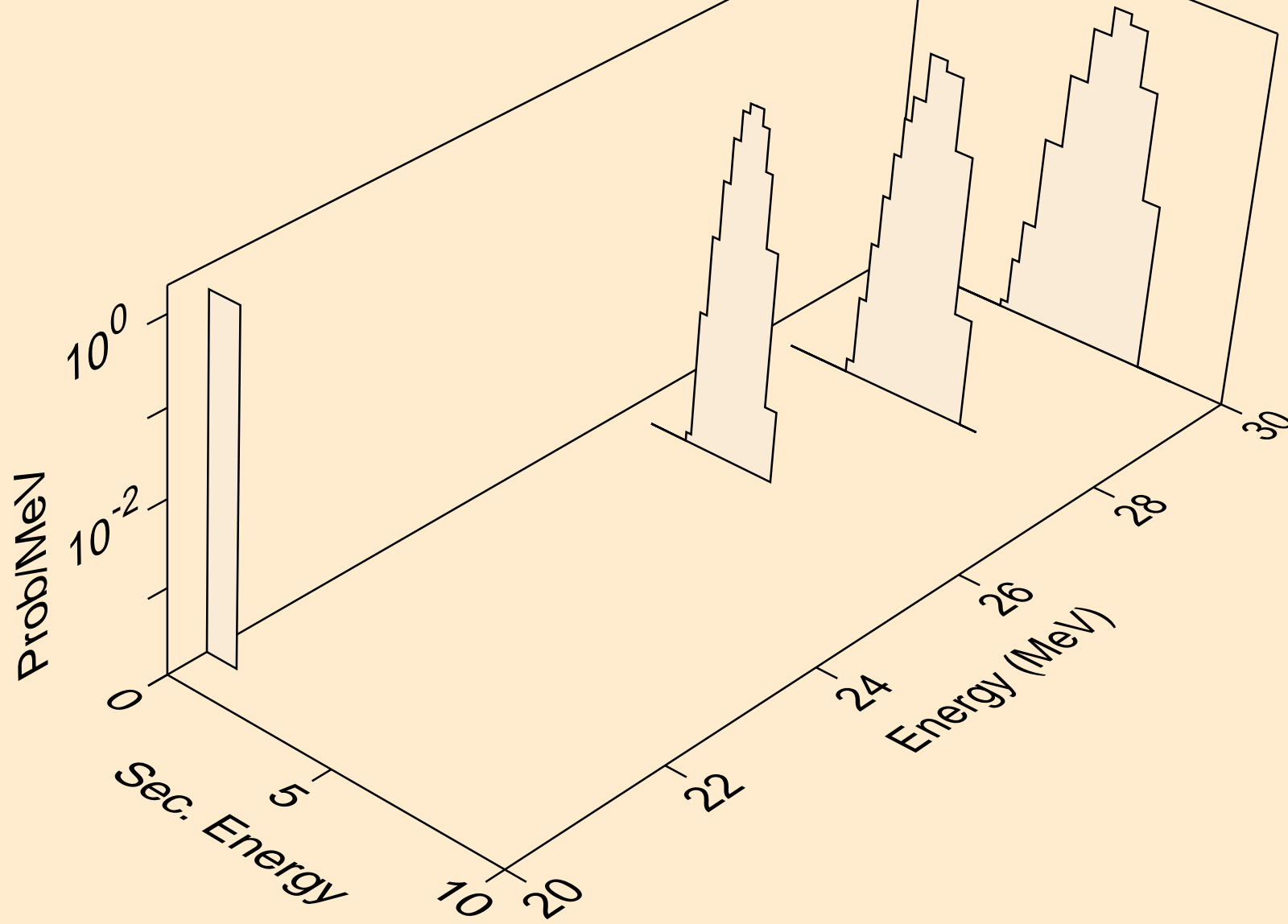

LA119 ALPHA ACER TENDL-2021 LIBRARY; T=0.K
he3s from (a,x)

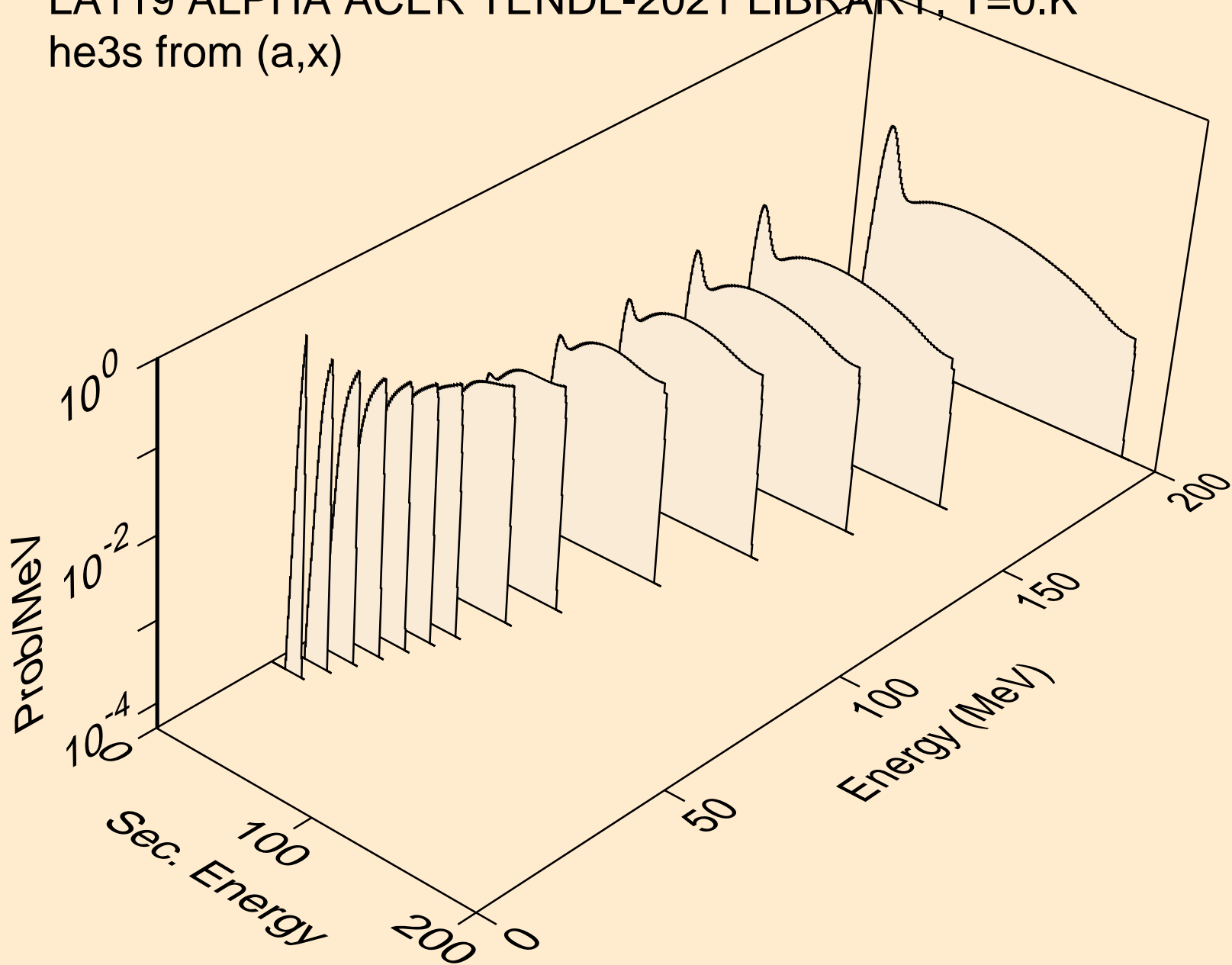

LA119 ALPHA ACER TENDL-2021 LIBRARY; T=0.K
he3s from (a,he3)

