

NP244 ALPHA ACER TENDL-2021 LIBRARY; T=0.K
Principal cross sections

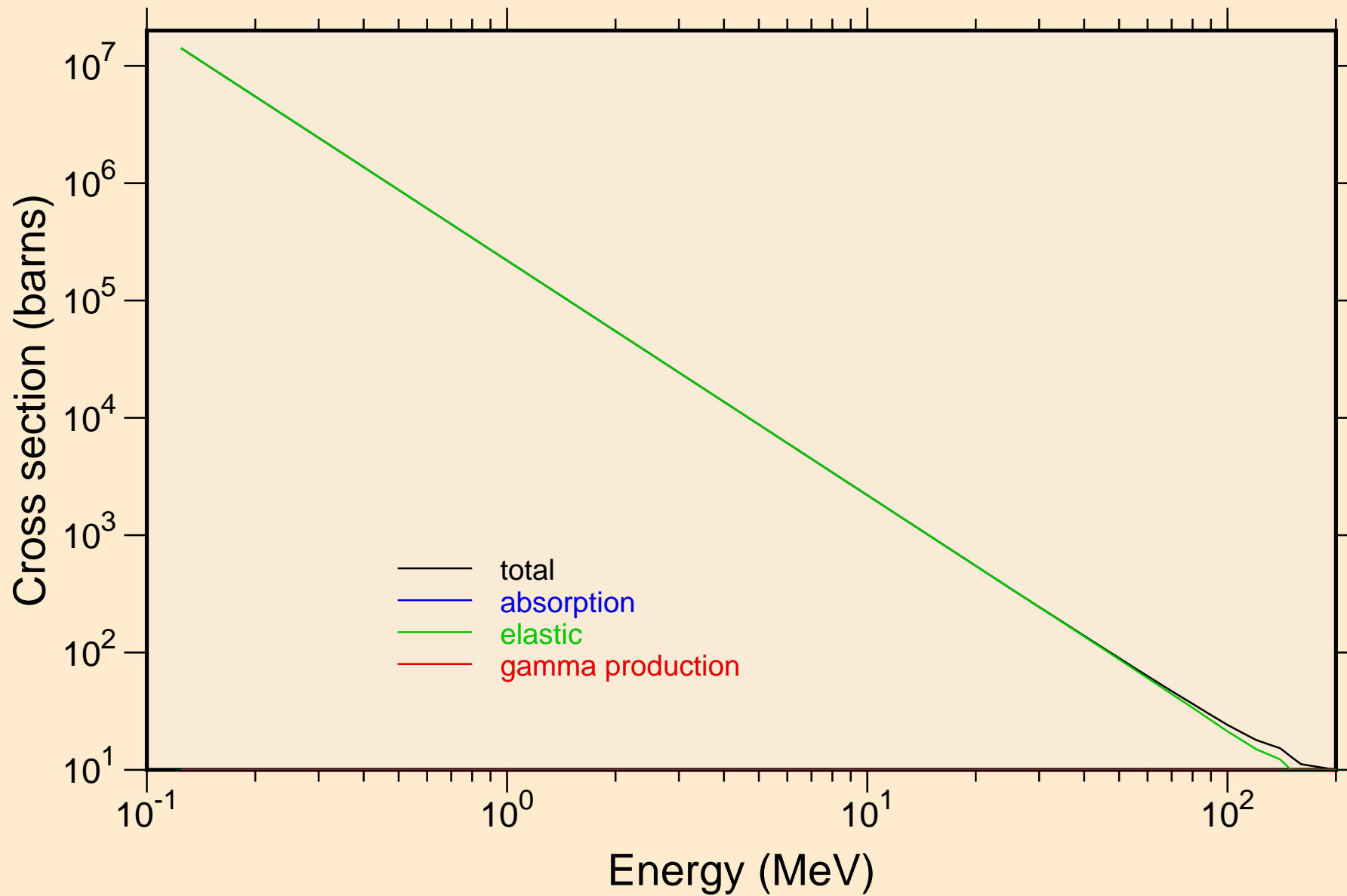

NP244 ALPHA ACER TENDL-2021 LIBRARY; T=0.K
Heating

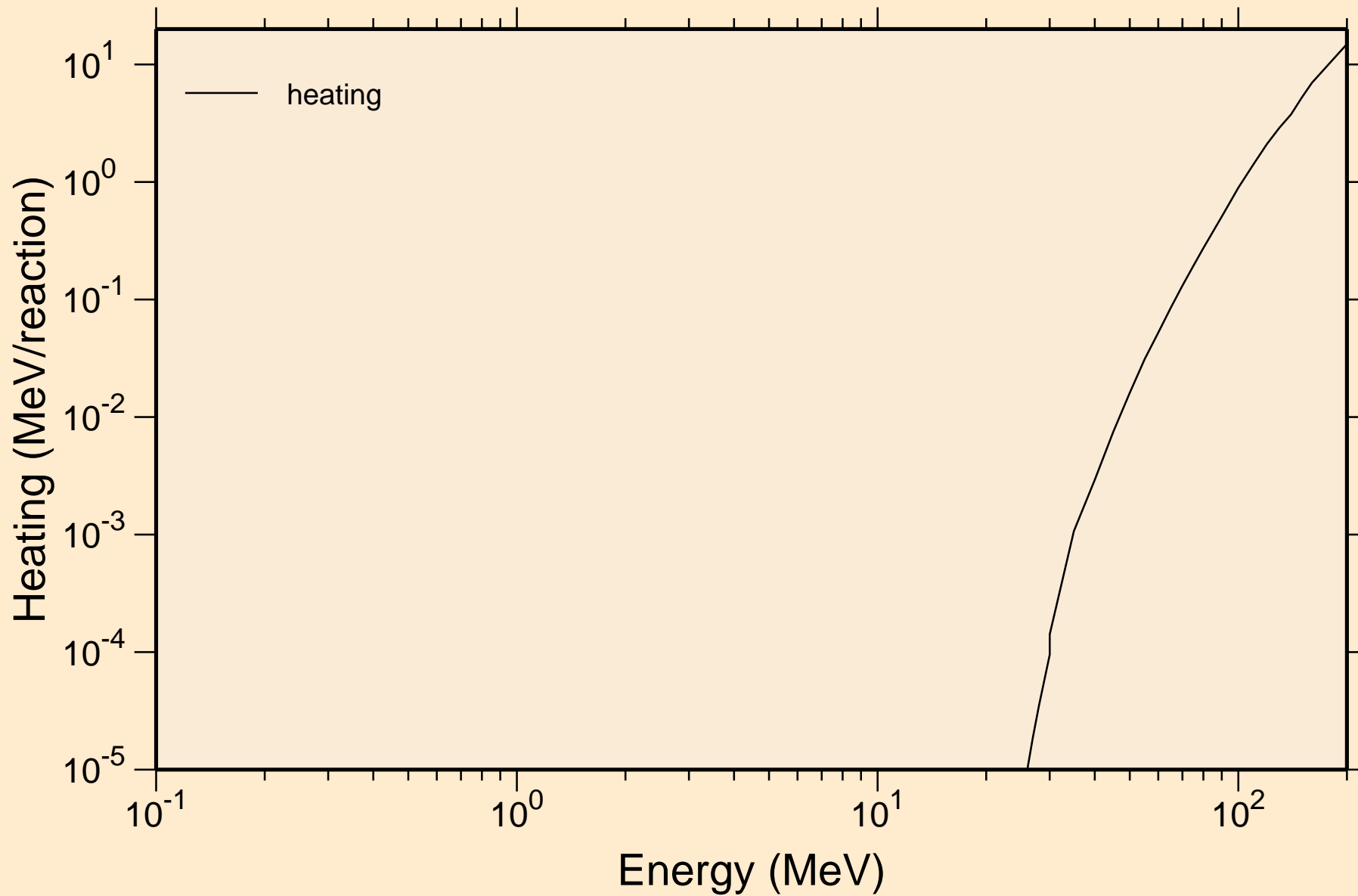

NP244 ALPHA ACER TENDL-2021 LIBRARY; T=0.K
Principal cross sections

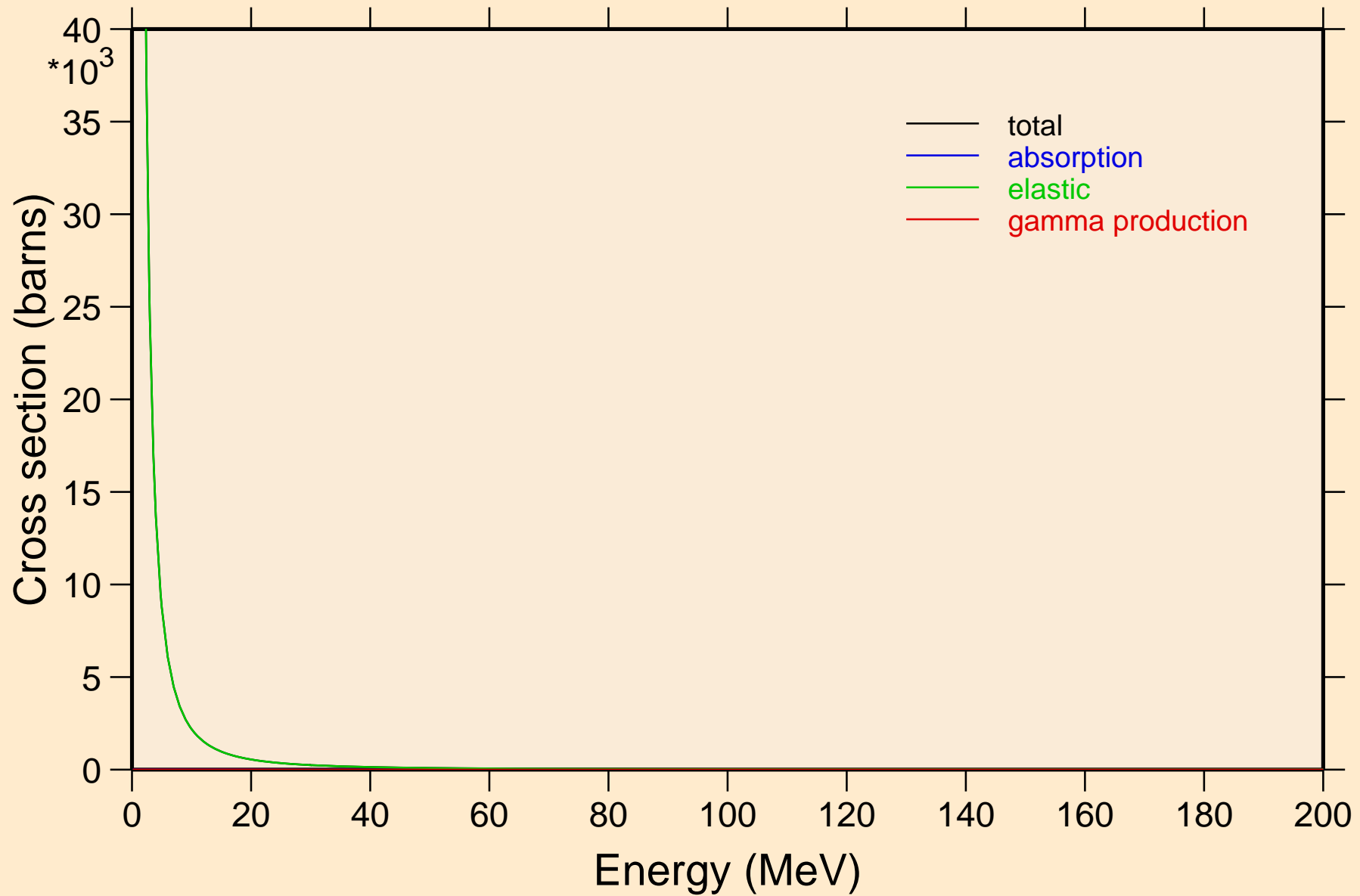

NP244 ALPHA ACER TENDL-2021 LIBRARY; T=0.K

Heating

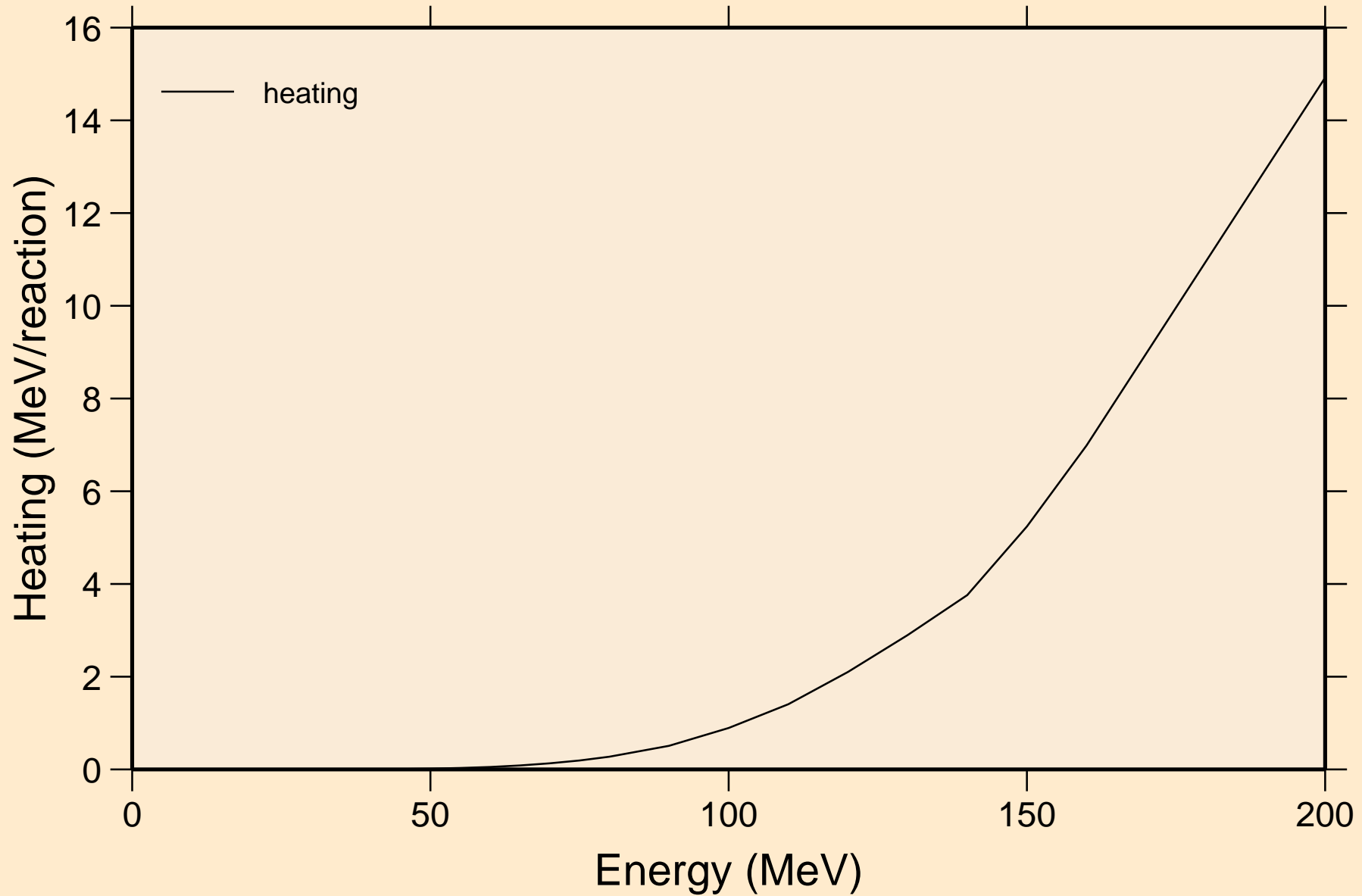

NP244 ALPHA ACER TENDL-2021 LIBRARY; T=0.K
Threshold reactions

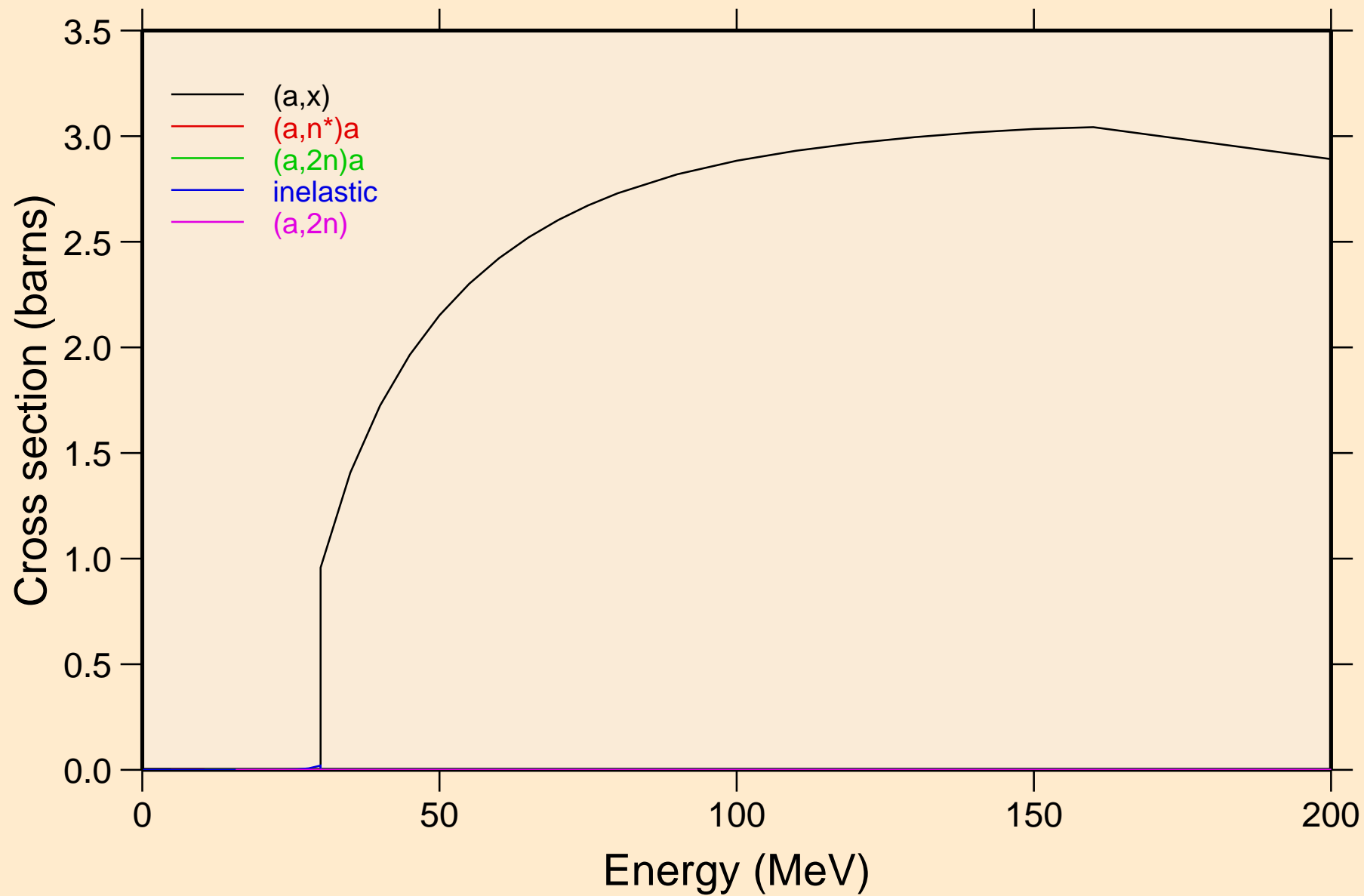

NP244 ALPHA ACER TENDL-2021 LIBRARY; T=0.K
Threshold reactions

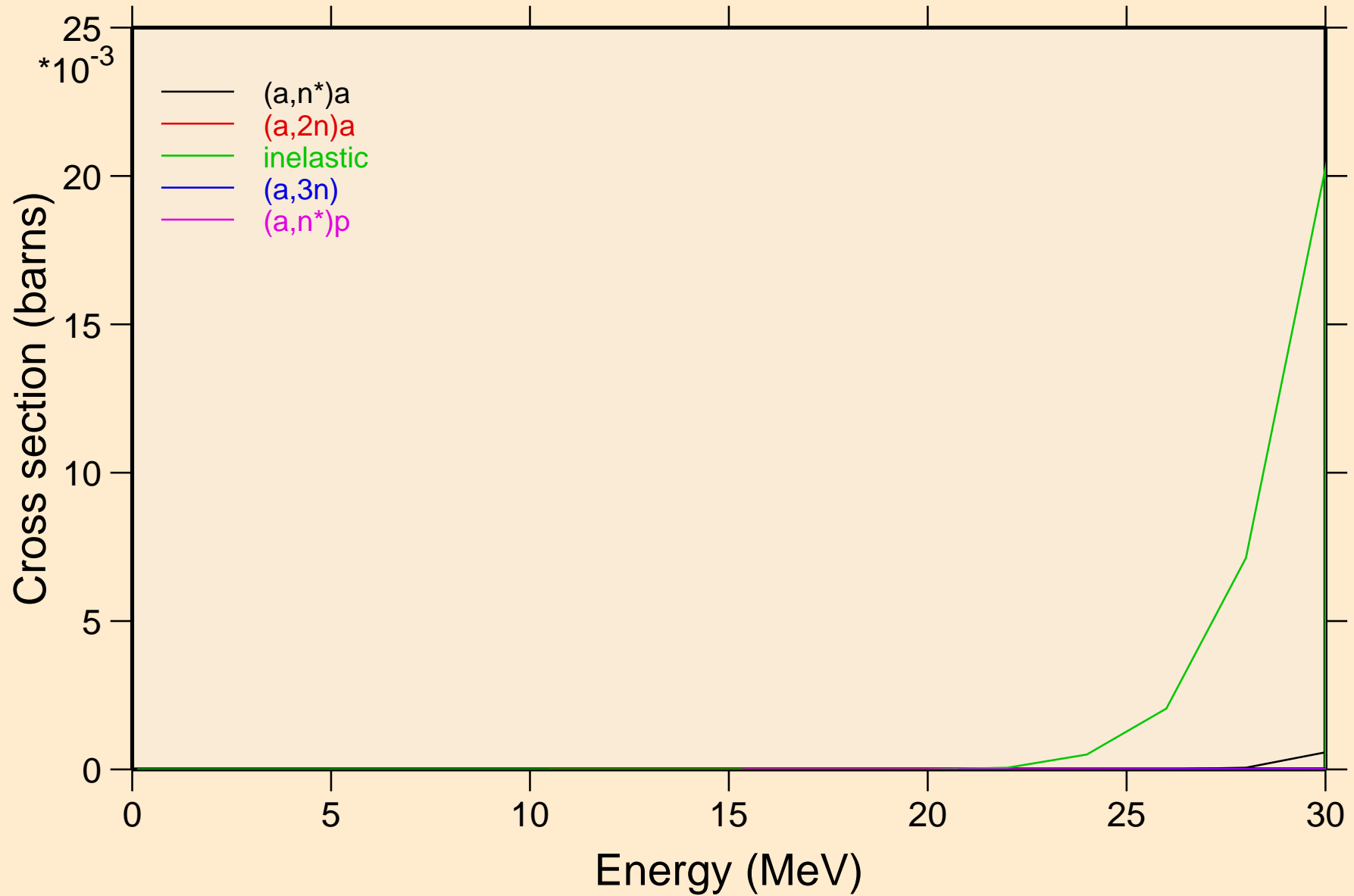

NP244 ALPHA ACER TENDL-2021 LIBRARY; T=0.K
Threshold reactions

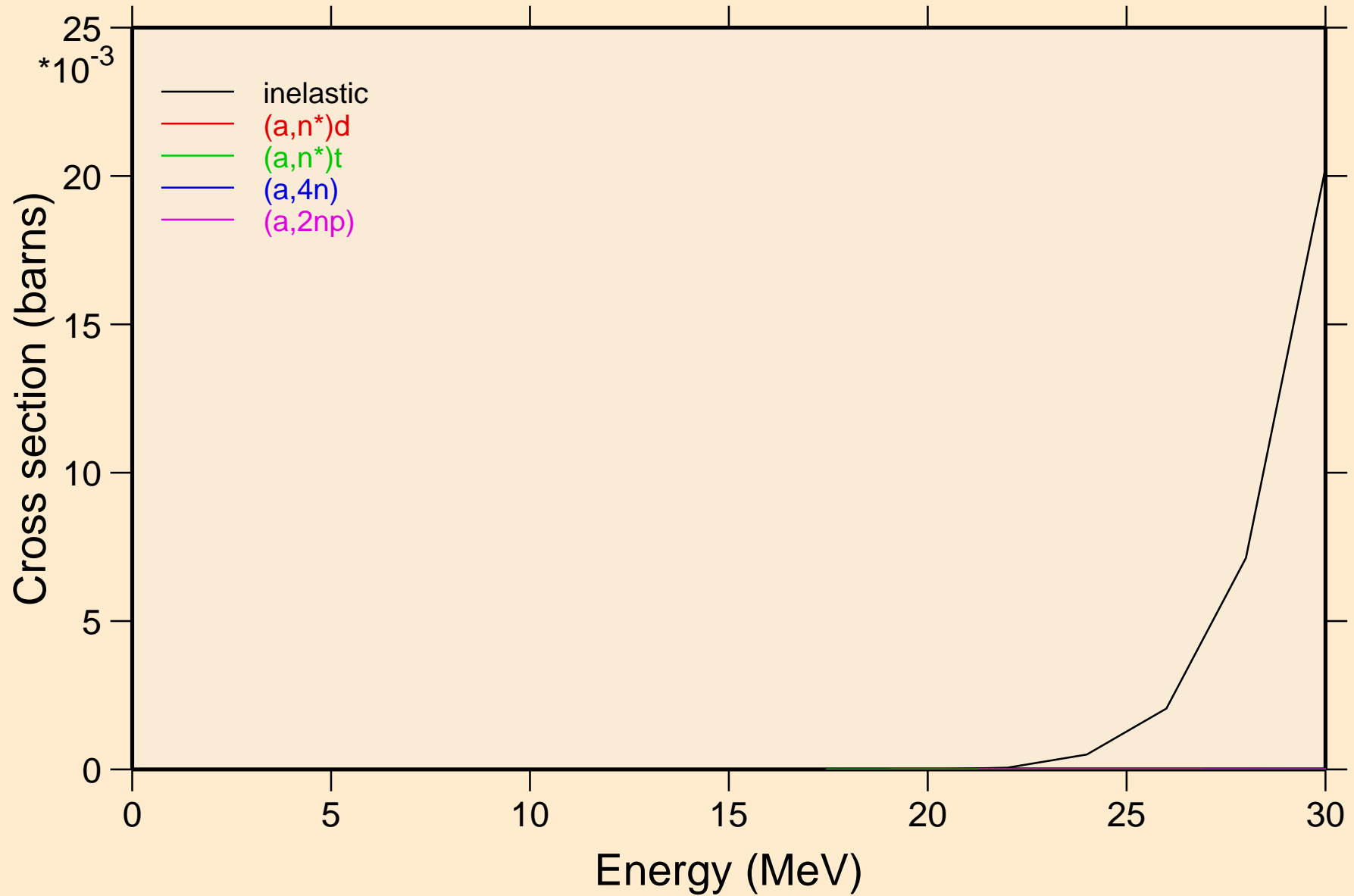

NP244 ALPHA ACER TENDL-2021 LIBRARY; T=0.K
Threshold reactions

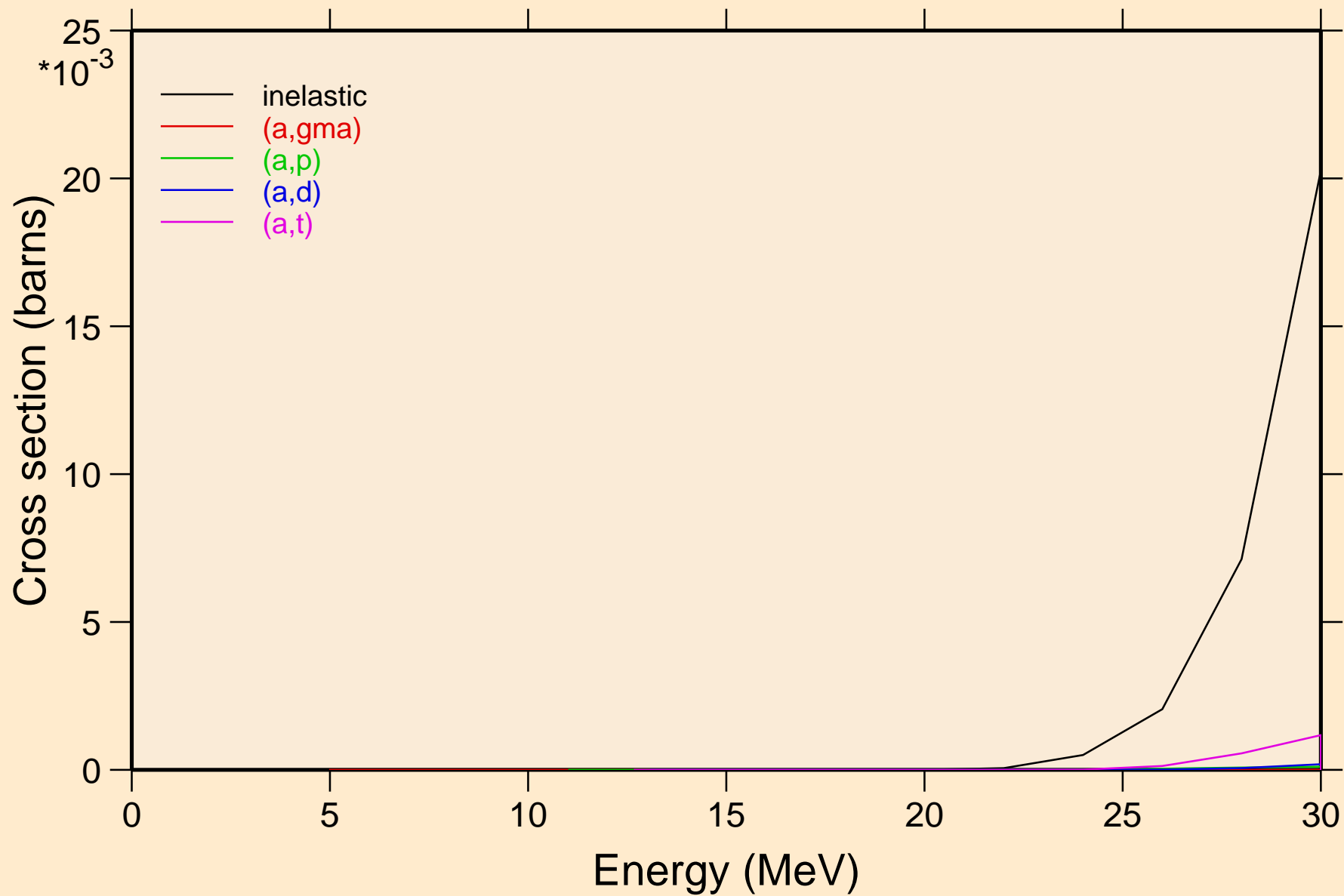

NP244 ALPHA ACER TENDL-2021 LIBRARY; T=0.K
Threshold reactions

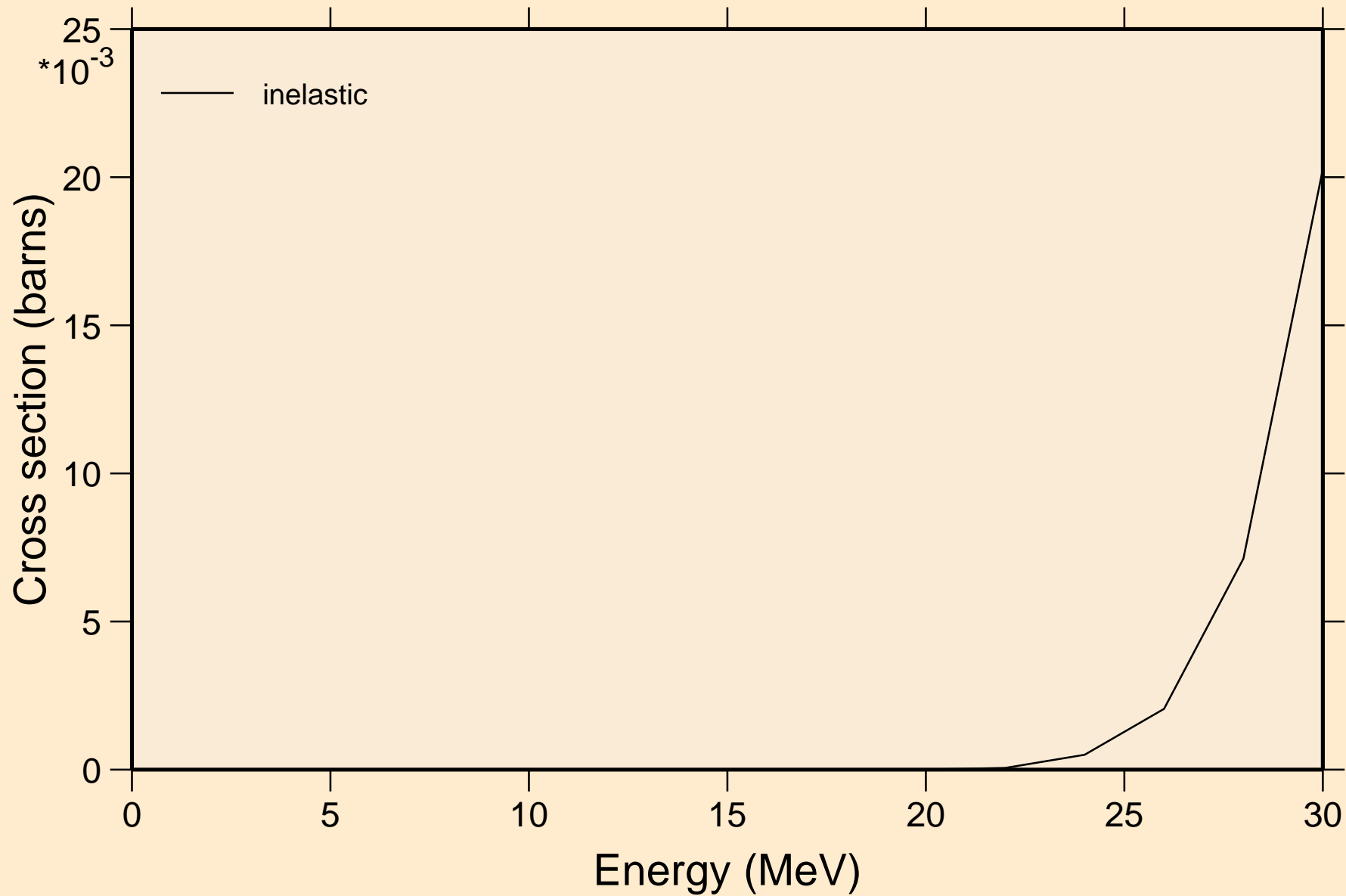

NP244 ALPHA ACER TENDL-2021 LIBRARY; T=0.K
angular distribution for elastic

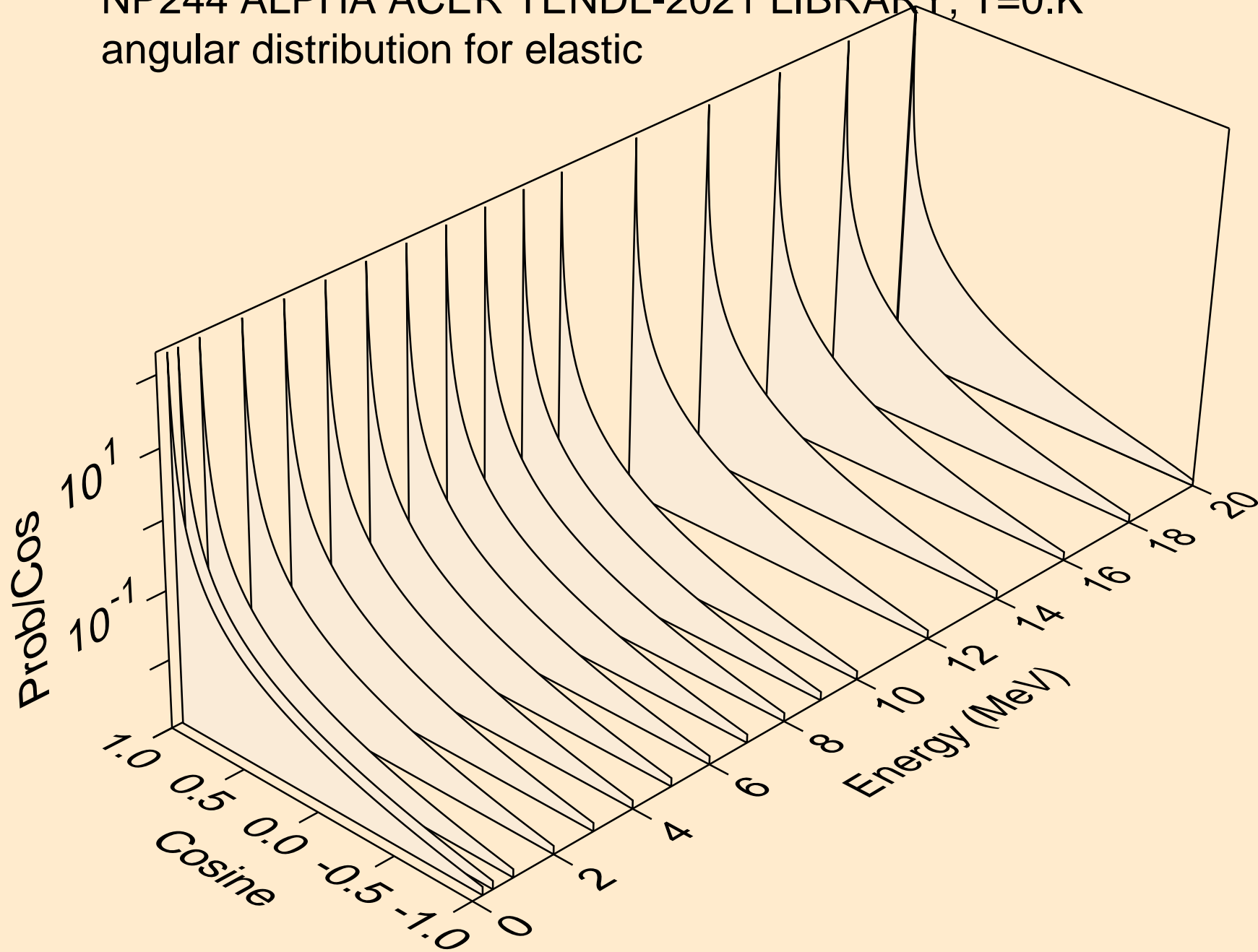

NP244 ALPHA ACER TENDL-2021 LIBRARY; T=0.K
angular distribution for elastic

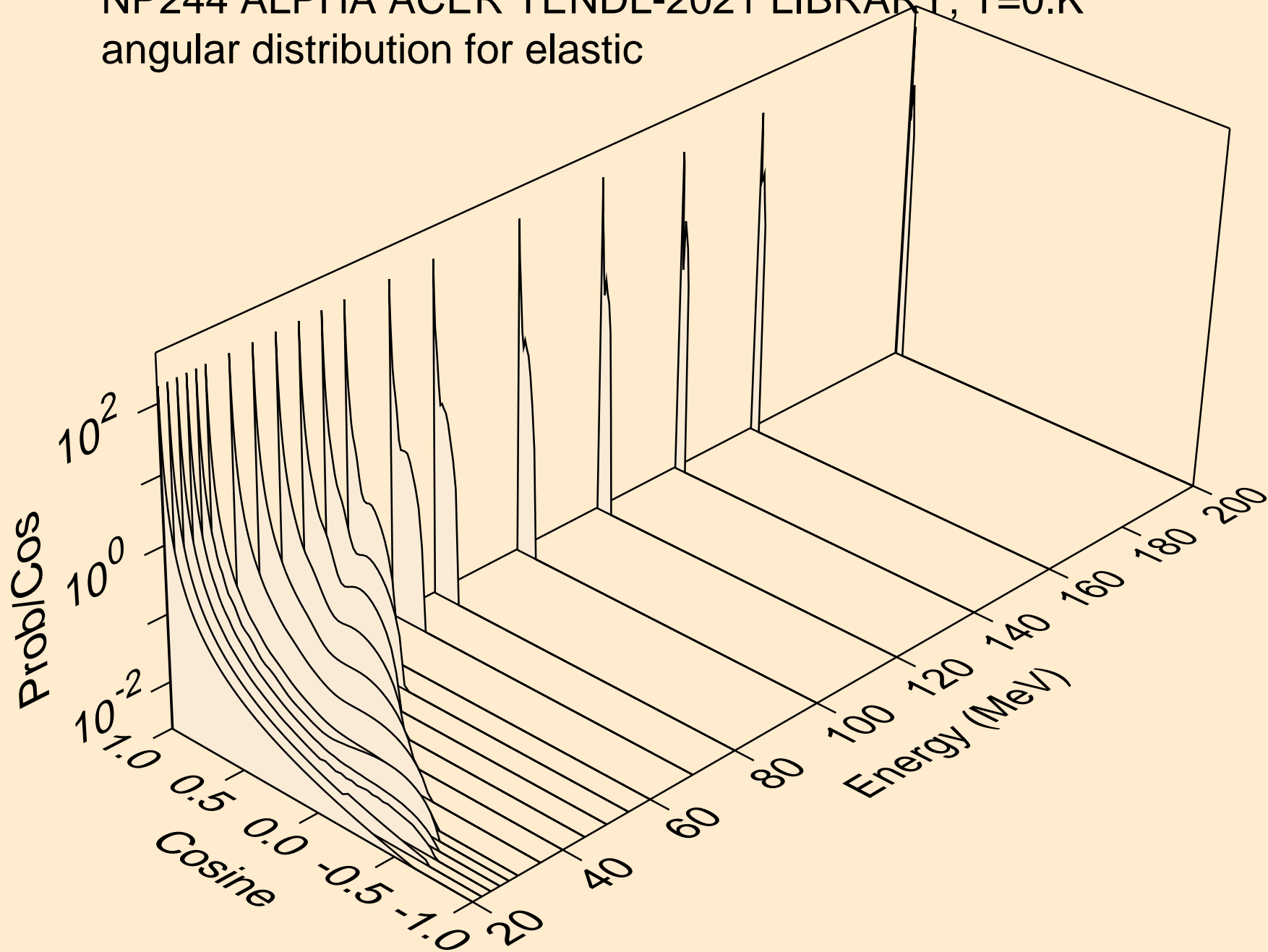

NP244 ALPHA ACER TENDL-2021 LIBRARY; T=0.K
Alpha emission for (a,x)

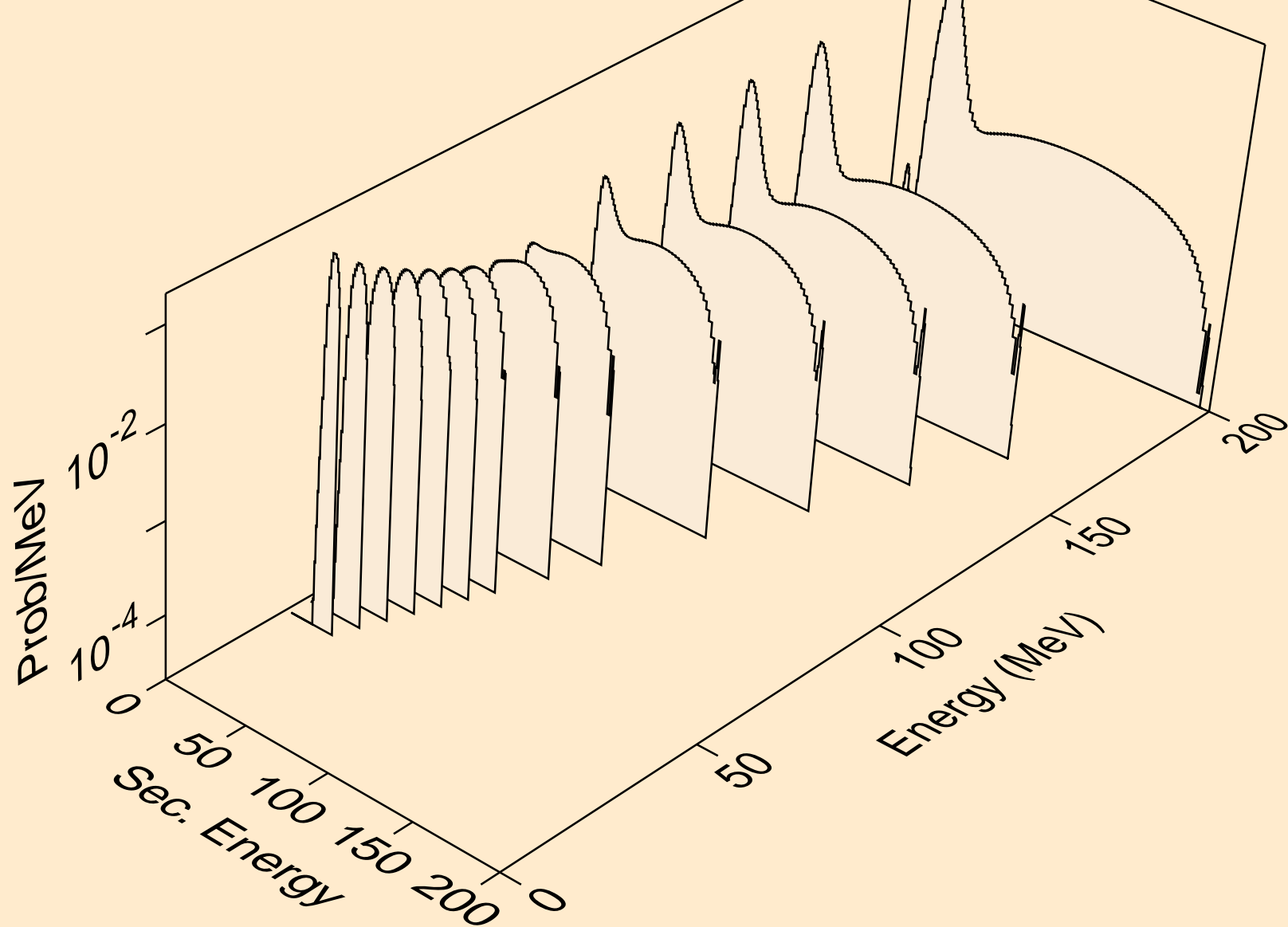

NP244 ALPHA ACER TENDL-2021 LIBRARY; T=0.K
Alpha emission for (a,n*)a

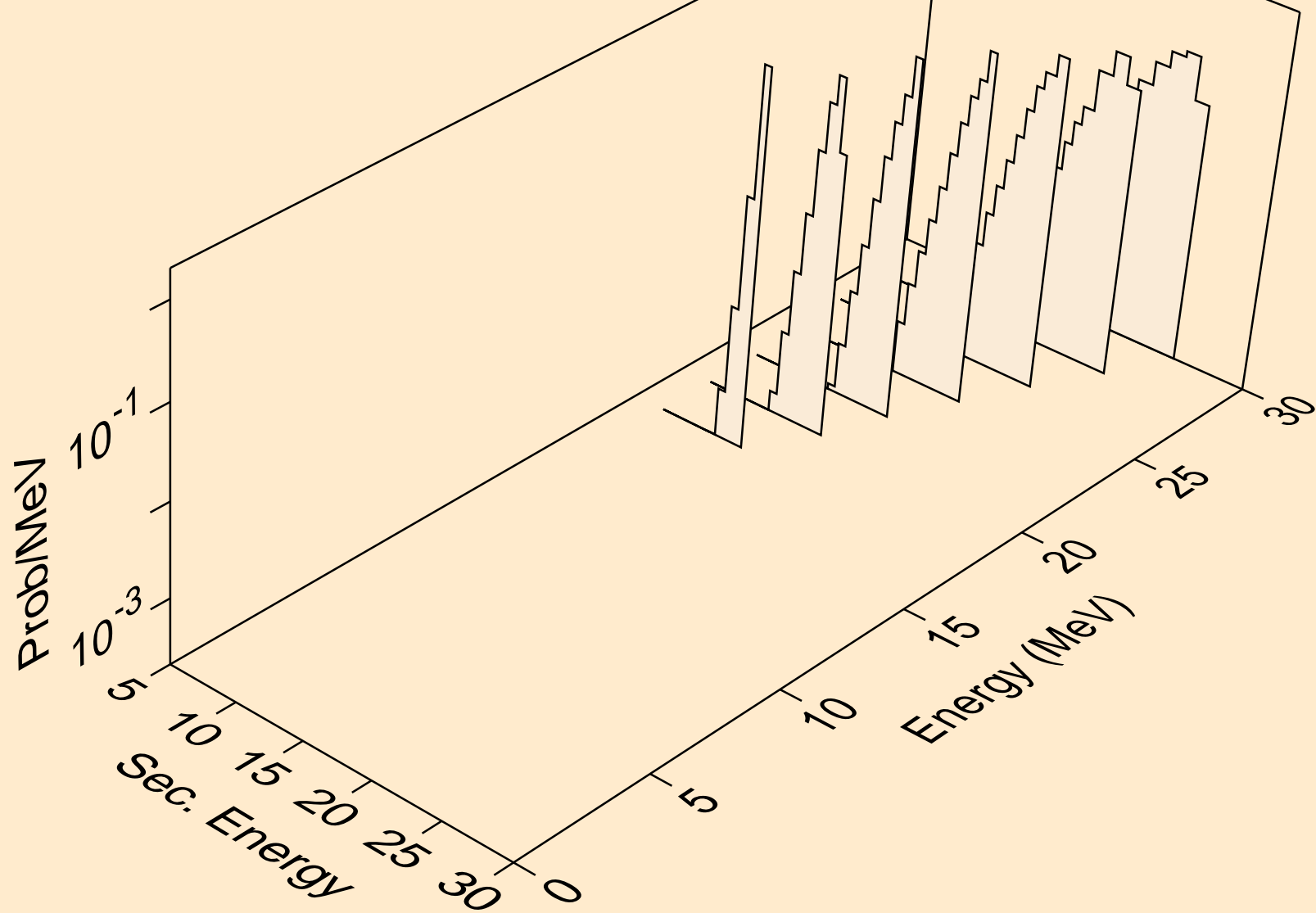

NP244 ALPHA ACER TENDL-2021 LIBRARY; T=0.K
Alpha emission for (a,2n)a

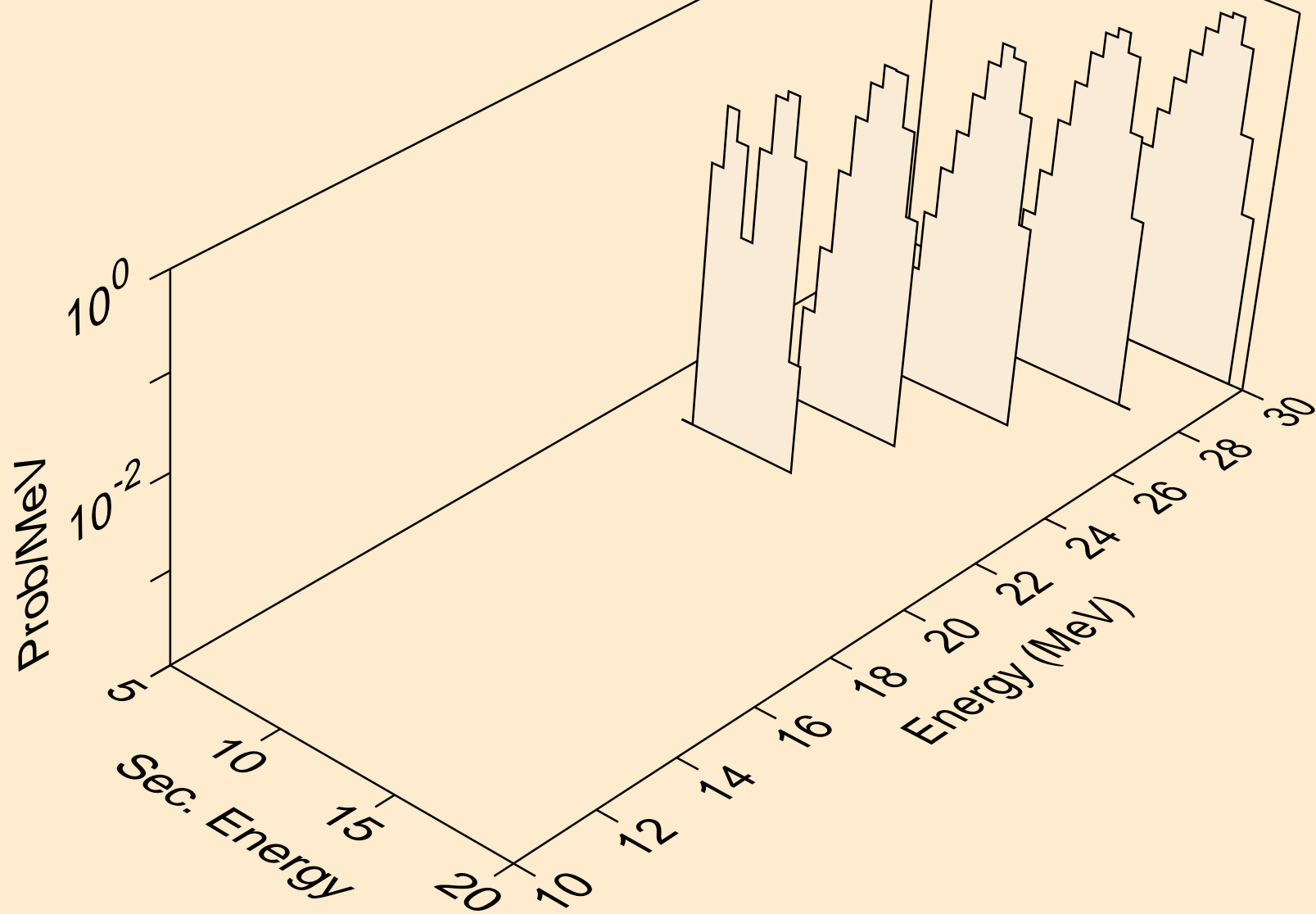

NP244 ALPHA ACER TENDL-2021 LIBRARY; T=0.K
Alpha emission for inelastic

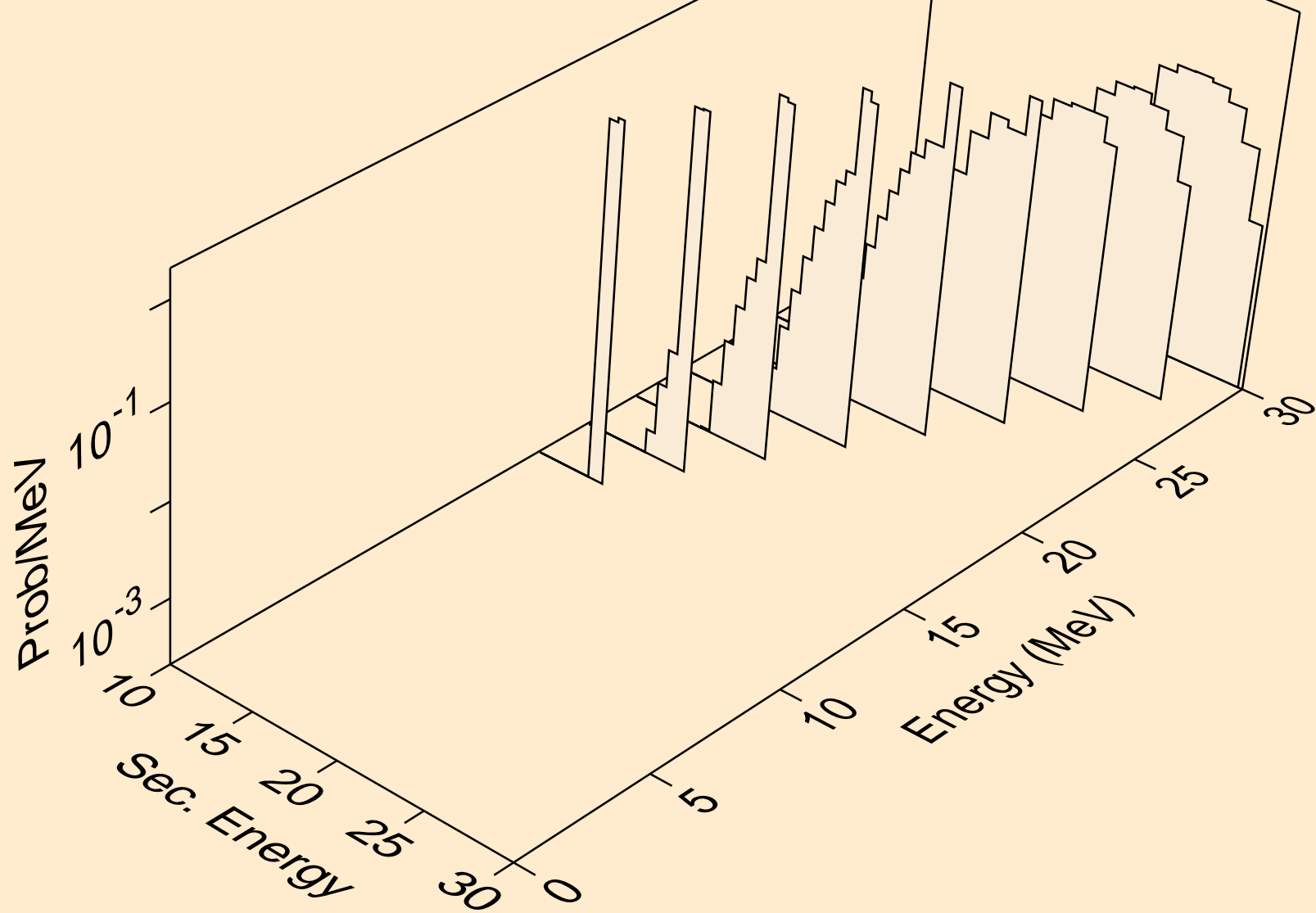

NP244 ALPHA ACER TENDL-2021 LIBRARY; T=0.K
Photon emission for (z,n)

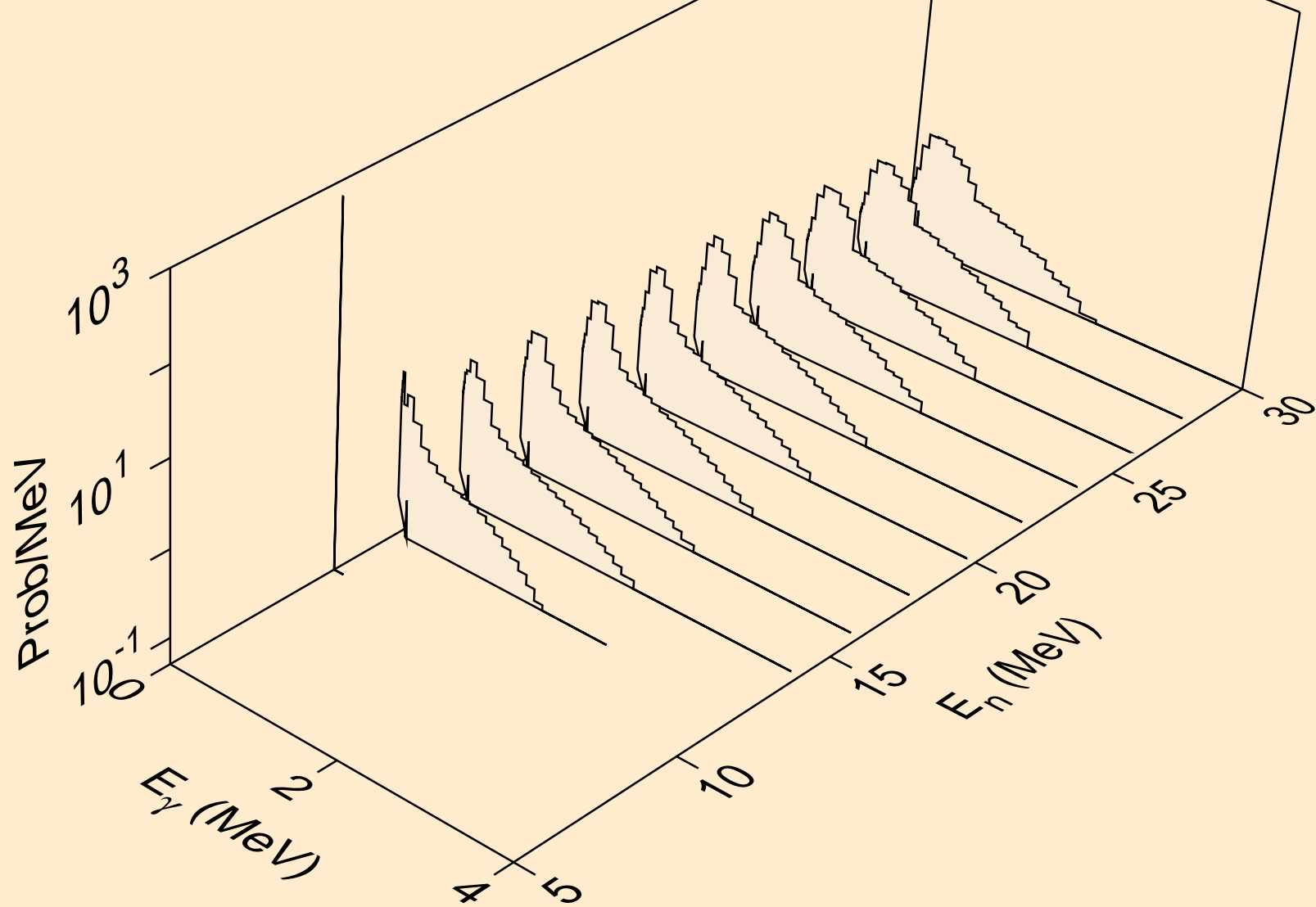

NP244 ALPHA ACER TENDL-2021 LIBRARY; T=0.K
Photon emission for (n,x)

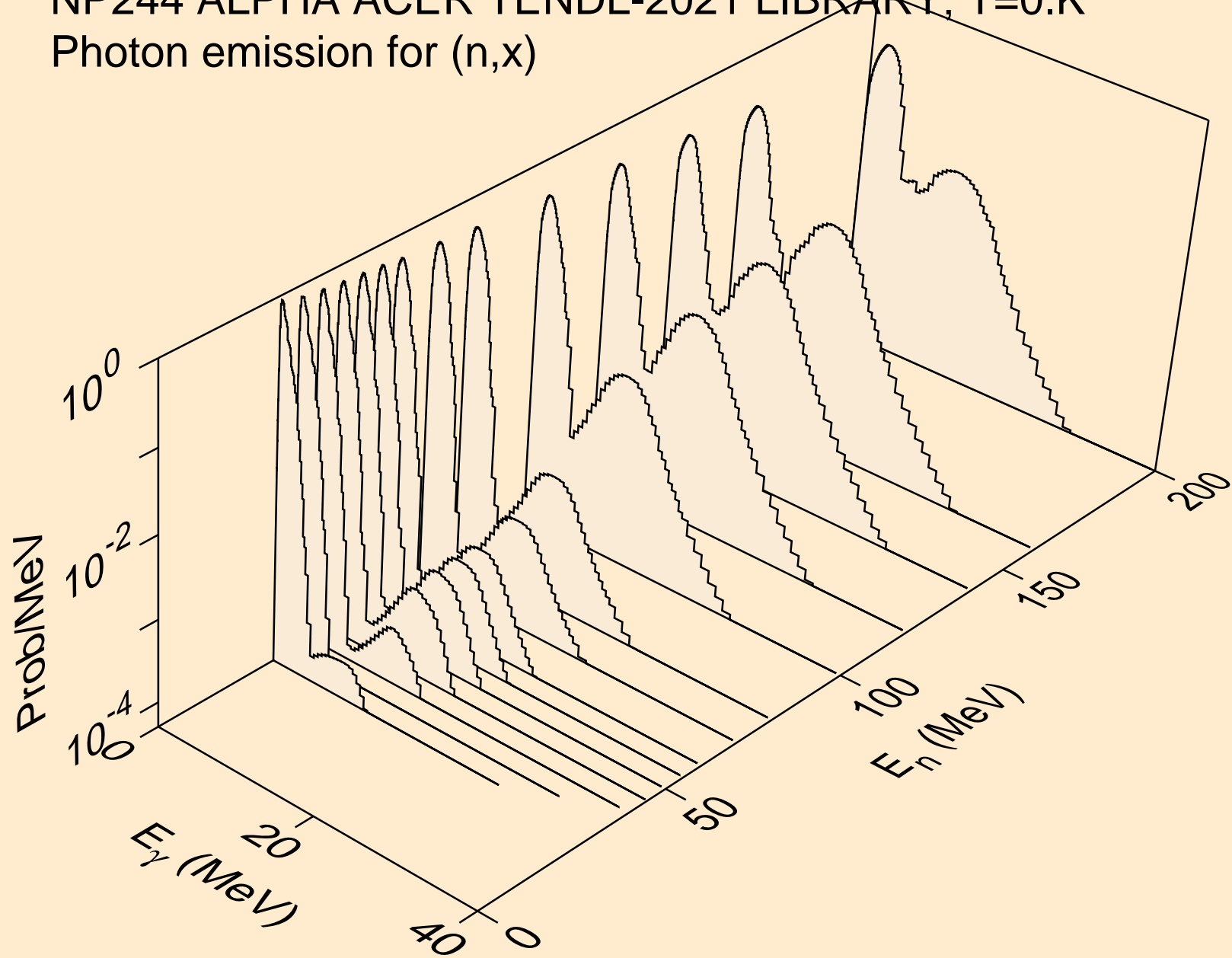

NP244 ALPHA ACER TENDL-2021 LIBRARY; T=0.K
Photon emission for (n,2n)

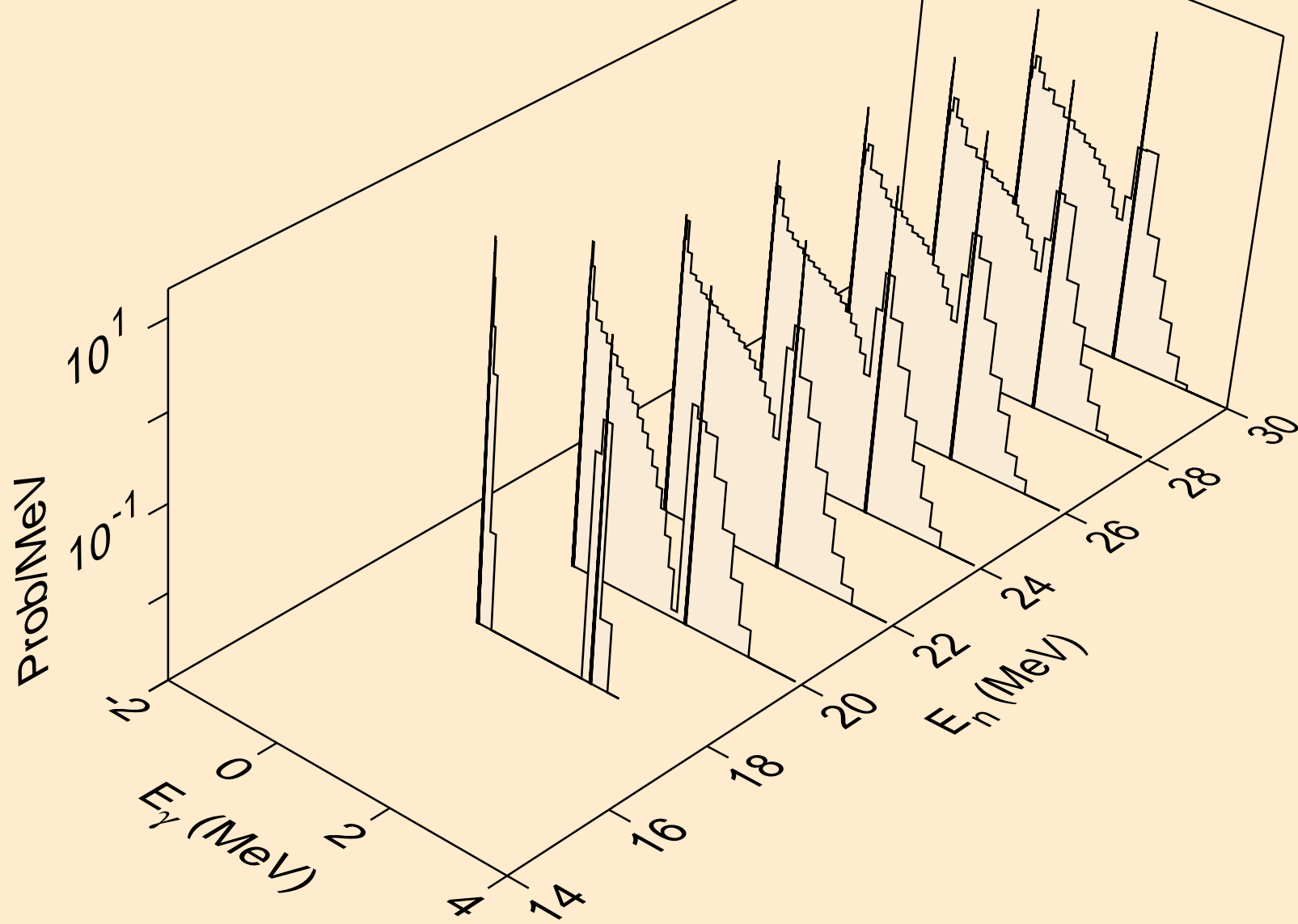

NP244 ALPHA ACER TENDL-2021 LIBRARY; T=0.K
Photon emission for (n,3n)

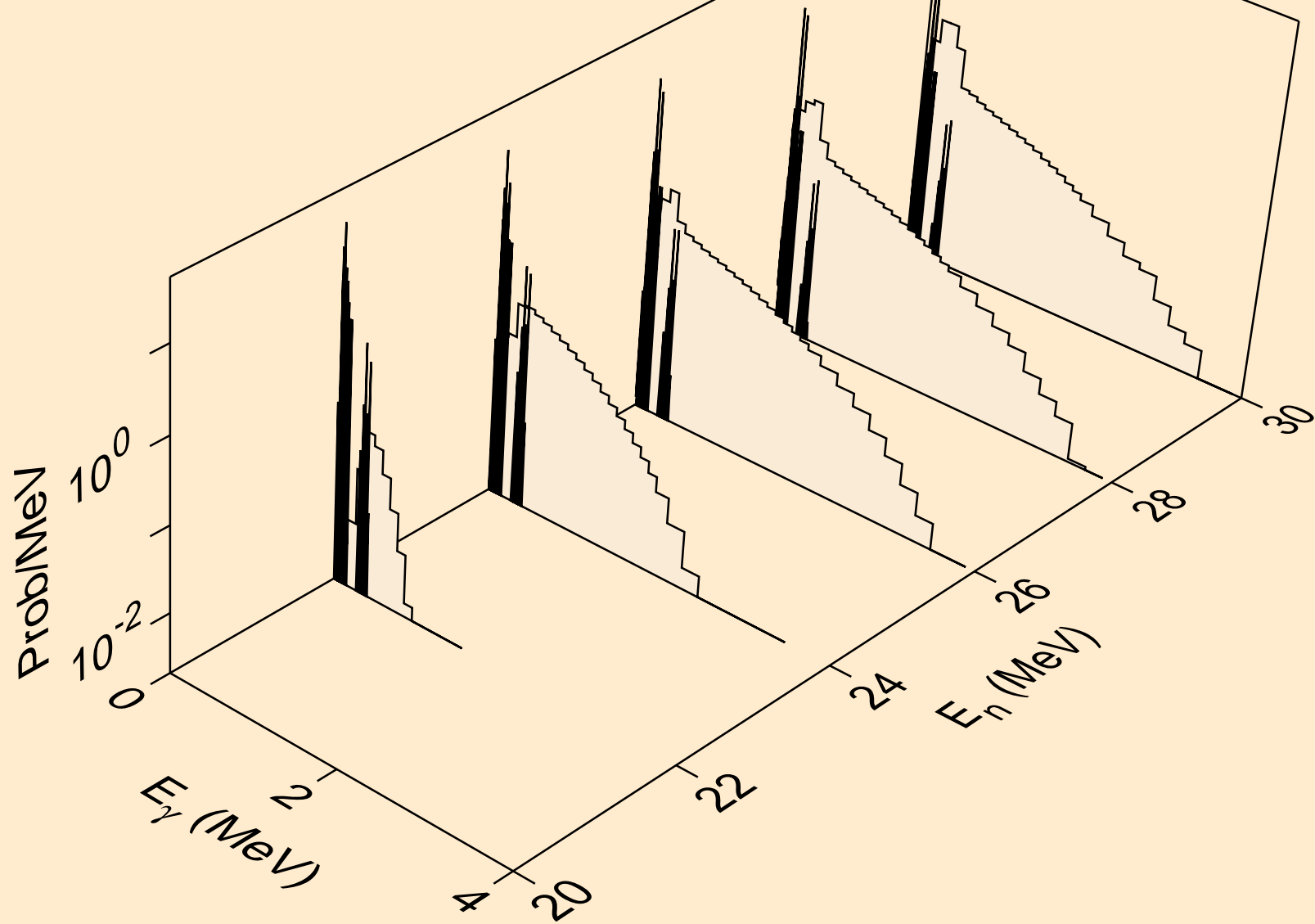

NP244 ALPHA ACER TENDL-2021 LIBRARY; T=0.K
Photon emission for (n,n*)a

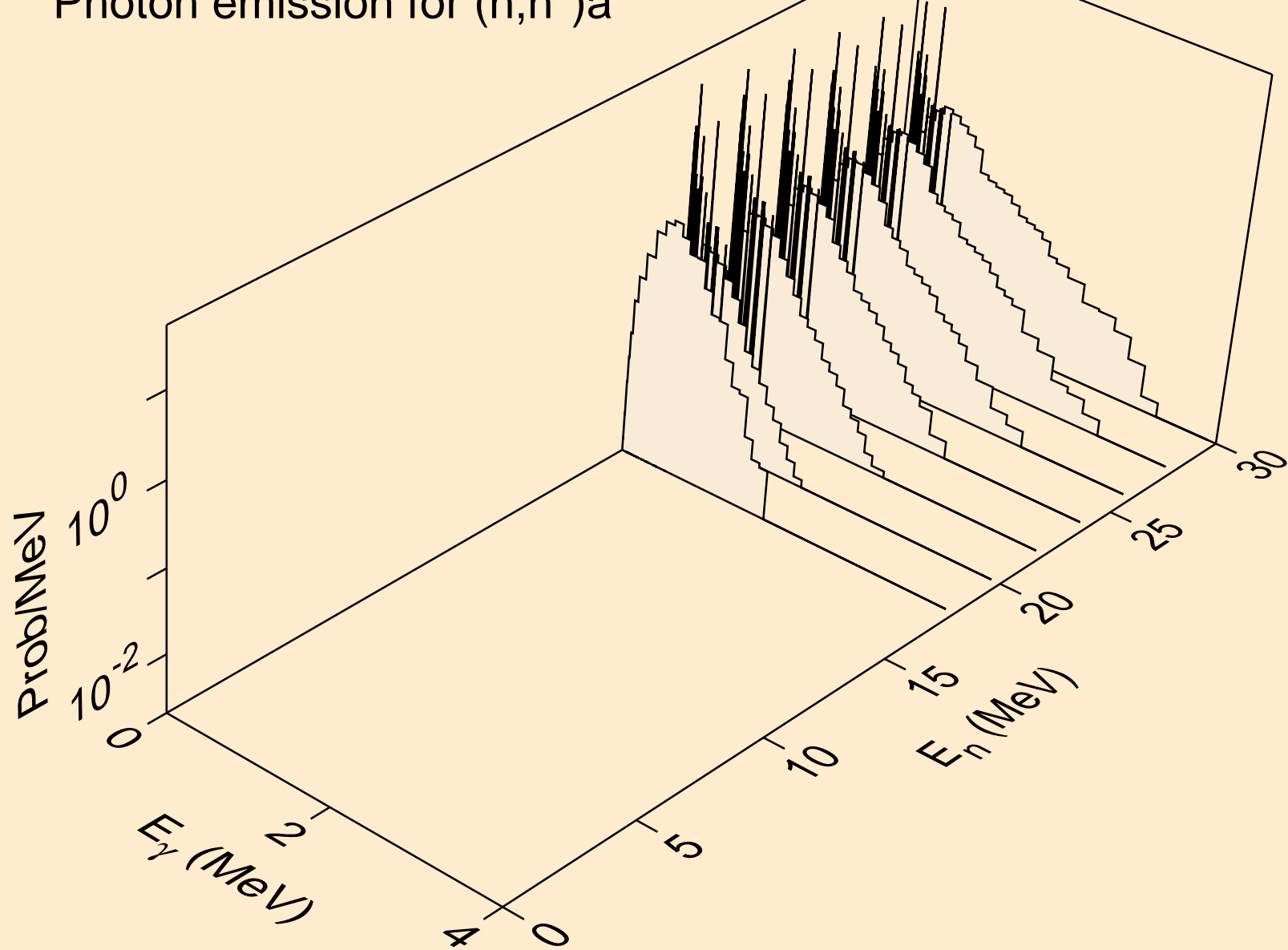

NP244 ALPHA ACER TENDL-2021 LIBRARY; T=0.K
Photon emission for (n,2n)a

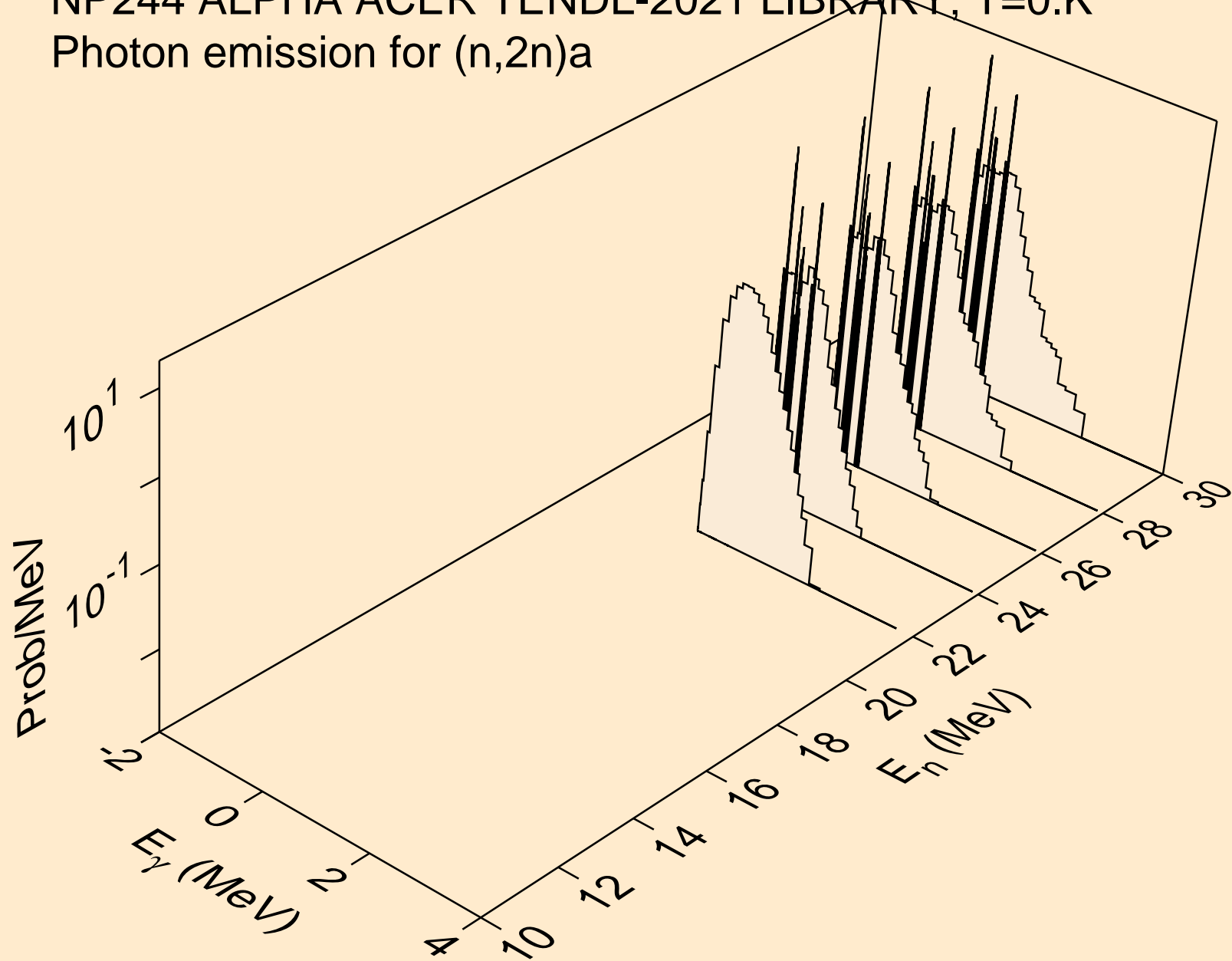

NP244 ALPHA ACER TENDL-2021 LIBRARY; T=0.K
Photon emission for (n,n*)p

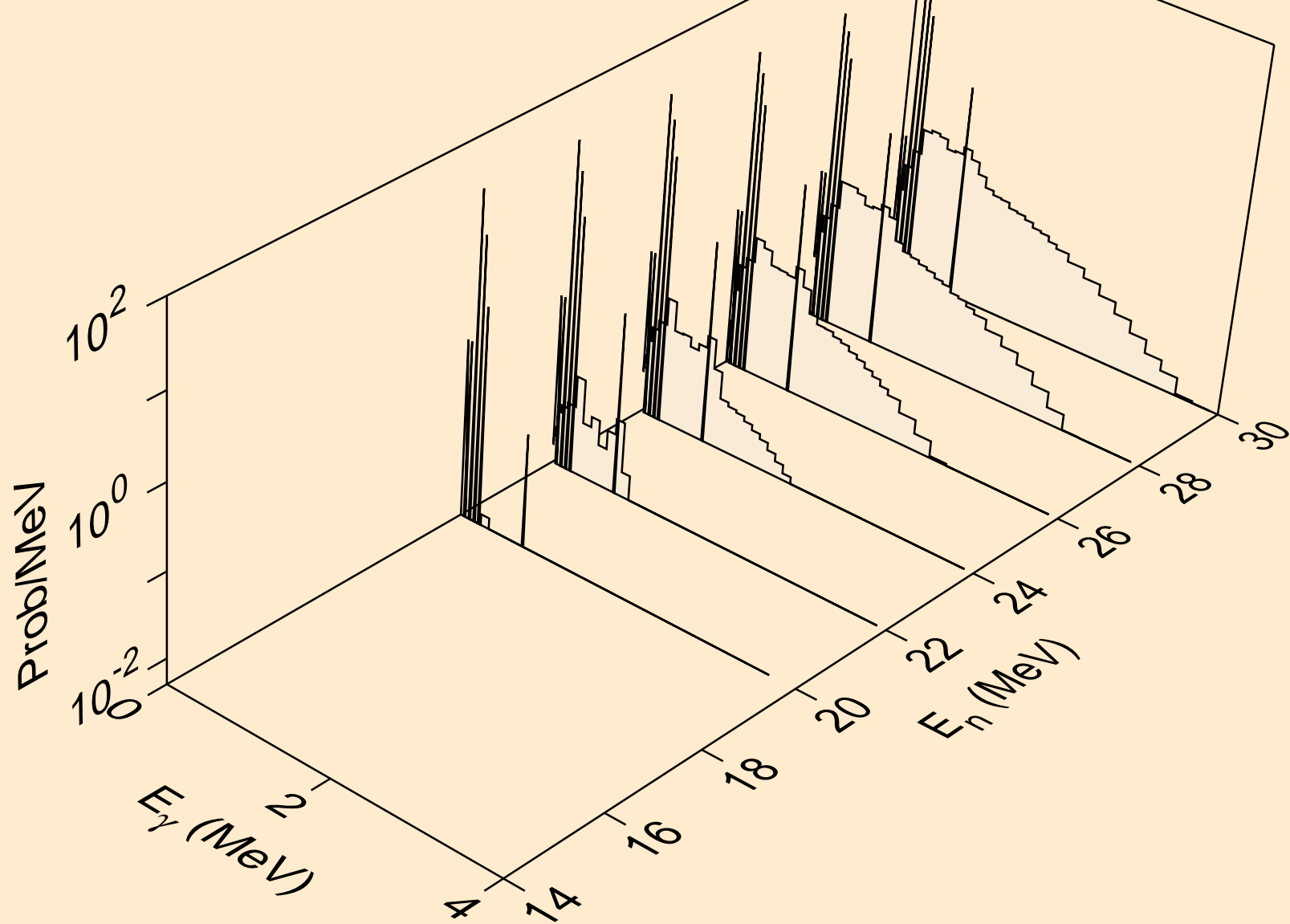

NP244 ALPHA ACER TENDL-2021 LIBRARY; T=0.K
Photon emission for (n,n*)d

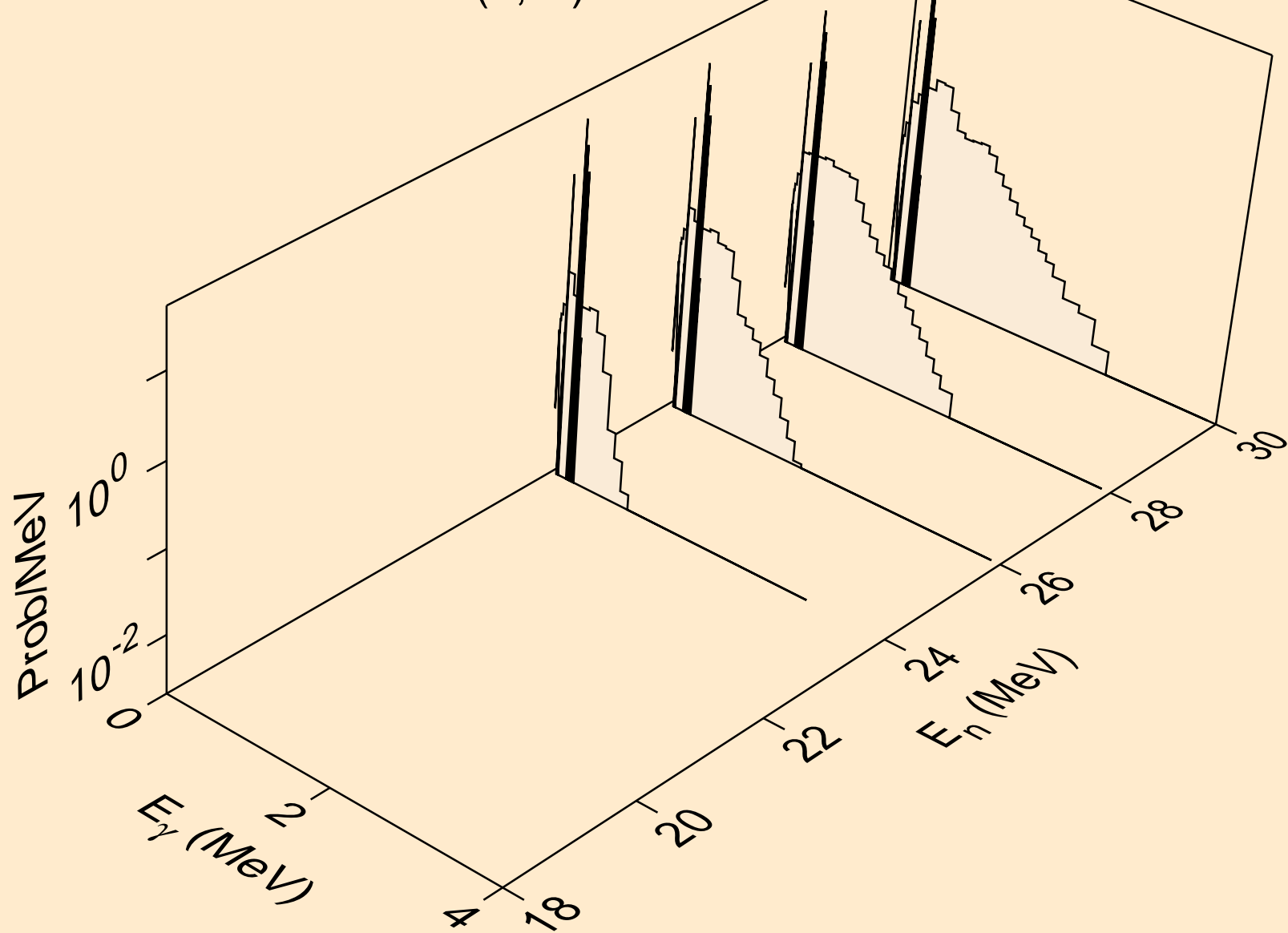

NP244 ALPHA ACER TENDL-2021 LIBRARY; T=0.K
Photon emission for (n,n*)t

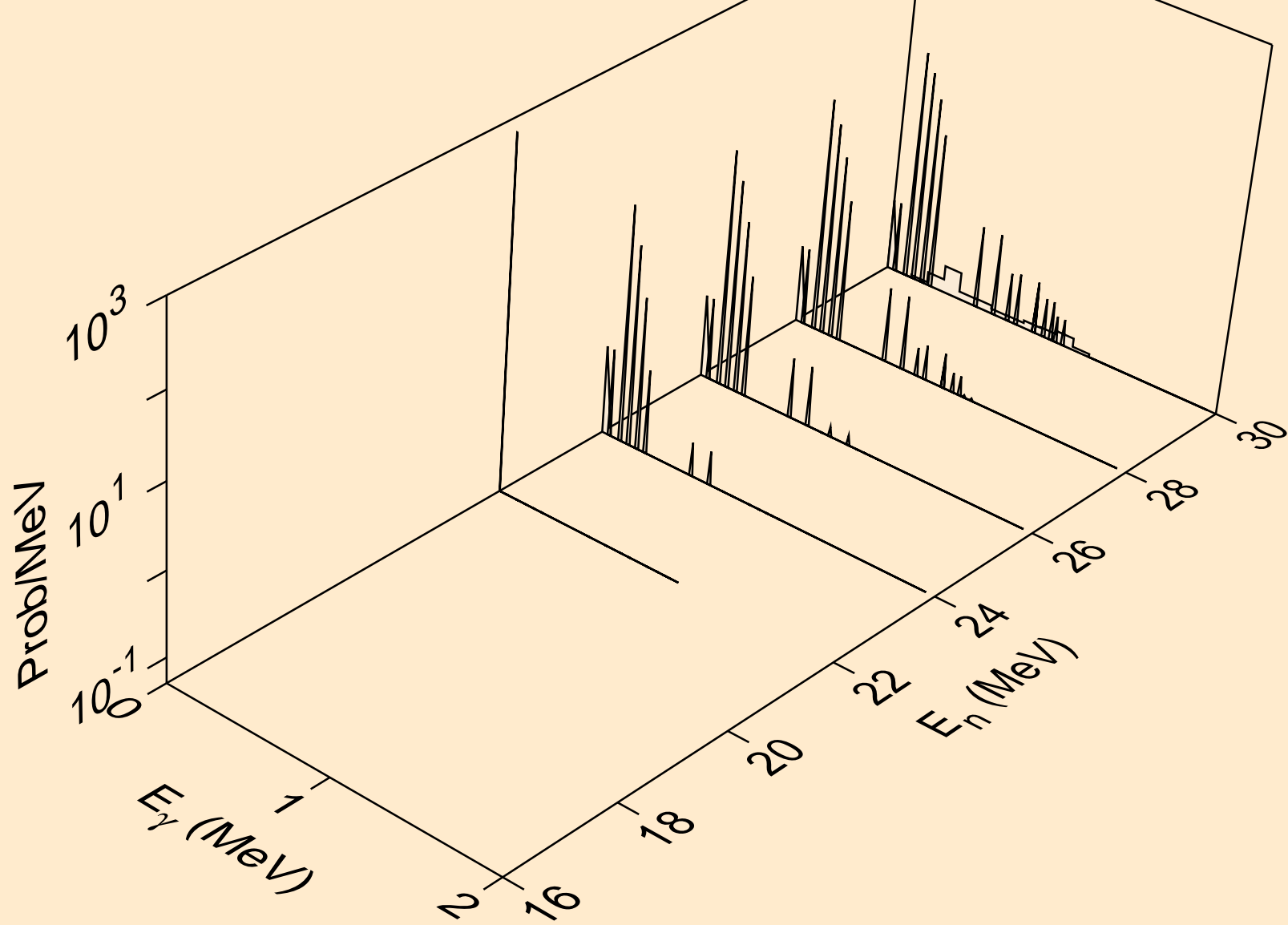

NP244 ALPHA ACER TENDL-2021 LIBRARY; T=0.K
Photon emission for (n,4n)

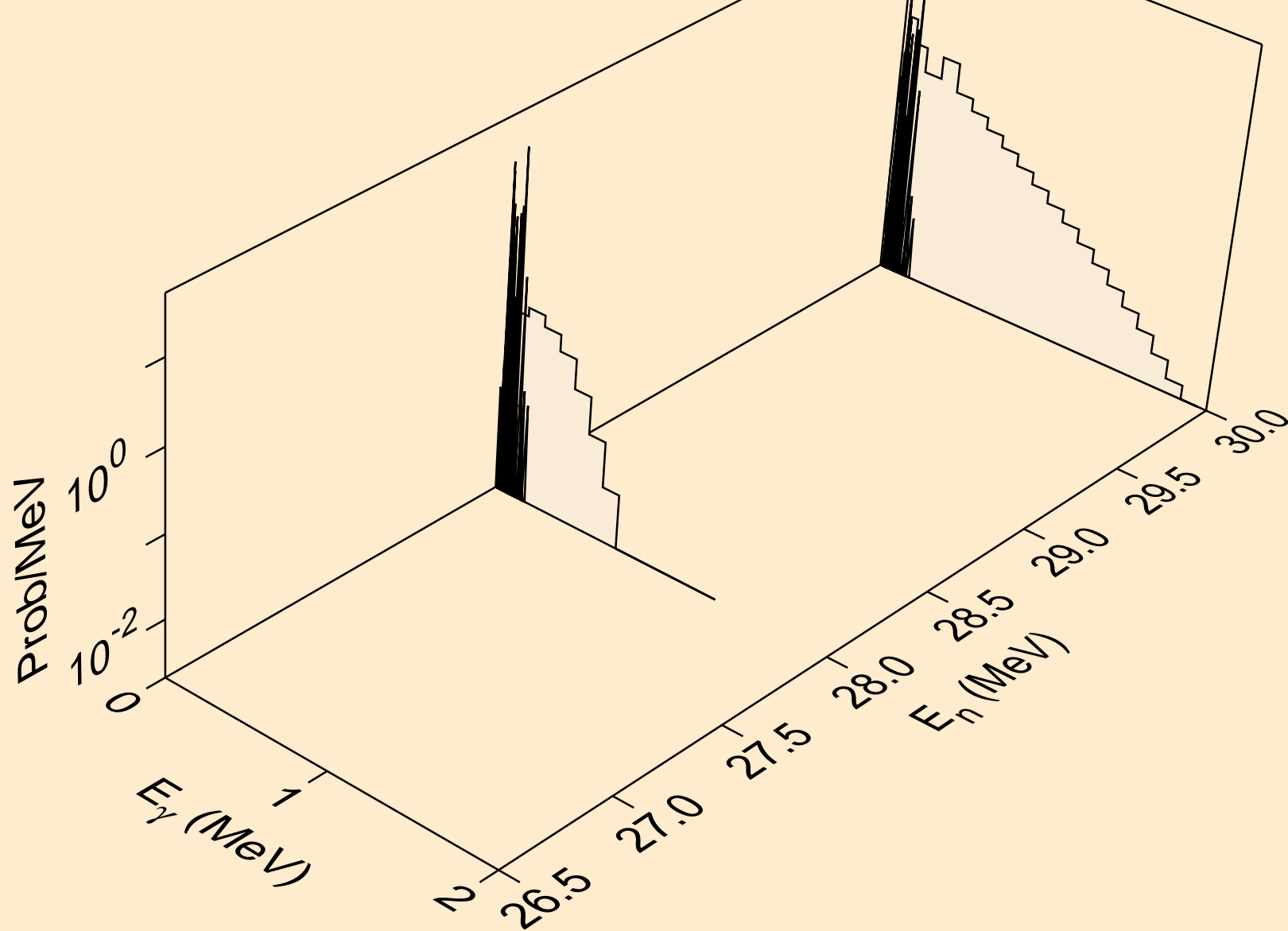

NP244 ALPHA ACER TENDL-2021 LIBRARY; T=0.K
Photon emission for (n,2np)

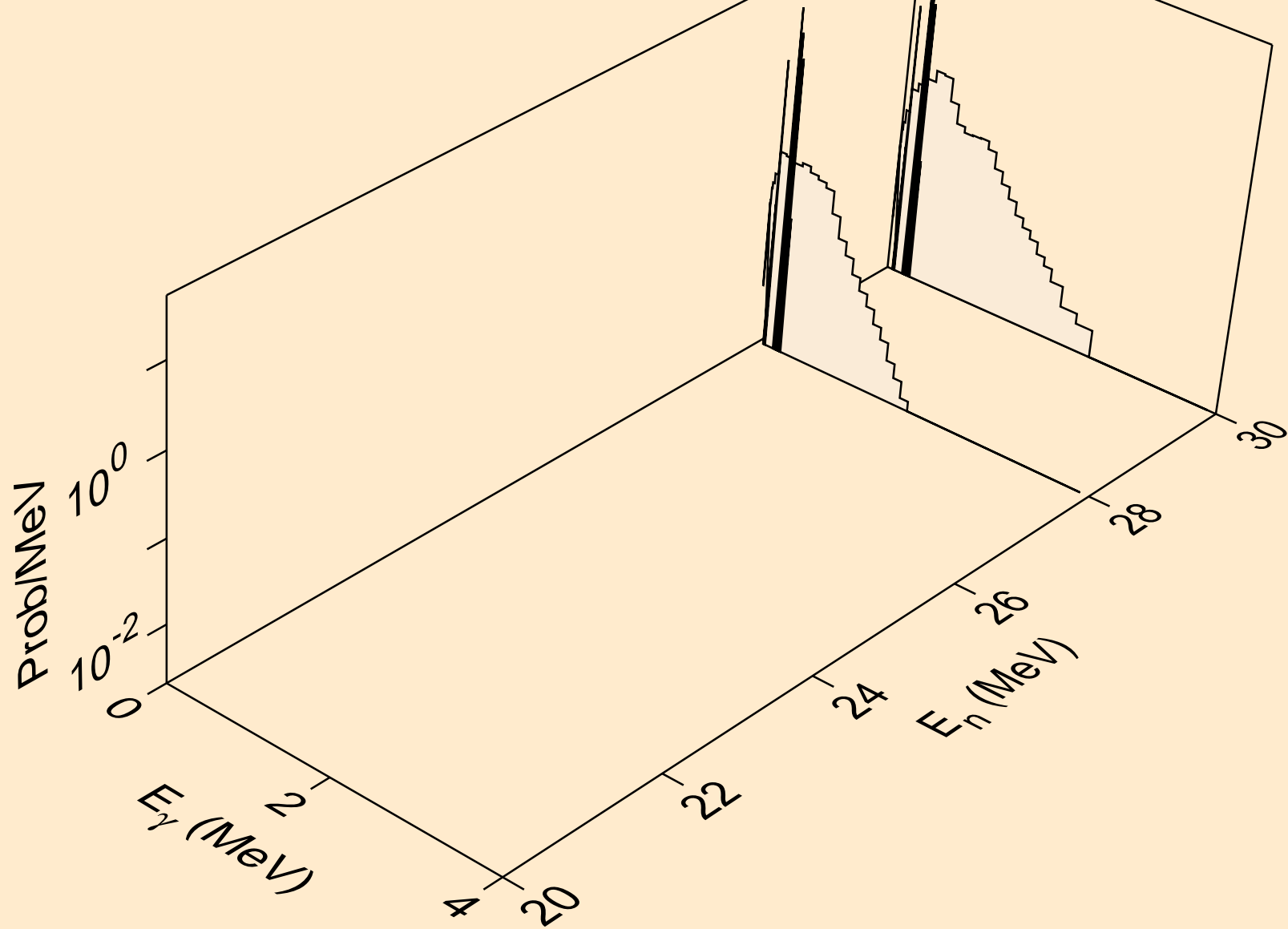

NP244 ALPHA ACER TENDL-2021 LIBRARY; T=0.K
Photon emission for (n,gma)

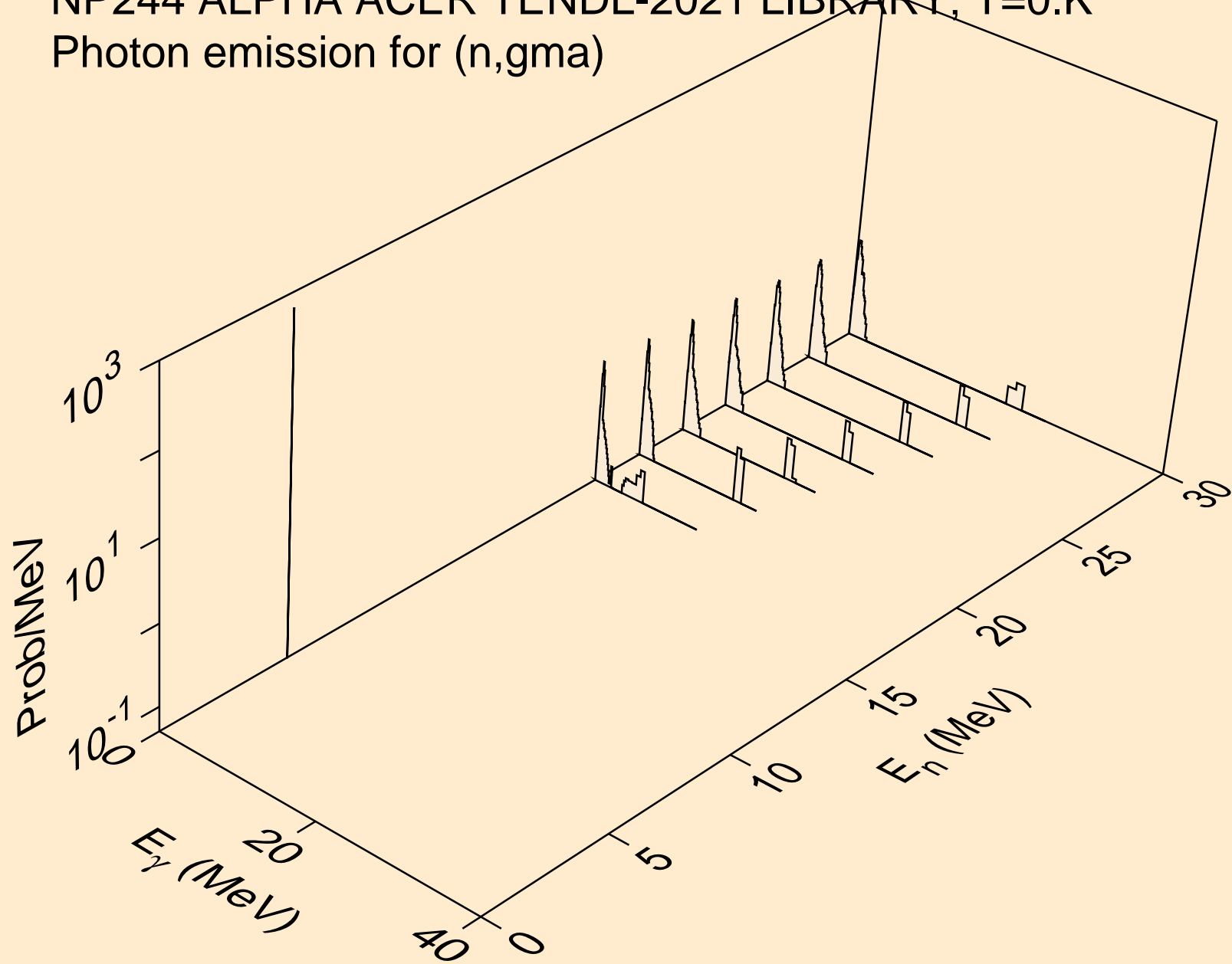

NP244 ALPHA ACER TENDL-2021 LIBRARY; T=0.K
Photon emission for (n,p)

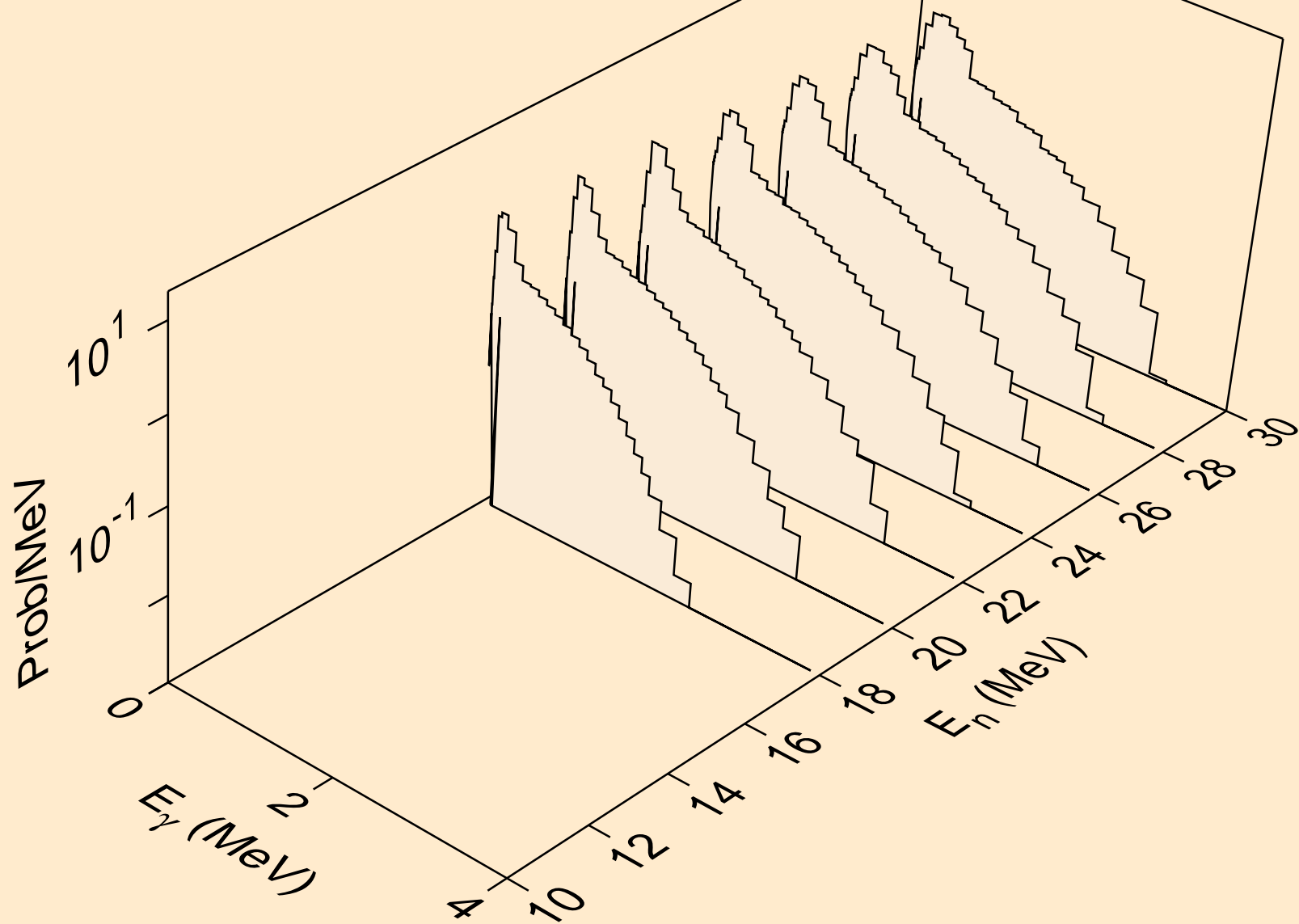

NP244 ALPHA ACER TENDL-2021 LIBRARY; T=0.K
Photon emission for (n,d)

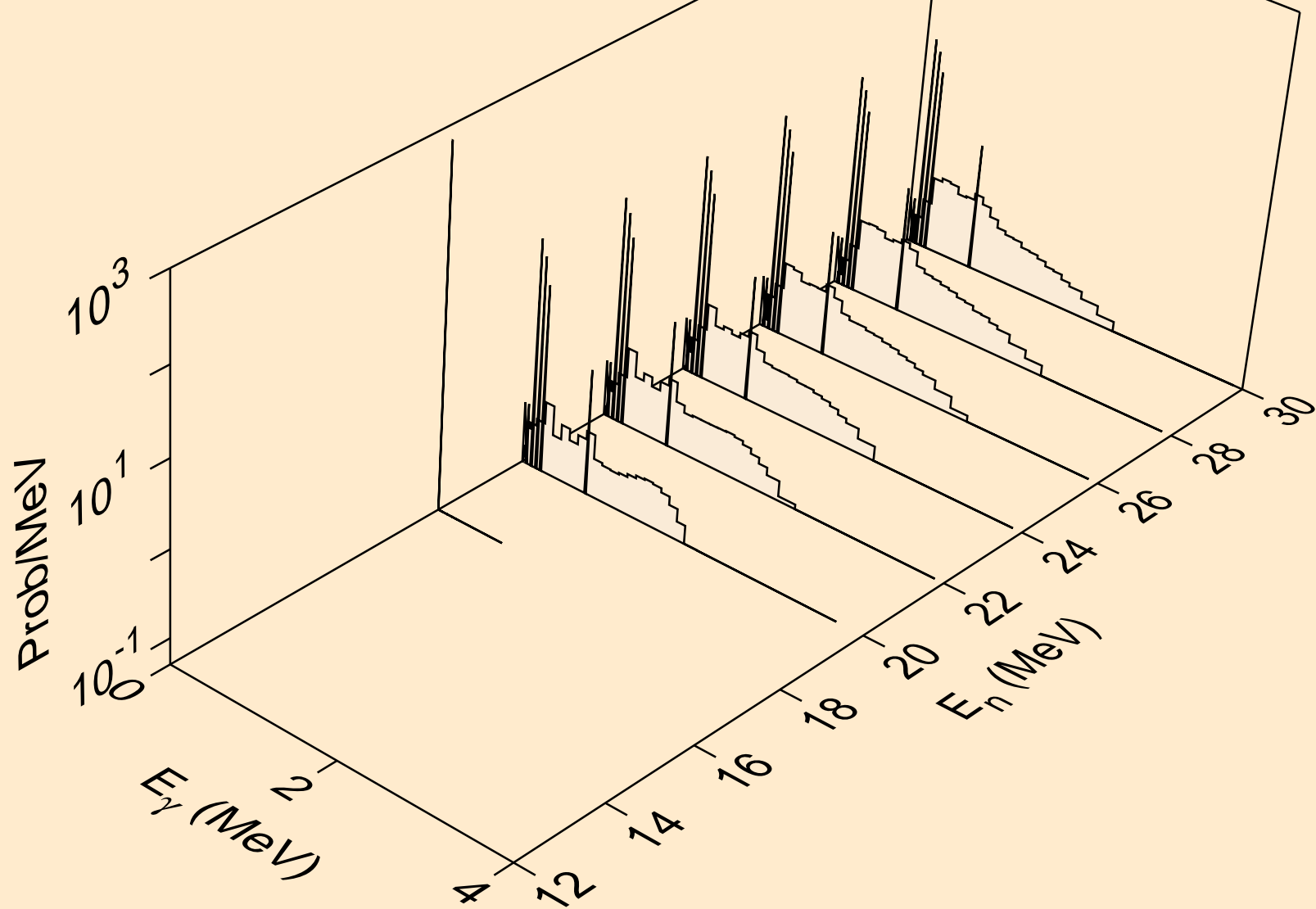

NP244 ALPHA ACER TENDL-2021 LIBRARY; T=0.K
Photon emission for (n,t)

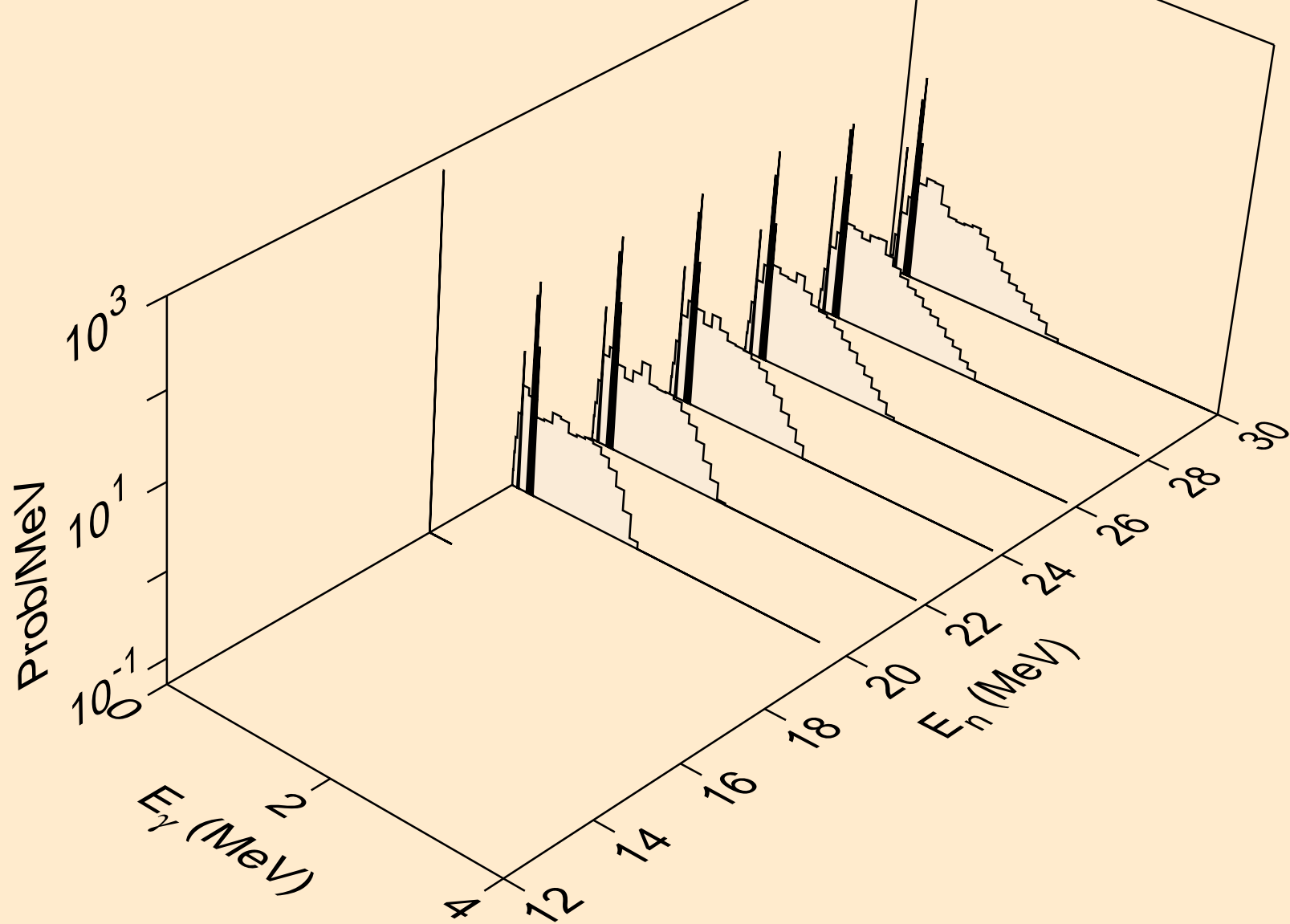

NP244 ALPHA ACER TENDL-2021 LIBRARY; T=0.K
Photon emission for inelastic

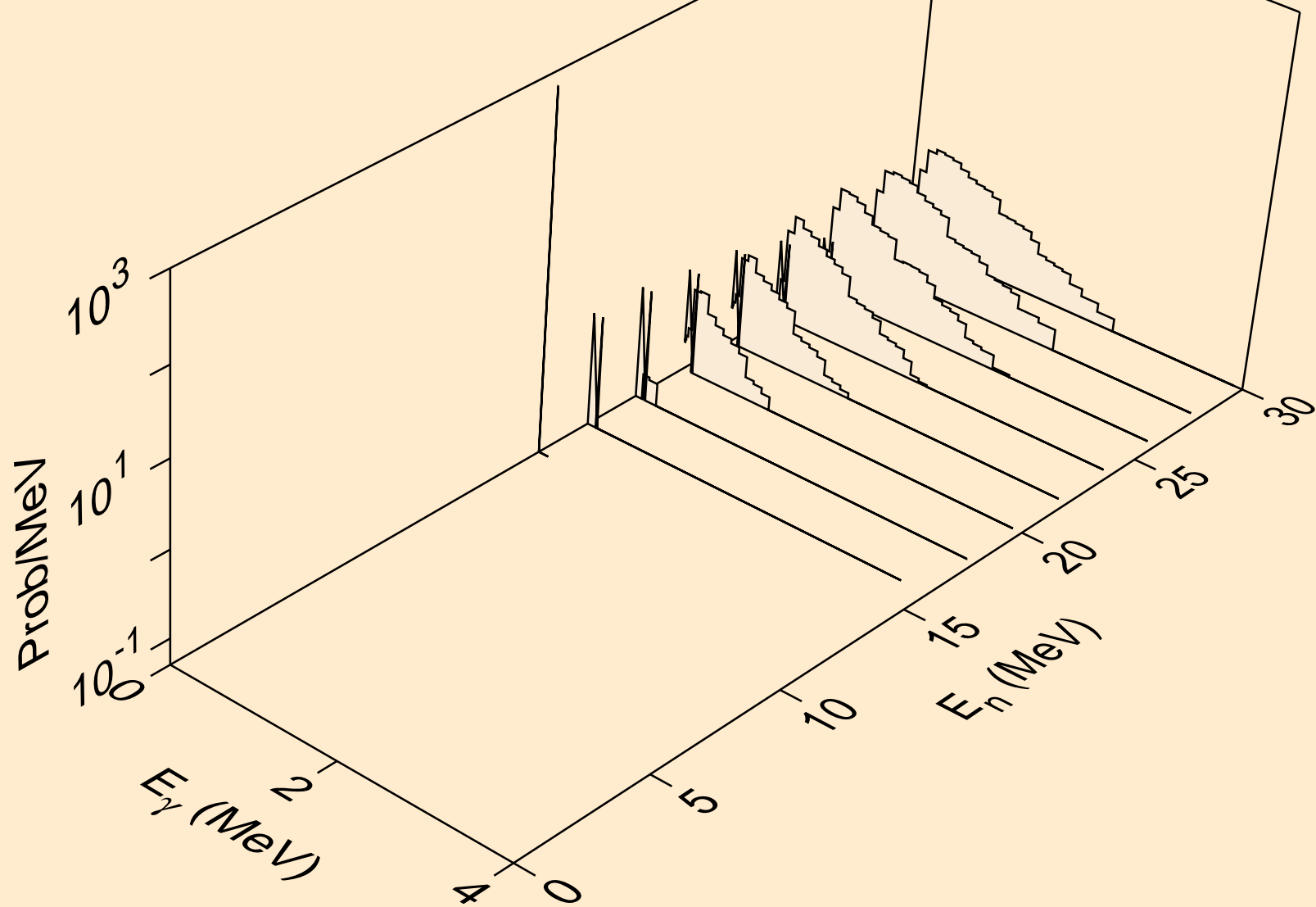

NP244 ALPHA ACER TENDL-2021 LIBRARY; T=0.K
Particle heating contributions

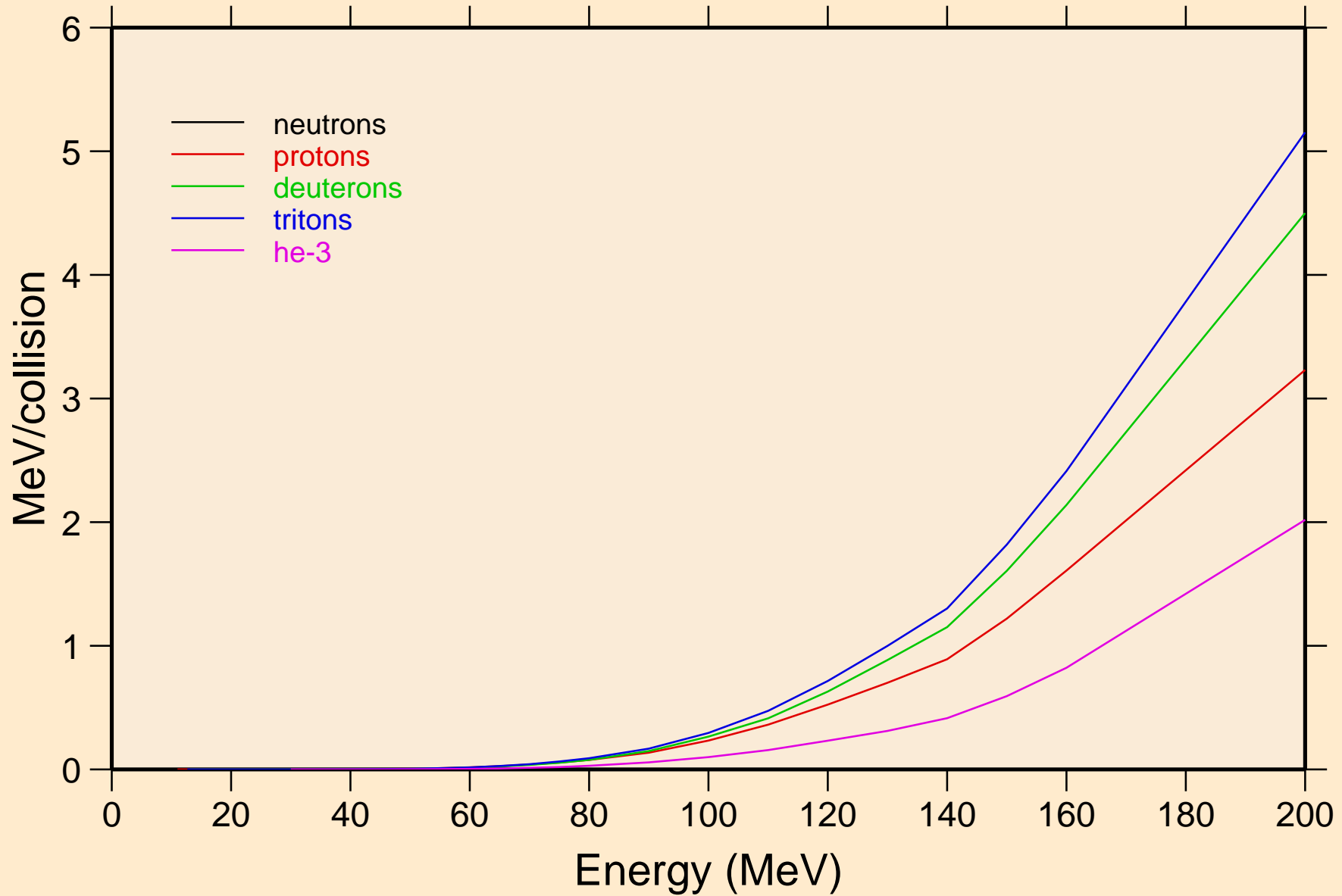

NP244 ALPHA ACER TENDL-2021 LIBRARY; T=0.K
Recoil Heating

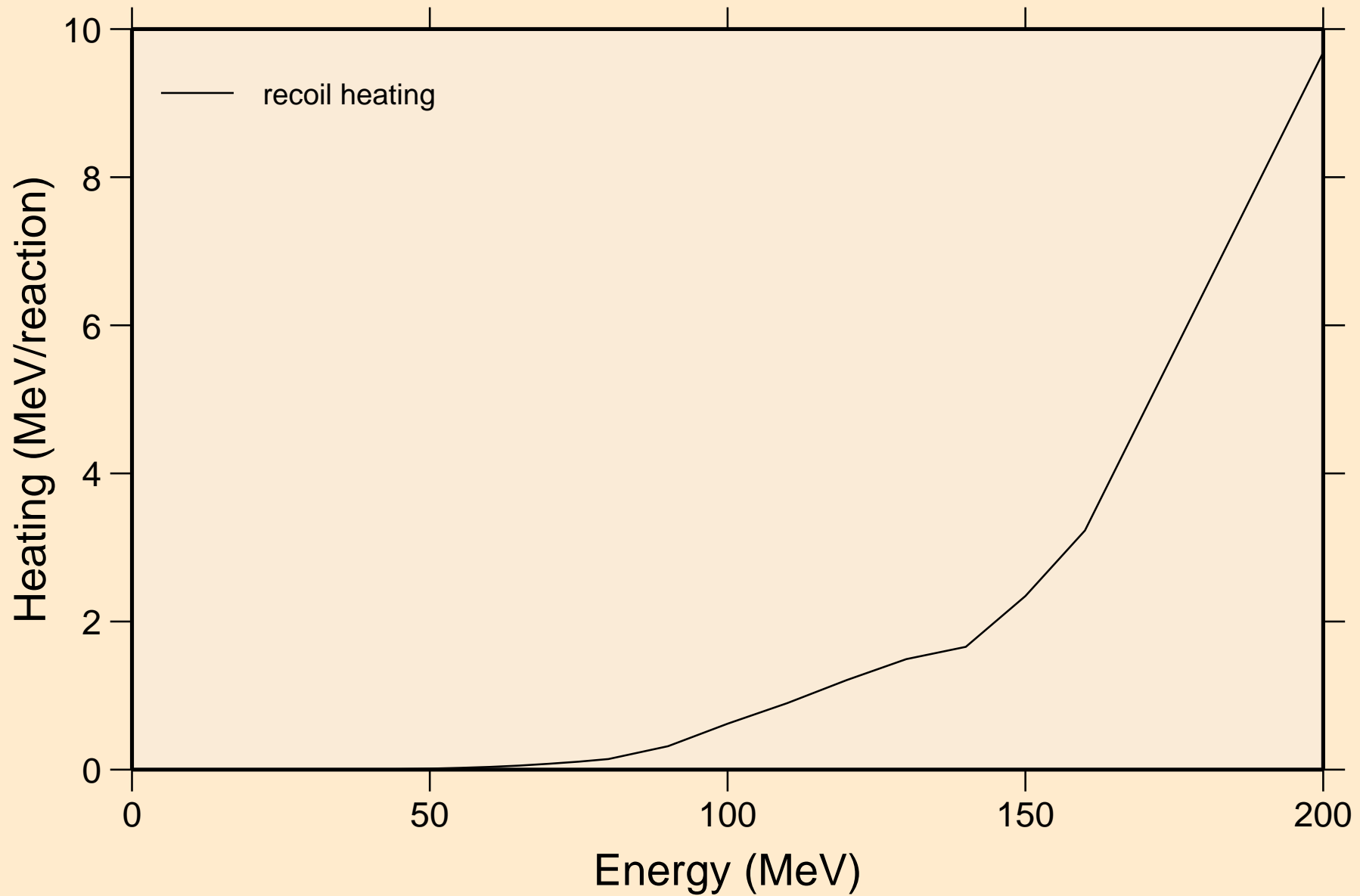

NP244 ALPHA ACER TENDL-2021 LIBRARY; T=0.K
Particle production cross sections

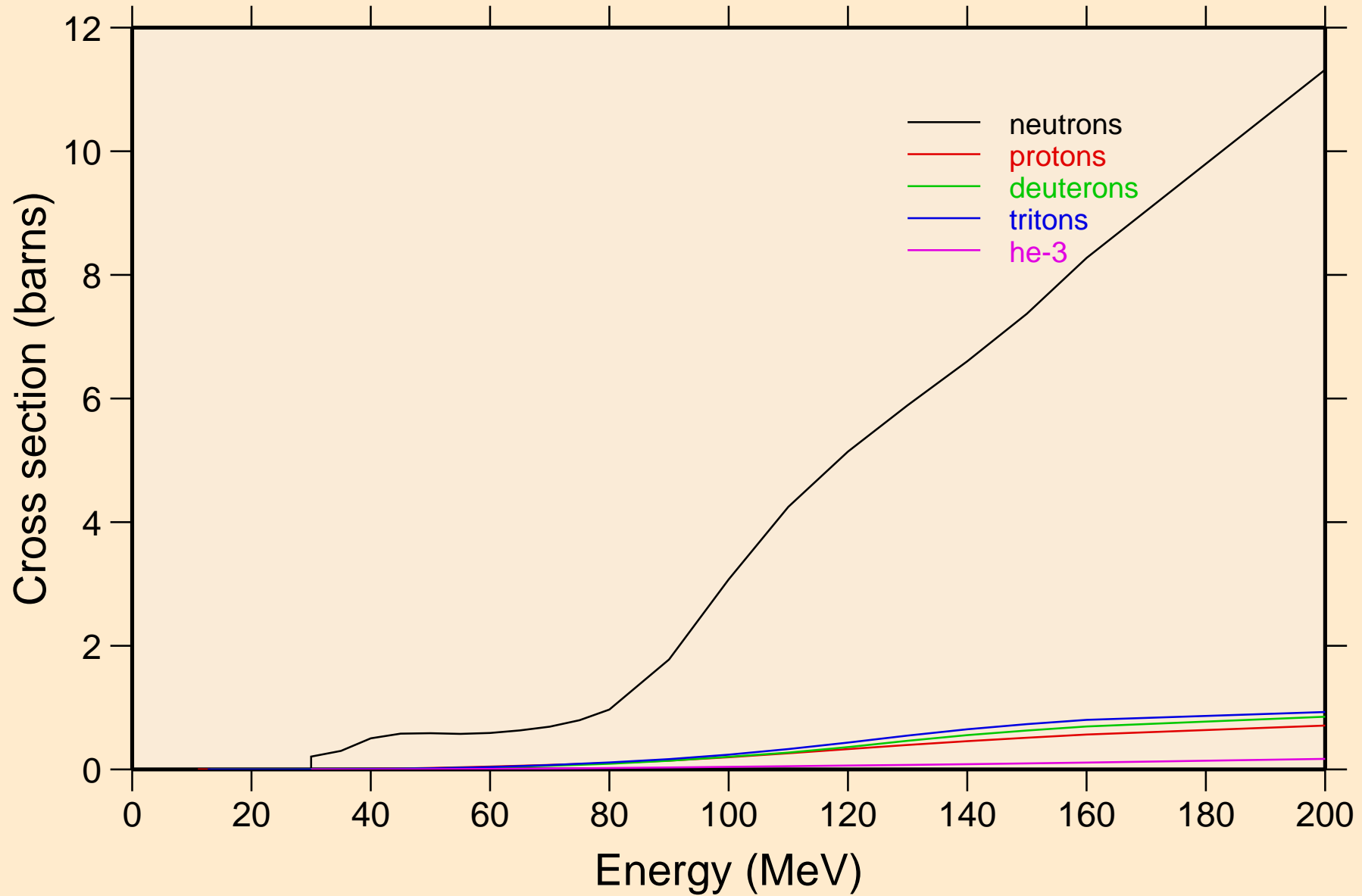

NP244 ALPHA ACER TENDL-2021 LIBRARY; T=0.K
neutrons from (a,n)

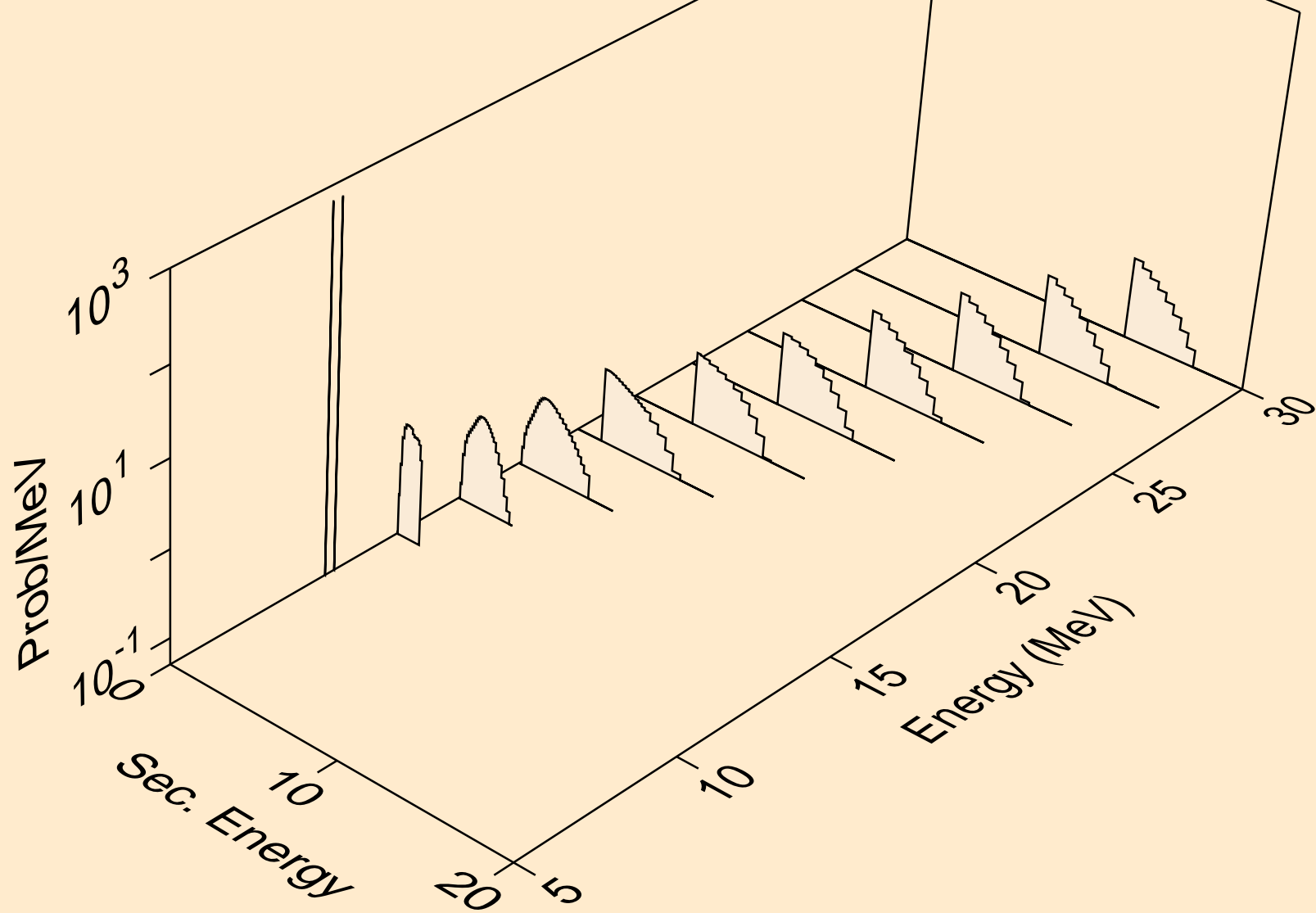

NP244 ALPHA ACER TENDL-2021 LIBRARY; T=0.K
neutrons from (a,x)

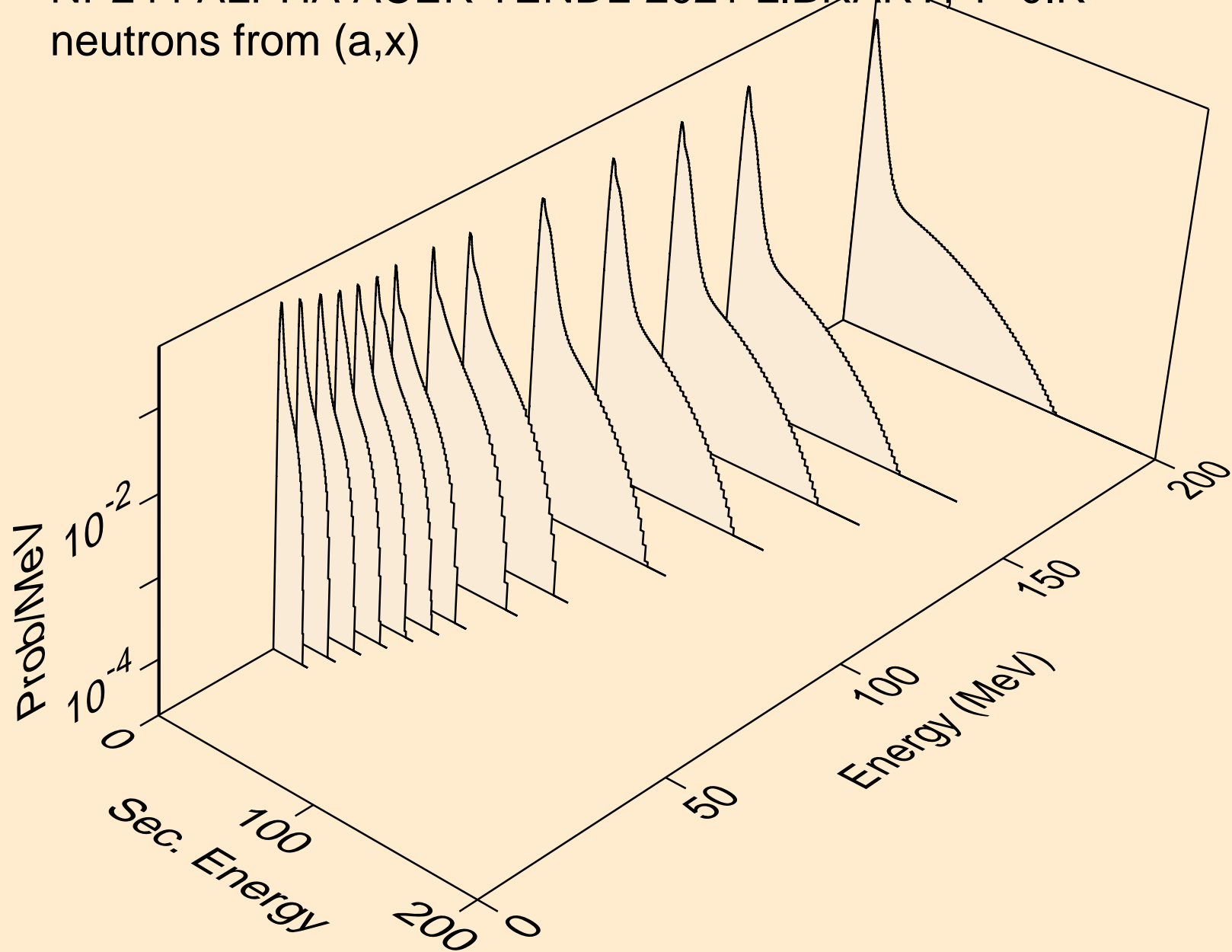

NP244 ALPHA ACER TENDL-2021 LIBRARY; T=0.K
neutrons from (a,2n)

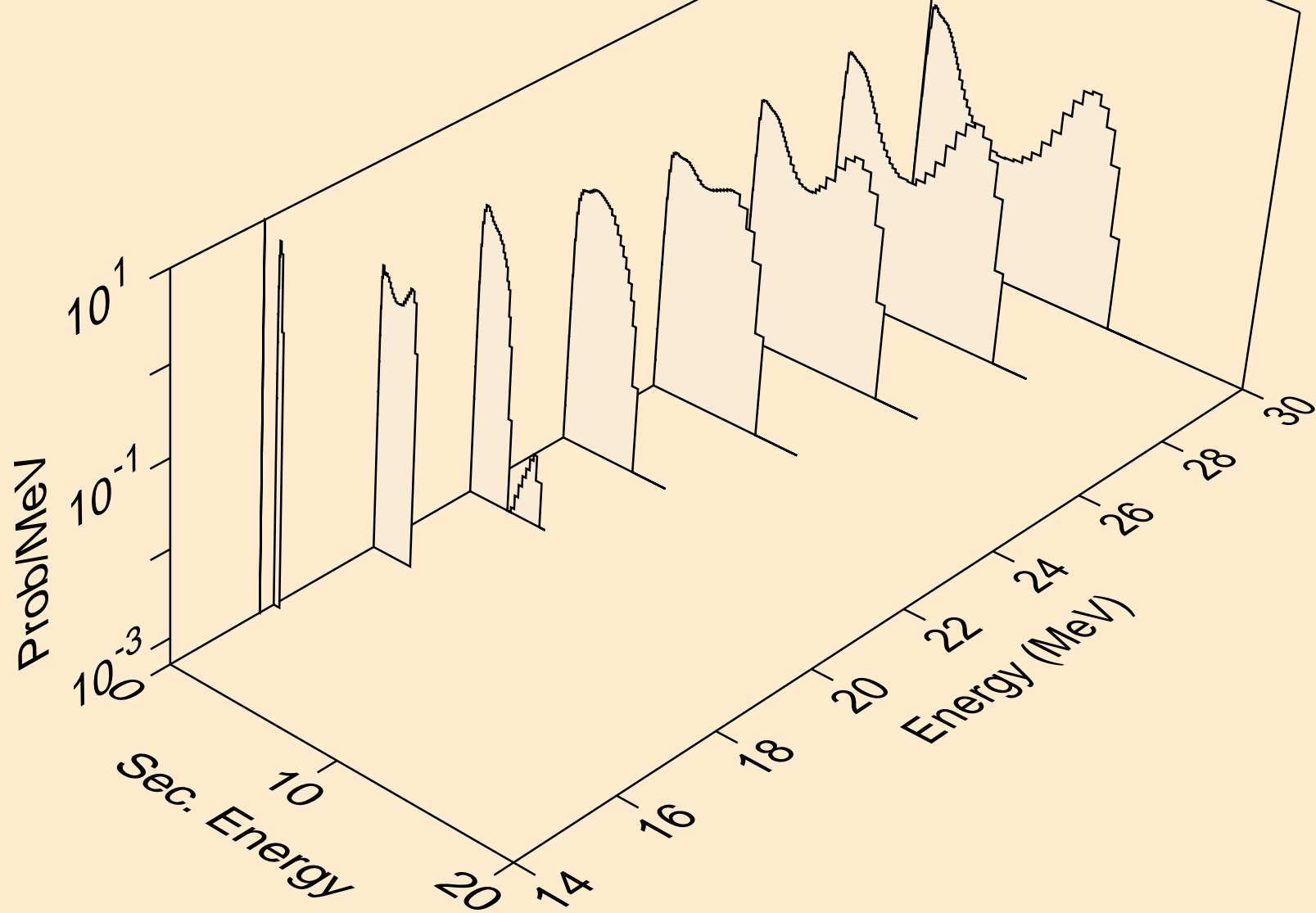

NP244 ALPHA ACER TENDL-2021 LIBRARY; T=0.K
neutrons from (a,3n)

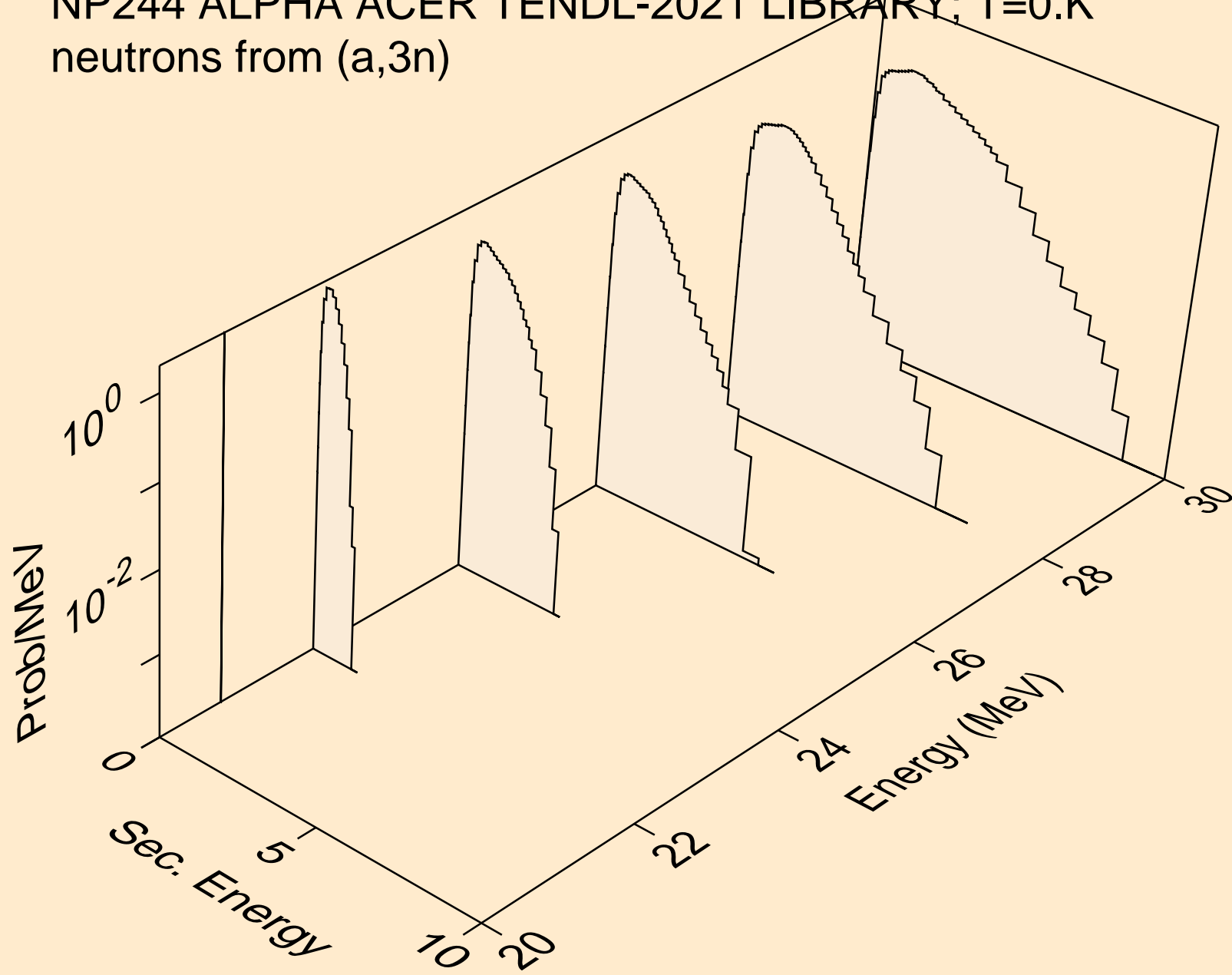

NP244 ALPHA ACER TENDL-2021 LIBRARY; T=0.K
neutrons from (a,n*)a

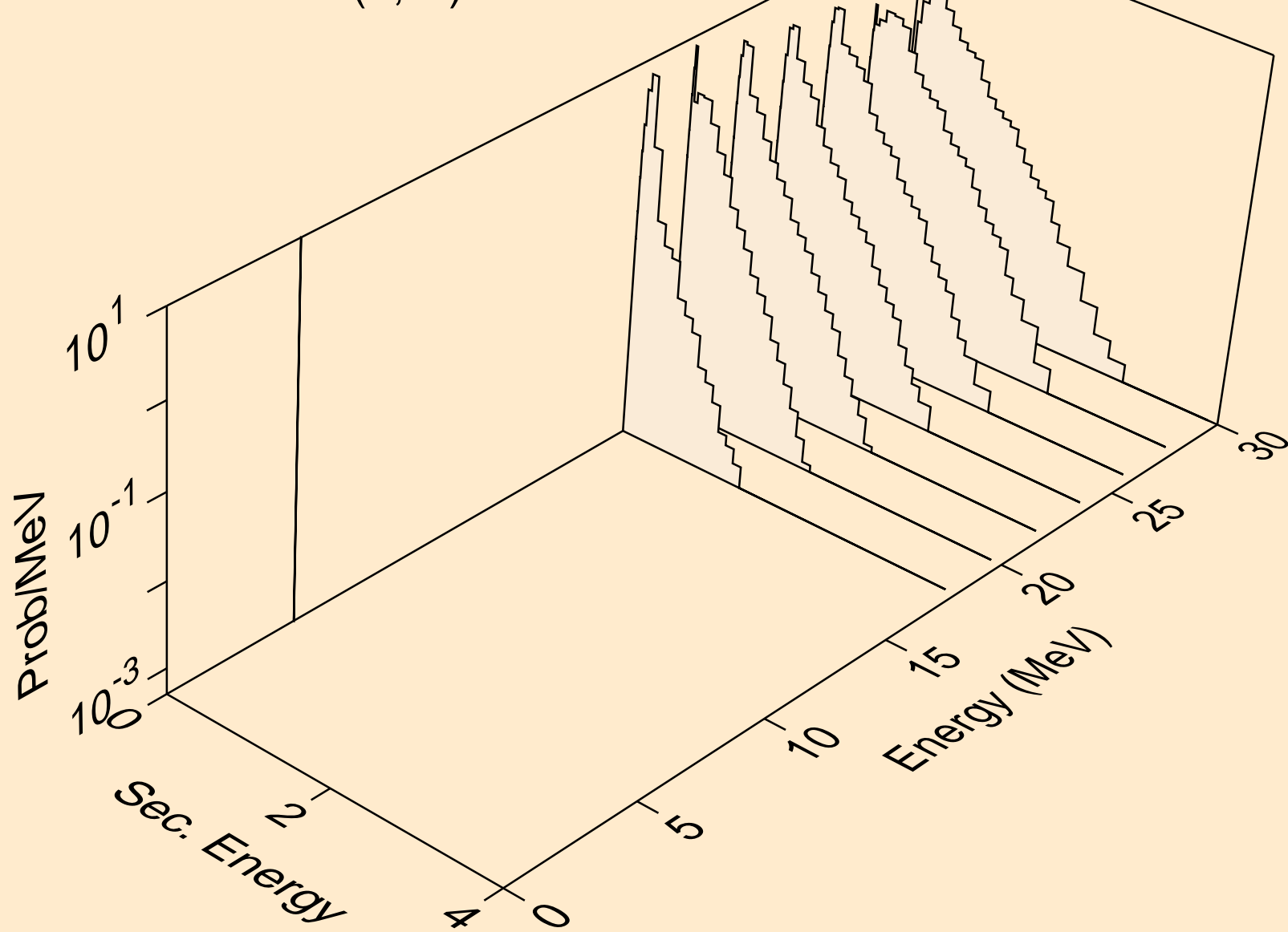

NP244 ALPHA ACER TENDL-2021 LIBRARY; T=0.K
neutrons from (a,2n)a

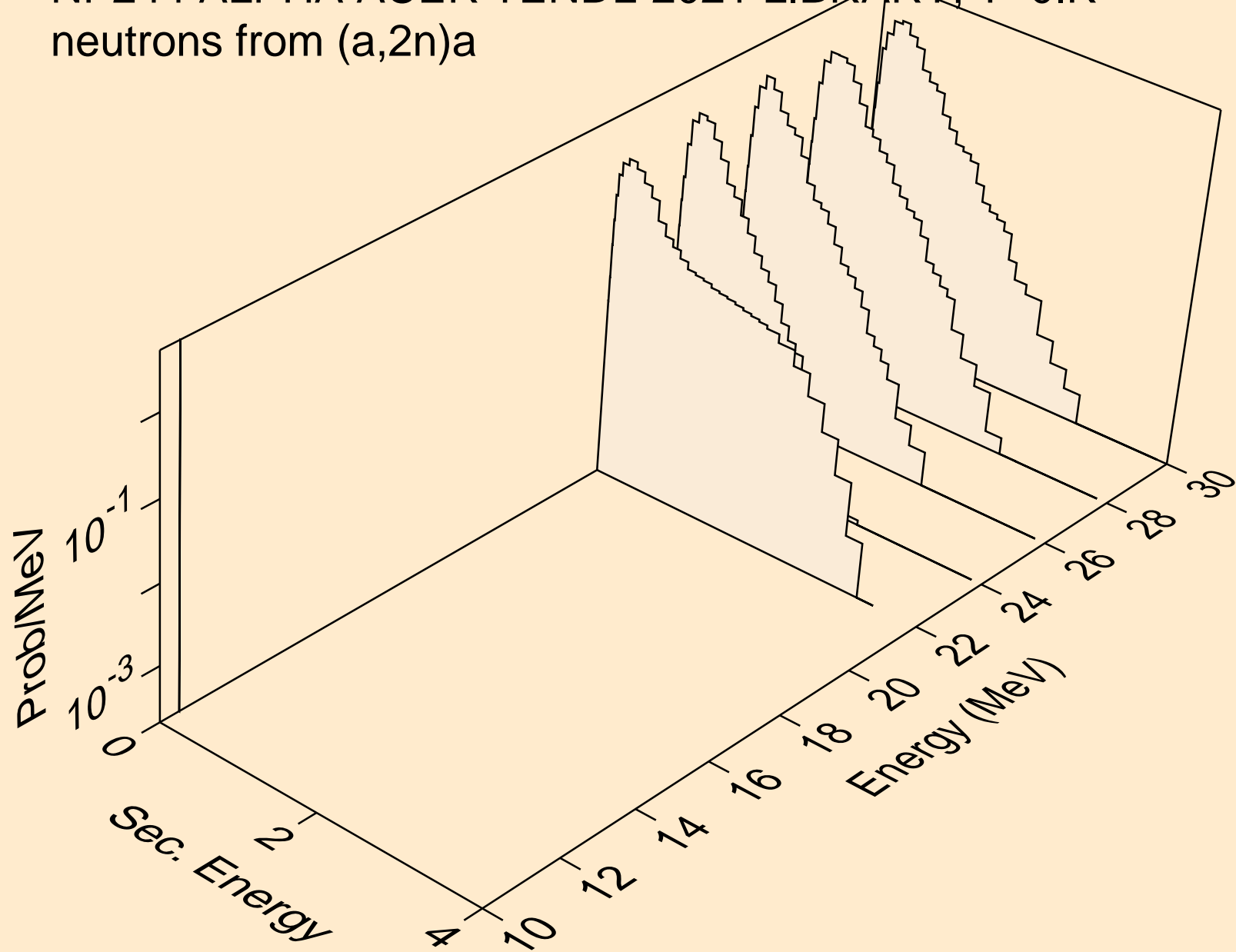

NP244 ALPHA ACER TENDL-2021 LIBRARY; T=0.K
neutrons from (a,n*)p

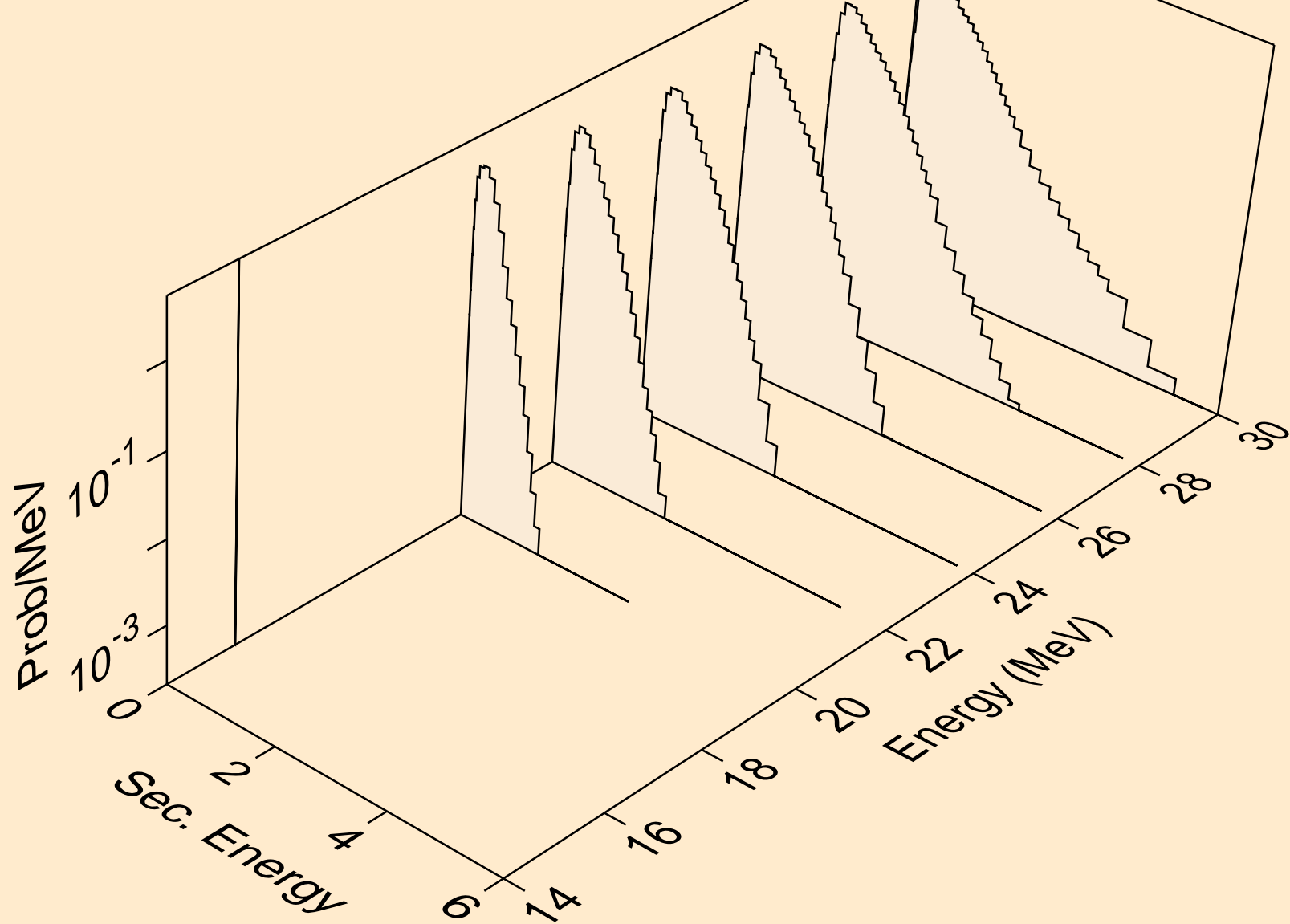

NP244 ALPHA ACER TENDL-2021 LIBRARY; T=0.K
neutrons from (a,n*)d

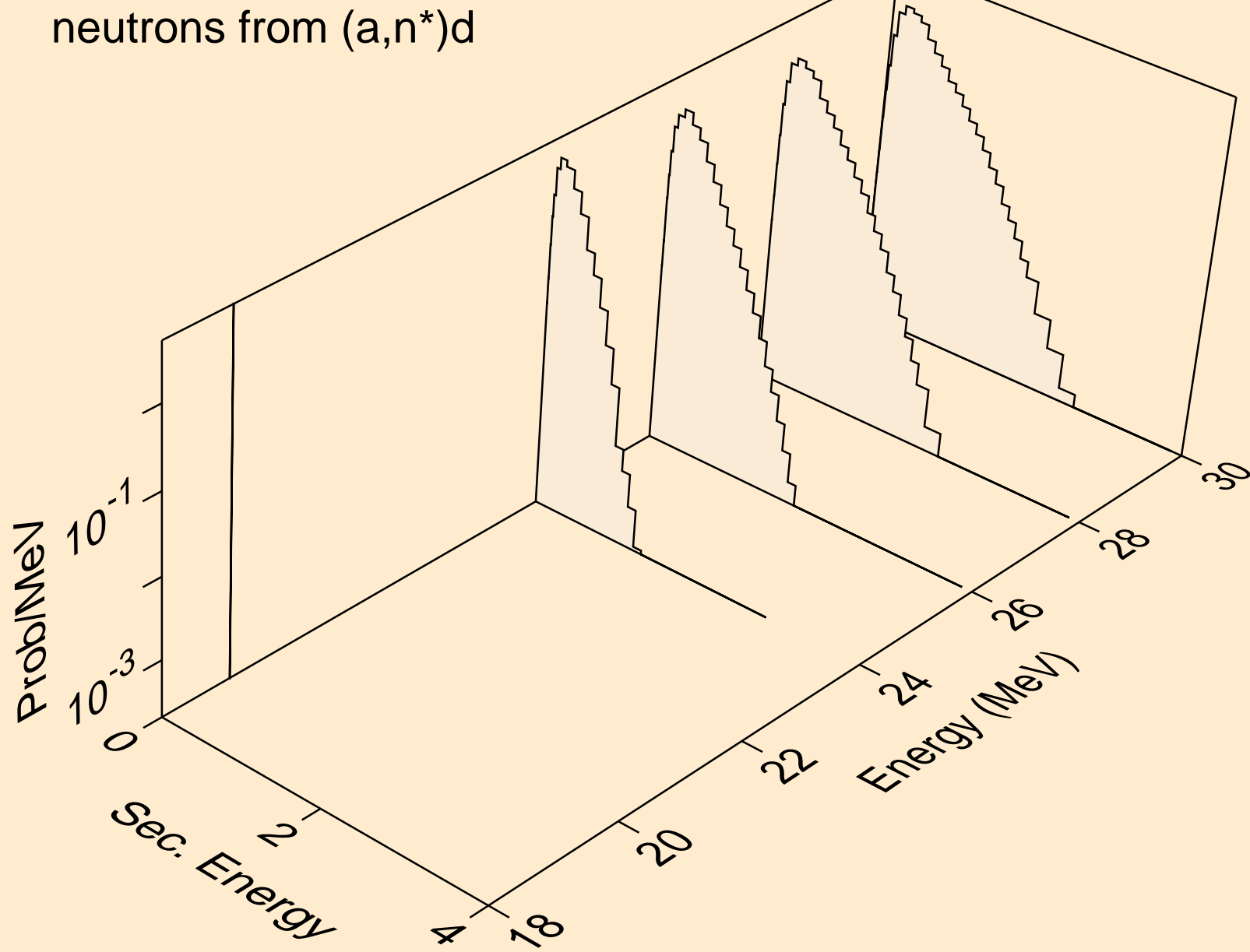

NP244 ALPHA ACER TENDL-2021 LIBRARY; T=0.K
neutrons from (a,n*)t

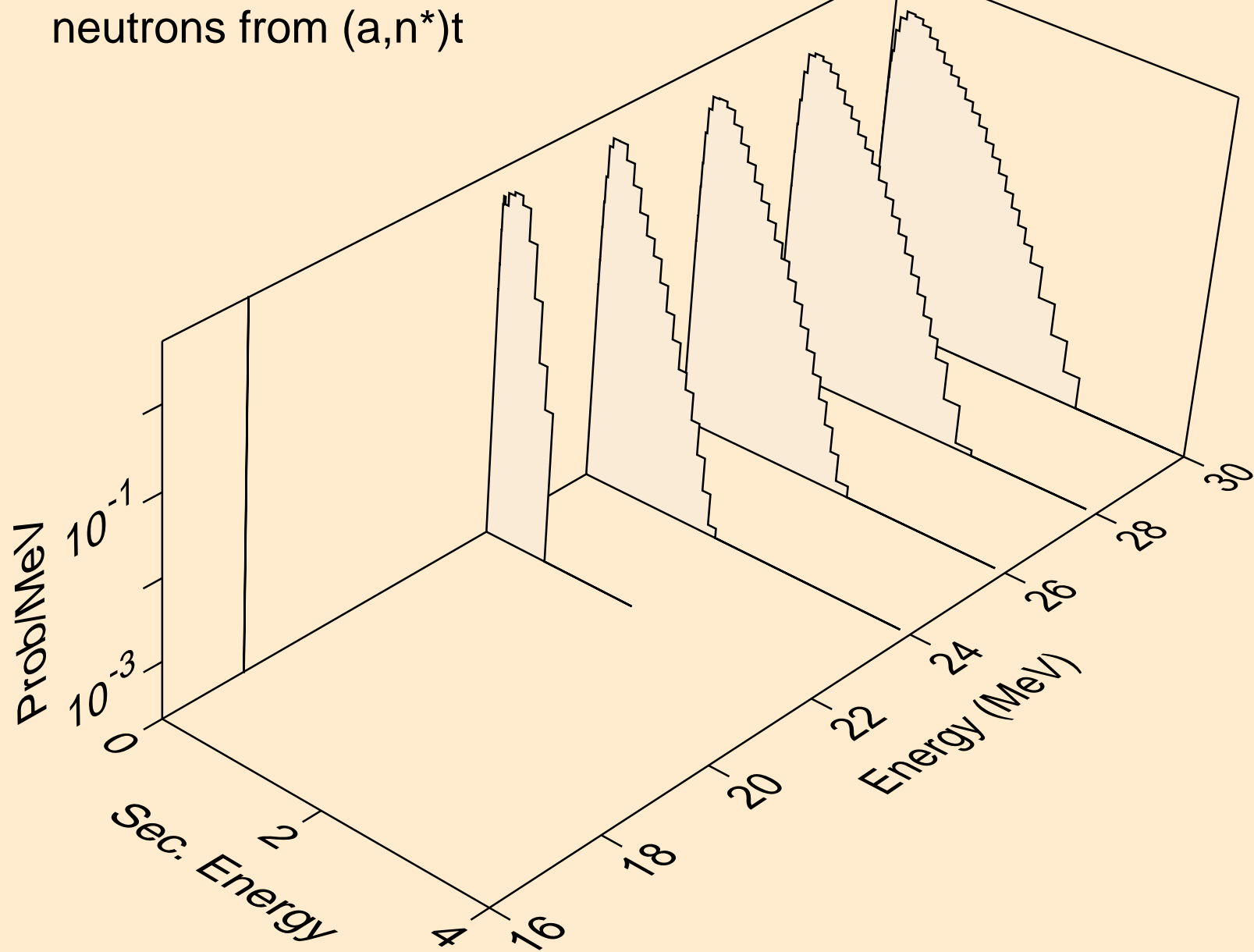

NP244 ALPHA ACER TENDL-2021 LIBRARY; T=0.K
neutrons from (a,4n)

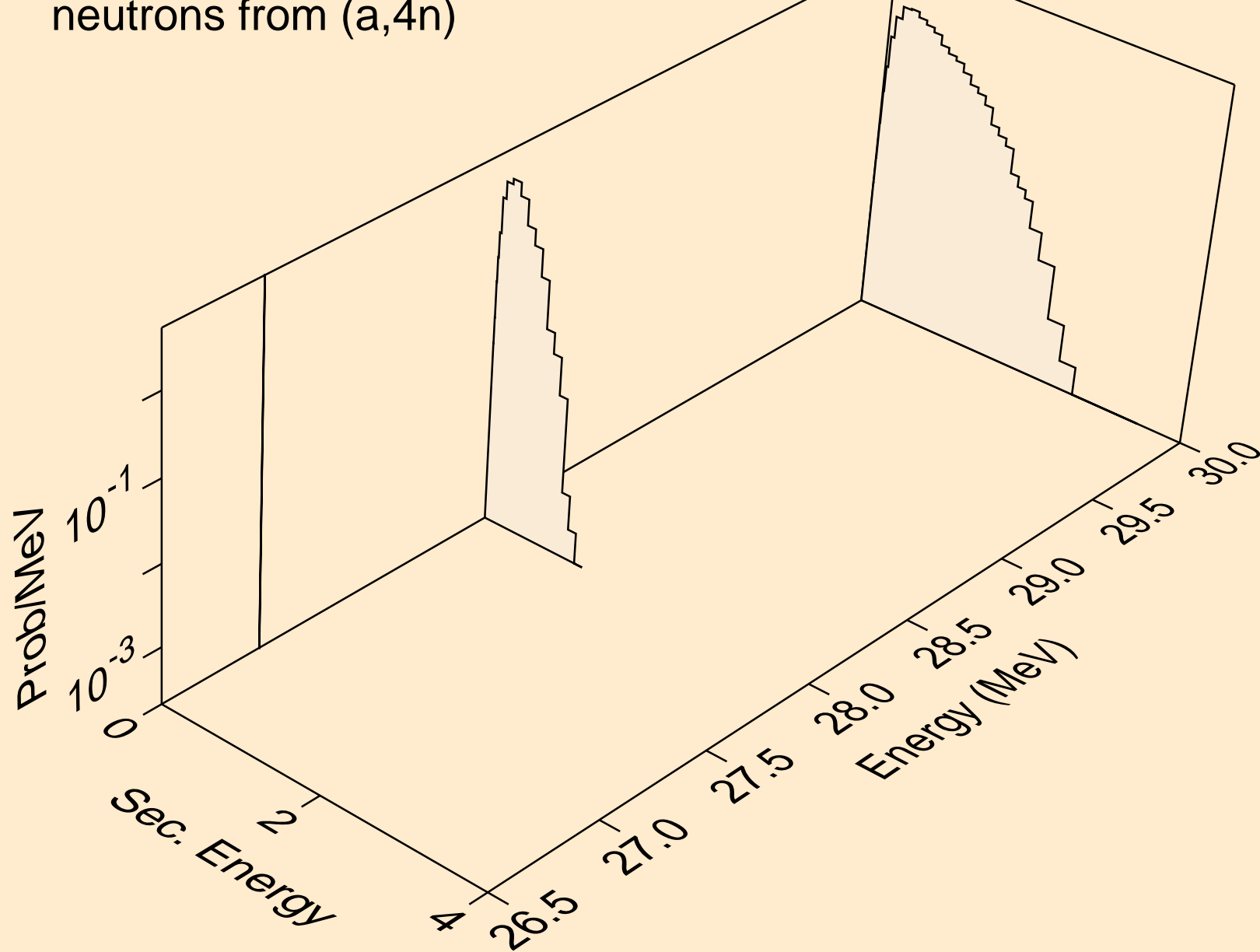

NP244 ALPHA ACER TENDL-2021 LIBRARY; T=0.K
neutrons from (a,2np)

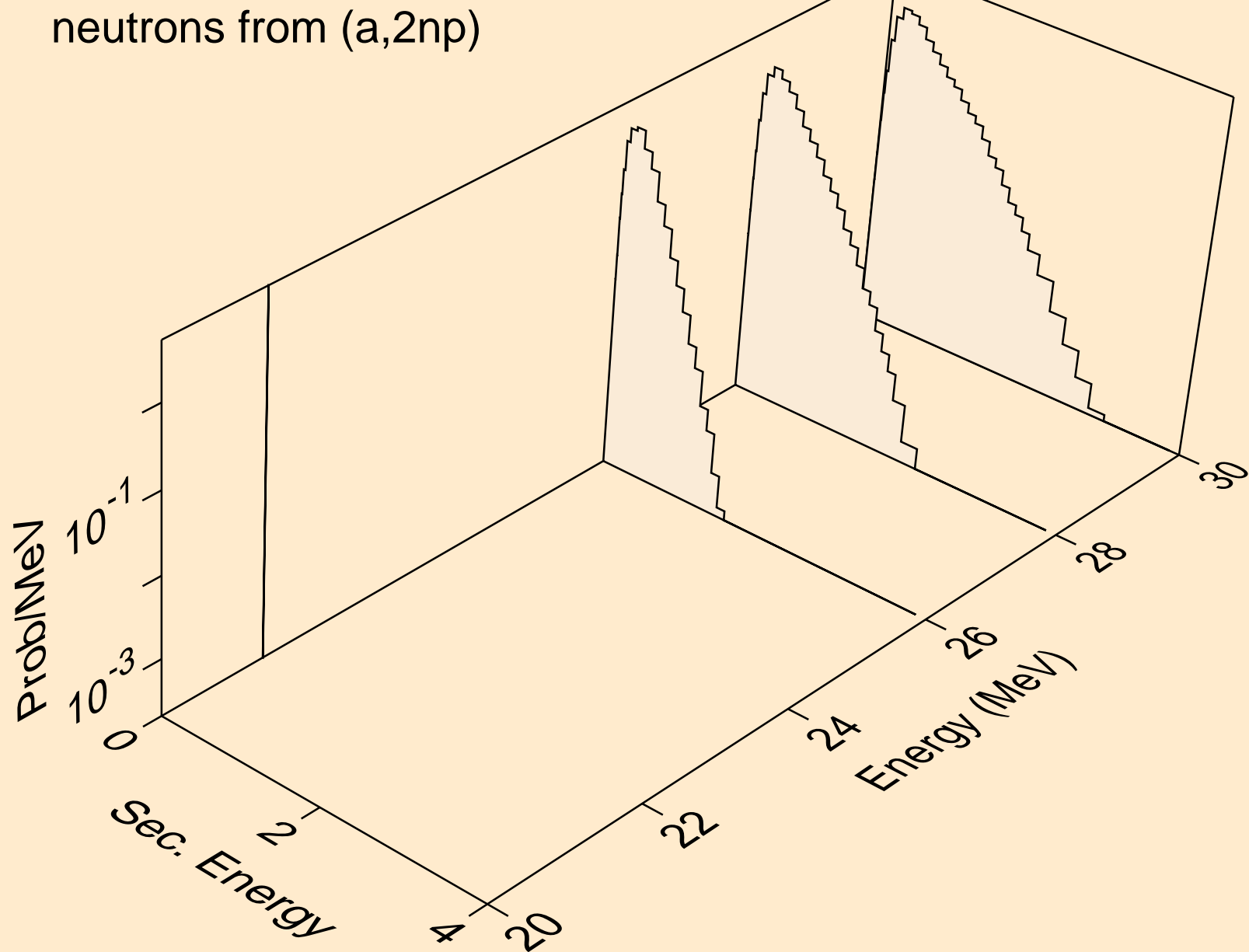

NP244 ALPHA ACER TENDL-2021 LIBRARY; T=0.K
protons from (a,x)

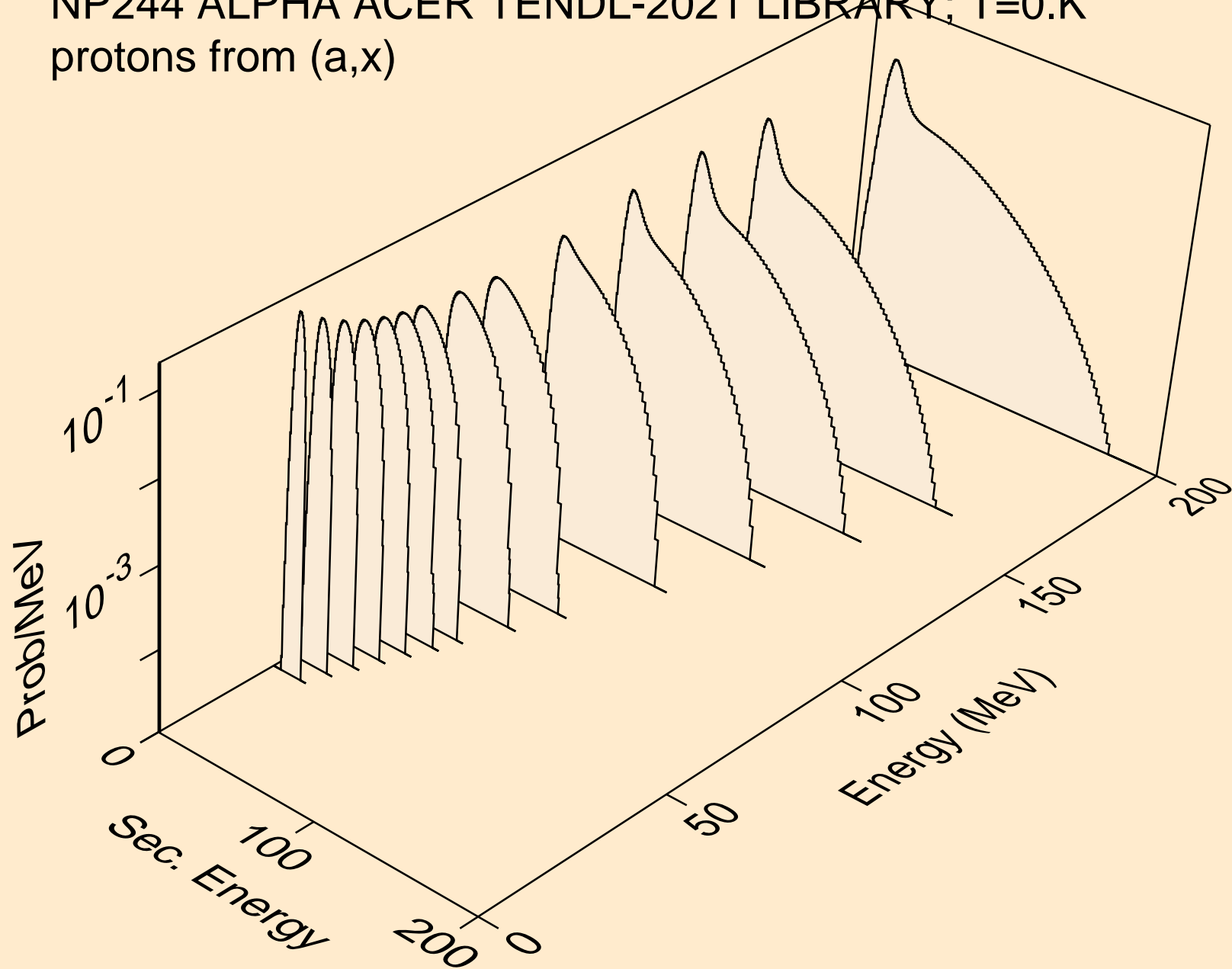

NP244 ALPHA ACER TENDL-2021 LIBRARY; T=0.K
protons from (a,n*)p

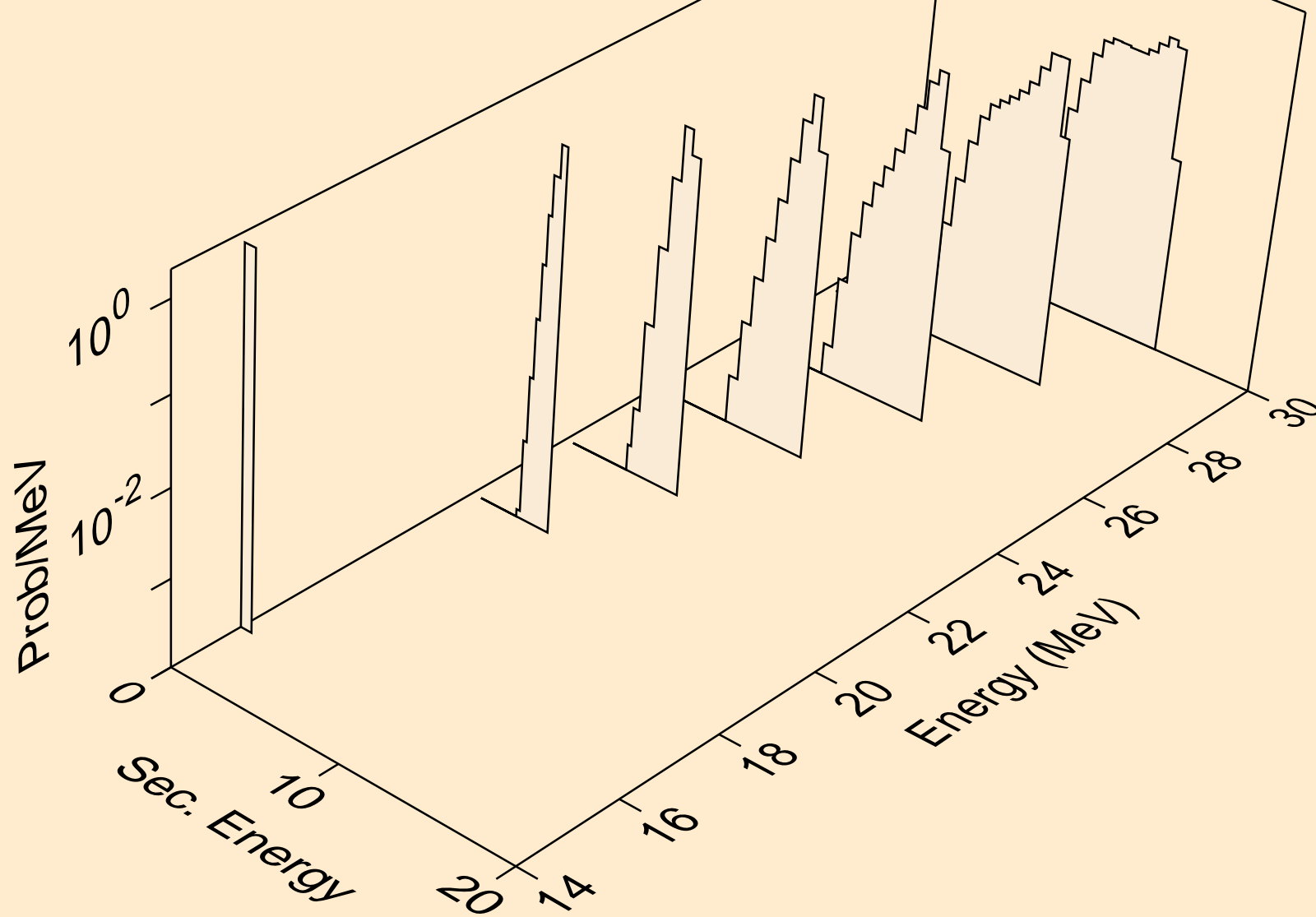

NP244 ALPHA ACER TENDL-2021 LIBRARY; T=0.K
protons from (a,2np)

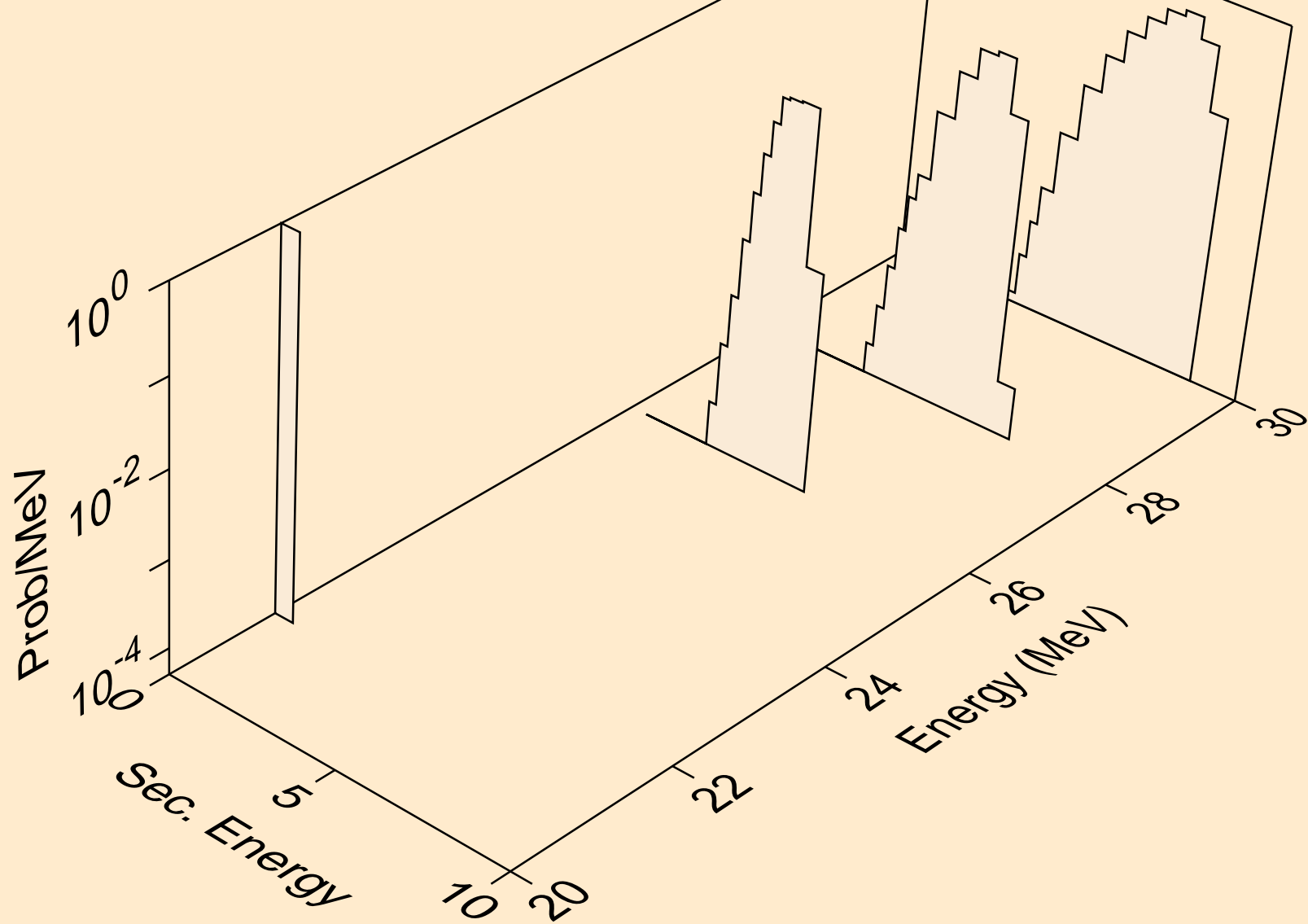

NP244 ALPHA ACER TENDL-2021 LIBRARY; T=0.K
protons from (a,p)

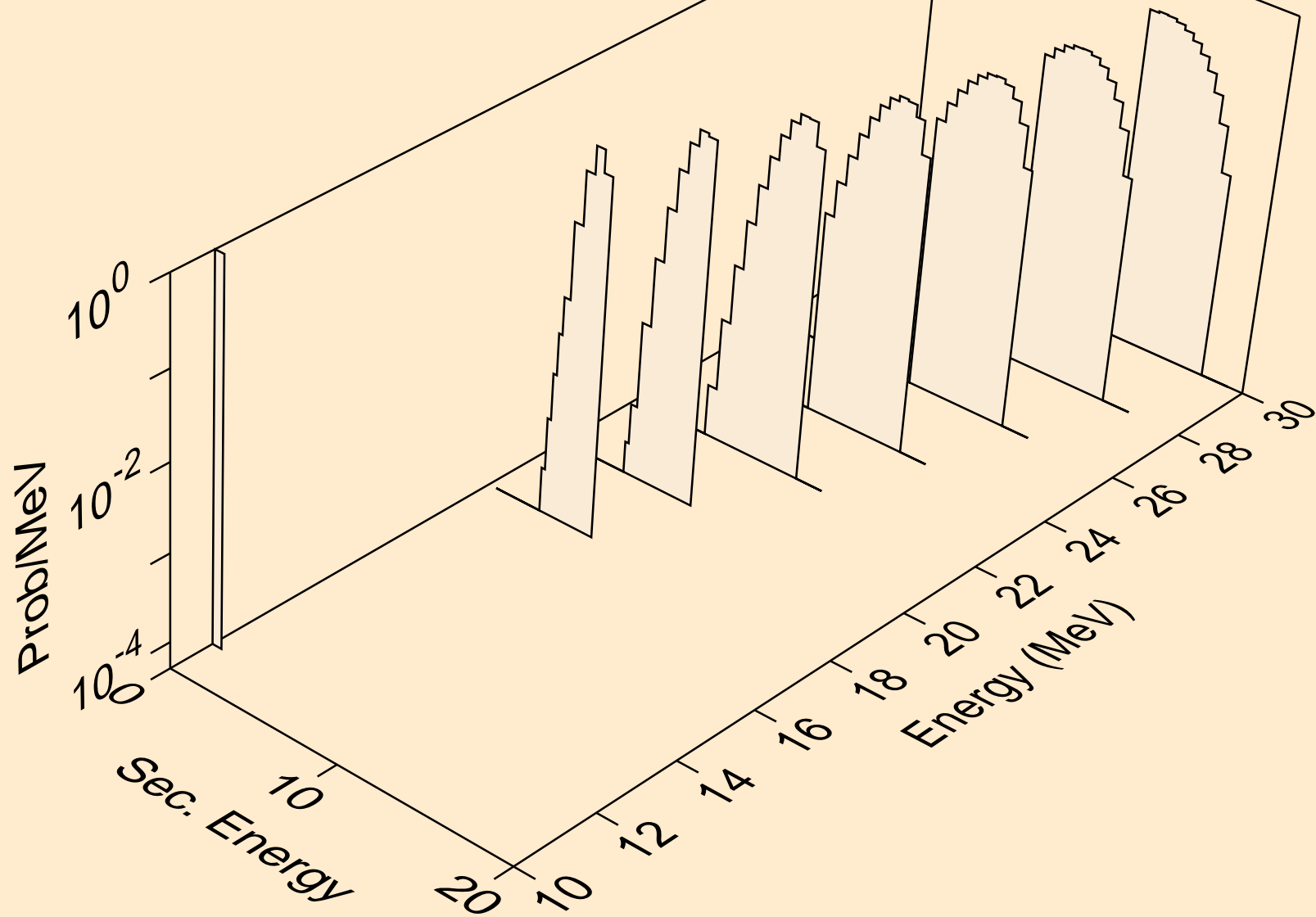

NP244 ALPHA ACER TENDL-2021 LIBRARY; T=0.K
deuterons from (a,x)

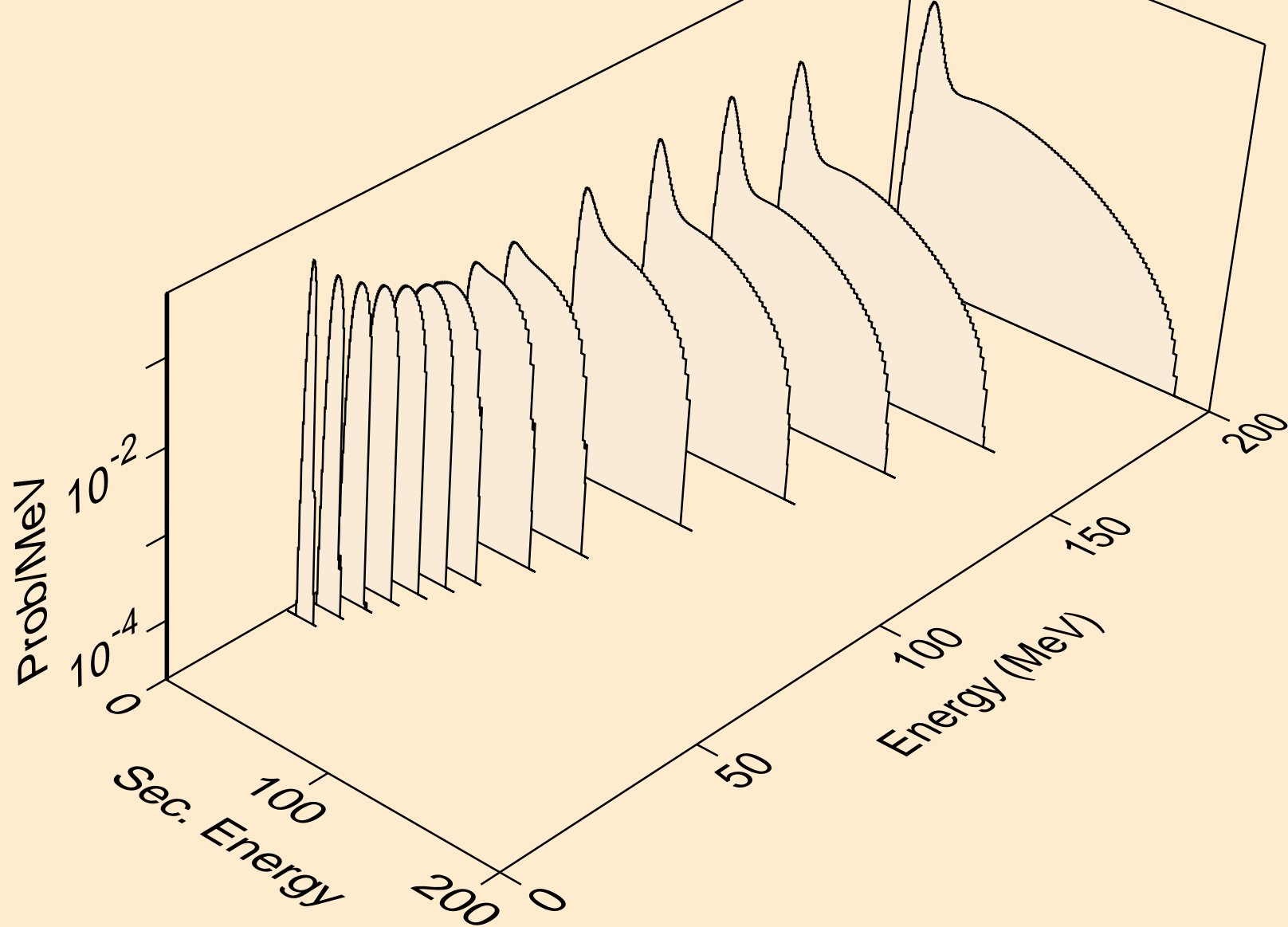

NP244 ALPHA ACER TENDL-2021 LIBRARY; T=0.K
deuterons from (a,n*)d

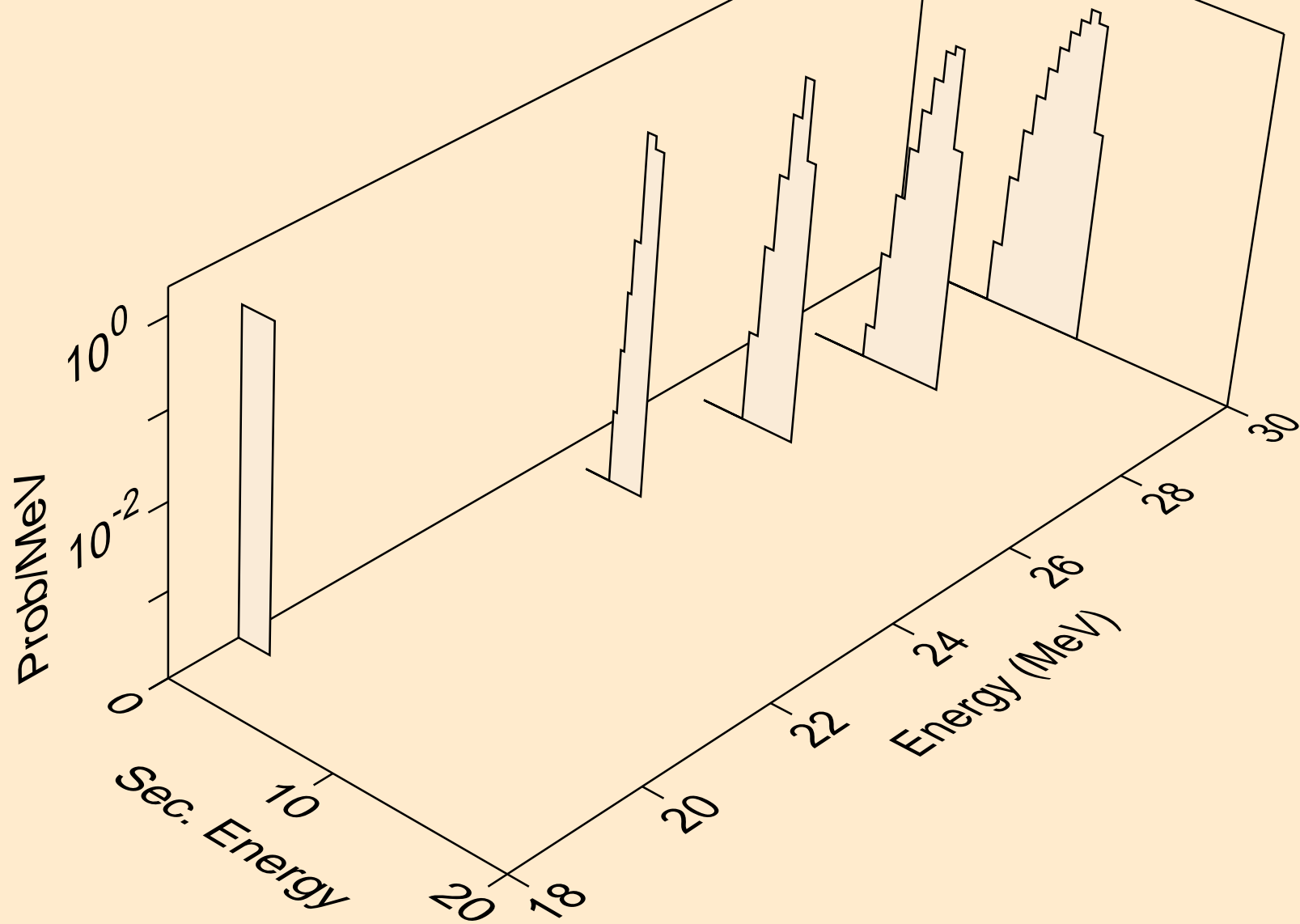

NP244 ALPHA ACER TENDL-2021 LIBRARY; T=0.K
deuterons from (a,d)

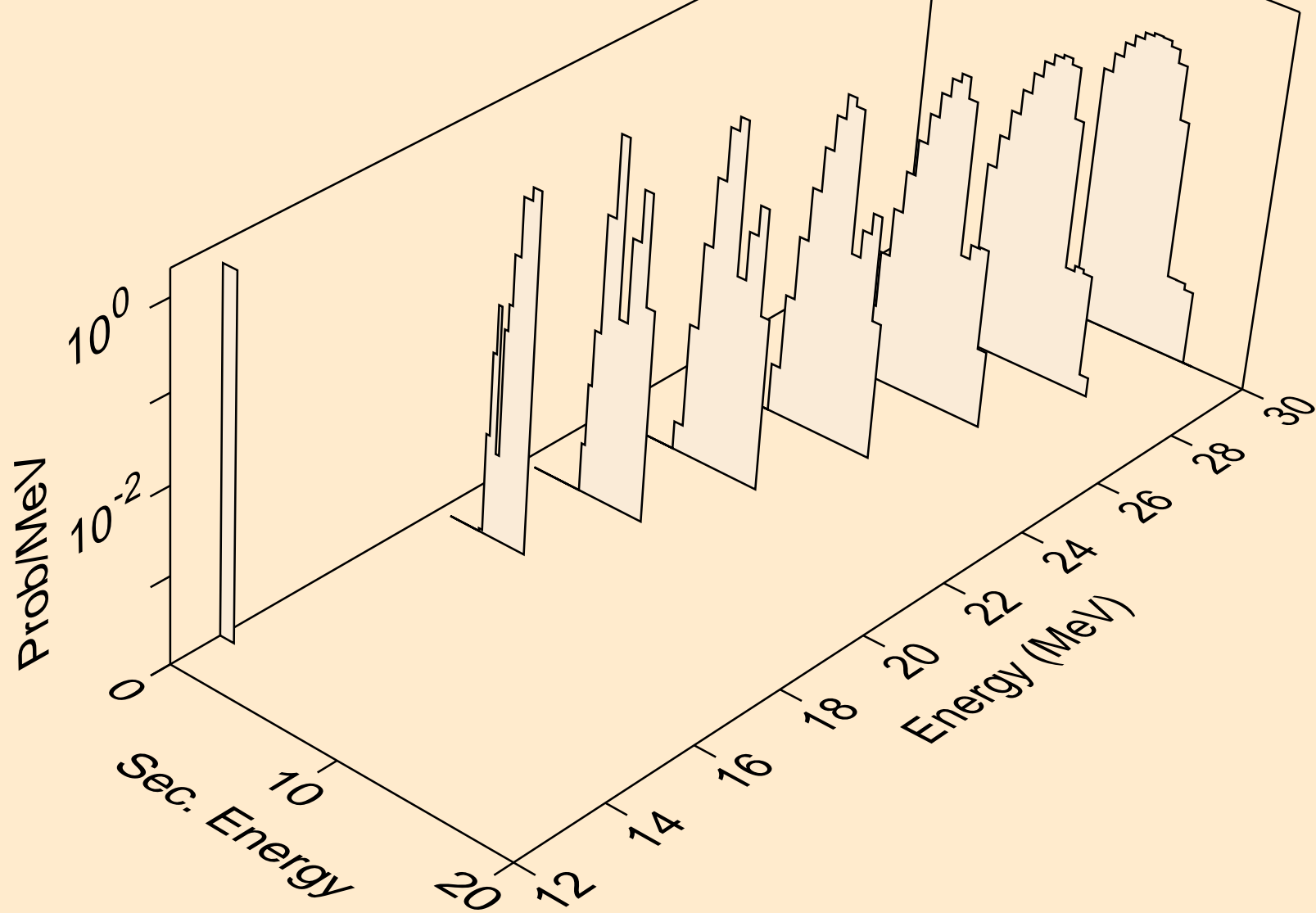

NP244 ALPHA ACER TENDL-2021 LIBRARY; T=0.K
tritons from (a,x)

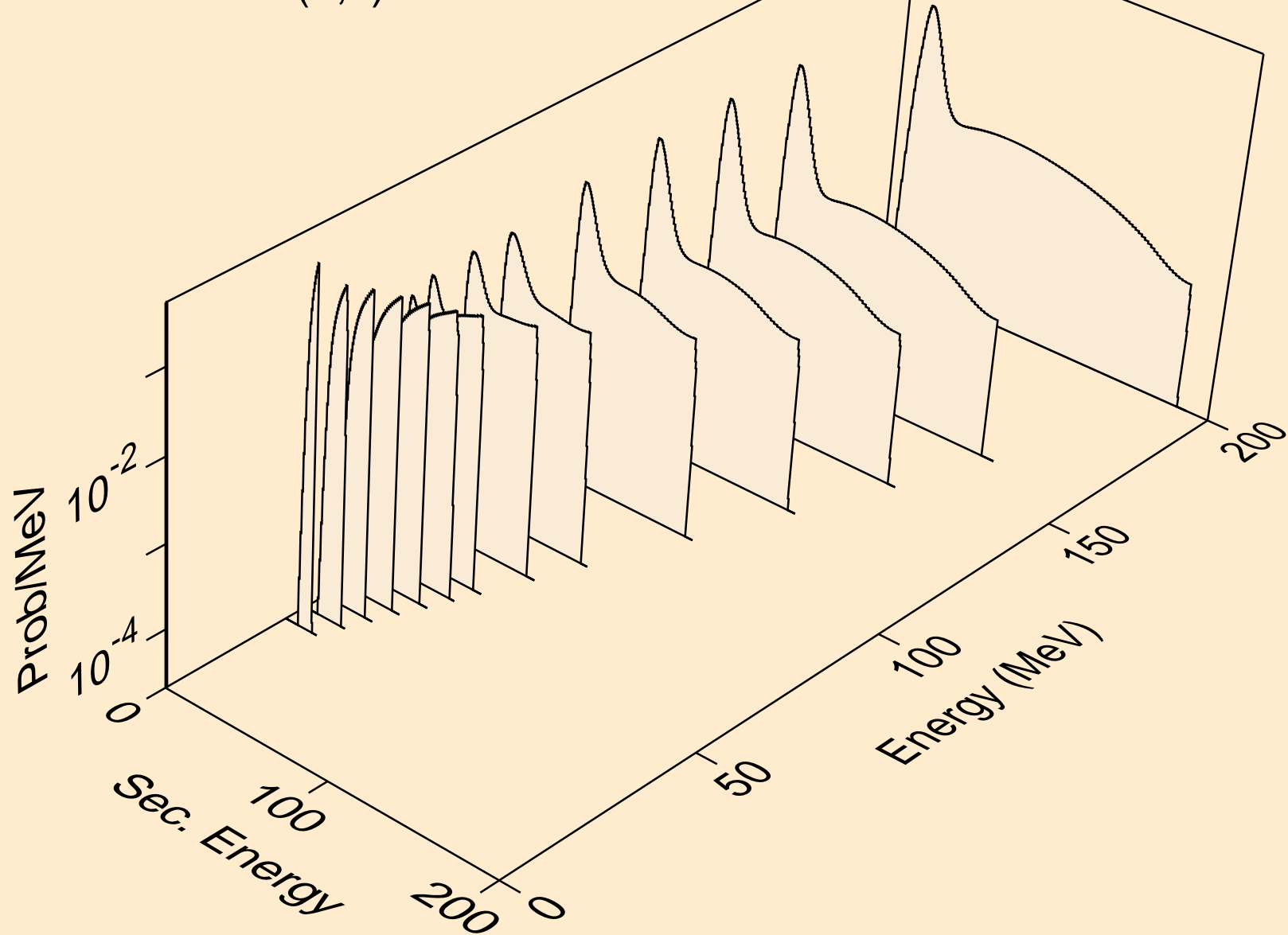

NP244 ALPHA ACER TENDL-2021 LIBRARY; T=0.K
tritons from (a,n*)t

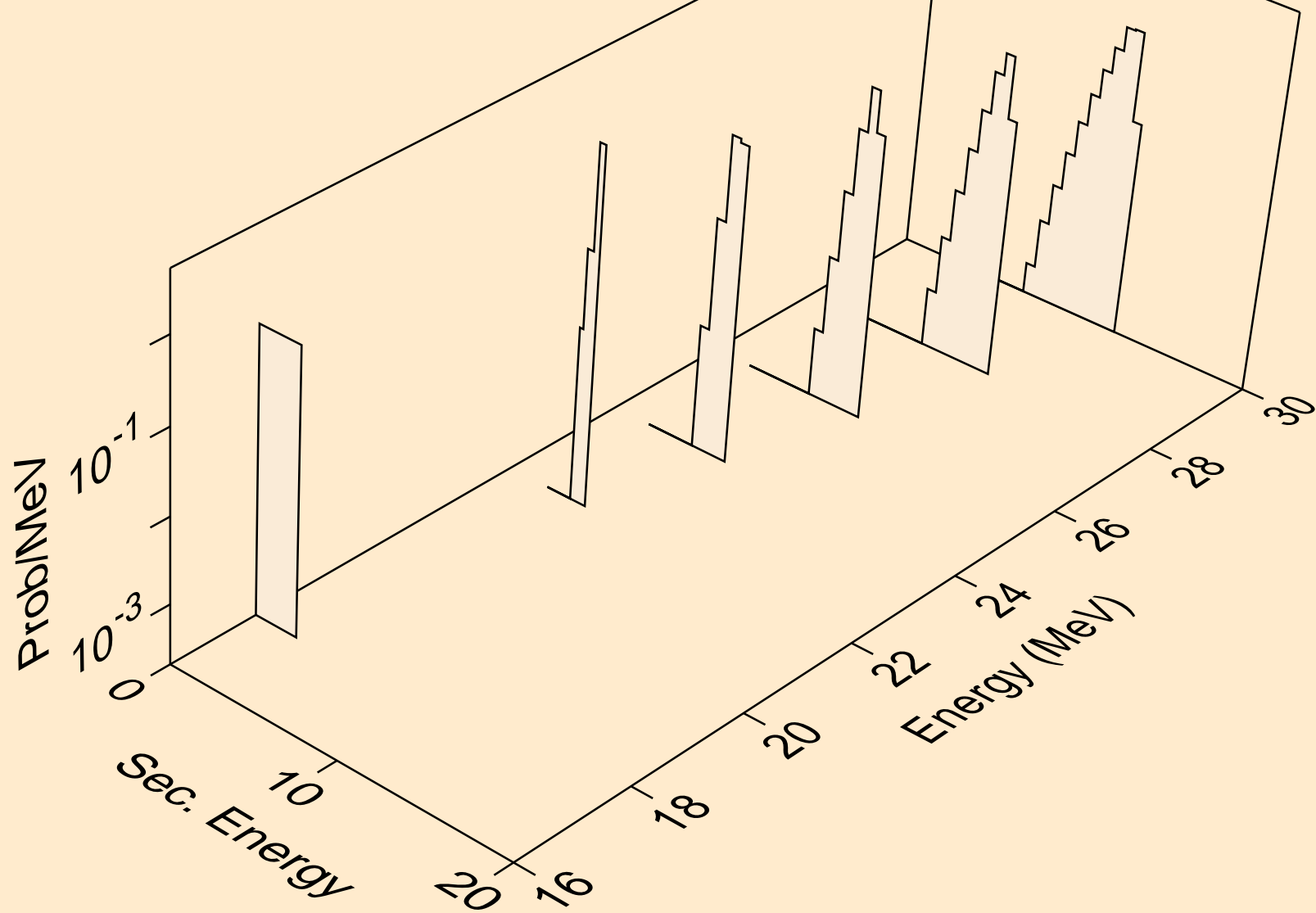

NP244 ALPHA ACER TENDL-2021 LIBRARY; T=0.K
tritons from (a,t)

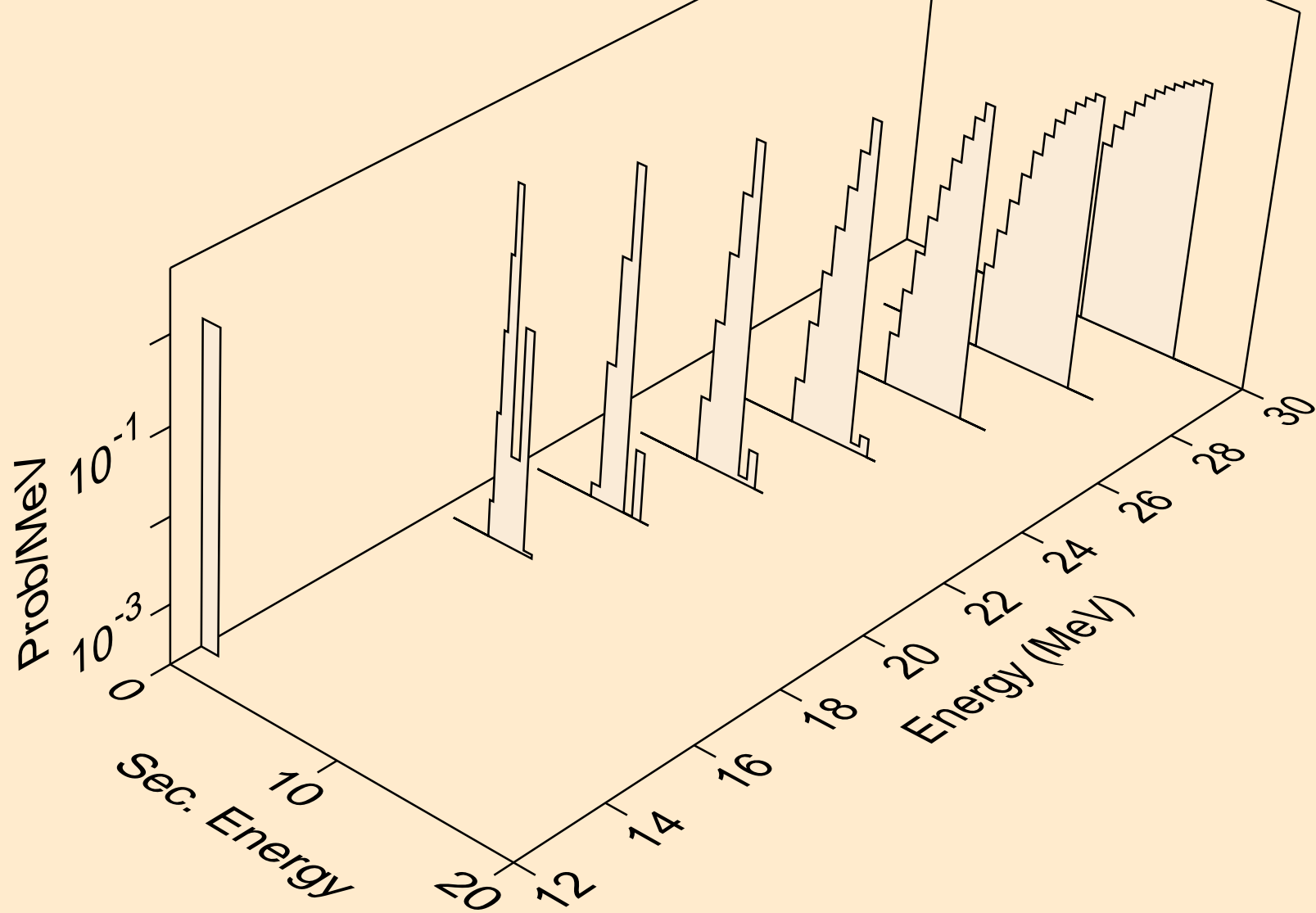

NP244 ALPHA ACER TENDL-2021 LIBRARY; T=0.K
he3s from (a,x)

