

PO198 ALPHA ACER TENDL-2021 LIBRARY; T=0.K  
Principal cross sections

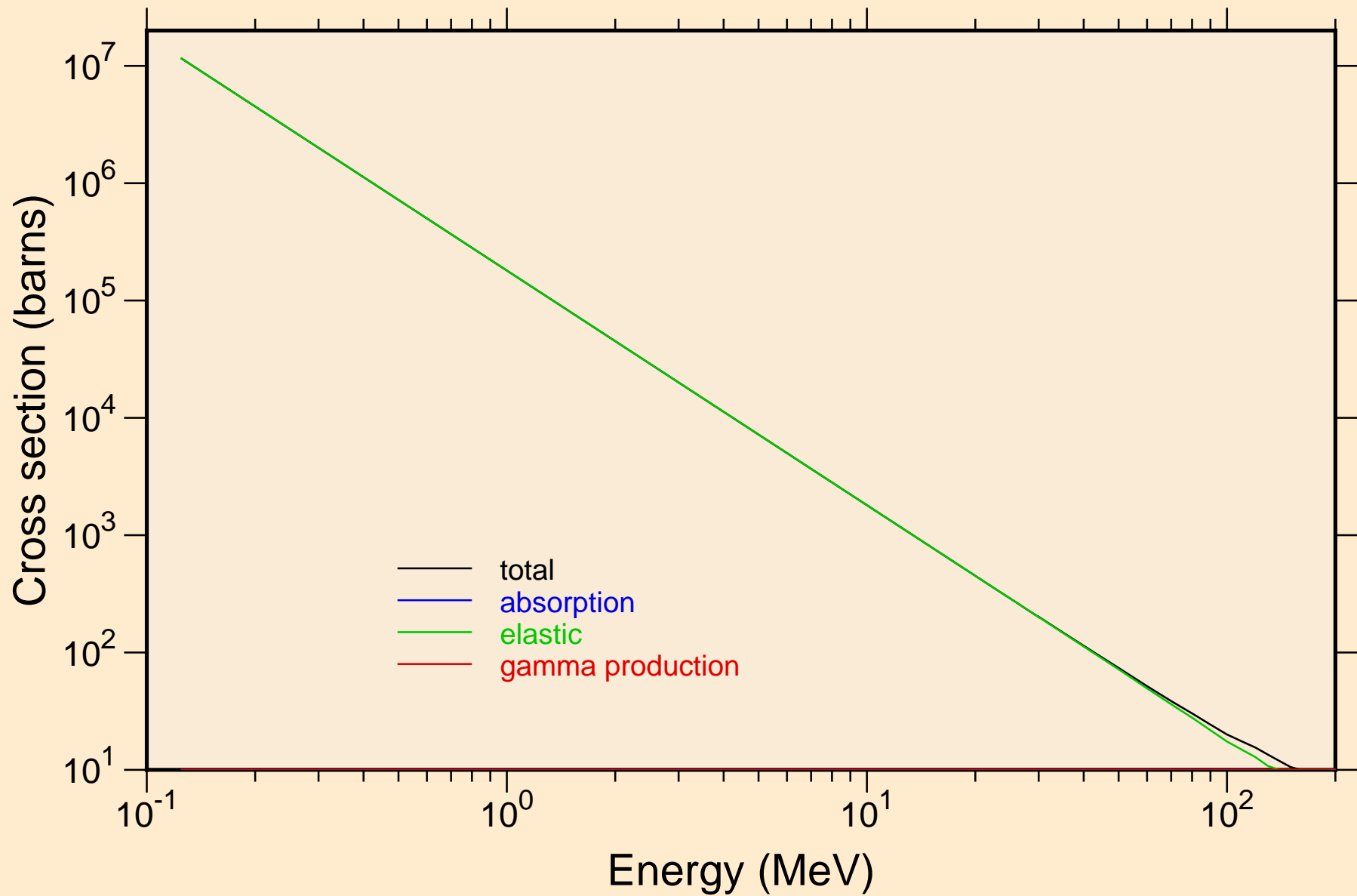

PO198 ALPHA ACER TENDL-2021 LIBRARY; T=0.K  
Heating

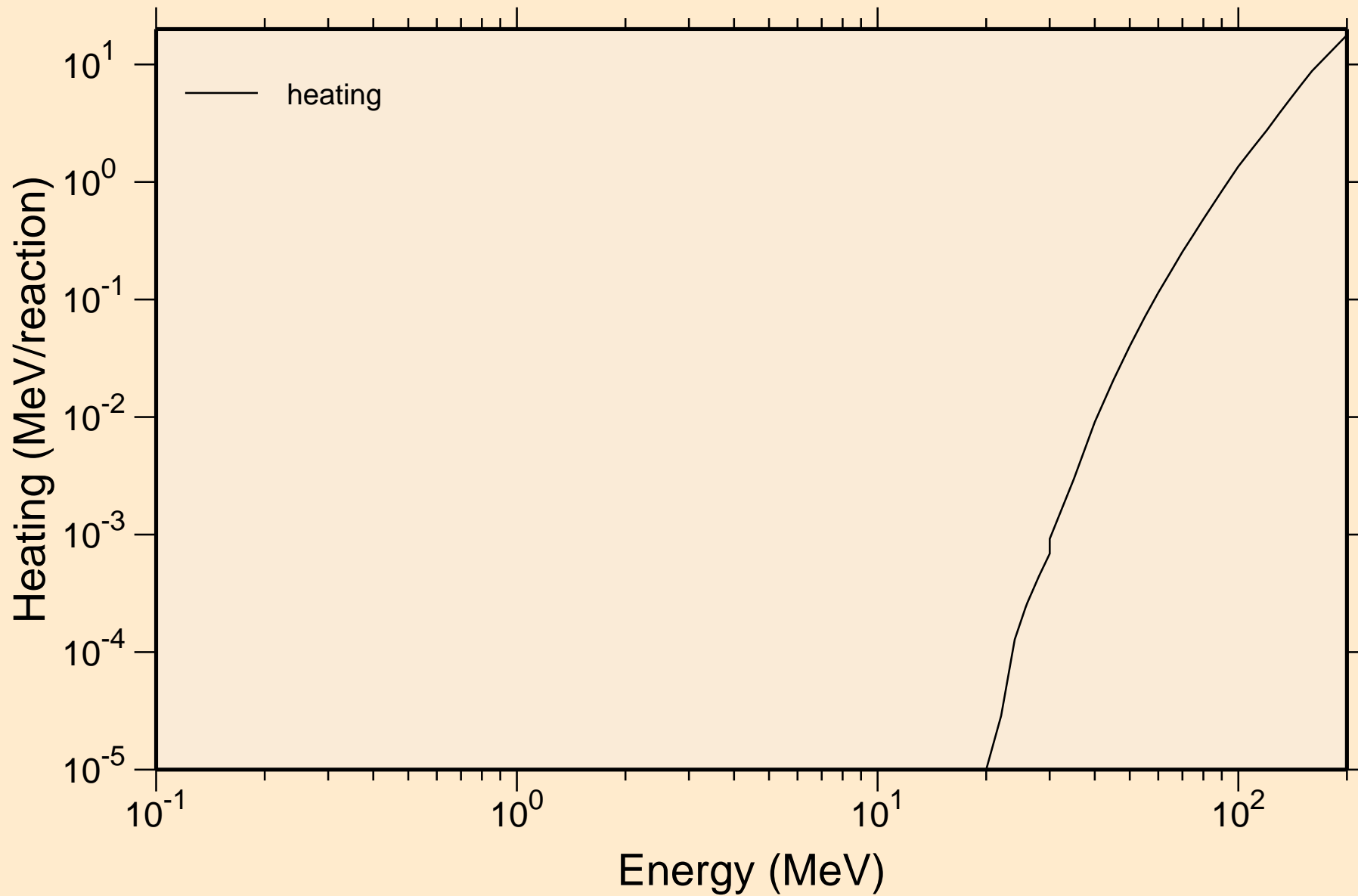

PO198 ALPHA ACER TENDL-2021 LIBRARY; T=0.K

Principal cross sections

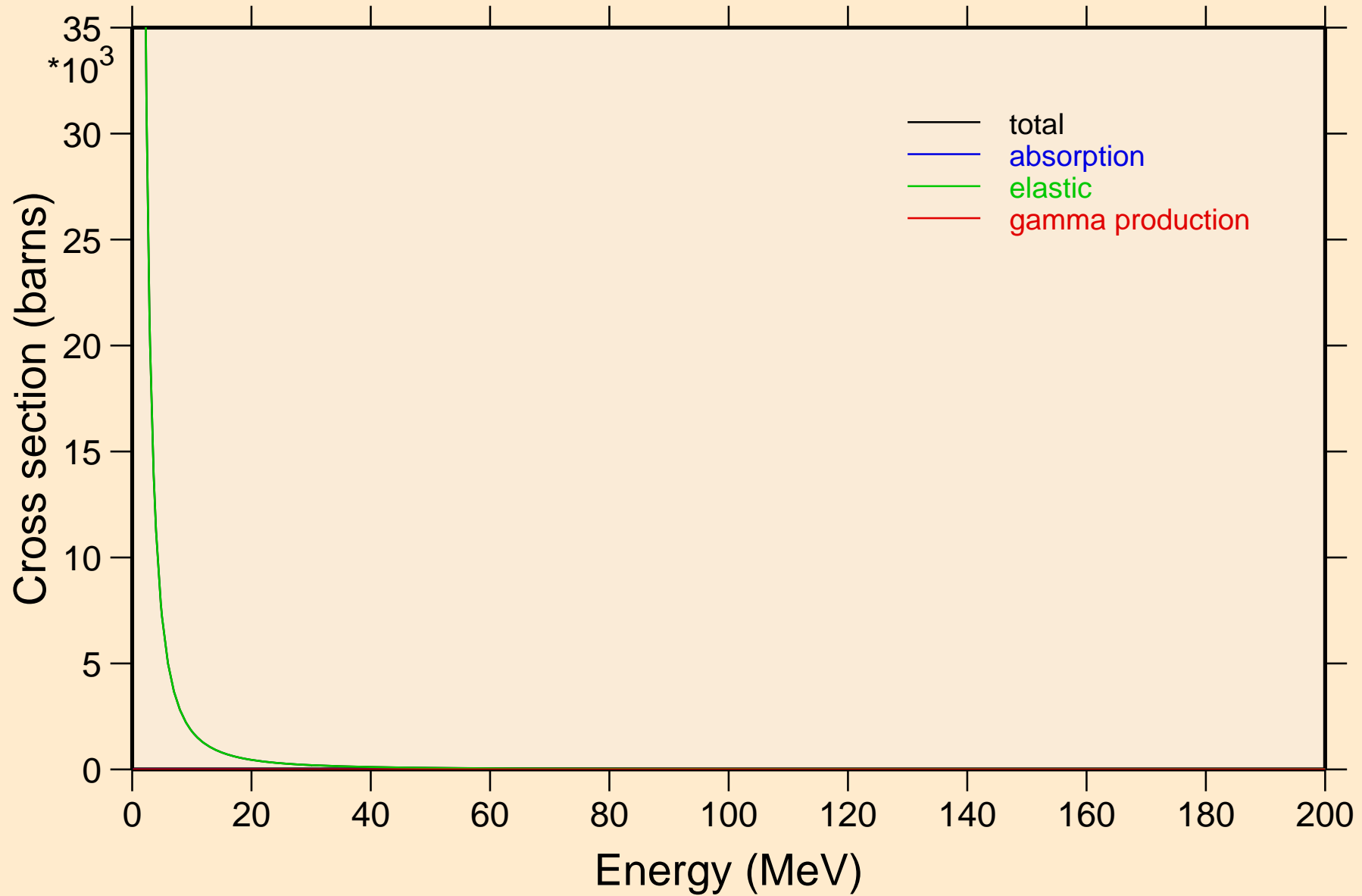

PO198 ALPHA ACER TENDL-2021 LIBRARY; T=0.K

Heating

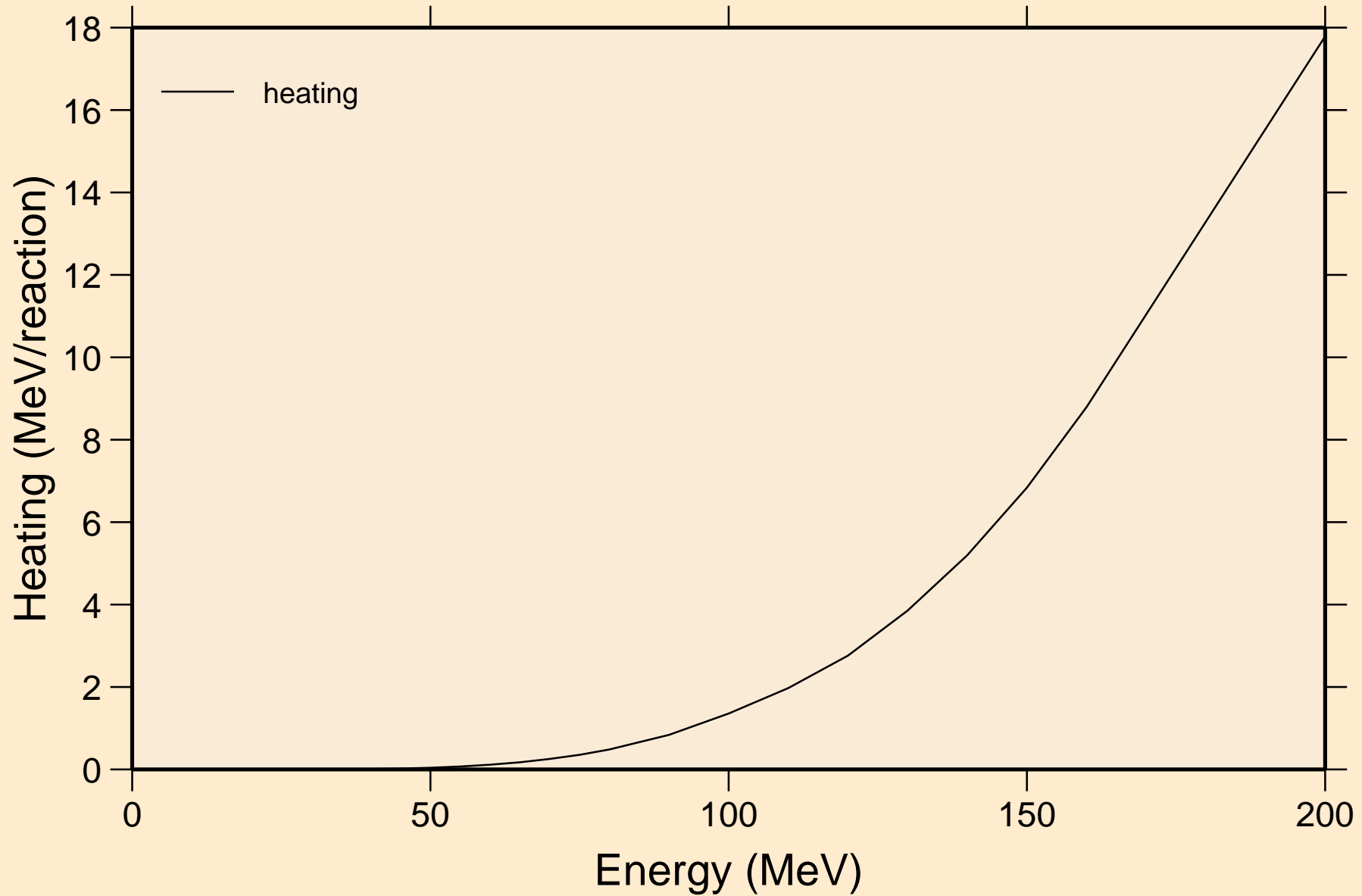

PO198 ALPHA ACER TENDL-2021 LIBRARY; T=0.K  
Threshold reactions

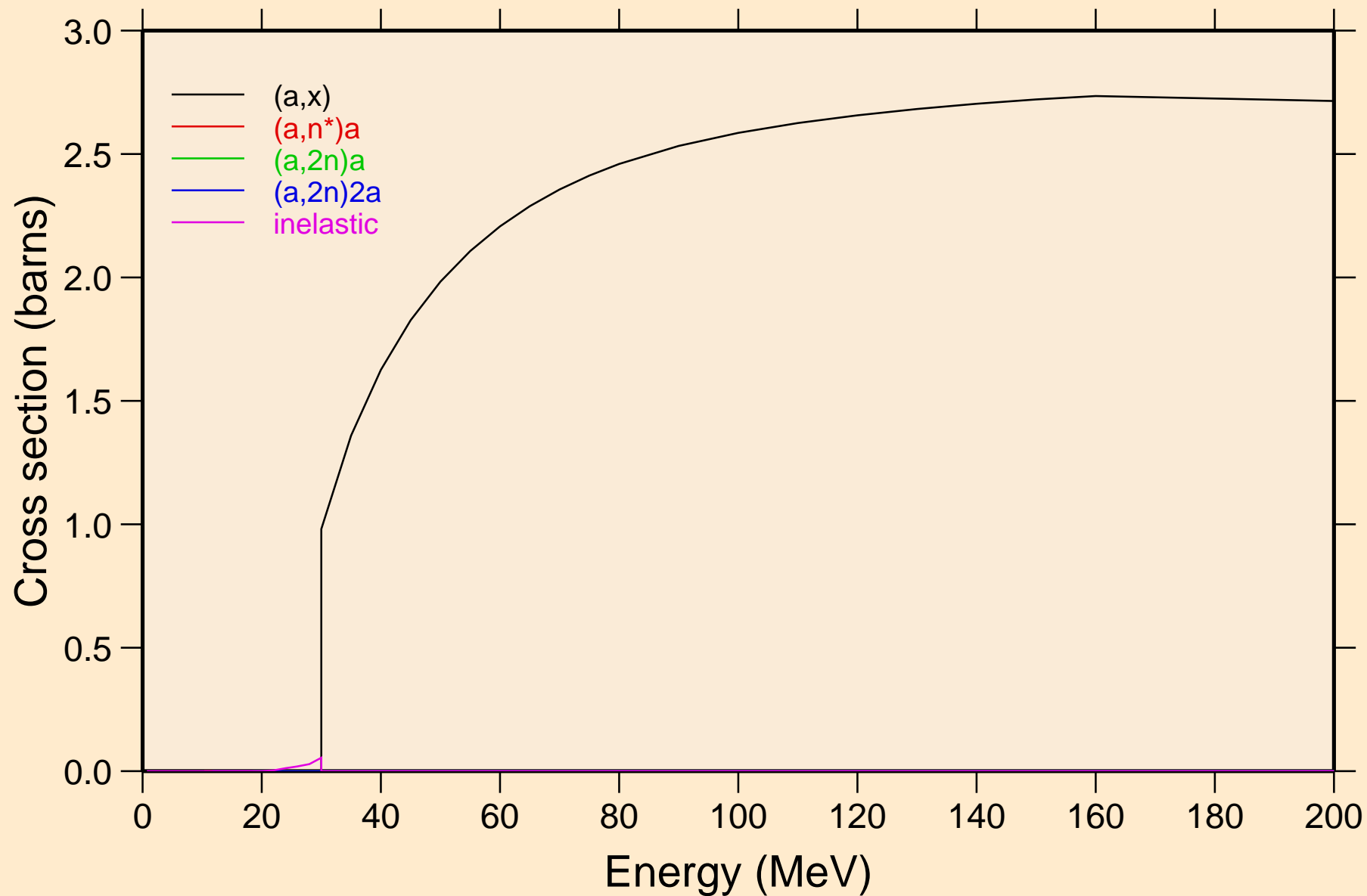

PO198 ALPHA ACER TENDL-2021 LIBRARY; T=0.K  
Threshold reactions

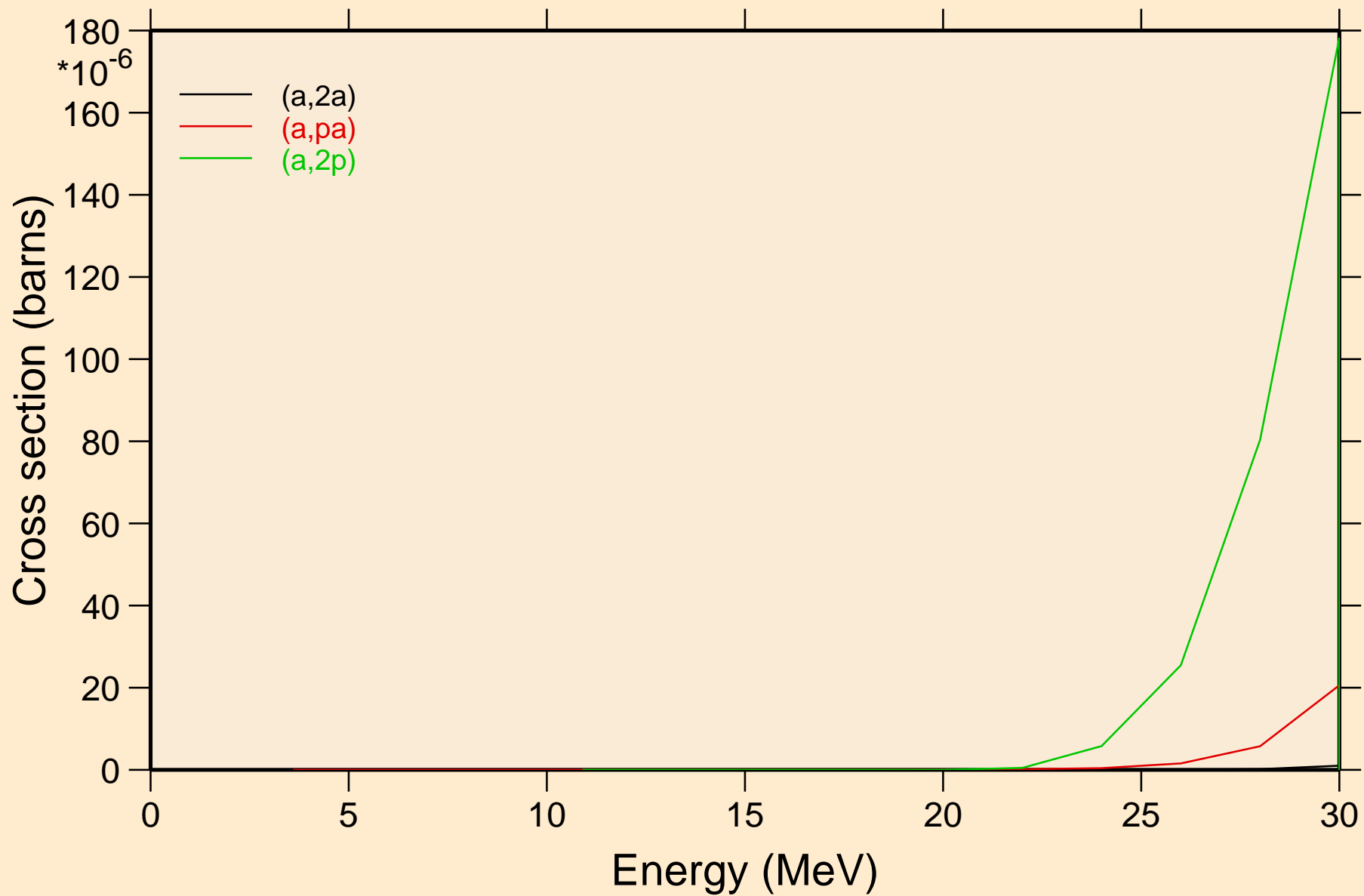

PO198 ALPHA ACER TENDL-2021 LIBRARY; T=0.K  
Threshold reactions

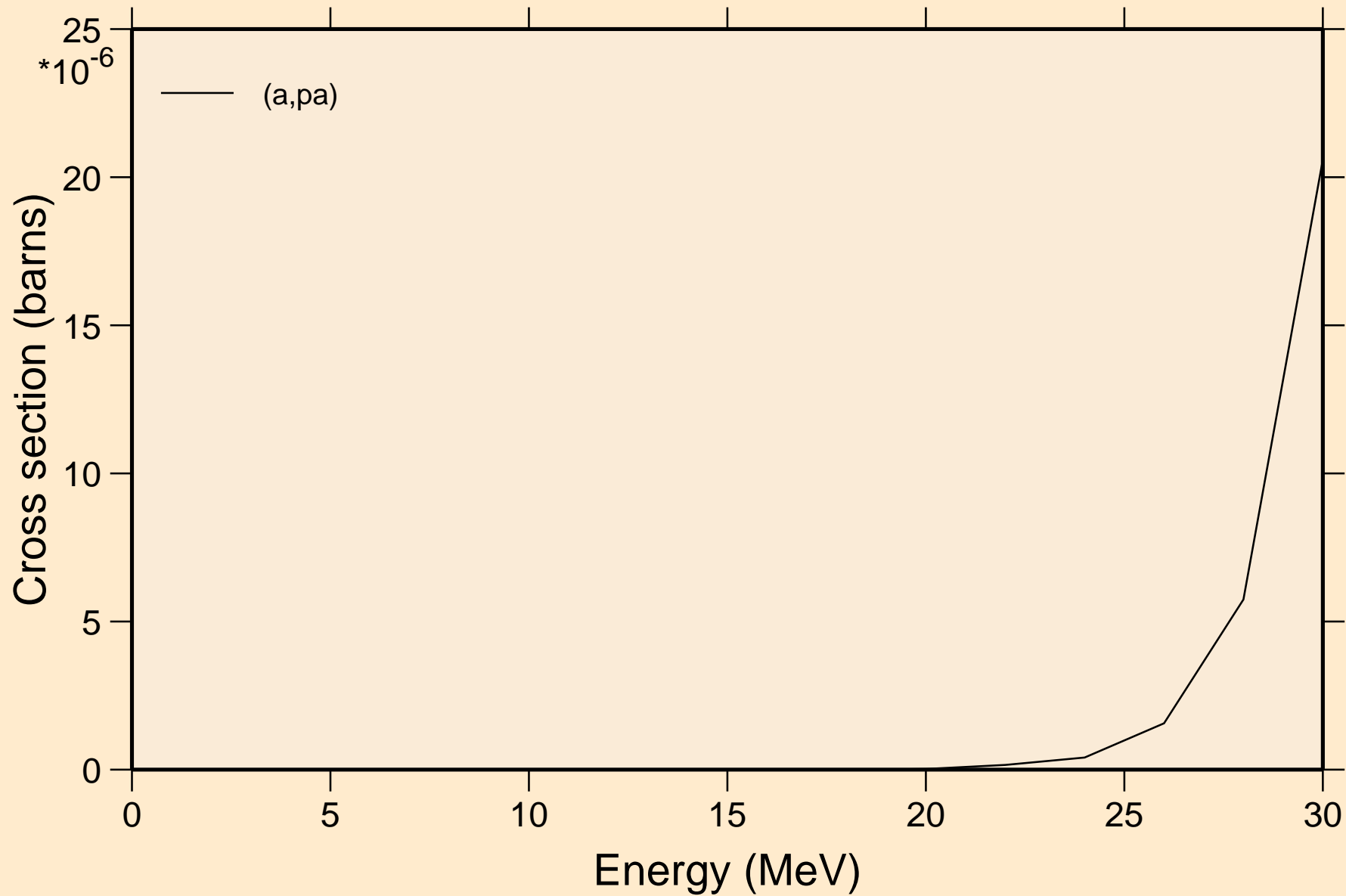

PO198 ALPHA ACER TENDL-2021 LIBRARY; T=0.K  
angular distribution for elastic

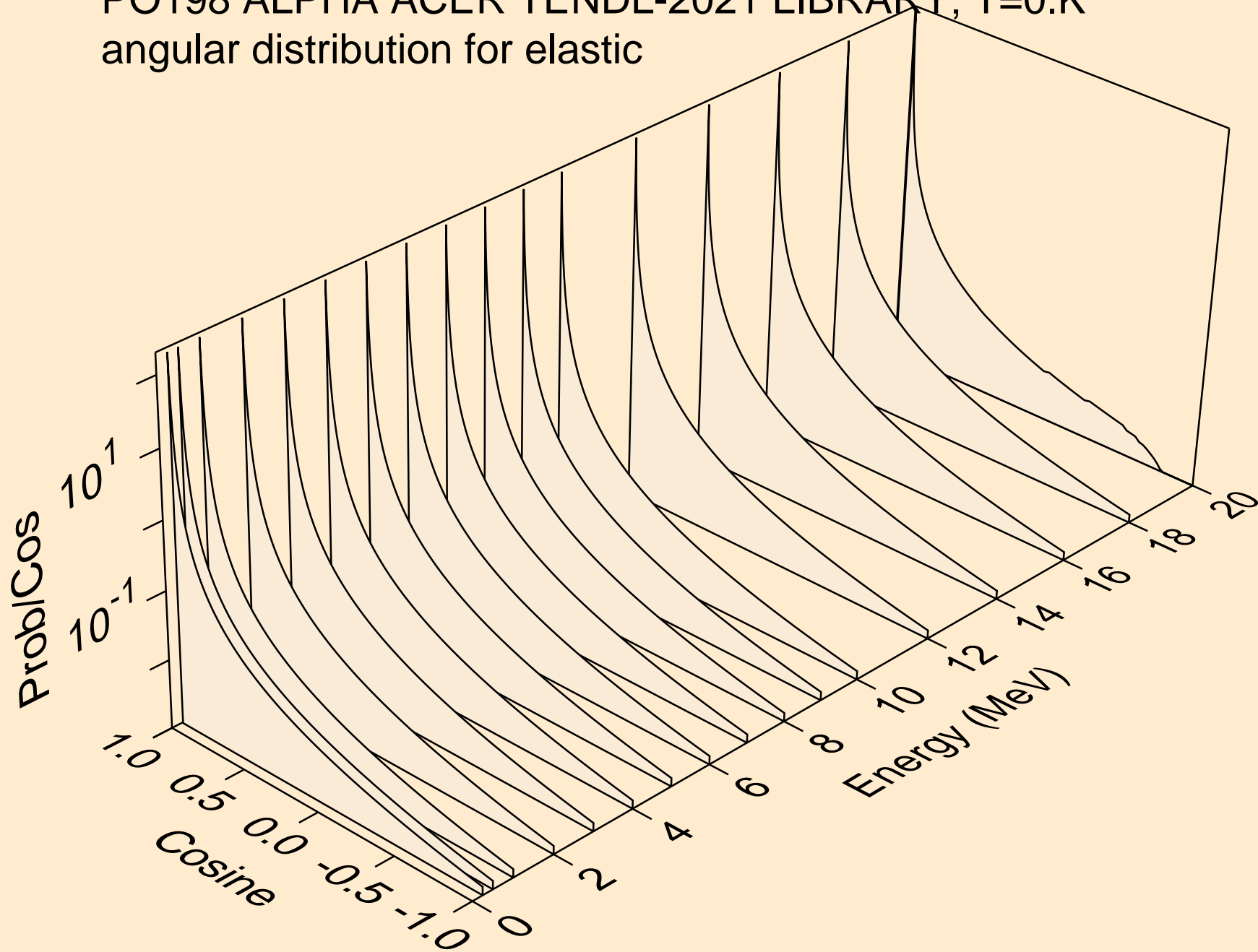



PO198 ALPHA ACER TENDL-2021 LIBRARY; T=0.K  
angular distribution for elastic

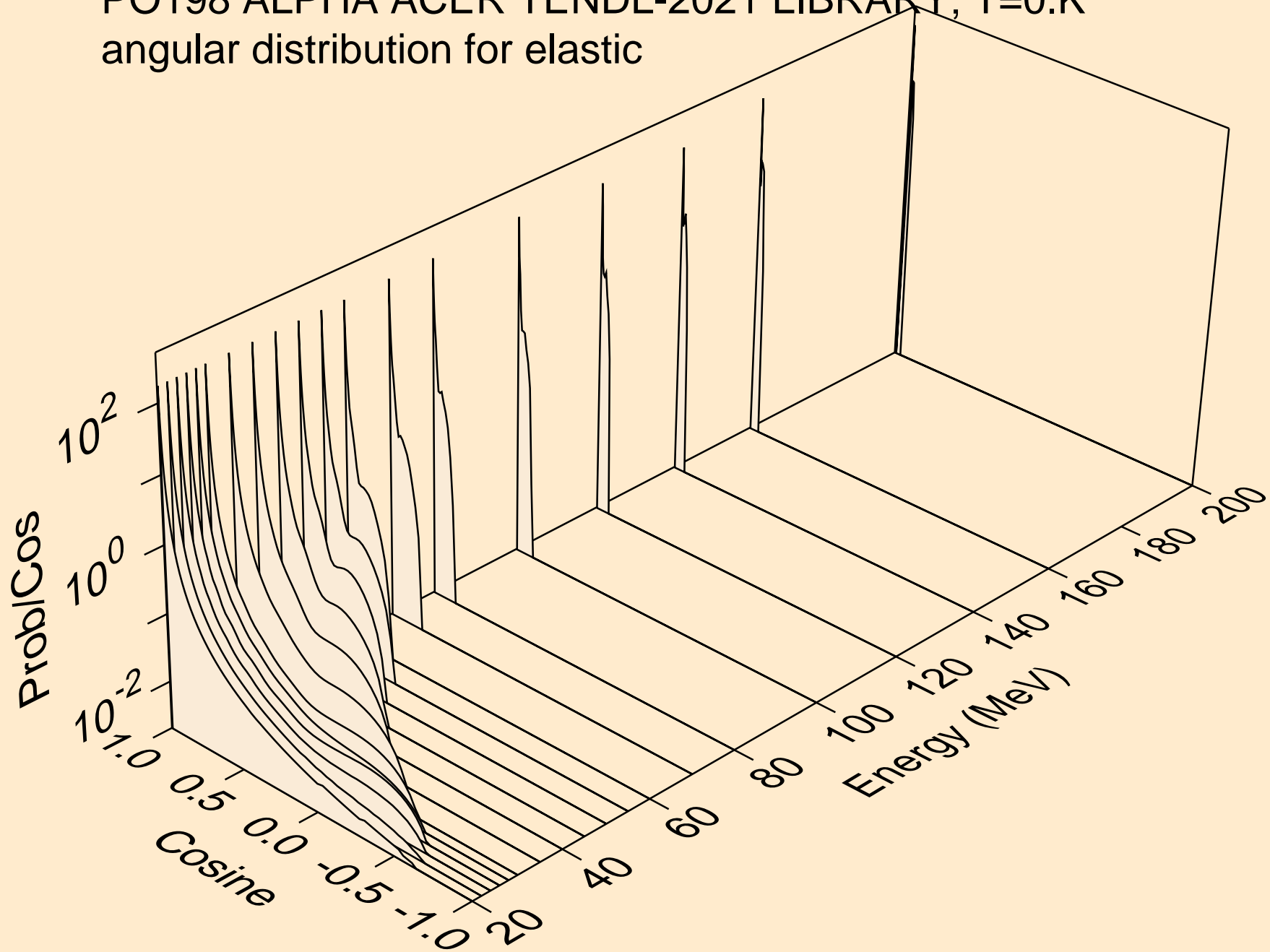

PO198 ALPHA ACER TENDL-2021 LIBRARY; T=0.K  
Alpha emission for (a,x)

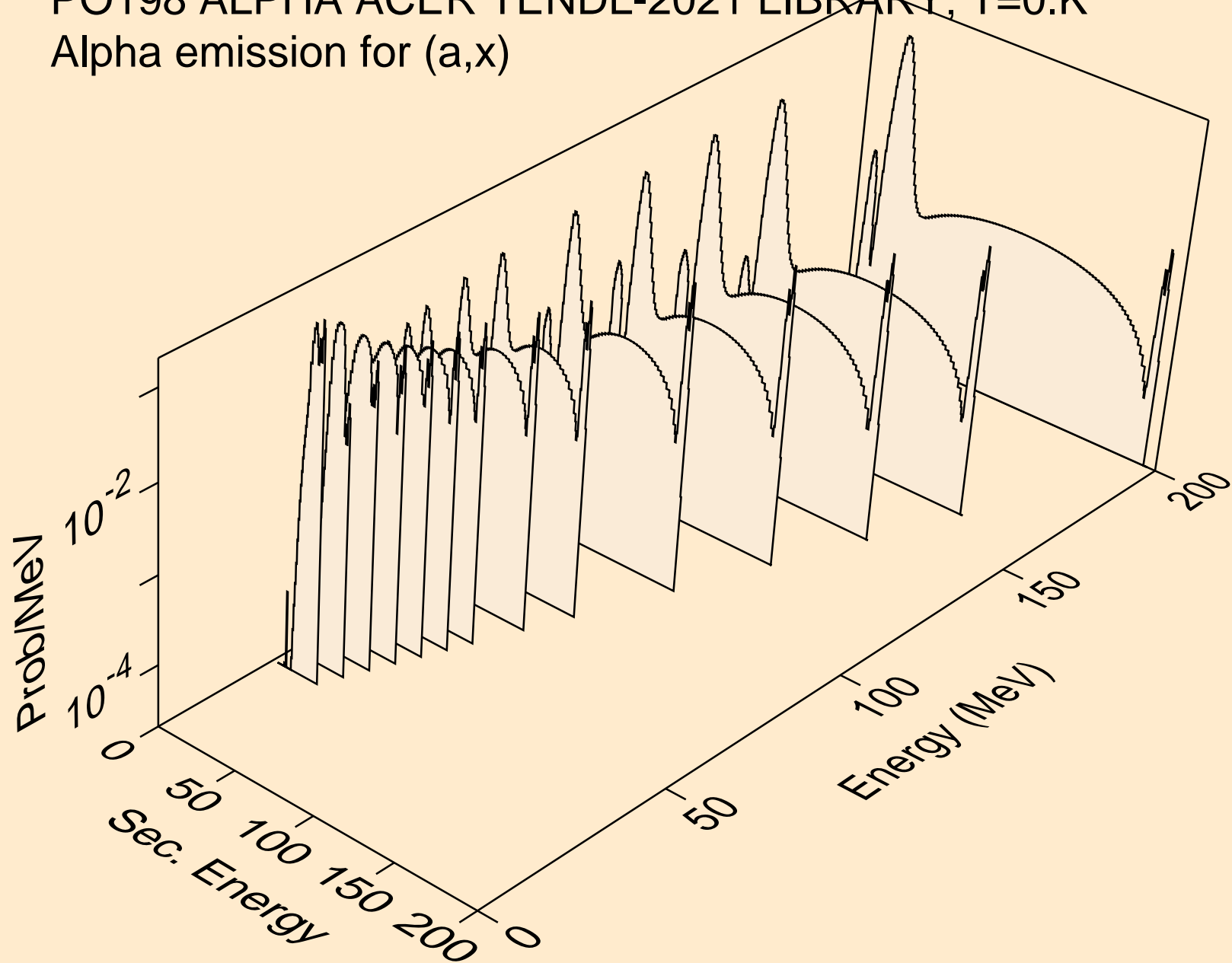

PO198 ALPHA ACER TENDL-2021 LIBRARY; T=0.K  
Alpha emission for (a,n\*)a

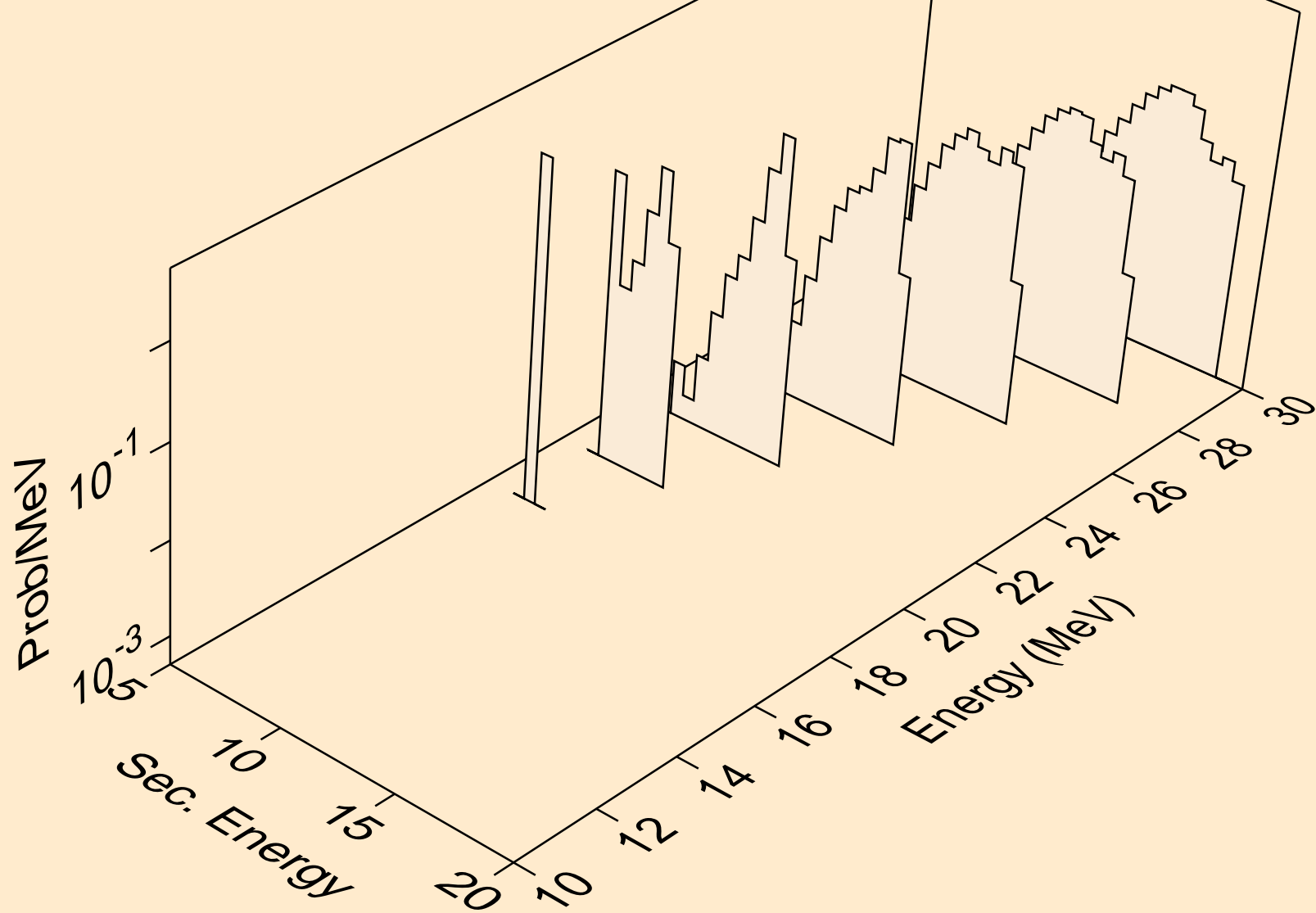

PO198 ALPHA ACER TENDL-2021 LIBRARY; T=0.K  
Alpha emission for (a,2n)a

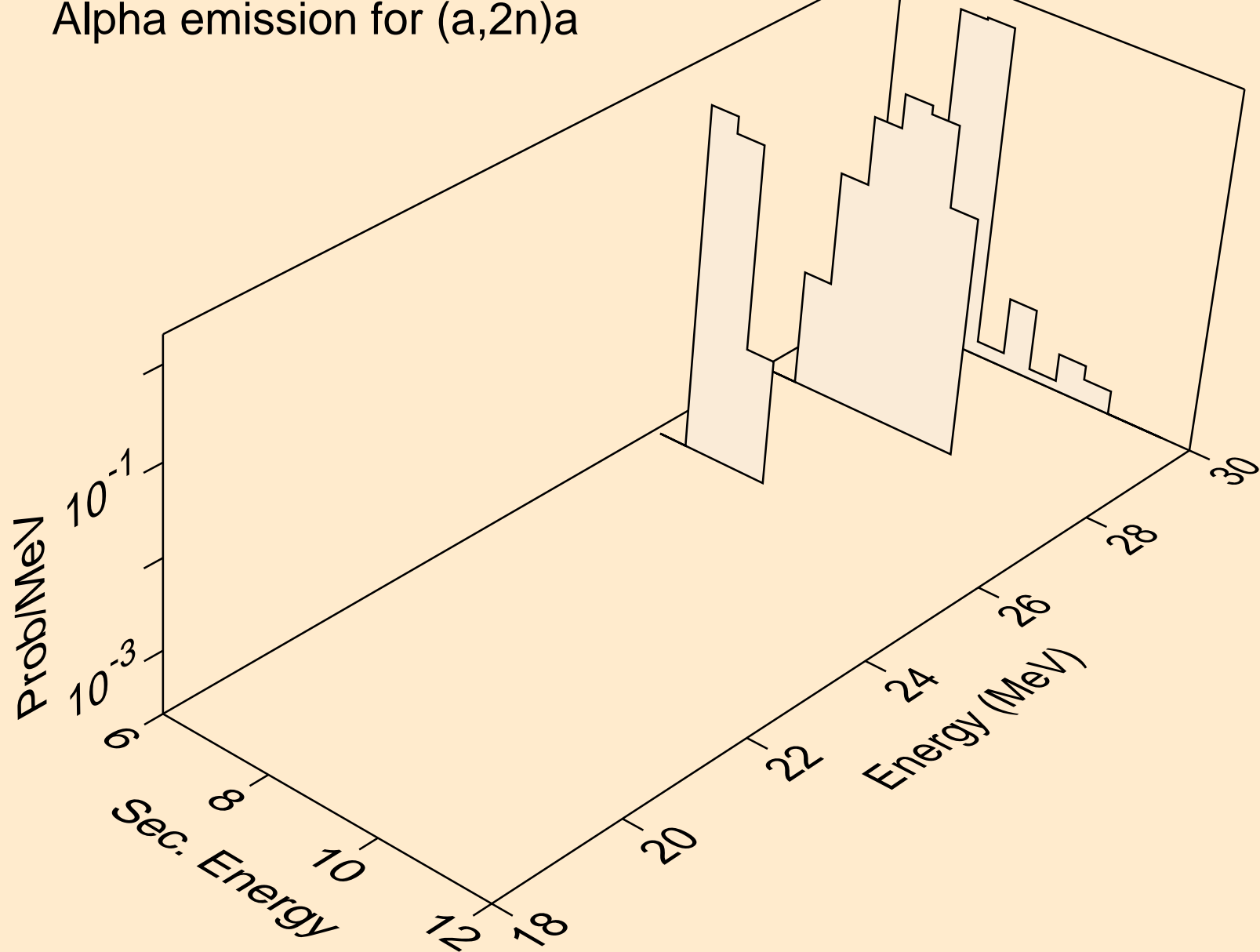

PO198 ALPHA ACER TENDL-2021 LIBRARY; T=0.K  
Alpha emission for (a,2n)2a

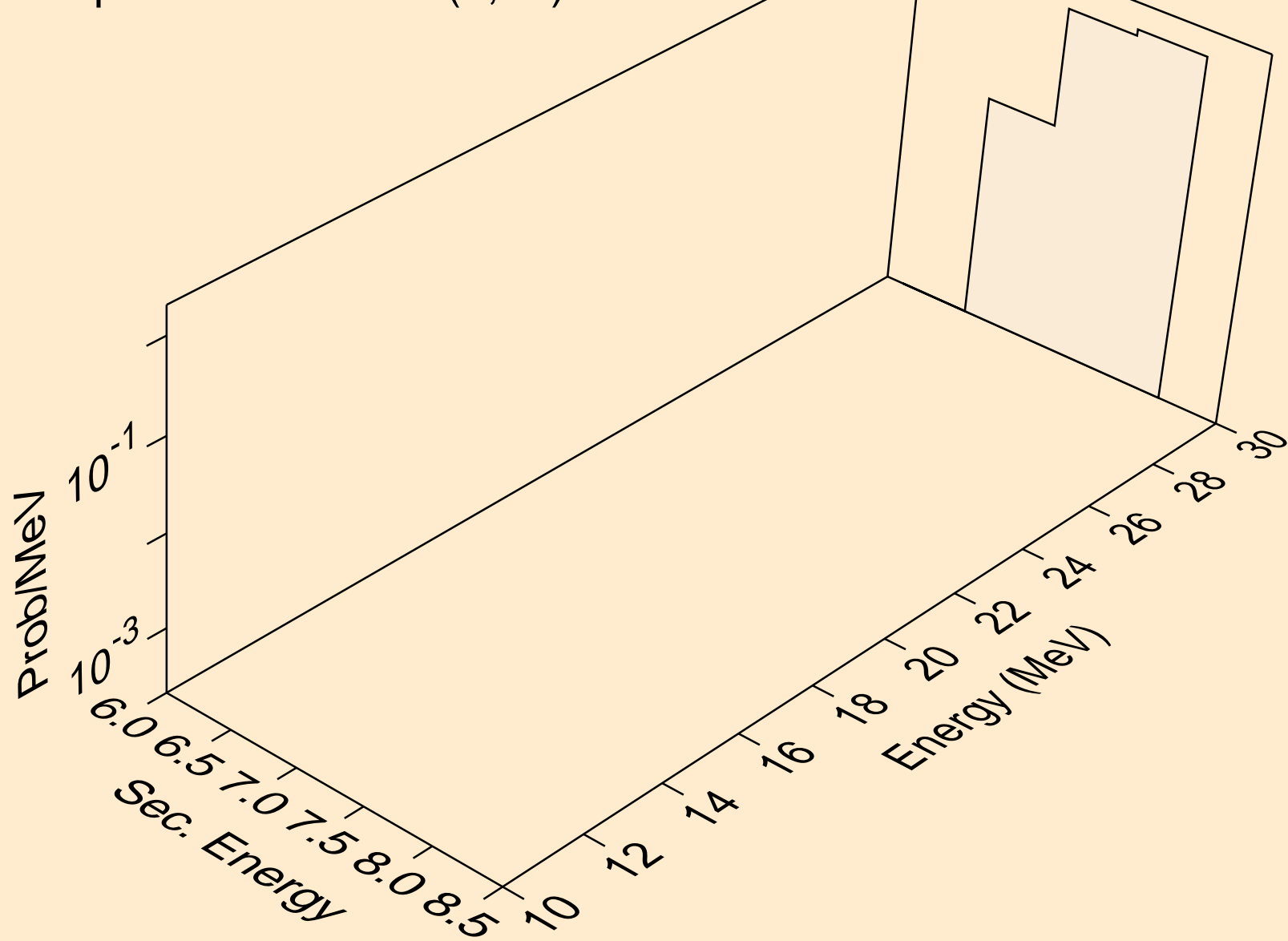

PO198 ALPHA ACER TENDL-2021 LIBRARY; T=0.K  
Alpha emission for inelastic

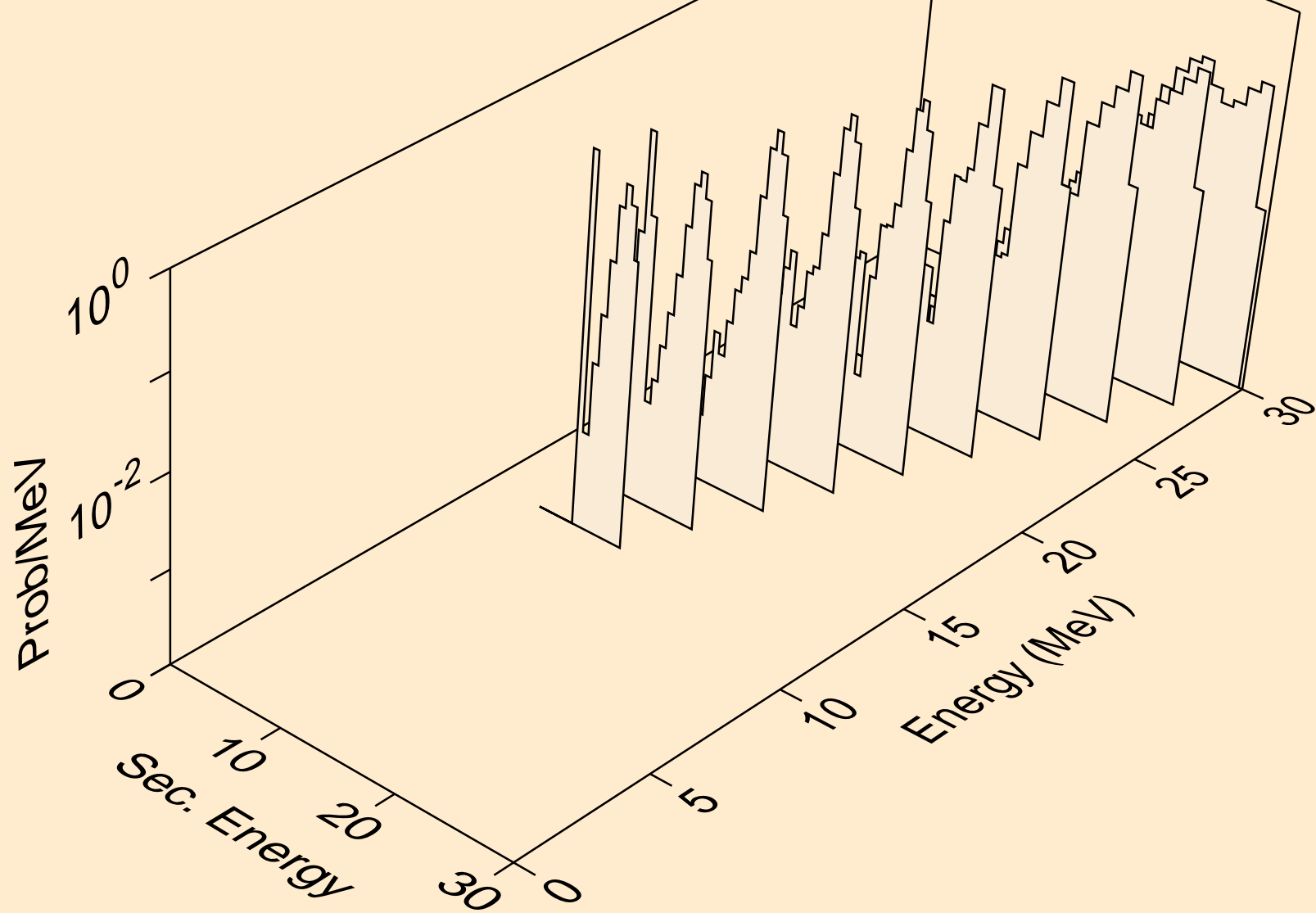

PO198 ALPHA ACER TENDL-2021 LIBRARY; T=0.K  
Alpha emission for (a,2a)

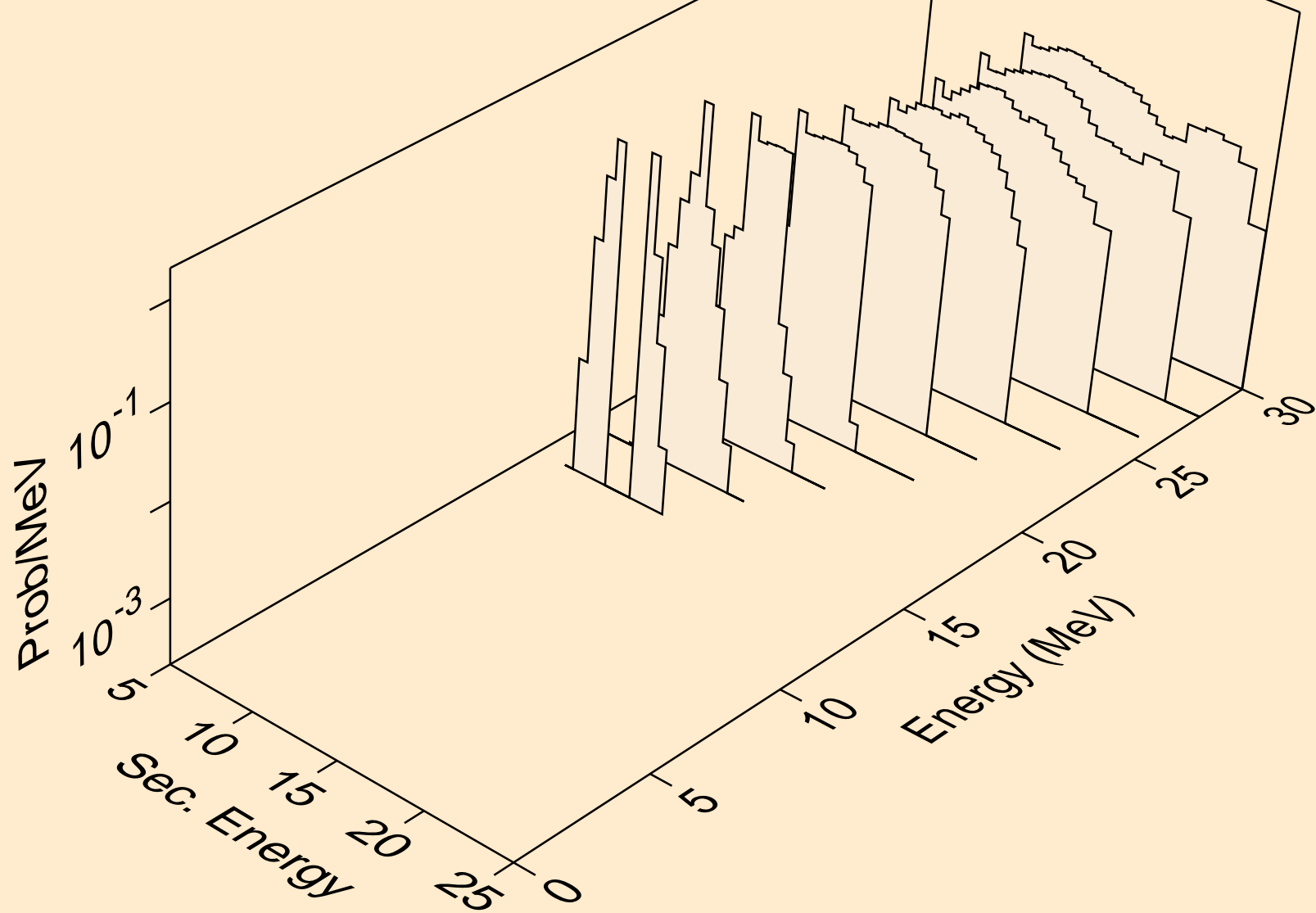

PO198 ALPHA ACER TENDL-2021 LIBRARY; T=0.K  
Alpha emission for (a,pa)

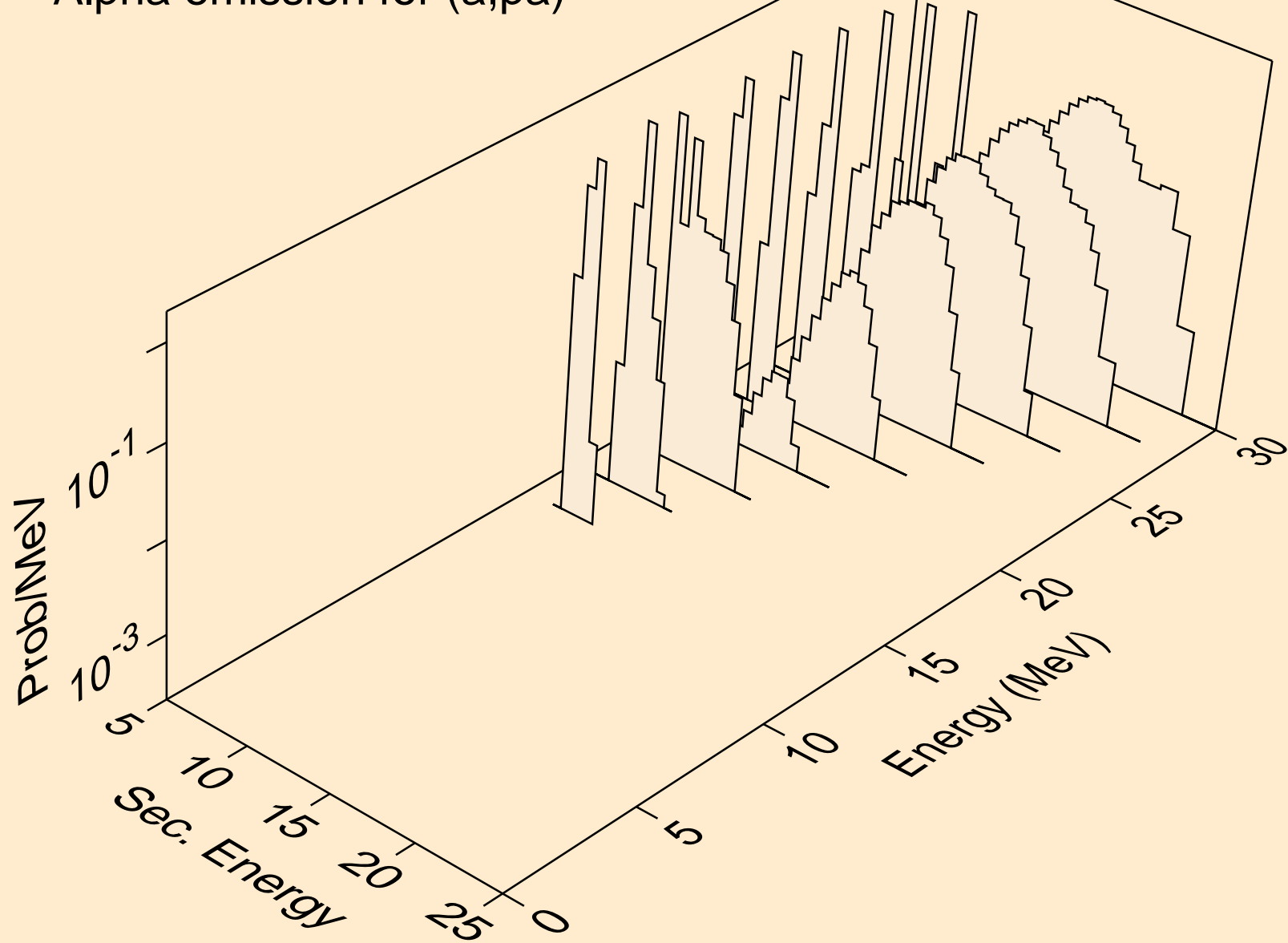



PO198 ALPHA ACER TENDL-2021 LIBRARY; T=0.K  
Photon emission for (z,n)

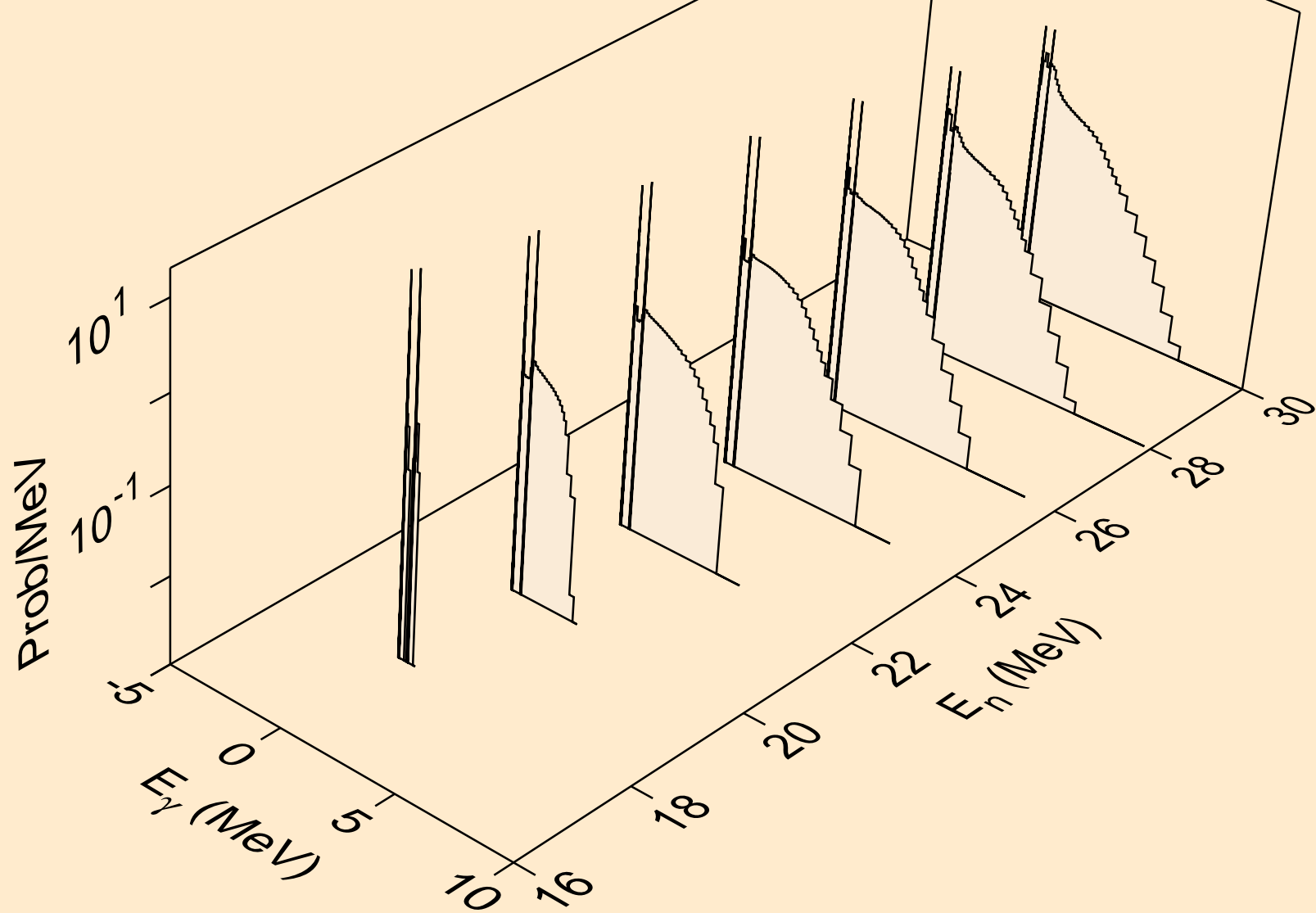

PO198 ALPHA ACER TENDL-2021 LIBRARY; T=0.K  
Photon emission for (n,x)

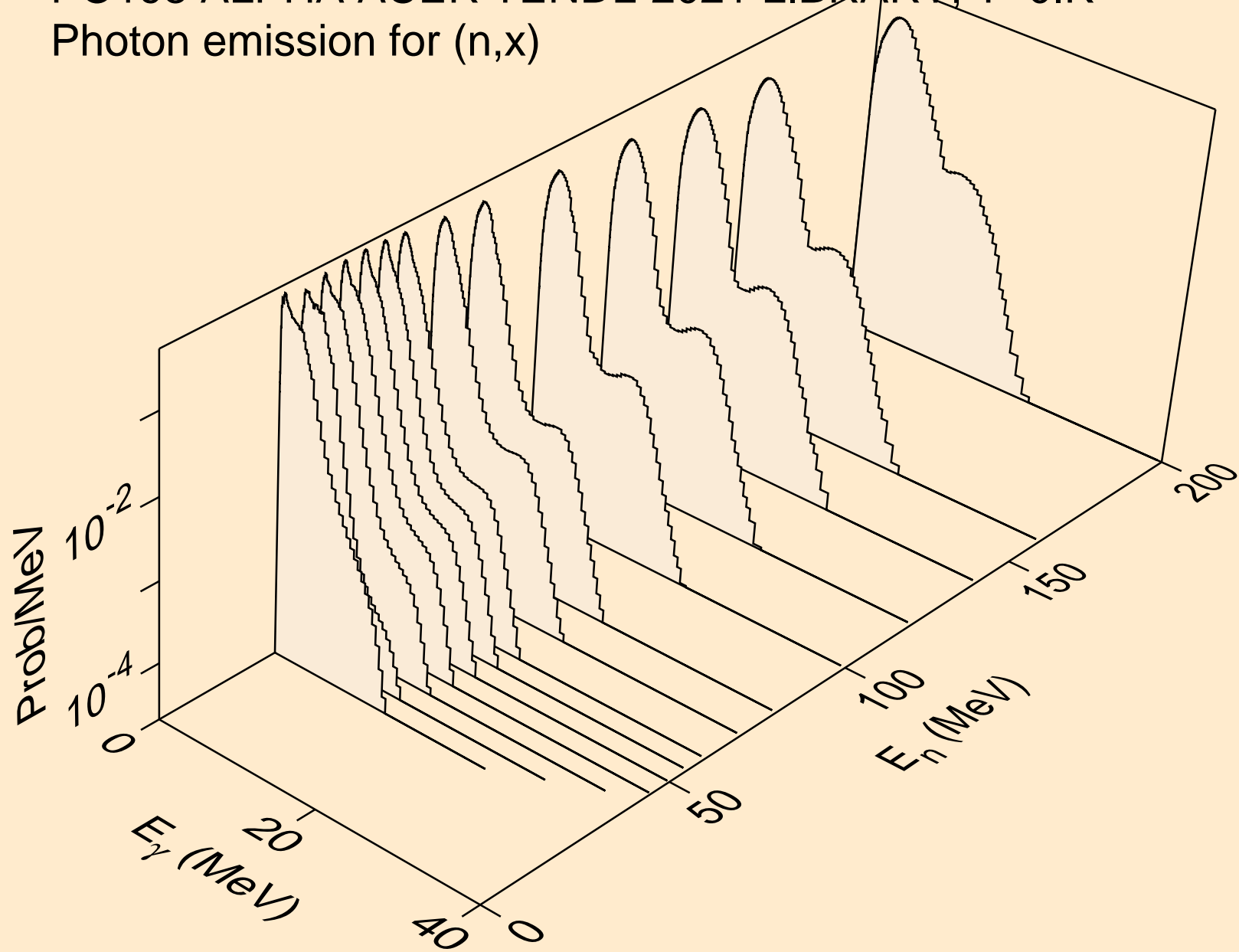

PO198 ALPHA ACER TENDL-2021 LIBRARY; T=0.K  
Photon emission for (n,2n)

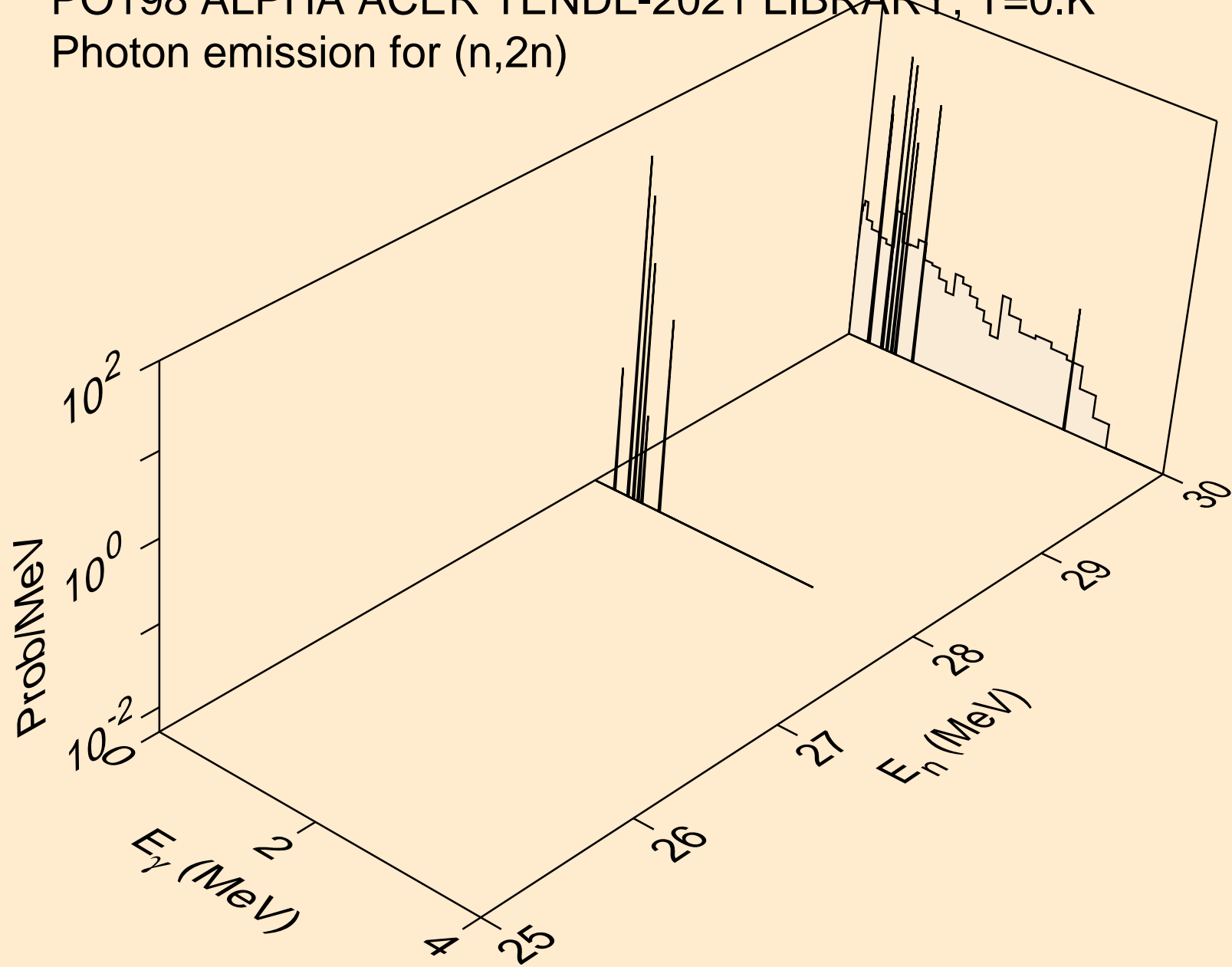

PO198 ALPHA ACER TENDL-2021 LIBRARY; T=0.K  
Photon emission for (n,n\*)a

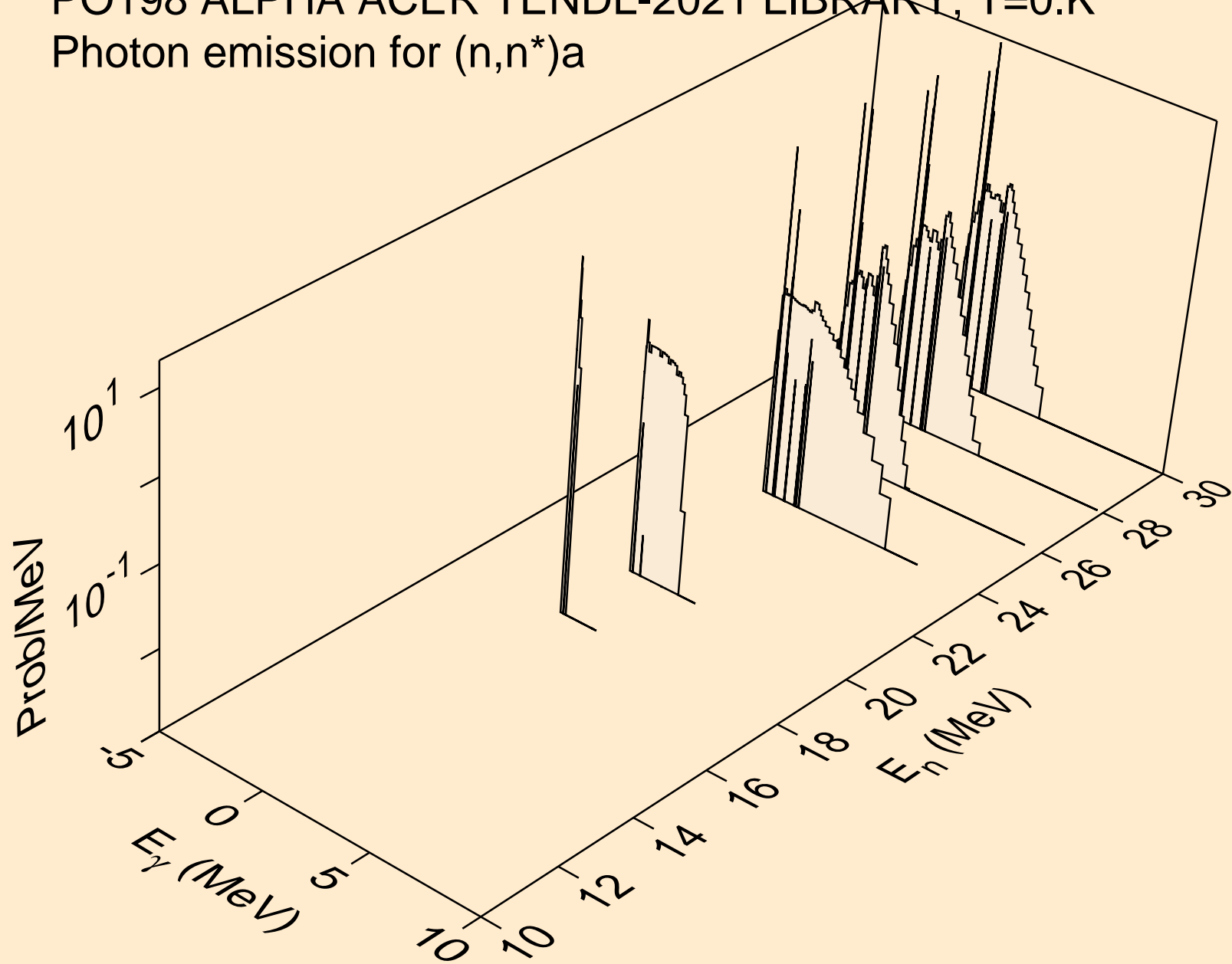

PO198 ALPHA ACER TENDL-2021 LIBRARY; T=0.K  
Photon emission for (n,2n)a

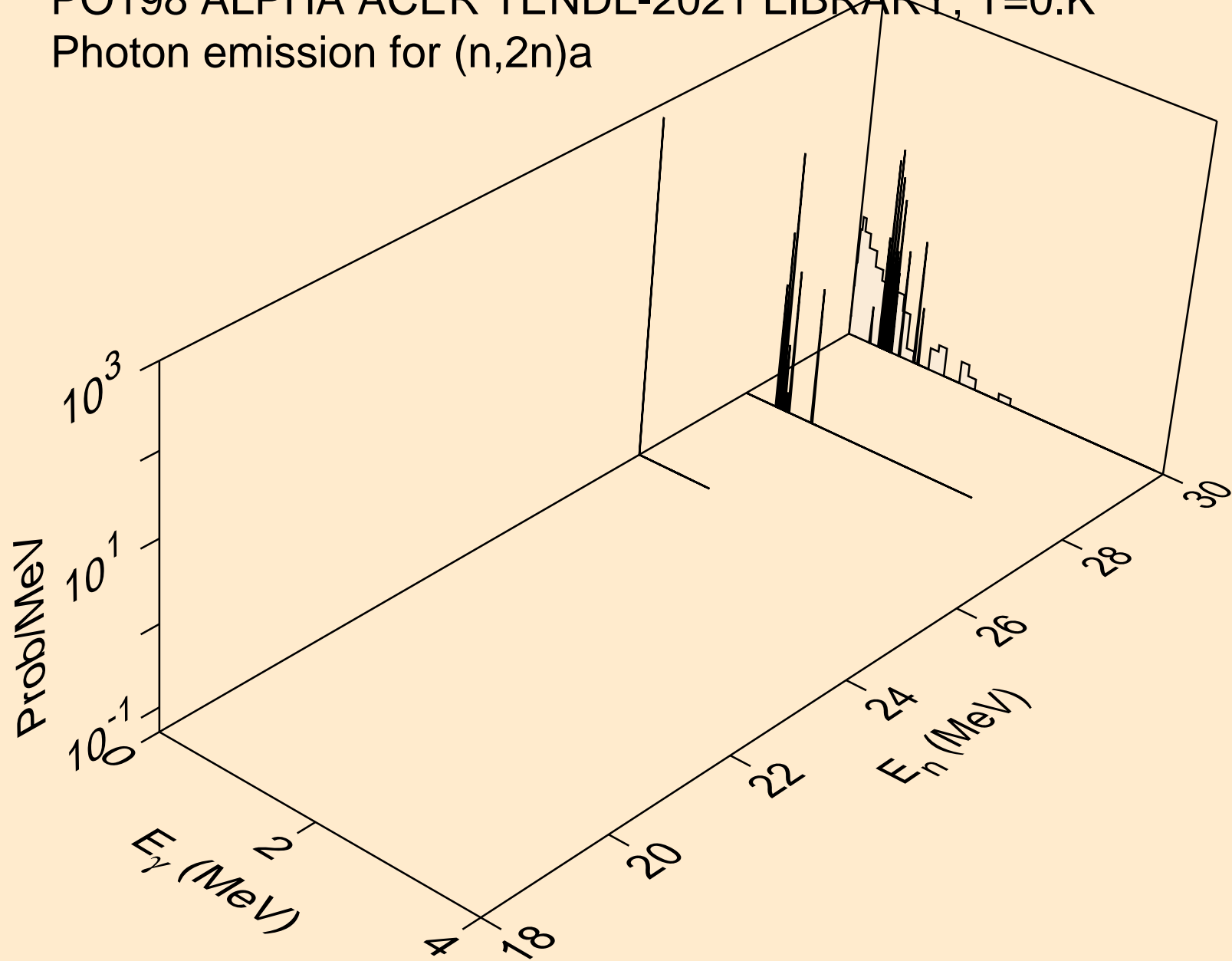

PO198 ALPHA ACER TENDL-2021 LIBRARY; T=0.K  
Photon emission for (n,n\*)p

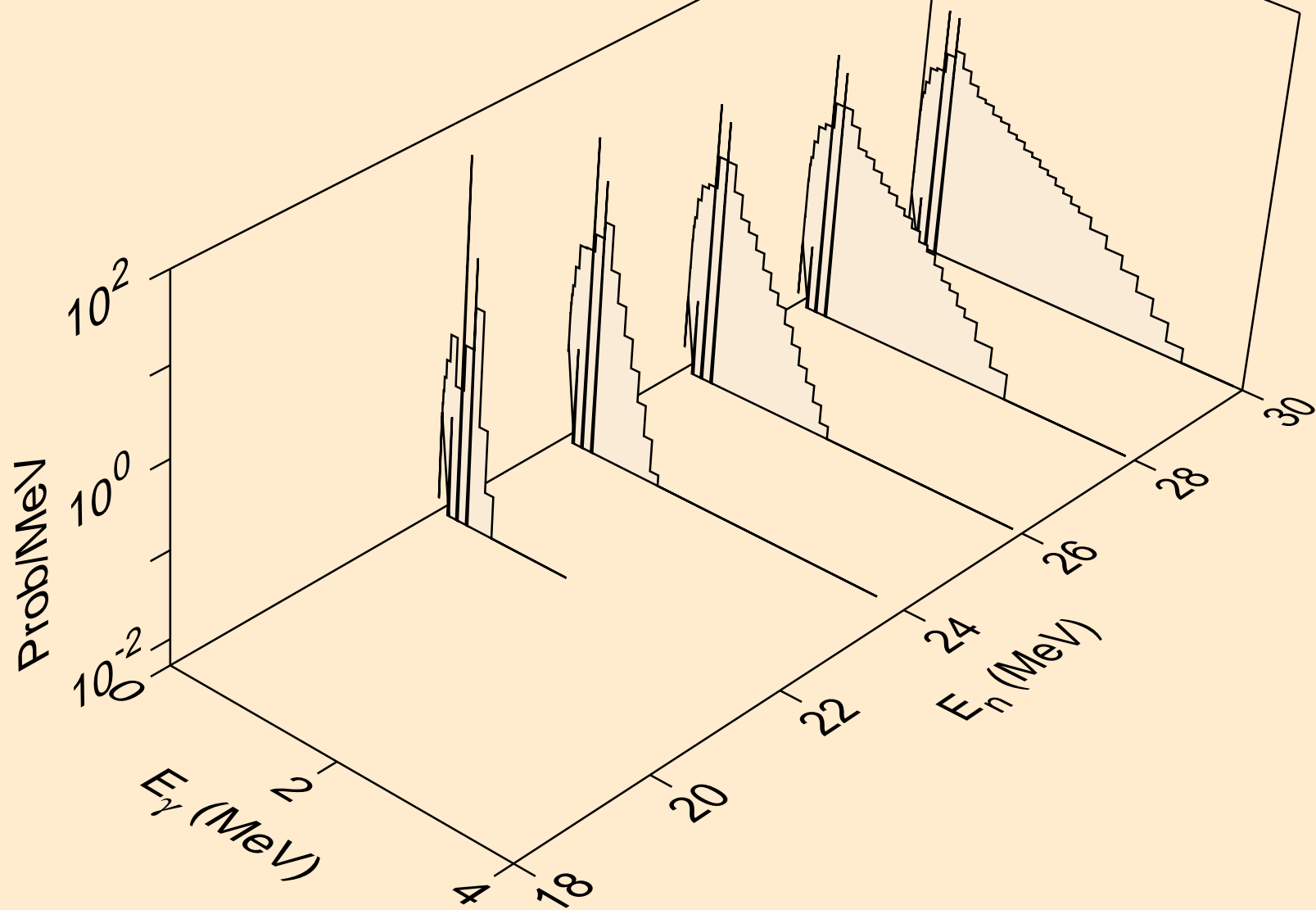

PO198 ALPHA ACER TENDL-2021 LIBRARY; T=0.K  
Photon emission for (n,2n)2a

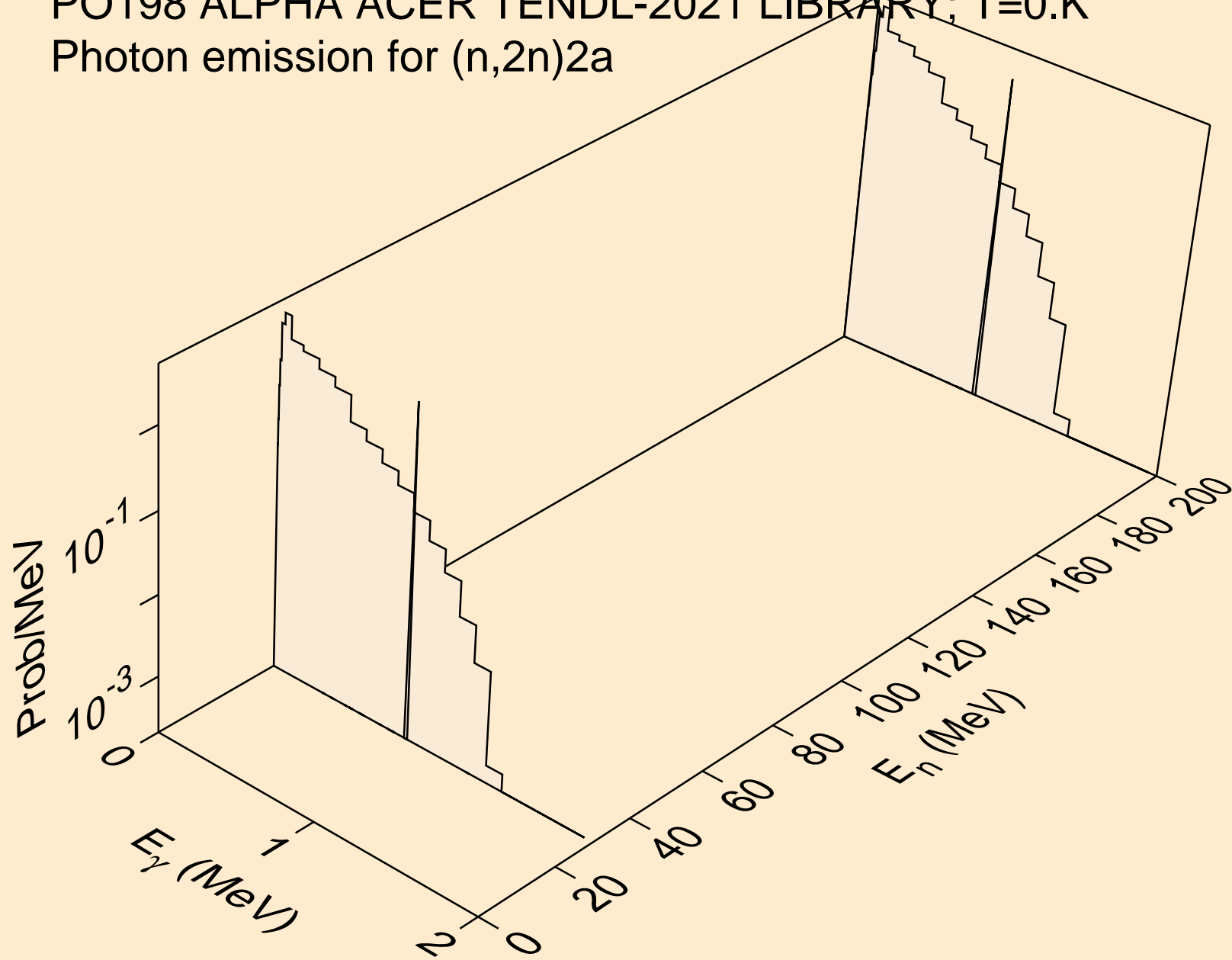

PO198 ALPHA ACER TENDL-2021 LIBRARY; T=0.K  
Photon emission for (n,gma)

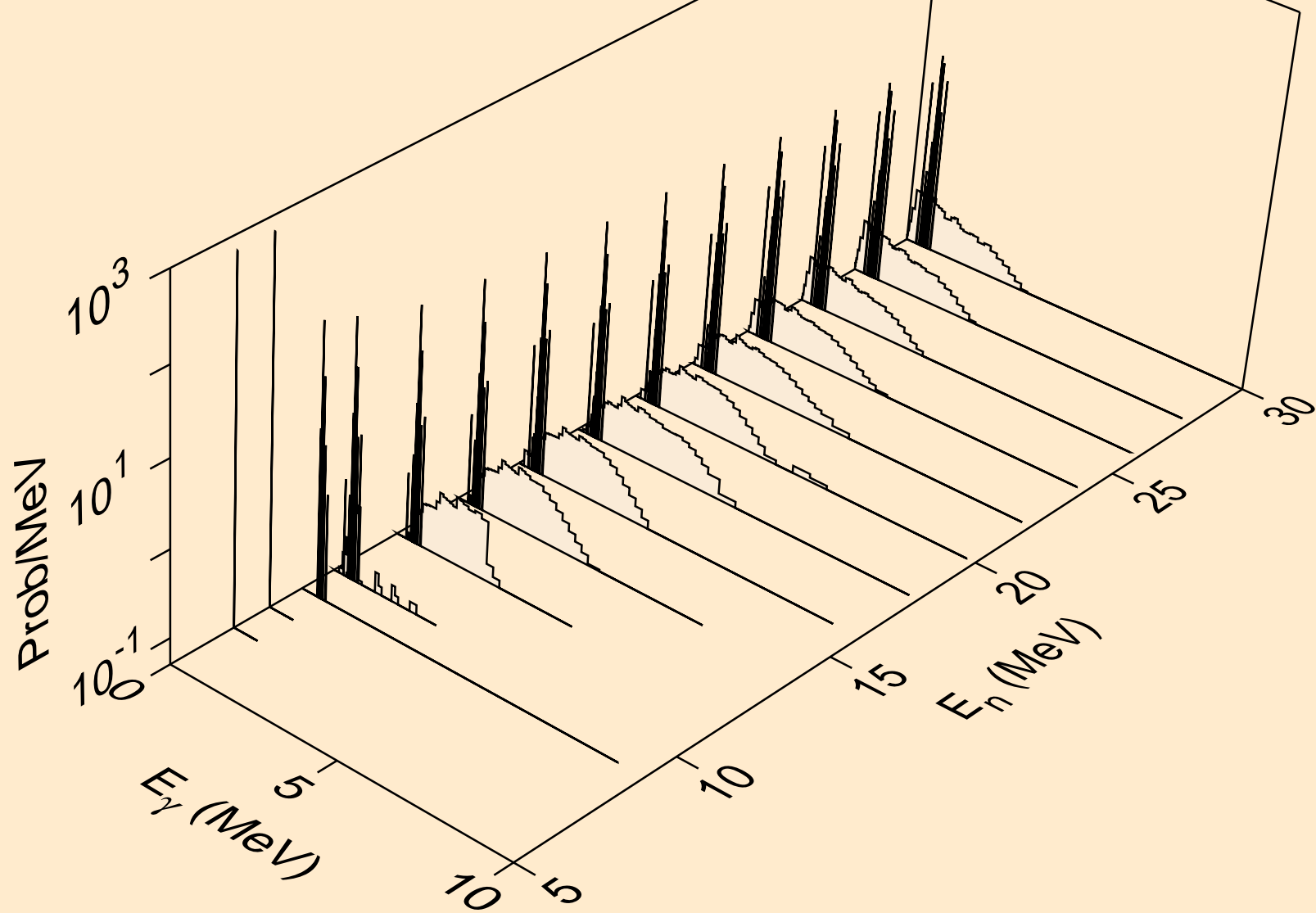



PO198 ALPHA ACER TENDL-2021 LIBRARY; T=0.K  
Photon emission for (n,p)

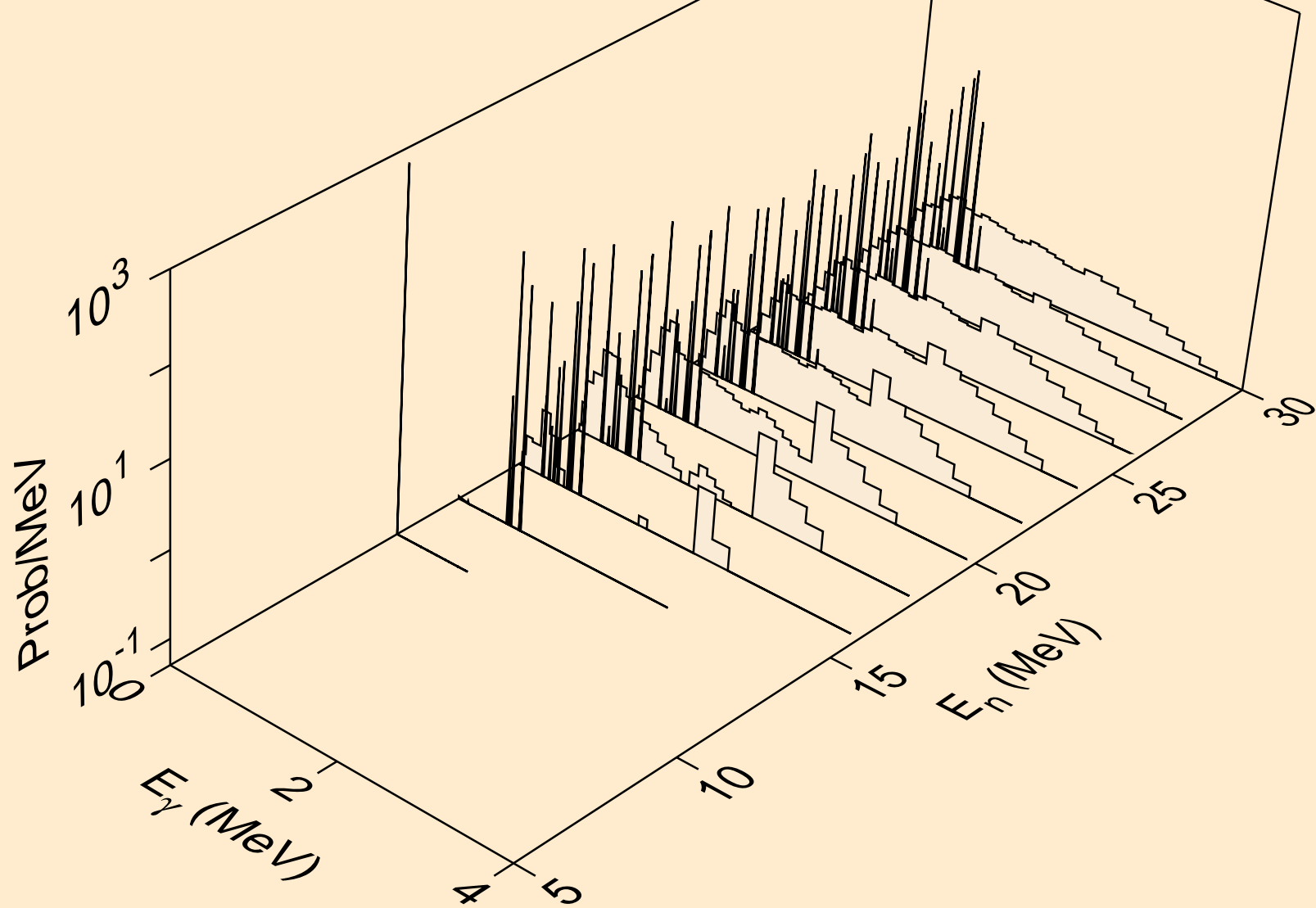

PO198 ALPHA ACER TENDL-2021 LIBRARY; T=0.K  
Photon emission for (n,d)

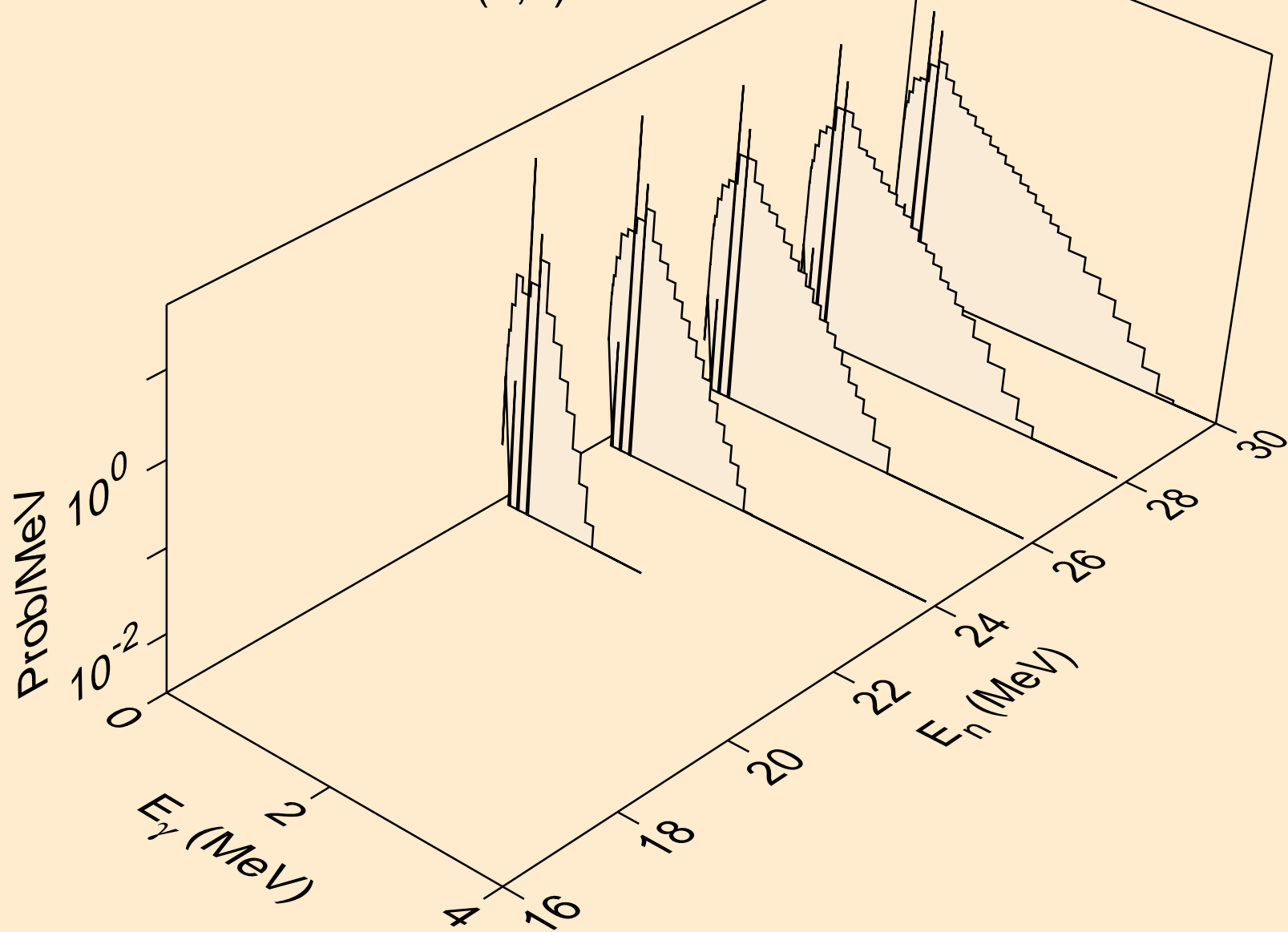

PO198 ALPHA ACER TENDL-2021 LIBRARY; T=0.K  
Photon emission for (n,t)

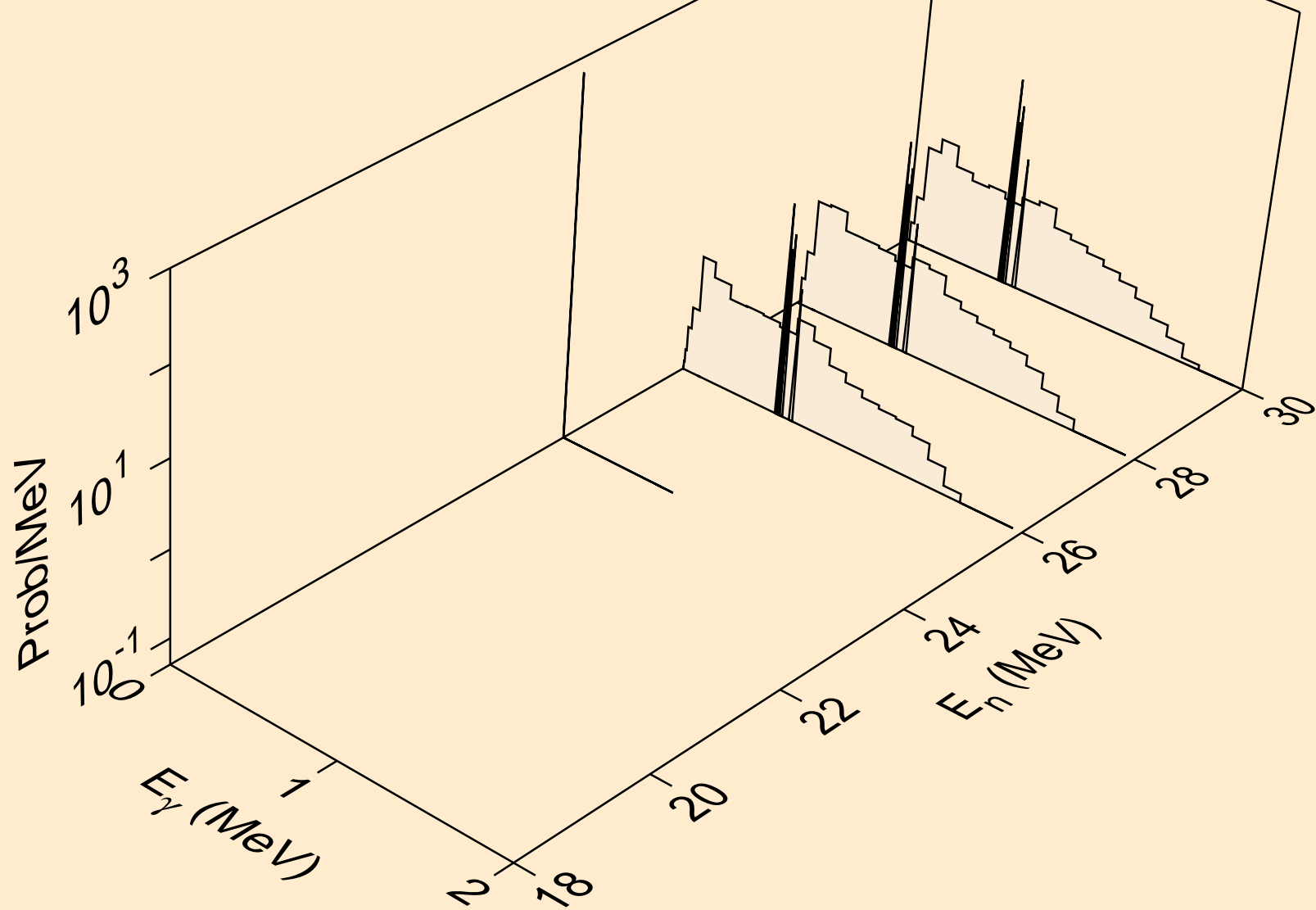

PO198 ALPHA ACER TENDL-2021 LIBRARY; T=0.K  
Photon emission for (n,he3)

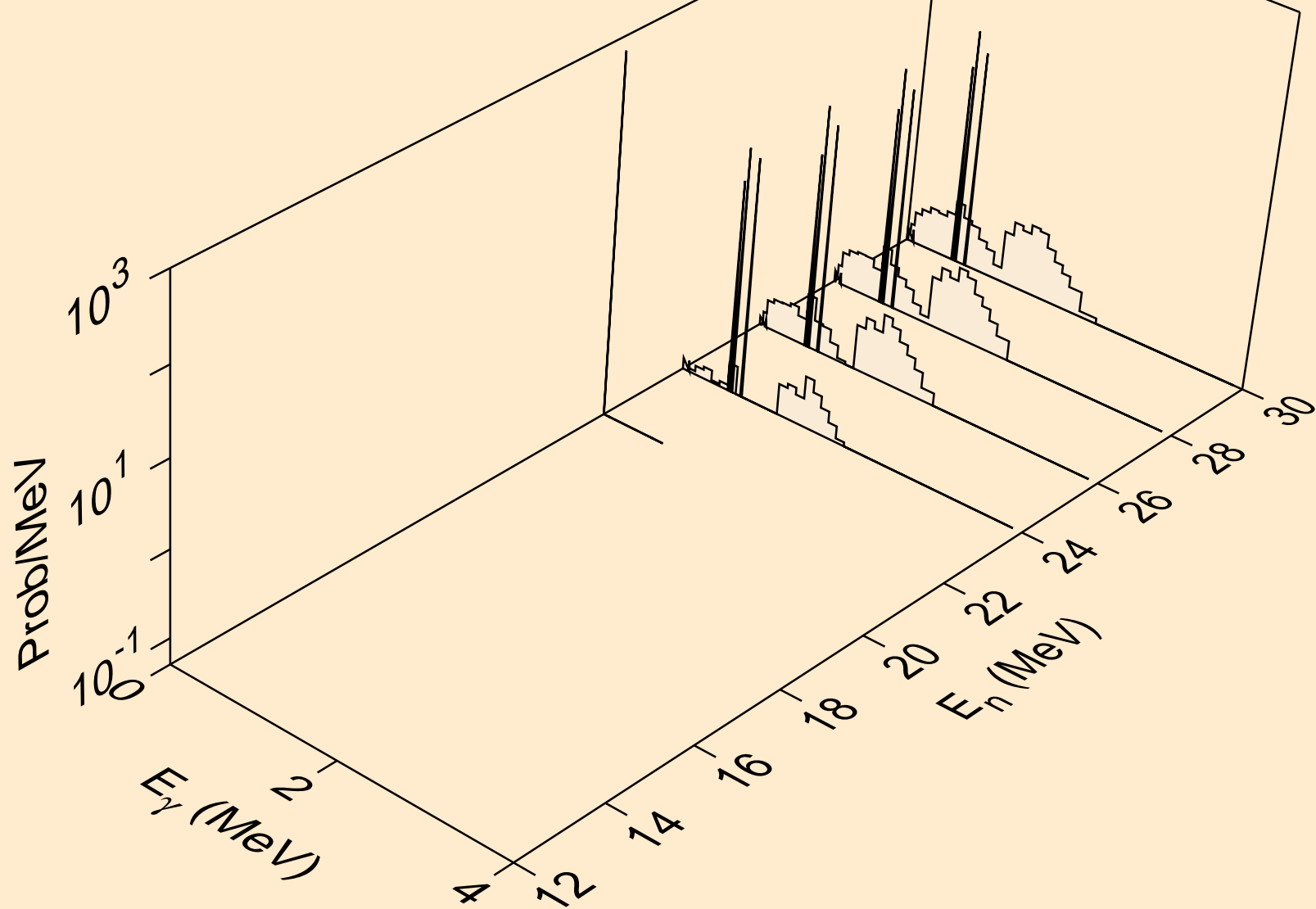

PO198 ALPHA ACER TENDL-2021 LIBRARY; T=0.K  
Photon emission for inelastic

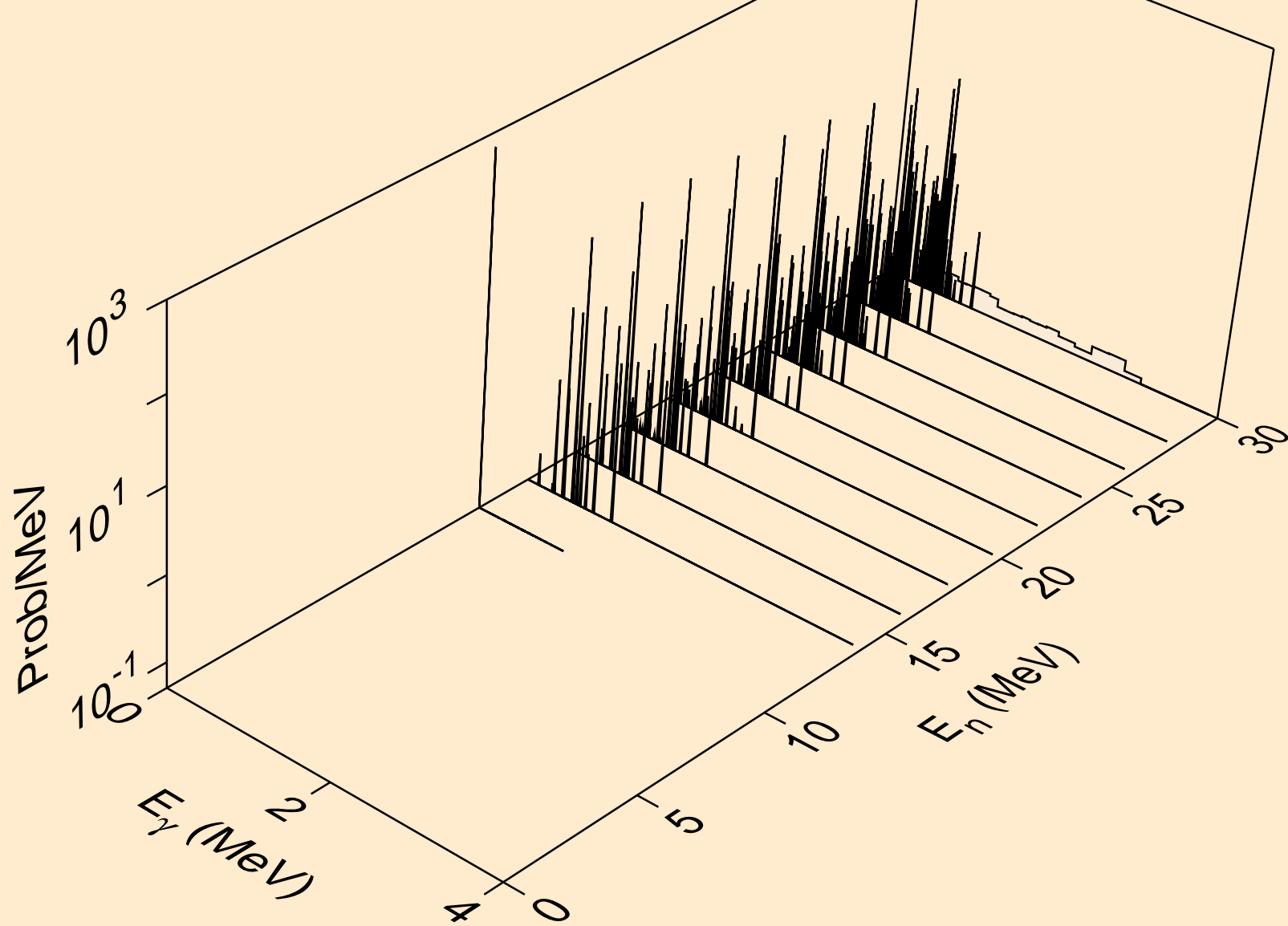

PO198 ALPHA ACER TENDL-2021 LIBRARY; T=0.K  
Photon emission for (n,2a)

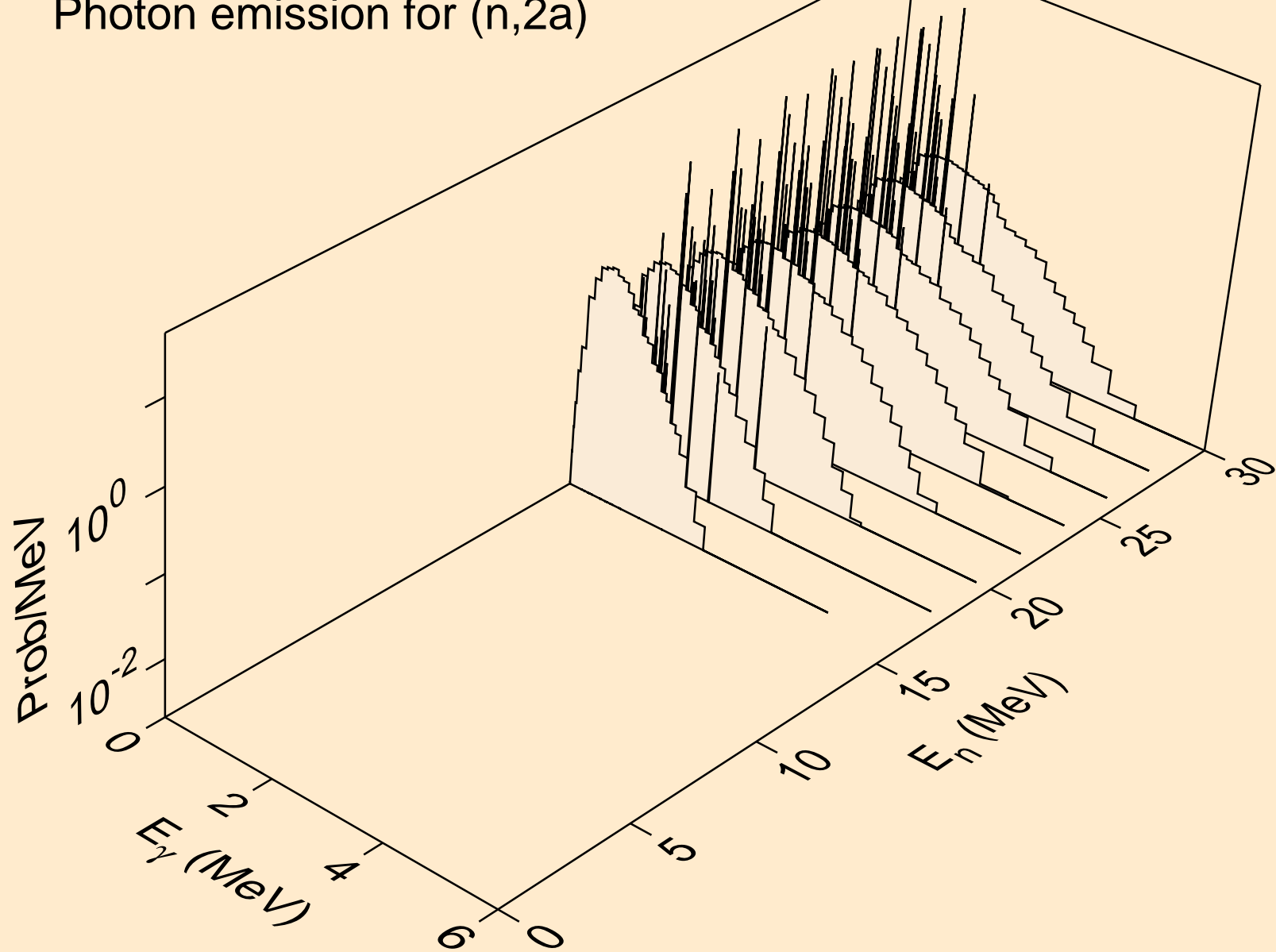

PO198 ALPHA ACER TENDL-2021 LIBRARY; T=0.K  
Photon emission for (n,2p)

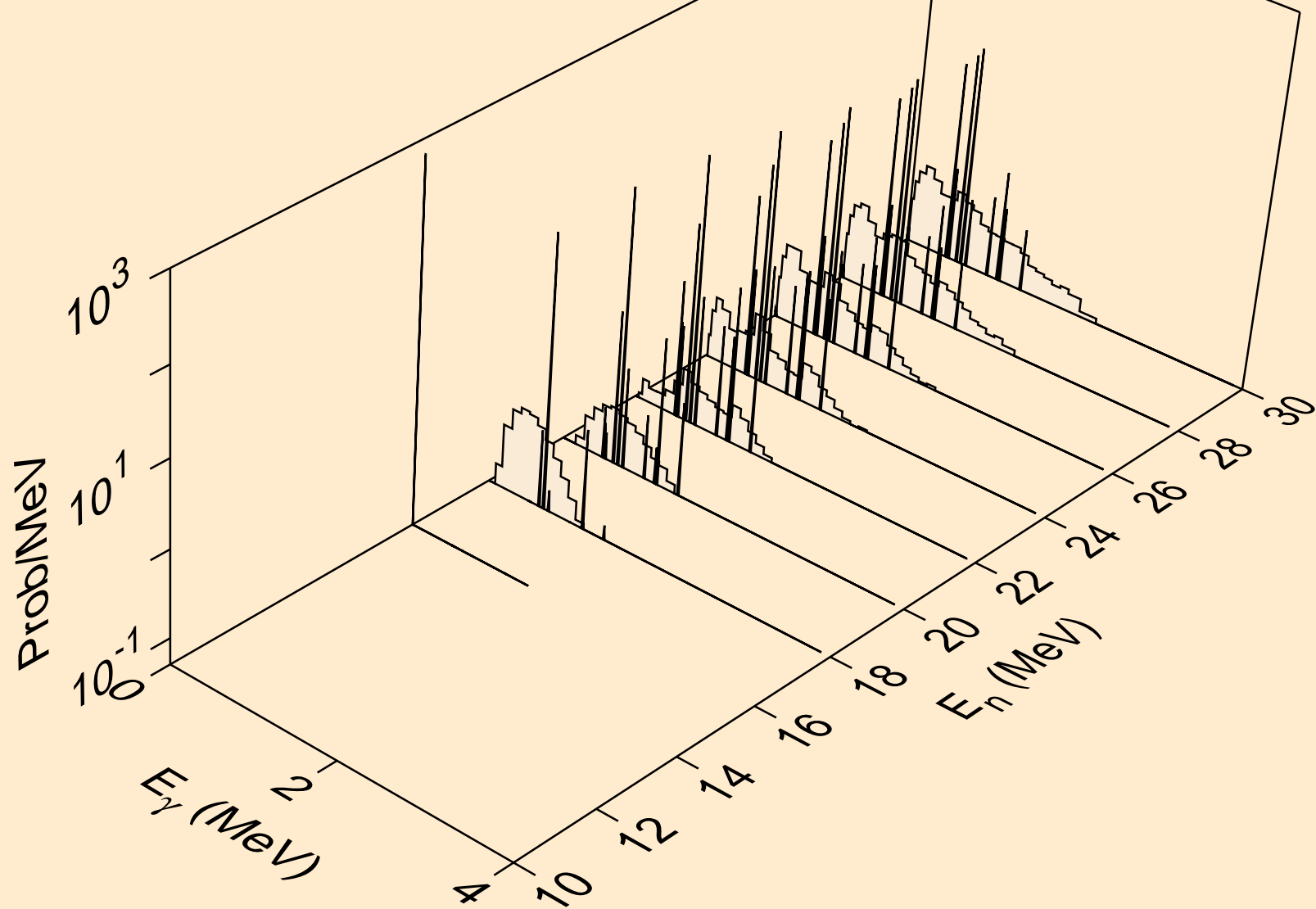

PO198 ALPHA ACER TENDL-2021 LIBRARY; T=0.K  
Photon emission for (n,pa)

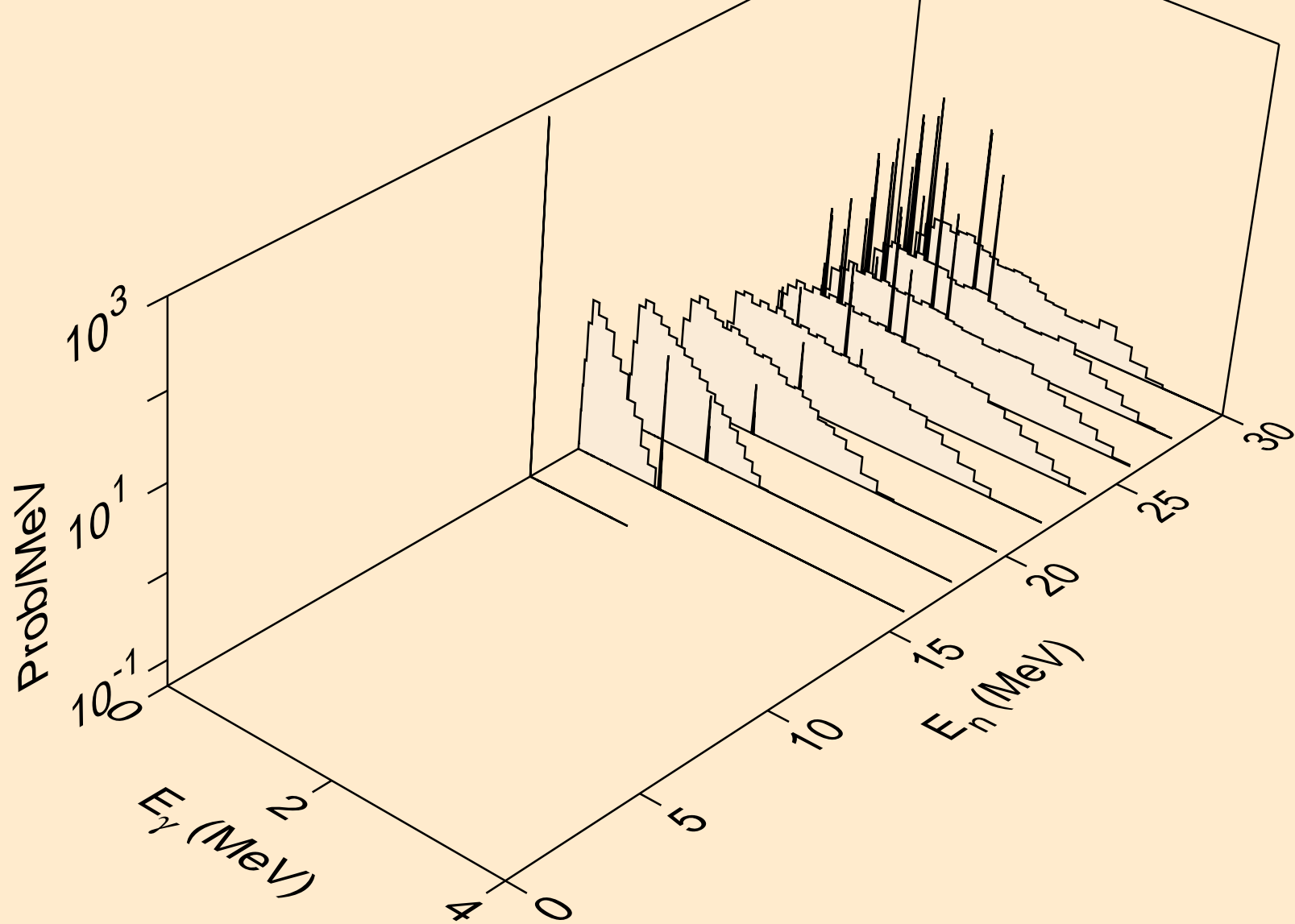



PO198 ALPHA ACER TENDL-2021 LIBRARY; T=0.K  
Particle heating contributions

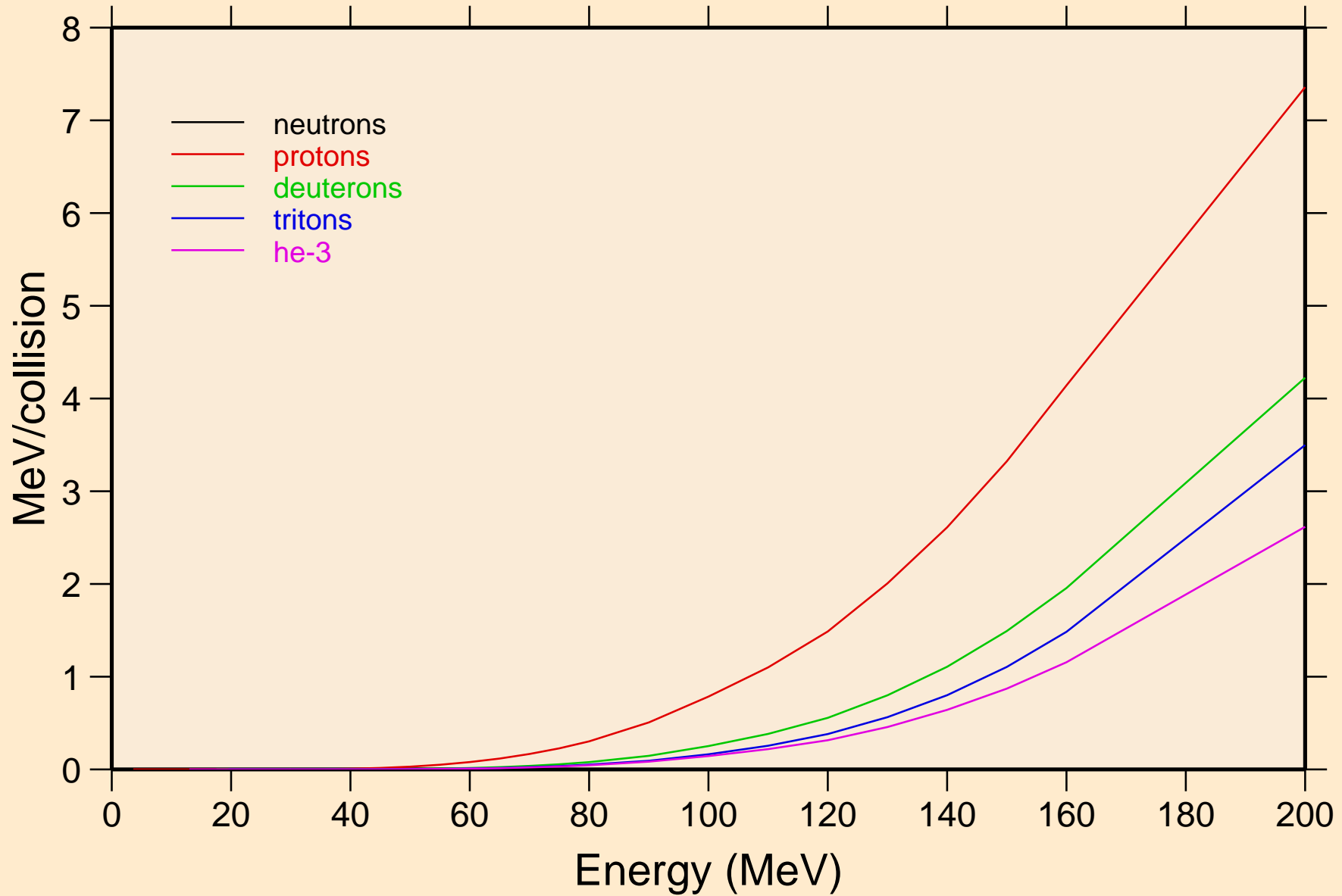

PO198 ALPHA ACER TENDL-2021 LIBRARY; T=0.K  
Recoil Heating

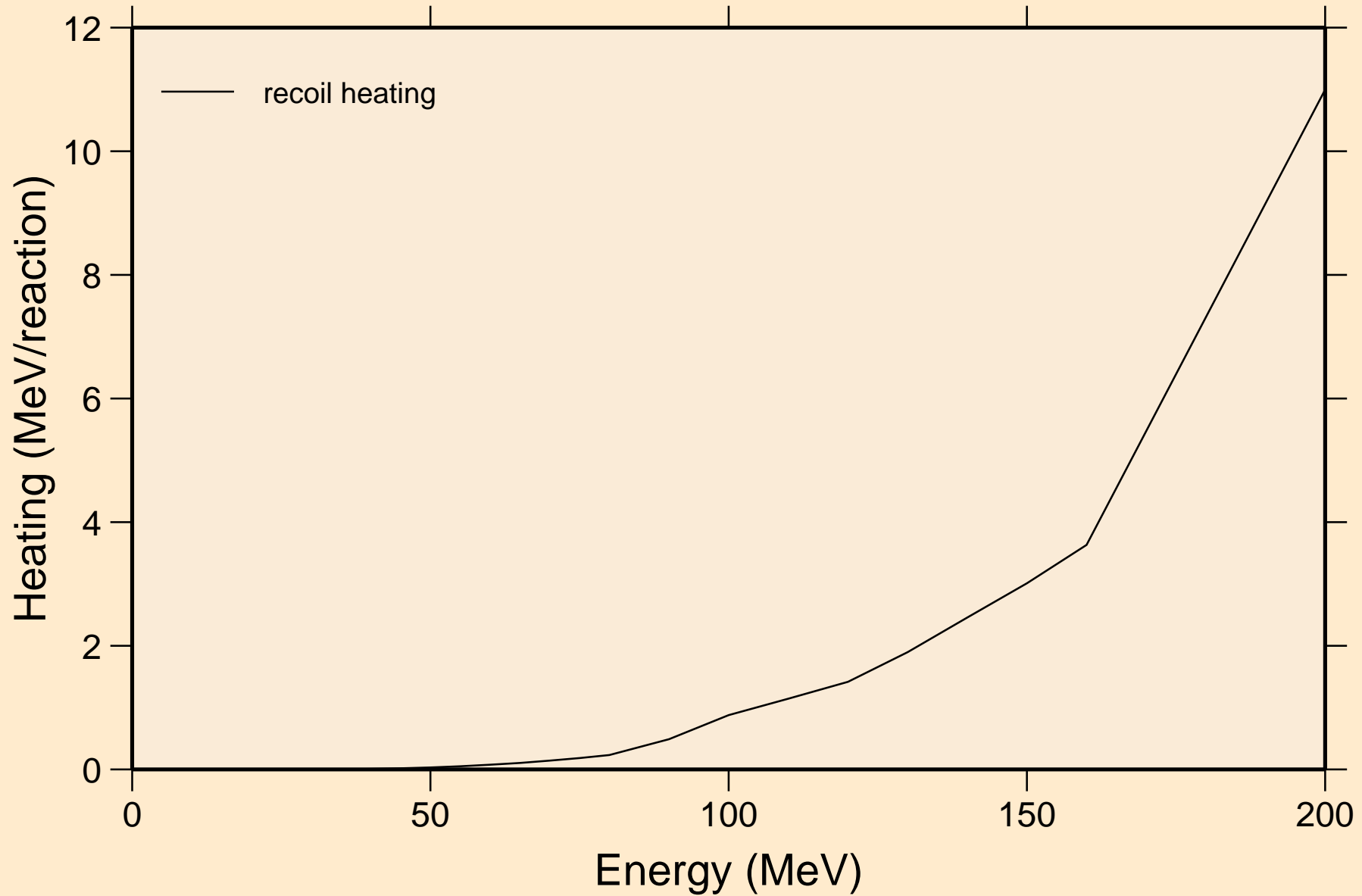

PO198 ALPHA ACER TENDL-2021 LIBRARY; T=0.K  
Particle production cross sections

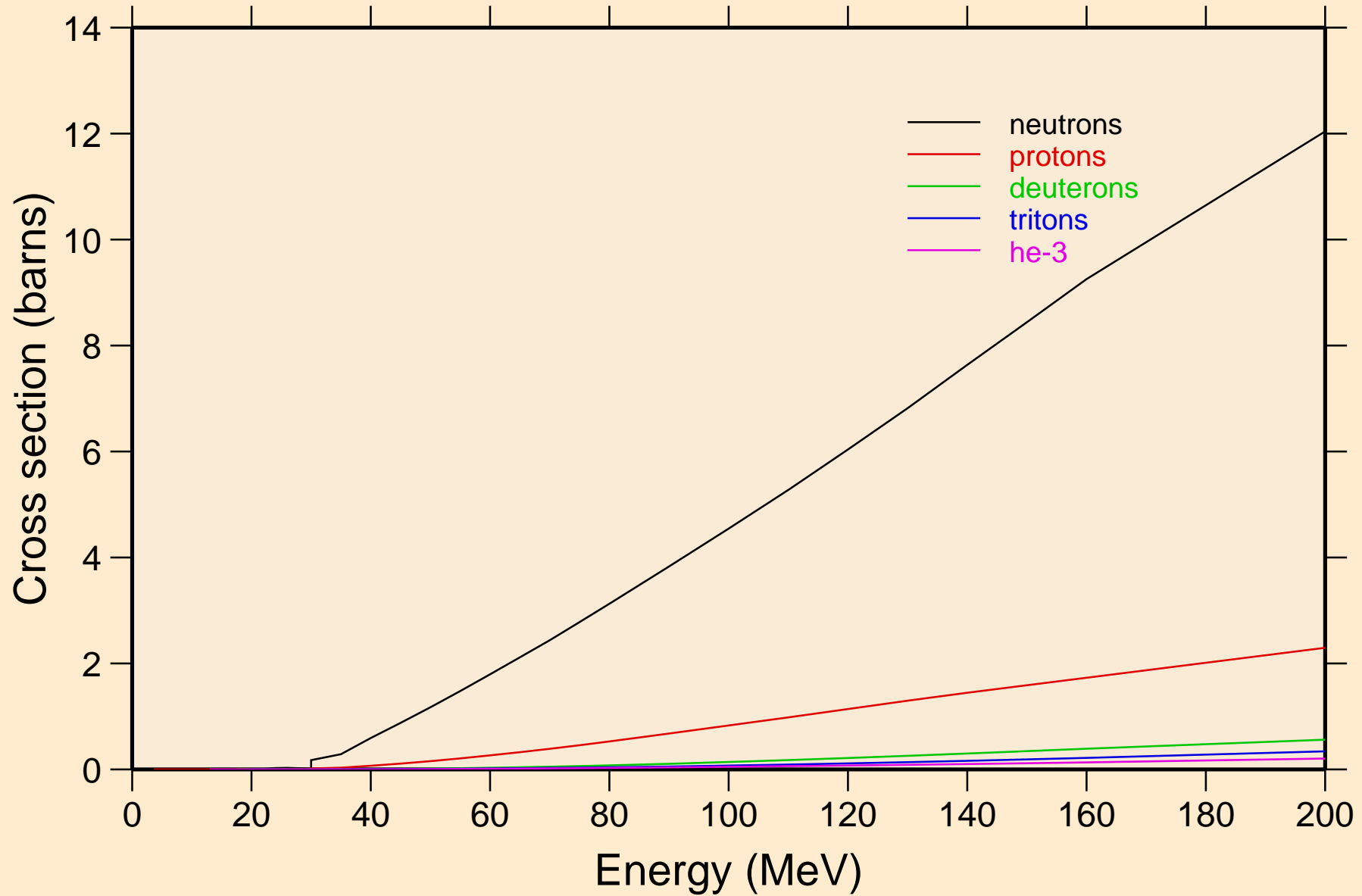

PO198 ALPHA ACER TENDL-2021 LIBRARY; T=0.K  
neutrons from (a,n)

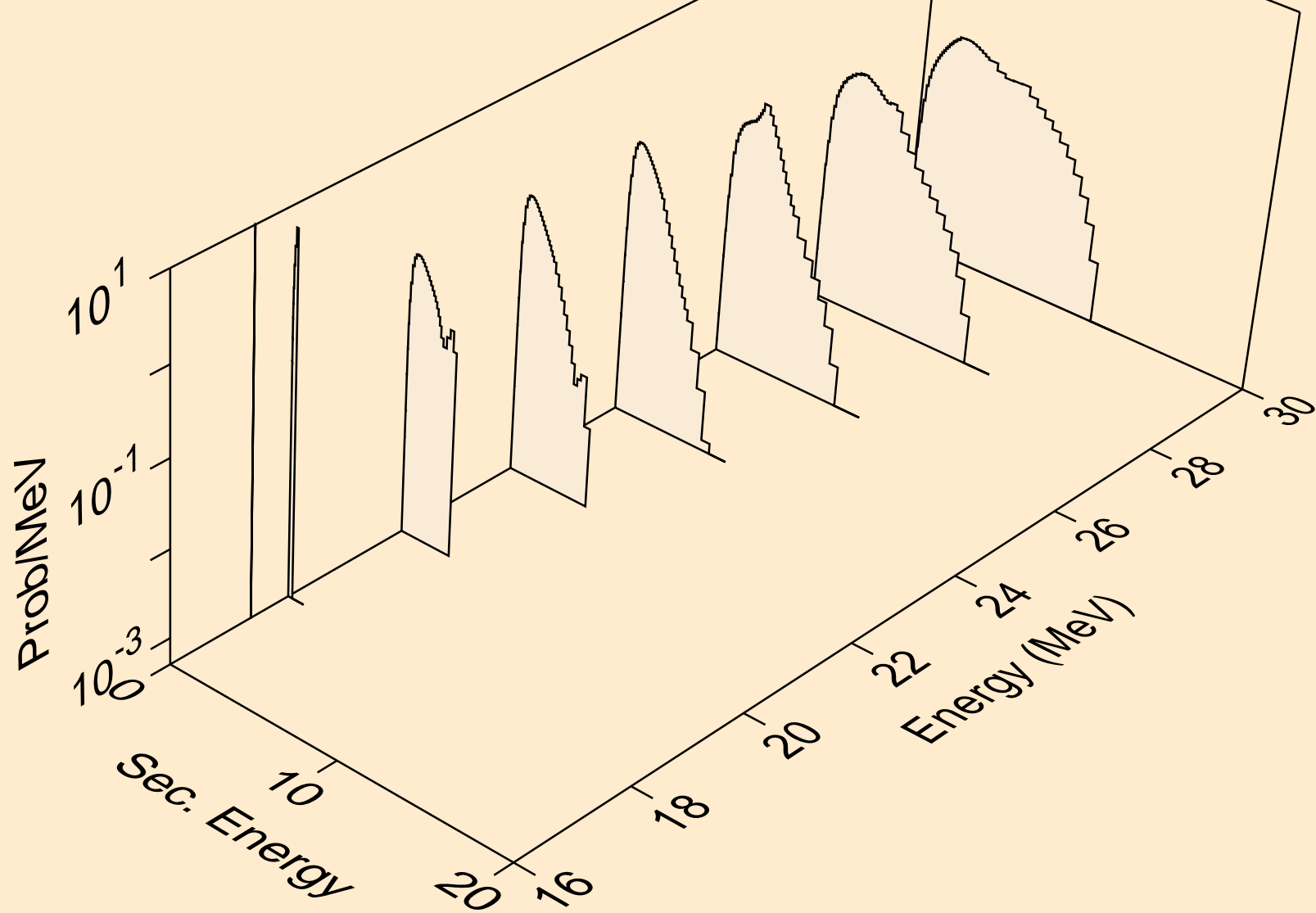

PO198 ALPHA ACER TENDL-2021 LIBRARY; T=0.K  
neutrons from (a,x)

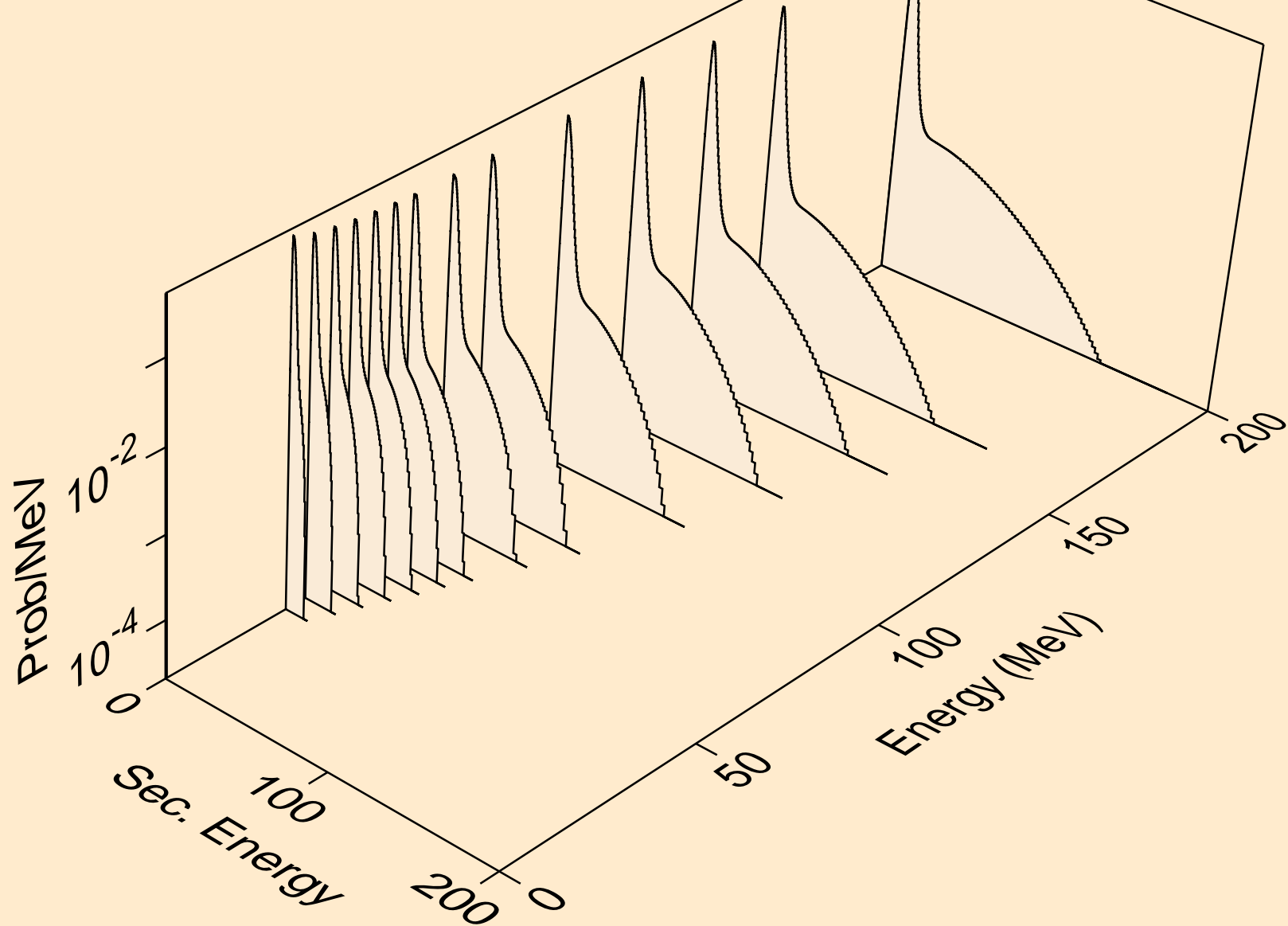

PO198 ALPHA ACER TENDL-2021 LIBRARY; T=0.K  
neutrons from (a,2n)

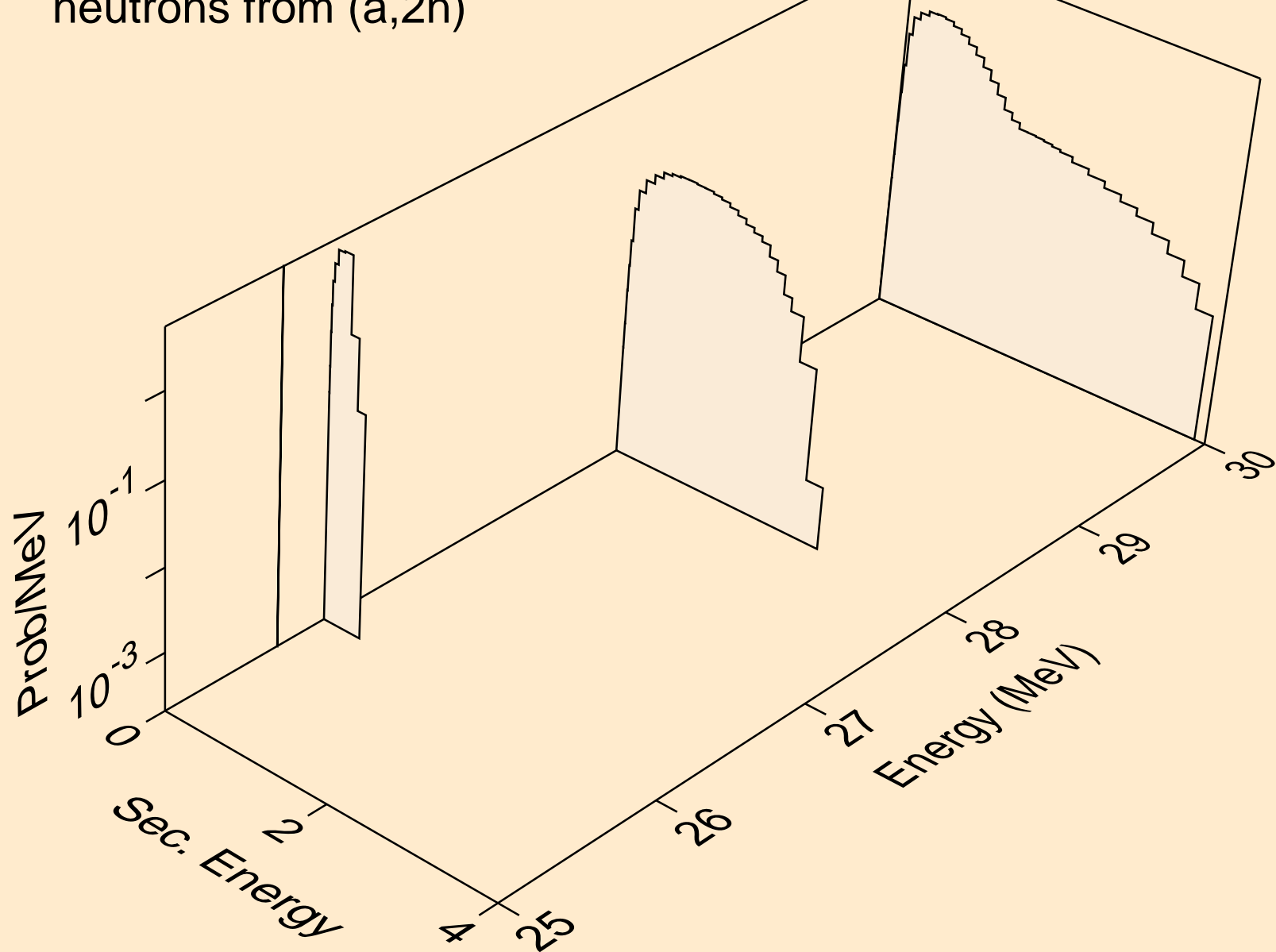

PO198 ALPHA ACER TENDL-2021 LIBRARY; T=0.K  
neutrons from (a,n\*)a

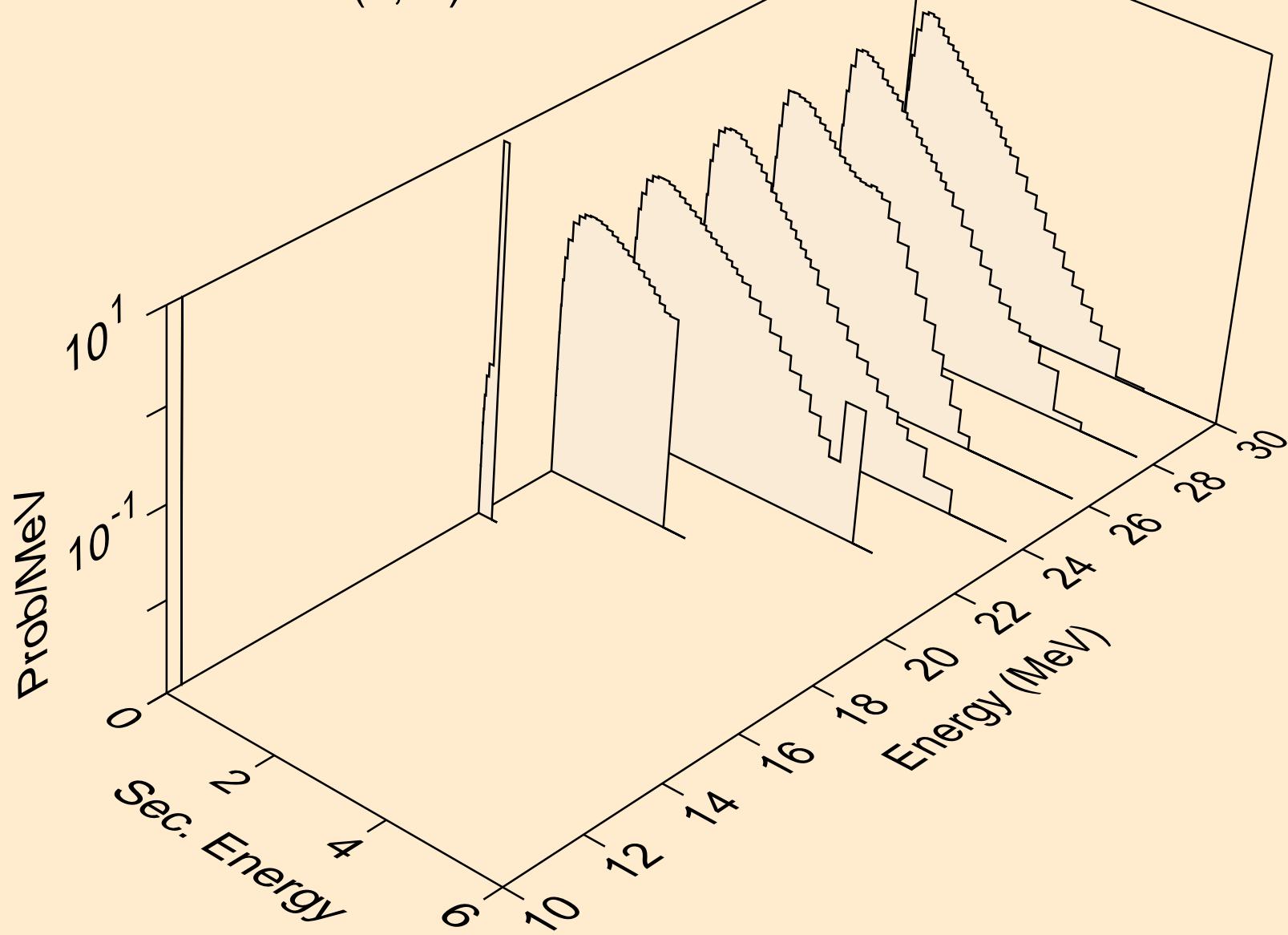

PO198 ALPHA ACER TENDL-2021 LIBRARY; T=0.K  
neutrons from (a,2n)a

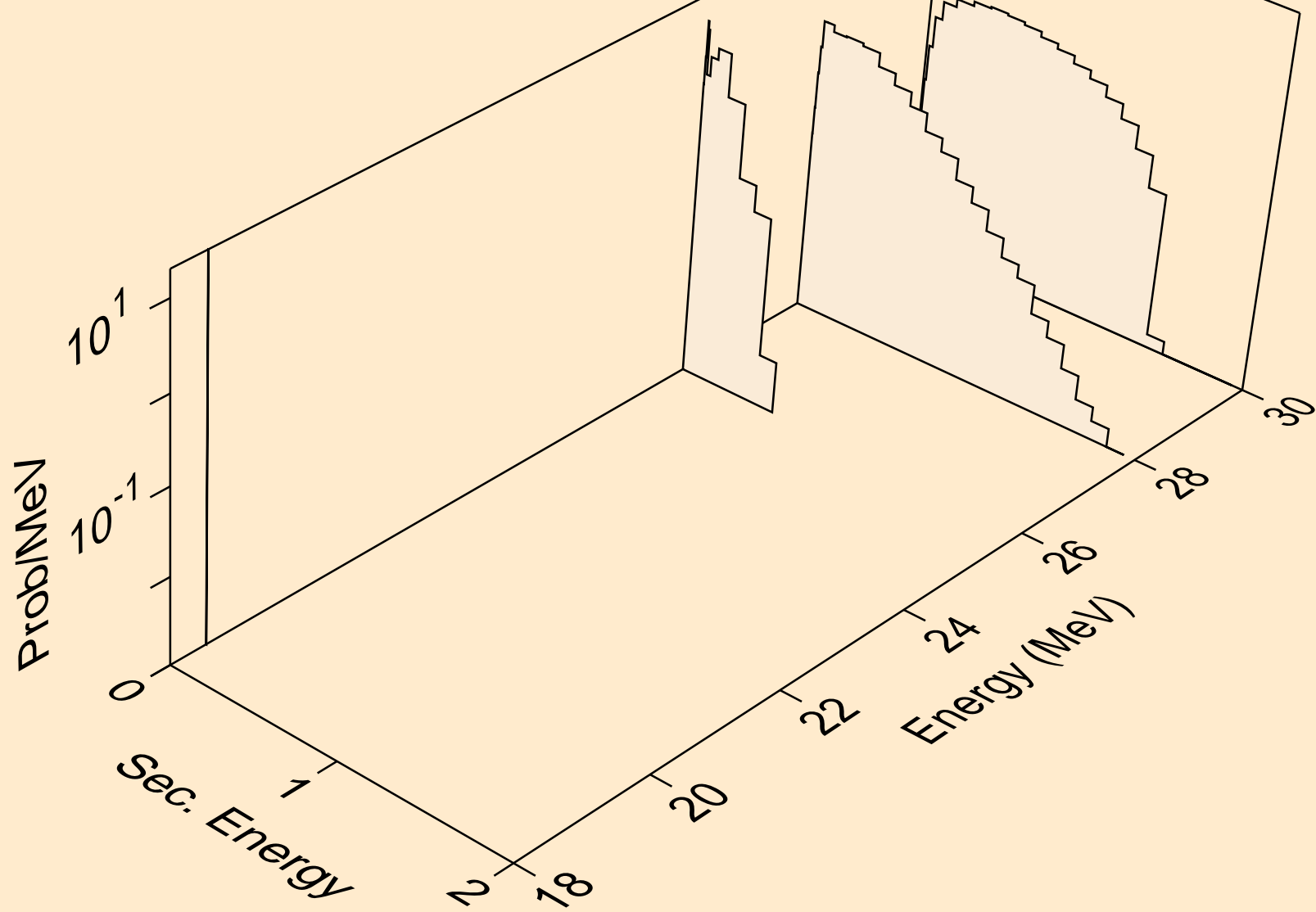



PO198 ALPHA ACER TENDL-2021 LIBRARY; T=0.K  
neutrons from (a,n\*)p

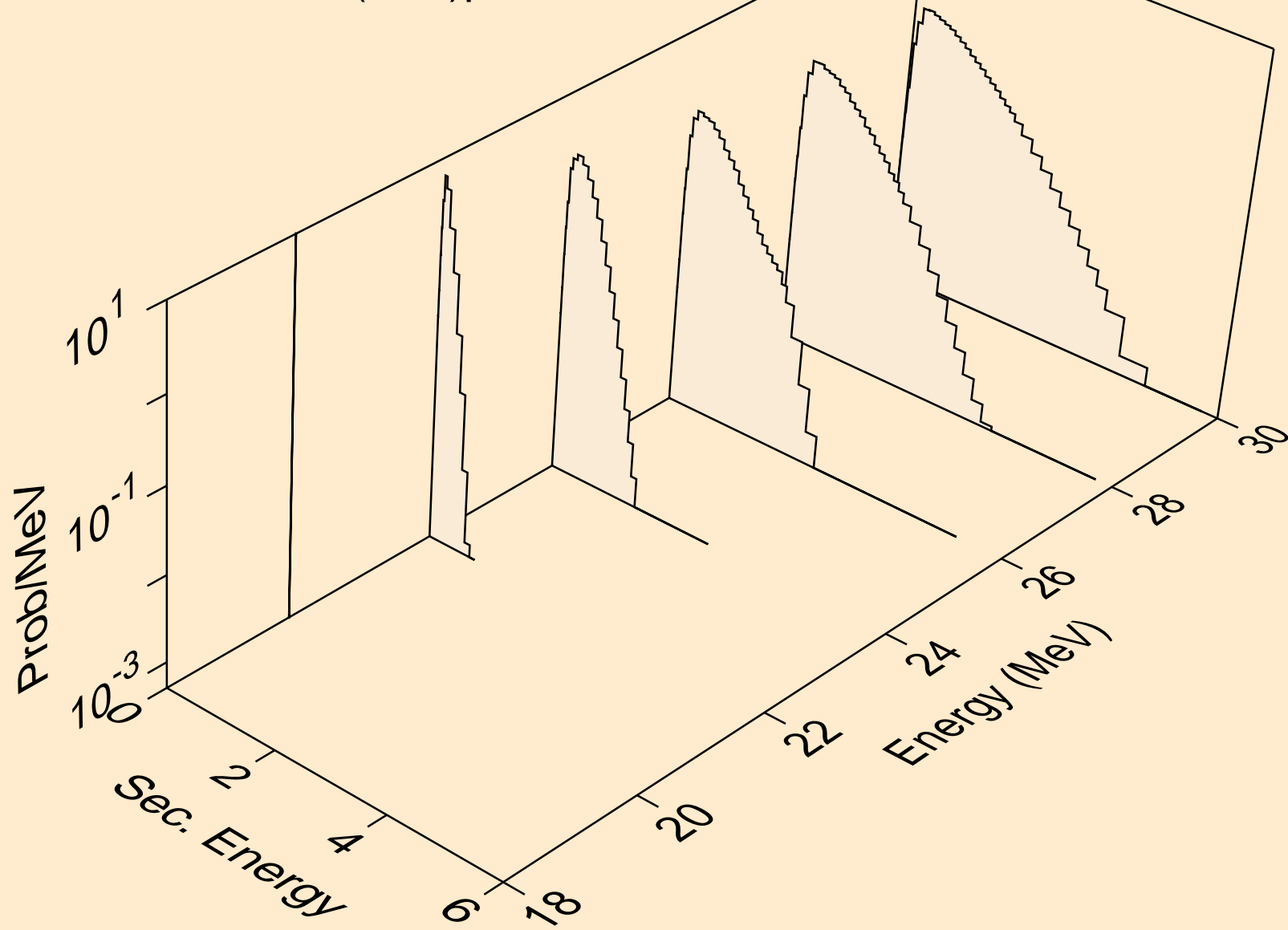

PO198 ALPHA ACER TENDL-2021 LIBRARY; T=0.K  
neutrons from (a,2n)2a

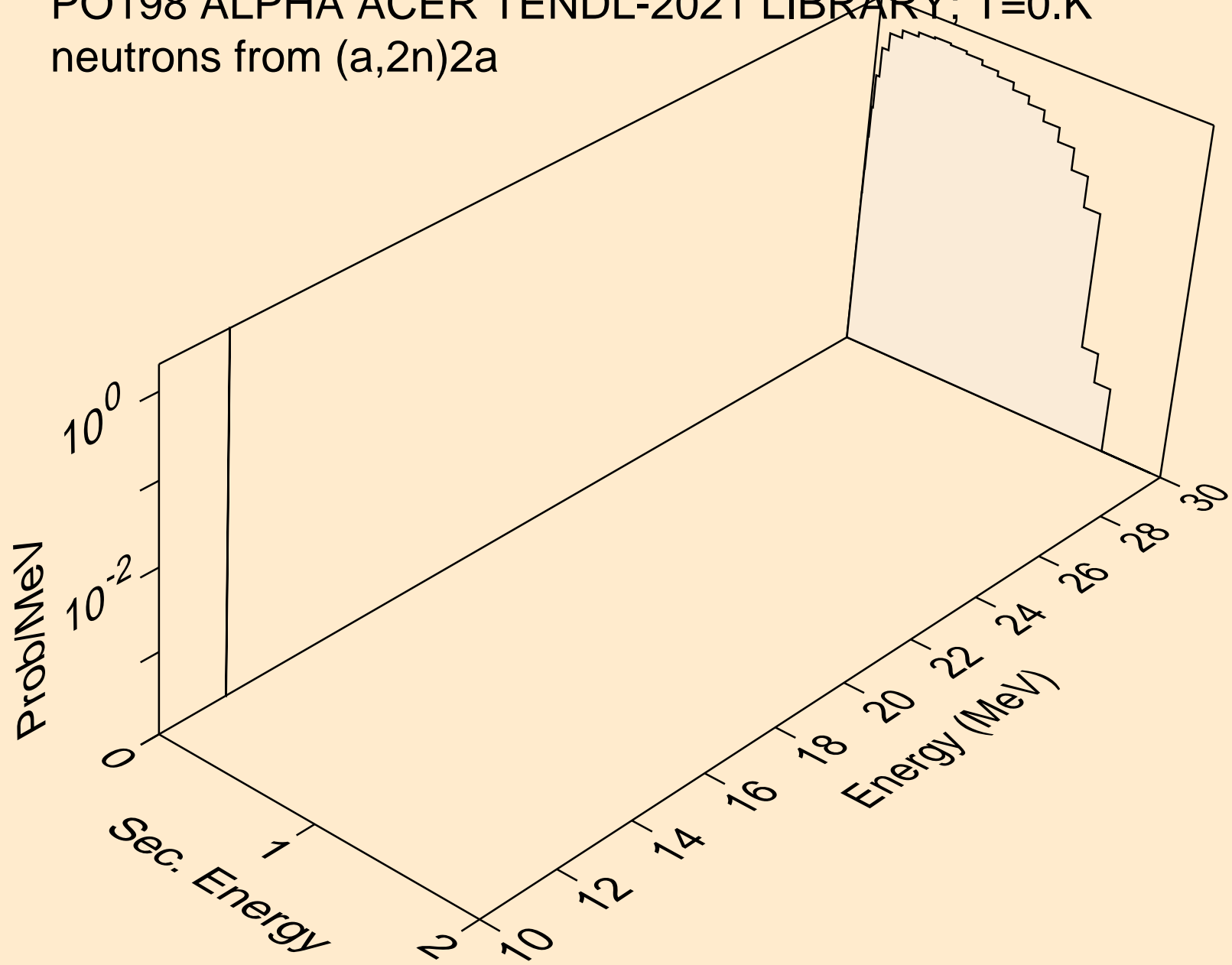

PO198 ALPHA ACER TENDL-2021 LIBRARY; T=0.K  
protons from (a,x)

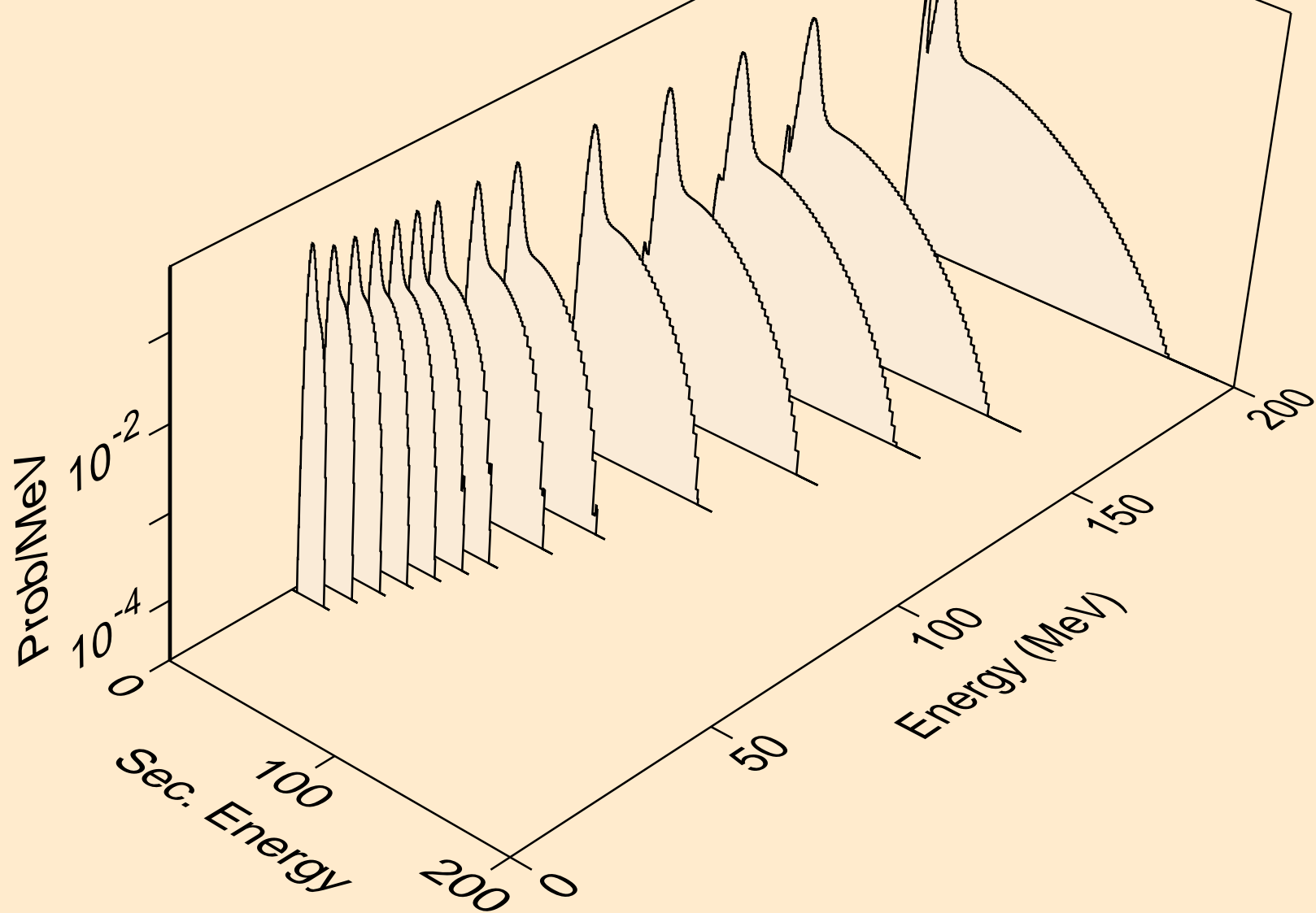

PO198 ALPHA ACER TENDL-2021 LIBRARY; T=0.K  
protons from (a,n\*)p

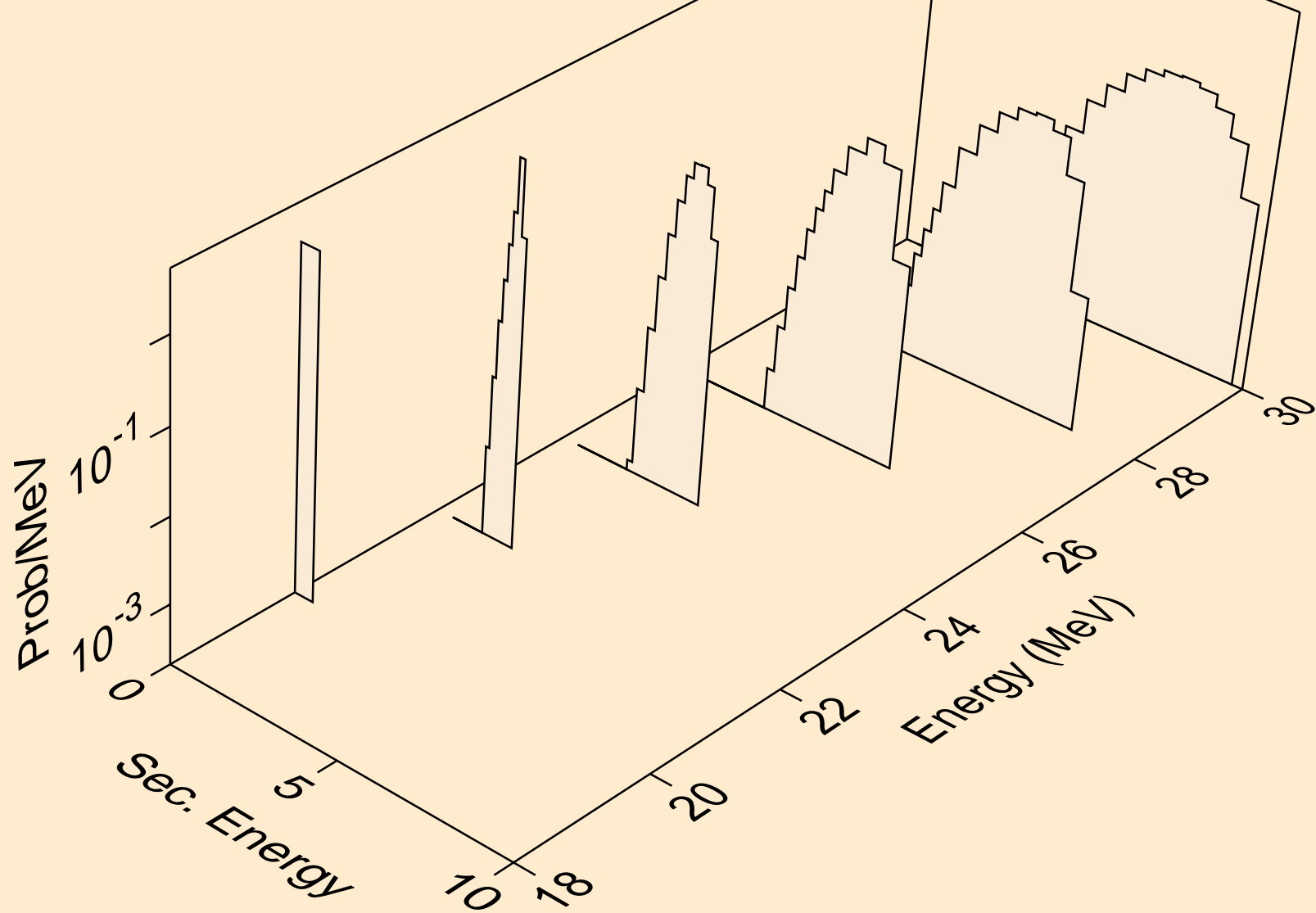

PO198 ALPHA ACER TENDL-2021 LIBRARY; T=0.K  
protons from (a,p)

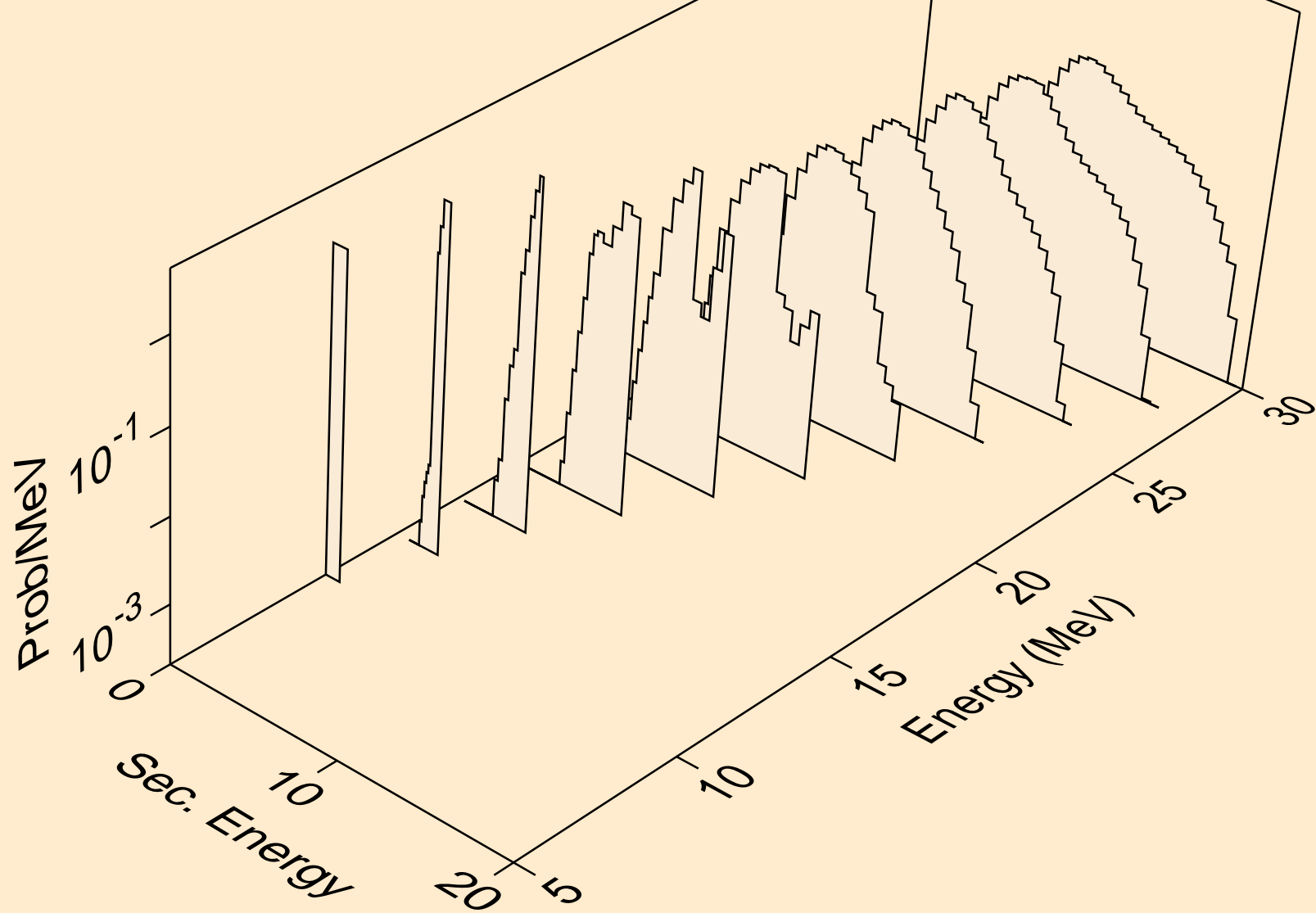

PO198 ALPHA ACER TENDL-2021 LIBRARY; T=0.K  
protons from (a,2p)

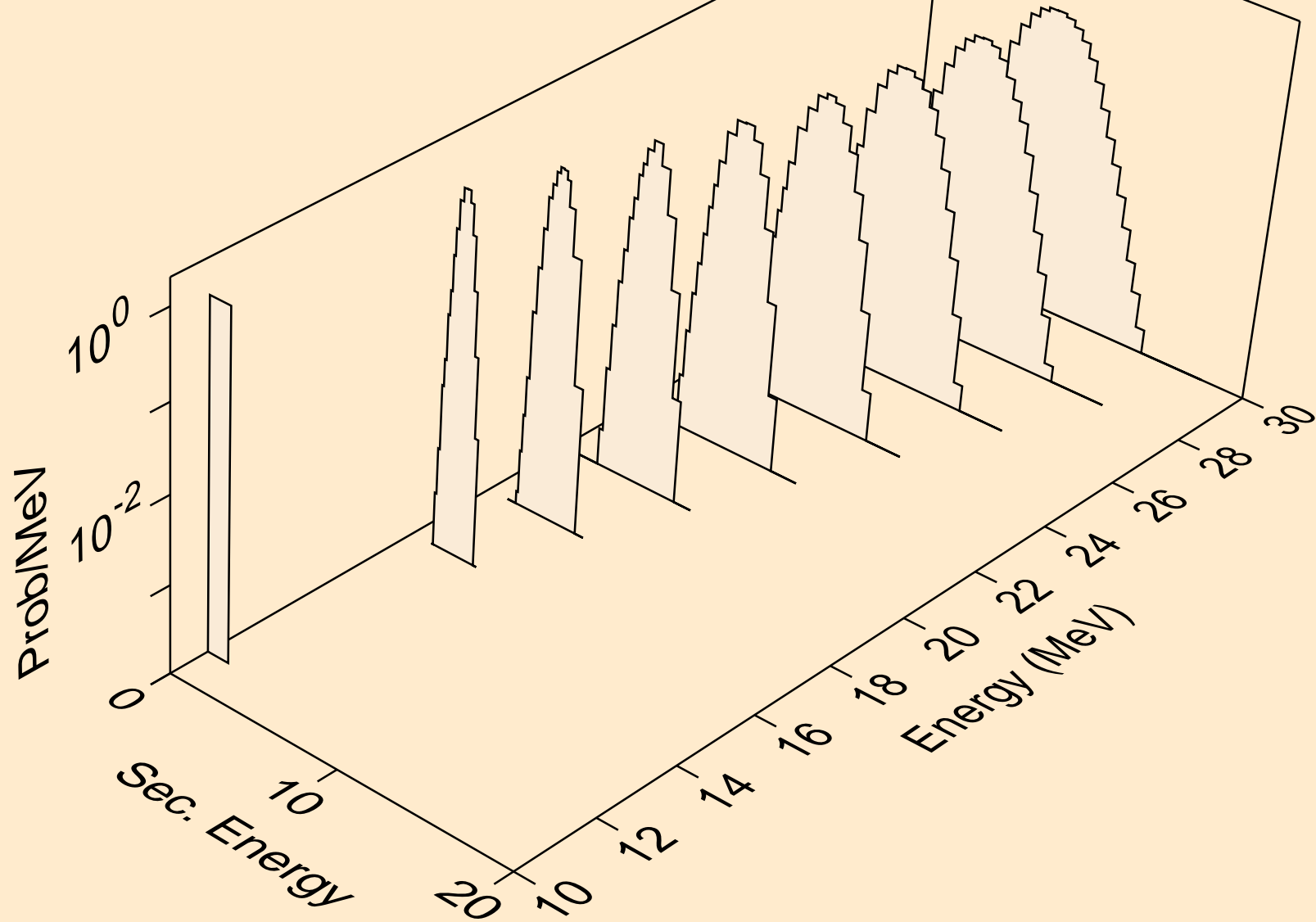

PO198 ALPHA ACER TENDL-2021 LIBRARY; T=0.K  
protons from (a,pa)

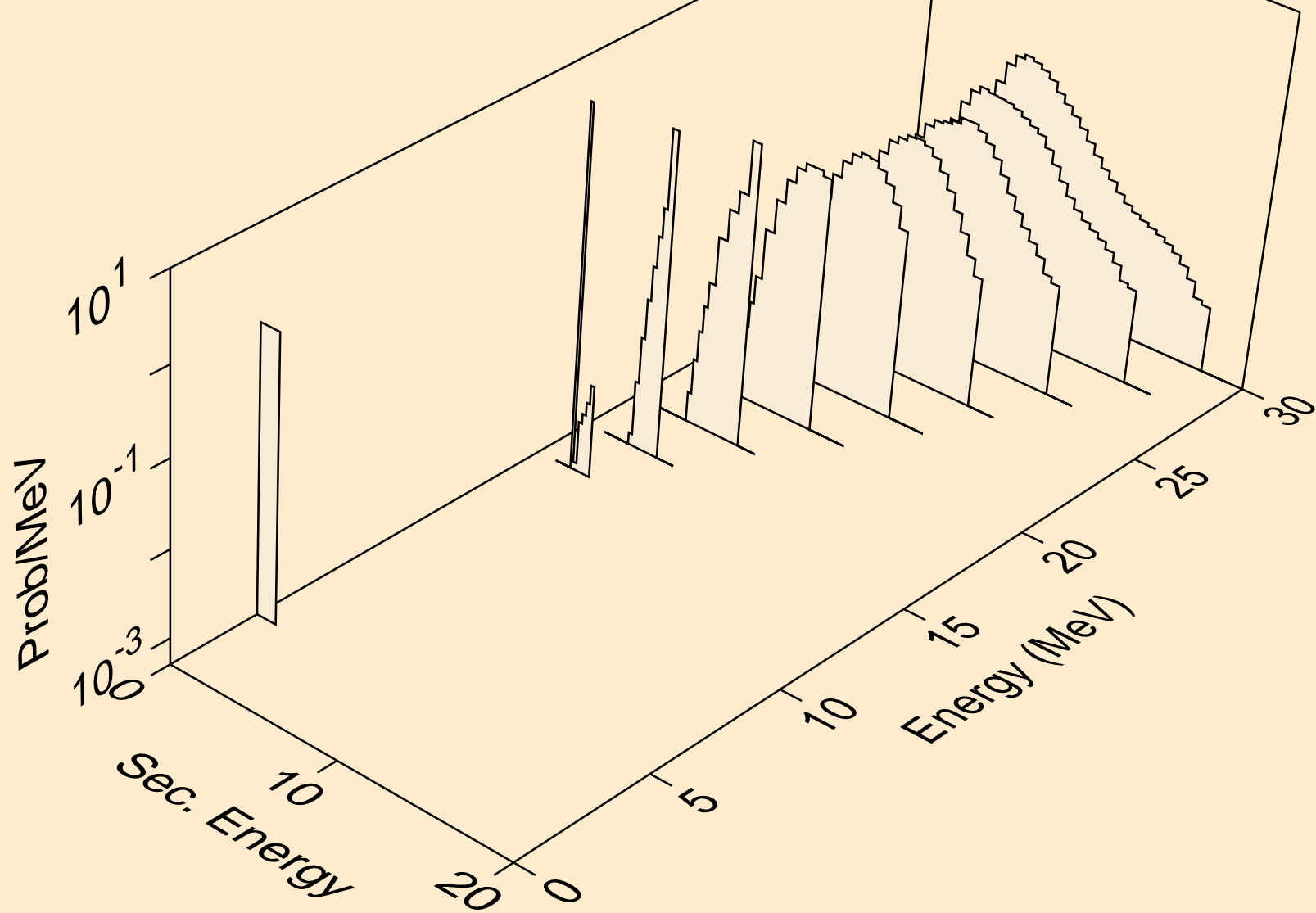

PO198 ALPHA ACER TENDL-2021 LIBRARY; T=0.K  
deuterons from (a,x)

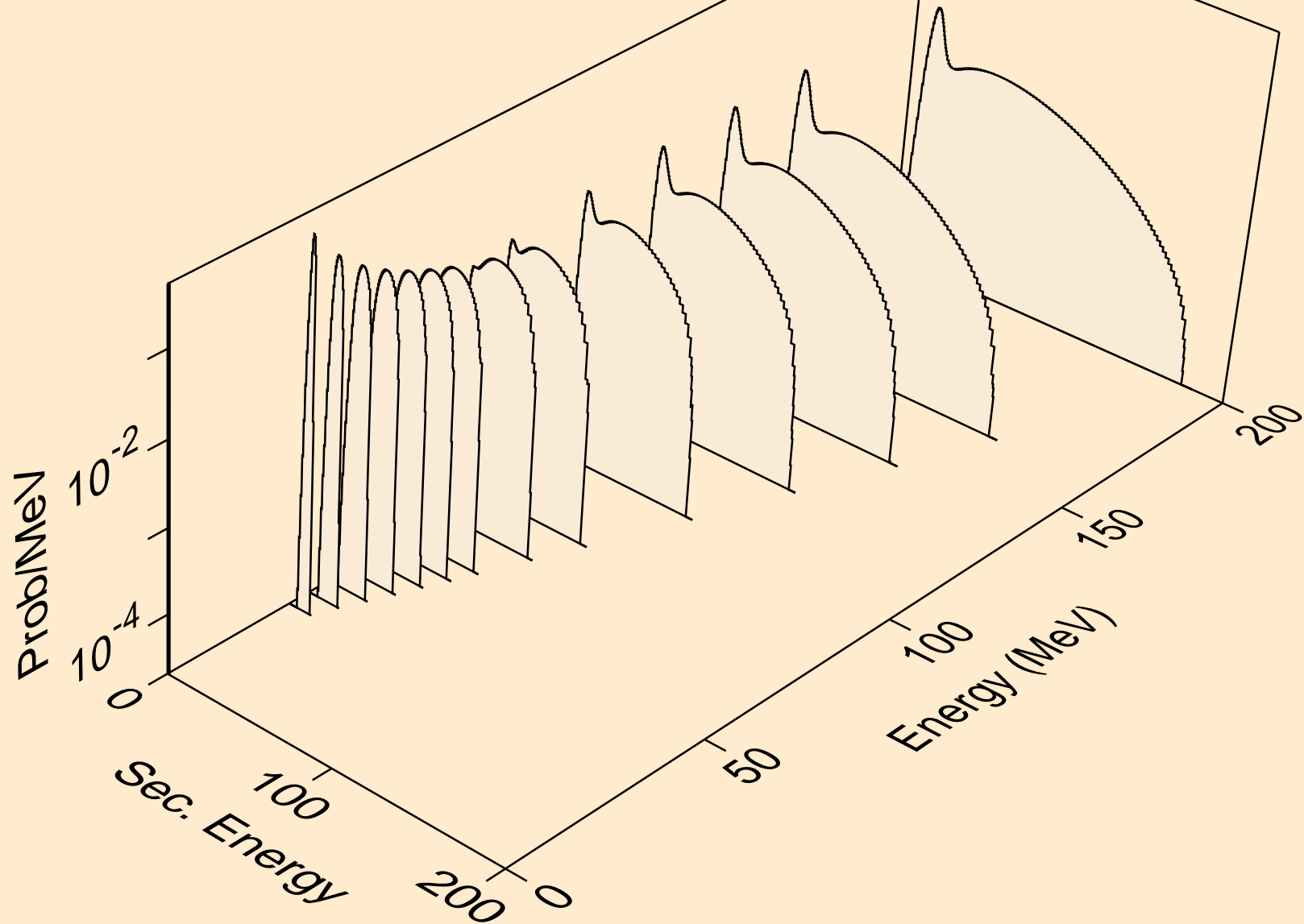



PO198 ALPHA ACER TENDL-2021 LIBRARY; T=0.K  
deuterons from (a,d)

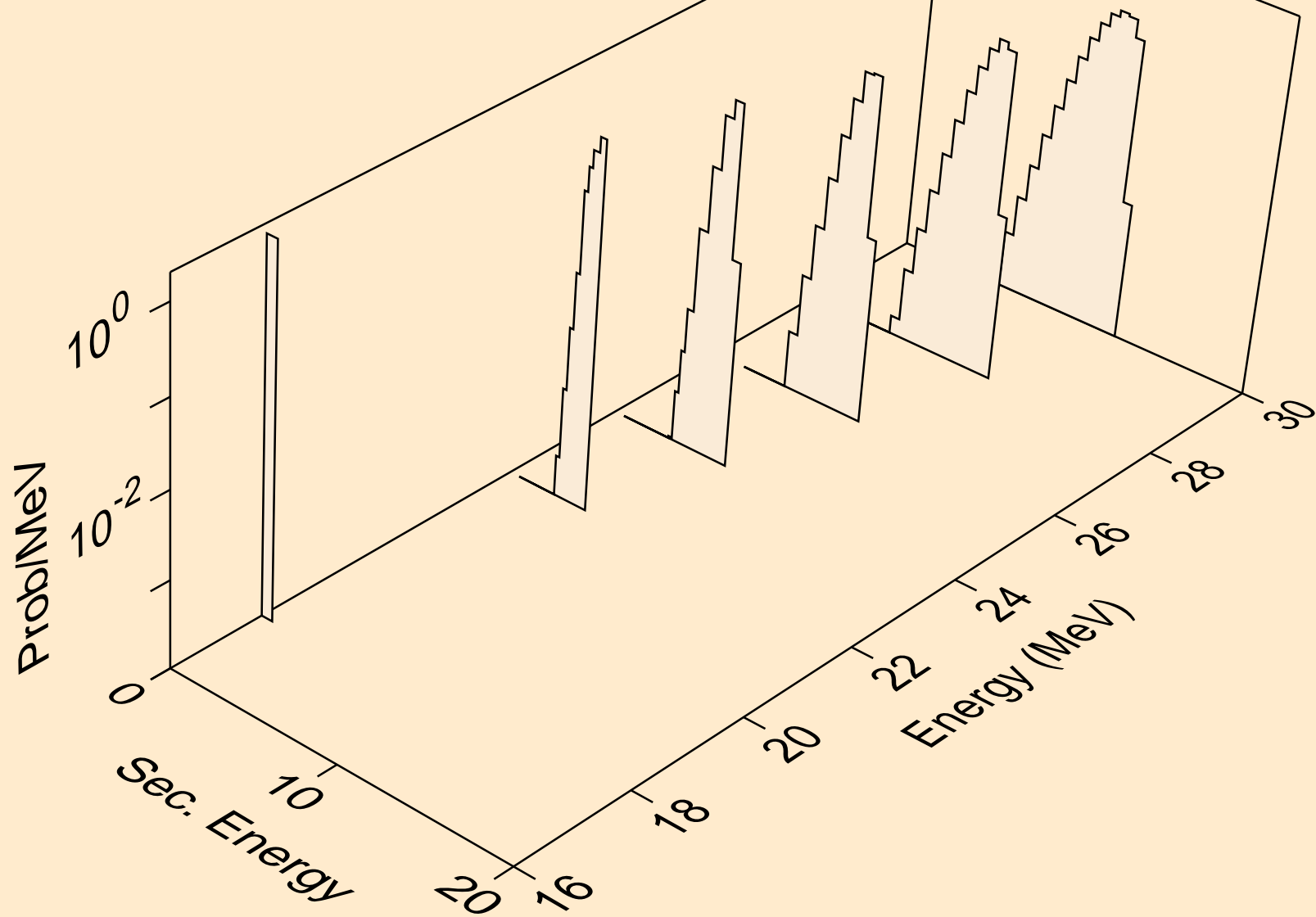

PO198 ALPHA ACER TENDL-2021 LIBRARY; T=0.K  
tritons from (a,x)

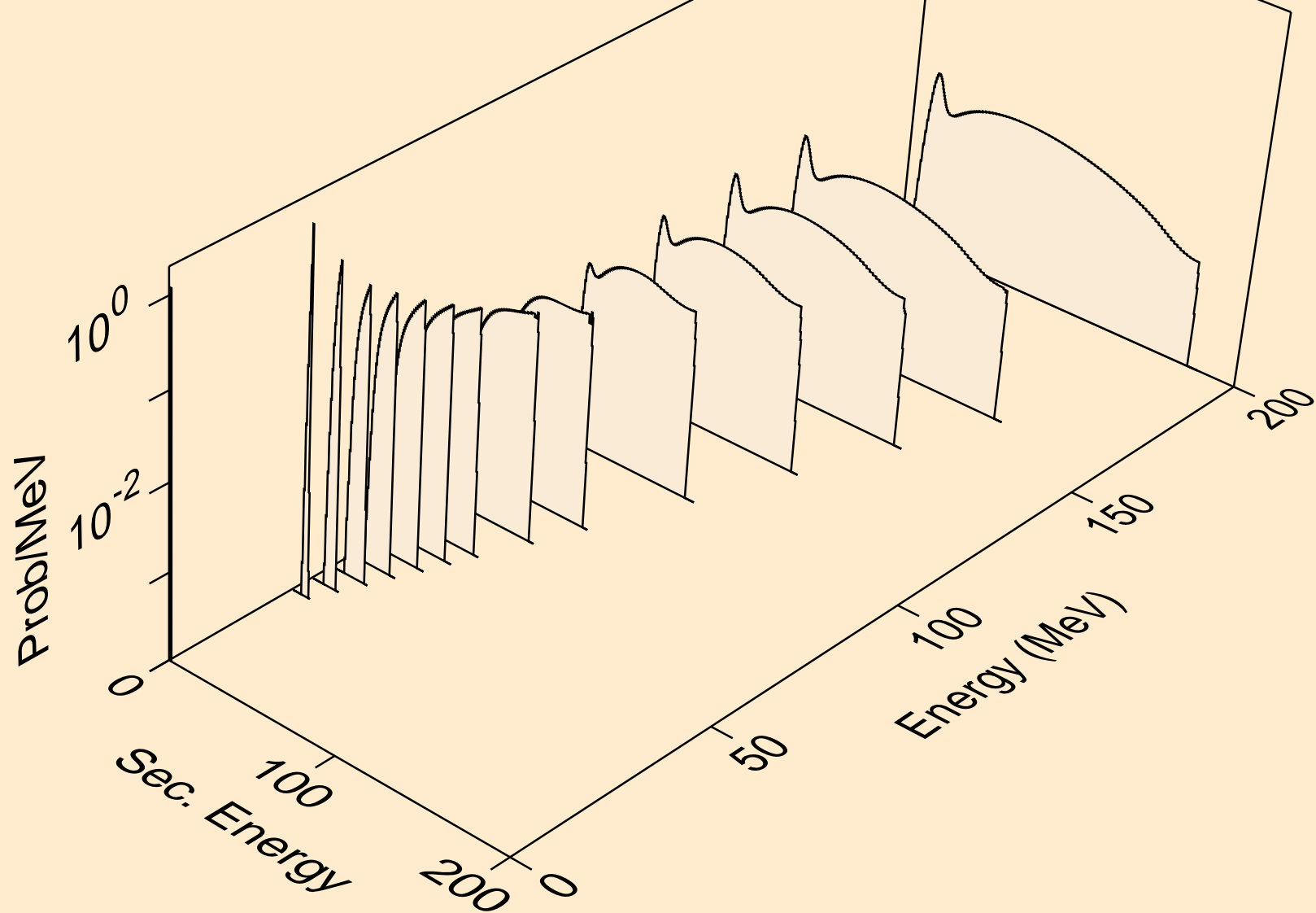

PO198 ALPHA ACER TENDL-2021 LIBRARY; T=0.K  
tritons from (a,t)

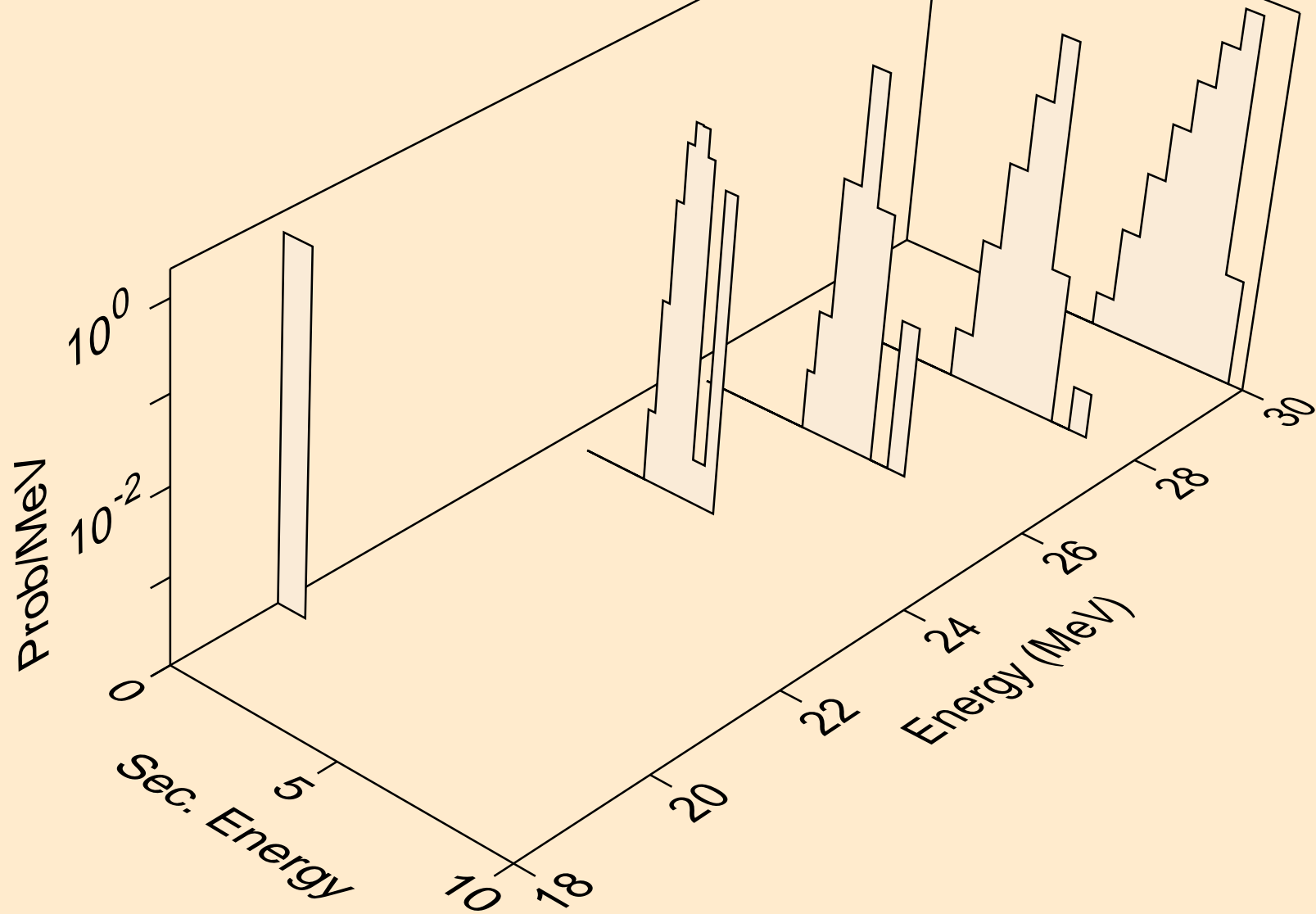

PO198 ALPHA ACER TENDL-2021 LIBRARY; T=0.K  
he3s from (a,x)

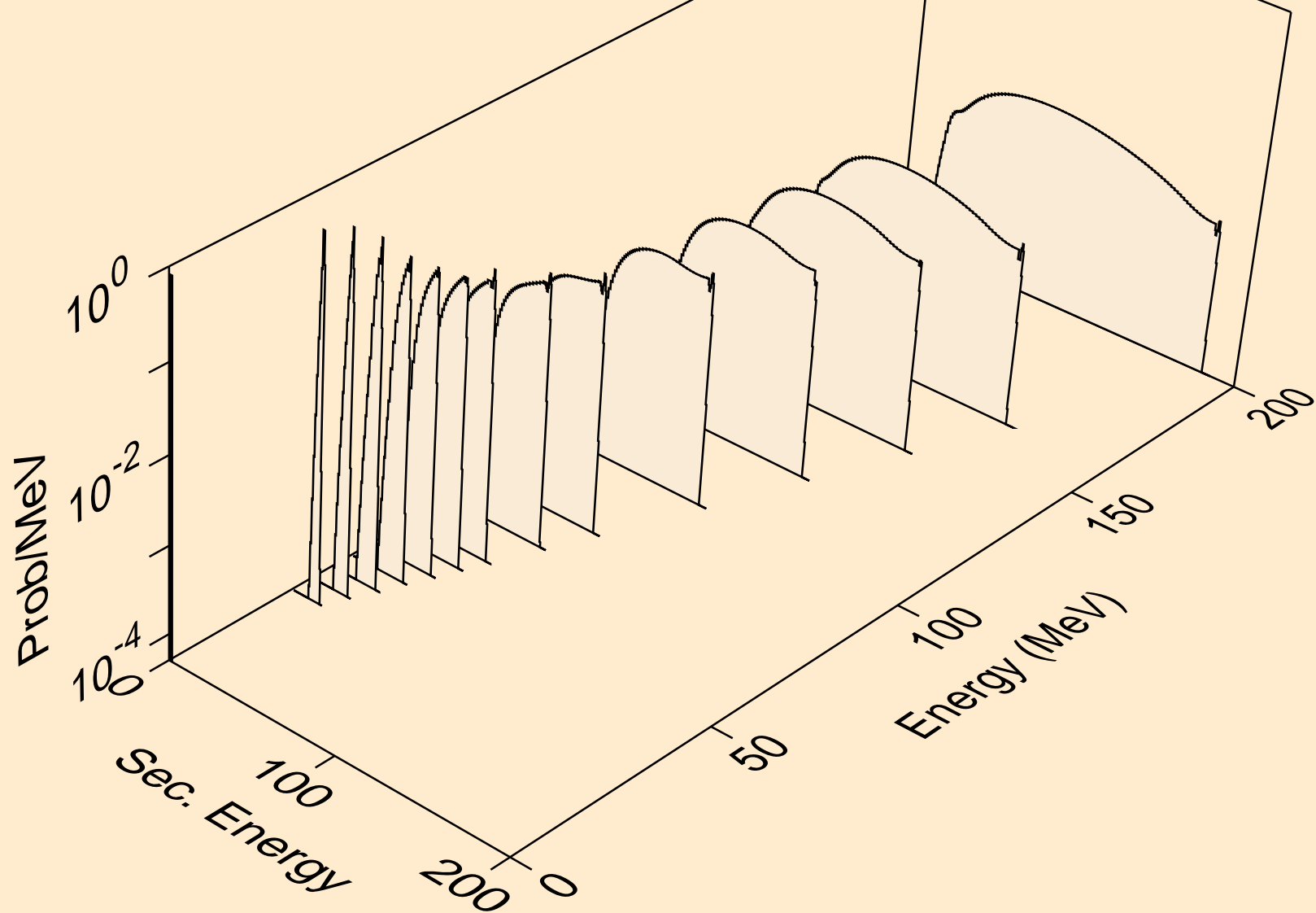

PO198 ALPHA ACER TENDL-2021 LIBRARY; T=0.K  
he3s from (a,he3)

