

PR155 ALPHA ACER TENDL-2021 LIBRARY; T=0.K

Principal cross sections

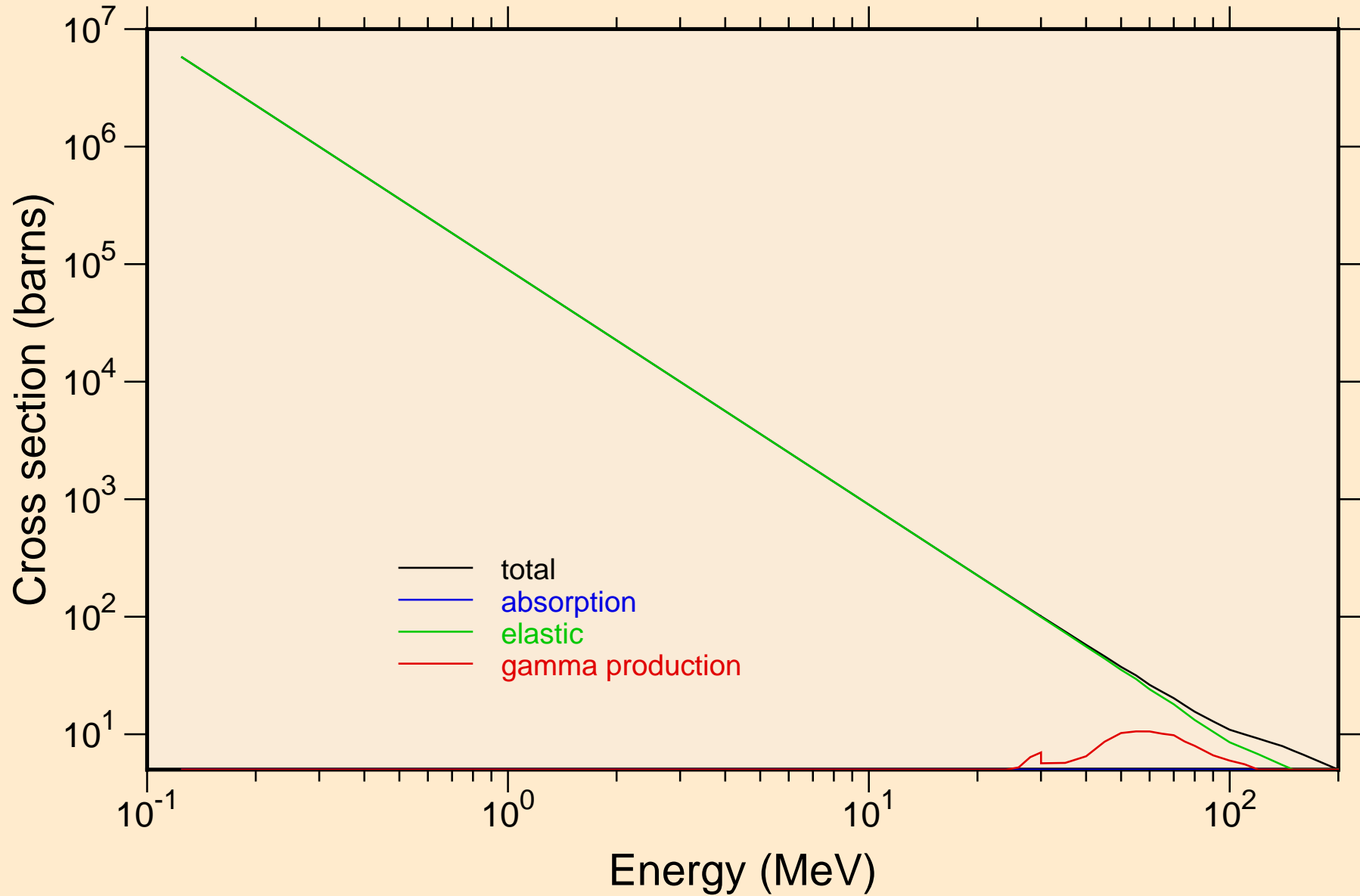

PR155 ALPHA ACER TENDL-2021 LIBRARY; T=0.K
Heating

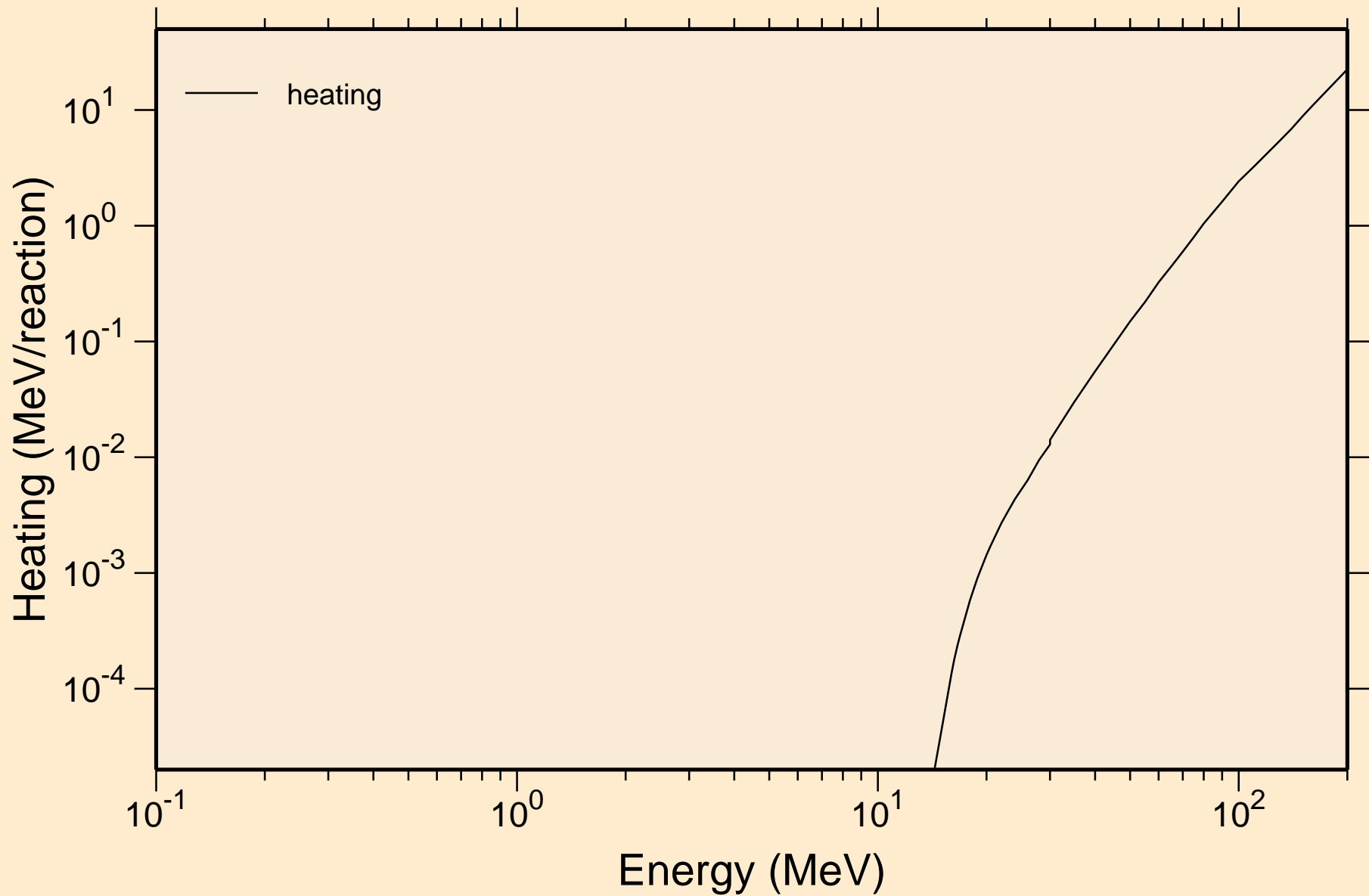

PR155 ALPHA ACER TENDL-2021 LIBRARY; T=0.K

Principal cross sections

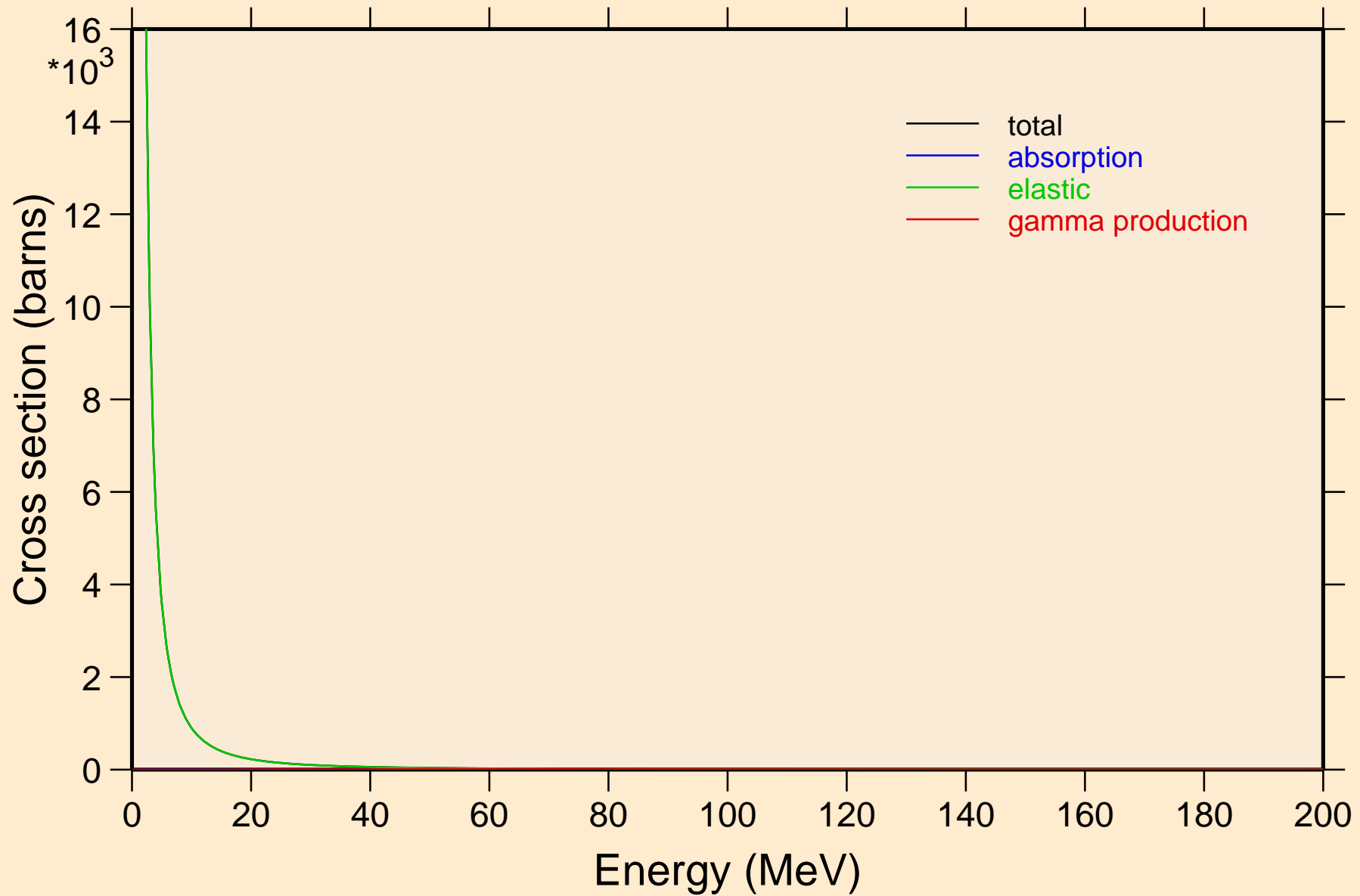

PR155 ALPHA ACER TENDL-2021 LIBRARY; T=0.K

Heating

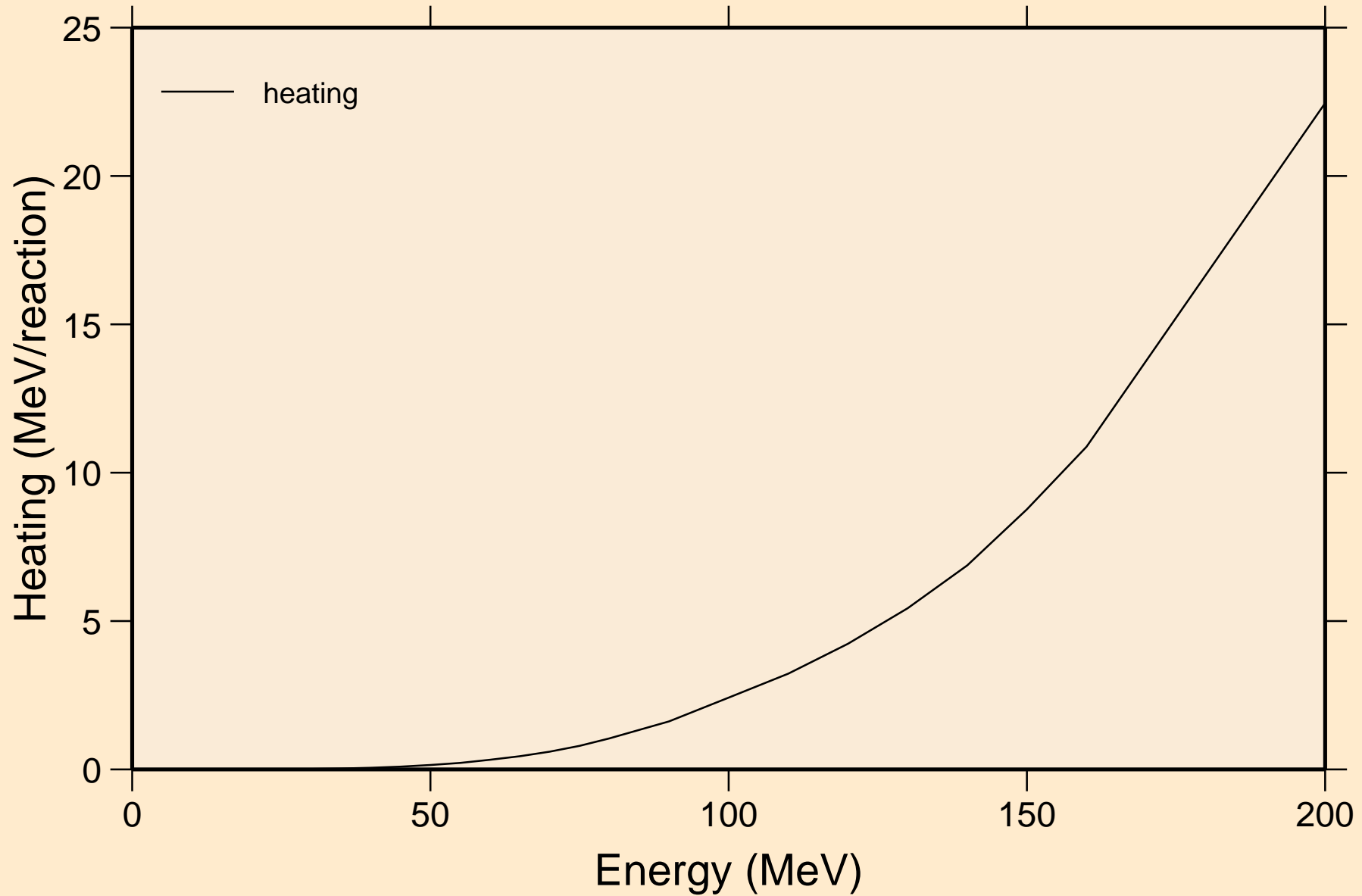

PR155 ALPHA ACER TENDL-2021 LIBRARY; T=0.K
Threshold reactions

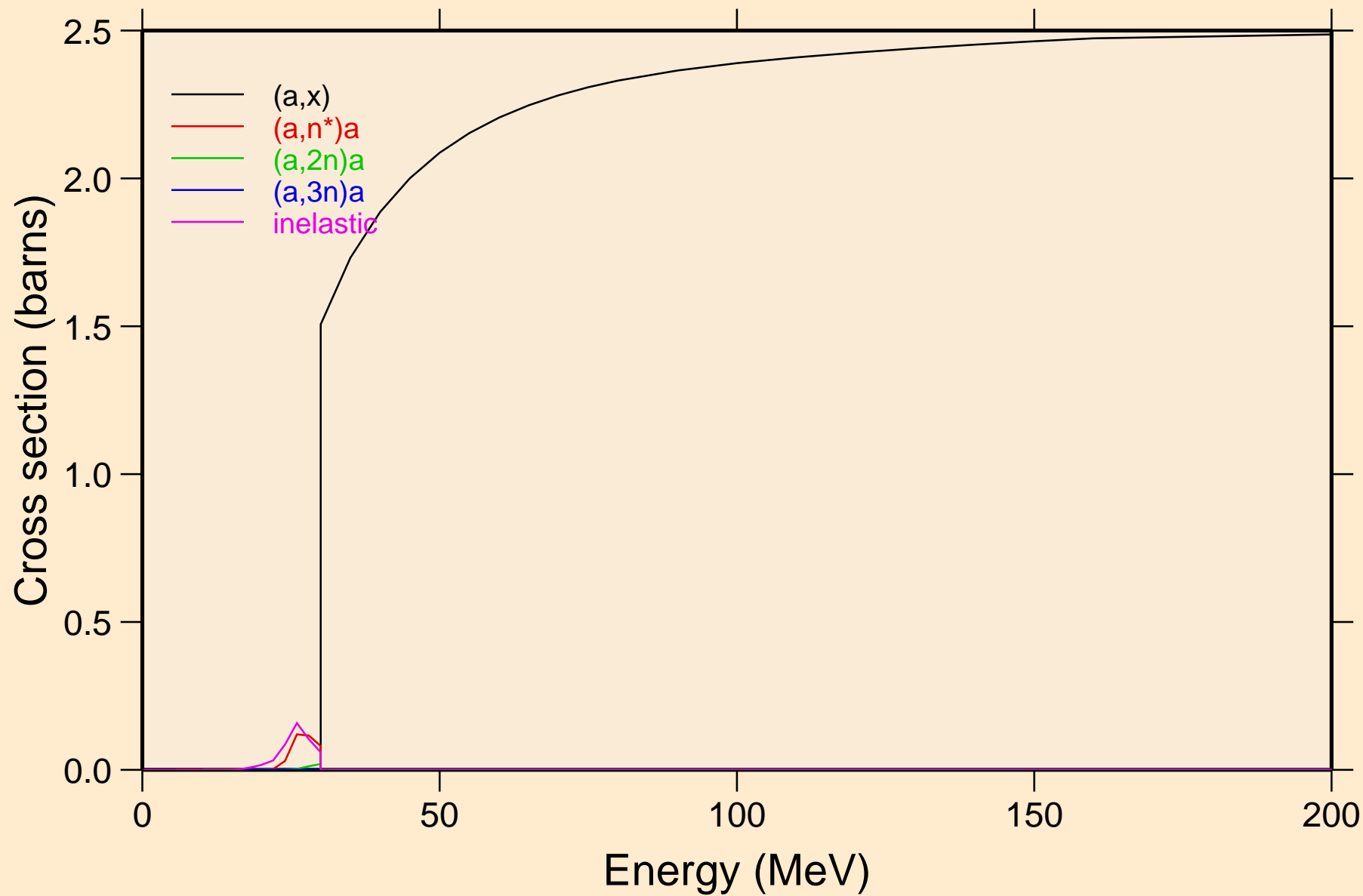

PR155 ALPHA ACER TENDL-2021 LIBRARY; T=0.K
angular distribution for elastic

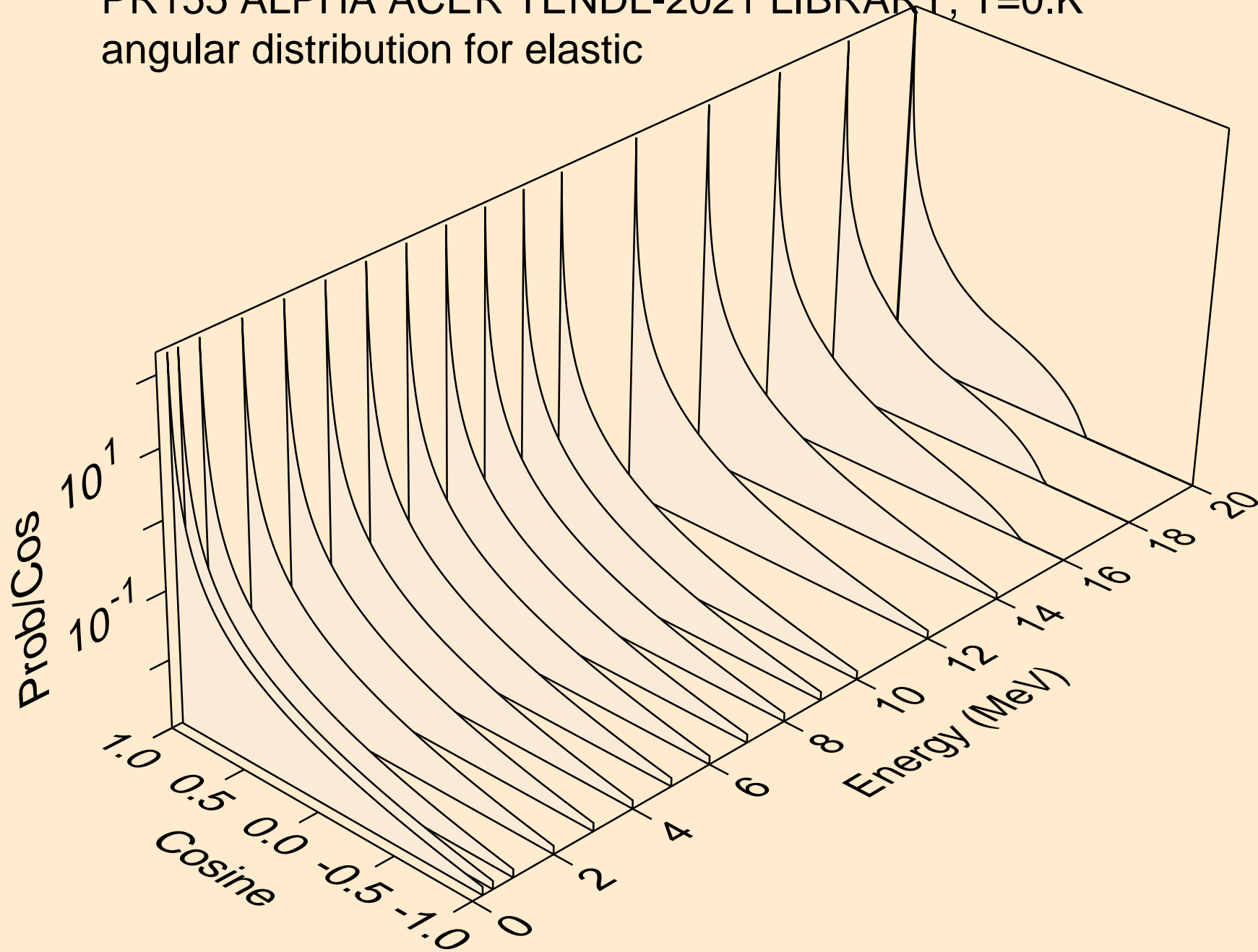

PR155 ALPHA ACER TENDL-2021 LIBRARY; T=0.K
angular distribution for elastic

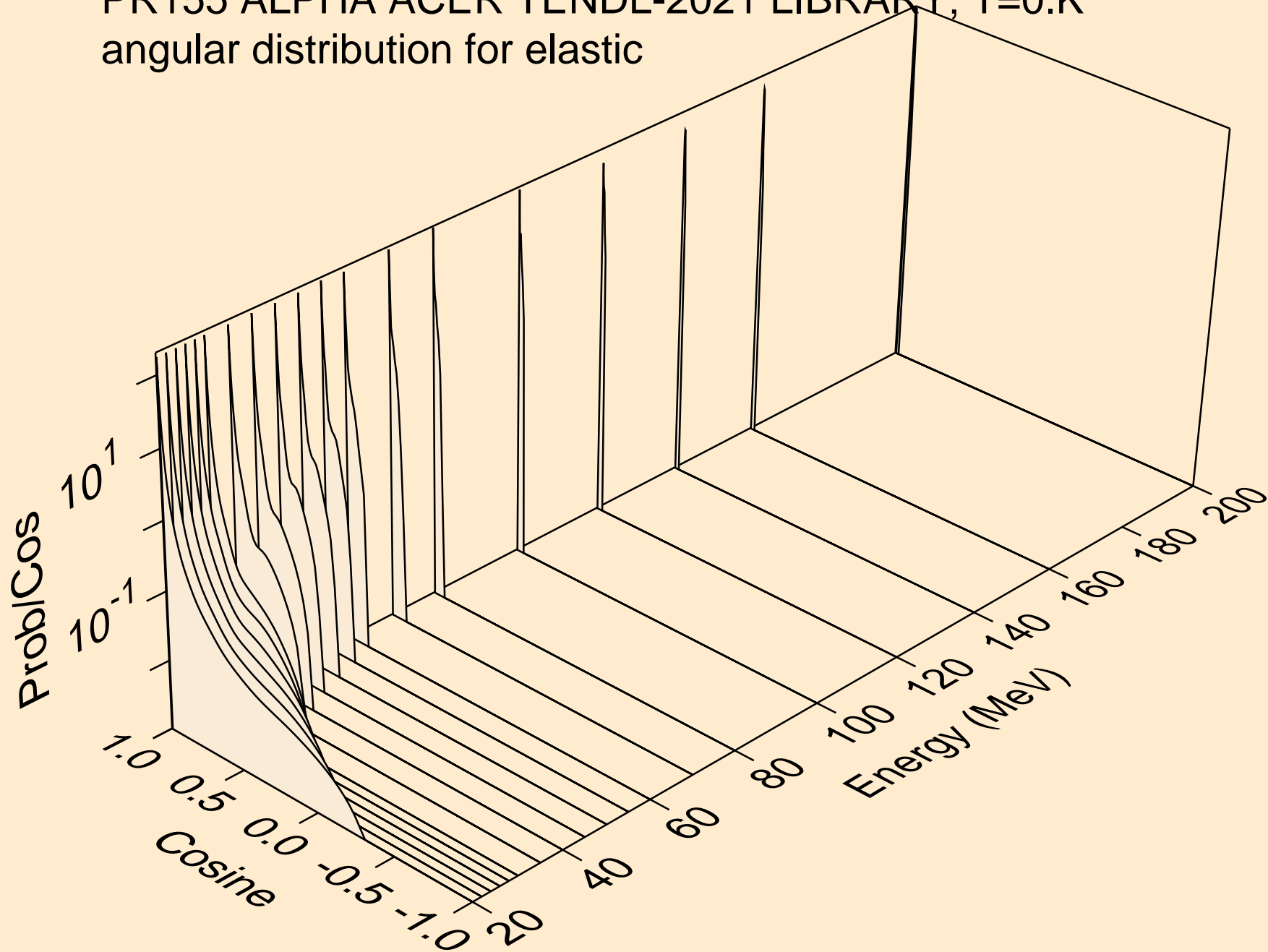

PR155 ALPHA ACER TENDL-2021 LIBRARY; T=0.K
Alpha emission for (a,x)

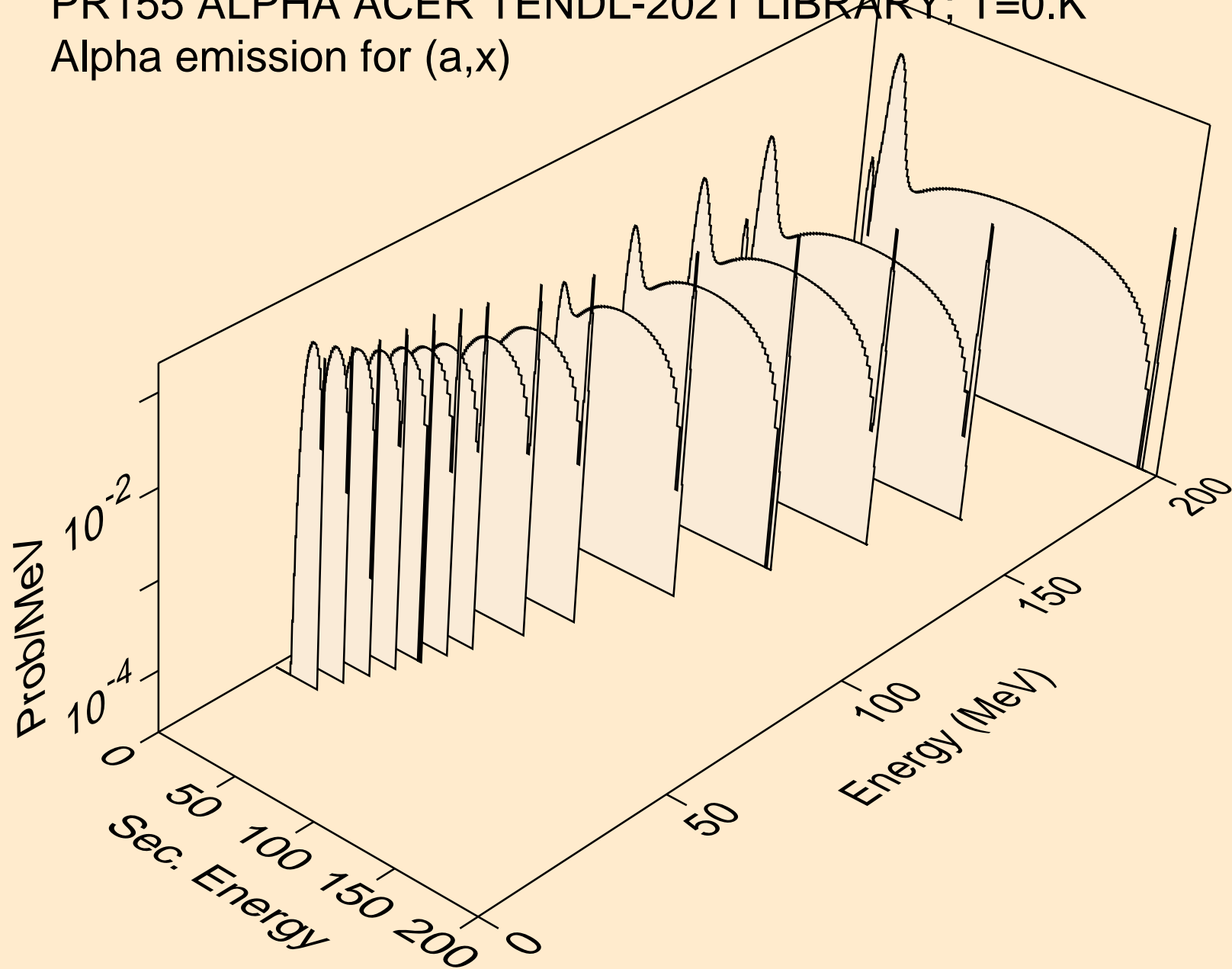

PR155 ALPHA ACER TENDL-2021 LIBRARY; T=0.K
Alpha emission for (a,n*)a

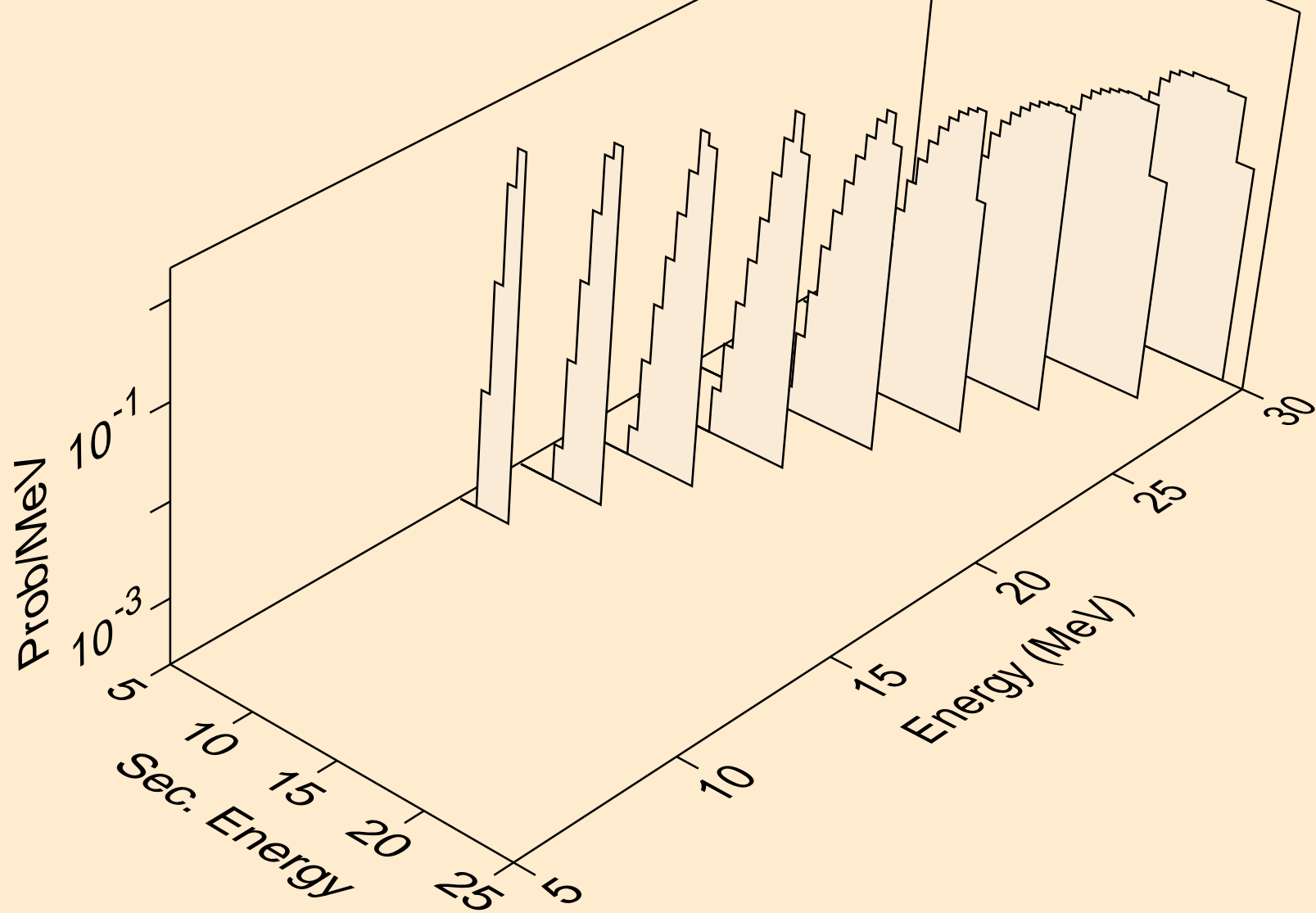

PR155 ALPHA ACER TENDL-2021 LIBRARY; T=0.K
Alpha emission for (a,2n)a

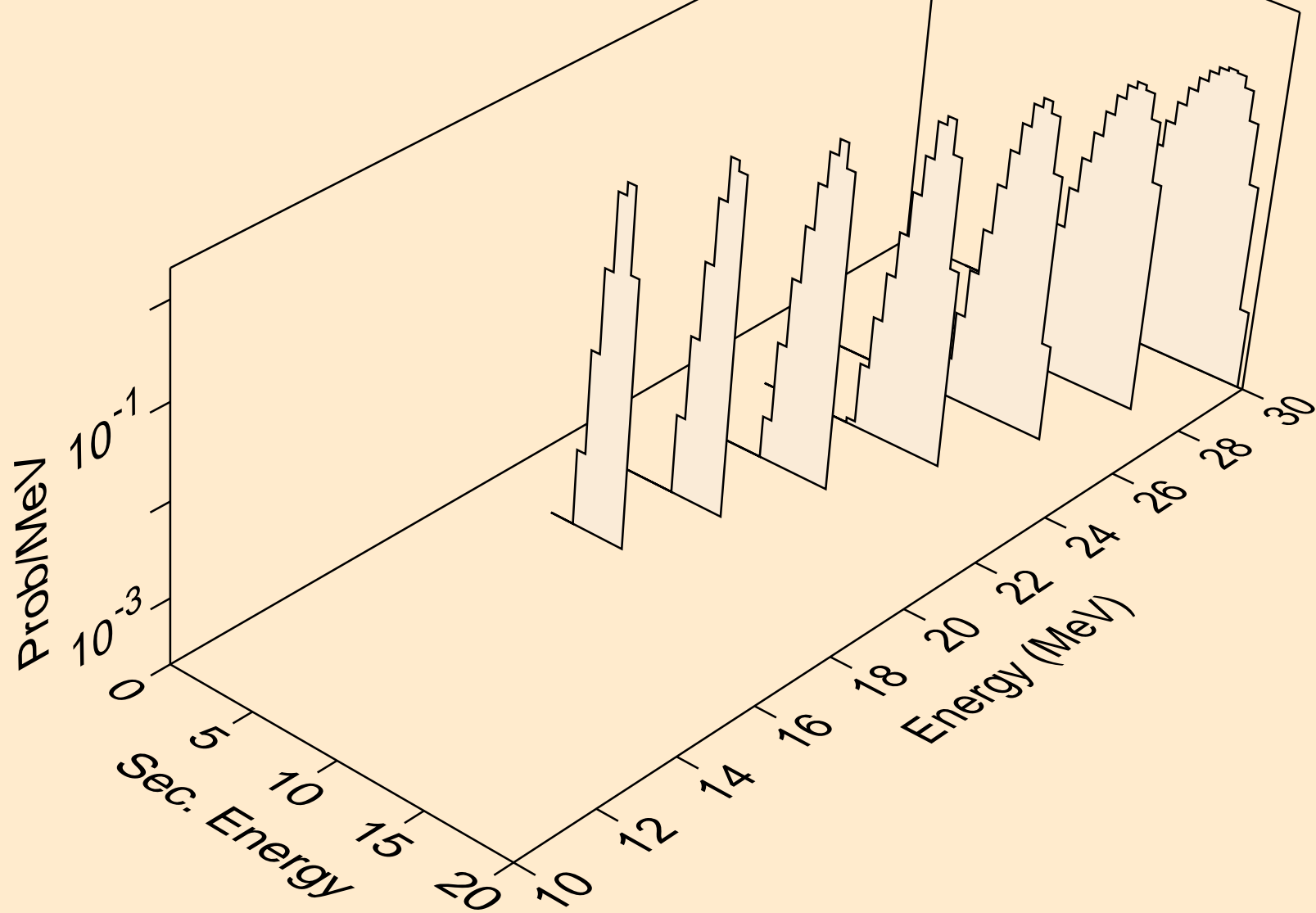

PR155 ALPHA ACER TENDL-2021 LIBRARY; T=0.K
Alpha emission for (a,3n)a

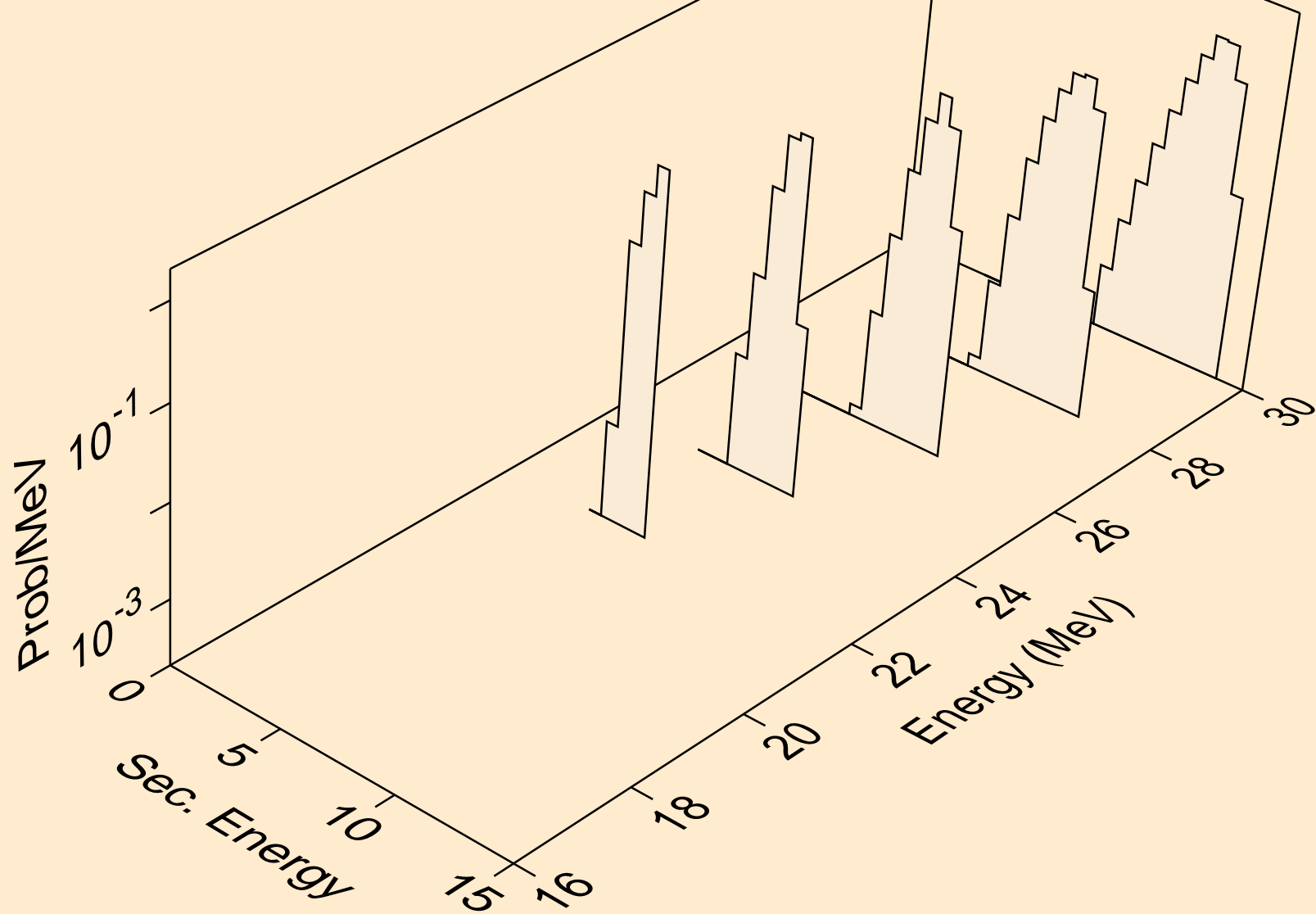

PR155 ALPHA ACER TENDL-2021 LIBRARY; T=0.K
Alpha emission for inelastic

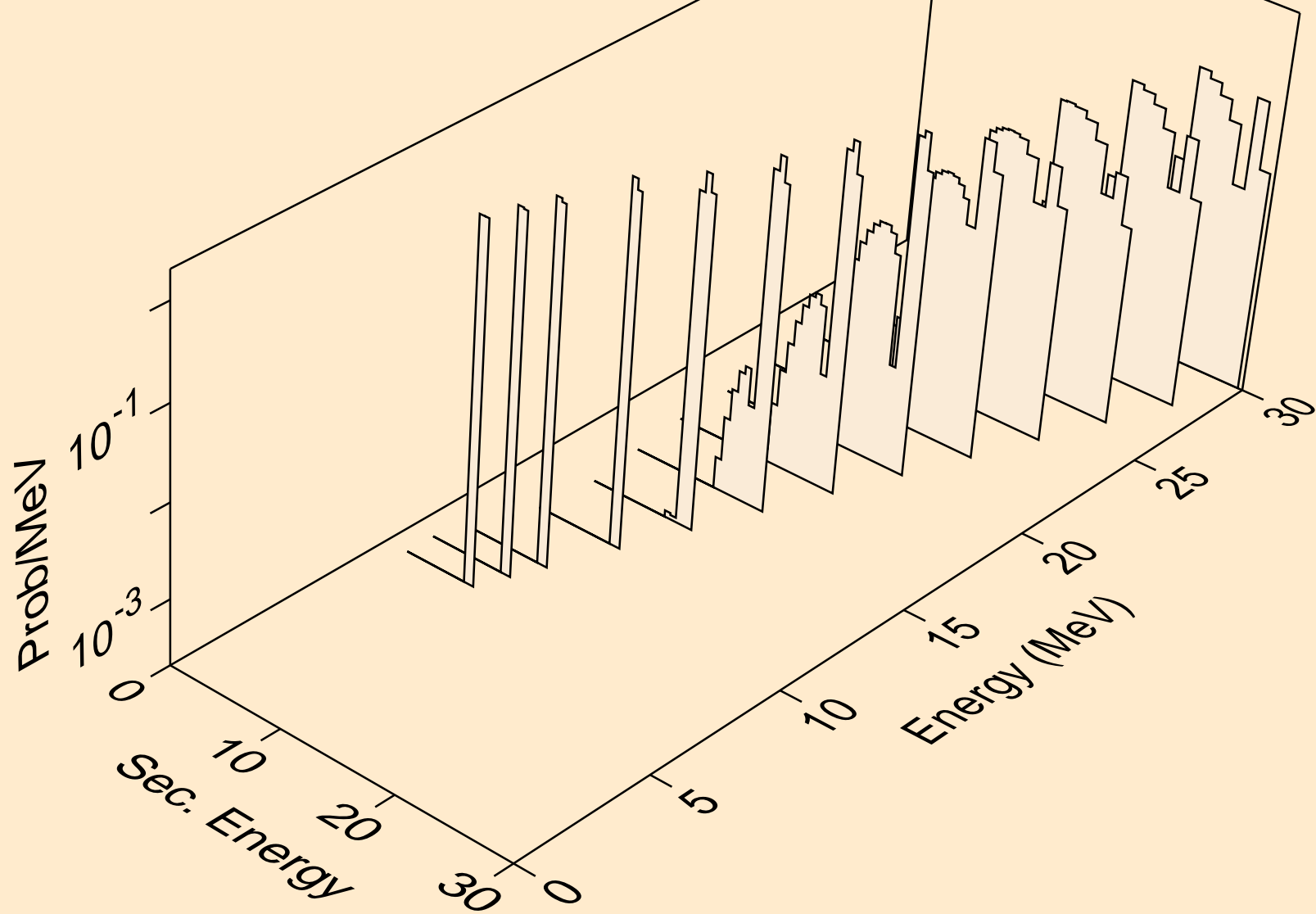

PR155 ALPHA ACER TENDL-2021 LIBRARY; T=0.K
Photon emission for (z,n)

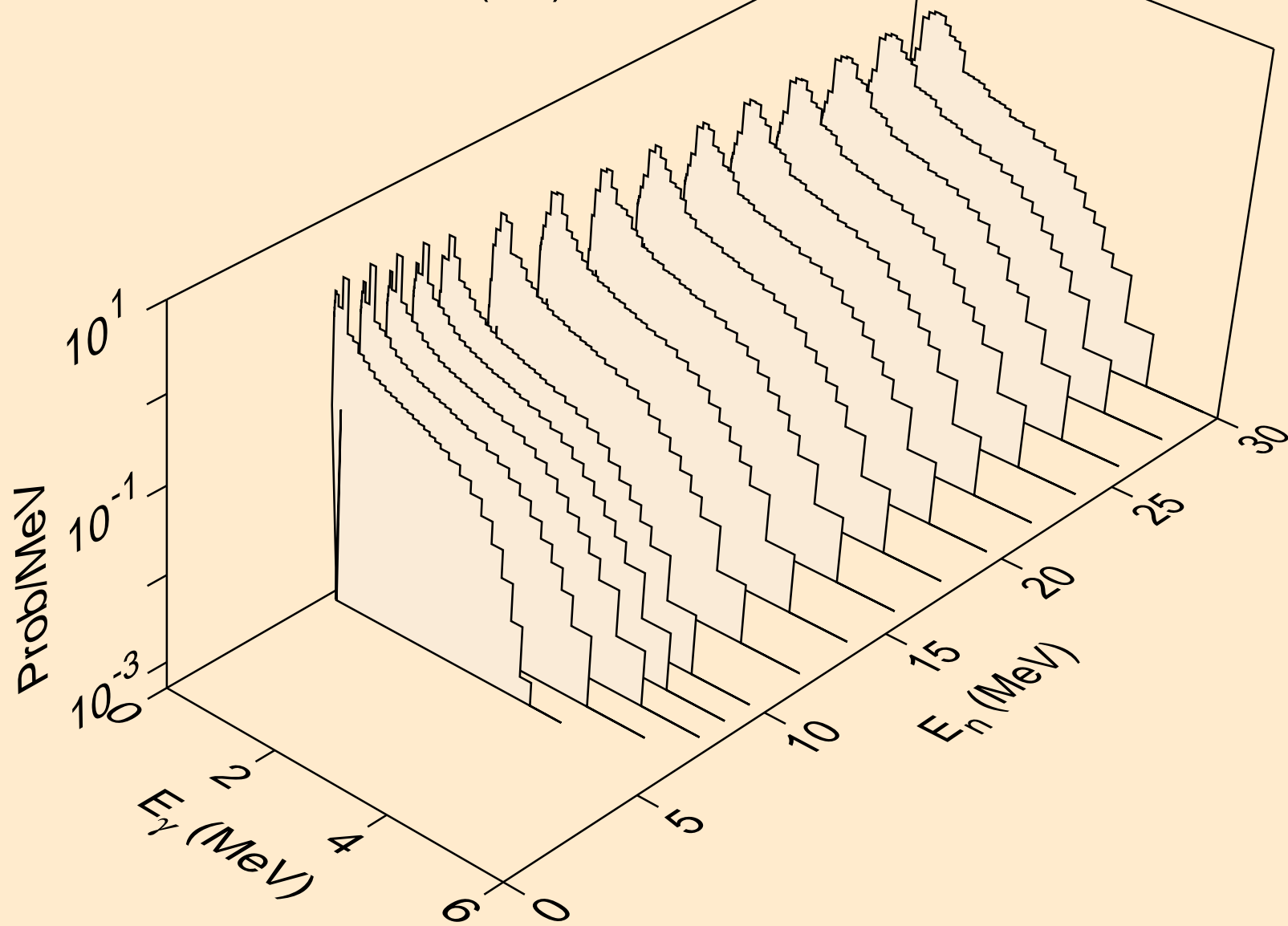

PR155 ALPHA ACER TENDL-2021 LIBRARY; T=0.K
Photon emission for (n,x)

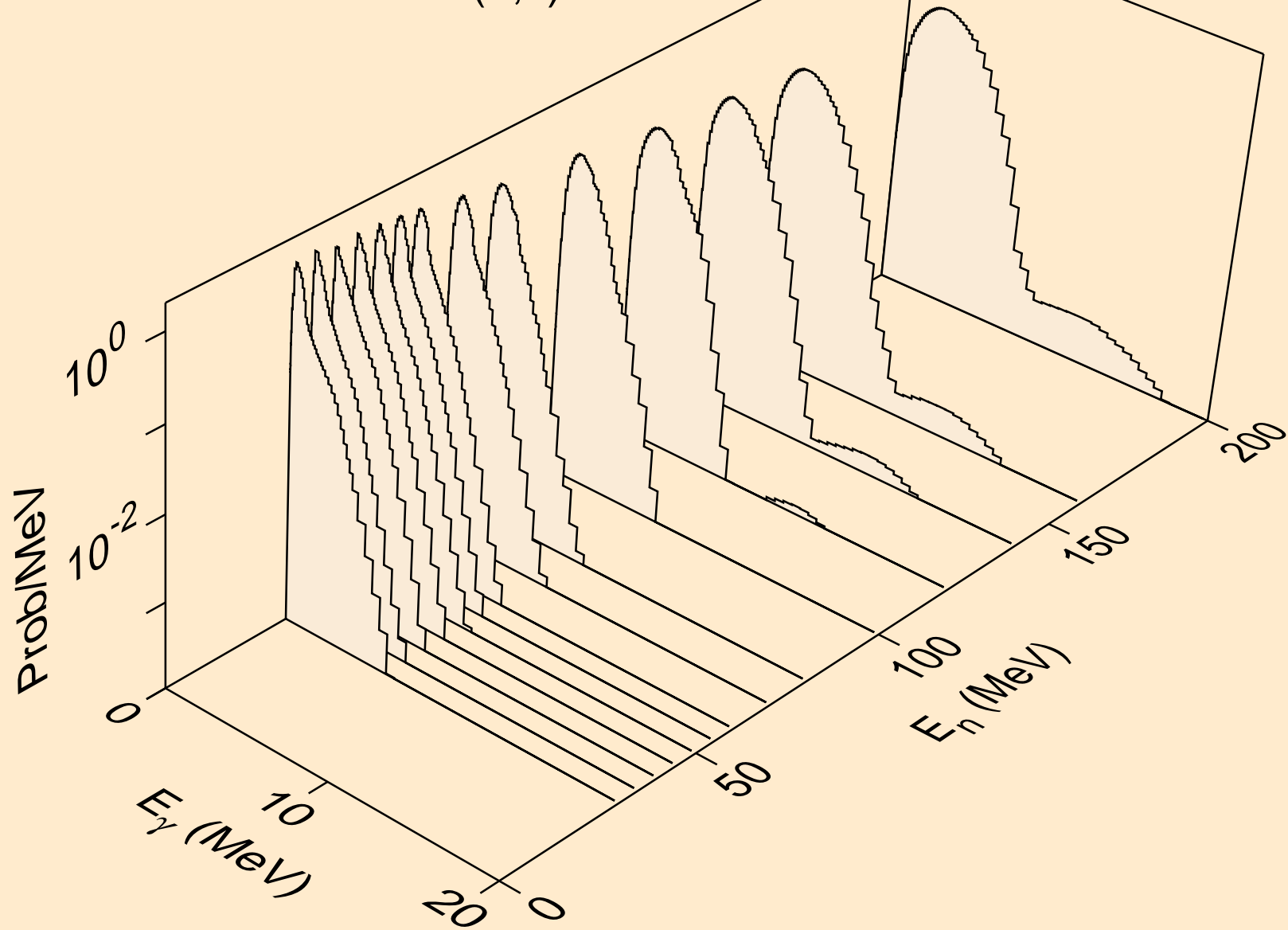

PR155 ALPHA ACER TENDL-2021 LIBRARY; T=0.K
Photon emission for (n,2nd)

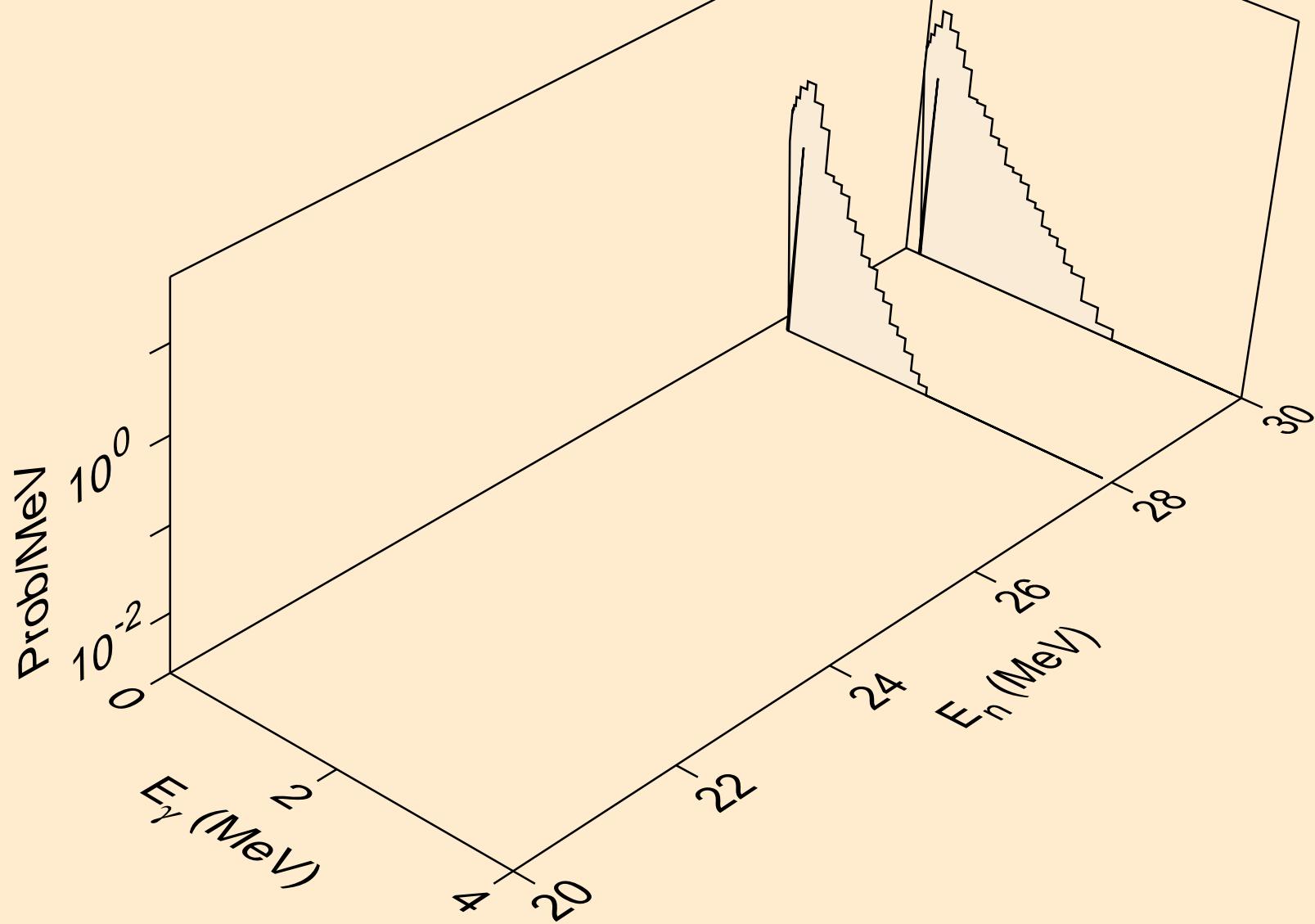

PR155 ALPHA ACER TENDL-2021 LIBRARY; T=0.K
Photon emission for (n,2n)

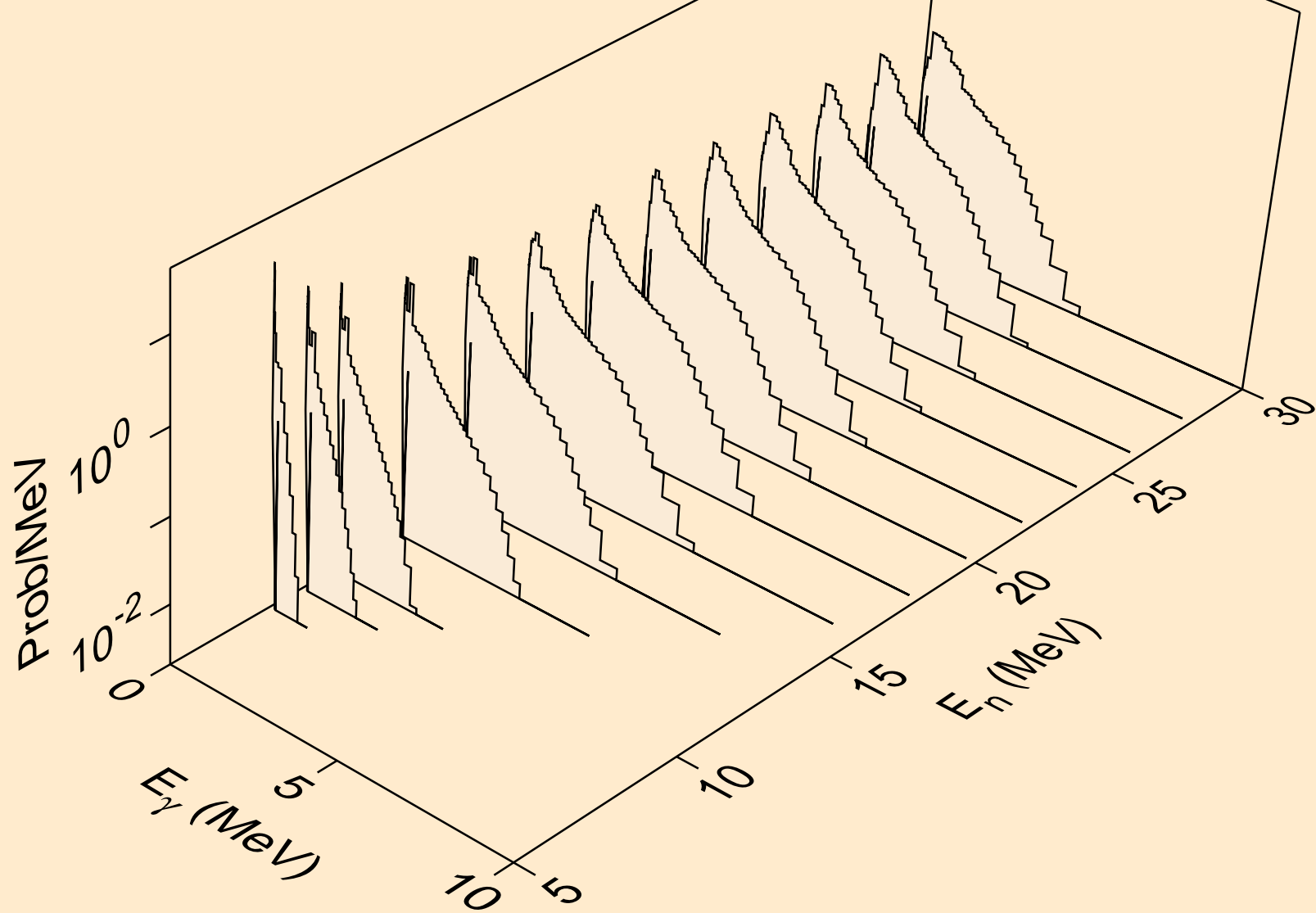

PR155 ALPHA ACER TENDL-2021 LIBRARY; T=0.K
Photon emission for (n,3n)

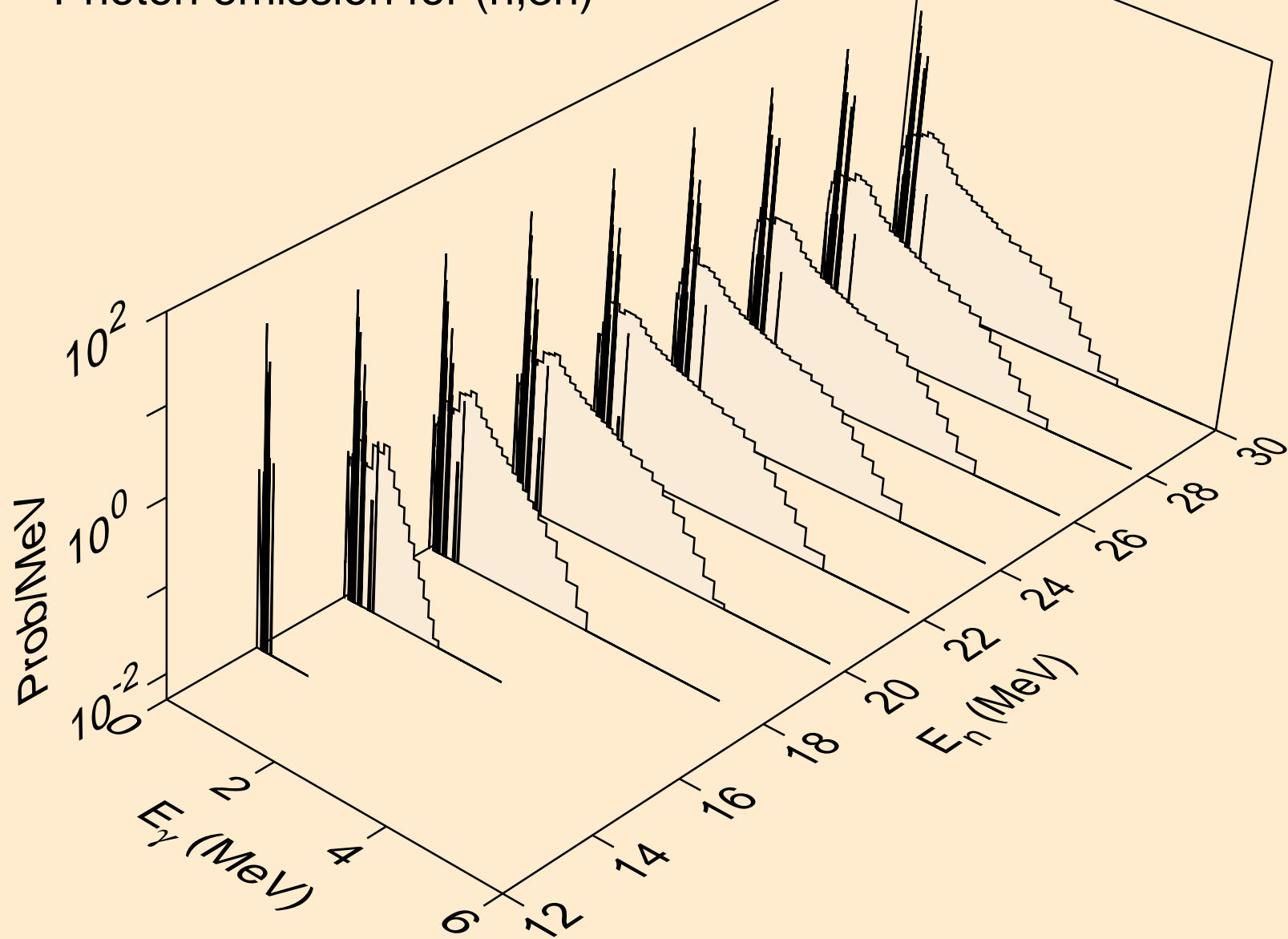

PR155 ALPHA ACER TENDL-2021 LIBRARY; T=0.K
Photon emission for (n,n*)a

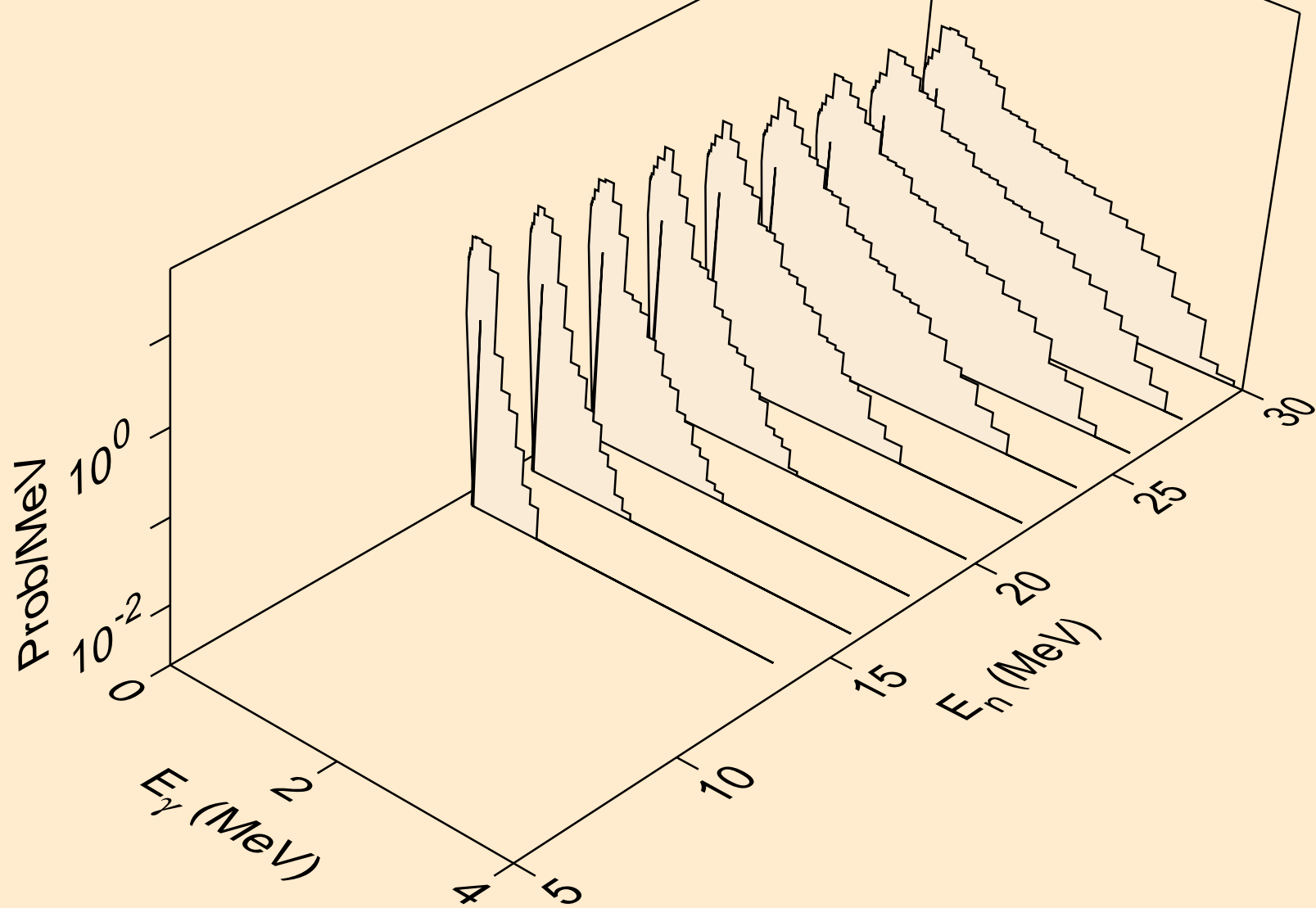

PR155 ALPHA ACER TENDL-2021 LIBRARY; T=0.K
Photon emission for (n,2n)a

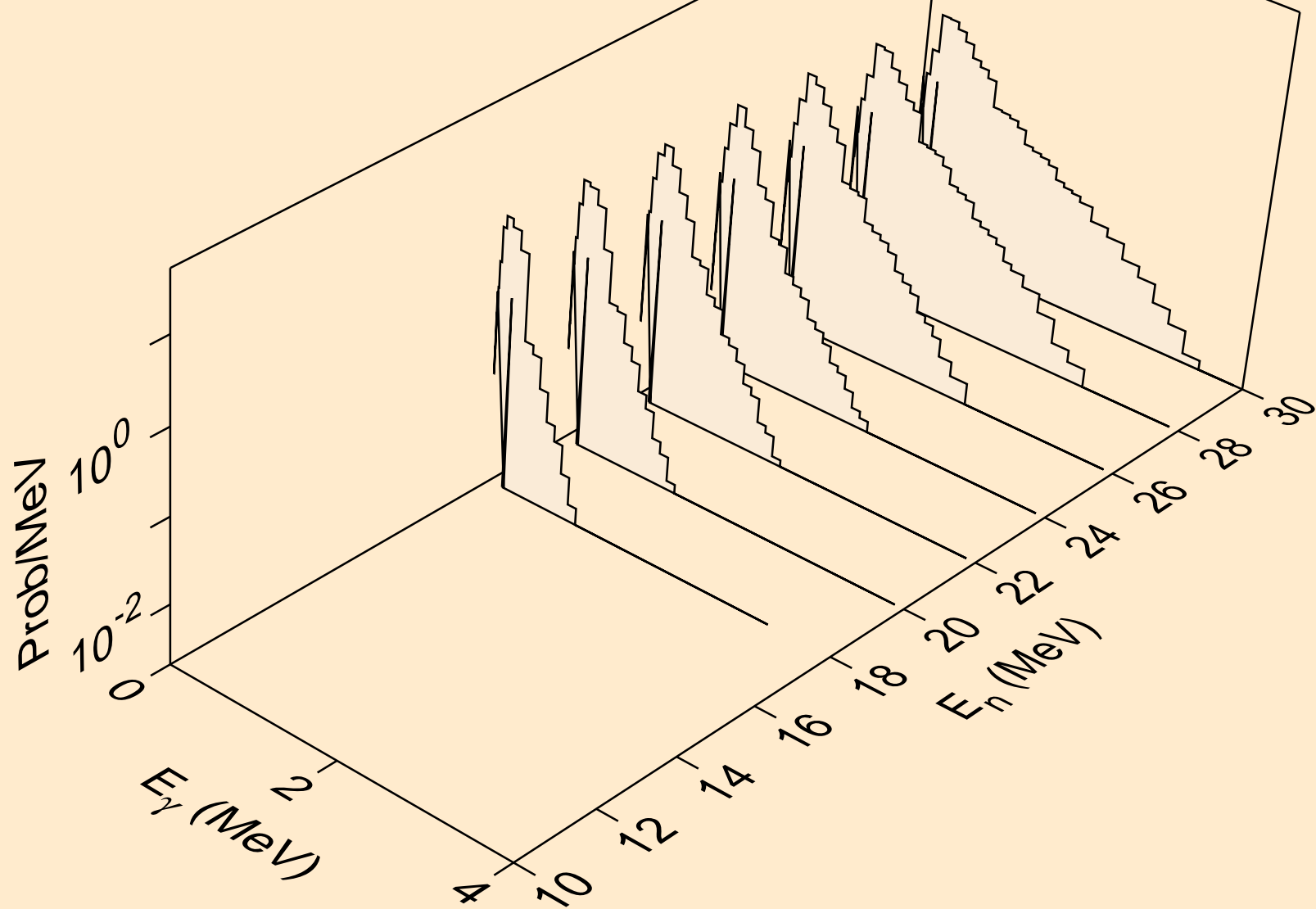

PR155 ALPHA ACER TENDL-2021 LIBRARY; T=0.K
Photon emission for (n,3n)a

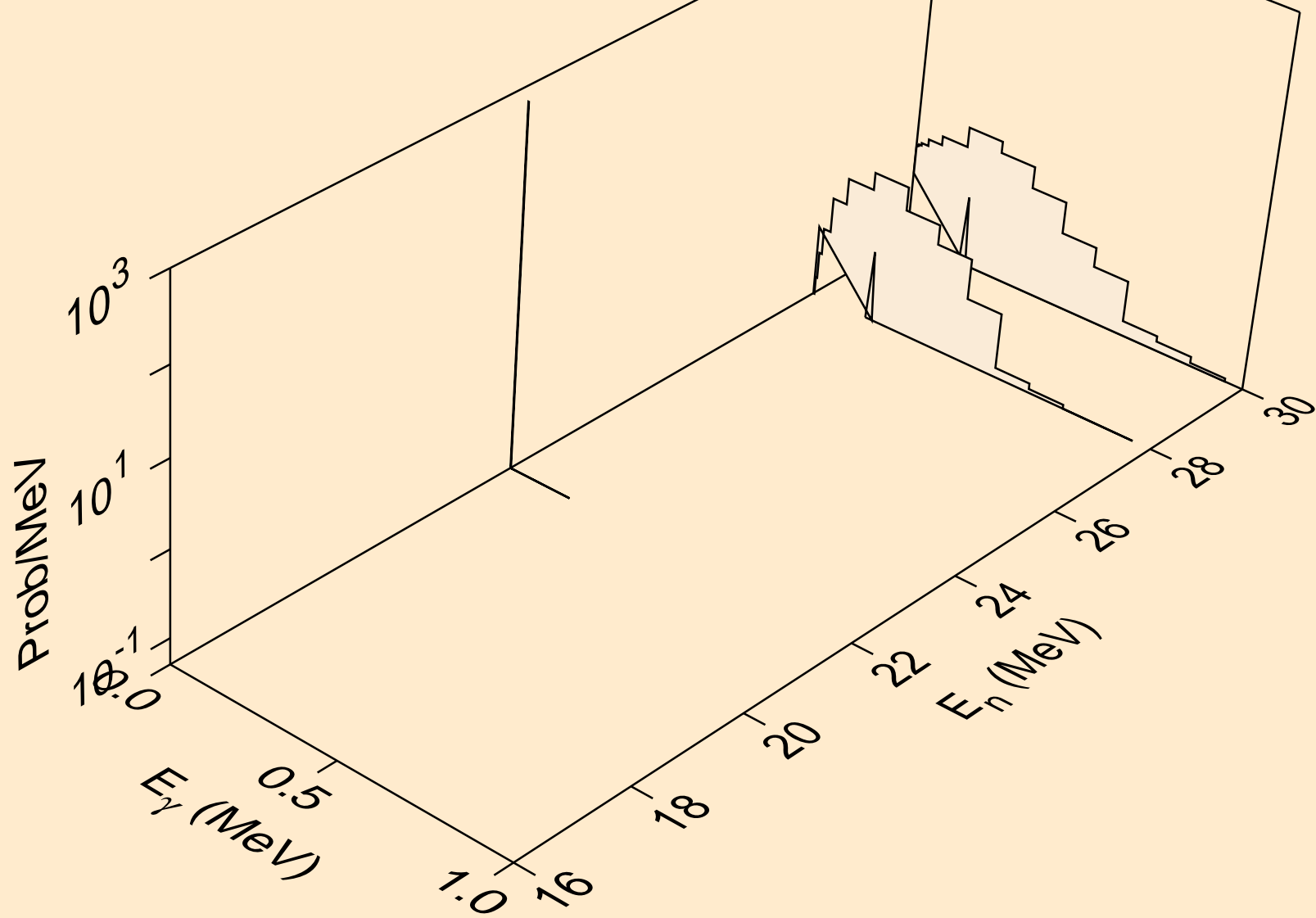

PR155 ALPHA ACER TENDL-2021 LIBRARY; T=0.K
Photon emission for (n,n*)p

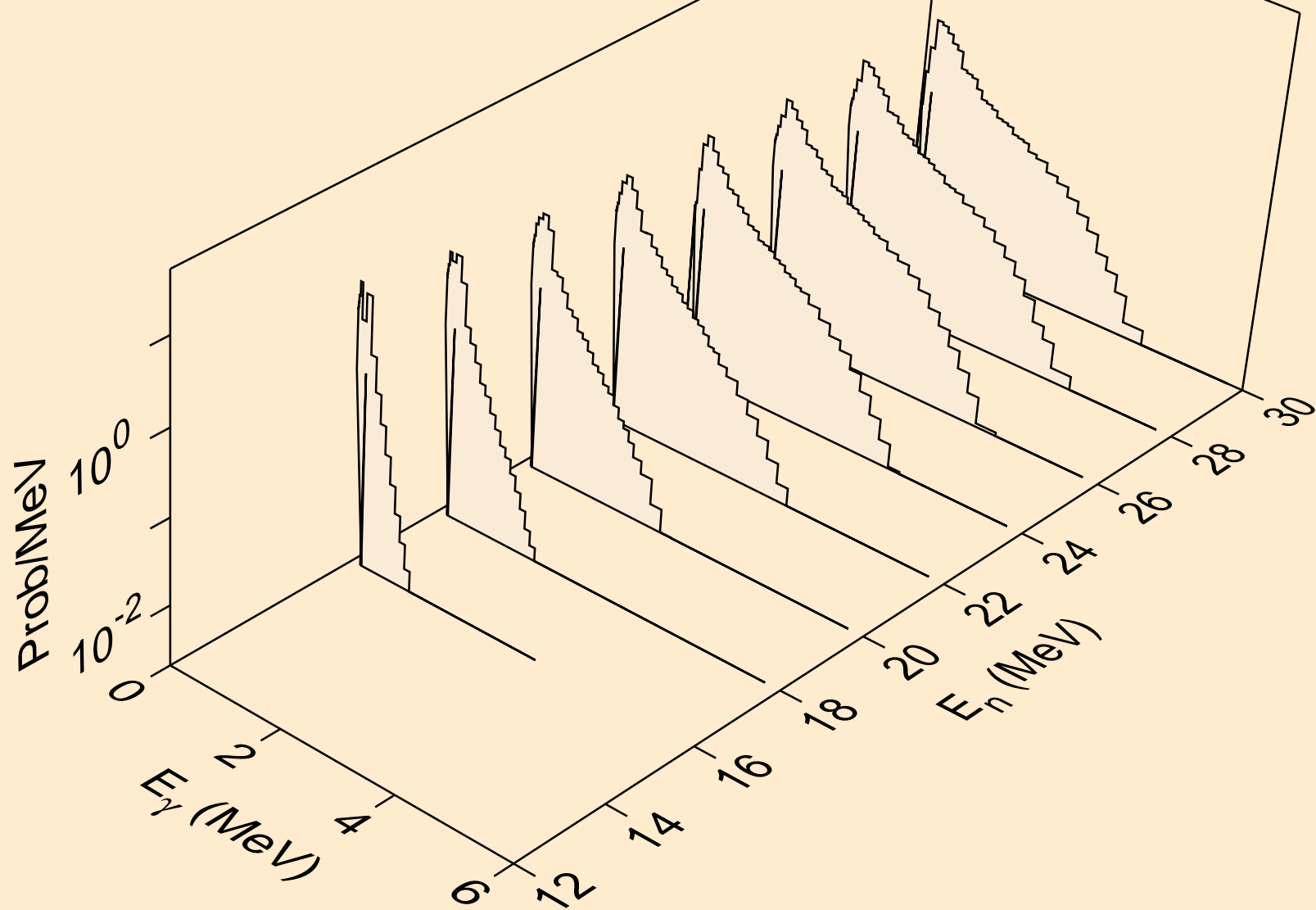

PR155 ALPHA ACER TENDL-2021 LIBRARY; T=0.K
Photon emission for (n,n*)d

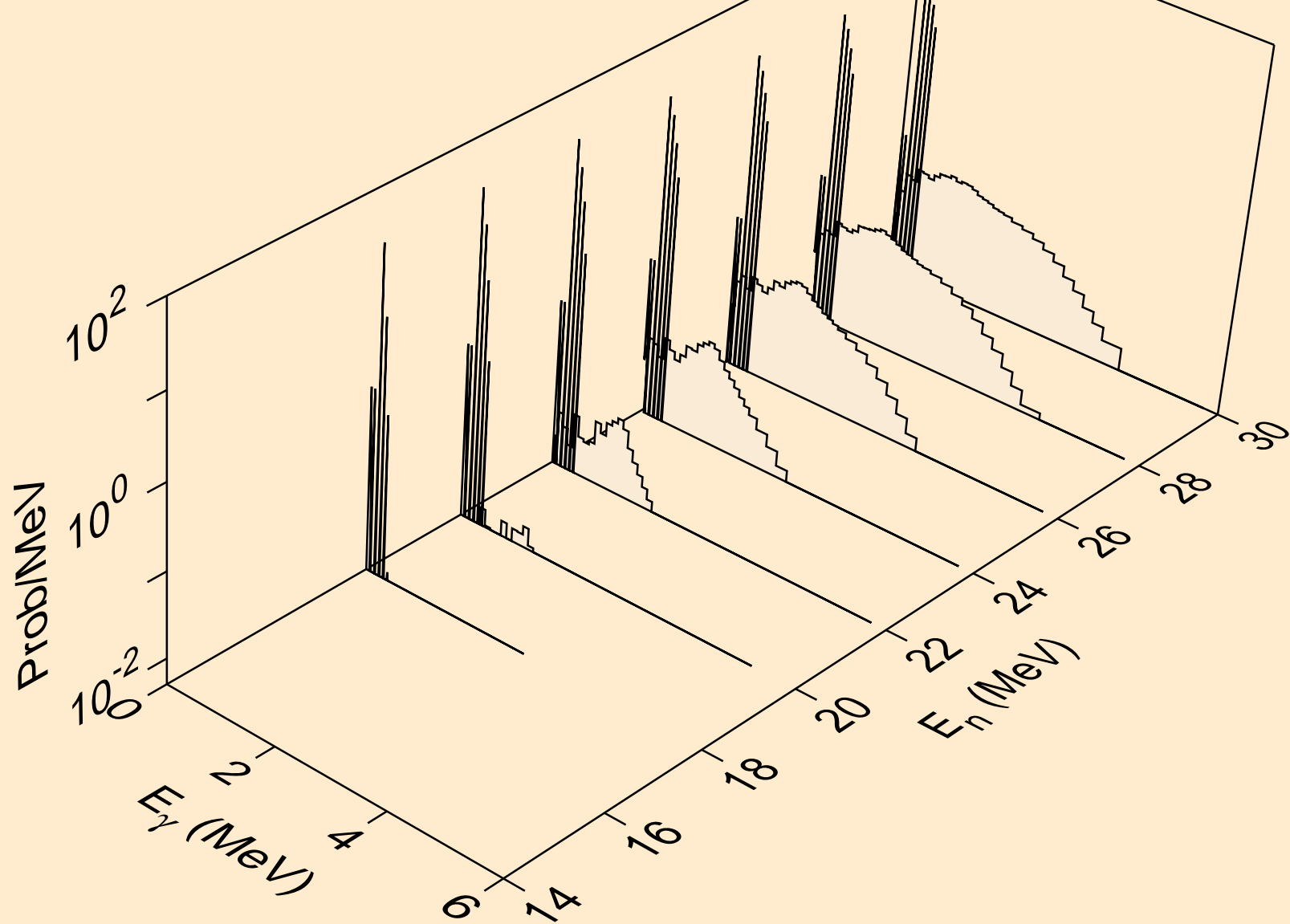

PR155 ALPHA ACER TENDL-2021 LIBRARY; T=0.K
Photon emission for (n,n*)t

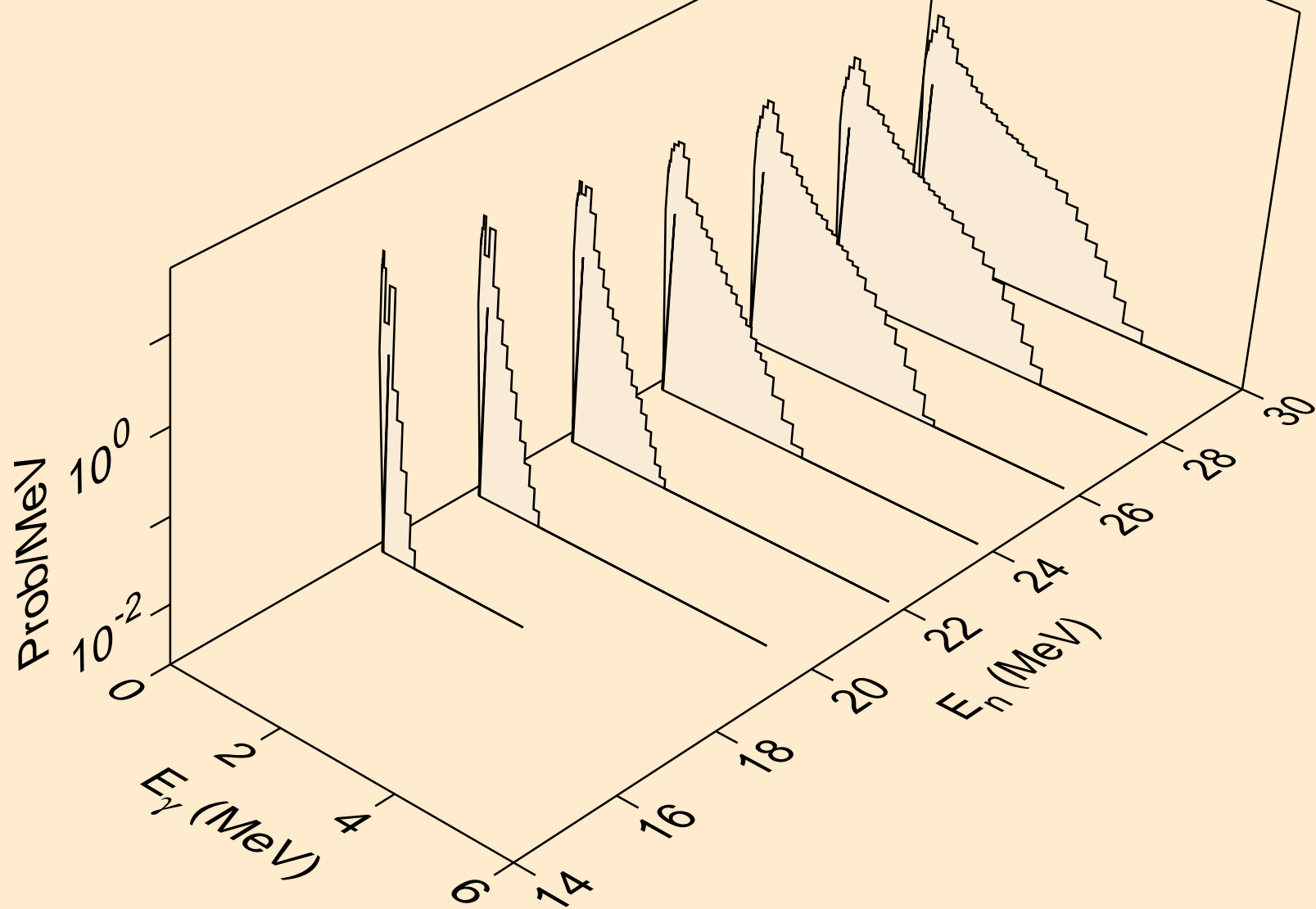

PR155 ALPHA ACER TENDL-2021 LIBRARY; T=0.K
Photon emission for (n,4n)

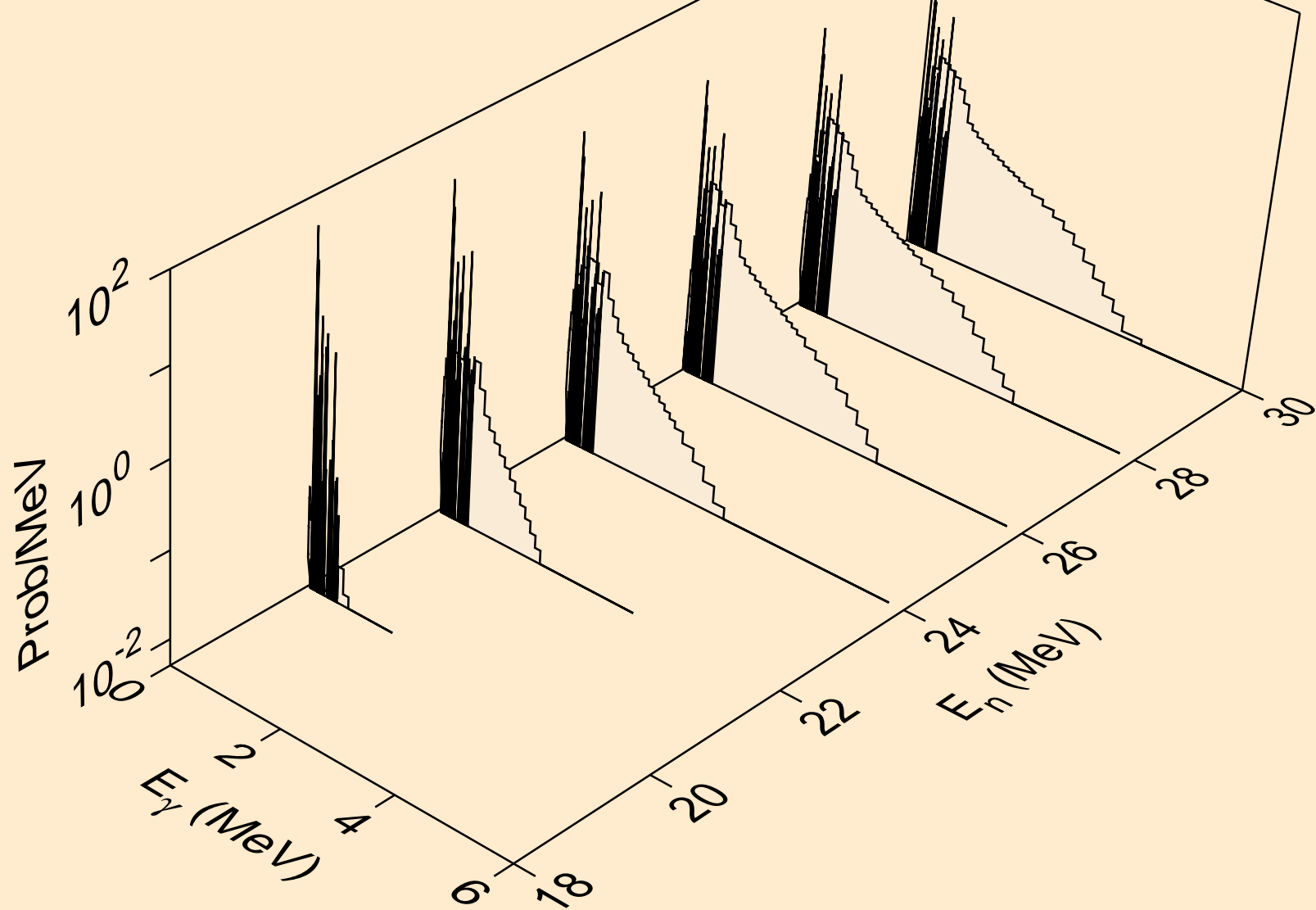

PR155 ALPHA ACER TENDL-2021 LIBRARY; T=0.K
Photon emission for (n,2np)

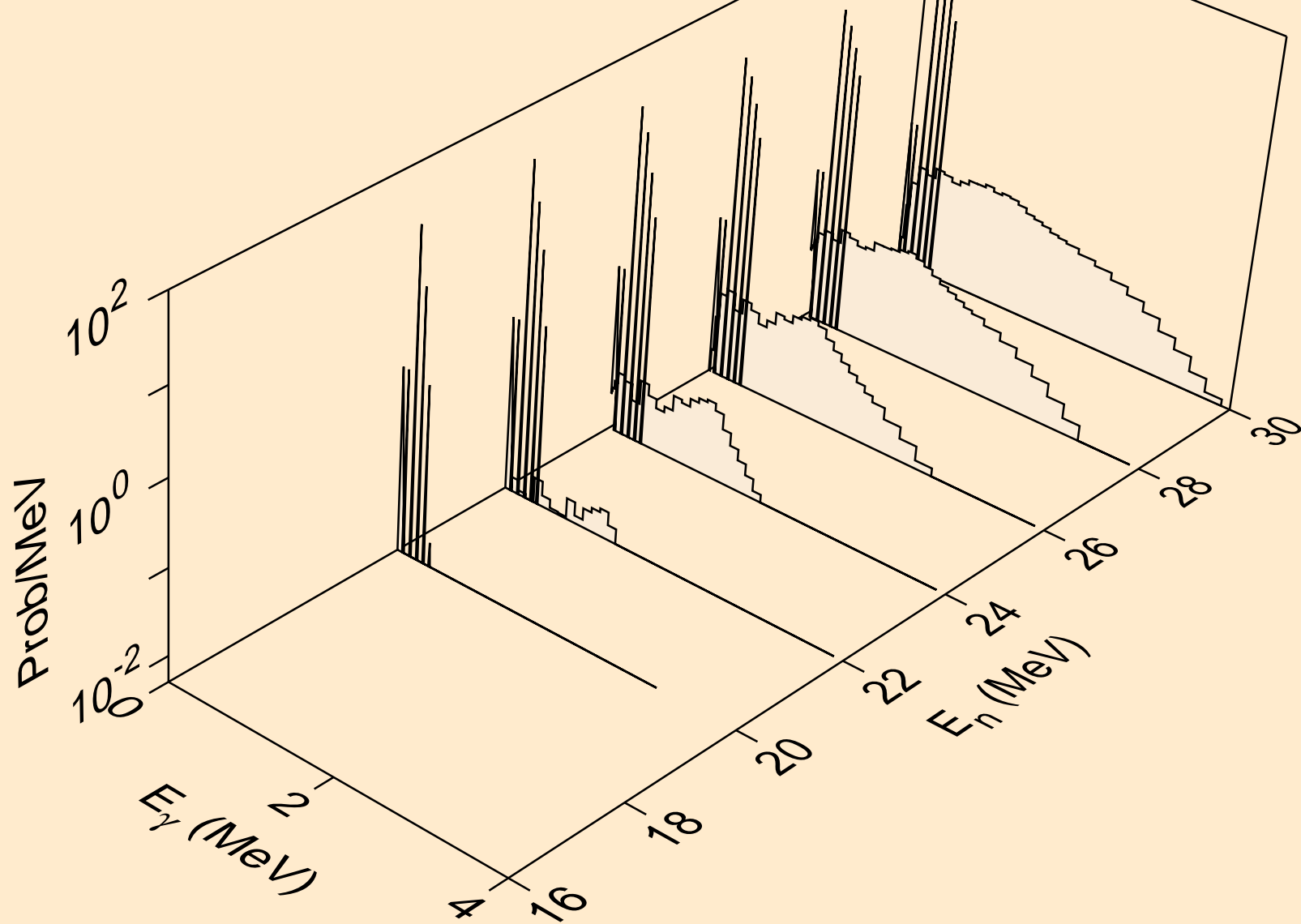

PR155 ALPHA ACER TENDL-2021 LIBRARY; T=0.K
Photon emission for (n,3np)

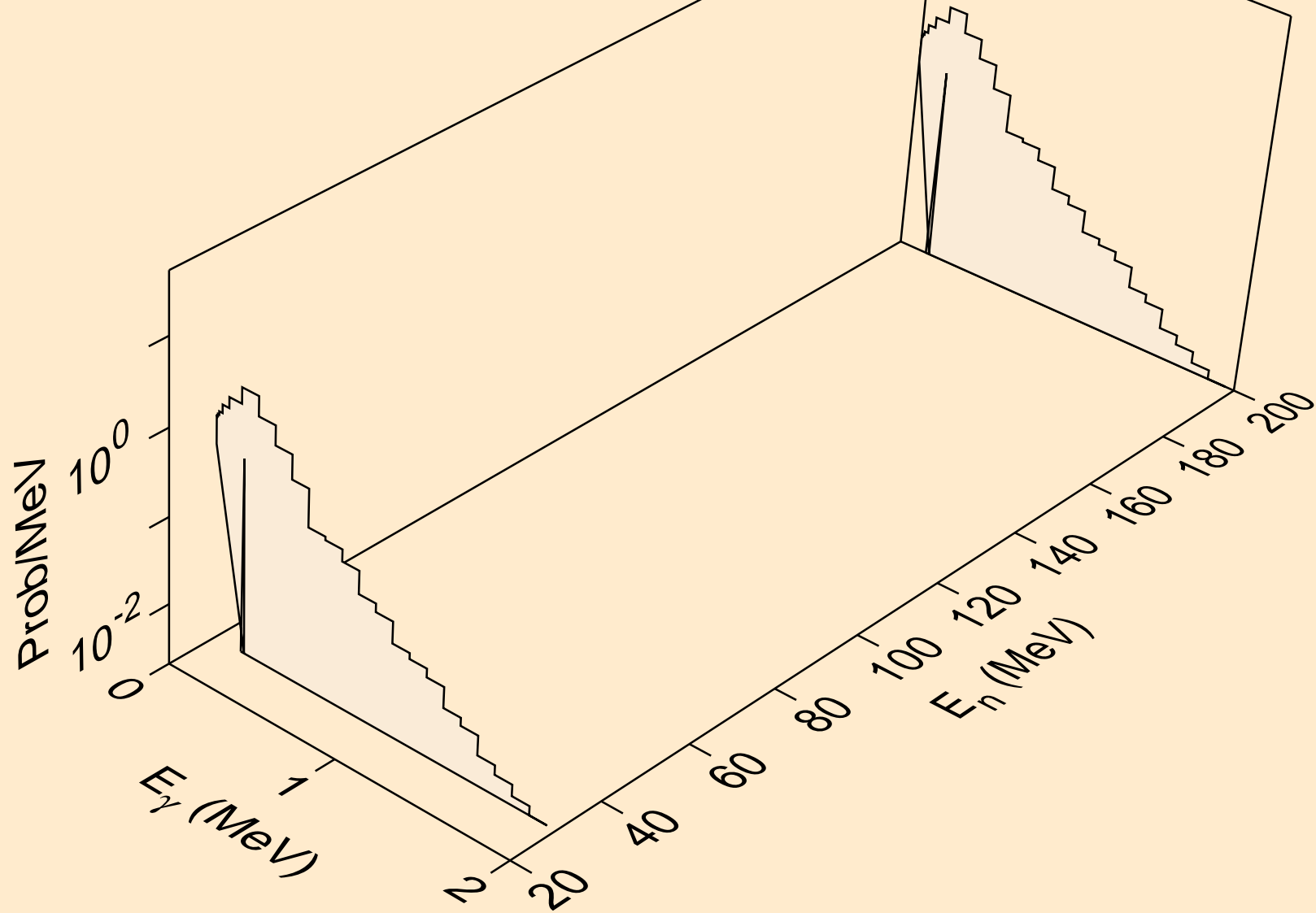

PR155 ALPHA ACER TENDL-2021 LIBRARY; T=0.K
Photon emission for (n,gma)

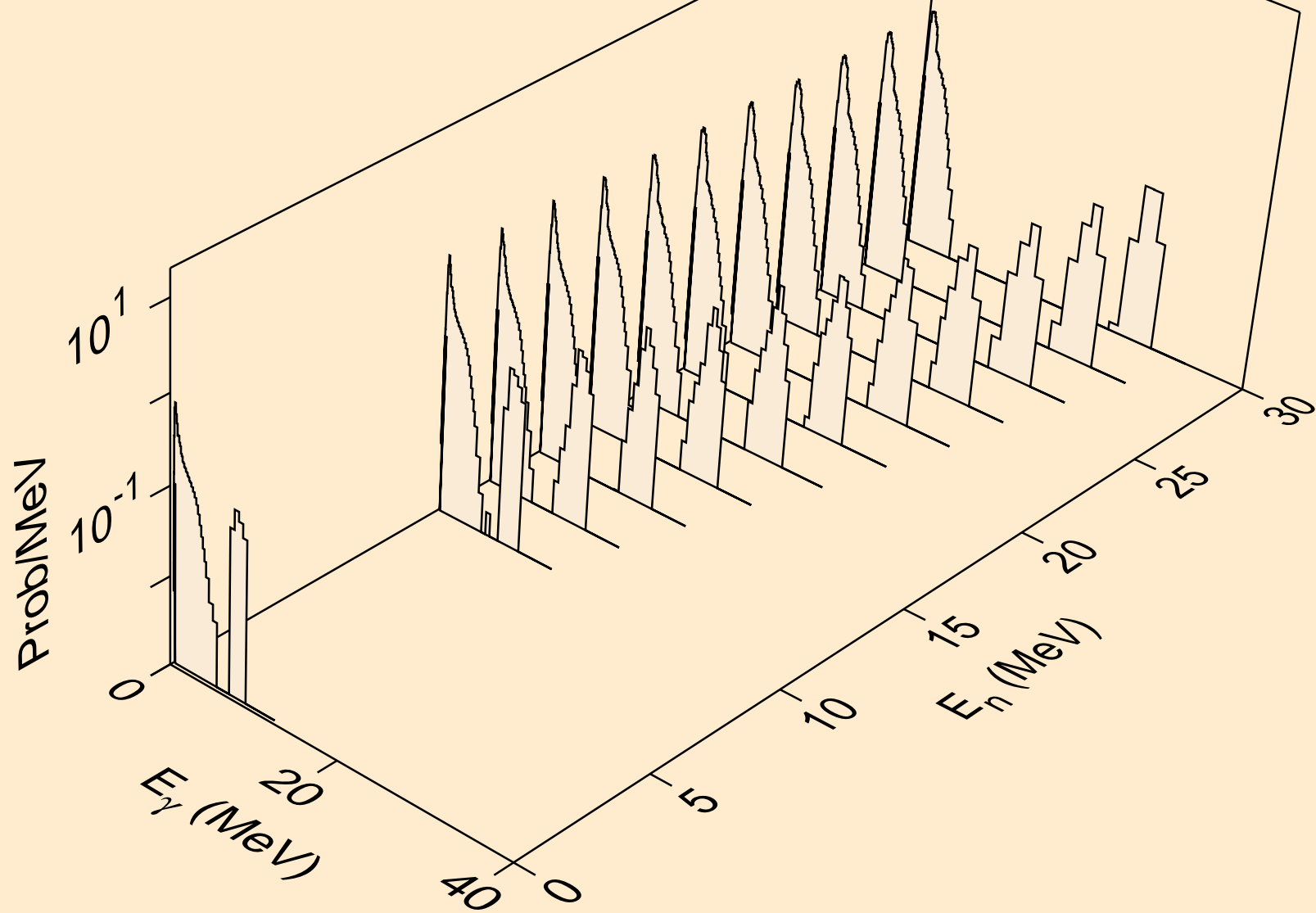

PR155 ALPHA ACER TENDL-2021 LIBRARY; T=0.K
Photon emission for (n,p)

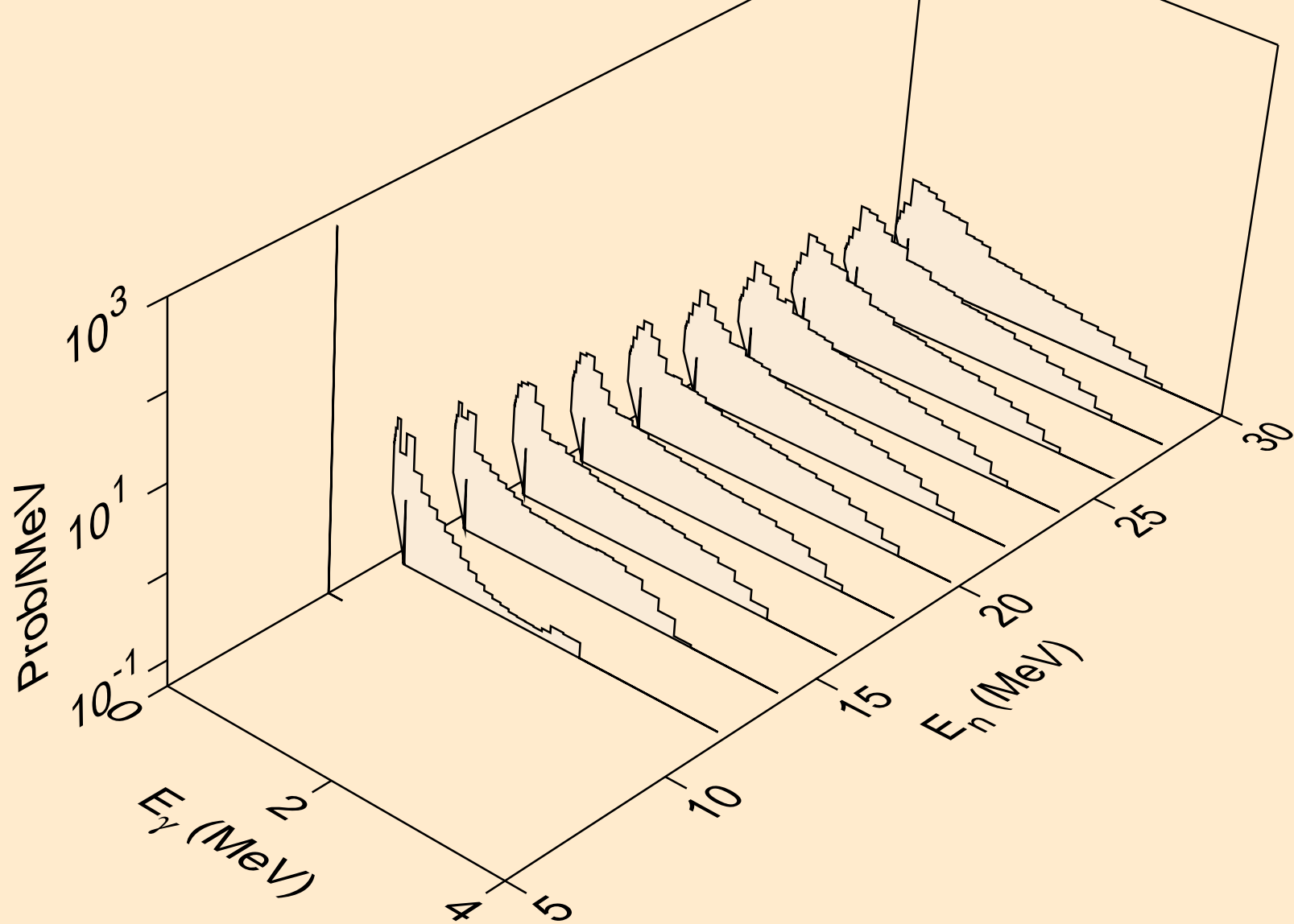

PR155 ALPHA ACER TENDL-2021 LIBRARY; T=0.K
Photon emission for (n,d)

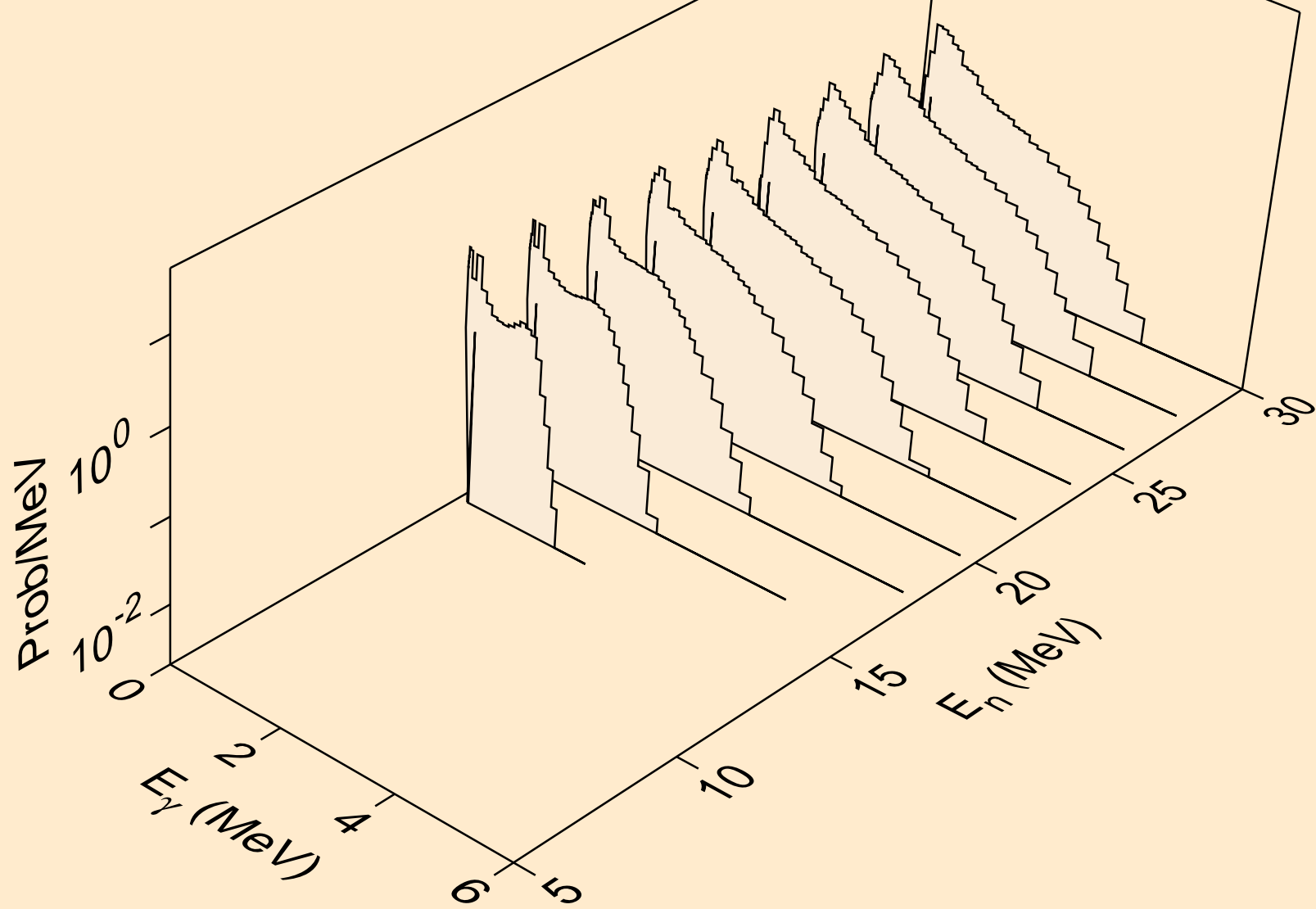

PR155 ALPHA ACER TENDL-2021 LIBRARY; T=0.K
Photon emission for (n,t)

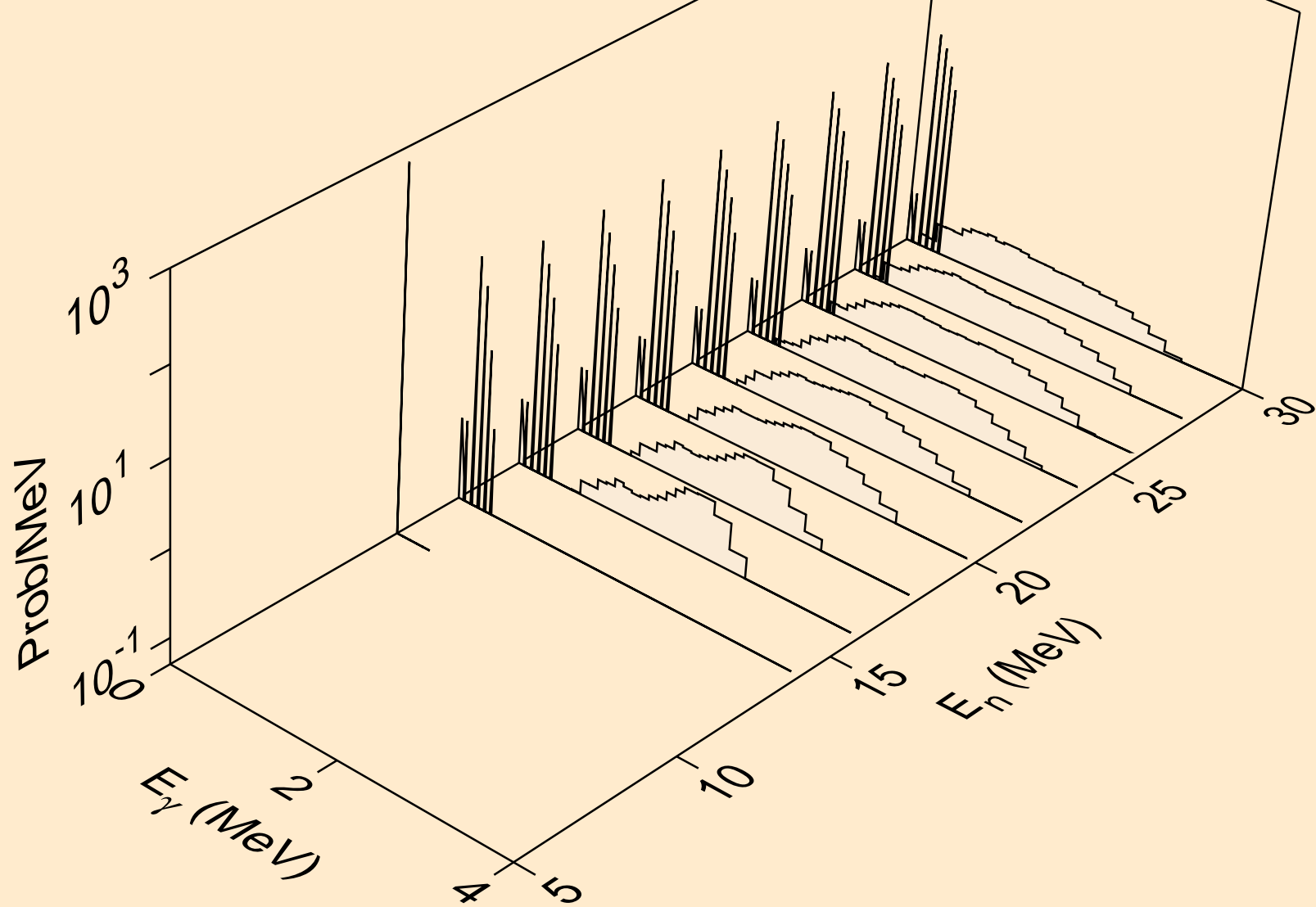

PR155 ALPHA ACER TENDL-2021 LIBRARY; T=0.K
Photon emission for (n,he3)

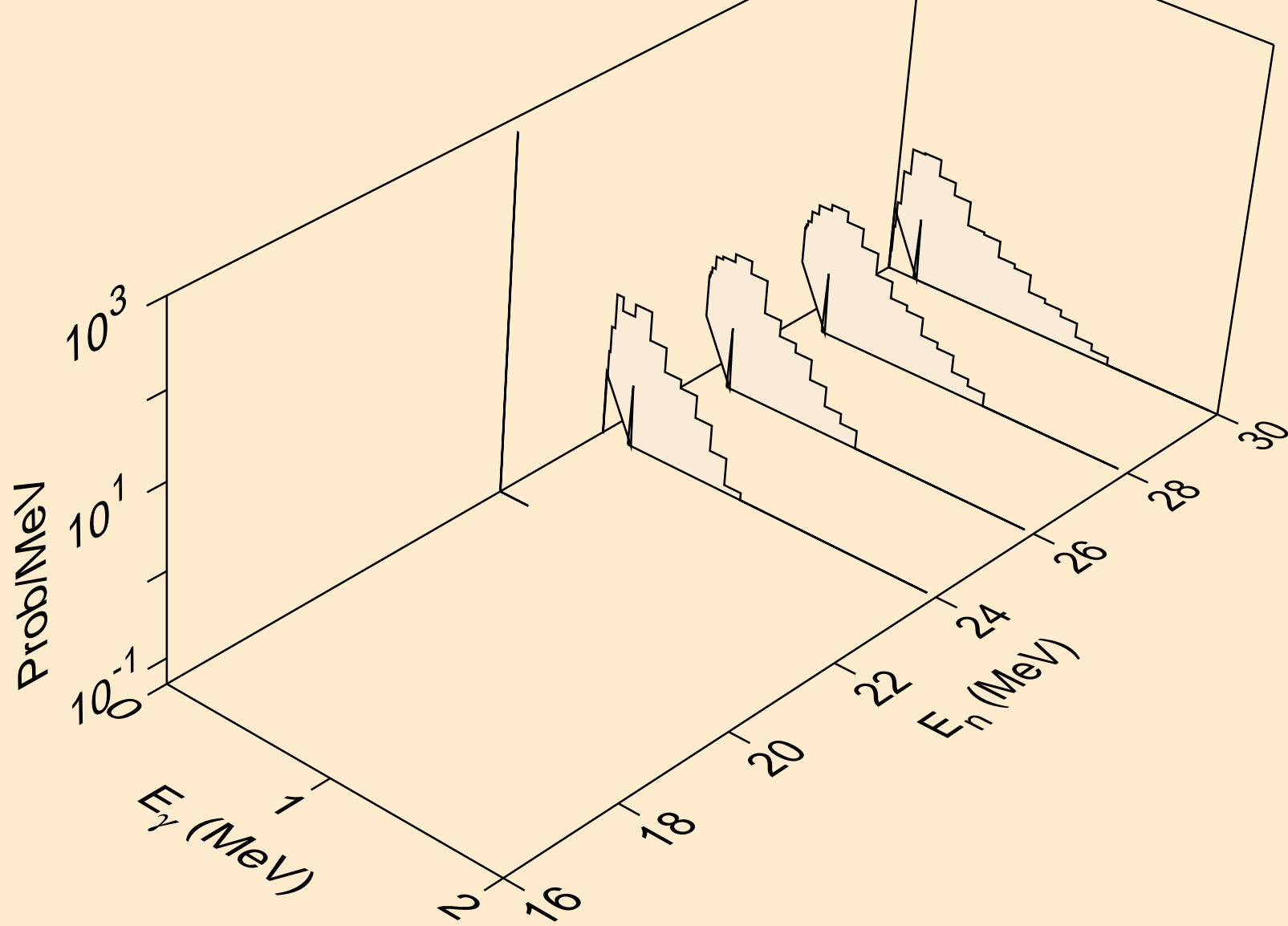

PR155 ALPHA ACER TENDL-2021 LIBRARY; T=0.K
Photon emission for inelastic

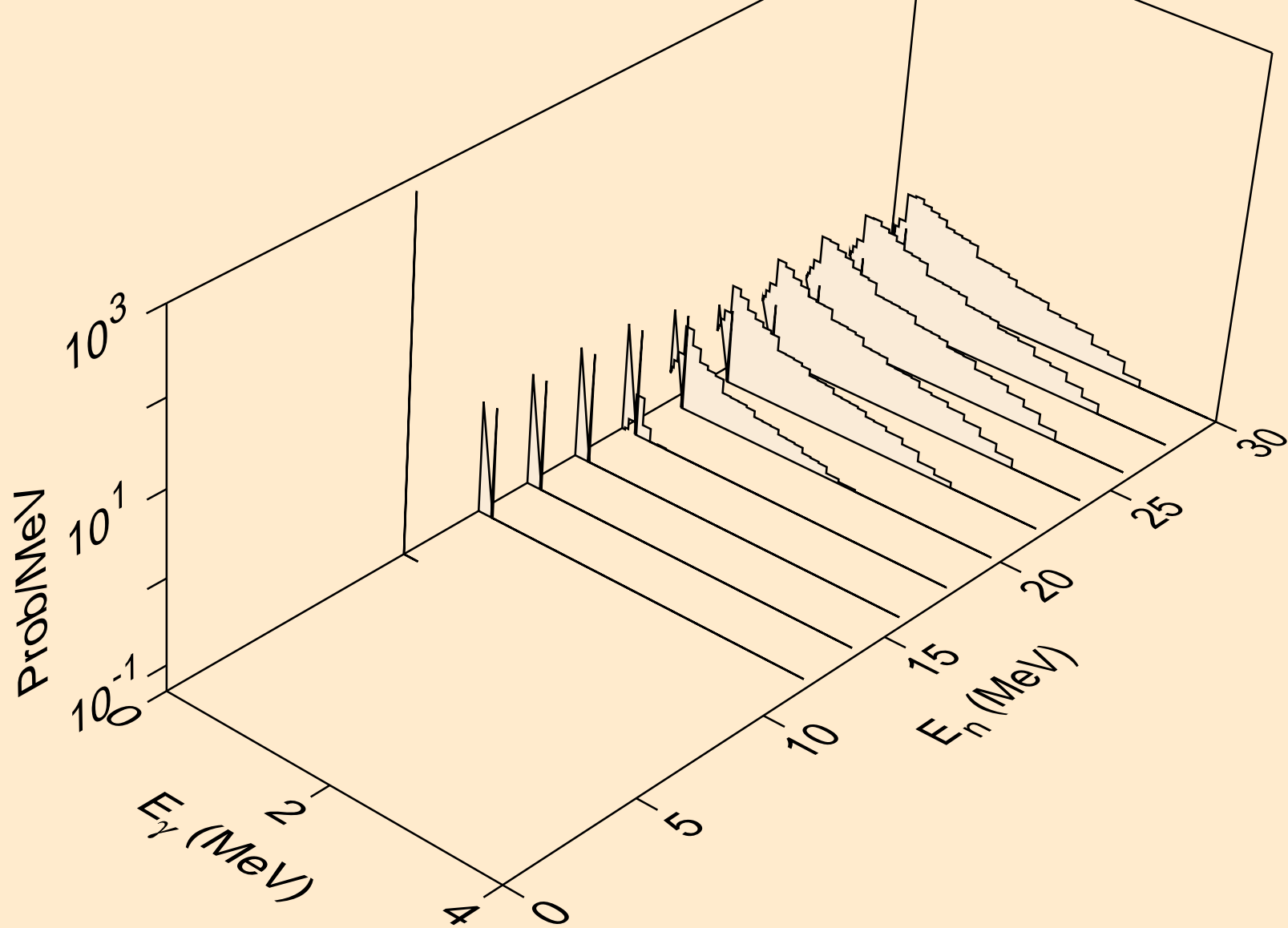

PR155 ALPHA ACER TENDL-2021 LIBRARY; T=0.K
Particle heating contributions

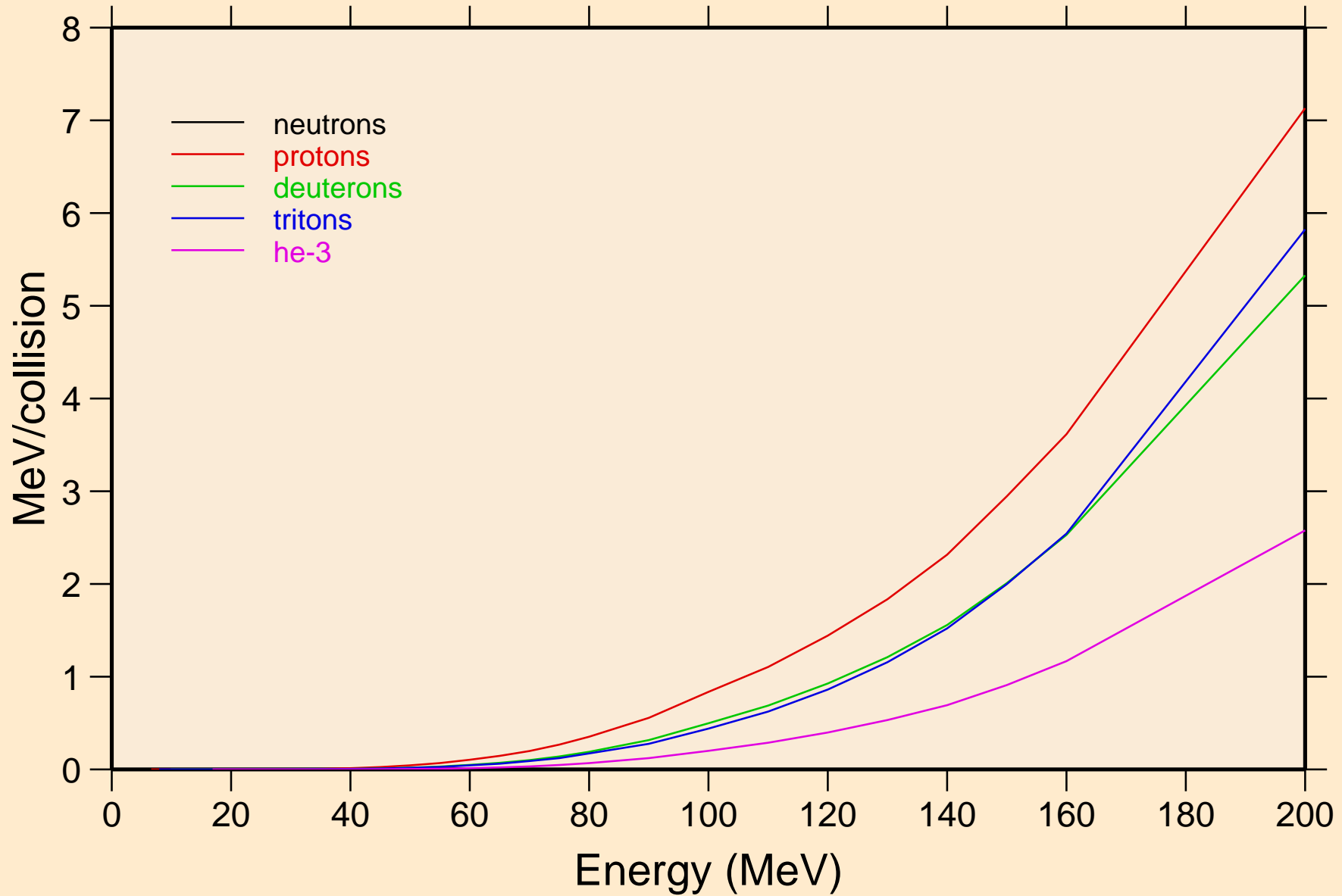

PR155 ALPHA ACER TENDL-2021 LIBRARY; T=0.K
Recoil Heating

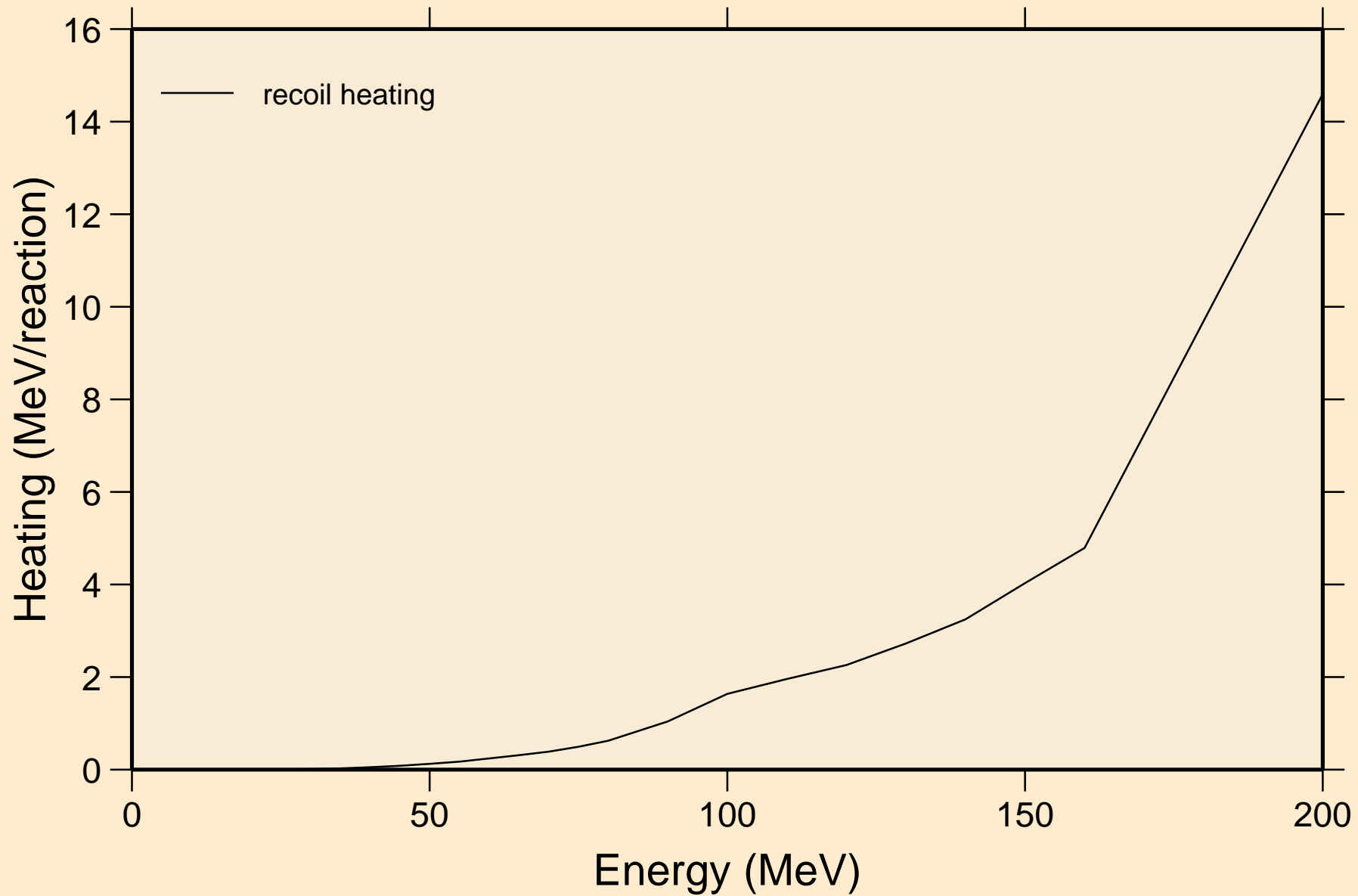

PR155 ALPHA ACER TENDL-2021 LIBRARY; T=0.K
Particle production cross sections

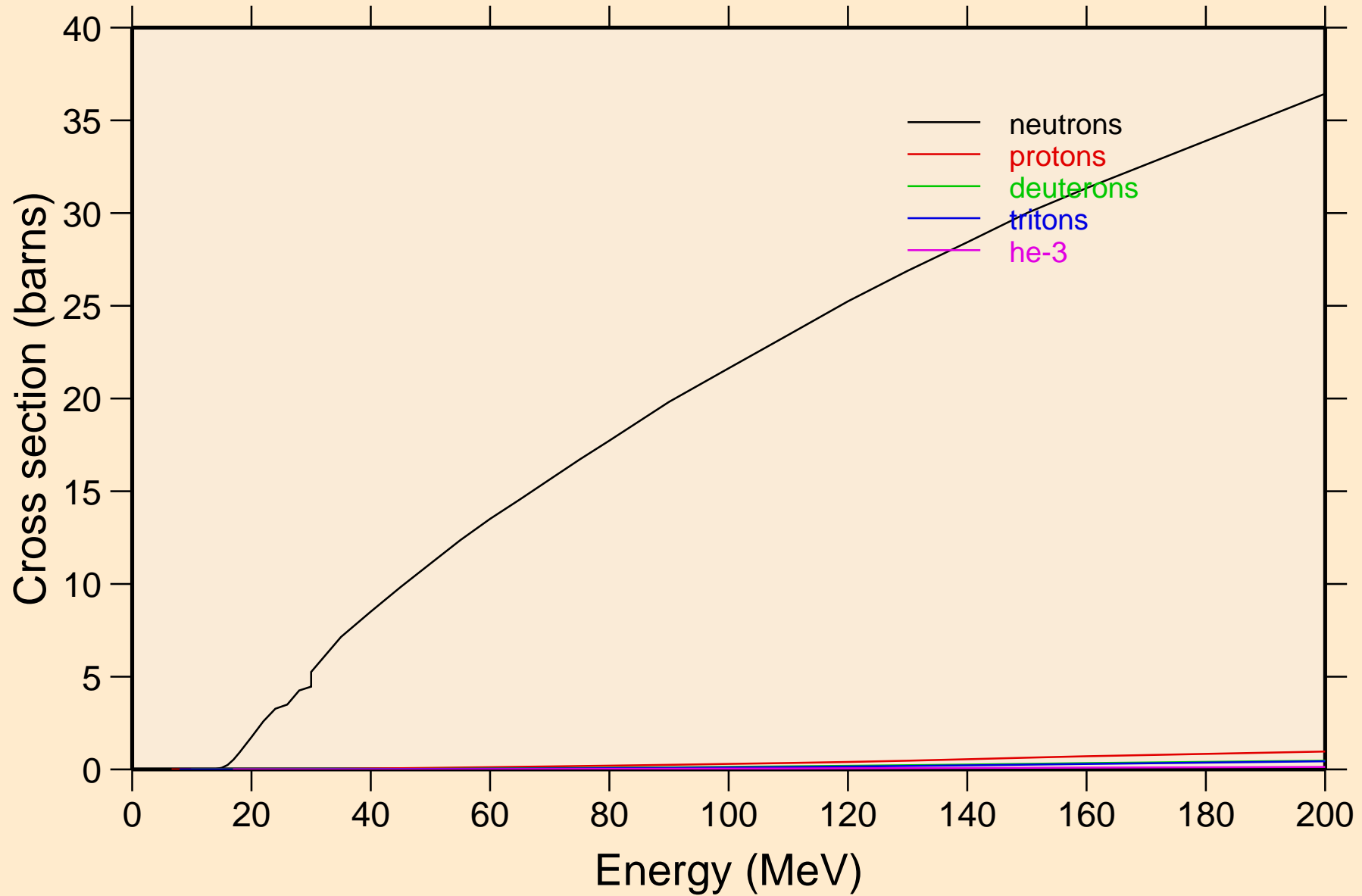

PR155 ALPHA ACER TENDL-2021 LIBRARY; T=0.K
neutrons from (a,n)

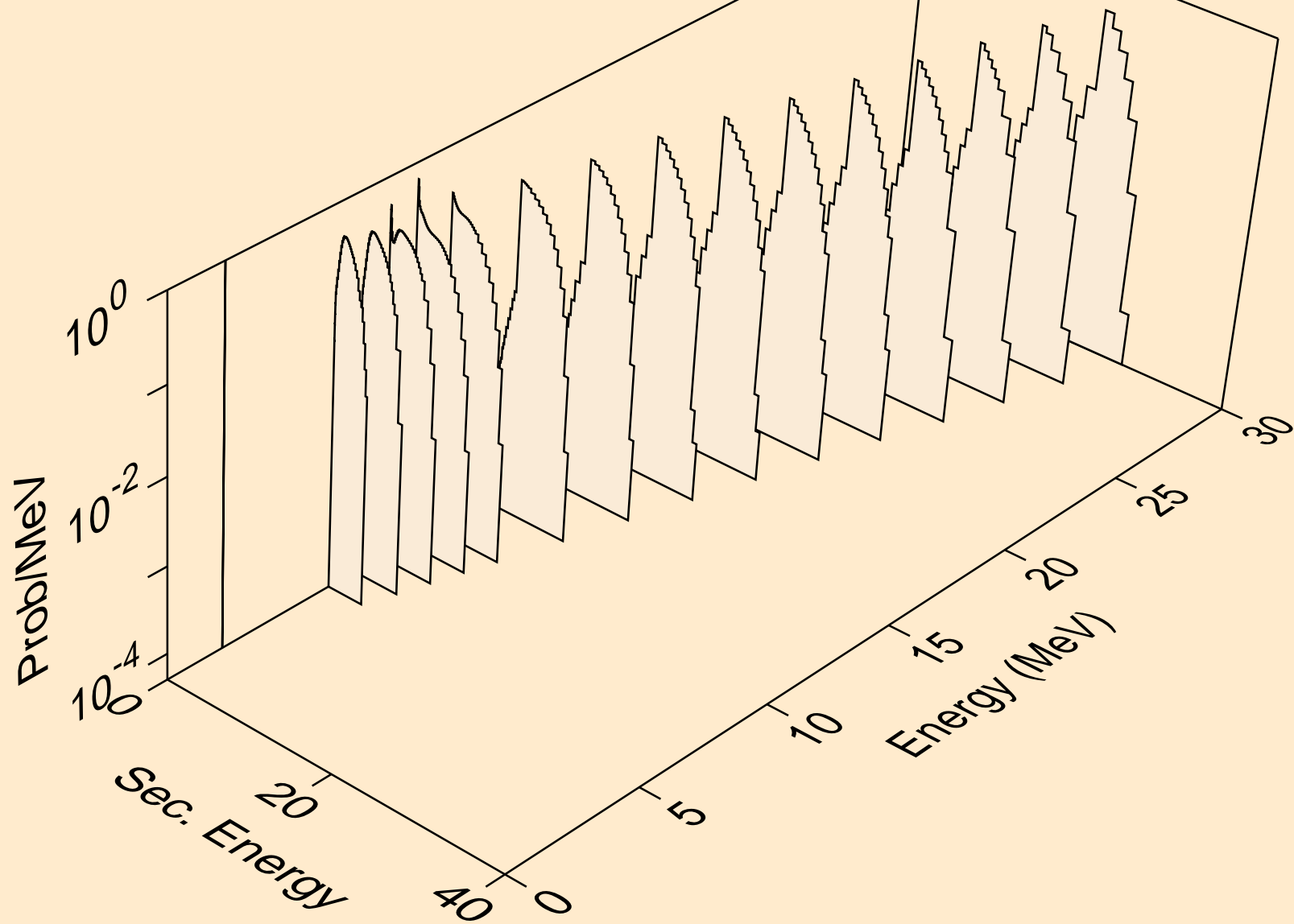

PR155 ALPHA ACER TENDL-2021 LIBRARY; T=0.K
neutrons from (a,x)

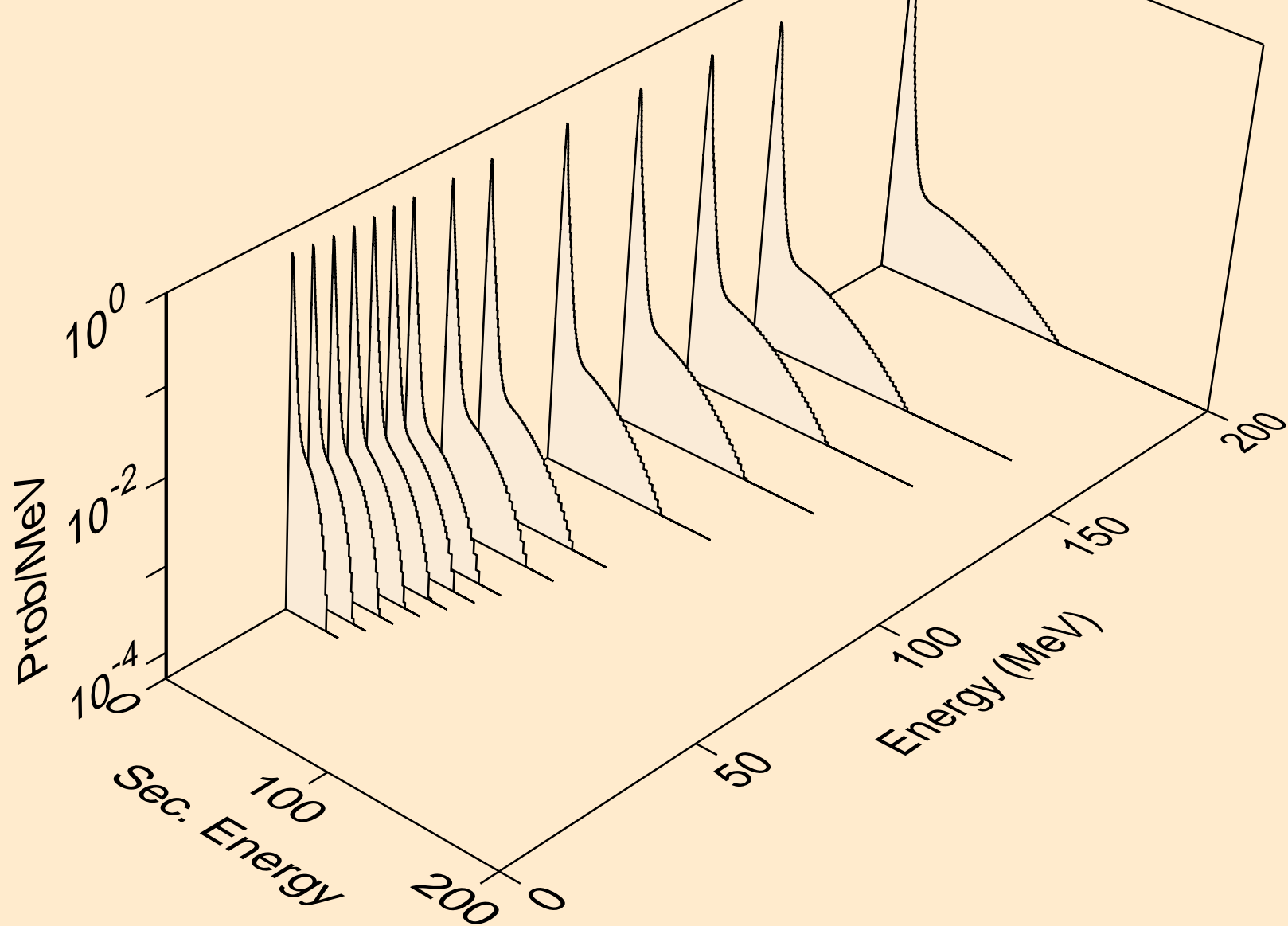

PR155 ALPHA ACER TENDL-2021 LIBRARY; T=0.K
neutrons from (a,2nd)

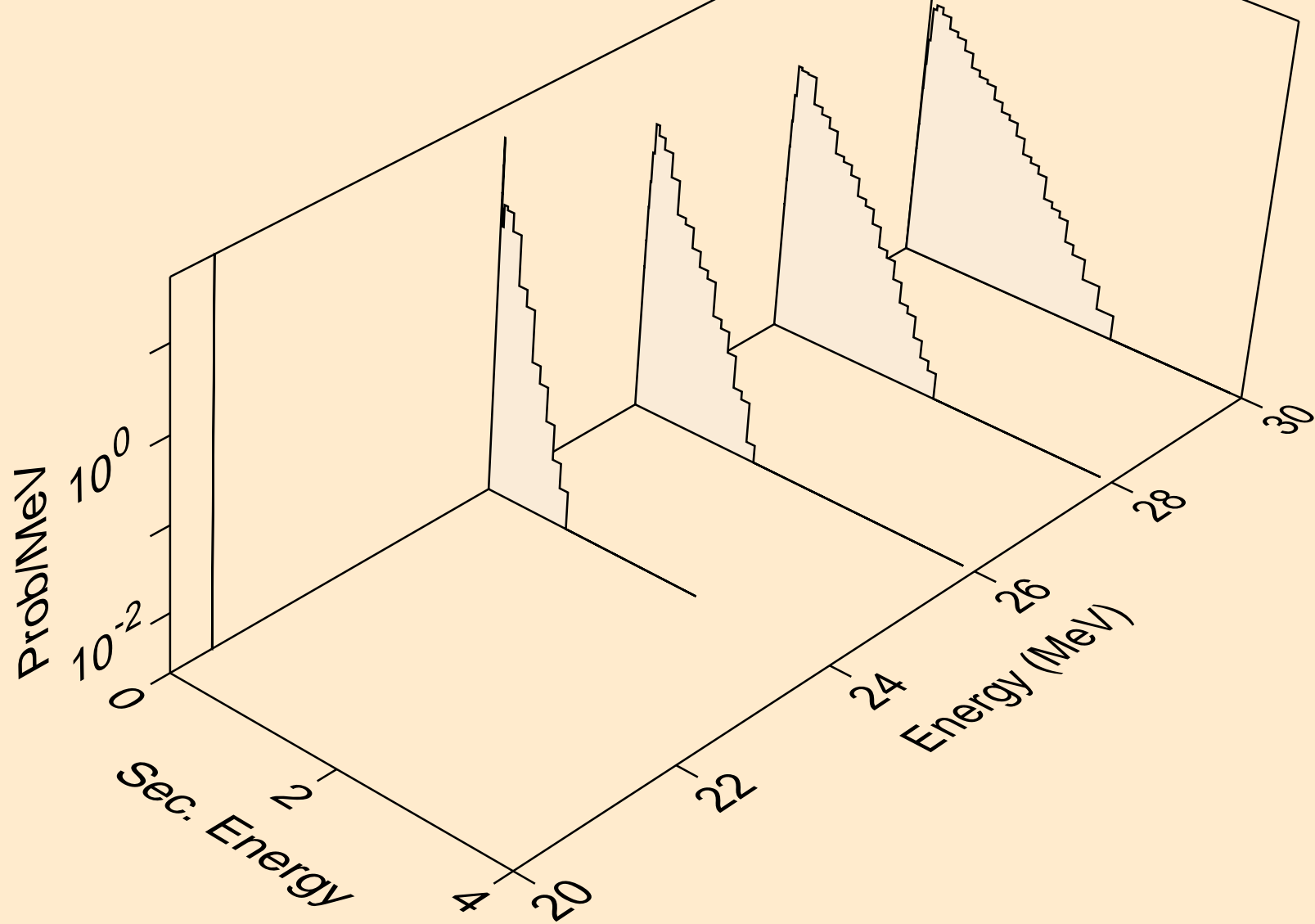

PR155 ALPHA ACER TENDL-2021 LIBRARY; T=0.K
neutrons from (a,2n)

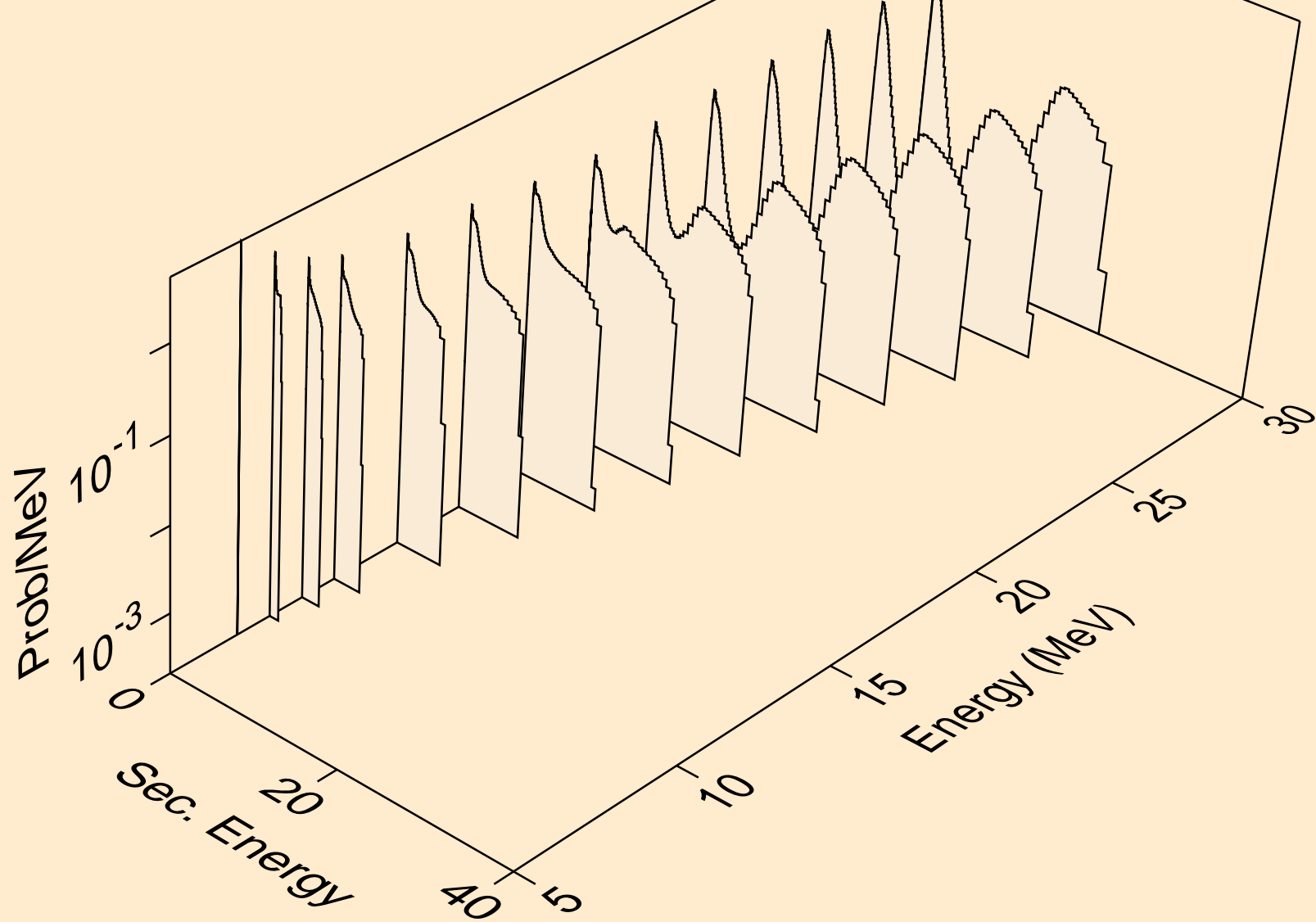

PR155 ALPHA ACER TENDL-2021 LIBRARY; T=0.K
neutrons from (a,3n)

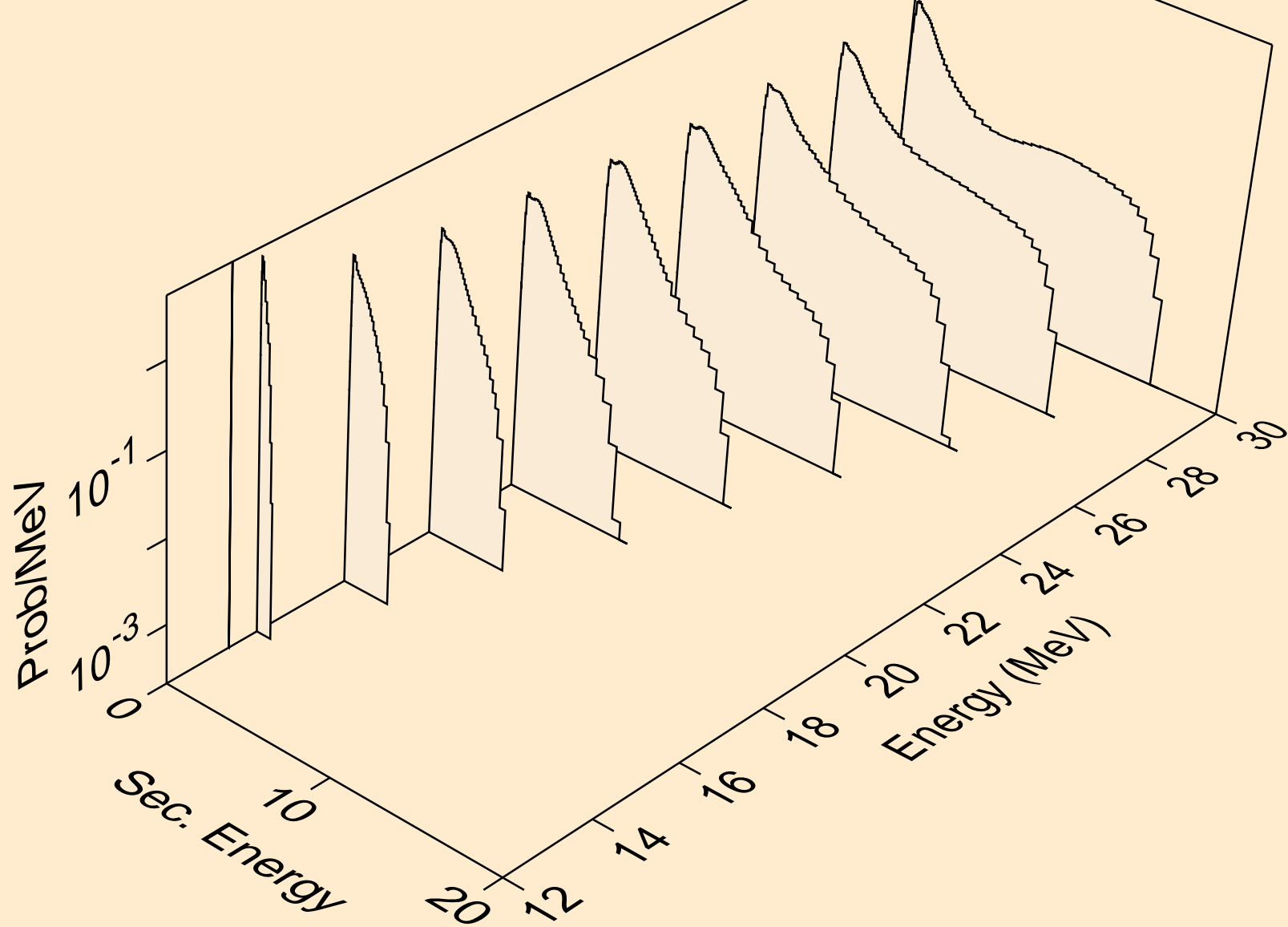

PR155 ALPHA ACER TENDL-2021 LIBRARY; T=0.K
neutrons from (a,n*)a

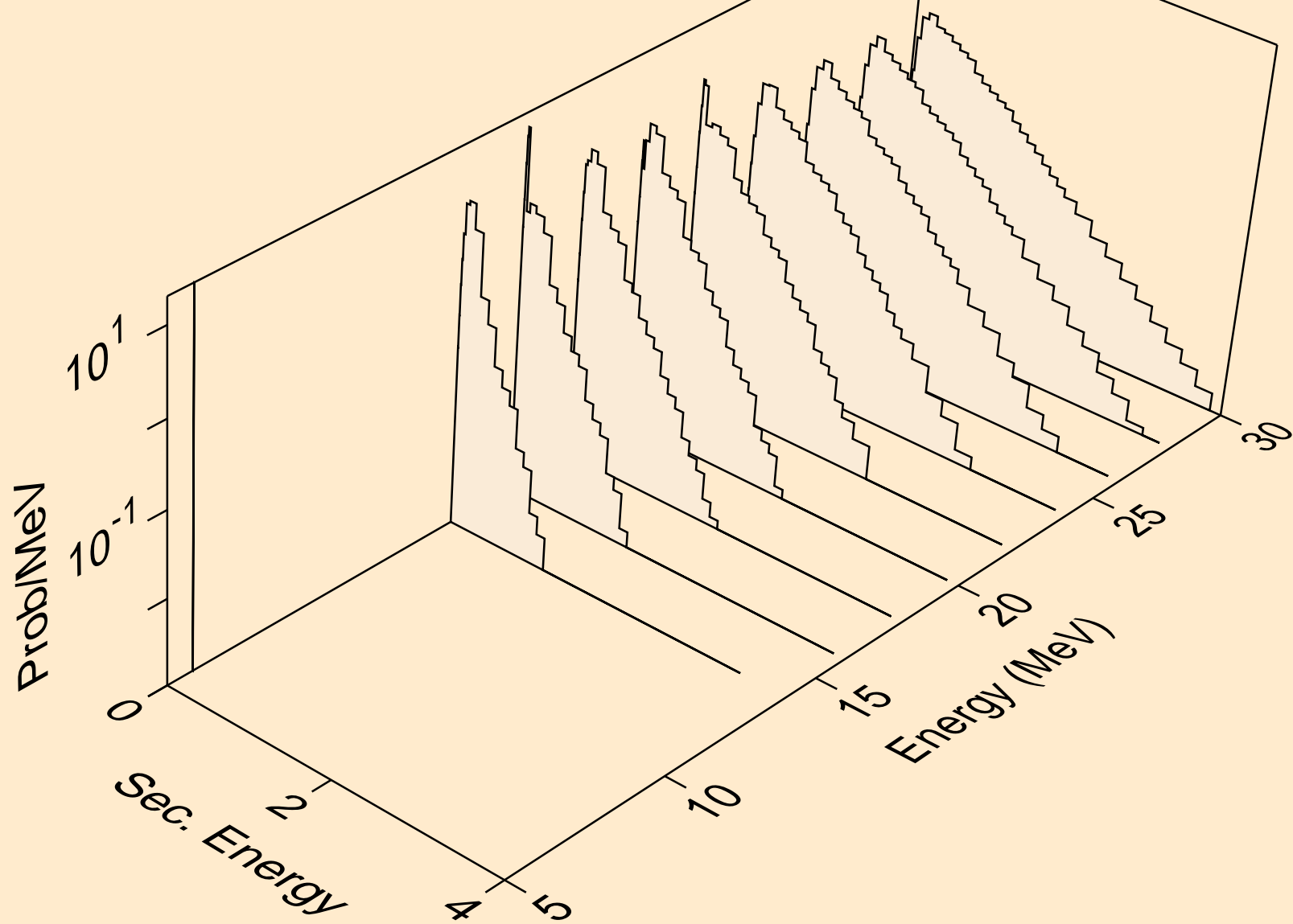

PR155 ALPHA ACER TENDL-2021 LIBRARY; T=0.K
neutrons from (a,2n)a

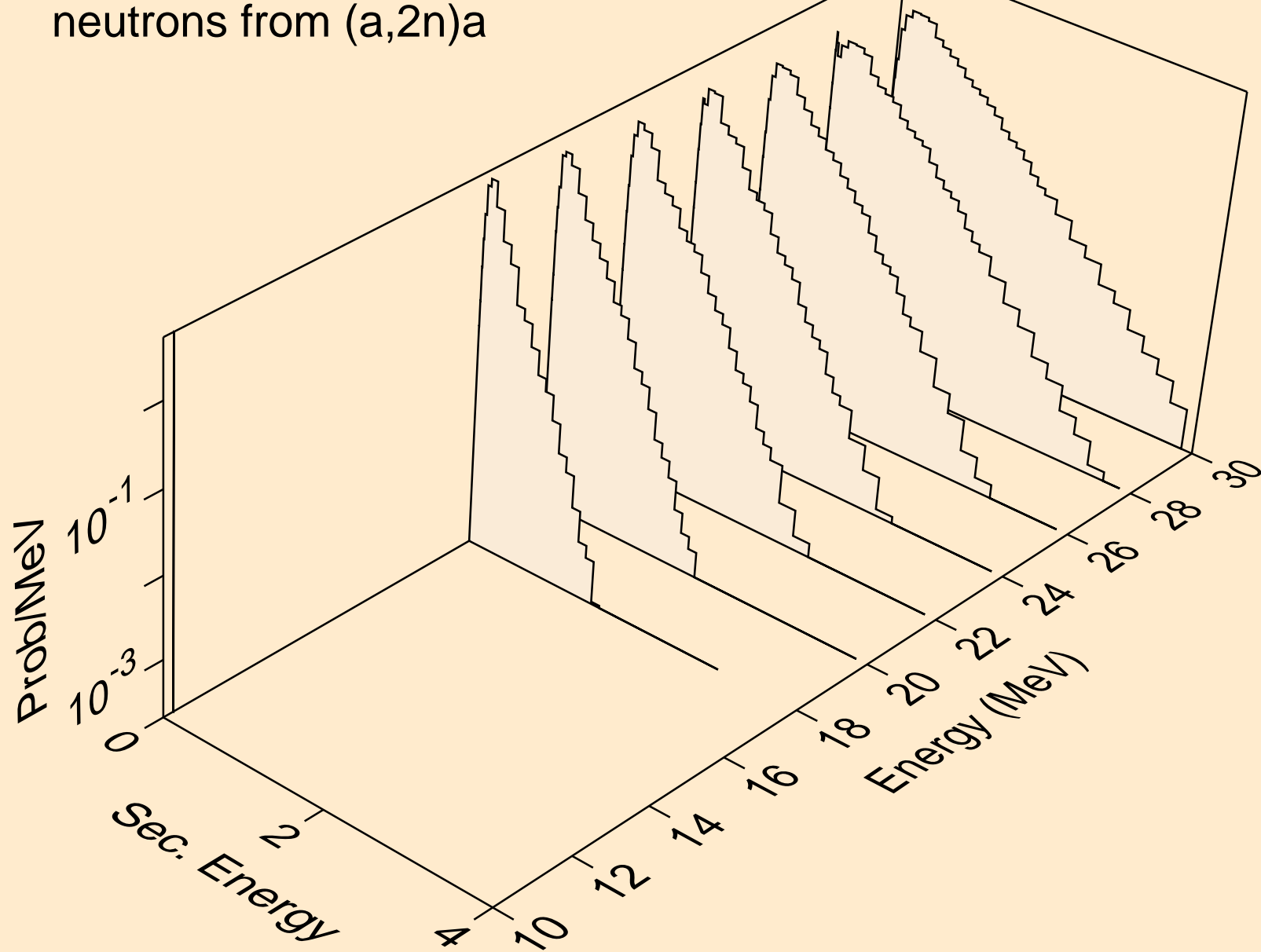

PR155 ALPHA ACER TENDL-2021 LIBRARY; T=0.K
neutrons from (a,3n)a

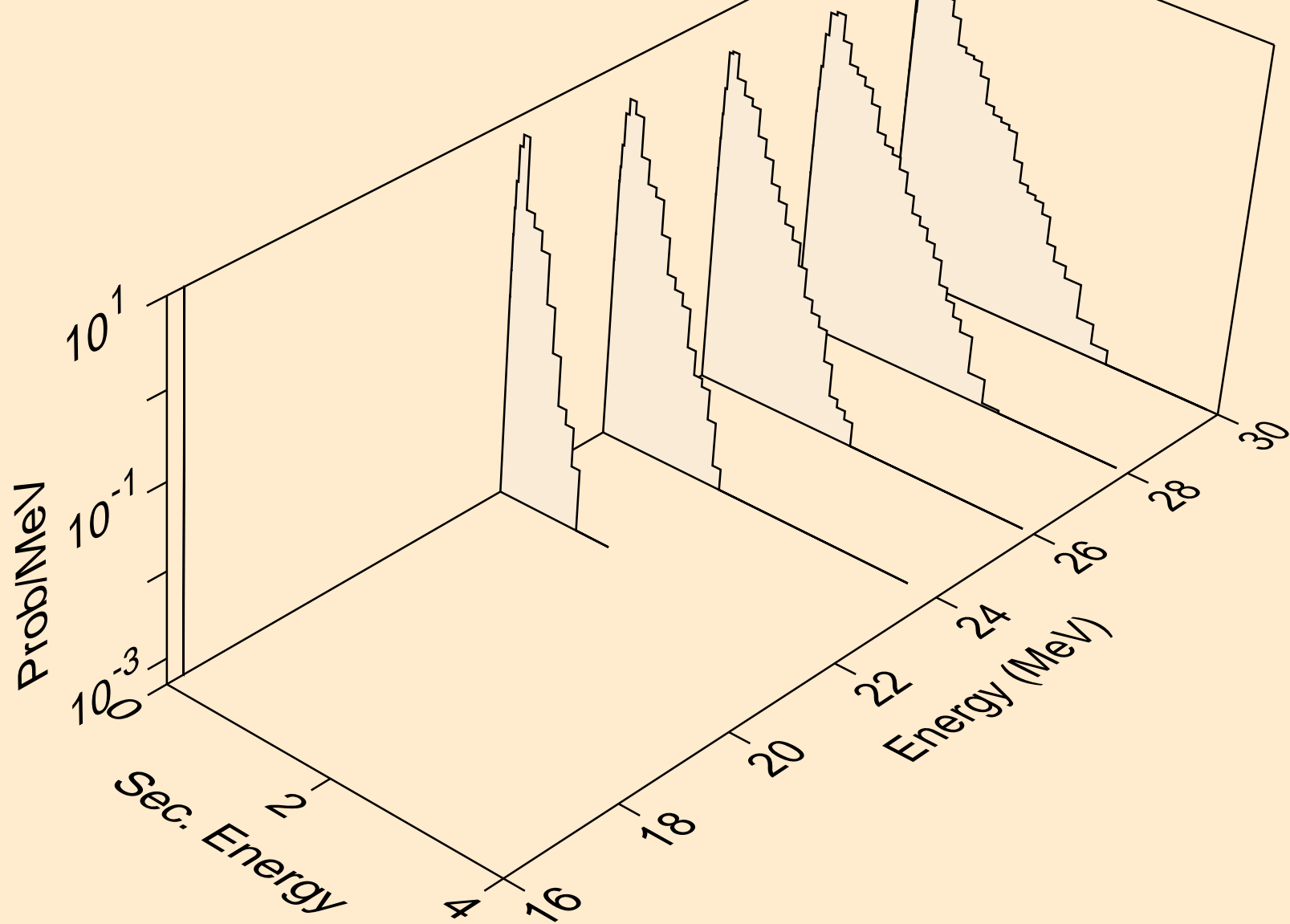

PR155 ALPHA ACER TENDL-2021 LIBRARY; T=0.K
neutrons from (a,n*)p

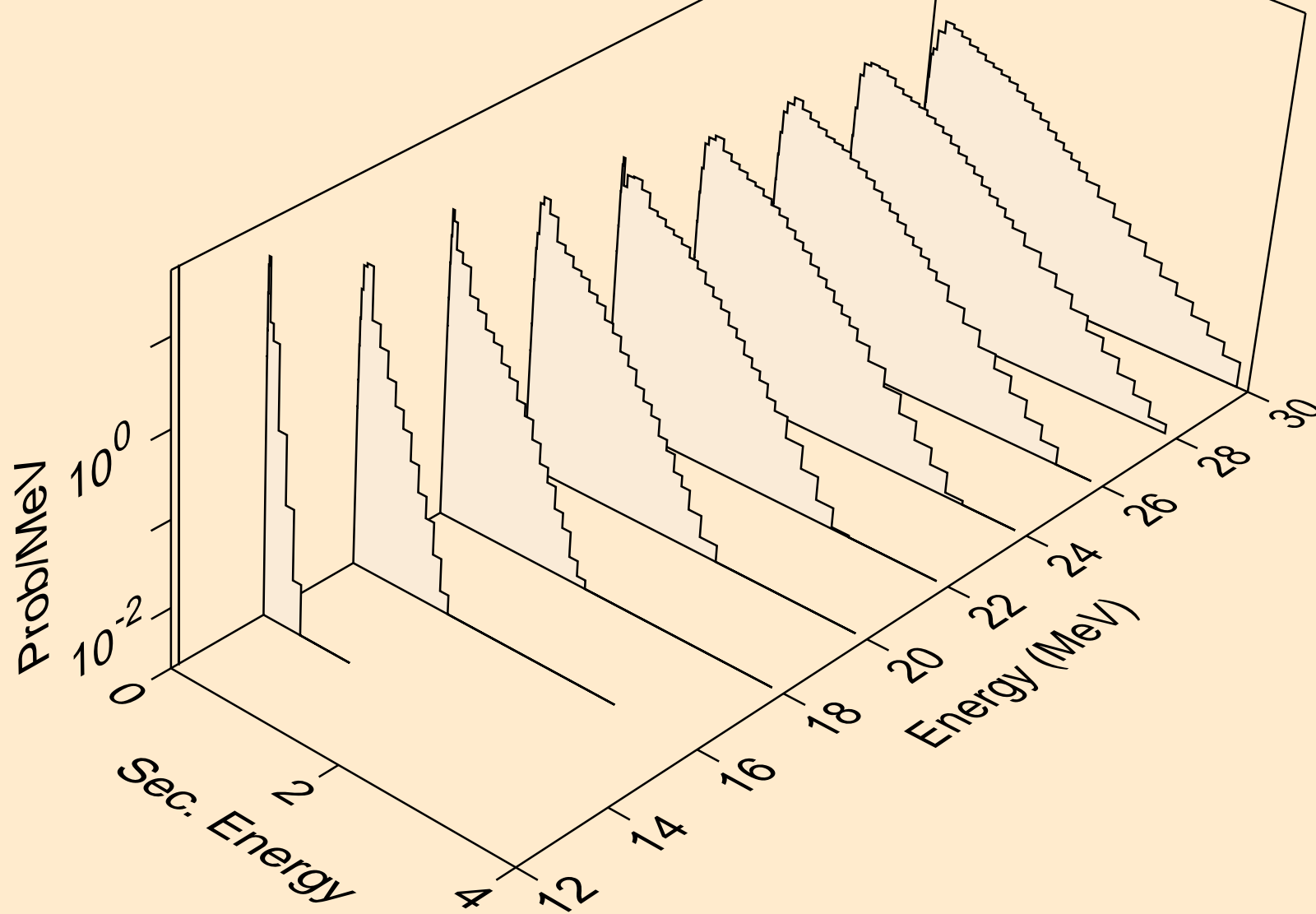

PR155 ALPHA ACER TENDL-2021 LIBRARY; T=0.K
neutrons from (a,n*)d

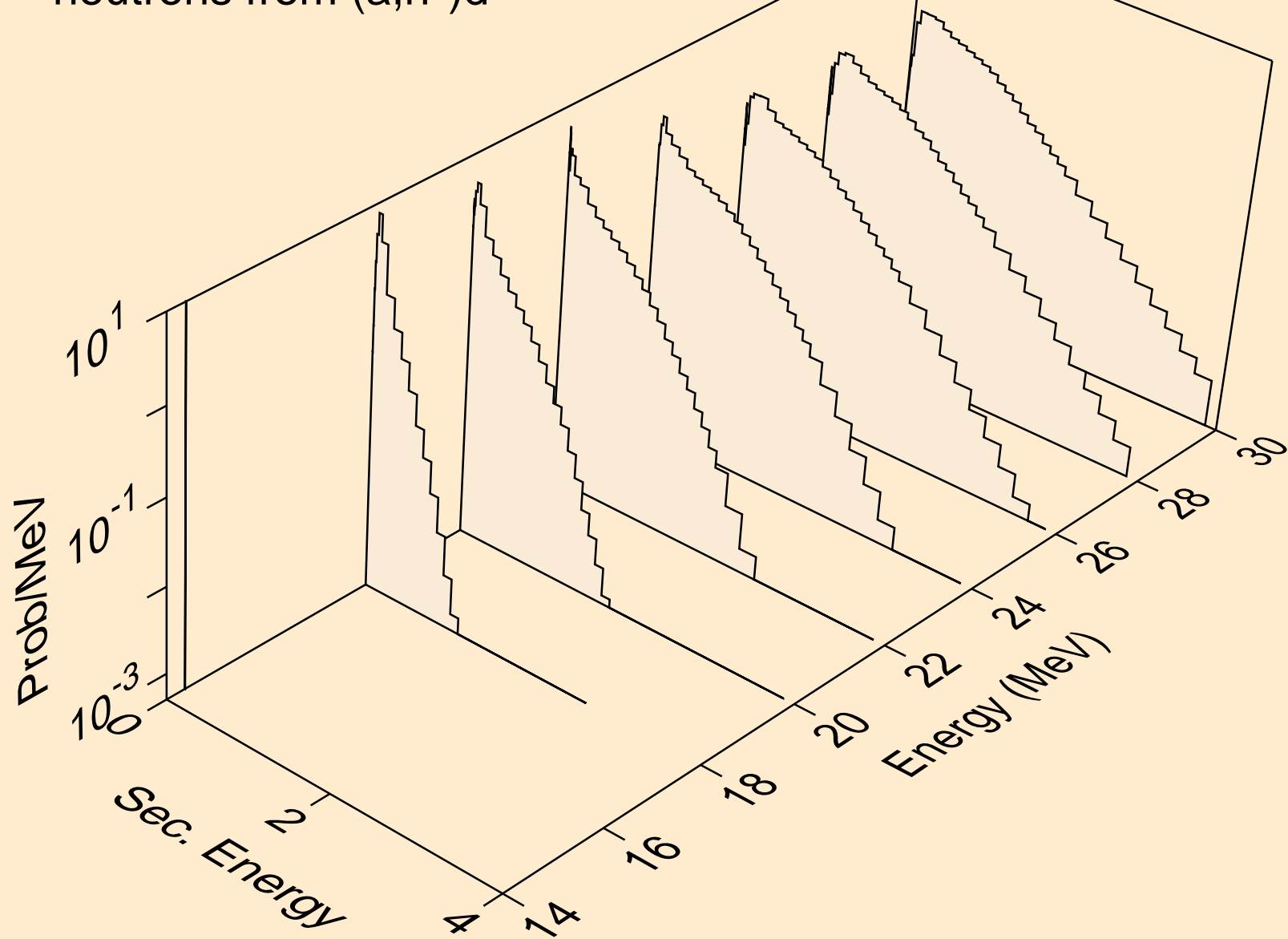

PR155 ALPHA ACER TENDL-2021 LIBRARY; T=0.K
neutrons from (a,n*)t

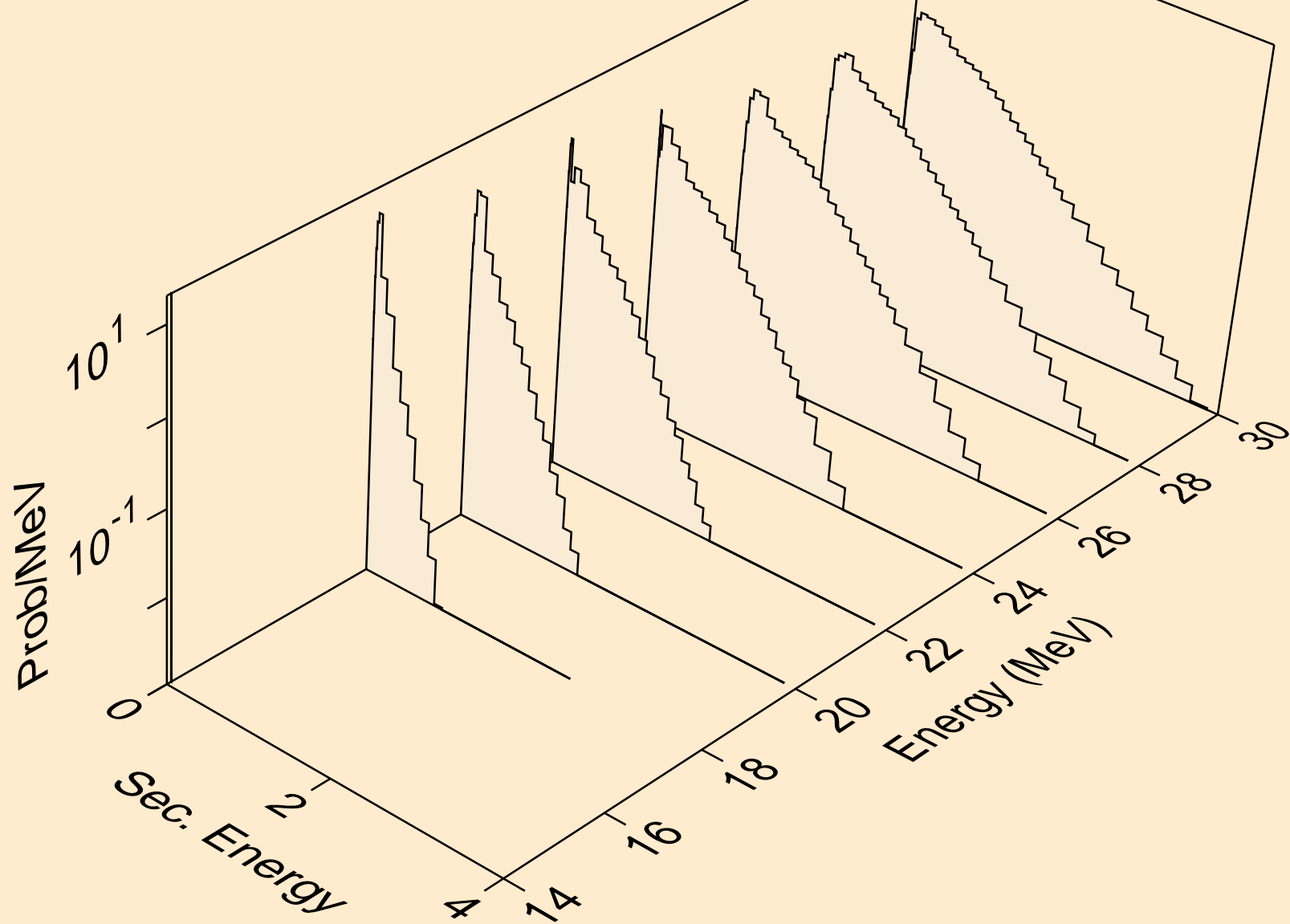

PR155 ALPHA ACER TENDL-2021 LIBRARY; T=0.K
neutrons from (a,4n)

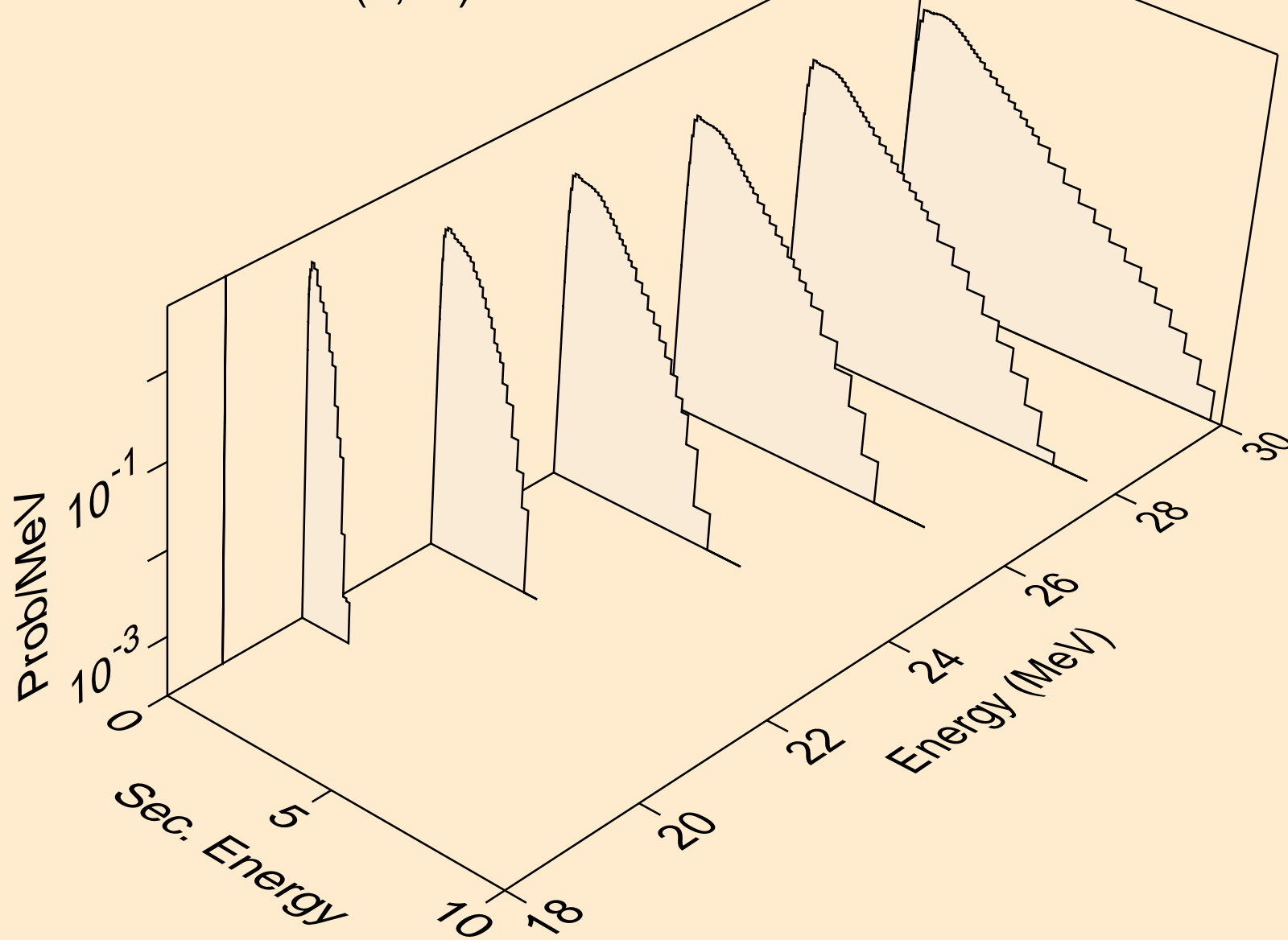

PR155 ALPHA ACER TENDL-2021 LIBRARY; T=0.K
neutrons from (a,2np)

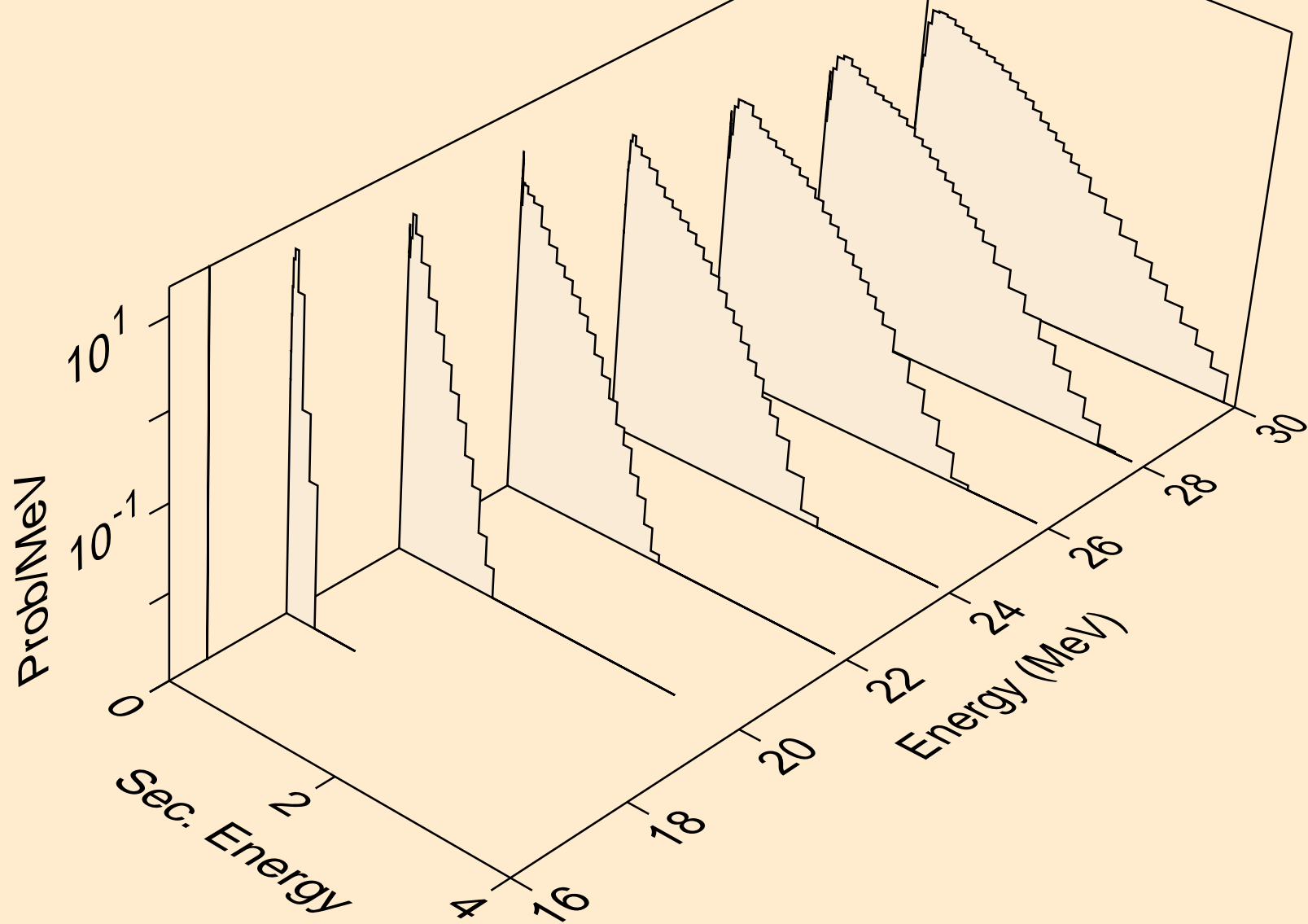

PR155 ALPHA ACER TENDL-2021 LIBRARY; T=0.K
neutrons from (a,3np)

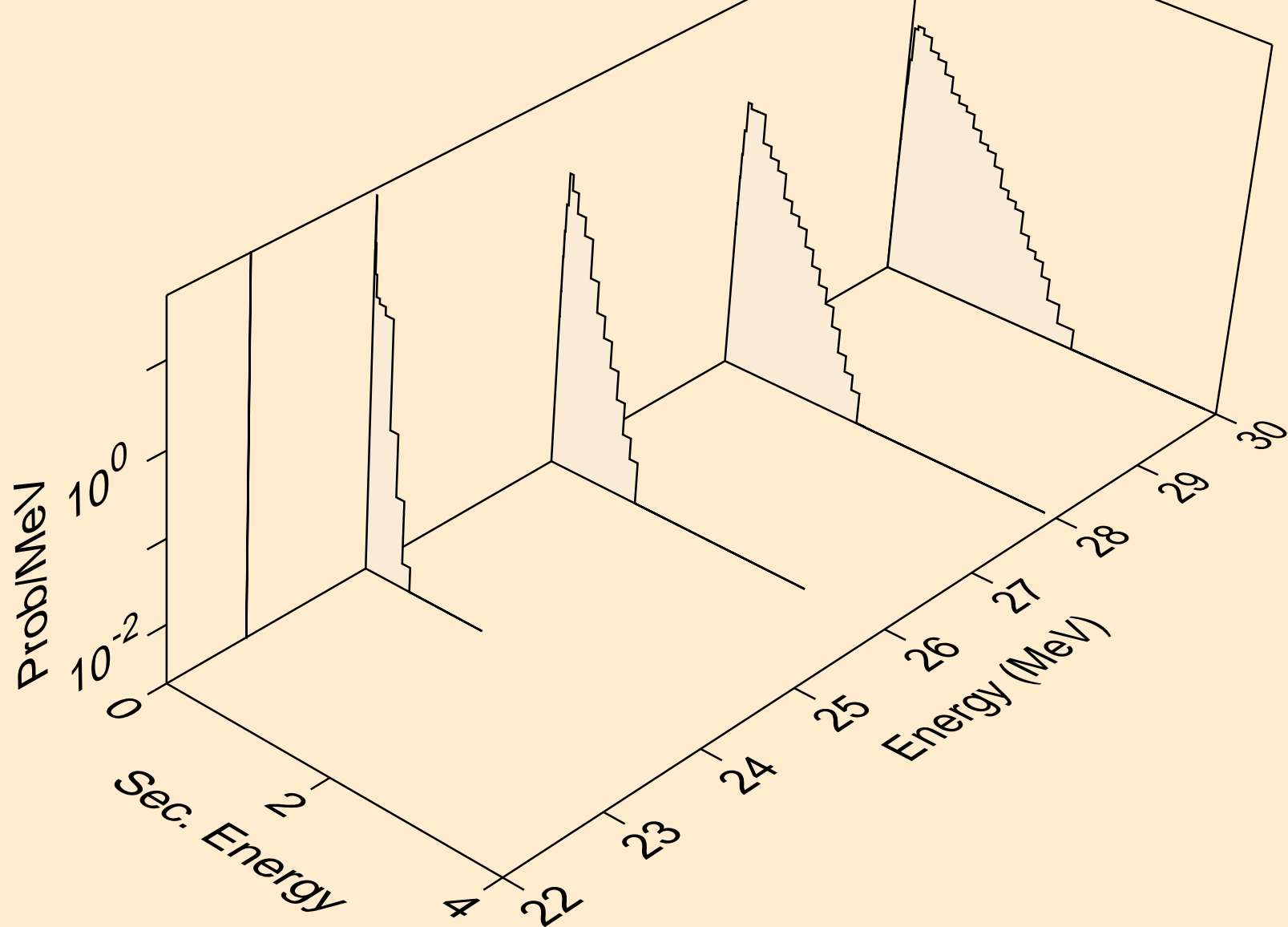

PR155 ALPHA ACER TENDL-2021 LIBRARY; T=0.K
protons from (a,x)

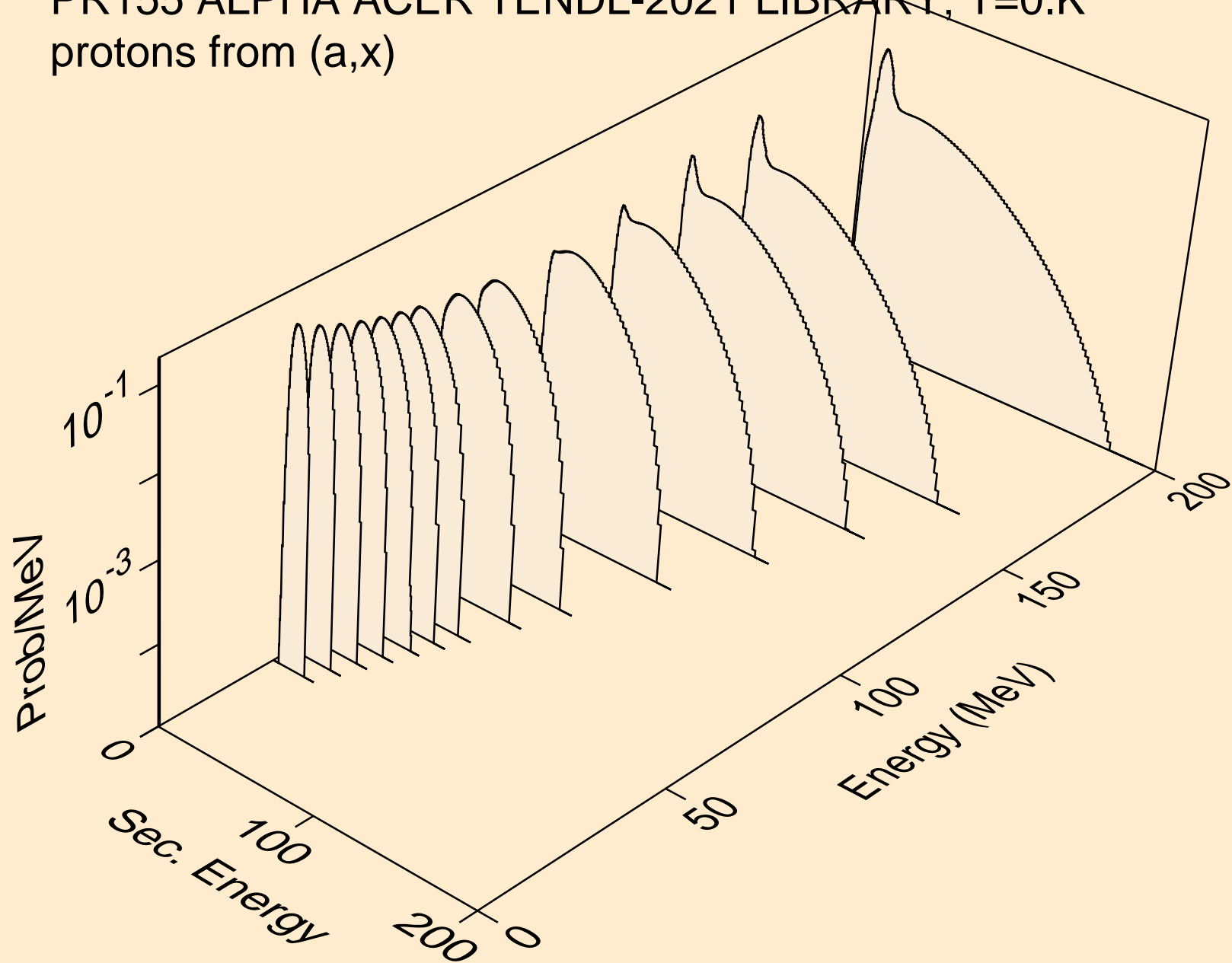

PR155 ALPHA ACER TENDL-2021 LIBRARY; T=0.K
protons from (a,n*)p

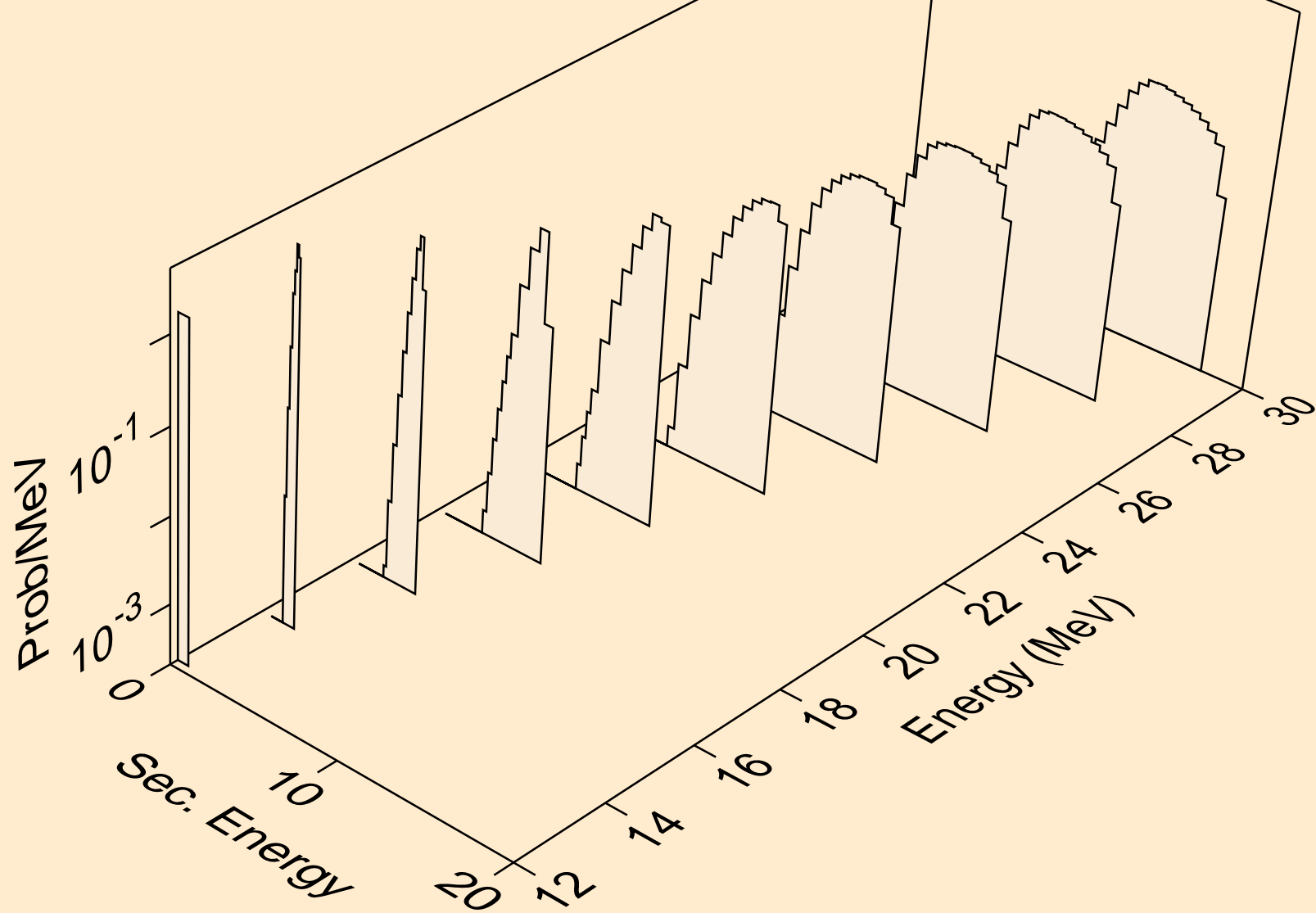

PR155 ALPHA ACER TENDL-2021 LIBRARY; T=0.K
protons from (a,2np)

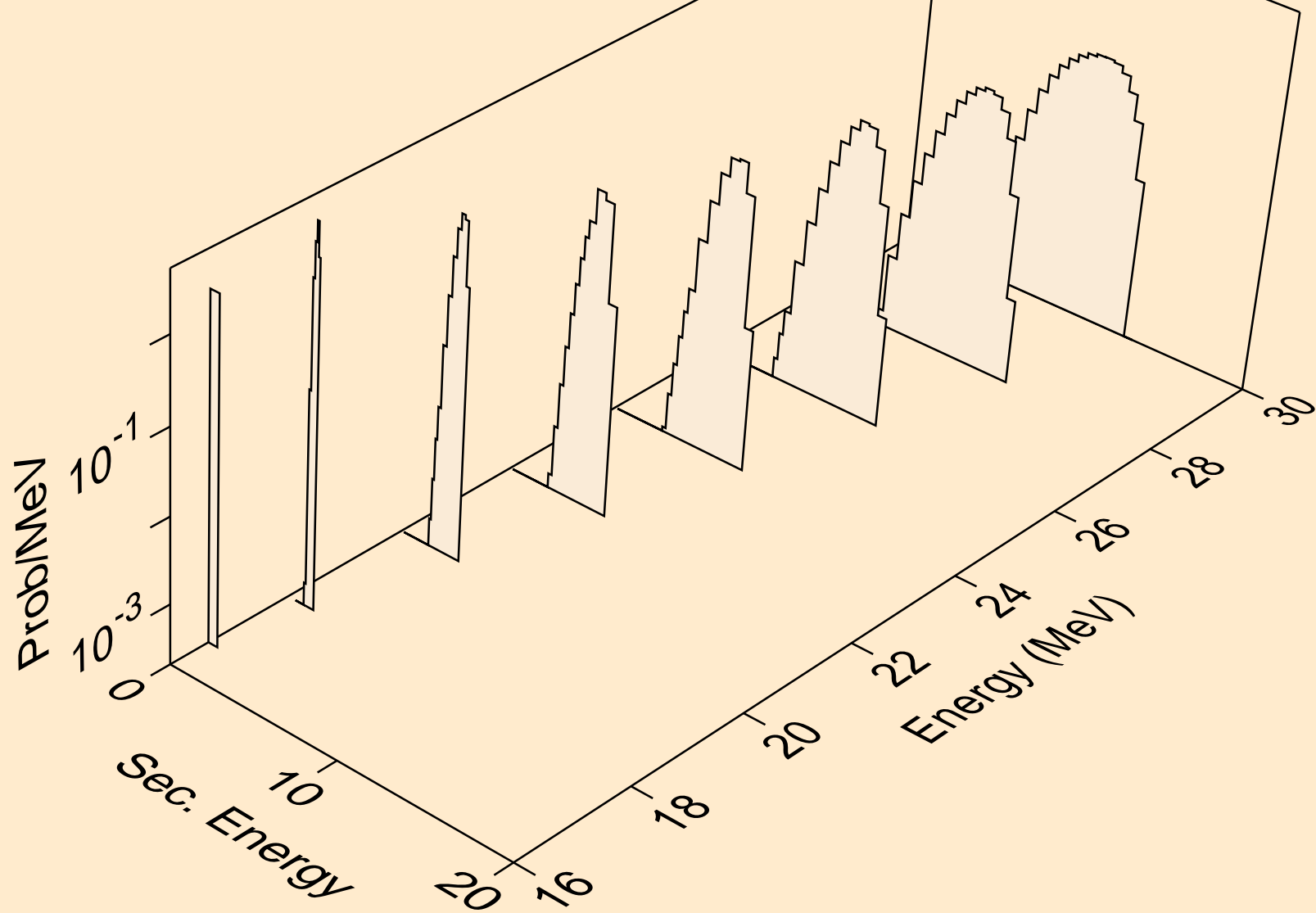

PR155 ALPHA ACER TENDL-2021 LIBRARY; T=0.K
protons from (a,3np)

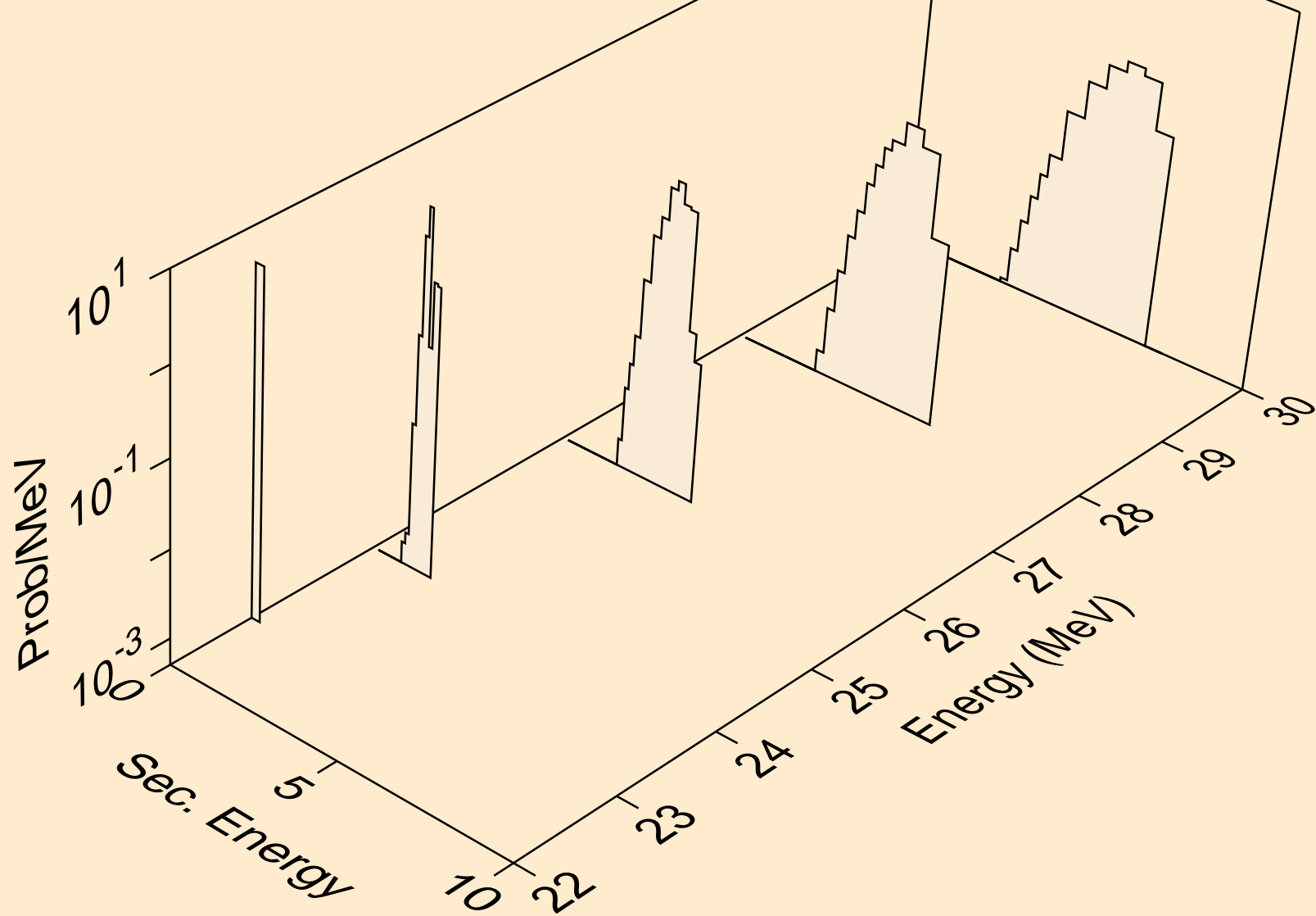

PR155 ALPHA ACER TENDL-2021 LIBRARY; T=0.K
protons from (a,p)

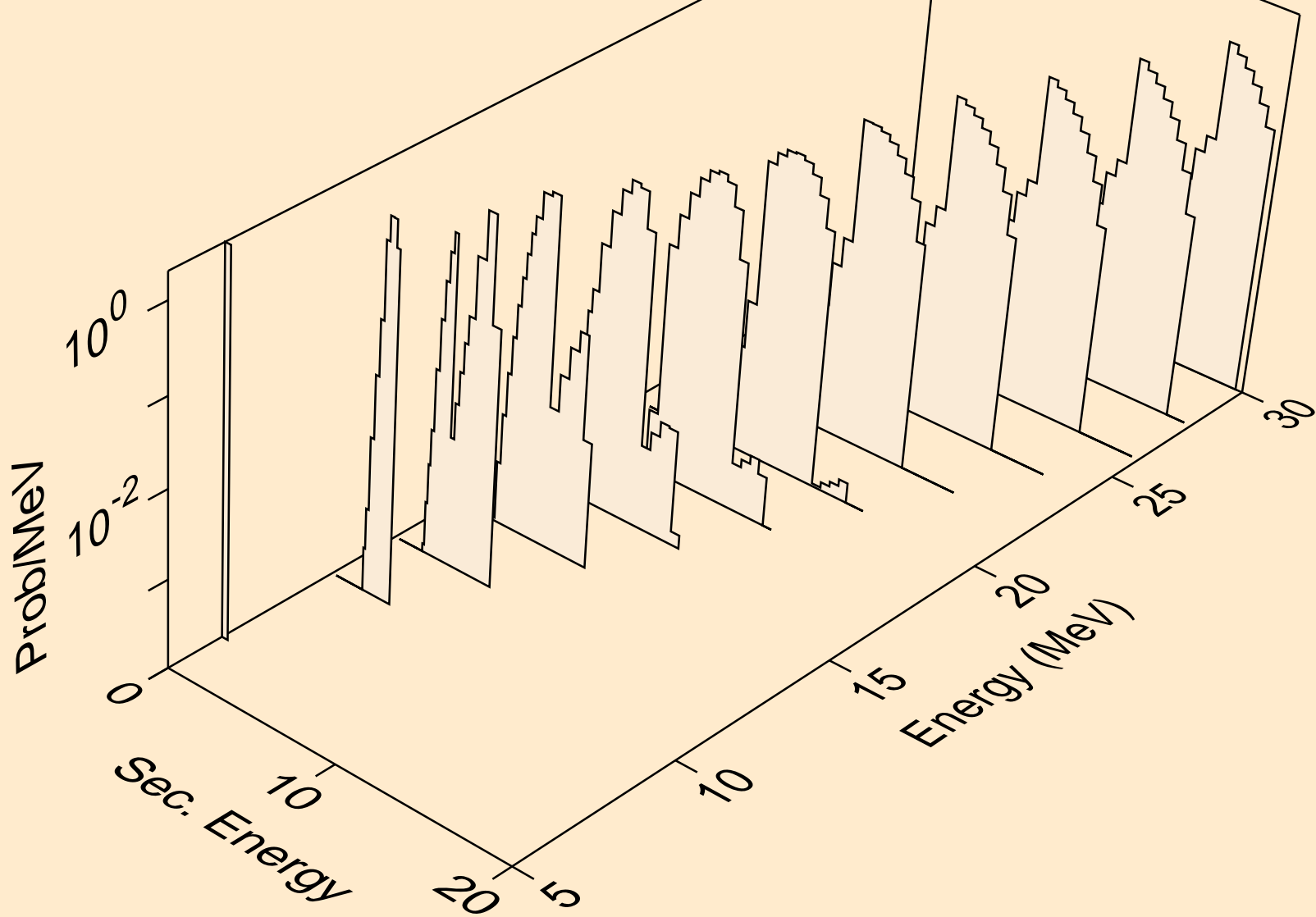

PR155 ALPHA ACER TENDL-2021 LIBRARY; T=0.K
deuterons from (a,x)

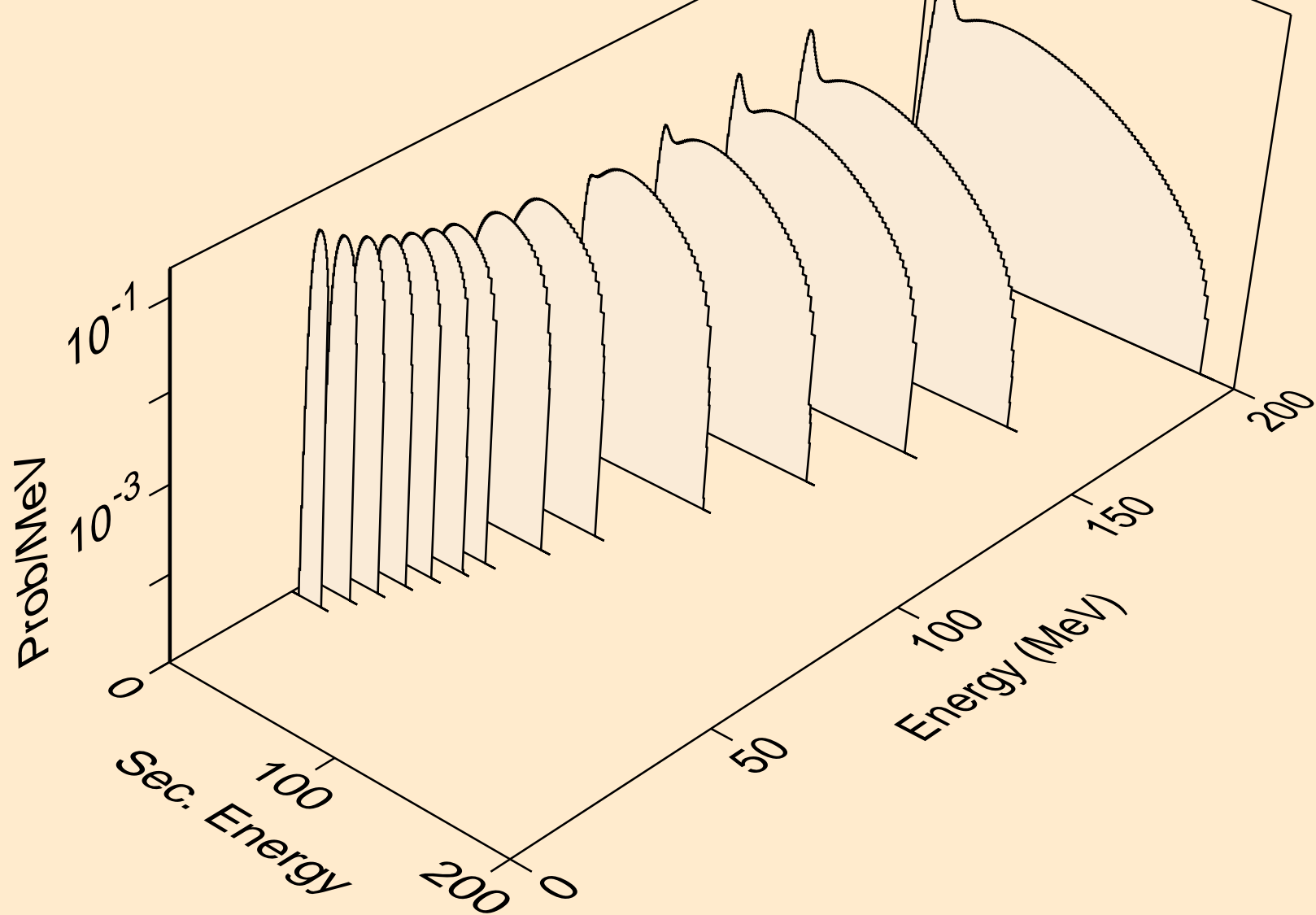

PR155 ALPHA ACER TENDL-2021 LIBRARY; T=0.K
deuterons from (a,2nd)

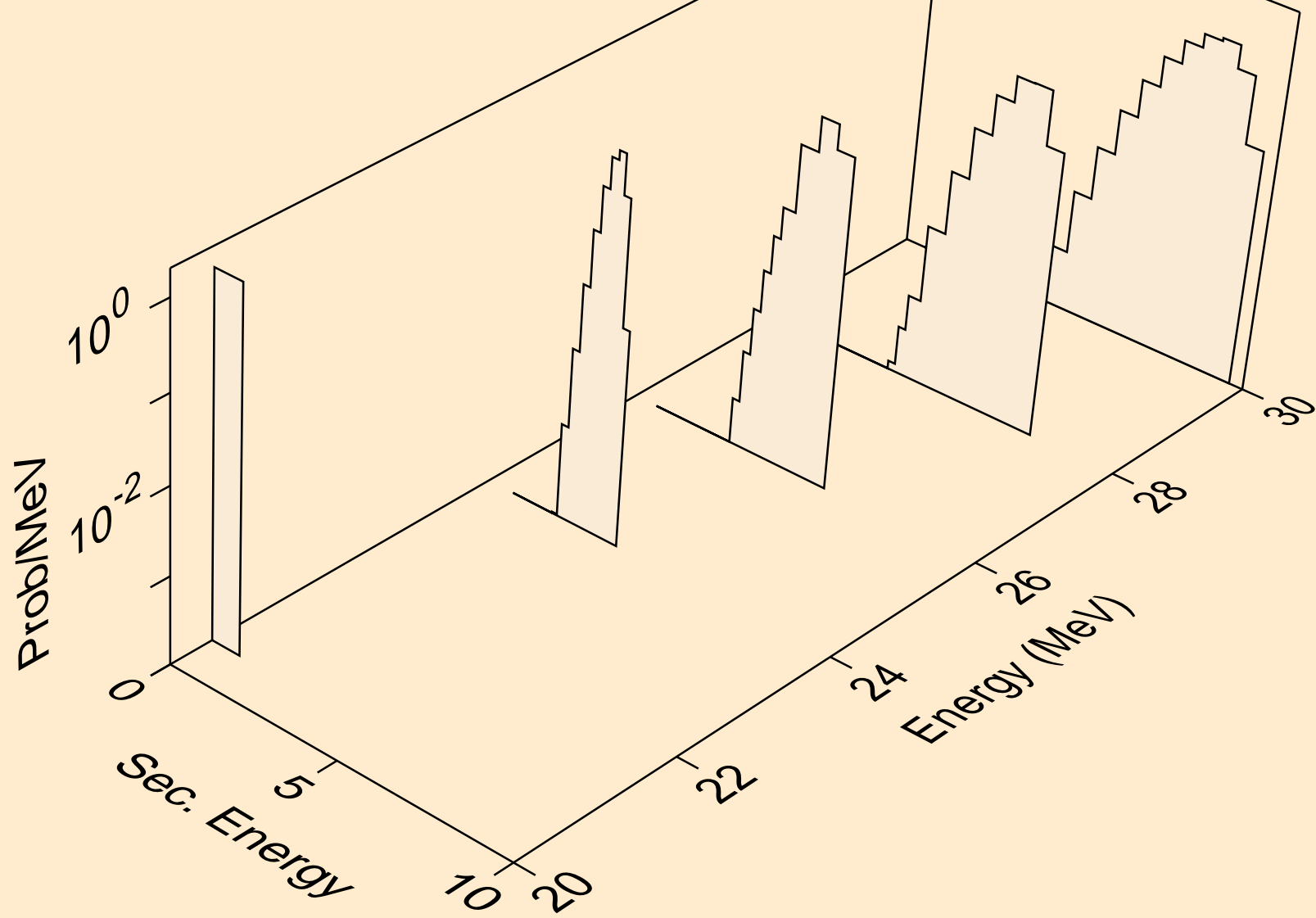

PR155 ALPHA ACER TENDL-2021 LIBRARY; T=0.K
deuterons from (a,n*)d

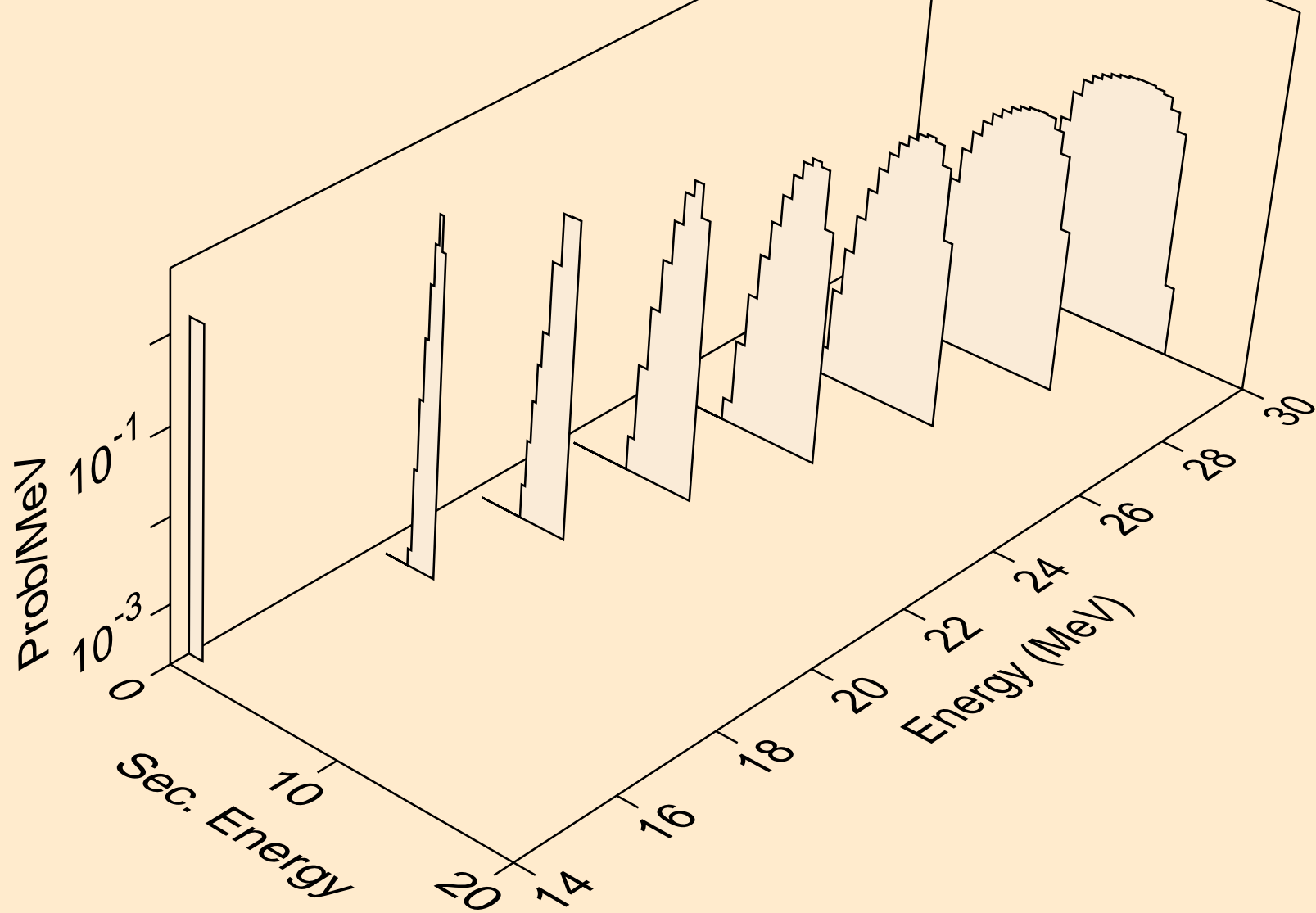

PR155 ALPHA ACER TENDL-2021 LIBRARY; T=0.K
deuterons from (a,d)

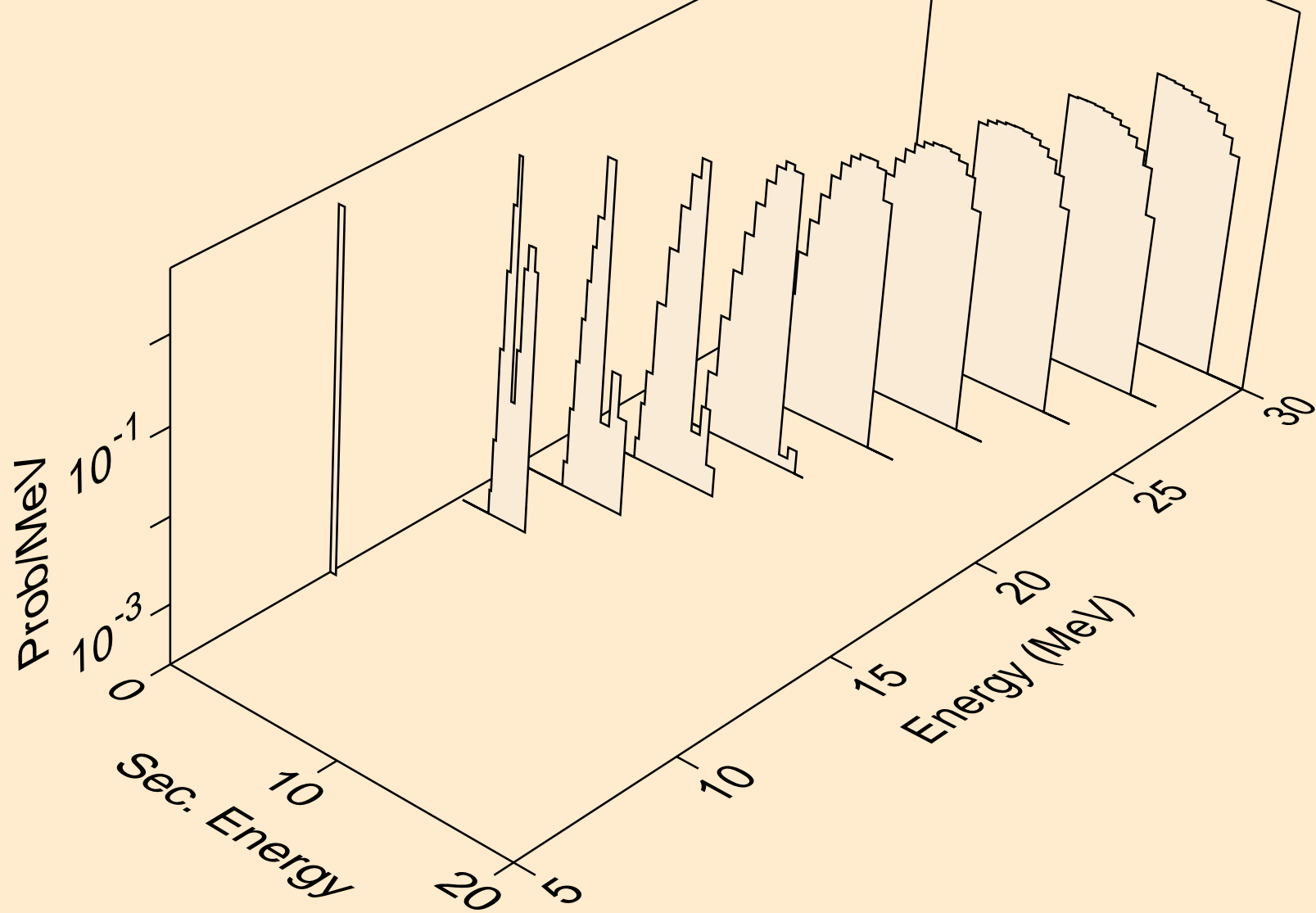

PR155 ALPHA ACER TENDL-2021 LIBRARY; T=0.K
tritons from (a,x)

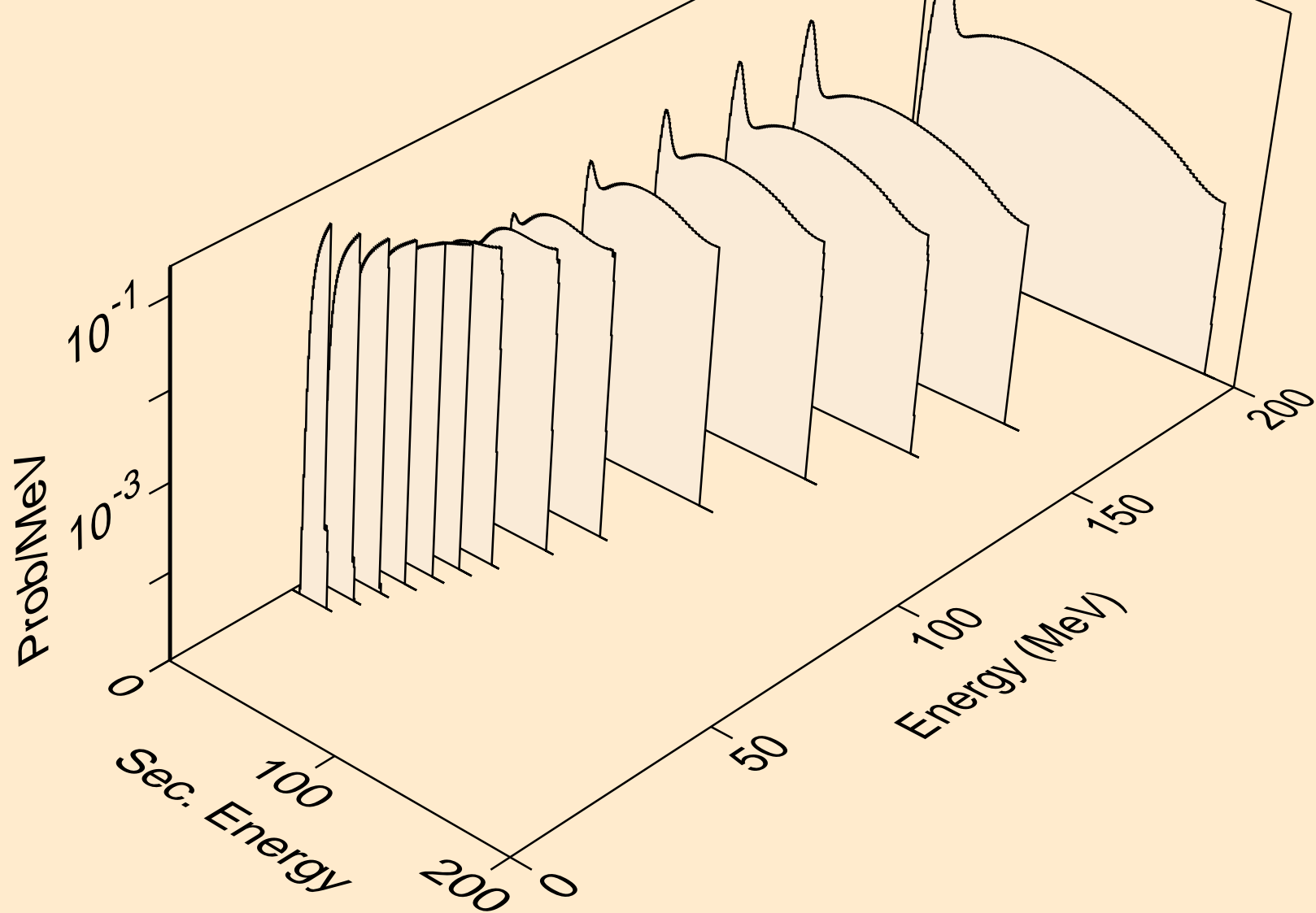

PR155 ALPHA ACER TENDL-2021 LIBRARY; T=0.K
tritons from (a,n*)t

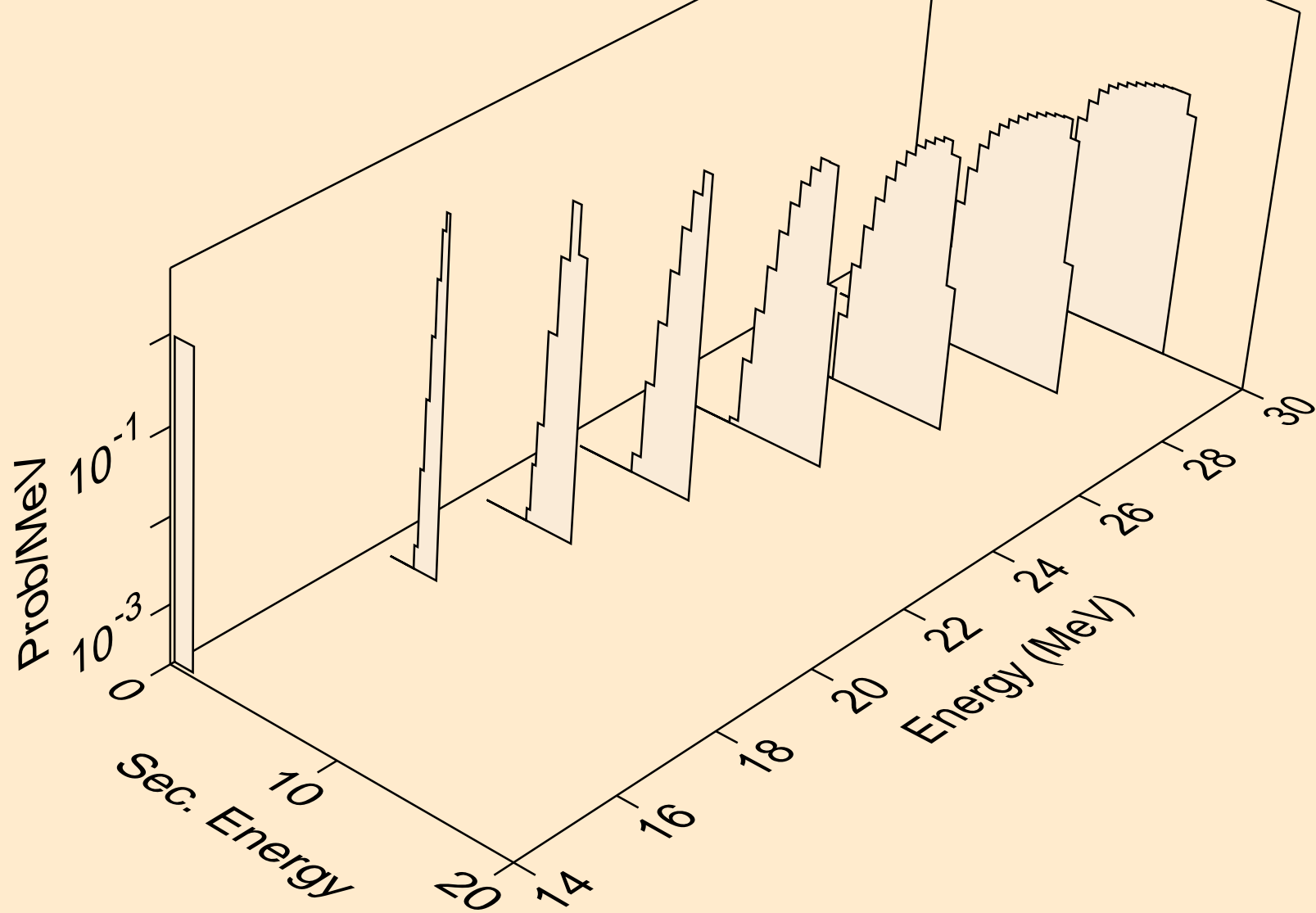

PR155 ALPHA ACER TENDL-2021 LIBRARY; T=0.K
tritons from (a,t)

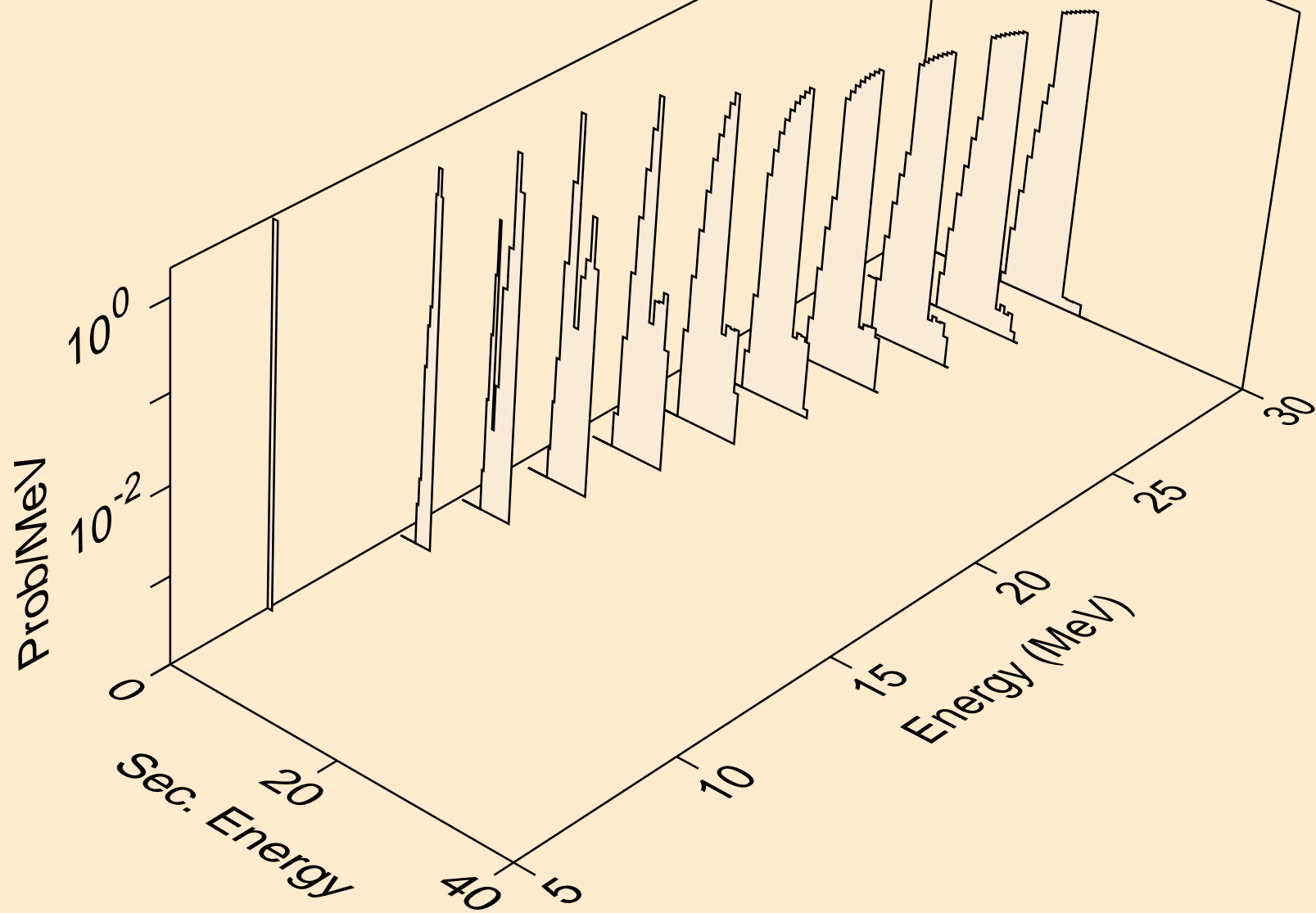

PR155 ALPHA ACER TENDL-2021 LIBRARY; T=0.K
he3s from (a,x)

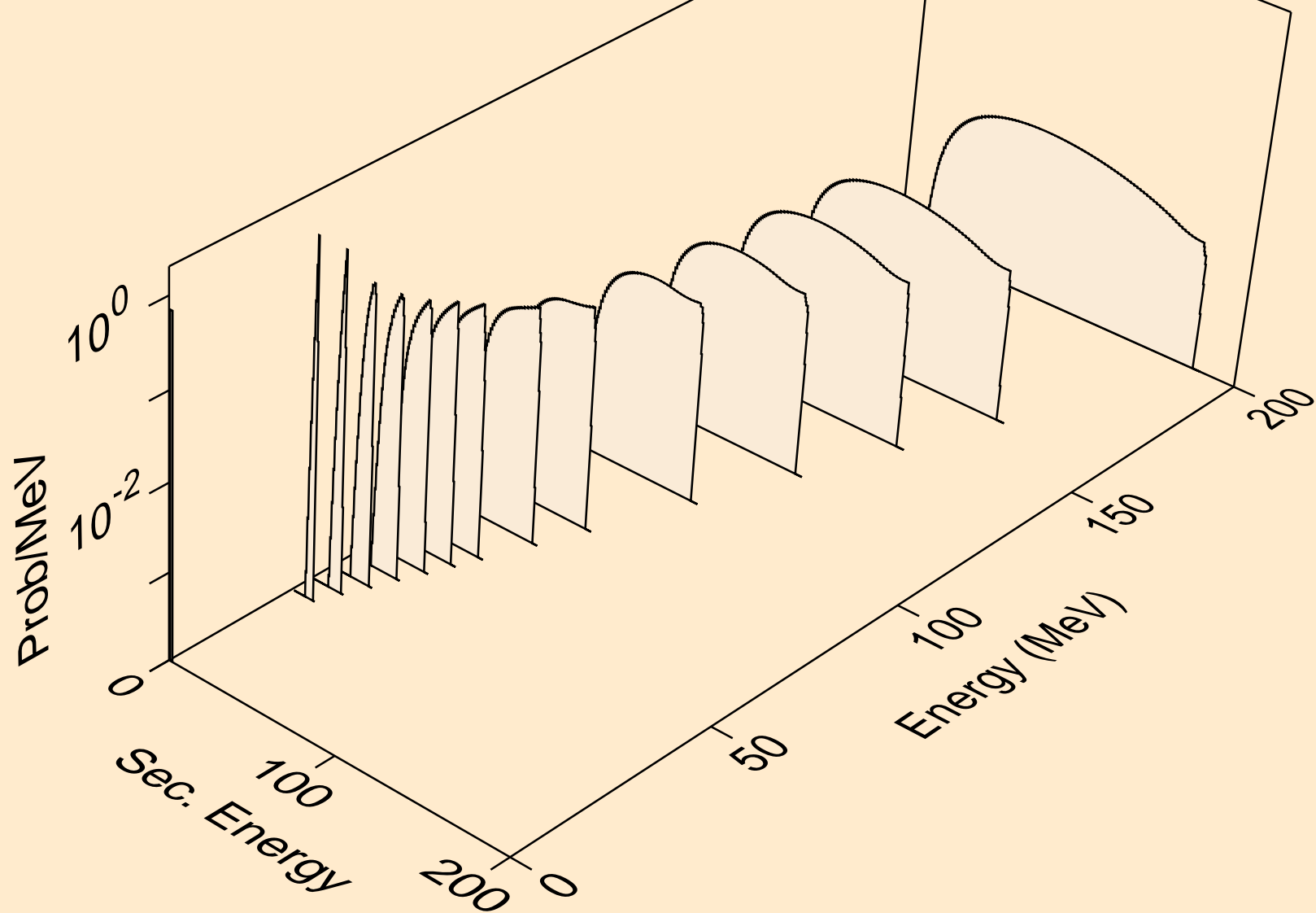

PR155 ALPHA ACER TENDL-2021 LIBRARY; T=0.K
he3s from (a,he3)

