

RA210 ALPHA ACER TENDL-2021 LIBRARY; T=0.K  
Principal cross sections

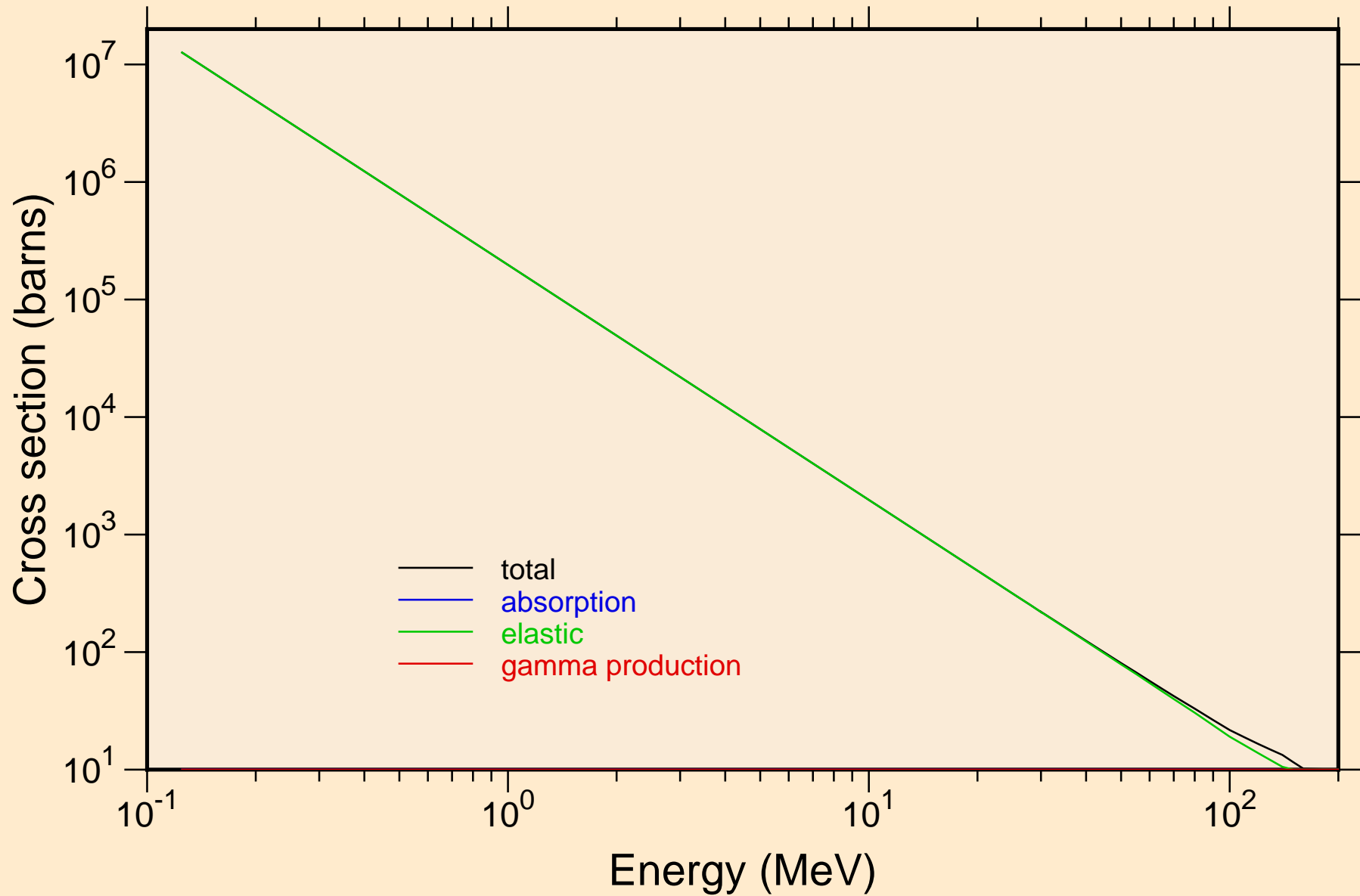

RA210 ALPHA ACER TENDL-2021 LIBRARY; T=0.K  
Heating

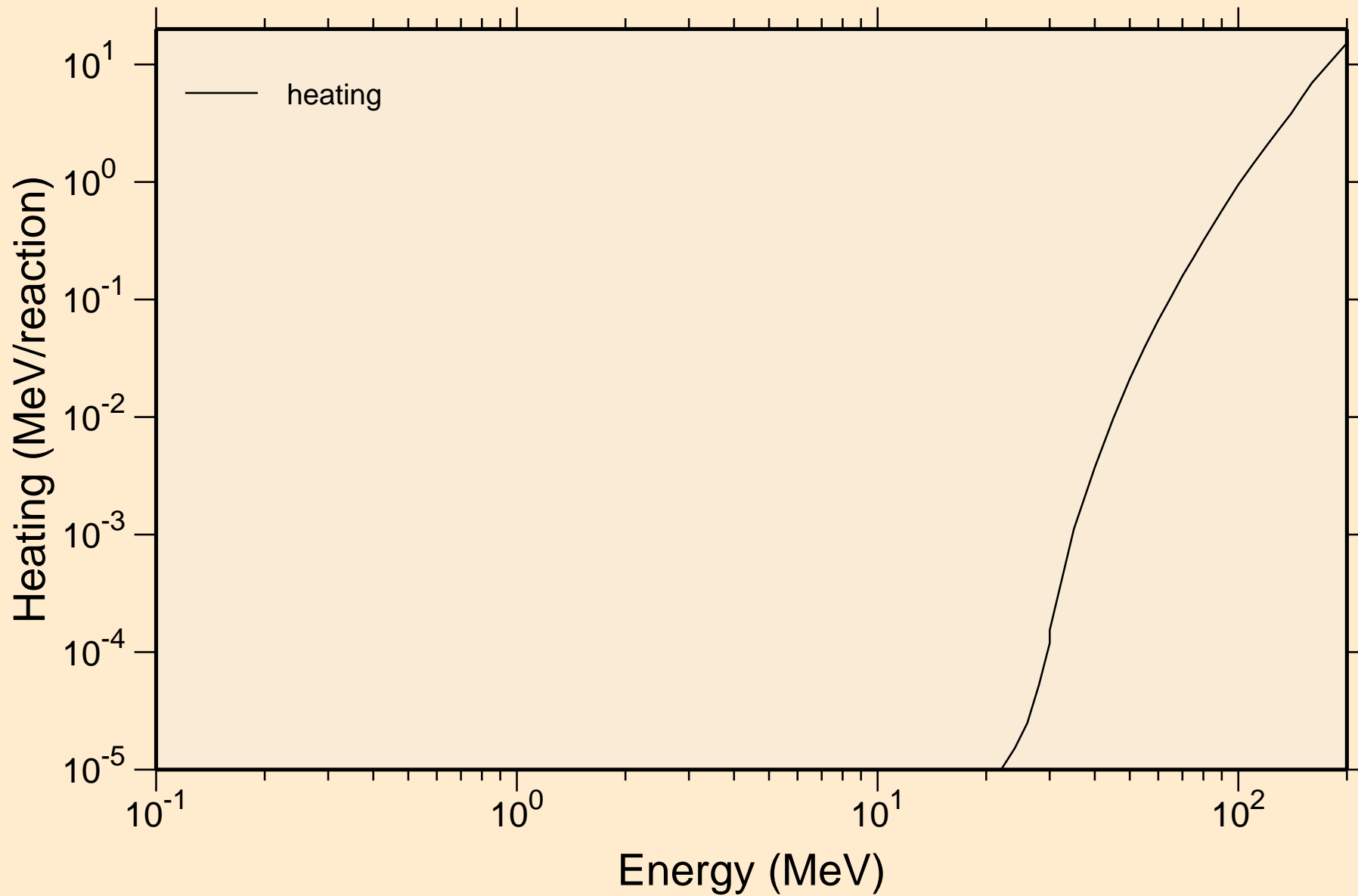

# RA210 ALPHA ACER TENDL-2021 LIBRARY; T=0.K

## Principal cross sections

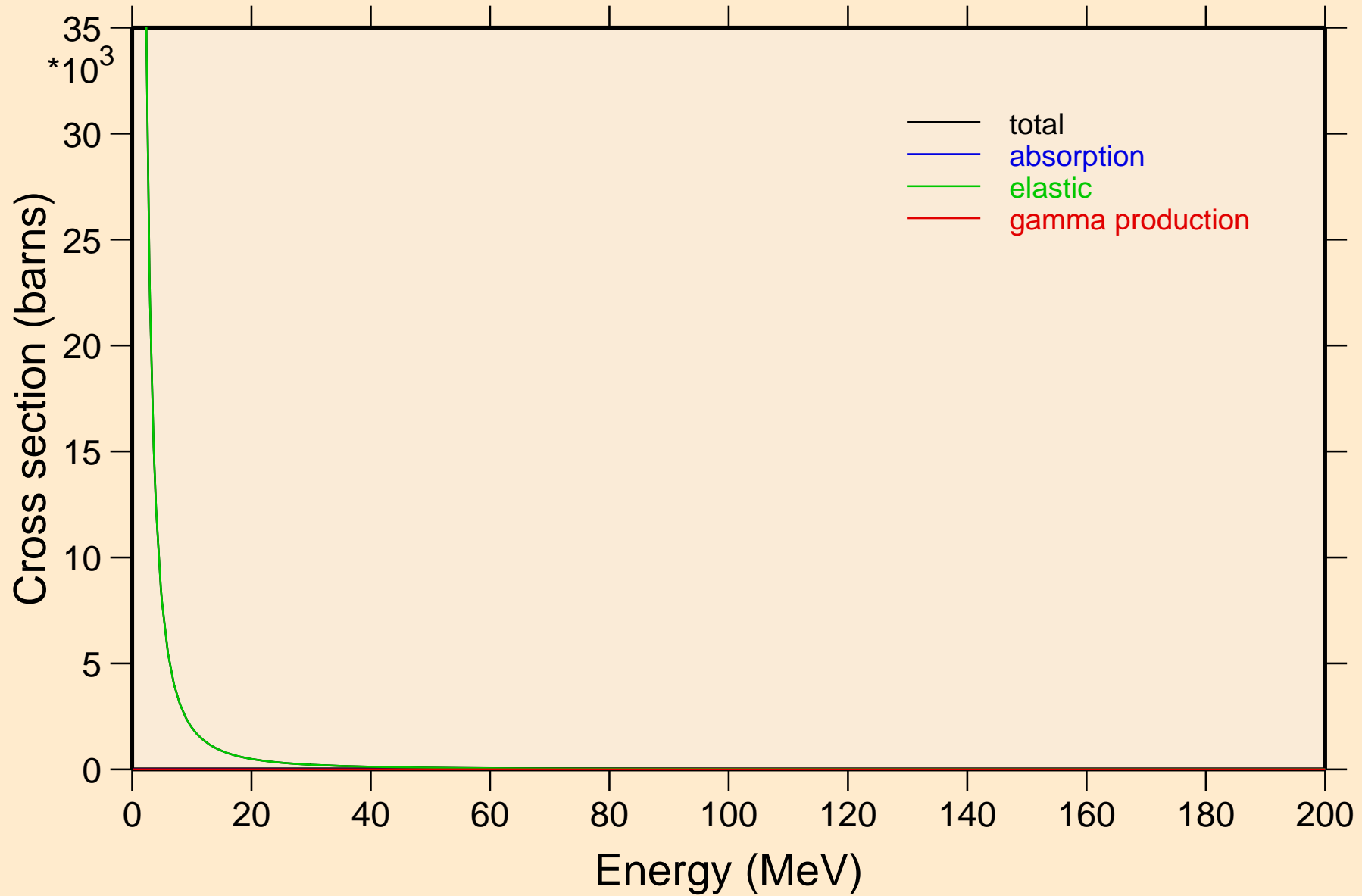

RA210 ALPHA ACER TENDL-2021 LIBRARY; T=0.K

Heating

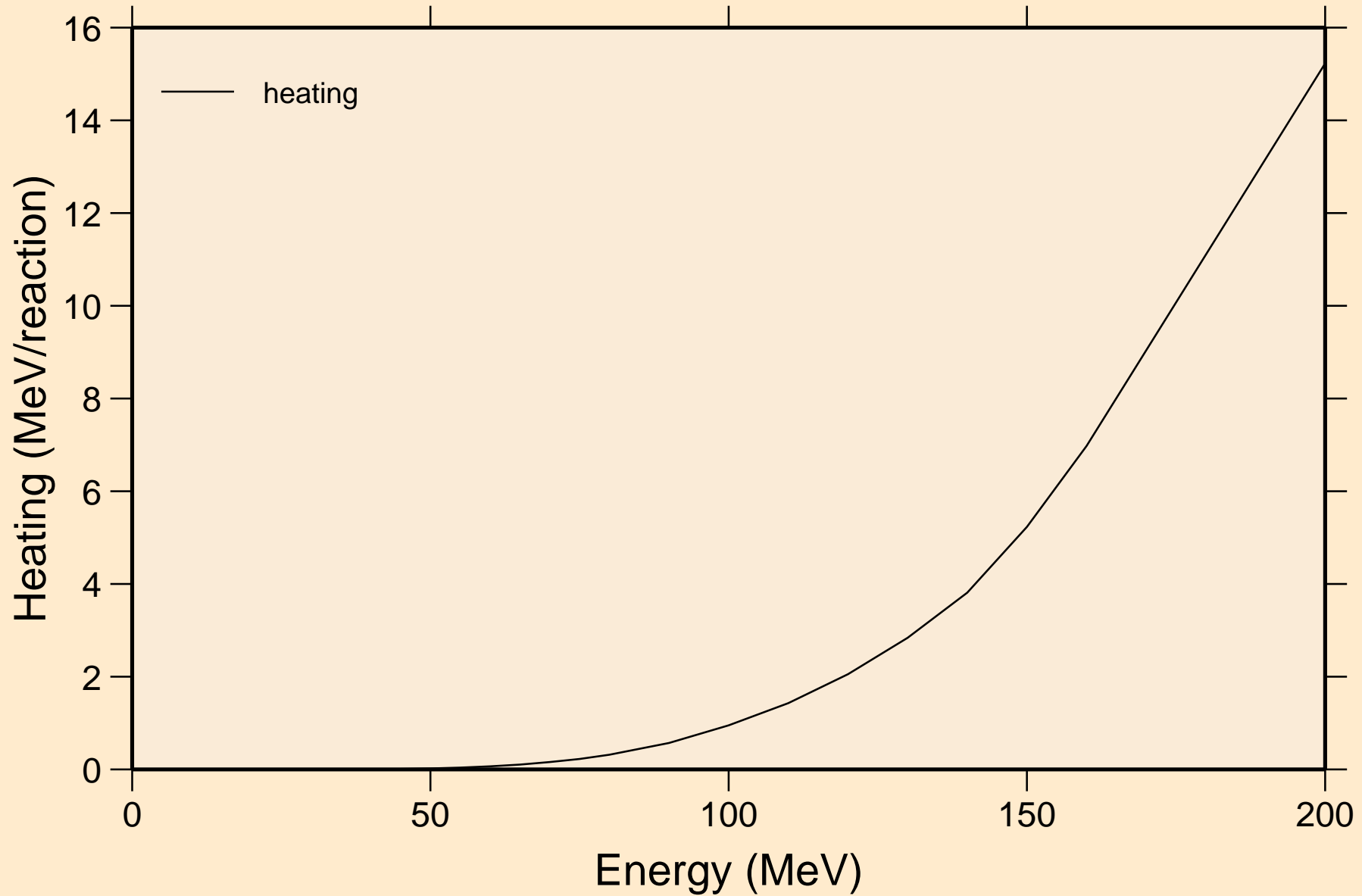

RA210 ALPHA ACER TENDL-2021 LIBRARY; T=0.K  
Threshold reactions

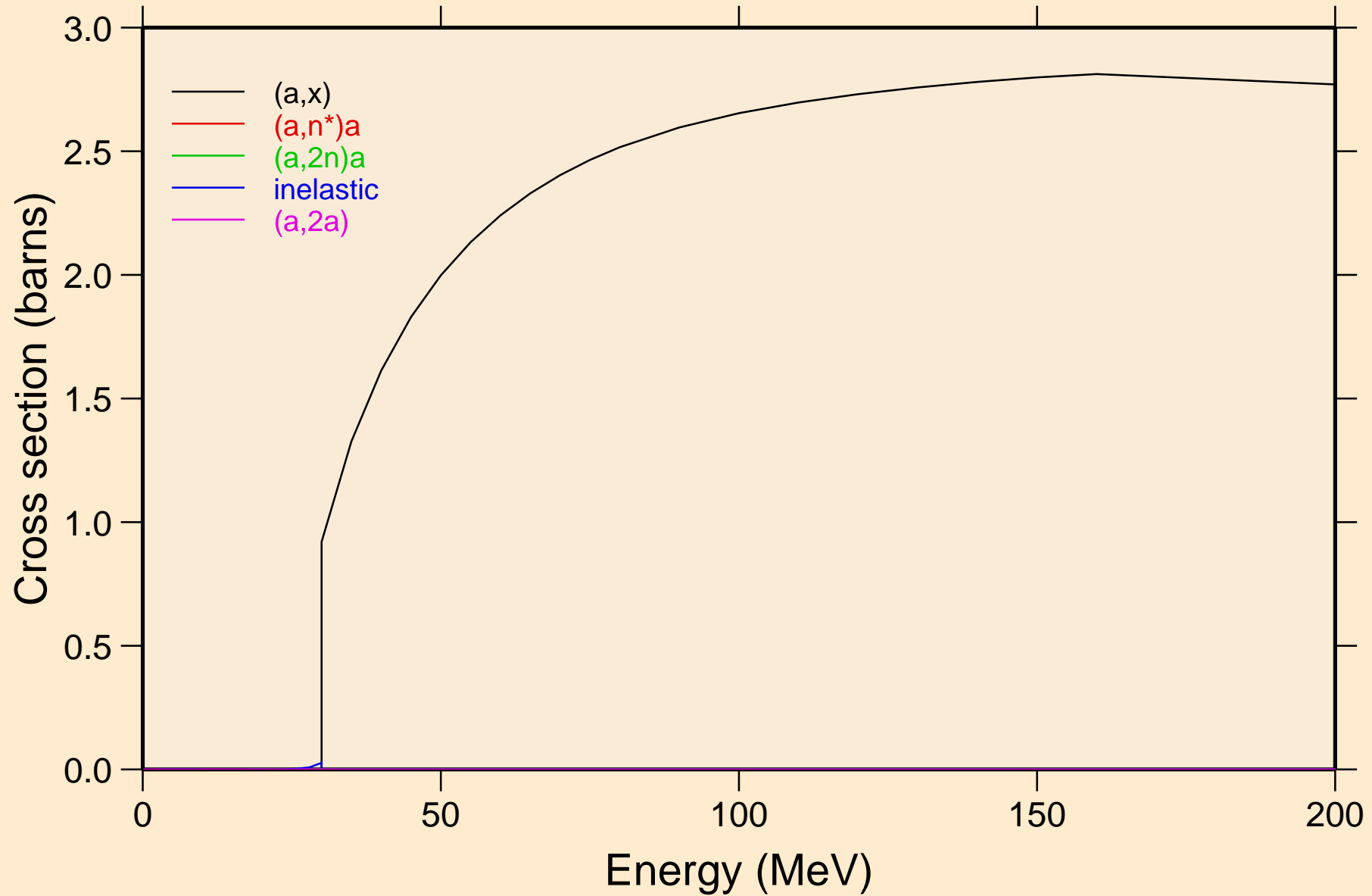

RA210 ALPHA ACER TENDL-2021 LIBRARY; T=0.K  
Threshold reactions

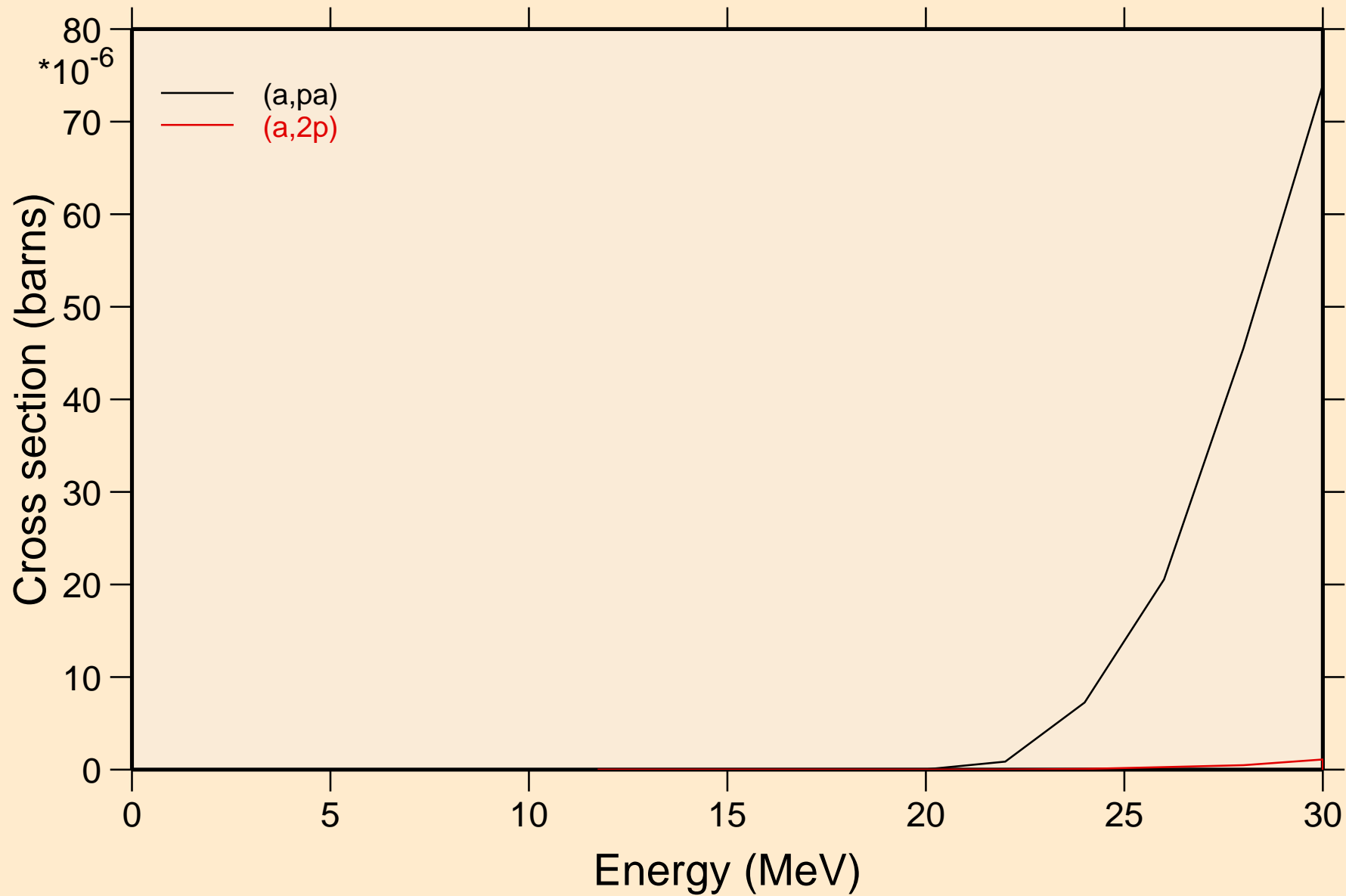

RA210 ALPHA ACER TENDL-2021 LIBRARY; T=0.K  
Threshold reactions

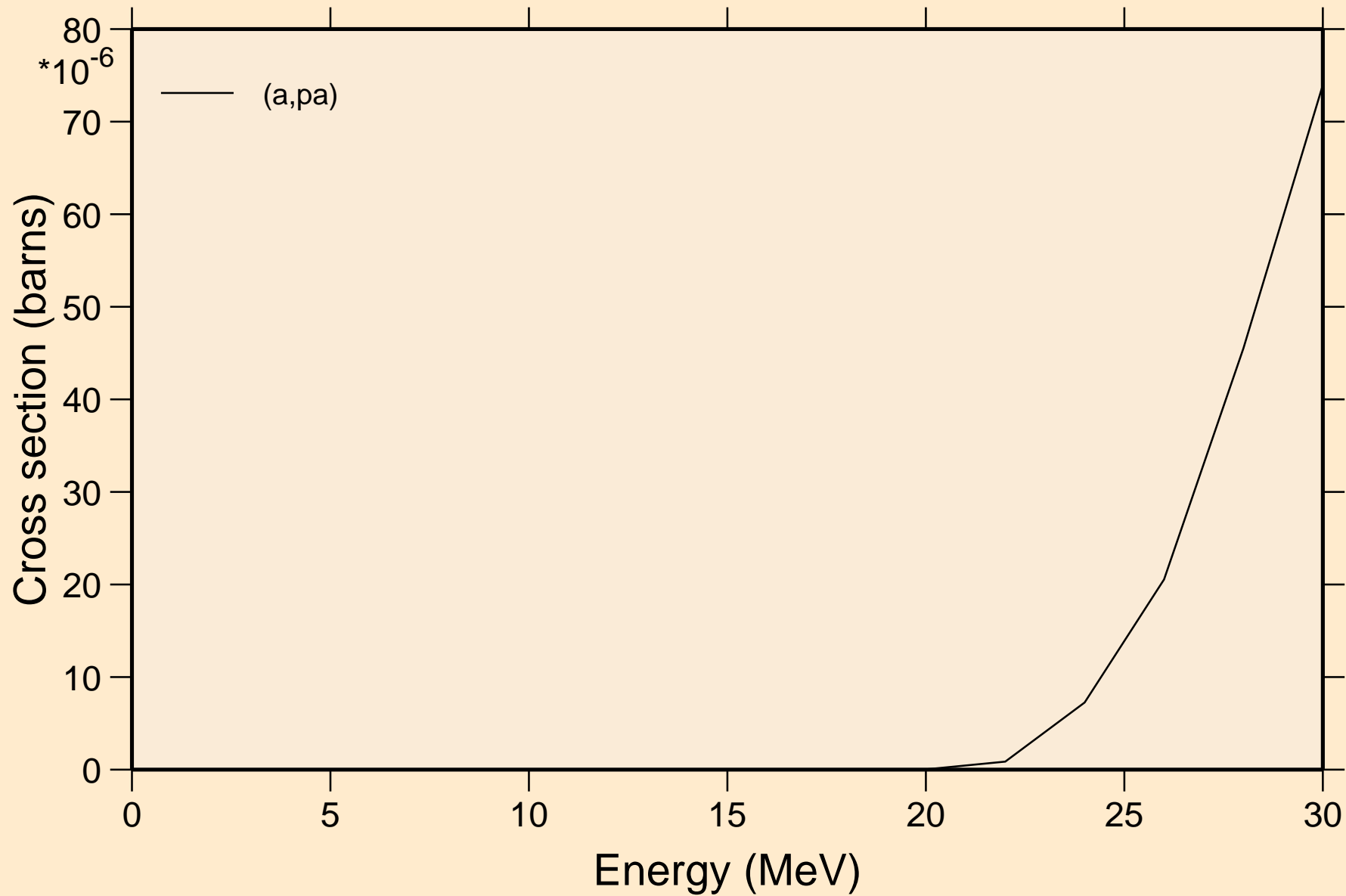

RA210 ALPHA ACER TENDL-2021 LIBRARY; T=0.K  
angular distribution for elastic

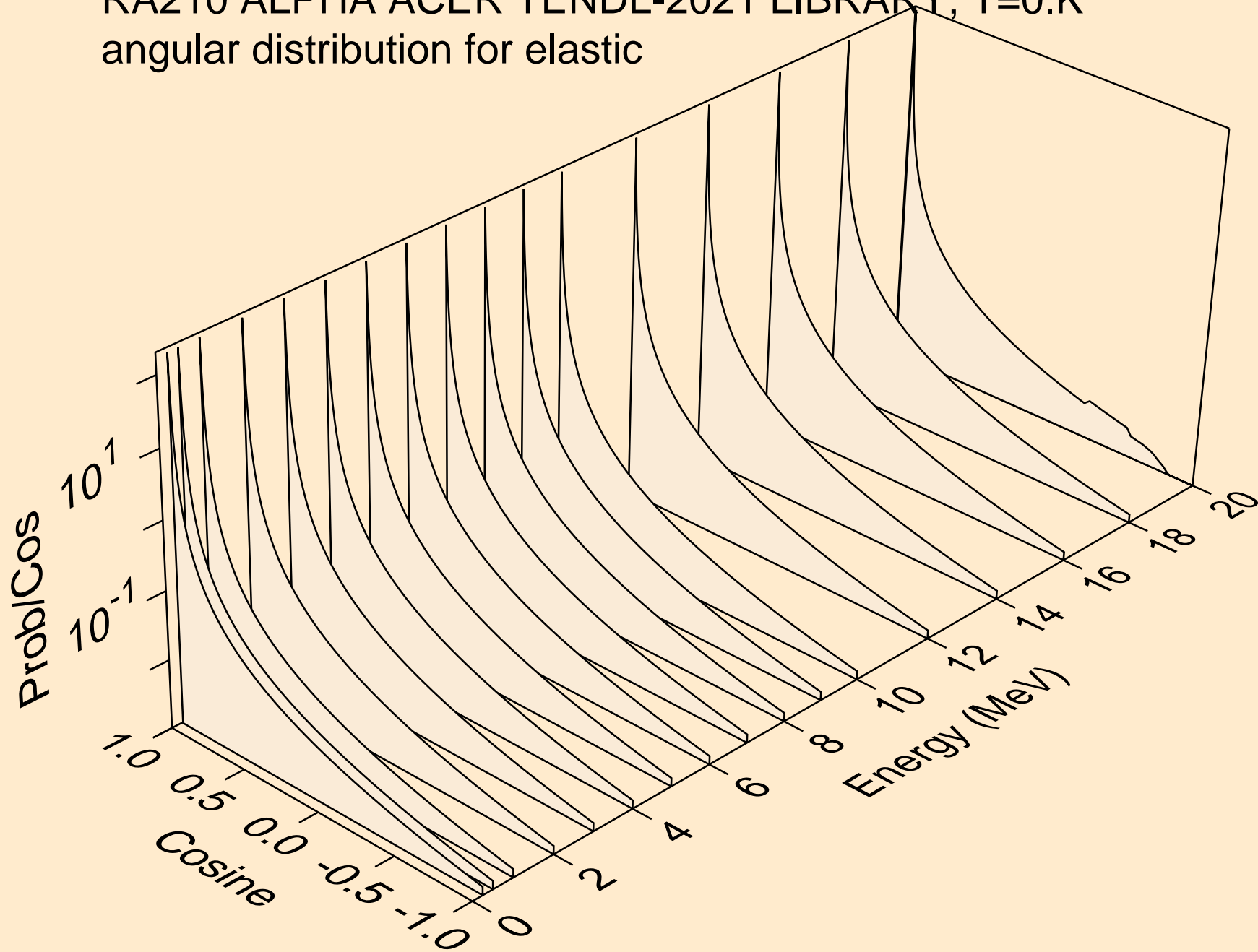



RA210 ALPHA ACER TENDL-2021 LIBRARY; T=0.K  
angular distribution for elastic

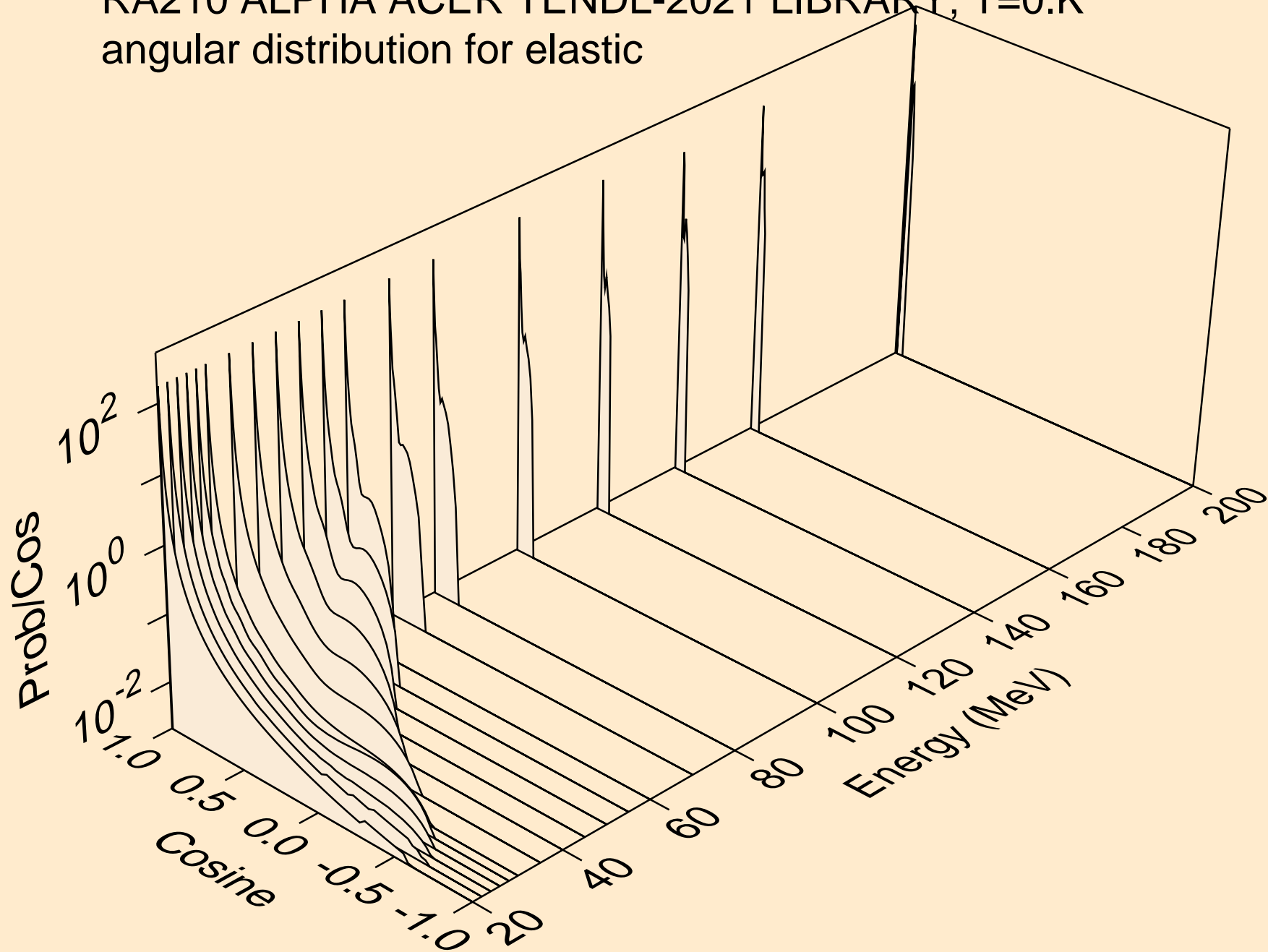

RA210 ALPHA ACER TENDL-2021 LIBRARY; T=0.K  
Alpha emission for (a,x)

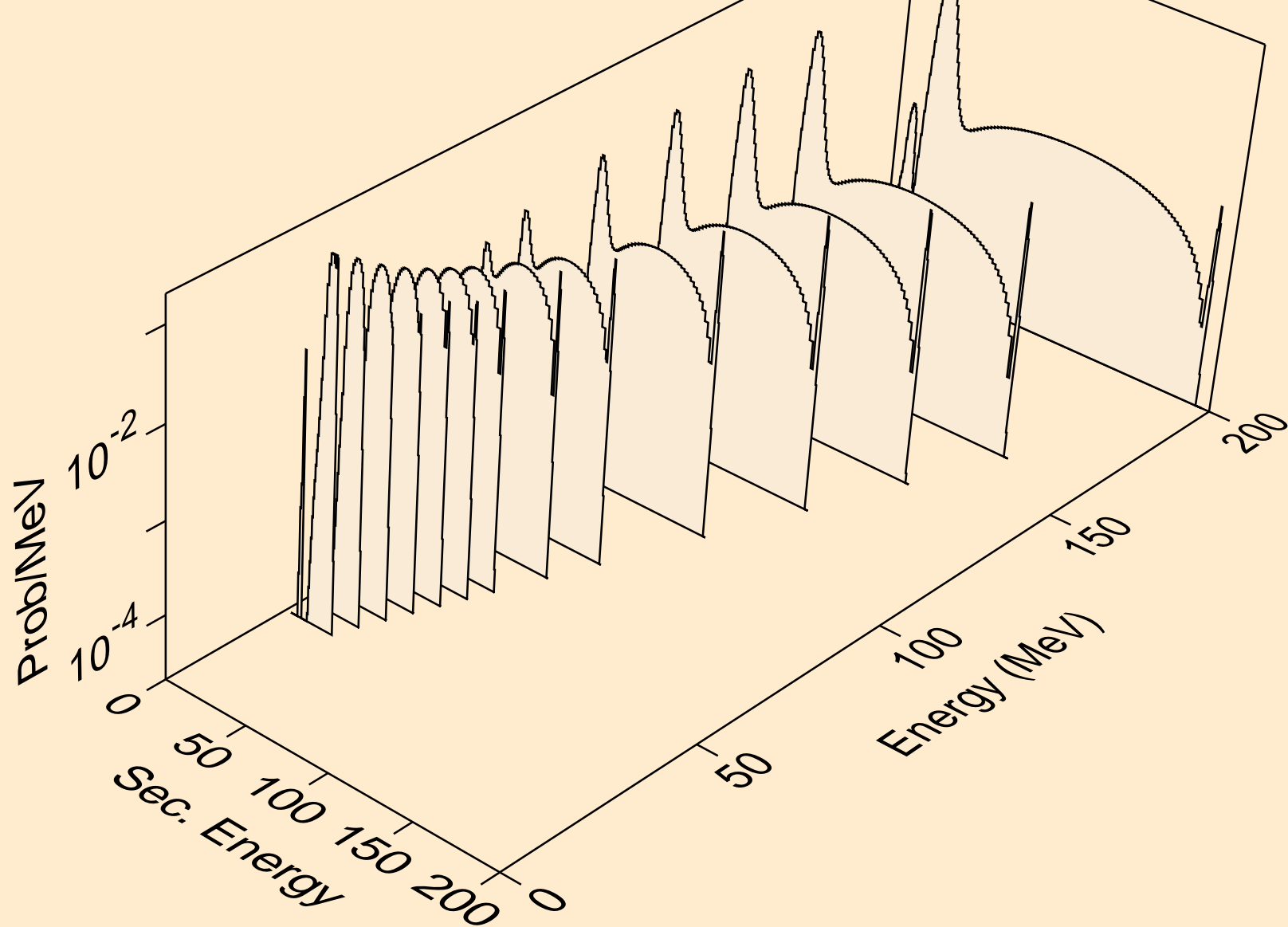

RA210 ALPHA ACER TENDL-2021 LIBRARY; T=0.K  
Alpha emission for (a,n\*)a

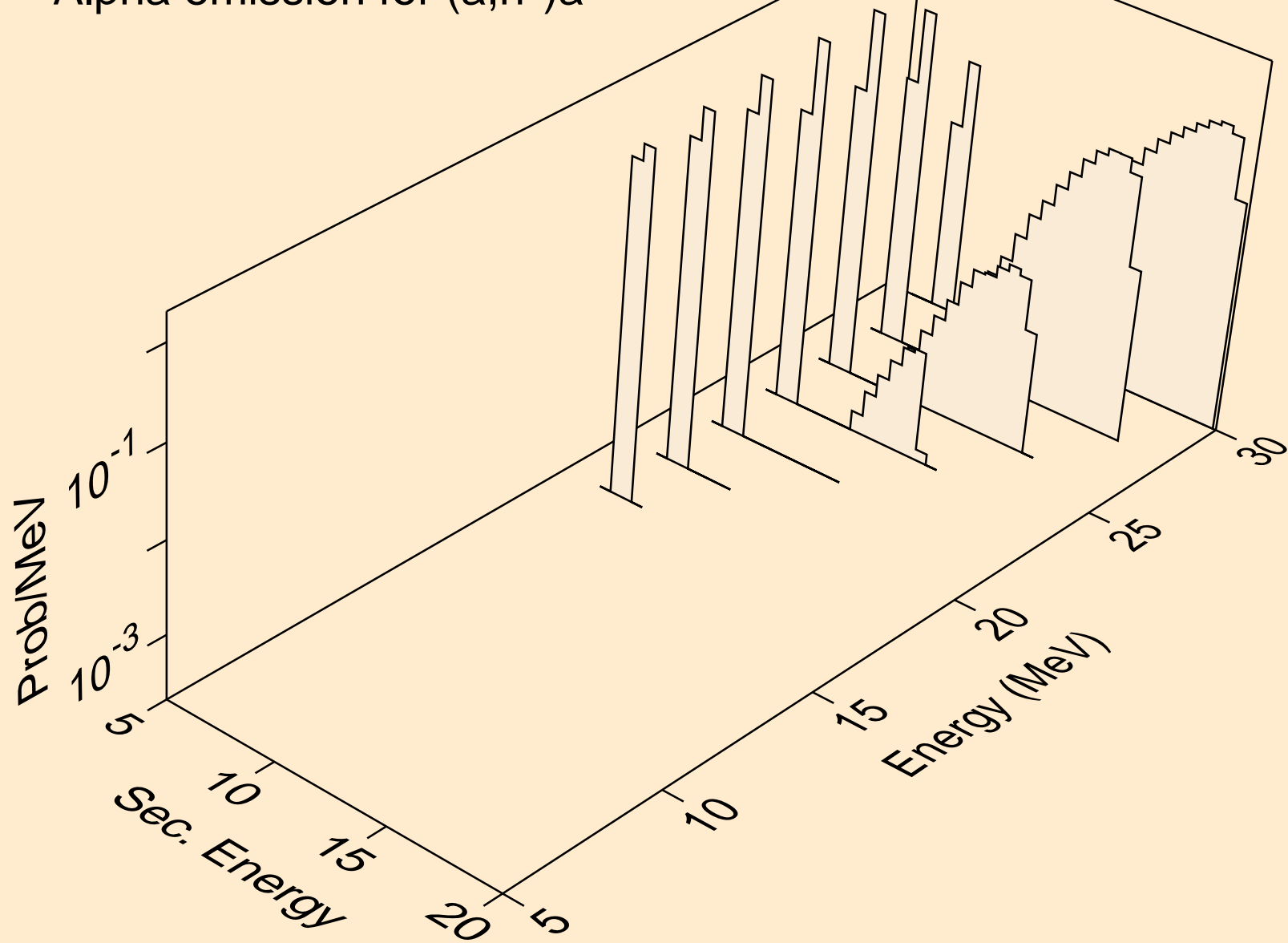

RA210 ALPHA ACER TENDL-2021 LIBRARY; T=0.K  
Alpha emission for (a,2n)a

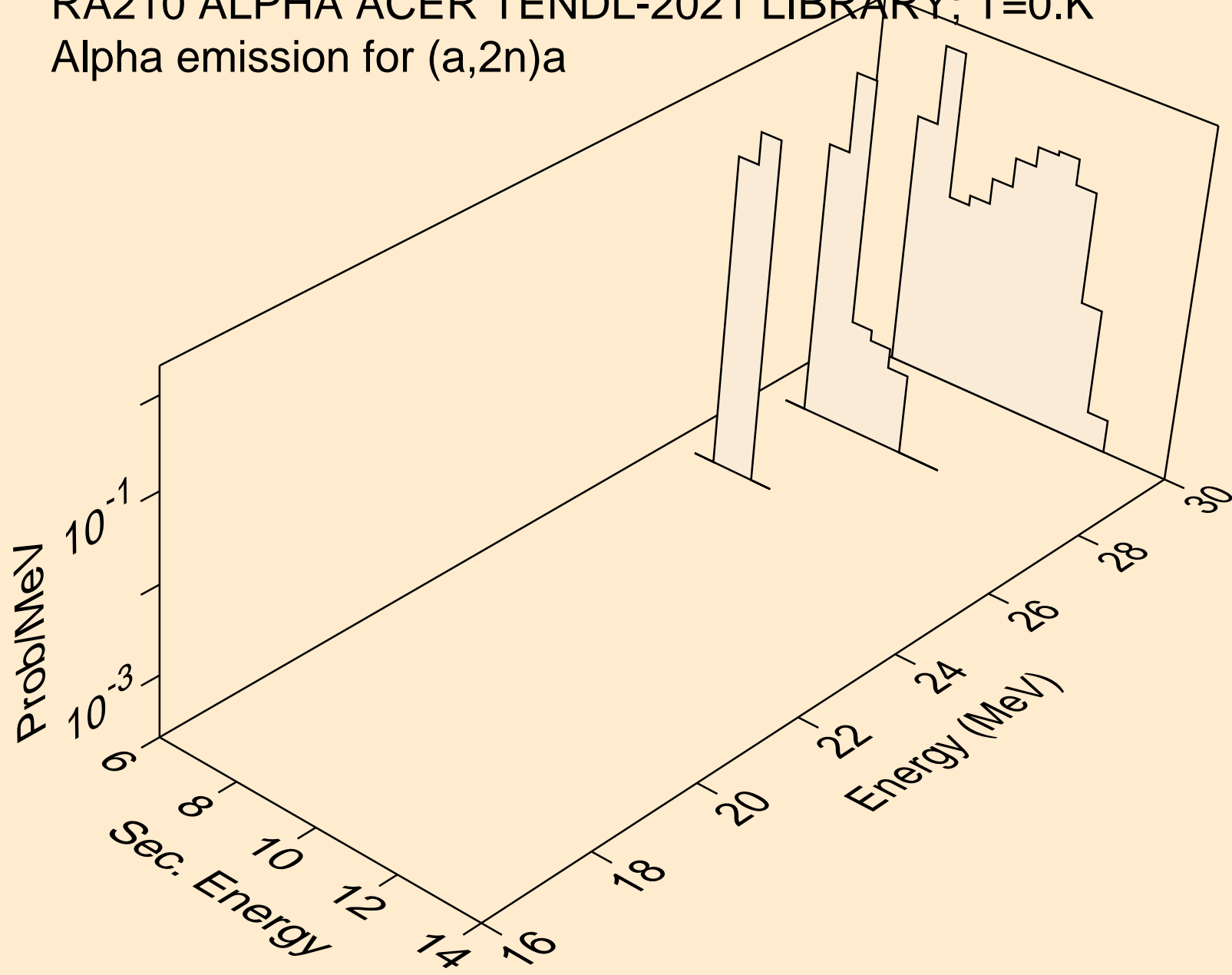

RA210 ALPHA ACER TENDL-2021 LIBRARY; T=0.K  
Alpha emission for inelastic

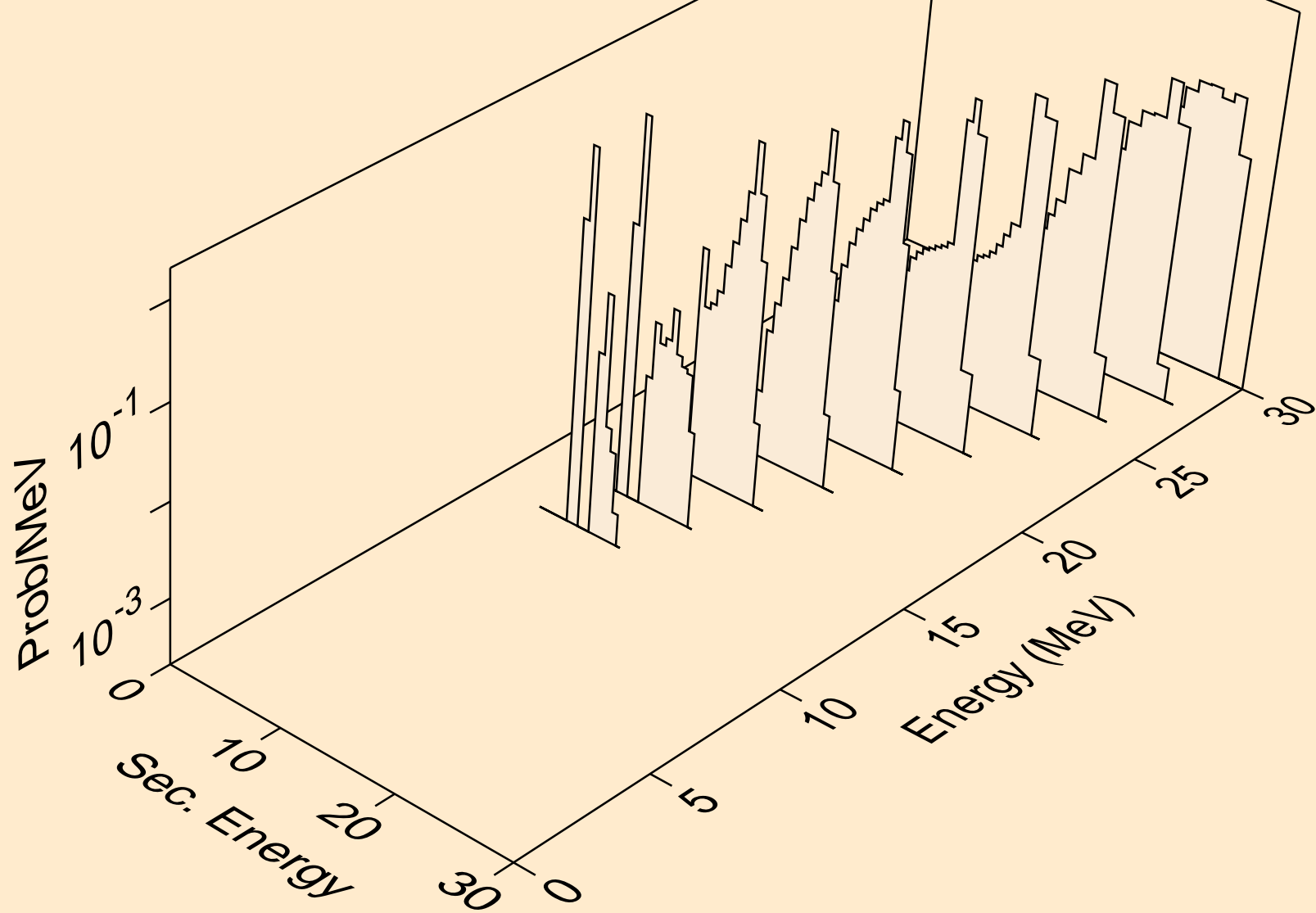

RA210 ALPHA ACER TENDL-2021 LIBRARY; T=0.K  
Alpha emission for (a,2a)

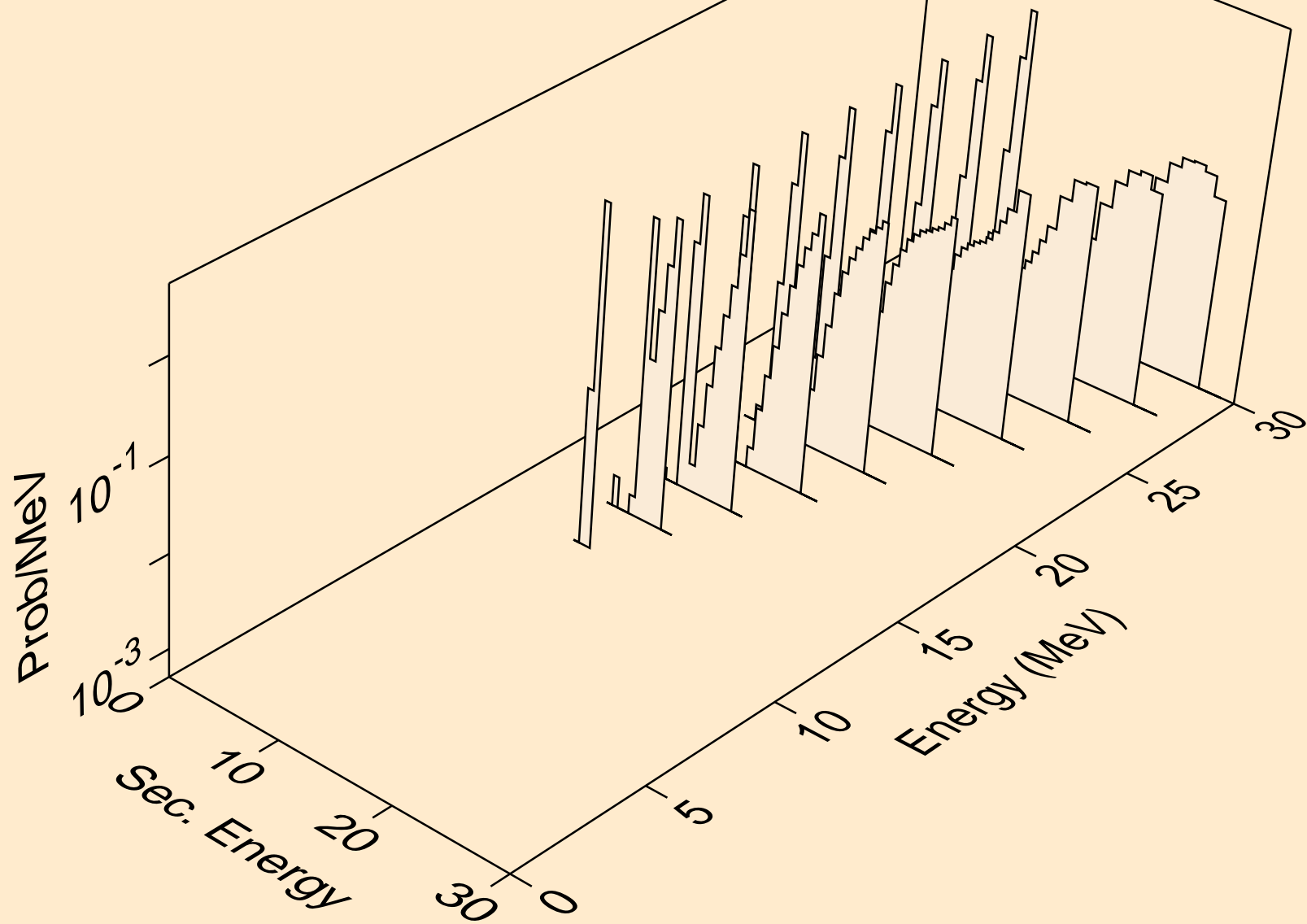

RA210 ALPHA ACER TENDL-2021 LIBRARY; T=0.K  
Alpha emission for (a,pa)

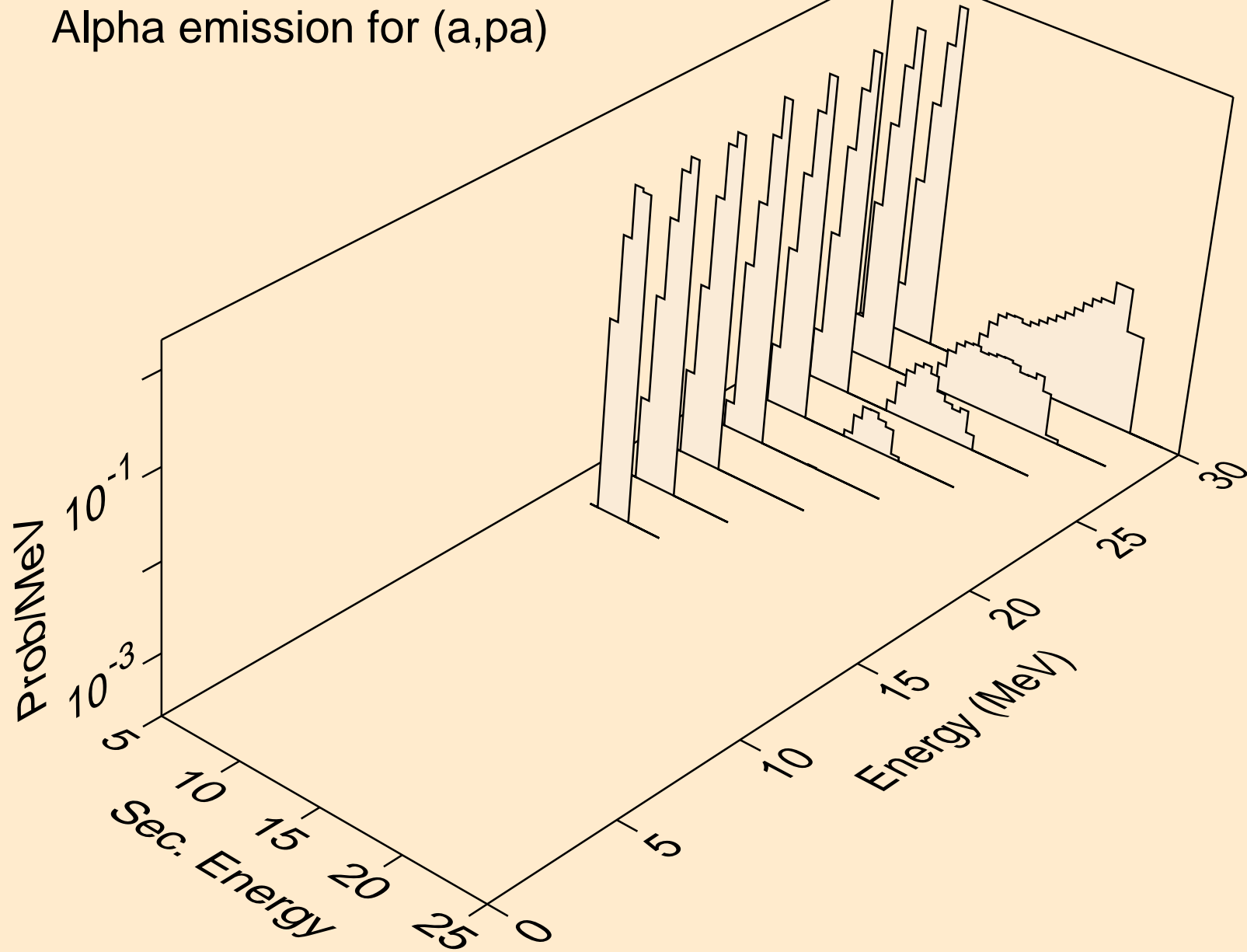

RA210 ALPHA ACER TENDL-2021 LIBRARY; T=0.K  
Photon emission for (z,n)

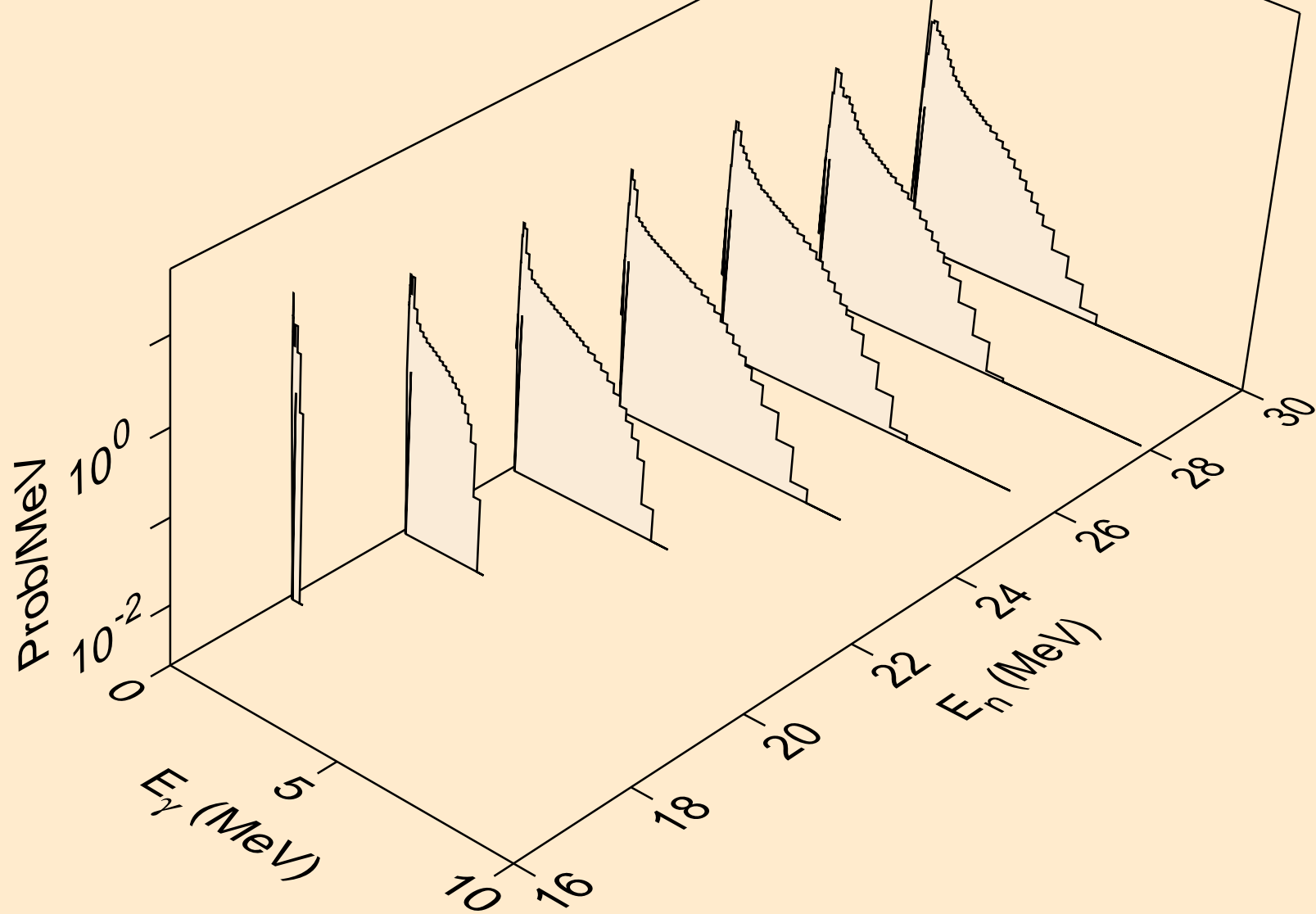



RA210 ALPHA ACER TENDL-2021 LIBRARY; T=0.K  
Photon emission for (n,x)

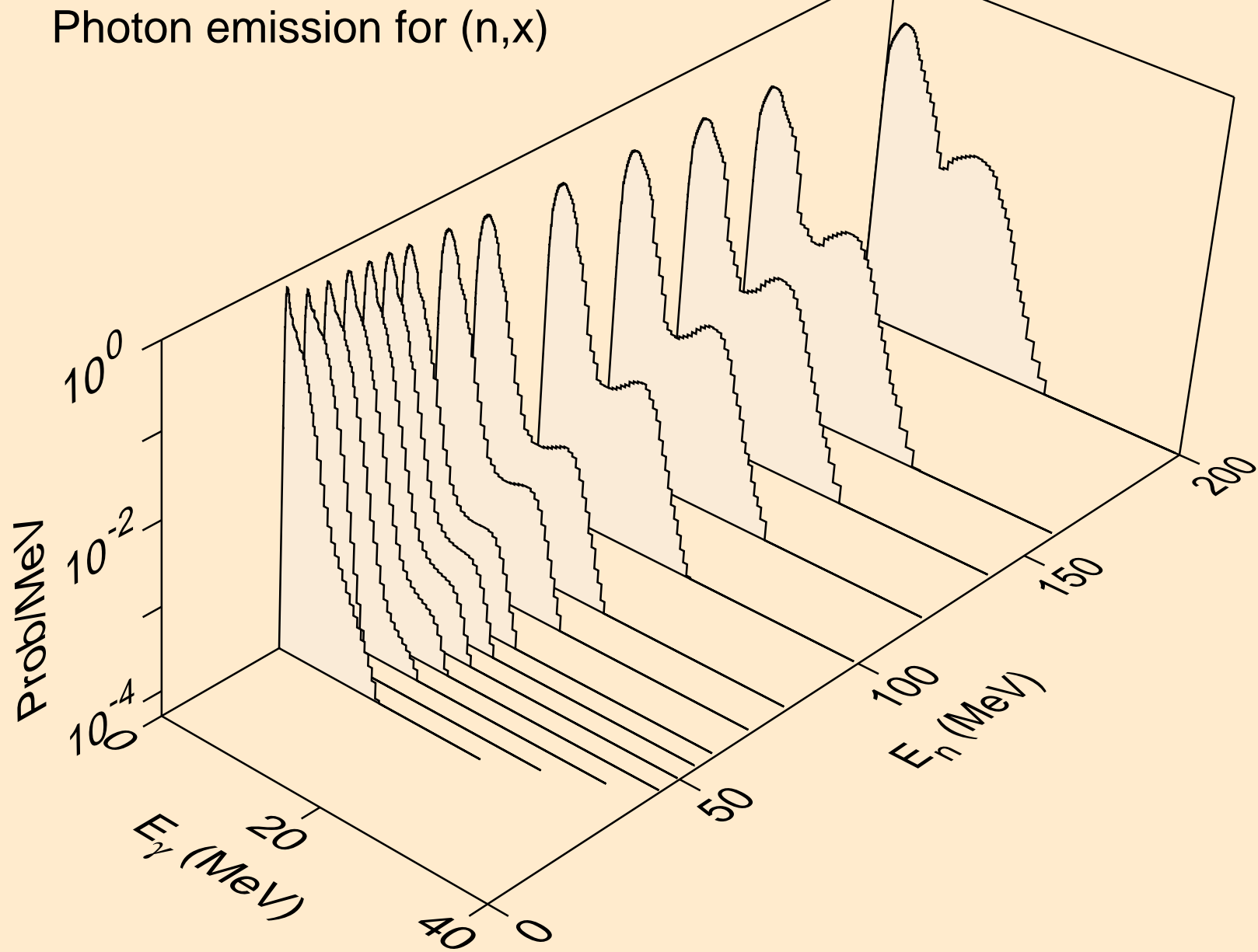

RA210 ALPHA ACER TENDL-2021 LIBRARY; T=0.K  
Photon emission for (n,2n)

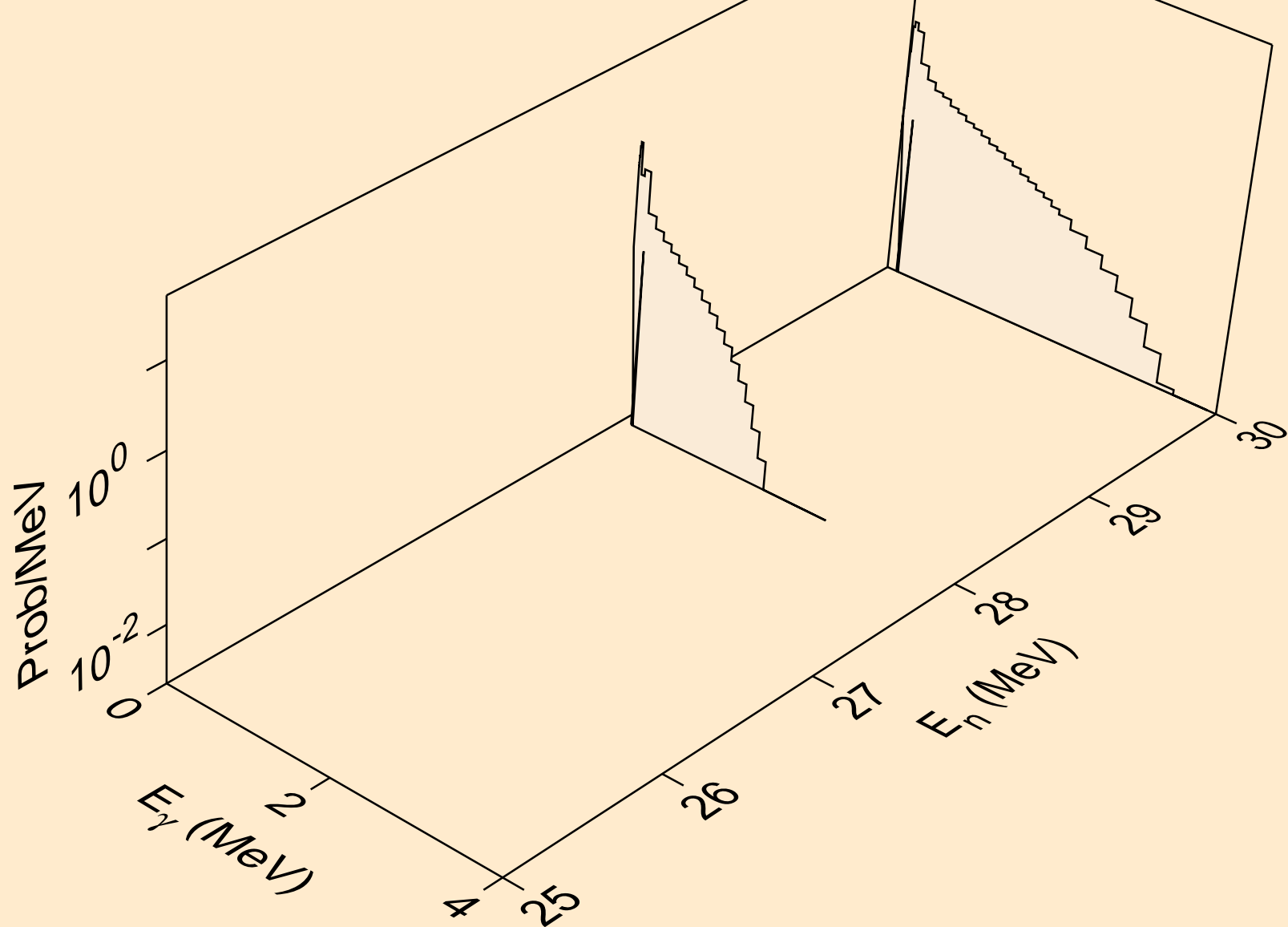

RA210 ALPHA ACER TENDL-2021 LIBRARY; T=0.K  
Photon emission for (n,n\*)a

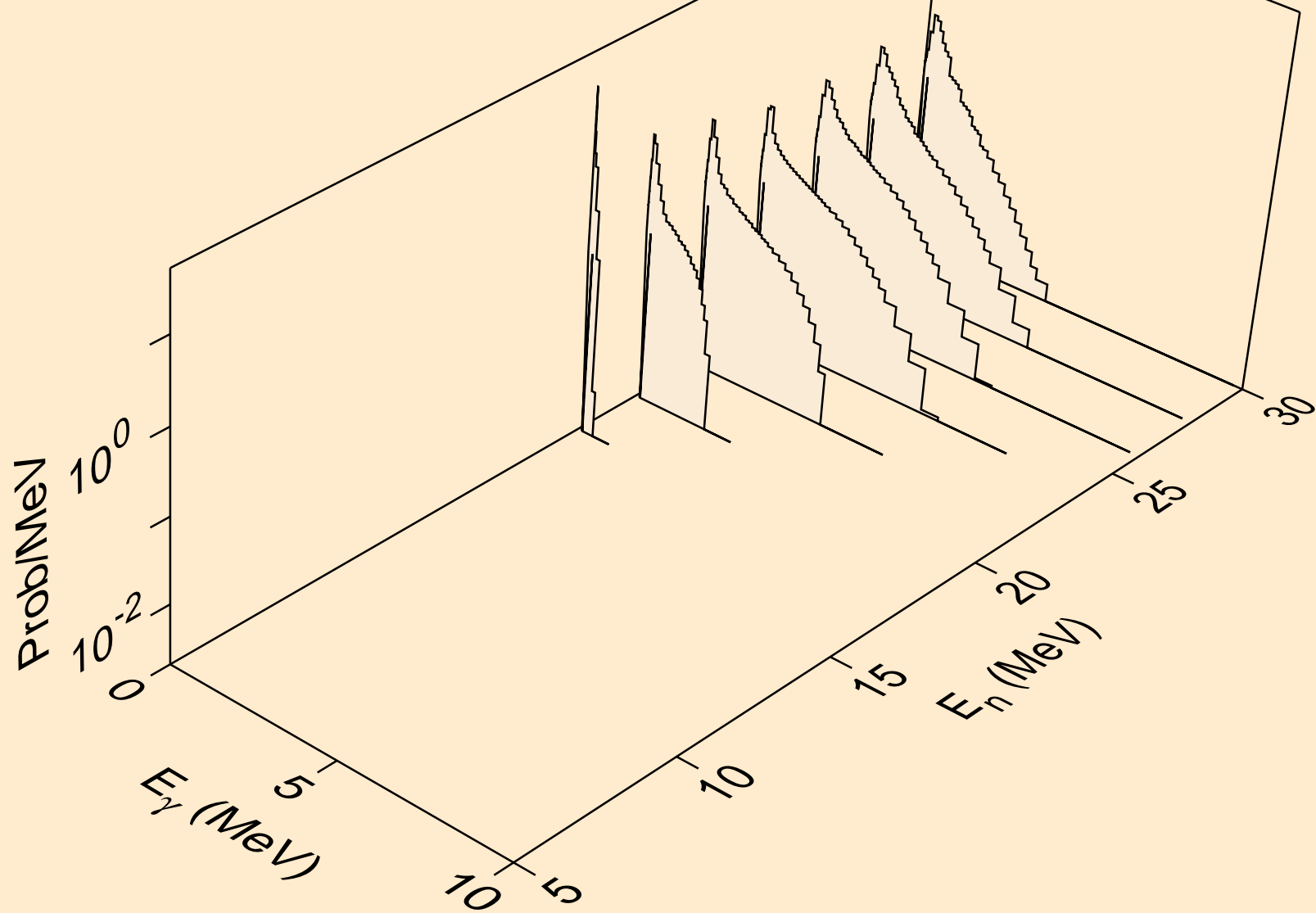

RA210 ALPHA ACER TENDL-2021 LIBRARY; T=0.K  
Photon emission for (n,2n)a

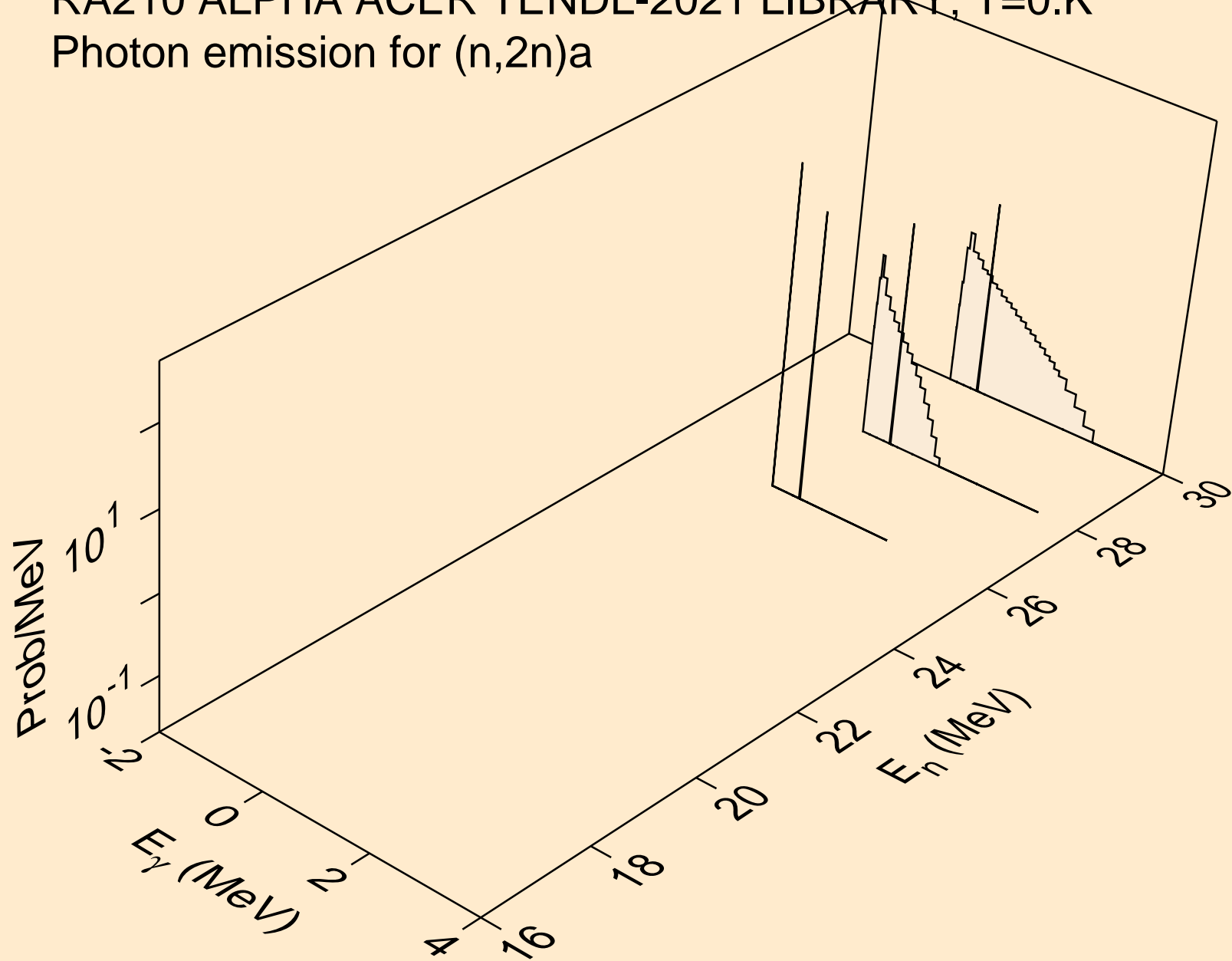

RA210 ALPHA ACER TENDL-2021 LIBRARY; T=0.K  
Photon emission for (n,n\*)p

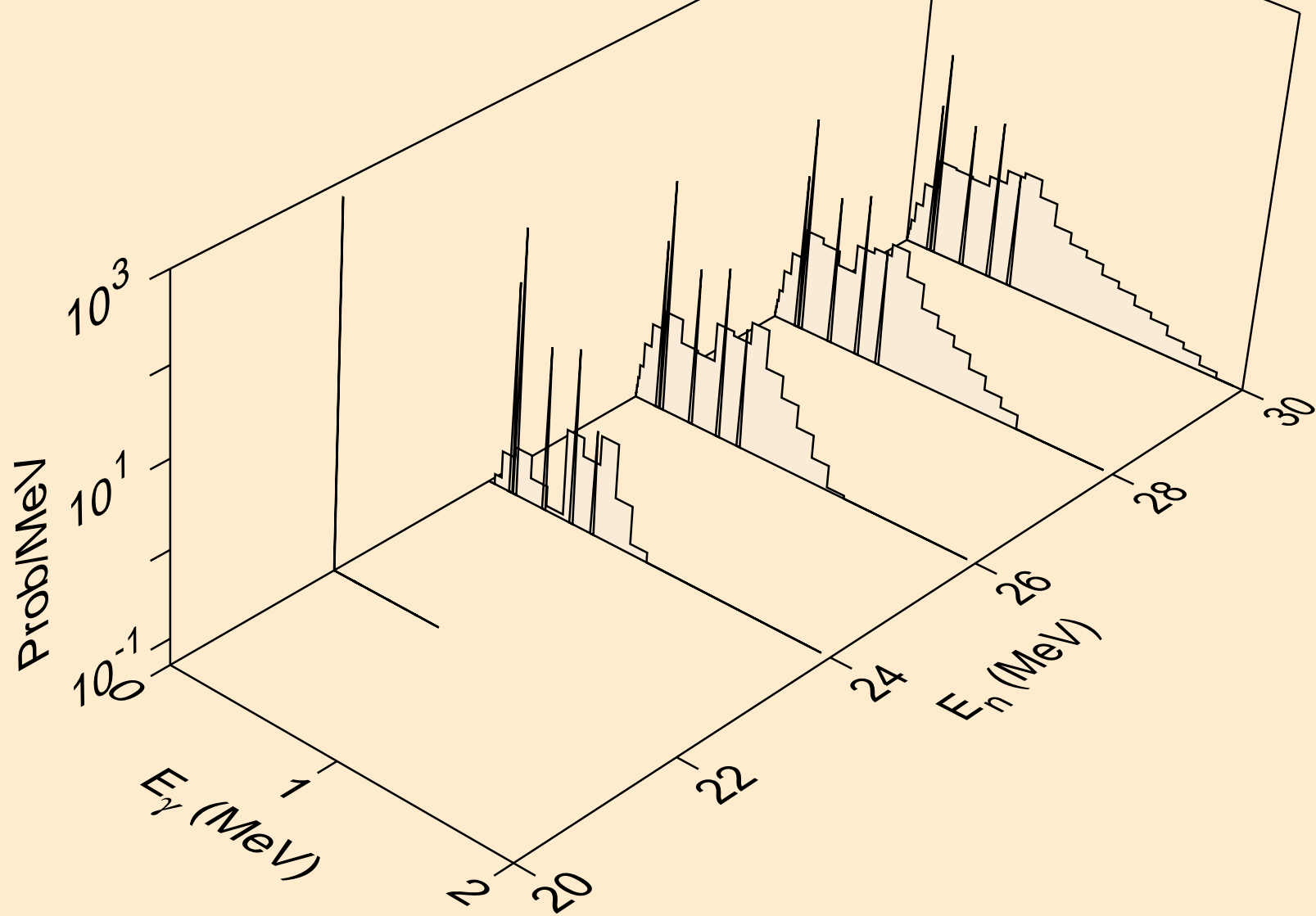

RA210 ALPHA ACER TENDL-2021 LIBRARY; T=0.K  
Photon emission for (n,gma)

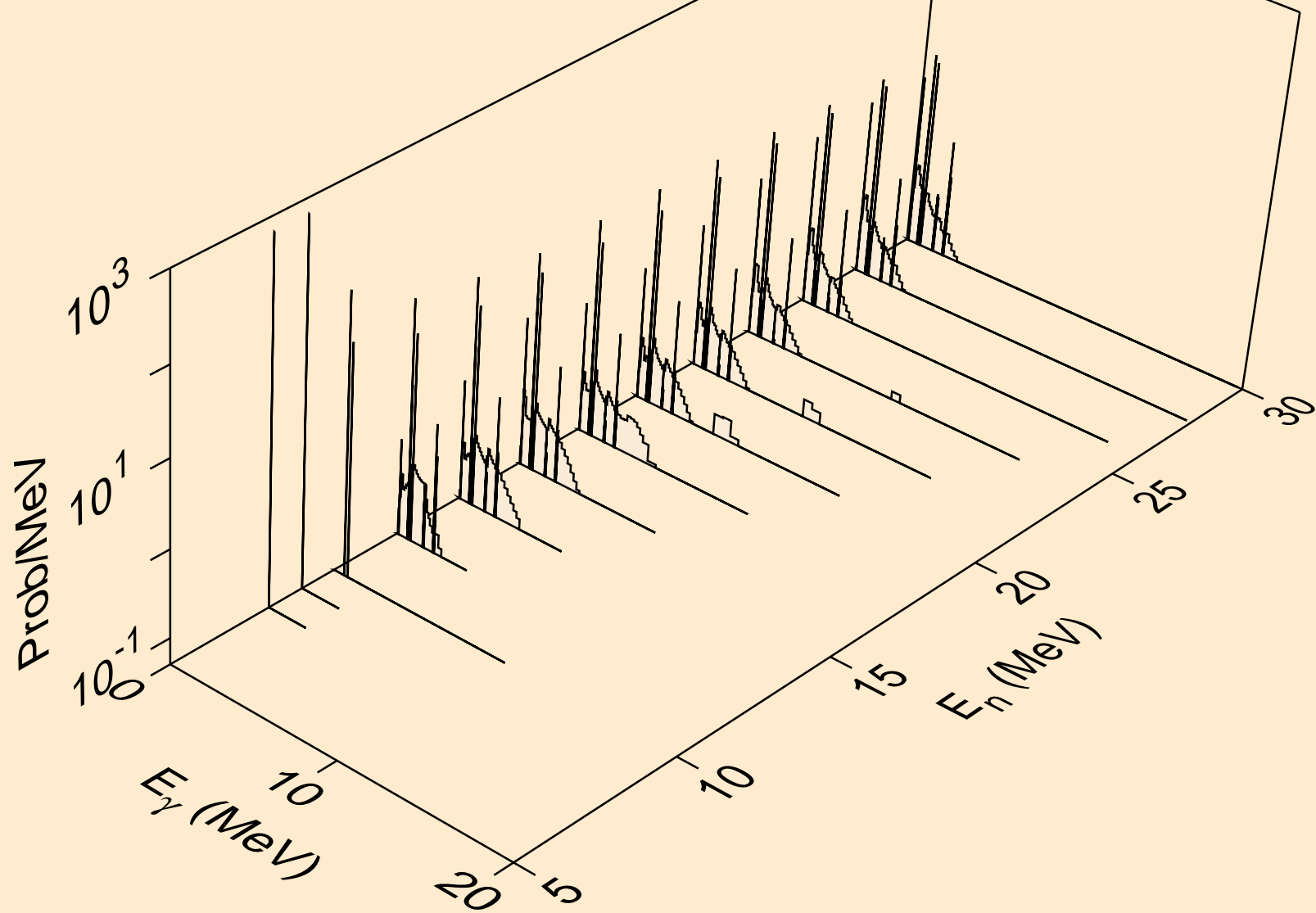

RA210 ALPHA ACER TENDL-2021 LIBRARY; T=0.K  
Photon emission for (n,p)

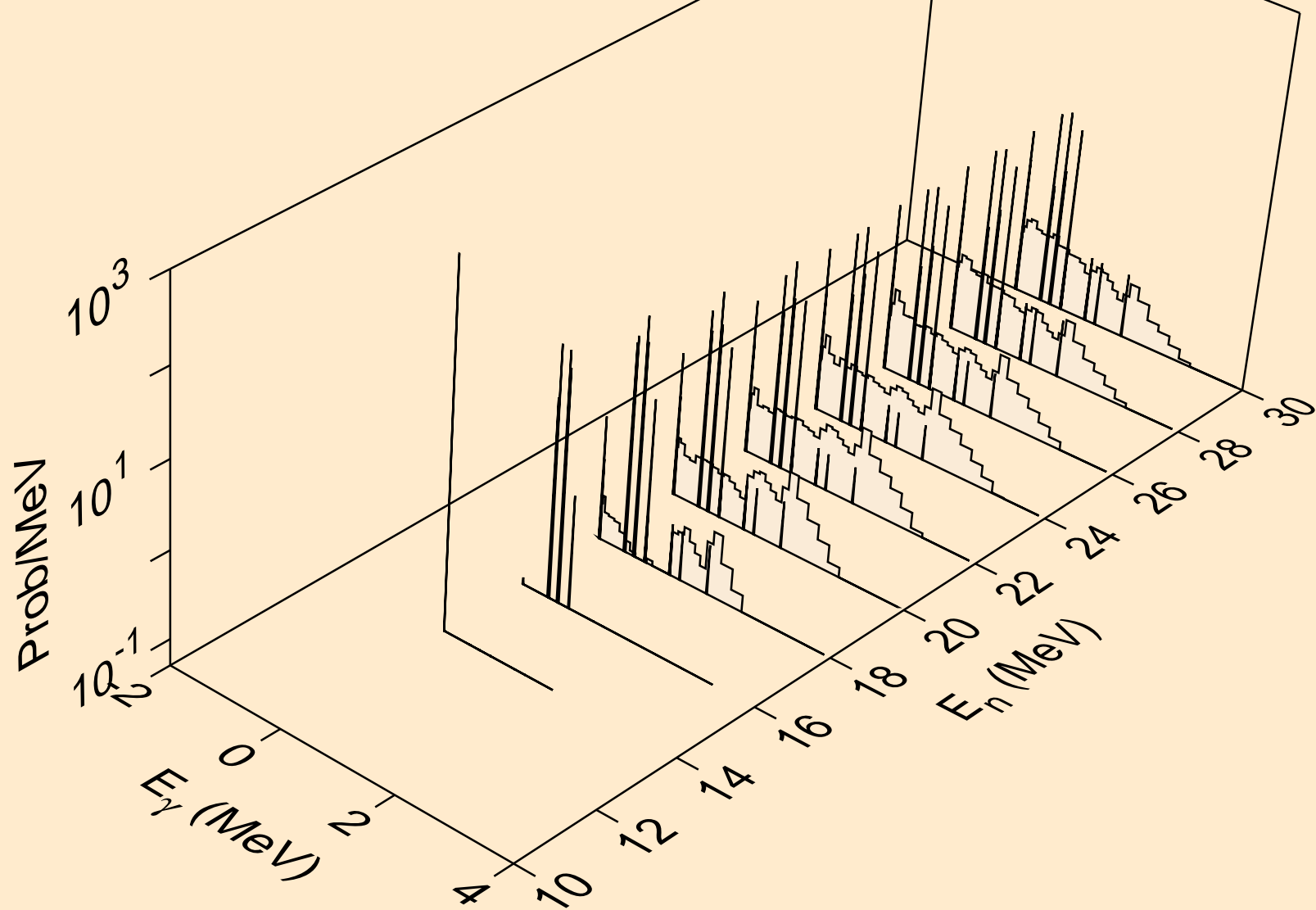

RA210 ALPHA ACER TENDL-2021 LIBRARY; T=0.K  
Photon emission for (n,d)

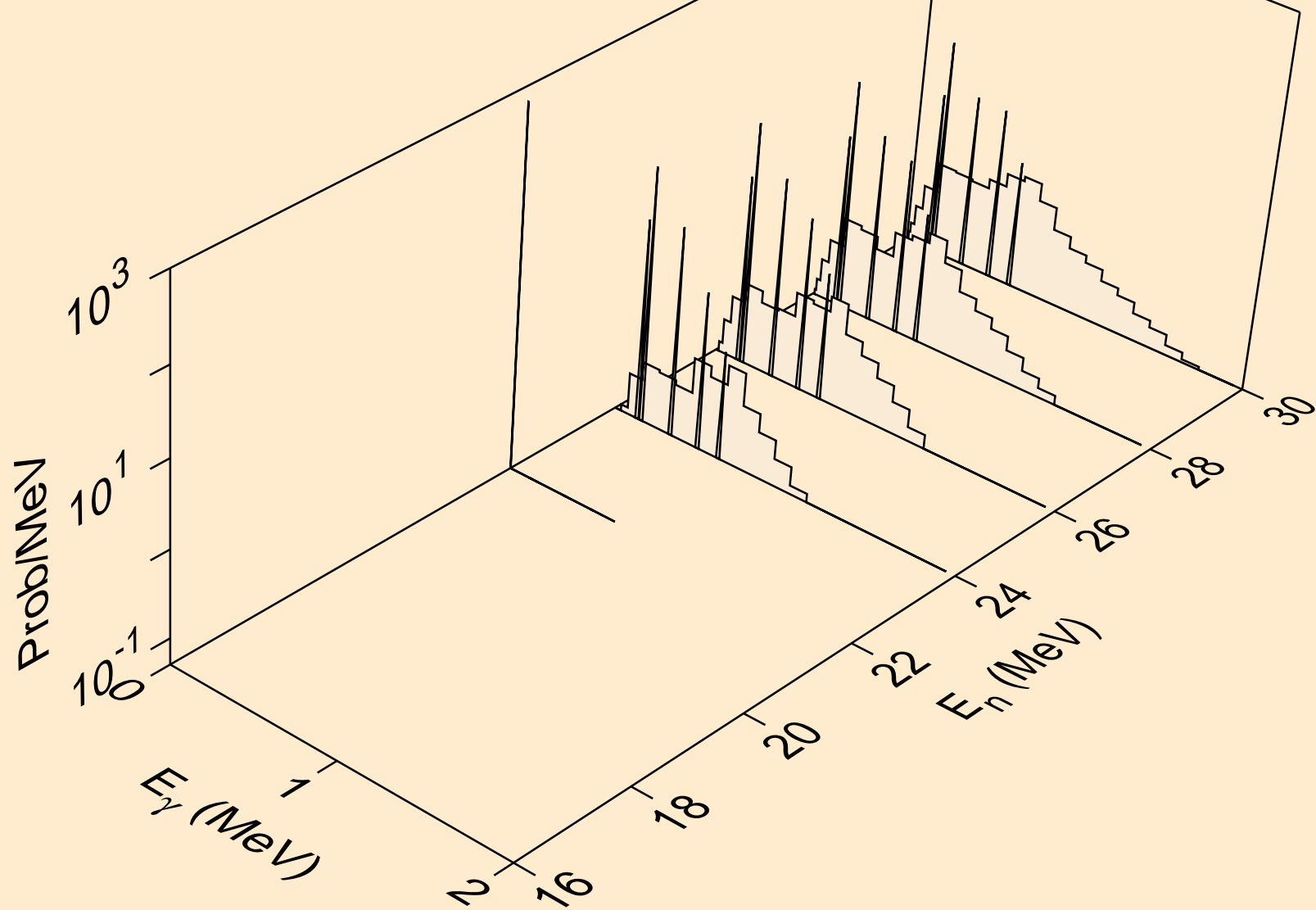



RA210 ALPHA ACER TENDL-2021 LIBRARY; T=0.K  
Photon emission for (n,t)

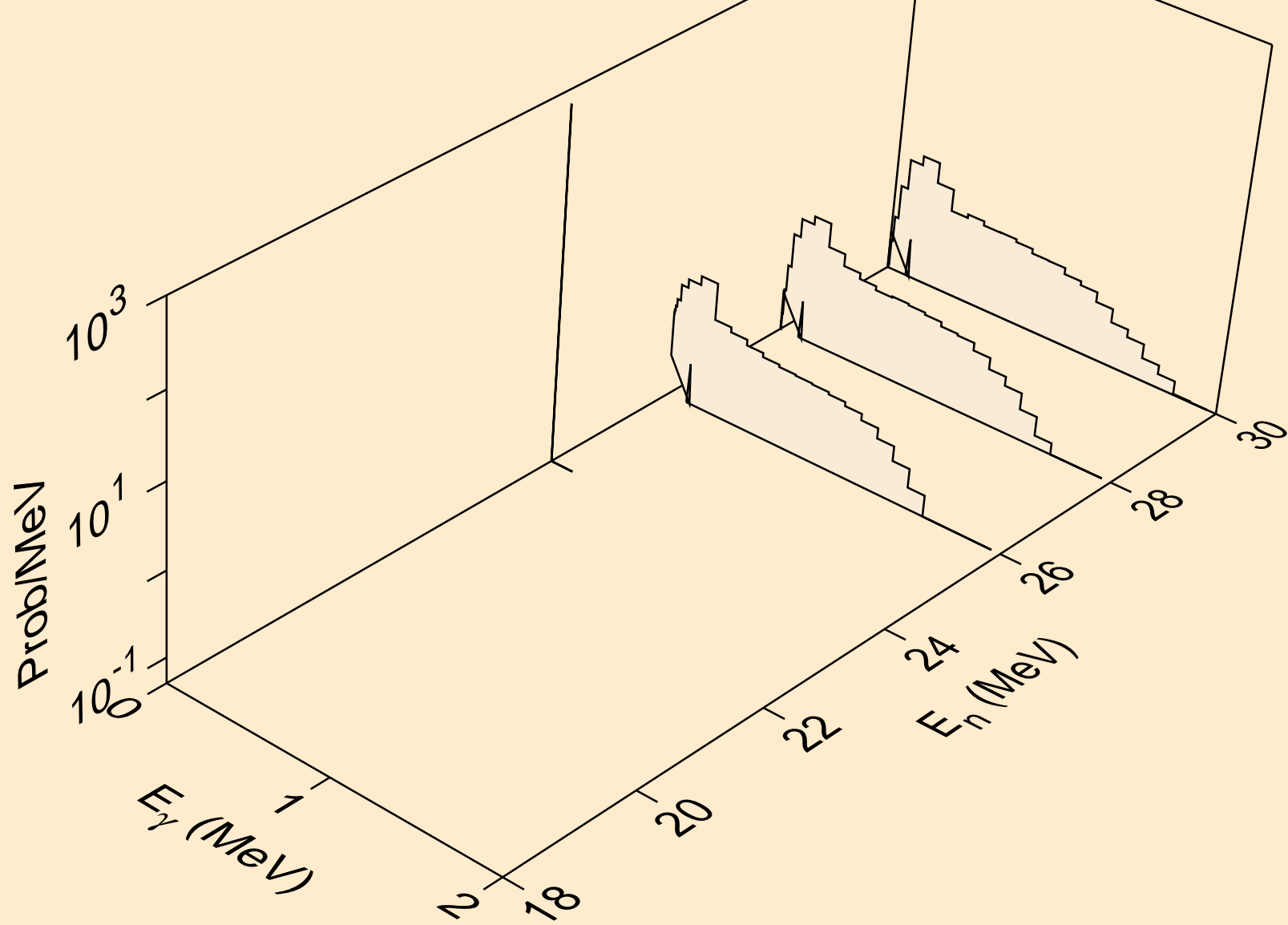

RA210 ALPHA ACER TENDL-2021 LIBRARY; T=0.K  
Photon emission for (n,he3)

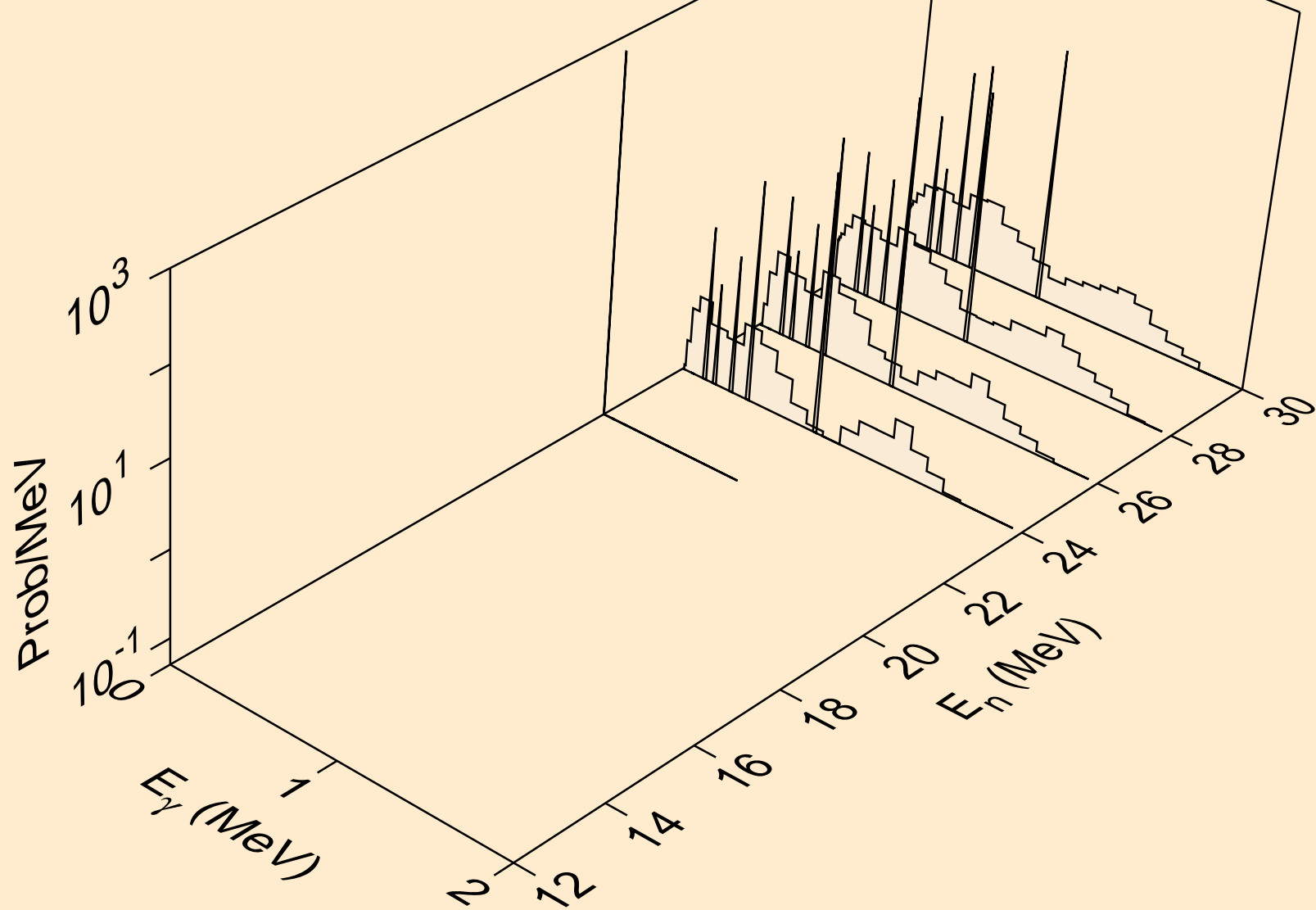

RA210 ALPHA ACER TENDL-2021 LIBRARY; T=0.K  
Photon emission for inelastic

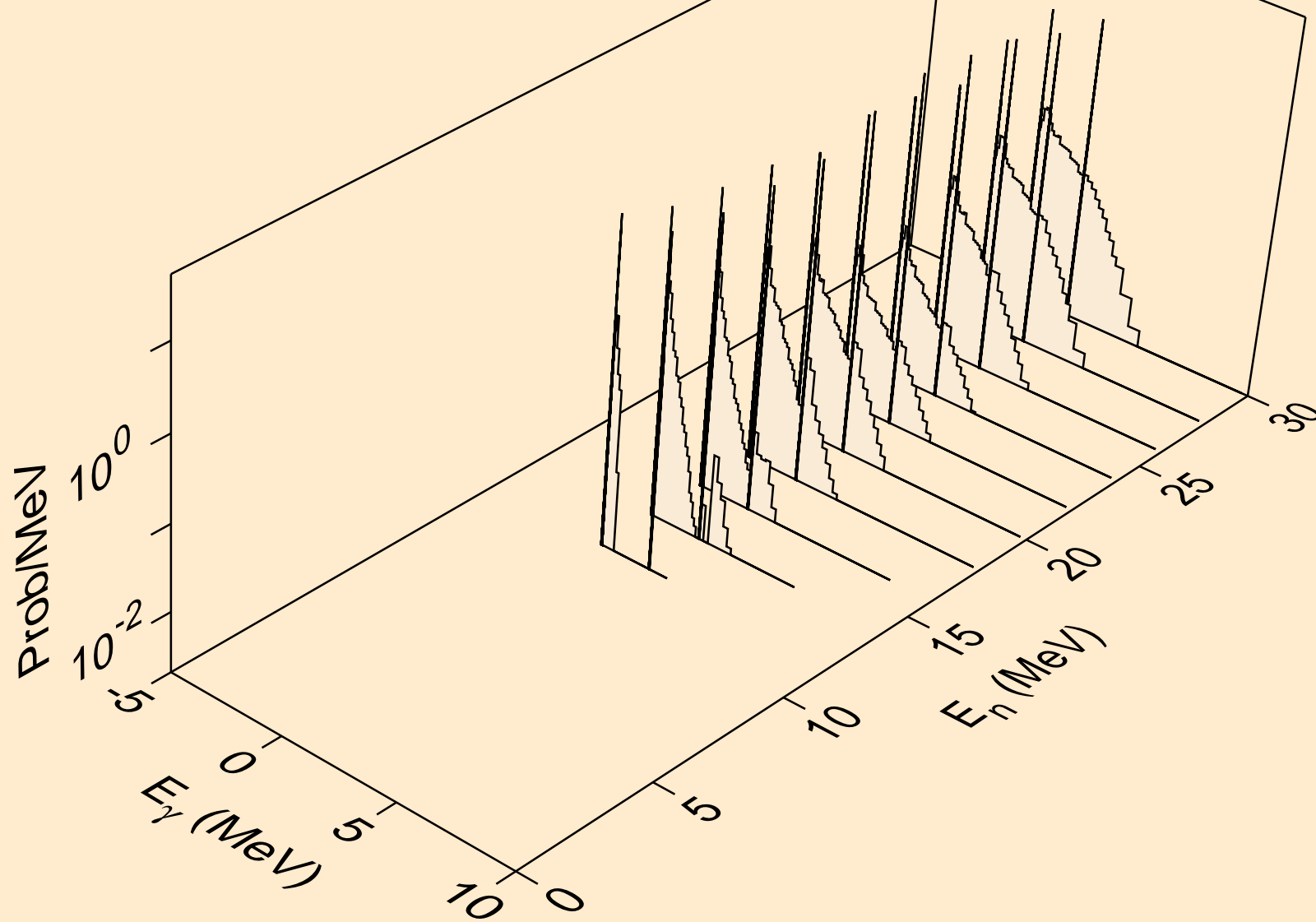

RA210 ALPHA ACER TENDL-2021 LIBRARY; T=0.K  
Photon emission for (n,2a)

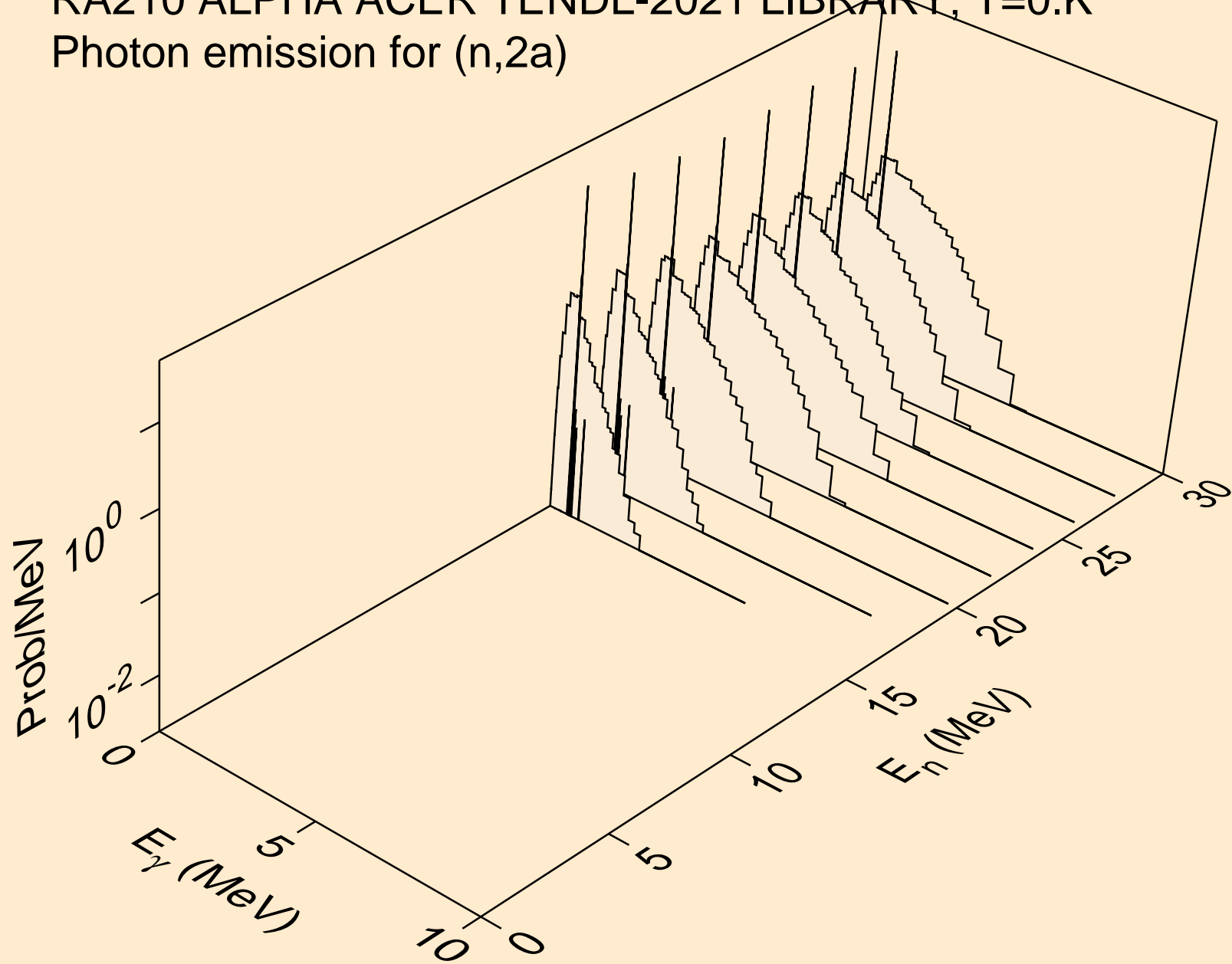

RA210 ALPHA ACER TENDL-2021 LIBRARY; T=0.K  
Photon emission for (n,2p)

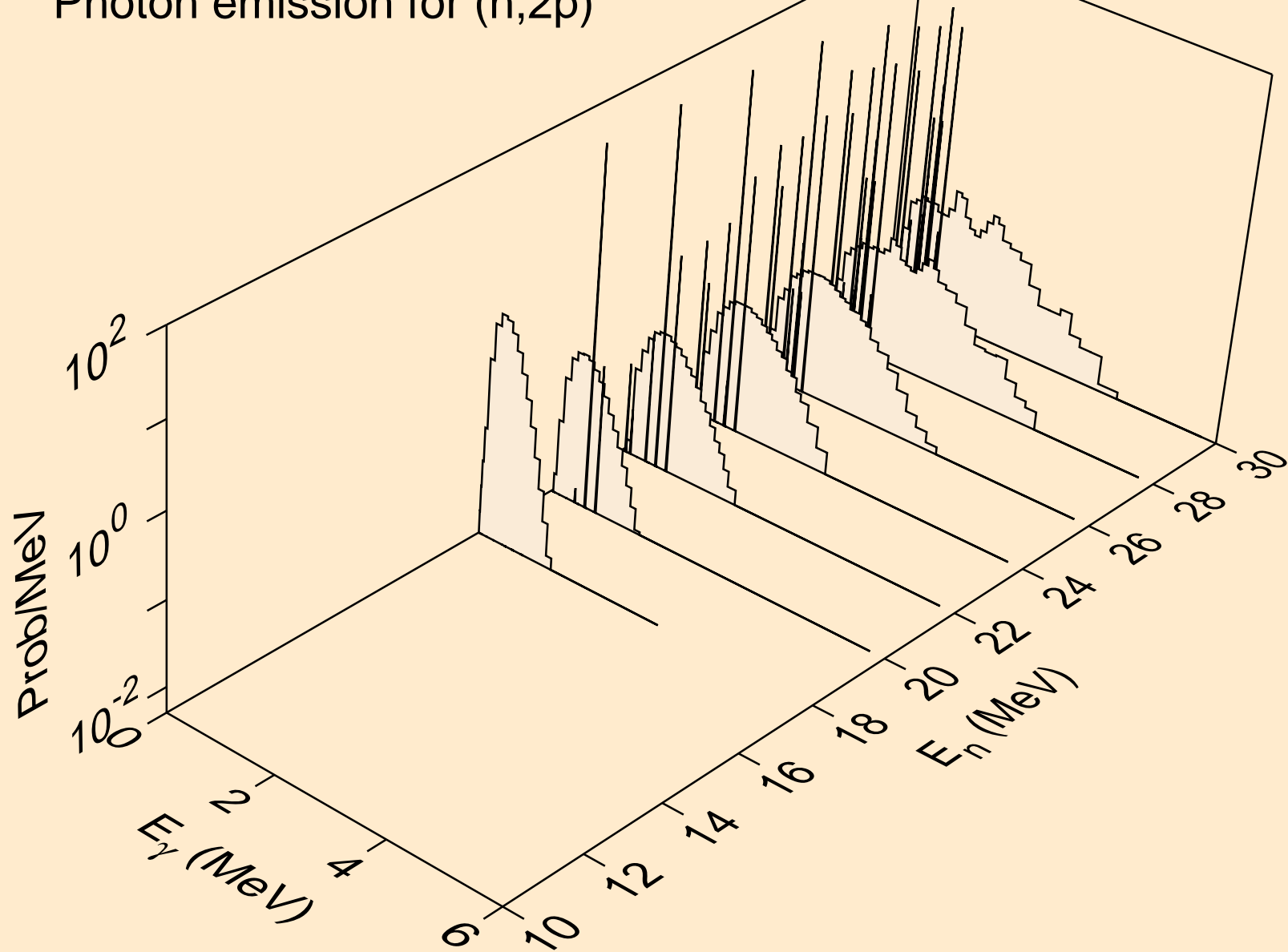

RA210 ALPHA ACER TENDL-2021 LIBRARY; T=0.K  
Photon emission for (n,pa)

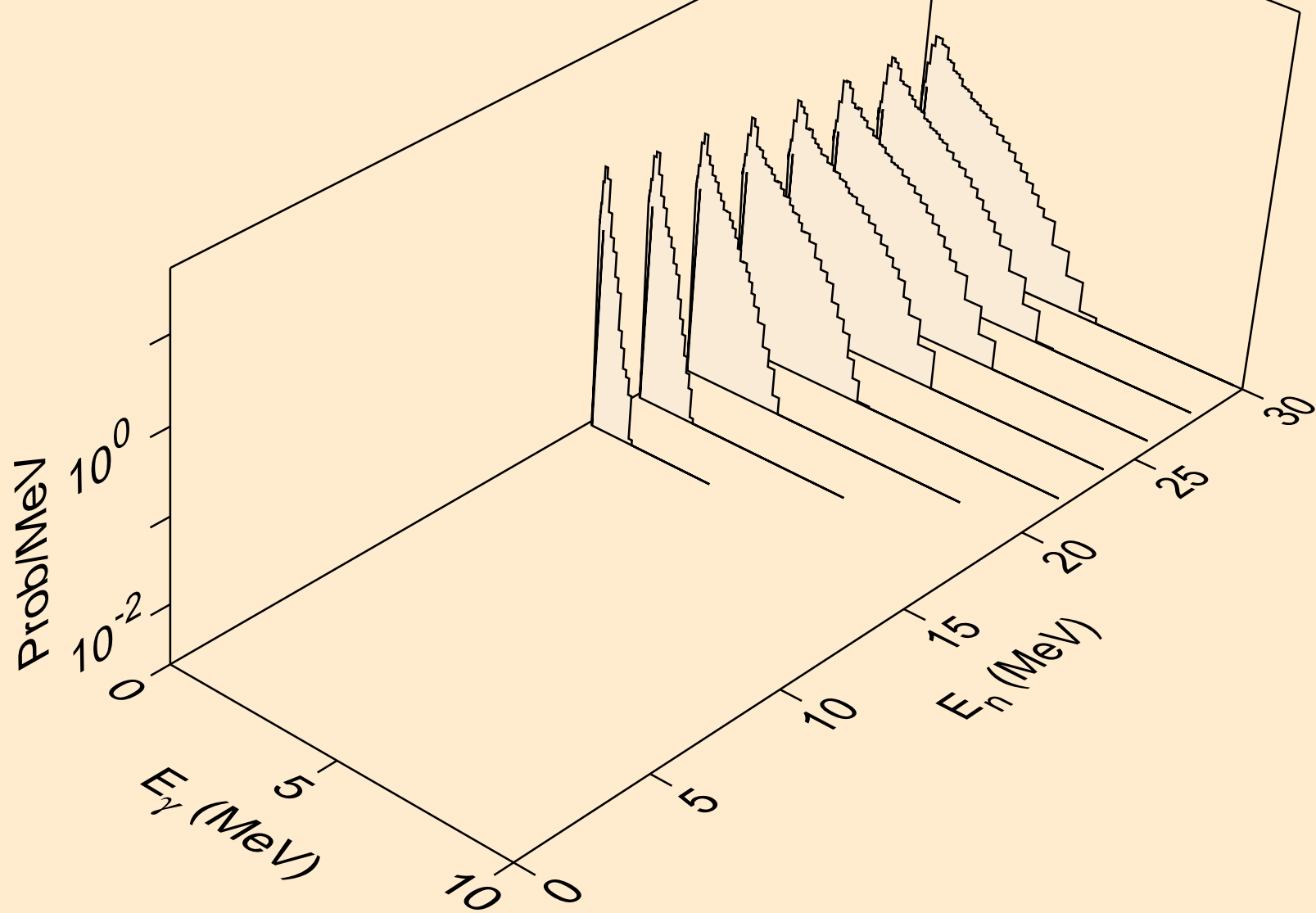

RA210 ALPHA ACER TENDL-2021 LIBRARY; T=0.K  
Particle heating contributions

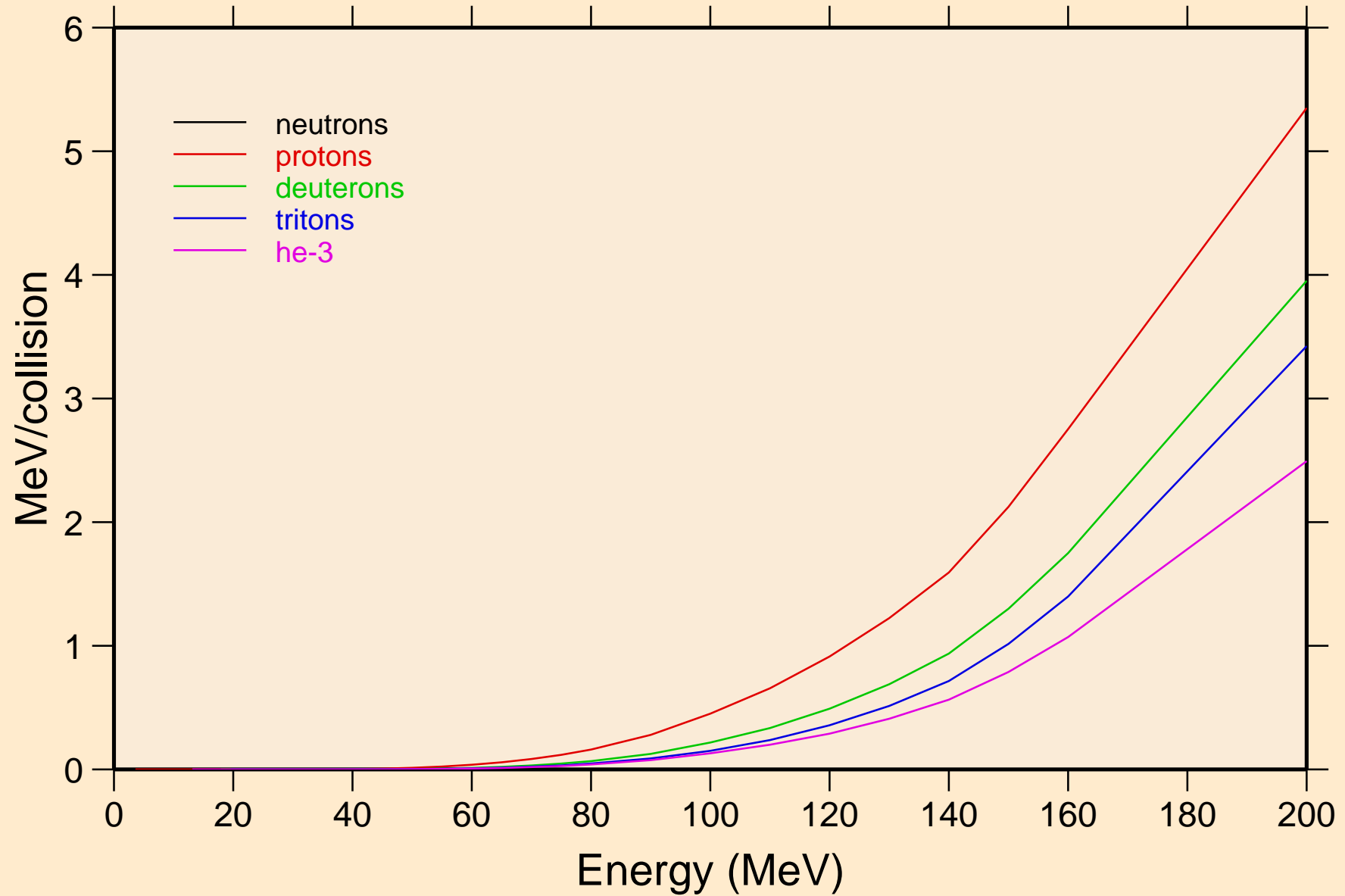

RA210 ALPHA ACER TENDL-2021 LIBRARY; T=0.K  
Recoil Heating

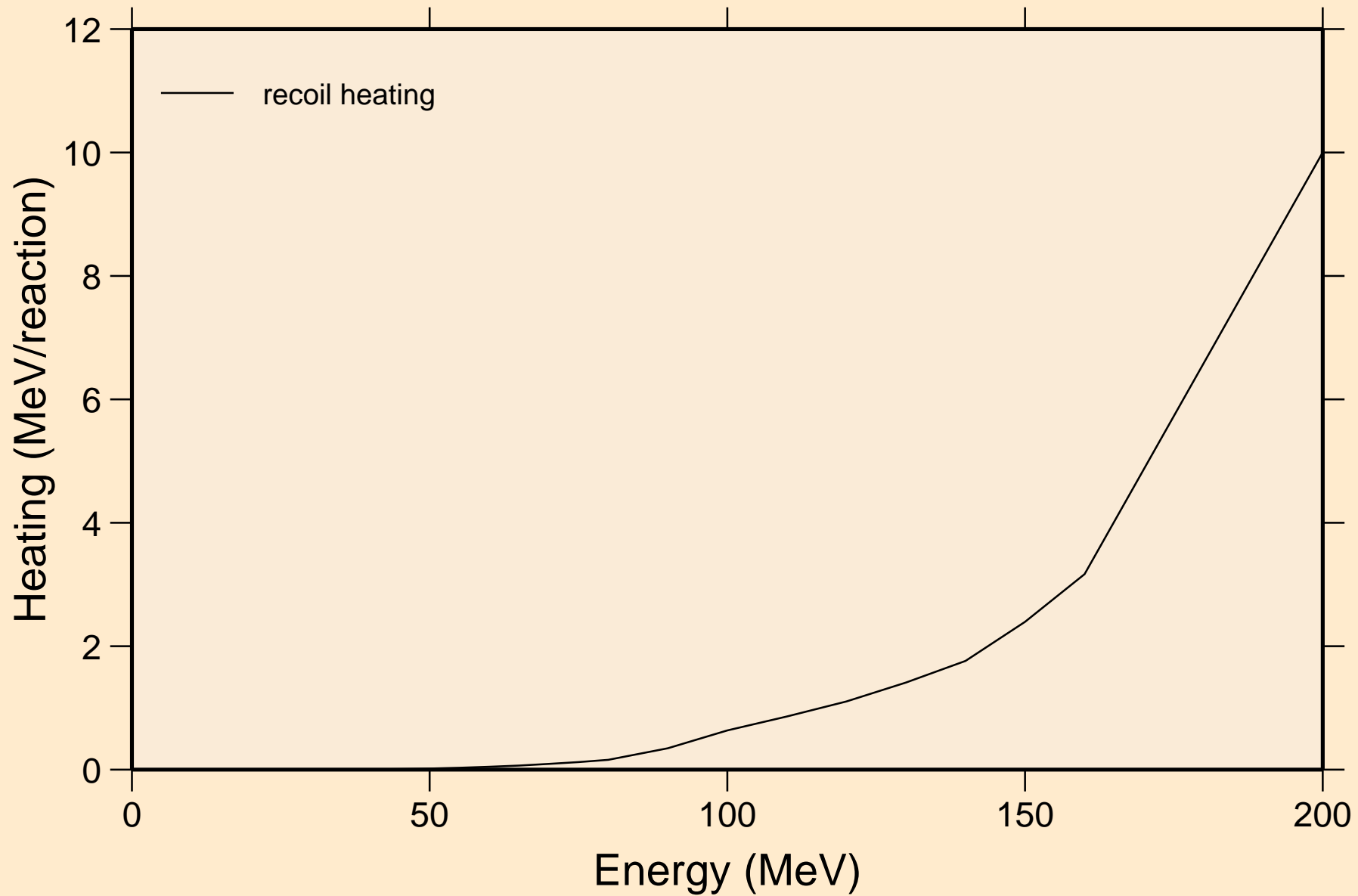



RA210 ALPHA ACER TENDL-2021 LIBRARY; T=0.K  
Particle production cross sections

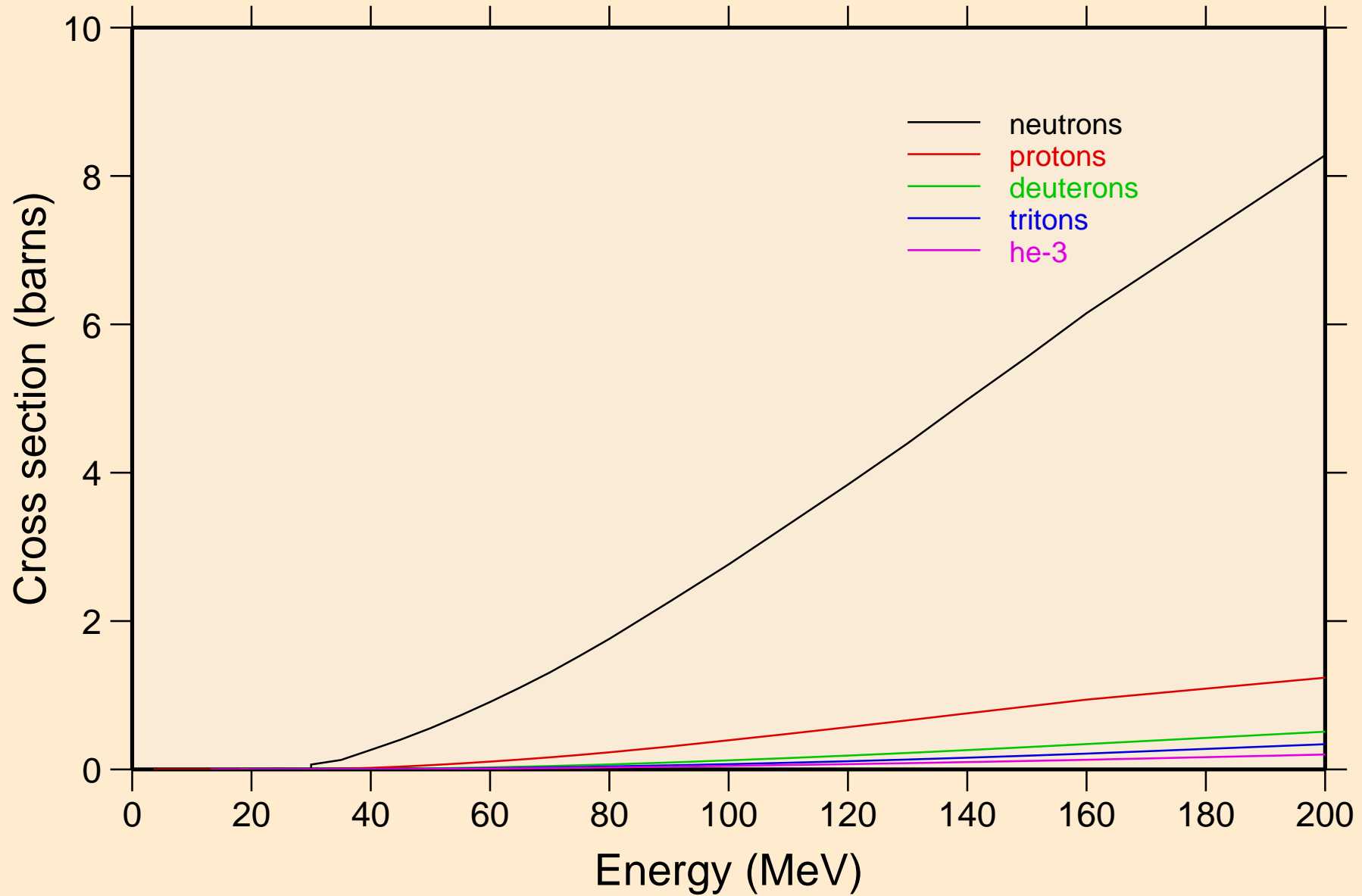

RA210 ALPHA ACER TENDL-2021 LIBRARY; T=0.K  
neutrons from (a,n)

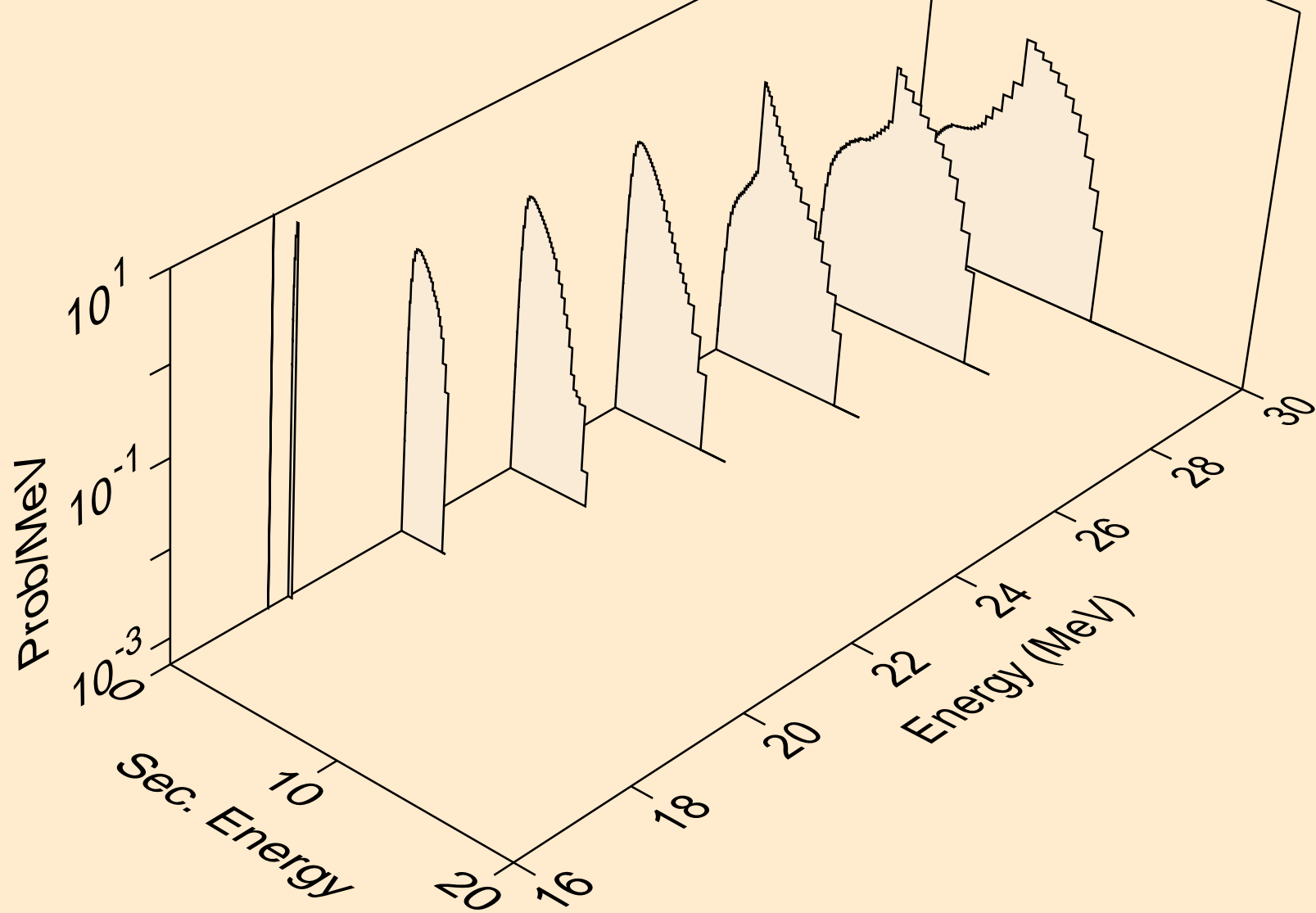

RA210 ALPHA ACER TENDL-2021 LIBRARY; T=0.K  
neutrons from (a,x)

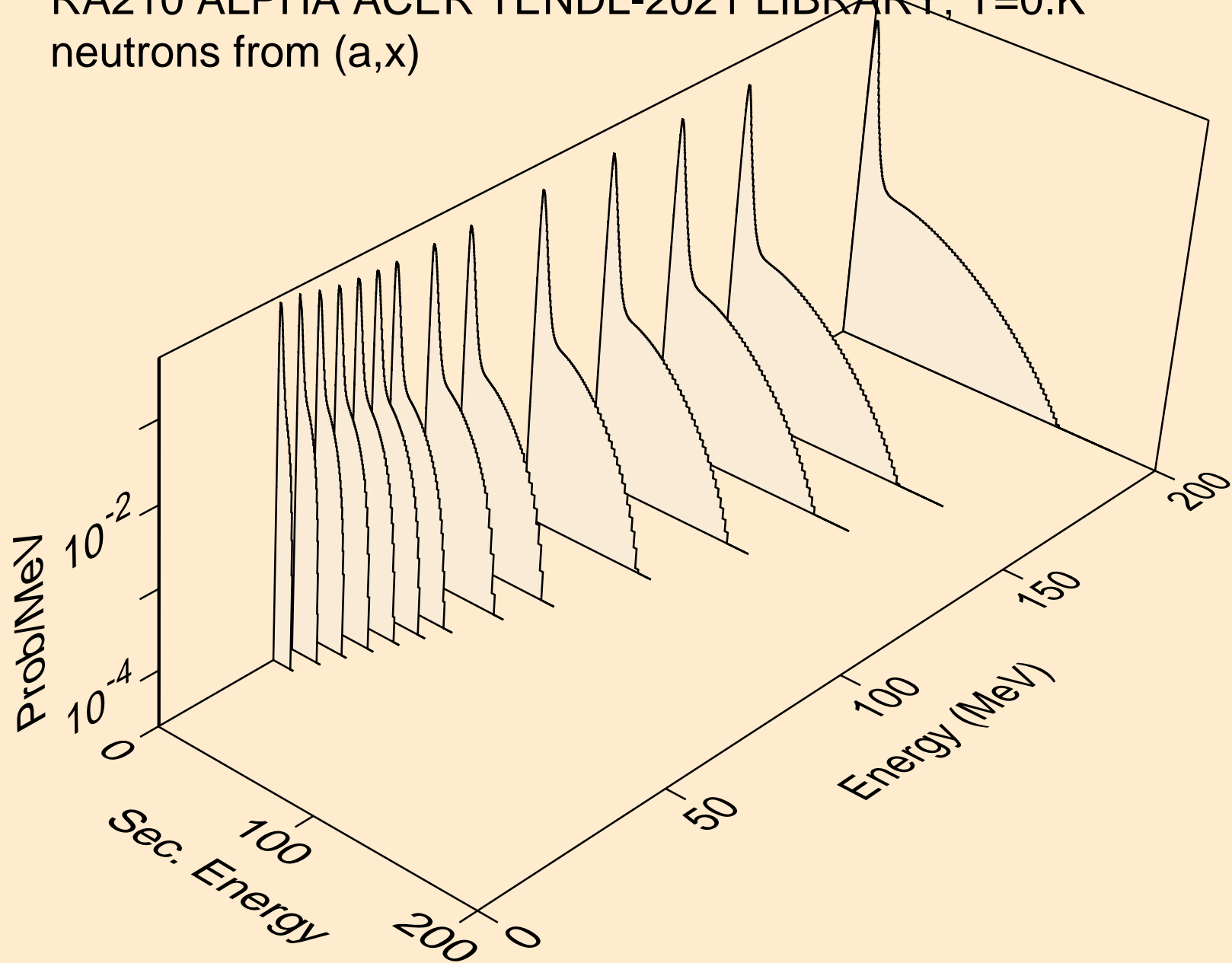

RA210 ALPHA ACER TENDL-2021 LIBRARY; T=0.K  
neutrons from (a,2n)

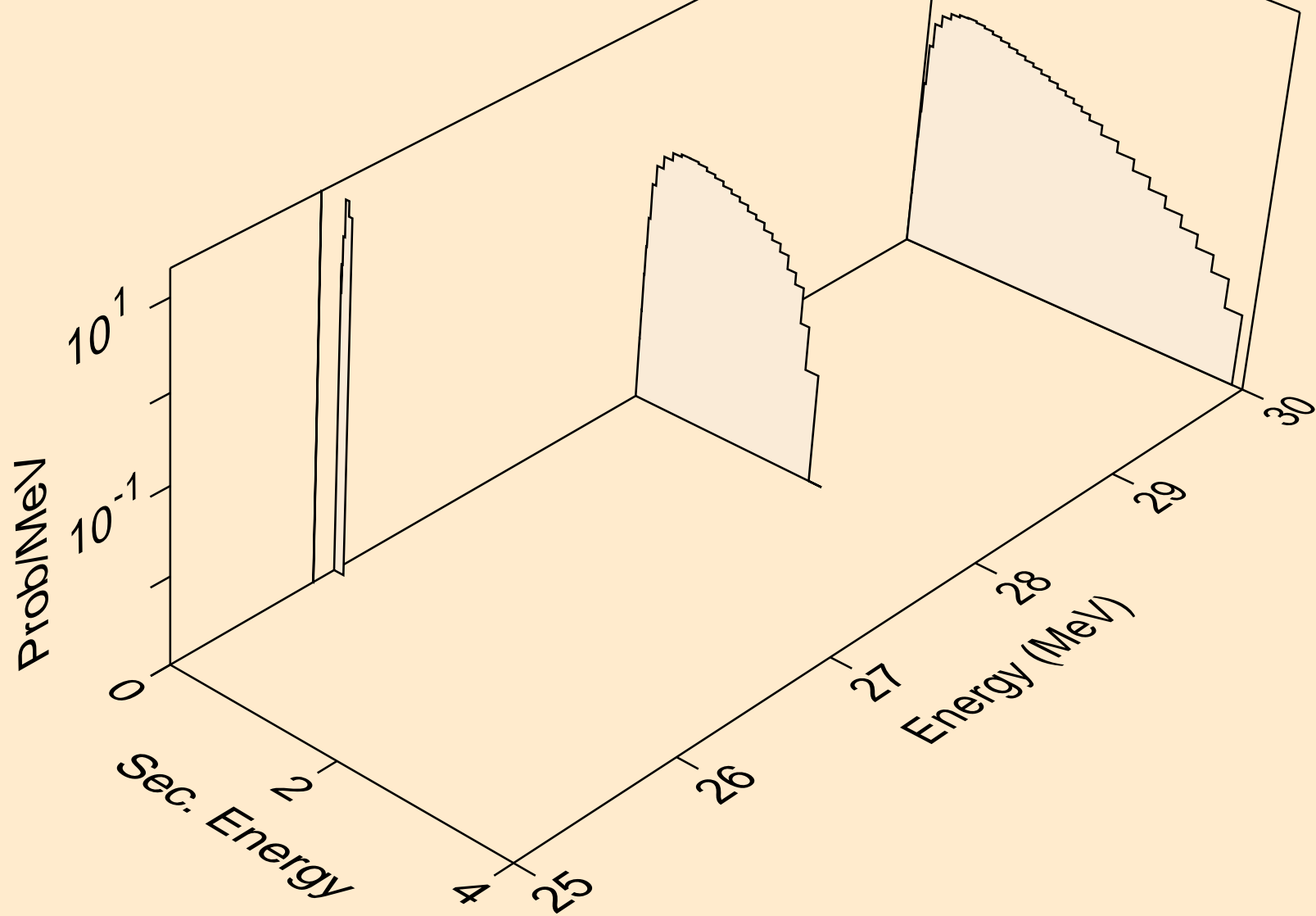

RA210 ALPHA ACER TENDL-2021 LIBRARY; T=0.K  
neutrons from (a,n\*)a

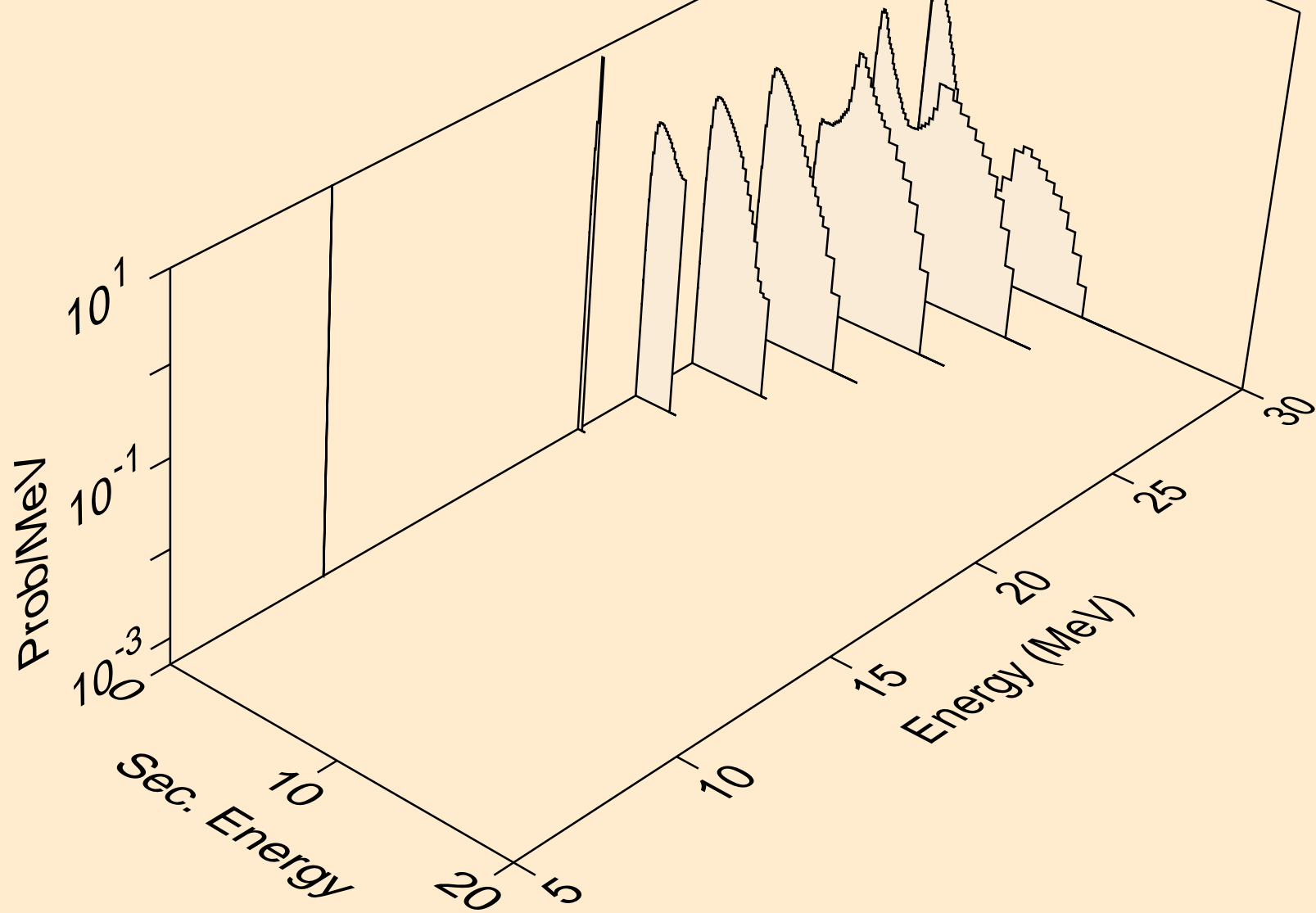

RA210 ALPHA ACER TENDL-2021 LIBRARY; T=0.K  
neutrons from (a,2n)a

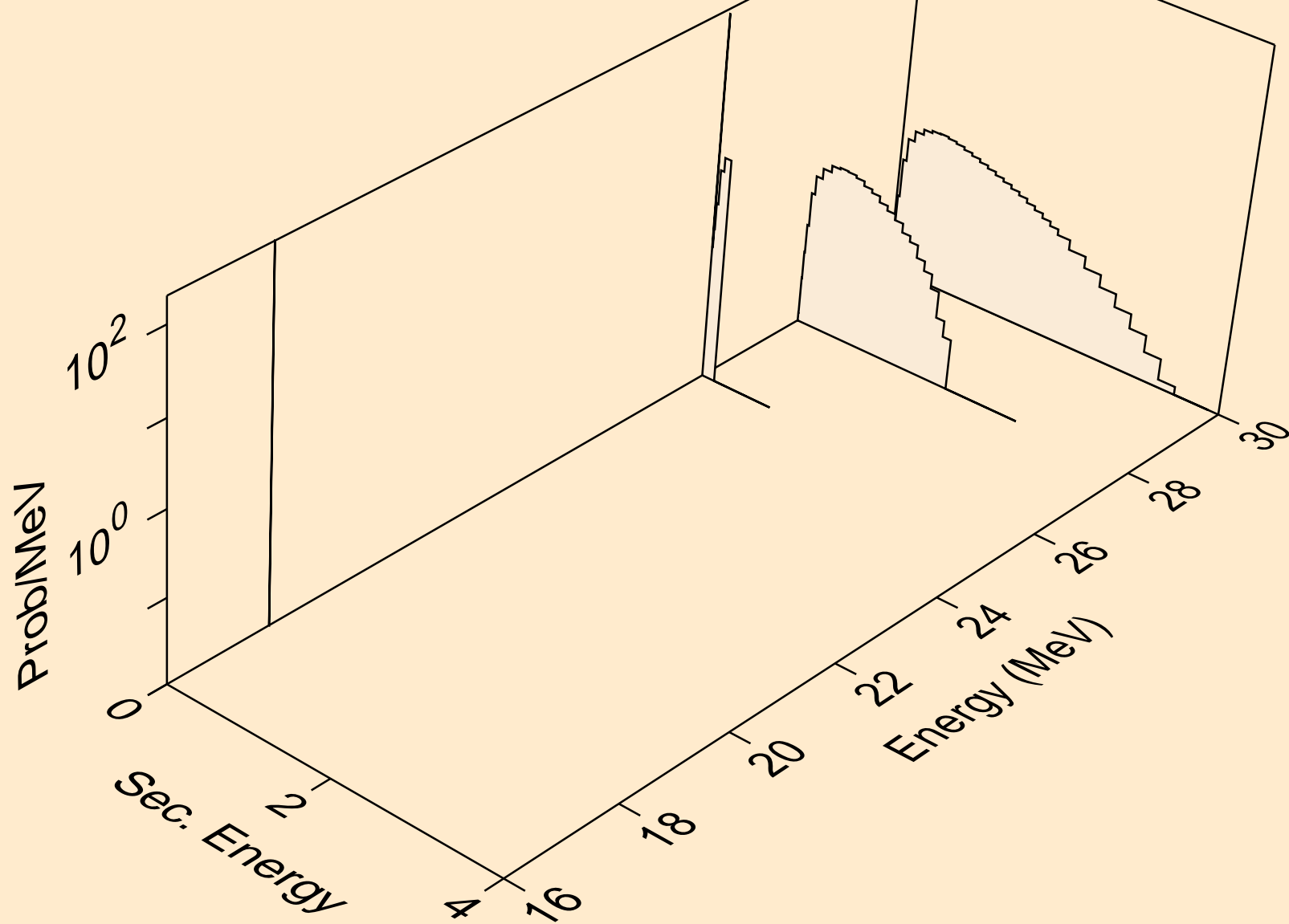

RA210 ALPHA ACER TENDL-2021 LIBRARY; T=0.K  
neutrons from (a,n\*)p

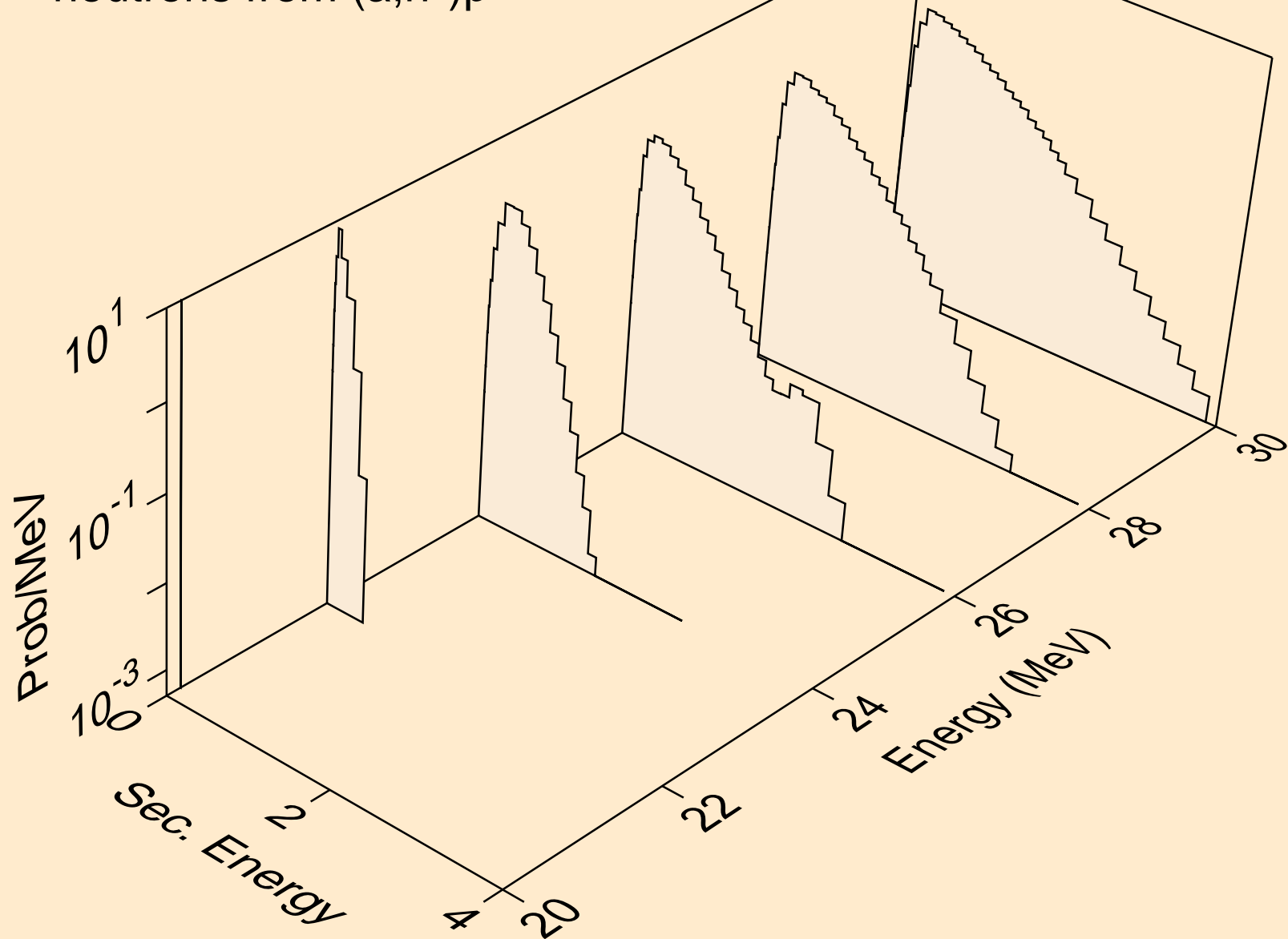

RA210 ALPHA ACER TENDL-2021 LIBRARY; T=0.K  
protons from (a,x)

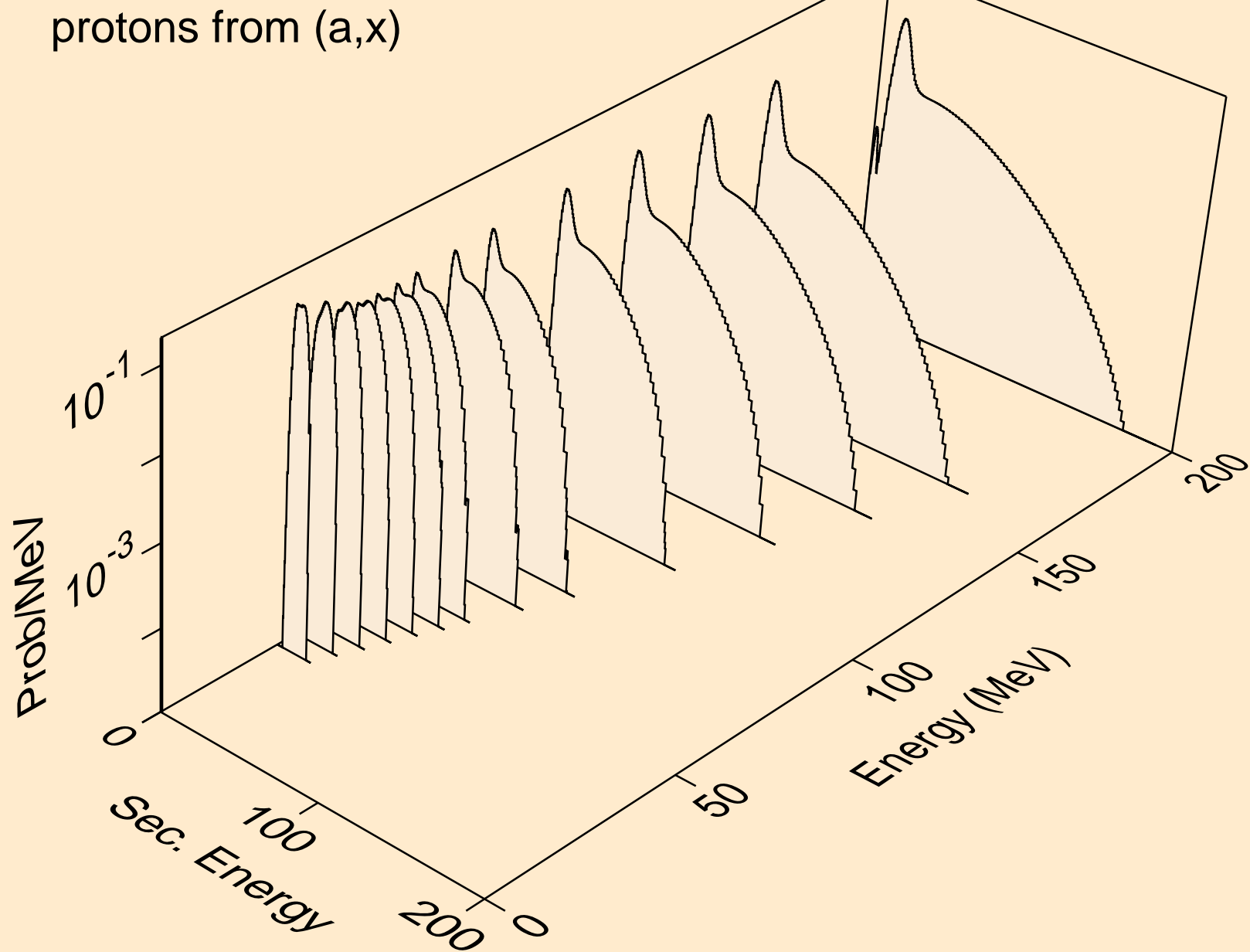



RA210 ALPHA ACER TENDL-2021 LIBRARY; T=0.K  
protons from (a,n\*)p

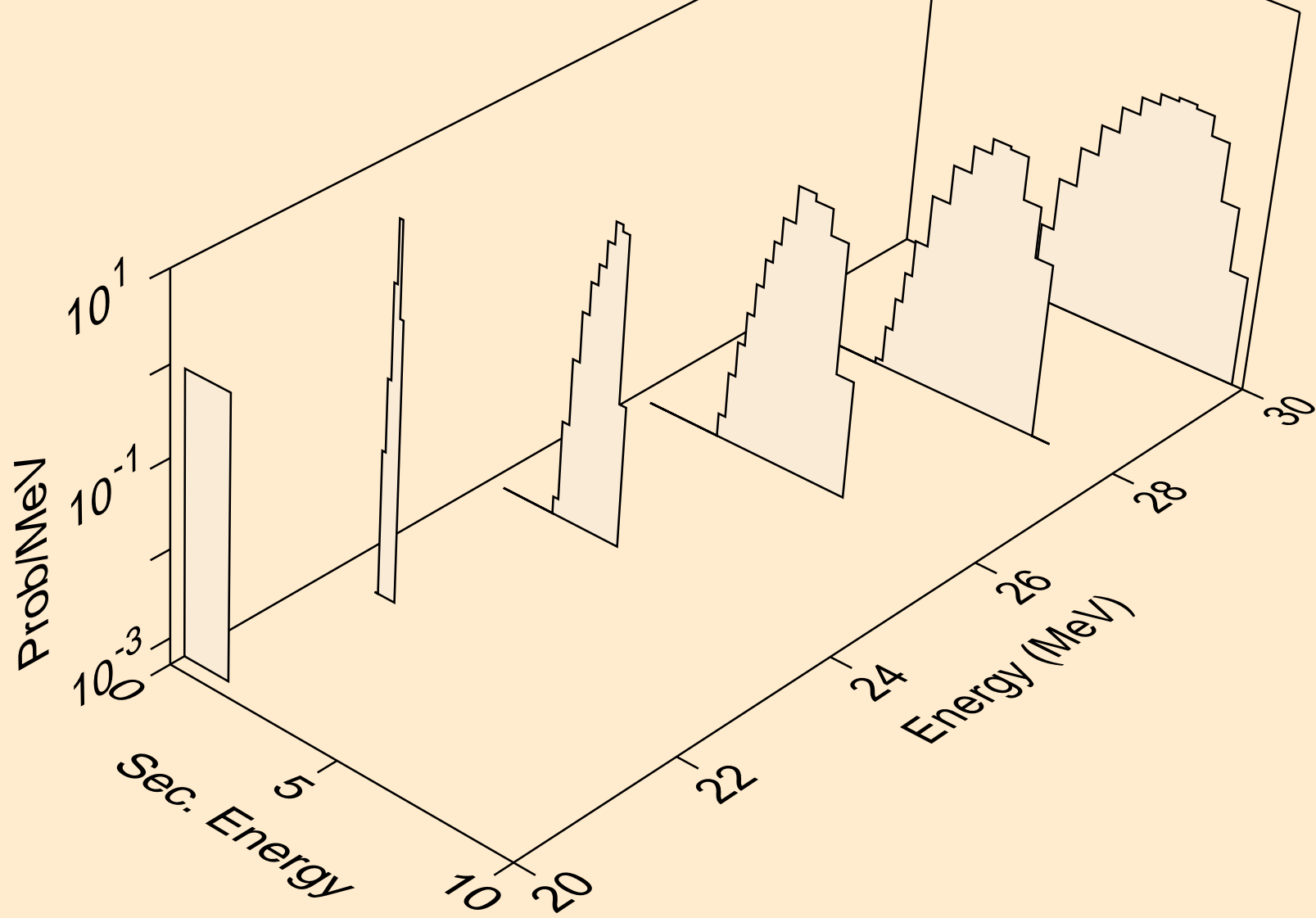

RA210 ALPHA ACER TENDL-2021 LIBRARY; T=0.K  
protons from (a,p)

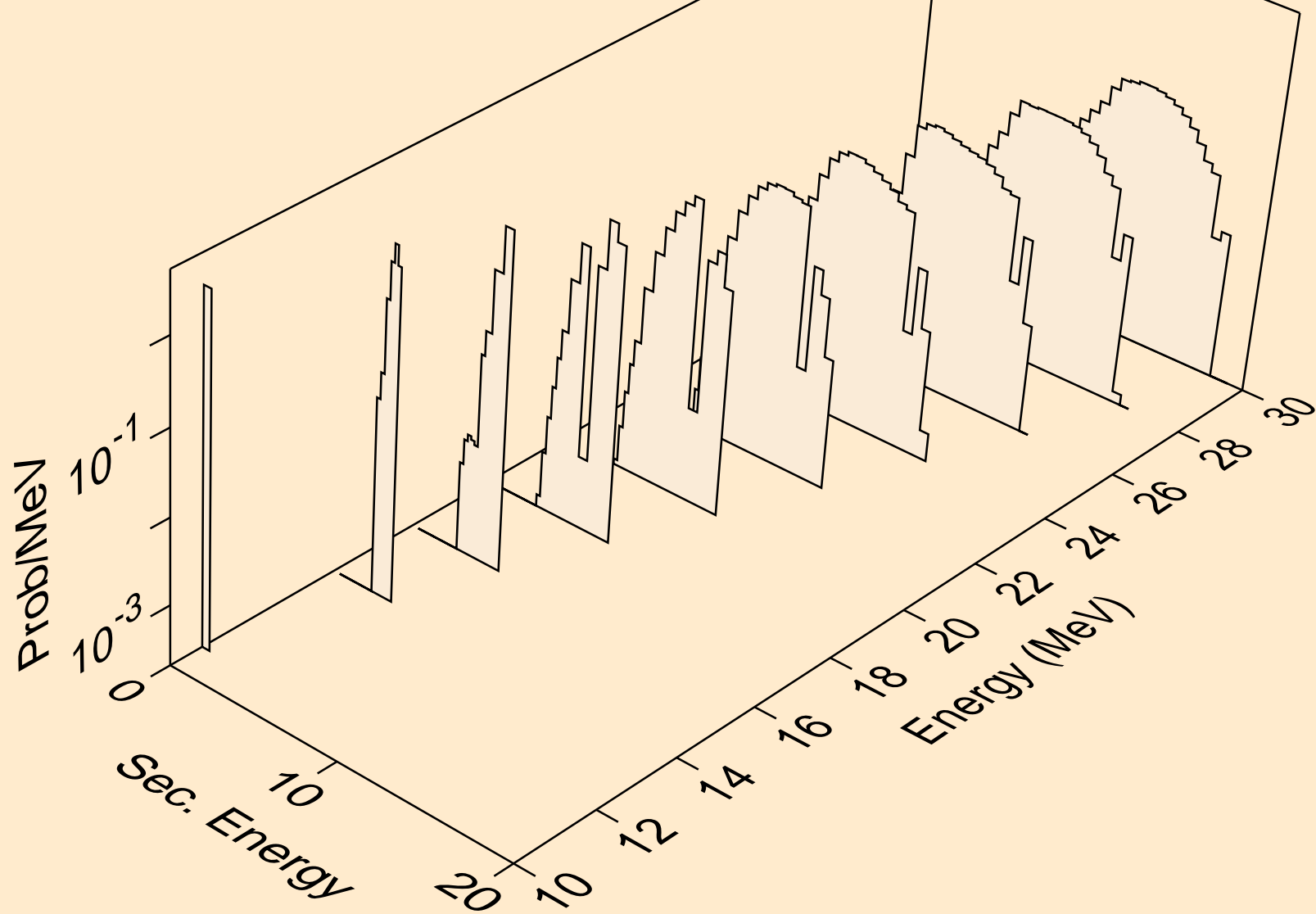

RA210 ALPHA ACER TENDL-2021 LIBRARY; T=0.K  
protons from (a,2p)

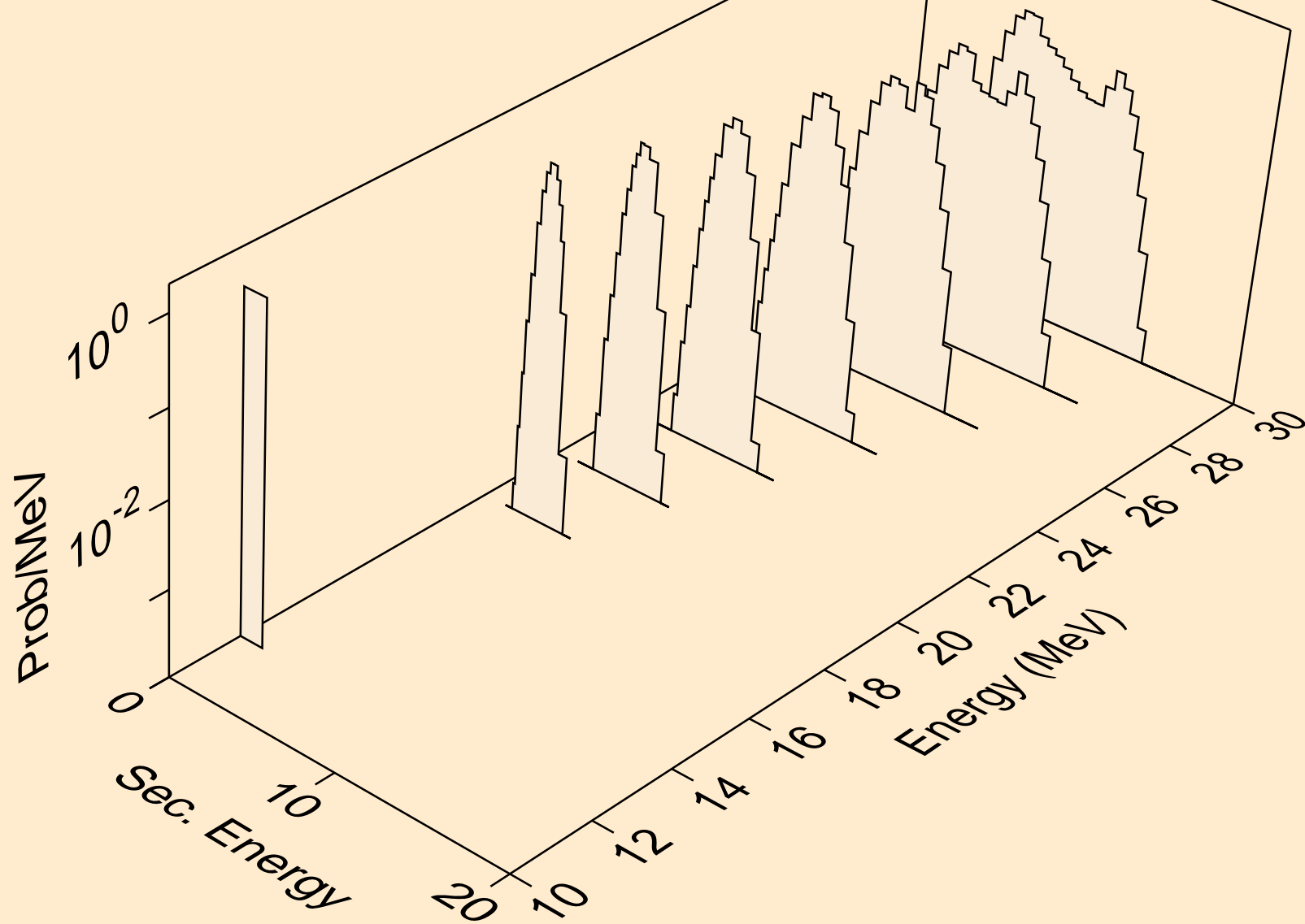

RA210 ALPHA ACER TENDL-2021 LIBRARY; T=0.K  
protons from (a,pa)

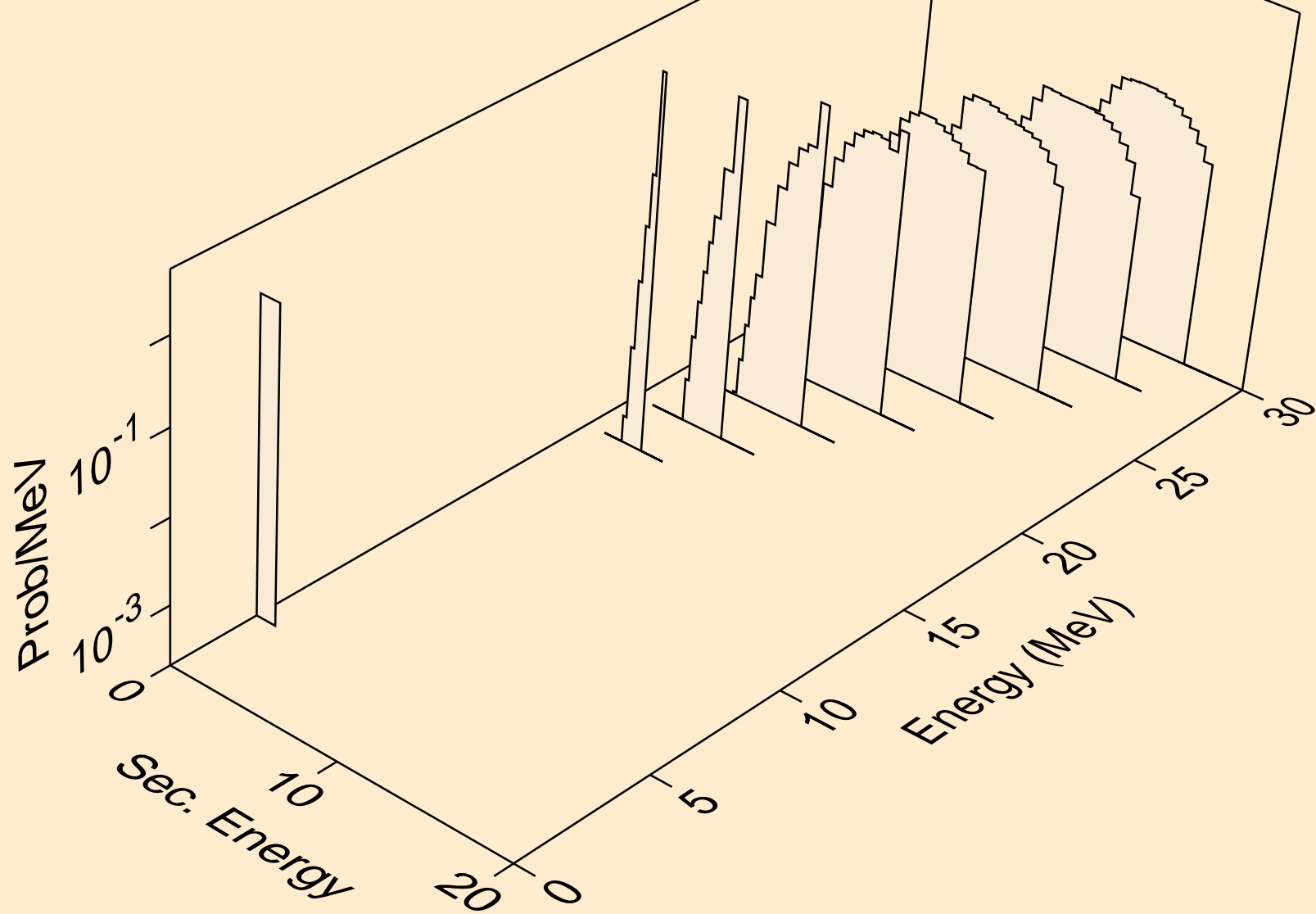

RA210 ALPHA ACER TENDL-2021 LIBRARY; T=0.K  
deuterons from (a,x)

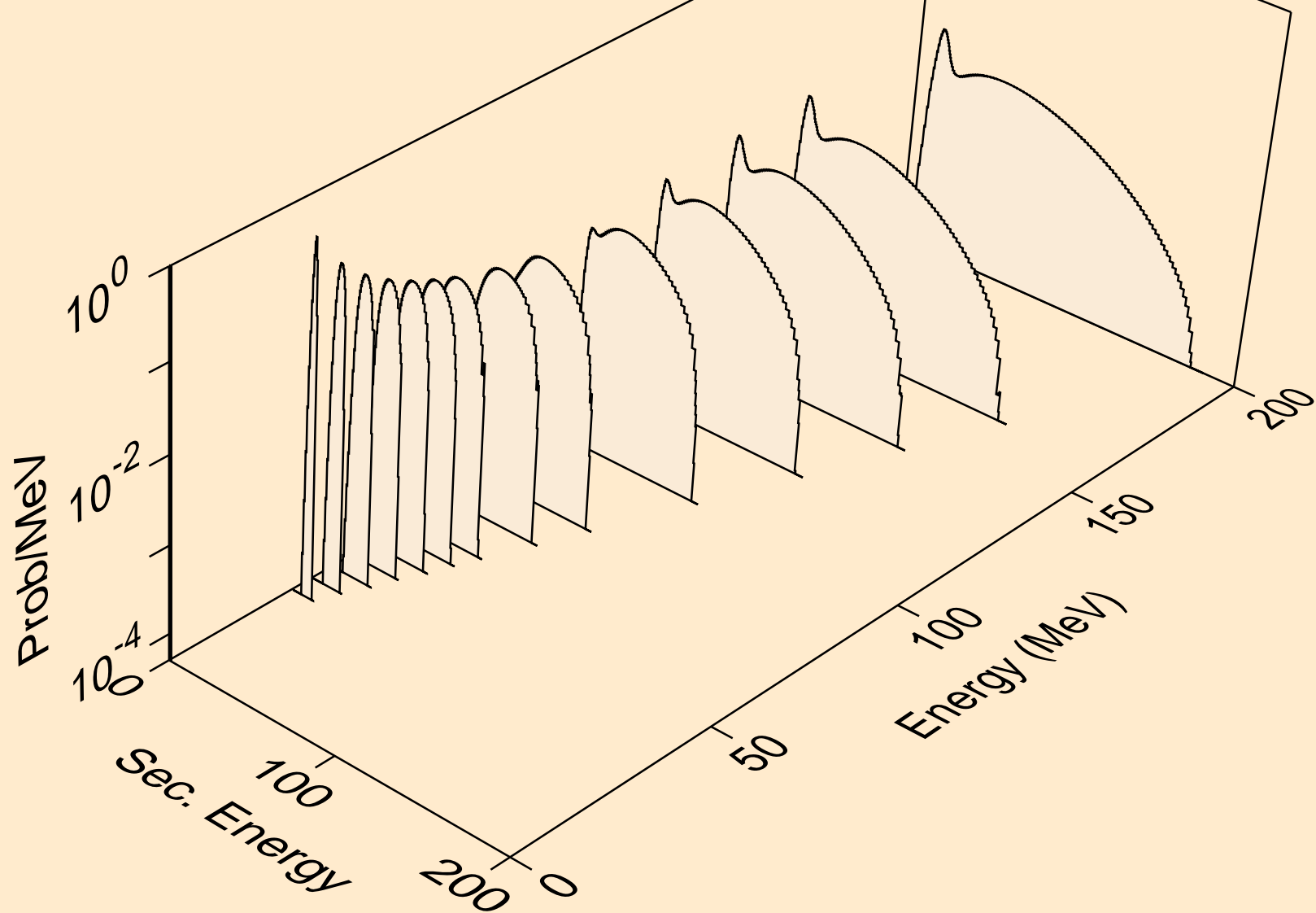

RA210 ALPHA ACER TENDL-2021 LIBRARY; T=0.K  
deuterons from (a,d)

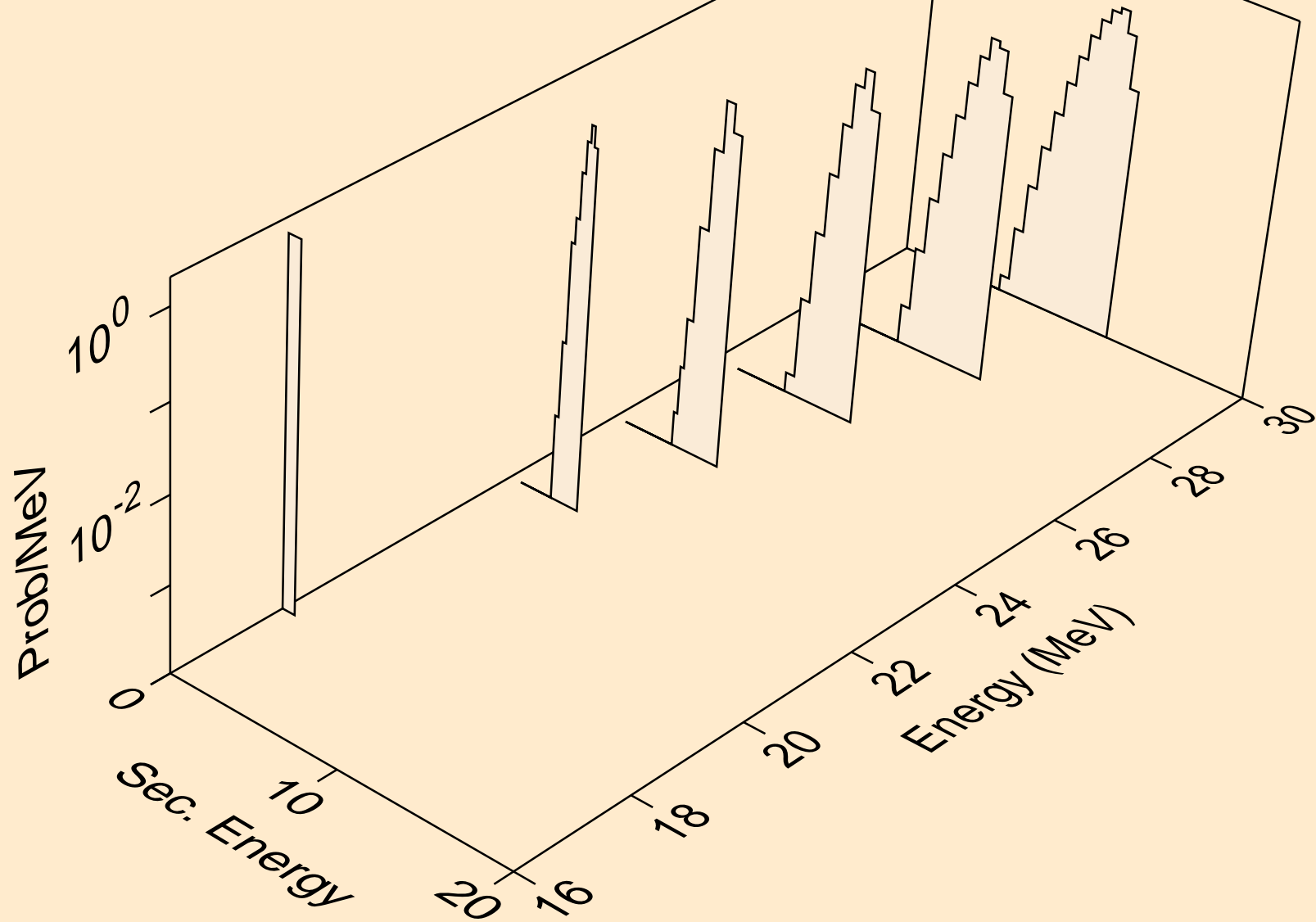

RA210 ALPHA ACER TENDL-2021 LIBRARY; T=0.K  
tritons from (a,x)

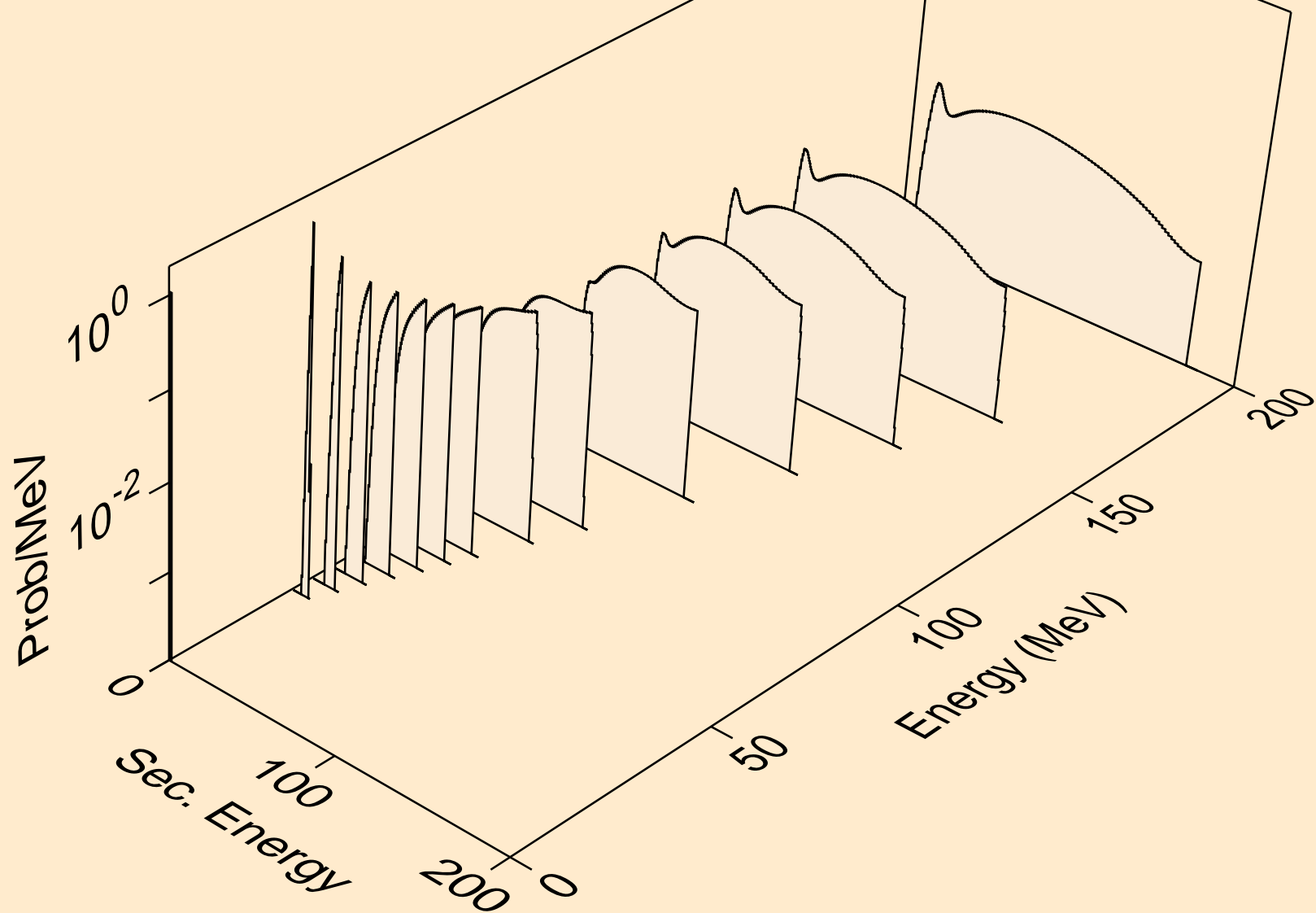

RA210 ALPHA ACER TENDL-2021 LIBRARY; T=0.K  
tritons from (a,t)

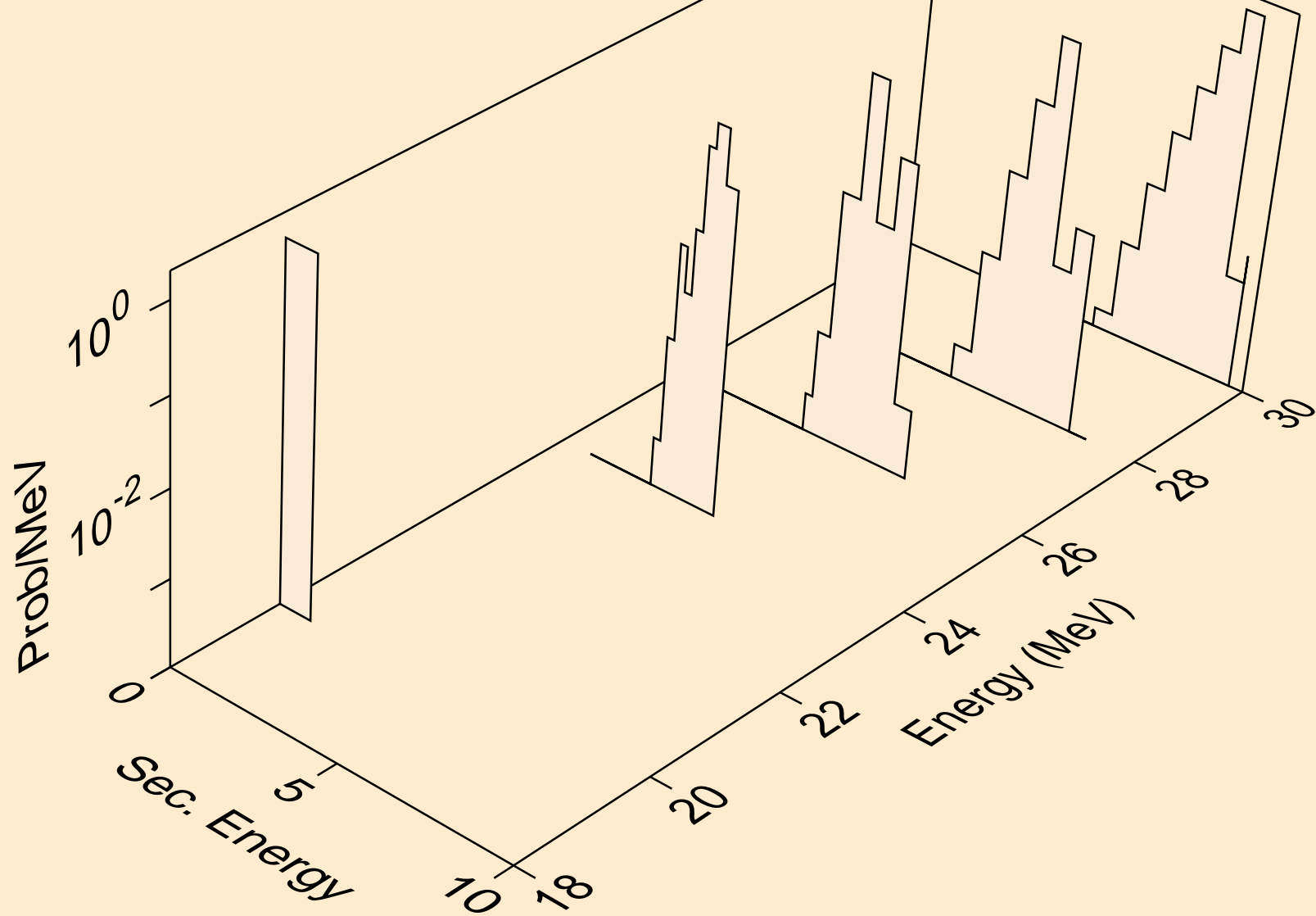



RA210 ALPHA ACER TENDL-2021 LIBRARY; T=0.K  
he3s from (a,x)

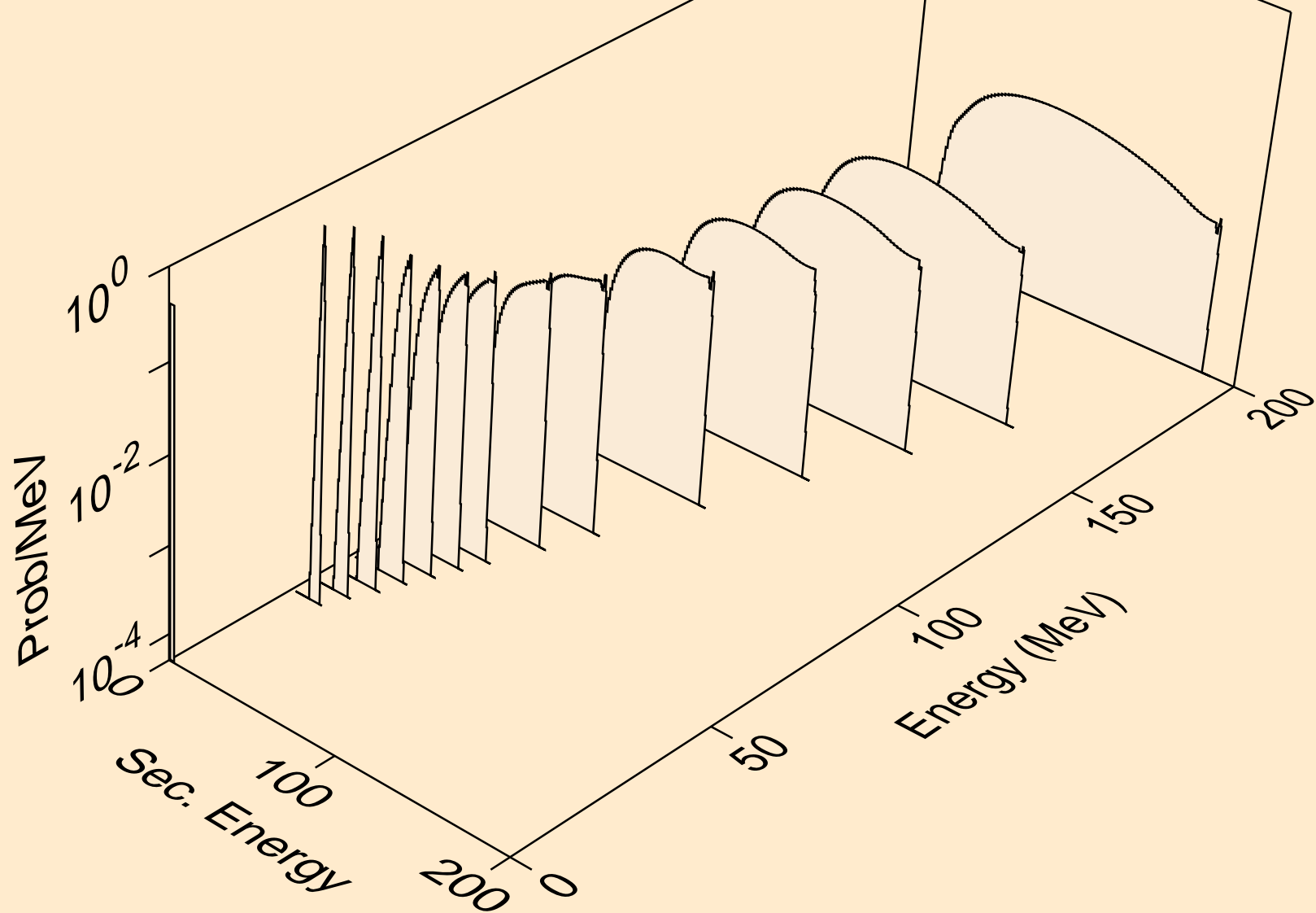

RA210 ALPHA ACER TENDL-2021 LIBRARY; T=0.K  
he3s from (a,he3)

