

SE084 ALPHA ACER TENDL-2021 LIBRARY; T=0.K
Principal cross sections

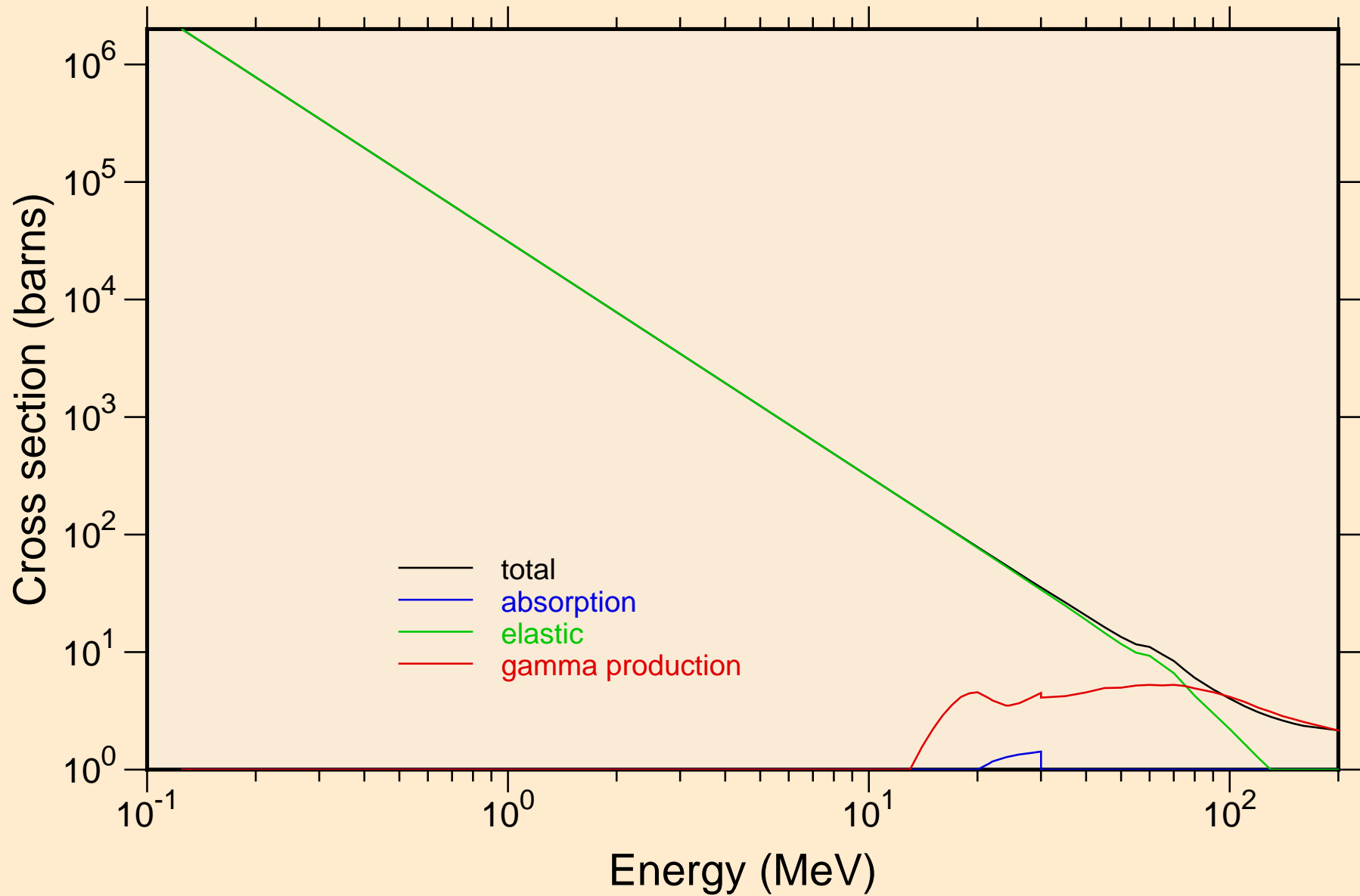

SE084 ALPHA ACER TENDL-2021 LIBRARY; T=0.K

Heating

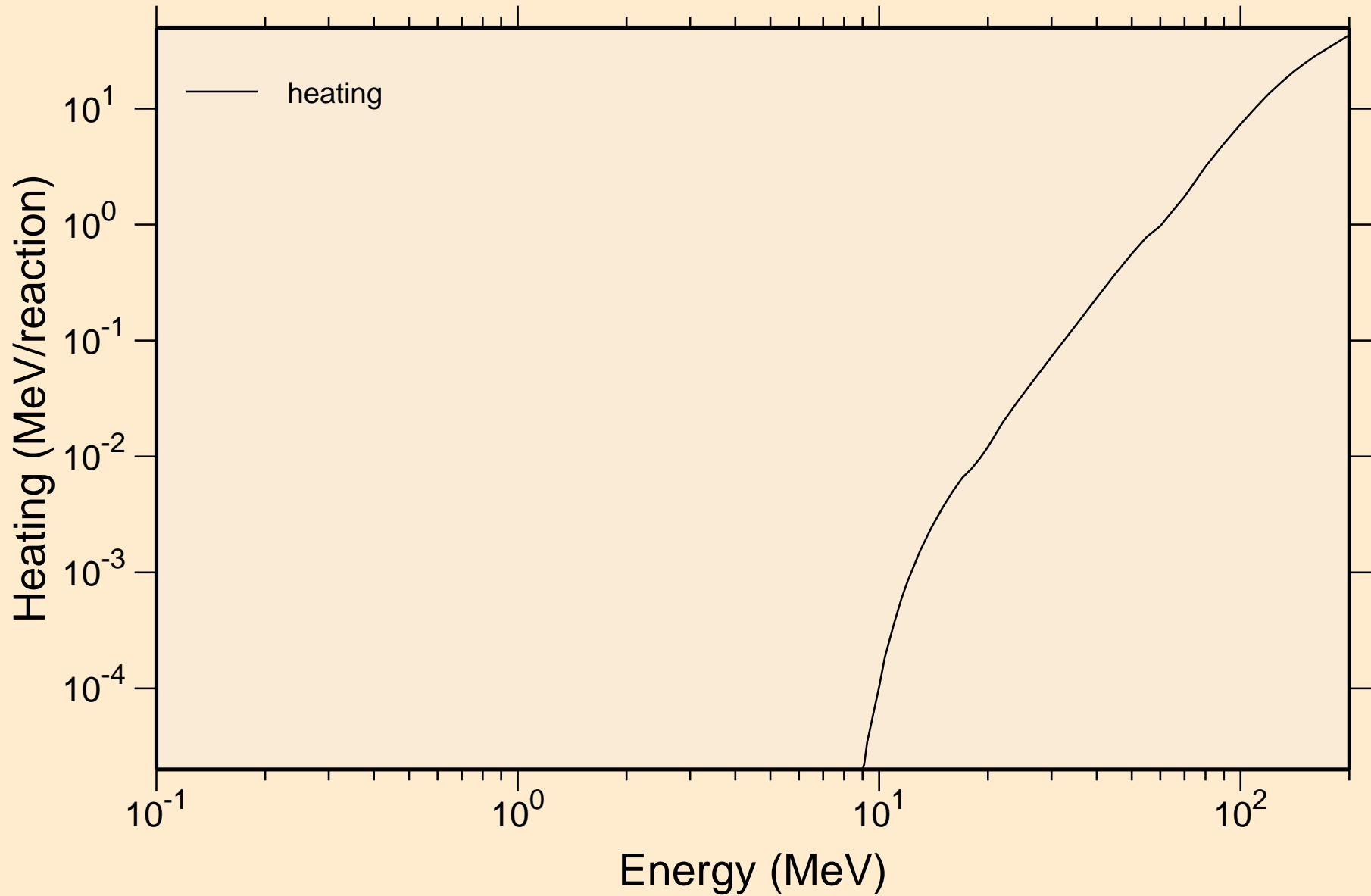

SE084 ALPHA ACER TENDL-2021 LIBRARY; T=0.K

Principal cross sections

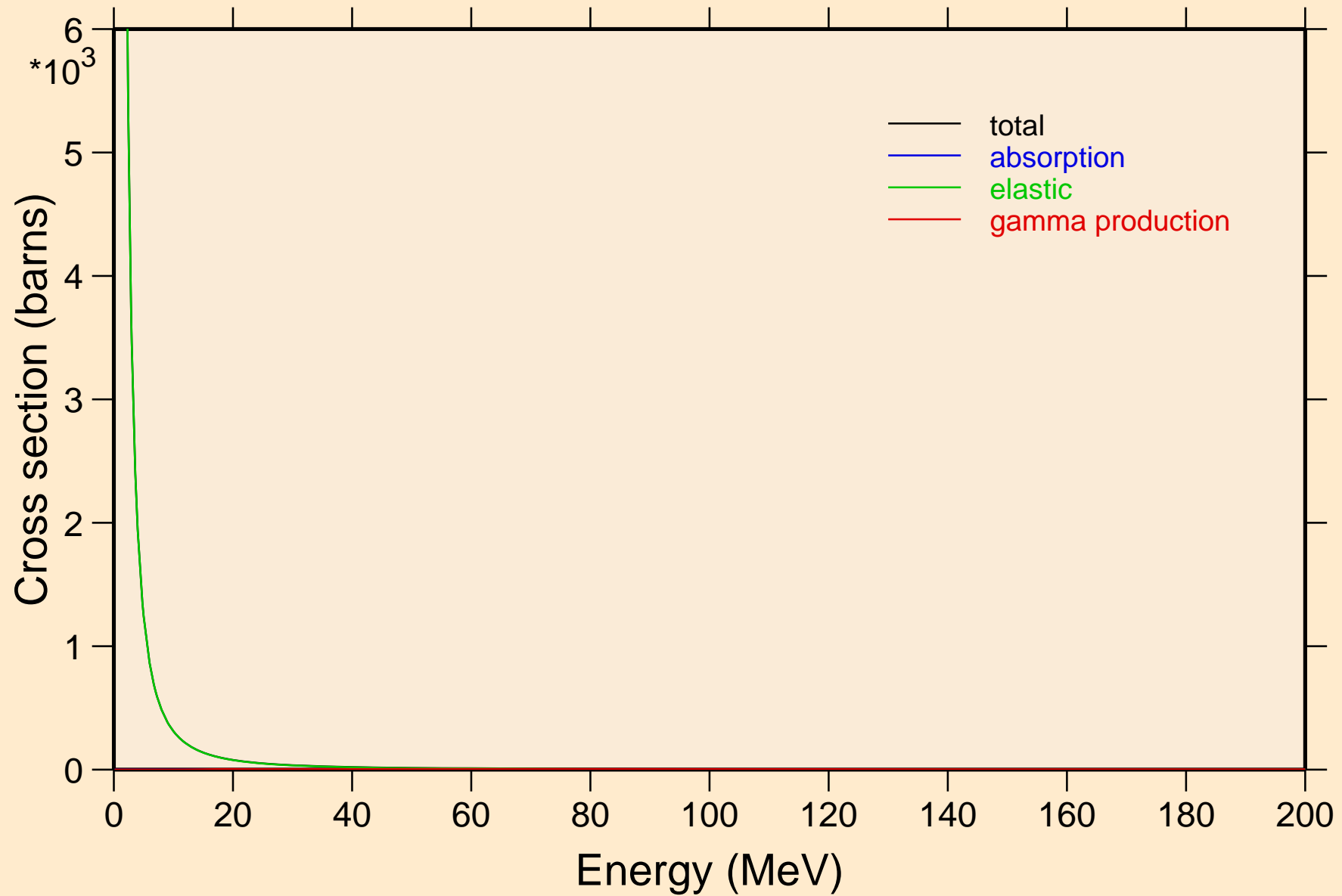

SE084 ALPHA ACER TENDL-2021 LIBRARY; T=0.K

Heating

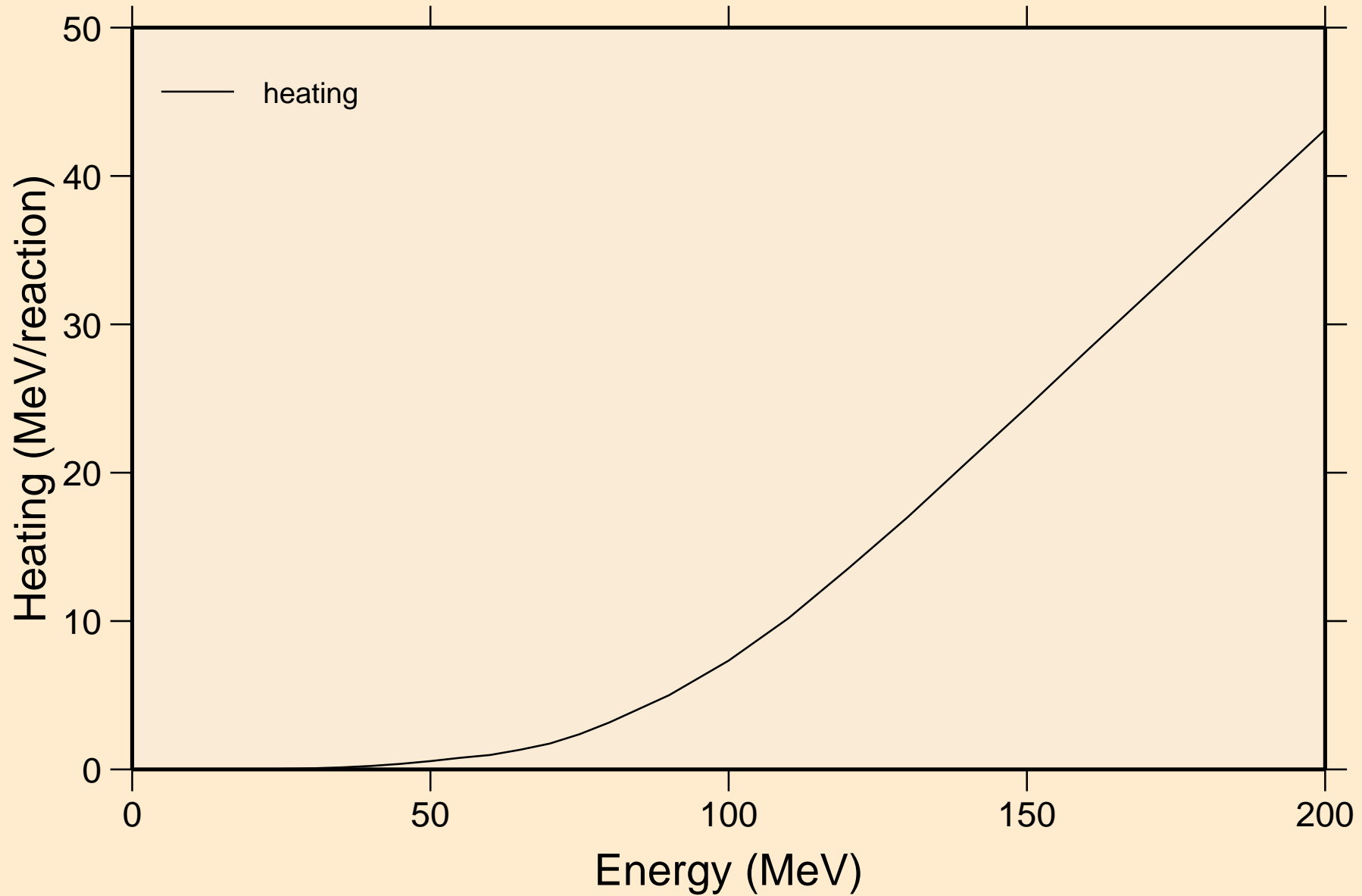

SE084 ALPHA ACER TENDL-2021 LIBRARY; T=0.K

Threshold reactions

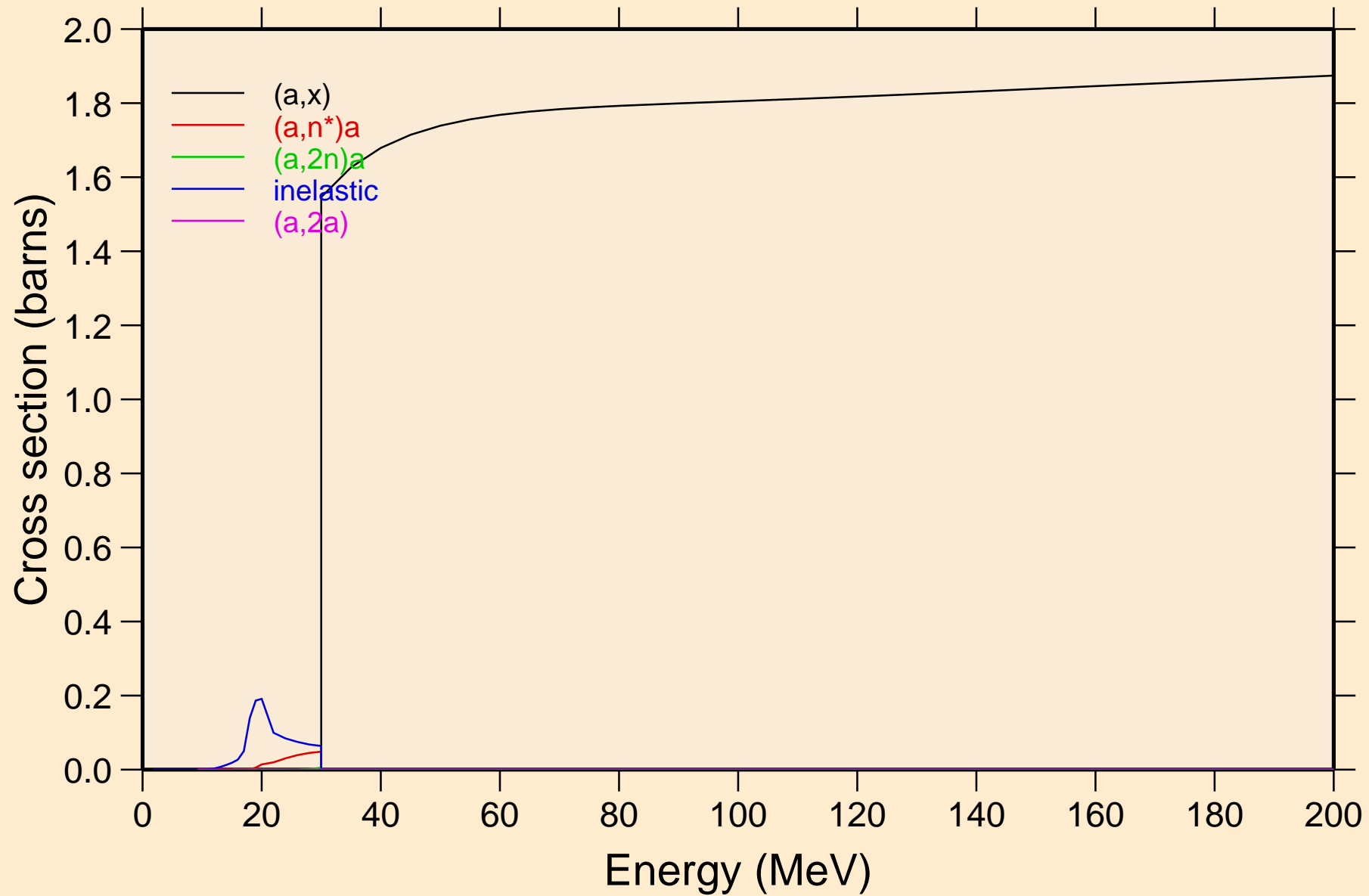

SE084 ALPHA ACER TENDL-2021 LIBRARY; T=0.K
Threshold reactions

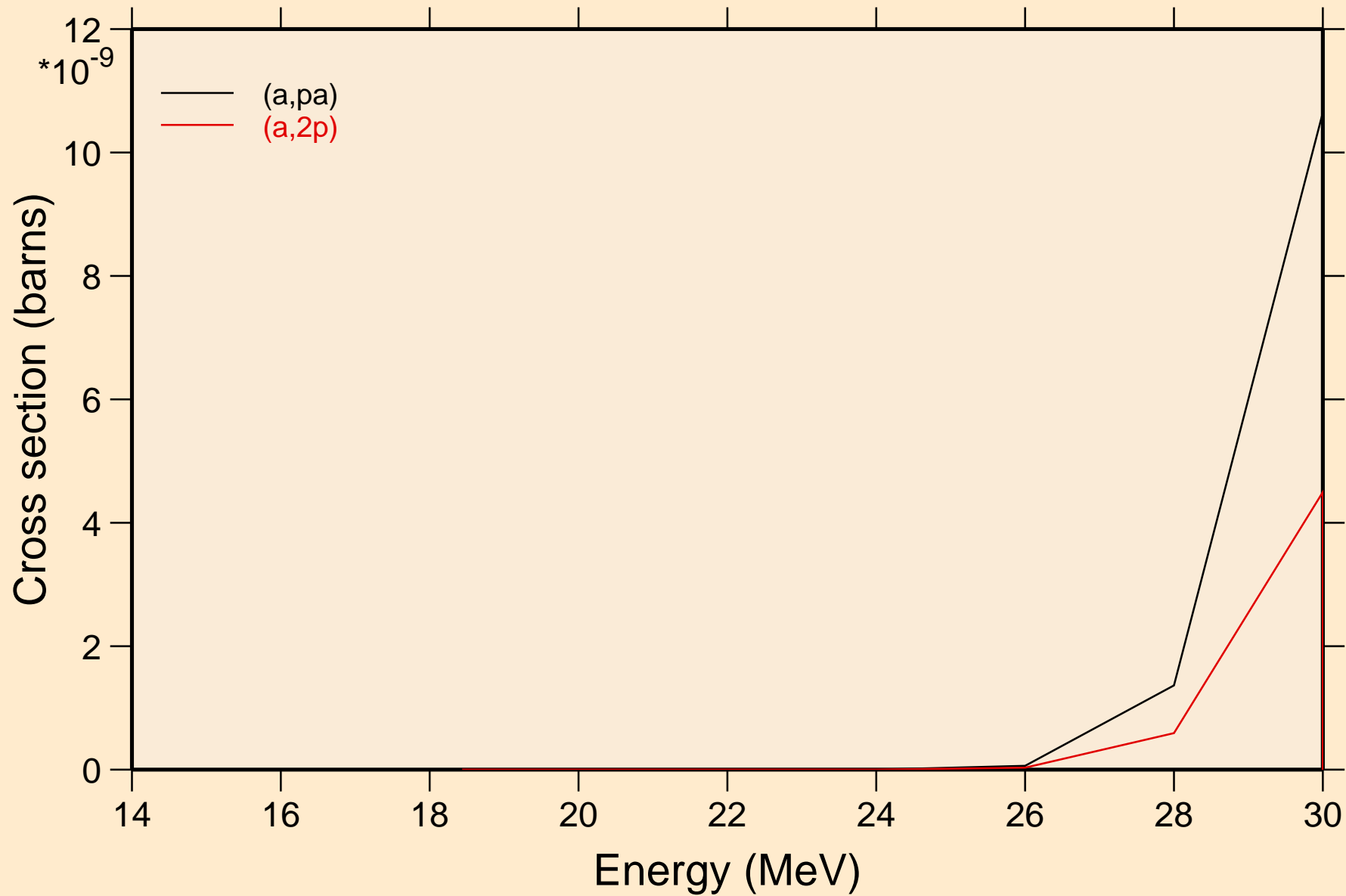

SE084 ALPHA ACER TENDL-2021 LIBRARY; T=0.K
Threshold reactions

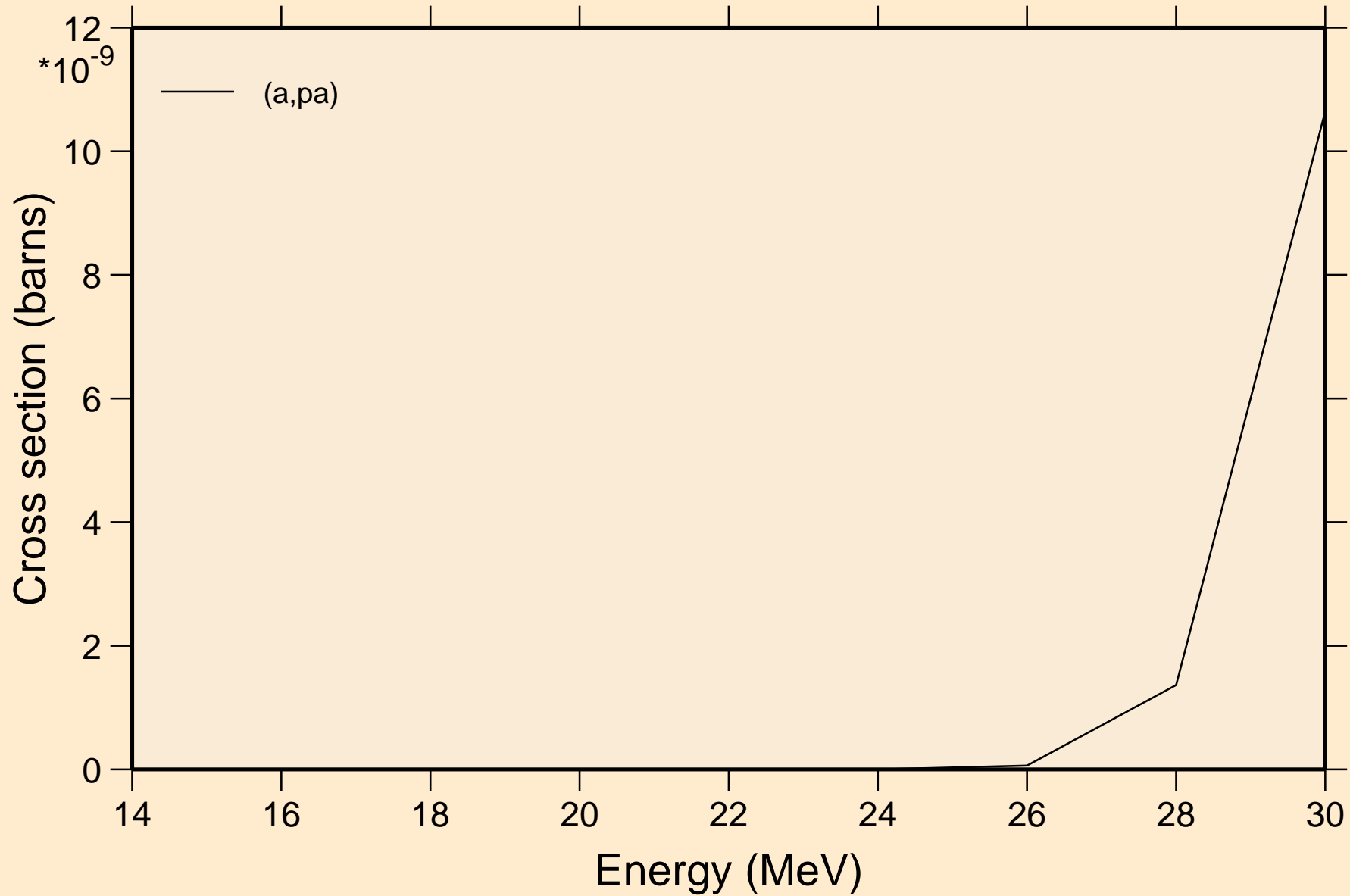

SE084 ALPHA ACER TENDL-2021 LIBRARY; T=0.K
angular distribution for elastic

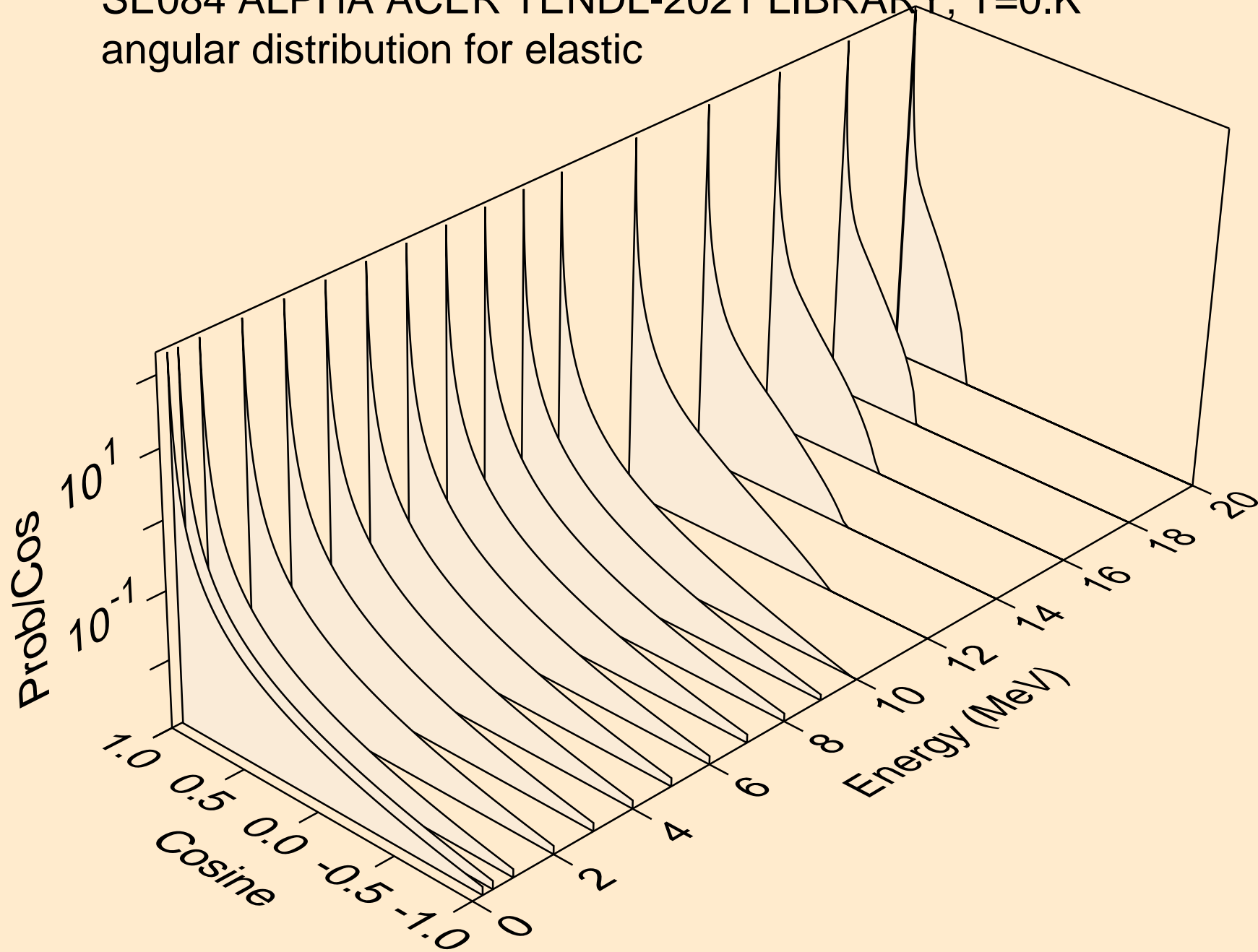

SE084 ALPHA ACER TENDL-2021 LIBRARY; T=0.K
angular distribution for elastic

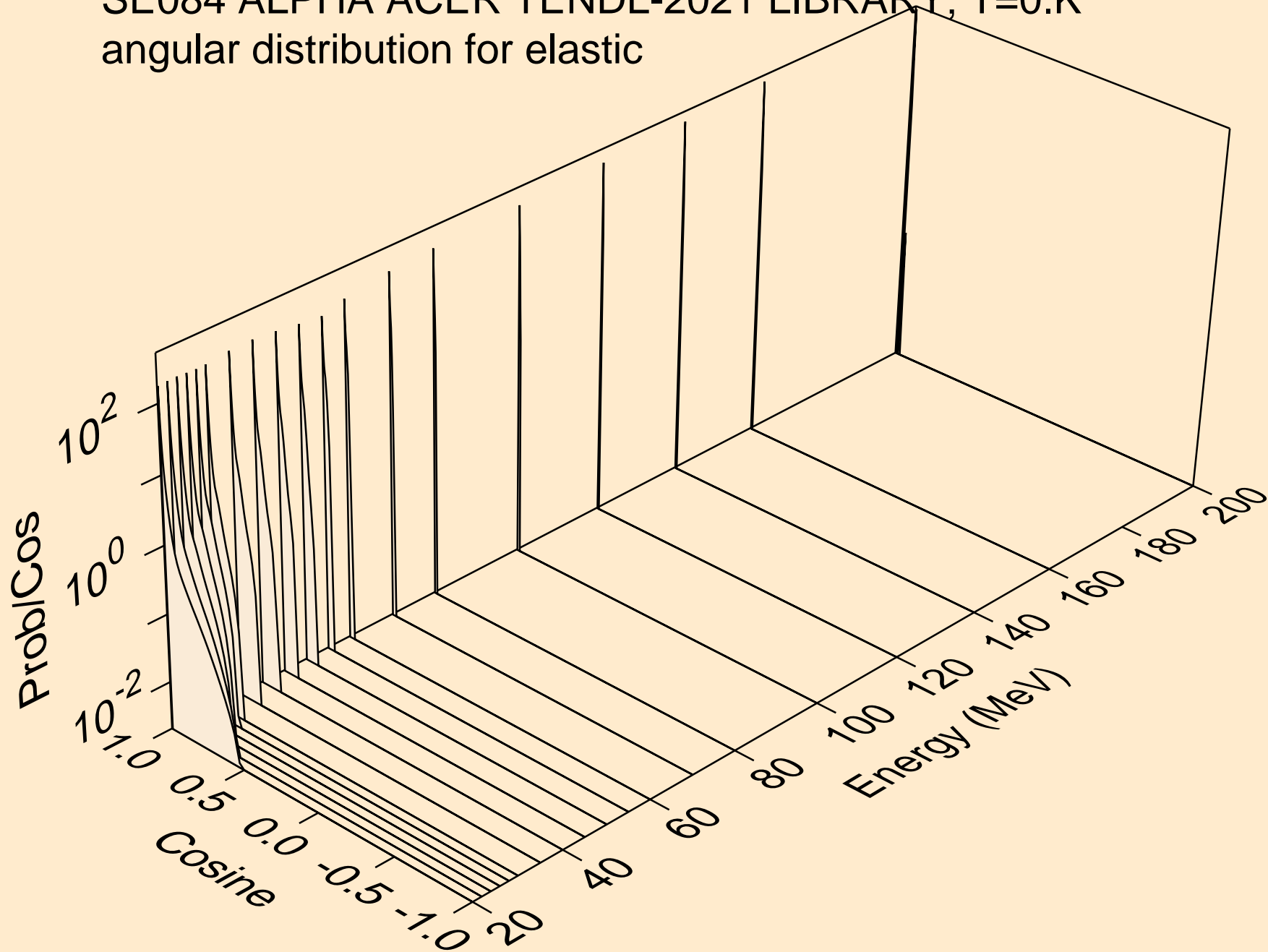

SE084 ALPHA ACER TENDL-2021 LIBRARY; T=0.K
Alpha emission for (a,x)

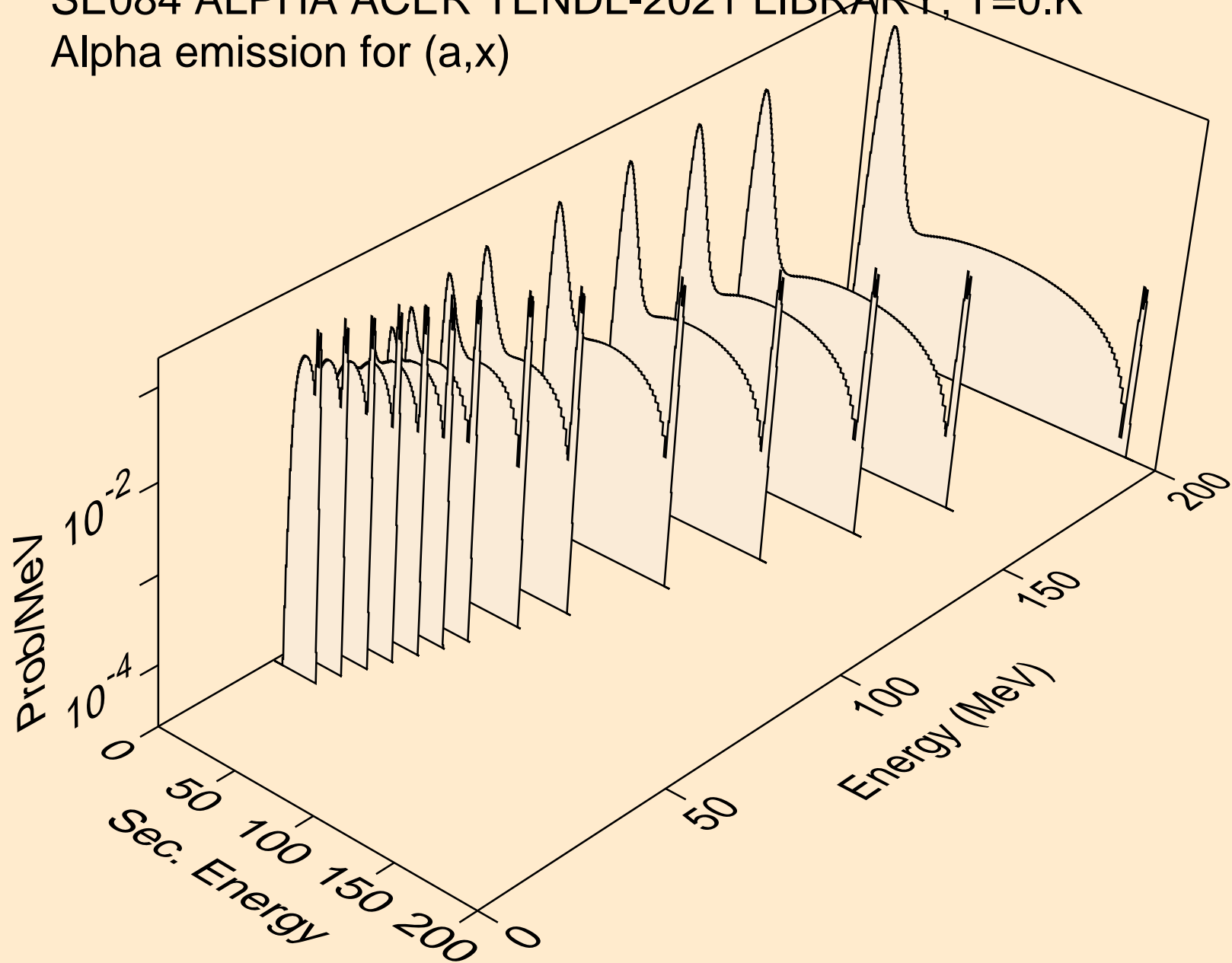

SE084 ALPHA ACER TENDL-2021 LIBRARY; T=0.K
Alpha emission for (a,n*)a

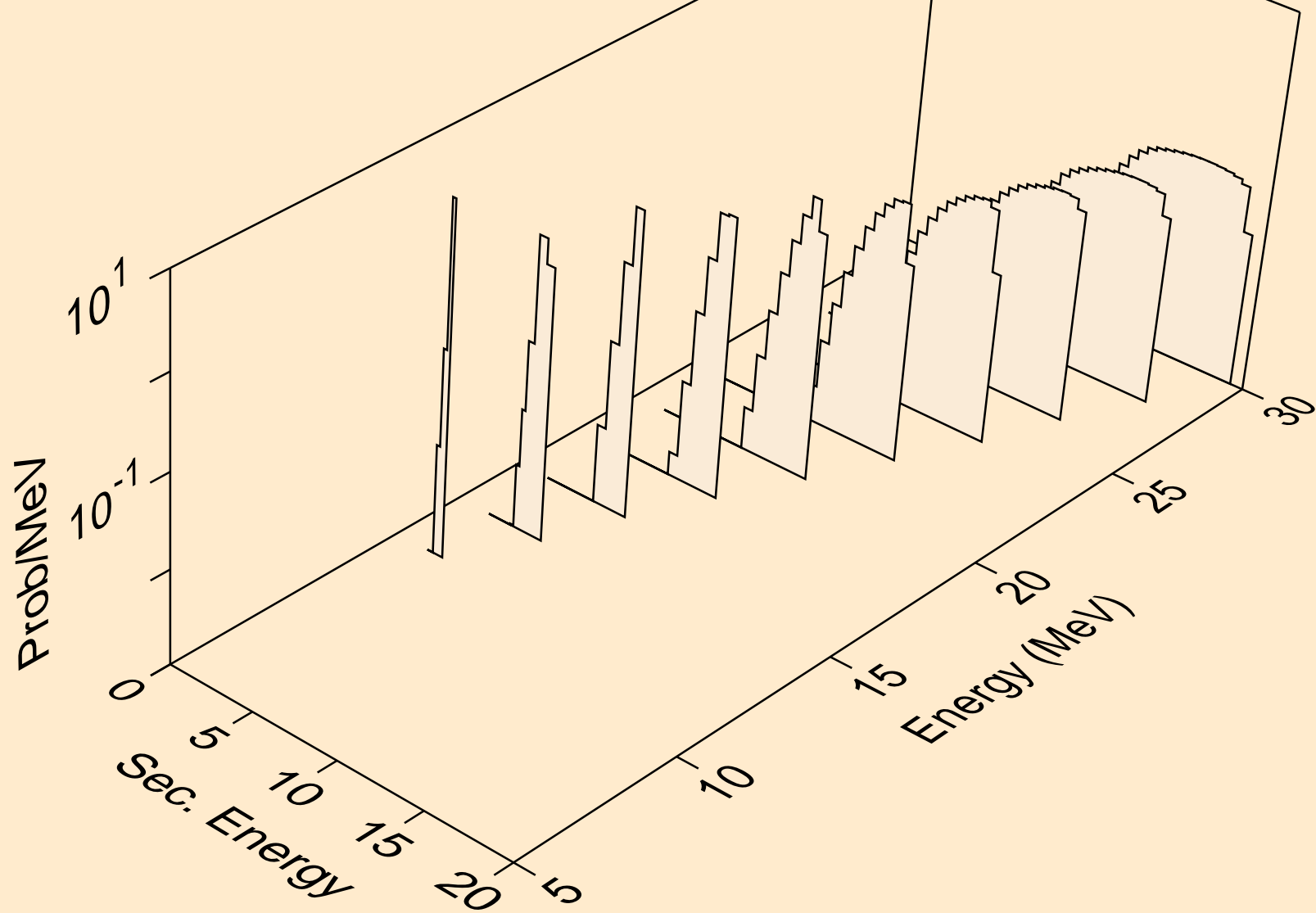

SE084 ALPHA ACER TENDL-2021 LIBRARY; T=0.K
Alpha emission for (a,2n)a

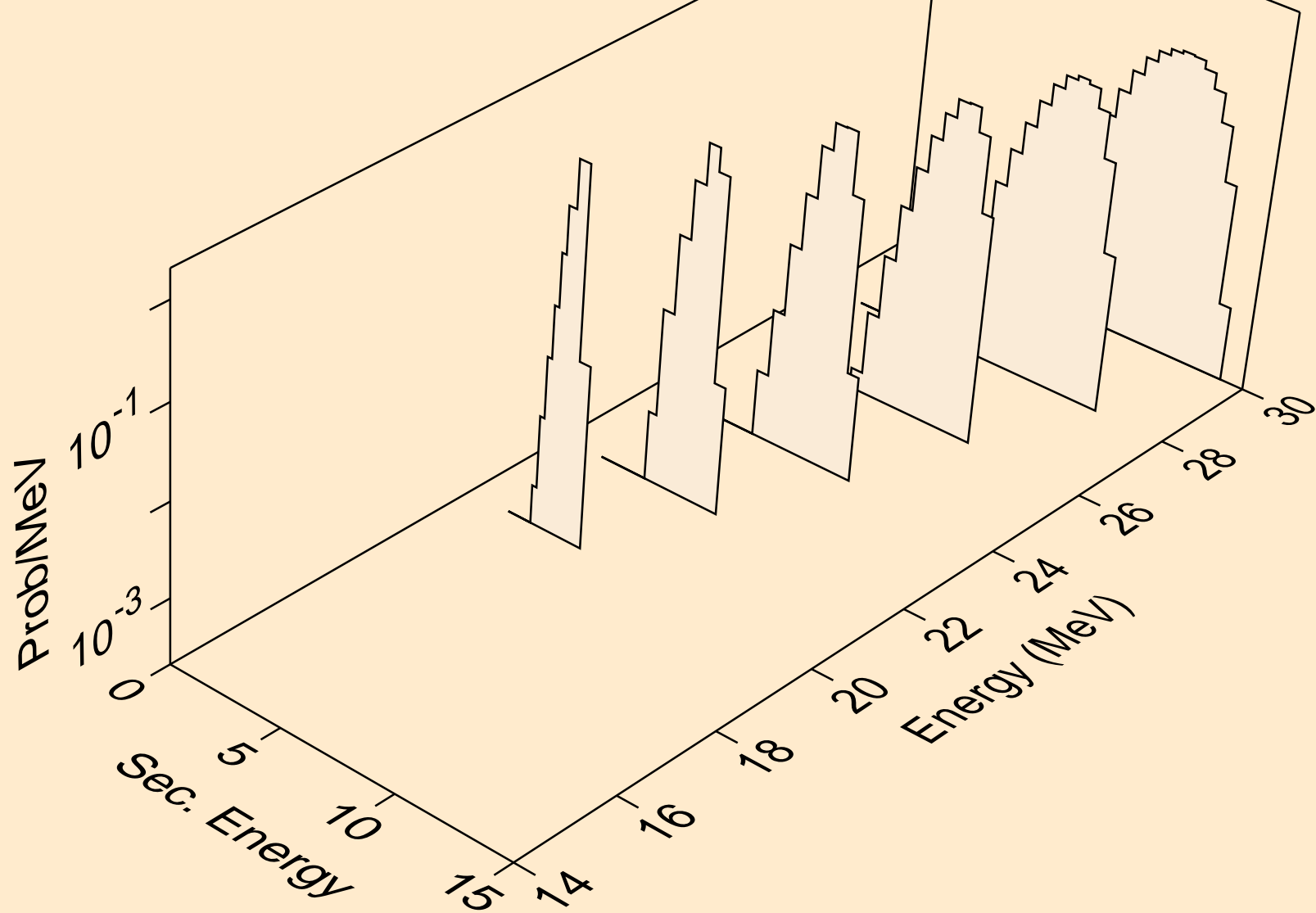

SE084 ALPHA ACER TENDL-2021 LIBRARY; T=0.K
Alpha emission for inelastic

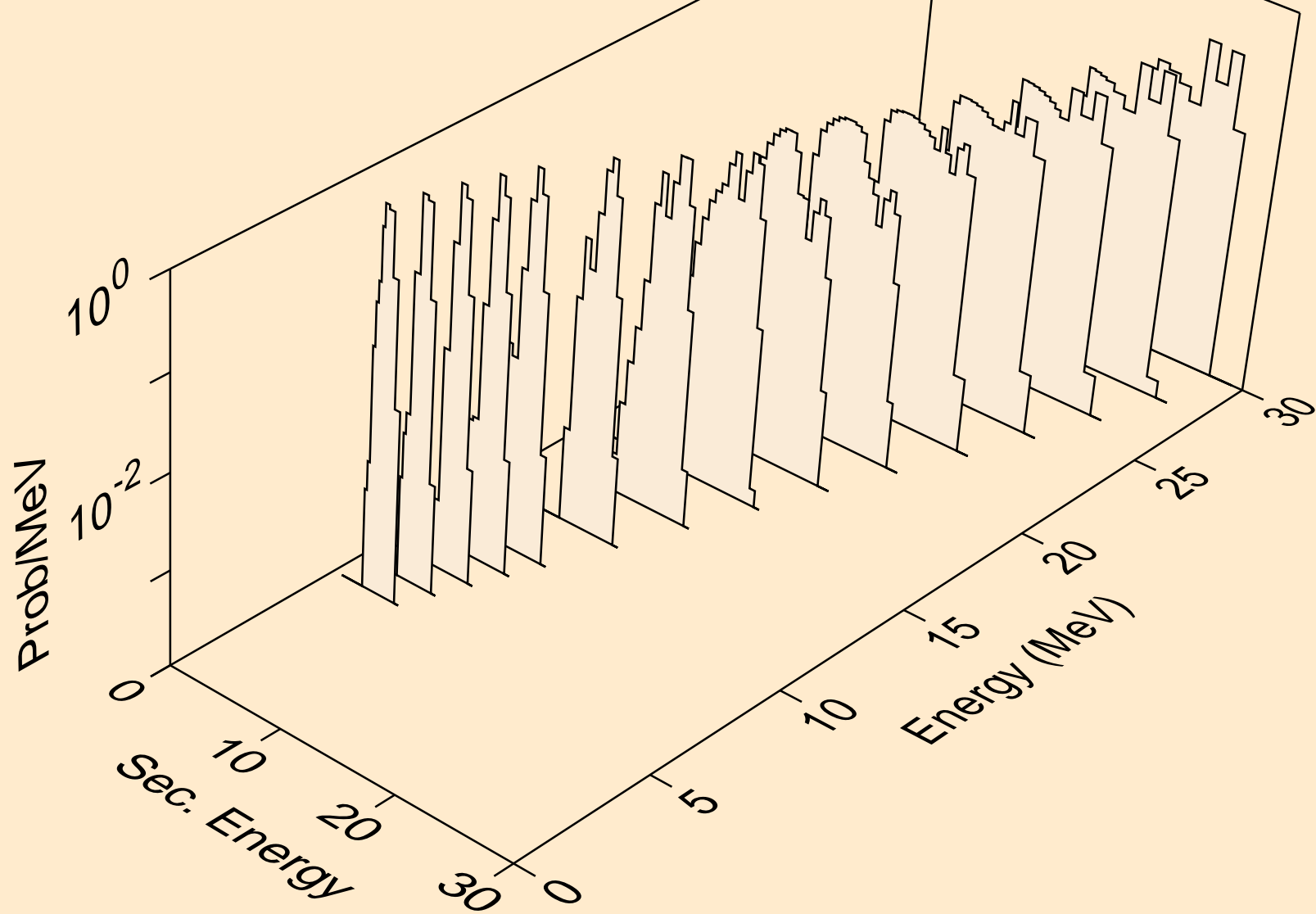

SE084 ALPHA ACER TENDL-2021 LIBRARY; T=0.K
Alpha emission for (a,2a)

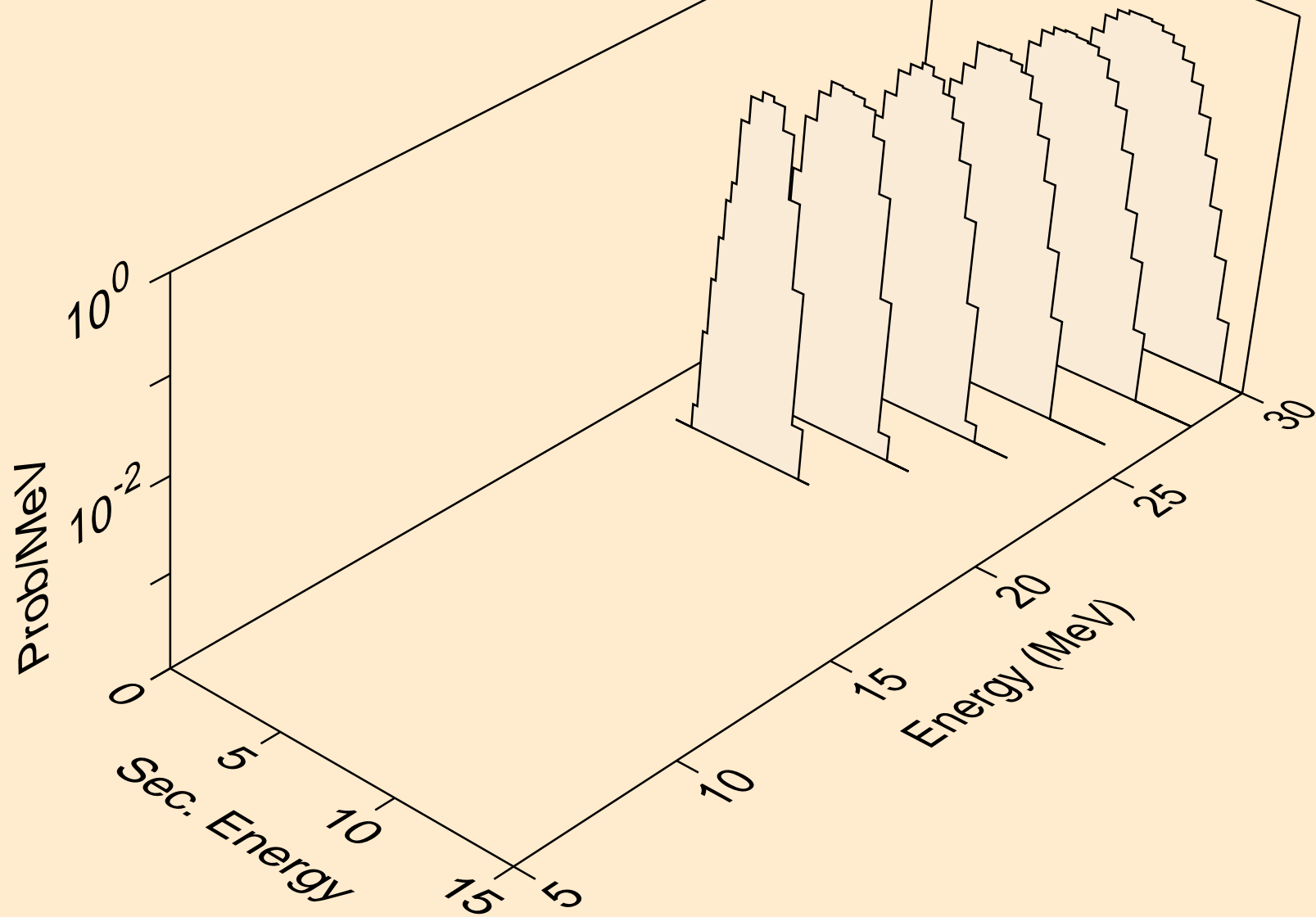

SE084 ALPHA ACER TENDL-2021 LIBRARY; T=0.K
Alpha emission for (a,pa)

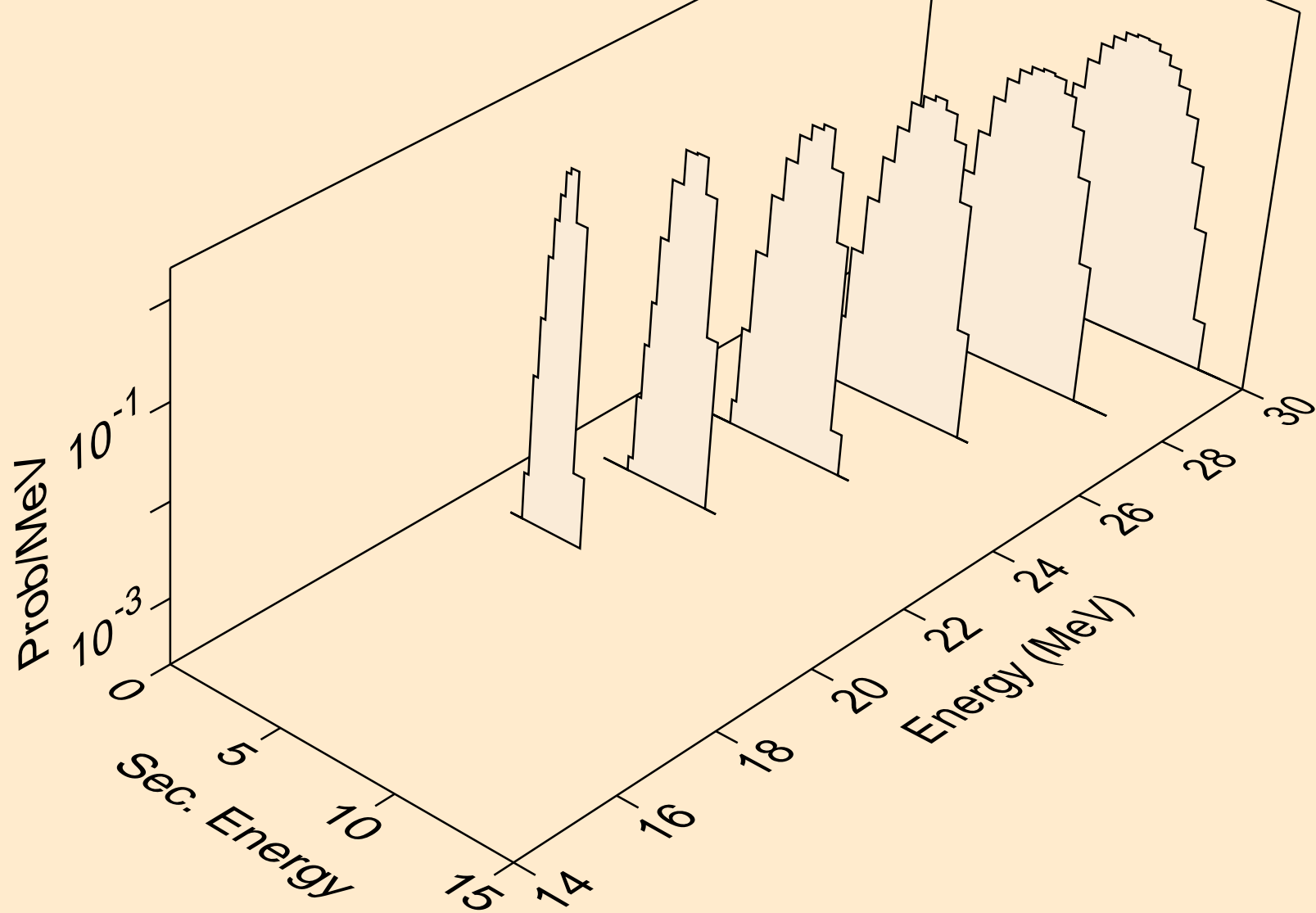

SE084 ALPHA ACER TENDL-2021 LIBRARY; T=0.K
Photon emission for (z,n)

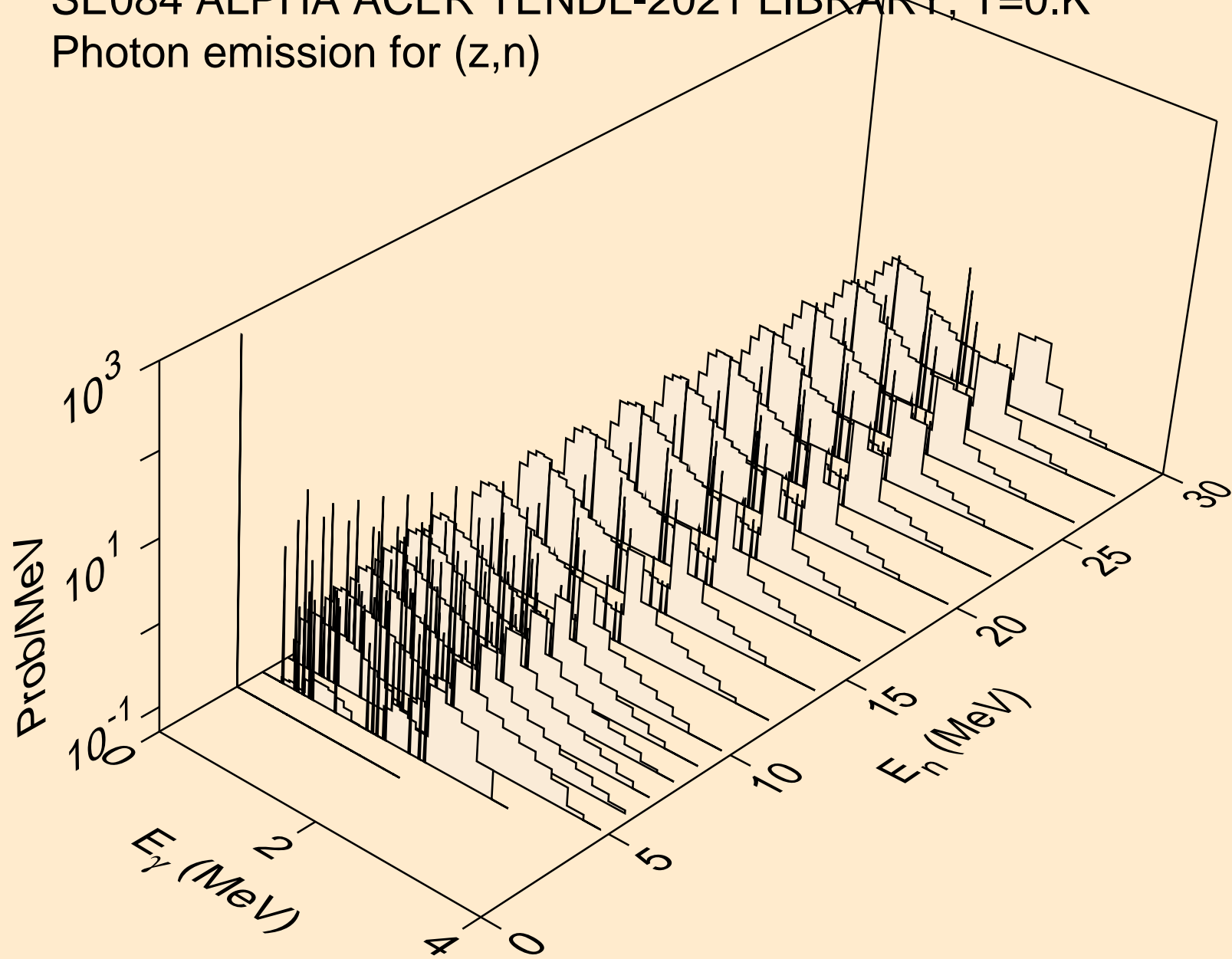

SE084 ALPHA ACER TENDL-2021 LIBRARY; T=0.K
Photon emission for (n,x)

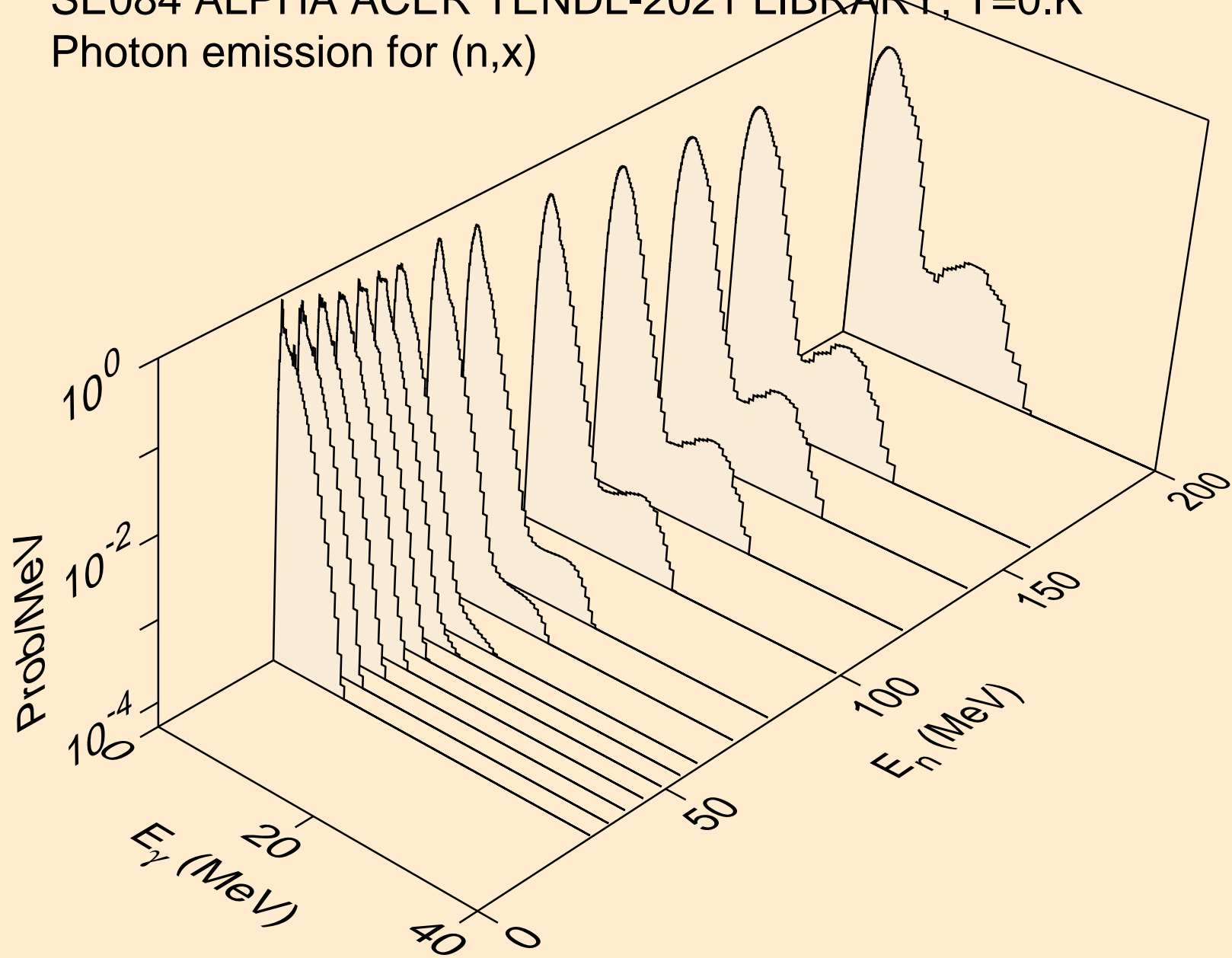

SE084 ALPHA ACER TENDL-2021 LIBRARY; T=0.K
Photon emission for (n,2nd)

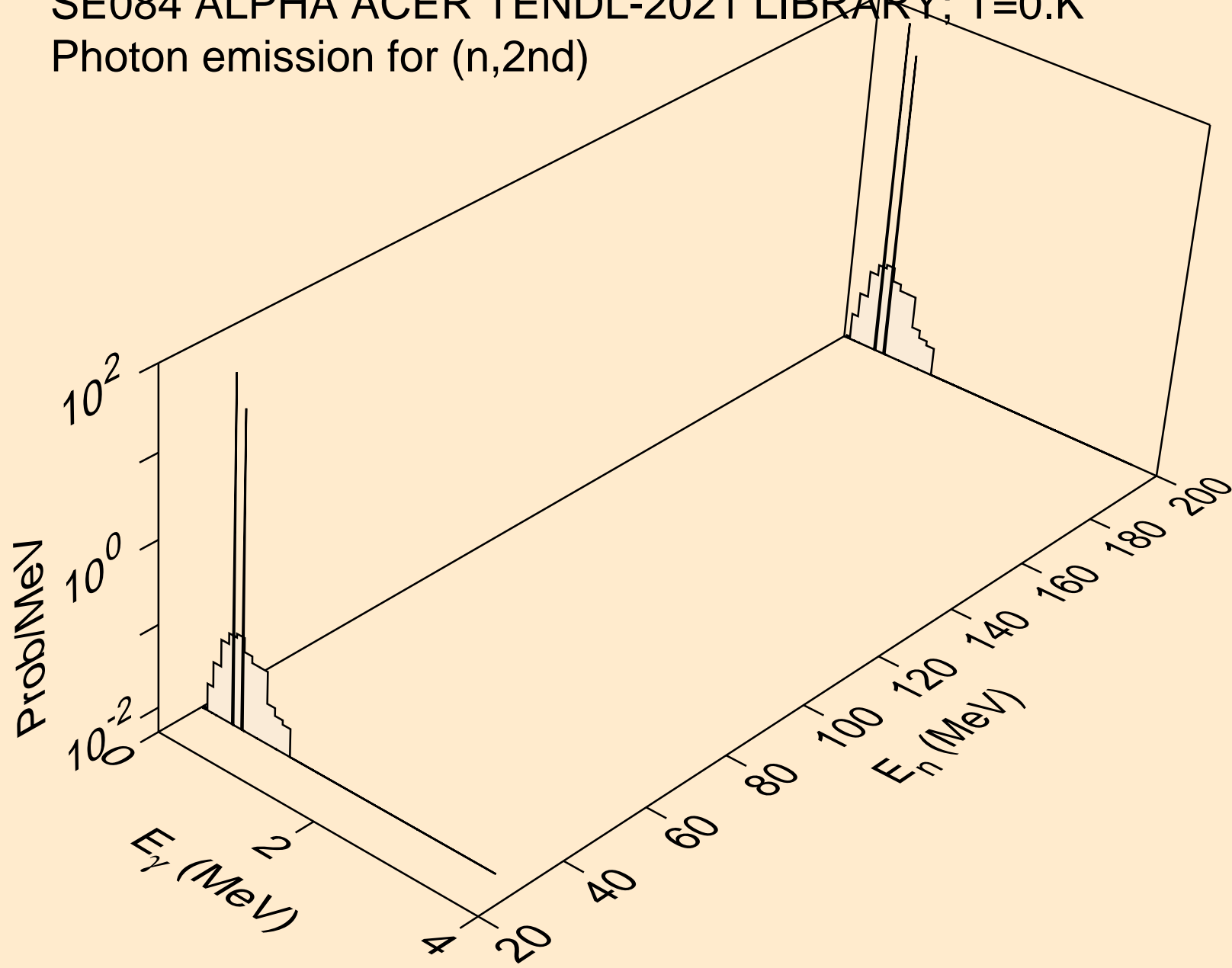

SE084 ALPHA ACER TENDL-2021 LIBRARY; T=0.K
Photon emission for (n,2n)

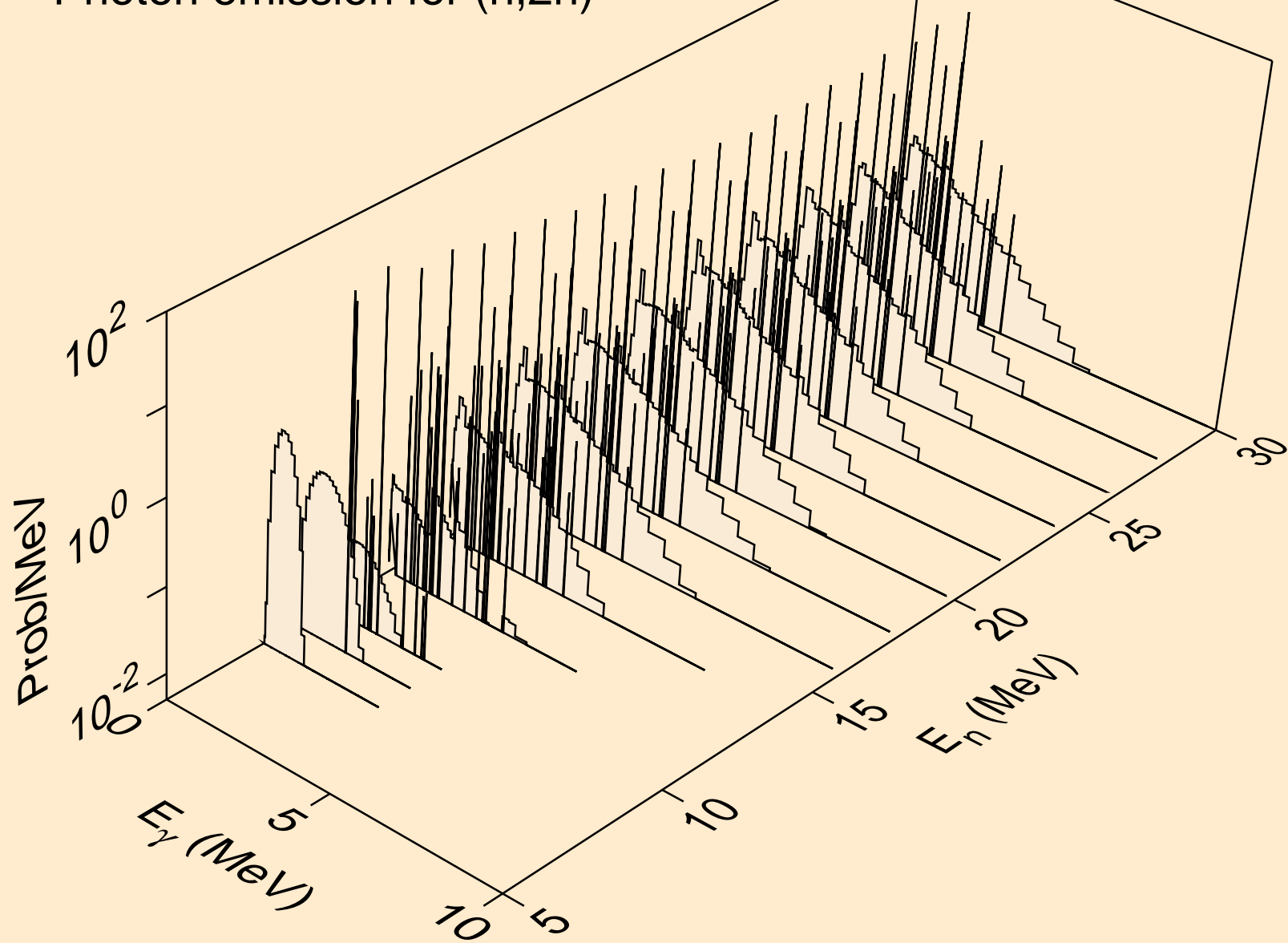

SE084 ALPHA ACER TENDL-2021 LIBRARY; T=0.K
Photon emission for (n,3n)

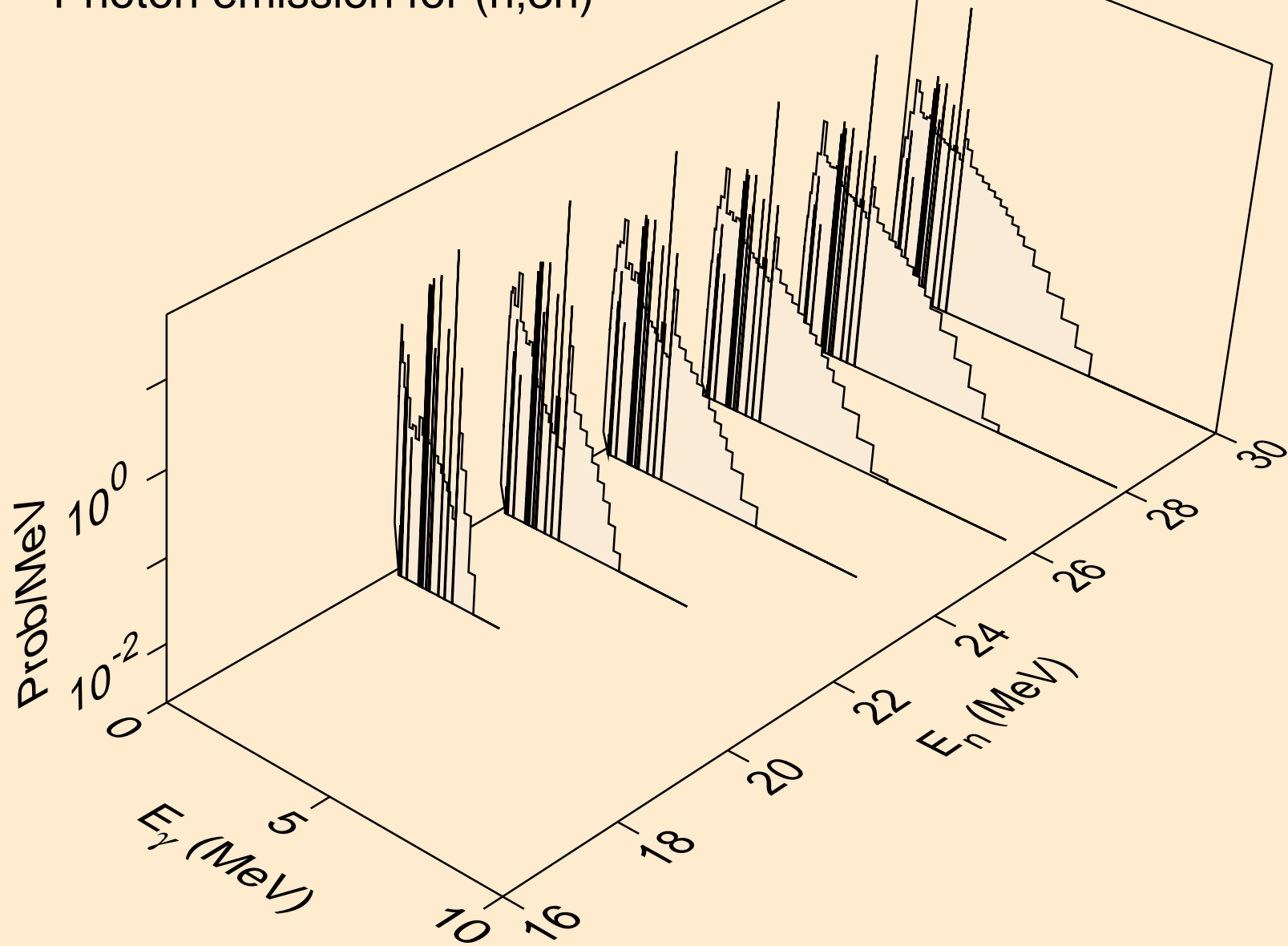

SE084 ALPHA ACER TENDL-2021 LIBRARY; T=0.K
Photon emission for (n,n*)a

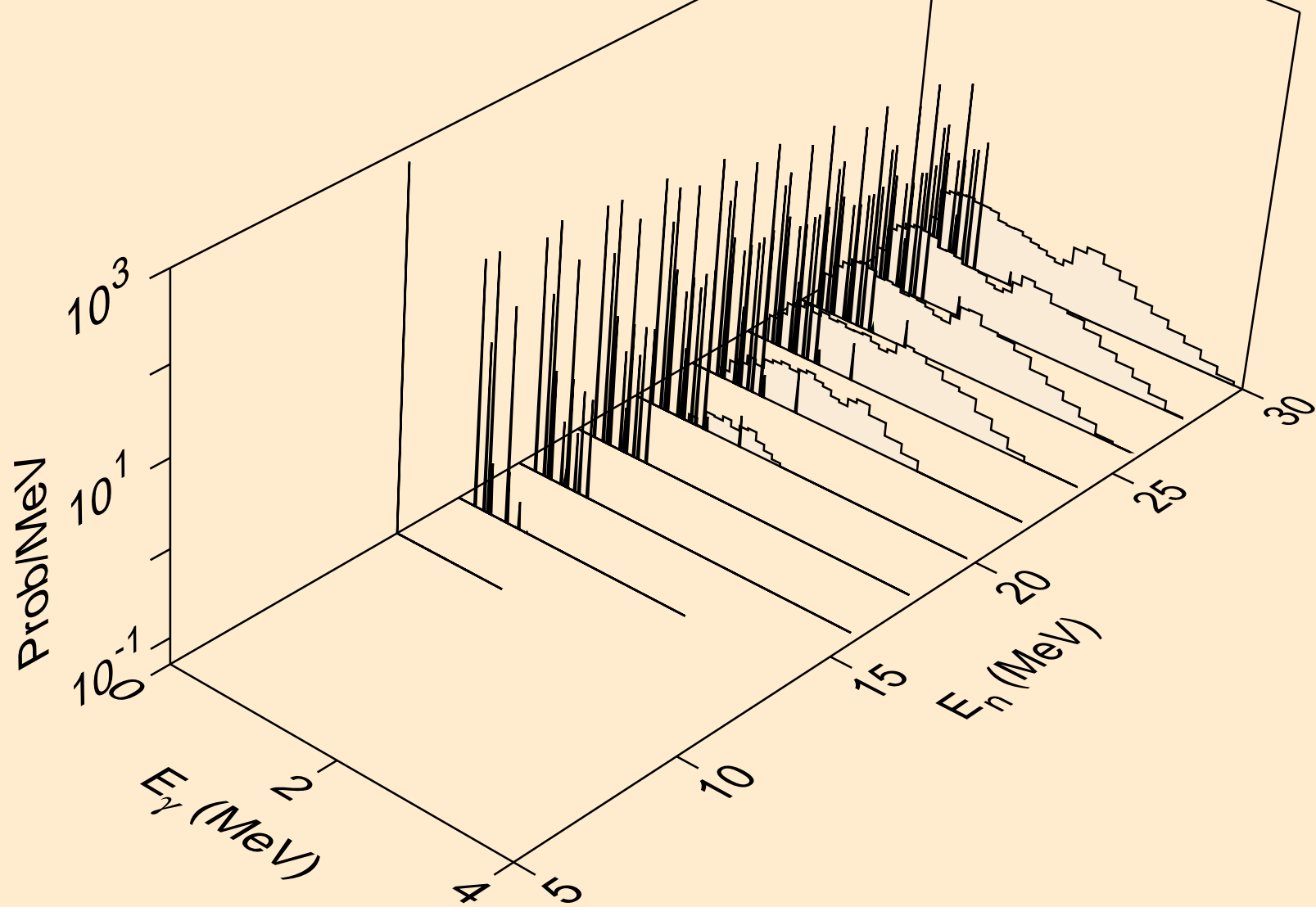

SE084 ALPHA ACER TENDL-2021 LIBRARY; T=0.K
Photon emission for (n,2n)a

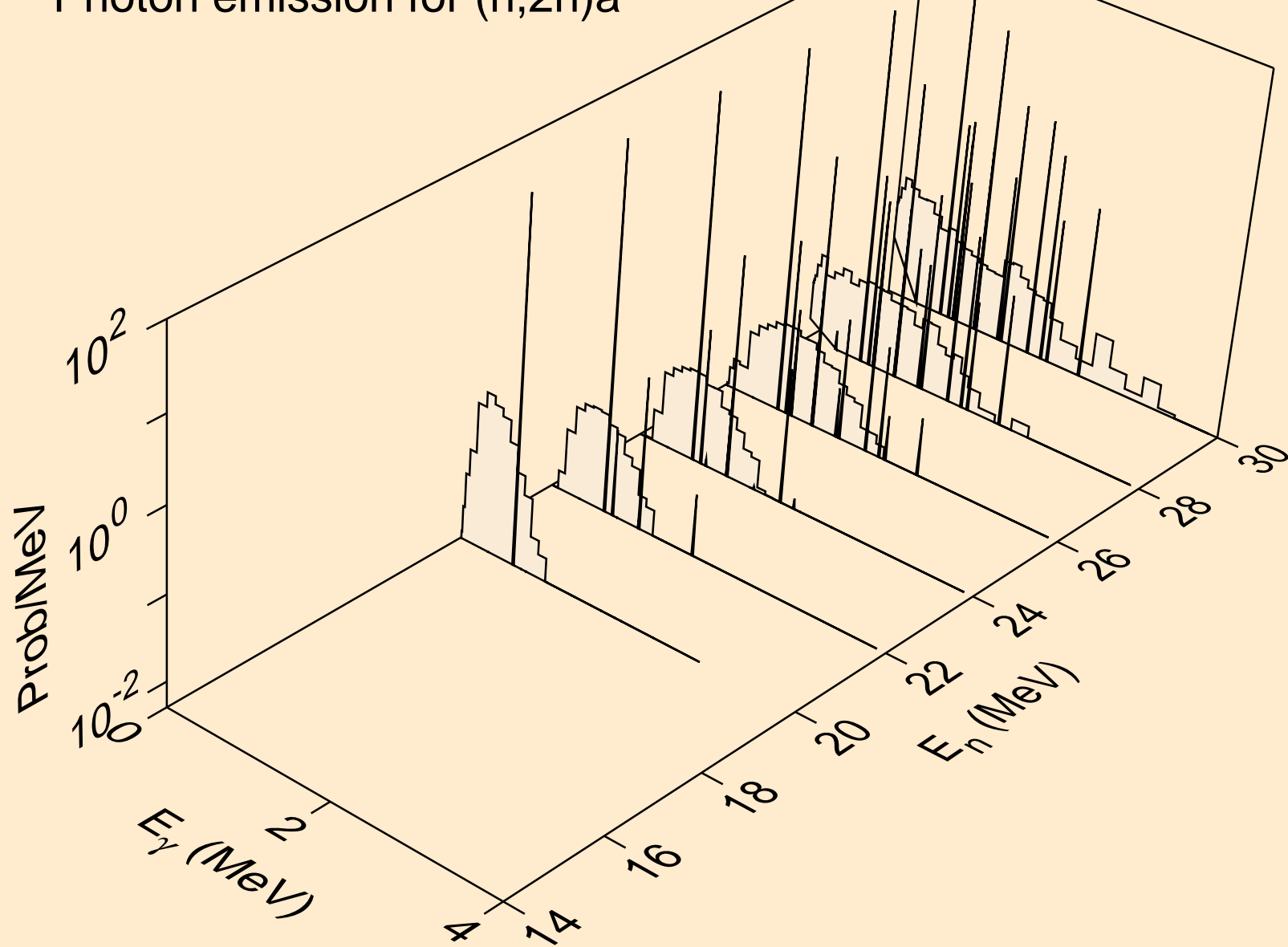

SE084 ALPHA ACER TENDL-2021 LIBRARY; T=0.K
Photon emission for (n,n*)p

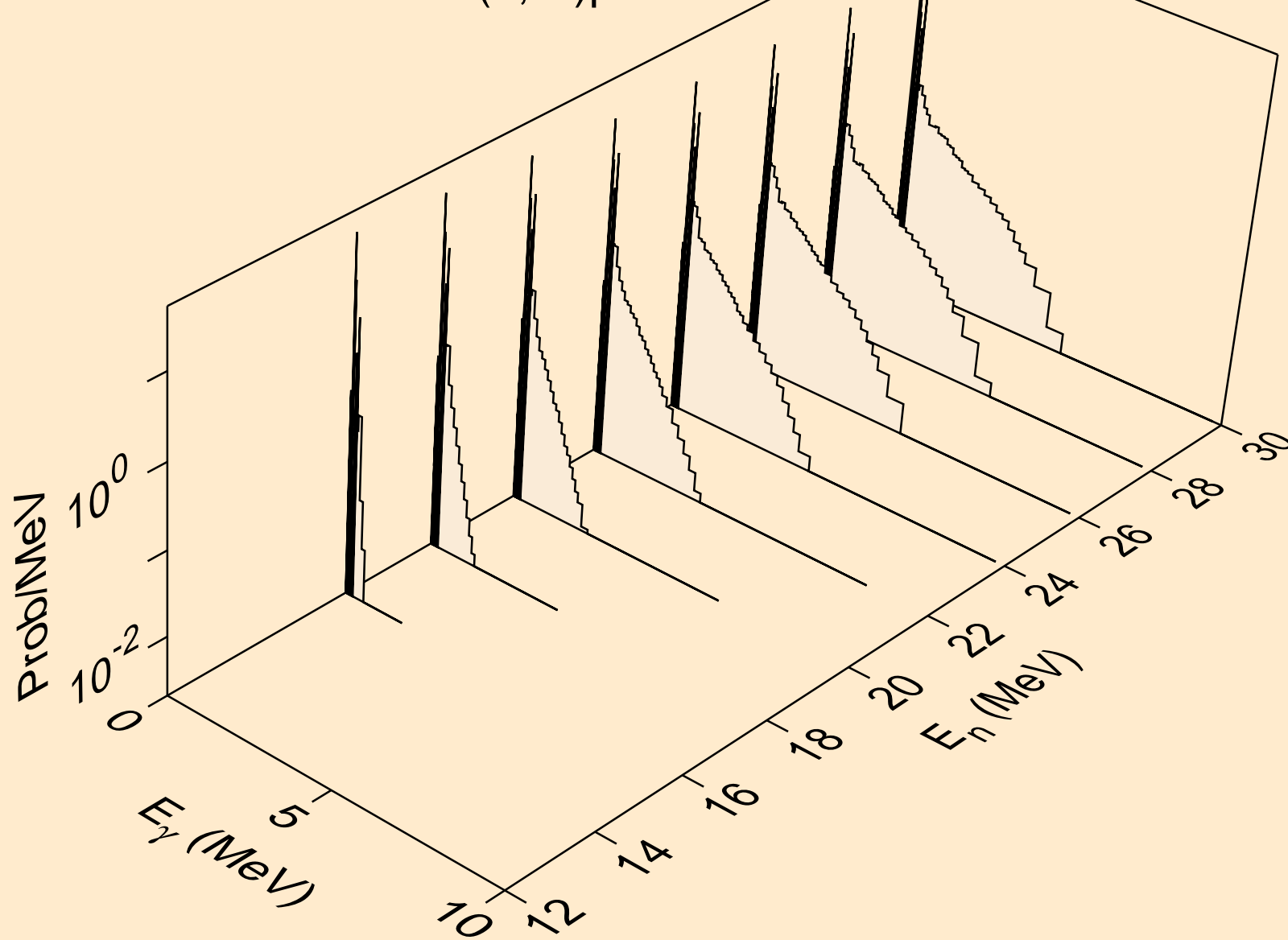

SE084 ALPHA ACER TENDL-2021 LIBRARY; T=0.K
Photon emission for (n,n*)d

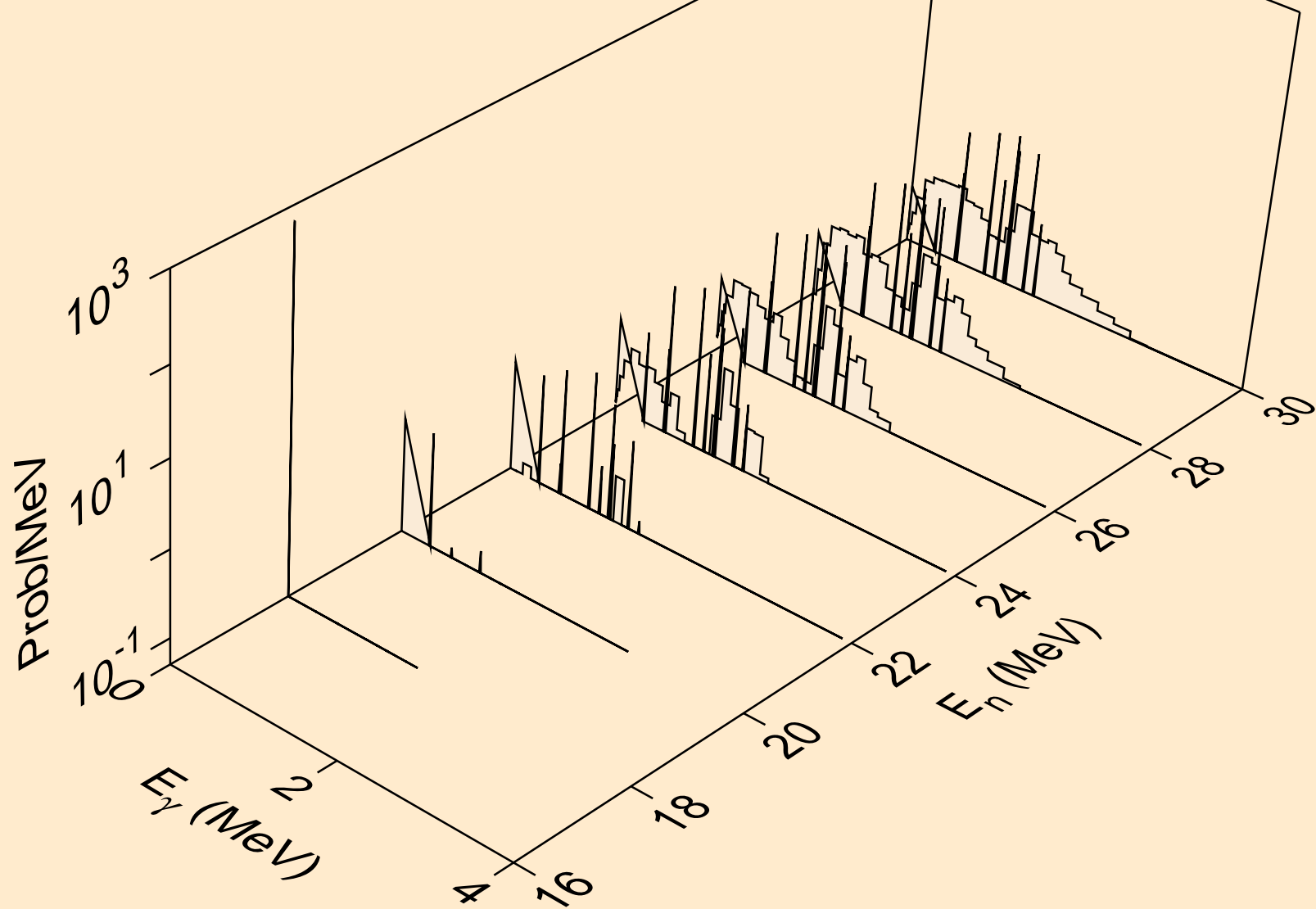

SE084 ALPHA ACER TENDL-2021 LIBRARY; T=0.K
Photon emission for (n,n*)t

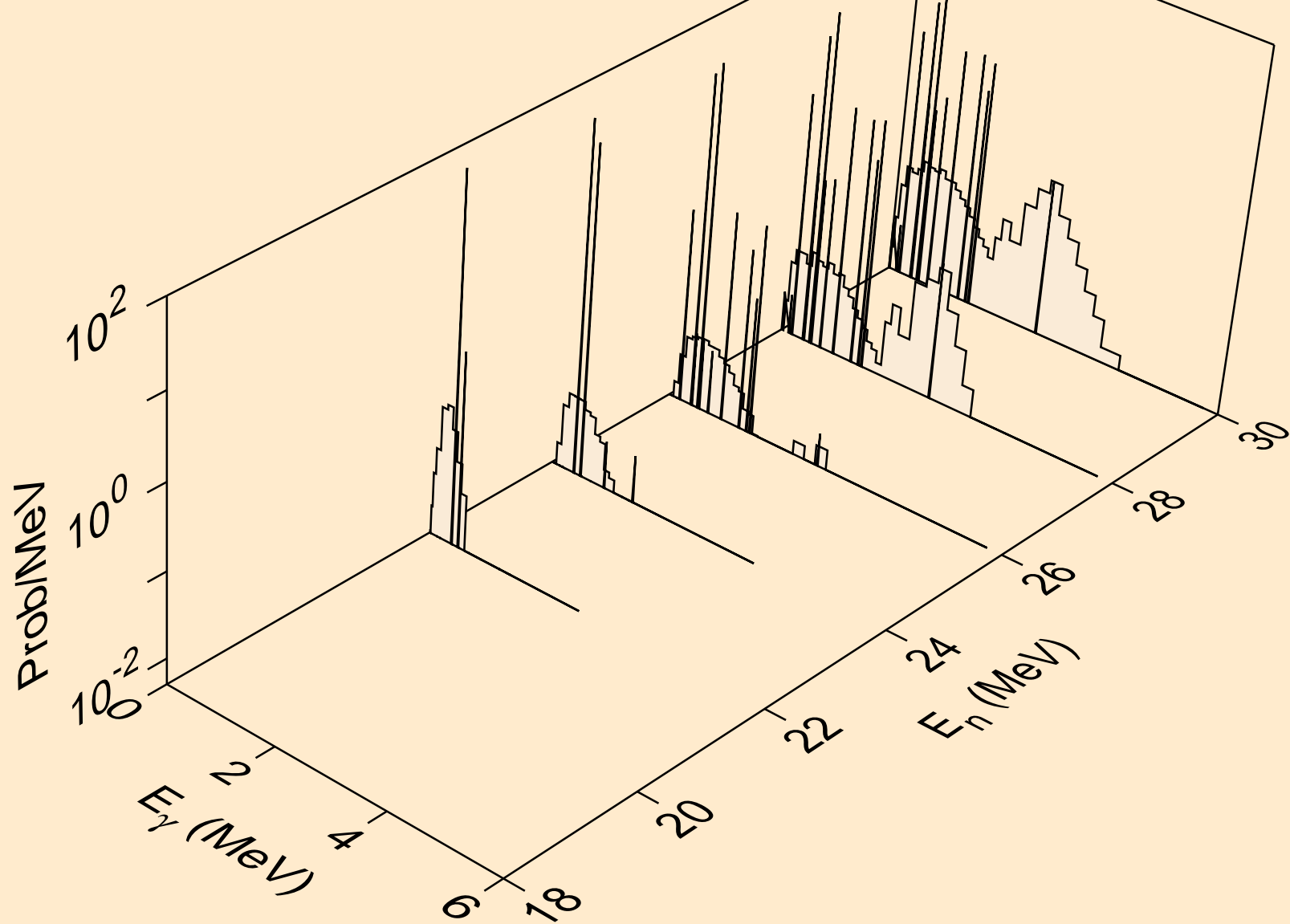

SE084 ALPHA ACER TENDL-2021 LIBRARY; T=0.K
Photon emission for (n,n*)he3

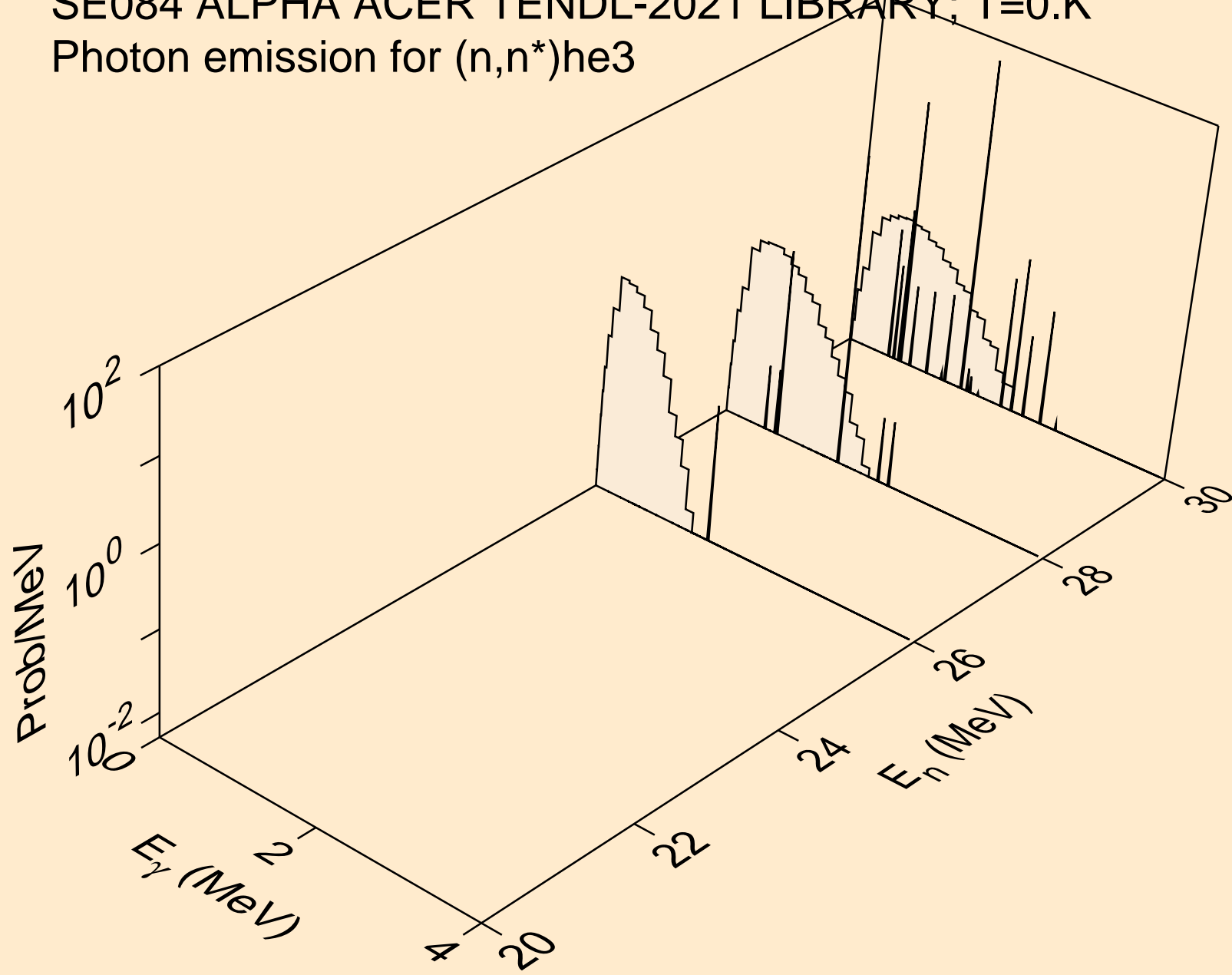

SE084 ALPHA ACER TENDL-2021 LIBRARY; T=0.K
Photon emission for (n,4n)

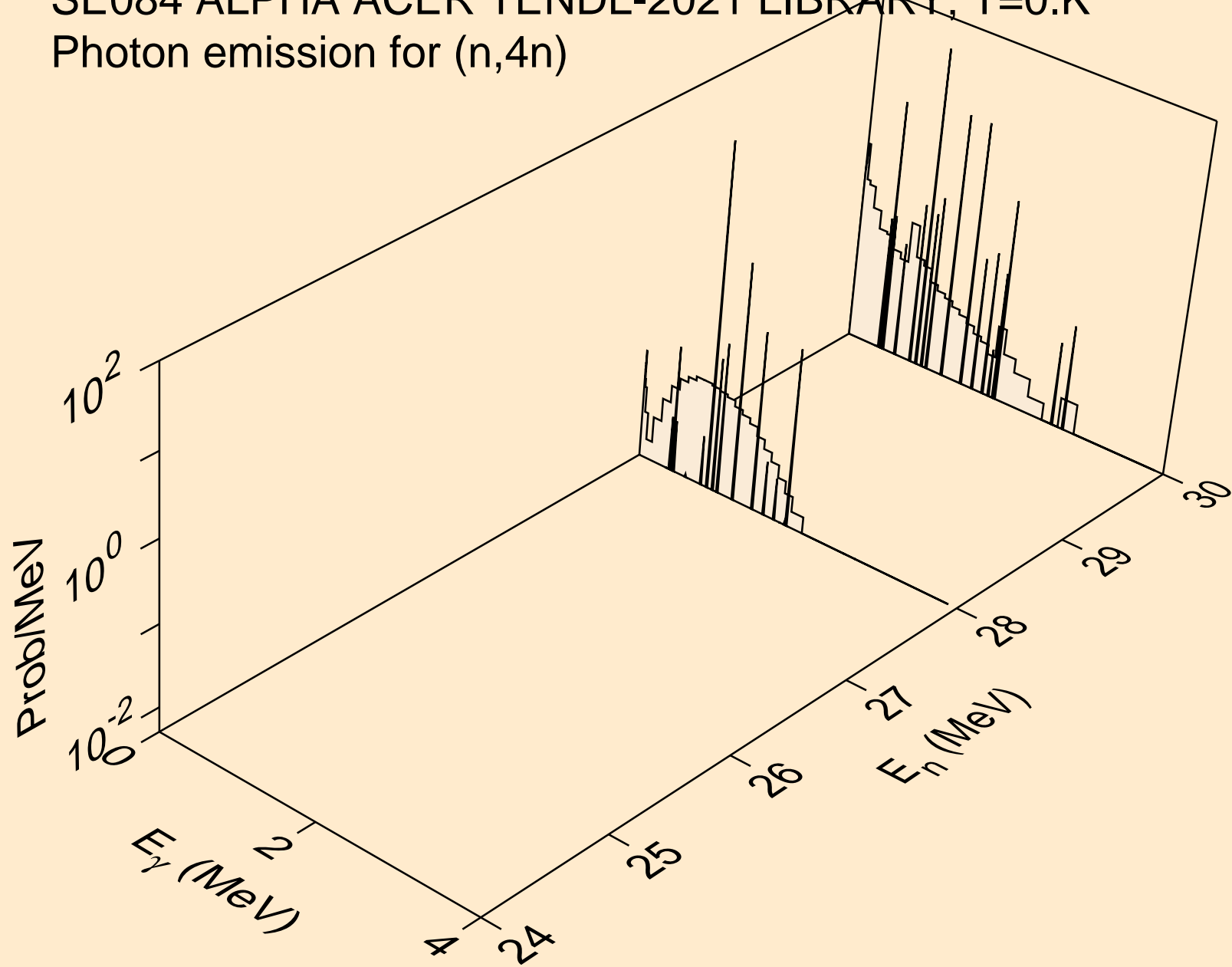

SE084 ALPHA ACER TENDL-2021 LIBRARY; T=0.K
Photon emission for (n,2np)

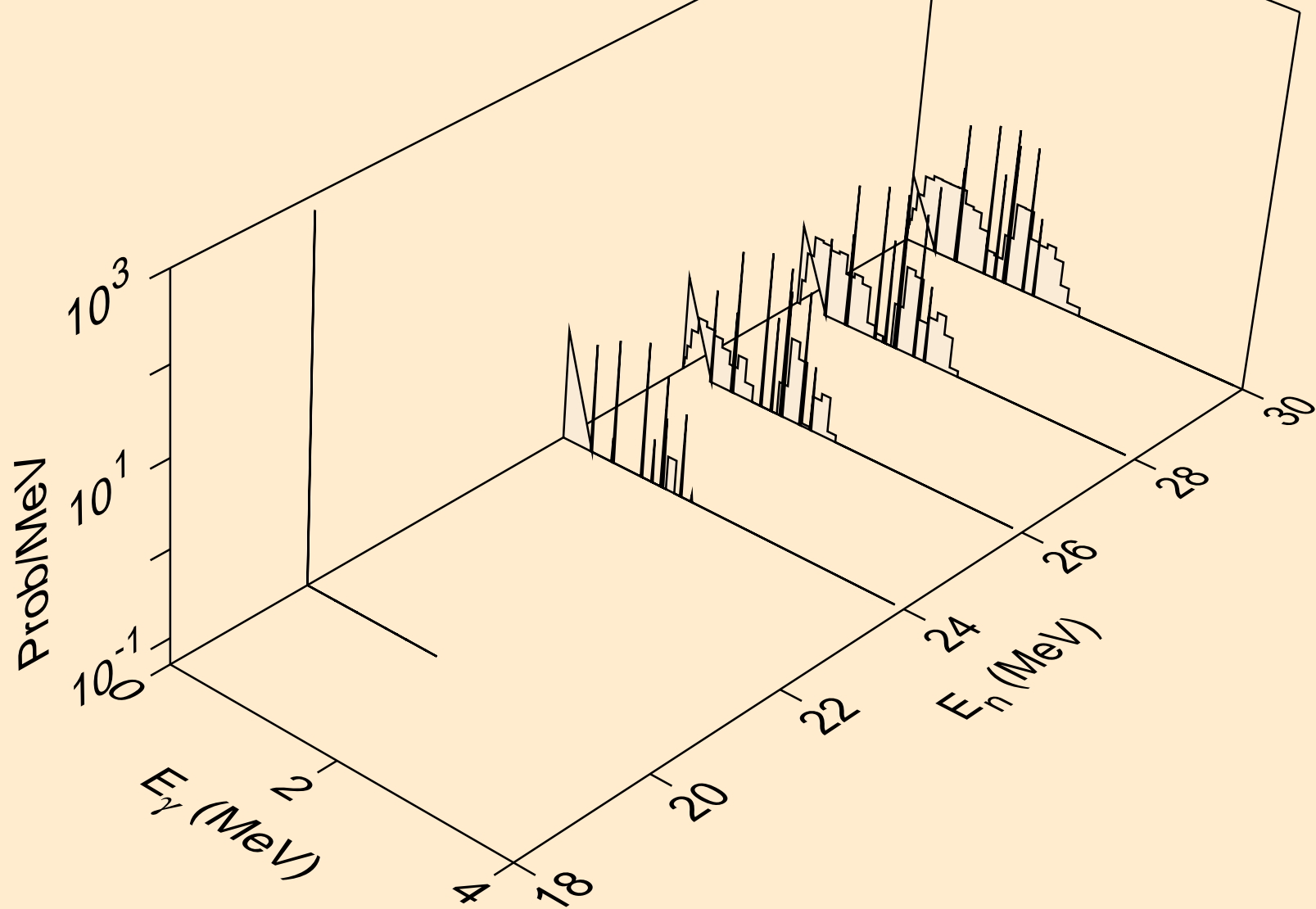

SE084 ALPHA ACER TENDL-2021 LIBRARY; T=0.K
Photon emission for (n,gma)

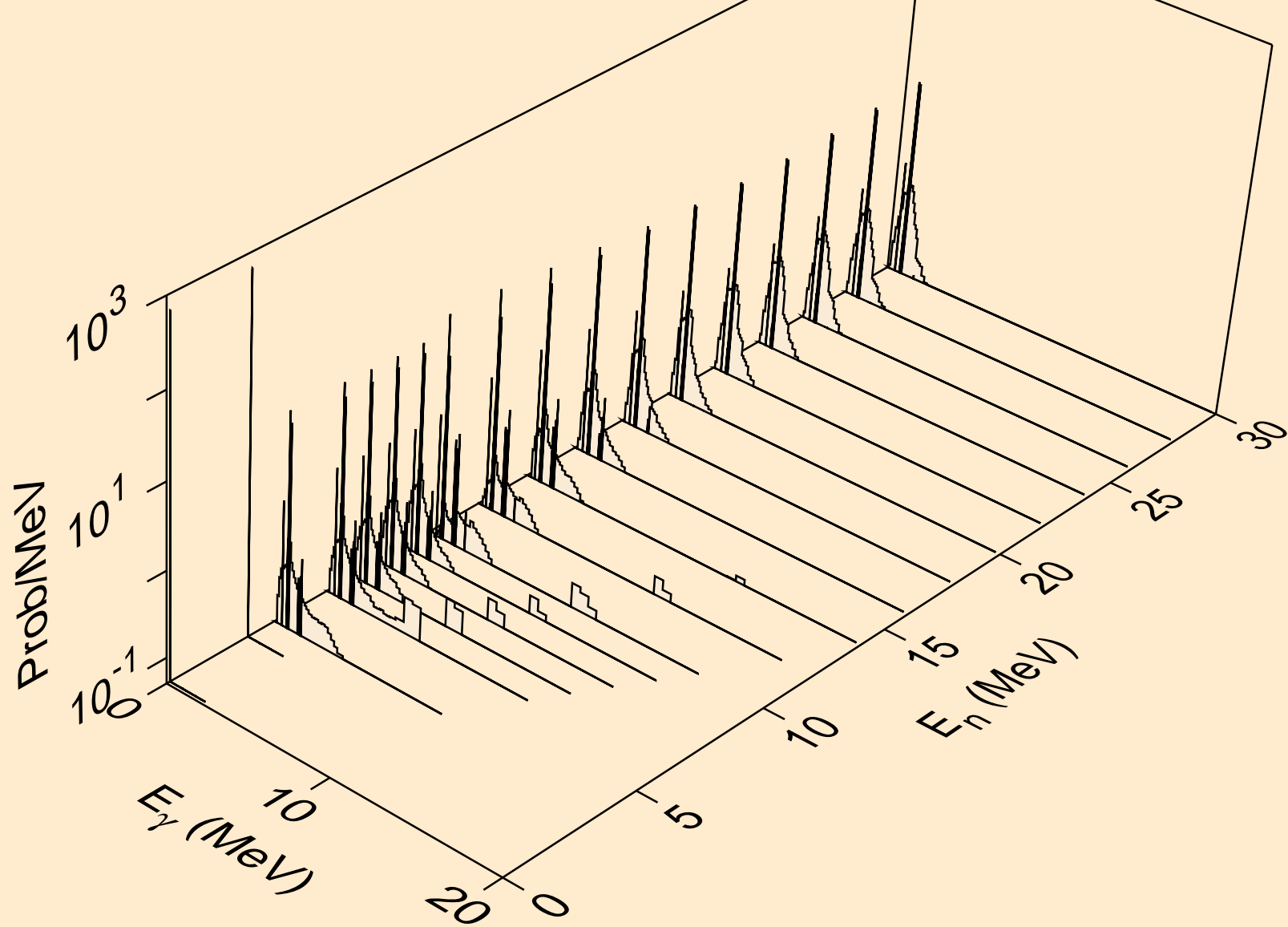

SE084 ALPHA ACER TENDL-2021 LIBRARY; T=0.K
Photon emission for (n,p)

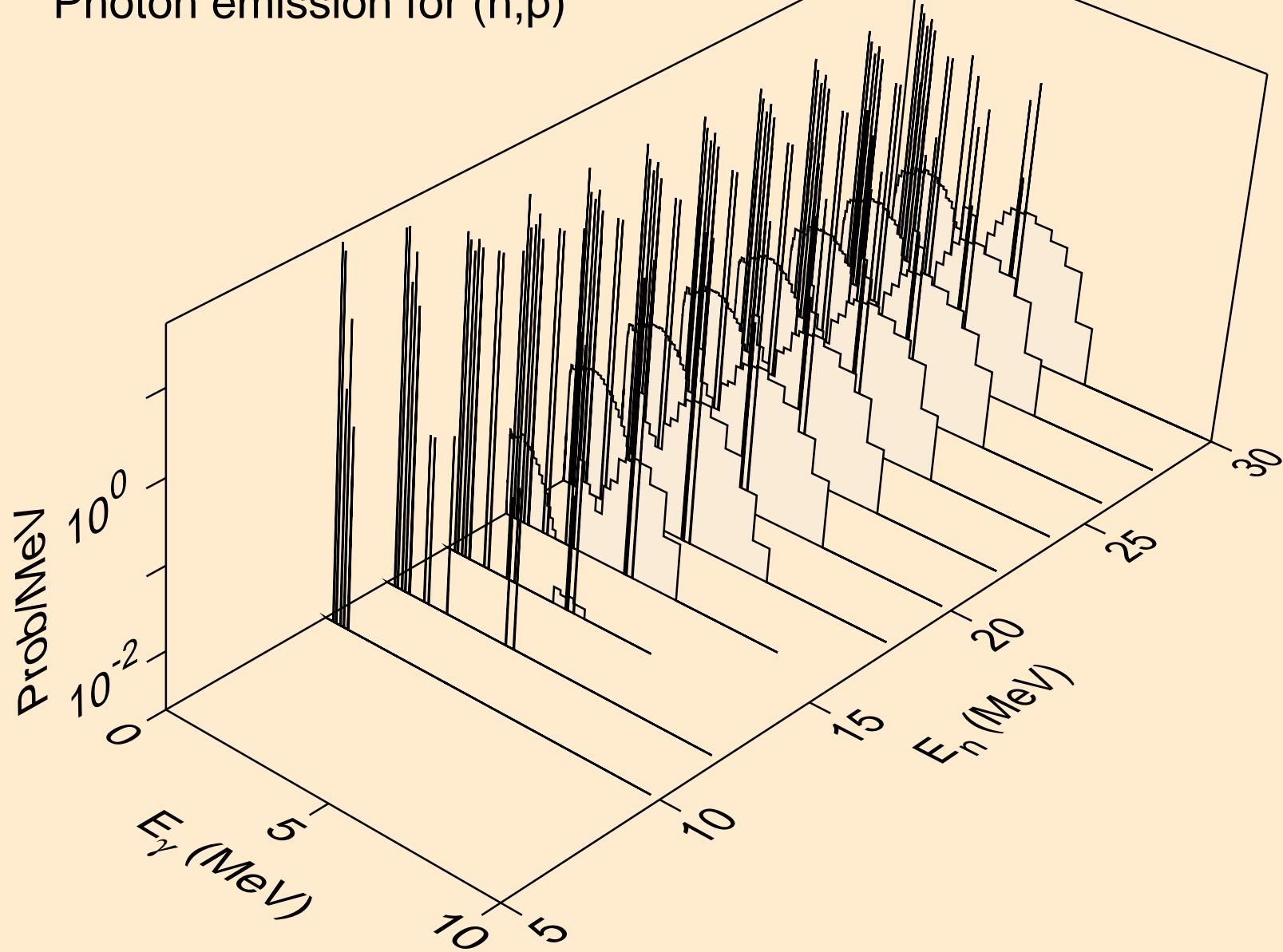

SE084 ALPHA ACER TENDL-2021 LIBRARY; T=0.K
Photon emission for (n,d)

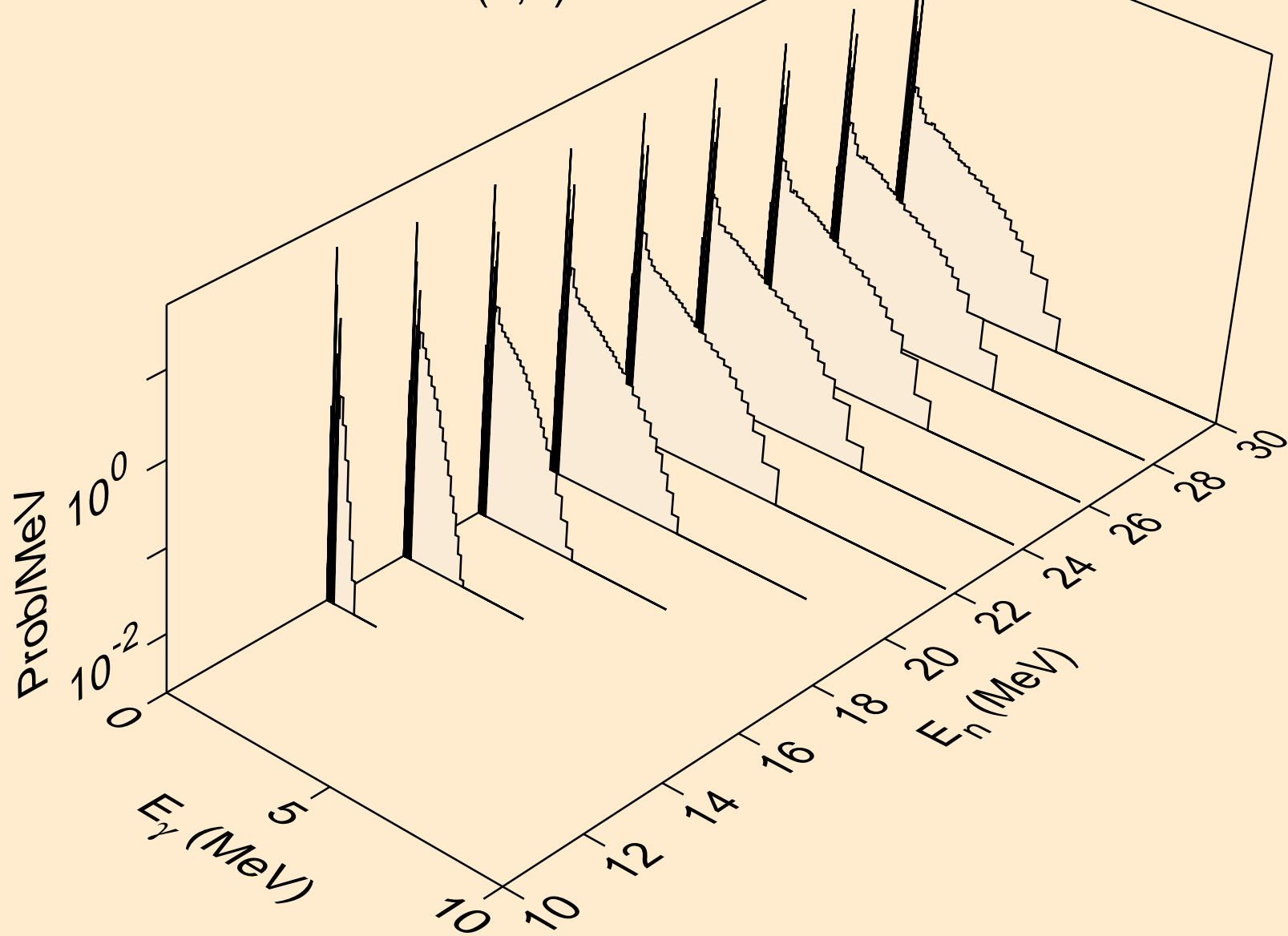

SE084 ALPHA ACER TENDL-2021 LIBRARY; T=0.K
Photon emission for (n,t)

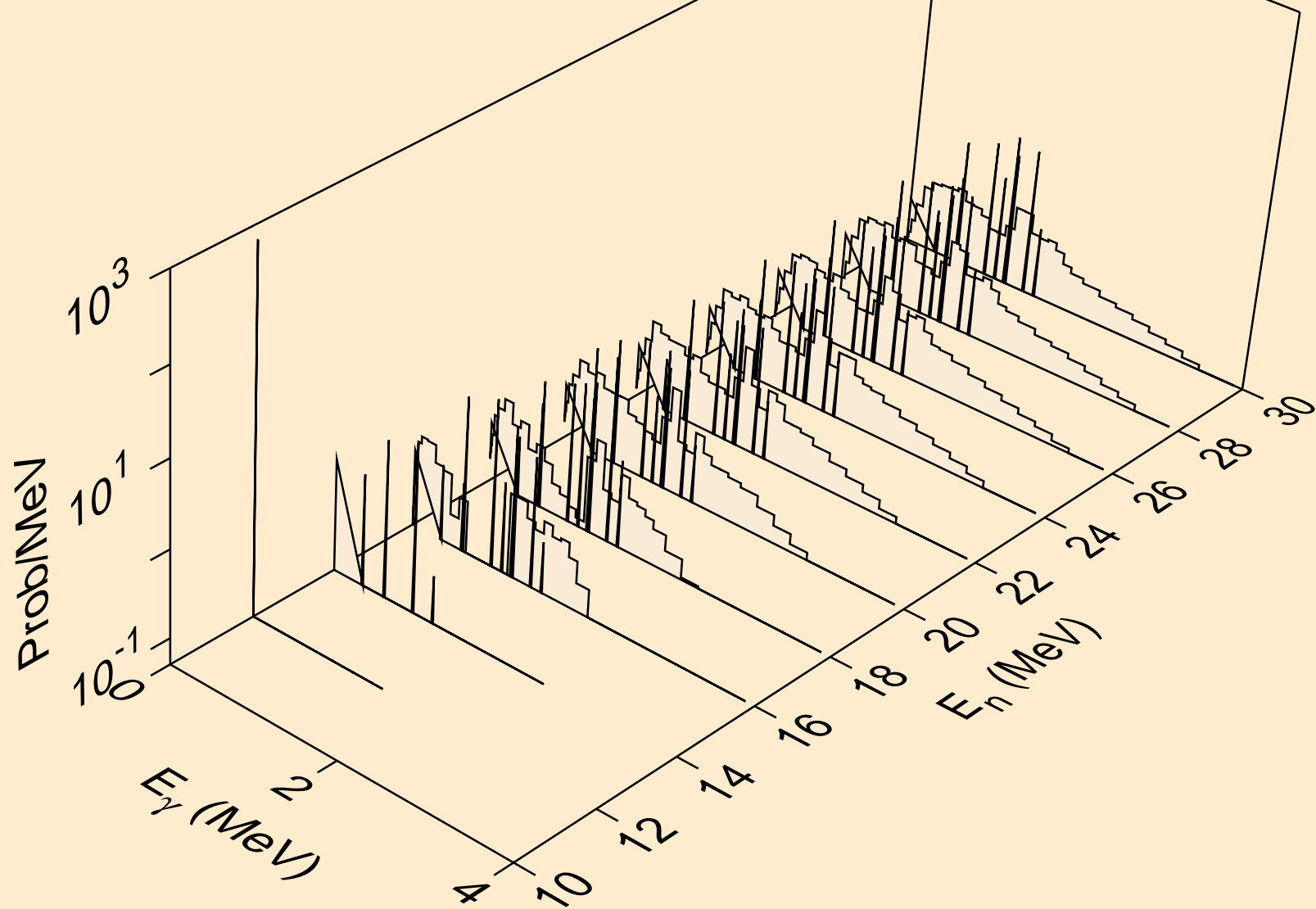

SE084 ALPHA ACER TENDL-2021 LIBRARY; T=0.K
Photon emission for (n,he3)

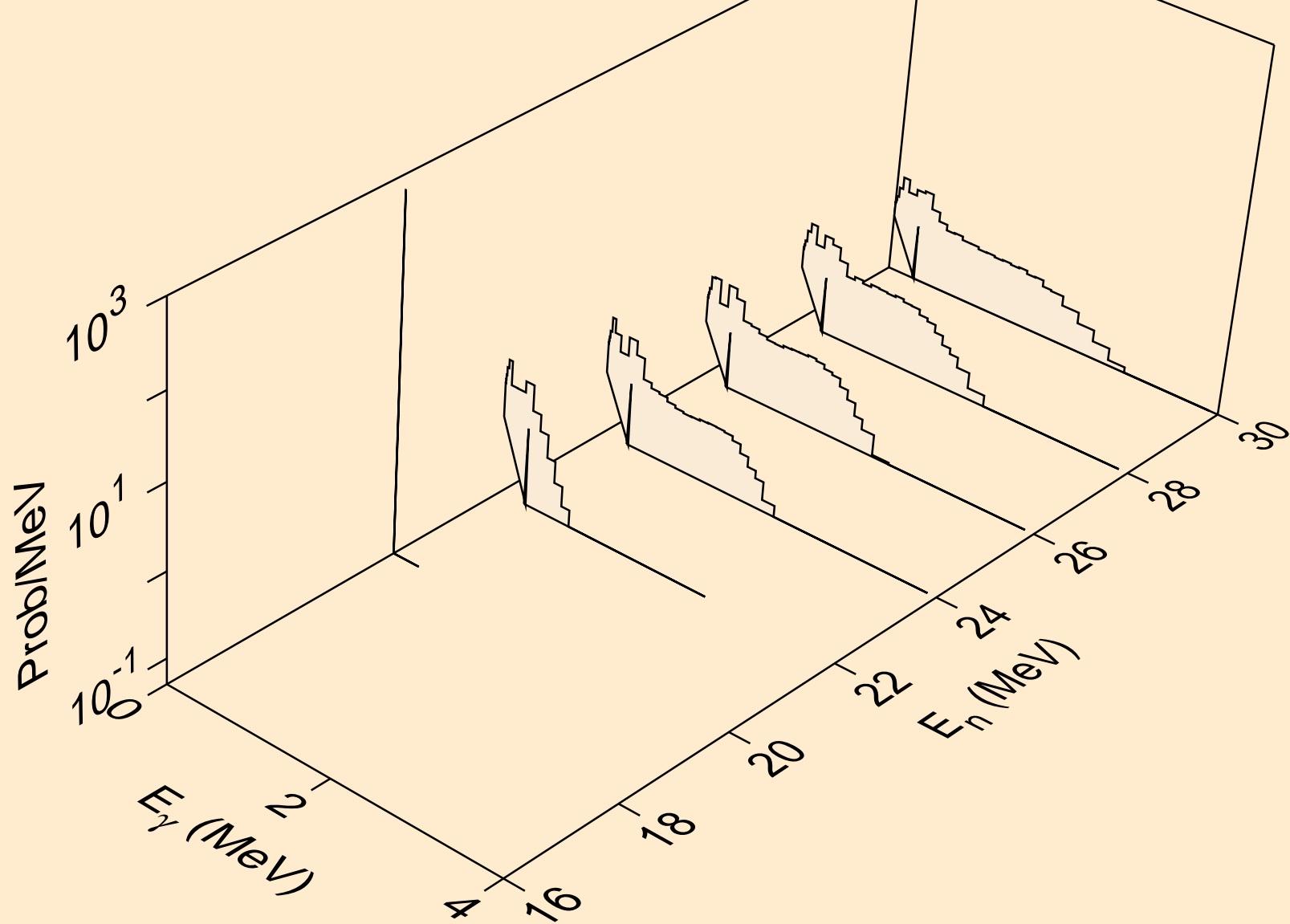

SE084 ALPHA ACER TENDL-2021 LIBRARY; T=0.K
Photon emission for inelastic

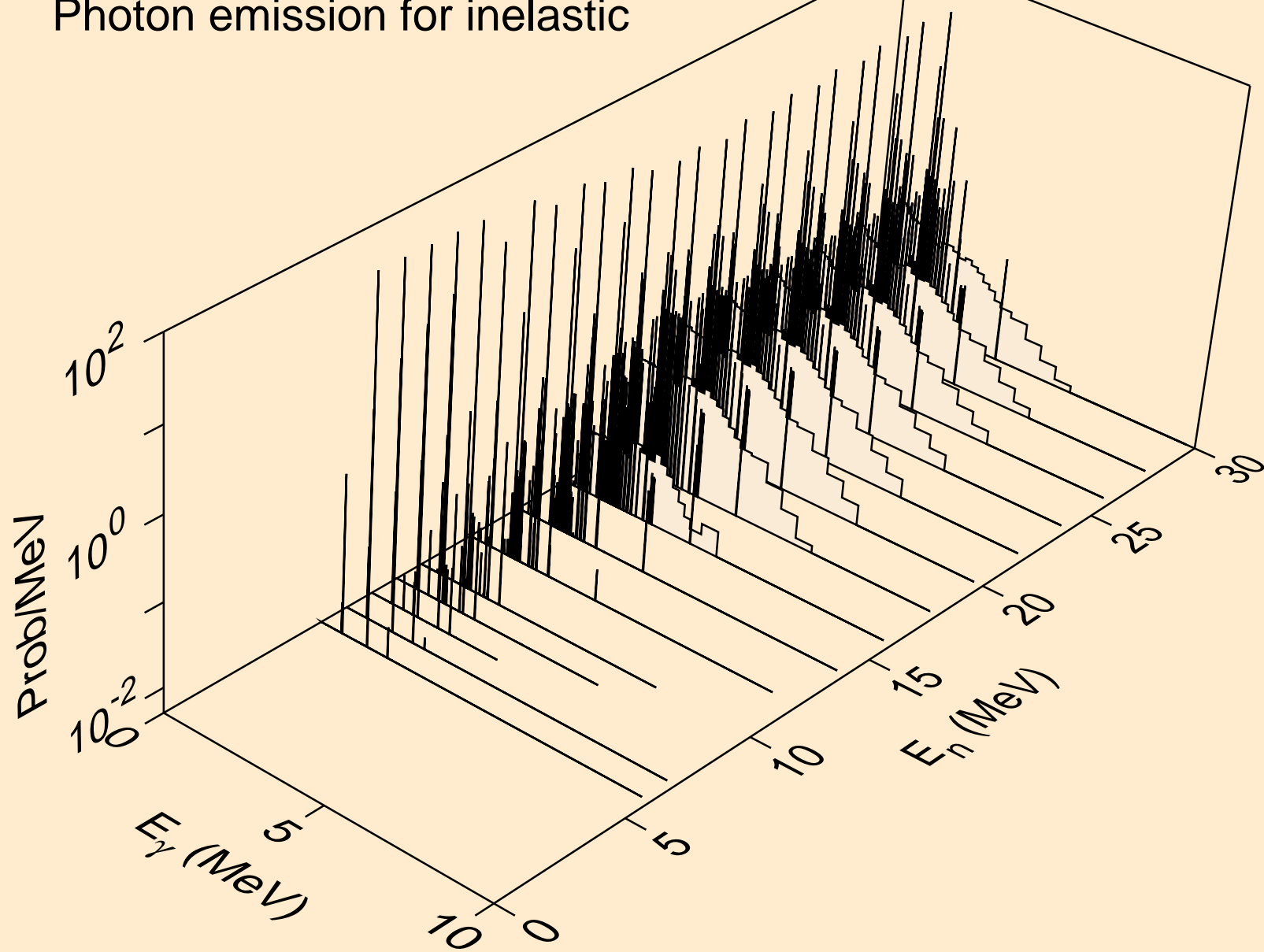

SE084 ALPHA ACER TENDL-2021 LIBRARY; T=0.K
Photon emission for (n,2a)

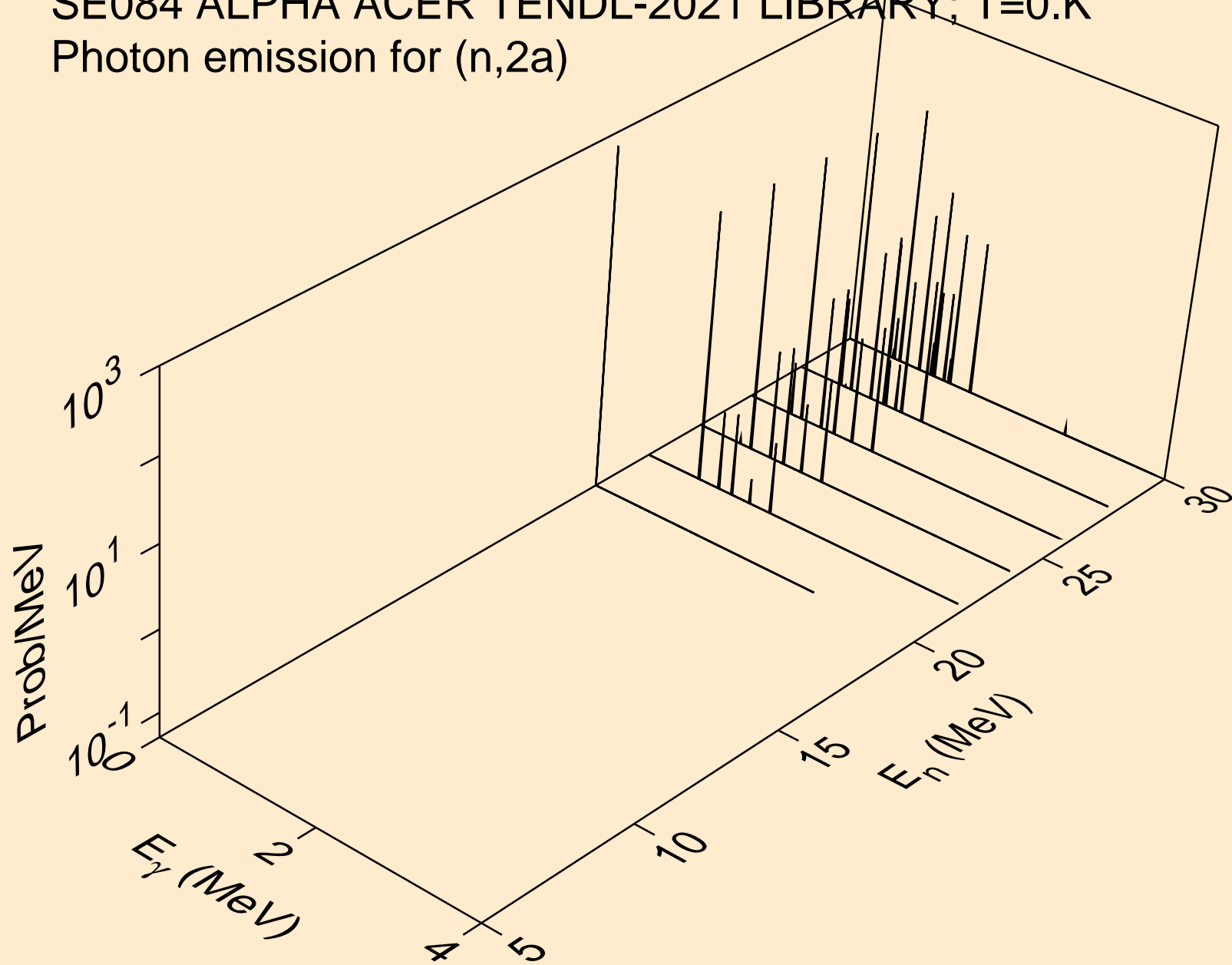

SE084 ALPHA ACER TENDL-2021 LIBRARY; T=0.K
Photon emission for (n,2p)

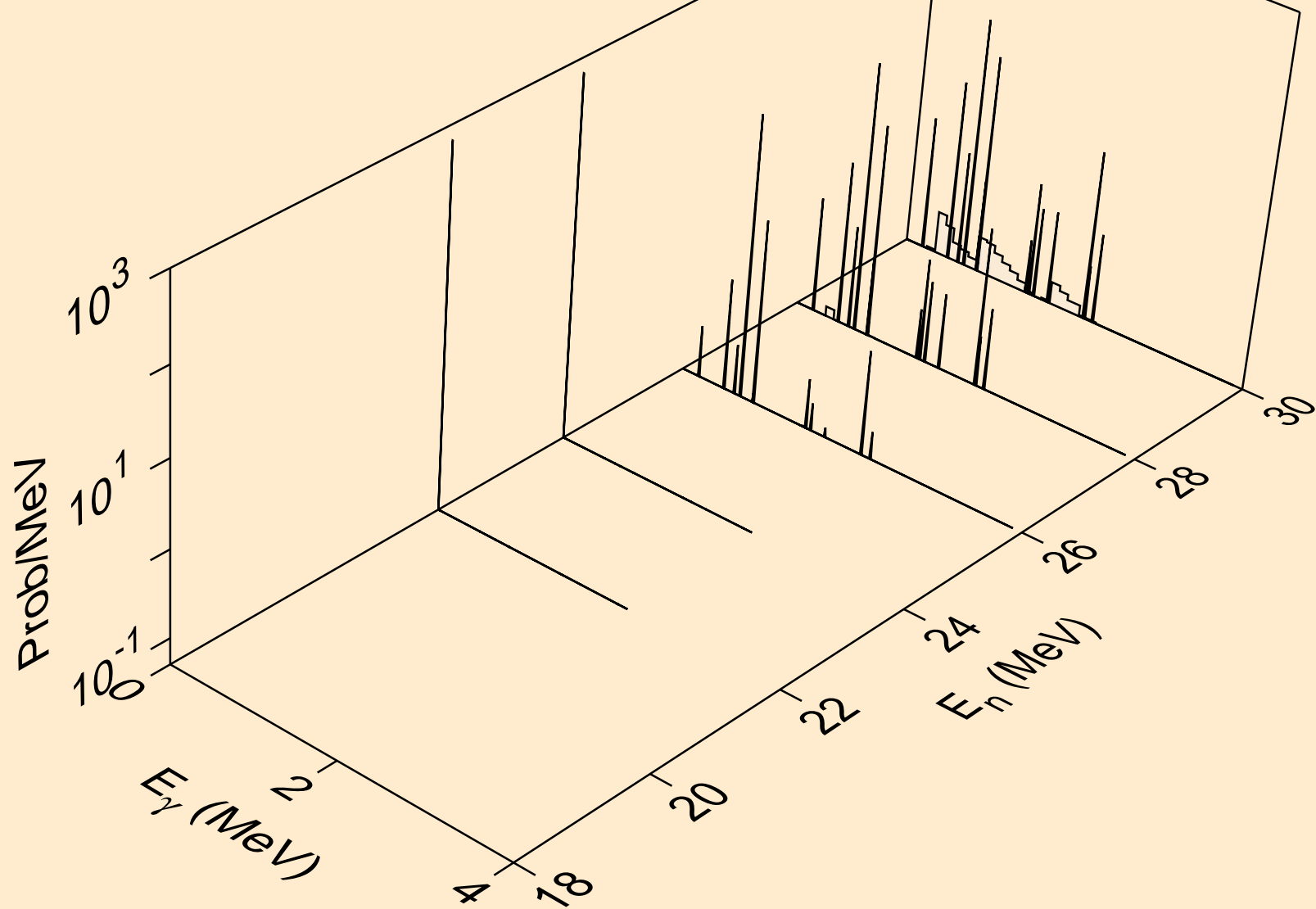

SE084 ALPHA ACER TENDL-2021 LIBRARY; T=0.K
Photon emission for (n,pa)

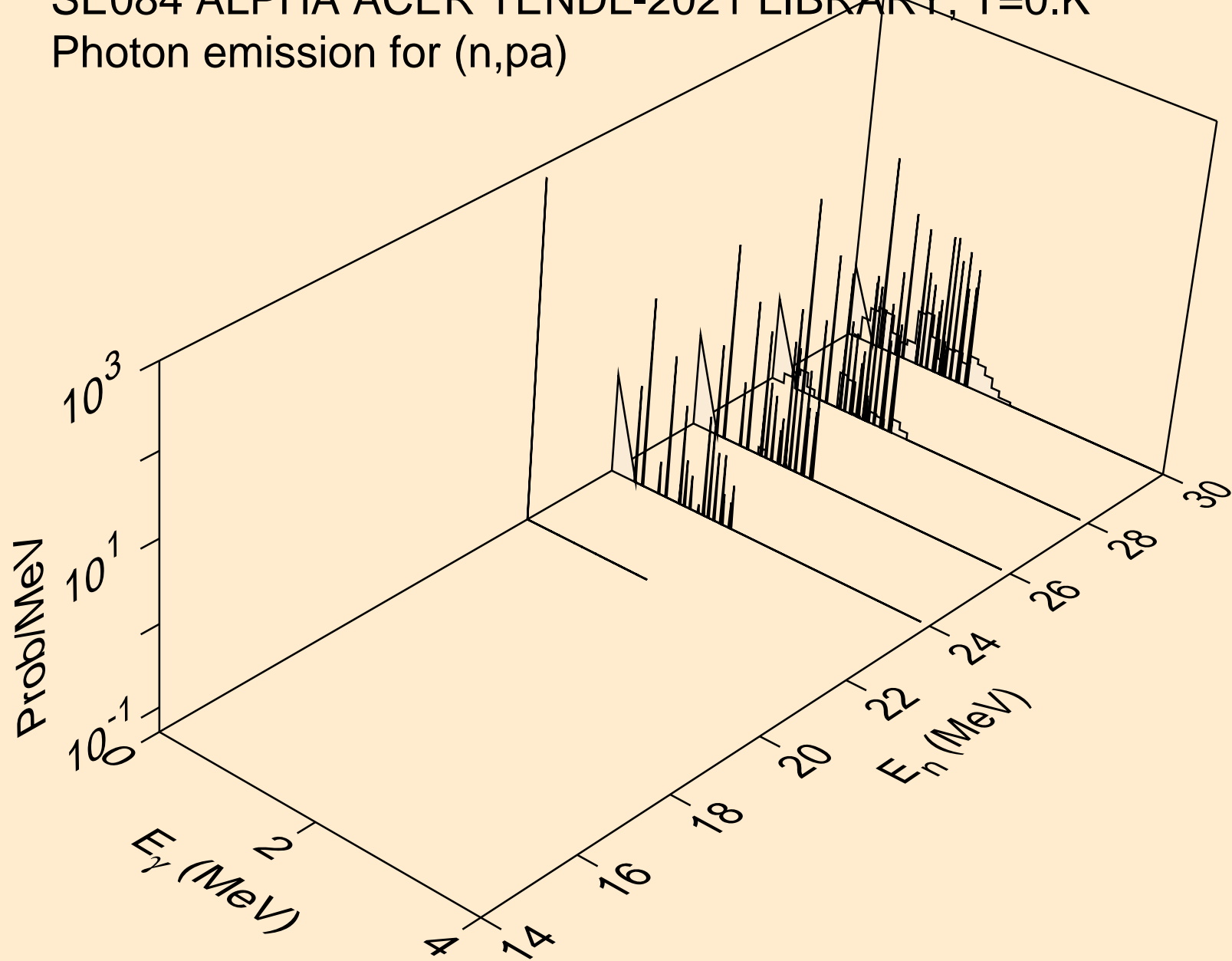

SE084 ALPHA ACER TENDL-2021 LIBRARY; T=0.K
Particle heating contributions

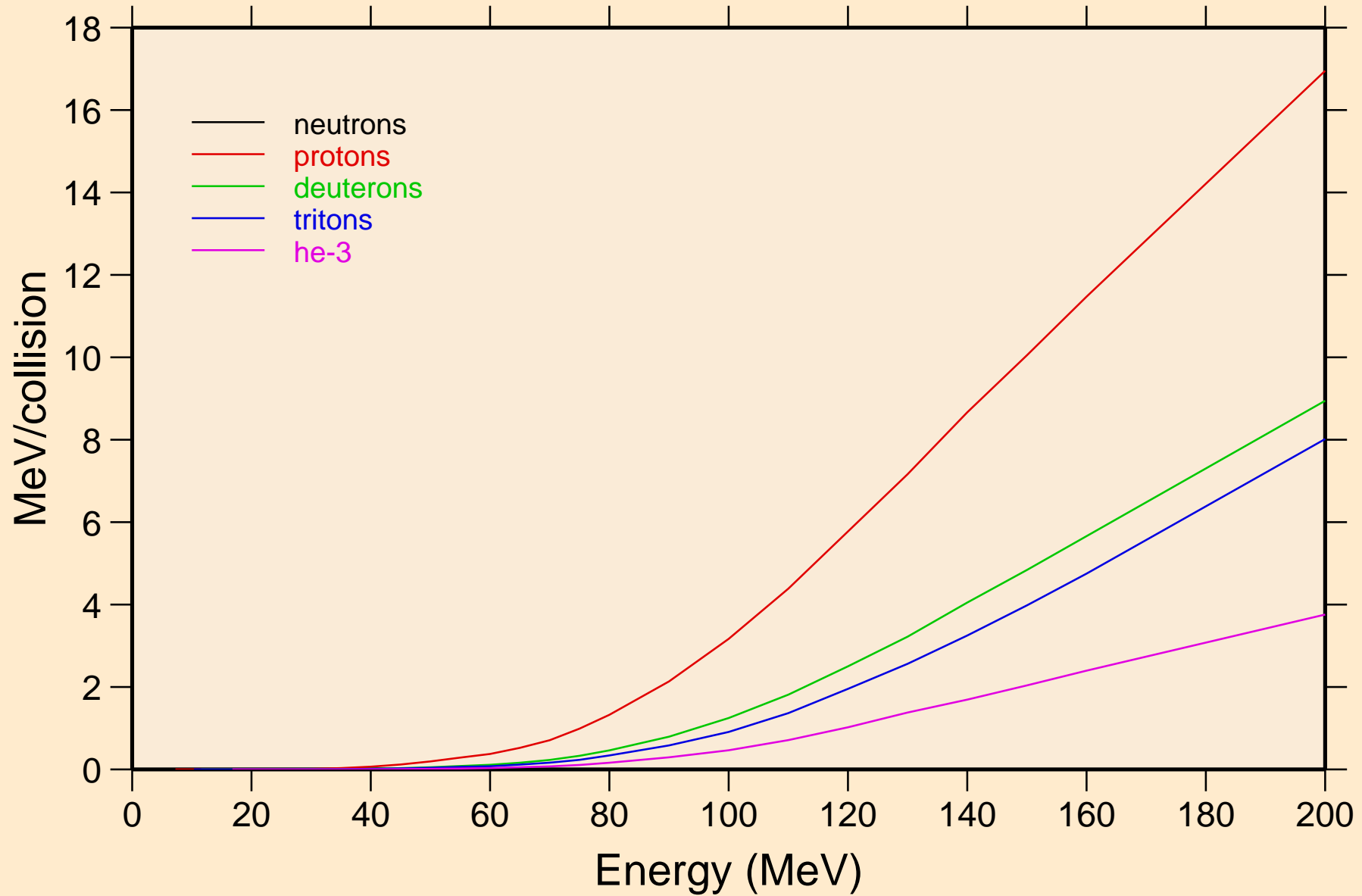

SE084 ALPHA ACER TENDL-2021 LIBRARY; T=0.K
Recoil Heating

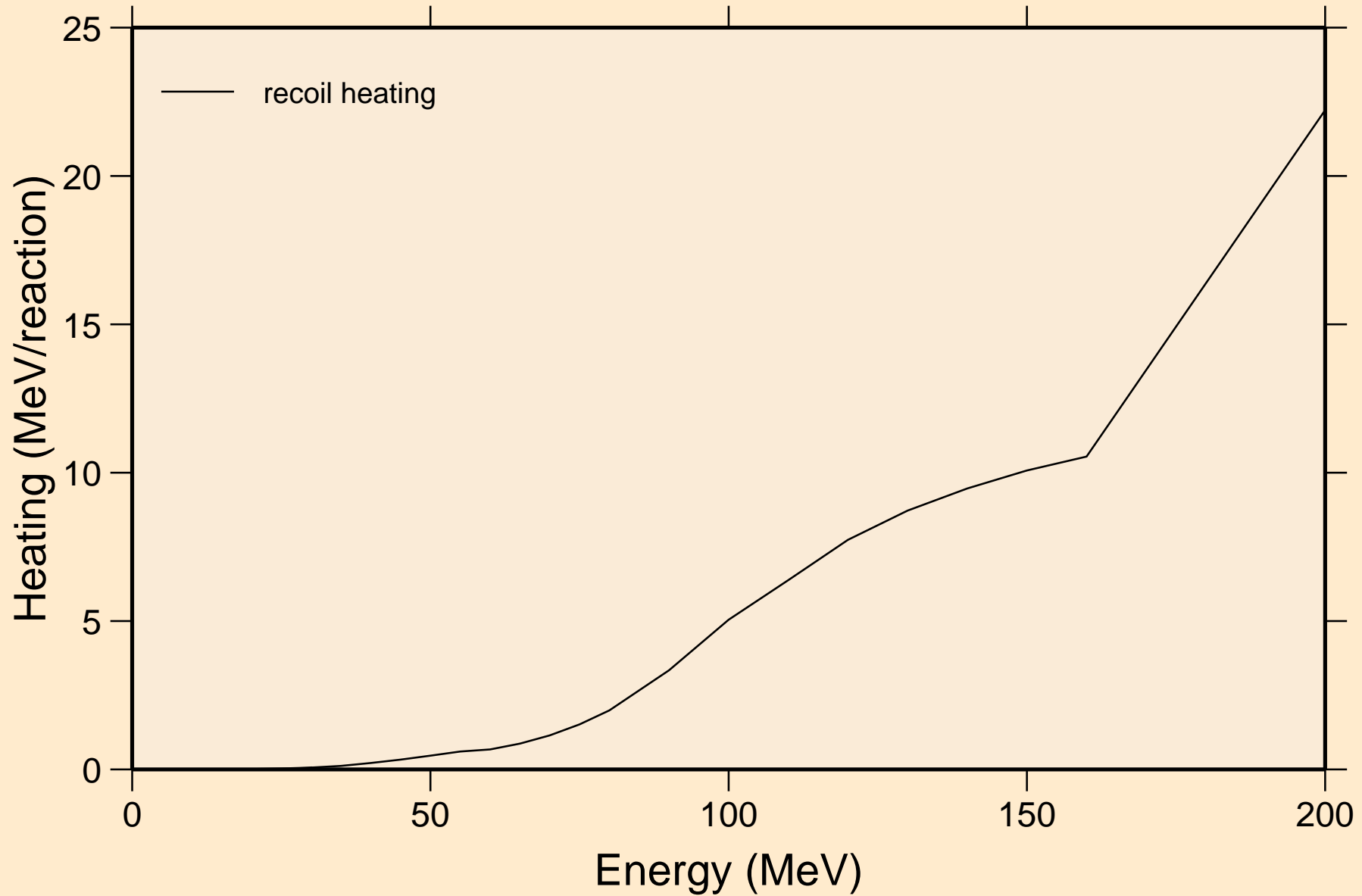

SE084 ALPHA ACER TENDL-2021 LIBRARY; T=0.K

Particle production cross sections

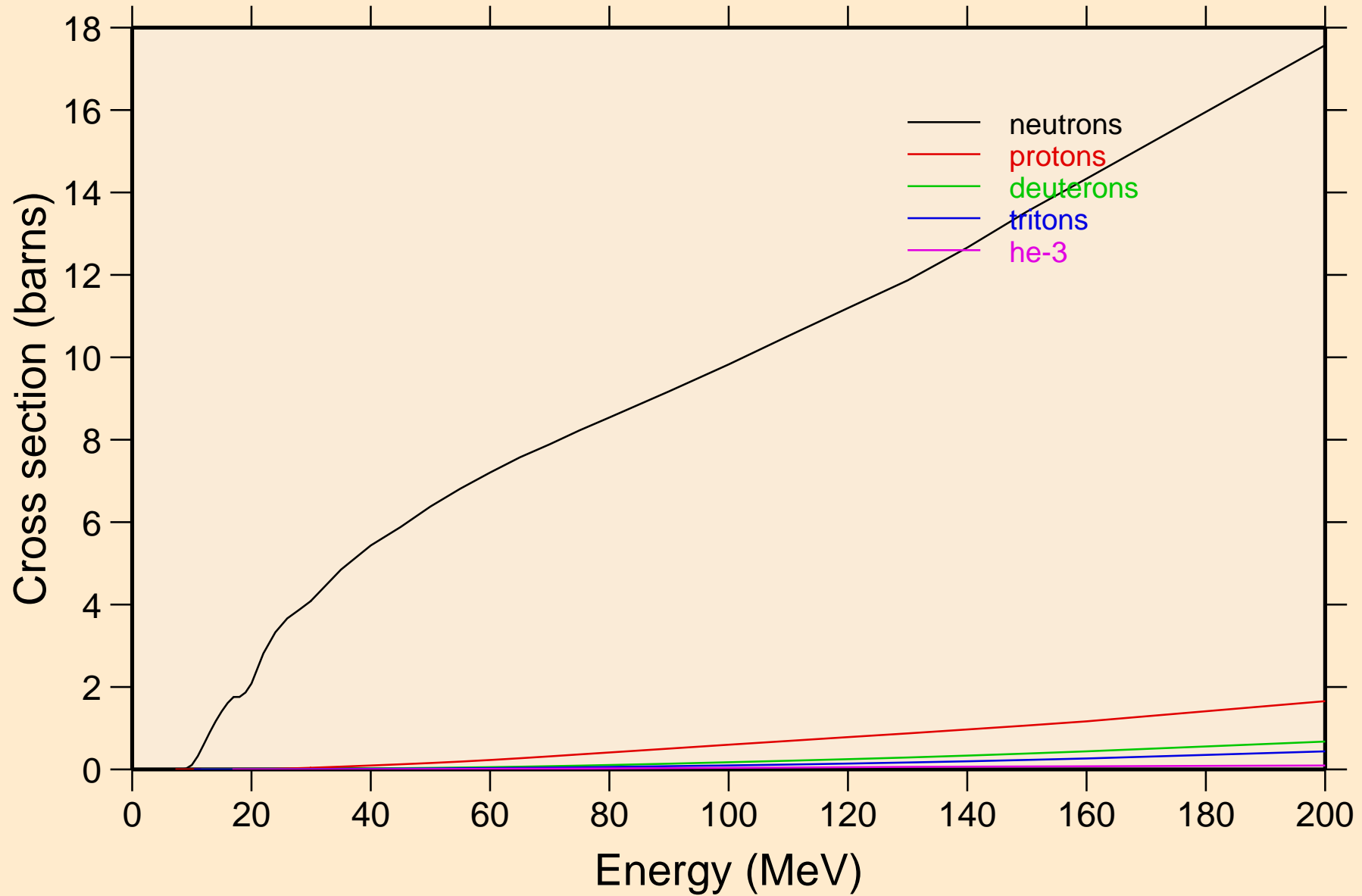

SE084 ALPHA ACER TENDL-2021 LIBRARY; T=0.K
neutrons from (a,n)

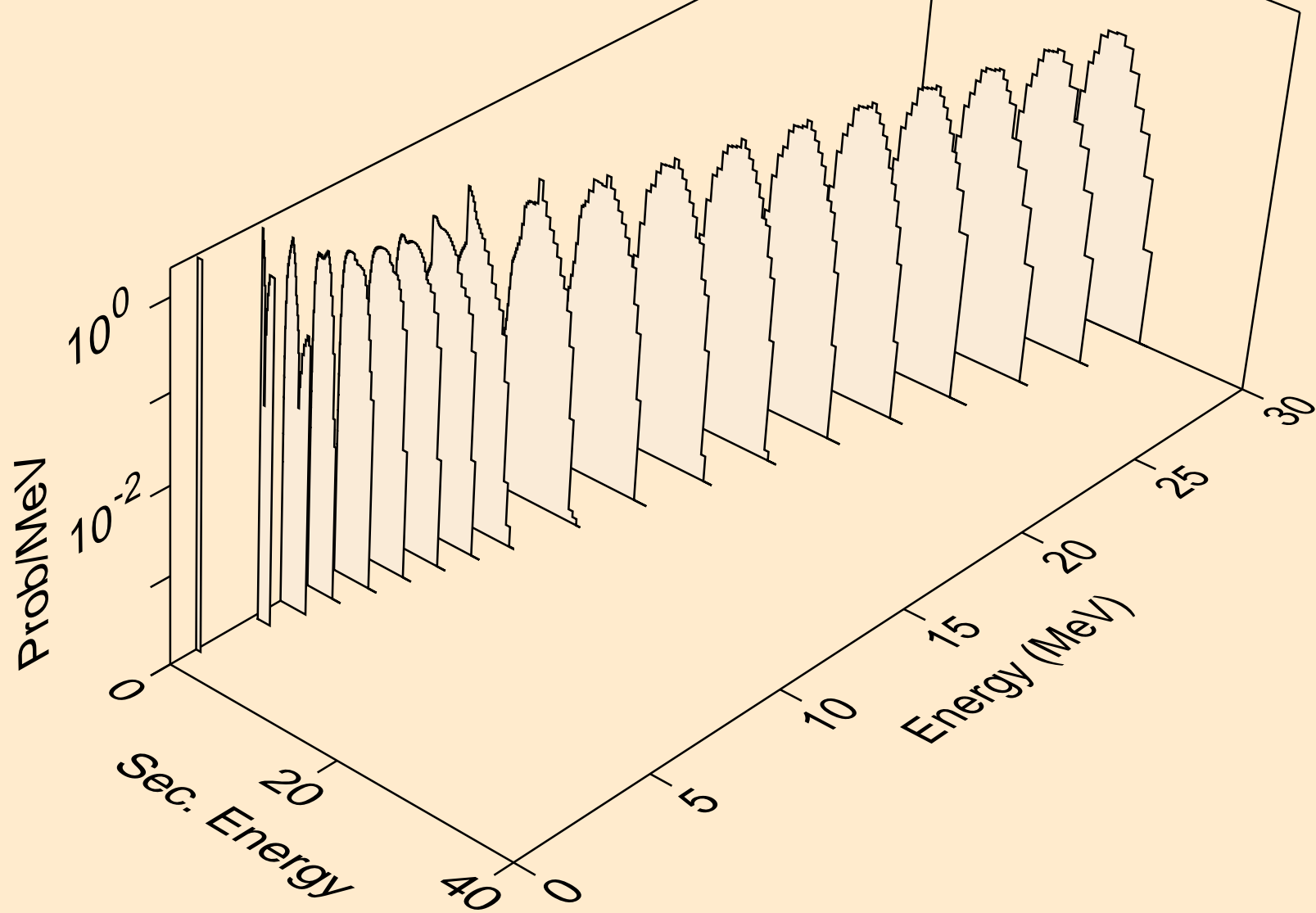

SE084 ALPHA ACER TENDL-2021 LIBRARY; T=0.K
neutrons from (a,x)

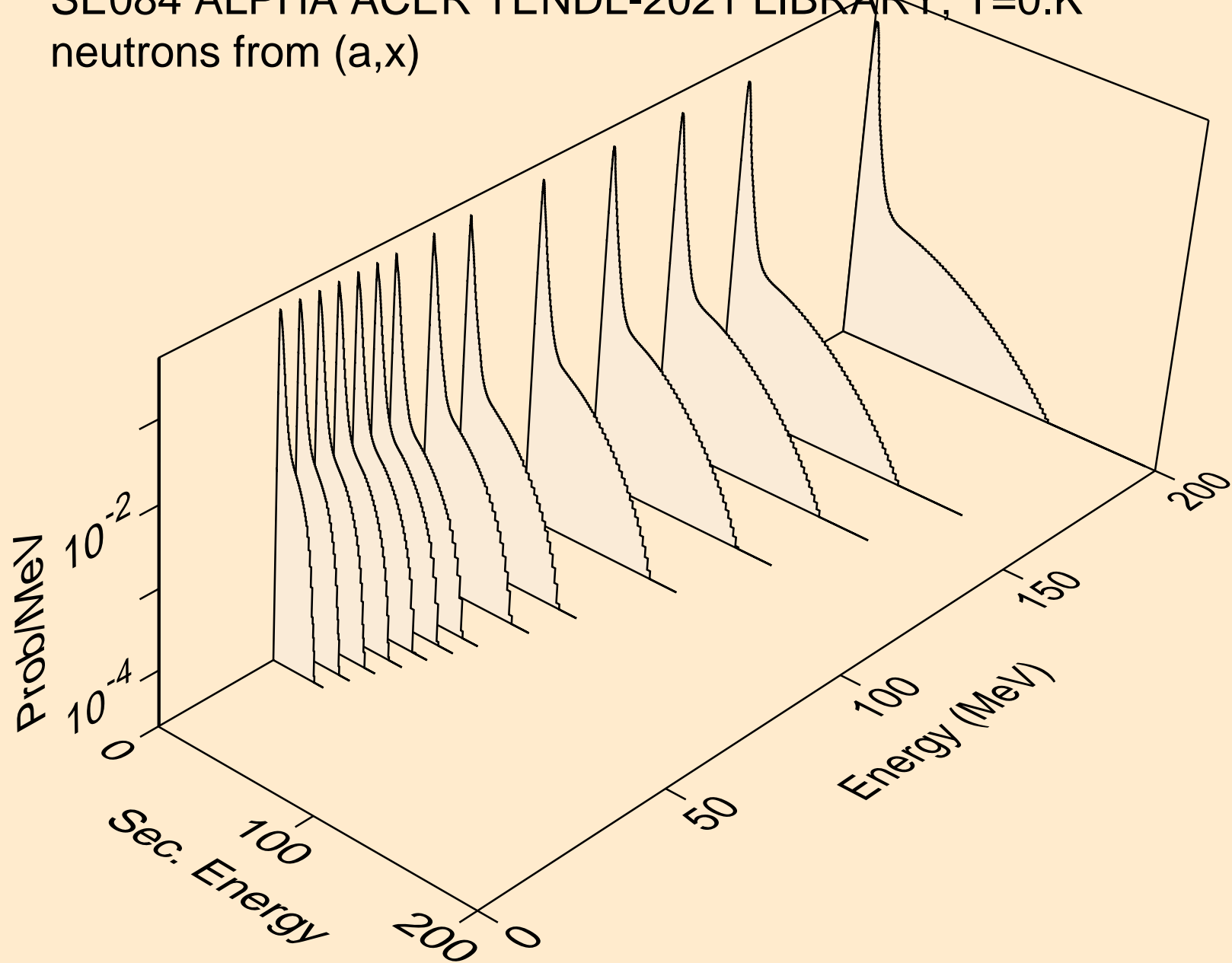

SE084 ALPHA ACER TENDL-2021 LIBRARY; T=0.K
neutrons from (a,2nd)

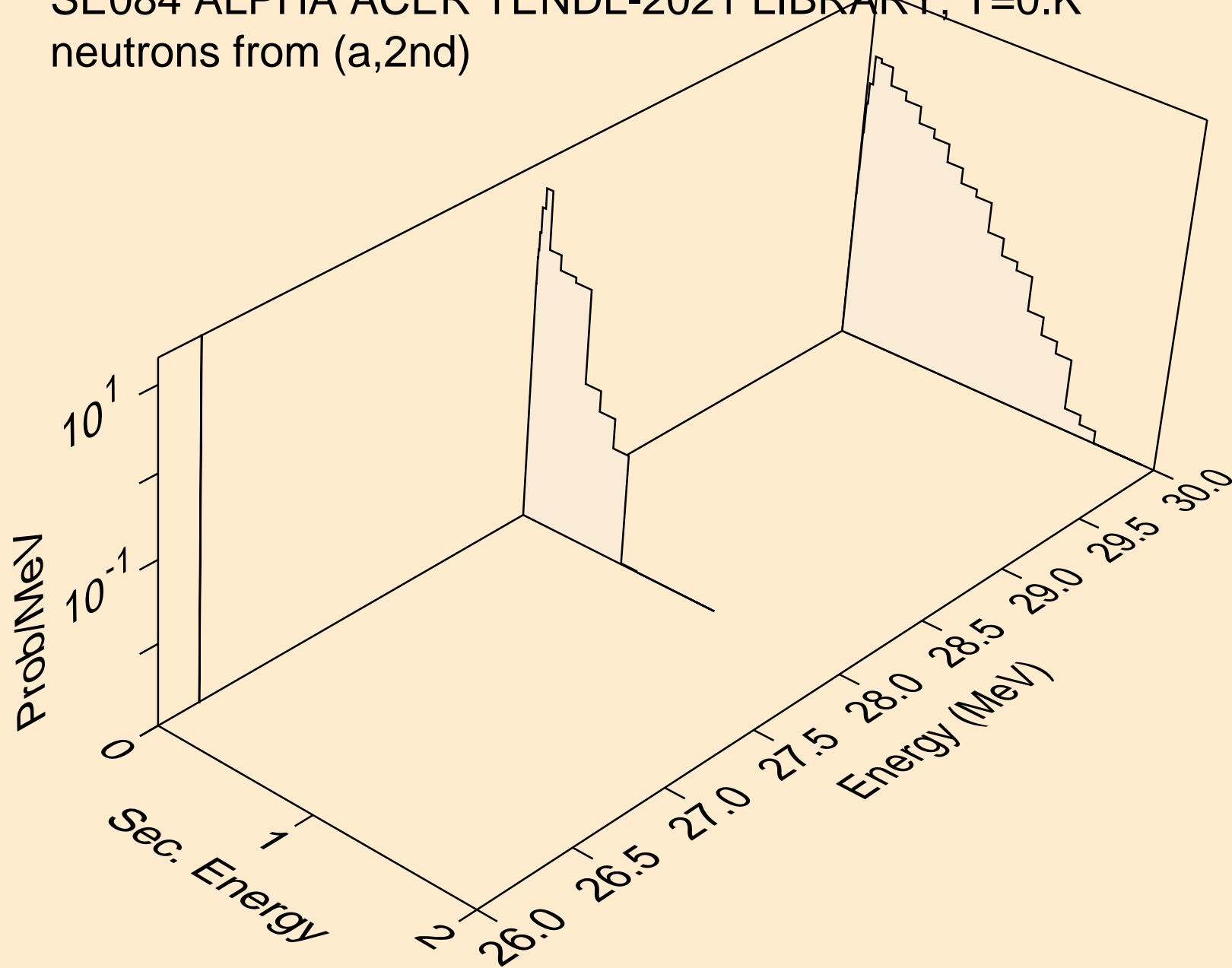

SE084 ALPHA ACER TENDL-2021 LIBRARY; T=0.K
neutrons from (a,2n)

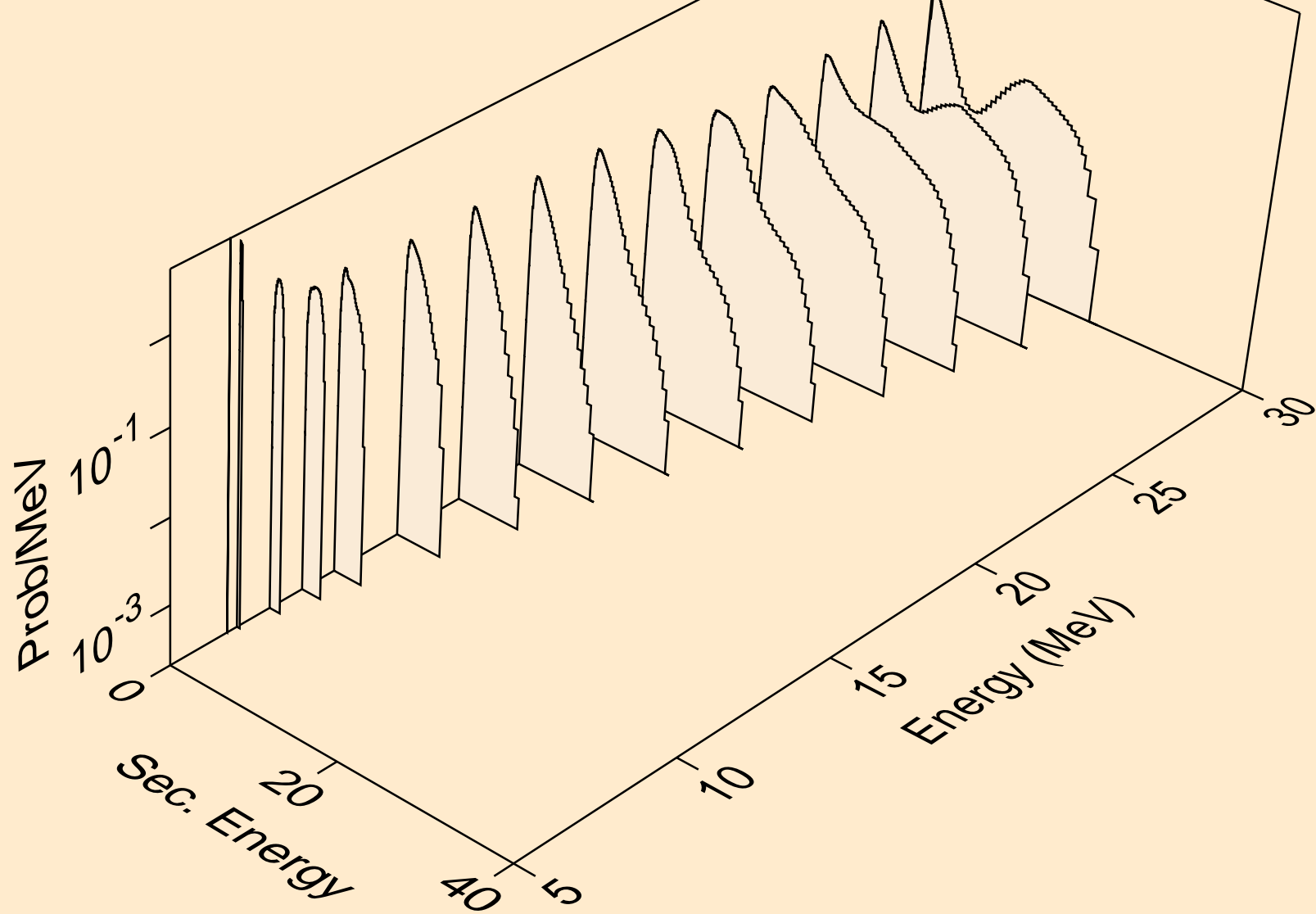

SE084 ALPHA ACER TENDL-2021 LIBRARY; T=0.K
neutrons from (a,3n)

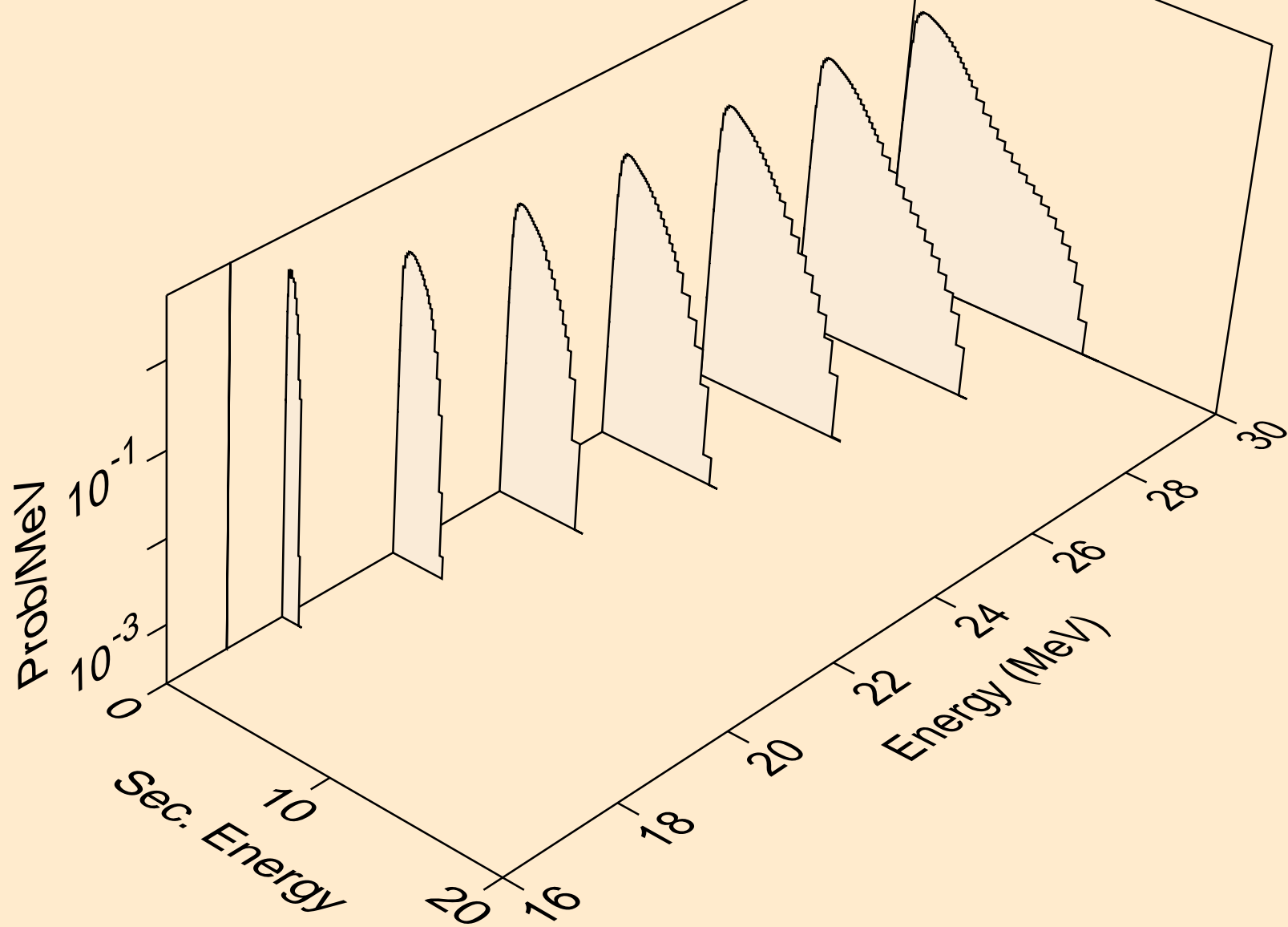

SE084 ALPHA ACER TENDL-2021 LIBRARY; T=0.K
neutrons from (a,n*)a

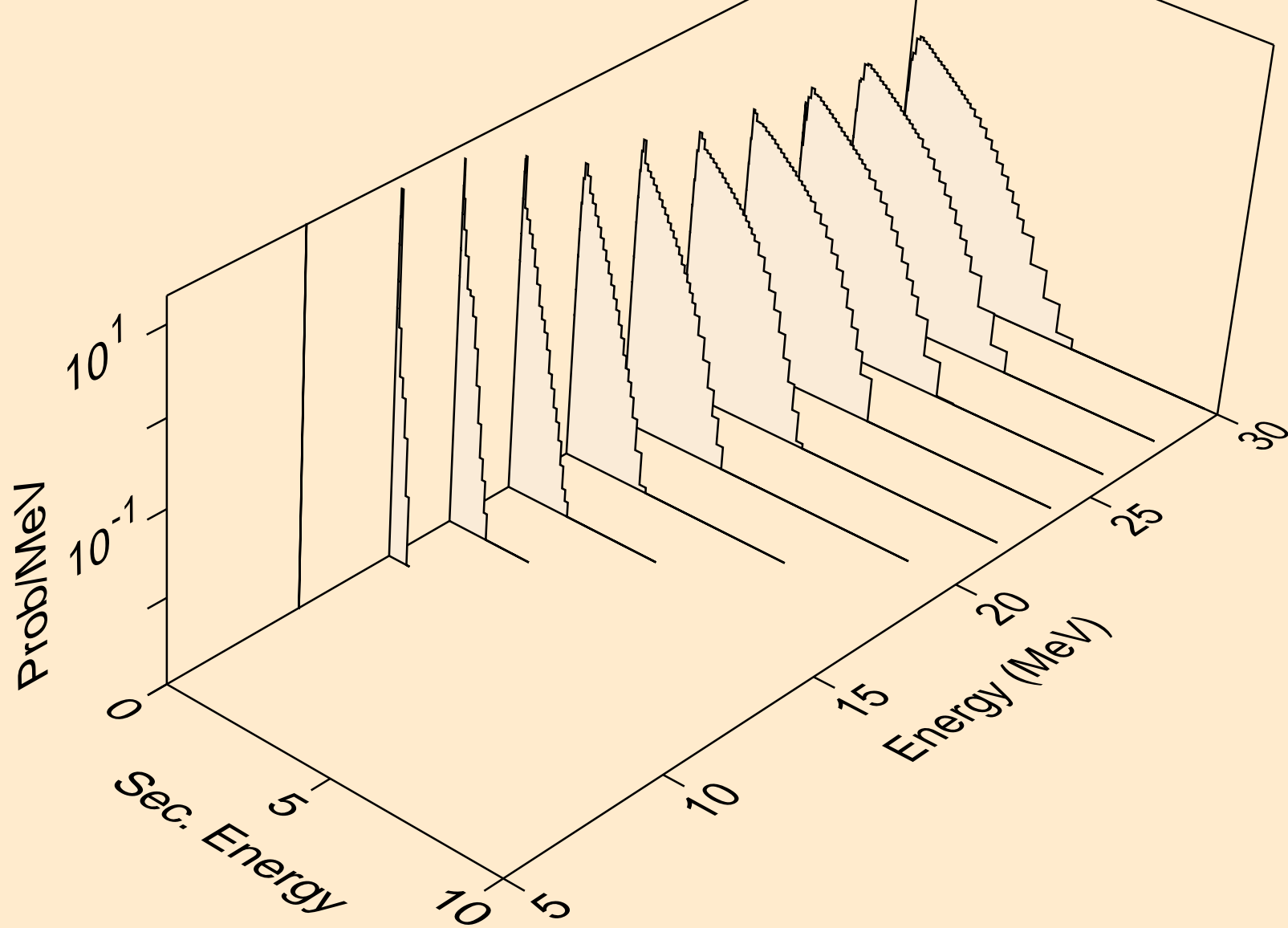

SE084 ALPHA ACER TENDL-2021 LIBRARY; T=0.K
neutrons from (a,2n)a

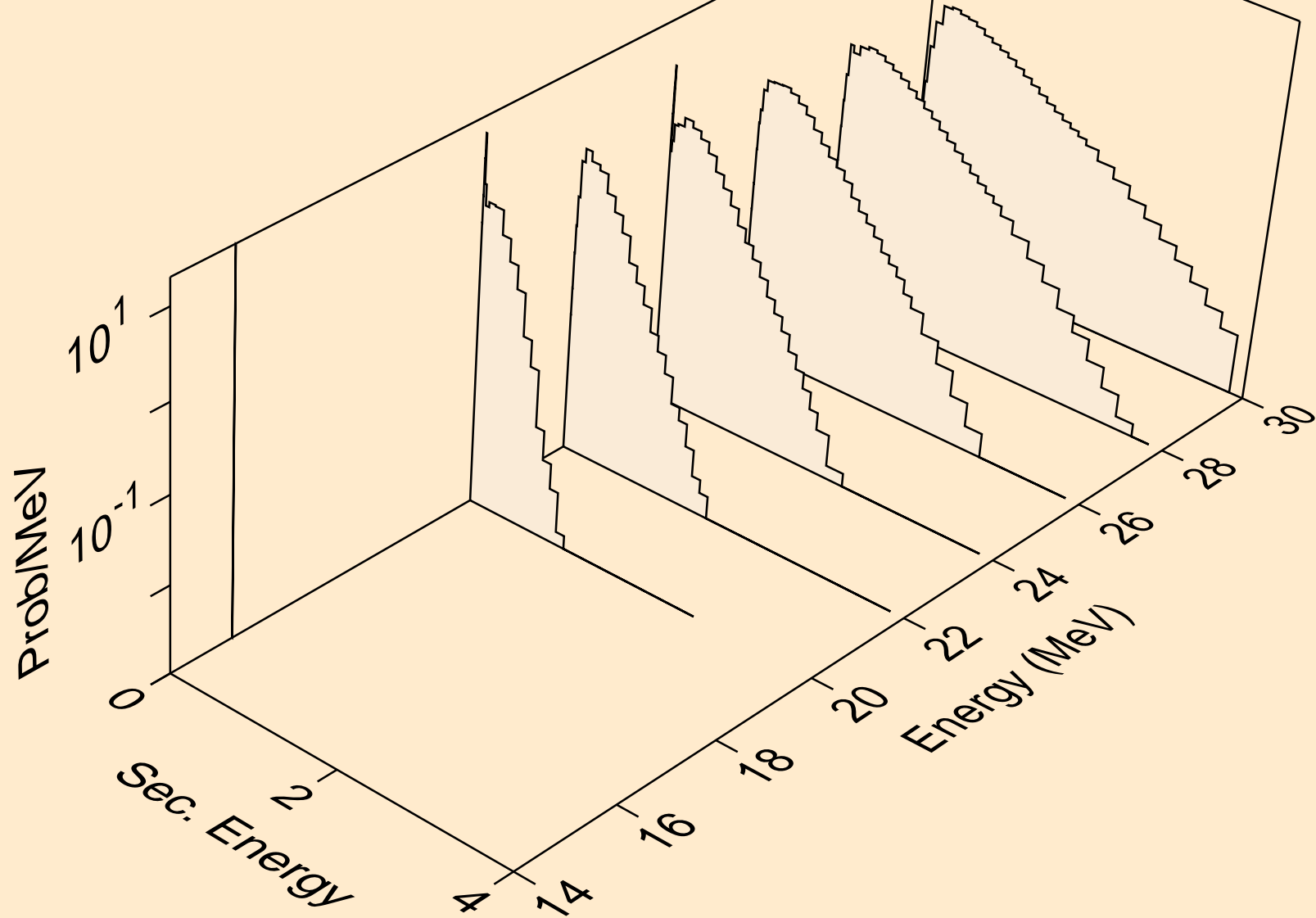

SE084 ALPHA ACER TENDL-2021 LIBRARY; T=0.K
neutrons from (a,n*)p

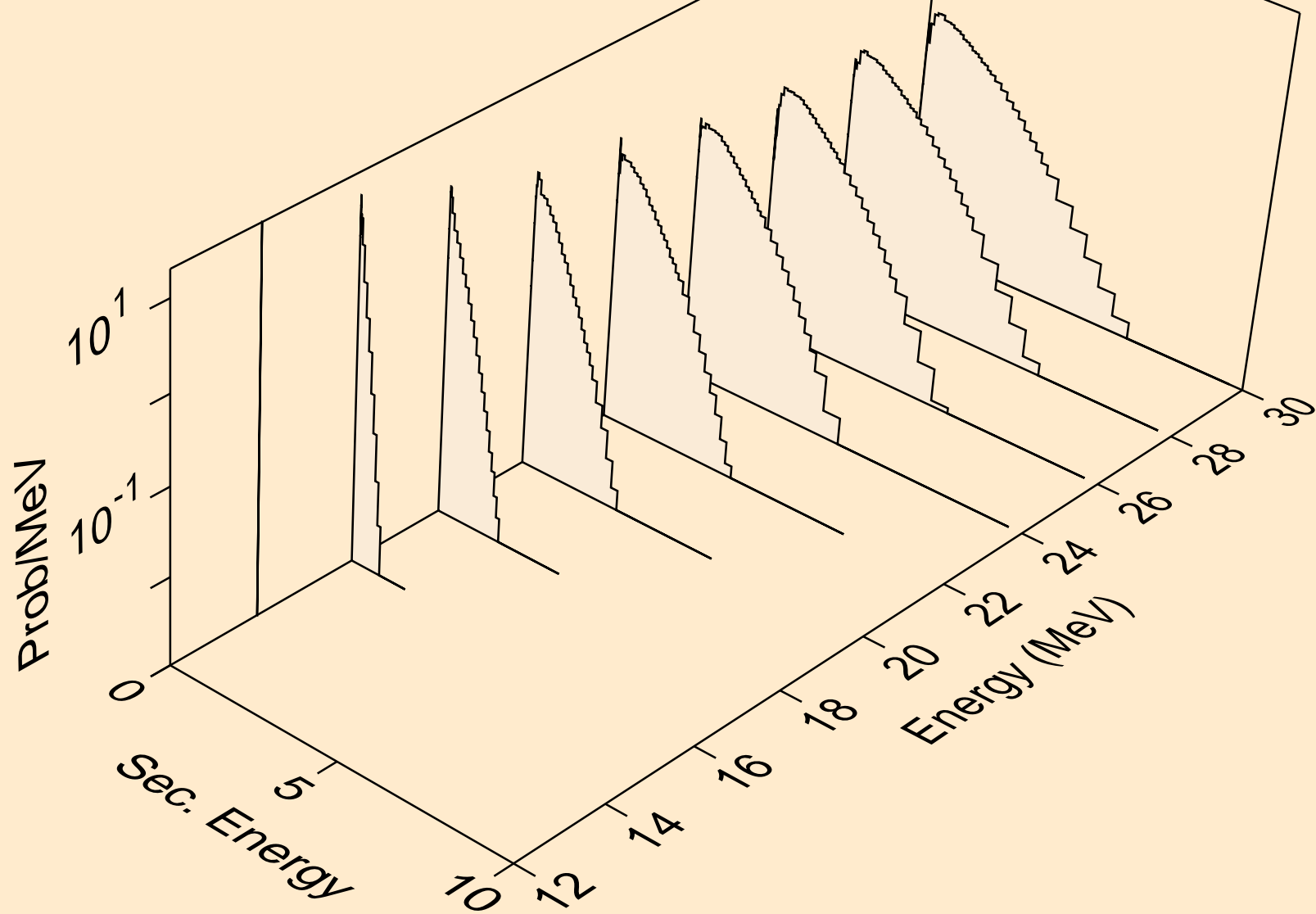

SE084 ALPHA ACER TENDL-2021 LIBRARY; T=0.K
neutrons from (a,n*)d

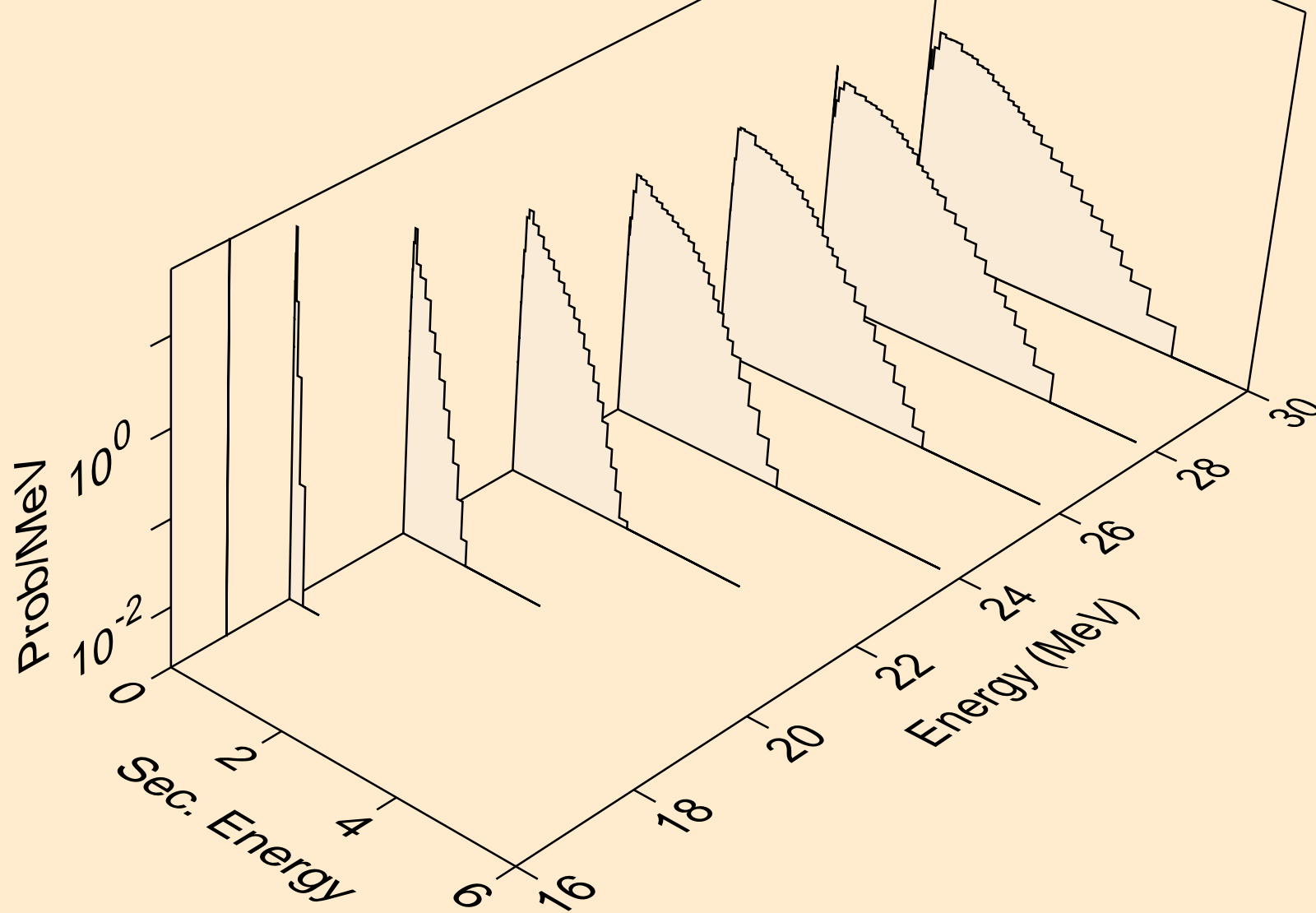

SE084 ALPHA ACER TENDL-2021 LIBRARY; T=0.K
neutrons from (a,n*)t

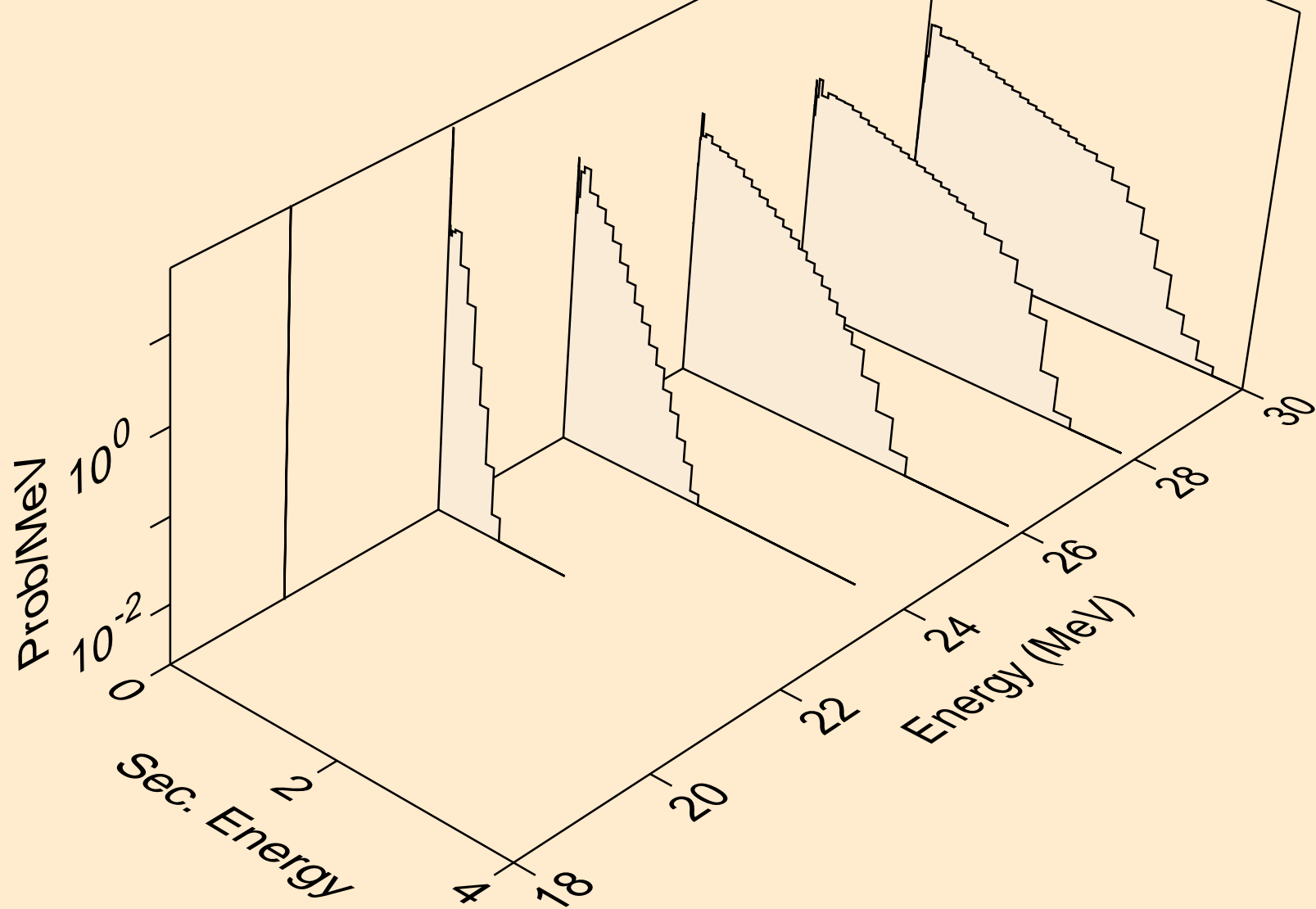

SE084 ALPHA ACER TENDL-2021 LIBRARY; T=0.K
neutrons from (a,n*)he3

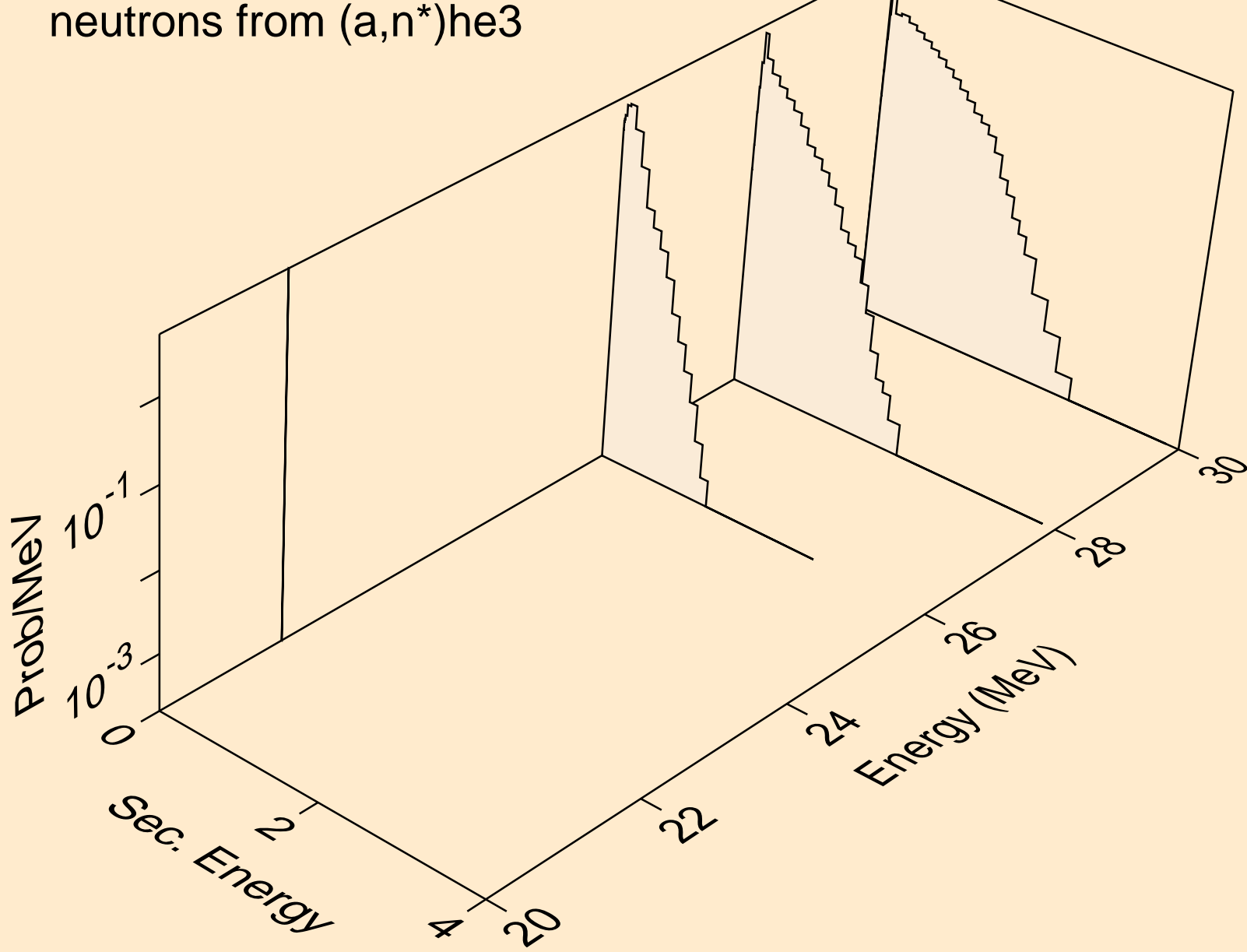

SE084 ALPHA ACER TENDL-2021 LIBRARY; T=0.K
neutrons from (a,4n)

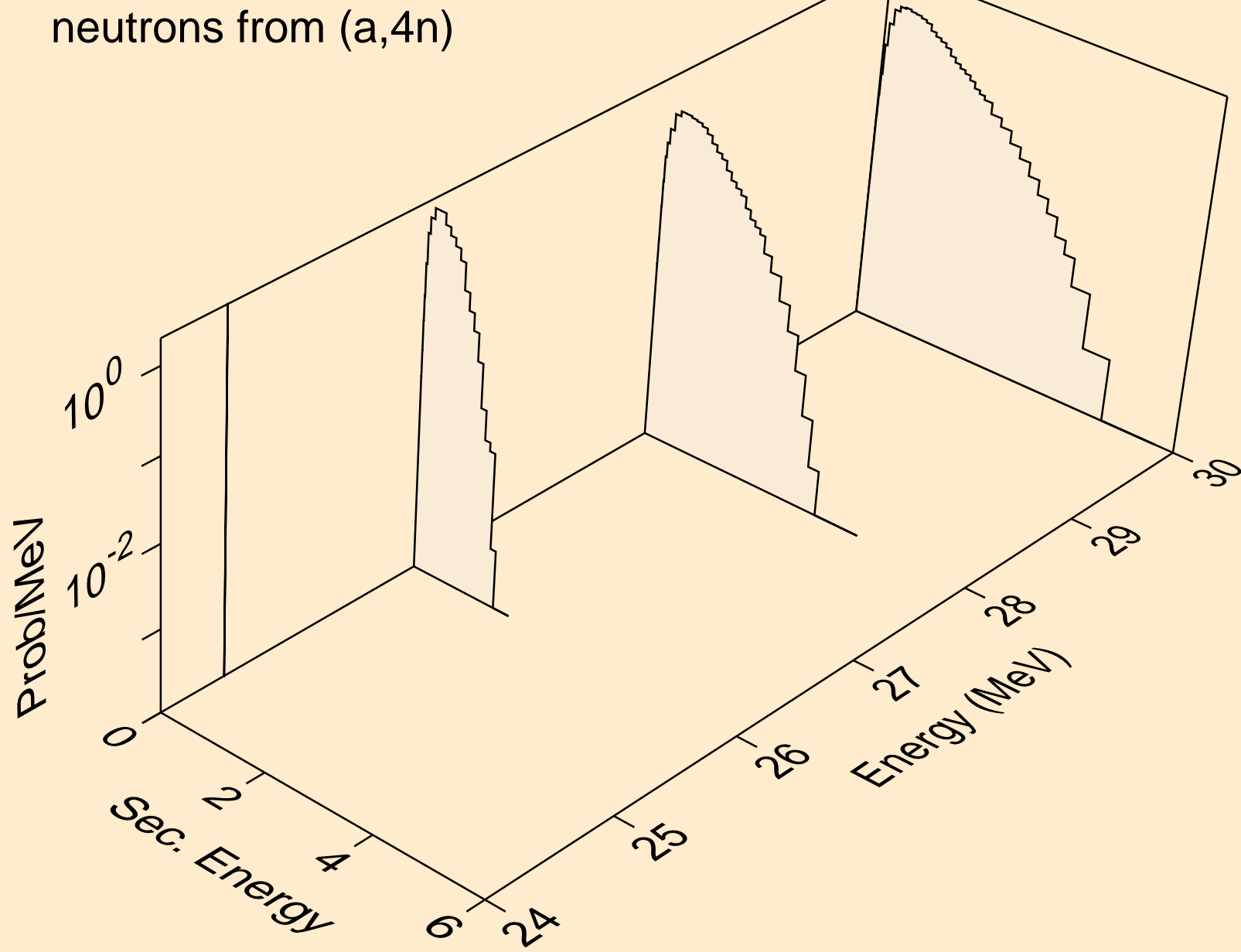

SE084 ALPHA ACER TENDL-2021 LIBRARY; T=0.K
neutrons from (a,2np)

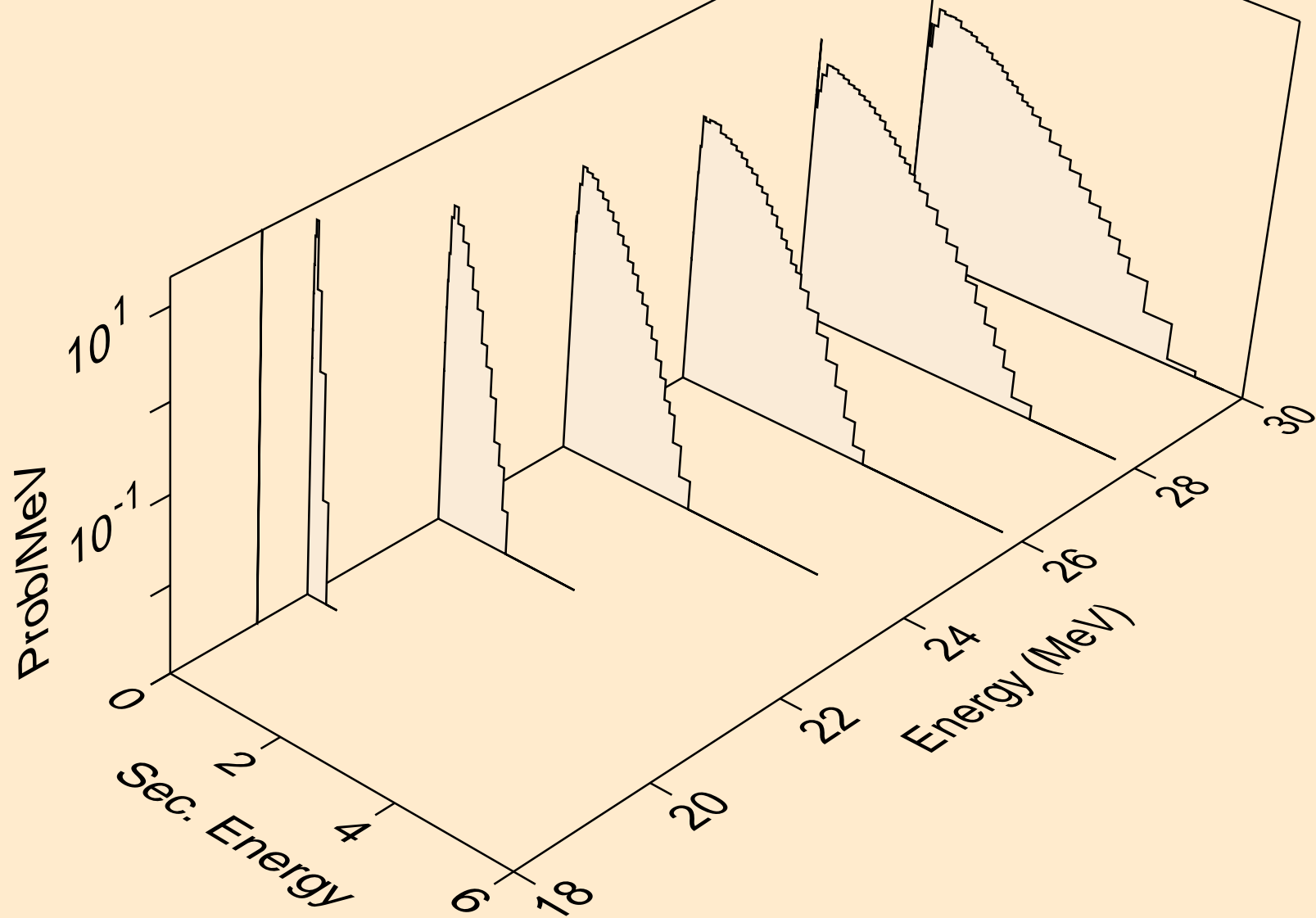

SE084 ALPHA ACER TENDL-2021 LIBRARY; T=0.K
protons from (a,x)

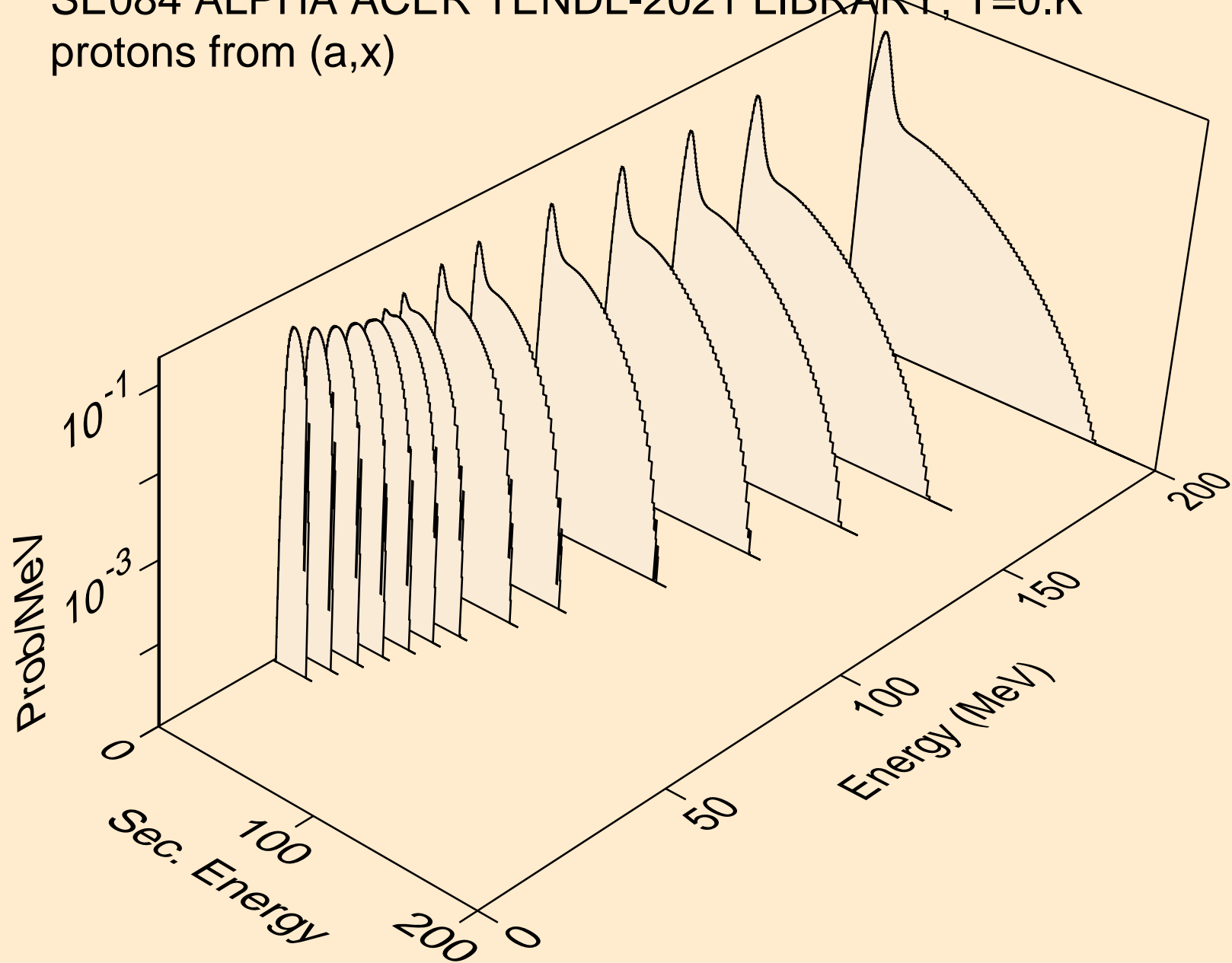

SE084 ALPHA ACER TENDL-2021 LIBRARY; T=0.K
protons from (a,n*)p

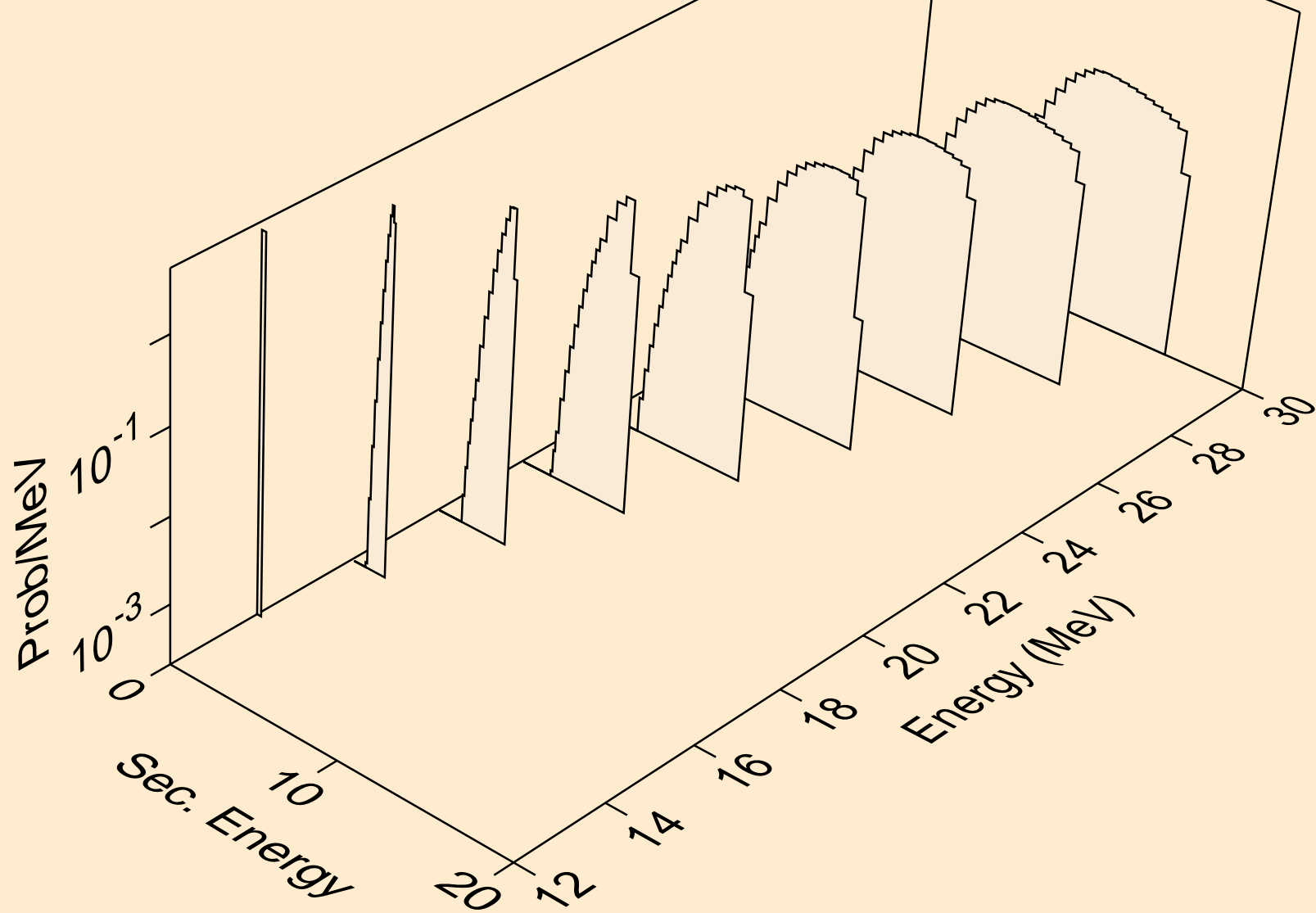

SE084 ALPHA ACER TENDL-2021 LIBRARY; T=0.K
protons from (a,2np)

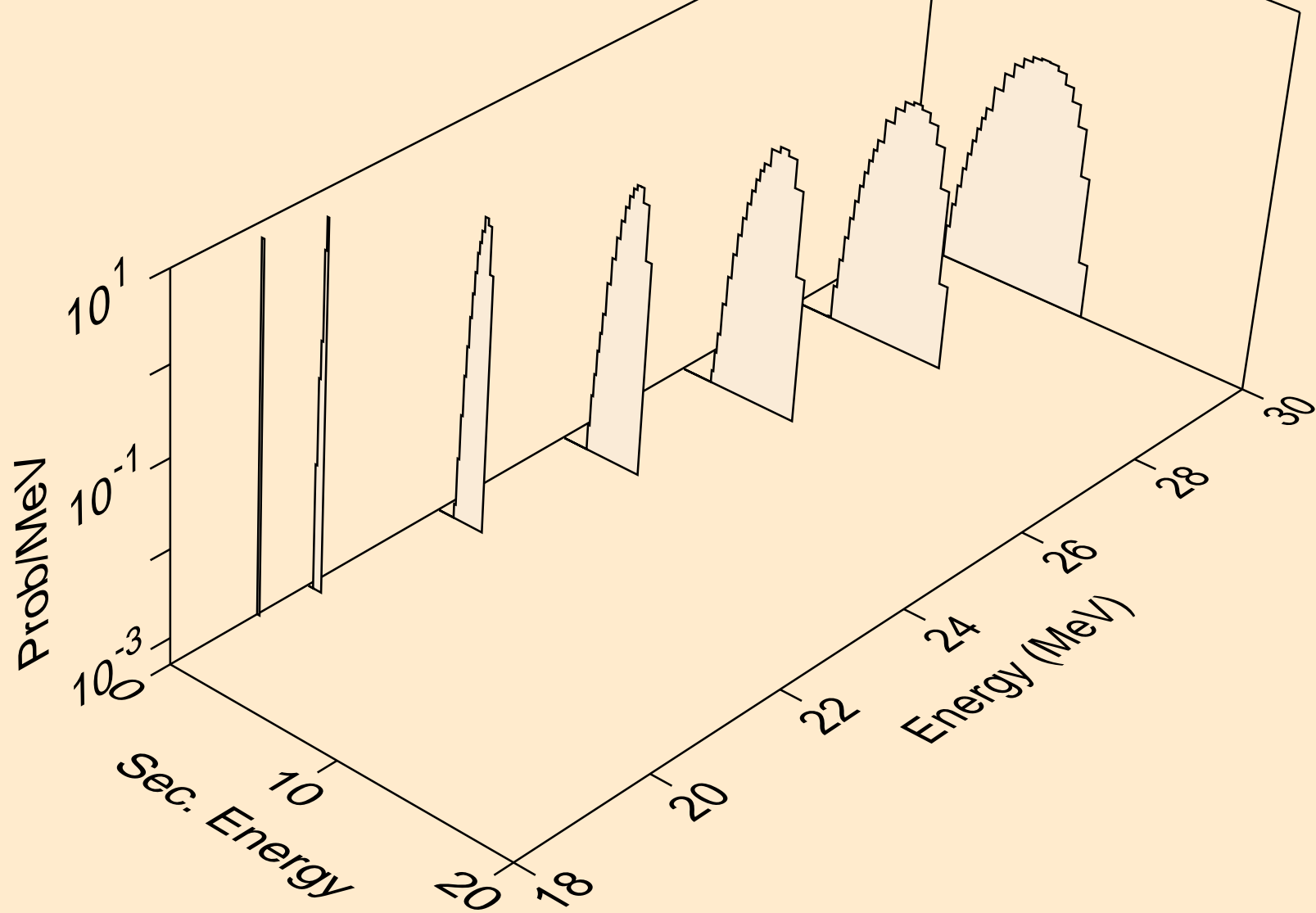

SE084 ALPHA ACER TENDL-2021 LIBRARY; T=0.K
protons from (a,p)

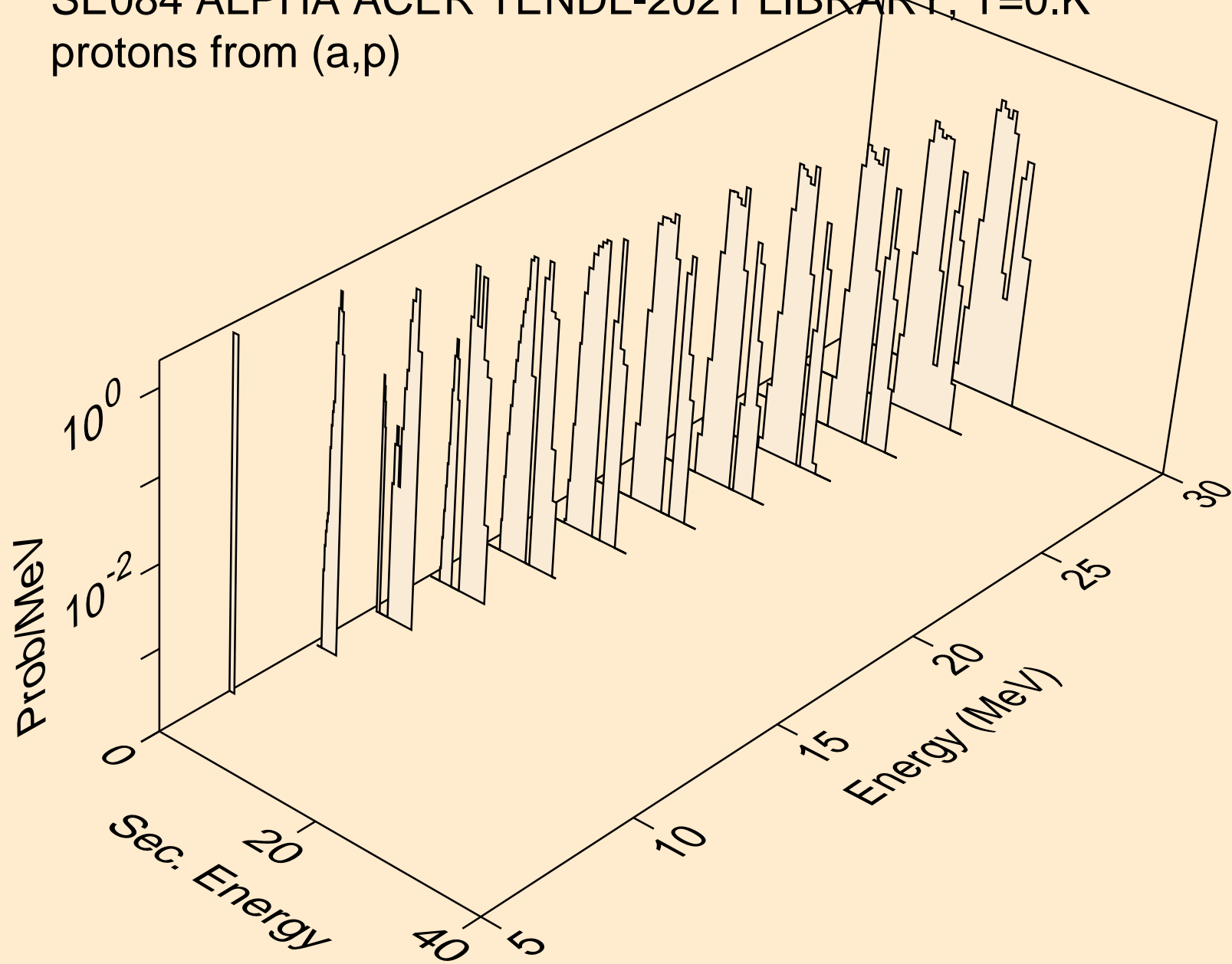

SE084 ALPHA ACER TENDL-2021 LIBRARY; T=0.K
protons from (a,2p)

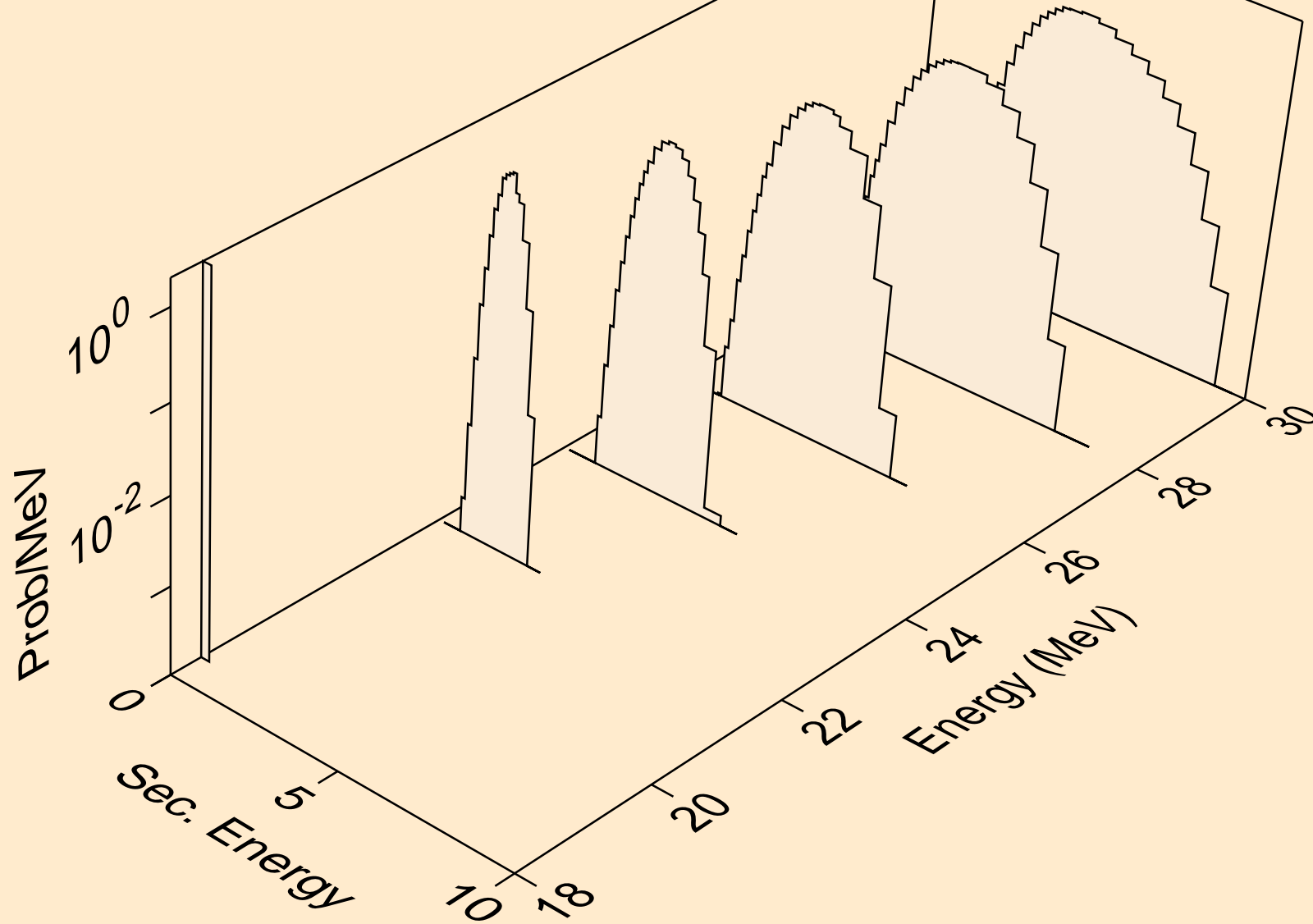

SE084 ALPHA ACER TENDL-2021 LIBRARY; T=0.K
protons from (a,pa)

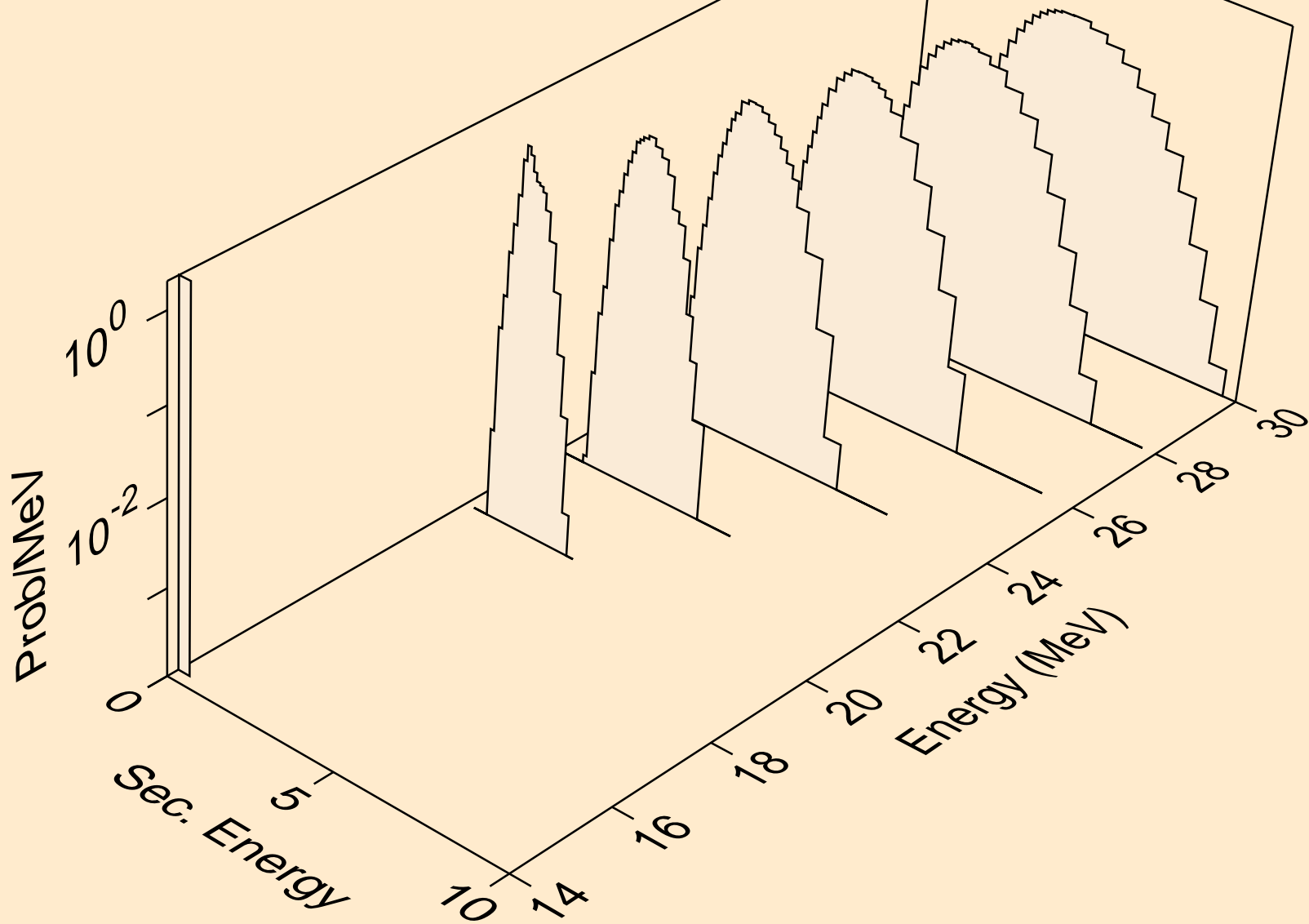

SE084 ALPHA ACER TENDL-2021 LIBRARY; T=0.K
deuterons from (a,x)

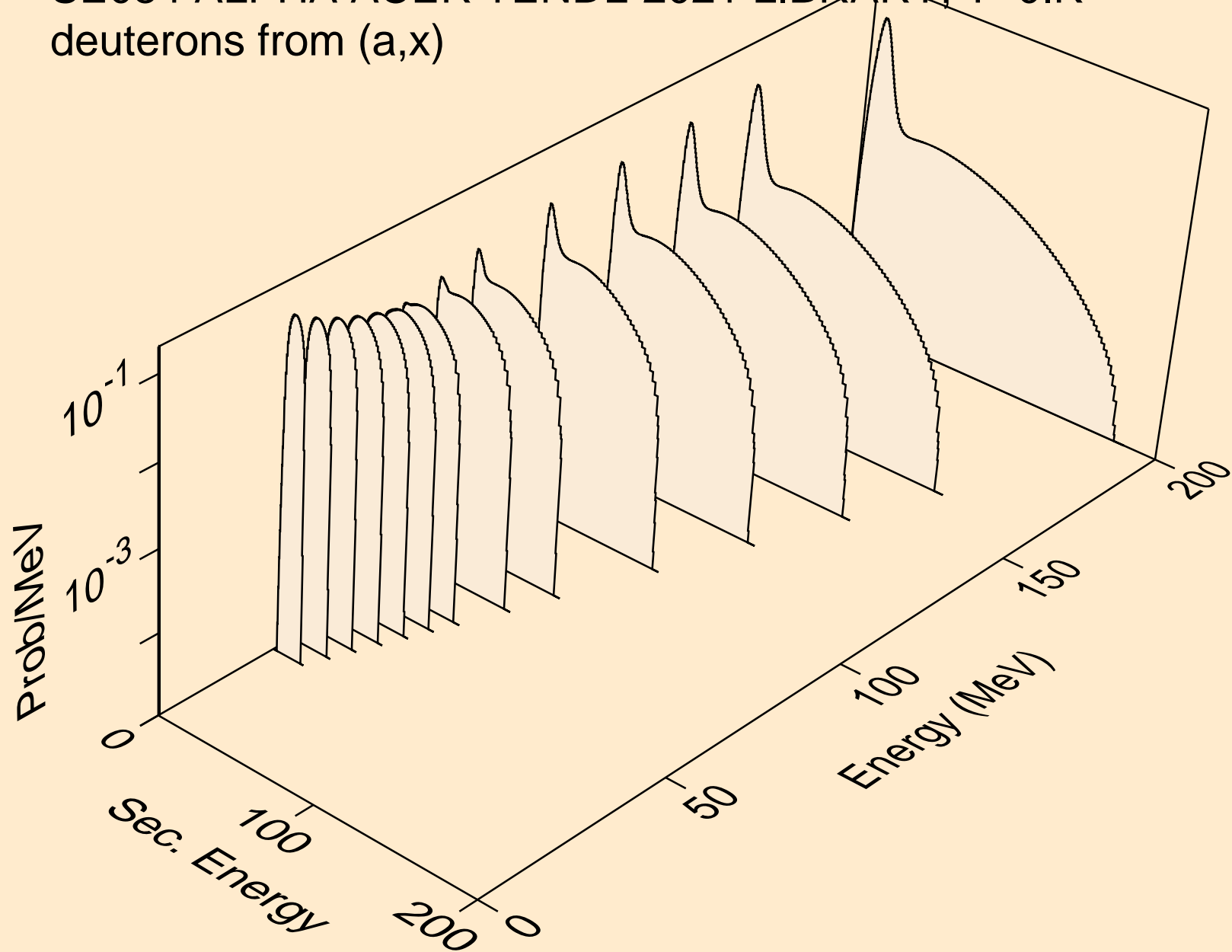

SE084 ALPHA ACER TENDL-2021 LIBRARY; T=0.K
deuterons from (a,2nd)

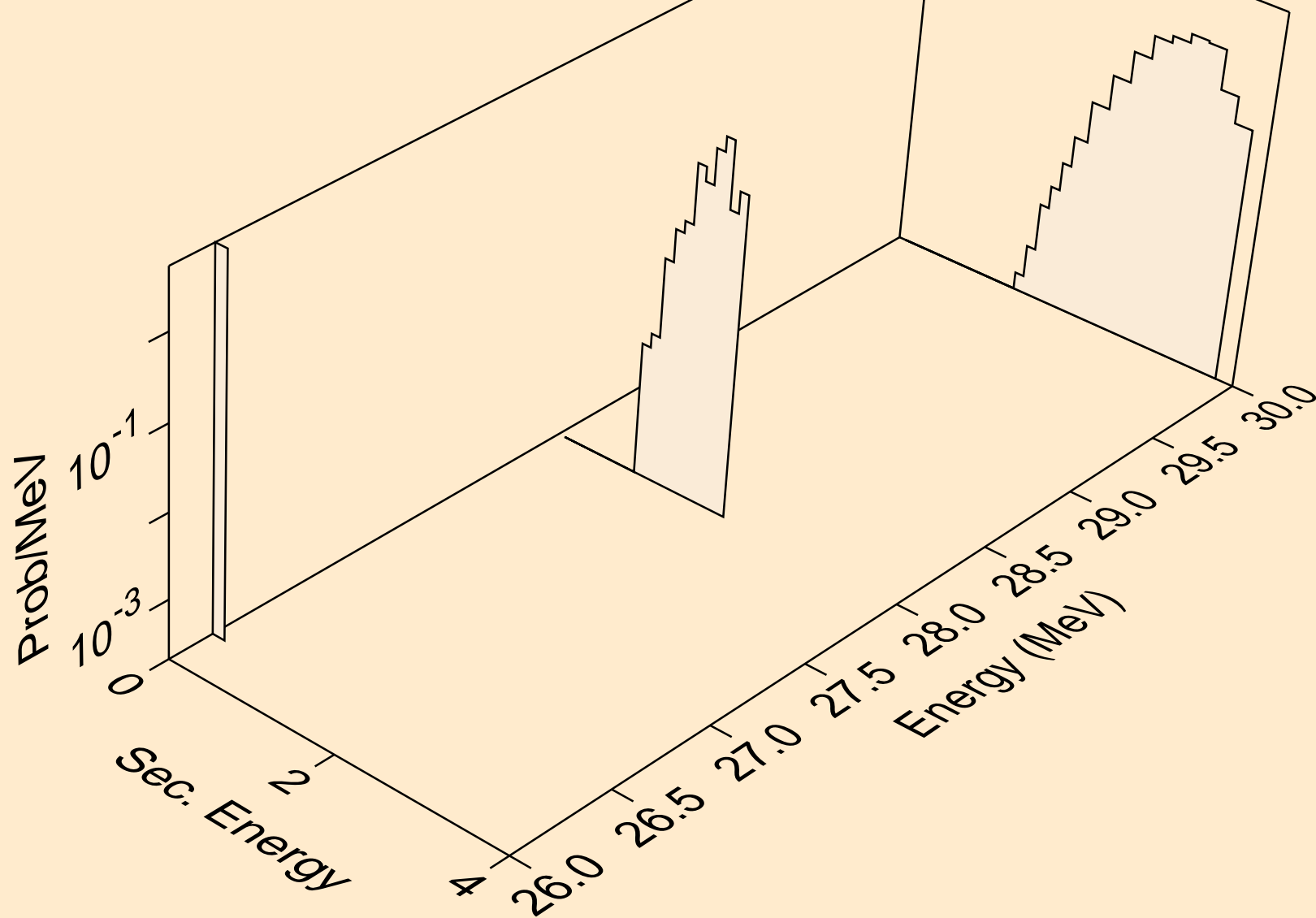

SE084 ALPHA ACER TENDL-2021 LIBRARY; T=0.K
deuterons from (a,n*)d

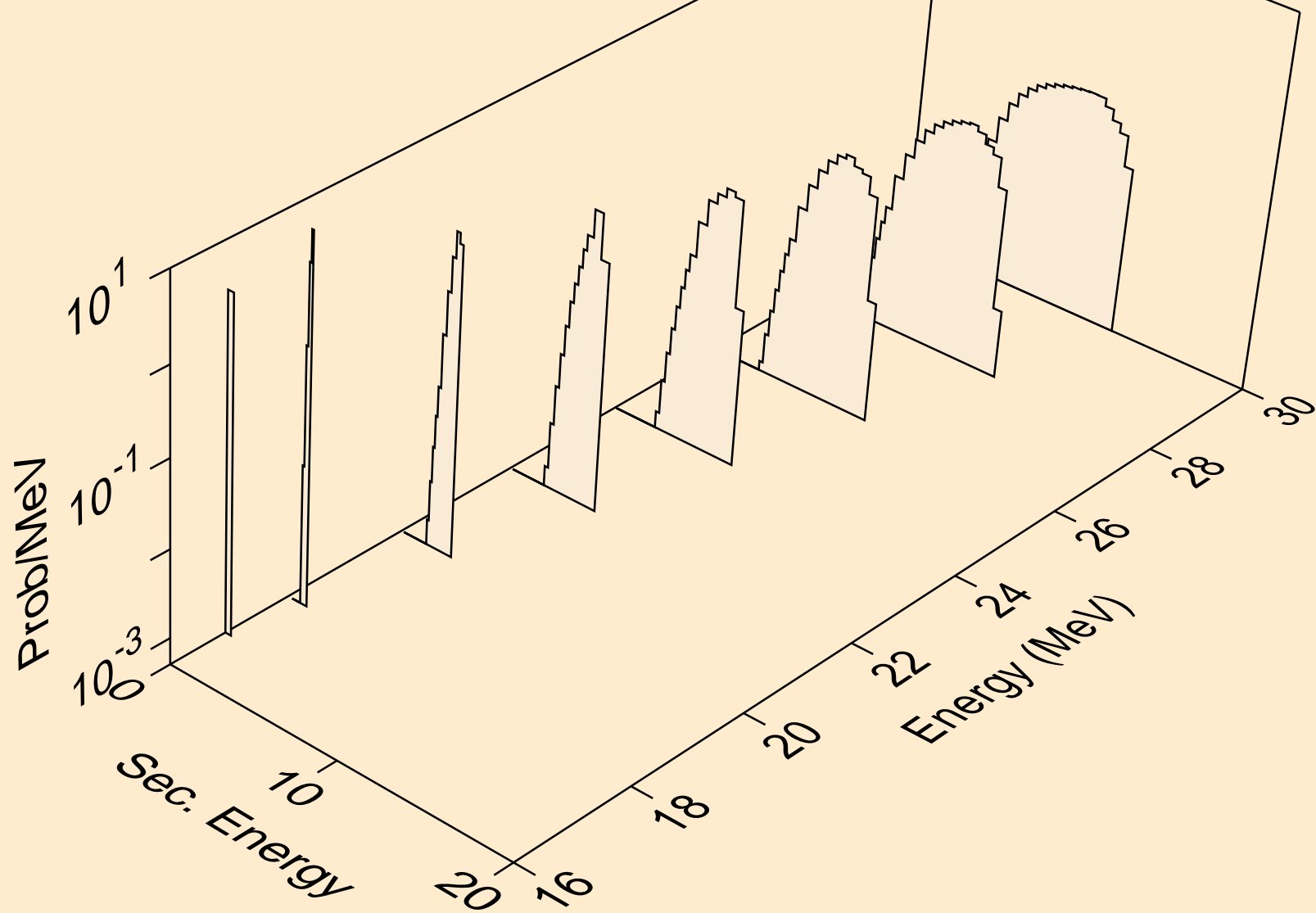

SE084 ALPHA ACER TENDL-2021 LIBRARY; T=0.K
deuterons from (a,d)

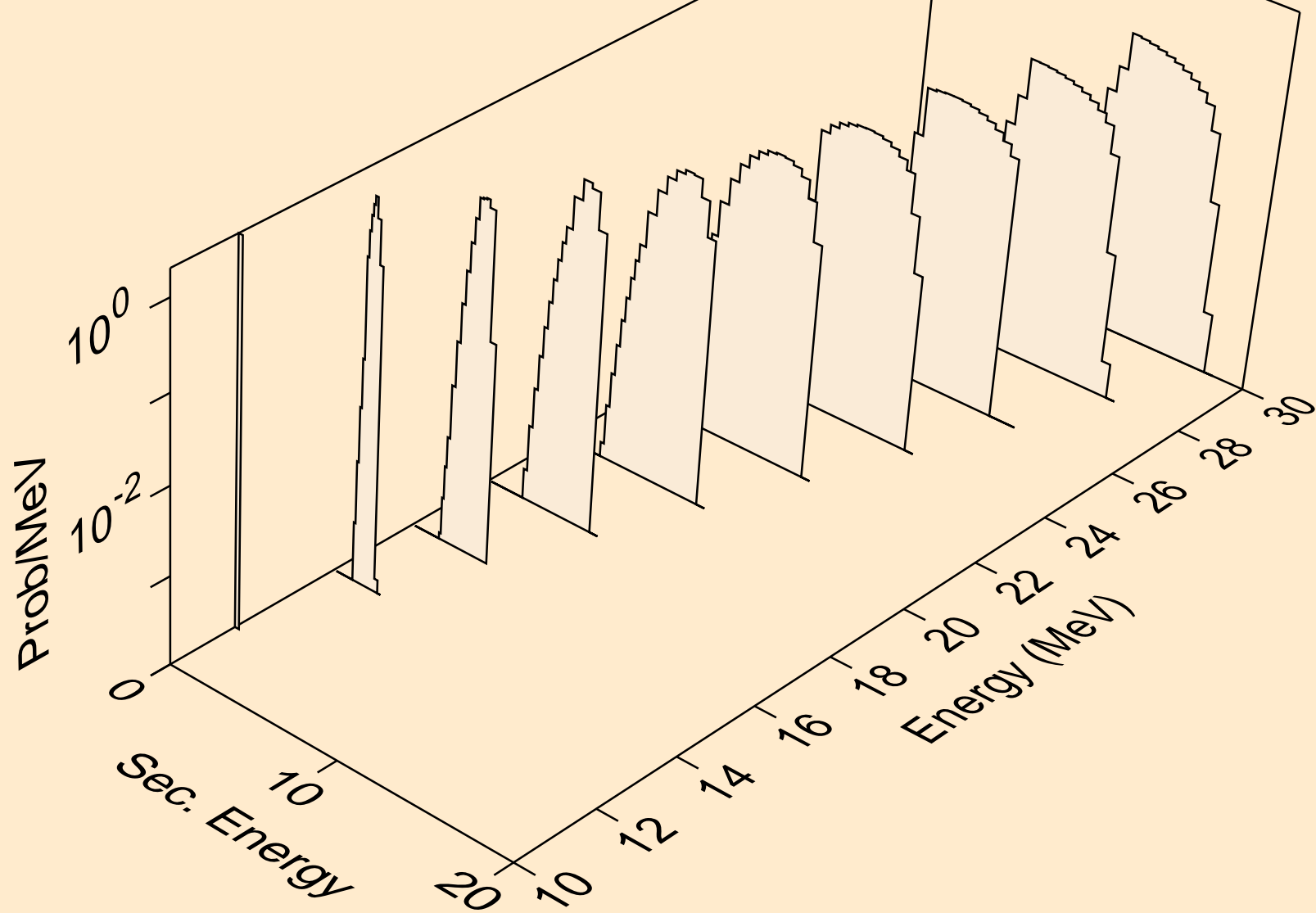

SE084 ALPHA ACER TENDL-2021 LIBRARY; T=0.K
tritons from (a,x)

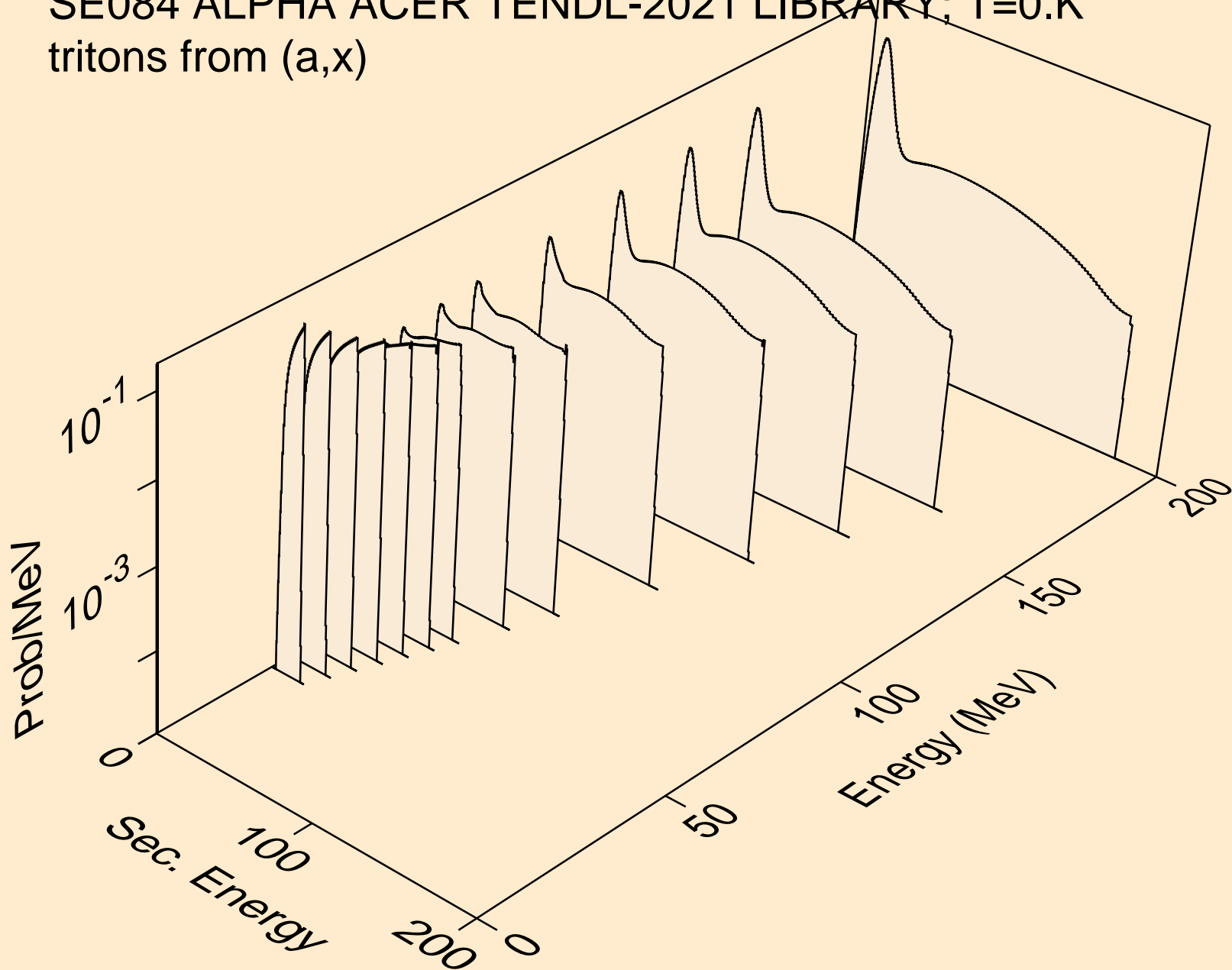

SE084 ALPHA ACER TENDL-2021 LIBRARY; T=0.K
tritons from (a,n*)t

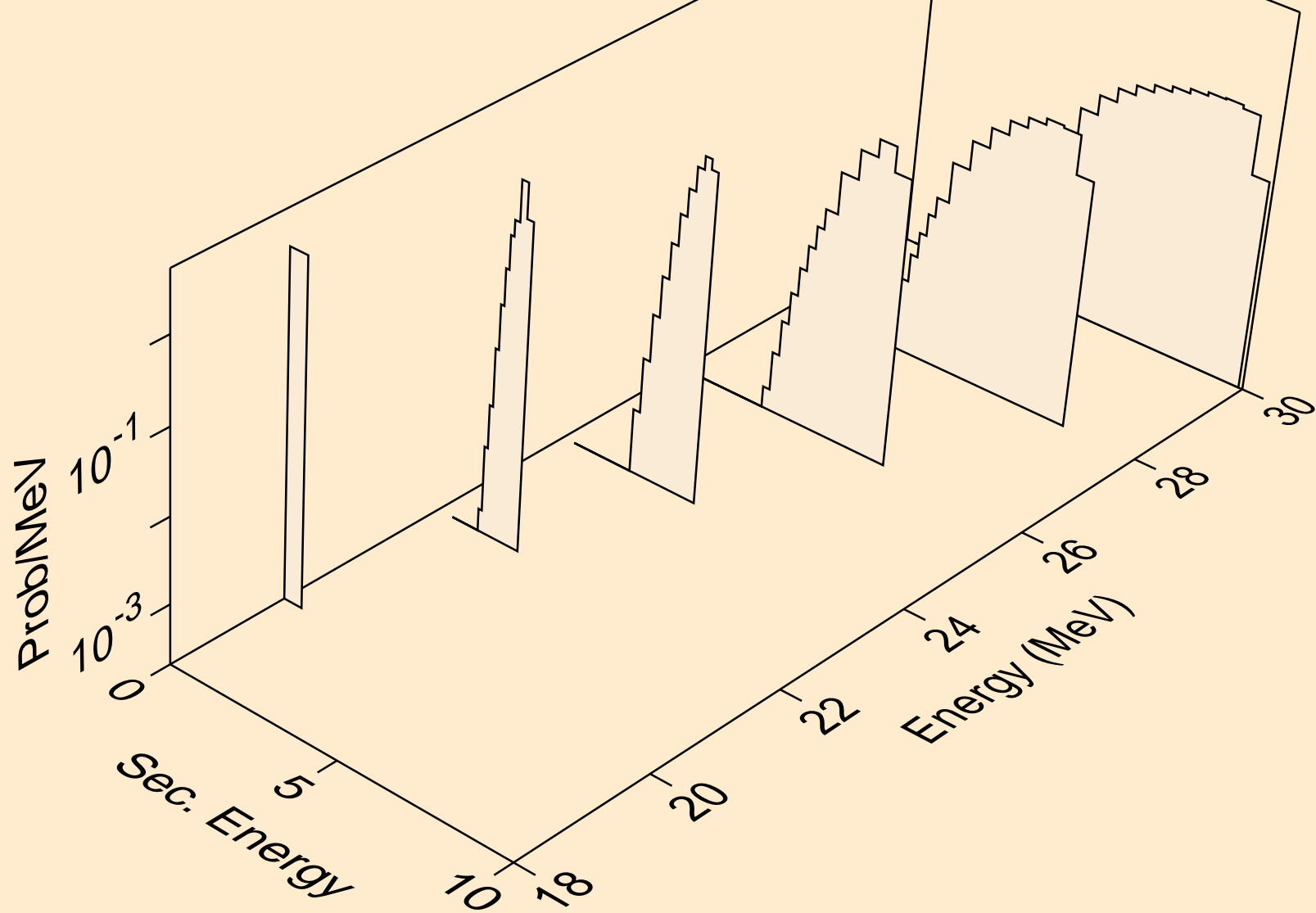

SE084 ALPHA ACER TENDL-2021 LIBRARY; T=0.K
tritons from (a,t)

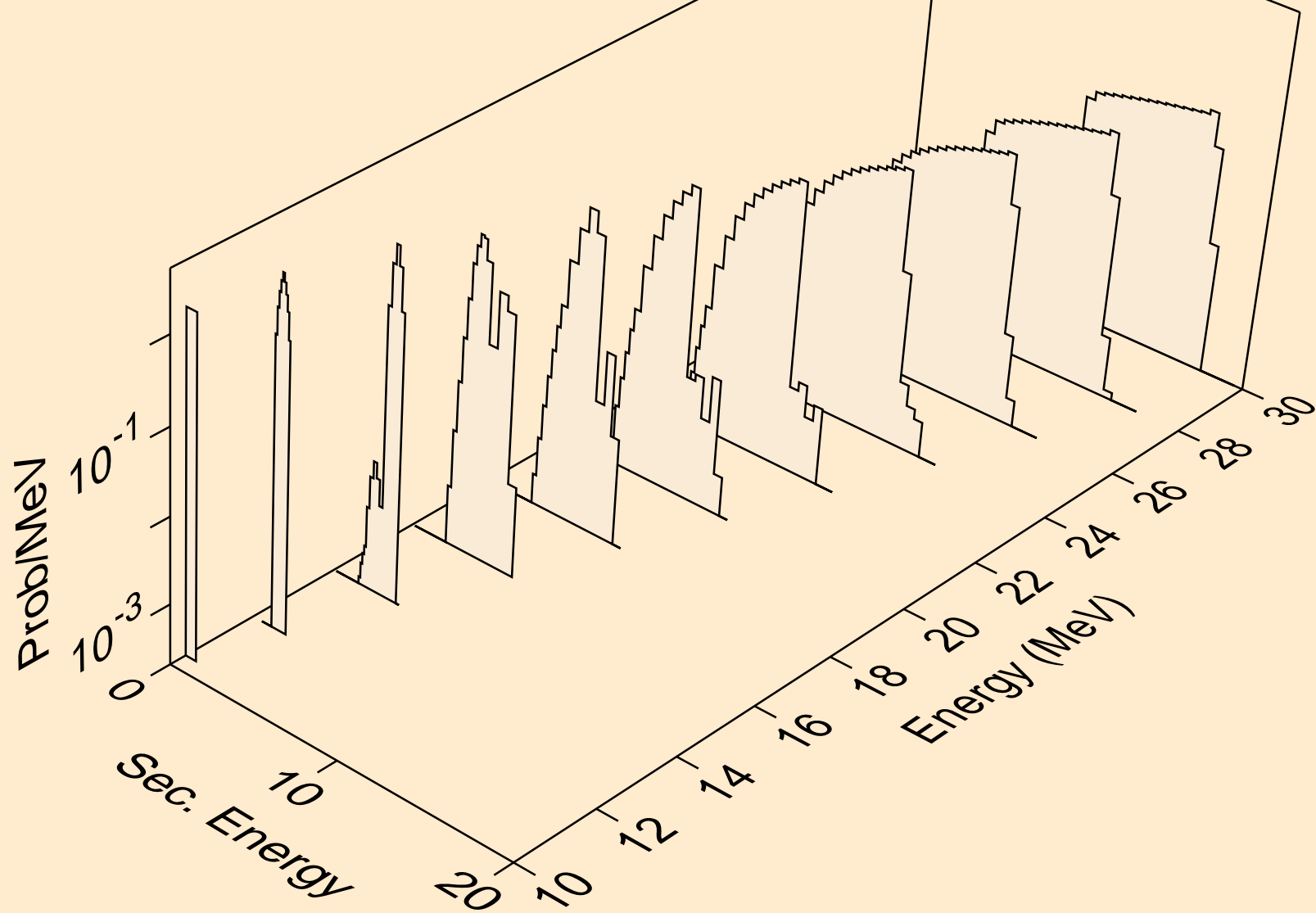

SE084 ALPHA ACER TENDL-2021 LIBRARY; T=0.K
he3s from (a,x)

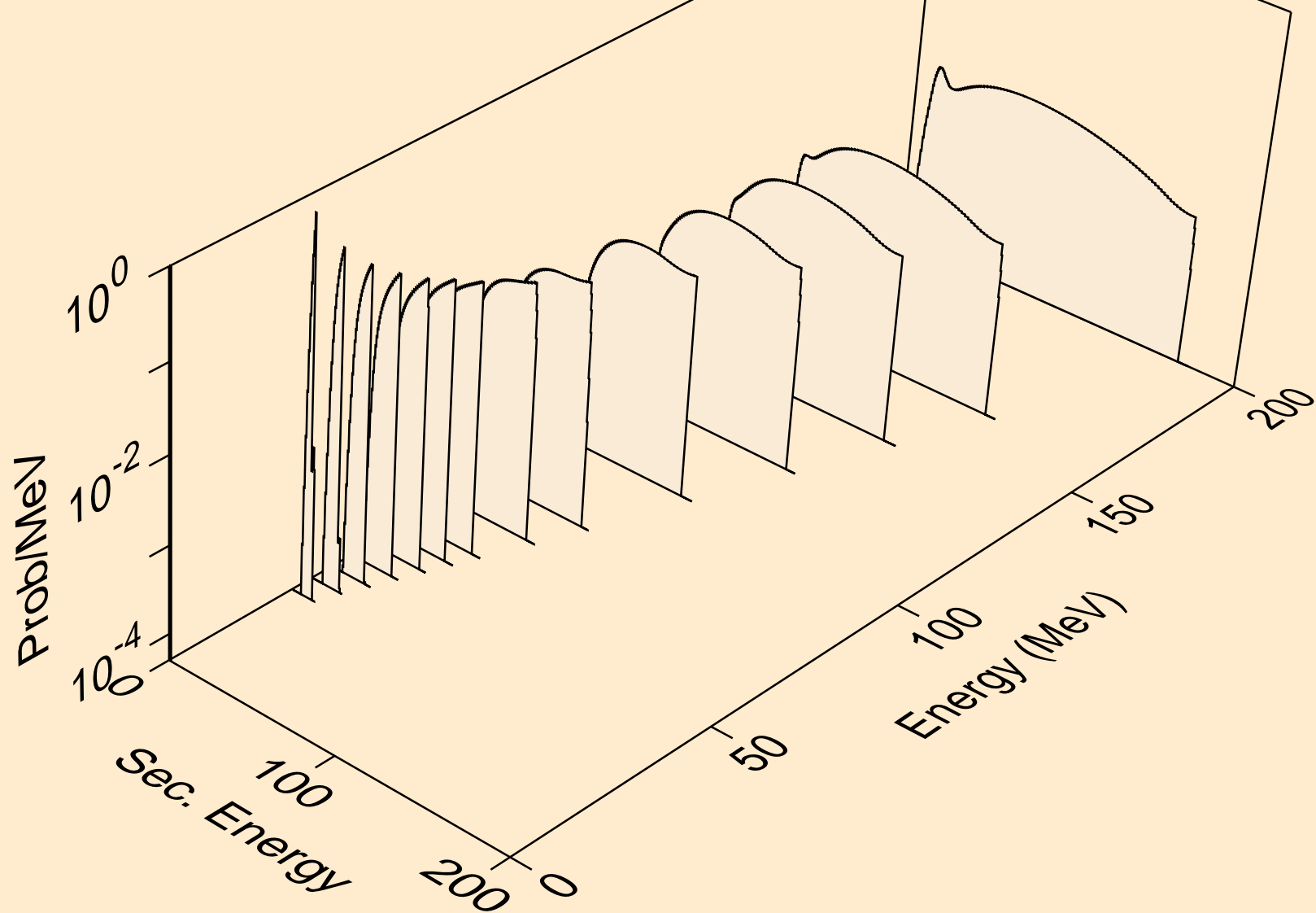

SE084 ALPHA ACER TENDL-2021 LIBRARY; T=0.K
he3s from (a,n*)he3

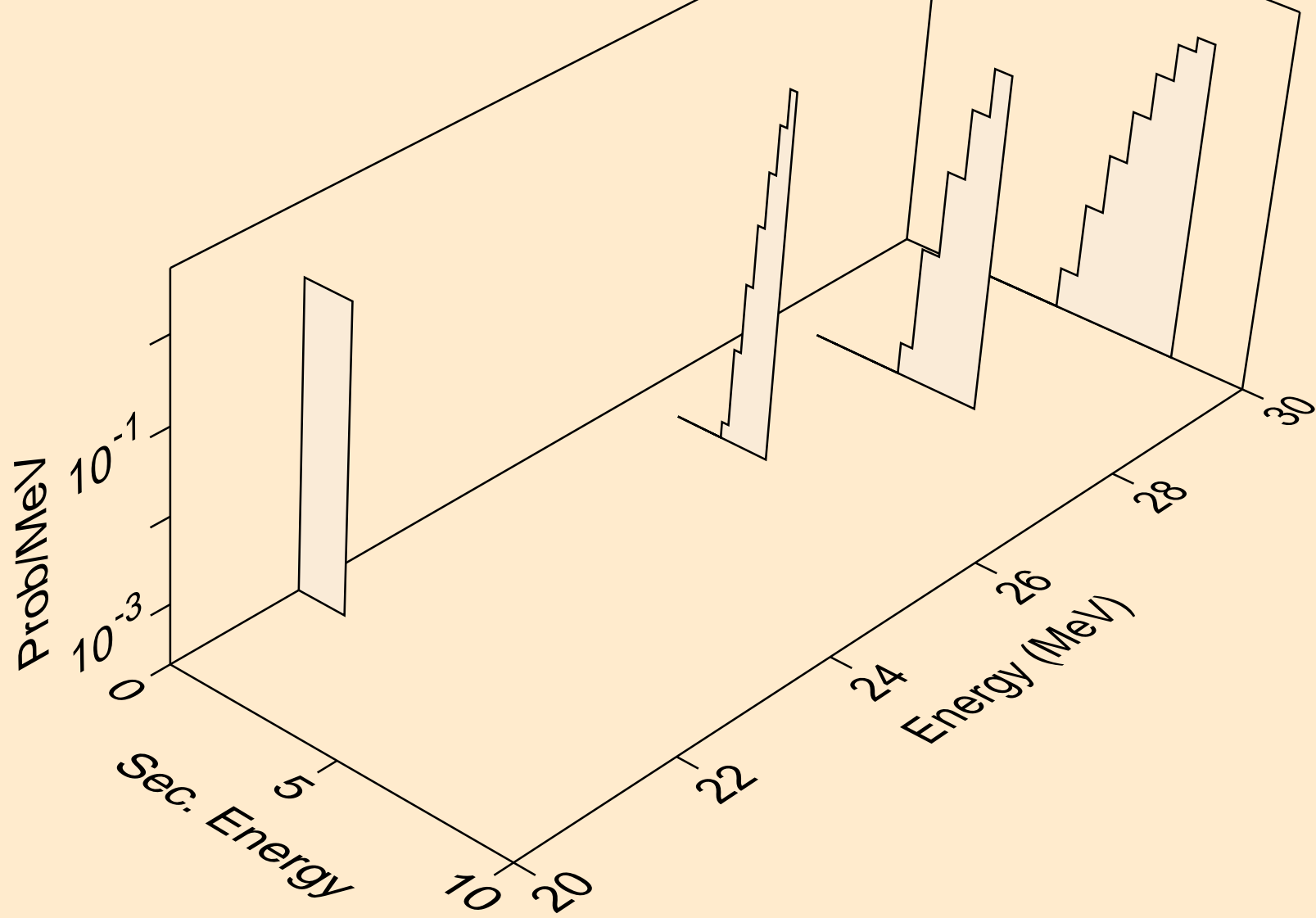

SE084 ALPHA ACER TENDL-2021 LIBRARY; T=0.K
he3s from (a,he3)

