

# SM163 ALPHA ACER TENDL-2021 LIBRARY; T=0.K

## Principal cross sections

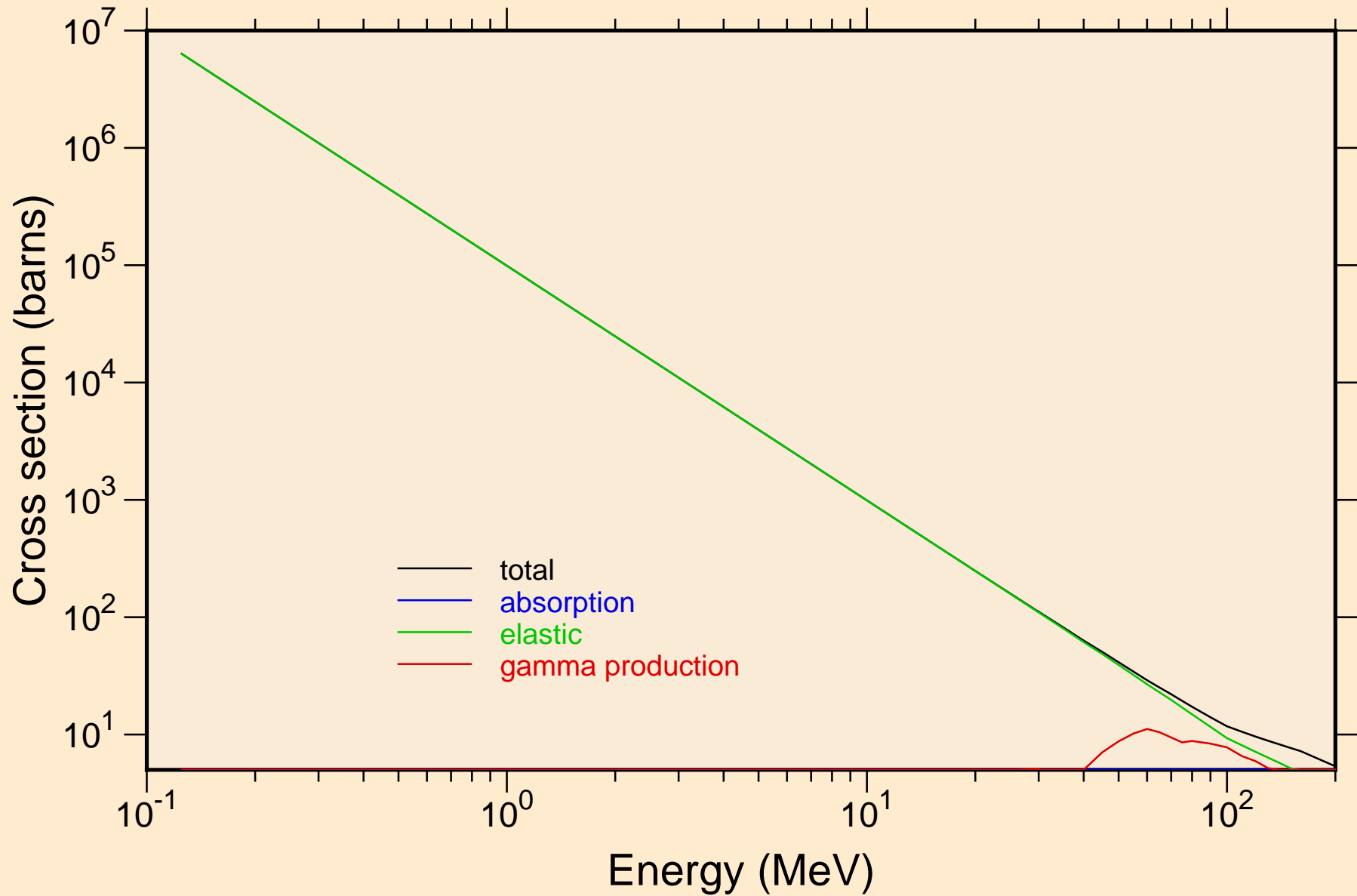

# SM163 ALPHA ACER TENDL-2021 LIBRARY; T=0.K

## Heating

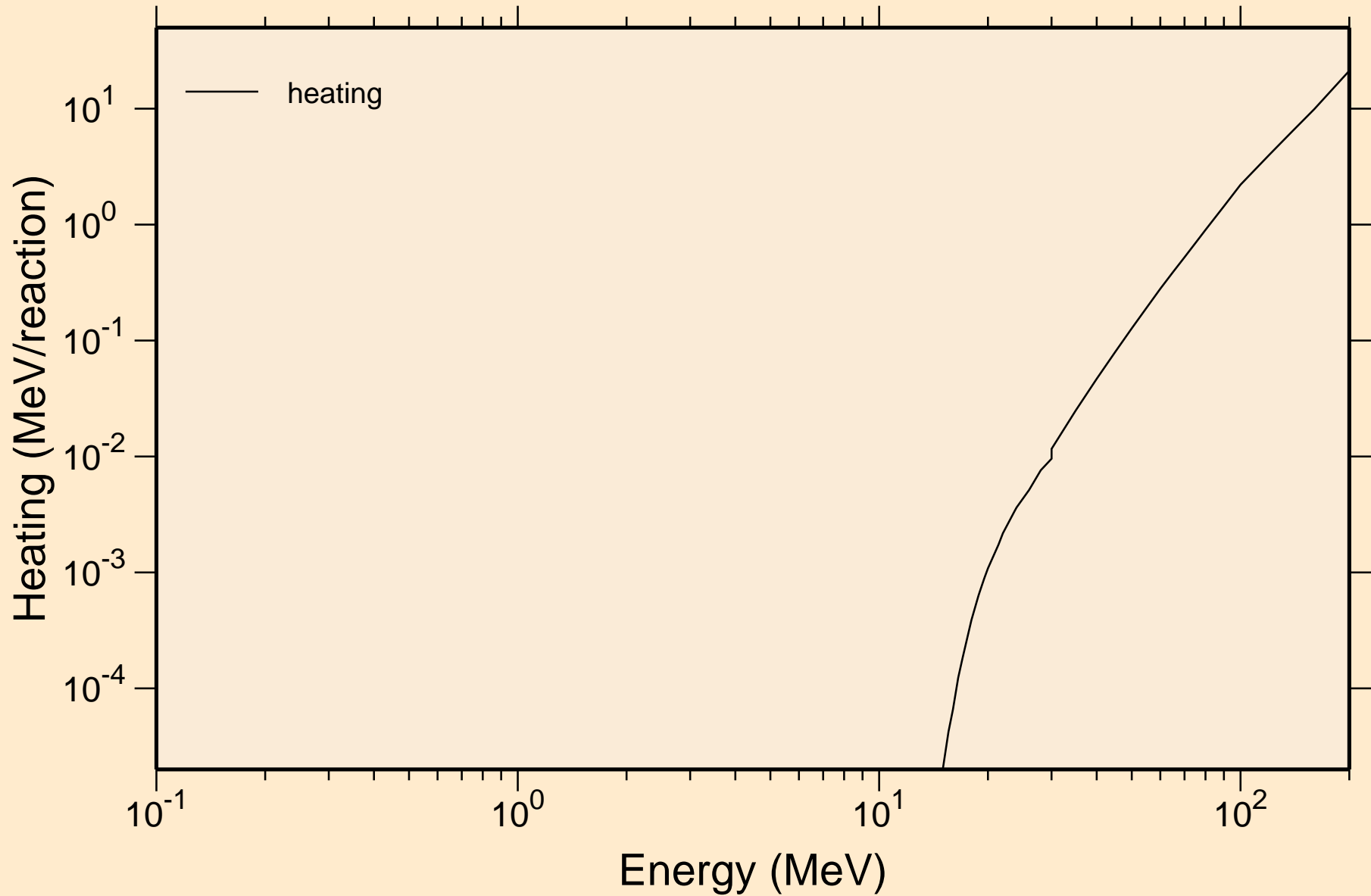

# SM163 ALPHA ACER TENDL-2021 LIBRARY; T=0.K

## Principal cross sections

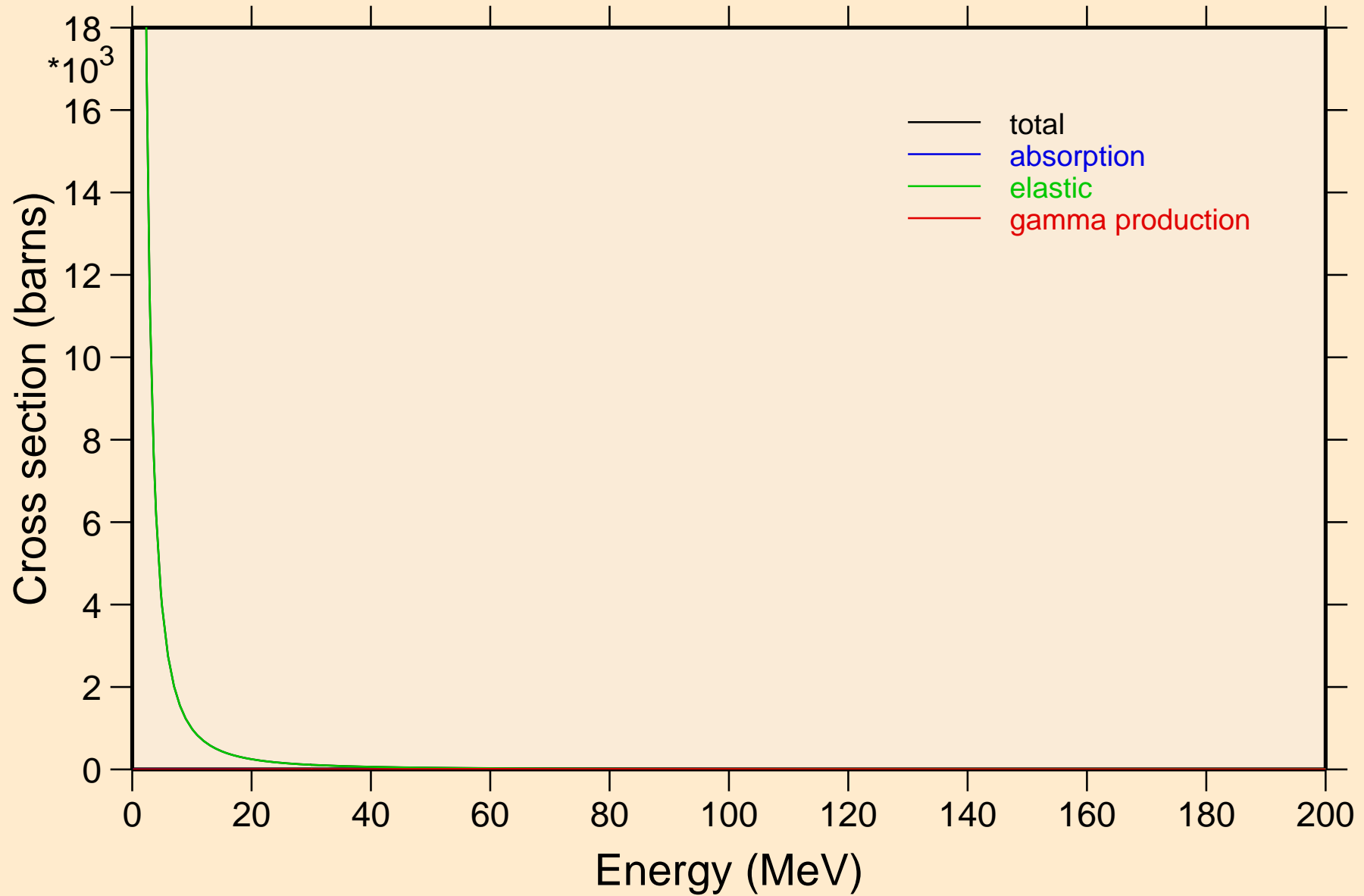

SM163 ALPHA ACER TENDL-2021 LIBRARY; T=0.K

Heating

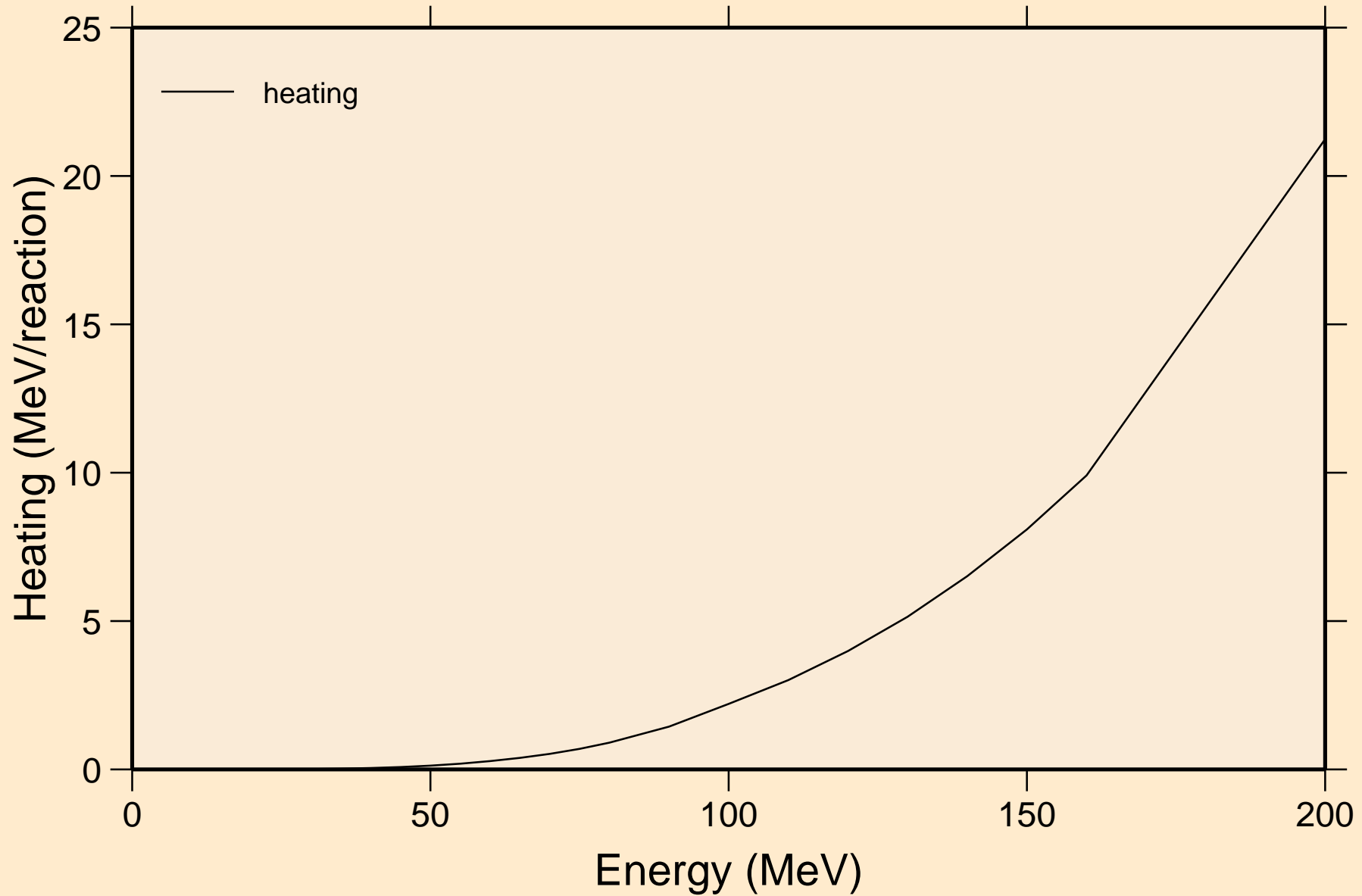

SM163 ALPHA ACER TENDL-2021 LIBRARY; T=0.K  
Threshold reactions

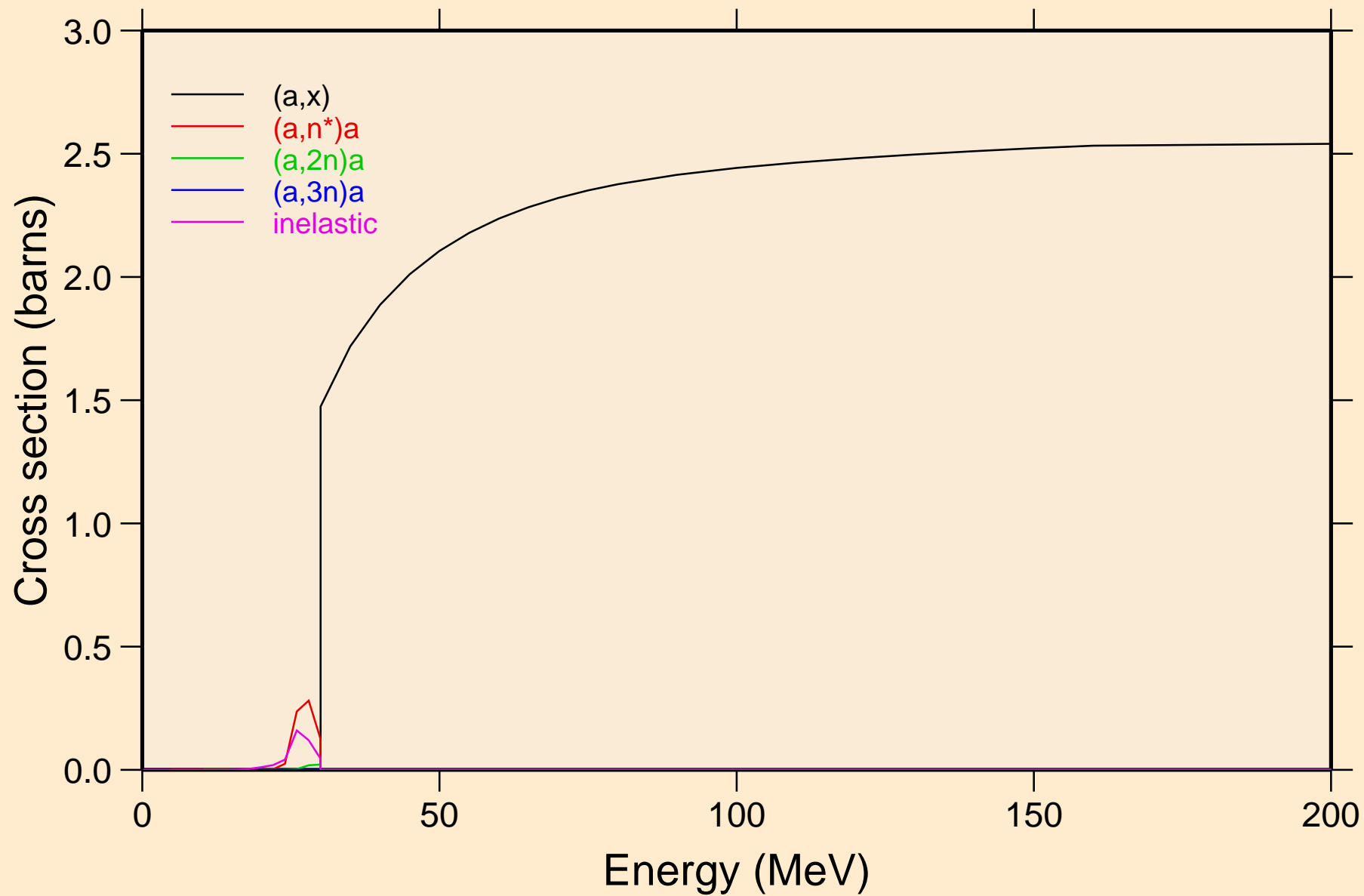

SM163 ALPHA ACER TENDL-2021 LIBRARY; T=0.K  
angular distribution for elastic

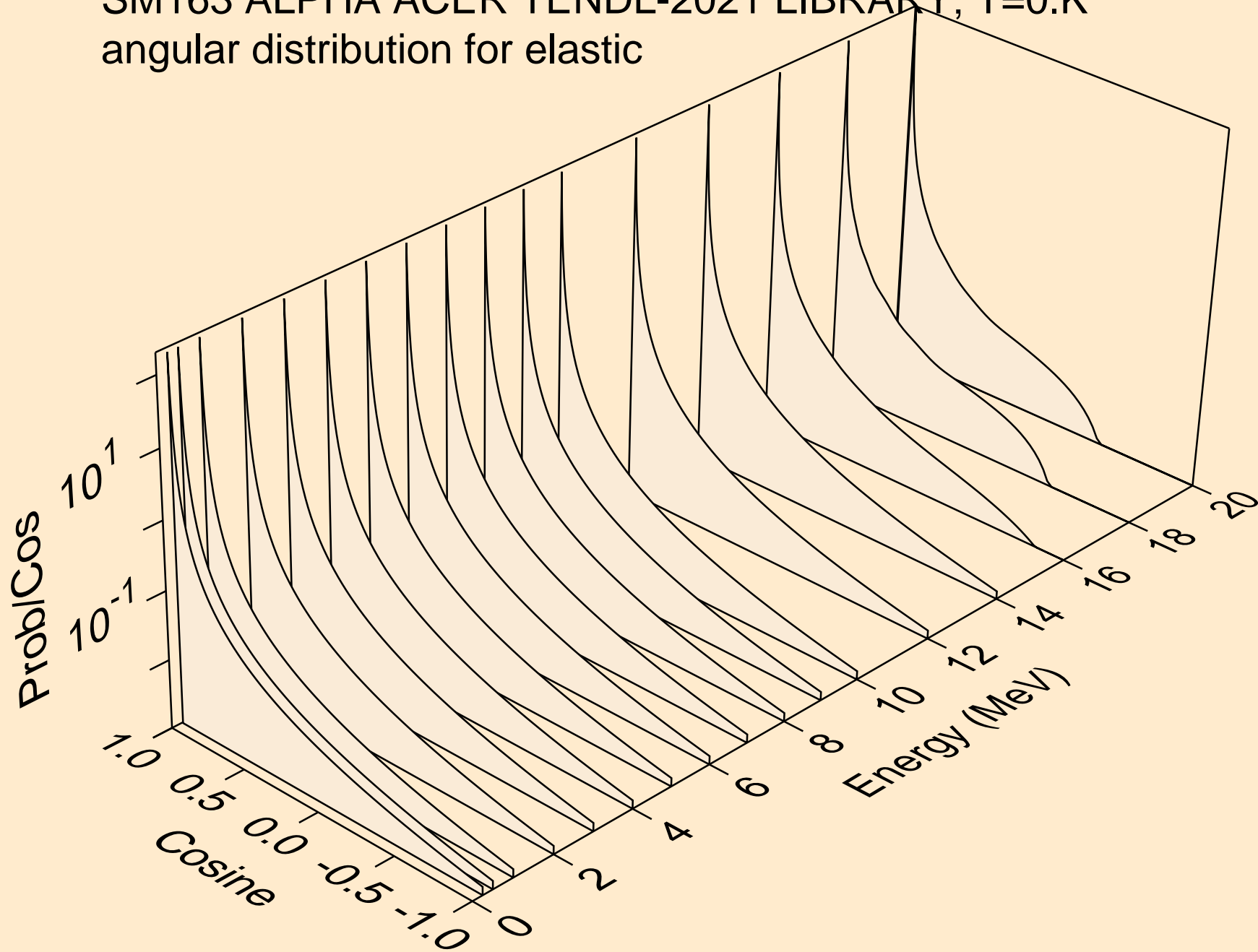

SM163 ALPHA ACER TENDL-2021 LIBRARY; T=0.K  
angular distribution for elastic

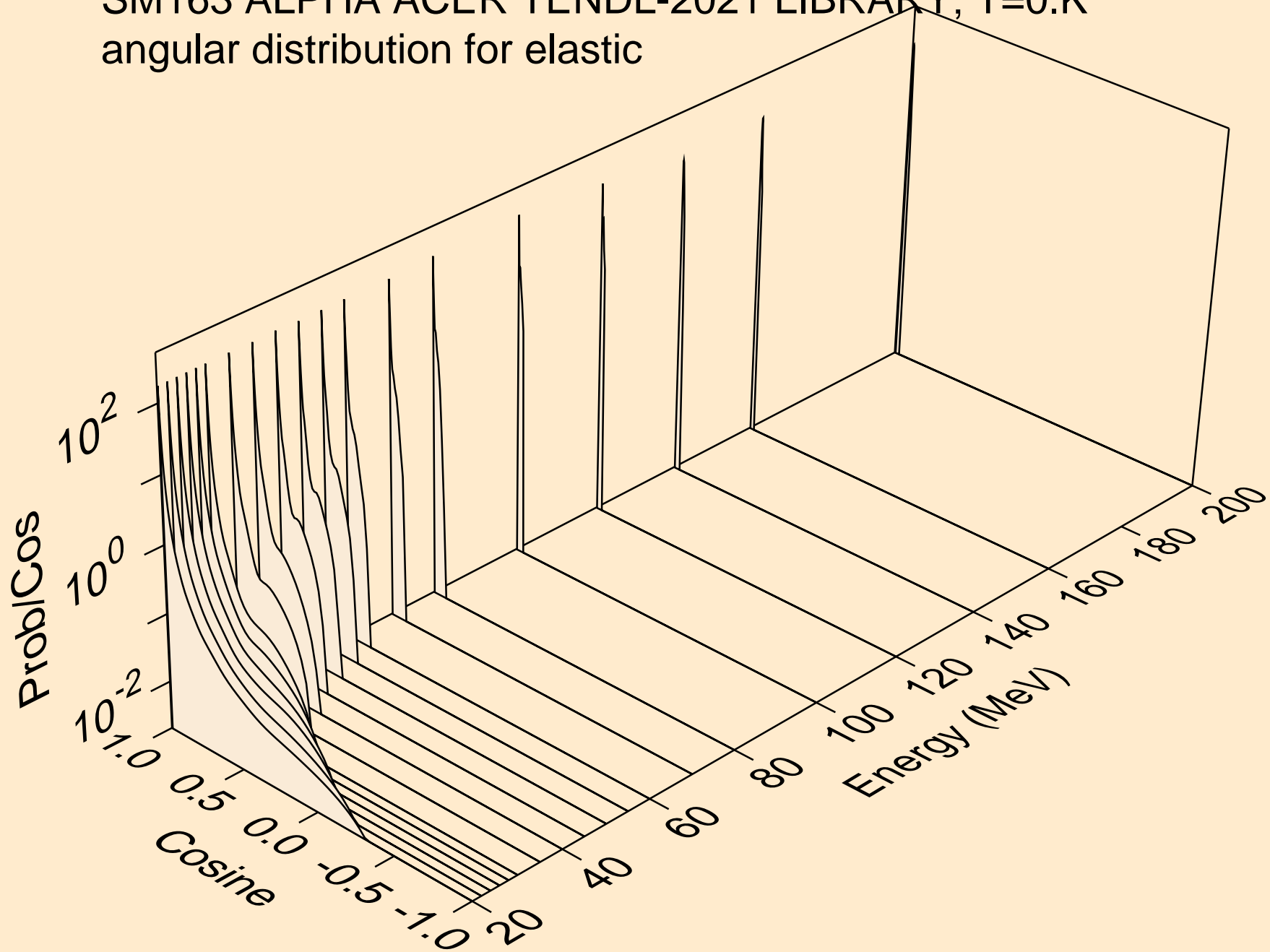

SM163 ALPHA ACER TENDL-2021 LIBRARY; T=0.K  
Alpha emission for (a,x)

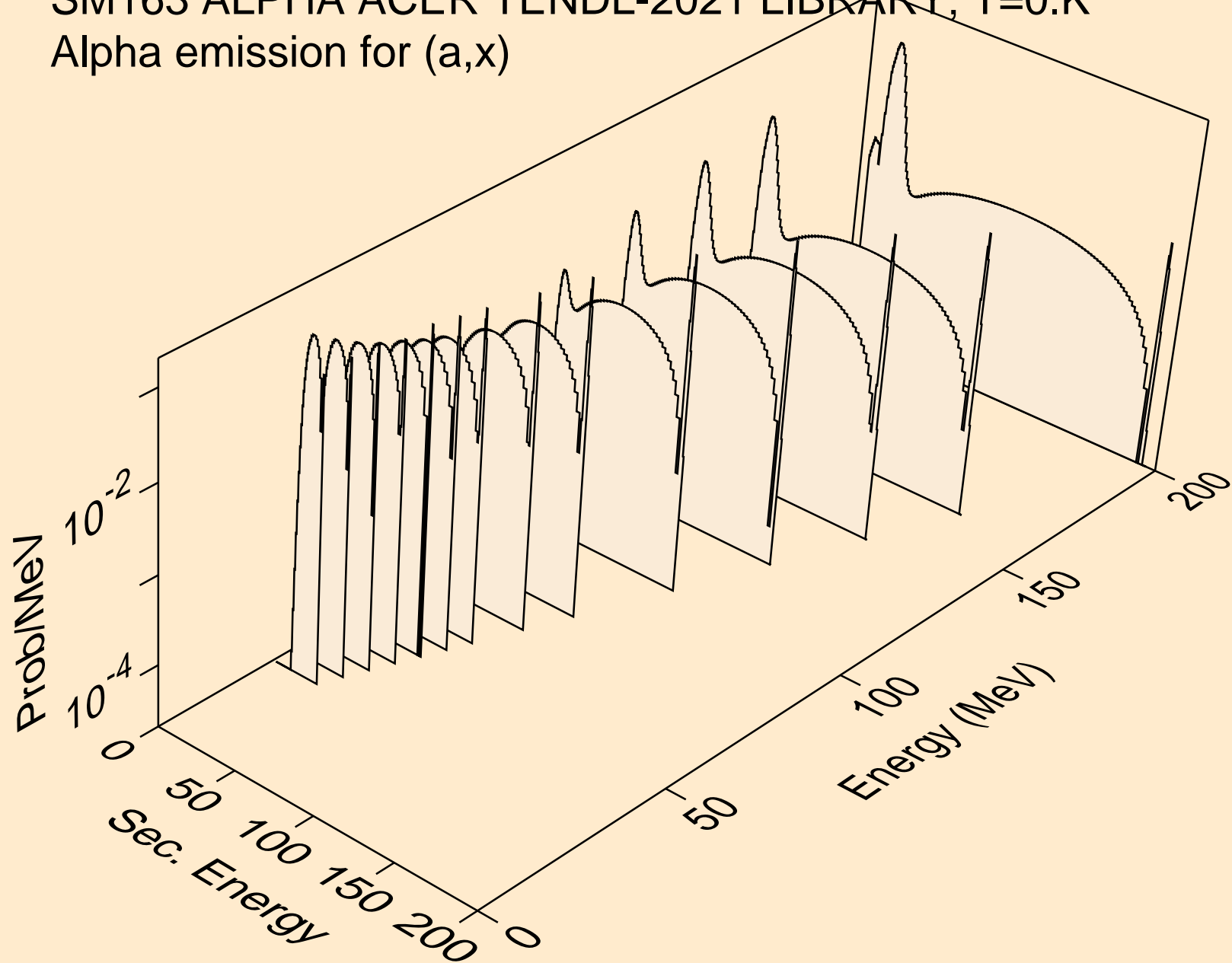



SM163 ALPHA ACER TENDL-2021 LIBRARY; T=0.K  
Alpha emission for (a,n\*)a

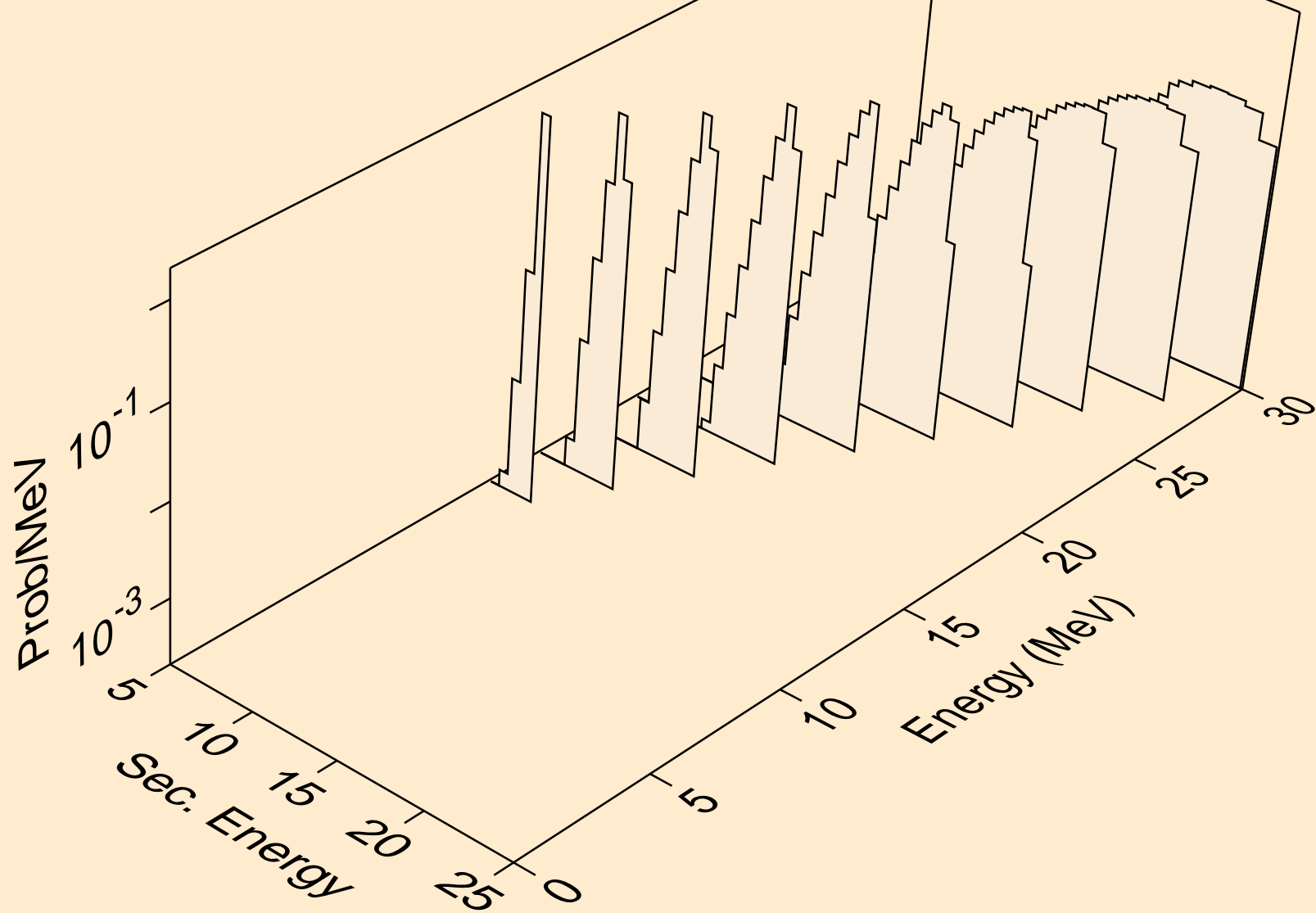

SM163 ALPHA ACER TENDL-2021 LIBRARY; T=0.K  
Alpha emission for (a,2n)a

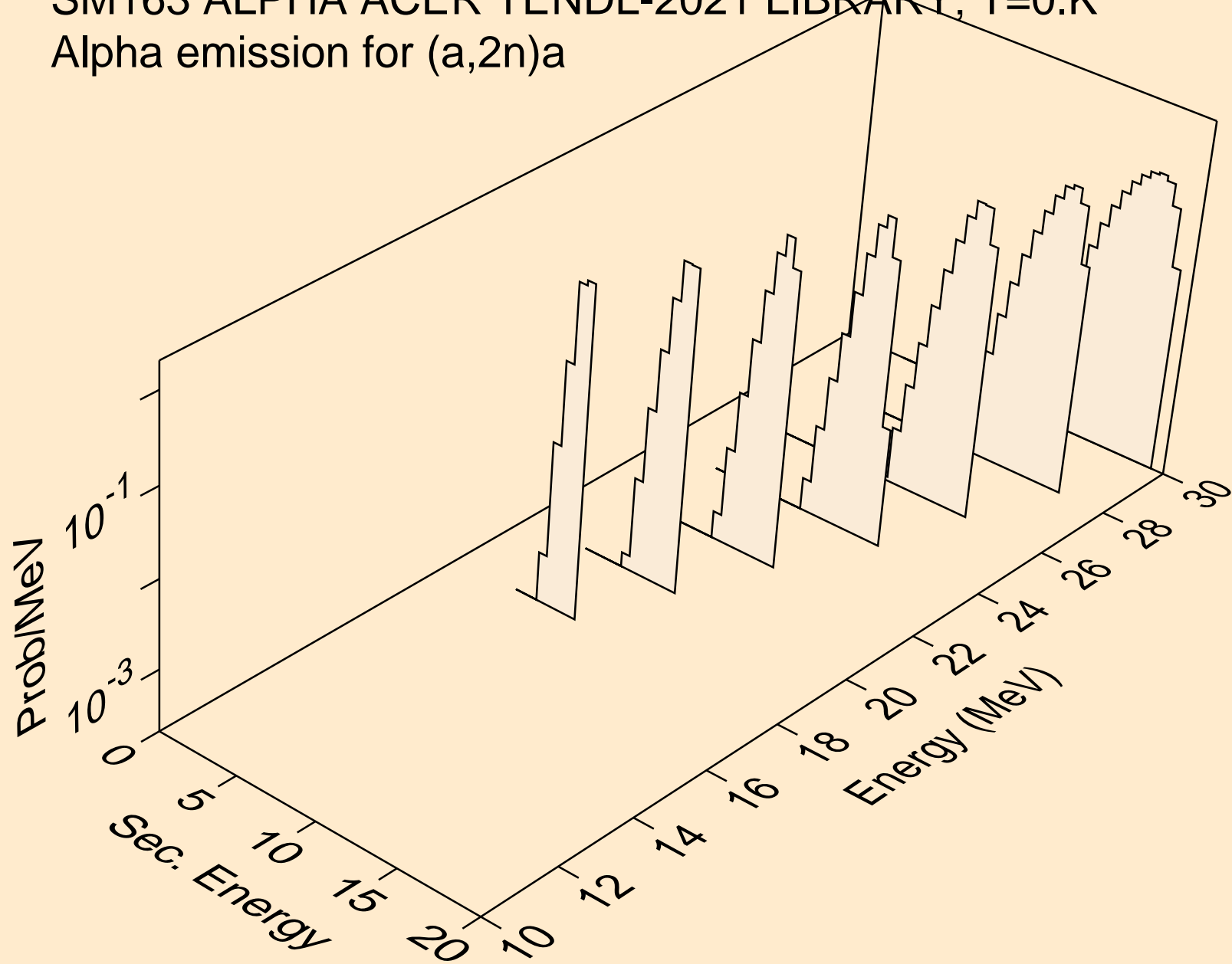

SM163 ALPHA ACER TENDL-2021 LIBRARY; T=0.K  
Alpha emission for (a,3n)a

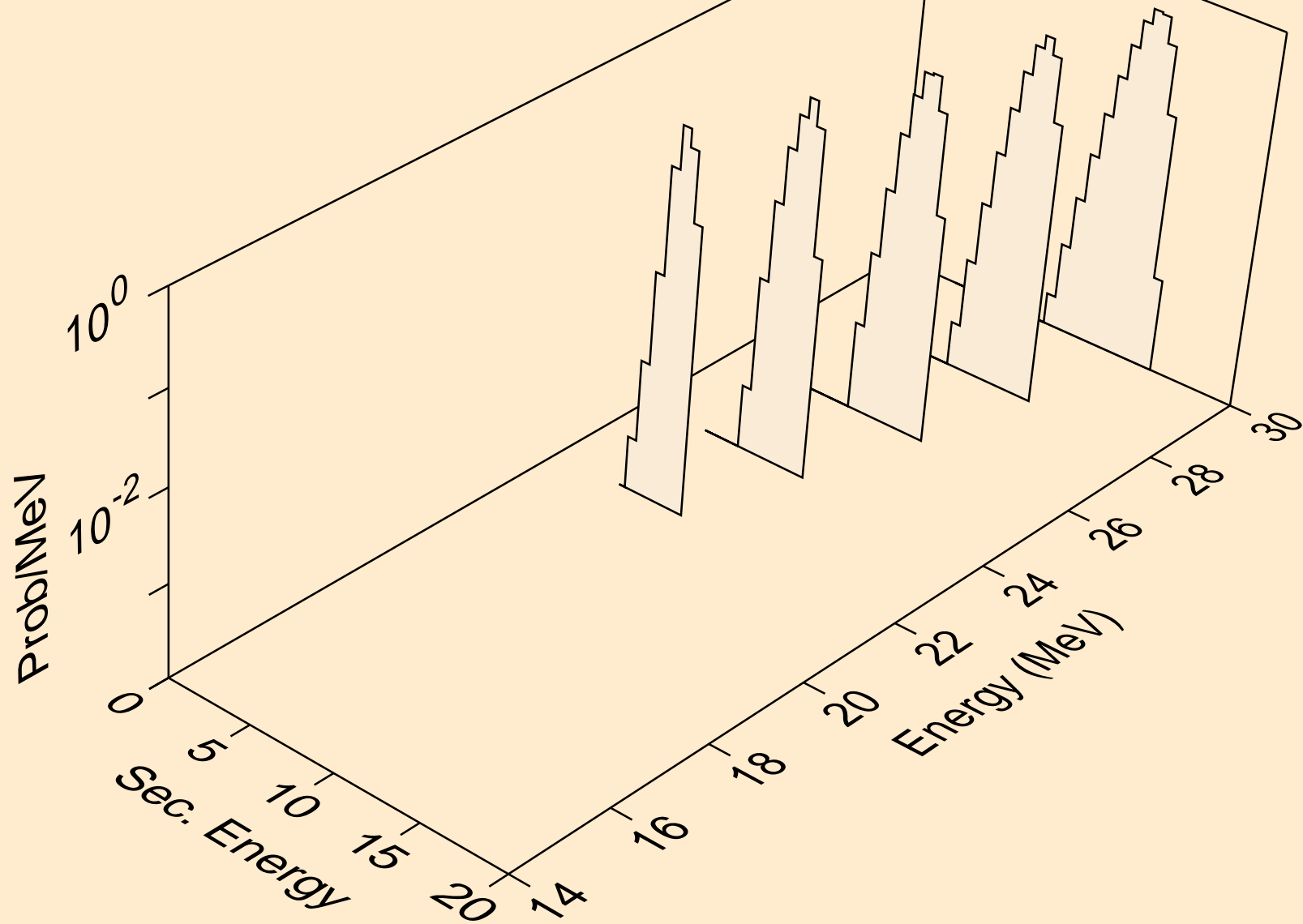

SM163 ALPHA ACER TENDL-2021 LIBRARY; T=0.K  
Alpha emission for inelastic

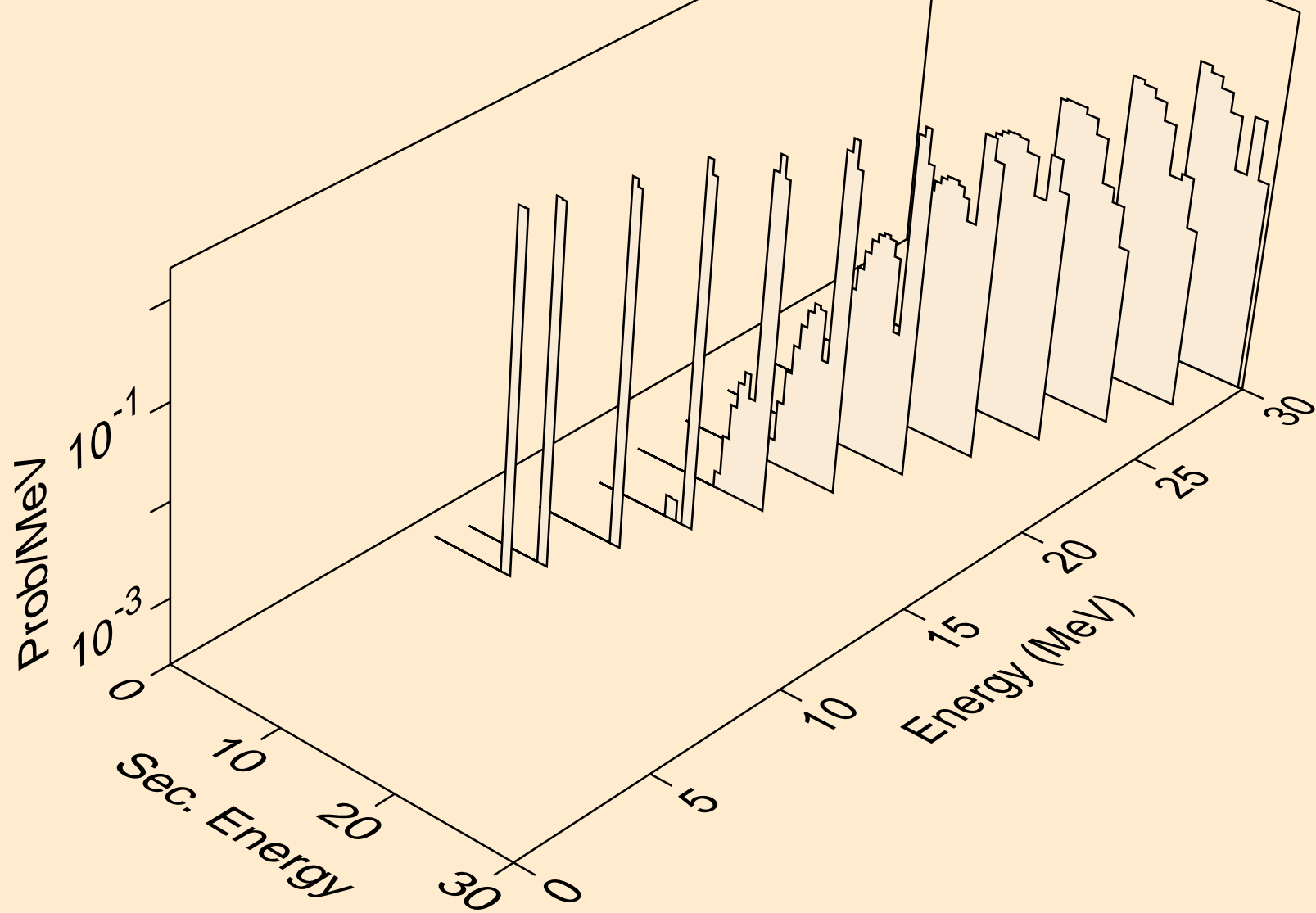

SM163 ALPHA ACER TENDL-2021 LIBRARY; T=0.K  
Photon emission for (z,n)

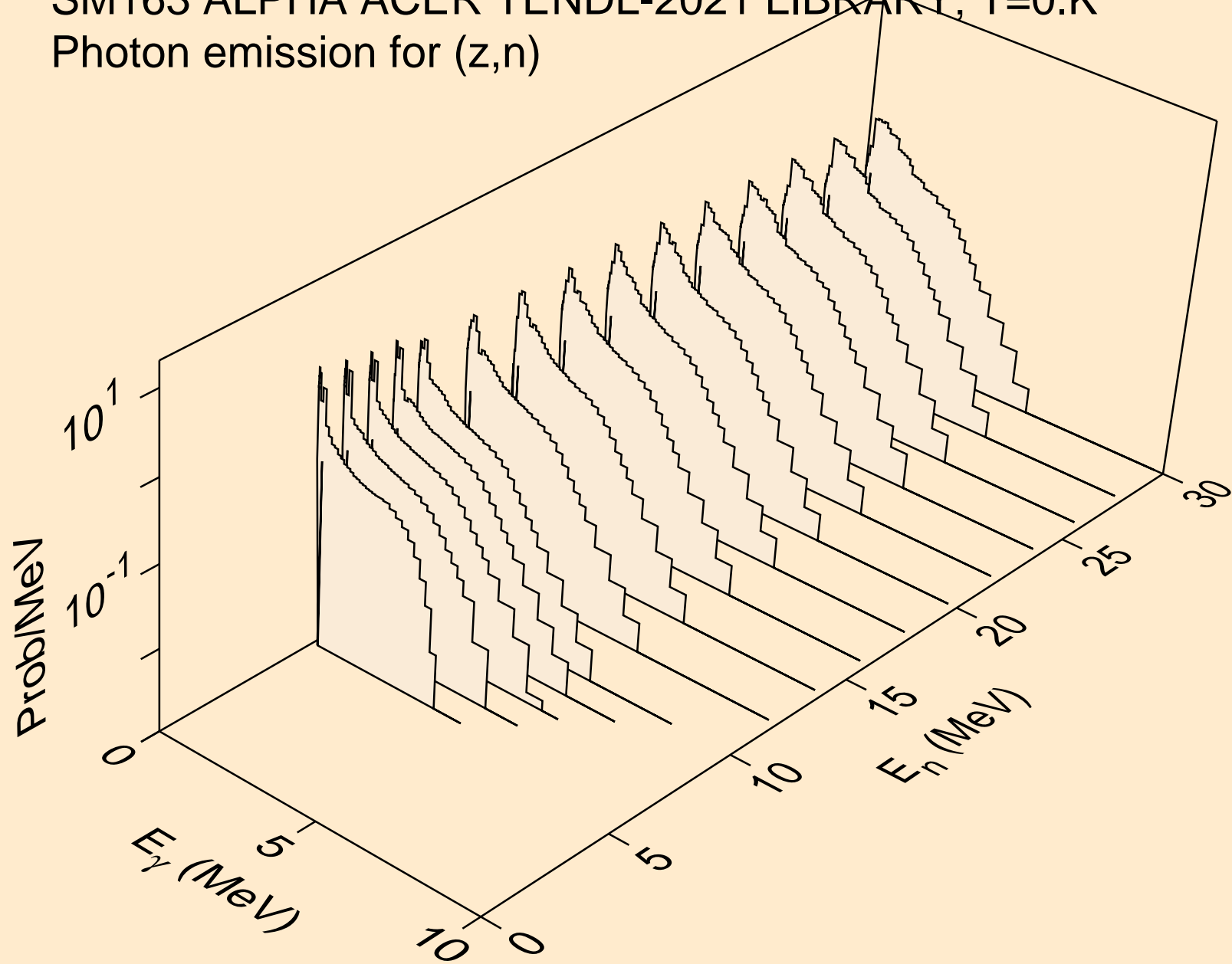

SM163 ALPHA ACER TENDL-2021 LIBRARY; T=0.K  
Photon emission for (n,x)

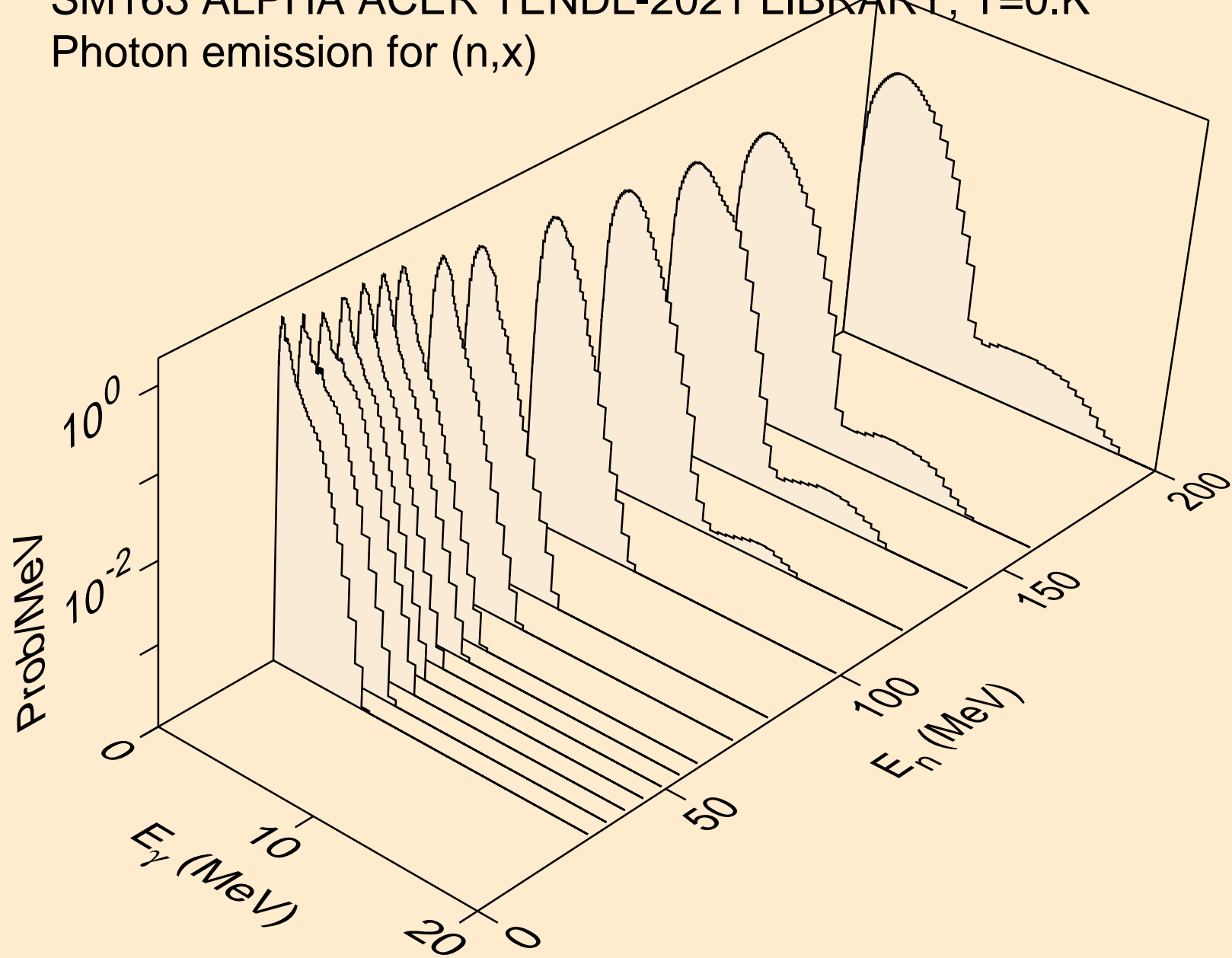

SM163 ALPHA ACER TENDL-2021 LIBRARY; T=0.K  
Photon emission for (n,2nd)

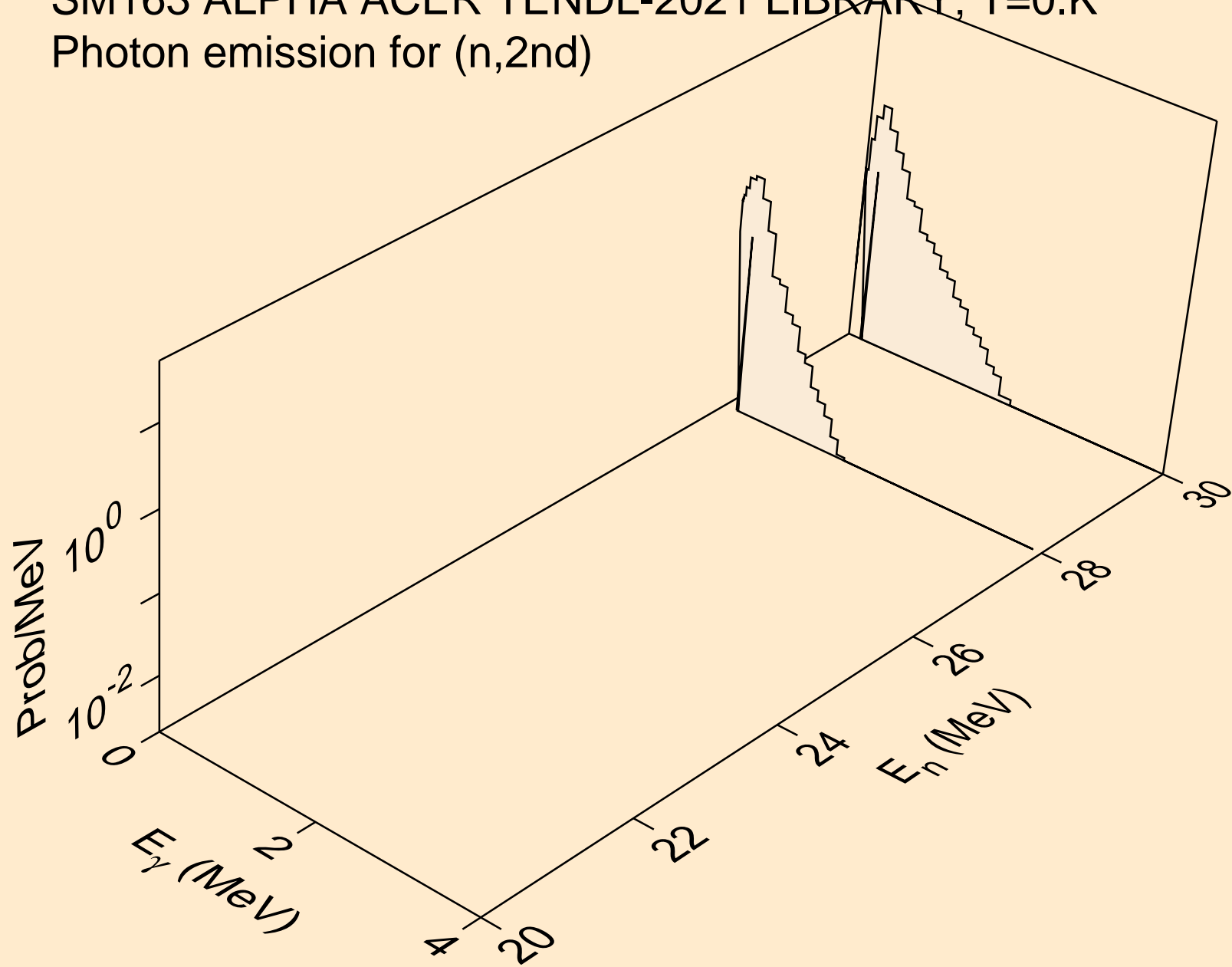

SM163 ALPHA ACER TENDL-2021 LIBRARY; T=0.K  
Photon emission for (n,2n)

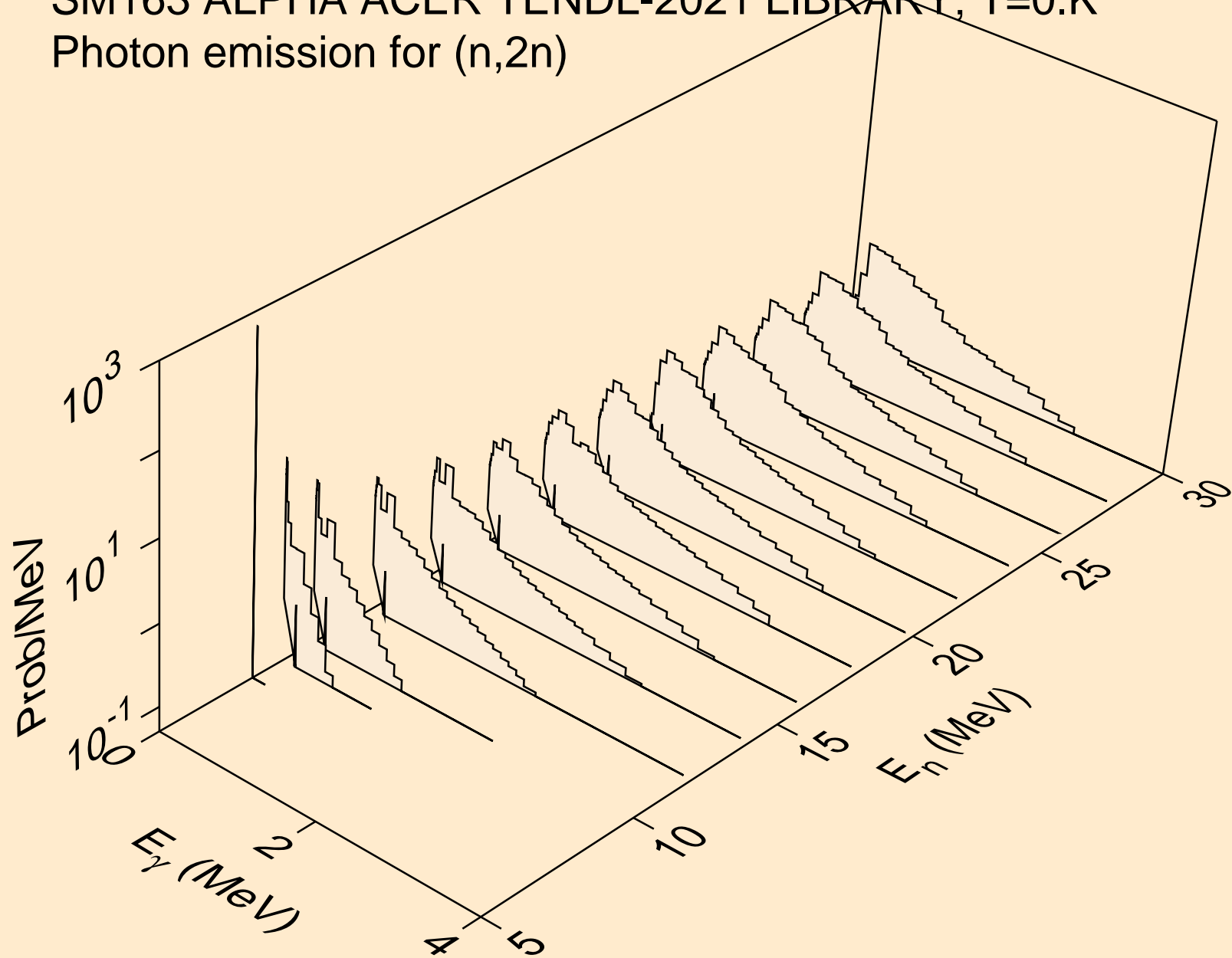



SM163 ALPHA ACER TENDL-2021 LIBRARY; T=0.K  
Photon emission for (n,3n)

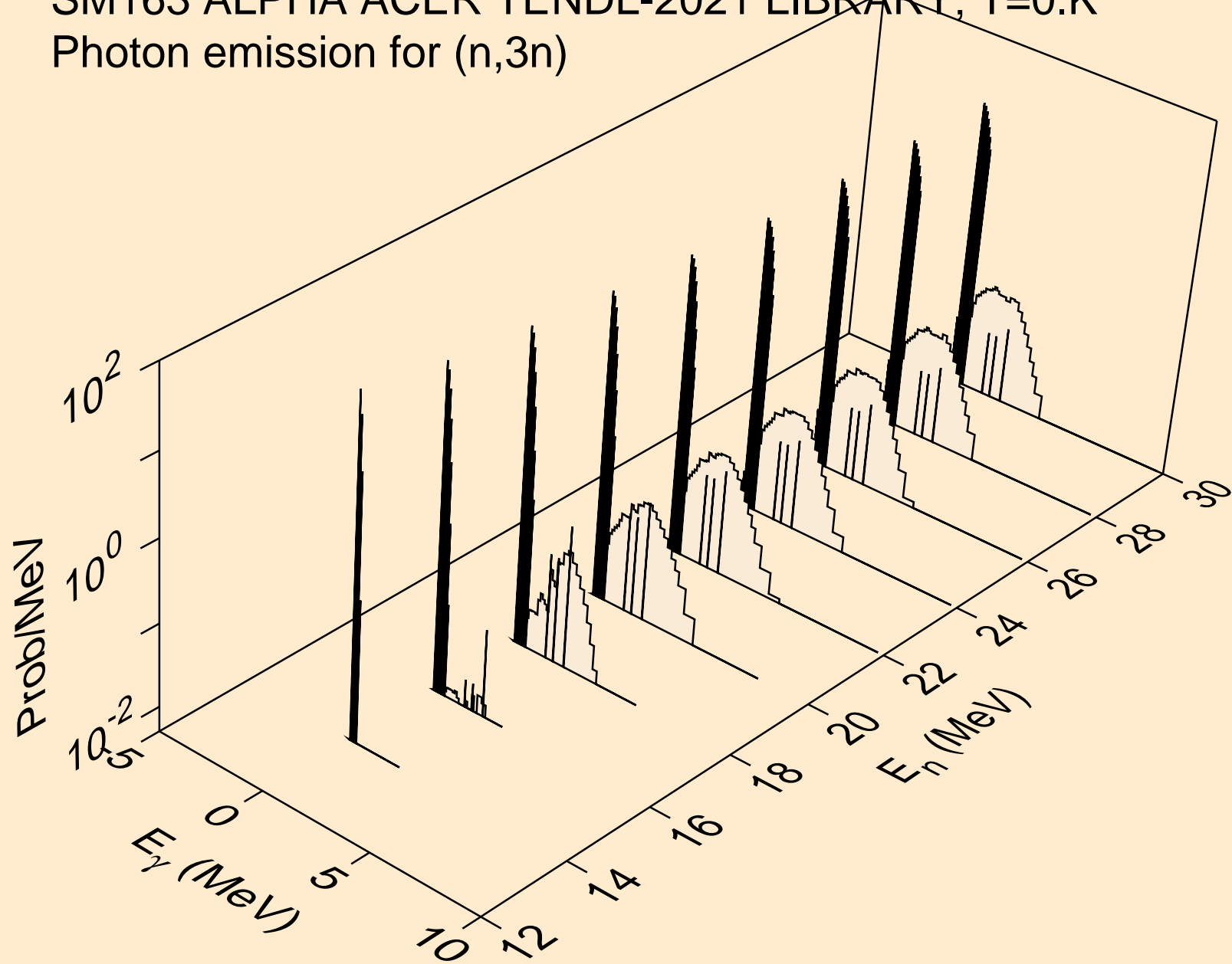

SM163 ALPHA ACER TENDL-2021 LIBRARY; T=0.K  
Photon emission for (n,n\*)a

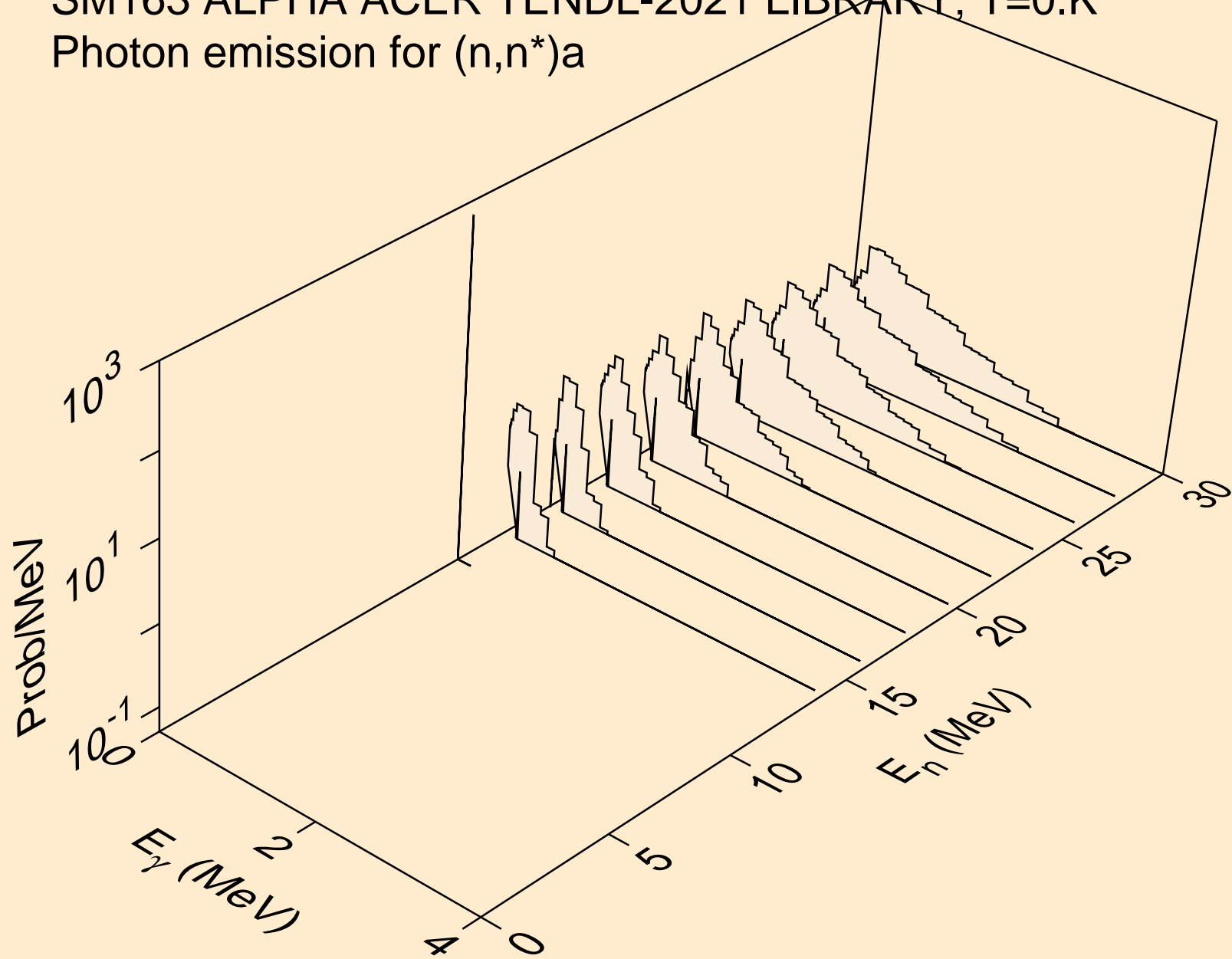

SM163 ALPHA ACER TENDL-2021 LIBRARY; T=0.K  
Photon emission for (n,2n)a

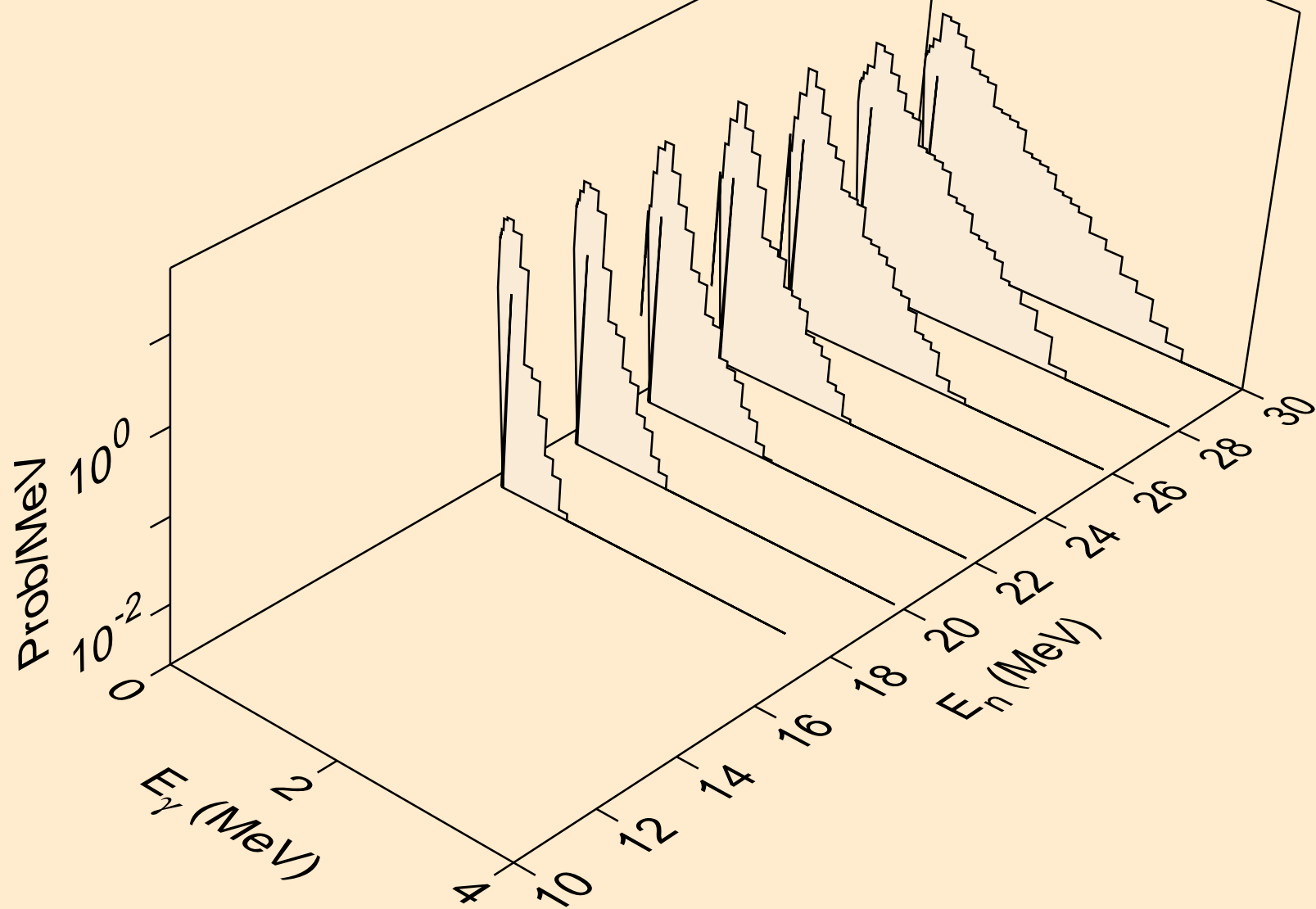

SM163 ALPHA ACER TENDL-2021 LIBRARY; T=0.K  
Photon emission for (n,3n)a

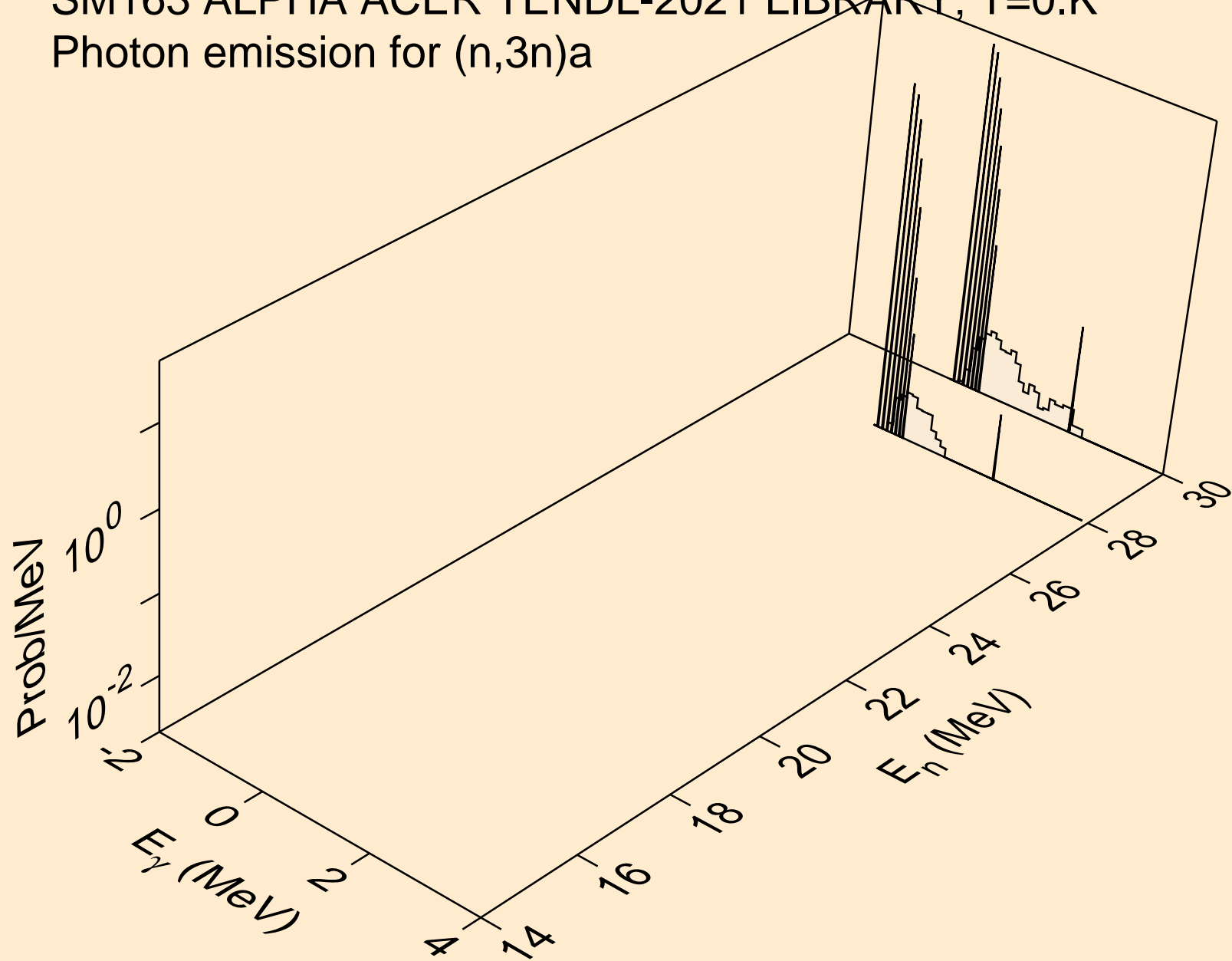

SM163 ALPHA ACER TENDL-2021 LIBRARY; T=0.K  
Photon emission for (n,n\*)p

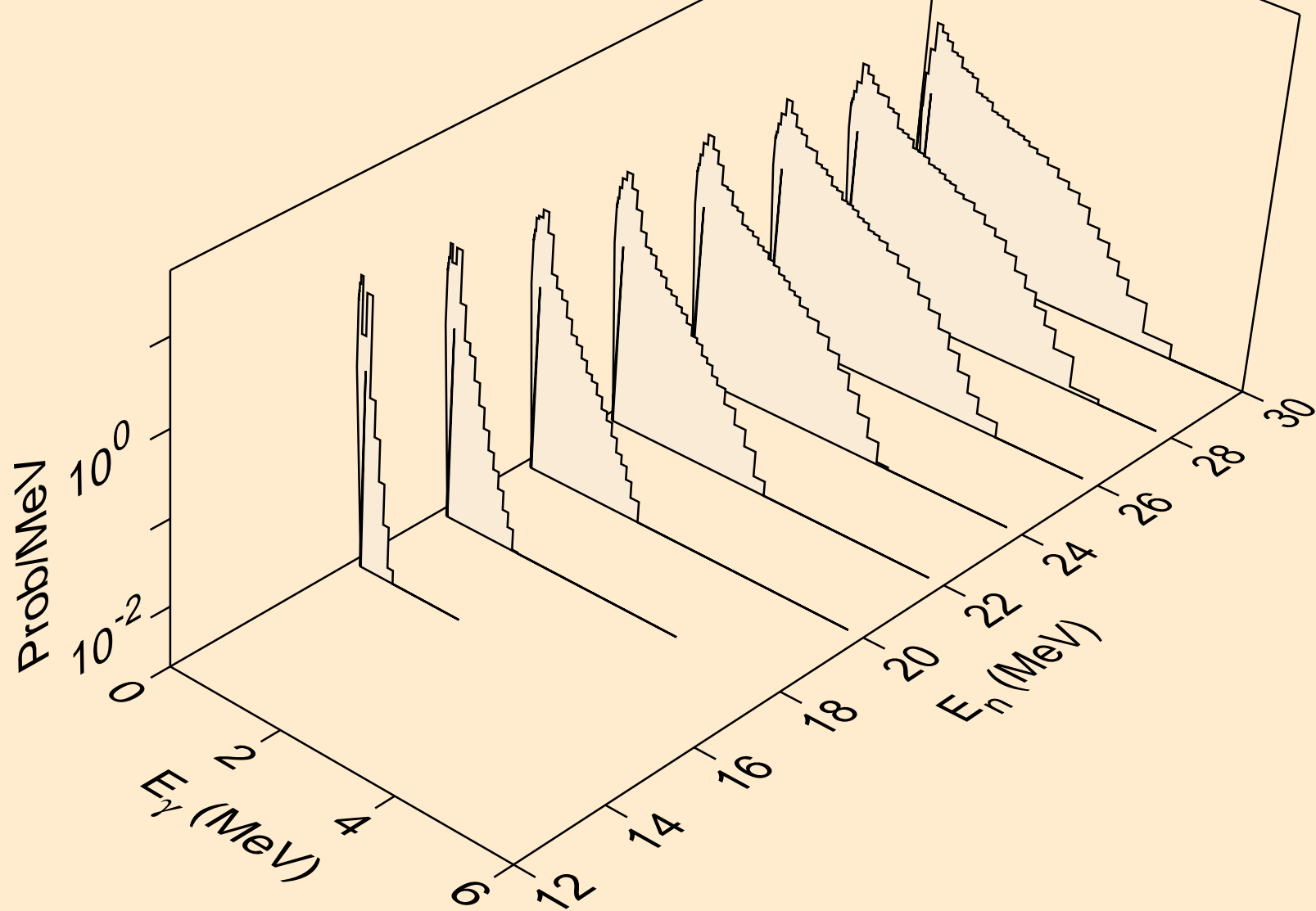

SM163 ALPHA ACER TENDL-2021 LIBRARY; T=0.K  
Photon emission for (n,n\*)d

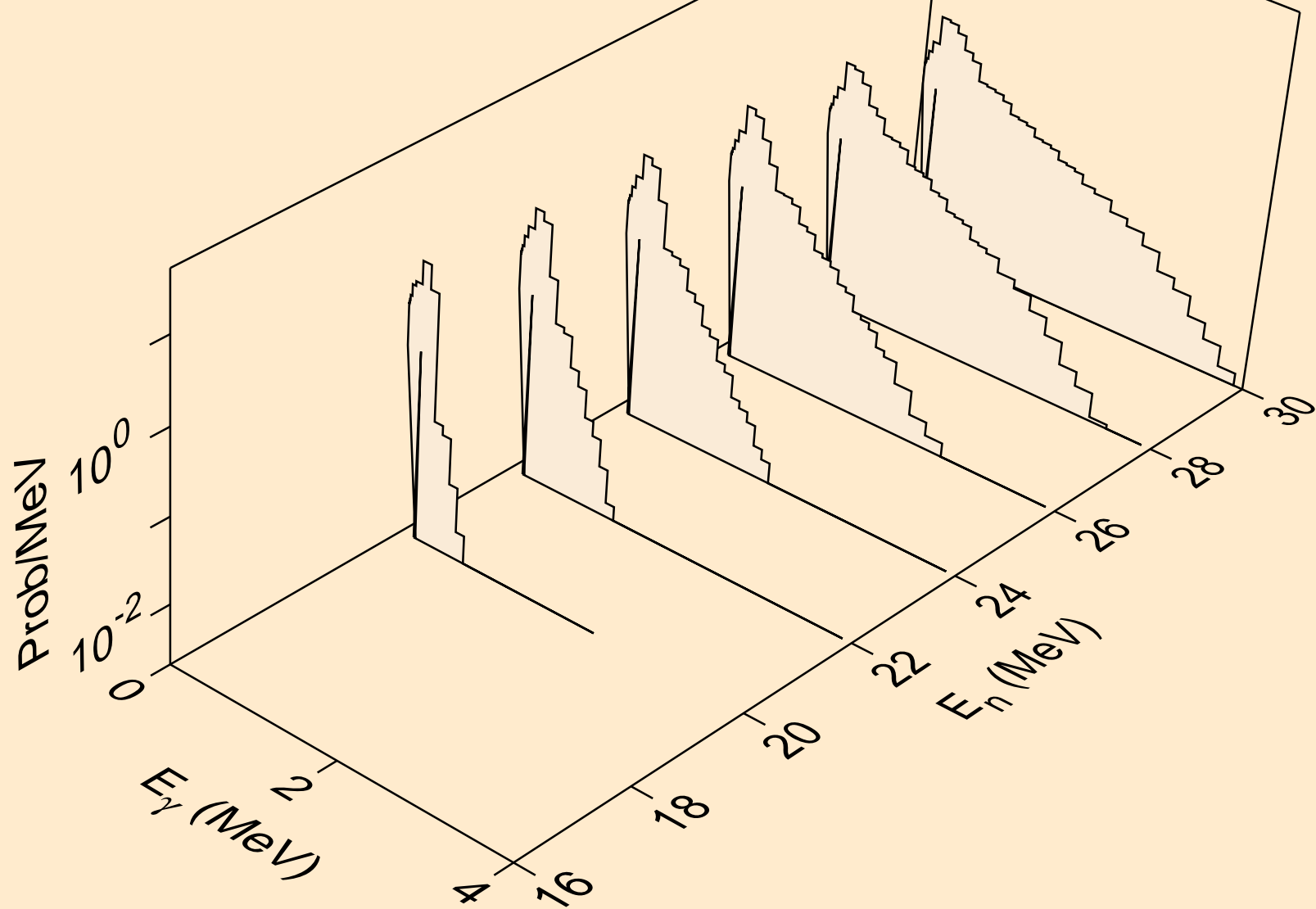

SM163 ALPHA ACER TENDL-2021 LIBRARY; T=0.K  
Photon emission for (n,n\*)t

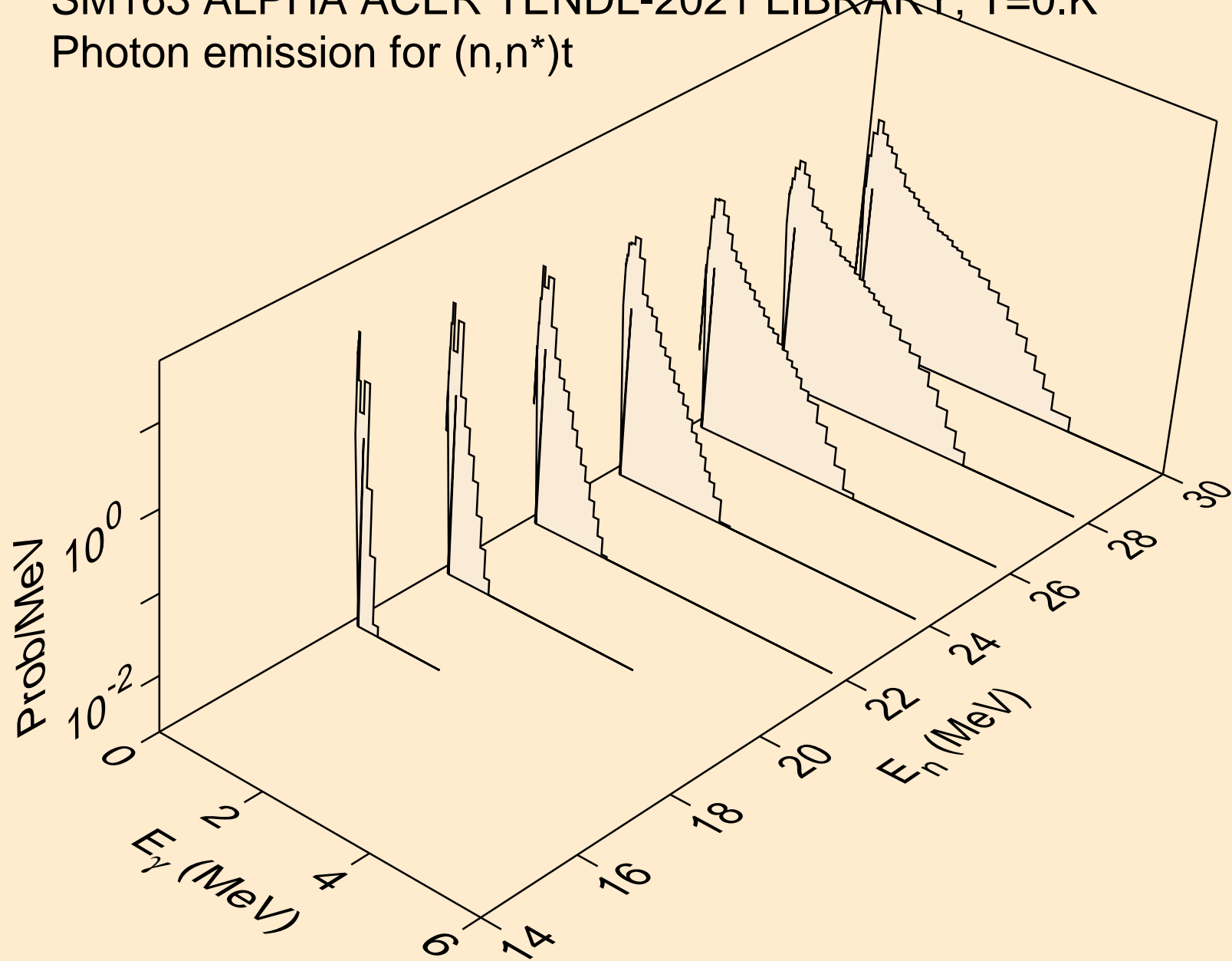

SM163 ALPHA ACER TENDL-2021 LIBRARY; T=0.K  
Photon emission for (n,4n)

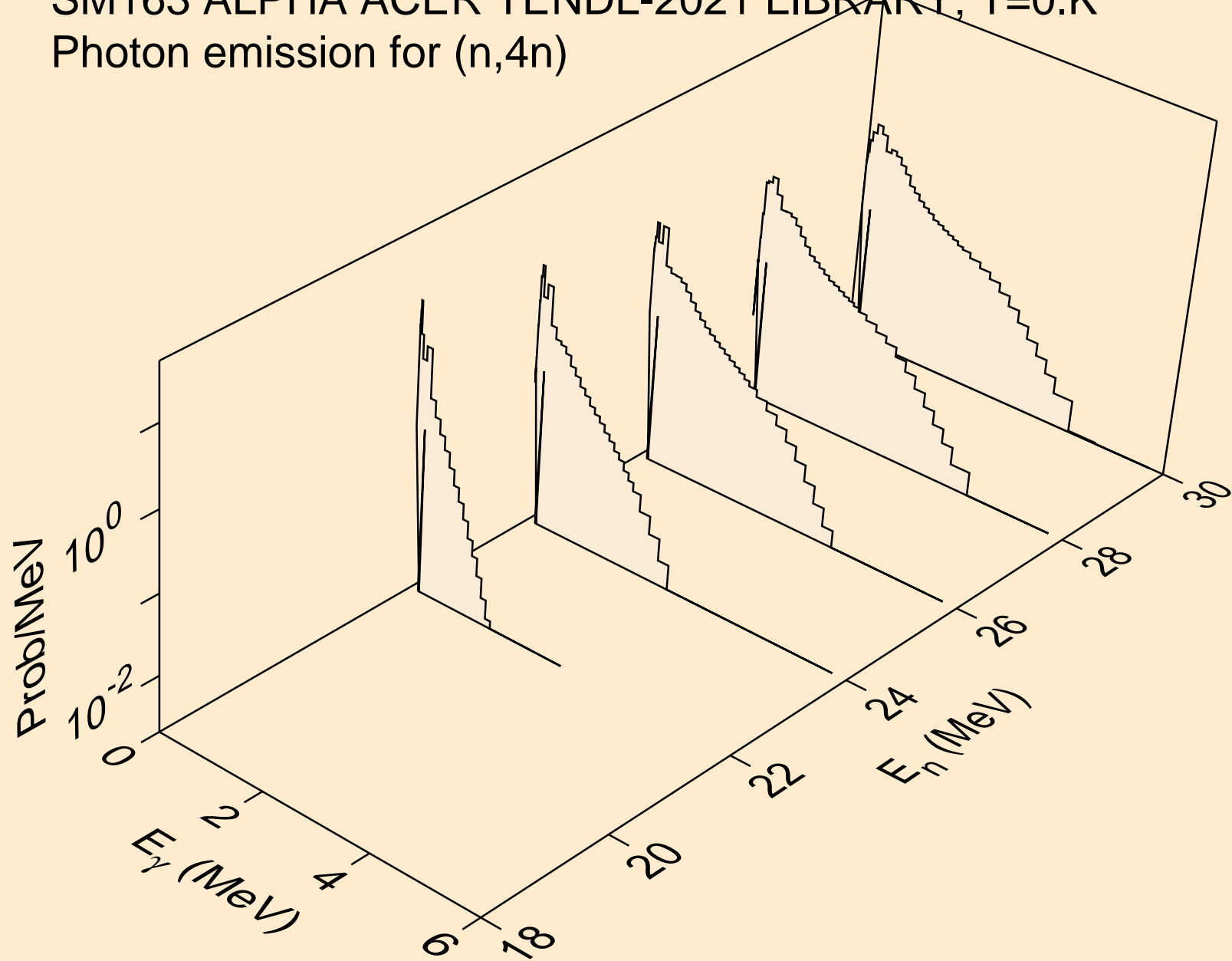



SM163 ALPHA ACER TENDL-2021 LIBRARY; T=0.K  
Photon emission for (n,2np)

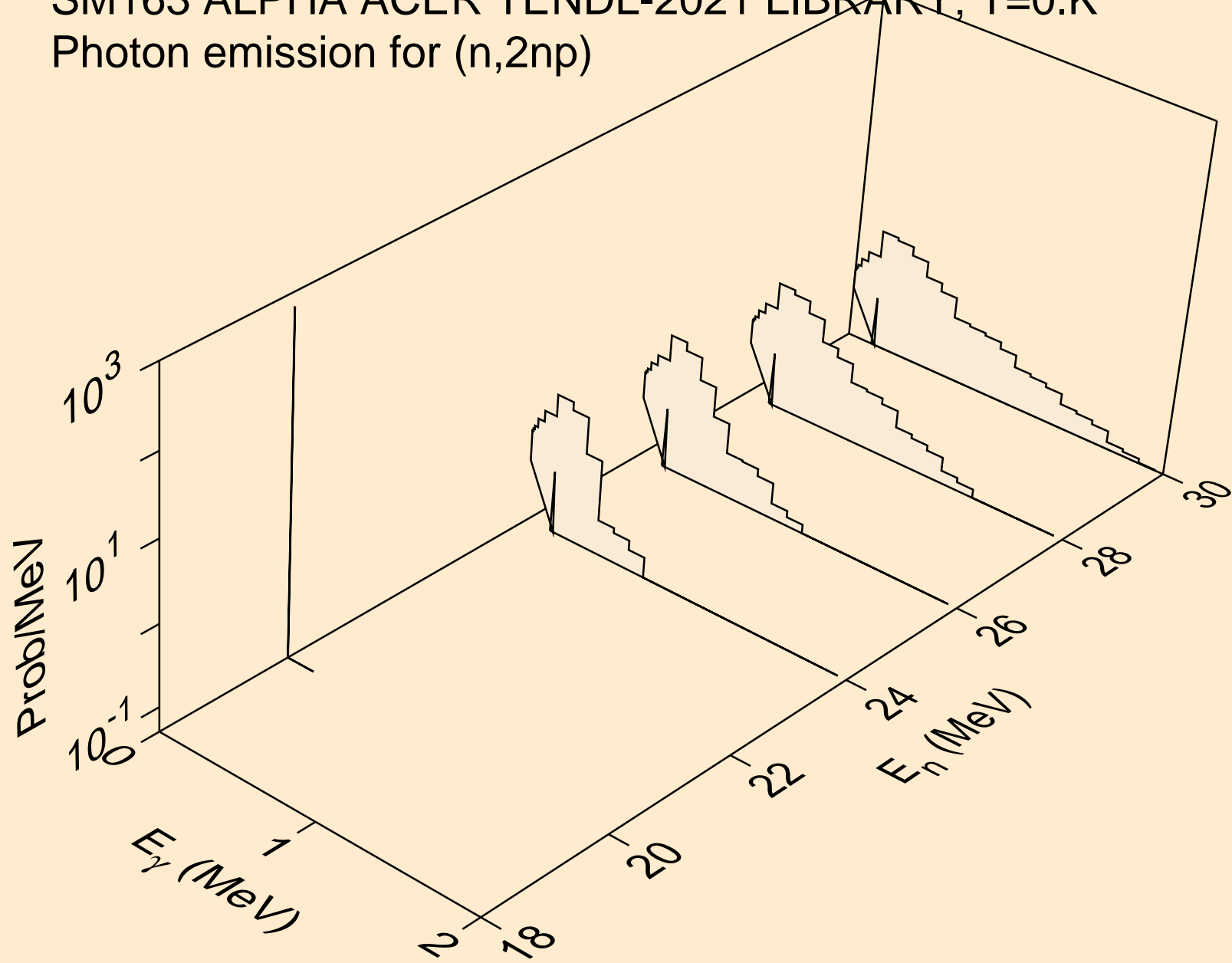

SM163 ALPHA ACER TENDL-2021 LIBRARY; T=0.K  
Photon emission for (n,3np)

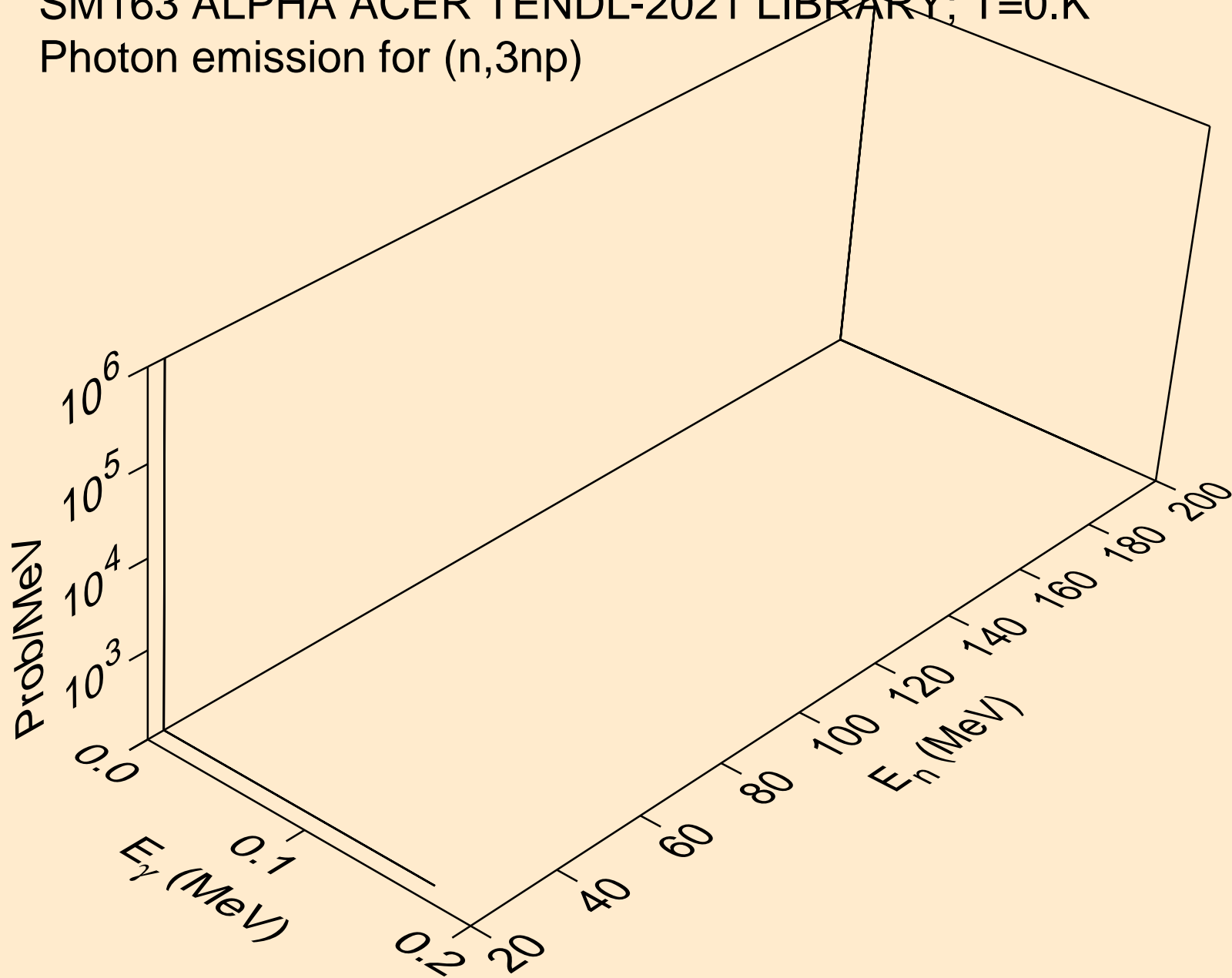

SM163 ALPHA ACER TENDL-2021 LIBRARY; T=0.K  
Photon emission for (n,gma)

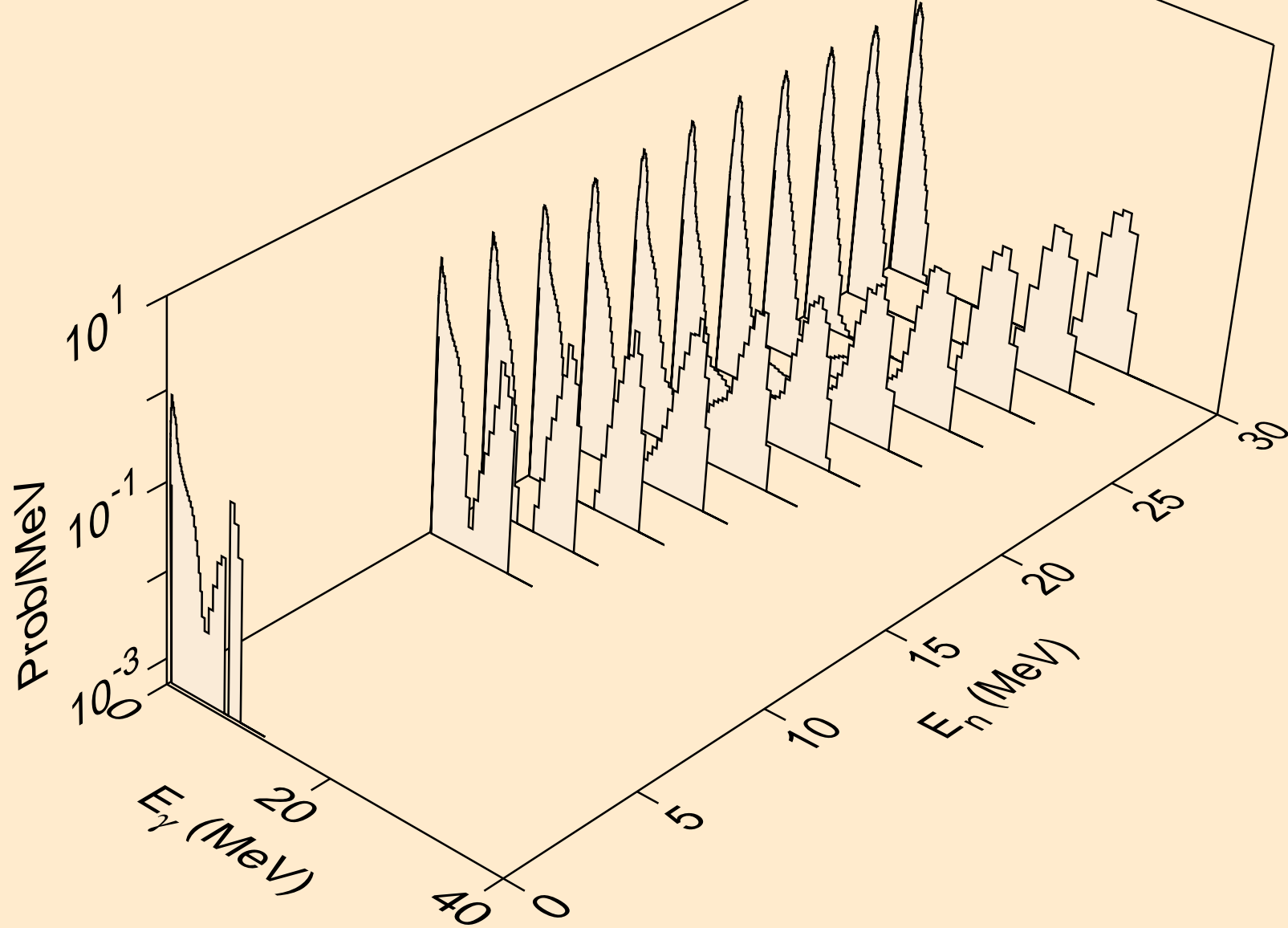

SM163 ALPHA ACER TENDL-2021 LIBRARY; T=0.K  
Photon emission for (n,p)

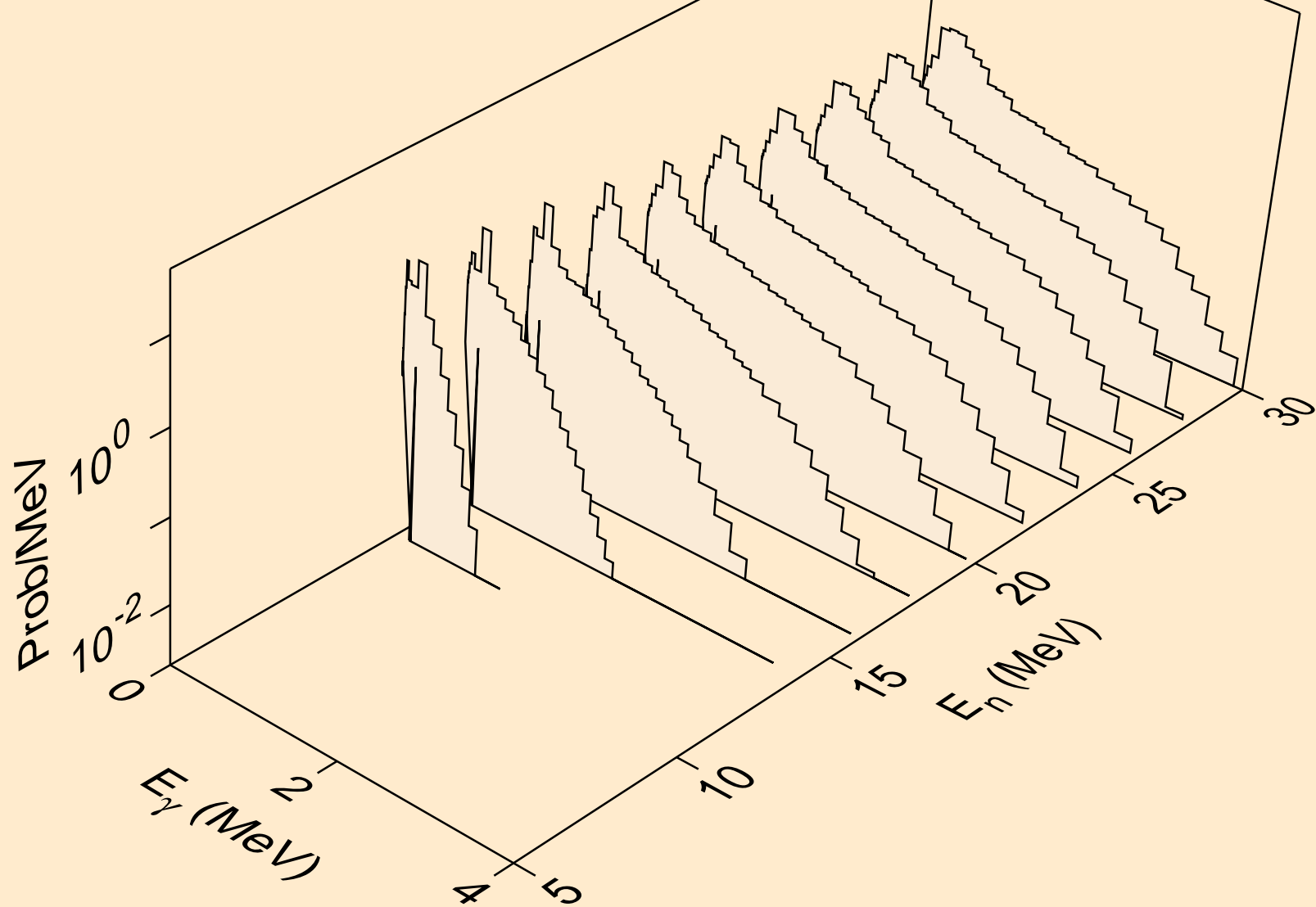

SM163 ALPHA ACER TENDL-2021 LIBRARY; T=0.K  
Photon emission for (n,d)

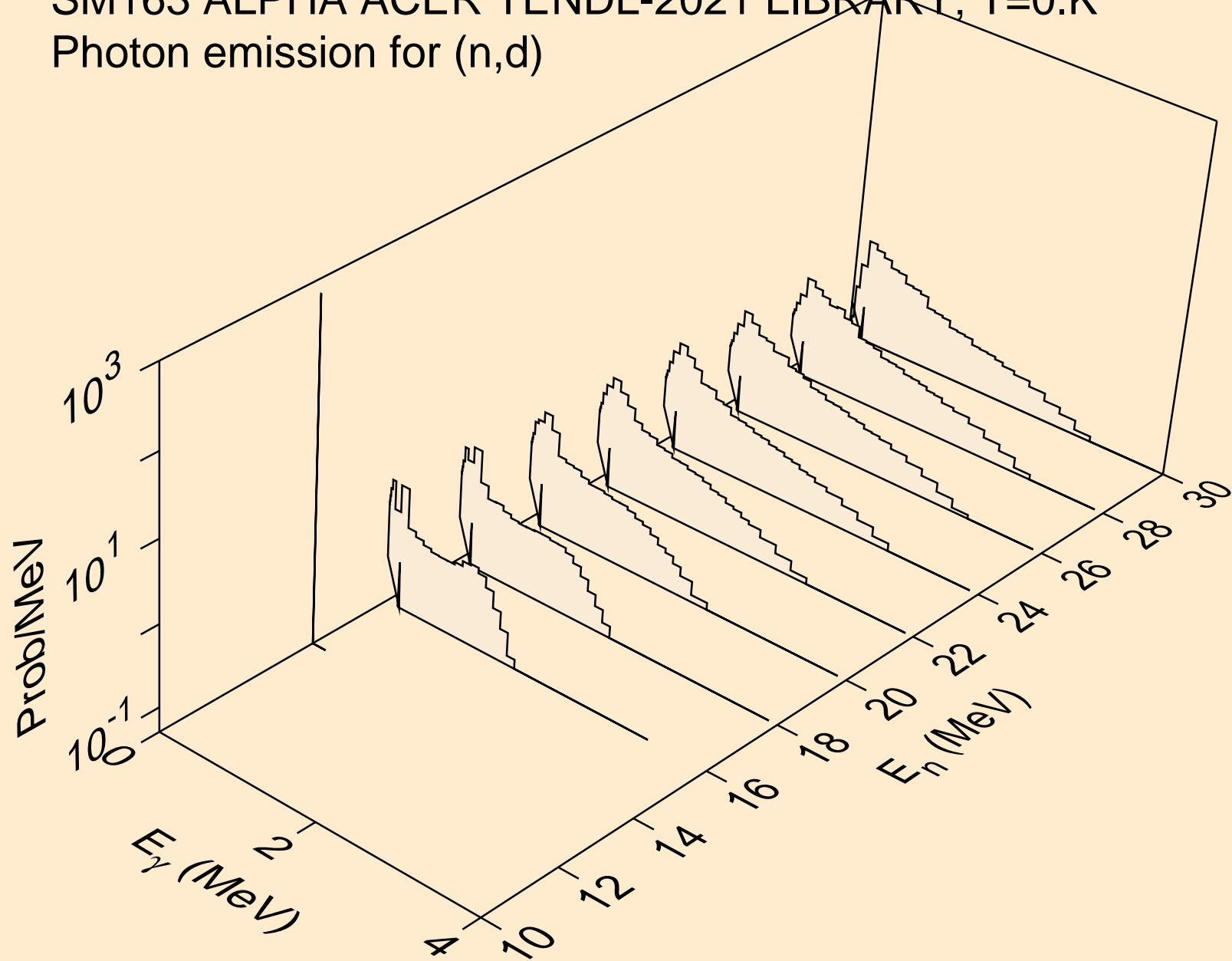

SM163 ALPHA ACER TENDL-2021 LIBRARY; T=0.K  
Photon emission for (n,t)

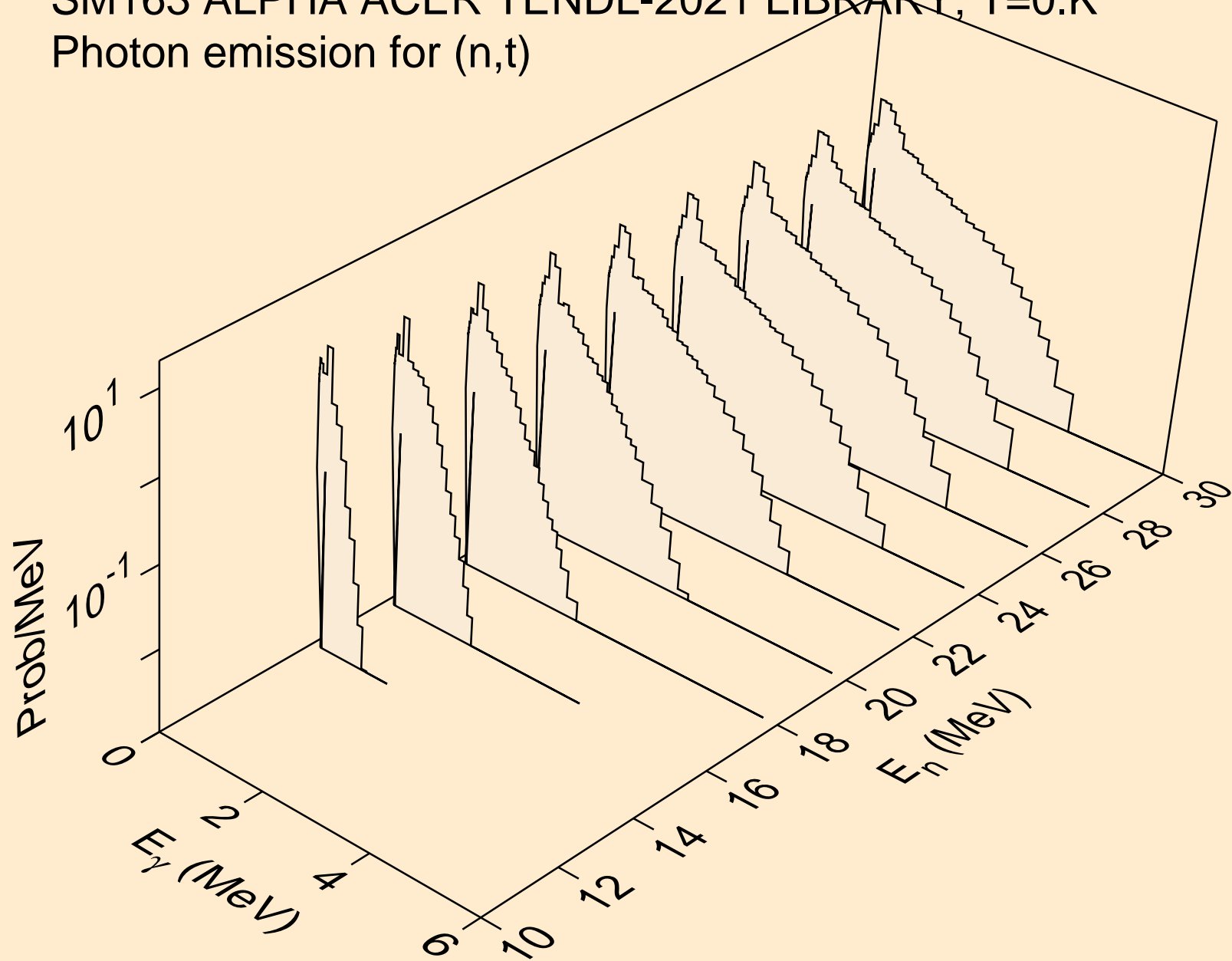

SM163 ALPHA ACER TENDL-2021 LIBRARY; T=0.K  
Photon emission for (n,he3)

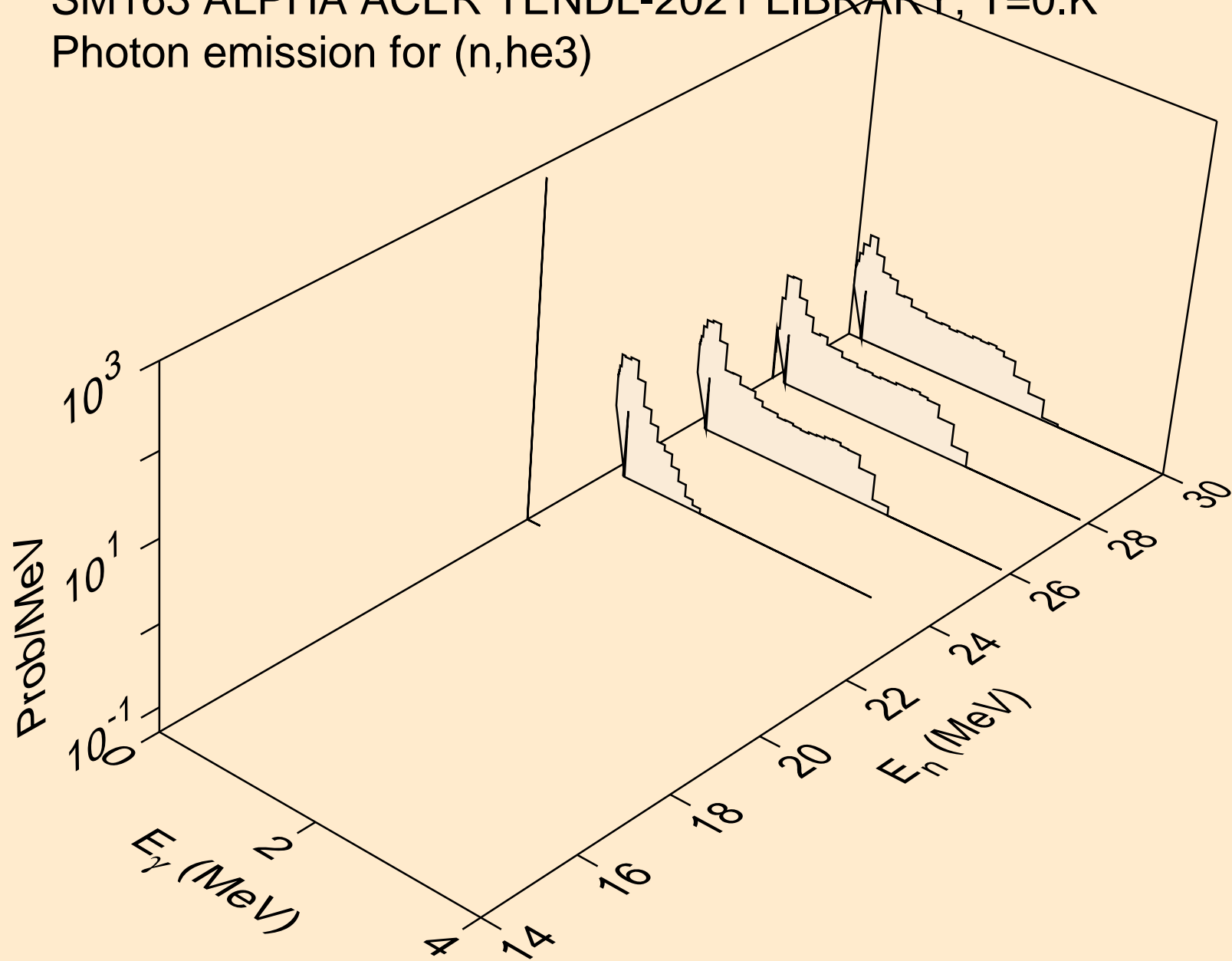

SM163 ALPHA ACER TENDL-2021 LIBRARY; T=0.K  
Photon emission for inelastic

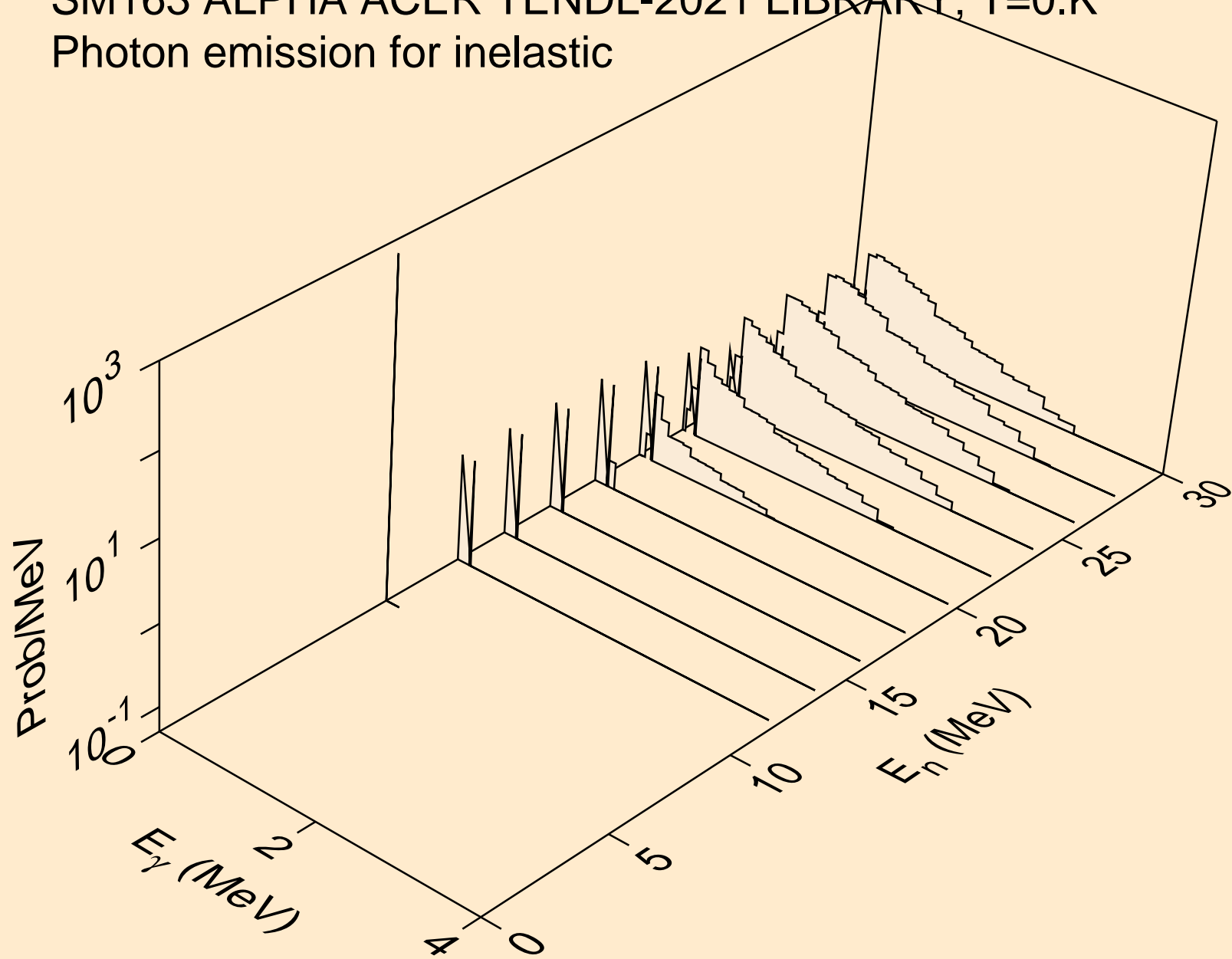



SM163 ALPHA ACER TENDL-2021 LIBRARY; T=0.K  
Particle heating contributions

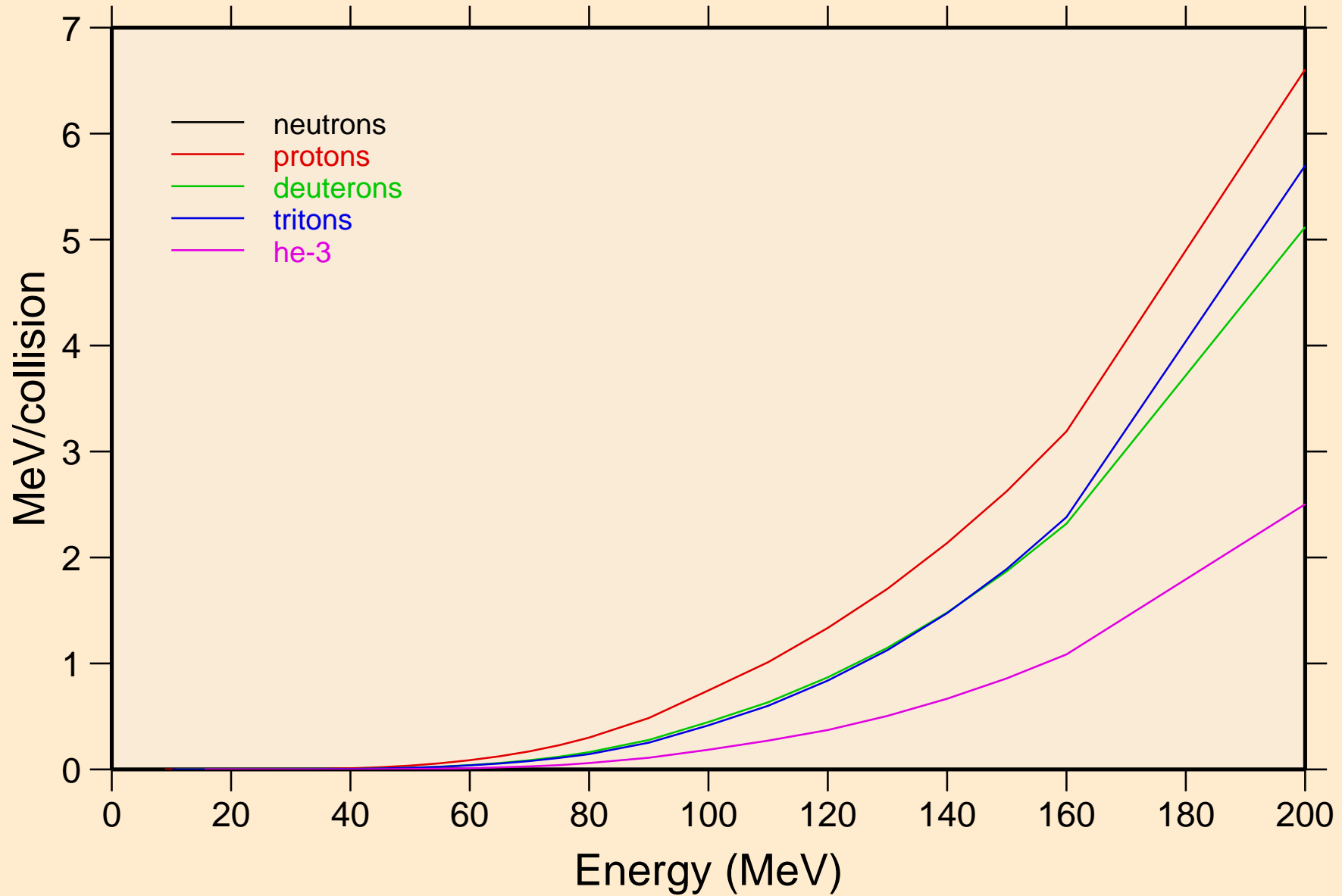

SM163 ALPHA ACER TENDL-2021 LIBRARY; T=0.K

Recoil Heating

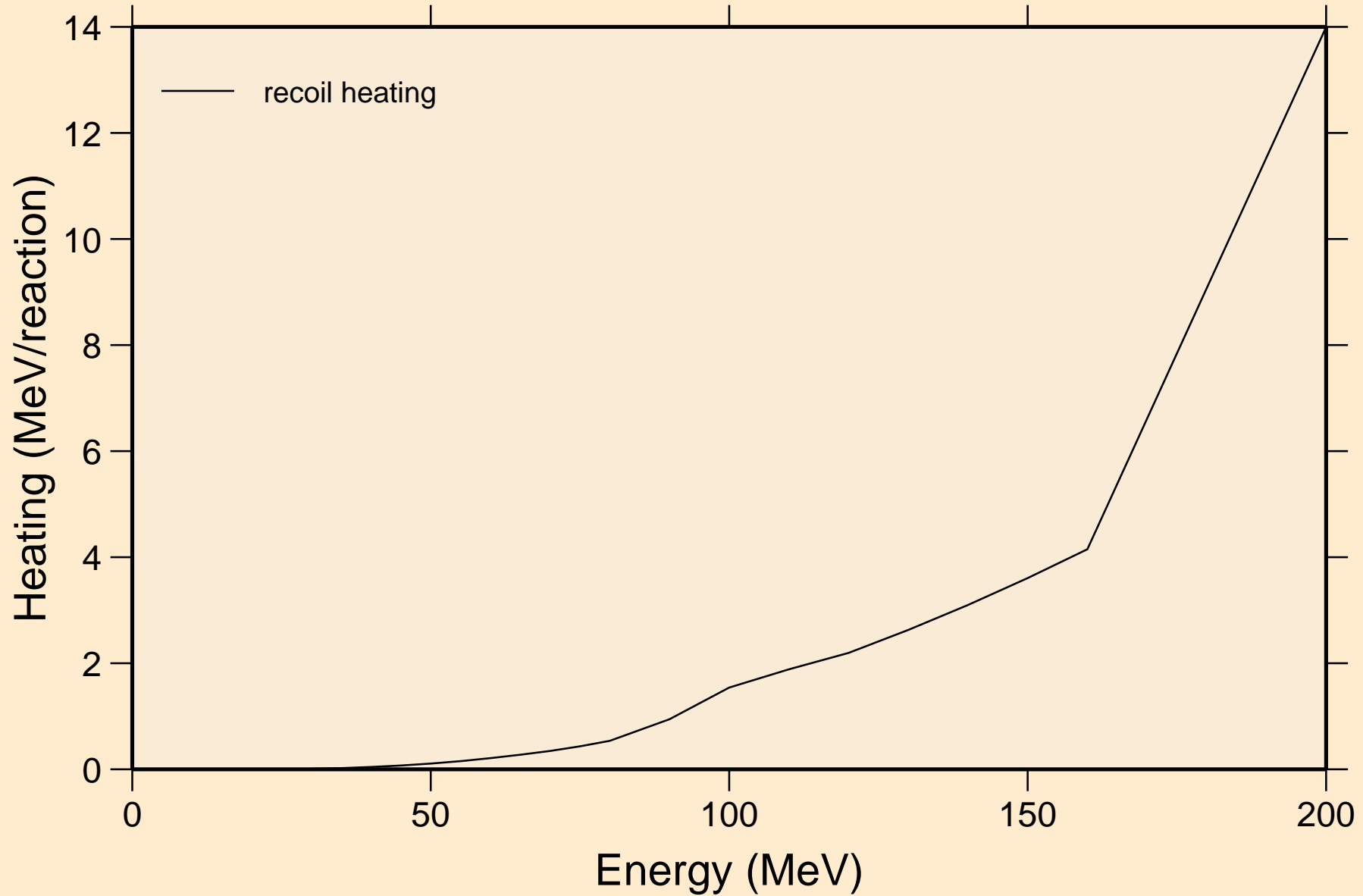

SM163 ALPHA ACER TENDL-2021 LIBRARY; T=0.K  
Particle production cross sections

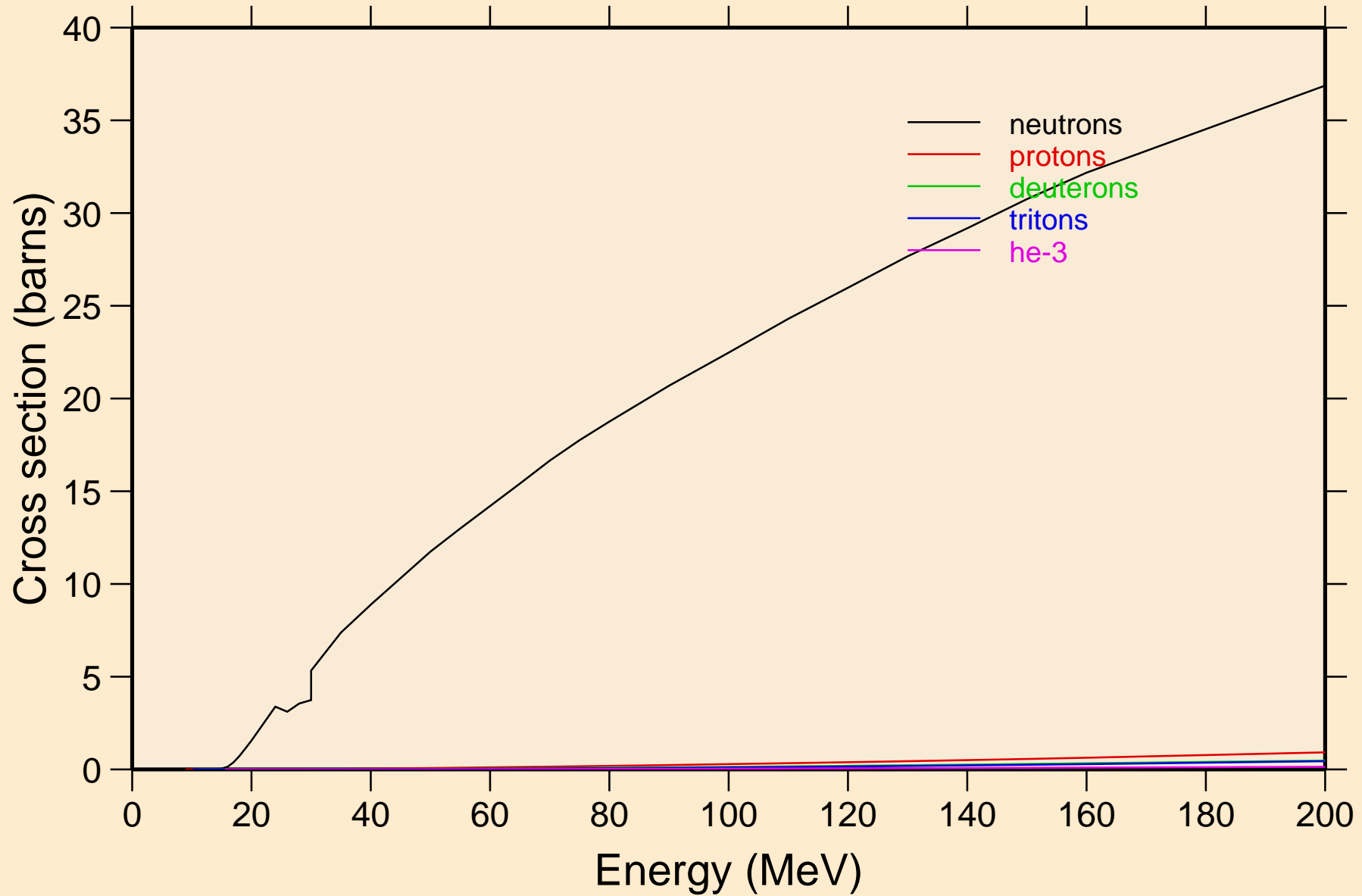

SM163 ALPHA ACER TENDL-2021 LIBRARY; T=0.K  
neutrons from (a,n)

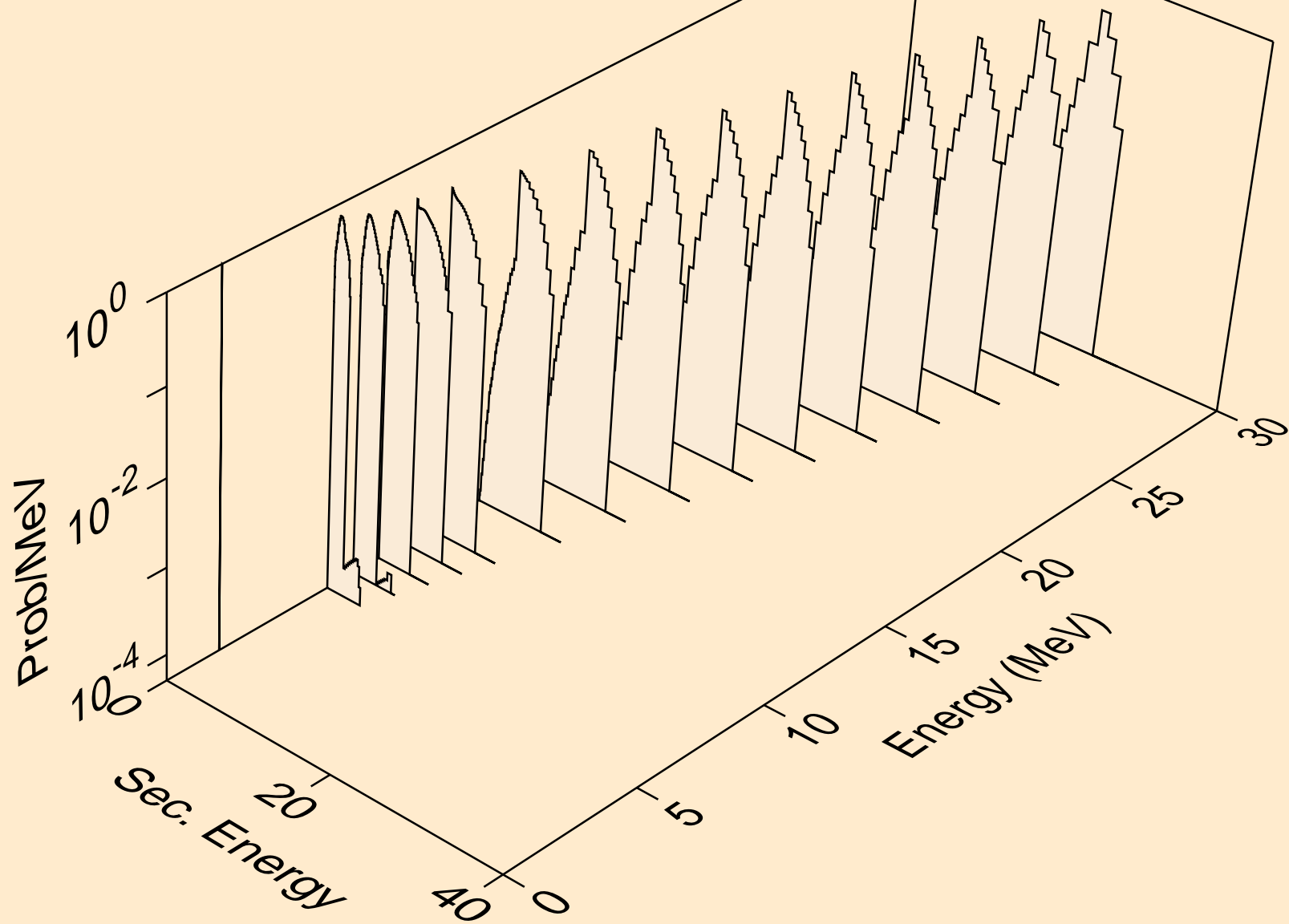

SM163 ALPHA ACER TENDL-2021 LIBRARY; T=0.K  
neutrons from (a,x)

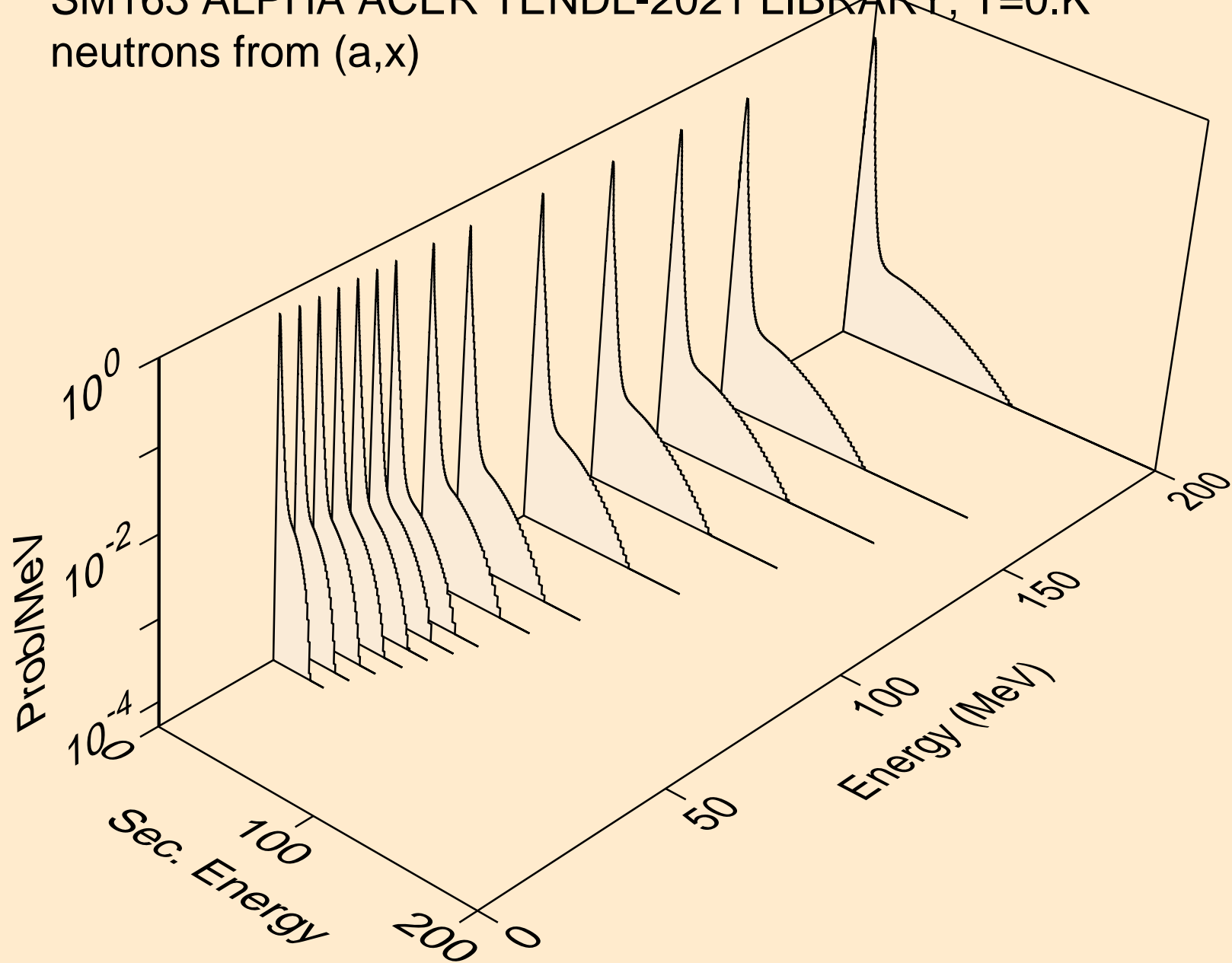

SM163 ALPHA ACER TENDL-2021 LIBRARY; T=0.K  
neutrons from (a,2nd)

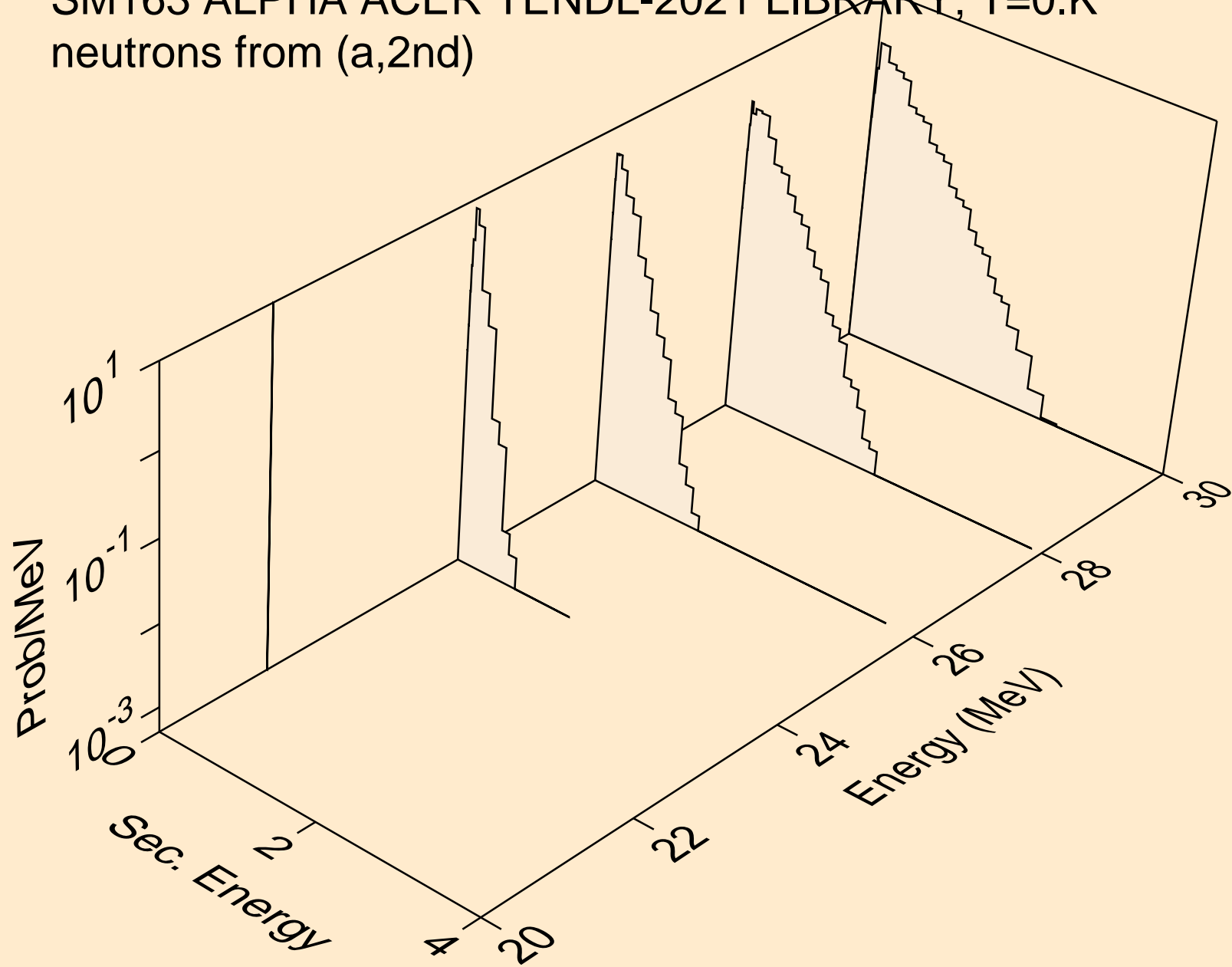

SM163 ALPHA ACER TENDL-2021 LIBRARY; T=0.K  
neutrons from (a,2n)

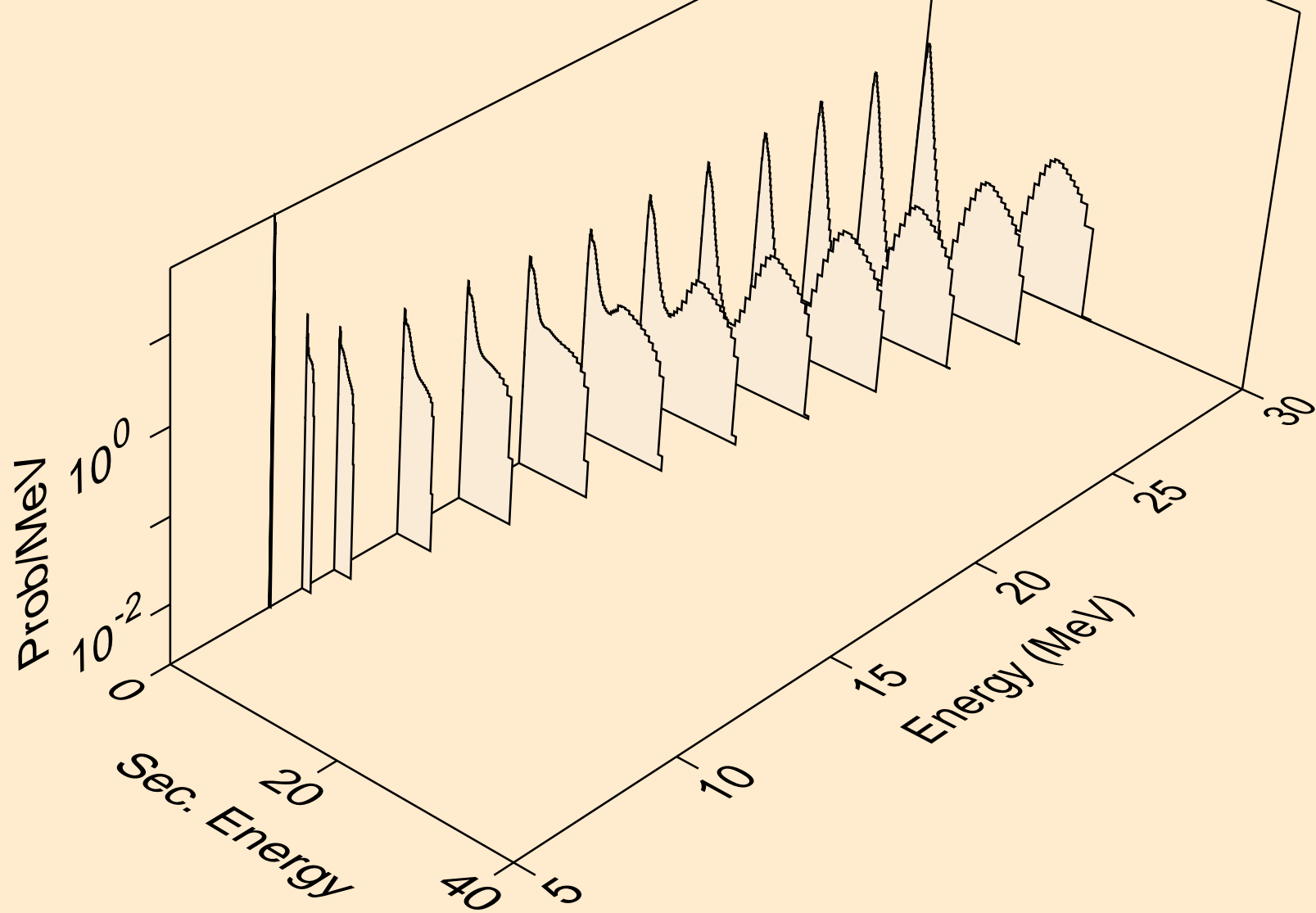

SM163 ALPHA ACER TENDL-2021 LIBRARY; T=0.K  
neutrons from (a,3n)

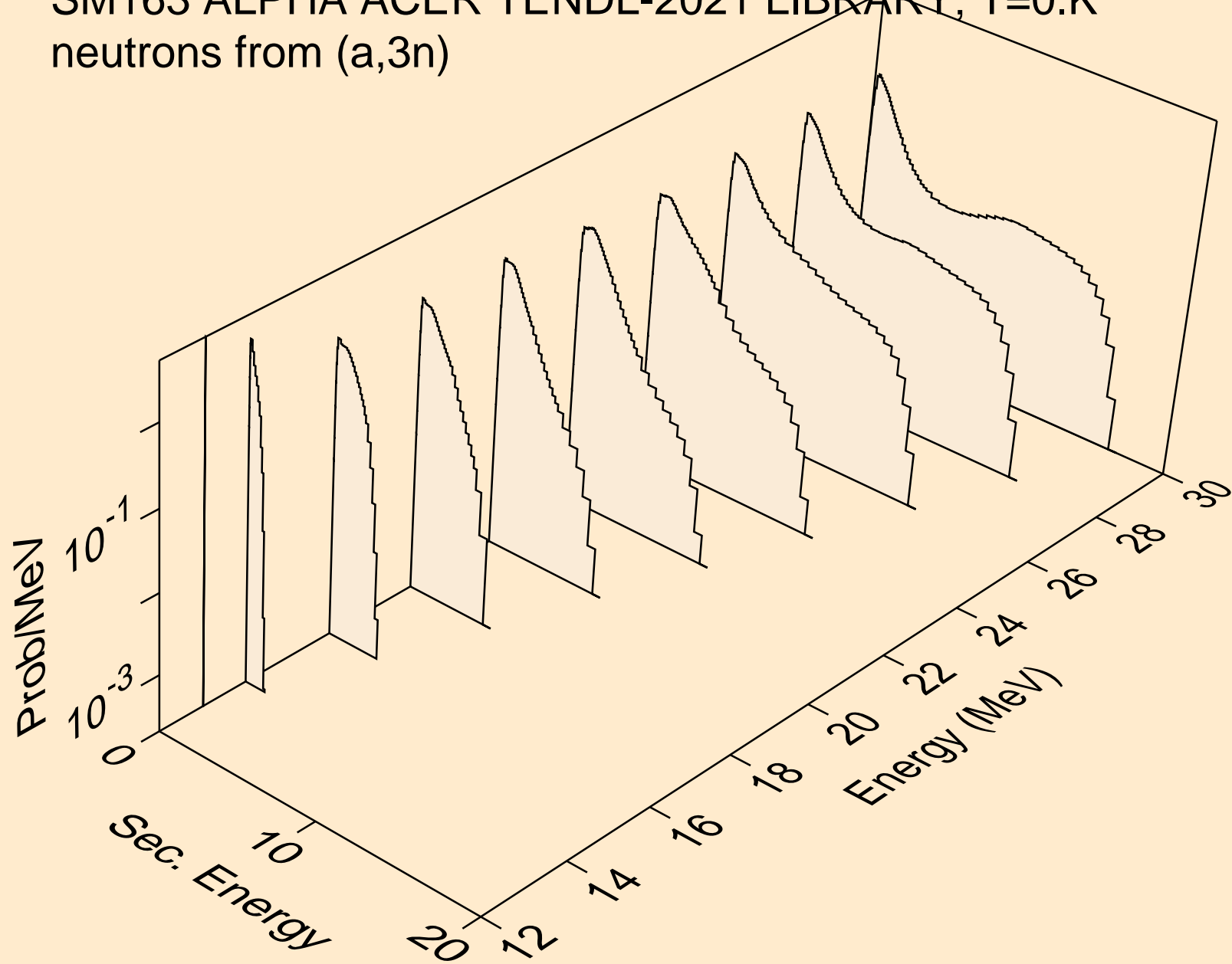



SM163 ALPHA ACER TENDL-2021 LIBRARY; T=0.K  
neutrons from (a,n\*)a

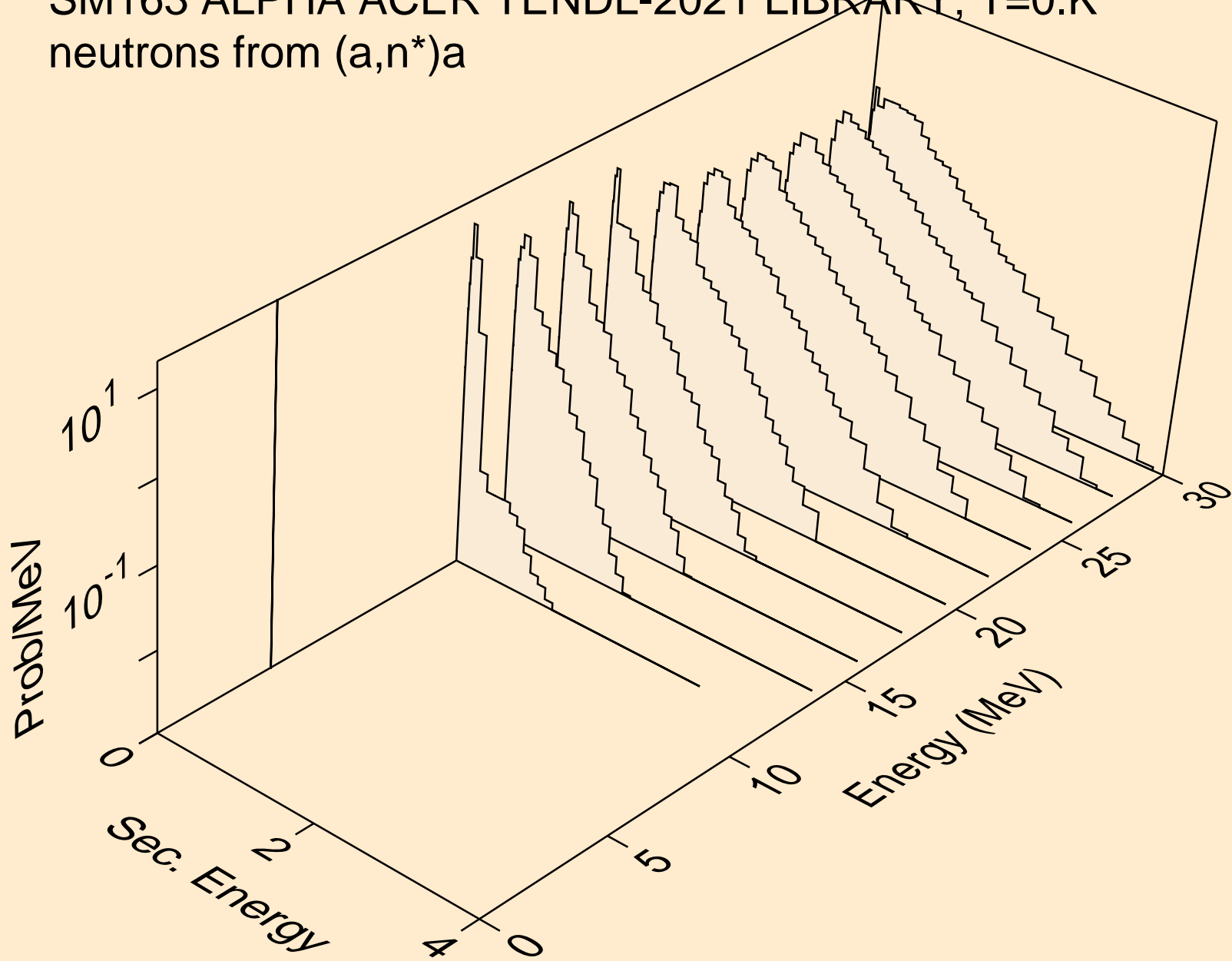

SM163 ALPHA ACER TENDL-2021 LIBRARY; T=0.K  
neutrons from (a,2n)a

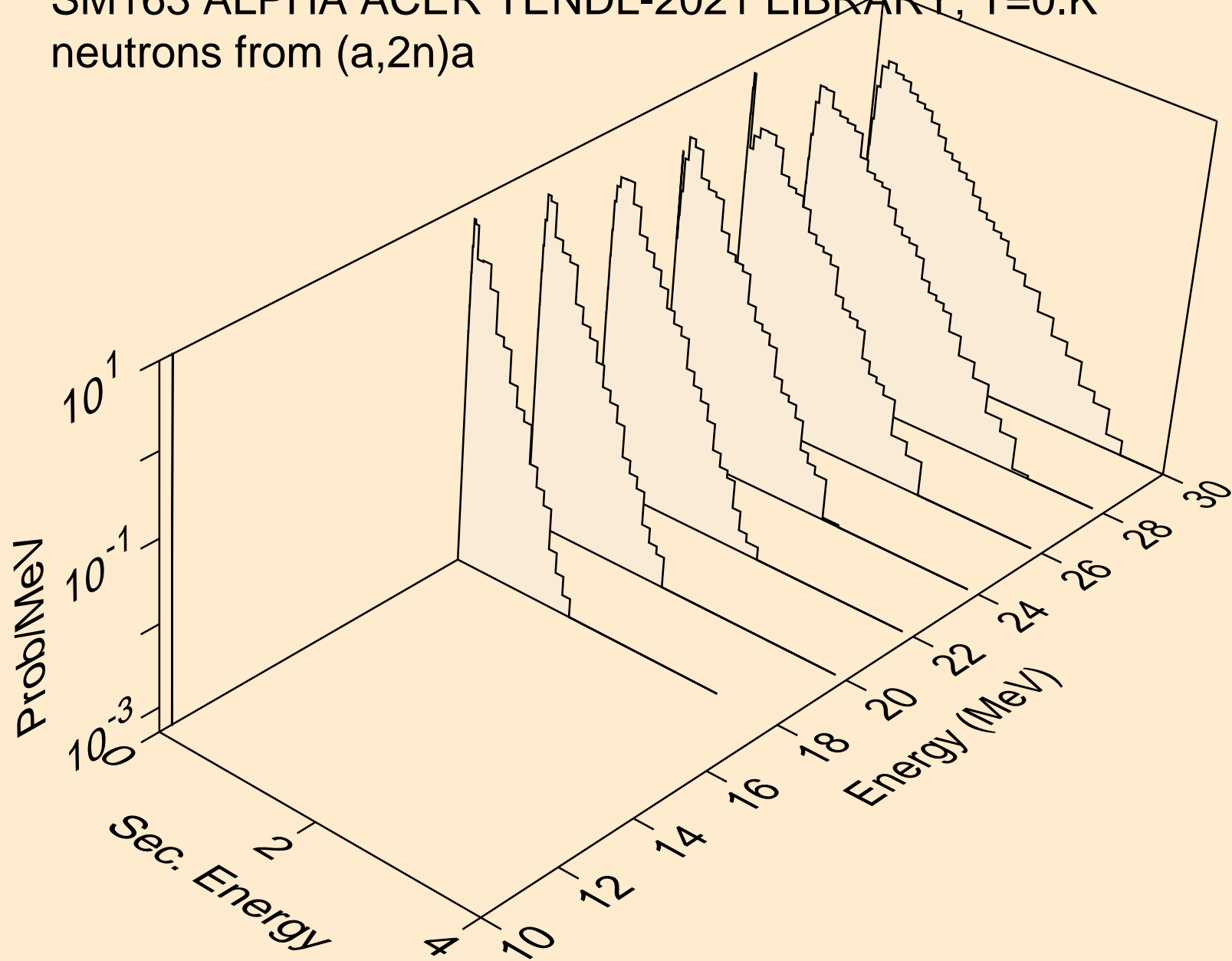

SM163 ALPHA ACER TENDL-2021 LIBRARY; T=0.K  
neutrons from (a,3n)a

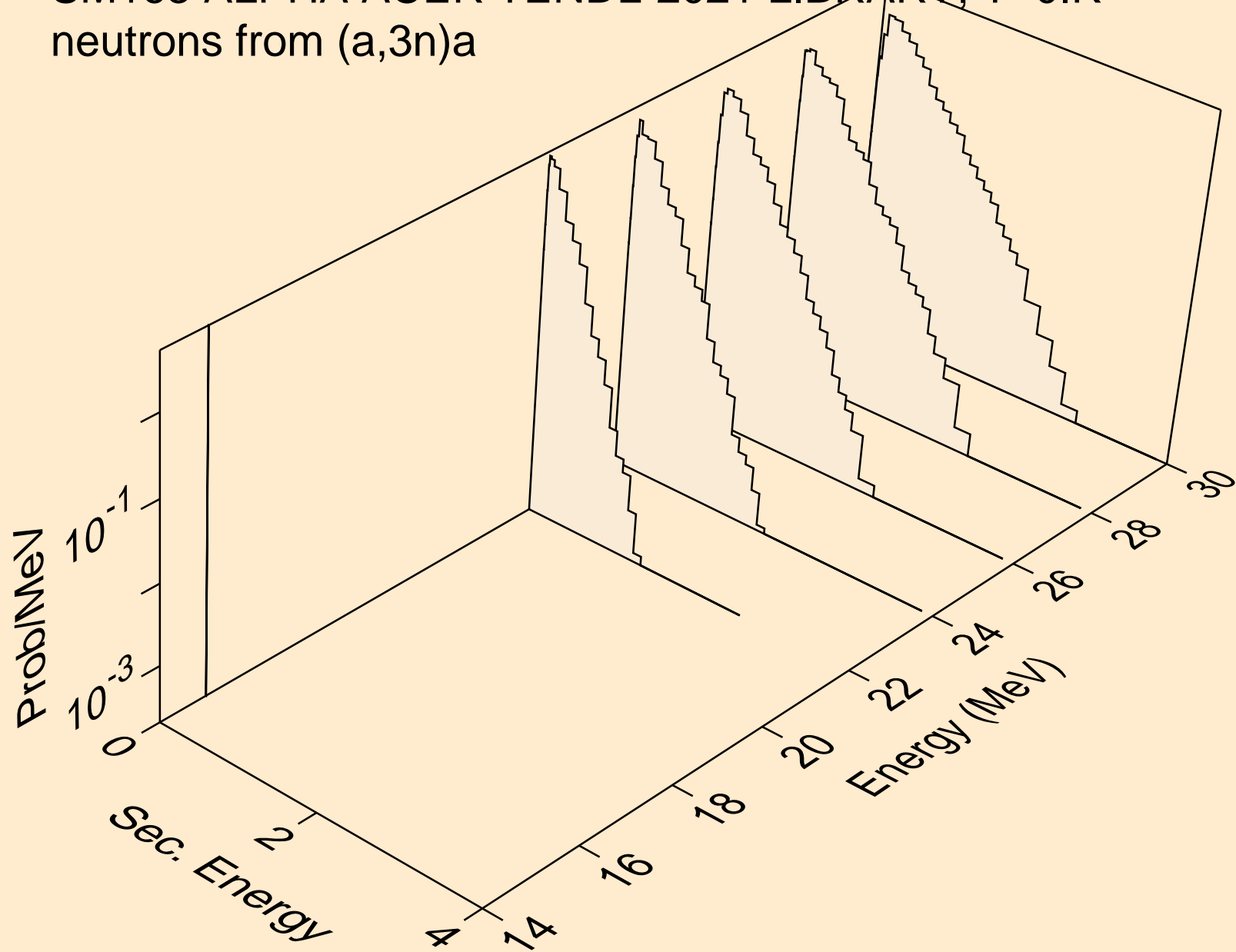

SM163 ALPHA ACER TENDL-2021 LIBRARY; T=0.K  
neutrons from (a,n\*)p

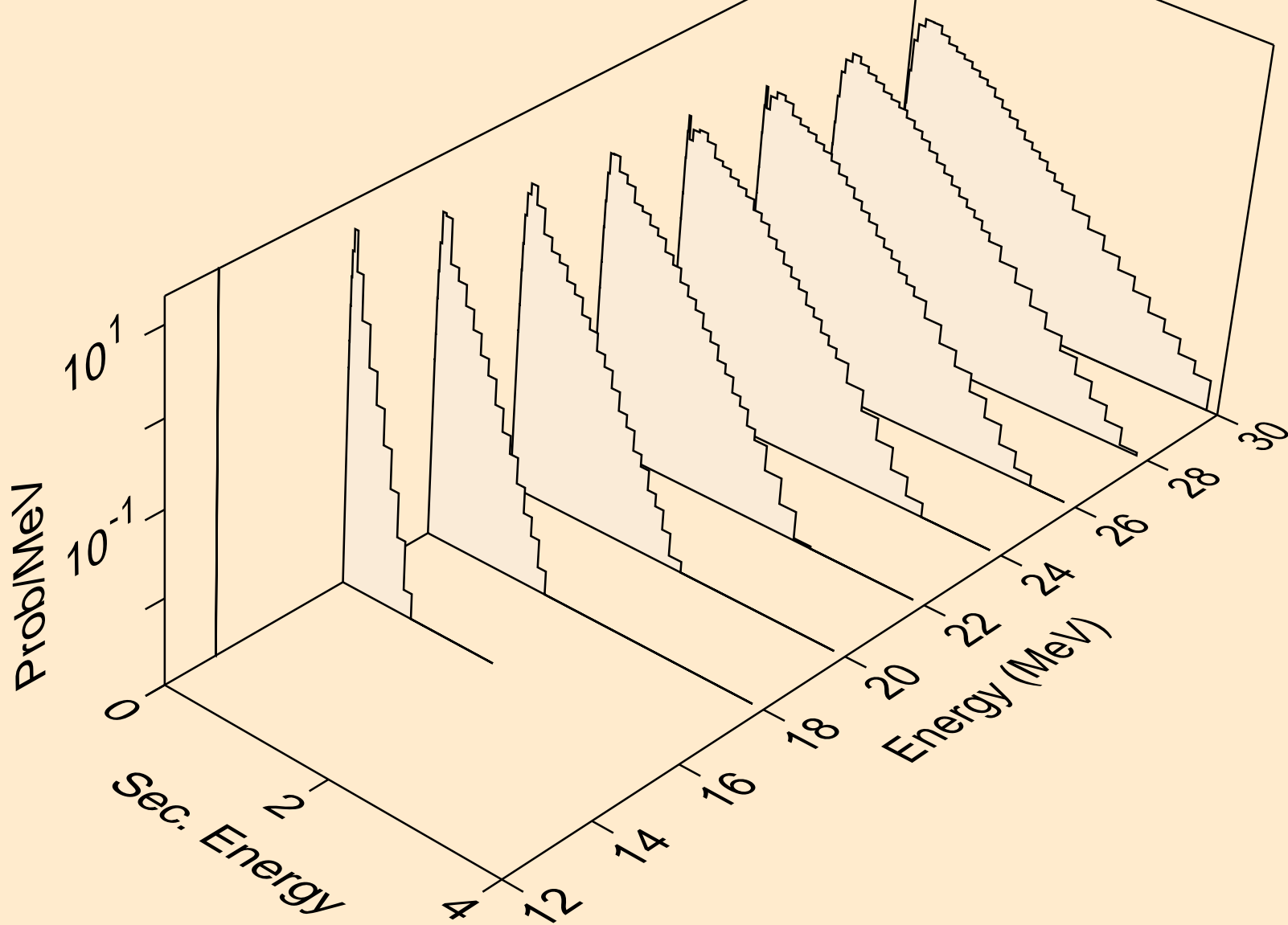

SM163 ALPHA ACER TENDL-2021 LIBRARY; T=0.K  
neutrons from (a,n\*)d

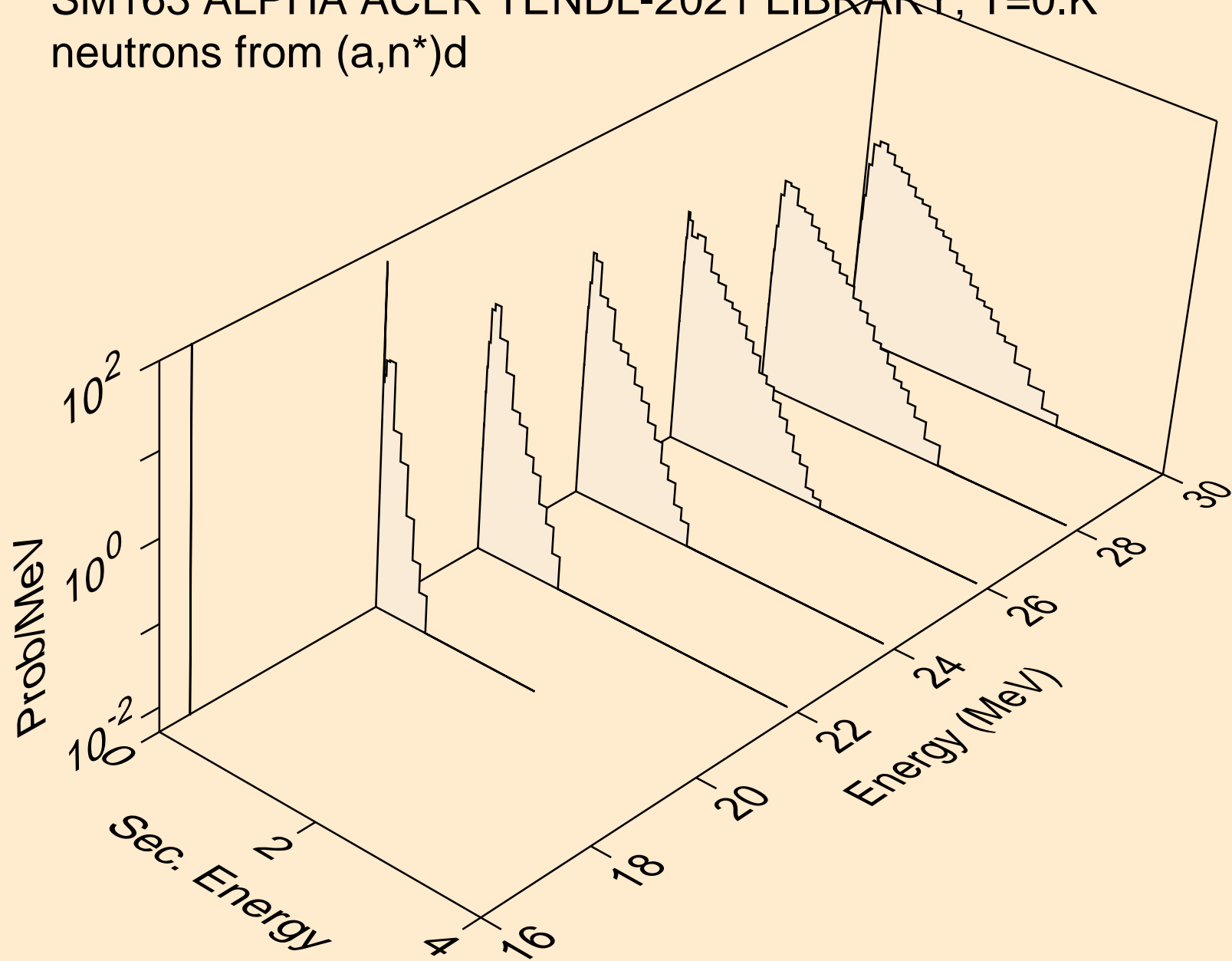

SM163 ALPHA ACER TENDL-2021 LIBRARY; T=0.K  
neutrons from (a,n\*)t

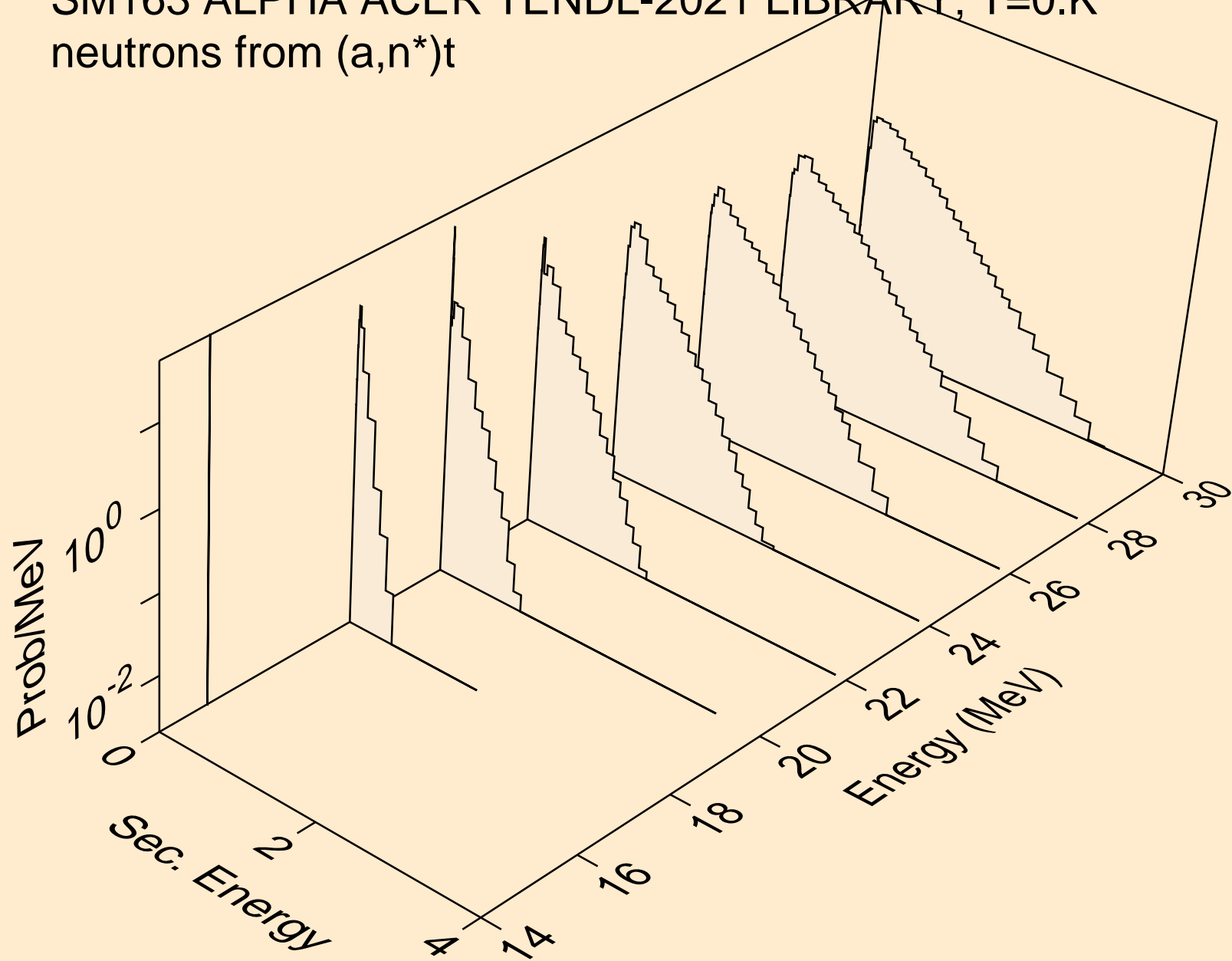

SM163 ALPHA ACER TENDL-2021 LIBRARY; T=0.K  
neutrons from (a,4n)

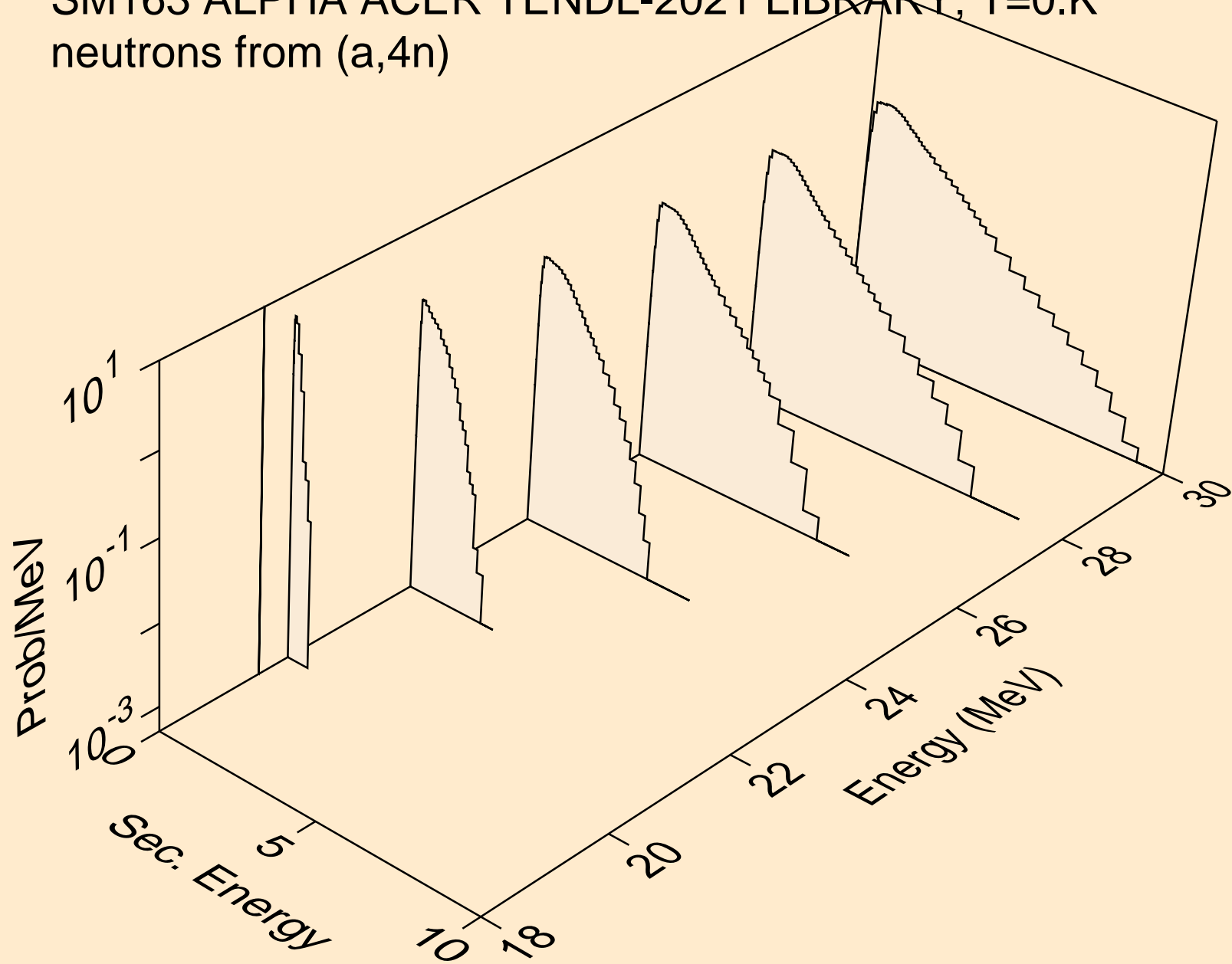

SM163 ALPHA ACER TENDL-2021 LIBRARY; T=0.K  
neutrons from (a,2np)

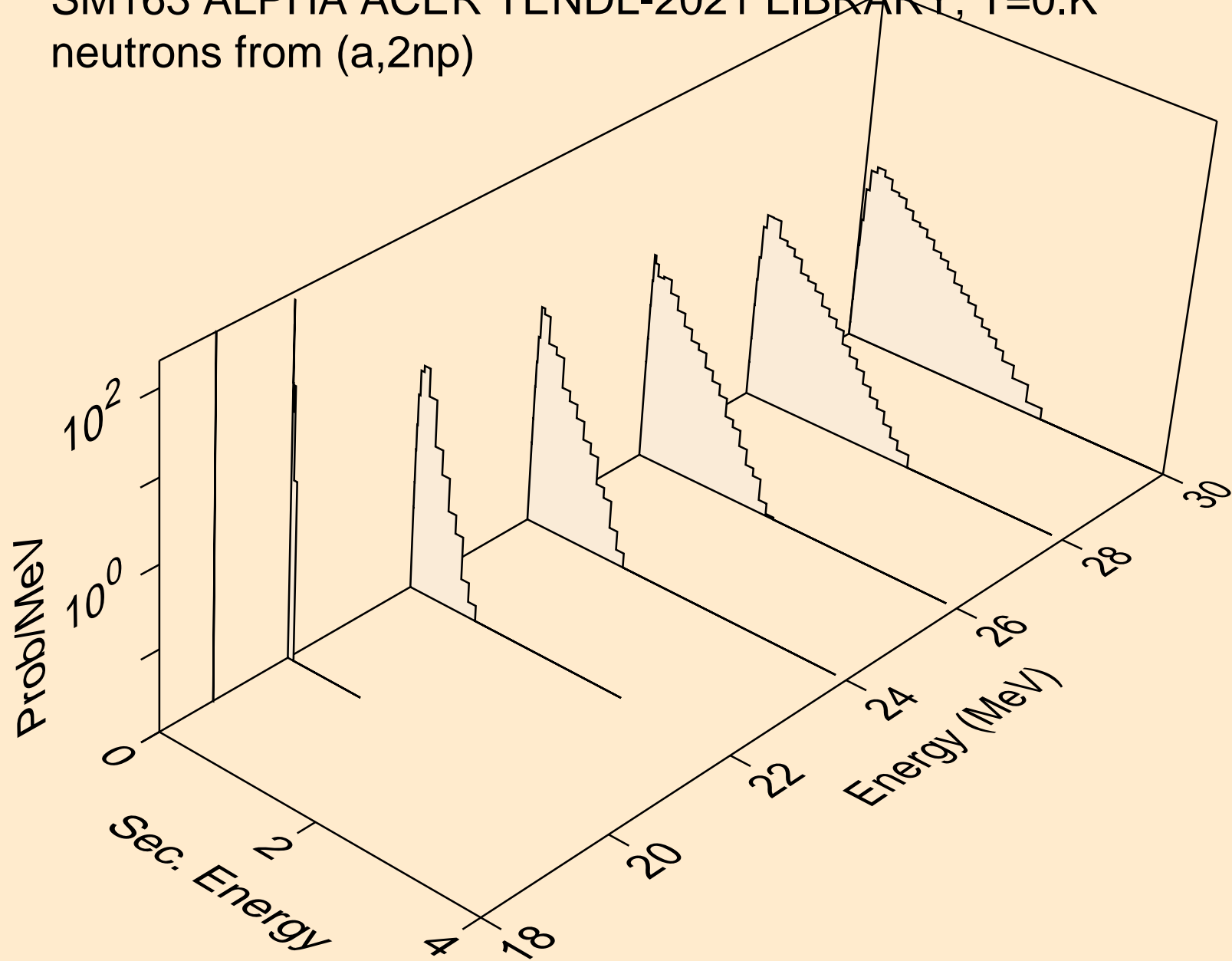



SM163 ALPHA ACER TENDL-2021 LIBRARY; T=0.K  
neutrons from (a,3np)

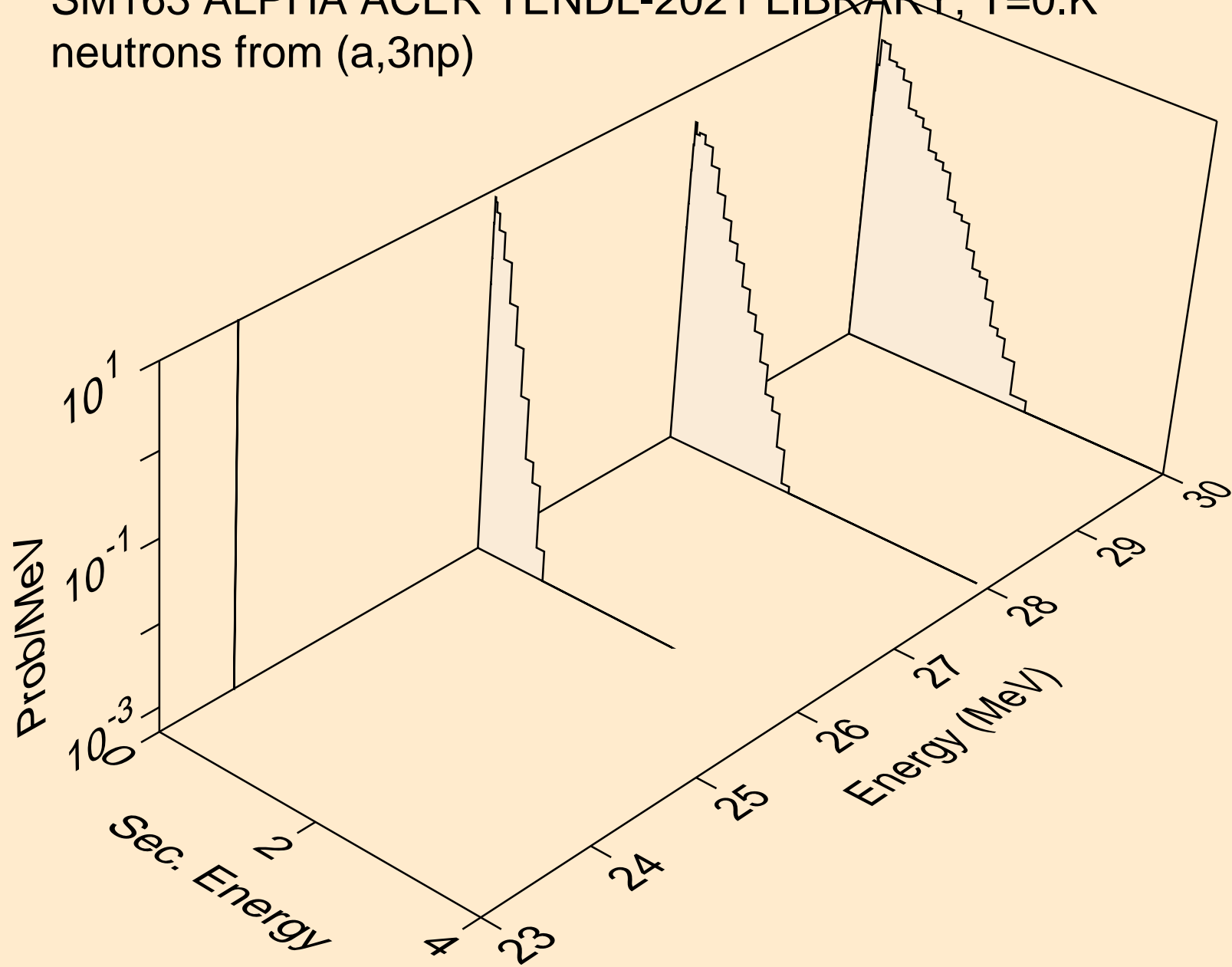

SM163 ALPHA ACER TENDL-2021 LIBRARY; T=0.K  
protons from (a,x)

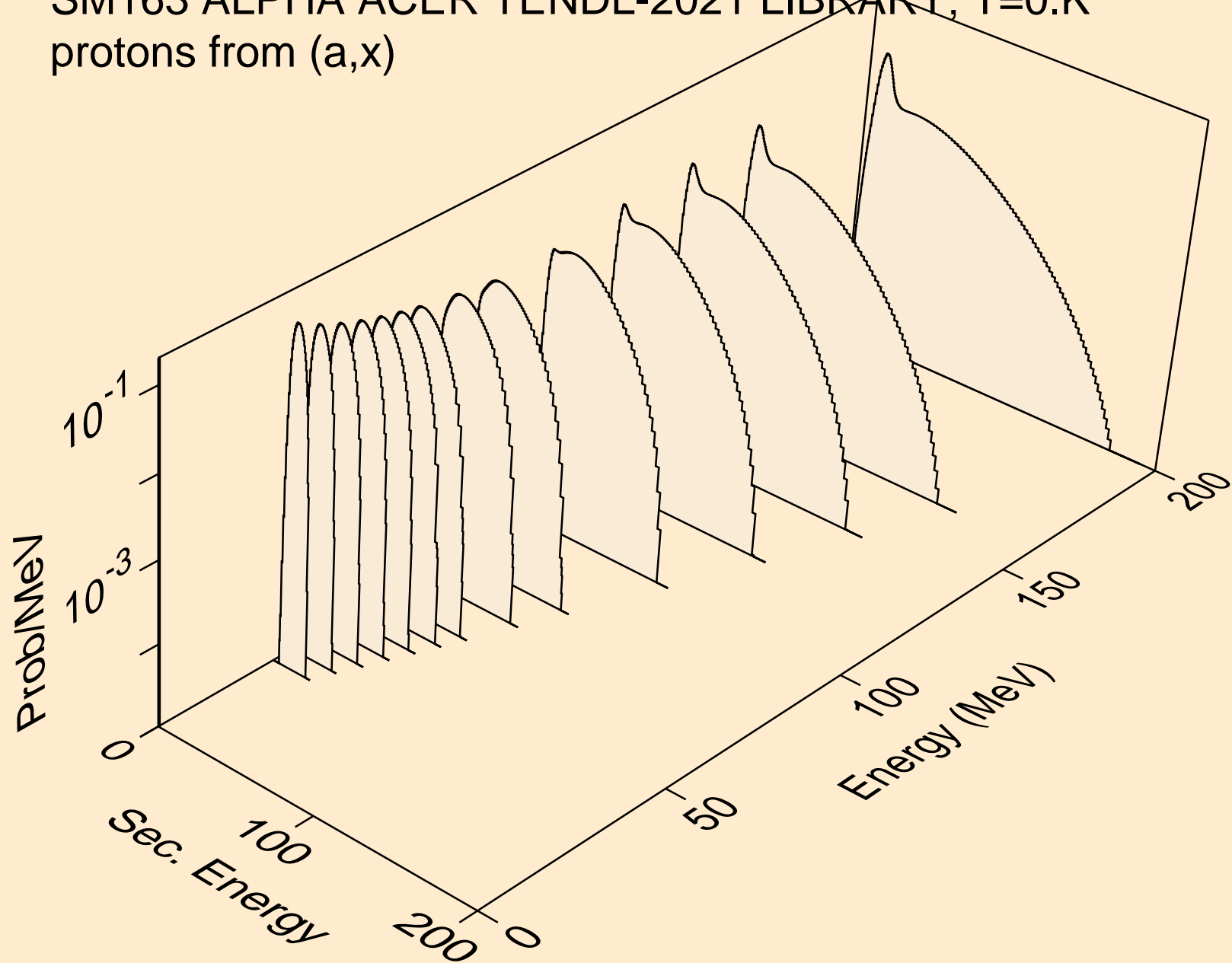

SM163 ALPHA ACER TENDL-2021 LIBRARY; T=0.K  
protons from (a,n\*)p

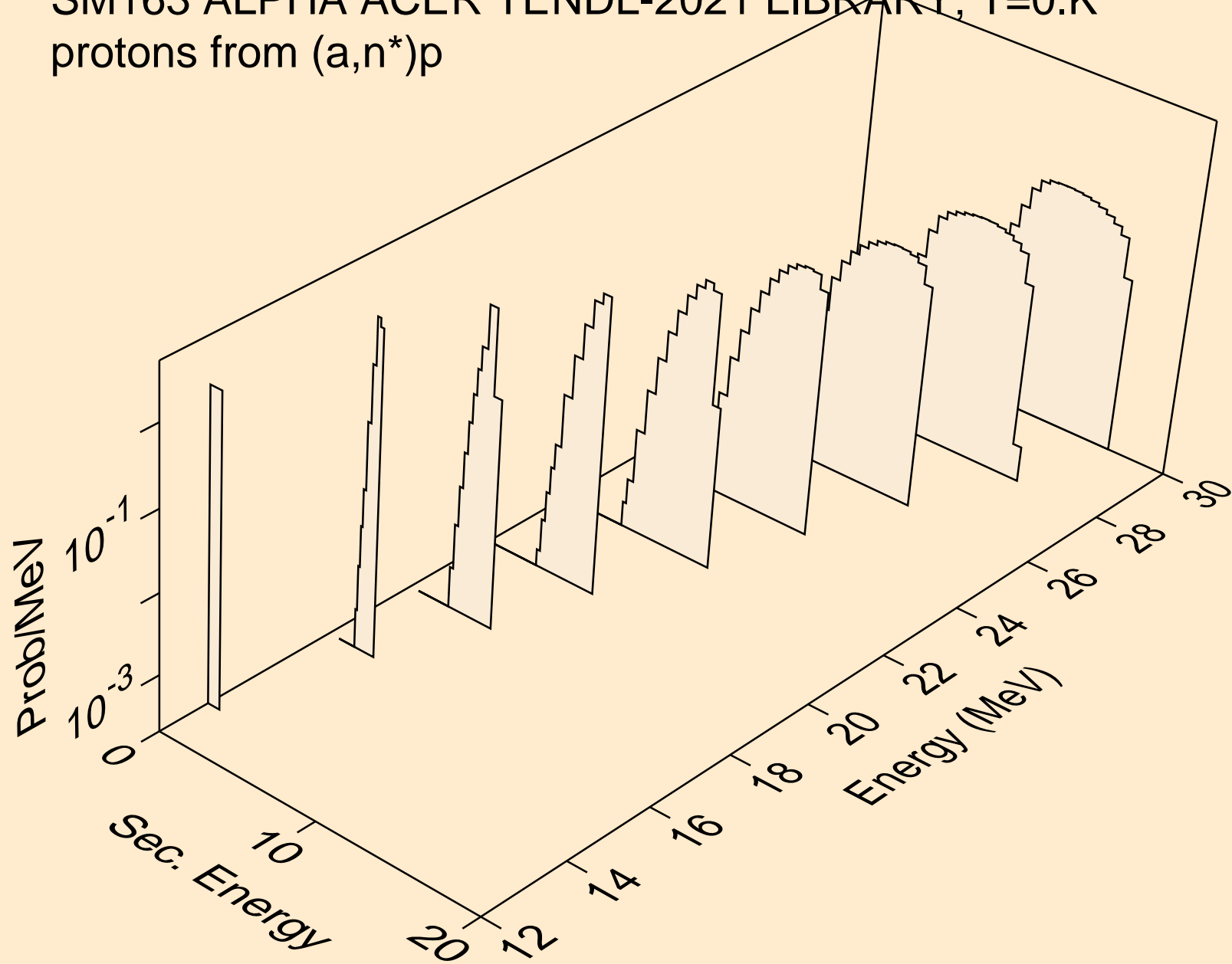

SM163 ALPHA ACER TENDL-2021 LIBRARY; T=0.K  
protons from (a,2np)

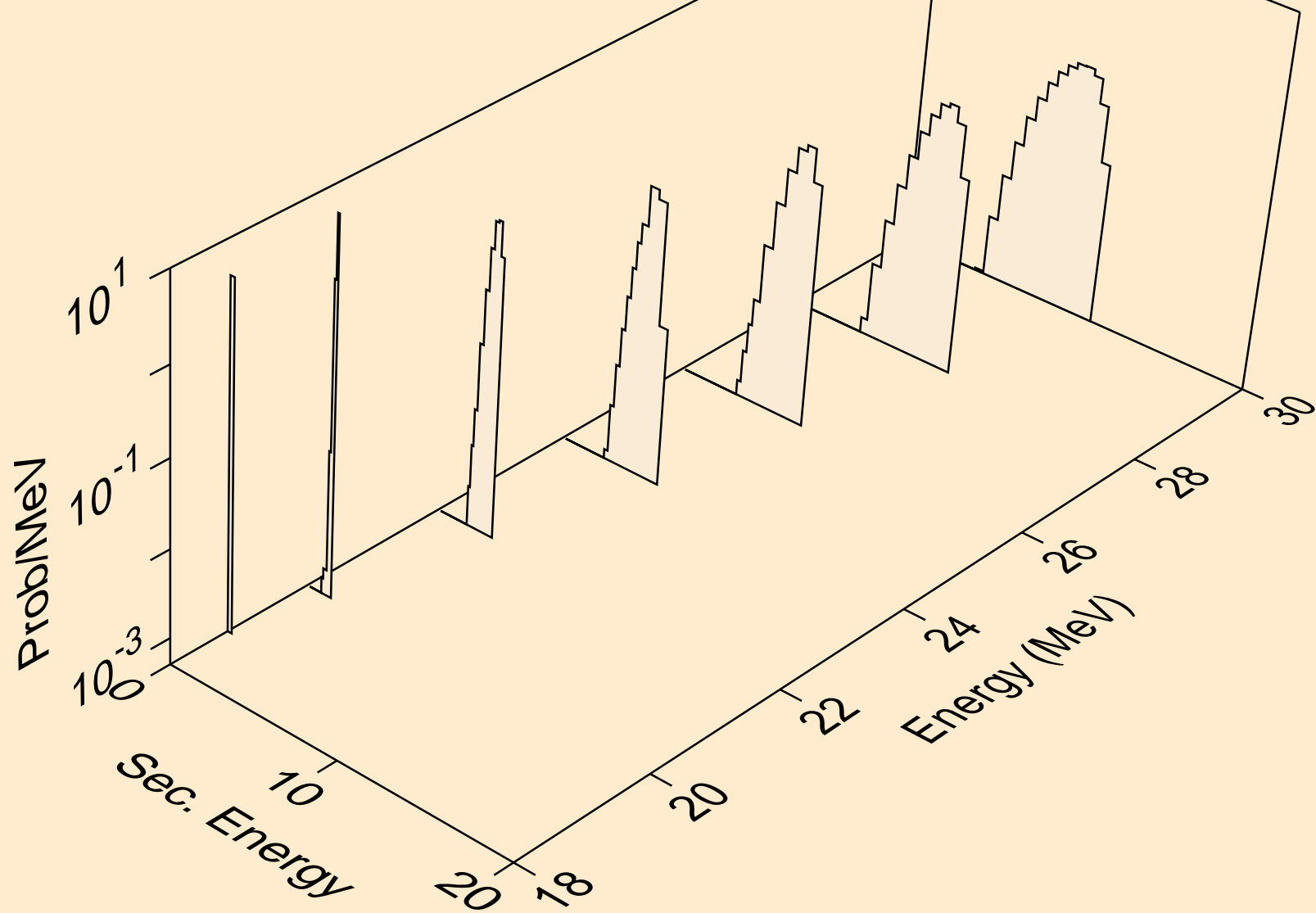

SM163 ALPHA ACER TENDL-2021 LIBRARY; T=0.K  
protons from (a,3np)

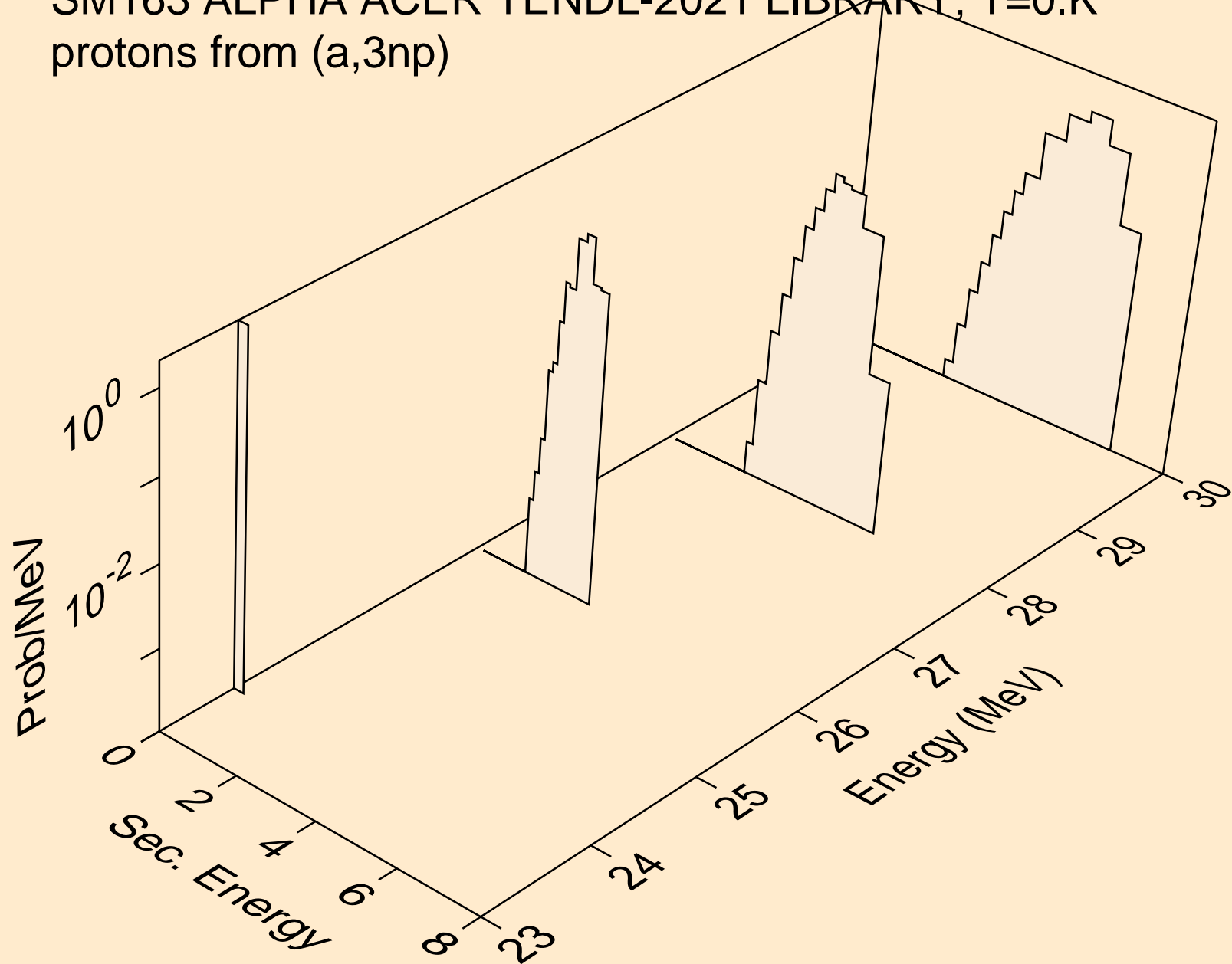

SM163 ALPHA ACER TENDL-2021 LIBRARY; T=0.K  
protons from (a,p)

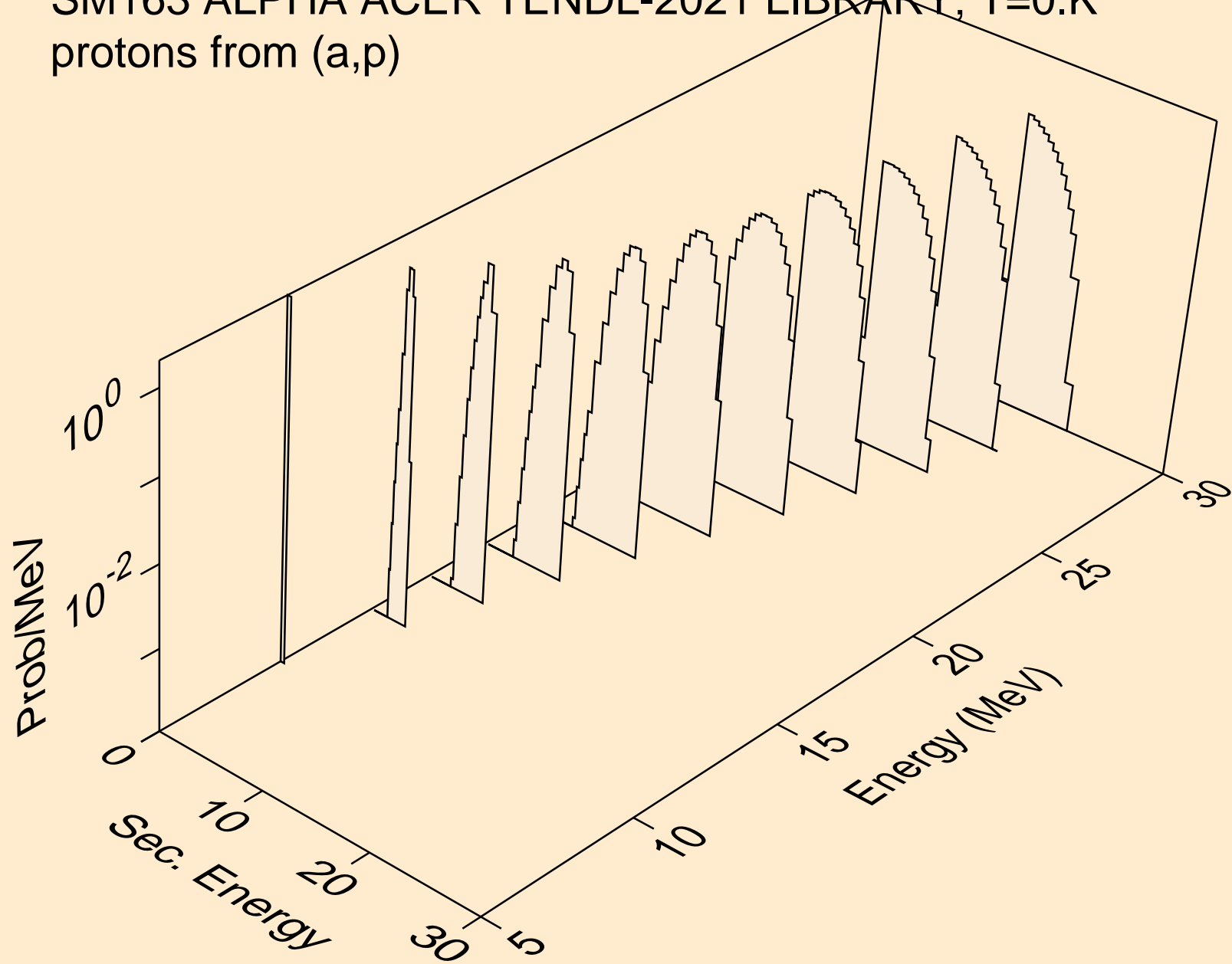

SM163 ALPHA ACER TENDL-2021 LIBRARY; T=0.K  
deuterons from (a,x)

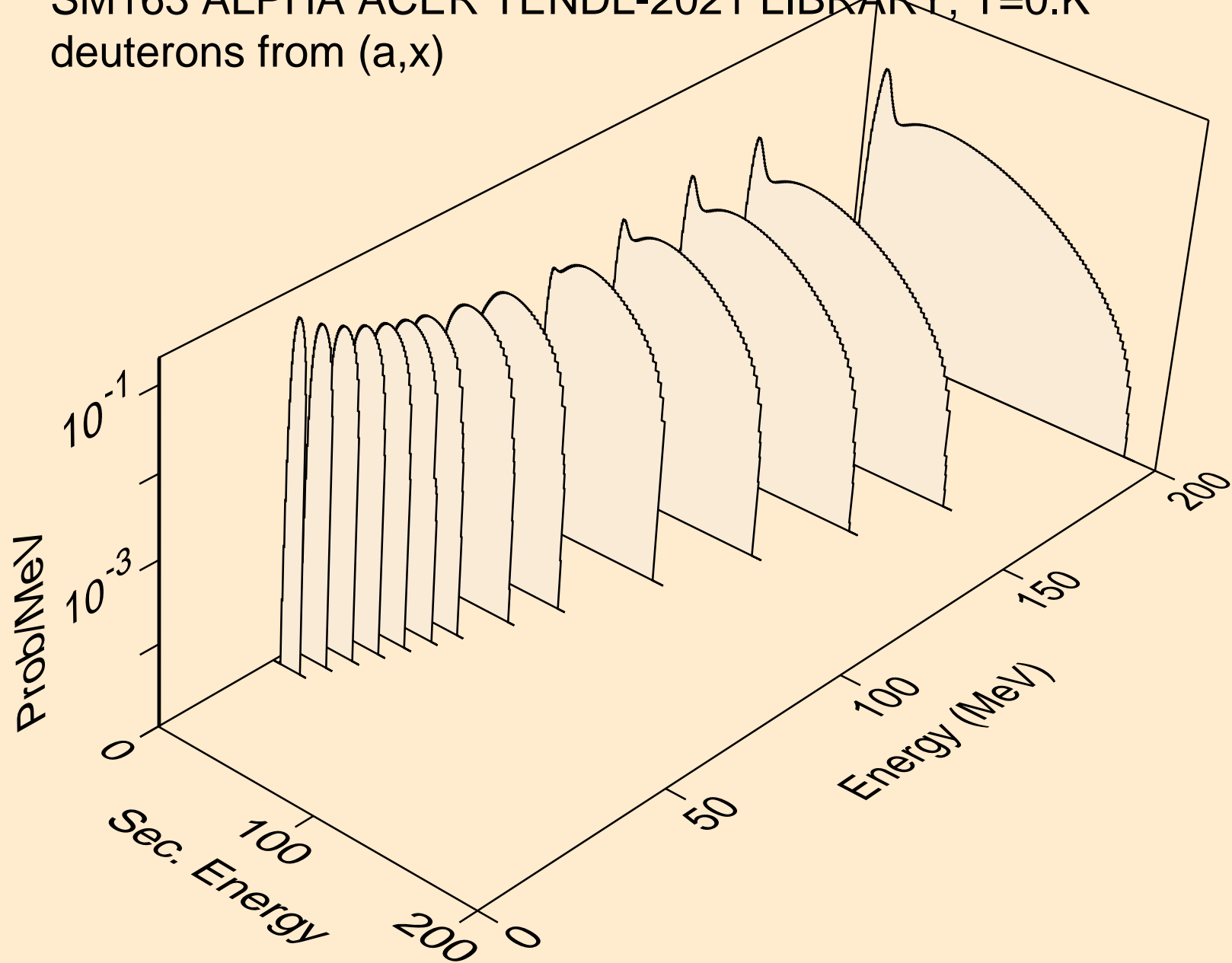

SM163 ALPHA ACER TENDL-2021 LIBRARY; T=0.K  
deuterons from (a,2nd)

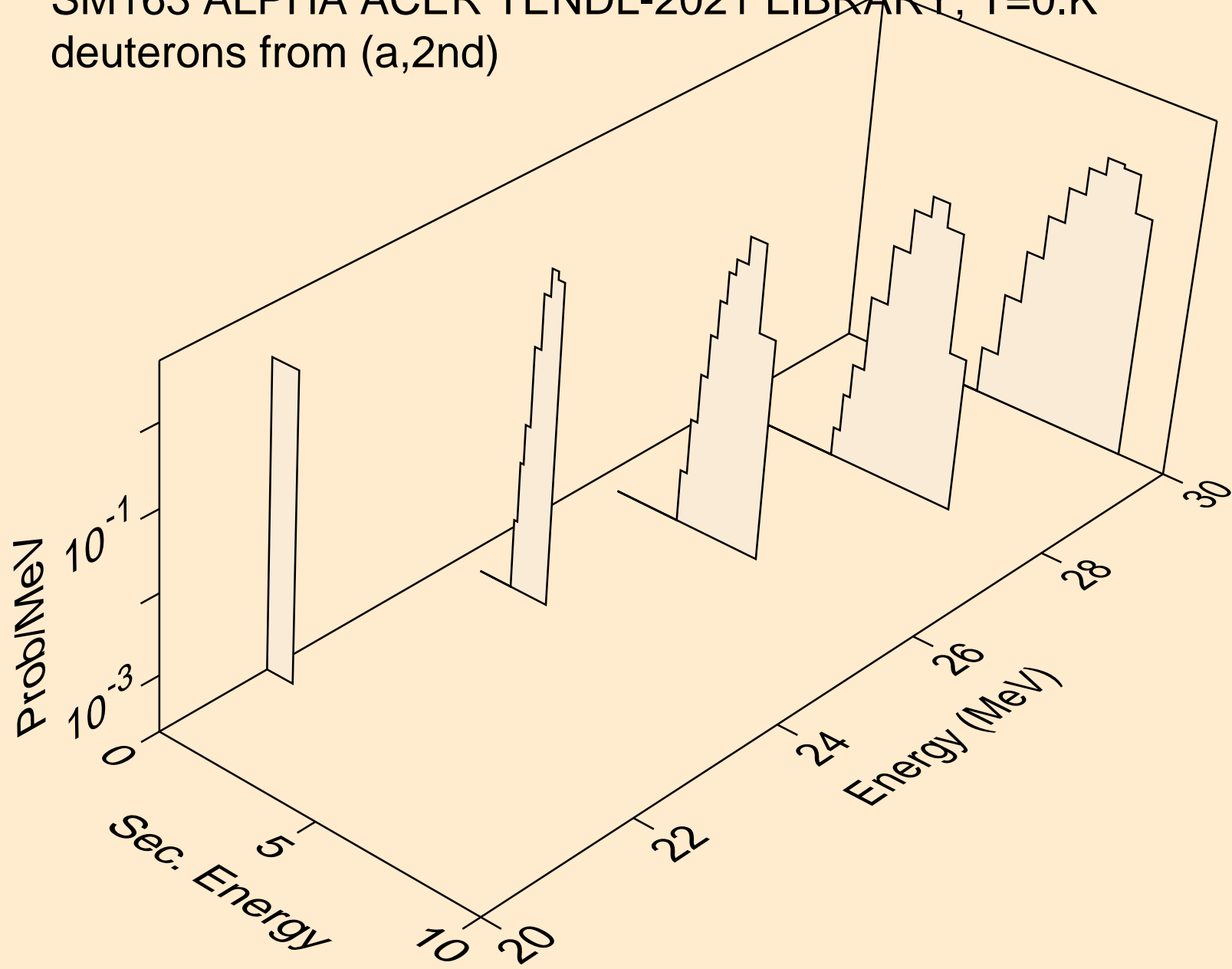



SM163 ALPHA ACER TENDL-2021 LIBRARY; T=0.K  
deuterons from (a,n\*)d

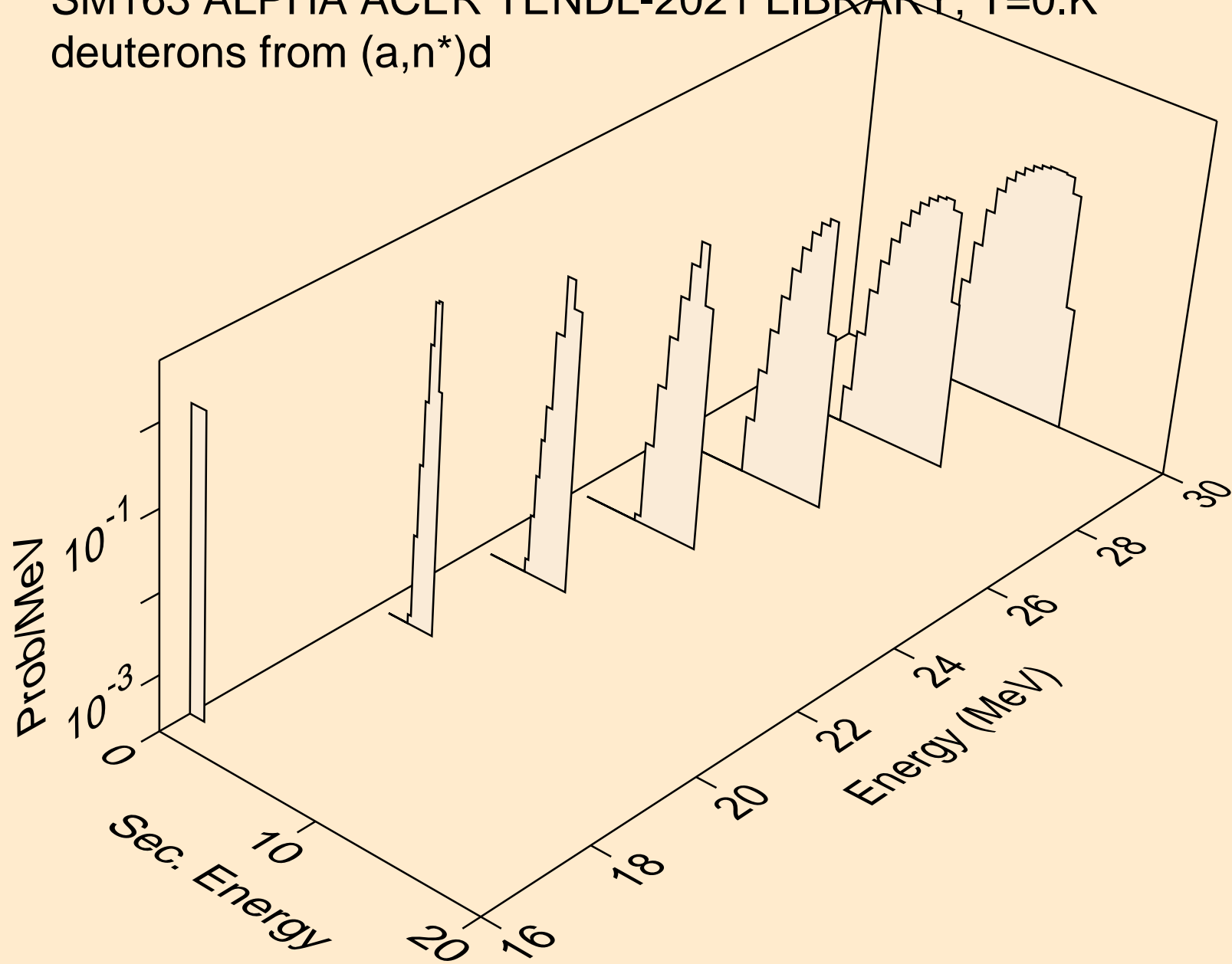

SM163 ALPHA ACER TENDL-2021 LIBRARY; T=0.K  
deuterons from (a,d)

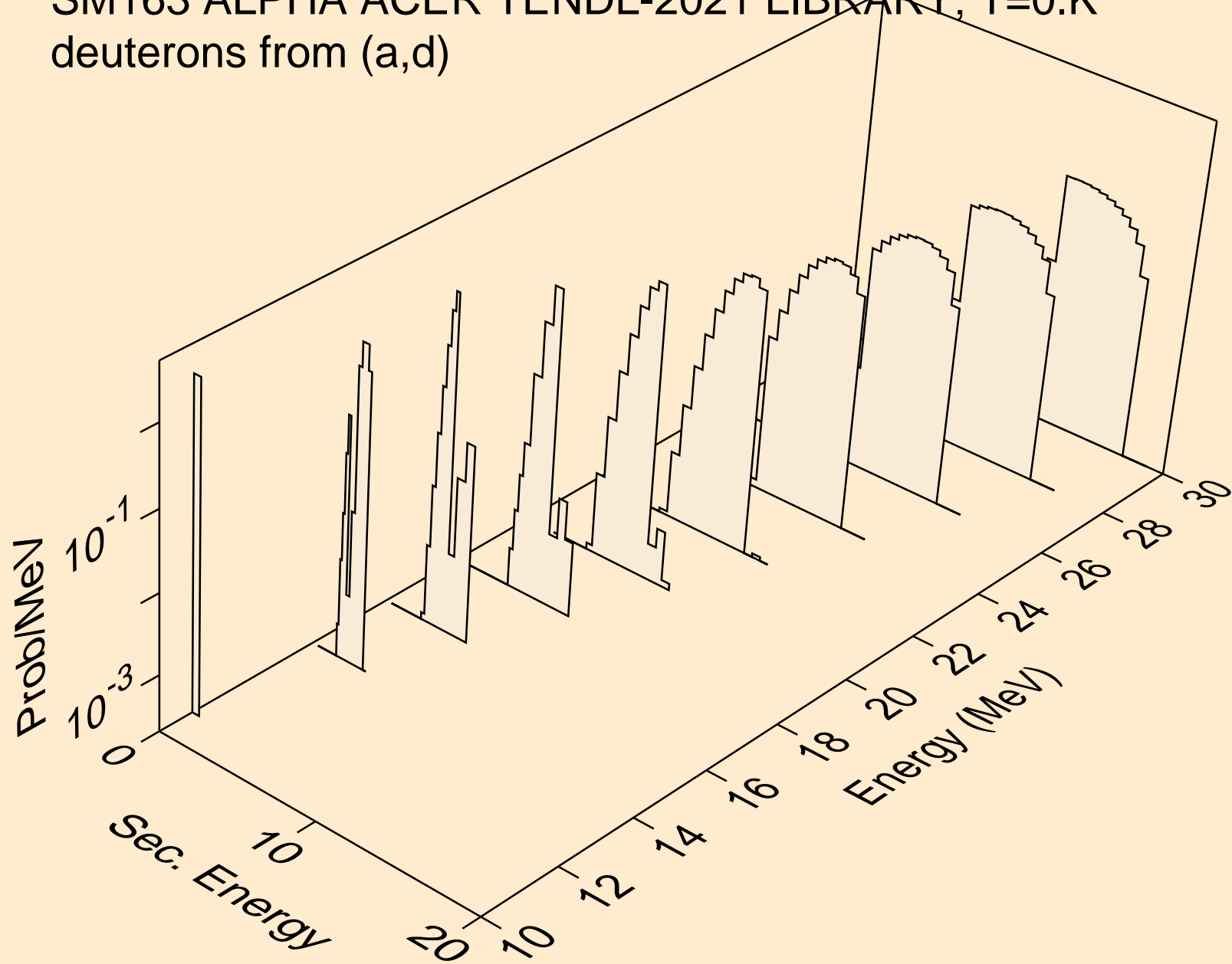

SM163 ALPHA ACER TENDL-2021 LIBRARY; T=0.K  
tritons from (a,x)

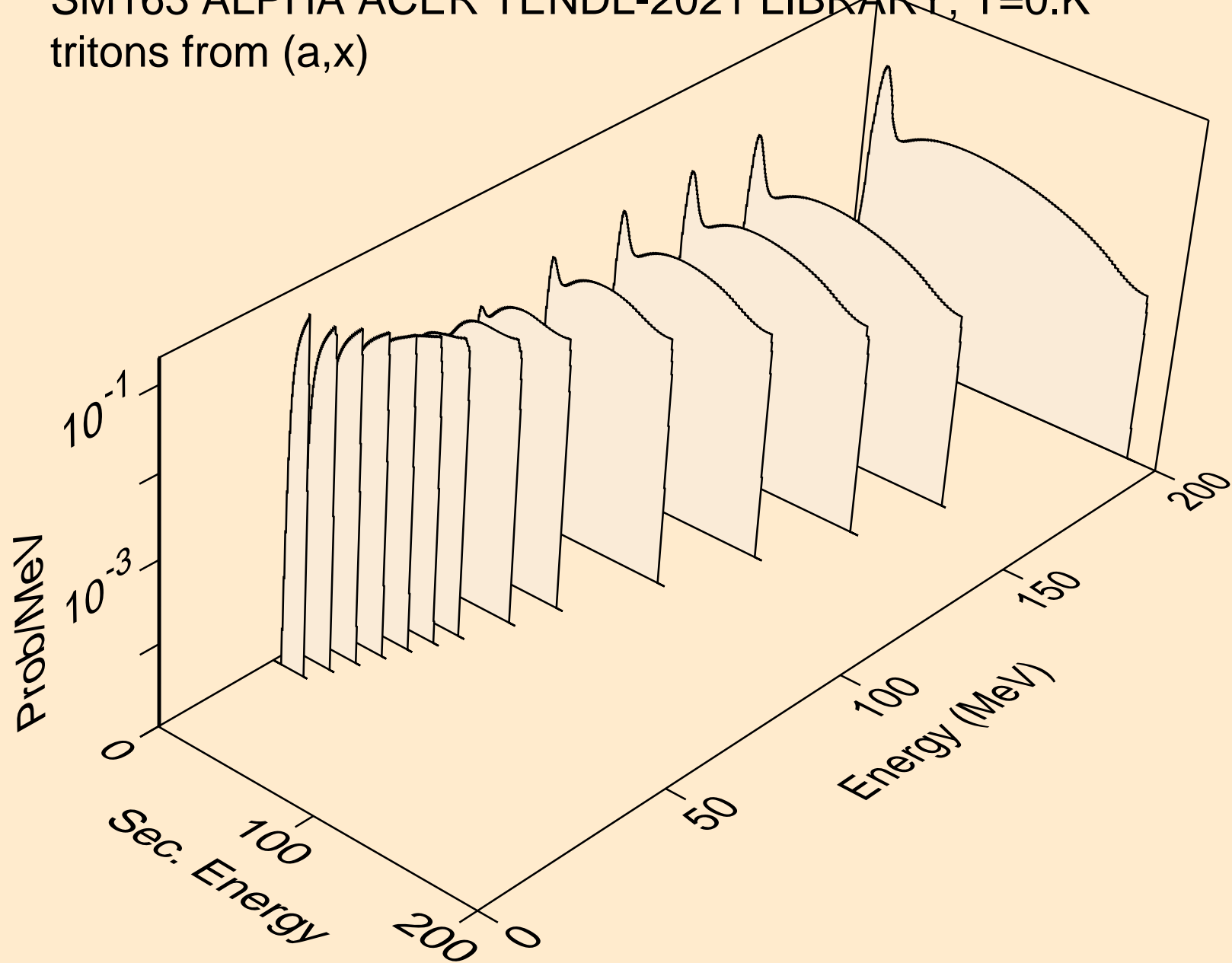

SM163 ALPHA ACER TENDL-2021 LIBRARY; T=0.K  
tritons from (a,n\*)t

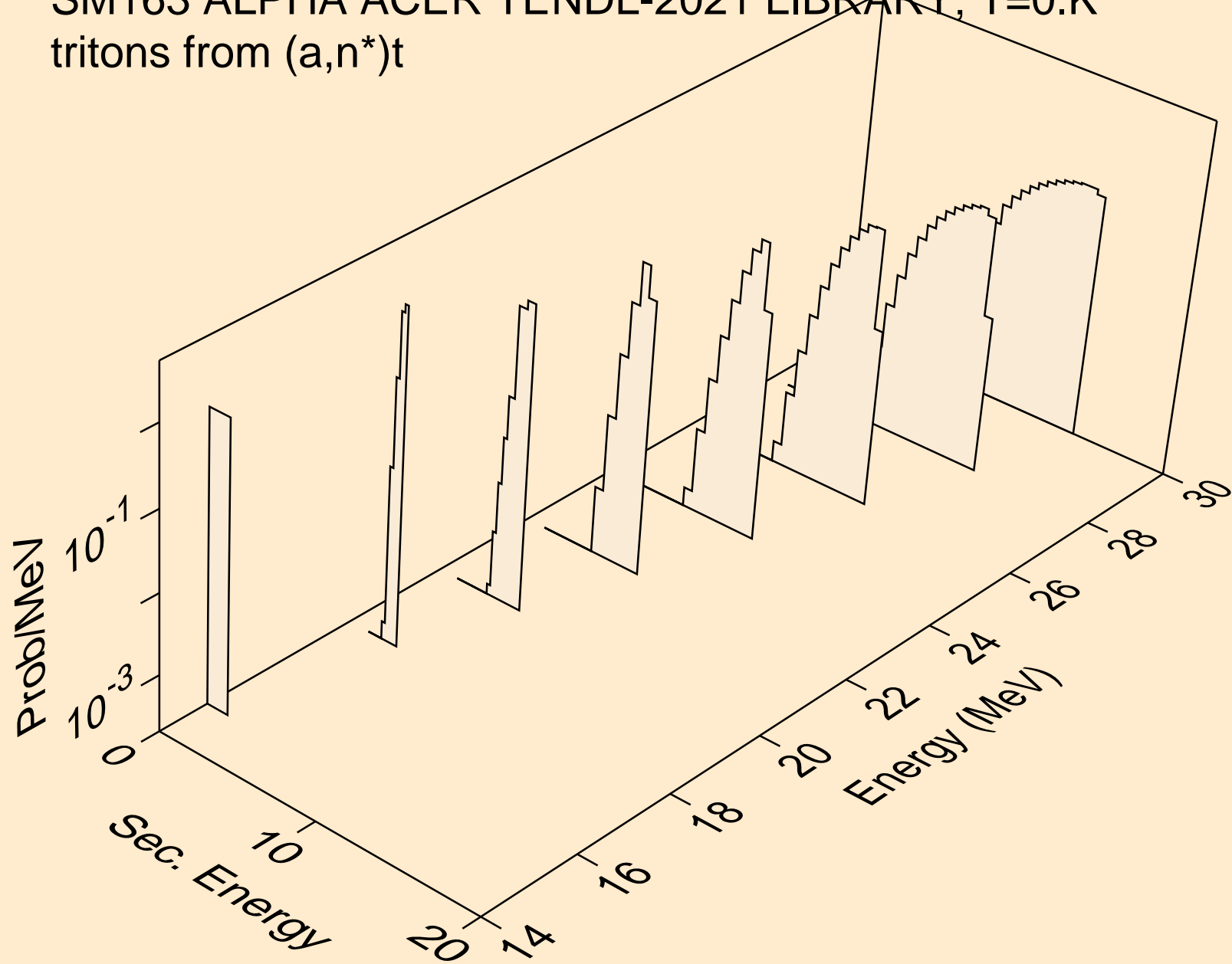

SM163 ALPHA ACER TENDL-2021 LIBRARY; T=0.K  
tritons from (a,t)

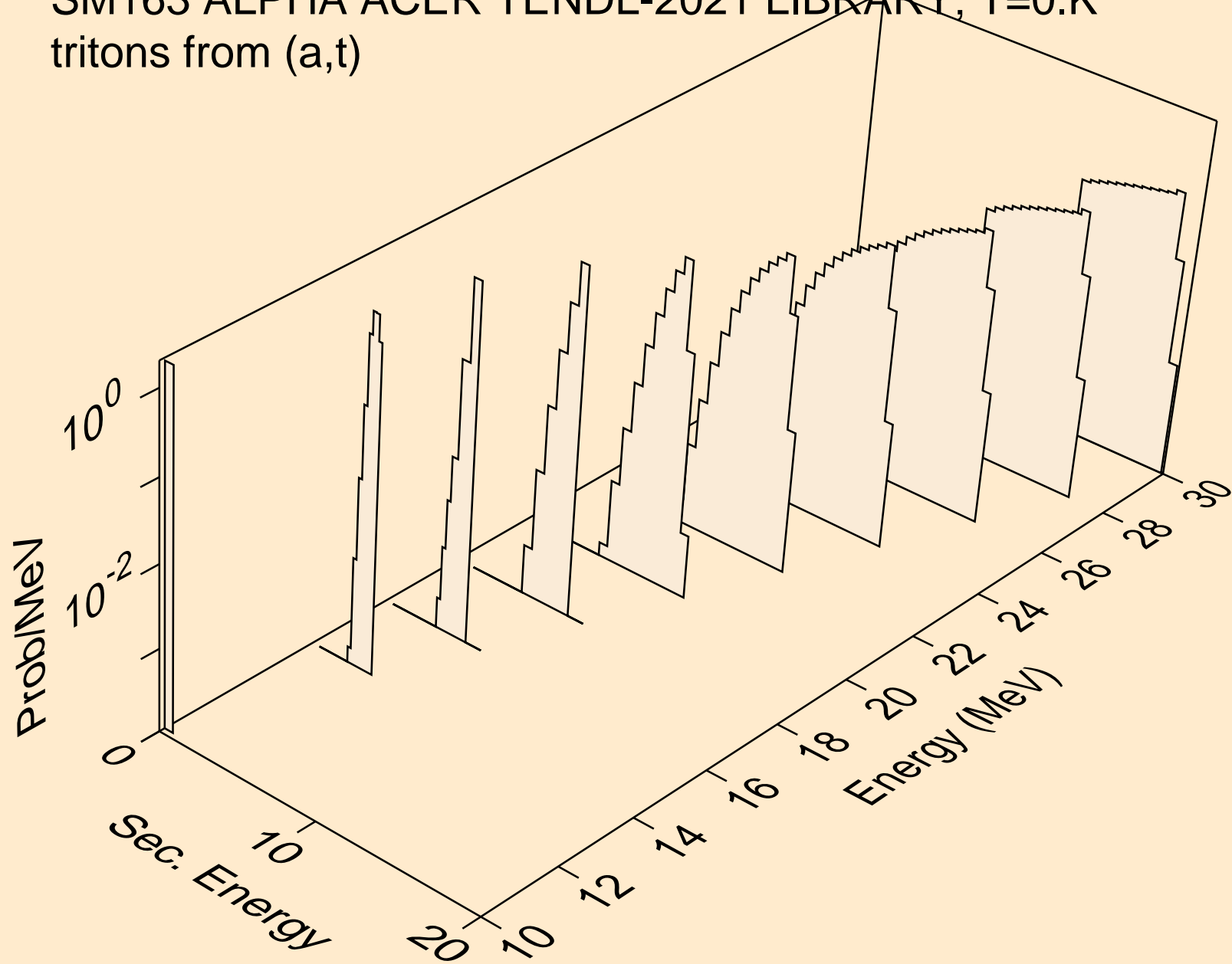

SM163 ALPHA ACER TENDL-2021 LIBRARY; T=0.K  
he3s from (a,x)

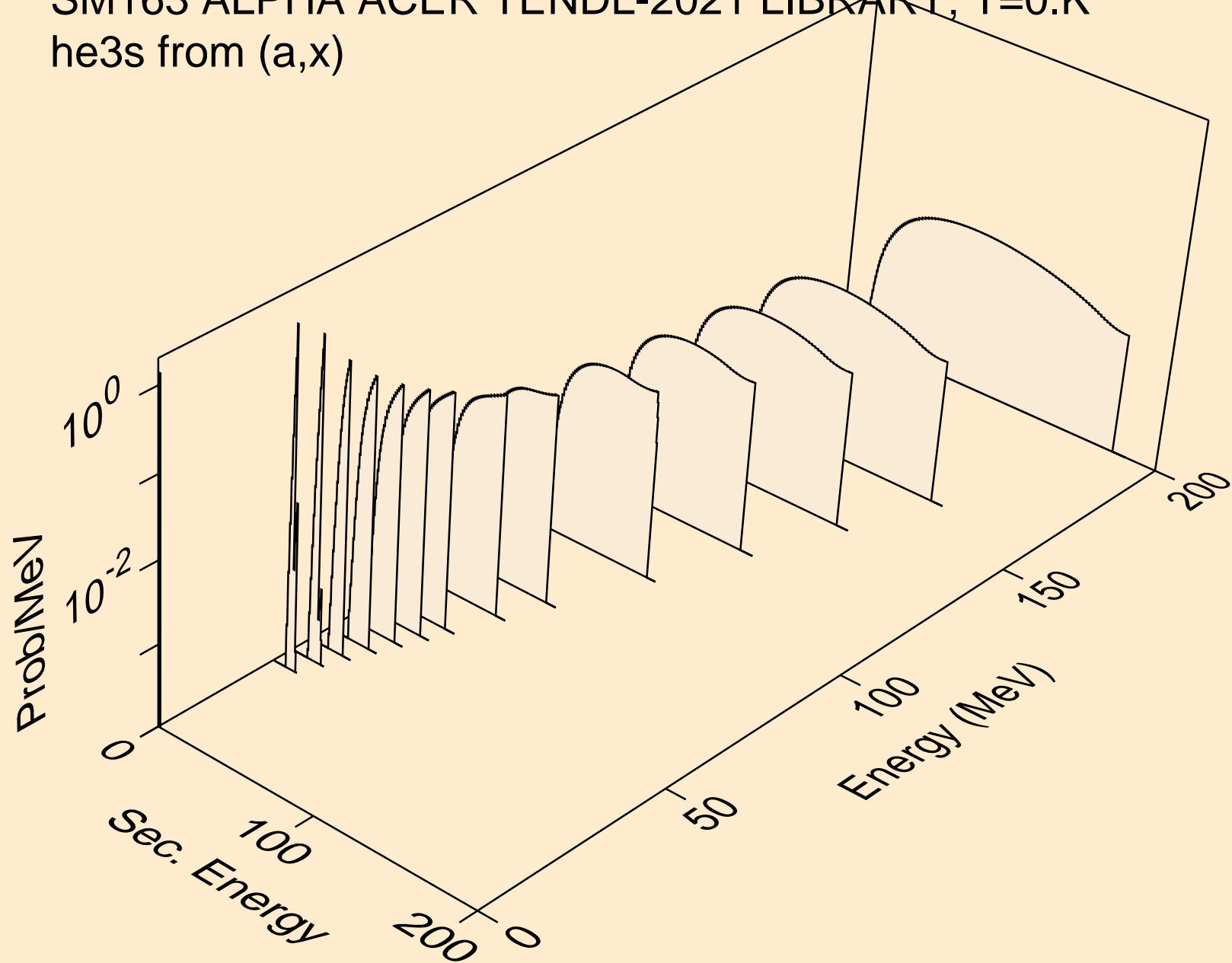

SM163 ALPHA ACER TENDL-2021 LIBRARY; T=0.K  
he3s from (a,he3)

