

TH239 ALPHA ACER TENDL-2021 LIBRARY; T=0.K
Principal cross sections

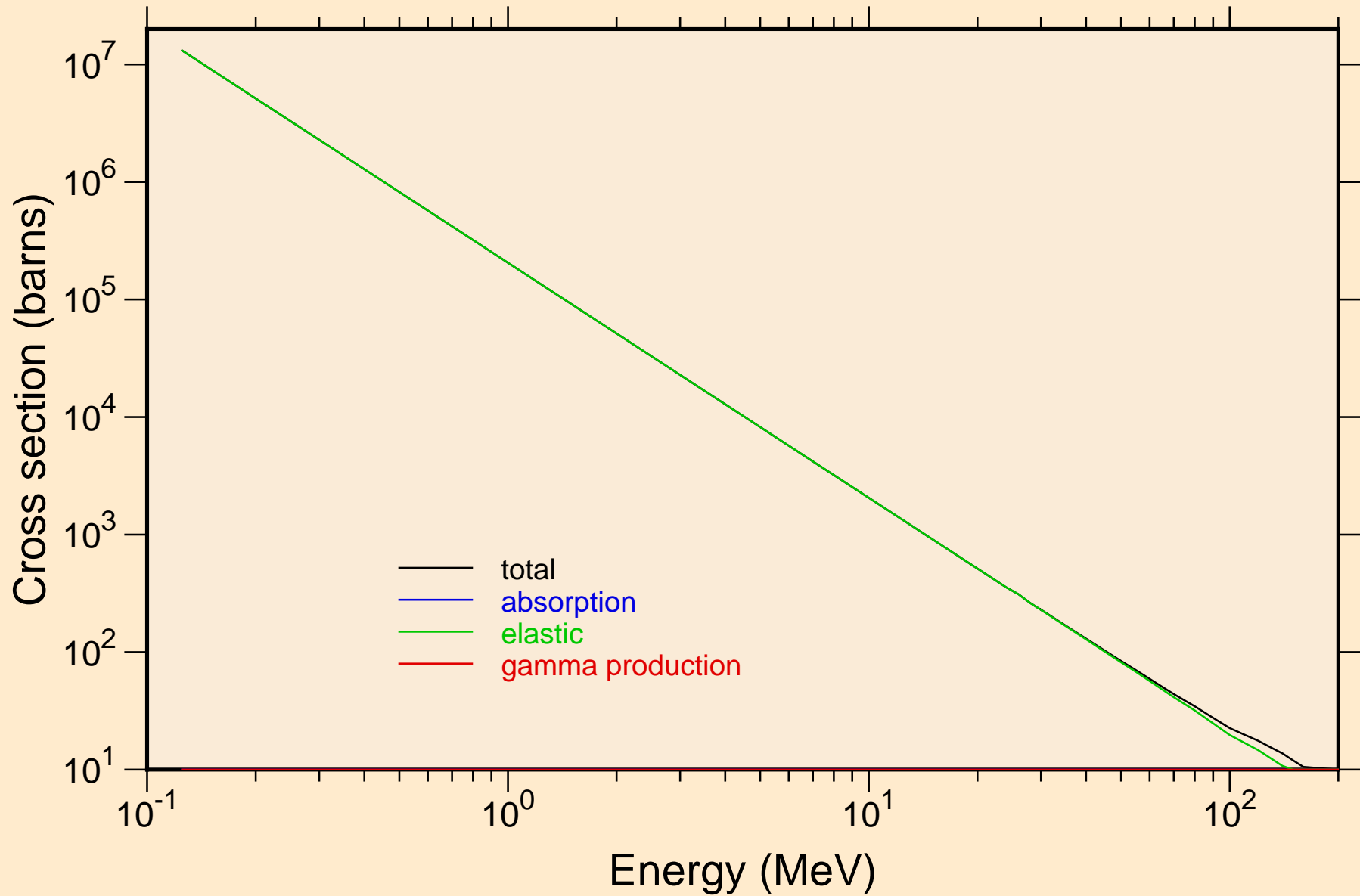

TH239 ALPHA ACER TENDL-2021 LIBRARY; T=0.K
Heating

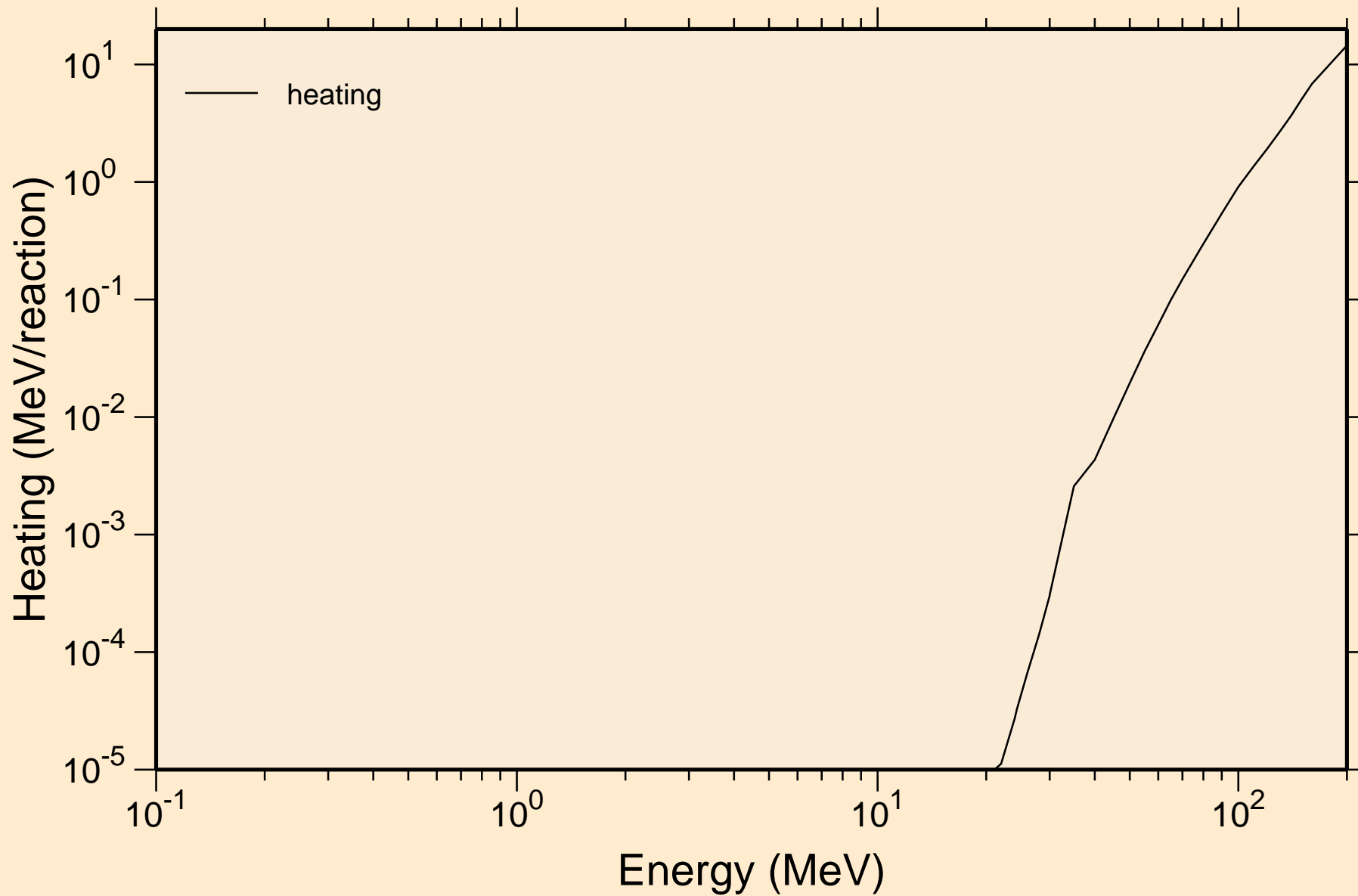

TH239 ALPHA ACER TENDL-2021 LIBRARY; T=0.K

Principal cross sections

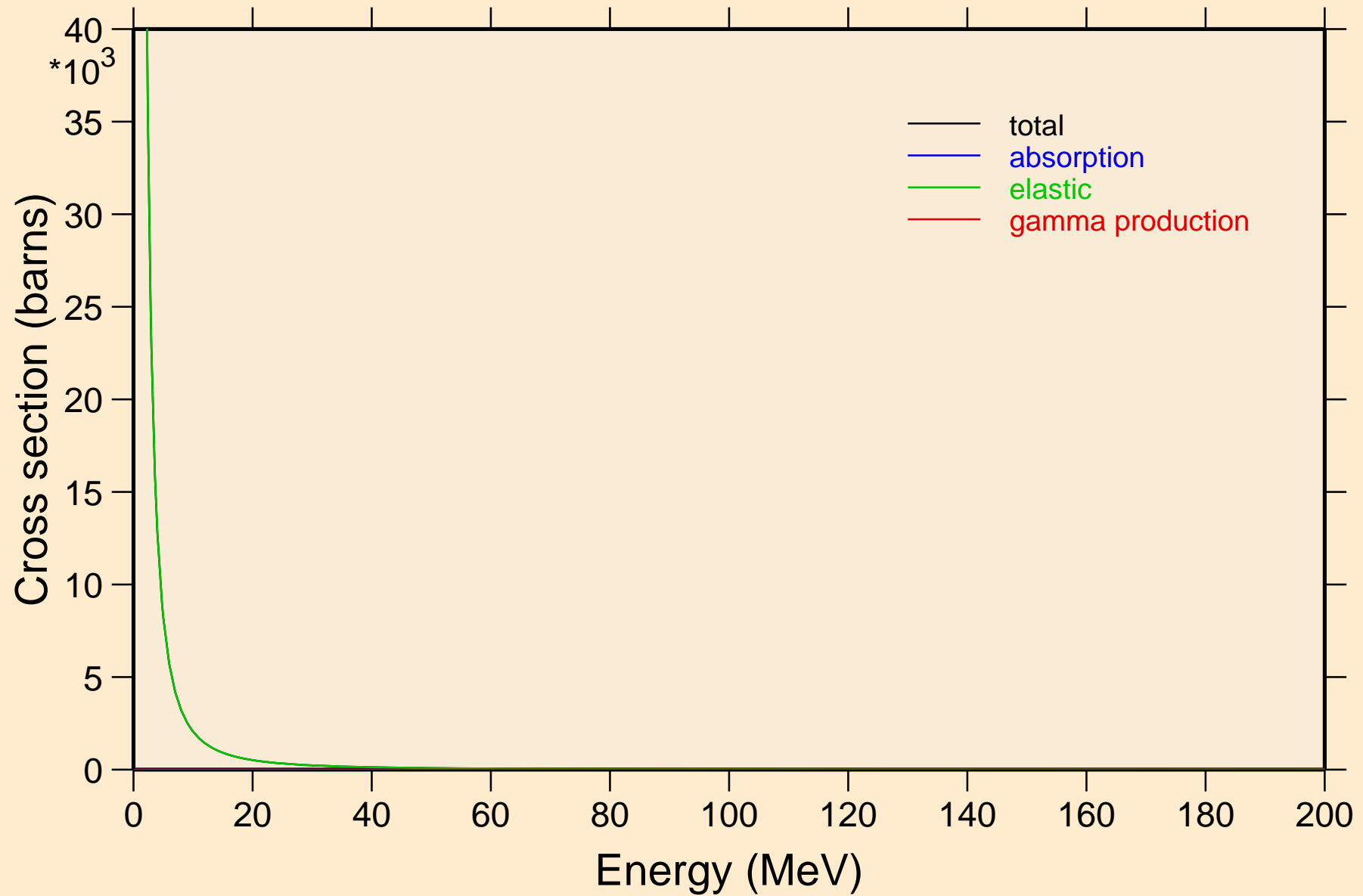

TH239 ALPHA ACER TENDL-2021 LIBRARY; T=0.K

Heating

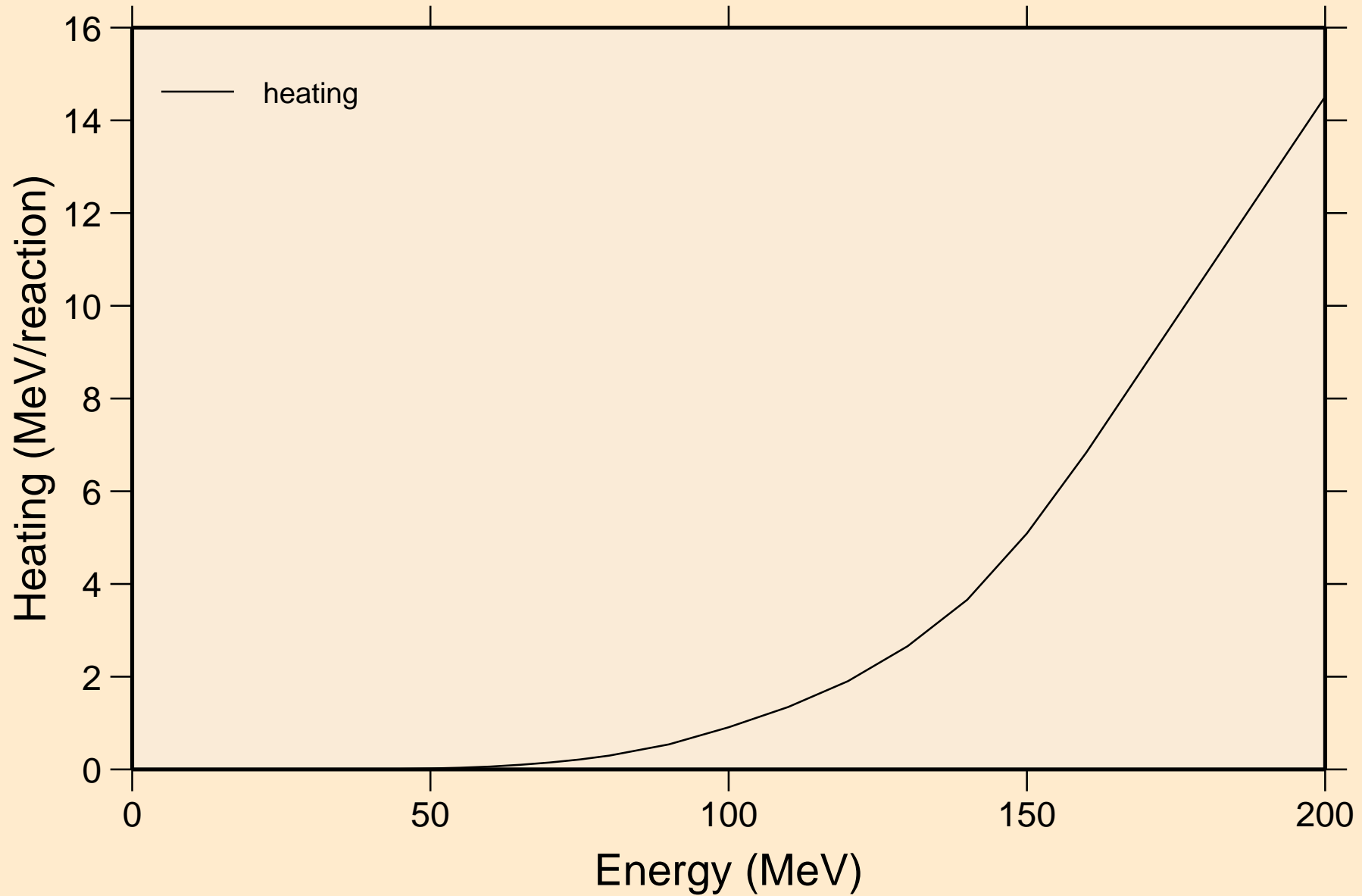

TH239 ALPHA ACER TENDL-2021 LIBRARY; T=0.K
Threshold reactions

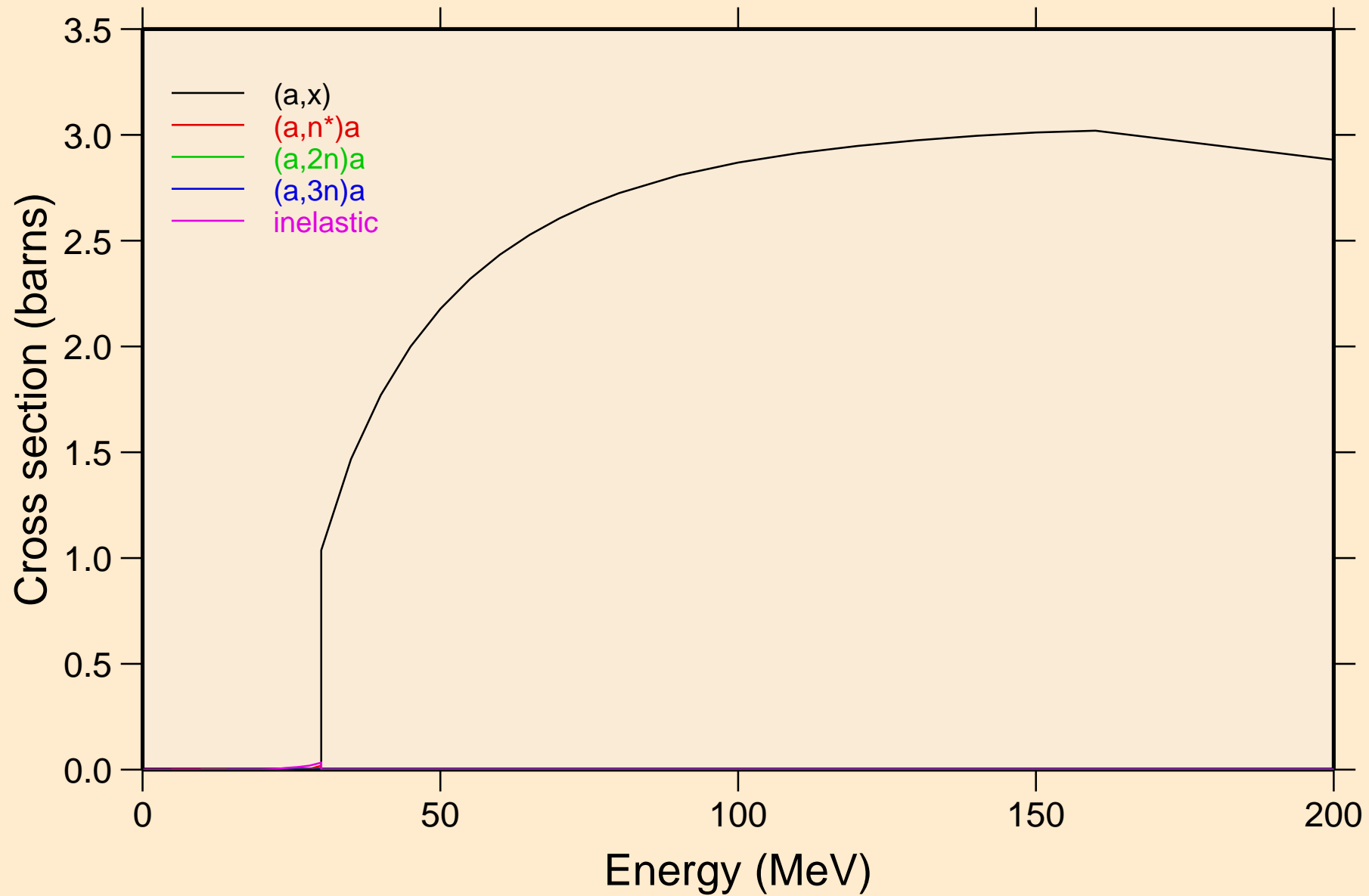

TH239 ALPHA ACER TENDL-2021 LIBRARY; T=0.K
angular distribution for elastic

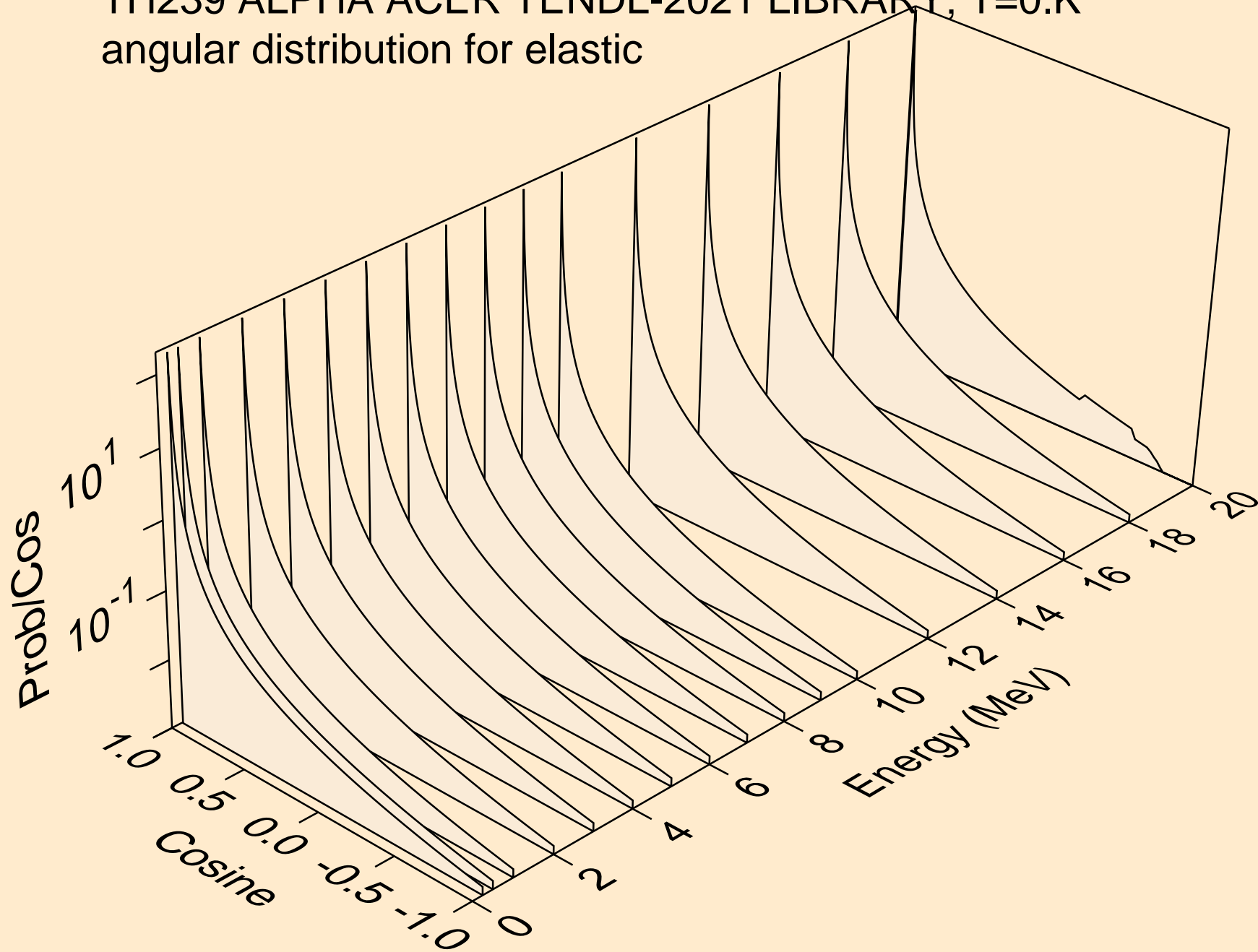

TH239 ALPHA ACER TENDL-2021 LIBRARY; T=0.K
angular distribution for elastic

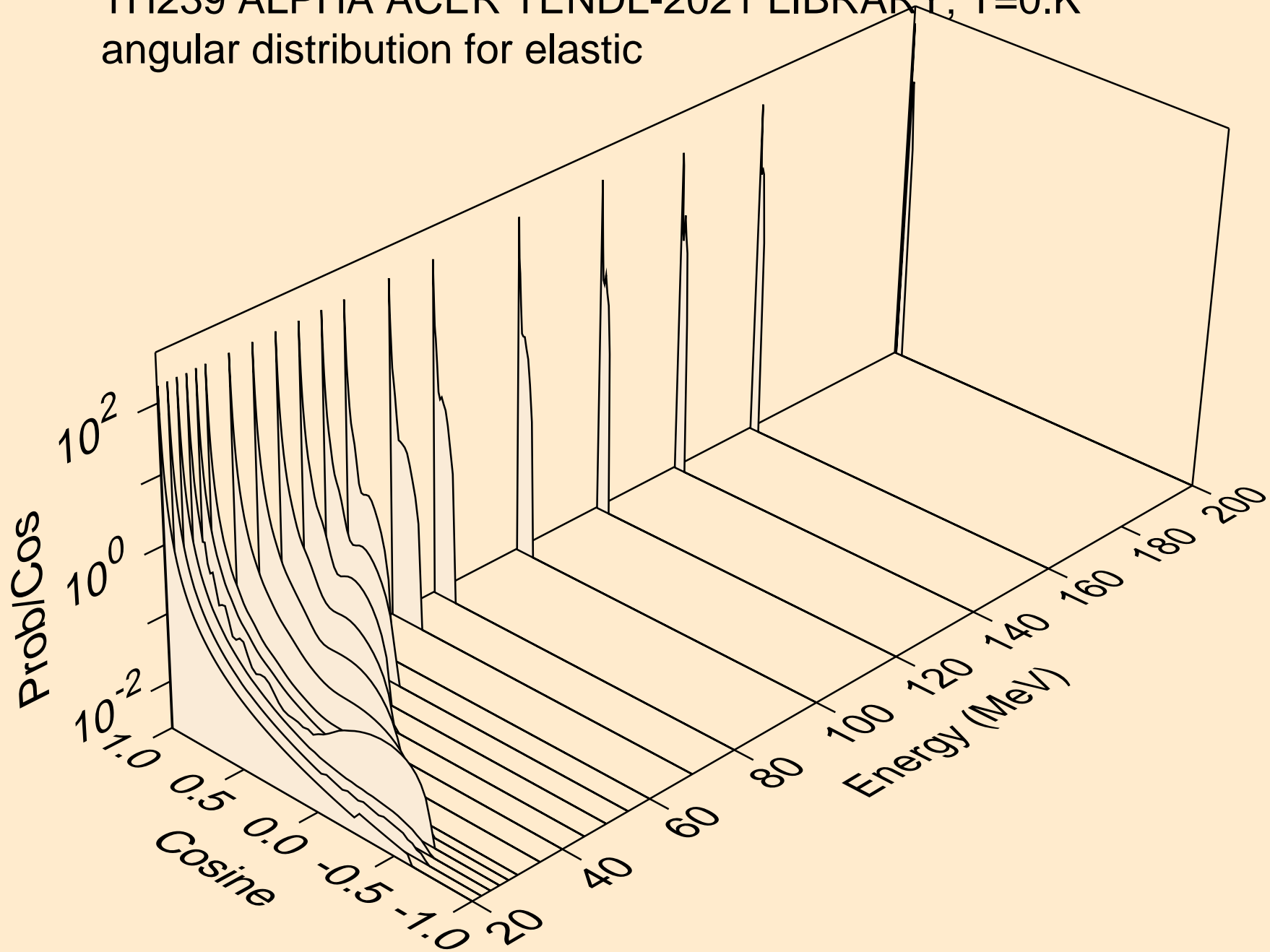

TH239 ALPHA ACER TENDL-2021 LIBRARY; T=0.K
Alpha emission for (a,x)

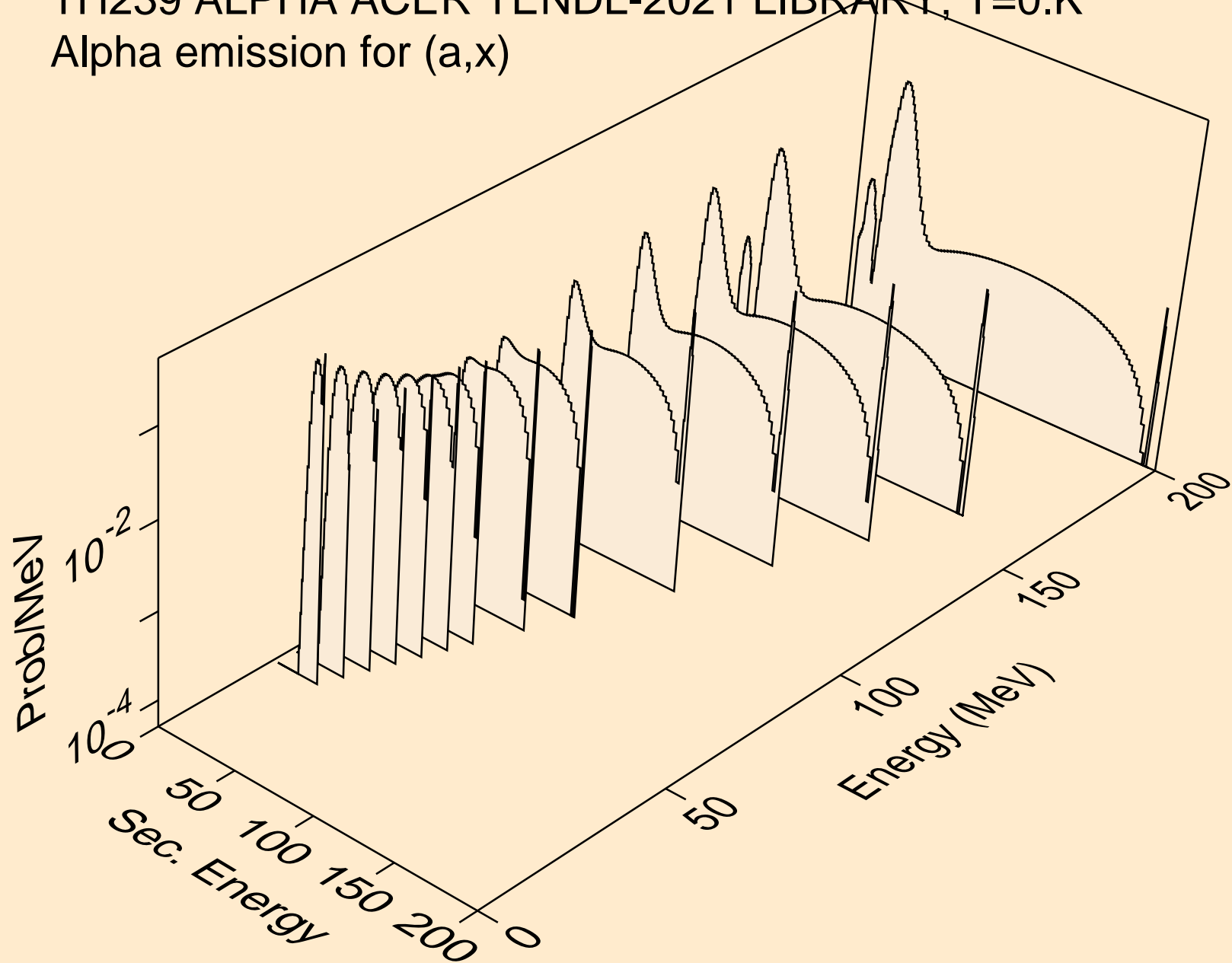

TH239 ALPHA ACER TENDL-2021 LIBRARY; T=0.K
Alpha emission for (a,n*)a

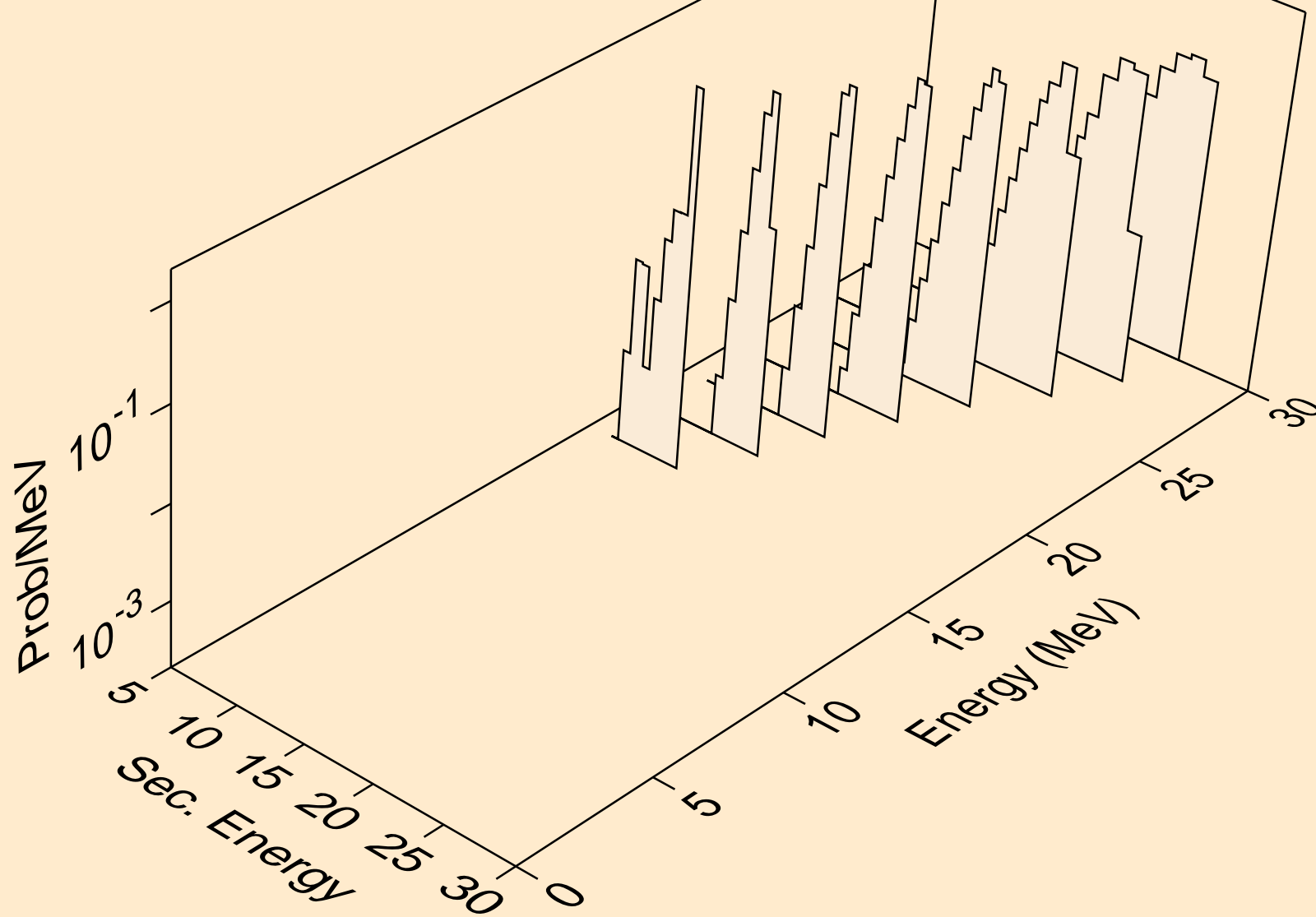

TH239 ALPHA ACER TENDL-2021 LIBRARY; T=0.K
Alpha emission for (a,2n)a

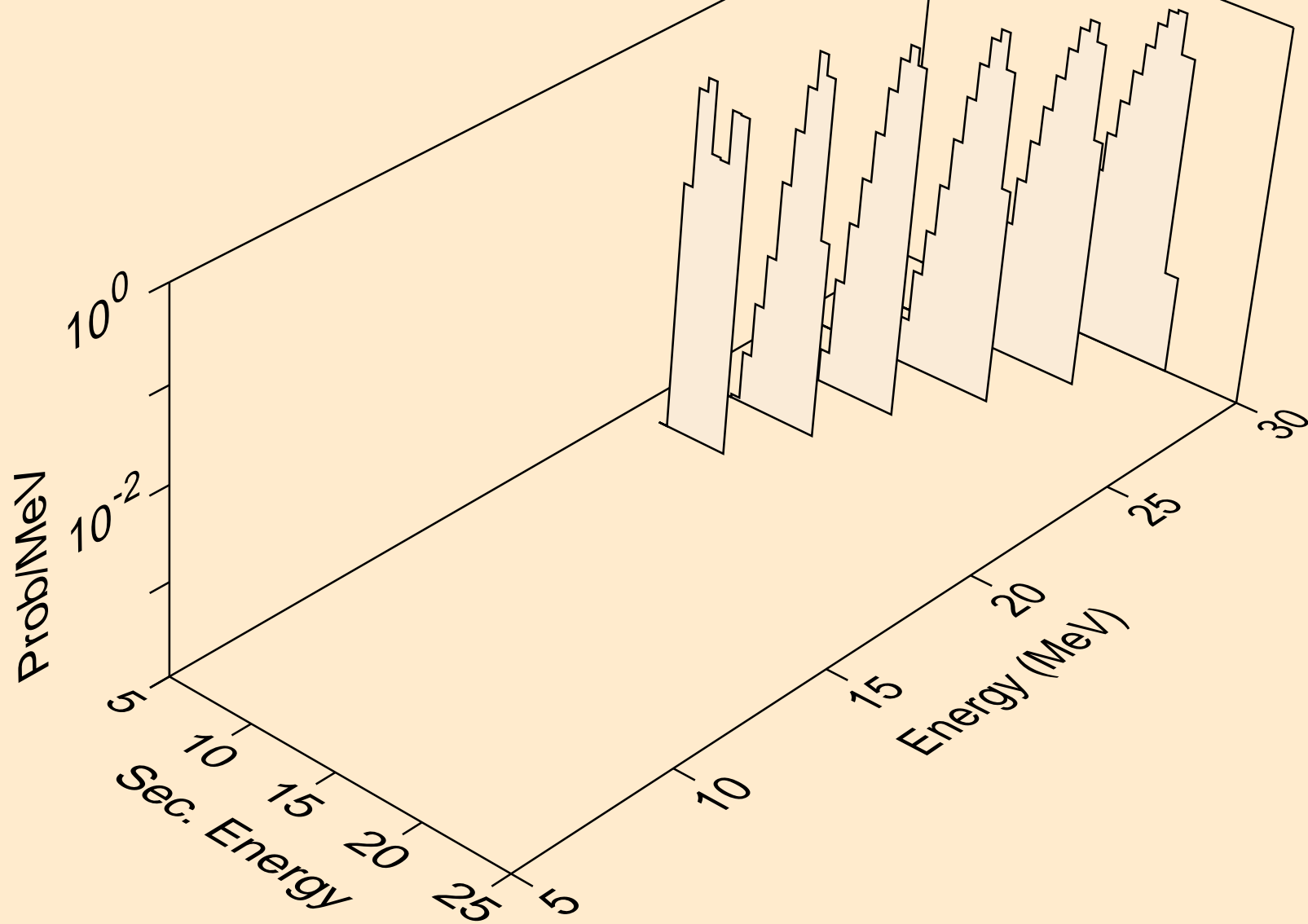

TH239 ALPHA ACER TENDL-2021 LIBRARY; T=0.K
Alpha emission for (a,3n)a

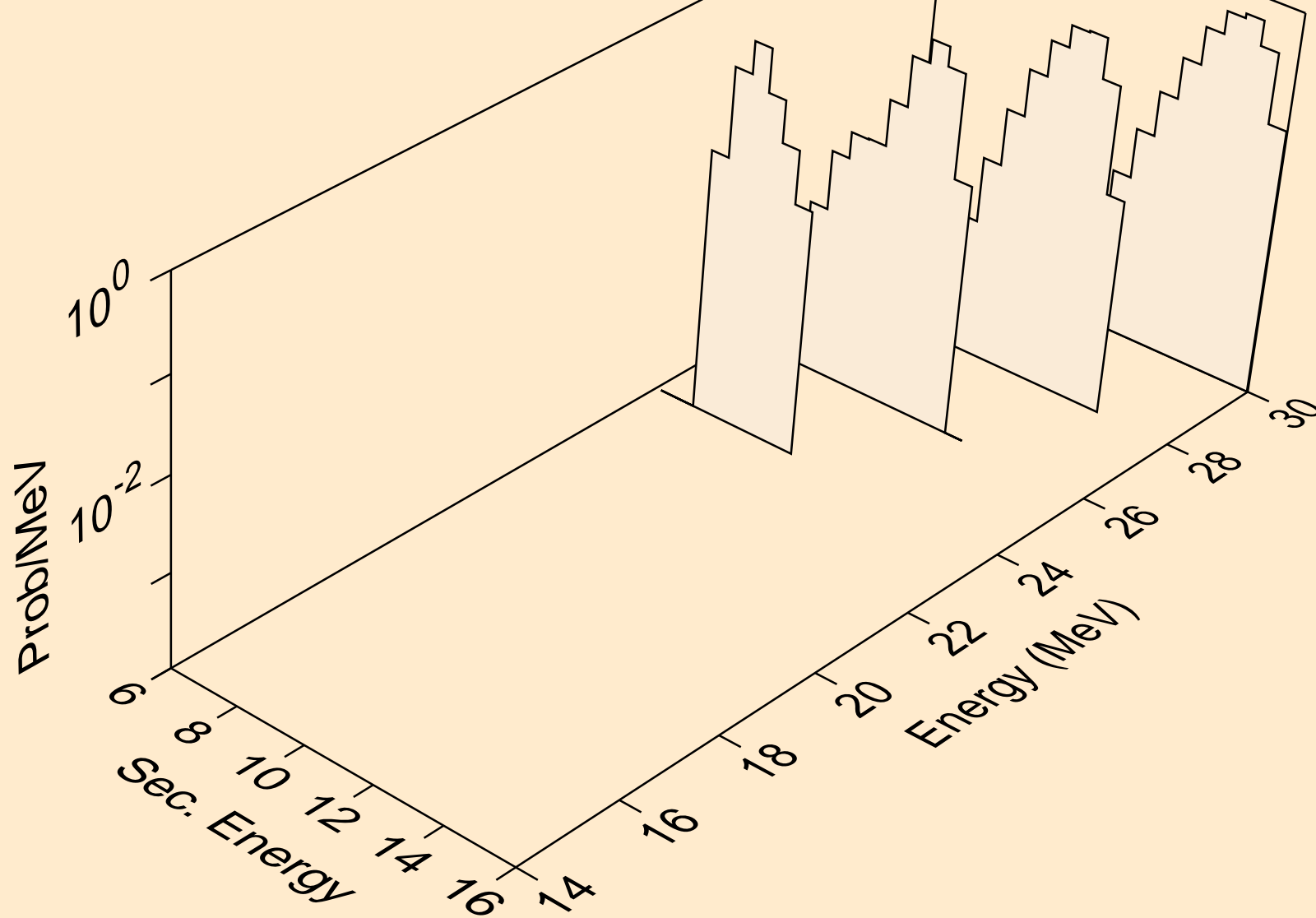

TH239 ALPHA ACER TENDL-2021 LIBRARY; T=0.K
Alpha emission for inelastic

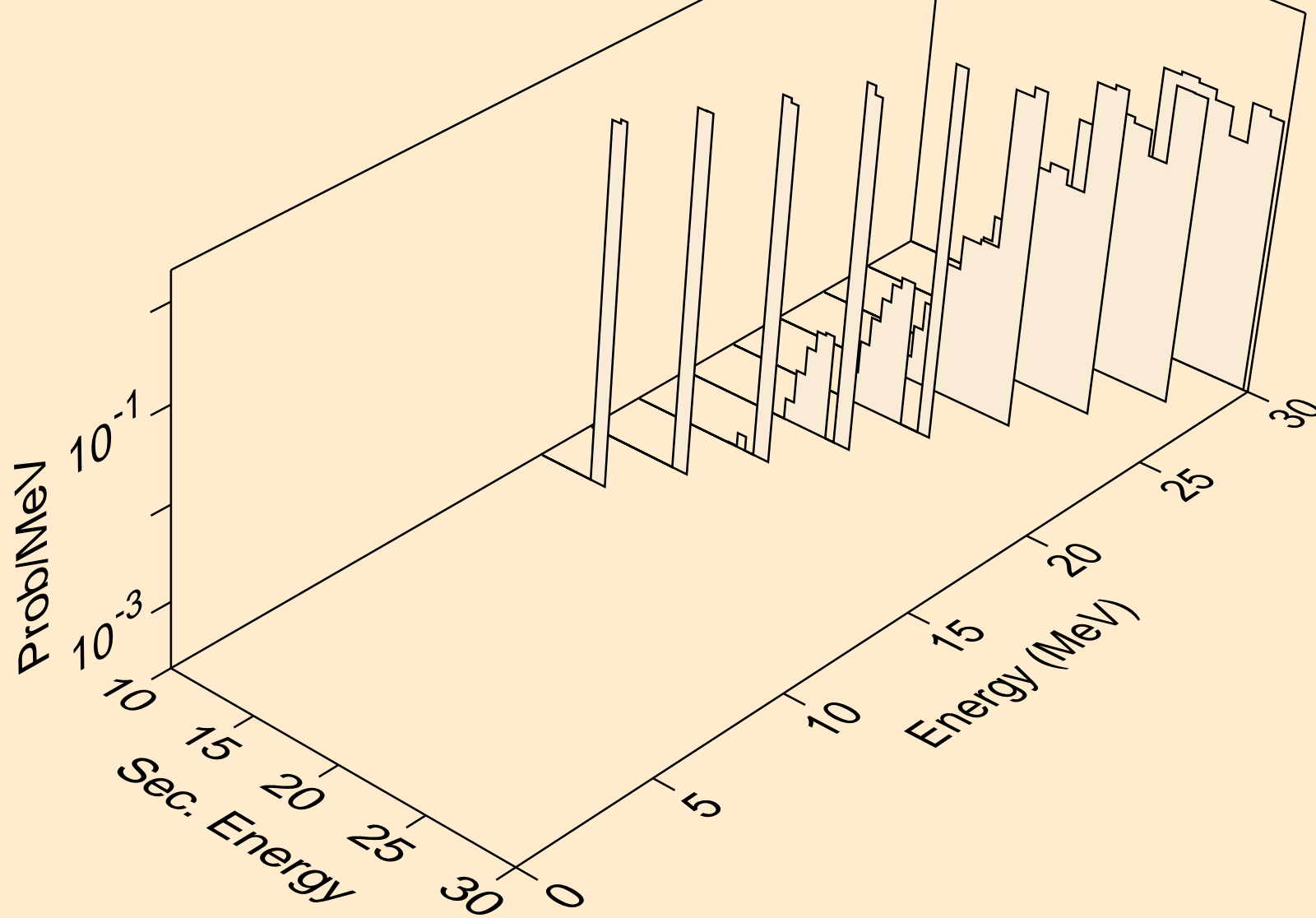

TH239 ALPHA ACER TENDL-2021 LIBRARY; T=0.K
Photon emission for (z,n)

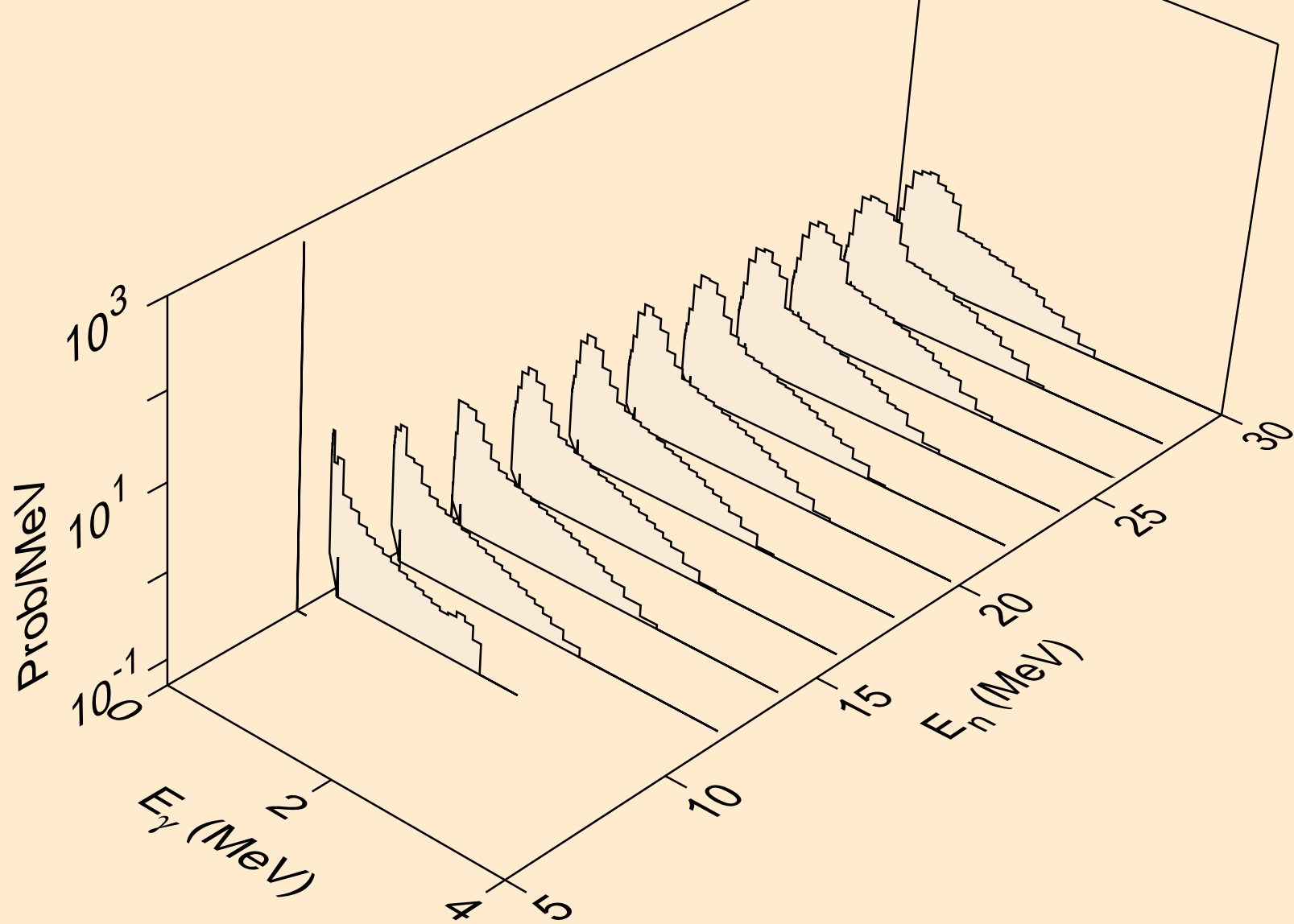

TH239 ALPHA ACER TENDL-2021 LIBRARY; T=0.K
Photon emission for (n,x)

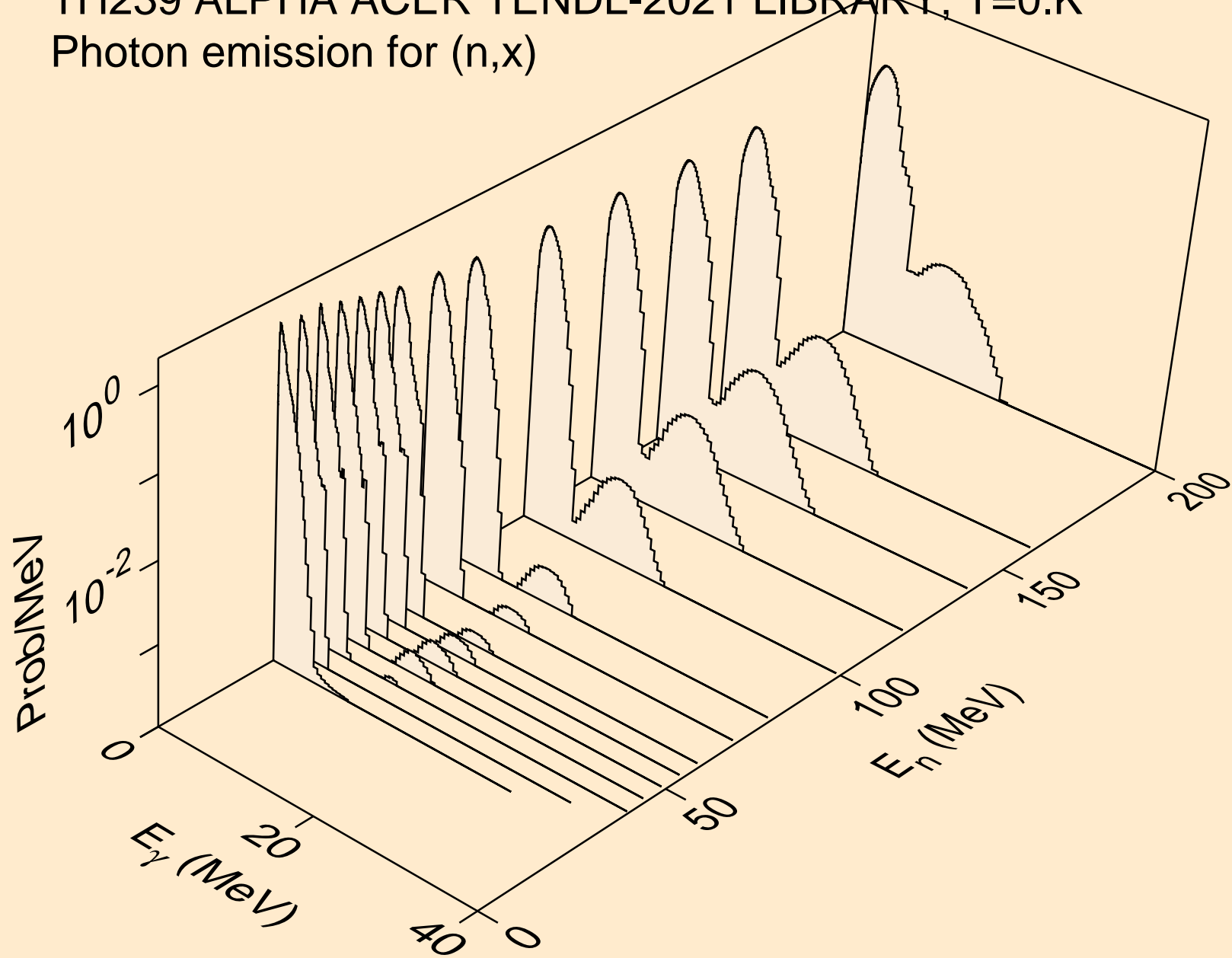

TH239 ALPHA ACER TENDL-2021 LIBRARY; T=0.K
Photon emission for (n,2n)

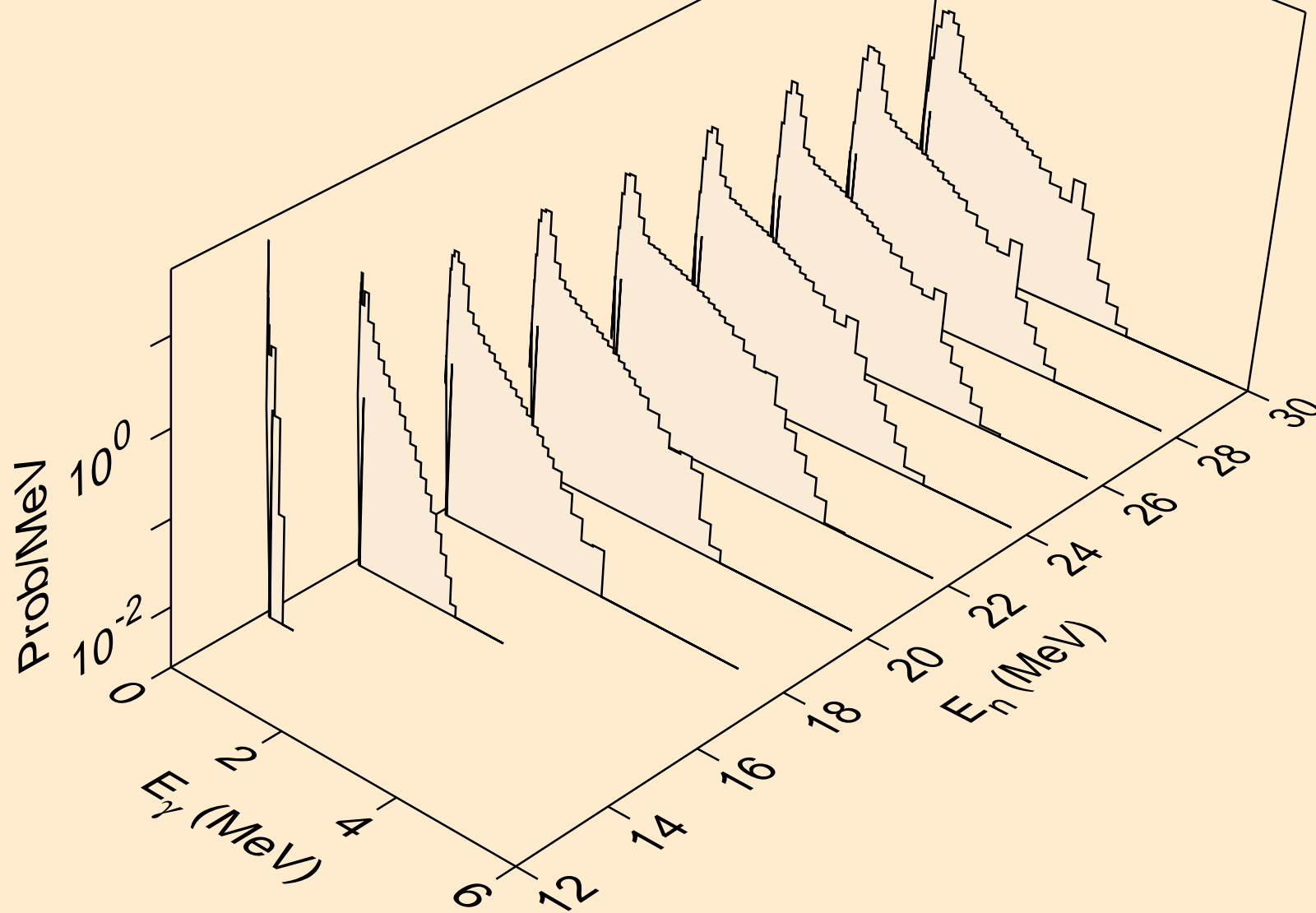

TH239 ALPHA ACER TENDL-2021 LIBRARY; T=0.K
Photon emission for (n,3n)

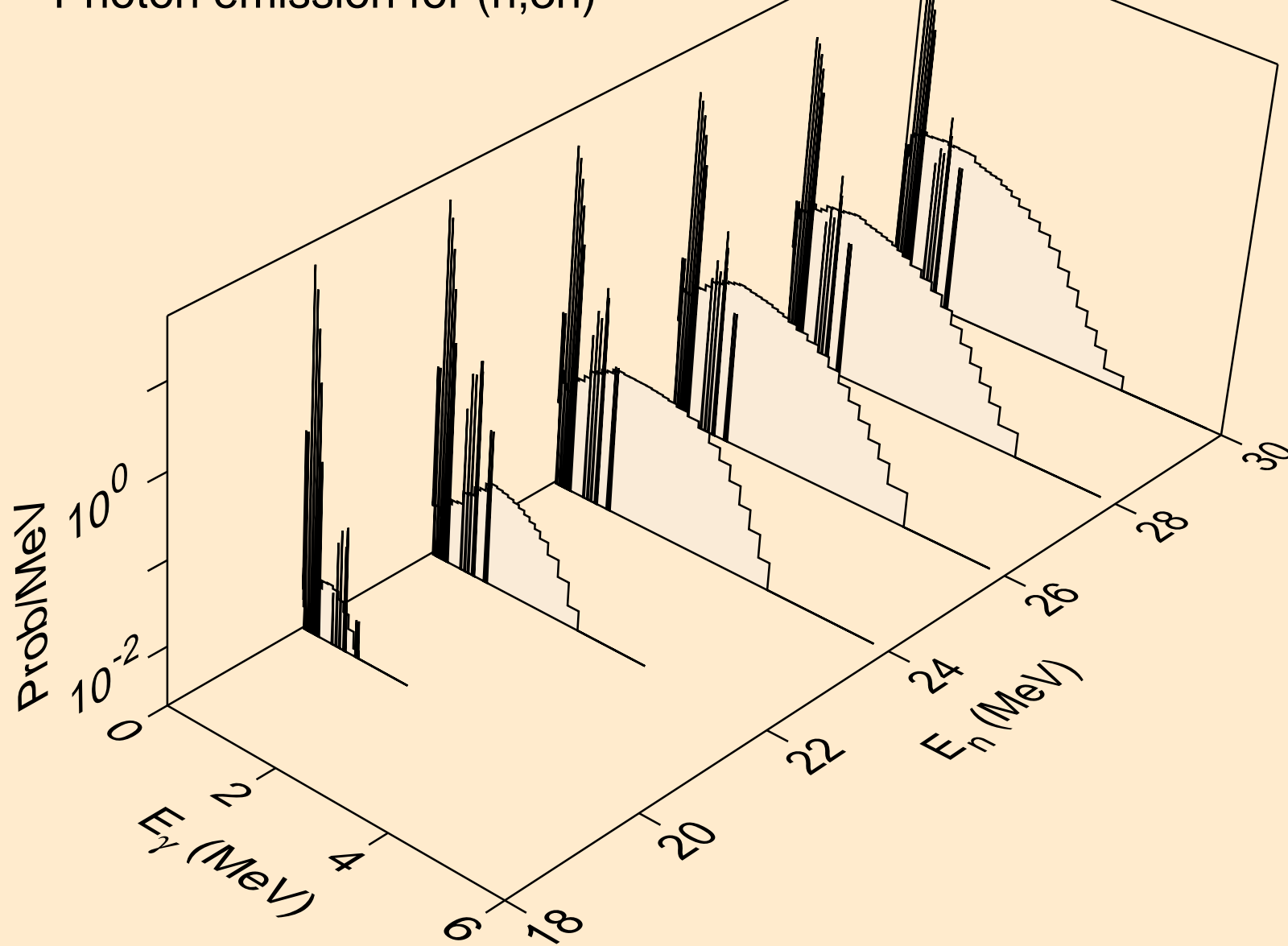

TH239 ALPHA ACER TENDL-2021 LIBRARY; T=0.K
Photon emission for (n,n*)a

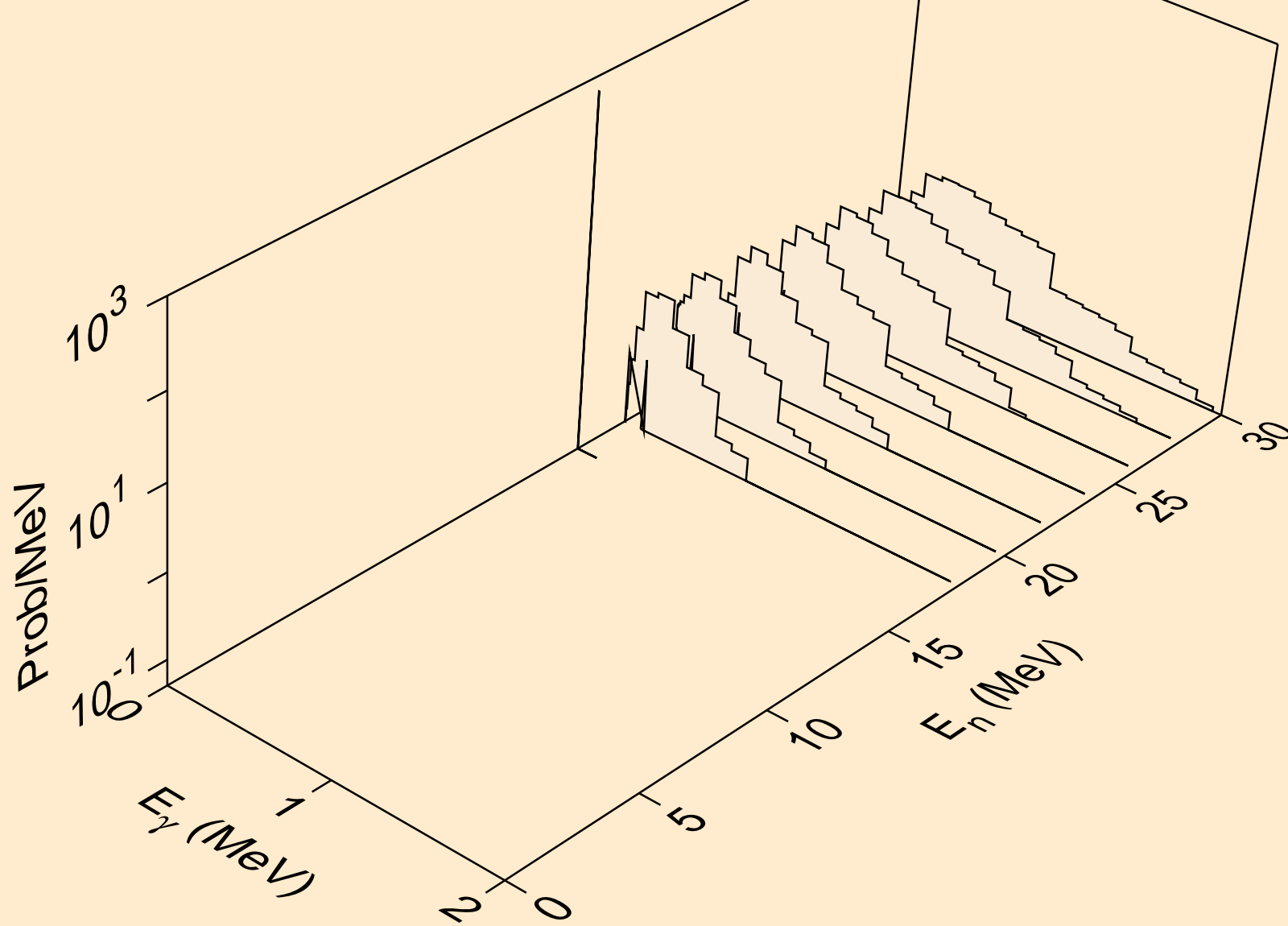

TH239 ALPHA ACER TENDL-2021 LIBRARY; T=0.K
Photon emission for (n,2n)a

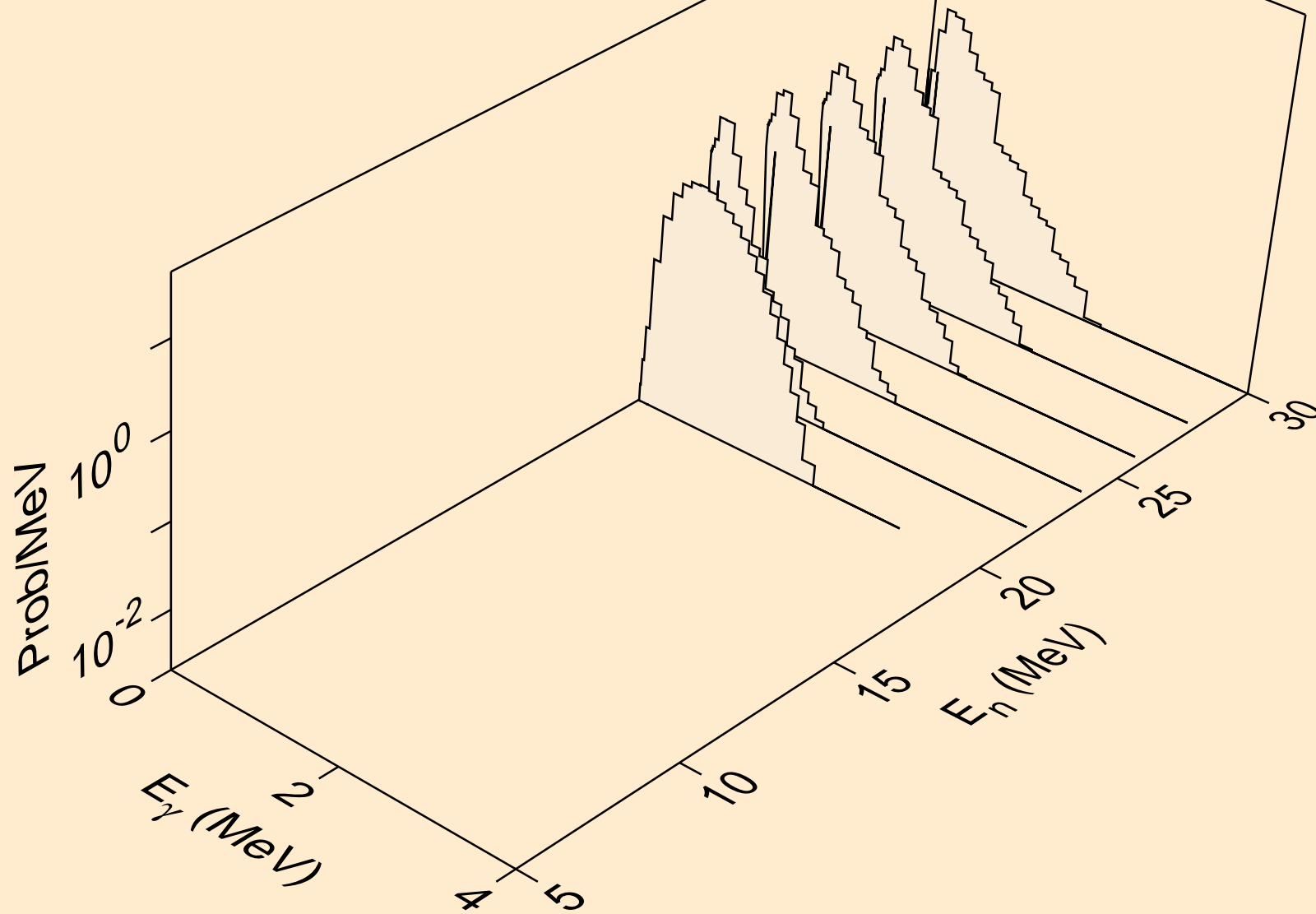

TH239 ALPHA ACER TENDL-2021 LIBRARY; T=0.K
Photon emission for (n,3n)a

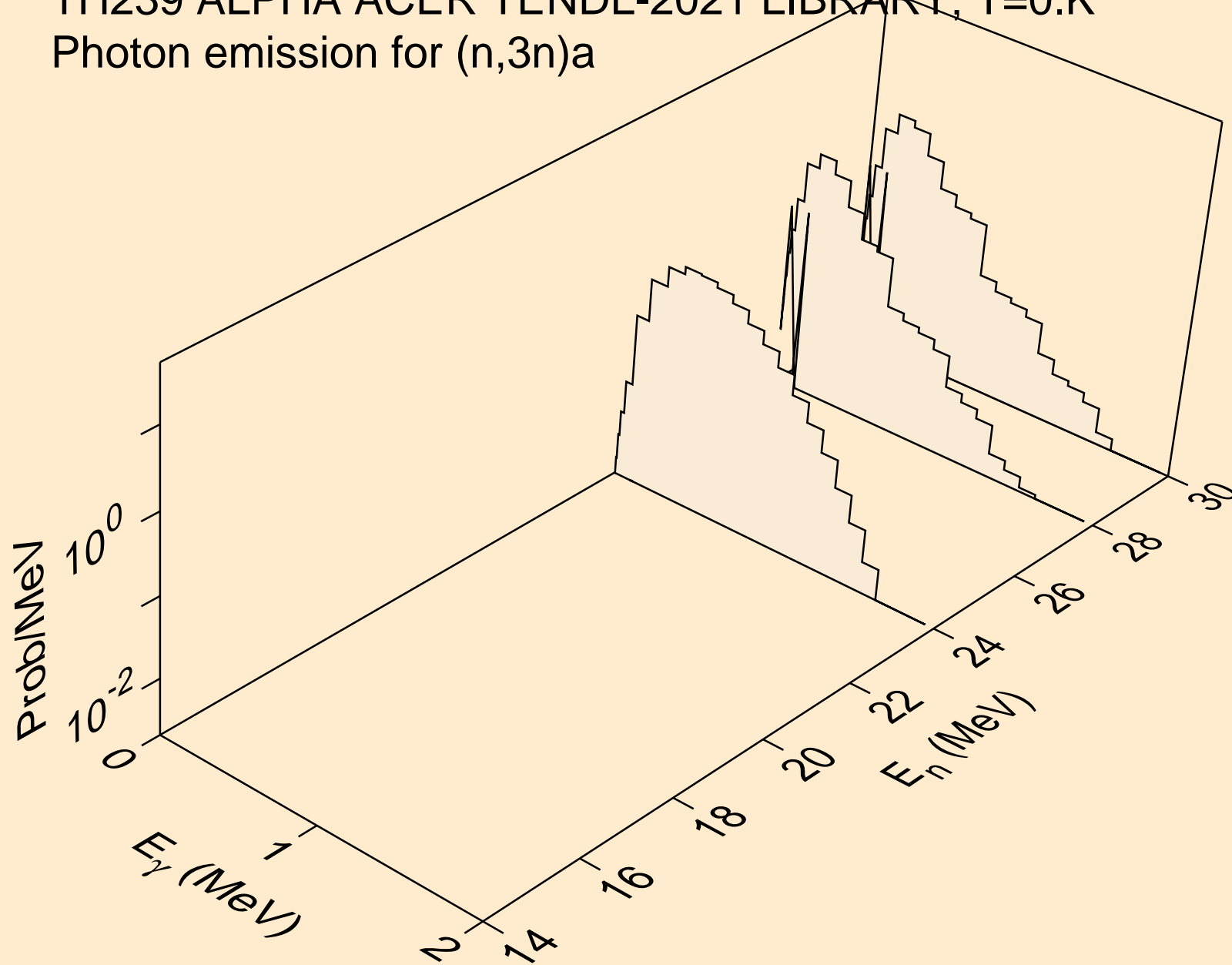

TH239 ALPHA ACER TENDL-2021 LIBRARY; T=0.K
Photon emission for (n,n*)p

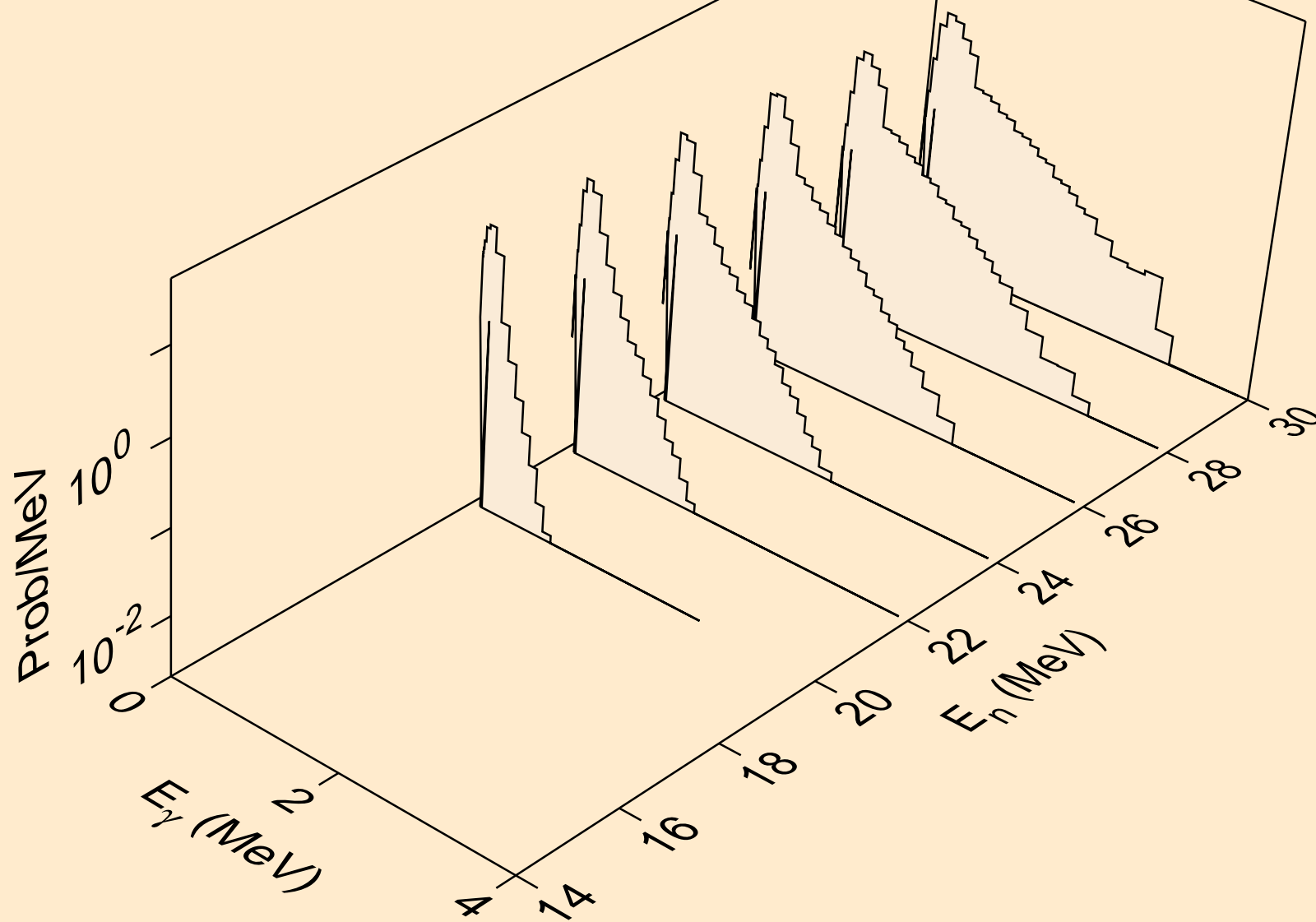

TH239 ALPHA ACER TENDL-2021 LIBRARY; T=0.K
Photon emission for (n,n*)d

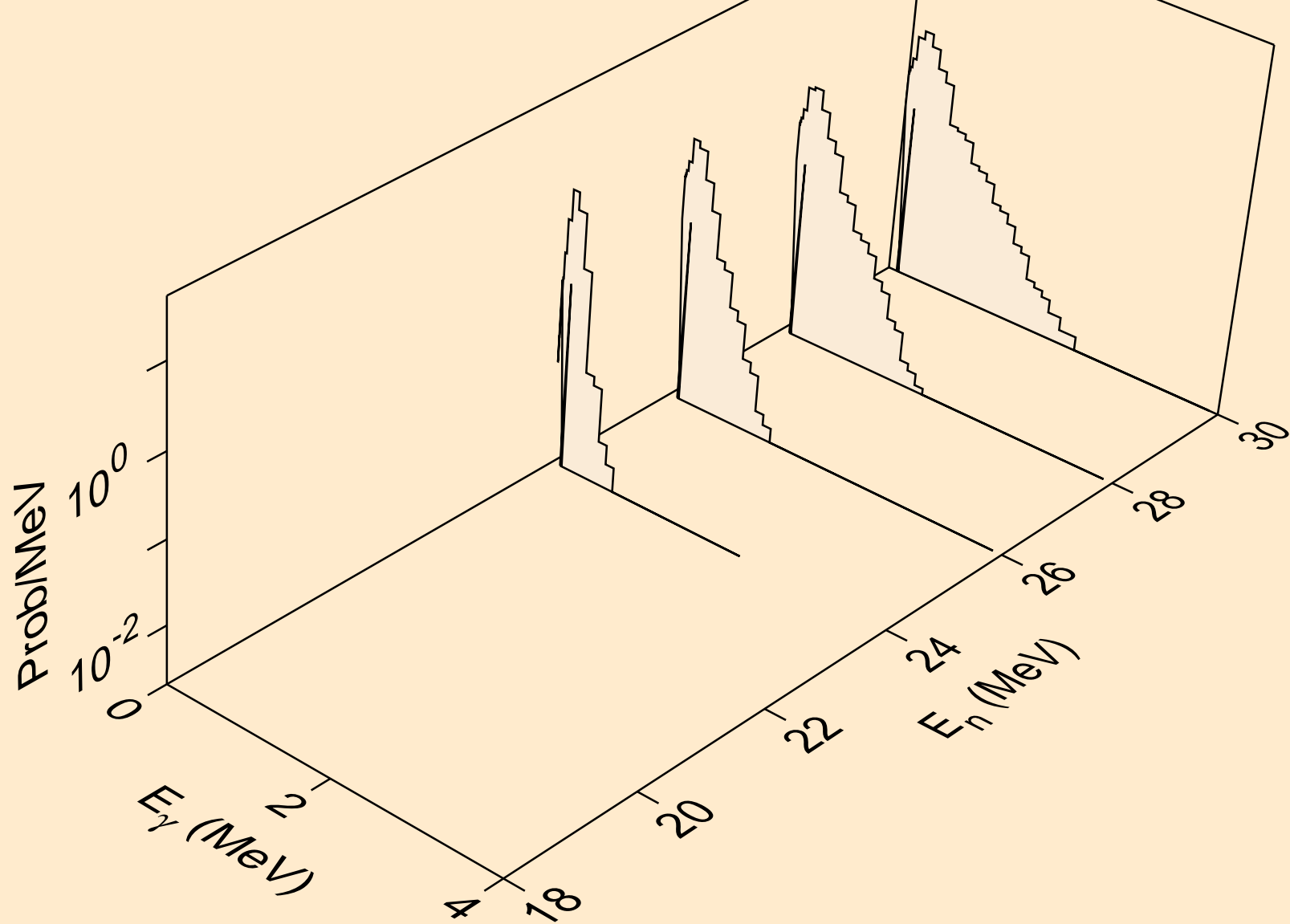

TH239 ALPHA ACER TENDL-2021 LIBRARY; T=0.K
Photon emission for (n,n*)t

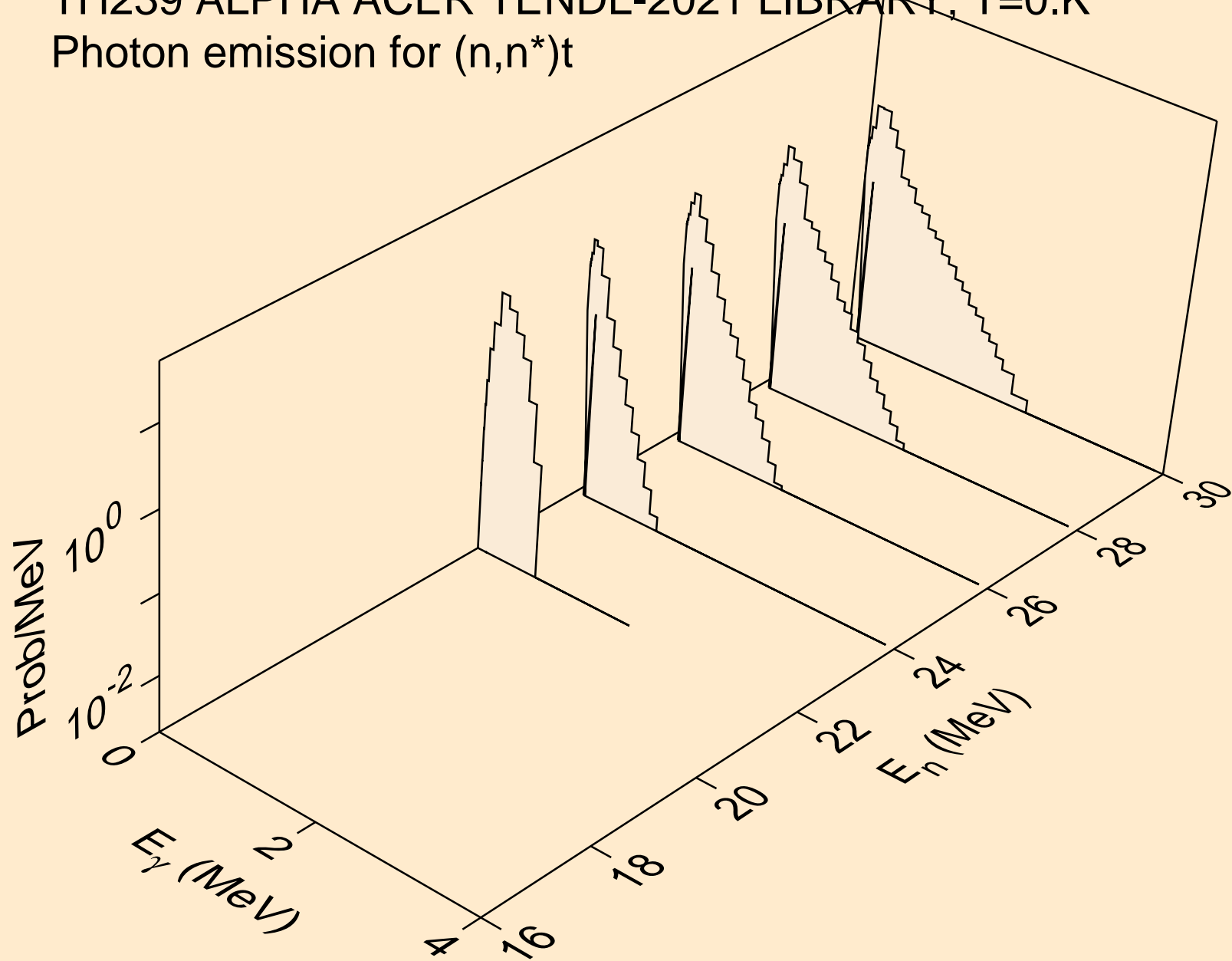

TH239 ALPHA ACER TENDL-2021 LIBRARY; T=0.K
Photon emission for (n,4n)

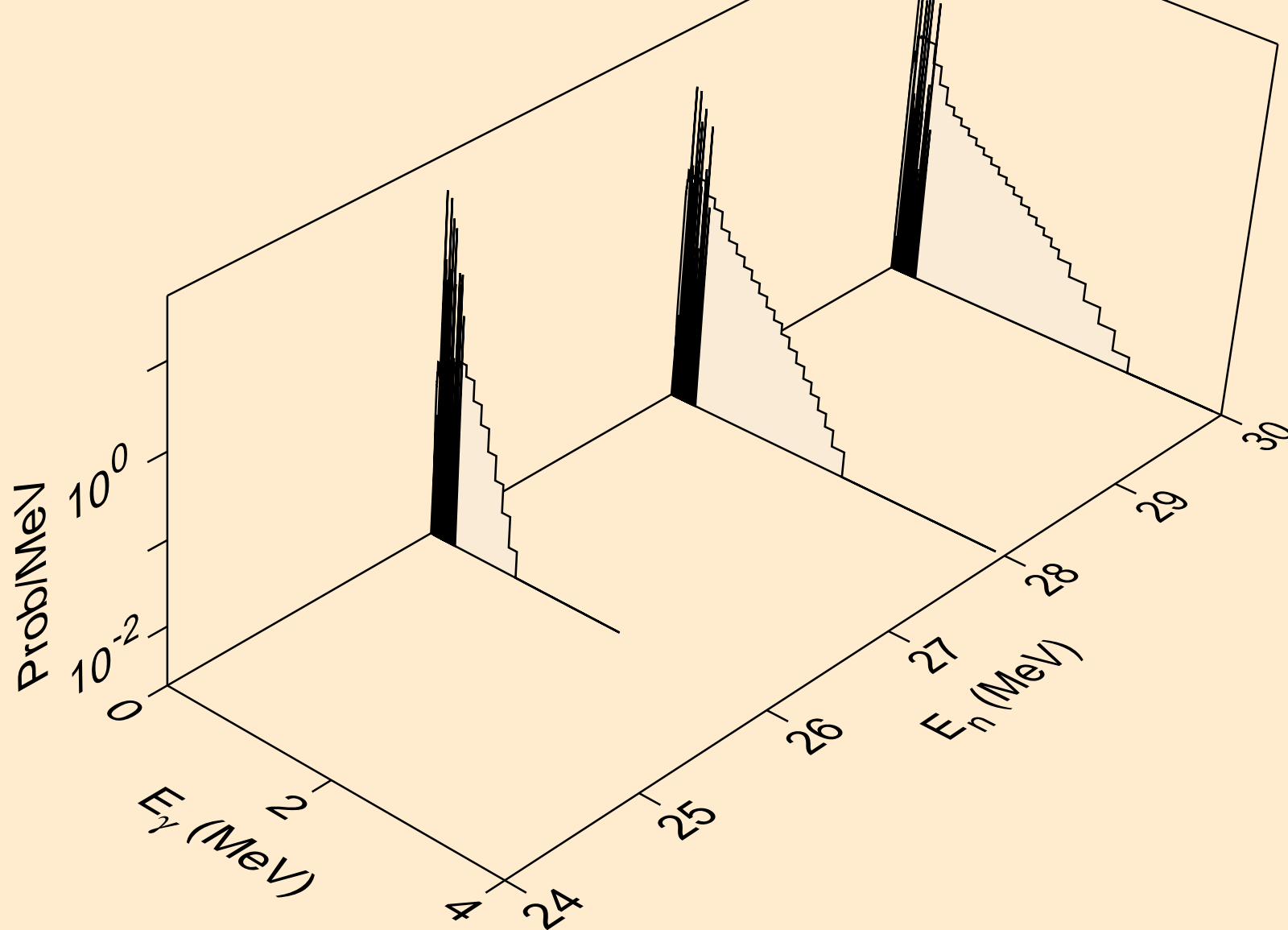

TH239 ALPHA ACER TENDL-2021 LIBRARY; T=0.K
Photon emission for (n,2np)

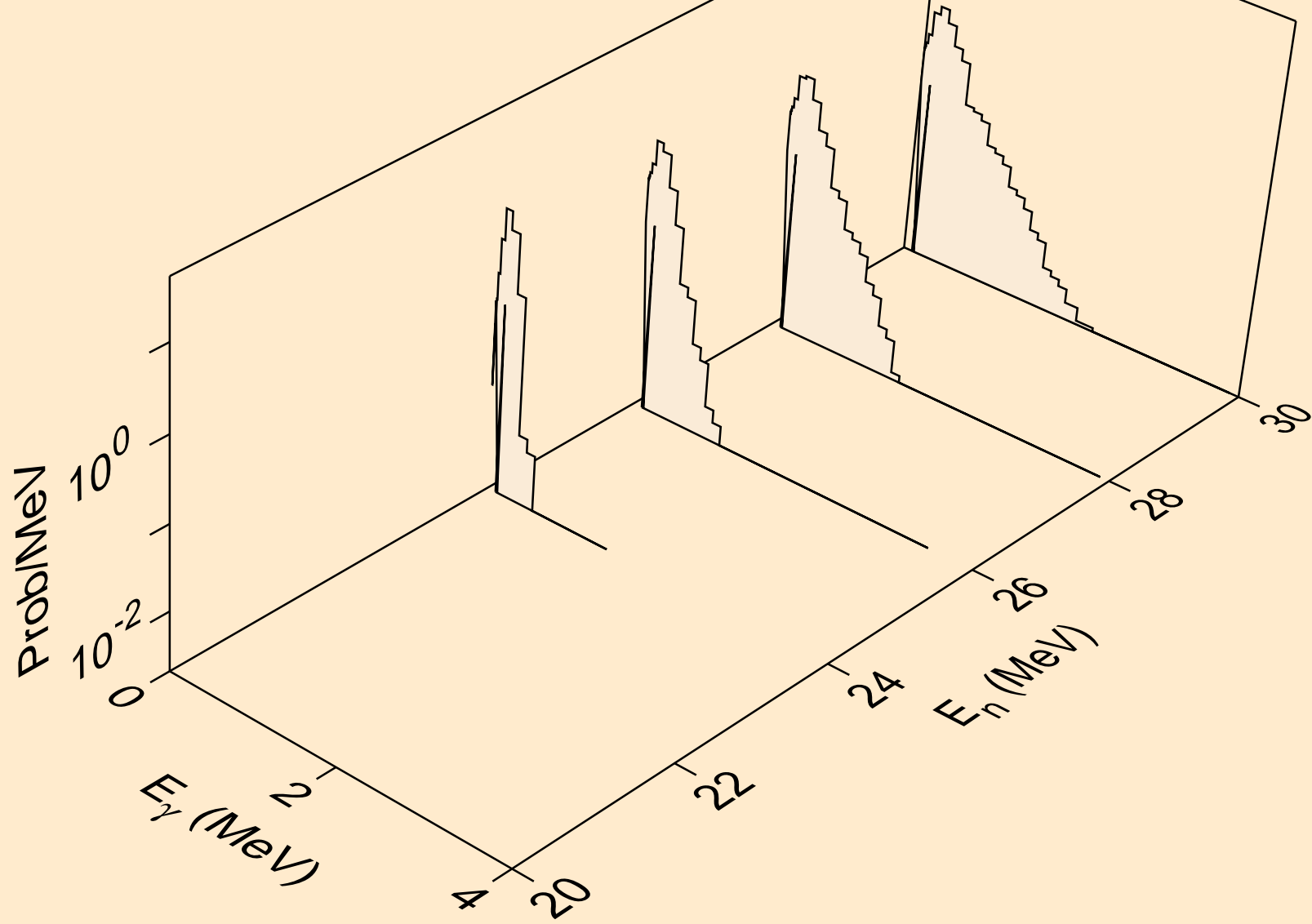

TH239 ALPHA ACER TENDL-2021 LIBRARY; T=0.K
Photon emission for (n,gma)

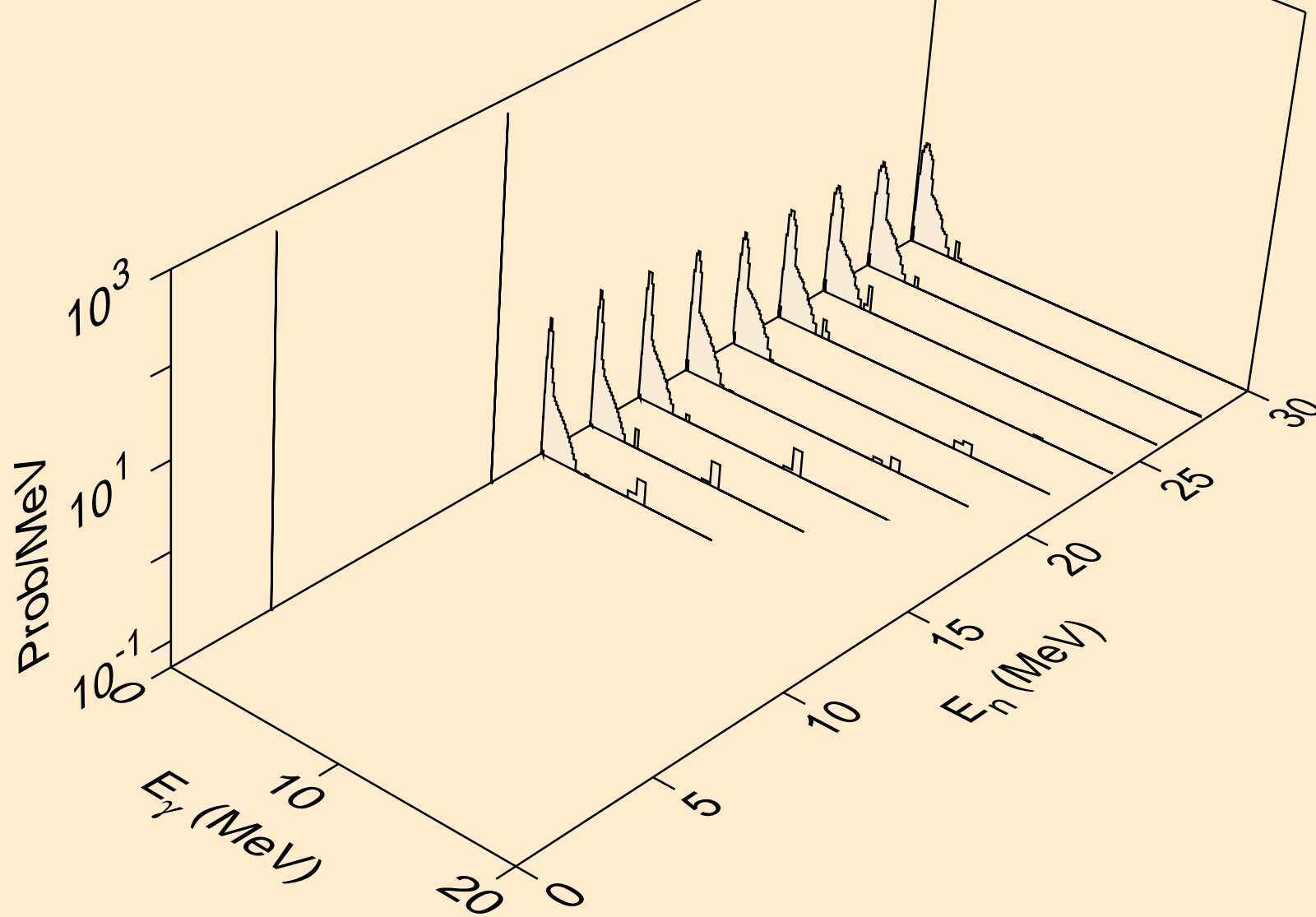

TH239 ALPHA ACER TENDL-2021 LIBRARY; T=0.K

Photon emission for (n,p)

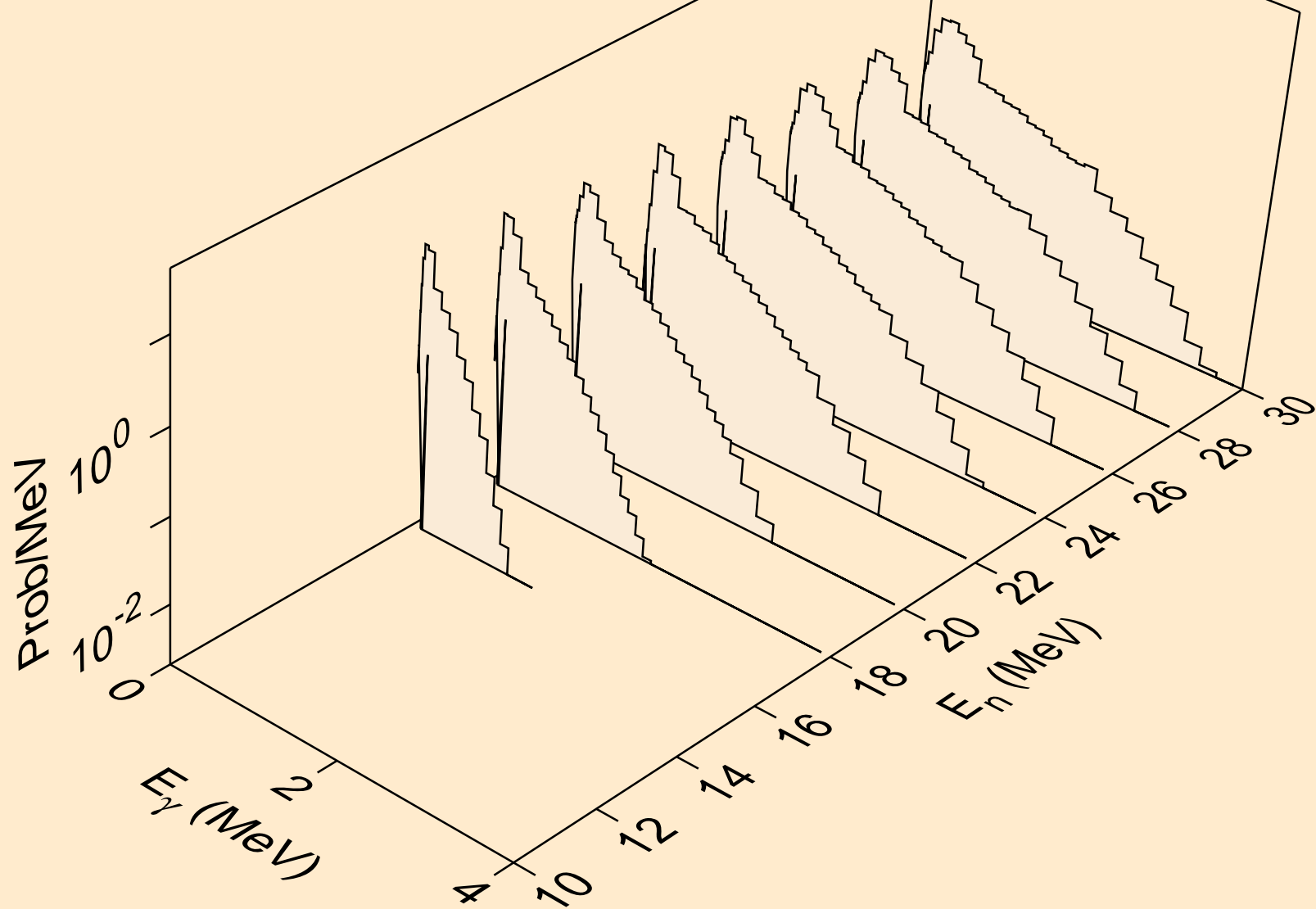

TH239 ALPHA ACER TENDL-2021 LIBRARY; T=0.K
Photon emission for (n,d)

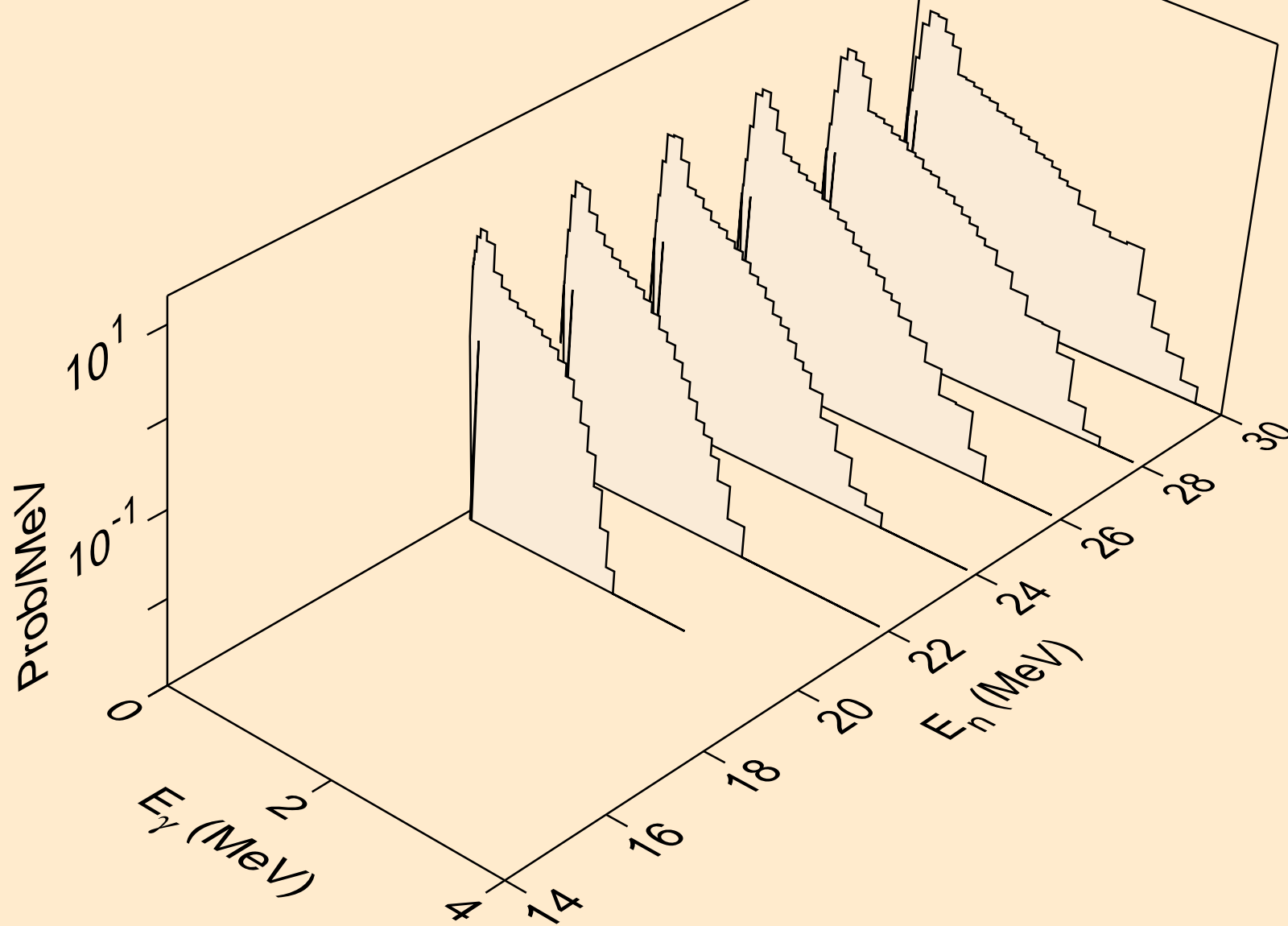

TH239 ALPHA ACER TENDL-2021 LIBRARY; T=0.K
Photon emission for (n,t)

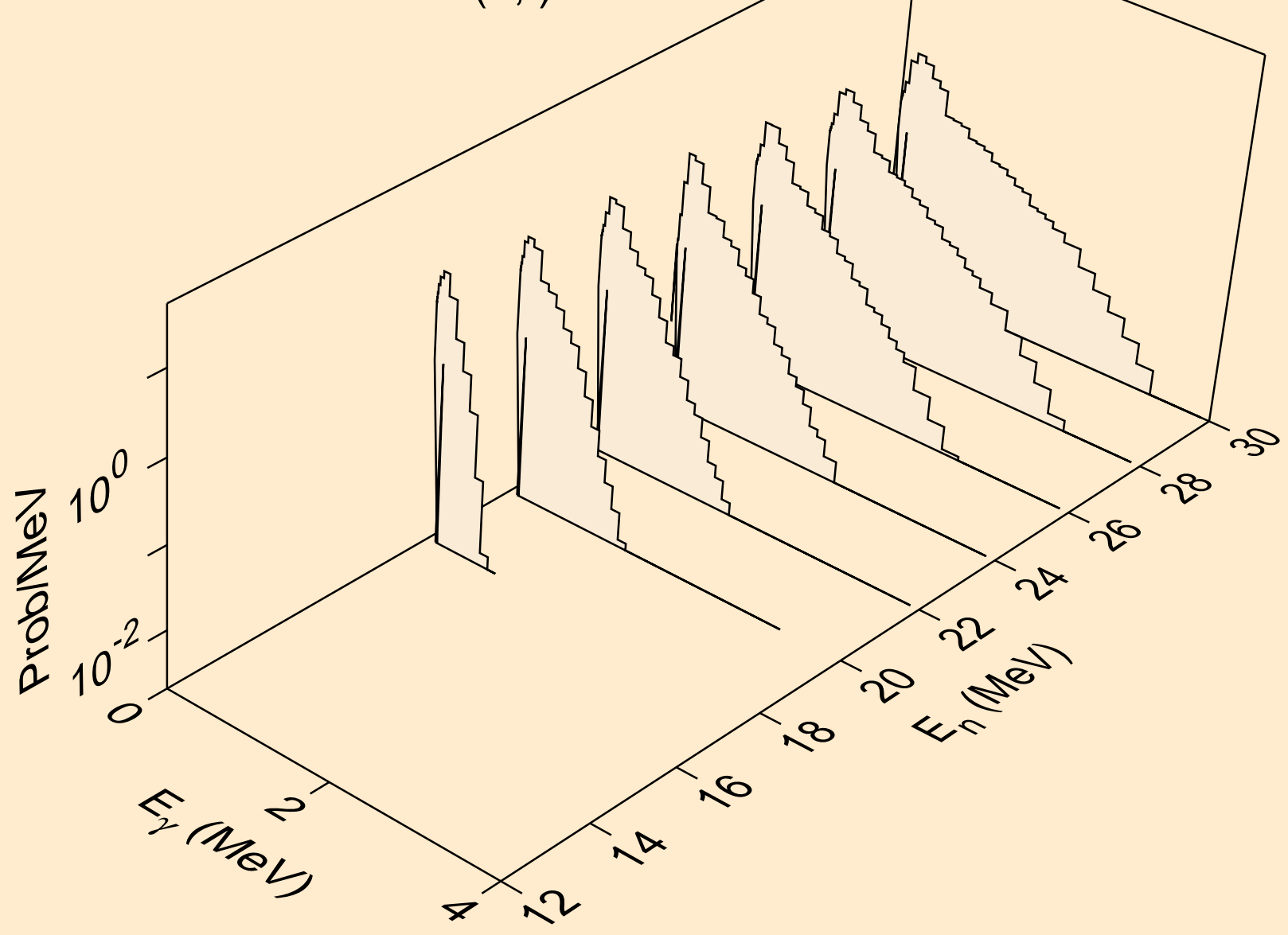

TH239 ALPHA ACER TENDL-2021 LIBRARY; T=0.K
Photon emission for inelastic

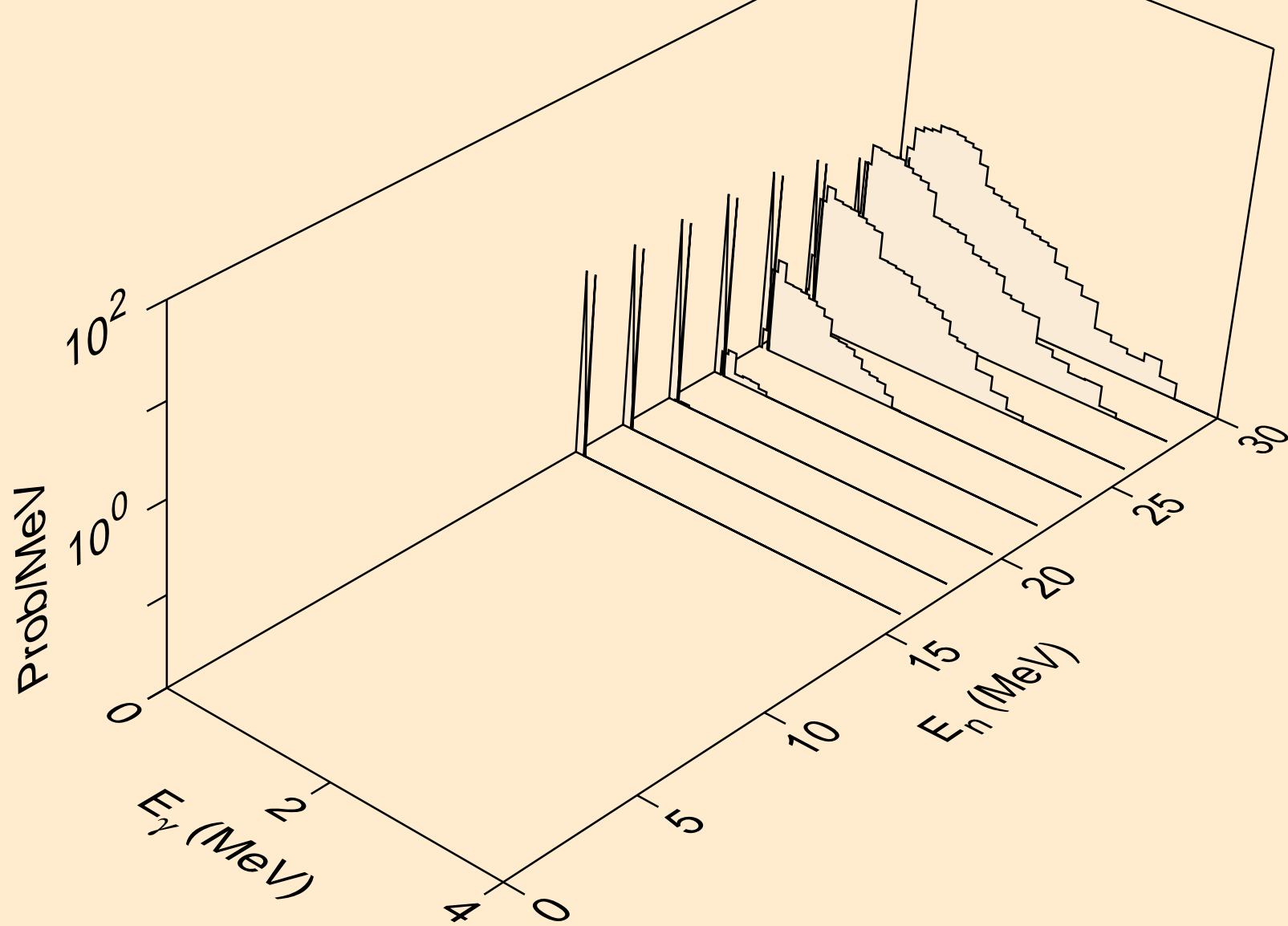

TH239 ALPHA ACER TENDL-2021 LIBRARY; T=0.K
Particle heating contributions

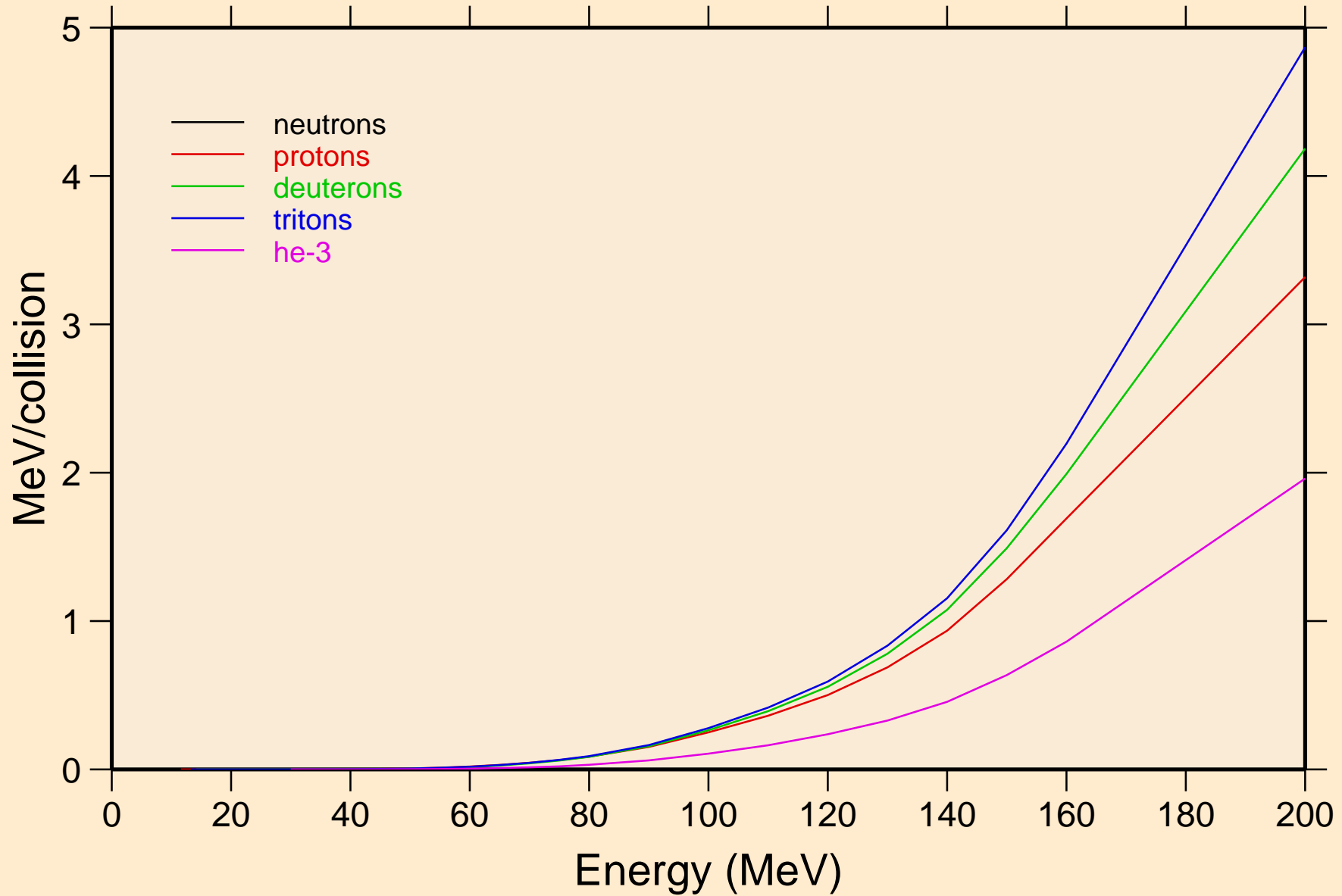

TH239 ALPHA ACER TENDL-2021 LIBRARY; T=0.K
Recoil Heating

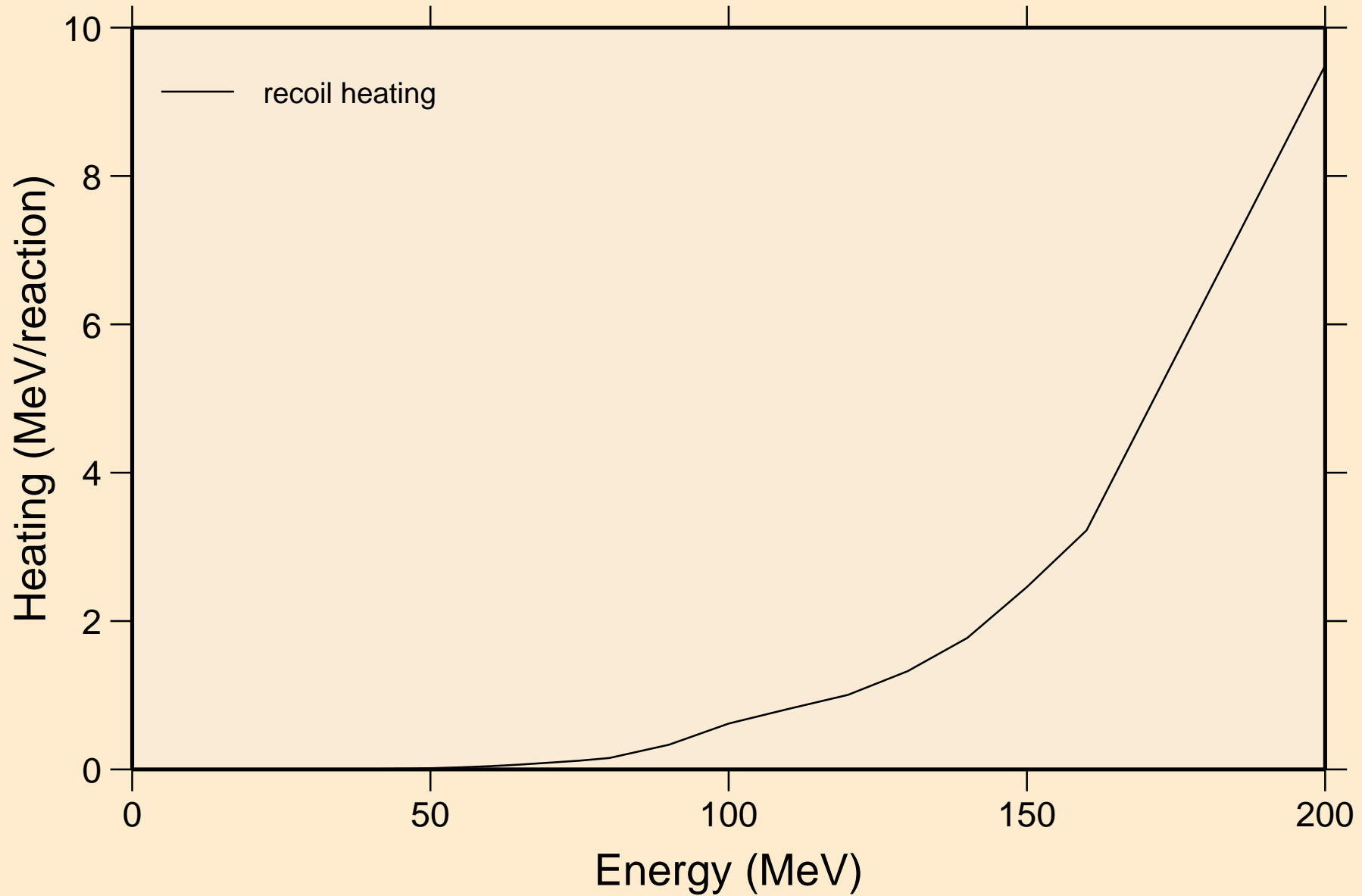

TH239 ALPHA ACER TENDL-2021 LIBRARY; T=0.K
Particle production cross sections

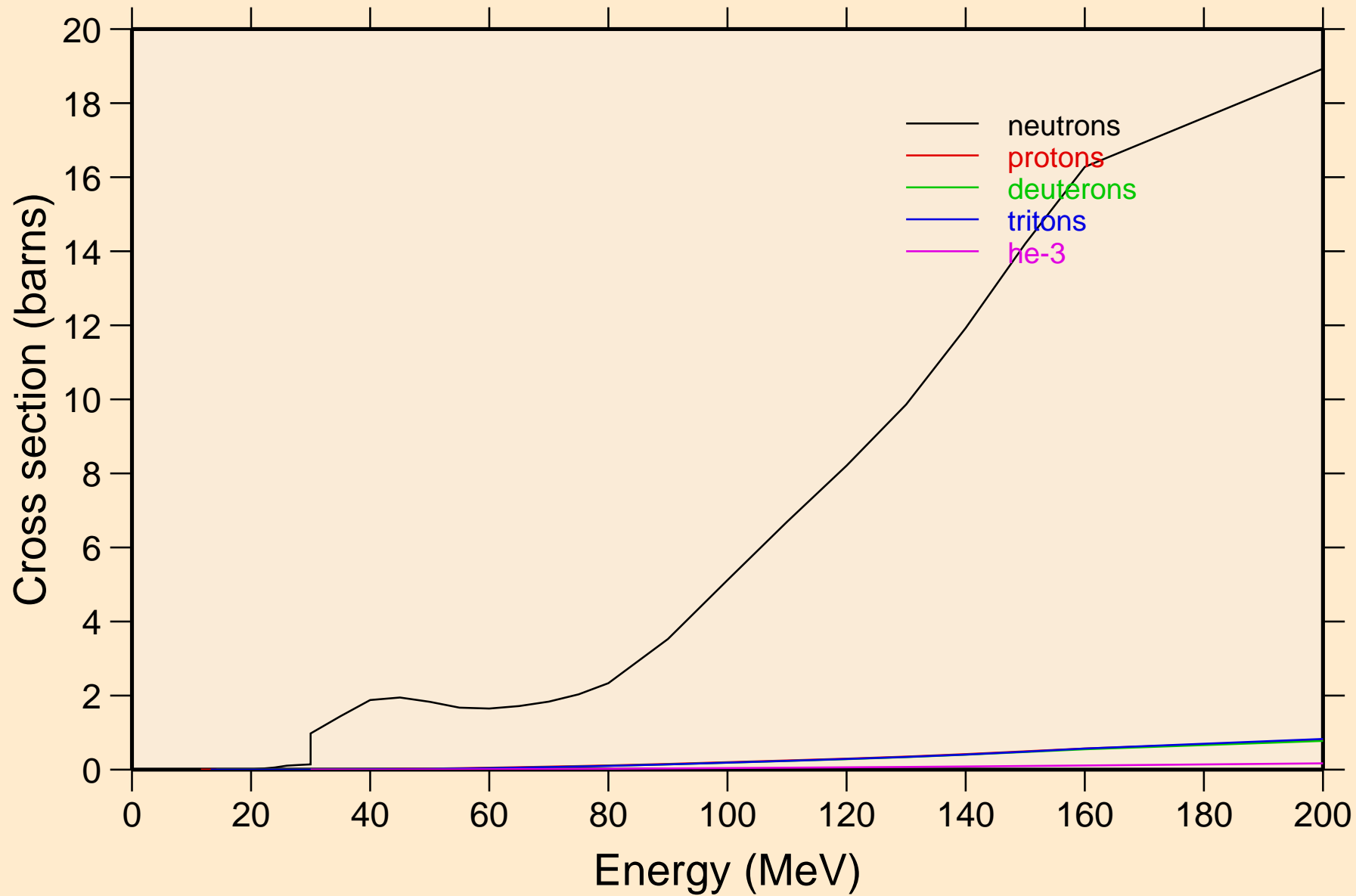

TH239 ALPHA ACER TENDL-2021 LIBRARY; T=0.K
neutrons from (a,n)

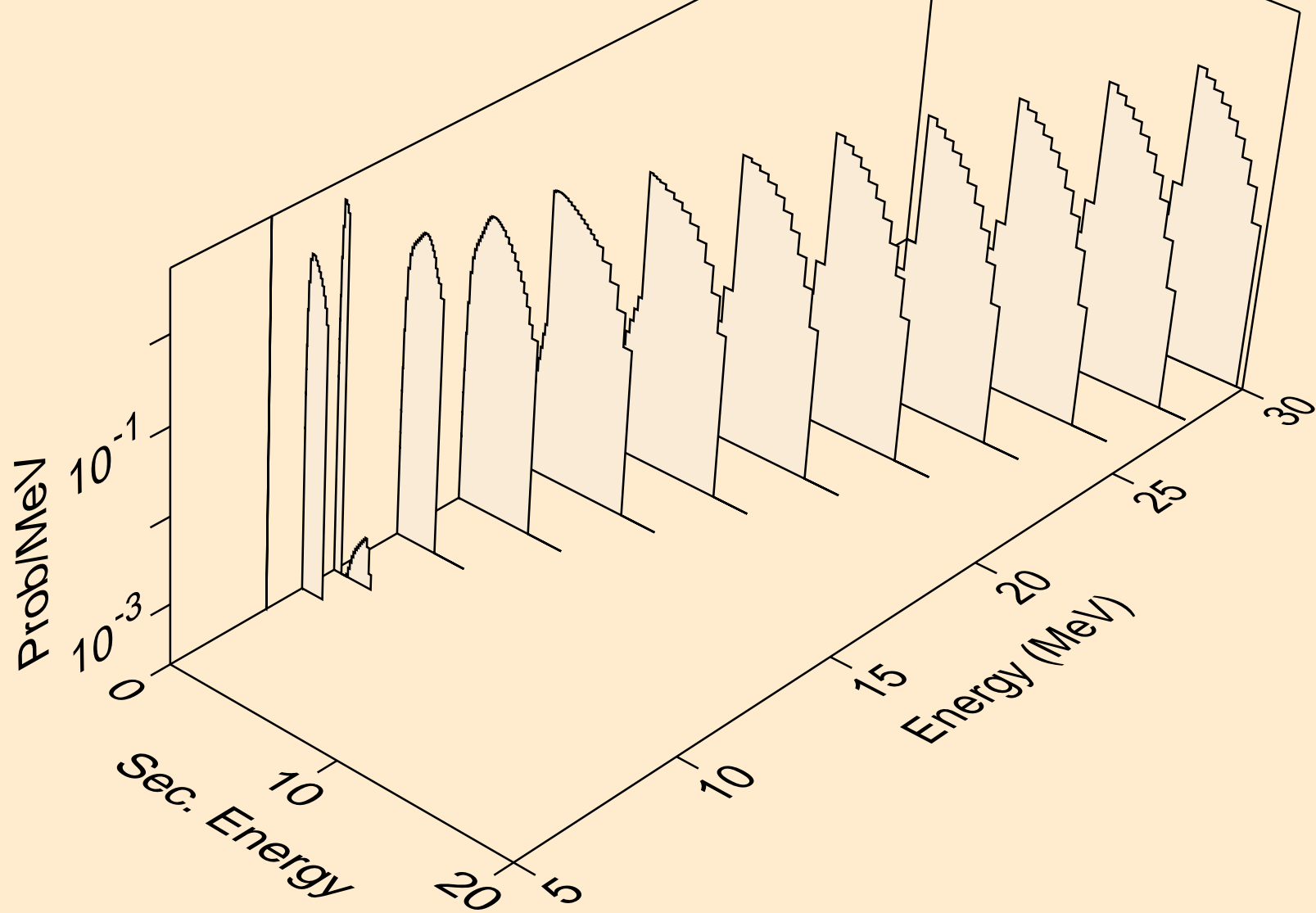

TH239 ALPHA ACER TENDL-2021 LIBRARY; T=0.K
neutrons from (a,x)

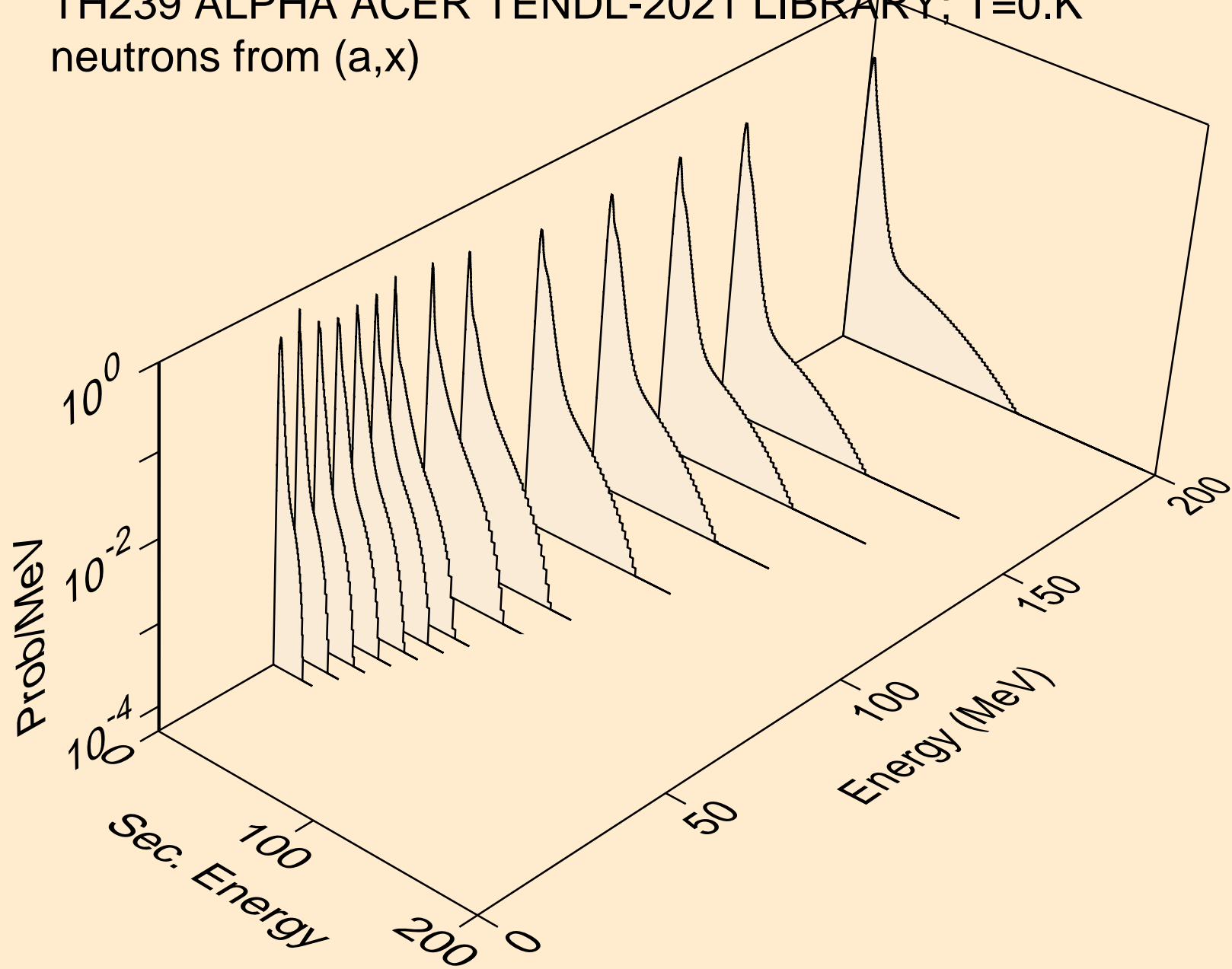

TH239 ALPHA ACER TENDL-2021 LIBRARY; T=0.K
neutrons from (a,2n)

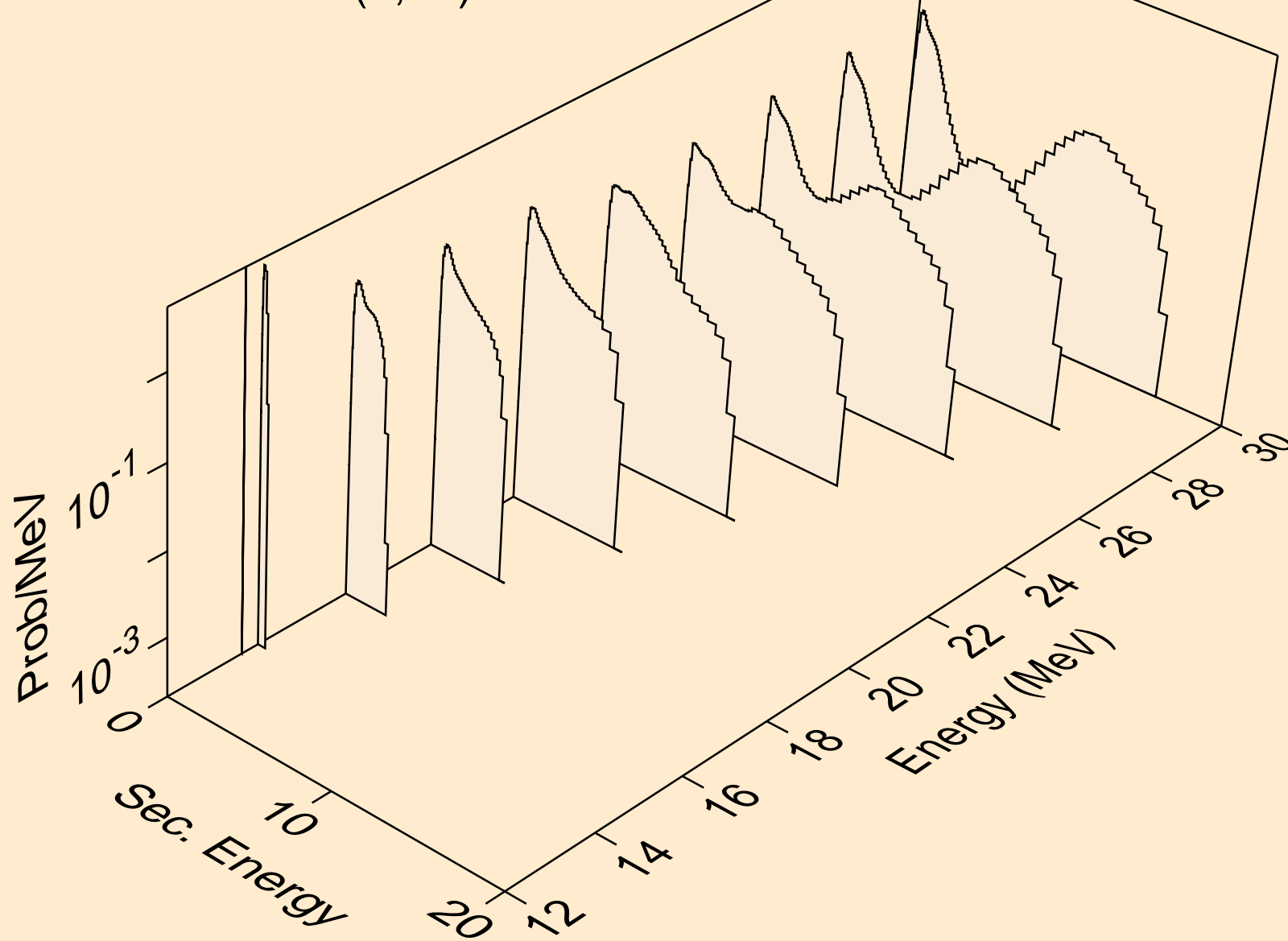

TH239 ALPHA ACER TENDL-2021 LIBRARY; T=0.K
neutrons from (a,3n)

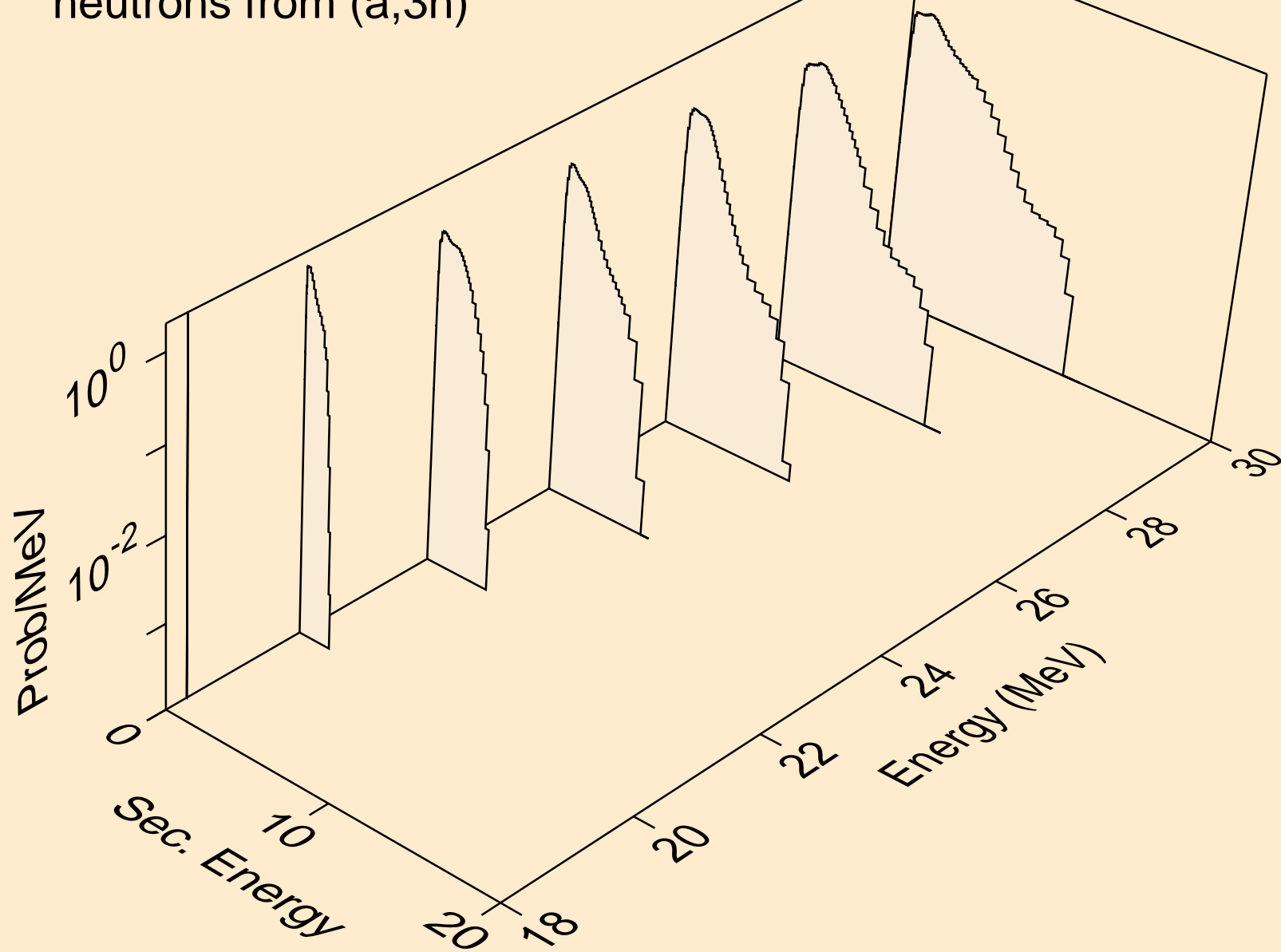

TH239 ALPHA ACER TENDL-2021 LIBRARY; T=0.K
neutrons from (a,n*)a

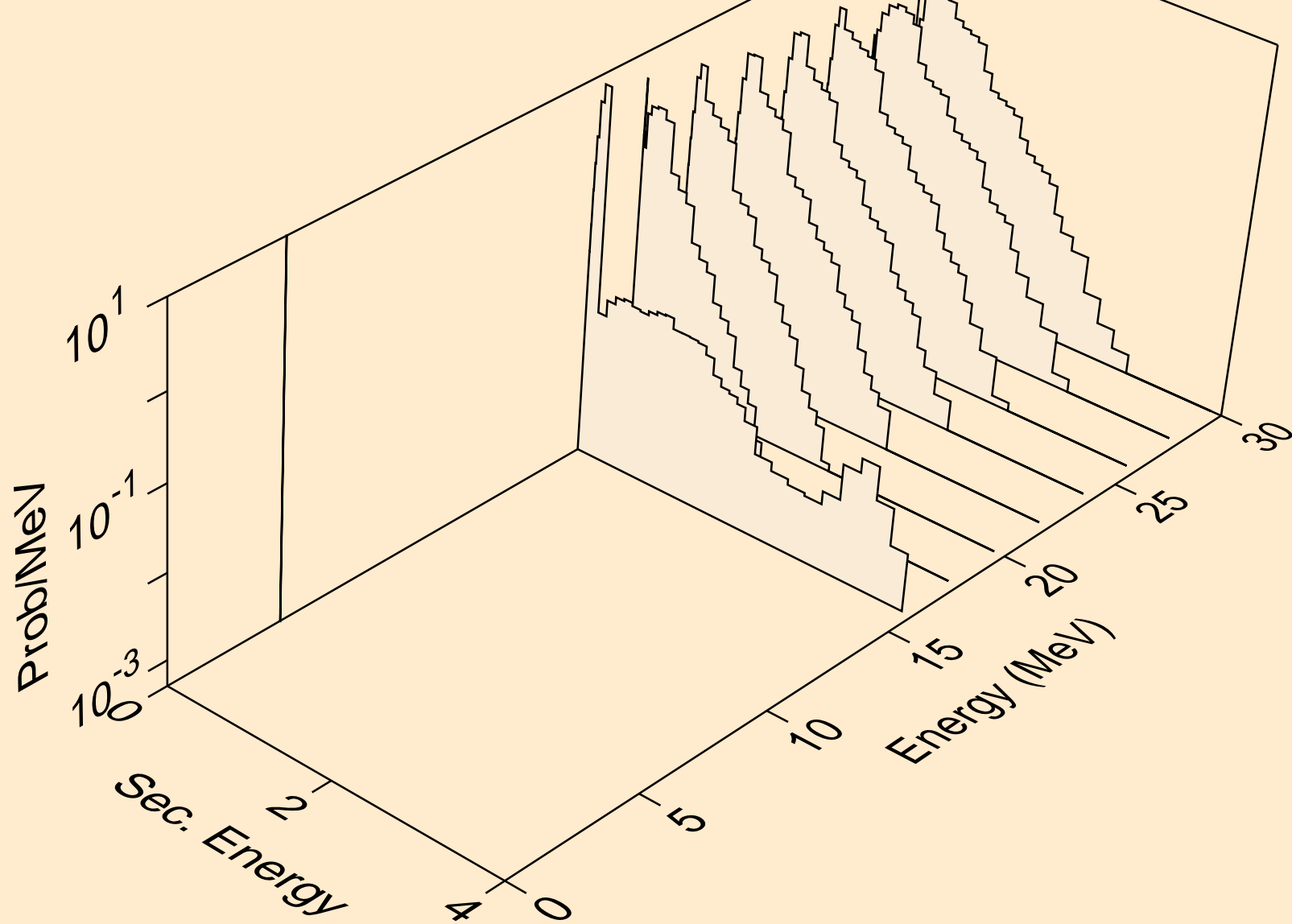

TH239 ALPHA ACER TENDL-2021 LIBRARY; T=0.K
neutrons from (a,2n)a

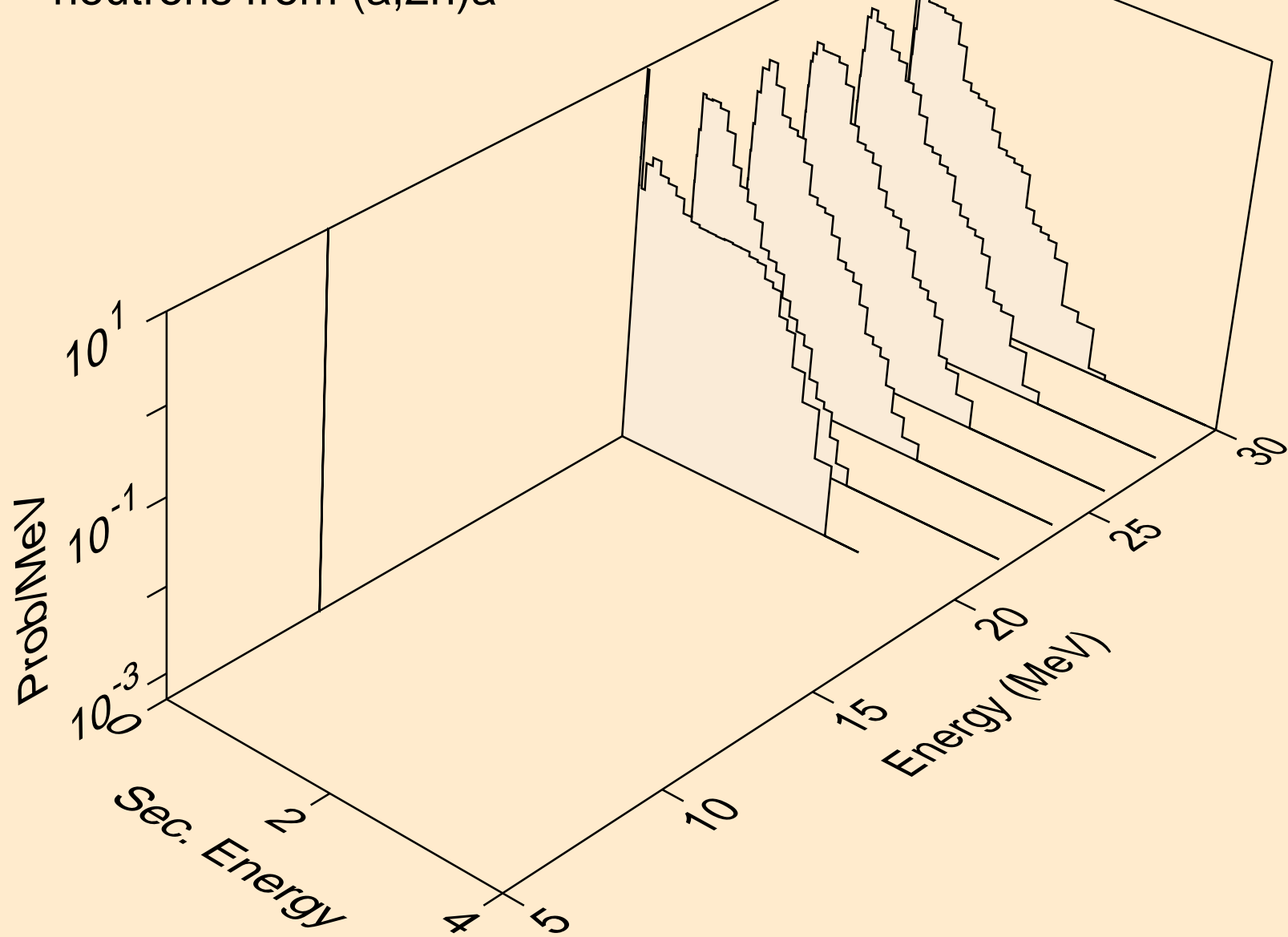

TH239 ALPHA ACER TENDL-2021 LIBRARY; T=0.K
neutrons from (a,3n)a

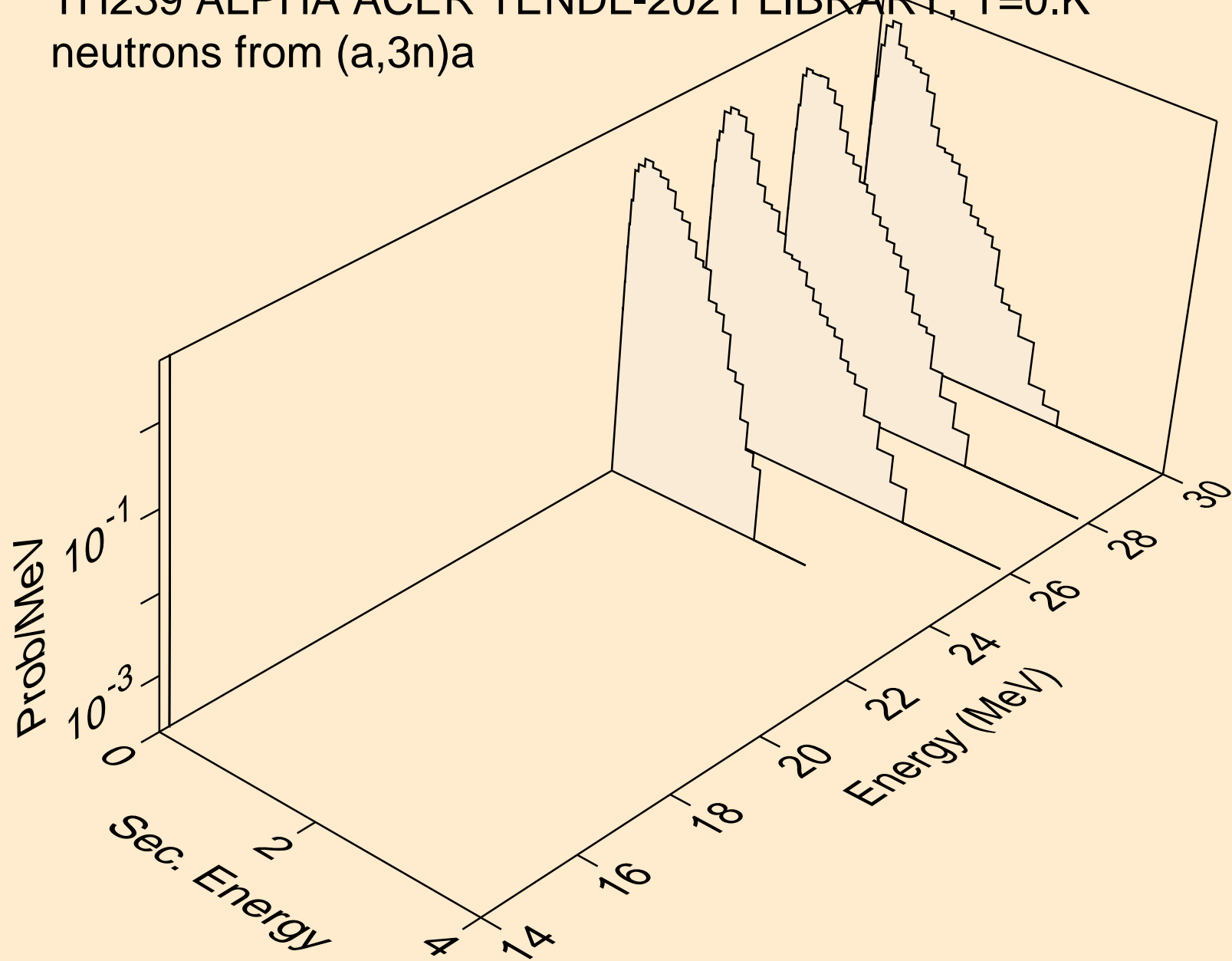

TH239 ALPHA ACER TENDL-2021 LIBRARY; T=0.K
neutrons from (a,n*)p

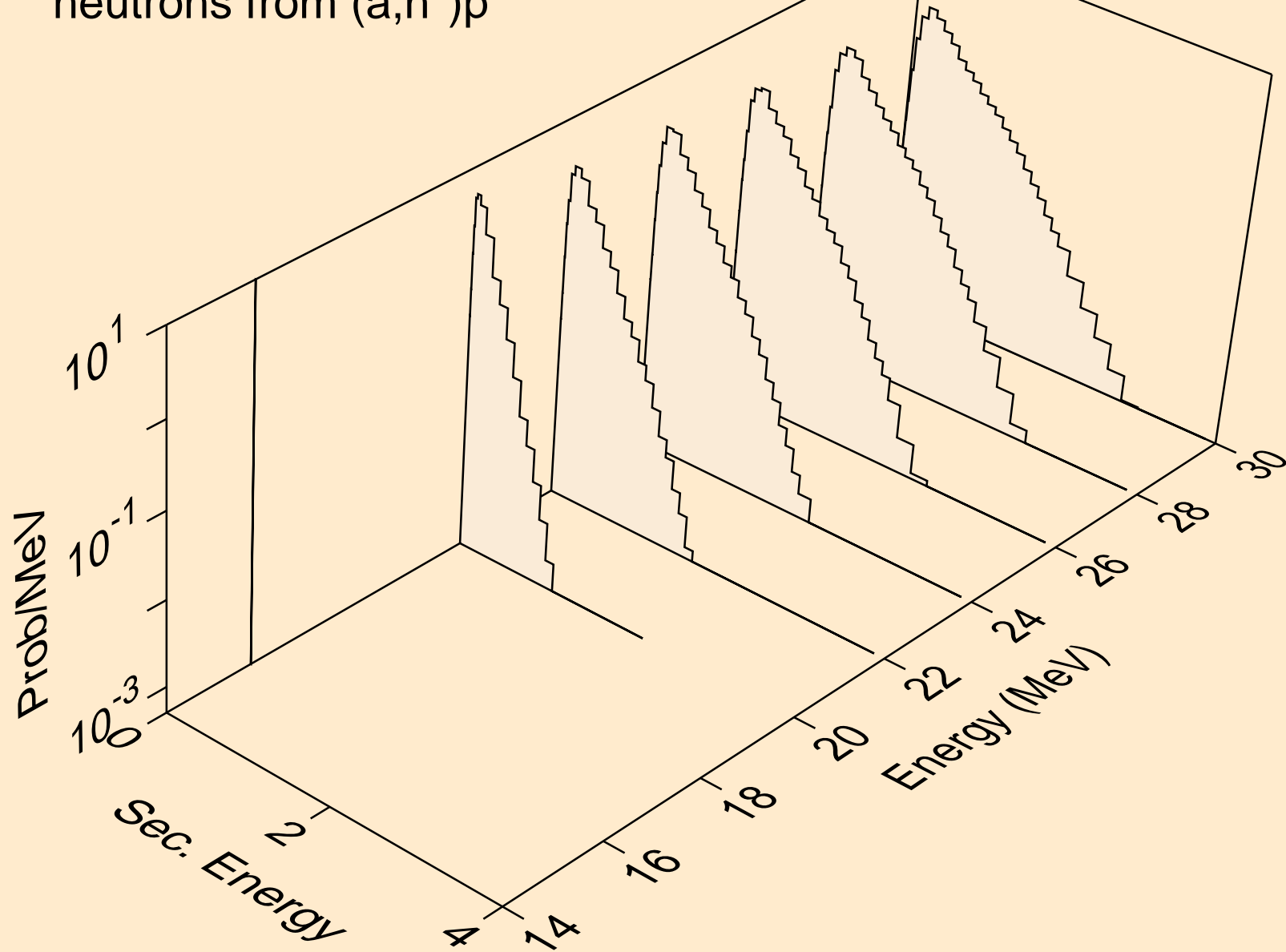

TH239 ALPHA ACER TENDL-2021 LIBRARY; T=0.K
neutrons from (a,n*)d

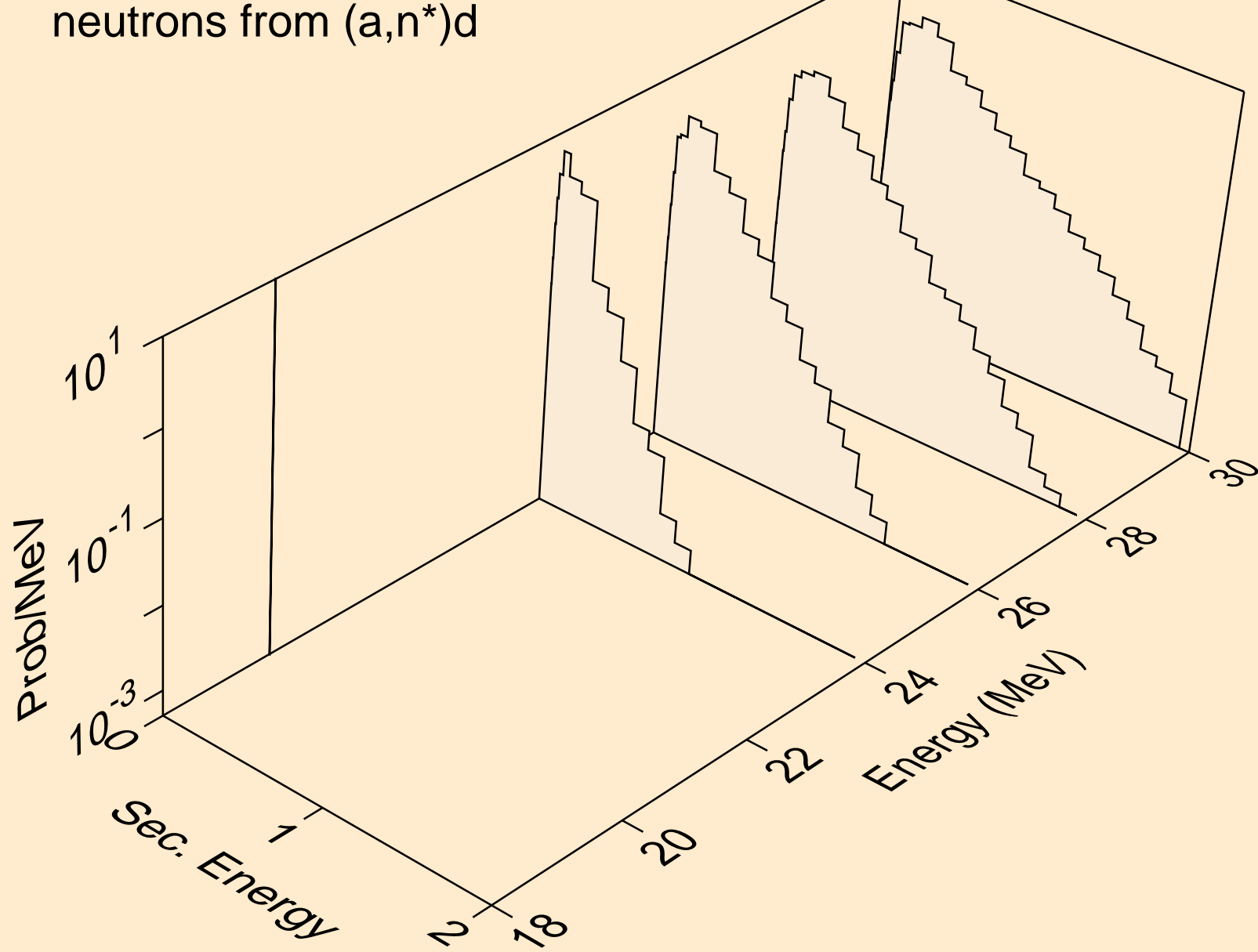

TH239 ALPHA ACER TENDL-2021 LIBRARY; T=0.K
neutrons from (a,n*)t

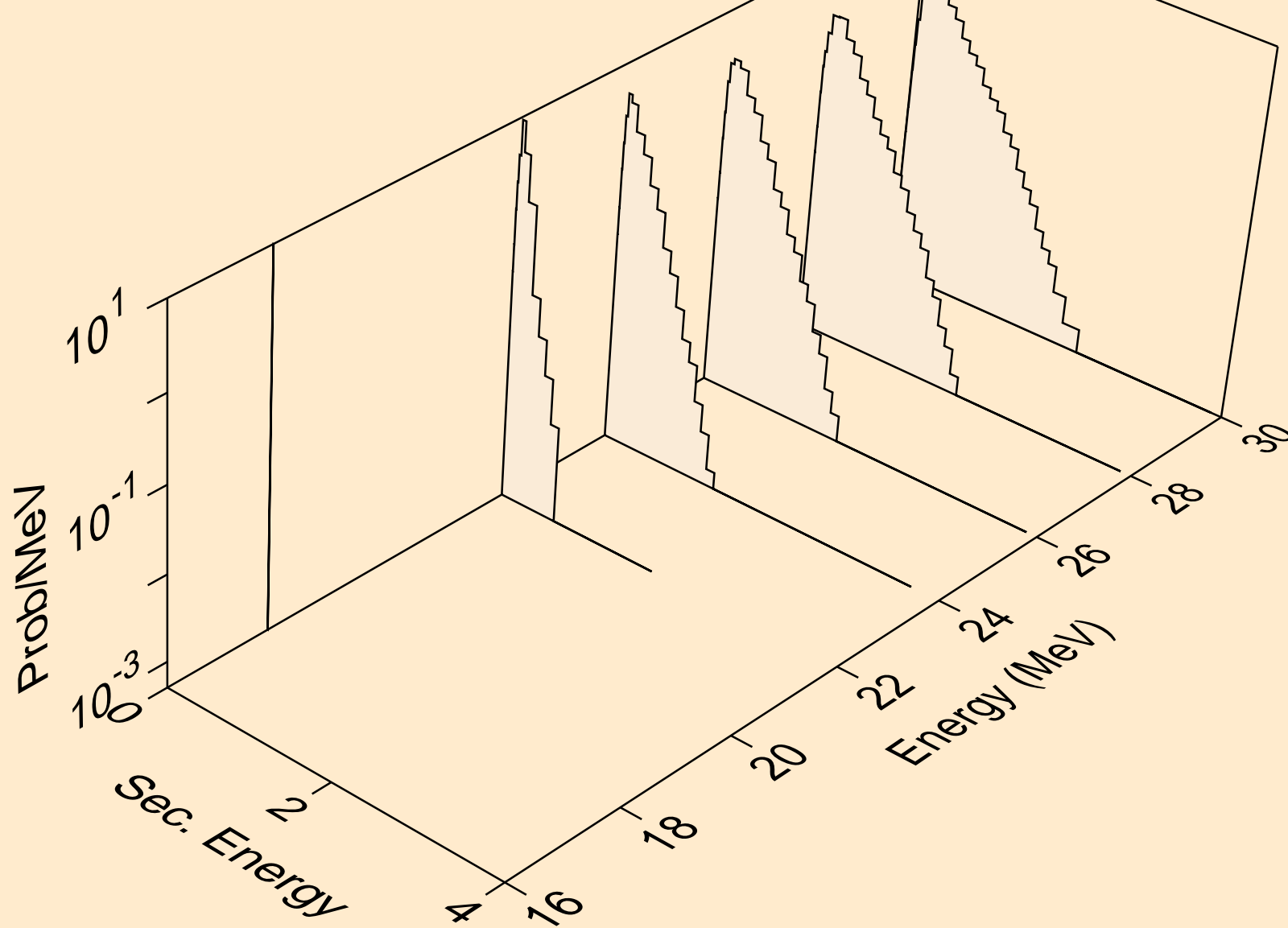

TH239 ALPHA ACER TENDL-2021 LIBRARY; T=0.K
neutrons from (a,4n)

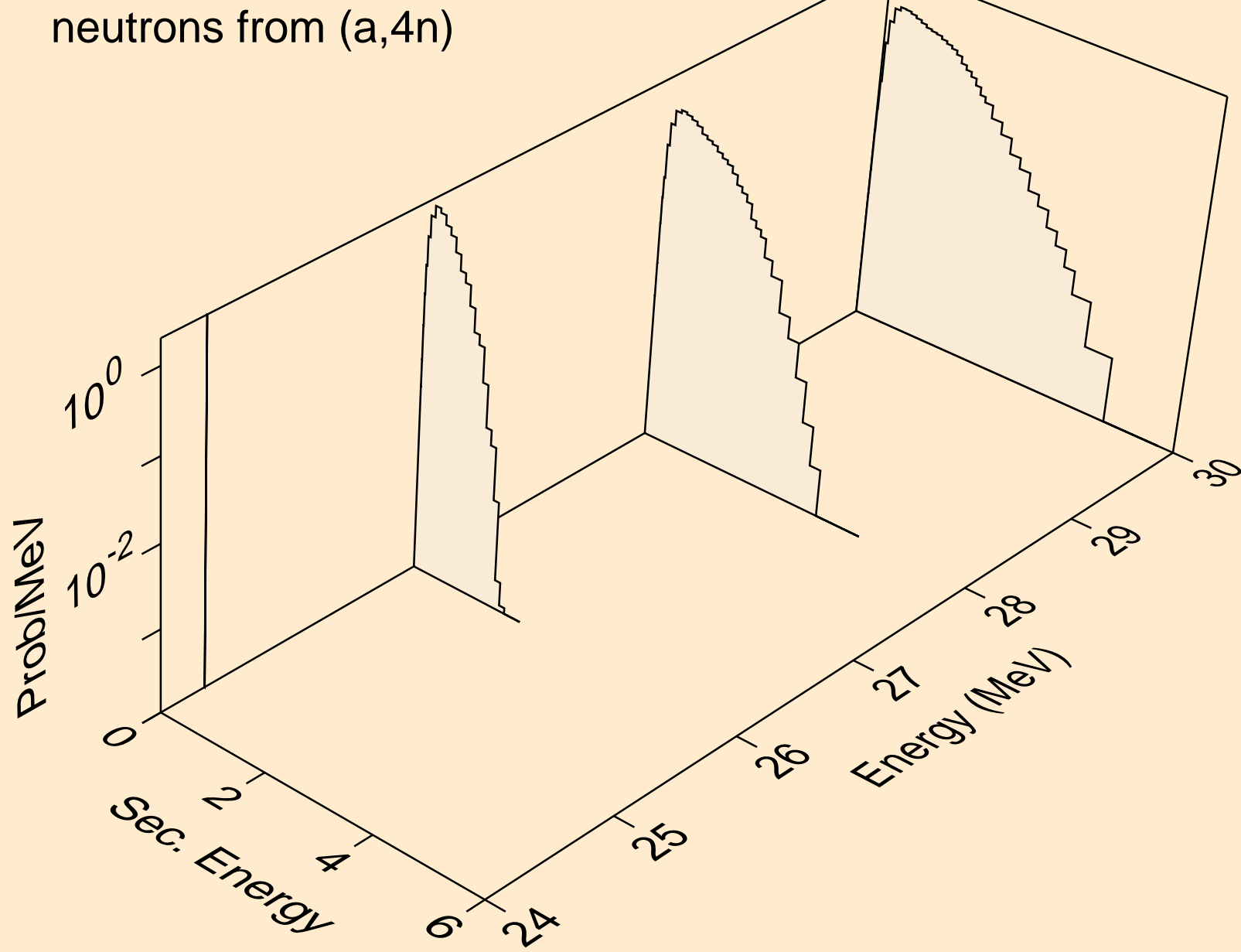

TH239 ALPHA ACER TENDL-2021 LIBRARY; T=0.K
neutrons from (a,2np)

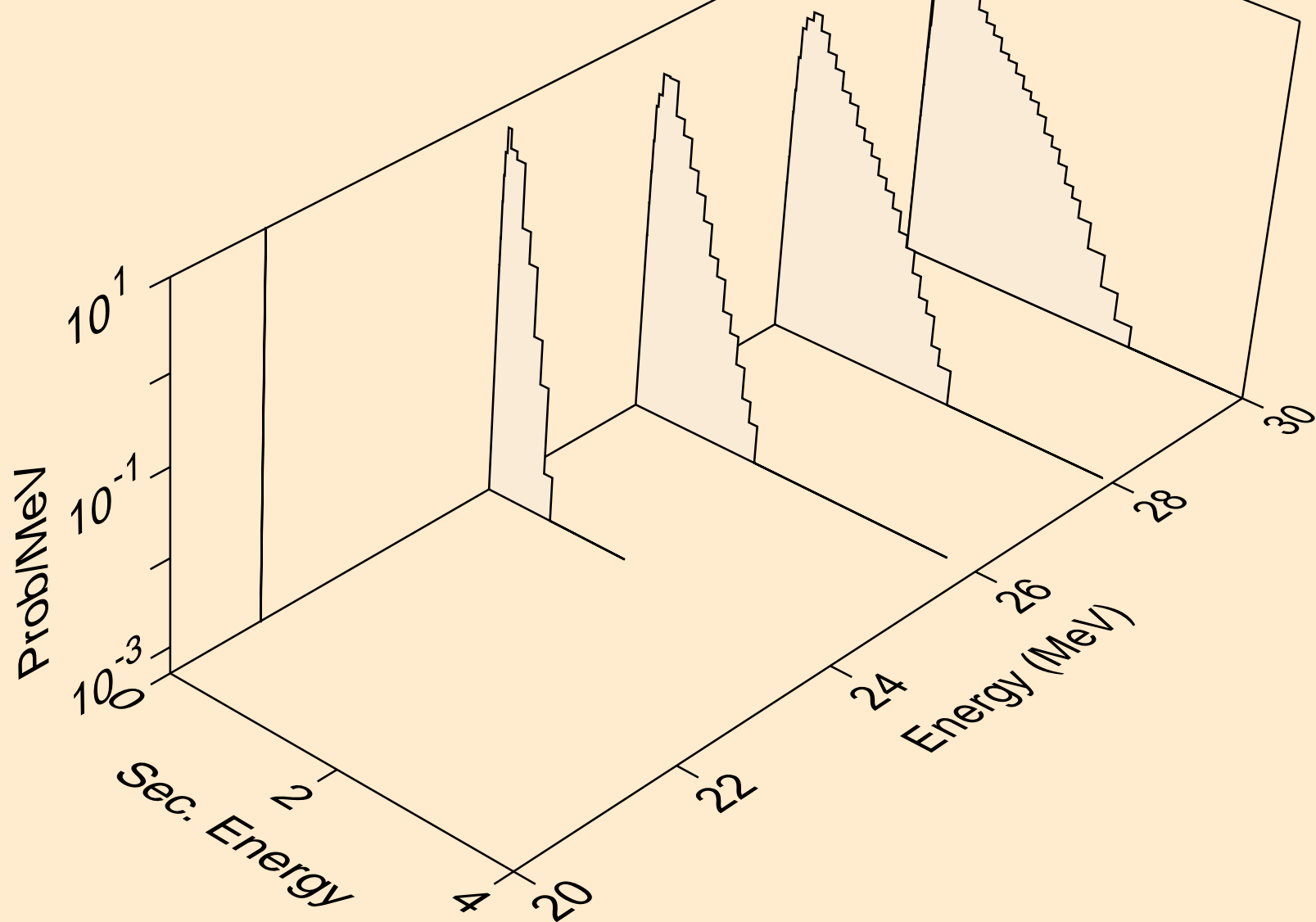

TH239 ALPHA ACER TENDL-2021 LIBRARY; T=0.K
protons from (a,x)

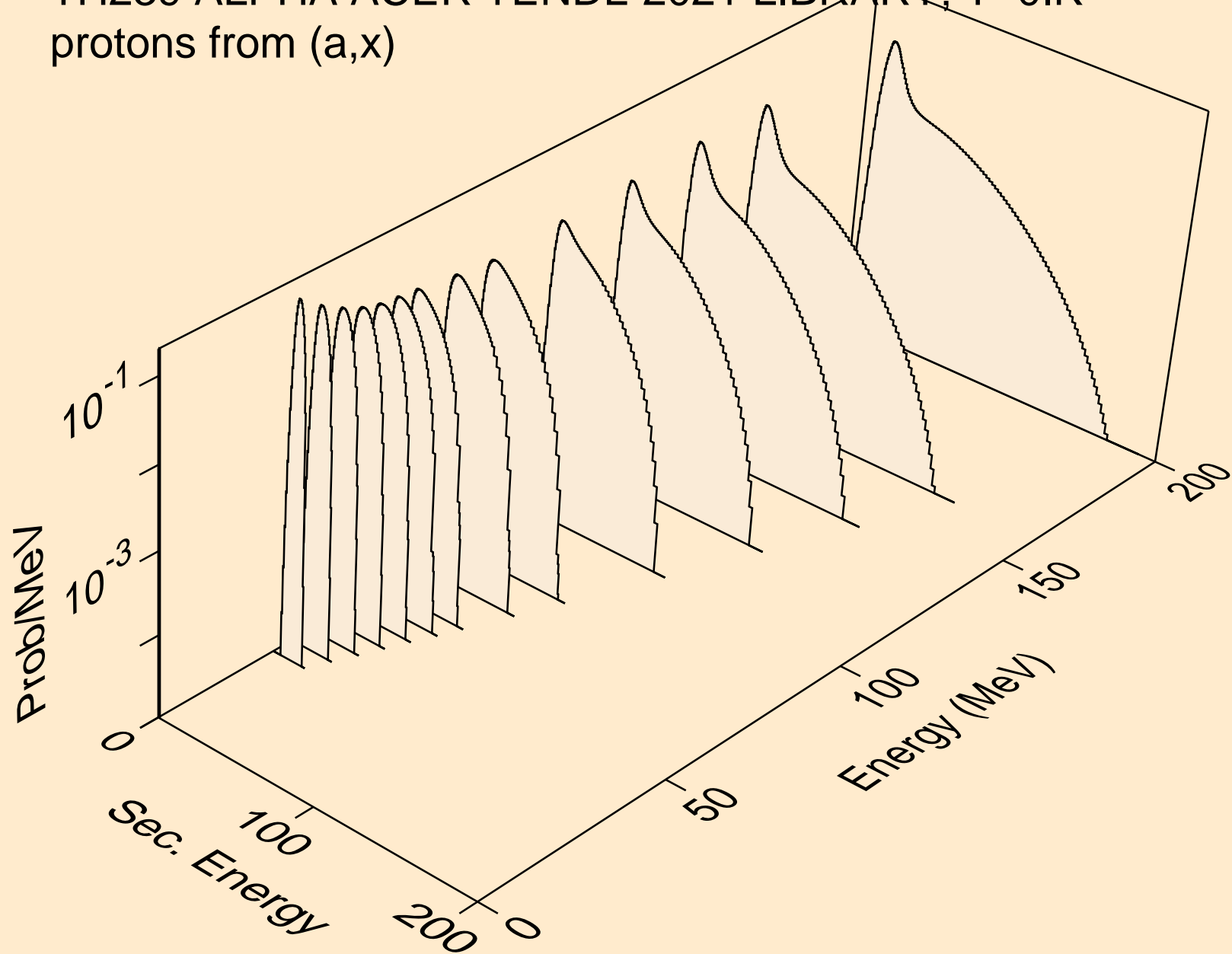

TH239 ALPHA ACER TENDL-2021 LIBRARY; T=0.K
protons from (a,n*)p

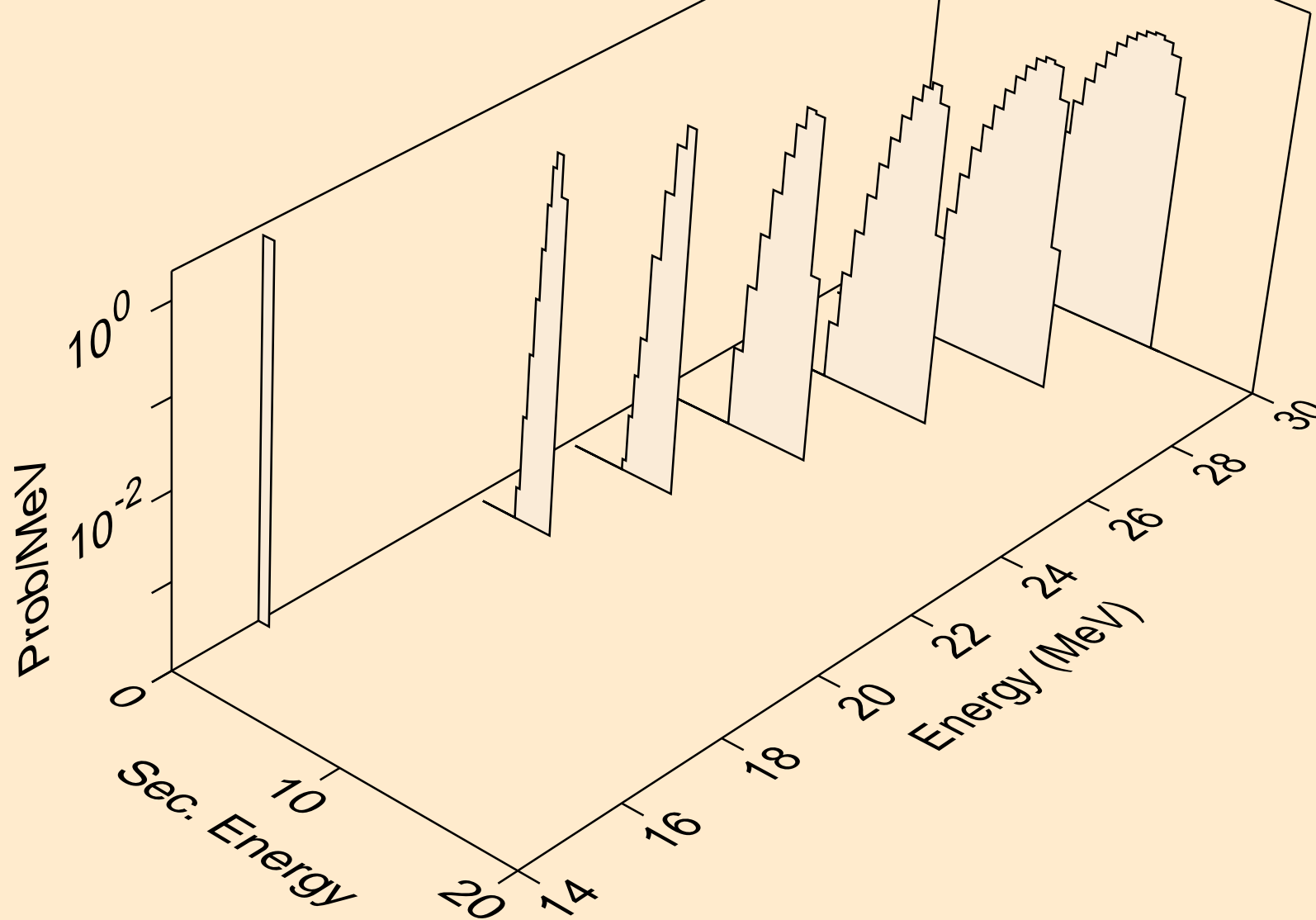

TH239 ALPHA ACER TENDL-2021 LIBRARY; T=0.K
protons from (a,2np)

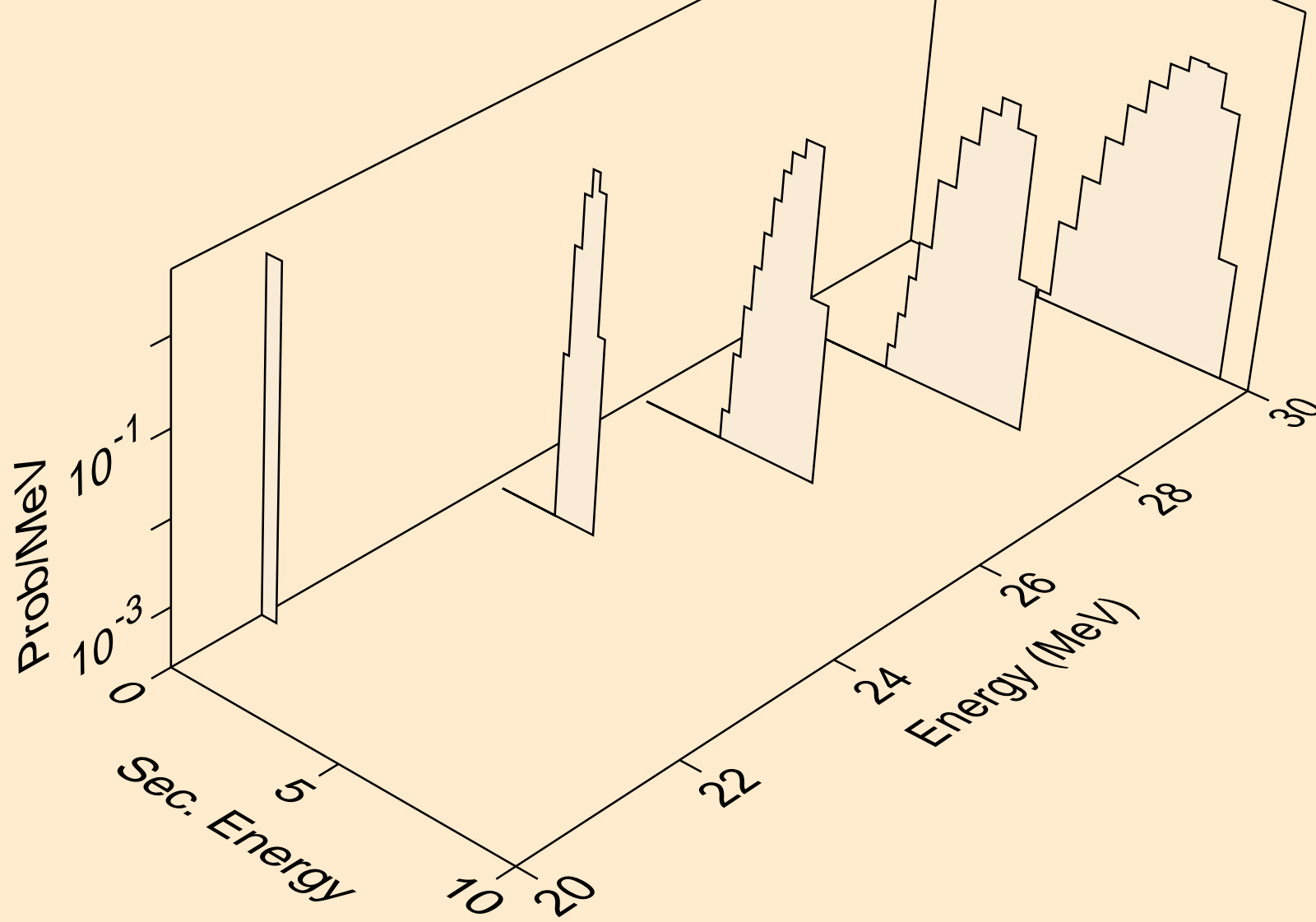

TH239 ALPHA ACER TENDL-2021 LIBRARY; T=0.K
protons from (a,p)

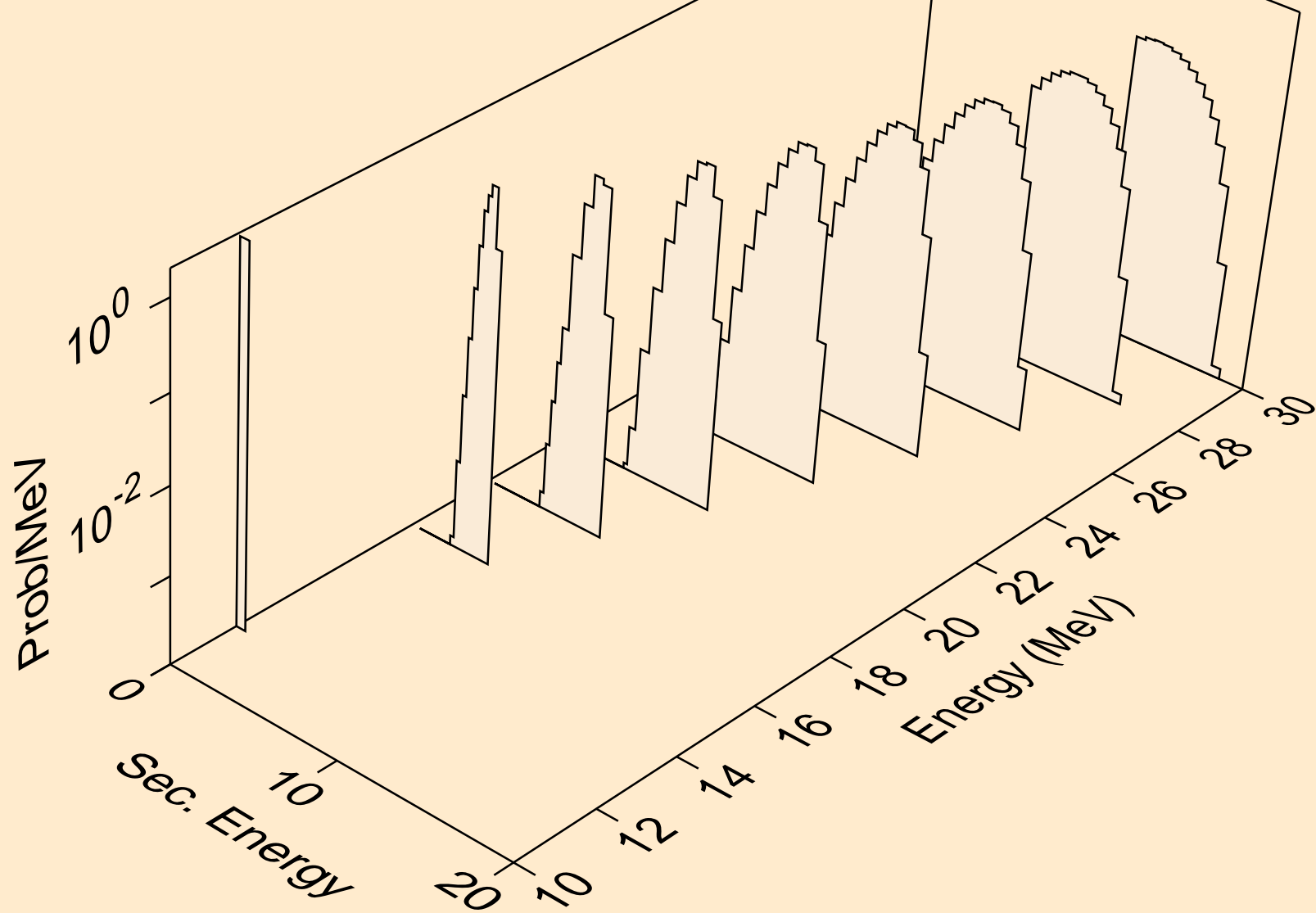

TH239 ALPHA ACER TENDL-2021 LIBRARY; T=0.K
deuterons from (a,x)

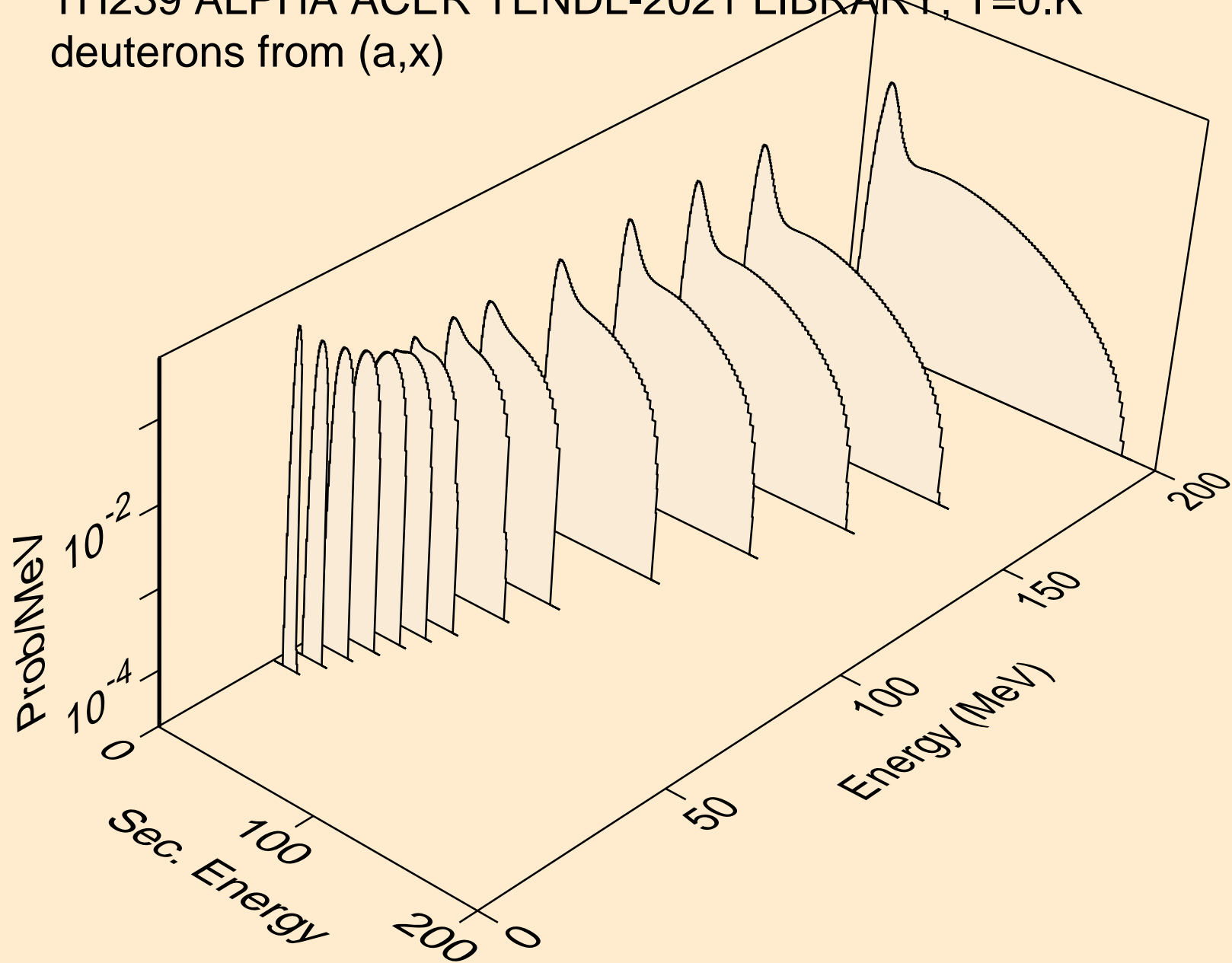

TH239 ALPHA ACER TENDL-2021 LIBRARY; T=0.K
deuterons from (a,n*)d

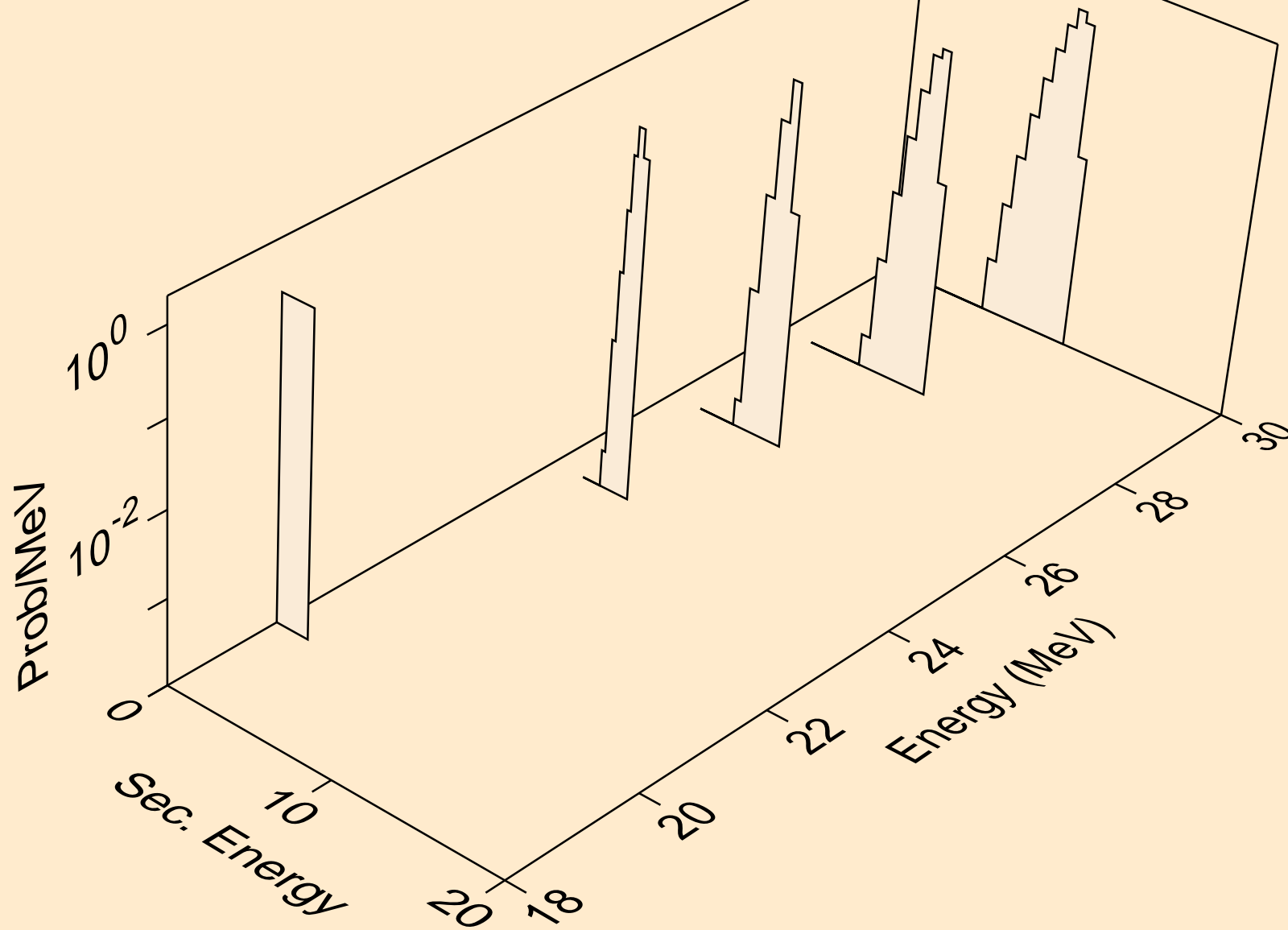

TH239 ALPHA ACER TENDL-2021 LIBRARY; T=0.K
deuterons from (a,d)

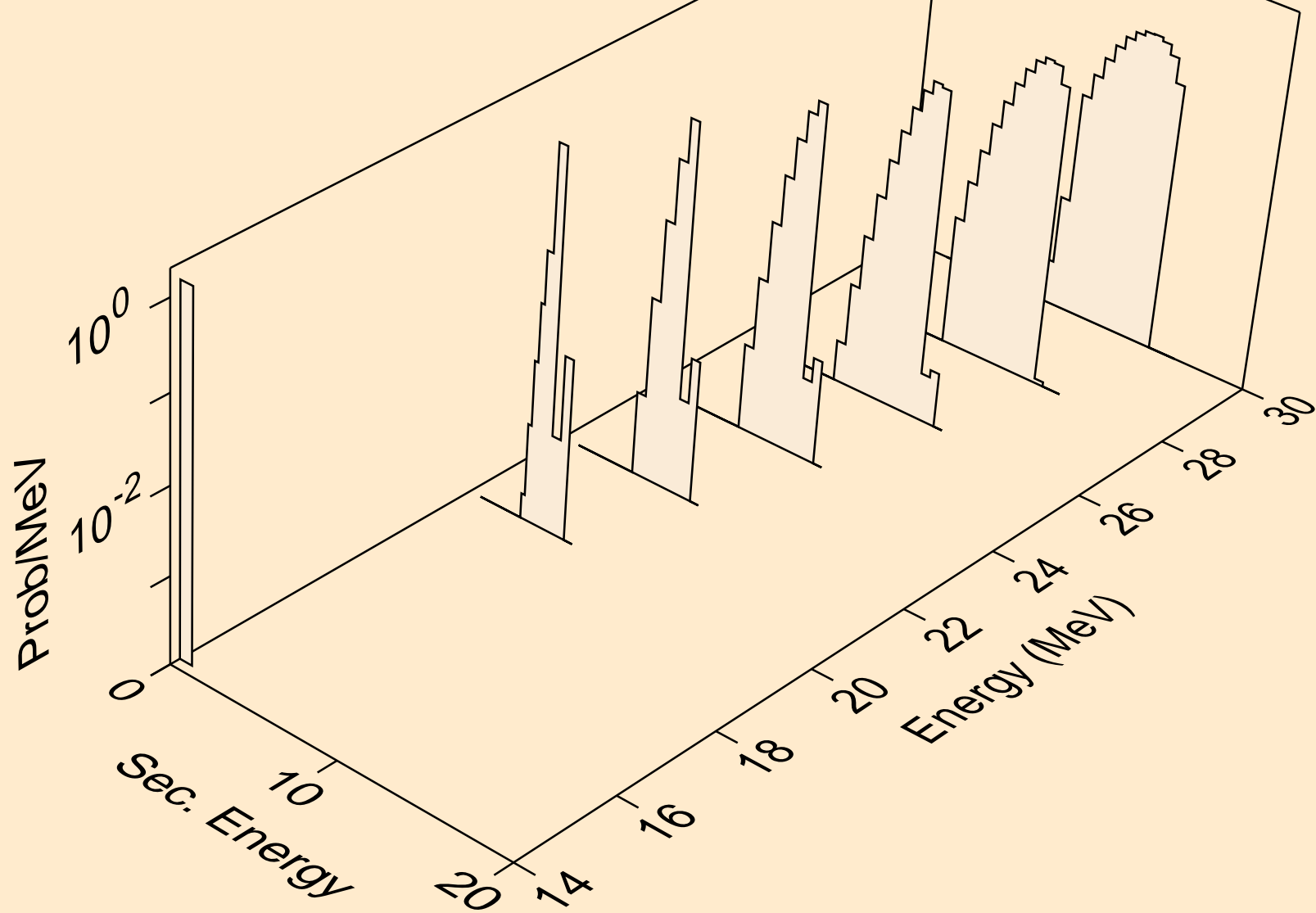

TH239 ALPHA ACER TENDL-2021 LIBRARY; T=0.K
tritons from (a,x)

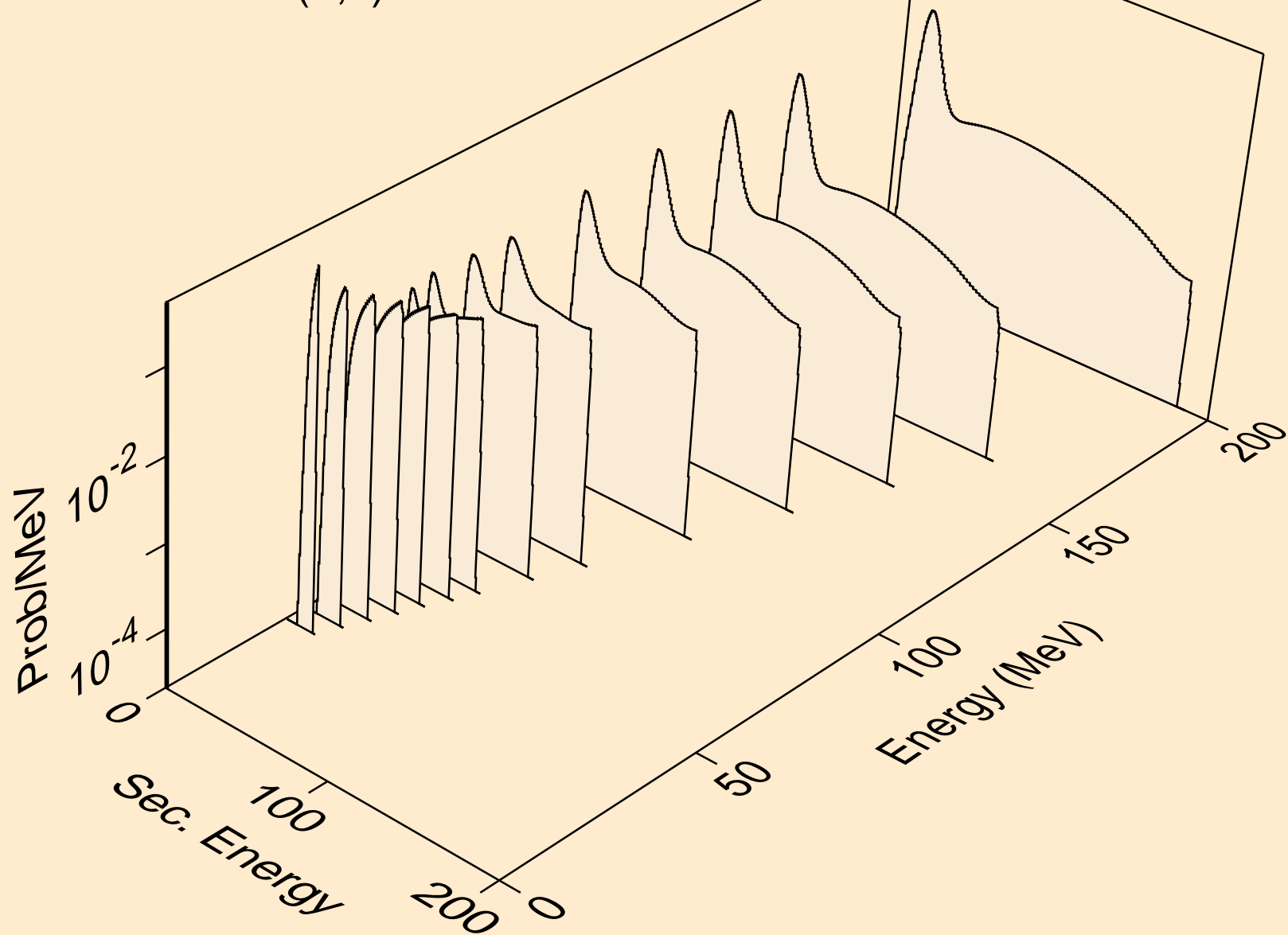

TH239 ALPHA ACER TENDL-2021 LIBRARY; T=0.K
tritons from (a,n*)t

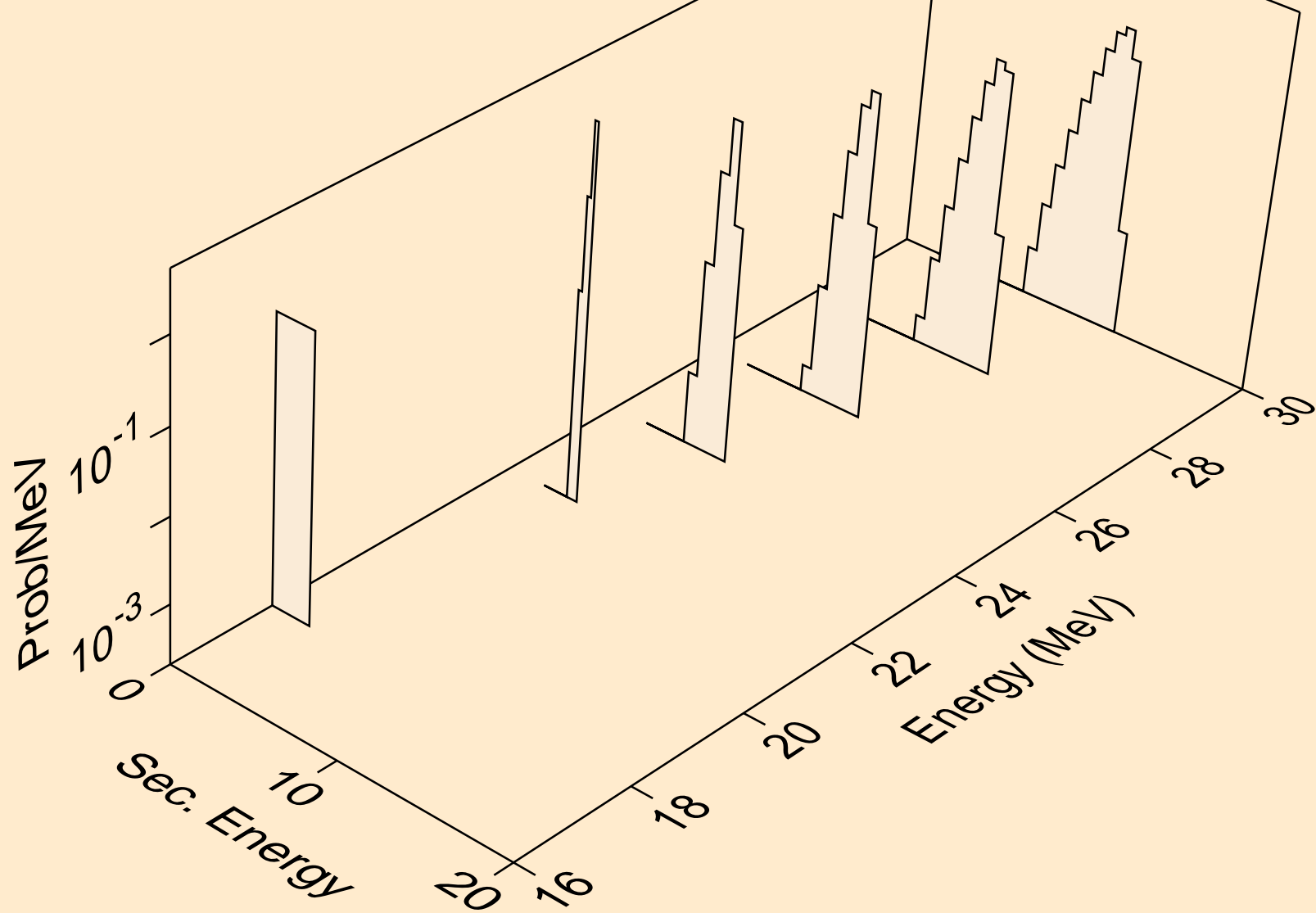

TH239 ALPHA ACER TENDL-2021 LIBRARY; T=0.K
tritons from (a,t)

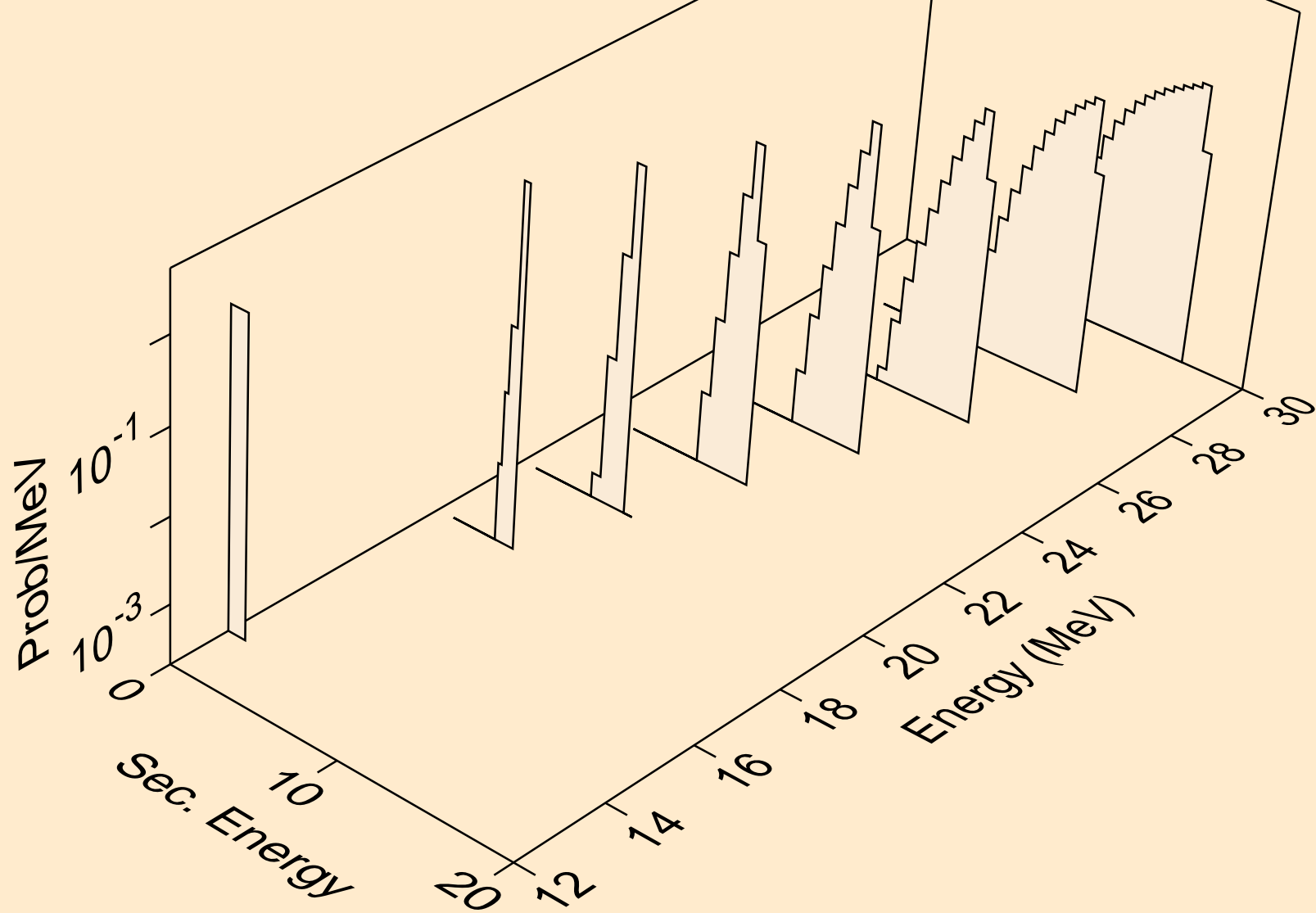

TH239 ALPHA ACER TENDL-2021 LIBRARY; T=0.K
he3s from (a,x)

