

TL188M ALPHA ACER TENDL-2021 LIBRARY; T=0.K  
Principal cross sections

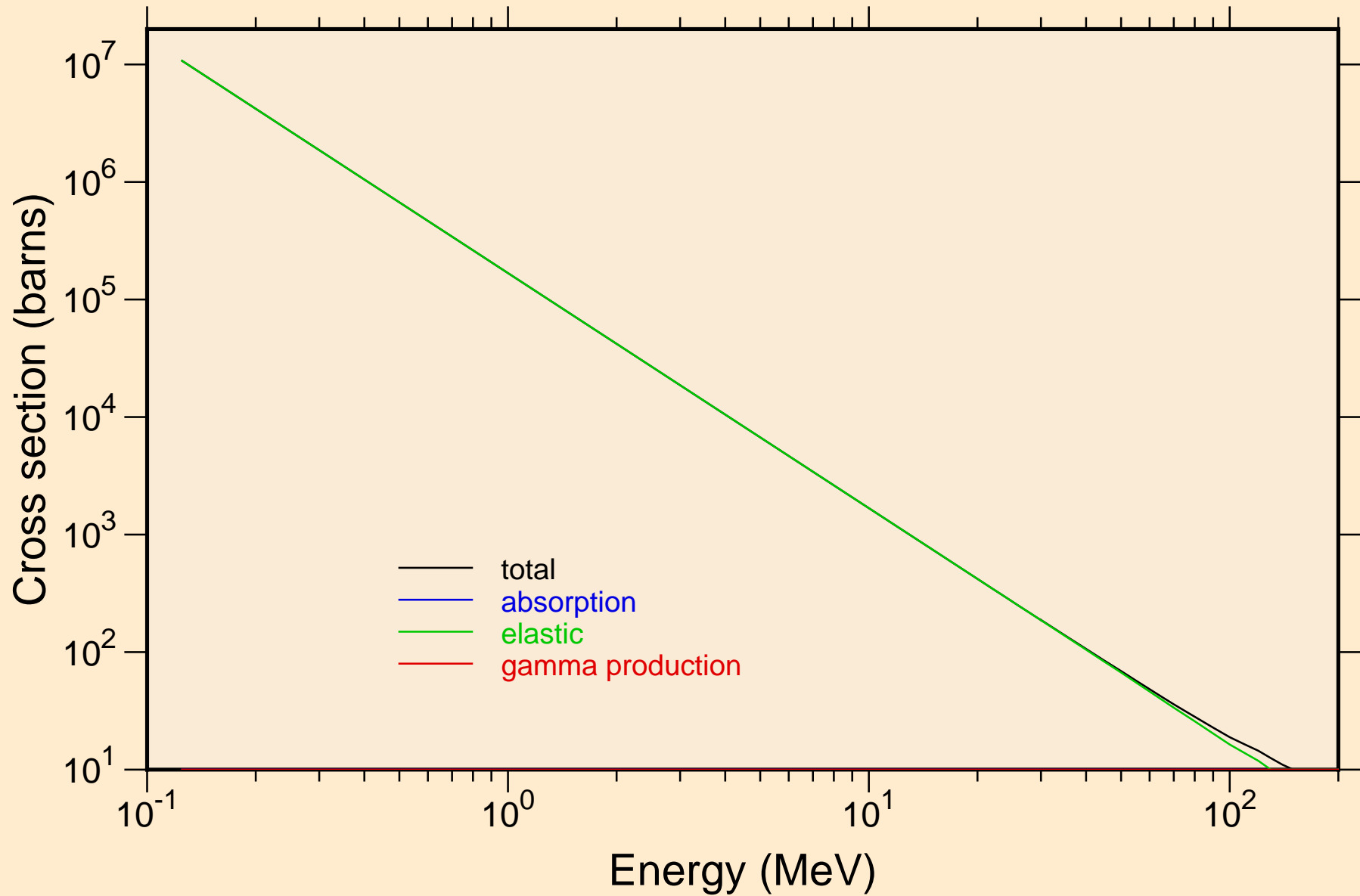

TL188M ALPHA ACER TENDL-2021 LIBRARY; T=0.K

Heating

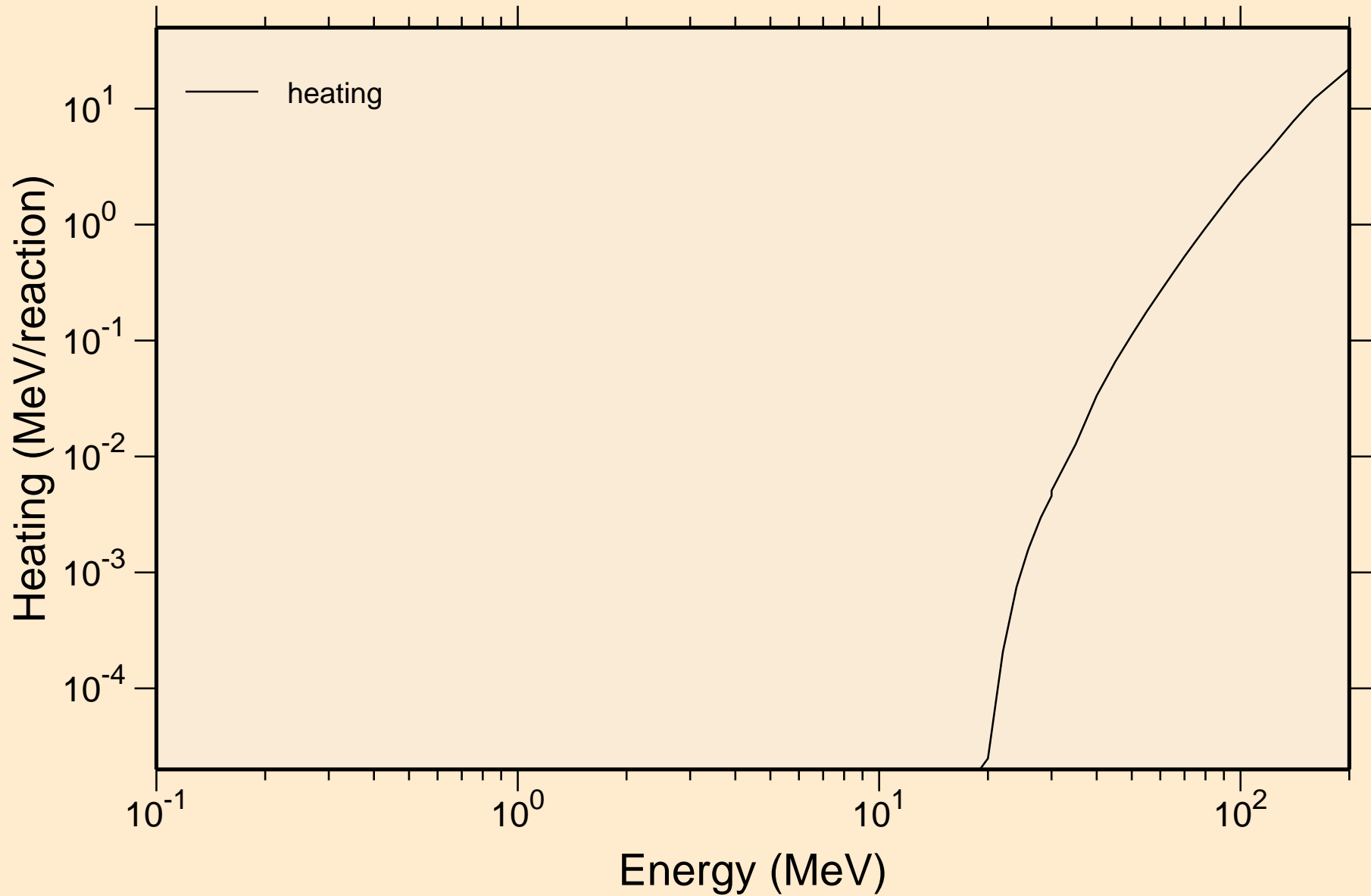

# TL188M ALPHA ACER TENDL-2021 LIBRARY; T=0.K

## Principal cross sections

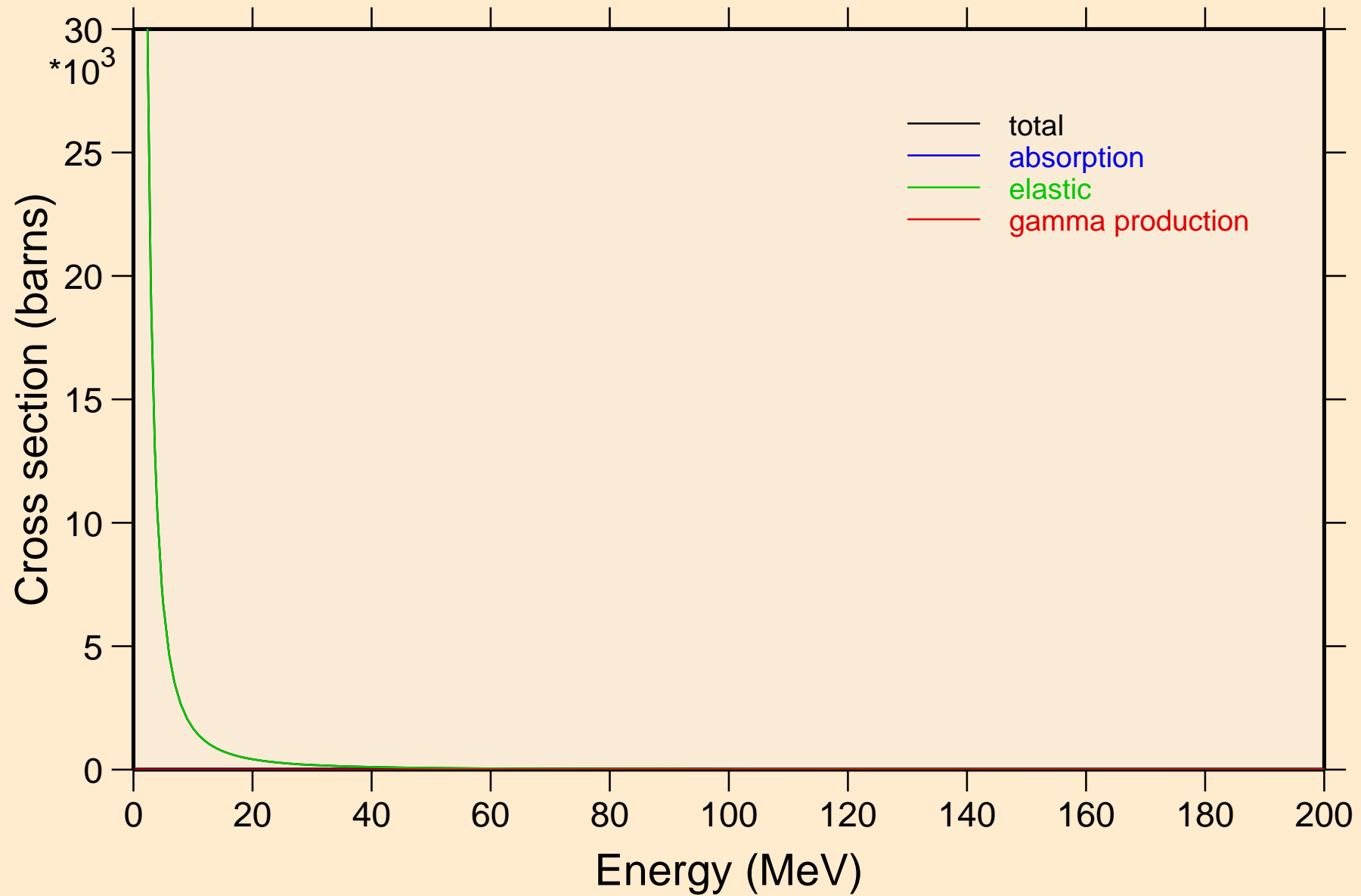

TL188M ALPHA ACER TENDL-2021 LIBRARY; T=0.K

Heating

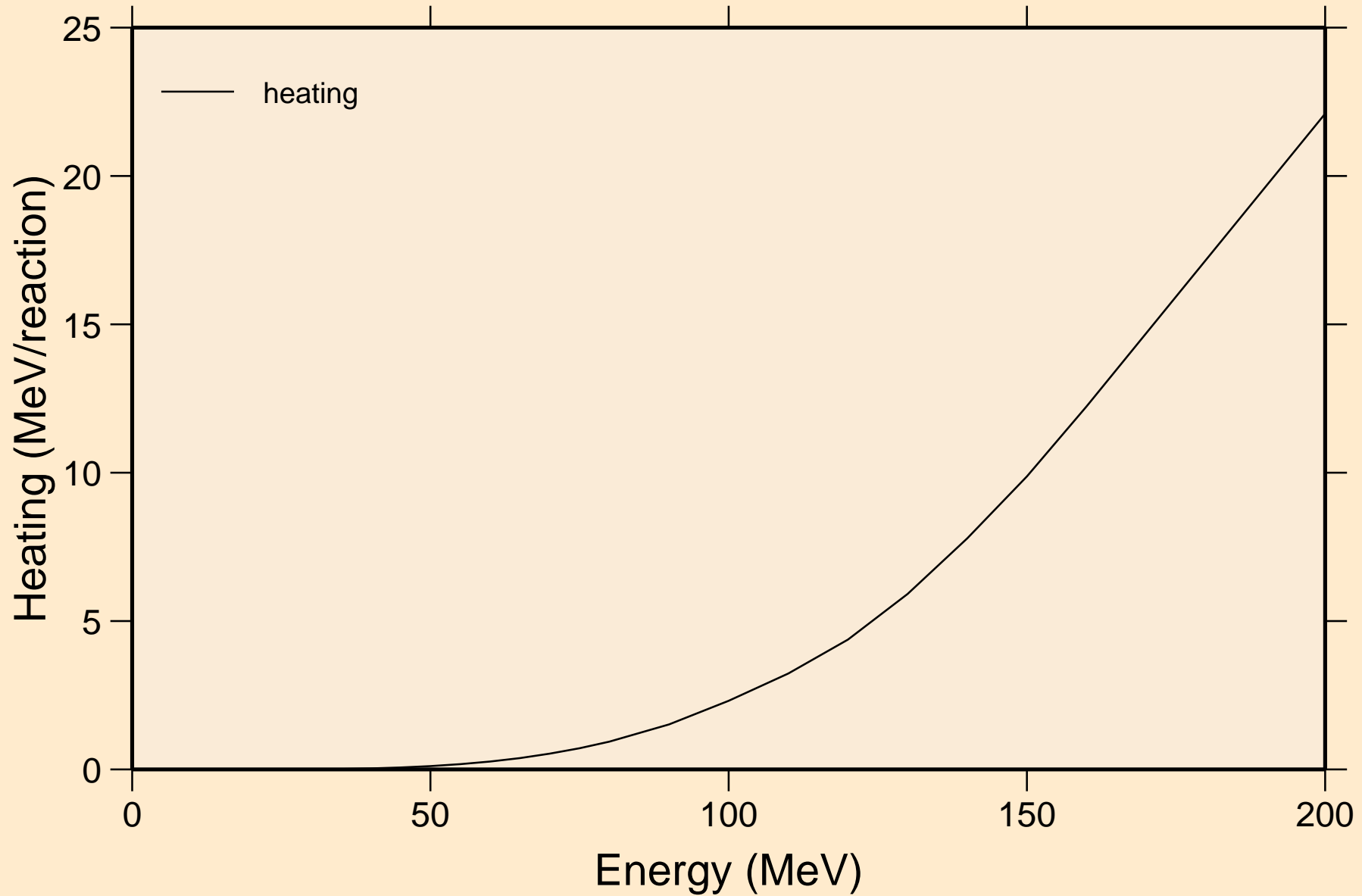

TL188M ALPHA ACER TENDL-2021 LIBRARY; T=0.K  
Threshold reactions

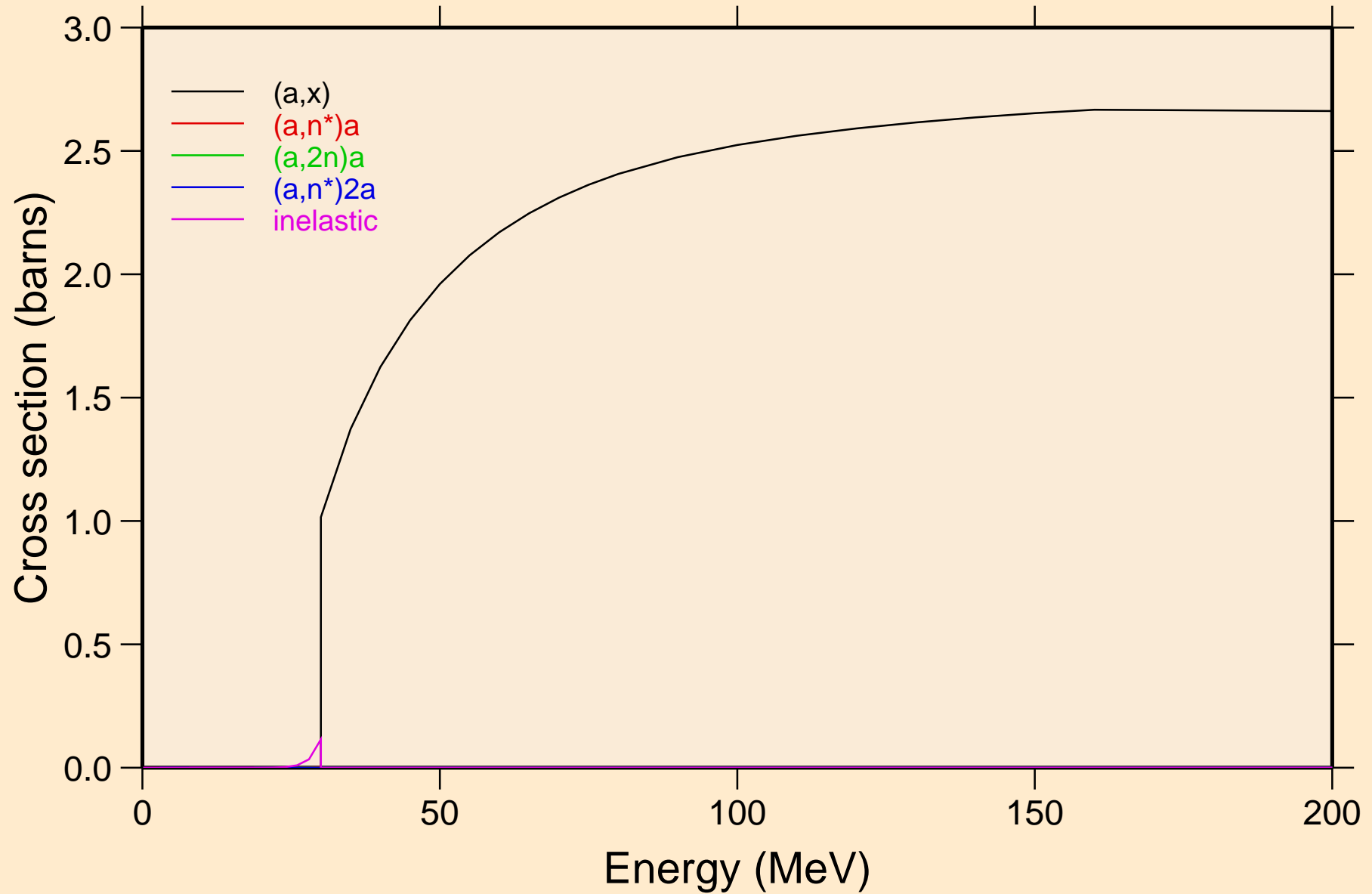

TL188M ALPHA ACER TENDL-2021 LIBRARY; T=0.K  
Threshold reactions

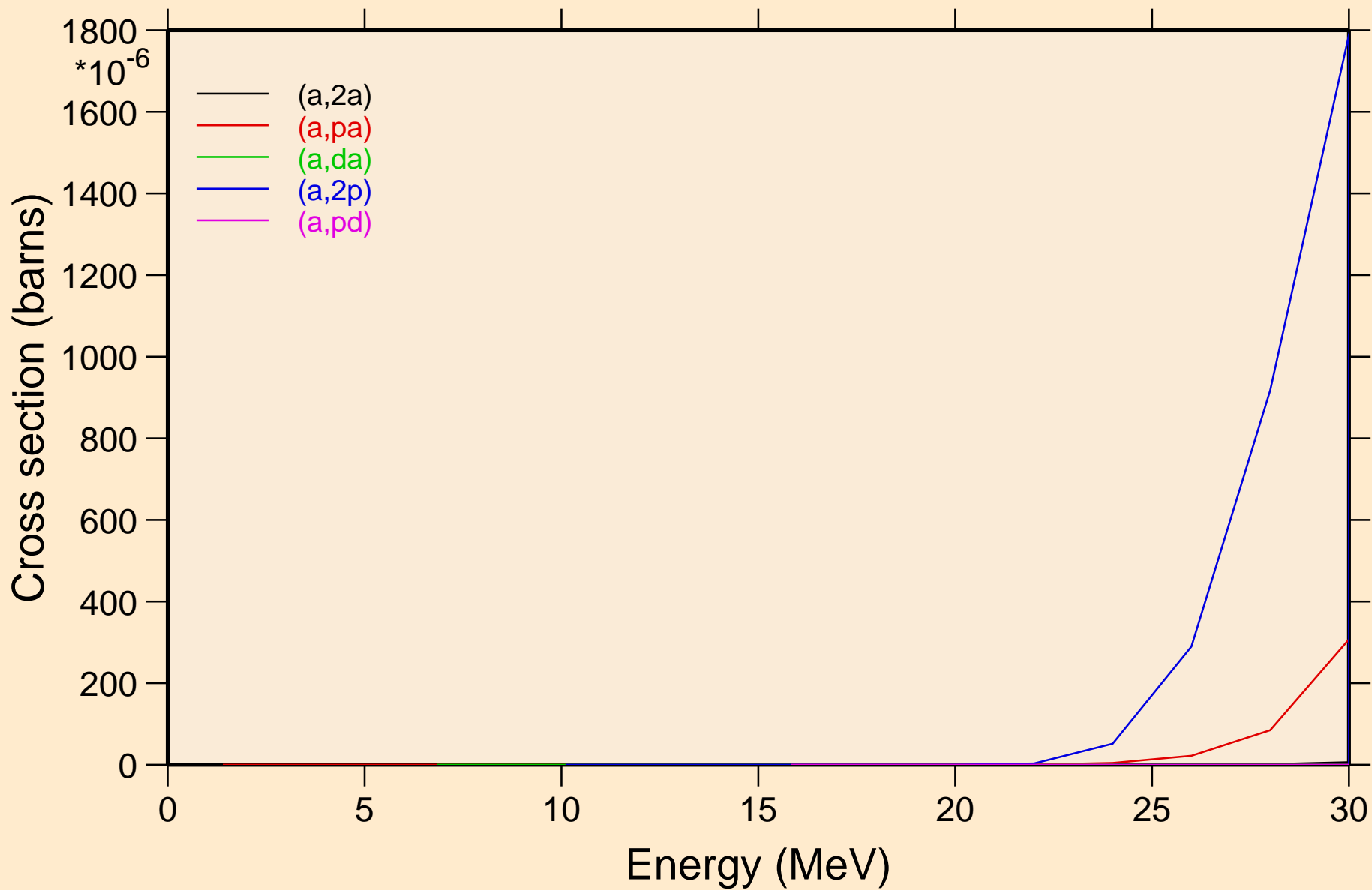

TL188M ALPHA ACER TENDL-2021 LIBRARY; T=0.K  
Threshold reactions

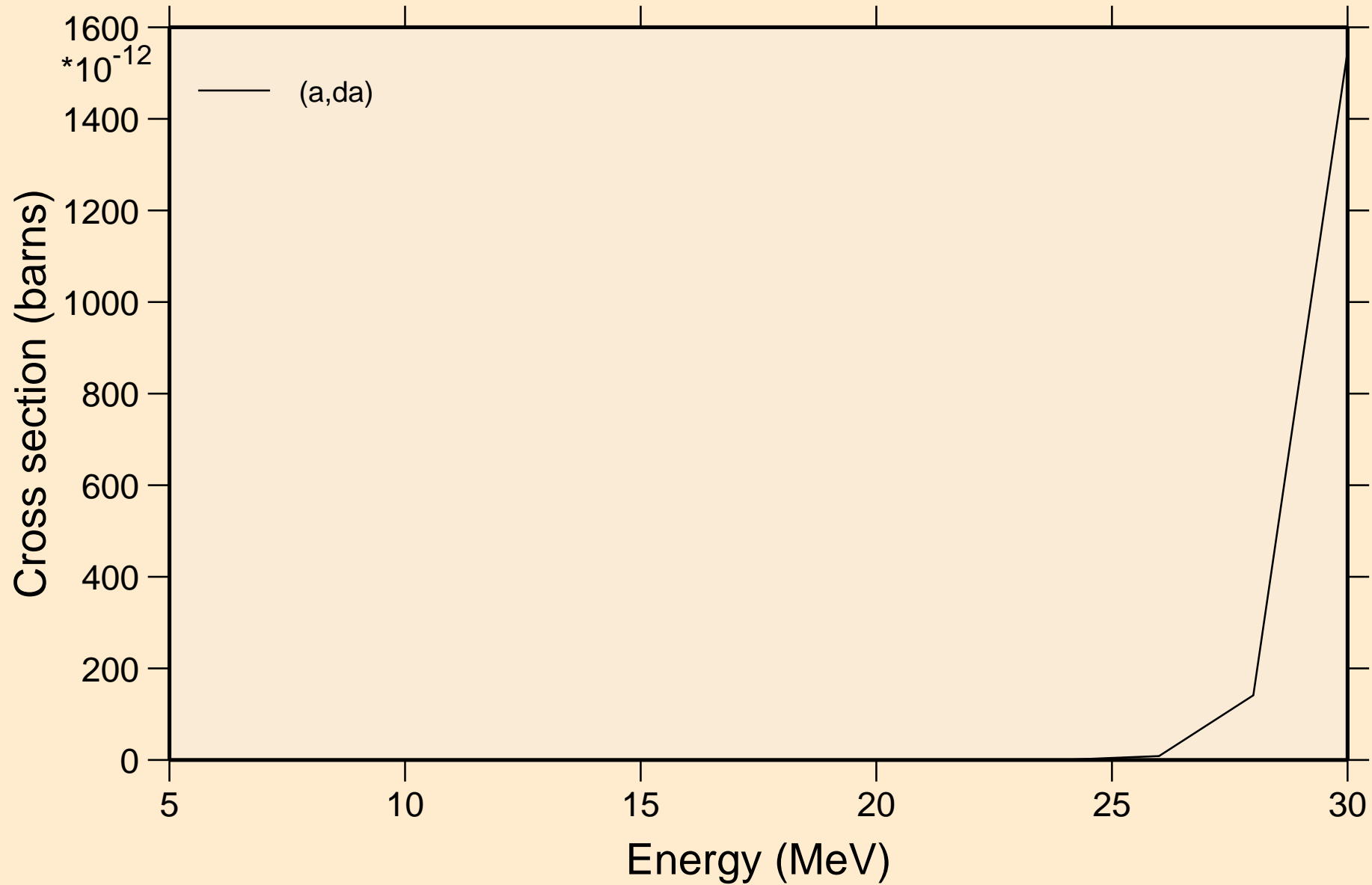

TL188M ALPHA ACER TENDL-2021 LIBRARY; T=0.K  
angular distribution for elastic

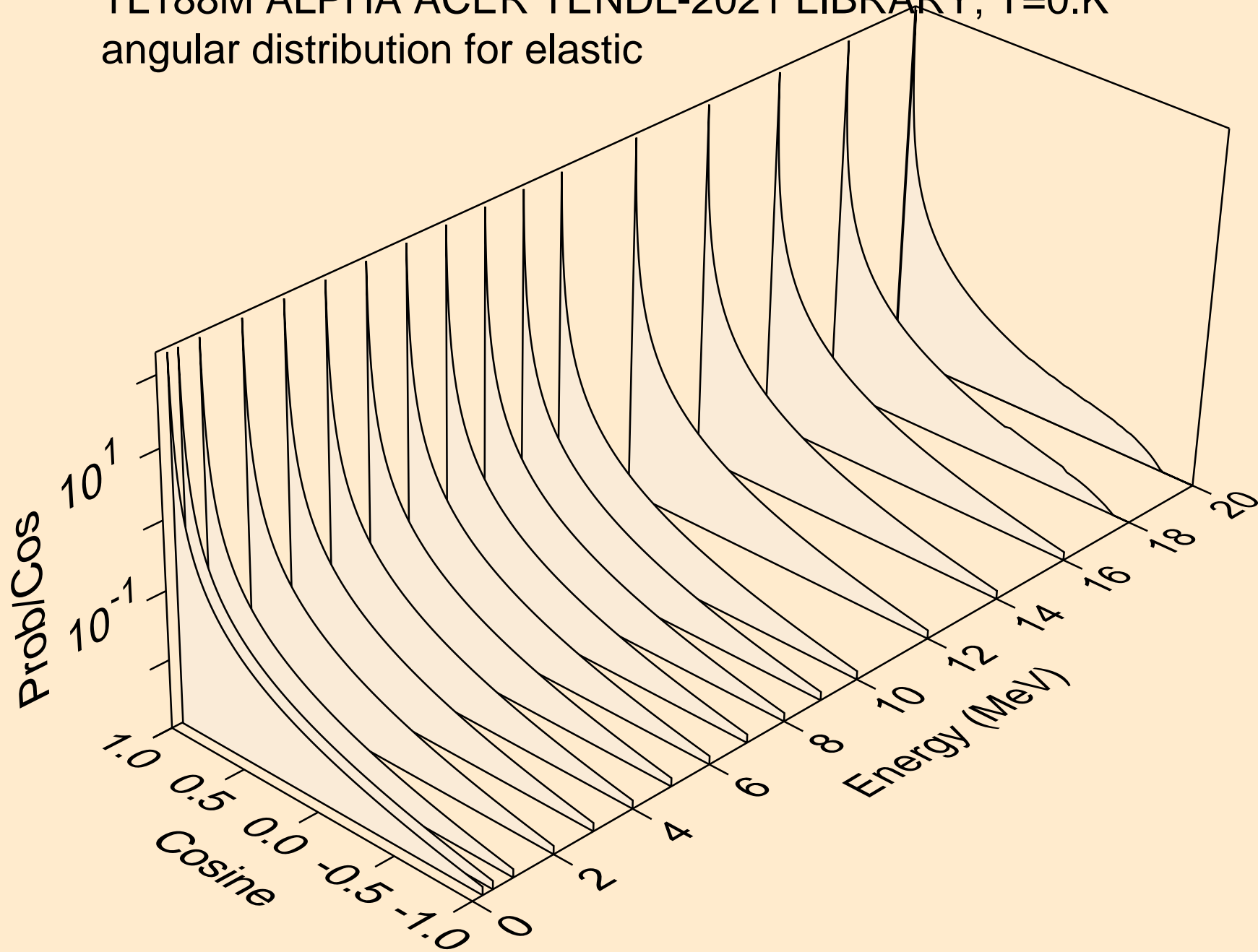



TL188M ALPHA ACER TENDL-2021 LIBRARY; T=0.K  
angular distribution for elastic

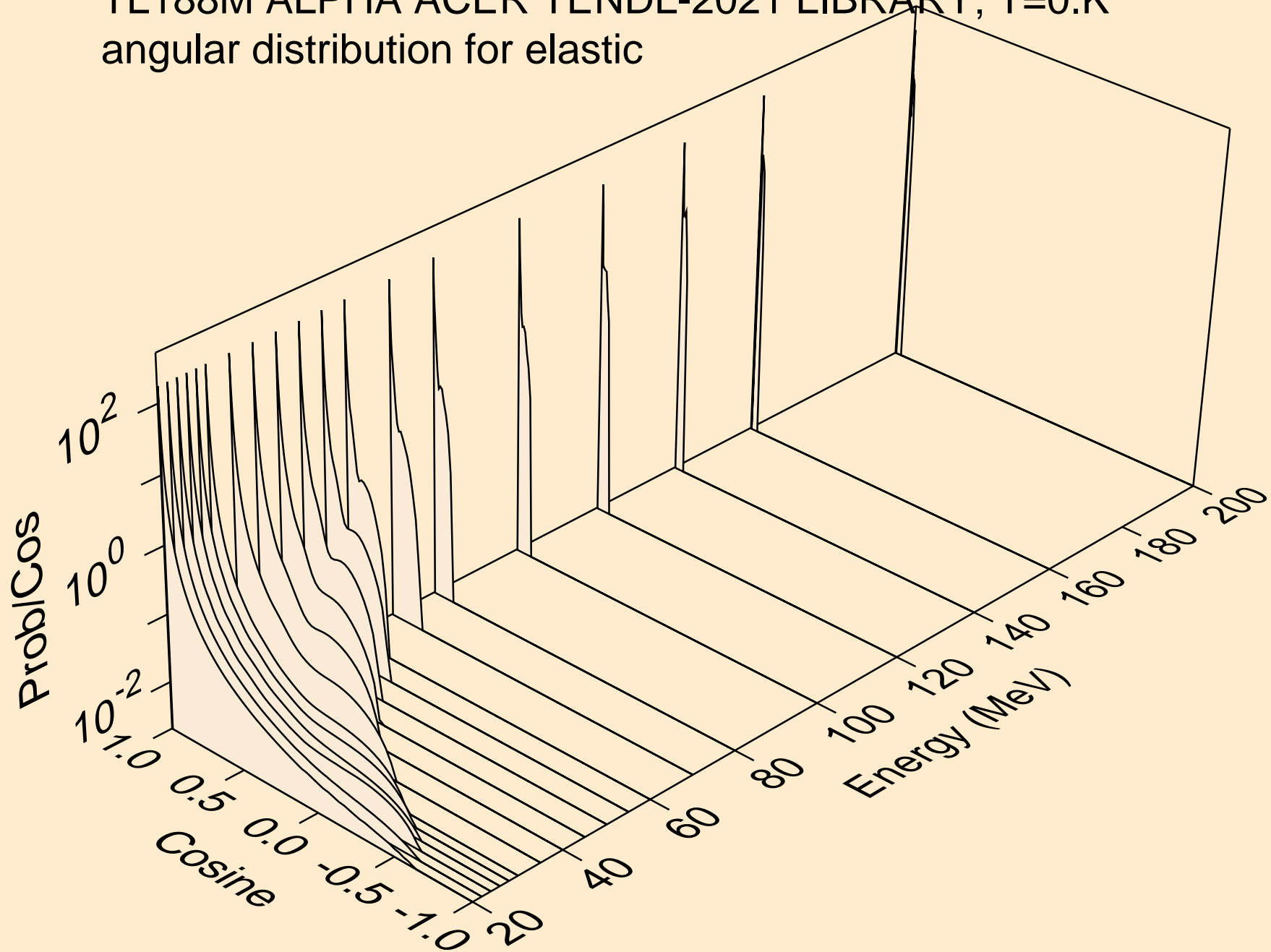

TL188M ALPHA ACER TENDL-2021 LIBRARY; T=0.K  
Alpha emission for (a,x)

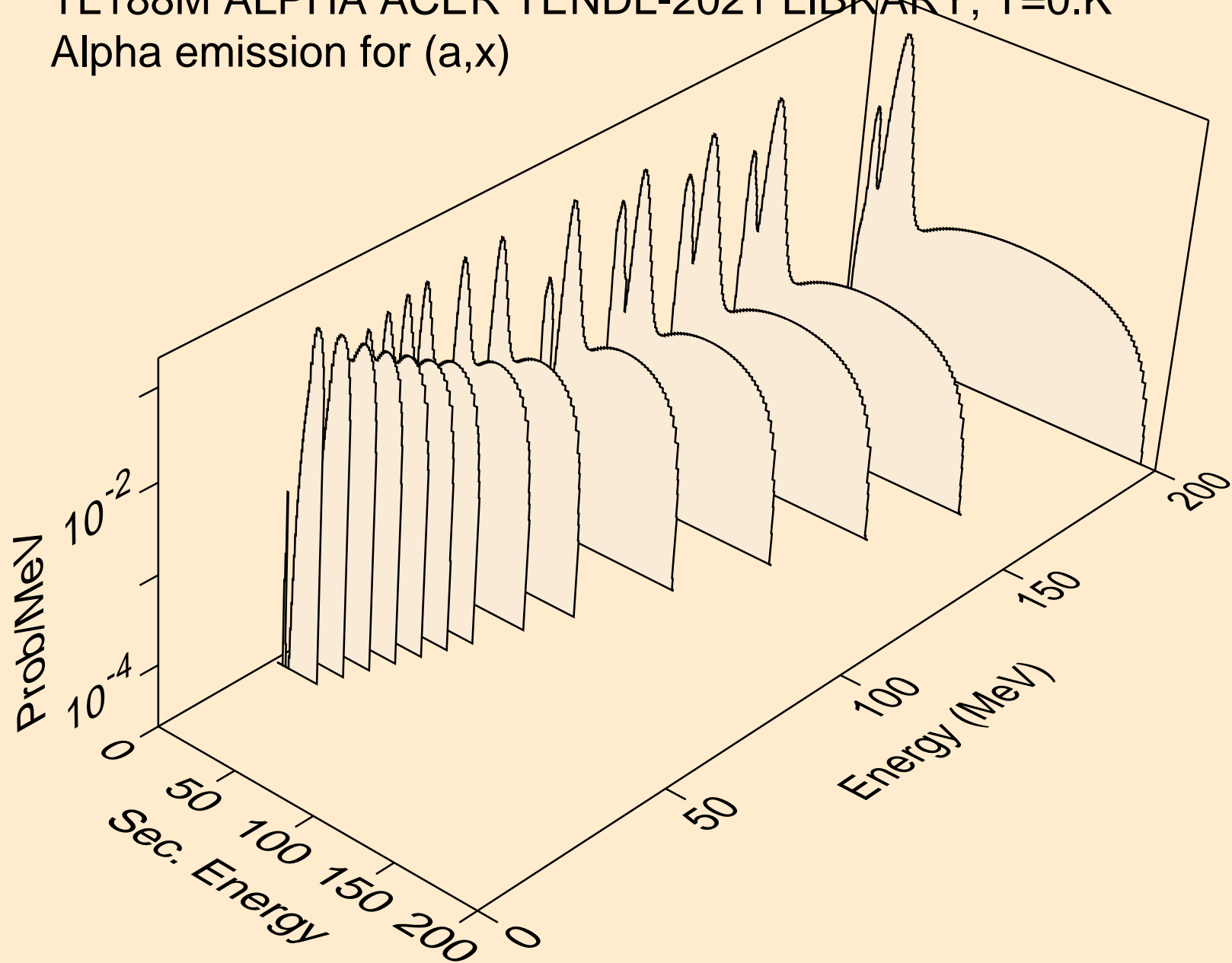

TL188M ALPHA ACER TENDL-2021 LIBRARY; T=0.K  
Alpha emission for (a,n\*)a

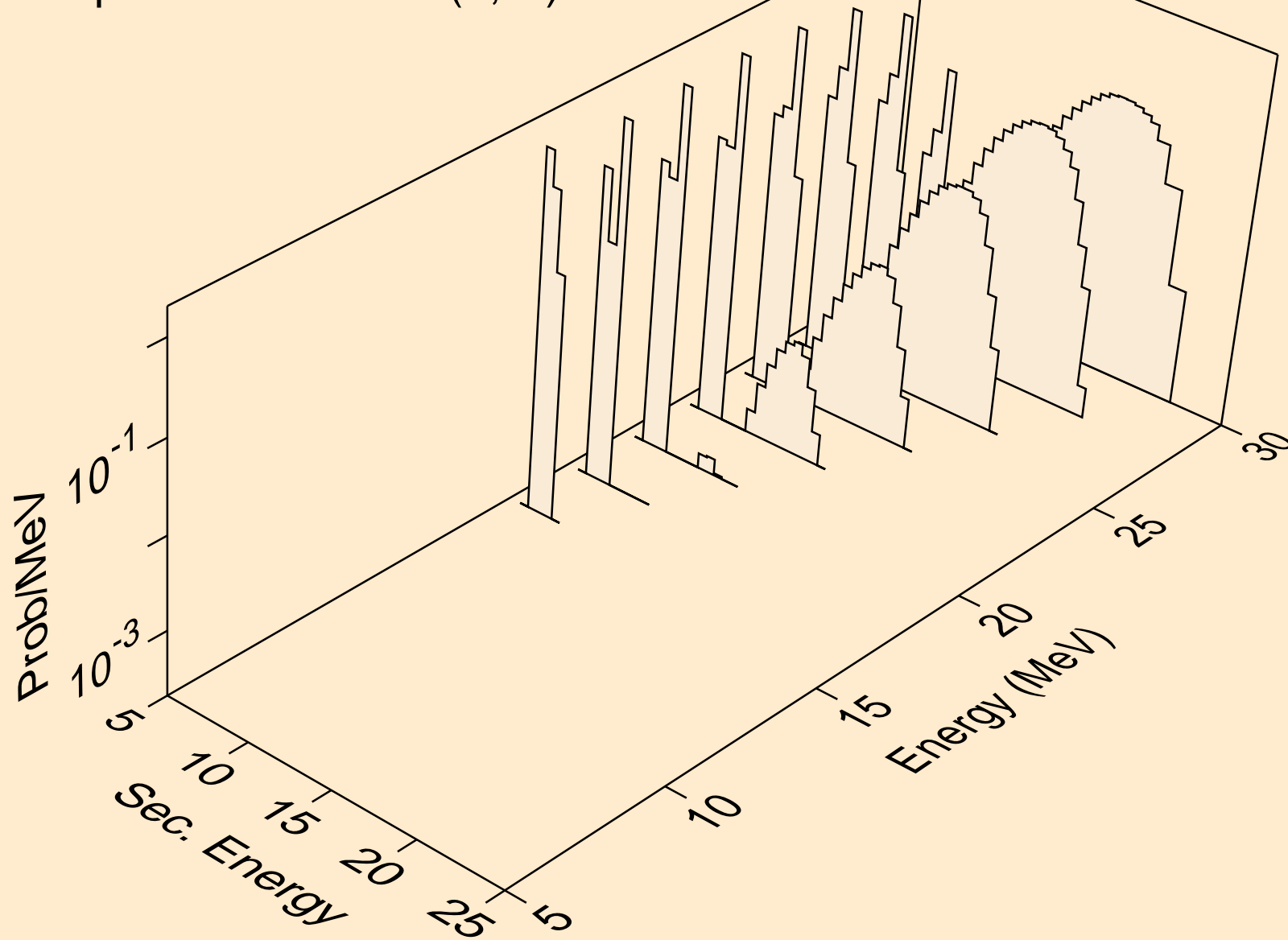

TL188M ALPHA ACER TENDL-2021 LIBRARY; T=0.K  
Alpha emission for (a,2n)a

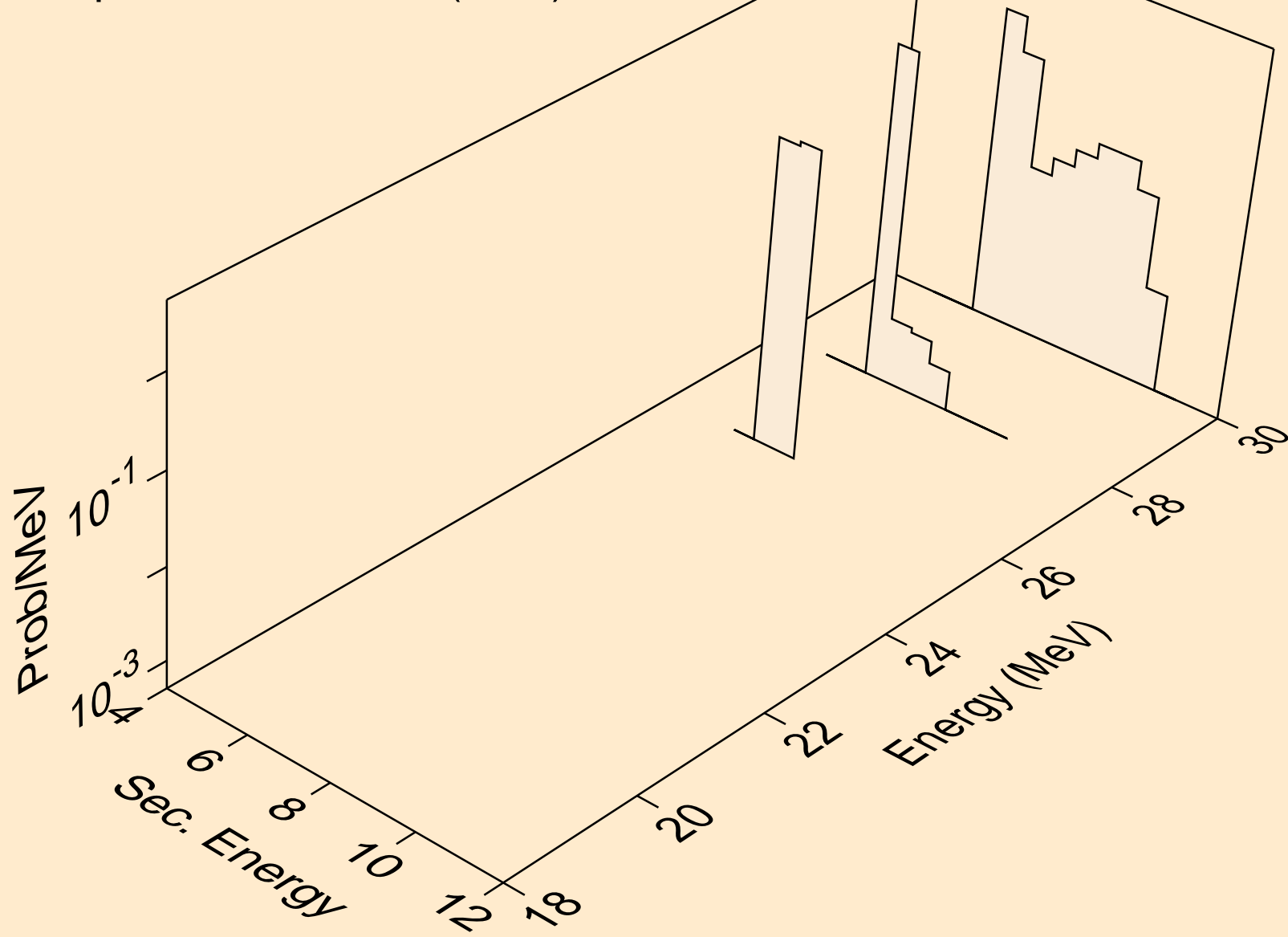

TL188M ALPHA ACER TENDL-2021 LIBRARY; T=0.K  
Alpha emission for (a,n\*)2a

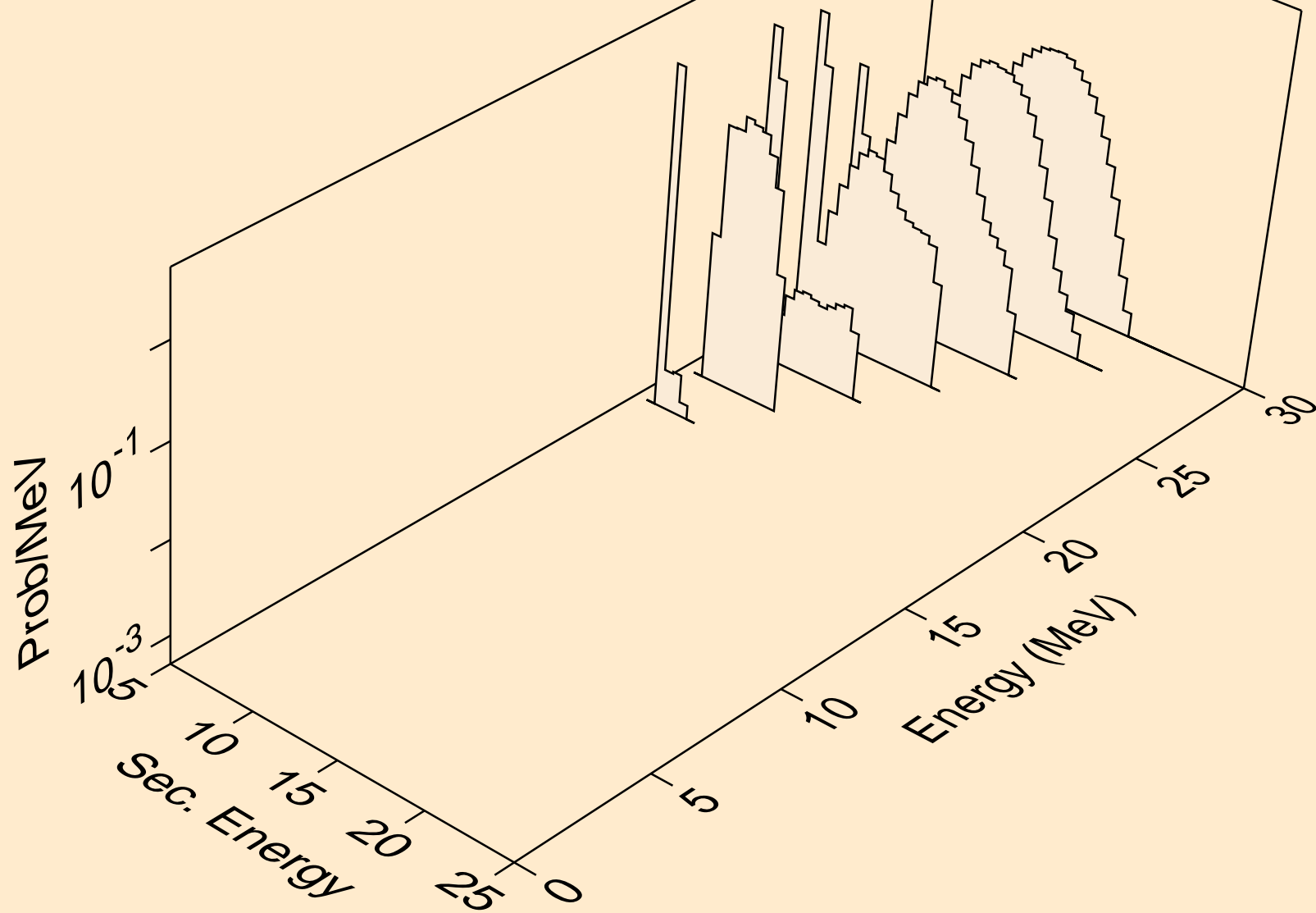

TL188M ALPHA ACER TENDL-2021 LIBRARY; T=0.K  
Alpha emission for inelastic

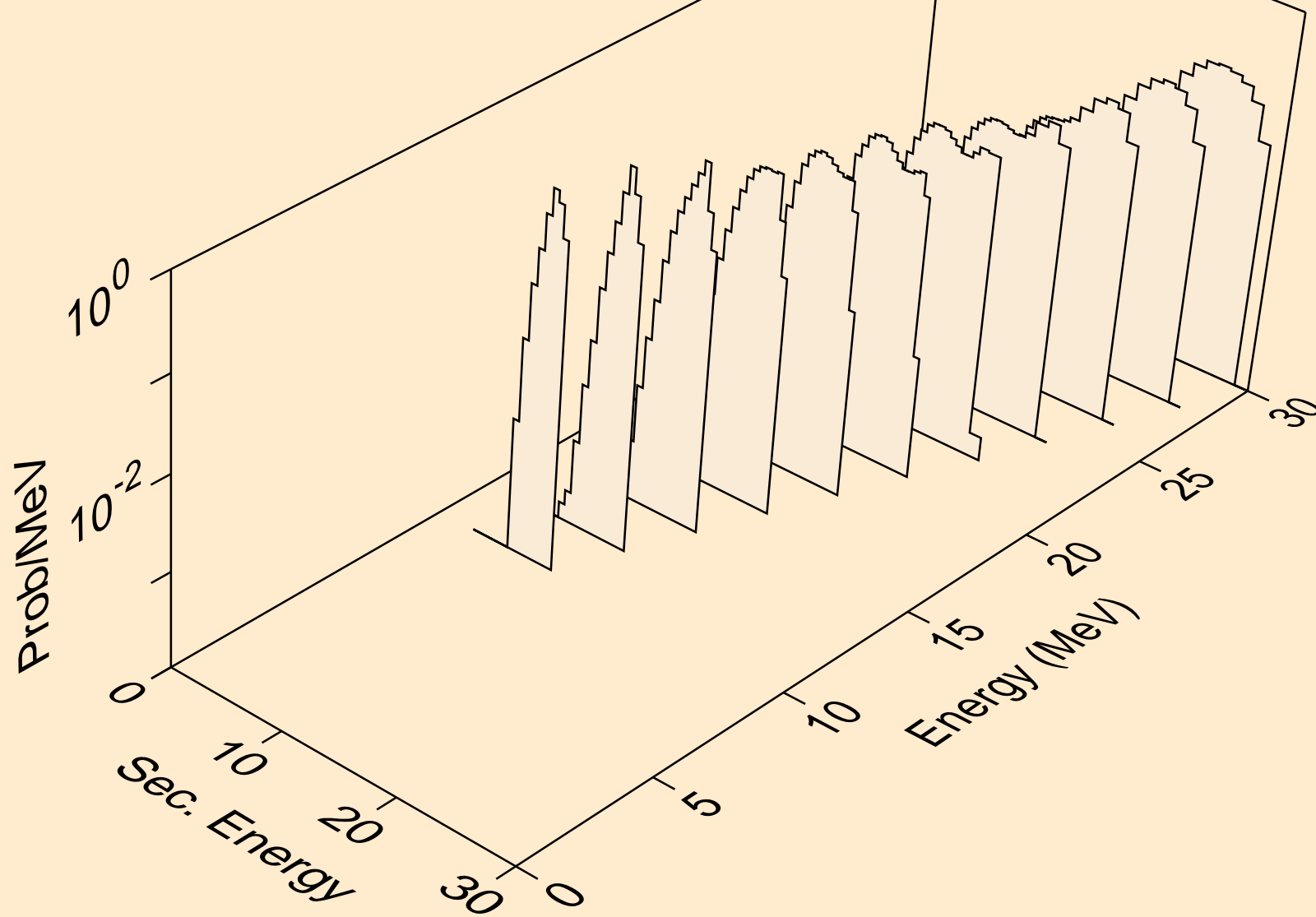

TL188M ALPHA ACER TENDL-2021 LIBRARY; T=0.K  
Alpha emission for (a,2a)

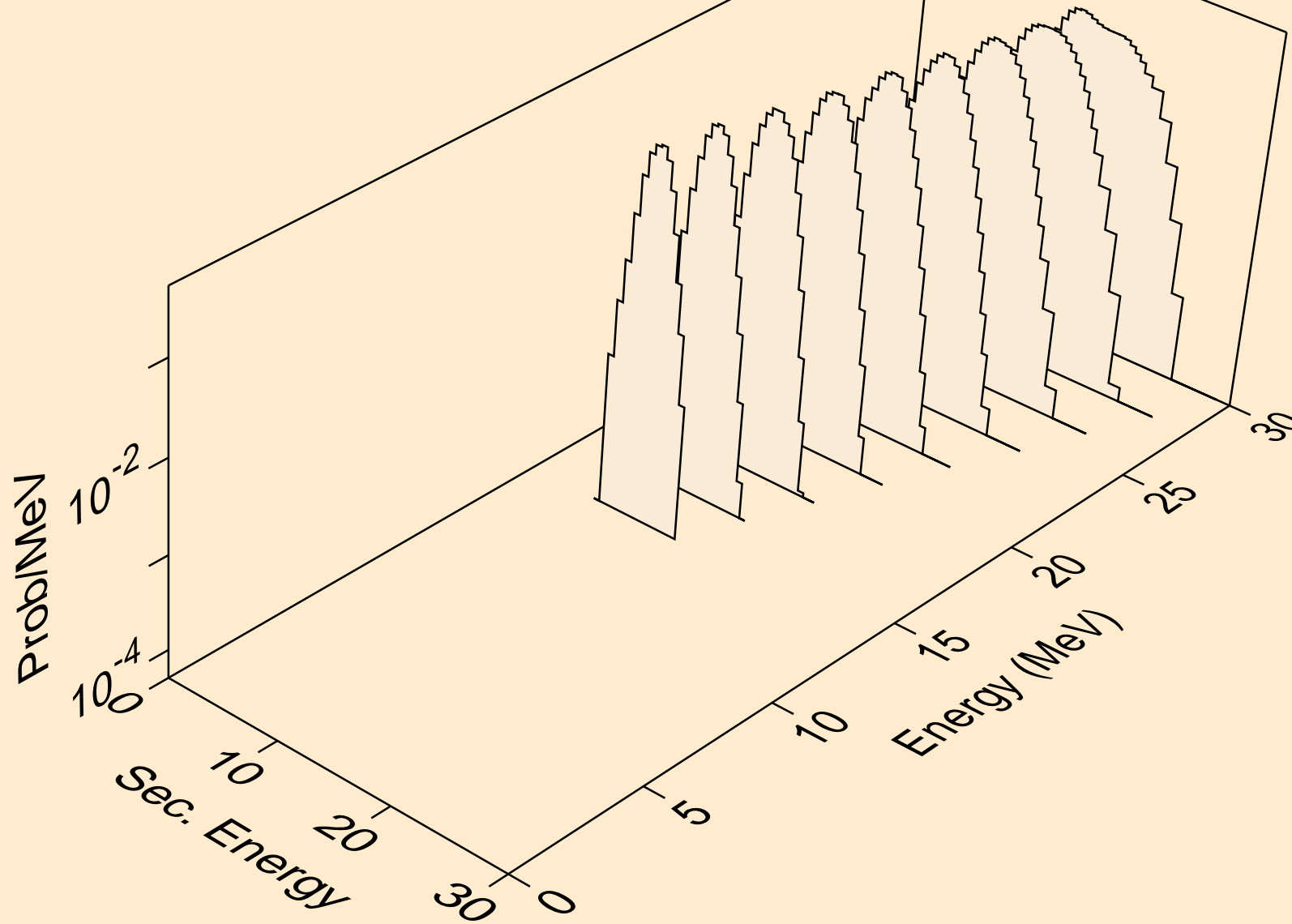

TL188M ALPHA ACER TENDL-2021 LIBRARY; T=0.K  
Alpha emission for (a,pa)

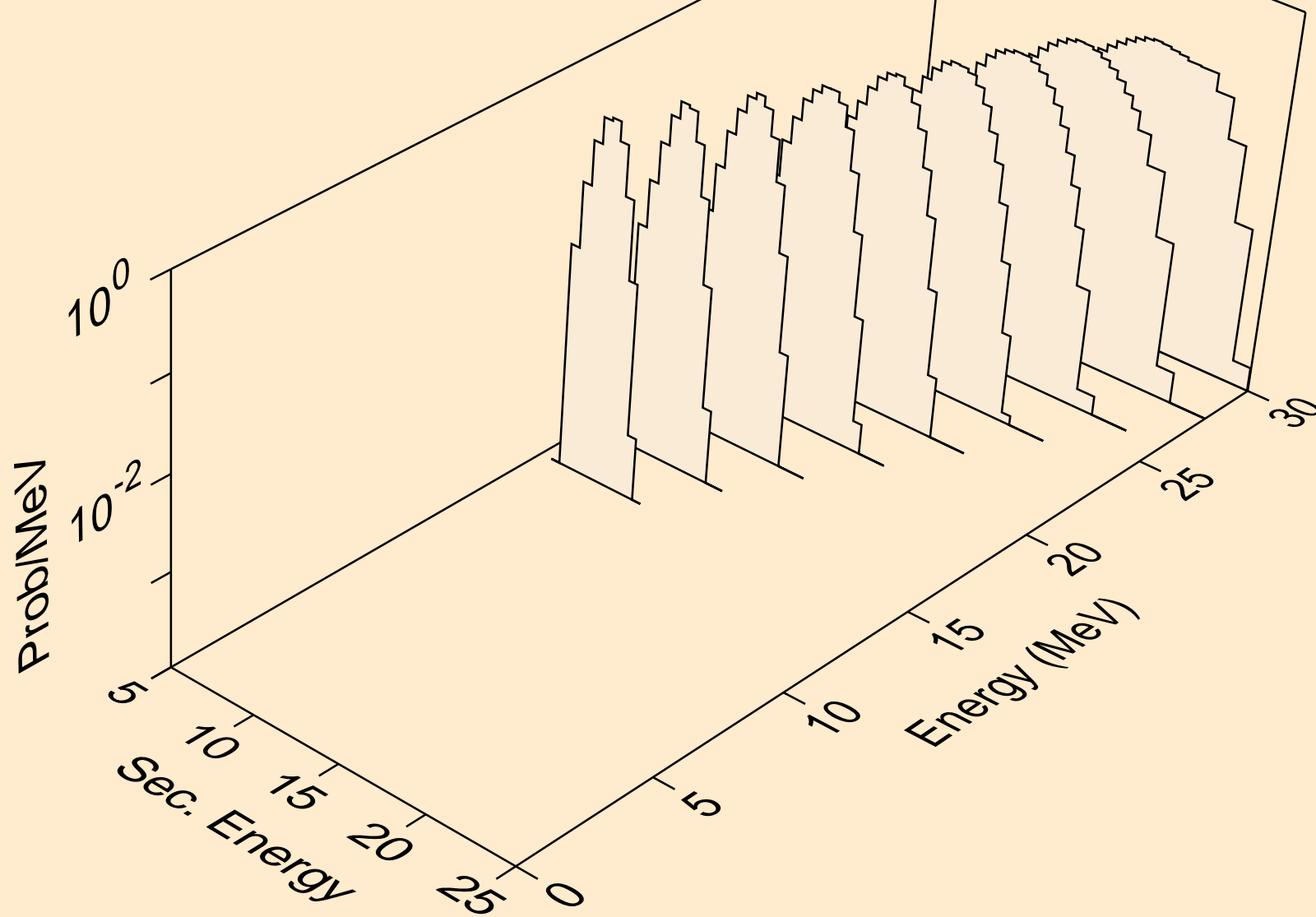



TL188M ALPHA ACER TENDL-2021 LIBRARY; T=0.K  
Alpha emission for (a,da)

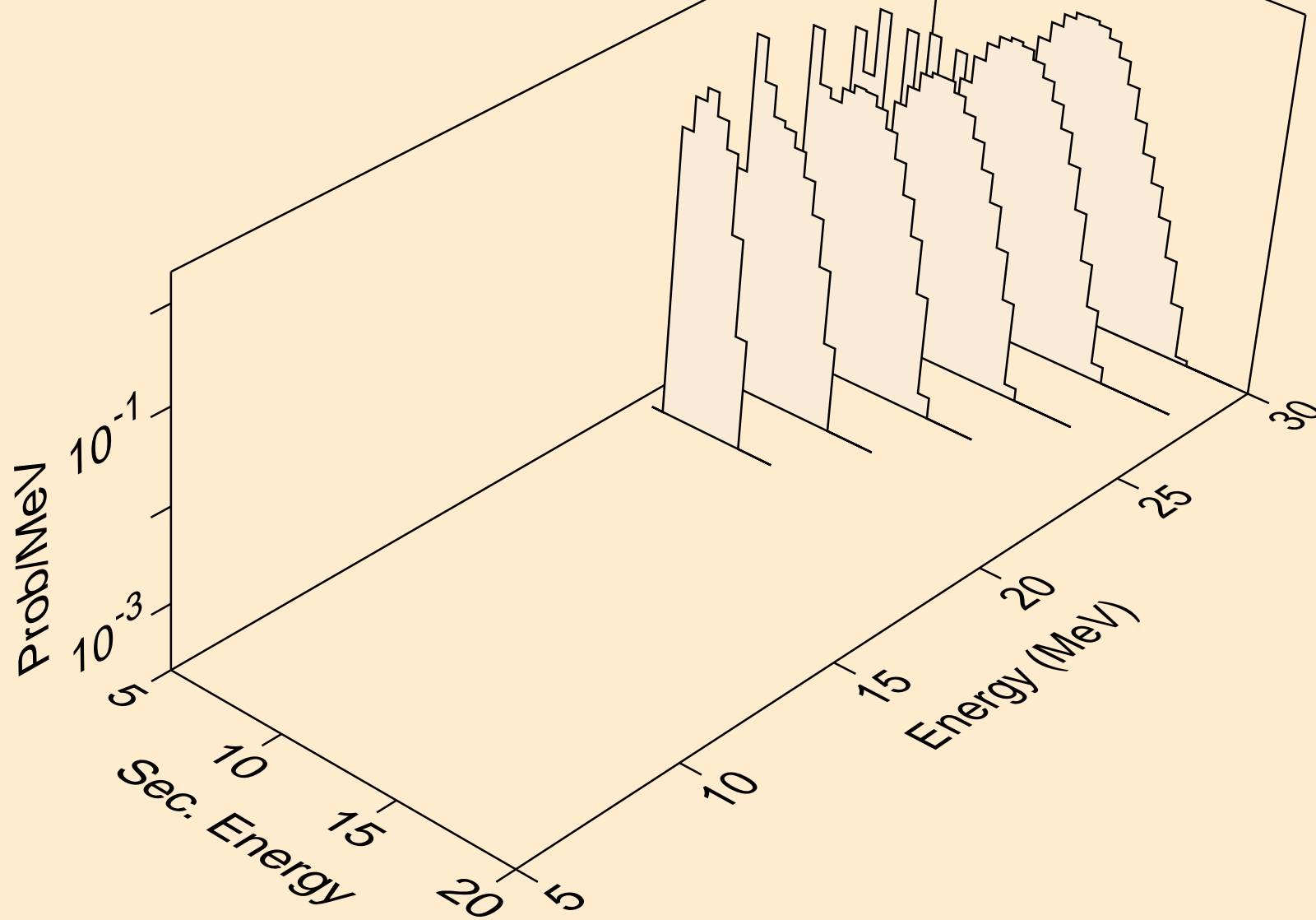

TL188M ALPHA ACER TENDL-2021 LIBRARY; T=0.K  
Photon emission for (z,n)

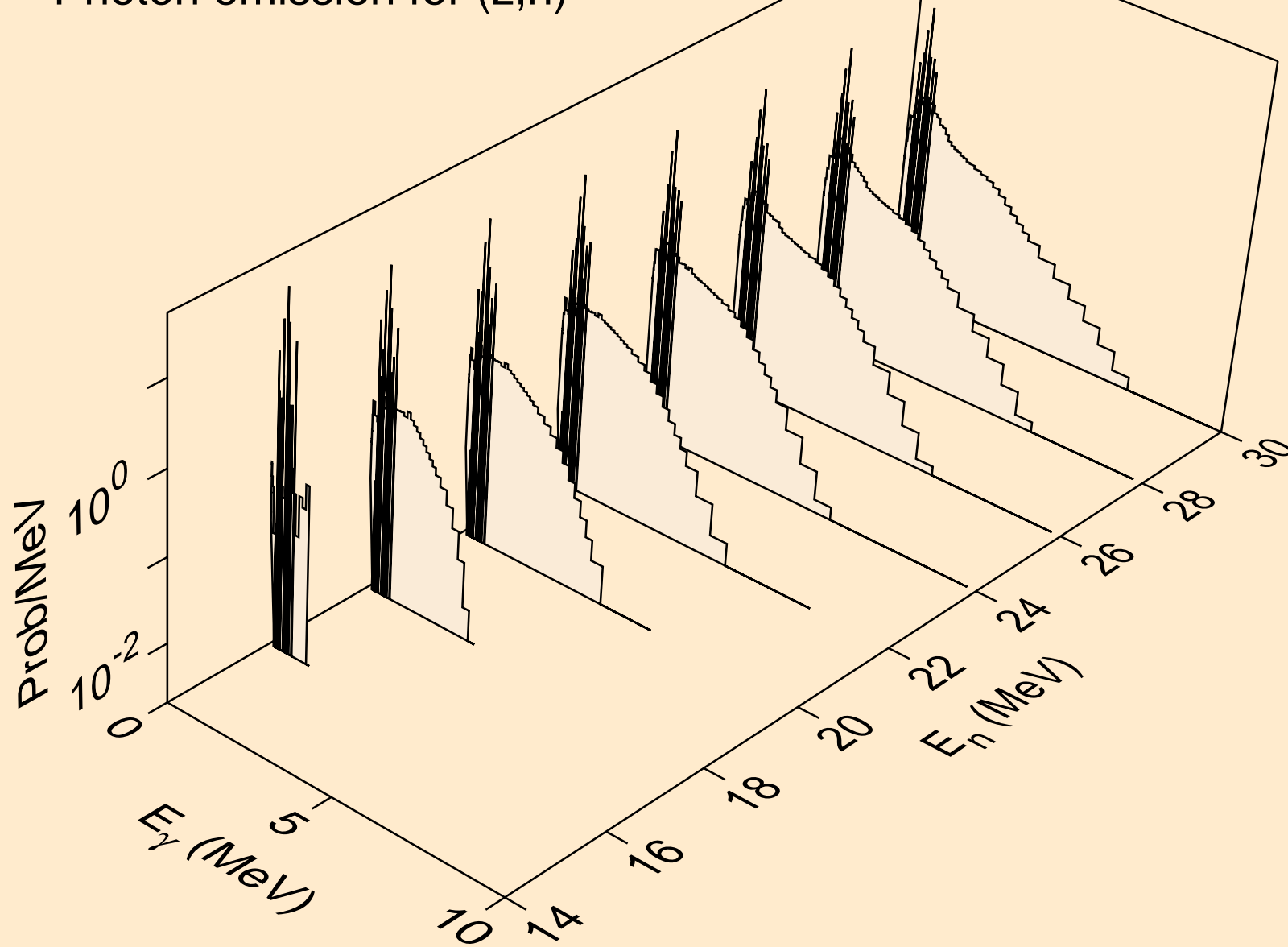

TL188M ALPHA ACER TENDL-2021 LIBRARY; T=0.K  
Photon emission for (n,x)

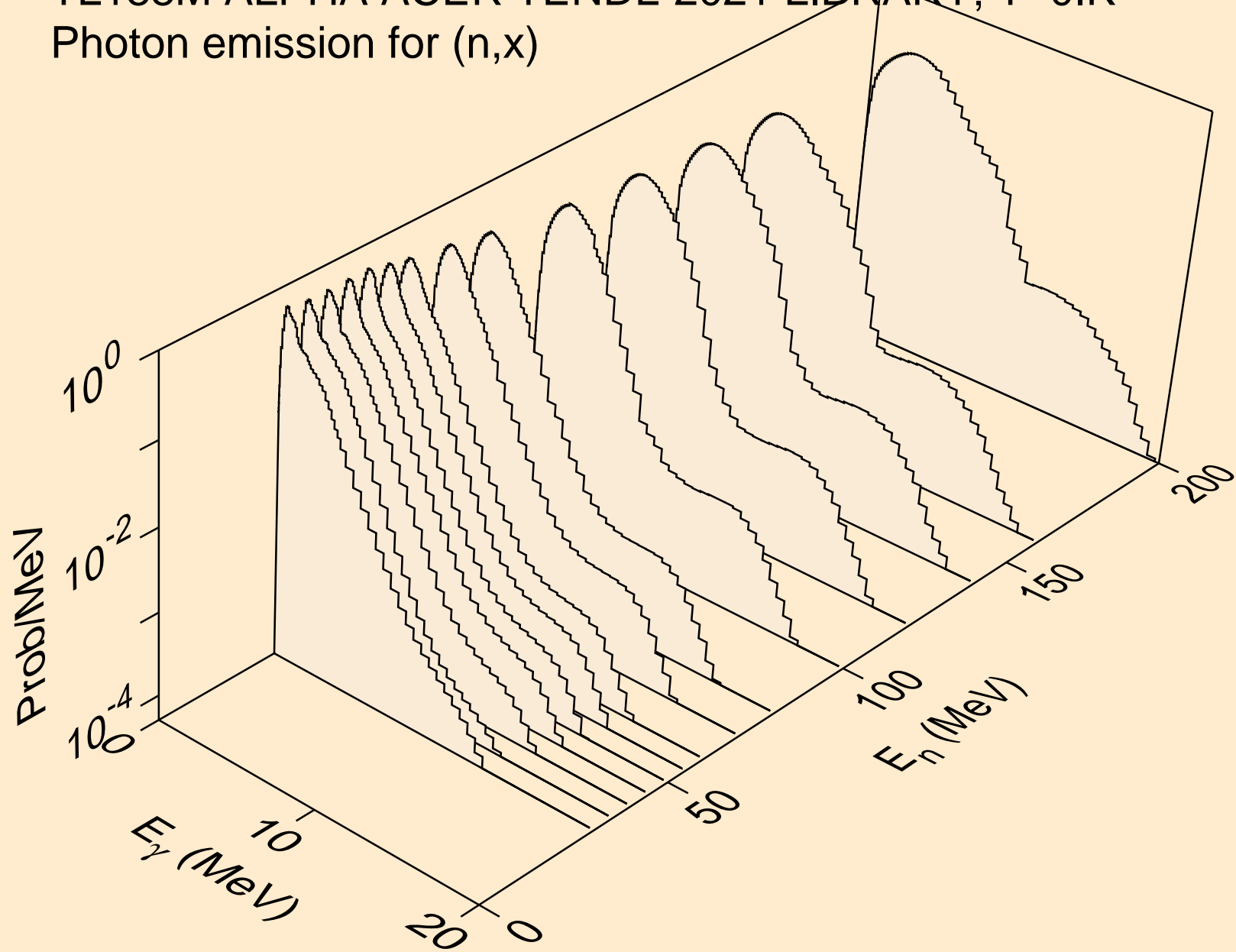

TL188M ALPHA ACER TENDL-2021 LIBRARY; T=0.K  
Photon emission for (n,2n)

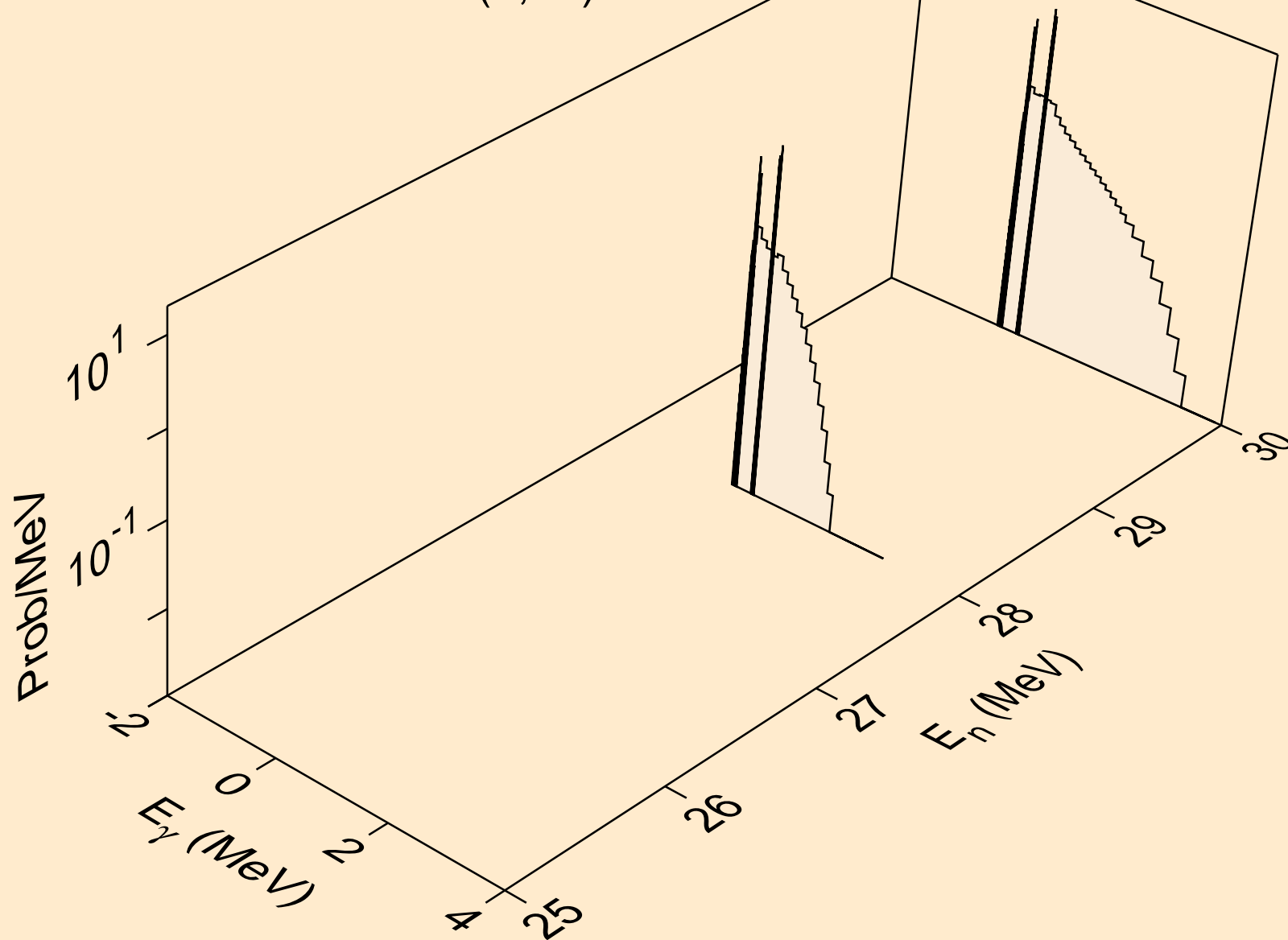

TL188M ALPHA ACER TENDL-2021 LIBRARY; T=0.K  
Photon emission for (n,n\*)a

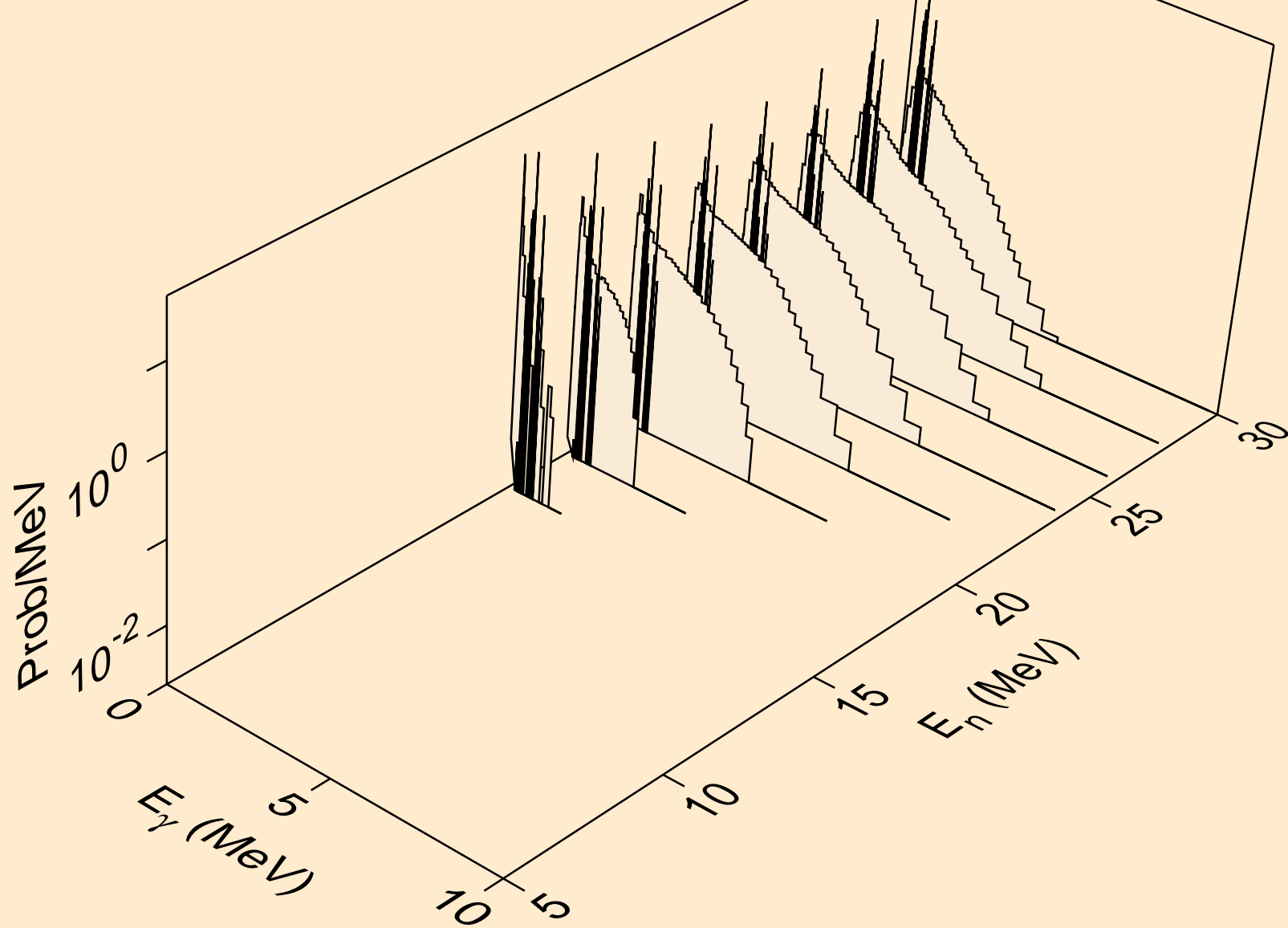

TL188M ALPHA ACER TENDL-2021 LIBRARY; T=0.K  
Photon emission for (n,2n)a

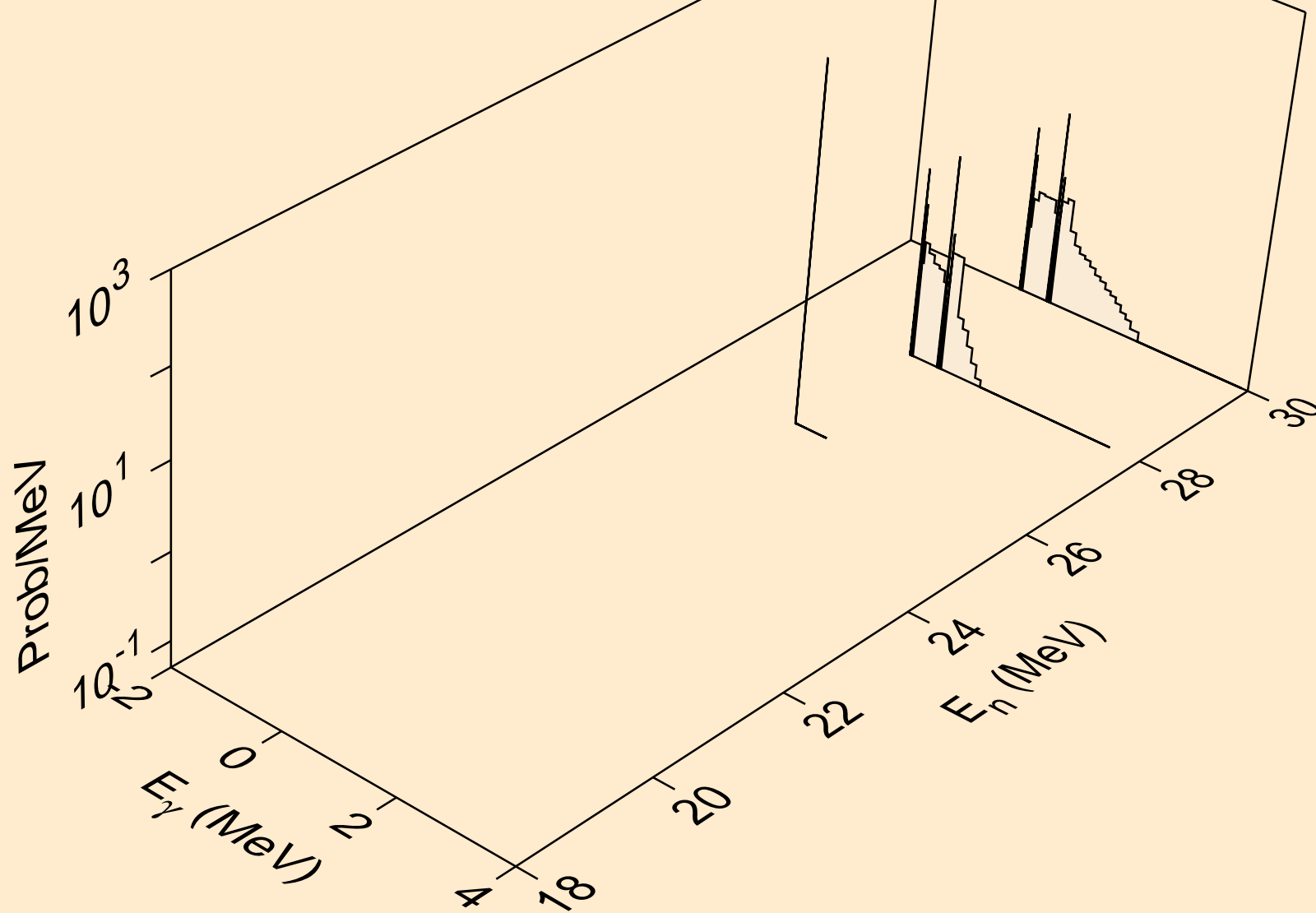

TL188M ALPHA ACER TENDL-2021 LIBRARY; T=0.K  
Photon emission for (n,n\*)p

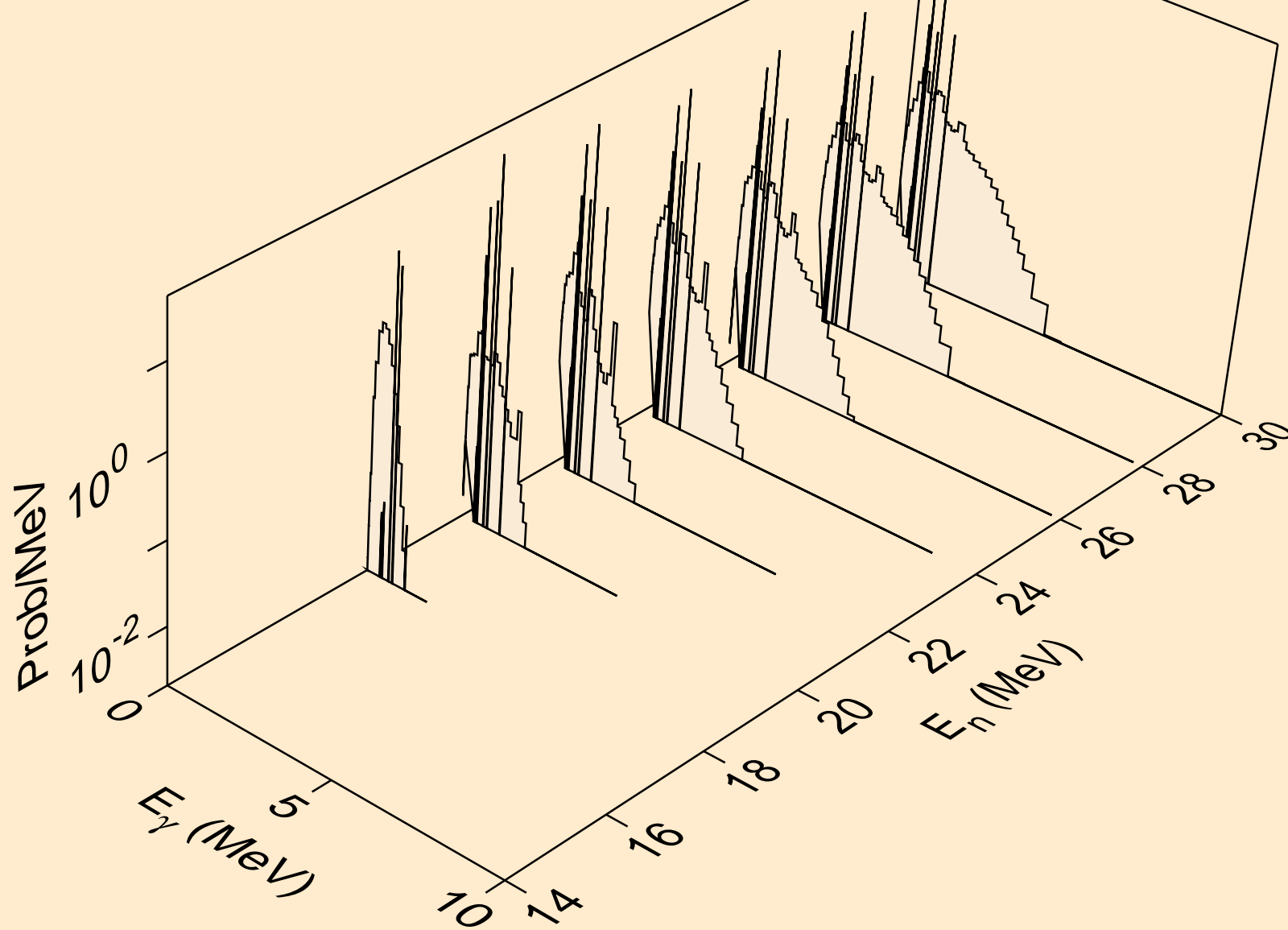

TL188M ALPHA ACER TENDL-2021 LIBRARY; T=0.K  
Photon emission for (n,n\*)2a

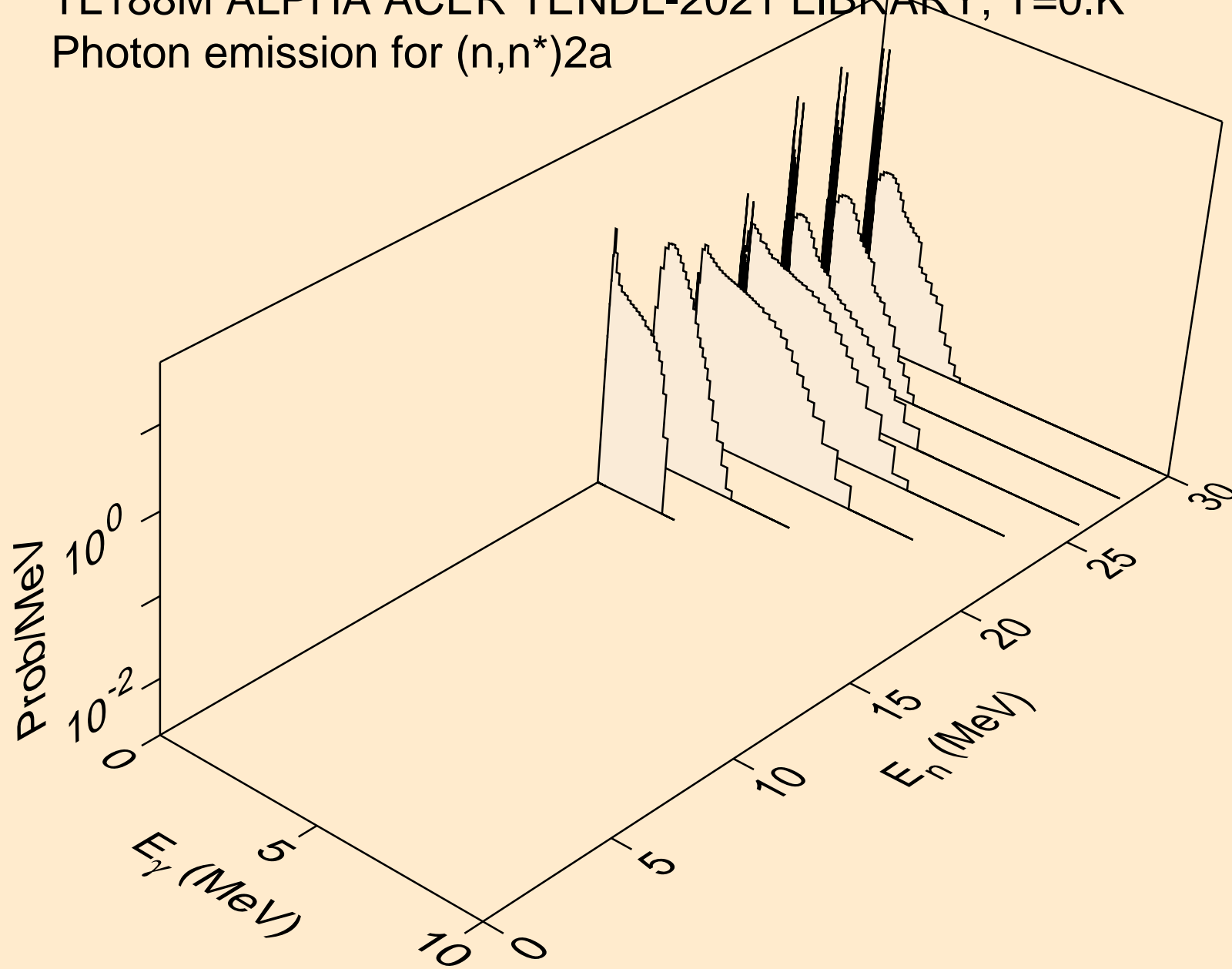



TL188M ALPHA ACER TENDL-2021 LIBRARY; T=0.K  
Photon emission for (n,2np)

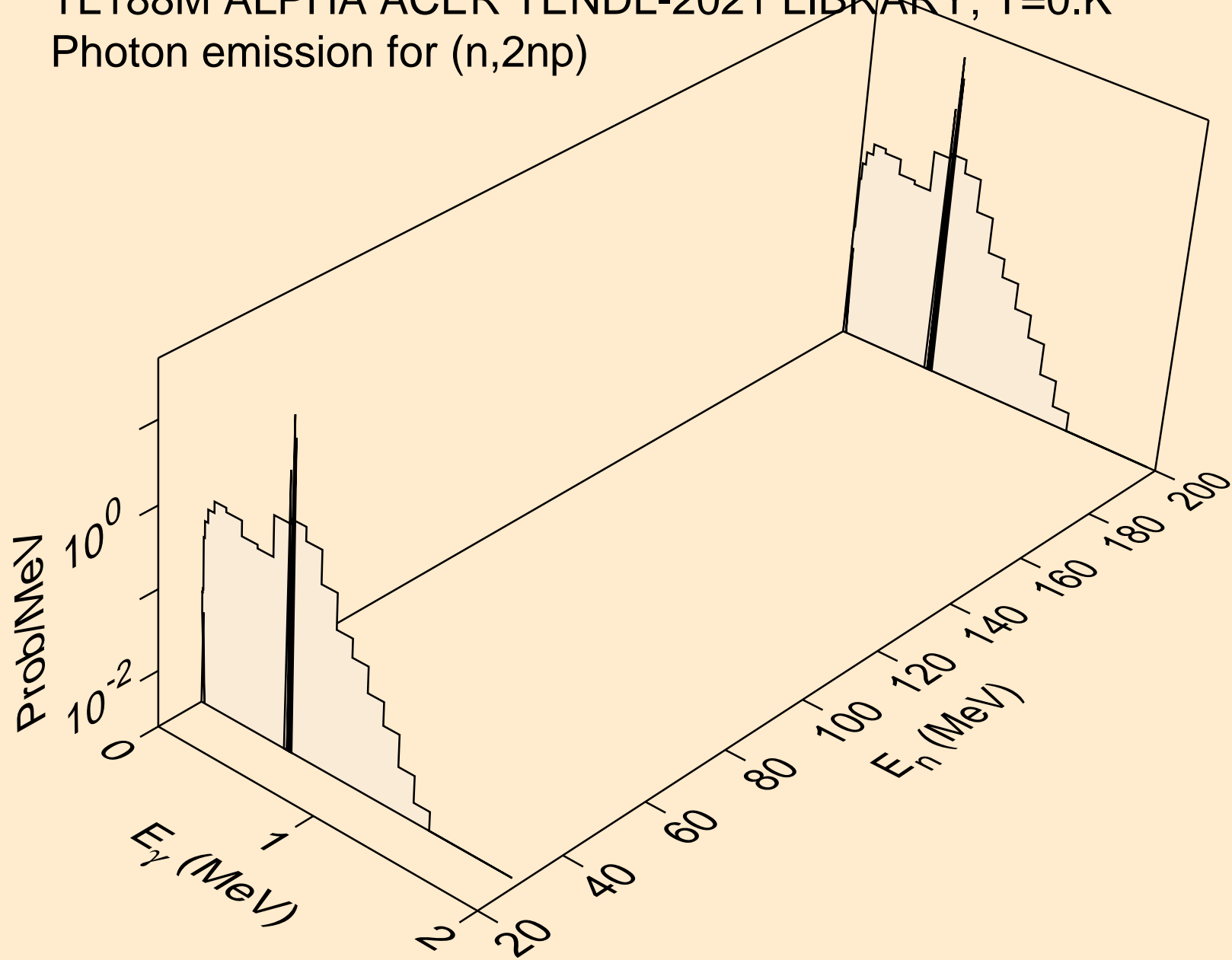

TL188M ALPHA ACER TENDL-2021 LIBRARY; T=0.K  
Photon emission for (n,2np)

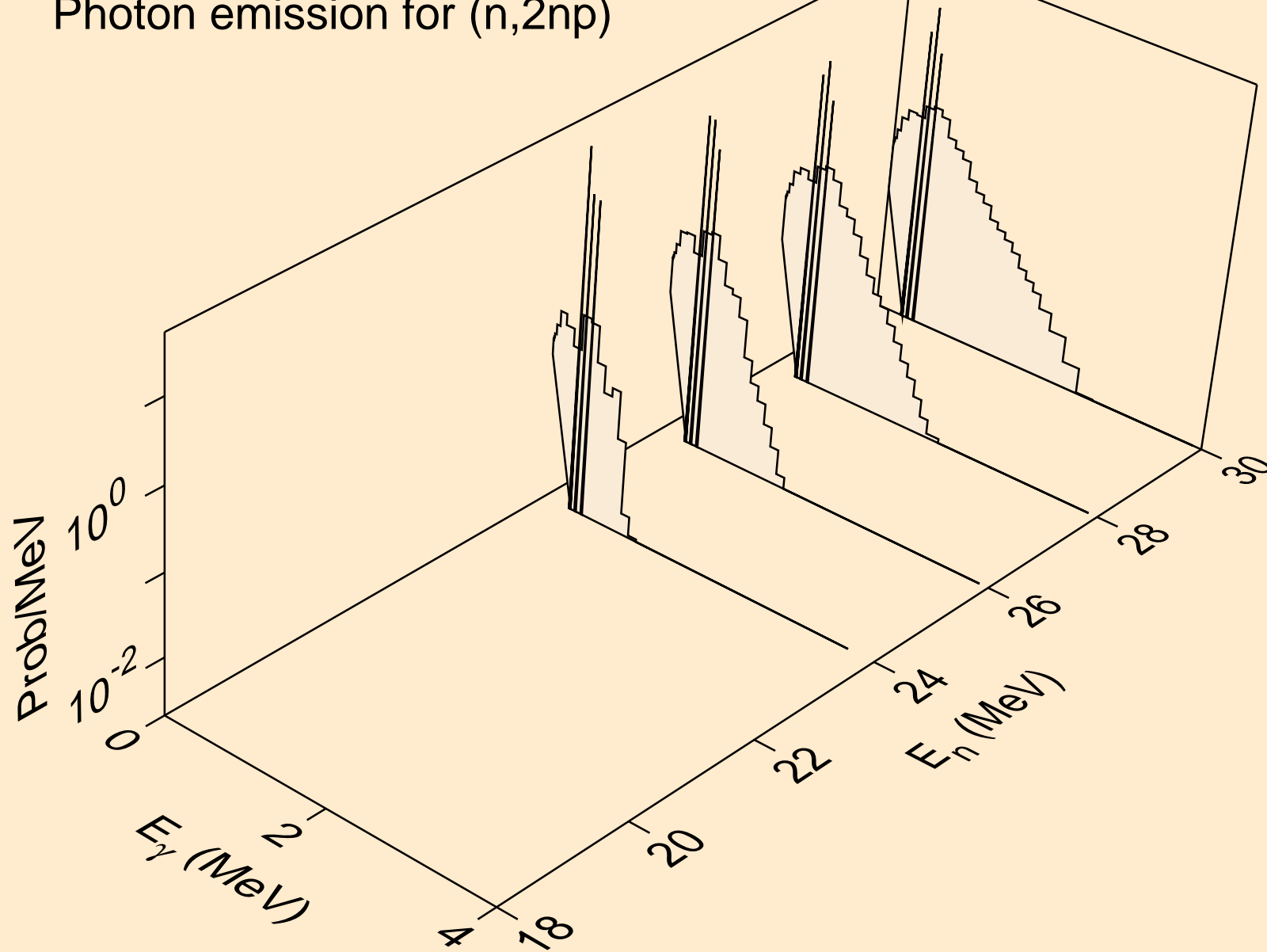

TL188M ALPHA ACER TENDL-2021 LIBRARY; T=0.K  
Photon emission for (n,npa)

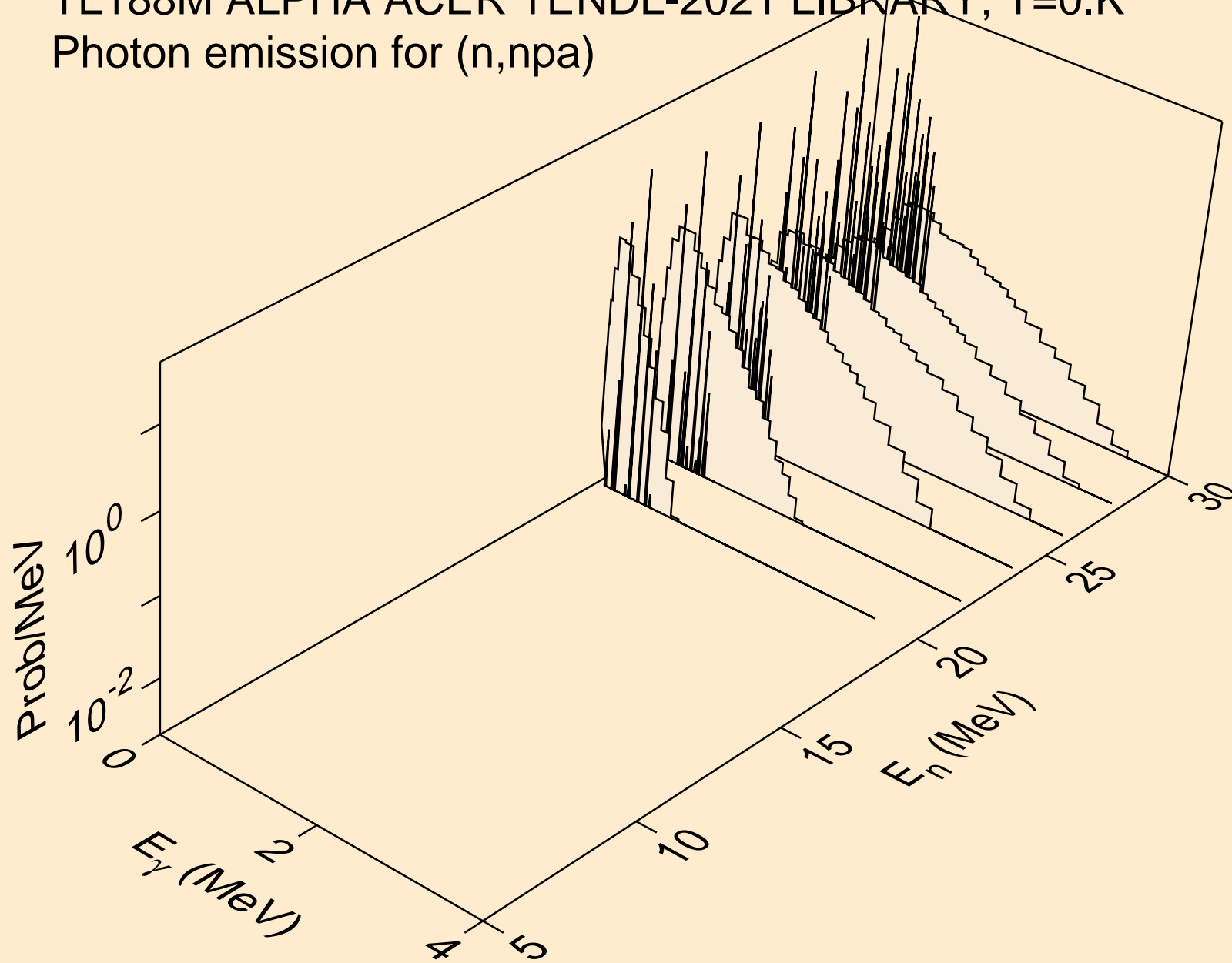

TL188M ALPHA ACER TENDL-2021 LIBRARY; T=0.K  
Photon emission for (n,gma)

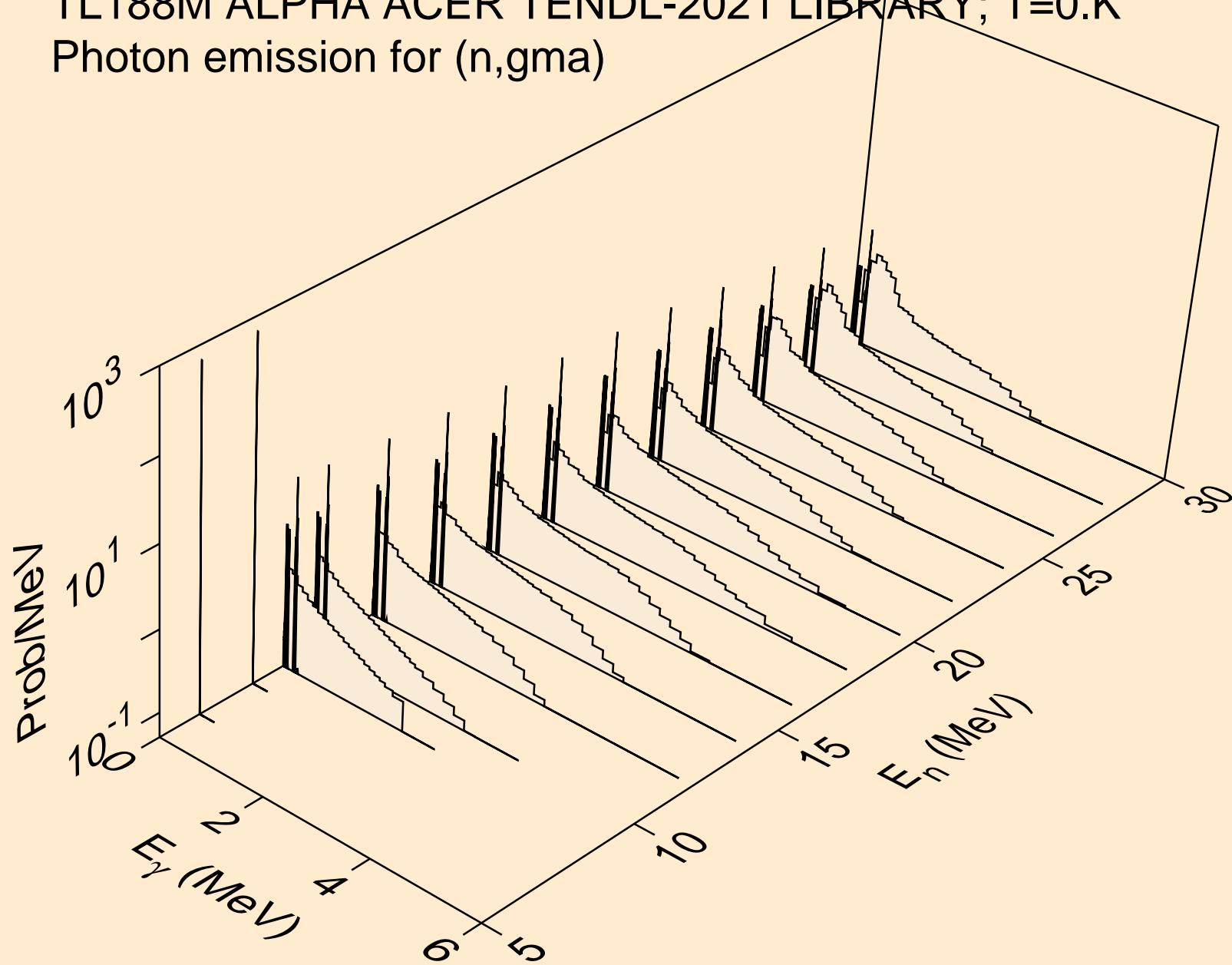

TL188M ALPHA ACER TENDL-2021 LIBRARY; T=0.K  
Photon emission for (n,p)

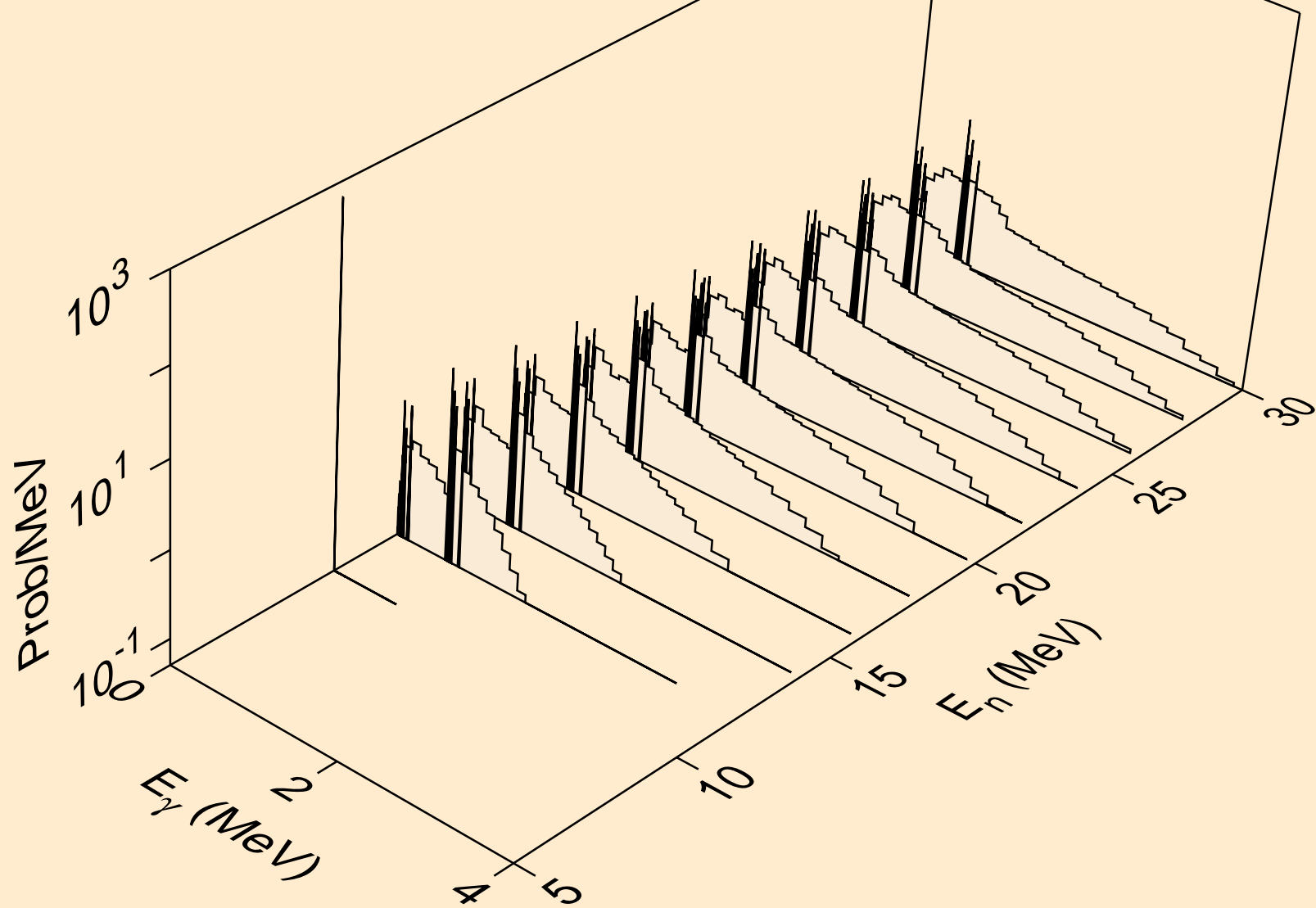

TL188M ALPHA ACER TENDL-2021 LIBRARY; T=0.K  
Photon emission for (n,d)

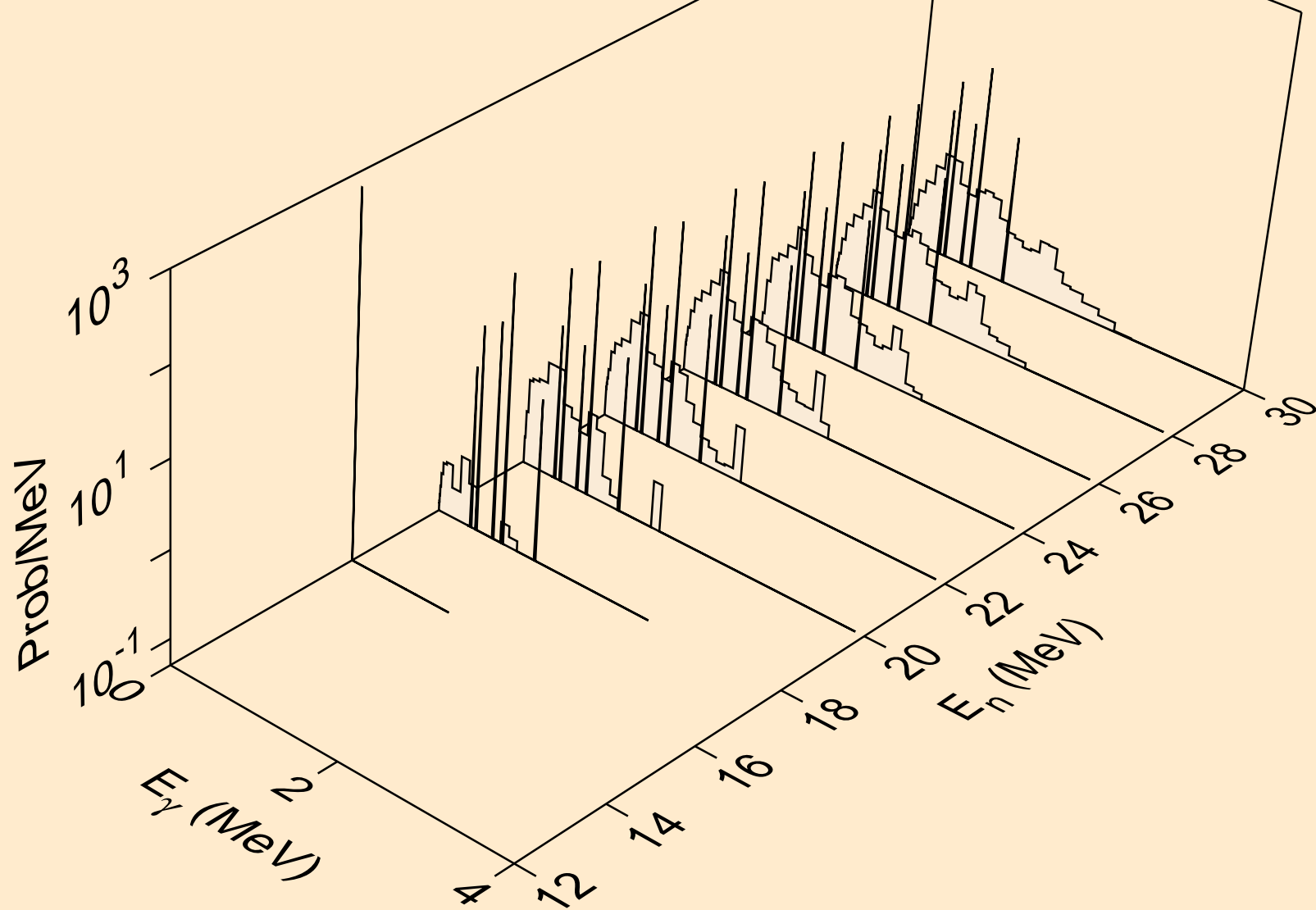

TL188M ALPHA ACER TENDL-2021 LIBRARY; T=0.K  
Photon emission for (n,t)

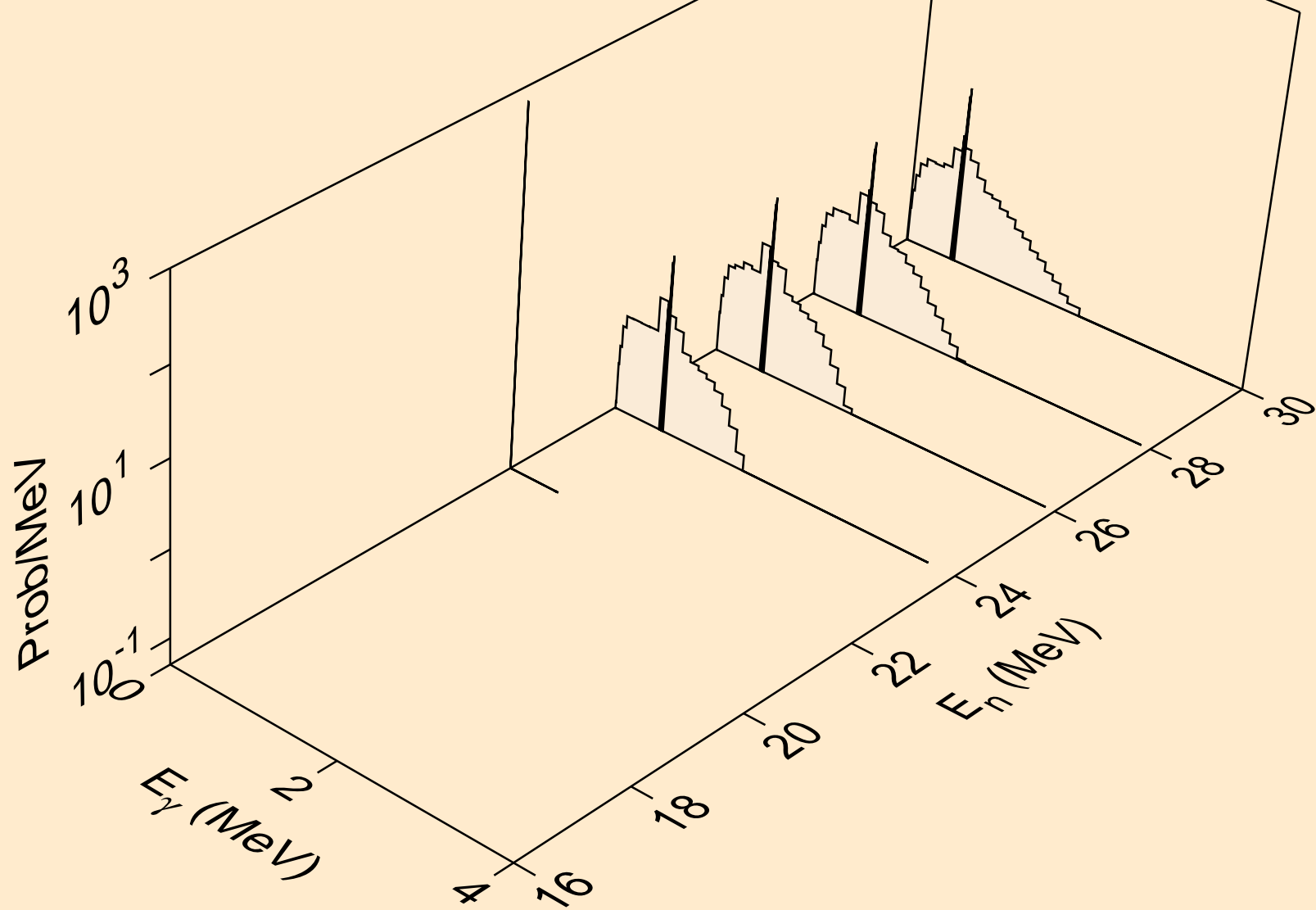

TL188M ALPHA ACER TENDL-2021 LIBRARY; T=0.K  
Photon emission for (n,he3)

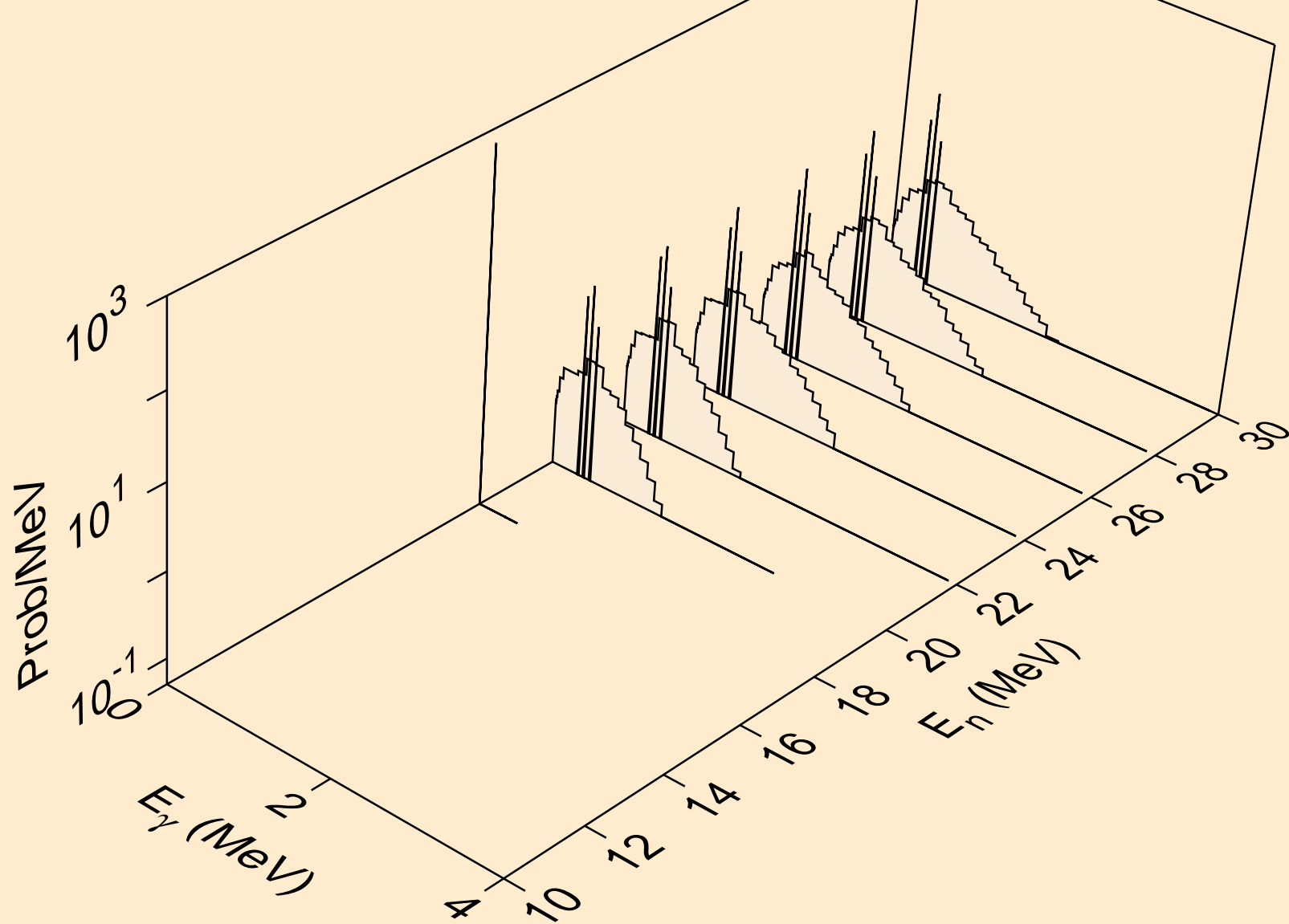



TL188M ALPHA ACER TENDL-2021 LIBRARY; T=0.K  
Photon emission for inelastic

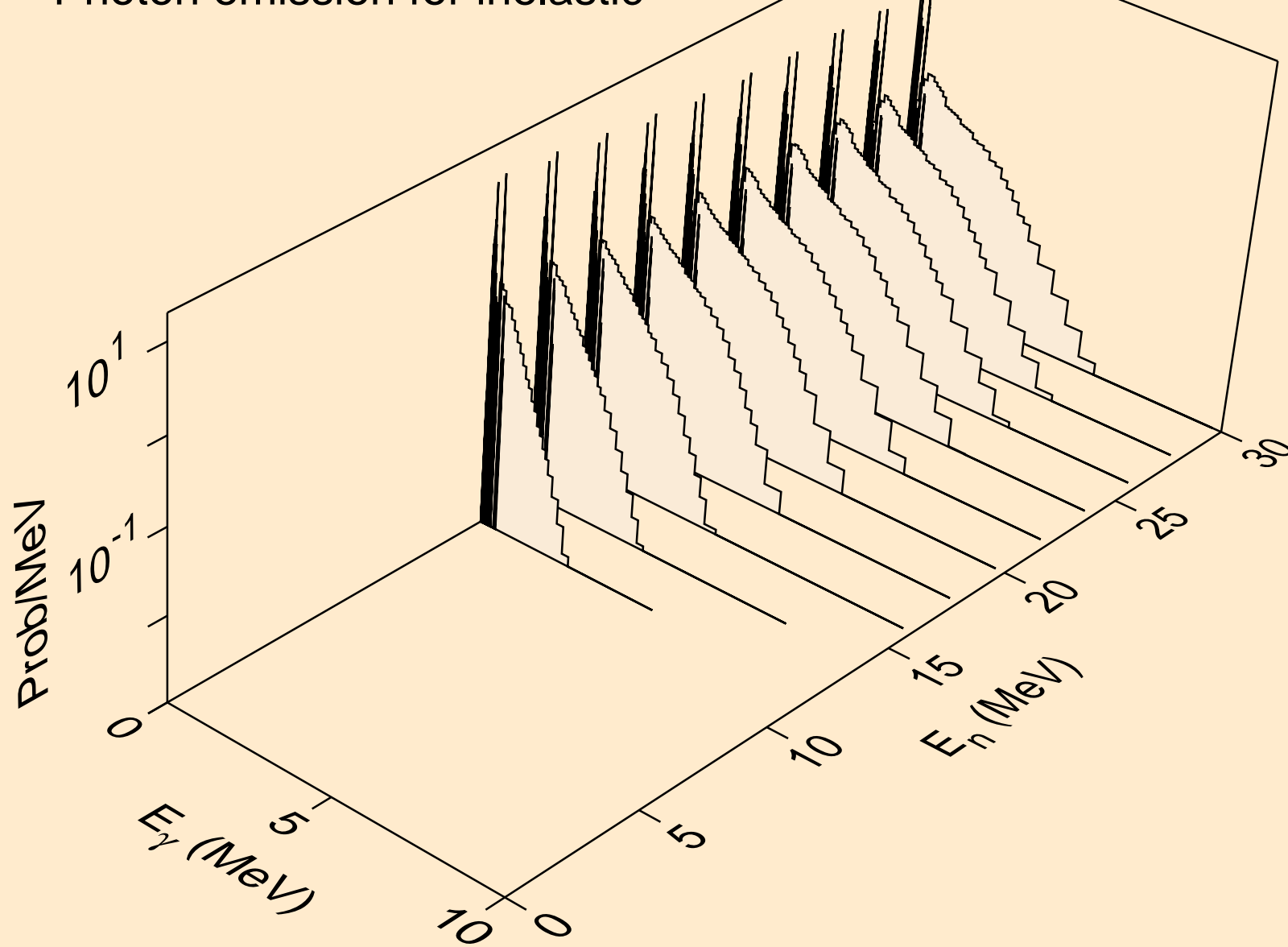

TL188M ALPHA ACER TENDL-2021 LIBRARY; T=0.K  
Photon emission for (n,2a)

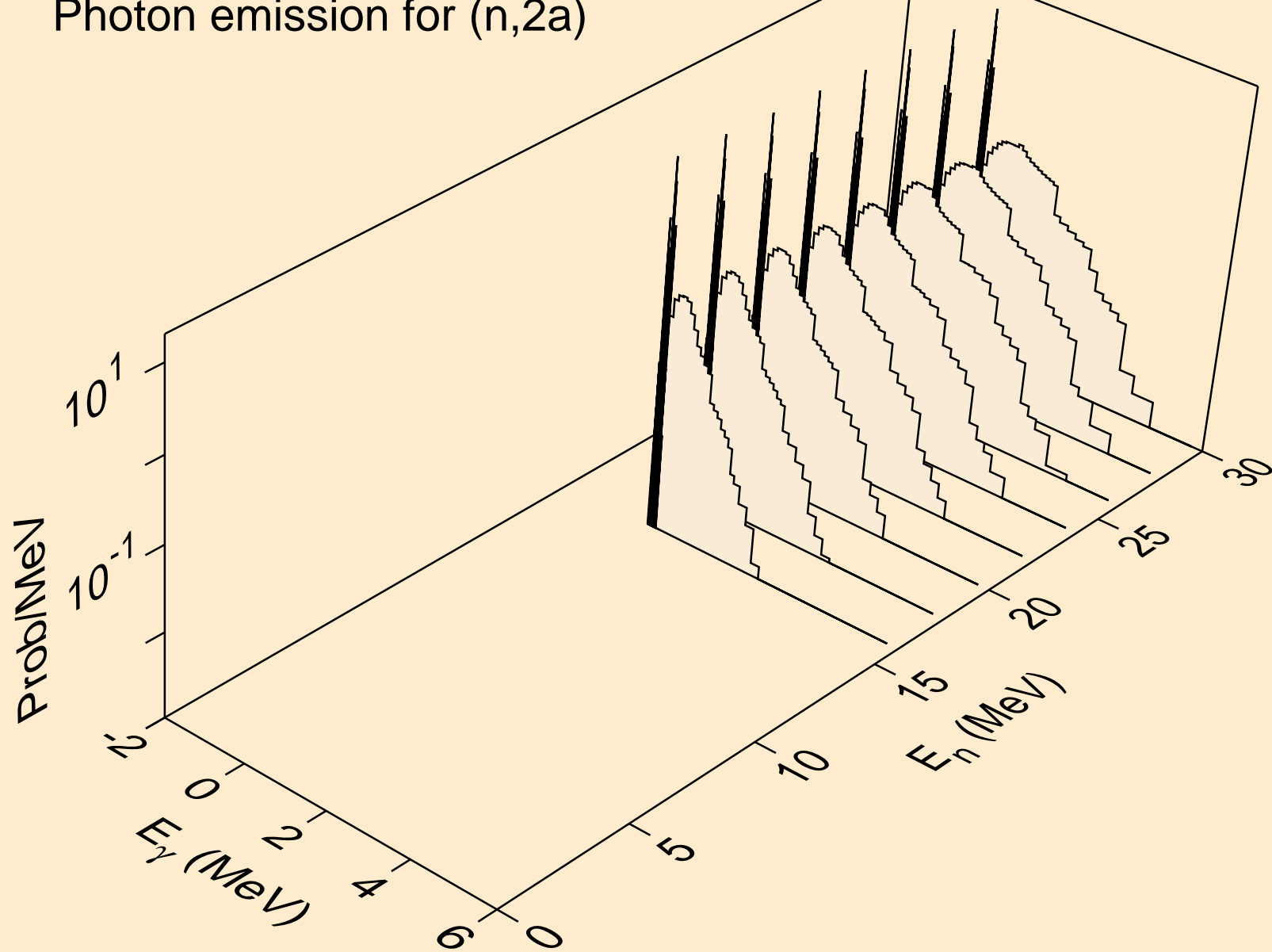

TL188M ALPHA ACER TENDL-2021 LIBRARY; T=0.K  
Photon emission for (n,2p)

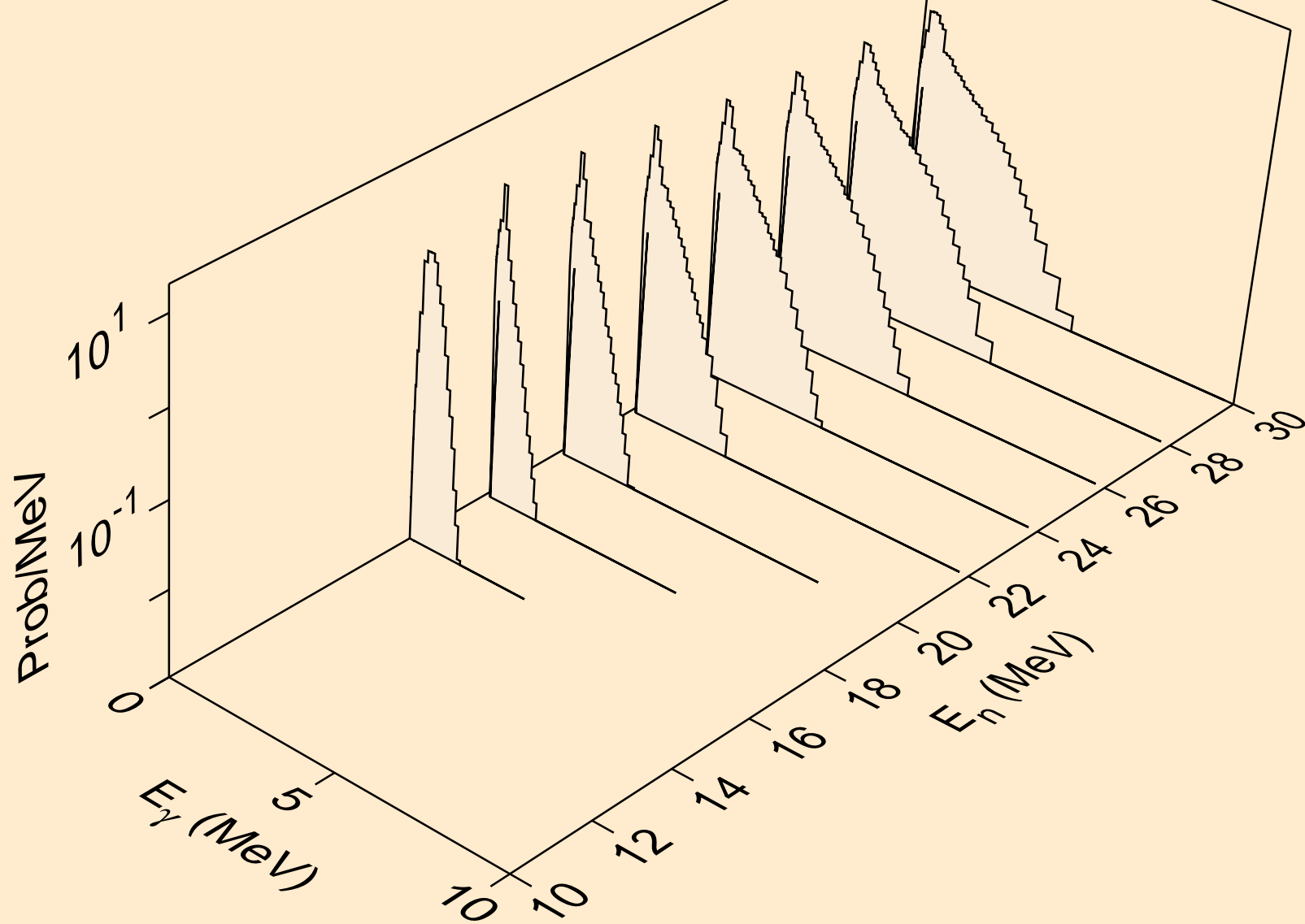

TL188M ALPHA ACER TENDL-2021 LIBRARY; T=0.K  
Photon emission for (n,pa)

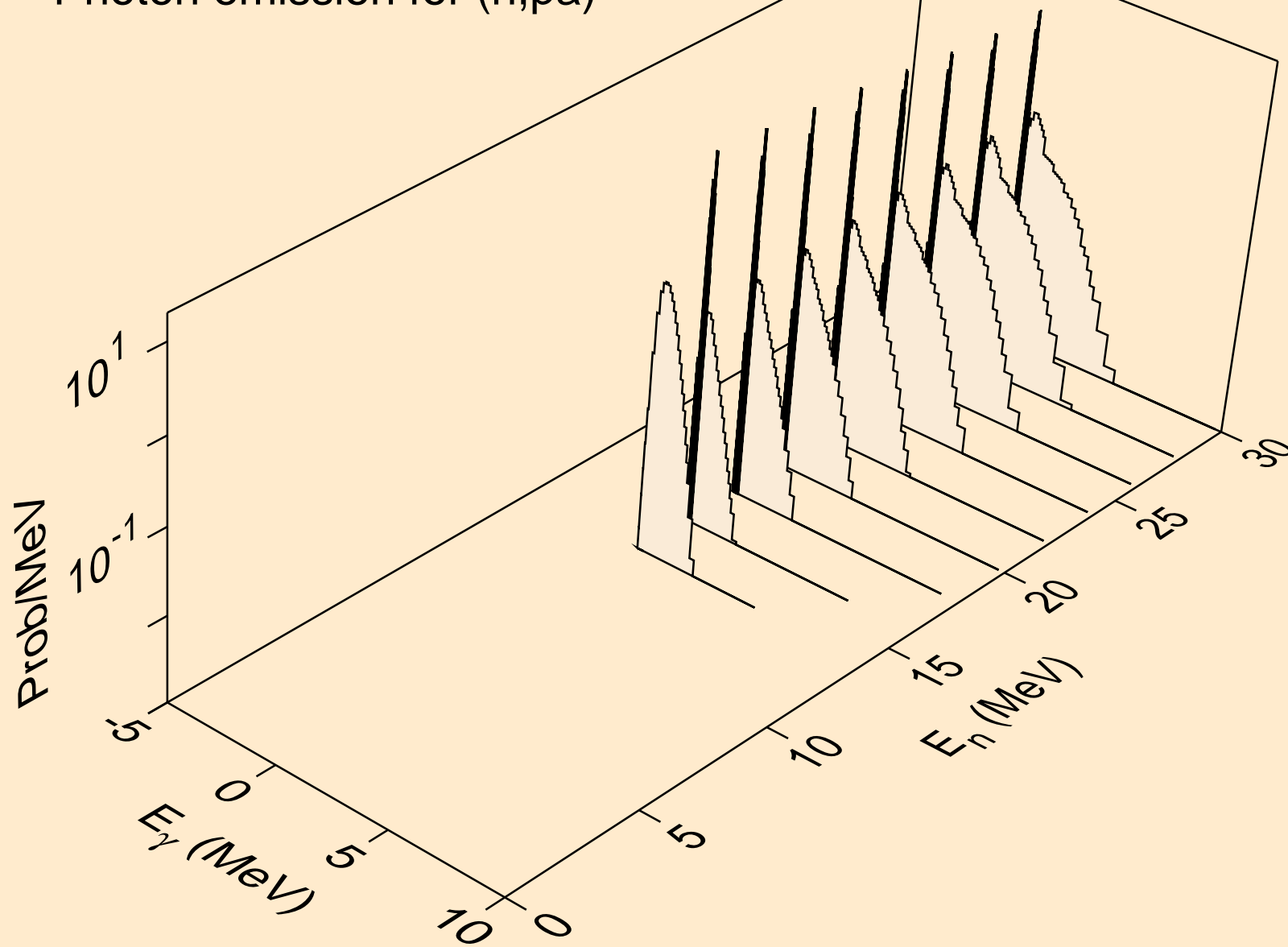

TL188M ALPHA ACER TENDL-2021 LIBRARY; T=0.K  
Photon emission for (n,pd)

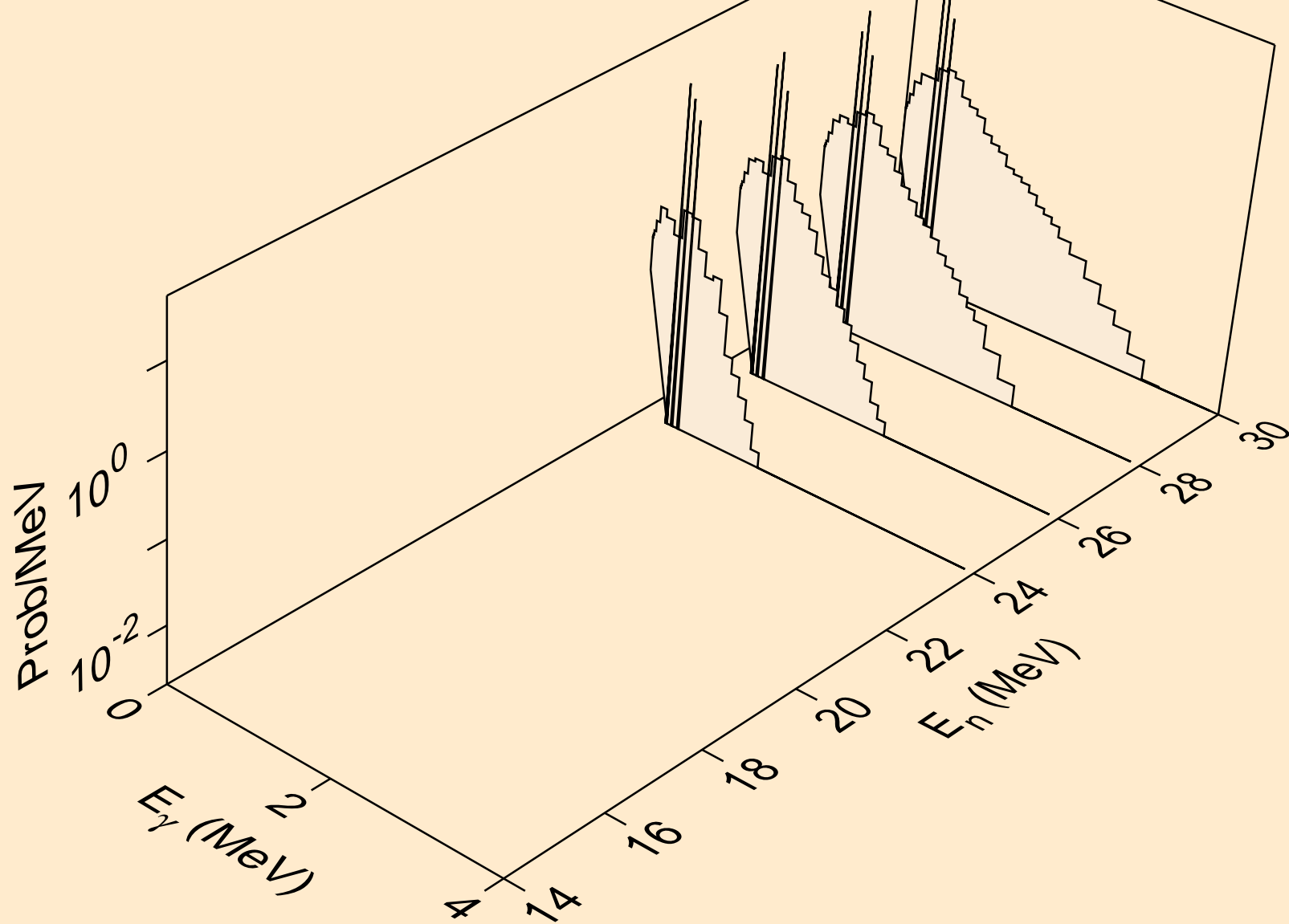

TL188M ALPHA ACER TENDL-2021 LIBRARY; T=0.K  
Photon emission for (n,da)

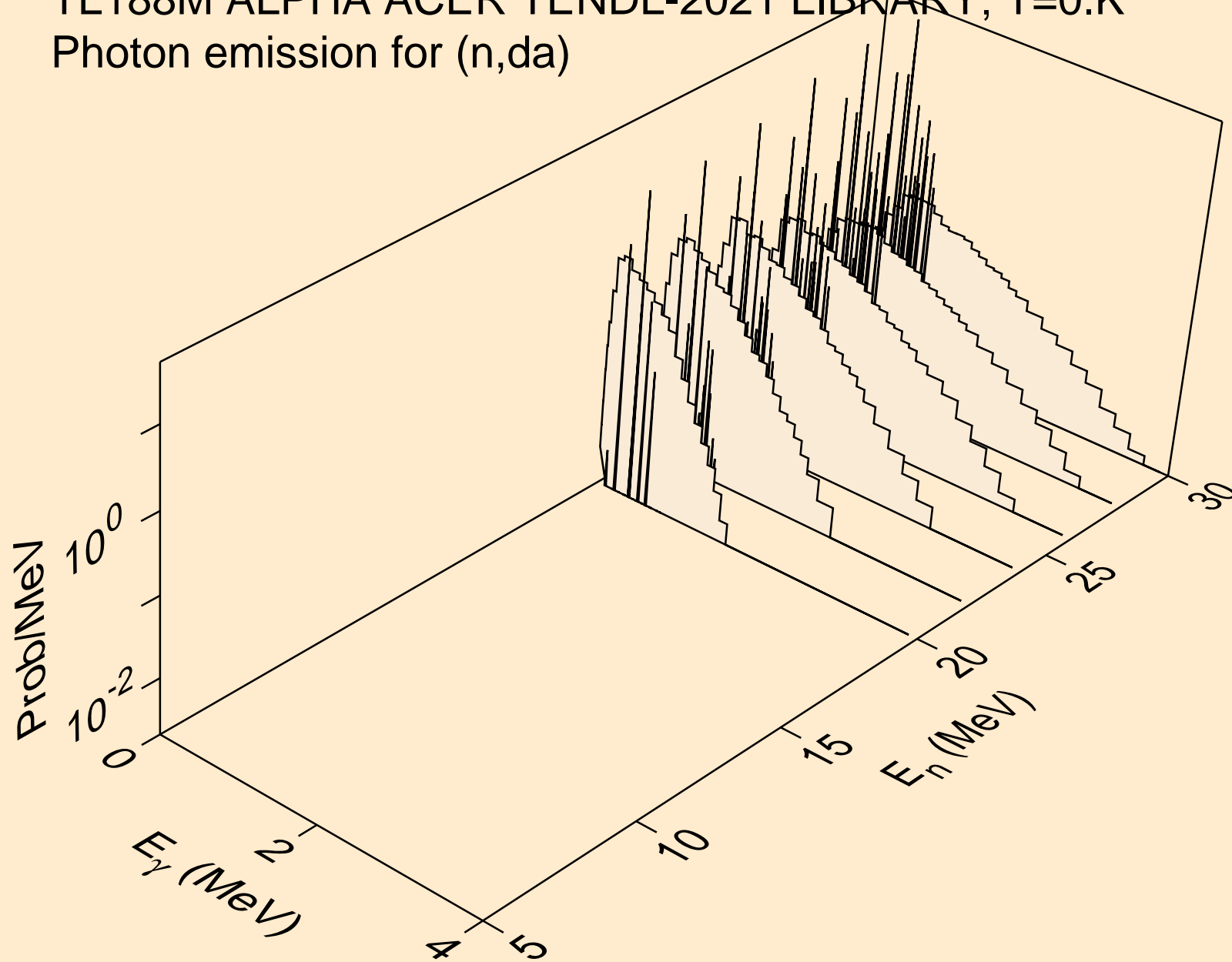

TL188M ALPHA ACER TENDL-2021 LIBRARY; T=0.K  
Particle heating contributions

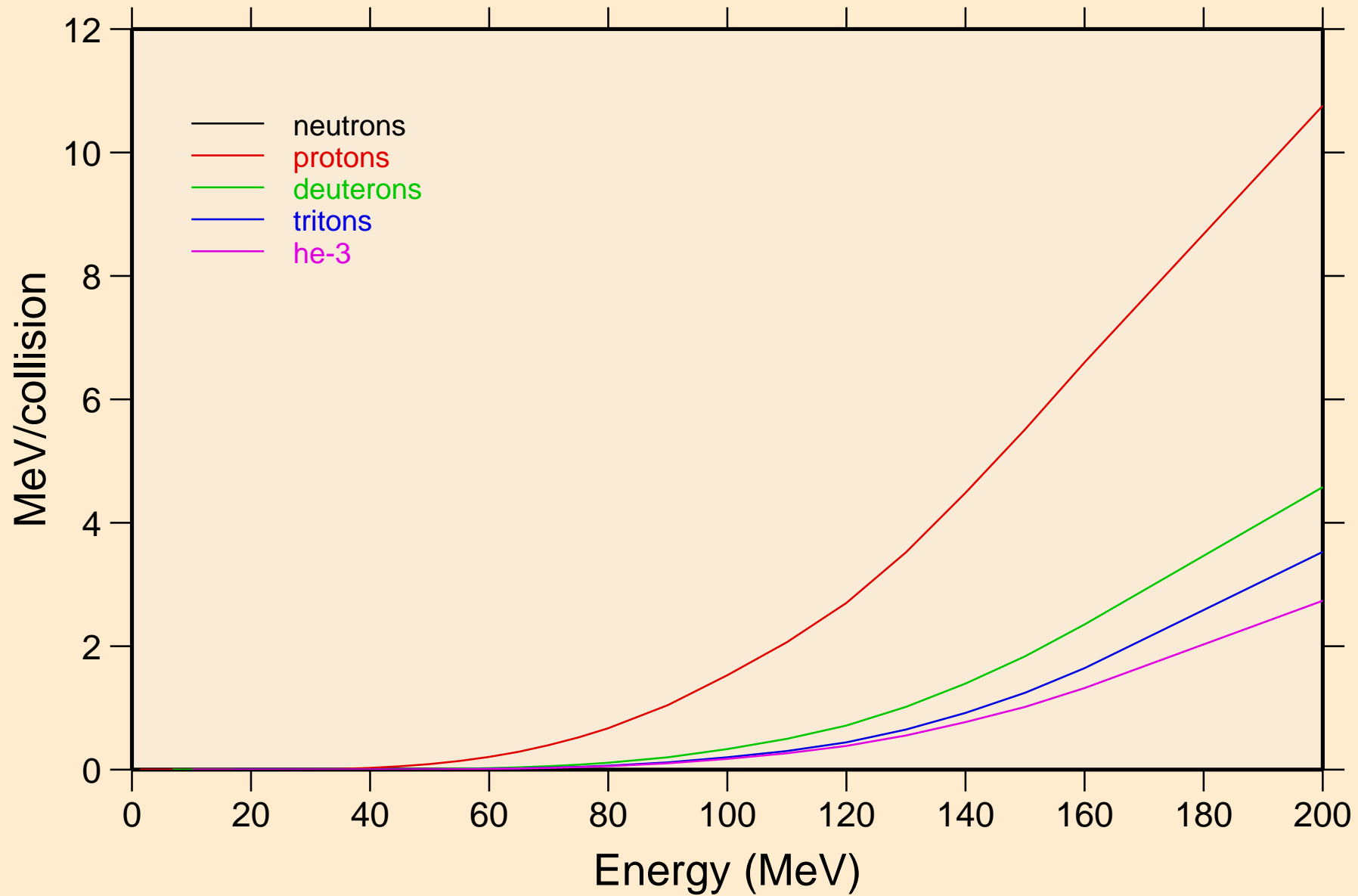

TL188M ALPHA ACER TENDL-2021 LIBRARY; T=0.K  
Recoil Heating

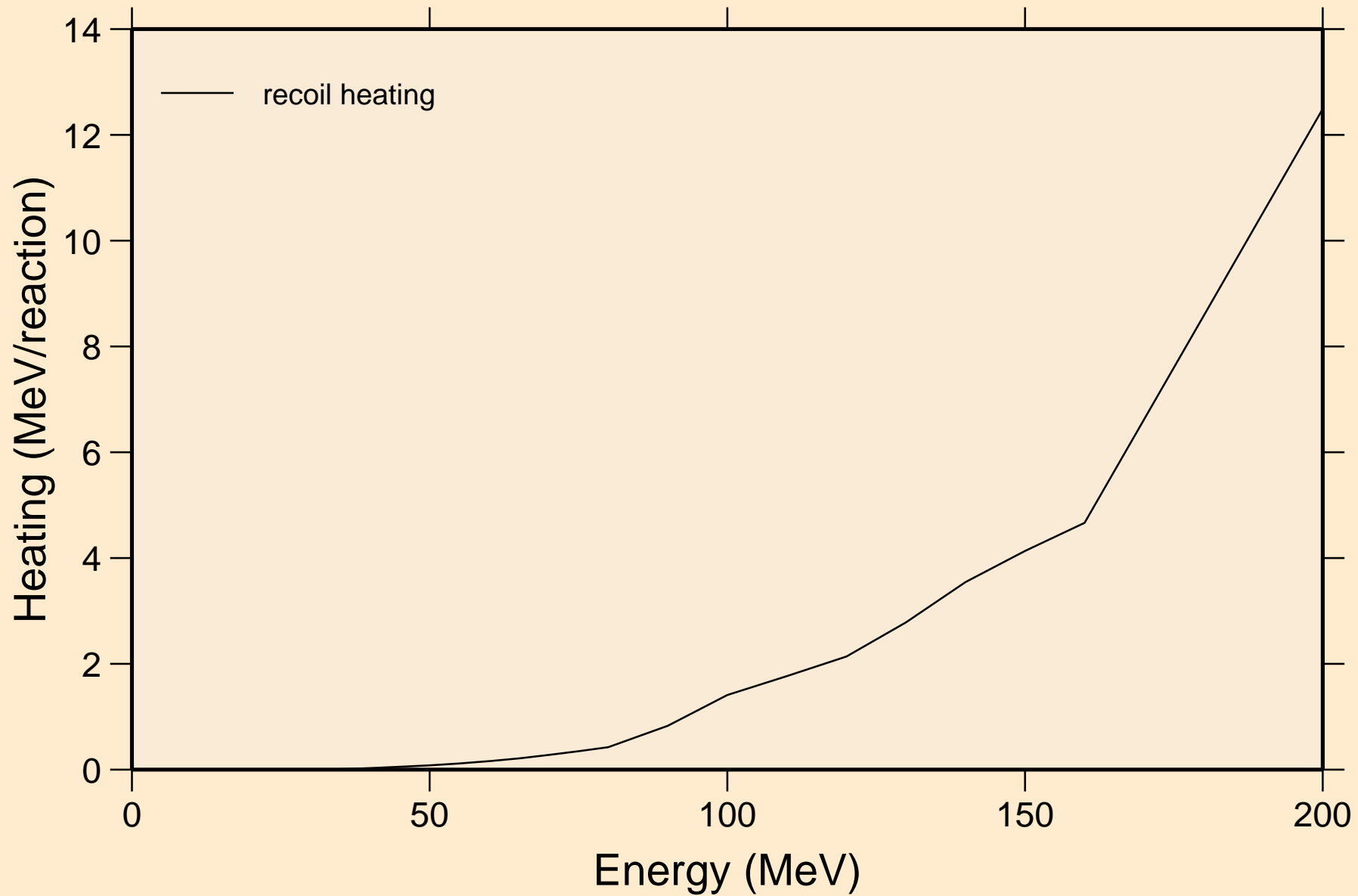



TL188M ALPHA ACER TENDL-2021 LIBRARY; T=0.K  
Particle production cross sections

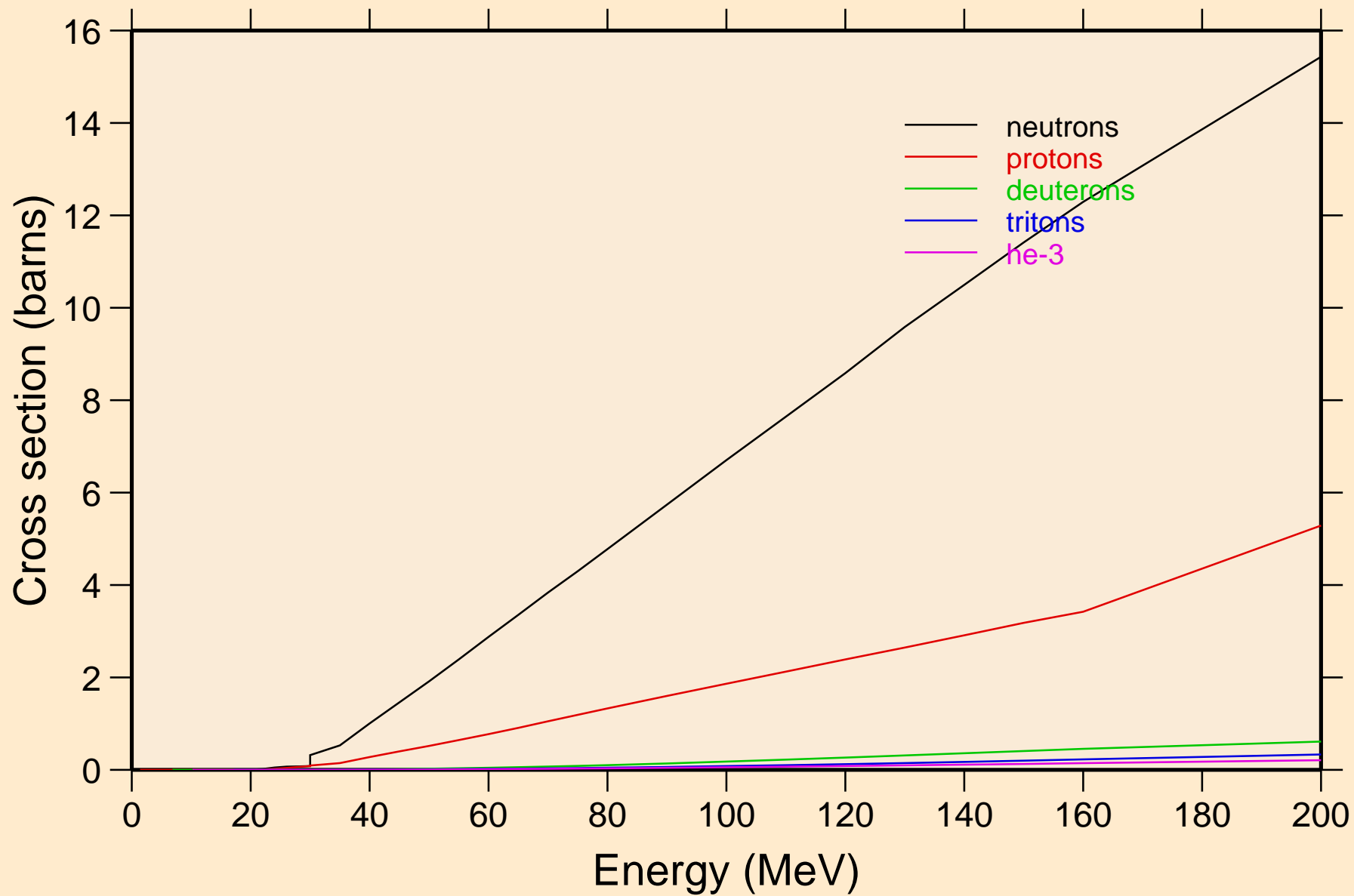

TL188M ALPHA ACER TENDL-2021 LIBRARY; T=0.K  
neutrons from (a,n)

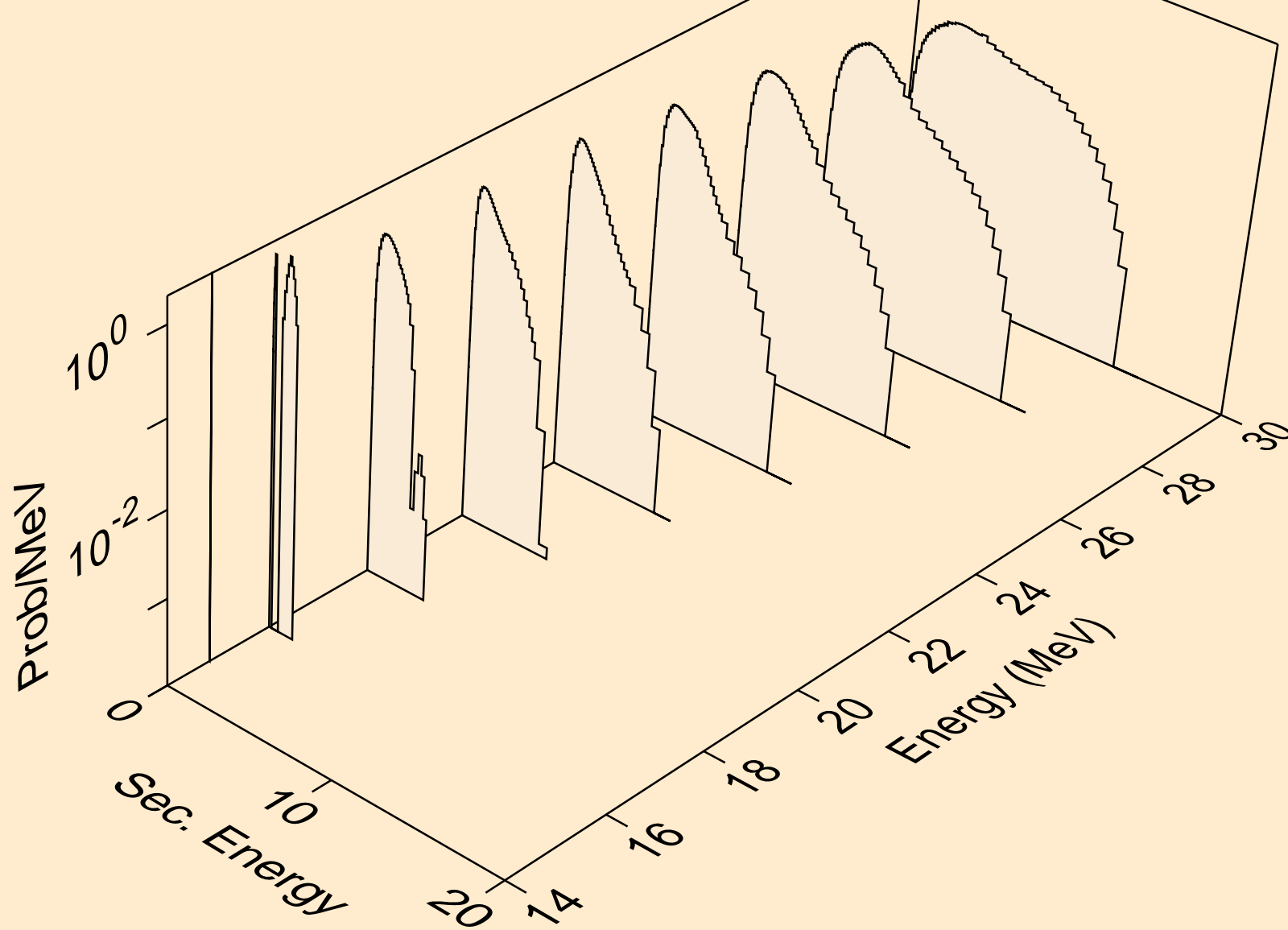

TL188M ALPHA ACER TENDL-2021 LIBRARY; T=0.K  
neutrons from (a,x)

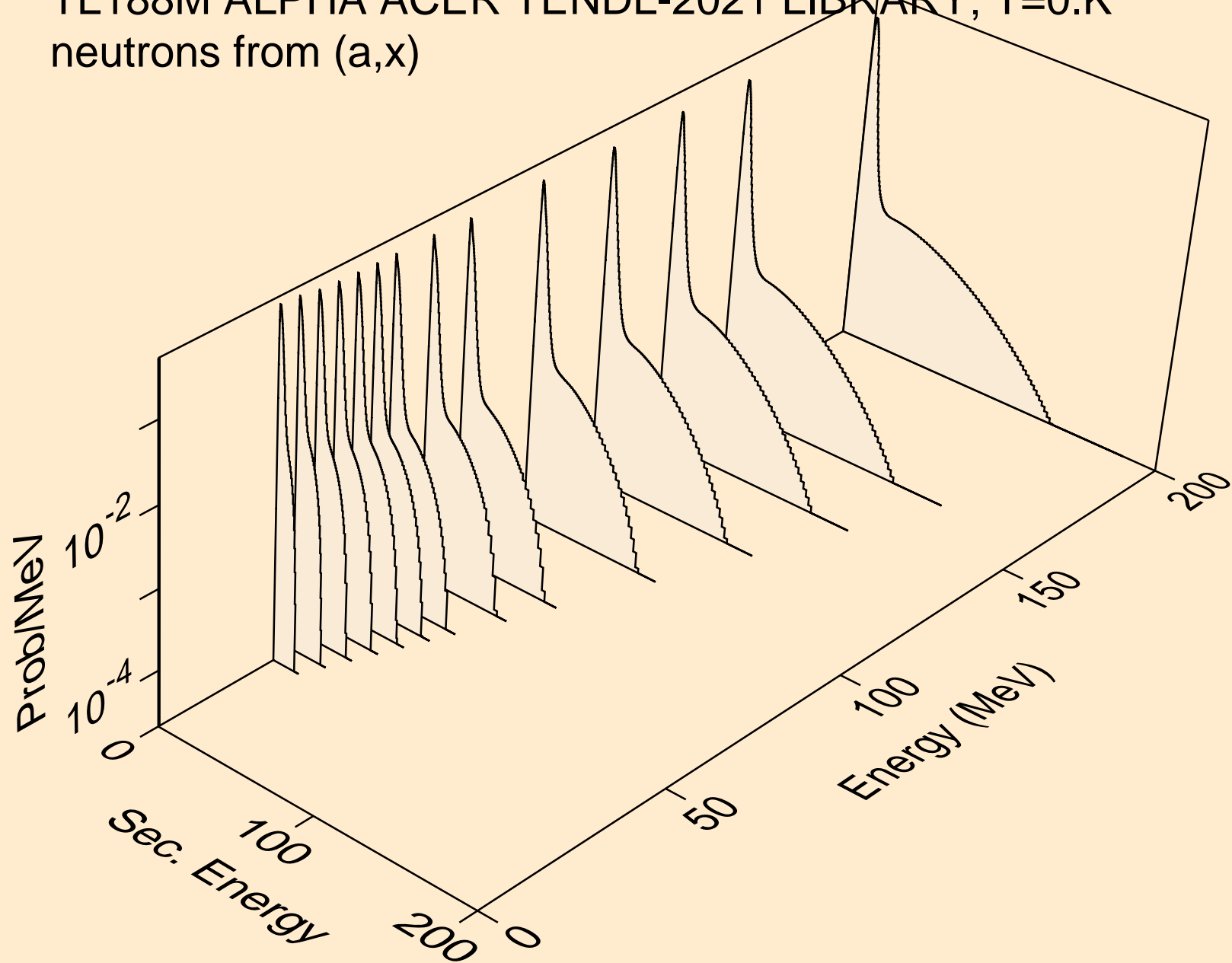

TL188M ALPHA ACER TENDL-2021 LIBRARY; T=0.K  
neutrons from (a,2n)

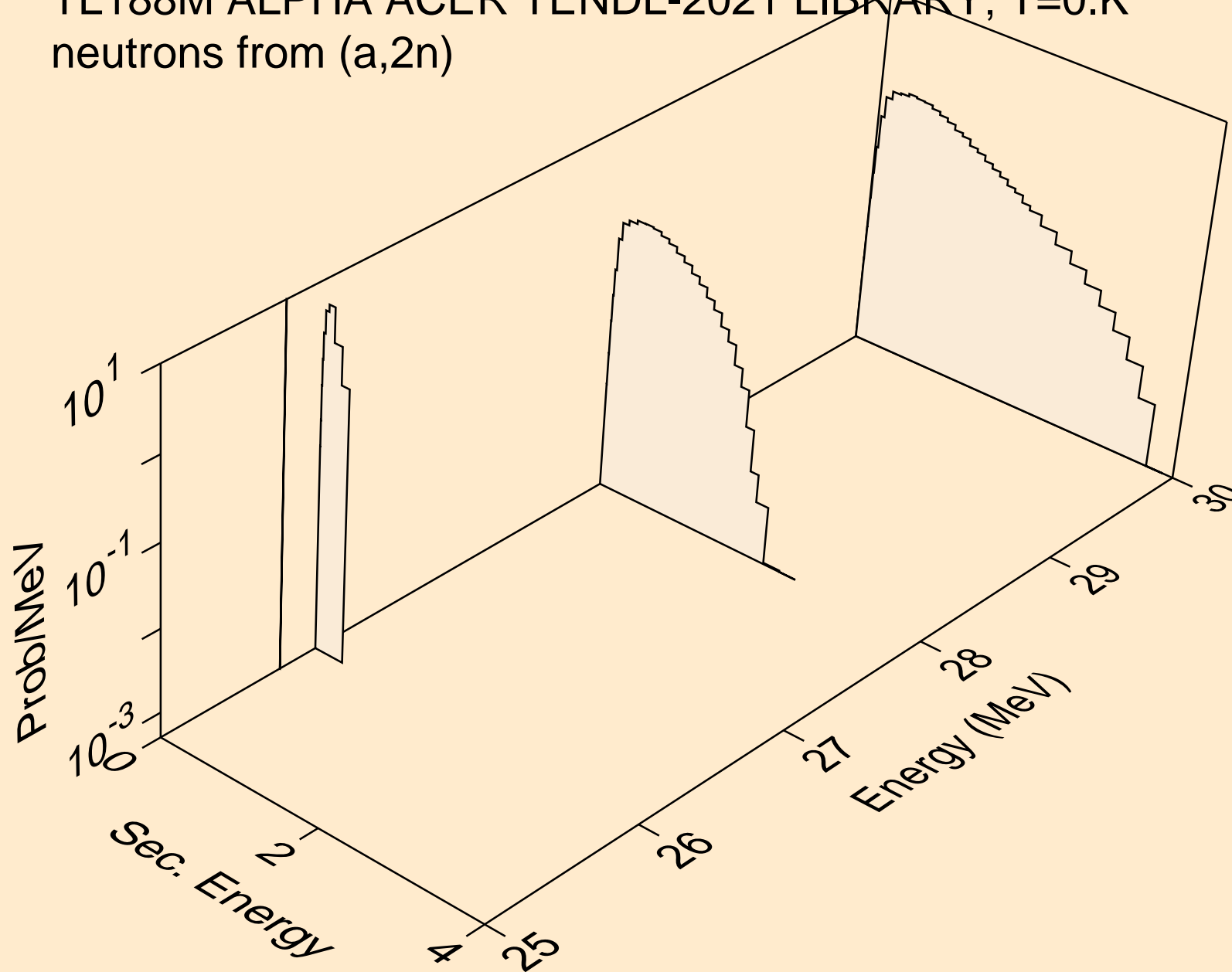

TL188M ALPHA ACER TENDL-2021 LIBRARY; T=0.K  
neutrons from (a,n\*)a

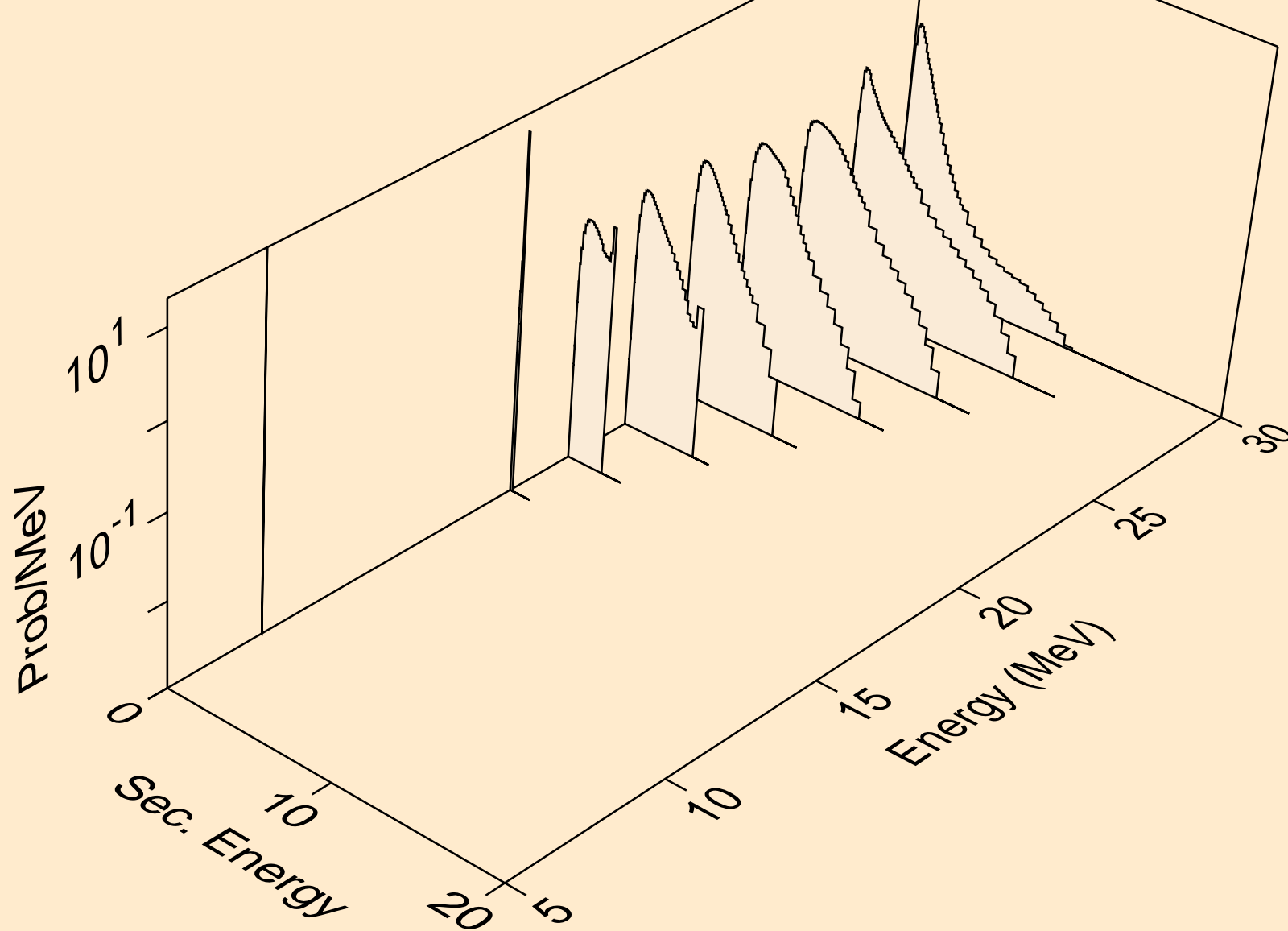

TL188M ALPHA ACER TENDL-2021 LIBRARY; T=0.K  
neutrons from (a,2n)a

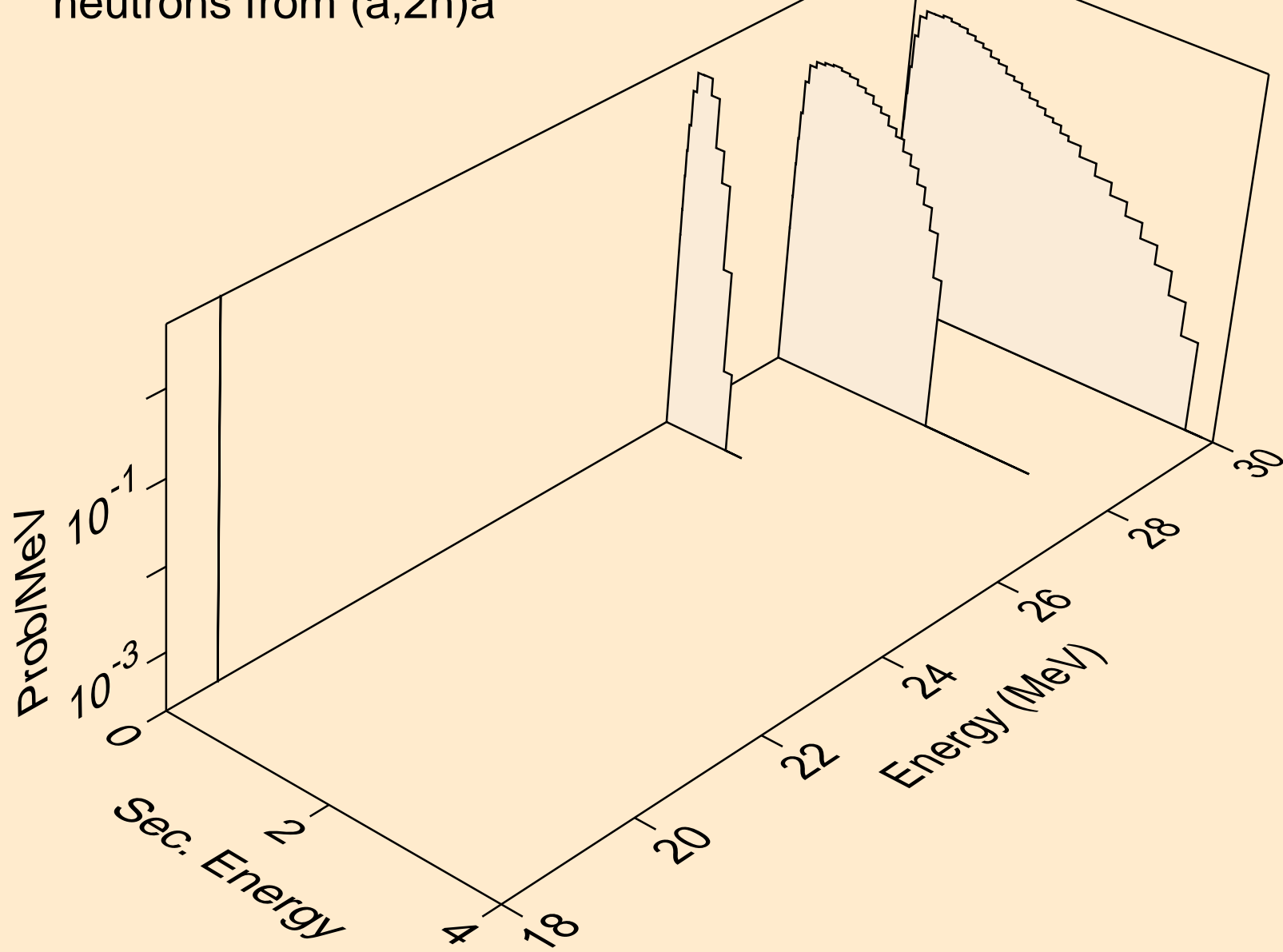

TL188M ALPHA ACER TENDL-2021 LIBRARY; T=0.K  
neutrons from (a,n\*)p

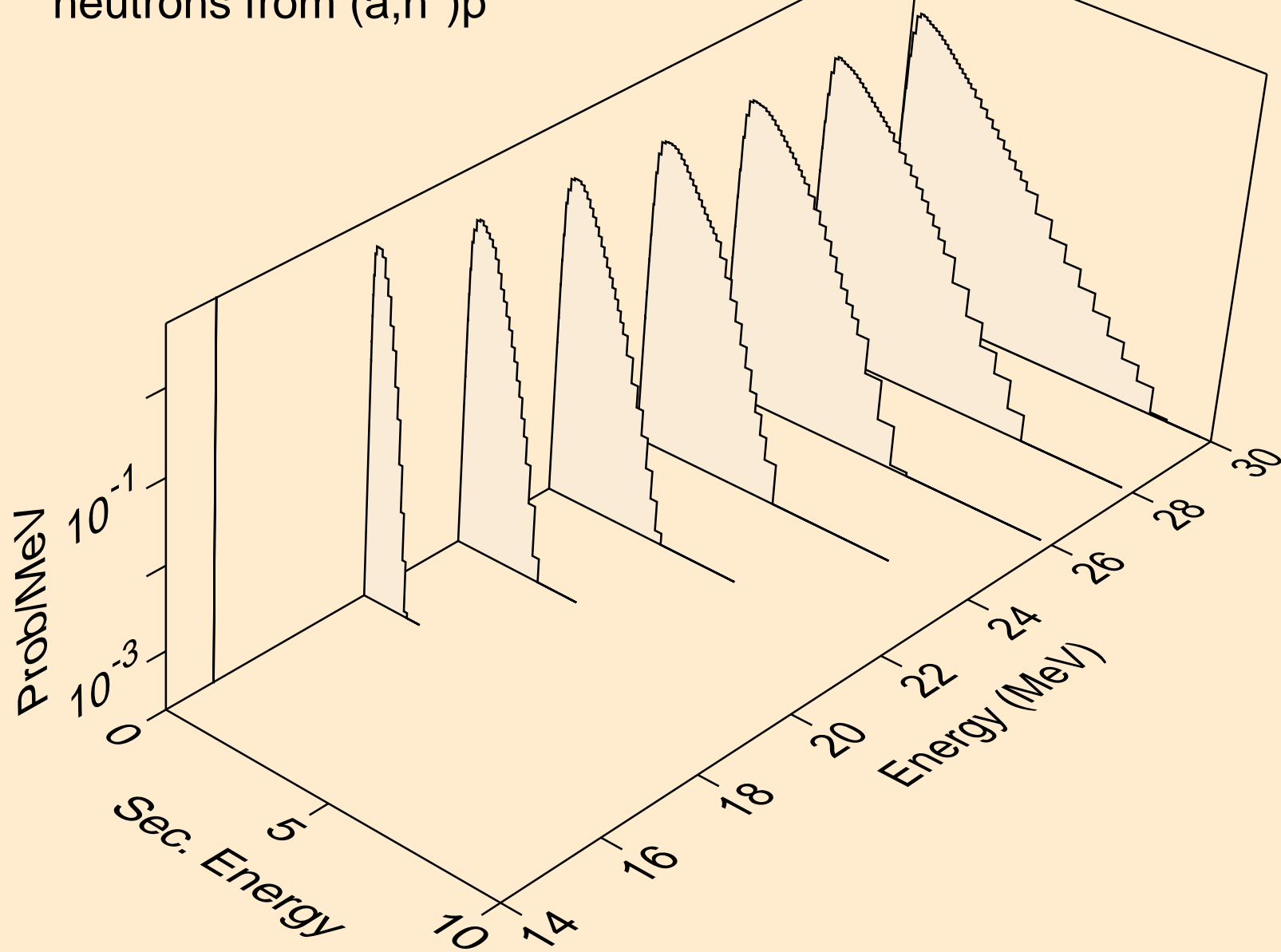

TL188M ALPHA ACER TENDL-2021 LIBRARY; T=0.K  
neutrons from (a,n\*)2a

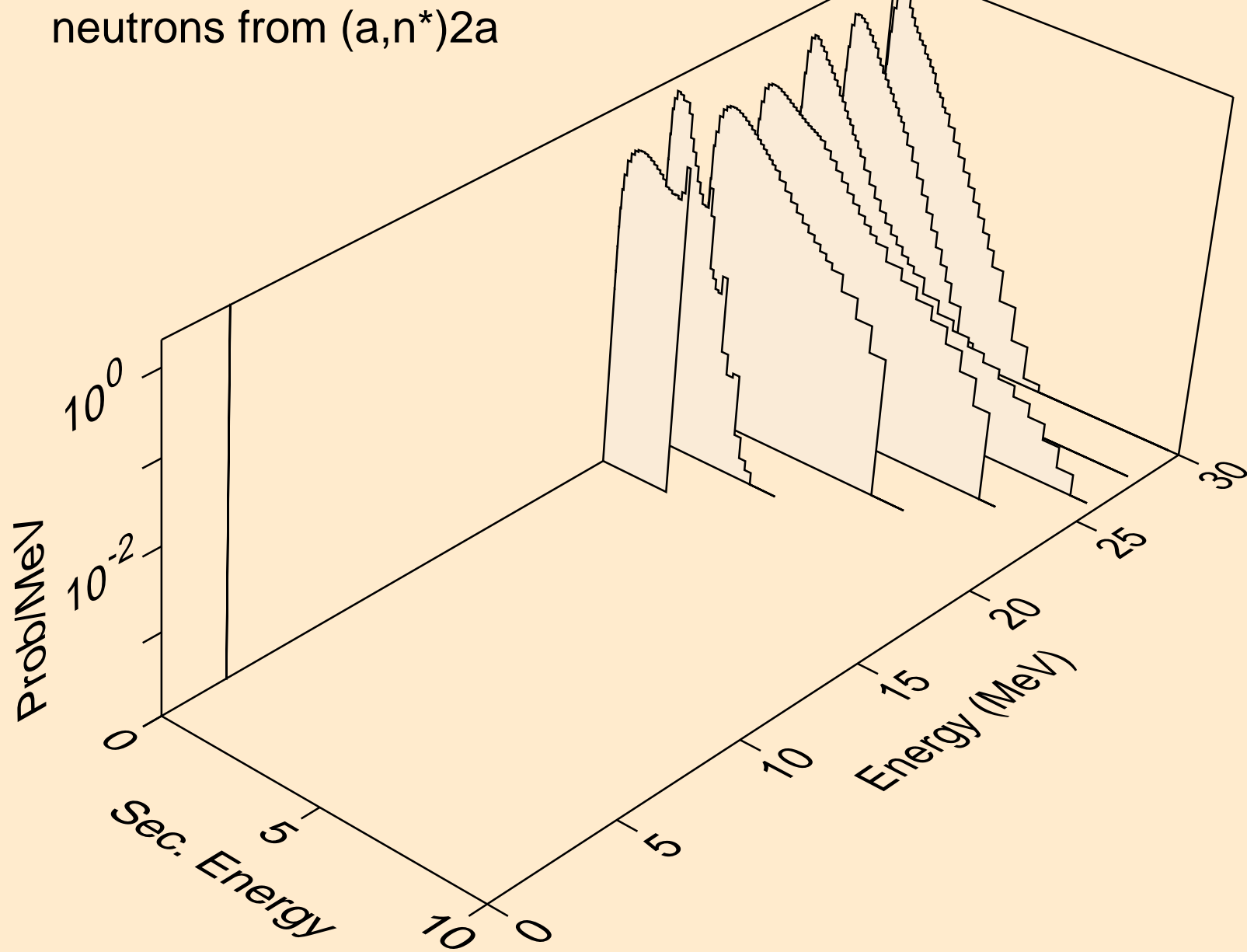



TL188M ALPHA ACER TENDL-2021 LIBRARY; T=0.K  
neutrons from (a,2np)

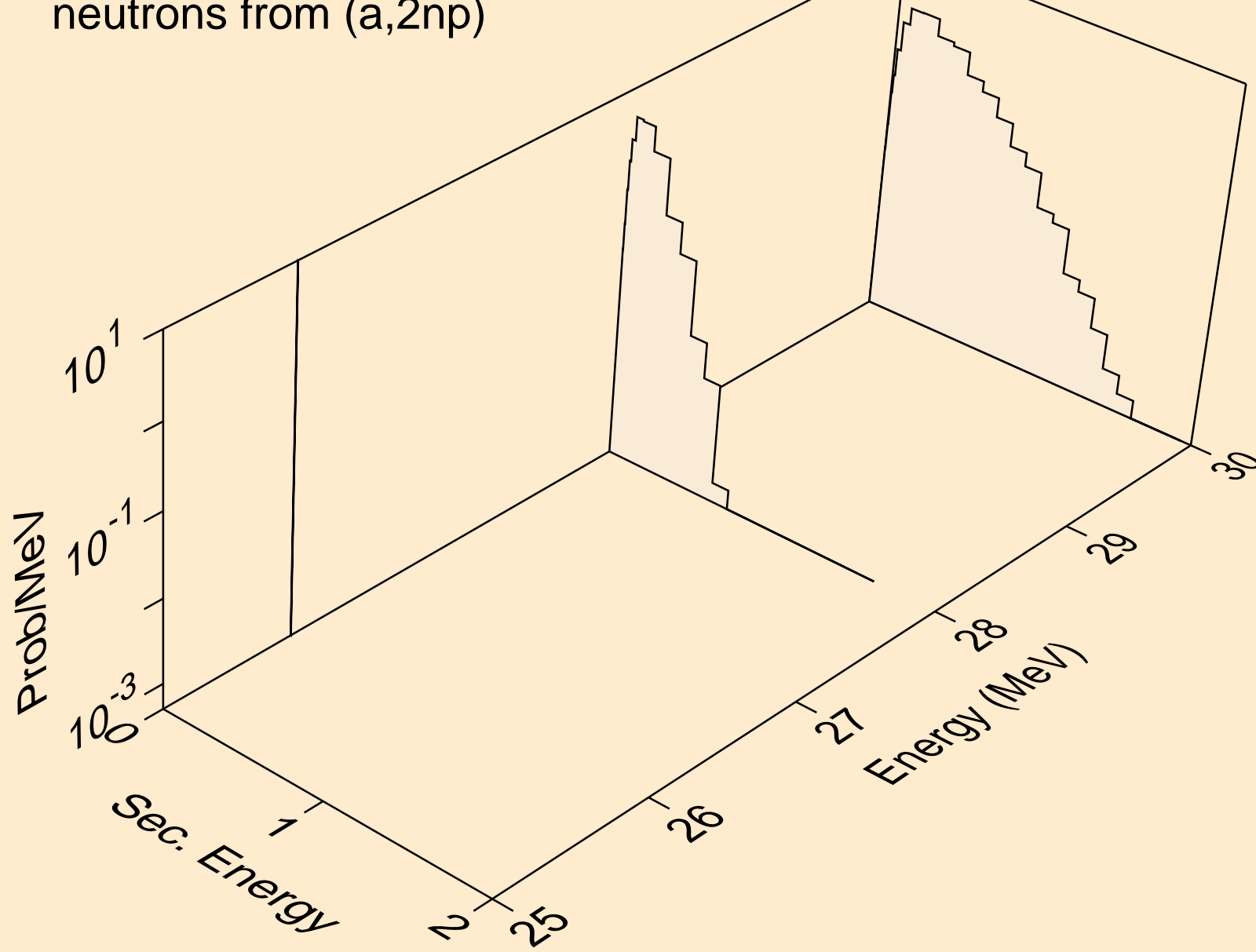

TL188M ALPHA ACER TENDL-2021 LIBRARY; T=0.K  
neutrons from (a,2np)

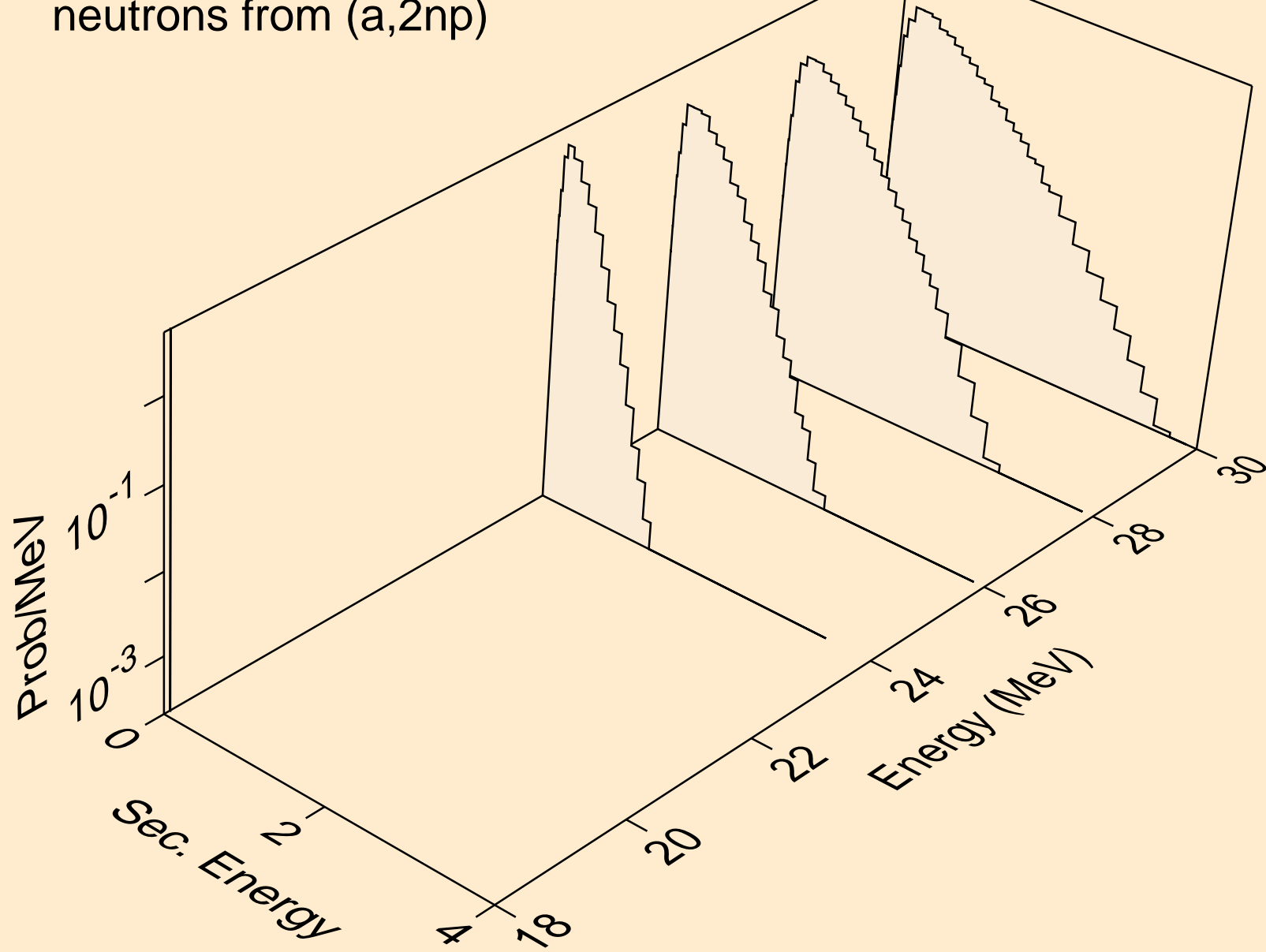

TL188M ALPHA ACER TENDL-2021 LIBRARY; T=0.K  
neutrons from (a,npa)

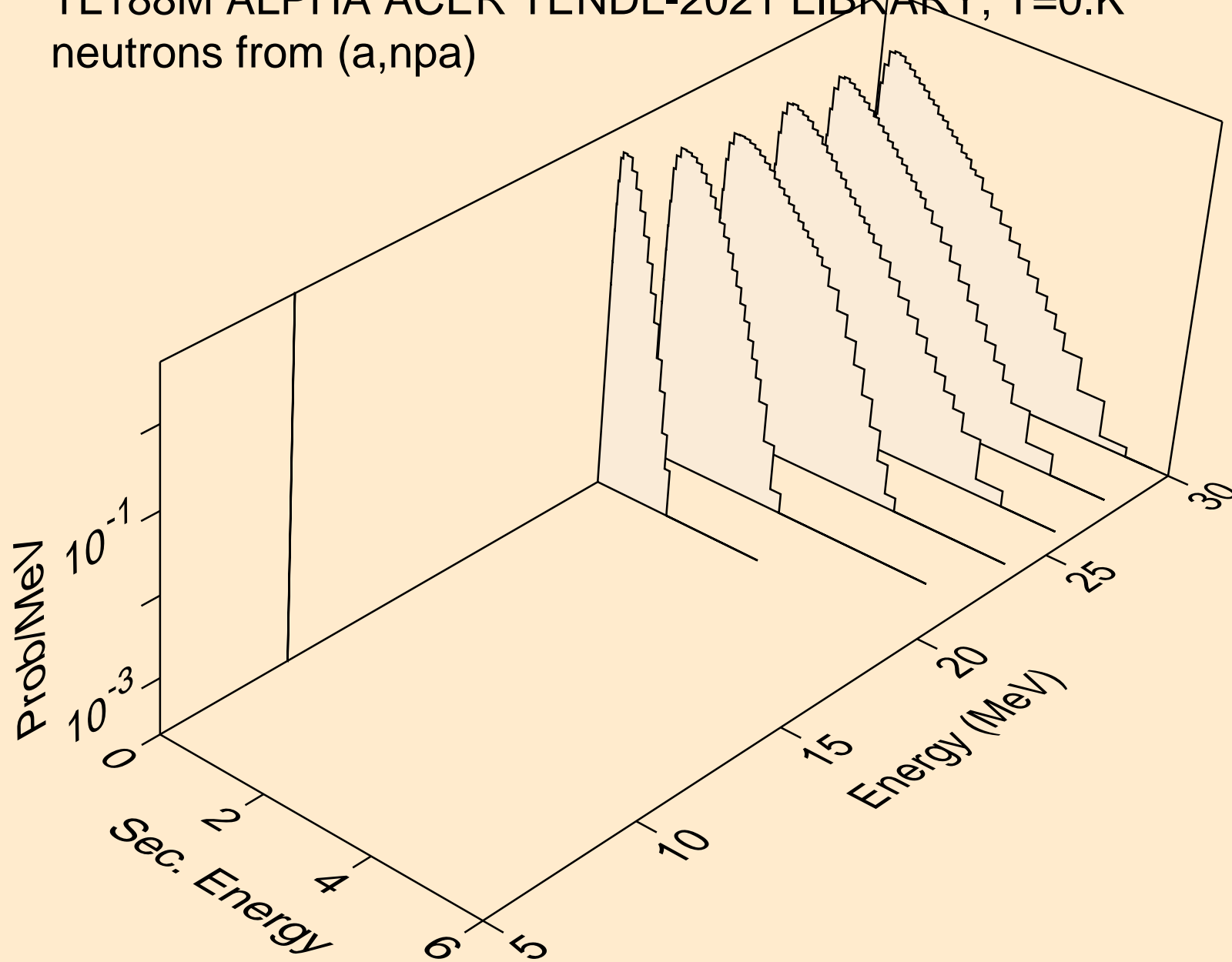

TL188M ALPHA ACER TENDL-2021 LIBRARY; T=0.K  
protons from (a,x)

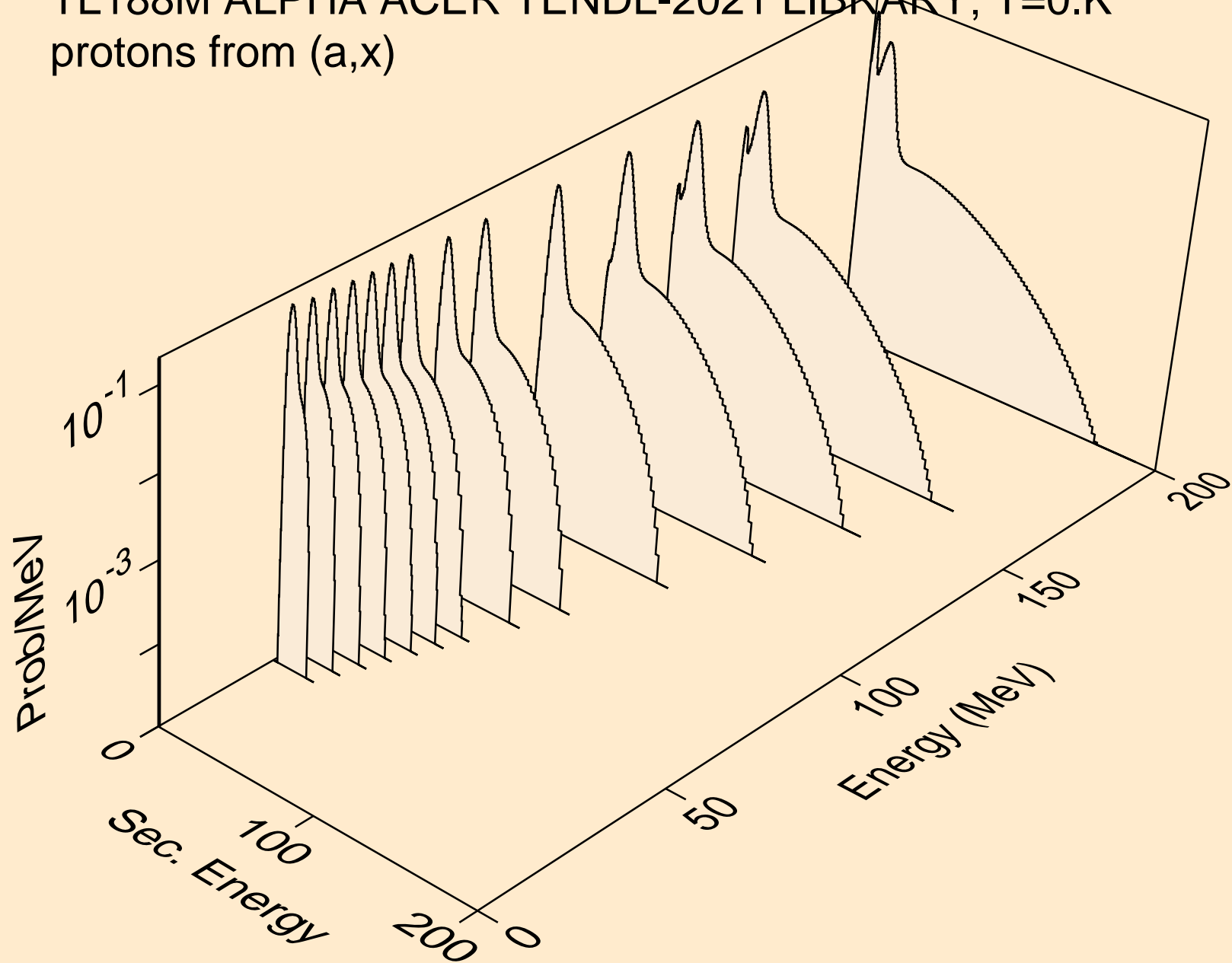

TL188M ALPHA ACER TENDL-2021 LIBRARY; T=0.K  
protons from (a,n\*)p

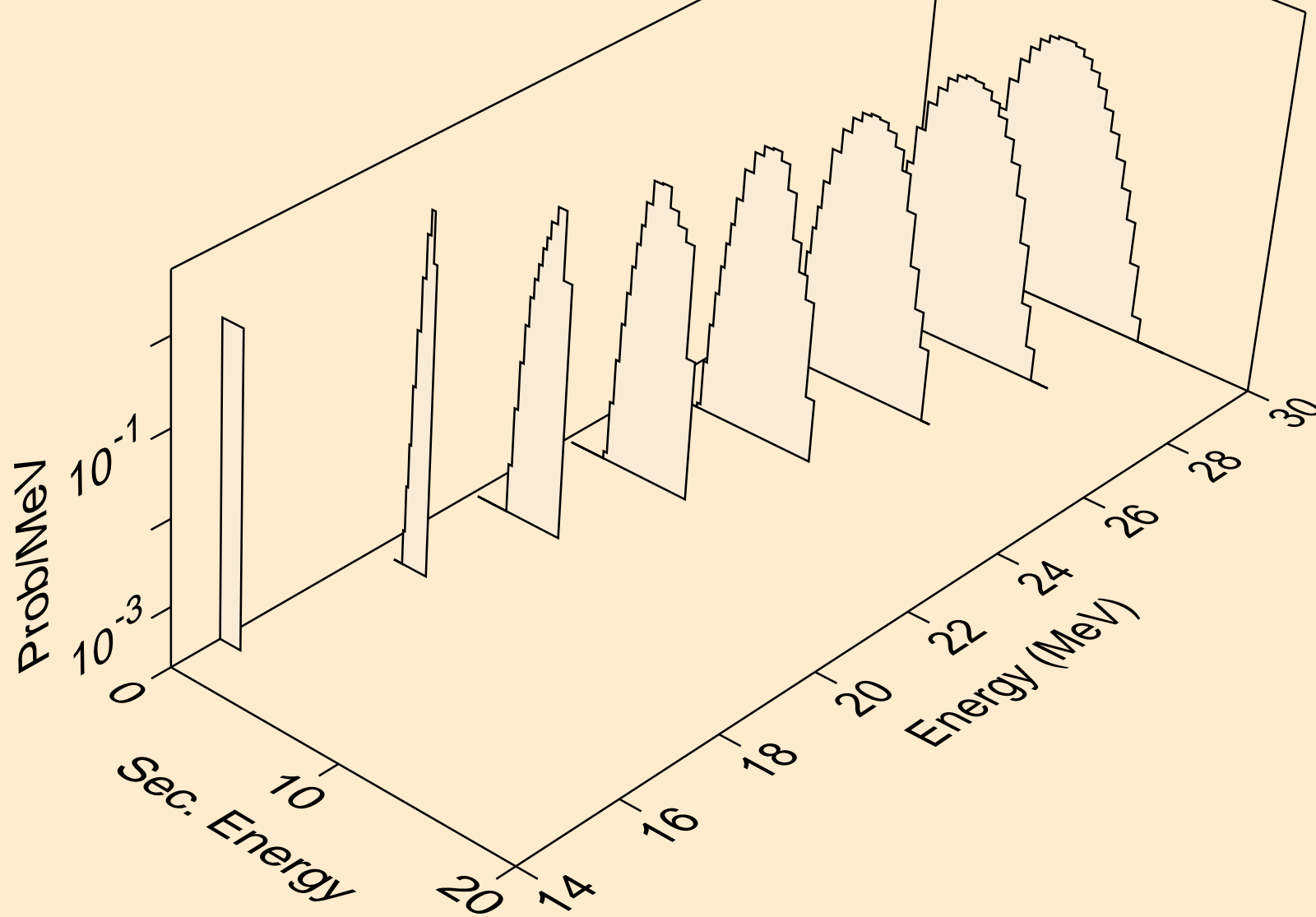

TL188M ALPHA ACER TENDL-2021 LIBRARY; T=0.K  
protons from (a,2np)

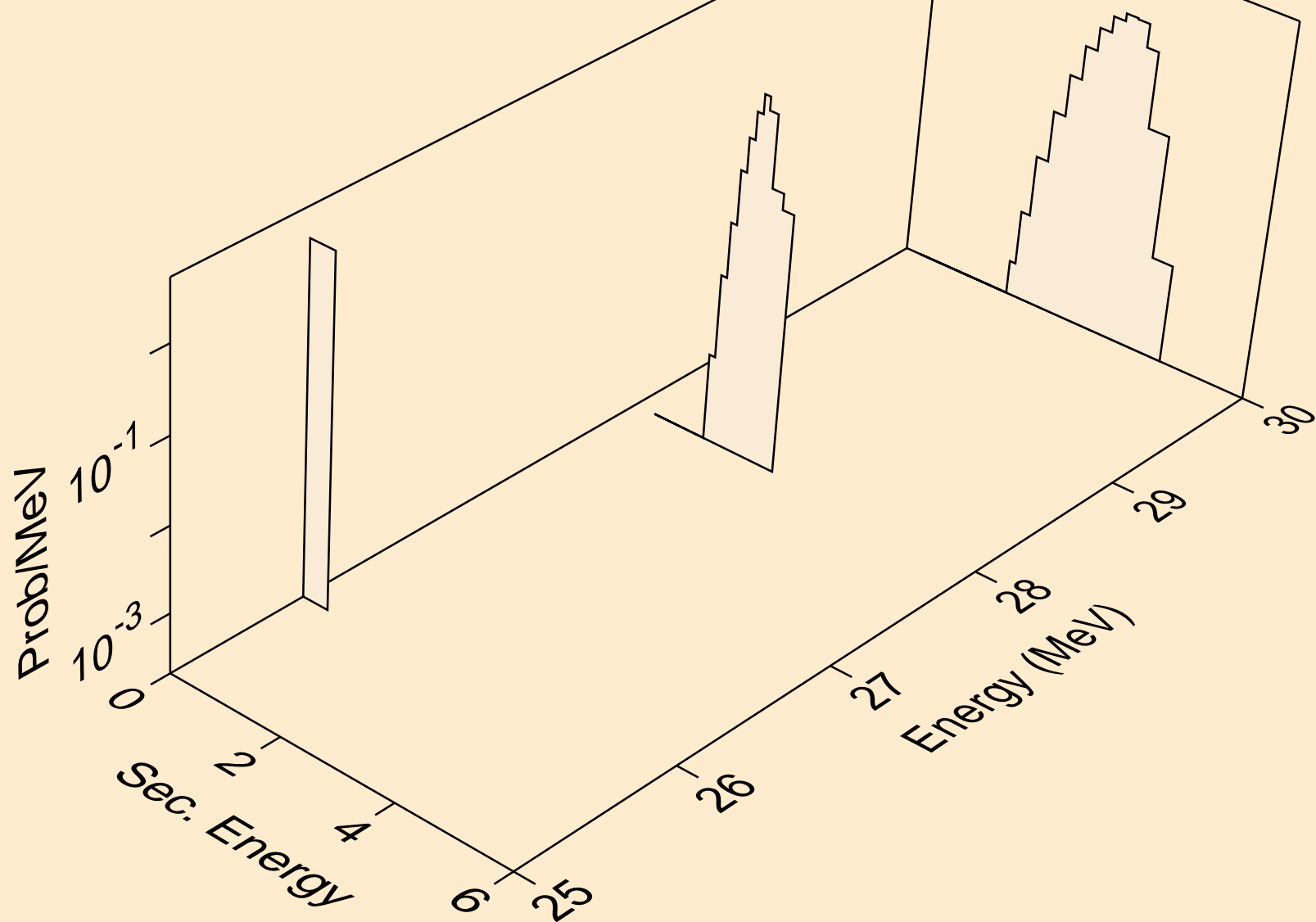

TL188M ALPHA ACER TENDL-2021 LIBRARY; T=0.K  
protons from (a,2np)

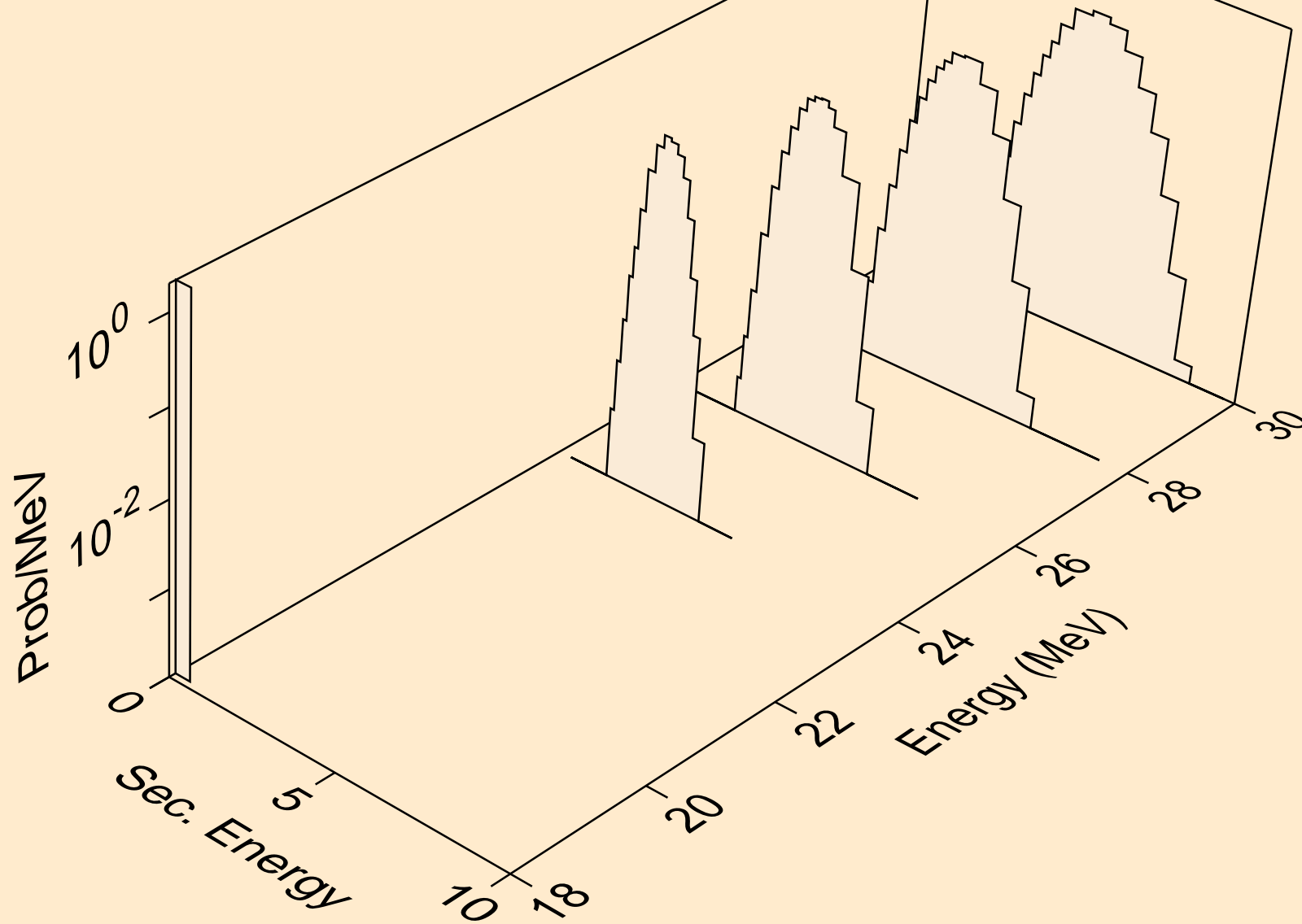

TL188M ALPHA ACER TENDL-2021 LIBRARY; T=0.K  
protons from (a,npa)

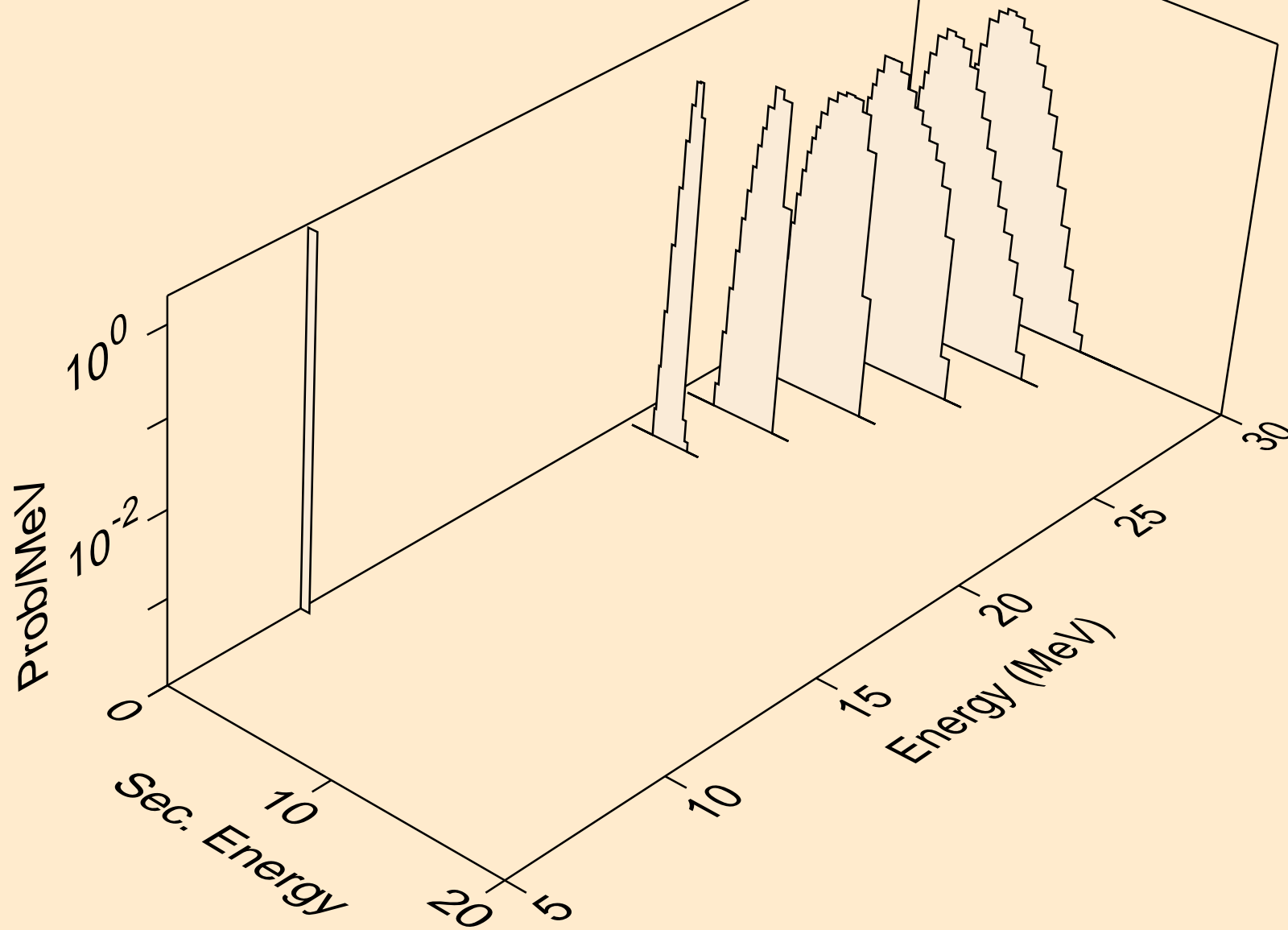



TL188M ALPHA ACER TENDL-2021 LIBRARY; T=0.K  
protons from (a,p)

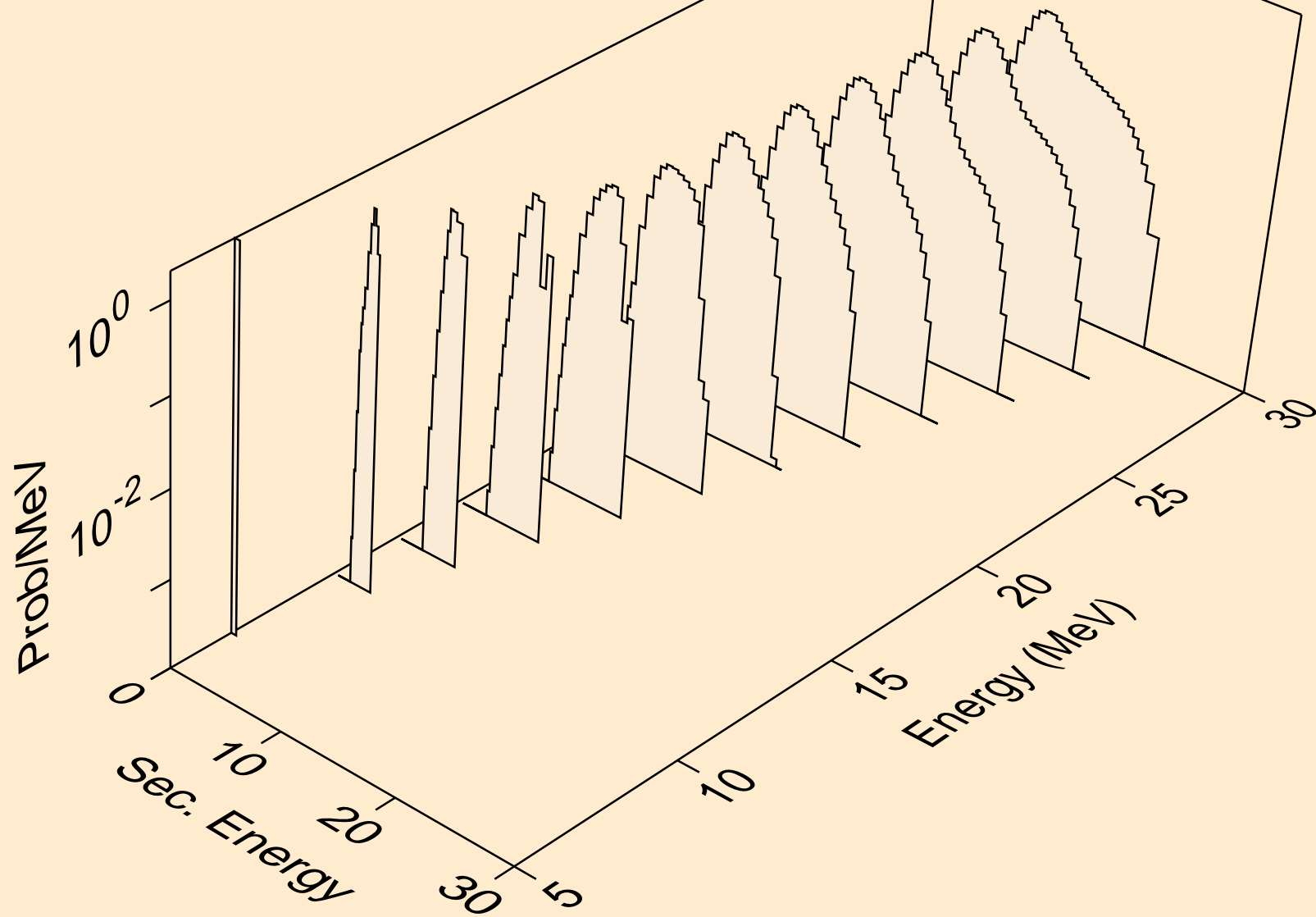

TL188M ALPHA ACER TENDL-2021 LIBRARY; T=0.K  
protons from (a,2p)

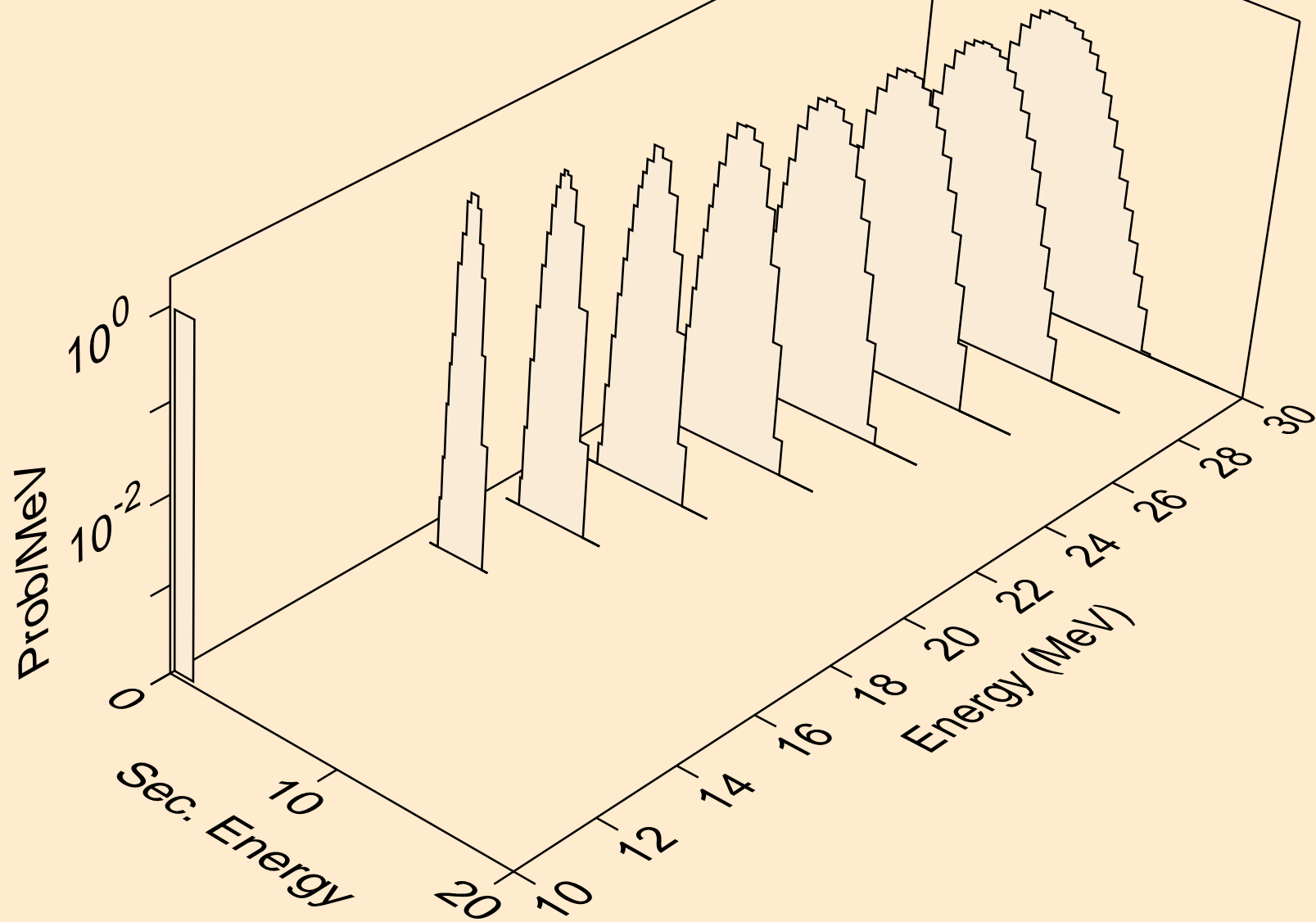

TL188M ALPHA ACER TENDL-2021 LIBRARY; T=0.K  
protons from (a,pa)

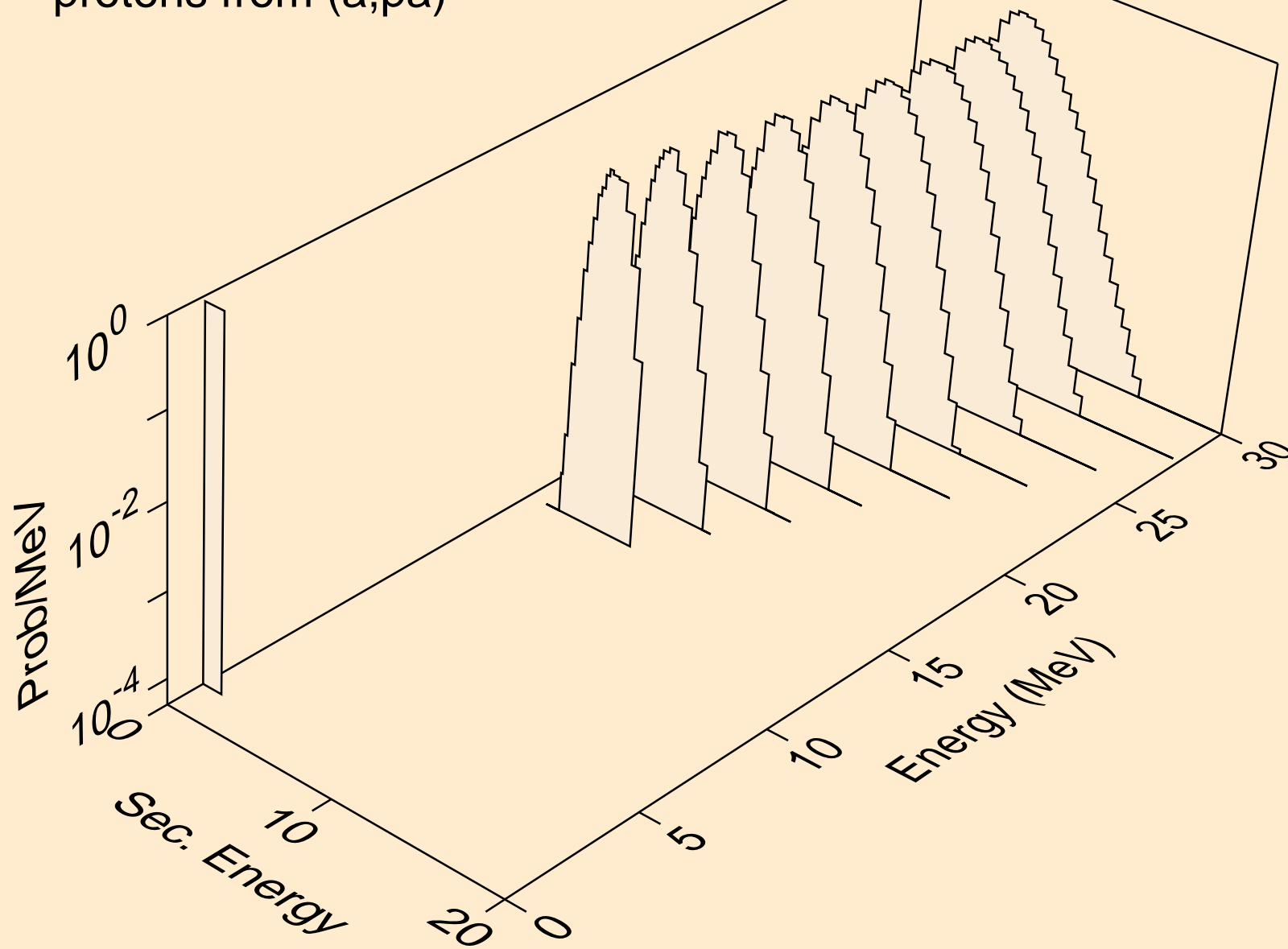

TL188M ALPHA ACER TENDL-2021 LIBRARY; T=0.K  
protons from (a,pd)

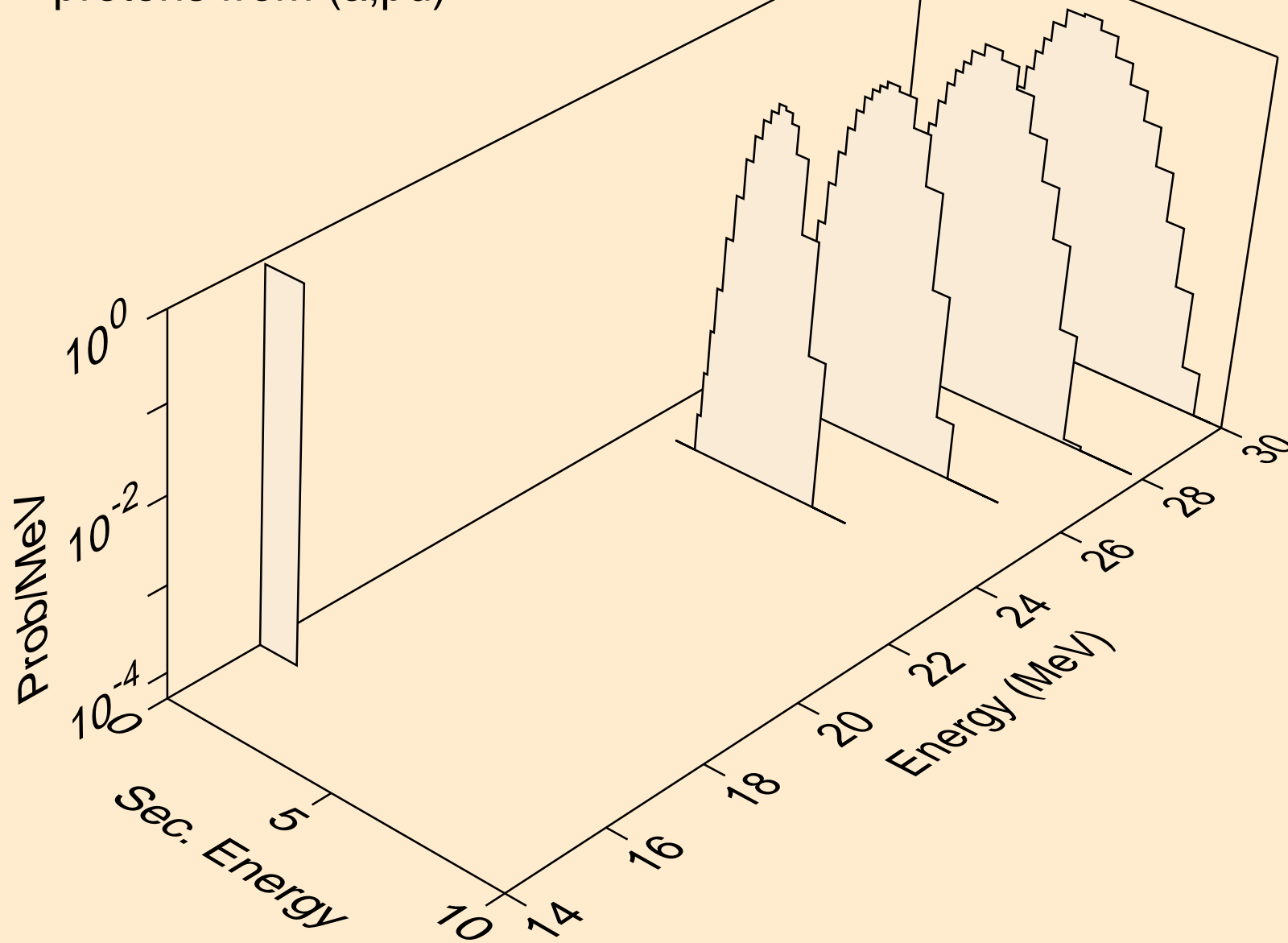

TL188M ALPHA ACER TENDL-2021 LIBRARY; T=0.K  
deuterons from (a,x)

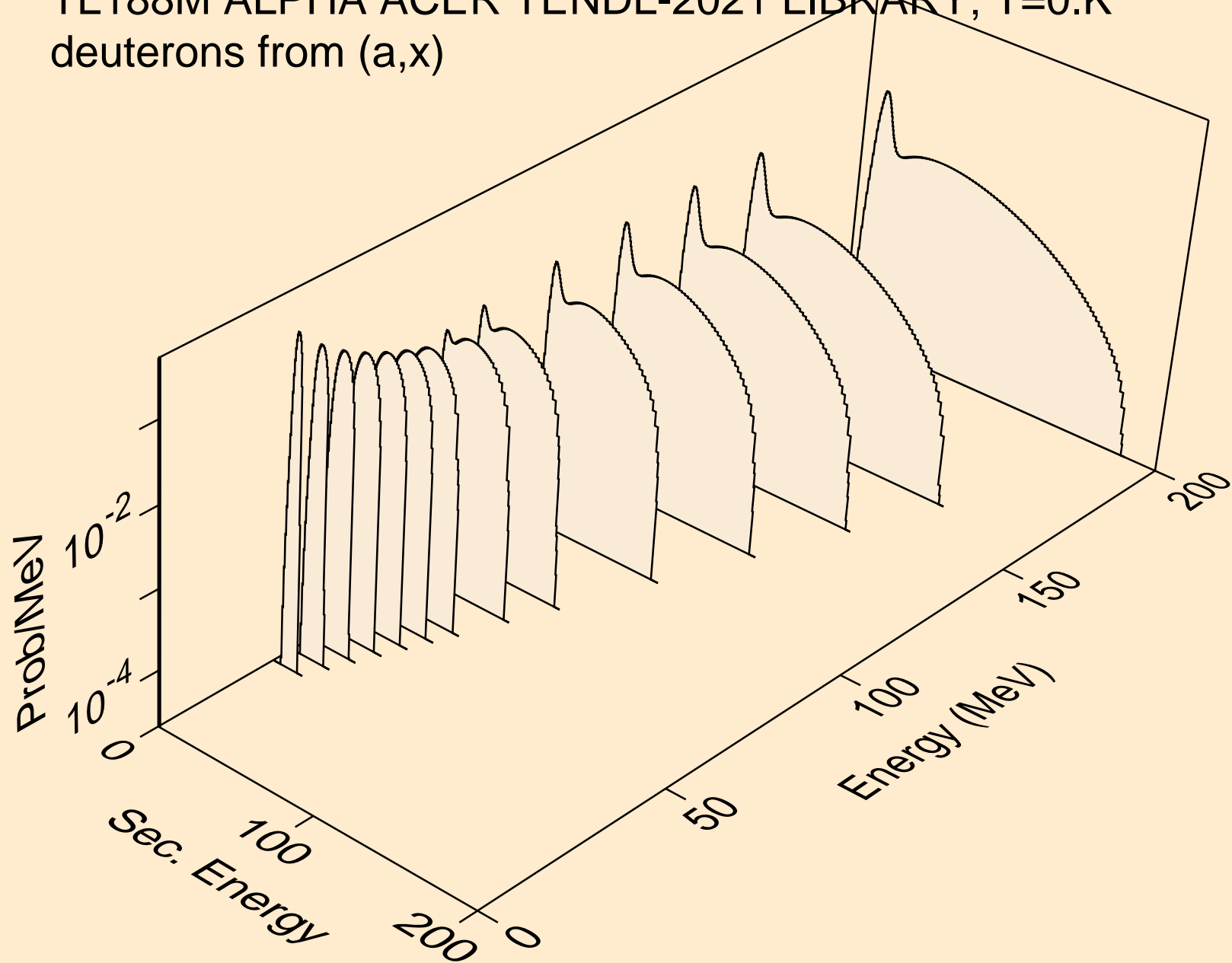

TL188M ALPHA ACER TENDL-2021 LIBRARY; T=0.K  
deuterons from (a,d)

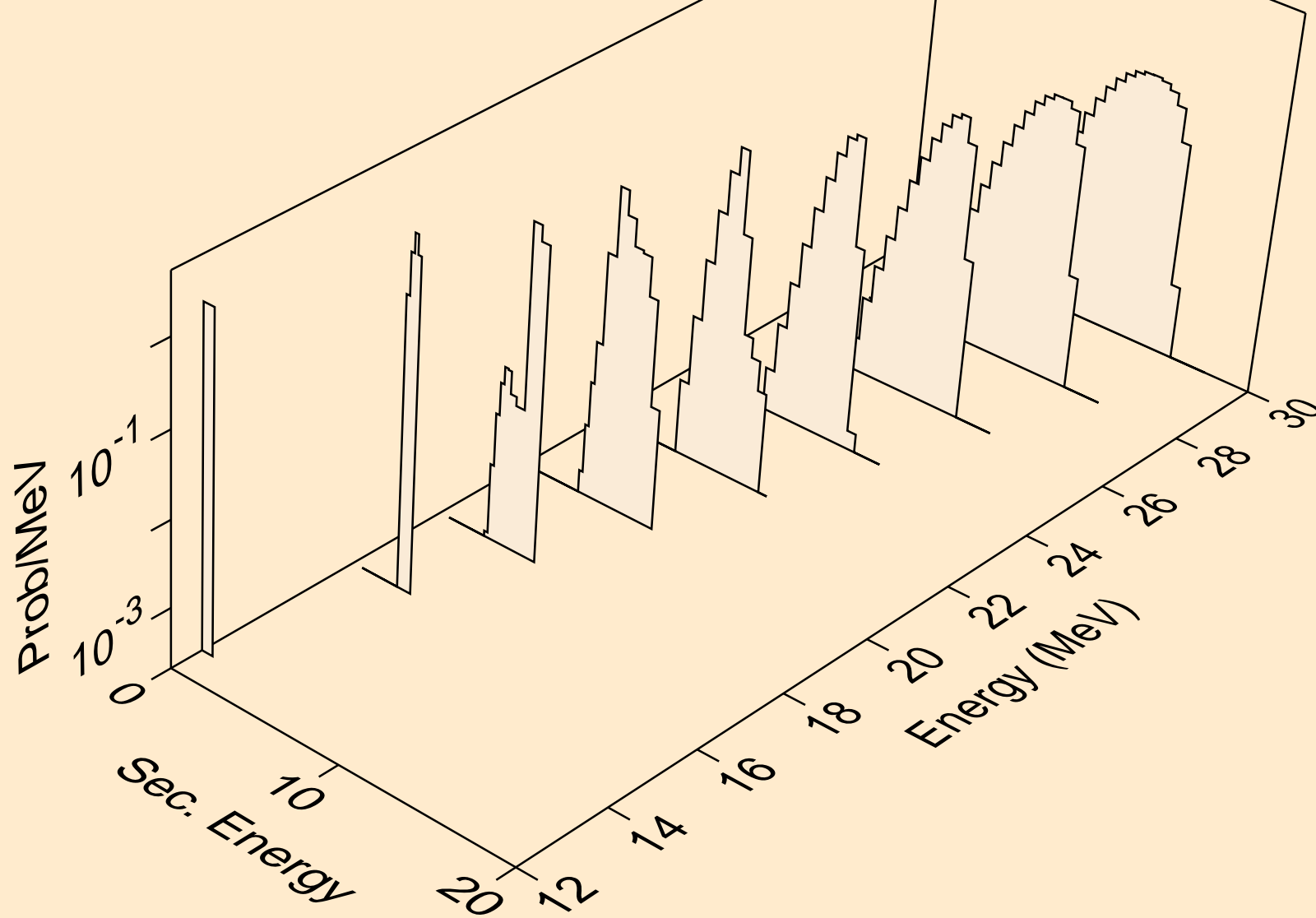

TL188M ALPHA ACER TENDL-2021 LIBRARY; T=0.K  
deuterons from (a,pd)

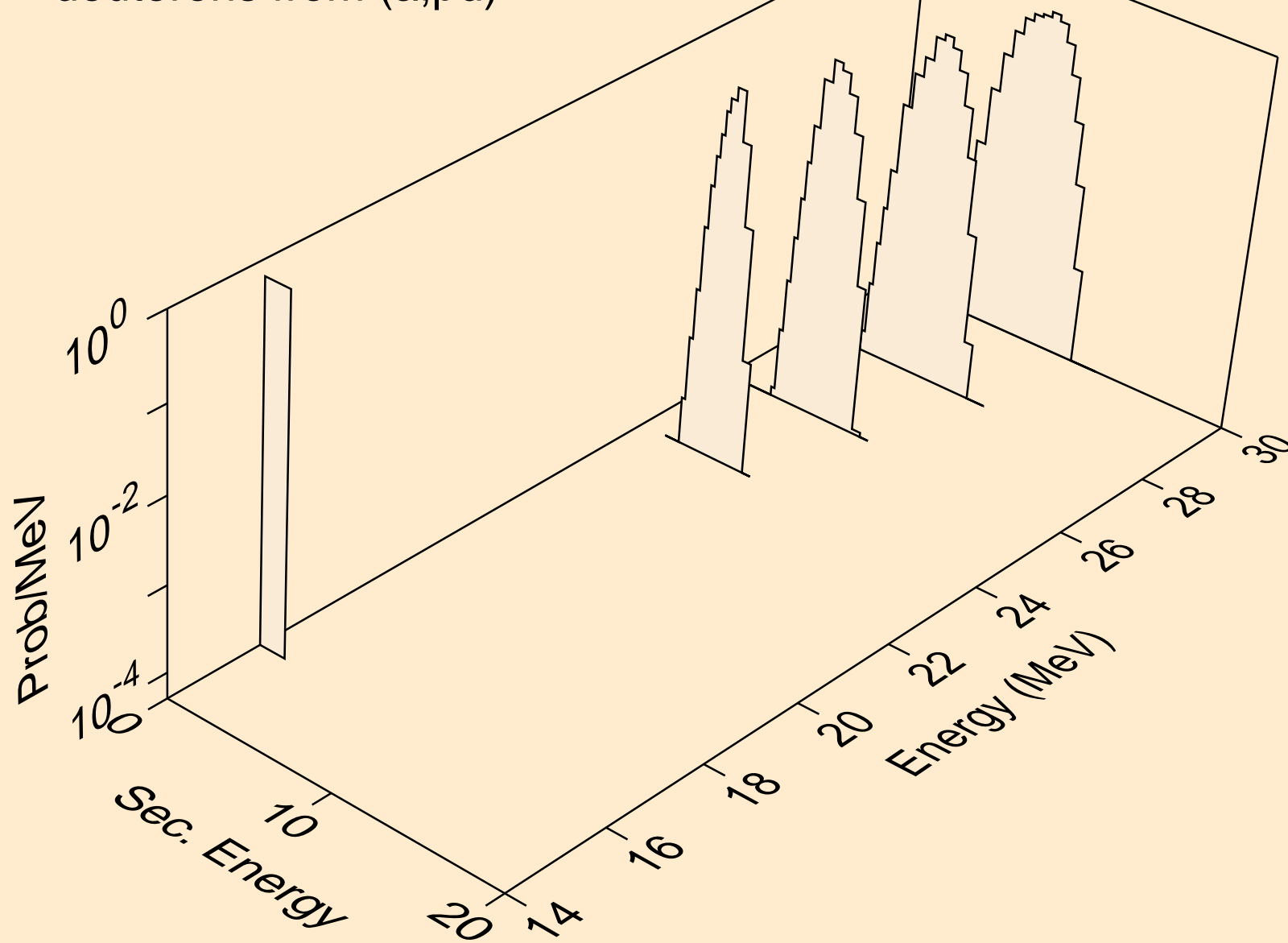

TL188M ALPHA ACER TENDL-2021 LIBRARY; T=0.K  
deuterons from (a,da)

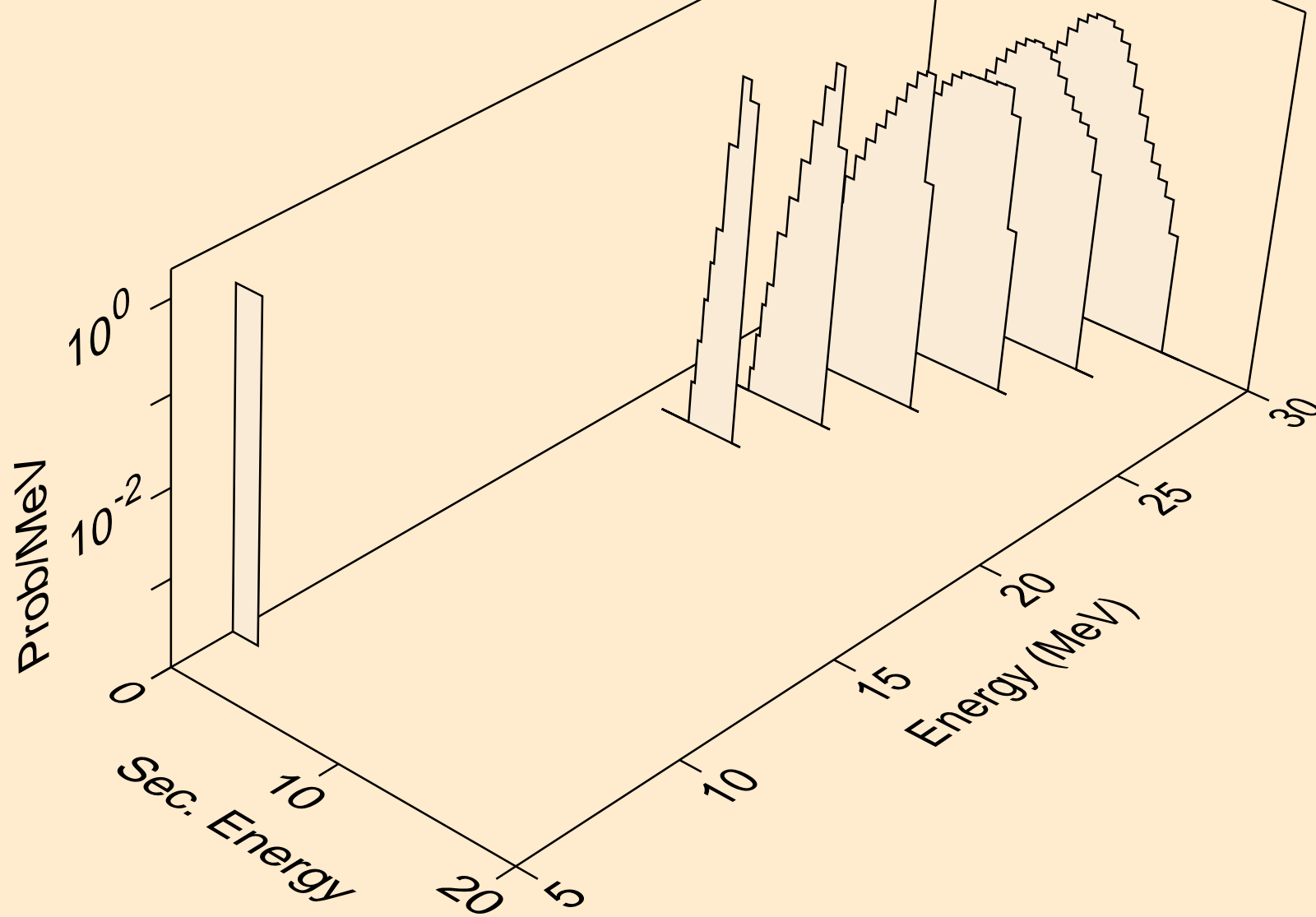



TL188M ALPHA ACER TENDL-2021 LIBRARY; T=0.K  
tritons from (a,x)

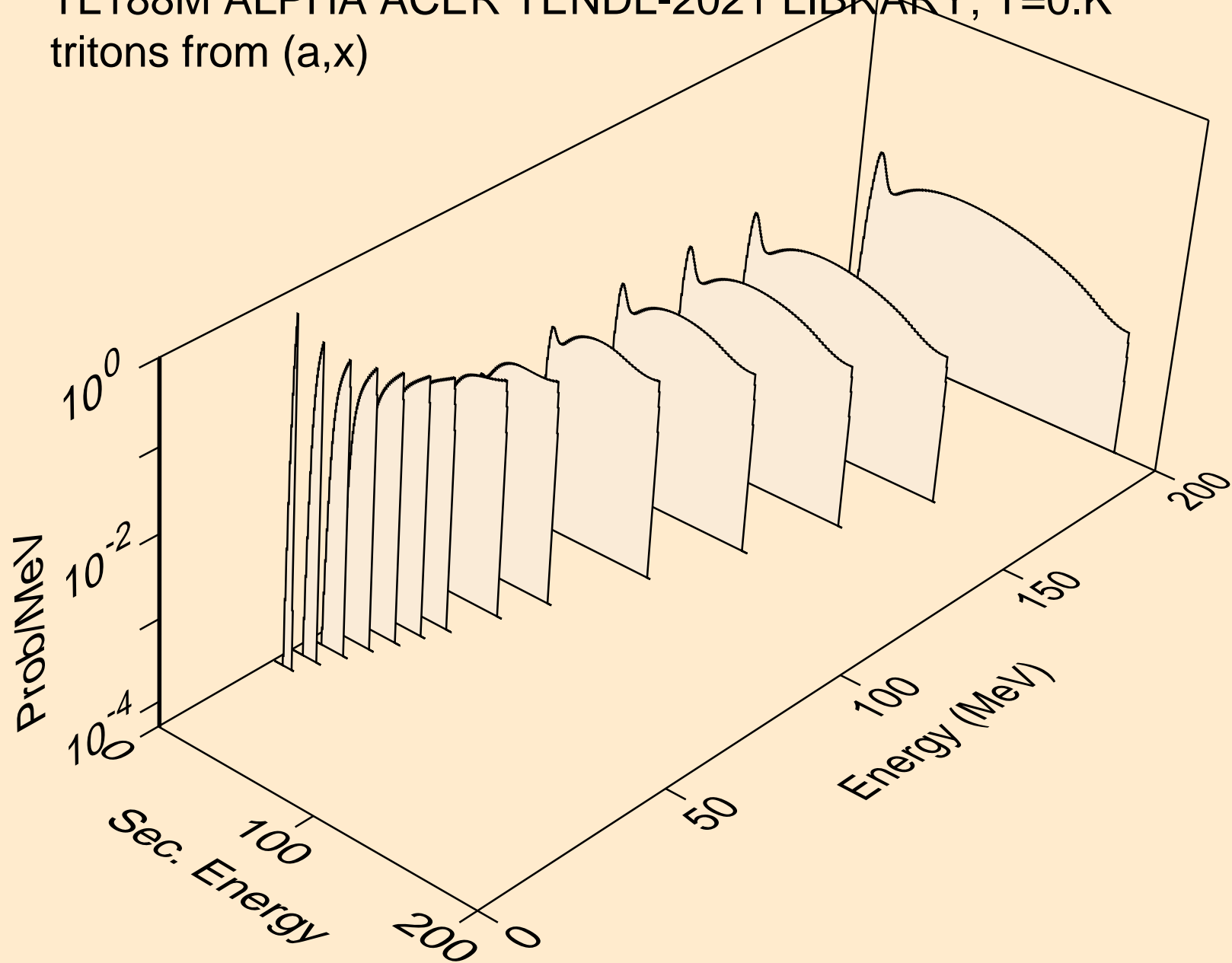

TL188M ALPHA ACER TENDL-2021 LIBRARY; T=0.K  
tritons from (a,t)

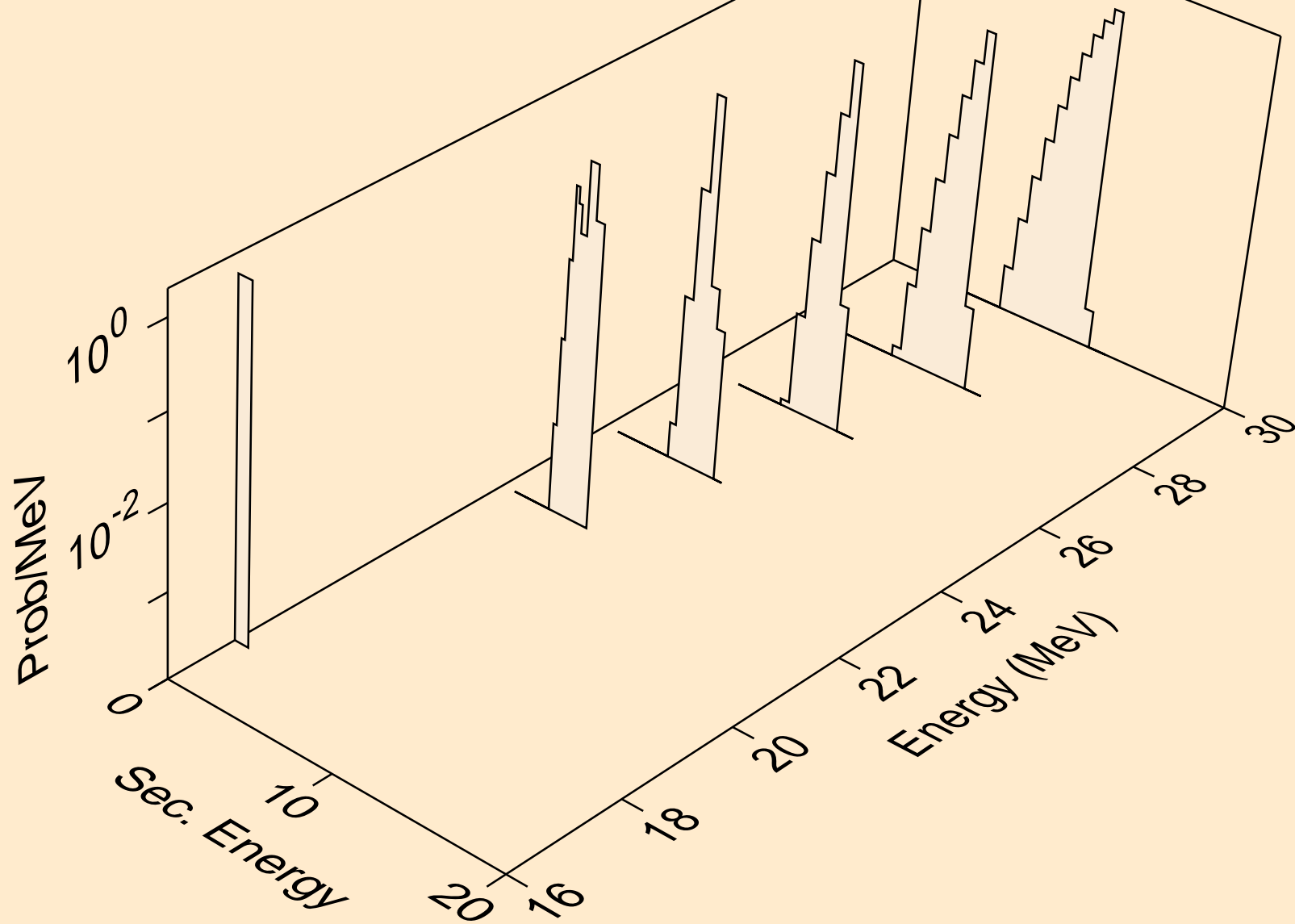

TL188M ALPHA ACER TENDL-2021 LIBRARY; T=0.K  
he3s from (a,x)

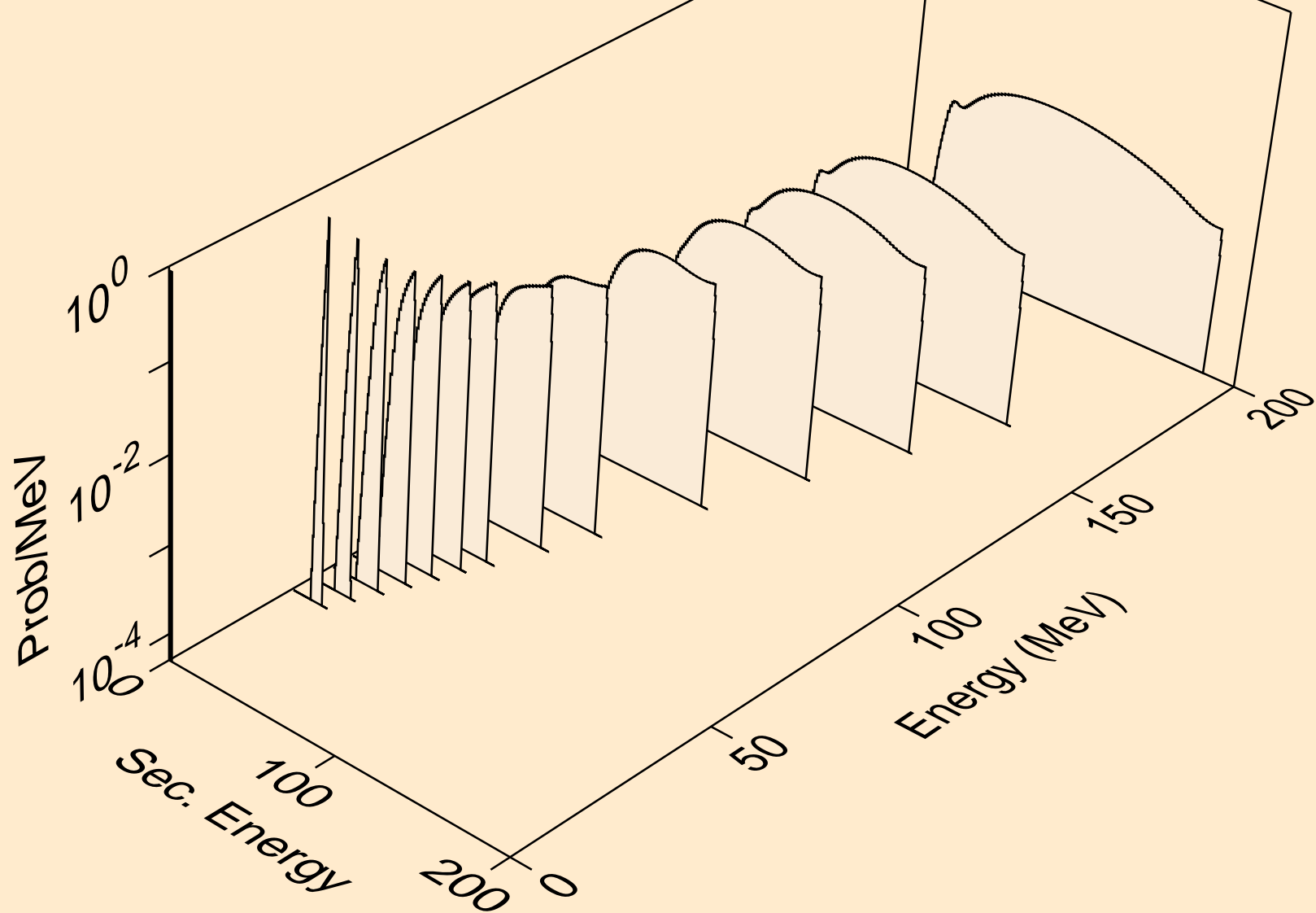

TL188M ALPHA ACER TENDL-2021 LIBRARY; T=0.K  
he3s from (a,he3)

