

TM177 ALPHA ACER TENDL-2021 LIBRARY; T=0.K
Principal cross sections

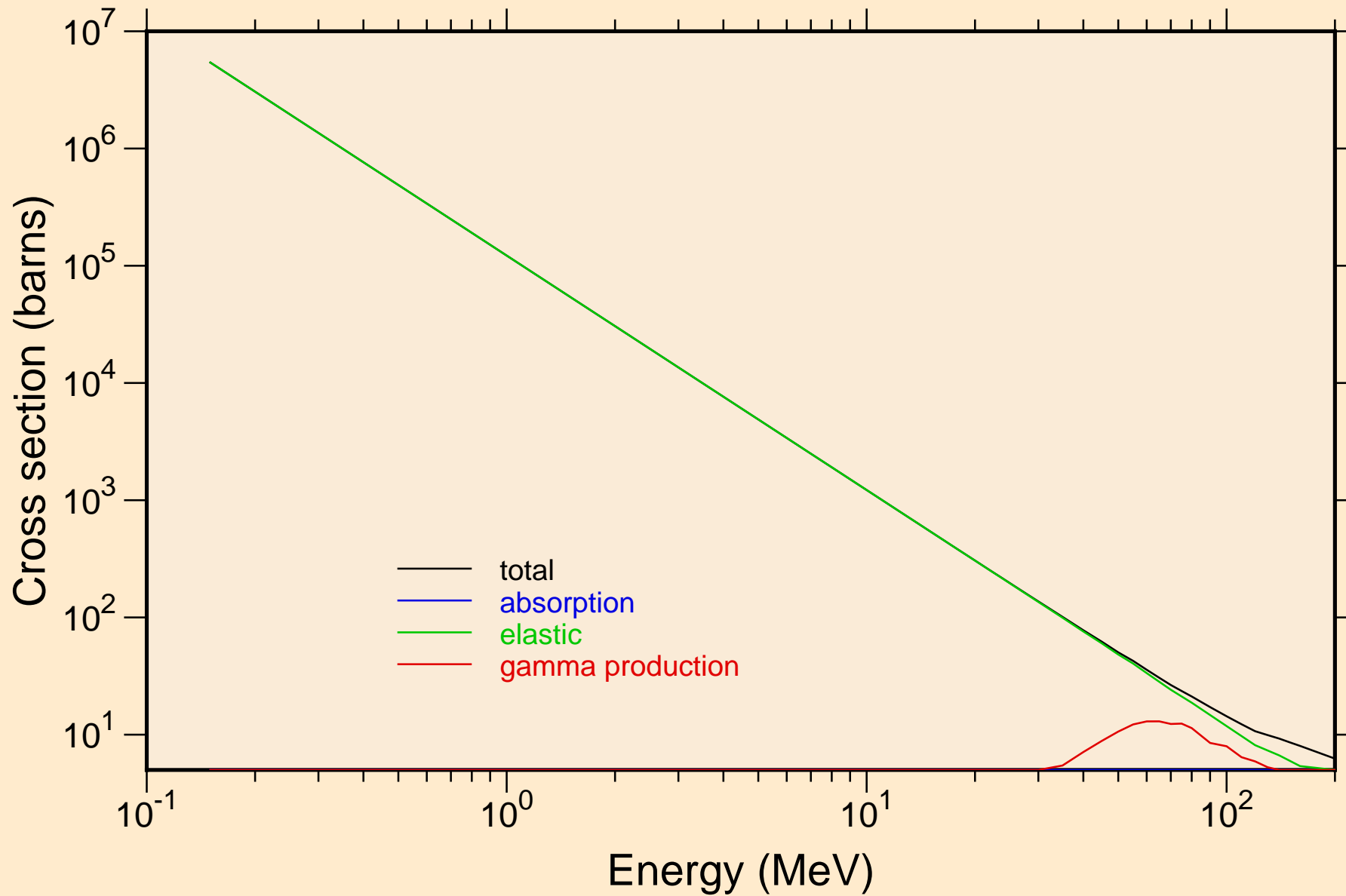

TM177 ALPHA ACER TENDL-2021 LIBRARY; T=0.K

Heating

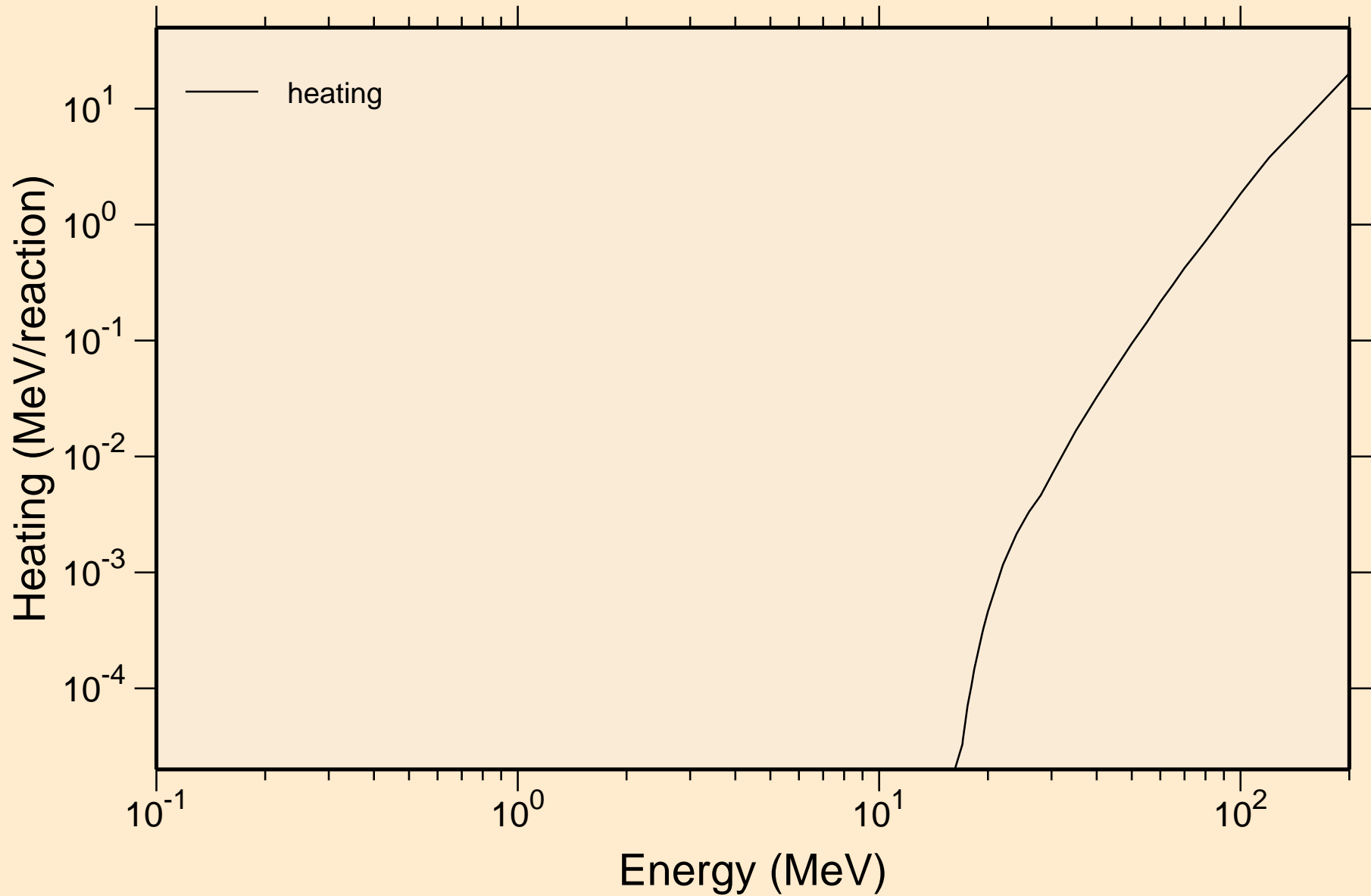

TM177 ALPHA ACER TENDL-2021 LIBRARY; T=0.K

Principal cross sections

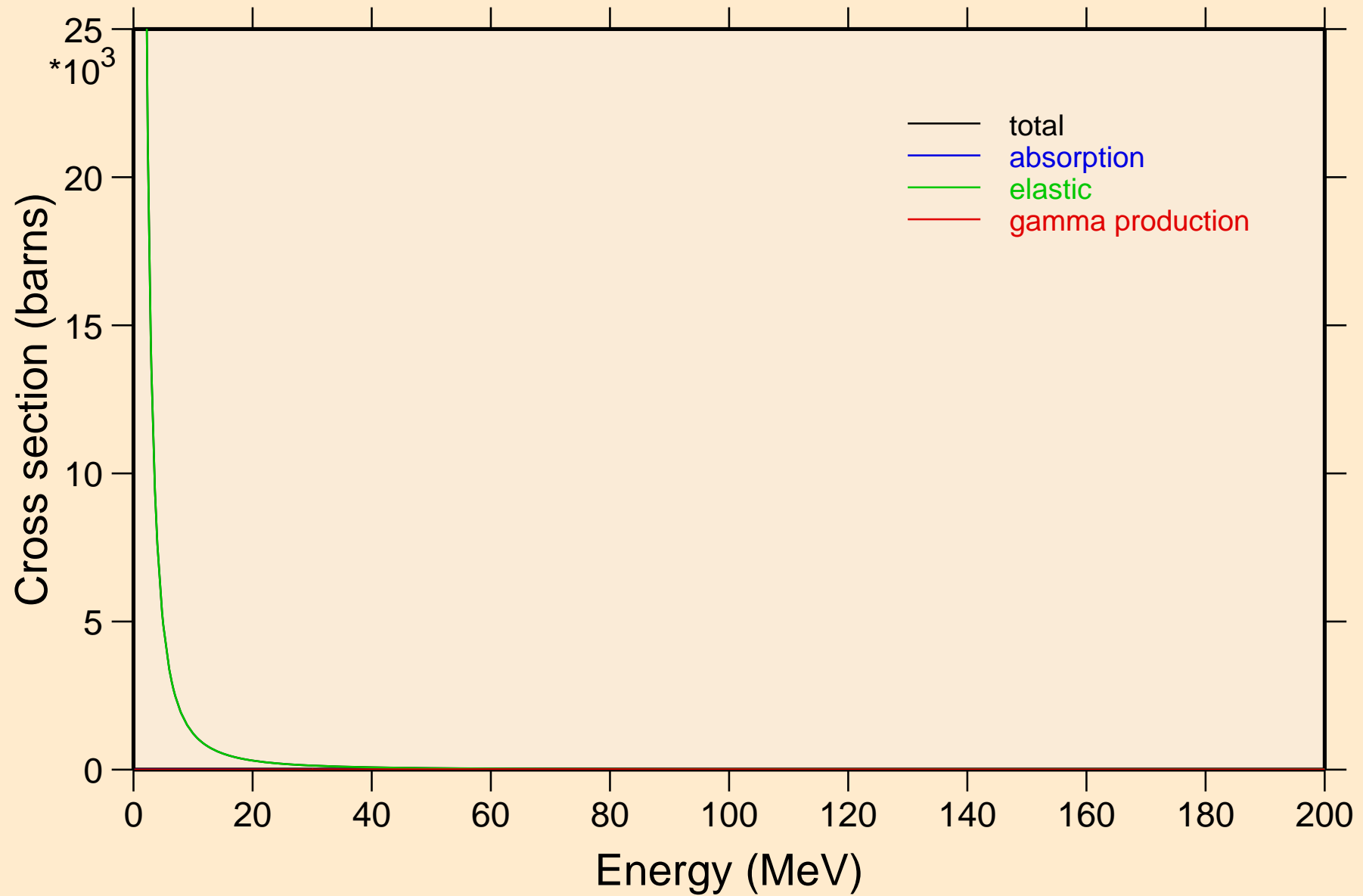

TM177 ALPHA ACER TENDL-2021 LIBRARY; T=0.K

Heating

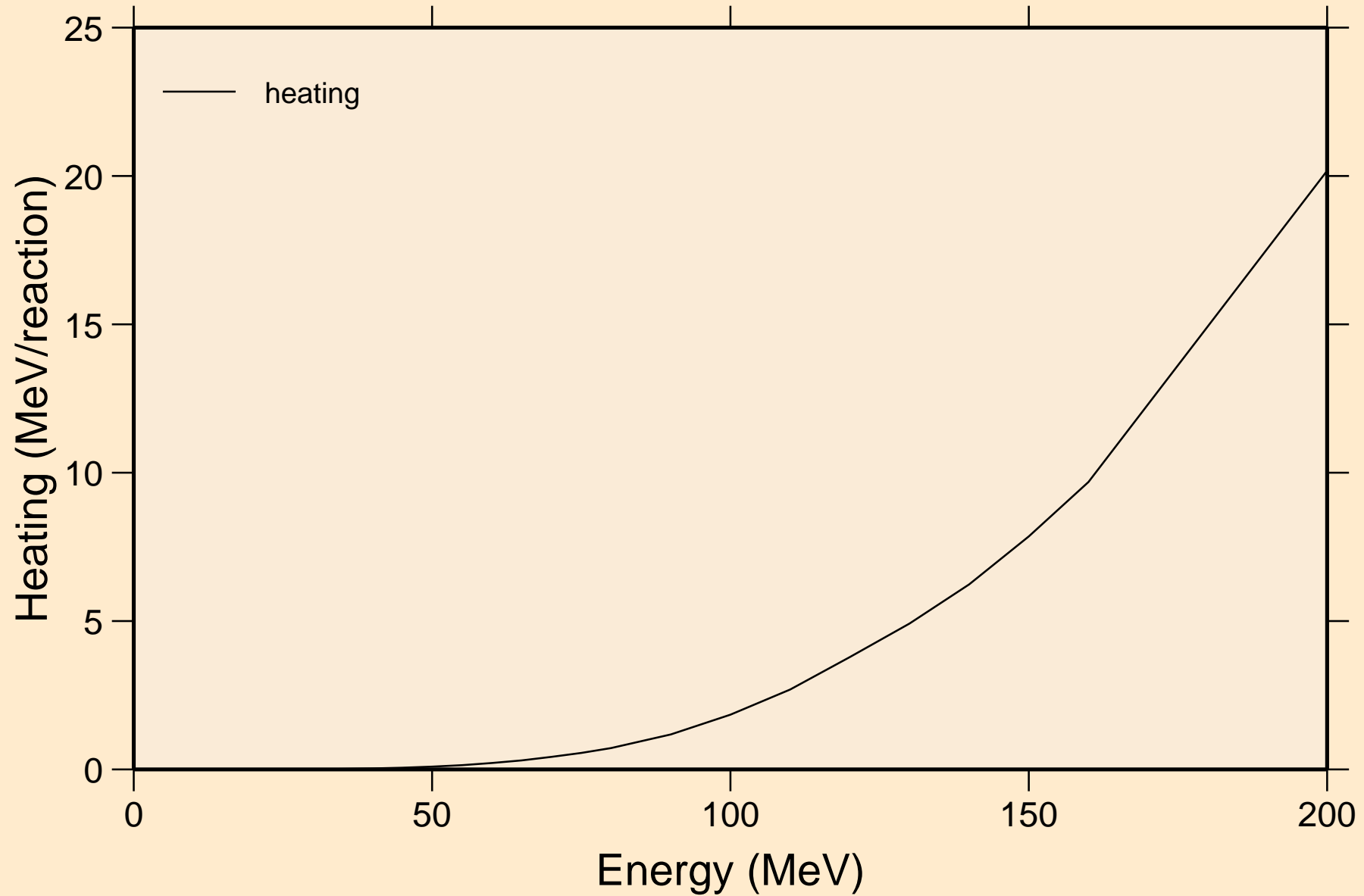

TM177 ALPHA ACER TENDL-2021 LIBRARY; T=0.K
Threshold reactions

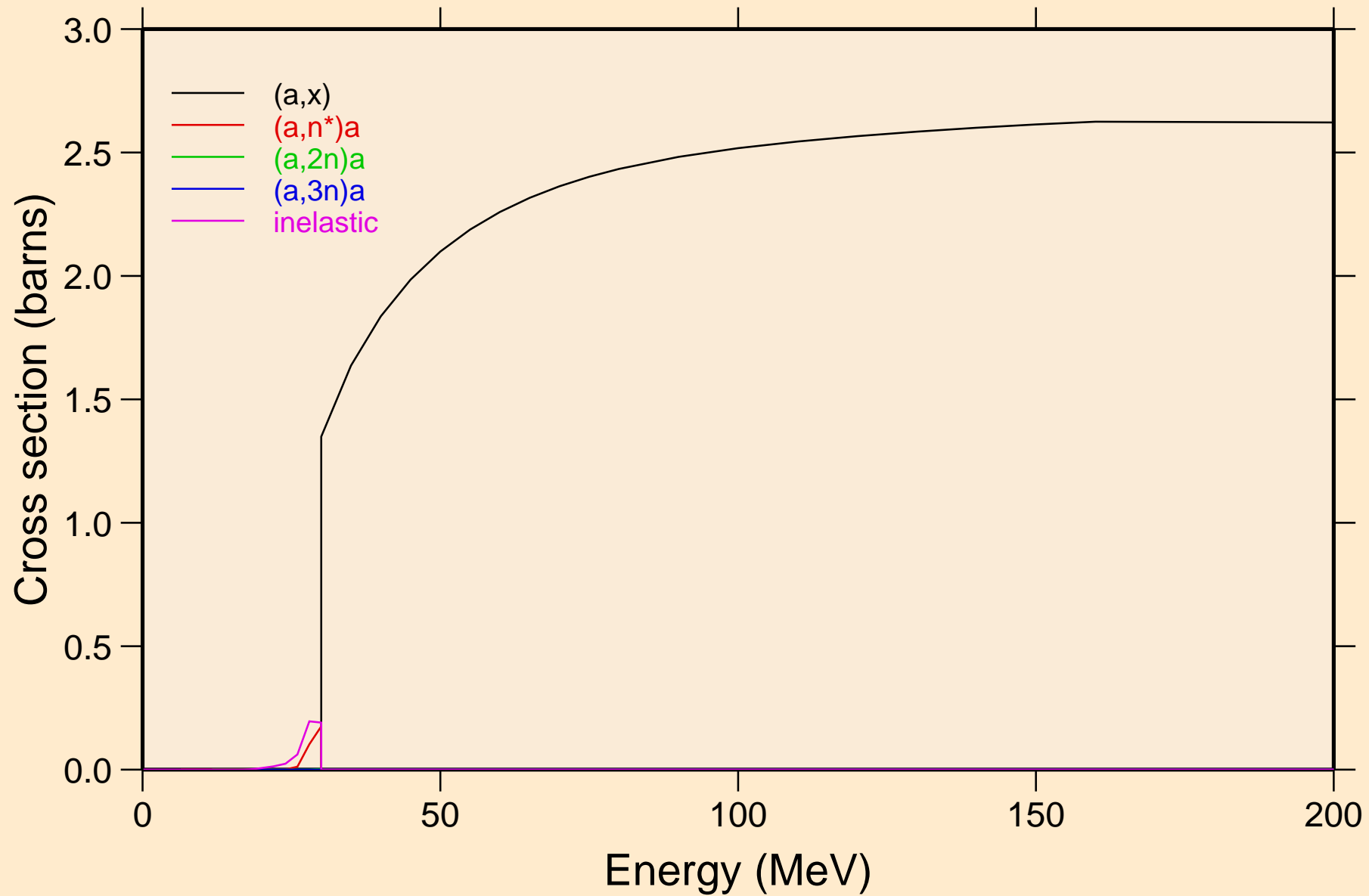

TM177 ALPHA ACER TENDL-2021 LIBRARY; T=0.K
angular distribution for elastic

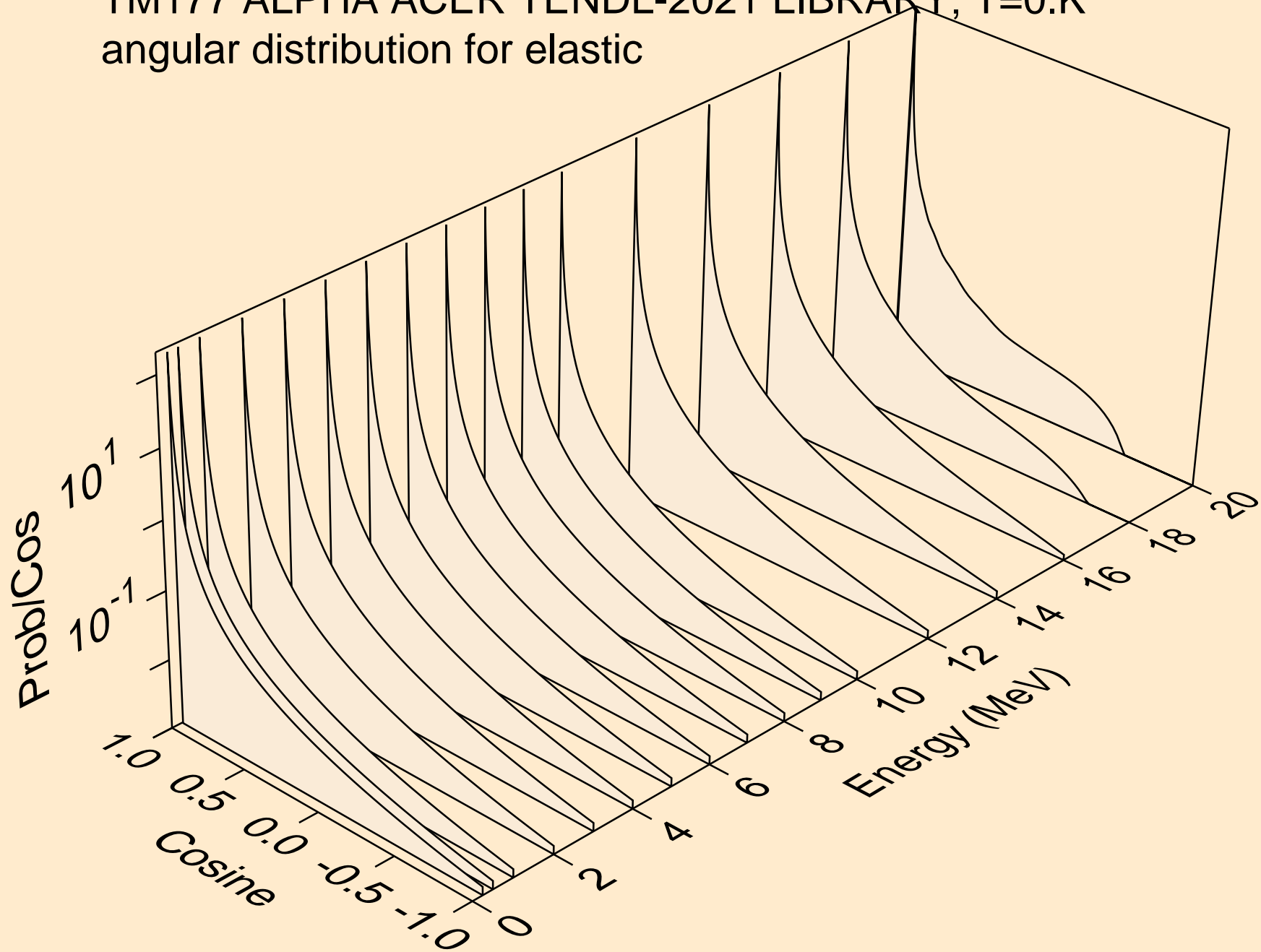

TM177 ALPHA ACER TENDL-2021 LIBRARY; T=0.K
angular distribution for elastic

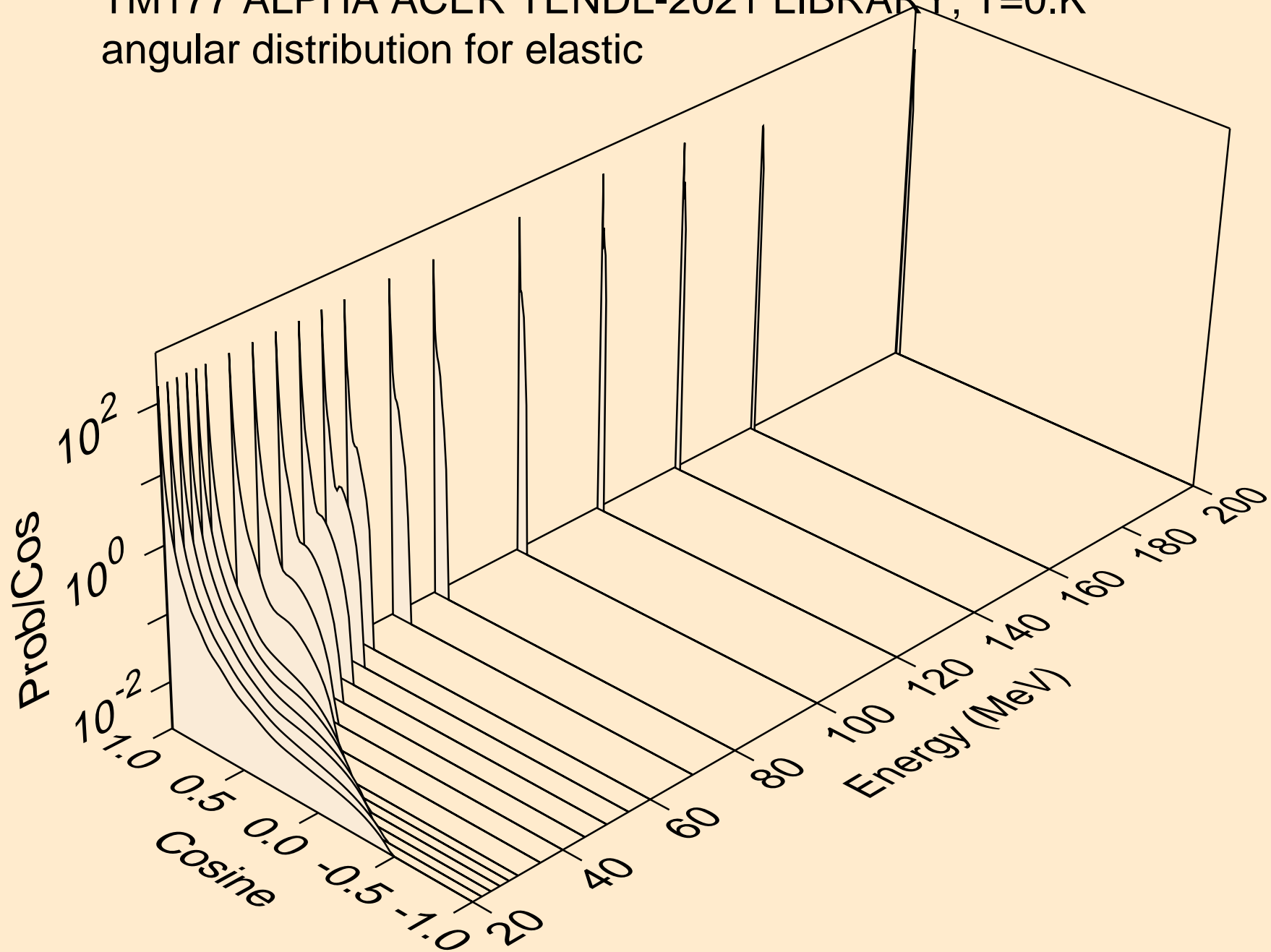

TM177 ALPHA ACER TENDL-2021 LIBRARY; T=0.K

Alpha emission for (a,x)

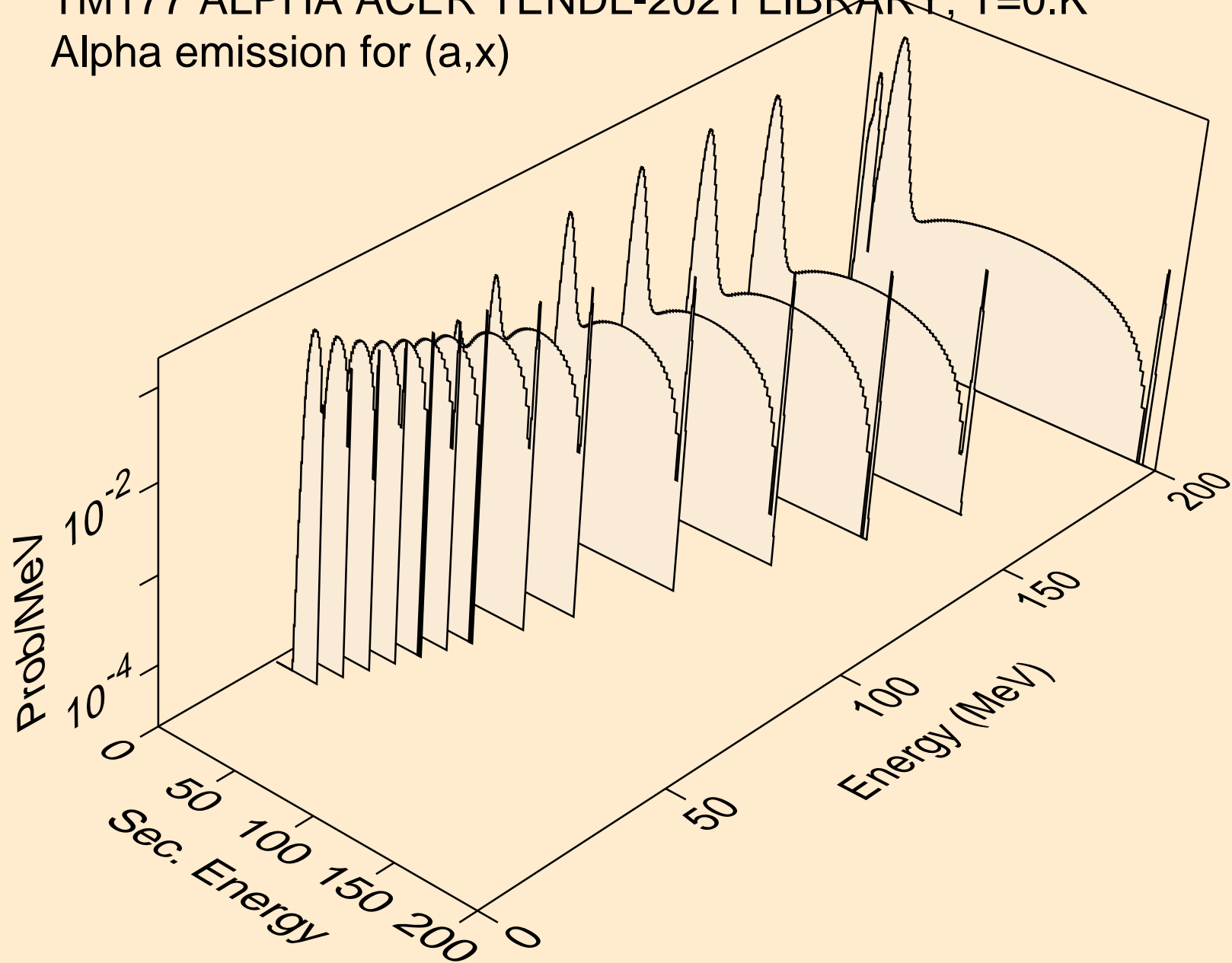

TM177 ALPHA ACER TENDL-2021 LIBRARY; T=0.K
Alpha emission for (a,n*)a

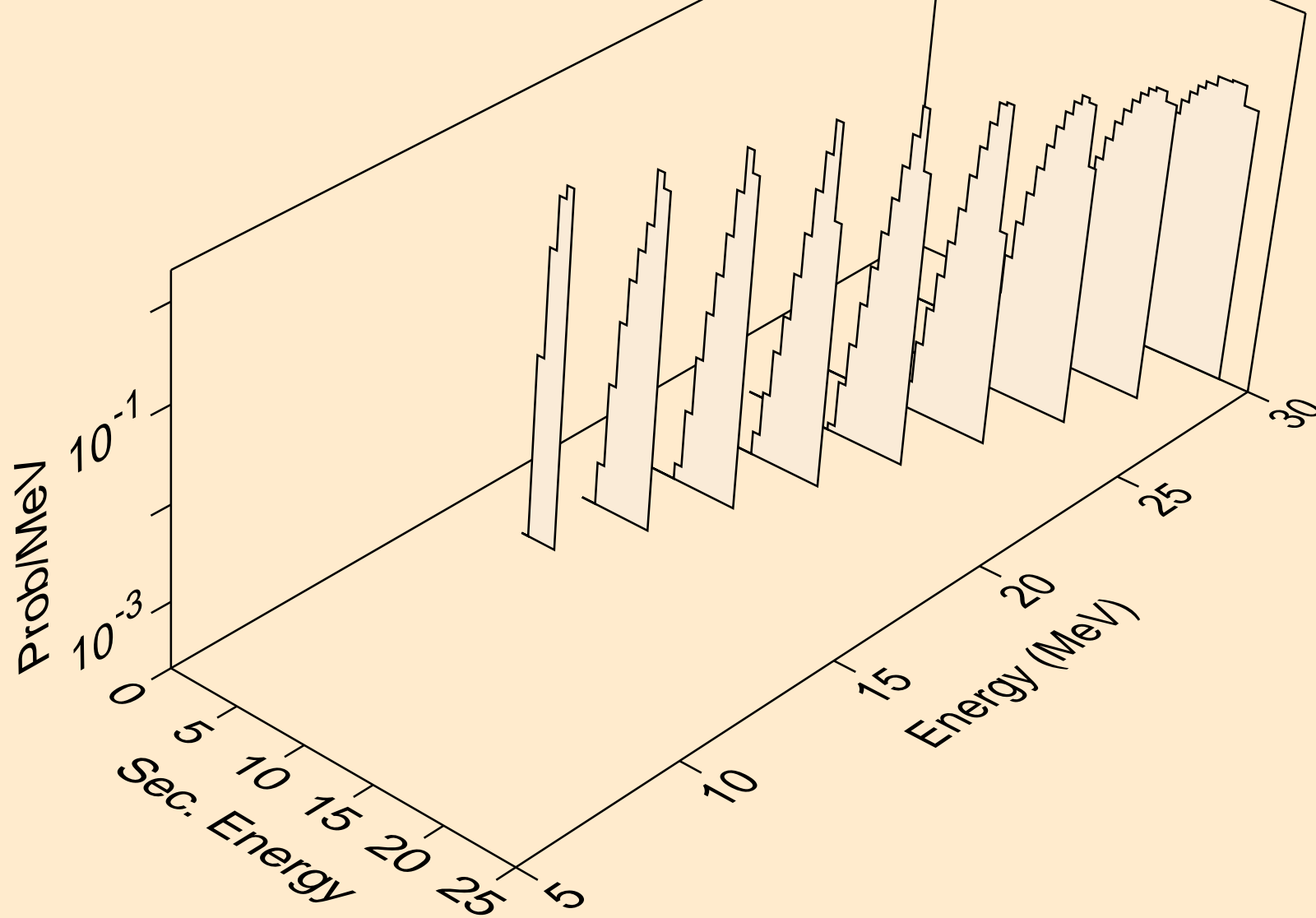

TM177 ALPHA ACER TENDL-2021 LIBRARY; T=0.K
Alpha emission for (a,2n)a

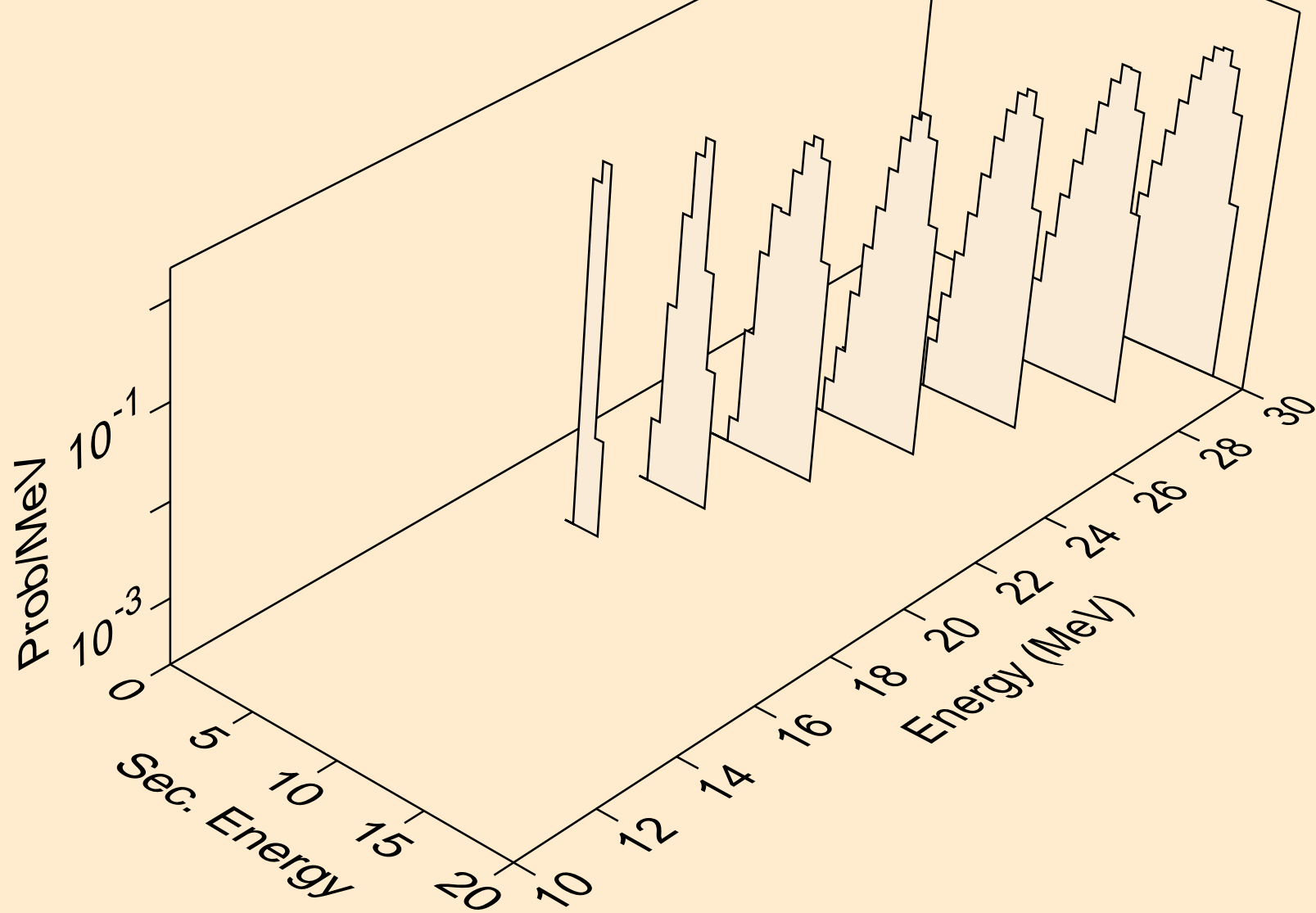

TM177 ALPHA ACER TENDL-2021 LIBRARY; T=0.K
Alpha emission for (a,3n)a

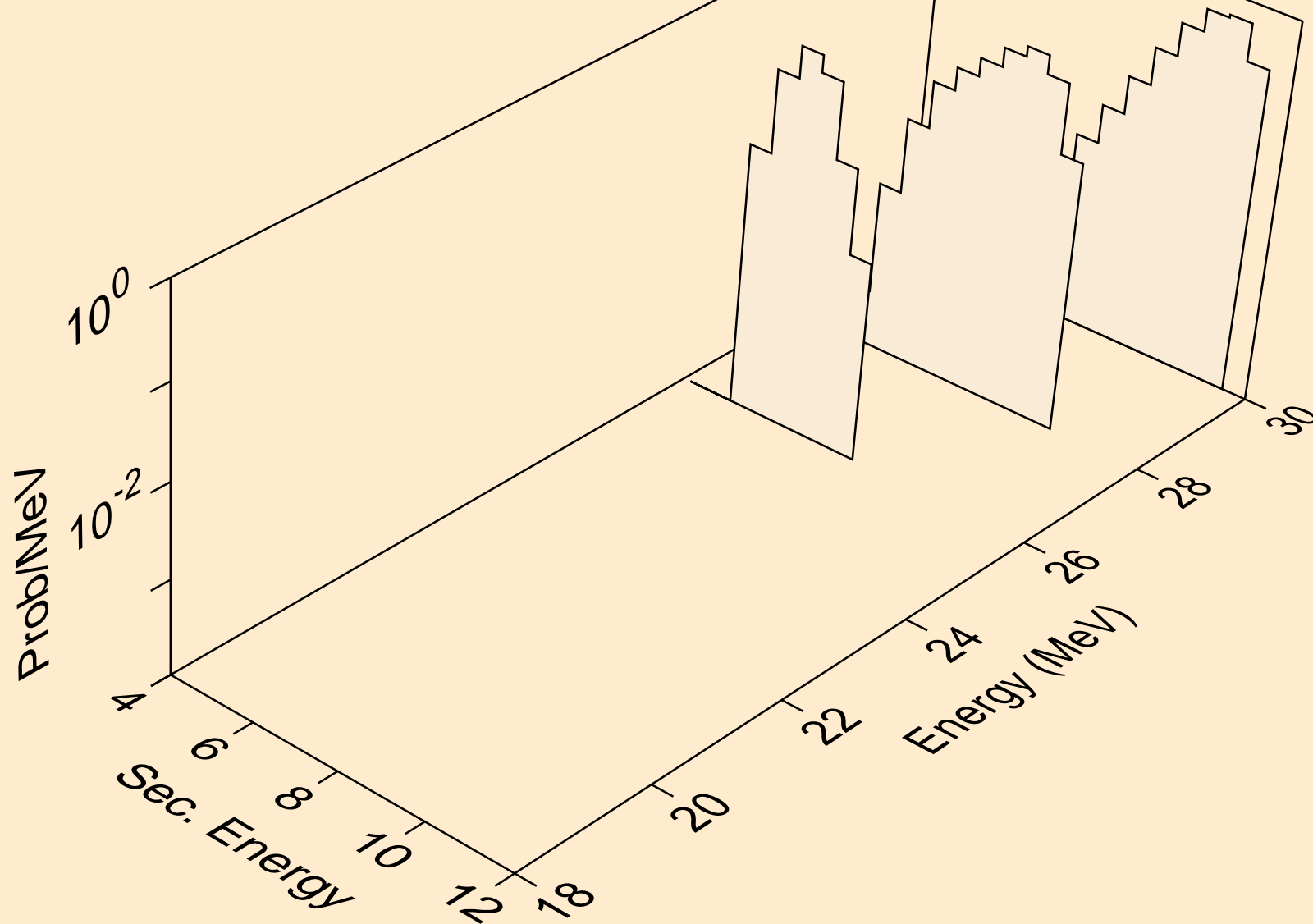

TM177 ALPHA ACER TENDL-2021 LIBRARY; T=0.K
Alpha emission for inelastic

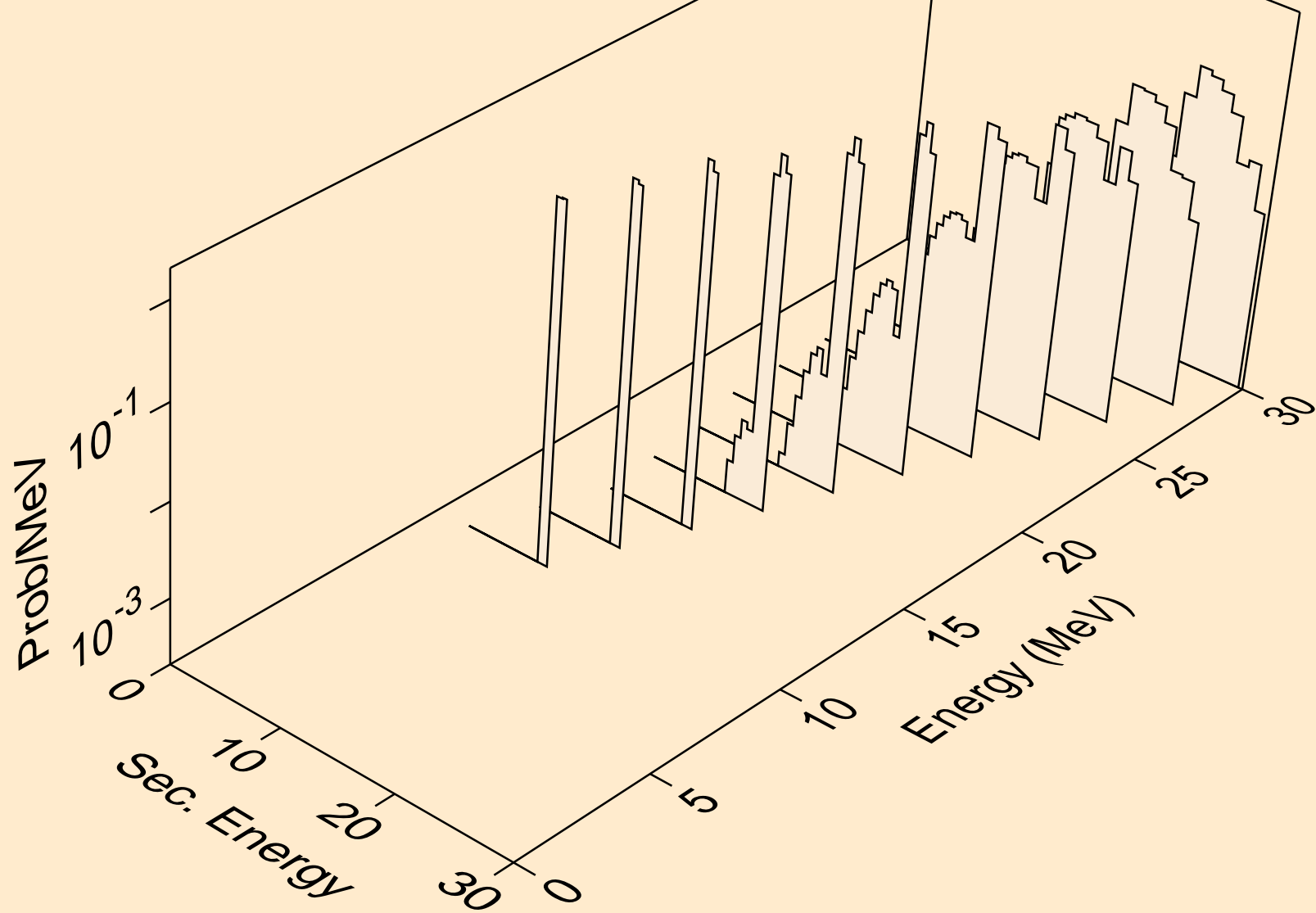

TM177 ALPHA ACER TENDL-2021 LIBRARY; T=0.K
Photon emission for (z,n)

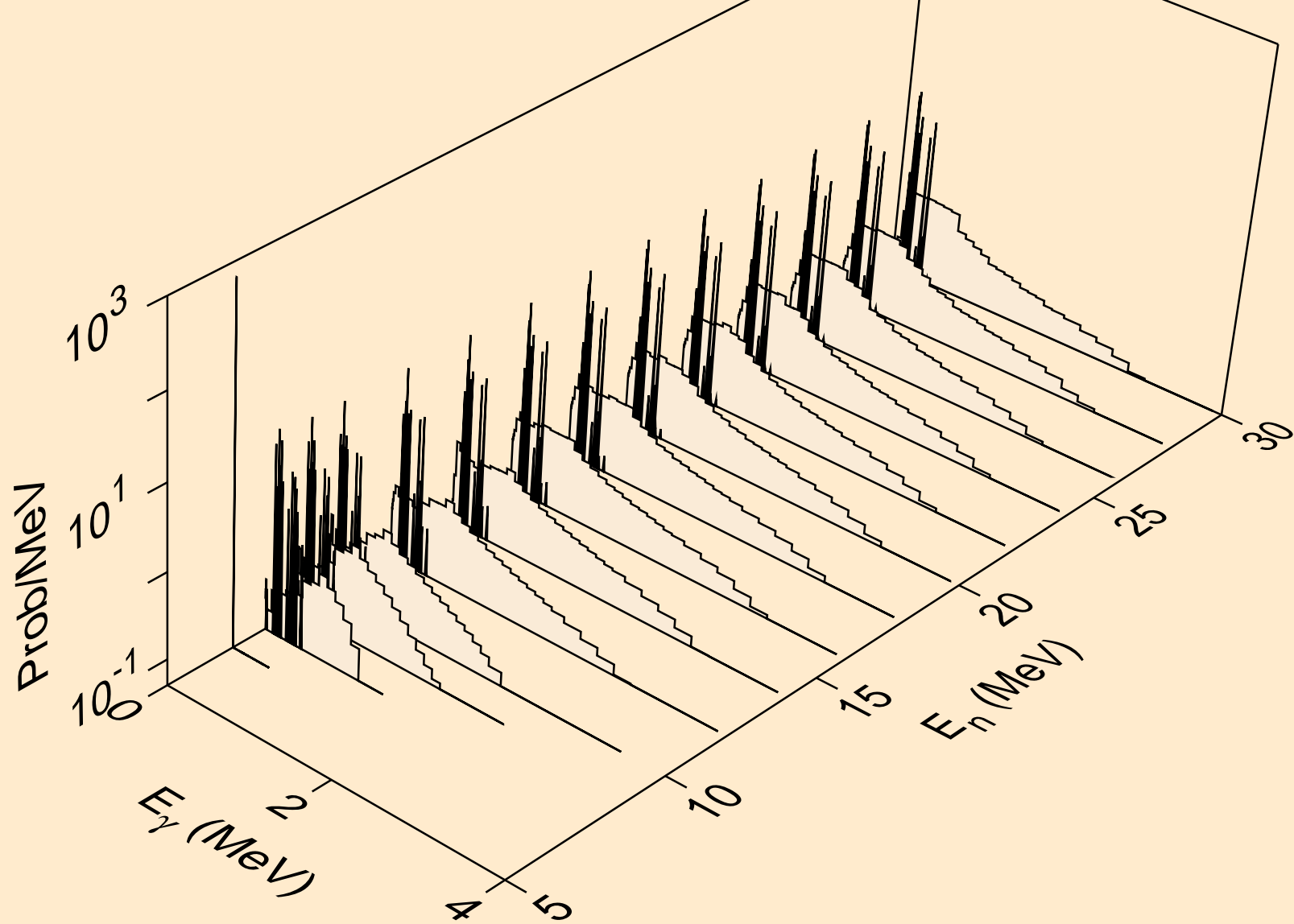

TM177 ALPHA ACER TENDL-2021 LIBRARY; T=0.K
Photon emission for (n,x)

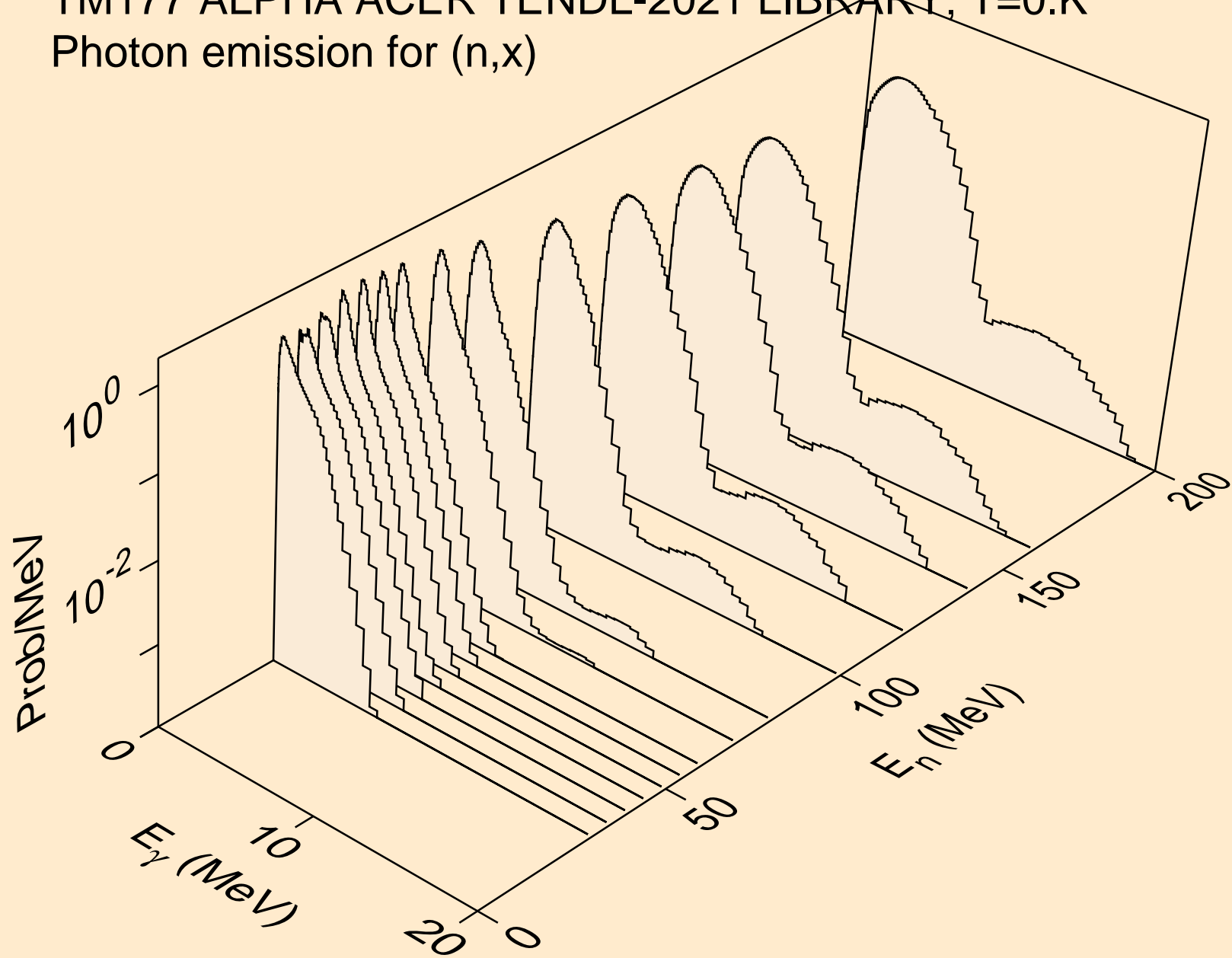

TM177 ALPHA ACER TENDL-2021 LIBRARY; T=0.K
Photon emission for (n,2nd)

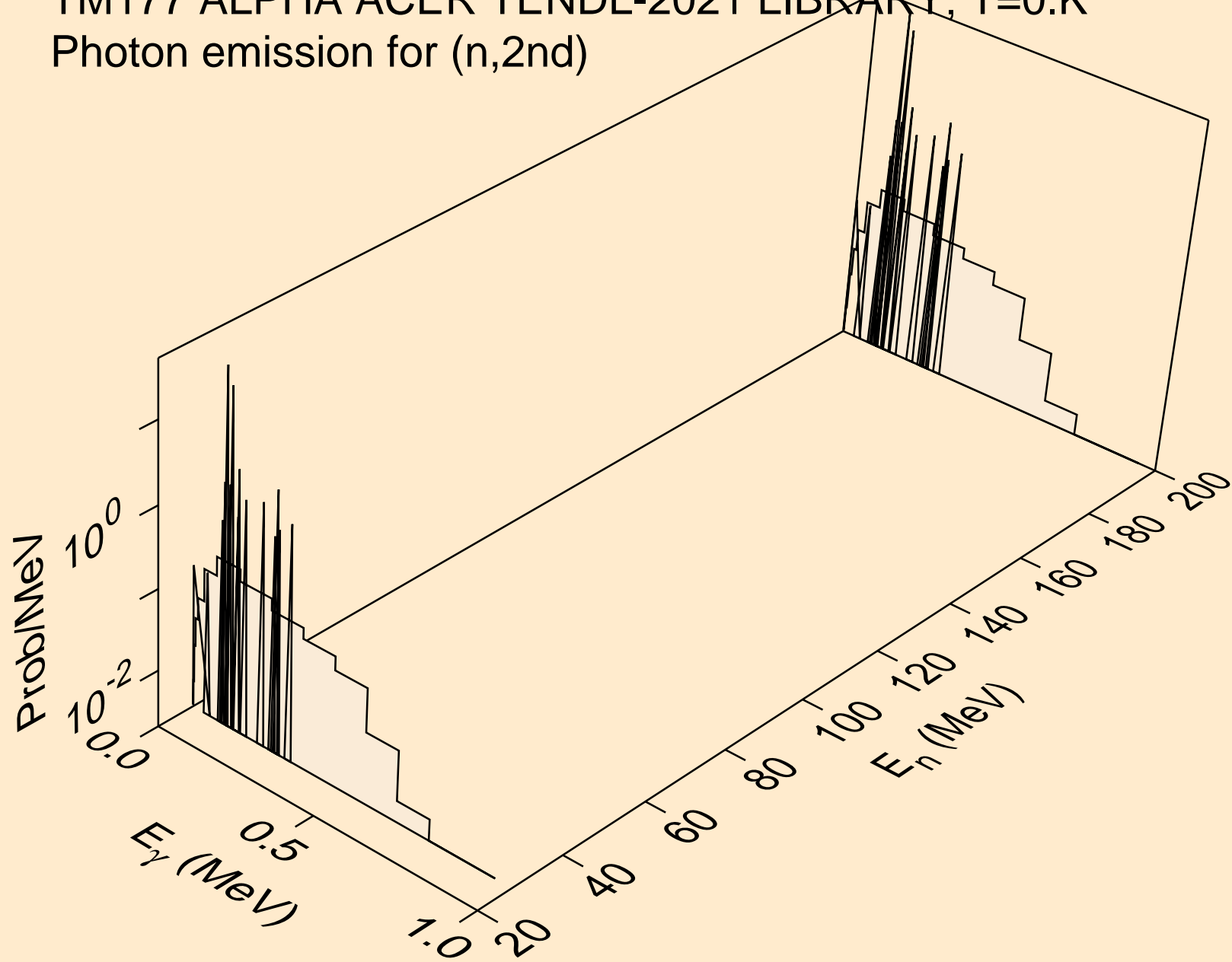

TM177 ALPHA ACER TENDL-2021 LIBRARY; T=0.K
Photon emission for (n,2n)

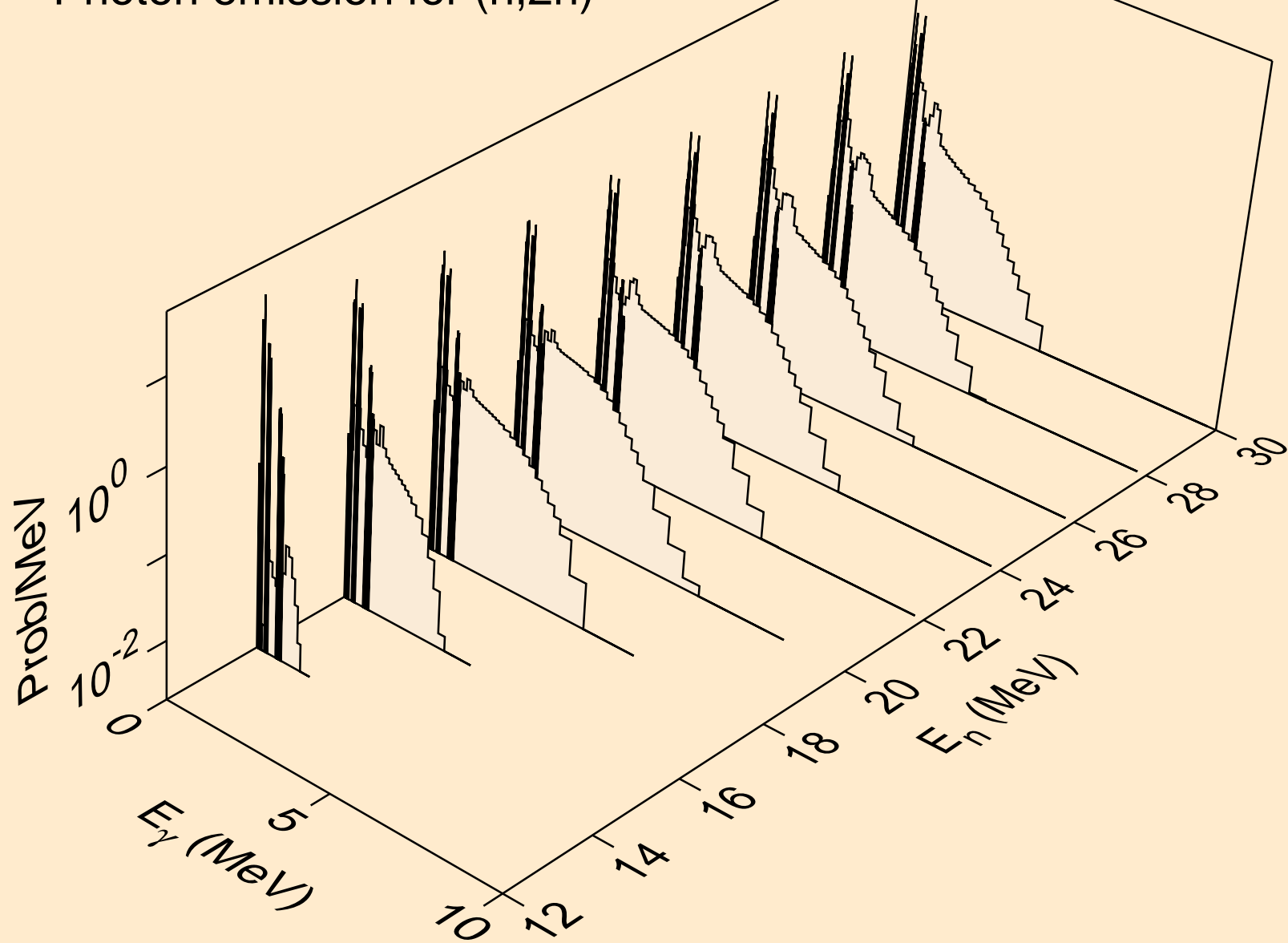

TM177 ALPHA ACER TENDL-2021 LIBRARY; T=0.K
Photon emission for (n,3n)

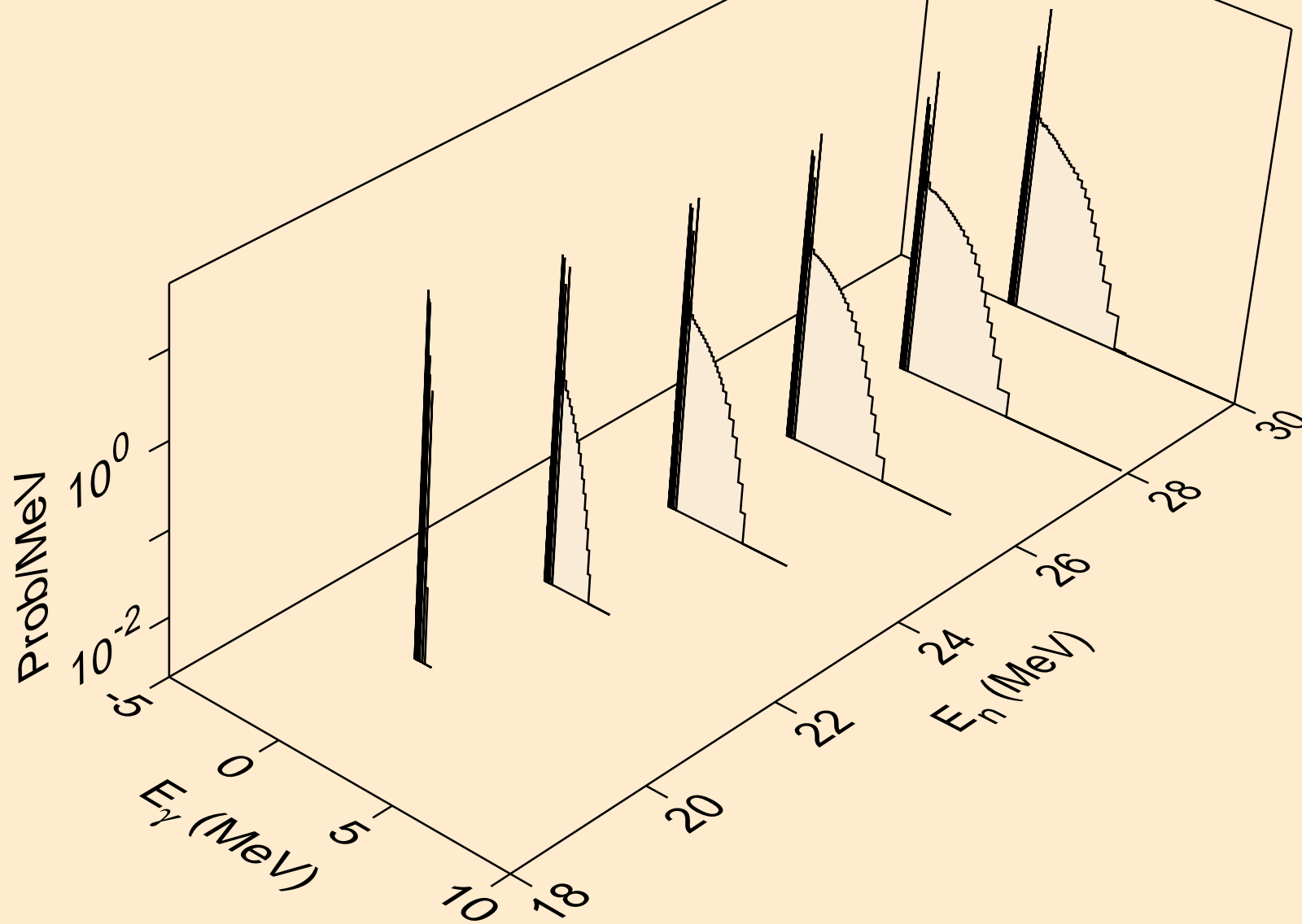

TM177 ALPHA ACER TENDL-2021 LIBRARY; T=0.K
Photon emission for (n,n*)a

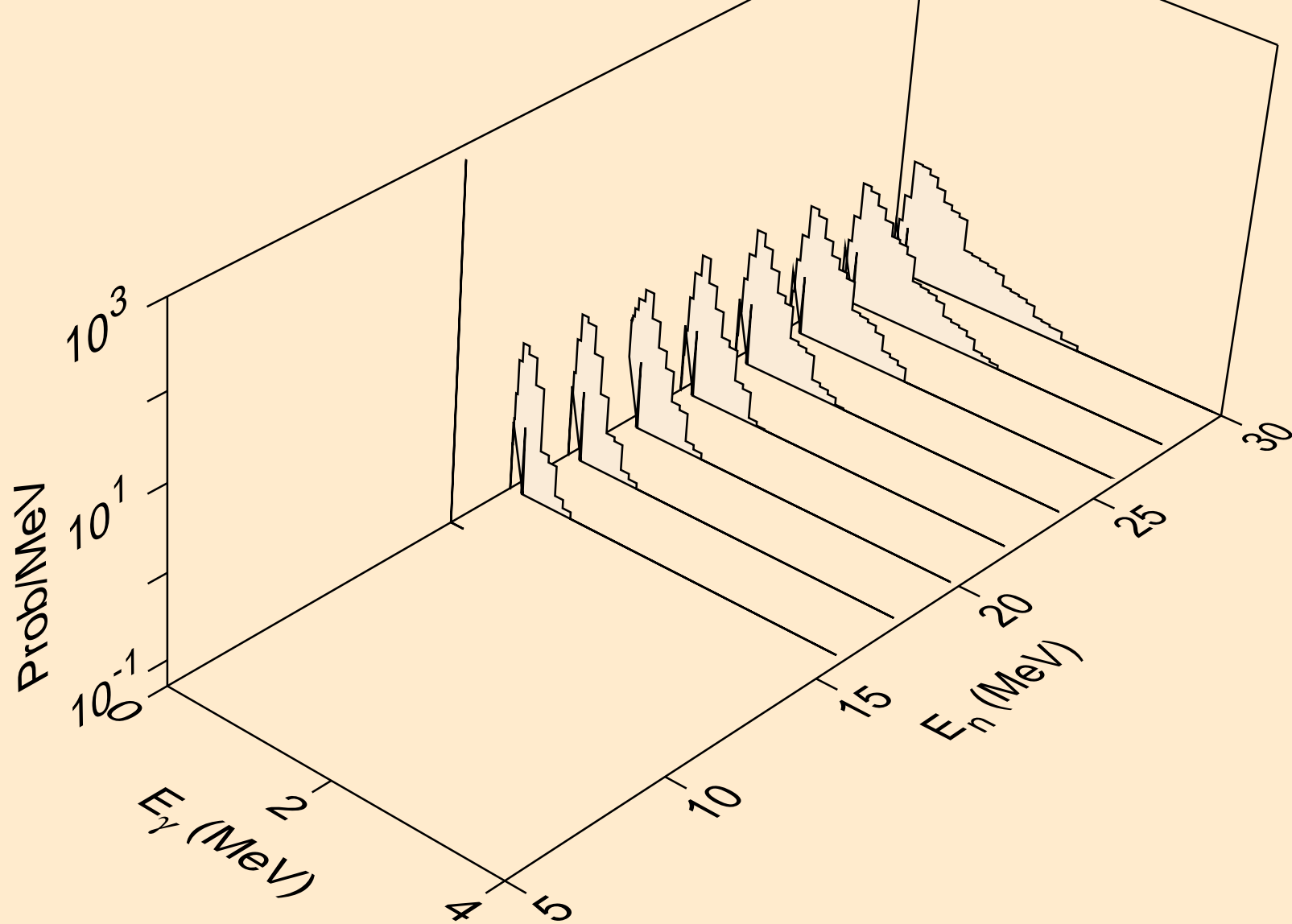

TM177 ALPHA ACER TENDL-2021 LIBRARY; T=0.K
Photon emission for (n,2n)a

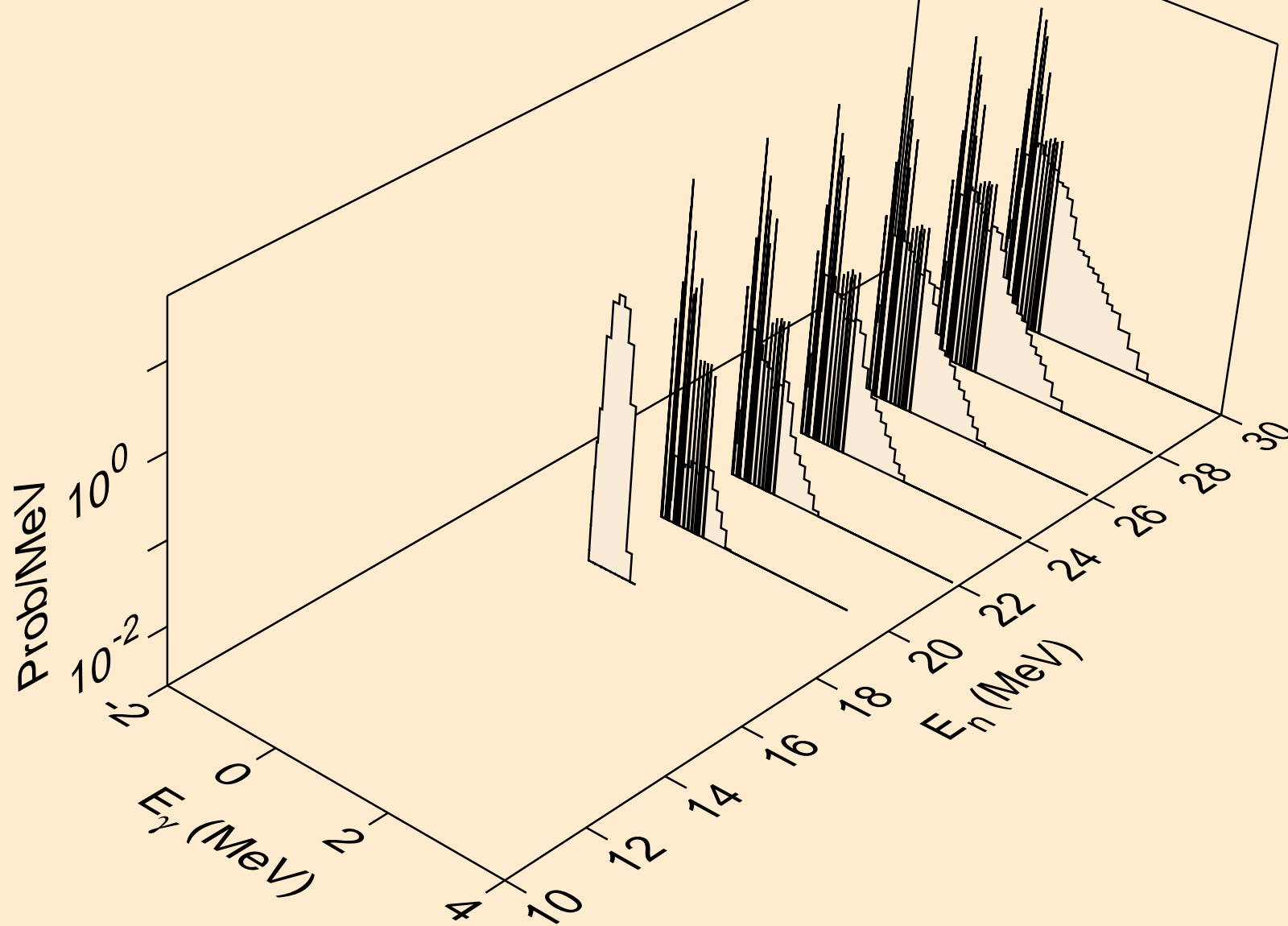

TM177 ALPHA ACER TENDL-2021 LIBRARY; T=0.K
Photon emission for (n,3n)a

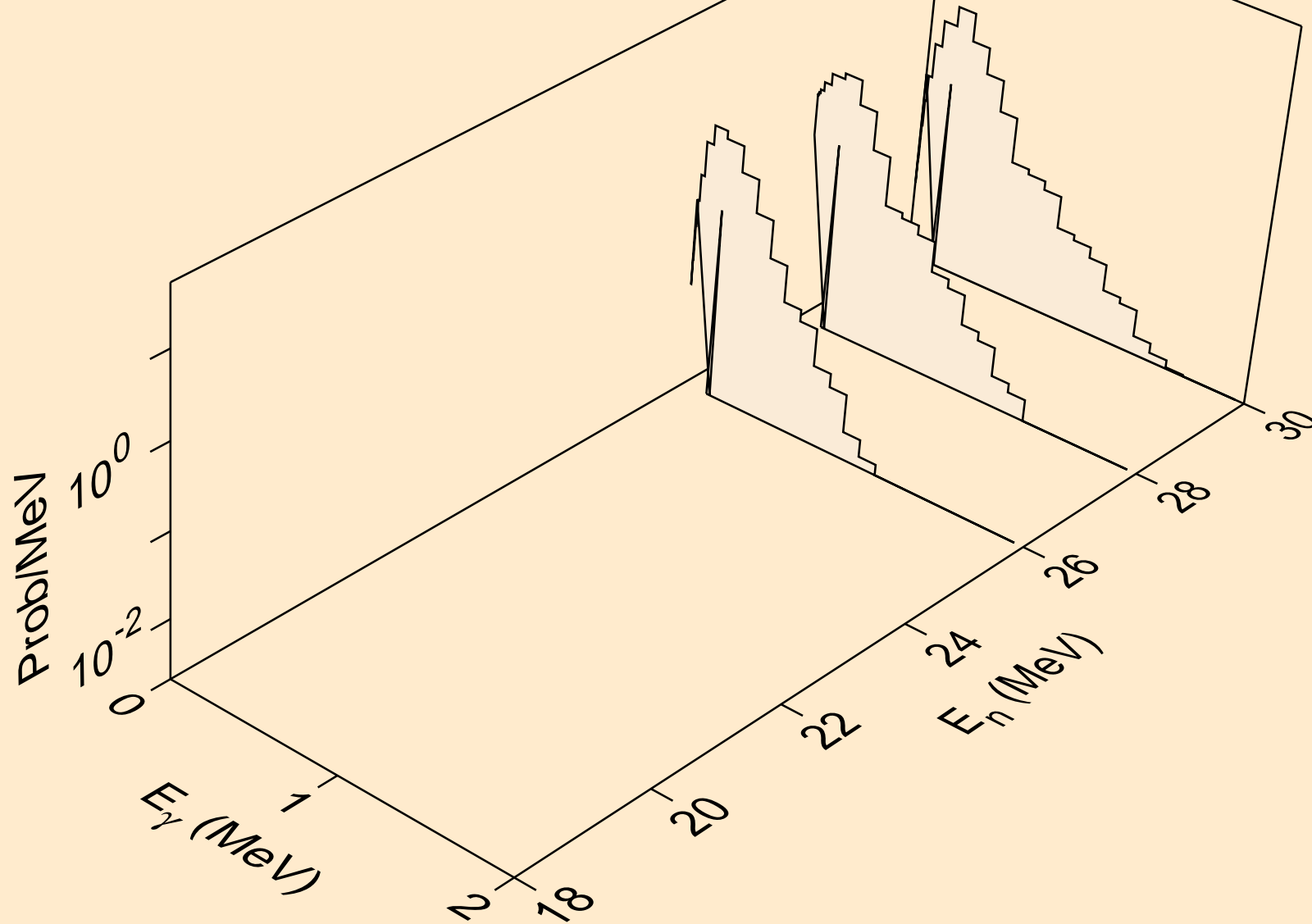

TM177 ALPHA ACER TENDL-2021 LIBRARY; T=0.K
Photon emission for (n,n*)p

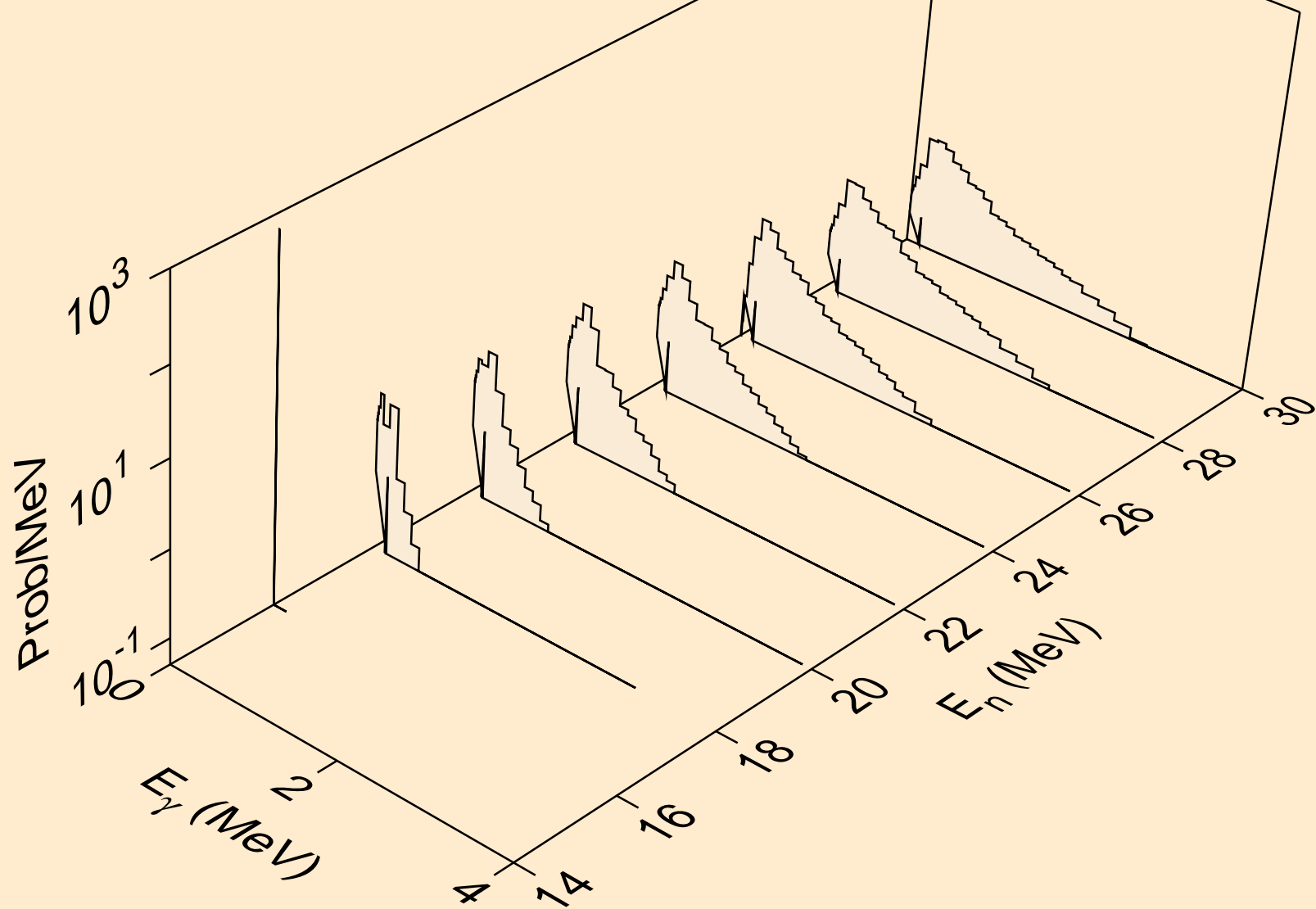

TM177 ALPHA ACER TENDL-2021 LIBRARY; T=0.K
Photon emission for (n,n*)d

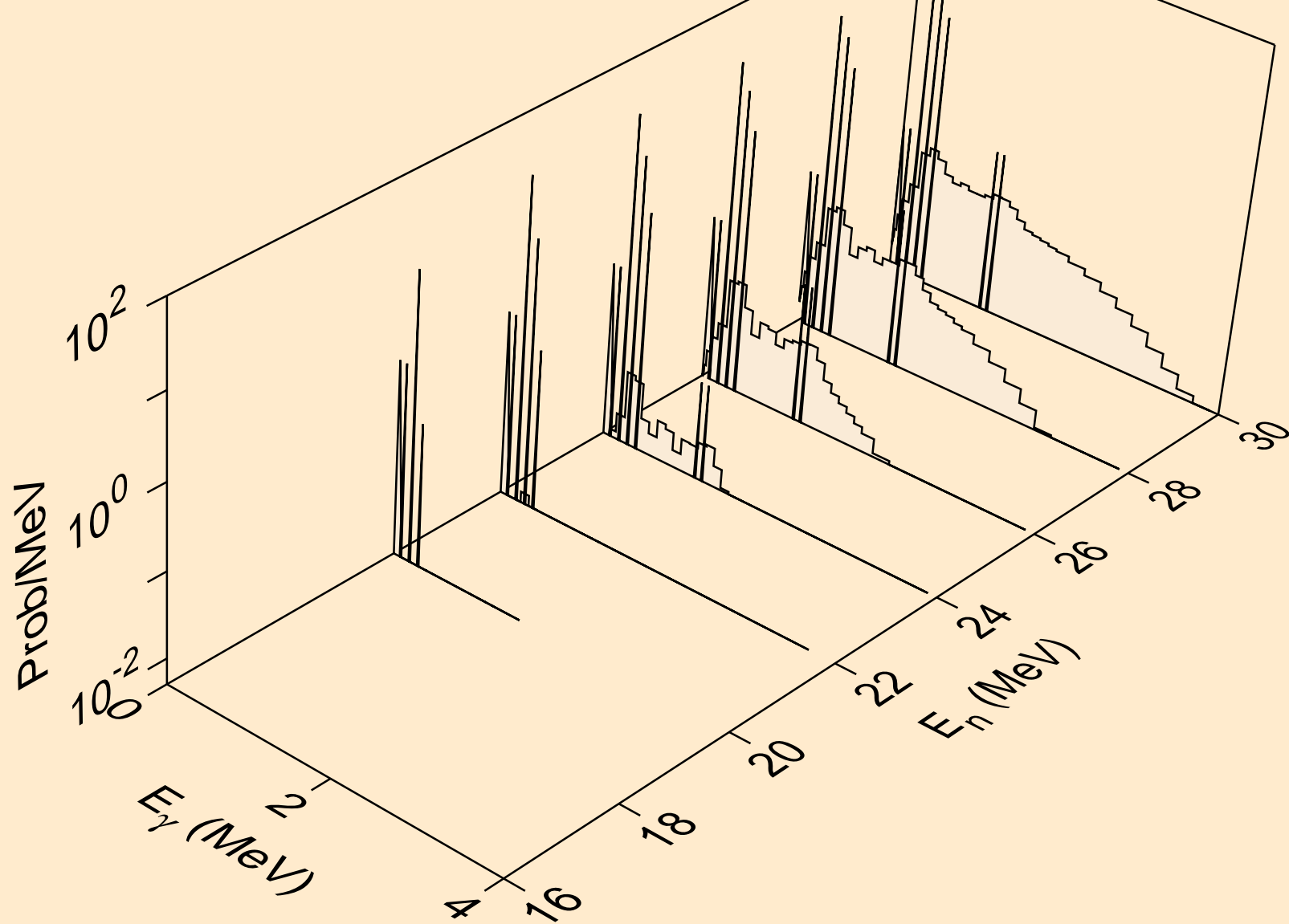

TM177 ALPHA ACER TENDL-2021 LIBRARY; T=0.K
Photon emission for (n,n*)t

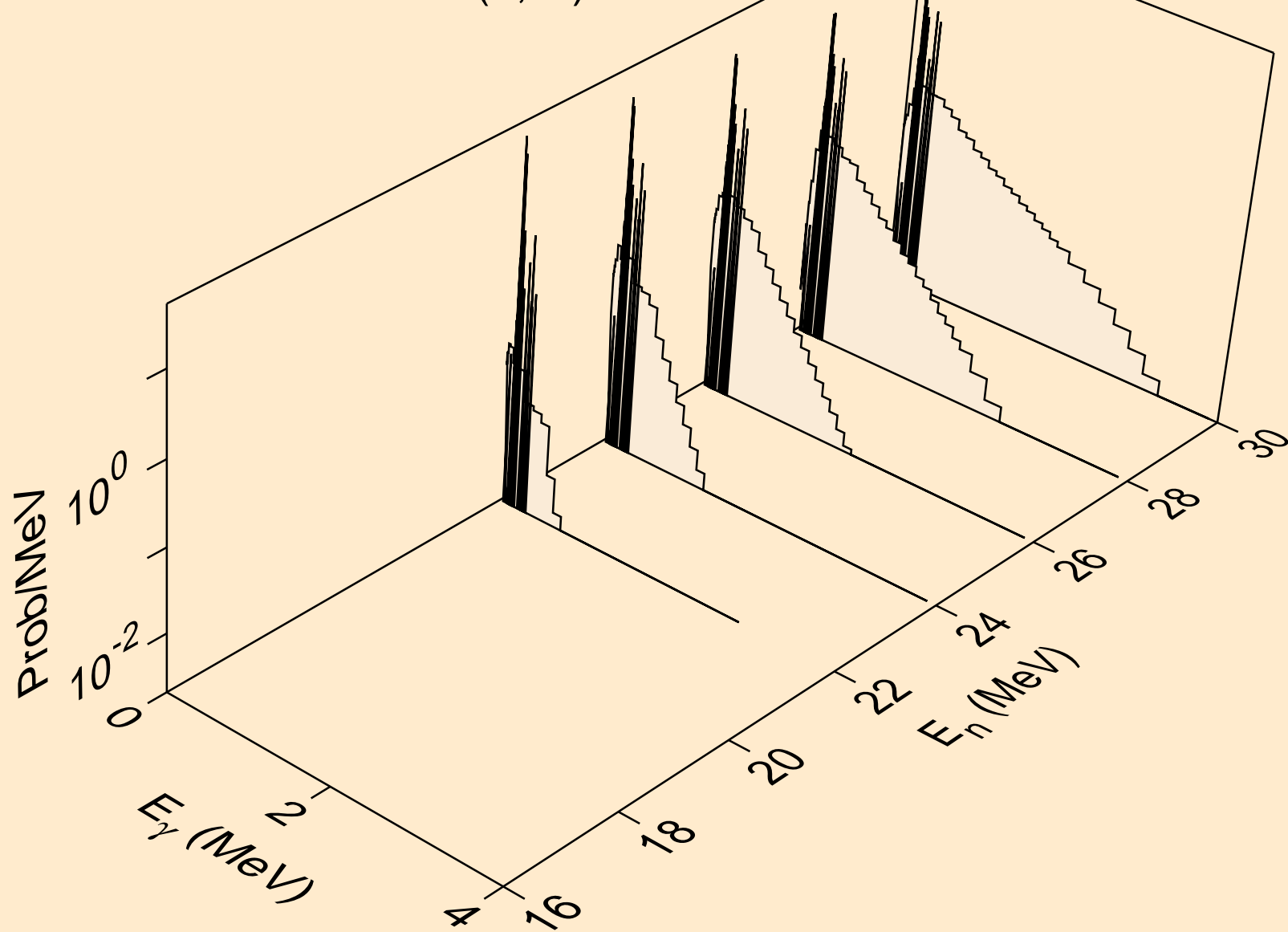

TM177 ALPHA ACER TENDL-2021 LIBRARY; T=0.K
Photon emission for (n,4n)

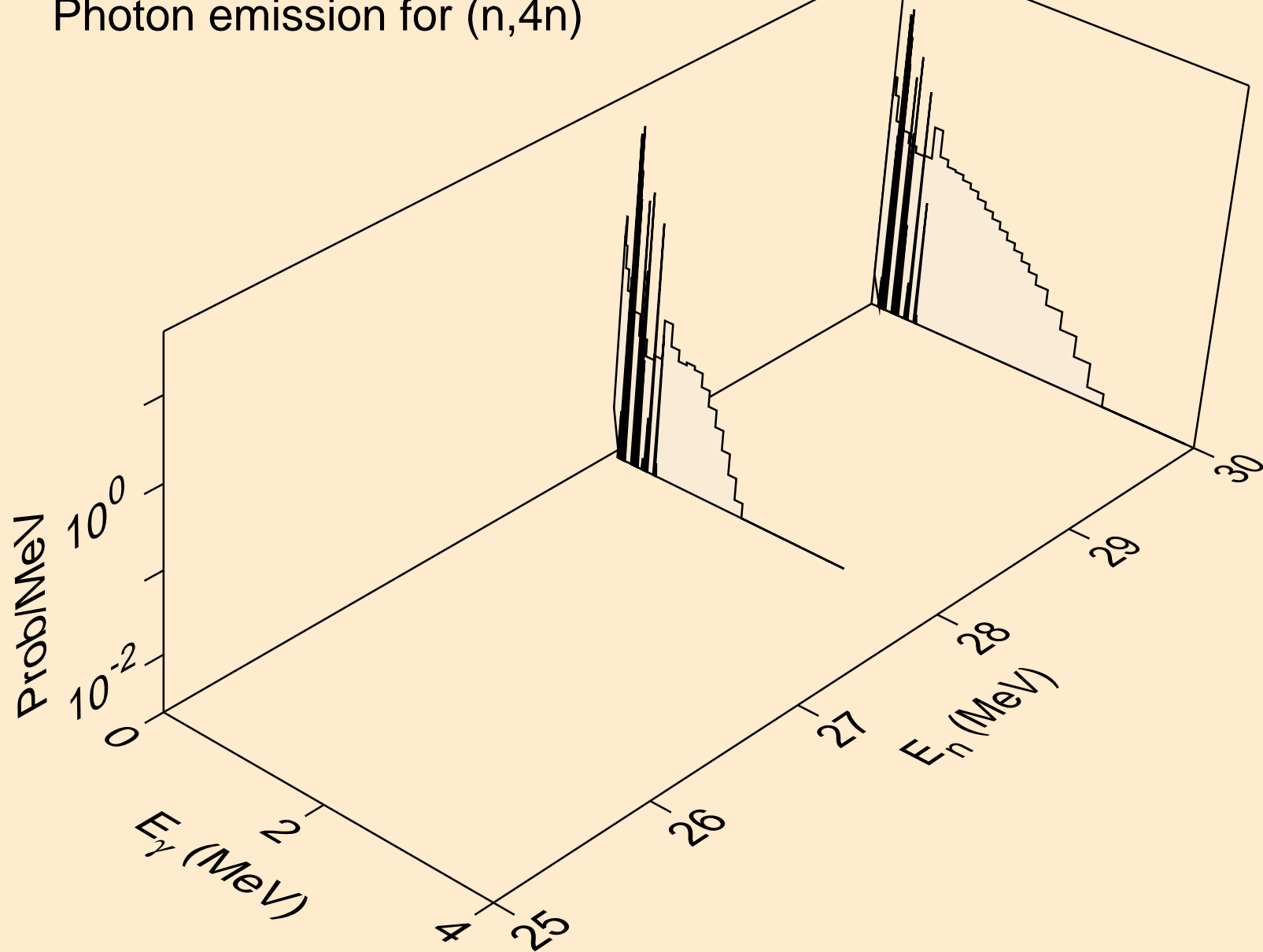

TM177 ALPHA ACER TENDL-2021 LIBRARY; T=0.K
Photon emission for (n,2np)

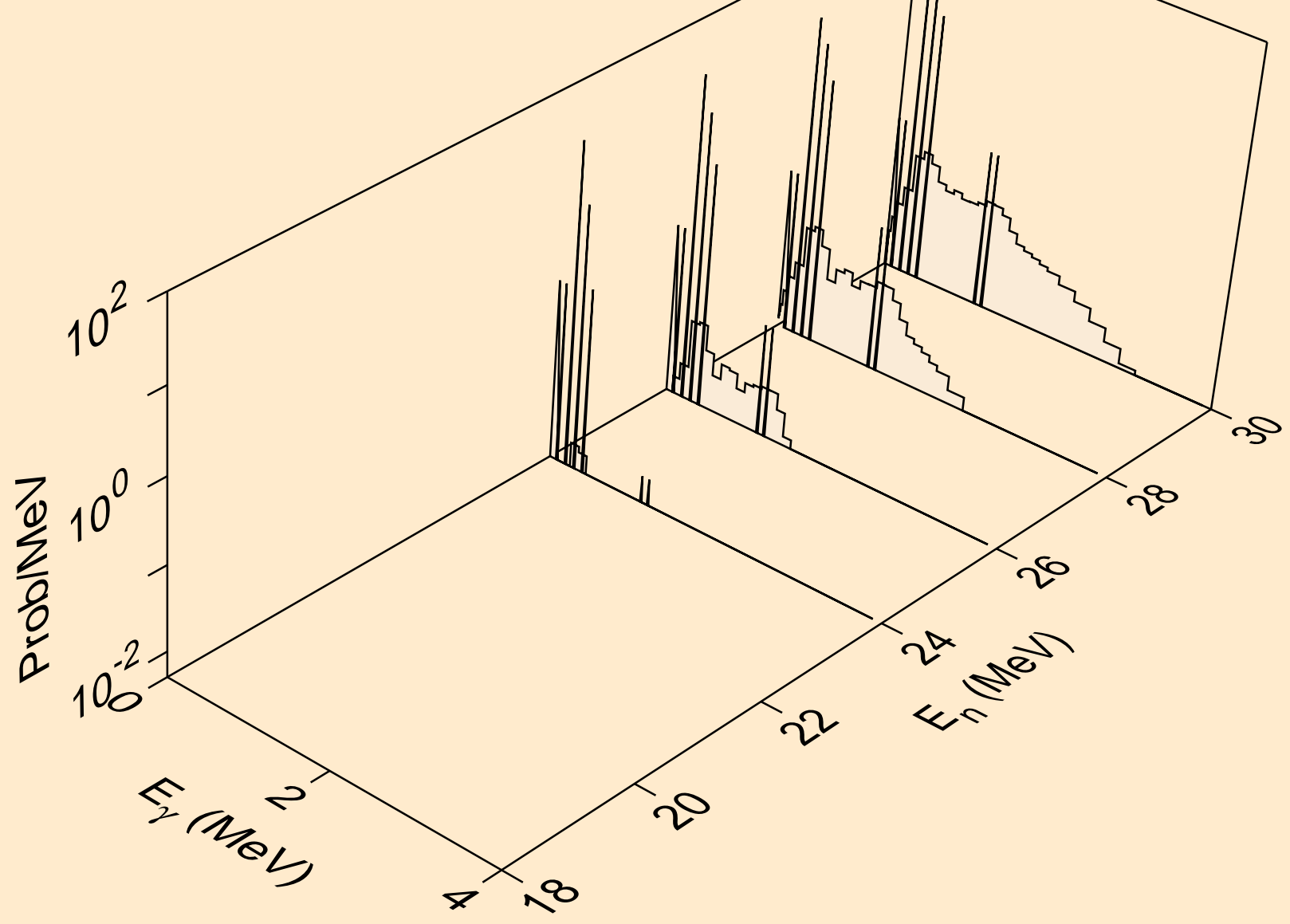

TM177 ALPHA ACER TENDL-2021 LIBRARY; T=0.K
Photon emission for (n,gma)

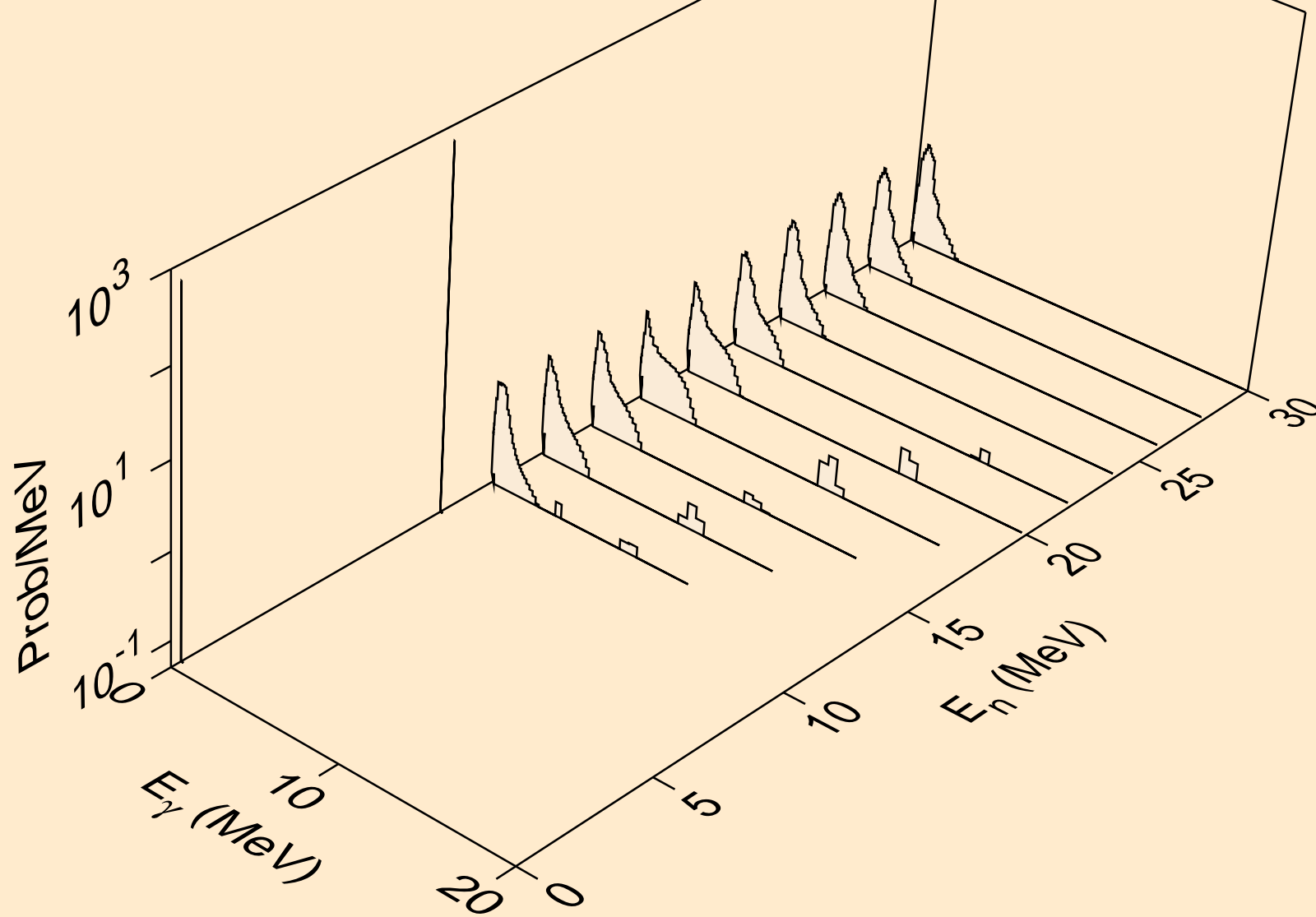

TM177 ALPHA ACER TENDL-2021 LIBRARY; T=0.K
Photon emission for (n,p)

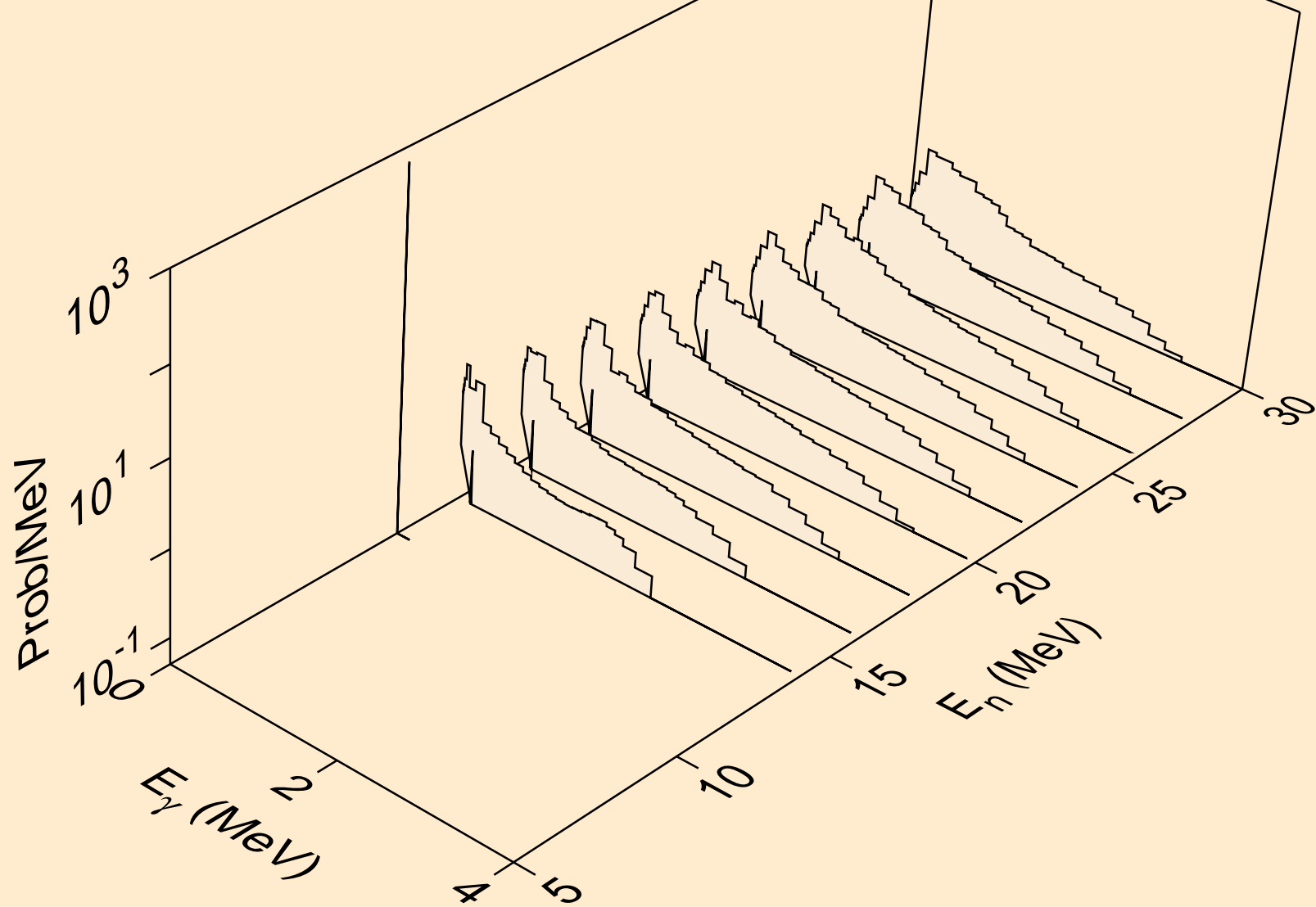

TM177 ALPHA ACER TENDL-2021 LIBRARY; T=0.K
Photon emission for (n,d)

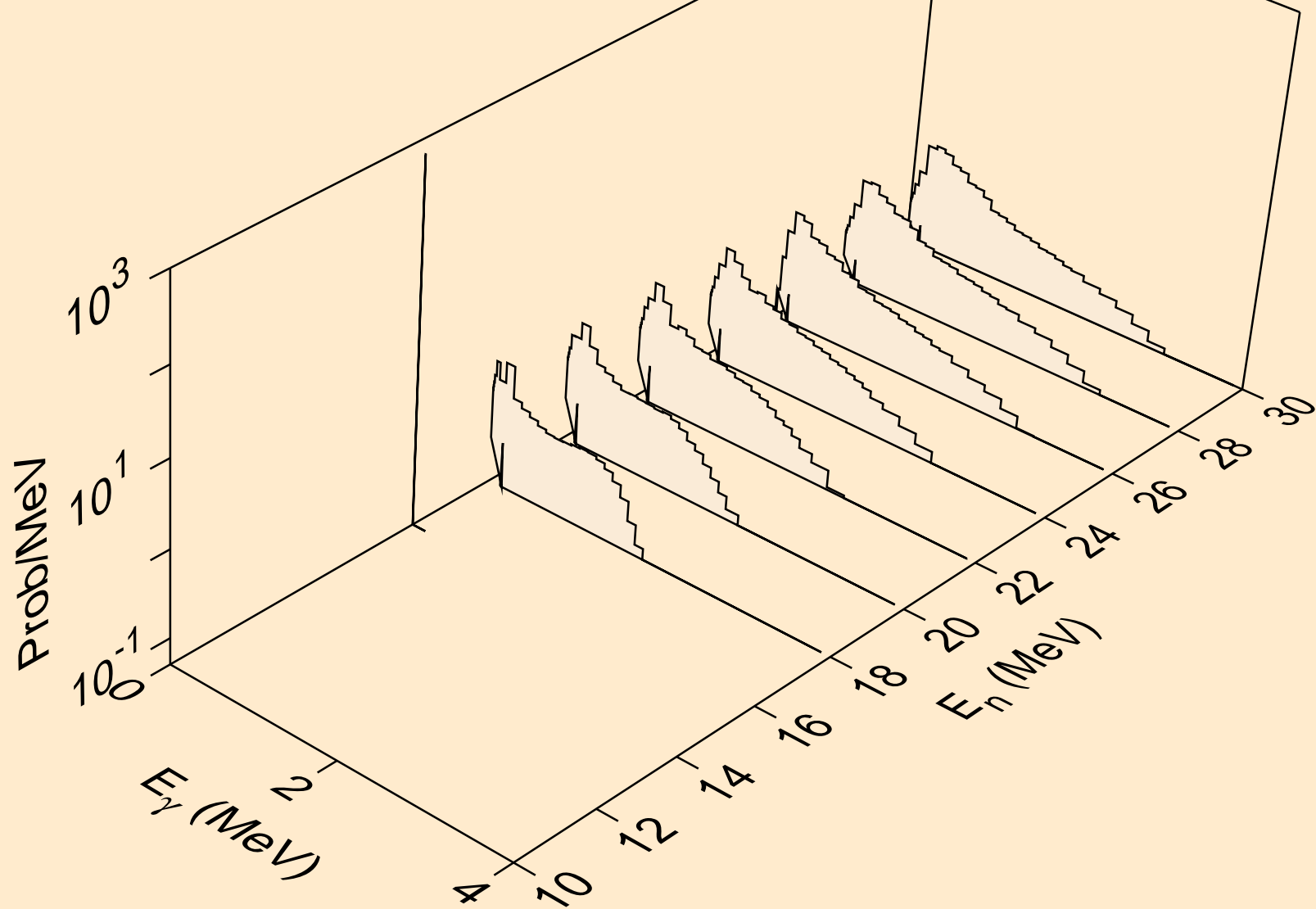

TM177 ALPHA ACER TENDL-2021 LIBRARY; T=0.K
Photon emission for (n,t)

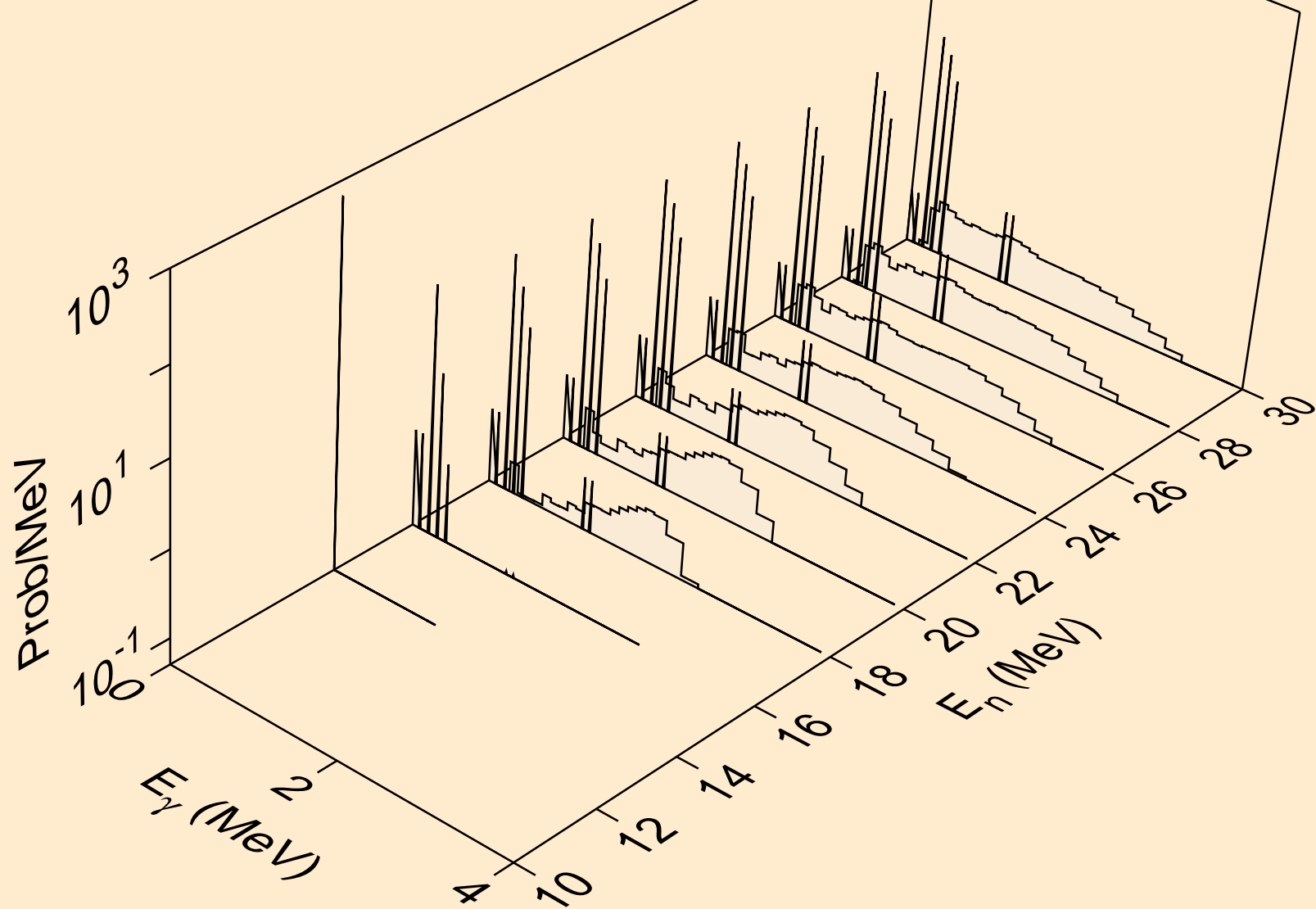

TM177 ALPHA ACER TENDL-2021 LIBRARY; T=0.K
Photon emission for (n,he3)

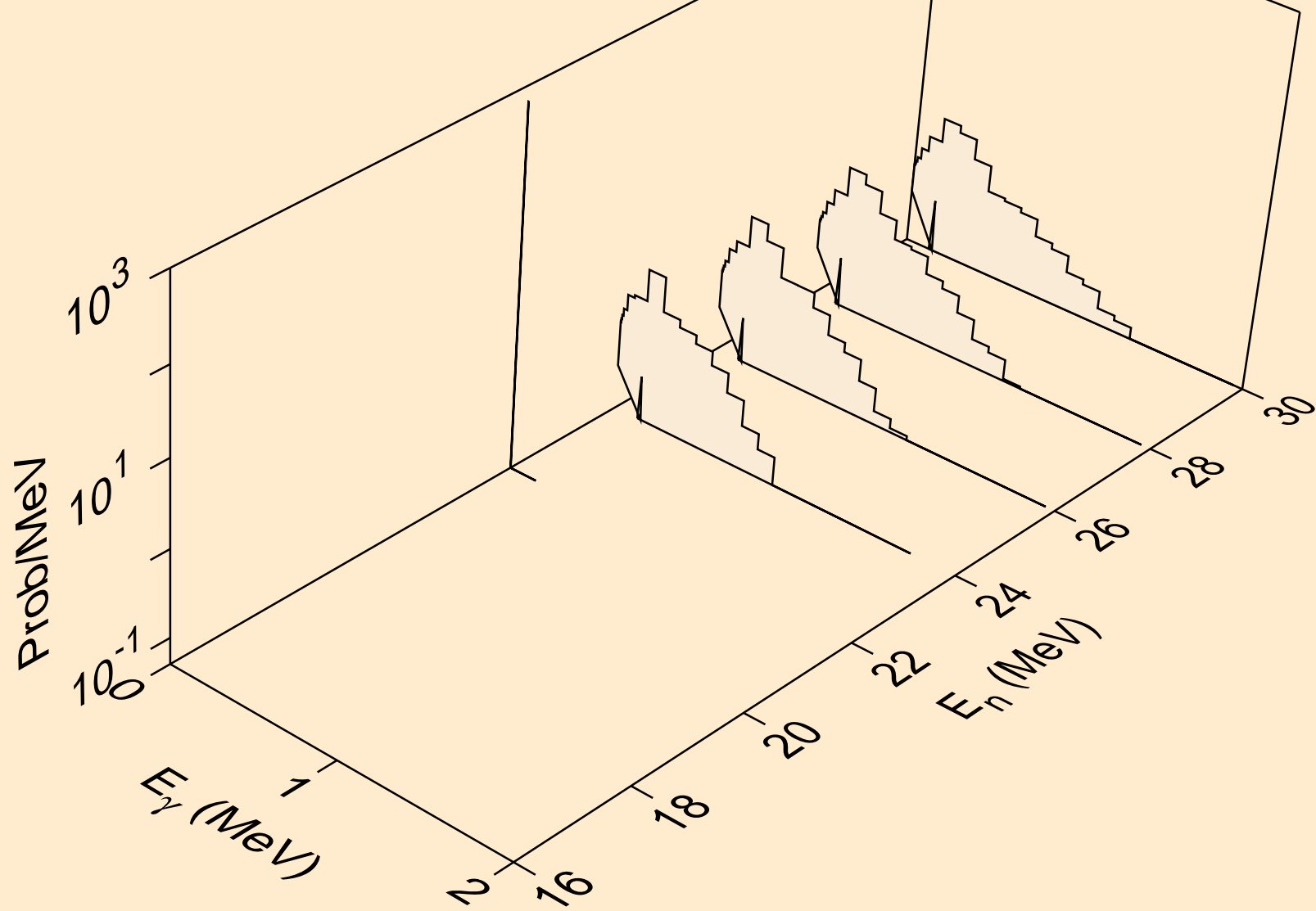

TM177 ALPHA ACER TENDL-2021 LIBRARY; T=0.K
Photon emission for inelastic

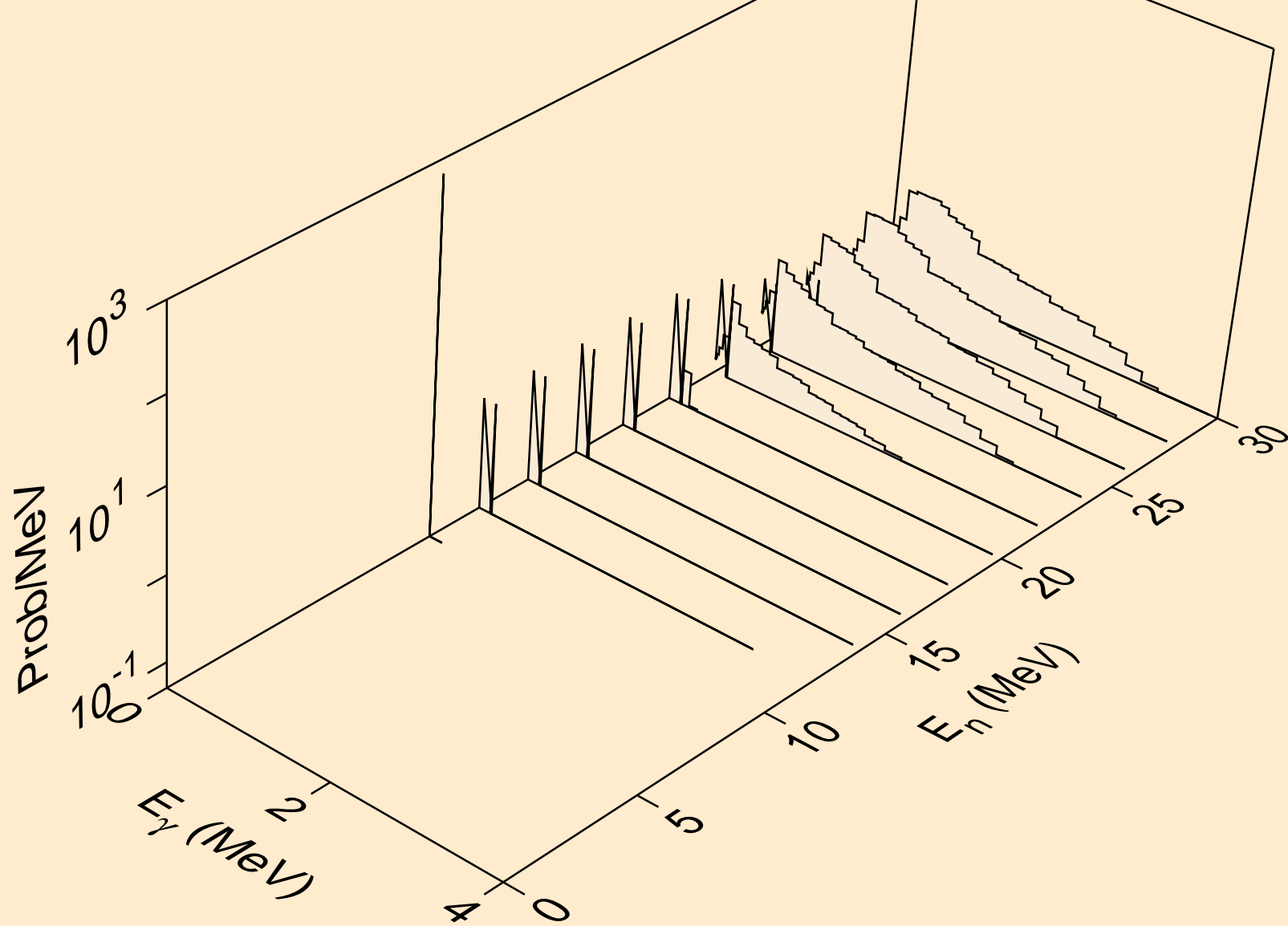

TM177 ALPHA ACER TENDL-2021 LIBRARY; T=0.K
Particle heating contributions

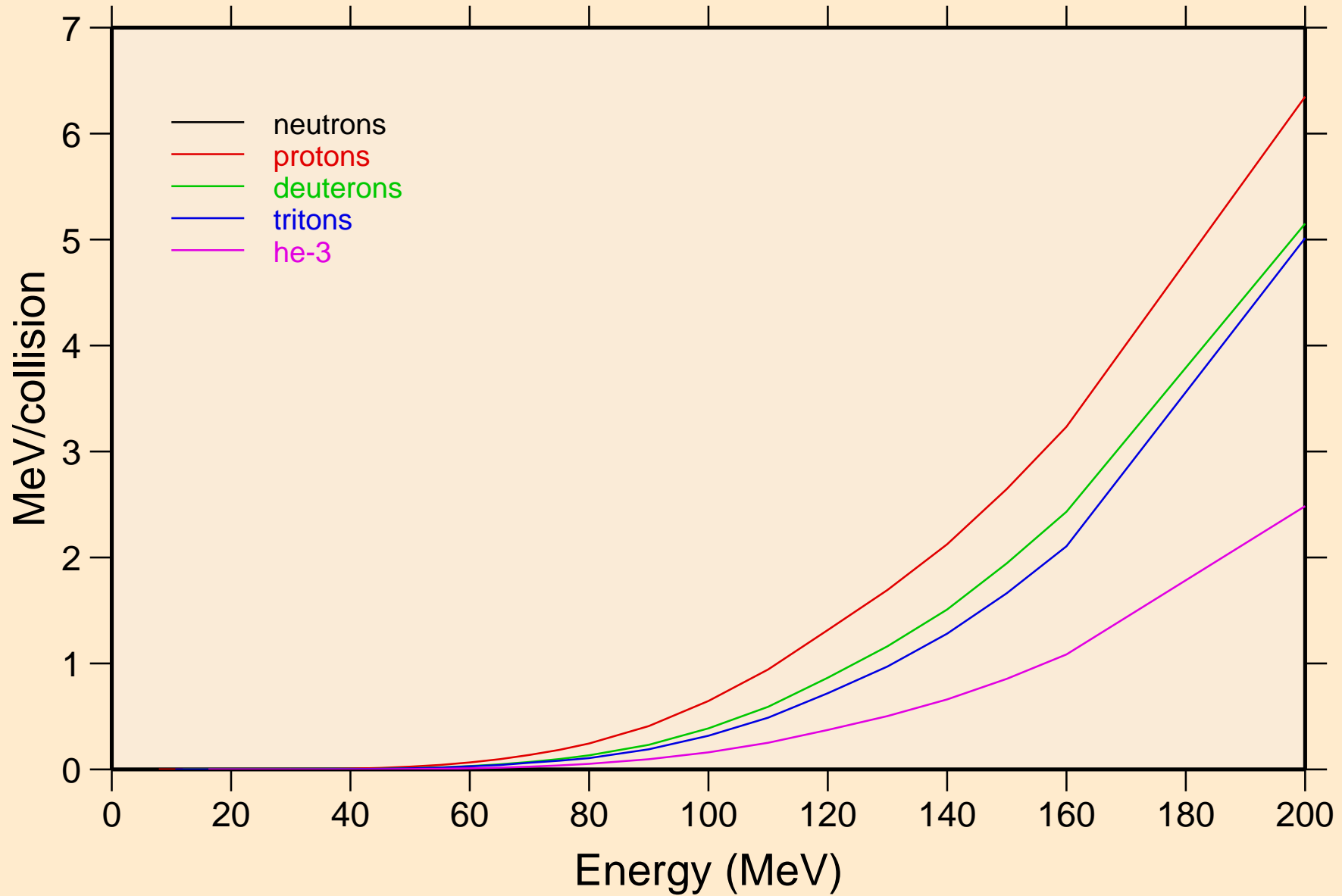

TM177 ALPHA ACER TENDL-2021 LIBRARY; T=0.K
Recoil Heating

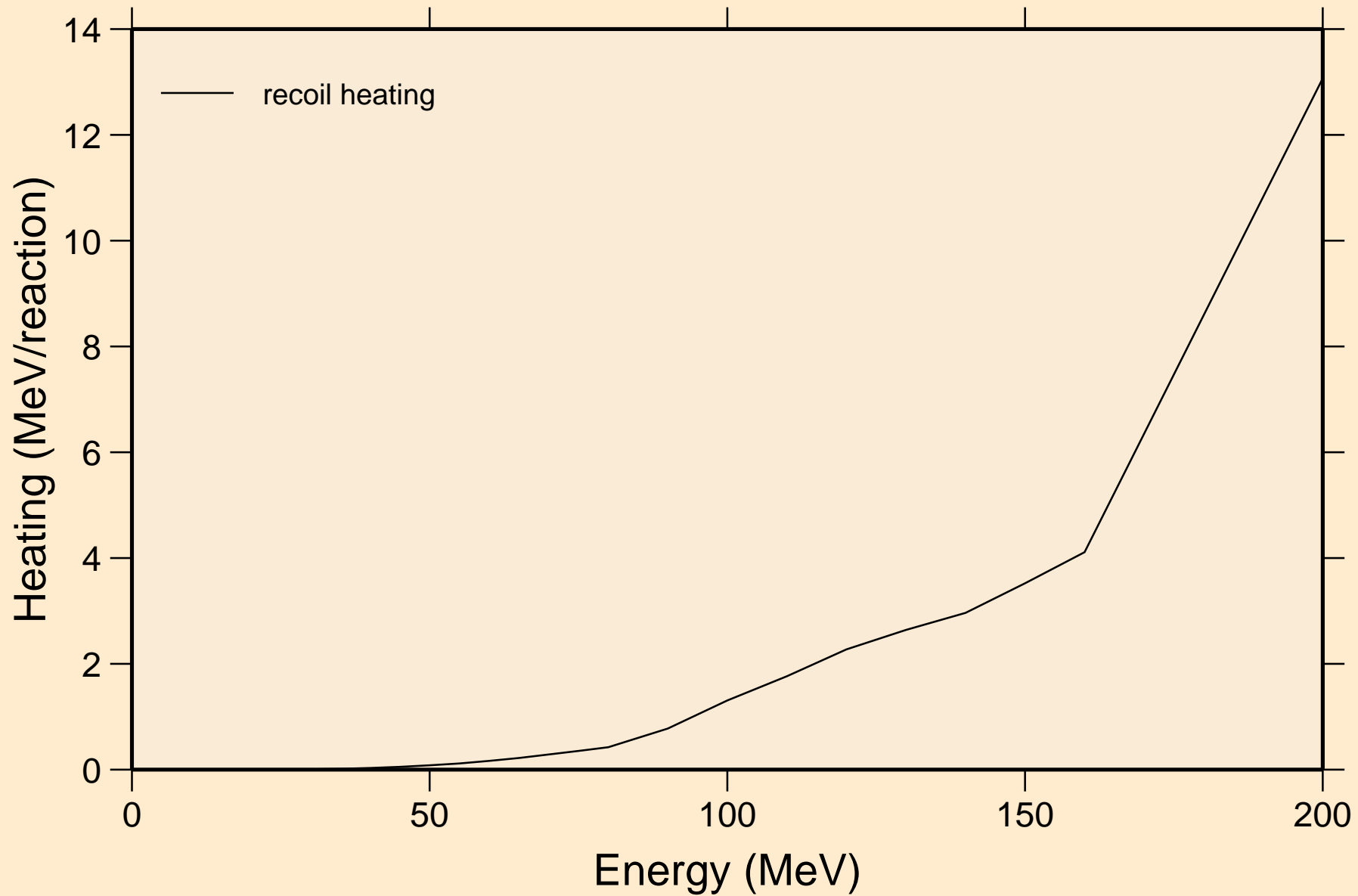

TM177 ALPHA ACER TENDL-2021 LIBRARY; T=0.K
Particle production cross sections

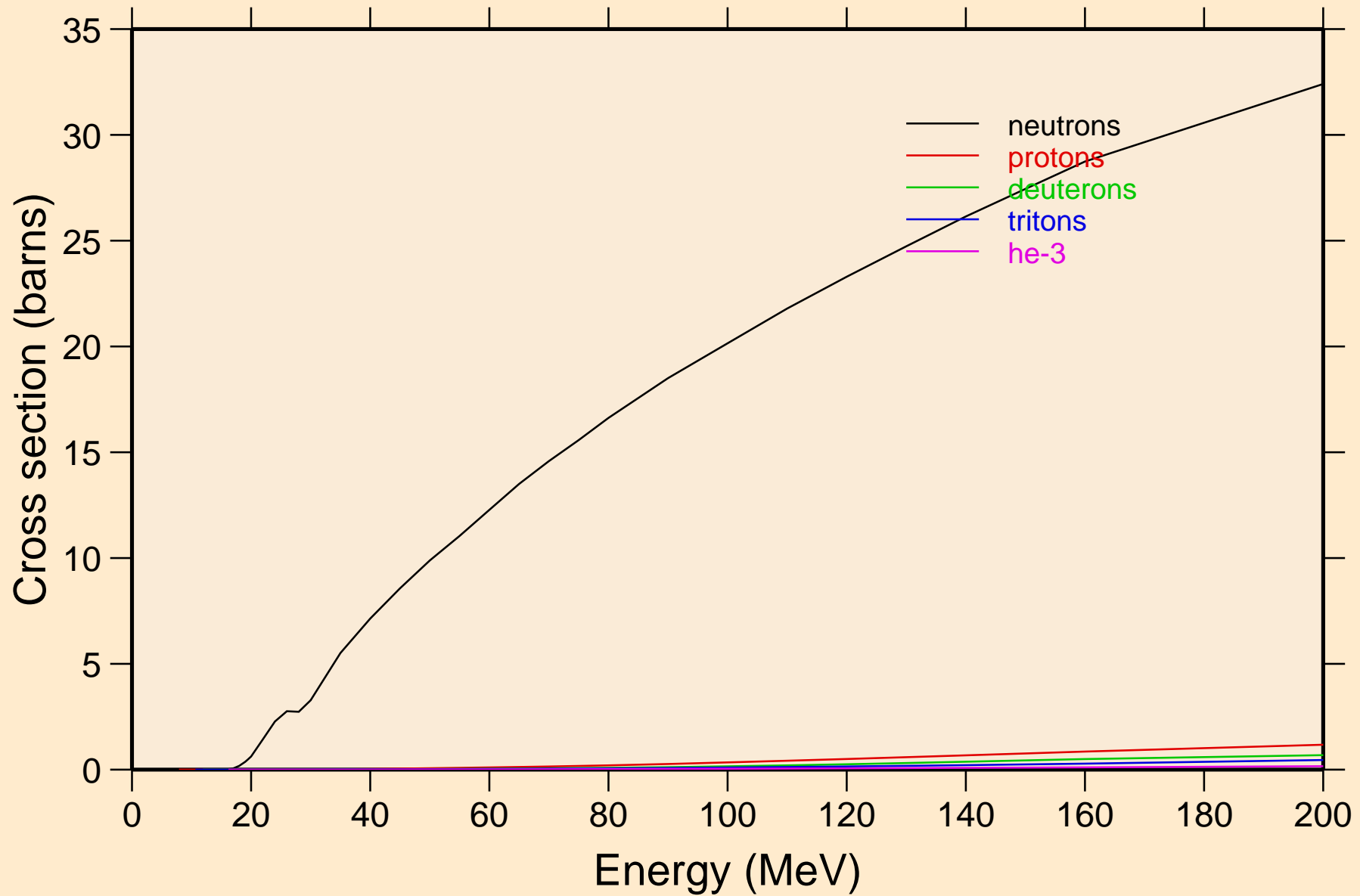

TM177 ALPHA ACER TENDL-2021 LIBRARY; T=0.K
neutrons from (a,n)

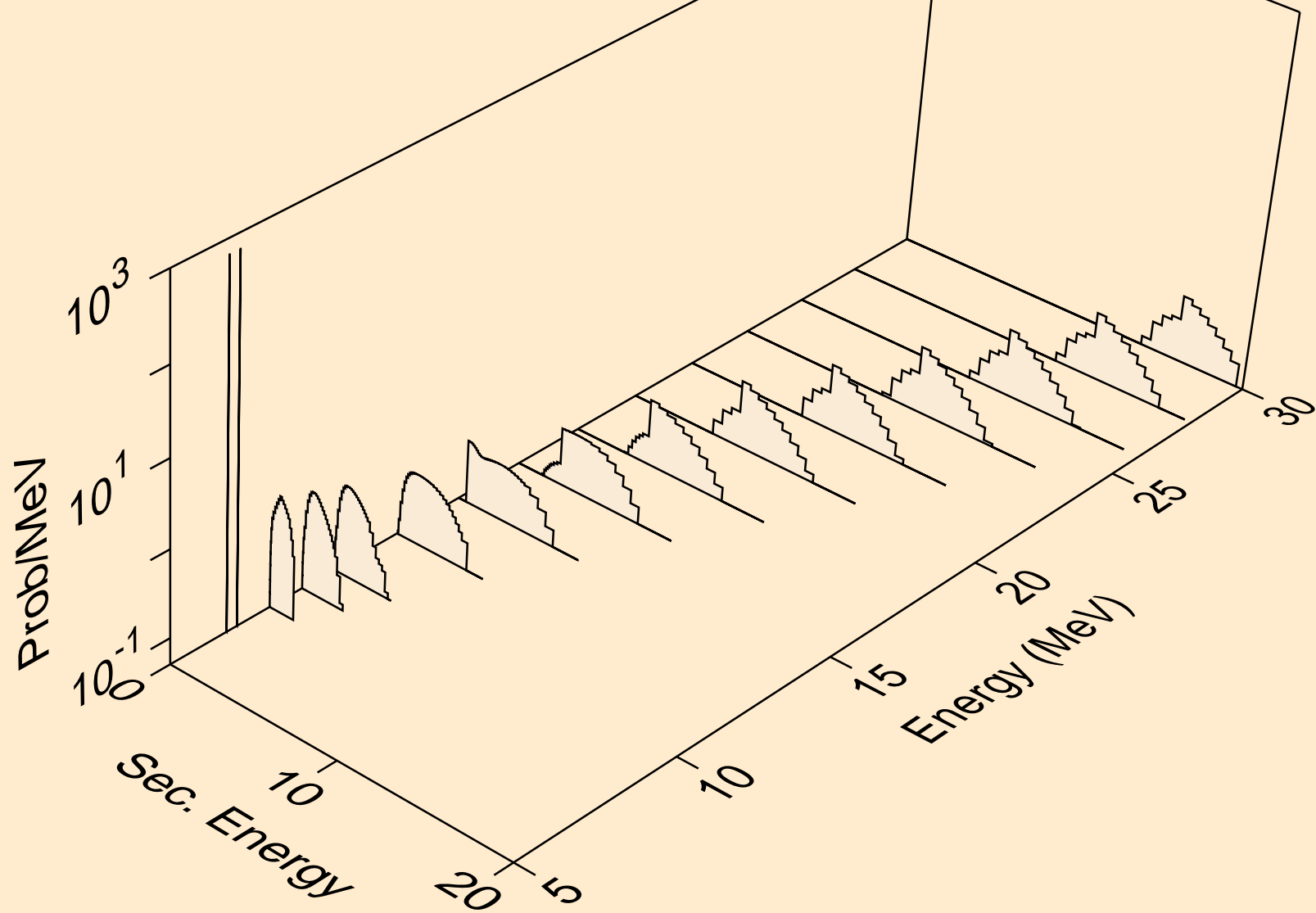

TM177 ALPHA ACER TENDL-2021 LIBRARY; T=0.K
neutrons from (a,x)

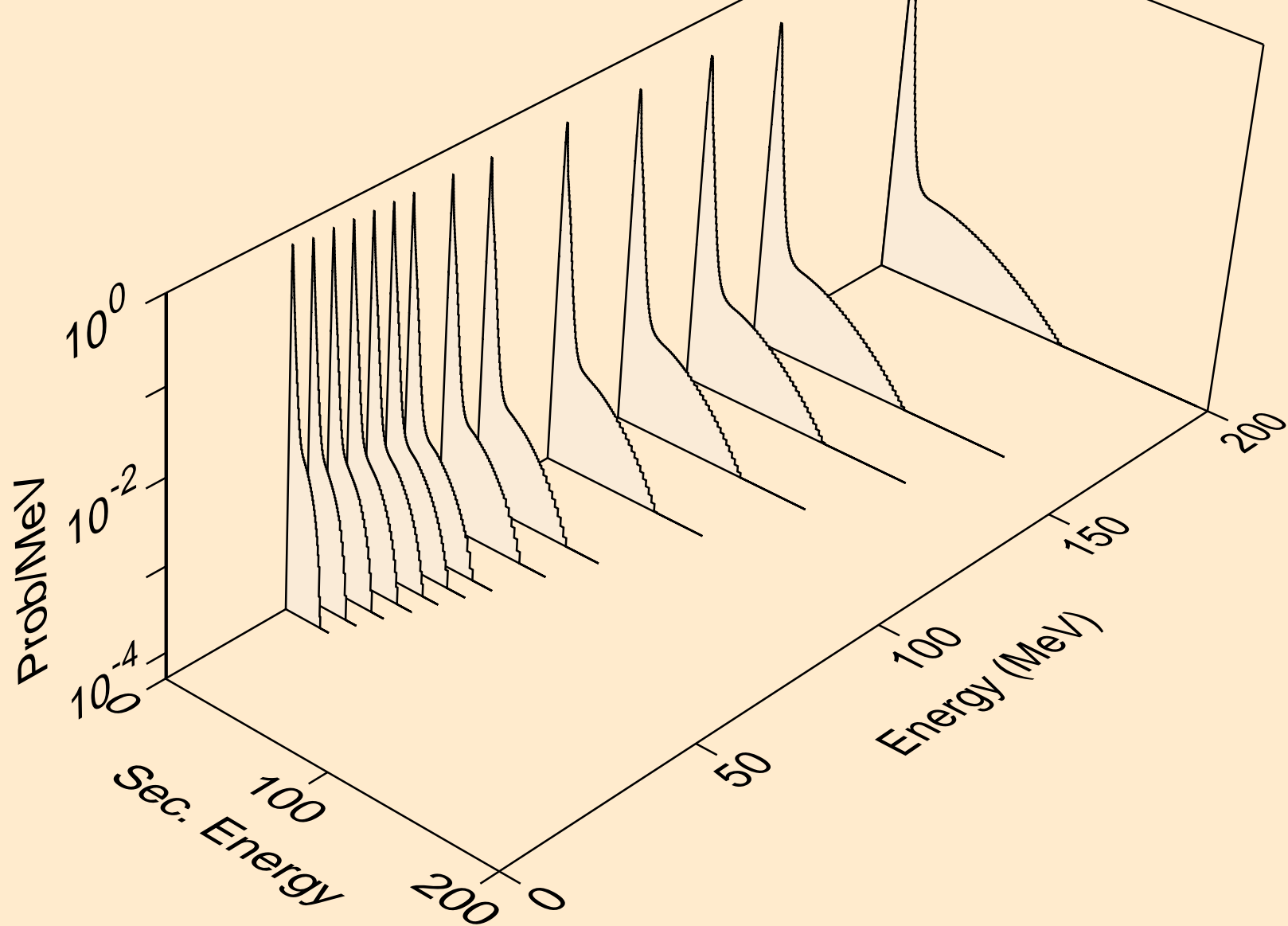

TM177 ALPHA ACER TENDL-2021 LIBRARY; T=0.K
neutrons from (a,2nd)

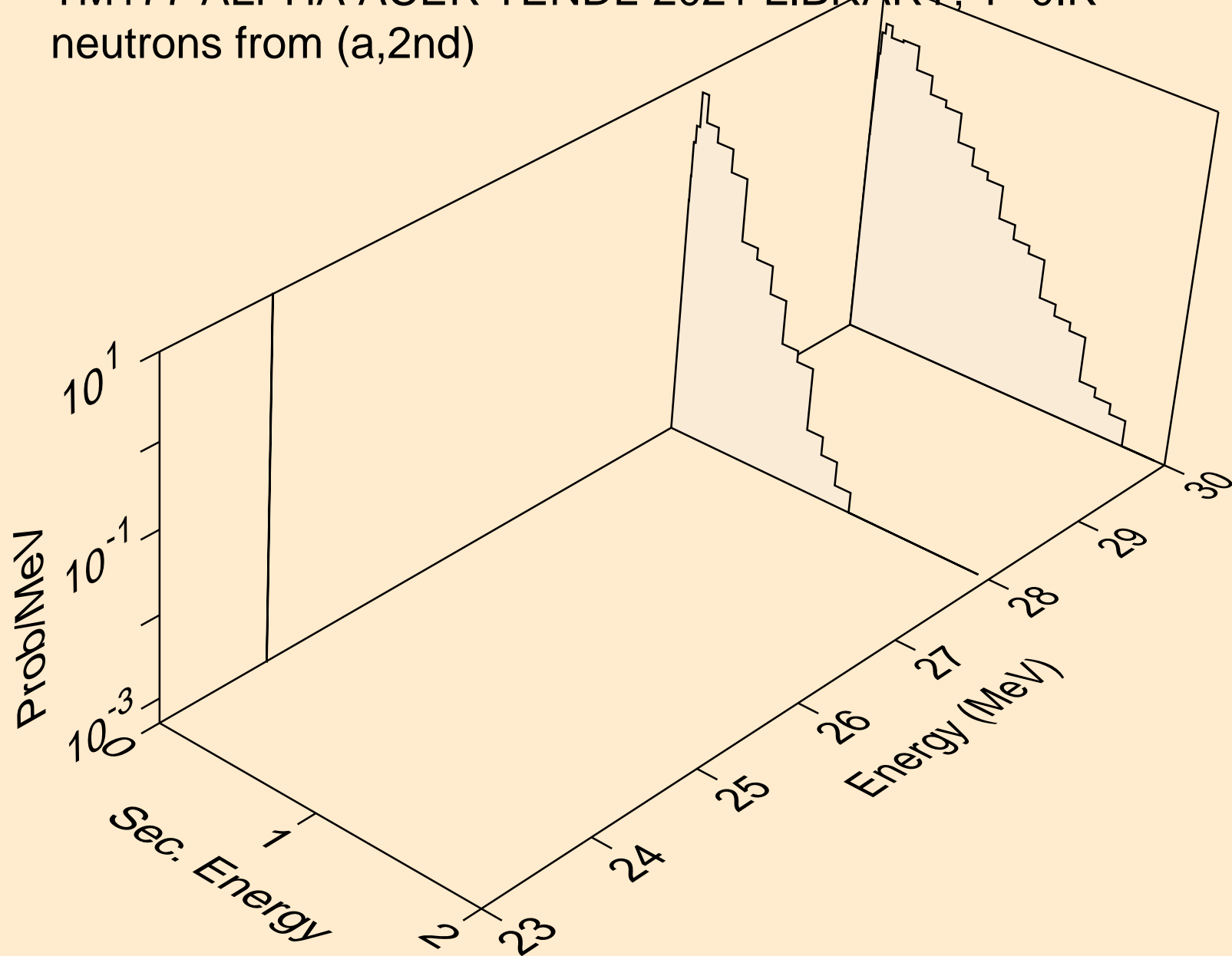

TM177 ALPHA ACER TENDL-2021 LIBRARY; T=0.K
neutrons from (a,2n)

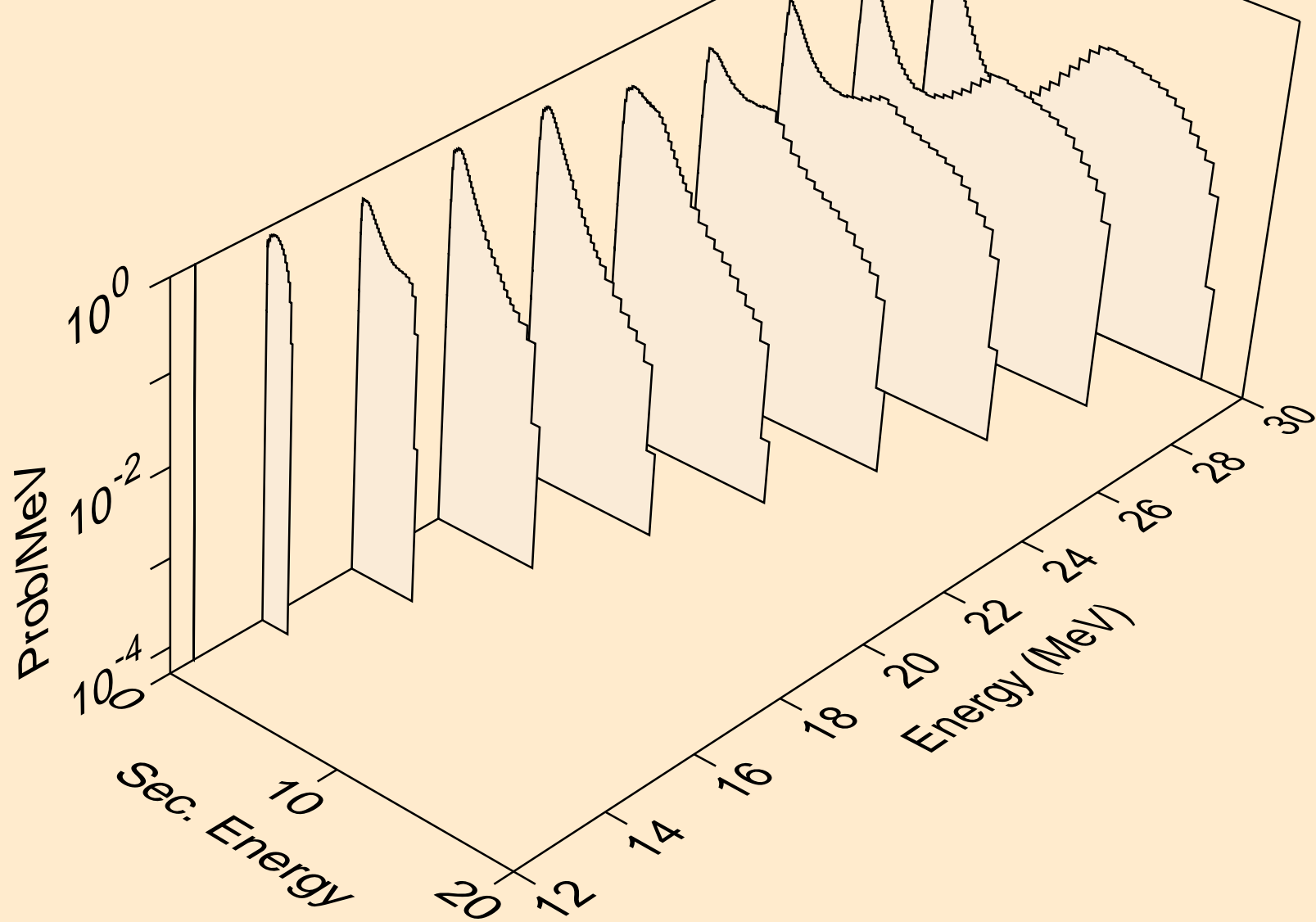

TM177 ALPHA ACER TENDL-2021 LIBRARY; T=0.K
neutrons from (a,3n)

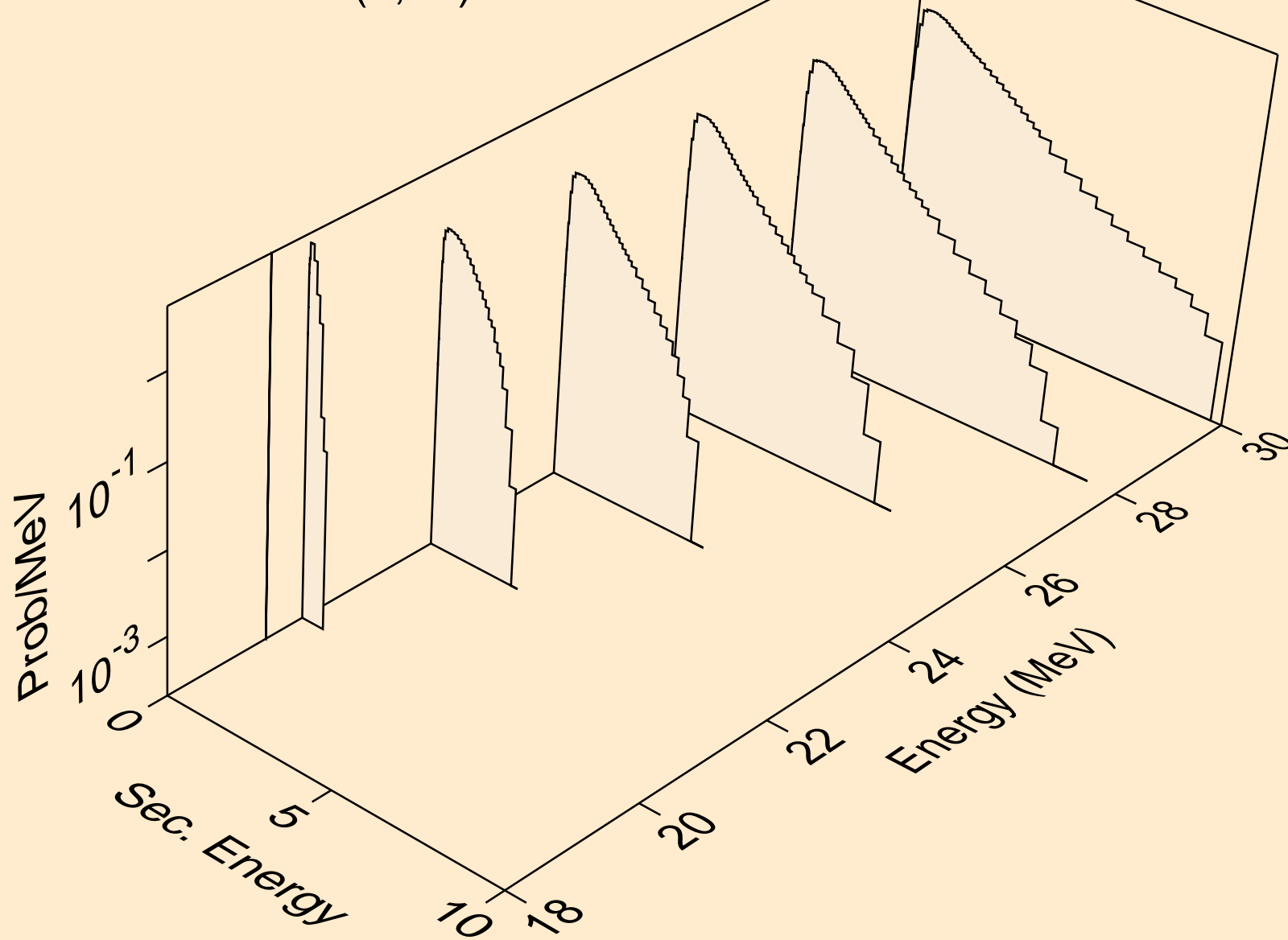

TM177 ALPHA ACER TENDL-2021 LIBRARY; T=0.K
neutrons from (a,n*)a

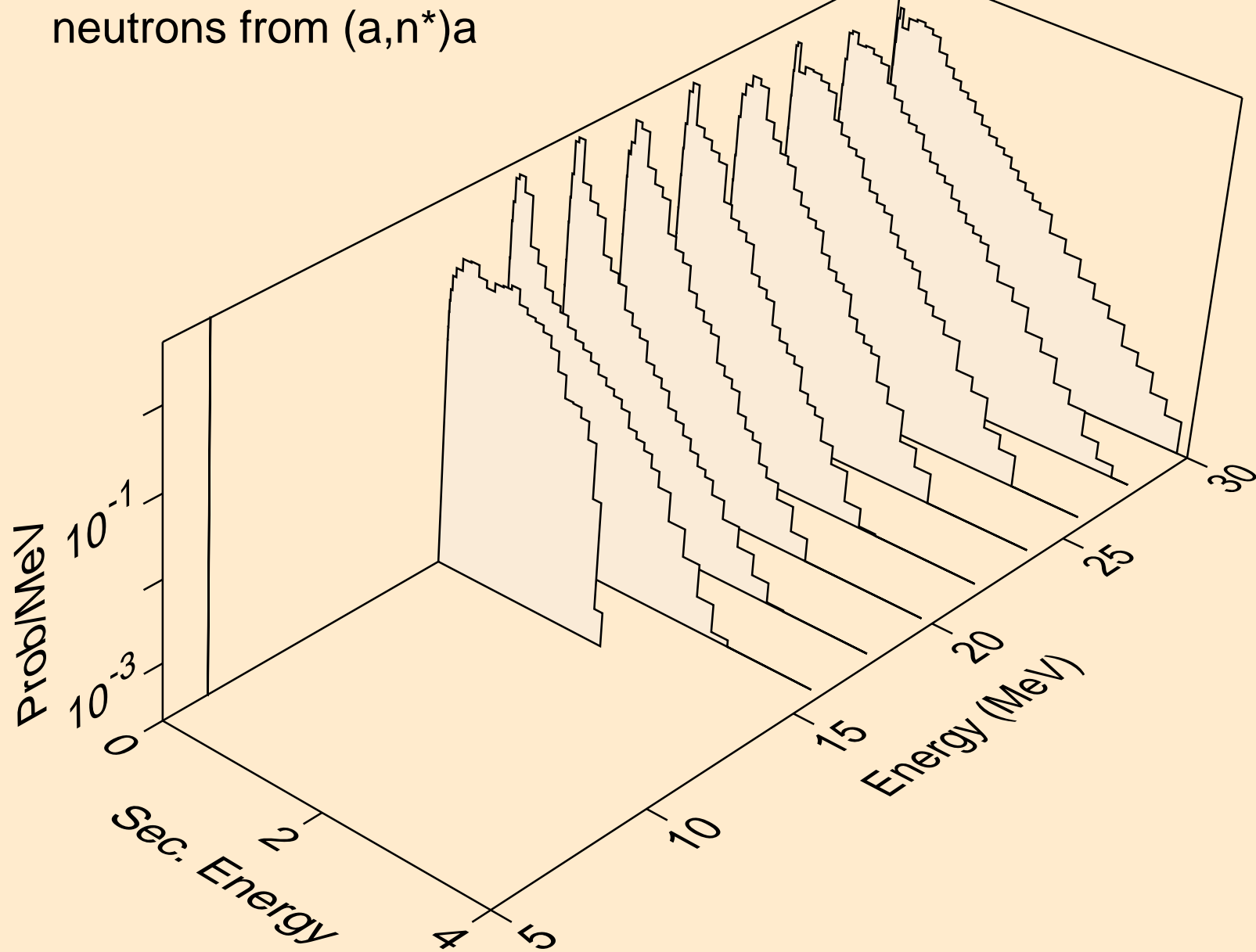

TM177 ALPHA ACER TENDL-2021 LIBRARY; T=0.K
neutrons from (a,2n)a

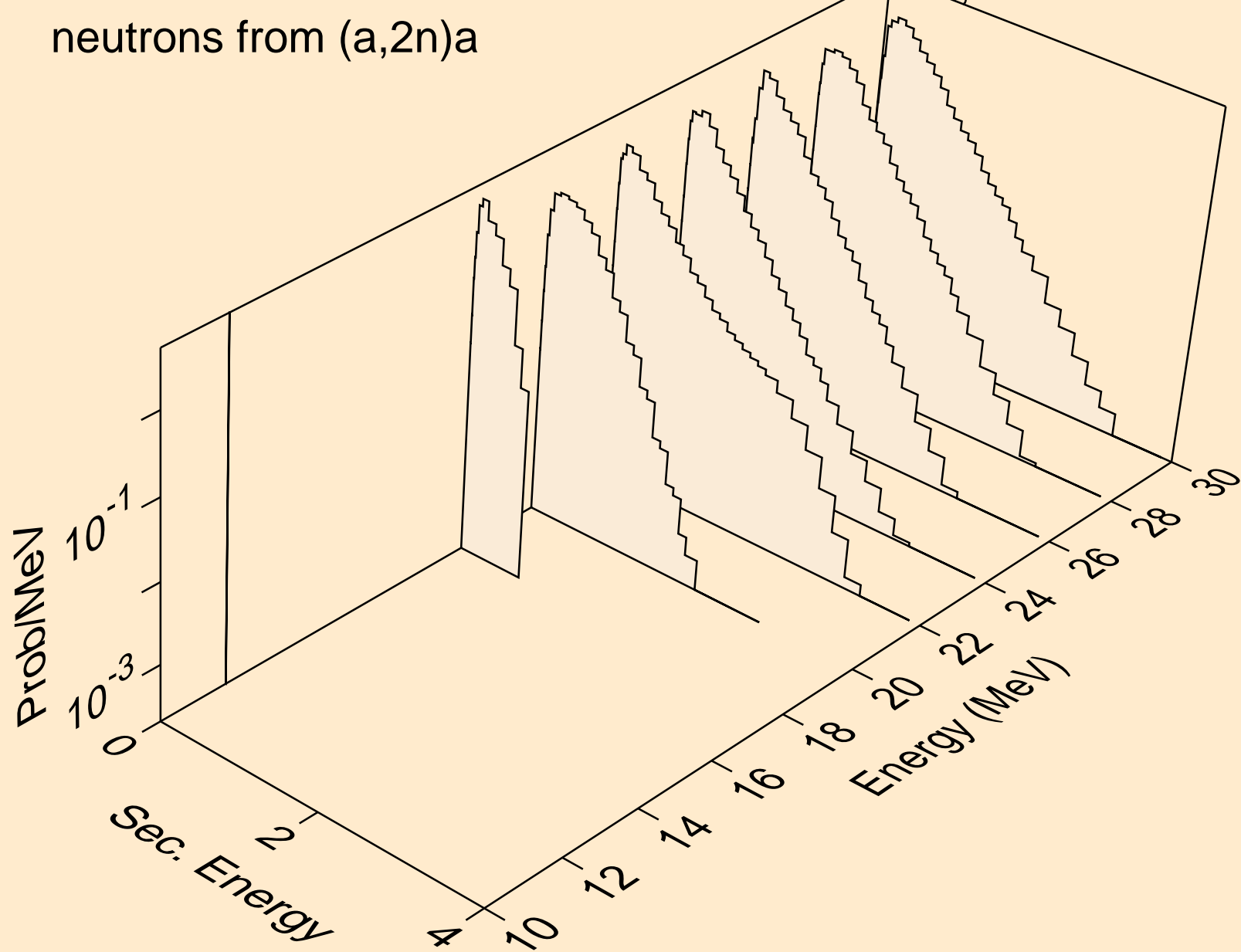

TM177 ALPHA ACER TENDL-2021 LIBRARY; T=0.K
neutrons from (a,3n)a

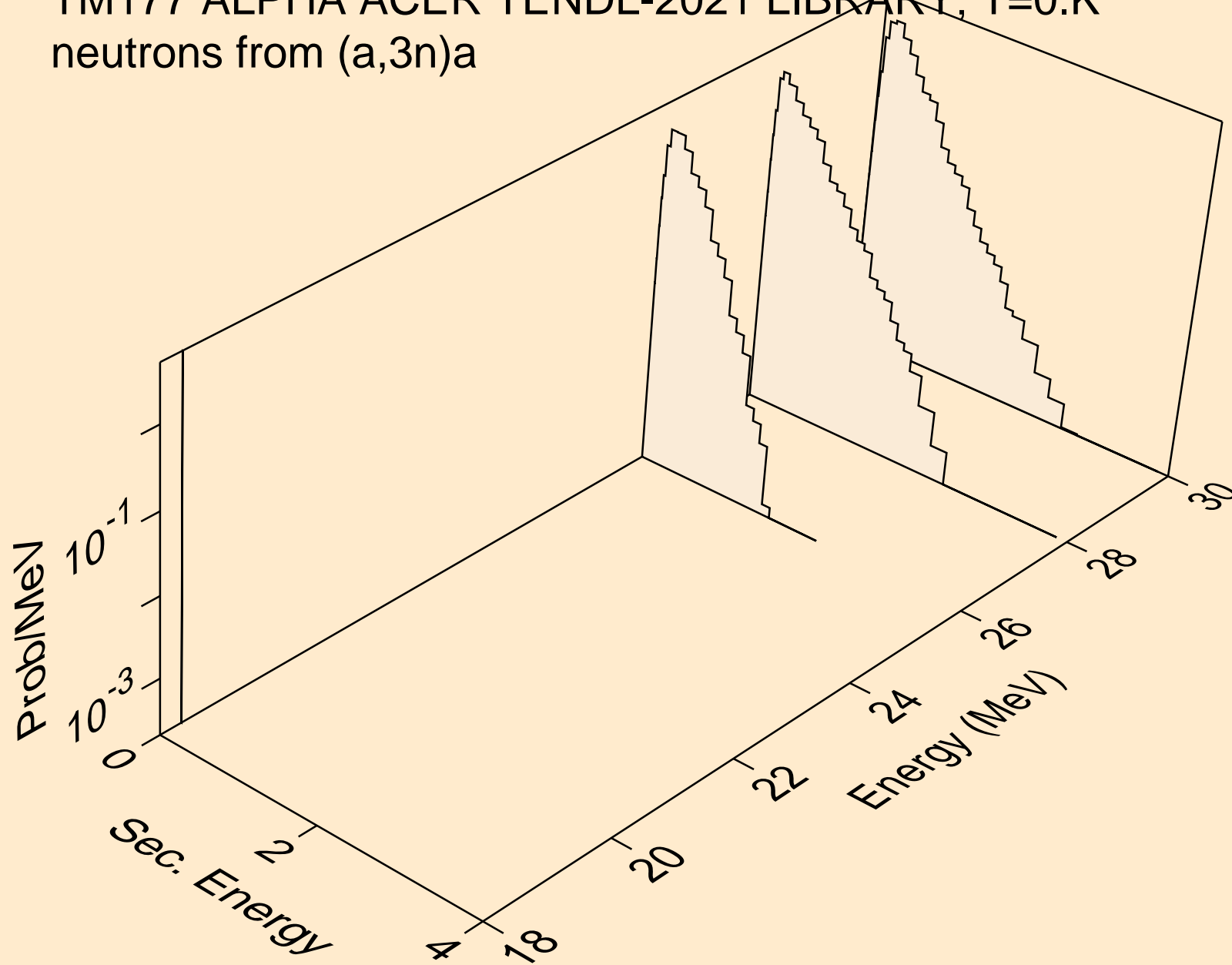

TM177 ALPHA ACER TENDL-2021 LIBRARY; T=0.K
neutrons from (a,n*)p

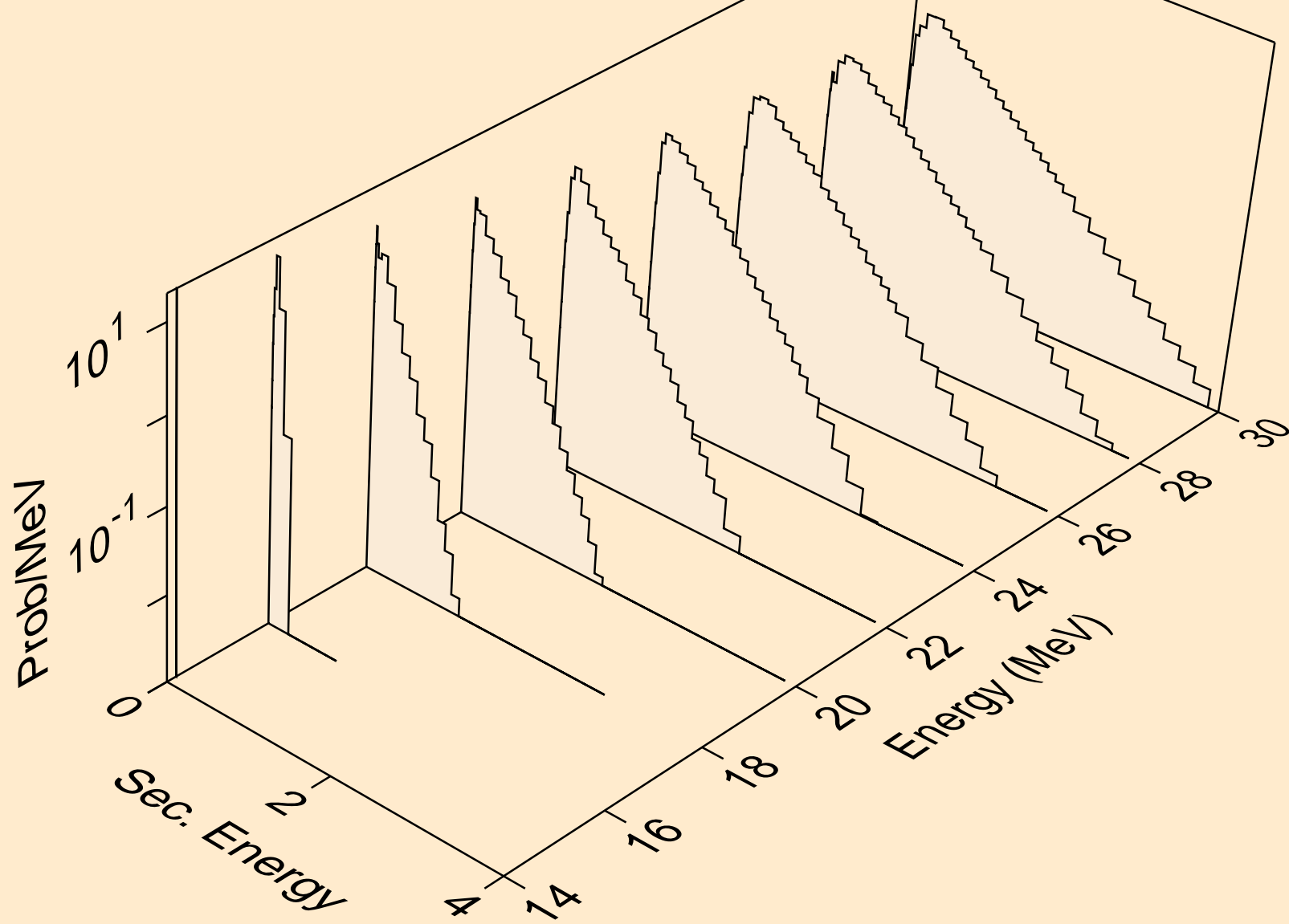

TM177 ALPHA ACER TENDL-2021 LIBRARY; T=0.K
neutrons from (a,n*)d

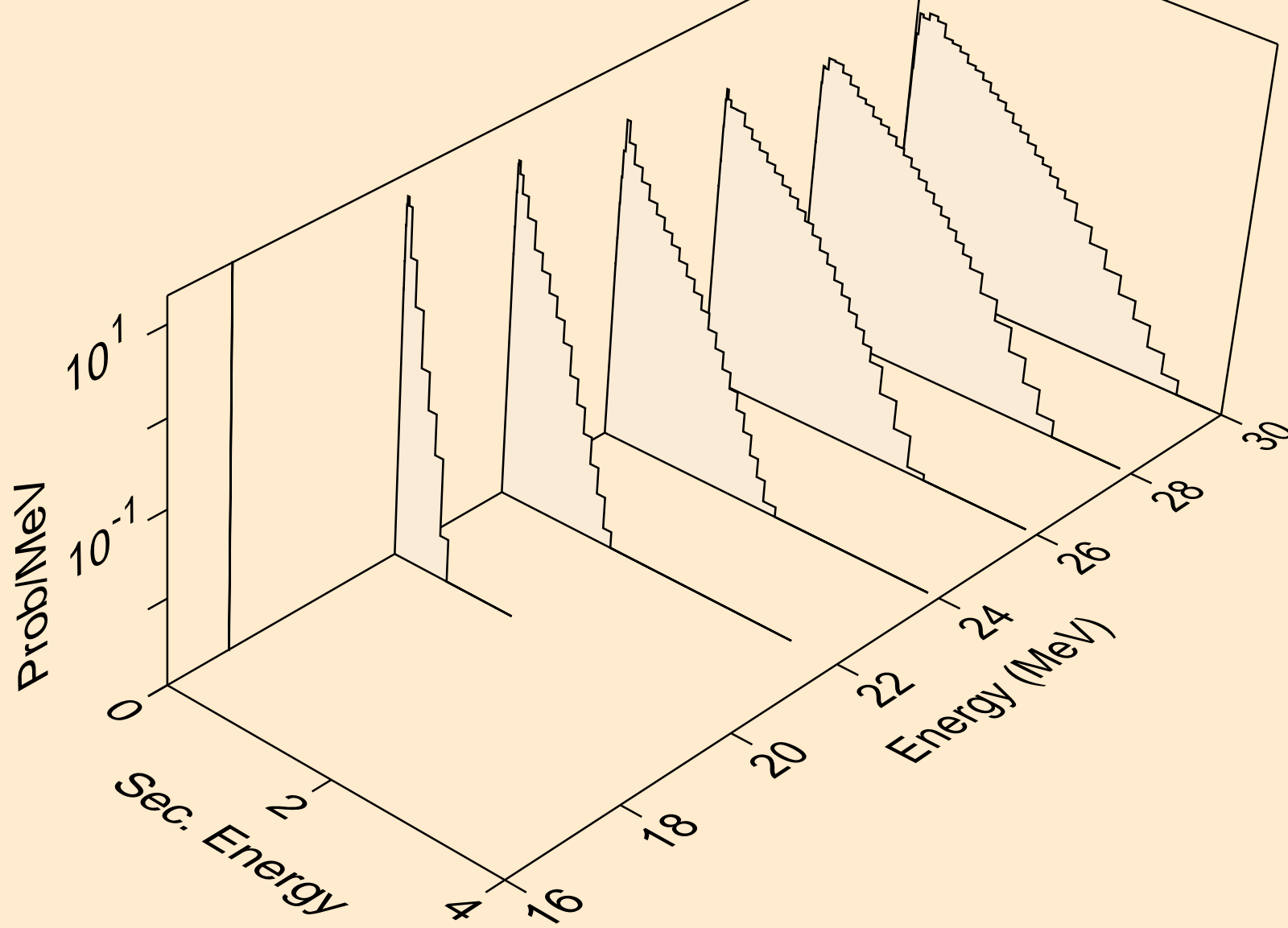

TM177 ALPHA ACER TENDL-2021 LIBRARY; T=0.K
neutrons from (a,n*)t

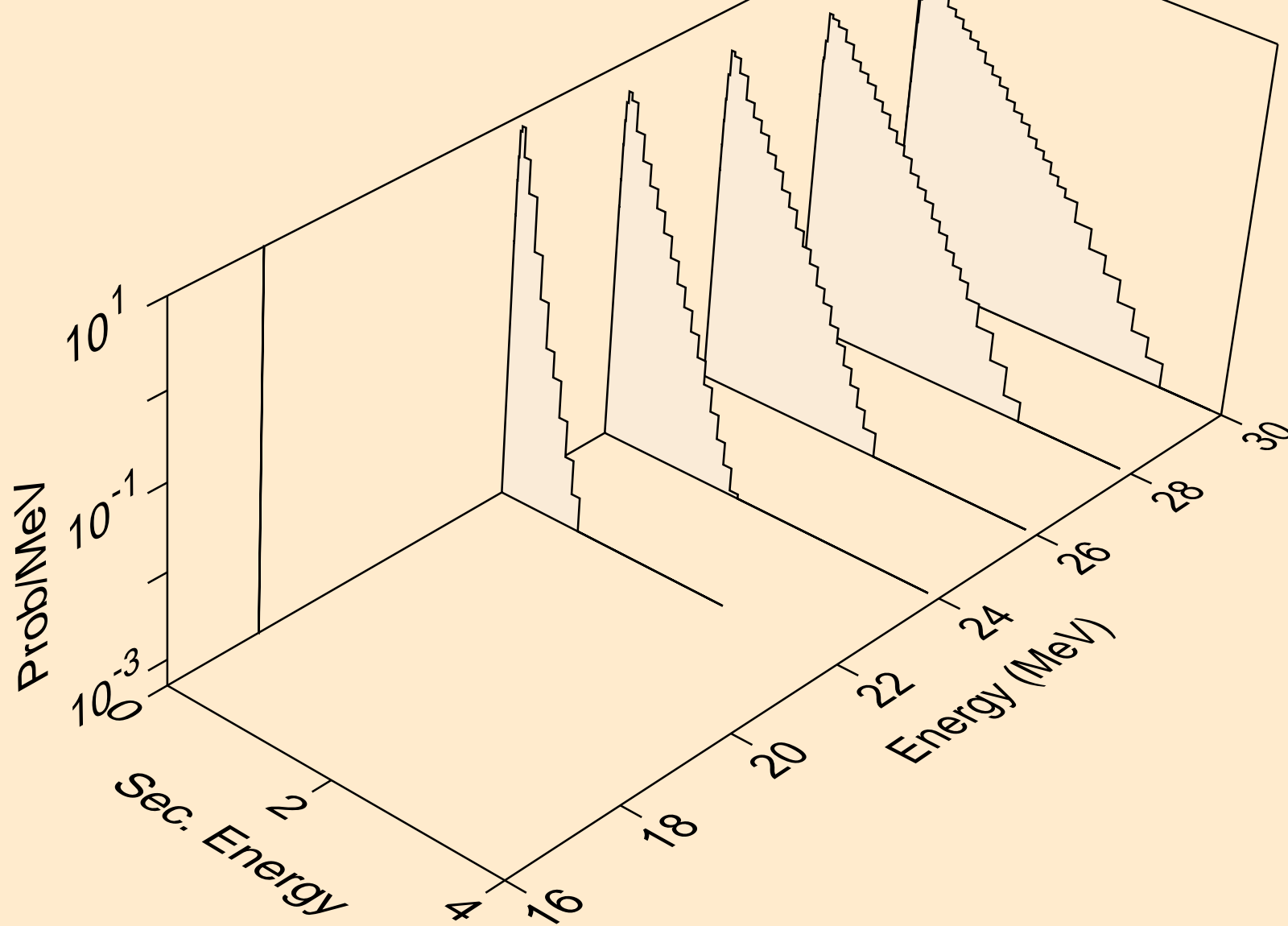

TM177 ALPHA ACER TENDL-2021 LIBRARY; T=0.K
neutrons from (a,4n)

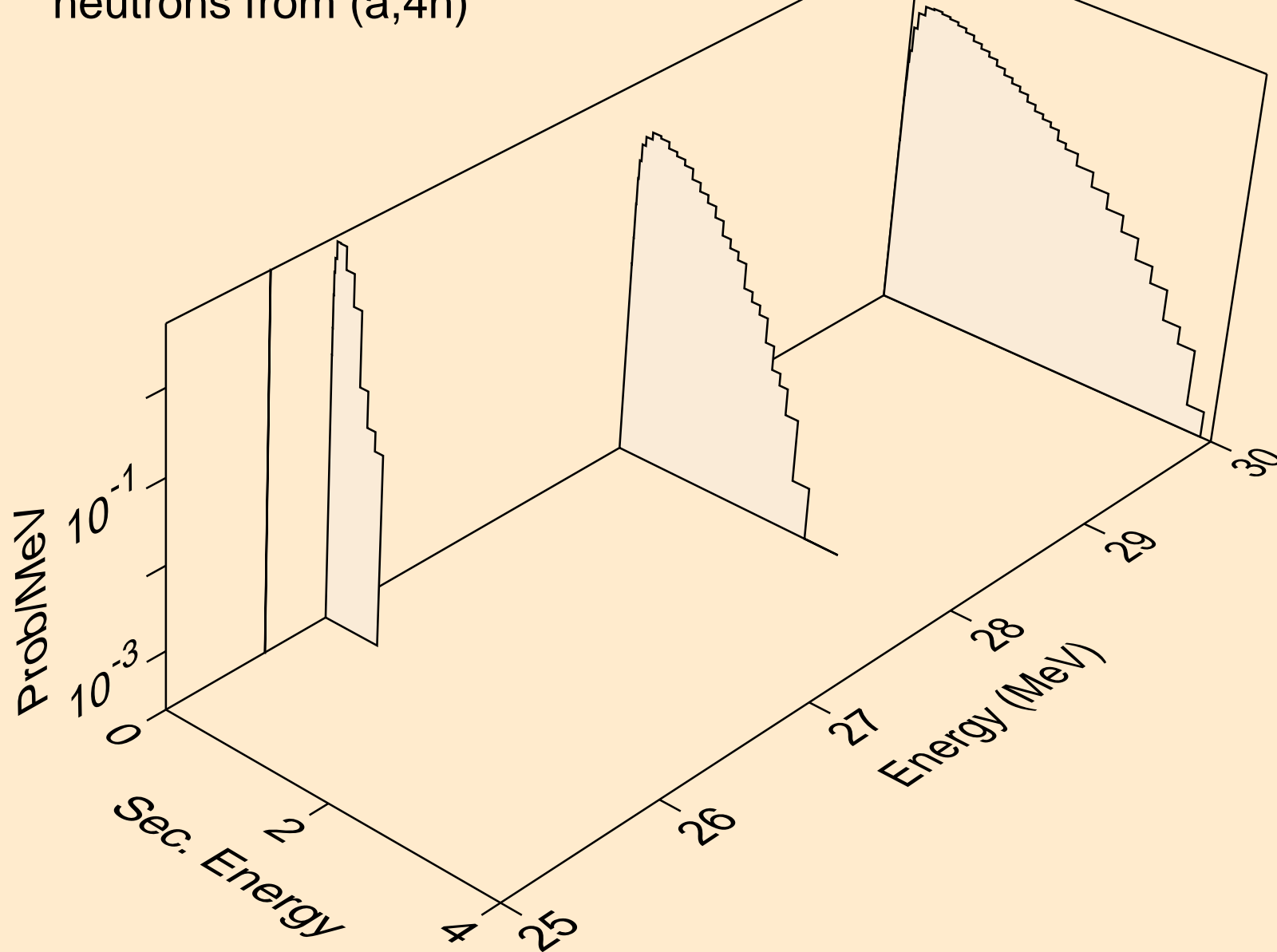

TM177 ALPHA ACER TENDL-2021 LIBRARY; T=0.K
neutrons from (a,2np)

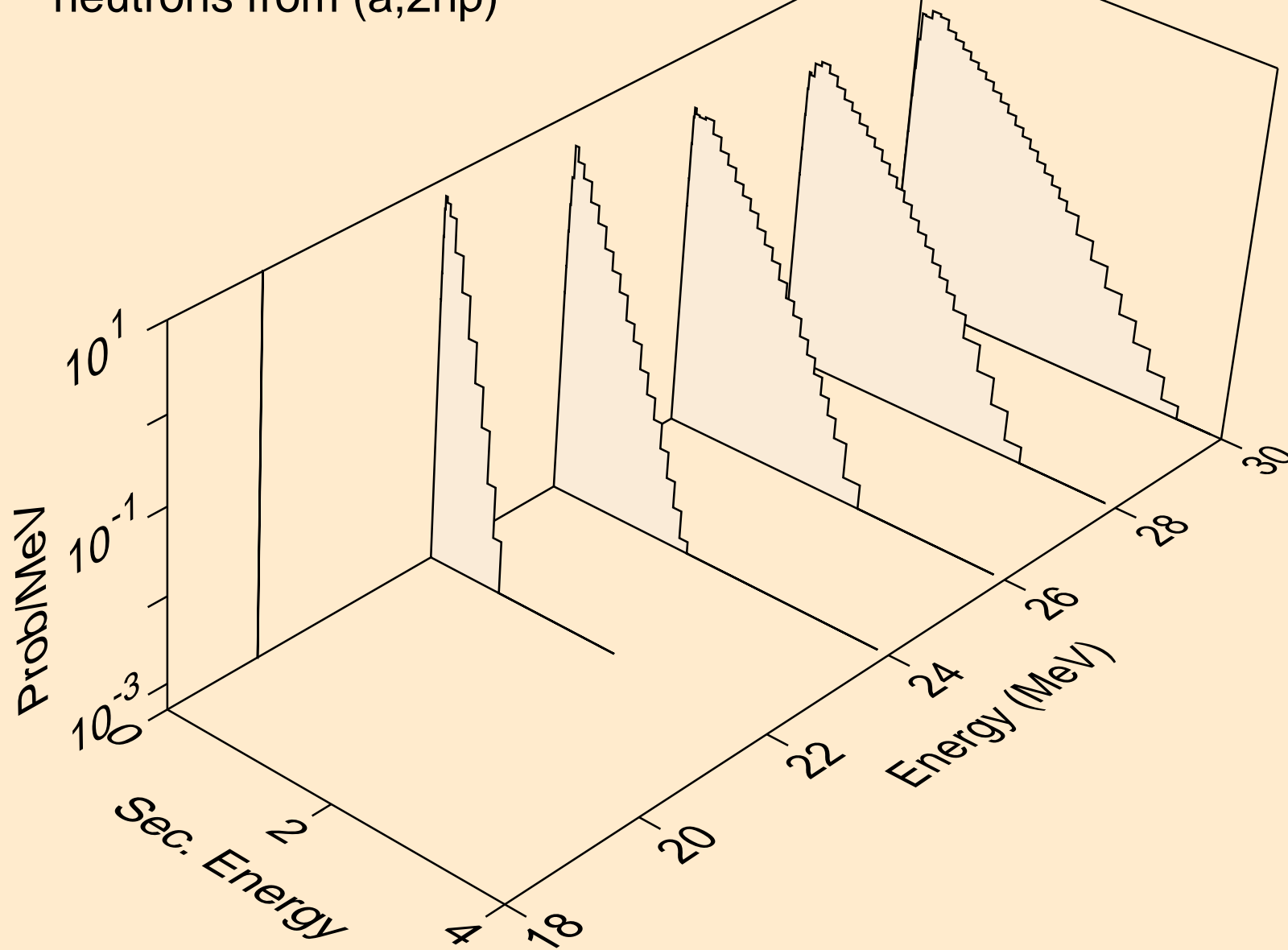

TM177 ALPHA ACER TENDL-2021 LIBRARY; T=0.K
protons from (a,x)

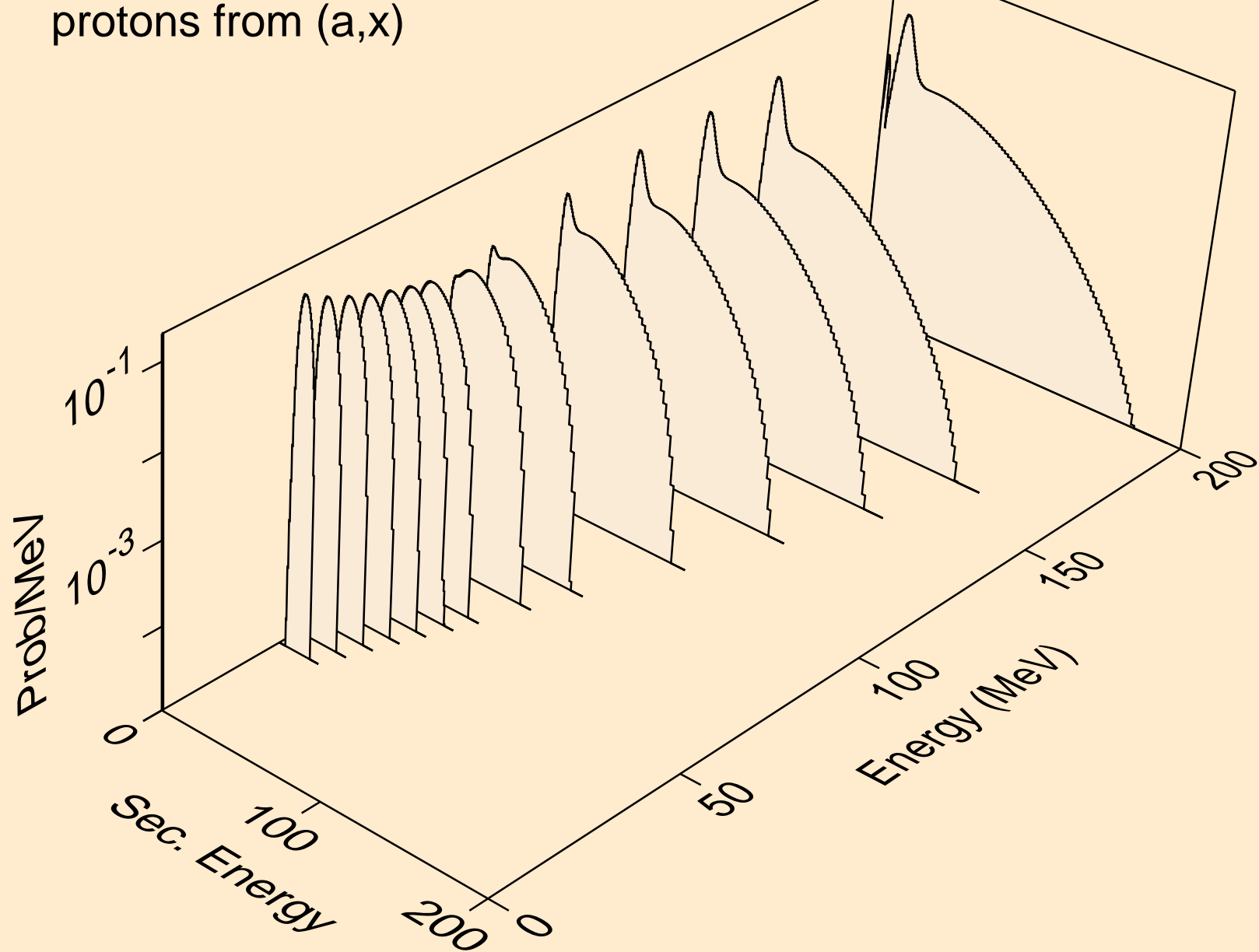

TM177 ALPHA ACER TENDL-2021 LIBRARY; T=0.K
protons from (a,n*)p

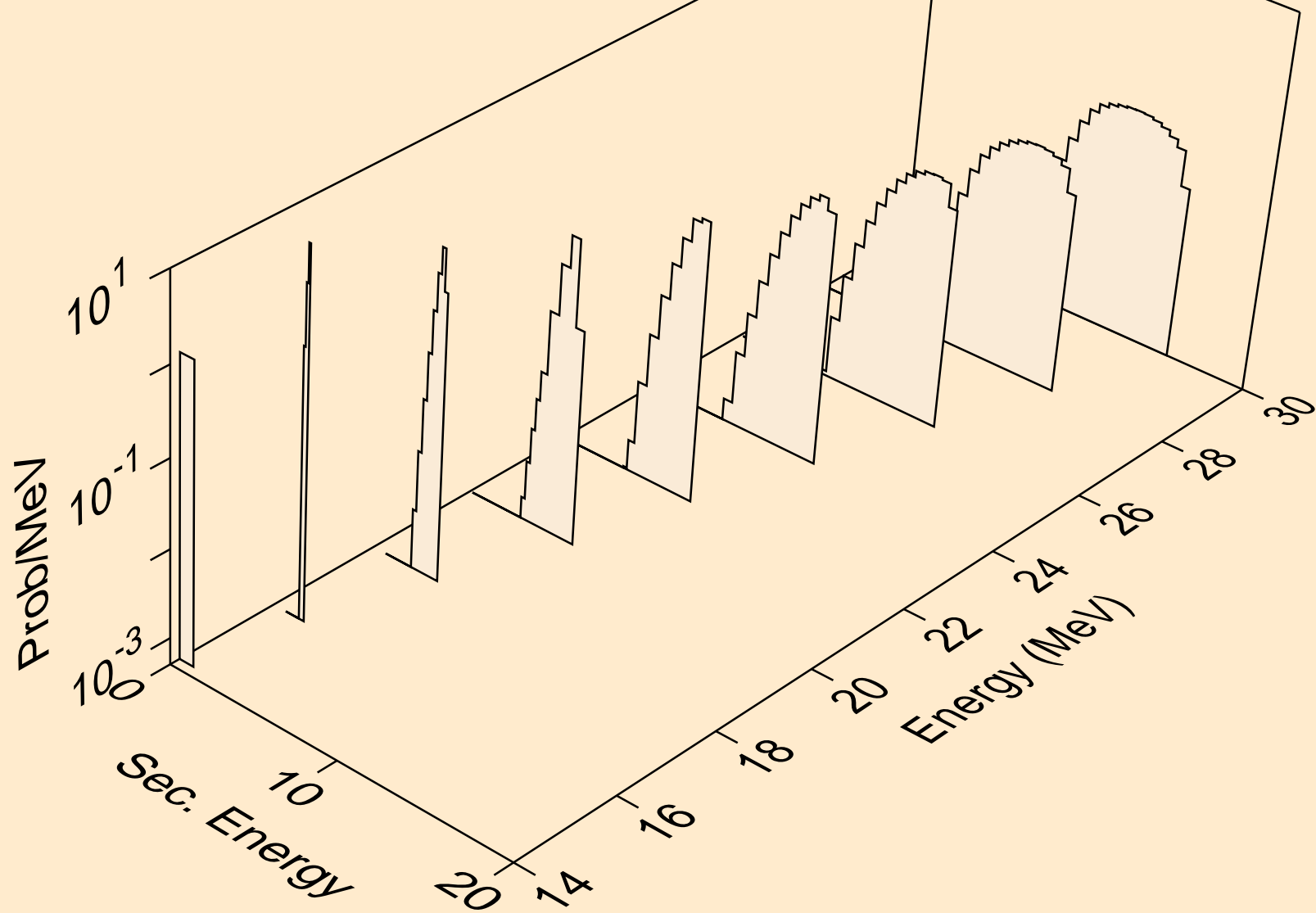

TM177 ALPHA ACER TENDL-2021 LIBRARY; T=0.K
protons from (a,2np)

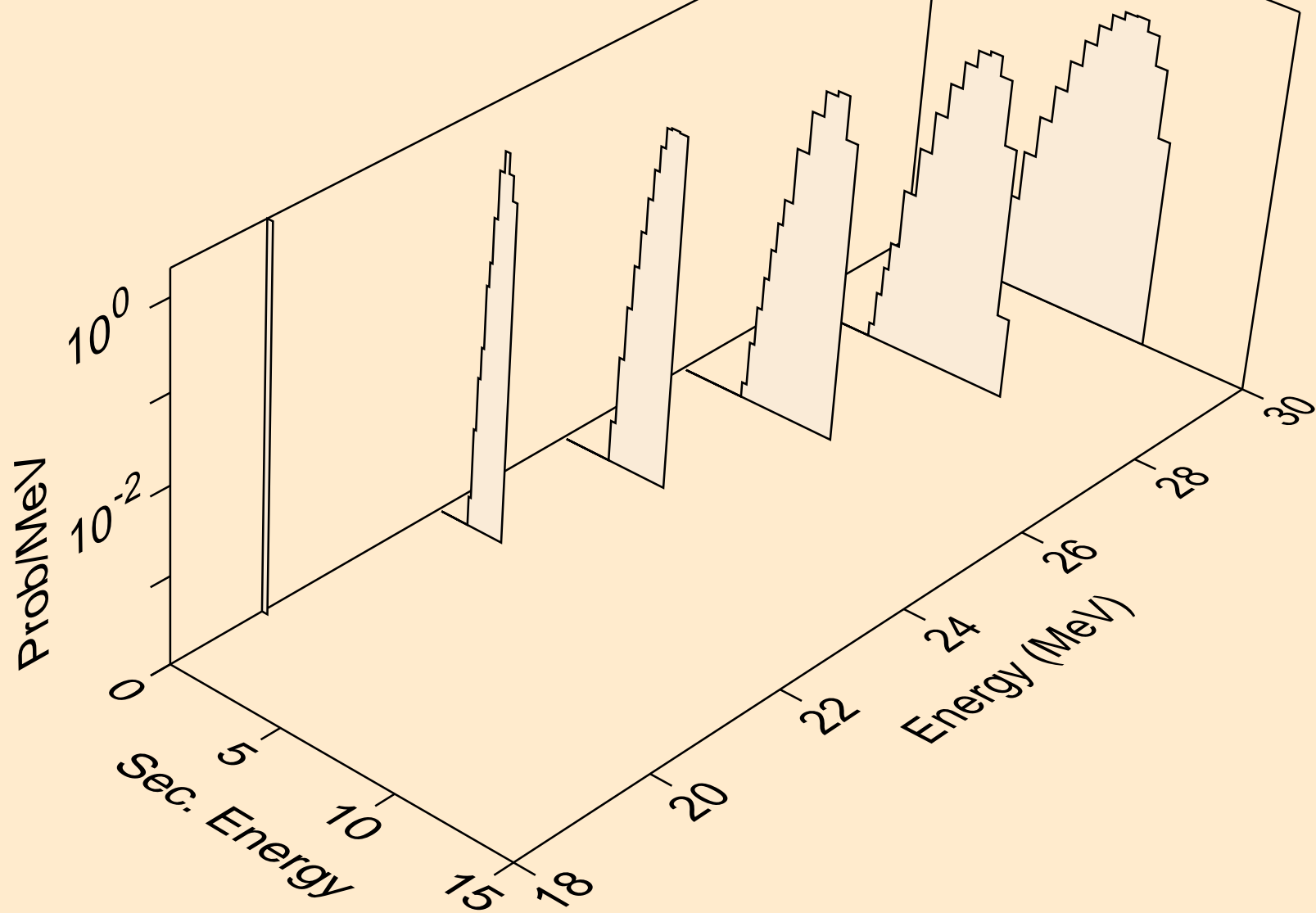

TM177 ALPHA ACER TENDL-2021 LIBRARY; T=0.K
protons from (a,p)

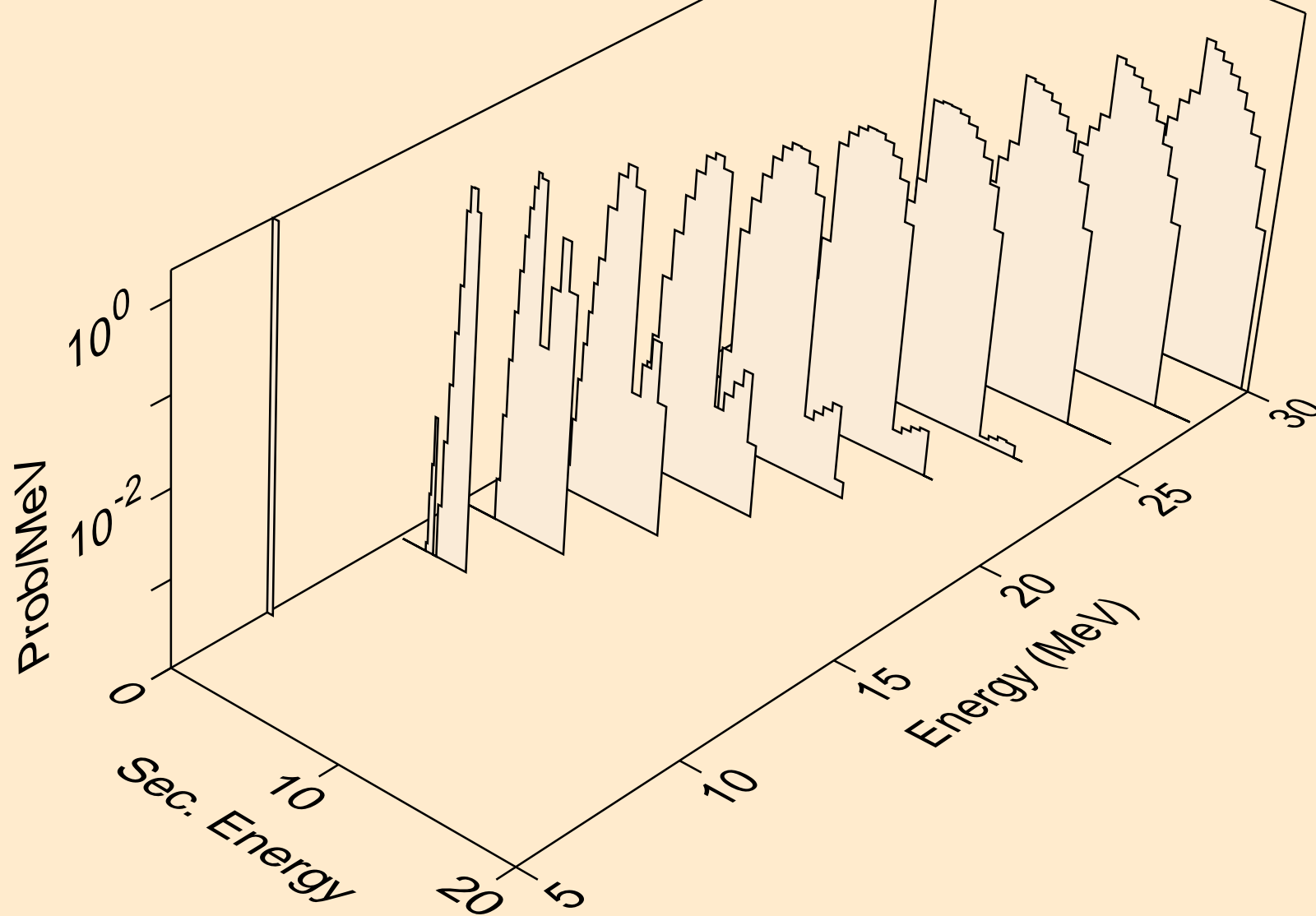

TM177 ALPHA ACER TENDL-2021 LIBRARY; T=0.K
deuterons from (a,x)

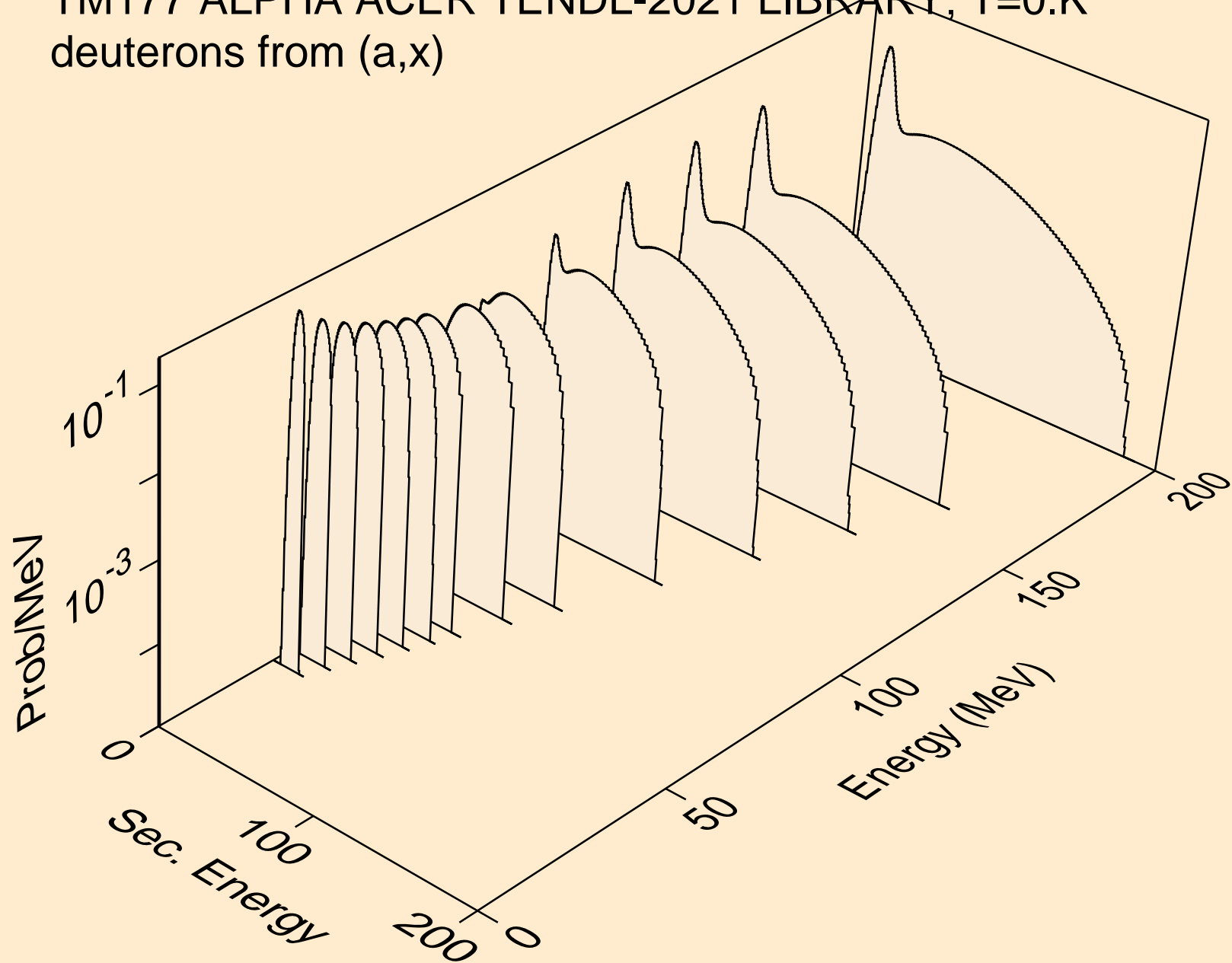

TM177 ALPHA ACER TENDL-2021 LIBRARY; T=0.K
deuterons from (a,2nd)

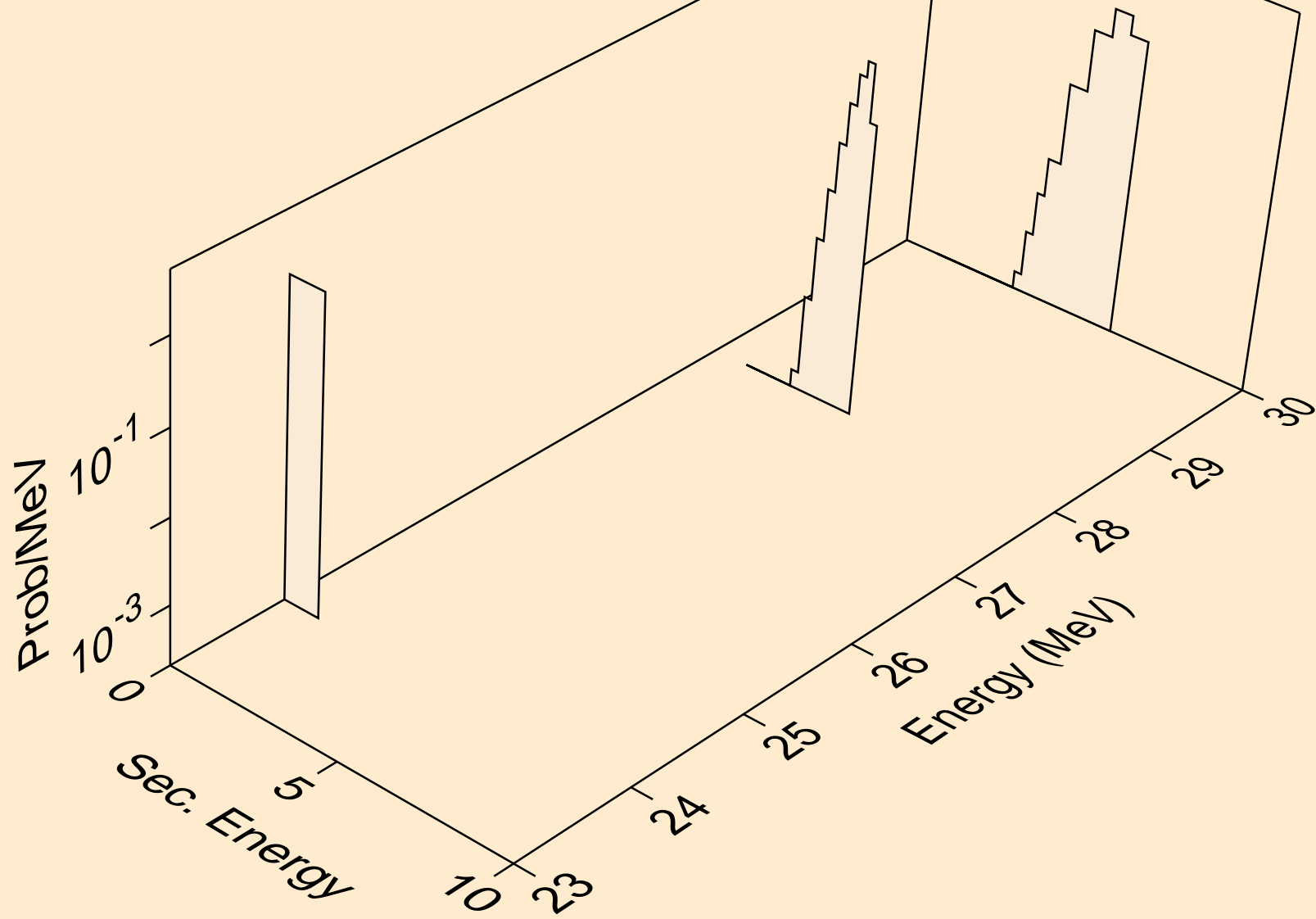

TM177 ALPHA ACER TENDL-2021 LIBRARY; T=0.K
deuterons from (a,n*)d

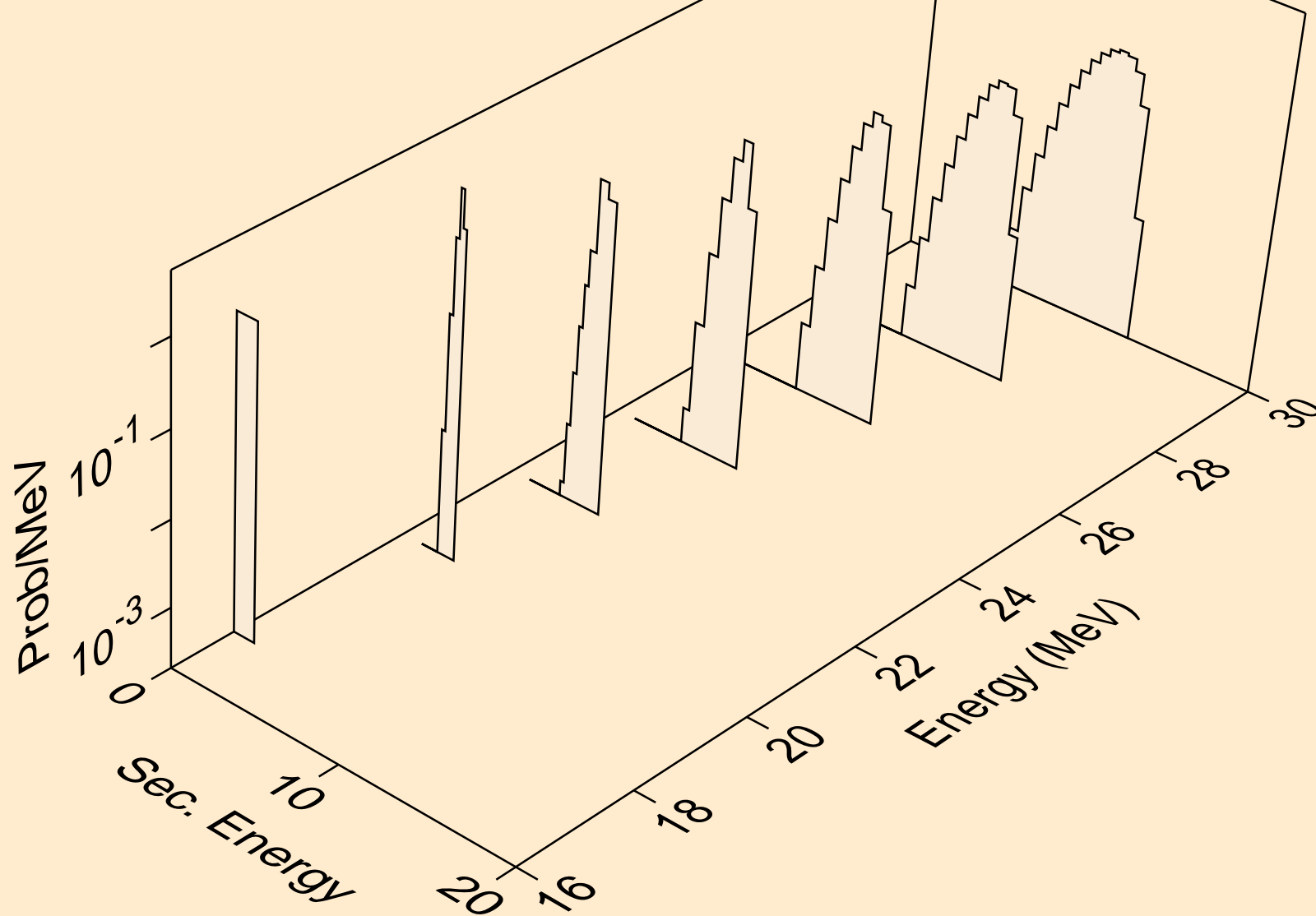

TM177 ALPHA ACER TENDL-2021 LIBRARY; T=0.K
deuterons from (a,d)

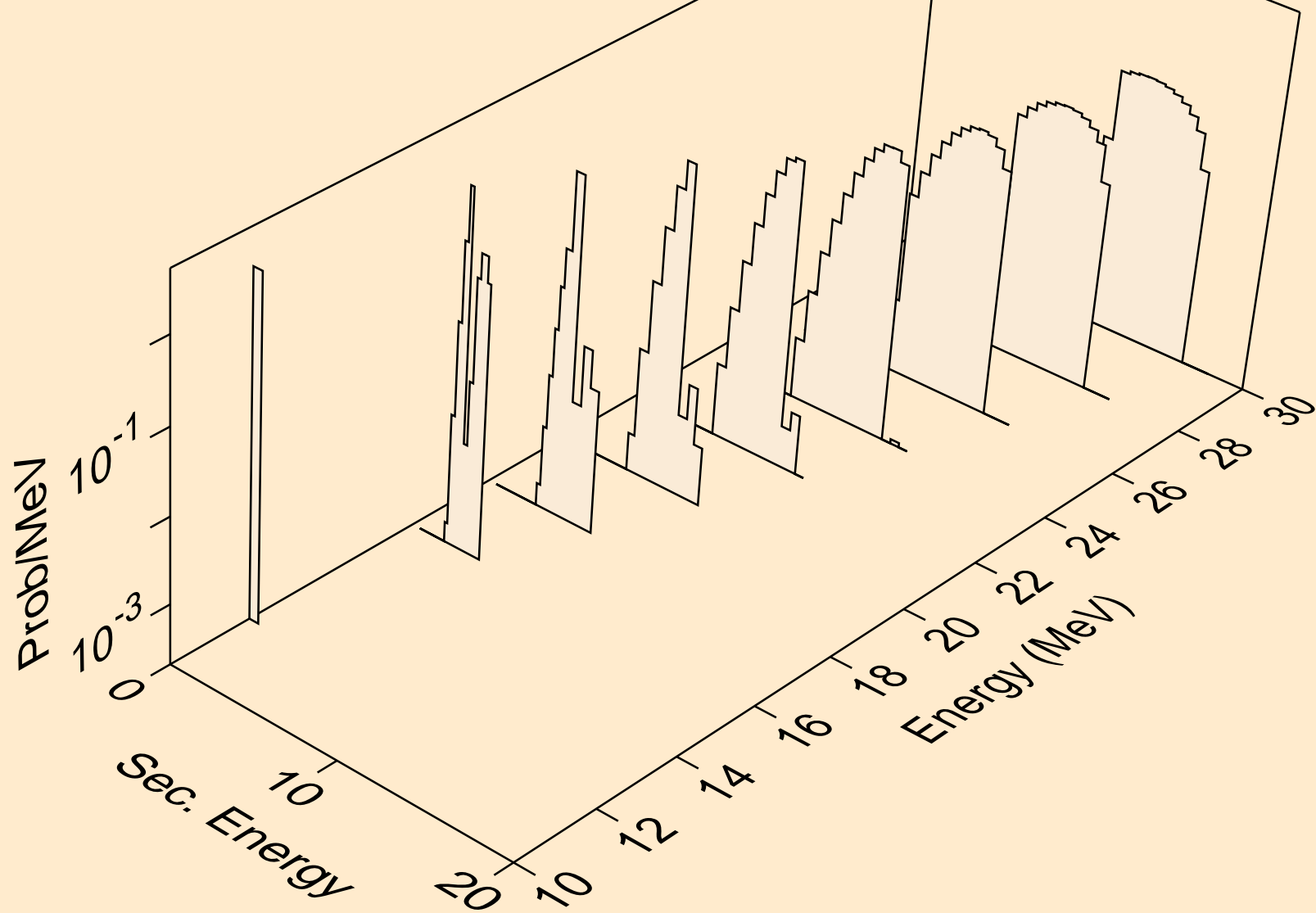

TM177 ALPHA ACER TENDL-2021 LIBRARY; T=0.K
tritons from (a,x)

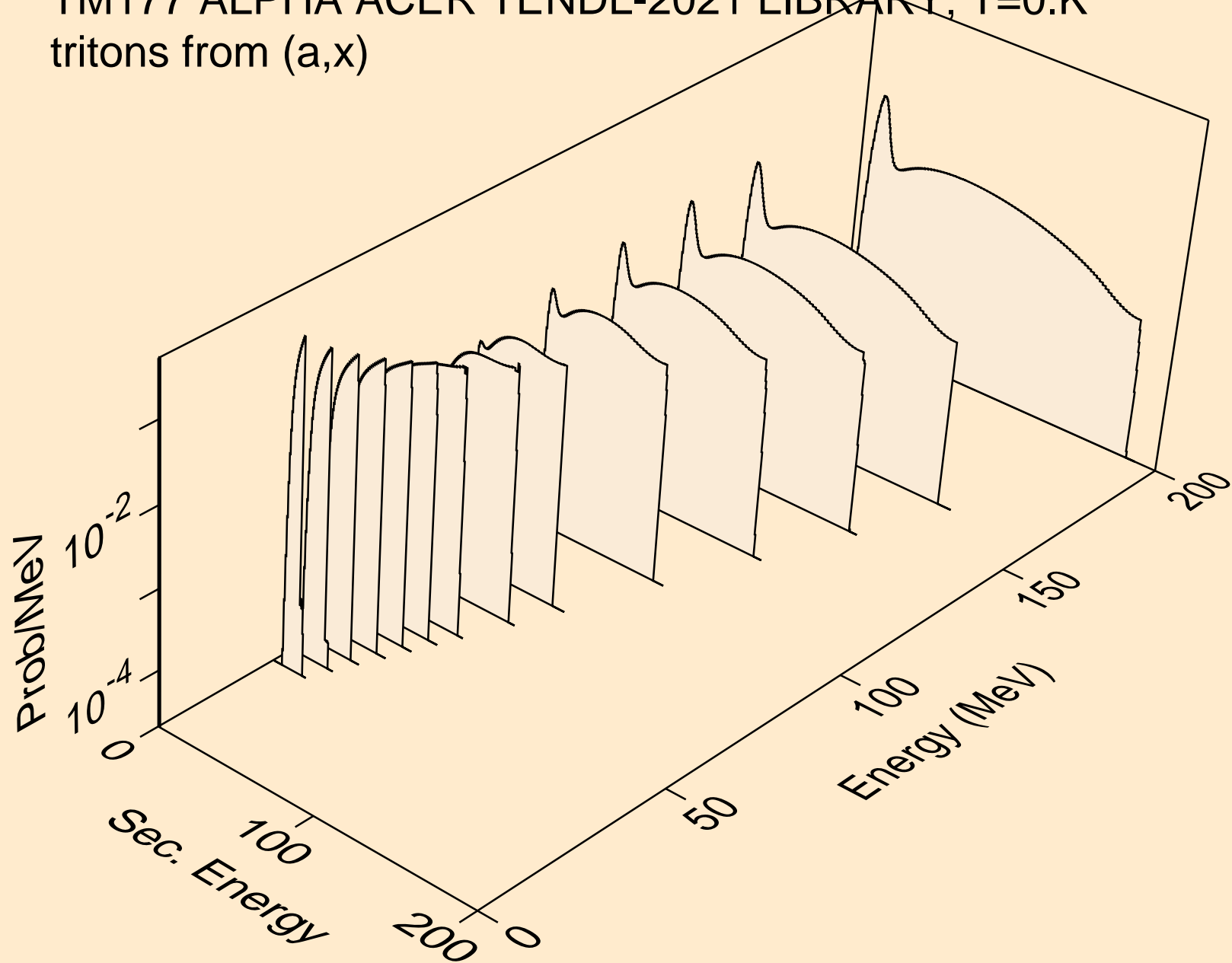

TM177 ALPHA ACER TENDL-2021 LIBRARY; T=0.K
tritons from (a,n*)t

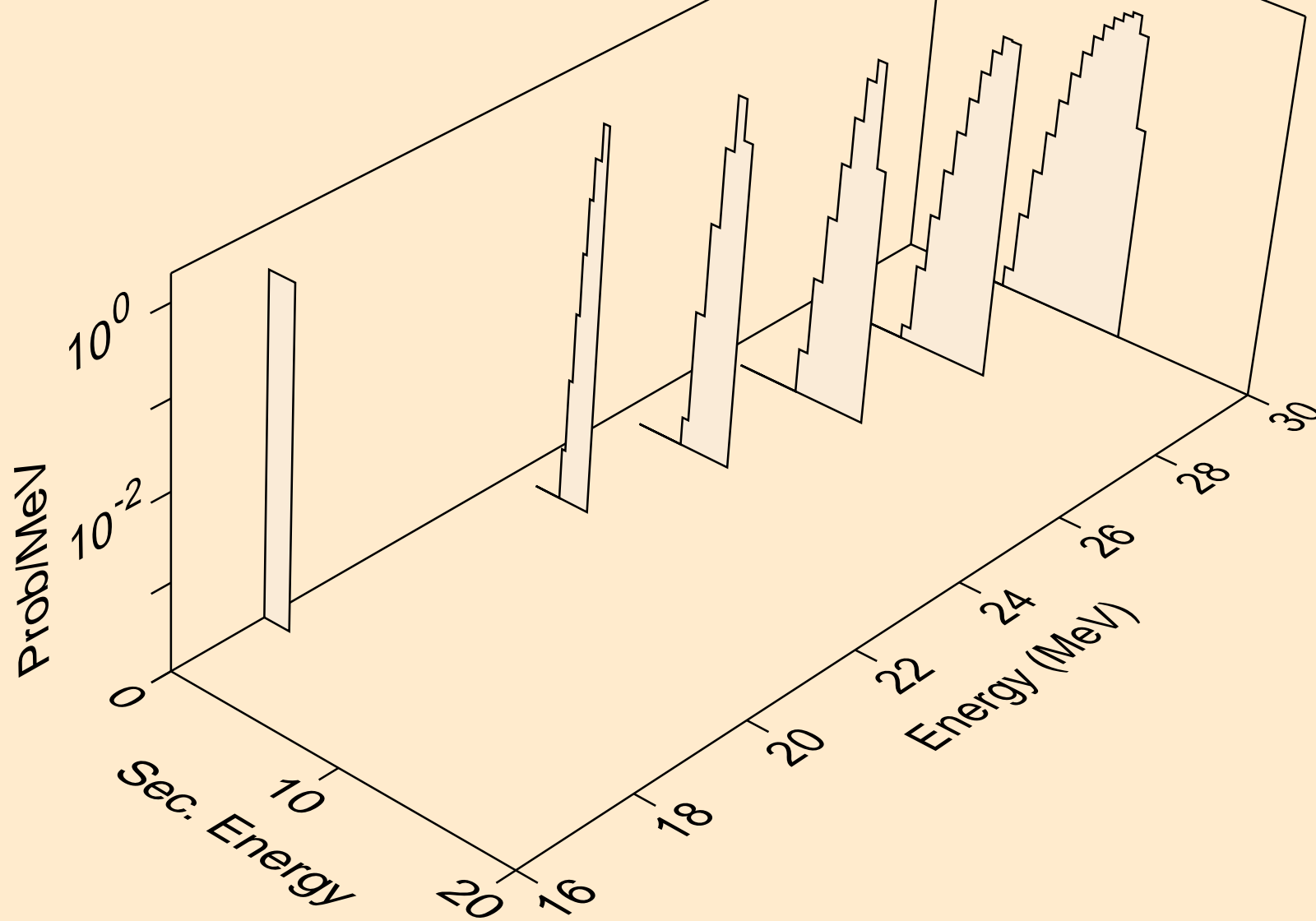

TM177 ALPHA ACER TENDL-2021 LIBRARY; T=0.K
tritons from (a,t)

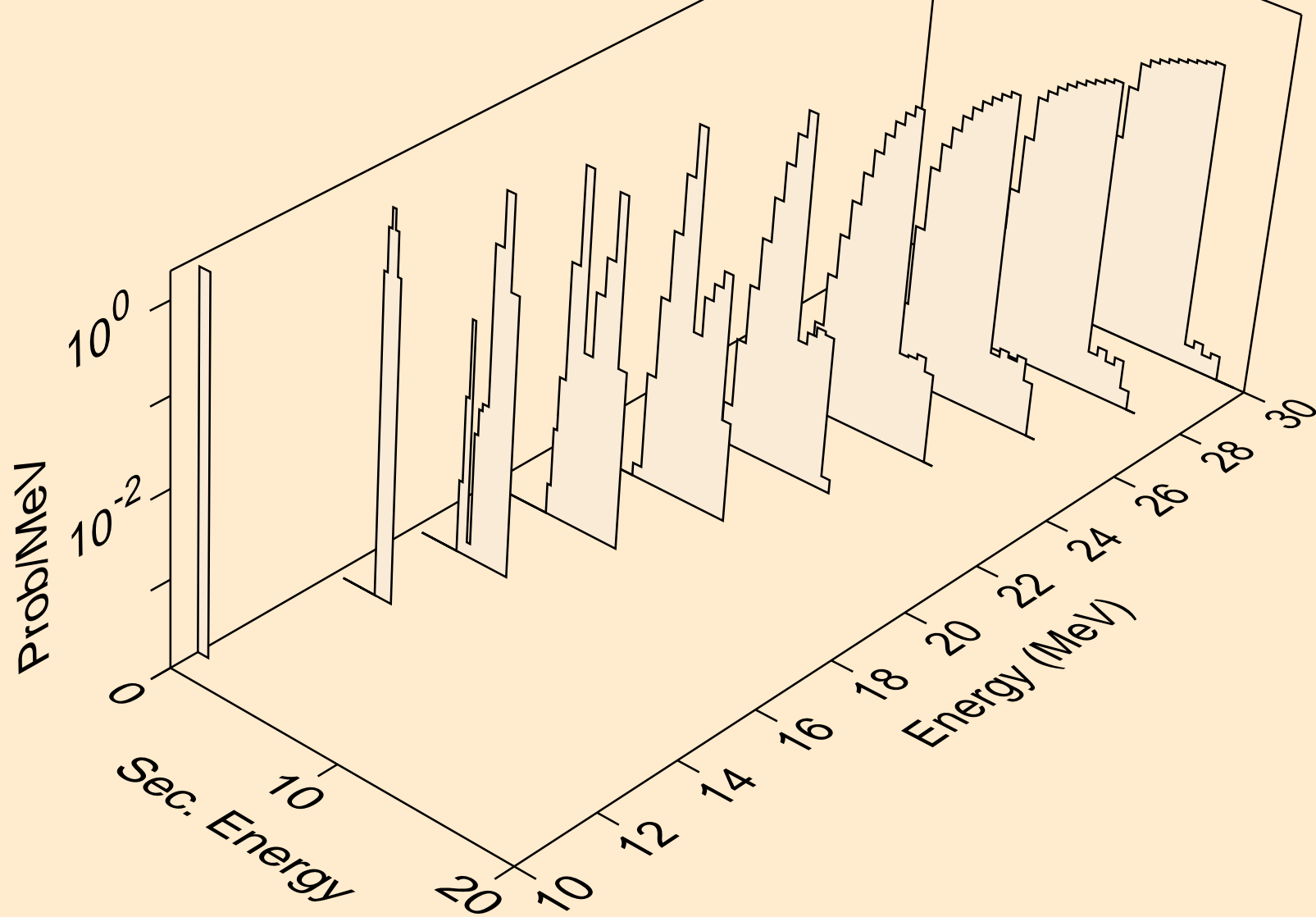

TM177 ALPHA ACER TENDL-2021 LIBRARY; T=0.K
he3s from (a,x)

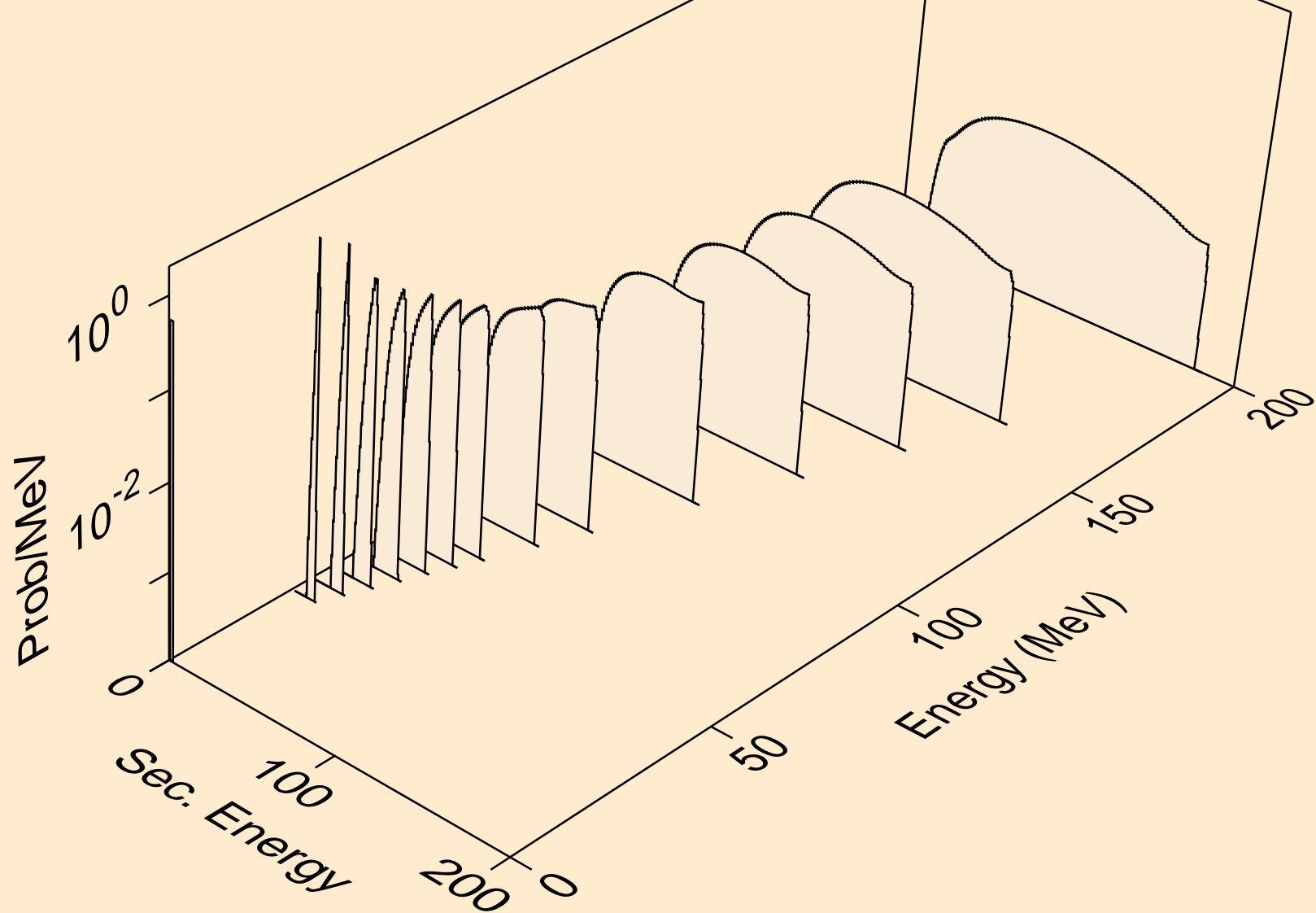

TM177 ALPHA ACER TENDL-2021 LIBRARY; T=0.K
he3s from (a,he3)

