

W193 ALPHA ACER TENDL-2021 LIBRARY; T=0.K  
Principal cross sections

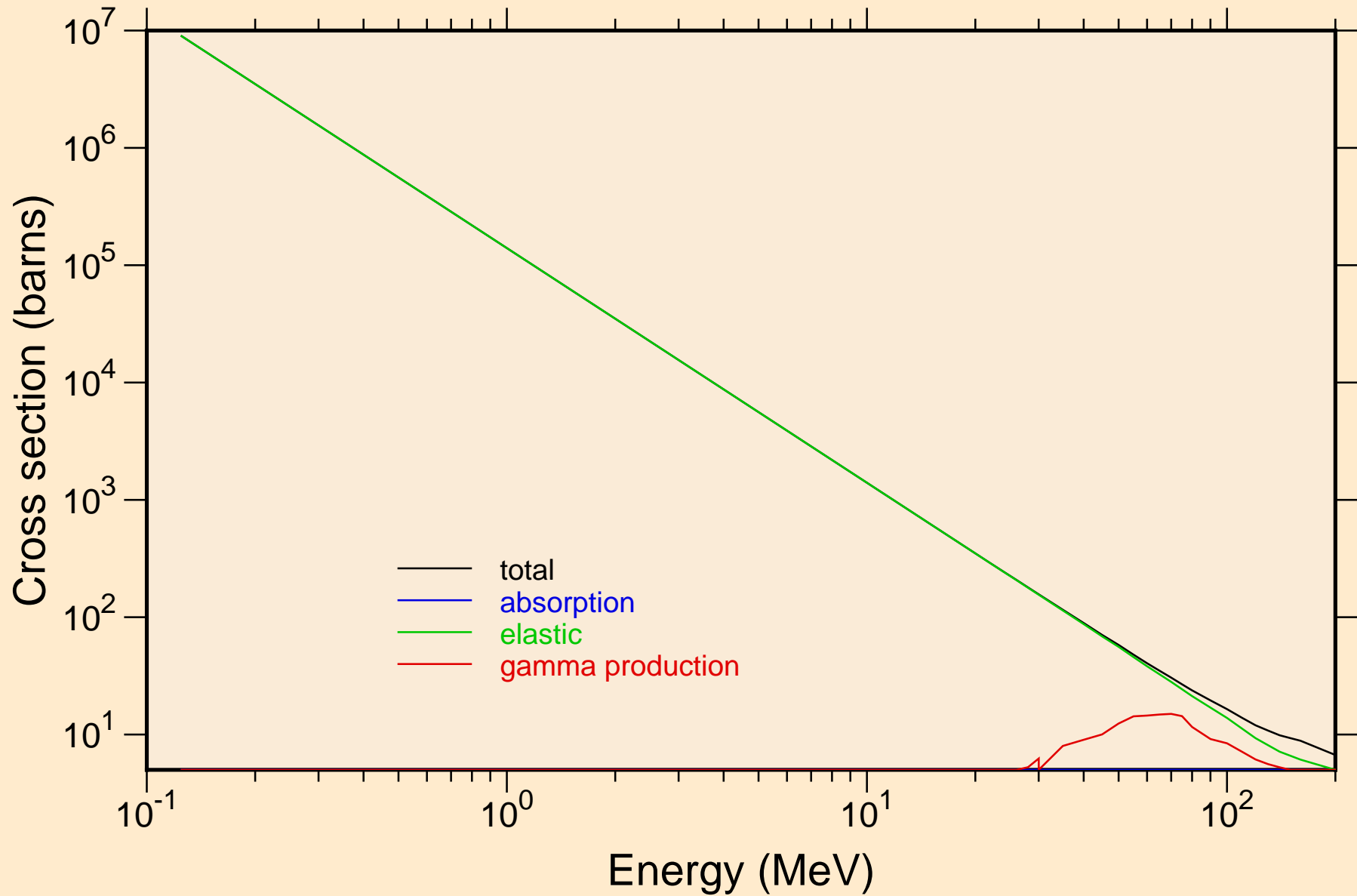

W193 ALPHA ACER TENDL-2021 LIBRARY; T=0.K  
Heating

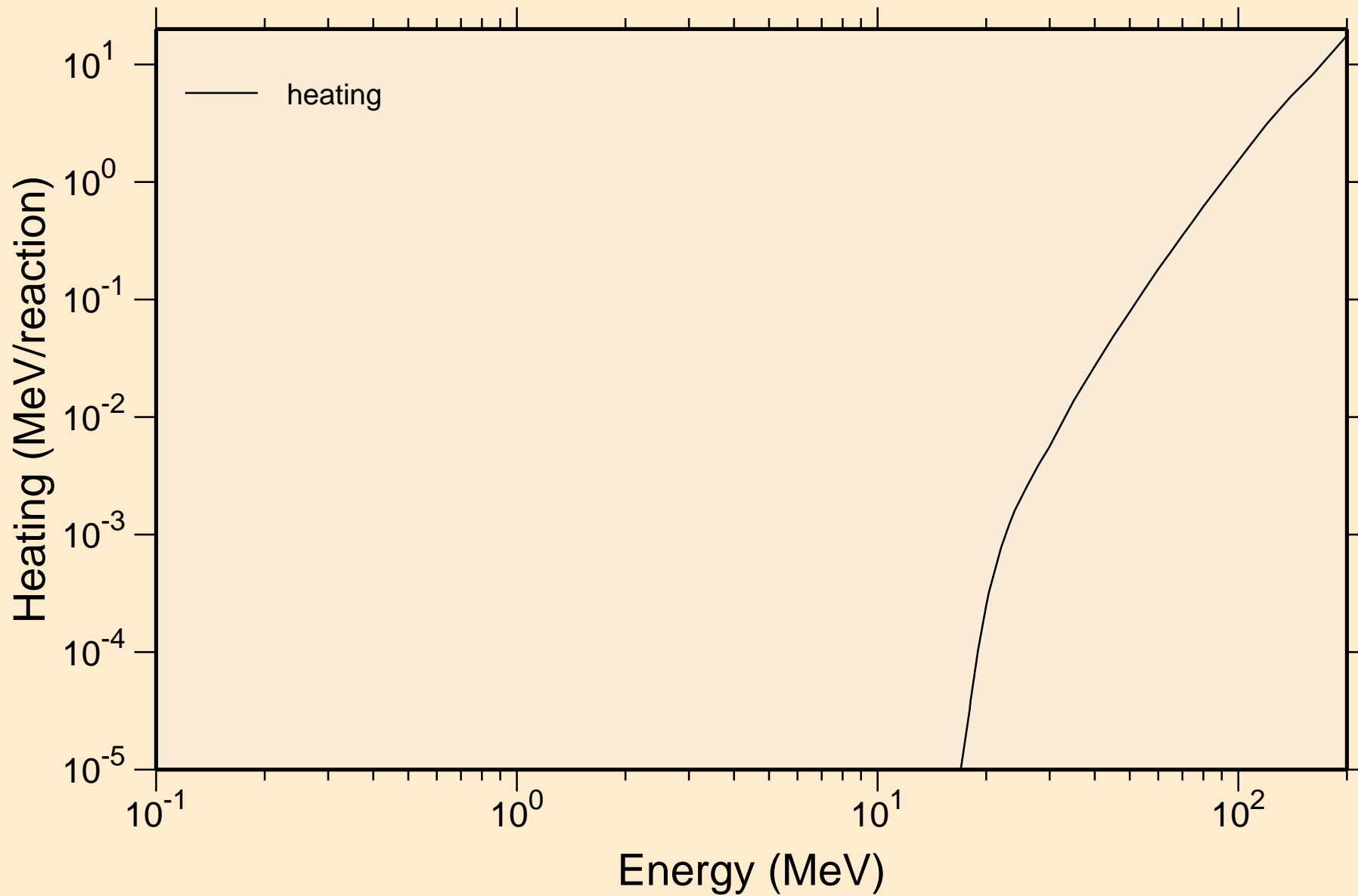

# W193 ALPHA ACER TENDL-2021 LIBRARY; T=0.K

## Principal cross sections

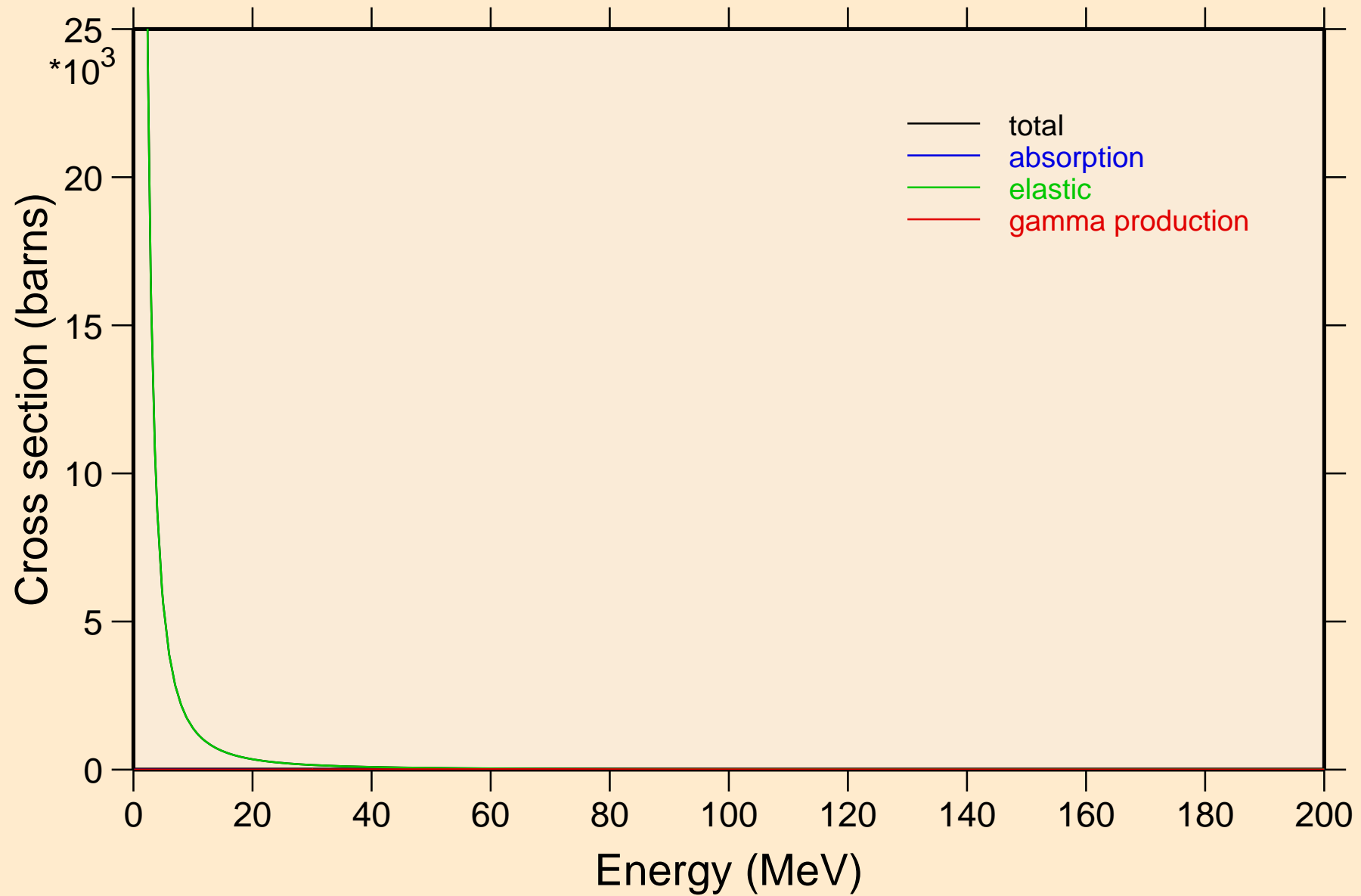

W193 ALPHA ACER TENDL-2021 LIBRARY; T=0.K

Heating

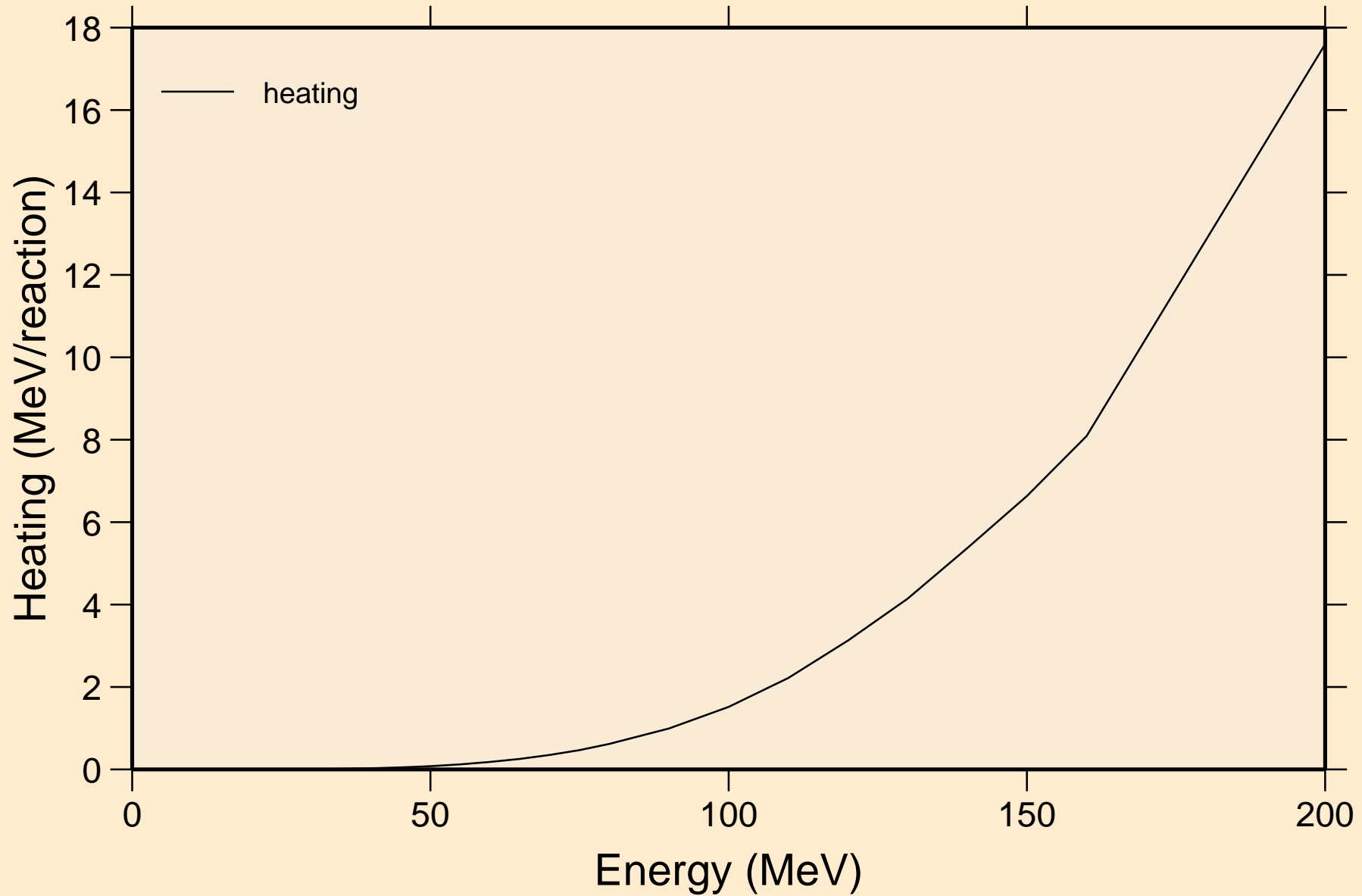

W193 ALPHA ACER TENDL-2021 LIBRARY; T=0.K  
Threshold reactions

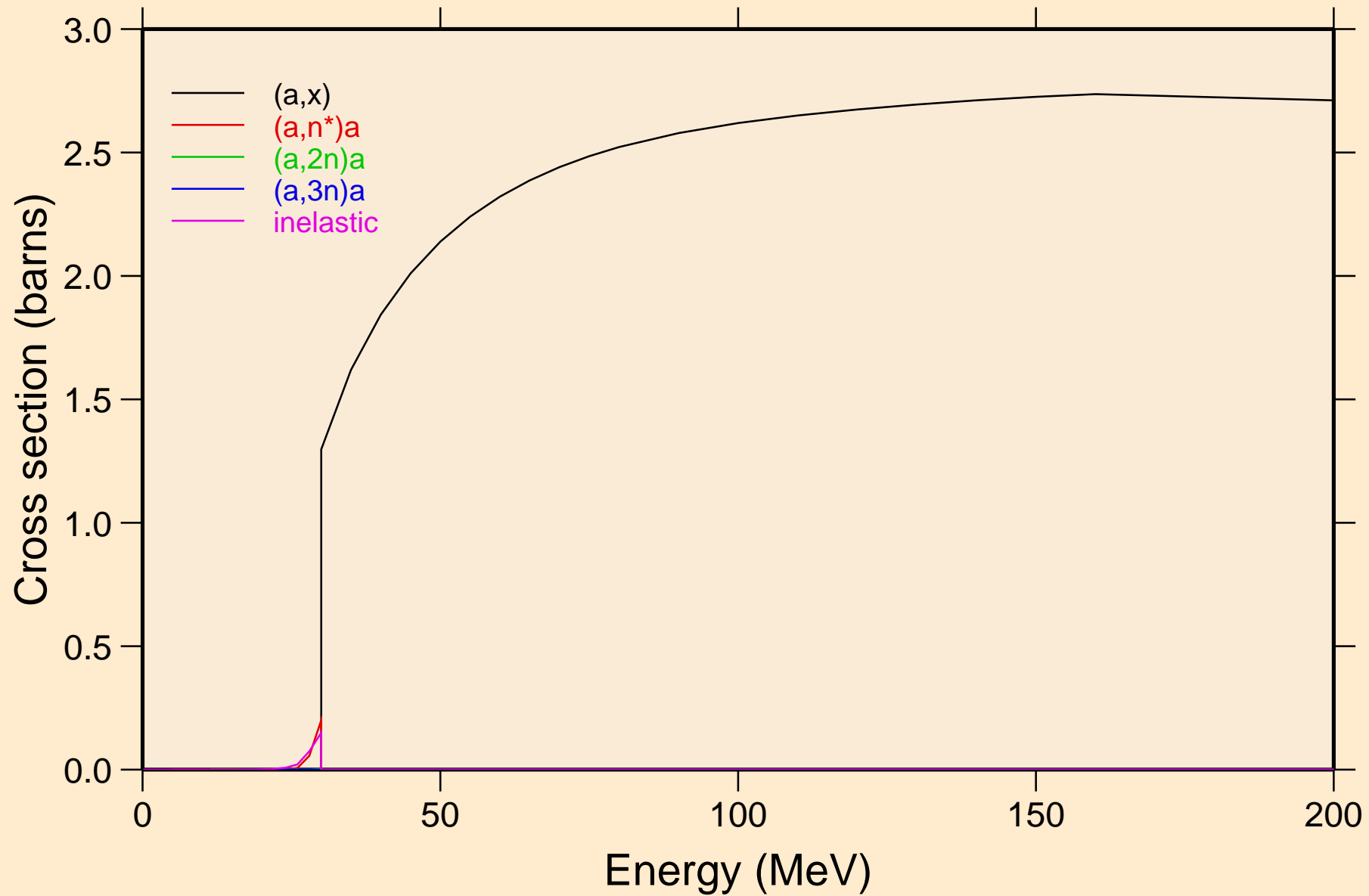

W193 ALPHA ACER TENDL-2021 LIBRARY; T=0.K  
angular distribution for elastic

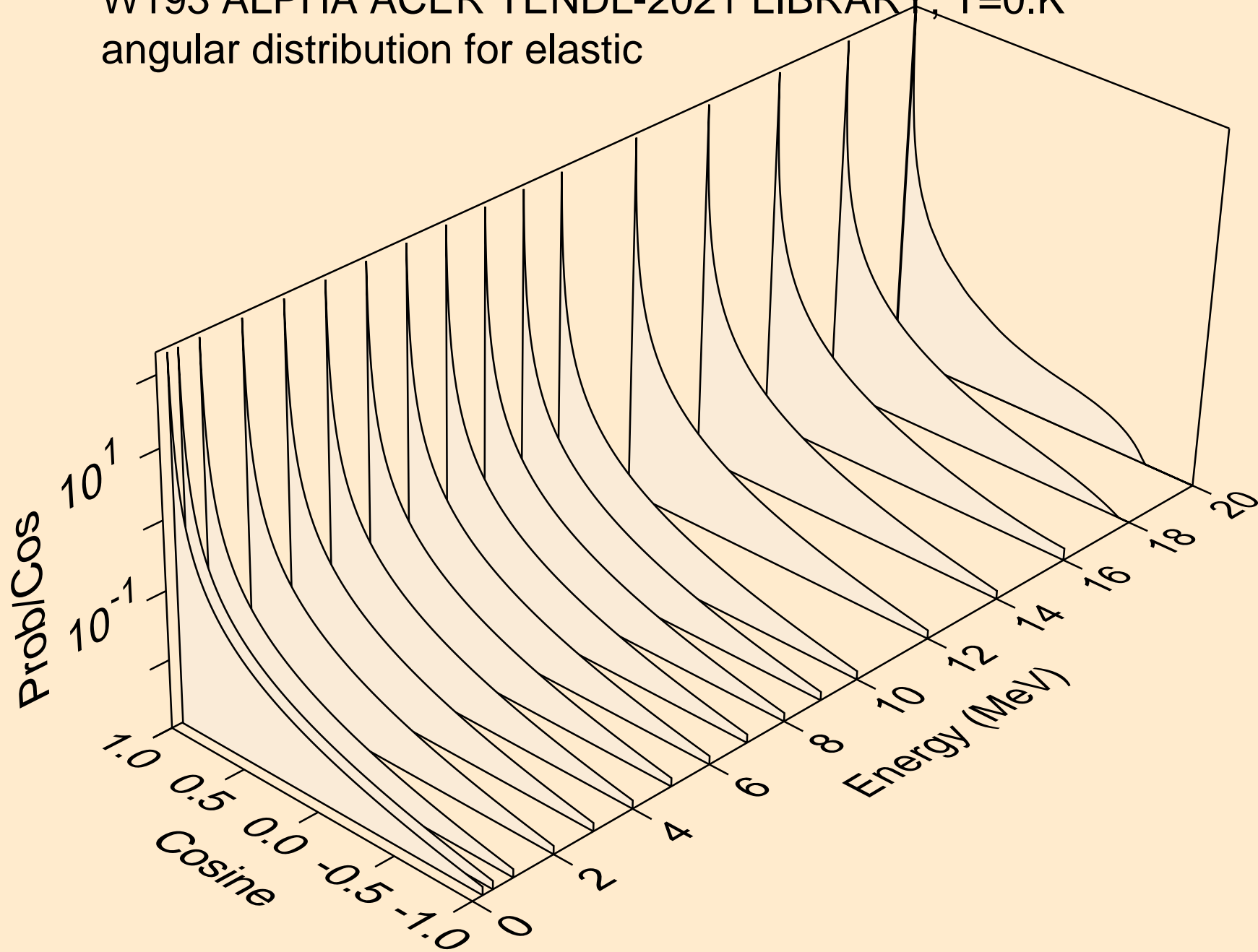

W193 ALPHA ACER TENDL-2021 LIBRARY; T=0.K  
angular distribution for elastic

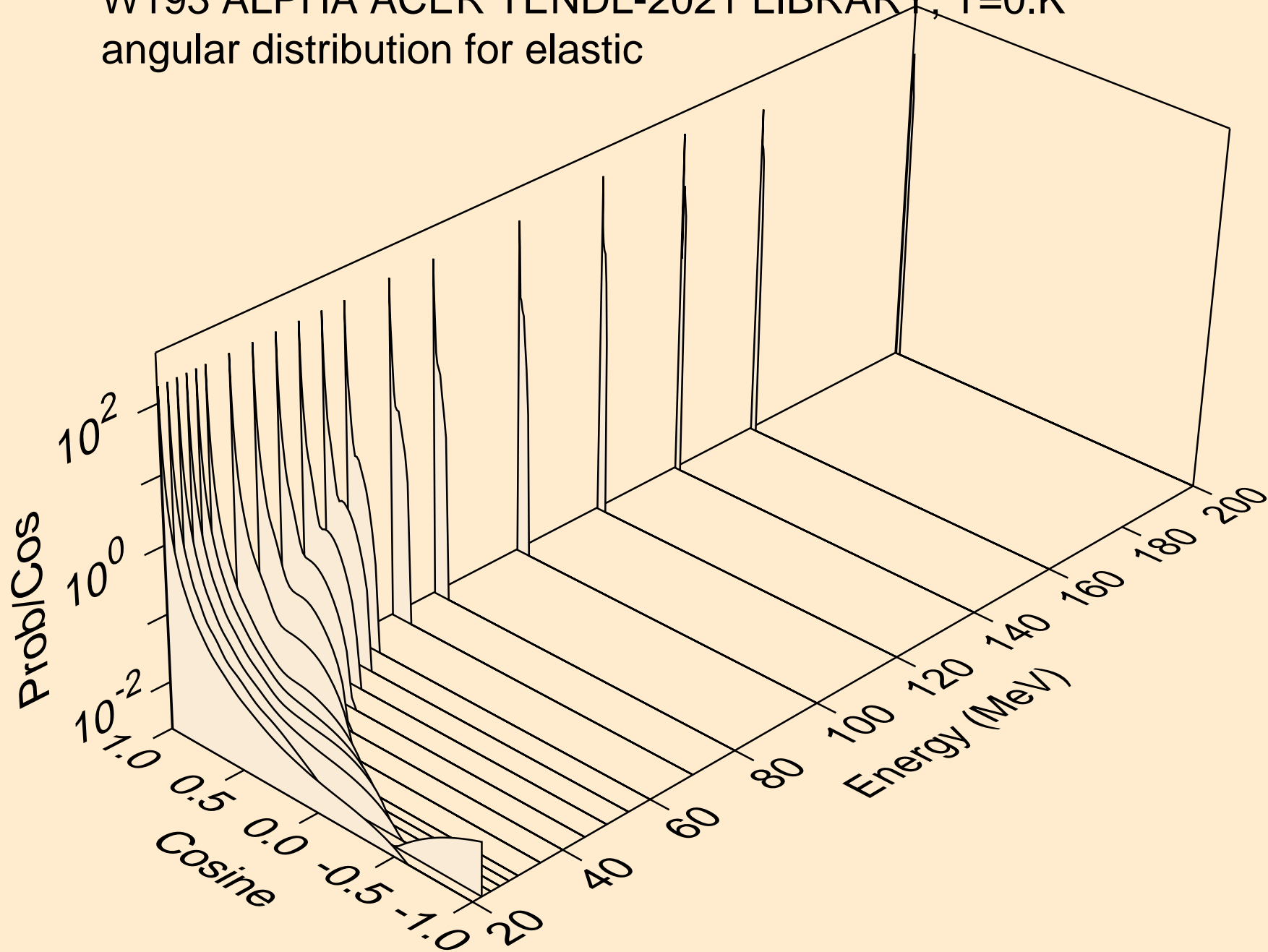

W193 ALPHA ACER TENDL-2021 LIBRARY; T=0.K  
Alpha emission for (a,x)

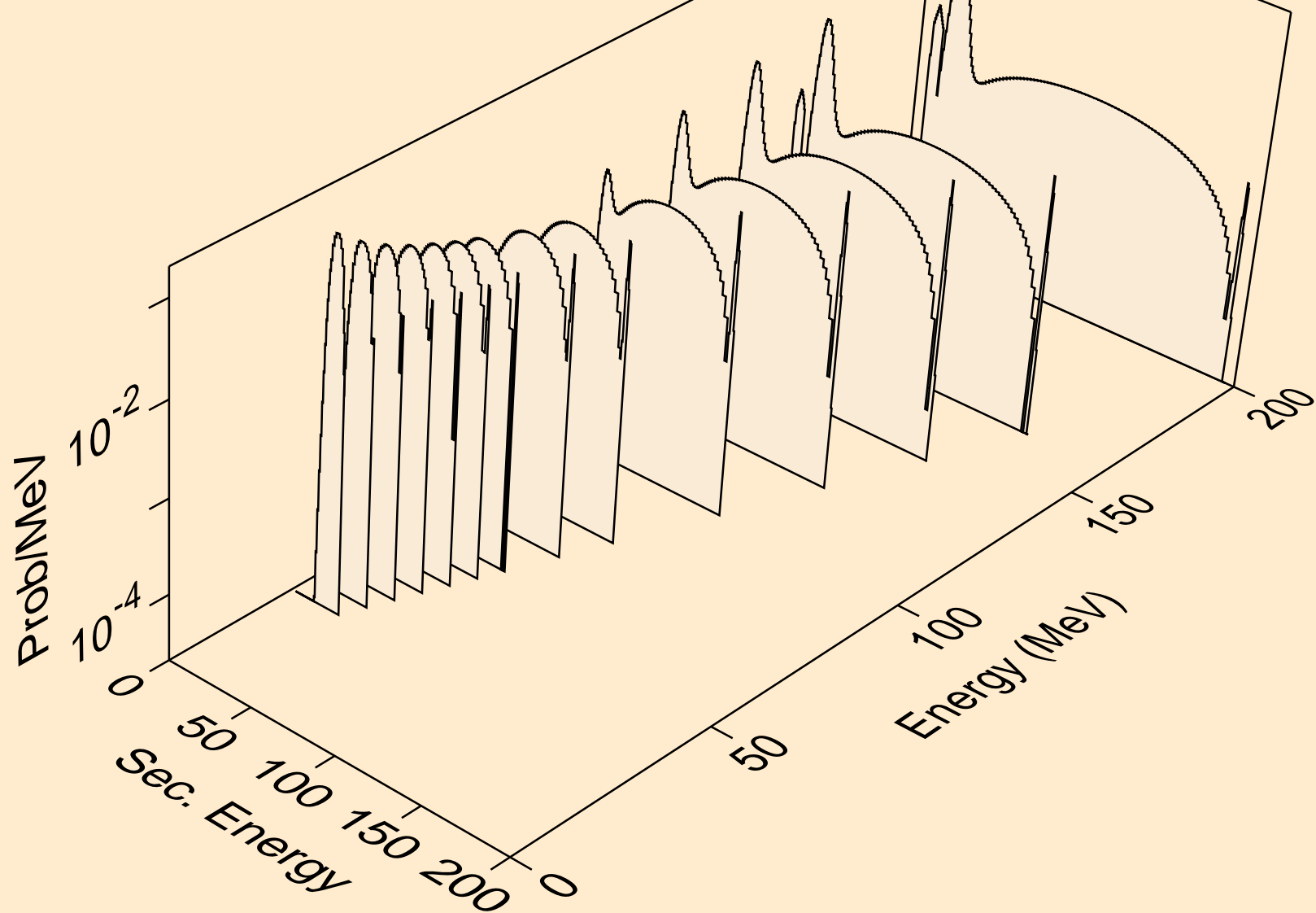



W193 ALPHA ACER TENDL-2021 LIBRARY; T=0.K  
Alpha emission for (a,n\*)a

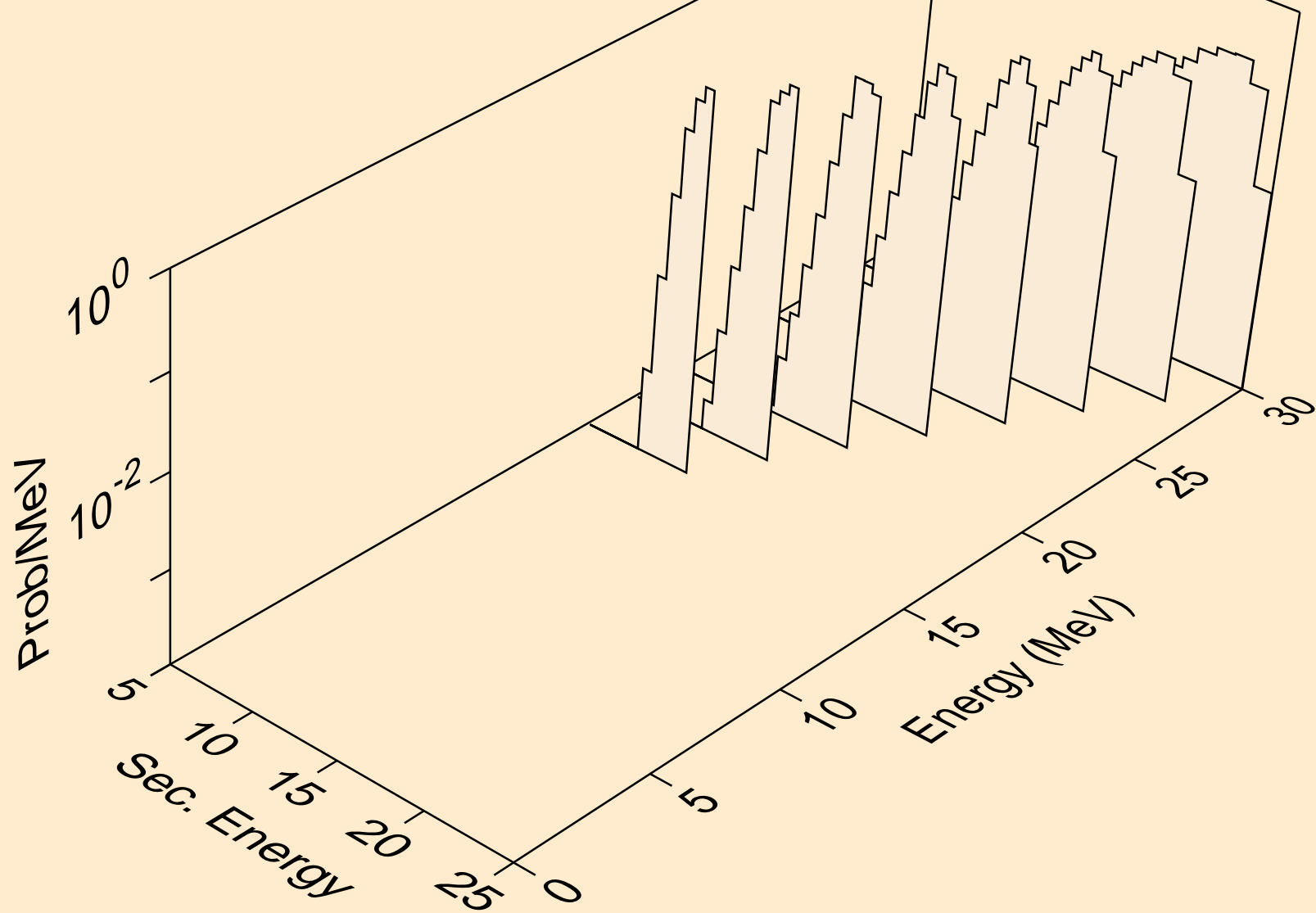

W193 ALPHA ACER TENDL-2021 LIBRARY; T=0.K  
Alpha emission for (a,2n)a

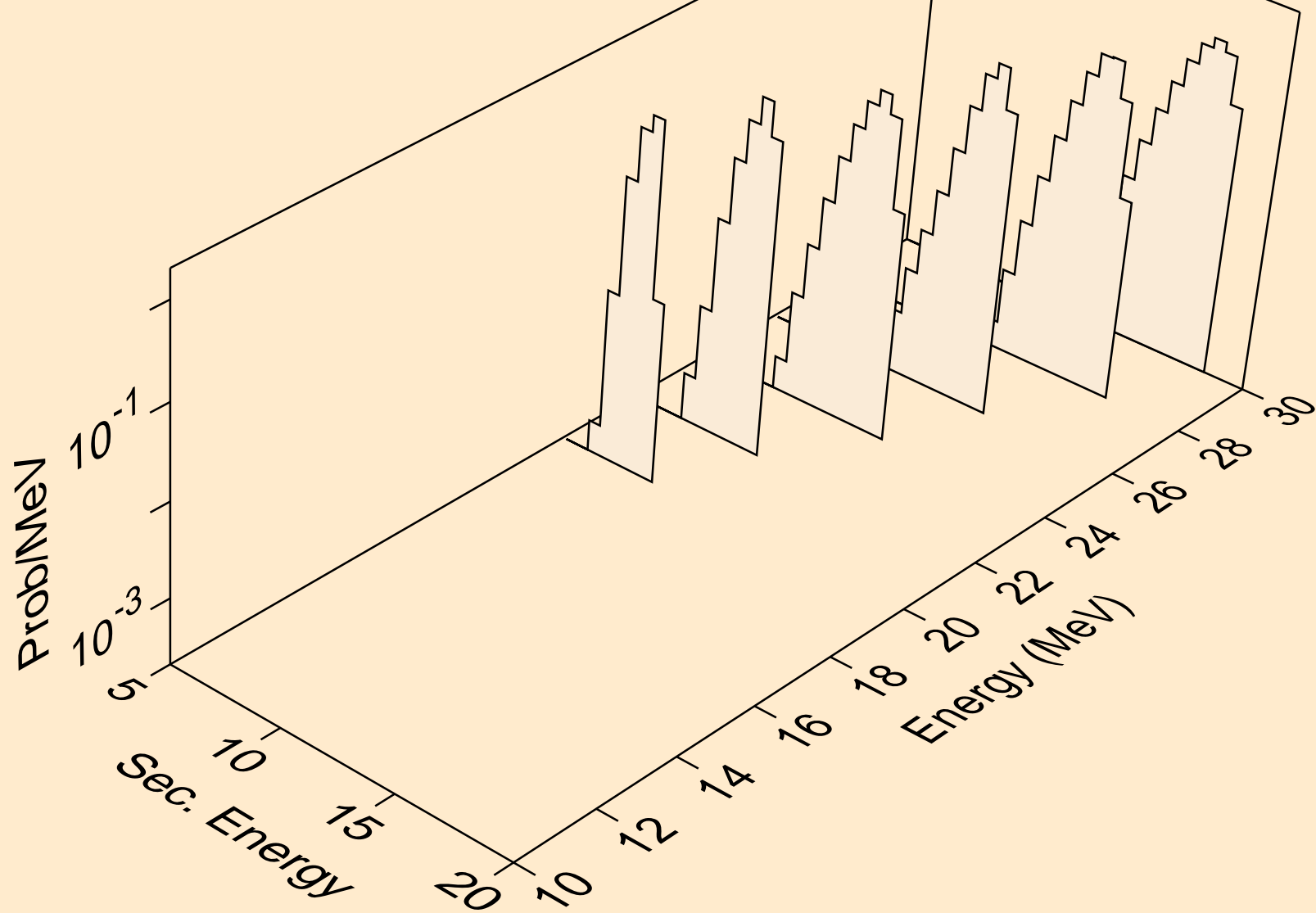

W193 ALPHA ACER TENDL-2021 LIBRARY; T=0.K  
Alpha emission for (a,3n)a

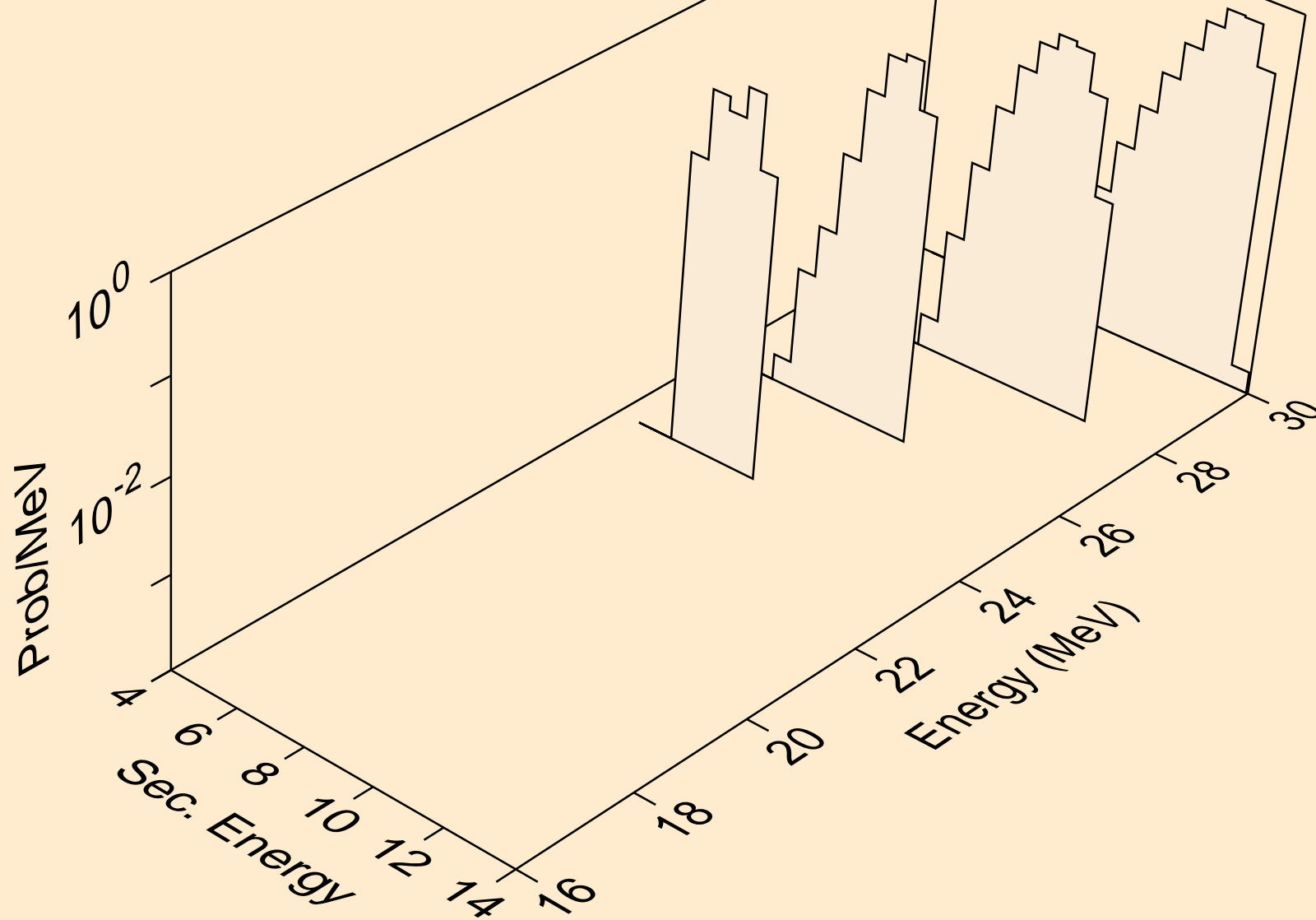

W193 ALPHA ACER TENDL-2021 LIBRARY; T=0.K  
Alpha emission for inelastic

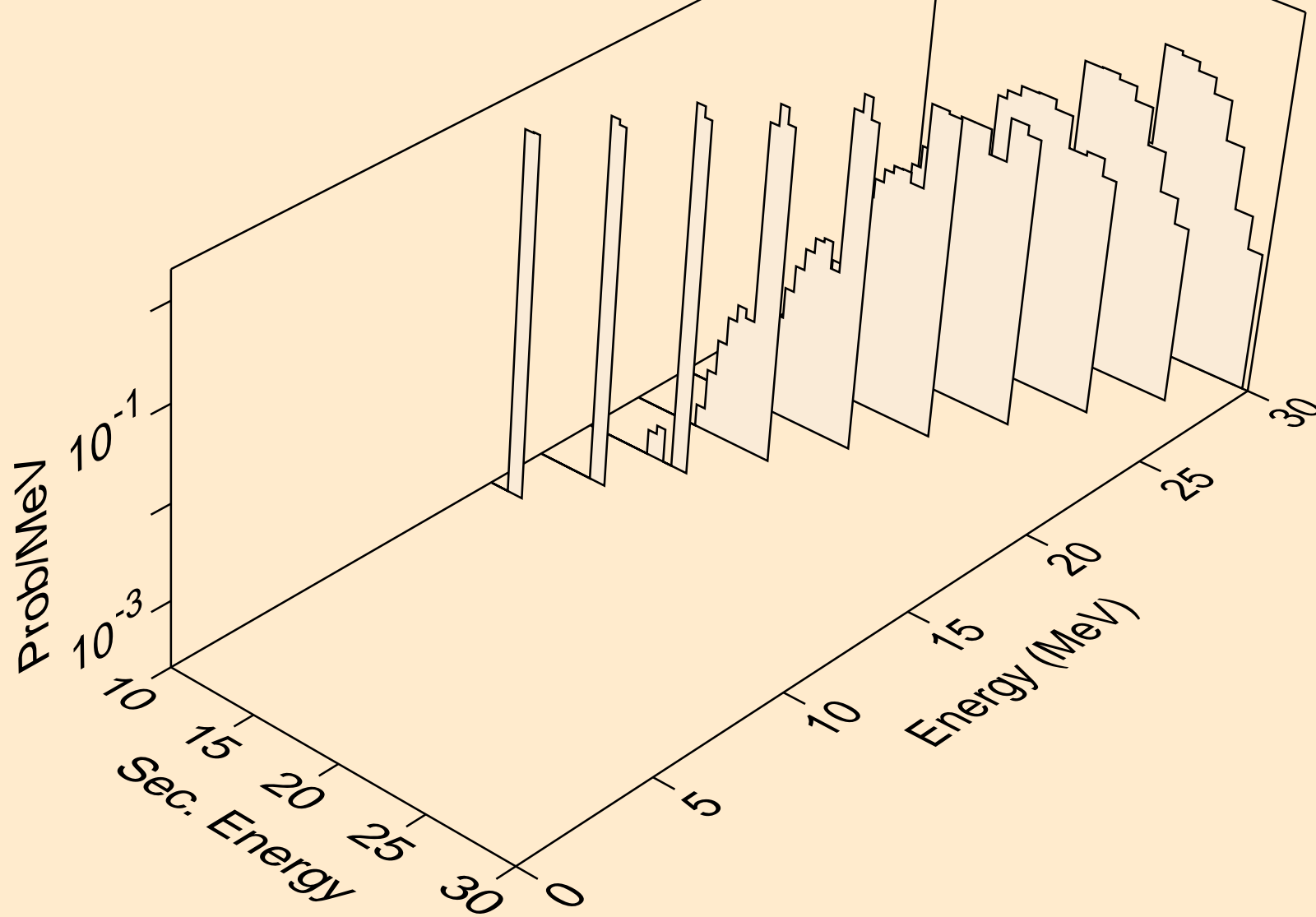

W193 ALPHA ACER TENDL-2021 LIBRARY; T=0.K  
Photon emission for (z,n)

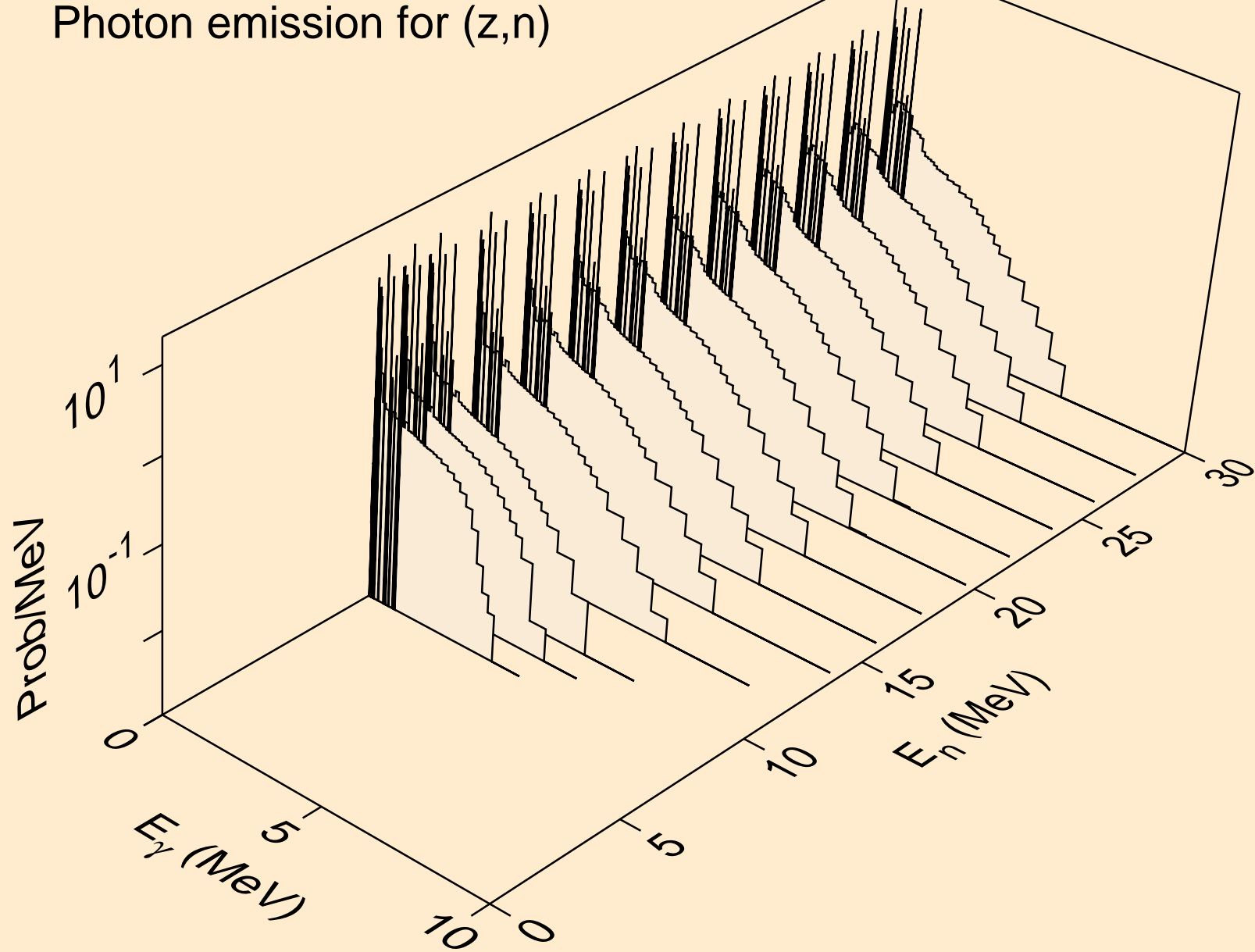

W193 ALPHA ACER TENDL-2021 LIBRARY; T=0.K  
Photon emission for (n,x)

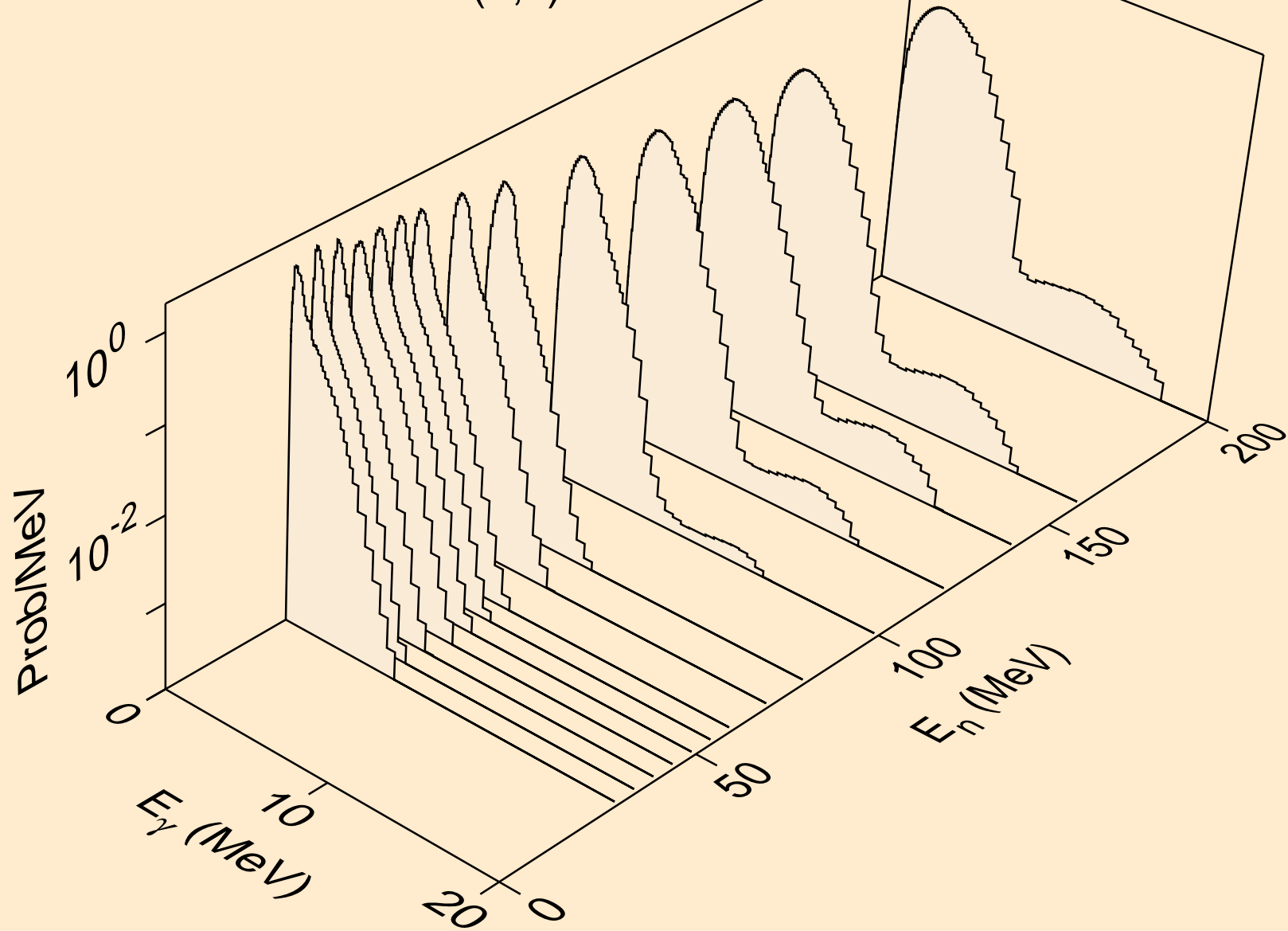

W193 ALPHA ACER TENDL-2021 LIBRARY; T=0.K  
Photon emission for (n,2nd)

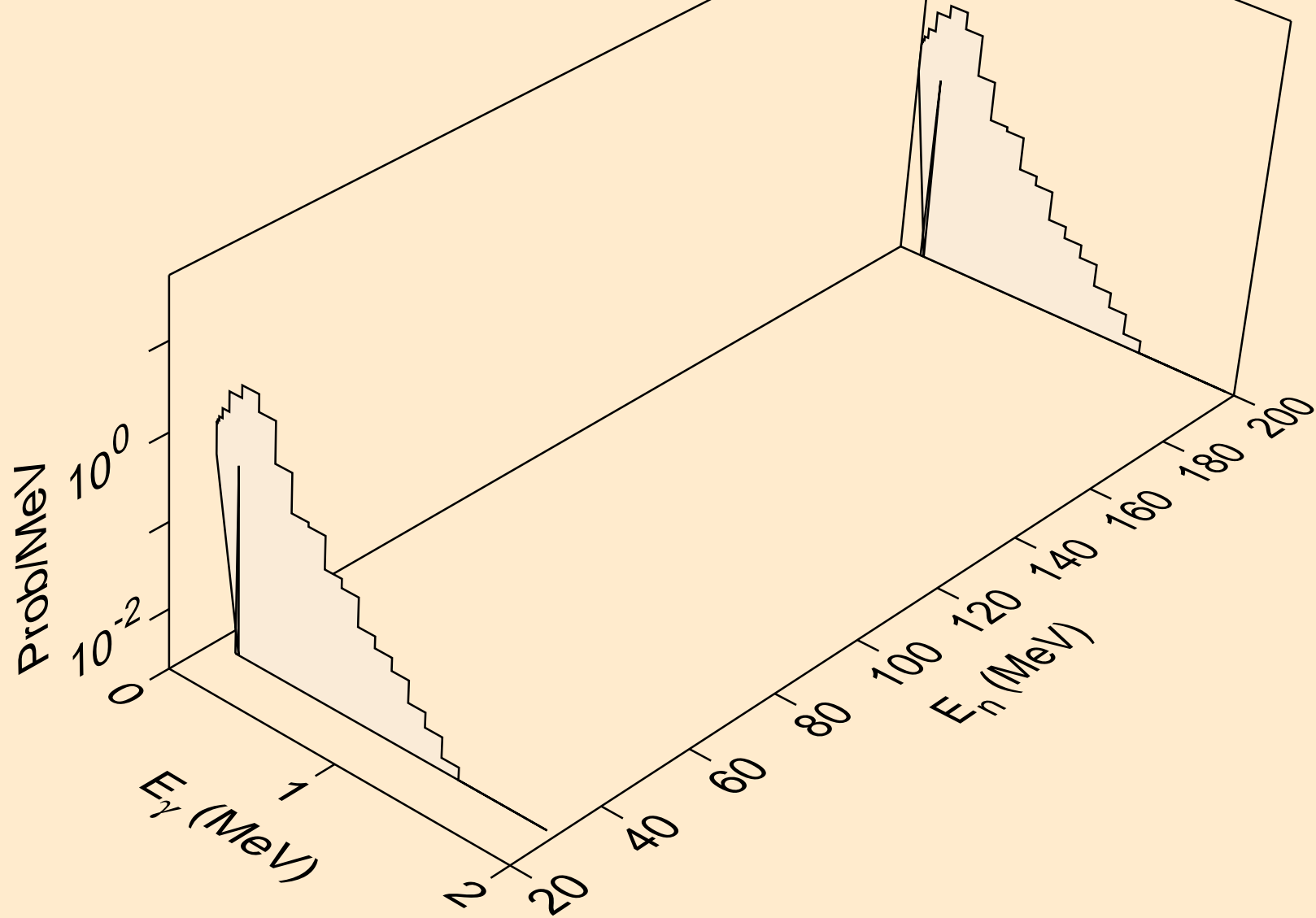

W193 ALPHA ACER TENDL-2021 LIBRARY; T=0.K  
Photon emission for (n,2n)

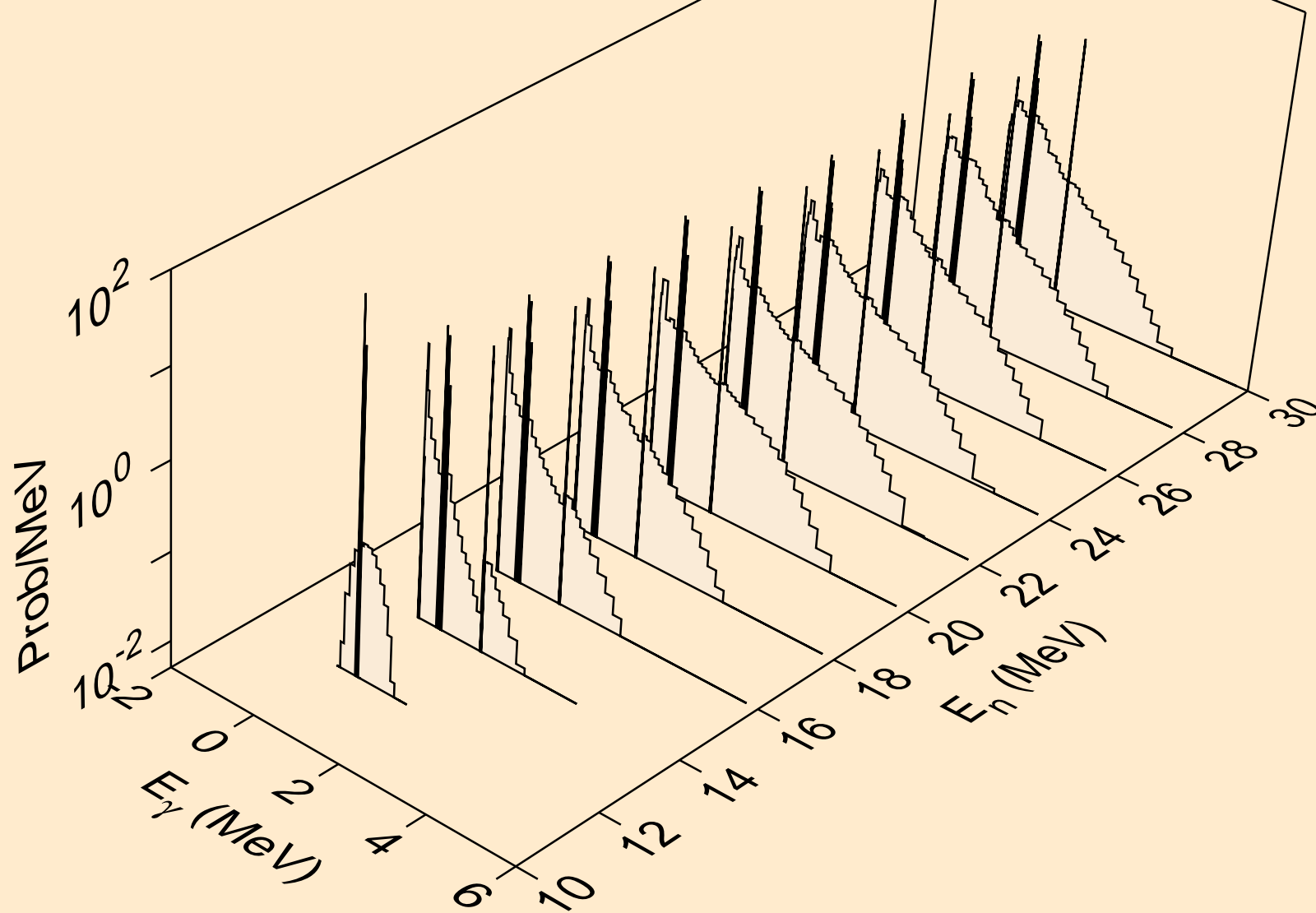



W193 ALPHA ACER TENDL-2021 LIBRARY; T=0.K  
Photon emission for (n,3n)

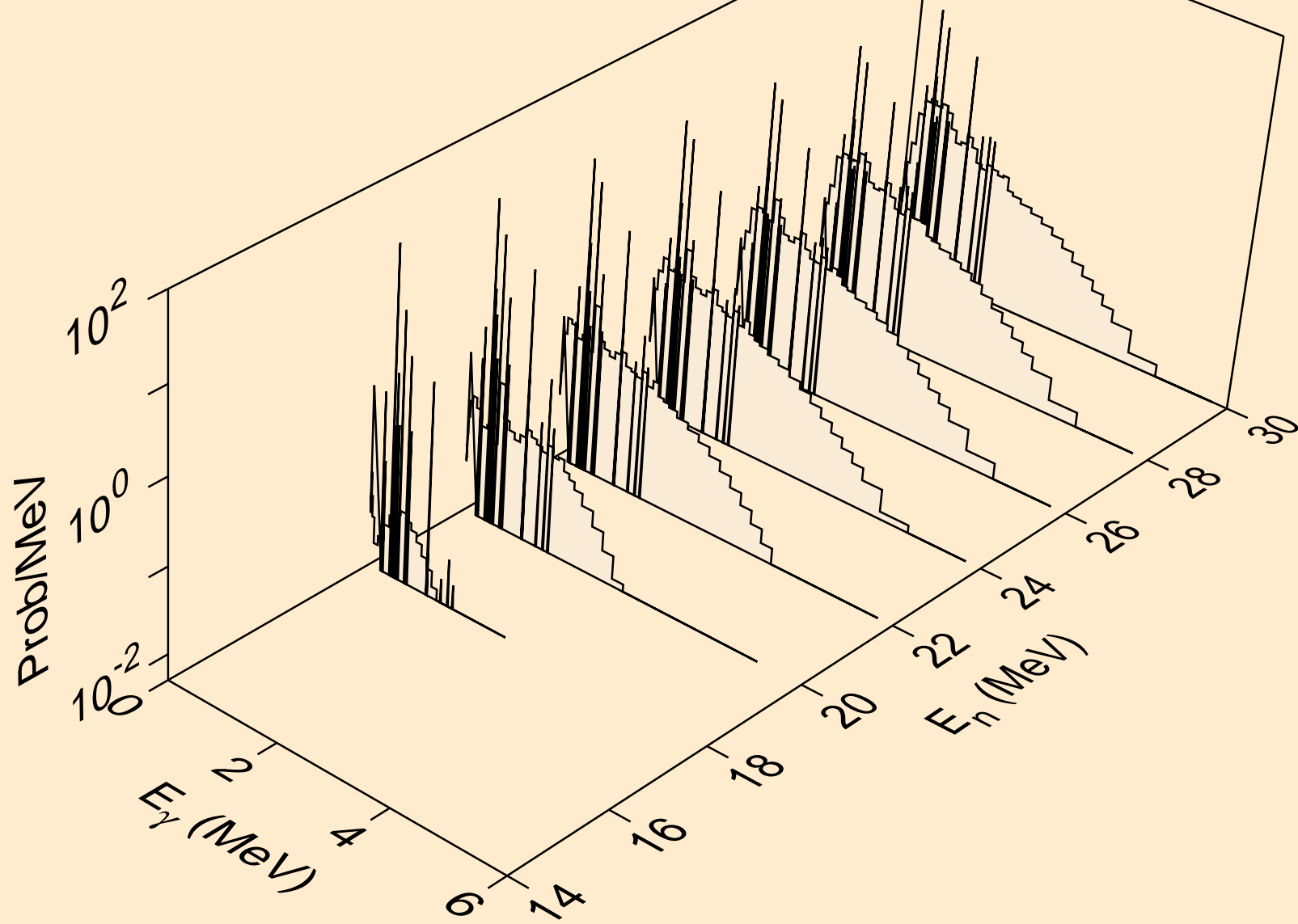

W193 ALPHA ACER TENDL-2021 LIBRARY; T=0.K  
Photon emission for (n,n\*)a

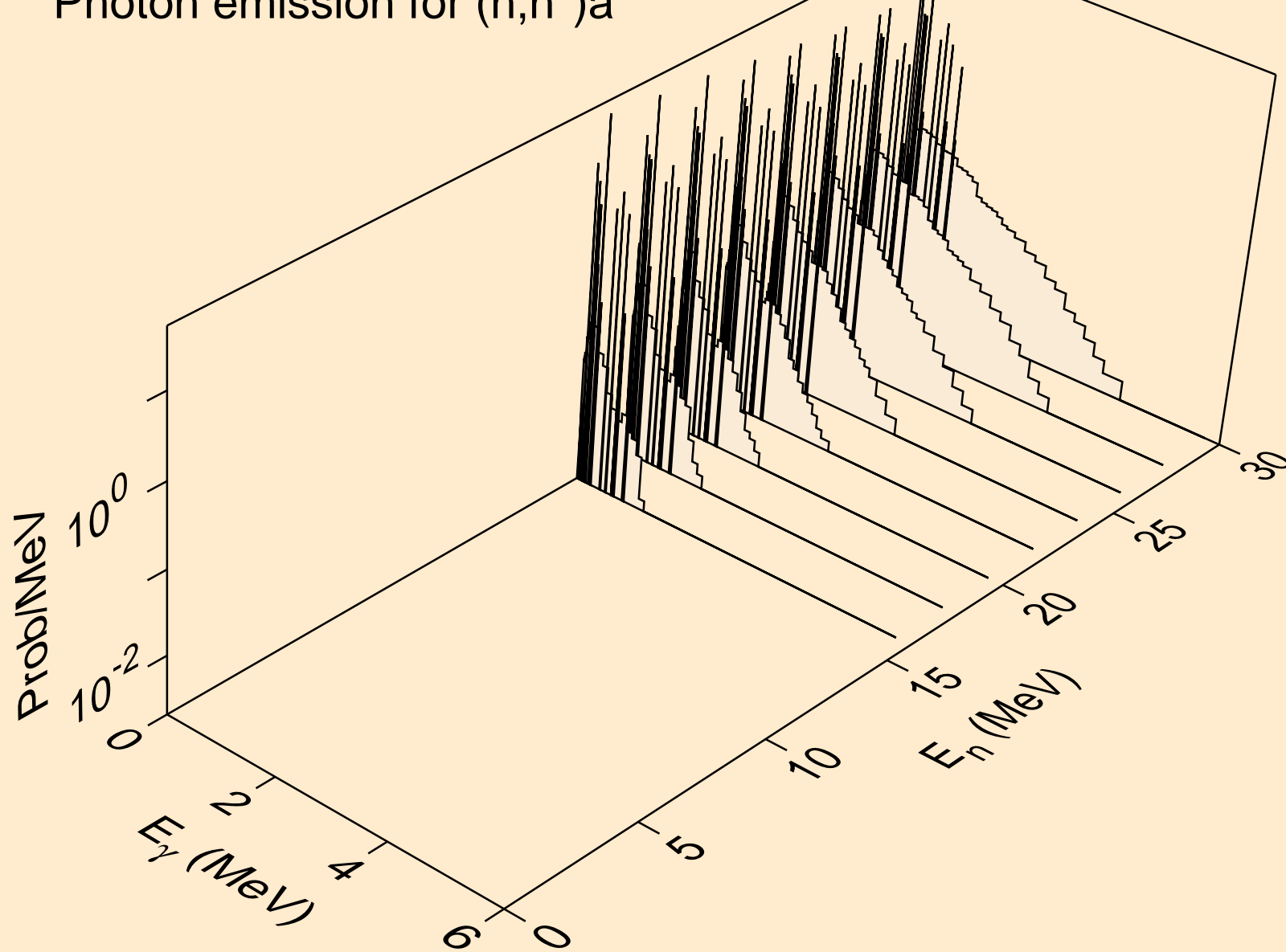

W193 ALPHA ACER TENDL-2021 LIBRARY; T=0.K  
Photon emission for (n,2n)a

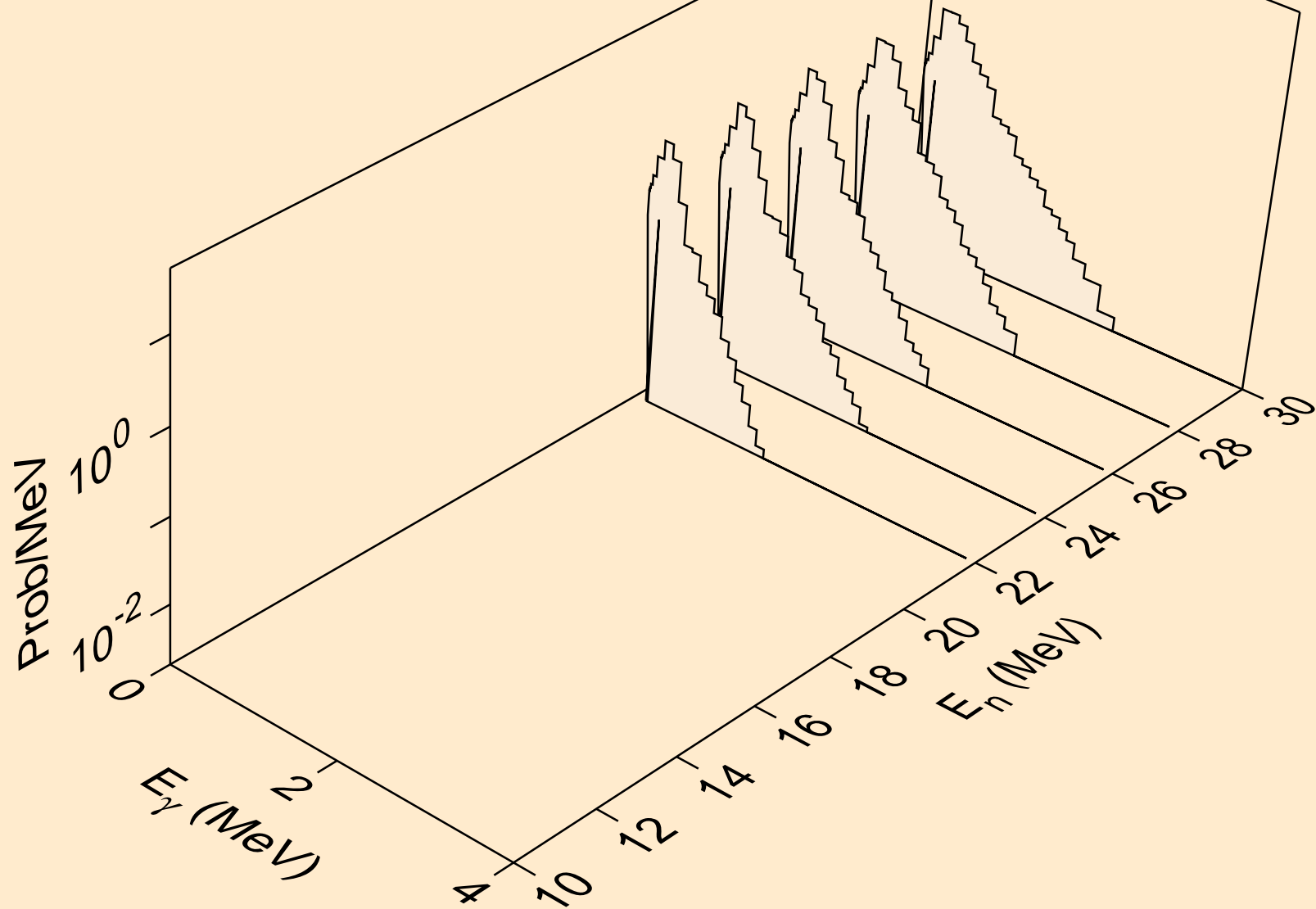

W193 ALPHA ACER TENDL-2021 LIBRARY; T=0.K  
Photon emission for (n,3n)a

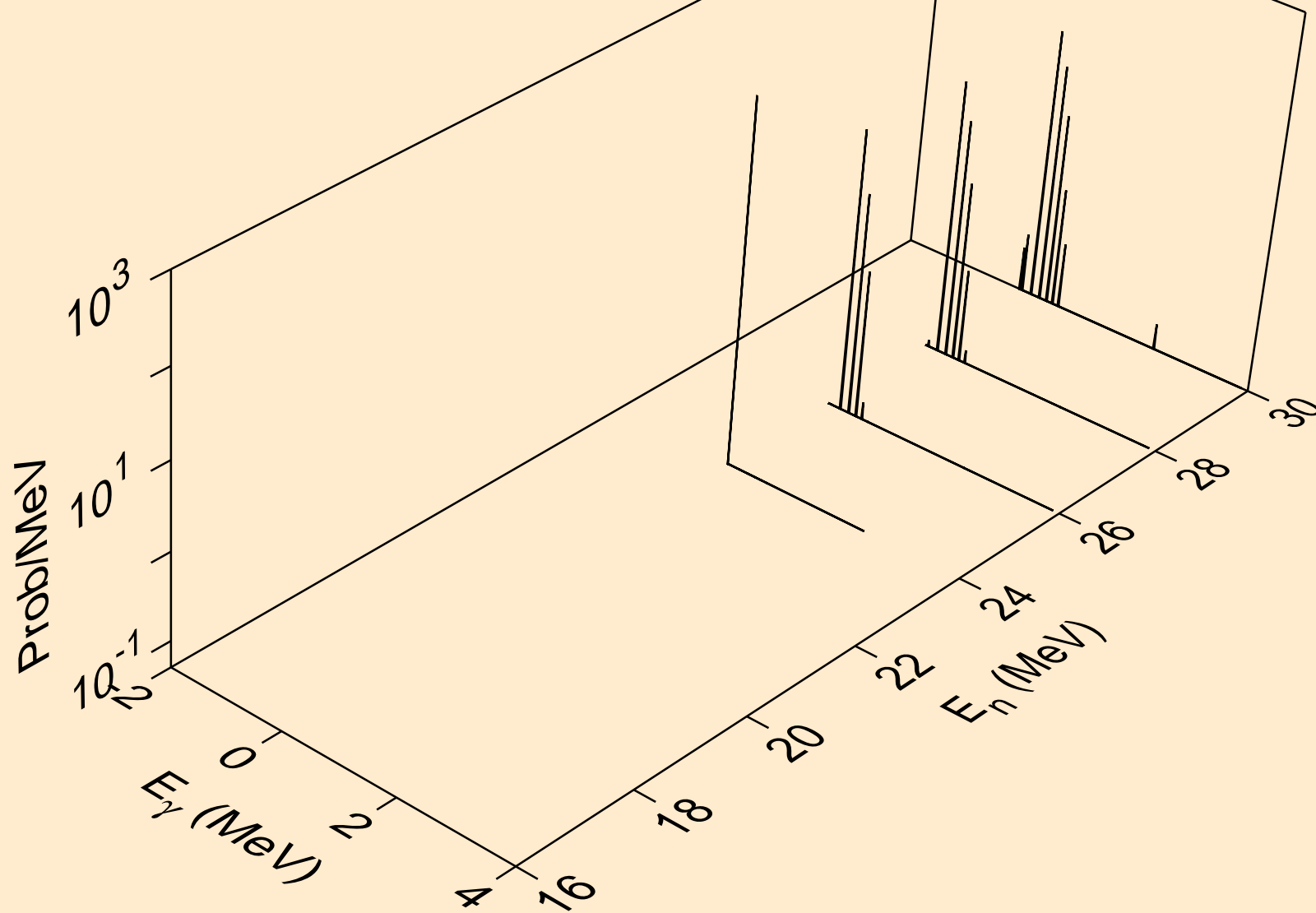

W193 ALPHA ACER TENDL-2021 LIBRARY; T=0.K  
Photon emission for (n,n\*)p

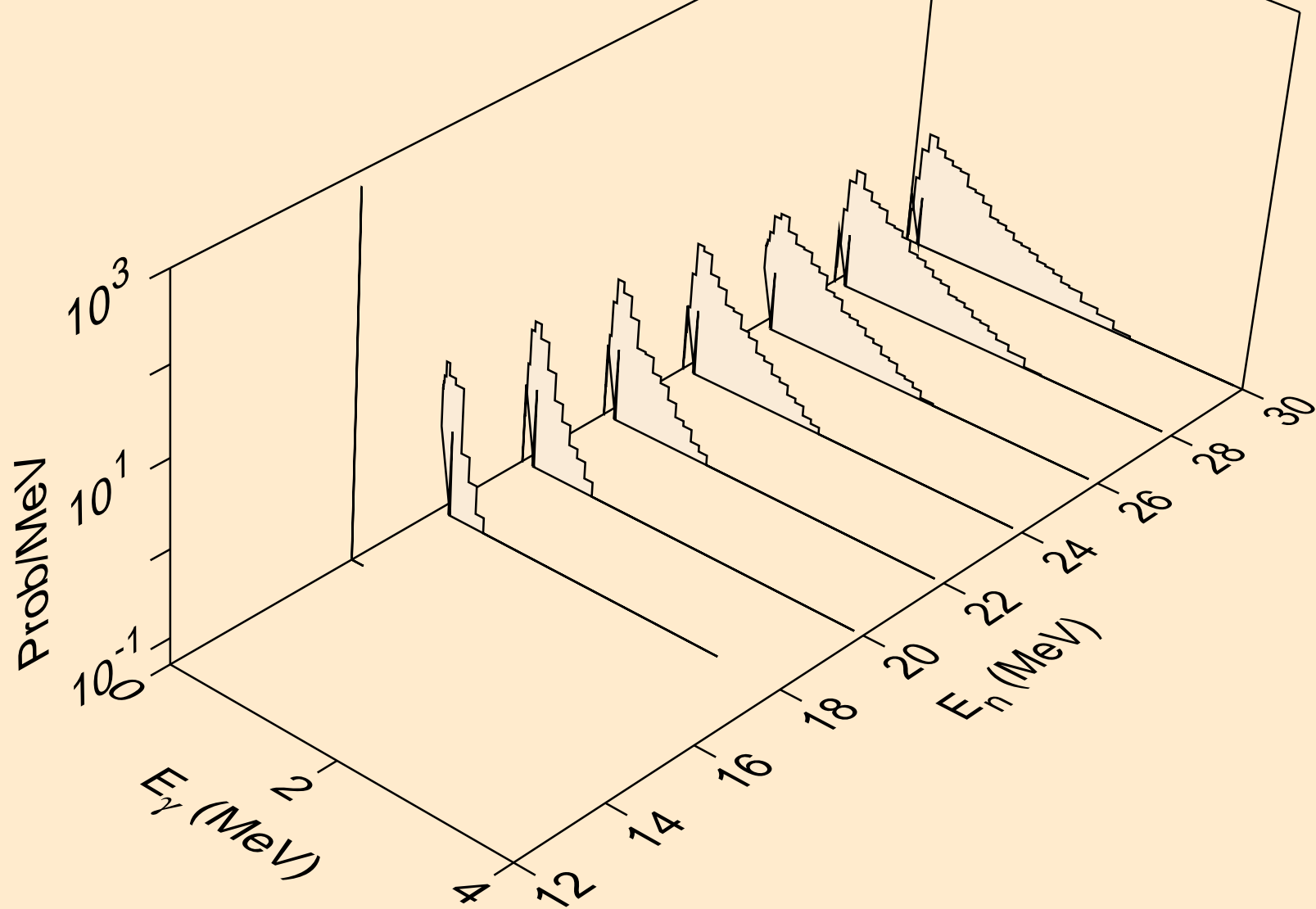

W193 ALPHA ACER TENDL-2021 LIBRARY; T=0.K  
Photon emission for (n,n\*)d

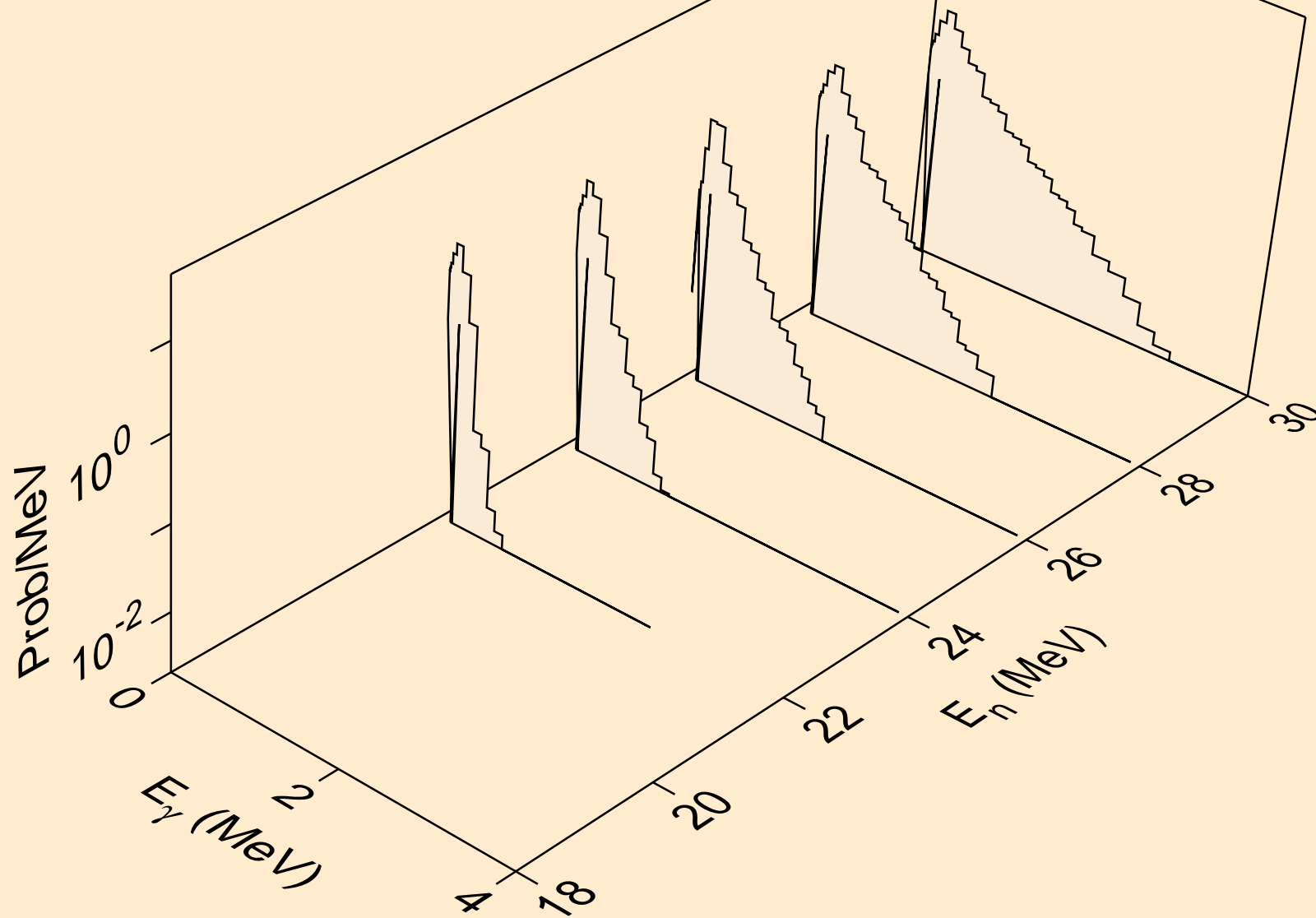

W193 ALPHA ACER TENDL-2021 LIBRARY; T=0.K  
Photon emission for (n,n\*)t

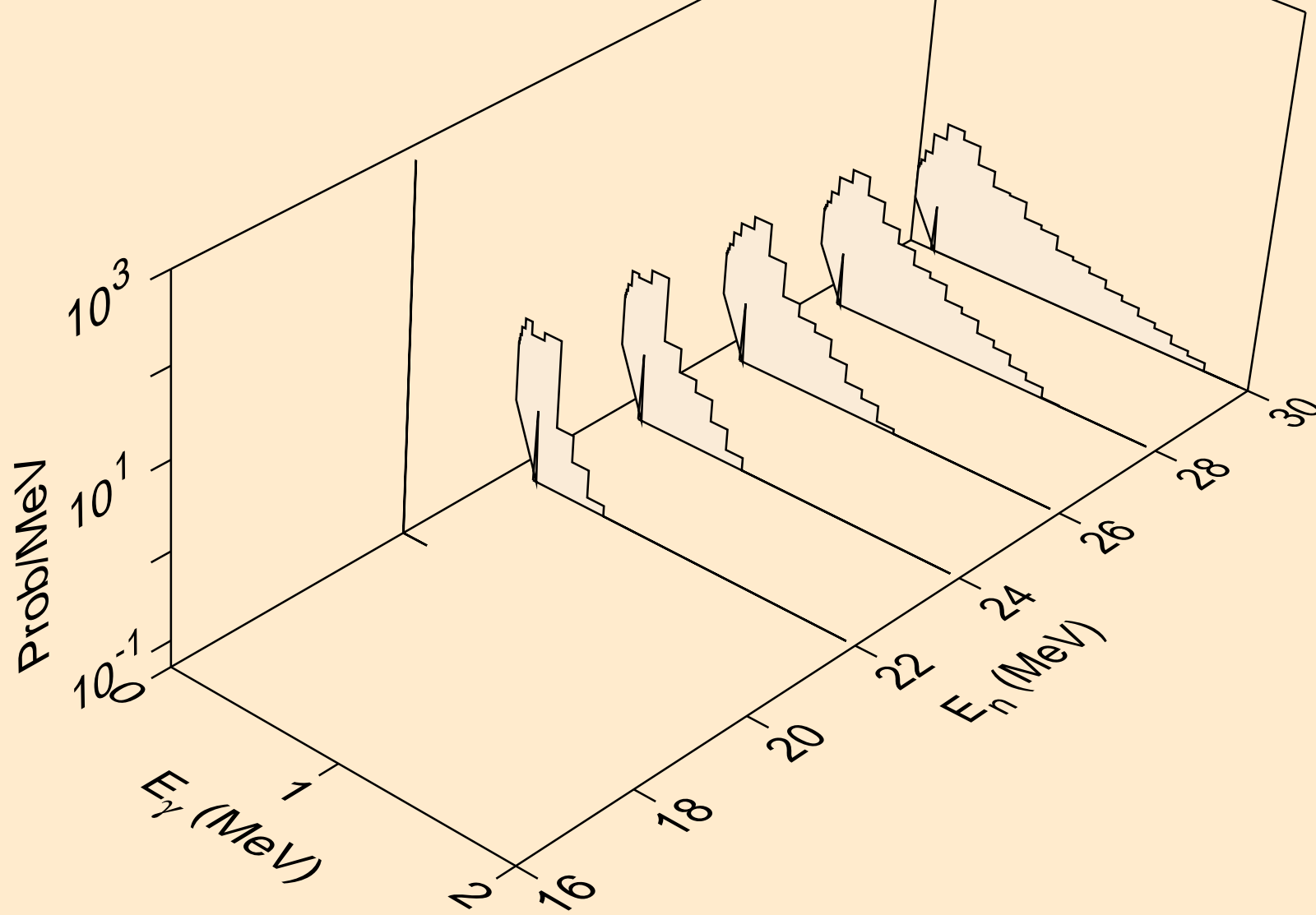

W193 ALPHA ACER TENDL-2021 LIBRARY; T=0.K  
Photon emission for (n,4n)

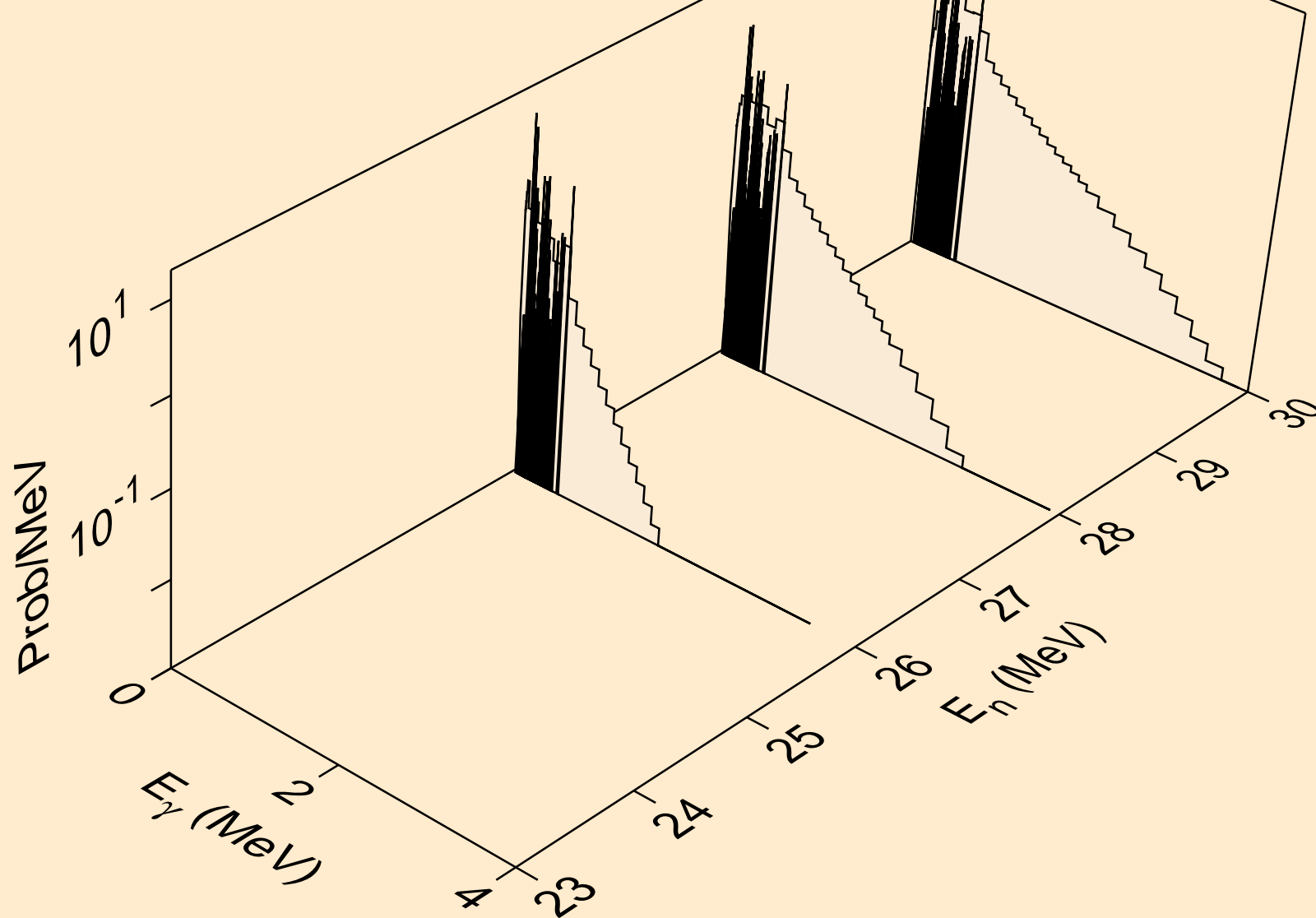



W193 ALPHA ACER TENDL-2021 LIBRARY; T=0.K  
Photon emission for (n,2np)

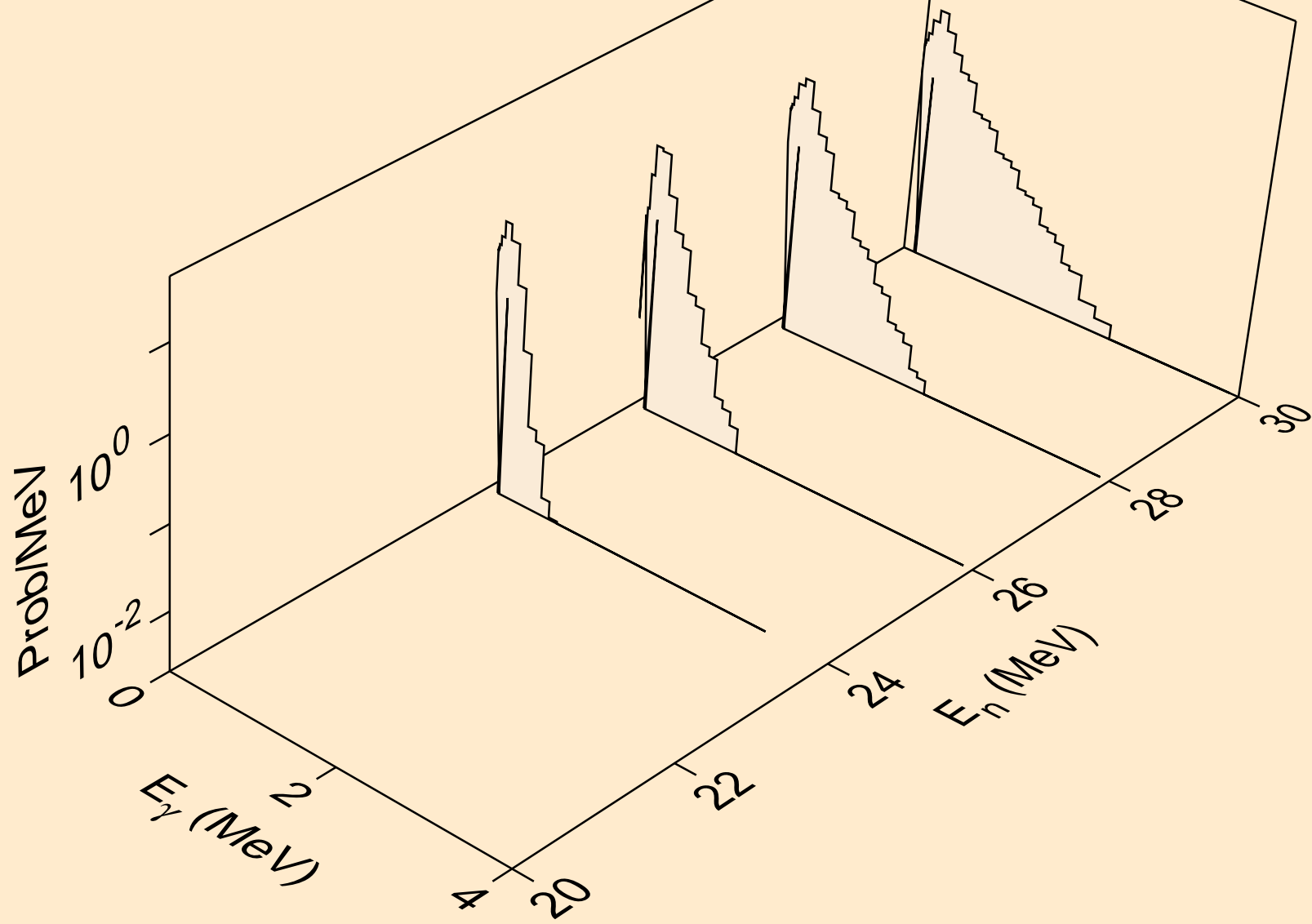

W193 ALPHA ACER TENDL-2021 LIBRARY; T=0.K  
Photon emission for (n,gma)

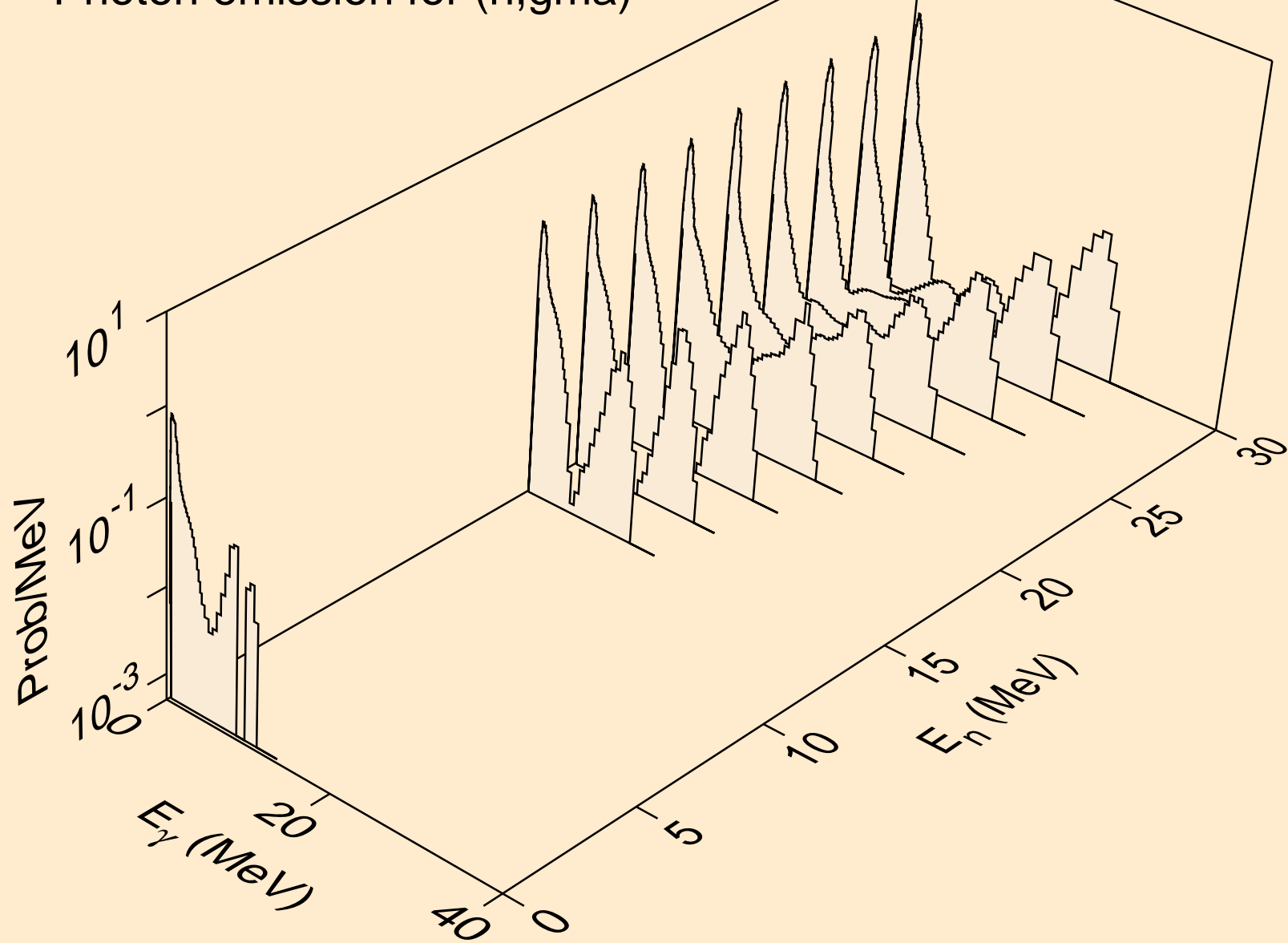

W193 ALPHA ACER TENDL-2021 LIBRARY; T=0.K  
Photon emission for (n,p)

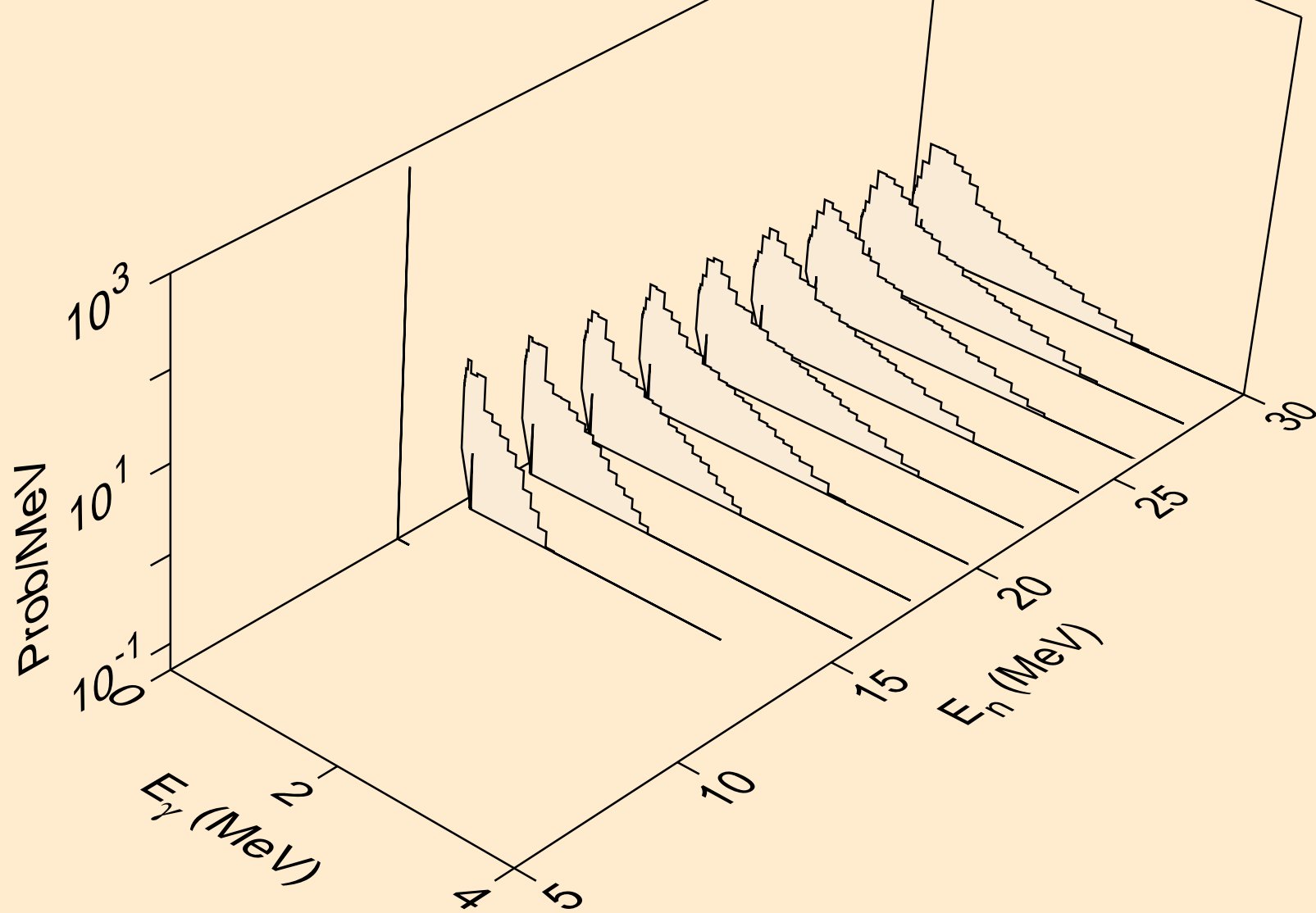

W193 ALPHA ACER TENDL-2021 LIBRARY; T=0.K  
Photon emission for (n,d)

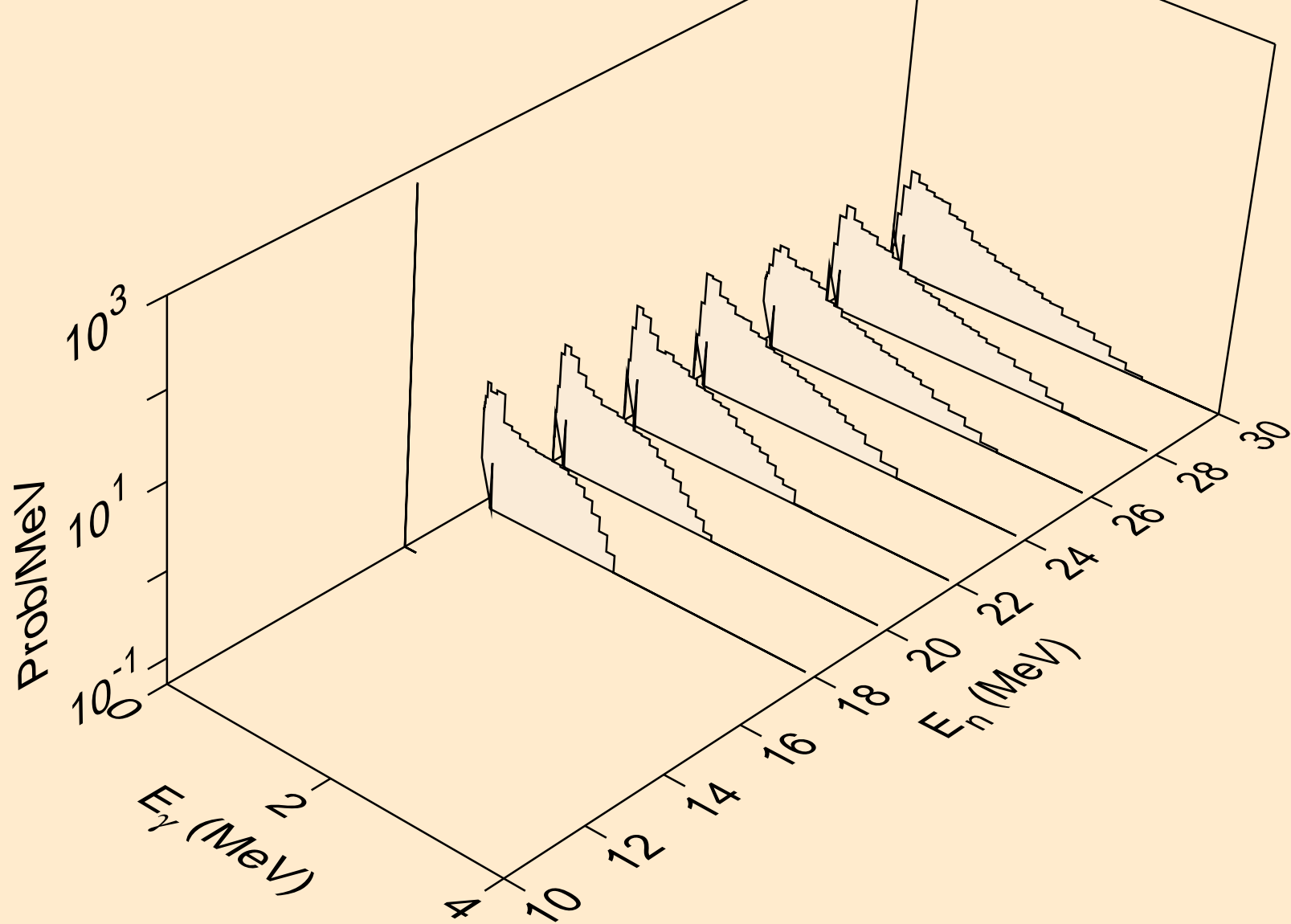

W193 ALPHA ACER TENDL-2021 LIBRARY; T=0.K  
Photon emission for (n,t)

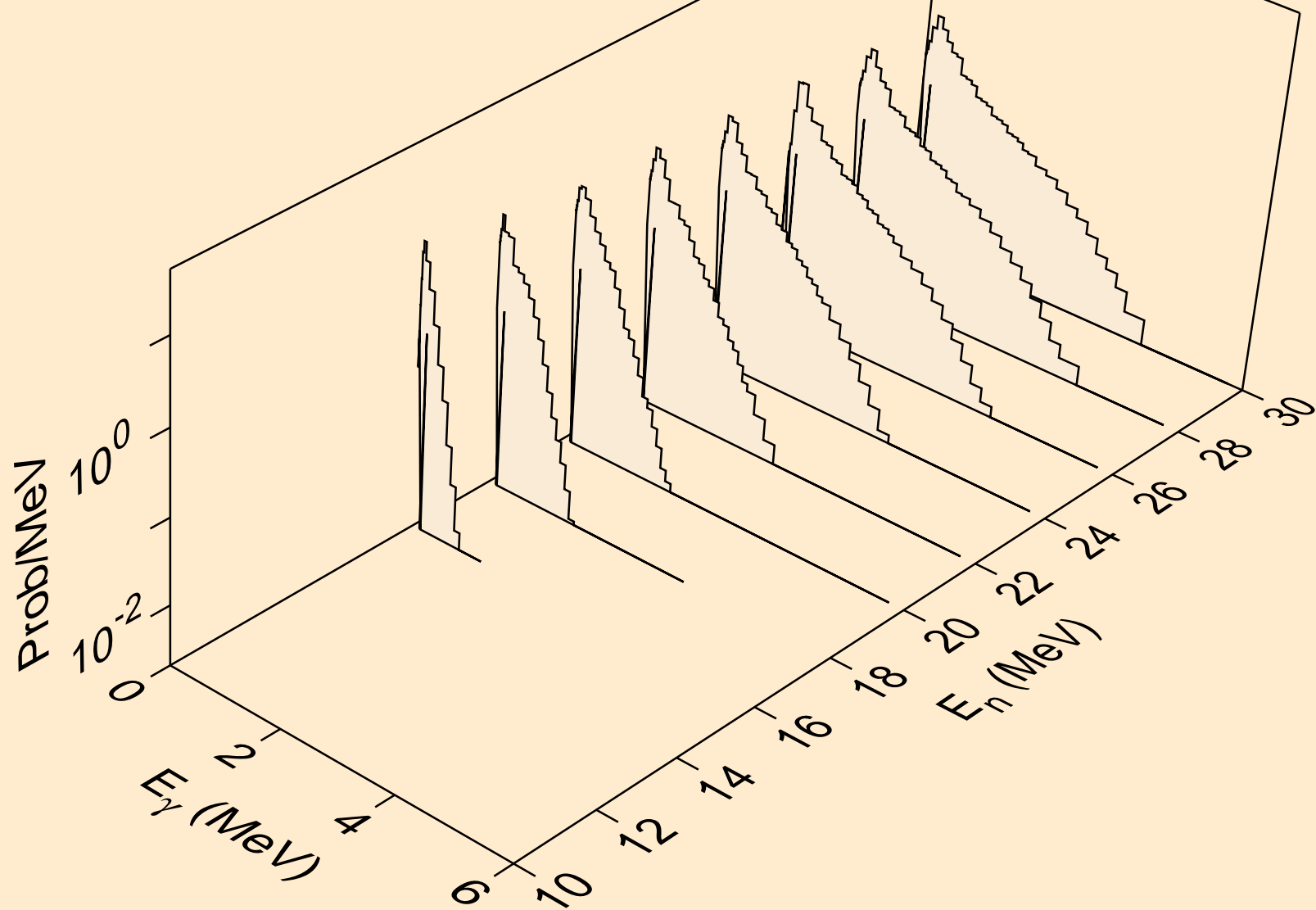

W193 ALPHA ACER TENDL-2021 LIBRARY; T=0.K  
Photon emission for (n,he3)

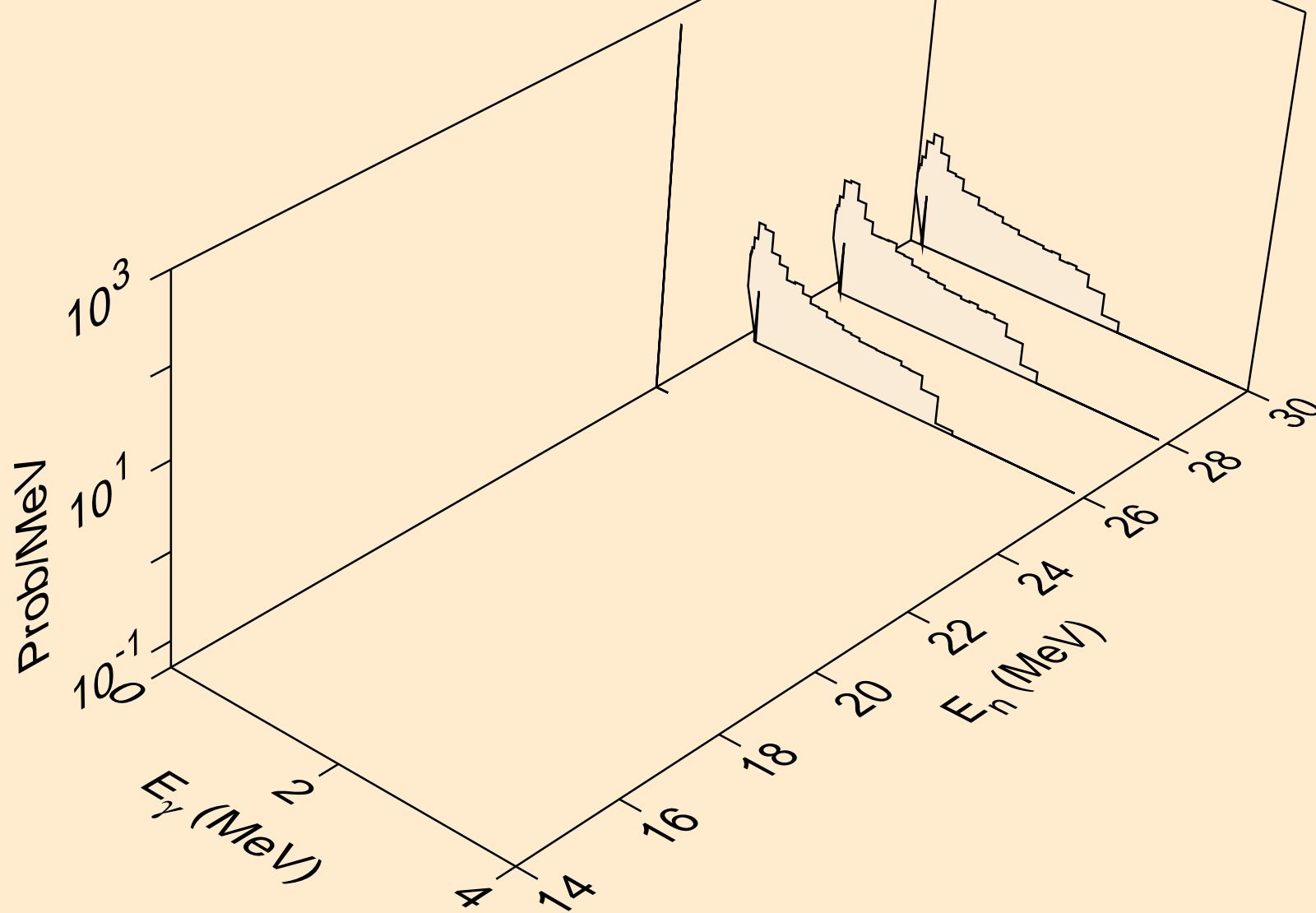

W193 ALPHA ACER TENDL-2021 LIBRARY; T=0.K  
Photon emission for inelastic

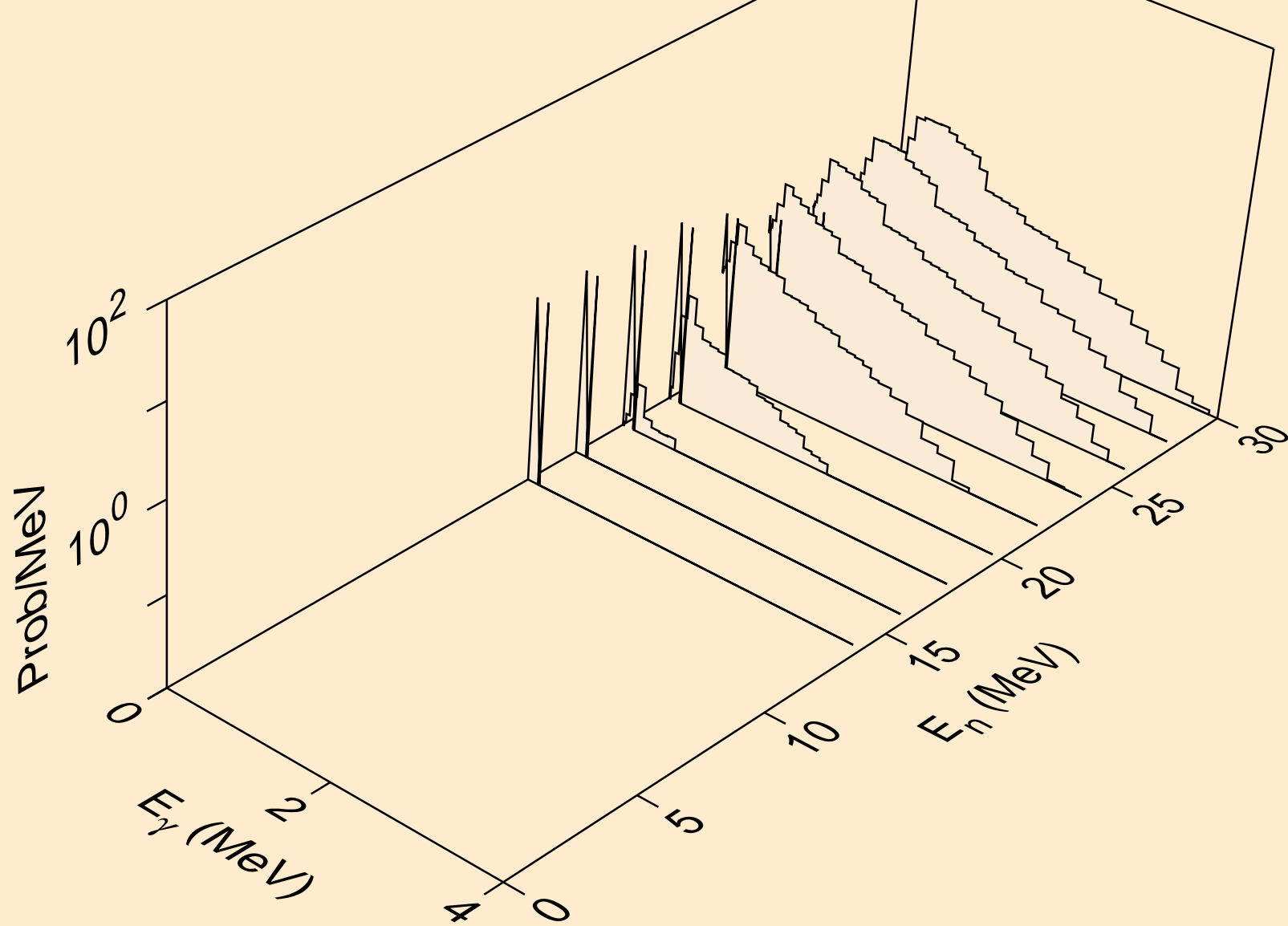

W193 ALPHA ACER TENDL-2021 LIBRARY; T=0.K  
Particle heating contributions

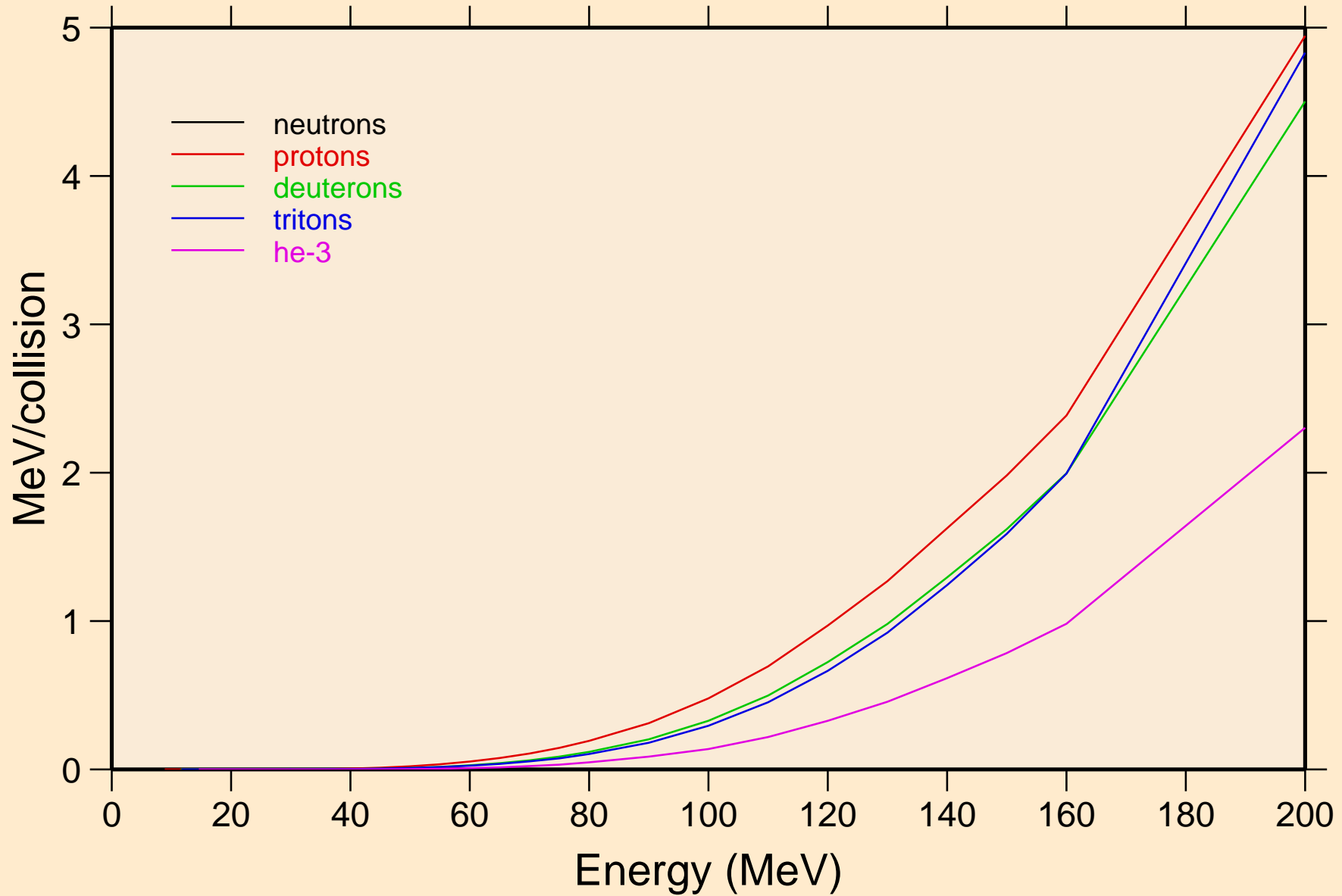



W193 ALPHA ACER TENDL-2021 LIBRARY; T=0.K  
Recoil Heating

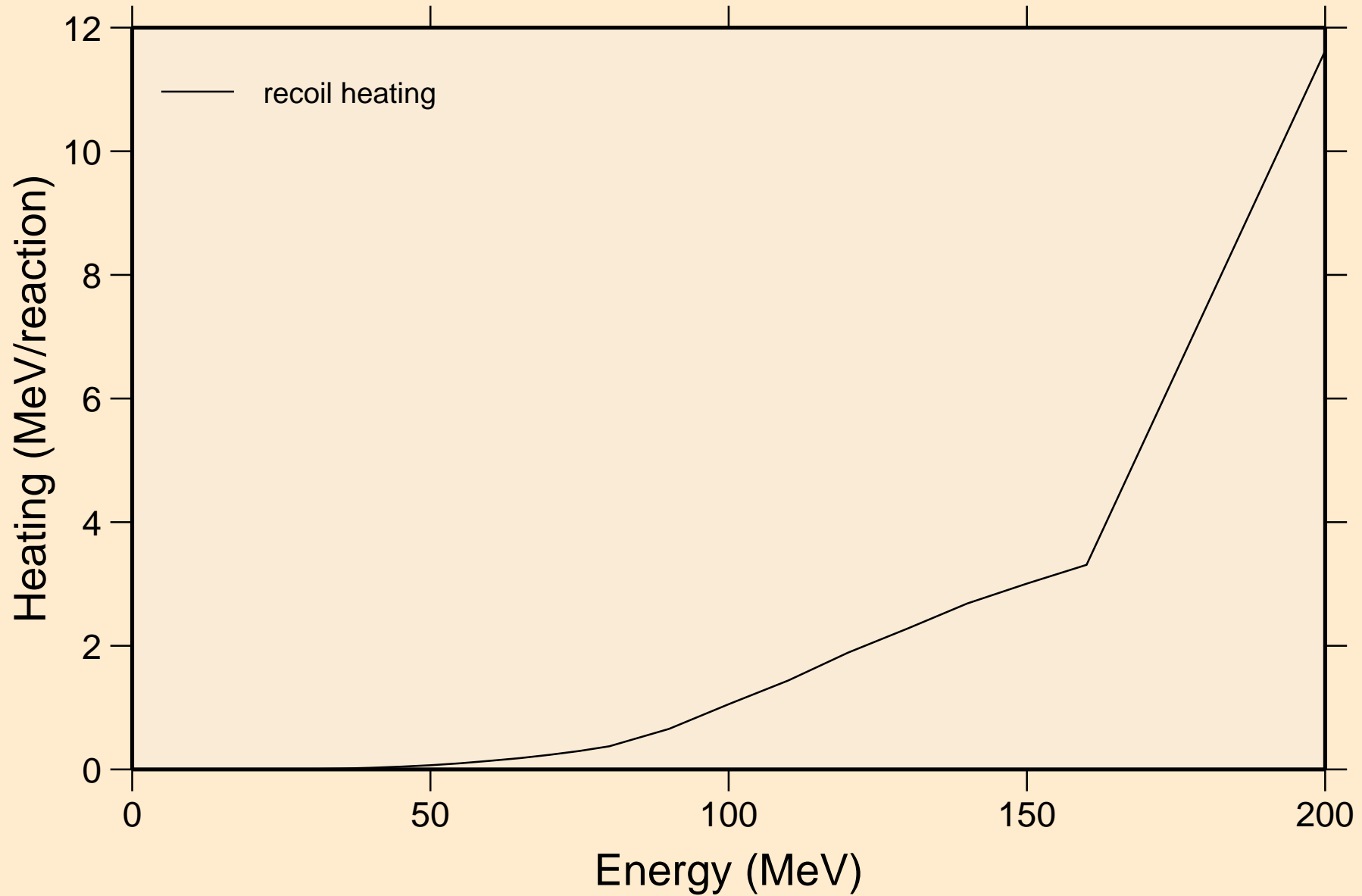

W193 ALPHA ACER TENDL-2021 LIBRARY; T=0.K  
Particle production cross sections

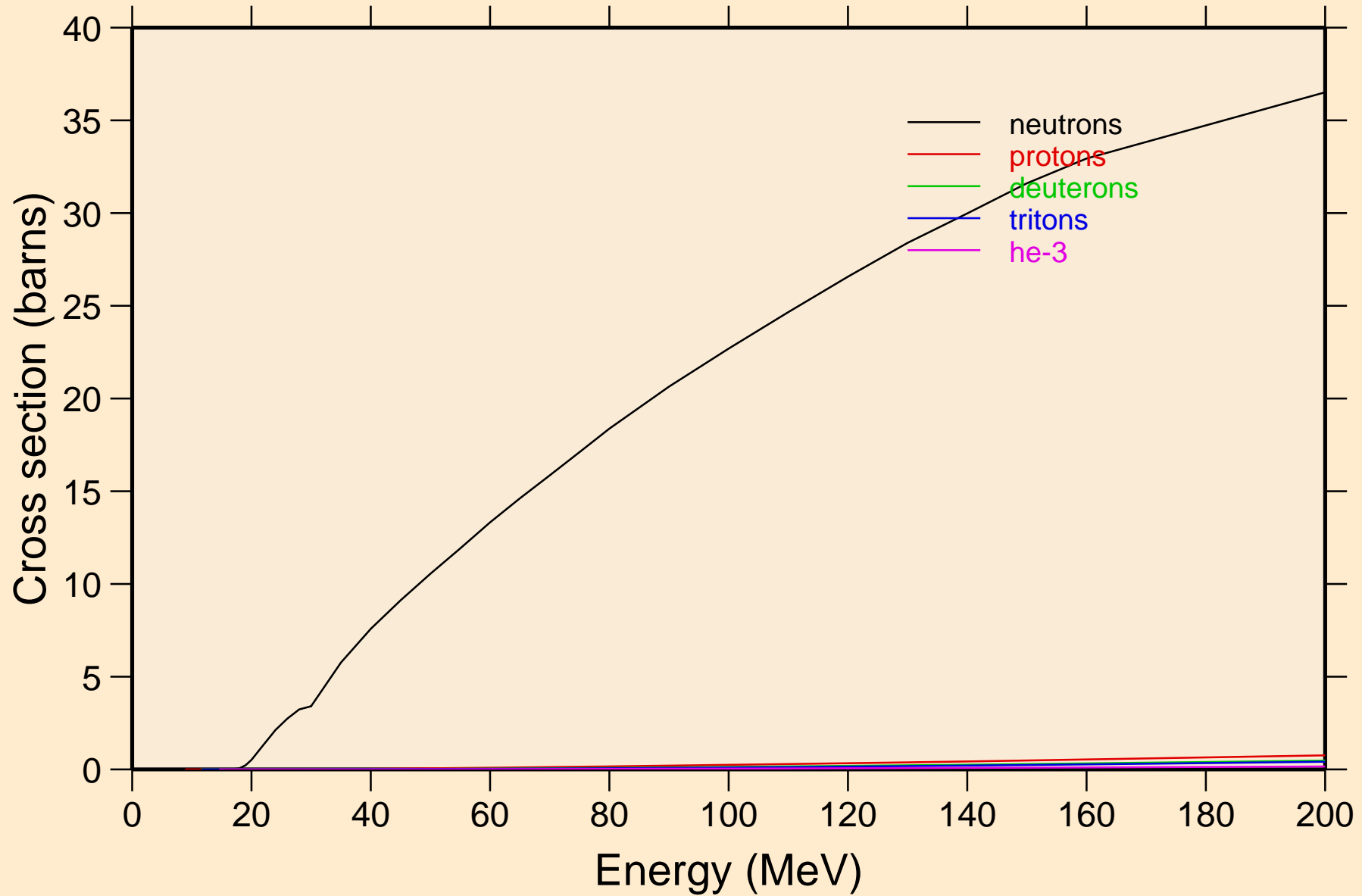

W193 ALPHA ACER TENDL-2021 LIBRARY; T=0.K  
neutrons from (a,n)

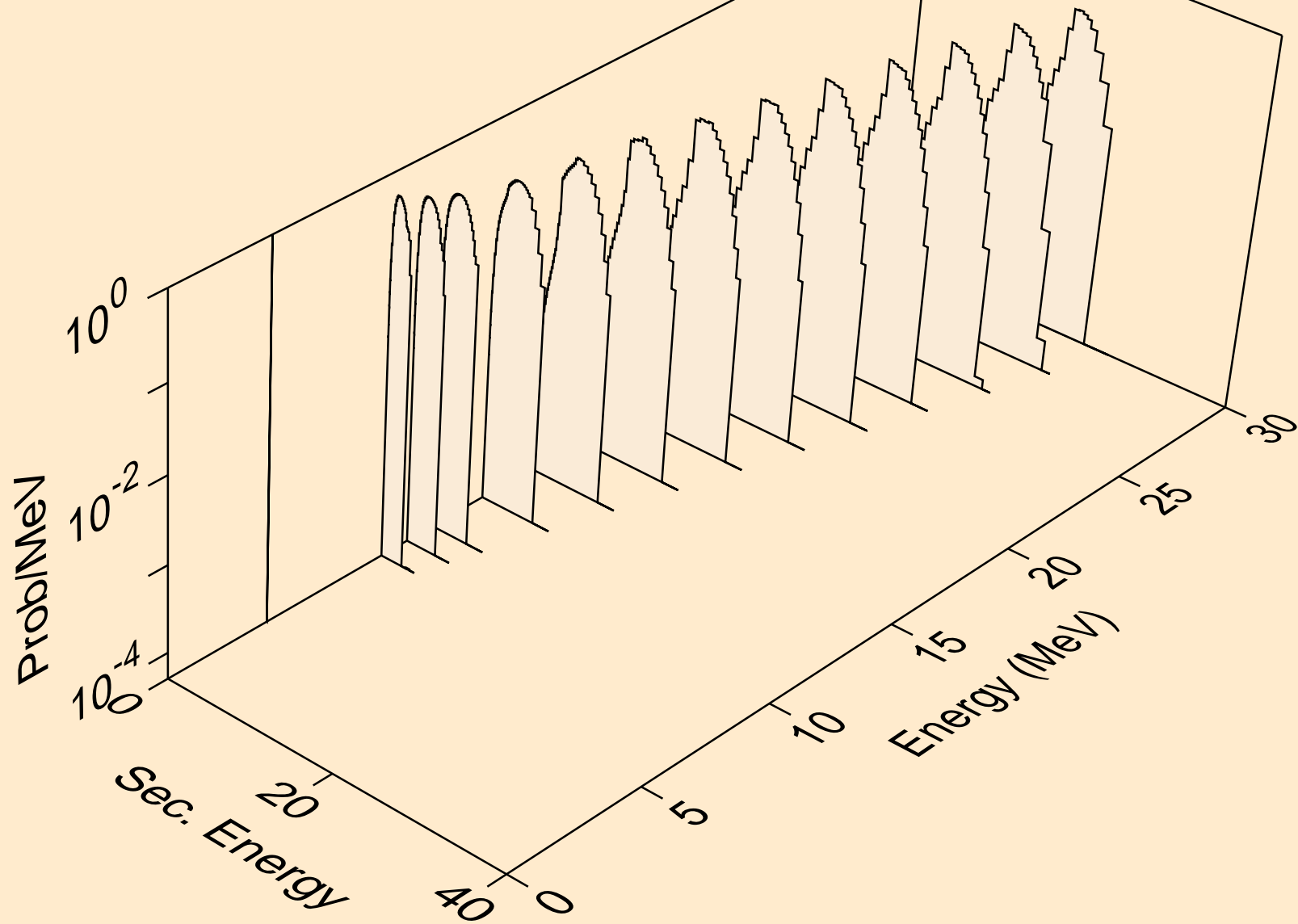

W193 ALPHA ACER TENDL-2021 LIBRARY; T=0.K  
neutrons from (a,x)

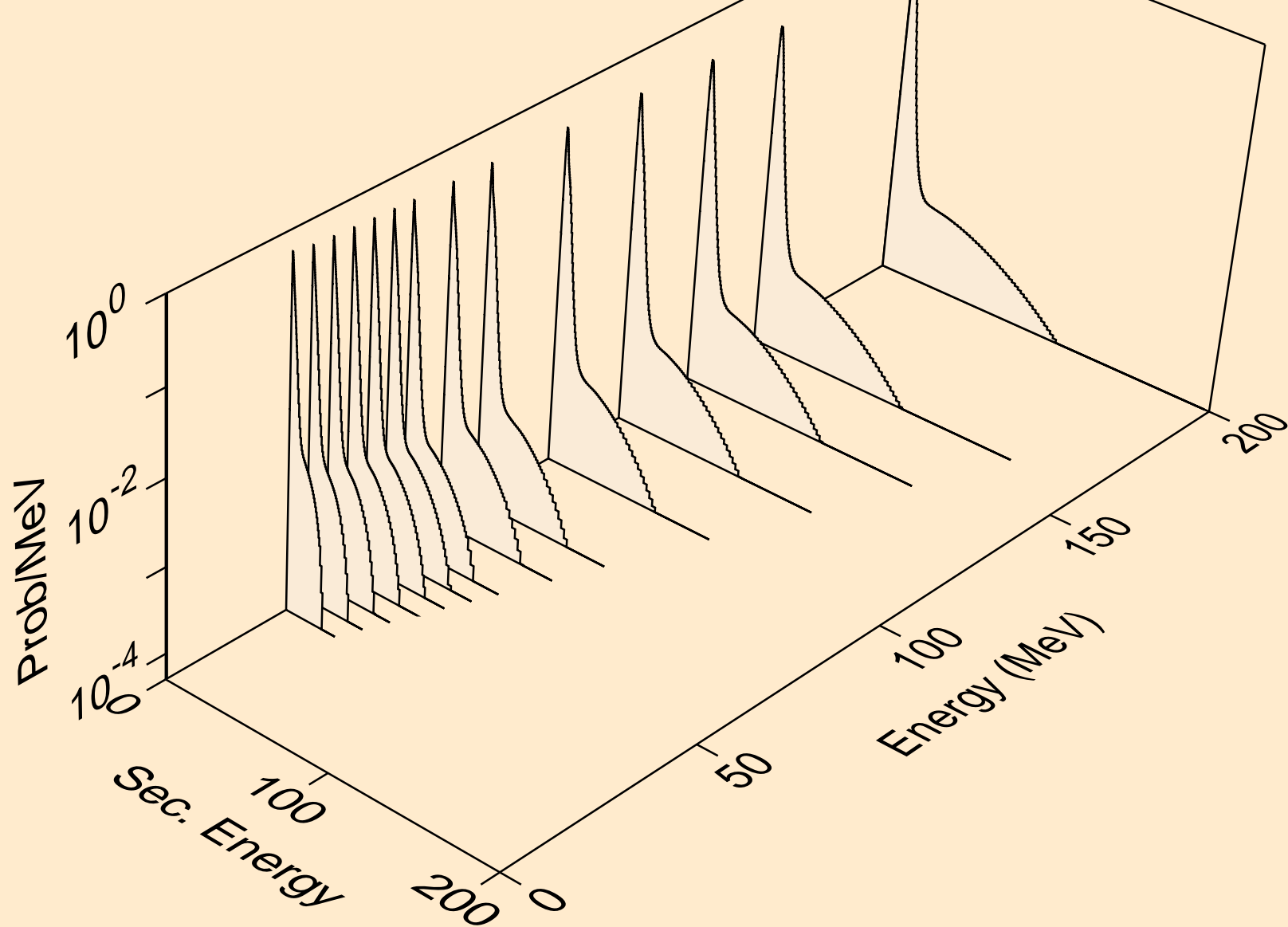

W193 ALPHA ACER TENDL-2021 LIBRARY; T=0.K  
neutrons from (a,2nd)

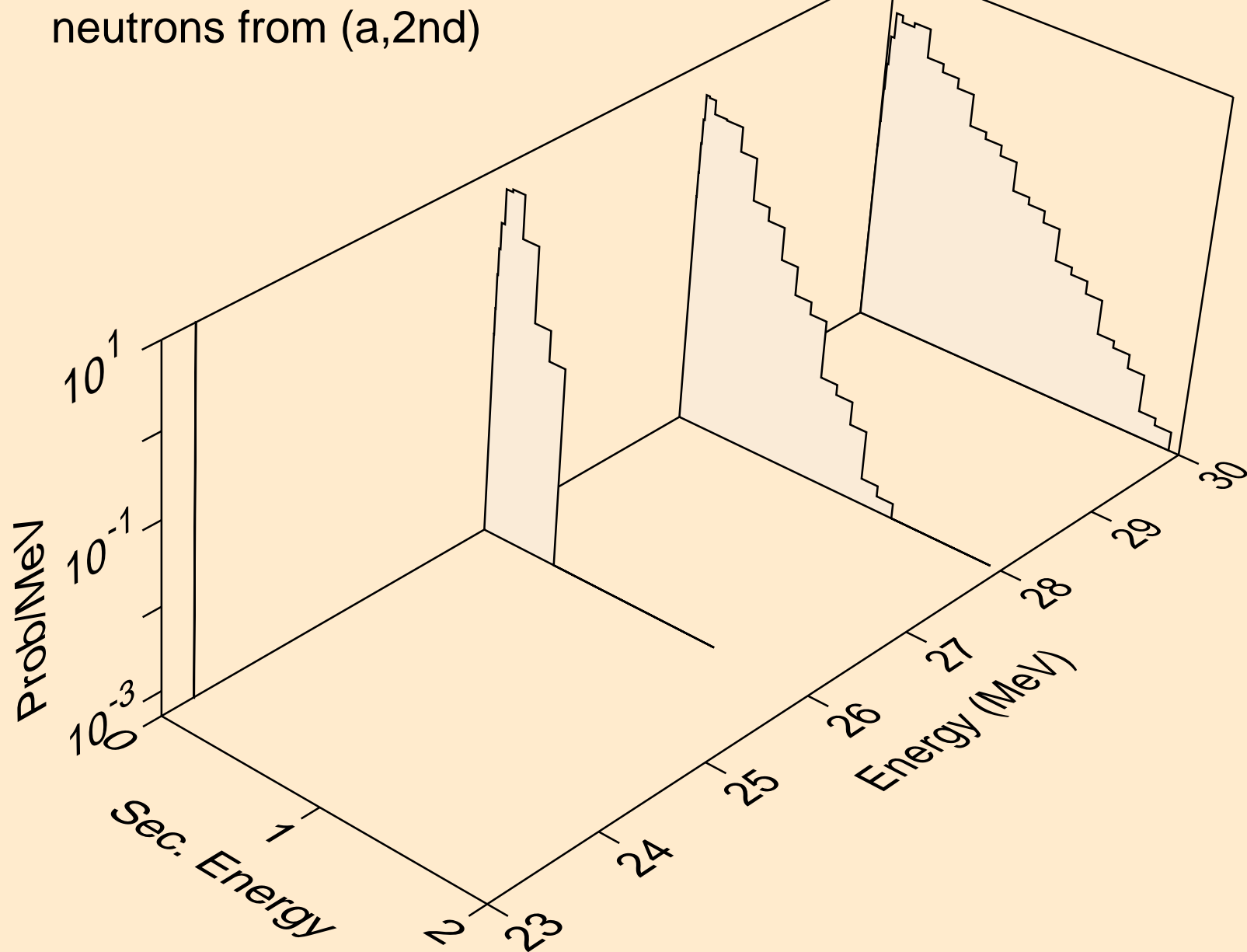

W193 ALPHA ACER TENDL-2021 LIBRARY; T=0.K  
neutrons from (a,2n)

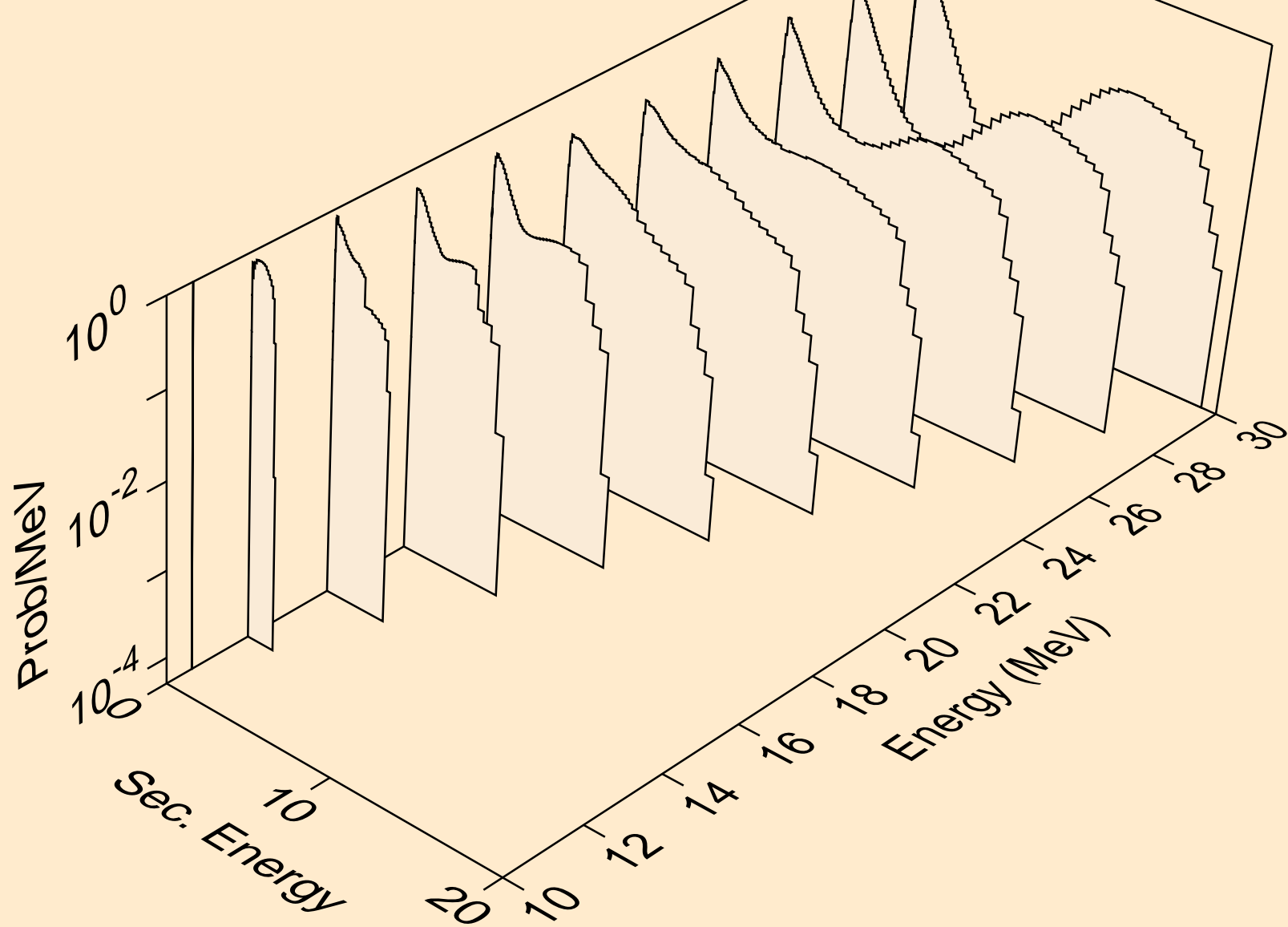

W193 ALPHA ACER TENDL-2021 LIBRARY; T=0.K  
neutrons from (a,3n)

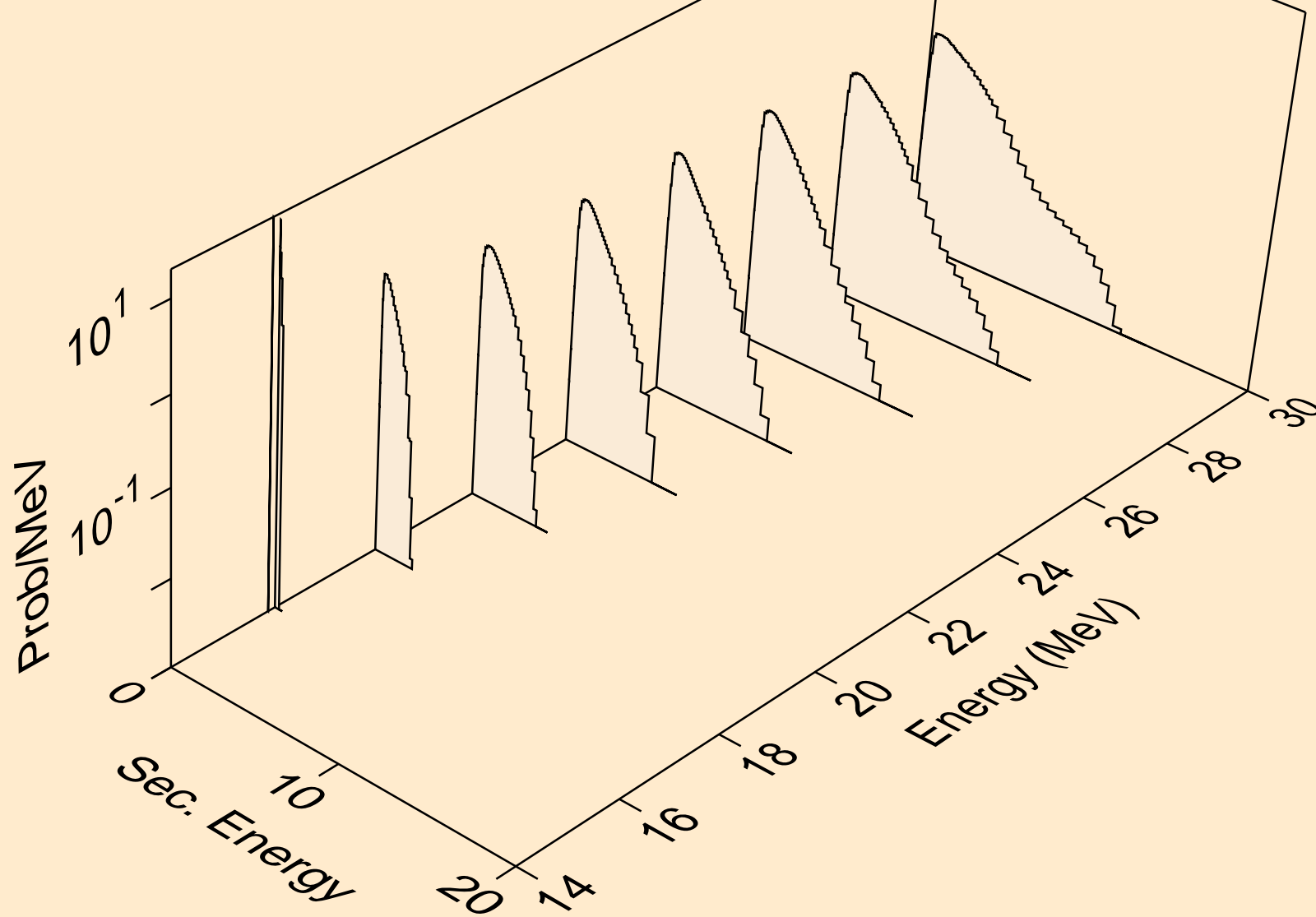

W193 ALPHA ACER TENDL-2021 LIBRARY; T=0.K  
neutrons from (a,n\*)a

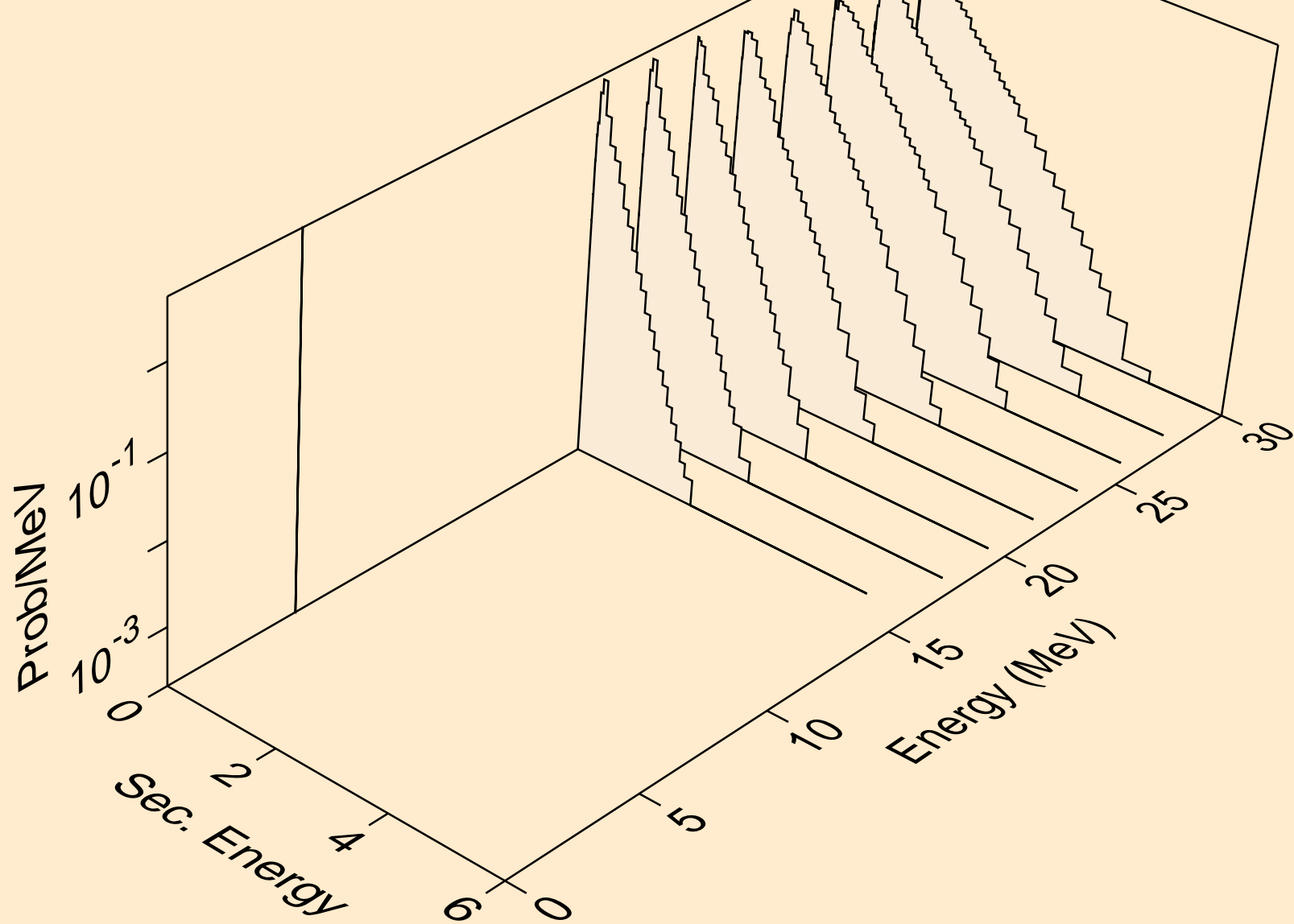



W193 ALPHA ACER TENDL-2021 LIBRARY; T=0.K  
neutrons from (a,2n)a

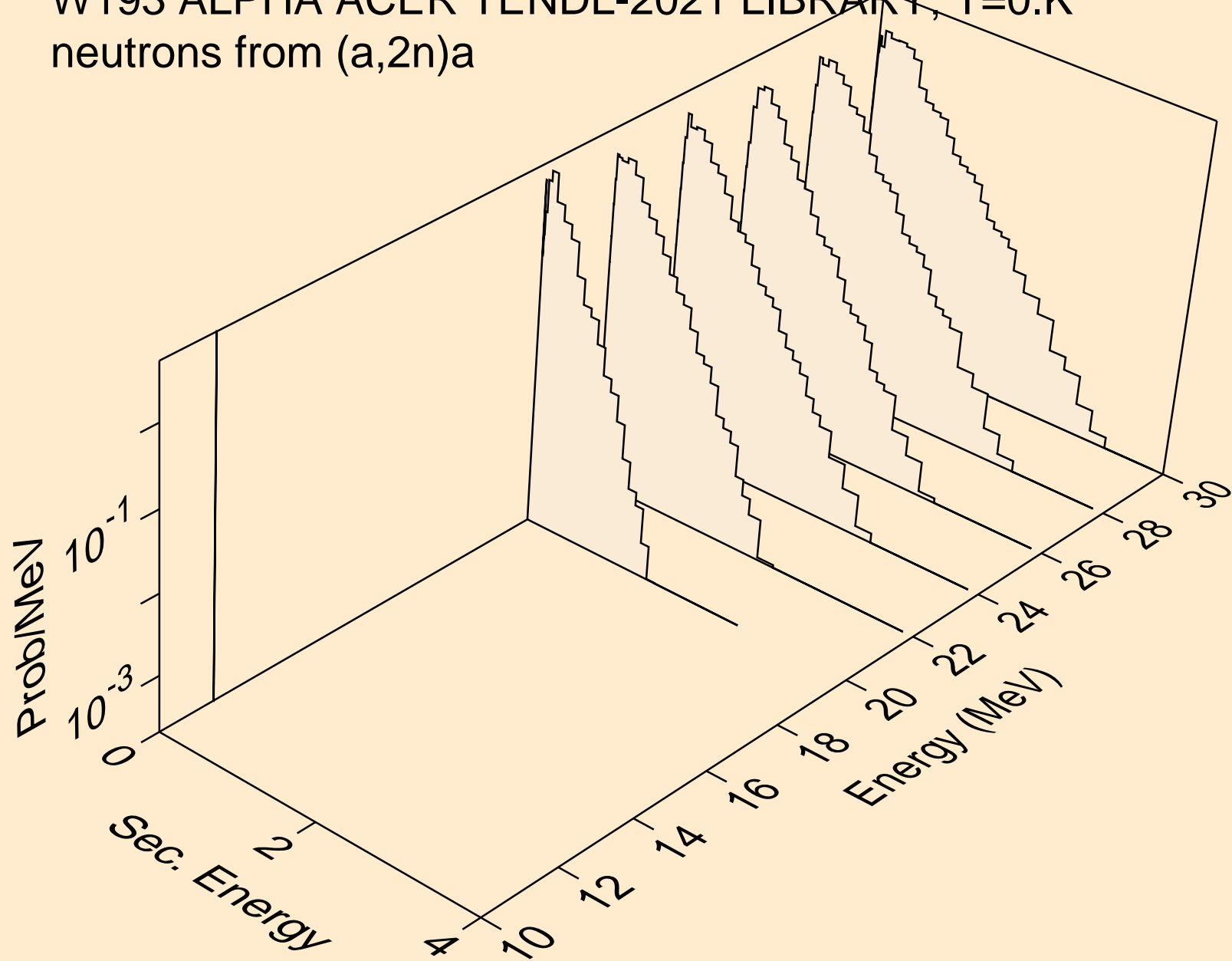

W193 ALPHA ACER TENDL-2021 LIBRARY; T=0.K  
neutrons from (a,3n)a

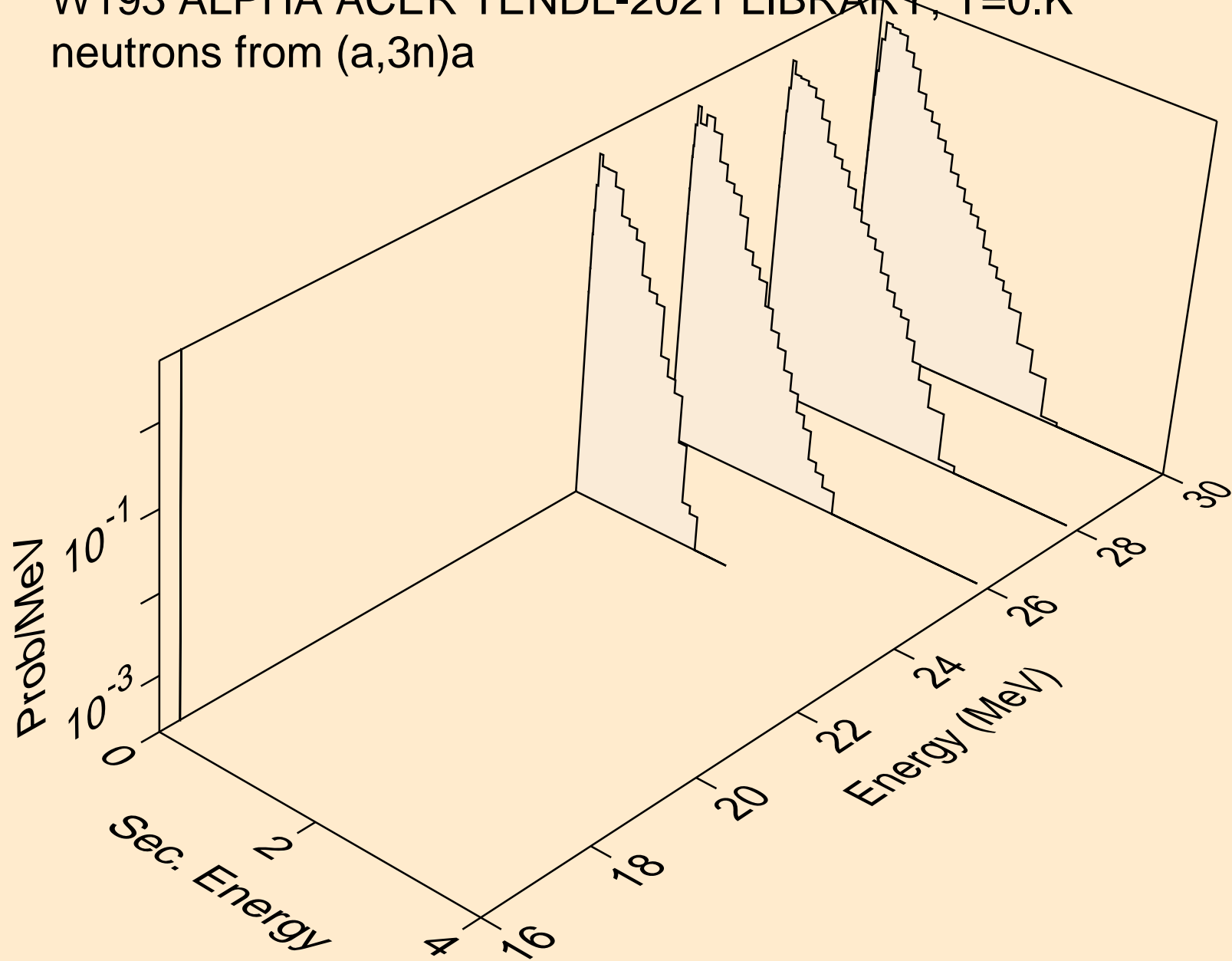

W193 ALPHA ACER TENDL-2021 LIBRARY; T=0.K  
neutrons from (a,n\*)p

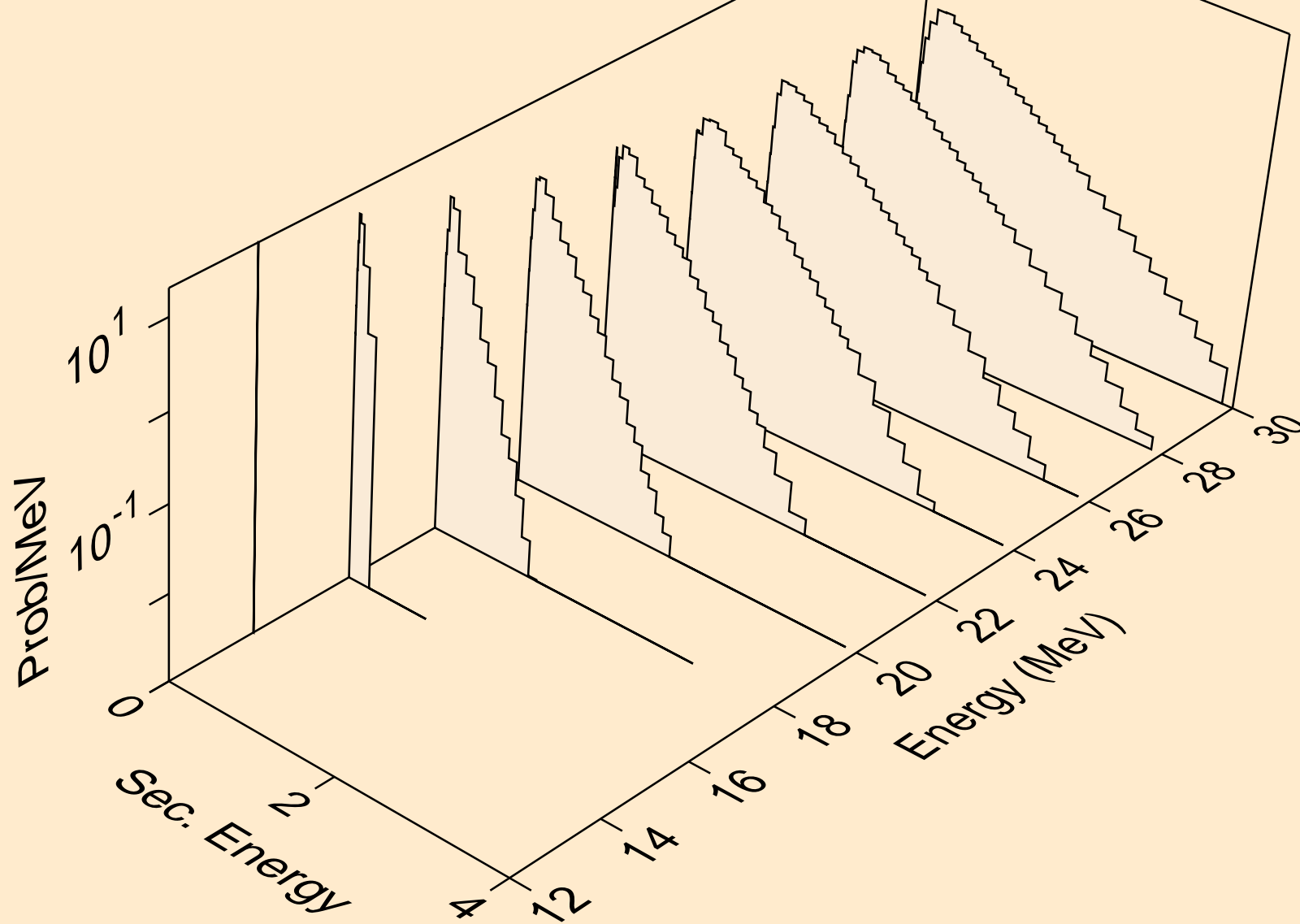

W193 ALPHA ACER TENDL-2021 LIBRARY; T=0.K  
neutrons from (a,n\*)d

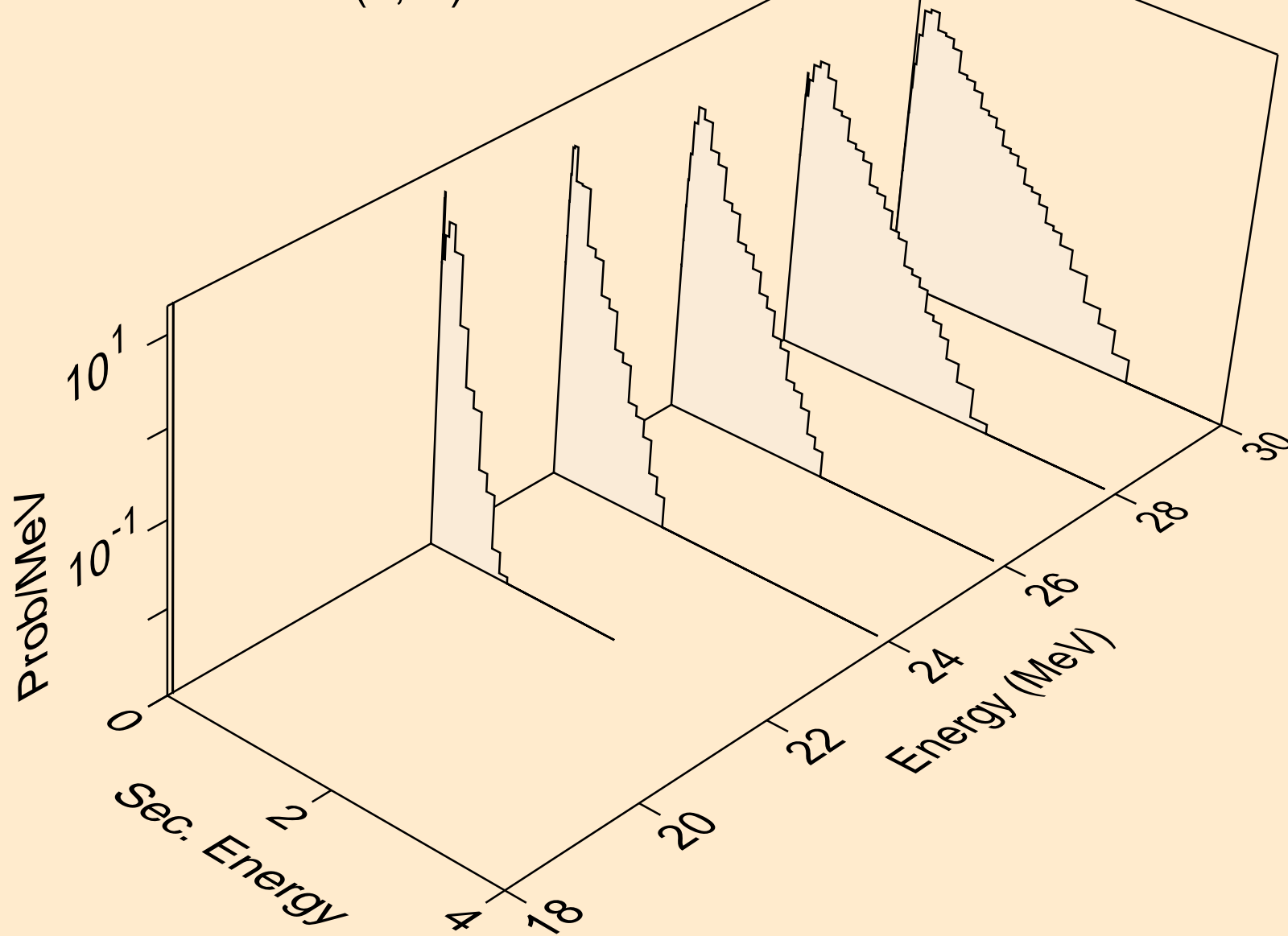

W193 ALPHA ACER TENDL-2021 LIBRARY; T=0.K  
neutrons from (a,n\*)t

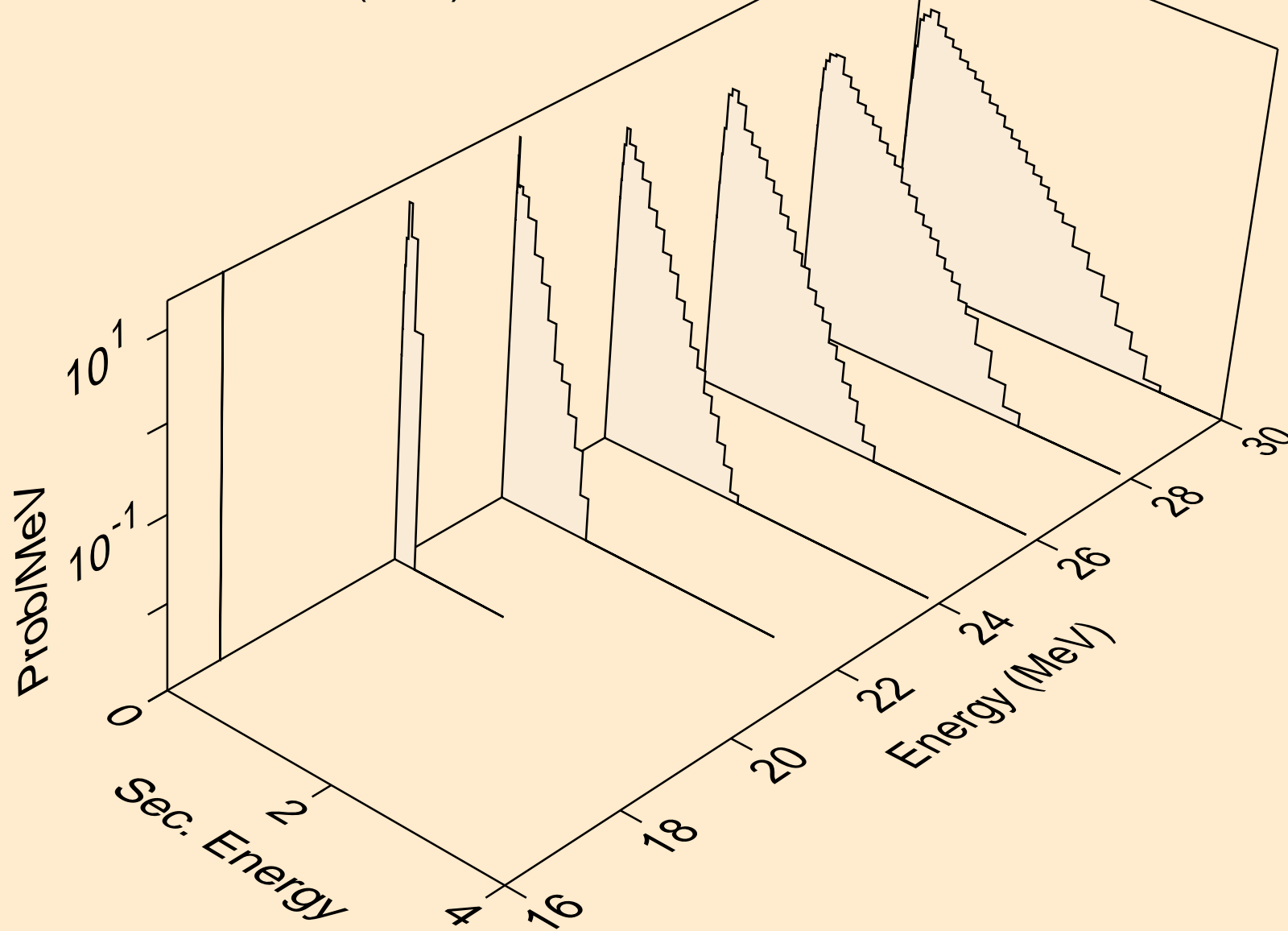

W193 ALPHA ACER TENDL-2021 LIBRARY; T=0.K  
neutrons from (a,4n)

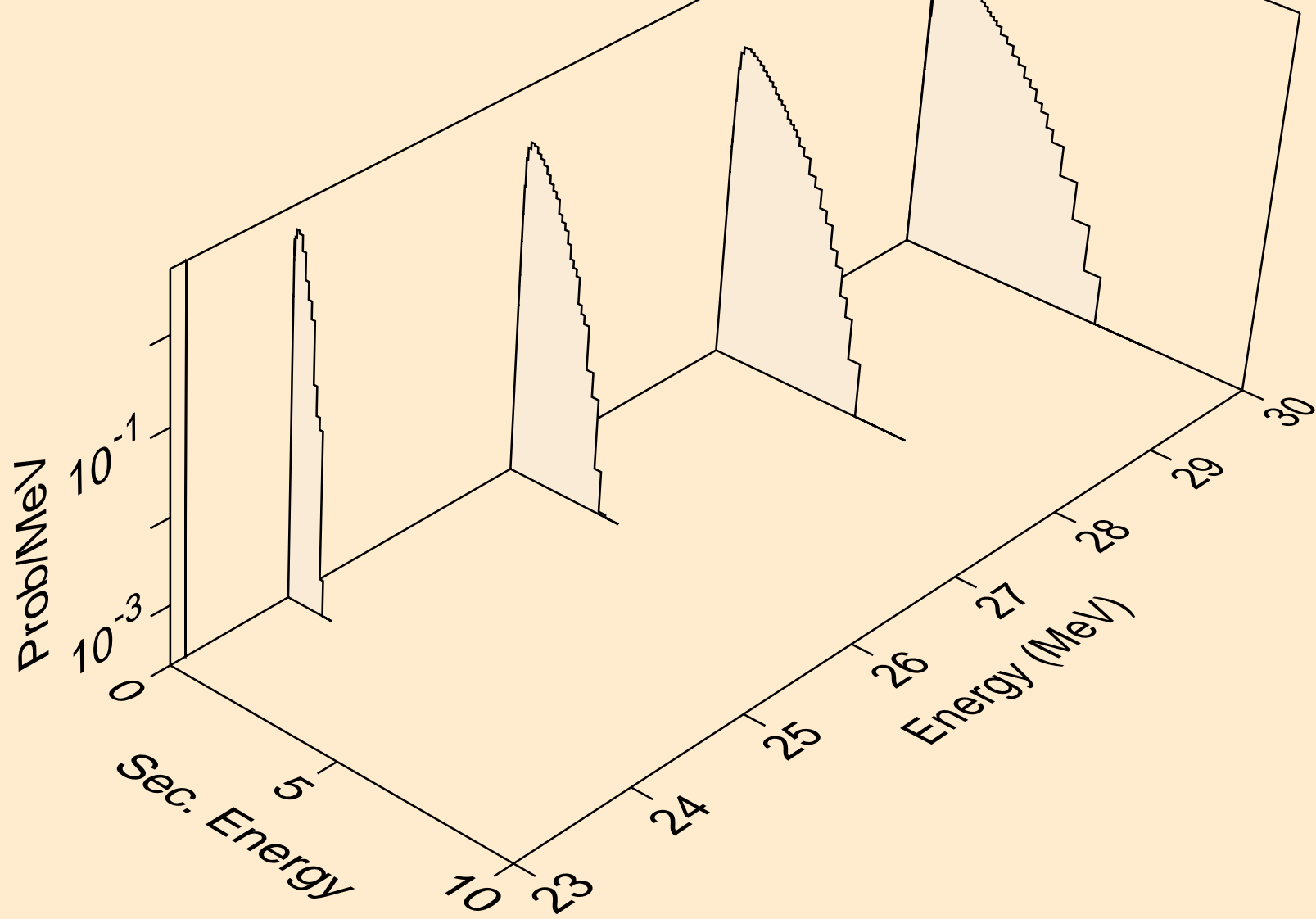

W193 ALPHA ACER TENDL-2021 LIBRARY; T=0.K  
neutrons from (a,2np)

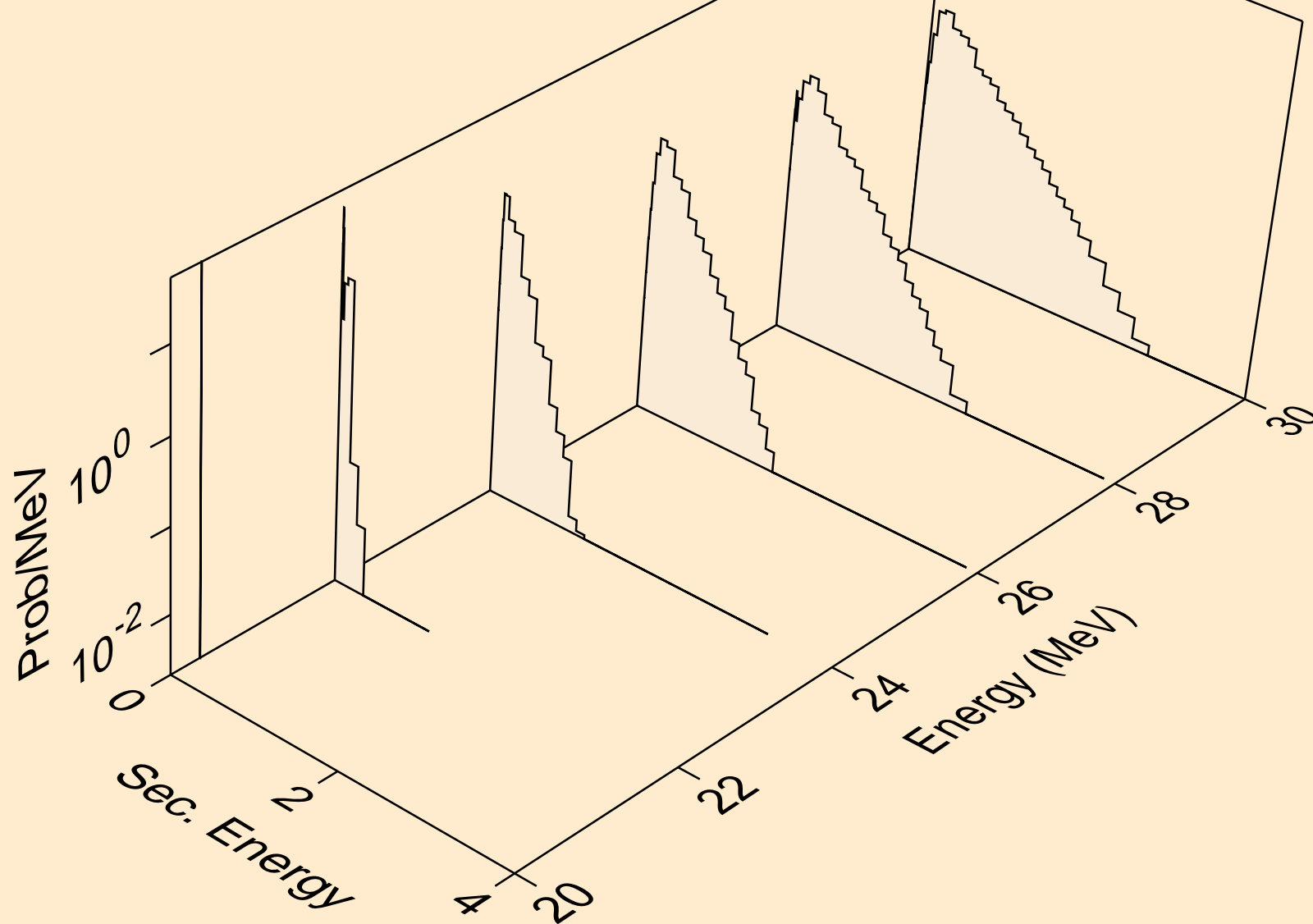

W193 ALPHA ACER TENDL-2021 LIBRARY; T=0.K  
protons from (a,x)

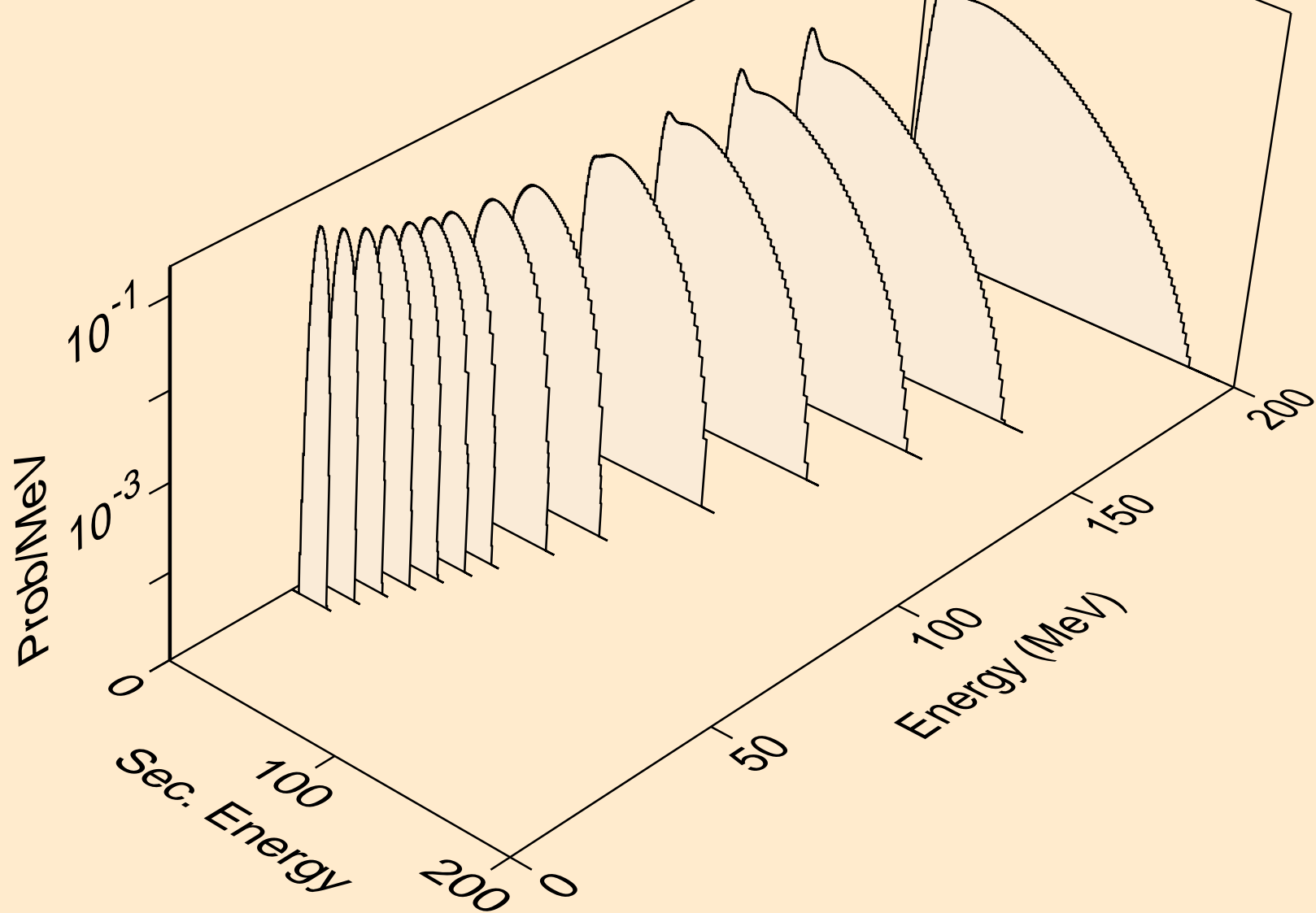



W193 ALPHA ACER TENDL-2021 LIBRARY; T=0.K  
protons from (a,n\*)p

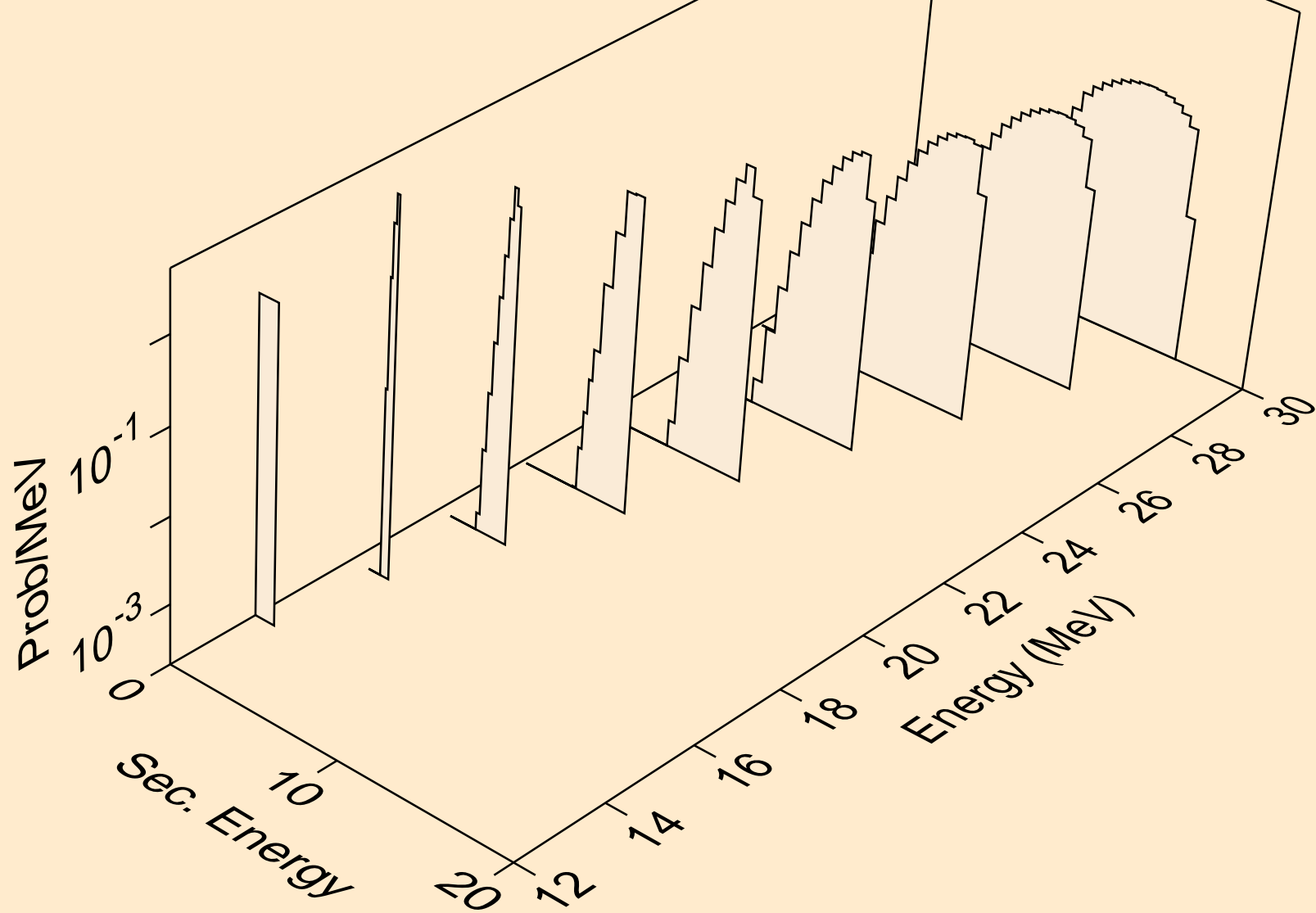

W193 ALPHA ACER TENDL-2021 LIBRARY; T=0.K  
protons from (a,2np)

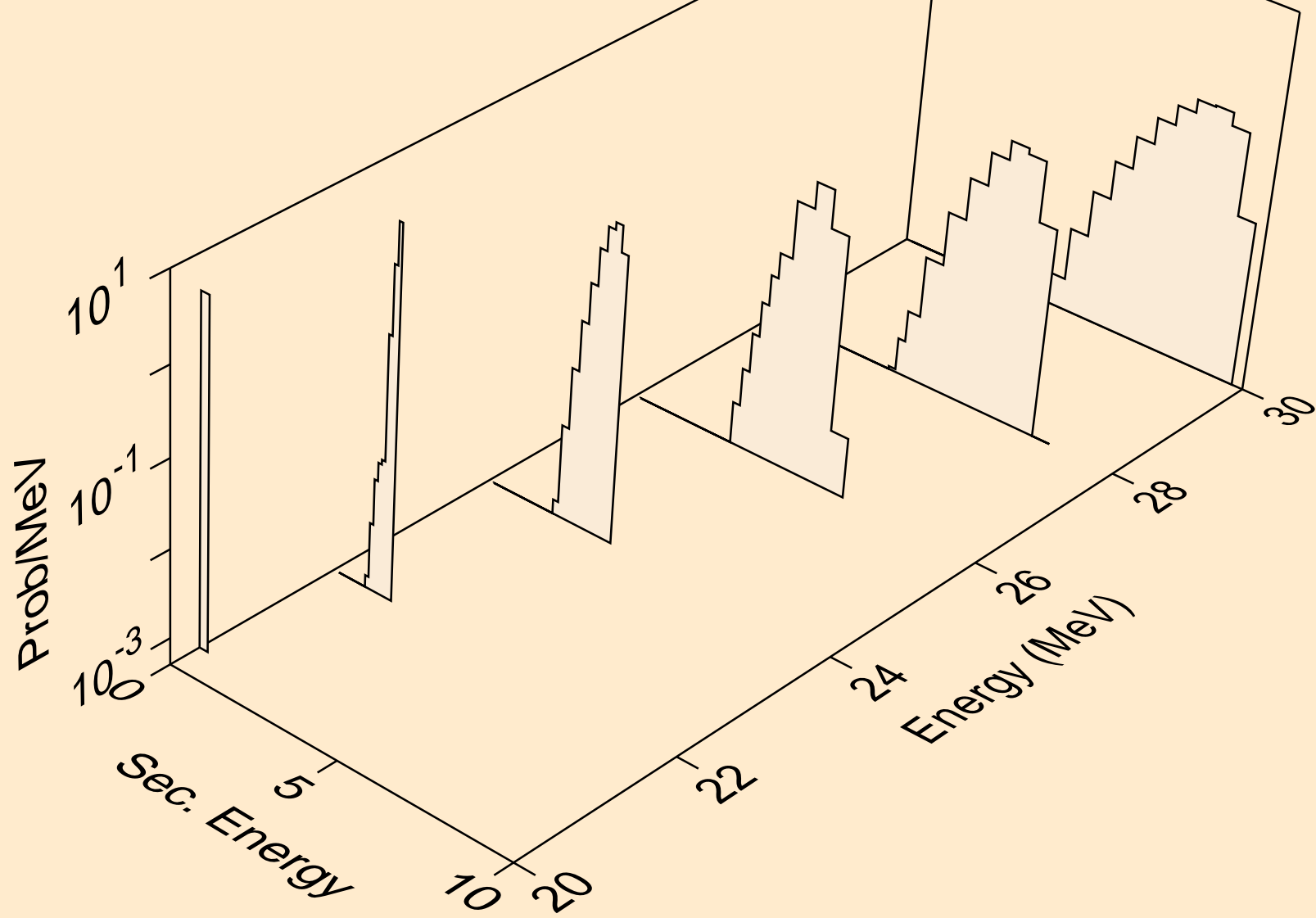

W193 ALPHA ACER TENDL-2021 LIBRARY; T=0.K  
protons from (a,p)

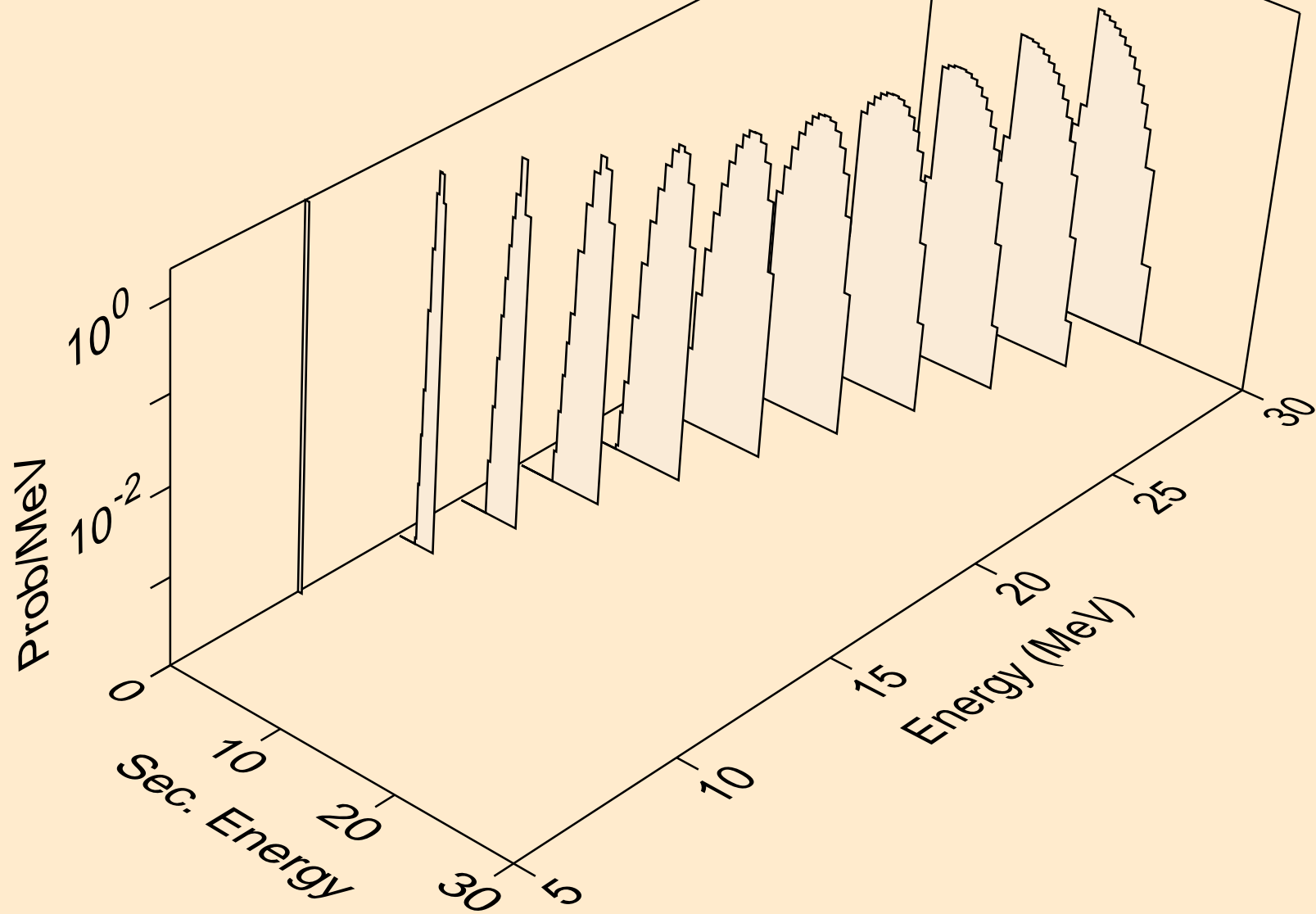

W193 ALPHA ACER TENDL-2021 LIBRARY; T=0.K  
deuterons from (a,x)

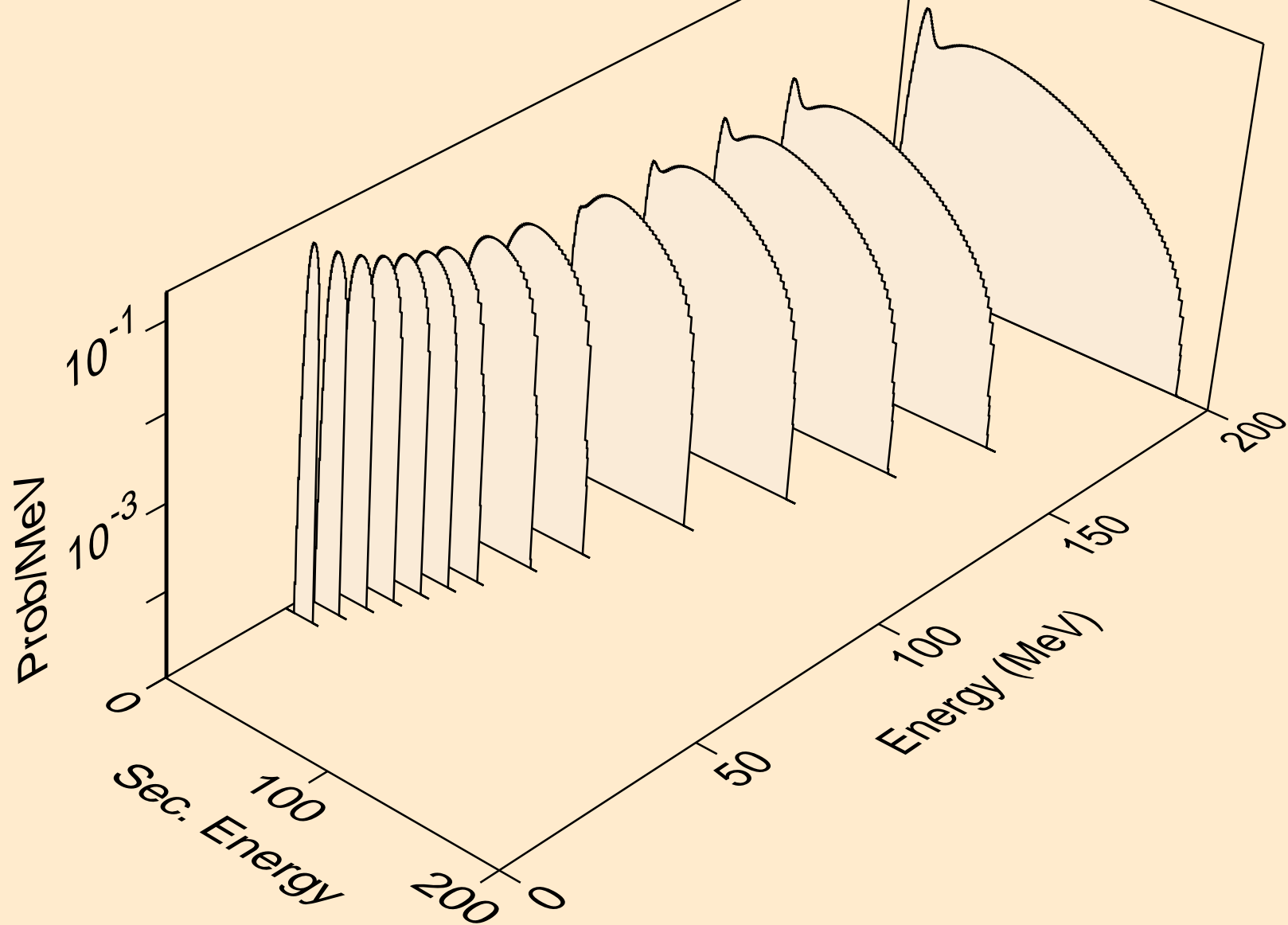

W193 ALPHA ACER TENDL-2021 LIBRARY; T=0.K  
deuterons from (a,2nd)

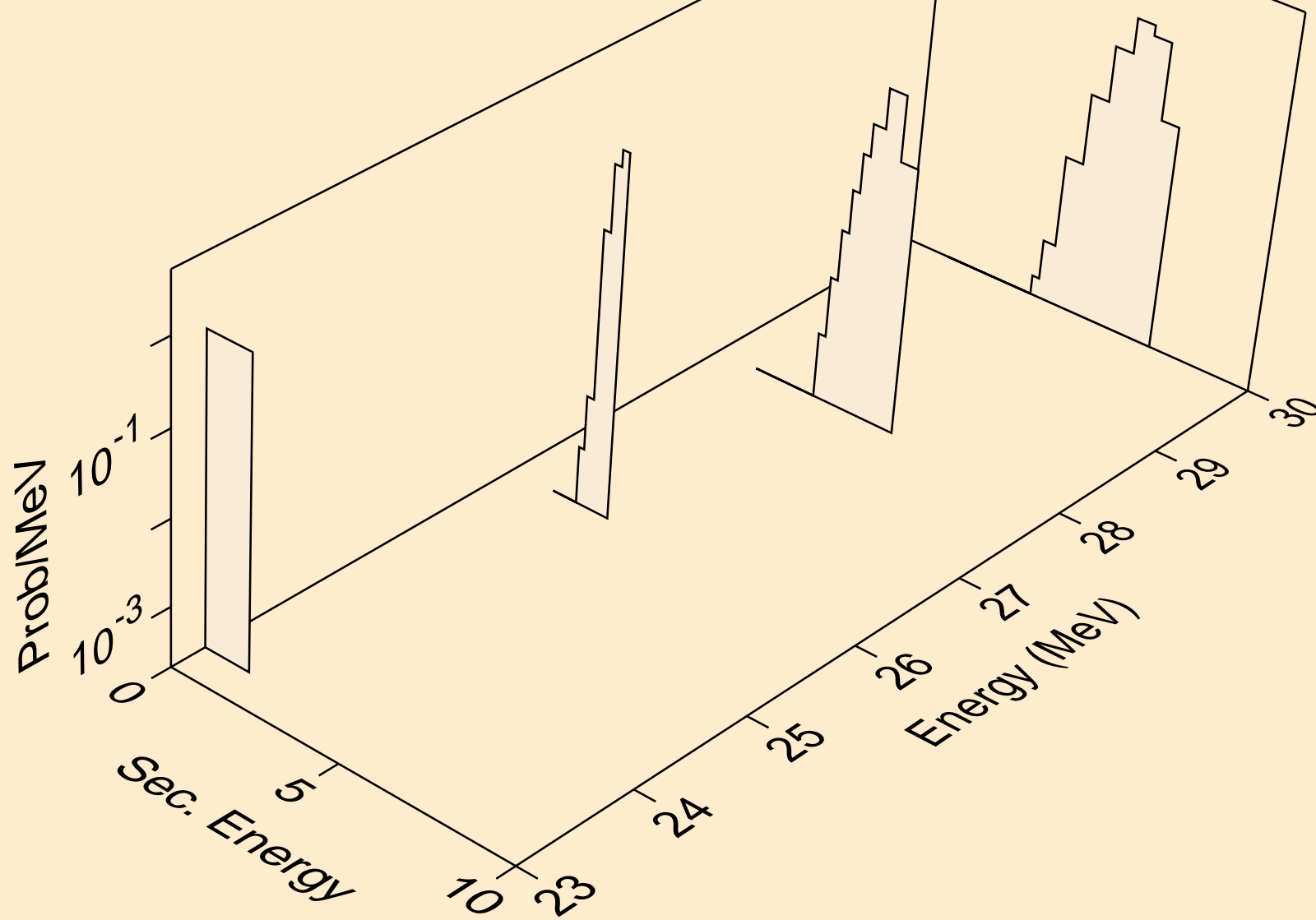

W193 ALPHA ACER TENDL-2021 LIBRARY; T=0.K  
deuterons from (a,n\*)d

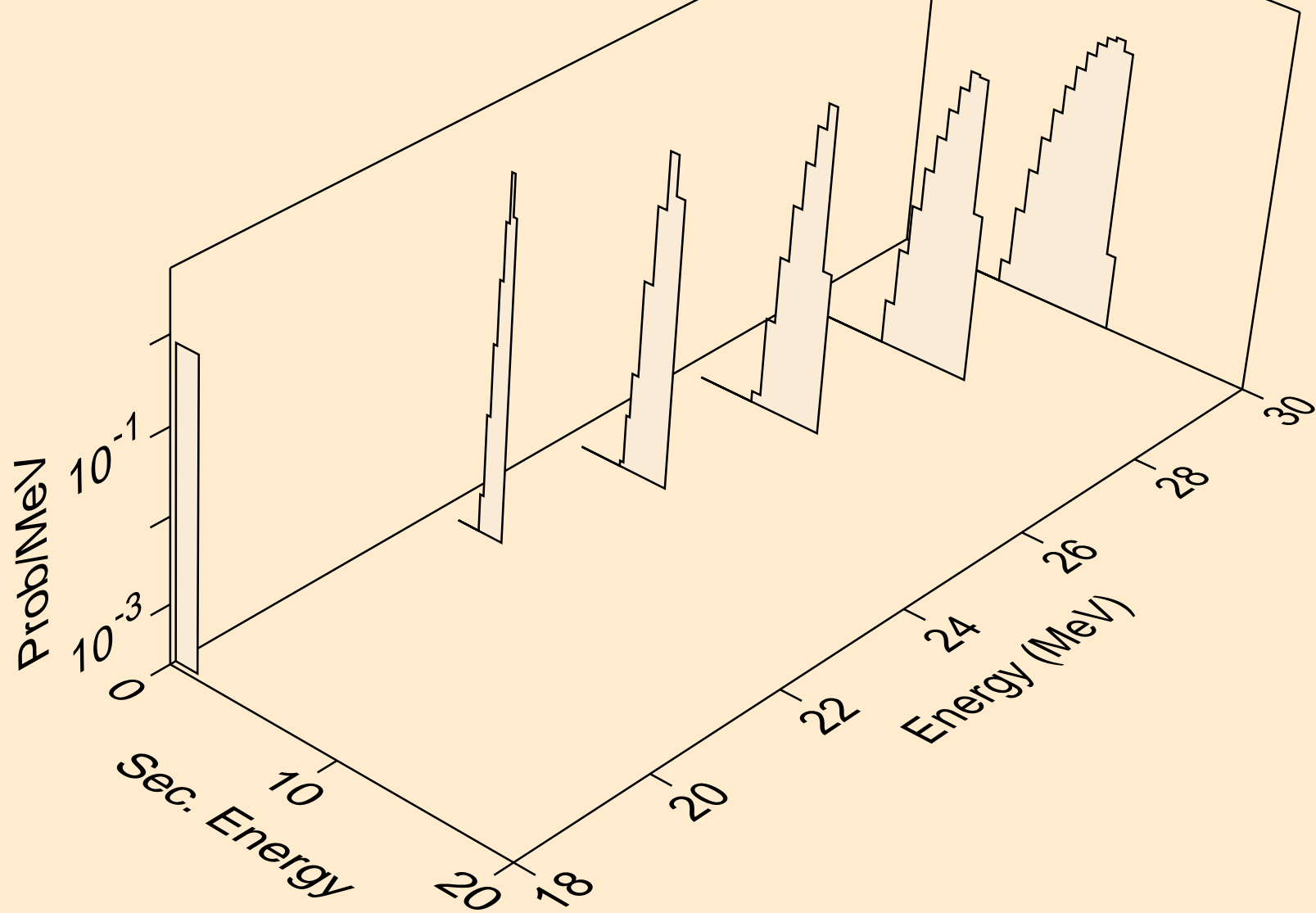

W193 ALPHA ACER TENDL-2021 LIBRARY; T=0.K  
deuterons from (a,d)

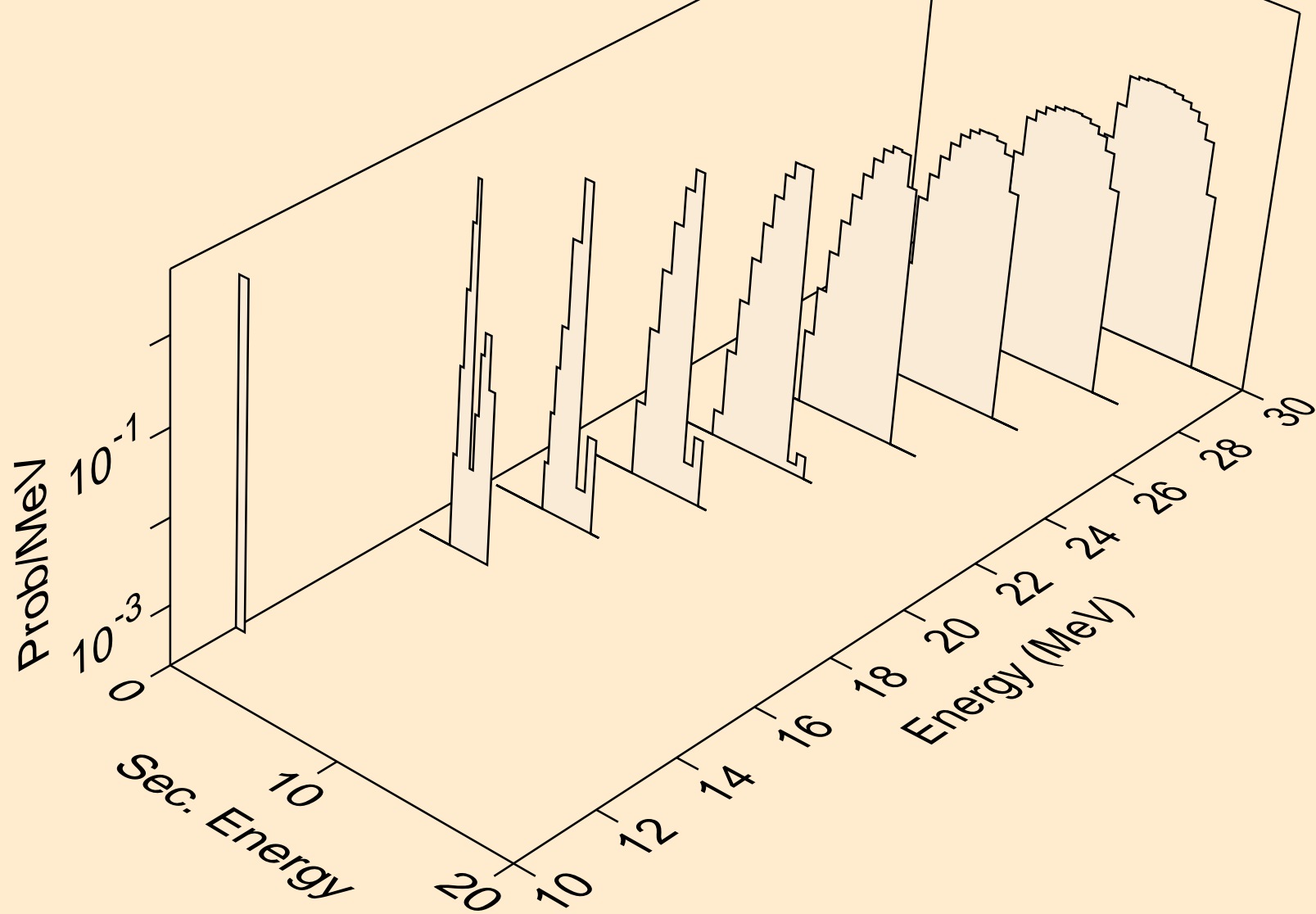

W193 ALPHA ACER TENDL-2021 LIBRARY; T=0.K  
tritons from (a,x)

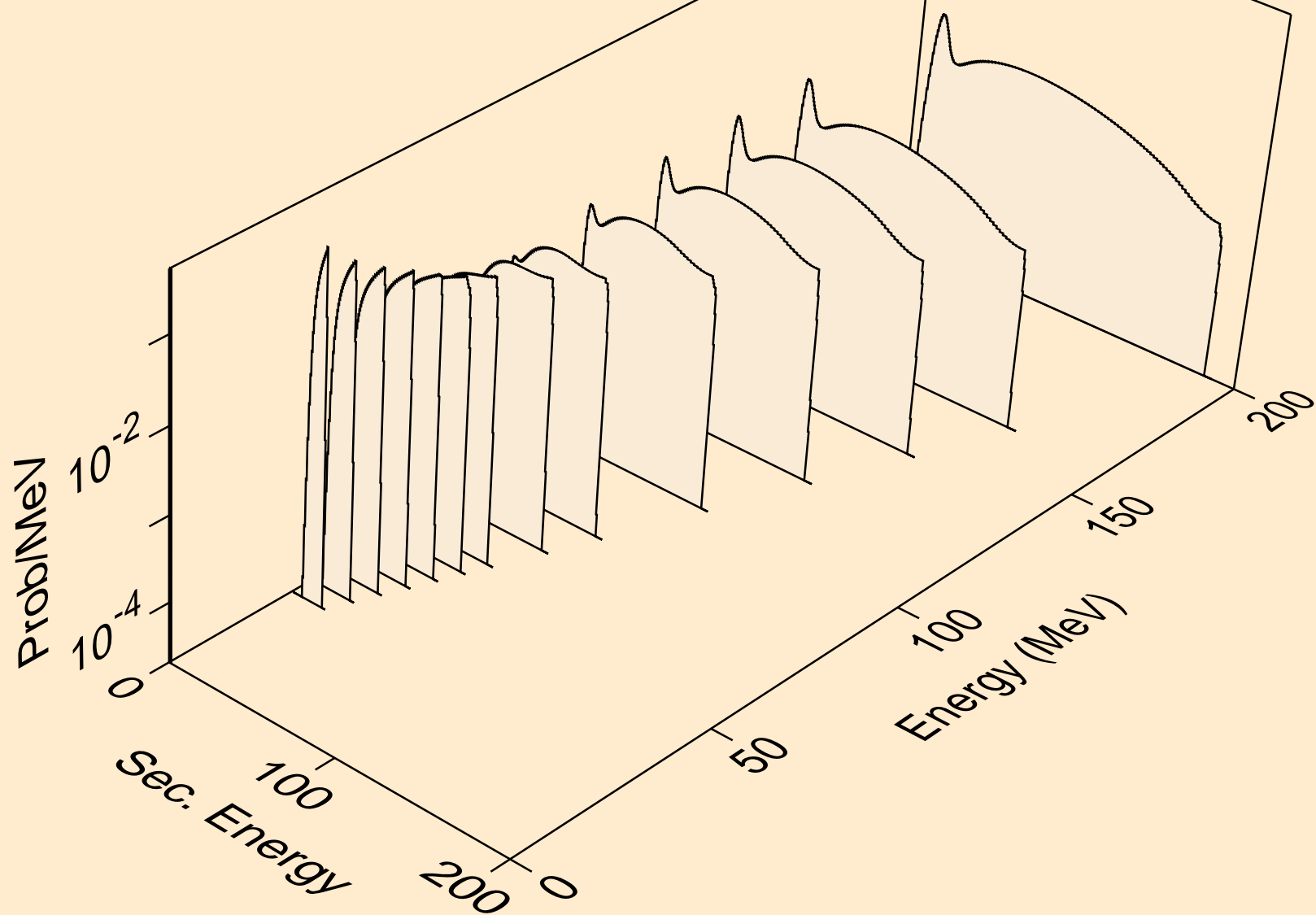



W193 ALPHA ACER TENDL-2021 LIBRARY; T=0.K  
tritons from (a,n\*)t

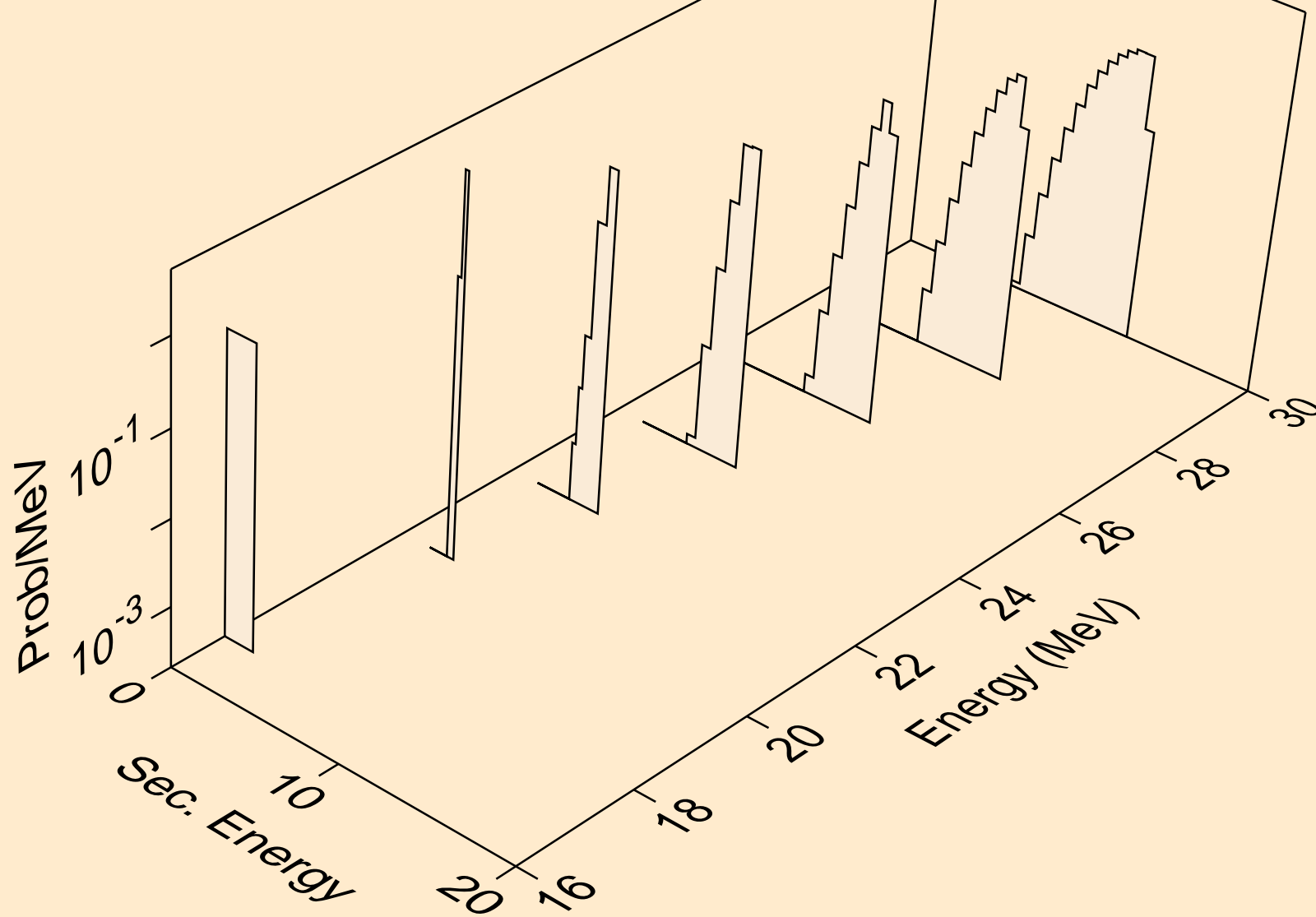

W193 ALPHA ACER TENDL-2021 LIBRARY; T=0.K  
tritons from (a,t)

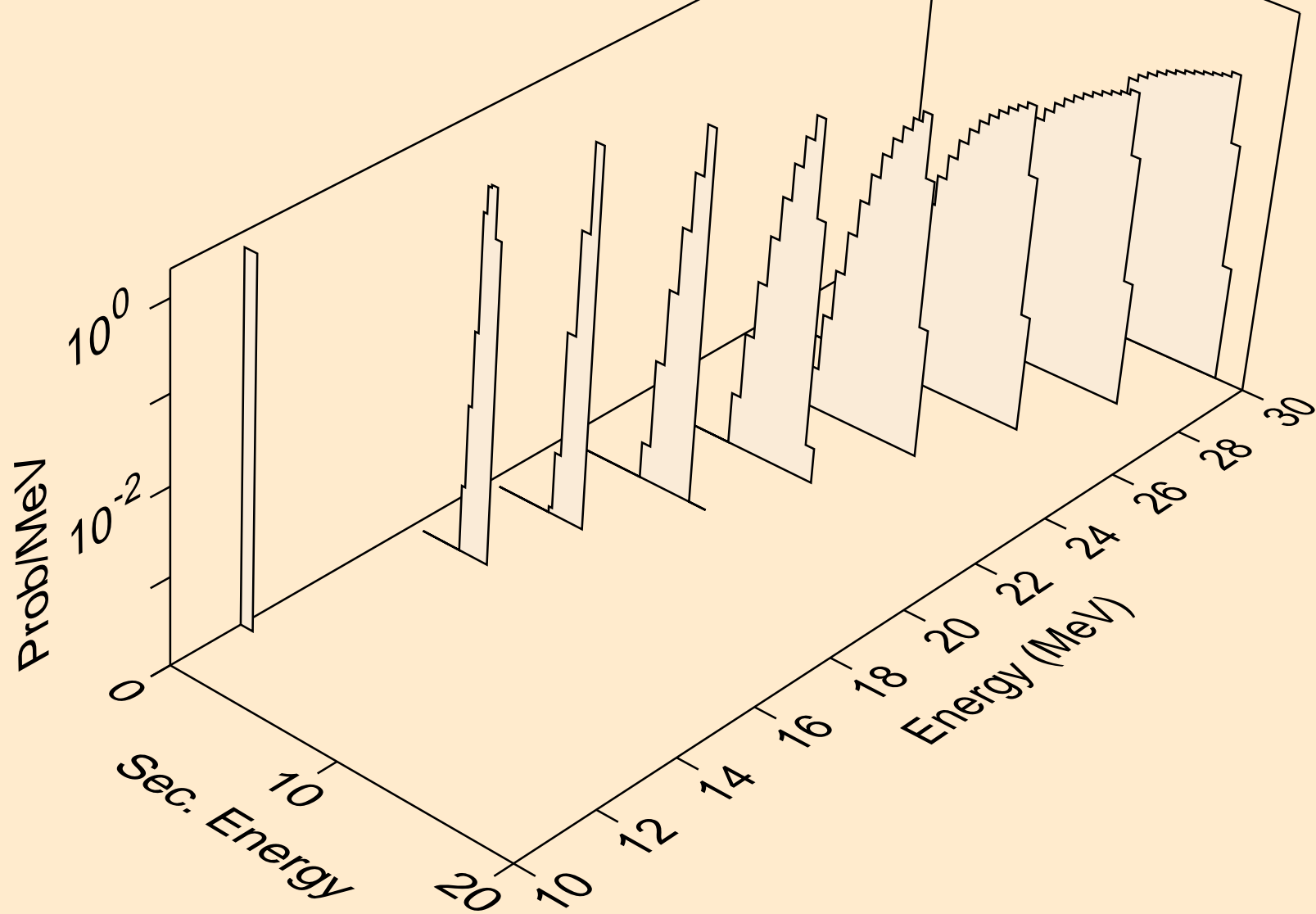

W193 ALPHA ACER TENDL-2021 LIBRARY; T=0.K  
he3s from (a,x)

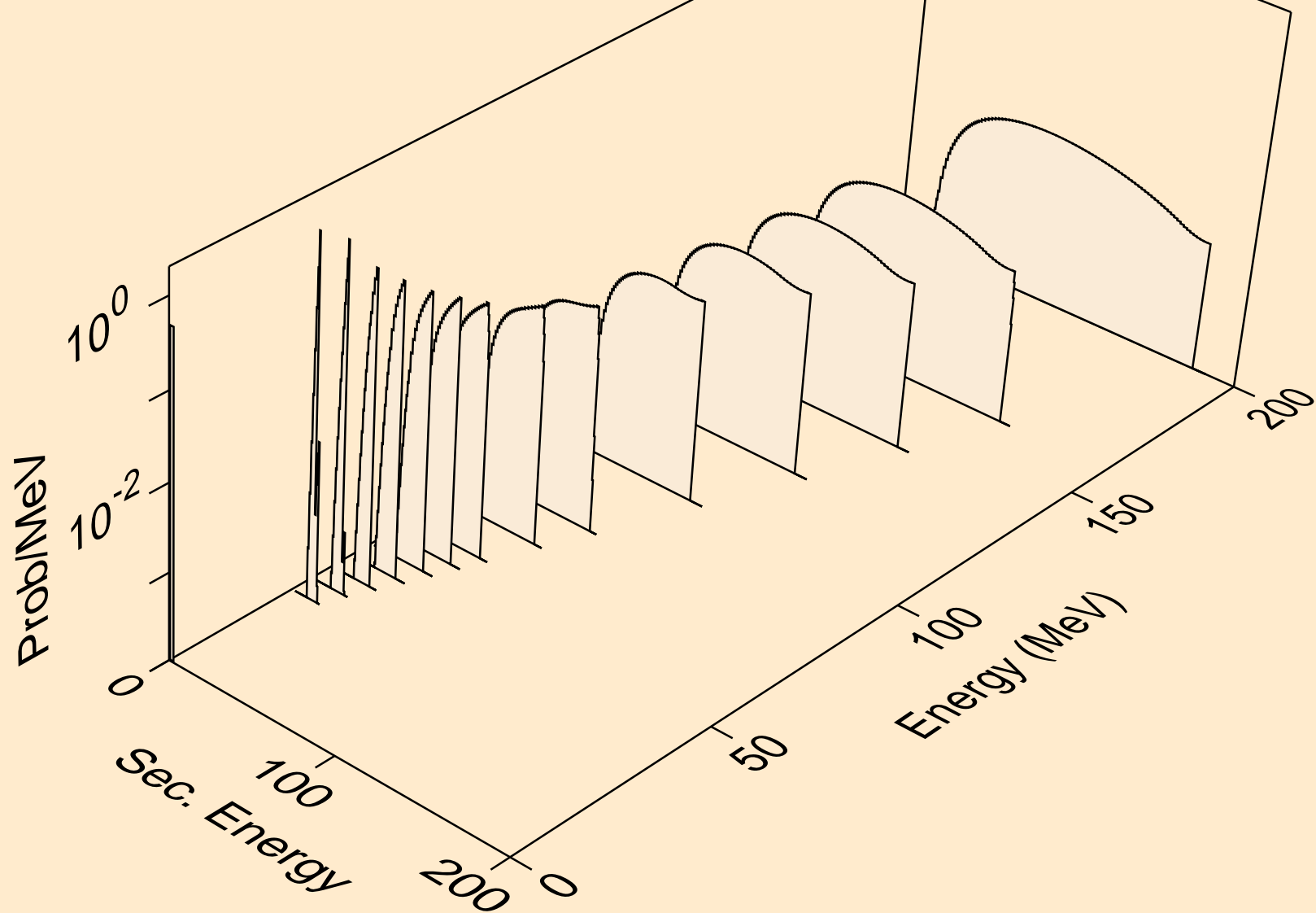

W193 ALPHA ACER TENDL-2021 LIBRARY; T=0.K  
he3s from (a,he3)

