

AM233 DEUTERON ACER TENDL-2021 LIBRARY; T=0.K
Principal cross sections

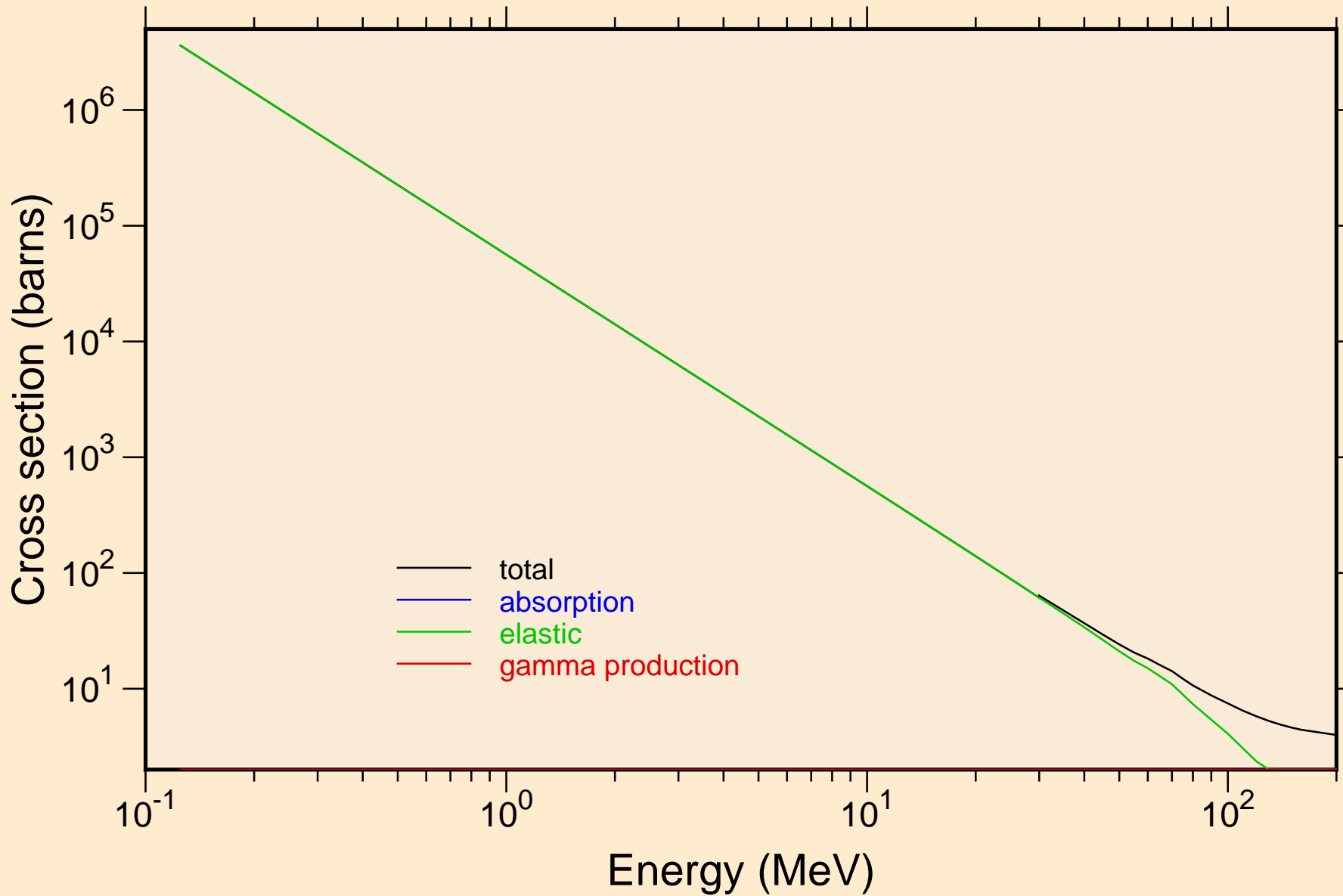

AM233 DEUTERON ACER TENDL-2021 LIBRARY; T=0.K

Heating

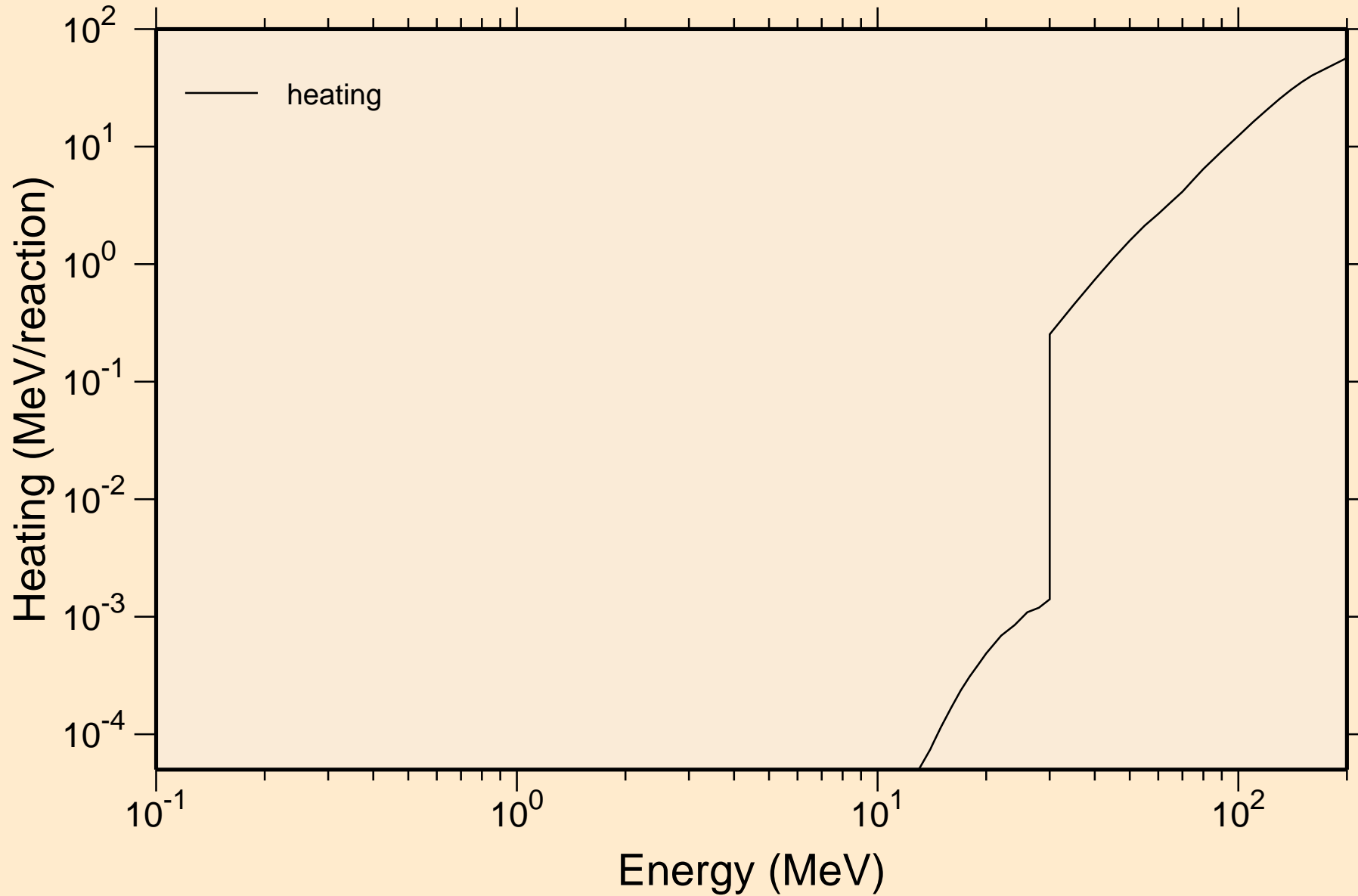

AM233 DEUTERON ACER TENDL-2021 LIBRARY; T=0.K
Principal cross sections

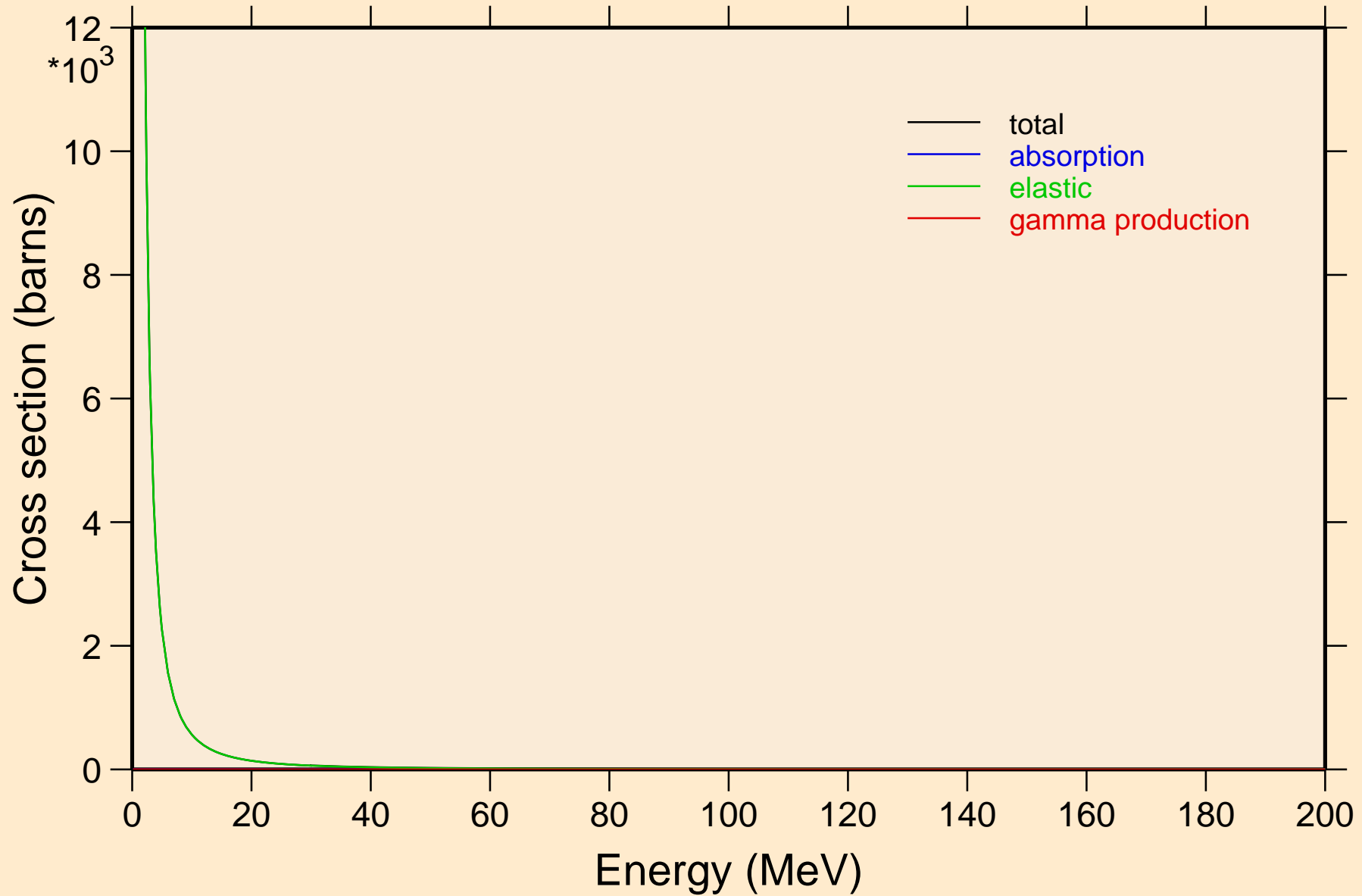

AM233 DEUTERON ACER TENDL-2021 LIBRARY; T=0.K

Heating

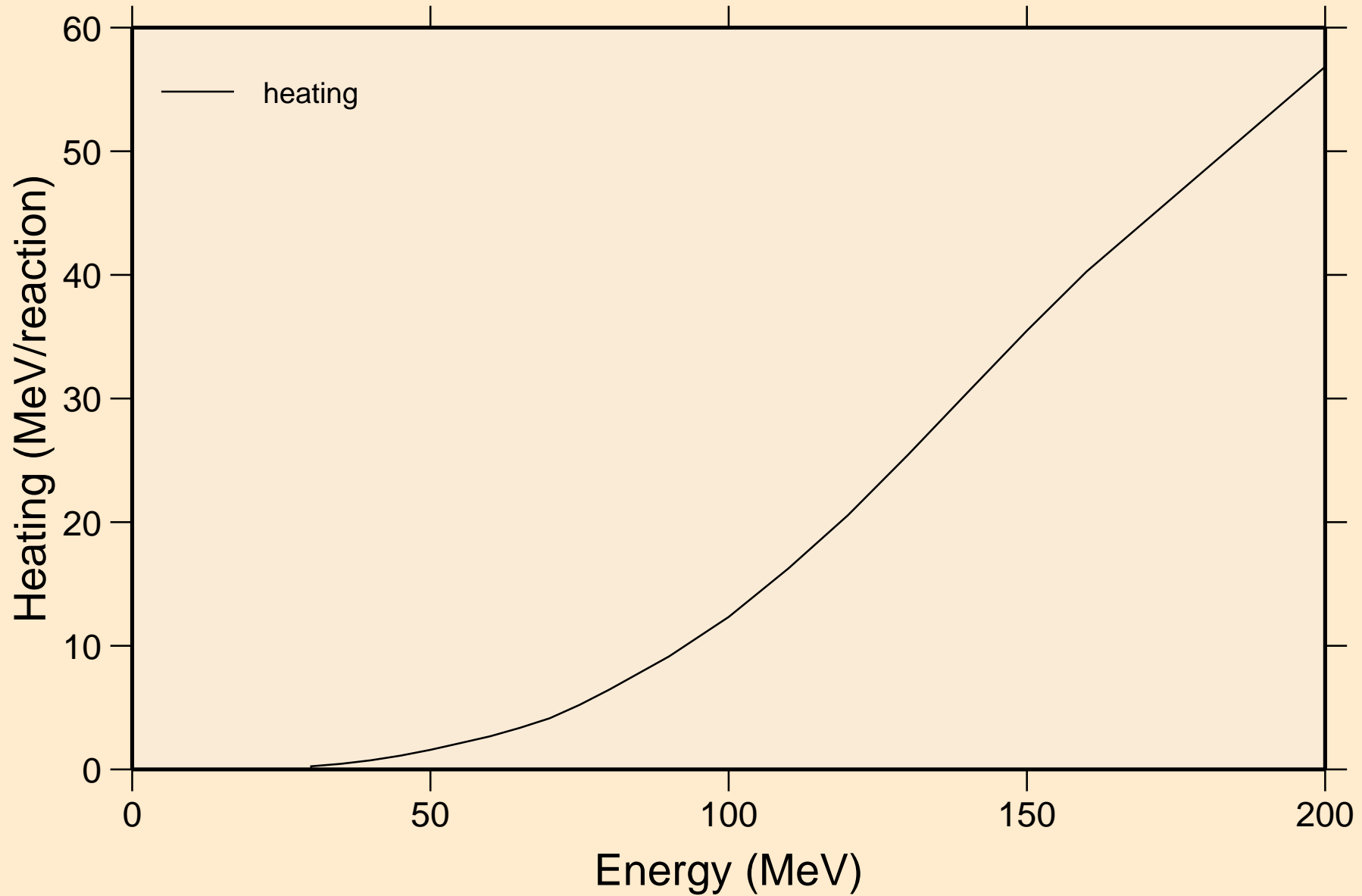

AM233 DEUTERON ACER TENDL-2021 LIBRARY; T=0.K

Threshold reactions

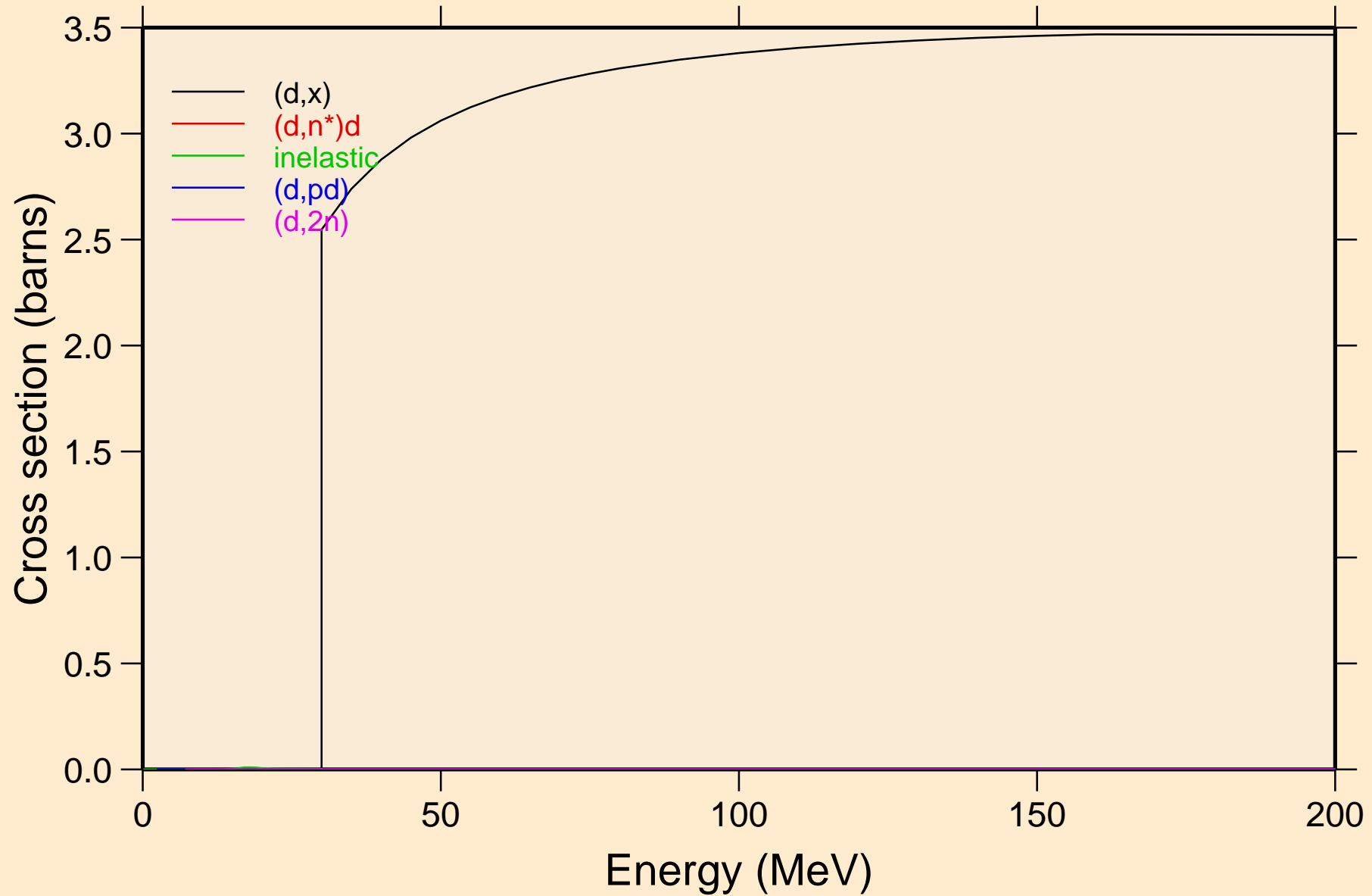

AM233 DEUTERON ACER TENDL-2021 LIBRARY; T=0.K

Threshold reactions

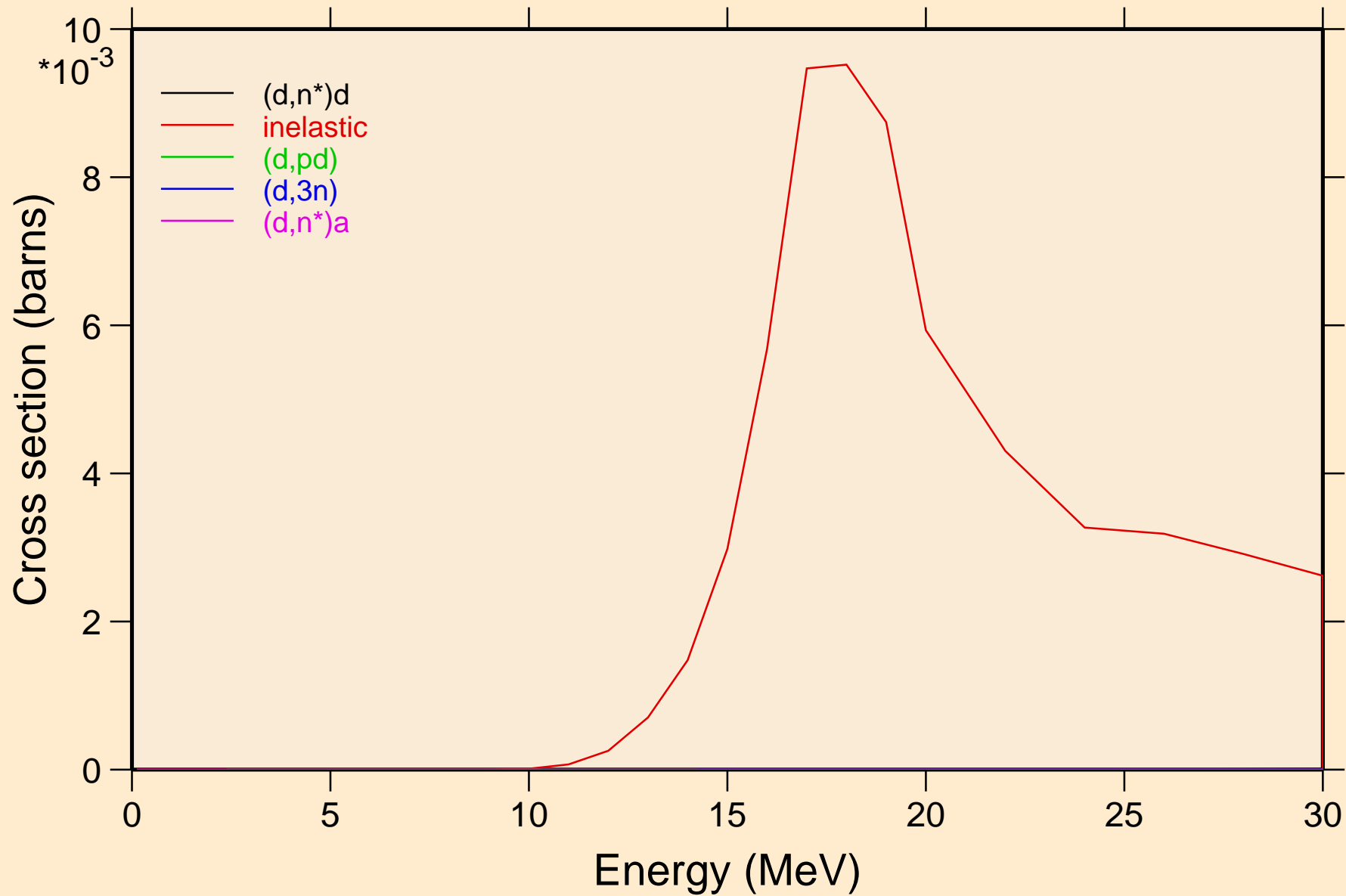

AM233 DEUTERON ACER TENDL-2021 LIBRARY; T=0.K
Threshold reactions

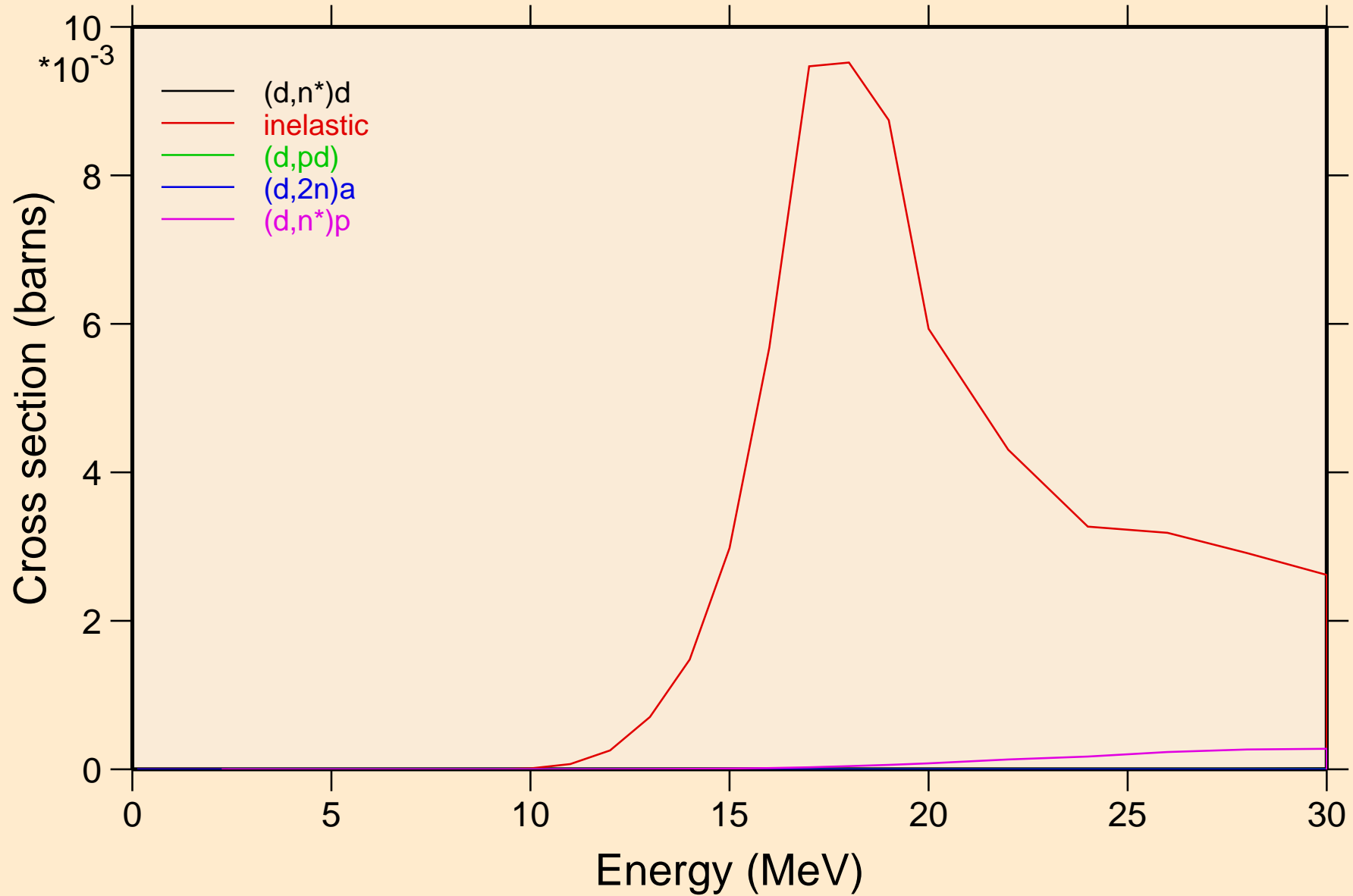

AM233 DEUTERON ACER TENDL-2021 LIBRARY; T=0.K
Threshold reactions

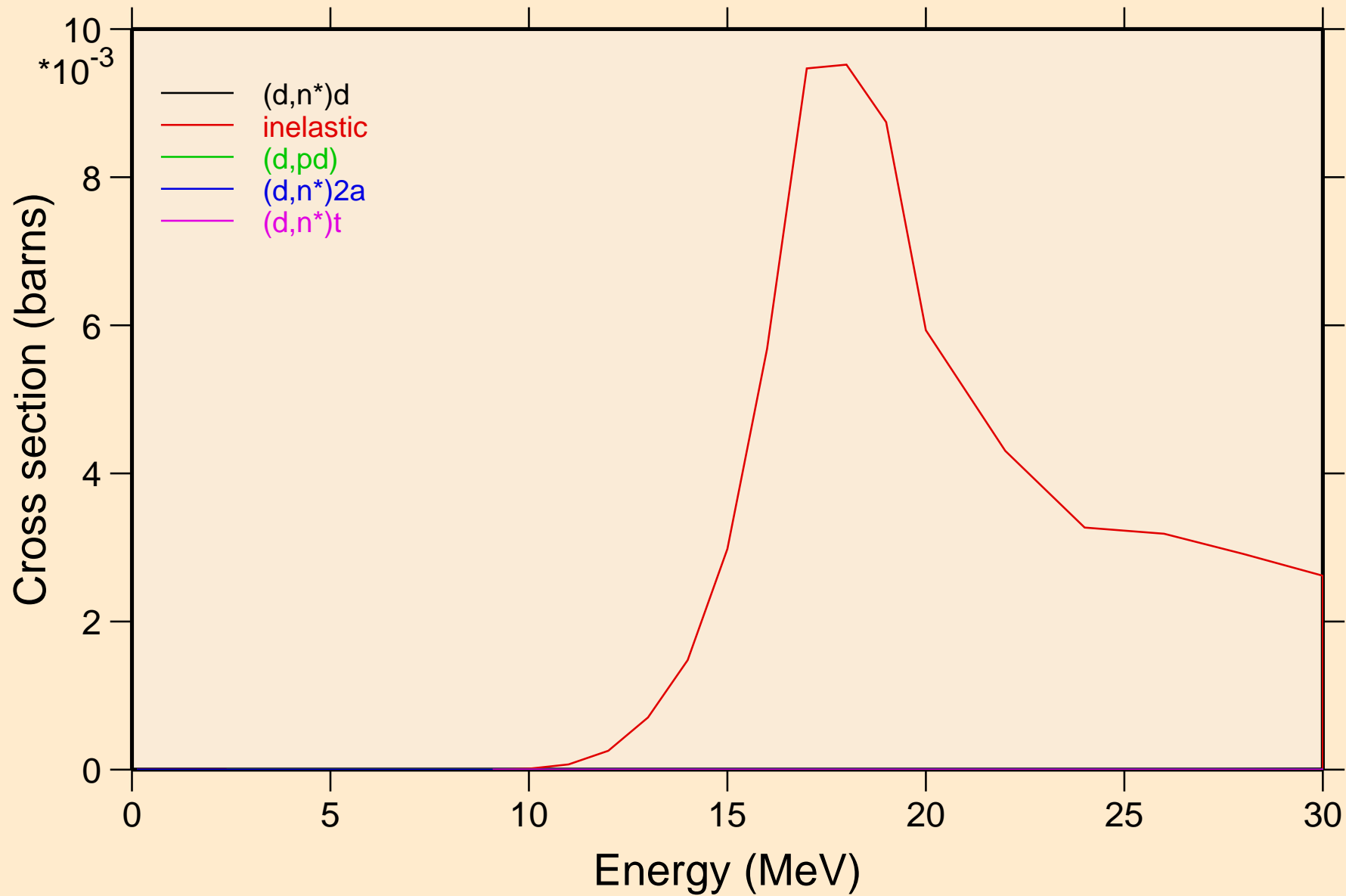

AM233 DEUTERON ACER TENDL-2021 LIBRARY; T=0.K

Threshold reactions

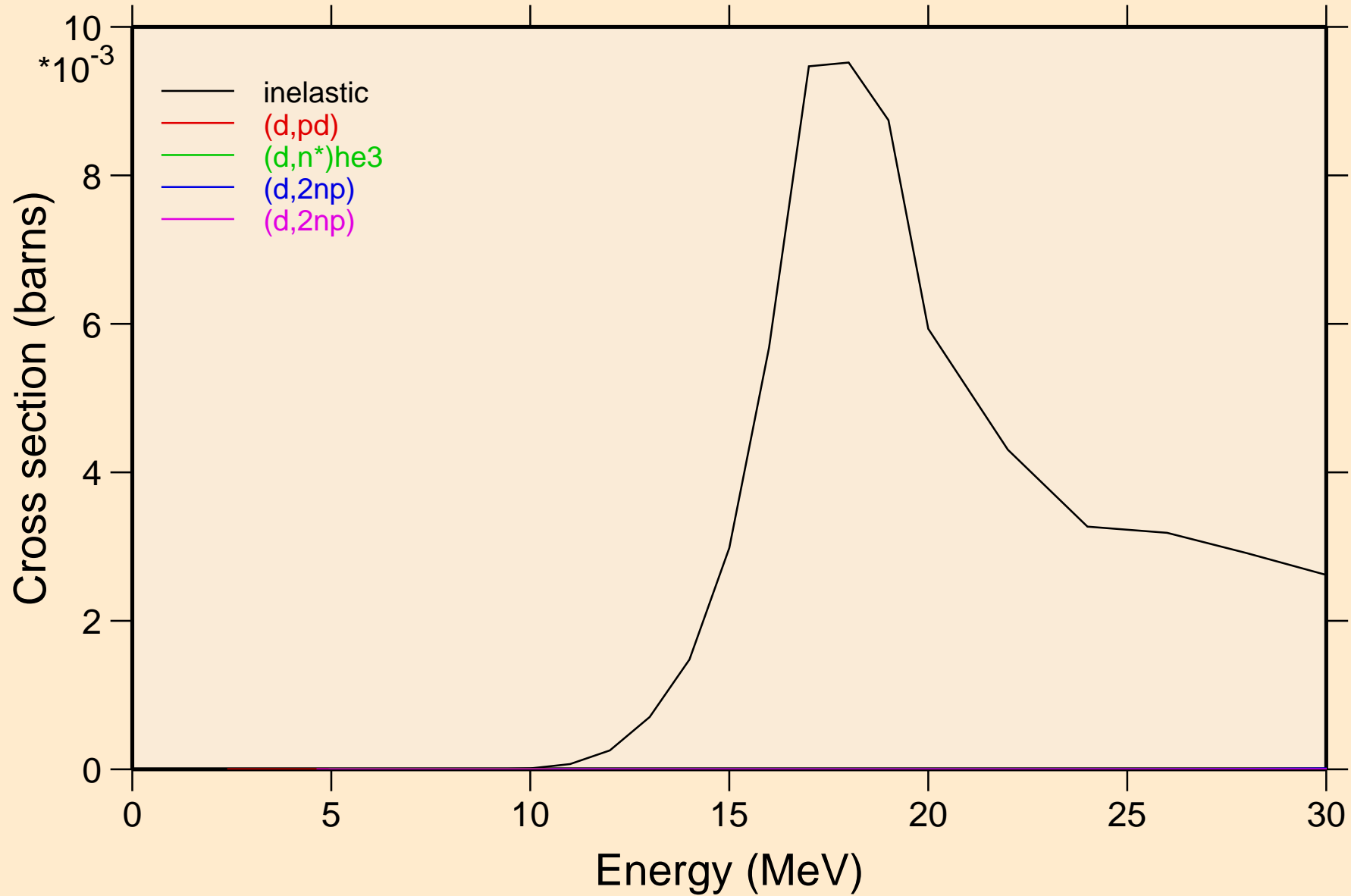

AM233 DEUTERON ACER TENDL-2021 LIBRARY; T=0.K

Threshold reactions

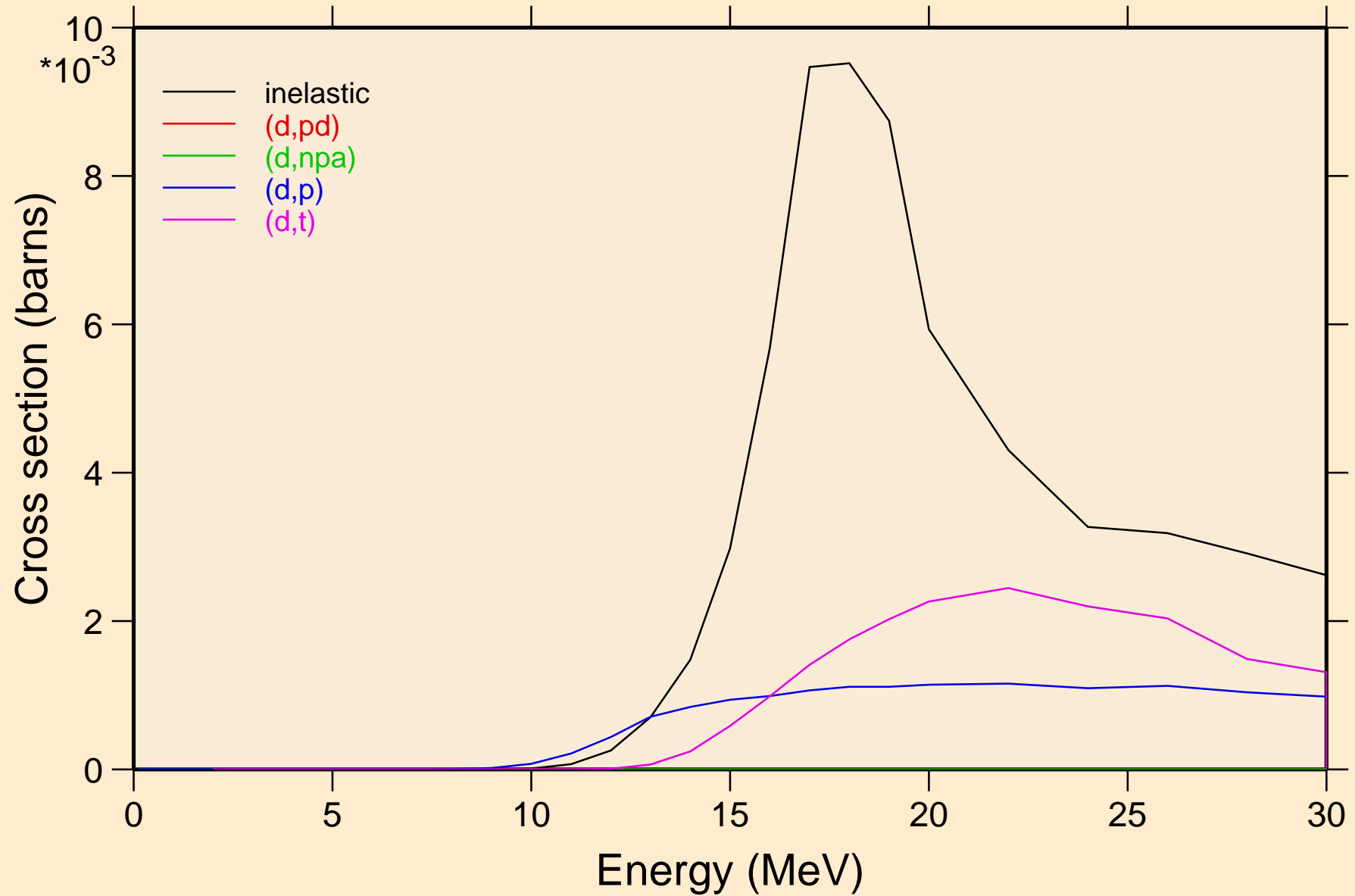

AM233 DEUTERON ACER TENDL-2021 LIBRARY; T=0.K
Threshold reactions

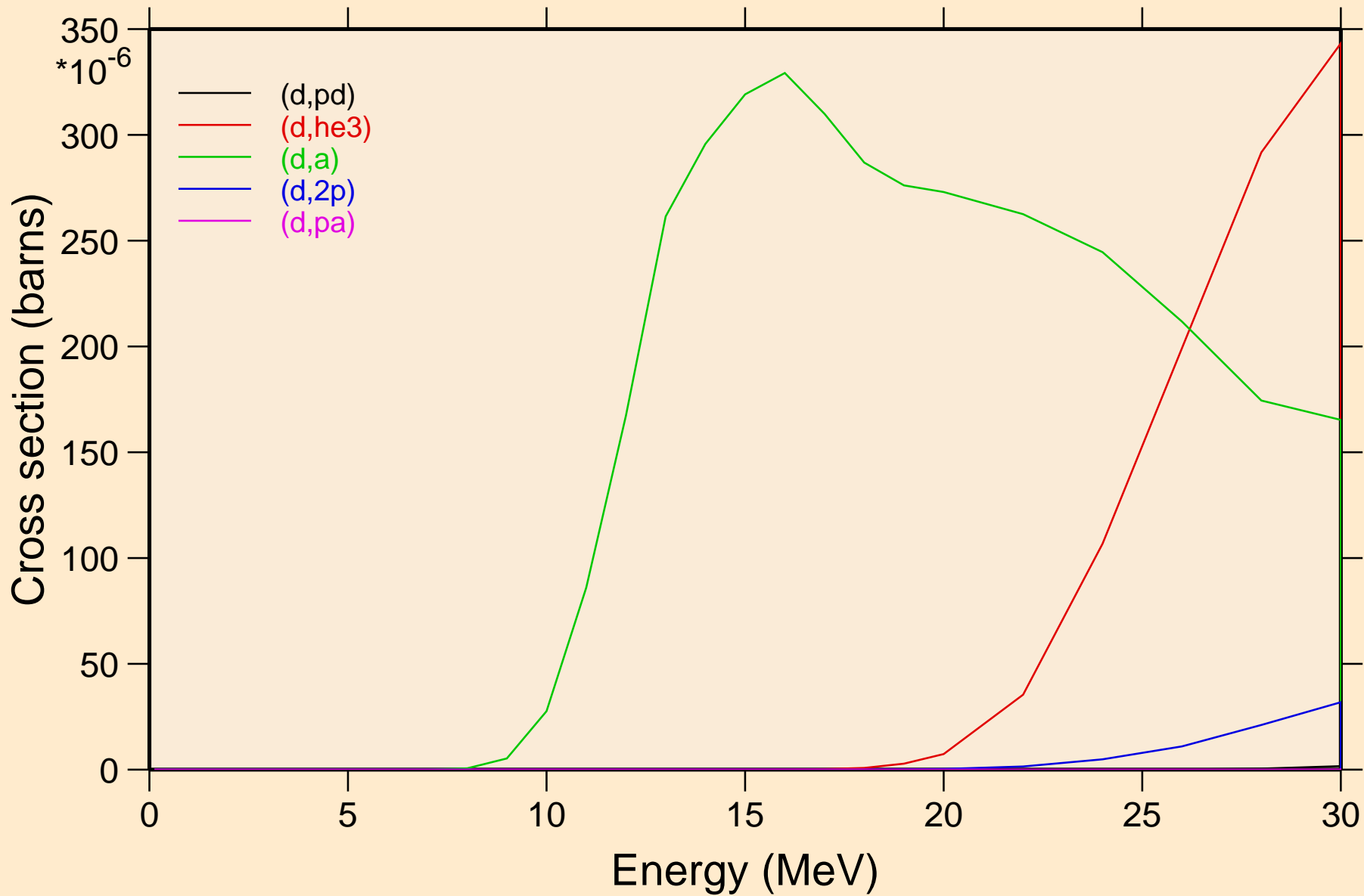

AM233 DEUTERON ACER TENDL-2021 LIBRARY; T=0.K
Threshold reactions

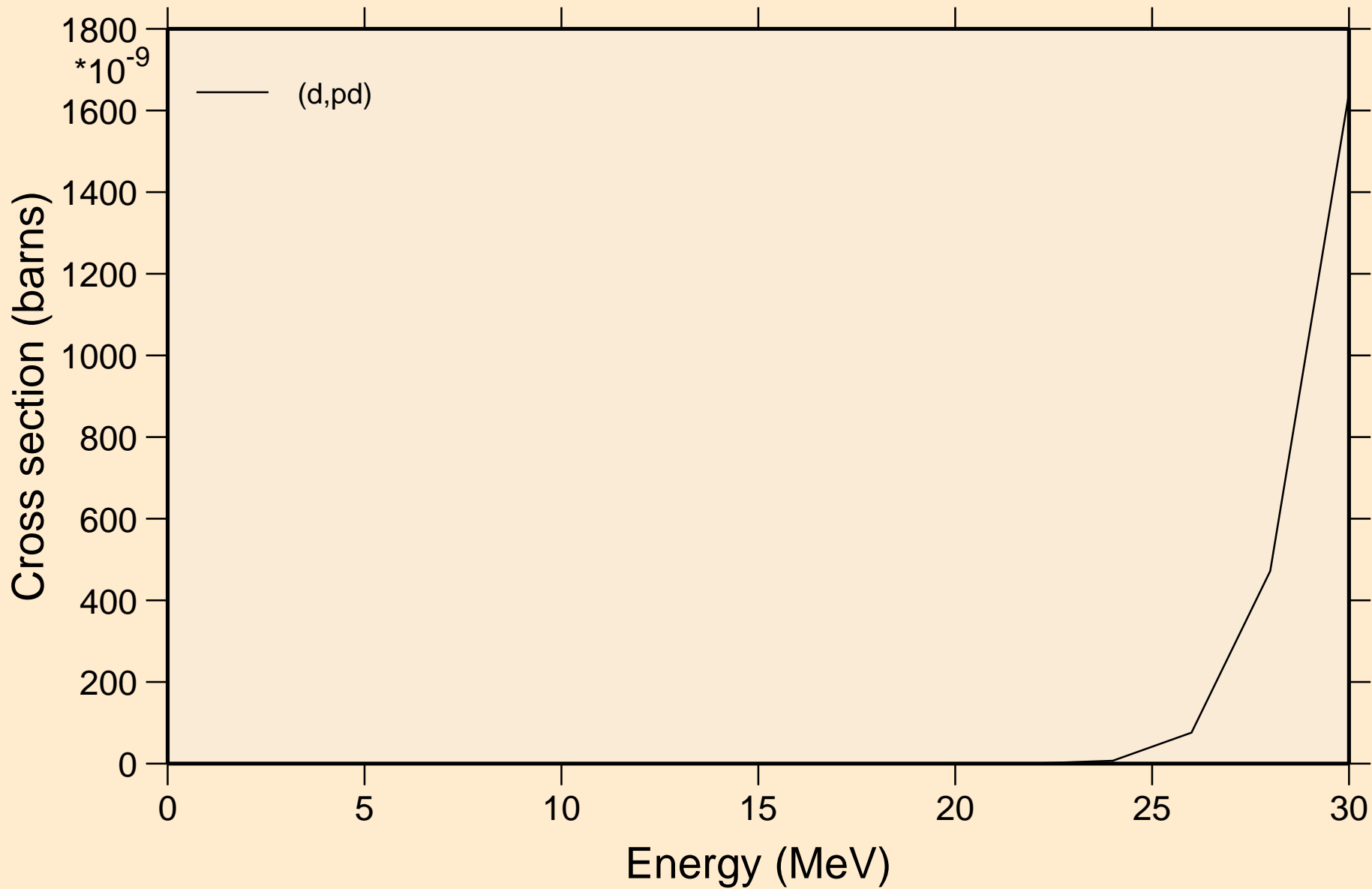

AM233 DEUTERON ACER TENDL-2021 LIBRARY; T=0.K
angular distribution for elastic

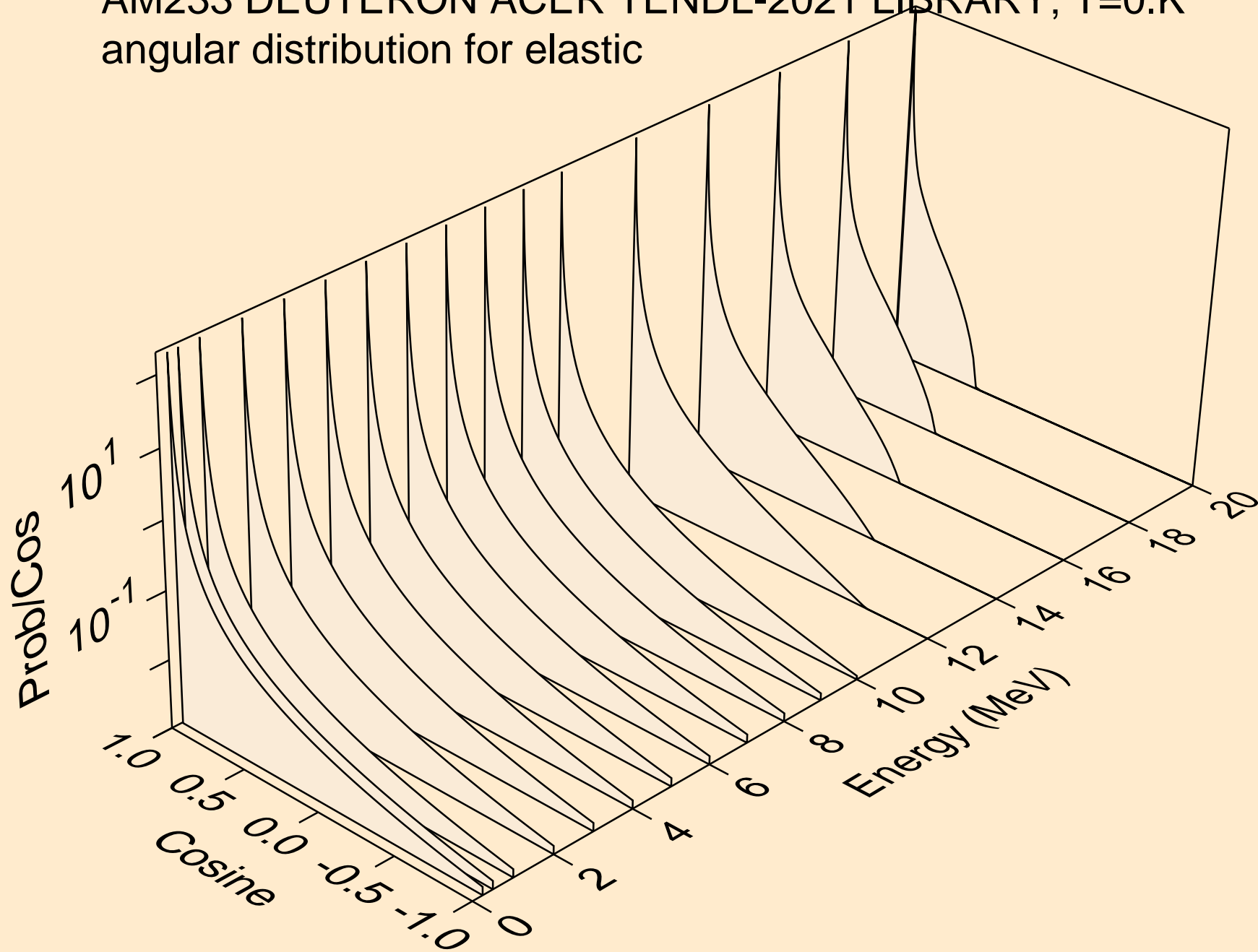

AM233 DEUTERON ACER TENDL-2021 LIBRARY; T=0.K
angular distribution for elastic

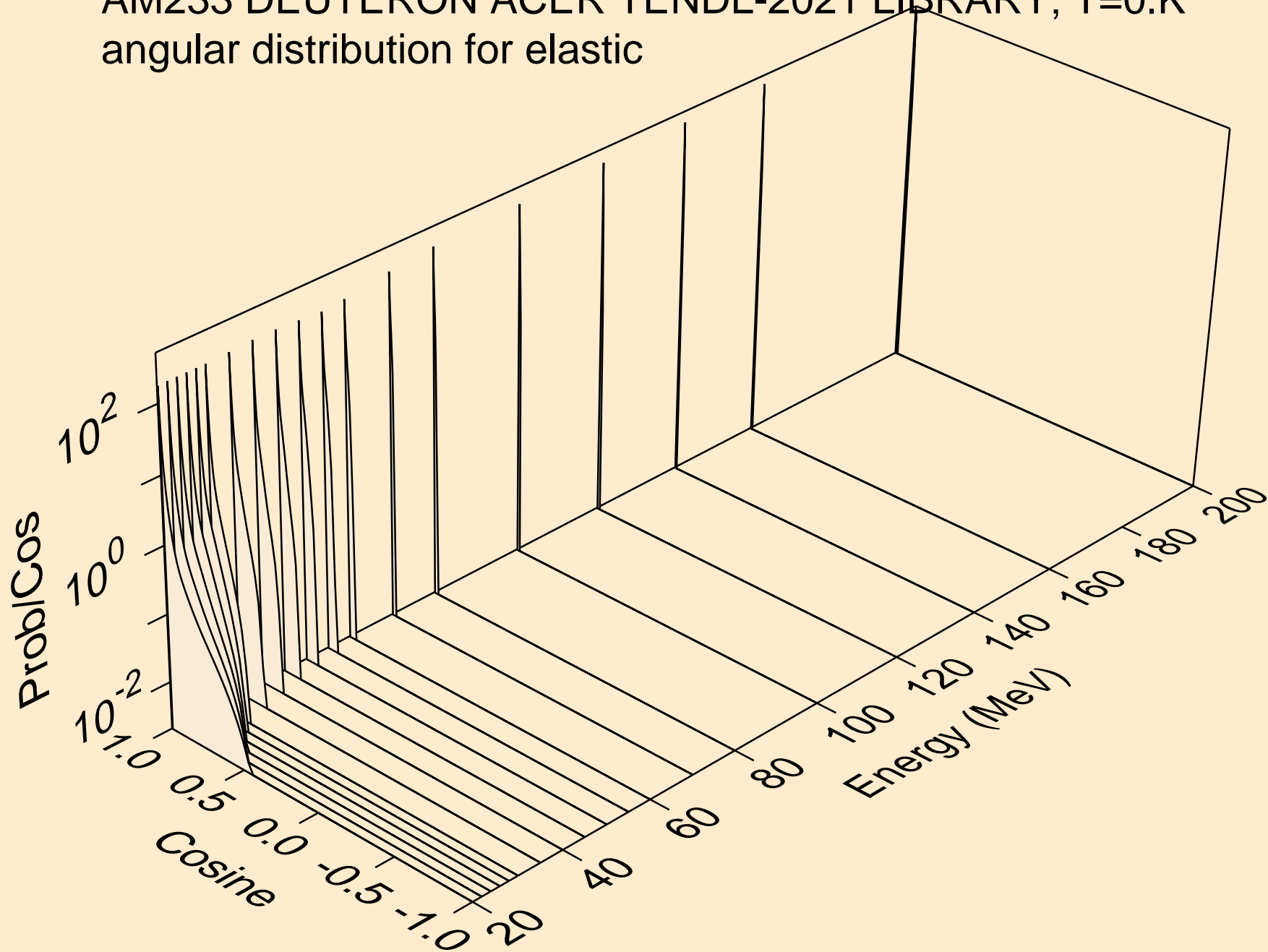

AM233 DEUTERON ACER TENDL-2021 LIBRARY; T=0.K
Deuteron emission for (d,x)

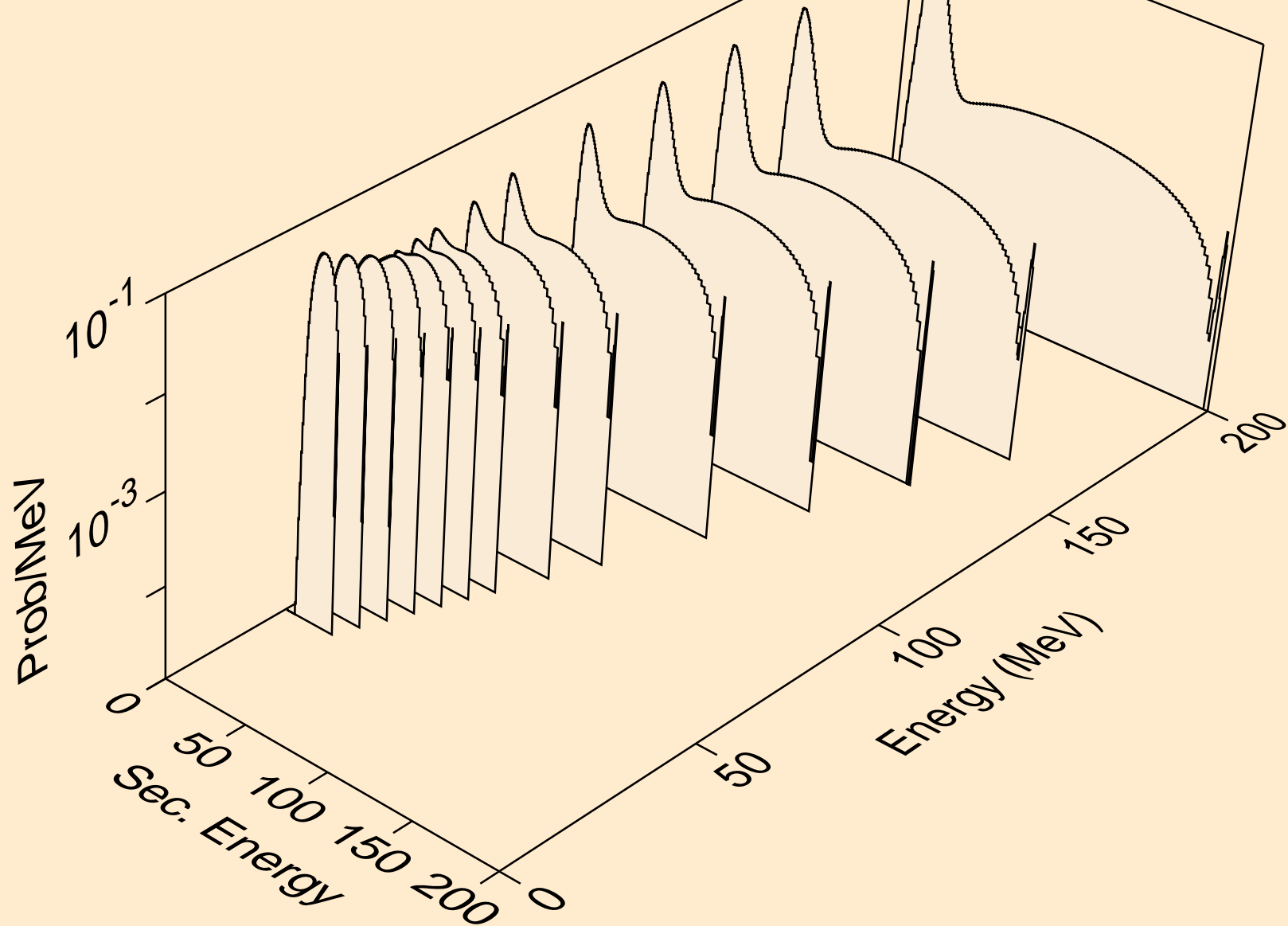

AM233 DEUTERON ACER TENDL-2021 LIBRARY; T=0.K
Deuteron emission for (d,n*)d

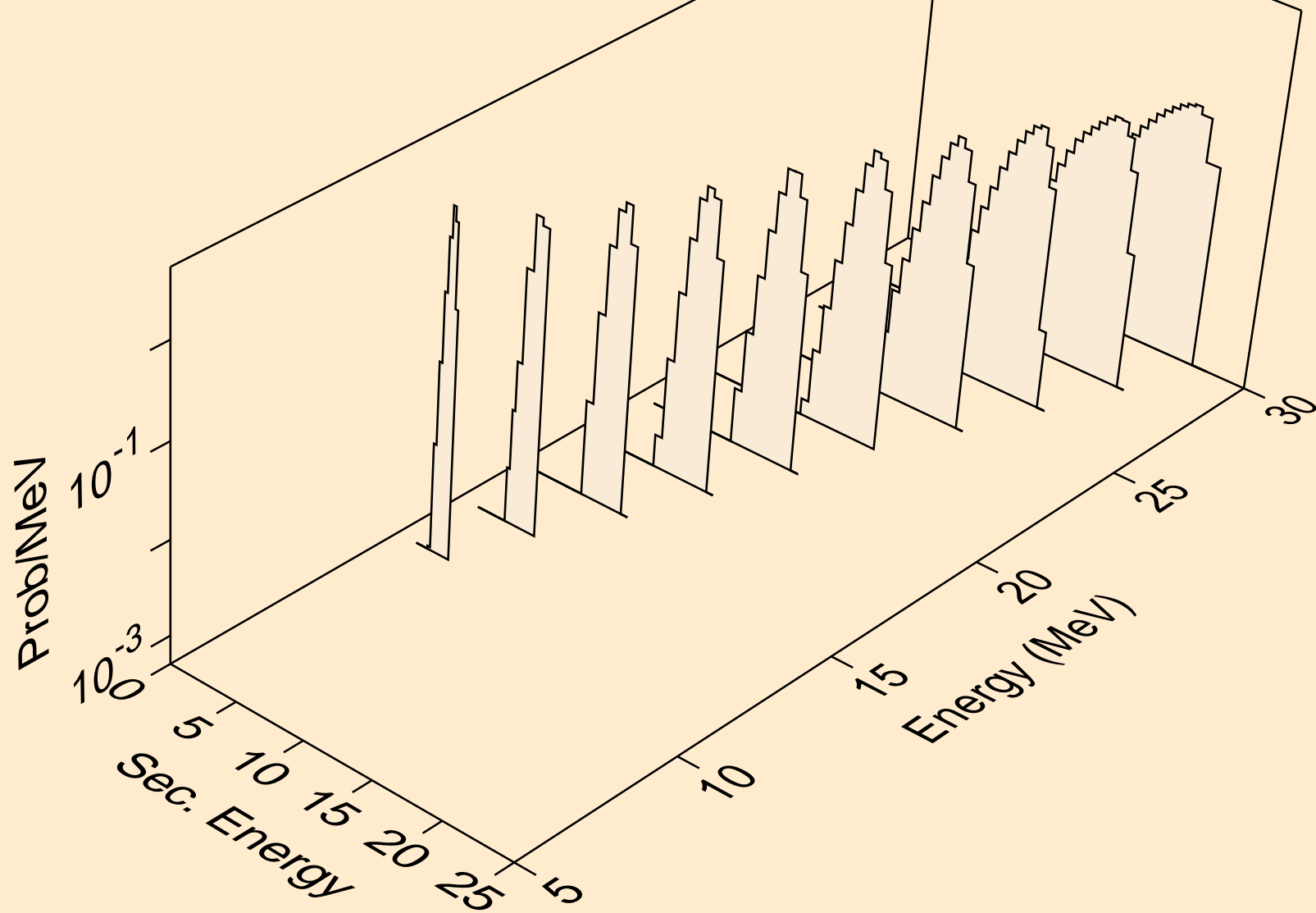

AM233 DEUTERON ACER TENDL-2021 LIBRARY; T=0.K
Deuteron emission for inelastic

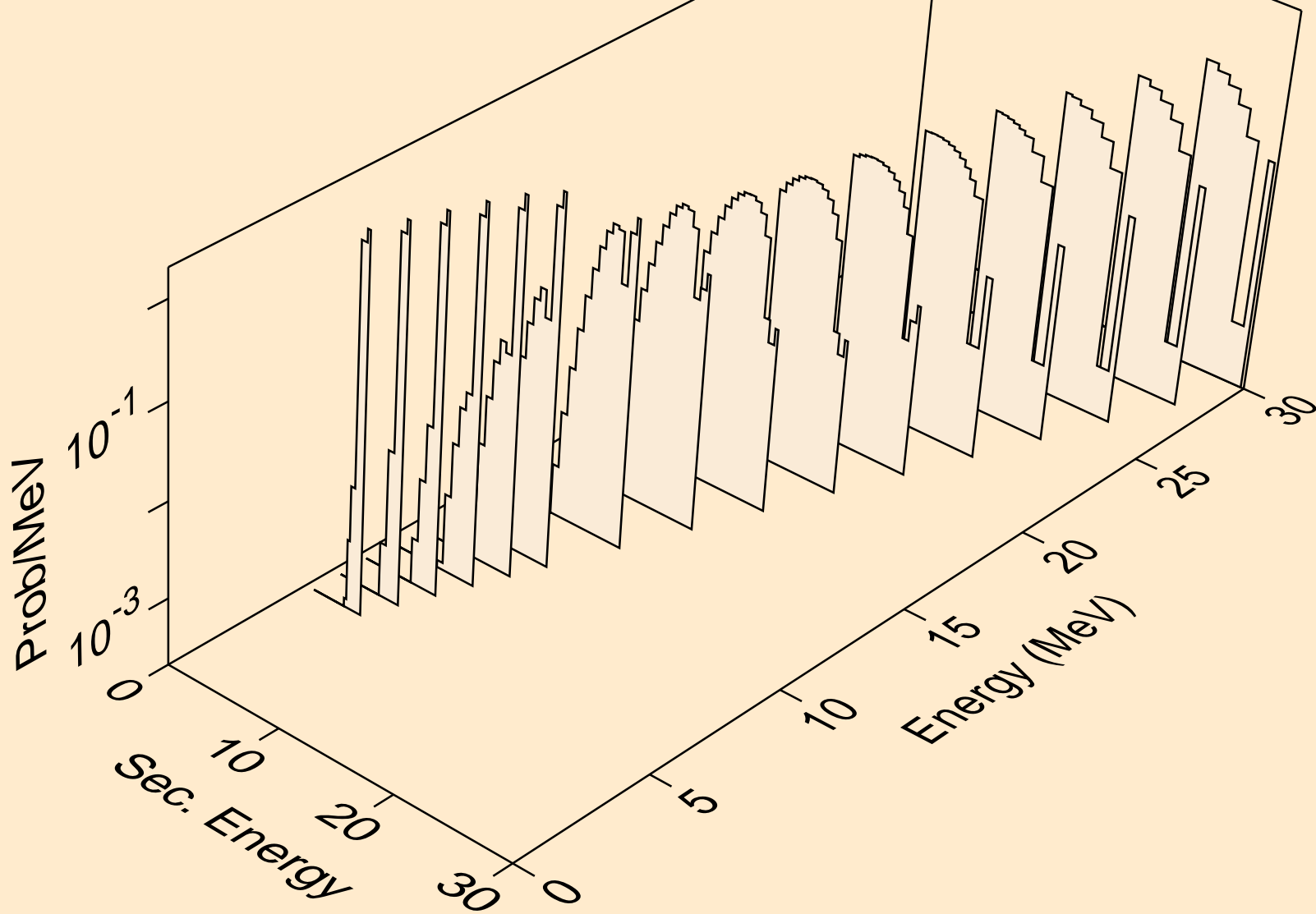

AM233 DEUTERON ACER TENDL-2021 LIBRARY; T=0.K
Deuteron emission for (d,pd)

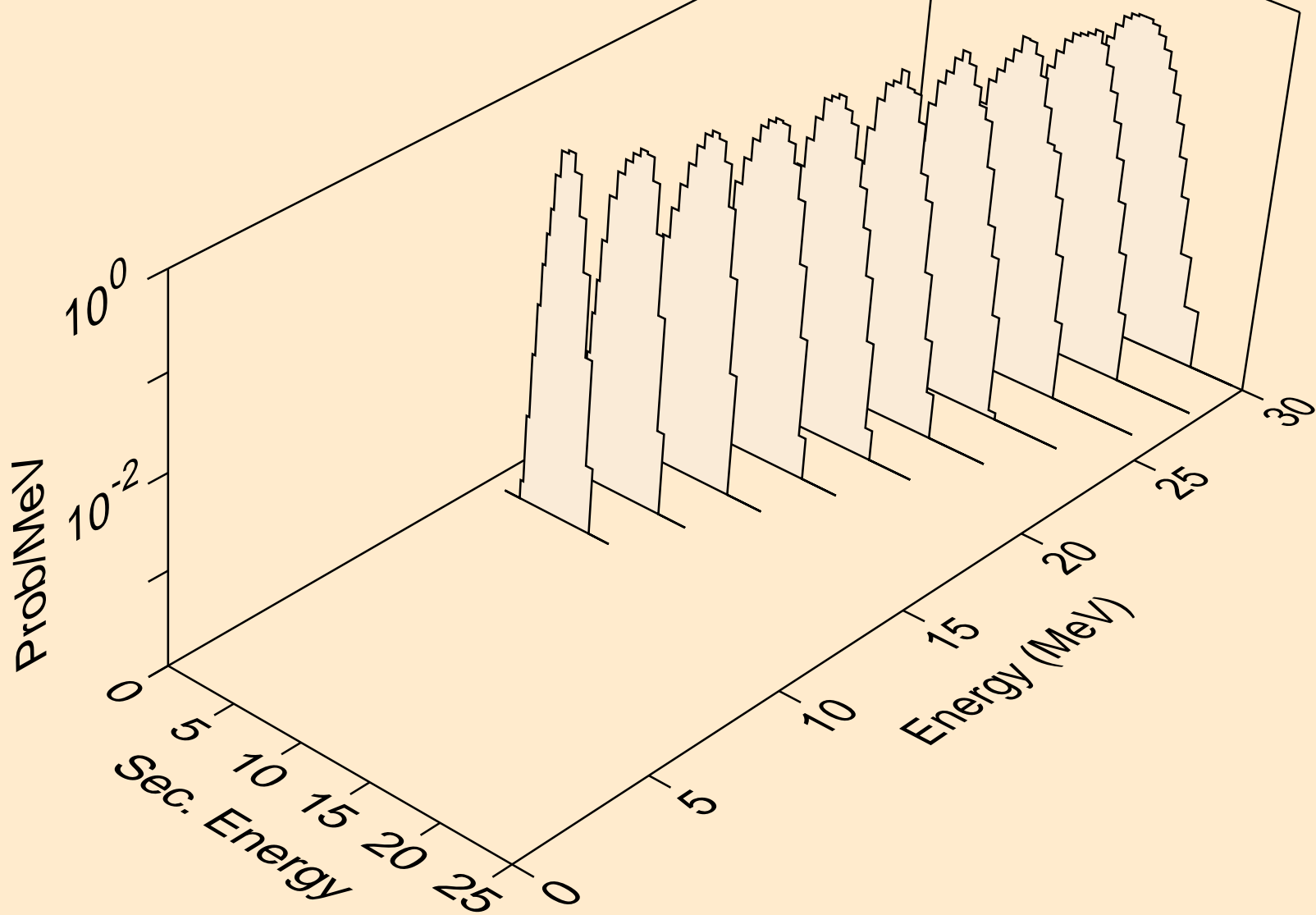

AM233 DEUTERON ACER TENDL-2021 LIBRARY; T=0.K
Photon emission for (z,n)

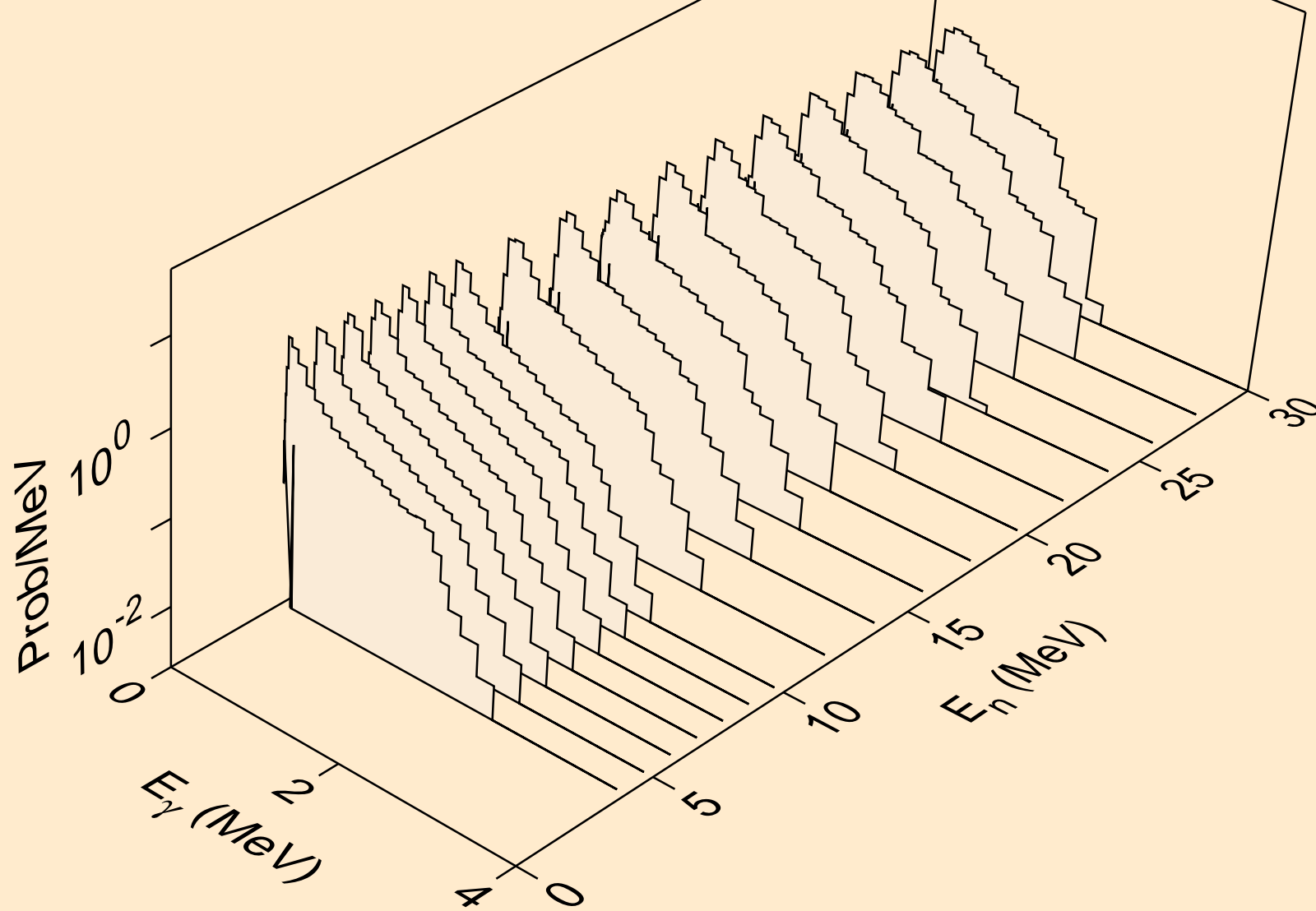

AM233 DEUTERON ACER TENDL-2021 LIBRARY; T=0.K
Photon emission for (n,x)

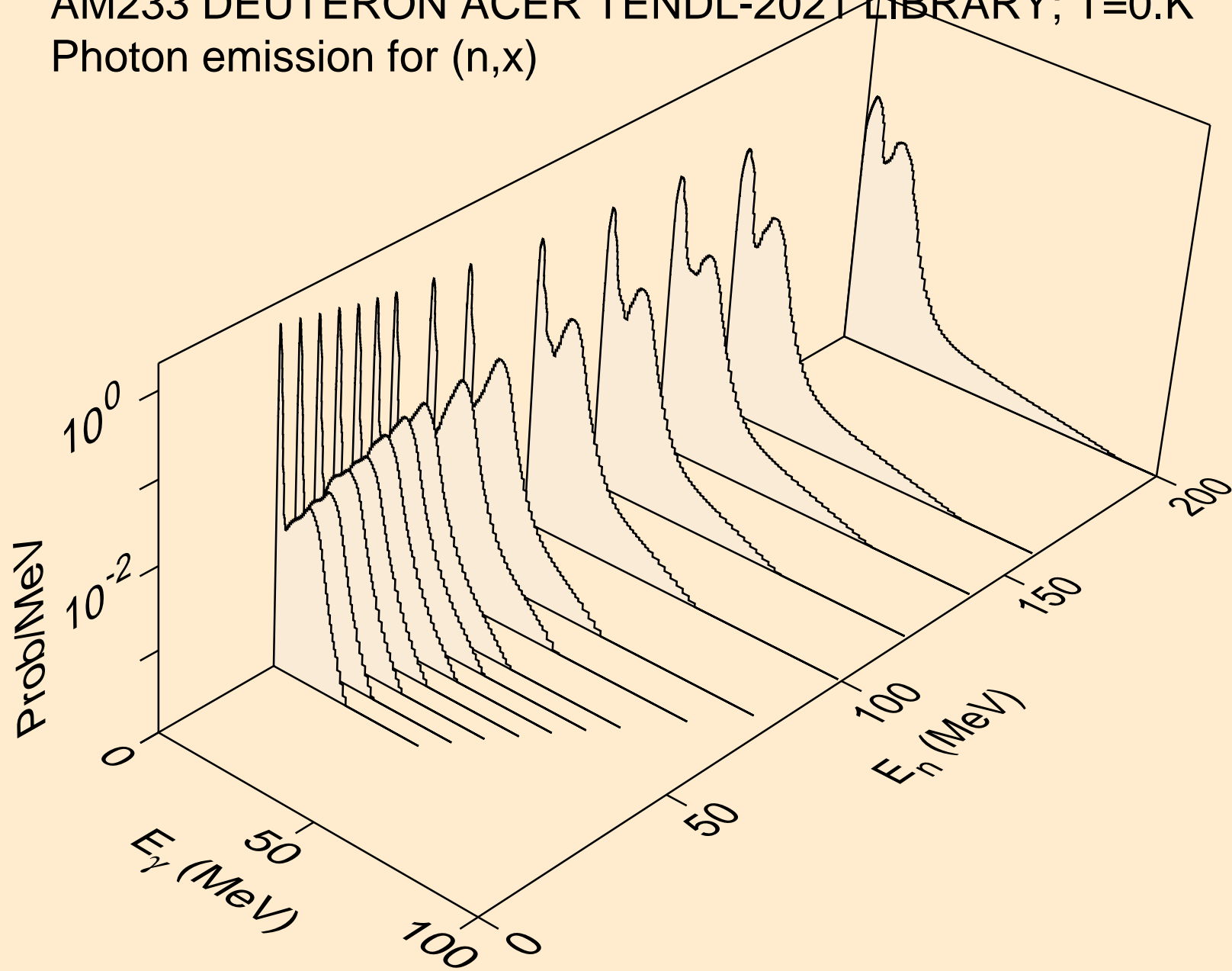

AM233 DEUTERON ACER TENDL-2021 LIBRARY; T=0.K
Photon emission for (n,2n)

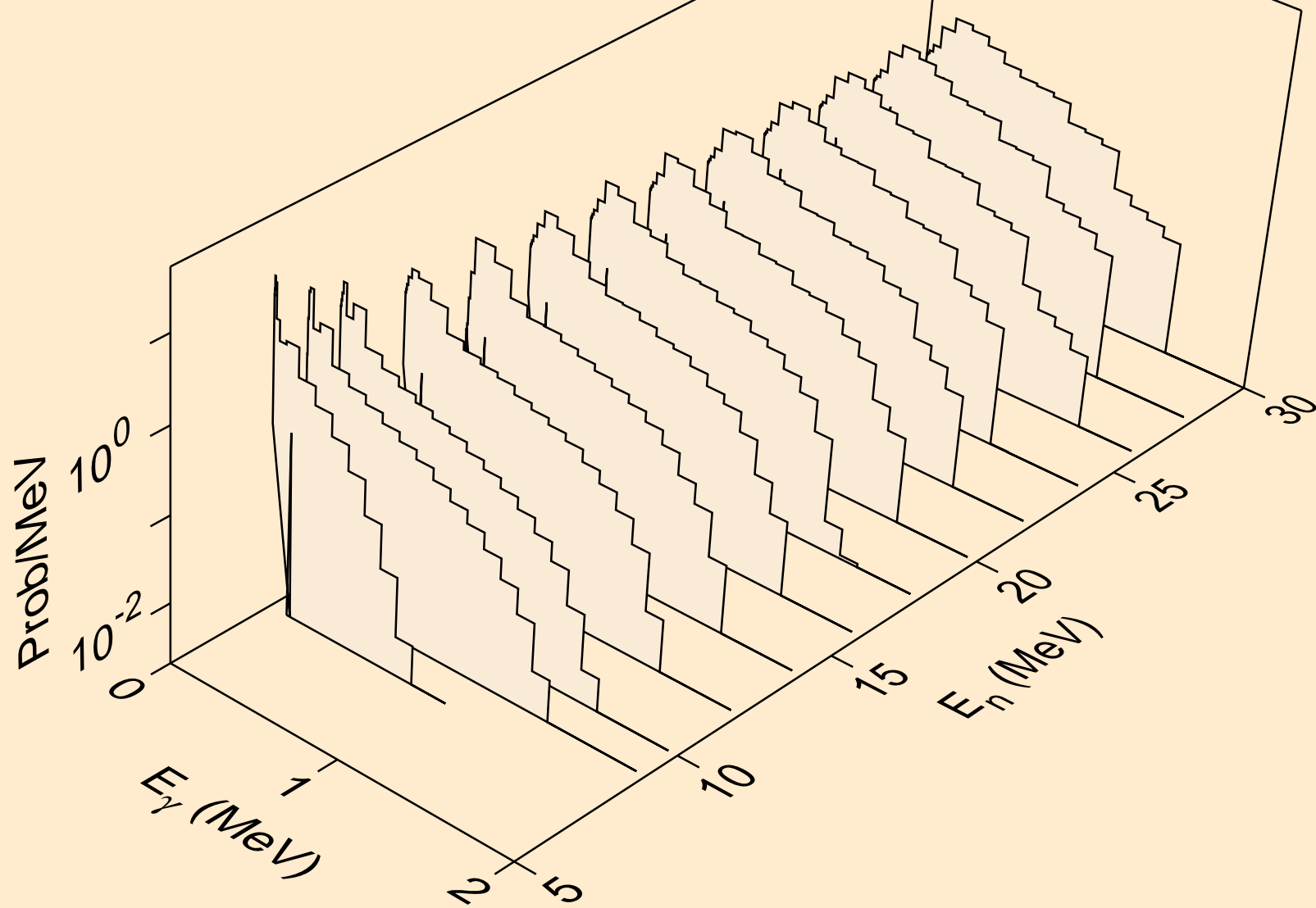

AM233 DEUTERON ACER TENDL-2021 LIBRARY; T=0.K
Photon emission for (n,3n)

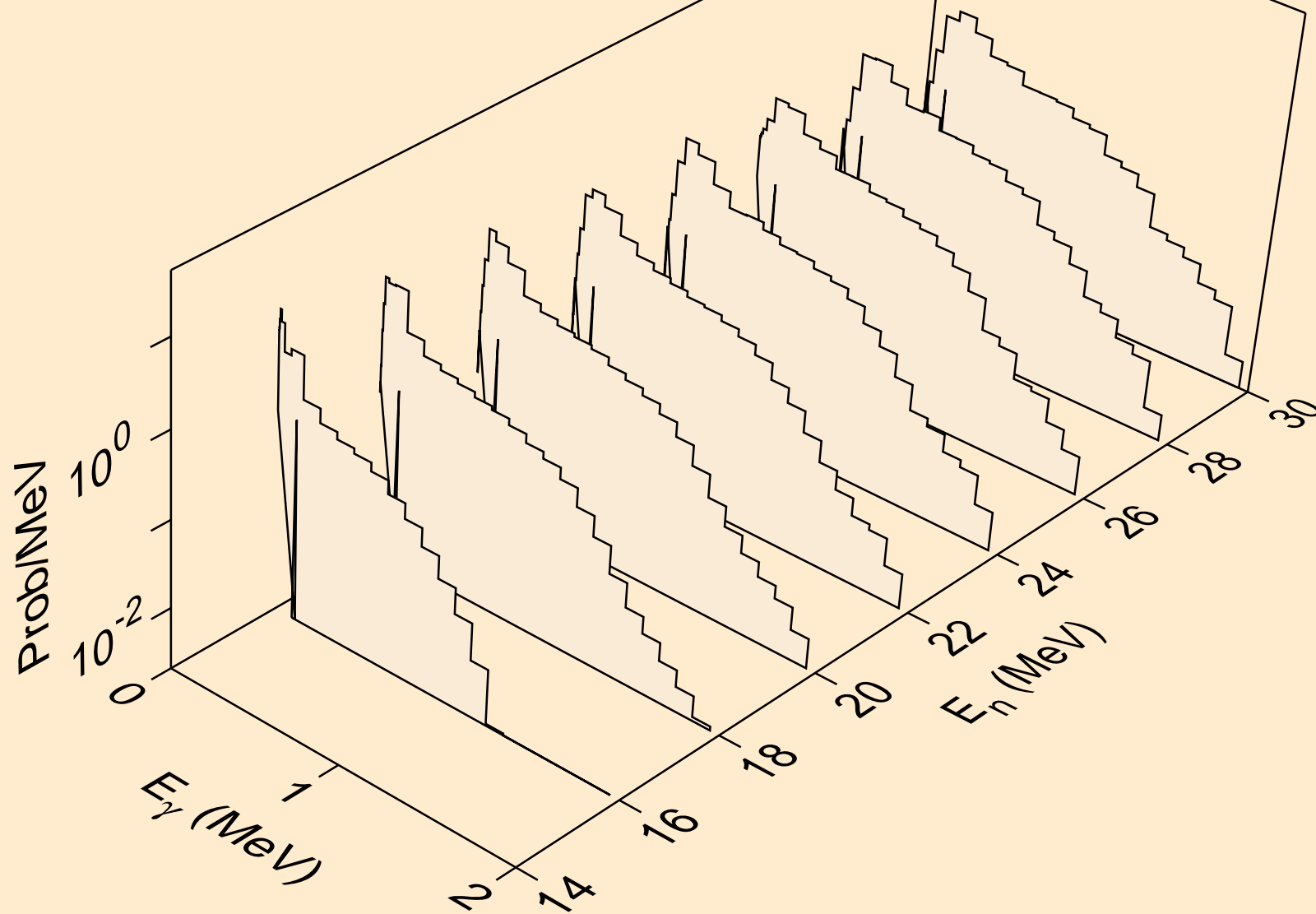

AM233 DEUTERON ACER TENDL-2021 LIBRARY; T=0.K
Photon emission for (n,n*)a

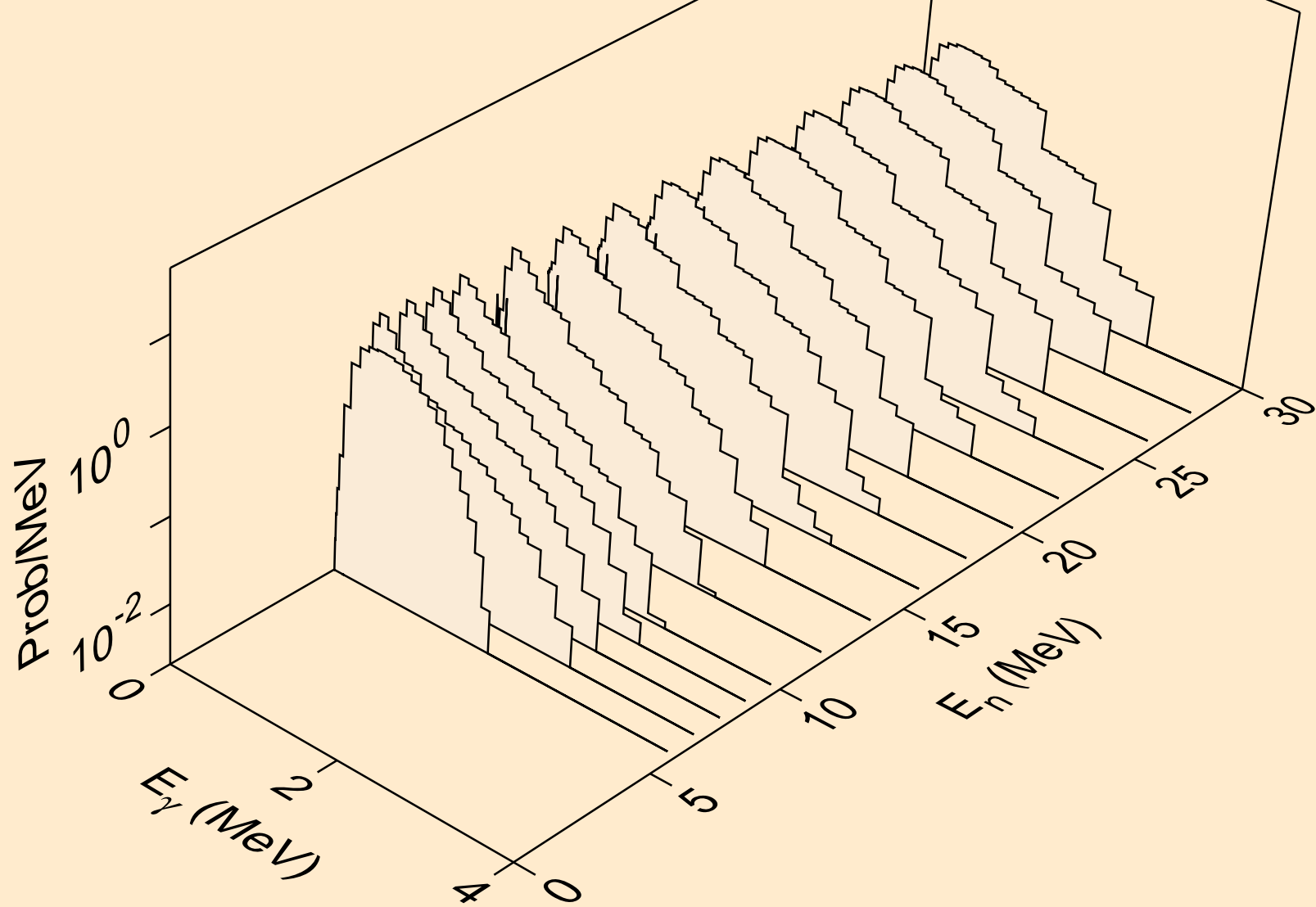

AM233 DEUTERON ACER TENDL-2021 LIBRARY; T=0.K
Photon emission for (n,2n) α

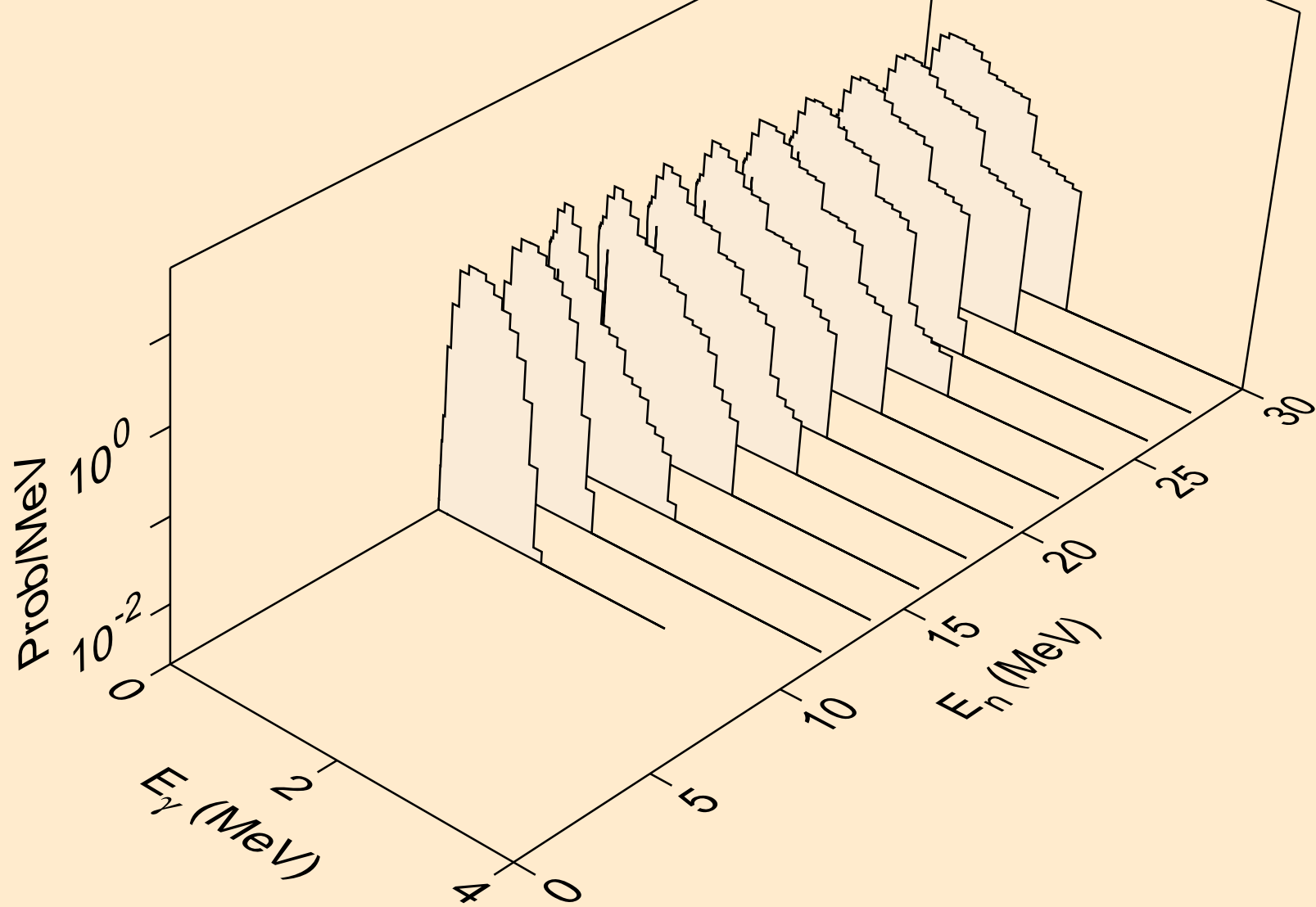

AM233 DEUTERON ACER TENDL-2021 LIBRARY; T=0.K
Photon emission for (n,n*)p

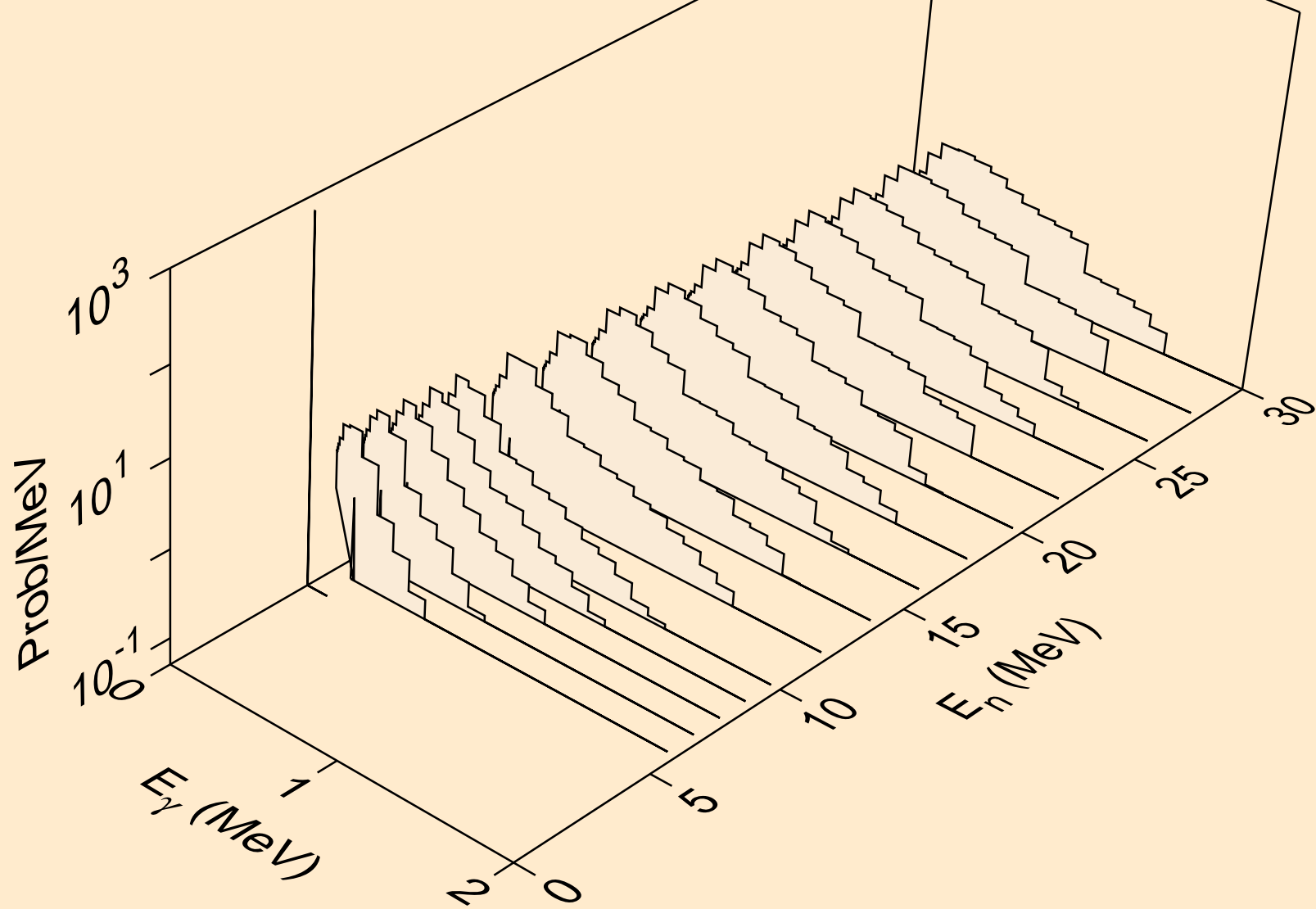

AM233 DEUTERON ACER TENDL-2021 LIBRARY; T=0.K
Photon emission for (n,n*)2a

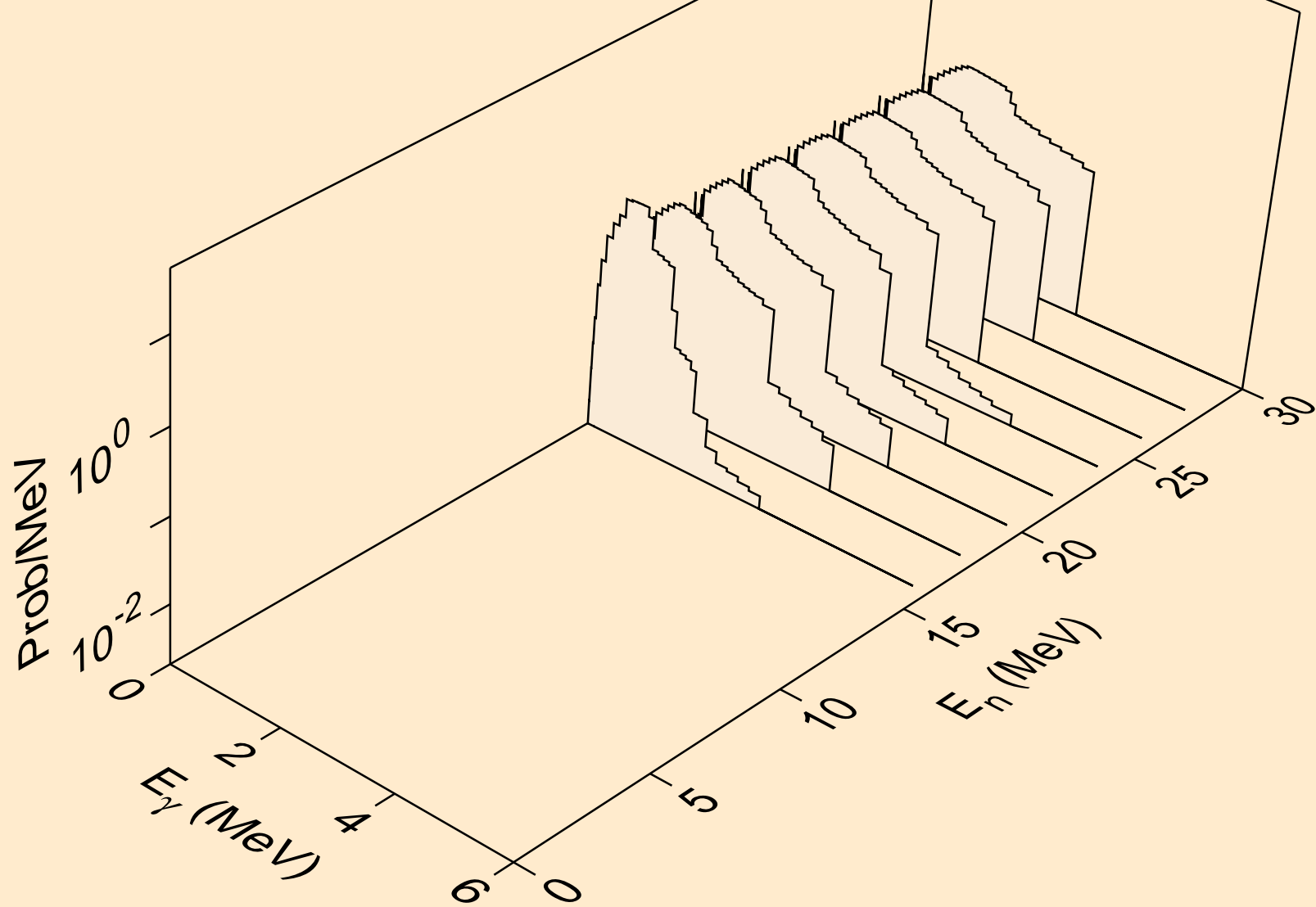

AM233 DEUTERON ACER TENDL-2021 LIBRARY; T=0.K
Photon emission for (n,n*)d

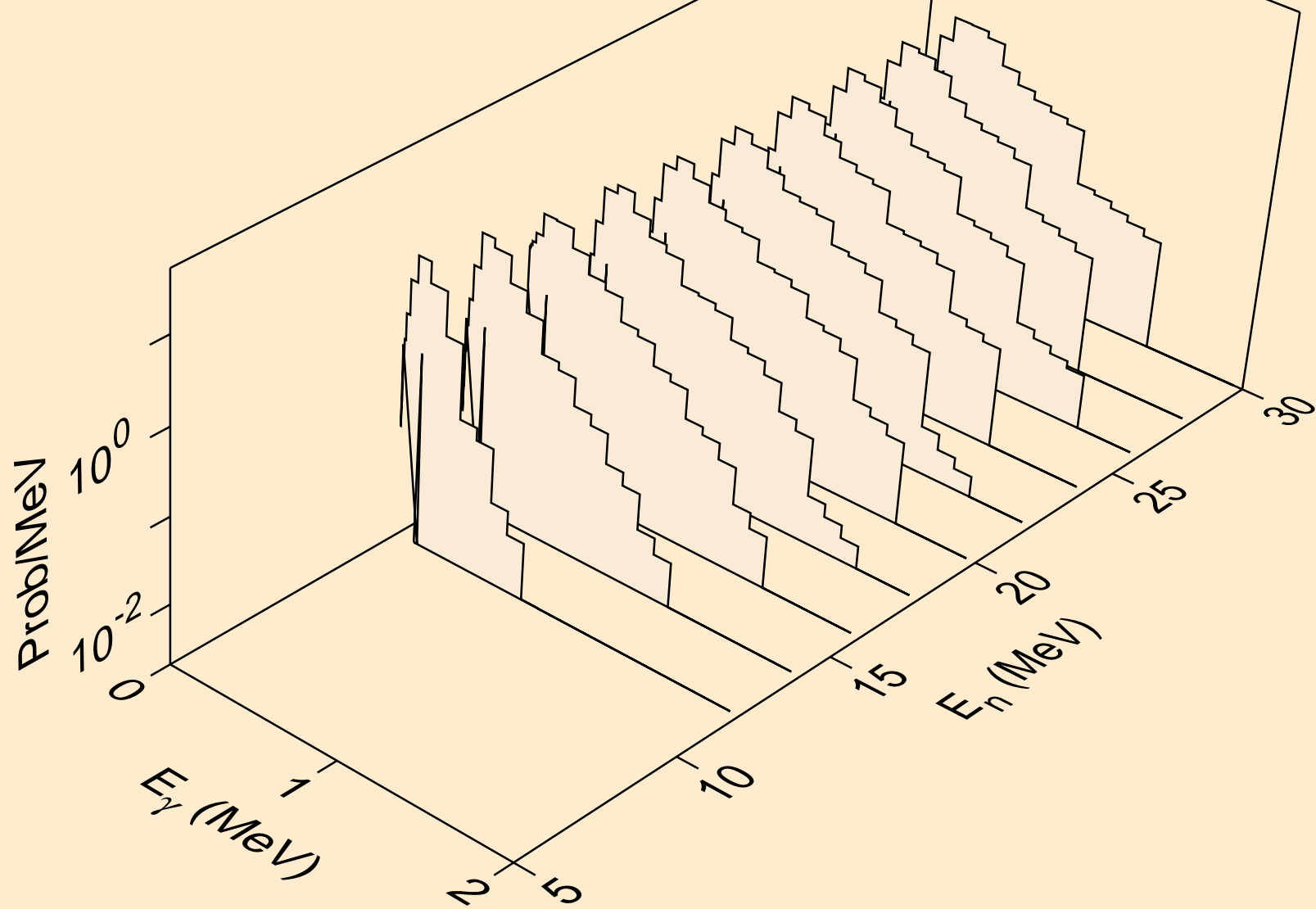

AM233 DEUTERON ACER TENDL-2021 LIBRARY; T=0.K
Photon emission for (n,n*)t

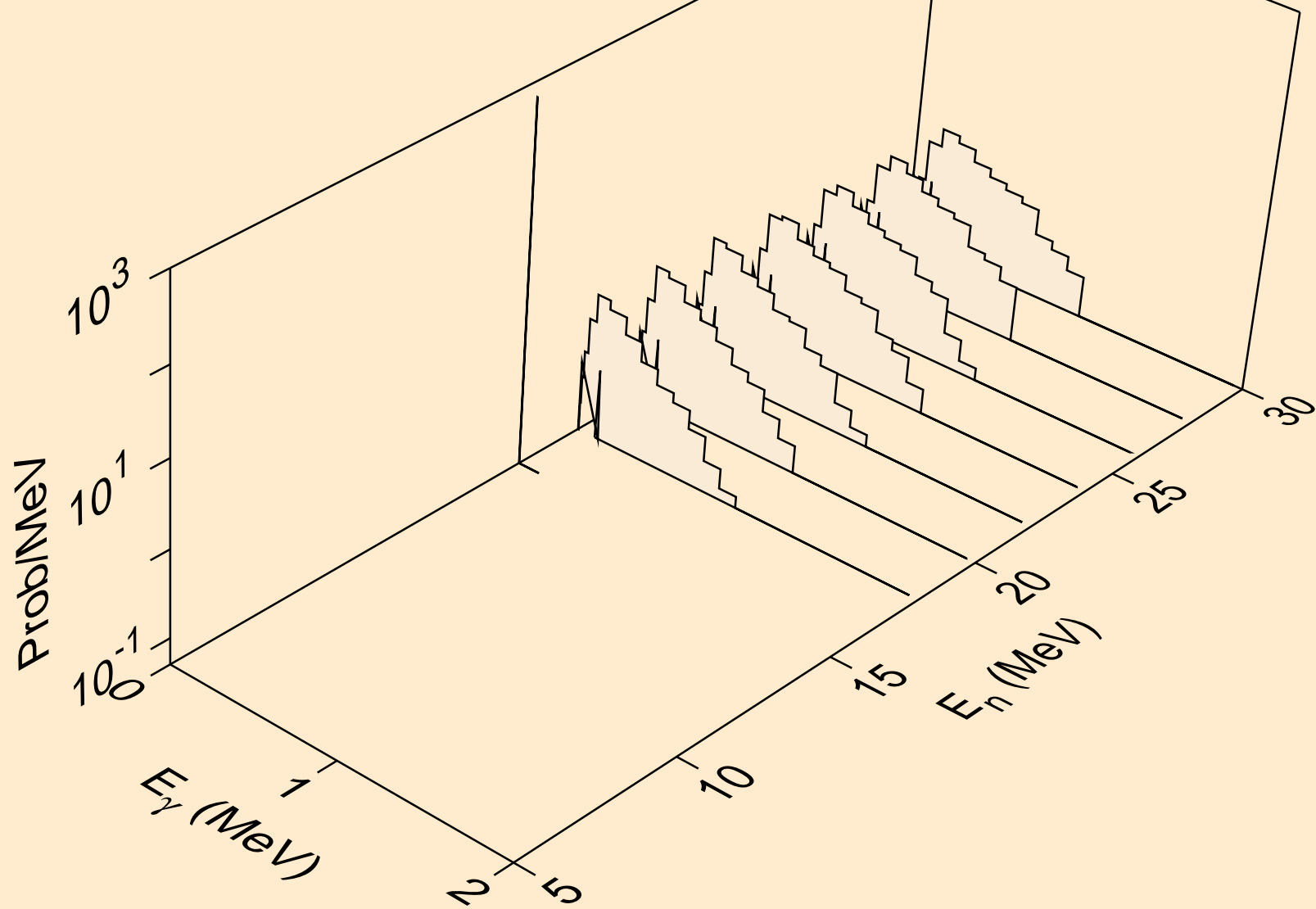

AM233 DEUTERON ACER TENDL-2021 LIBRARY; T=0.K
Photon emission for (n,n*)he3

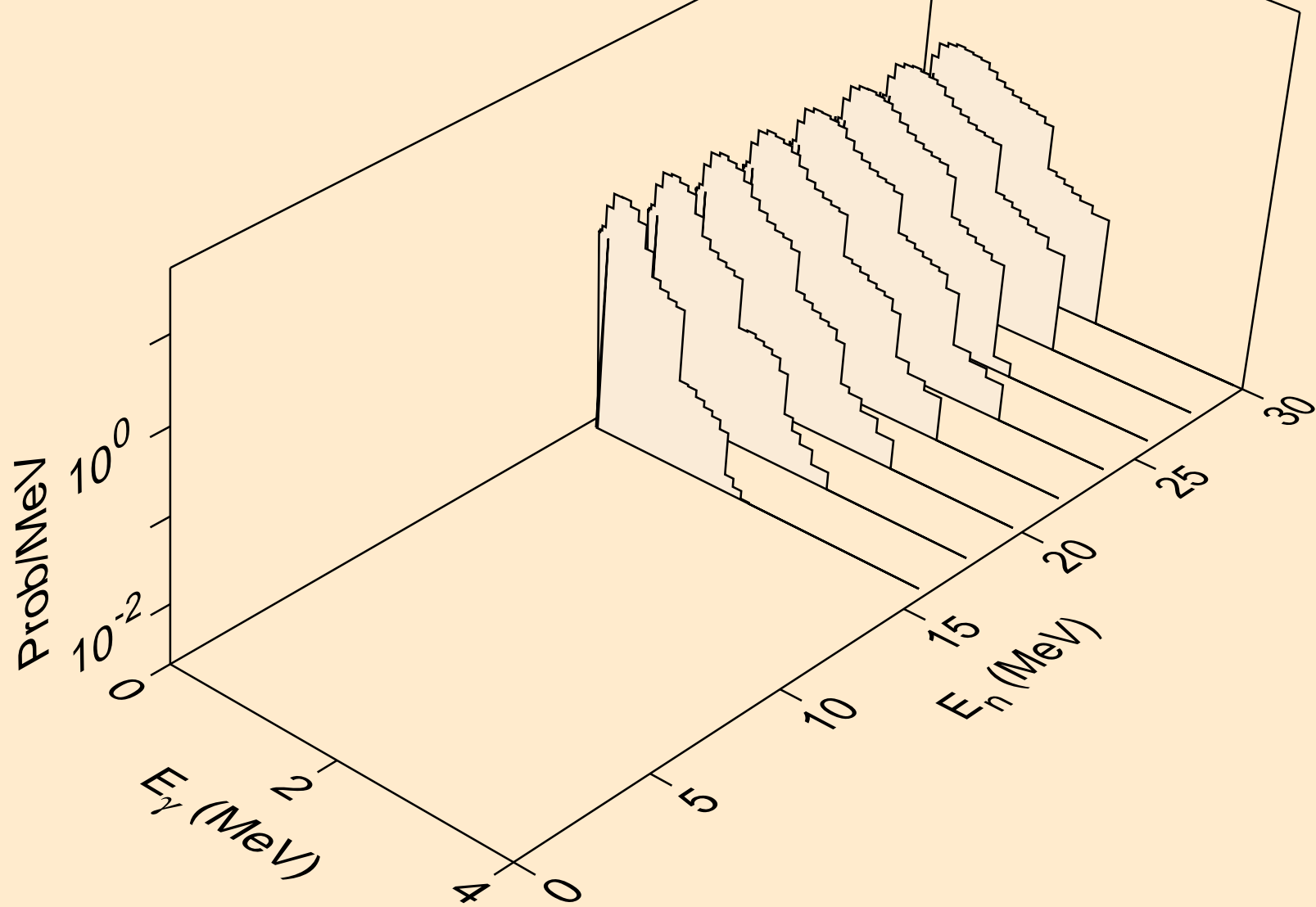

AM233 DEUTERON ACER TENDL-2021 LIBRARY; T=0.K
Photon emission for (n,2np)

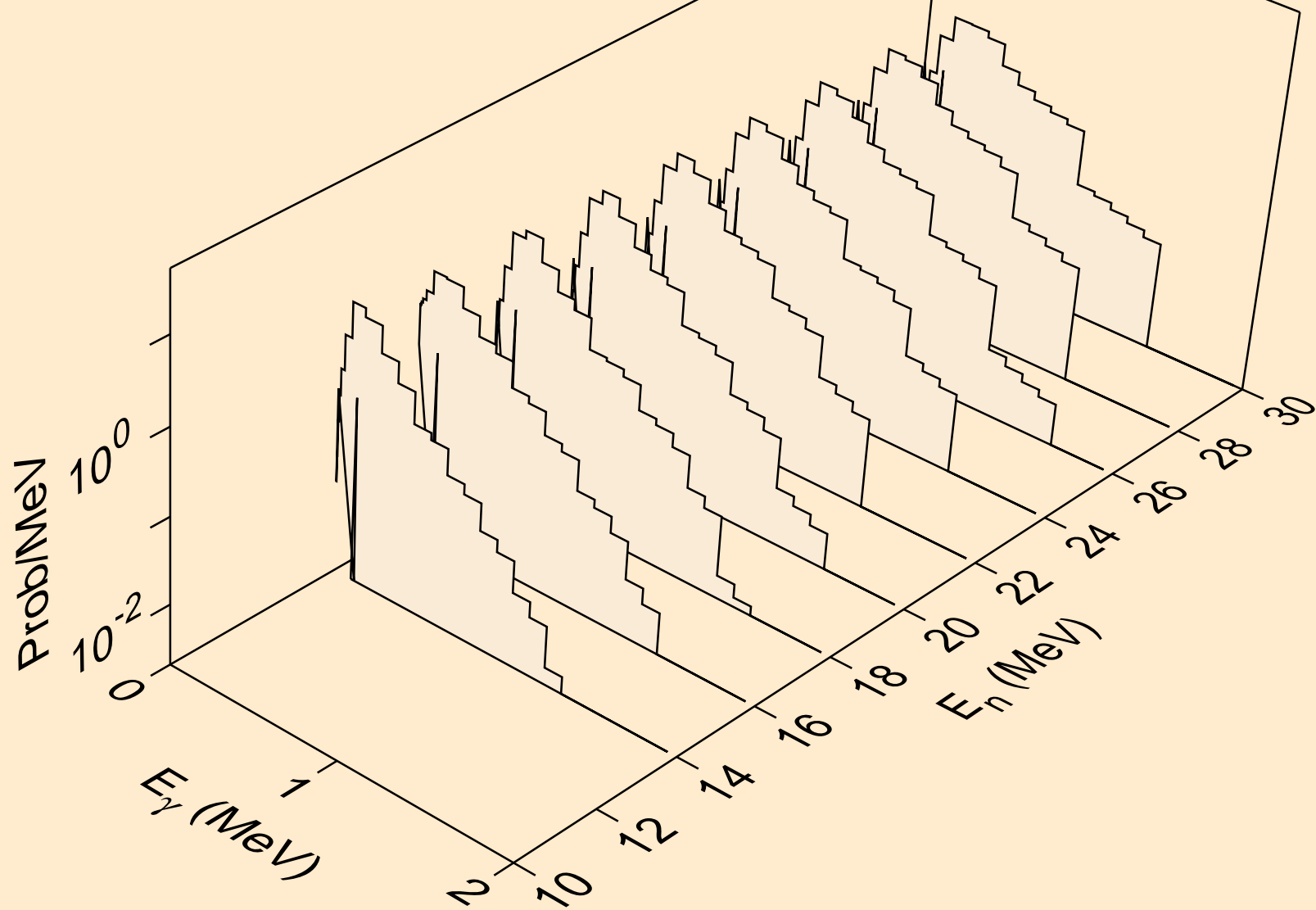

AM233 DEUTERON ACER TENDL-2021 LIBRARY; T=0.K
Photon emission for (n,2np)

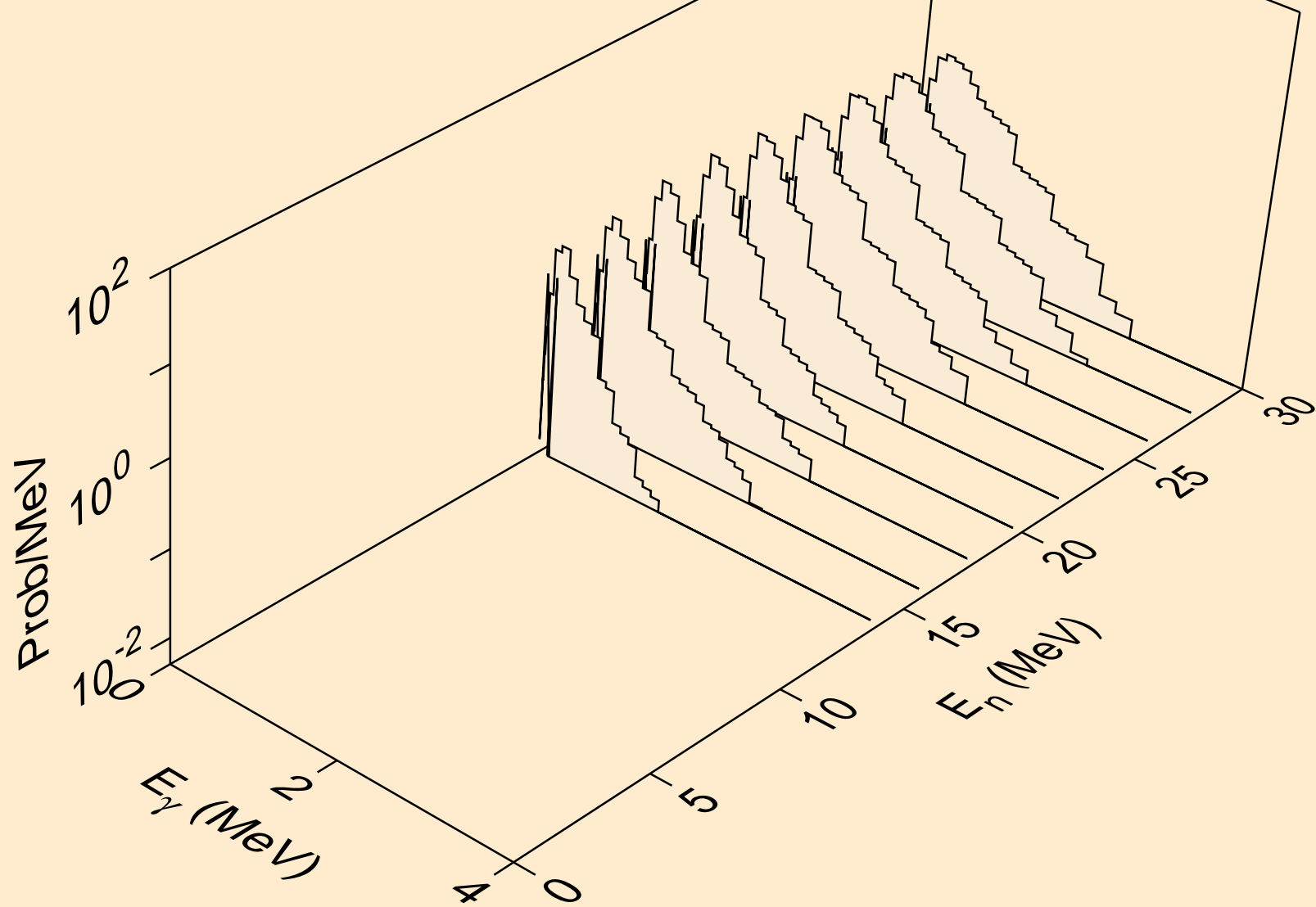

AM233 DEUTERON ACER TENDL-2021 LIBRARY; T=0.K
Photon emission for (n,npa)

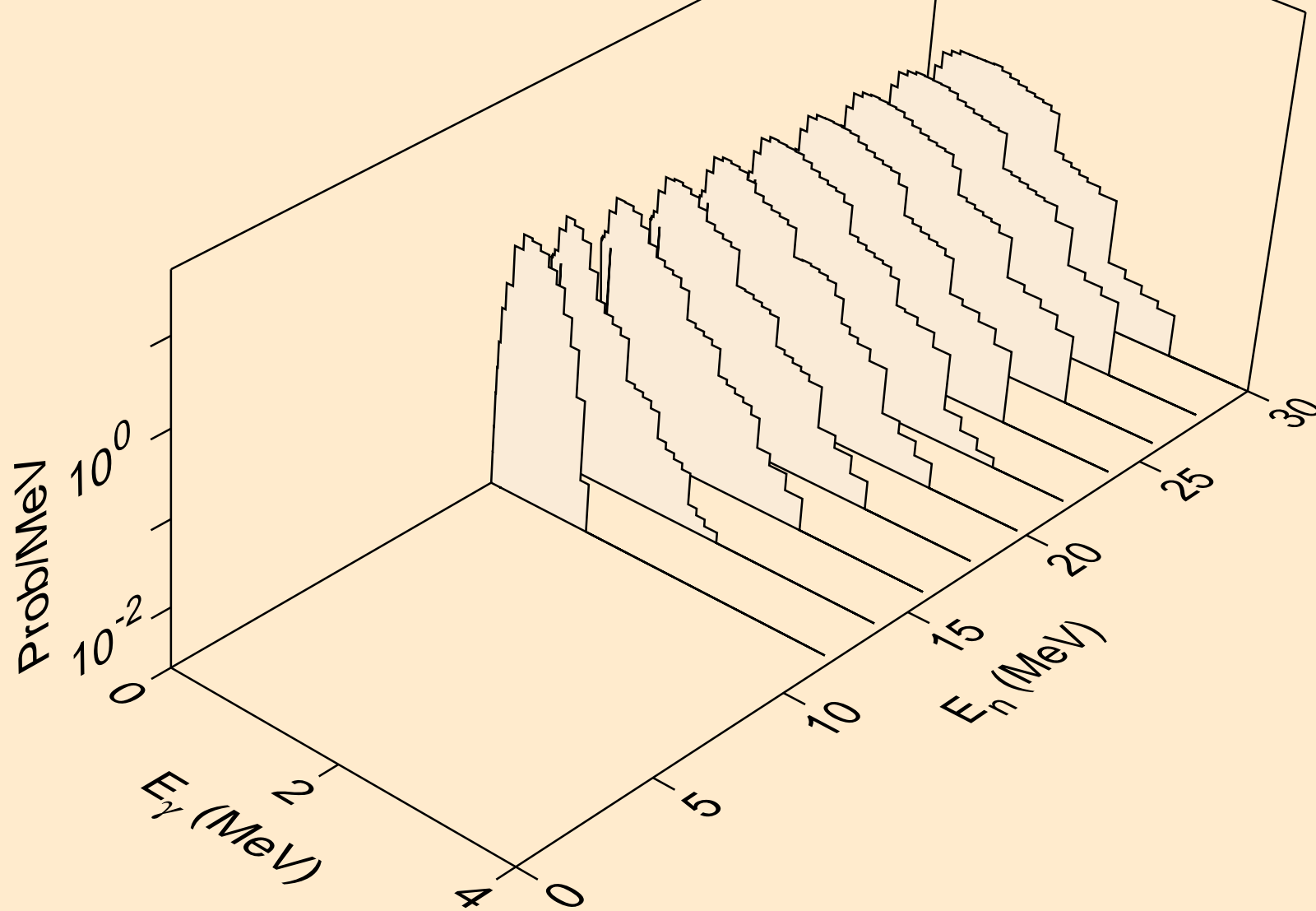

AM233 DEUTERON ACER TENDL-2021 LIBRARY; T=0.K
Photon emission for (n,p)

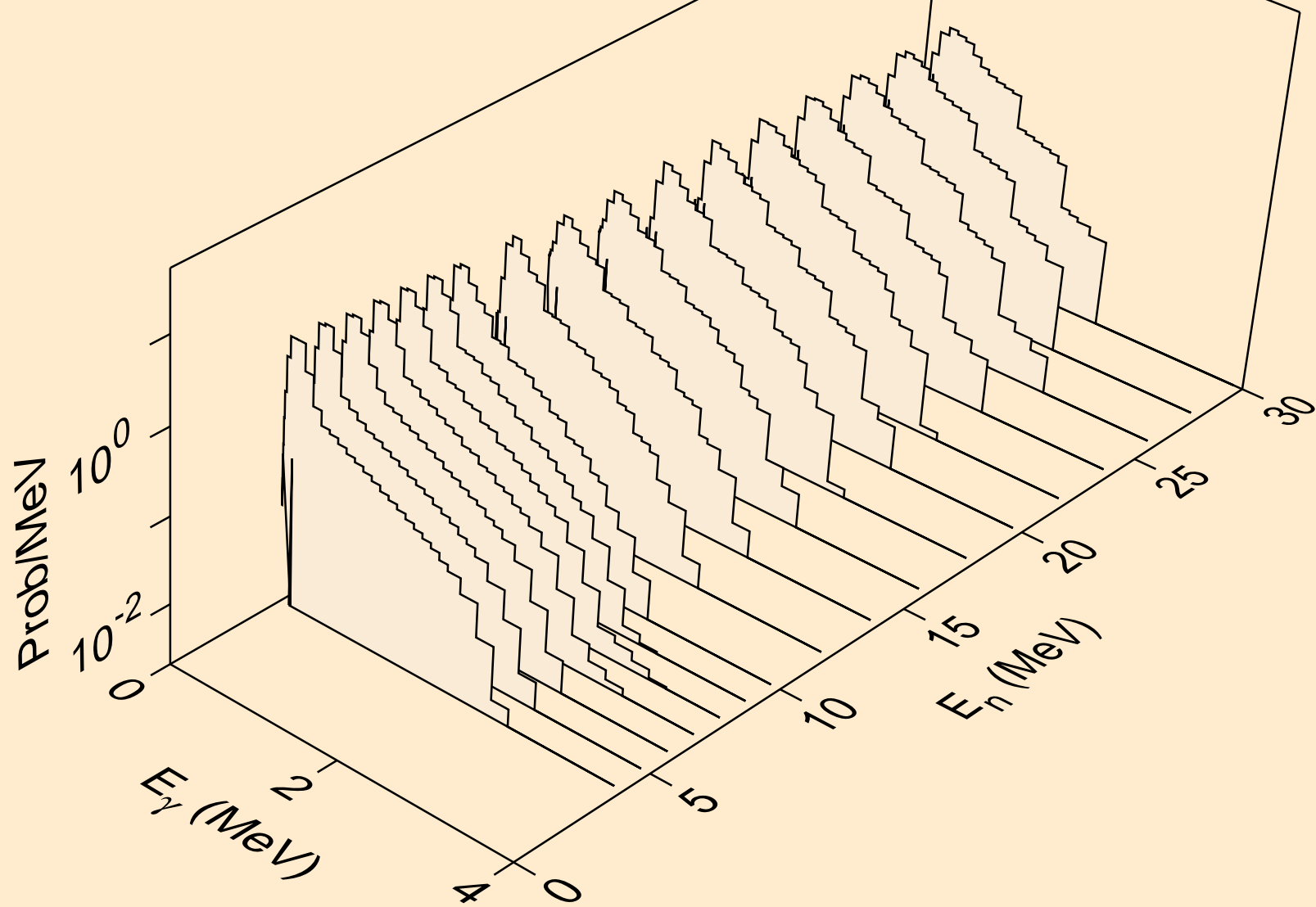

AM233 DEUTERON ACER TENDL-2021 LIBRARY; T=0.K
Photon emission for inelastic

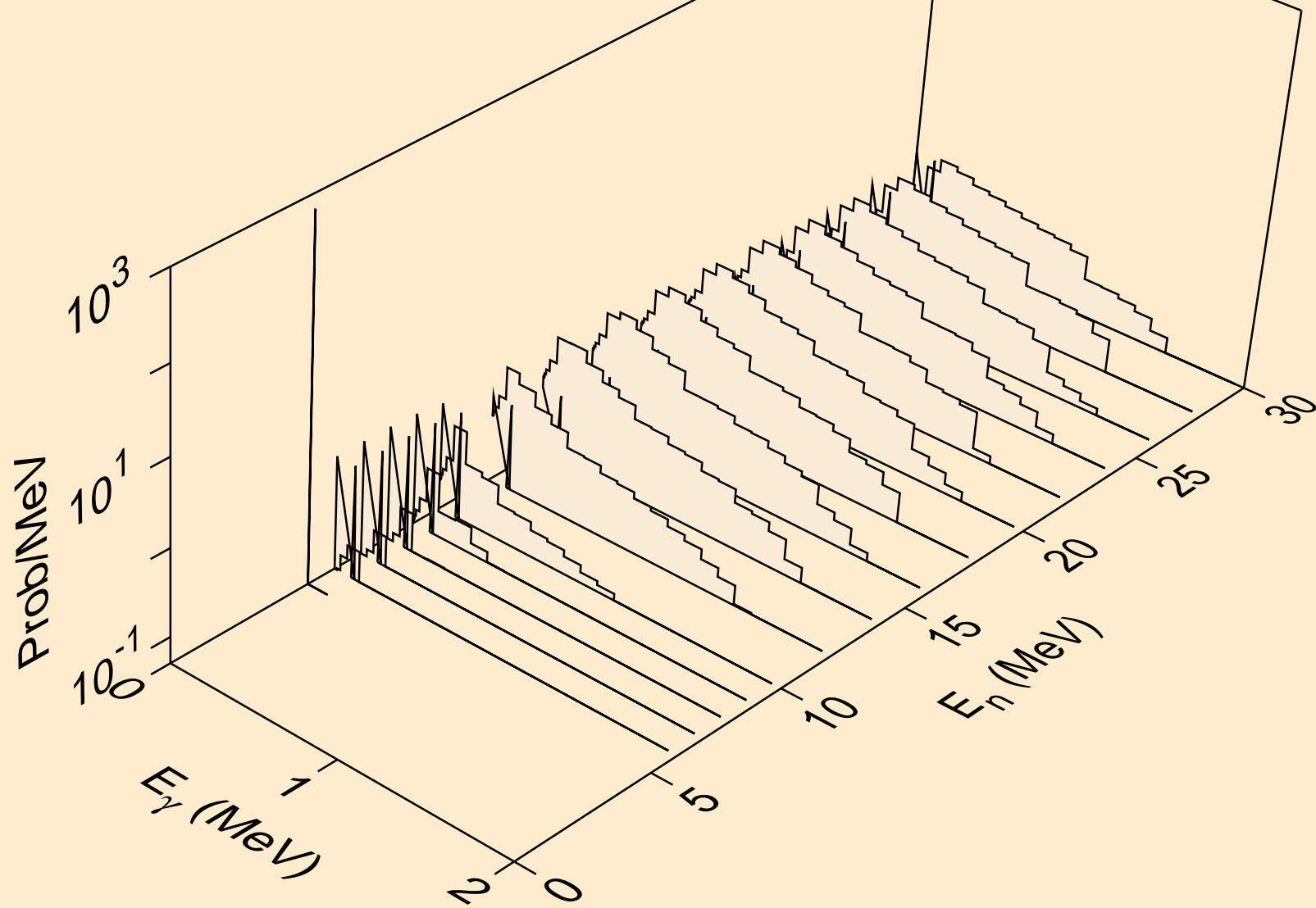

AM233 DEUTERON ACER TENDL-2021 LIBRARY; T=0.K
Photon emission for (n,t)

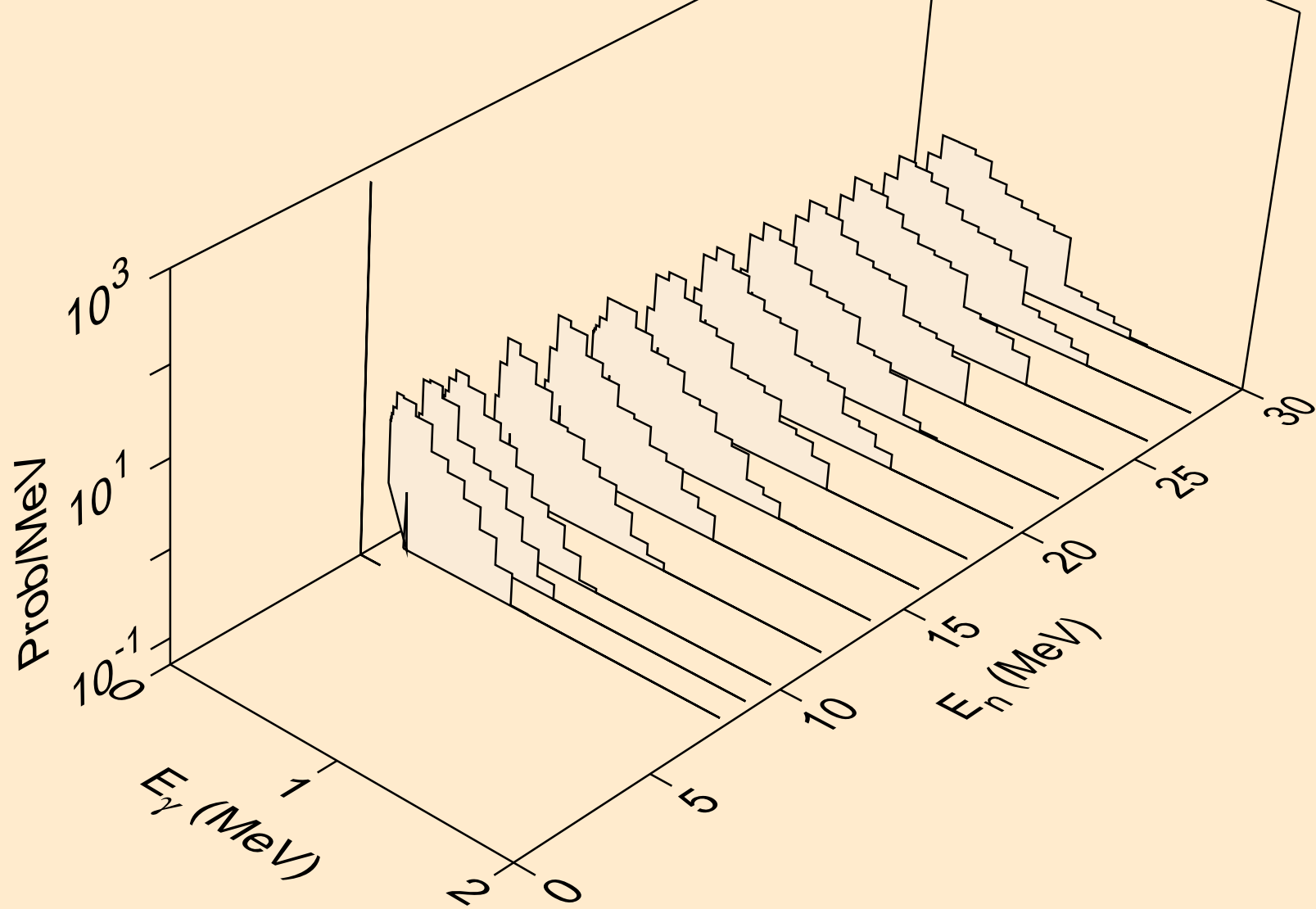

AM233 DEUTERON ACER TENDL-2021 LIBRARY; T=0.K
Photon emission for (n,he3)

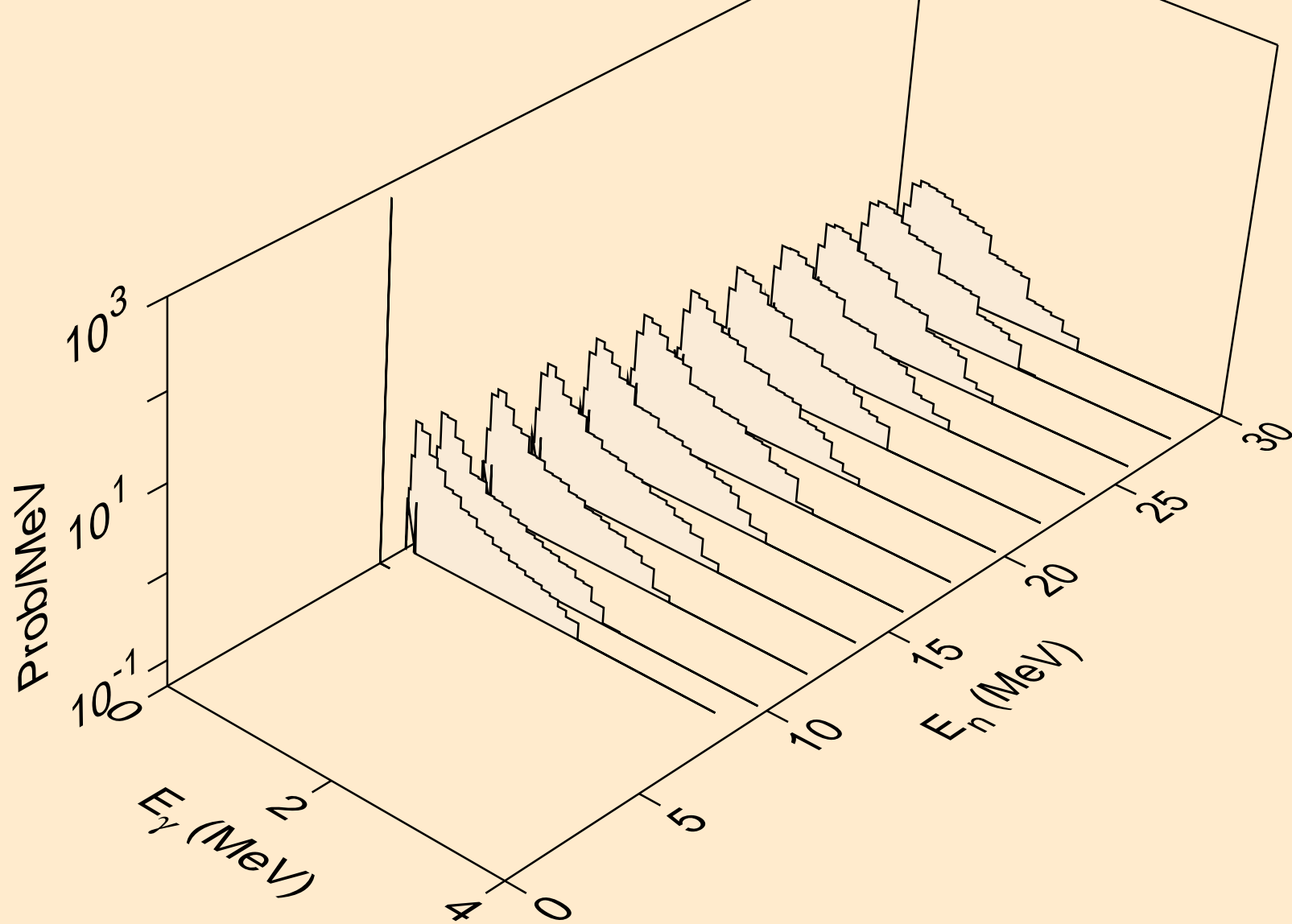

AM233 DEUTERON ACER TENDL-2021 LIBRARY; T=0.K
Photon emission for (n,a)

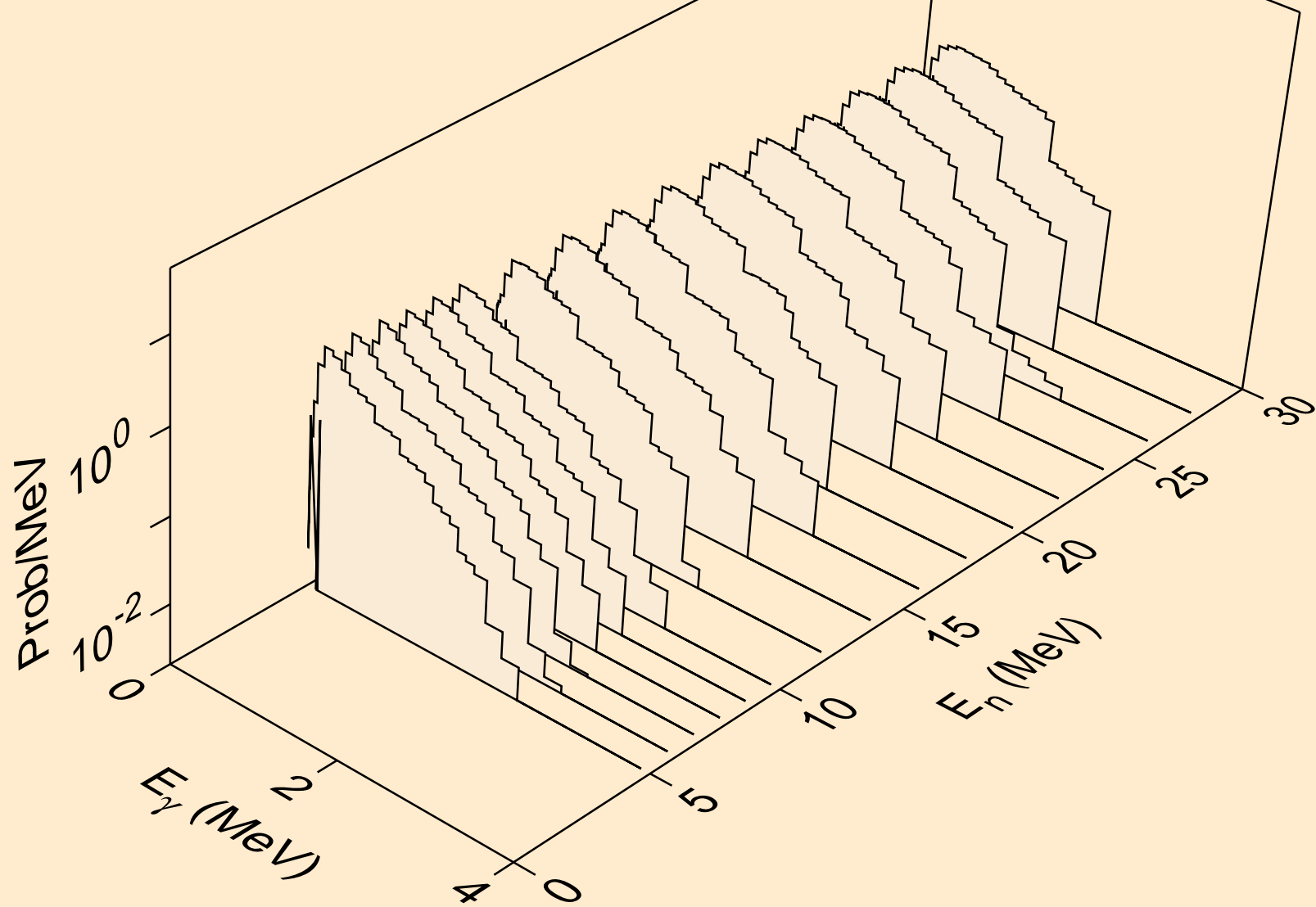

AM233 DEUTERON ACER TENDL-2021 LIBRARY; T=0.K
Photon emission for (n,2p)

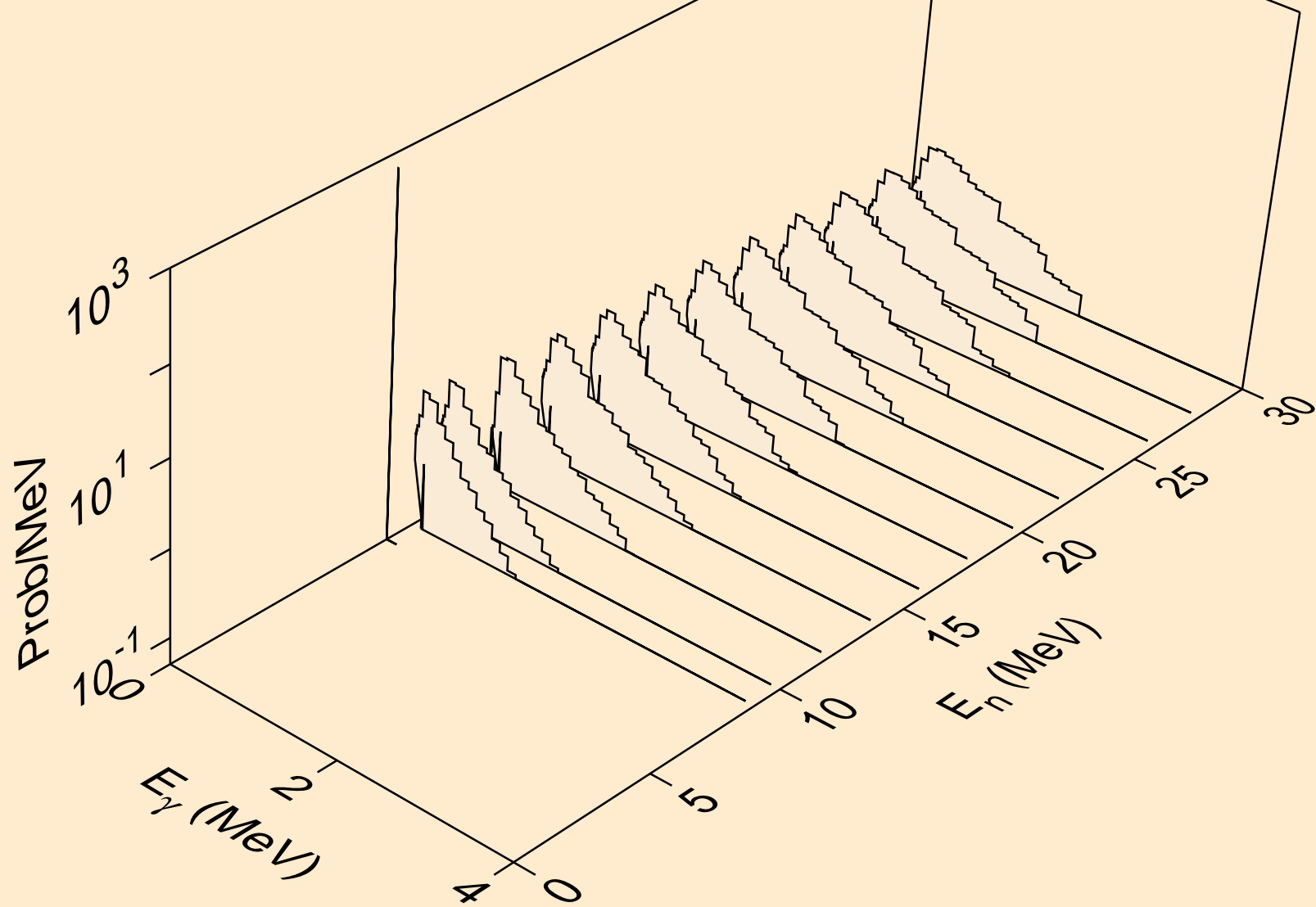

AM233 DEUTERON ACER TENDL-2021 LIBRARY; T=0.K
Photon emission for (n,p)

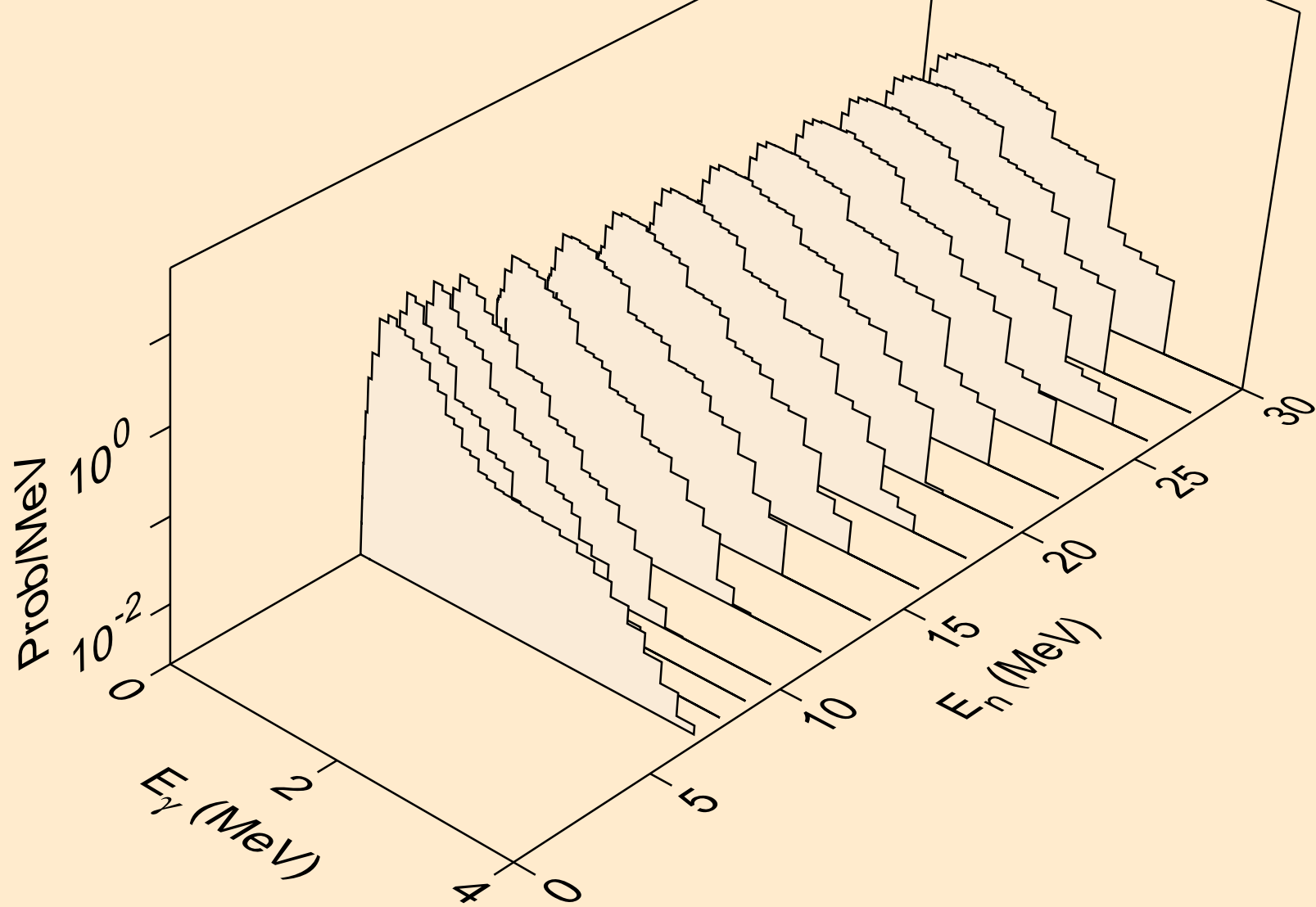

AM233 DEUTERON ACER TENDL-2021 LIBRARY; T=0.K
Photon emission for (n,pd)

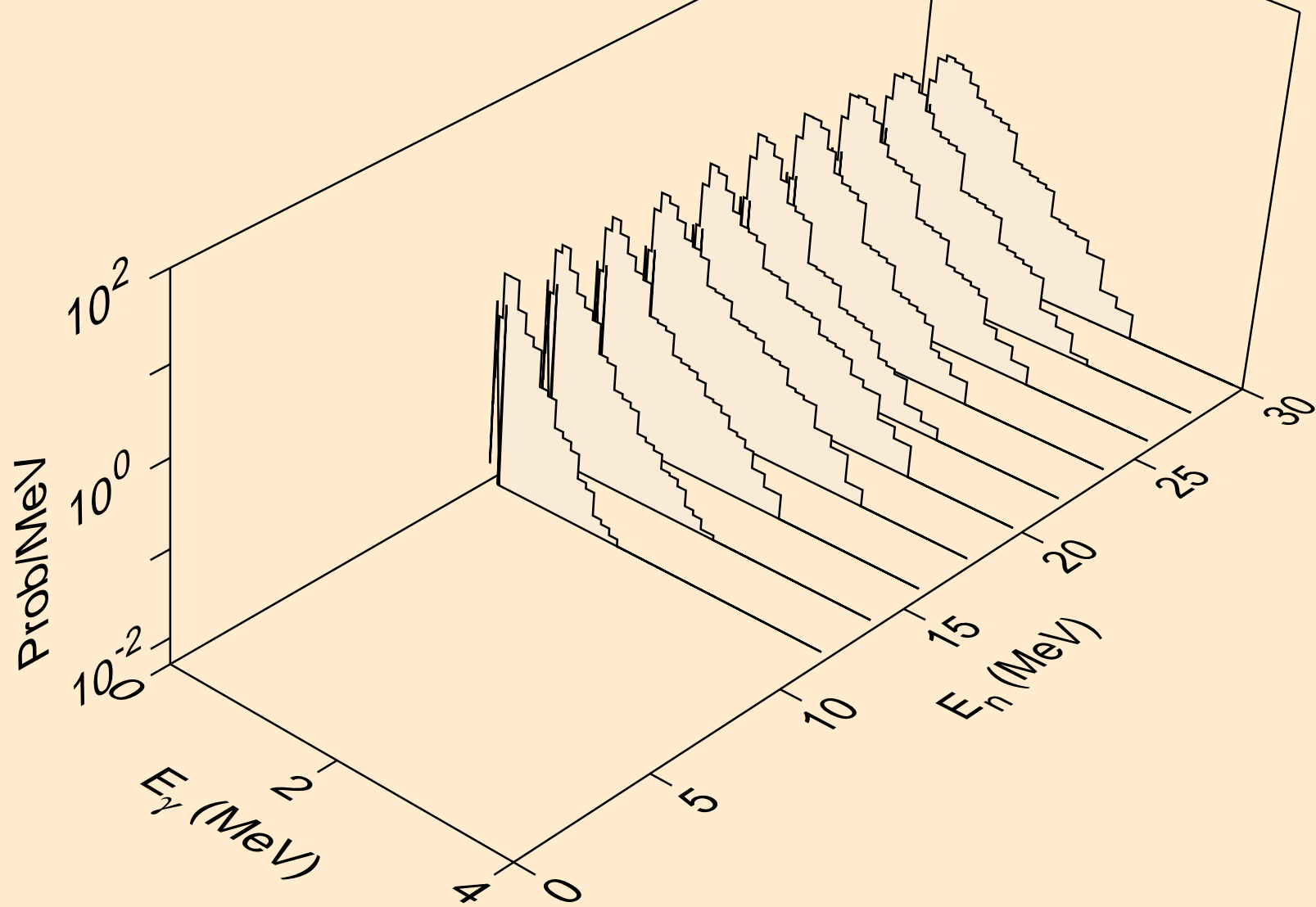

AM233 DEUTERON ACER TENDL-2021 LIBRARY; T=0.K

Particle heating contributions

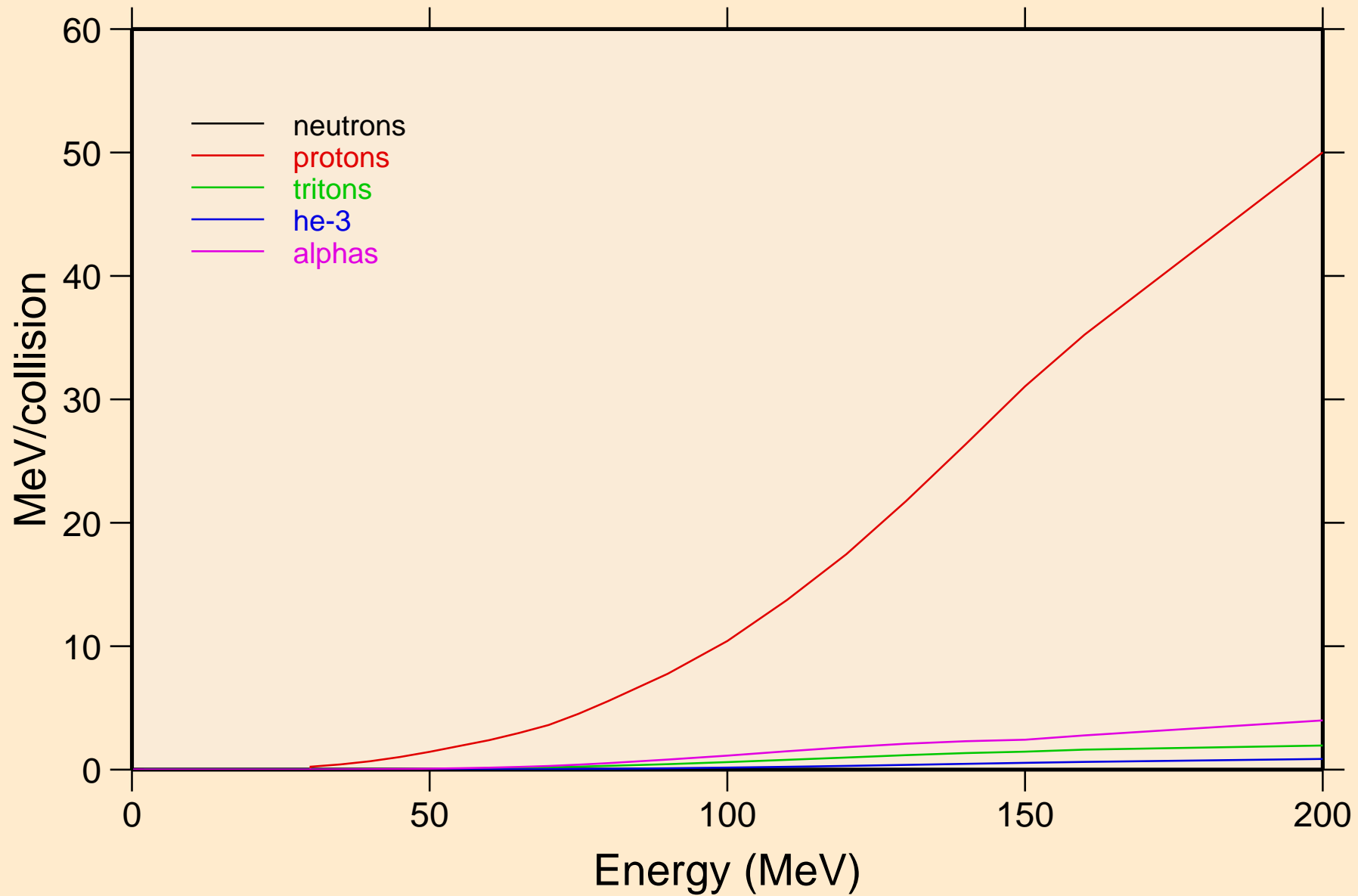

AM233 DEUTERON ACER TENDL-2021 LIBRARY; T=0.K
Recoil Heating

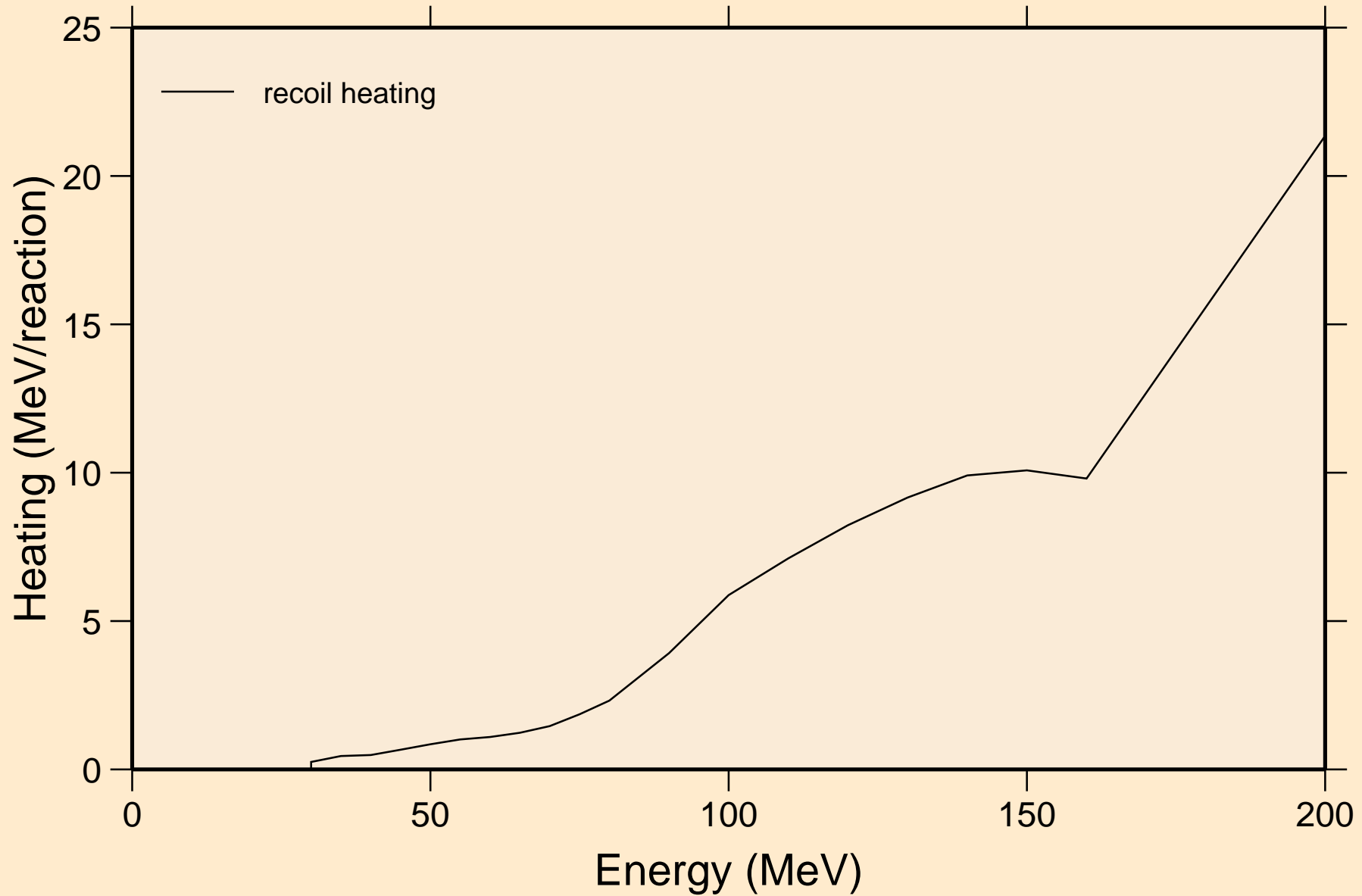

AM233 DEUTERON ACER TENDL-2021 LIBRARY; T=0.K
Particle production cross sections

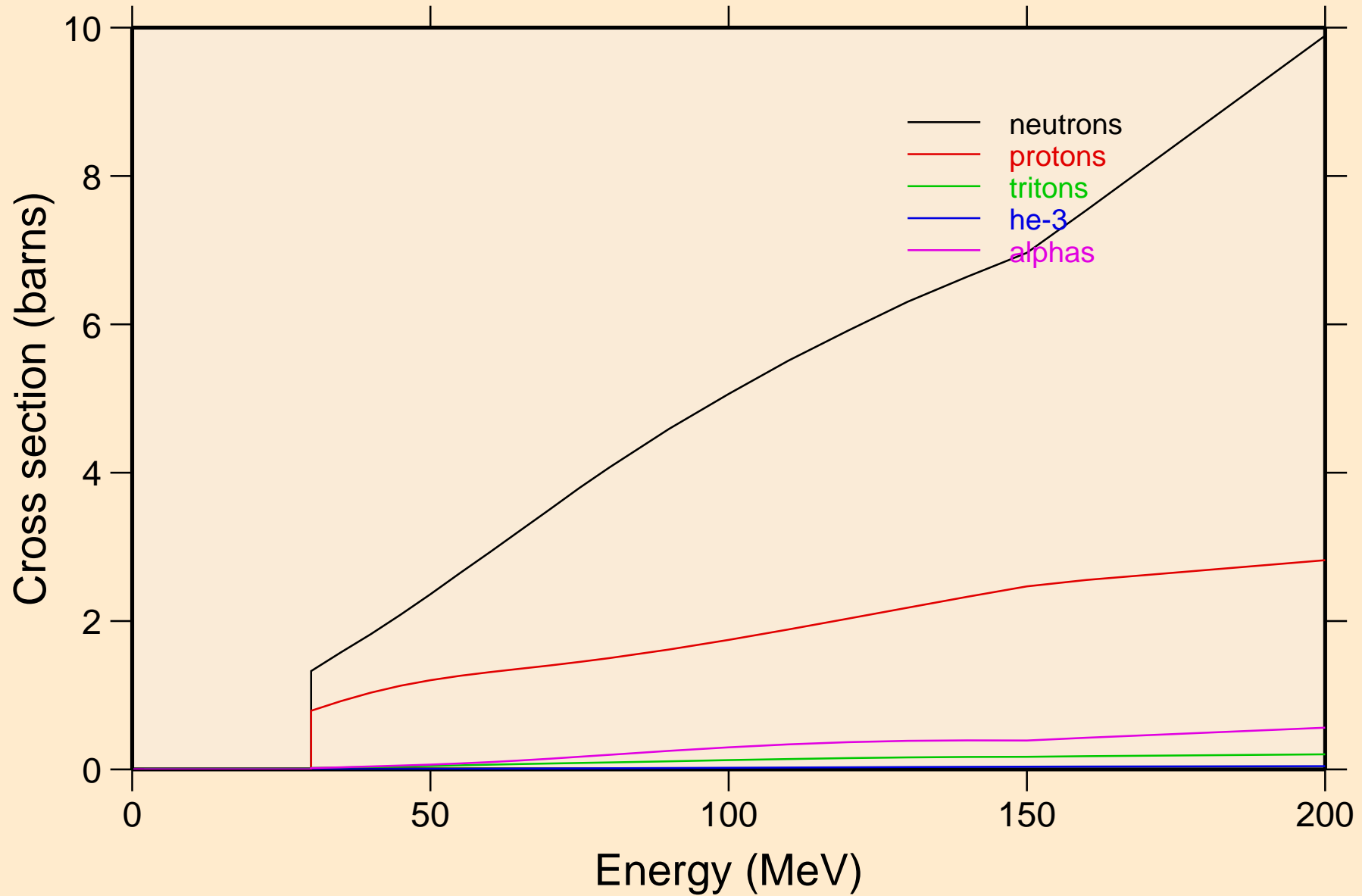

AM233 DEUTERON ACER TENDL-2021 LIBRARY; T=0.K
neutrons from (d,n)

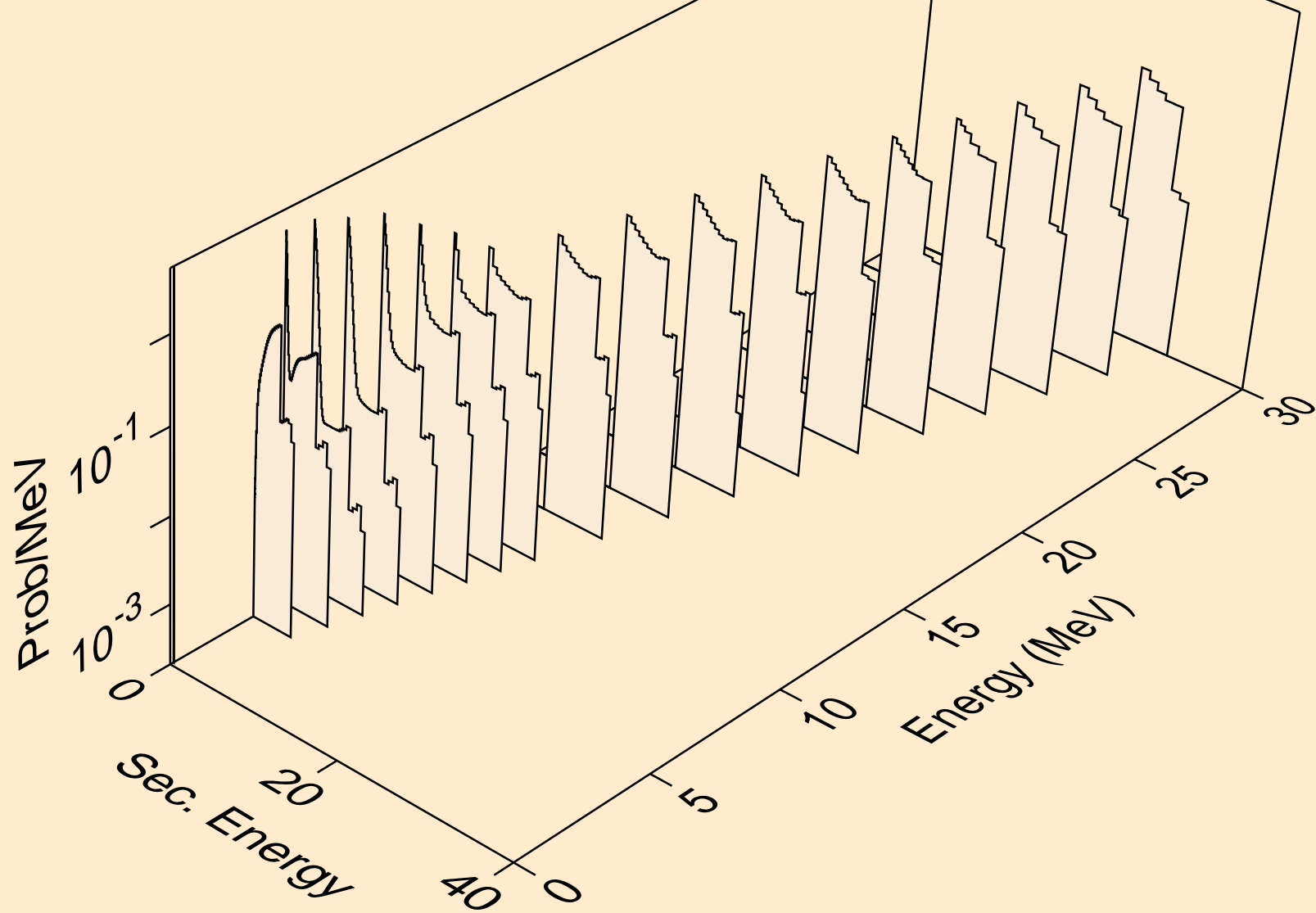

AM233 DEUTERON ACER TENDL-2021 LIBRARY; T=0.K
neutrons from (d,x)

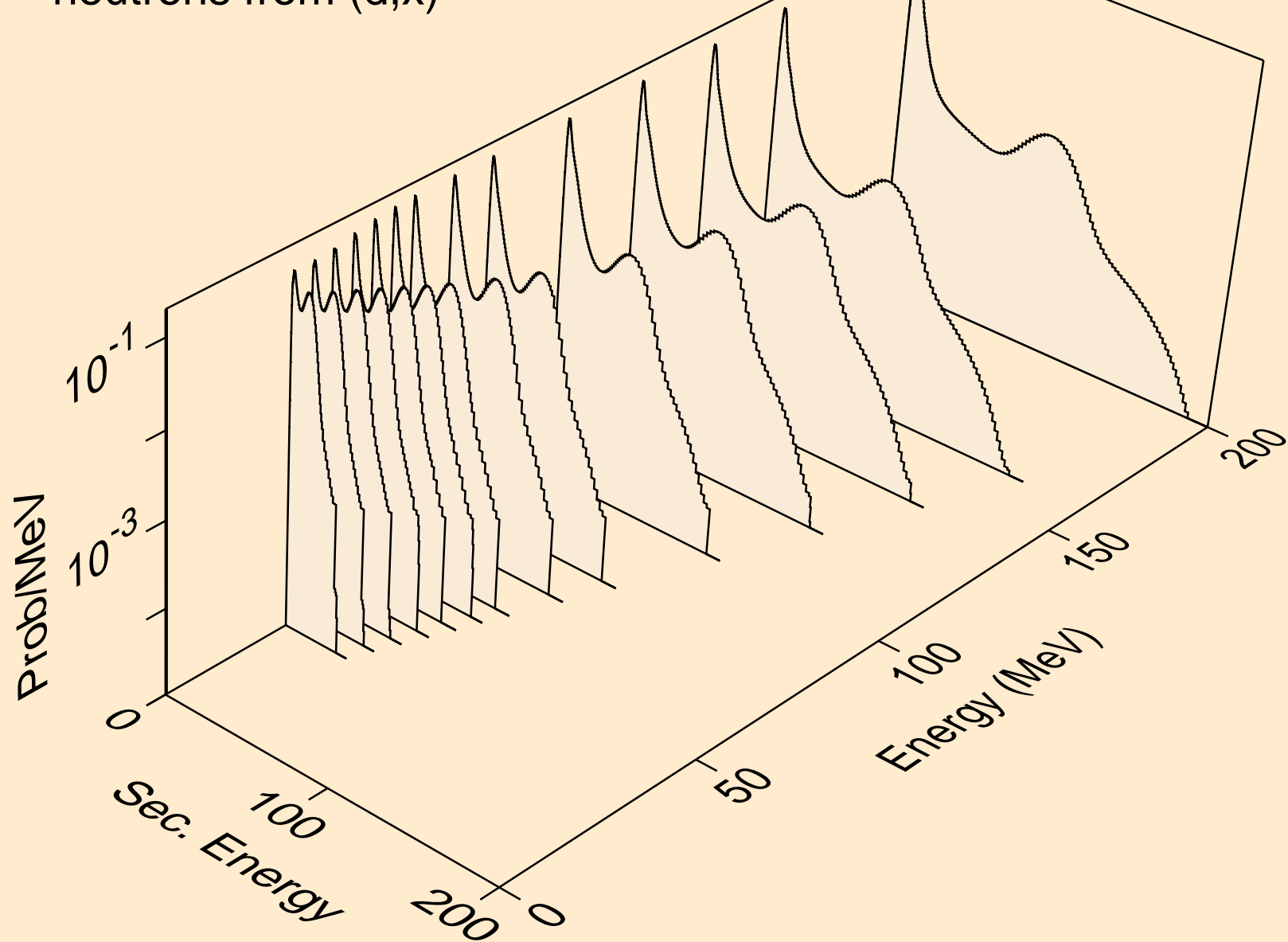

AM233 DEUTERON ACER TENDL-2021 LIBRARY; T=0.K
neutrons from (d,2n)

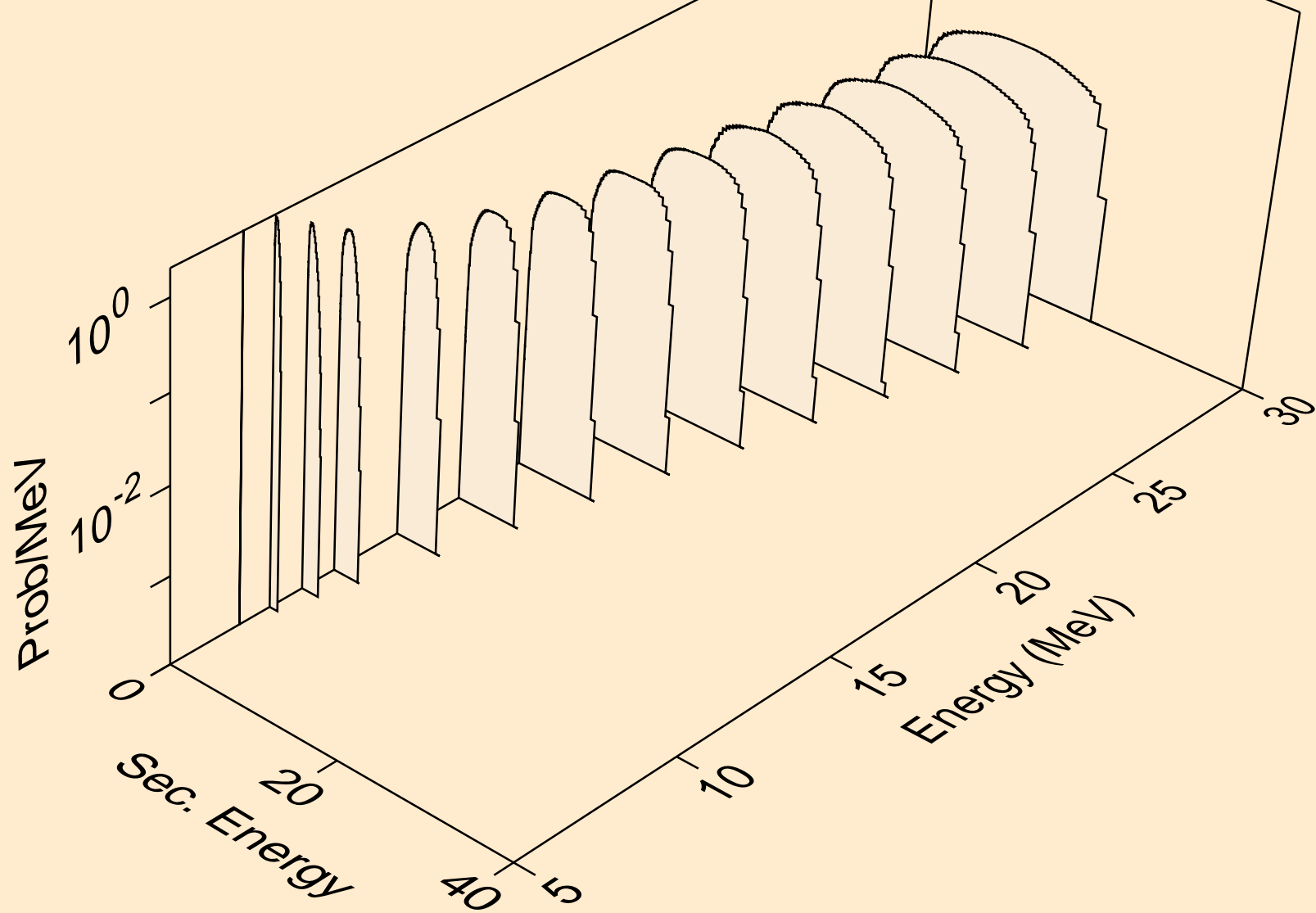

AM233 DEUTERON ACER TENDL-2021 LIBRARY; T=0.K
neutrons from (d,3n)

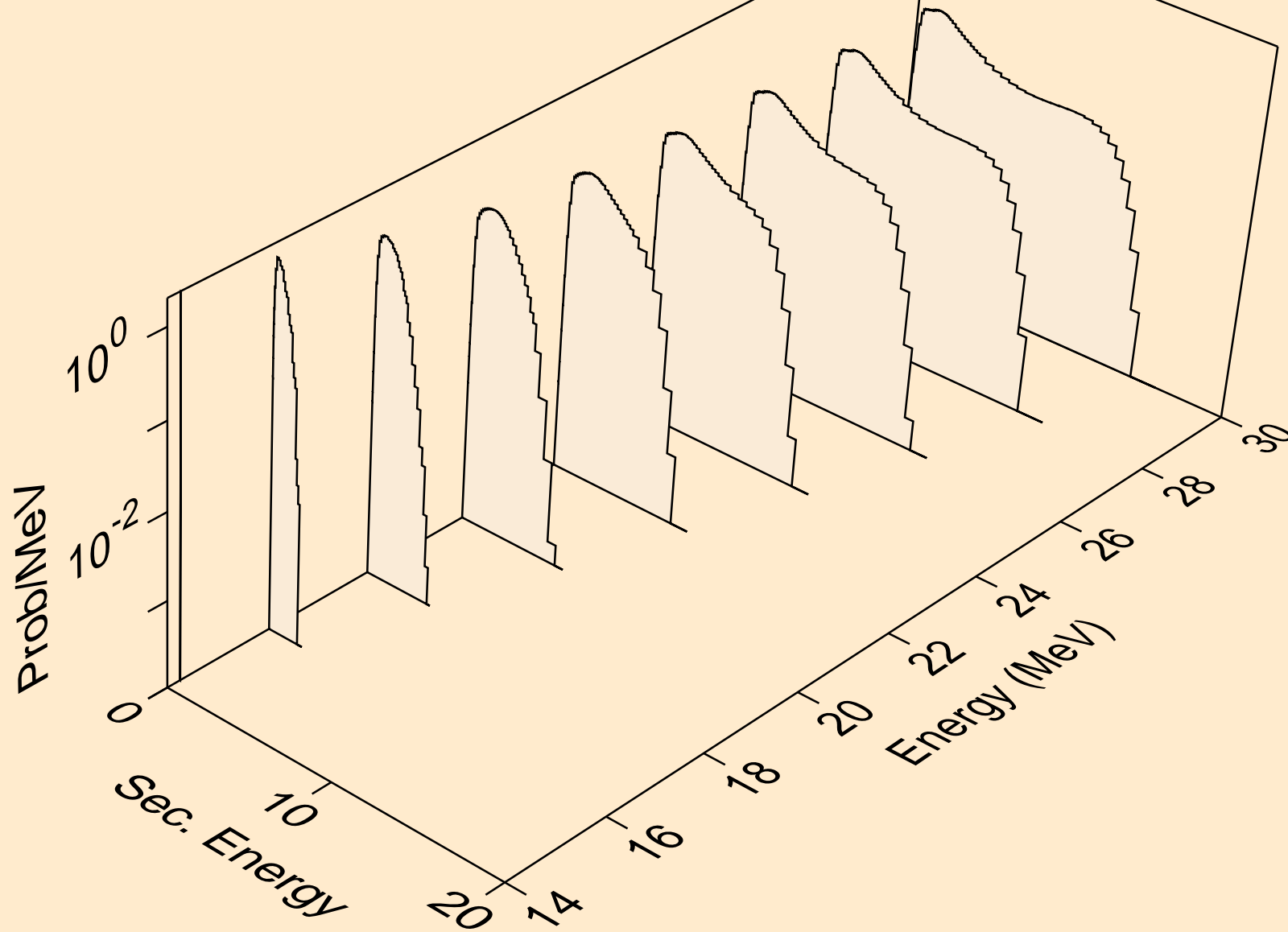

AM233 DEUTERON ACER TENDL-2021 LIBRARY; T=0.K
neutrons from (d,n*)a

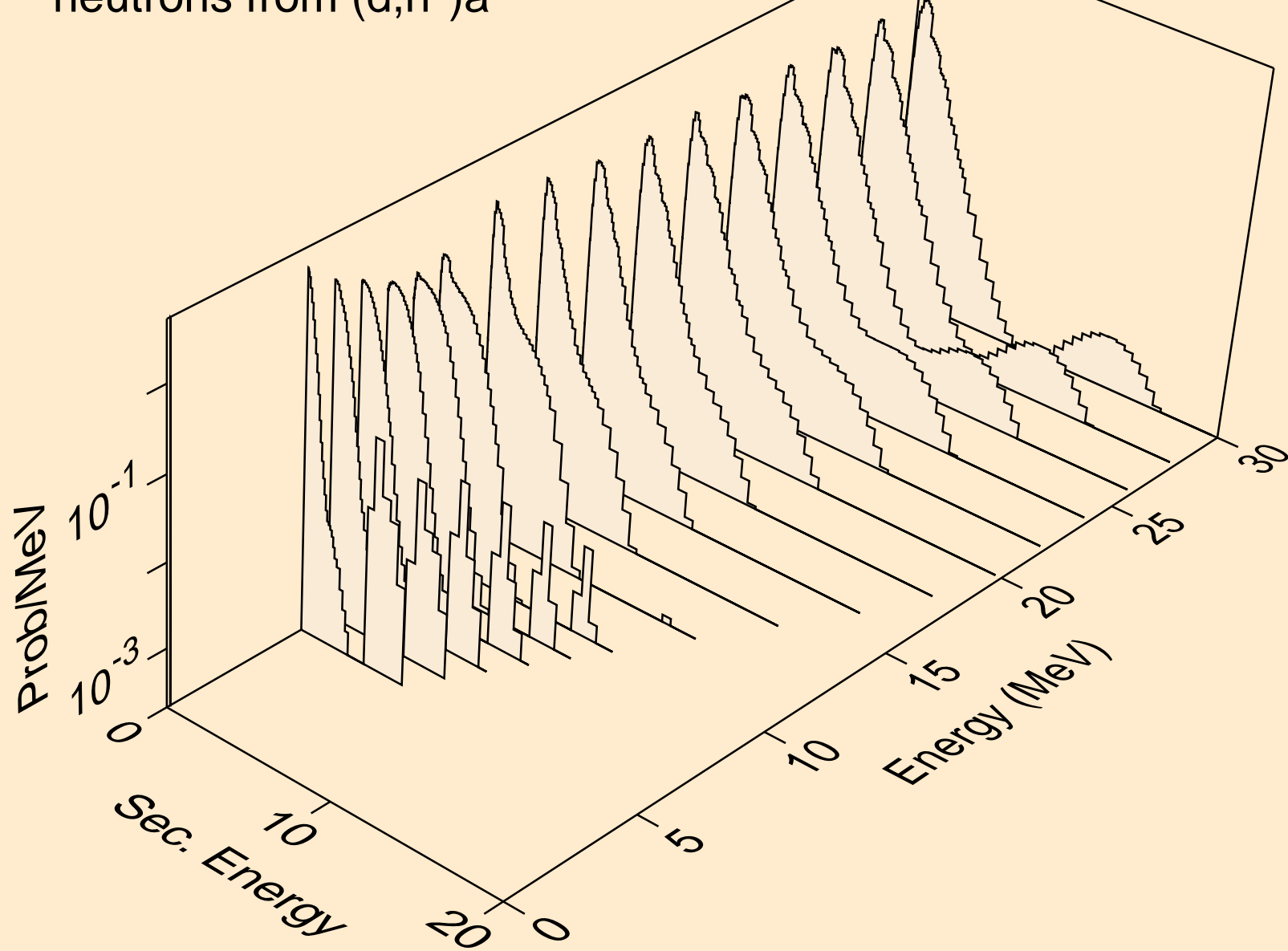

AM233 DEUTERON ACER TENDL-2021 LIBRARY; T=0.K
neutrons from (d,2n)a

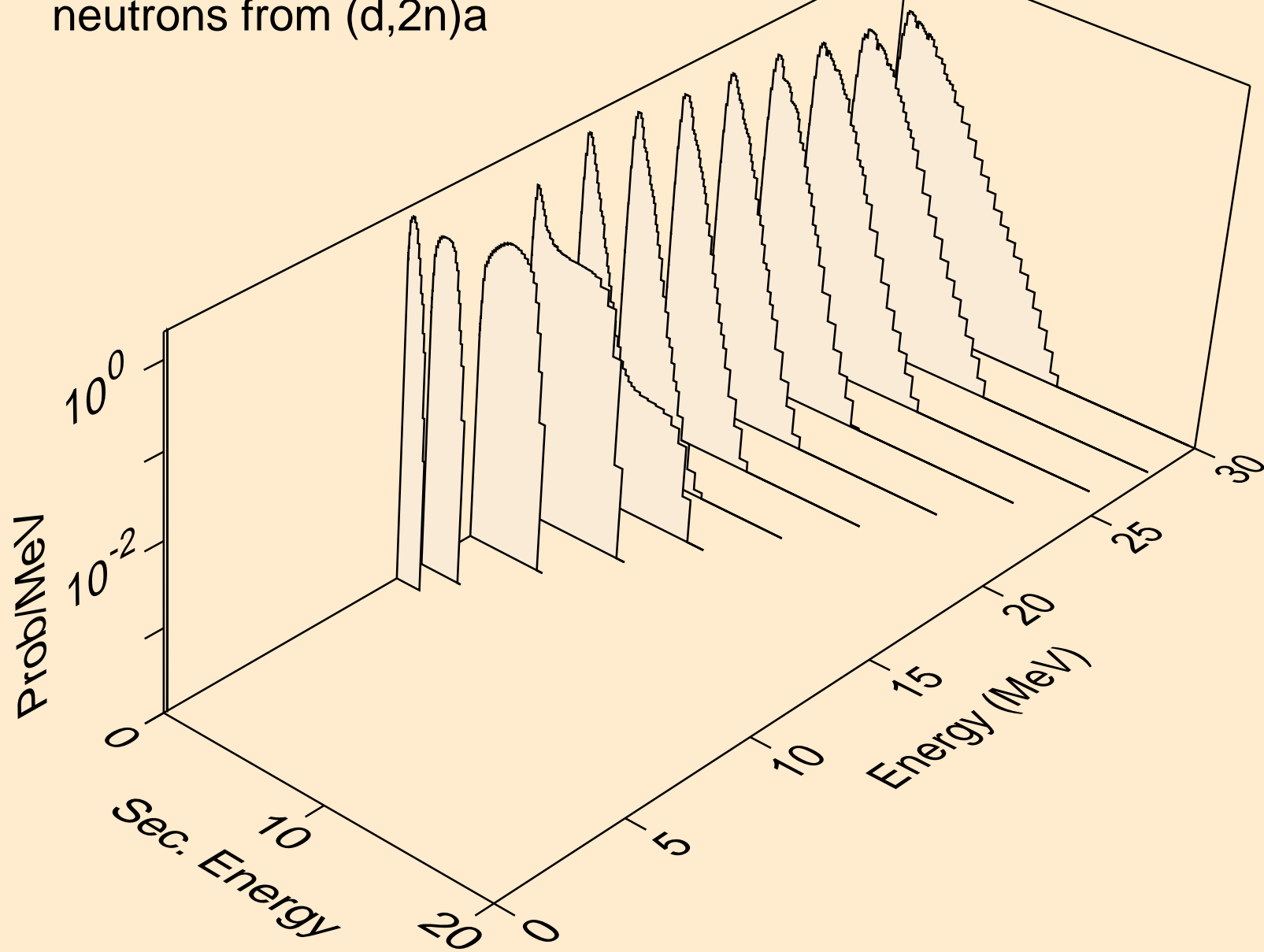

AM233 DEUTERON ACER TENDL-2021 LIBRARY; T=0.K
neutrons from (d,n*)p

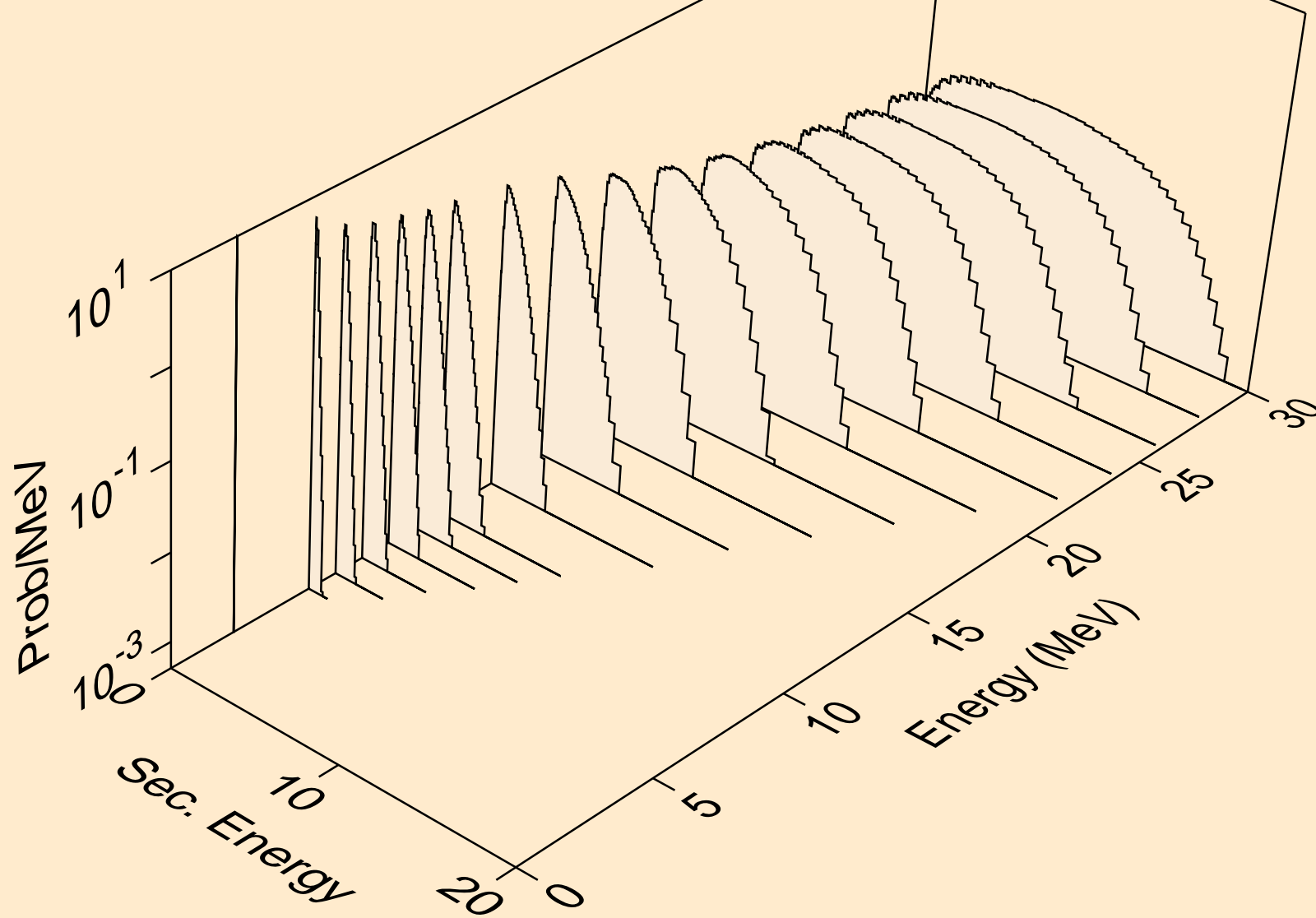

AM233 DEUTERON ACER TENDL-2021 LIBRARY; T=0.K
neutrons from (d,n*)2a

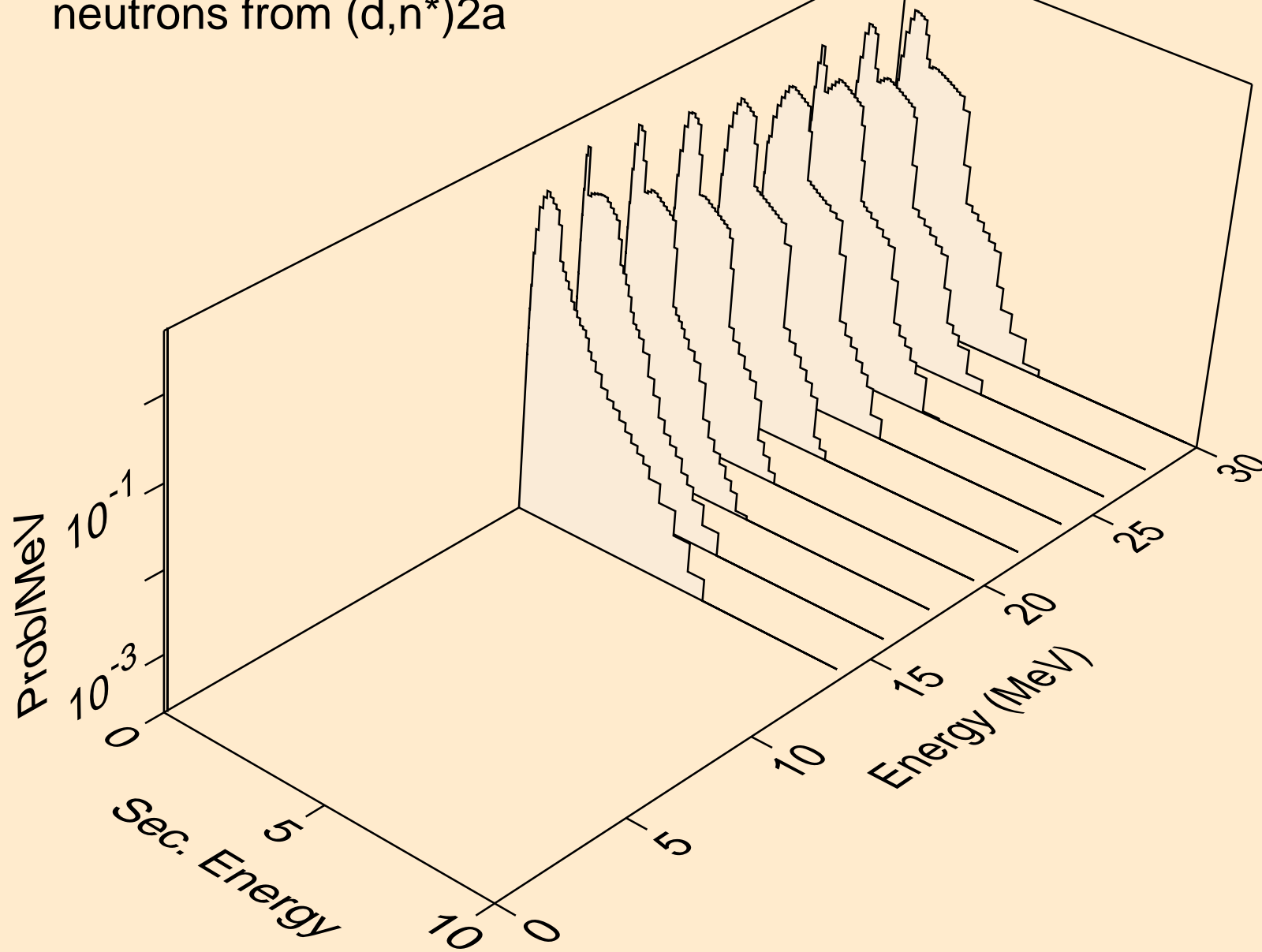

AM233 DEUTERON ACER TENDL-2021 LIBRARY; T=0.K
neutrons from (d,n*)d

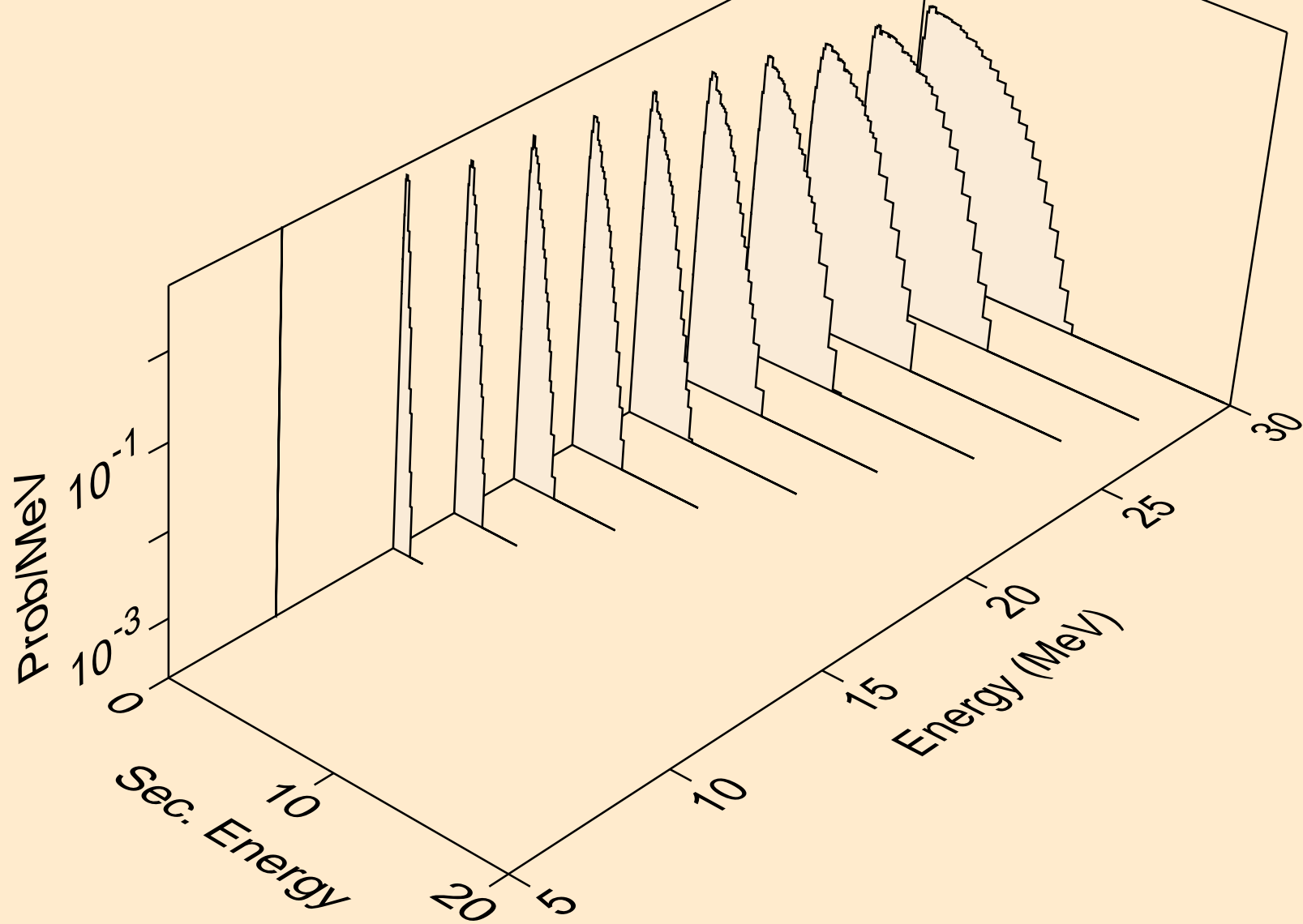

AM233 DEUTERON ACER TENDL-2021 LIBRARY; T=0.K
neutrons from (d,n*)t

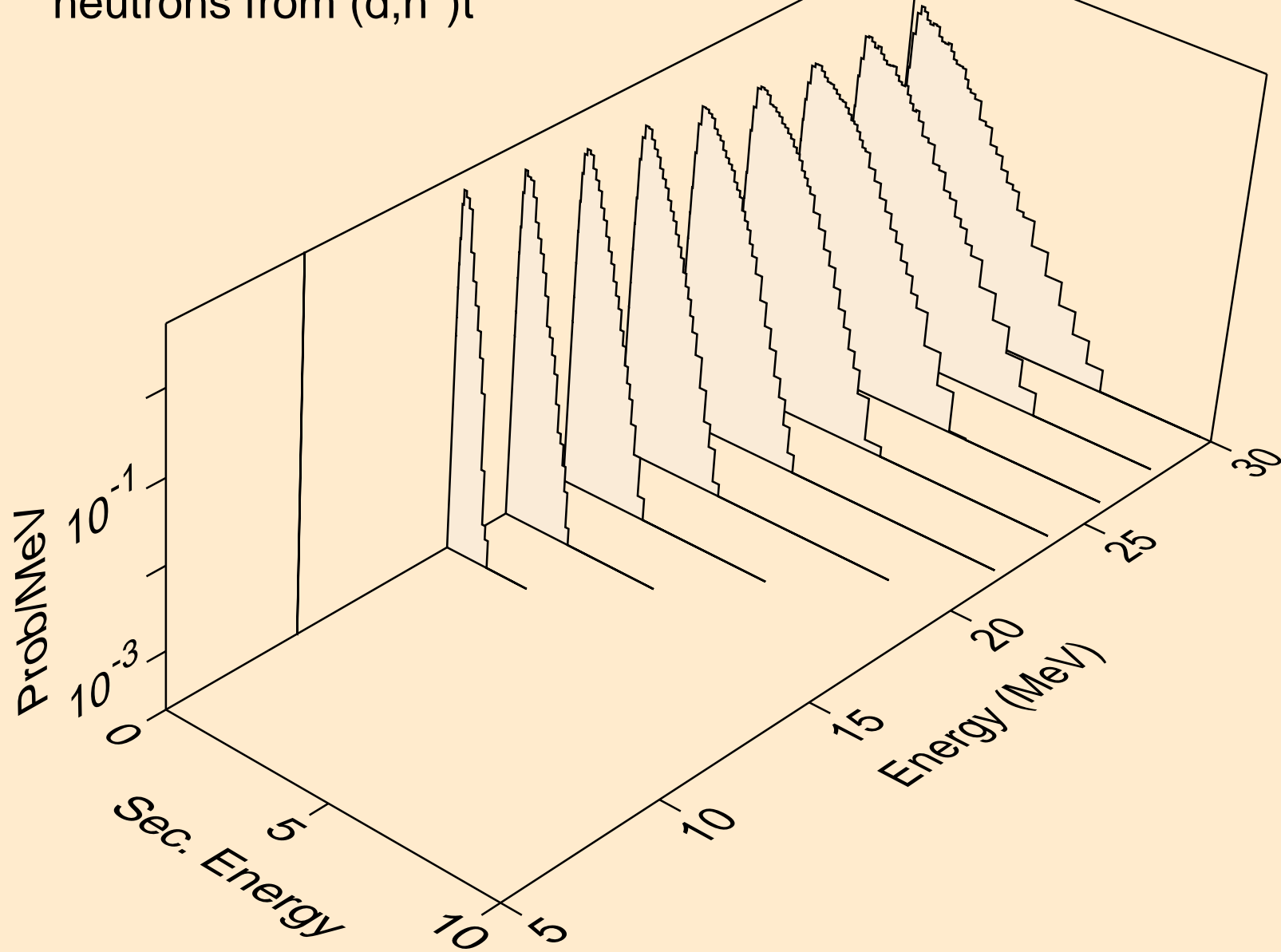

AM233 DEUTERON ACER TENDL-2021 LIBRARY; T=0.K
neutrons from (d,n*)he3

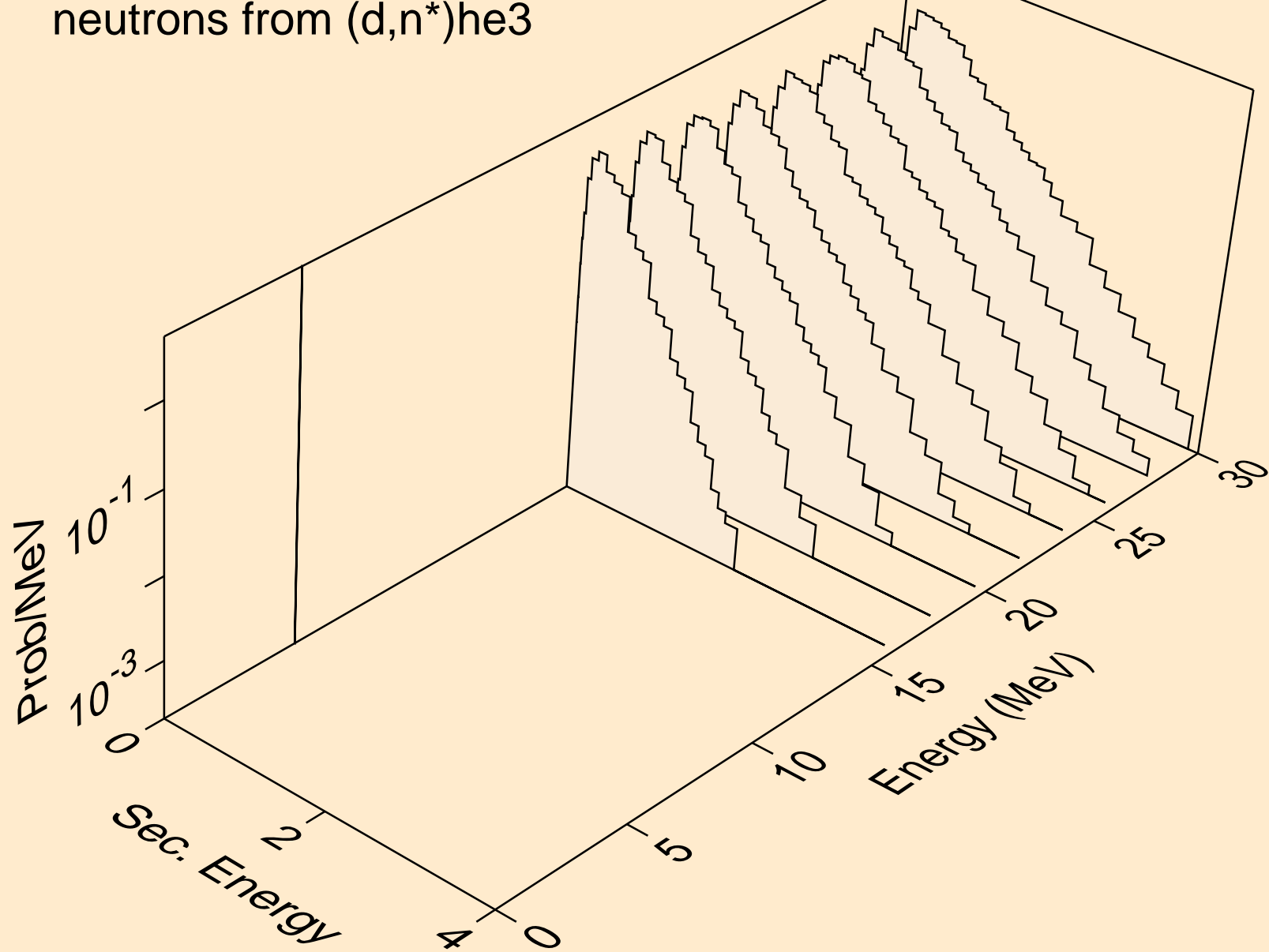

AM233 DEUTERON ACER TENDL-2021 LIBRARY; T=0.K
neutrons from (d,2np)

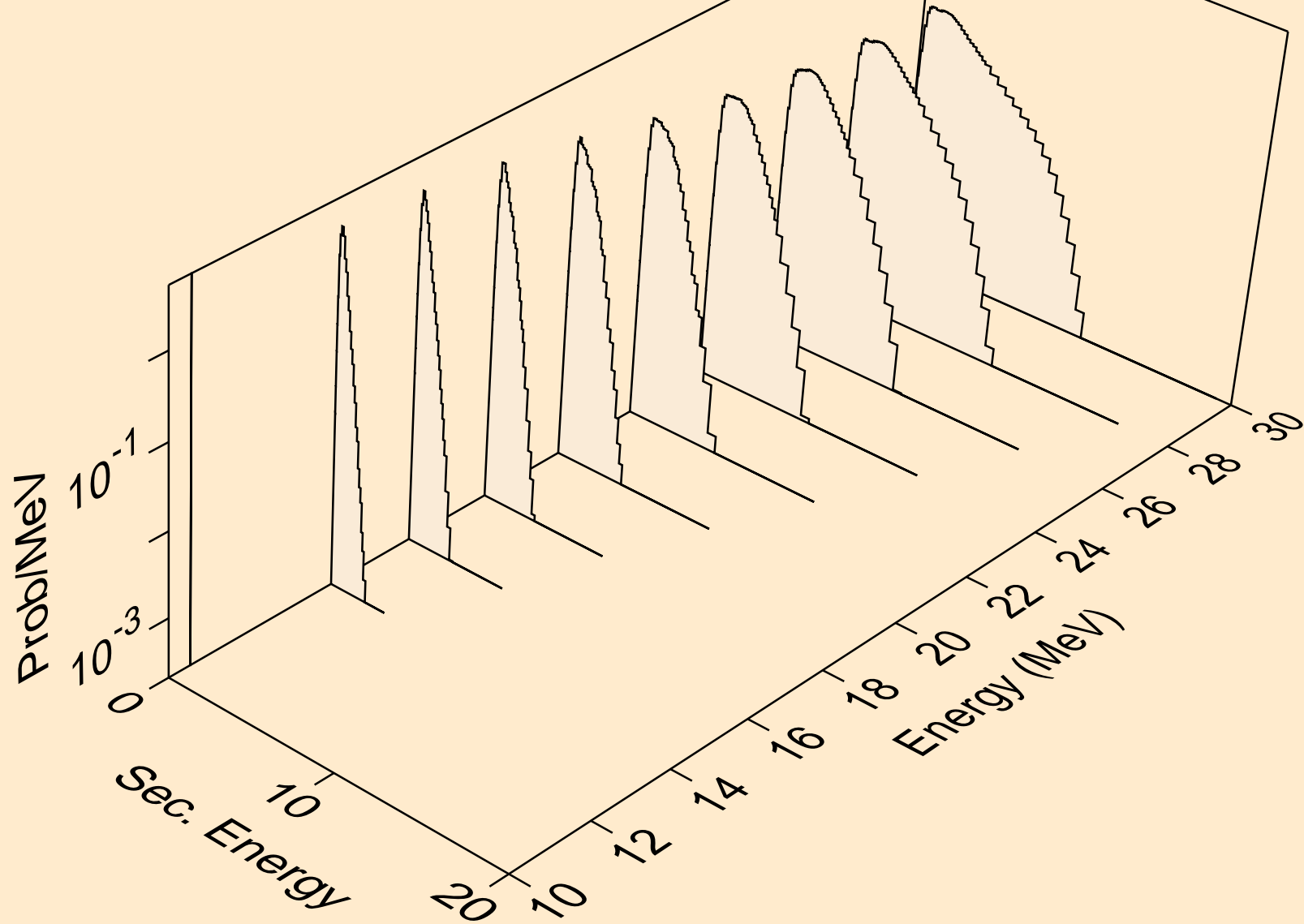

AM233 DEUTERON ACER TENDL-2021 LIBRARY; T=0.K
neutrons from (d,2np)

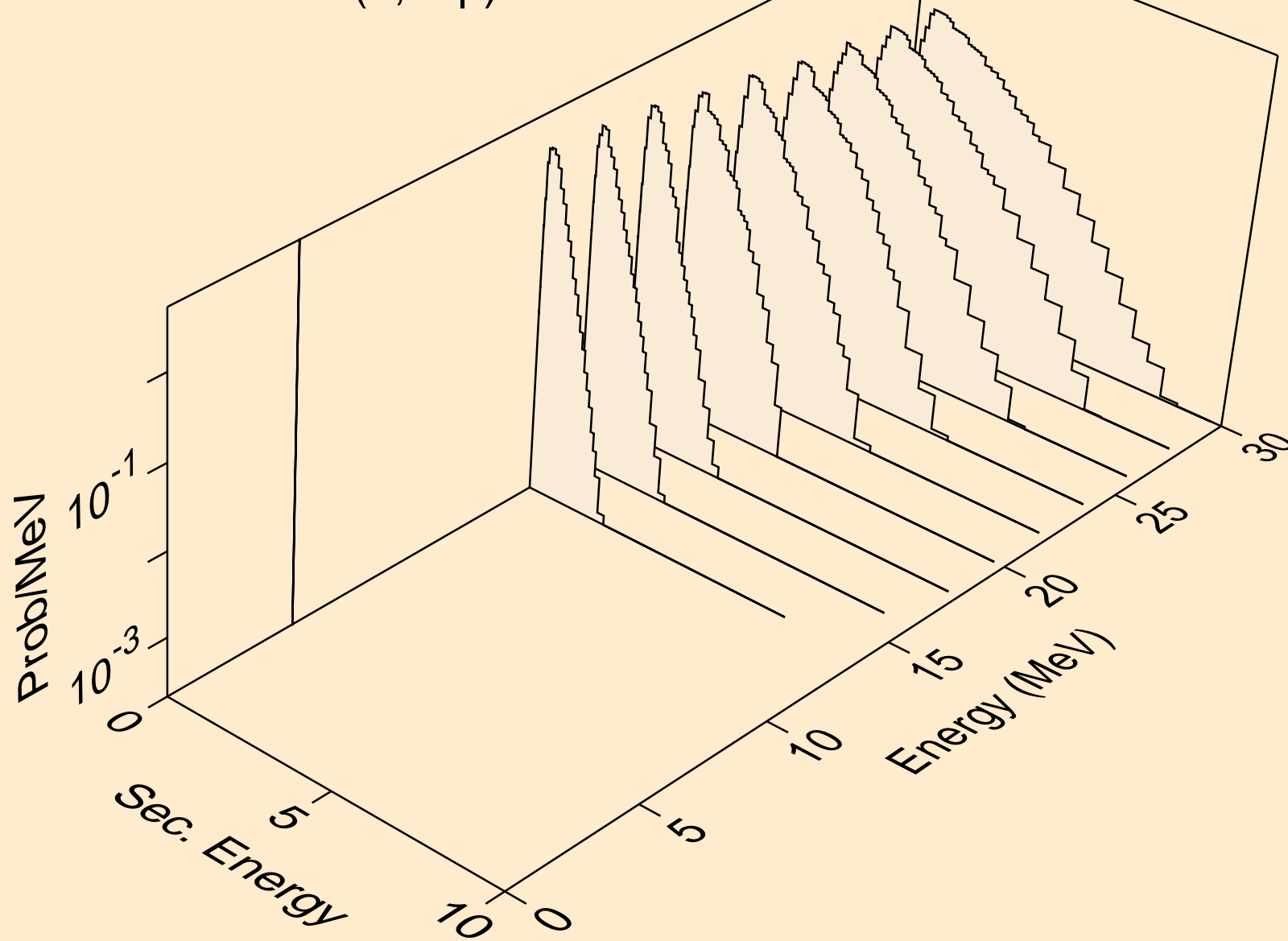

AM233 DEUTERON ACER TENDL-2021 LIBRARY; T=0.K
neutrons from (d,npa)

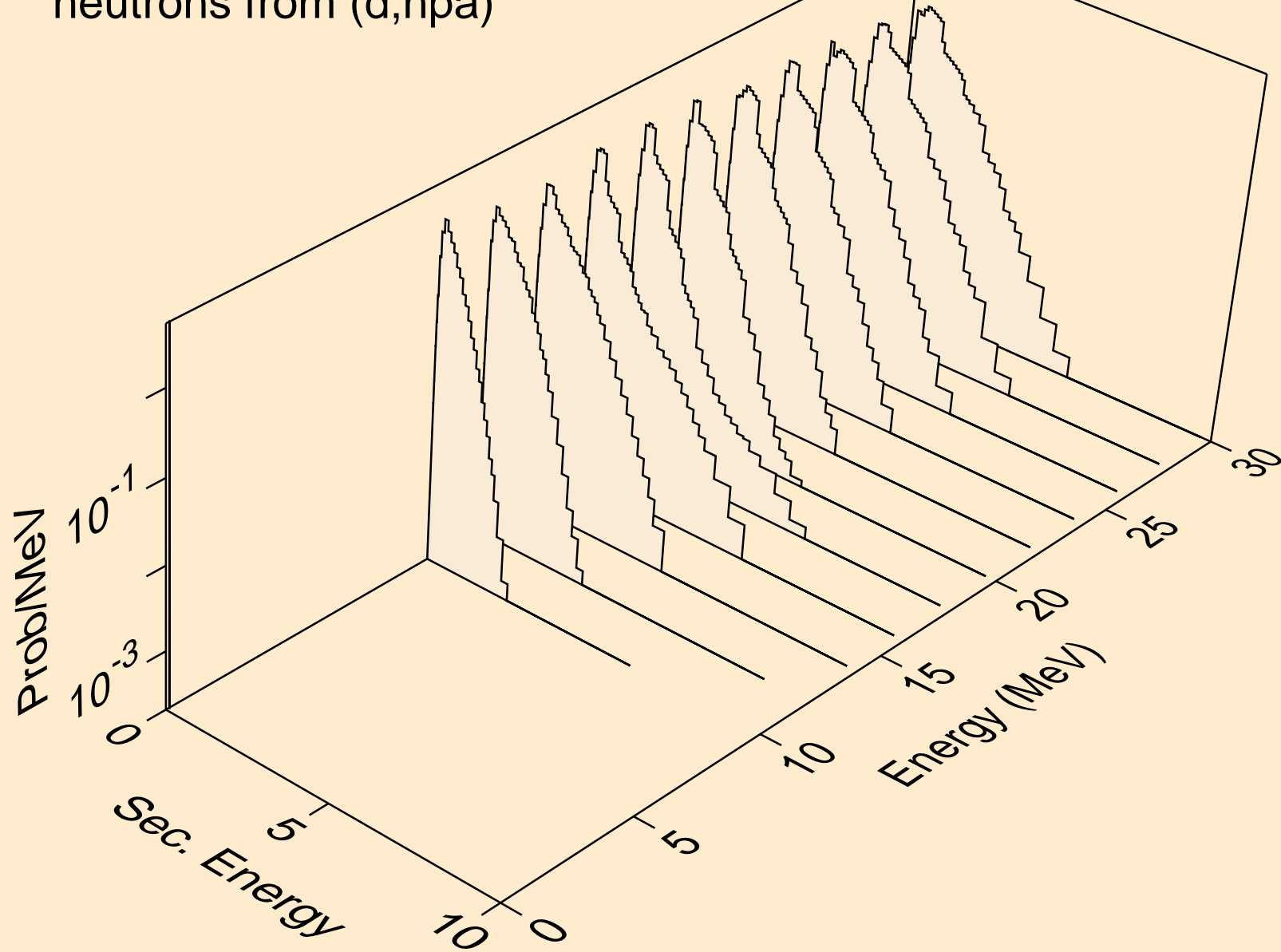

AM233 DEUTERON ACER TENDL-2021 LIBRARY; T=0.K
protons from (d,x)

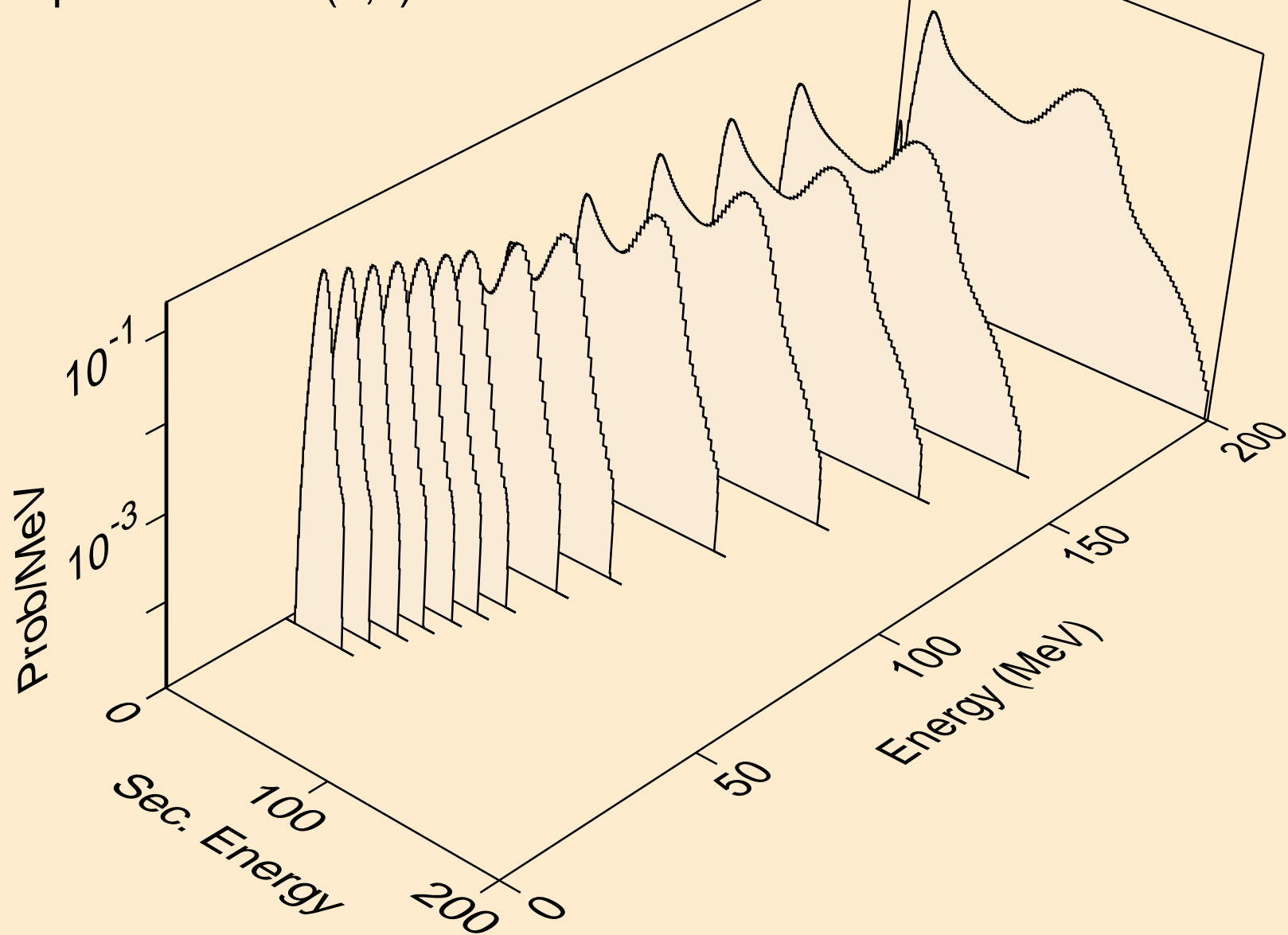

AM233 DEUTERON ACER TENDL-2021 LIBRARY; T=0.K
protons from (d,n*)p

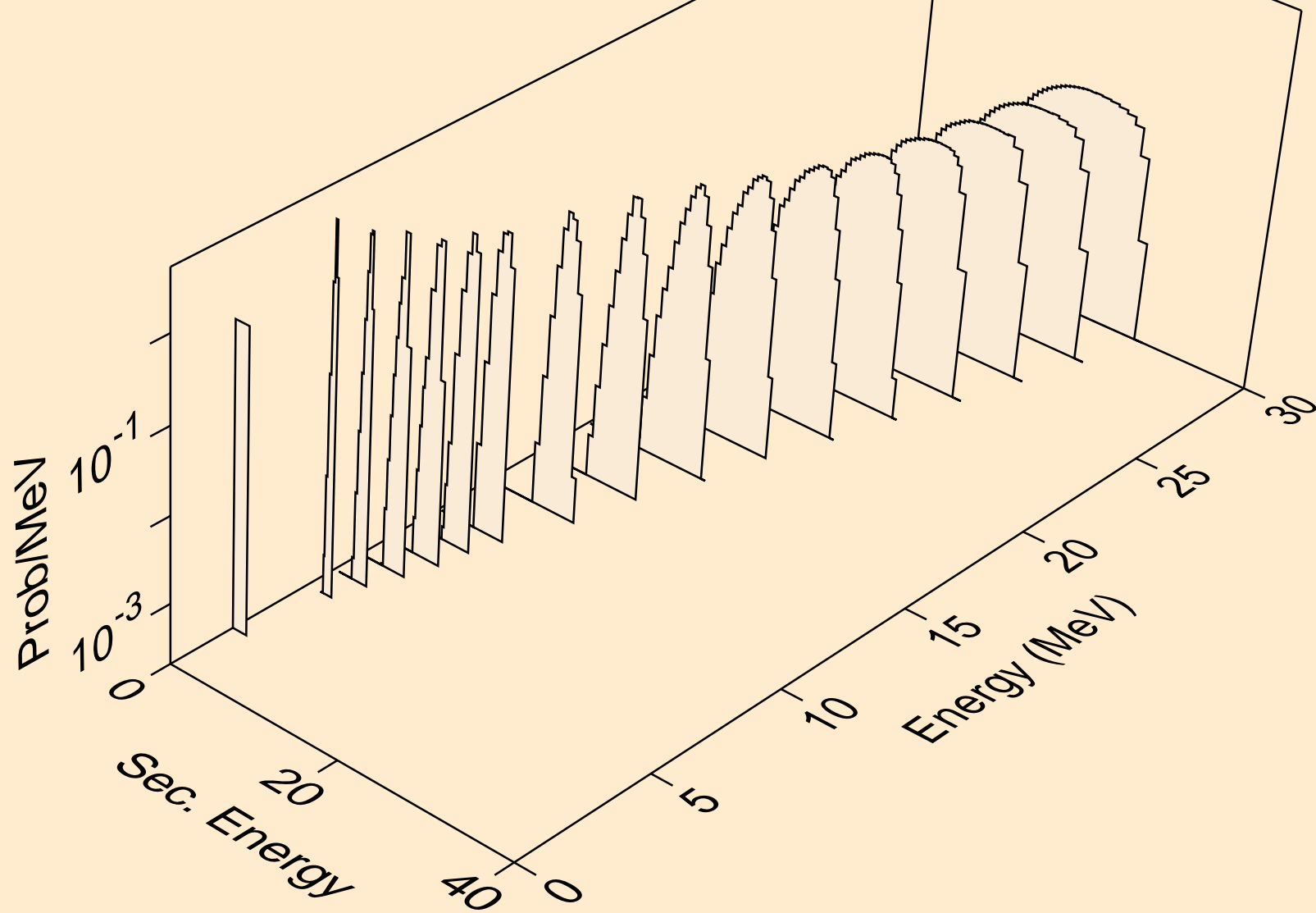

AM233 DEUTERON ACER TENDL-2021 LIBRARY; T=0.K
protons from (d,2np)

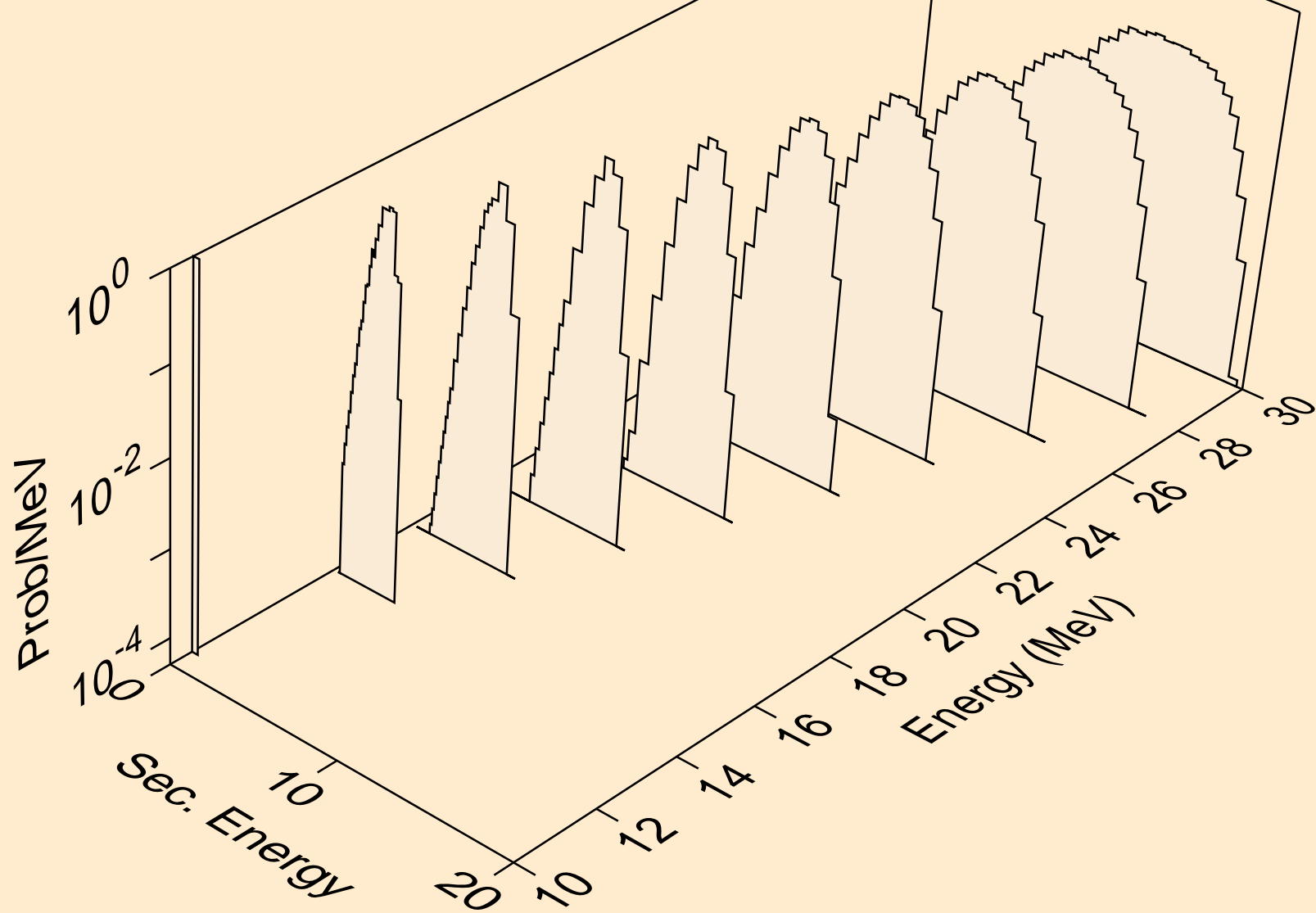

AM233 DEUTERON ACER TENDL-2021 LIBRARY; T=0.K
protons from (d,2np)

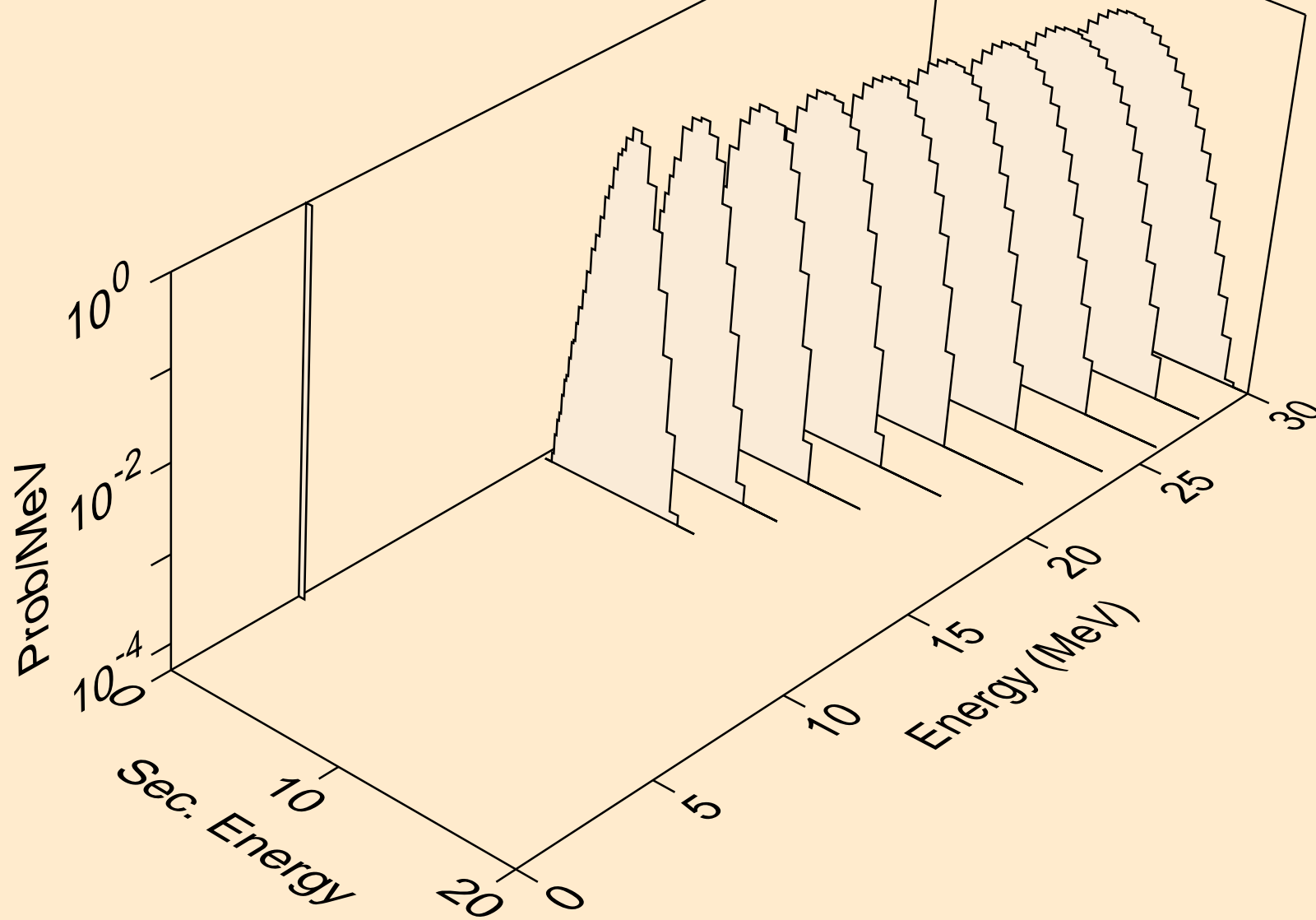

AM233 DEUTERON ACER TENDL-2021 LIBRARY; T=0.K
protons from (d,npa)

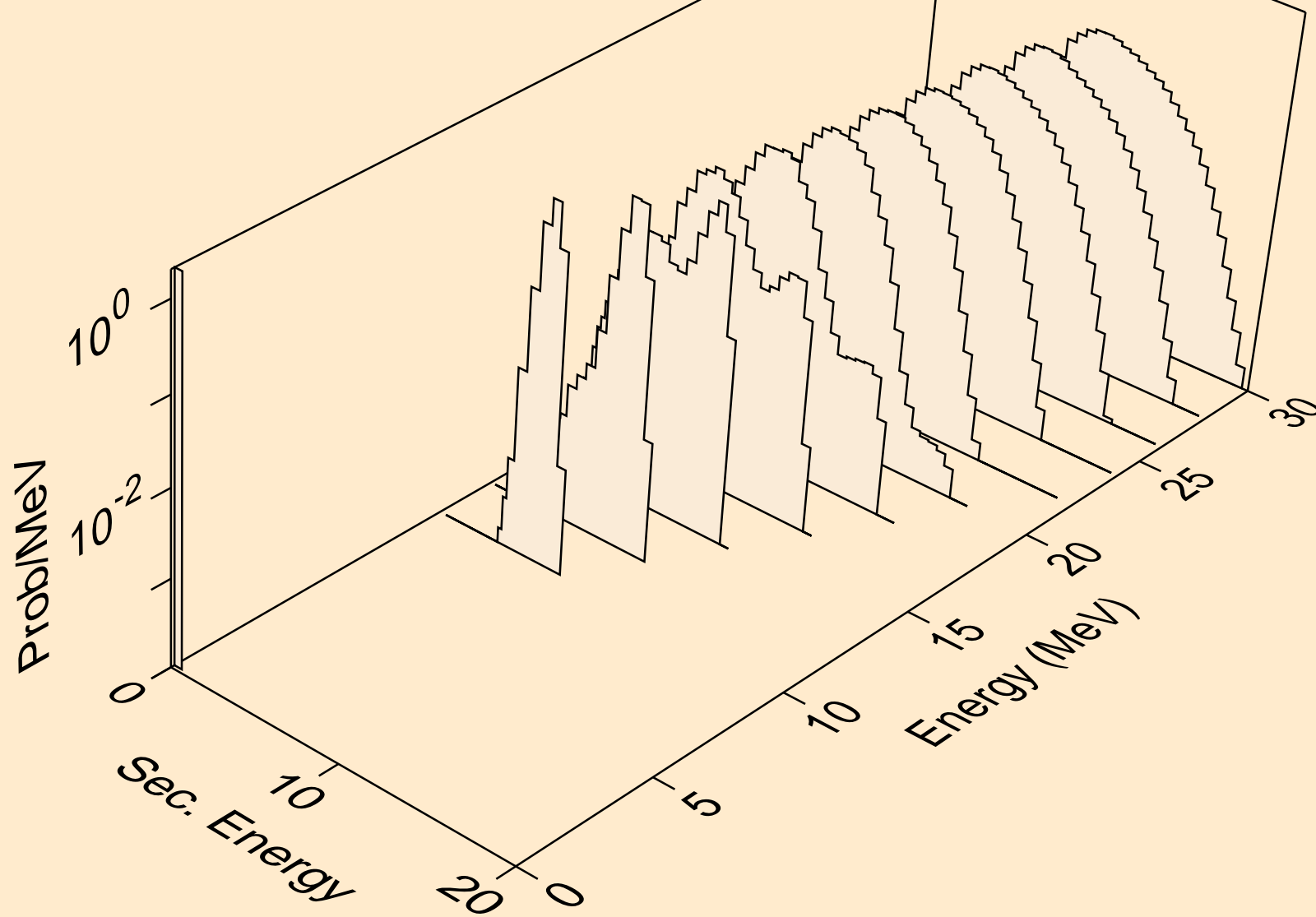

AM233 DEUTERON ACER TENDL-2021 LIBRARY; T=0.K
protons from (d,p)

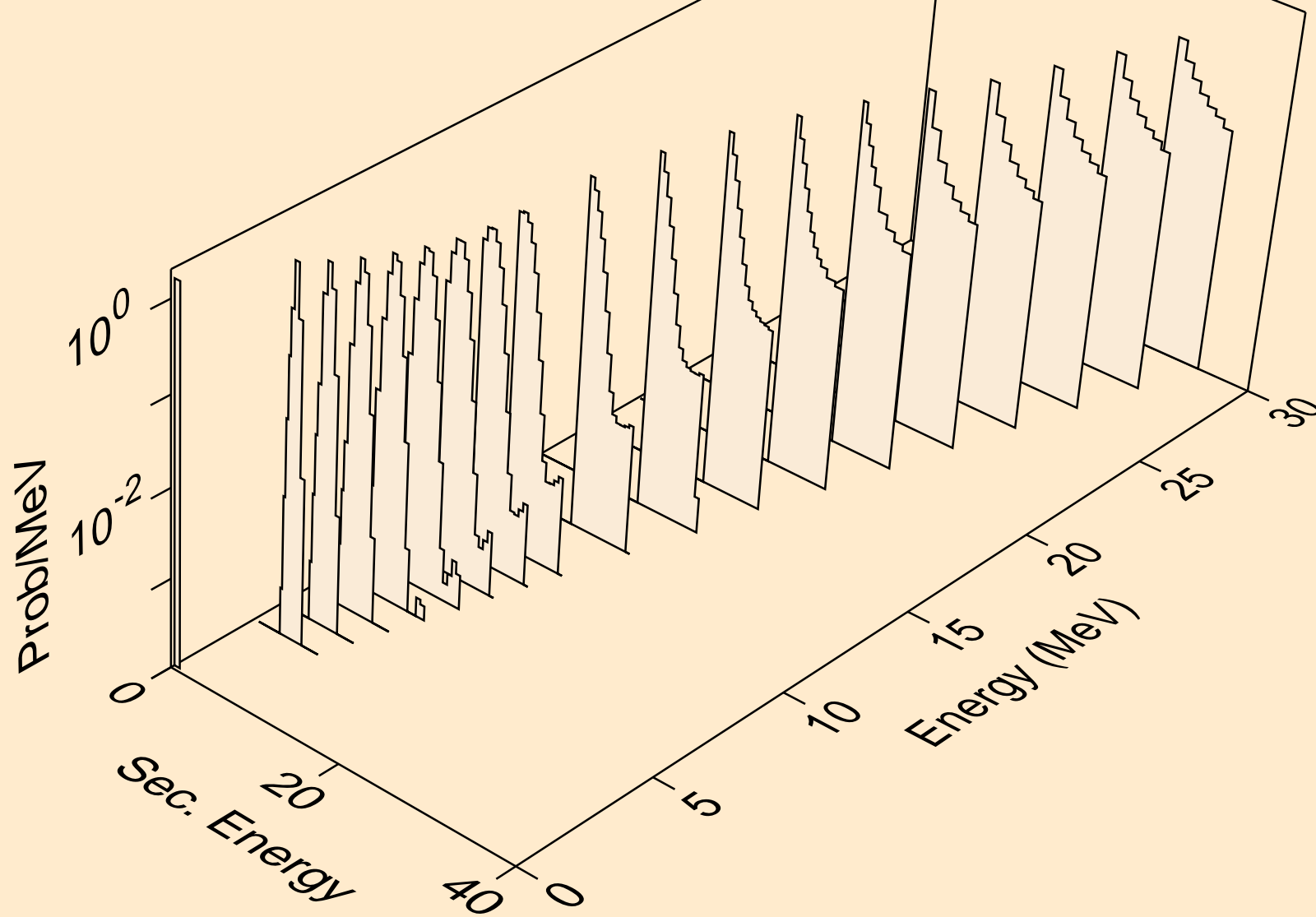

AM233 DEUTERON ACER TENDL-2021 LIBRARY; T=0.K
protons from (d,2p)

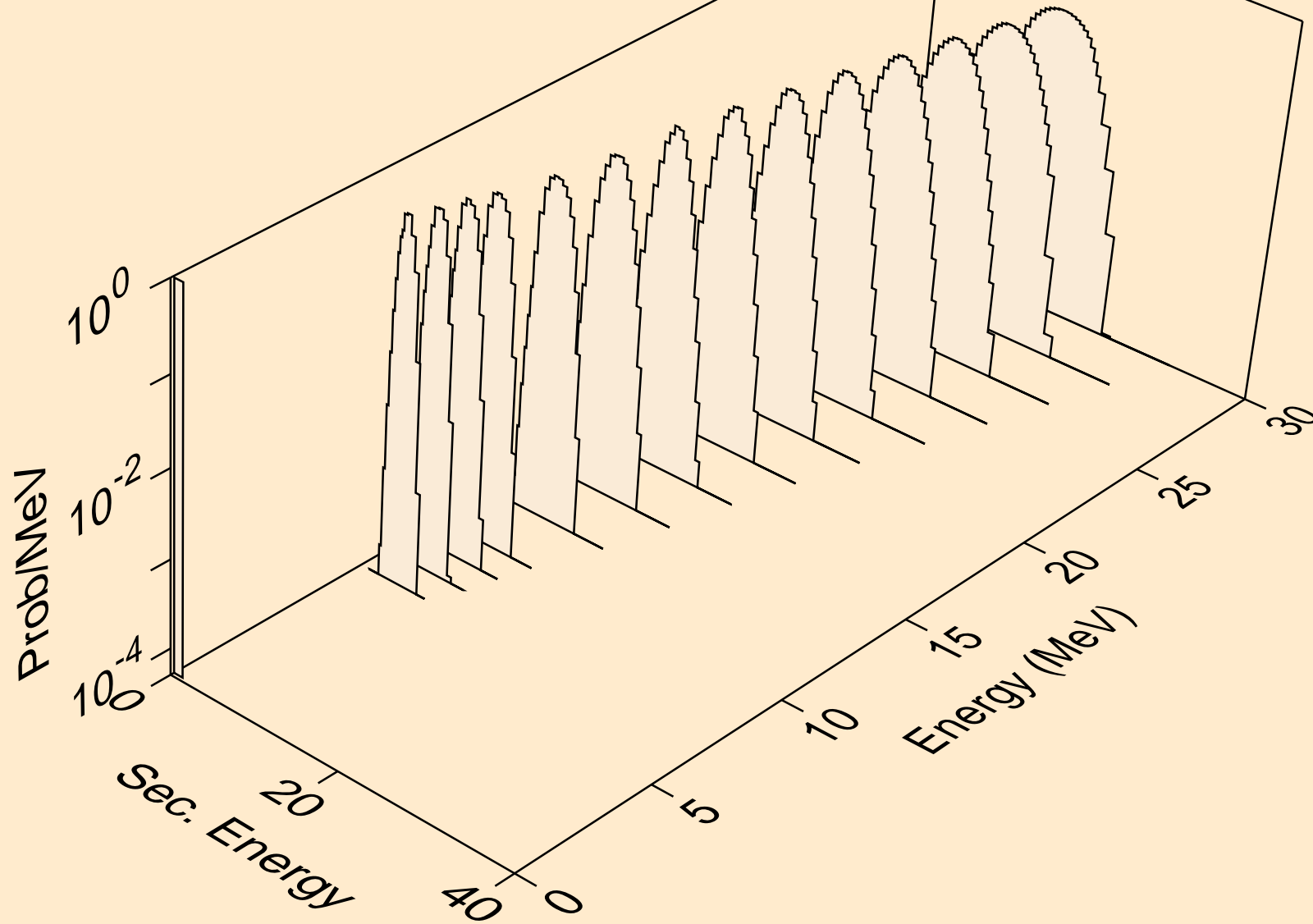

AM233 DEUTERON ACER TENDL-2021 LIBRARY; T=0.K
protons from (d,pa)

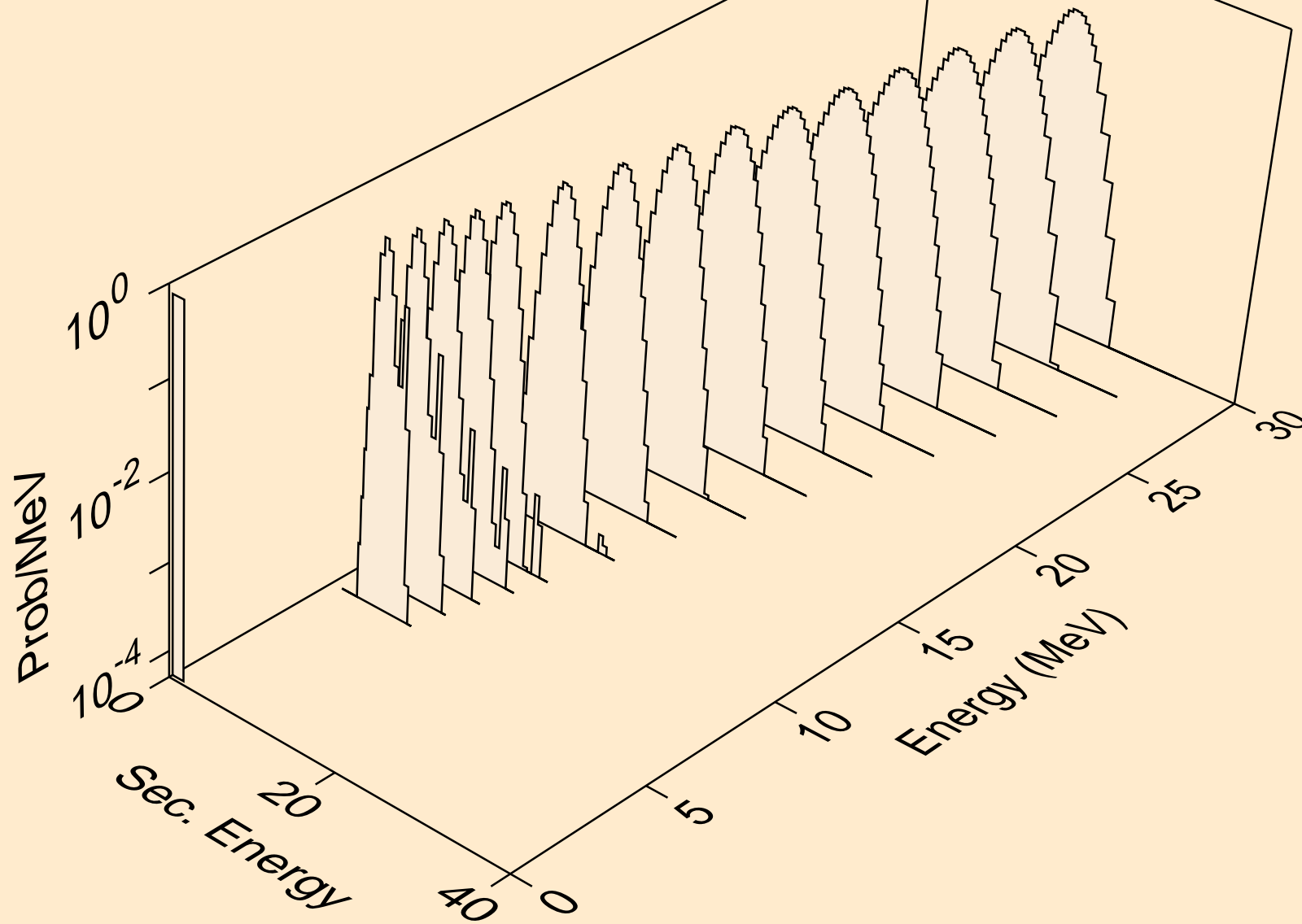

AM233 DEUTERON ACER TENDL-2021 LIBRARY; T=0.K
protons from (d,pd)

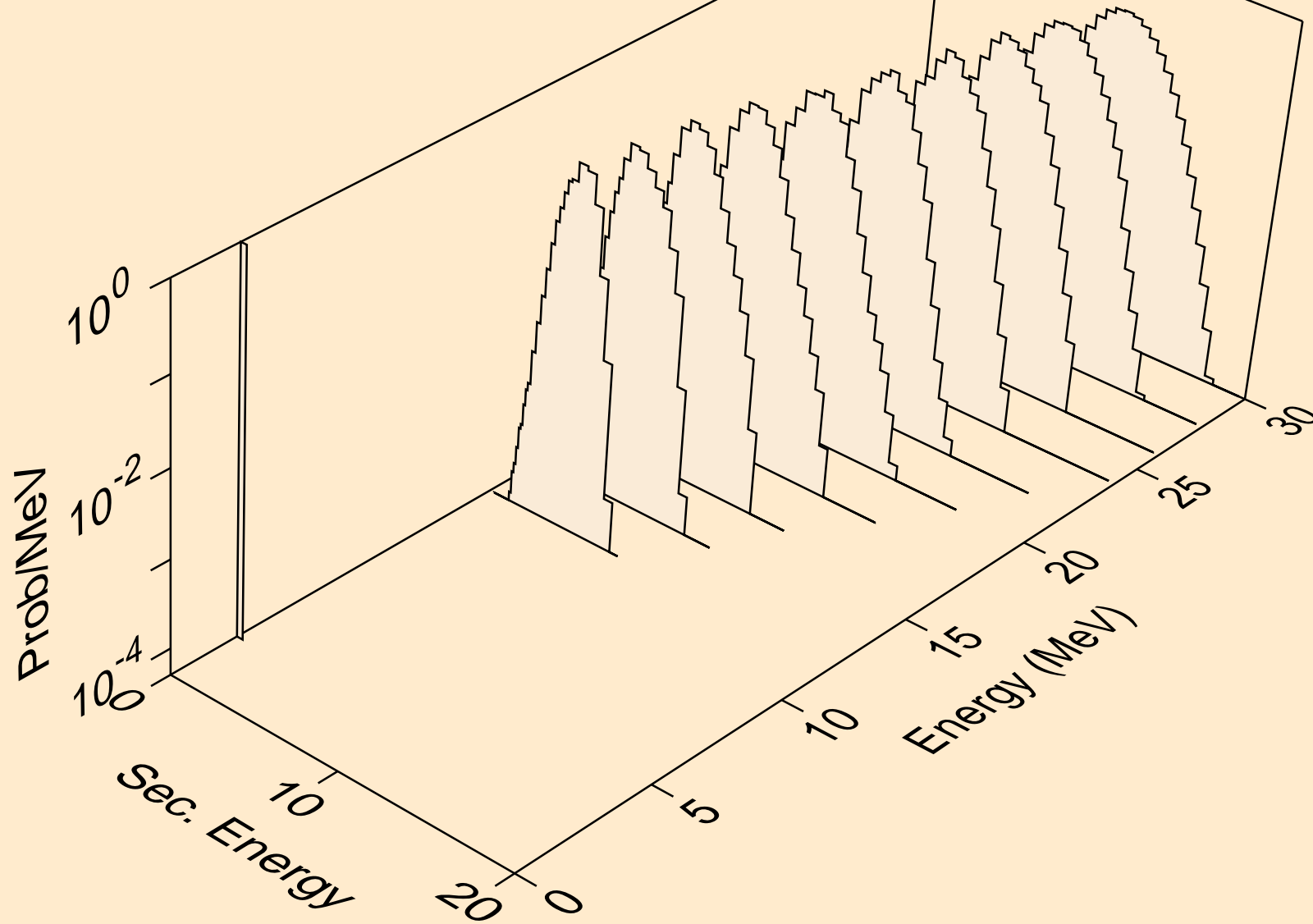

AM233 DEUTERON ACER TENDL-2021 LIBRARY; T=0.K
tritons from (d,x)

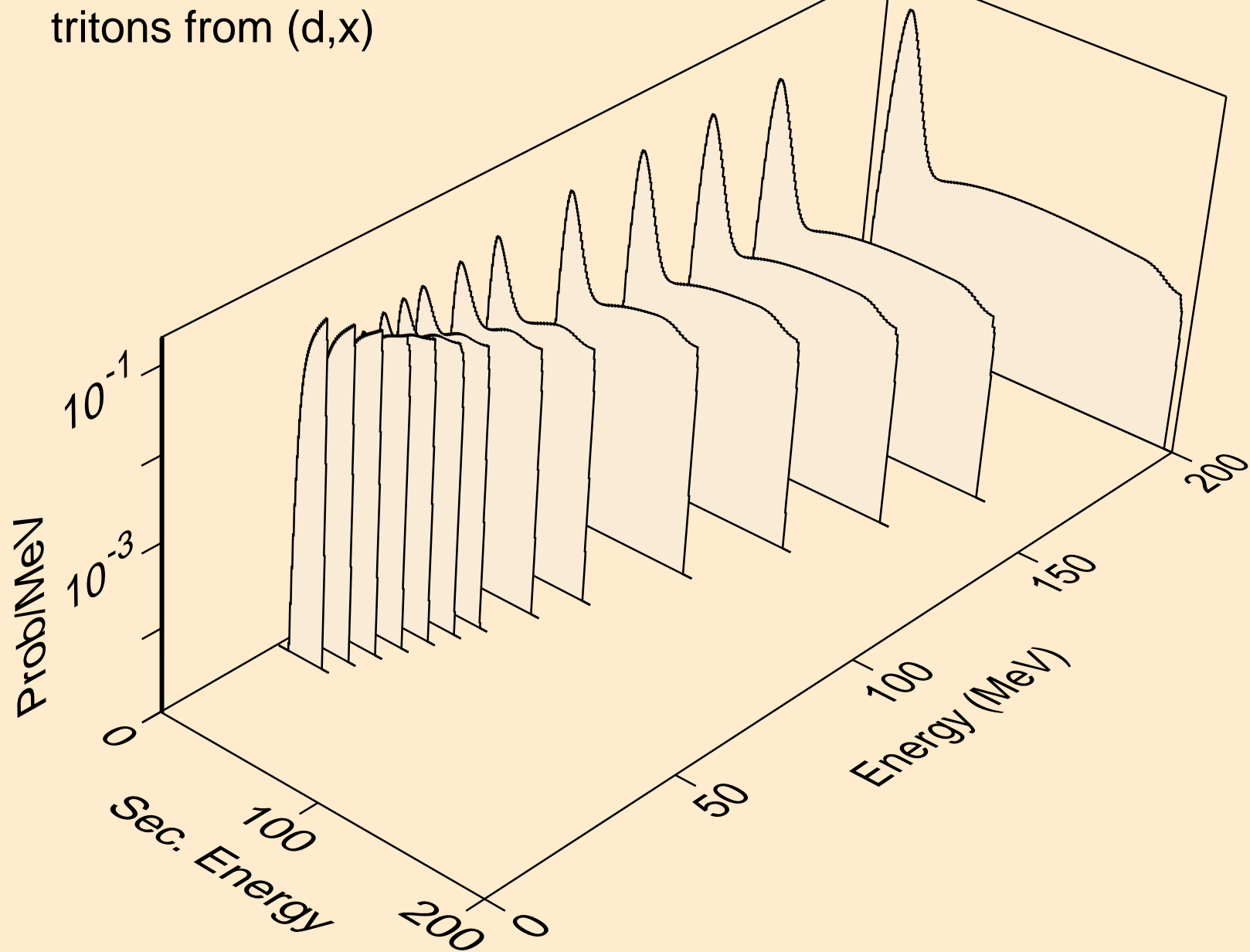

AM233 DEUTERON ACER TENDL-2021 LIBRARY; T=0.K
tritons from (d,n*)t

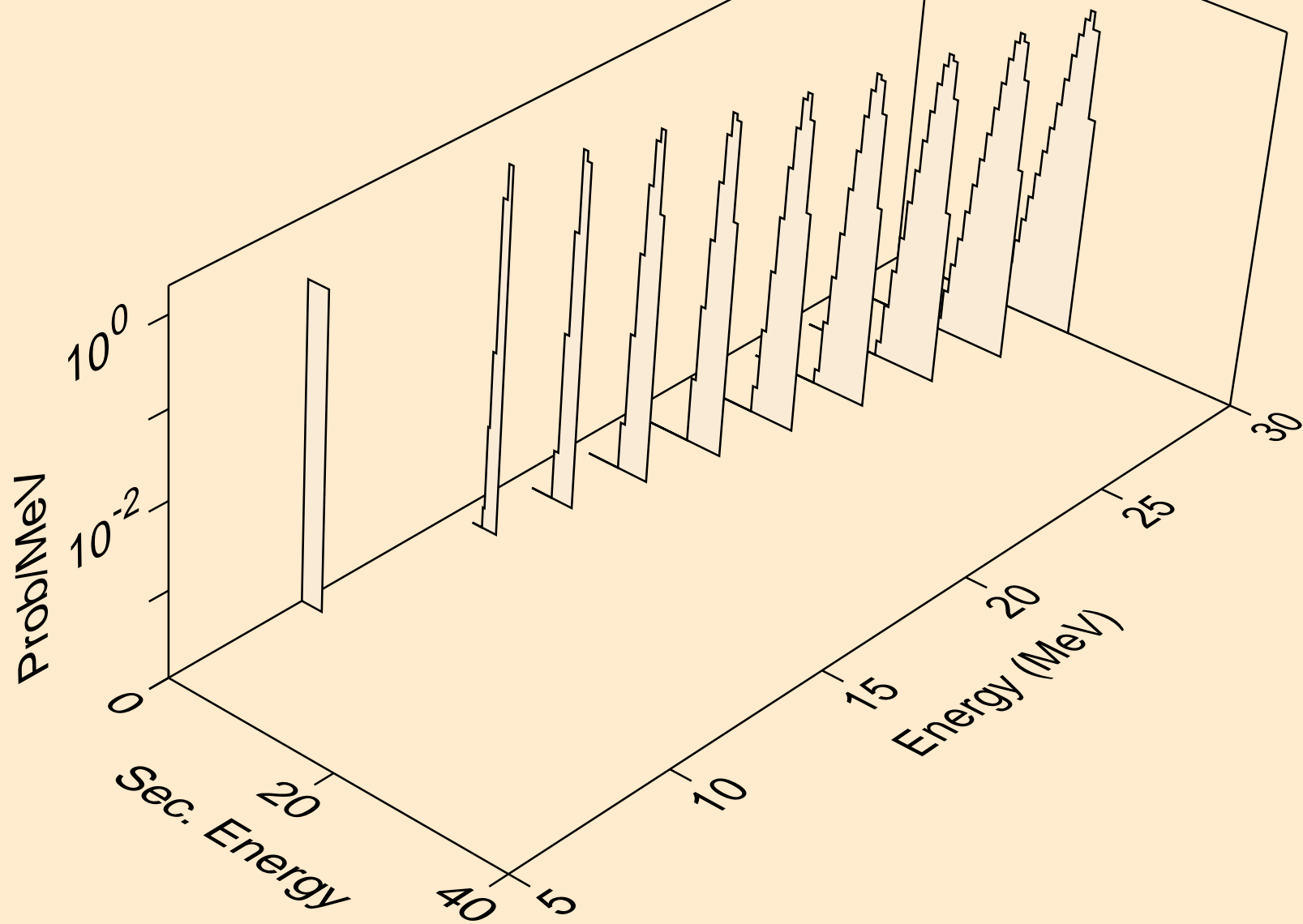

AM233 DEUTERON ACER TENDL-2021 LIBRARY; T=0.K
tritons from (d,t)

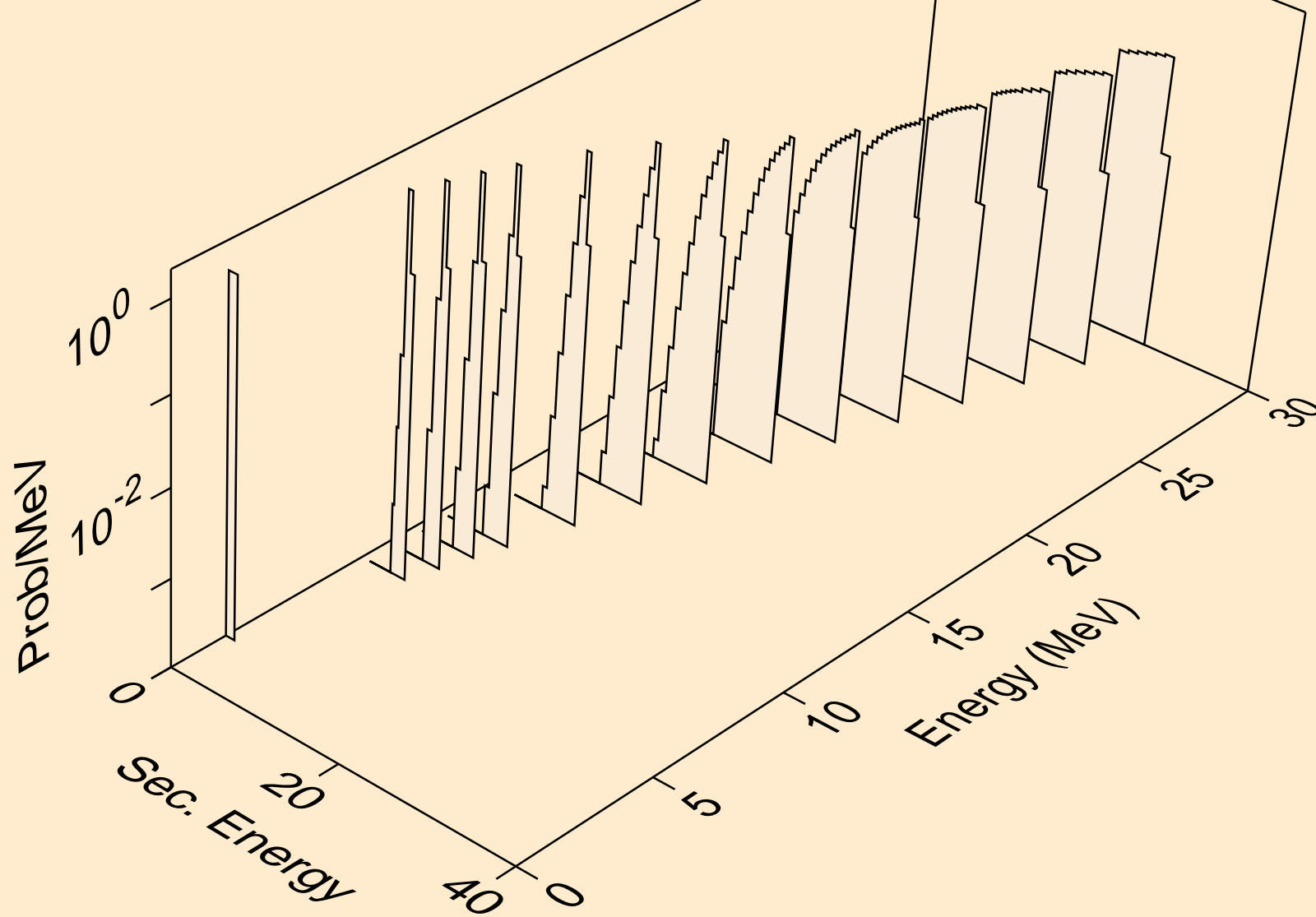

AM233 DEUTERON ACER TENDL-2021 LIBRARY; T=0.K
he3s from (d,x)

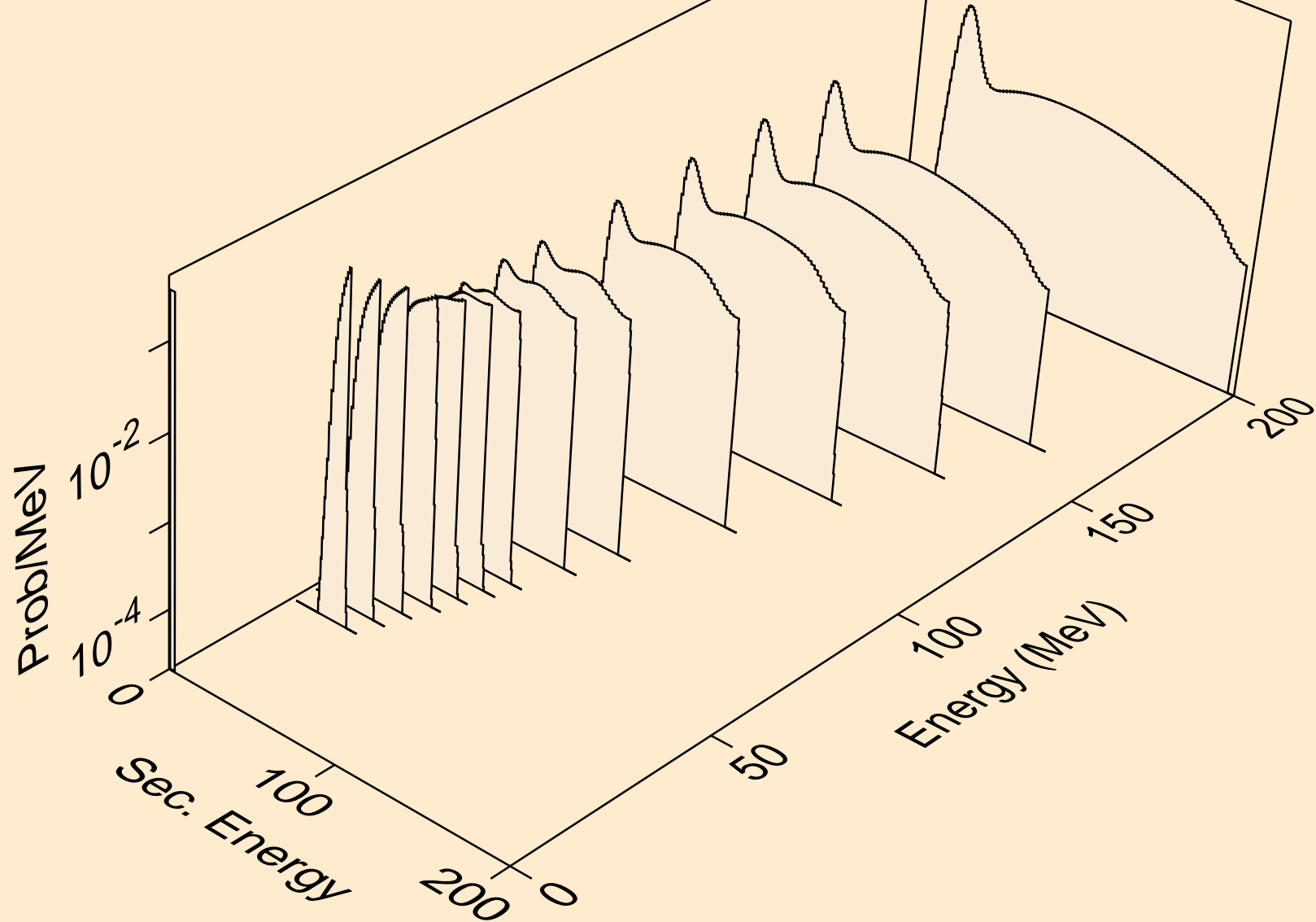

AM233 DEUTERON ACER TENDL-2021 LIBRARY; T=0.K
he3s from (d,n*)he3

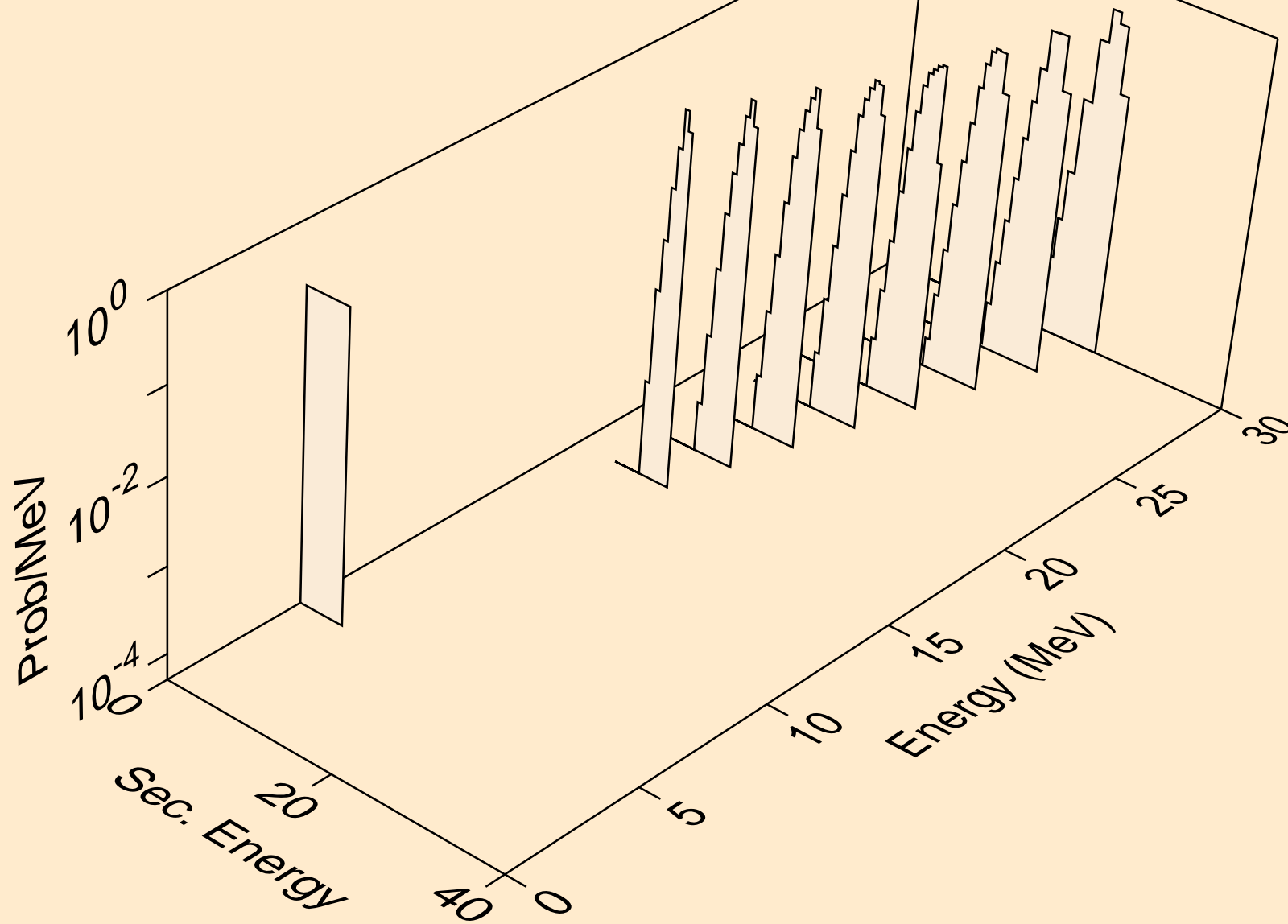

AM233 DEUTERON ACER TENDL-2021 LIBRARY; T=0.K
he3s from (d,he3)

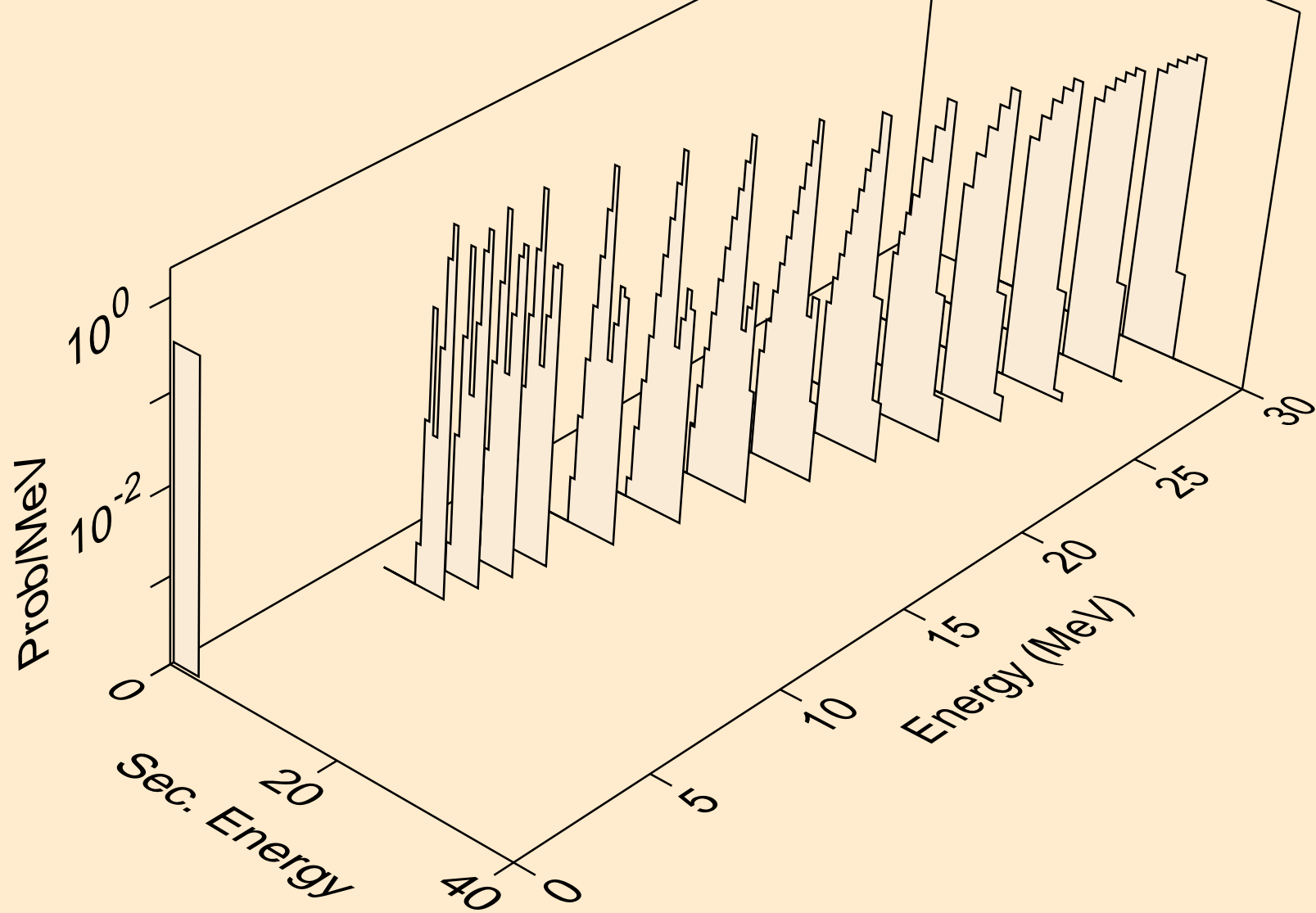

AM233 DEUTERON ACER TENDL-2021 LIBRARY; T=0.K
alphas from (d,x)

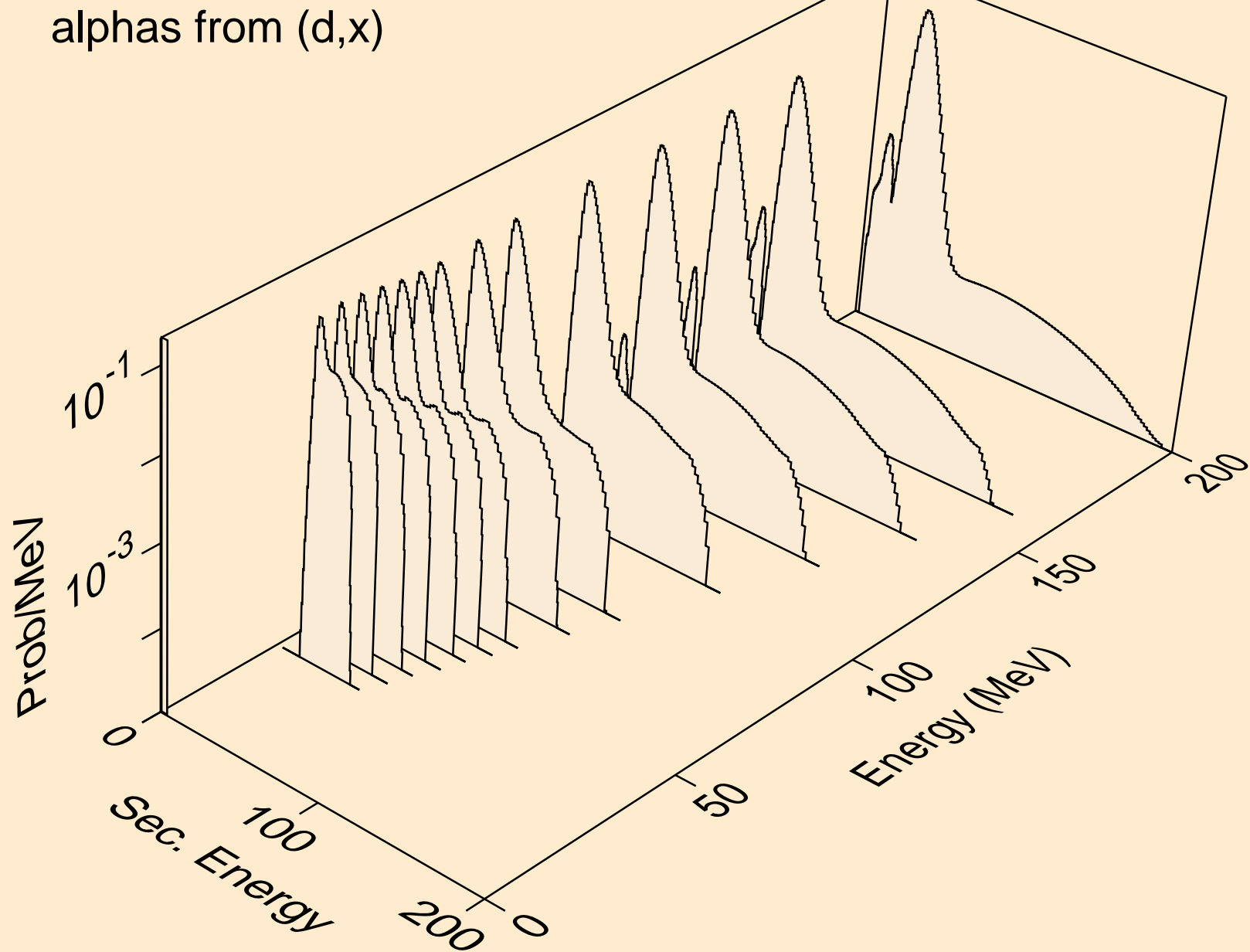

AM233 DEUTERON ACER TENDL-2021 LIBRARY; T=0.K
alphas from (d,n*)a

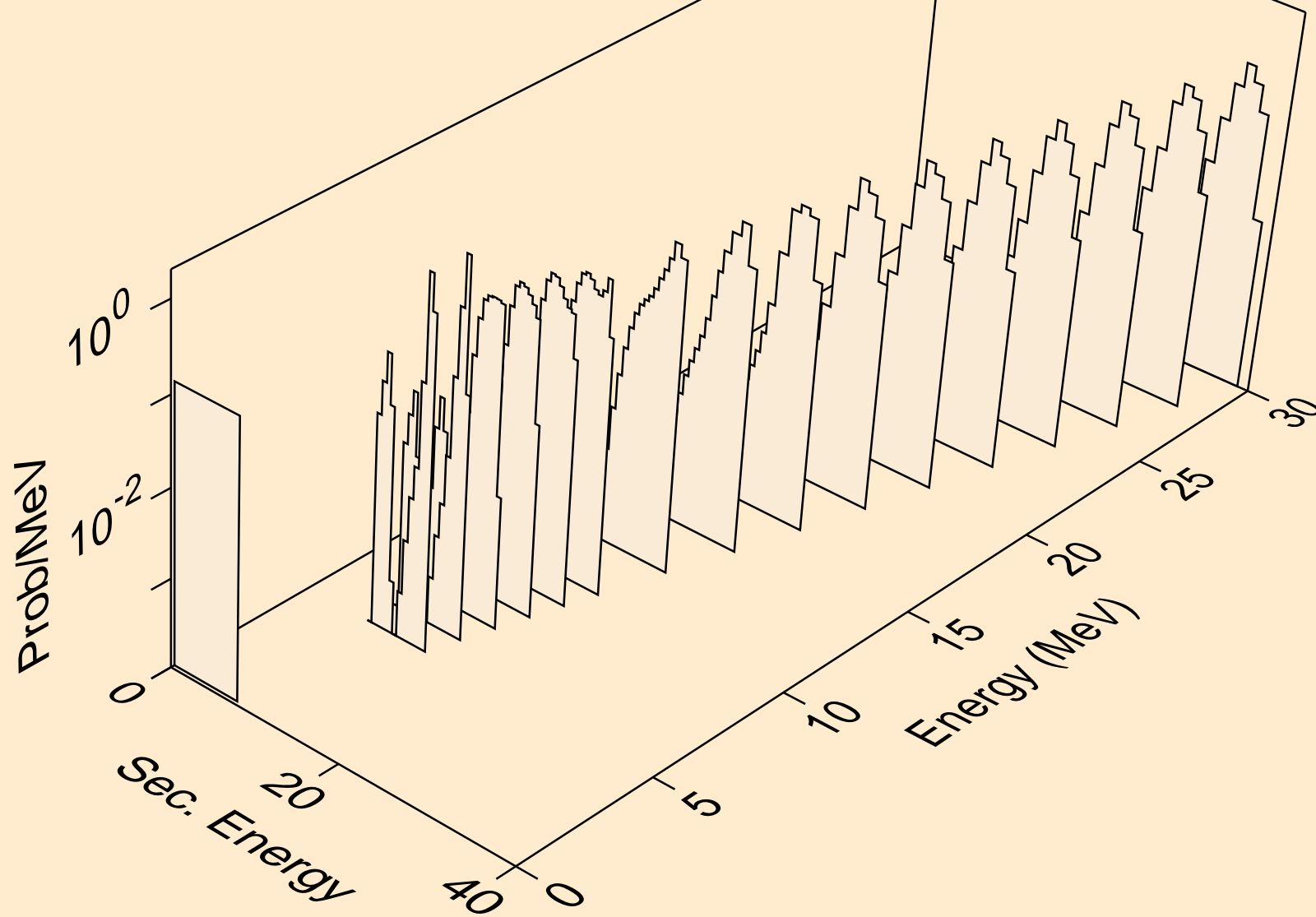

AM233 DEUTERON ACER TENDL-2021 LIBRARY; T=0.K
alphas from (d,2n)a

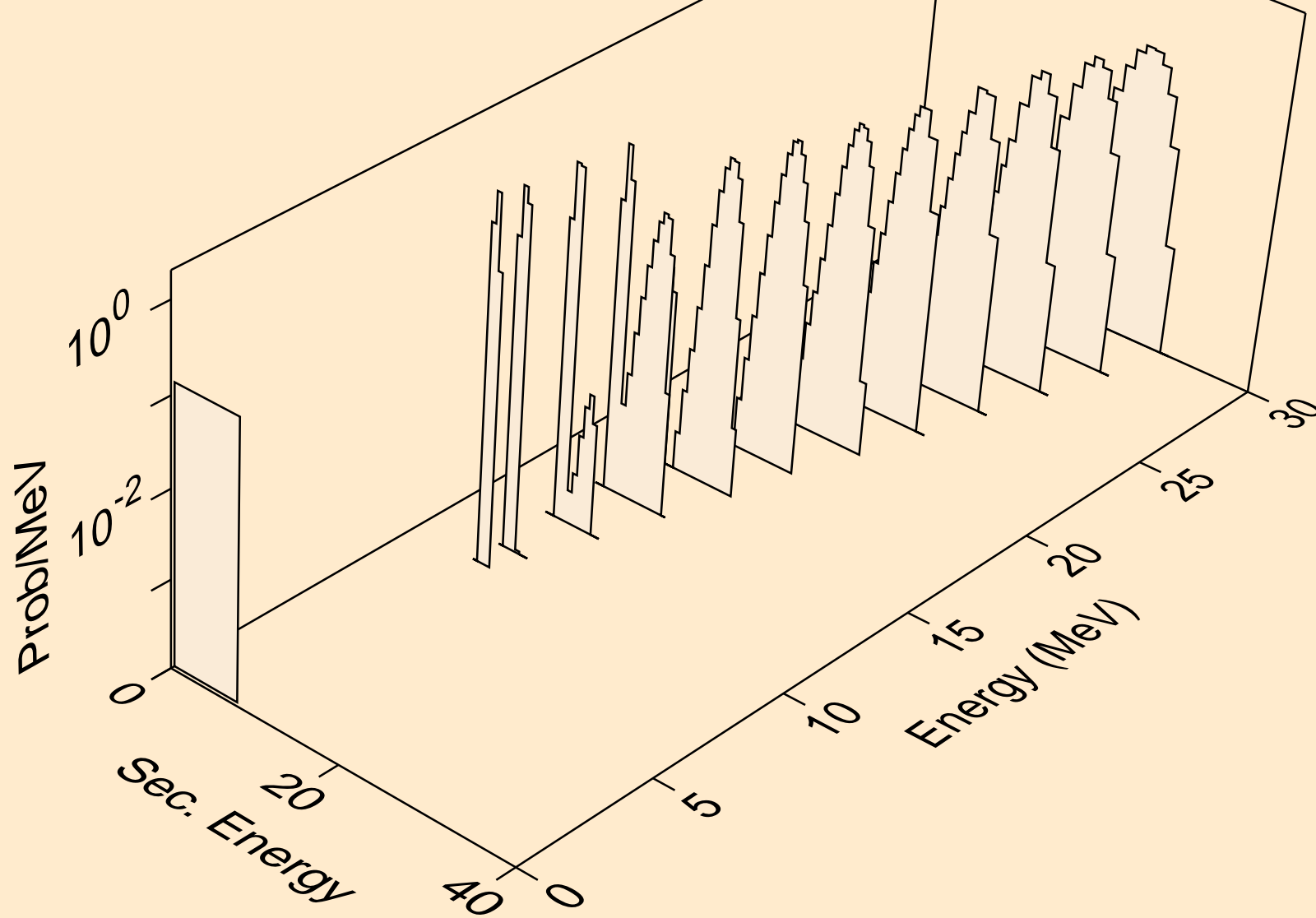

AM233 DEUTERON ACER TENDL-2021 LIBRARY; T=0.K
alphas from (d,n*)2a

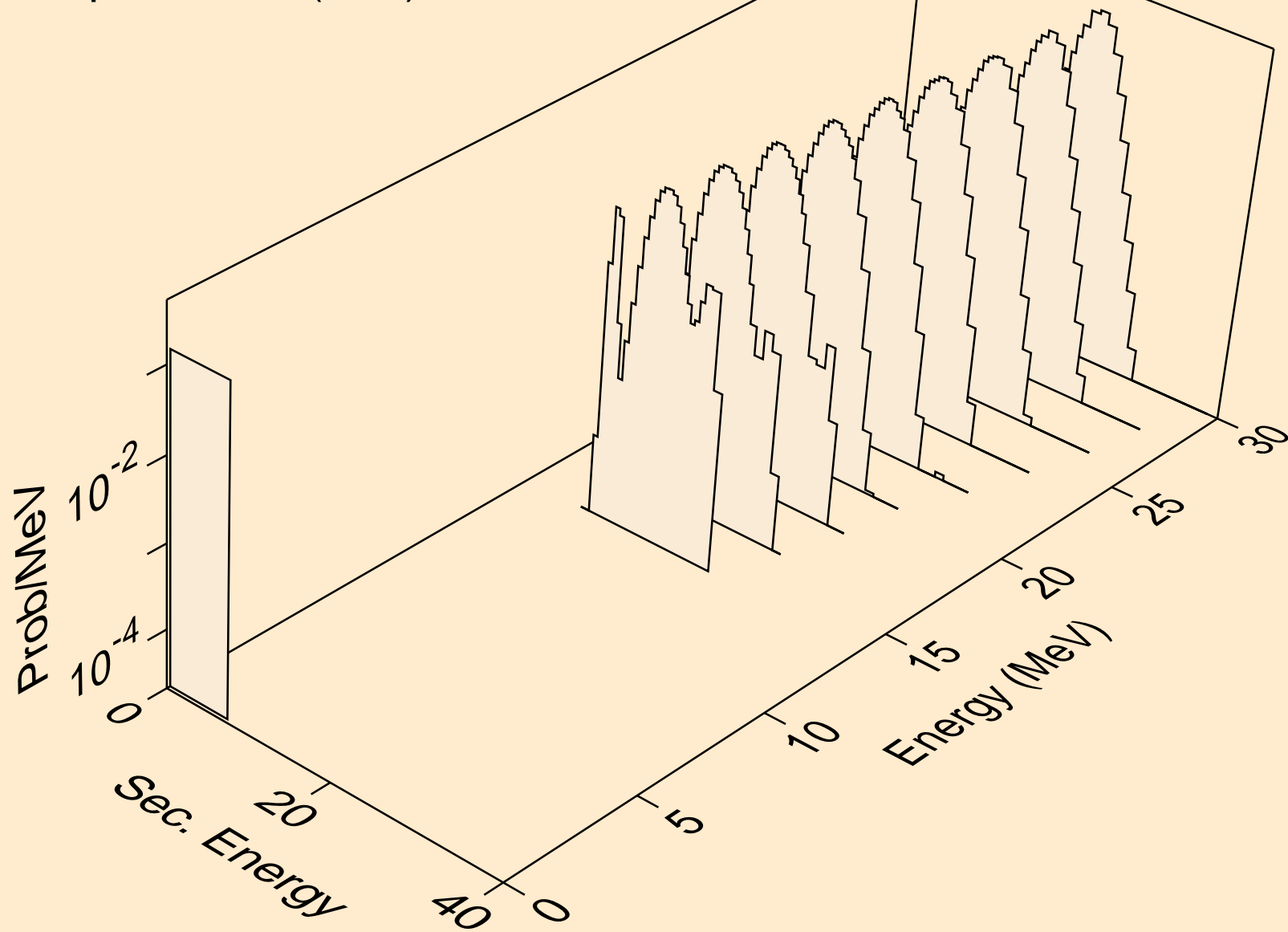

AM233 DEUTERON ACER TENDL-2021 LIBRARY; T=0.K
alphas from (d,npa)

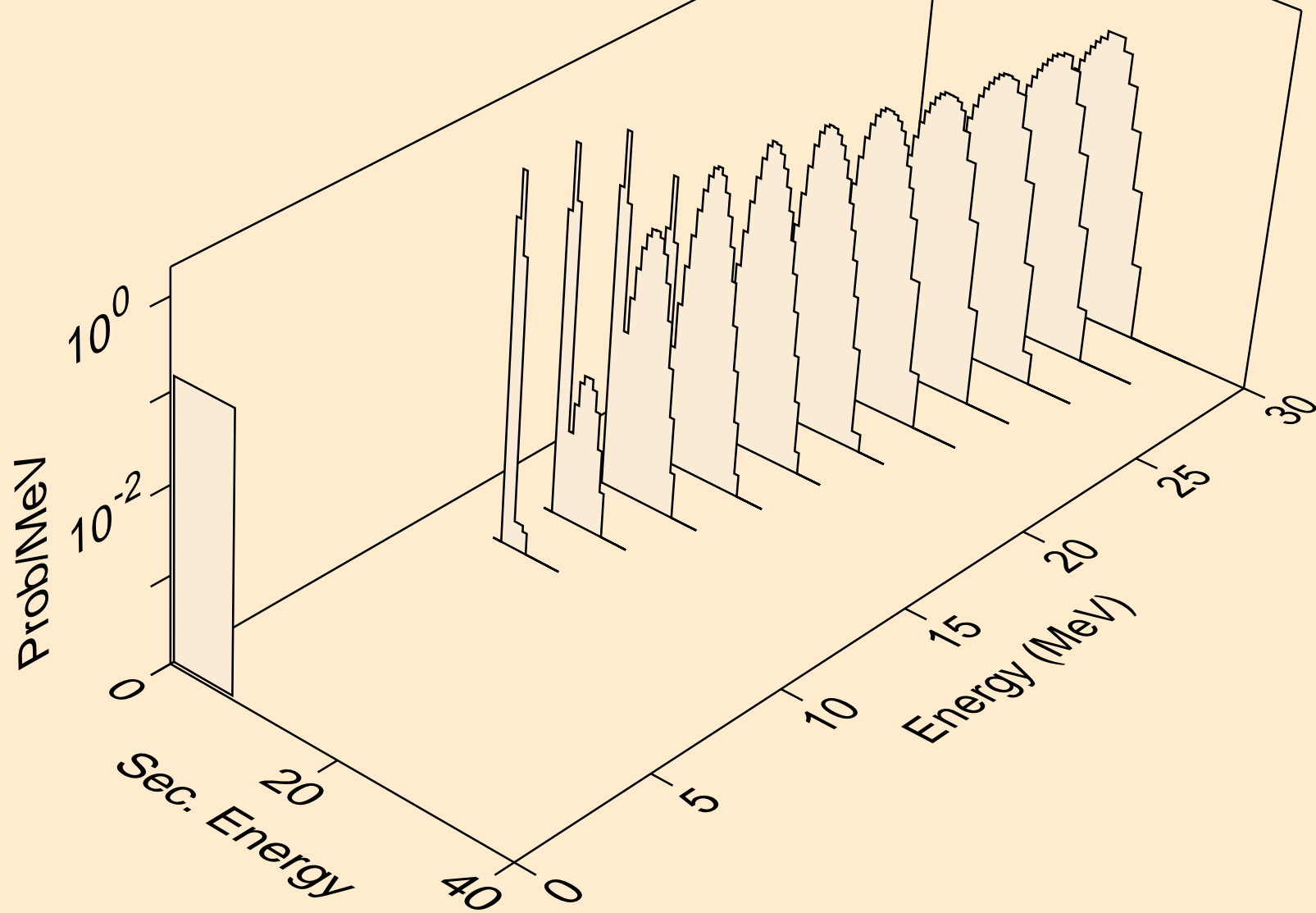

AM233 DEUTERON ACER TENDL-2021 LIBRARY; T=0.K
alphas from (d,a)

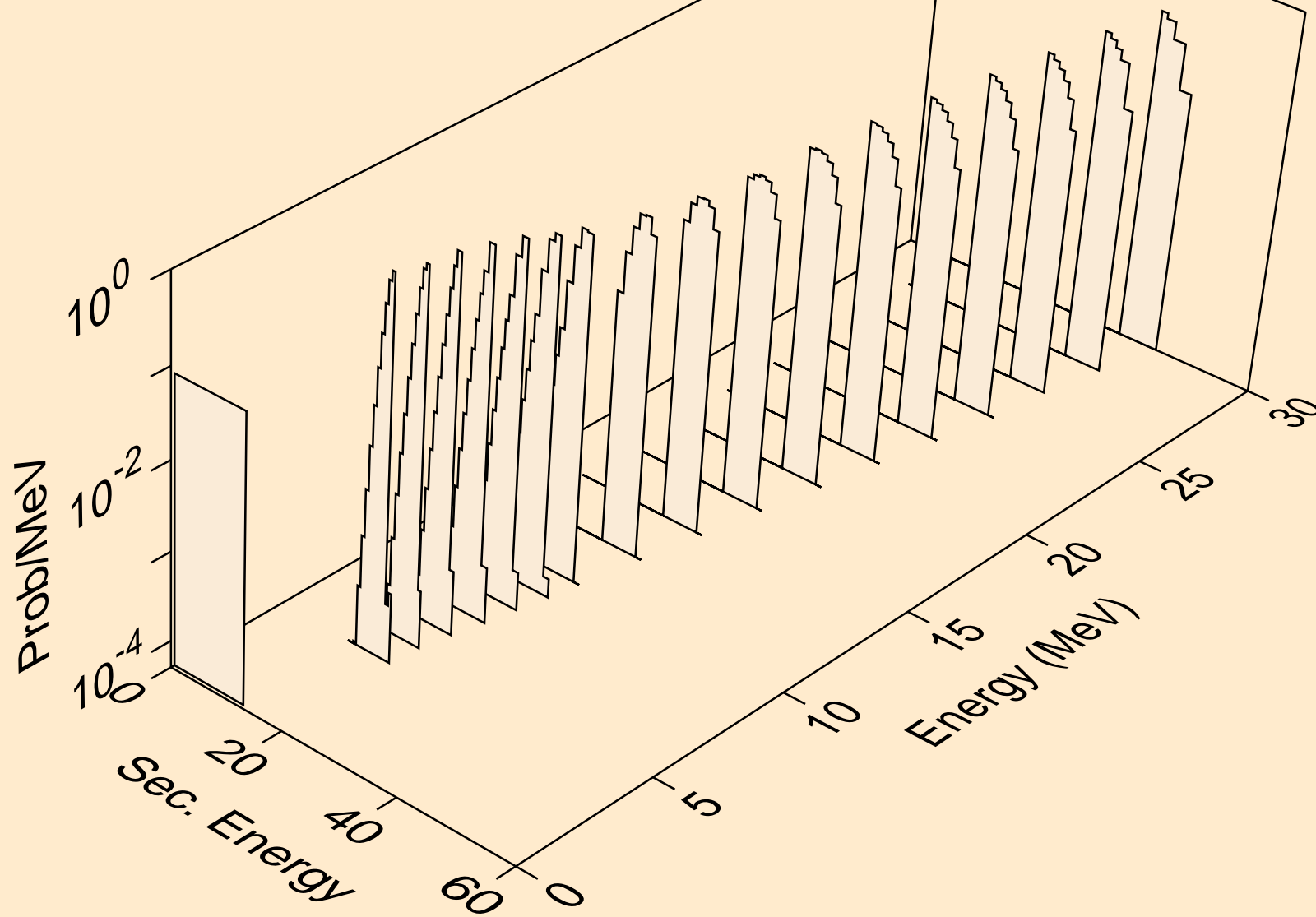

AM233 DEUTERON ACER TENDL-2021 LIBRARY; T=0.K
alphas from (d,pa)

