

BE009 DEUTERON ACER TENDL-2021 LIBRARY; T=0.K
Principal cross sections

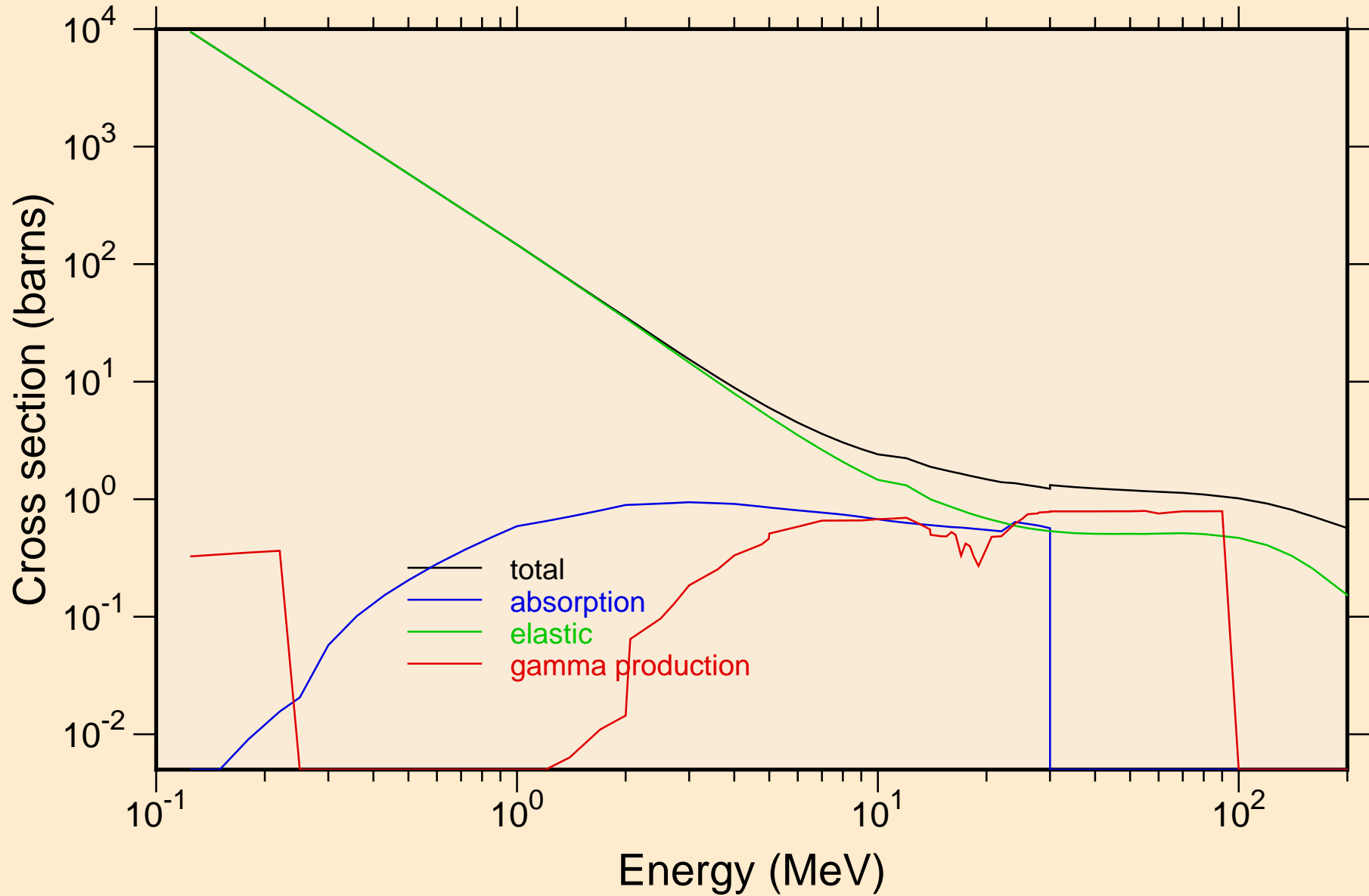

BE009 DEUTERON ACER TENDL-2021 LIBRARY; T=0.K

Heating

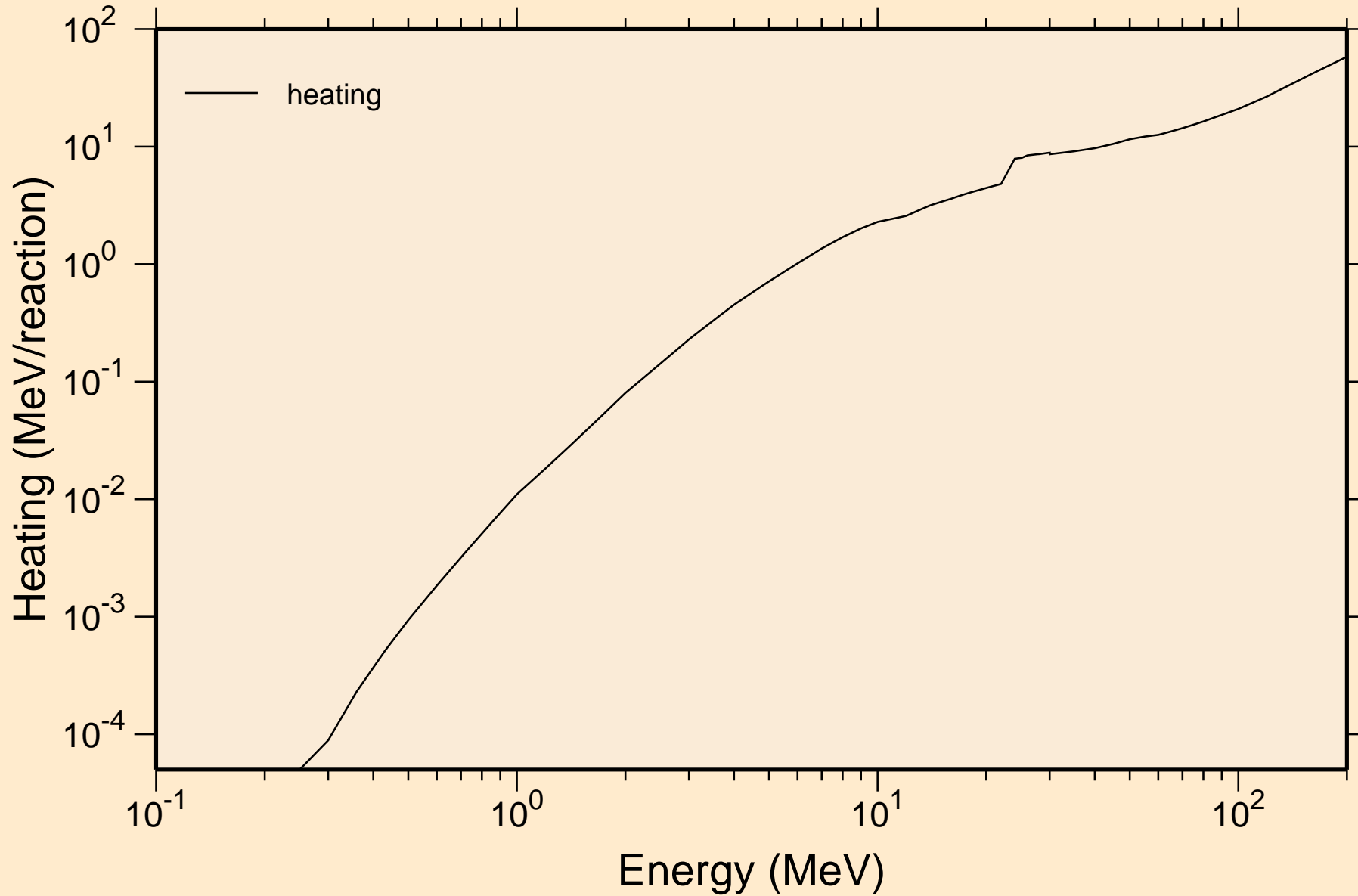

BE009 DEUTERON ACER TENDL-2021 LIBRARY; T=0.K
Principal cross sections

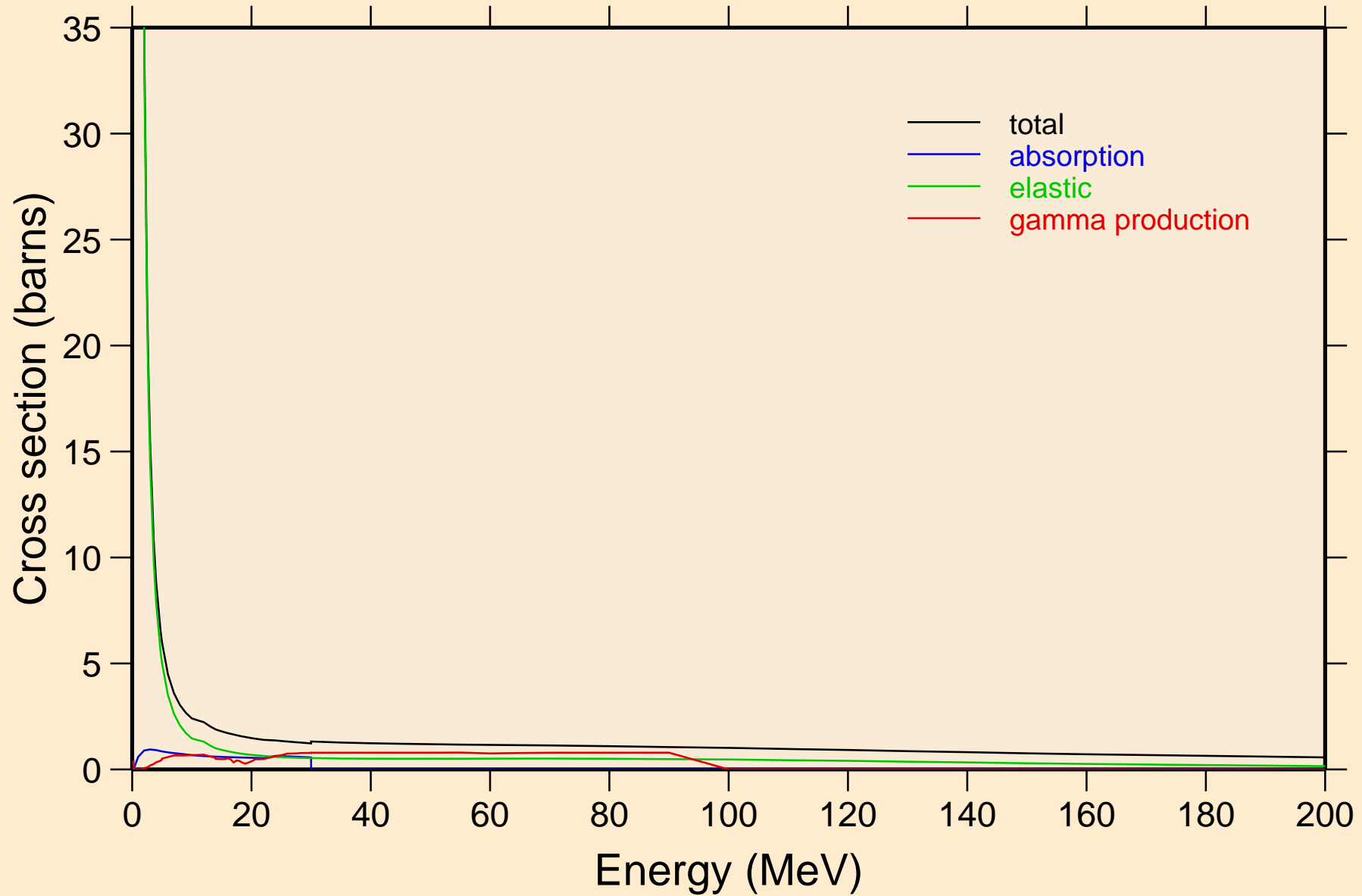

BE009 DEUTERON ACER TENDL-2021 LIBRARY; T=0.K

Heating

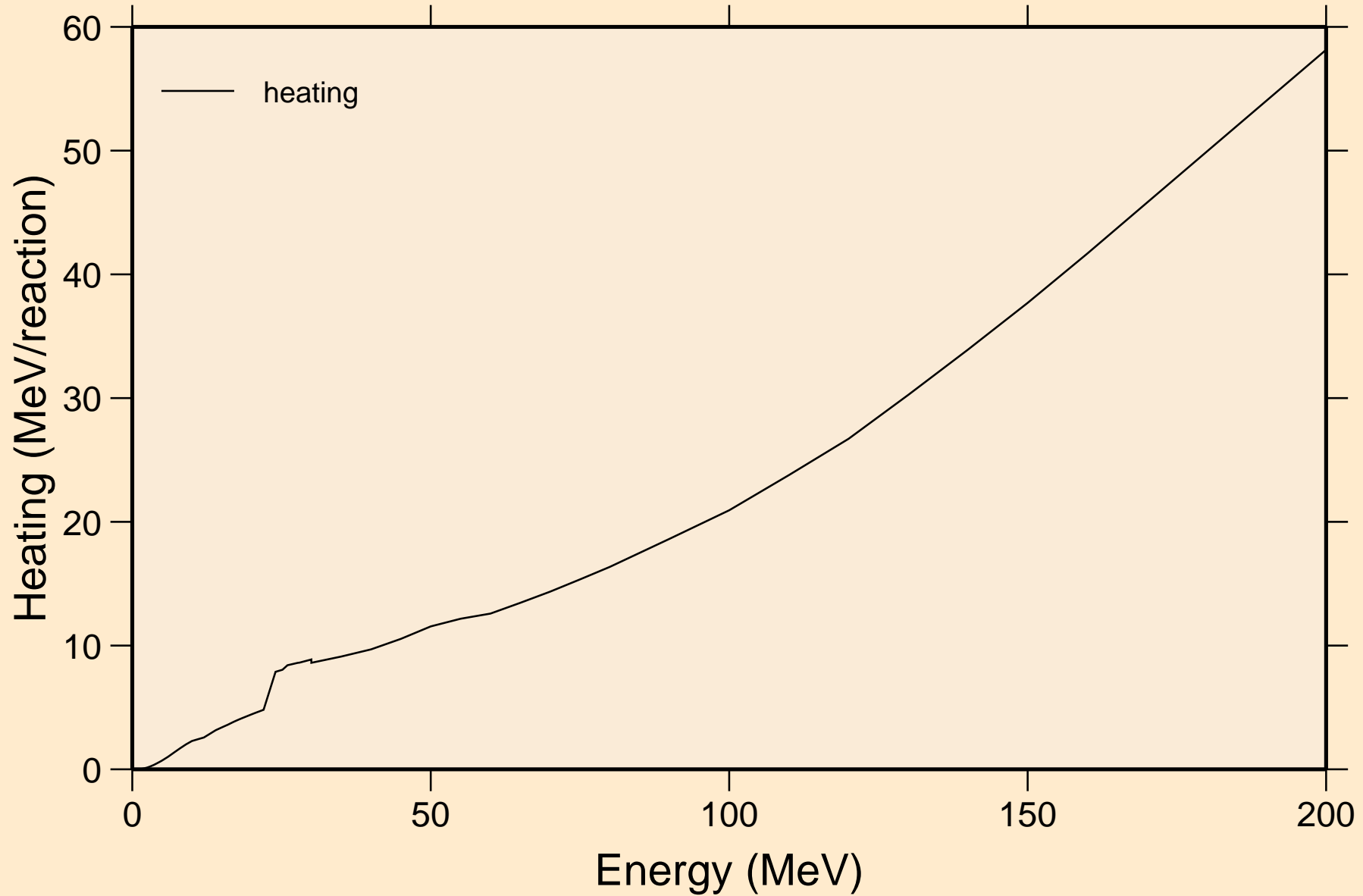

BE009 DEUTERON ACER TENDL-2021 LIBRARY; T=0.K
Threshold reactions

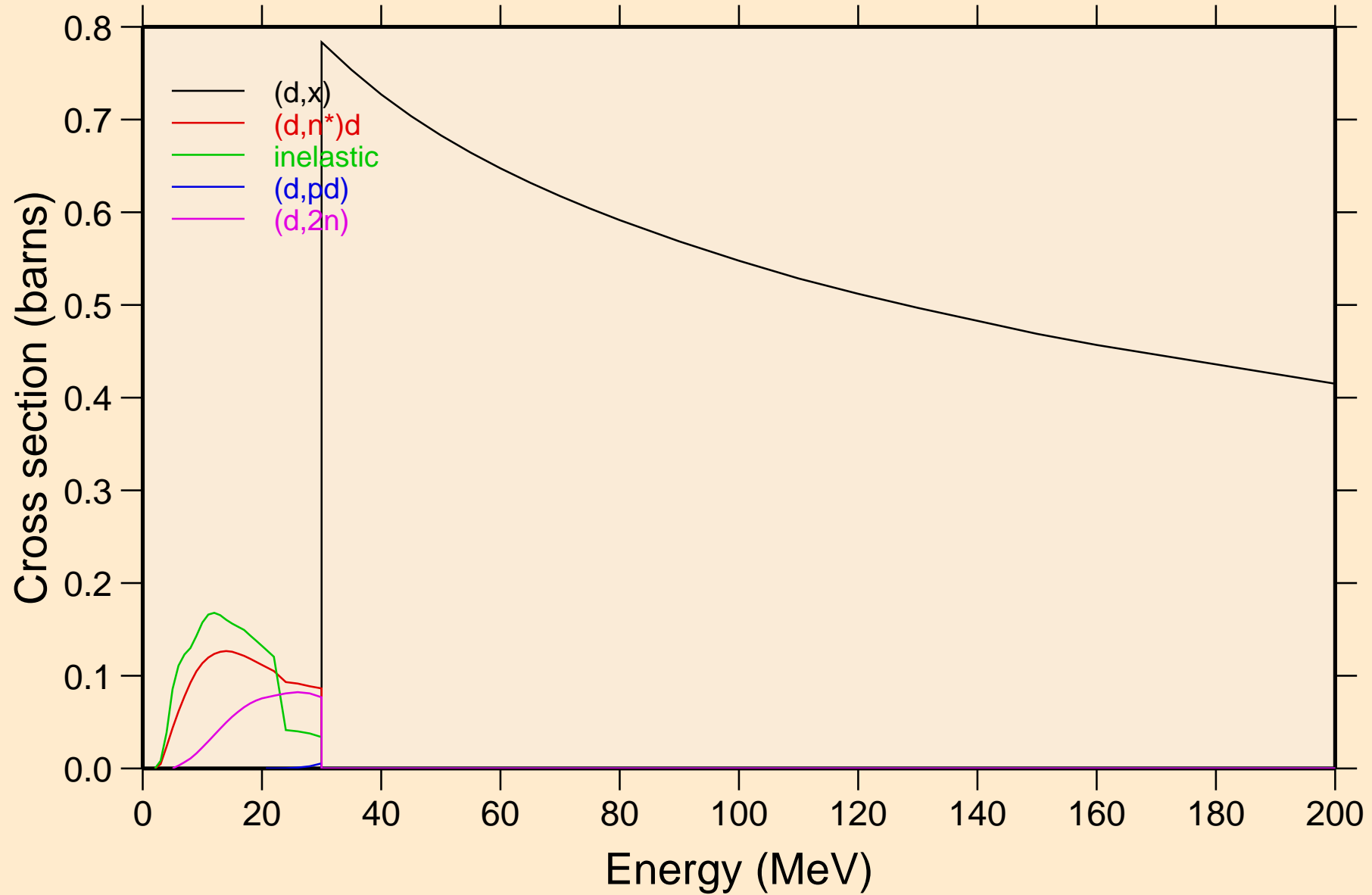

BE009 DEUTERON ACER TENDL-2021 LIBRARY; T=0.K
Threshold reactions

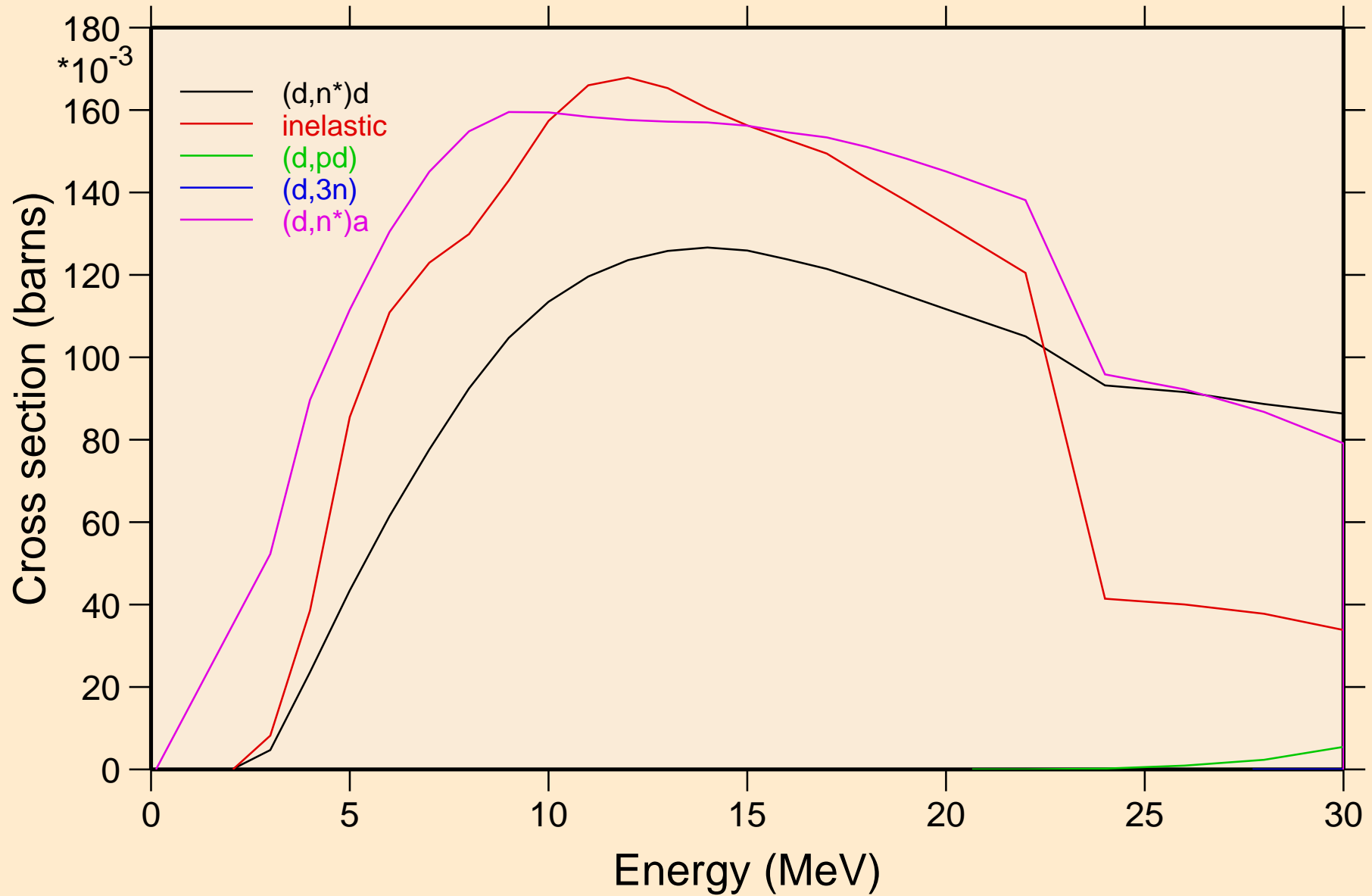

BE009 DEUTERON ACER TENDL-2021 LIBRARY; T=0.K
Threshold reactions

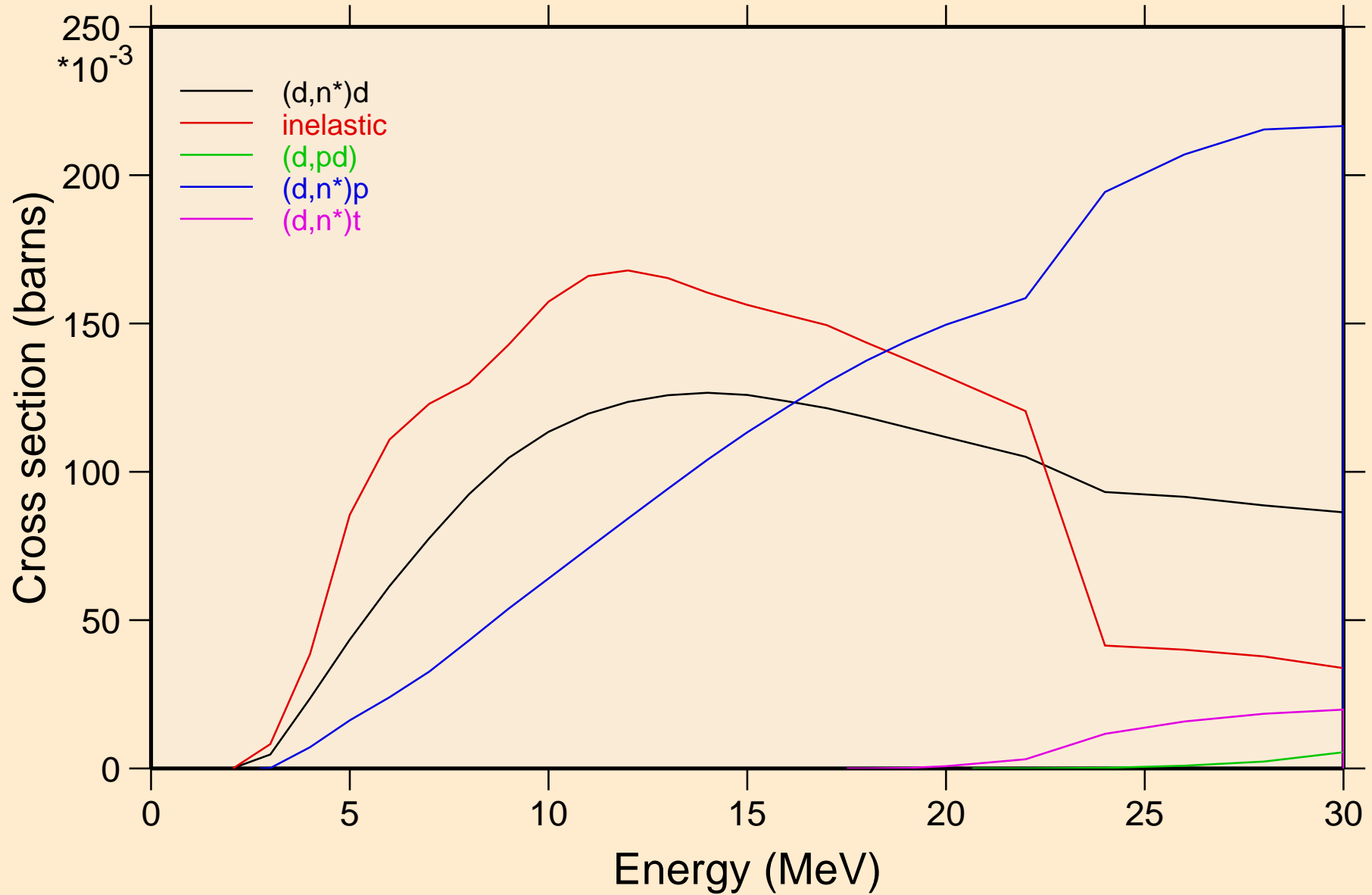

BE009 DEUTERON ACER TENDL-2021 LIBRARY; T=0.K
Threshold reactions

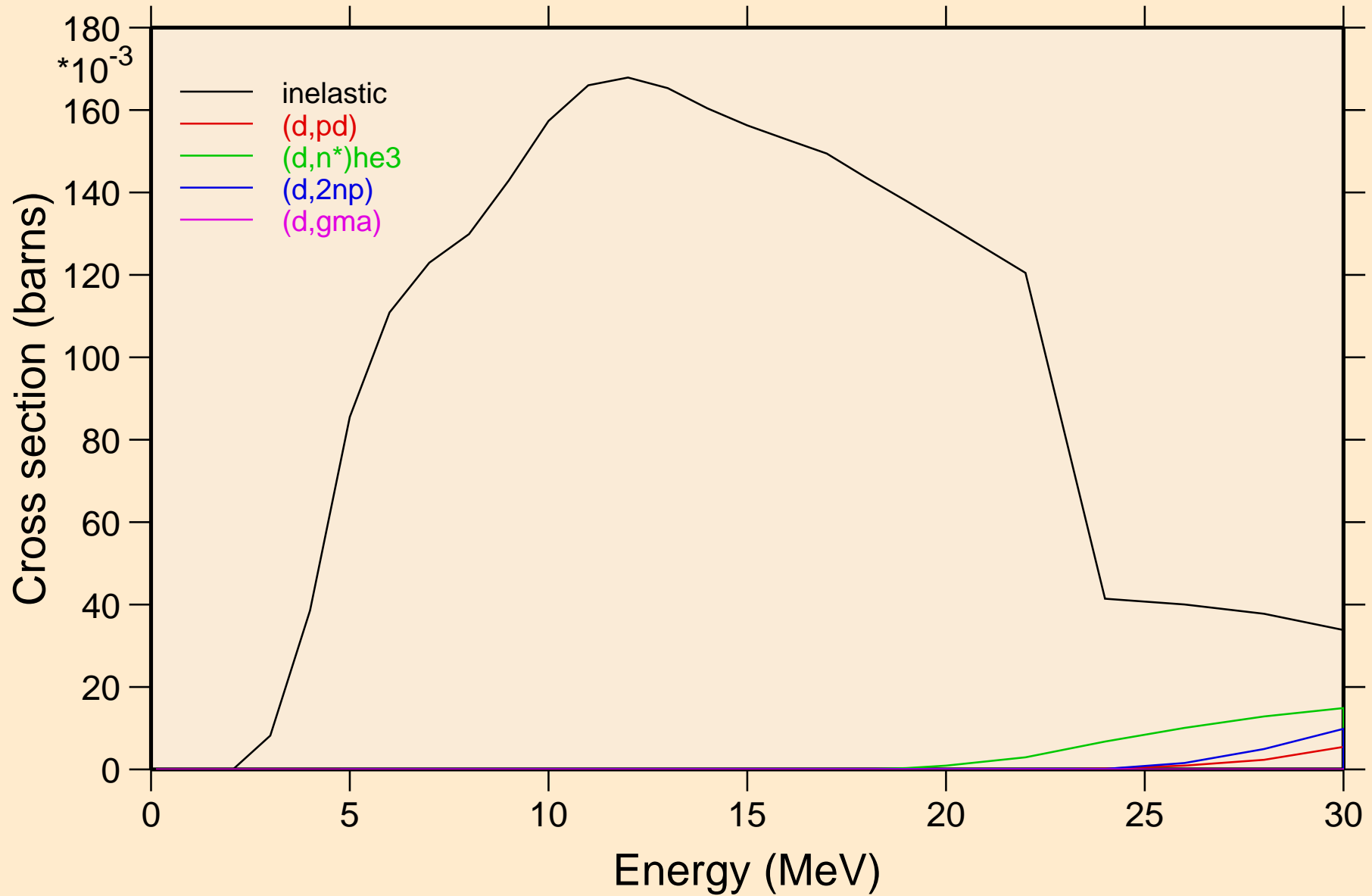

BE009 DEUTERON ACER TENDL-2021 LIBRARY; T=0.K

Threshold reactions

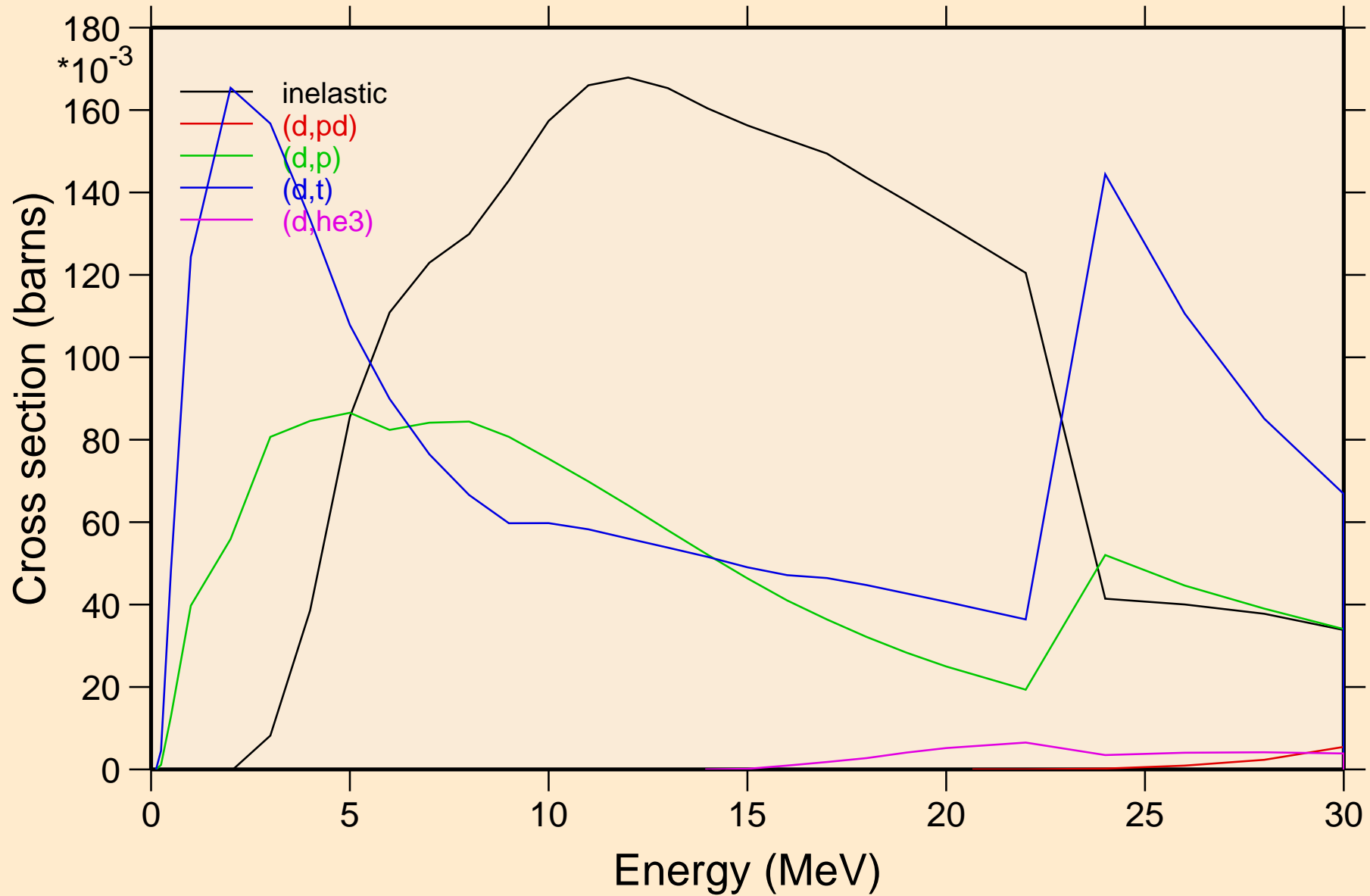

BE009 DEUTERON ACER TENDL-2021 LIBRARY; T=0.K

Threshold reactions

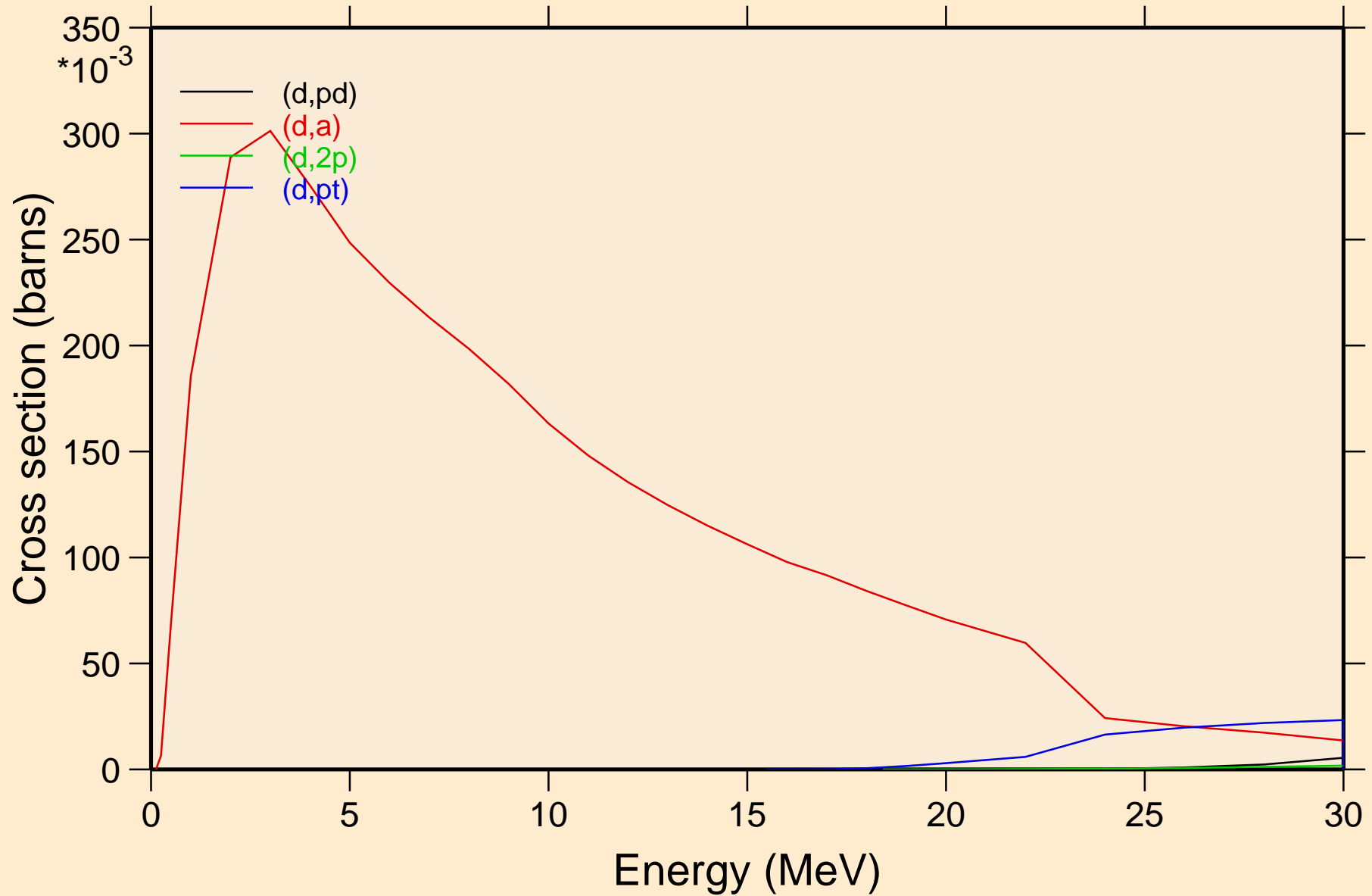

BE009 DEUTERON ACER TENDL-2021 LIBRARY; T=0.K
angular distribution for elastic

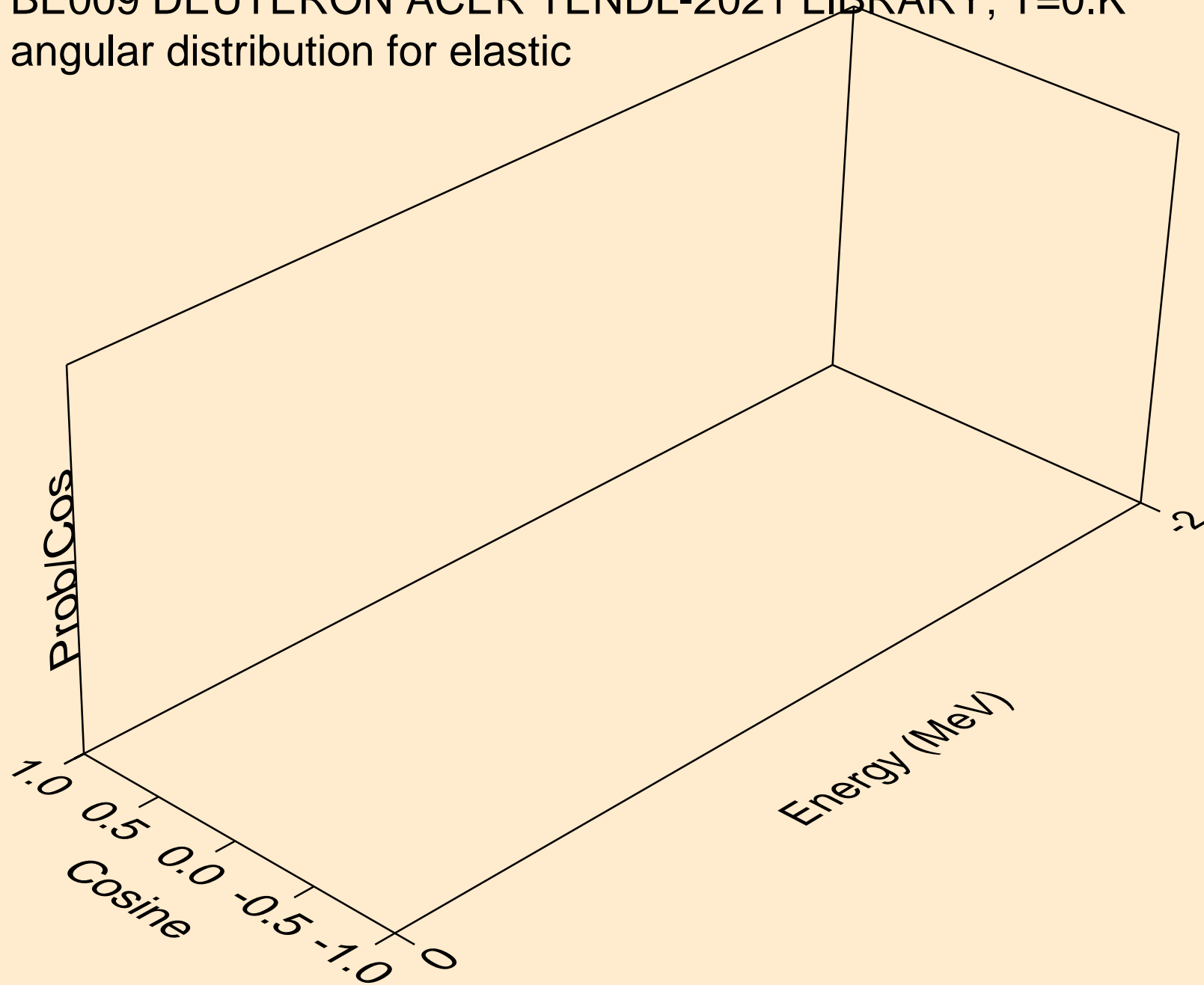

BE009 DEUTERON ACER TENDL-2021 LIBRARY; T=0.K
angular distribution for (d,pd)

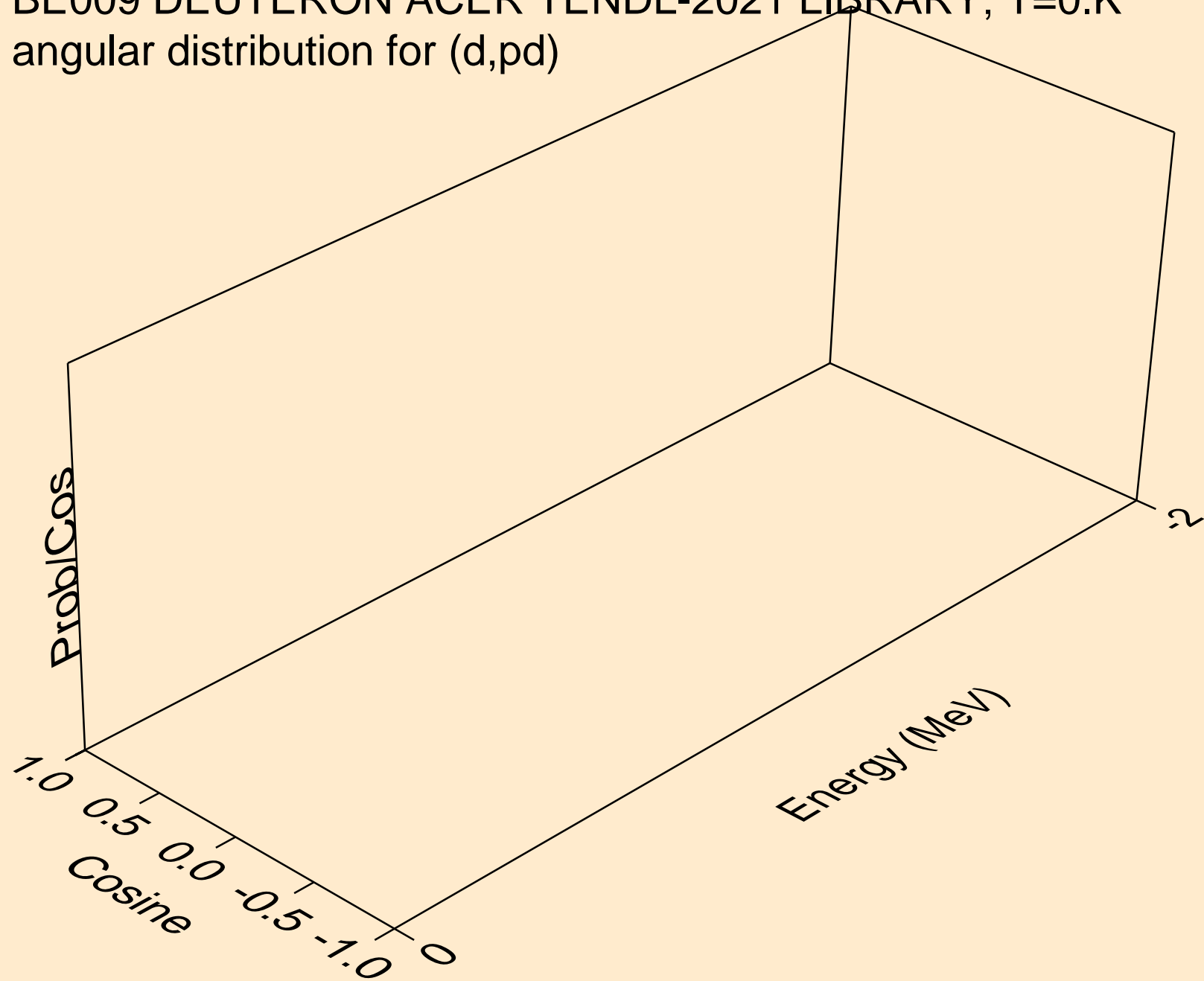

BE009 DEUTERON ACER TENDL-2021 LIBRARY; T=0.K
Particle heating contributions

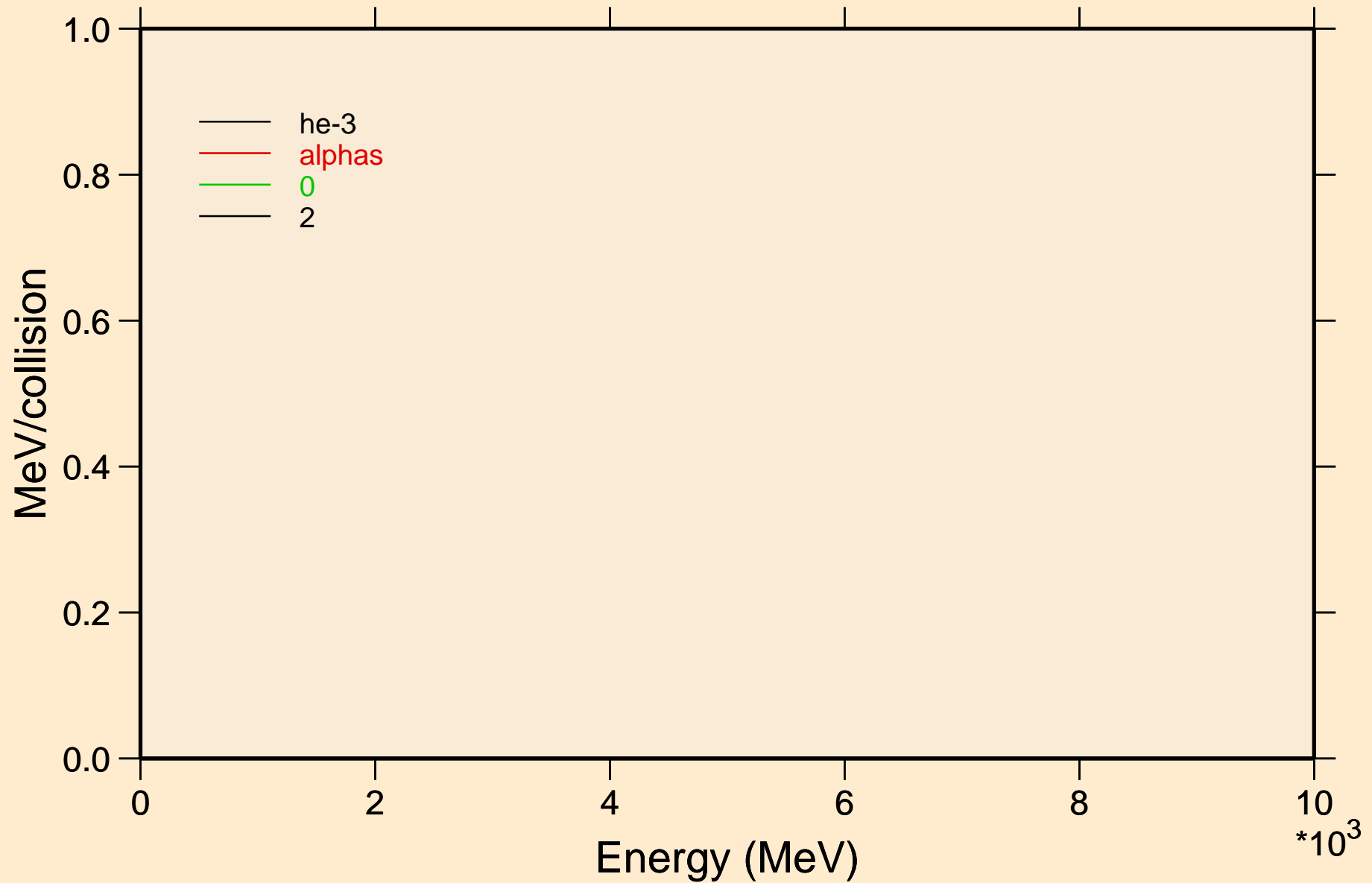

BE009 DEUTERON ACER TENDL-2021 LIBRARY; T=0.K
Recoil Heating

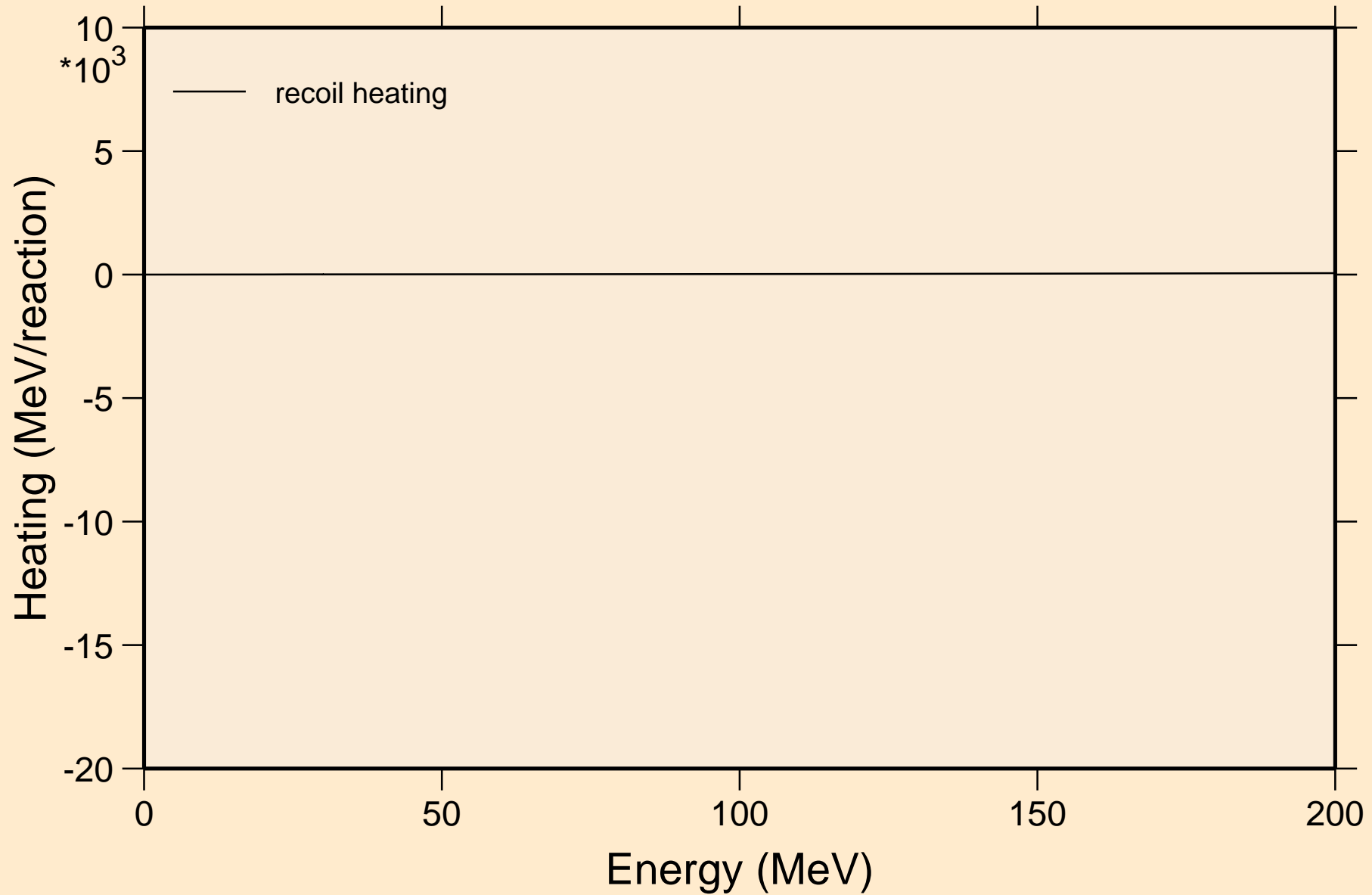

BE009 DEUTERON ACER TENDL-2021 LIBRARY; T=0.K
Particle production cross sections

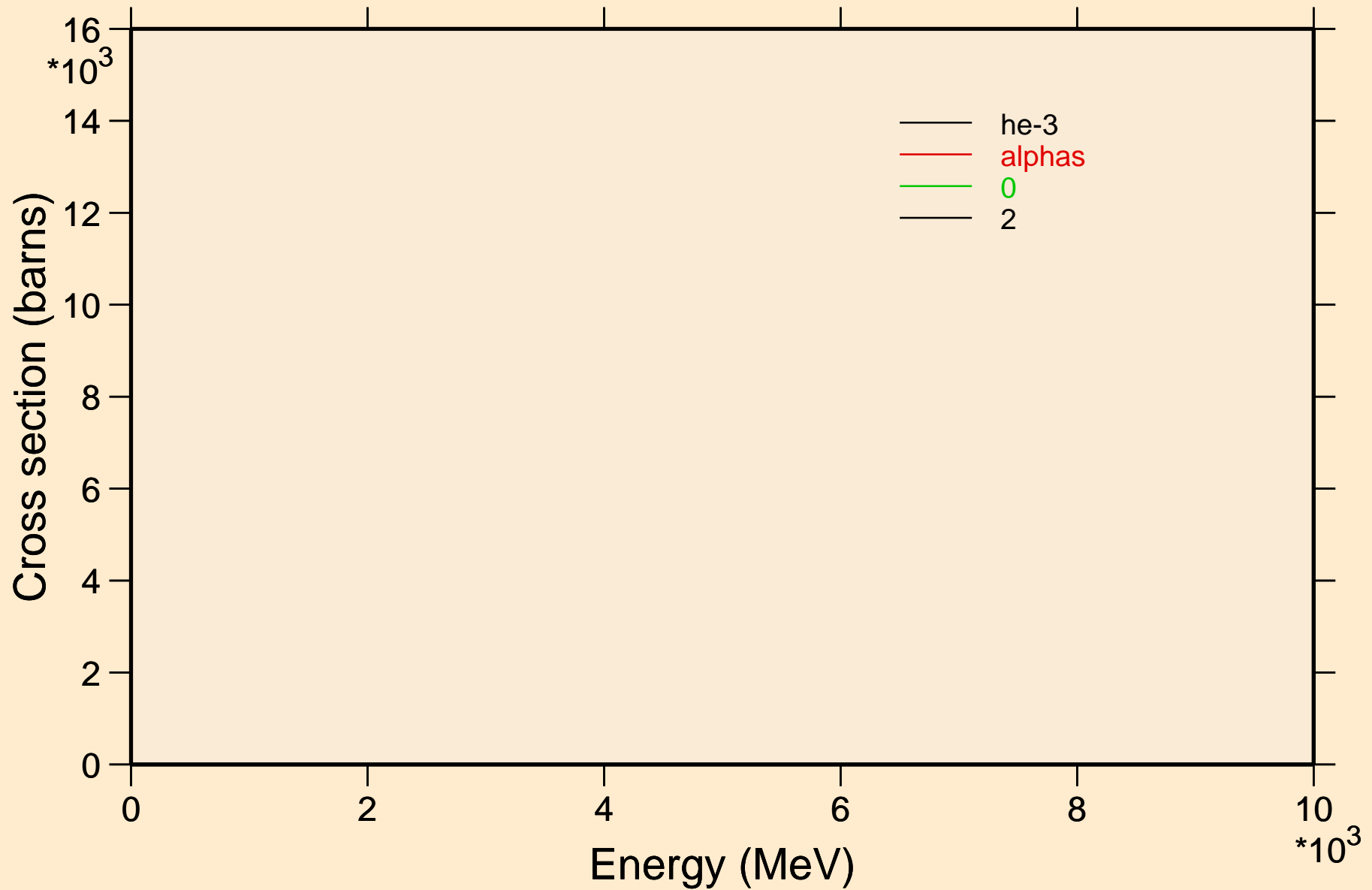

BE009 DEUTERON ACER TENDL-2021 LIBRARY; T=0.K
angular distribution for elastic 3He

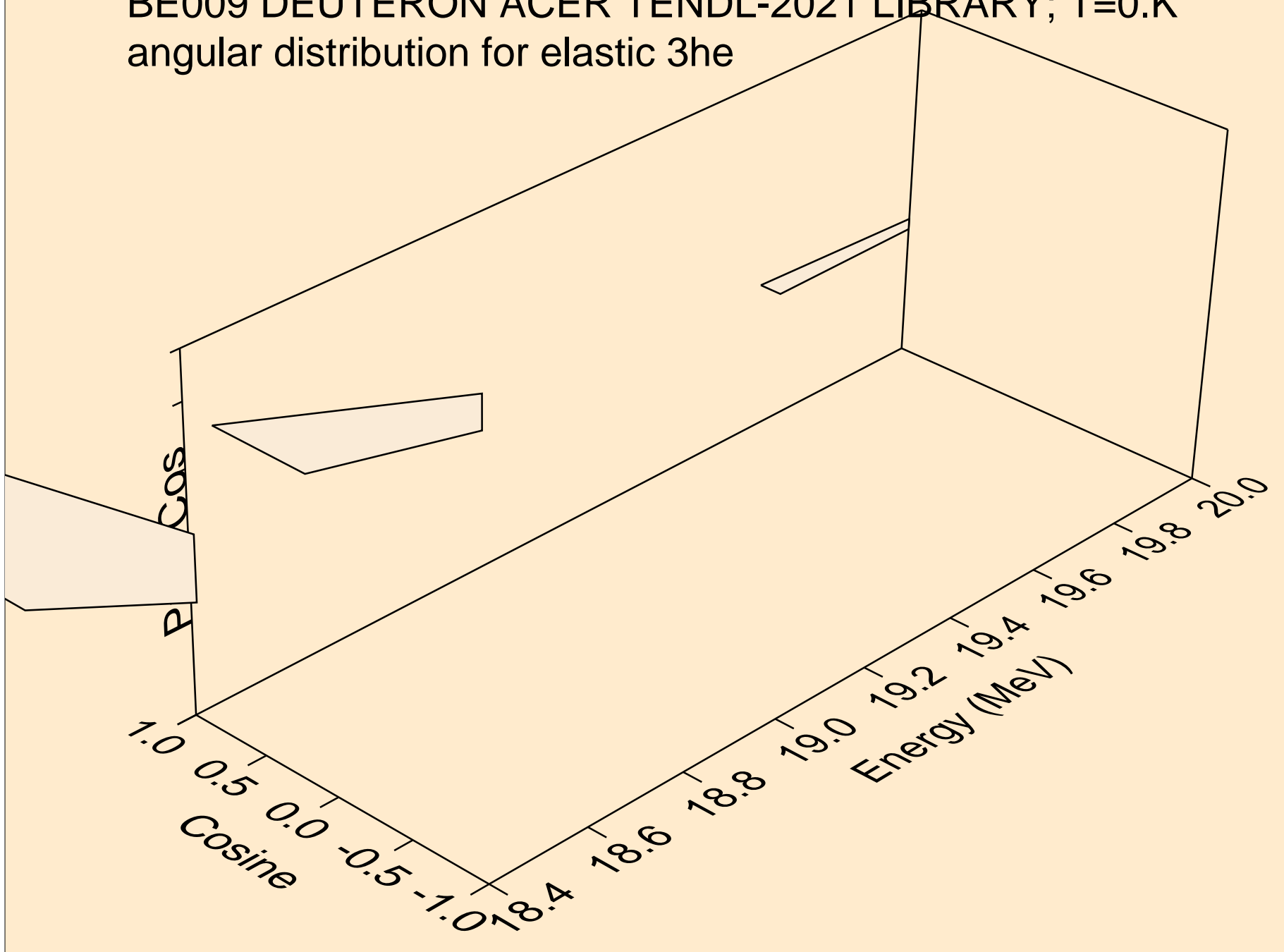

BE009 DEUTERON ACER TENDL-2021 LIBRARY; T=0.K
angular distribution for elastic 3He

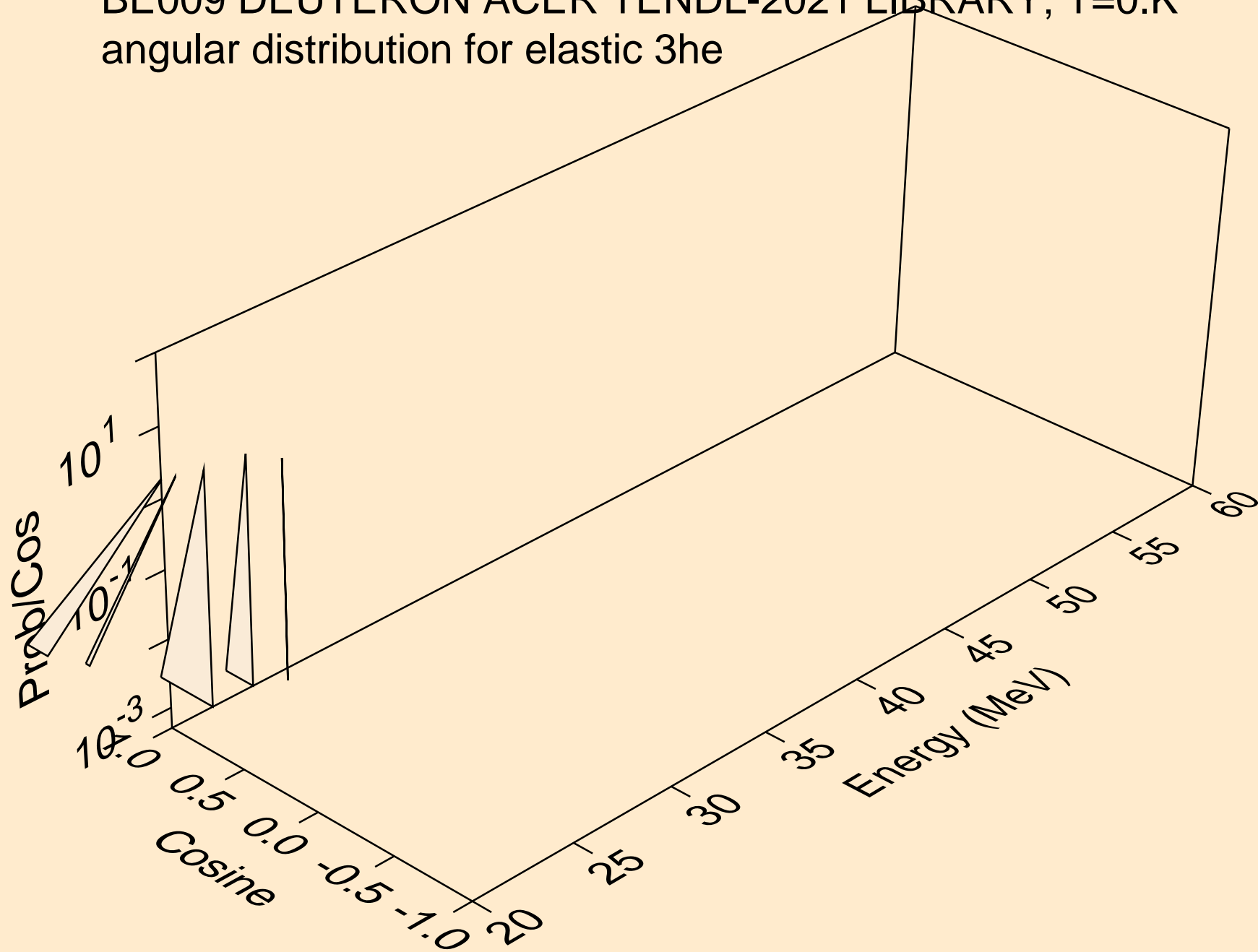

BE009 DEUTERON ACER TENDL-2021 LIBRARY; T=0.K
angular distribution for elastic 3He

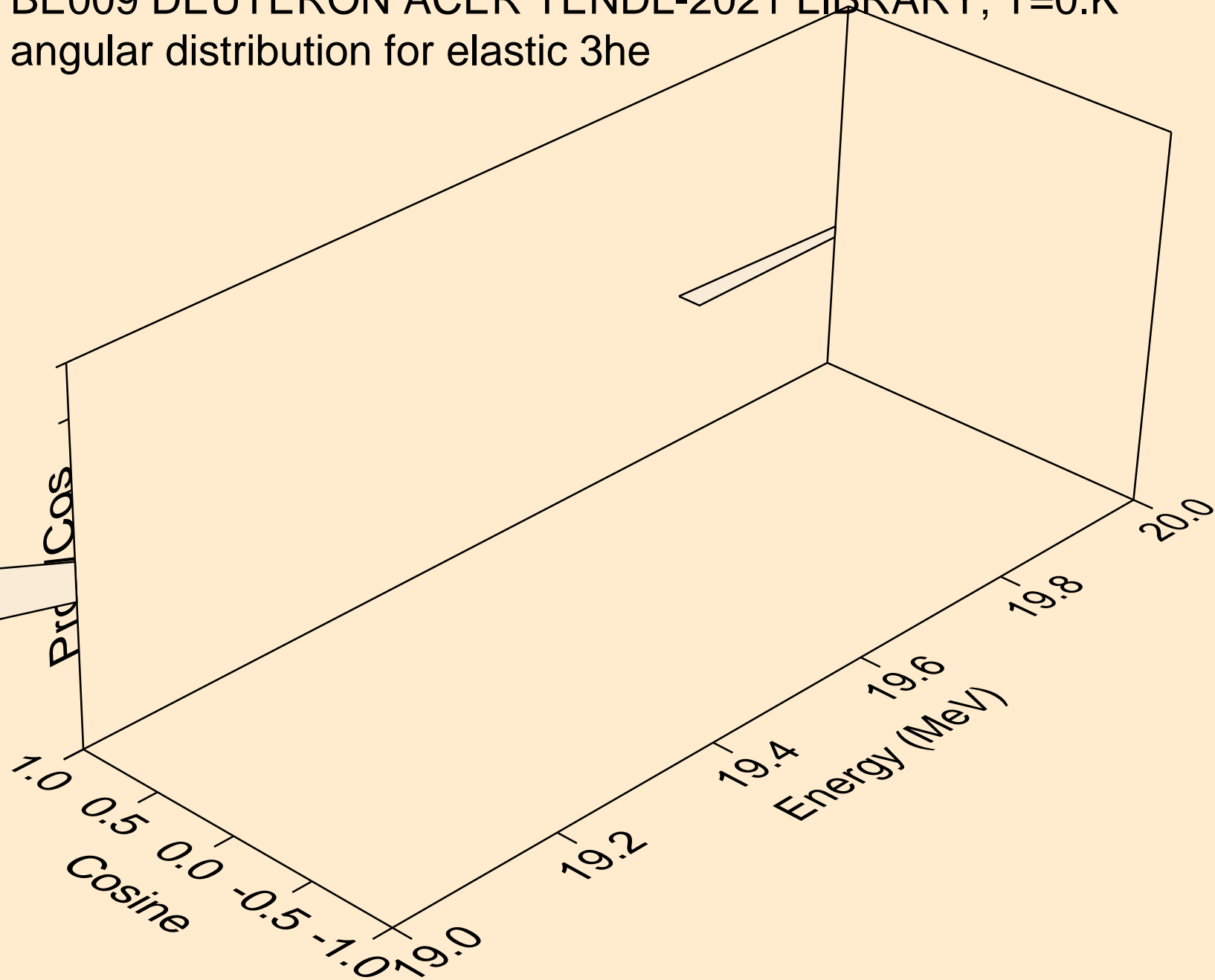

BE009 DEUTERON ACER TENDL-2021 LIBRARY; T=0.K
angular distribution for elastic 3He

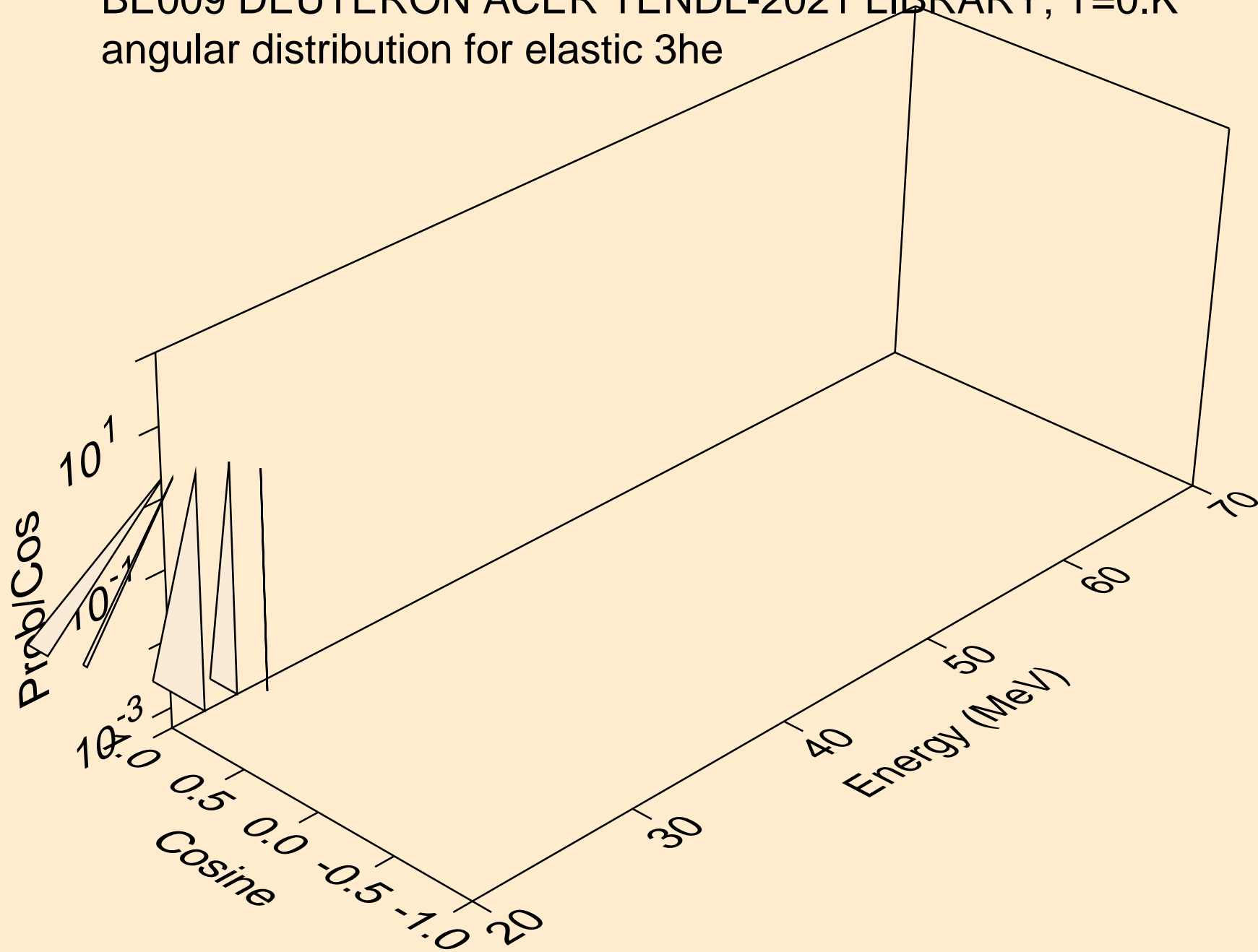

BE009 DEUTERON ACER TENDL-2021 LIBRARY; T=0.K
angular distribution for elastic 3He

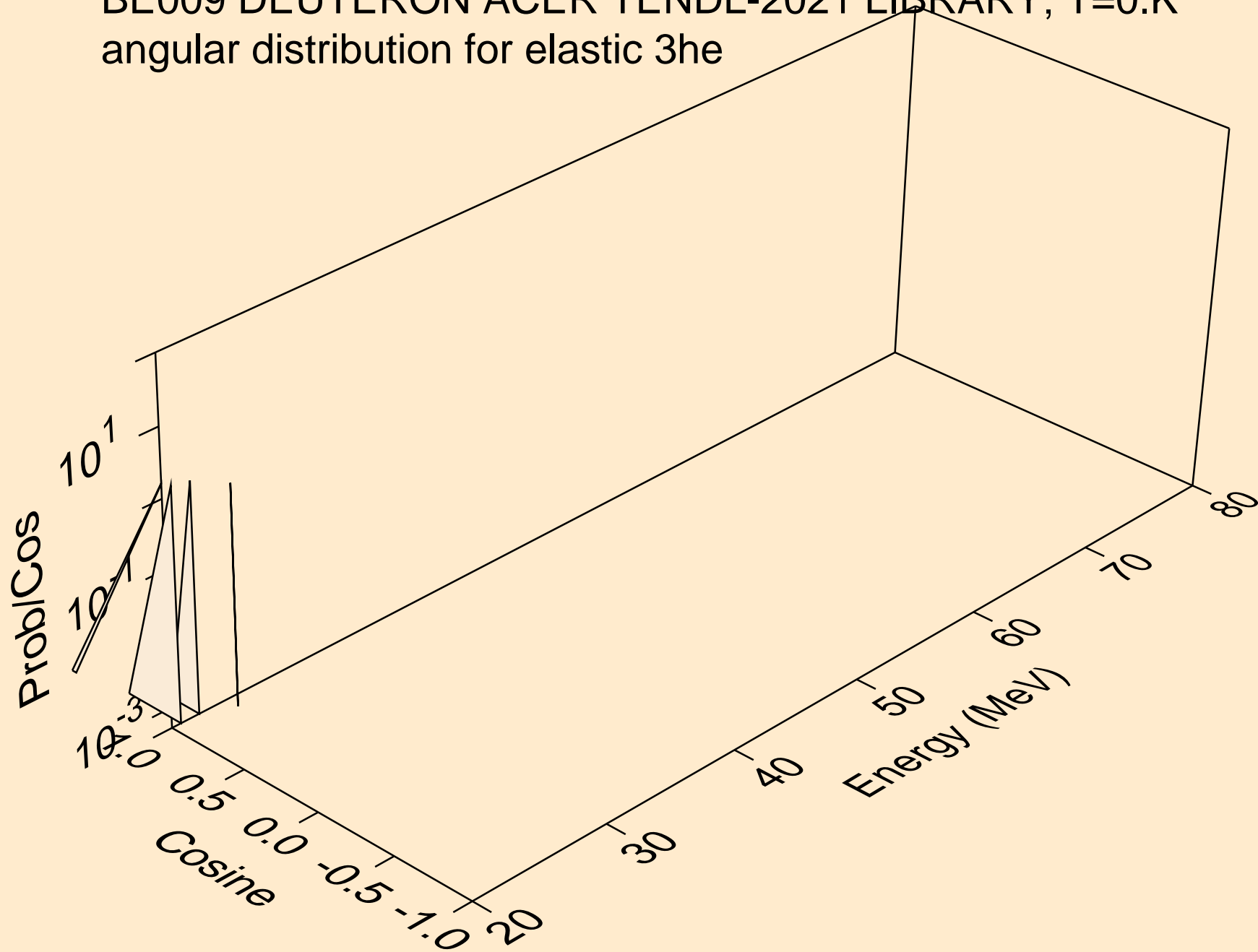

BE009 DEUTERON ACER TENDL-2021 LIBRARY; T=0.K
angular distribution for elastic 3He

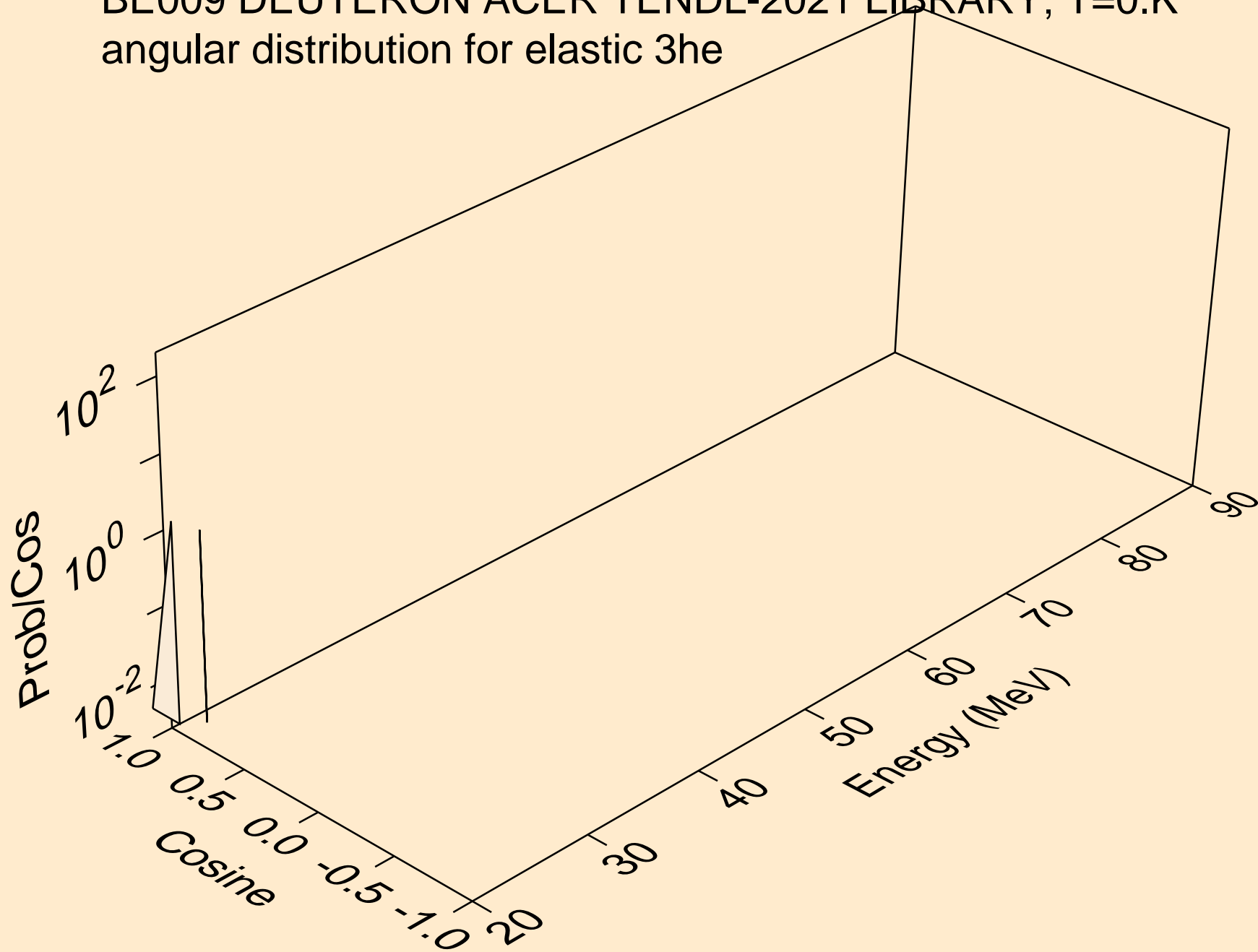

BE009 DEUTERON ACER TENDL-2021 LIBRARY; T=0.K
angular distribution for elastic 3He

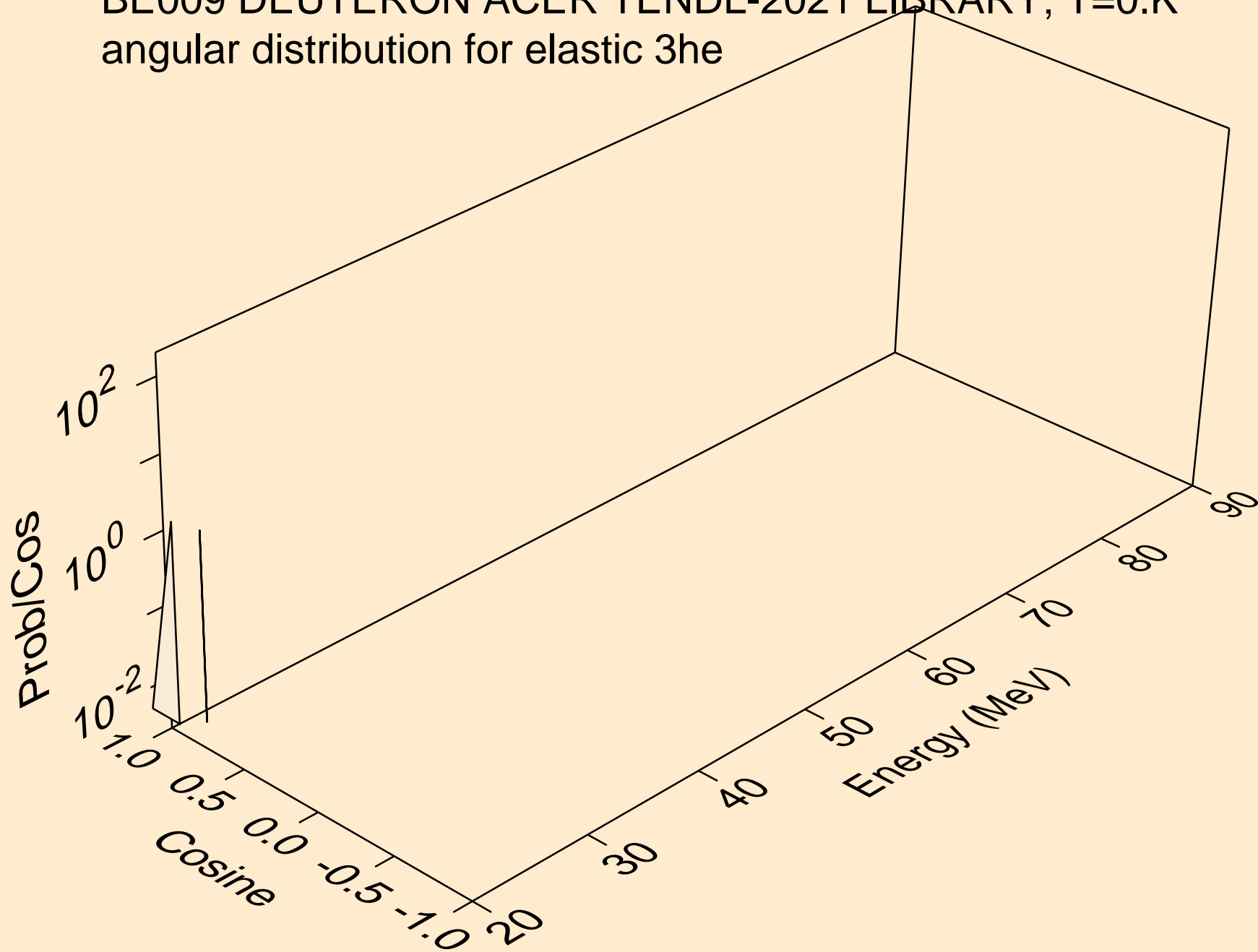

BE009 DEUTERON ACER TENDL-2021 LIBRARY; T=0.K
angular distribution for elastic 3He

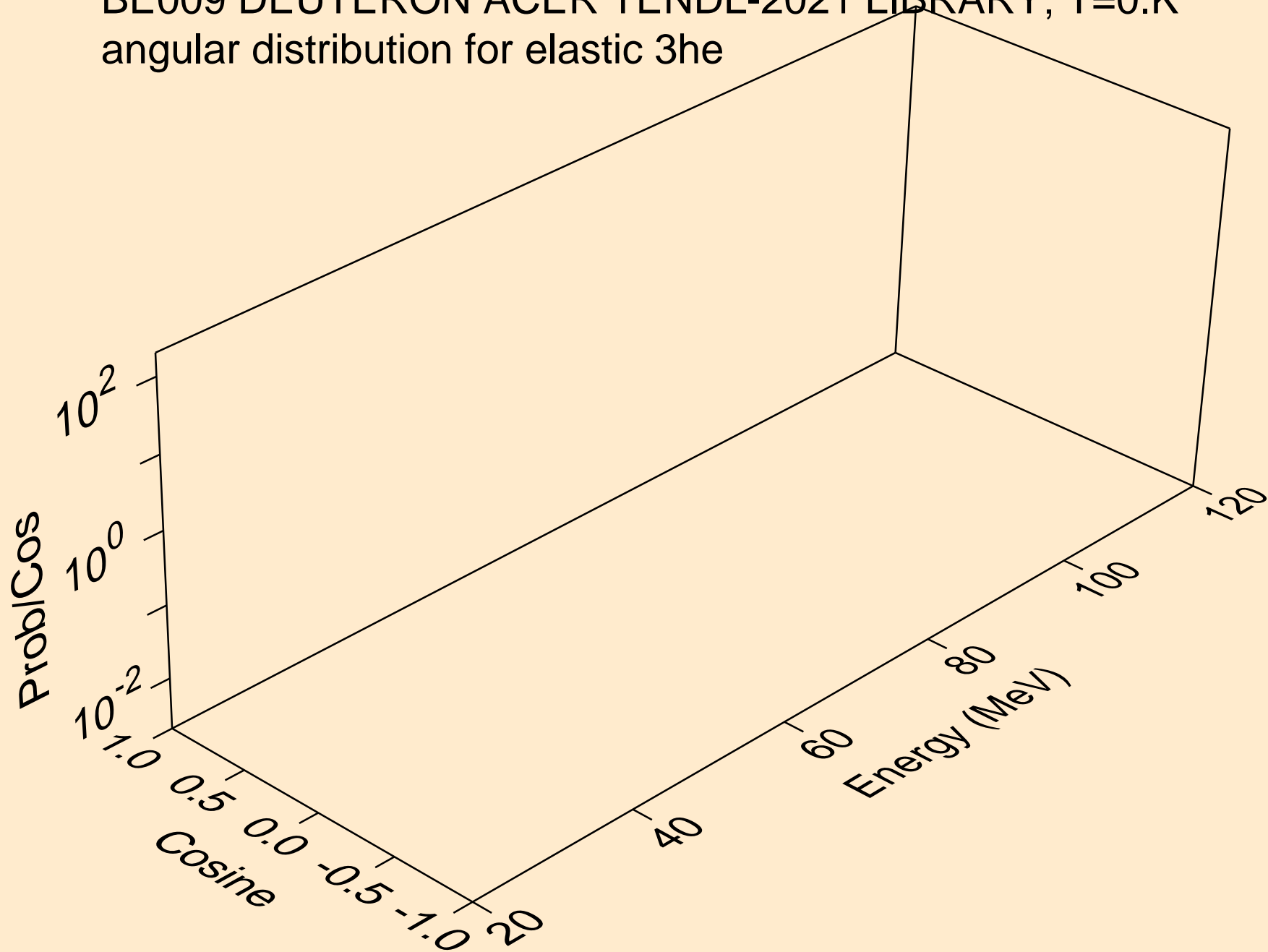

BE009 DEUTERON ACER TENDL-2021 LIBRARY; T=0.K
angular distribution for total 3he

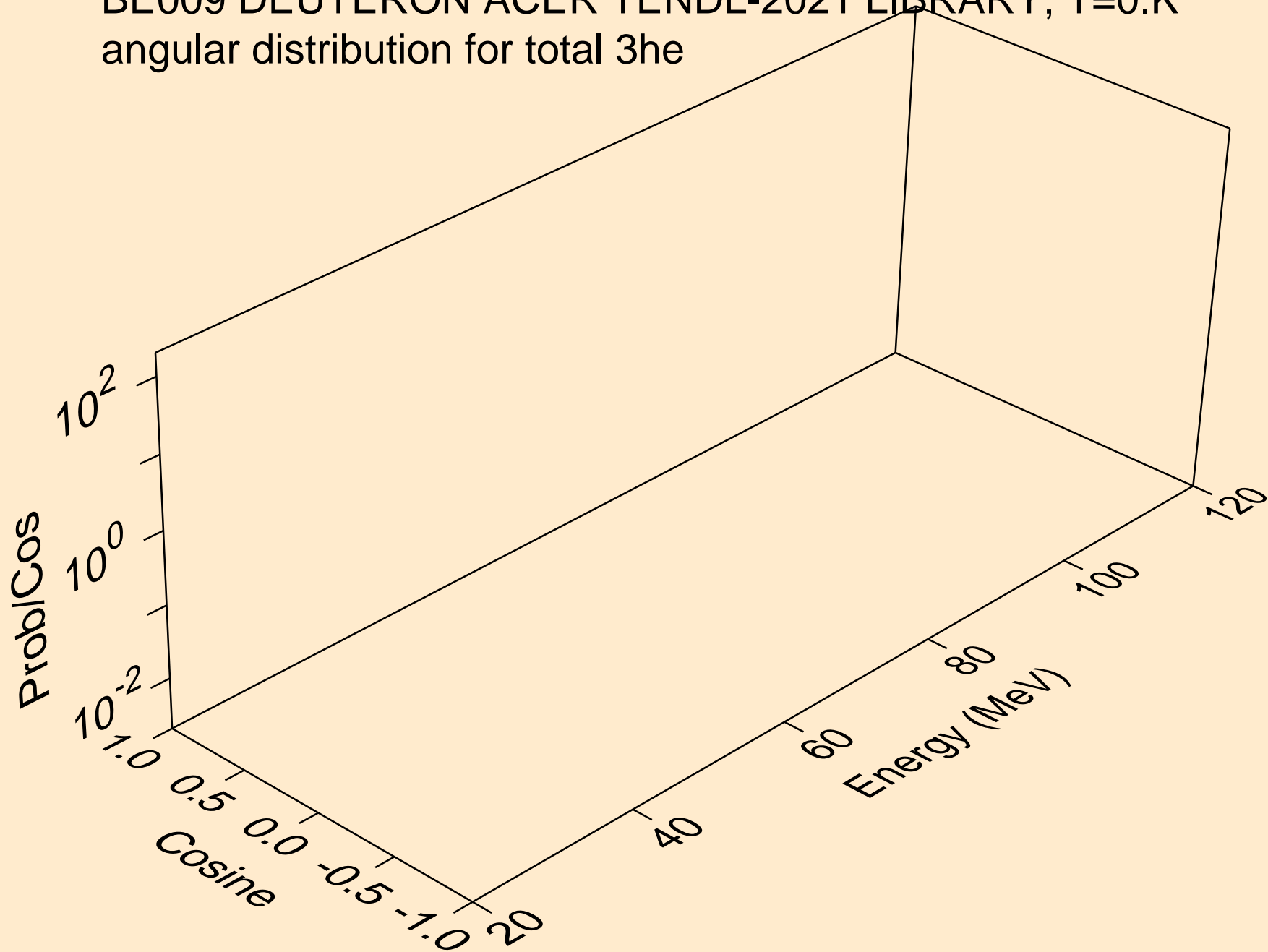

BE009 DEUTERON ACER TENDL-2021 LIBRARY; T=0.K
angular distribution for total 3he

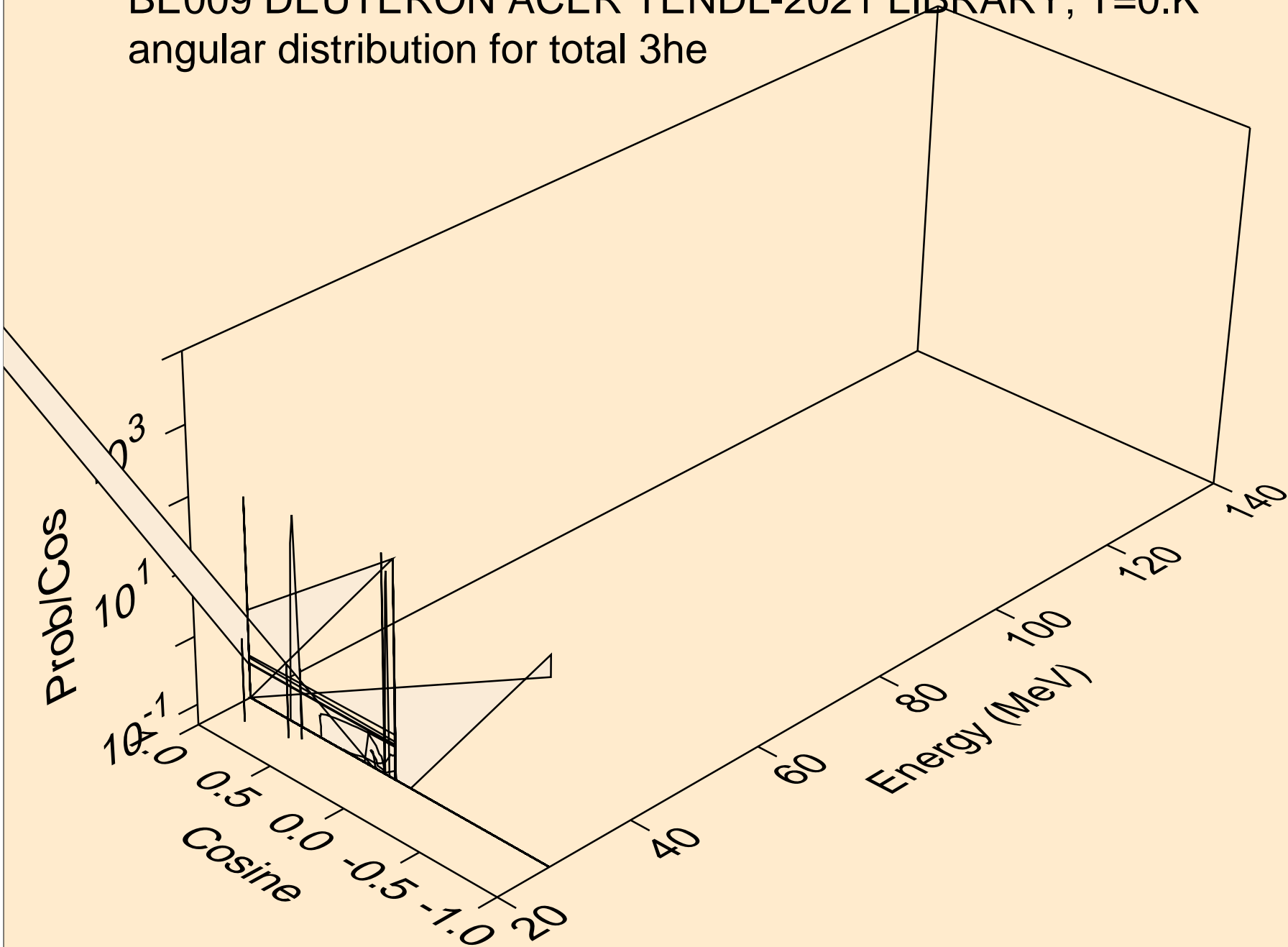

BE009 DEUTERON ACER TENDL-2021 LIBRARY; T=0.K
angular distribution for total 3he

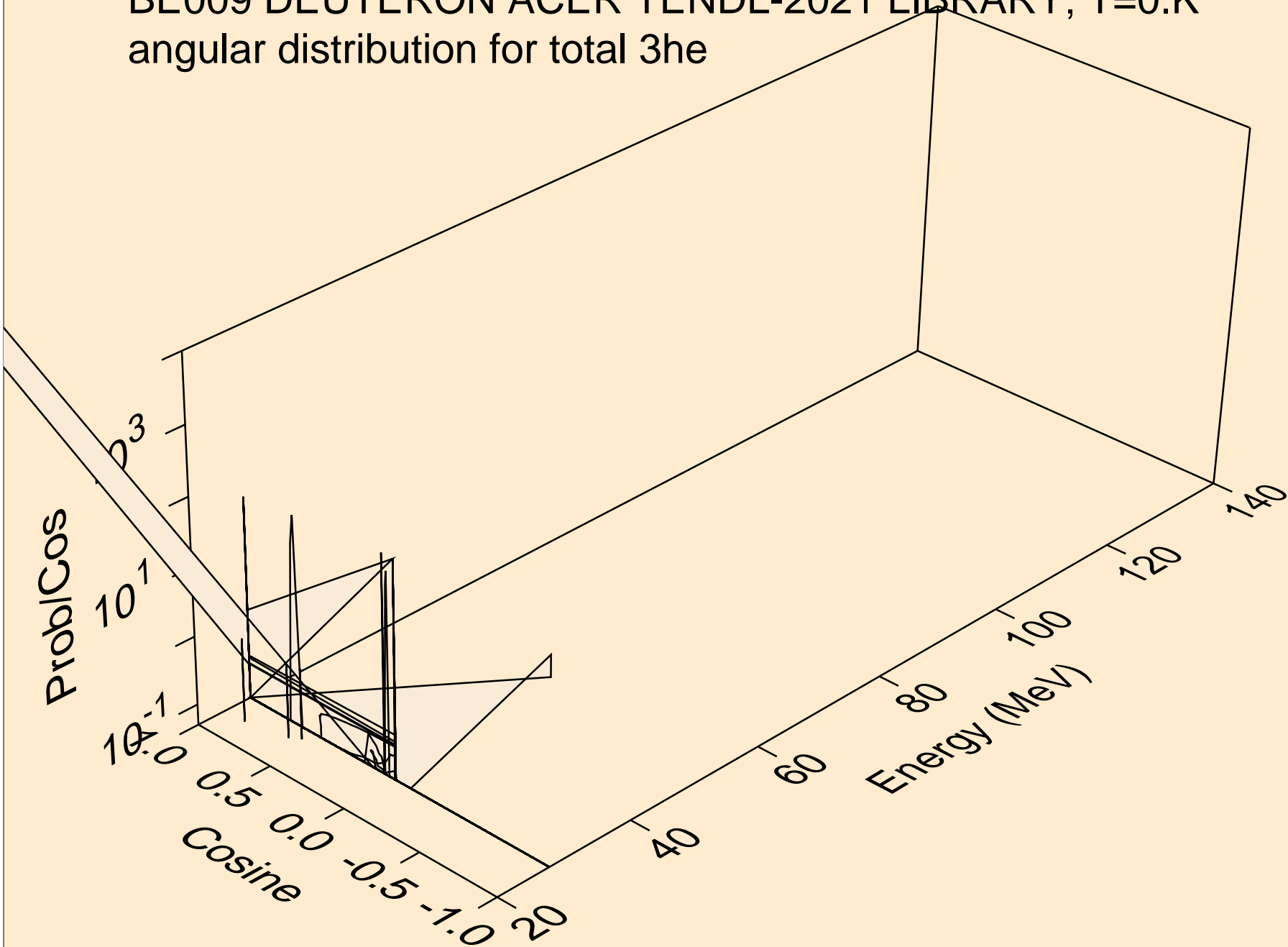

BE009 DEUTERON ACER TENDL-2021 LIBRARY; T=0.K
angular distribution for total 3he

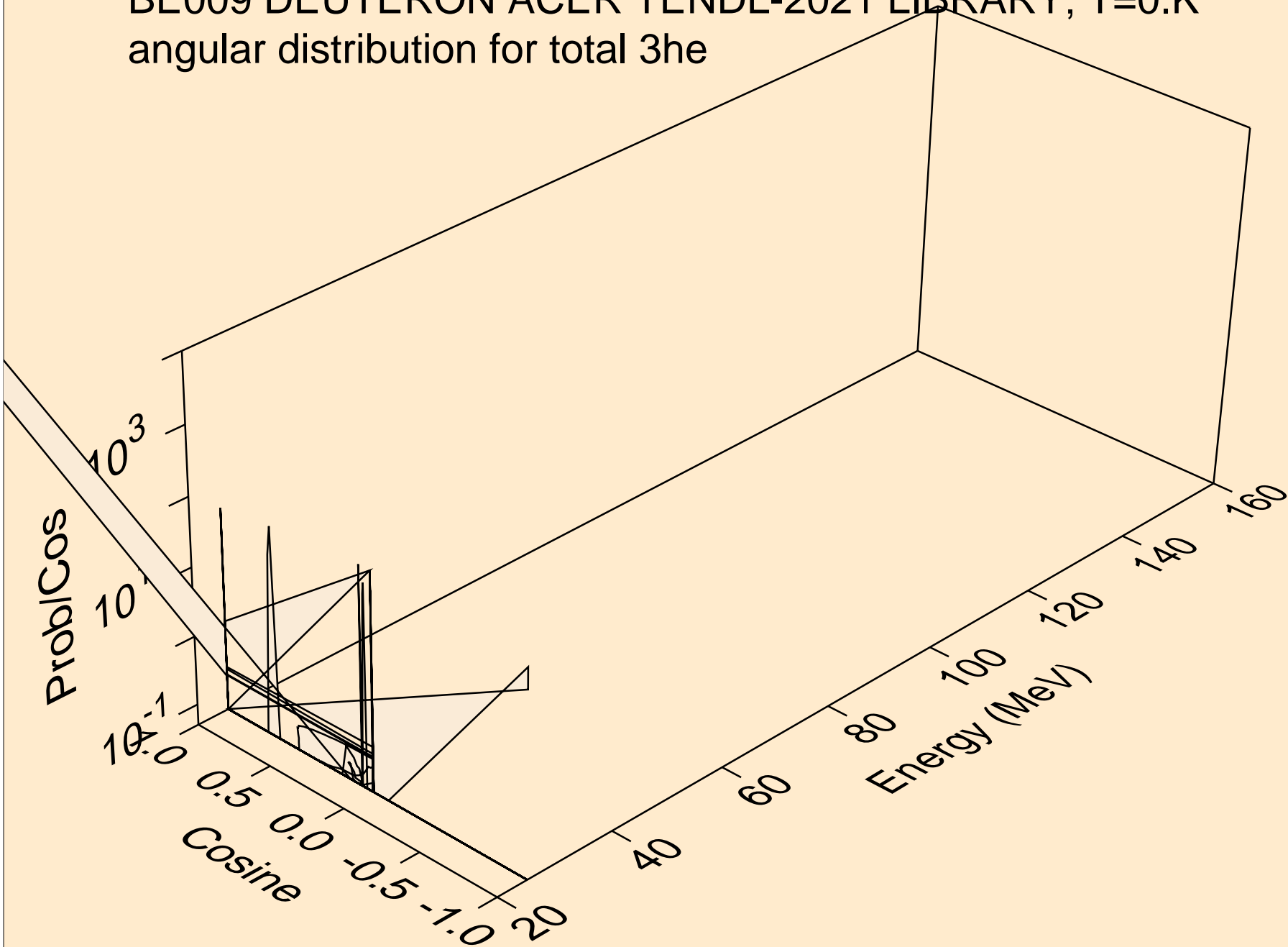

BE009 DEUTERON ACER TENDL-2021 LIBRARY; T=0.K
angular distribution for total 3he

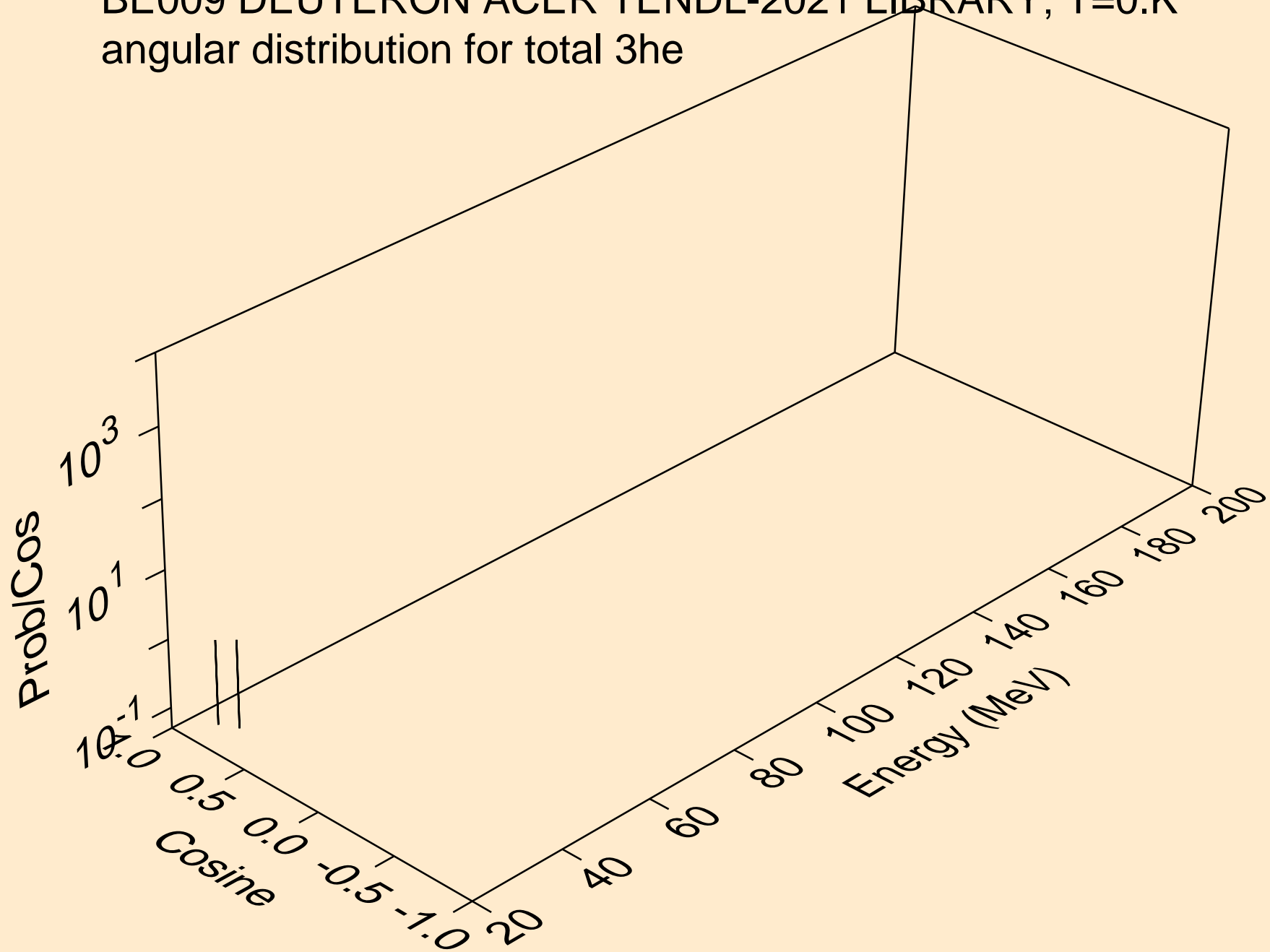

BE009 DEUTERON ACER TENDL-2021 LIBRARY; T=0.K
angular distribution for total 3he

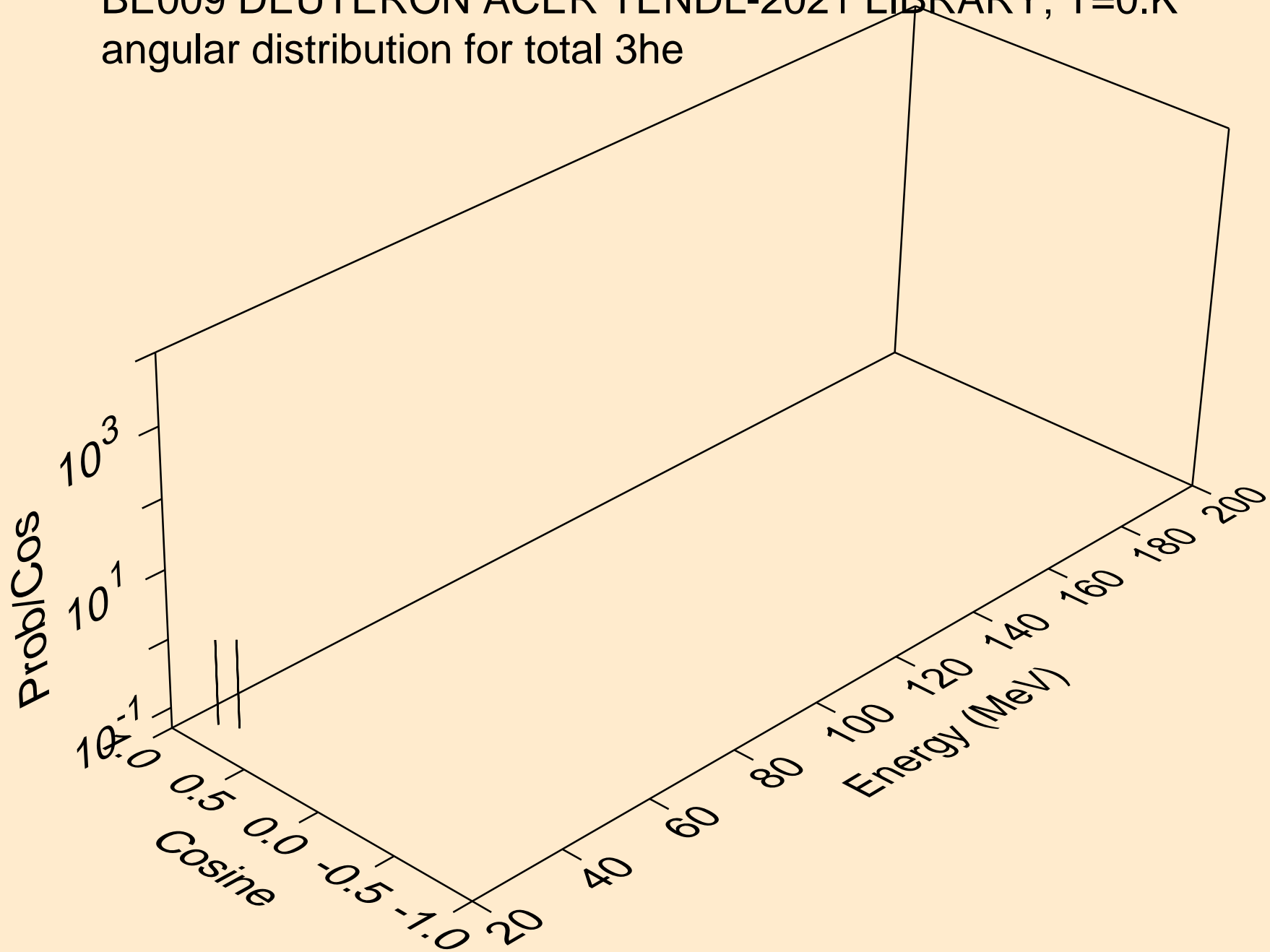

BE009 DEUTERON ACER TENDL-2021 LIBRARY; T=0.K
angular distribution for total 3he

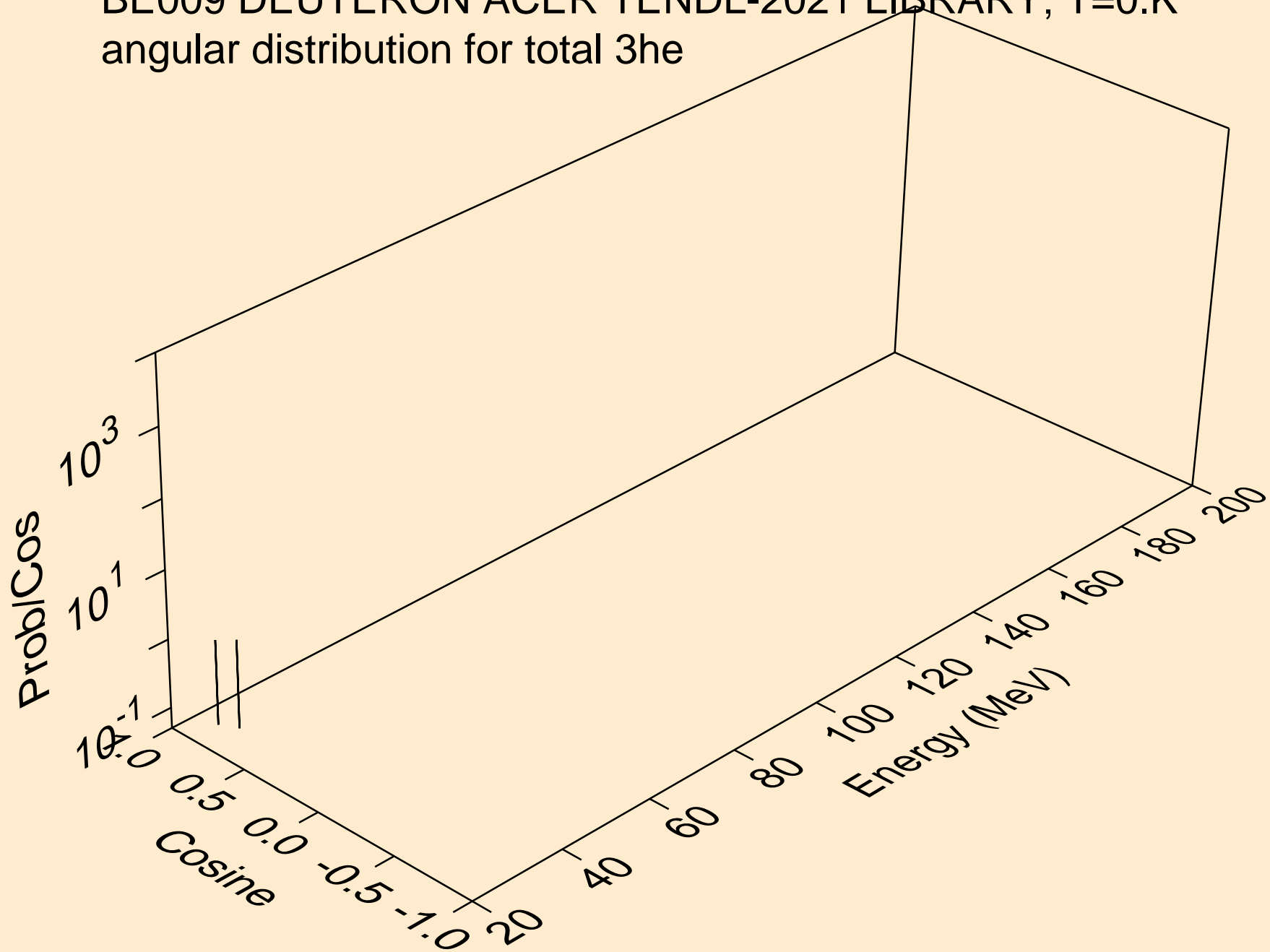

BE009 DEUTERON ACER TENDL-2021 LIBRARY; T=0.K
angular distribution for total 3he

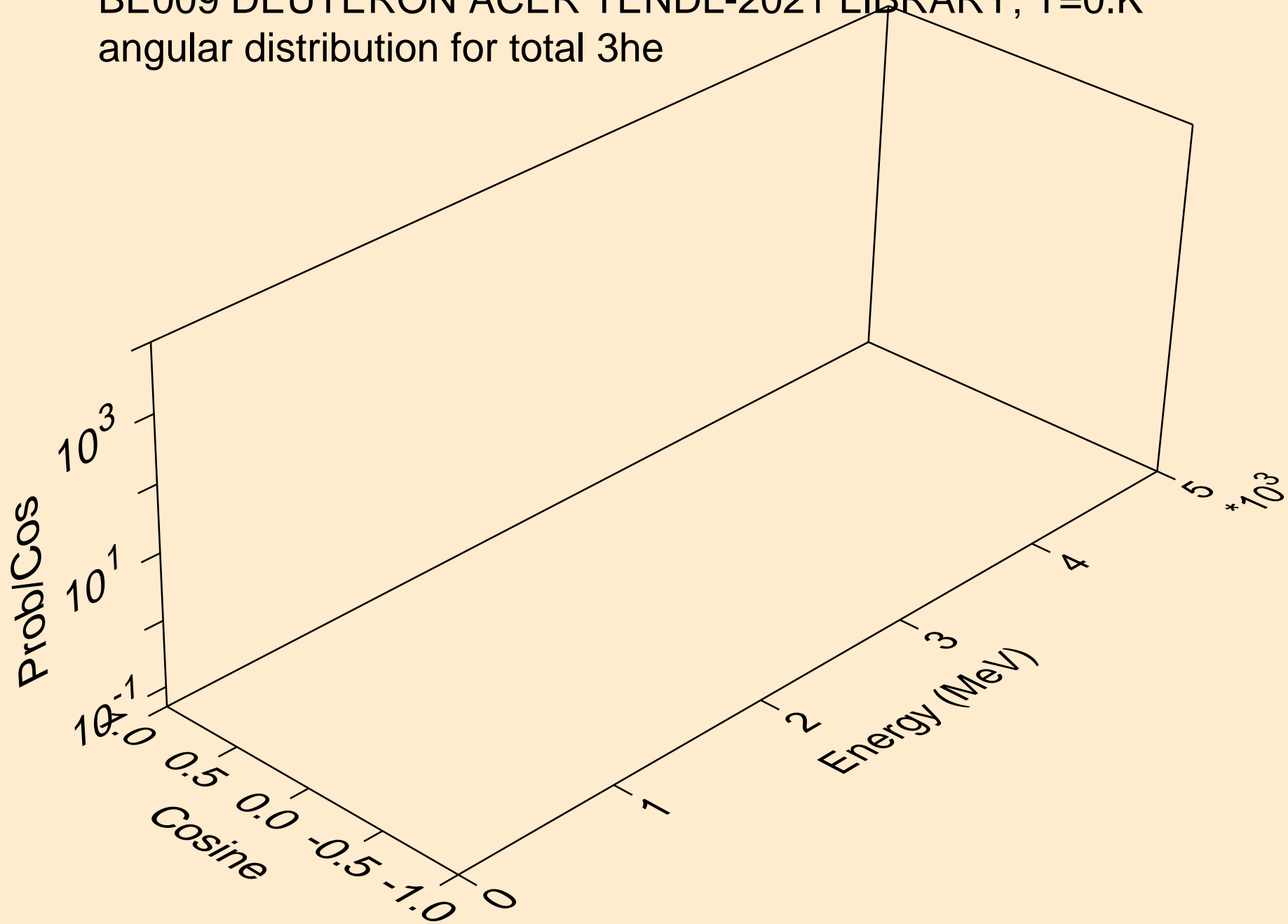

BE009 DEUTERON ACER TENDL-2021 LIBRARY; T=0.K
angular distribution for total 3he

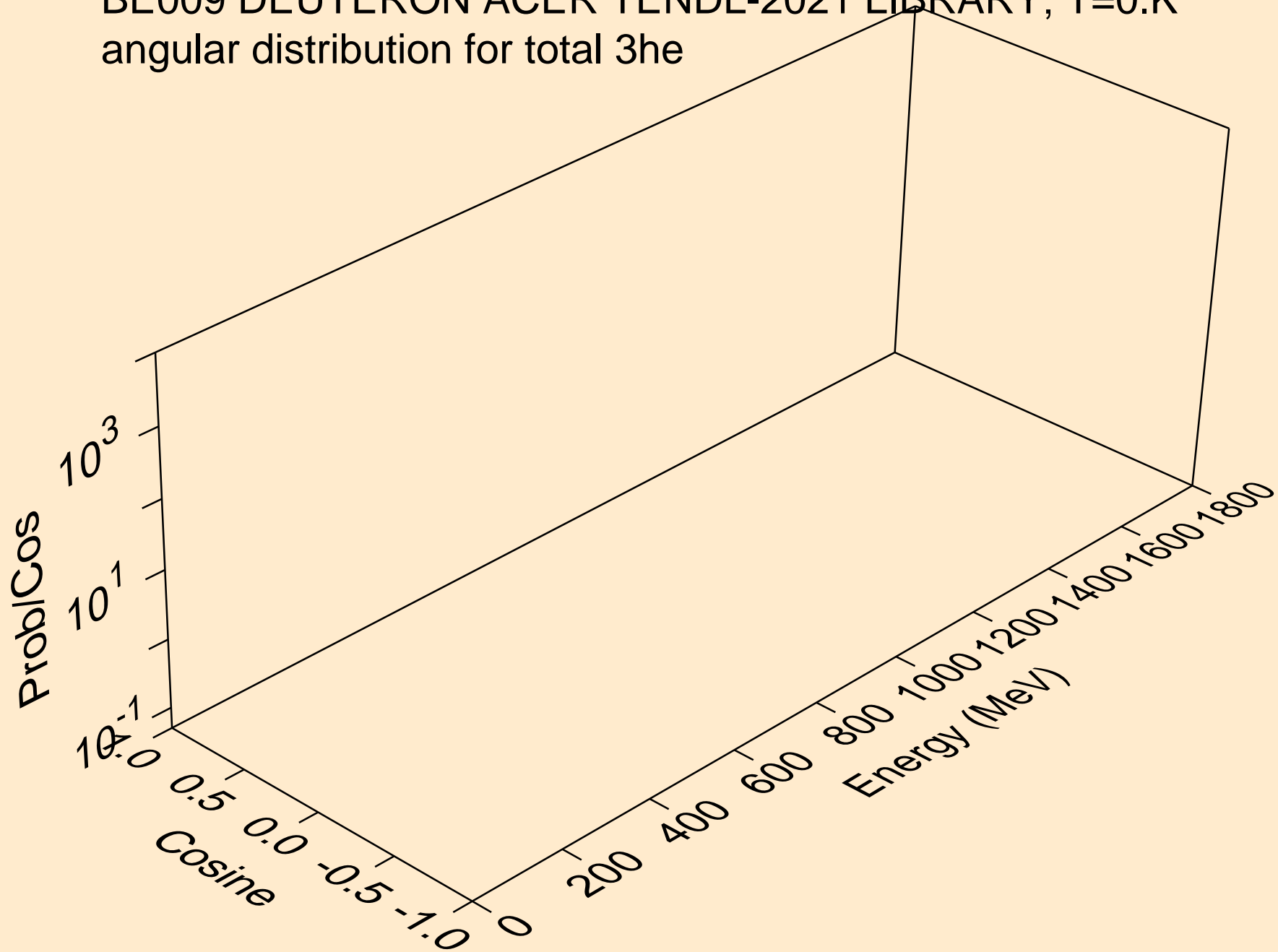

BE009 DEUTERON ACER TENDL-2021 LIBRARY; T=0.K
angular distribution for total 3he

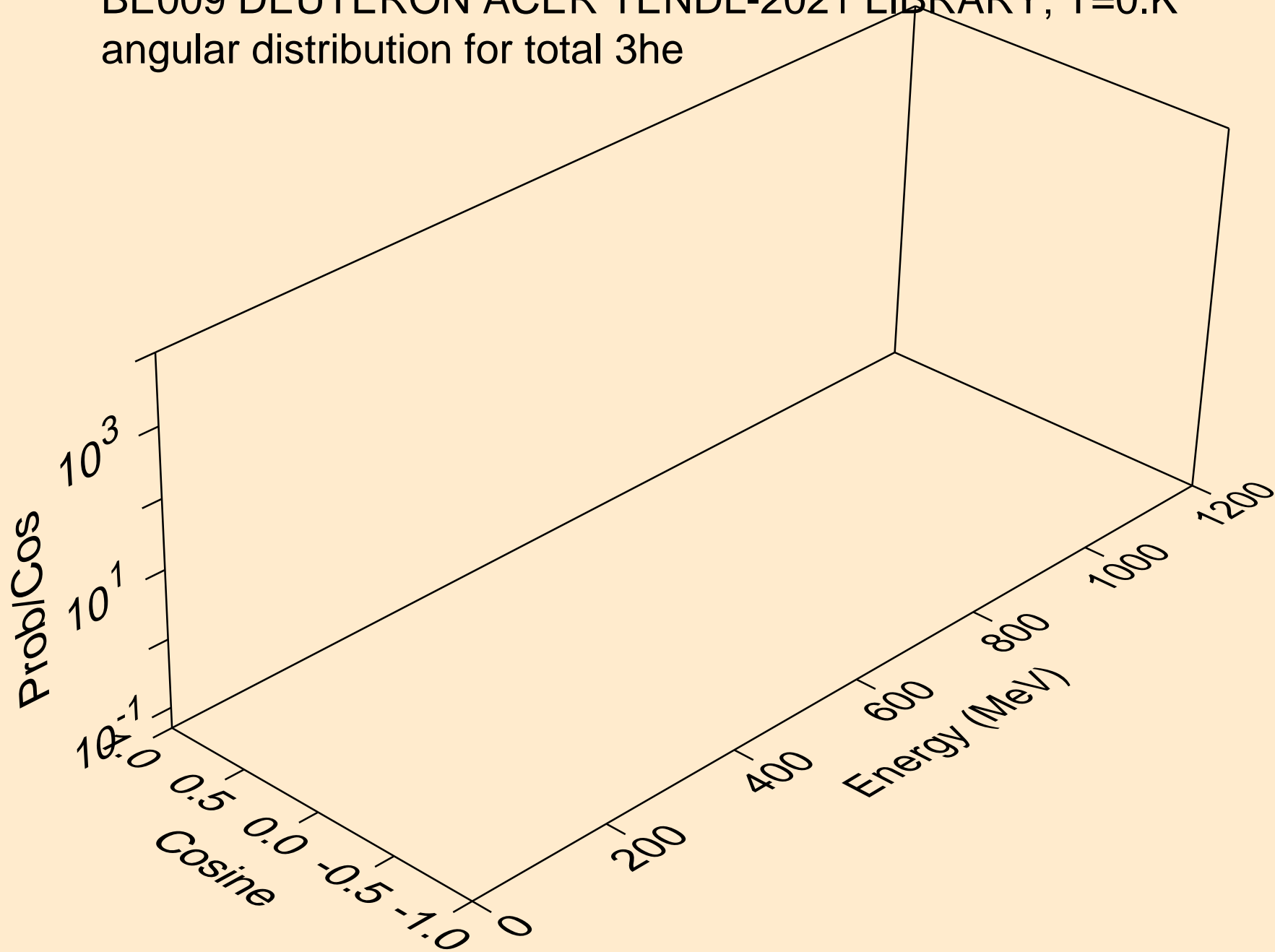

BE009 DEUTERON ACER TENDL-2021 LIBRARY; T=0.K
angular distribution for total 3he

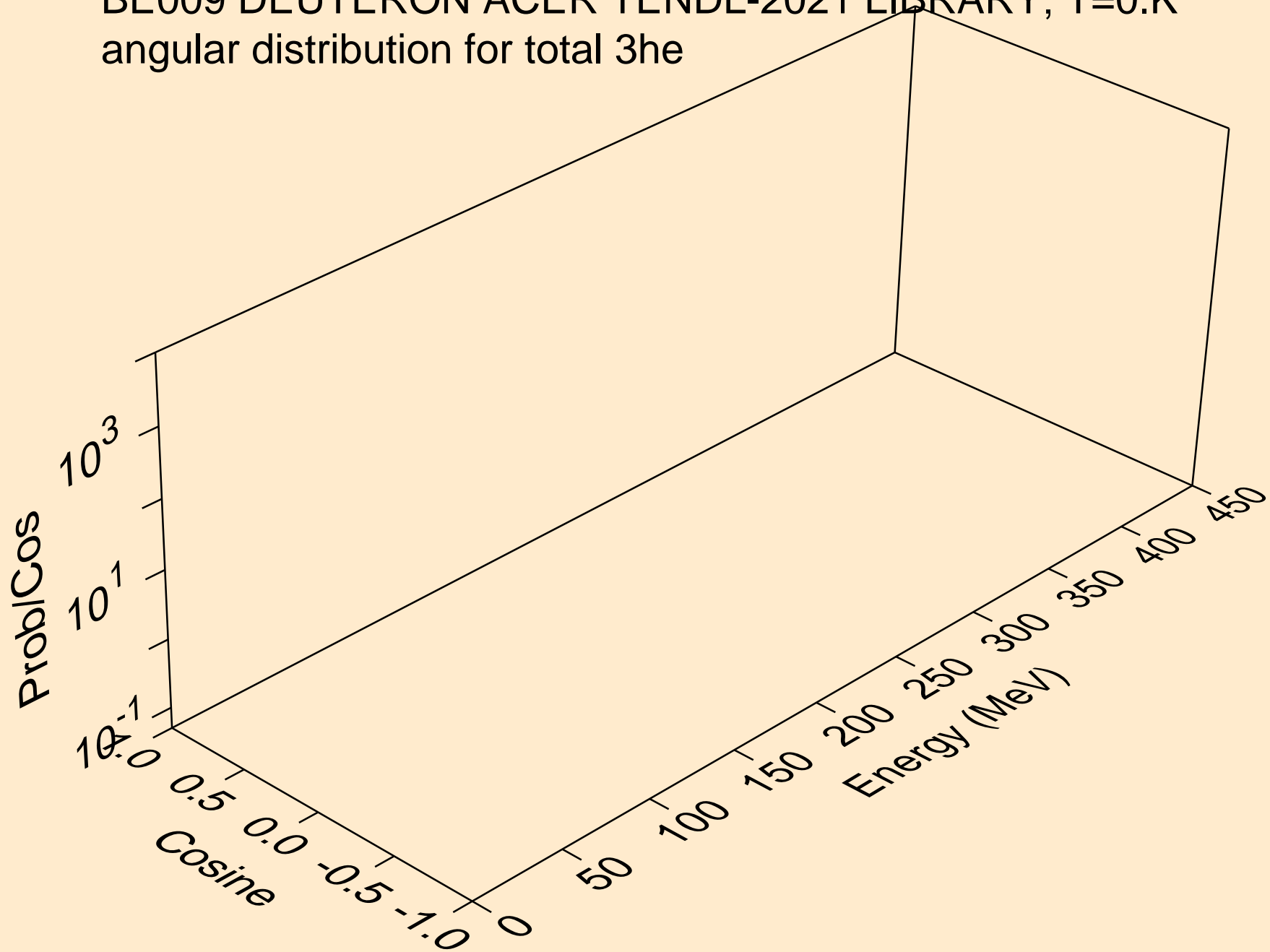

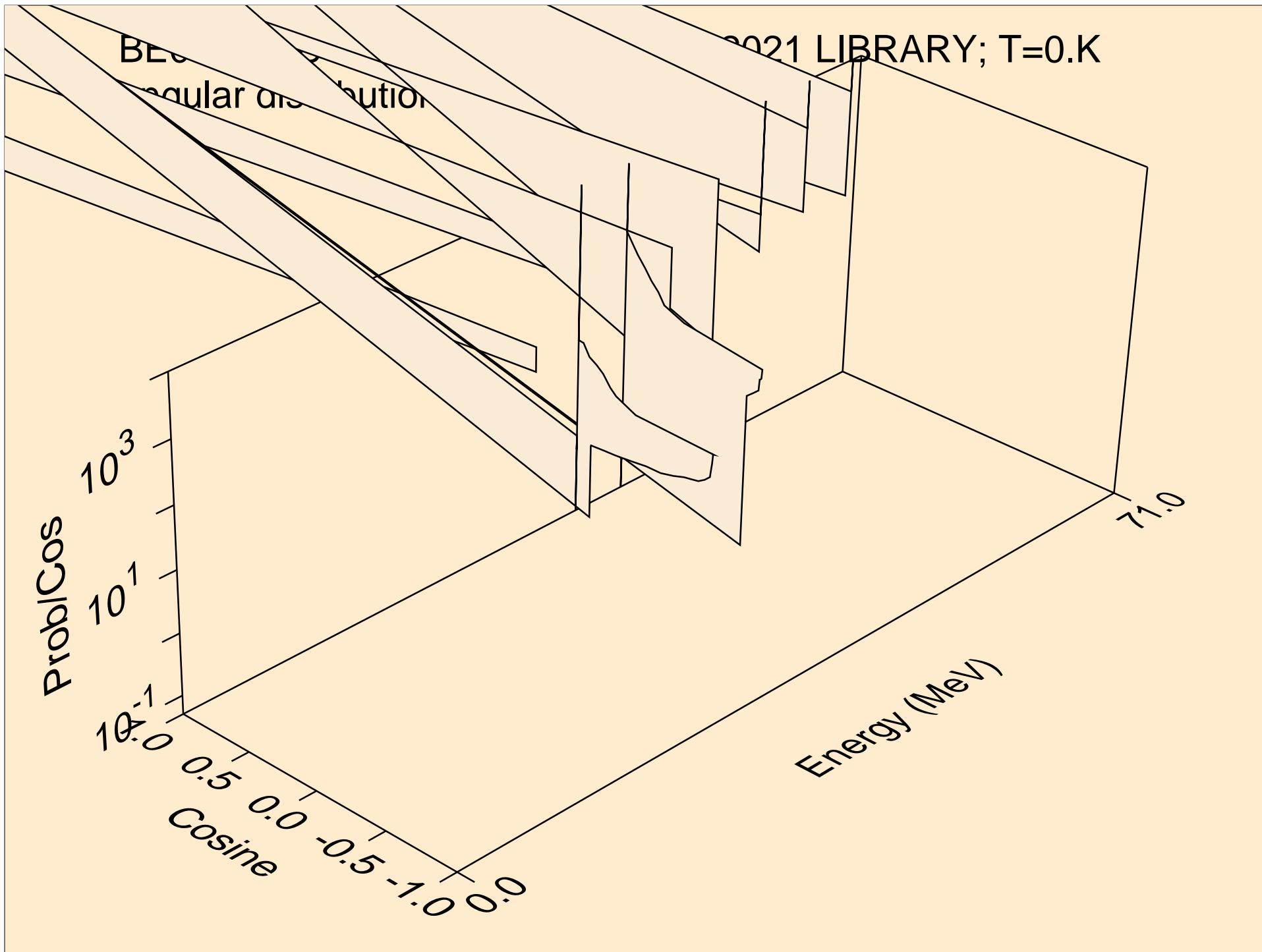

FILTERON ACER TENDL-2021 LIBRARY; T=0.K

Reaction for total 3he

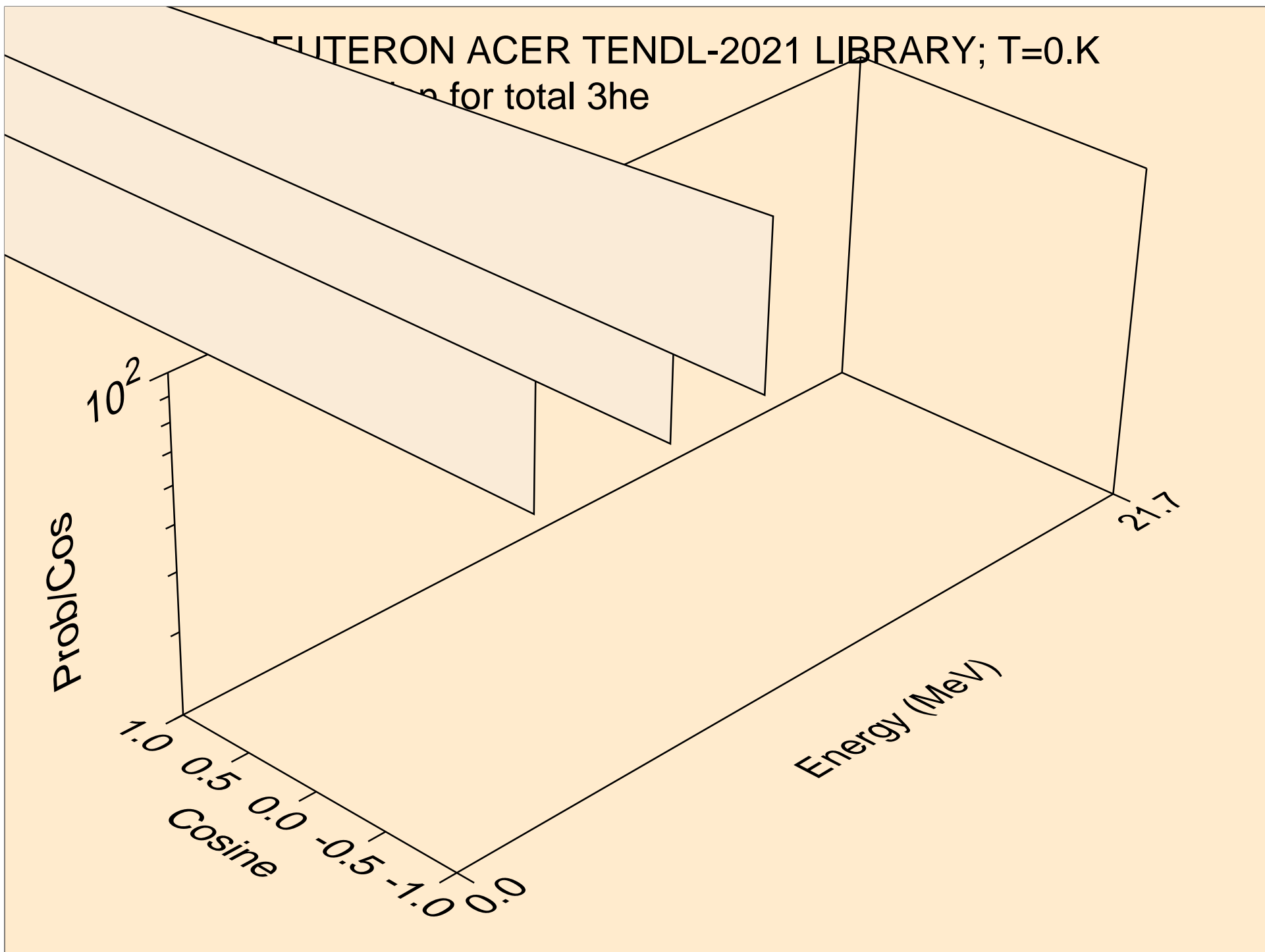

NEUTRON ACER TENDL-2021 LIBRARY; T=0.K
for total 3he

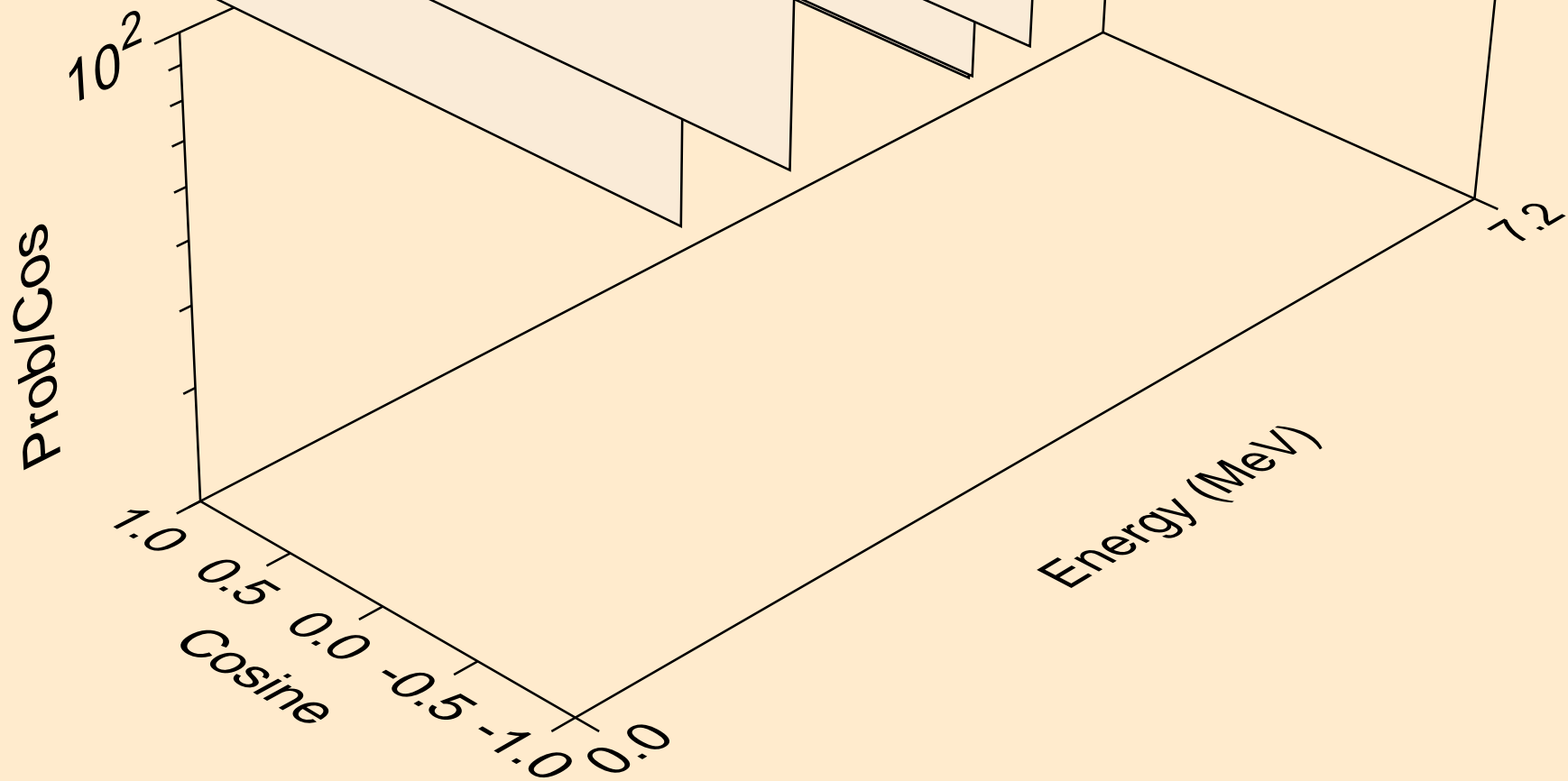

09 DEUTERON ACER TENDL-2021 LIBRARY; T=0.K
Distribution for total 3He

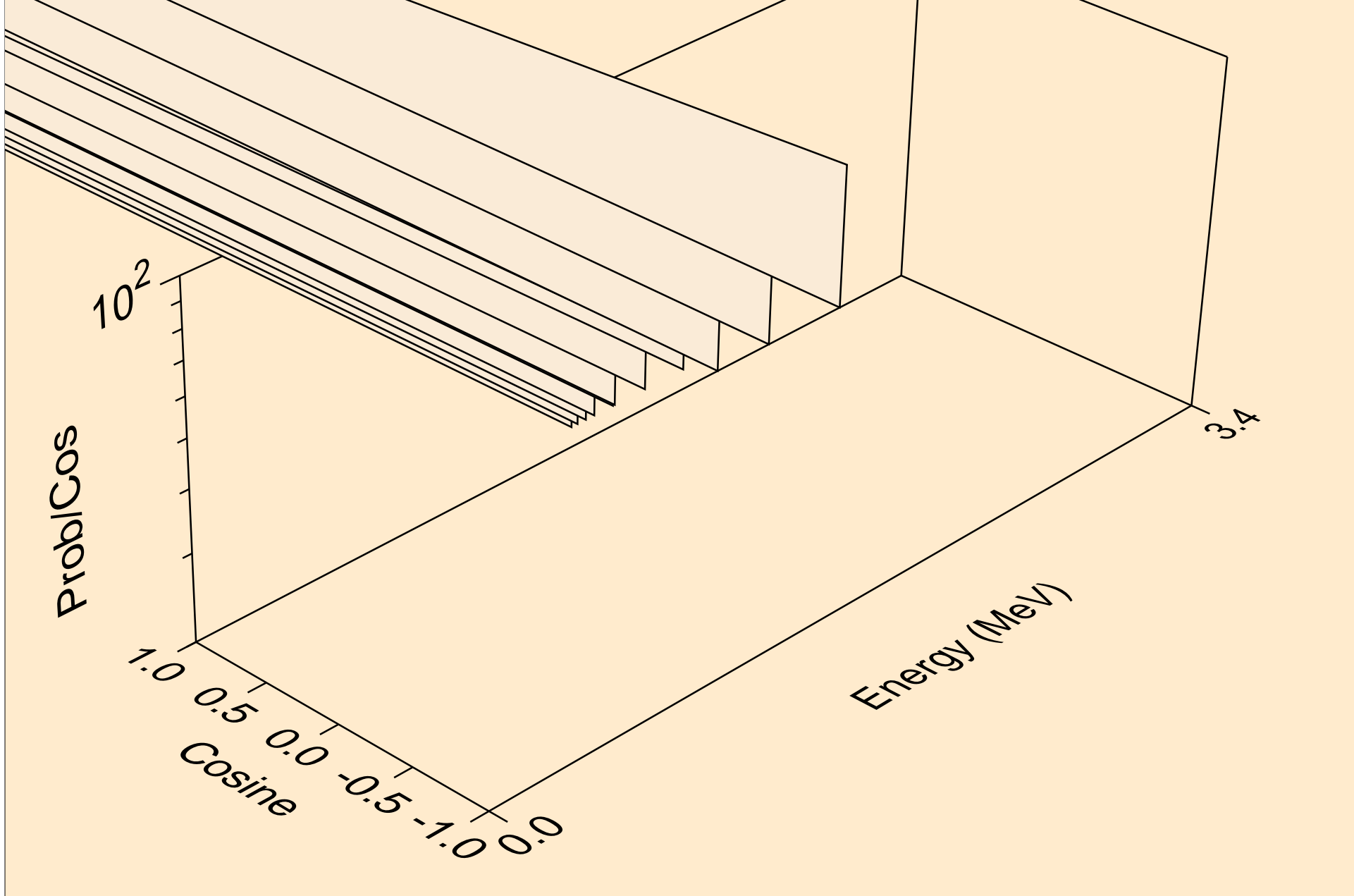

09 DEUTERON ACER TENDL-2021 LIBRARY; T=0.K
Distribution for total 3He

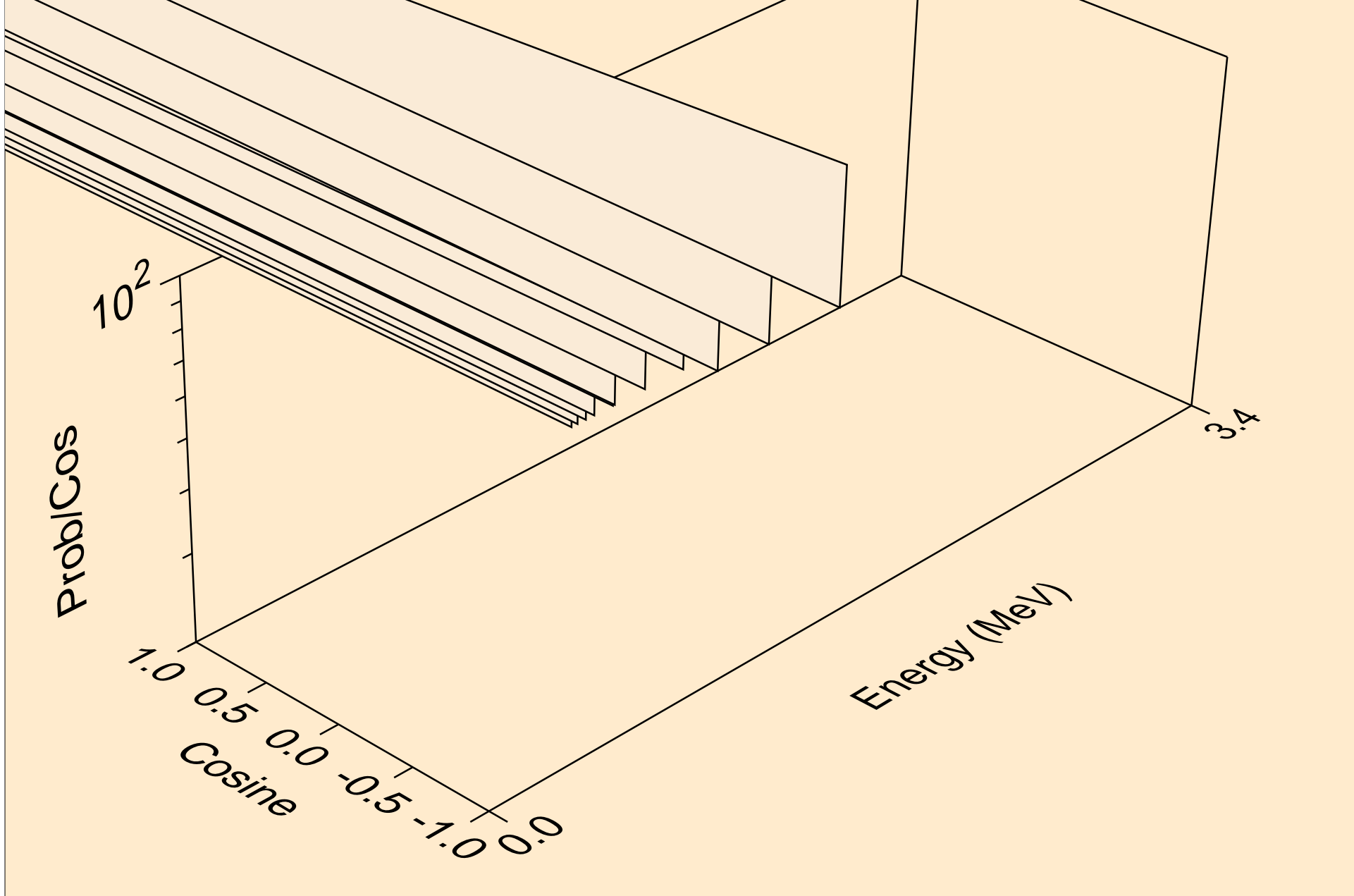

FERON ACER TENDL-2021 LIBRARY; T=0.K
total 3he

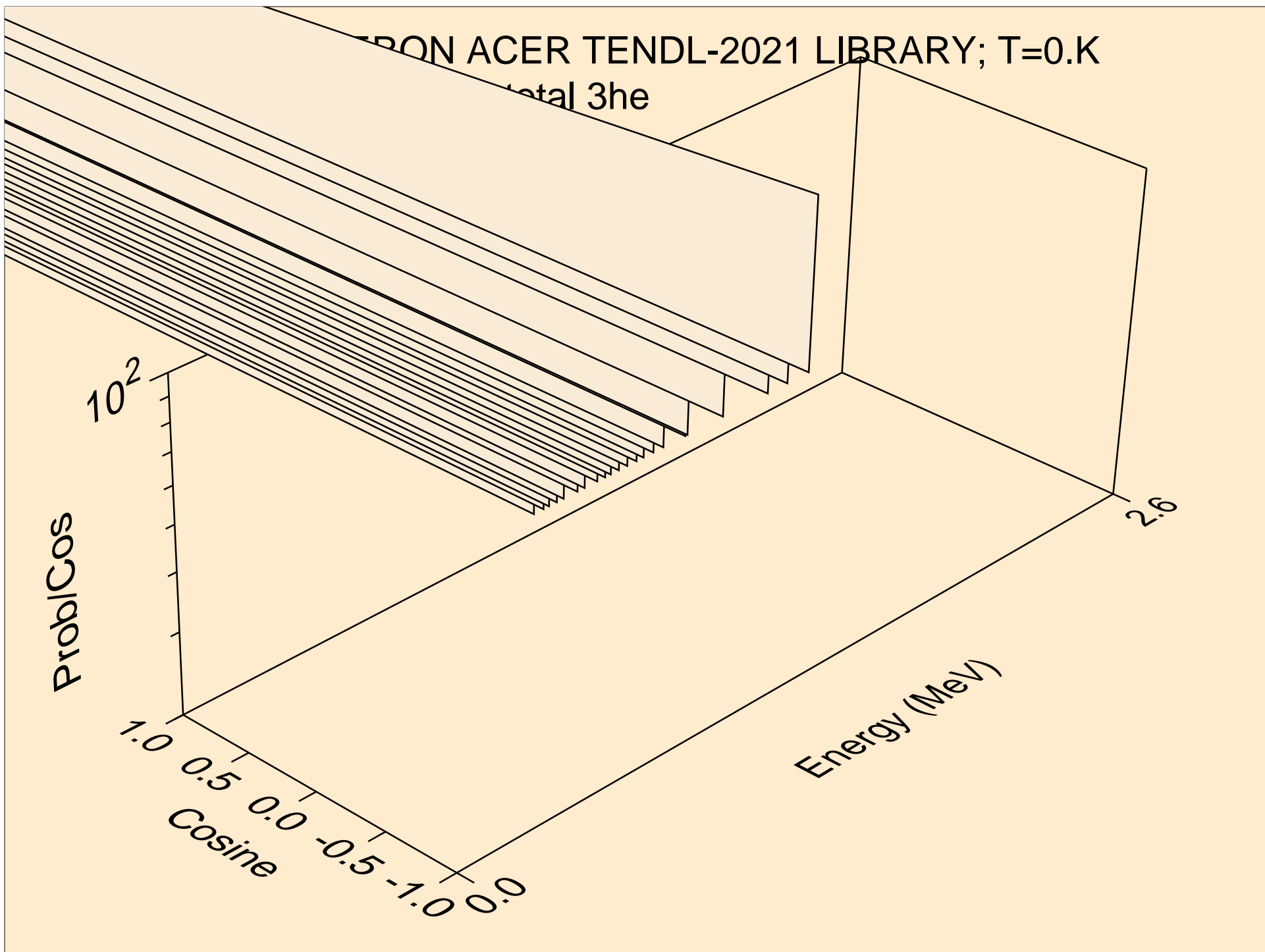

FERON ACER TENDL-2021 LIBRARY; T=0.K
total 3he

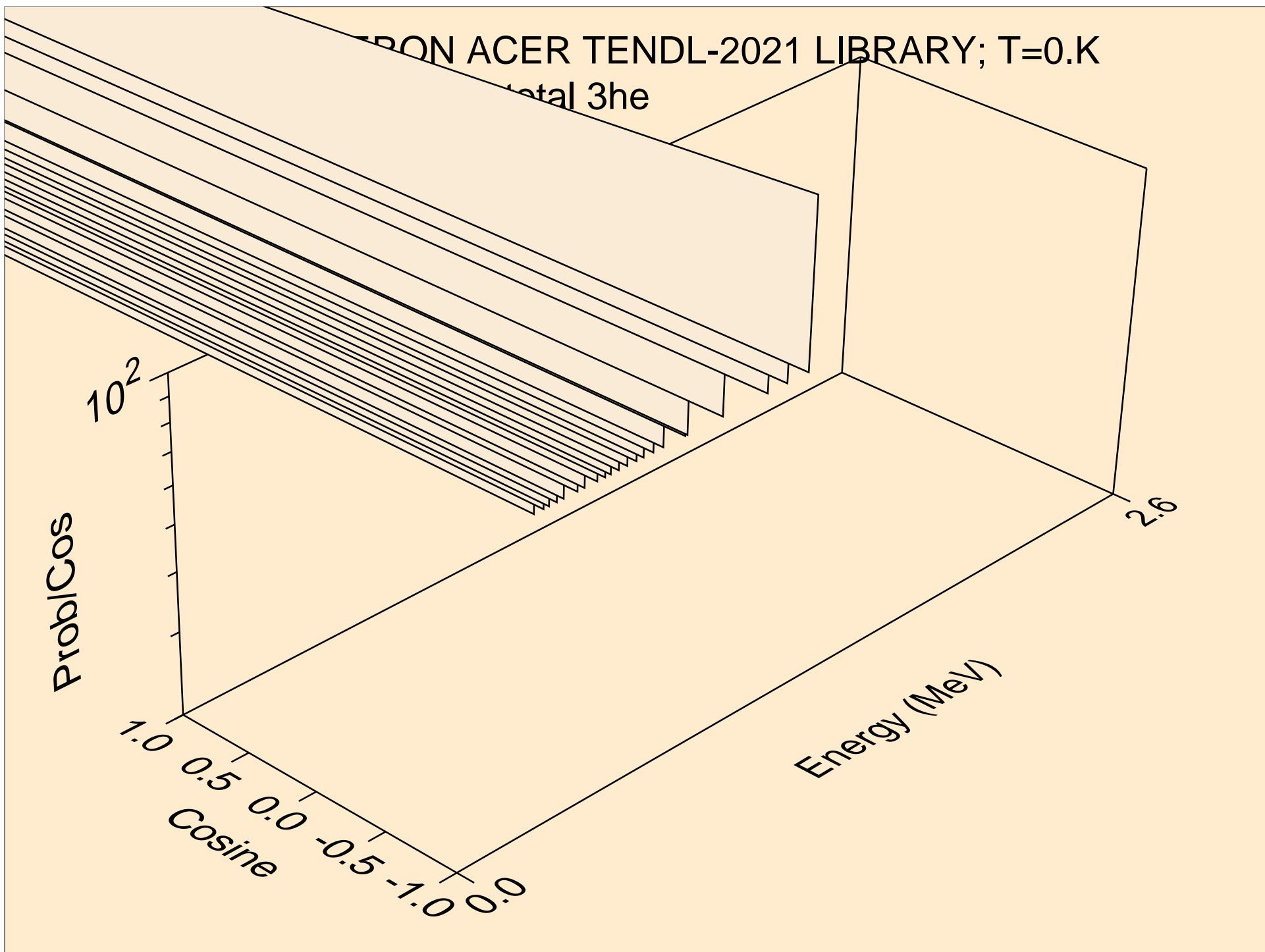

IRON ACER TENDL-2021 LIBRARY; T=0.K

total 3he

ans

