

# BH274 DEUTERON ACER TENDL-2021 LIBRARY; T=0.K

## Principal cross sections

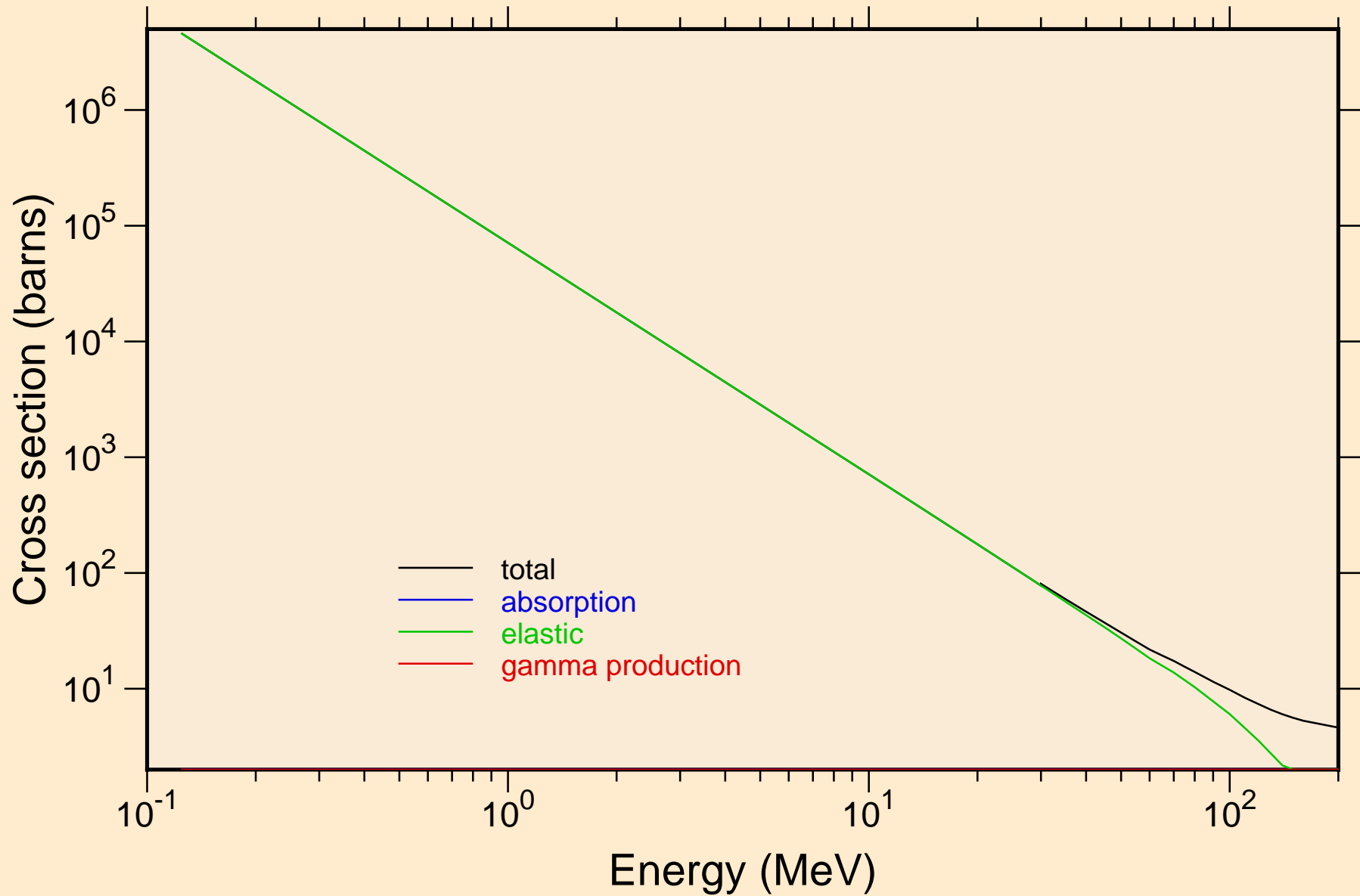

BH274 DEUTERON ACER TENDL-2021 LIBRARY; T=0.K  
Heating

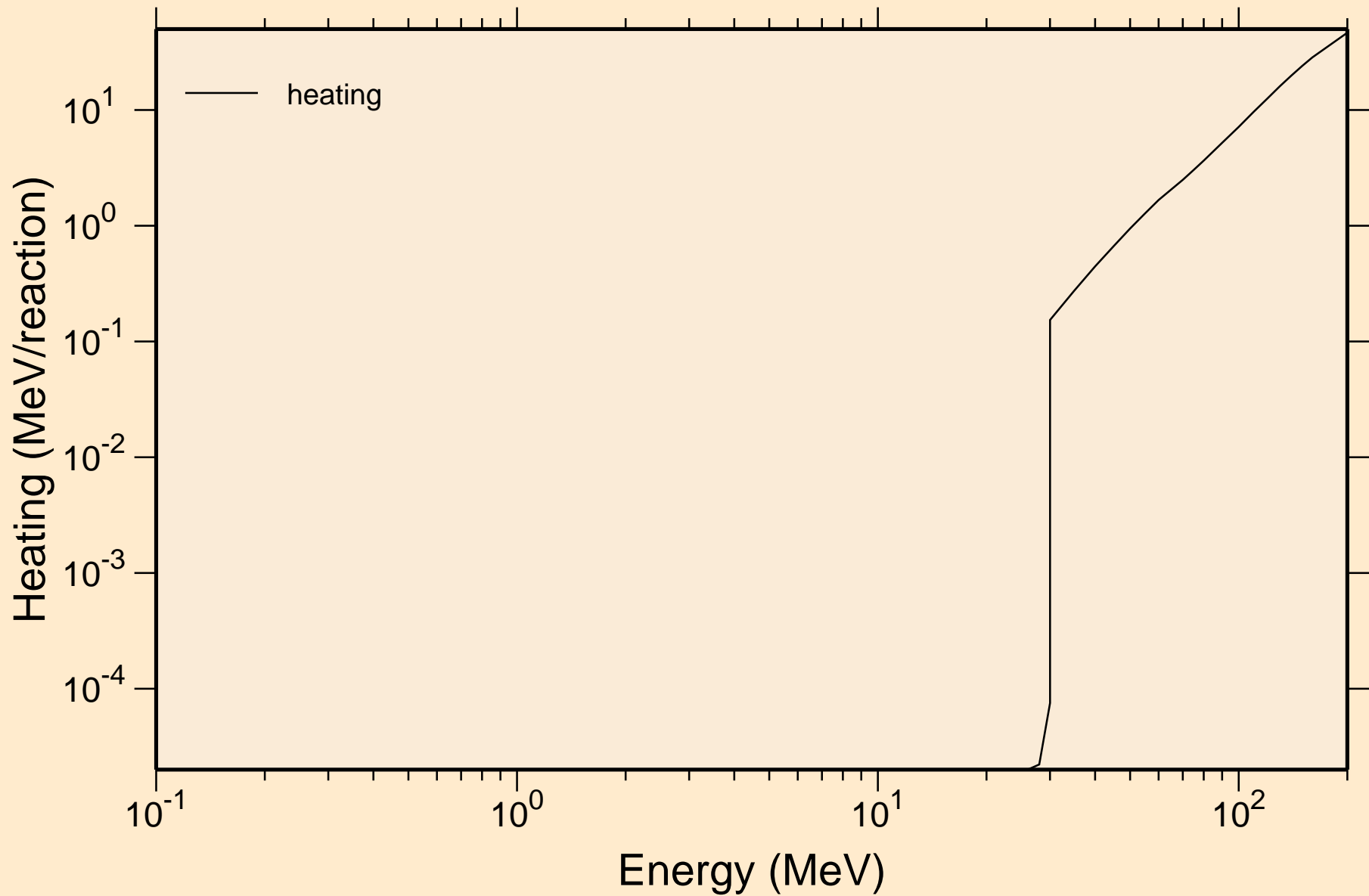

BH274 DEUTERON ACER TENDL-2021 LIBRARY; T=0.K  
Principal cross sections

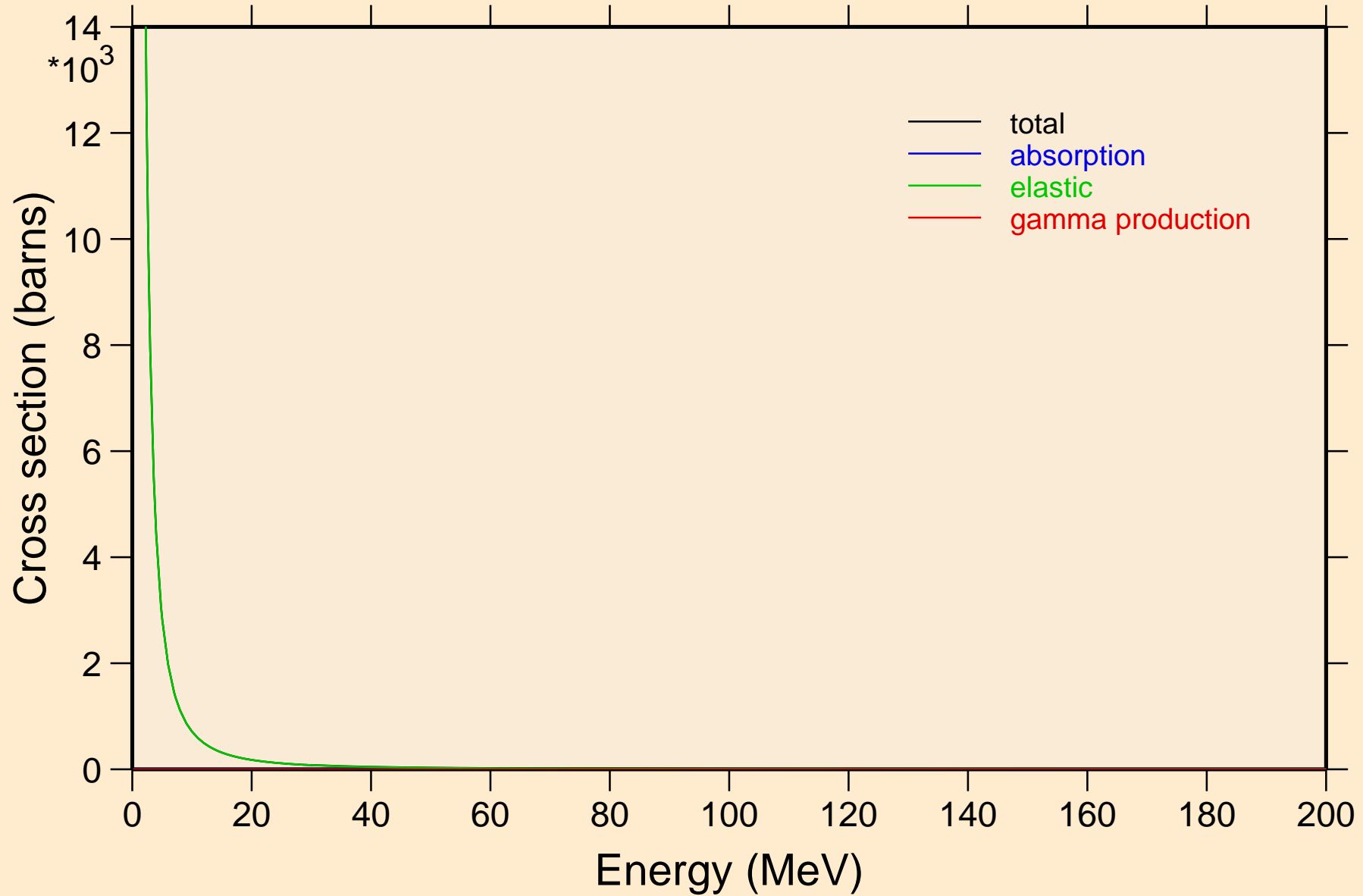

# BH274 DEUTERON ACER TENDL-2021 LIBRARY; T=0.K

## Heating

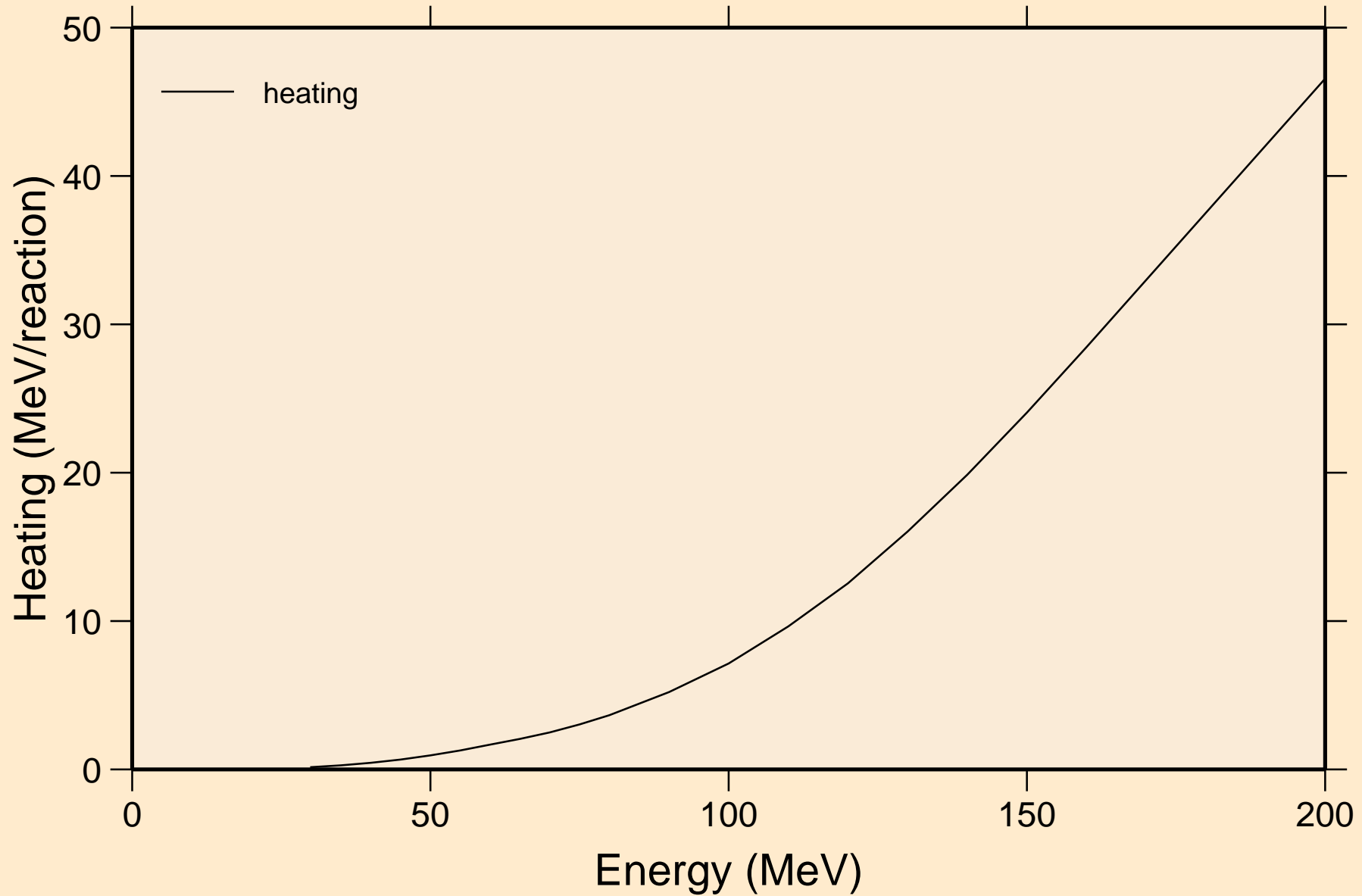

BH274 DEUTERON ACER TENDL-2021 LIBRARY; T=0.K  
Threshold reactions

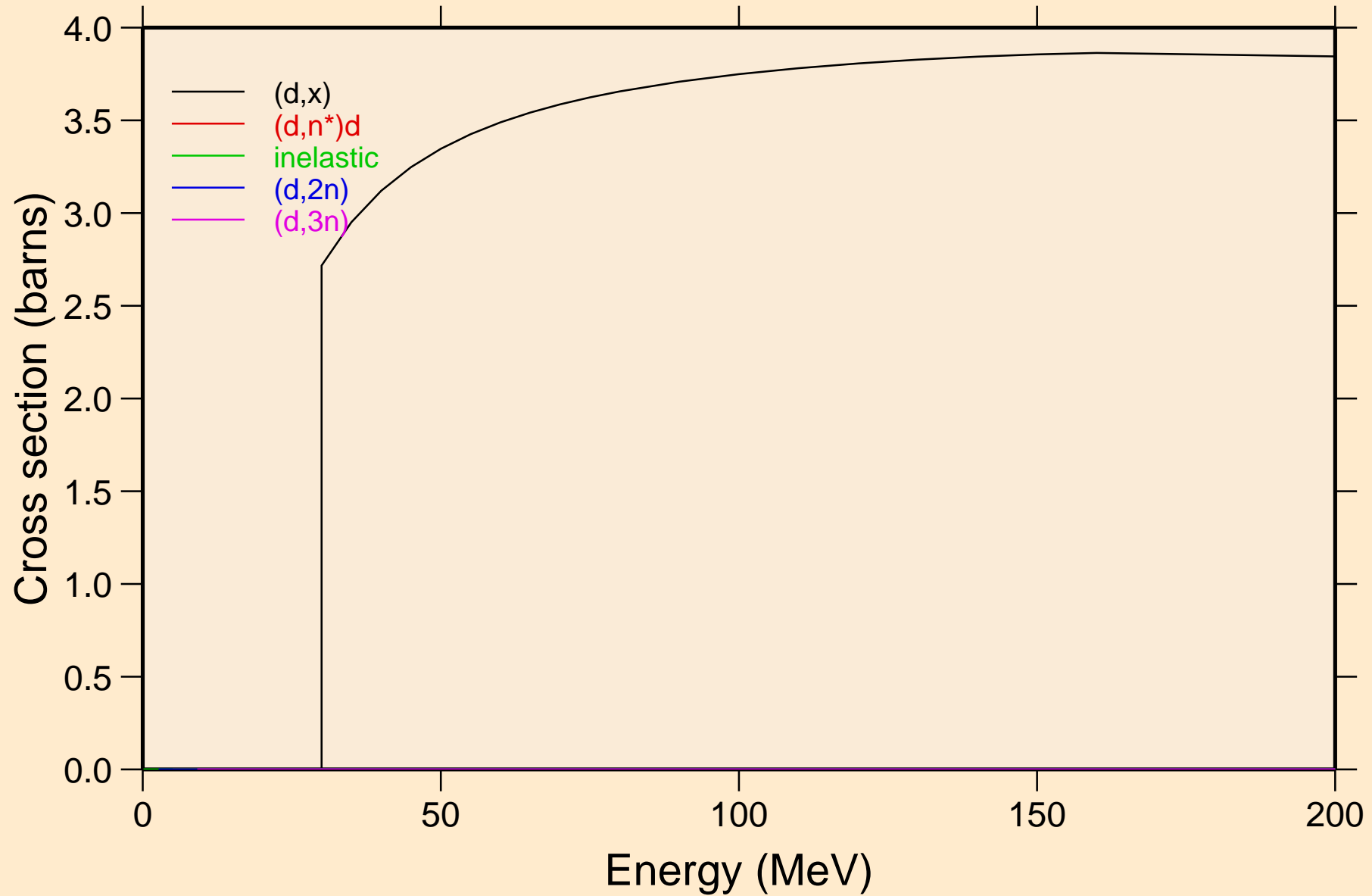

# BH274 DEUTERON ACER TENDL-2021 LIBRARY; T=0.K

## Threshold reactions

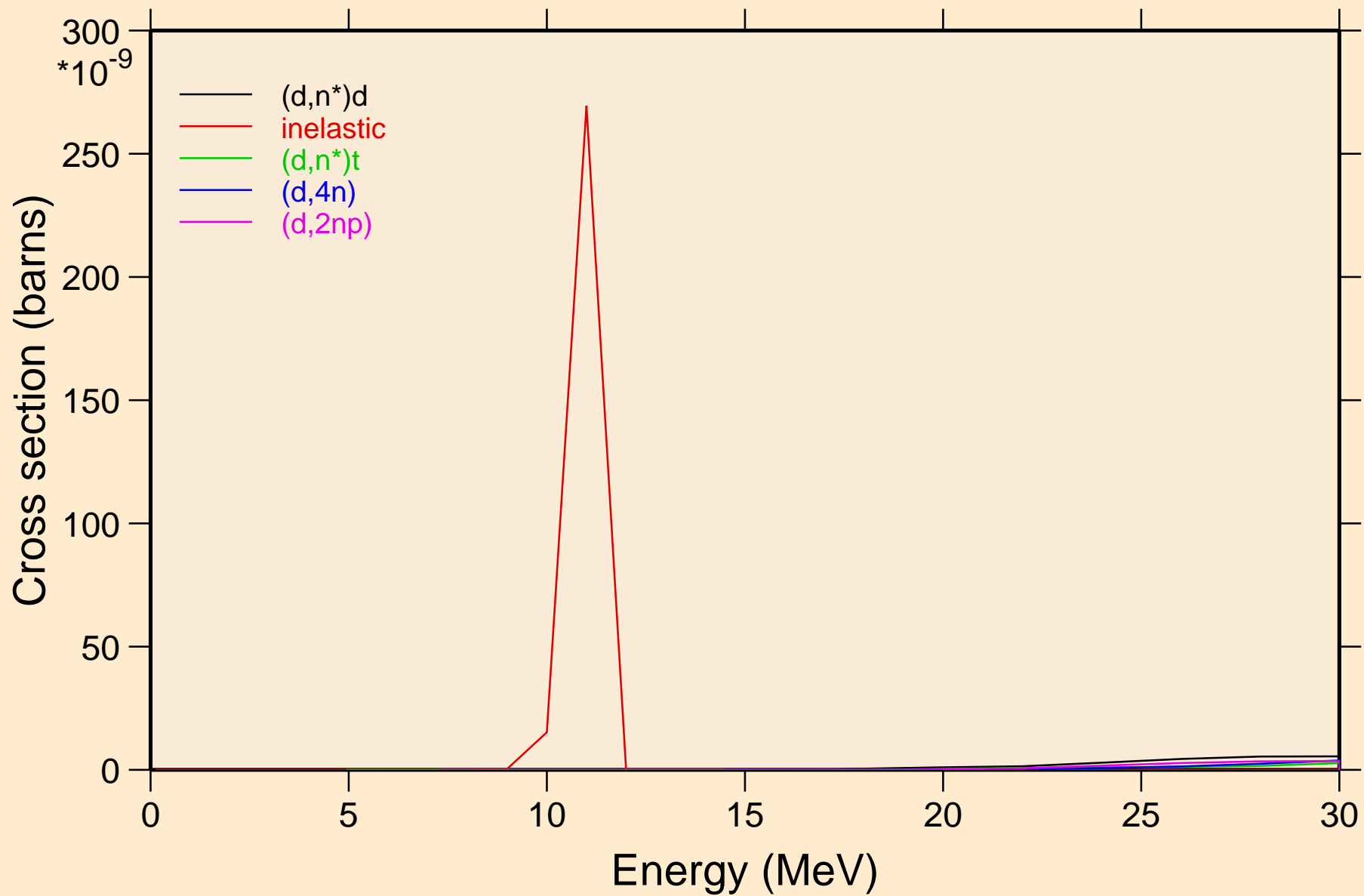

# BH274 DEUTERON ACER TENDL-2021 LIBRARY; T=0.K

## Threshold reactions

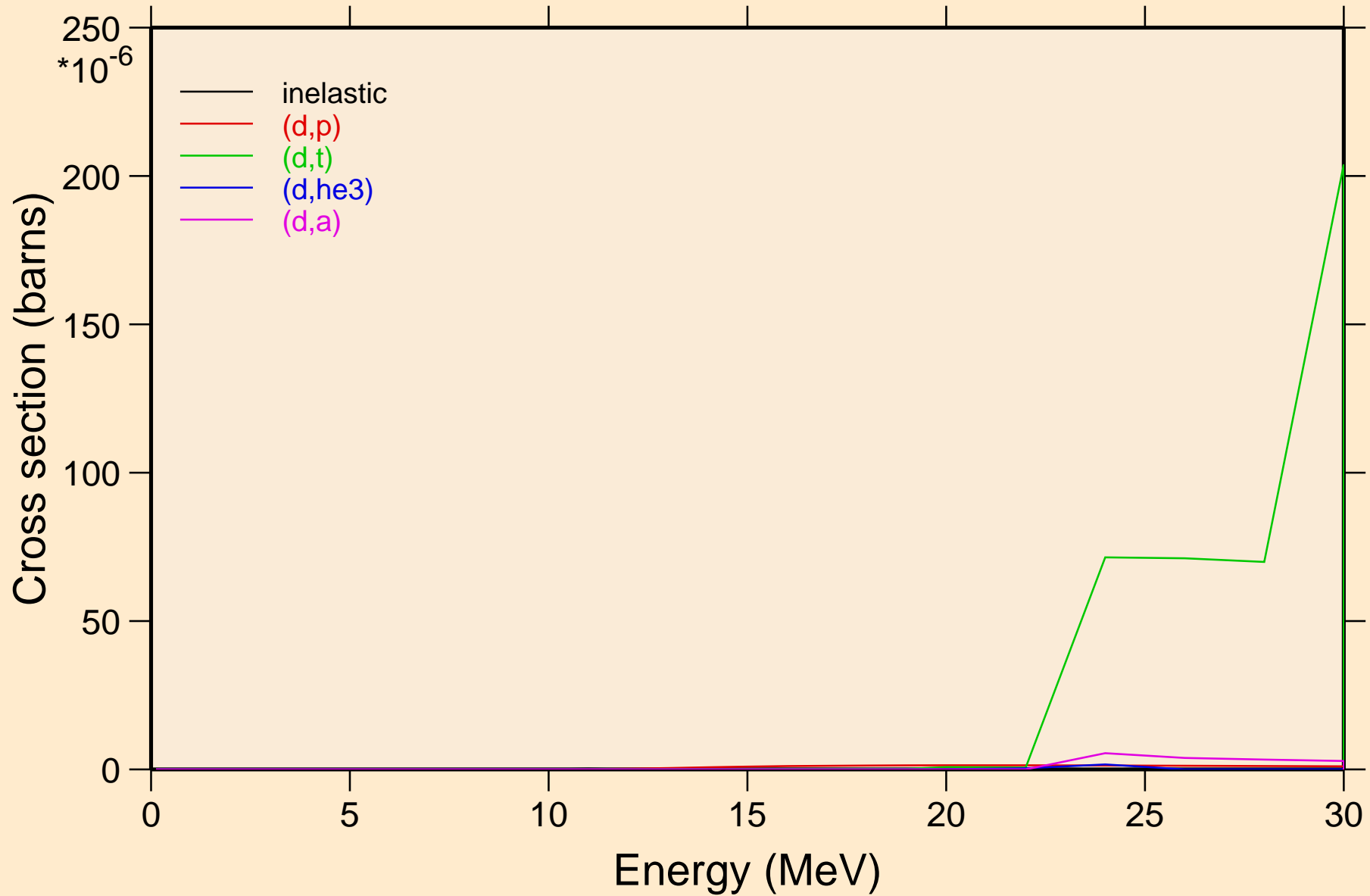

BH274 DEUTERON ACER TENDL-2021 LIBRARY; T=0.K  
Threshold reactions

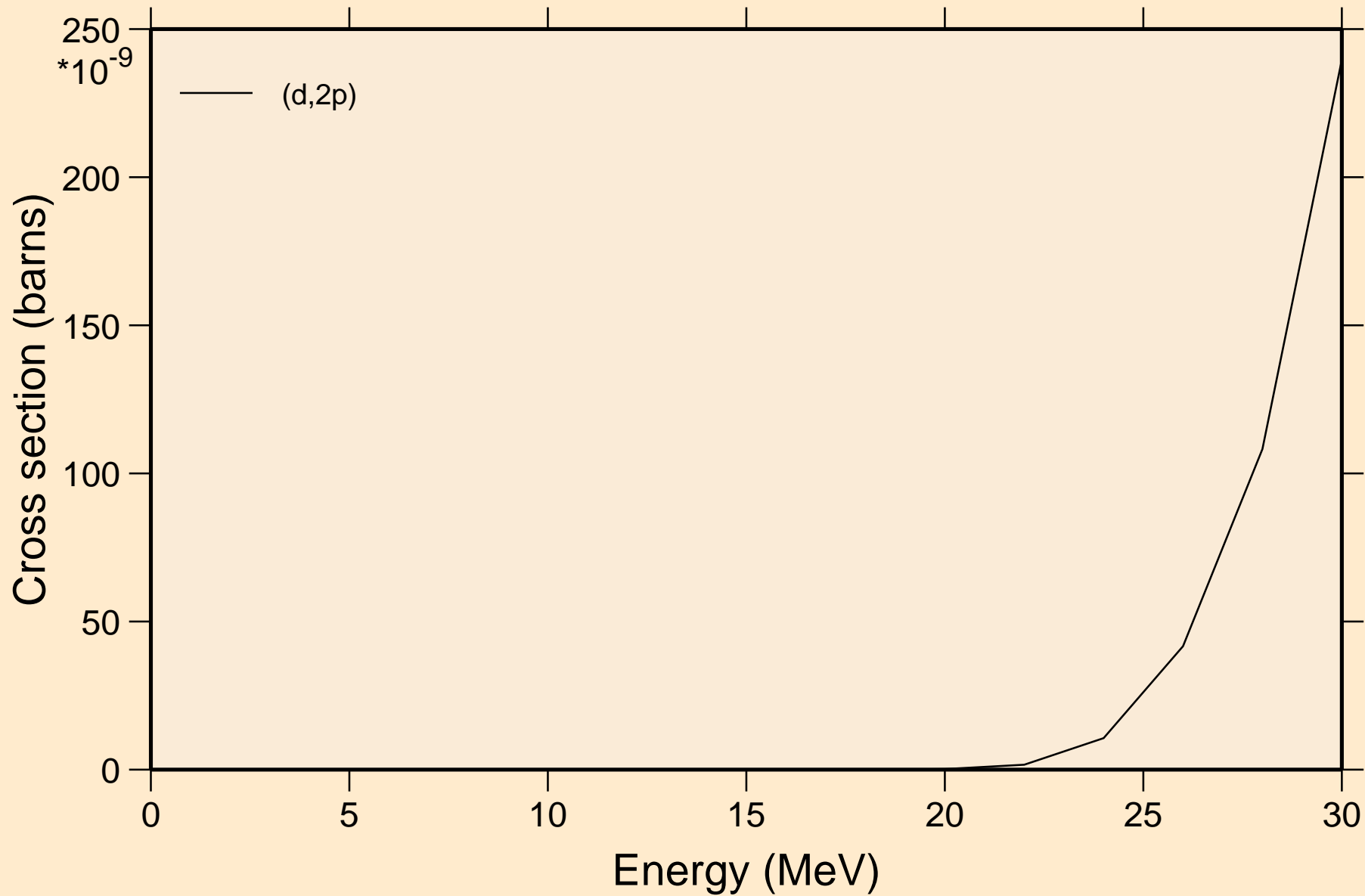



BH274 DEUTERON ACER TENDL-2021 LIBRARY; T=0.K  
angular distribution for elastic

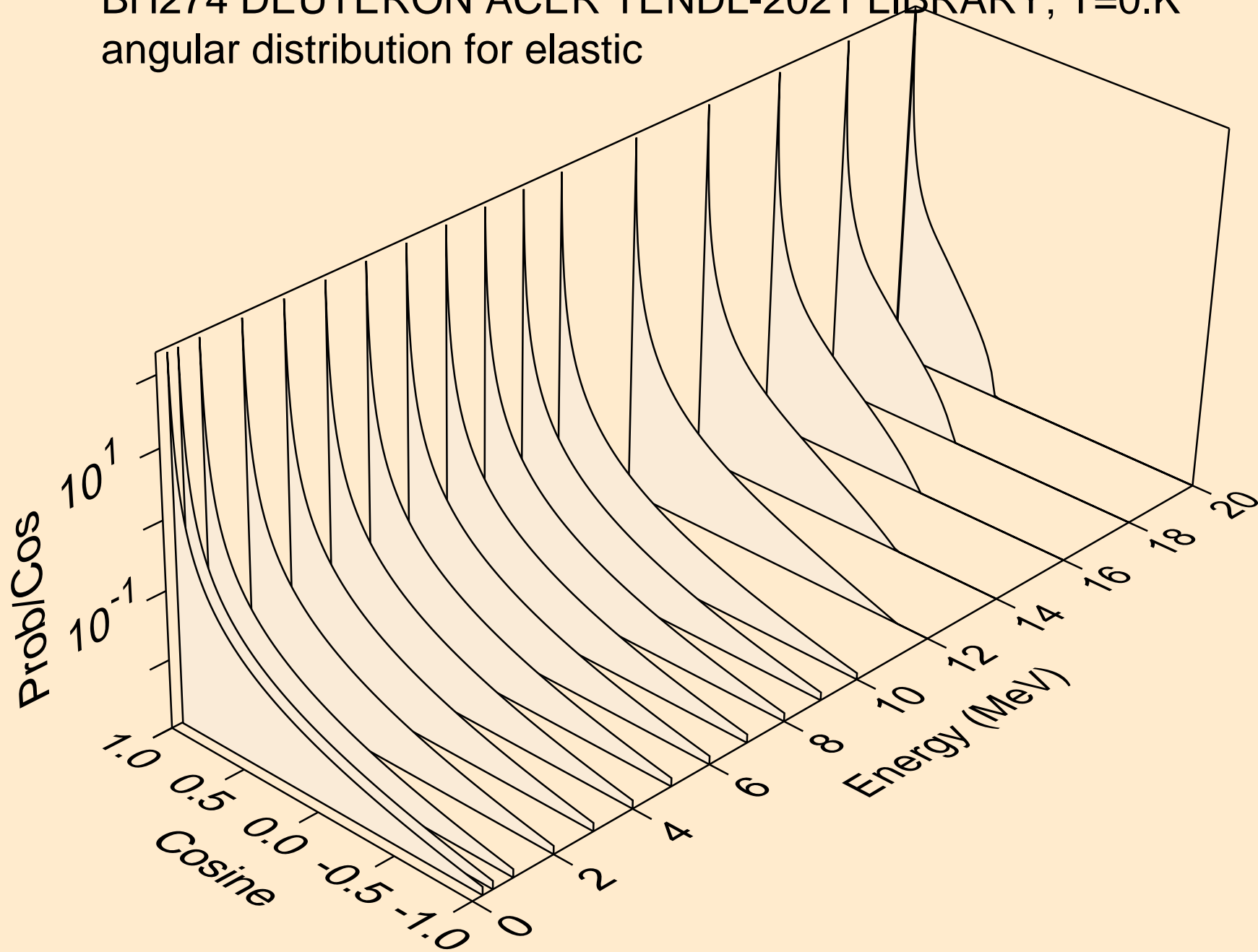

BH274 DEUTERON ACER TENDL-2021 LIBRARY; T=0.K  
angular distribution for elastic

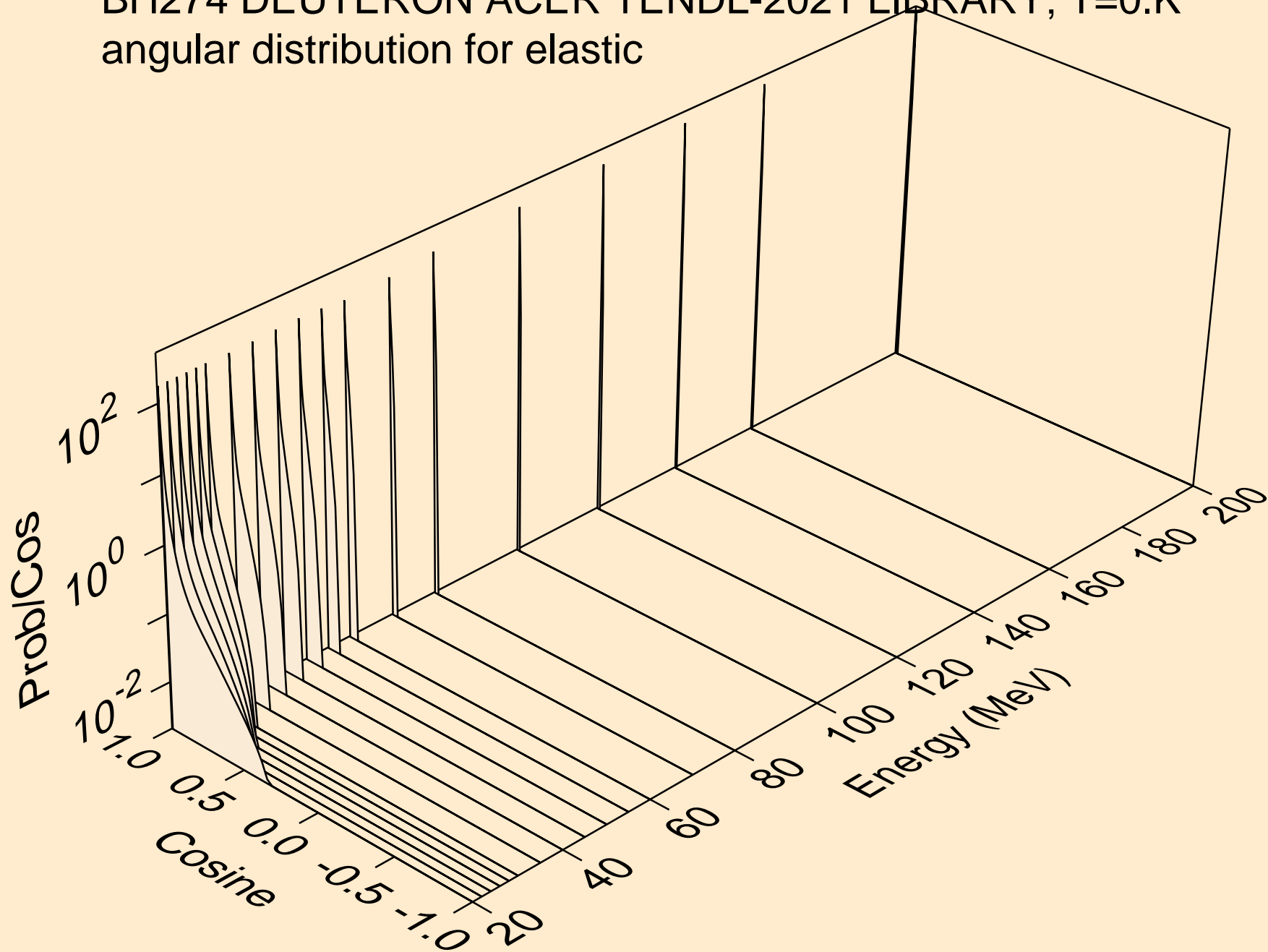

BH274 DEUTERON ACER TENDL-2021 LIBRARY; T=0.K  
Deuteron emission for (d,x)

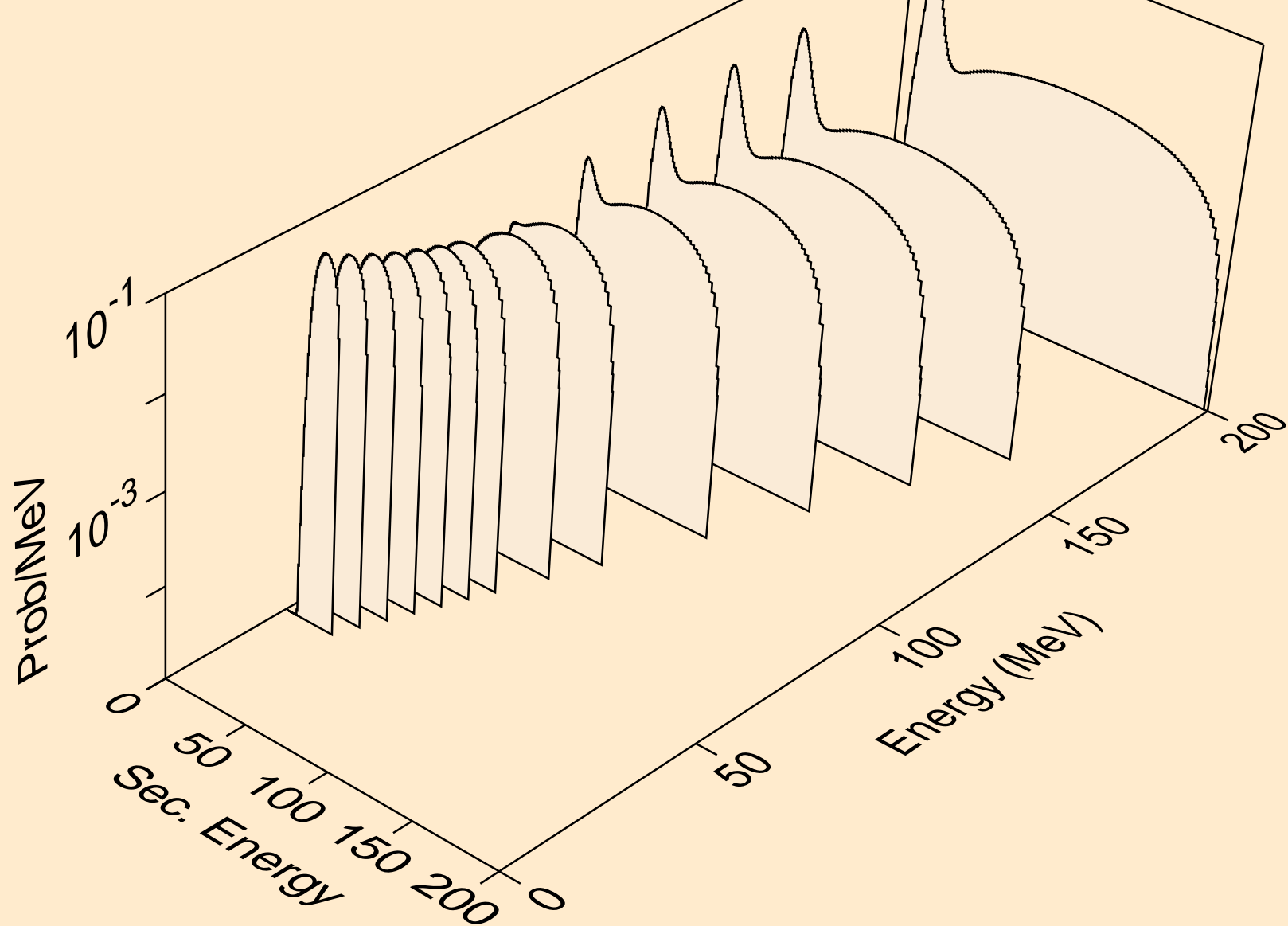

BH274 DEUTERON ACER TENDL-2021 LIBRARY; T=0.K  
Deuteron emission for (d,n\*)d

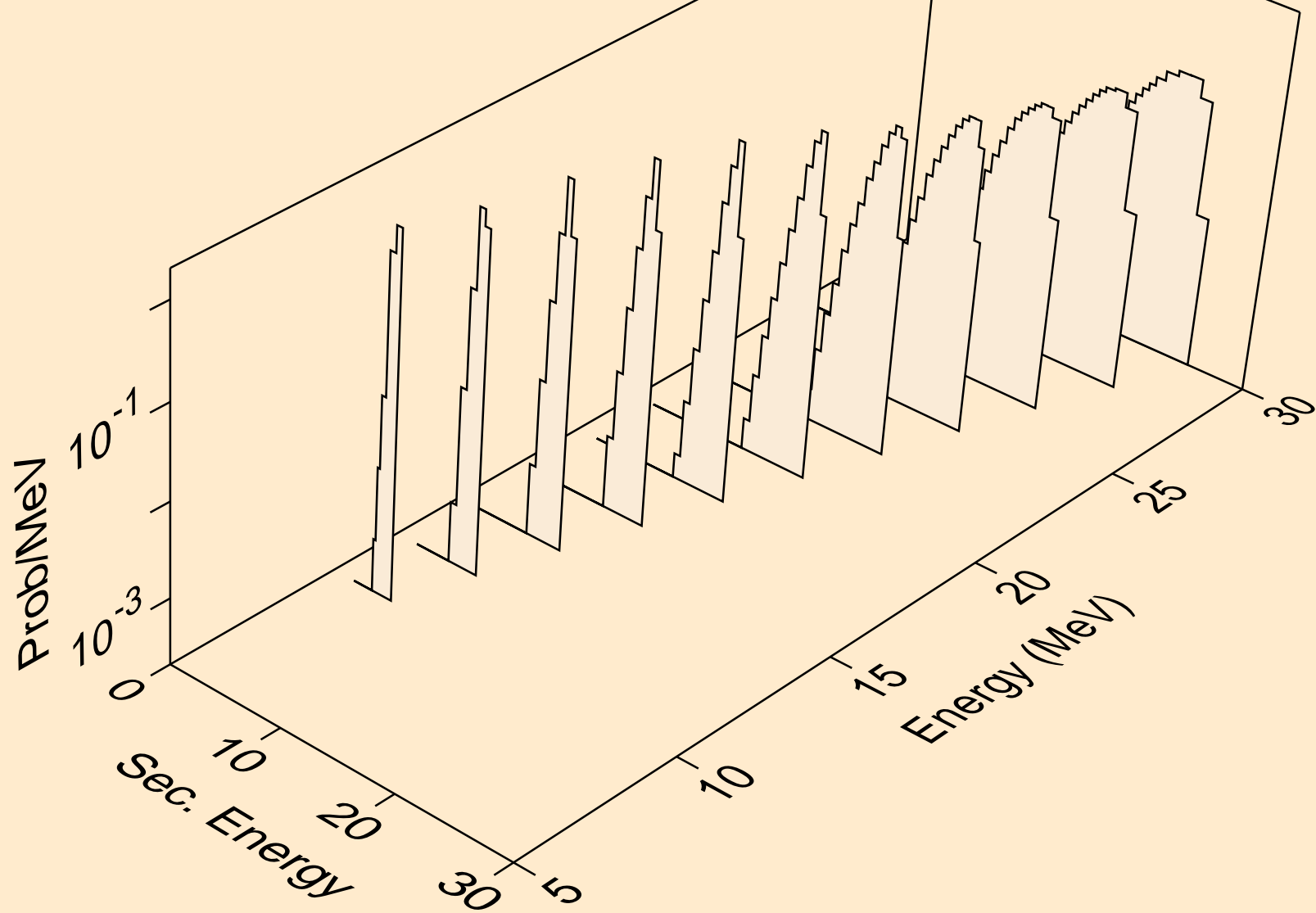

BH274 DEUTERON ACER TENDL-2021 LIBRARY; T=0.K  
Deuteron emission for inelastic

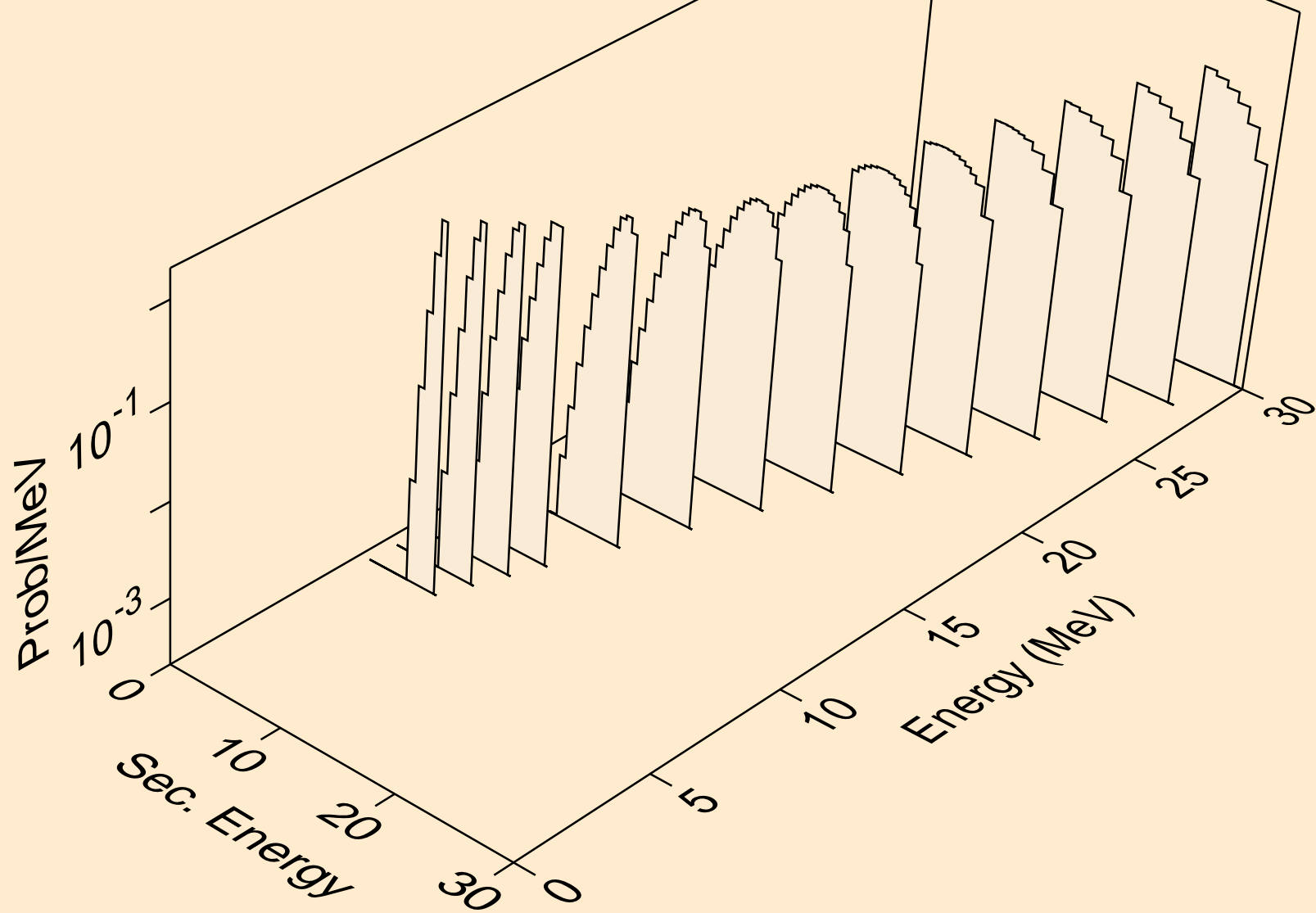

BH274 DEUTERON ACER TENDL-2021 LIBRARY; T=0.K  
Photon emission for (z,n)

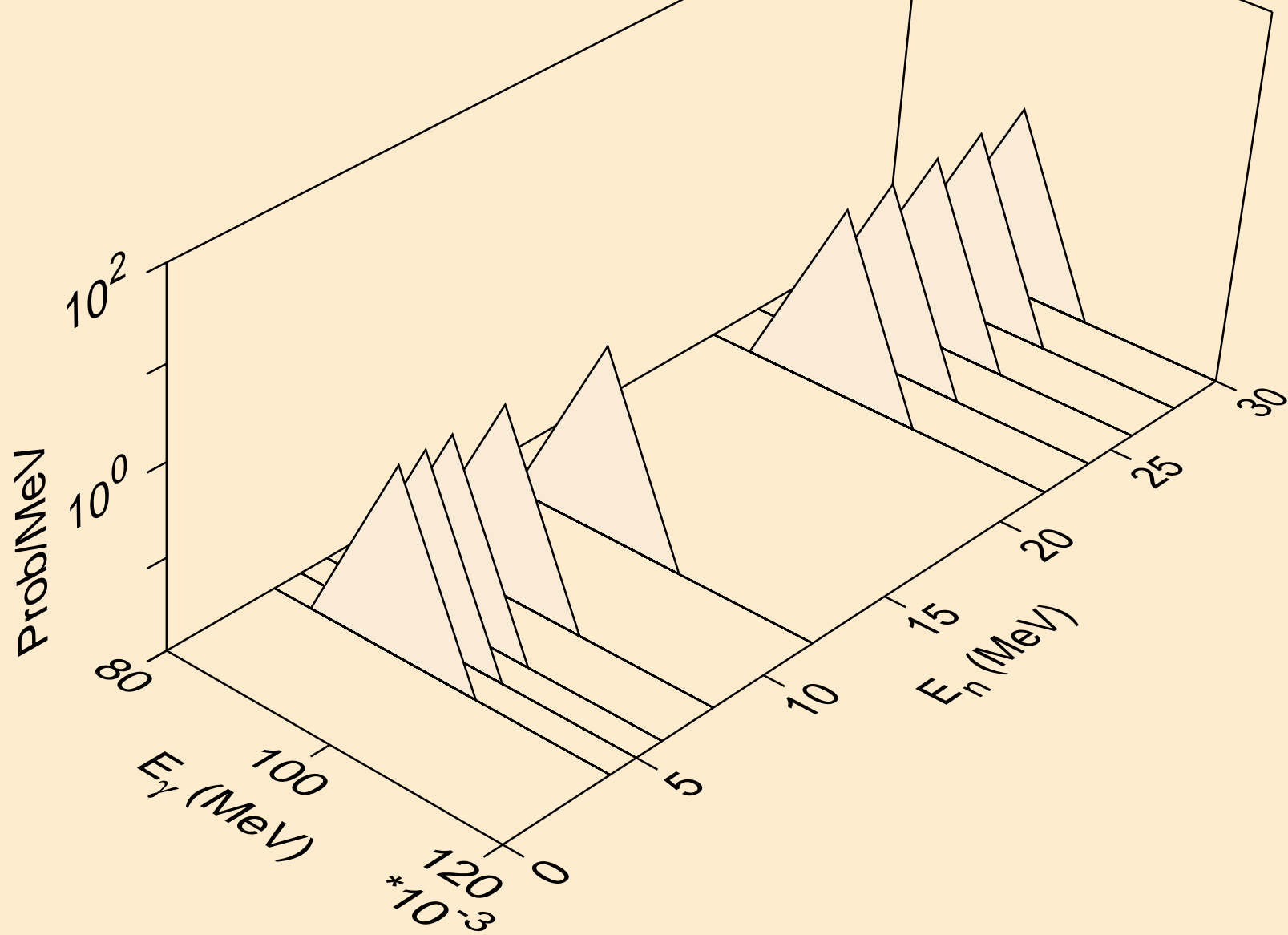

BH274 DEUTERON ACER TENDL-2021 LIBRARY; T=0.K  
Photon emission for (n,x)

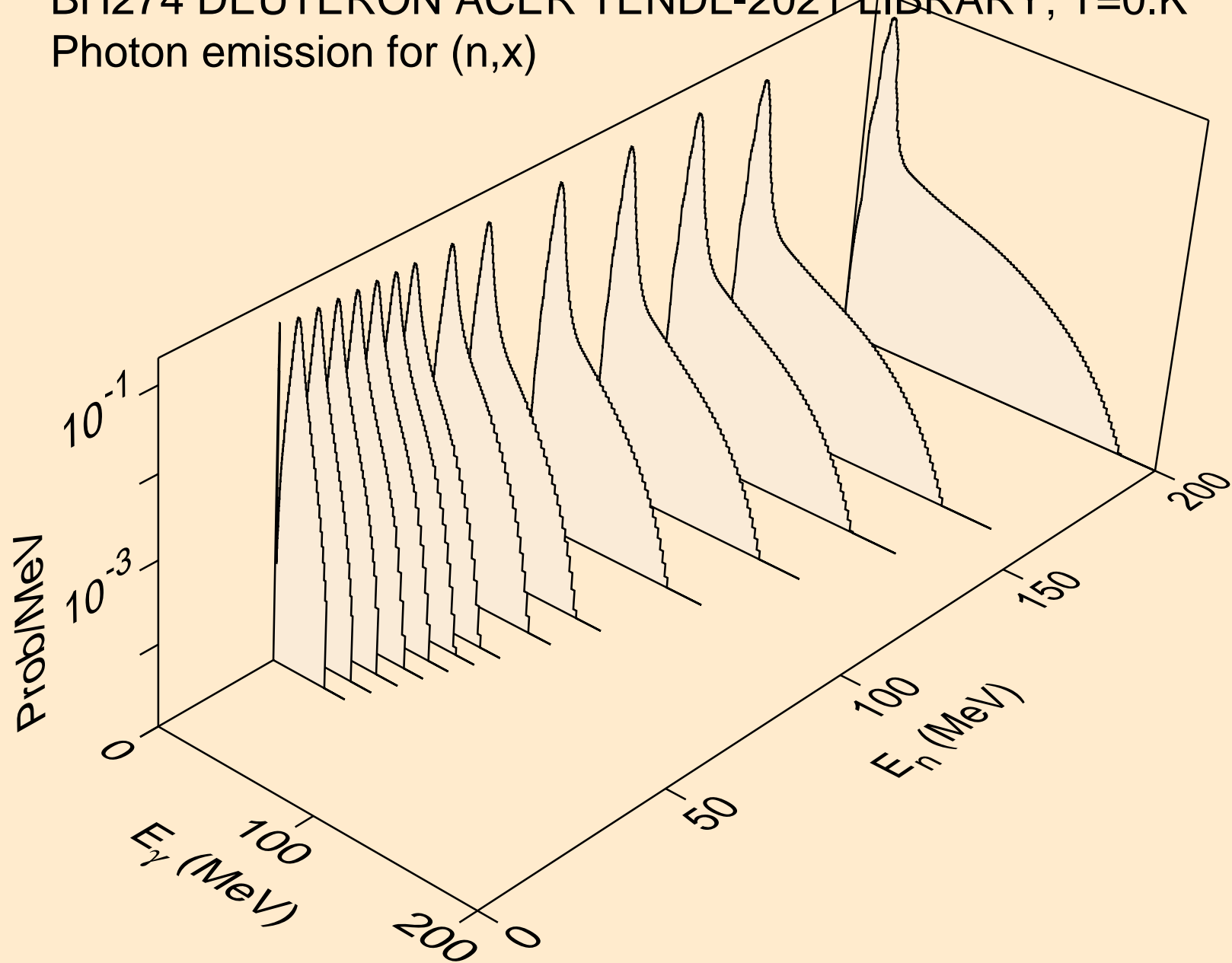

BH274 DEUTERON ACER TENDL-2021 LIBRARY; T=0.K  
Photon emission for (n,2n)

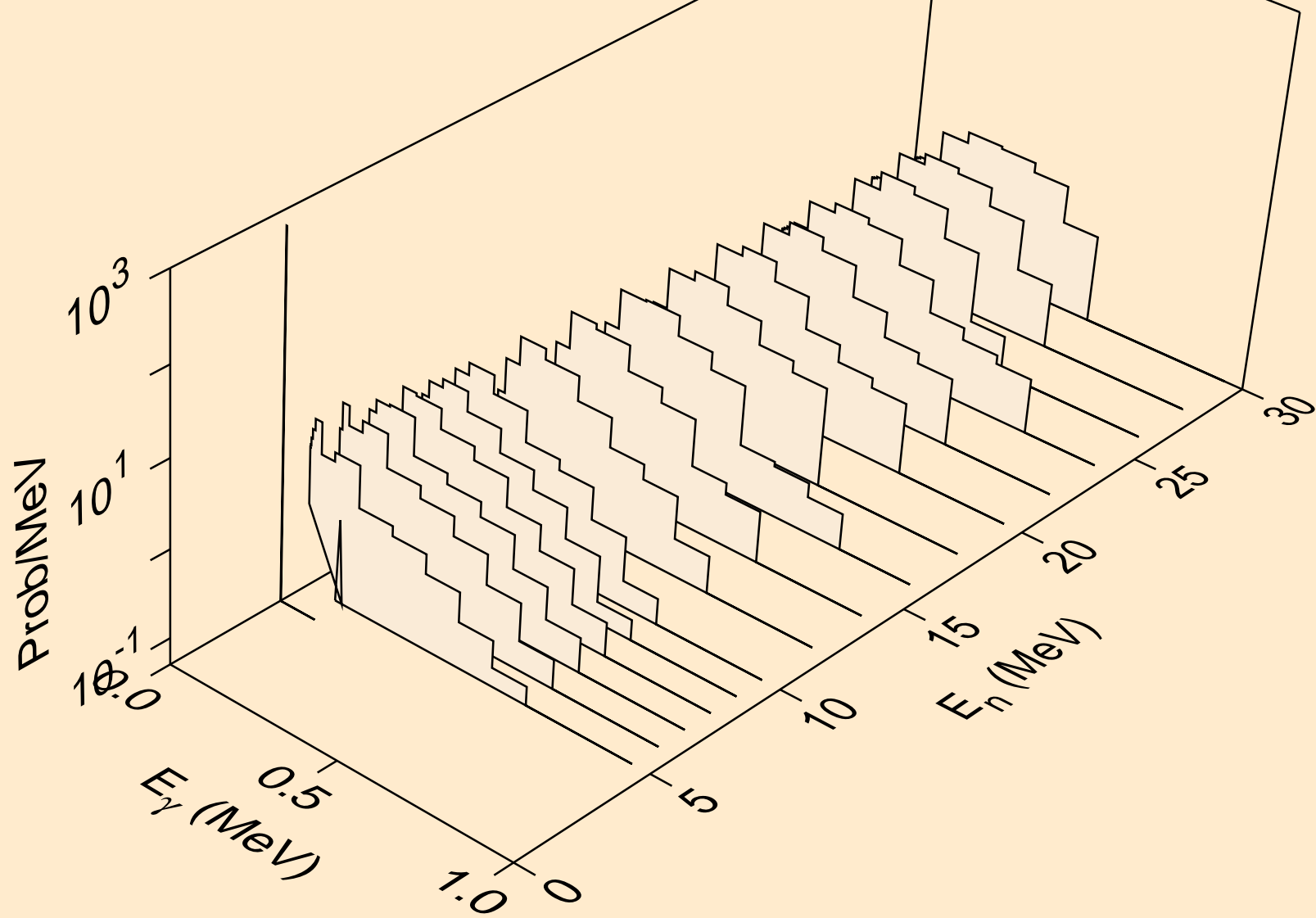



BH274 DEUTERON ACER TENDL-2021 LIBRARY; T=0.K  
Photon emission for (n,3n)

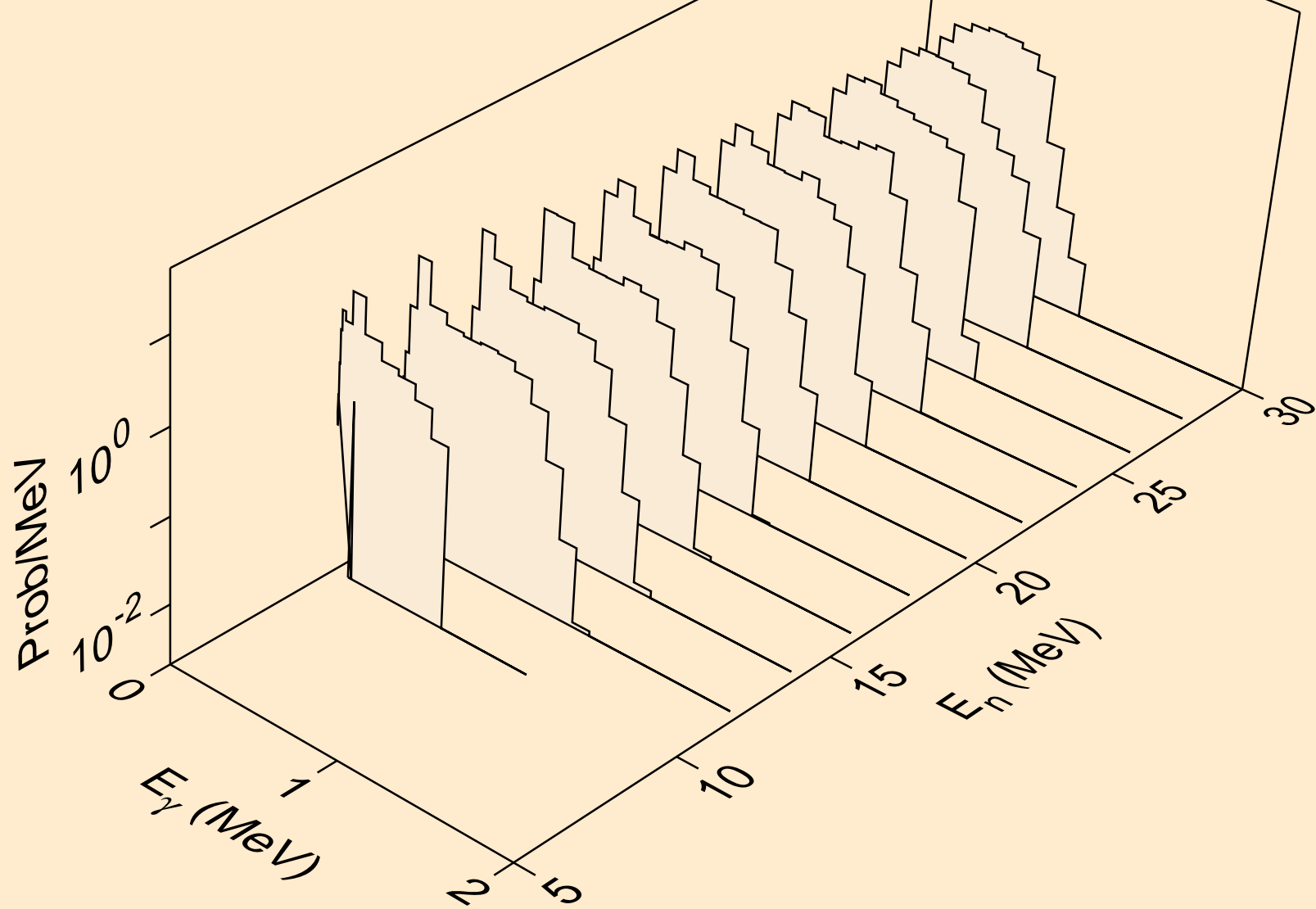

BH274 DEUTERON ACER TENDL-2021 LIBRARY; T=0.K  
Photon emission for (n,n\*)d

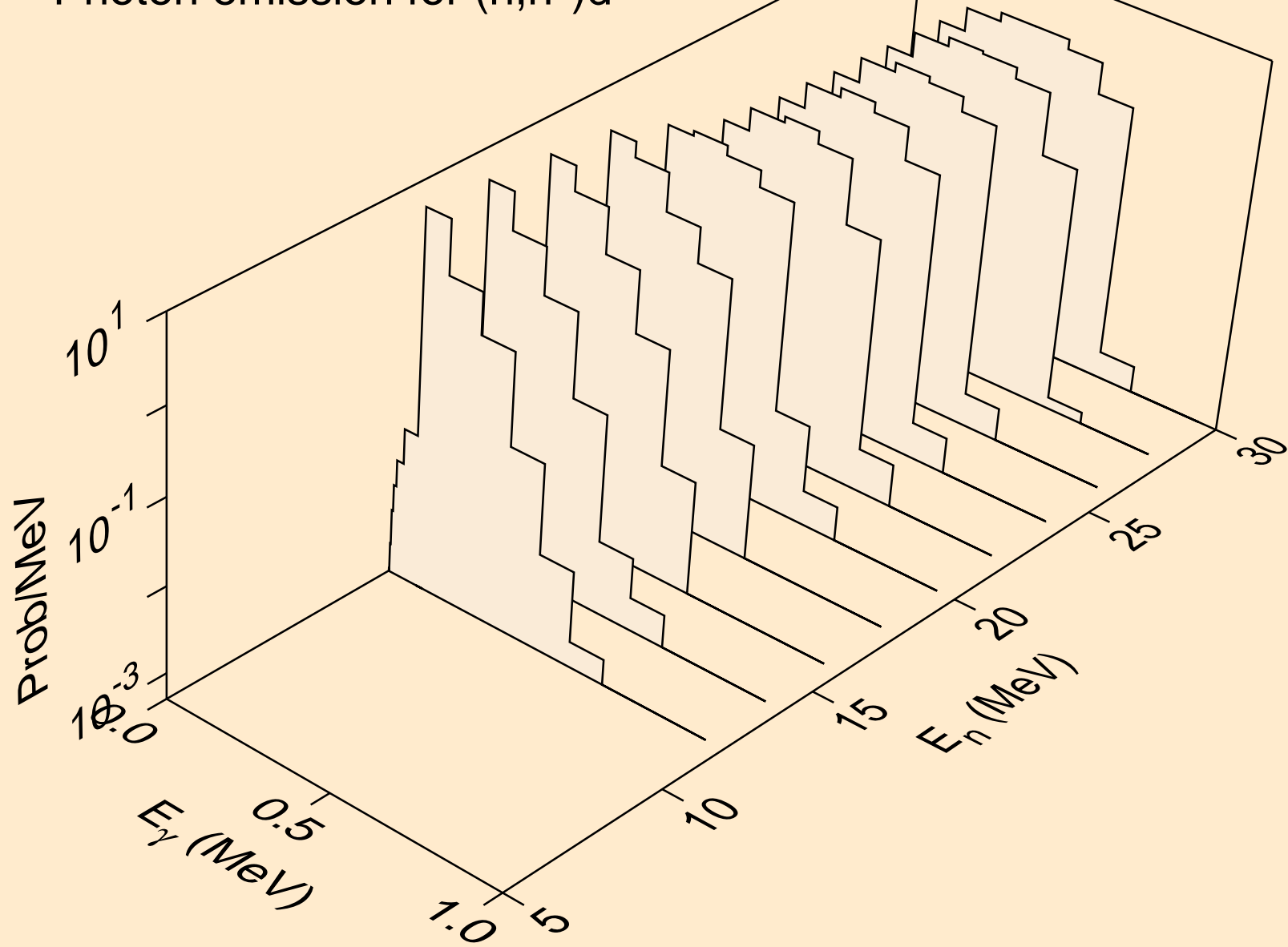

BH274 DEUTERON ACER TENDL-2021 LIBRARY; T=0.K  
Photon emission for (n,n\*)t

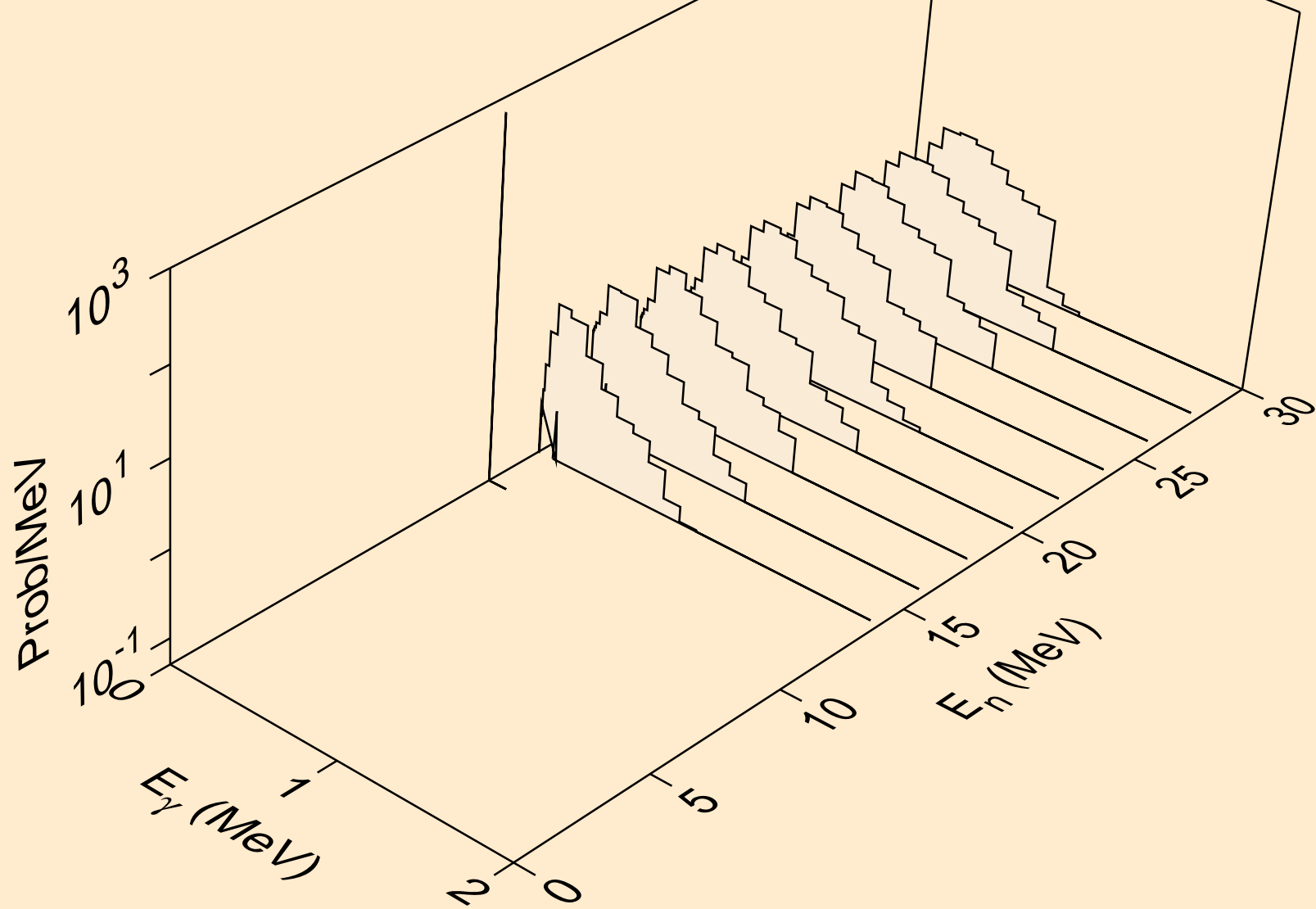

BH274 DEUTERON ACER TENDL-2021 LIBRARY; T=0.K  
Photon emission for (n,4n)

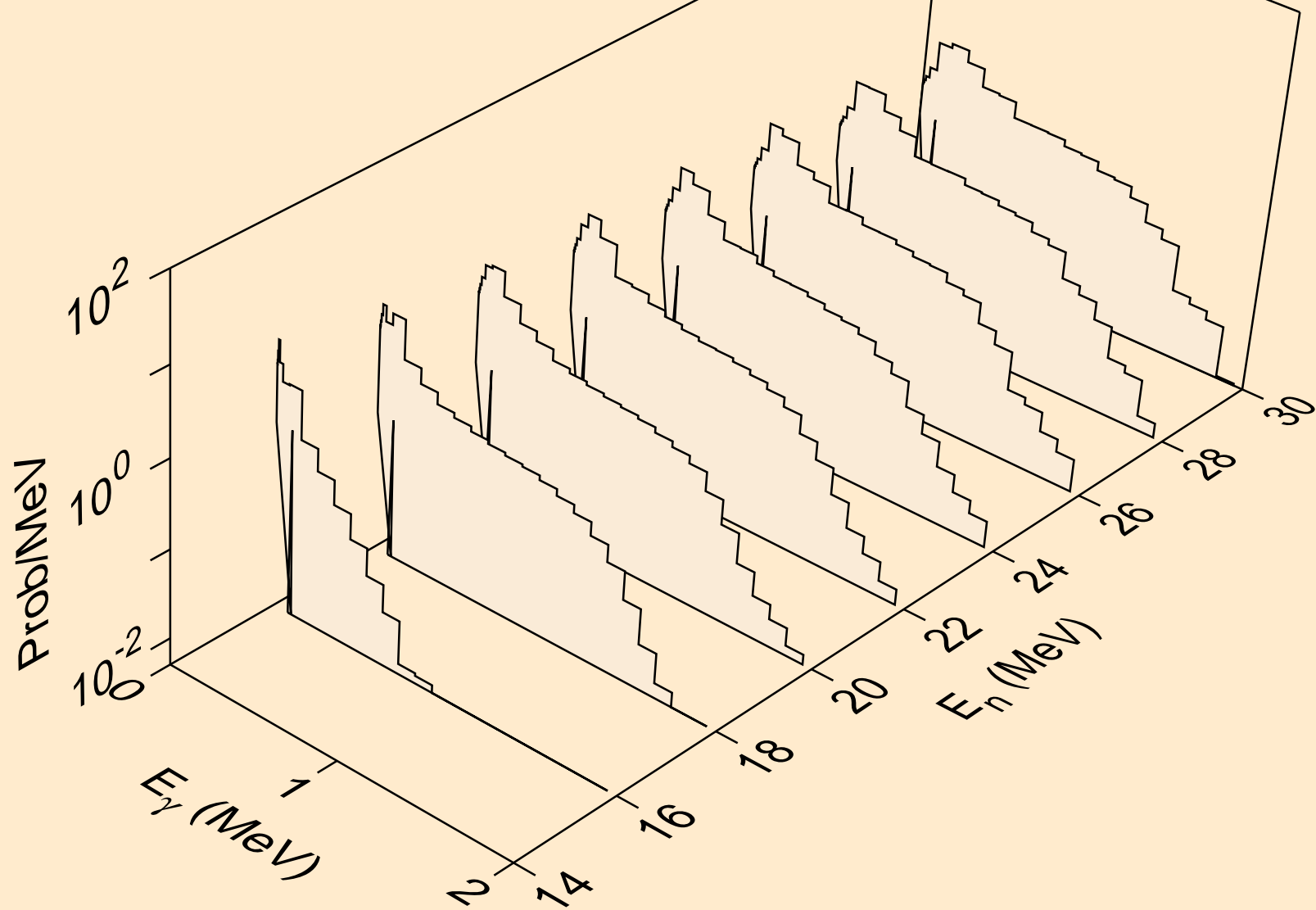

BH274 DEUTERON ACER TENDL-2021 LIBRARY; T=0.K  
Photon emission for (n,2np)

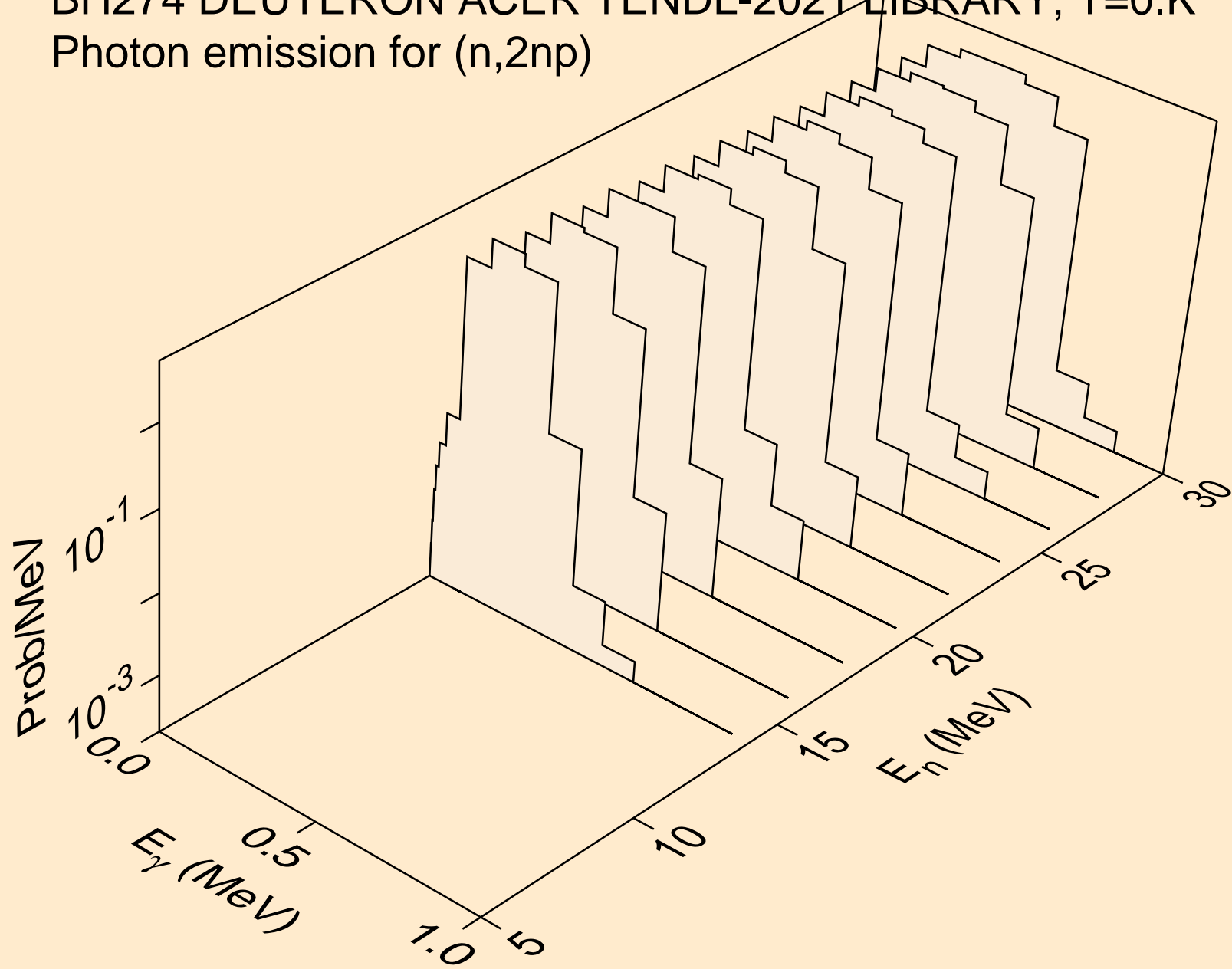

BH274 DEUTERON ACER TENDL-2021 LIBRARY; T=0.K  
Photon emission for (n,p)

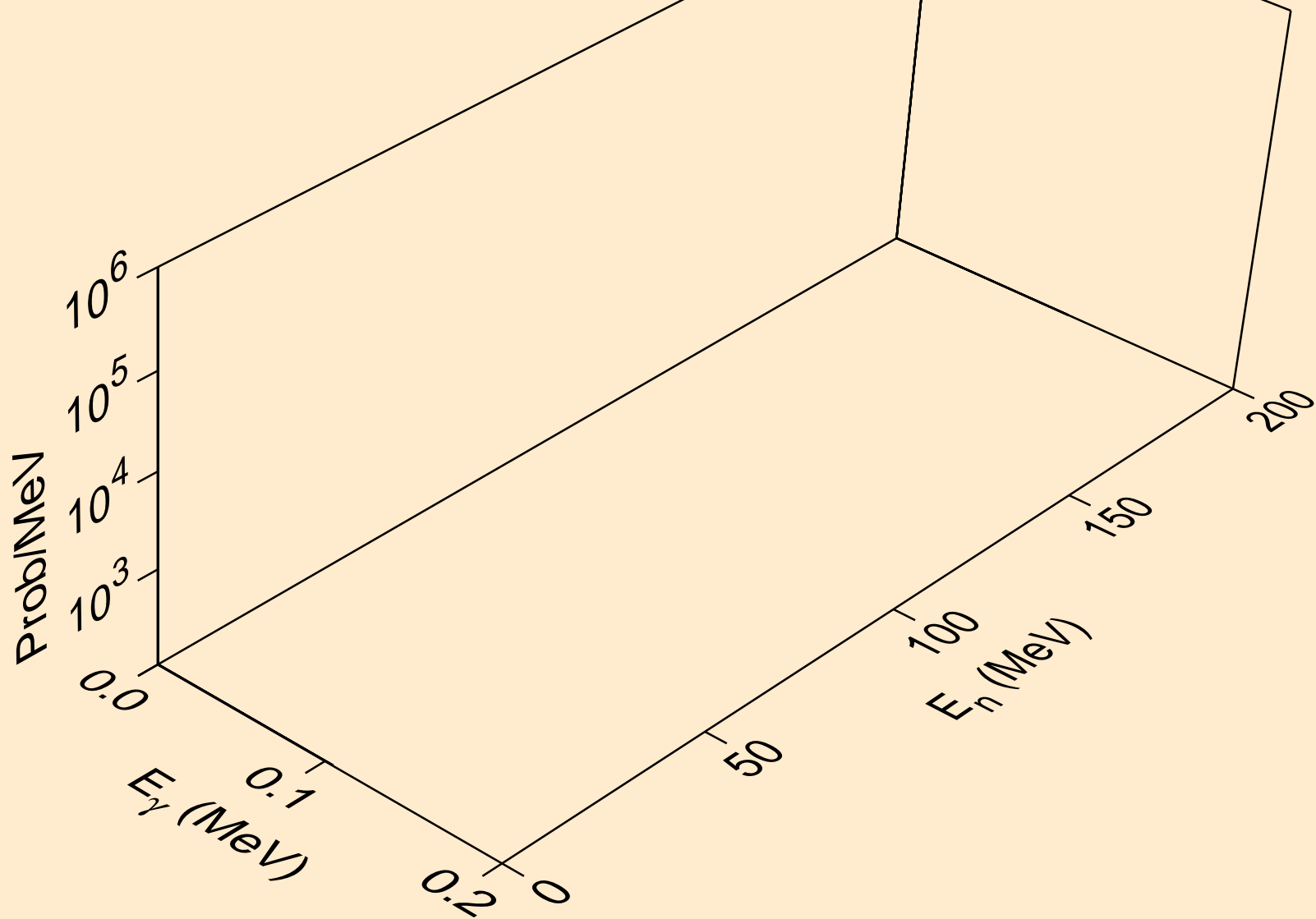

BH274 DEUTERON ACER TENDL-2021 LIBRARY; T=0.K  
Photon emission for inelastic

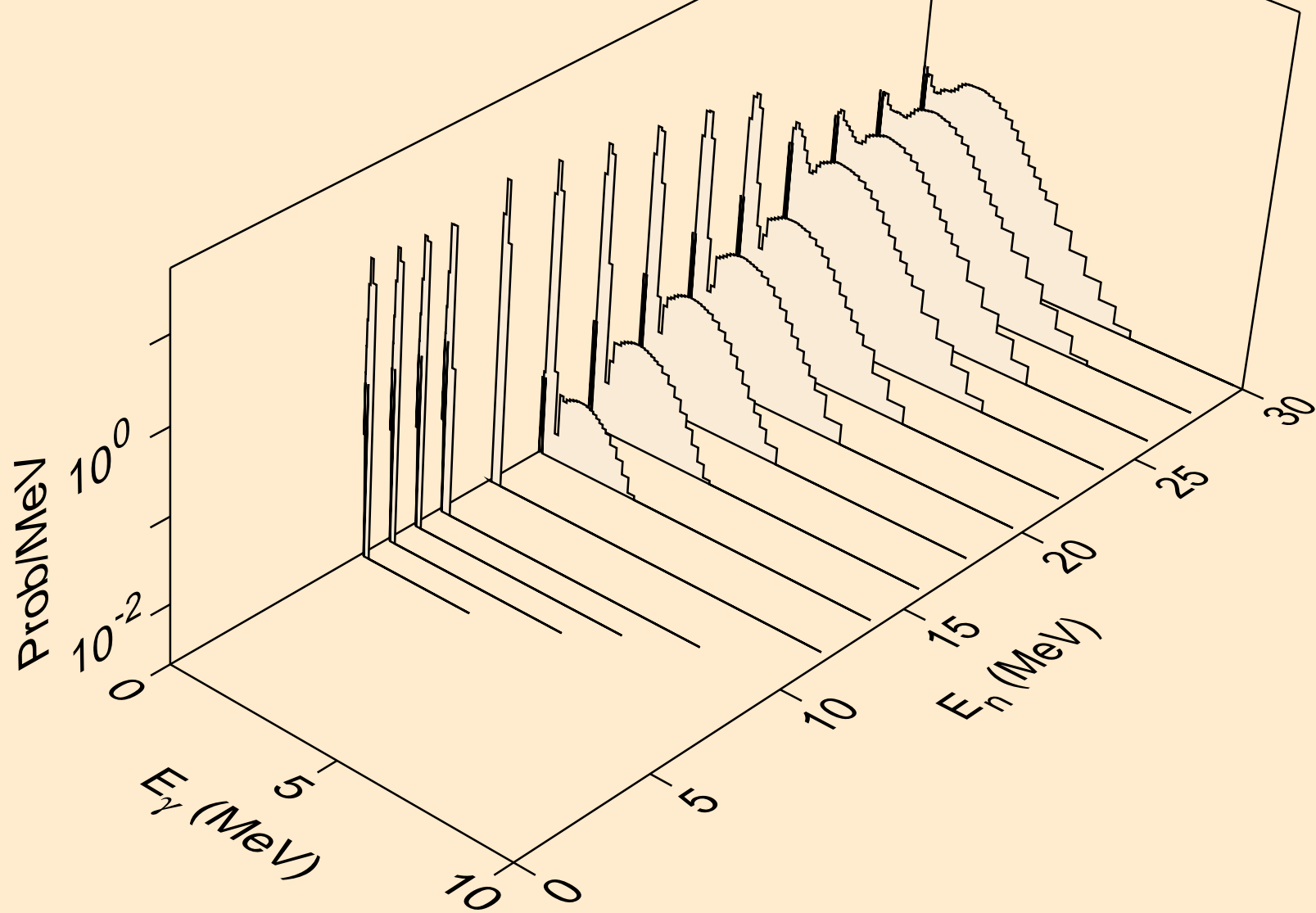

BH274 DEUTERON ACER TENDL-2021 LIBRARY; T=0.K  
Photon emission for (n,t)

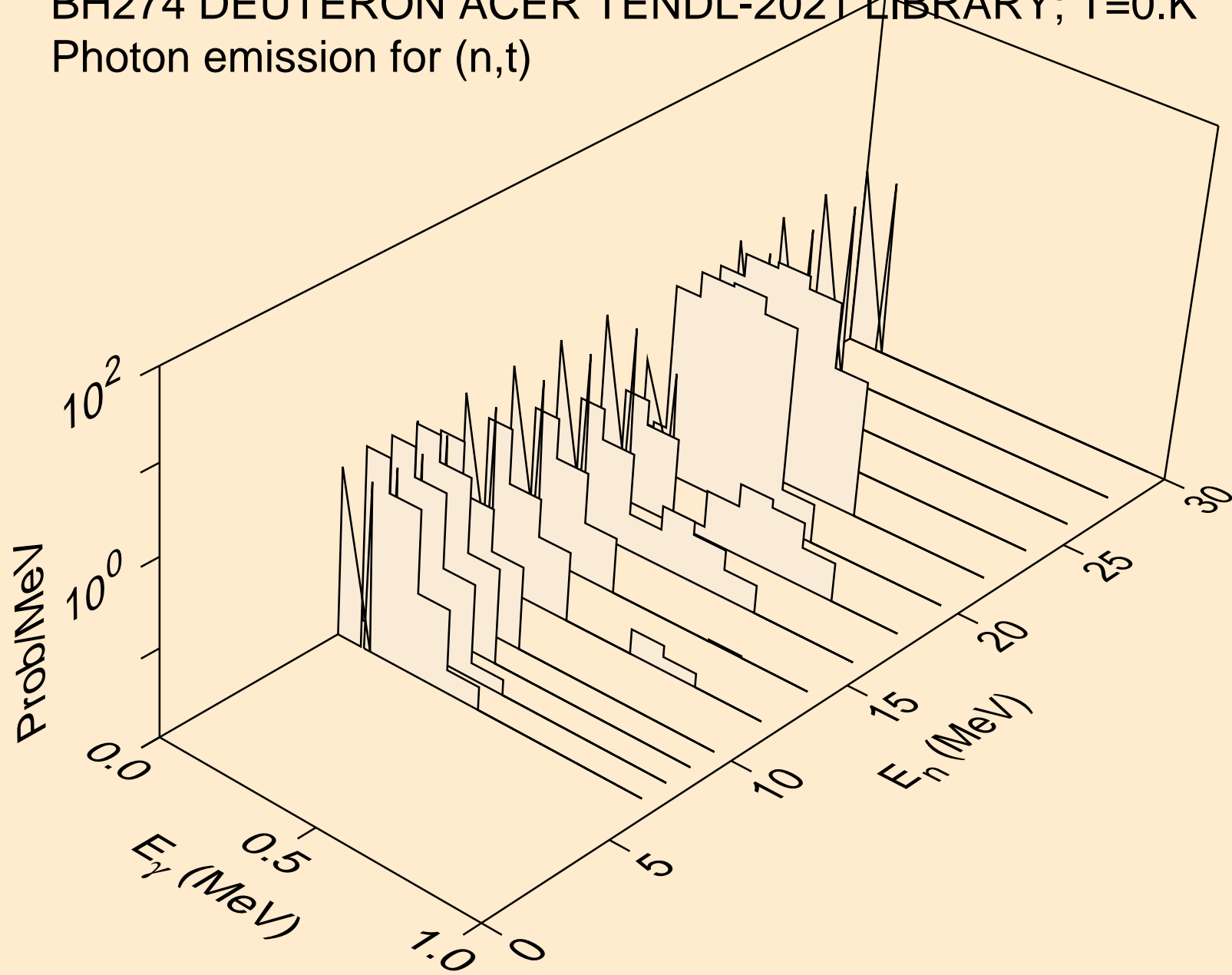



BH274 DEUTERON ACER TENDL-2021 LIBRARY; T=0.K  
Photon emission for (n,he3)

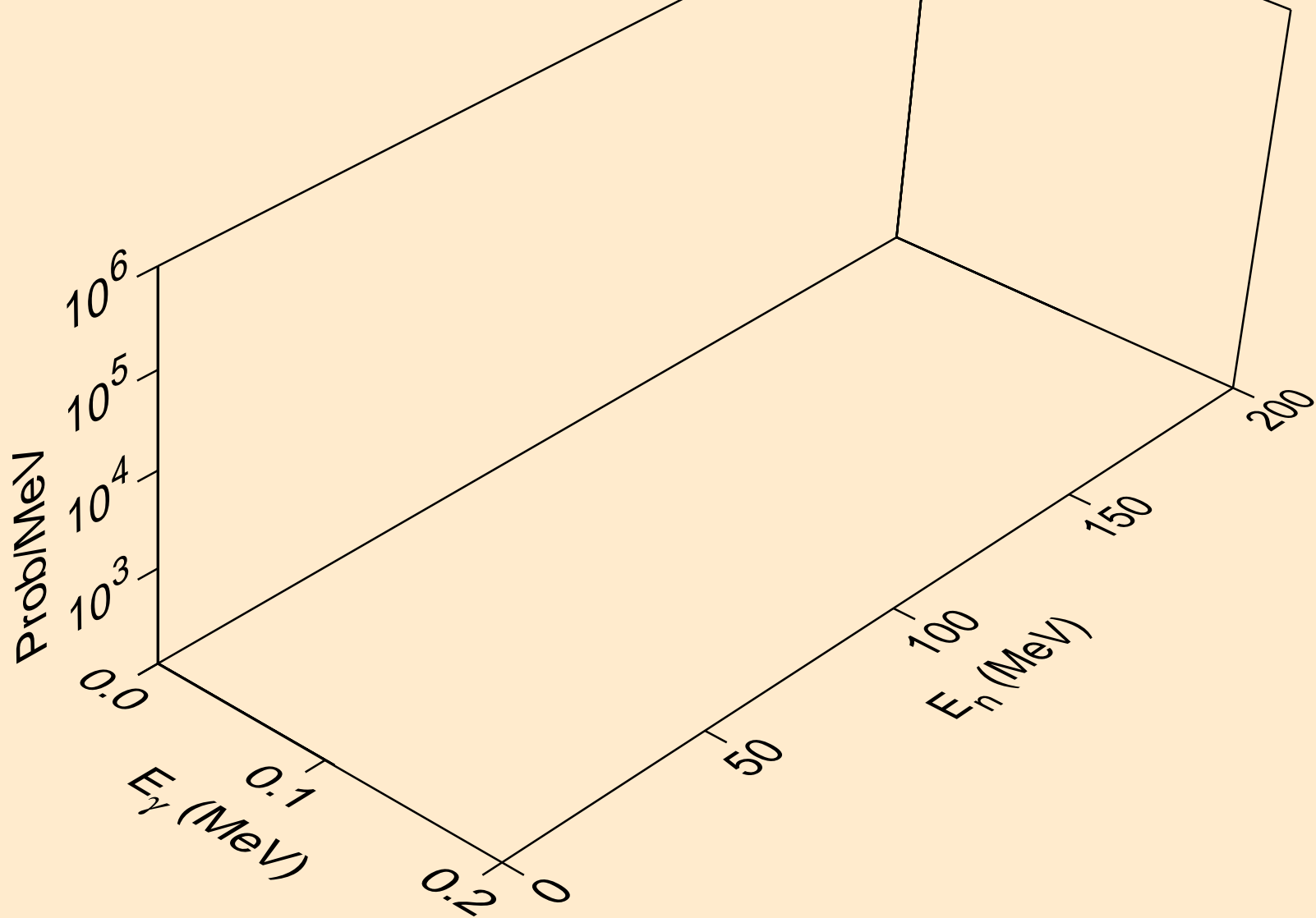

BH274 DEUTERON ACER TENDL-2021 LIBRARY; T=0.K  
Photon emission for (n,a)

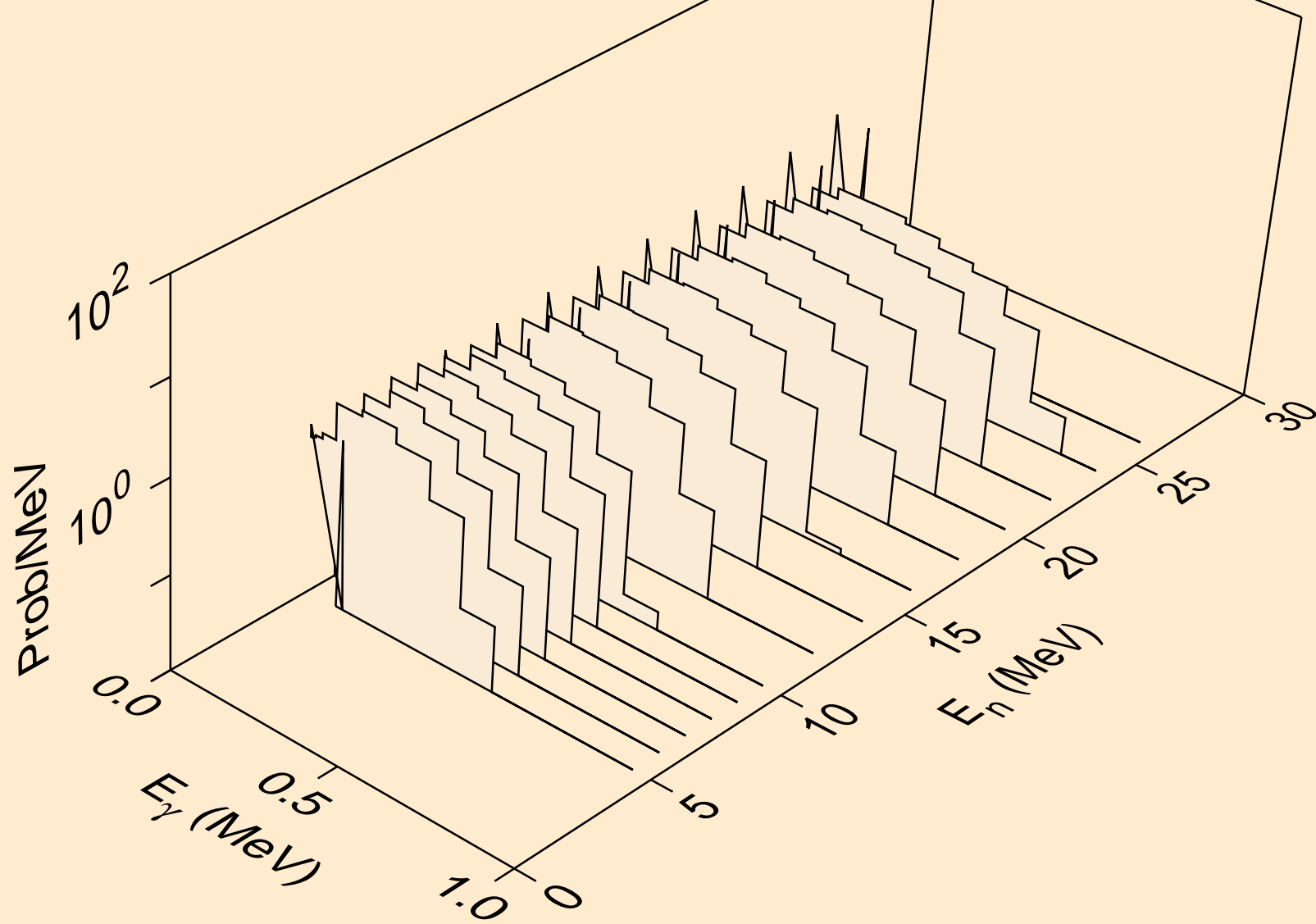

BH274 DEUTERON ACER TENDL-2021 LIBRARY; T=0.K  
Photon emission for (n,2p)

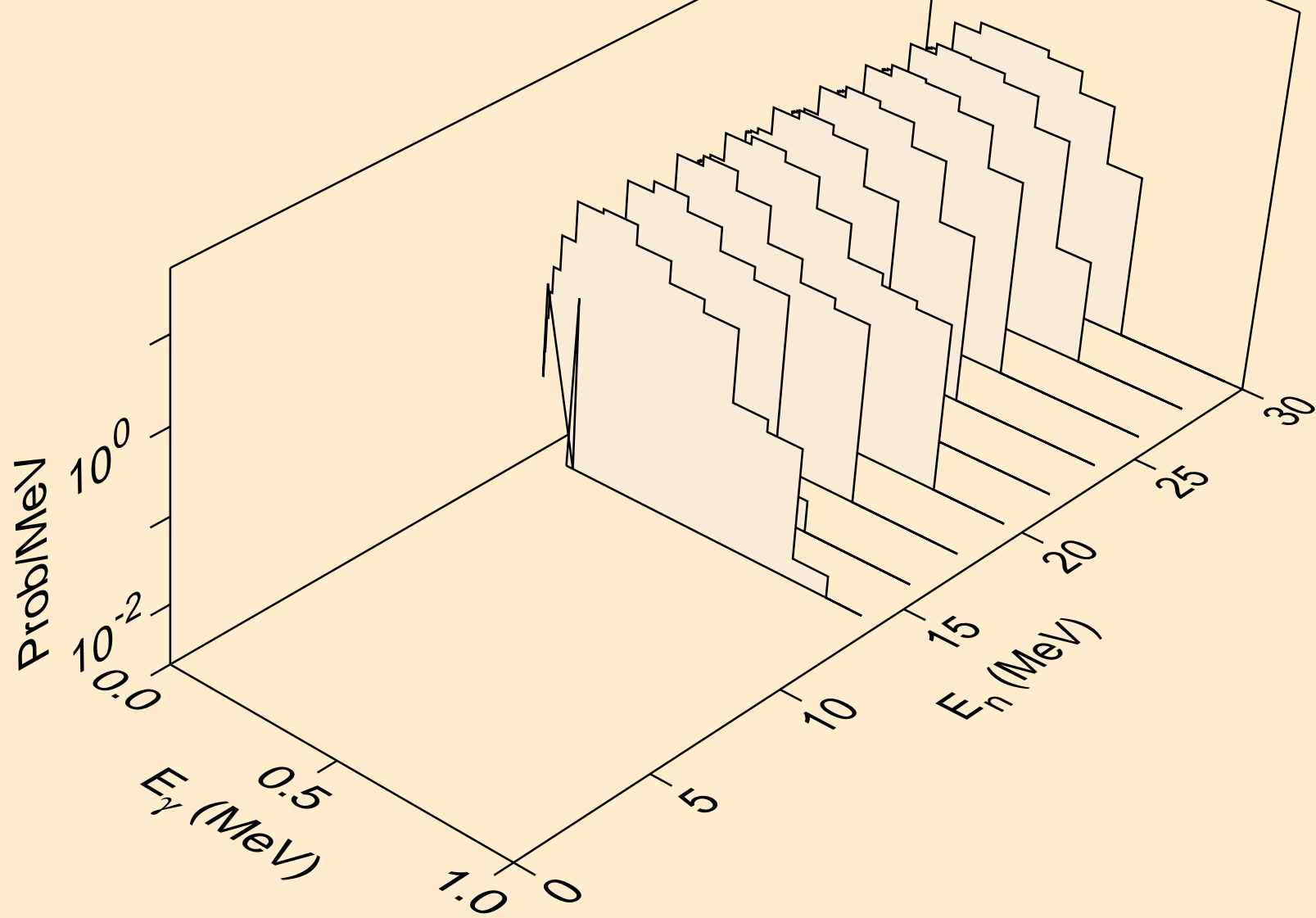

BH274 DEUTERON ACER TENDL-2021 LIBRARY; T=0.K  
Particle heating contributions

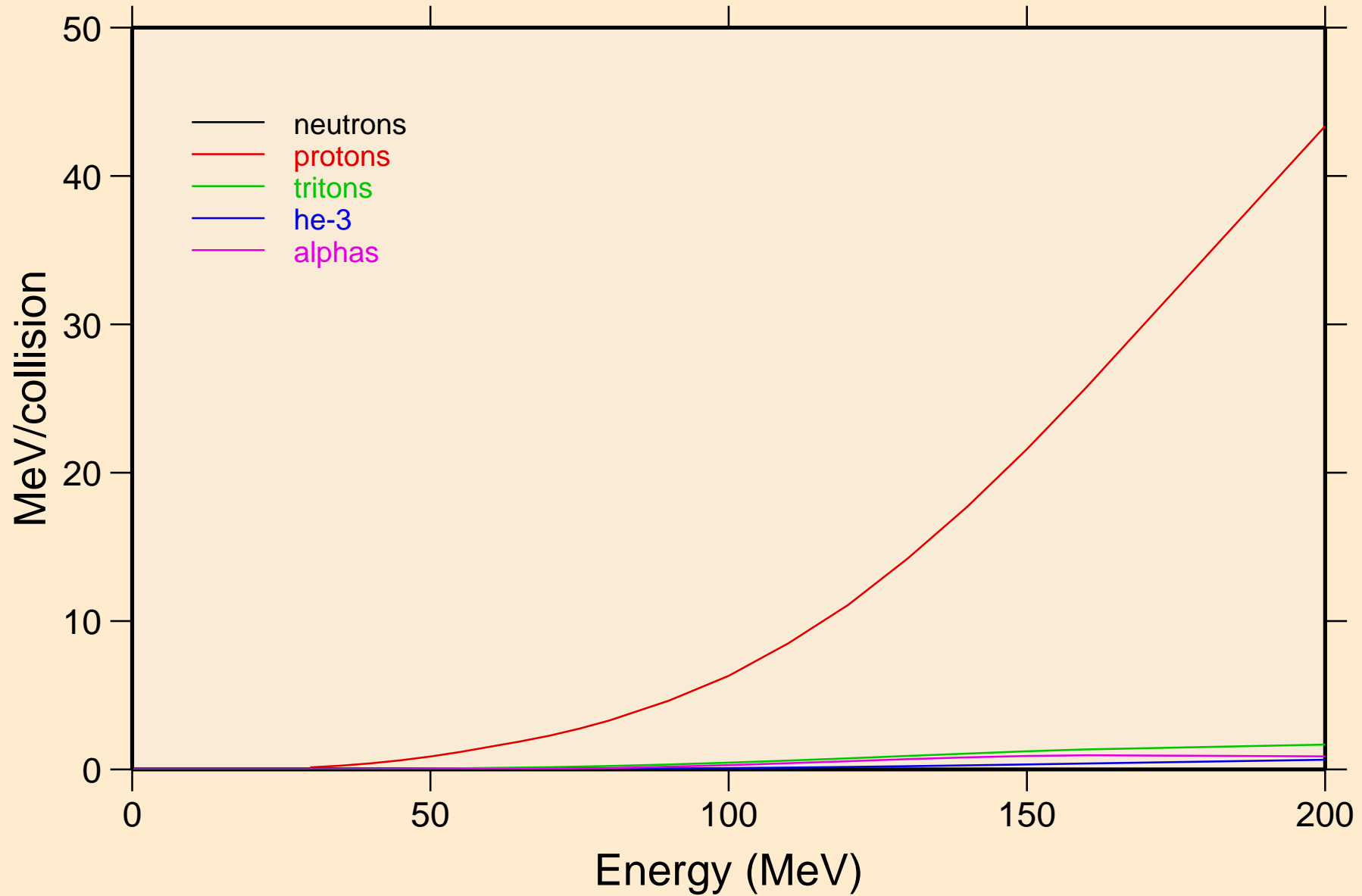

BH274 DEUTERON ACER TENDL-2021 LIBRARY; T=0.K  
Recoil Heating

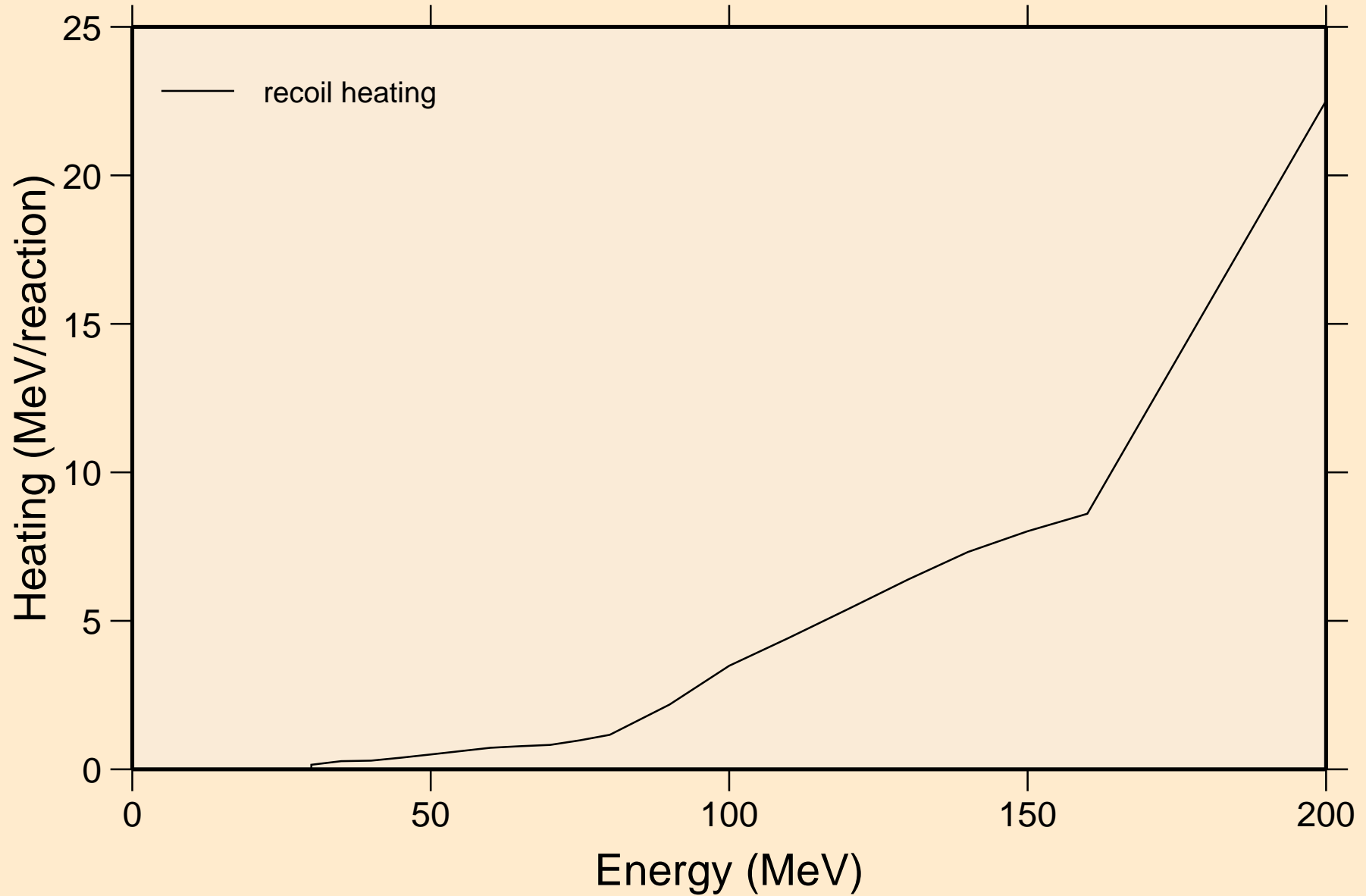

BH274 DEUTERON ACER TENDL-2021 LIBRARY; T=0.K  
Particle production cross sections

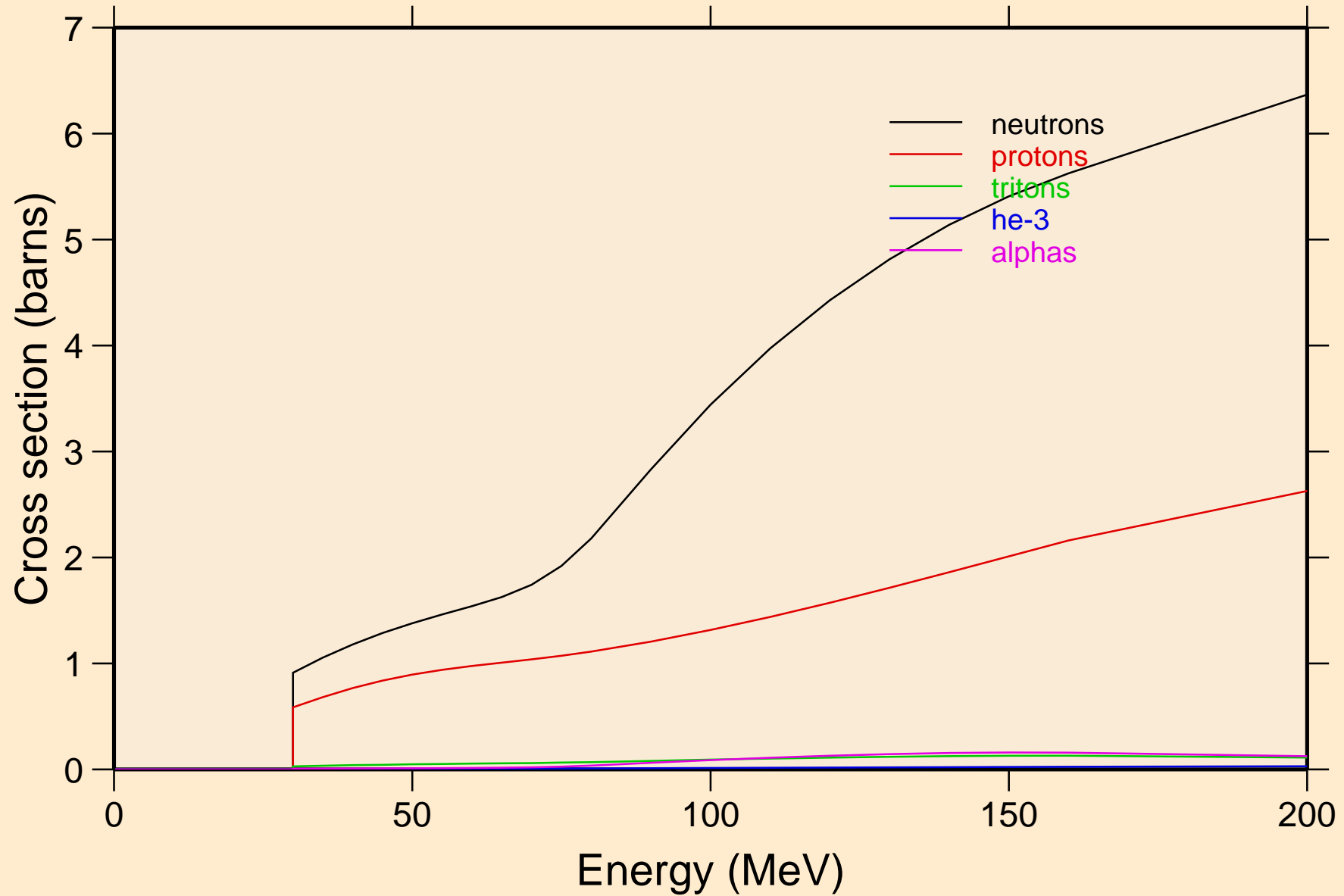

BH274 DEUTERON ACER TENDL-2021 LIBRARY; T=0.K  
neutrons from (d,n)

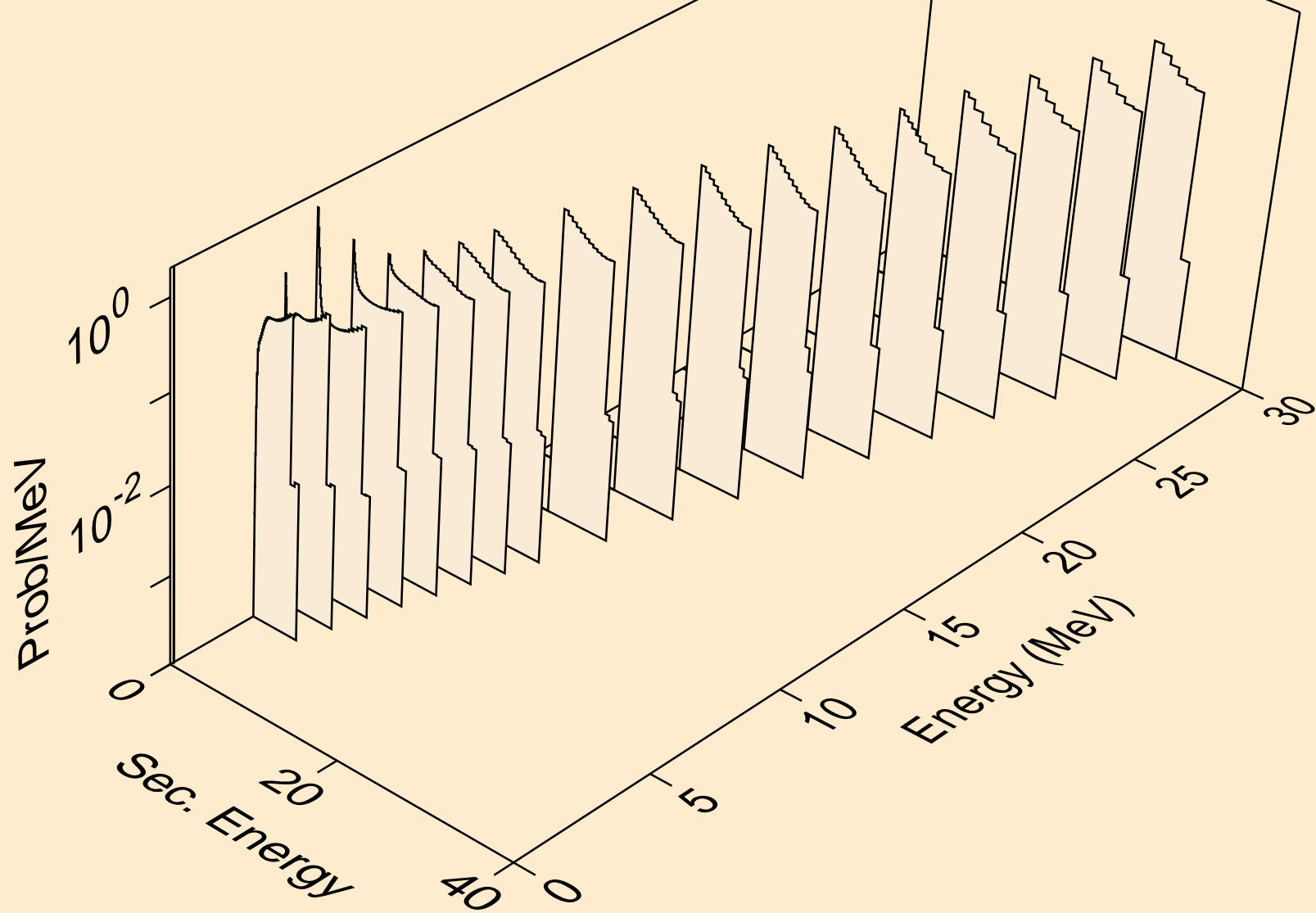

BH274 DEUTERON ACER TENDL-2021 LIBRARY; T=0.K  
neutrons from (d,x)

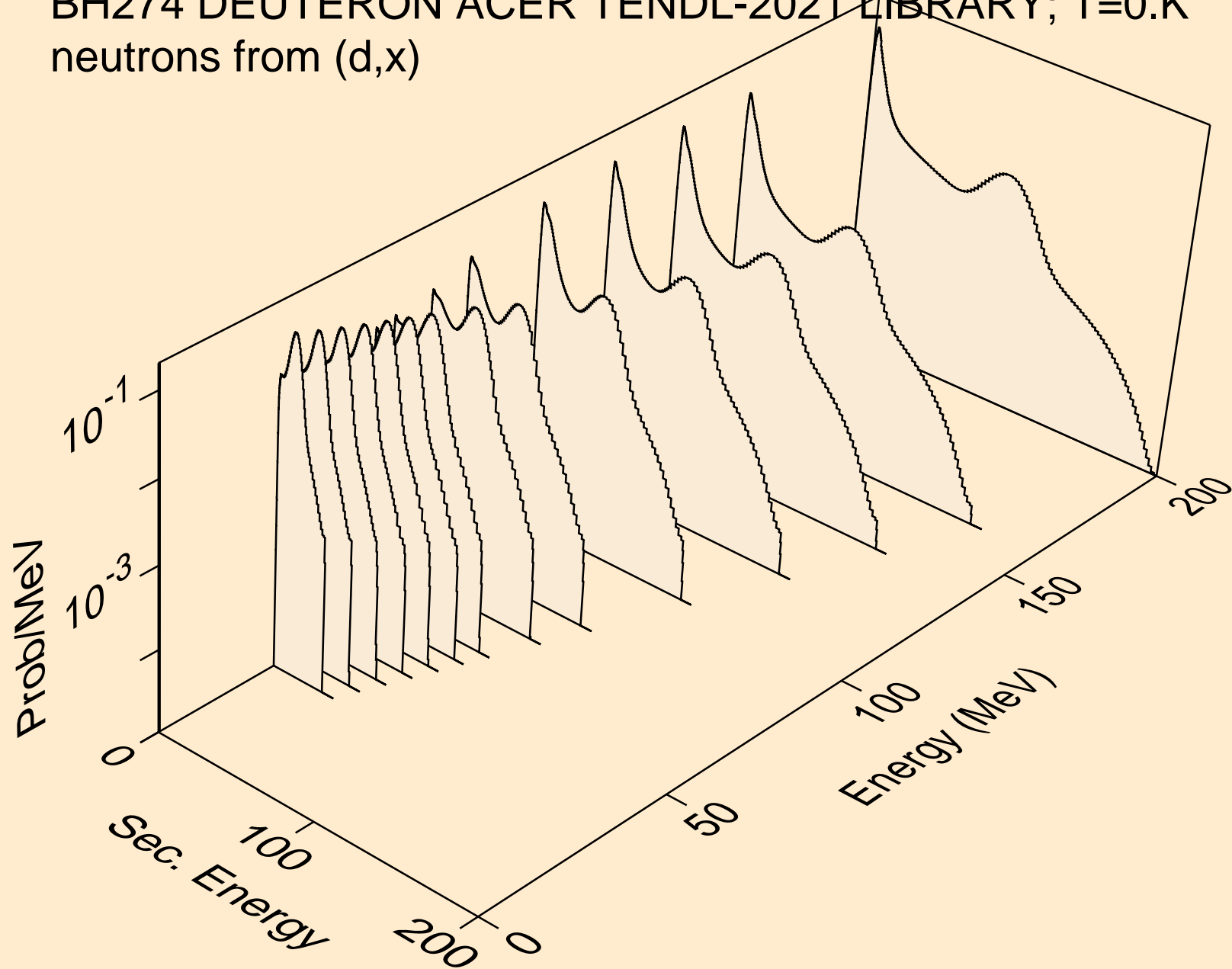



BH274 DEUTERON ACER TENDL-2021 LIBRARY; T=0.K  
neutrons from (d,2n)

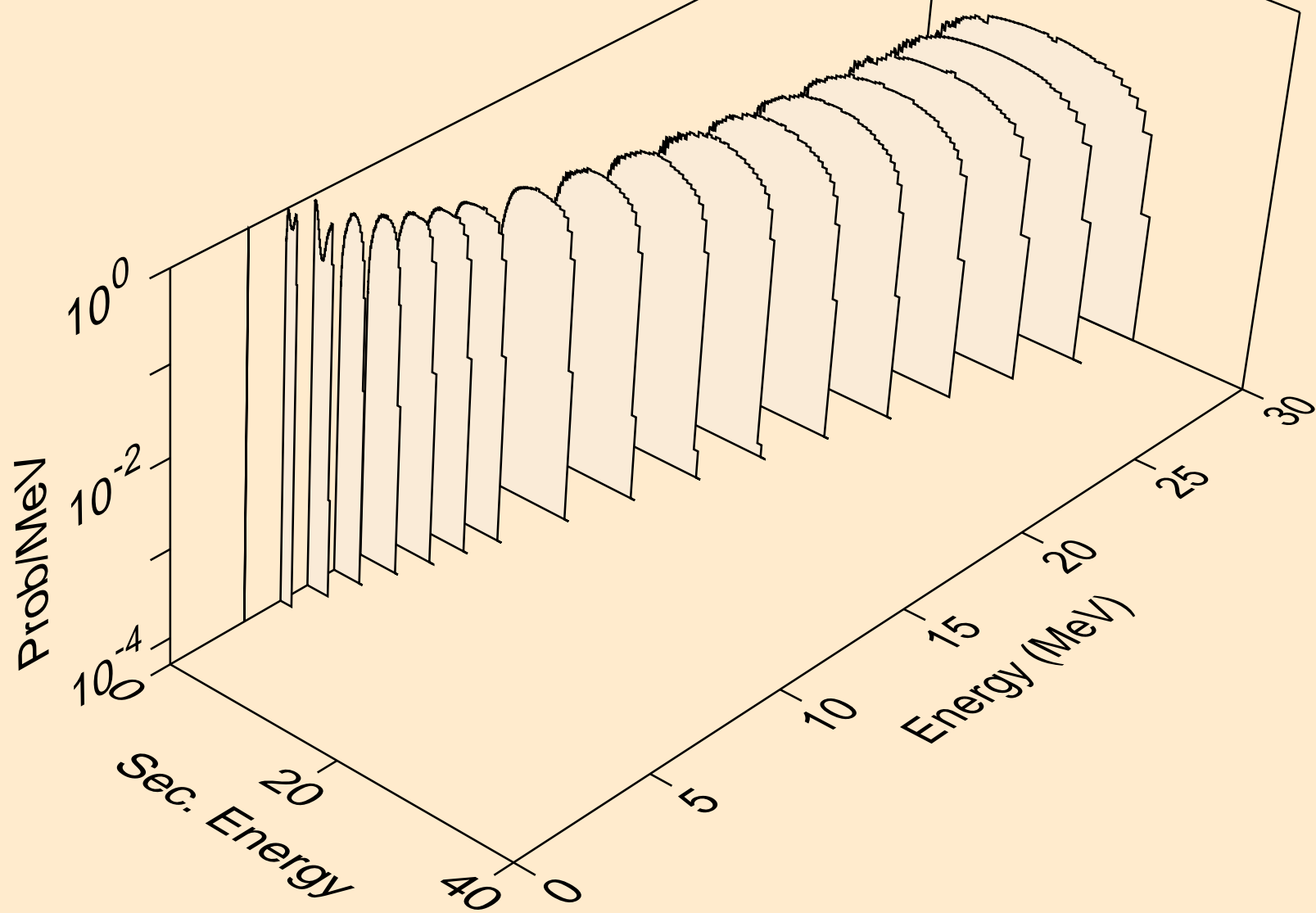

BH274 DEUTERON ACER TENDL-2021 LIBRARY; T=0.K  
neutrons from (d,3n)

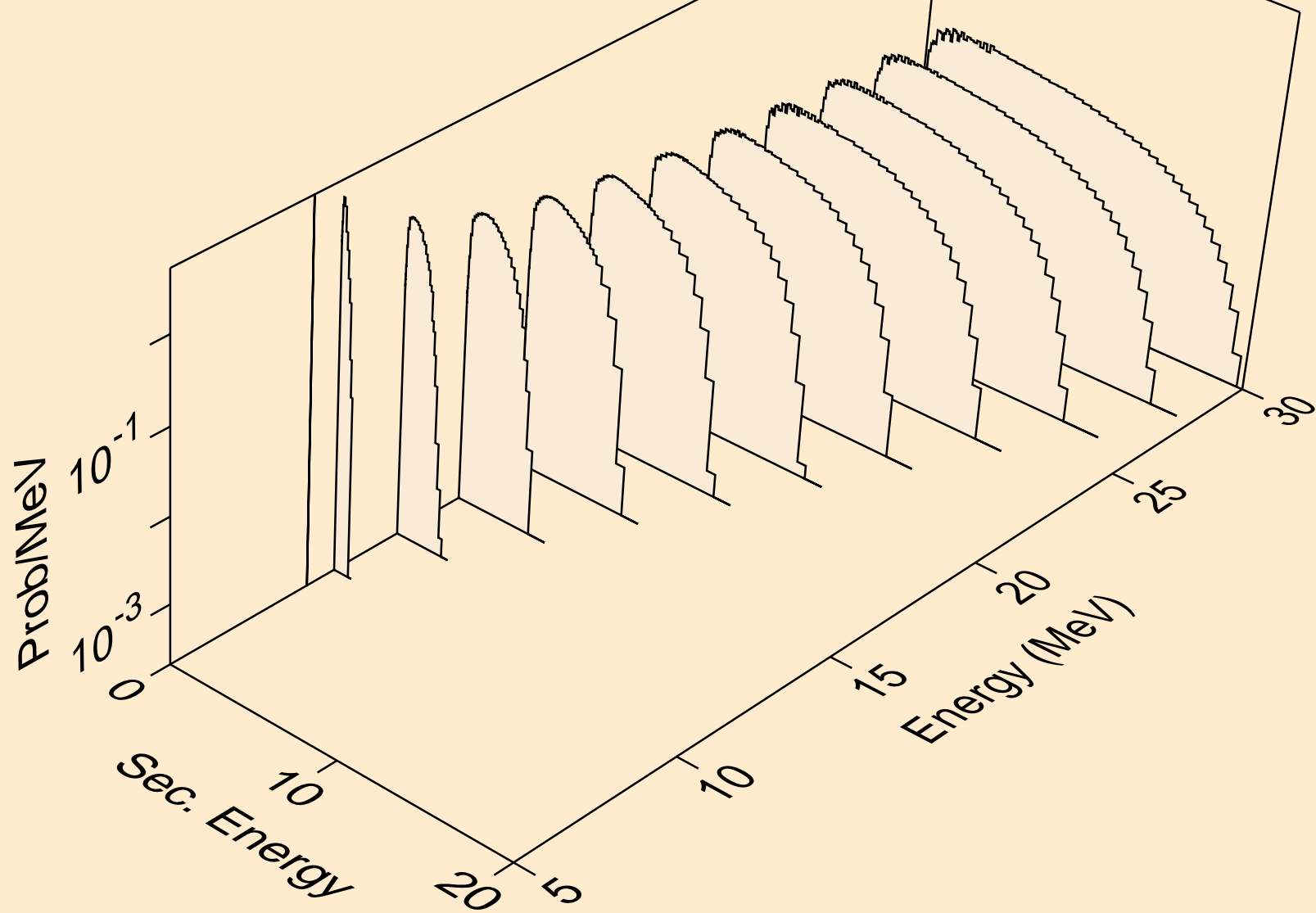

BH274 DEUTERON ACER TENDL-2021 LIBRARY; T=0.K  
neutrons from (d,n\*)d

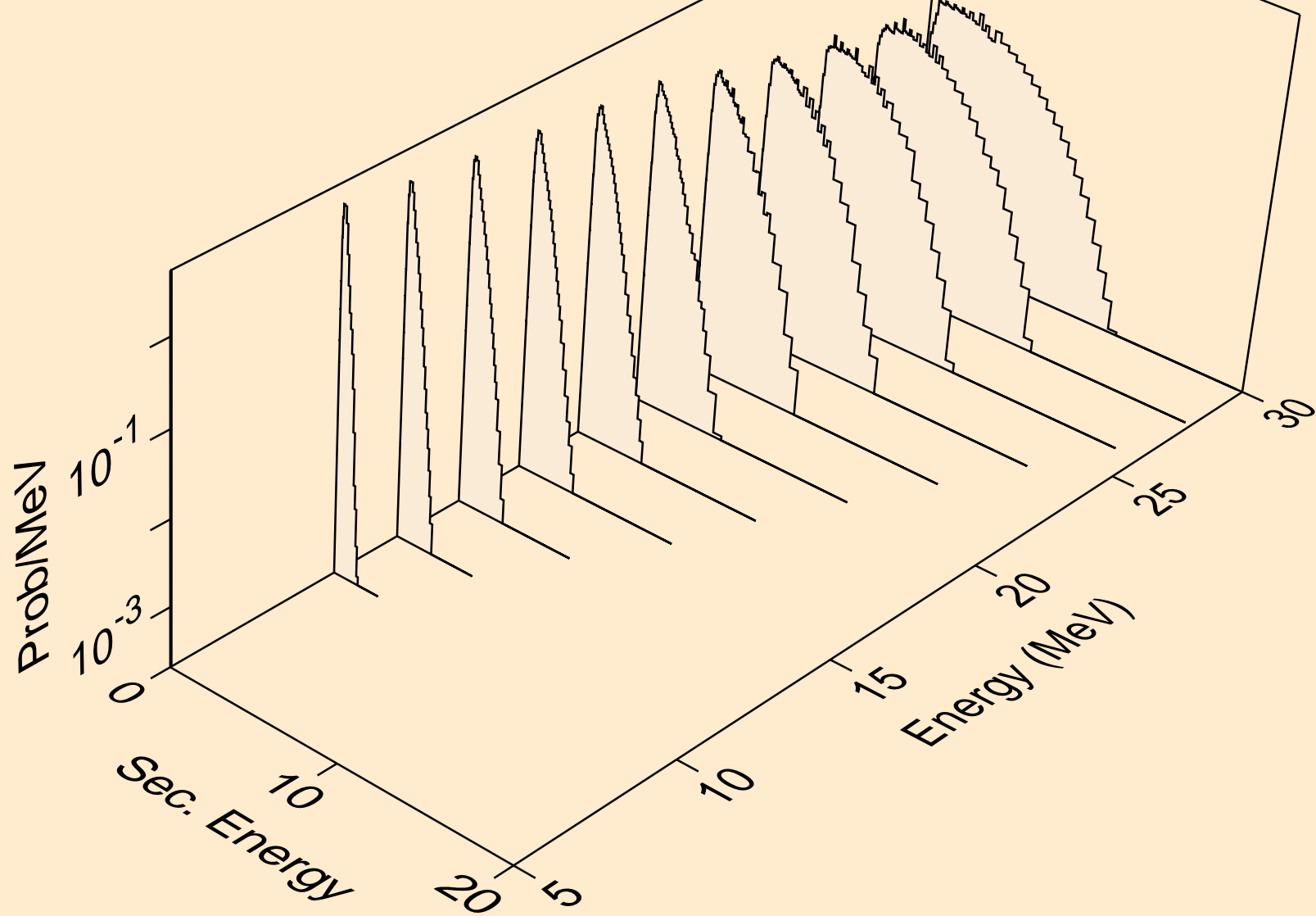

BH274 DEUTERON ACER TENDL-2021 LIBRARY; T=0.K  
neutrons from (d,n\*)t

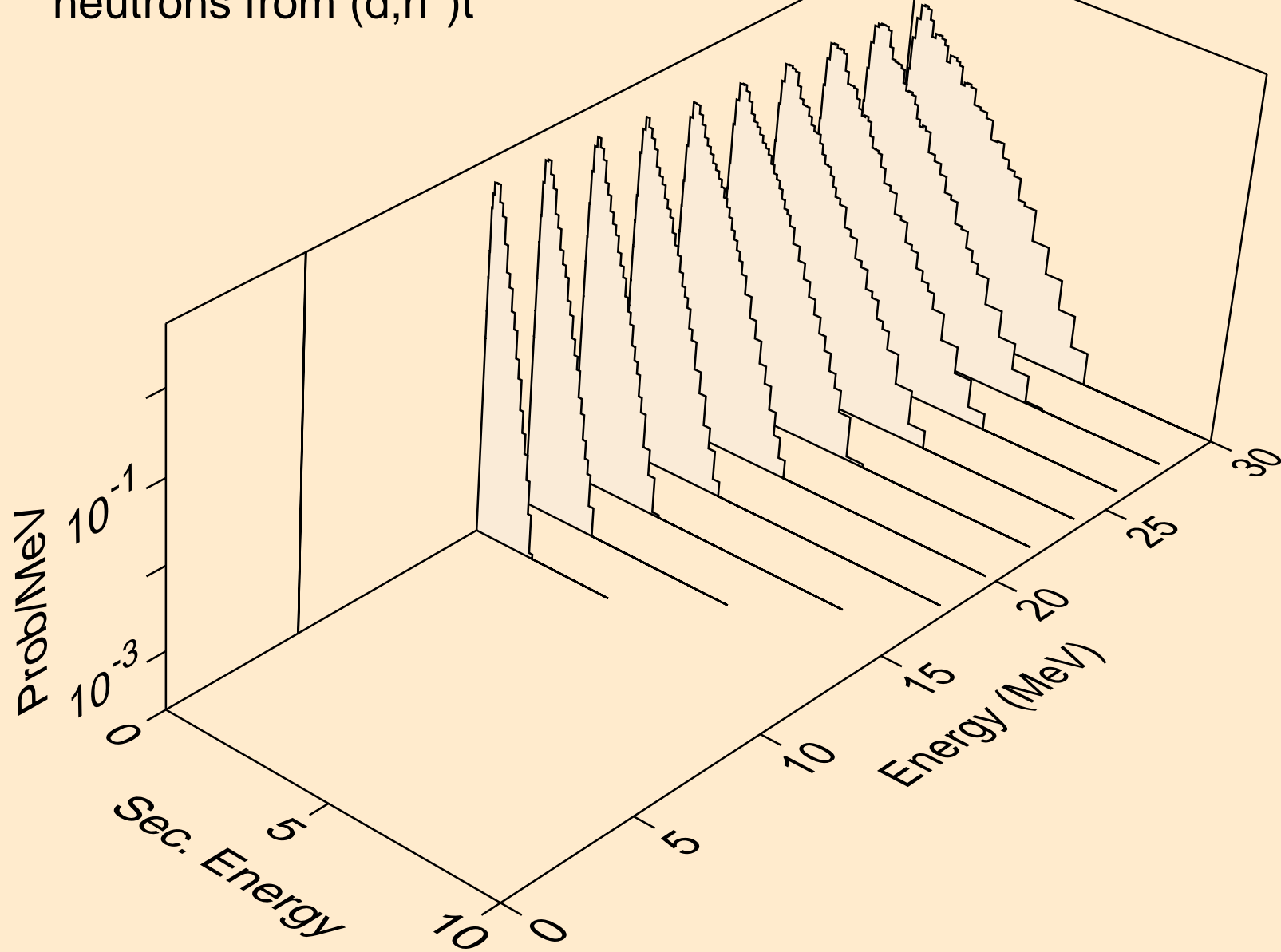

BH274 DEUTERON ACER TENDL-2021 LIBRARY; T=0.K  
neutrons from (d,4n)

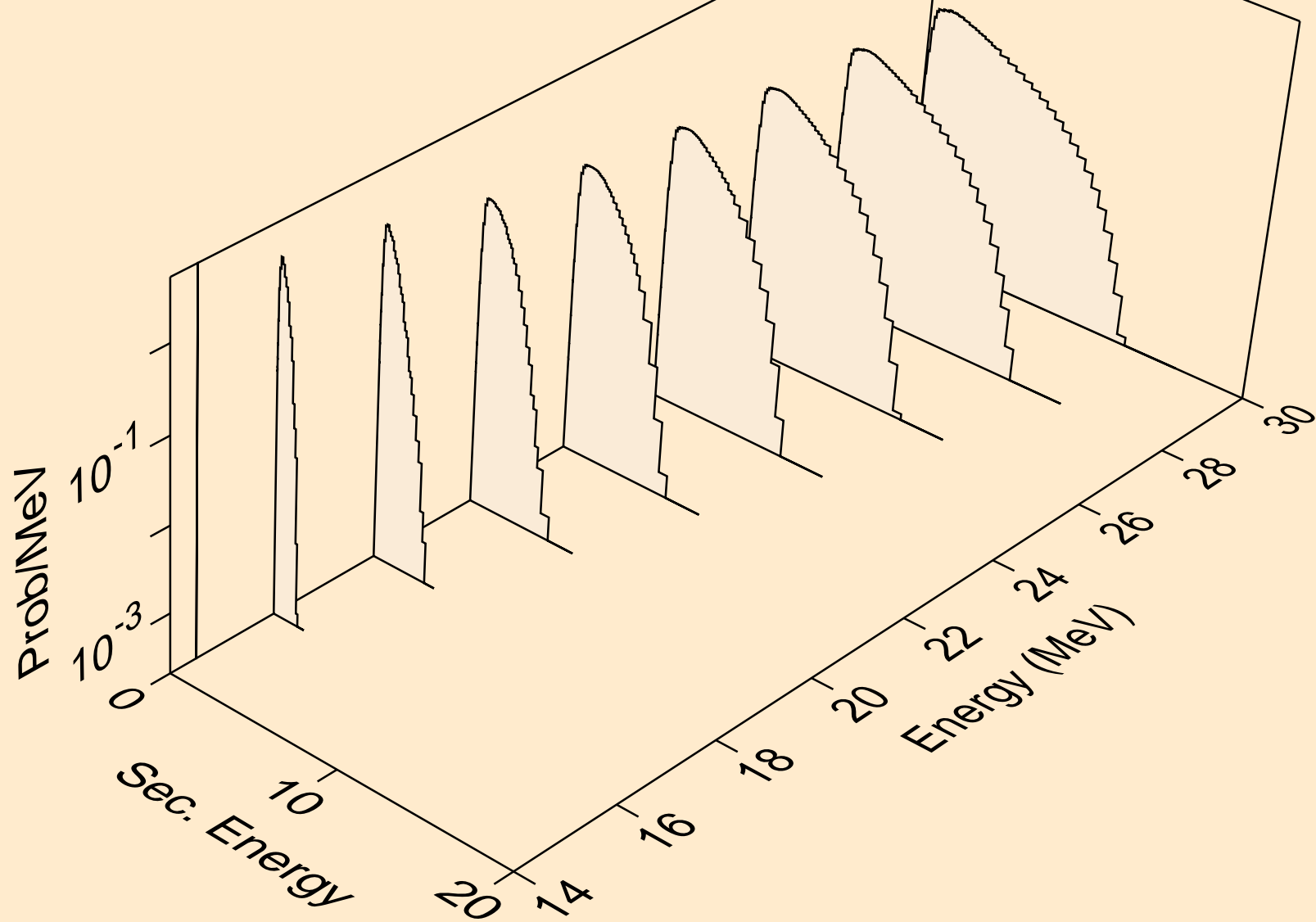

BH274 DEUTERON ACER TENDL-2021 LIBRARY; T=0.K  
neutrons from (d,2np)

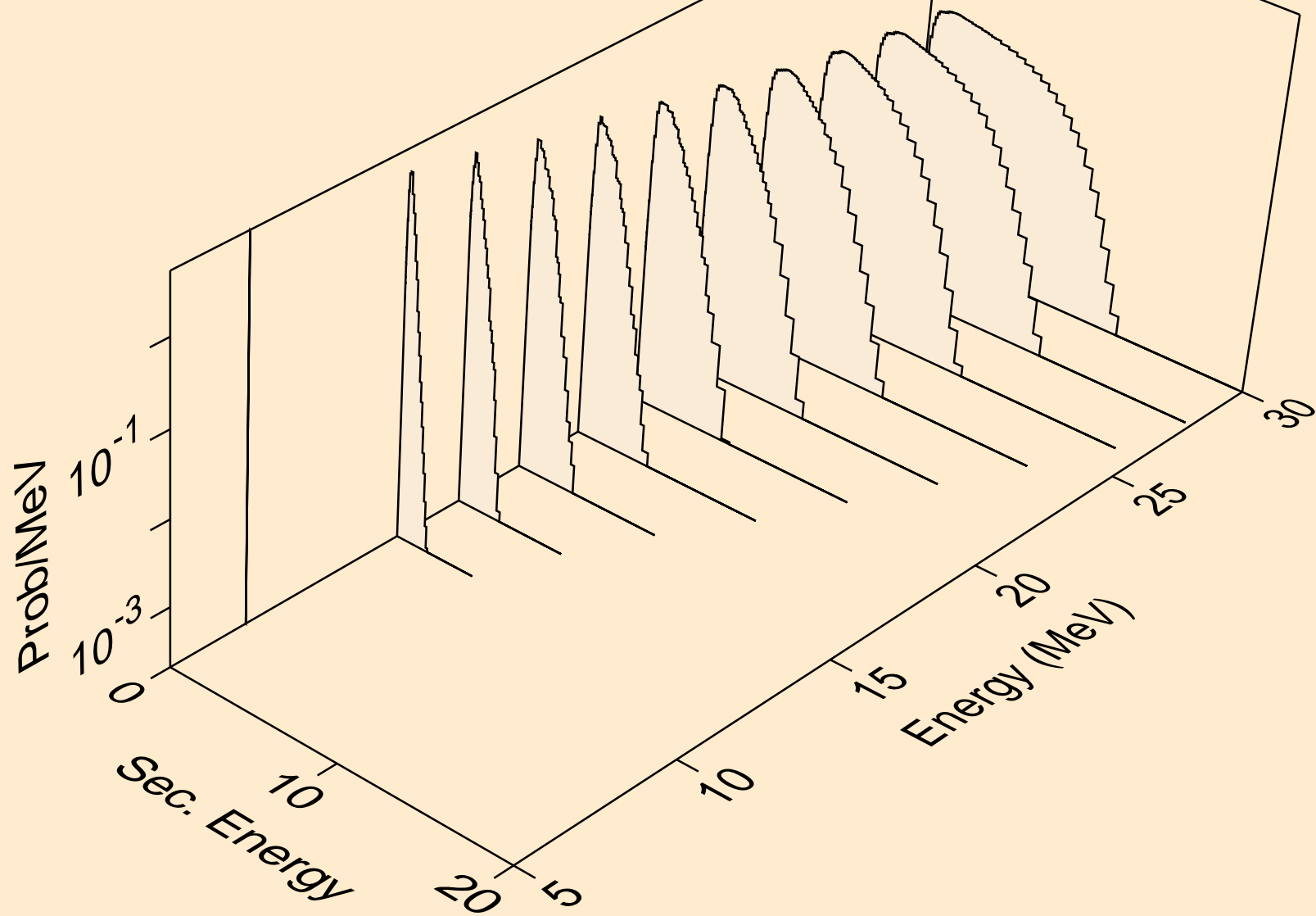

BH274 DEUTERON ACER TENDL-2021 LIBRARY; T=0.K  
protons from (d,x)

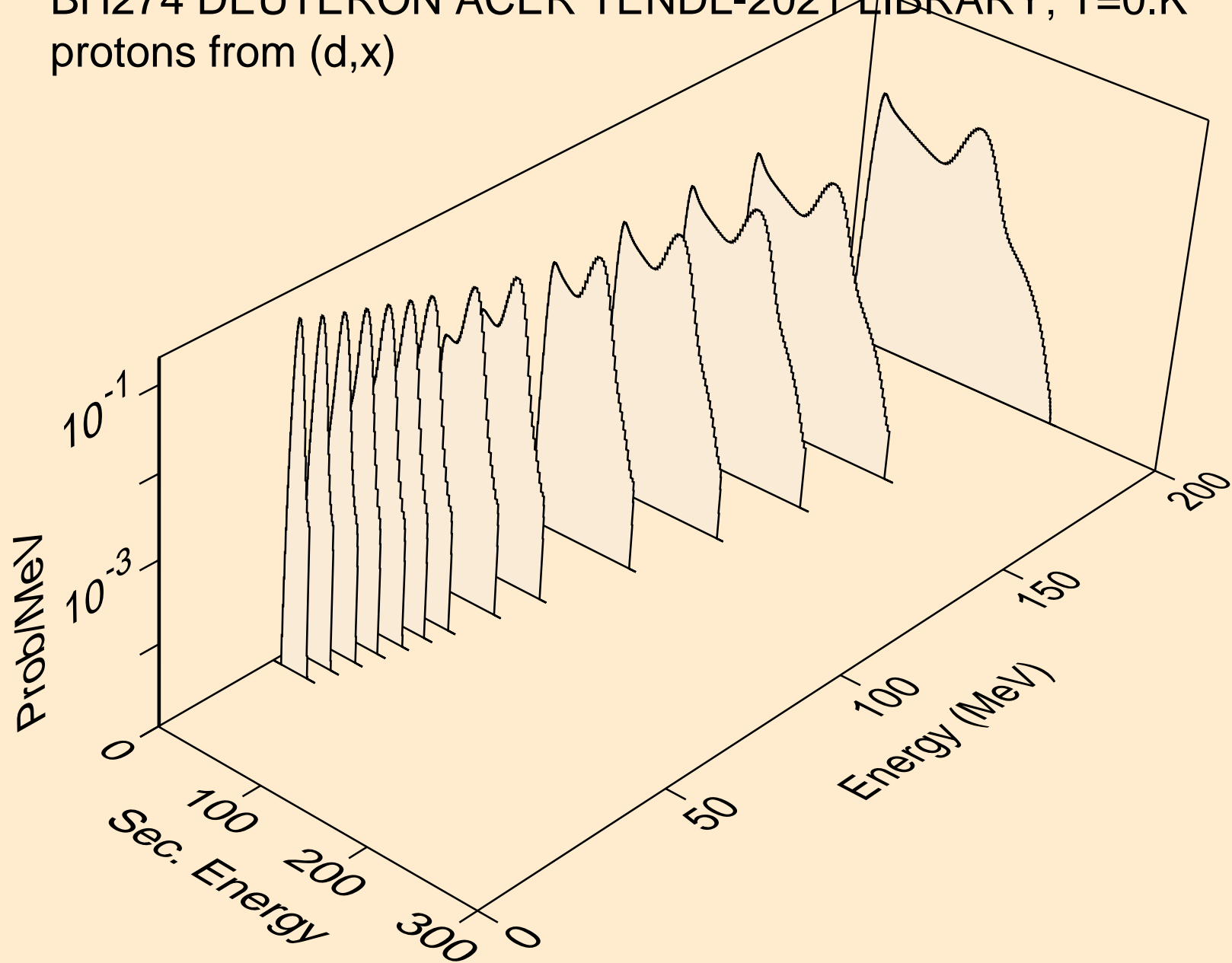

BH274 DEUTERON ACER TENDL-2021 LIBRARY; T=0.K  
protons from (d,2np)

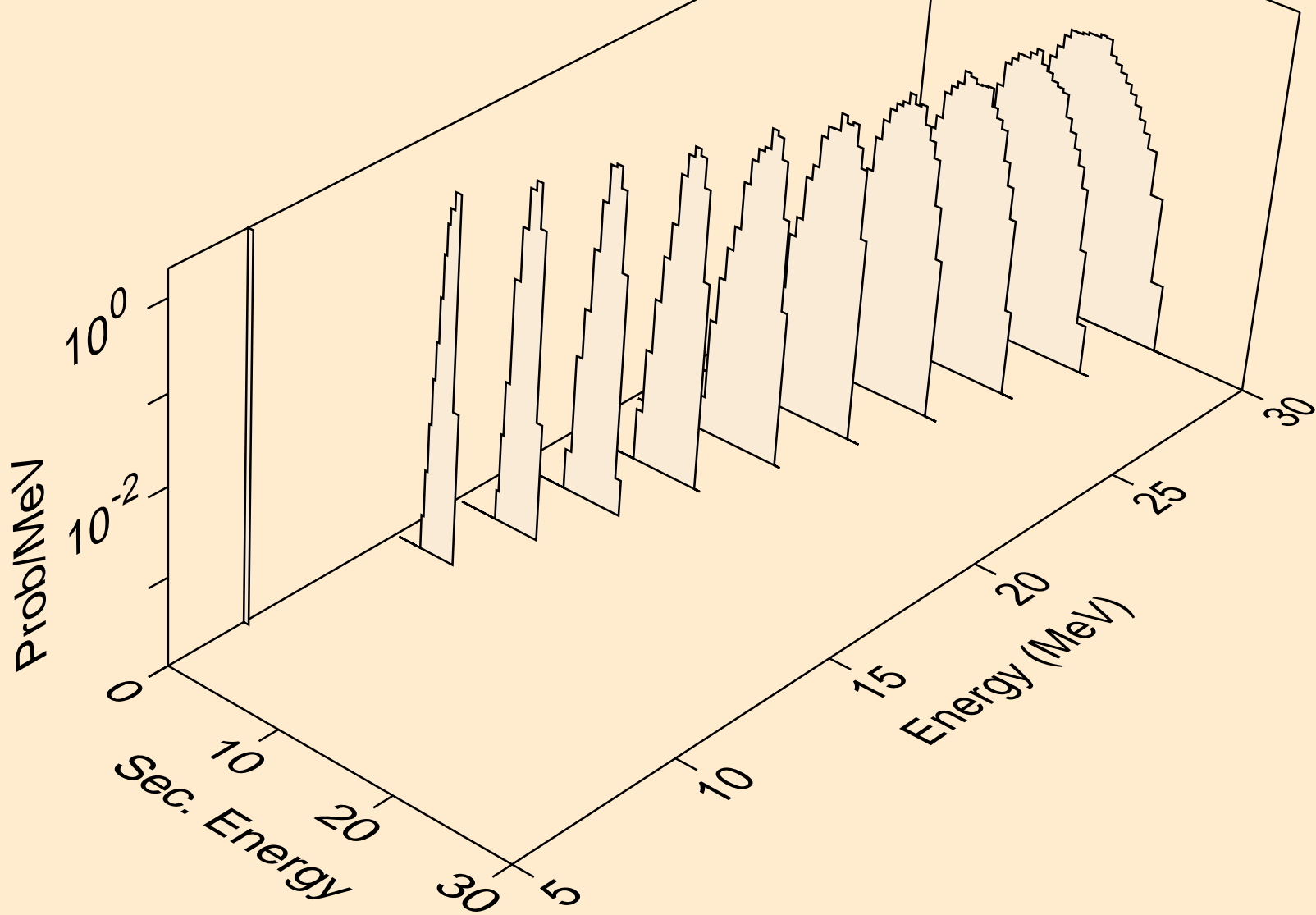



BH274 DEUTERON ACER TENDL-2021 LIBRARY; T=0.K  
protons from (d,p)

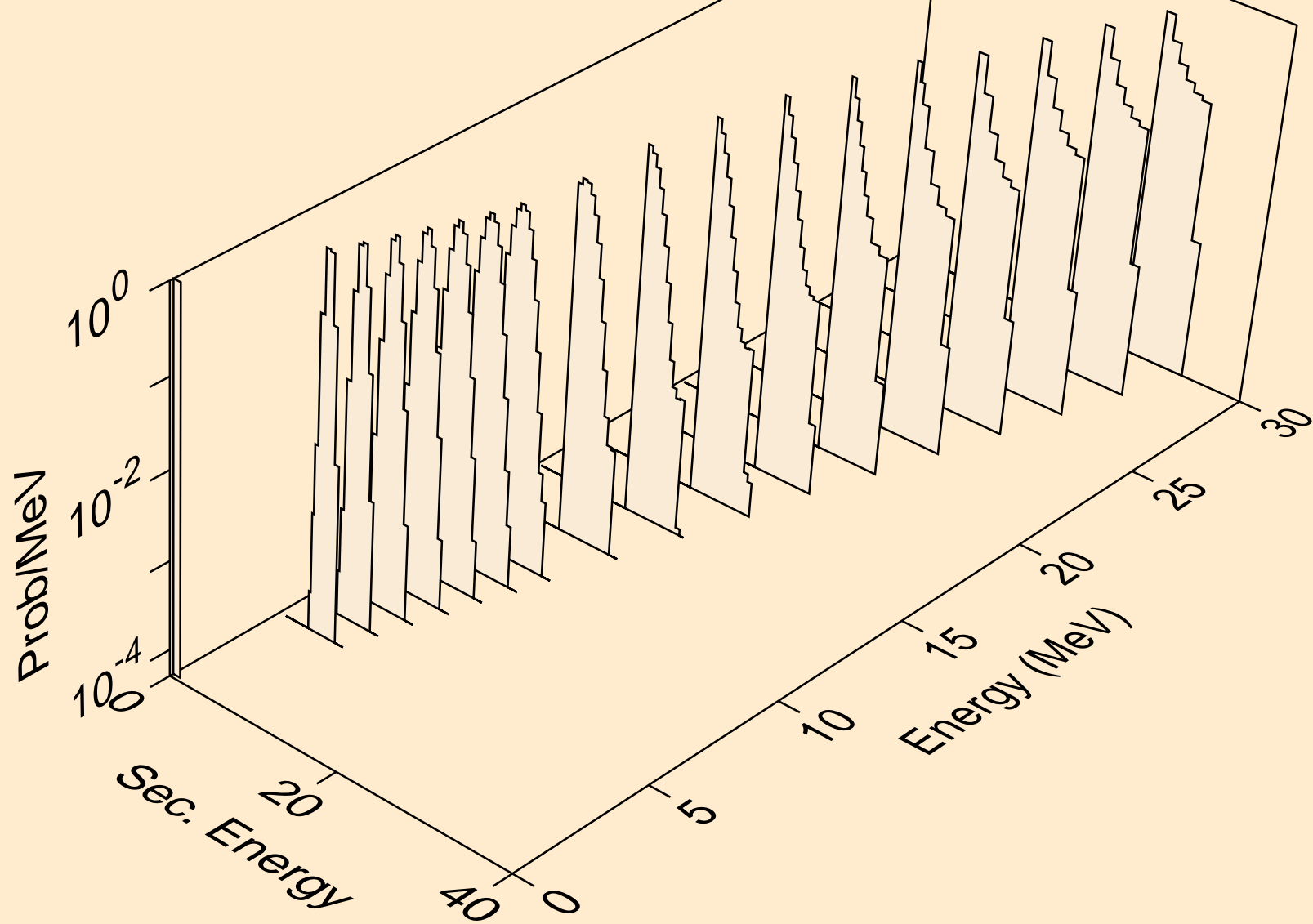

BH274 DEUTERON ACER TENDL-2021 LIBRARY; T=0.K  
protons from (d,2p)

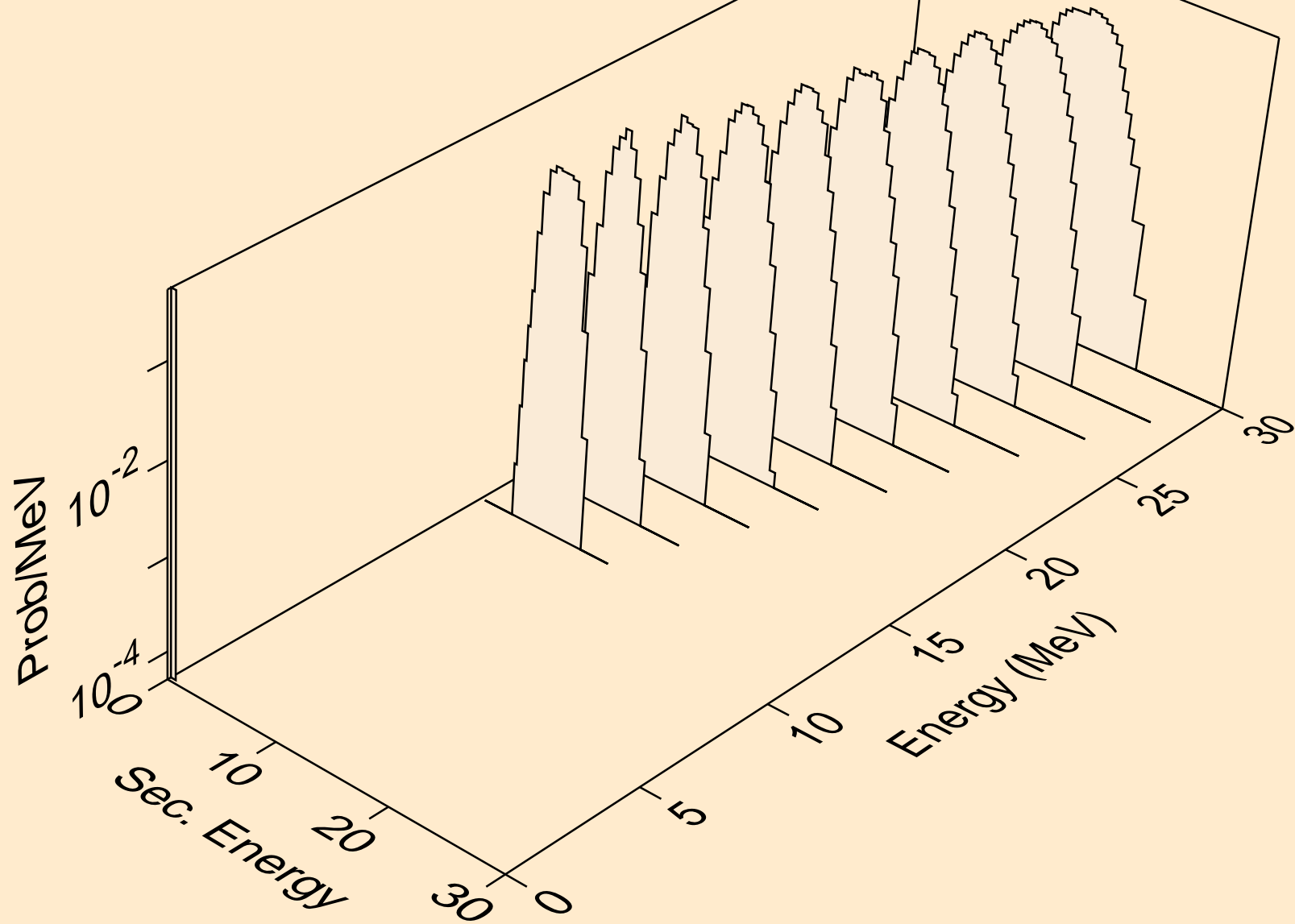

BH274 DEUTERON ACER TENDL-2021 LIBRARY; T=0.K  
tritons from (d,x)

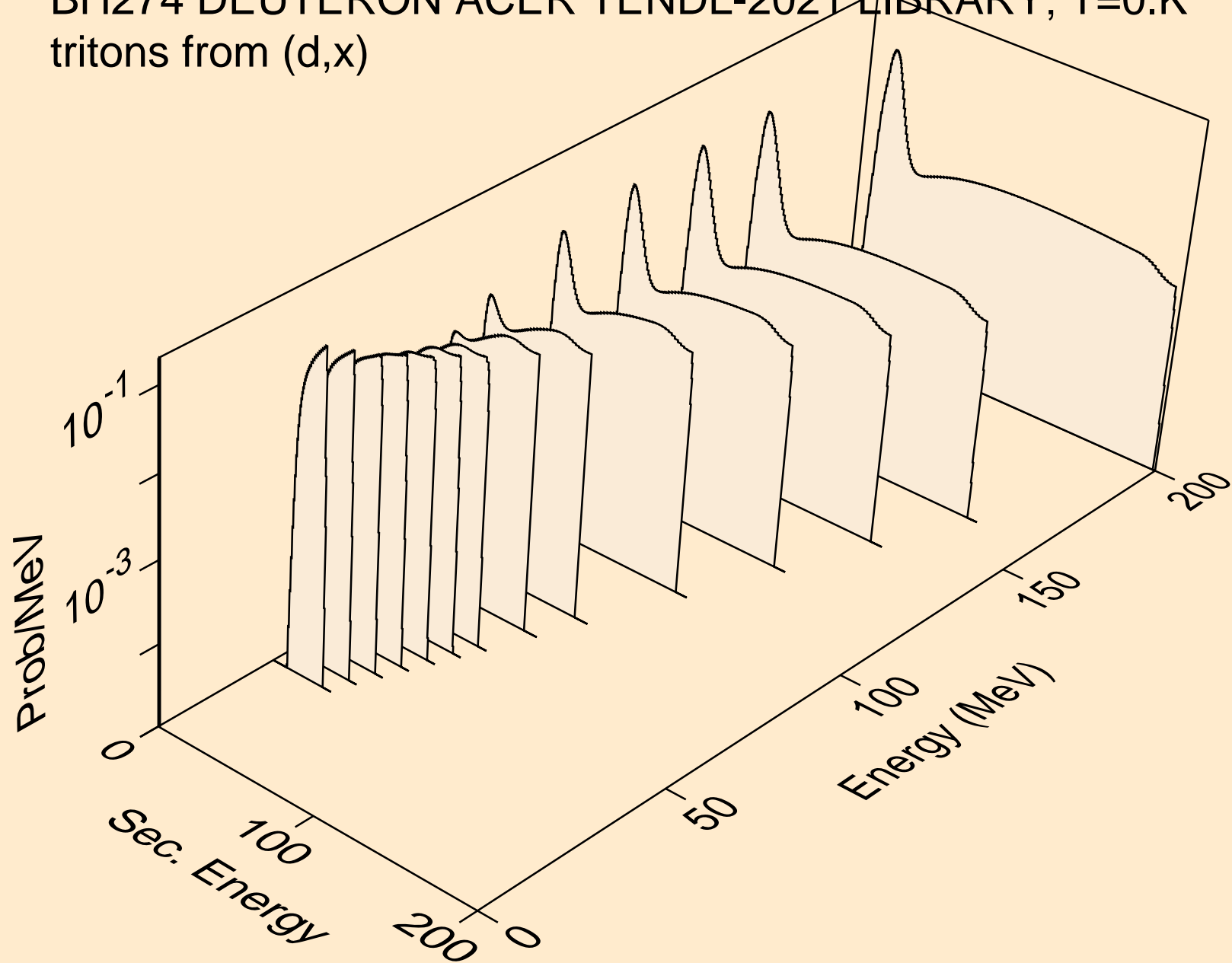

BH274 DEUTERON ACER TENDL-2021 LIBRARY; T=0.K  
tritons from (d,n\*)t

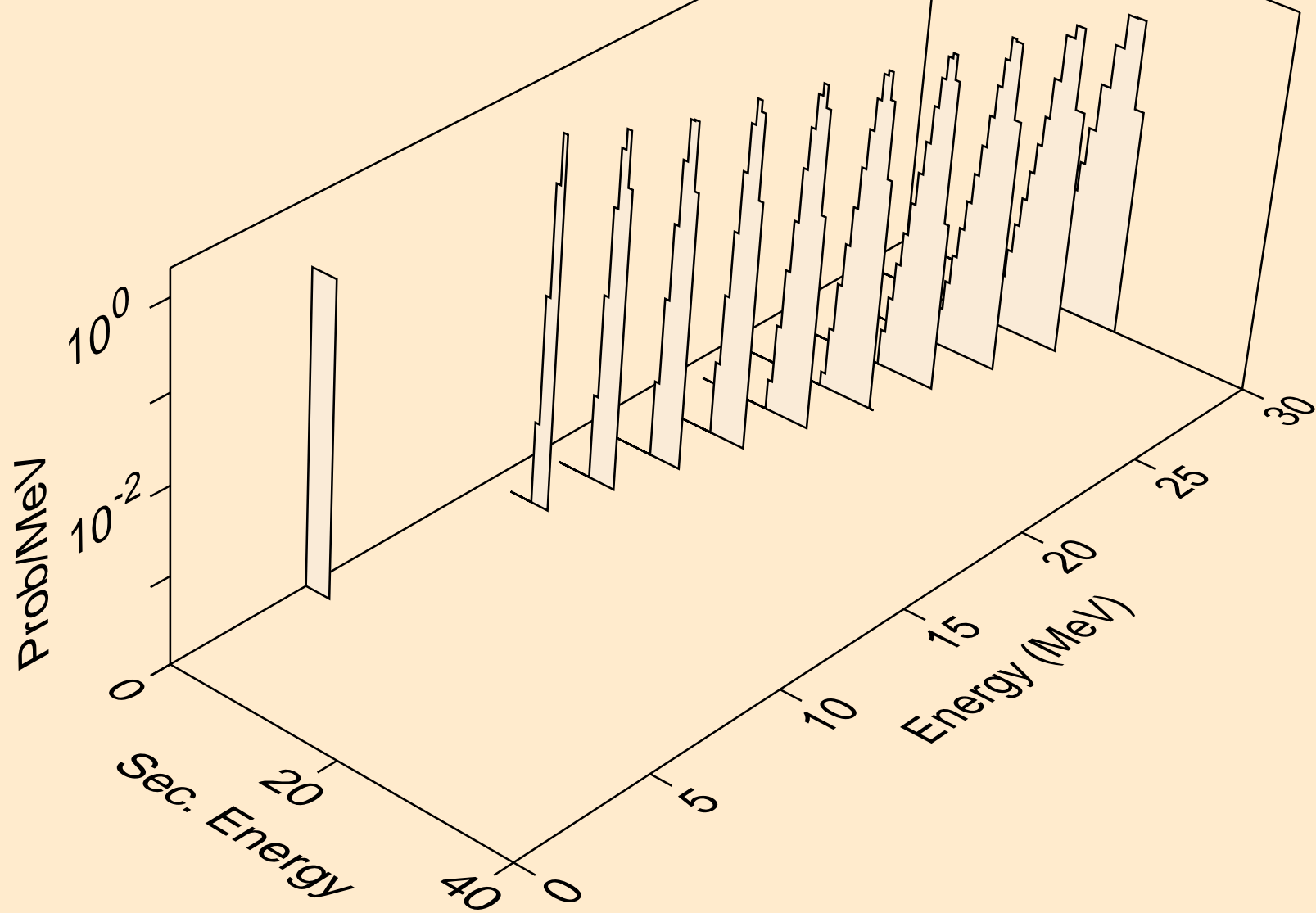

BH274 DEUTERON ACER TENDL-2021 LIBRARY; T=0.K  
tritons from (d,t)

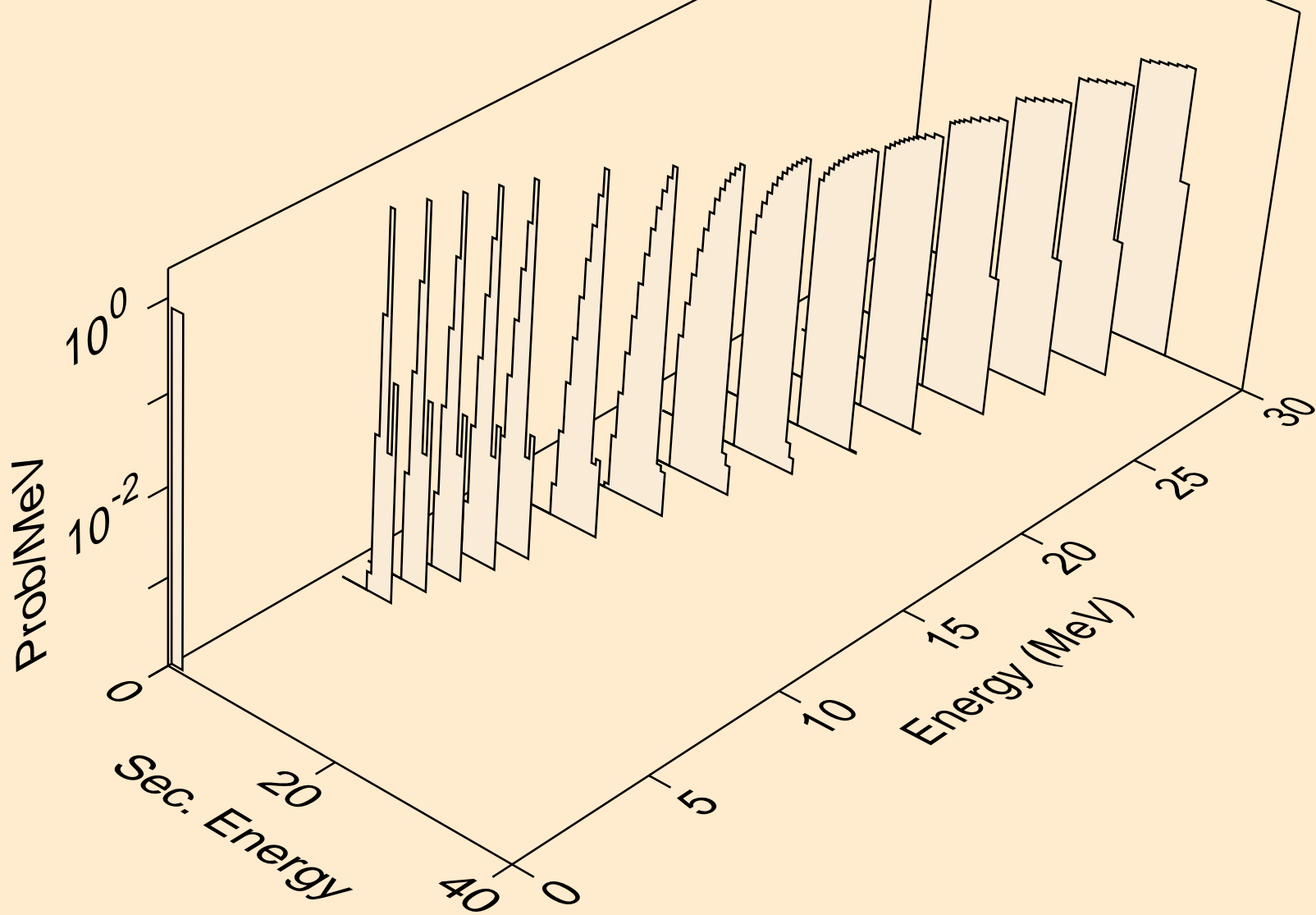

BH274 DEUTERON ACER TENDL-2021 LIBRARY; T=0.K  
he3s from (d,x)

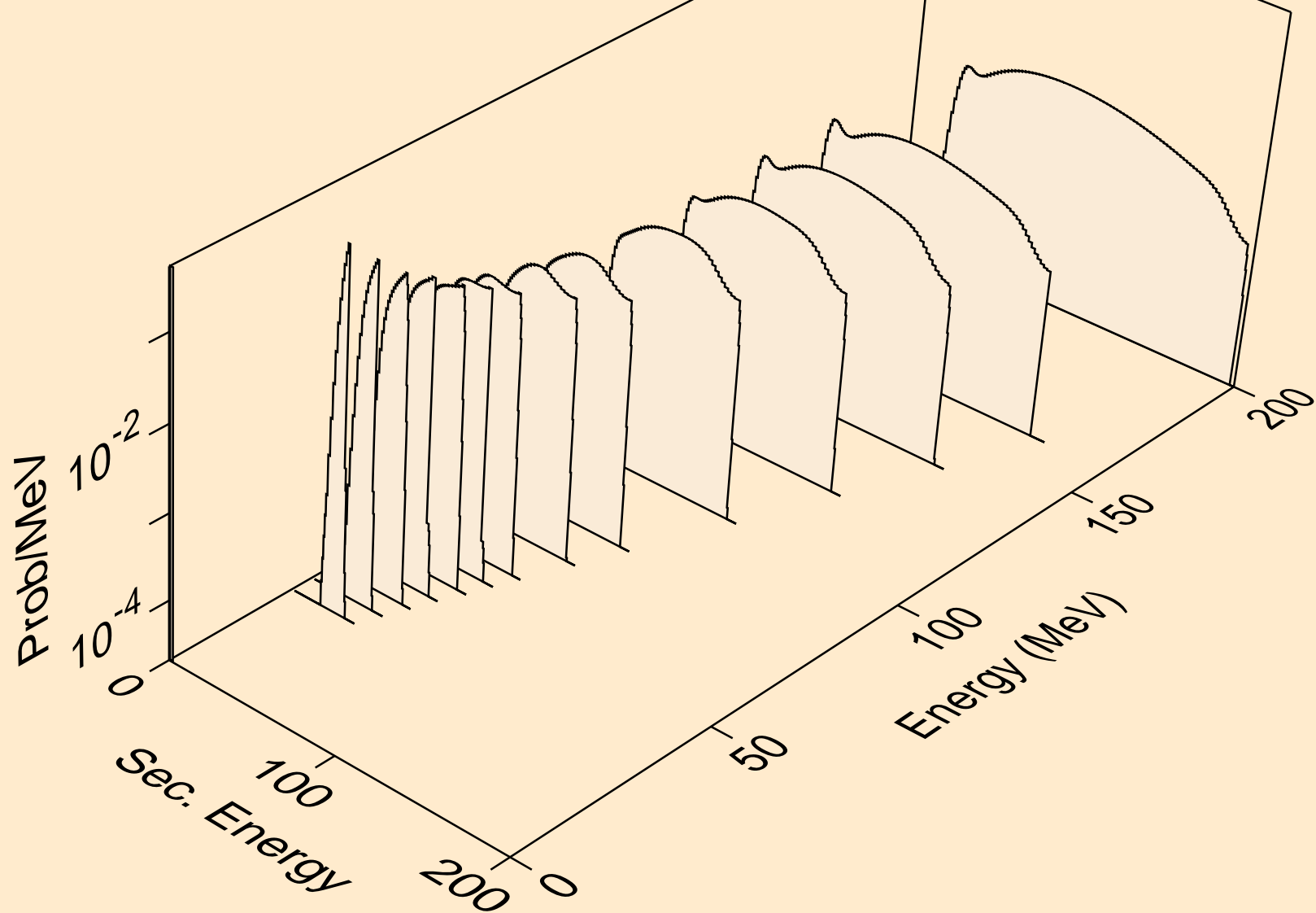

BH274 DEUTERON ACER TENDL-2021 LIBRARY; T=0.K  
he3s from (d,he3)

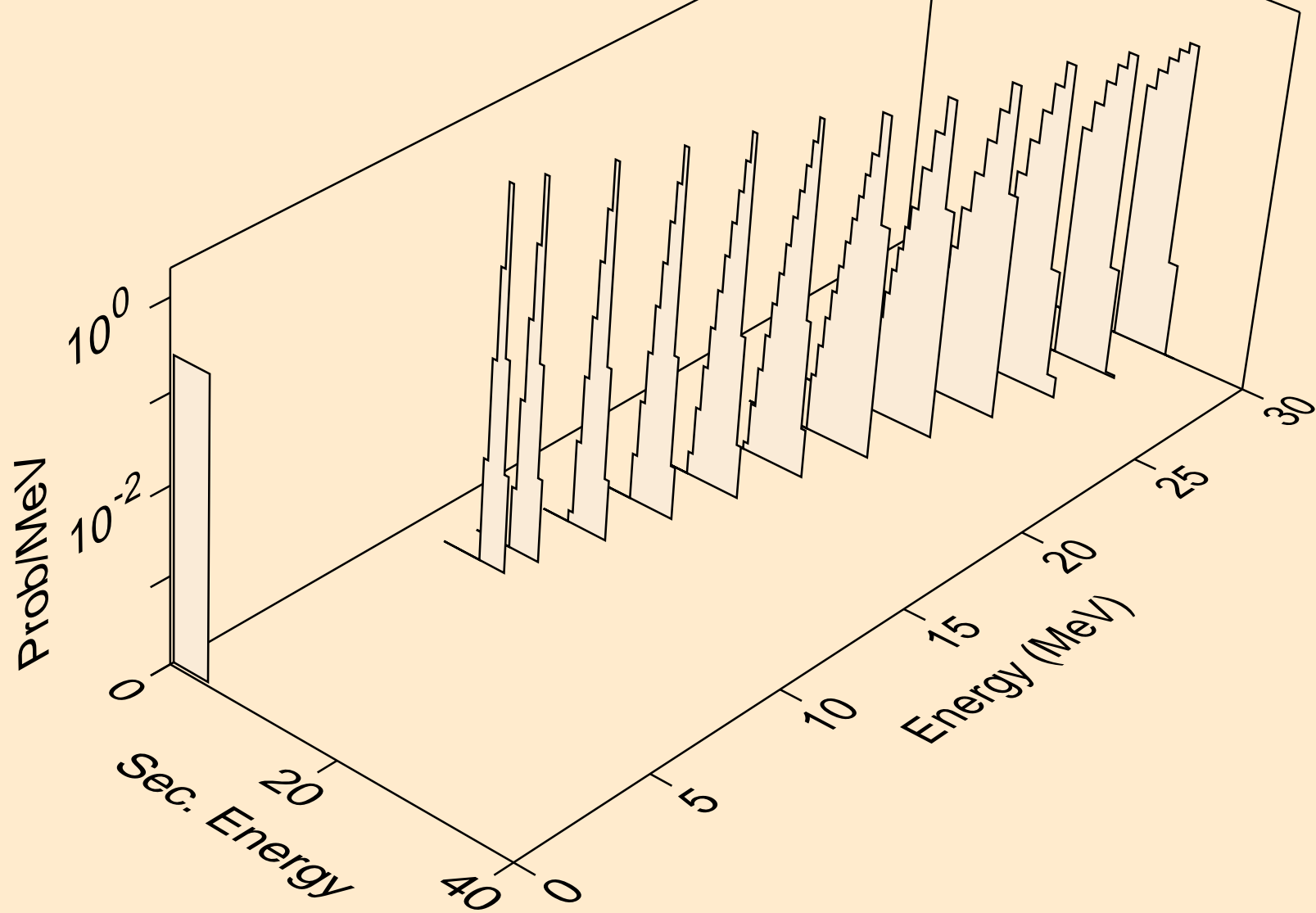

BH274 DEUTERON ACER TENDL-2021 LIBRARY; T=0.K  
alphas from (d,x)

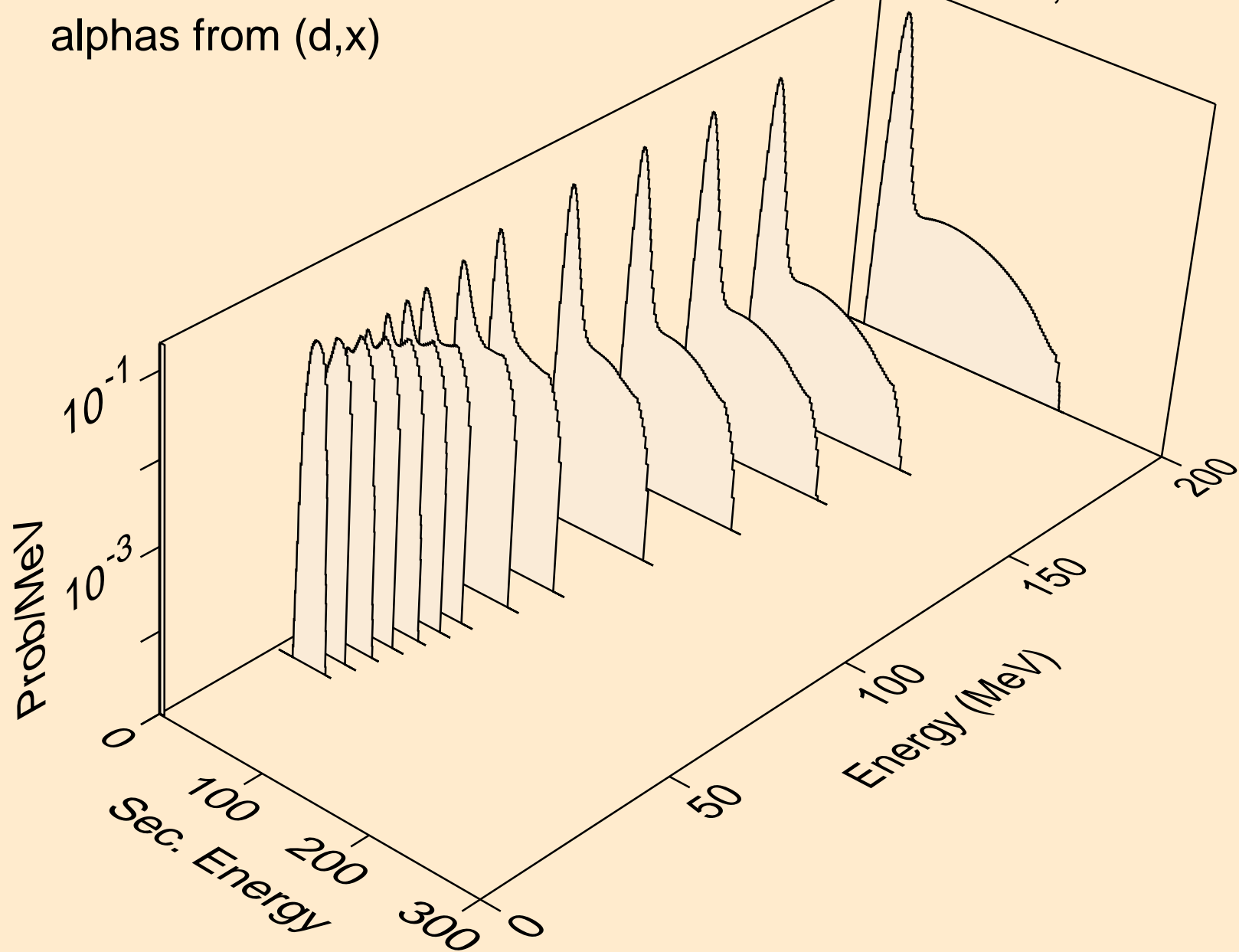



BH274 DEUTERON ACER TENDL-2021 LIBRARY; T=0.K  
alphas from (d,a)

