

CE121 DEUTERON ACER TENDL-2021 LIBRARY; T=0.K

Principal cross sections

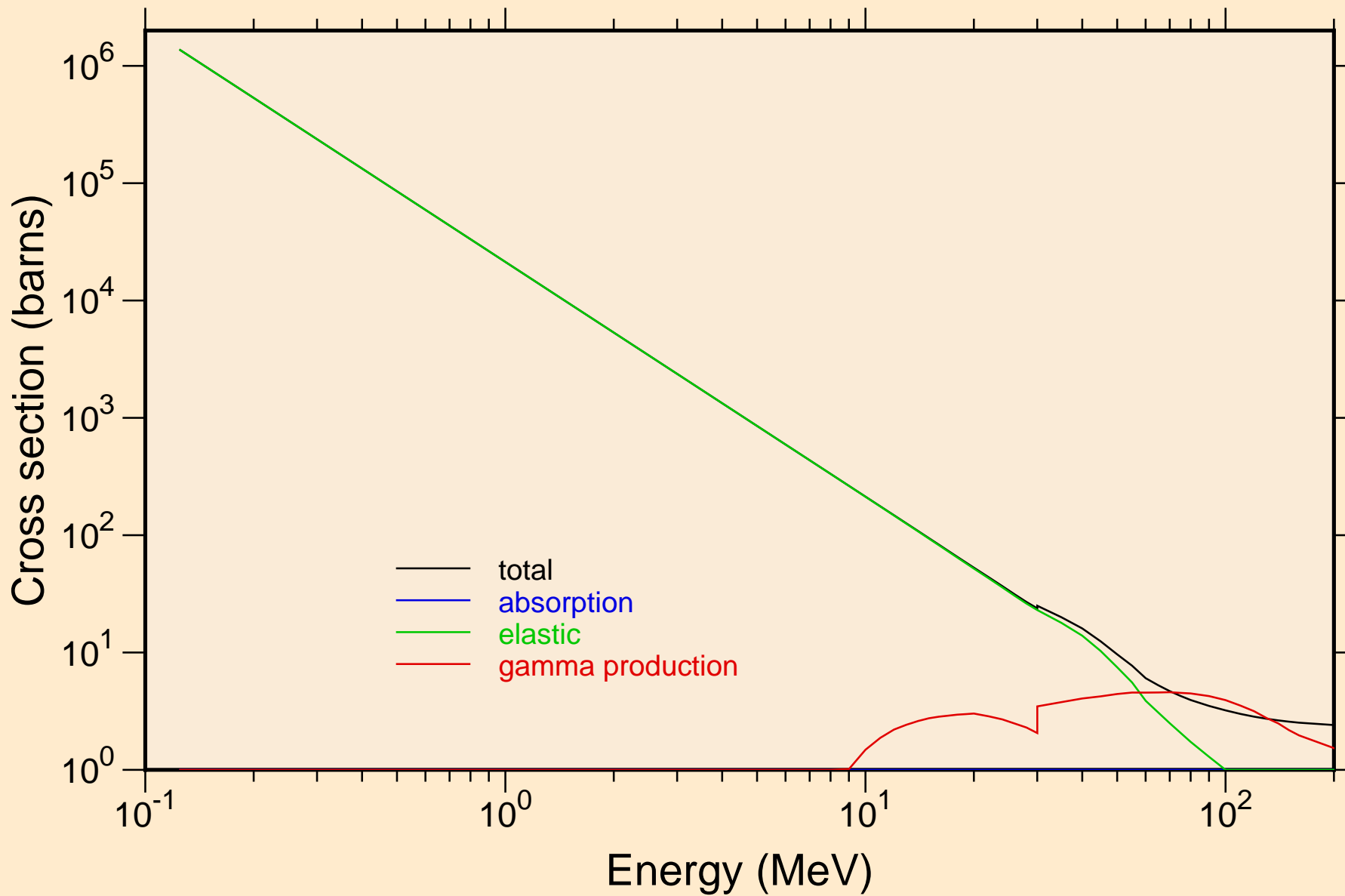

CE121 DEUTERON ACER TENDL-2021 LIBRARY; T=0.K
Heating

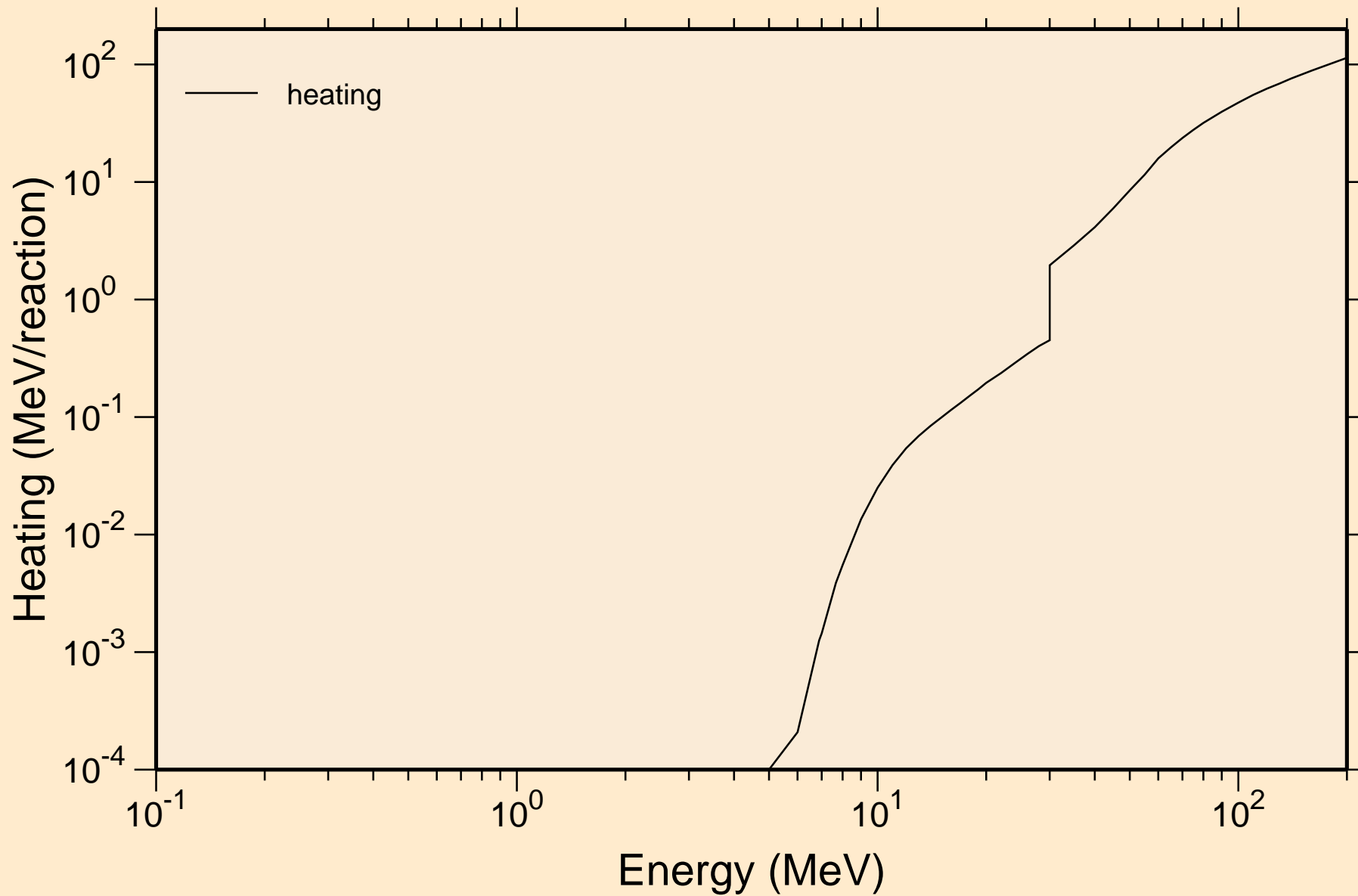

CE121 DEUTERON ACER TENDL-2021 LIBRARY; T=0.K

Principal cross sections

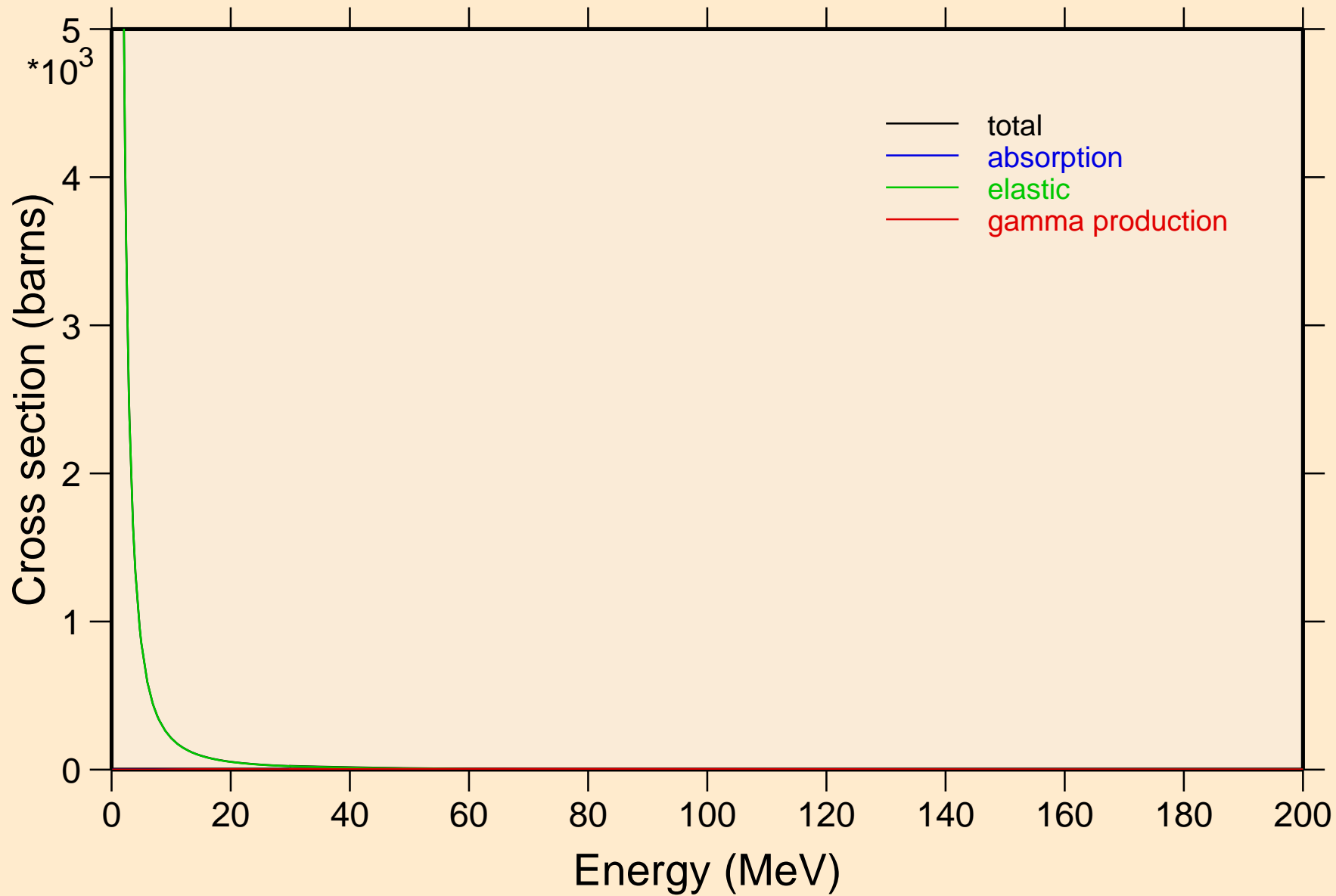

CE121 DEUTERON ACER TENDL-2021 LIBRARY; T=0.K
Heating

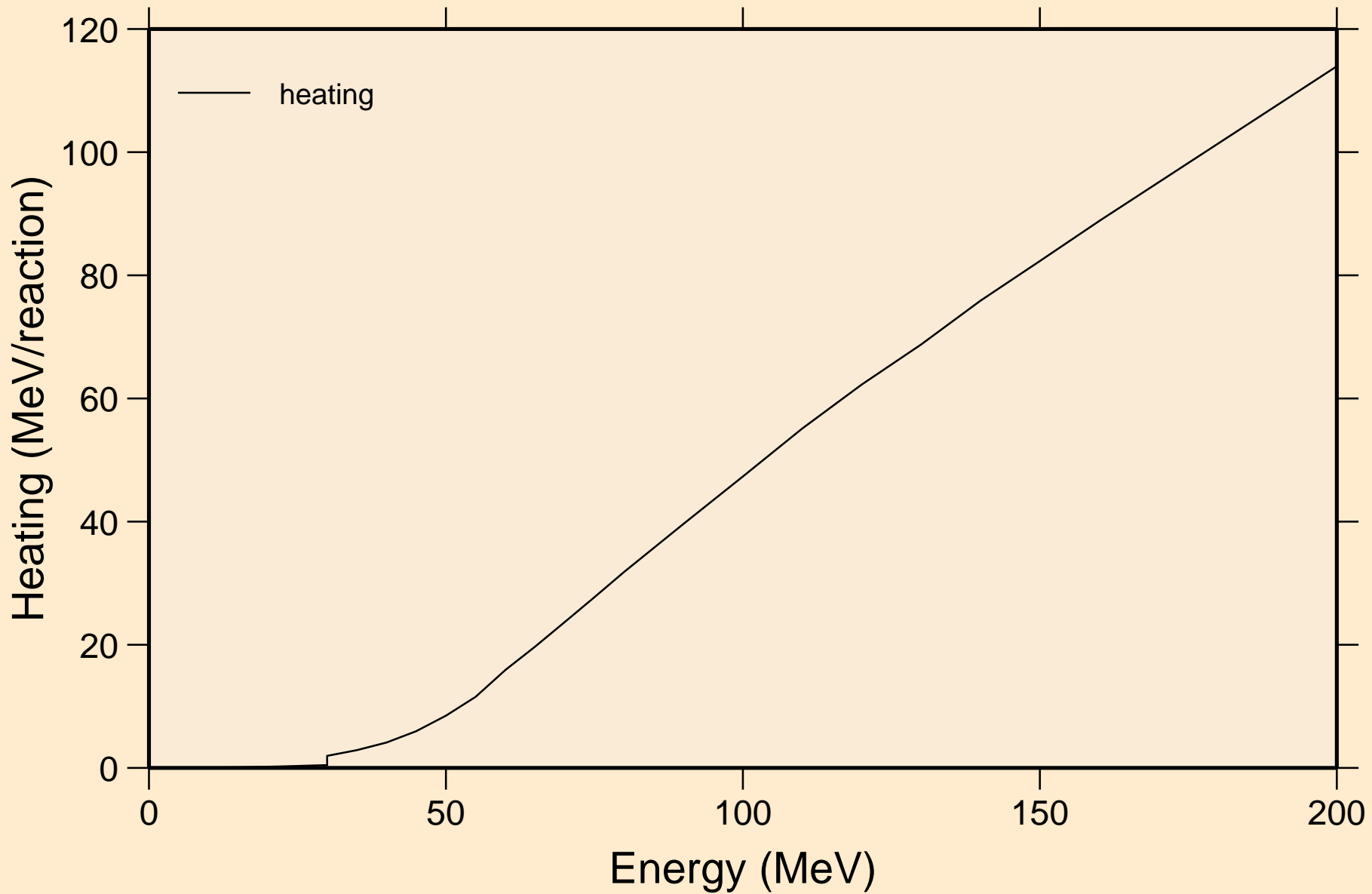

CE121 DEUTERON ACER TENDL-2021 LIBRARY; T=0.K

Threshold reactions

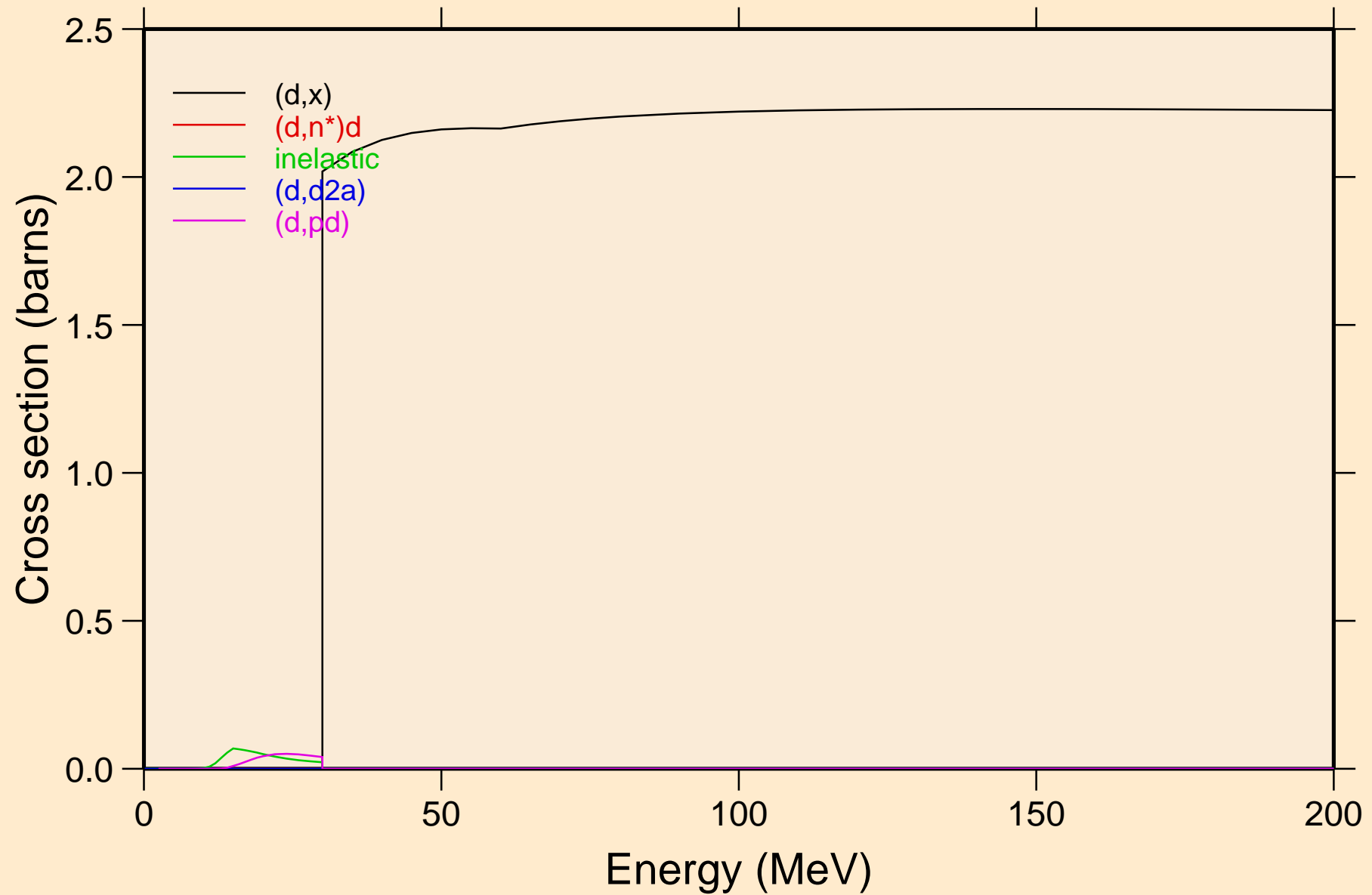

CE121 DEUTERON ACER TENDL-2021 LIBRARY; T=0.K
Threshold reactions

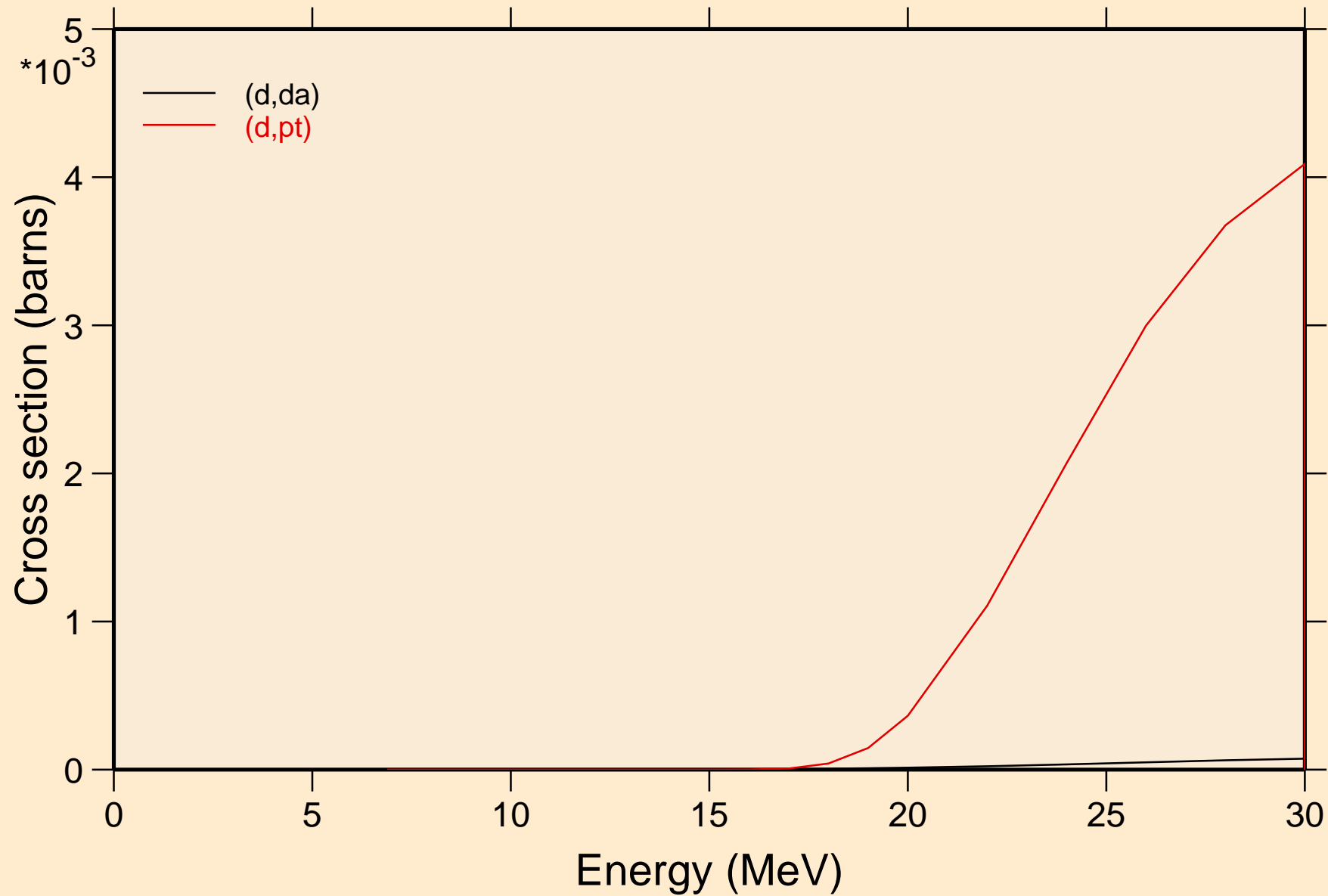

CE121 DEUTERON ACER TENDL-2021 LIBRARY; T=0.K
Threshold reactions

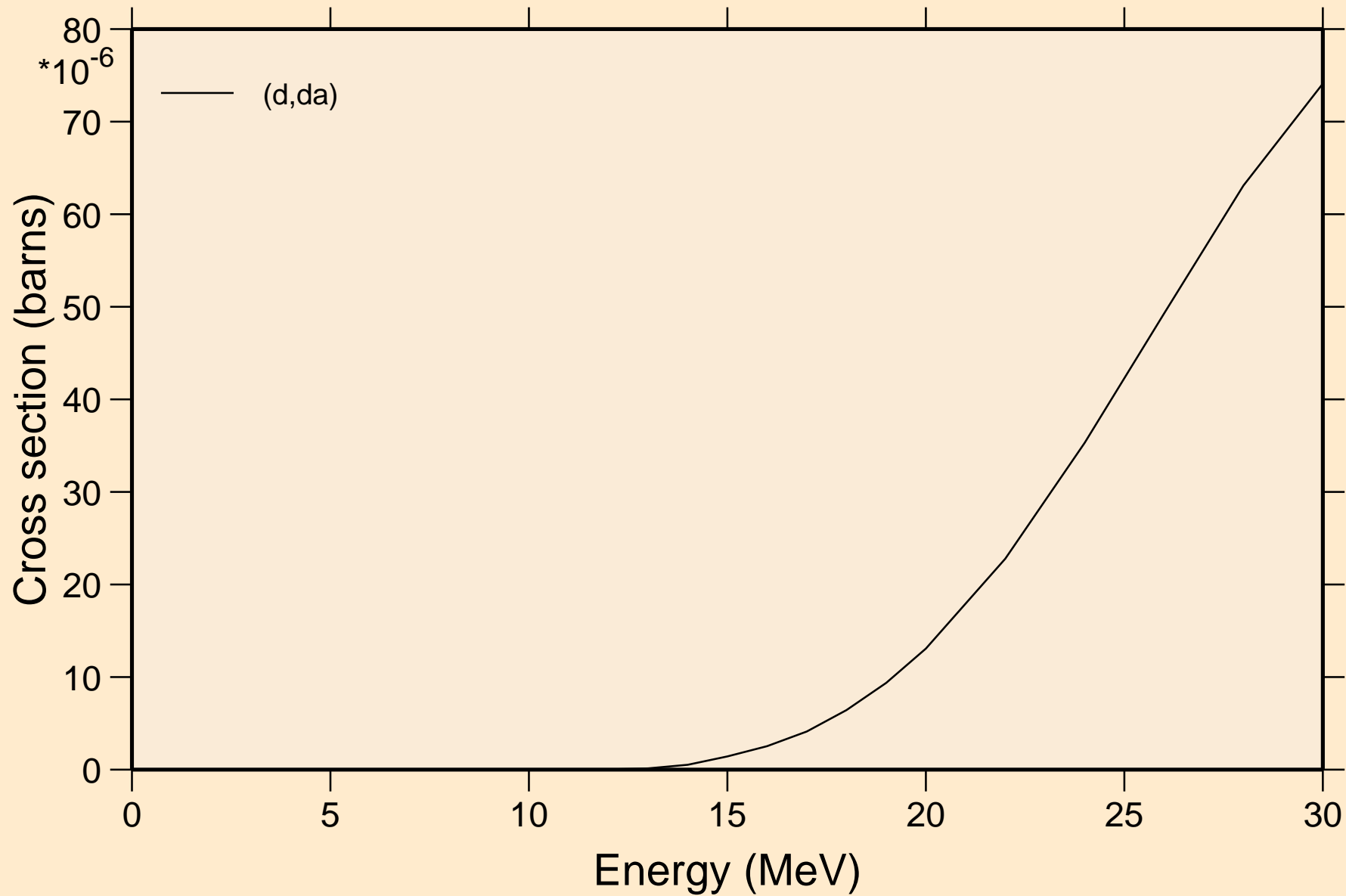

CE121 DEUTERON ACER TENDL-2021 LIBRARY; T=0.K
angular distribution for elastic

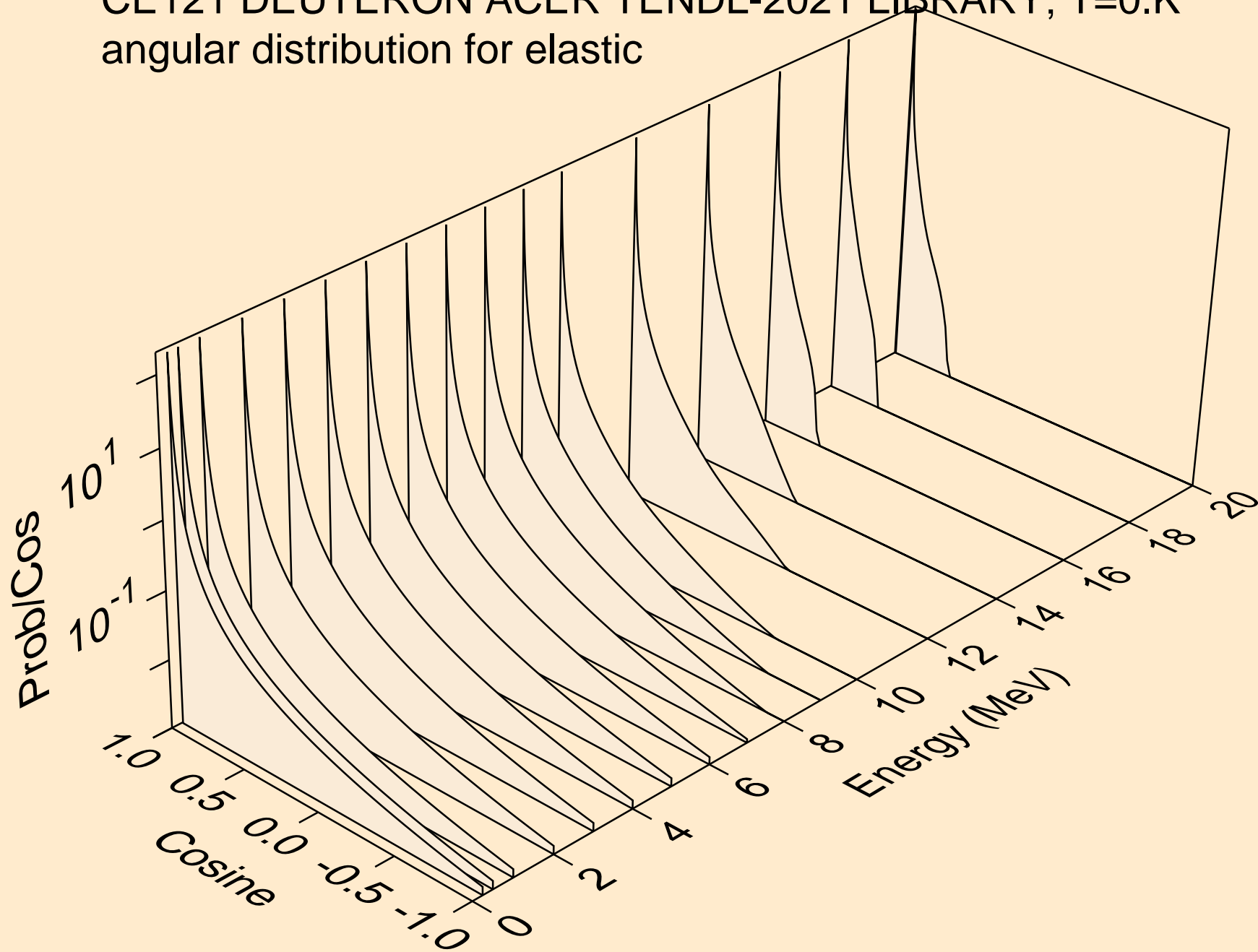

CE121 DEUTERON ACER TENDL-2021 LIBRARY; T=0.K
angular distribution for elastic

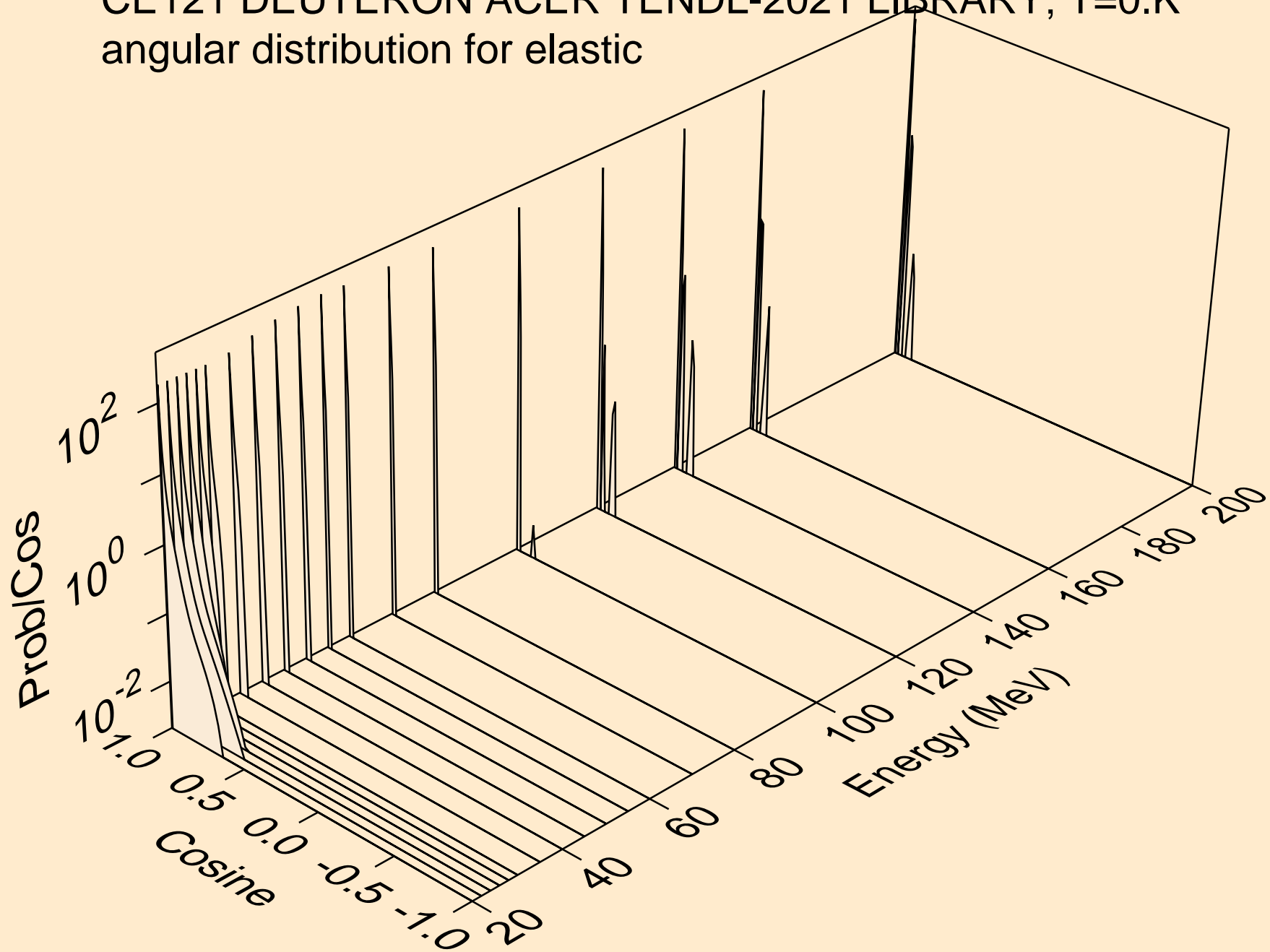

CE121 DEUTERON ACER TENDL-2021 LIBRARY; T=0.K
Deuteron emission for (d,x)

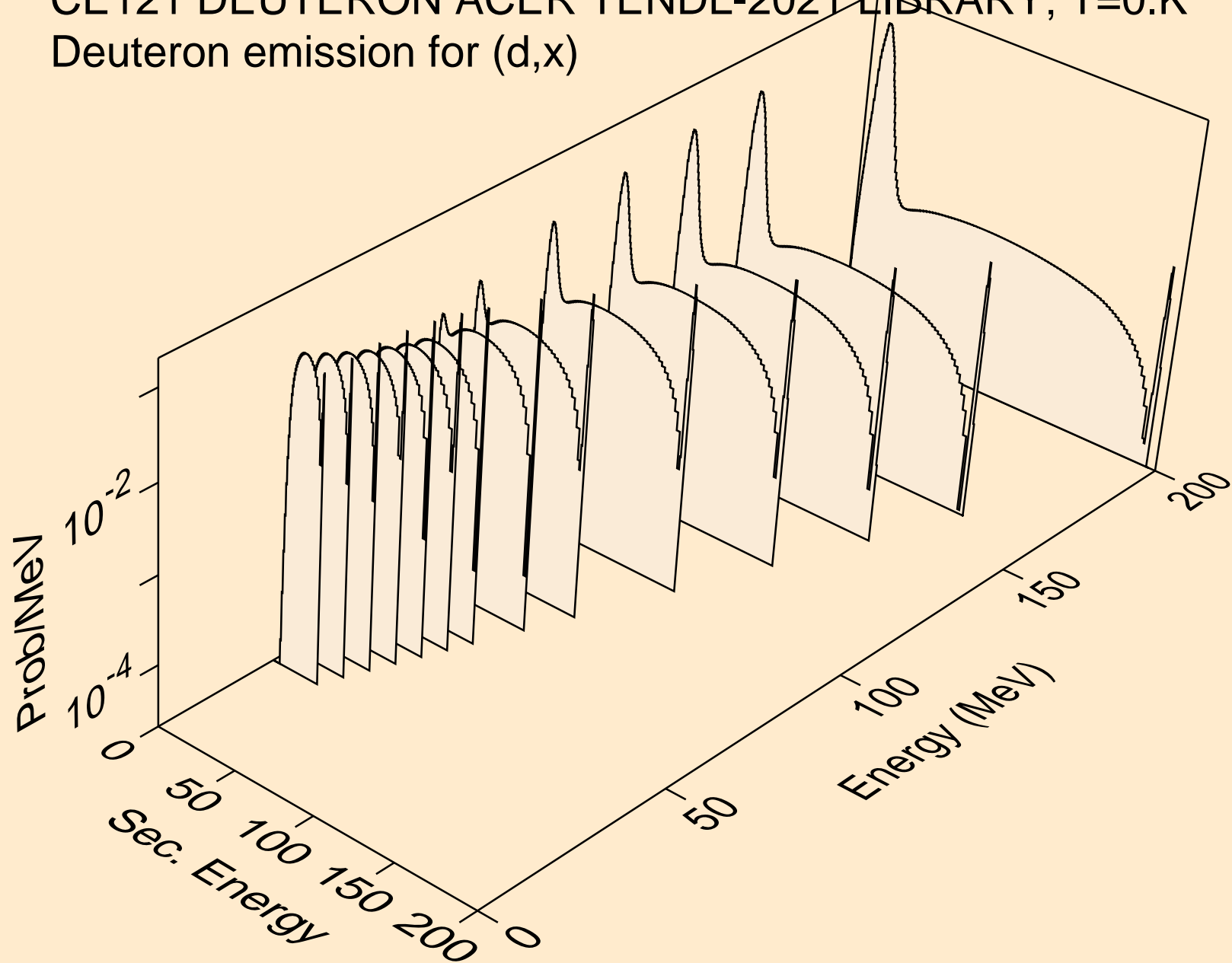

CE121 DEUTERON ACER TENDL-2021 LIBRARY; T=0.K
Deuteron emission for (d,n*)d

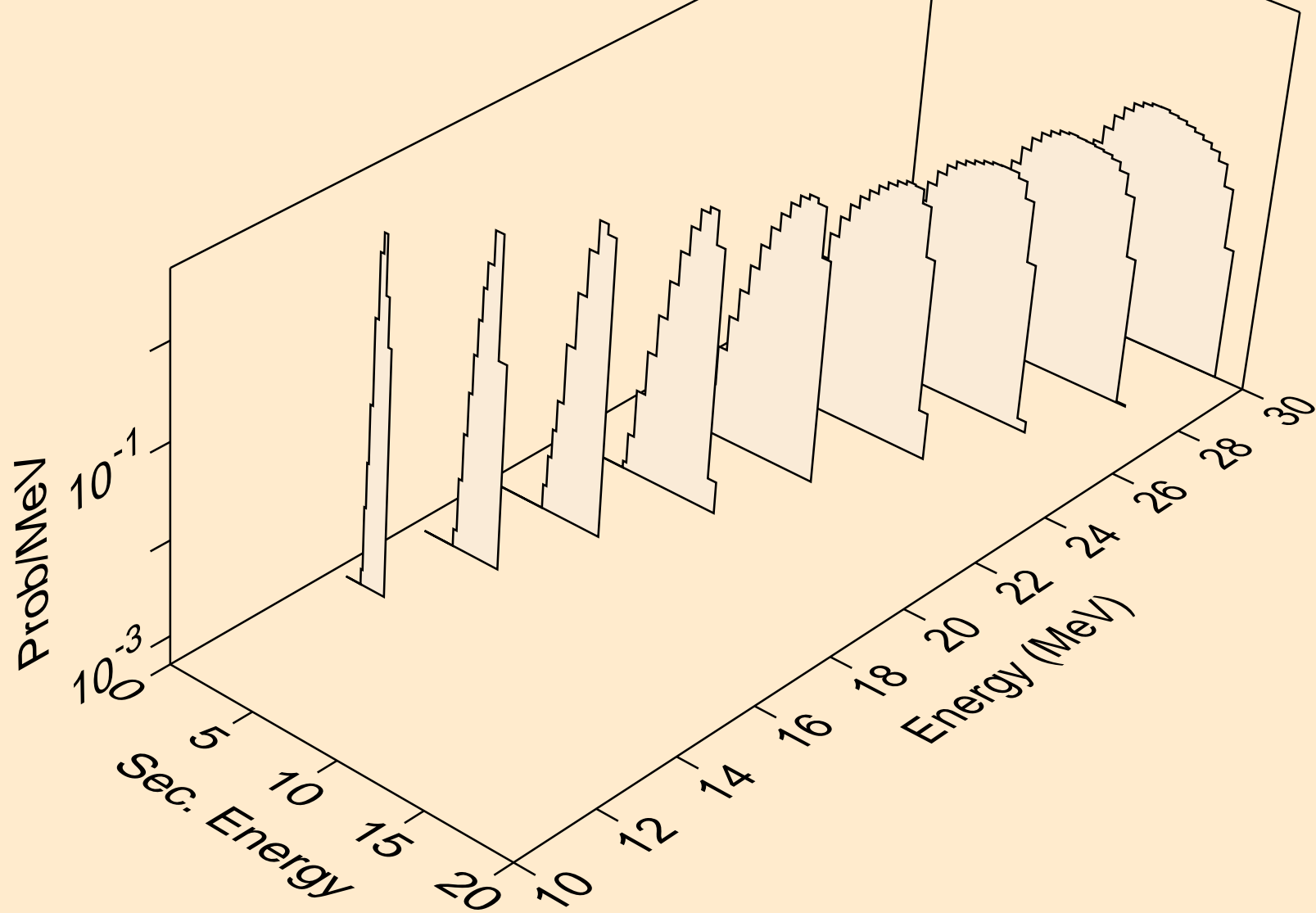

CE121 DEUTERON ACER TENDL-2021 LIBRARY; T=0.K
Deuteron emission for inelastic

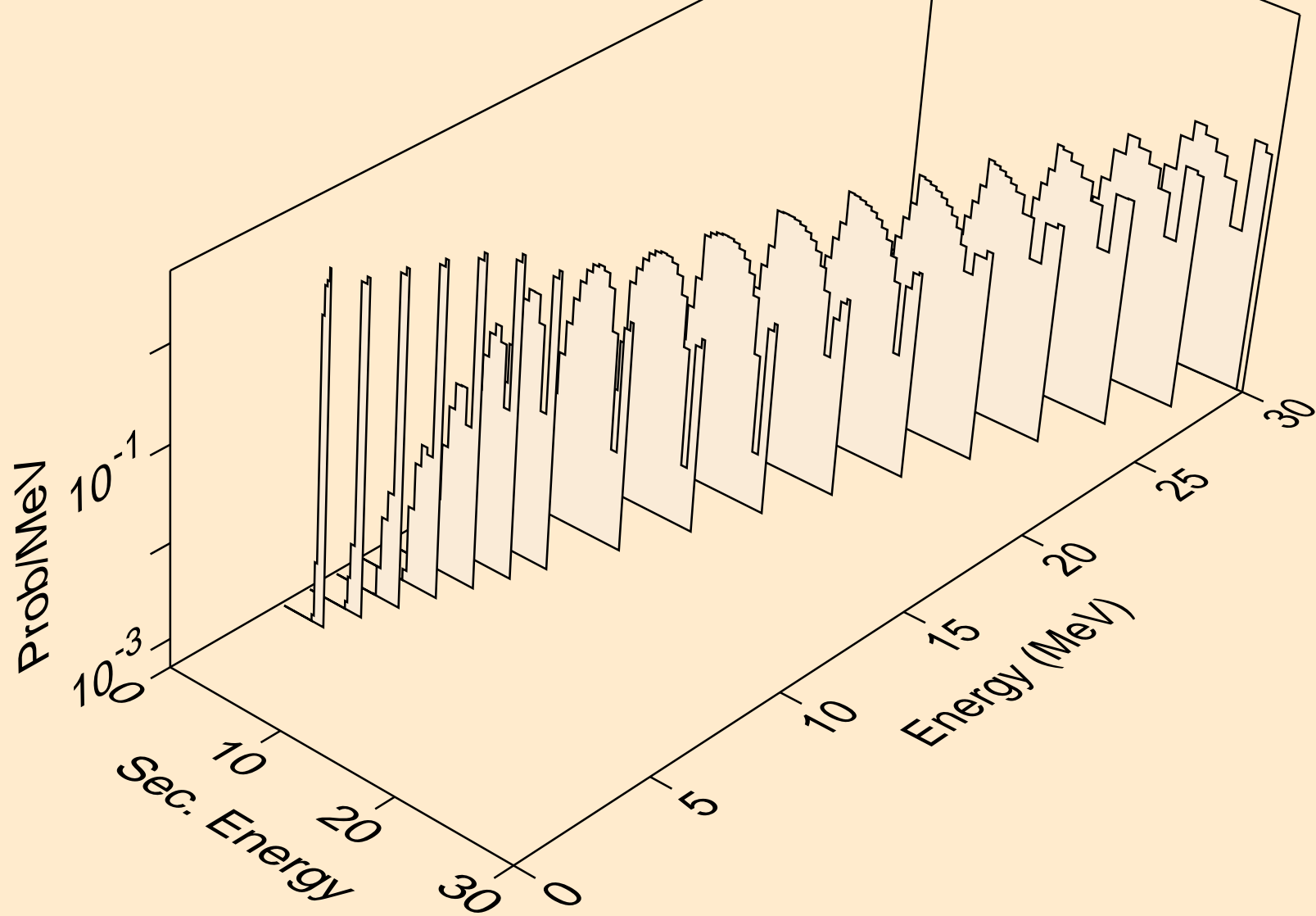

CE121 DEUTERON ACER TENDL-2021 LIBRARY; T=0.K
Deuteron emission for (d,d2a)

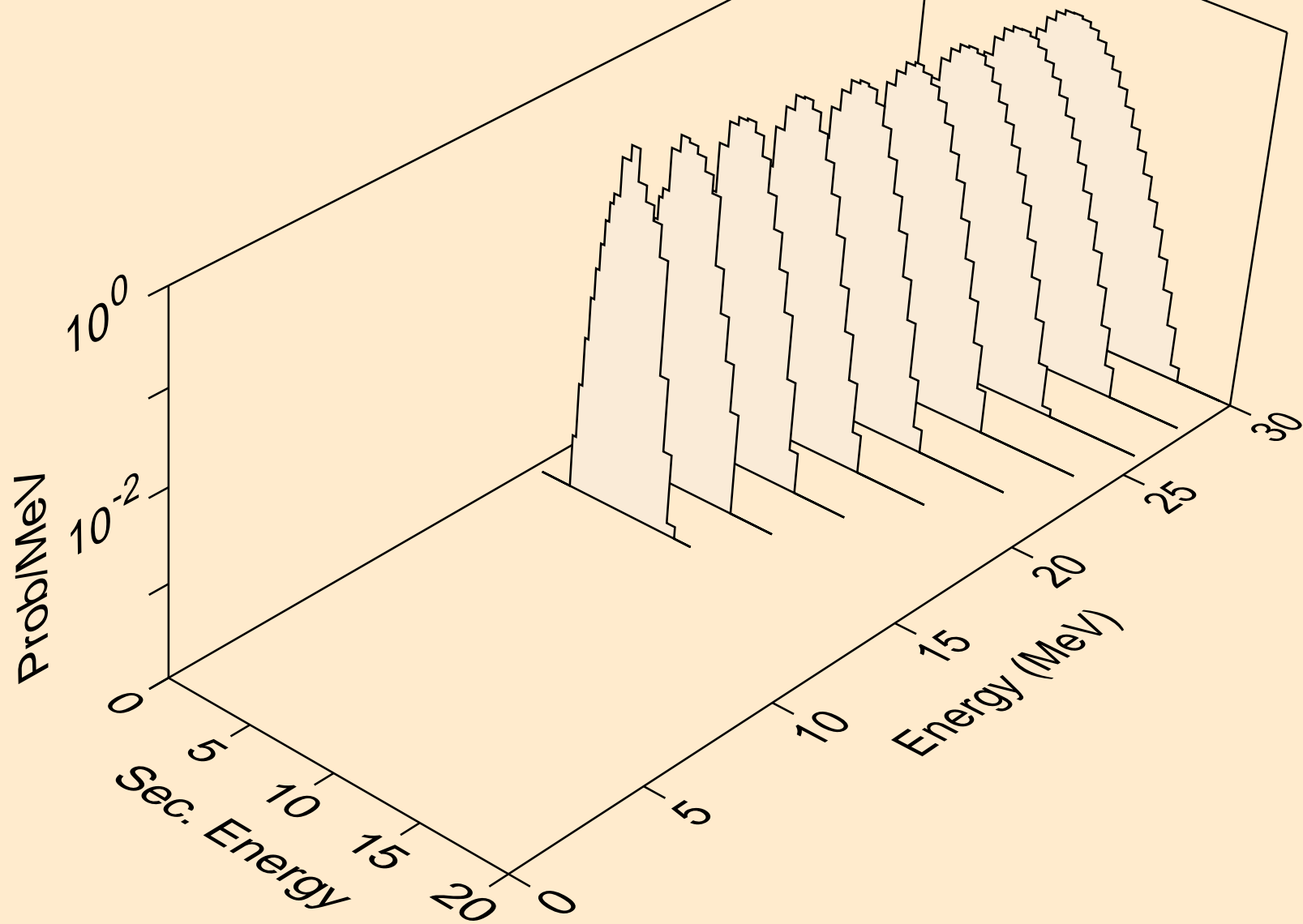

CE121 DEUTERON ACER TENDL-2021 LIBRARY; T=0.K
Deuteron emission for (d,pd)

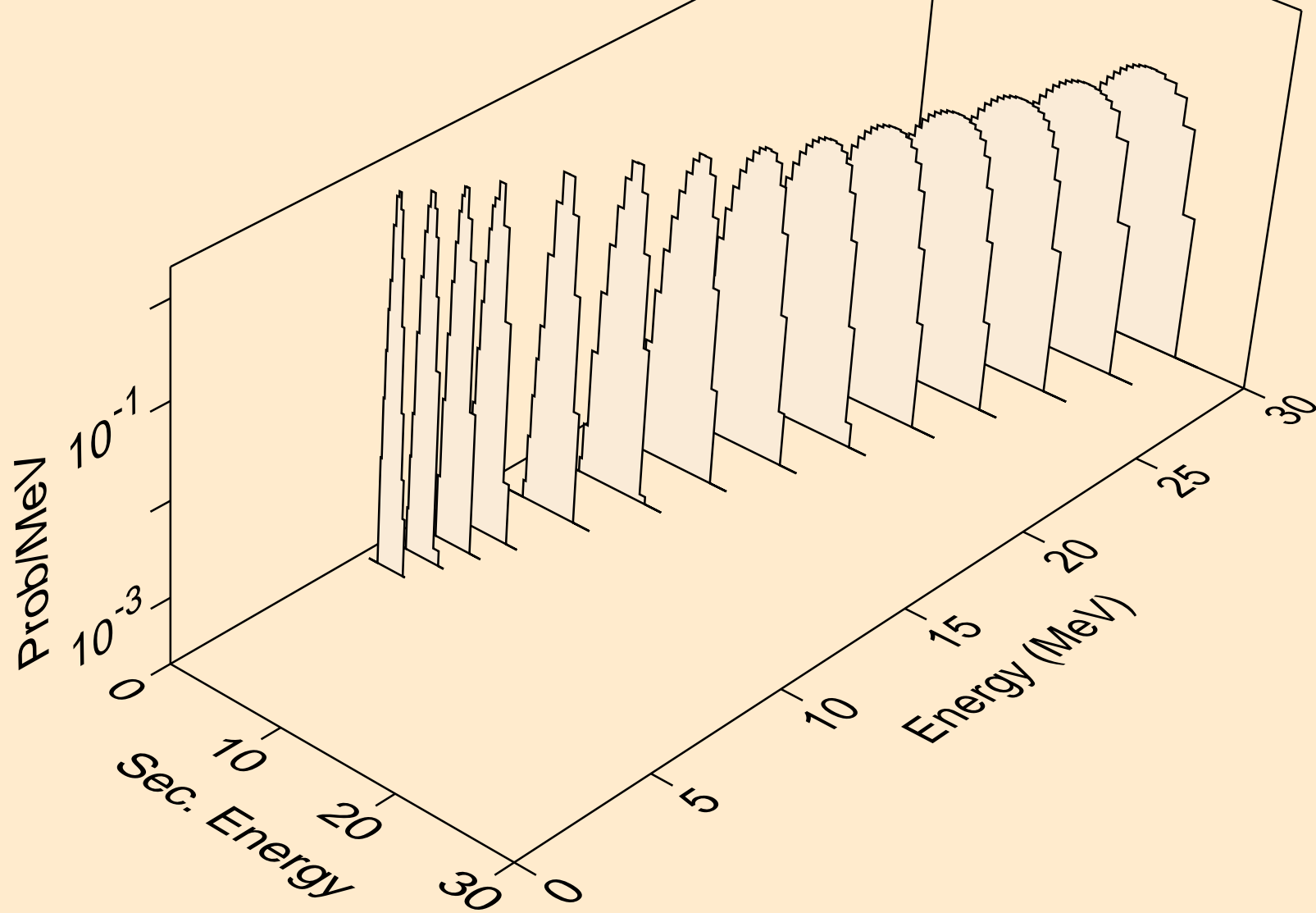

CE121 DEUTERON ACER TENDL-2021 LIBRARY; T=0.K
Deuteron emission for (d,da)

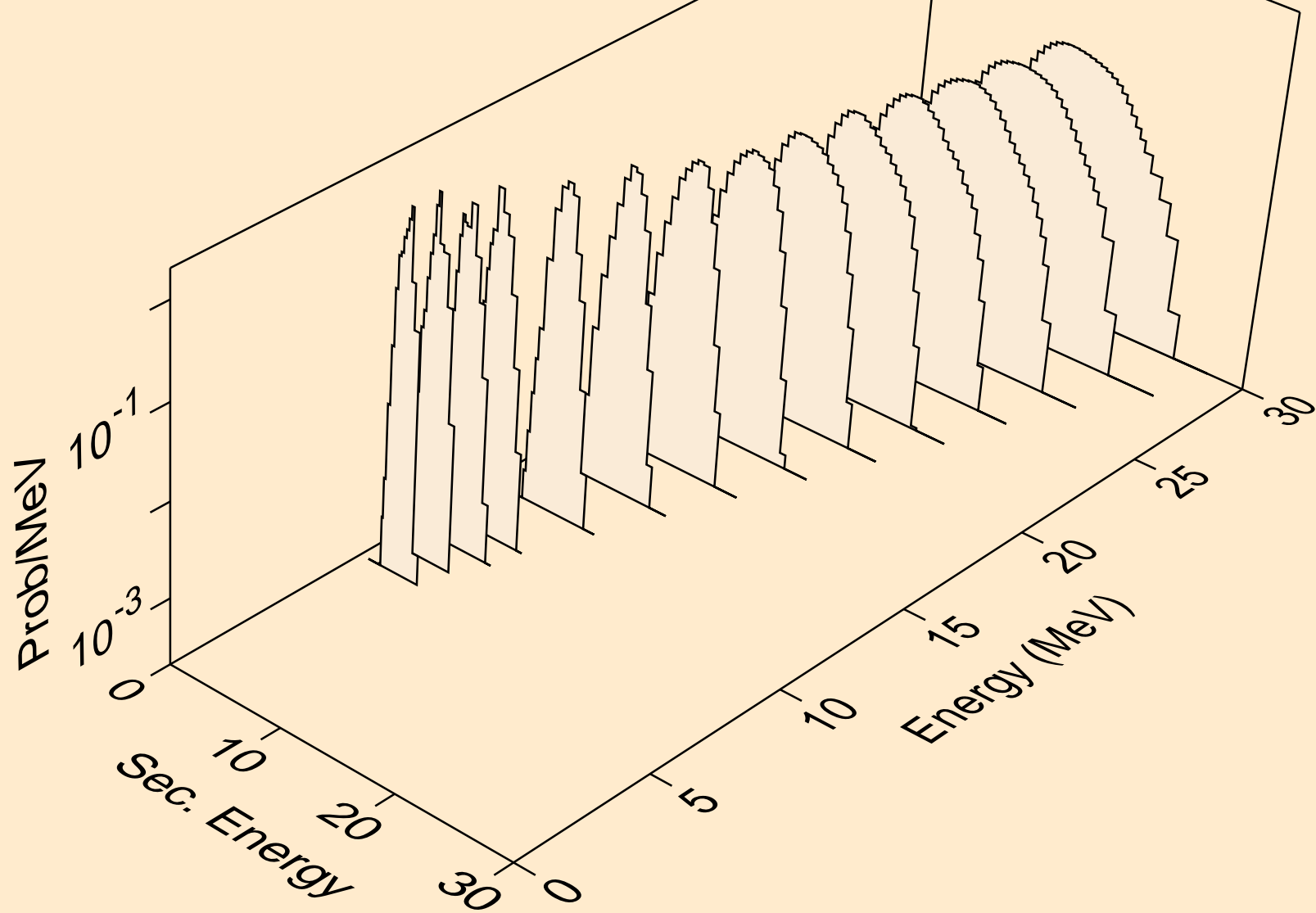

CE121 DEUTERON ACER TENDL-2021 LIBRARY; T=0.K
Photon emission for (z,n)

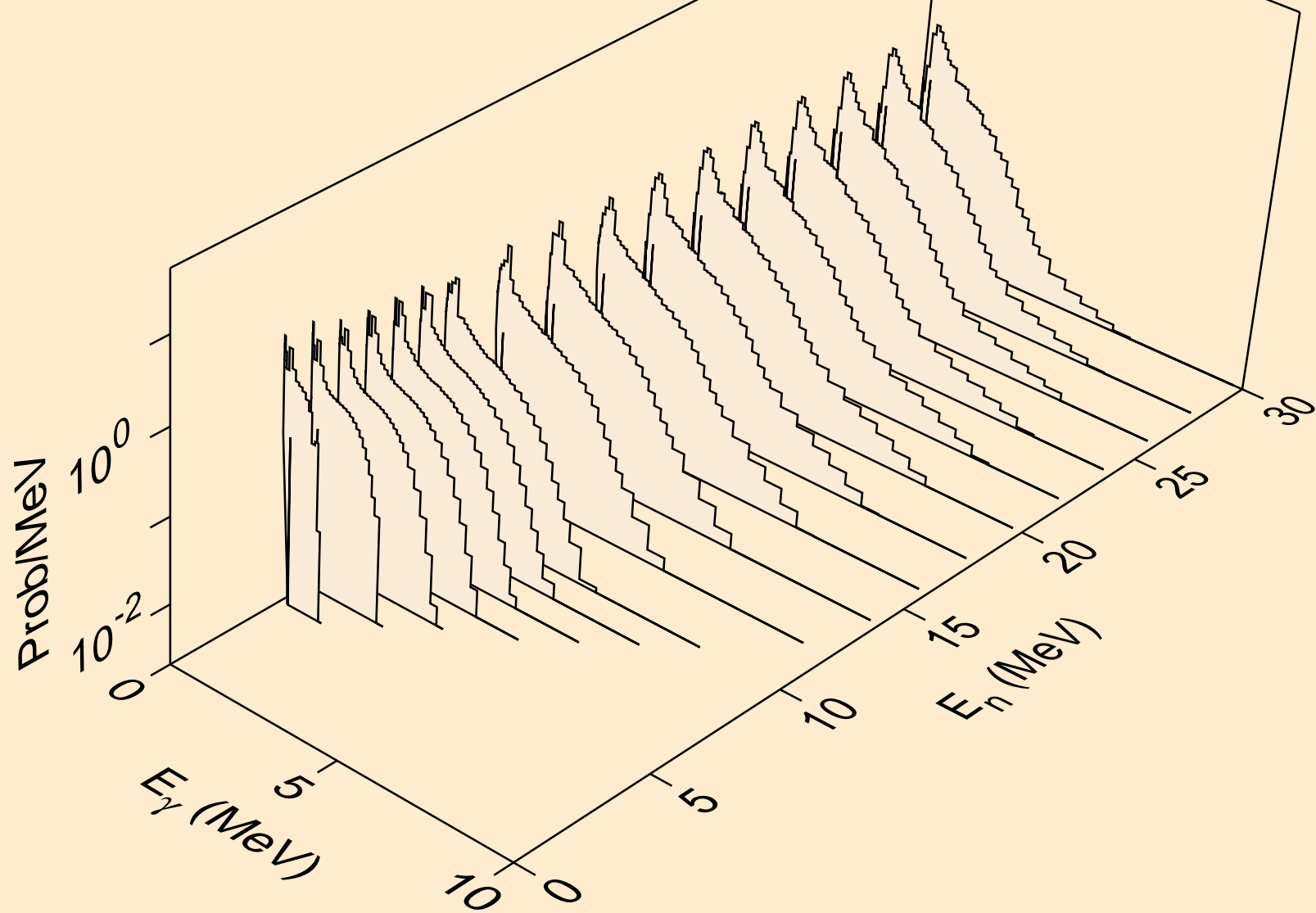

CE121 DEUTERON ACER TENDL-2021 LIBRARY; T=0.K
Photon emission for (n,x)

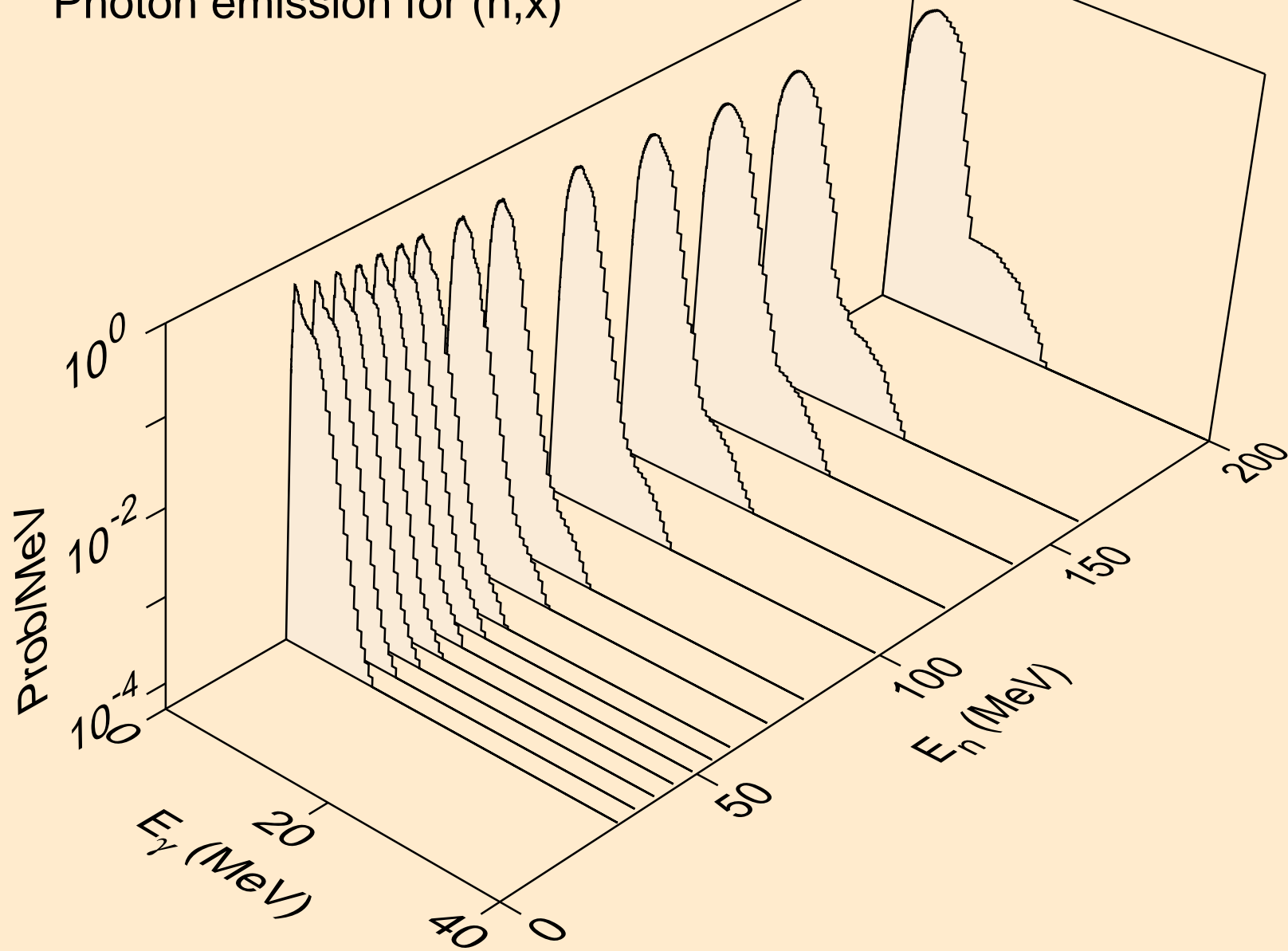

CE121 DEUTERON ACER TENDL-2021 LIBRARY; T=0.K
Photon emission for (n,2n)

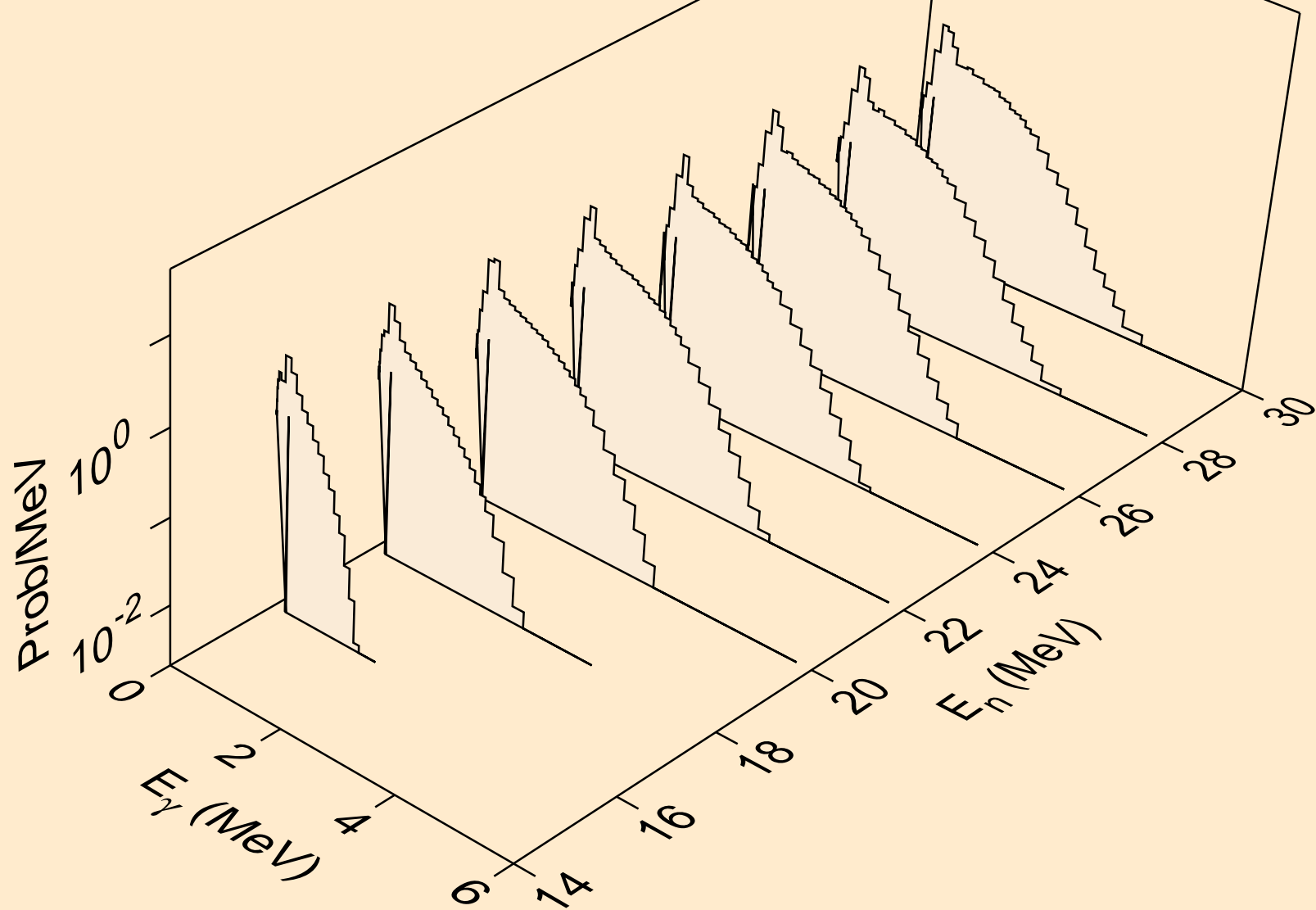

CE121 DEUTERON ACER TENDL-2021 LIBRARY; T=0.K
Photon emission for (n,n*)a

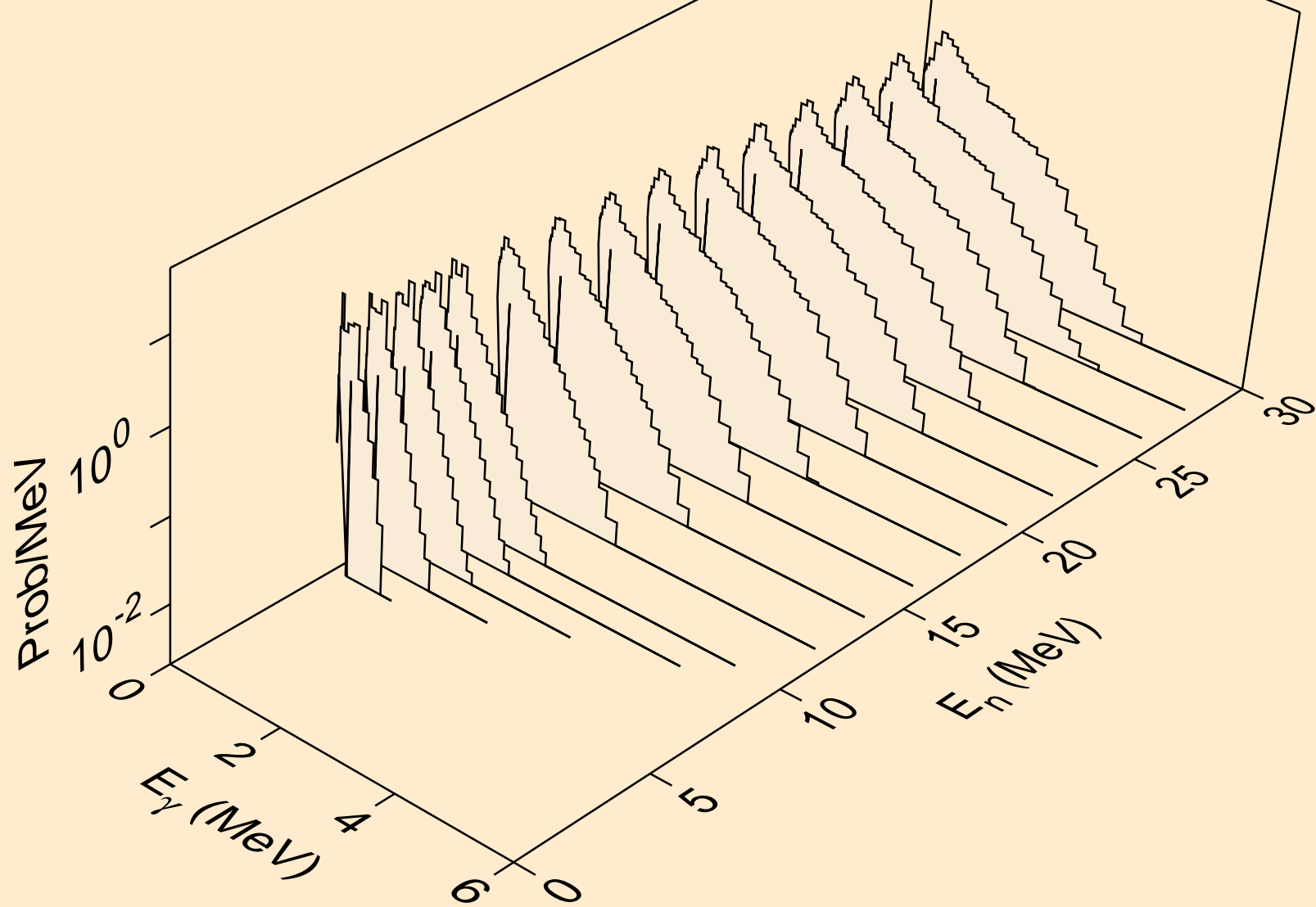

CE121 DEUTERON ACER TENDL-2021 LIBRARY; T=0.K
Photon emission for (n,2n)a

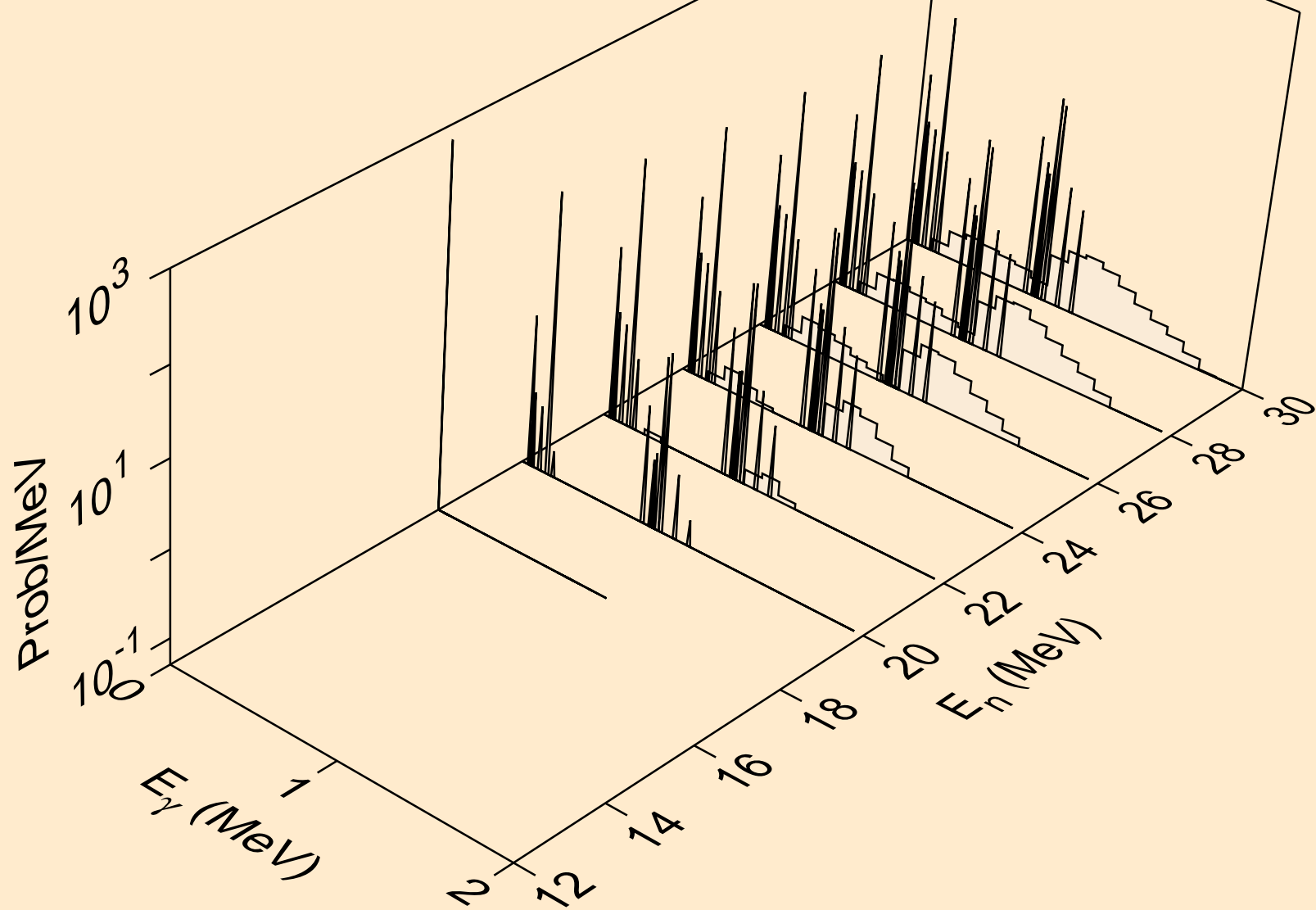

CE121 DEUTERON ACER TENDL-2021 LIBRARY; T=0.K
Photon emission for (n,n*)p

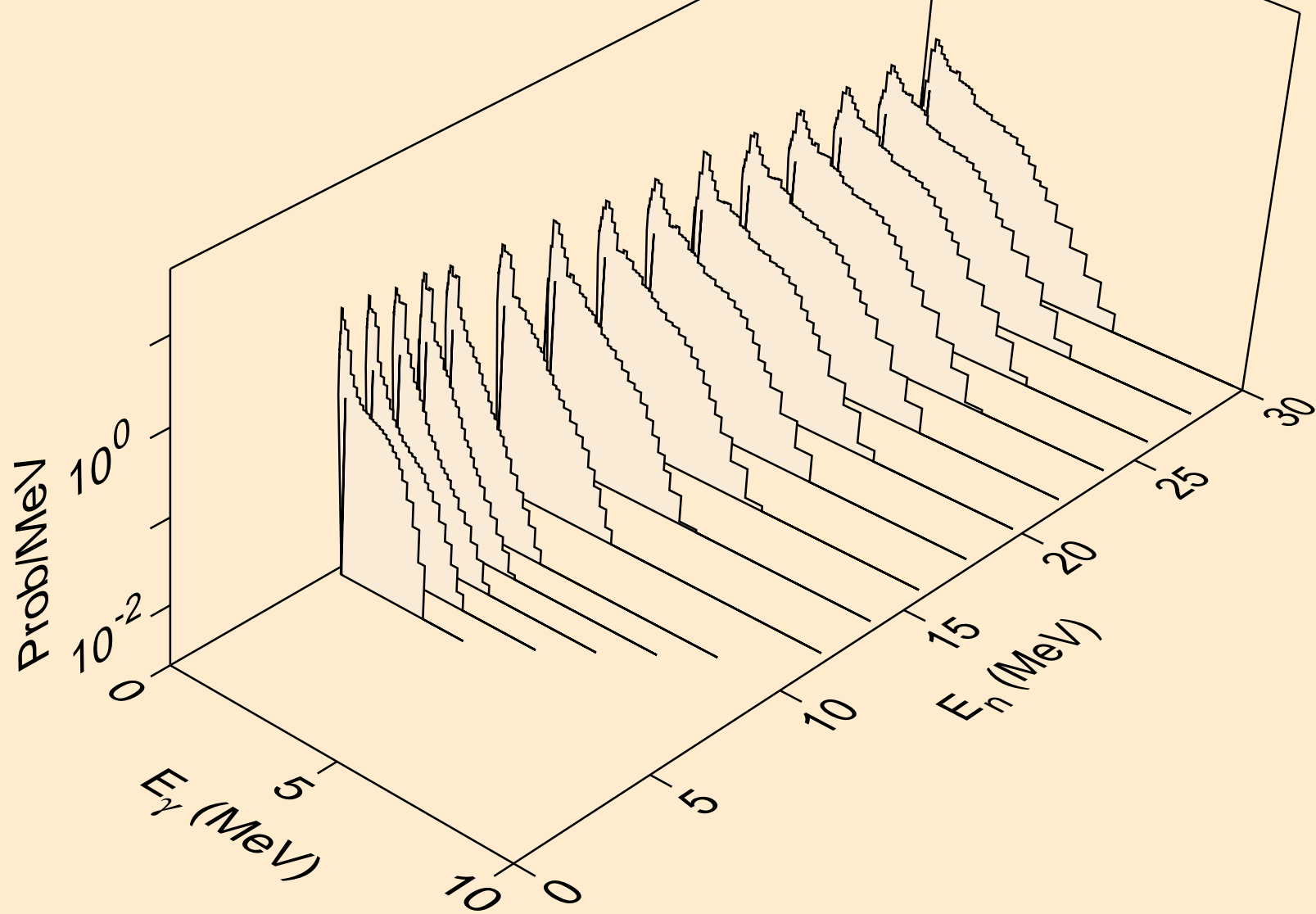

CE121 DEUTERON ACER TENDL-2021 LIBRARY; T=0.K
Photon emission for (n,n*)2a

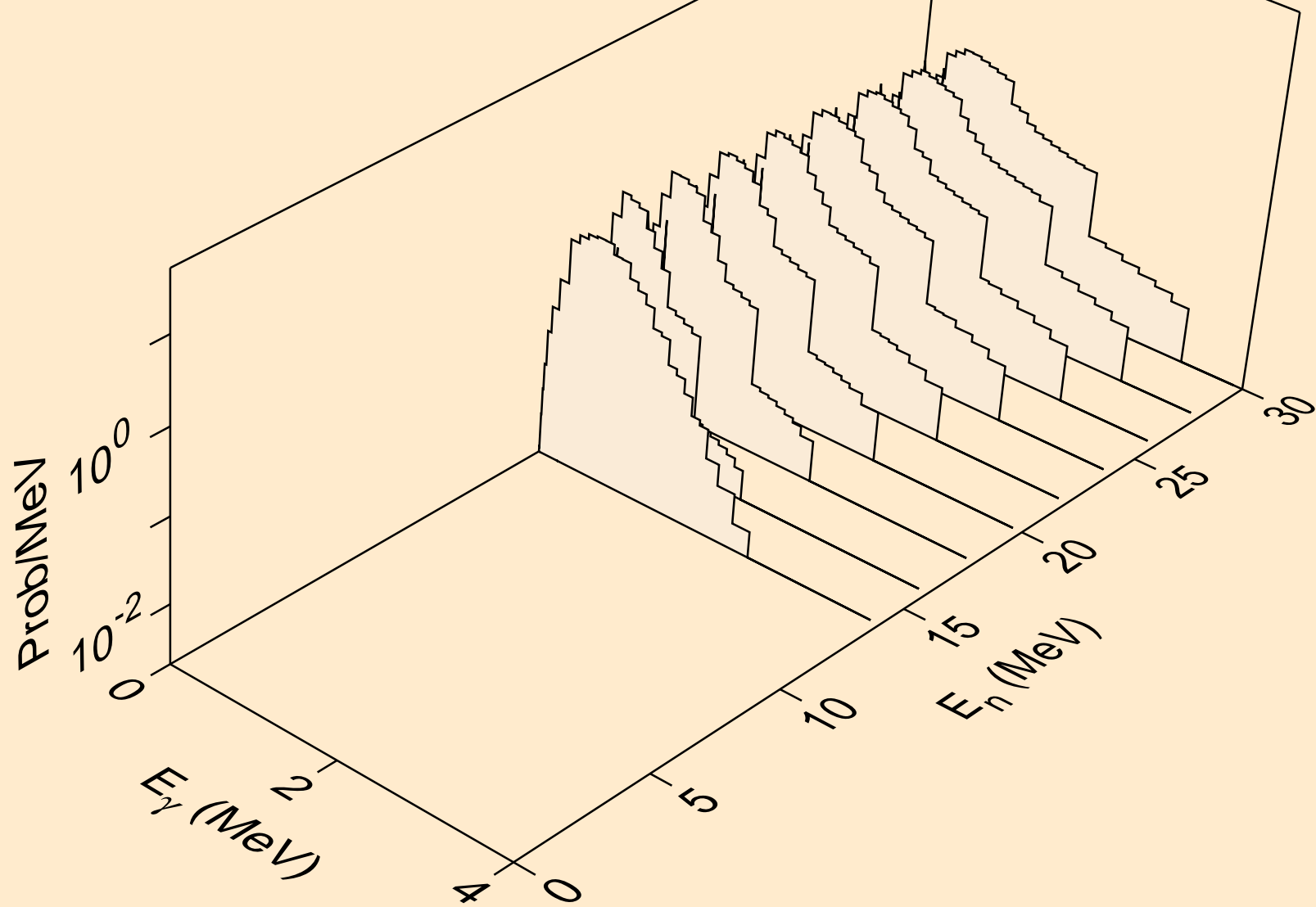

CE121 DEUTERON ACER TENDL-2021 LIBRARY; T=0.K
Photon emission for (n,n*)d

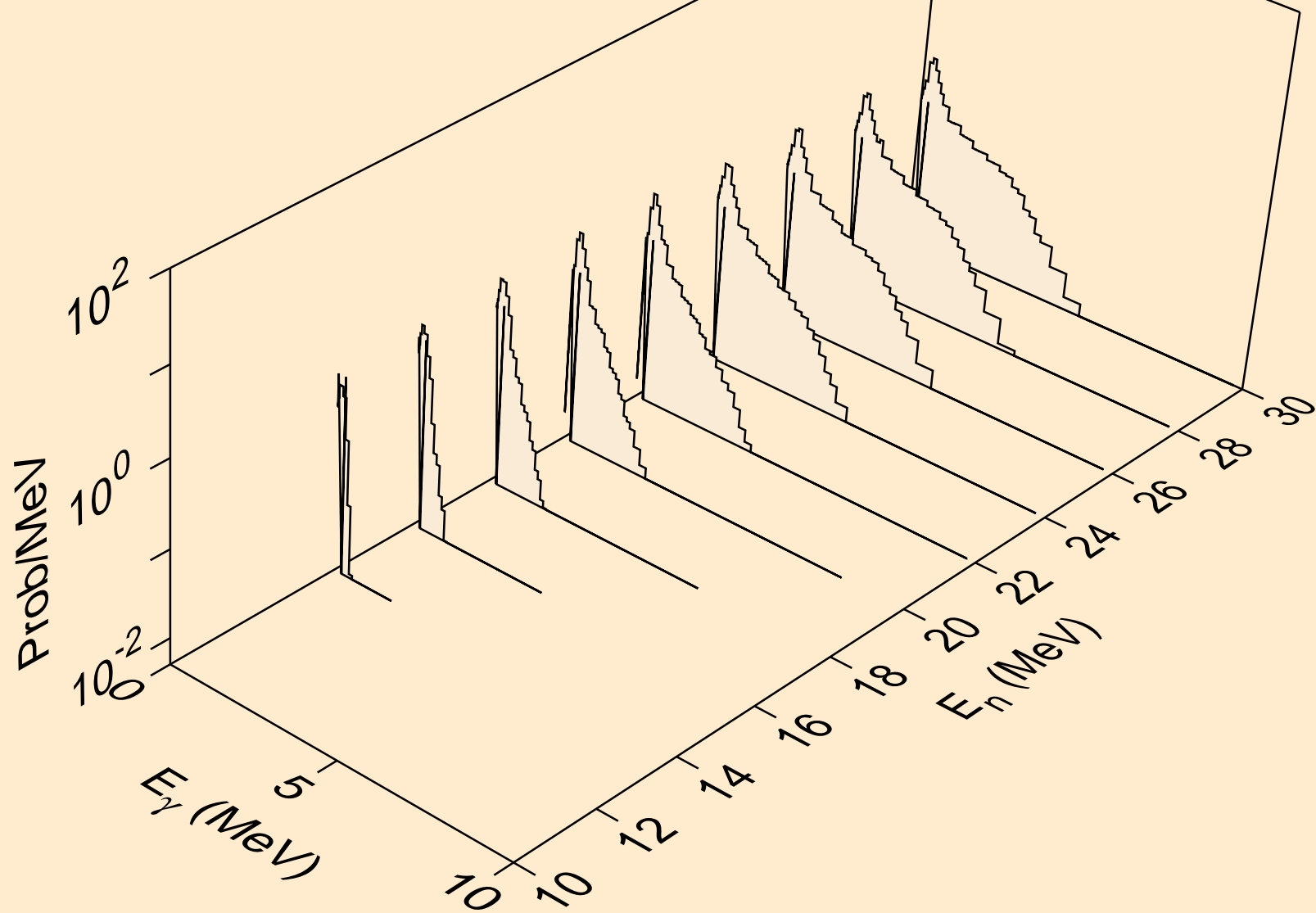

CE121 DEUTERON ACER TENDL-2021 LIBRARY; T=0.K
Photon emission for (n,n*)t

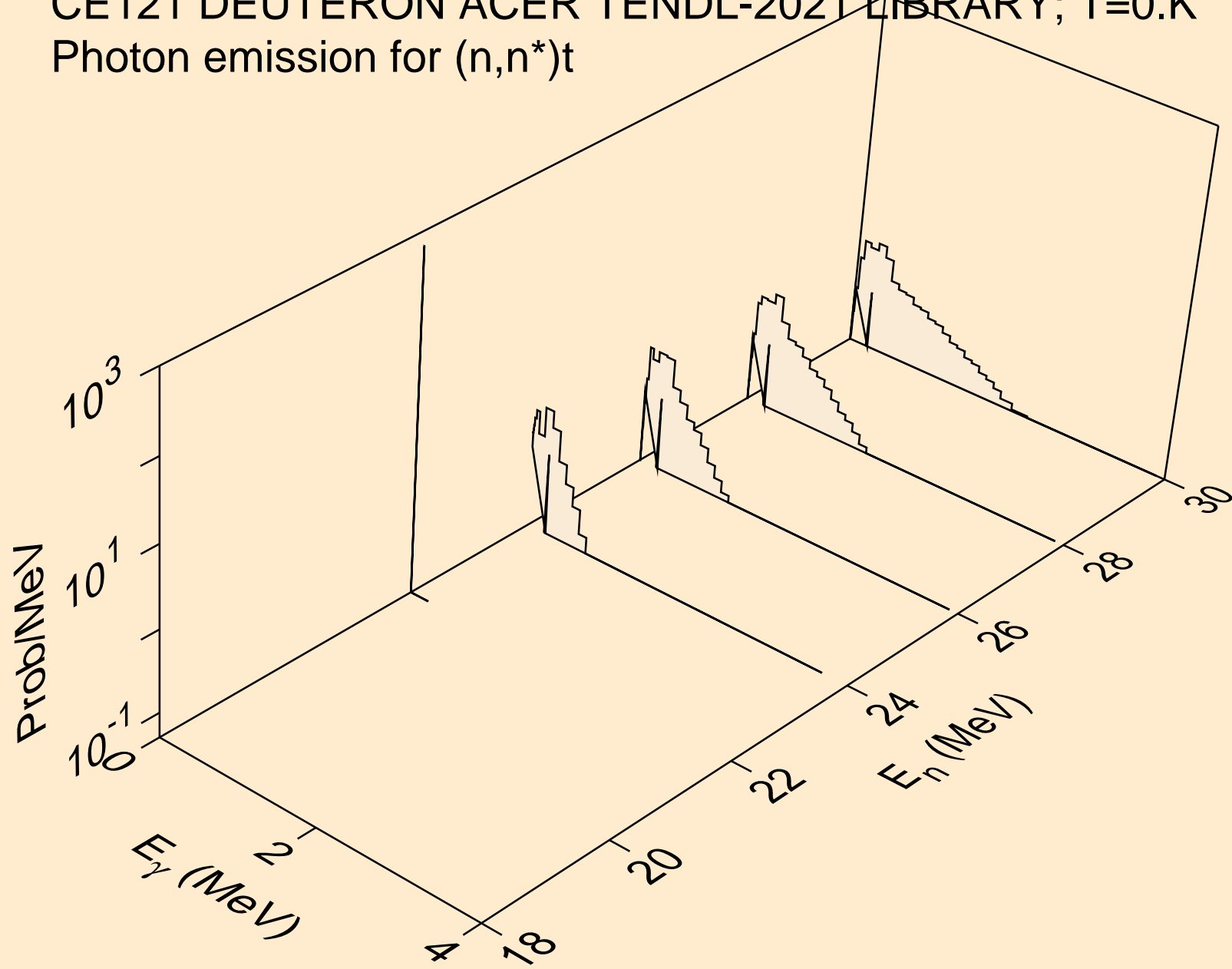

CE121 DEUTERON ACER TENDL-2021 LIBRARY; T=0.K
Photon emission for (n,n*)he3

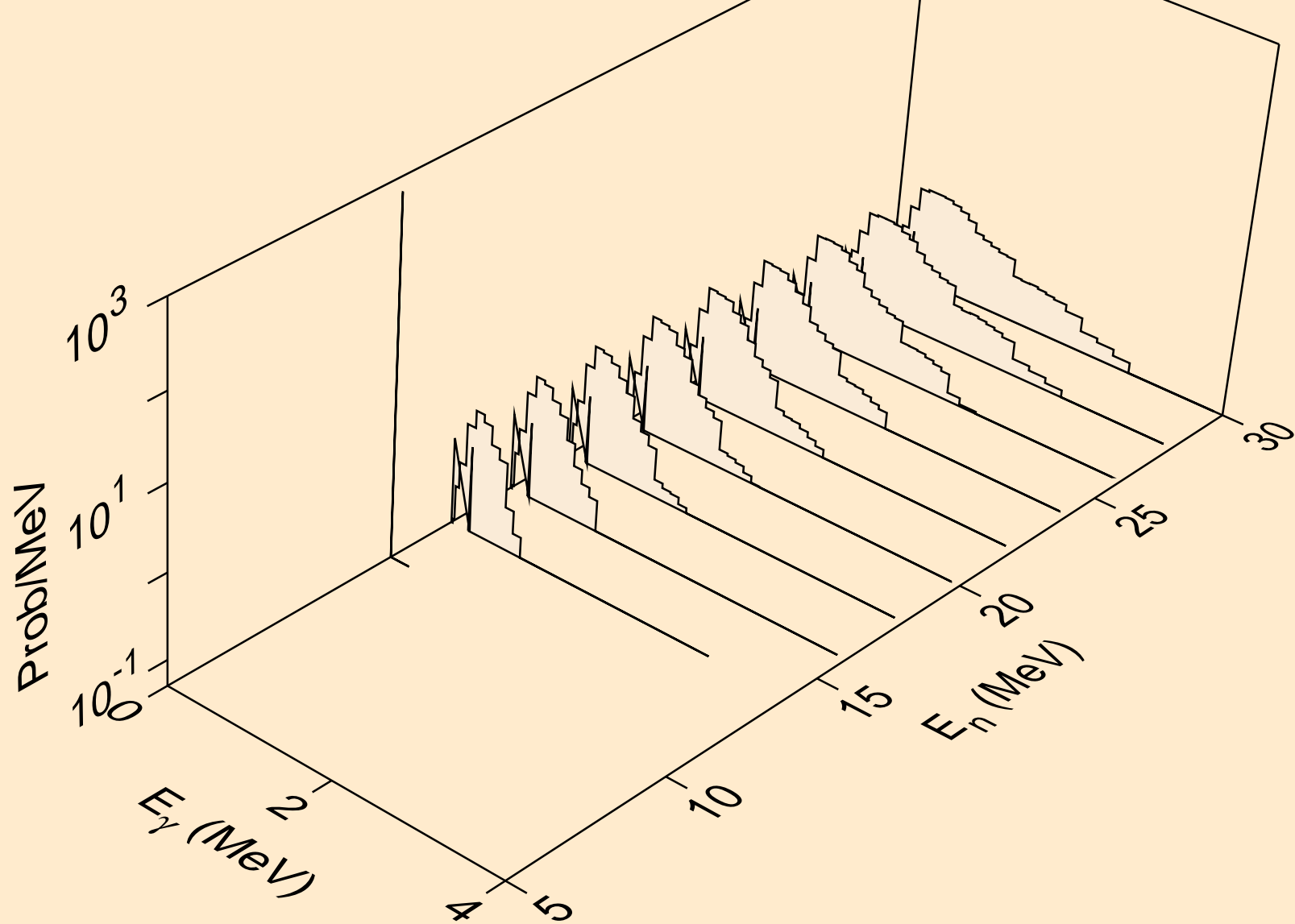

CE121 DEUTERON ACER TENDL-2021 LIBRARY; T=0.K
Photon emission for (n,2np)

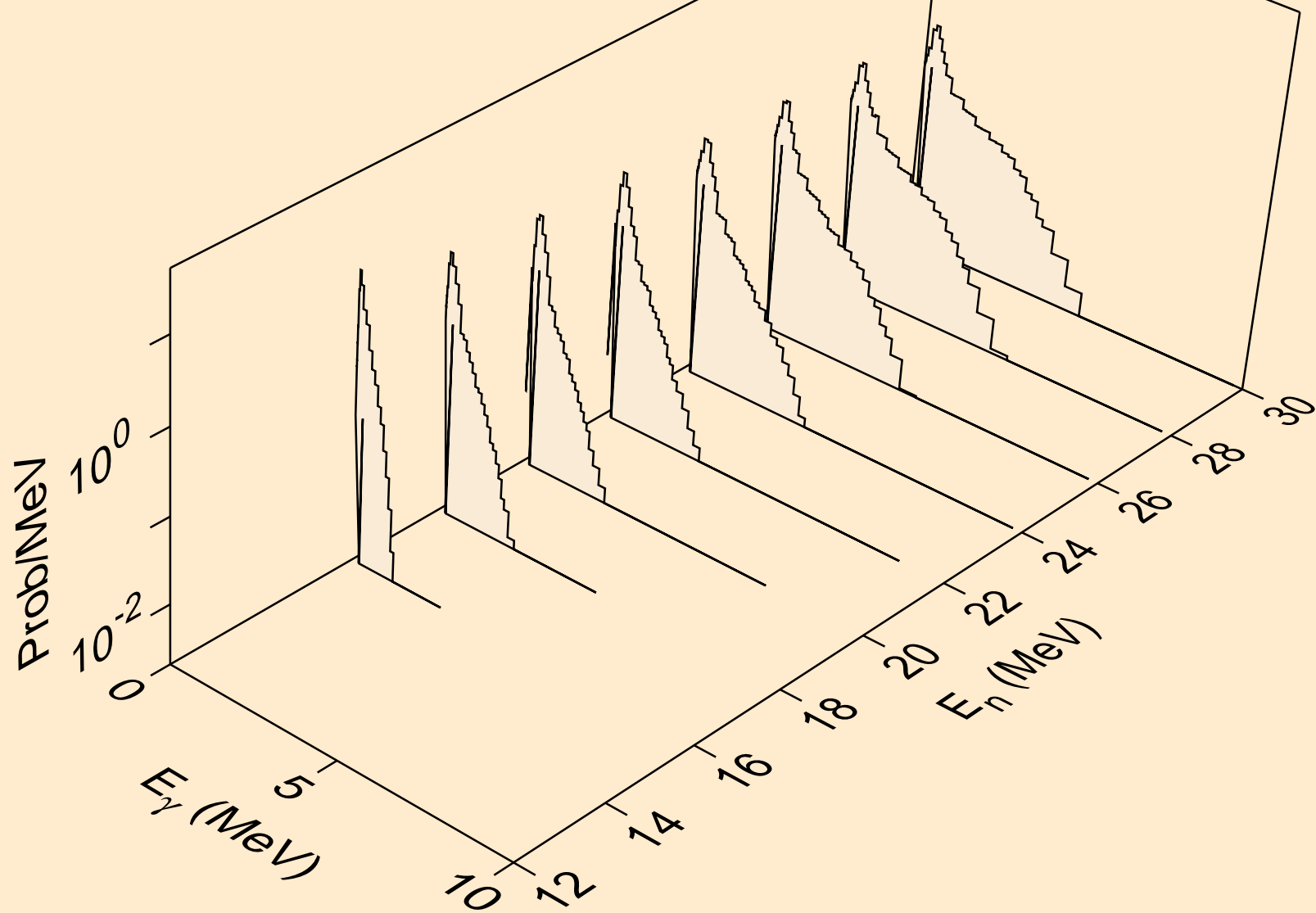

CE121 DEUTERON ACER TENDL-2021 LIBRARY; T=0.K
Photon emission for (n,2np)

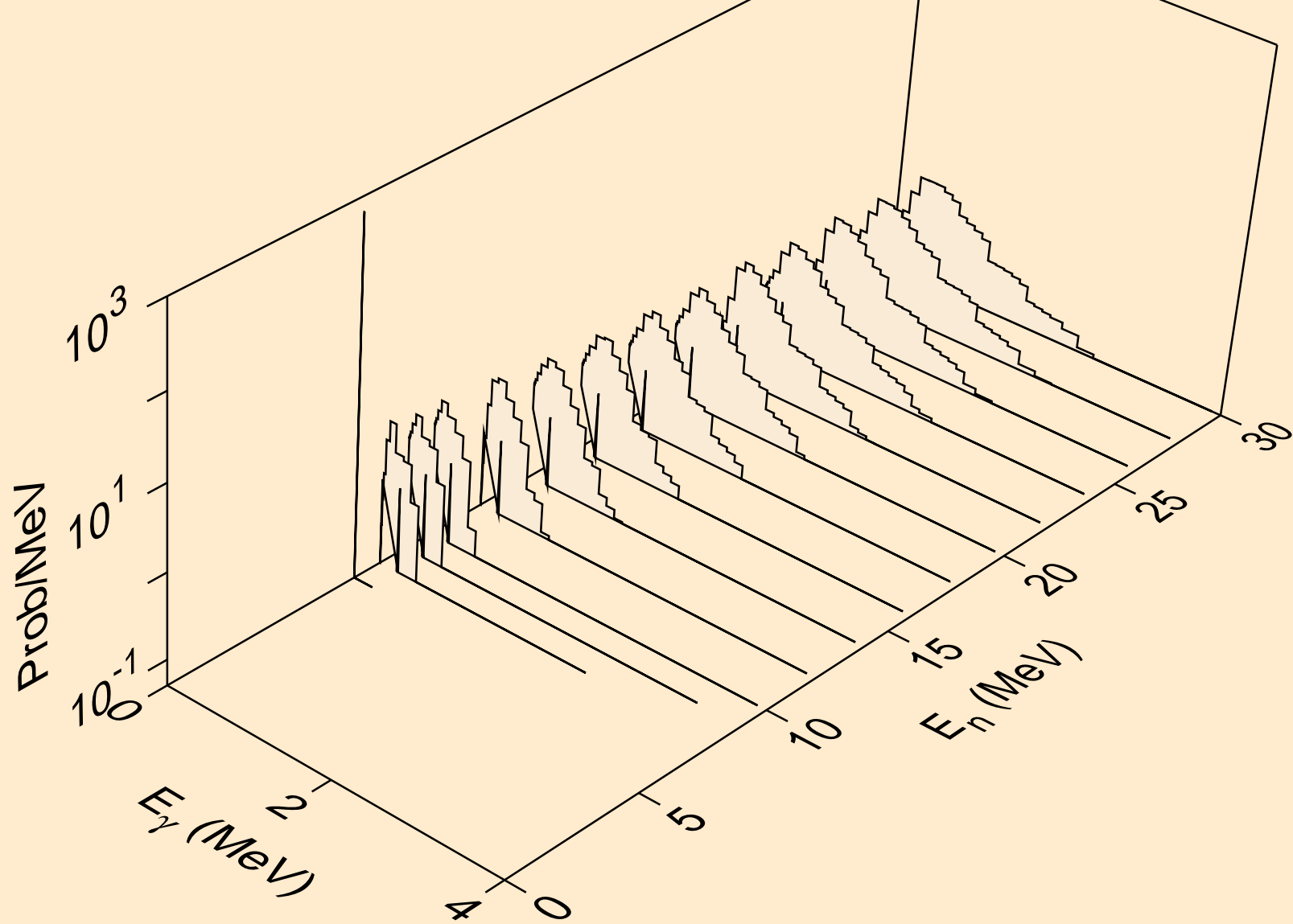

CE121 DEUTERON ACER TENDL-2021 LIBRARY; T=0.K
Photon emission for (n,npa)

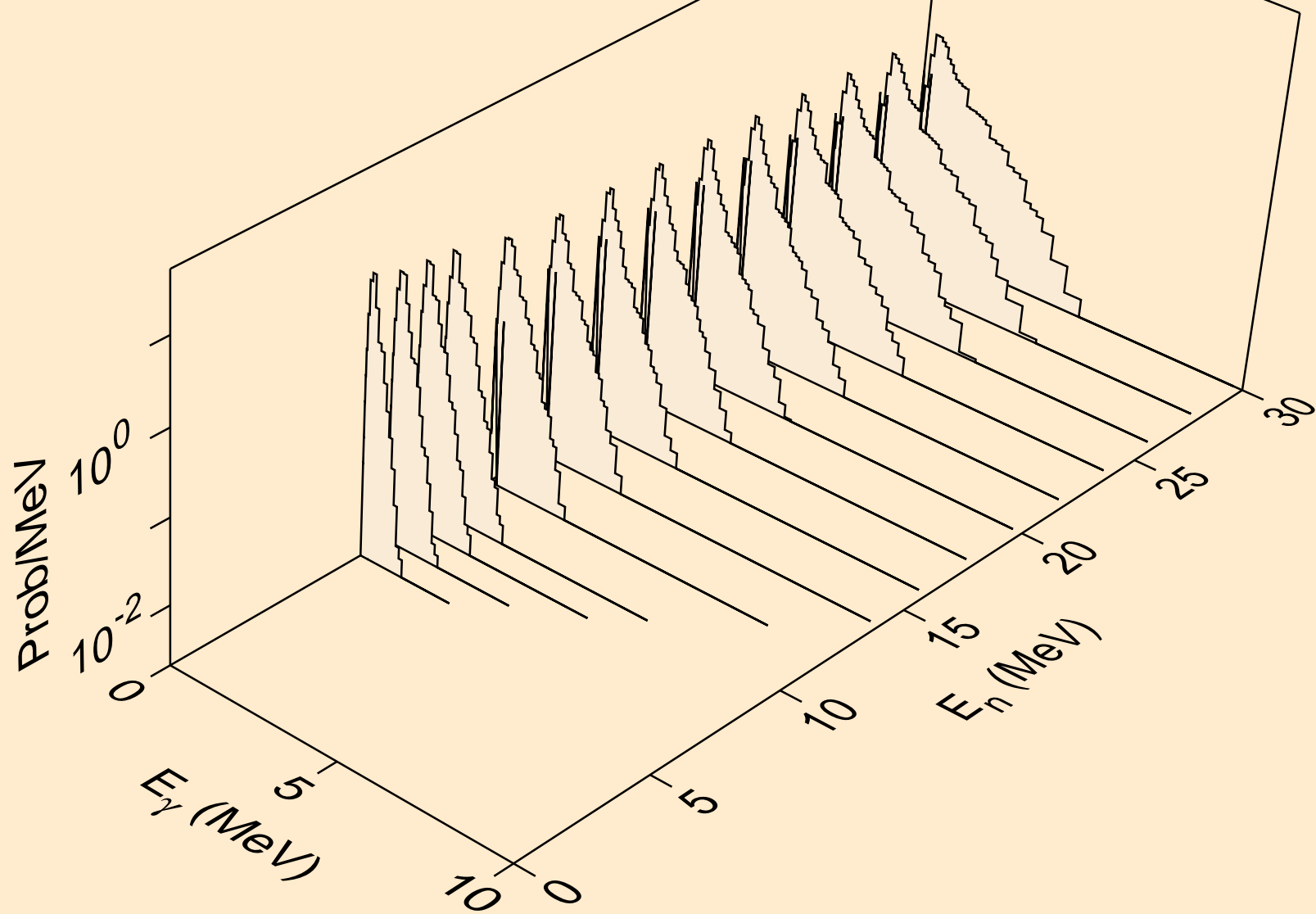

CE121 DEUTERON ACER TENDL-2021 LIBRARY; T=0.K
Photon emission for (n,gma)

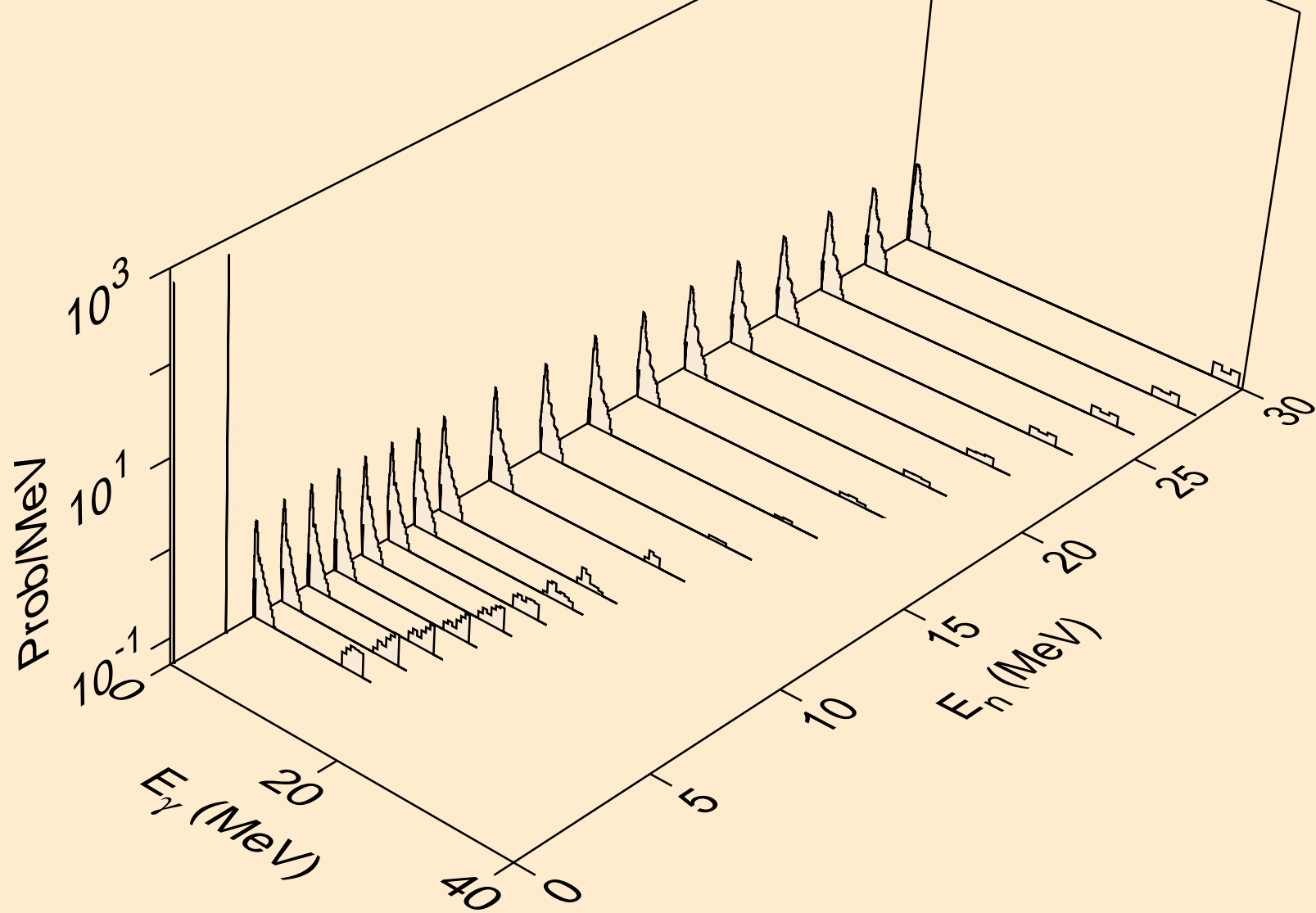

CE121 DEUTERON ACER TENDL-2021 LIBRARY; T=0.K
Photon emission for (n,p)

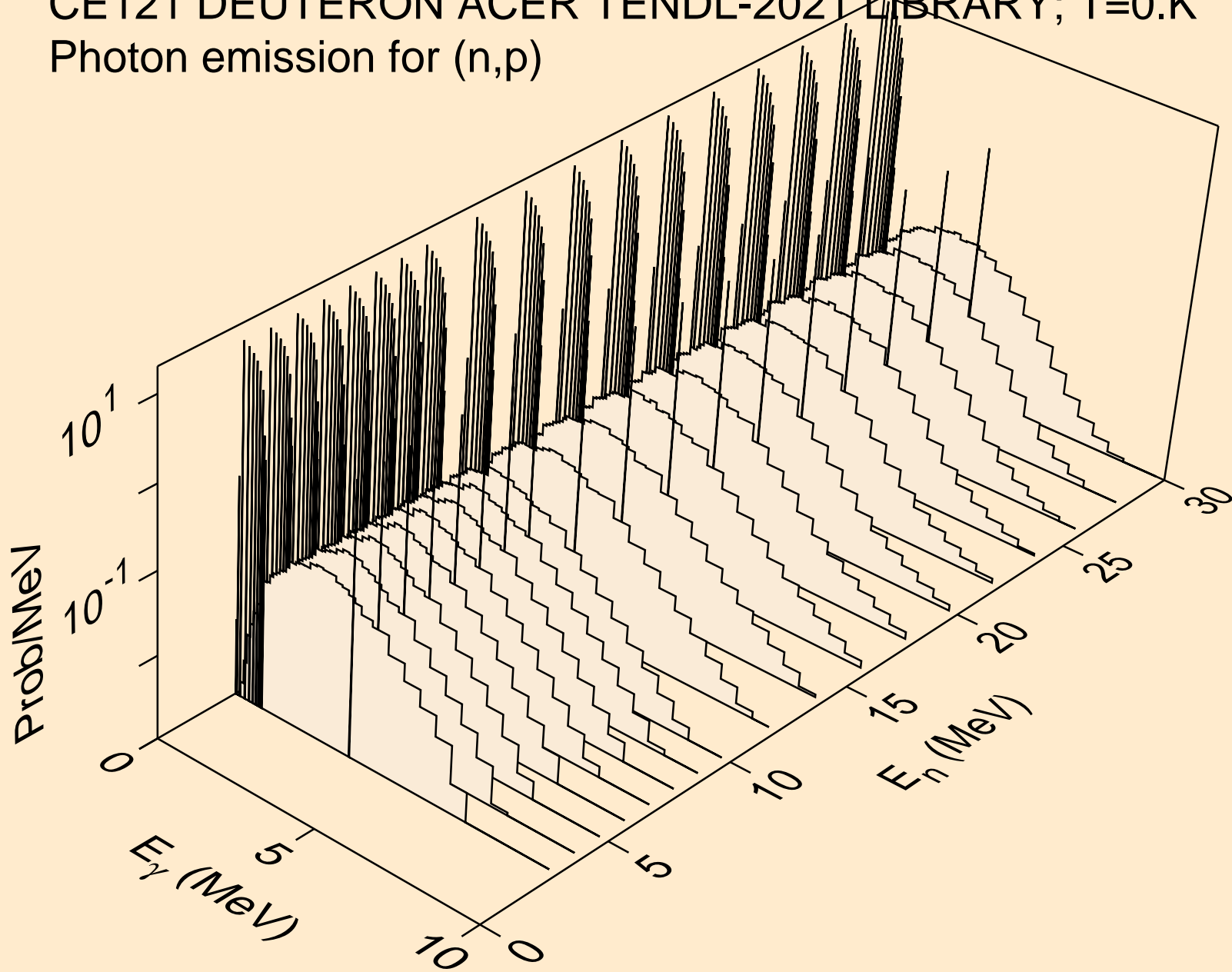

CE121 DEUTERON ACER TENDL-2021 LIBRARY; T=0.K
Photon emission for inelastic

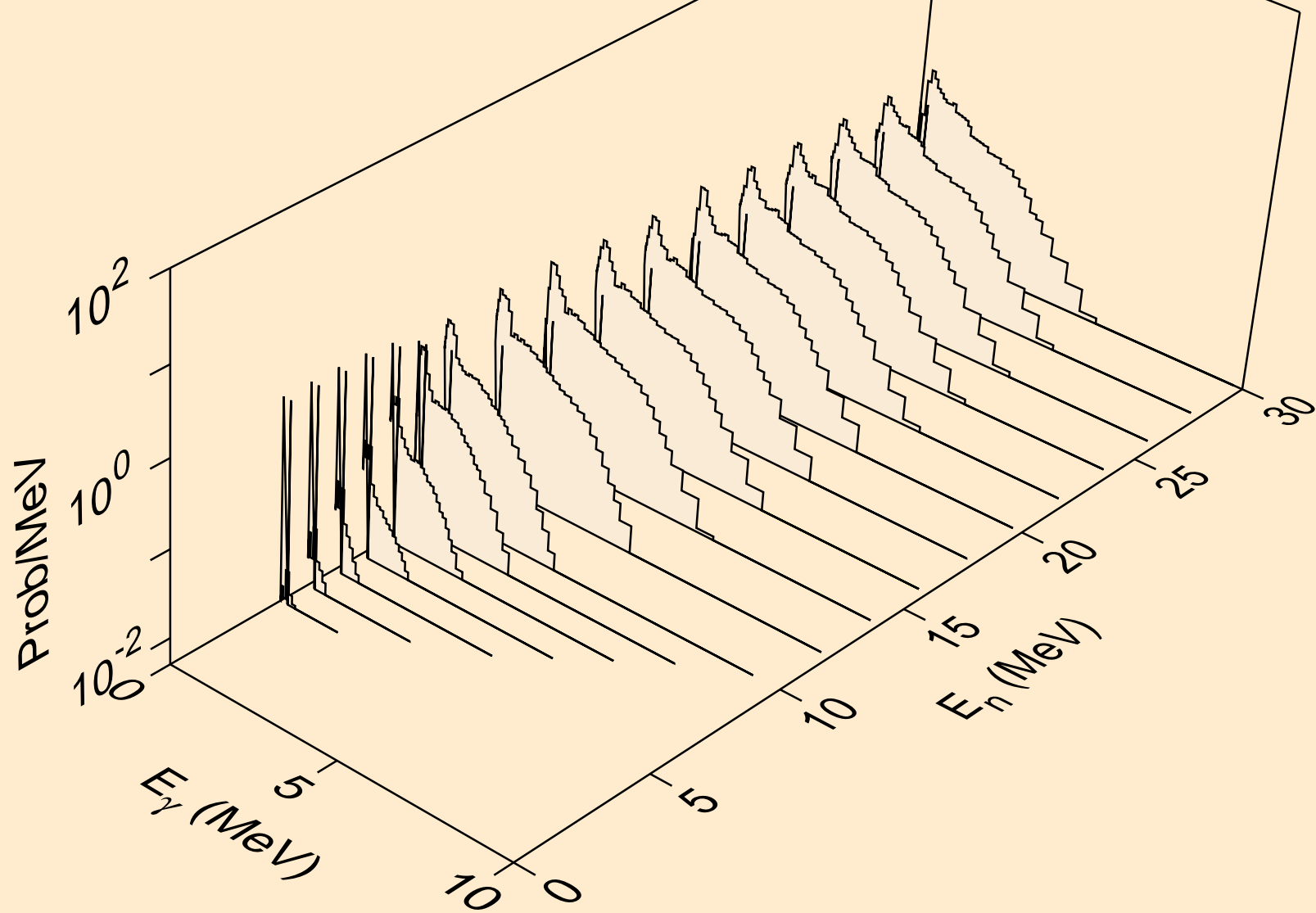

CE121 DEUTERON ACER TENDL-2021 LIBRARY; T=0.K
Photon emission for (n,t)

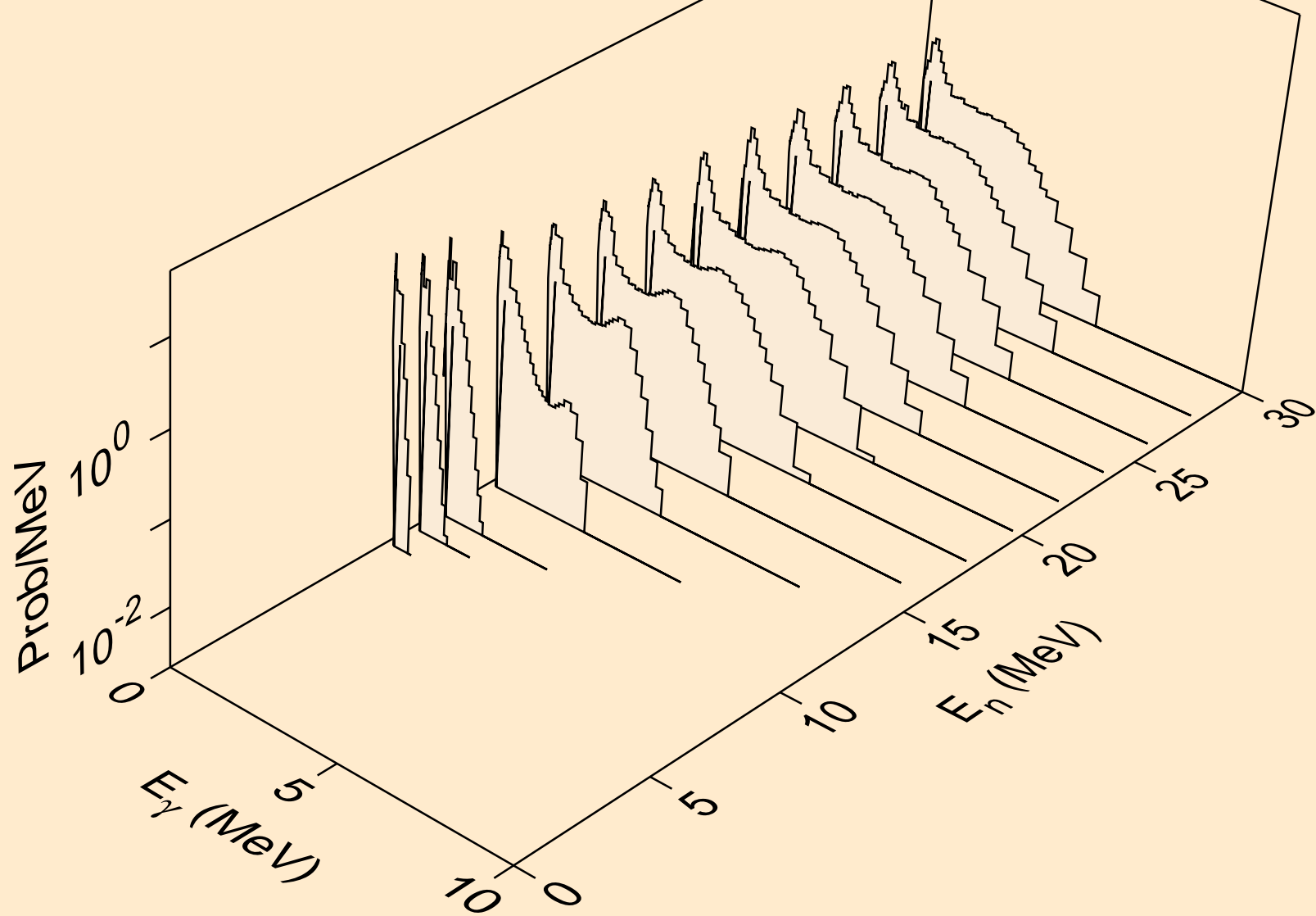

CE121 DEUTERON ACER TENDL-2021 LIBRARY; T=0.K
Photon emission for (n,he3)

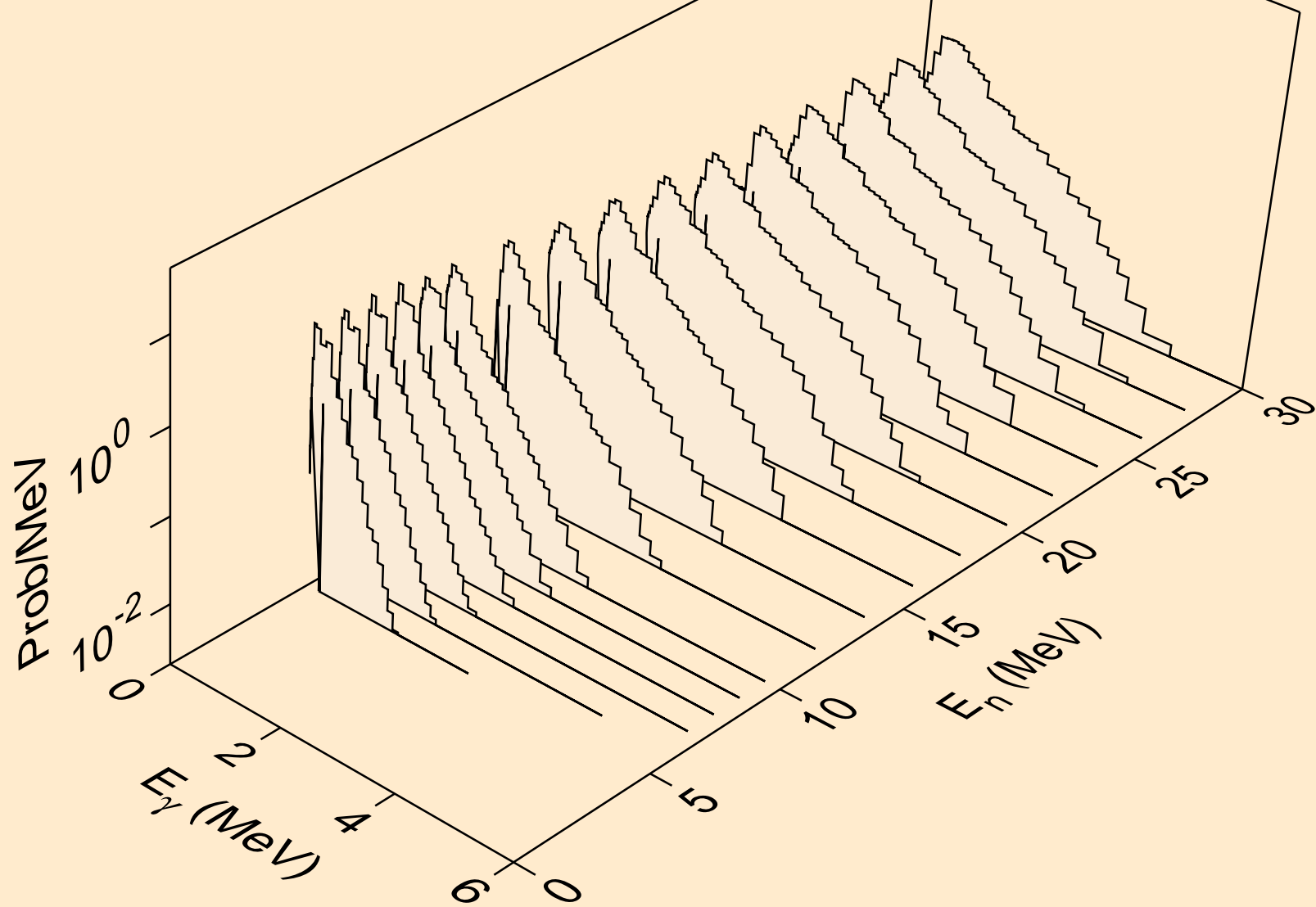

CE121 DEUTERON ACER TENDL-2021 LIBRARY; T=0.K
Photon emission for (n,a)

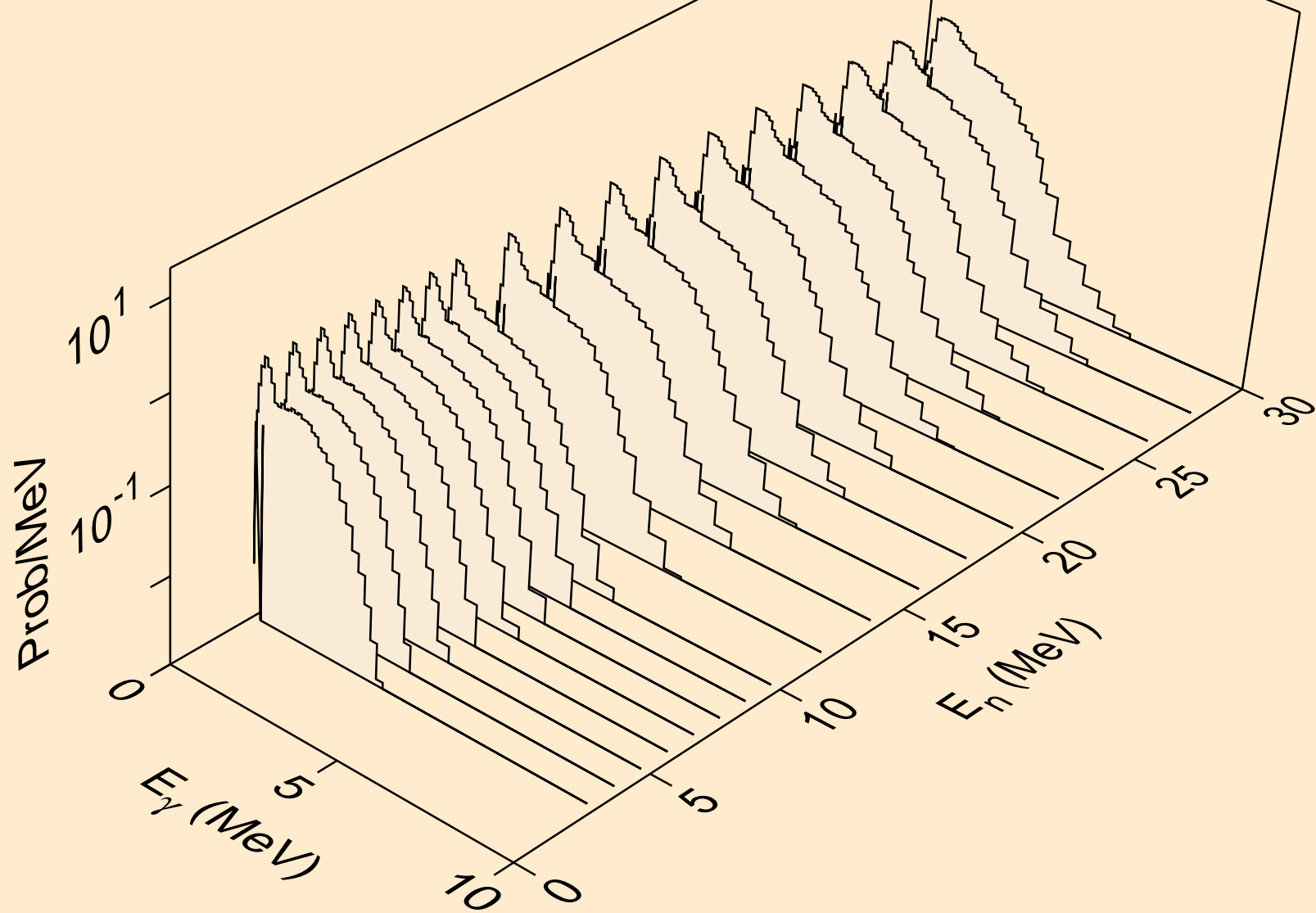

CE121 DEUTERON ACER TENDL-2021 LIBRARY; T=0.K
Photon emission for (n,2a)

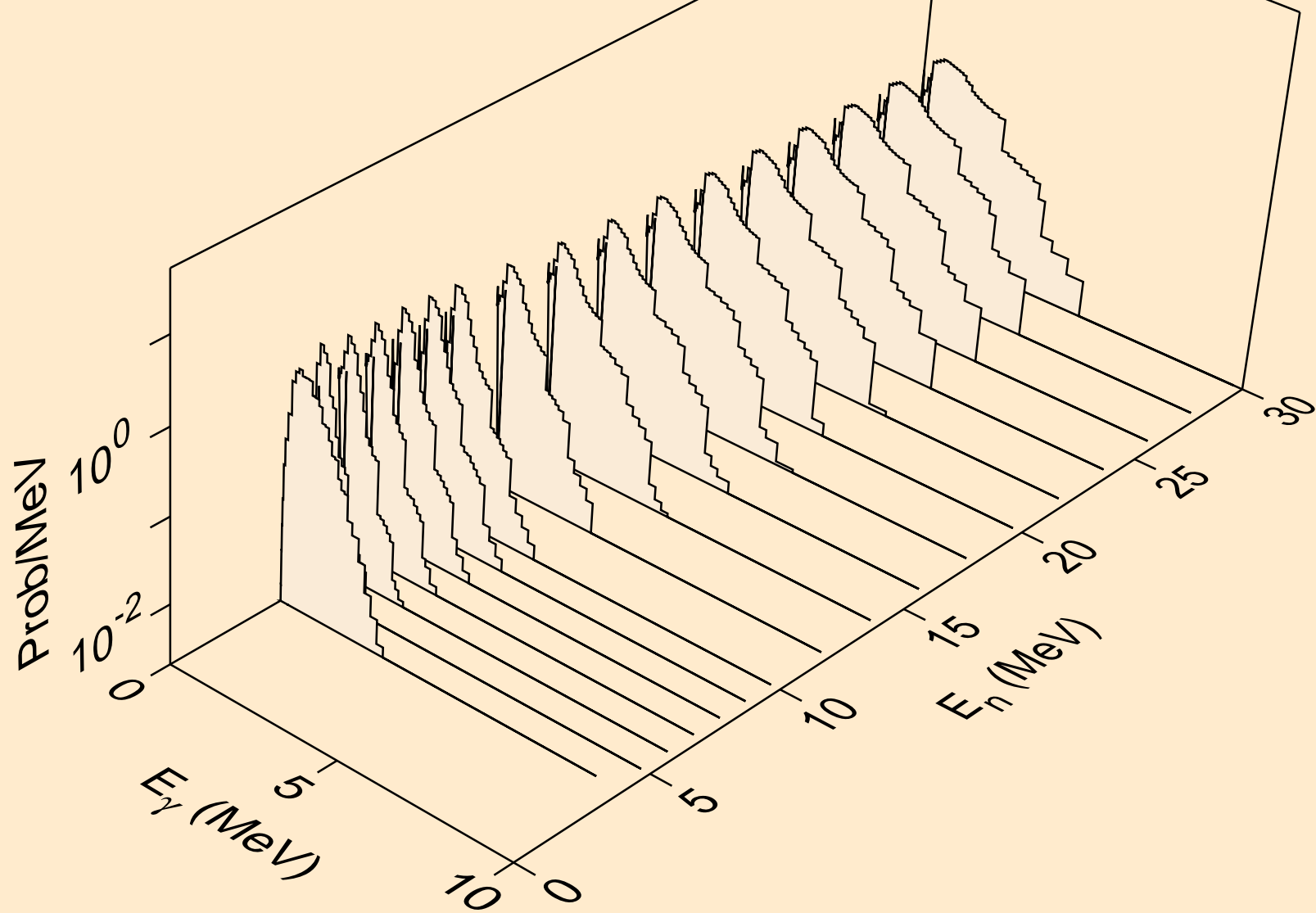

CE121 DEUTERON ACER TENDL-2021 LIBRARY; T=0.K
Photon emission for (n,3a)

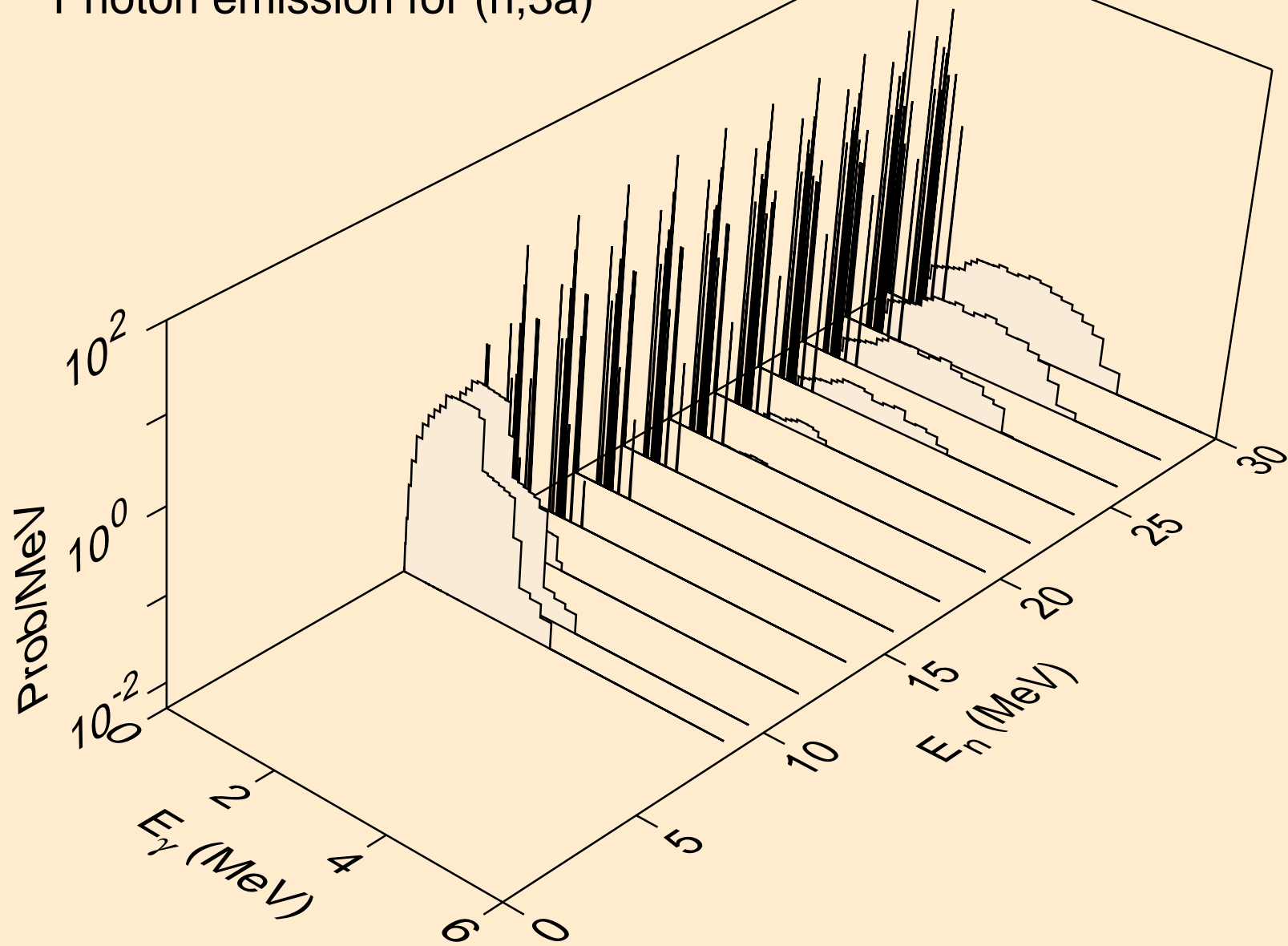

CE121 DEUTERON ACER TENDL-2021 LIBRARY; T=0.K
Photon emission for (n,2p)

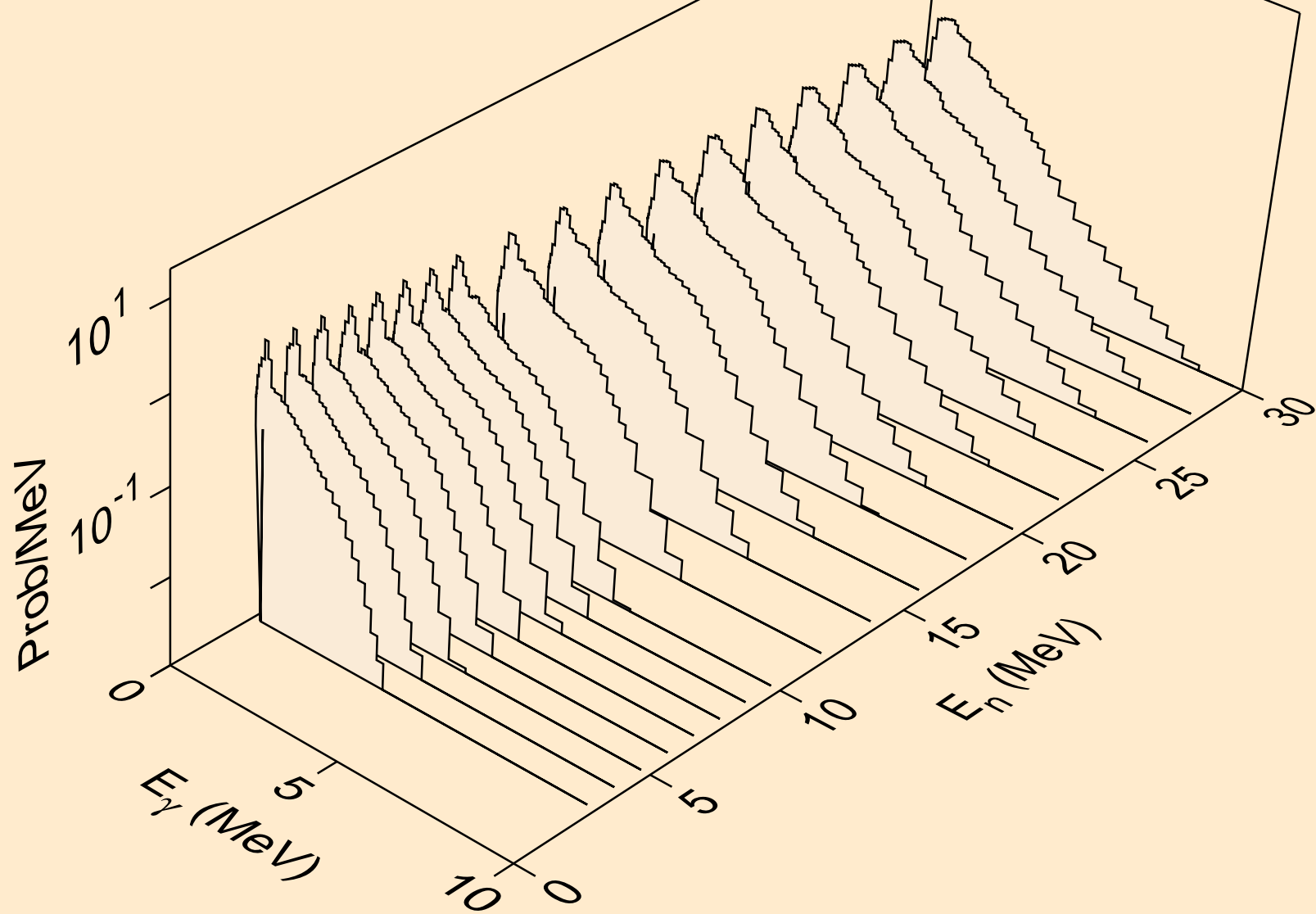

CE121 DEUTERON ACER TENDL-2021 LIBRARY; T=0.K
Photon emission for (n,p)

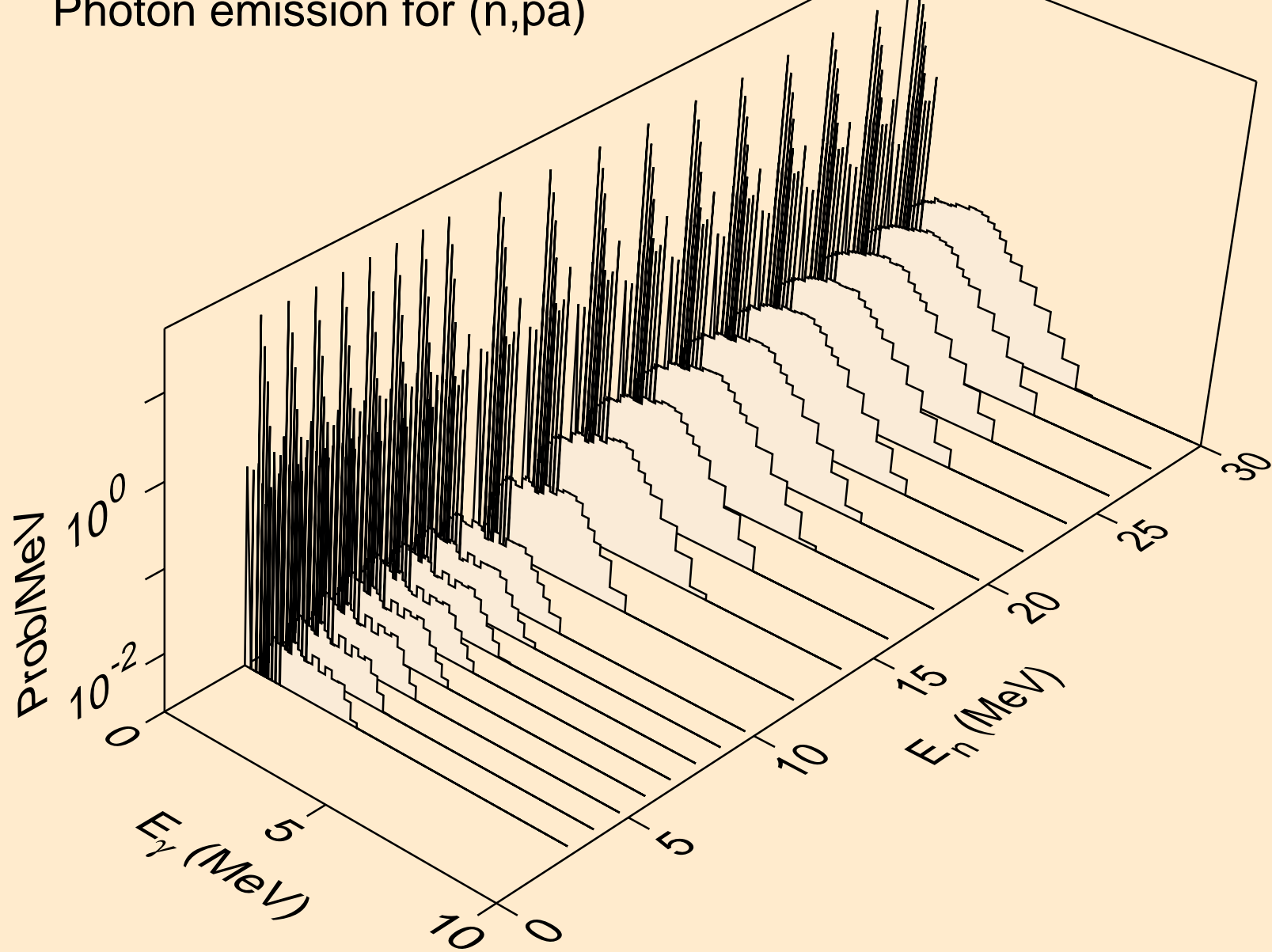

CE121 DEUTERON ACER TENDL-2021 LIBRARY; T=0.K
Photon emission for (n,d2a)

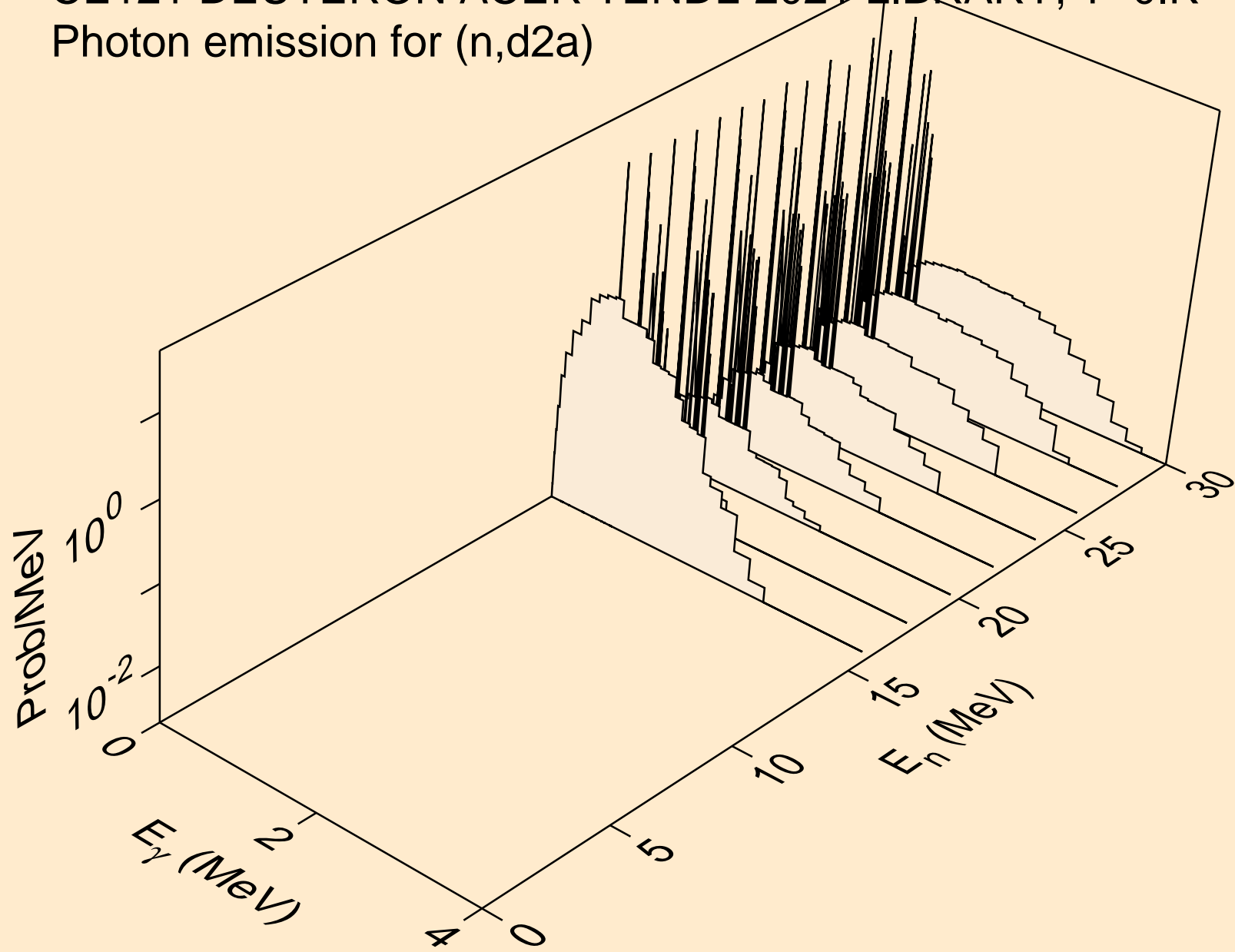

CE121 DEUTERON ACER TENDL-2021 LIBRARY; T=0.K
Photon emission for (n,pd)

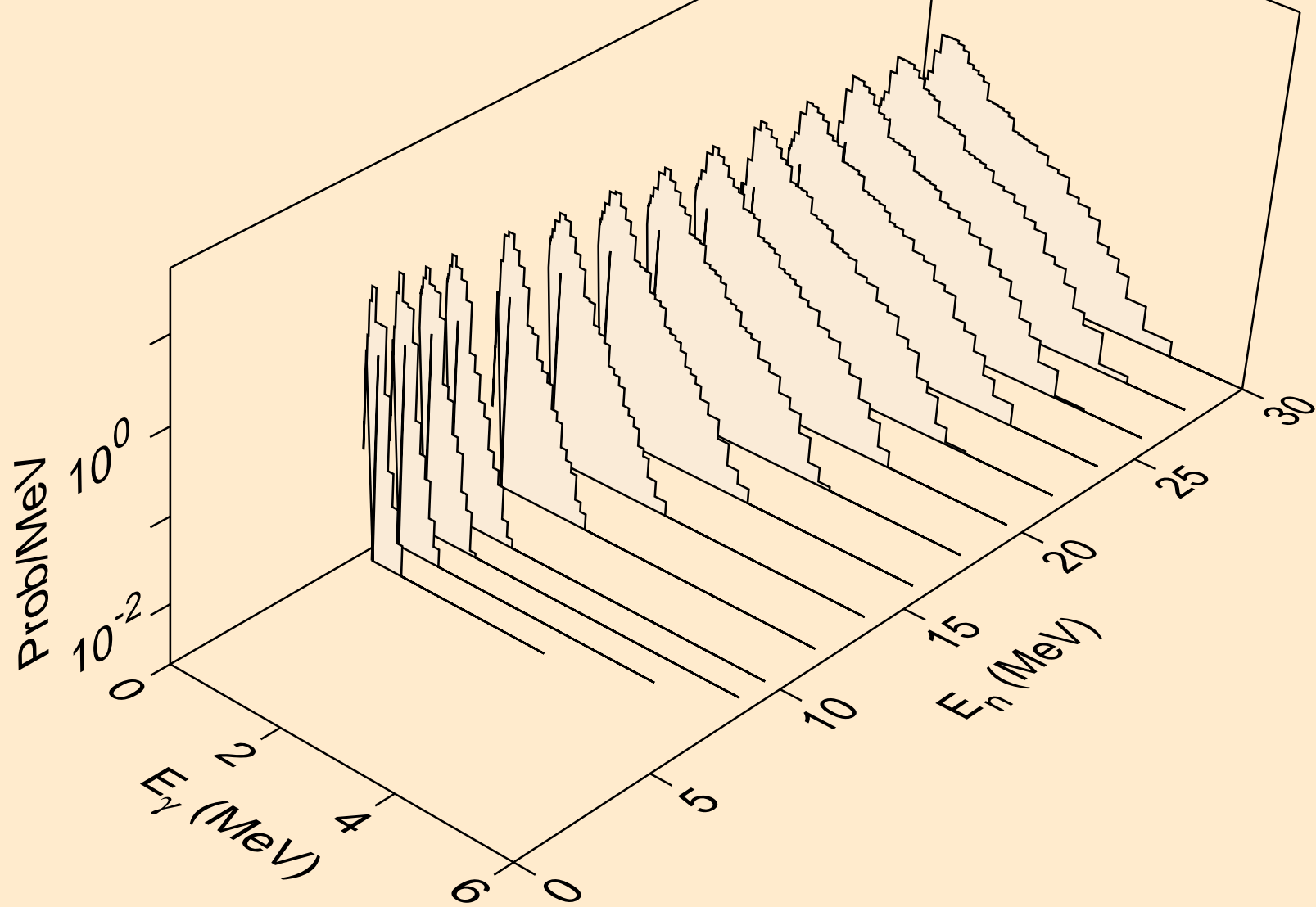

CE121 DEUTERON ACER TENDL-2021 LIBRARY; T=0.K
Photon emission for (n,pt)

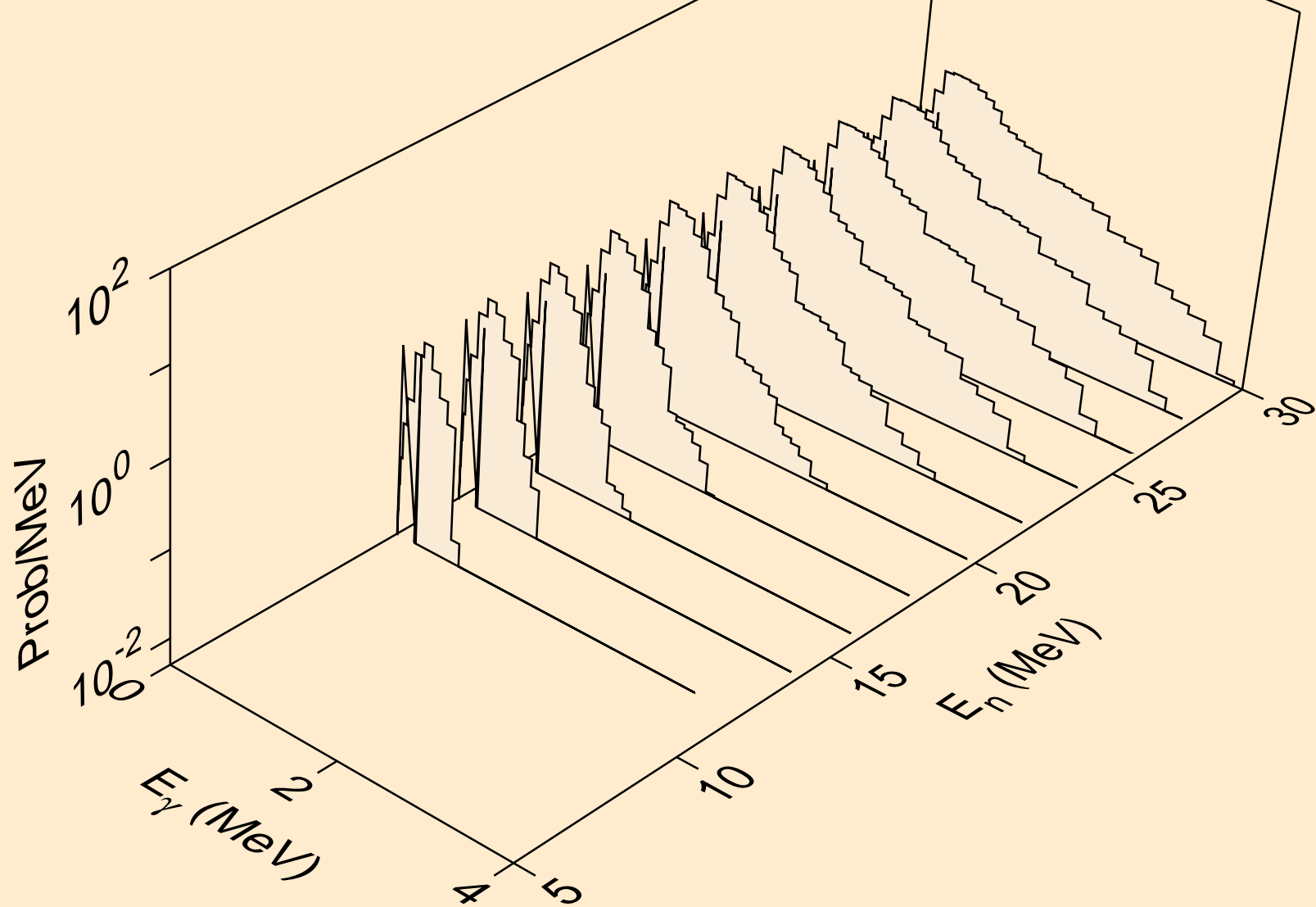

CE121 DEUTERON ACER TENDL-2021 LIBRARY; T=0.K
Photon emission for (n,da)

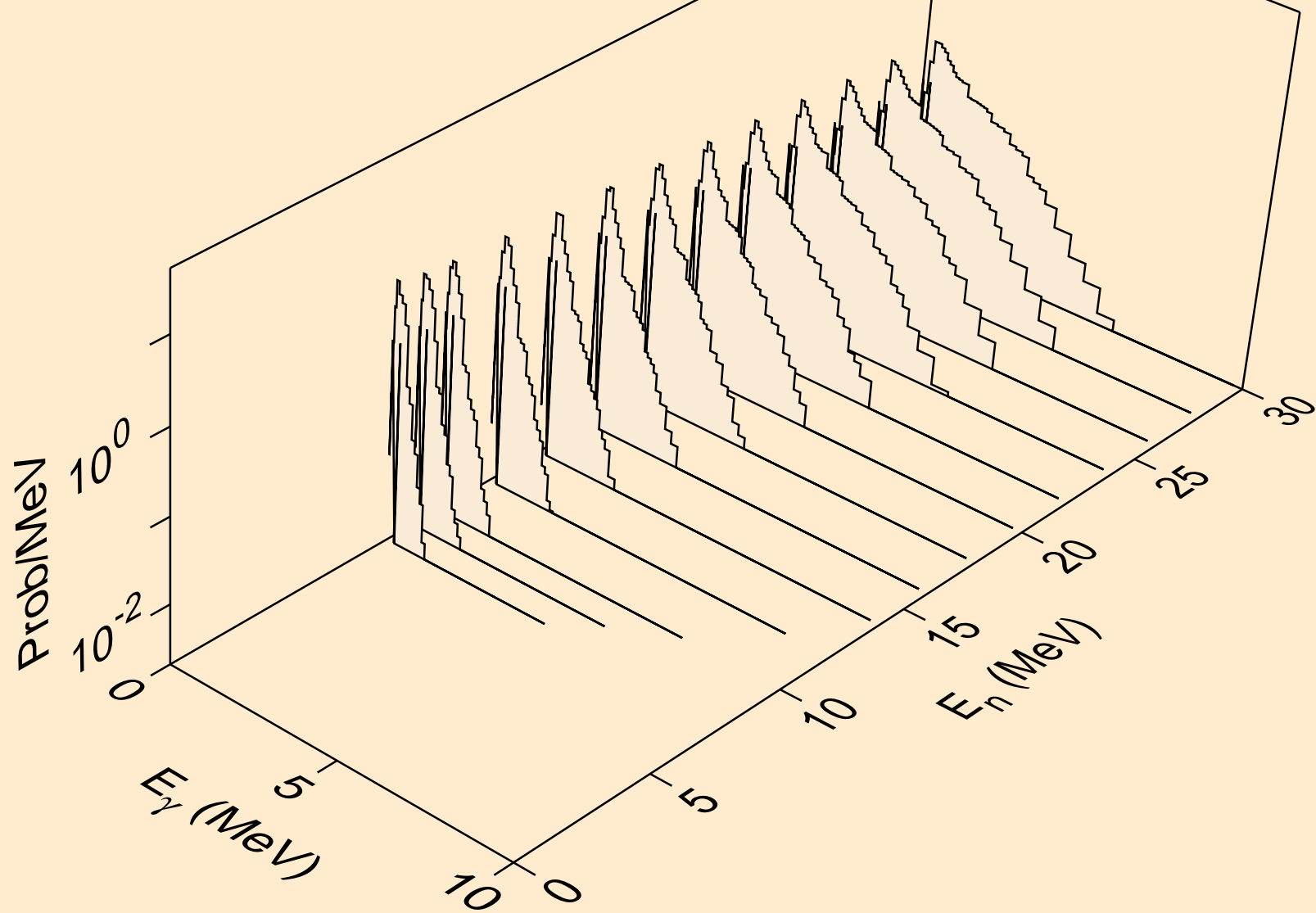

CE121 DEUTERON ACER TENDL-2021 LIBRARY; T=0.K

Particle heating contributions

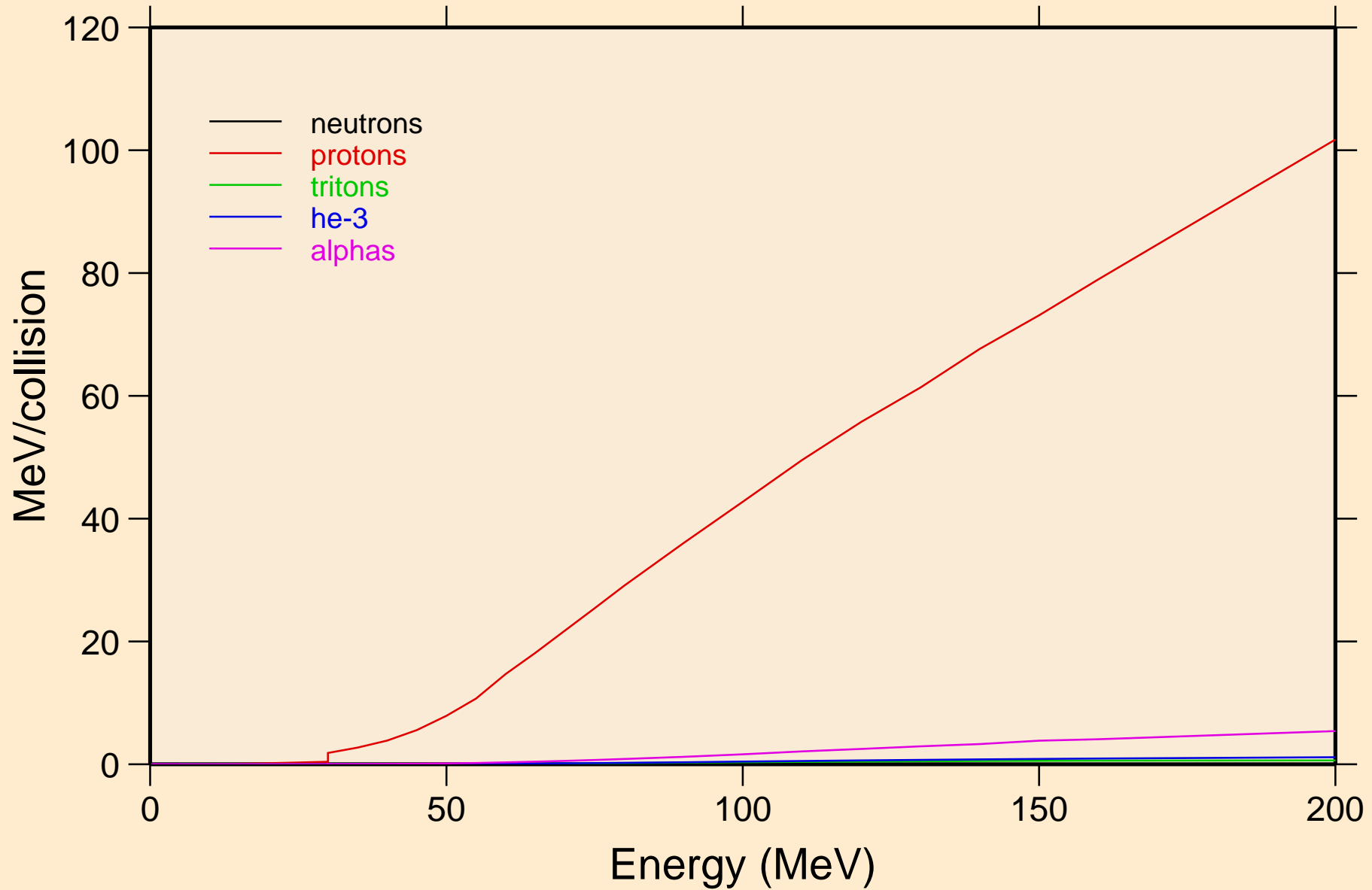

CE121 DEUTERON ACER TENDL-2021 LIBRARY; T=0.K
Recoil Heating

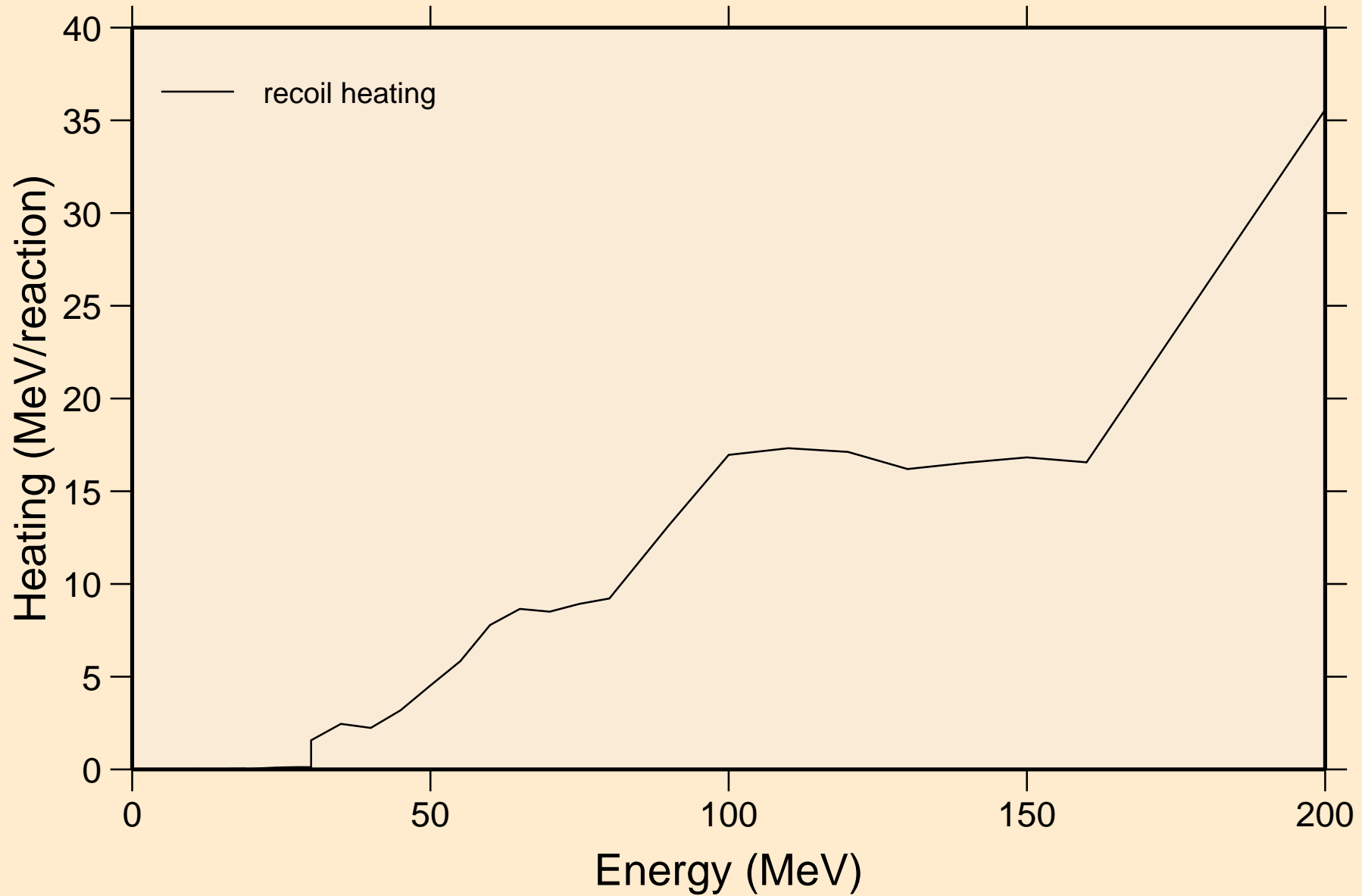

CE121 DEUTERON ACER TENDL-2021 LIBRARY; T=0.K

Particle production cross sections

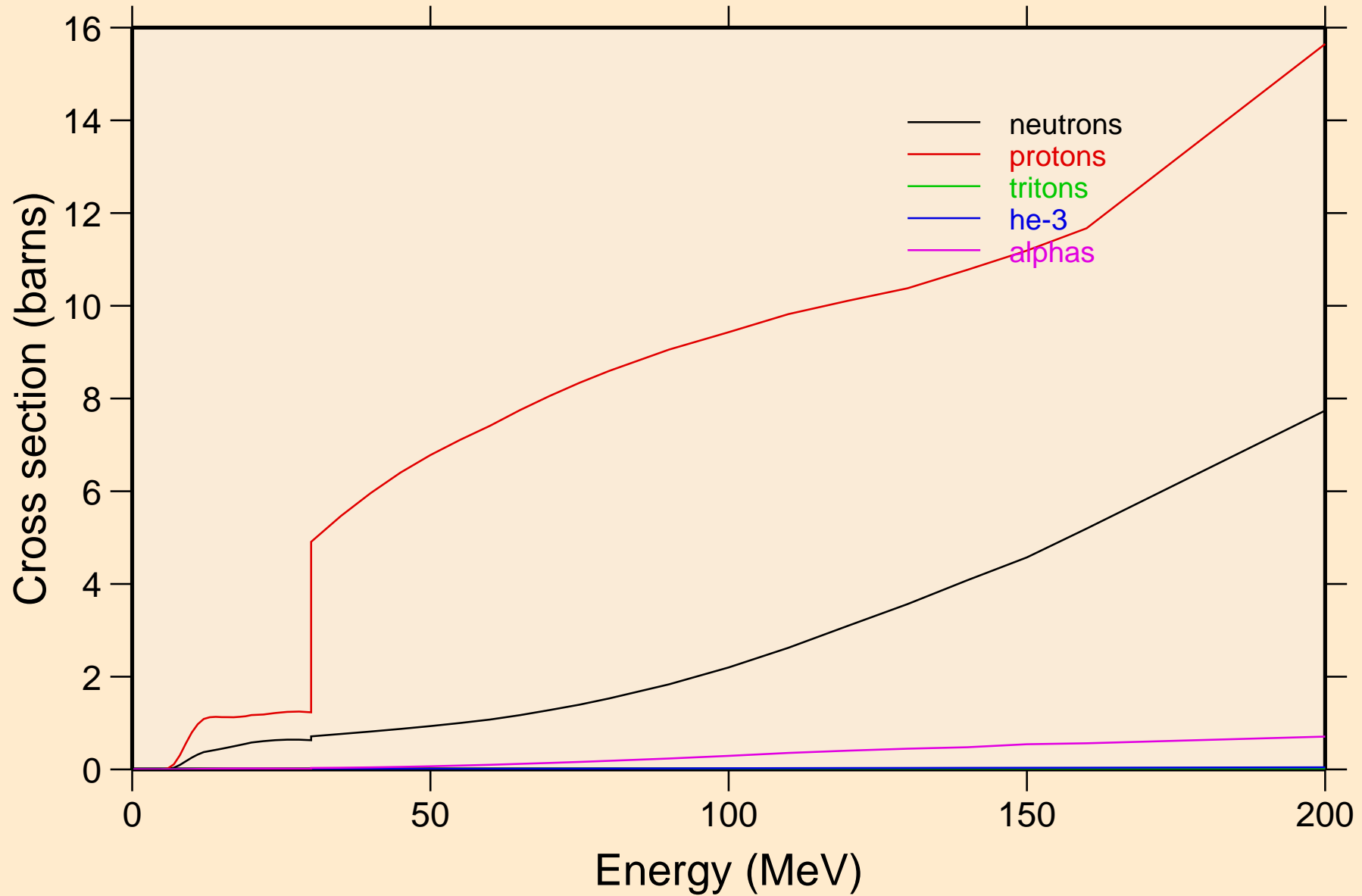

CE121 DEUTERON ACER TENDL-2021 LIBRARY; T=0.K
neutrons from (d,n)

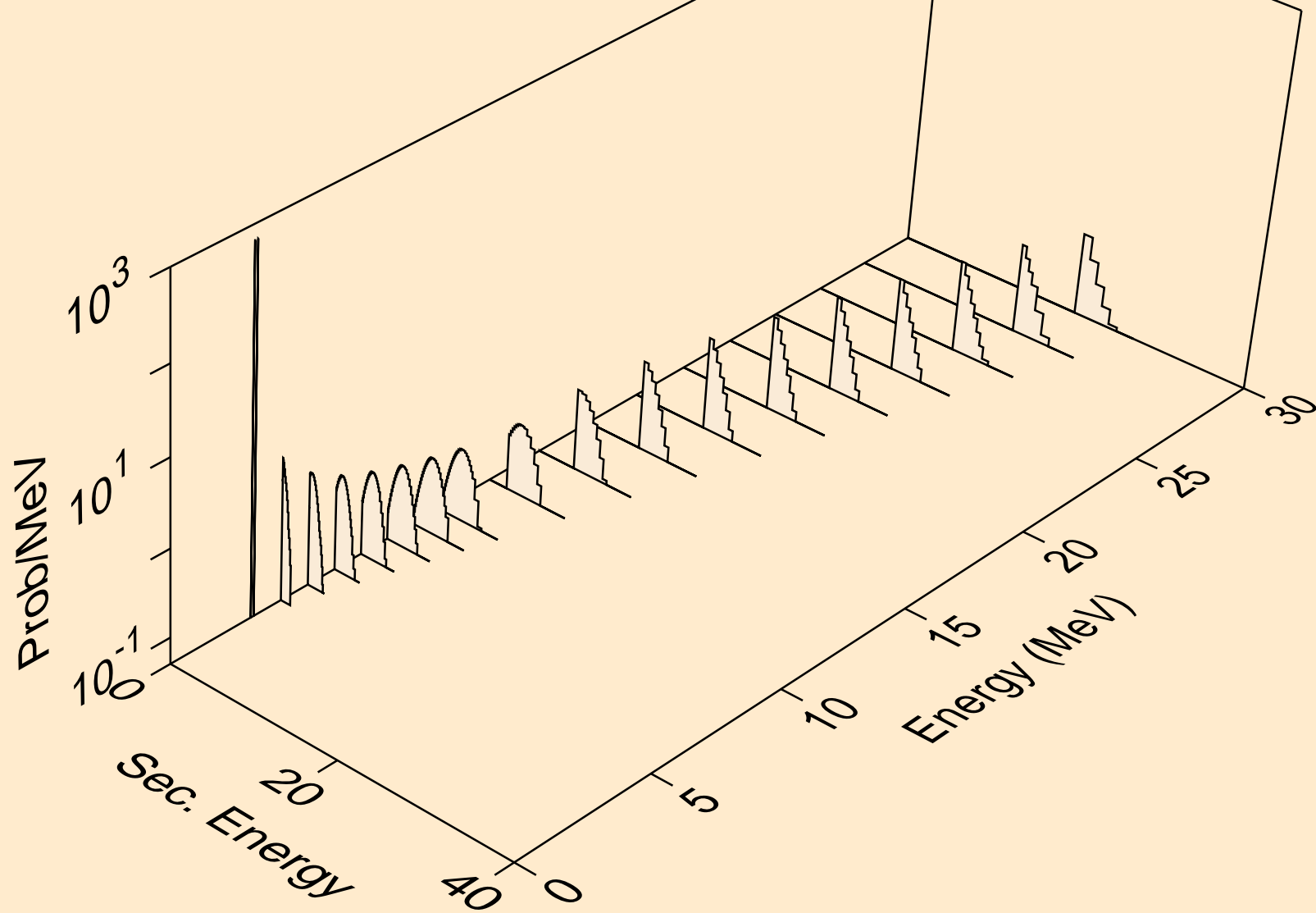

CE121 DEUTERON ACER TENDL-2021 LIBRARY; T=0.K
neutrons from (d,x)

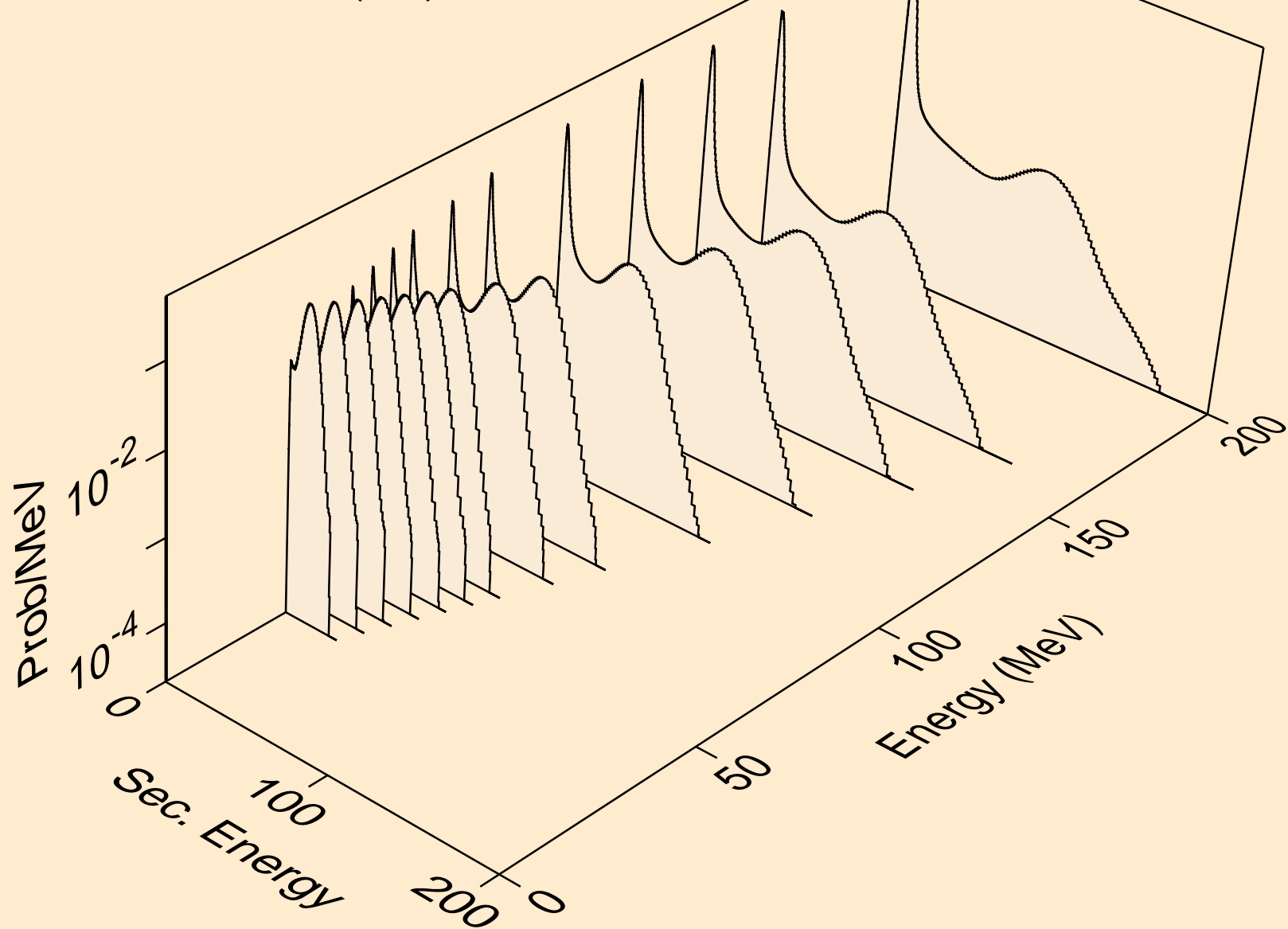

CE121 DEUTERON ACER TENDL-2021 LIBRARY; T=0.K
neutrons from (d,2n)

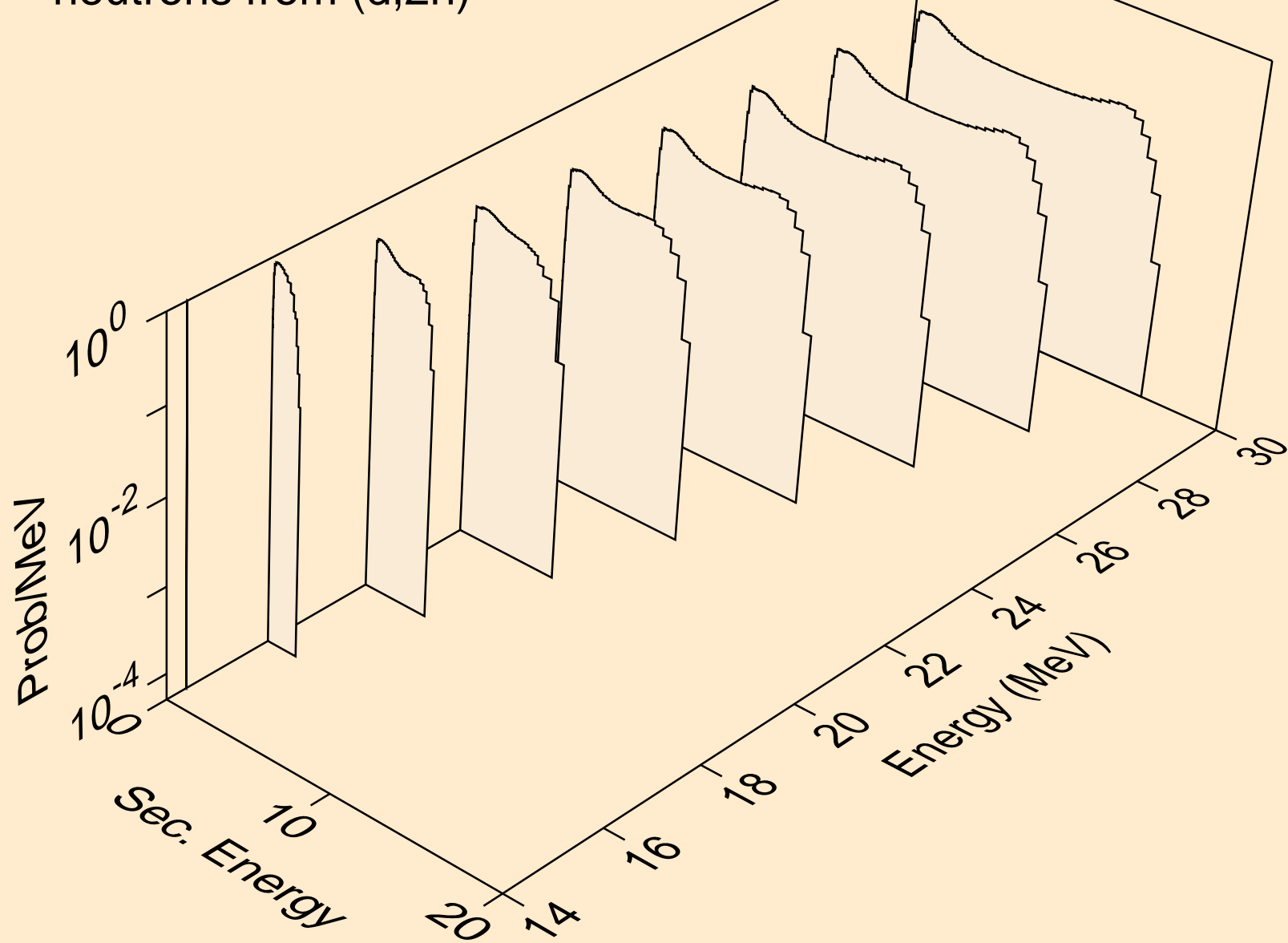

CE121 DEUTERON ACER TENDL-2021 LIBRARY; T=0.K
neutrons from (d,n*)a

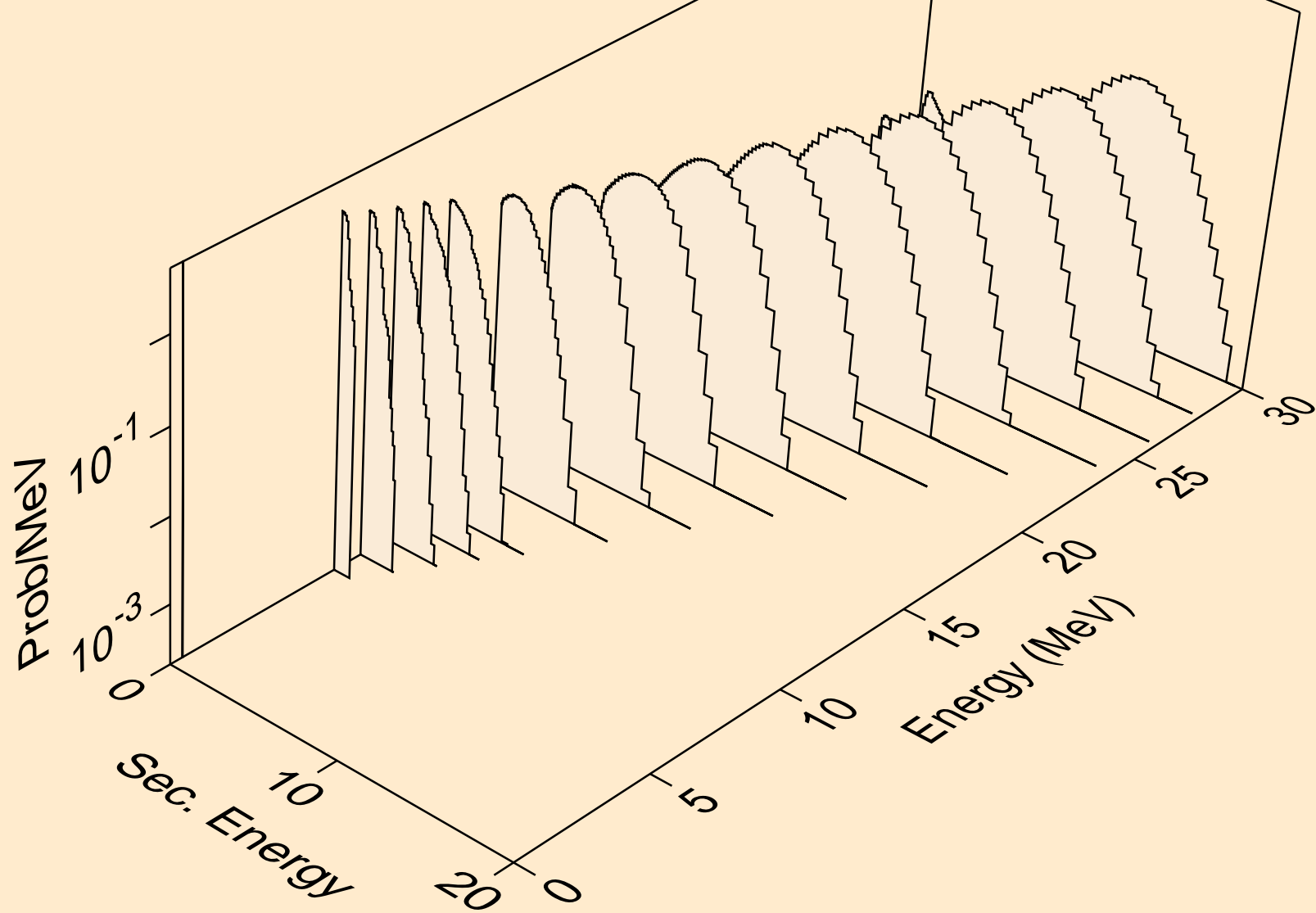

CE121 DEUTERON ACER TENDL-2021 LIBRARY; T=0.K
neutrons from (d,2n)a

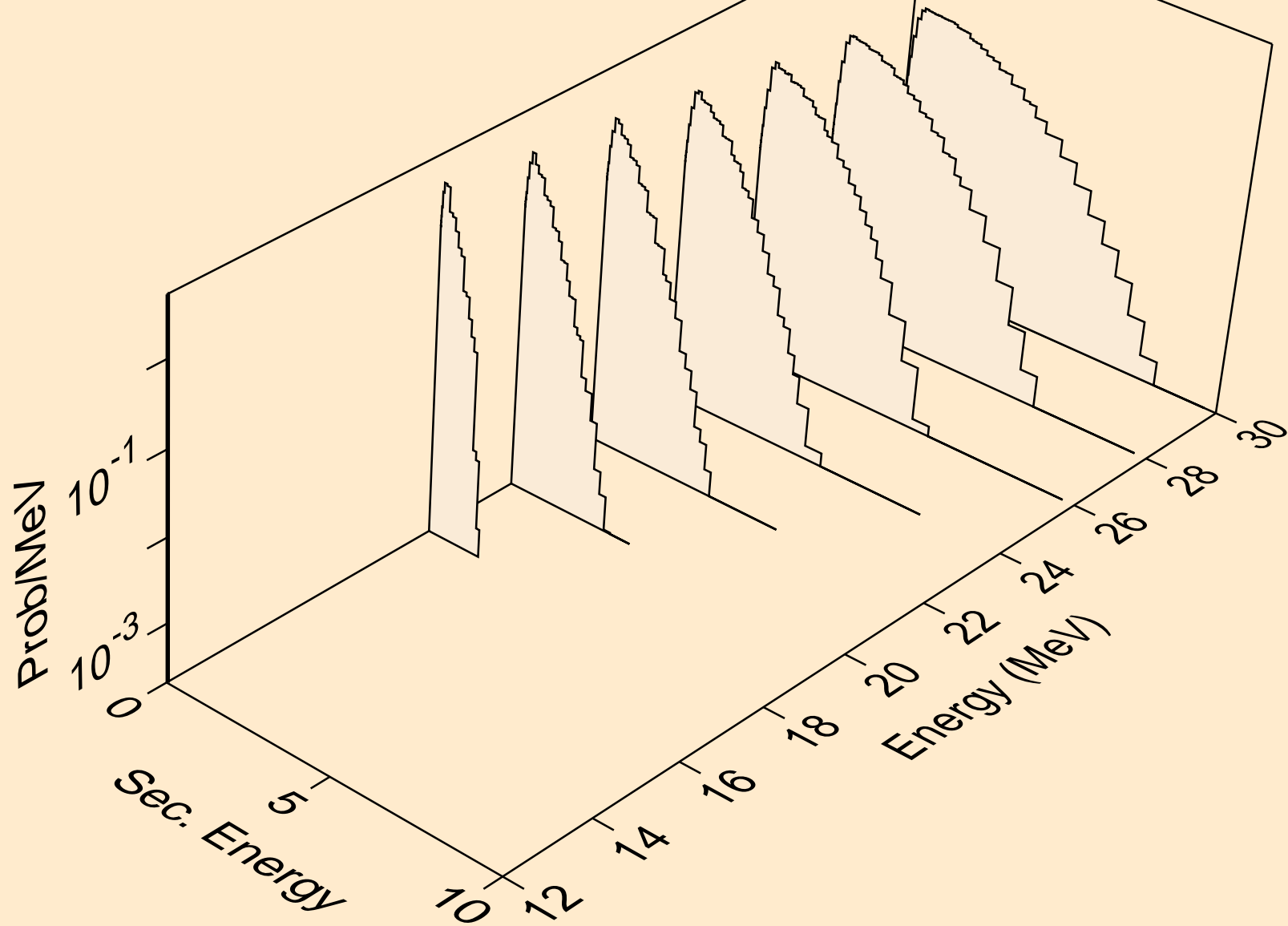

CE121 DEUTERON ACER TENDL-2021 LIBRARY; T=0.K
neutrons from (d,n*)p

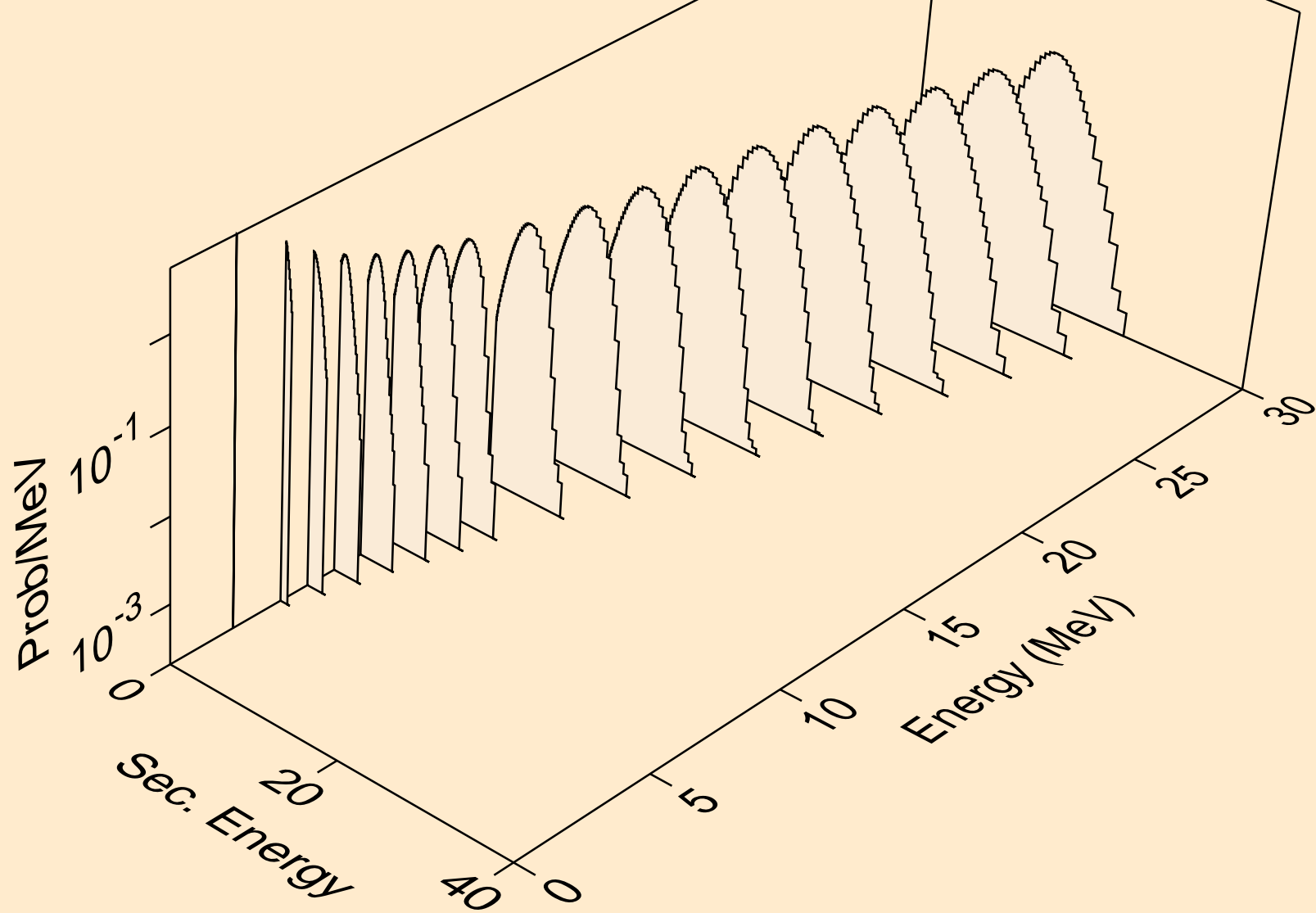

CE121 DEUTERON ACER TENDL-2021 LIBRARY; T=0.K
neutrons from (d,n*)2a

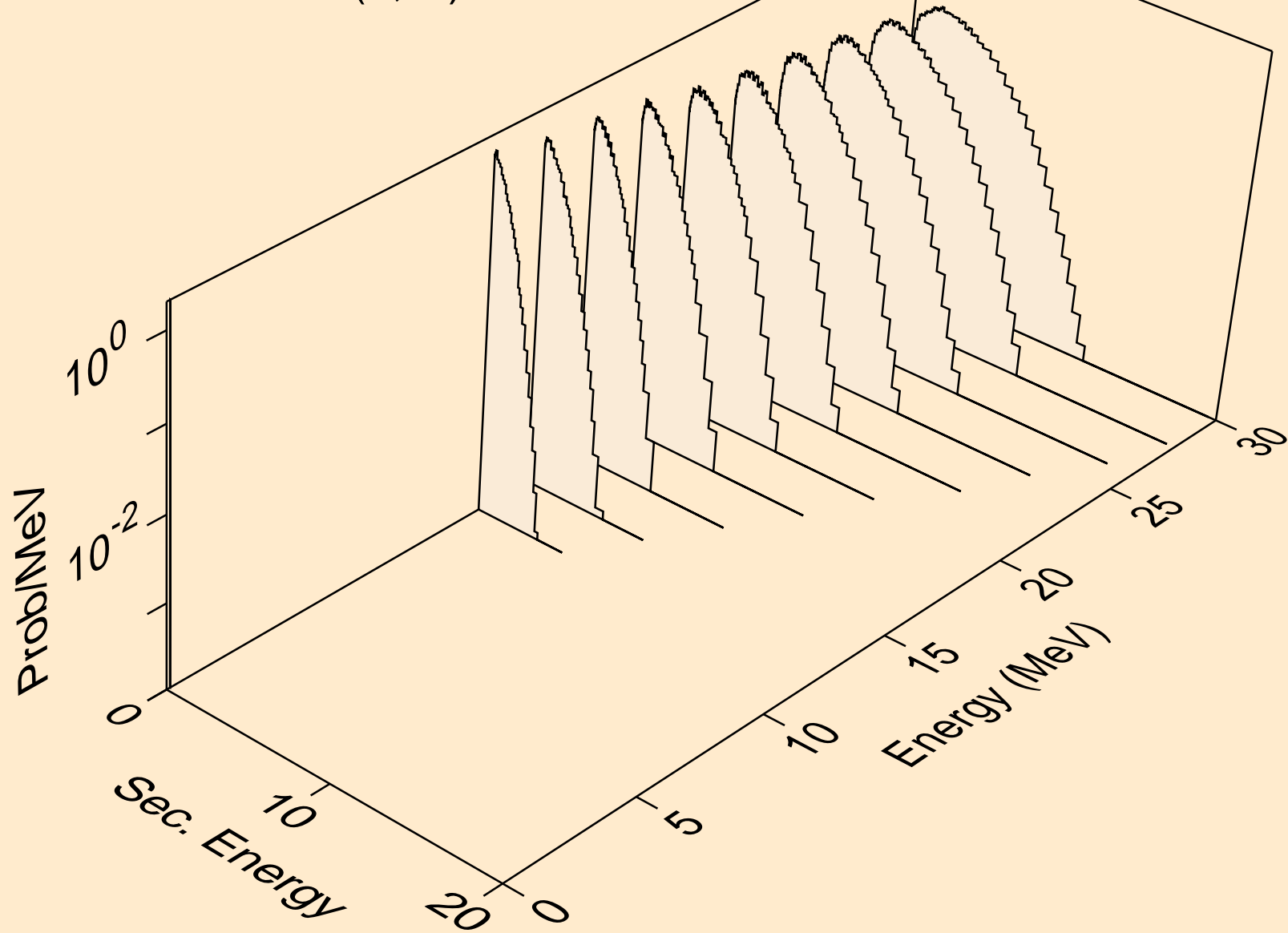

CE121 DEUTERON ACER TENDL-2021 LIBRARY; T=0.K
neutrons from (d,n*)d

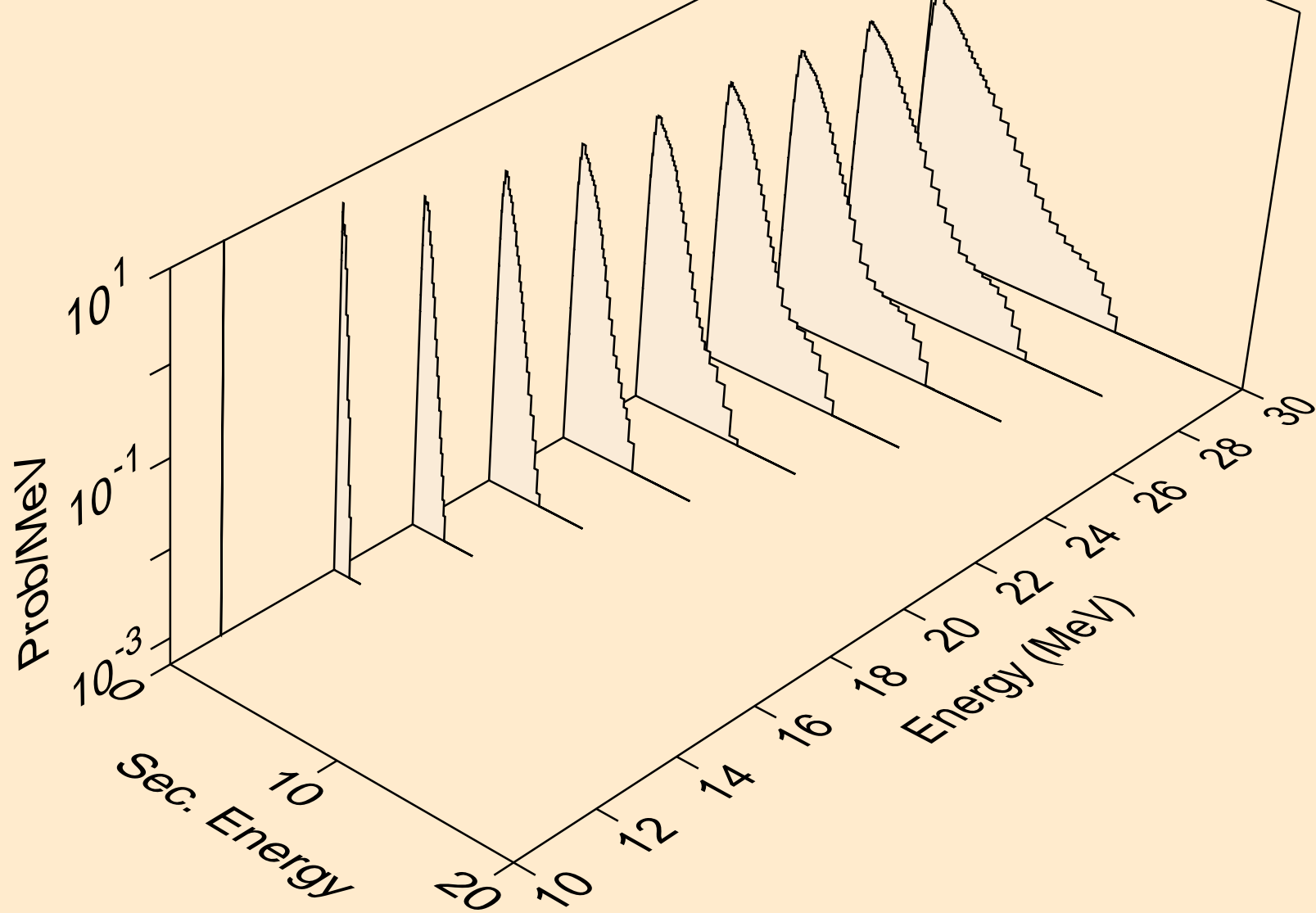

CE121 DEUTERON ACER TENDL-2021 LIBRARY; T=0.K
neutrons from (d,n*)t

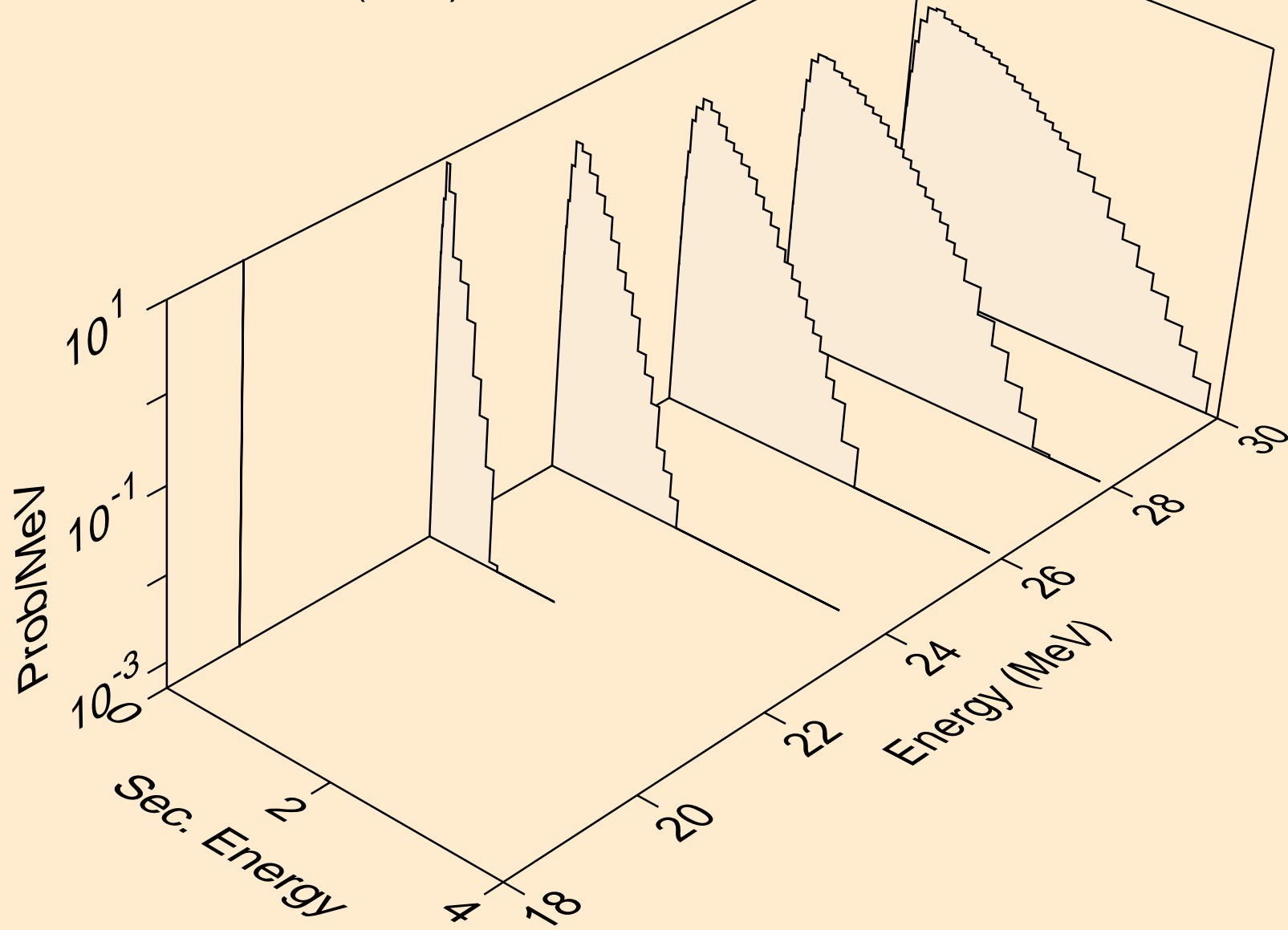

CE121 DEUTERON ACER TENDL-2021 LIBRARY; T=0.K
neutrons from (d,n*)he3

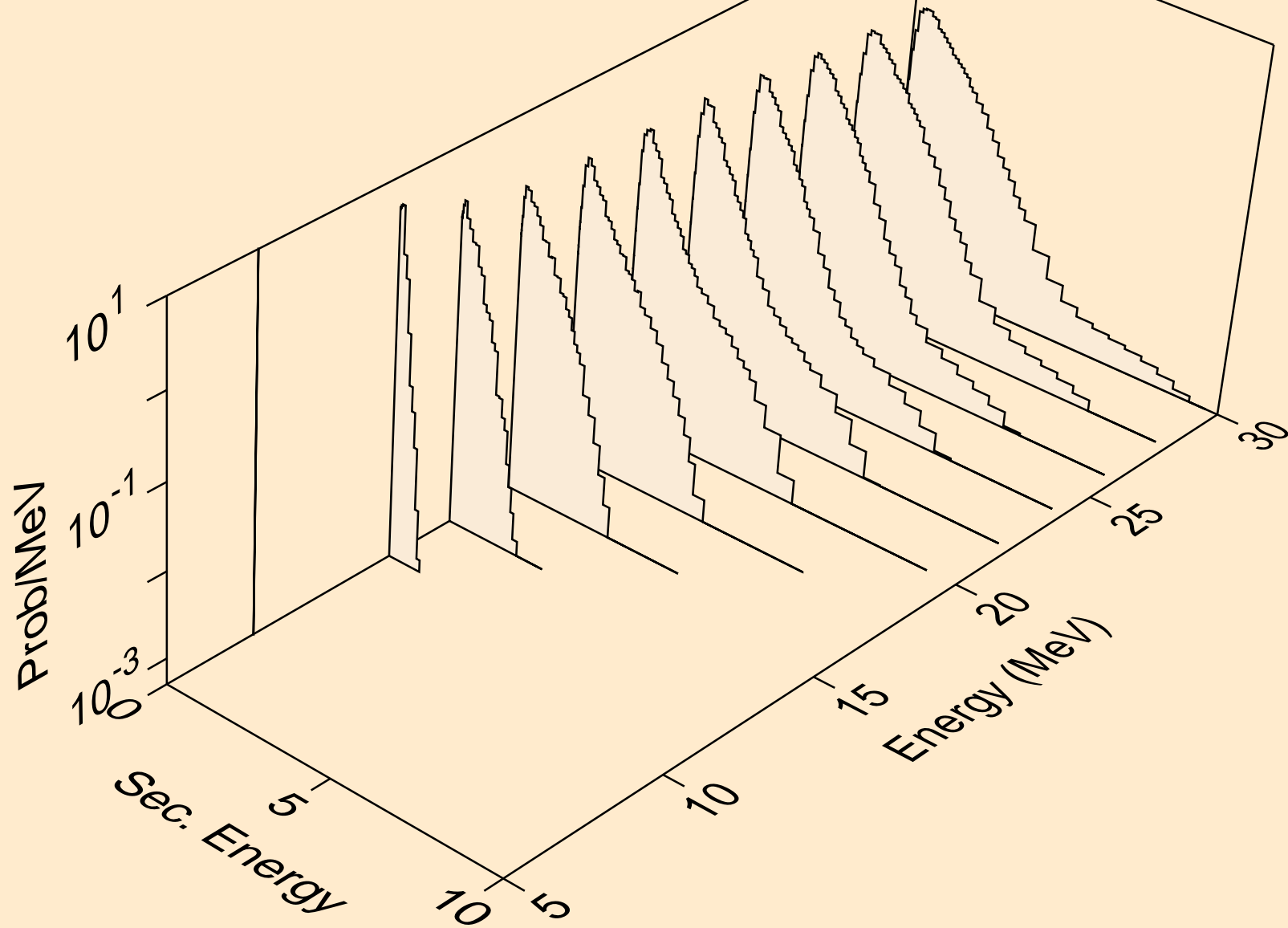

CE121 DEUTERON ACER TENDL-2021 LIBRARY; T=0.K
neutrons from (d,2np)

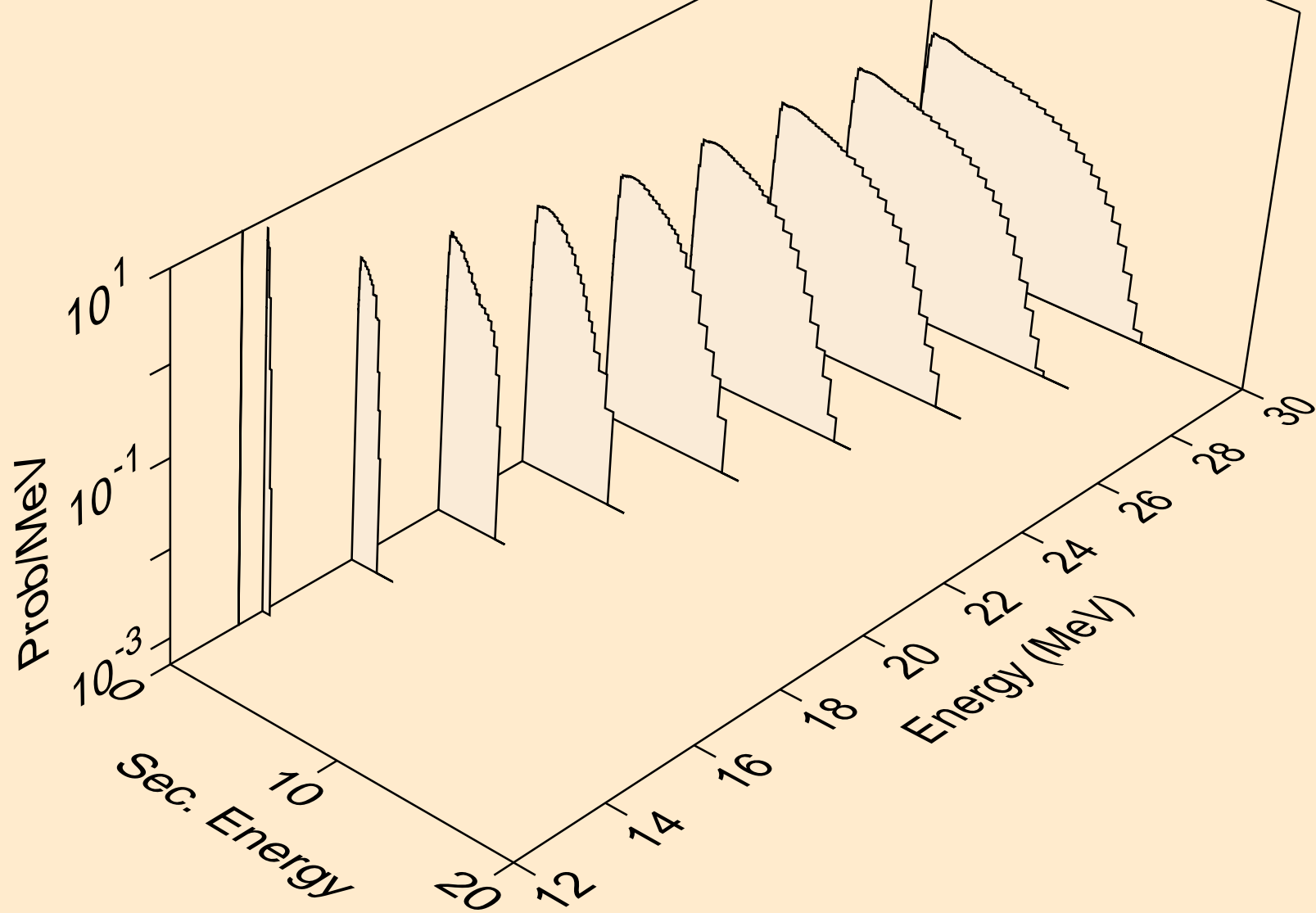

CE121 DEUTERON ACER TENDL-2021 LIBRARY; T=0.K
neutrons from (d,2np)

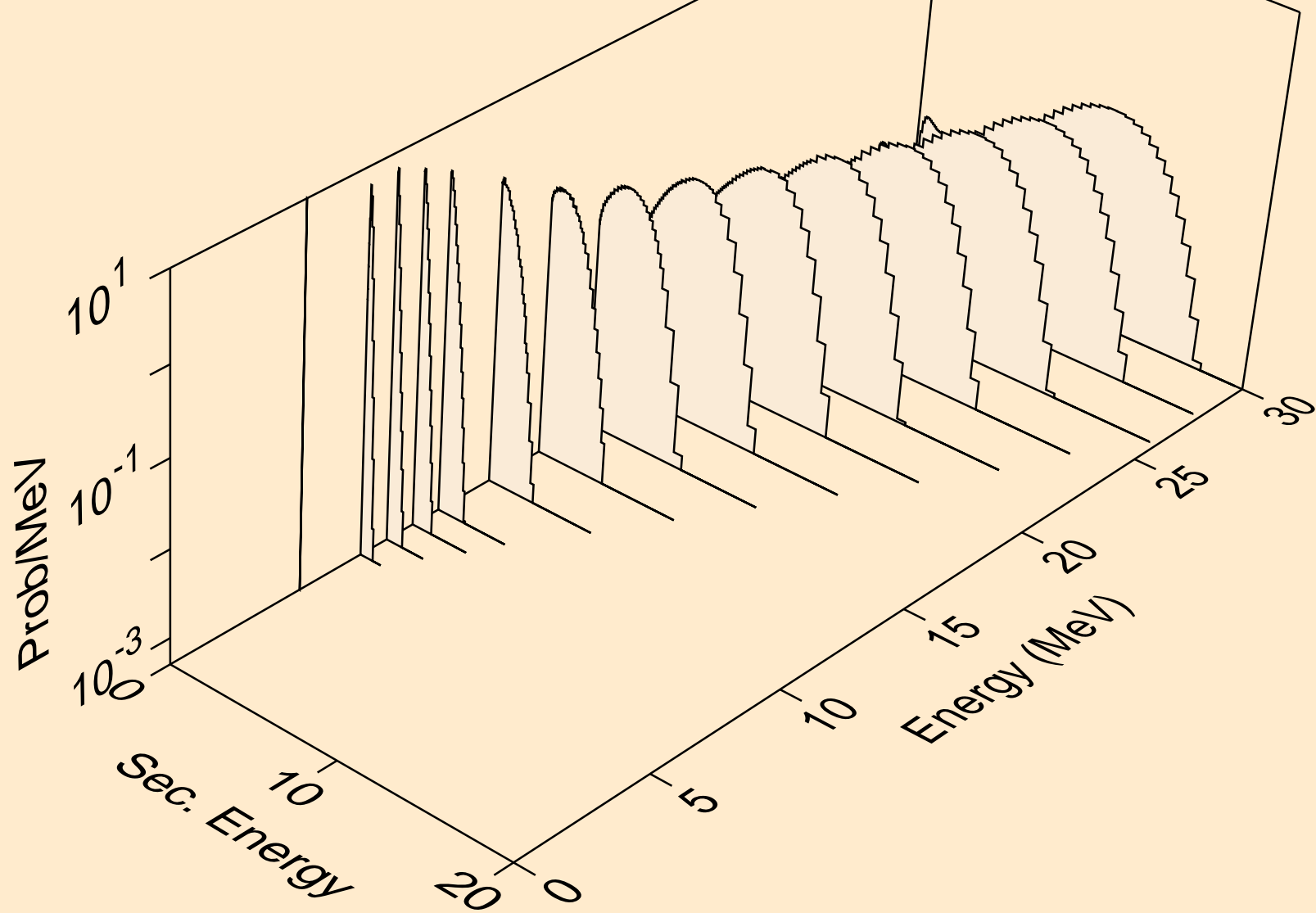

CE121 DEUTERON ACER TENDL-2021 LIBRARY; T=0.K
neutrons from (d,npa)

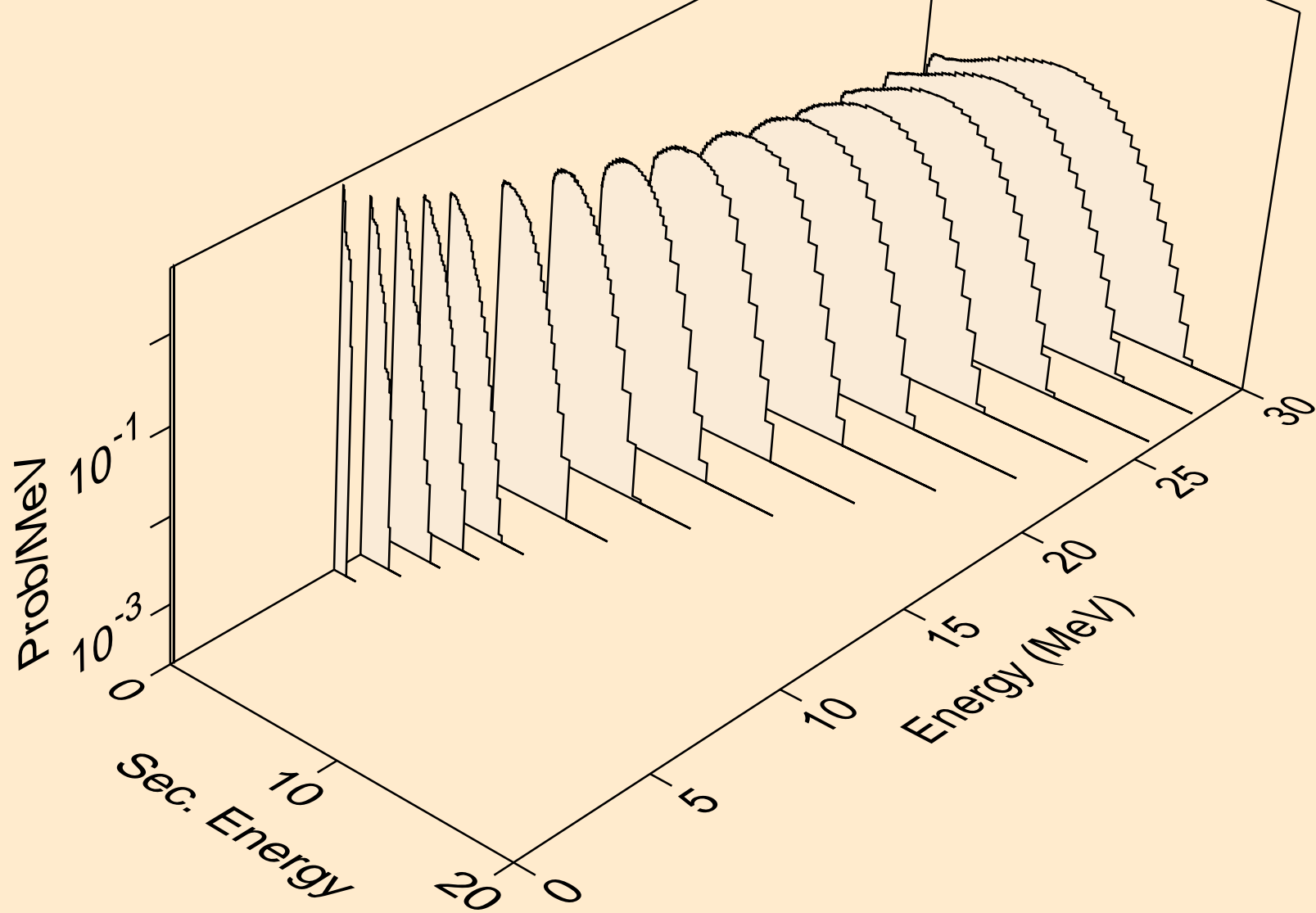

CE121 DEUTERON ACER TENDL-2021 LIBRARY; T=0.K
protons from (d,x)

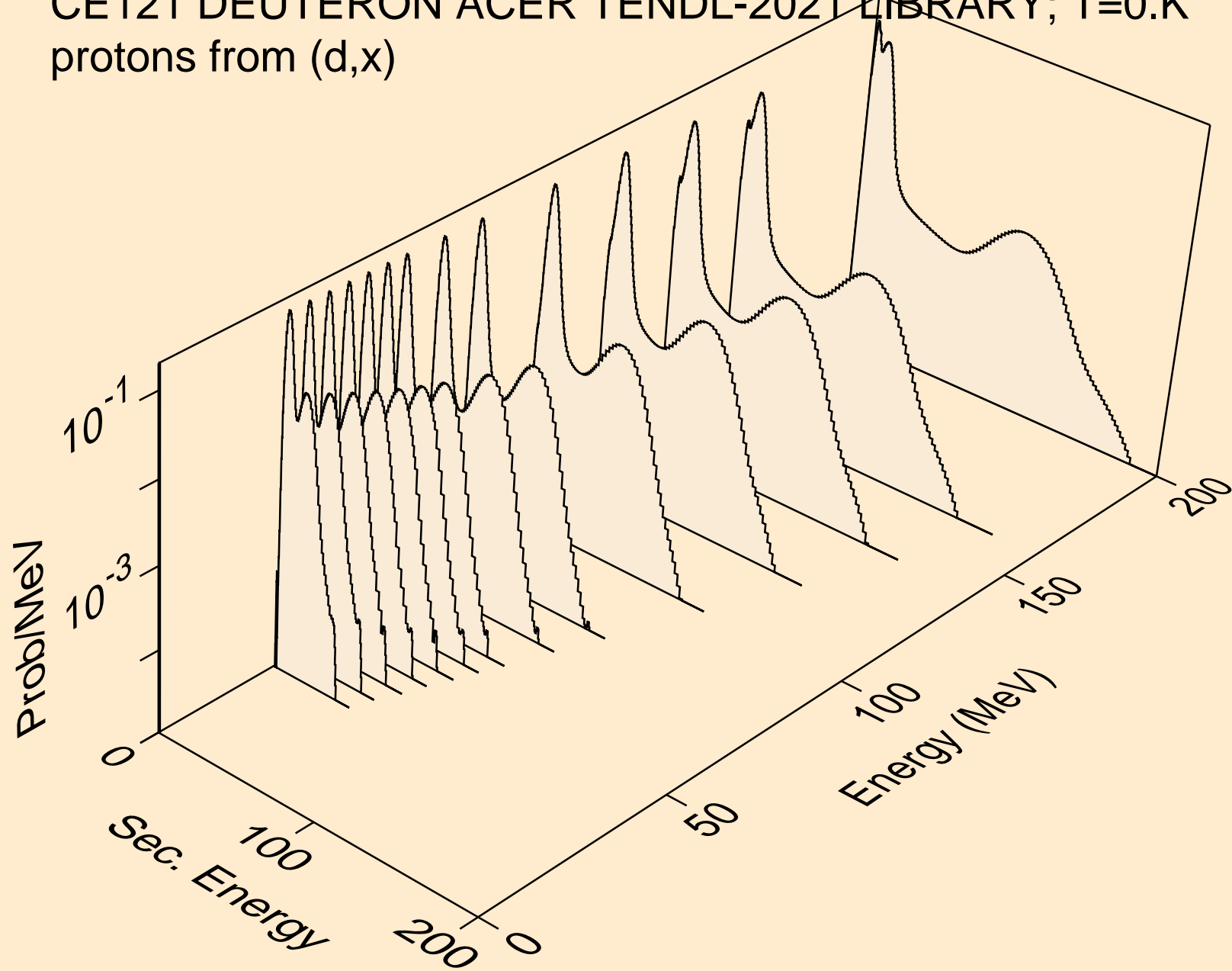

CE121 DEUTERON ACER TENDL-2021 LIBRARY; T=0.K
protons from (d,n*)p

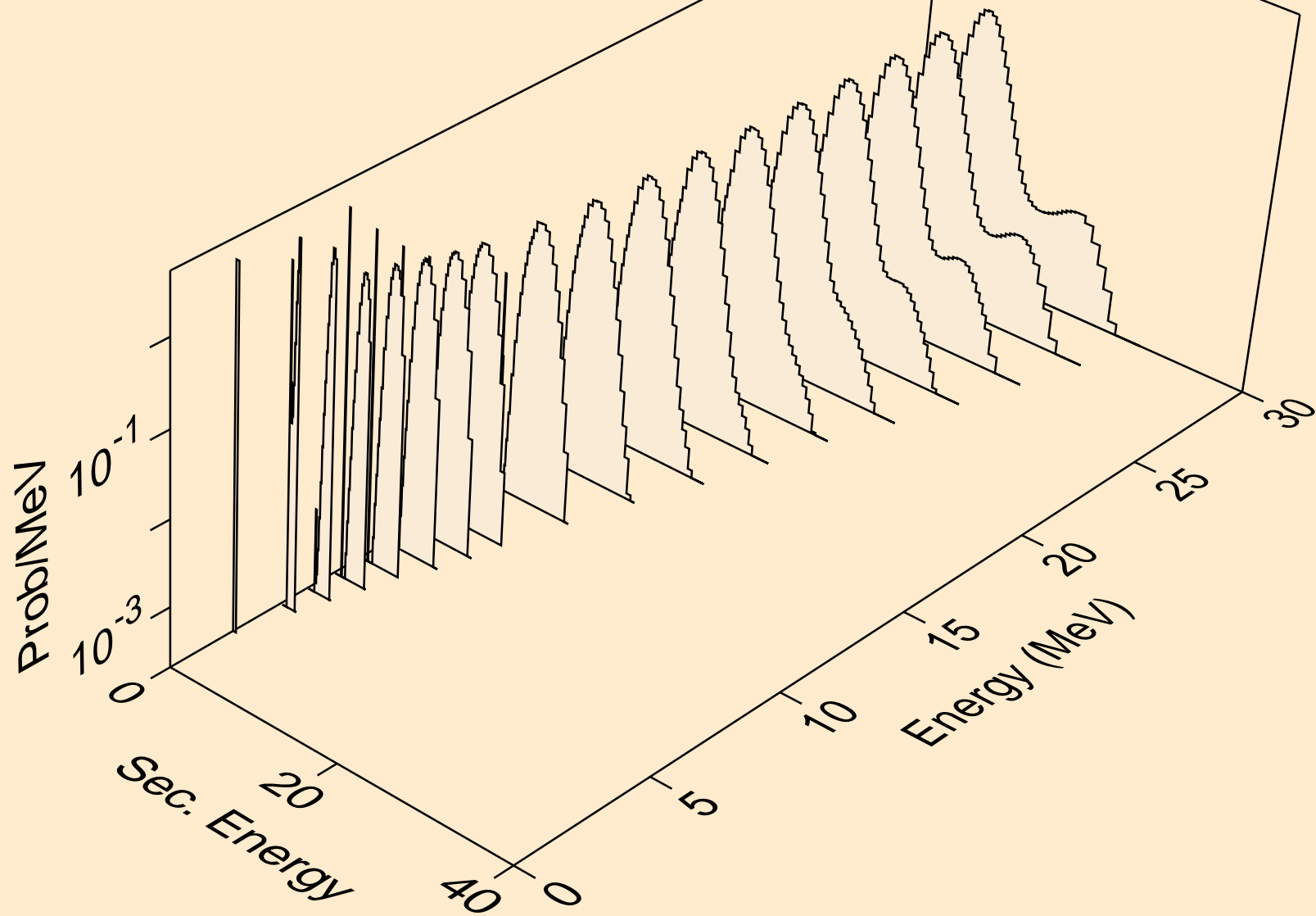

CE121 DEUTERON ACER TENDL-2021 LIBRARY; T=0.K
protons from (d,2np)

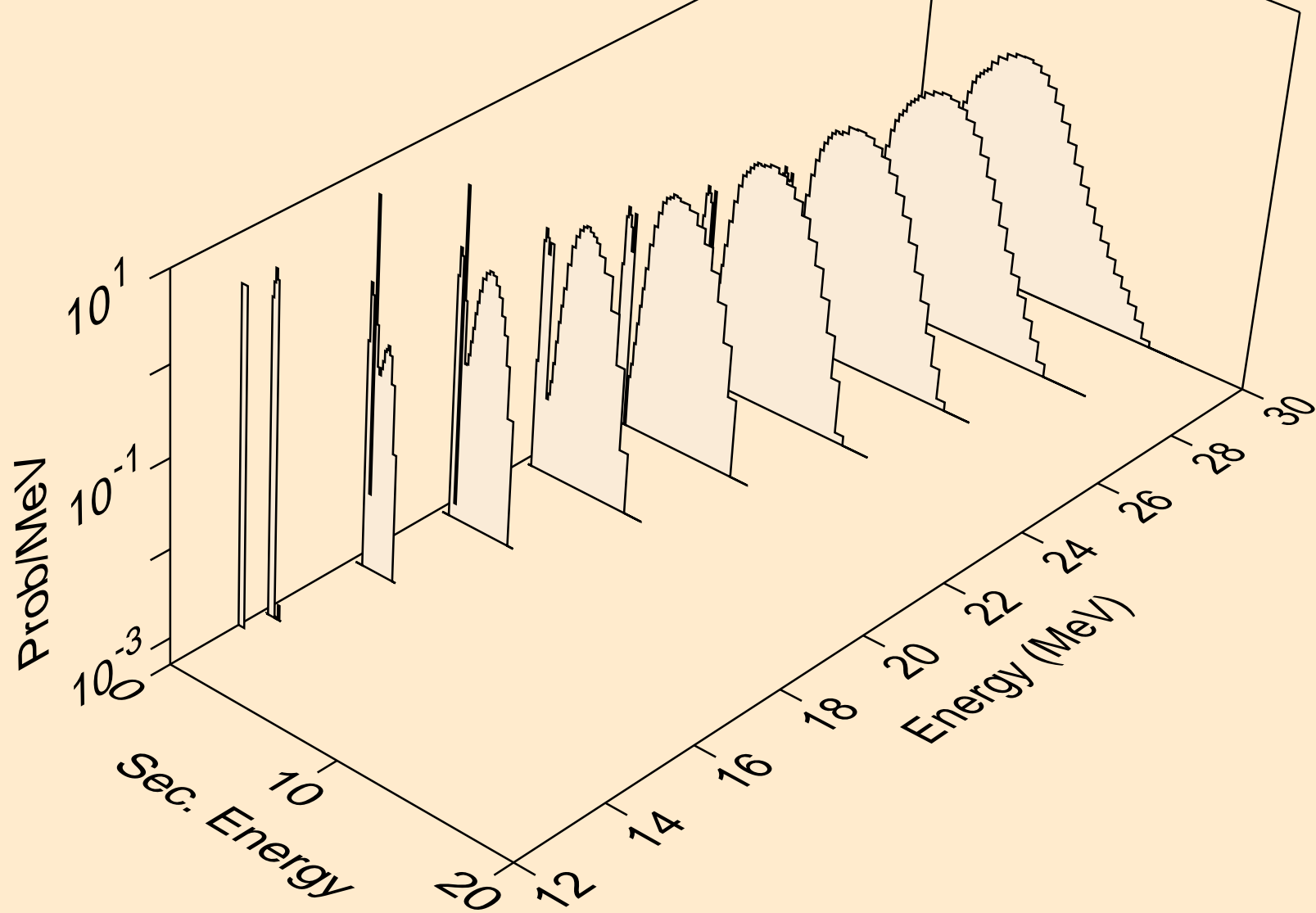

CE121 DEUTERON ACER TENDL-2021 LIBRARY; T=0.K
protons from (d,2np)

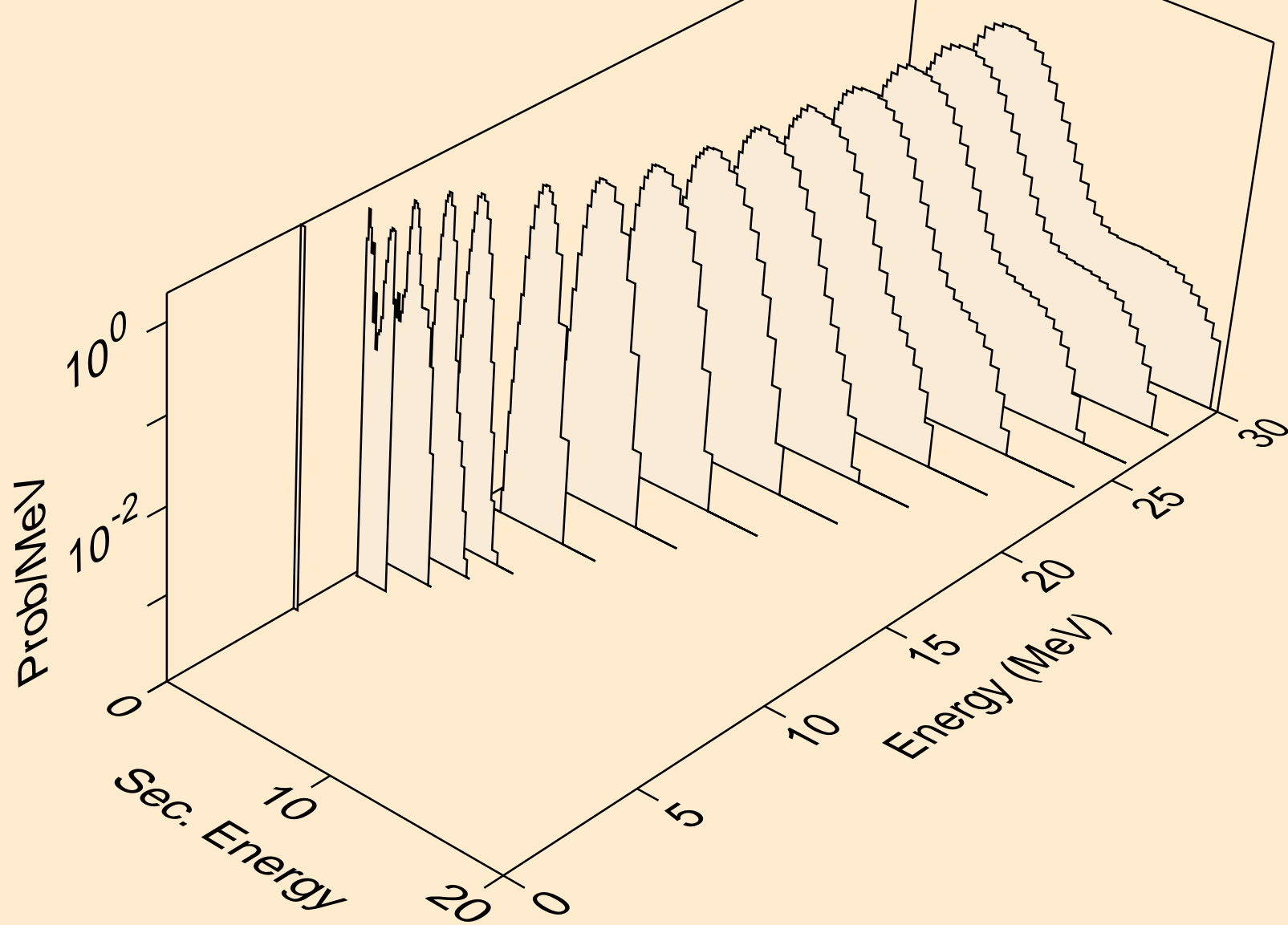

CE121 DEUTERON ACER TENDL-2021 LIBRARY; T=0.K
protons from (d,npa)

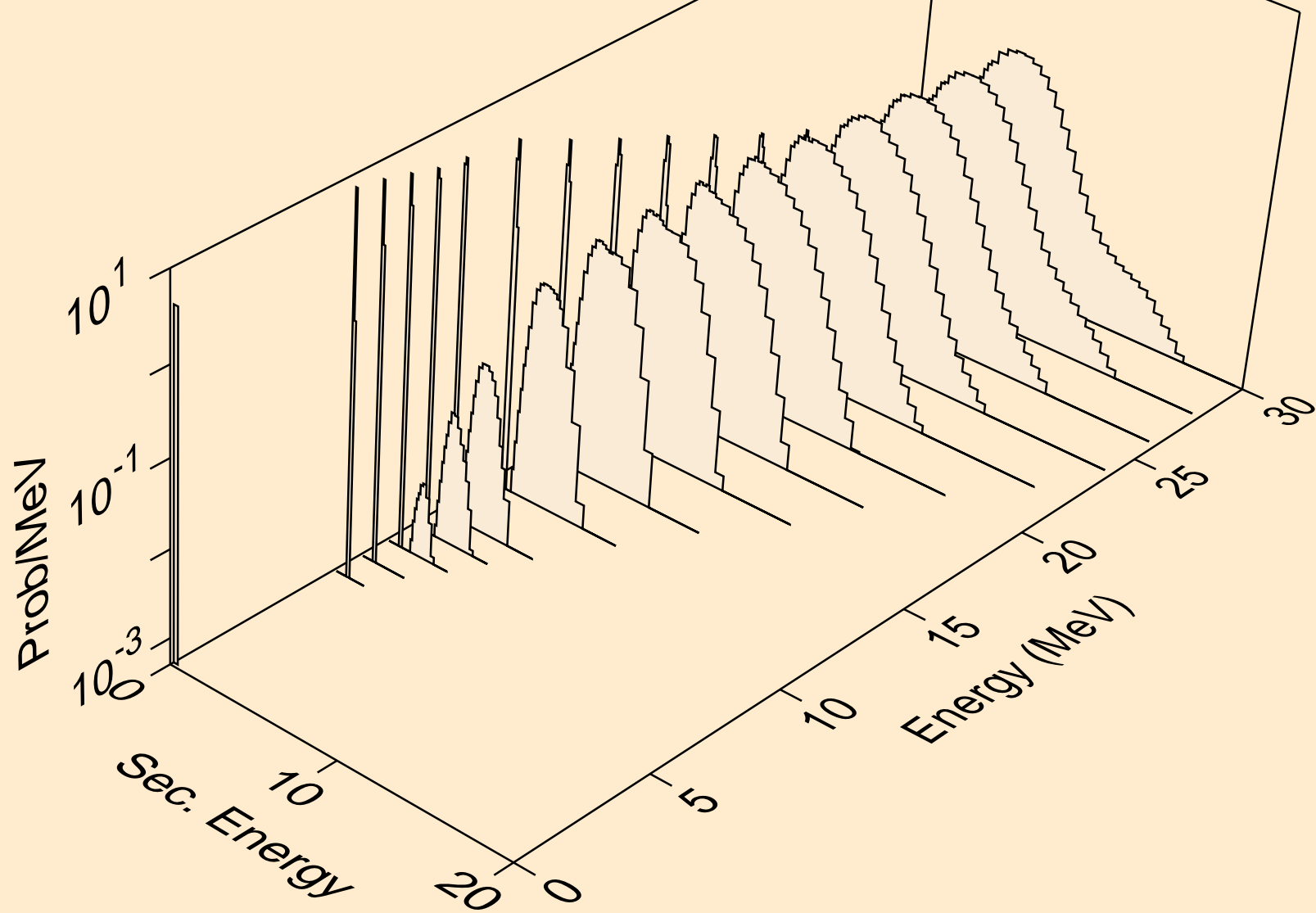

CE121 DEUTERON ACER TENDL-2021 LIBRARY; T=0.K
protons from (d,p)

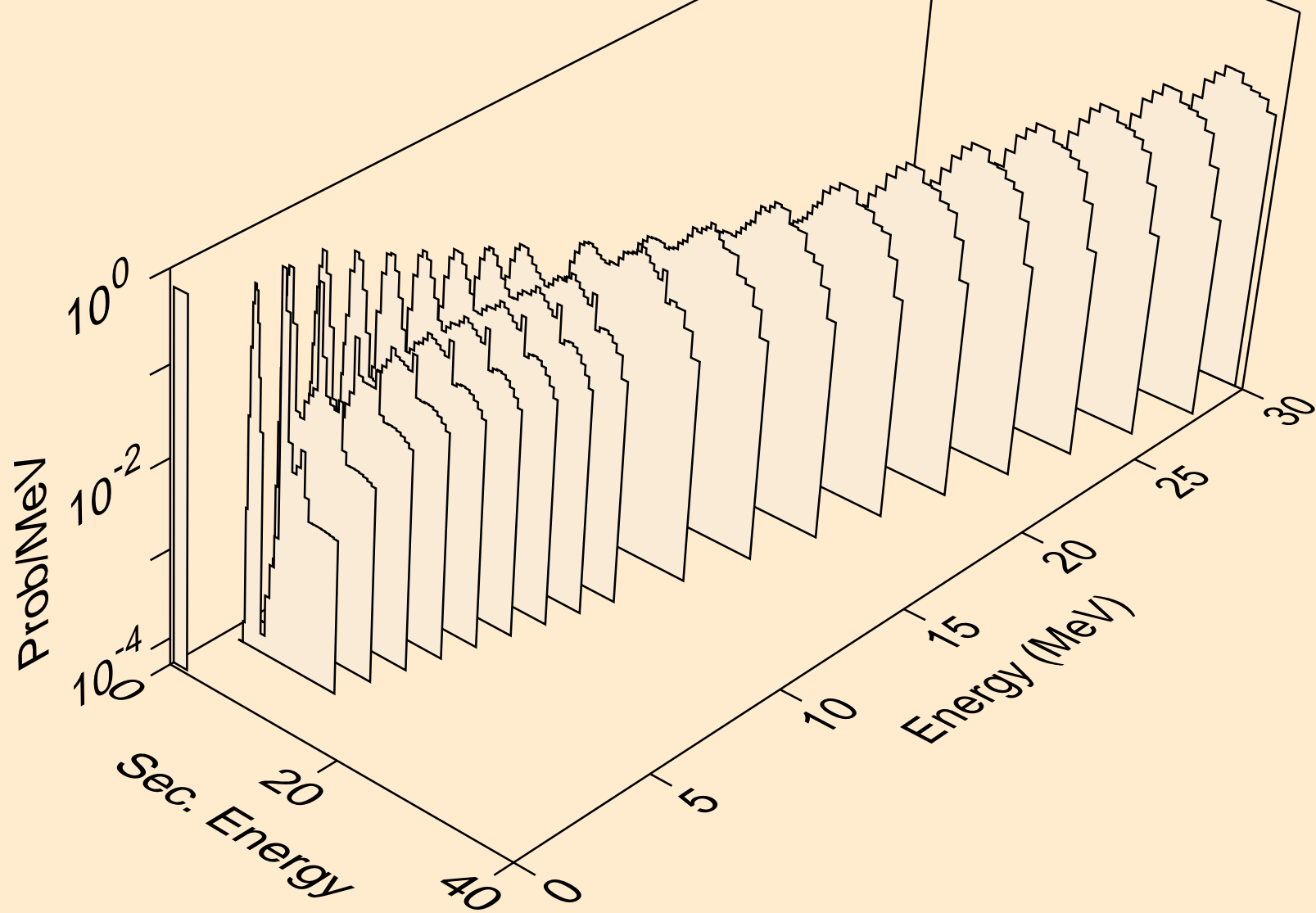

CE121 DEUTERON ACER TENDL-2021 LIBRARY; T=0.K
protons from (d,2p)

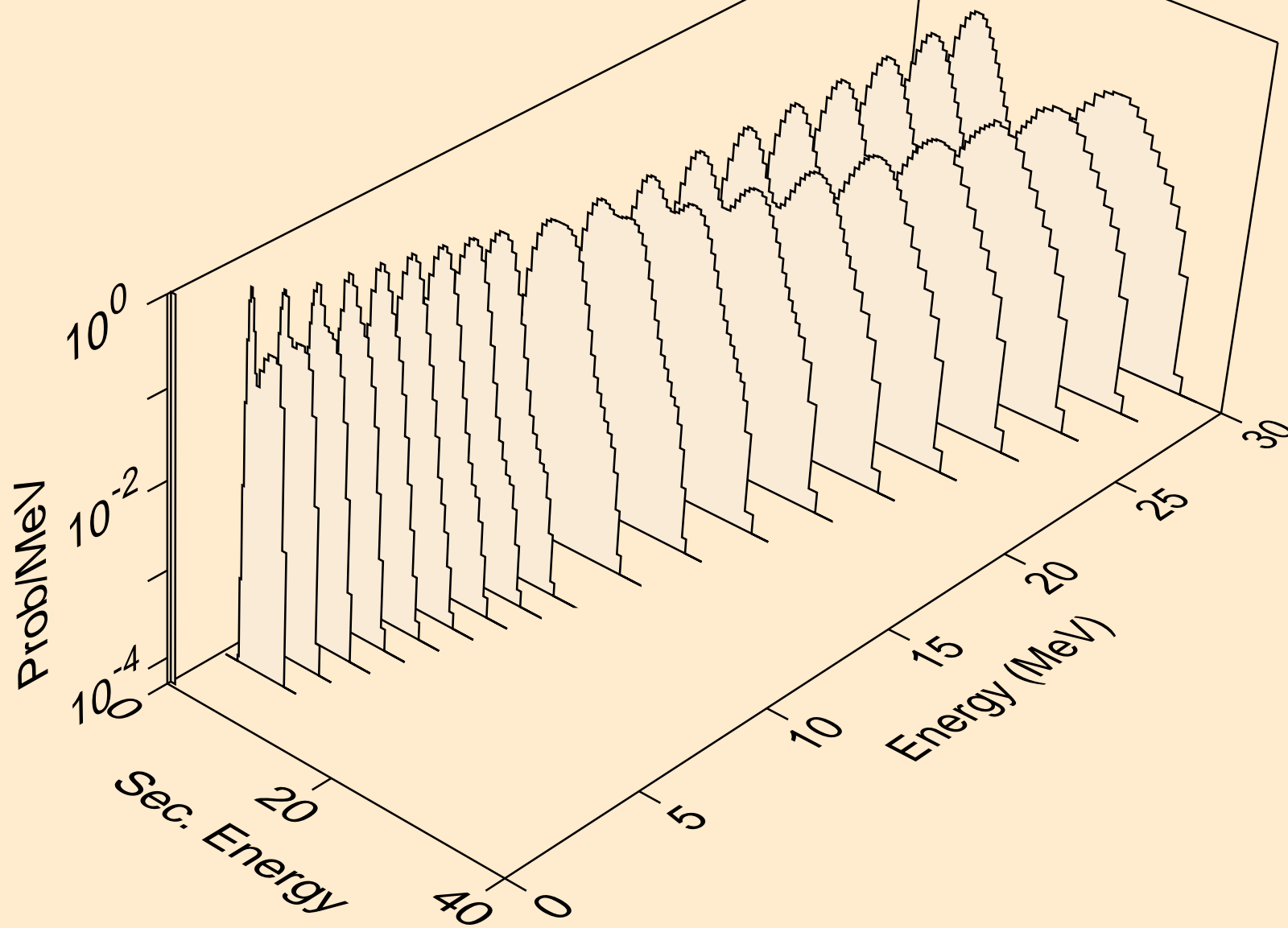

CE121 DEUTERON ACER TENDL-2021 LIBRARY; T=0.K
protons from (d,pa)

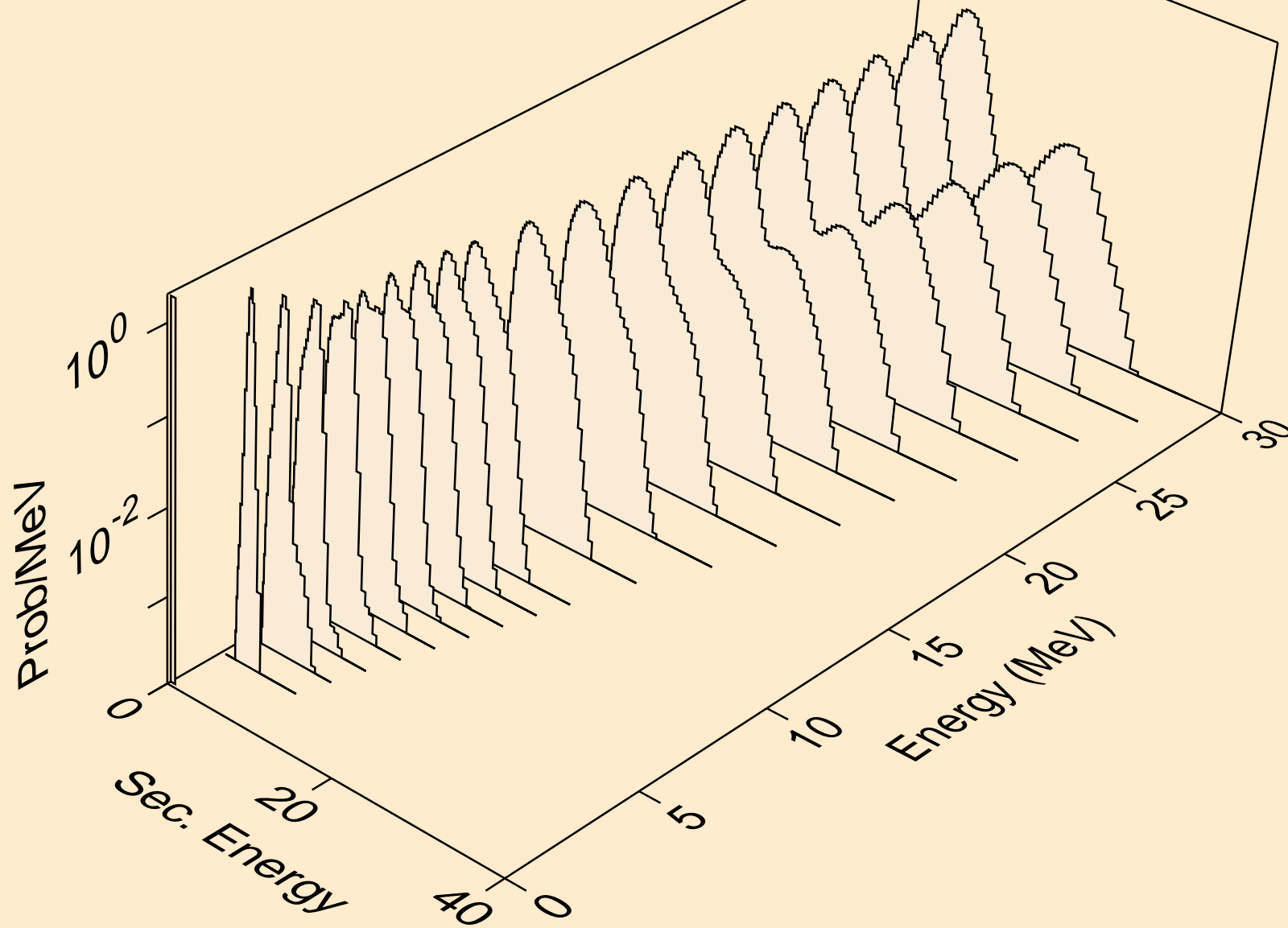

CE121 DEUTERON ACER TENDL-2021 LIBRARY; T=0.K
protons from (d,pd)

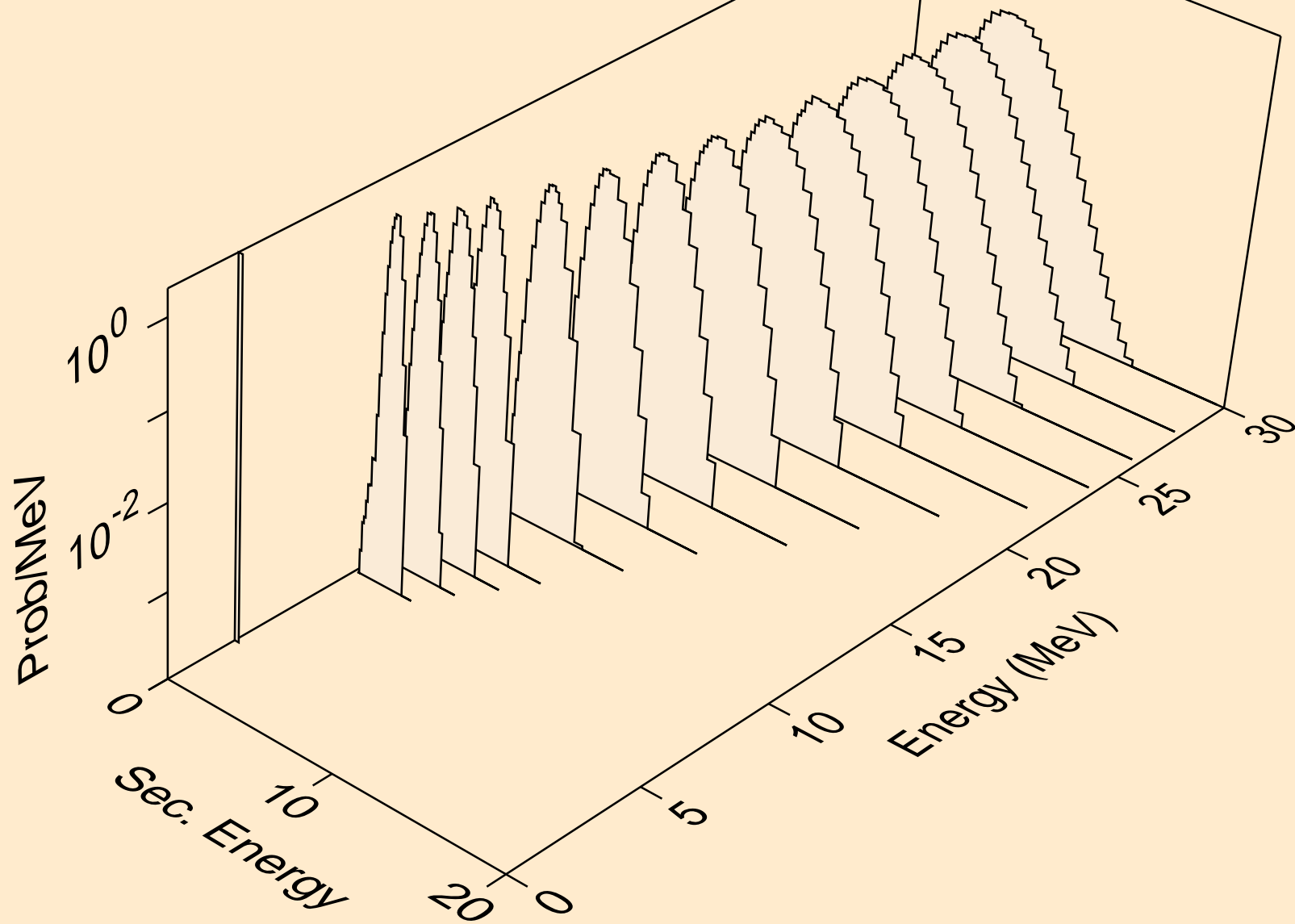

CE121 DEUTERON ACER TENDL-2021 LIBRARY; T=0.K
protons from (d,pt)

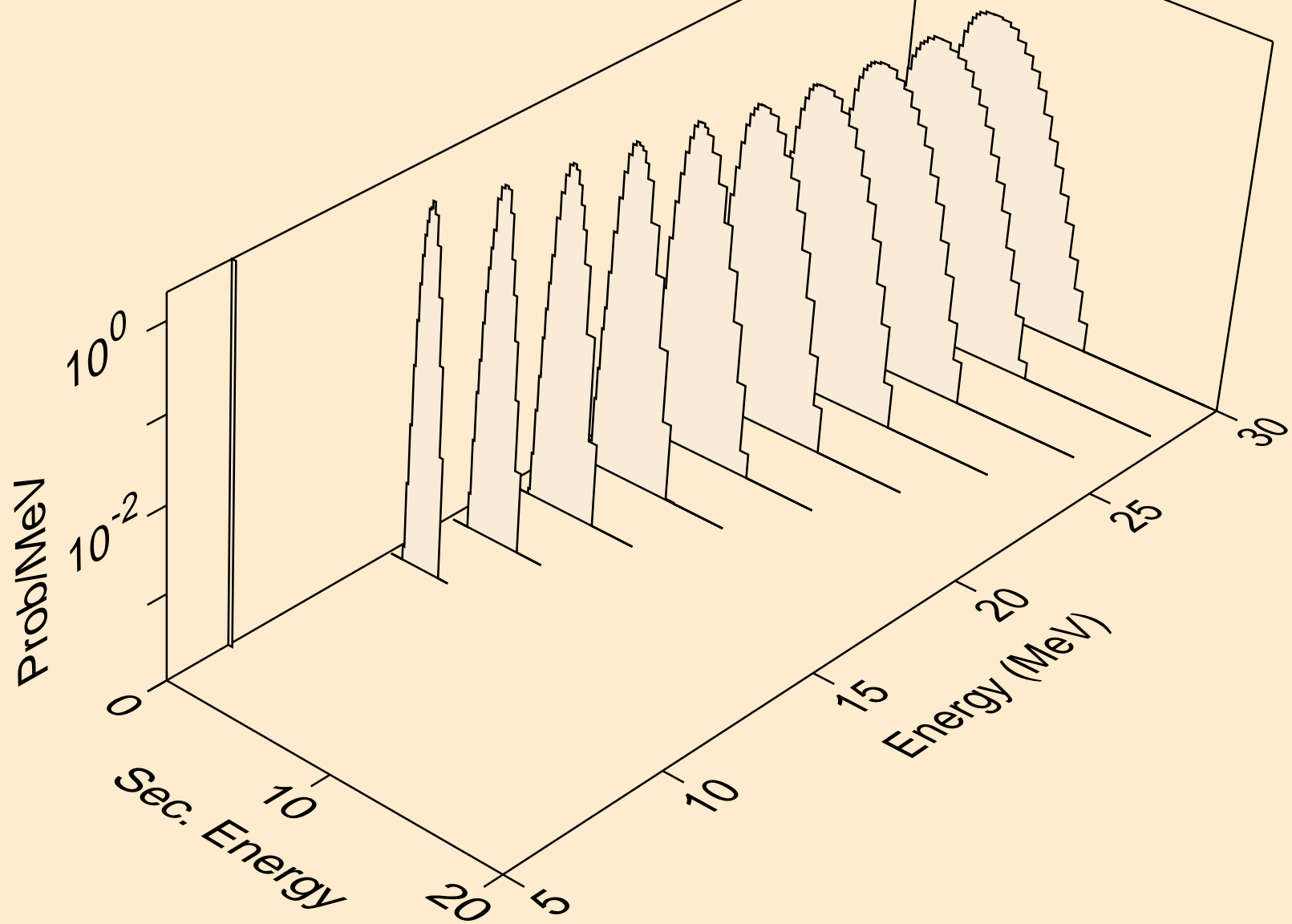

CE121 DEUTERON ACER TENDL-2021 LIBRARY; T=0.K
tritons from (d,x)

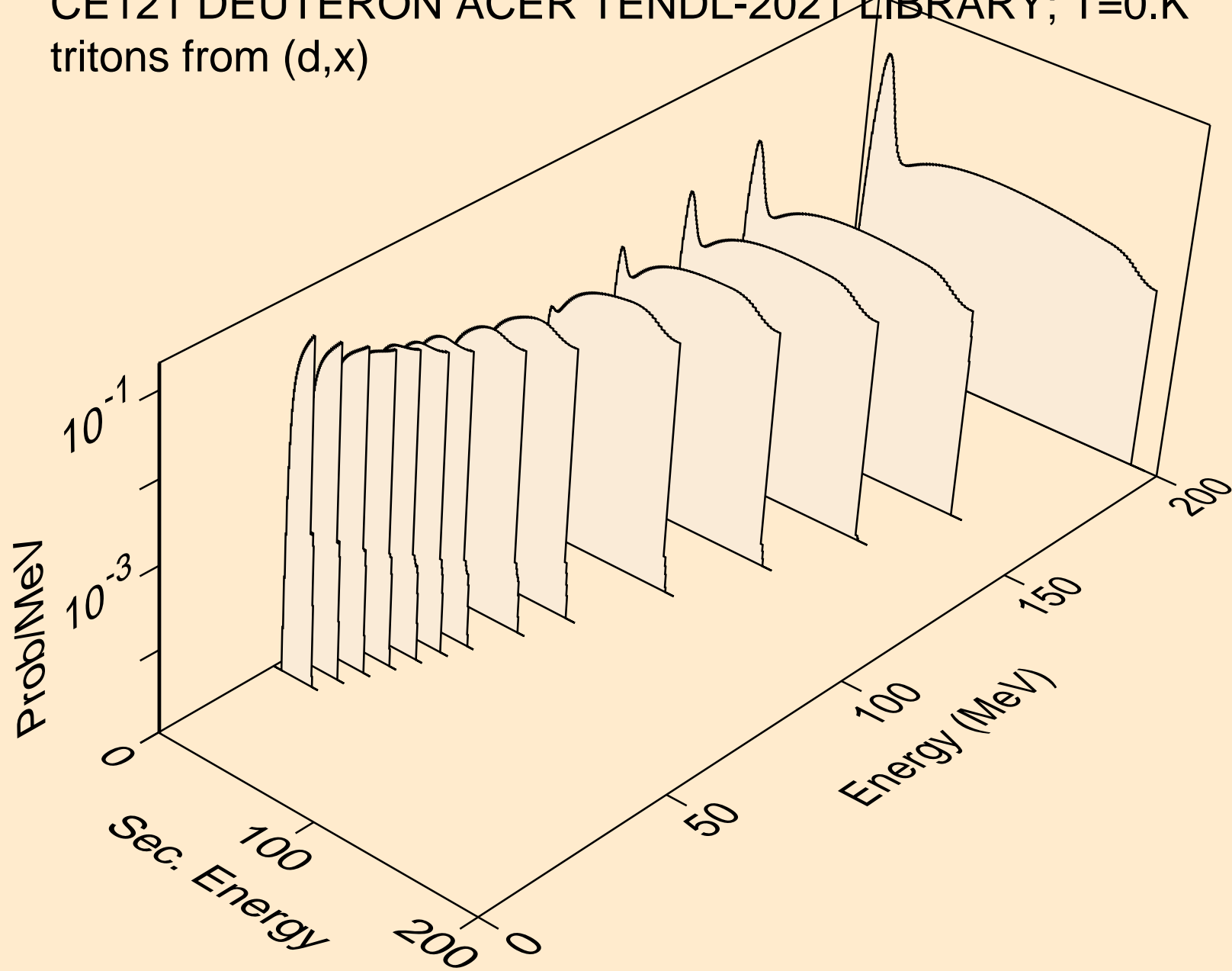

CE121 DEUTERON ACER TENDL-2021 LIBRARY; T=0.K
tritons from (d,n*)t

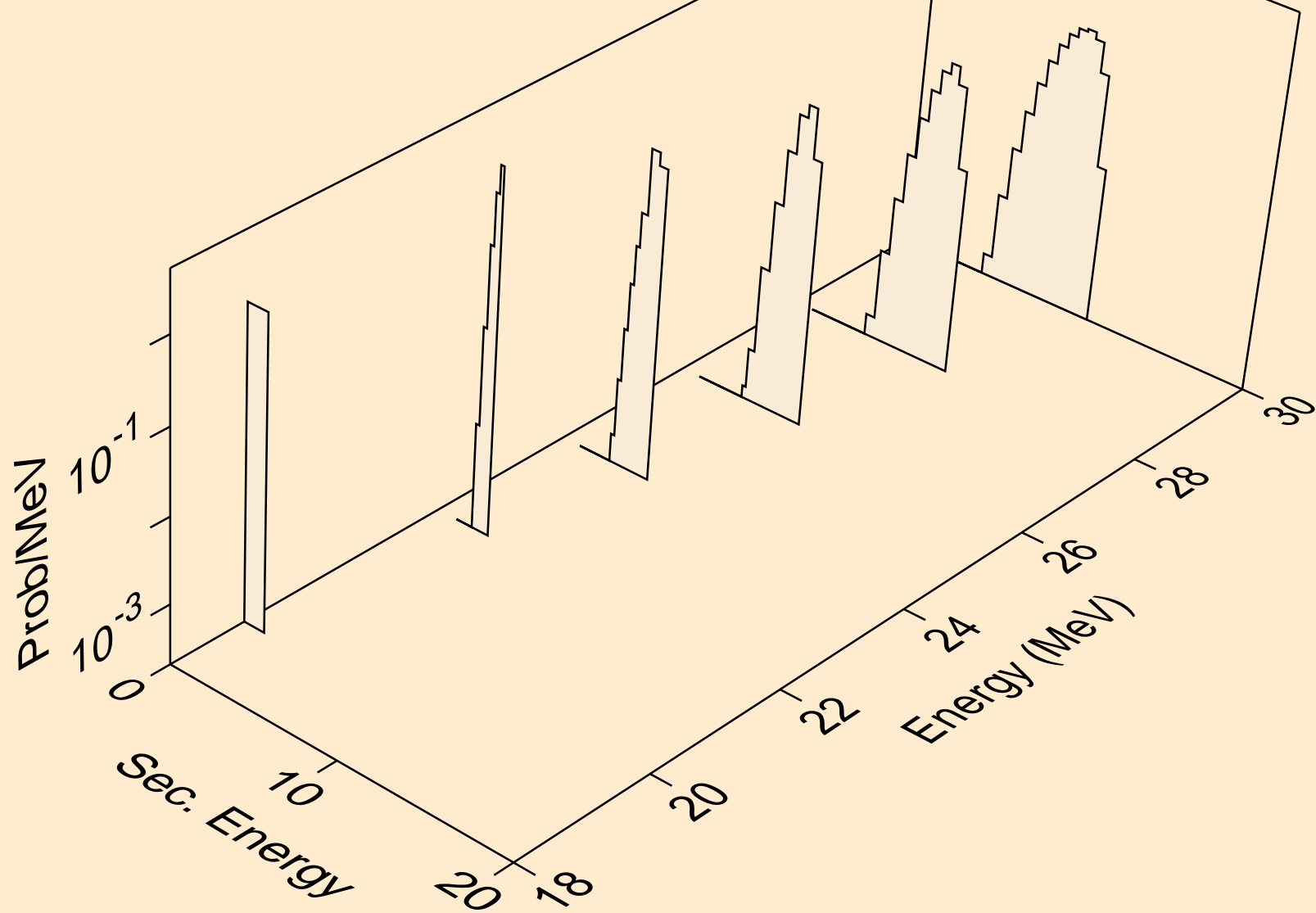

CE121 DEUTERON ACER TENDL-2021 LIBRARY; T=0.K
tritons from (d,t)

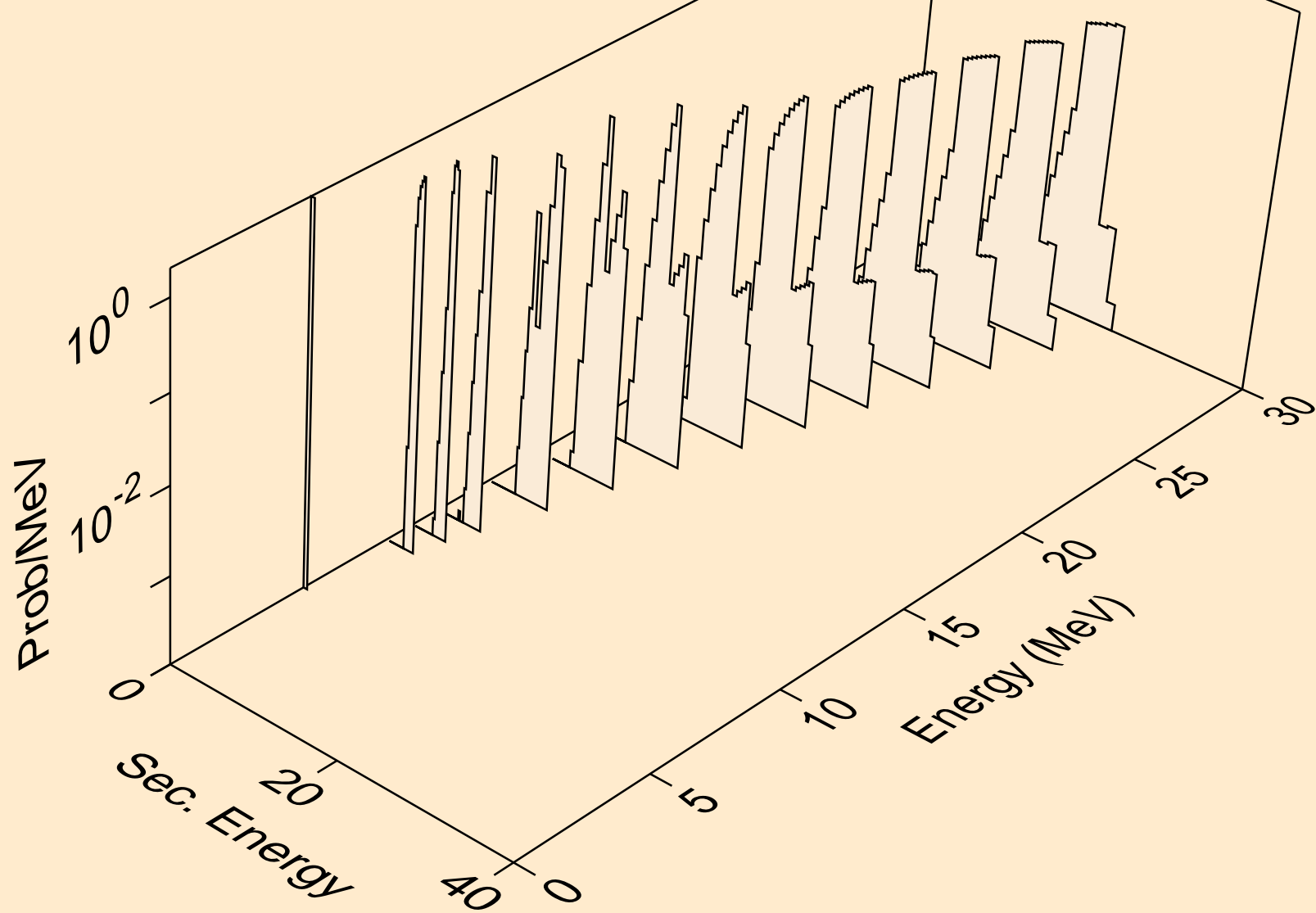

CE121 DEUTERON ACER TENDL-2021 LIBRARY; T=0.K
tritons from (d,pt)

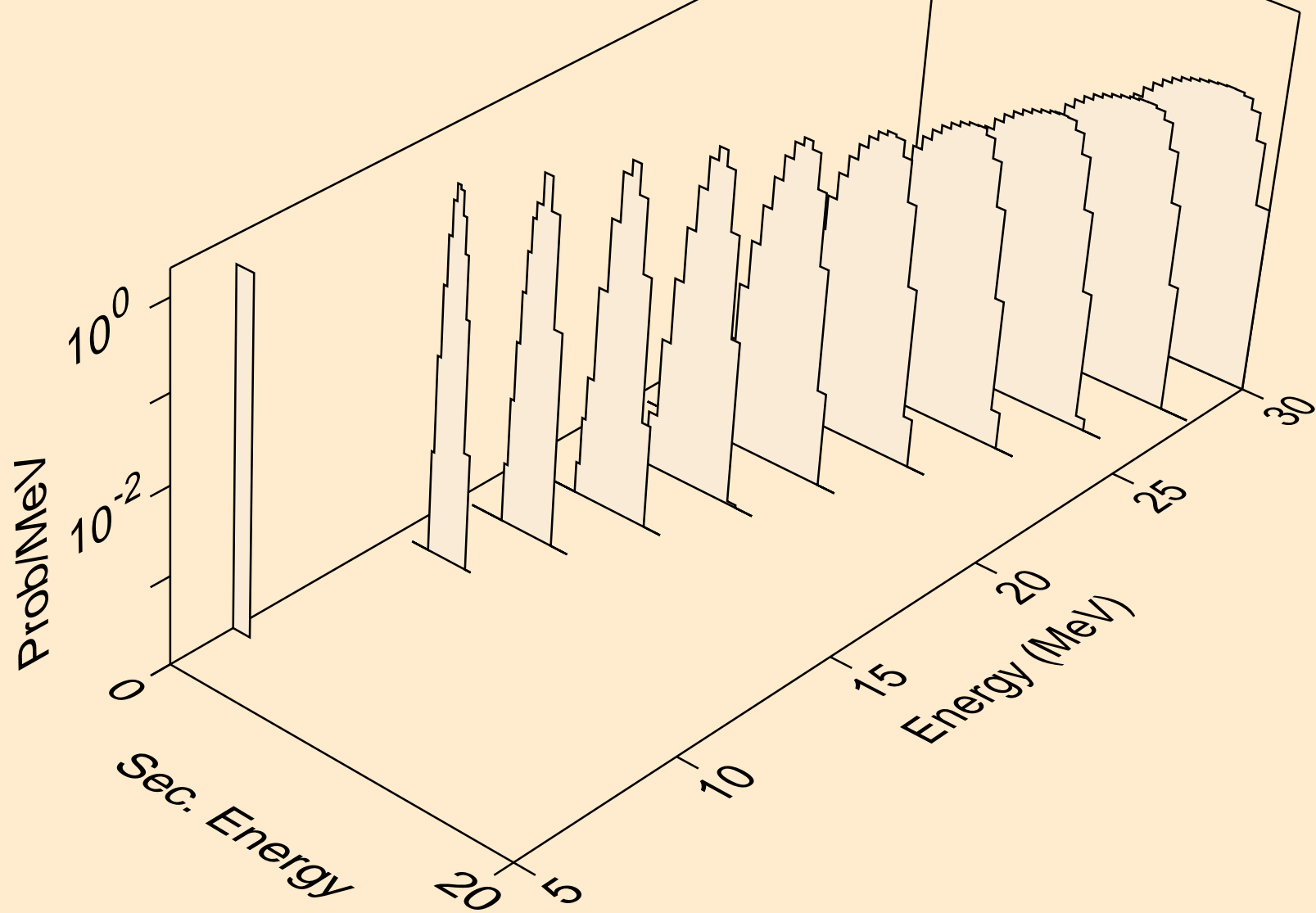

CE121 DEUTERON ACER TENDL-2021 LIBRARY; T=0.K
he3s from (d,x)

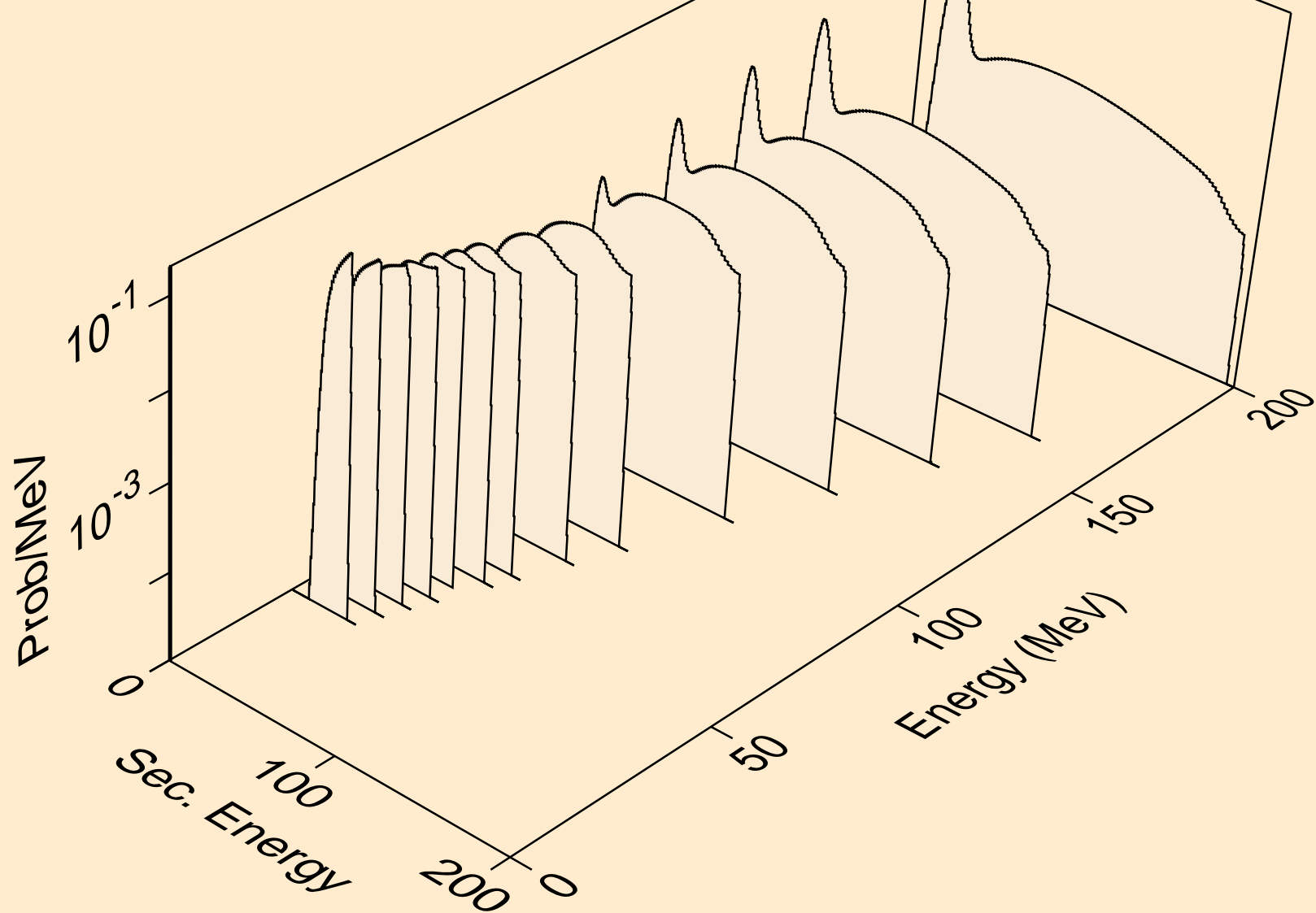

CE121 DEUTERON ACER TENDL-2021 LIBRARY; T=0.K
he3s from (d,n*)he3

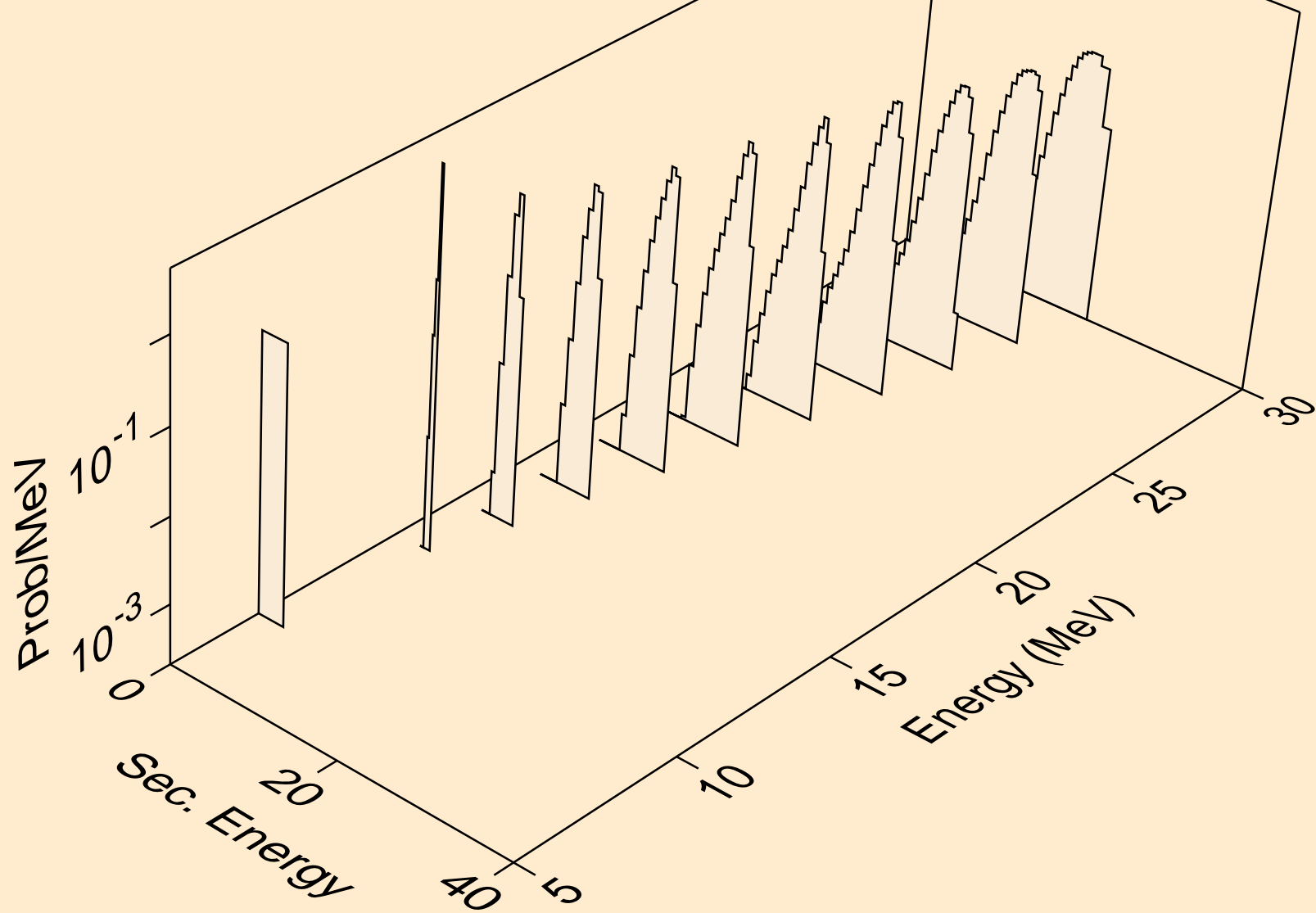

CE121 DEUTERON ACER TENDL-2021 LIBRARY; T=0.K
he3s from (d,he3)

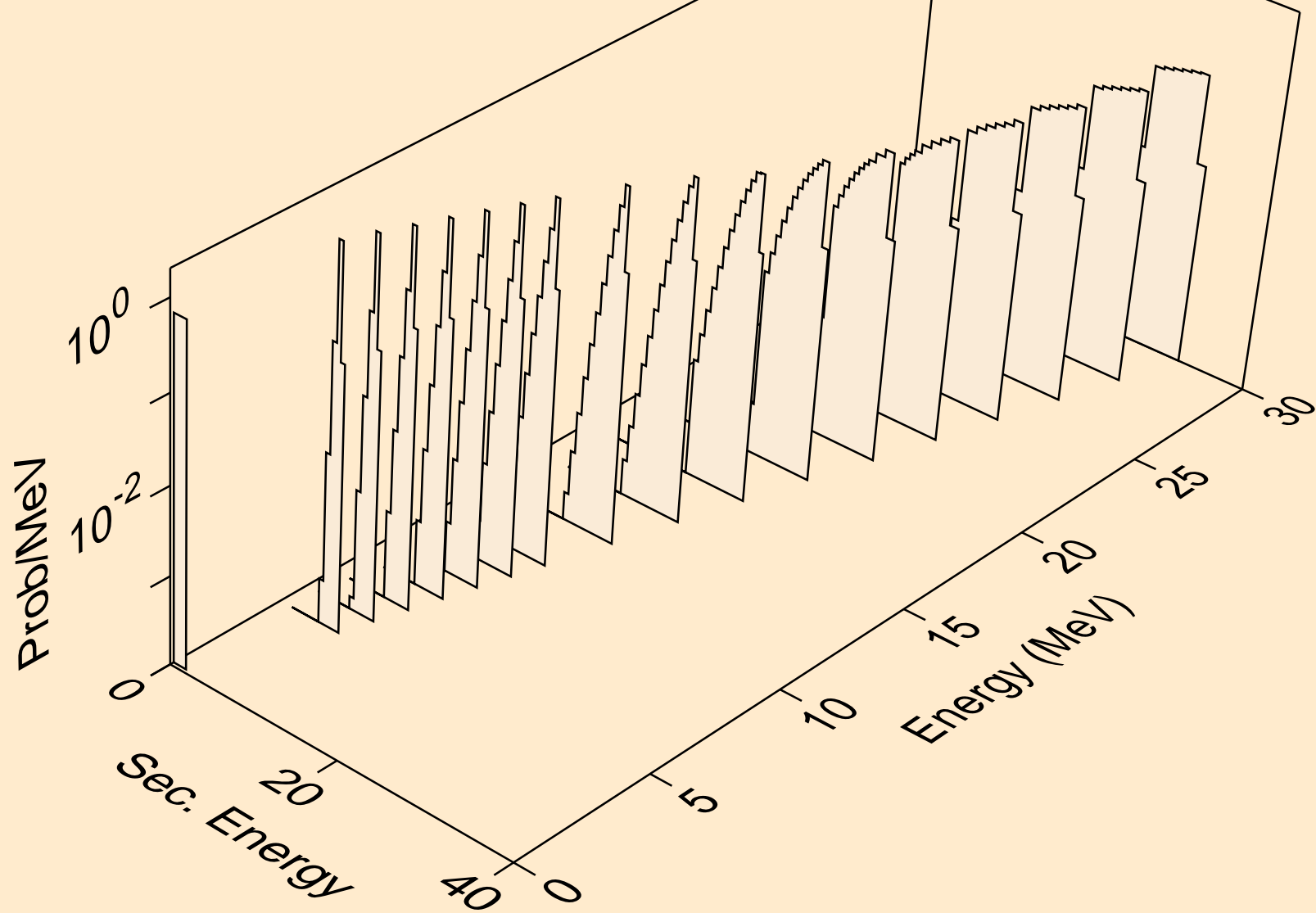

CE121 DEUTERON ACER TENDL-2021 LIBRARY; T=0.K
alphas from (d,x)

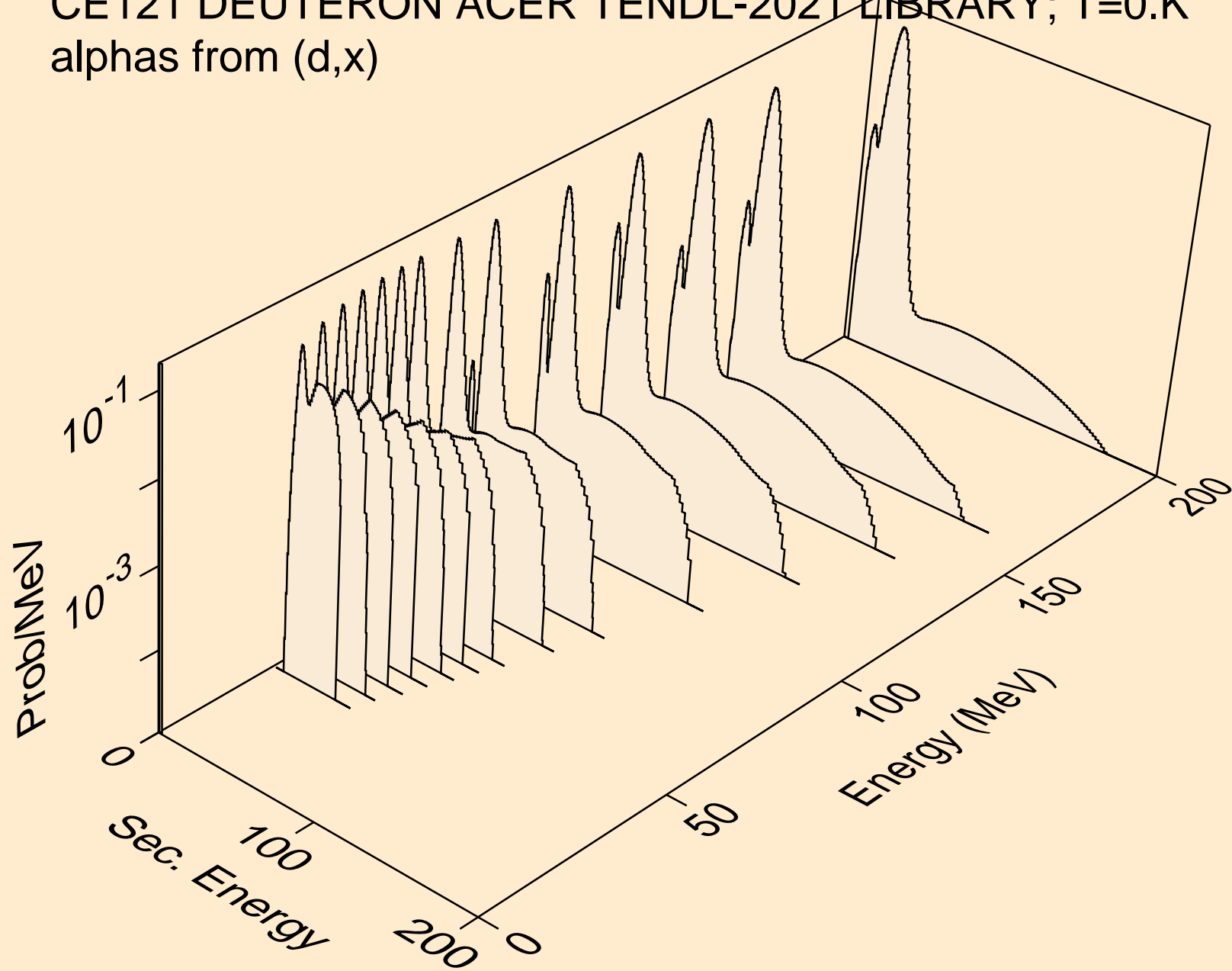

CE121 DEUTERON ACER TENDL-2021 LIBRARY; T=0.K
alphas from (d,n*)a

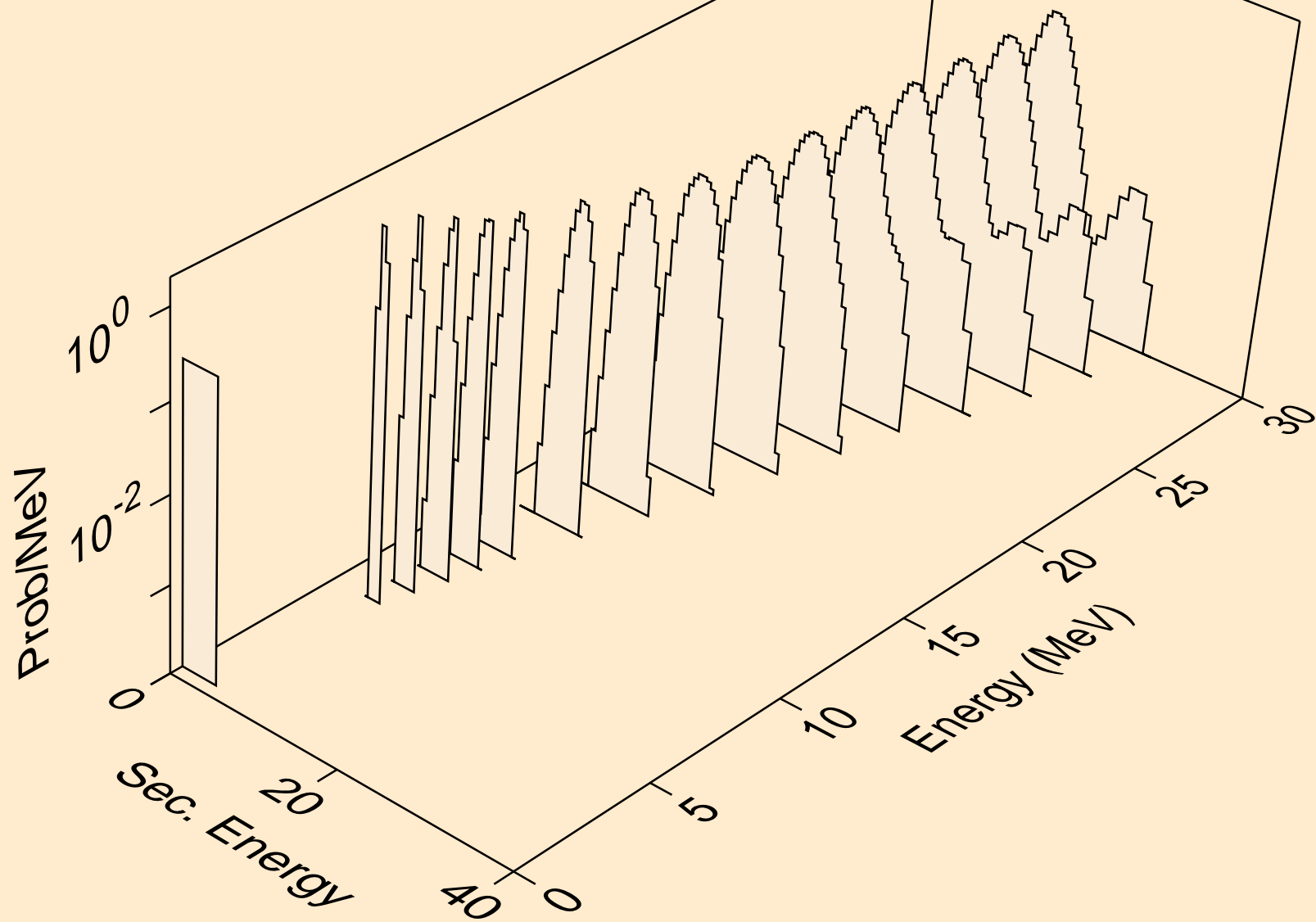

CE121 DEUTERON ACER TENDL-2021 LIBRARY; T=0.K
alphas from (d,2n)a

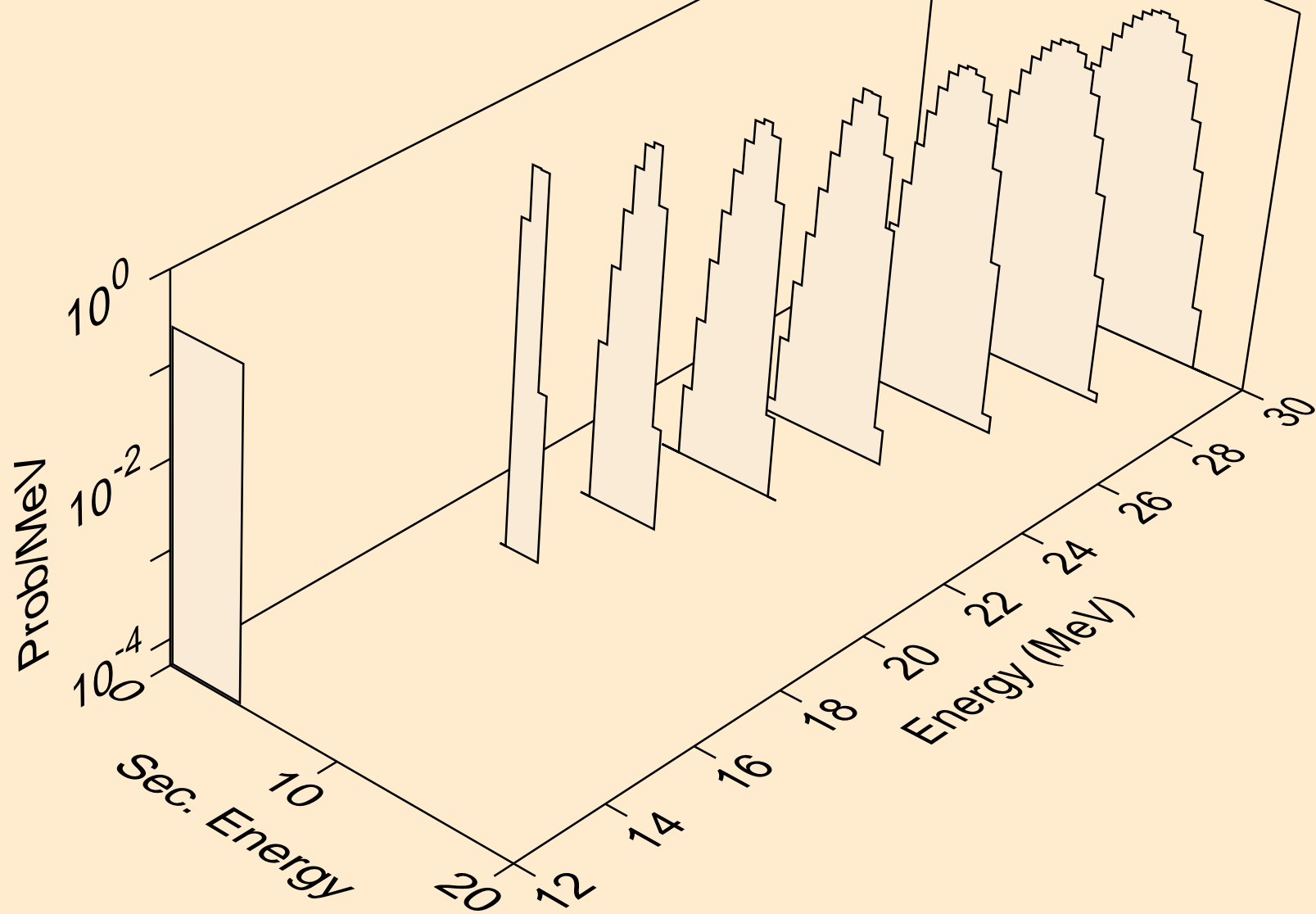

CE121 DEUTERON ACER TENDL-2021 LIBRARY; T=0.K
alphas from (d,n*)2a

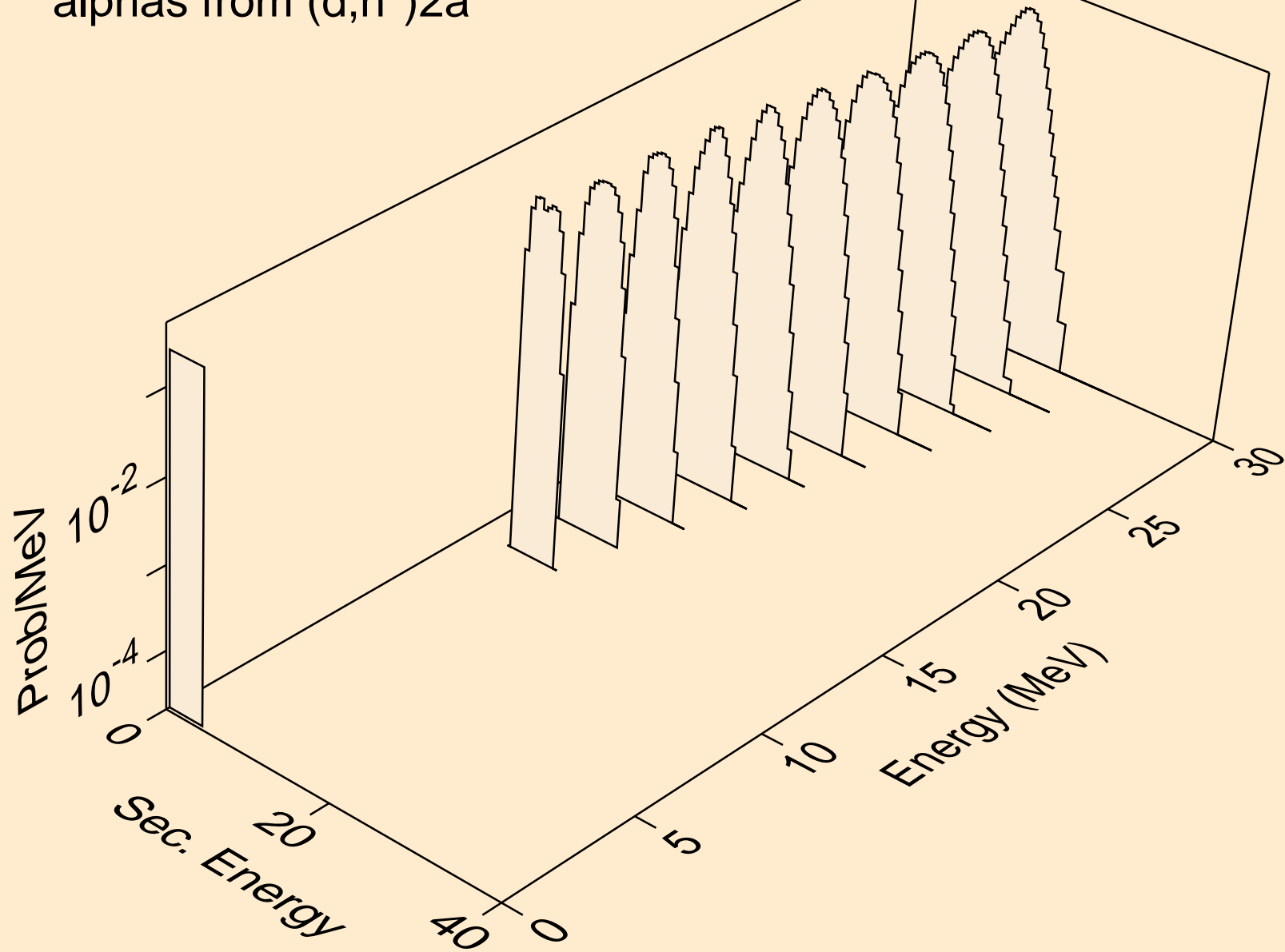

CE121 DEUTERON ACER TENDL-2021 LIBRARY; T=0.K
alphas from (d,npa)

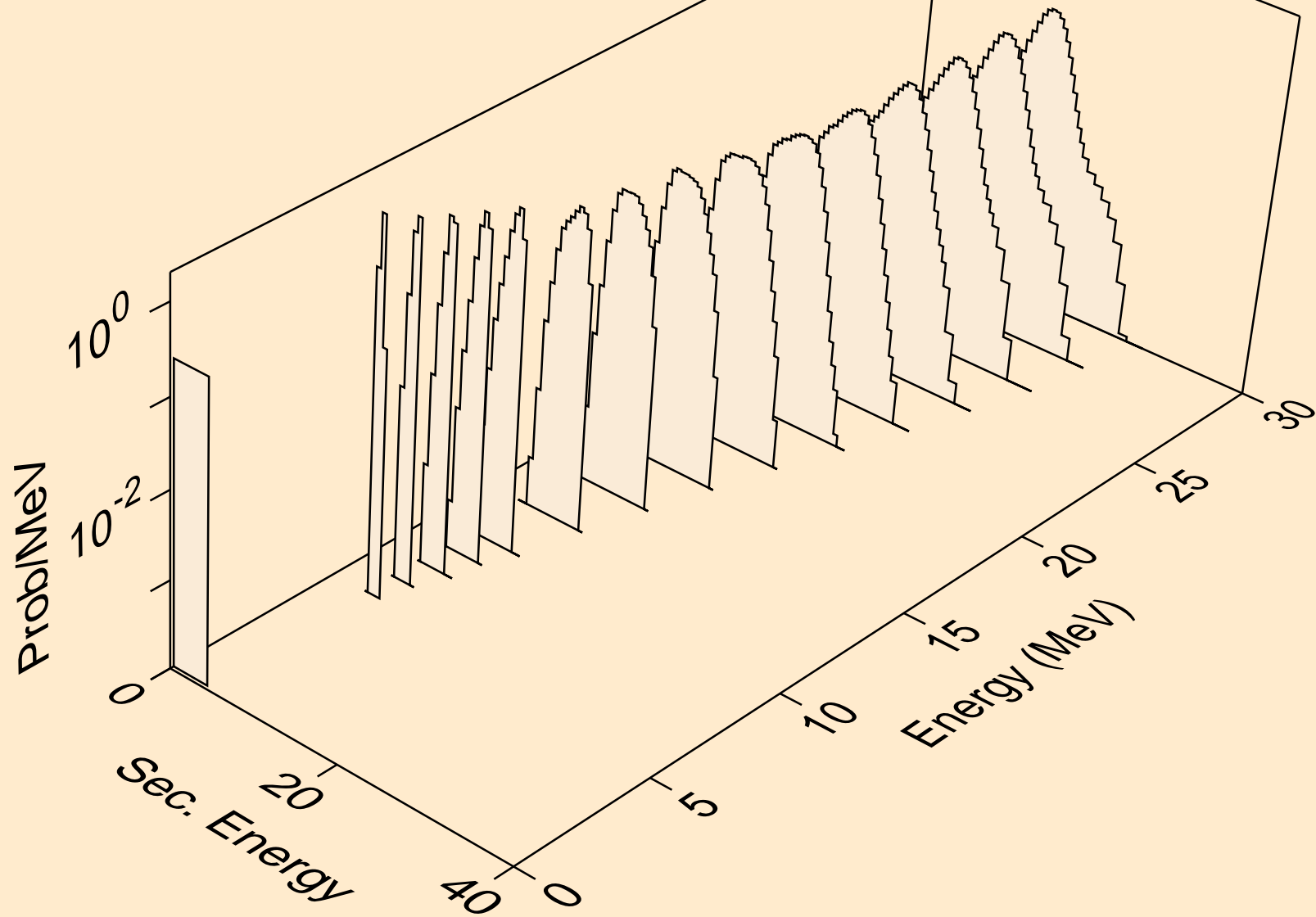

CE121 DEUTERON ACER TENDL-2021 LIBRARY; T=0.K
alphas from (d,a)

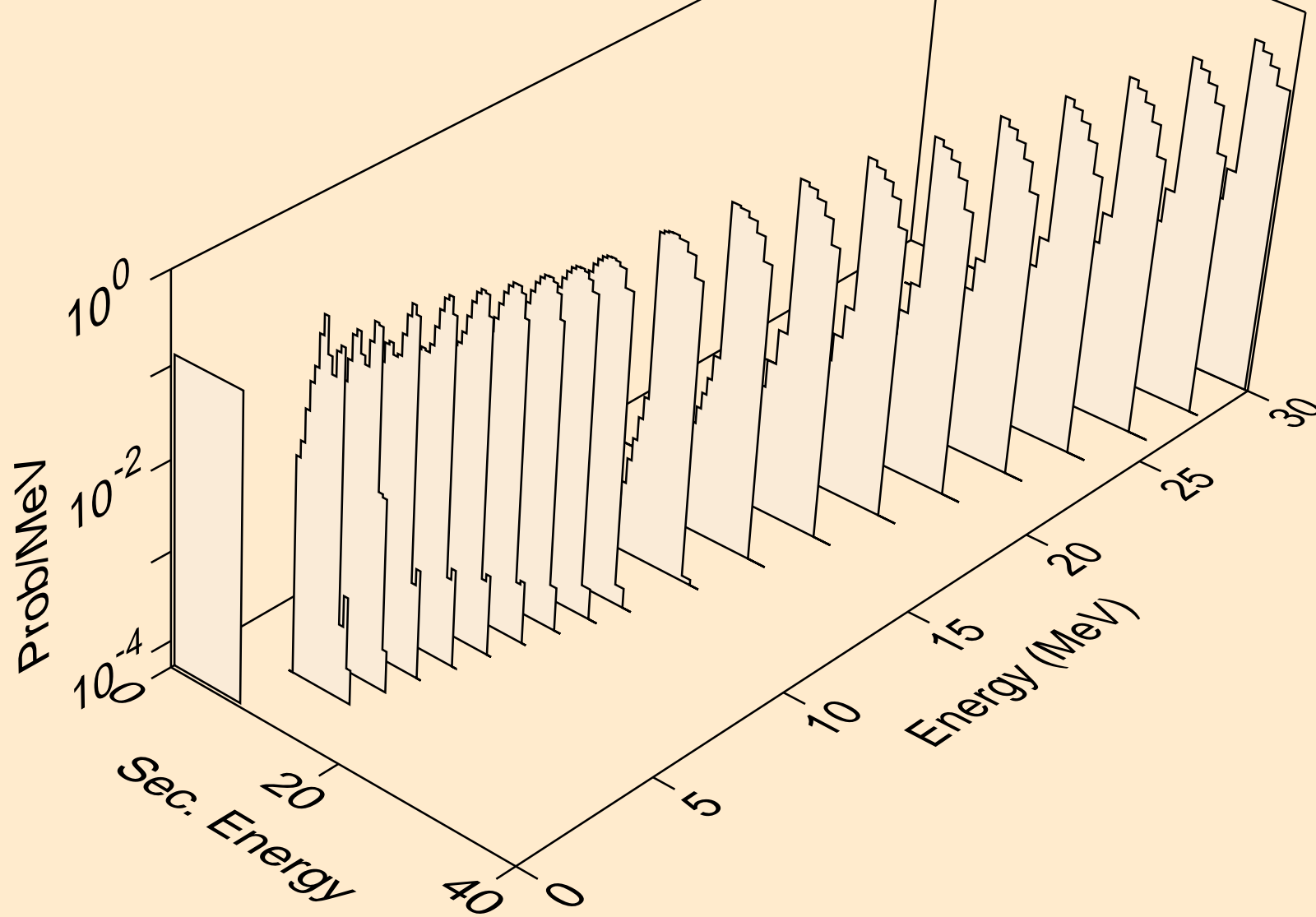

CE121 DEUTERON ACER TENDL-2021 LIBRARY; T=0.K
alphas from (d,2a)

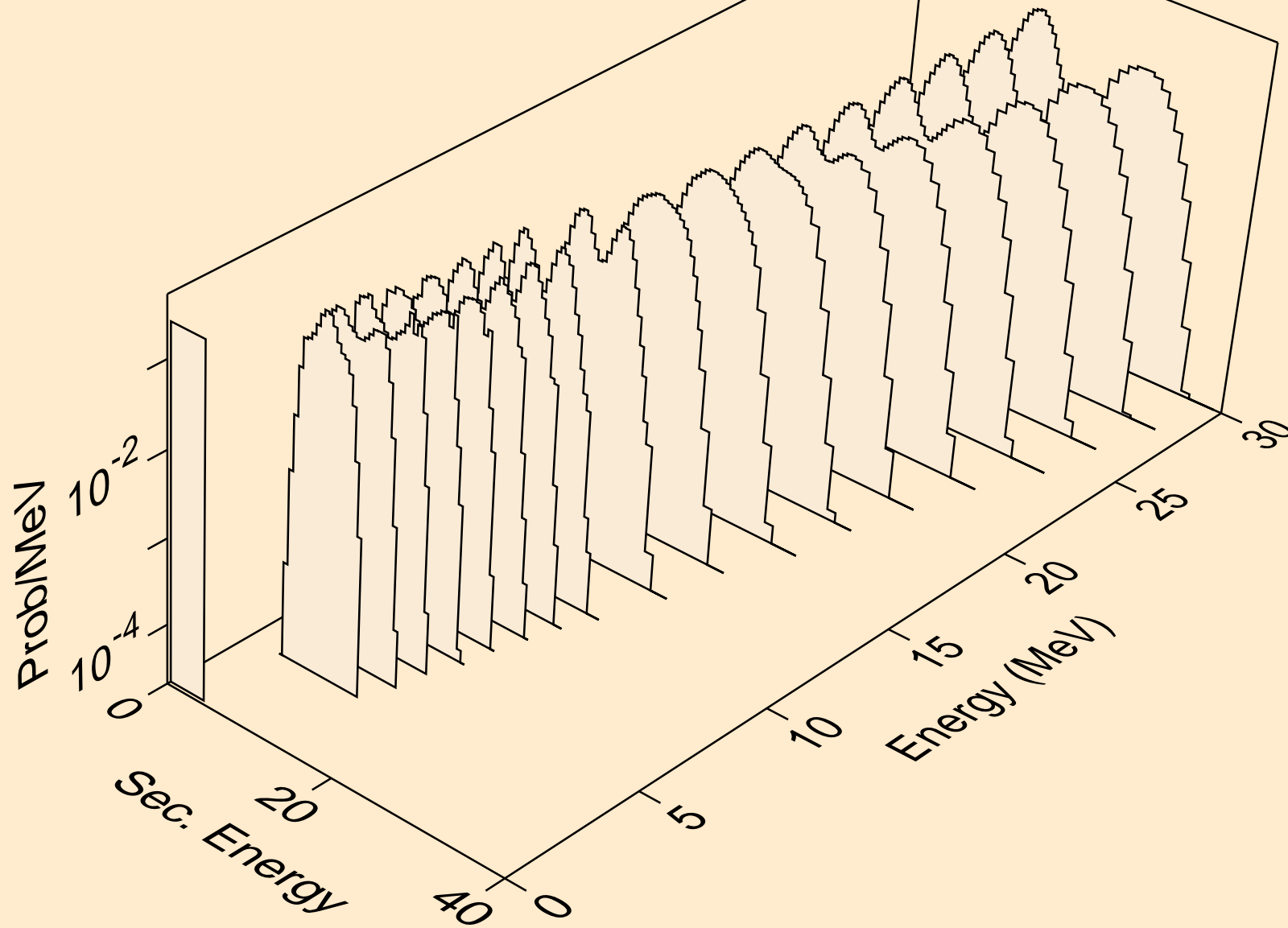

CE121 DEUTERON ACER TENDL-2021 LIBRARY; T=0.K
alphas from (d,3a)

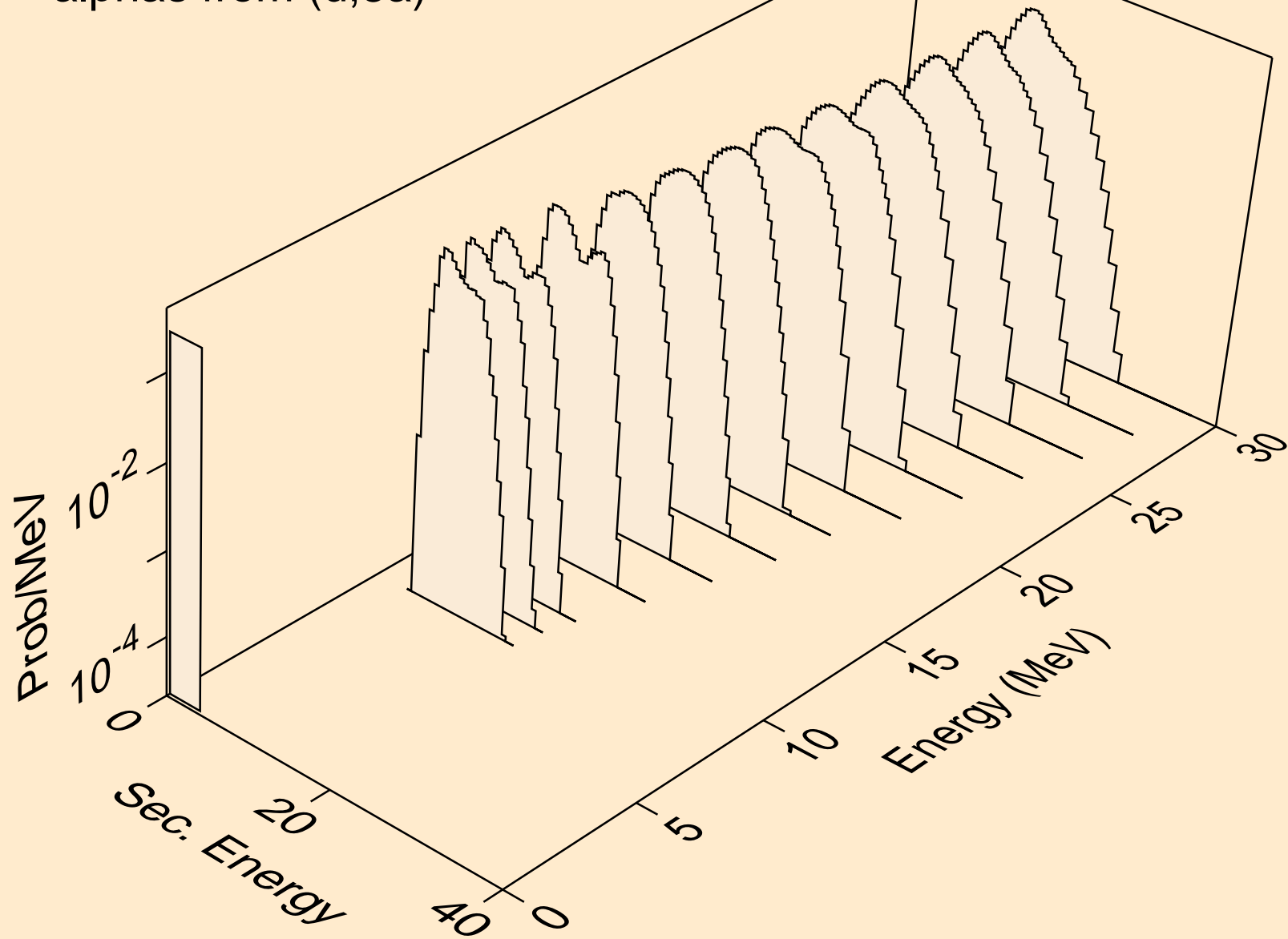

CE121 DEUTERON ACER TENDL-2021 LIBRARY; T=0.K
alphas from (d,pa)

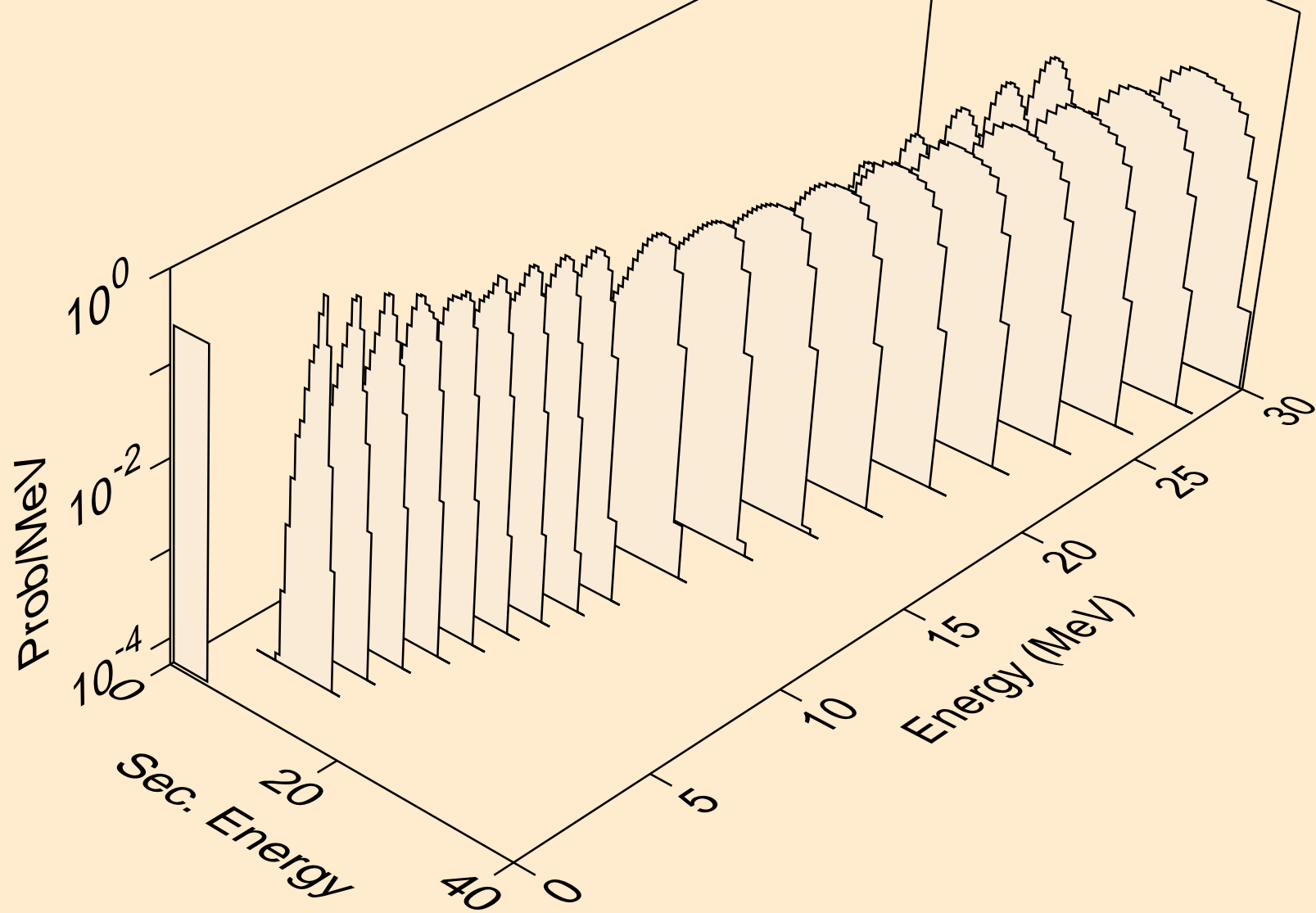

CE121 DEUTERON ACER TENDL-2021 LIBRARY; T=0.K
alphas from (d,d2a)

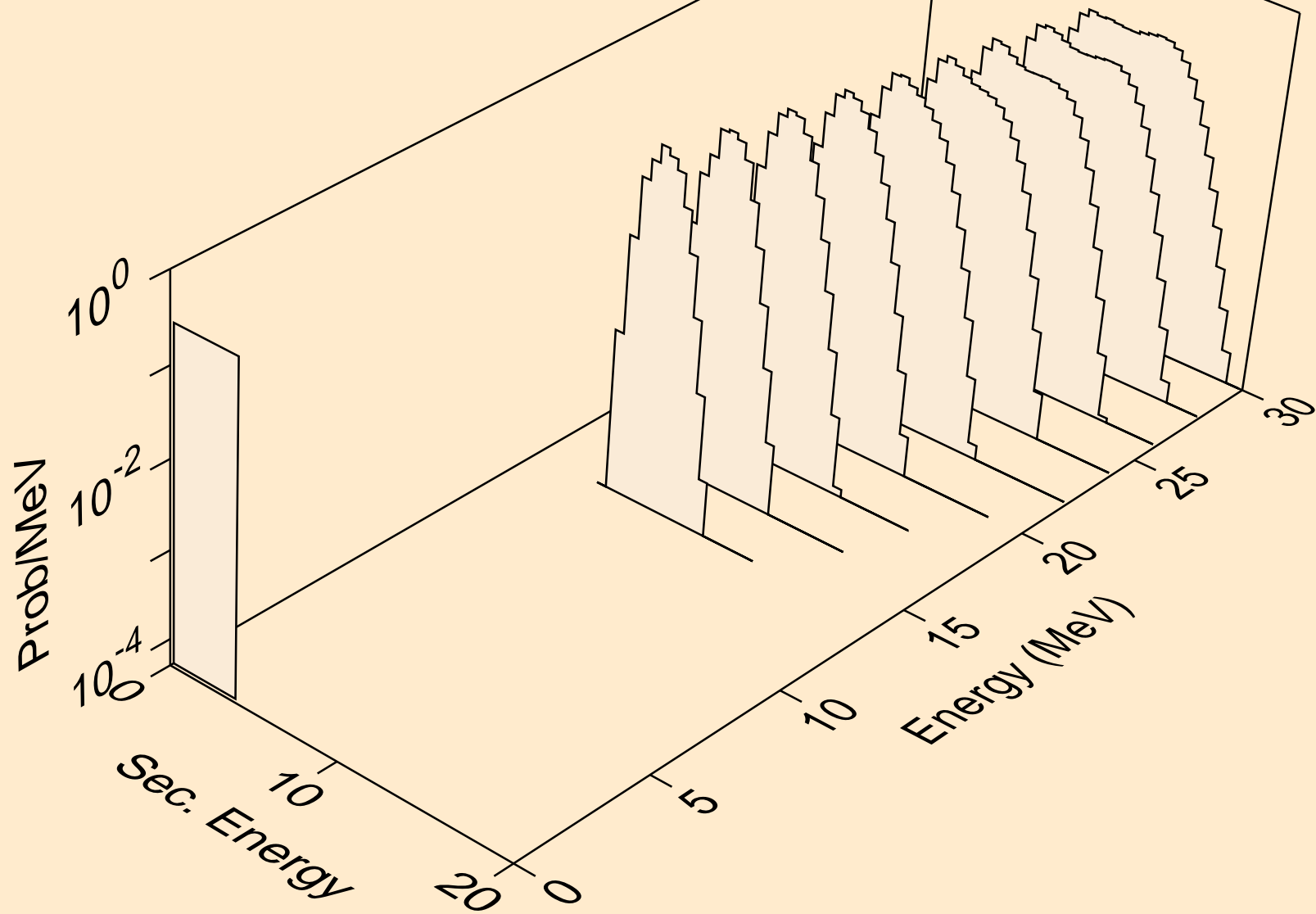

CE121 DEUTERON ACER TENDL-2021 LIBRARY; T=0.K
alphas from (d,da)

