

# CM252 DEUTERON ACER TENDL-2021 LIBRARY; T=0.K

## Principal cross sections

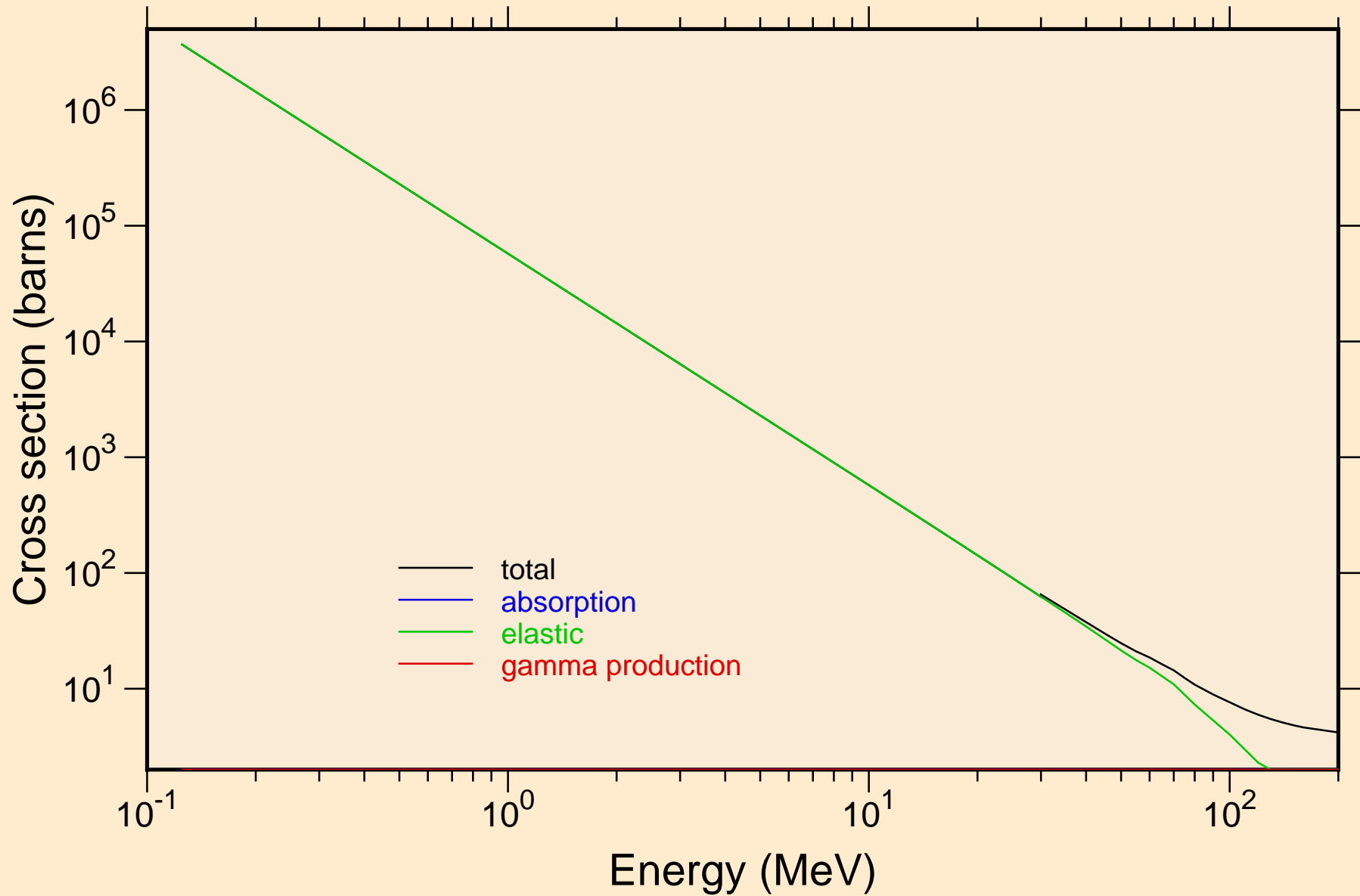

CM252 DEUTERON ACER TENDL-2021 LIBRARY; T=0.K  
Heating

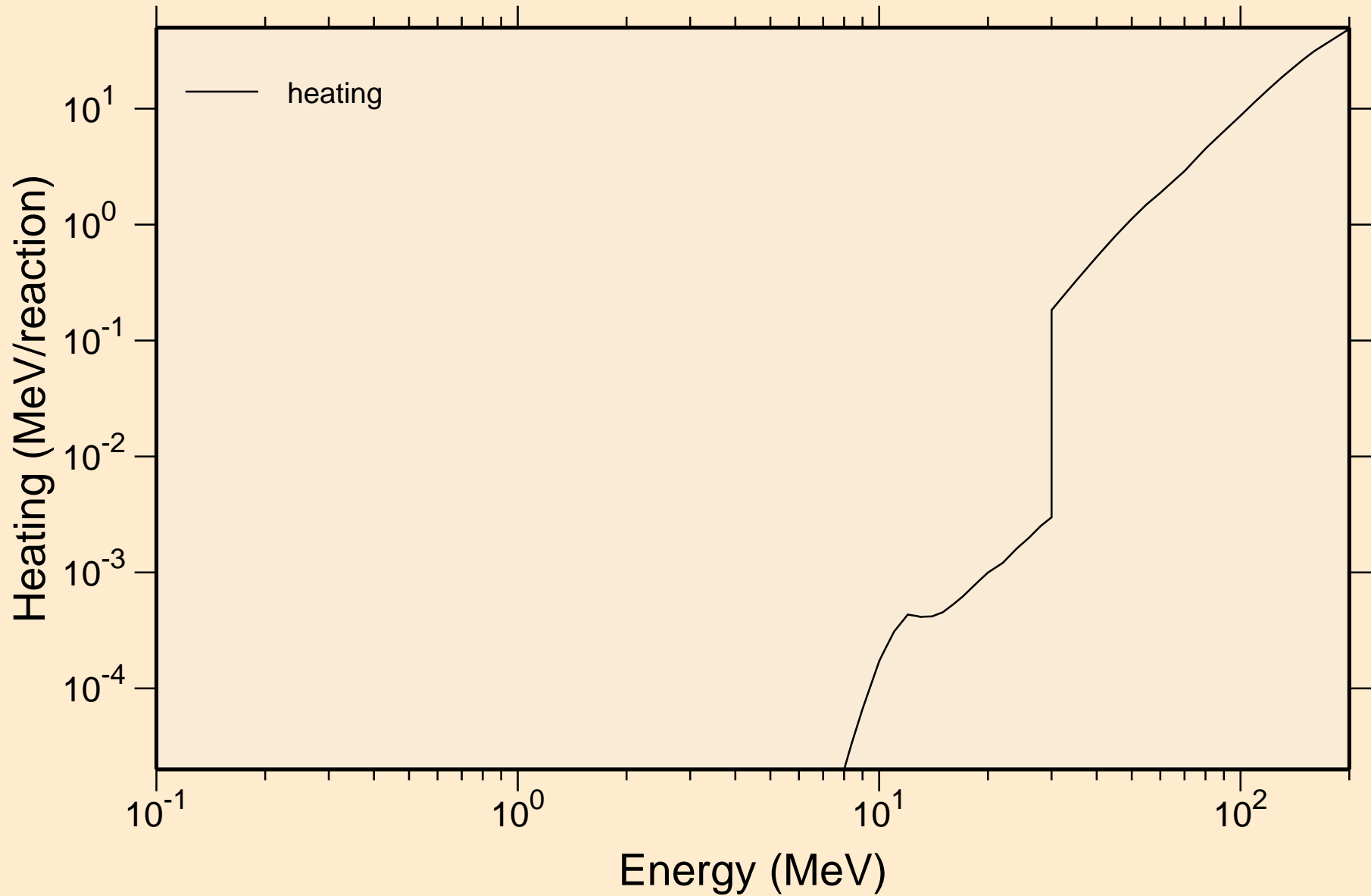

CM252 DEUTERON ACER TENDL-2021 LIBRARY; T=0.K  
Principal cross sections

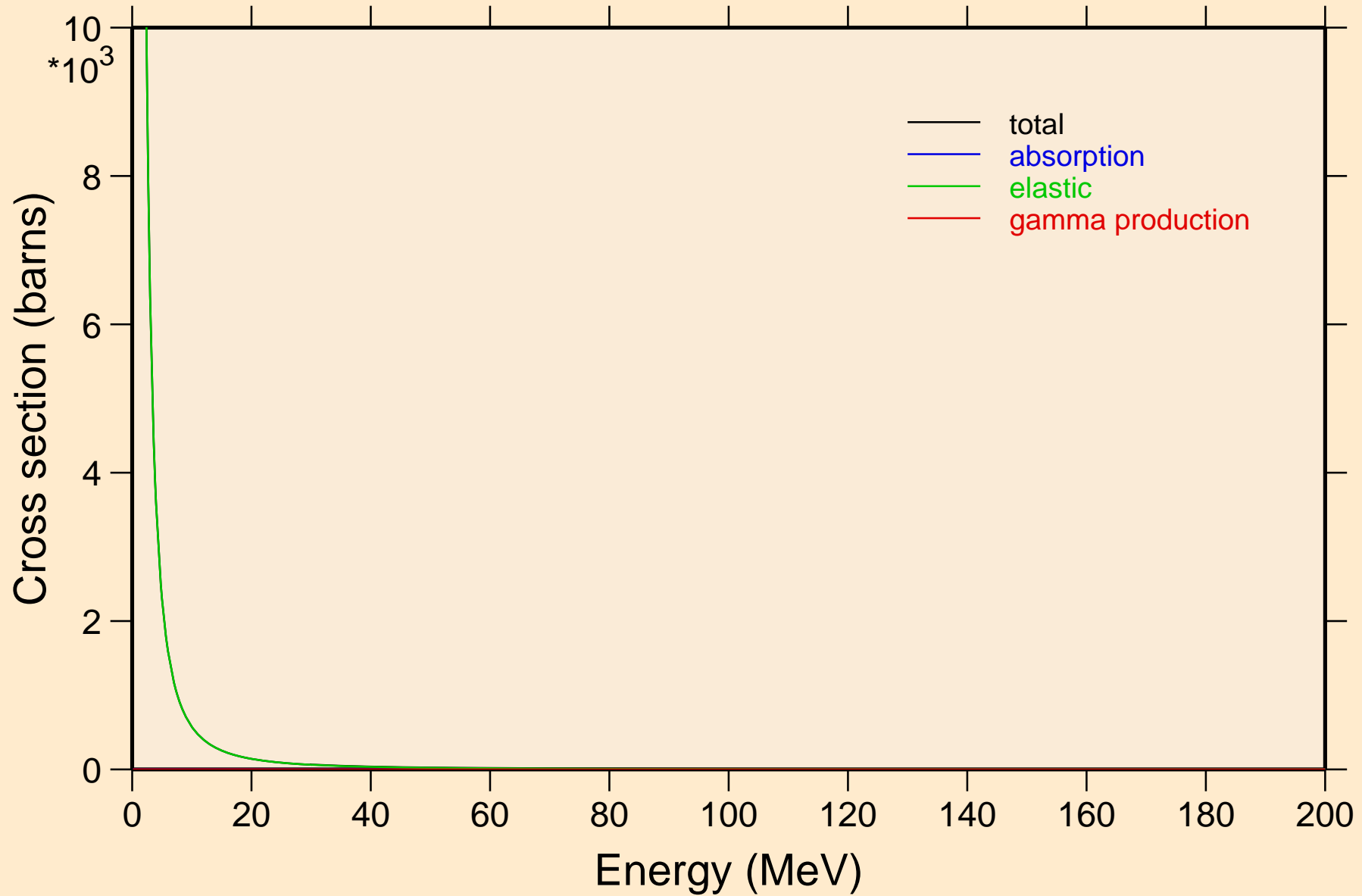

# CM252 DEUTERON ACER TENDL-2021 LIBRARY; T=0.K

## Heating

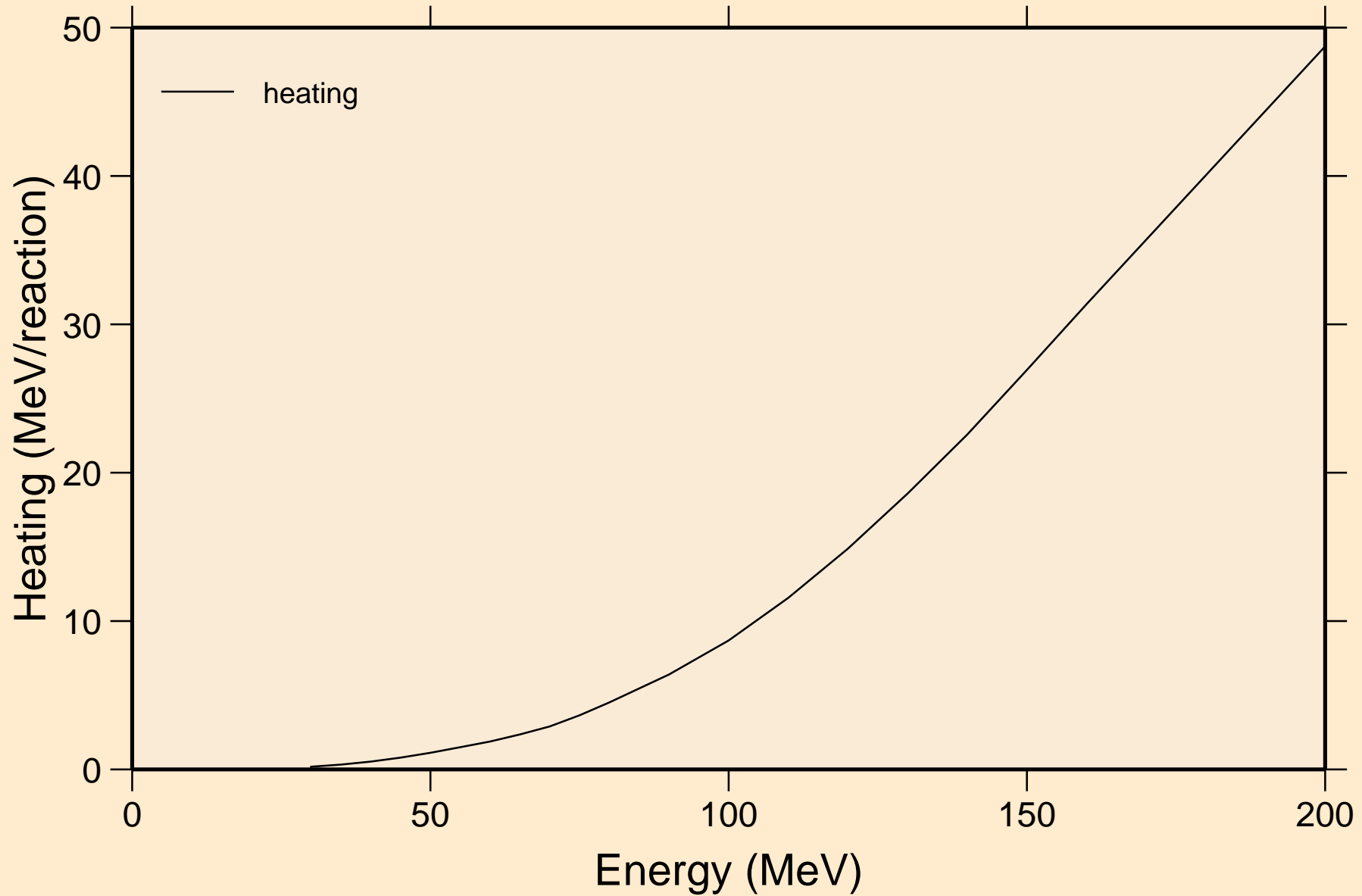

# CM252 DEUTERON ACER TENDL-2021 LIBRARY; T=0.K

## Threshold reactions

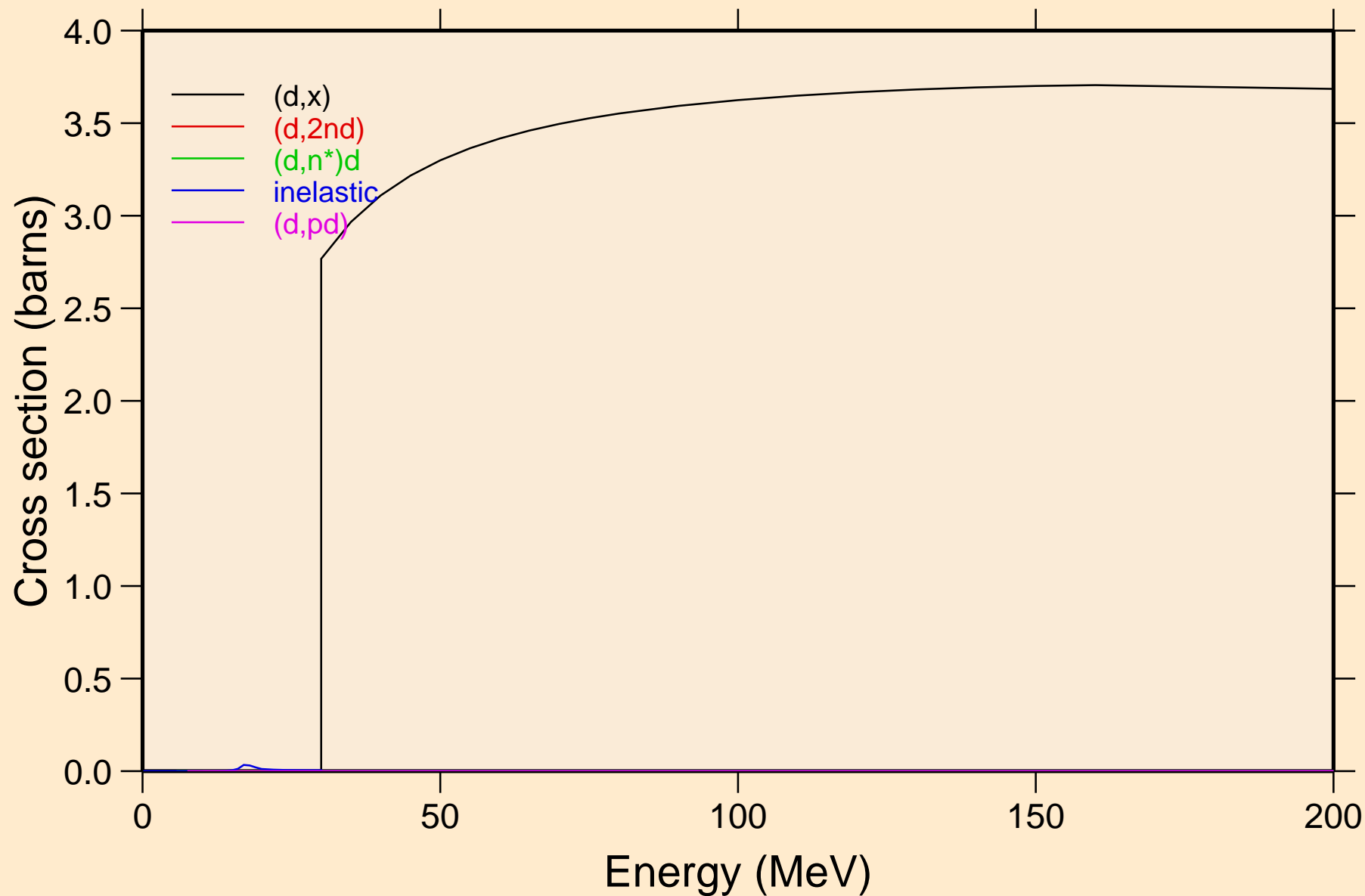

CM252 DEUTERON ACER TENDL-2021 LIBRARY; T=0.K  
angular distribution for elastic

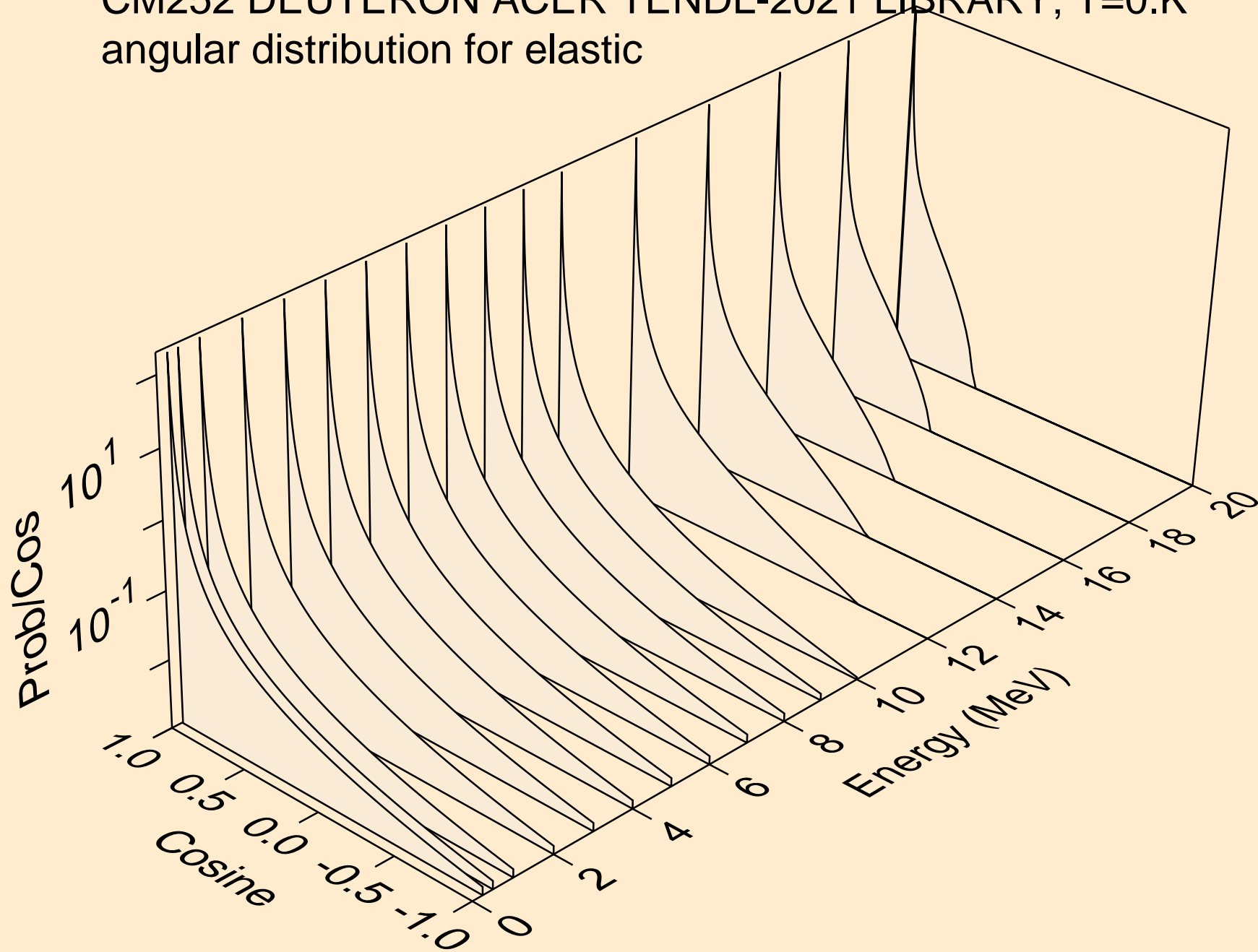

CM252 DEUTERON ACER TENDL-2021 LIBRARY; T=0.K  
angular distribution for elastic

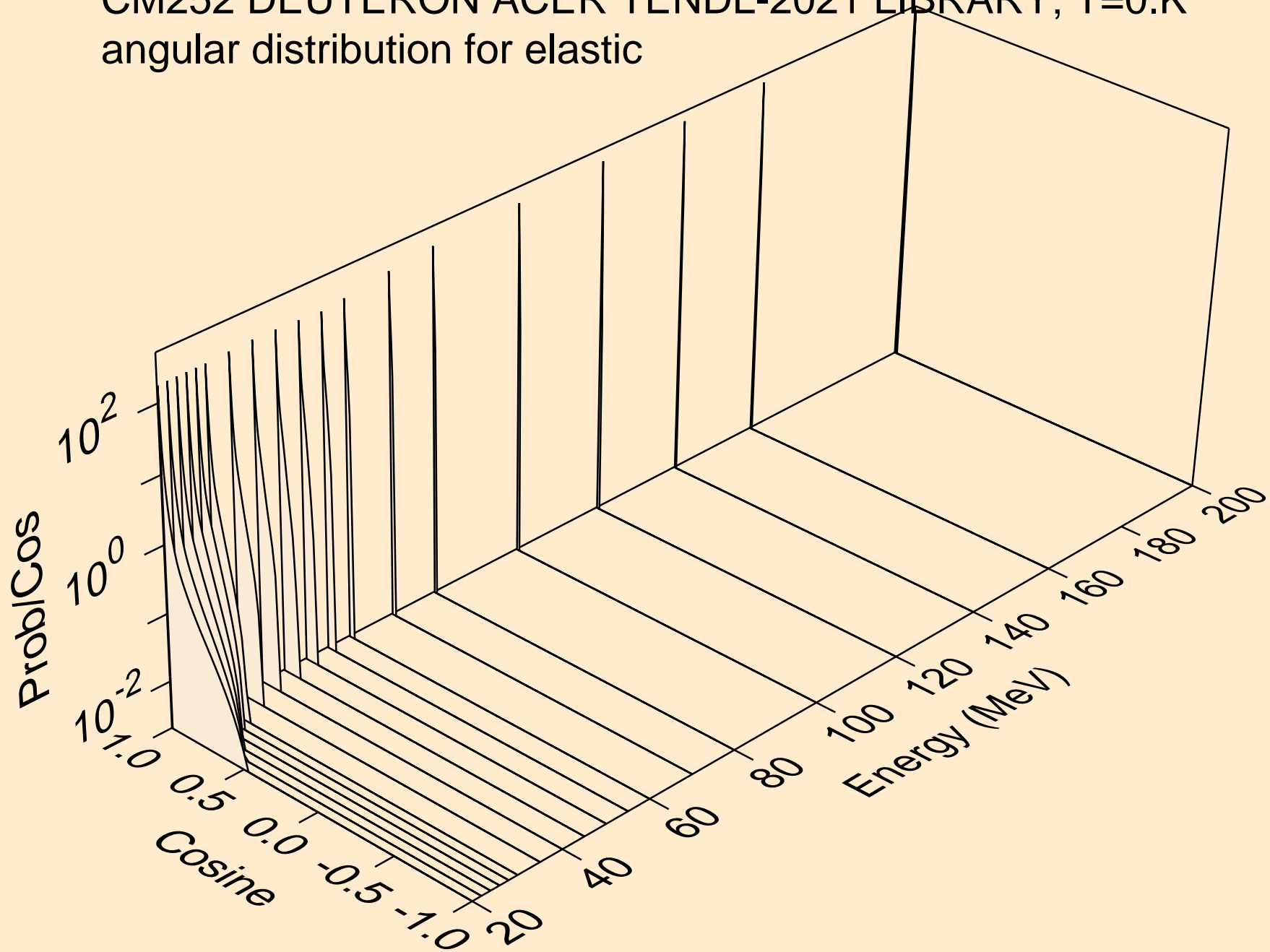

CM252 DEUTERON ACER TENDL-2021 LIBRARY; T=0.K  
Deuteron emission for (d,x)

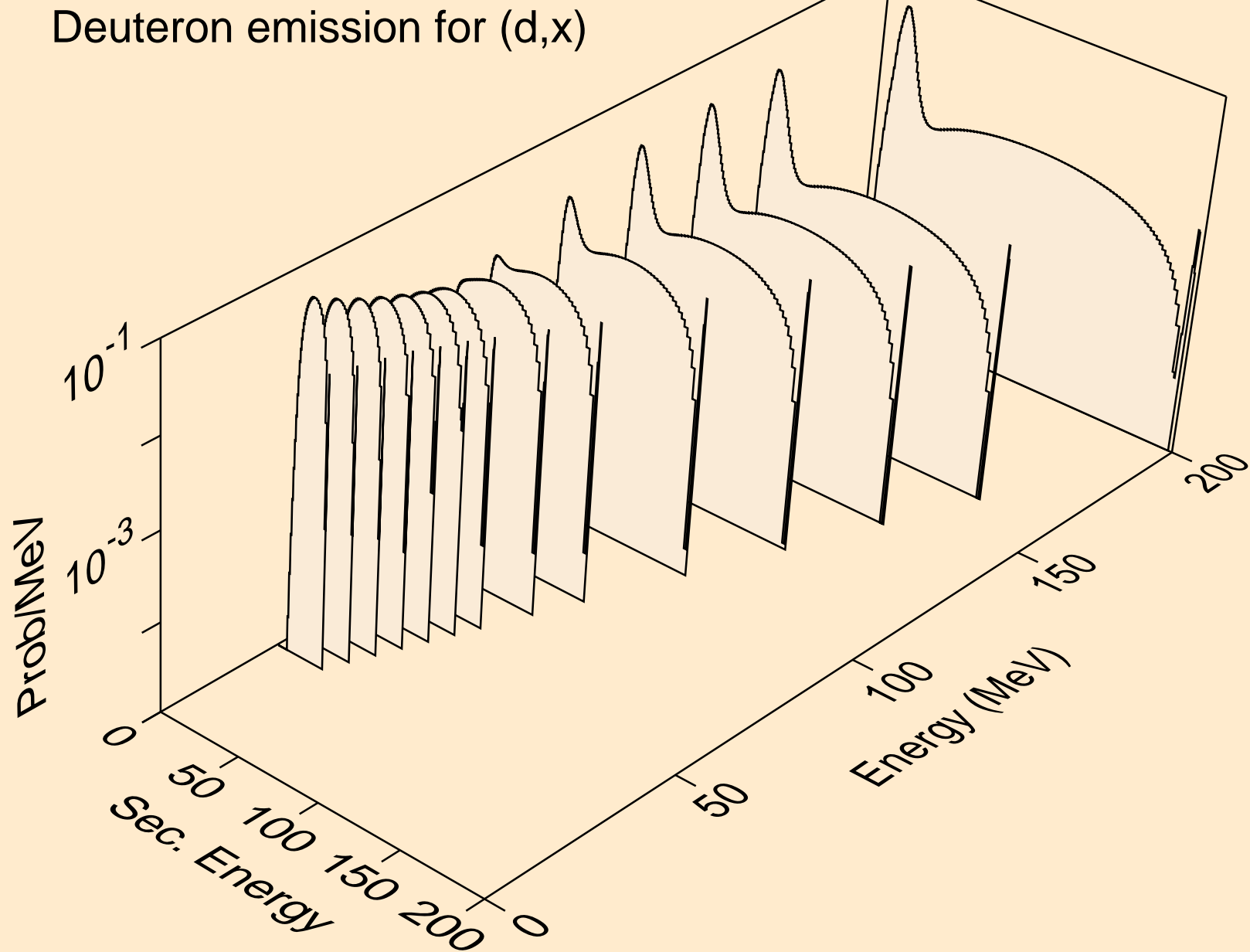



CM252 DEUTERON ACER TENDL-2021 LIBRARY; T=0.K  
Deuteron emission for (d,2nd)

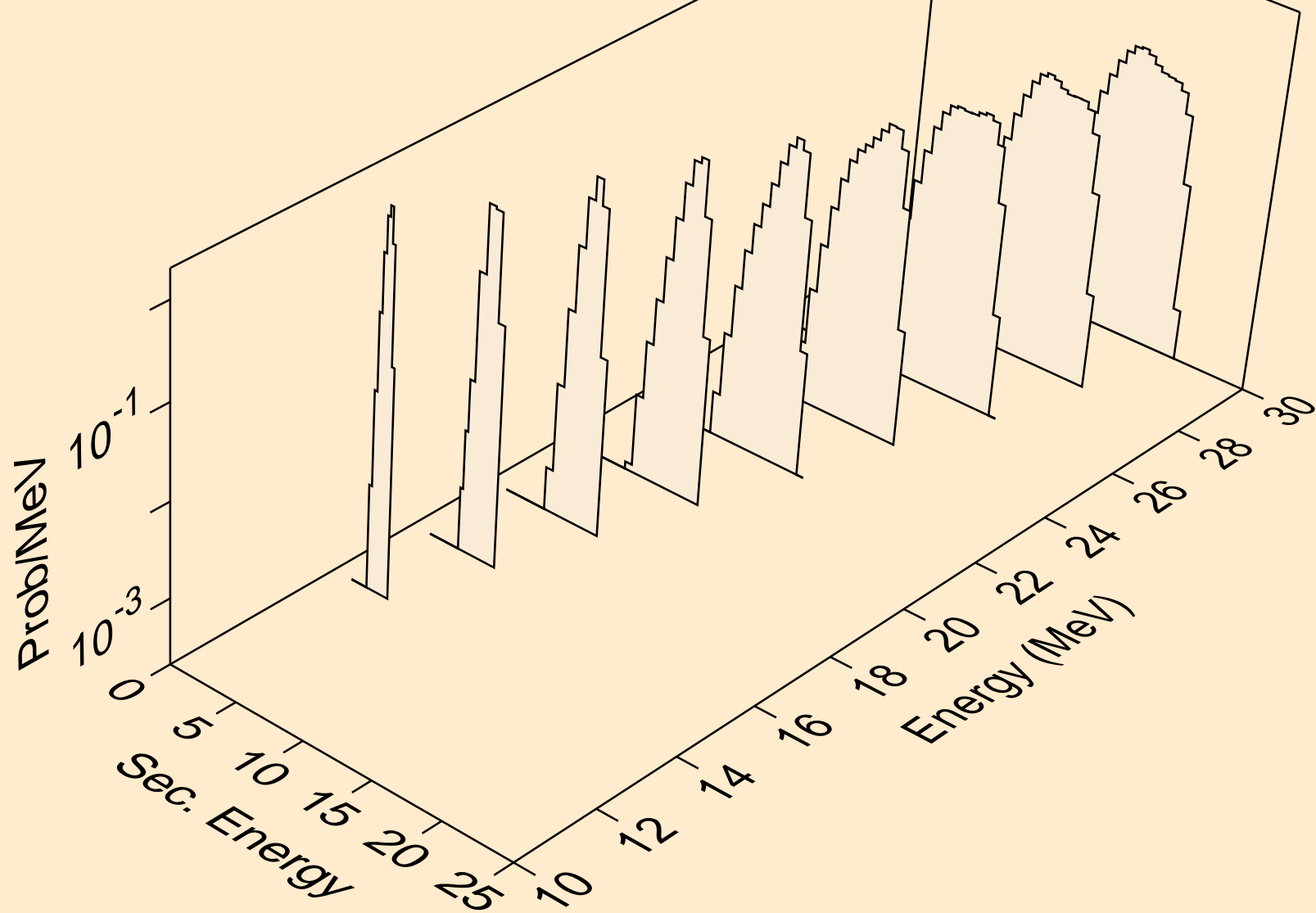

CM252 DEUTERON ACER TENDL-2021 LIBRARY; T=0.K  
Deuteron emission for (d,n\*)d

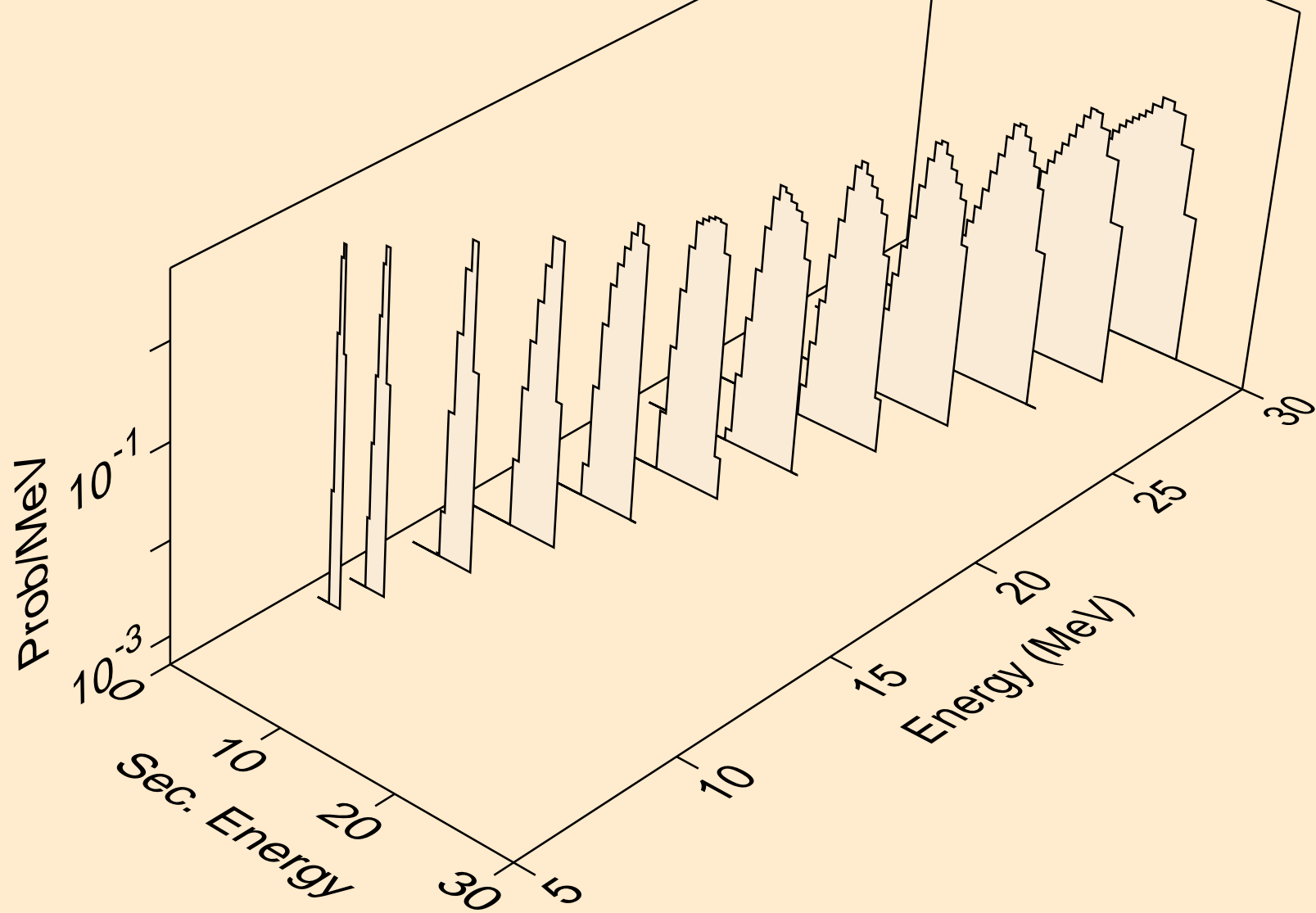

CM252 DEUTERON ACER TENDL-2021 LIBRARY; T=0.K  
Deuteron emission for inelastic

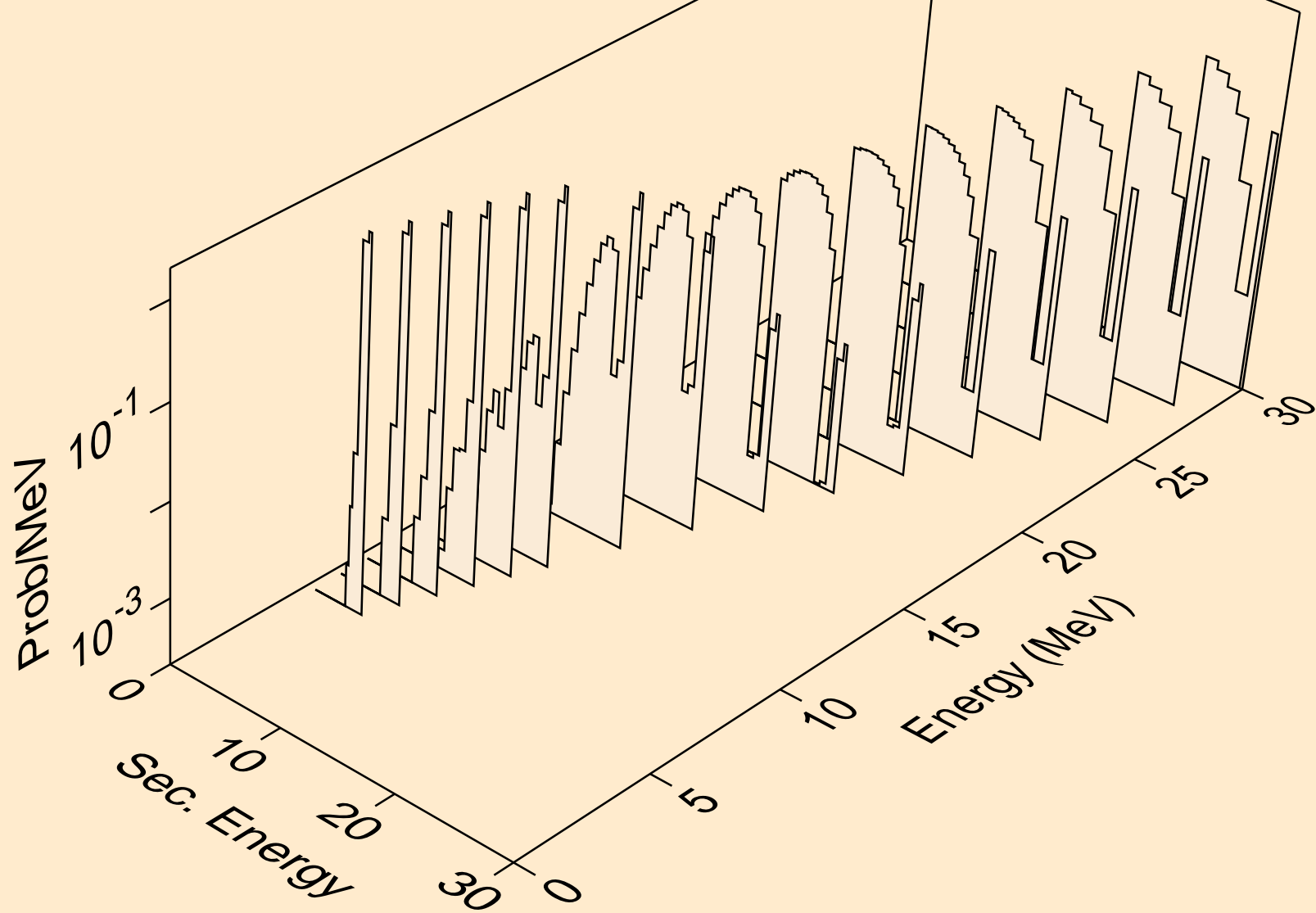

CM252 DEUTERON ACER TENDL-2021 LIBRARY; T=0.K  
Deuteron emission for (d,pd)

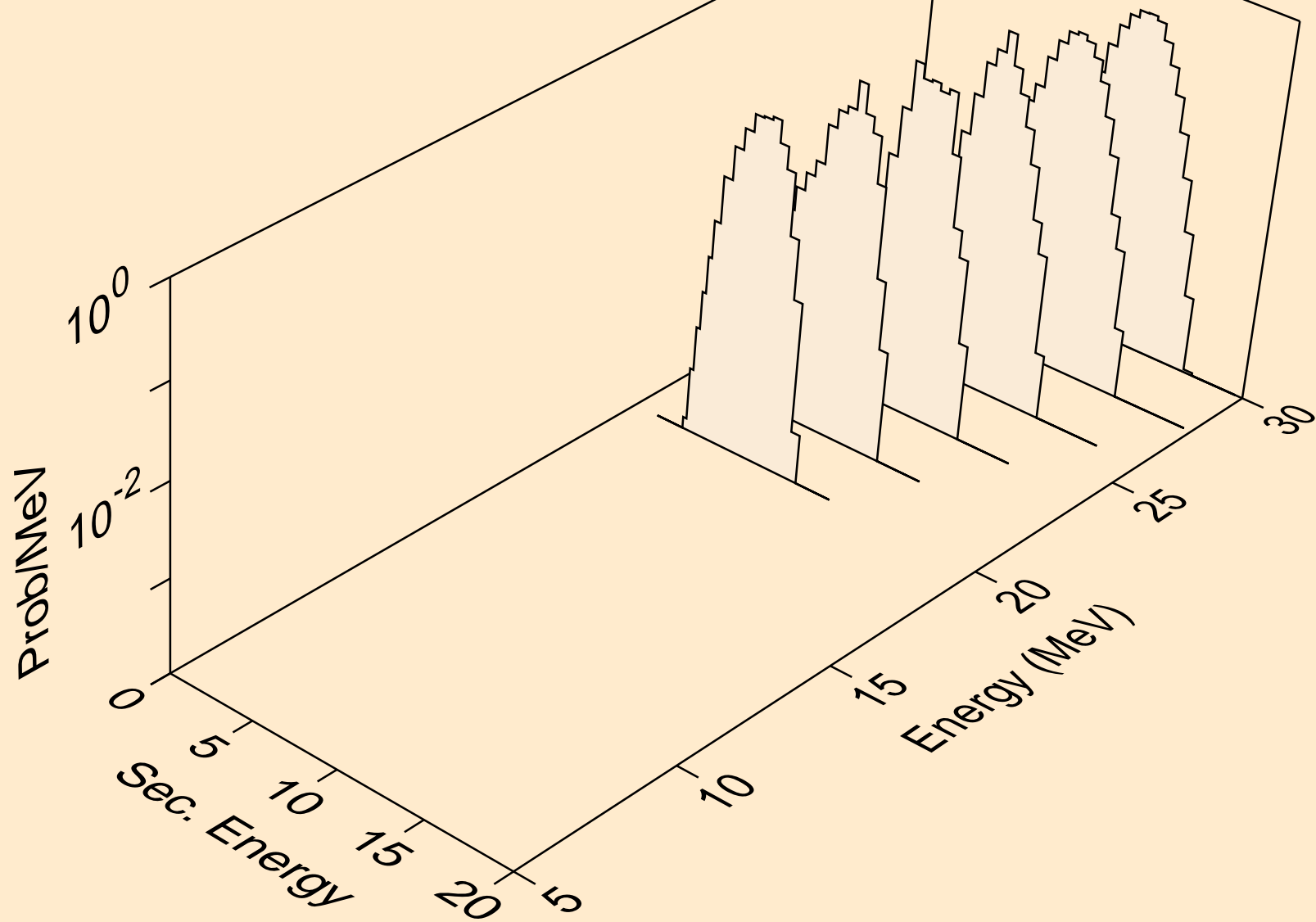

CM252 DEUTERON ACER TENDL-2021 LIBRARY; T=0.K  
Photon emission for (z,n)

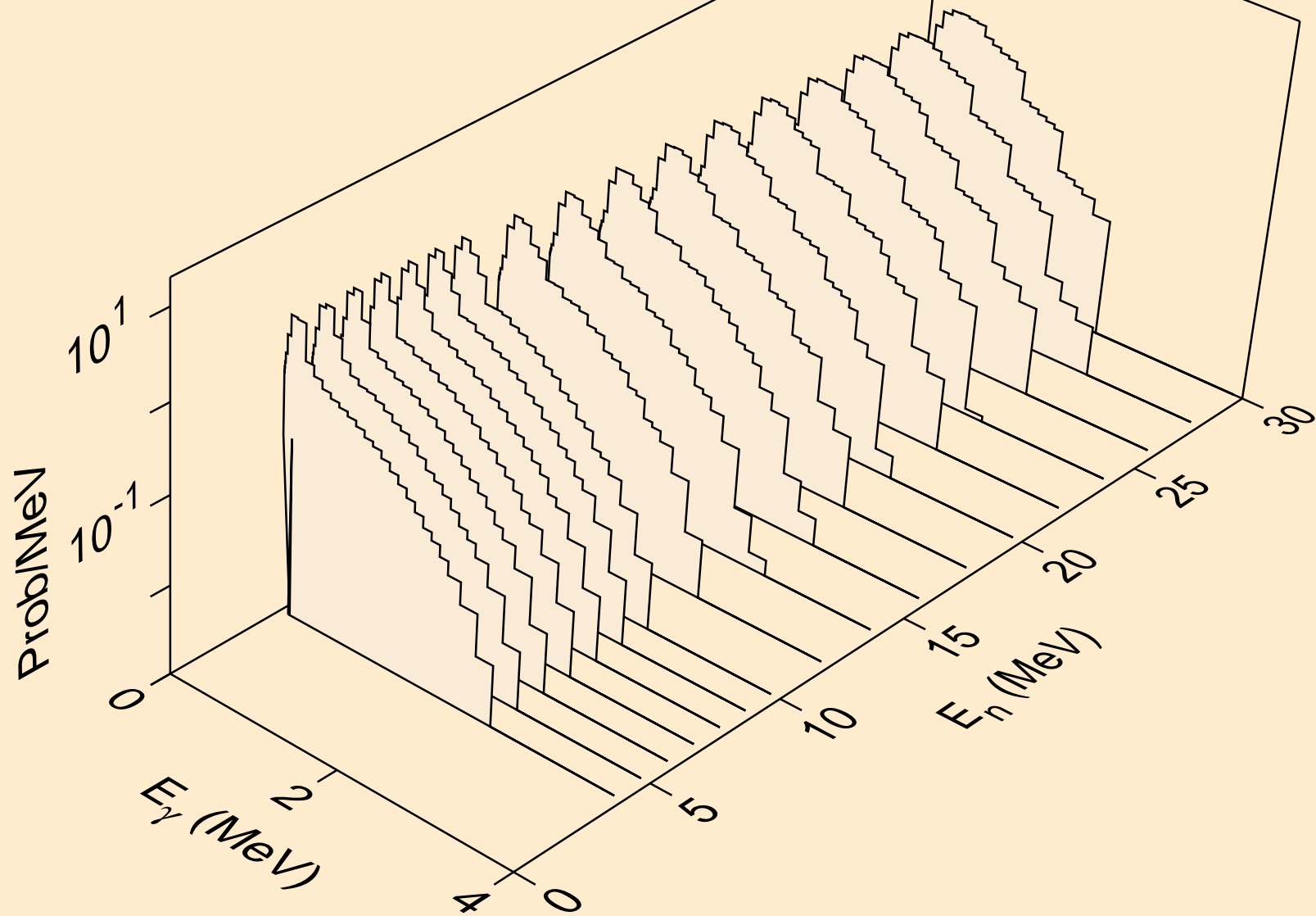

CM252 DEUTERON ACER TENDL-2021 LIBRARY; T=0.K  
Photon emission for (n,x)

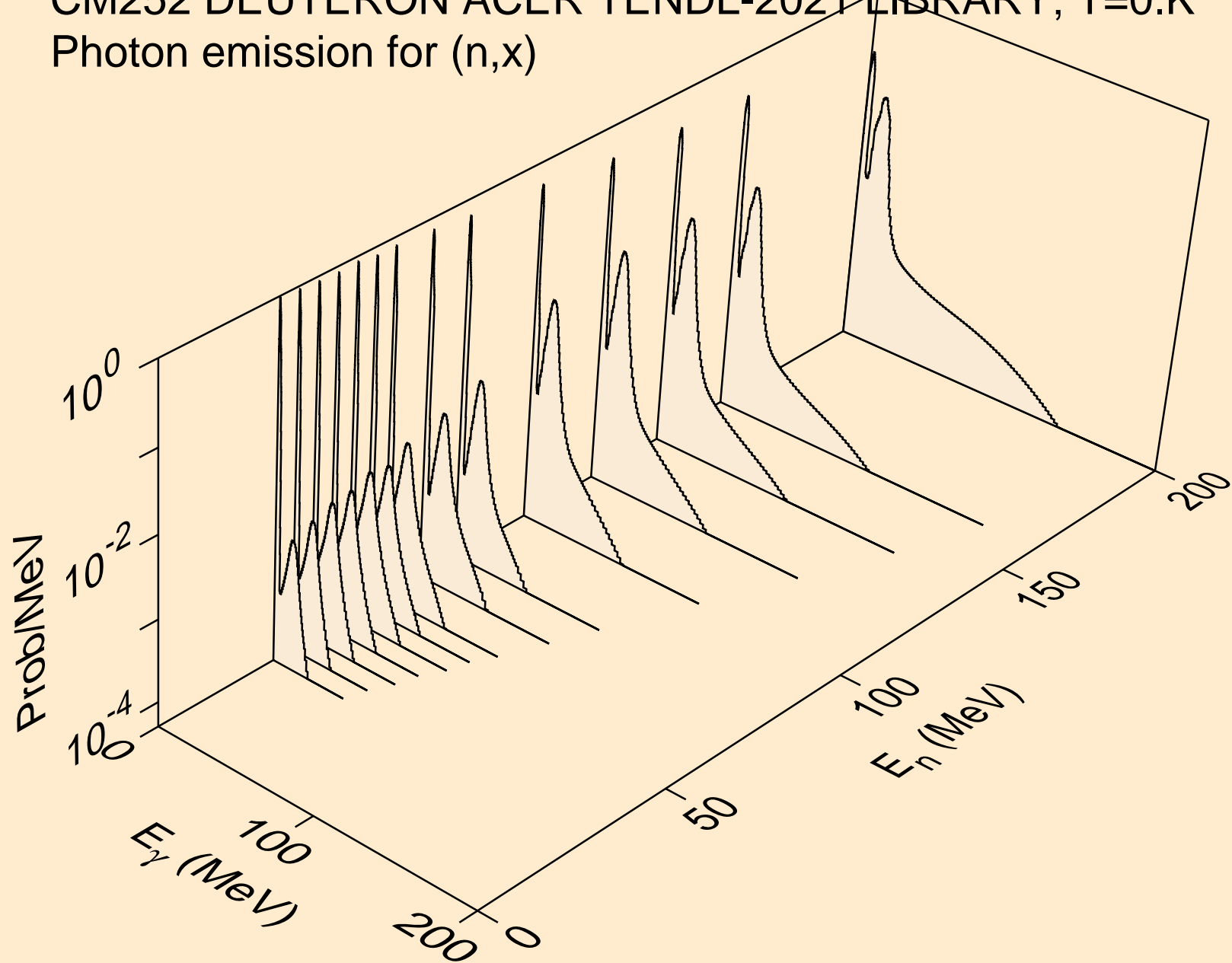

CM252 DEUTERON ACER TENDL-2021 LIBRARY; T=0.K  
Photon emission for (n,2nd)

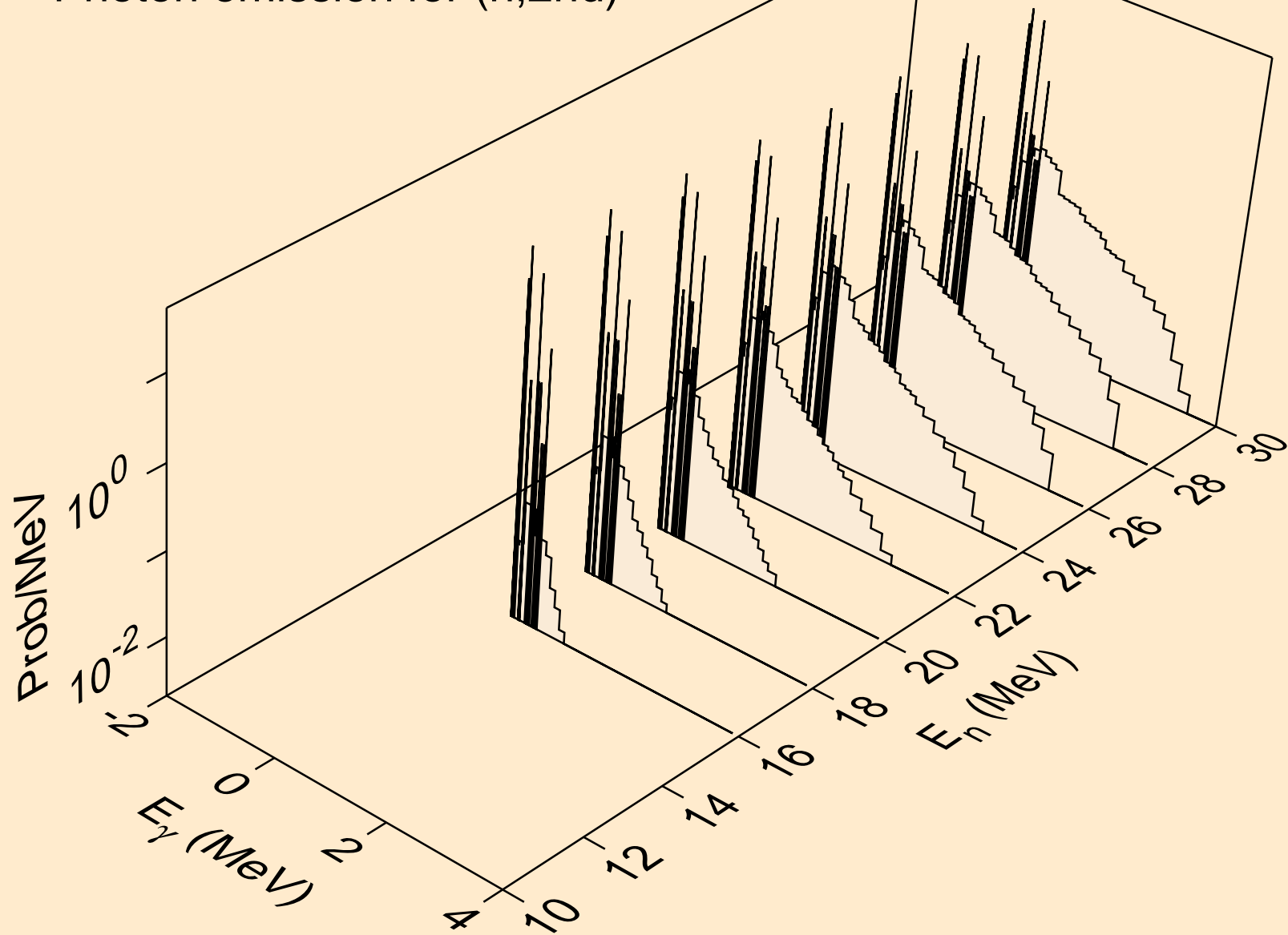

CM252 DEUTERON ACER TENDL-2021 LIBRARY; T=0.K  
Photon emission for (n,2n)

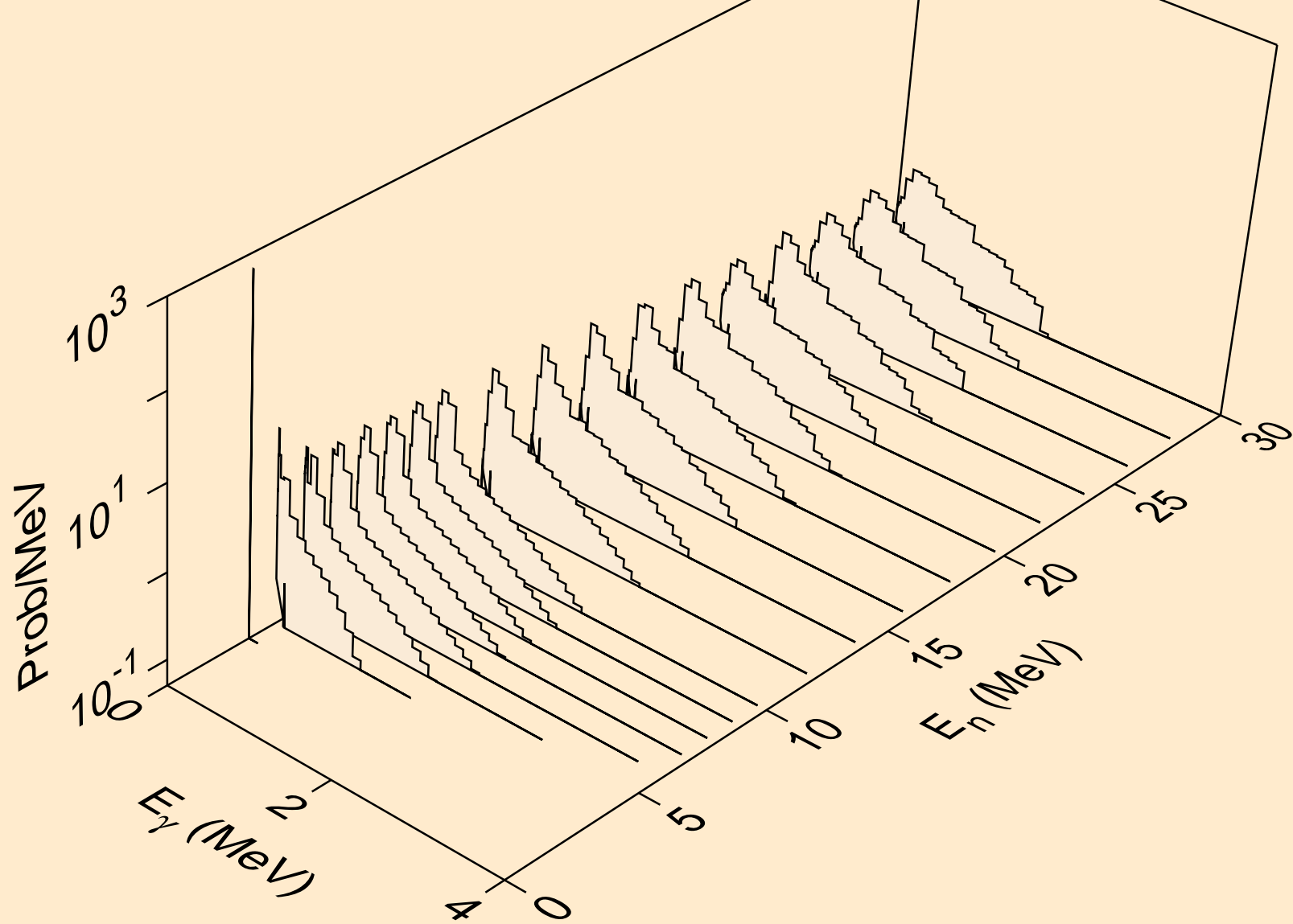



CM252 DEUTERON ACER TENDL-2021 LIBRARY; T=0.K  
Photon emission for (n,3n)

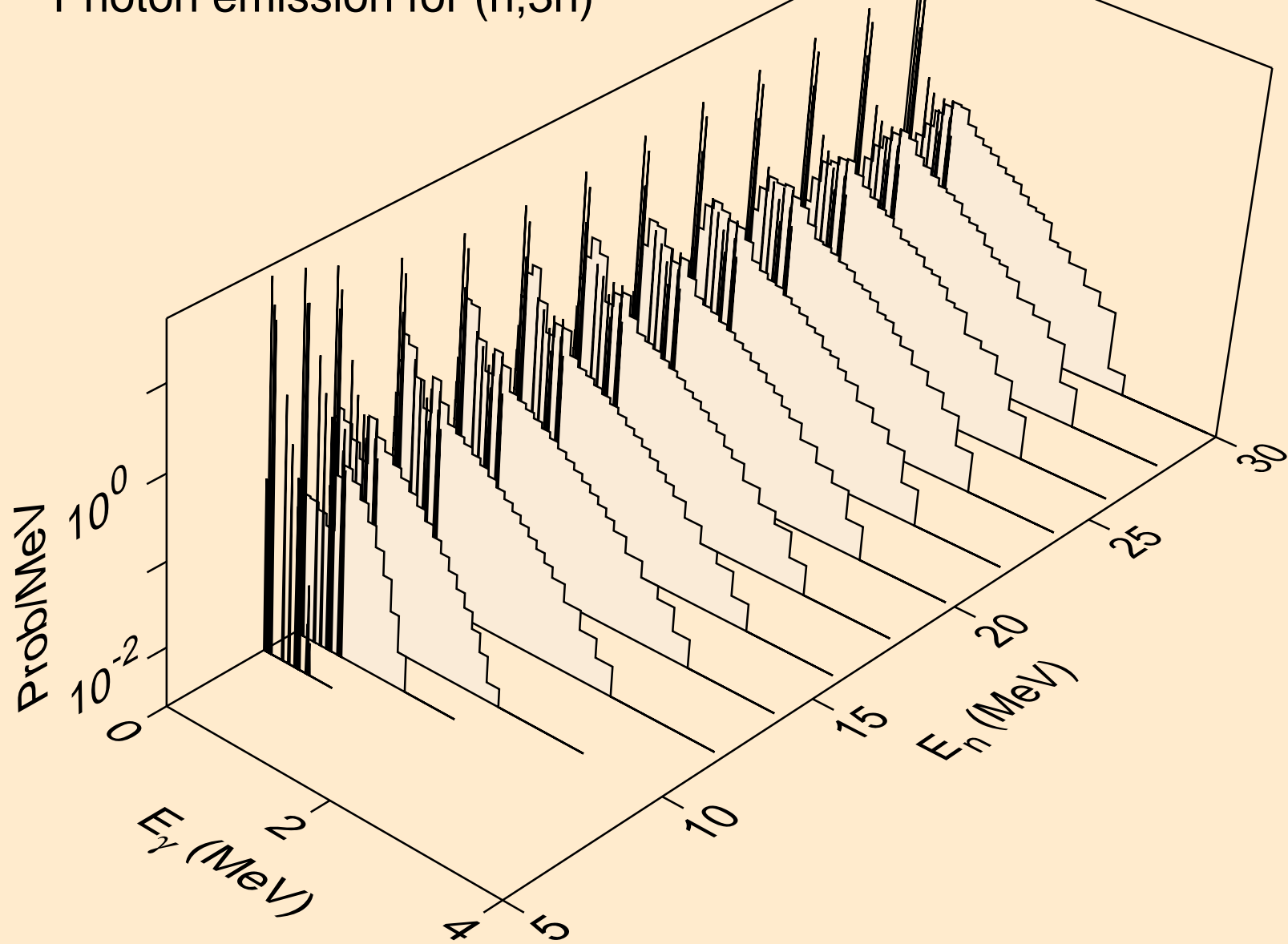

CM252 DEUTERON ACER TENDL-2021 LIBRARY; T=0.K  
Photon emission for (n,n\*)a

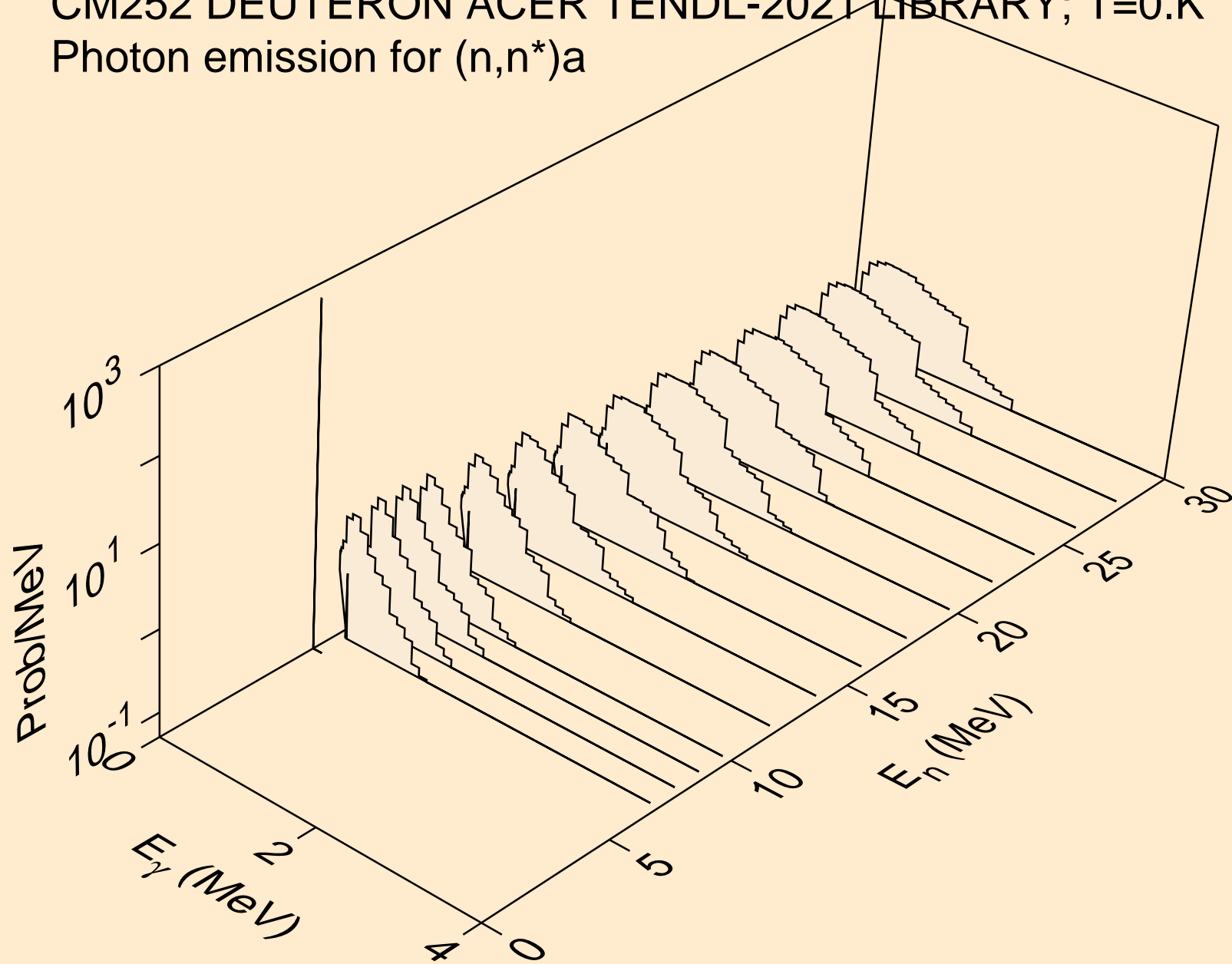

CM252 DEUTERON ACER TENDL-2021 LIBRARY; T=0.K  
Photon emission for (n,2n) $\alpha$

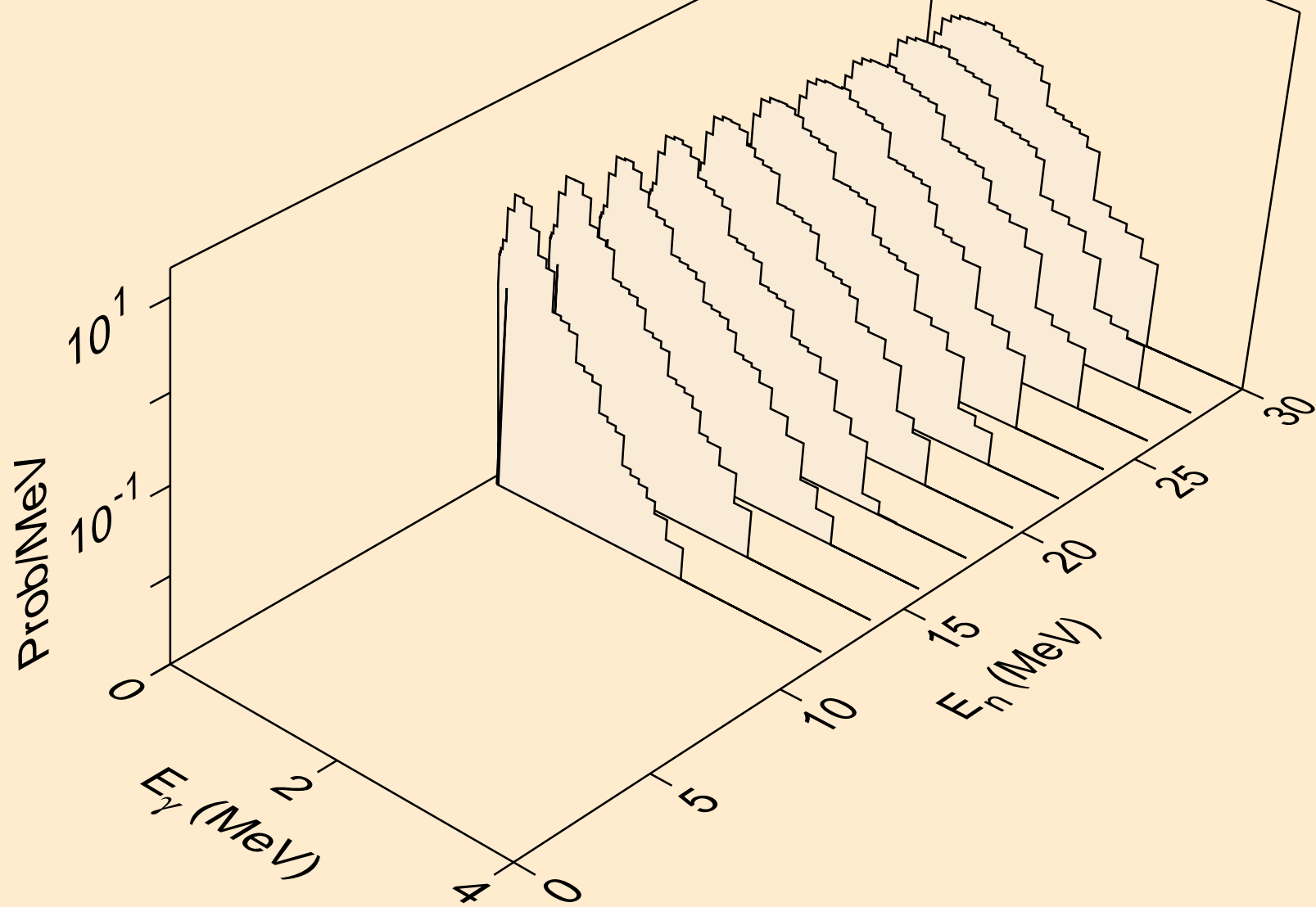

CM252 DEUTERON ACER TENDL-2021 LIBRARY; T=0.K  
Photon emission for (n,3n)a

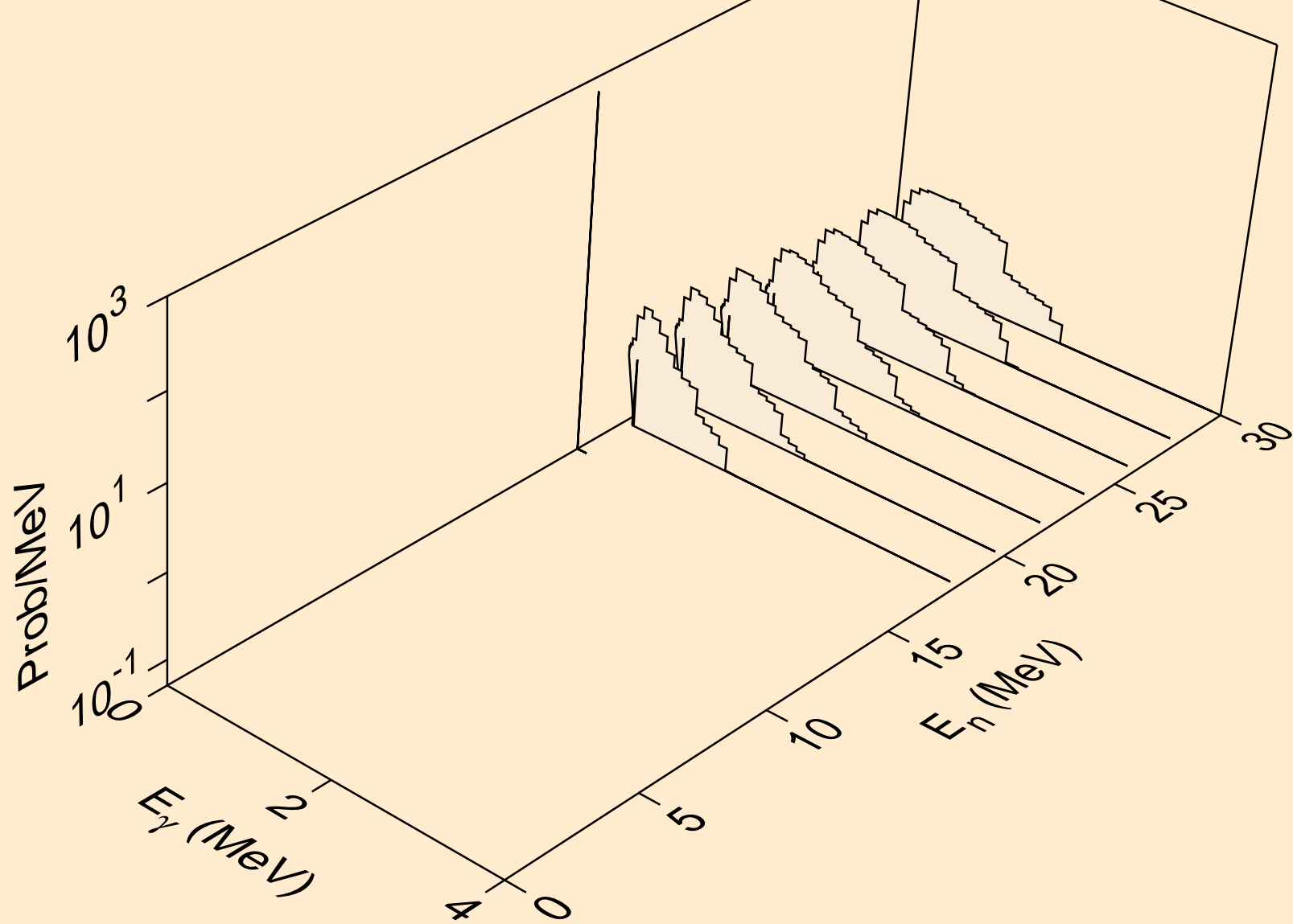

CM252 DEUTERON ACER TENDL-2021 LIBRARY; T=0.K  
Photon emission for (n,n\*)p

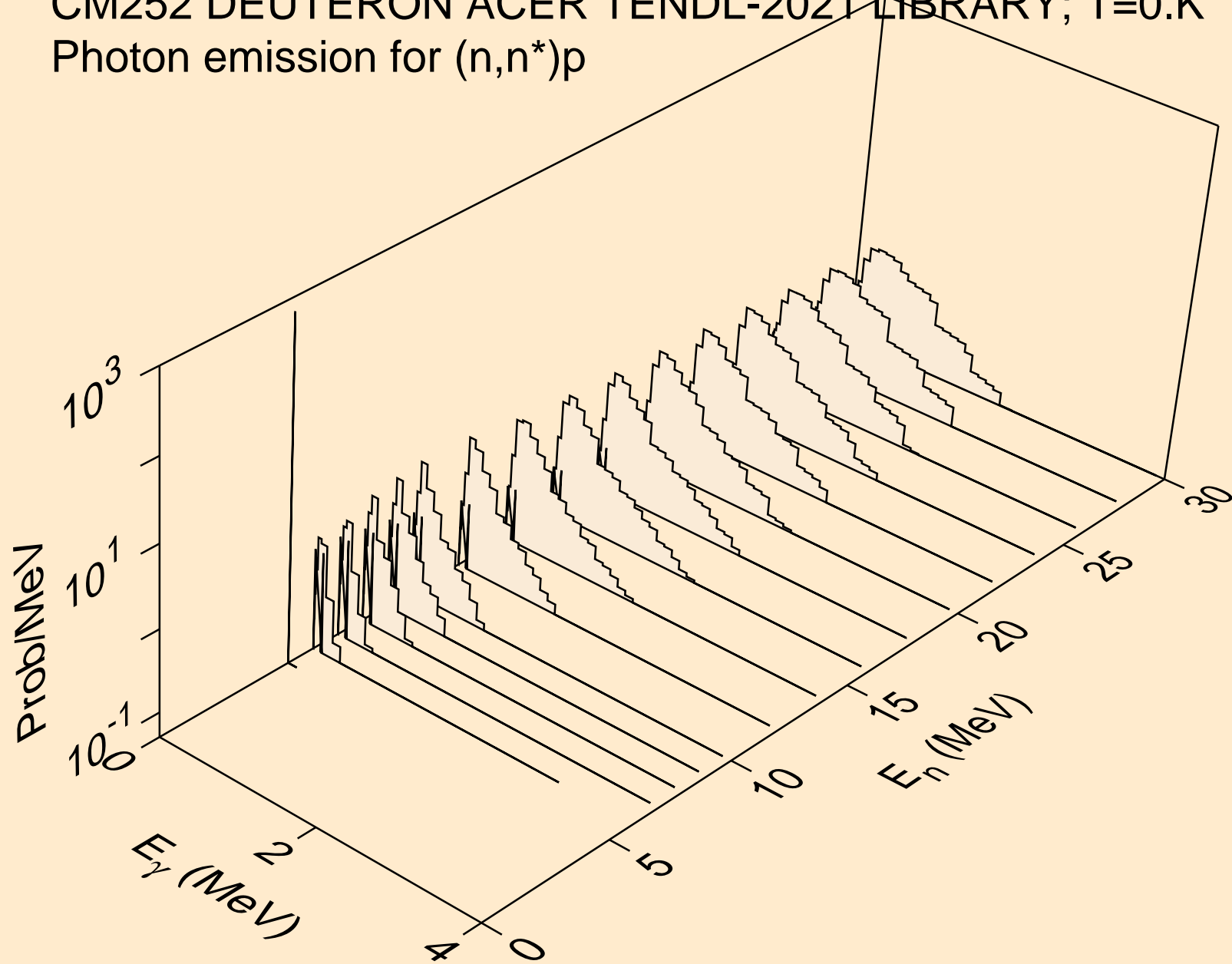

CM252 DEUTERON ACER TENDL-2021 LIBRARY; T=0.K  
Photon emission for (n,n\*)d

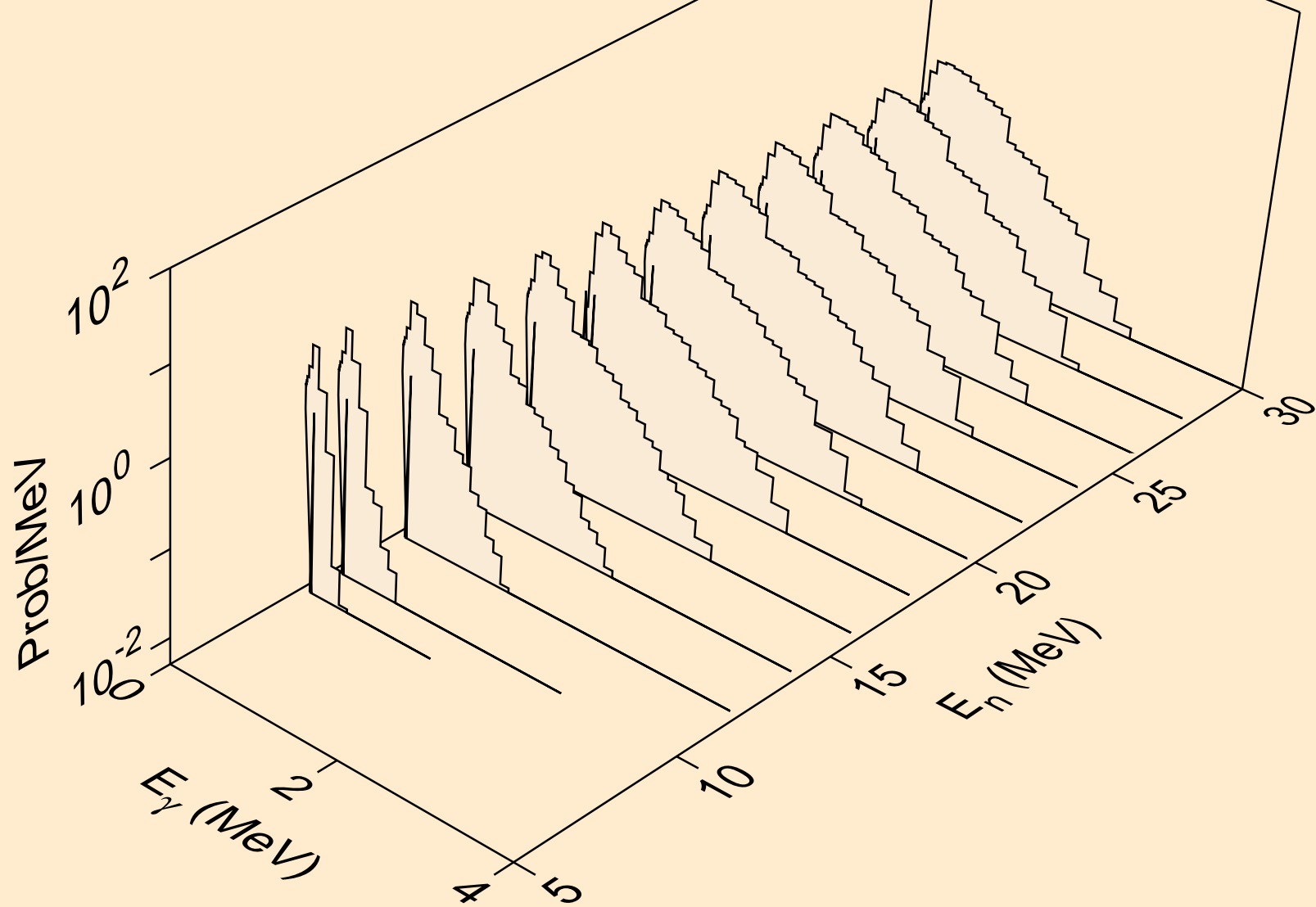

CM252 DEUTERON ACER TENDL-2021 LIBRARY; T=0.K  
Photon emission for (n,n\*)t

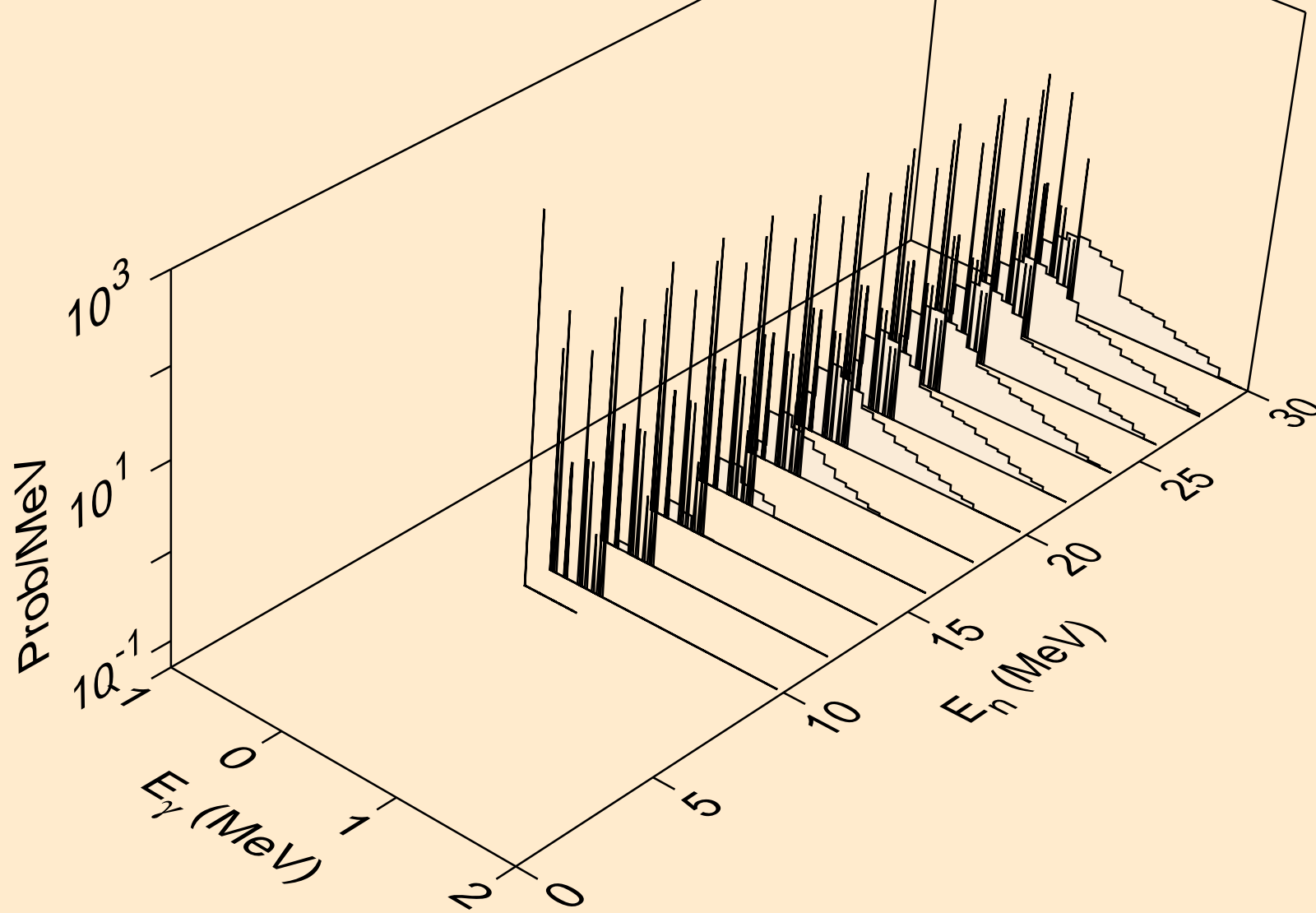

CM252 DEUTERON ACER TENDL-2021 LIBRARY; T=0.K  
Photon emission for (n,n\*)he3

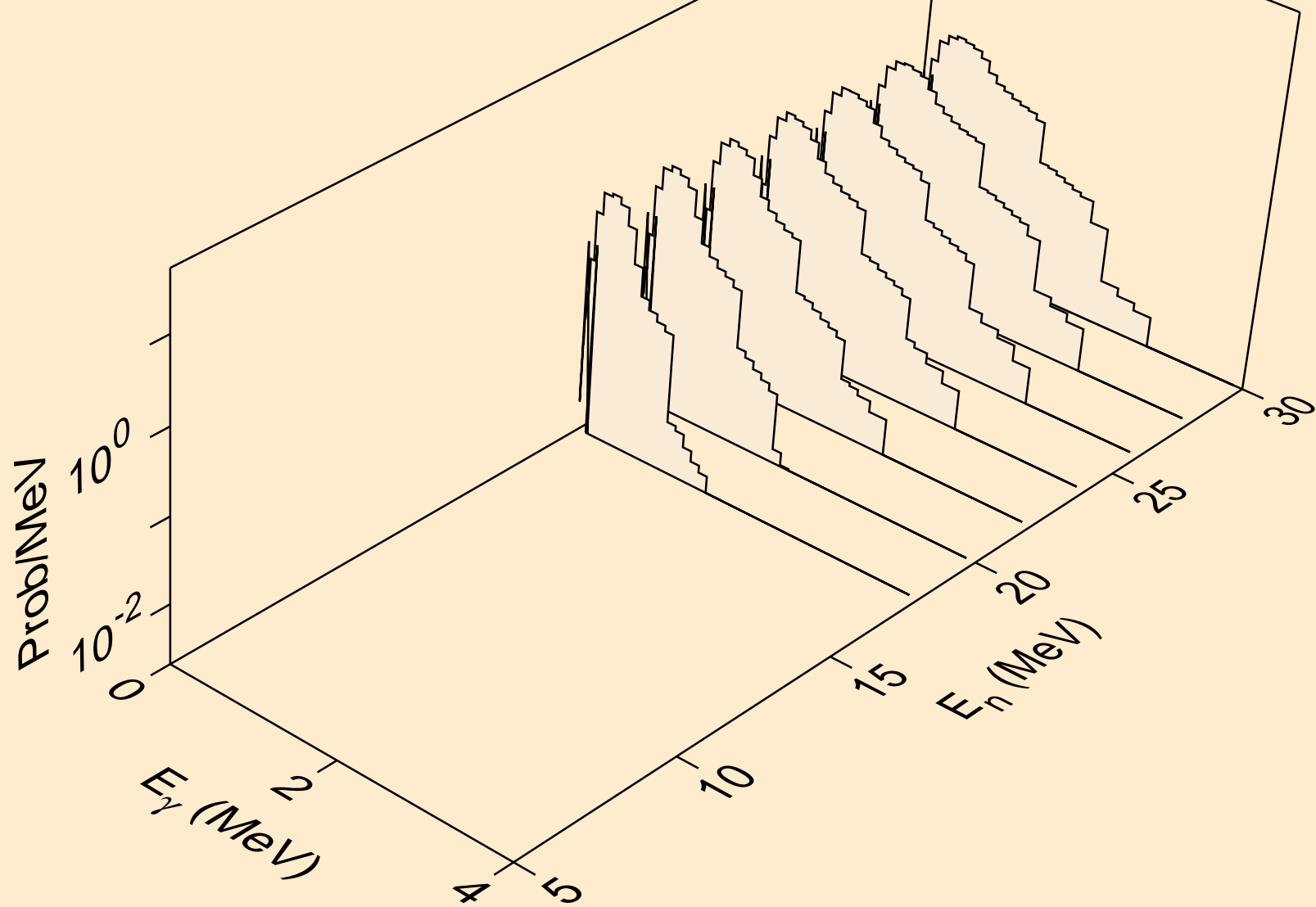



CM252 DEUTERON ACER TENDL-2021 LIBRARY; T=0.K  
Photon emission for (n,4n)

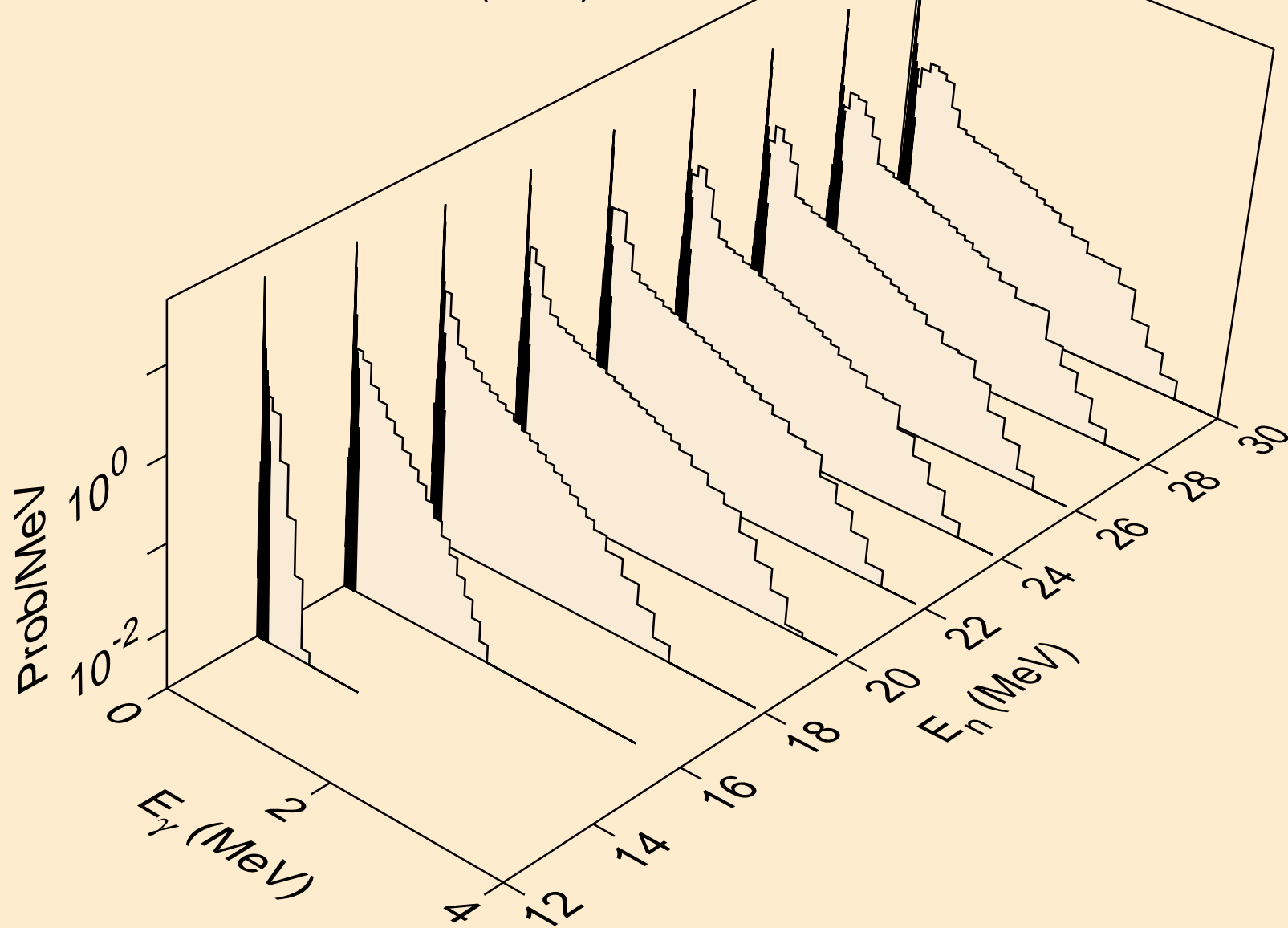

CM252 DEUTERON ACER TENDL-2021 LIBRARY; T=0.K  
Photon emission for (n,2np)

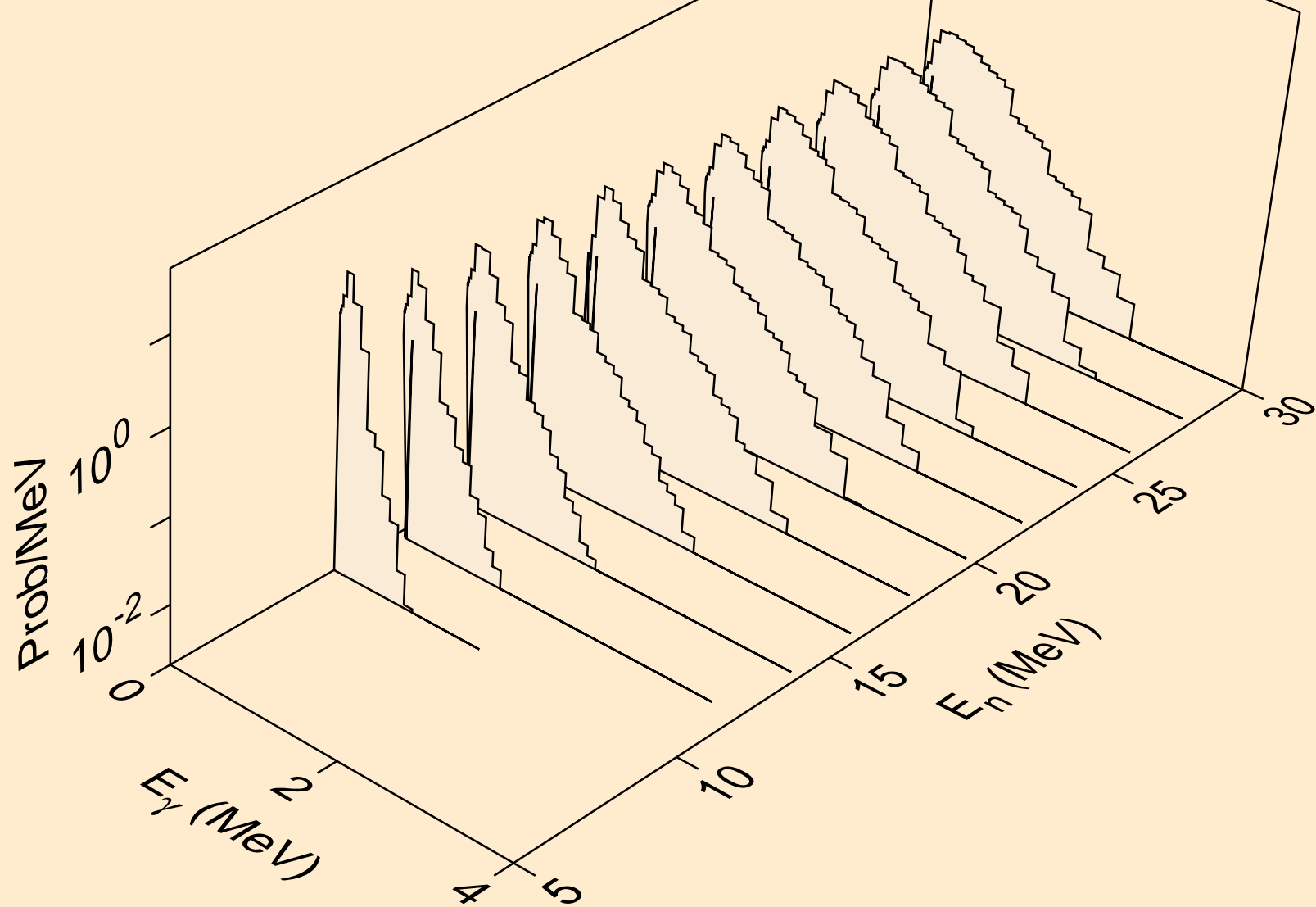

CM252 DEUTERON ACER TENDL-2021 LIBRARY; T=0.K  
Photon emission for (n,3np)

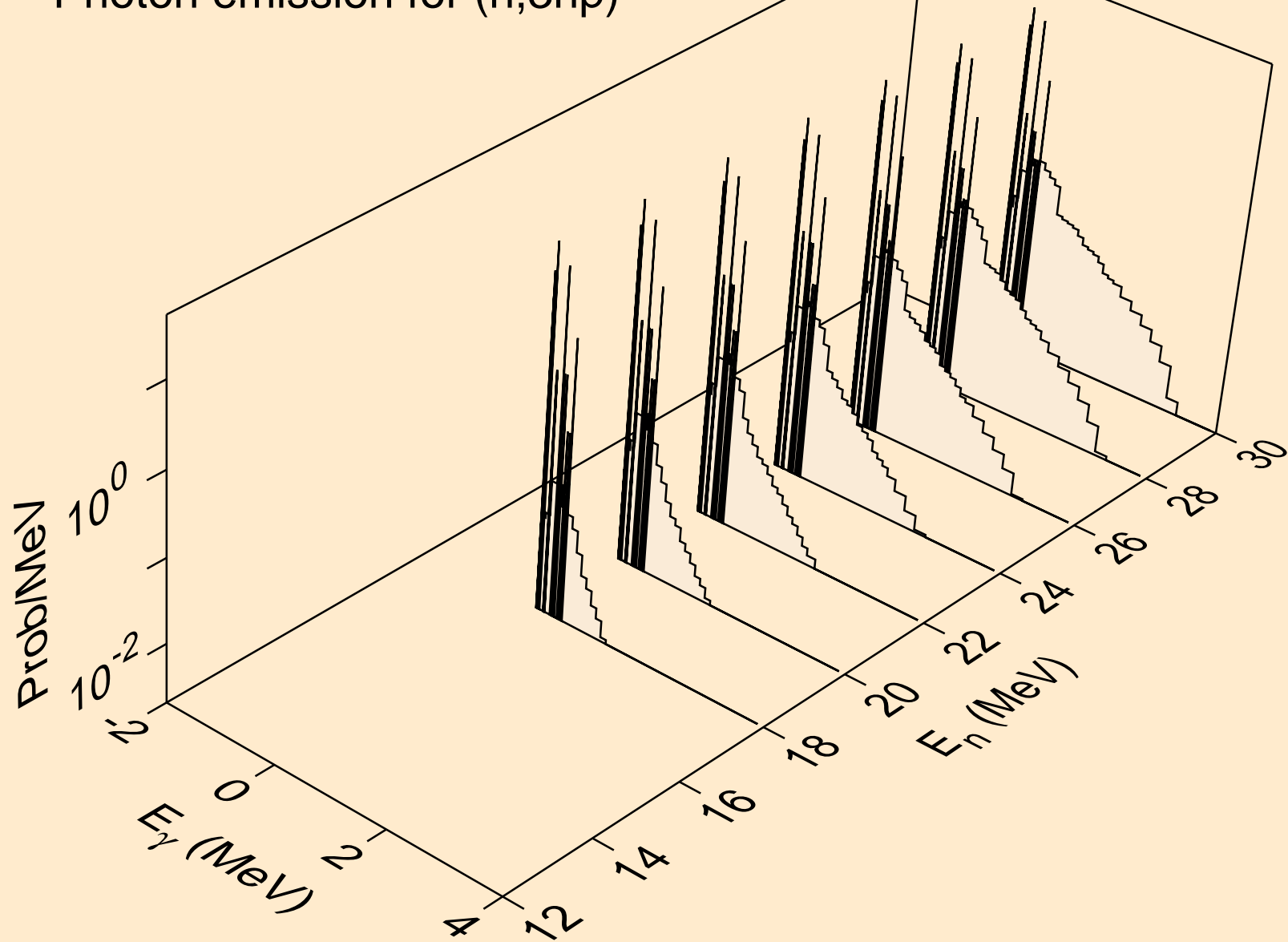

CM252 DEUTERON ACER TENDL-2021 LIBRARY; T=0.K  
Photon emission for (n,2np)

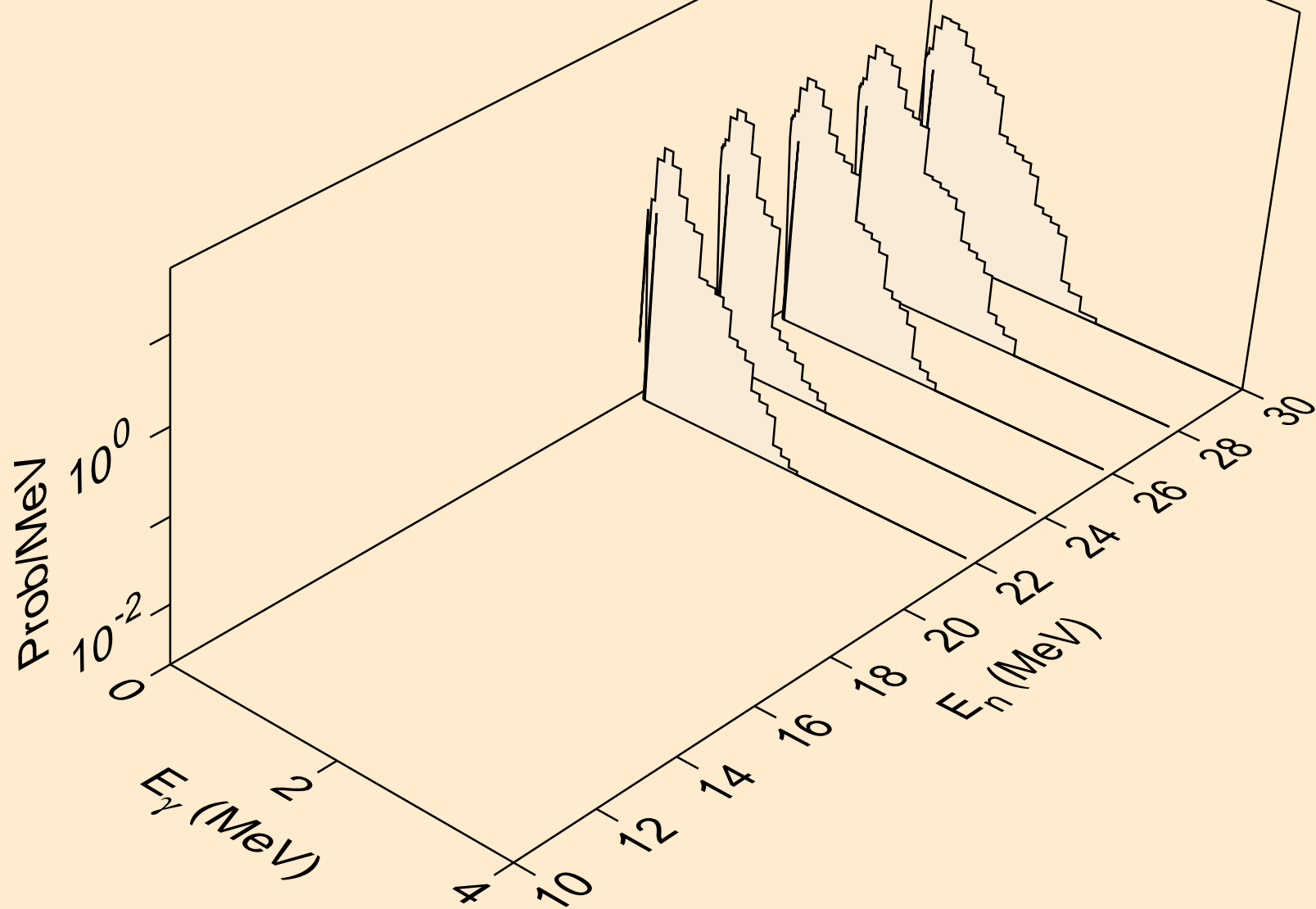

CM252 DEUTERON ACER TENDL-2021 LIBRARY; T=0.K  
Photon emission for (n,p)

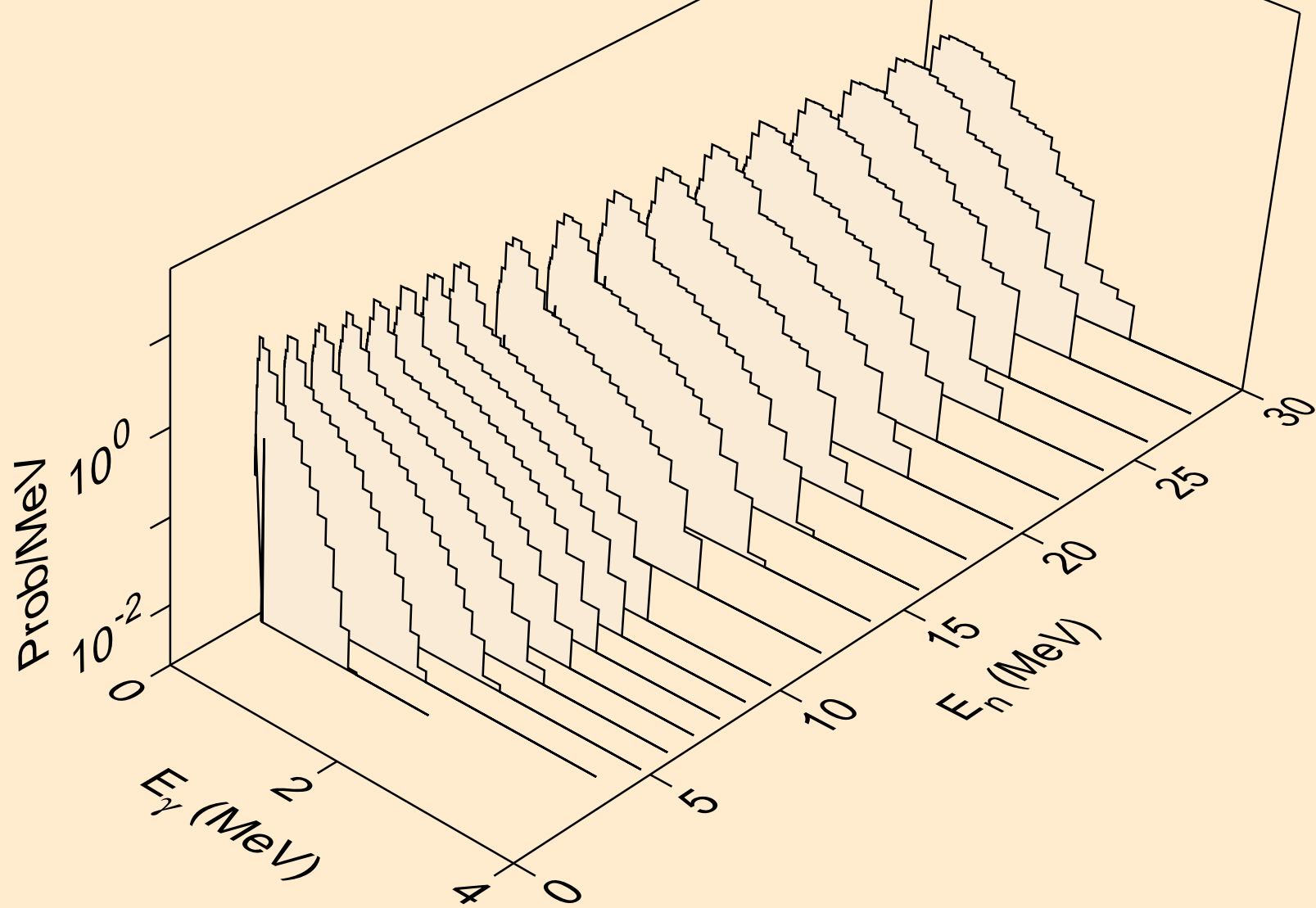

CM252 DEUTERON ACER TENDL-2021 LIBRARY; T=0.K  
Photon emission for inelastic

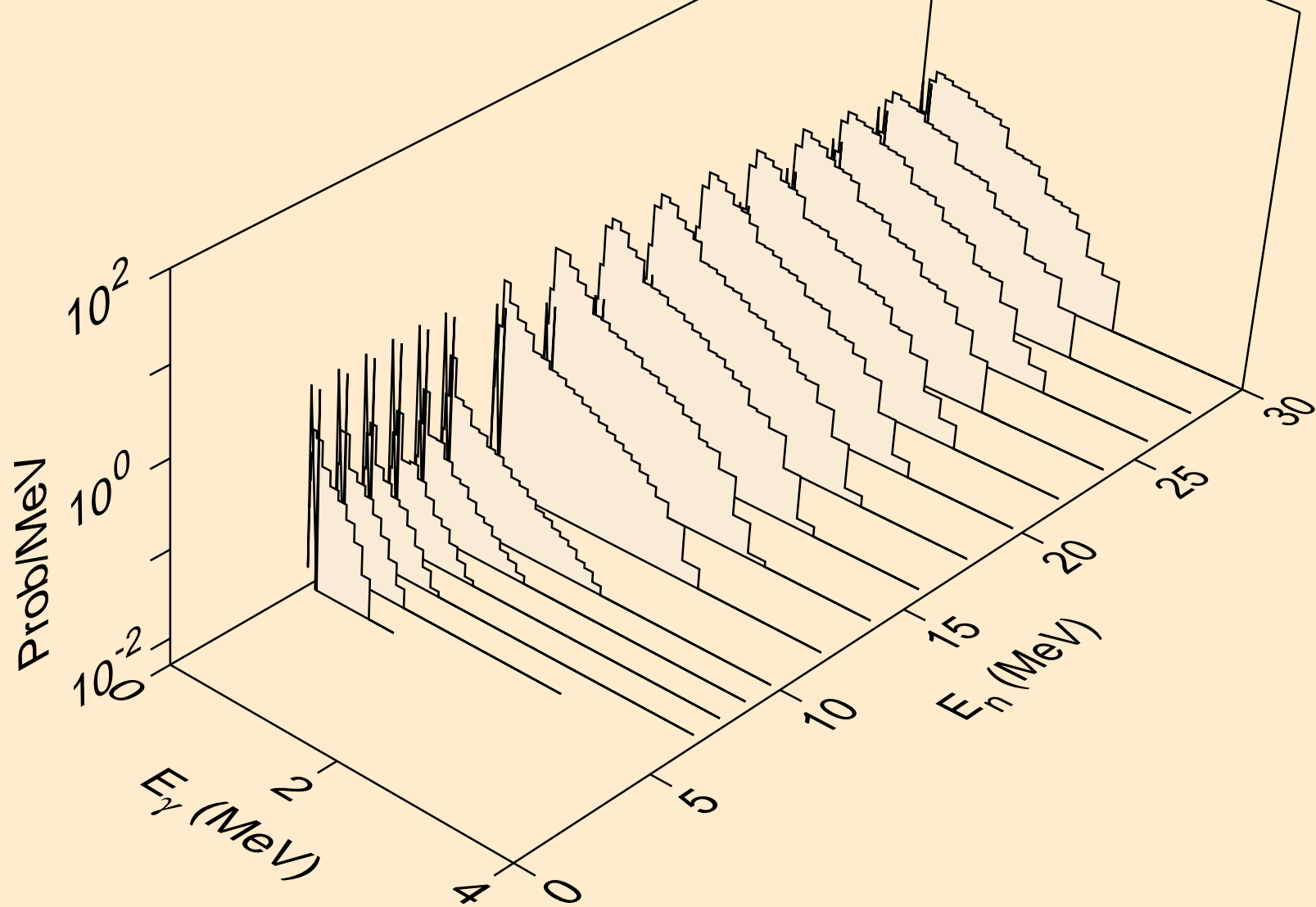

CM252 DEUTERON ACER TENDL-2021 LIBRARY; T=0.K  
Photon emission for (n,t)

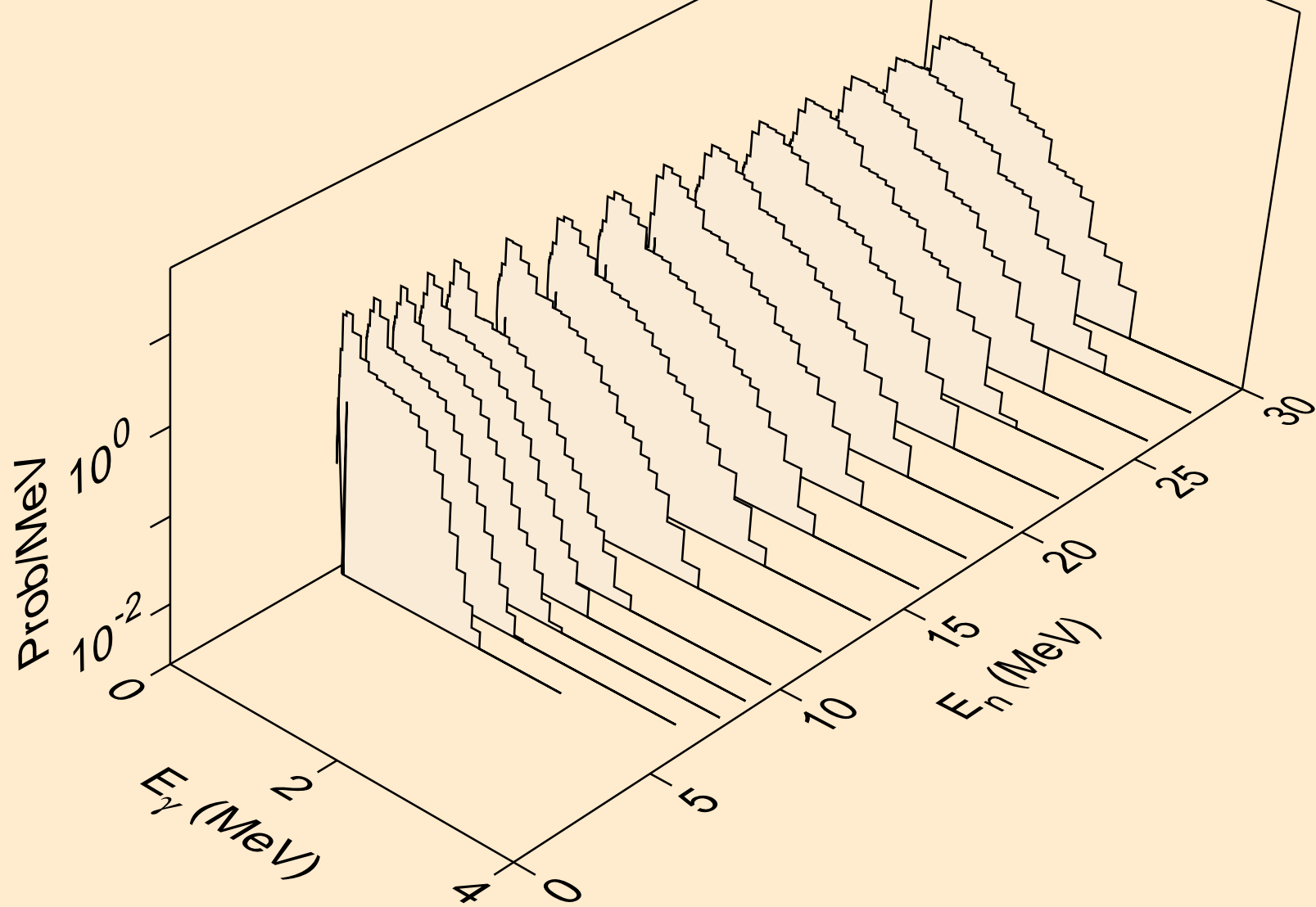

CM252 DEUTERON ACER TENDL-2021 LIBRARY; T=0.K  
Photon emission for (n,he3)

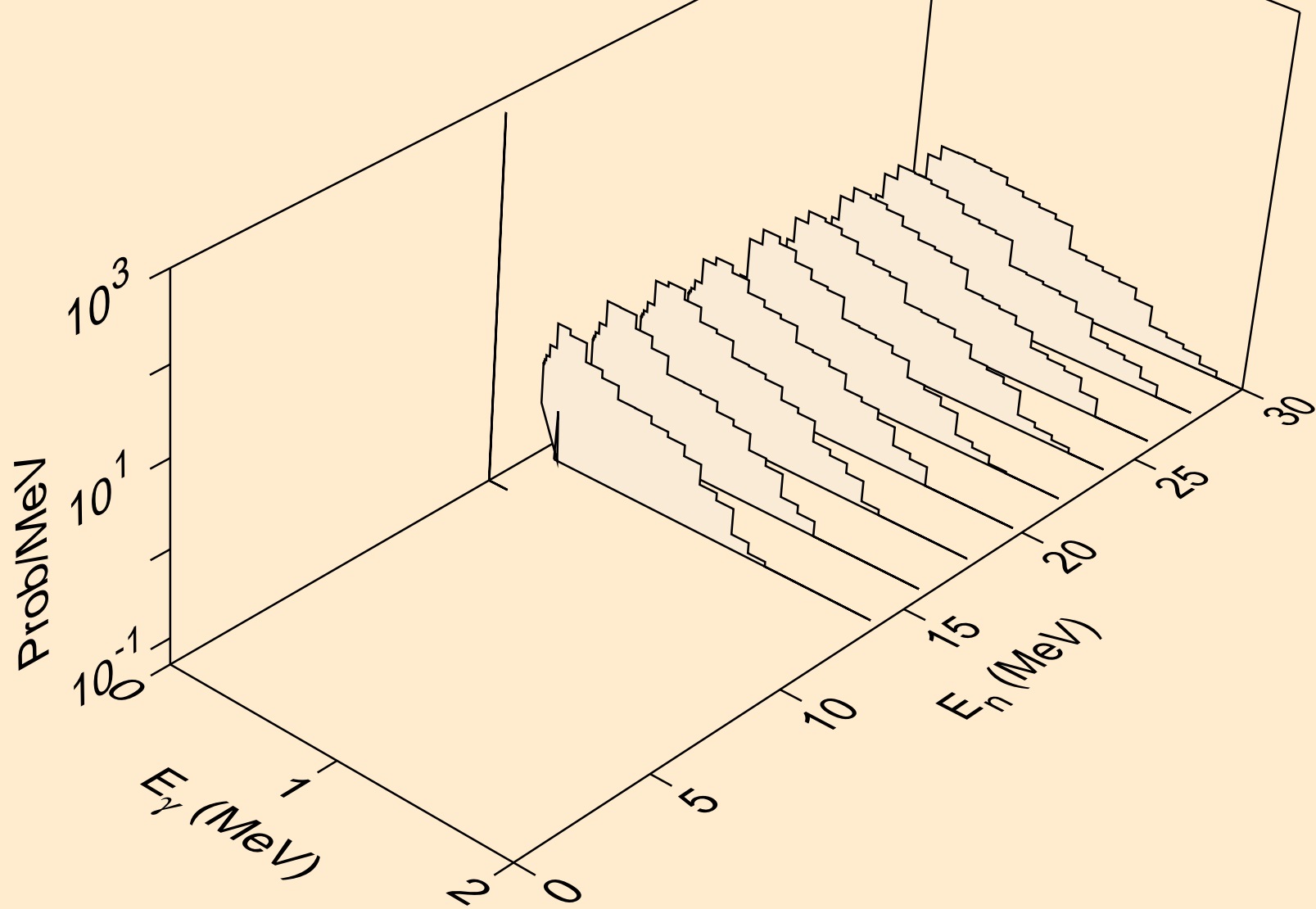



CM252 DEUTERON ACER TENDL-2021 LIBRARY; T=0.K  
Photon emission for (n,a)

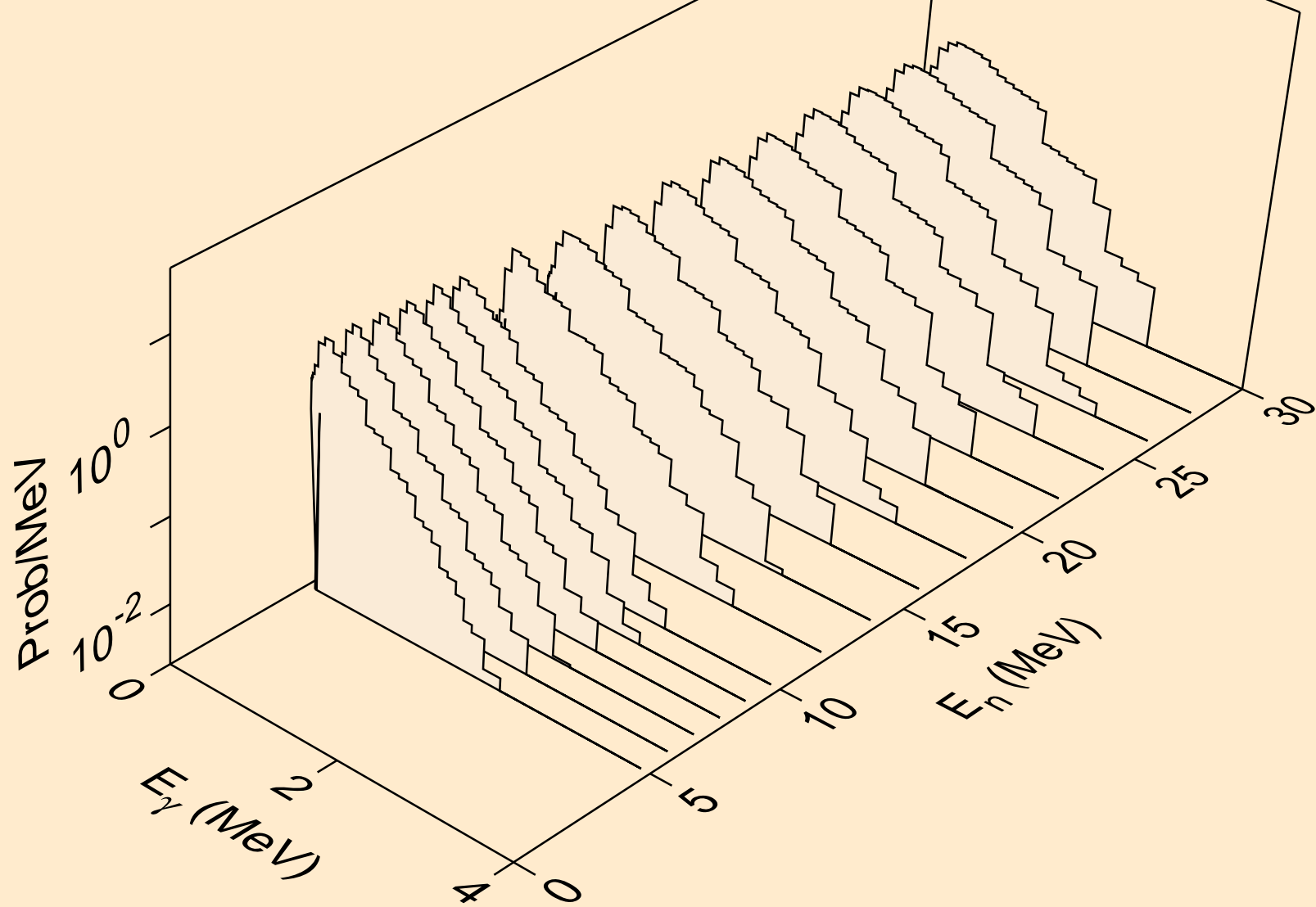

CM252 DEUTERON ACER TENDL-2021 LIBRARY; T=0.K  
Photon emission for (n,2p)

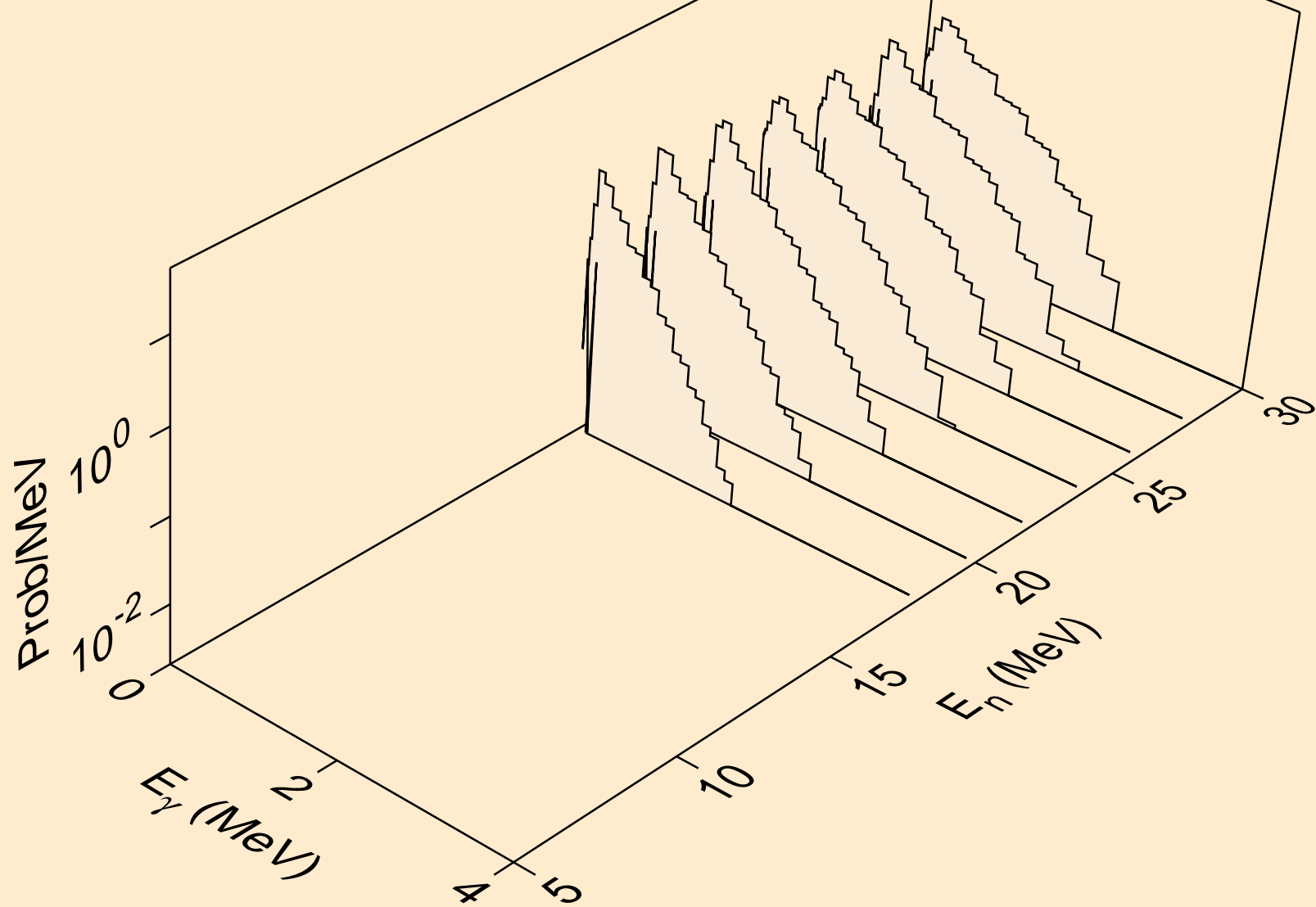

CM252 DEUTERON ACER TENDL-2021 LIBRARY; T=0.K  
Photon emission for (n,pd)

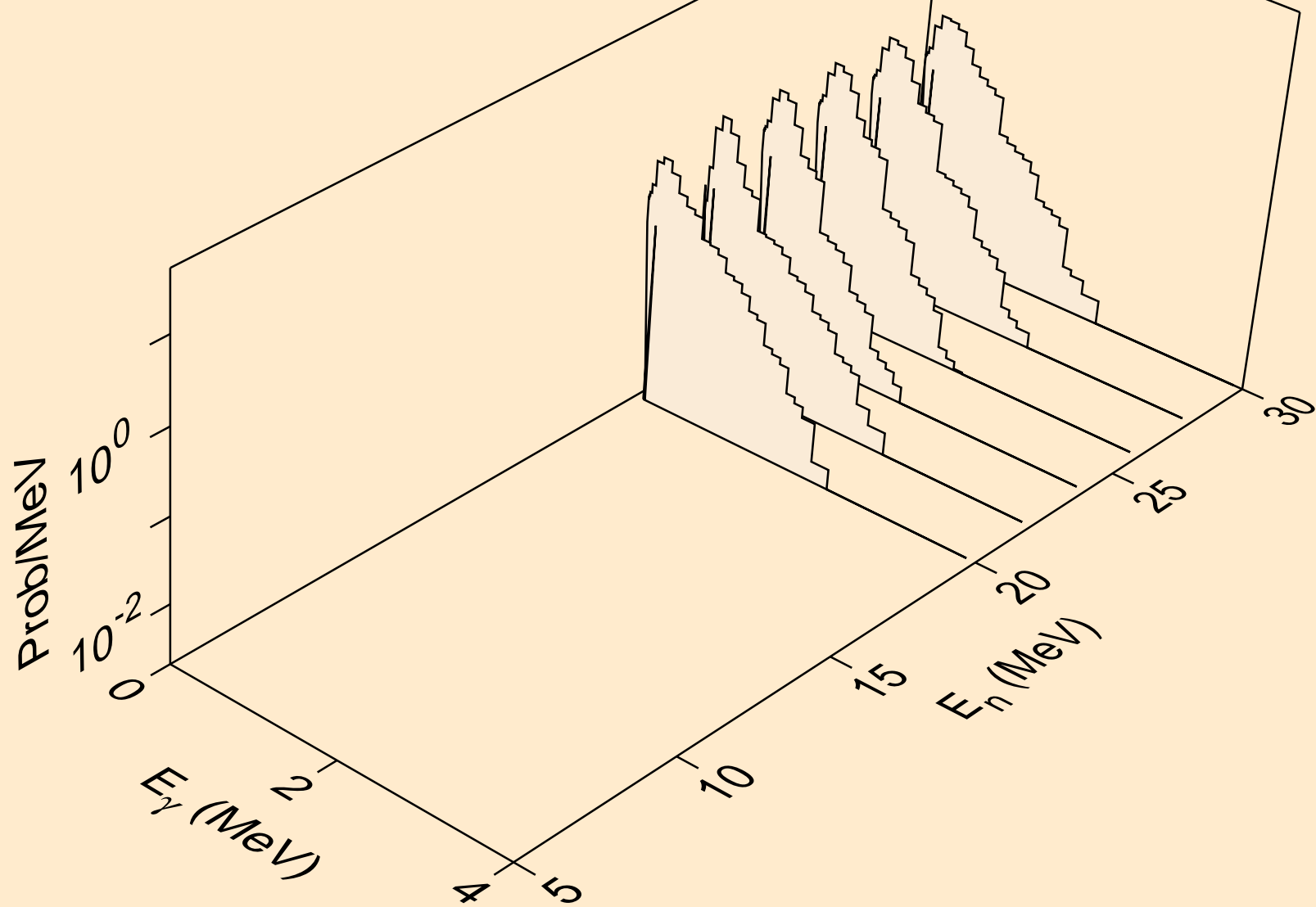

# CM252 DEUTERON ACER TENDL-2021 LIBRARY; T=0.K

## Particle heating contributions

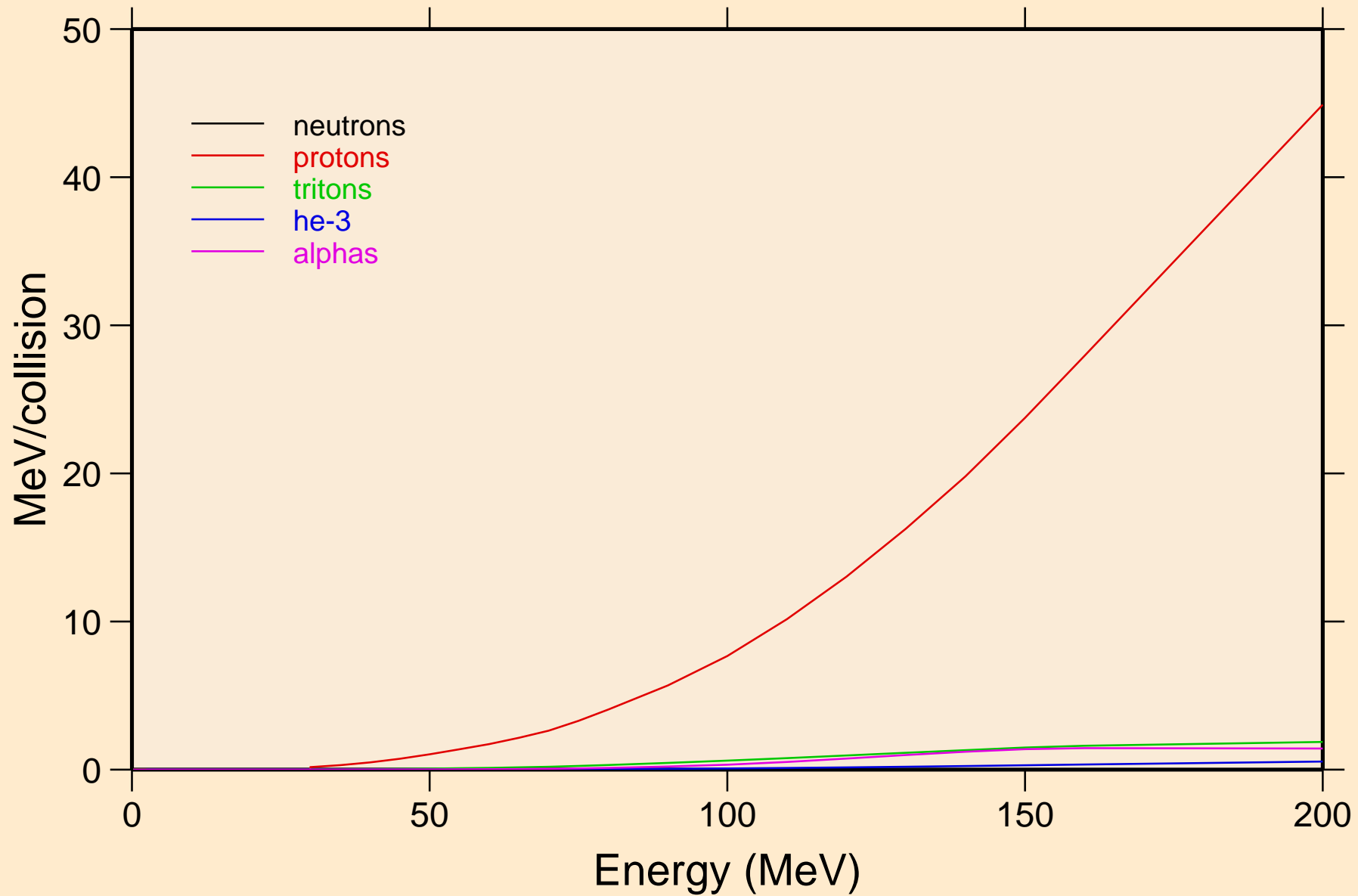

CM252 DEUTERON ACER TENDL-2021 LIBRARY; T=0.K  
Recoil Heating

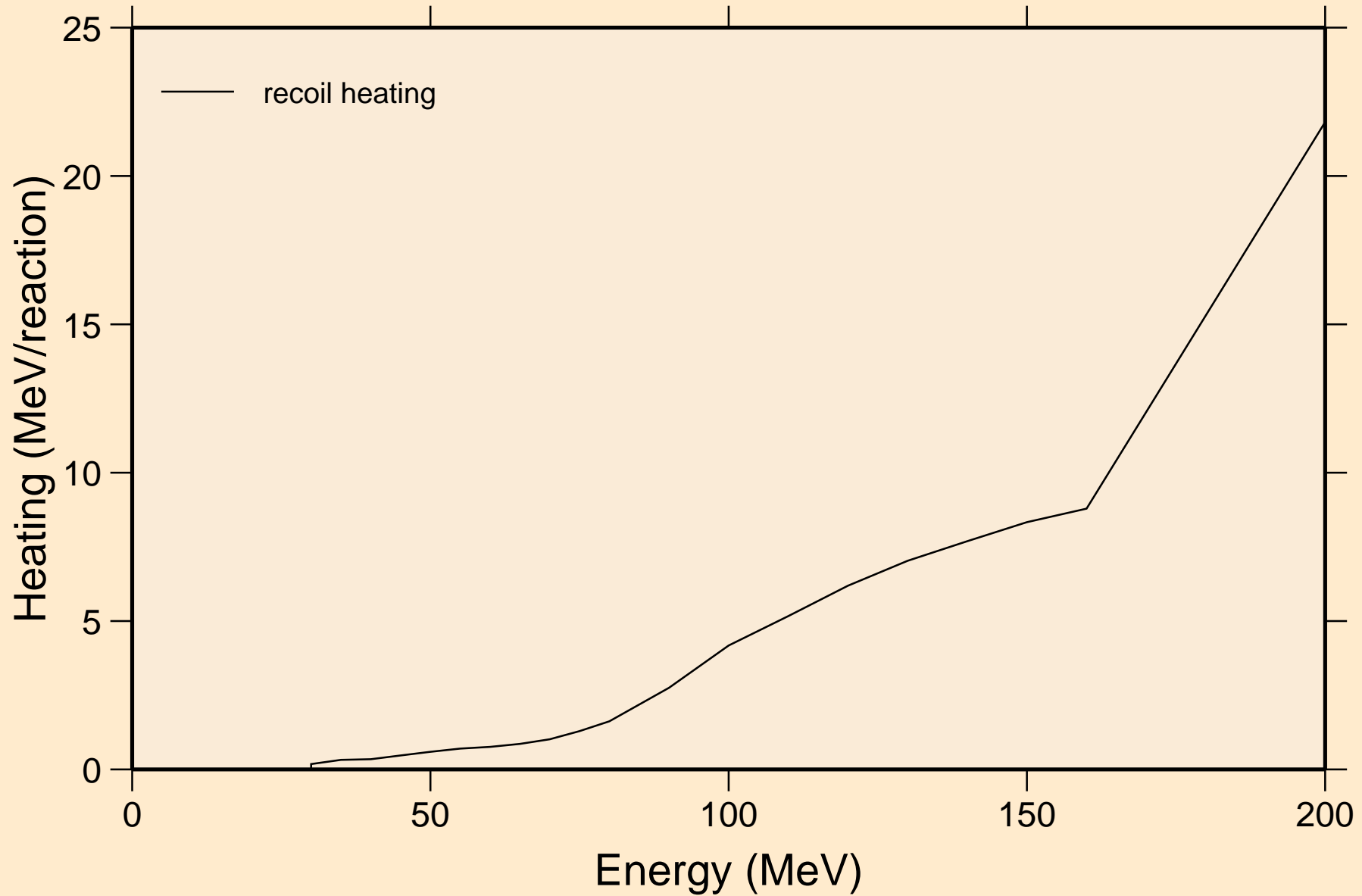

CM252 DEUTERON ACER TENDL-2021 LIBRARY; T=0.K  
Particle production cross sections

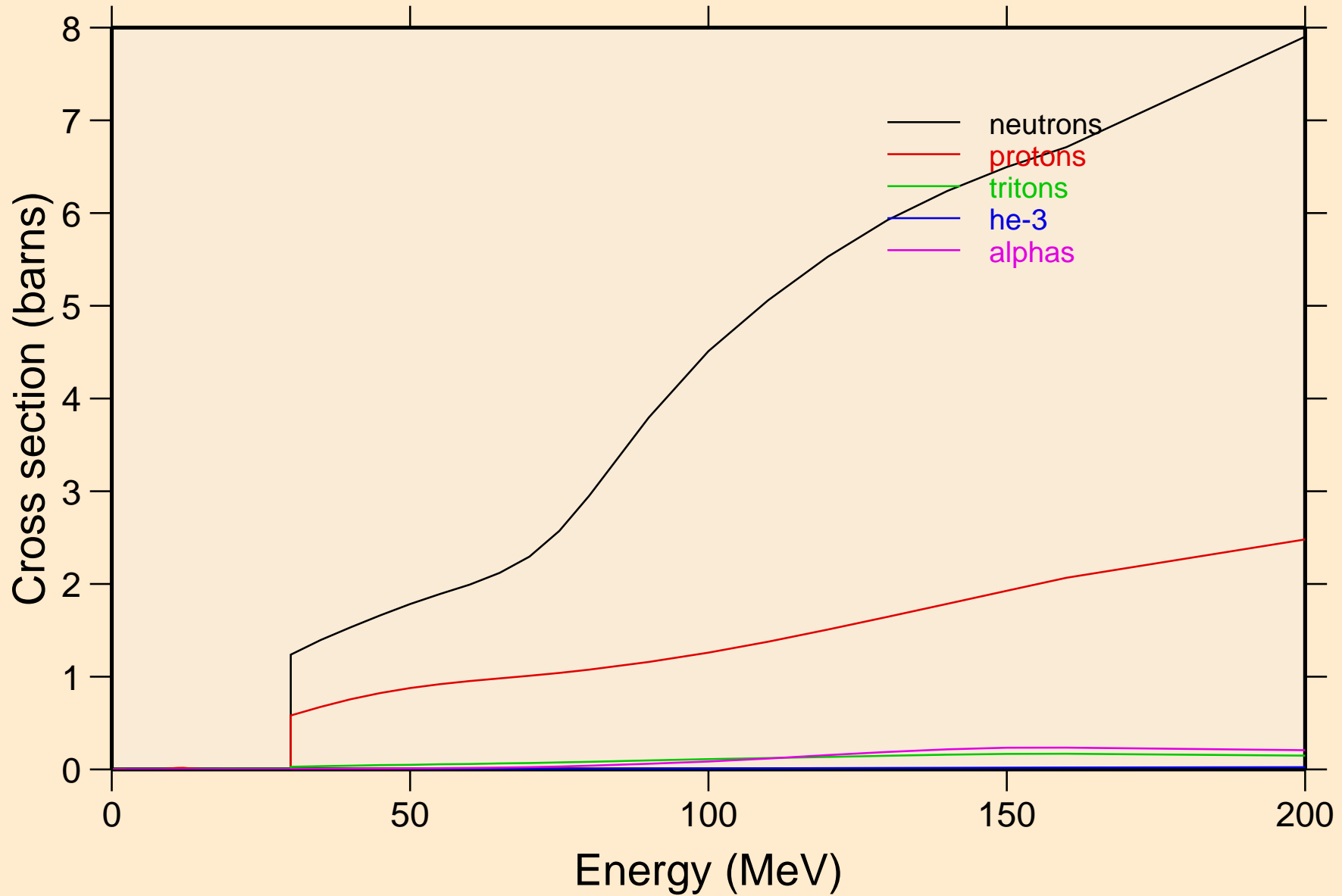

CM252 DEUTERON ACER TENDL-2021 LIBRARY; T=0.K  
neutrons from (d,n)

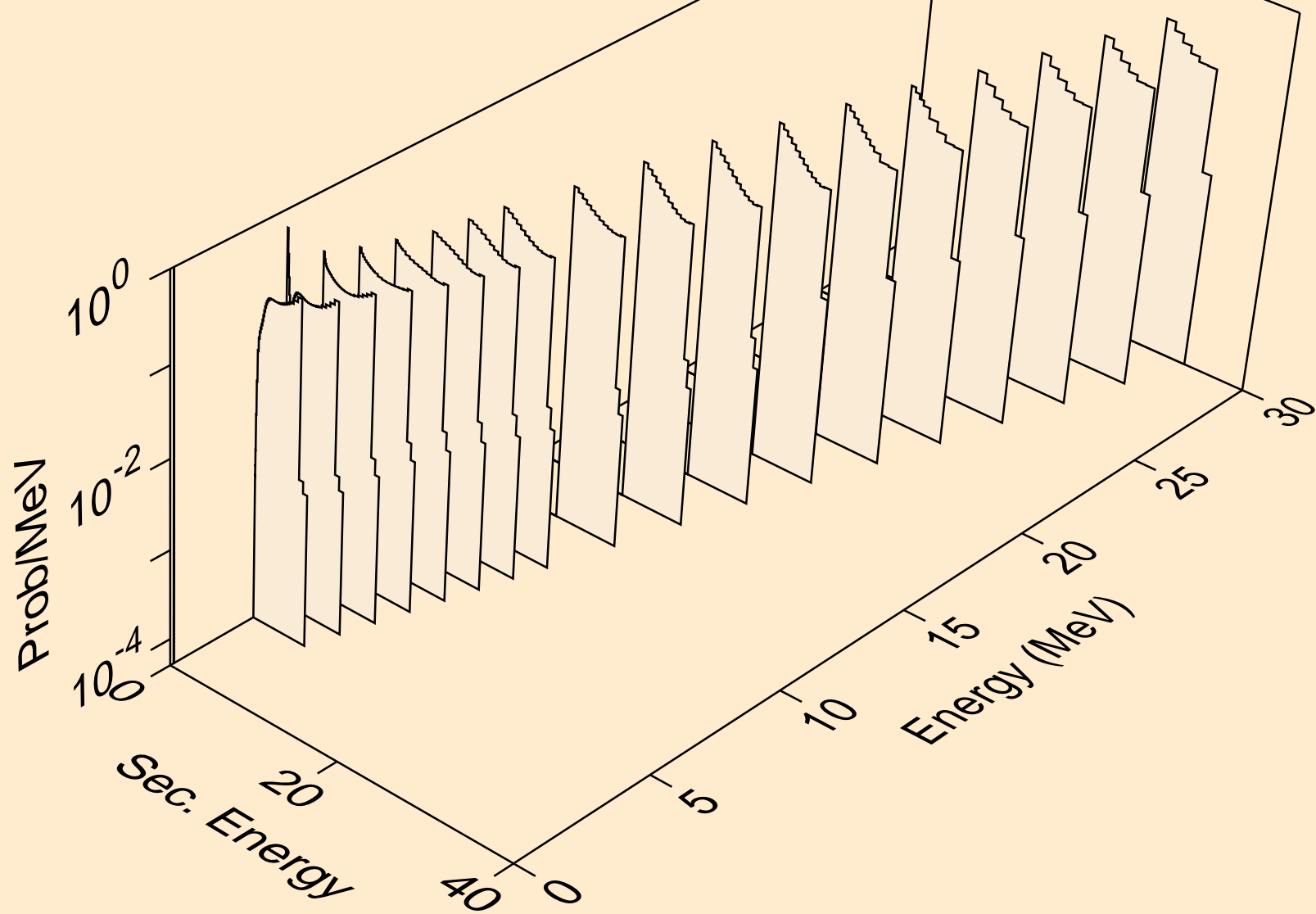

CM252 DEUTERON ACER TENDL-2021 LIBRARY; T=0.K  
neutrons from (d,x)

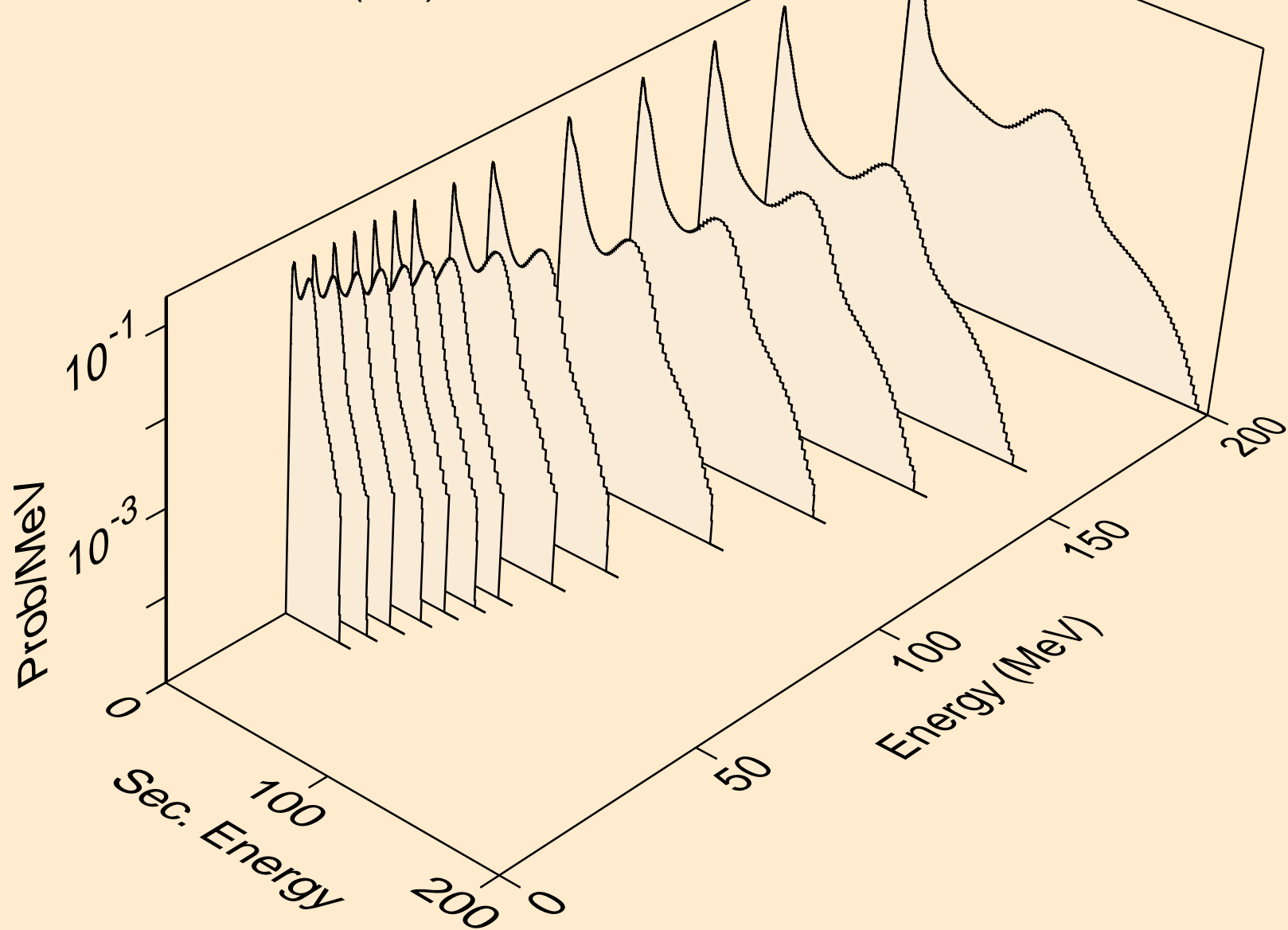



CM252 DEUTERON ACER TENDL-2021 LIBRARY; T=0.K  
neutrons from (d,2nd)

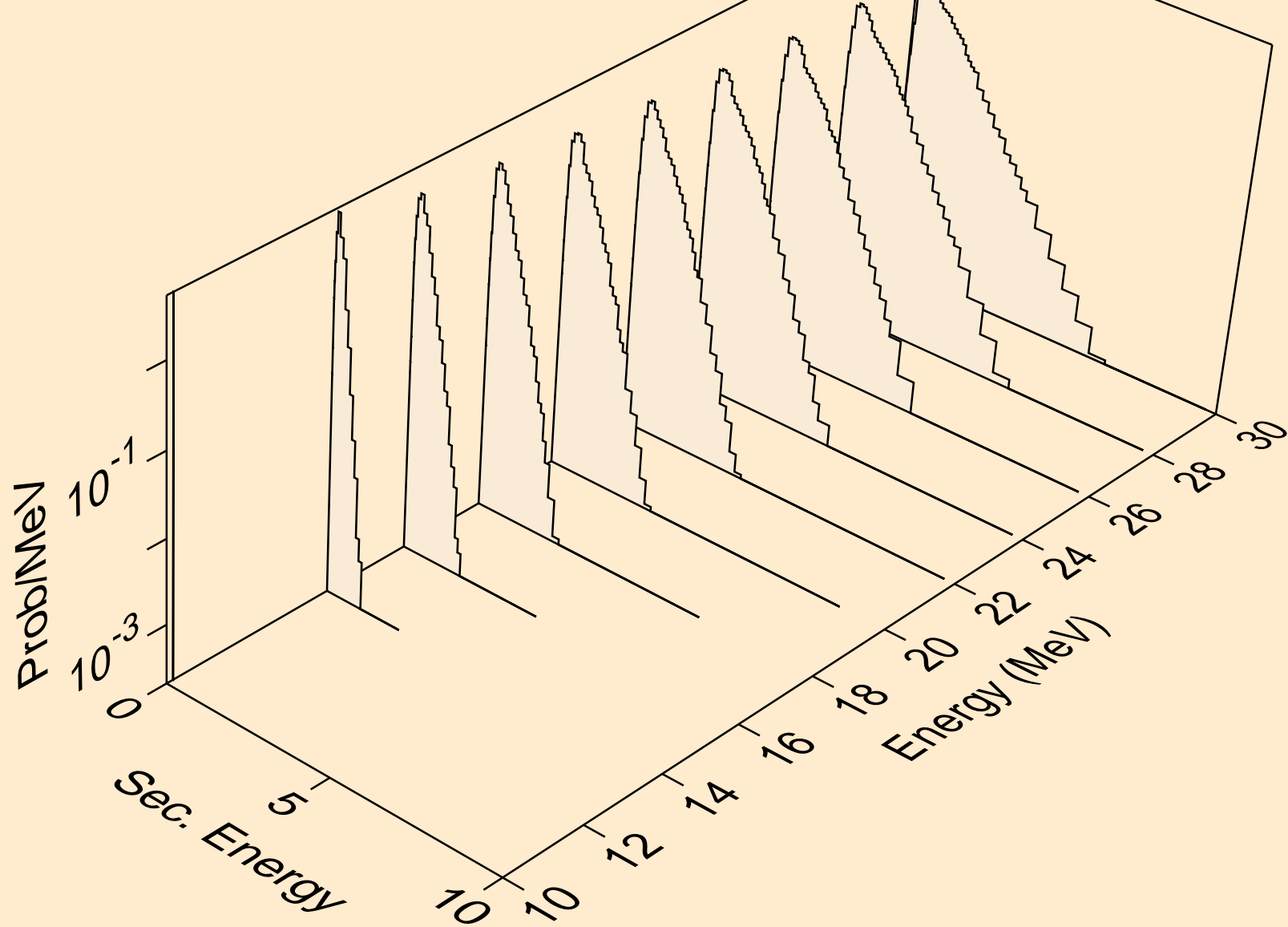

CM252 DEUTERON ACER TENDL-2021 LIBRARY; T=0.K  
neutrons from (d,2n)

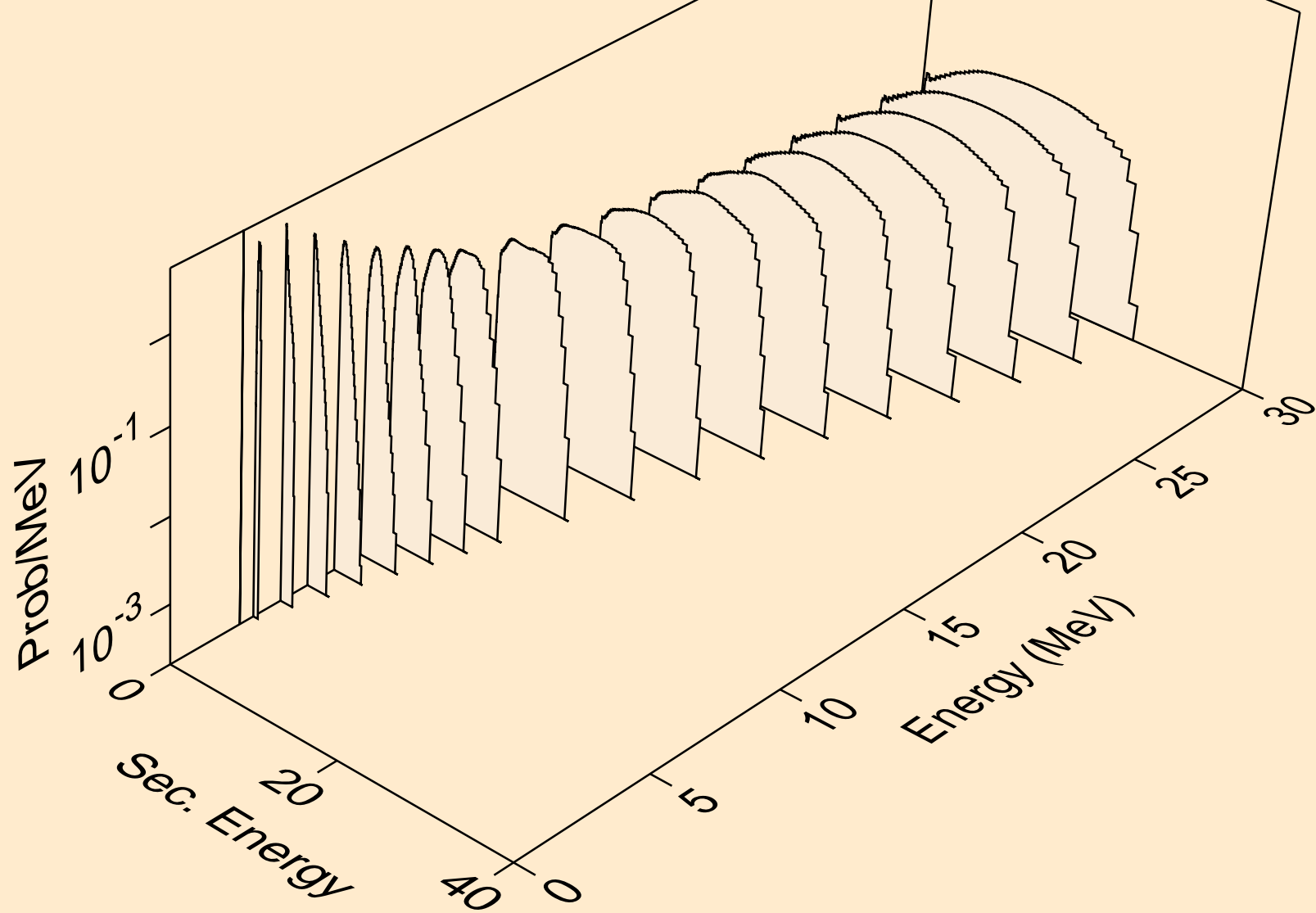

CM252 DEUTERON ACER TENDL-2021 LIBRARY; T=0.K  
neutrons from (d,3n)

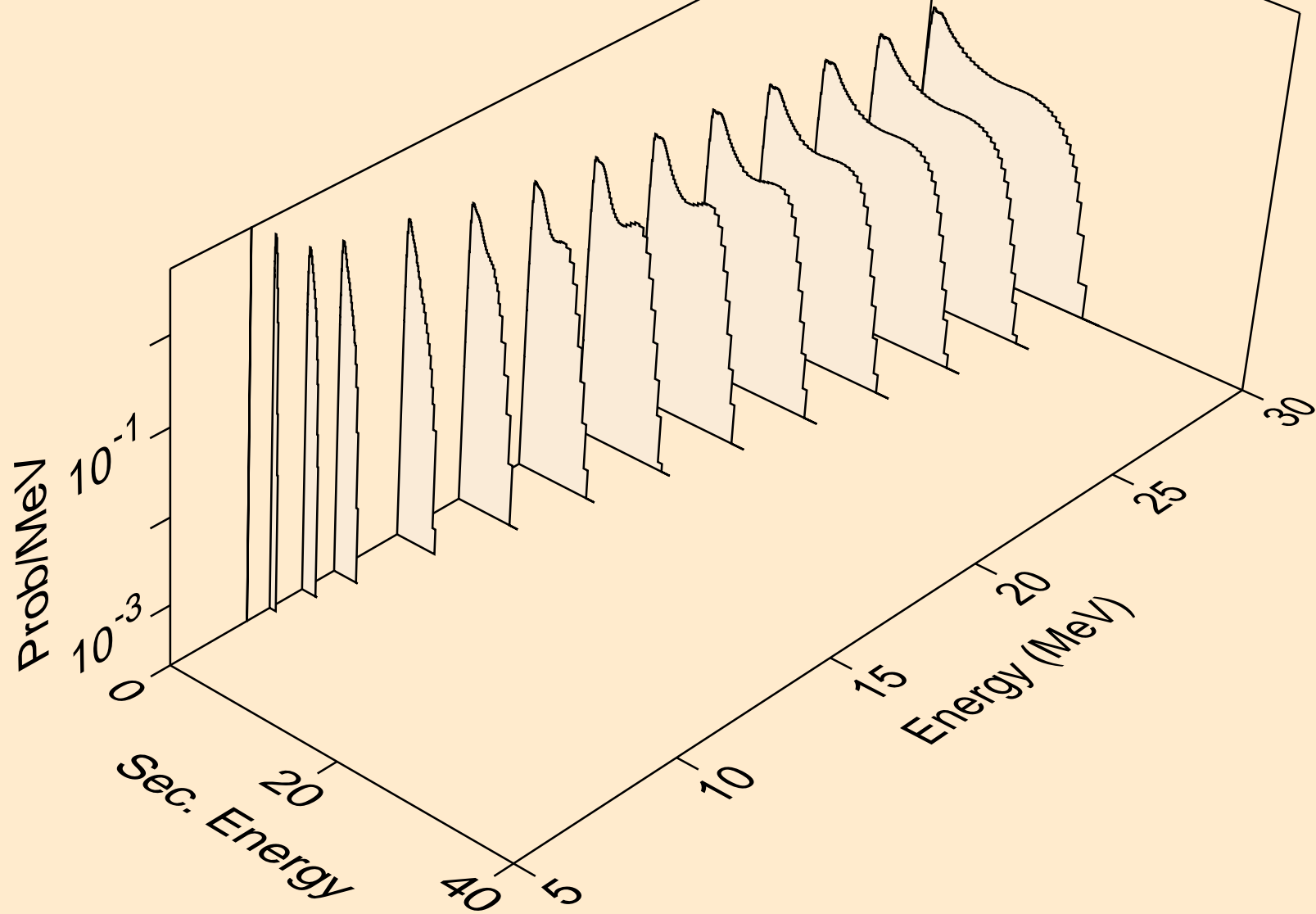

CM252 DEUTERON ACER TENDL-2021 LIBRARY; T=0.K  
neutrons from (d,n\*)a

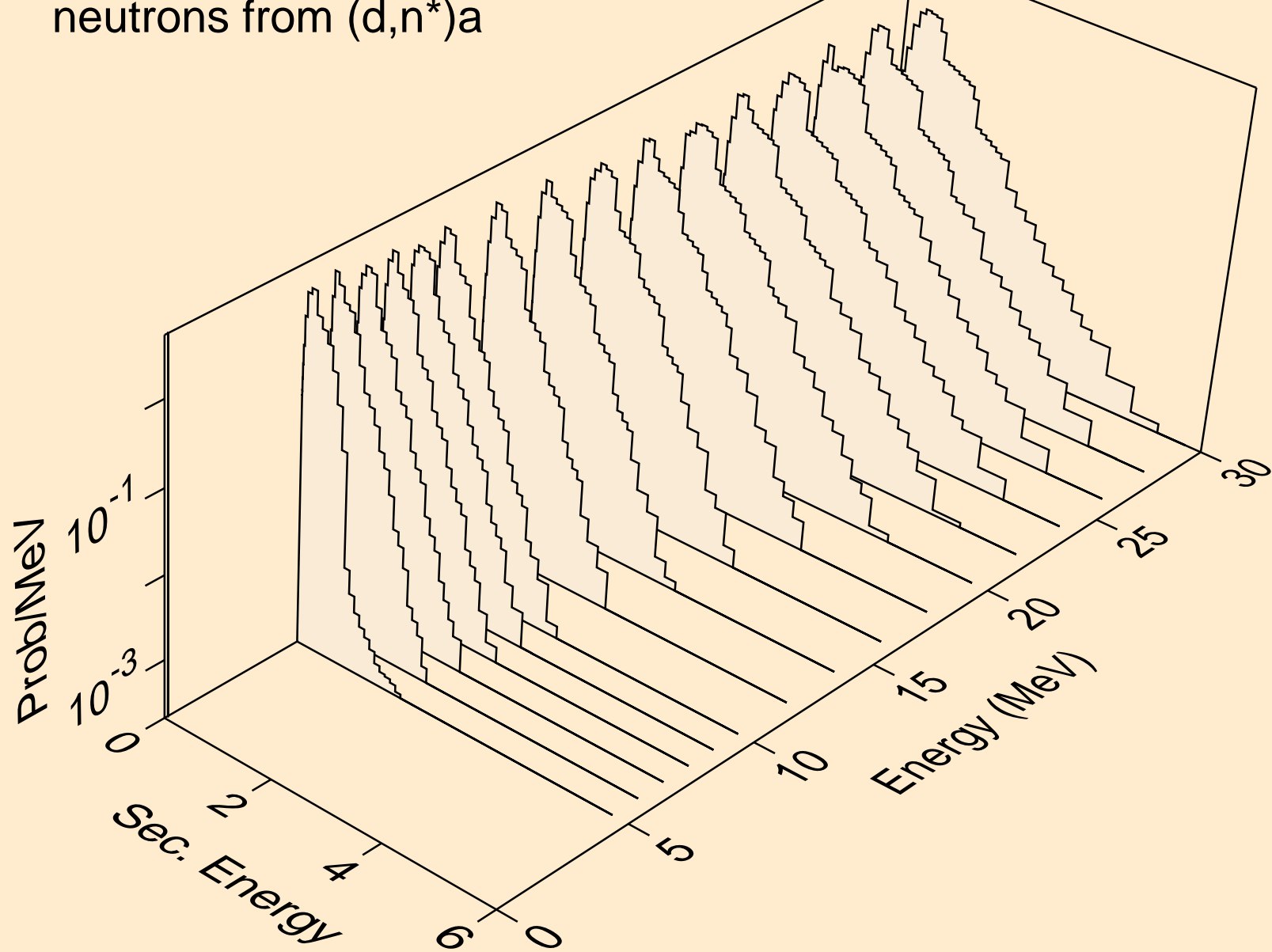

CM252 DEUTERON ACER TENDL-2021 LIBRARY; T=0.K  
neutrons from (d,2n)a

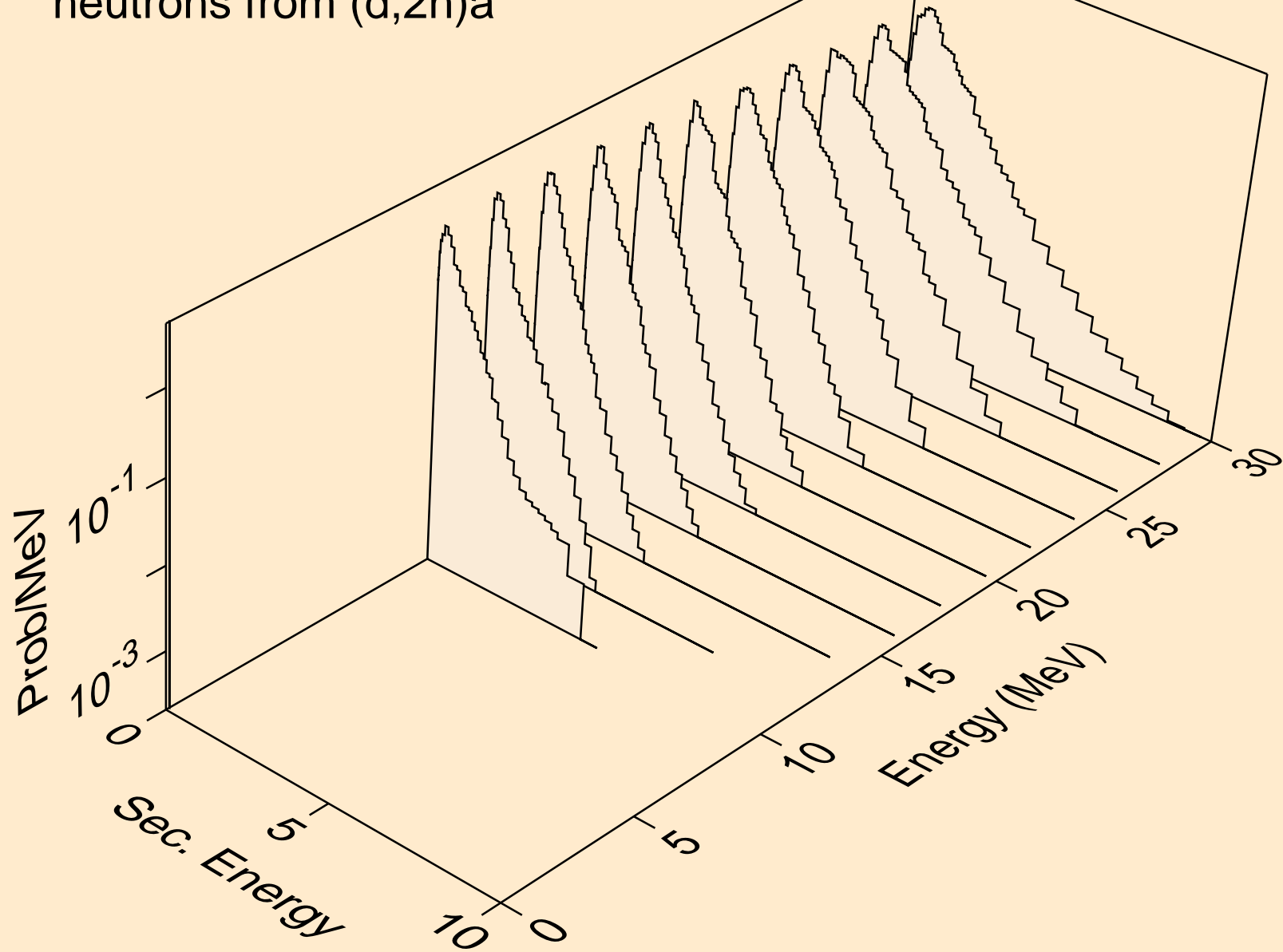

CM252 DEUTERON ACER TENDL-2021 LIBRARY; T=0.K  
neutrons from (d,3n)a

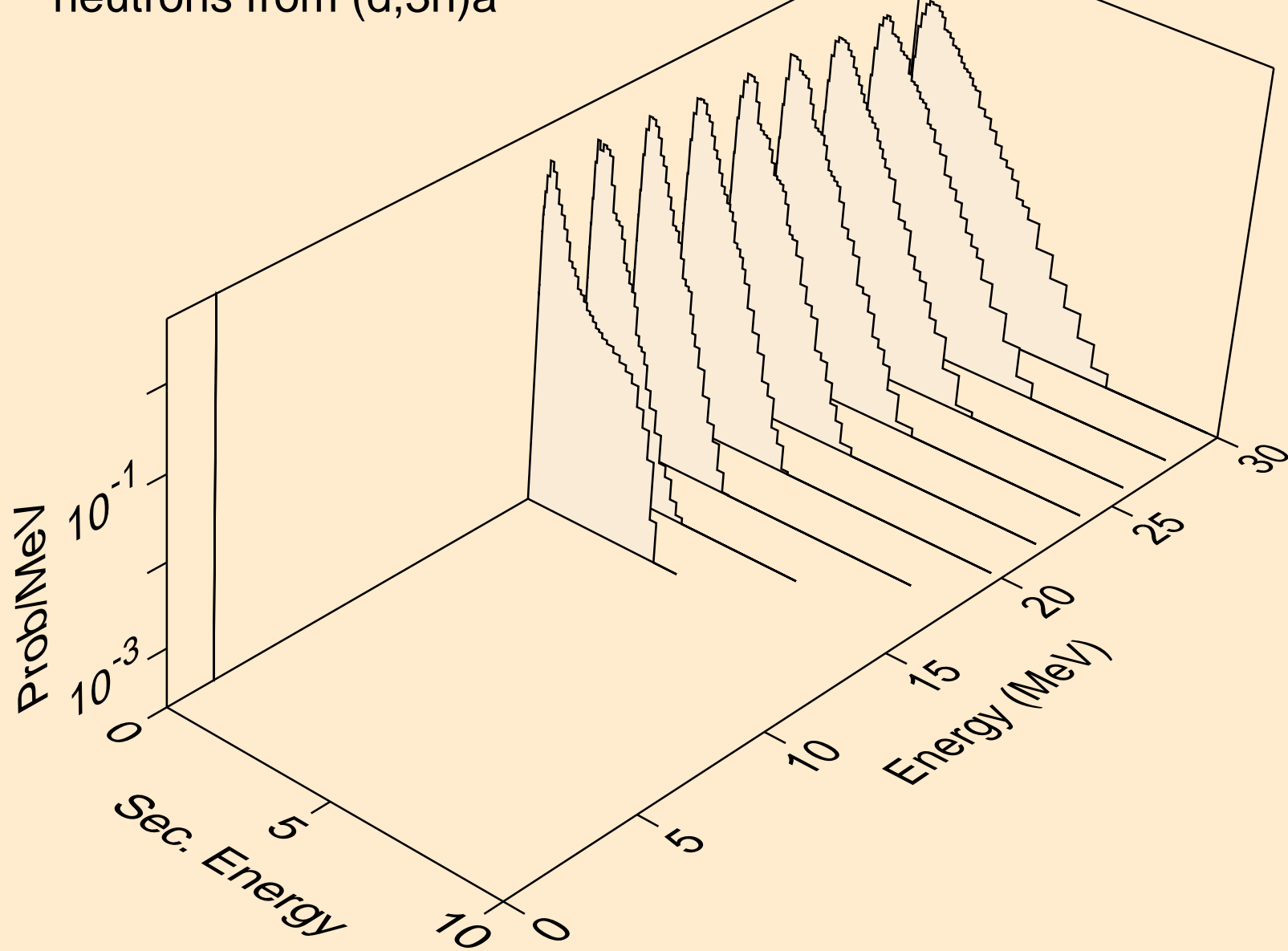

CM252 DEUTERON ACER TENDL-2021 LIBRARY; T=0.K  
neutrons from (d,n\*)p

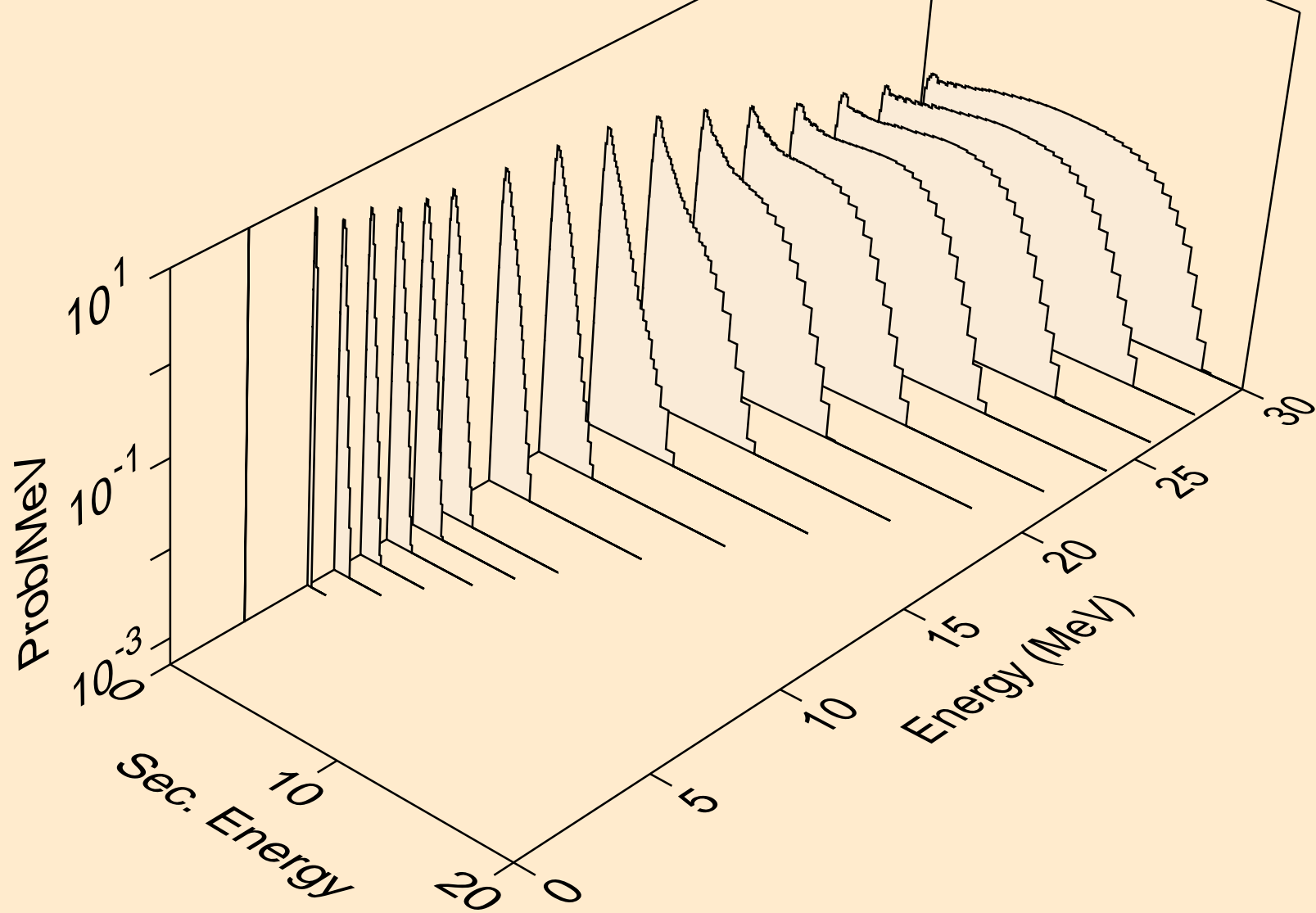

CM252 DEUTERON ACER TENDL-2021 LIBRARY; T=0.K  
neutrons from (d,n\*)d

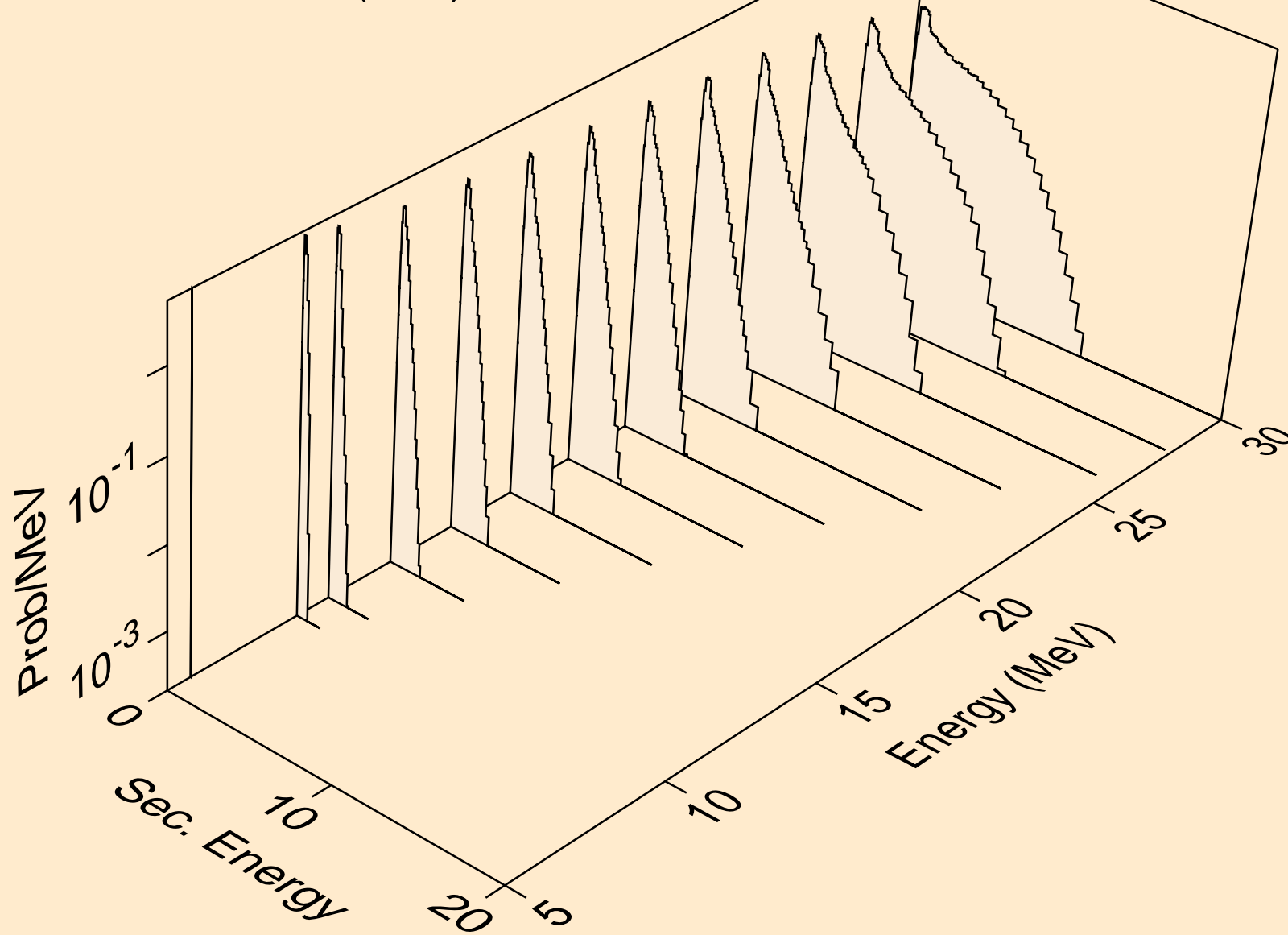



CM252 DEUTERON ACER TENDL-2021 LIBRARY; T=0.K  
neutrons from (d,n\*)t

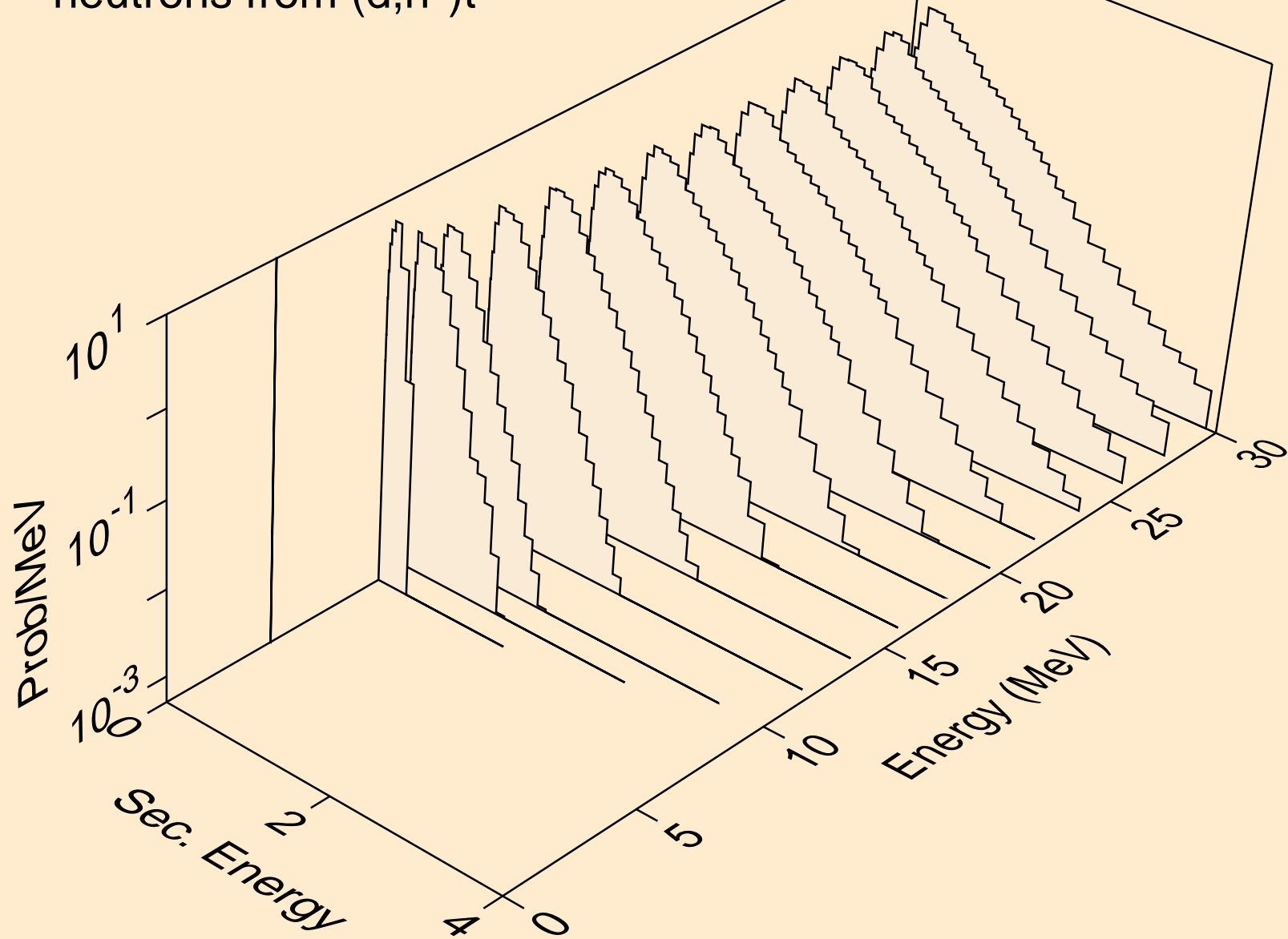

CM252 DEUTERON ACER TENDL-2021 LIBRARY; T=0.K  
neutrons from (d,n\*)he3

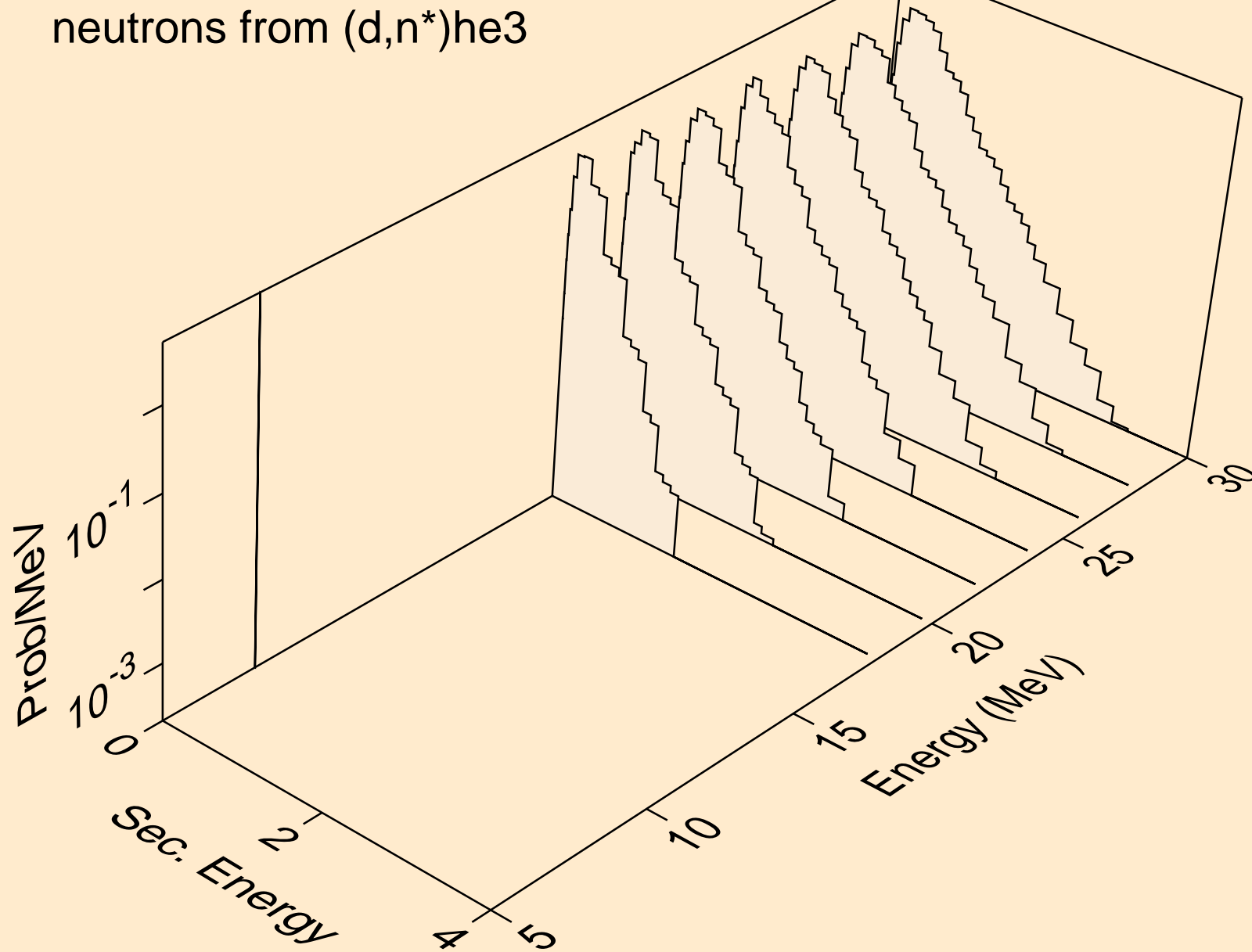

CM252 DEUTERON ACER TENDL-2021 LIBRARY; T=0.K  
neutrons from (d,4n)

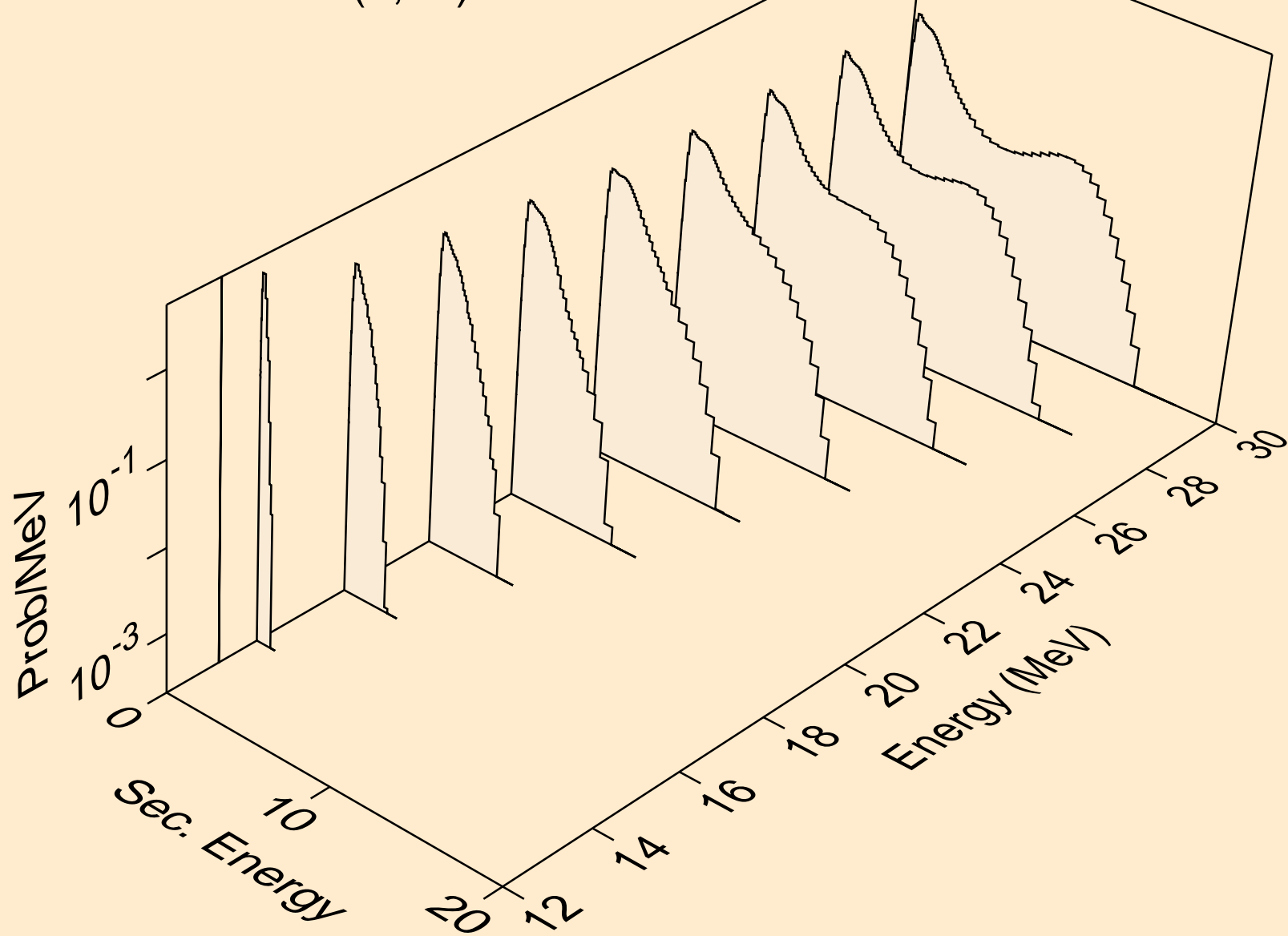

CM252 DEUTERON ACER TENDL-2021 LIBRARY; T=0.K  
neutrons from (d,2np)

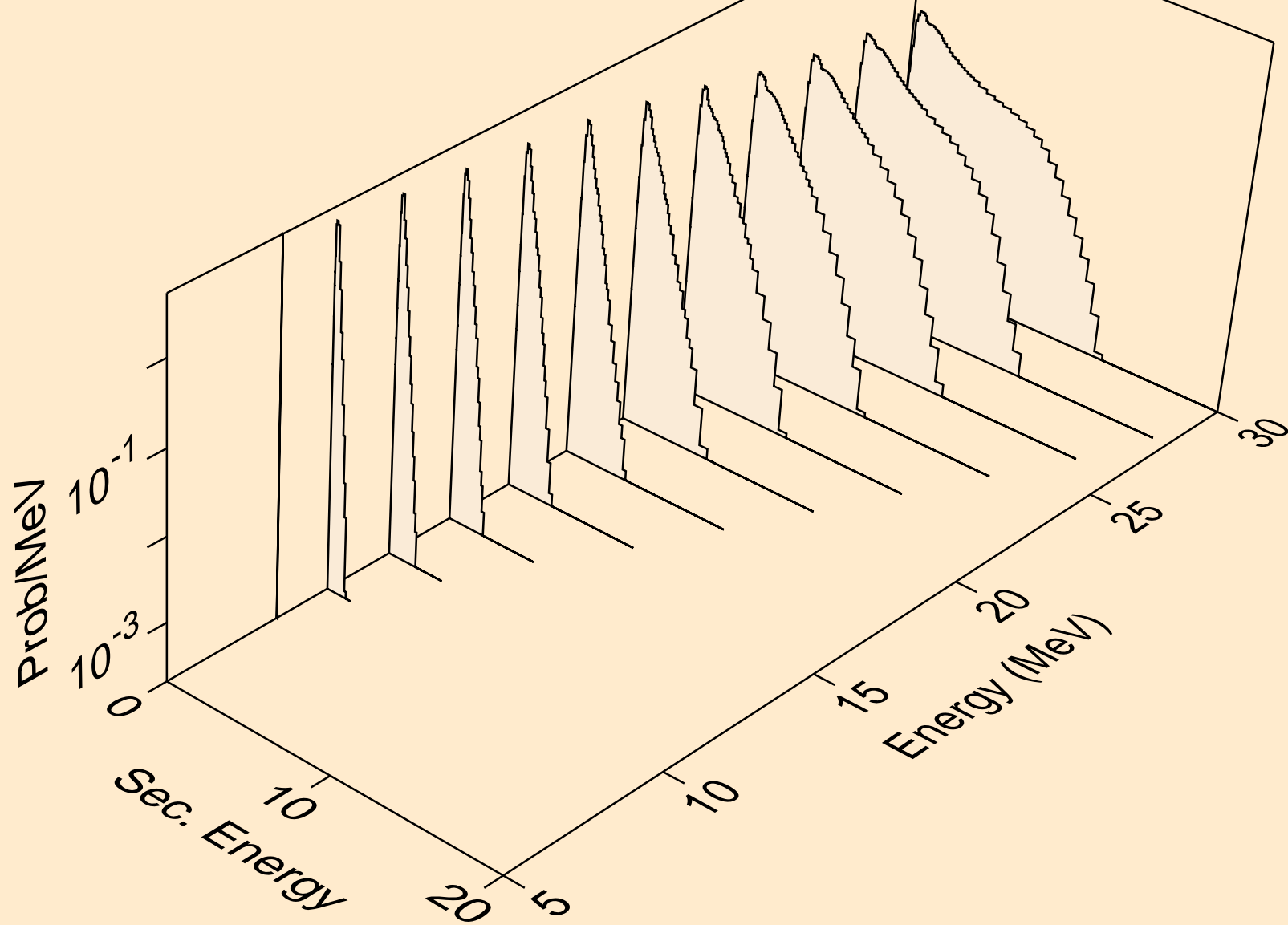

CM252 DEUTERON ACER TENDL-2021 LIBRARY; T=0.K  
neutrons from (d,3np)

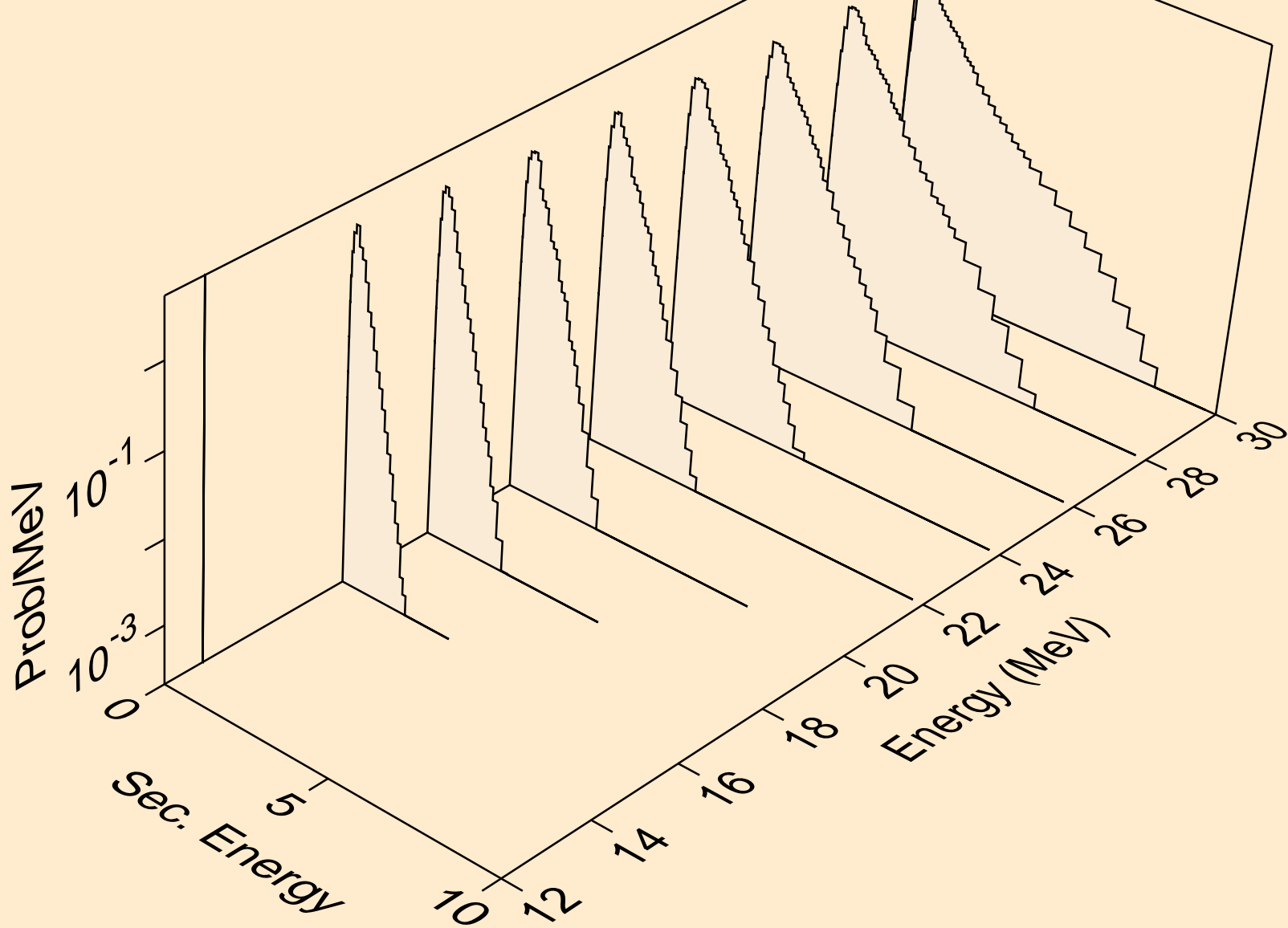

CM252 DEUTERON ACER TENDL-2021 LIBRARY; T=0.K  
neutrons from (d,2np)

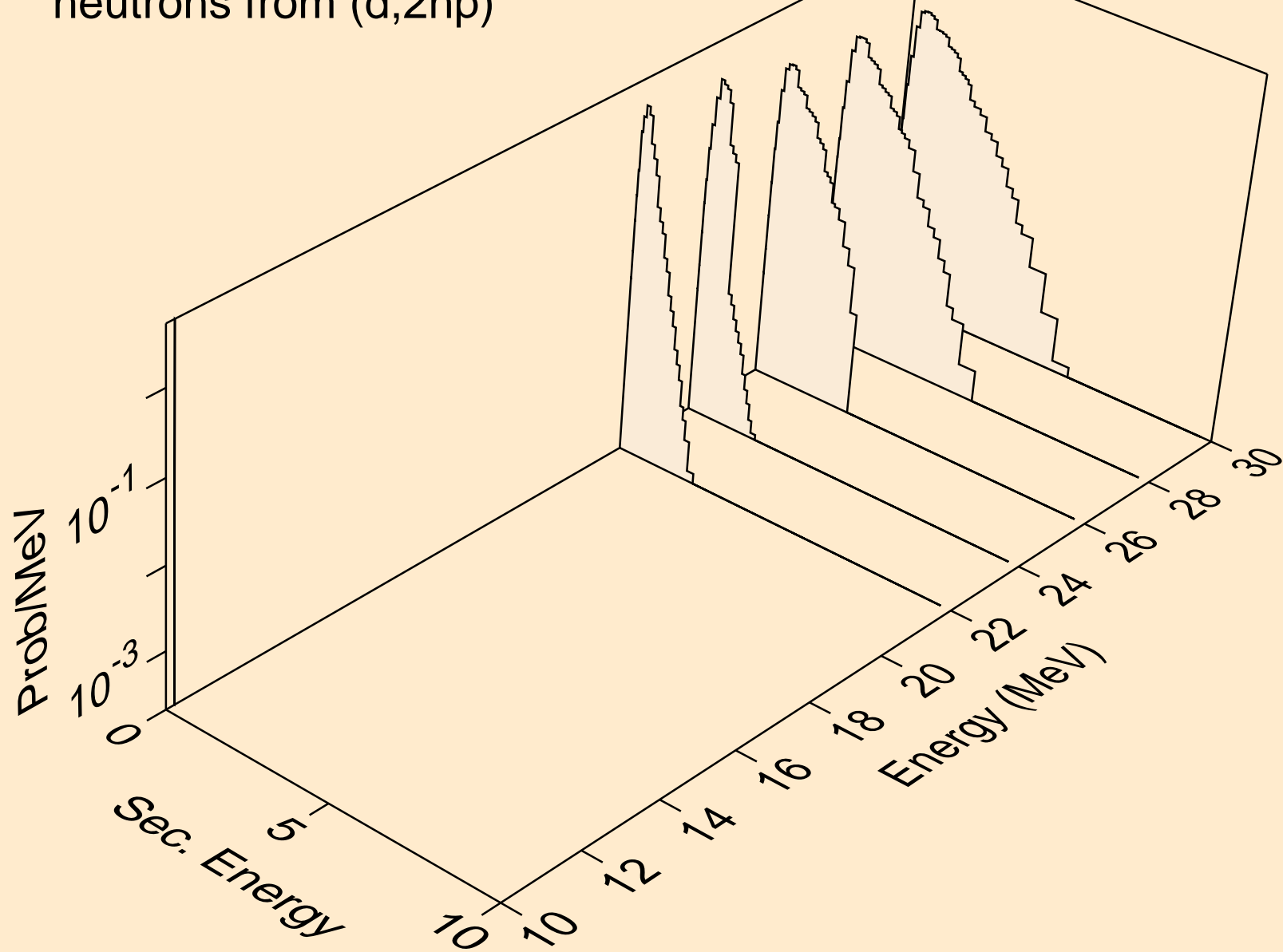

CM252 DEUTERON ACER TENDL-2021 LIBRARY; T=0.K  
protons from (d,x)

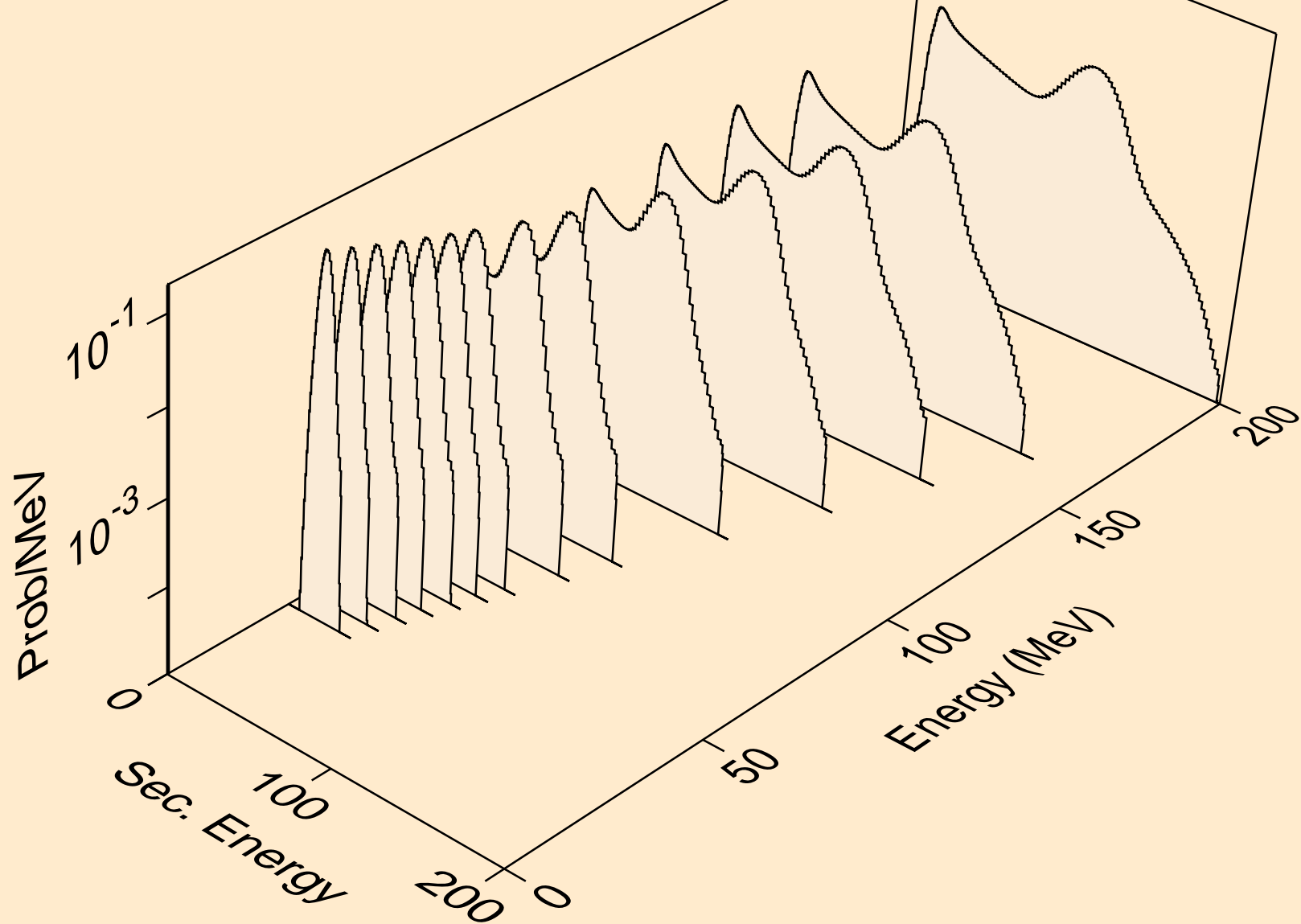

CM252 DEUTERON ACER TENDL-2021 LIBRARY; T=0.K  
protons from (d,n\*)p

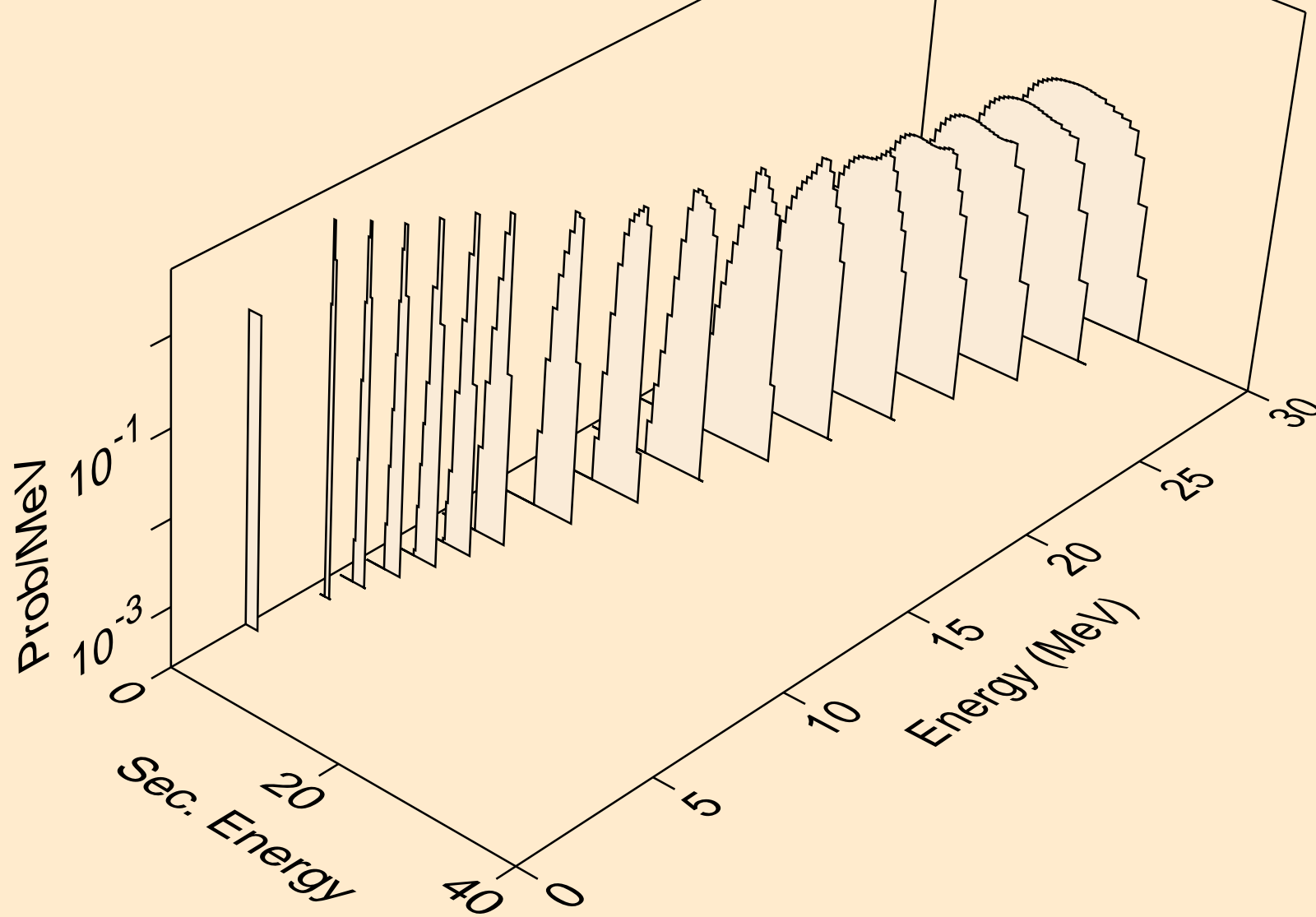



CM252 DEUTERON ACER TENDL-2021 LIBRARY; T=0.K  
protons from (d,2np)

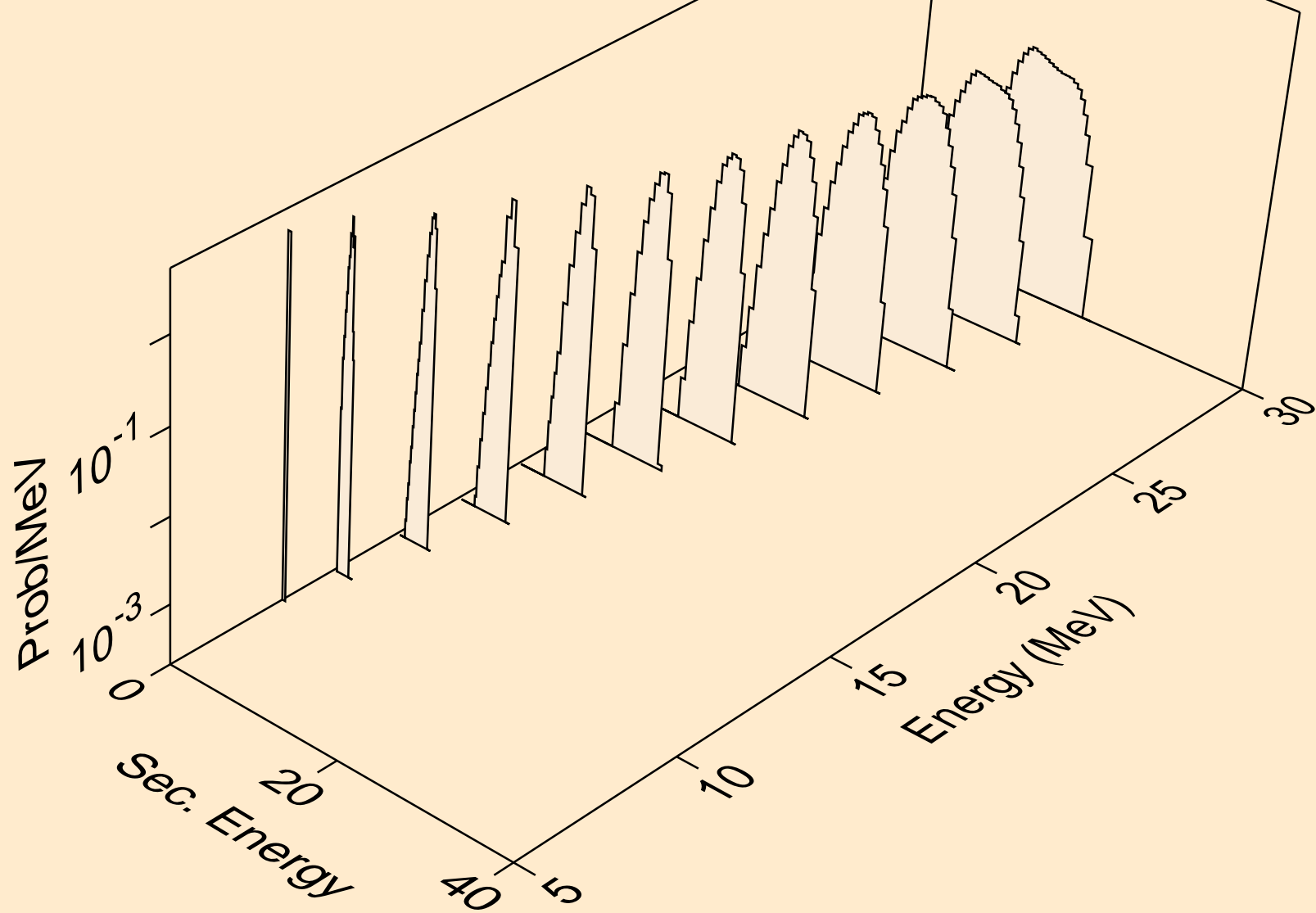

CM252 DEUTERON ACER TENDL-2021 LIBRARY; T=0.K  
protons from (d,3np)

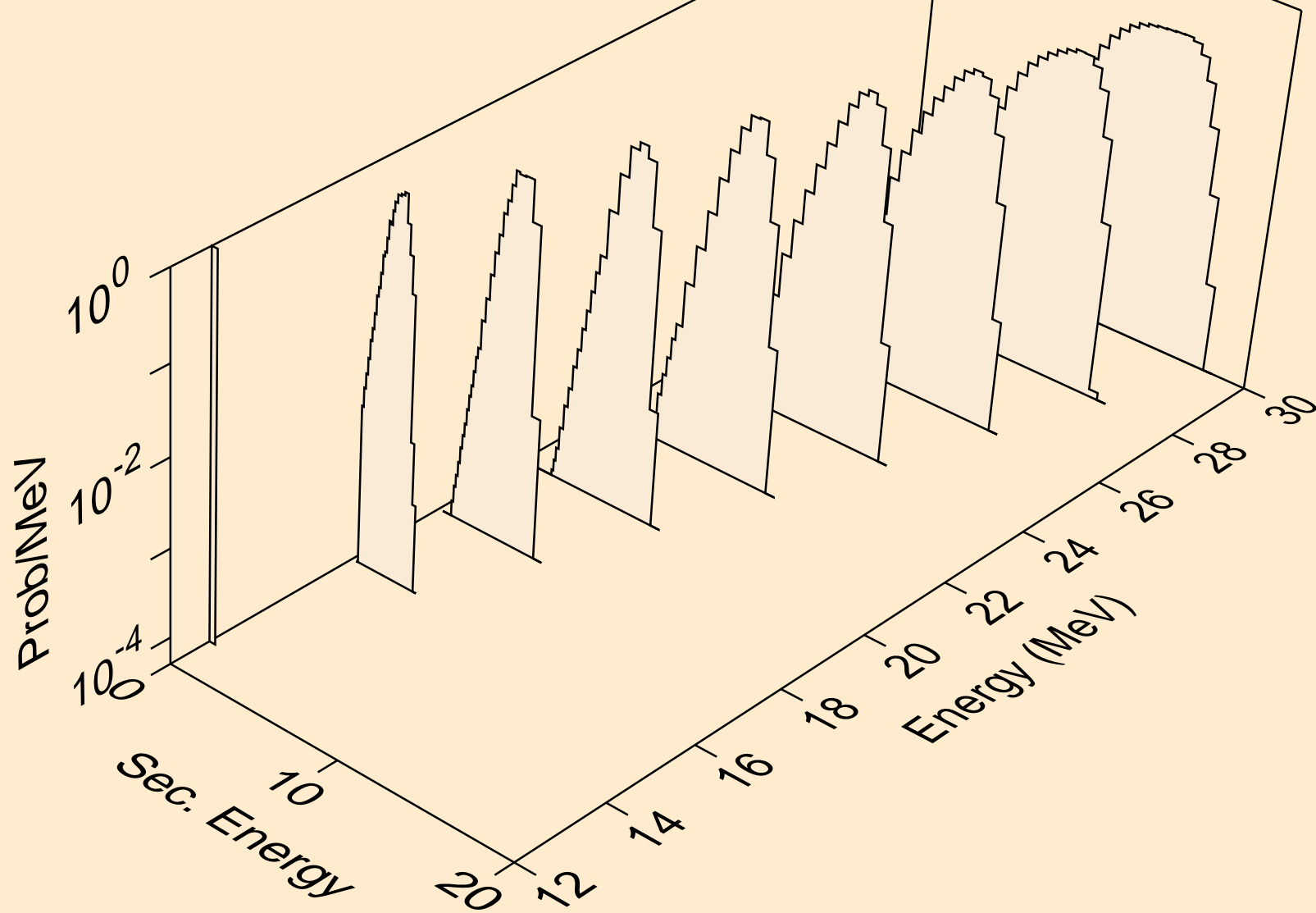

CM252 DEUTERON ACER TENDL-2021 LIBRARY; T=0.K  
protons from (d,2np)

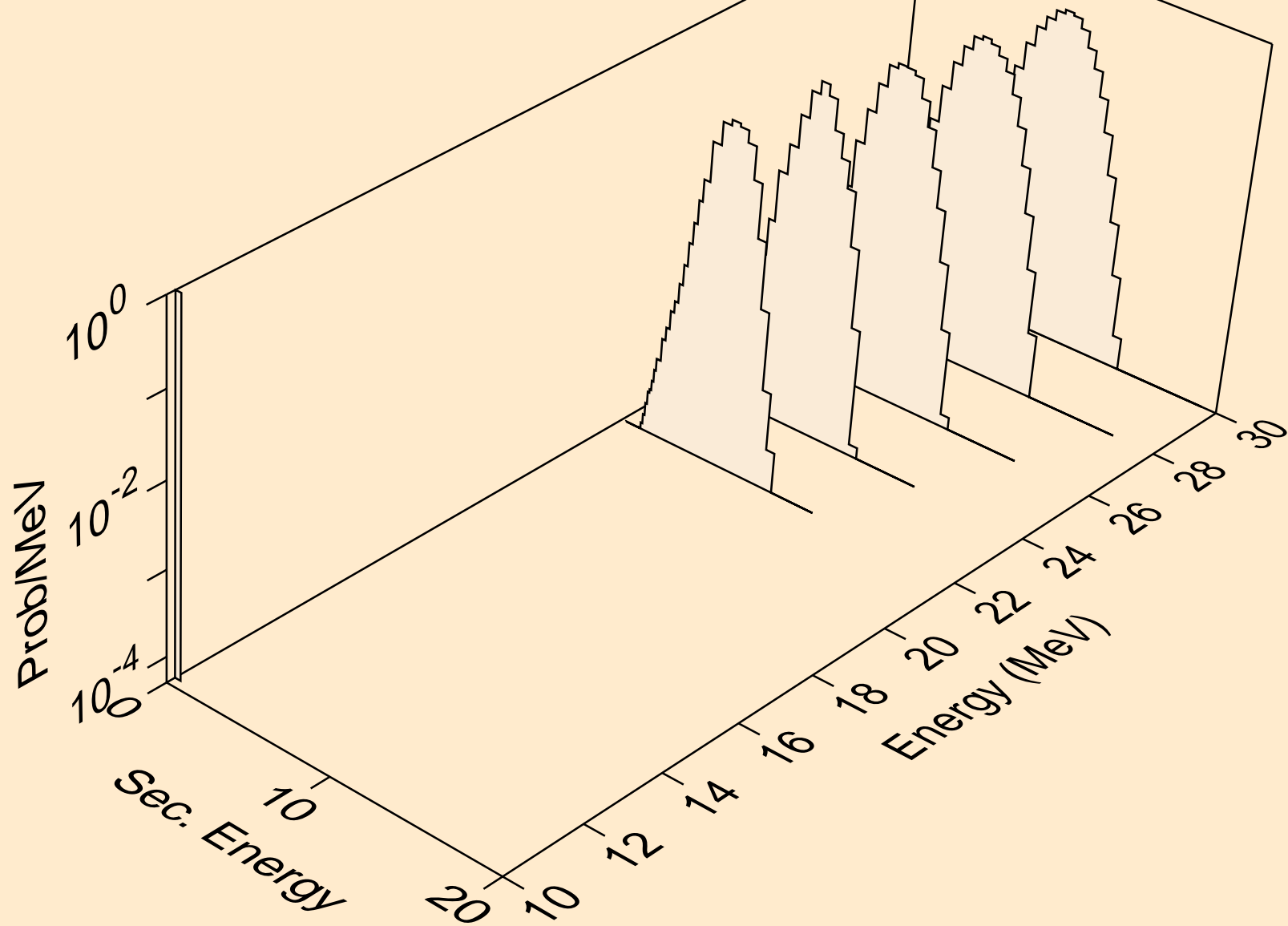

CM252 DEUTERON ACER TENDL-2021 LIBRARY; T=0.K  
protons from (d,p)

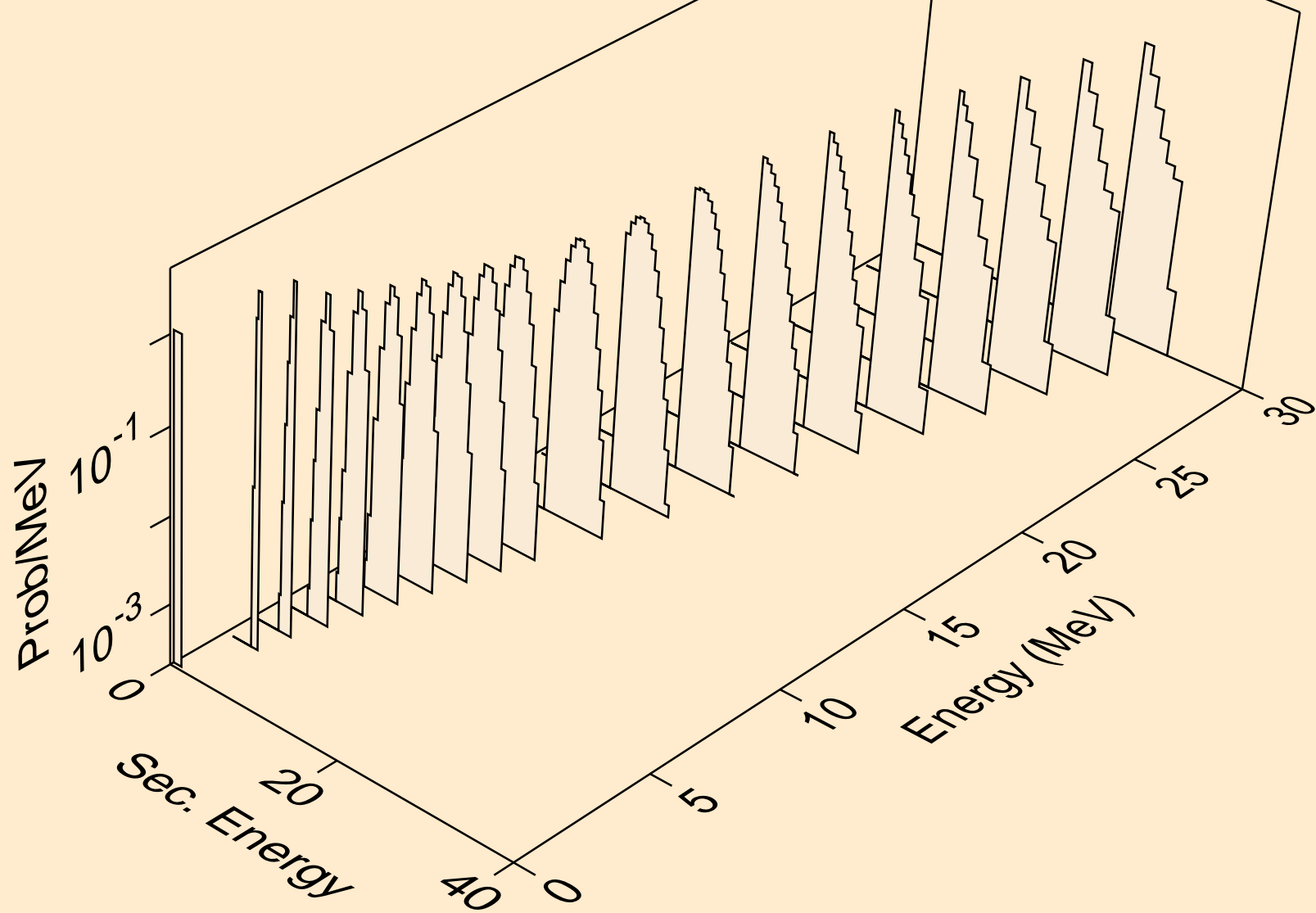

CM252 DEUTERON ACER TENDL-2021 LIBRARY; T=0.K  
protons from (d,2p)

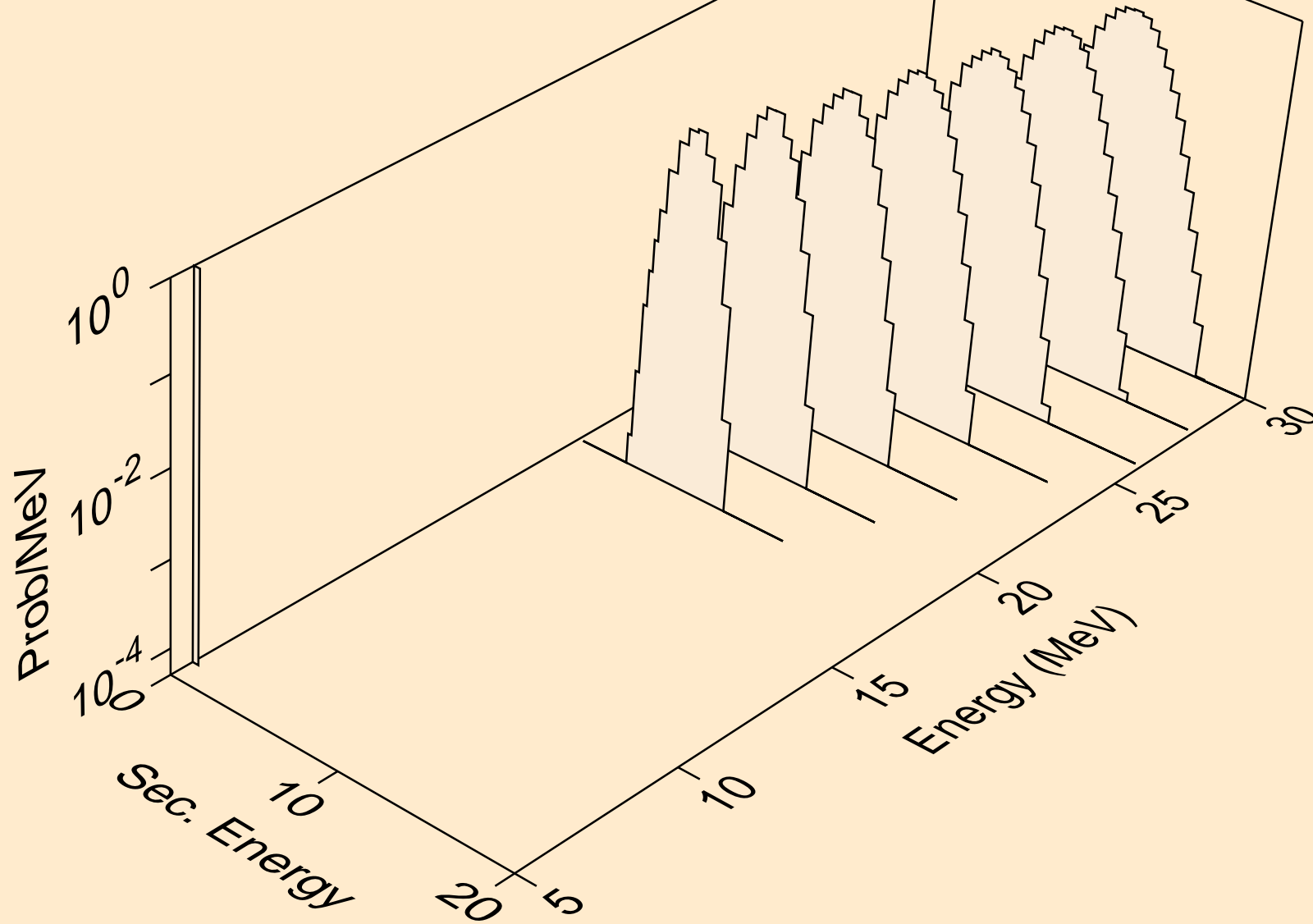

CM252 DEUTERON ACER TENDL-2021 LIBRARY; T=0.K  
protons from (d,pd)

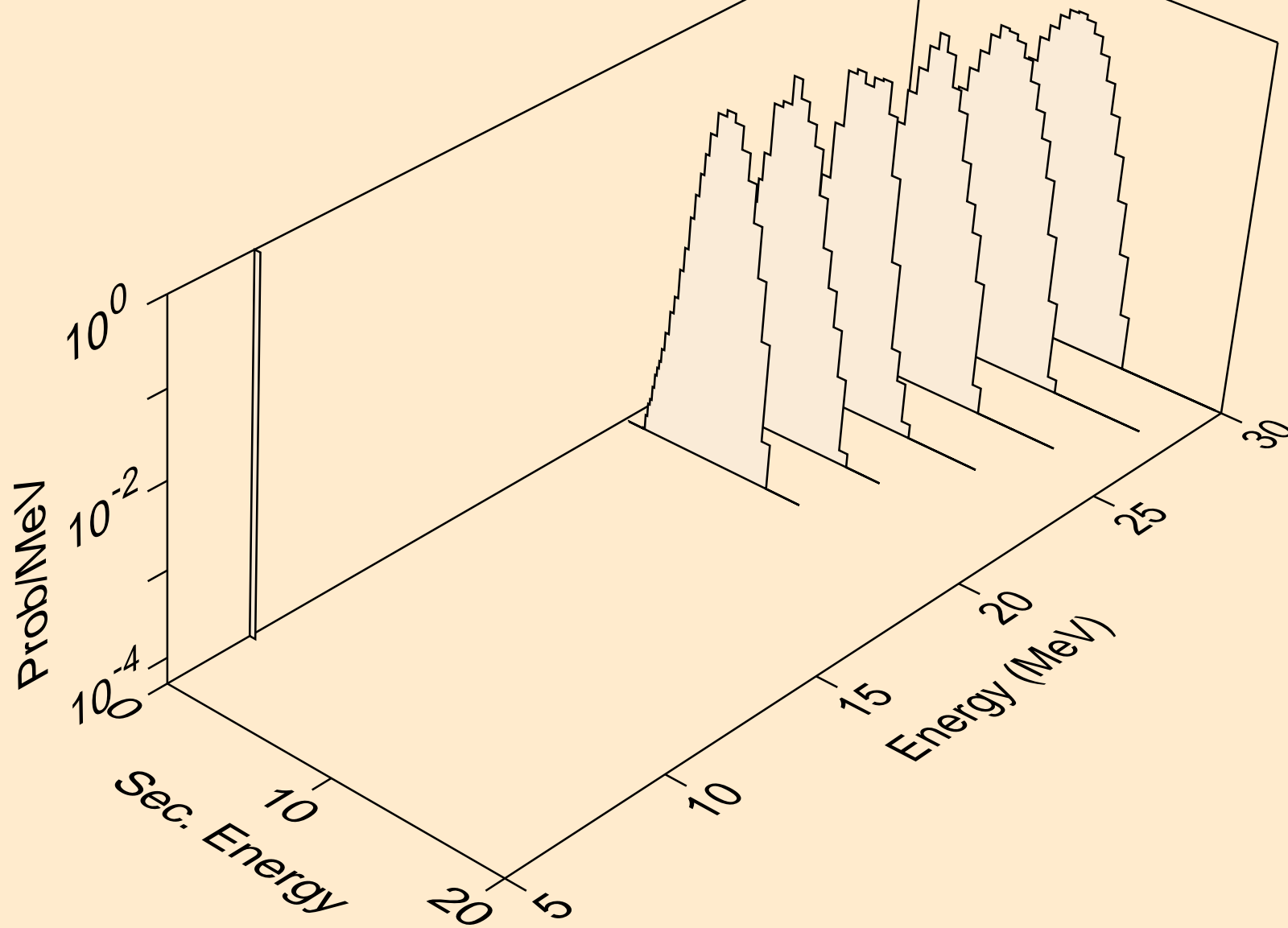

CM252 DEUTERON ACER TENDL-2021 LIBRARY; T=0.K  
tritons from (d,x)

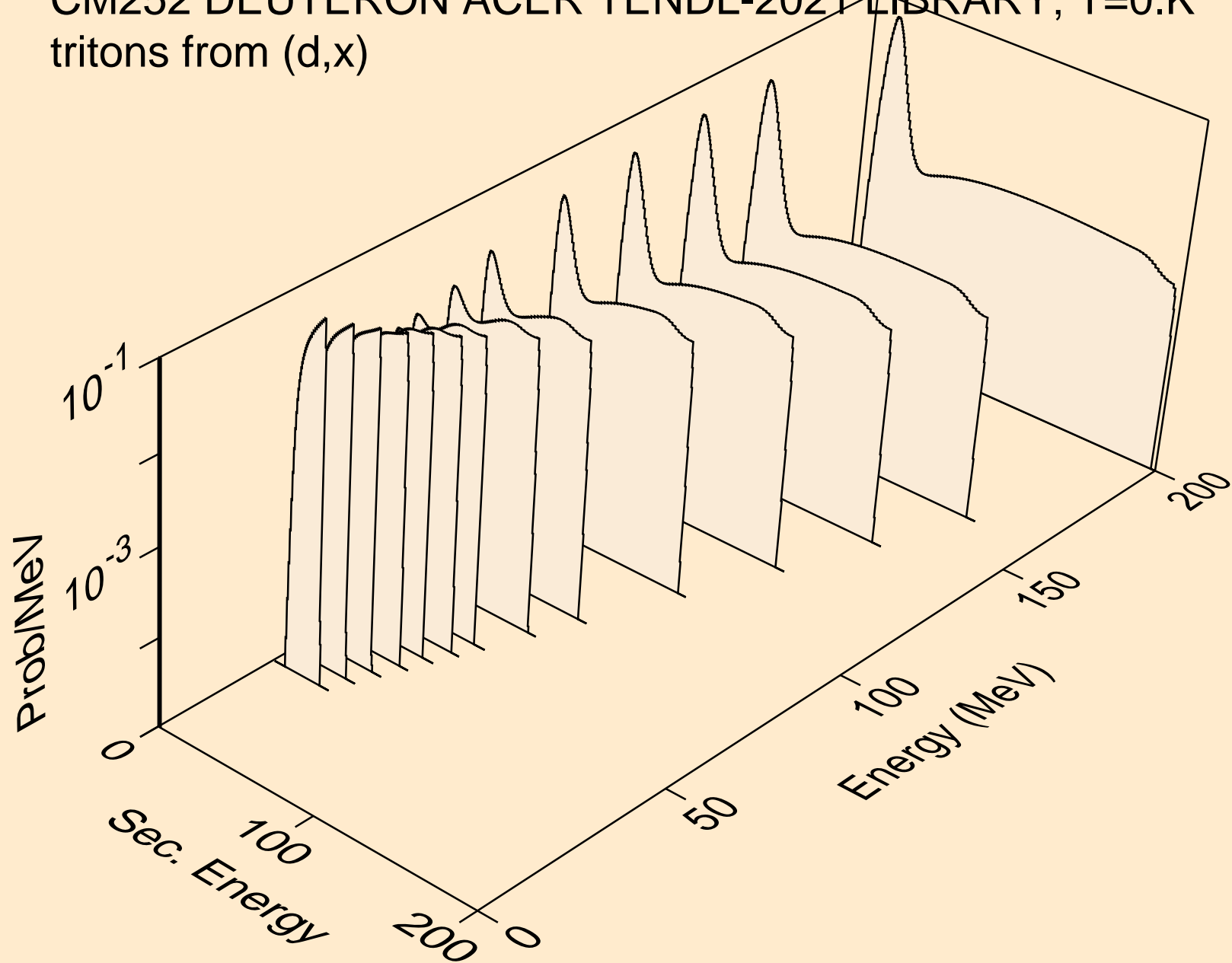

CM252 DEUTERON ACER TENDL-2021 LIBRARY; T=0.K  
tritons from (d,n\*)t

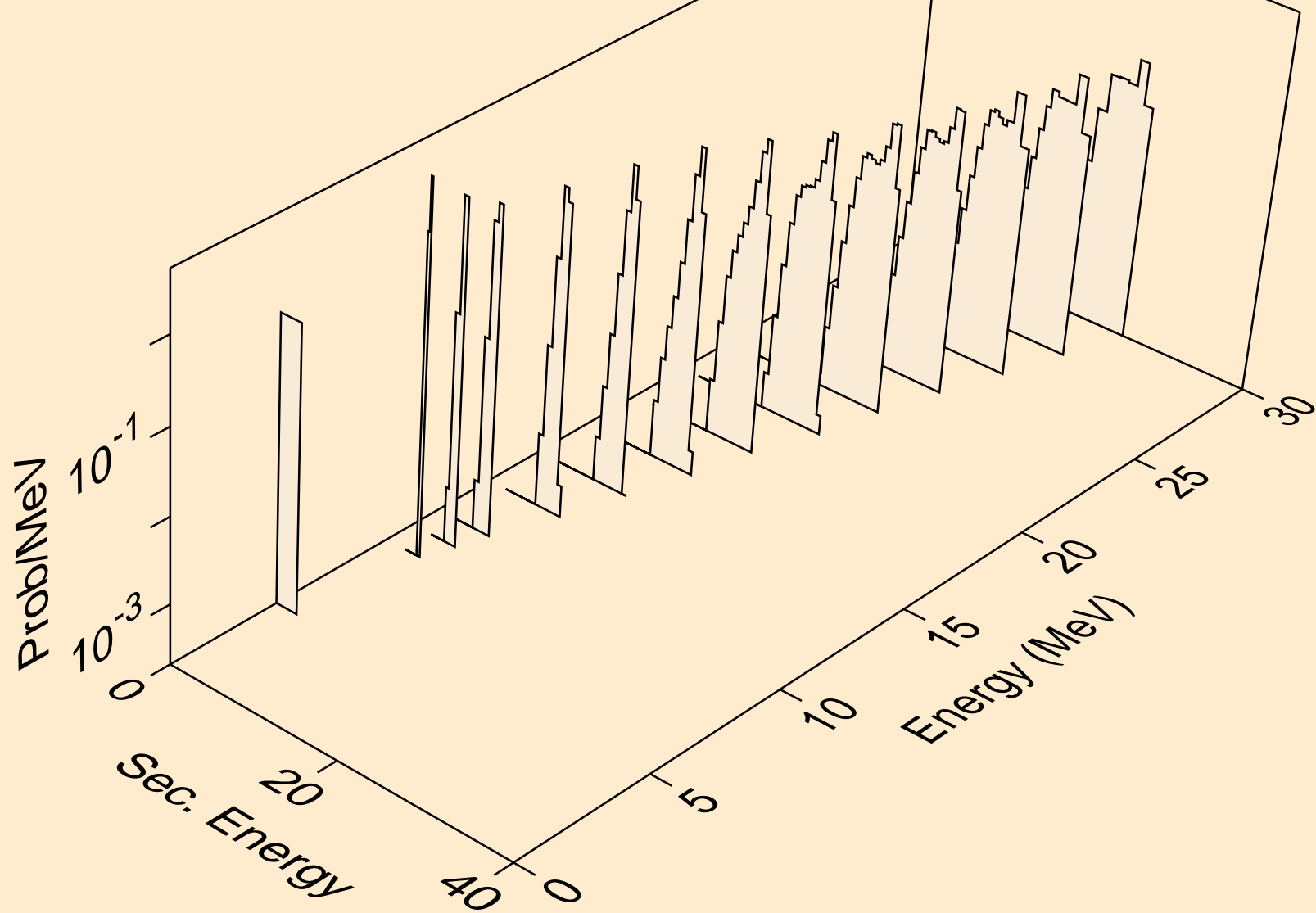



CM252 DEUTERON ACER TENDL-2021 LIBRARY; T=0.K  
tritons from (d,t)

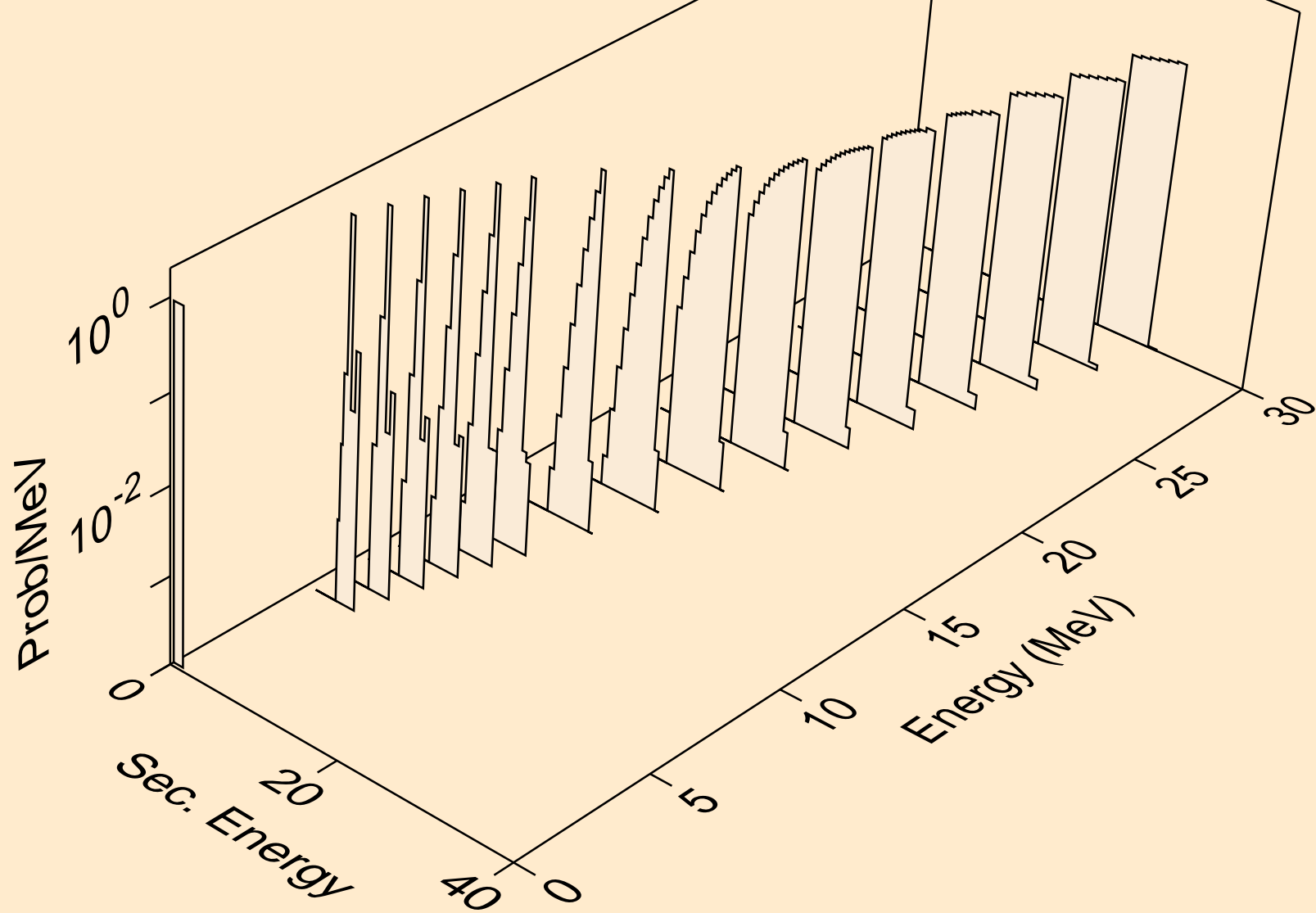

CM252 DEUTERON ACER TENDL-2021 LIBRARY; T=0.K  
he3s from (d,x)

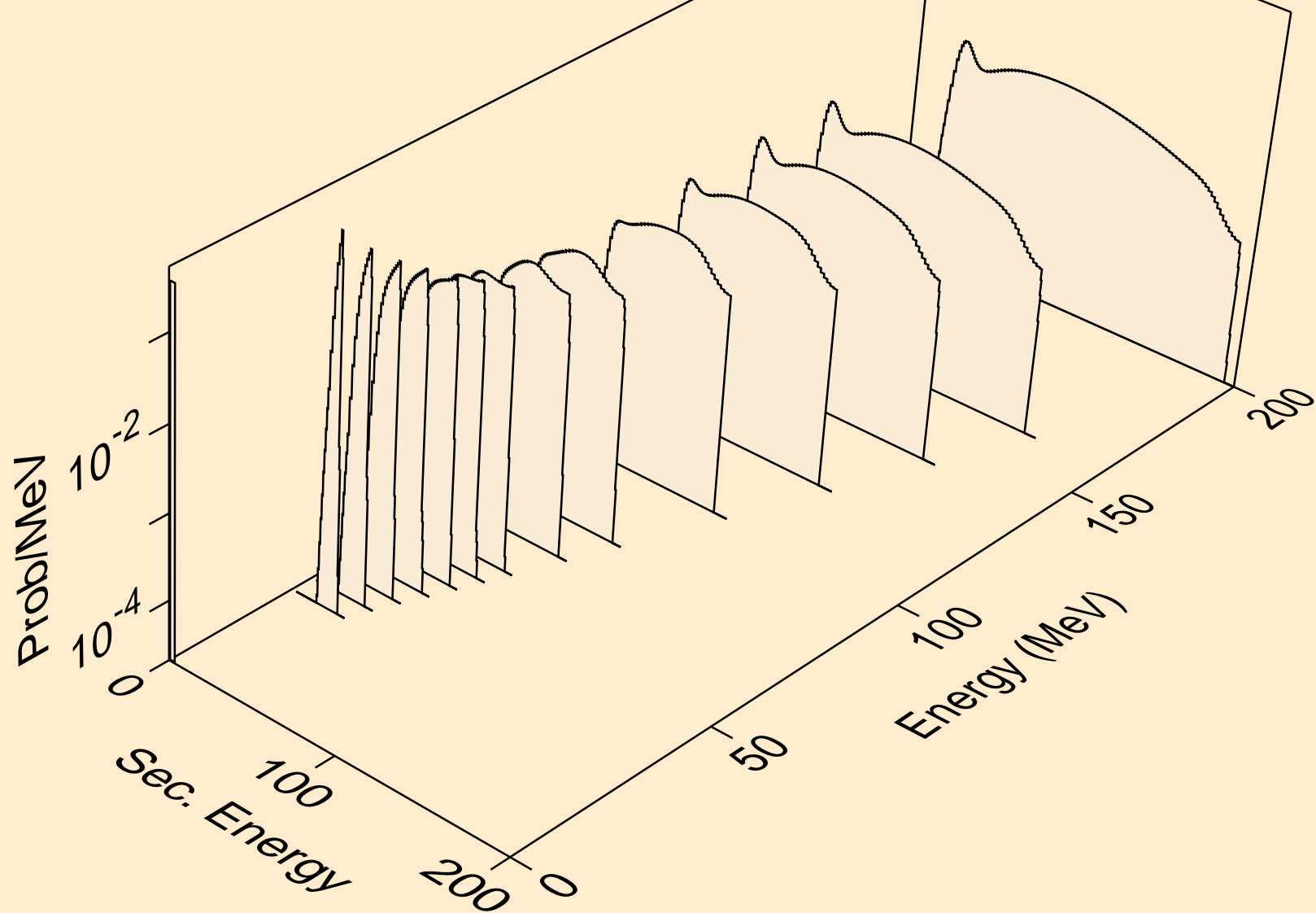

CM252 DEUTERON ACER TENDL-2021 LIBRARY; T=0.K  
he3s from (d,n\*)he3

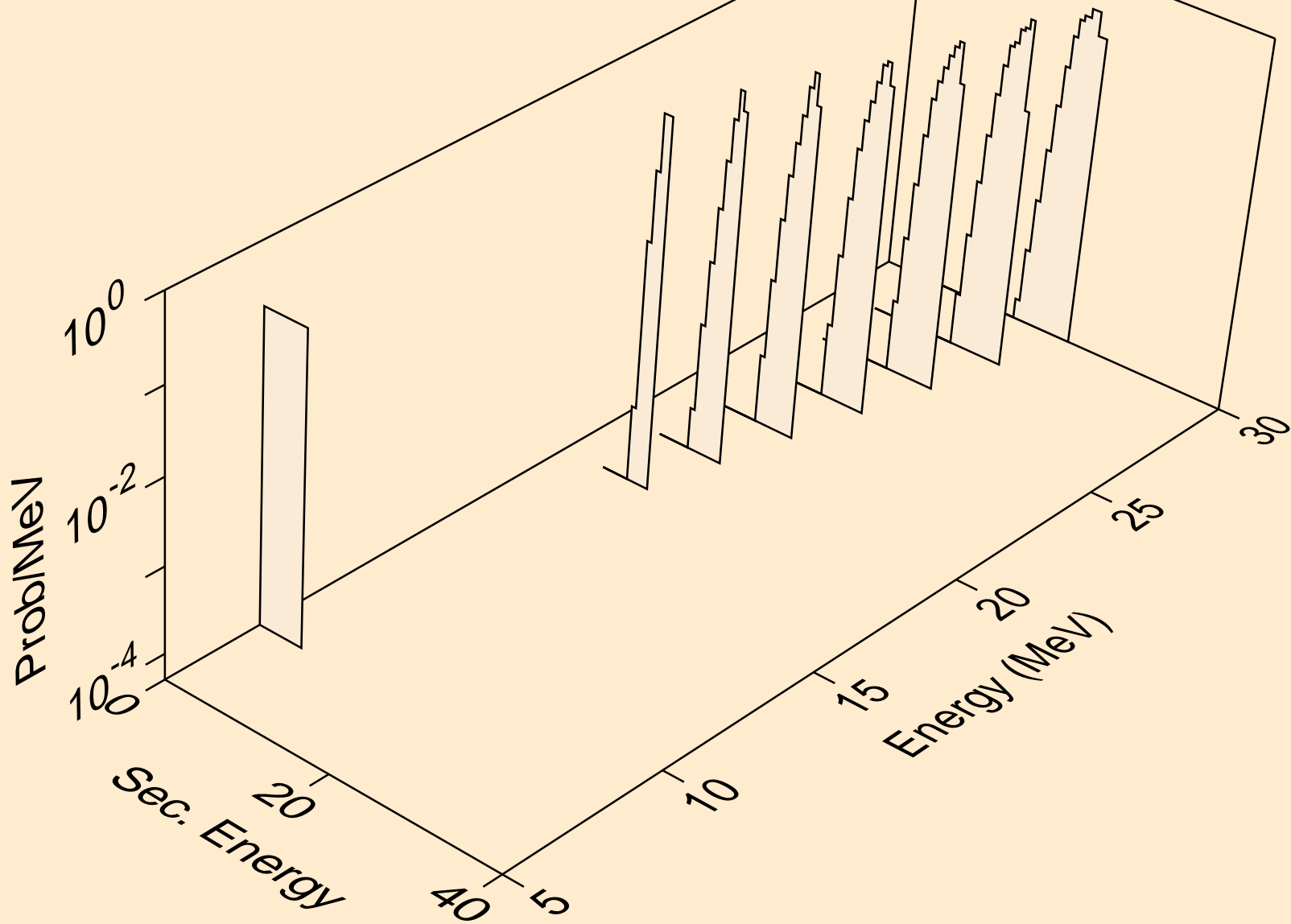

CM252 DEUTERON ACER TENDL-2021 LIBRARY; T=0.K  
he3s from (d,he3)

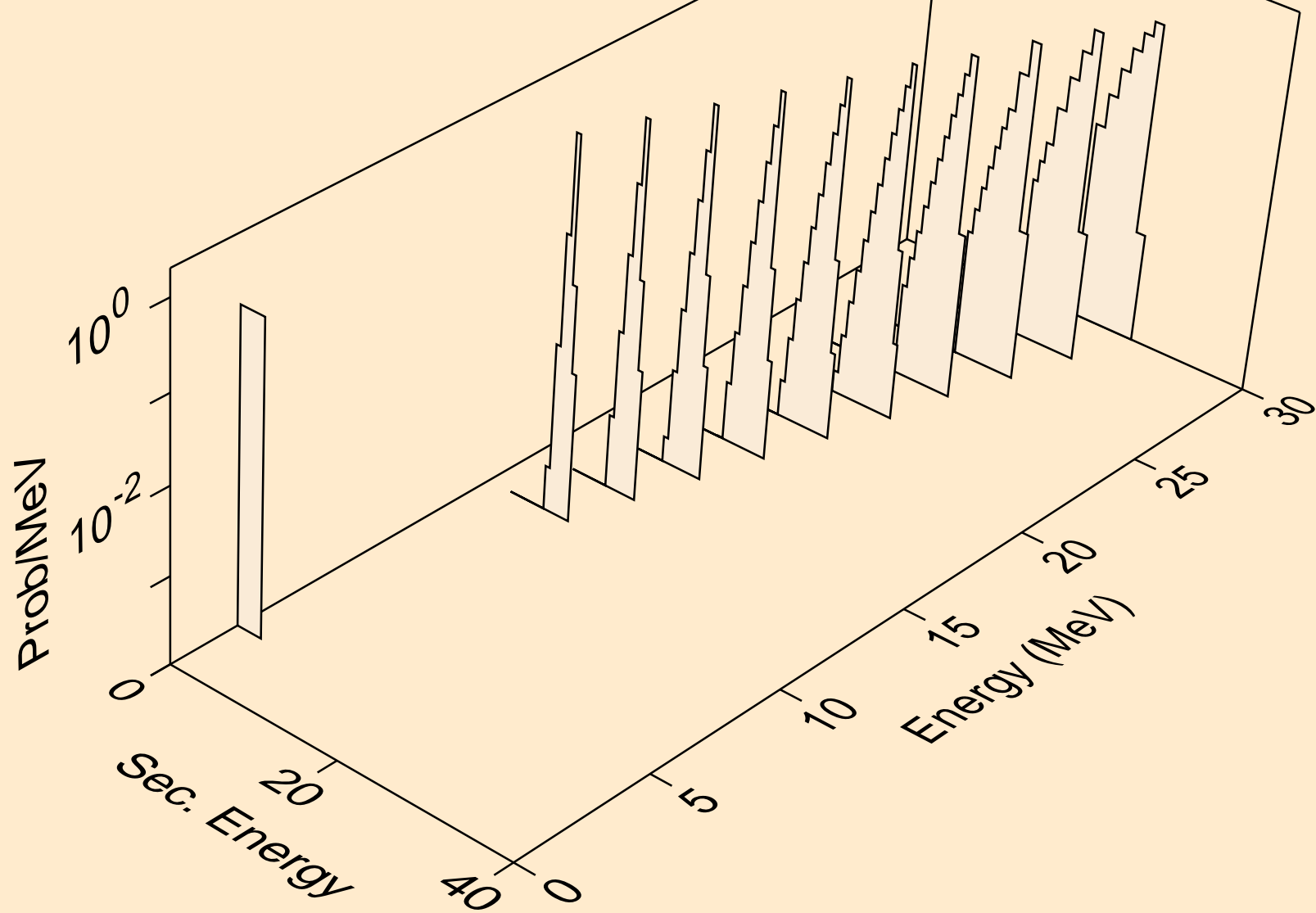

CM252 DEUTERON ACER TENDL-2021 LIBRARY; T=0.K  
alphas from (d,x)

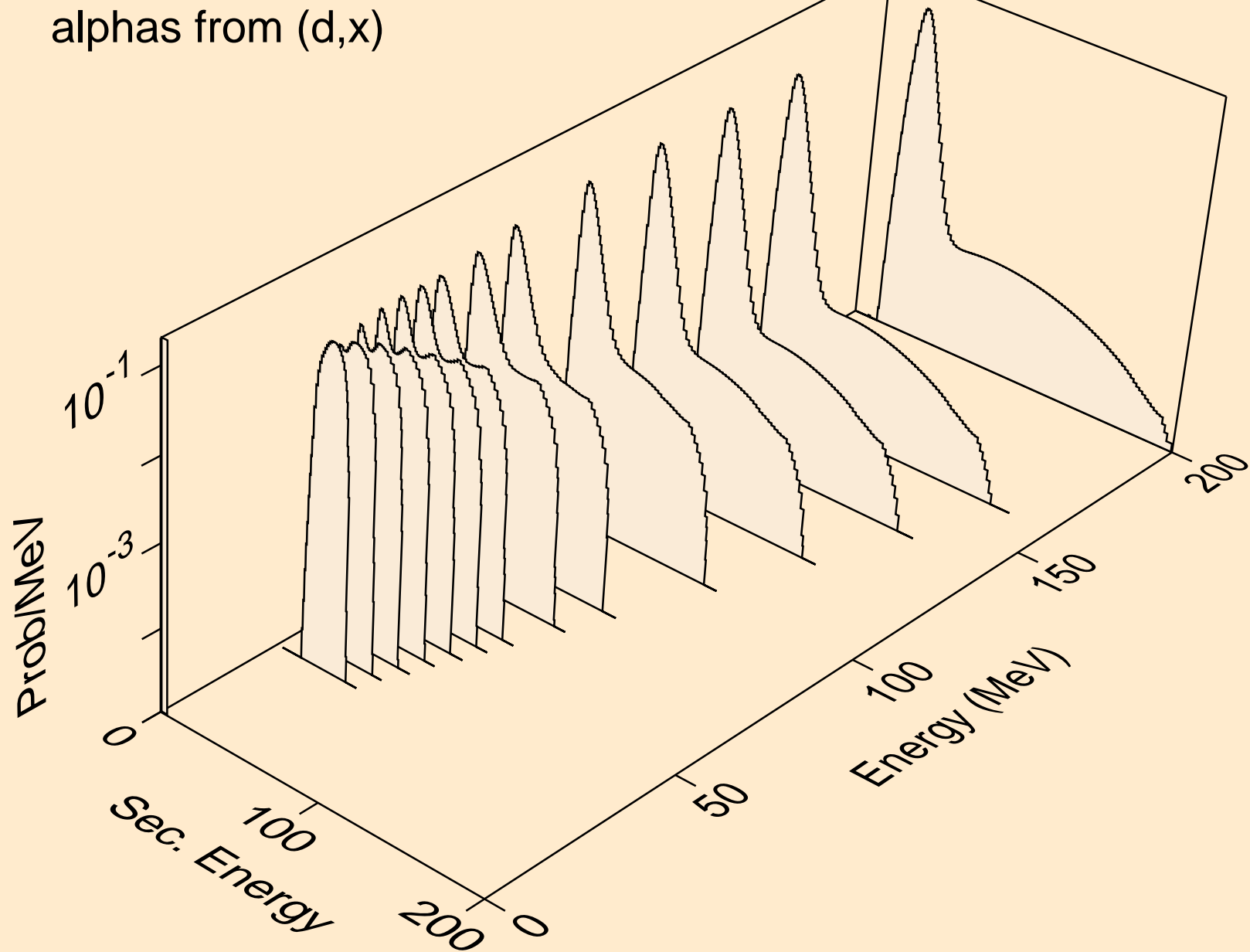

CM252 DEUTERON ACER TENDL-2021 LIBRARY; T=0.K  
alphas from (d,n\*)a

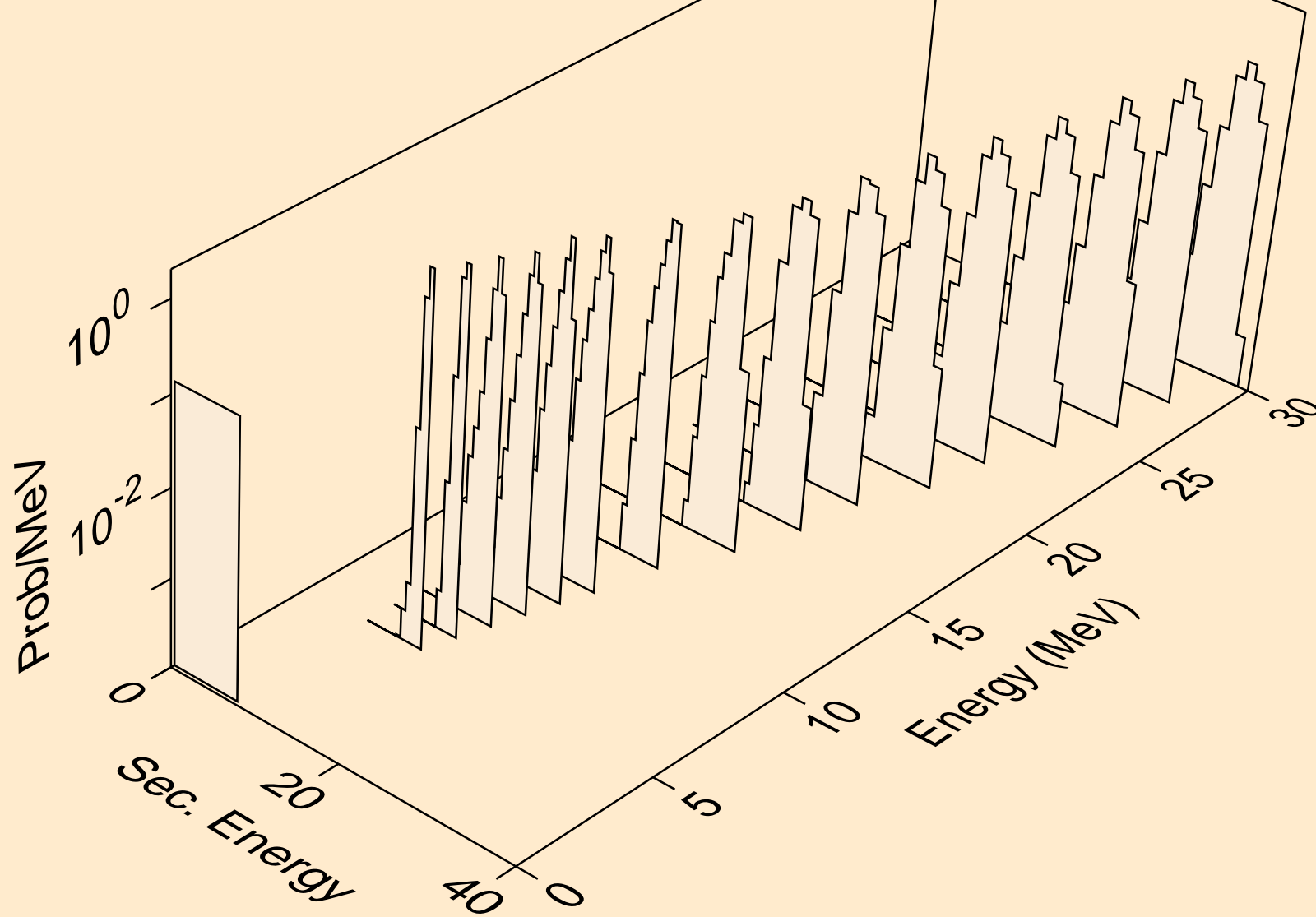

CM252 DEUTERON ACER TENDL-2021 LIBRARY; T=0.K  
alphas from (d,2n)a

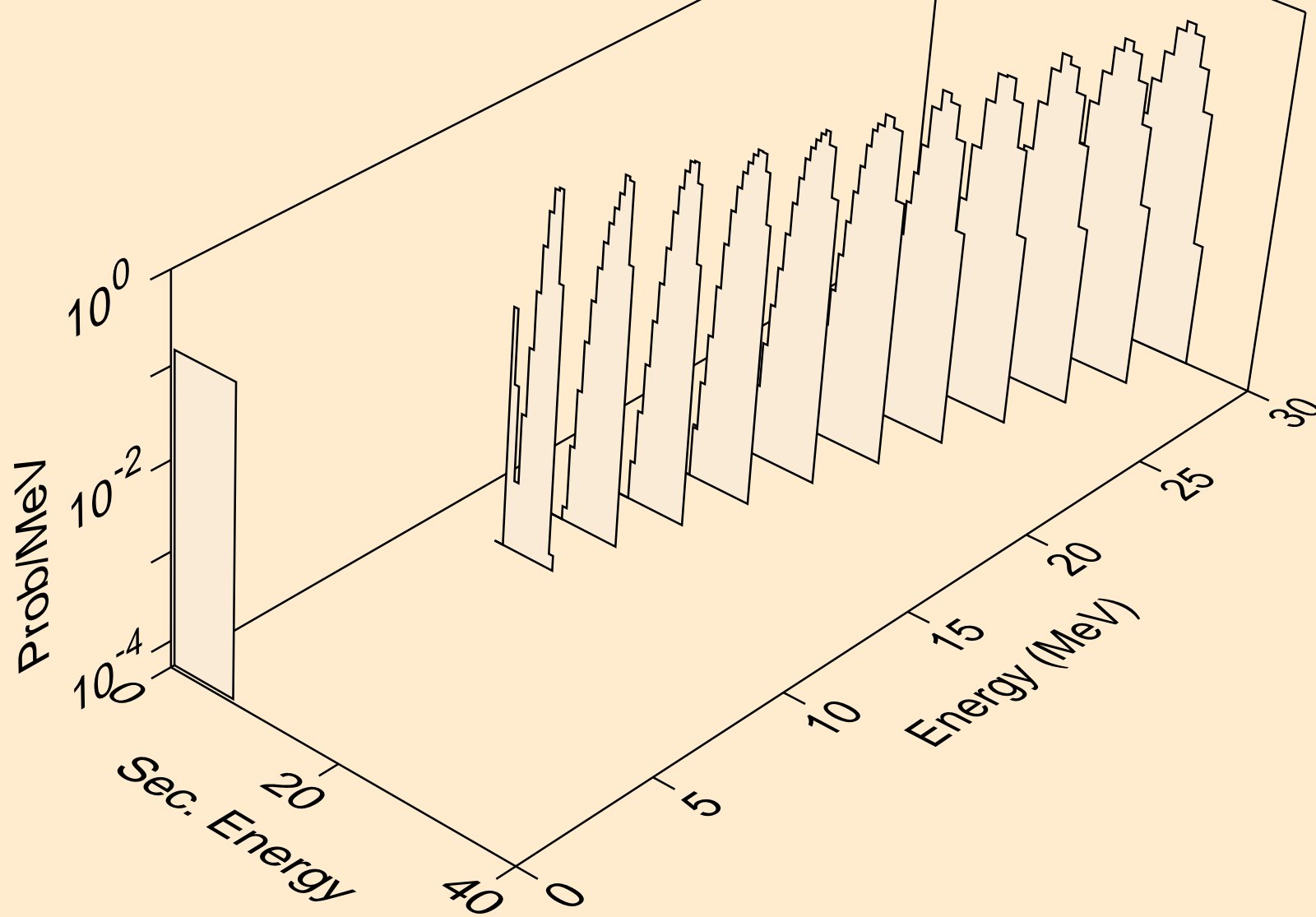

CM252 DEUTERON ACER TENDL-2021 LIBRARY; T=0.K  
alphas from (d,3n)a

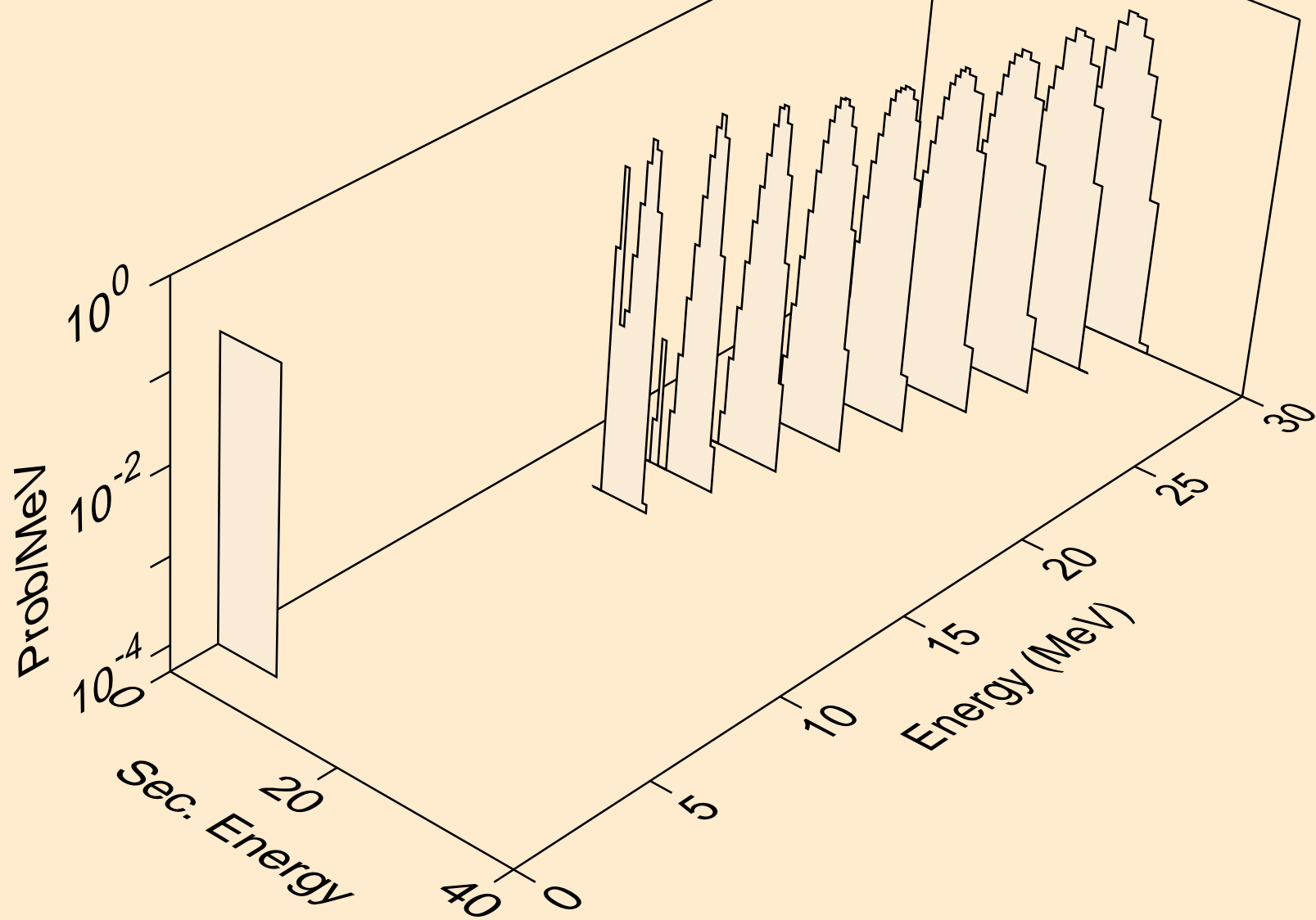



CM252 DEUTERON ACER TENDL-2021 LIBRARY; T=0.K  
alphas from (d,a)

