

DB261 DEUTERON ACER TENDL-2021 LIBRARY; T=0.K
Principal cross sections

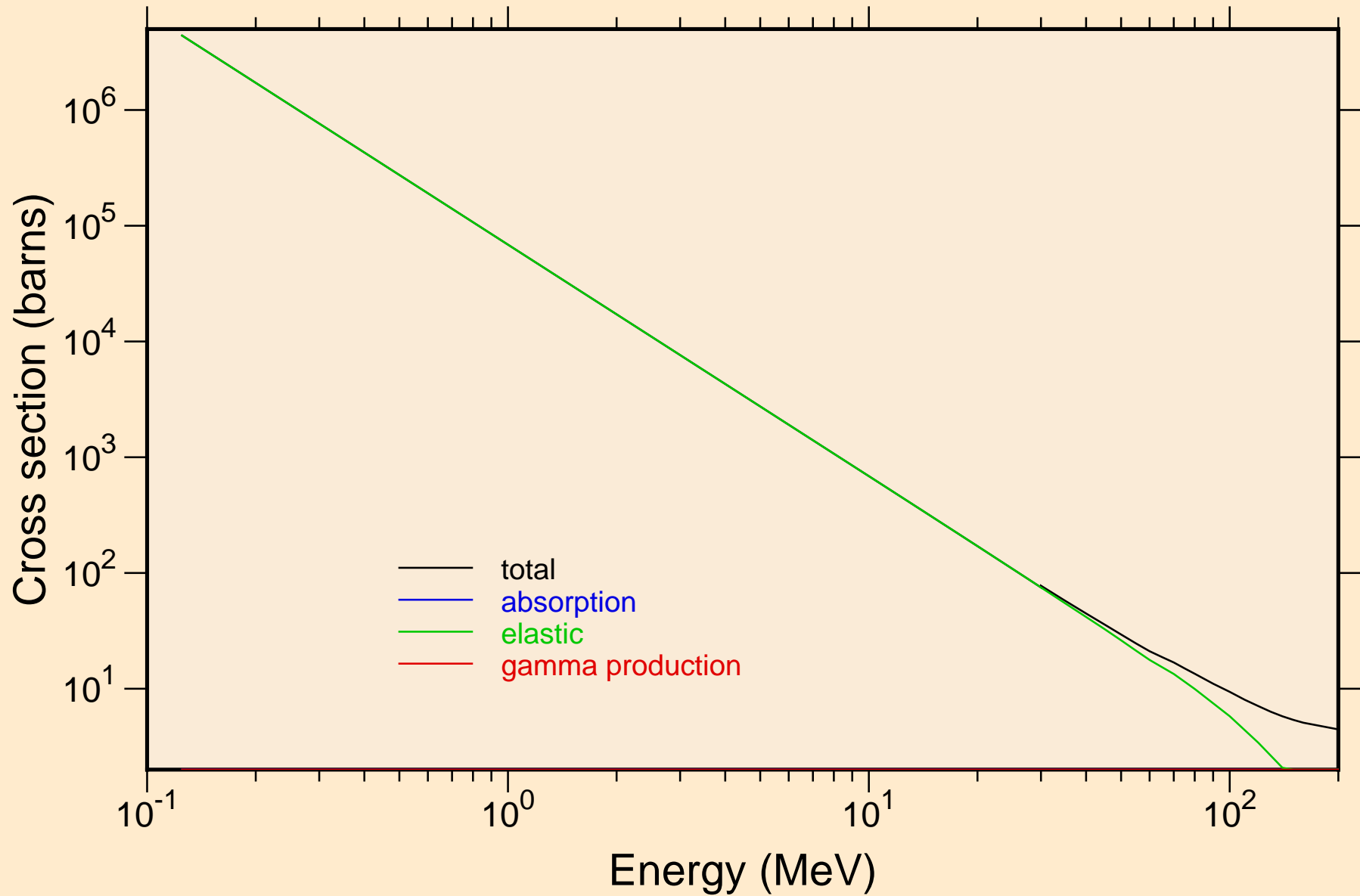

DB261 DEUTERON ACER TENDL-2021 LIBRARY; T=0.K
Heating

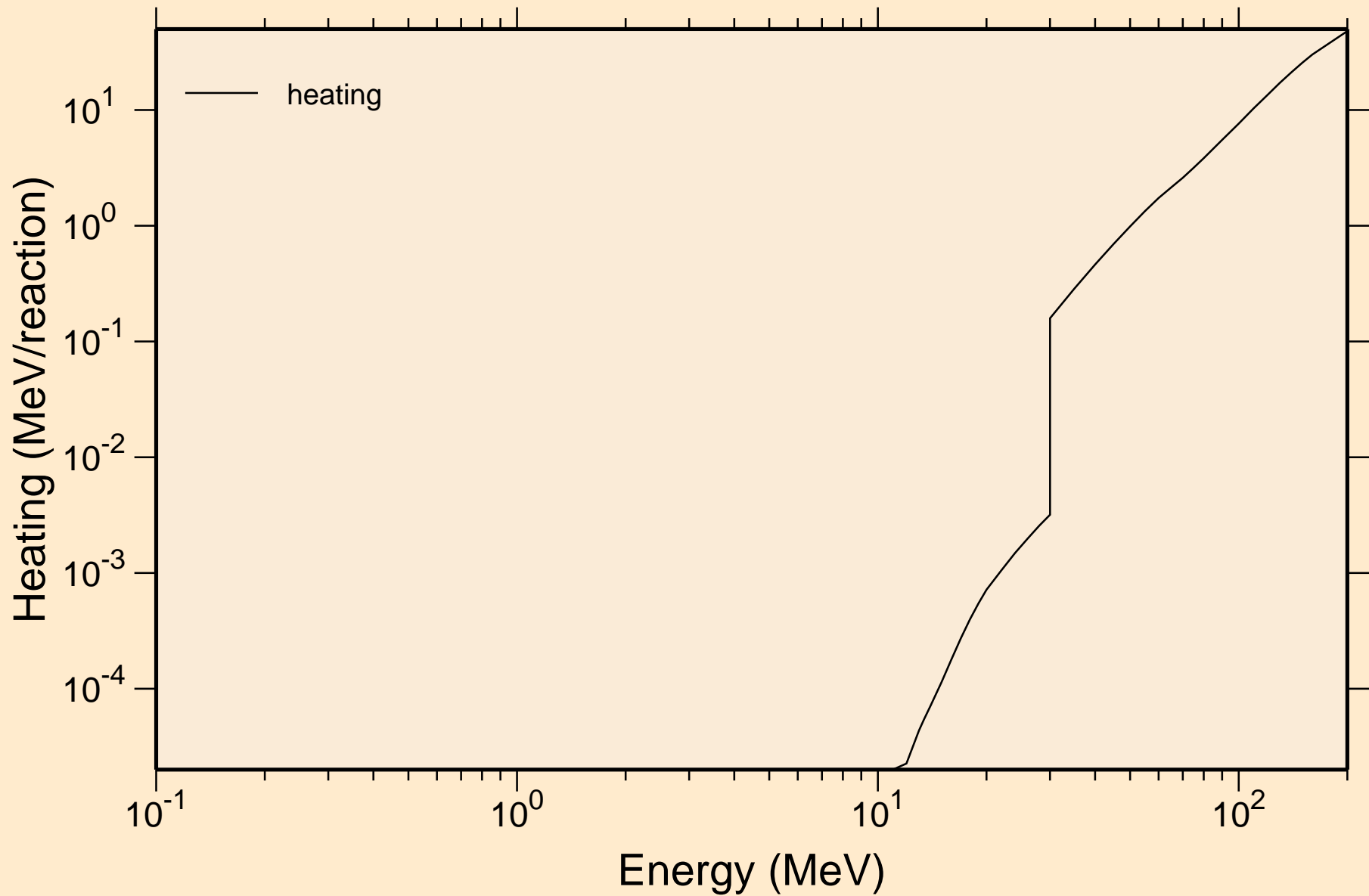

DB261 DEUTERON ACER TENDL-2021 LIBRARY; T=0.K
Principal cross sections

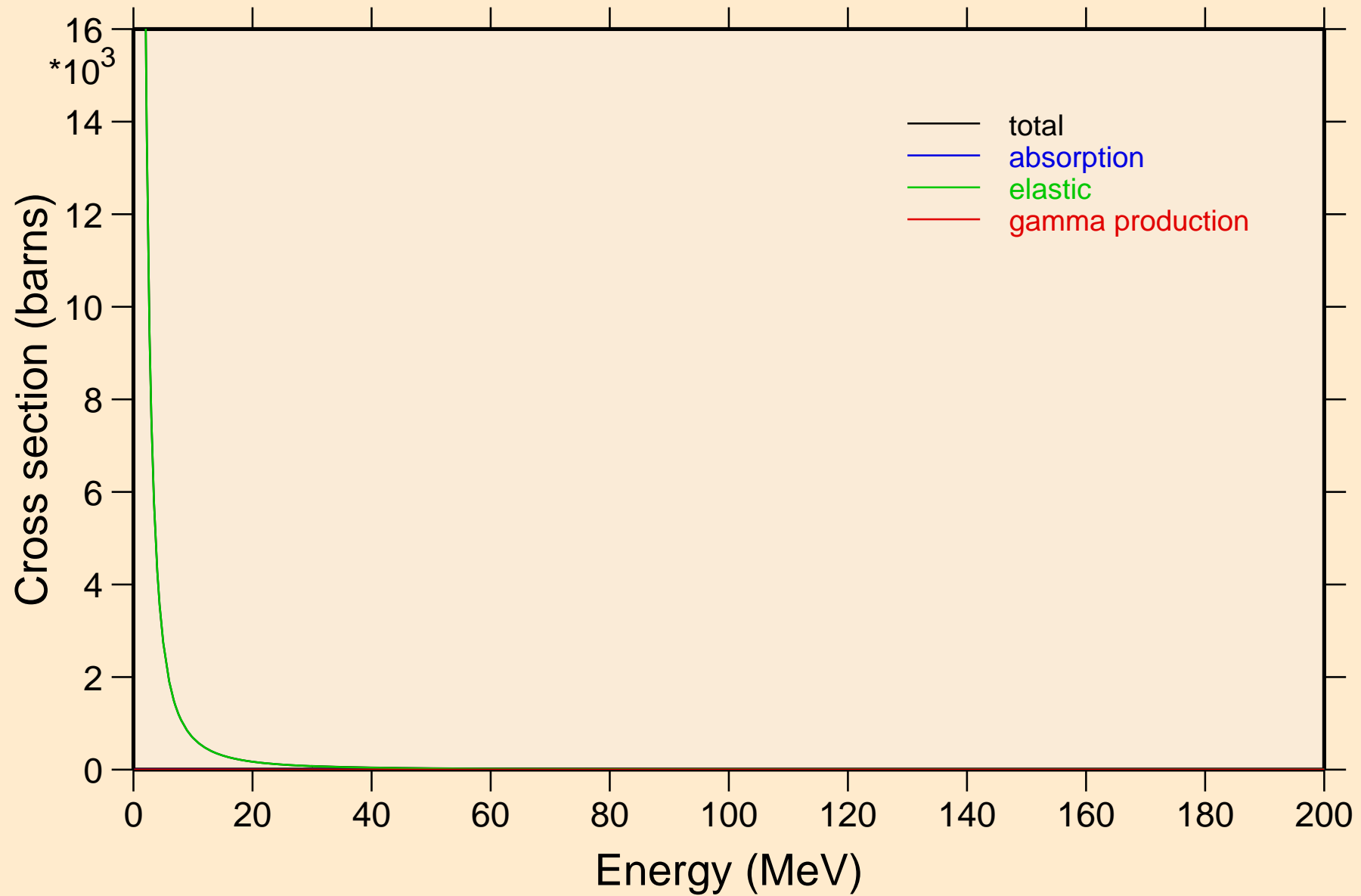

DB261 DEUTERON ACER TENDL-2021 LIBRARY; T=0.K

Heating

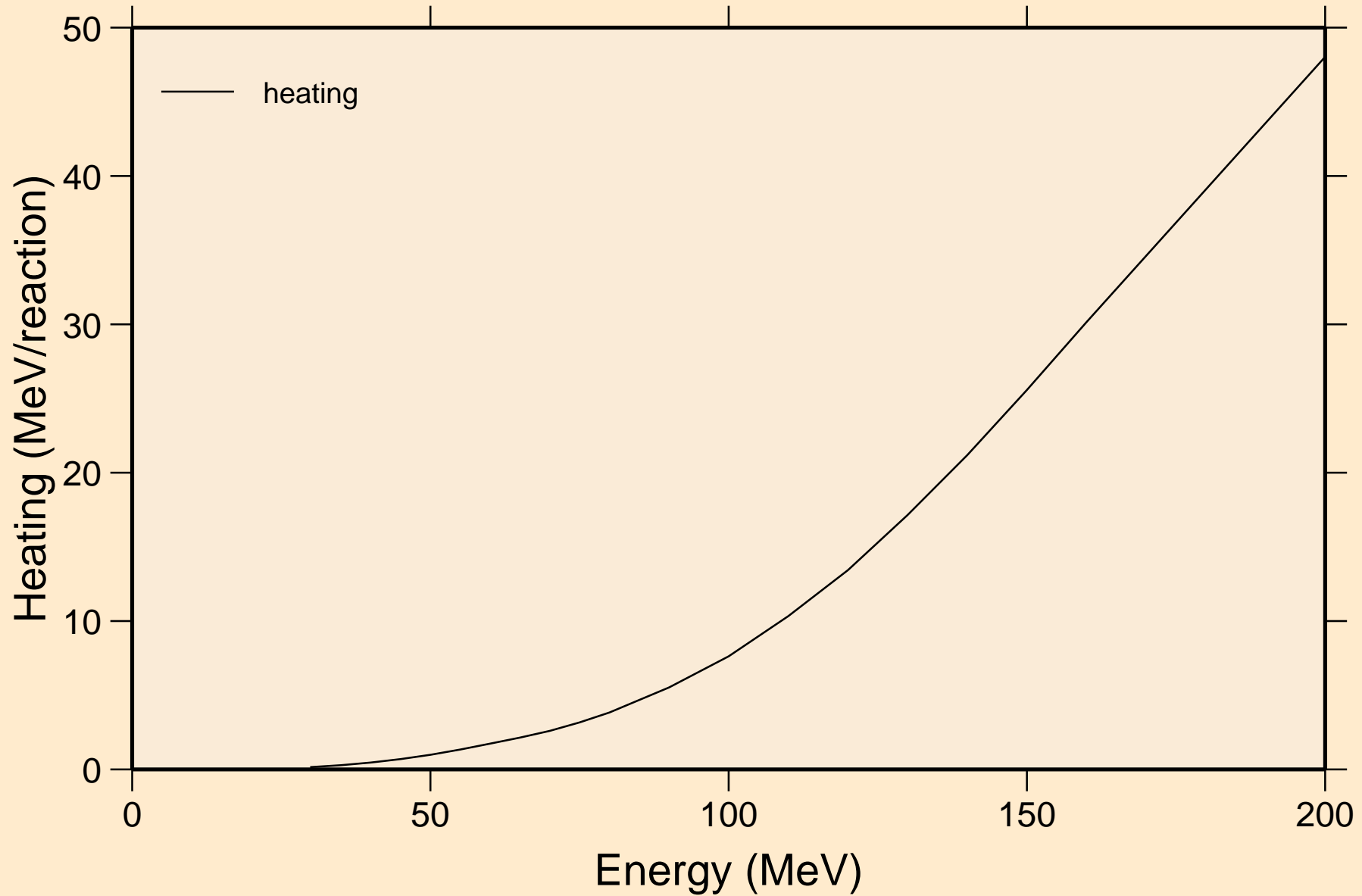

DB261 DEUTERON ACER TENDL-2021 LIBRARY; T=0.K
Threshold reactions

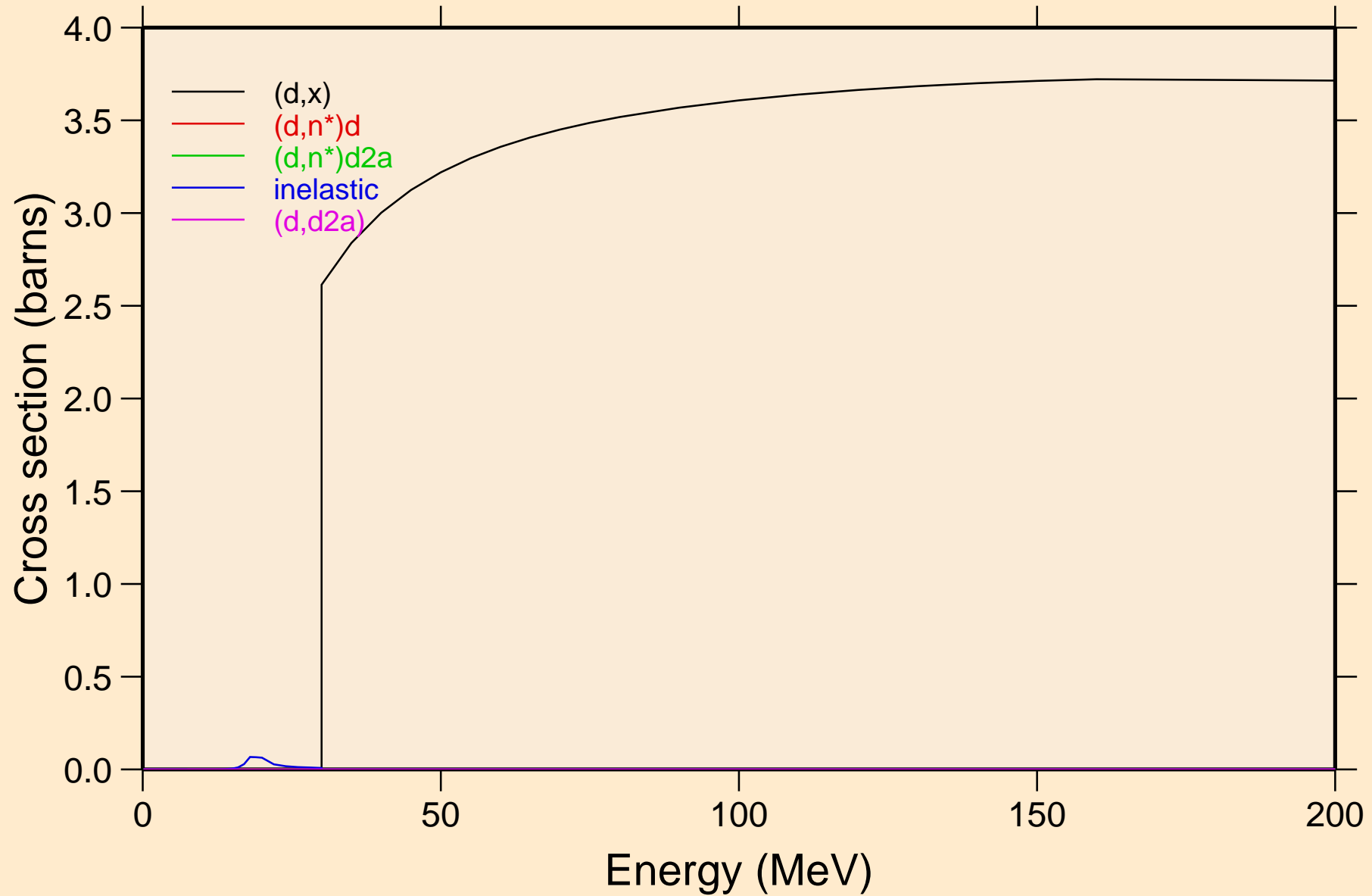

DB261 DEUTERON ACER TENDL-2021 LIBRARY; T=0.K
Threshold reactions

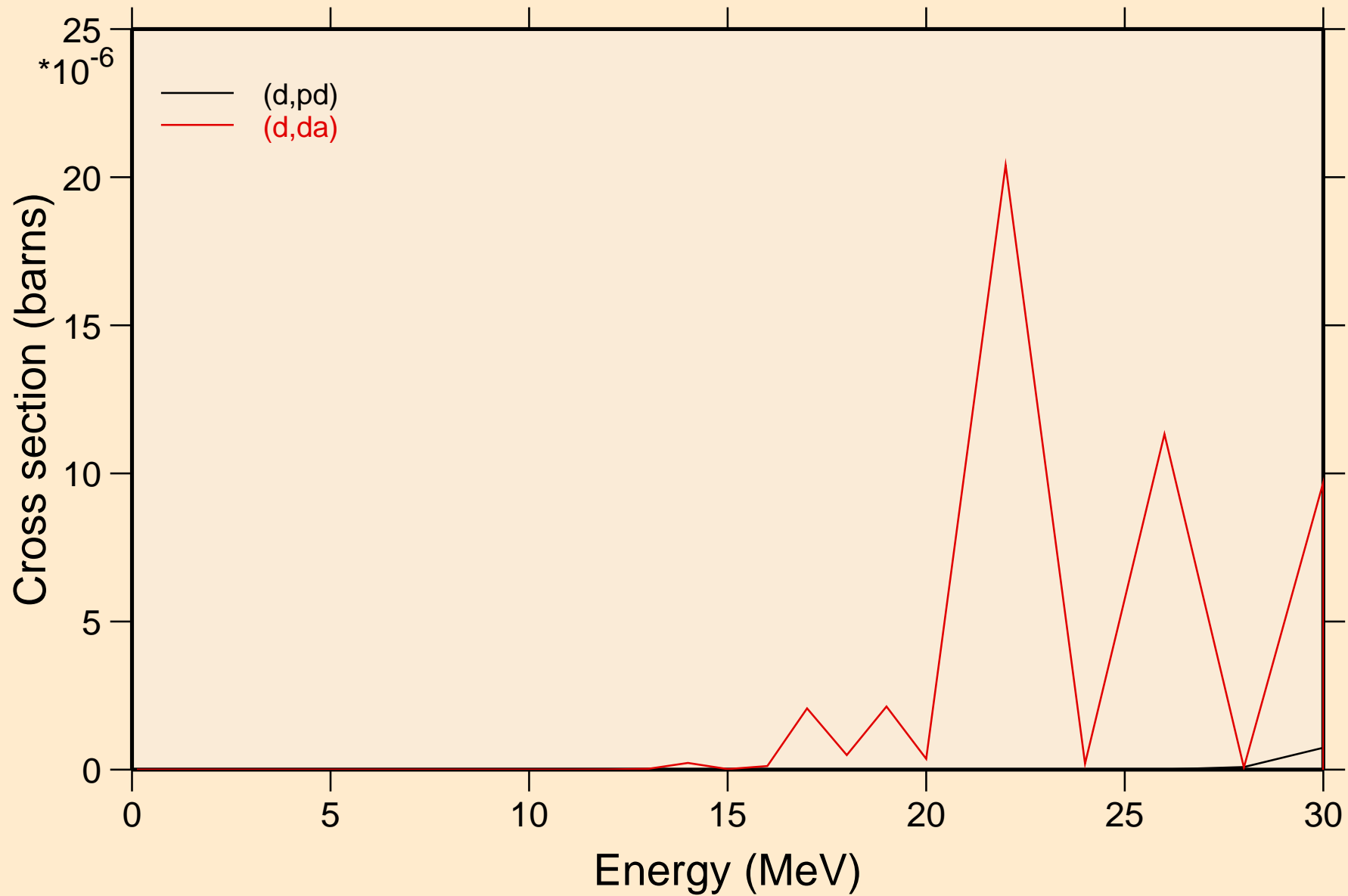

DB261 DEUTERON ACER TENDL-2021 LIBRARY; T=0.K
angular distribution for elastic

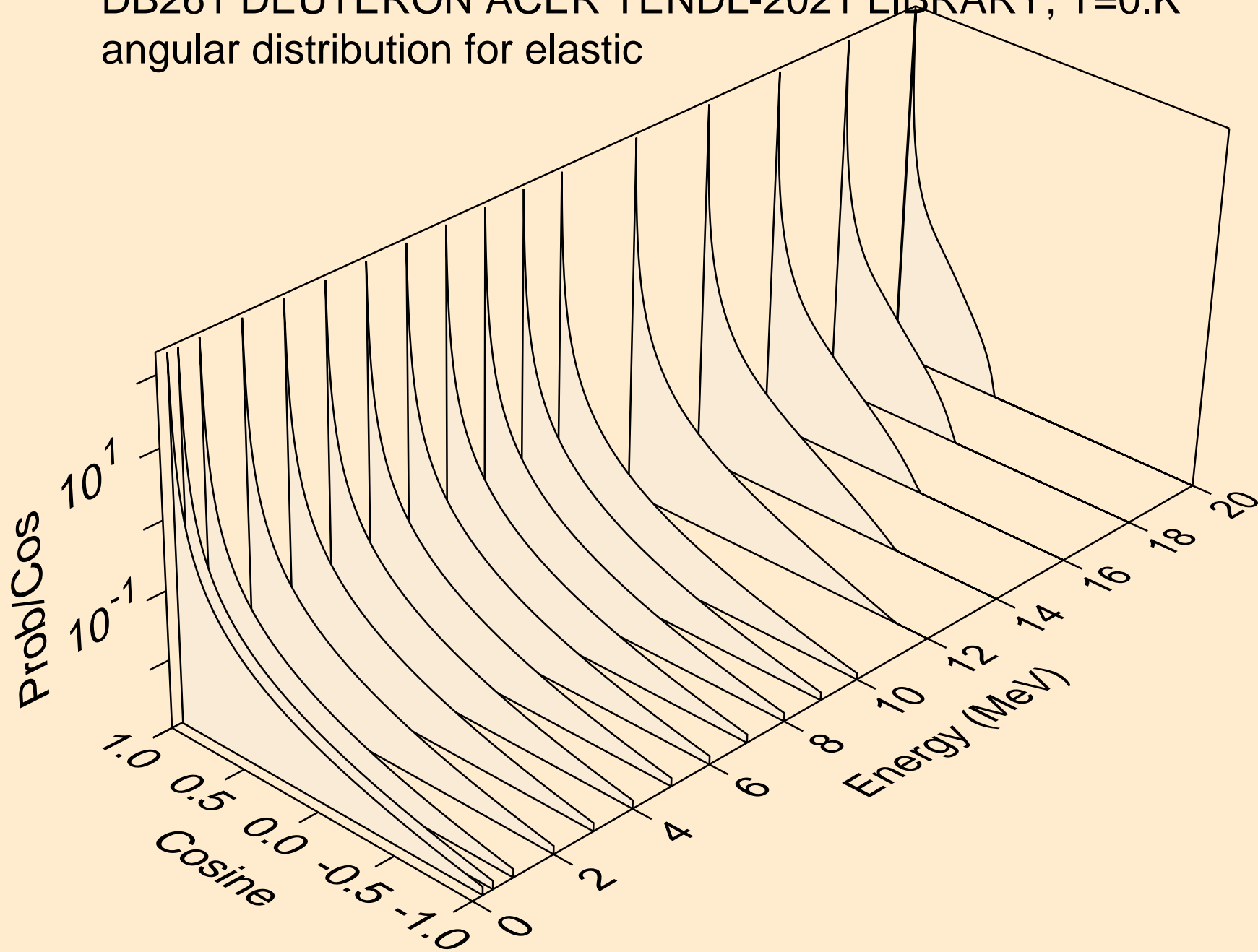

DB261 DEUTERON ACER TENDL-2021 LIBRARY; T=0.K
angular distribution for elastic

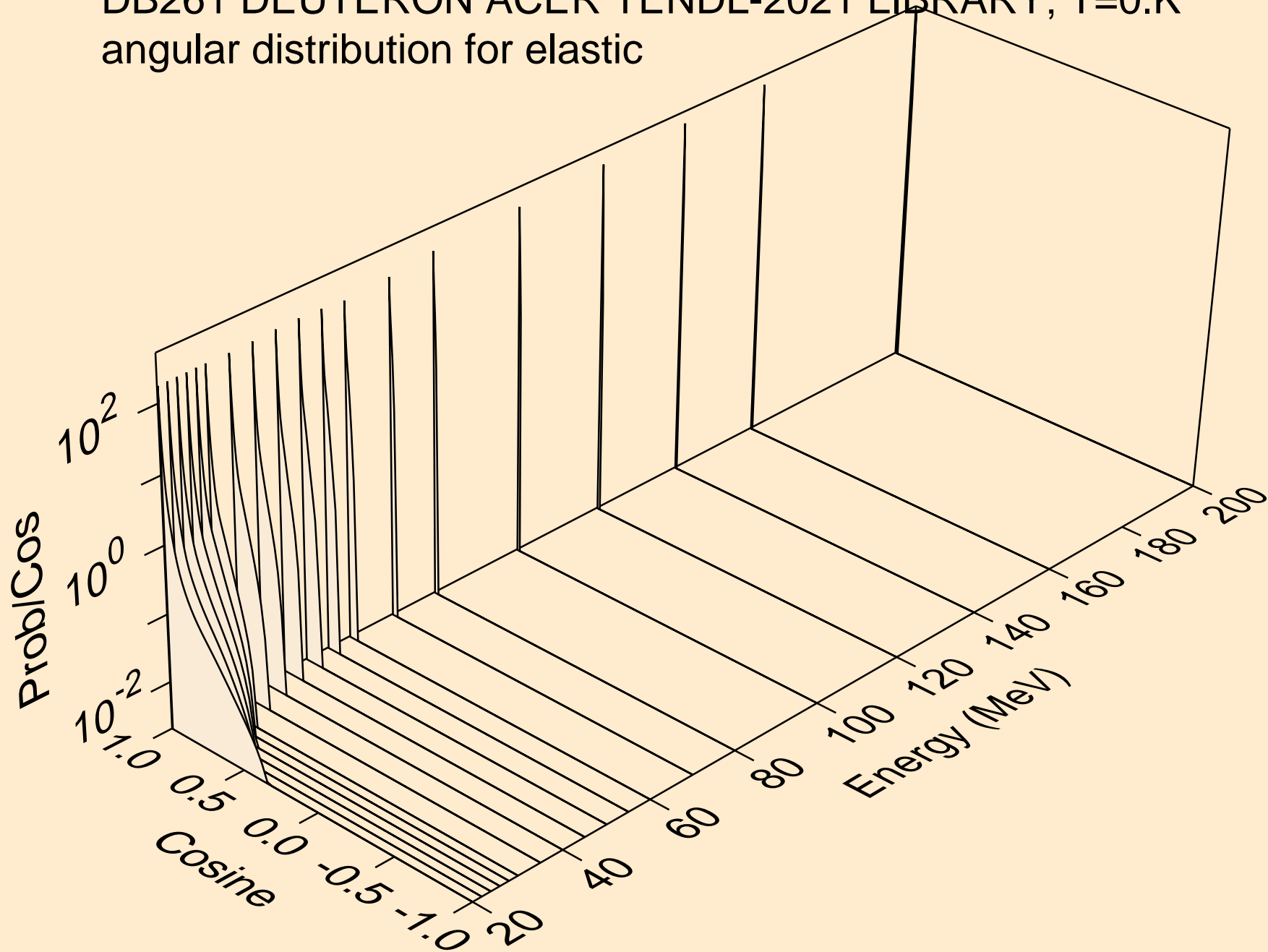

DB261 DEUTERON ACER TENDL-2021 LIBRARY; T=0.K
Deuteron emission for (d,x)

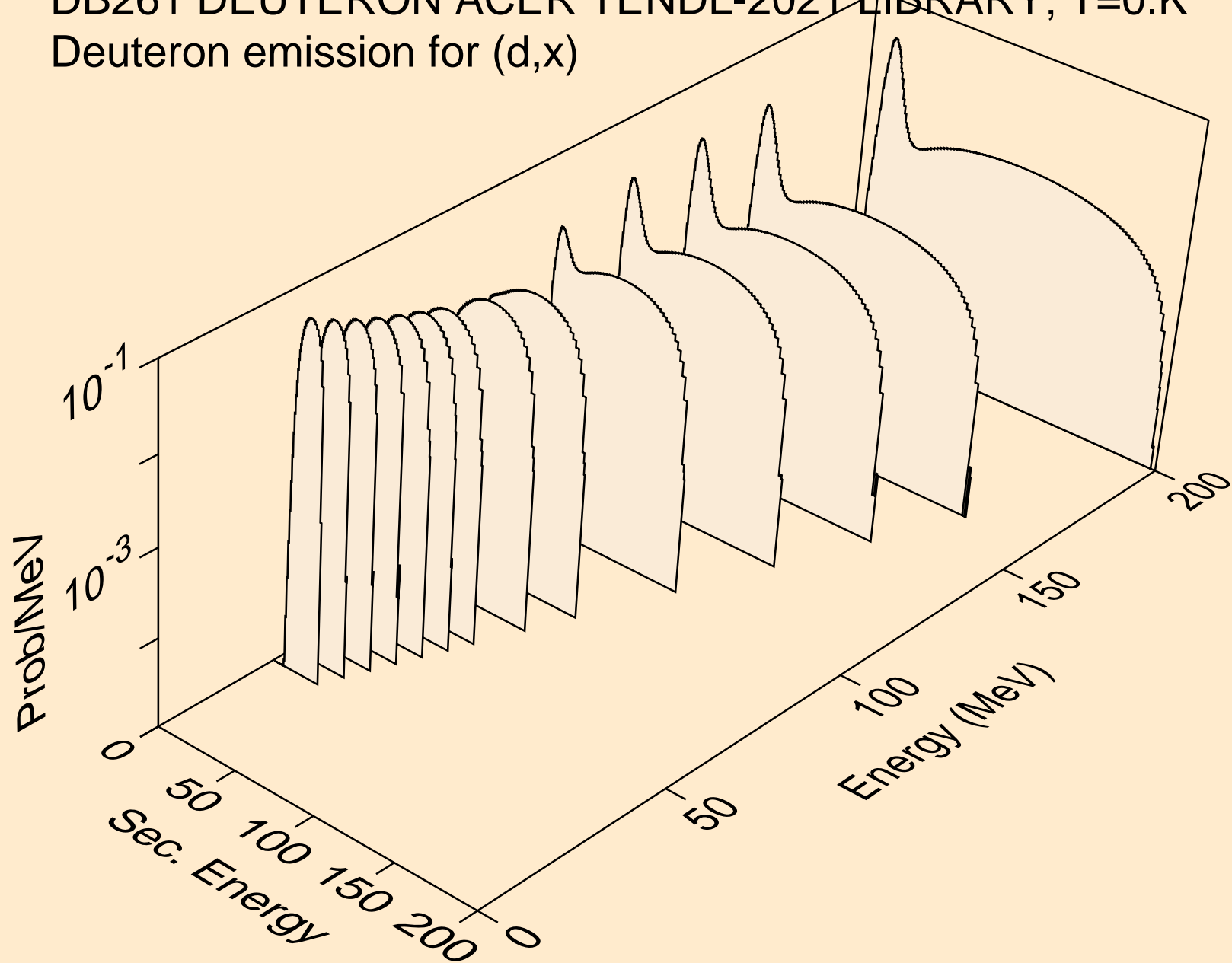

DB261 DEUTERON ACER TENDL-2021 LIBRARY; T=0.K
Deuteron emission for (d,n*)d

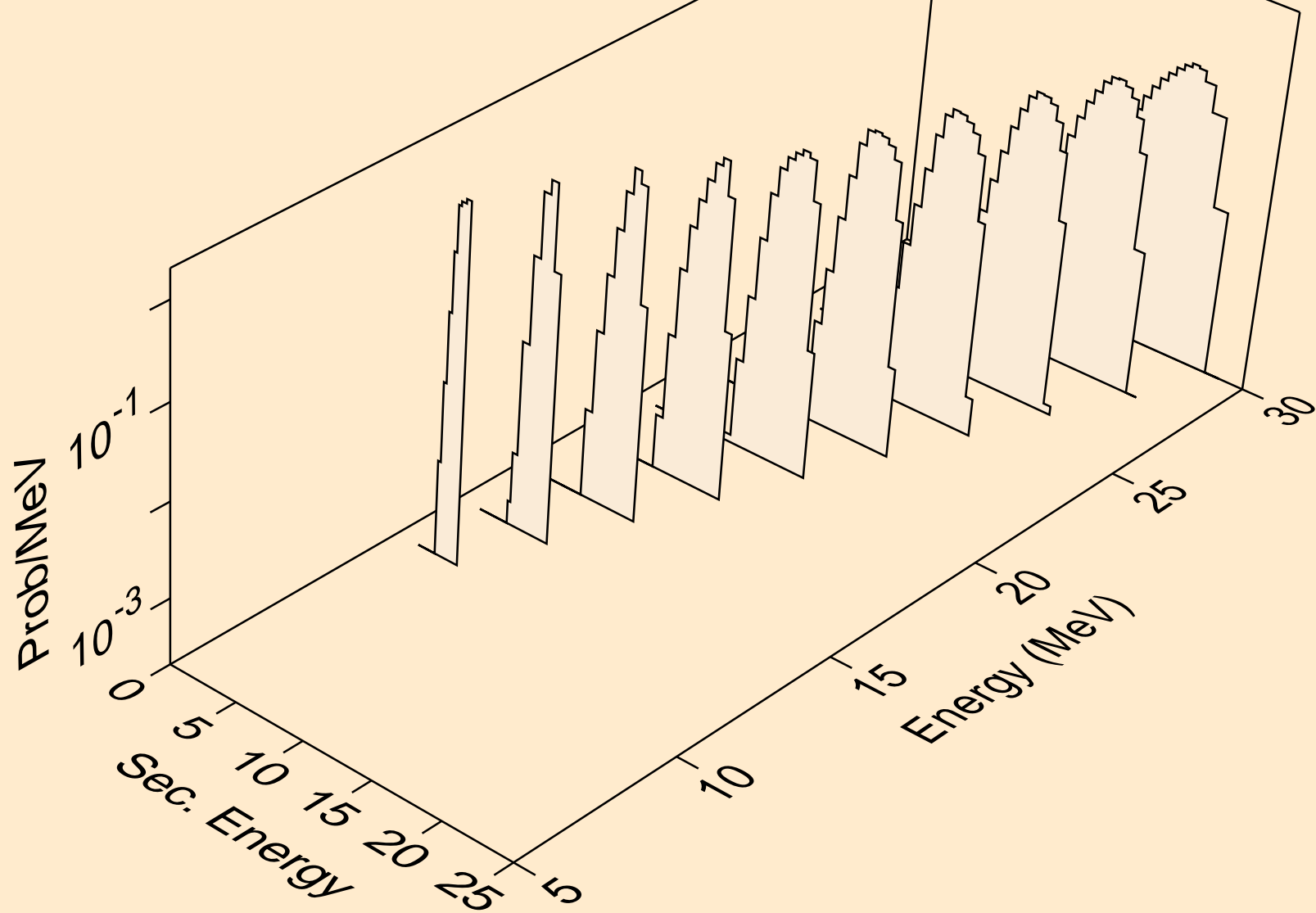

DB261 DEUTERON ACER TENDL-2021 LIBRARY; T=0.K
Deuteron emission for (d,n*)d2a

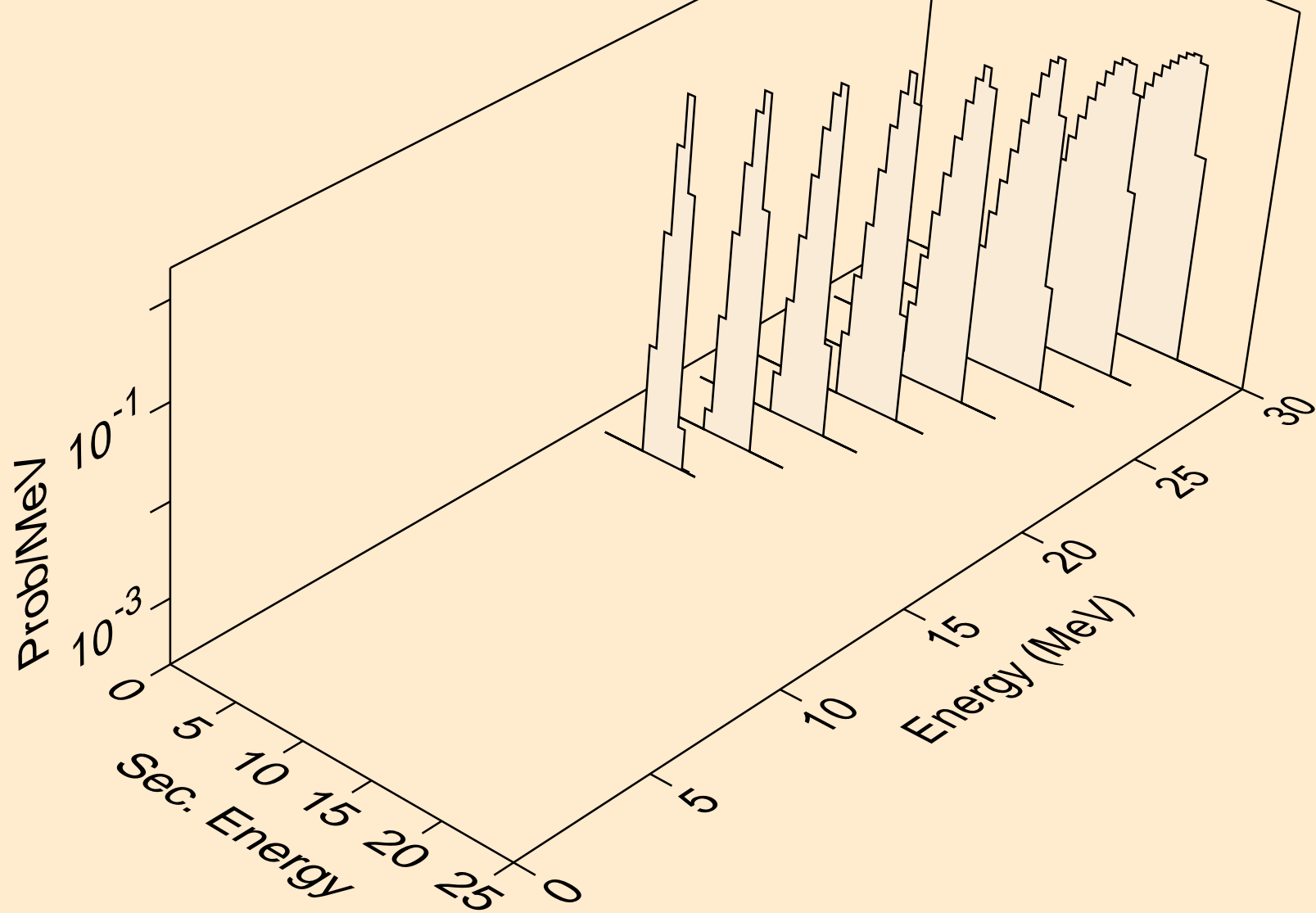

DB261 DEUTERON ACER TENDL-2021 LIBRARY; T=0.K
Deuteron emission for inelastic

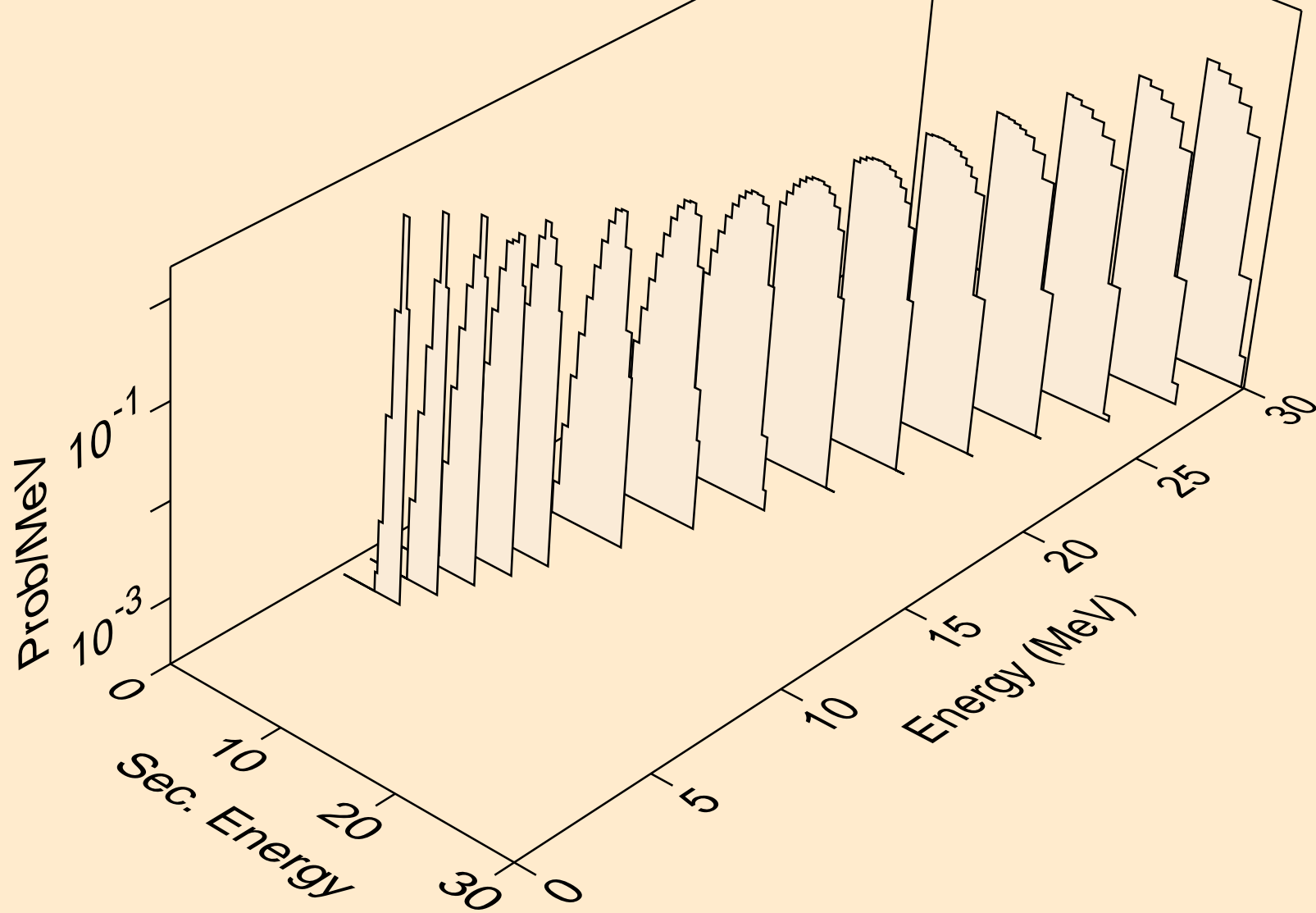

DB261 DEUTERON ACER TENDL-2021 LIBRARY; T=0.K
Deuteron emission for (d,d2a)

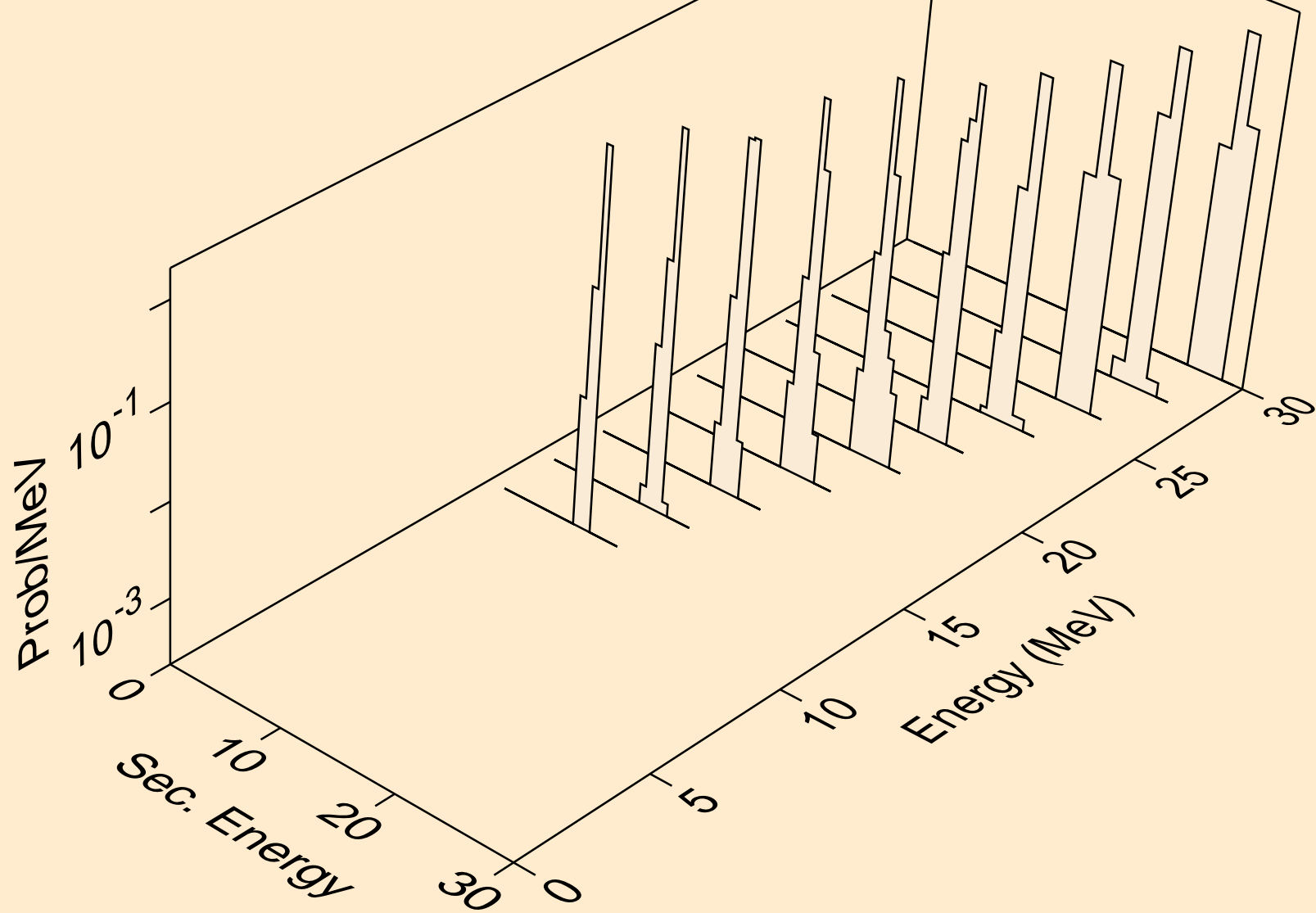

DB261 DEUTERON ACER TENDL-2021 LIBRARY; T=0.K
Deuteron emission for (d,pd)

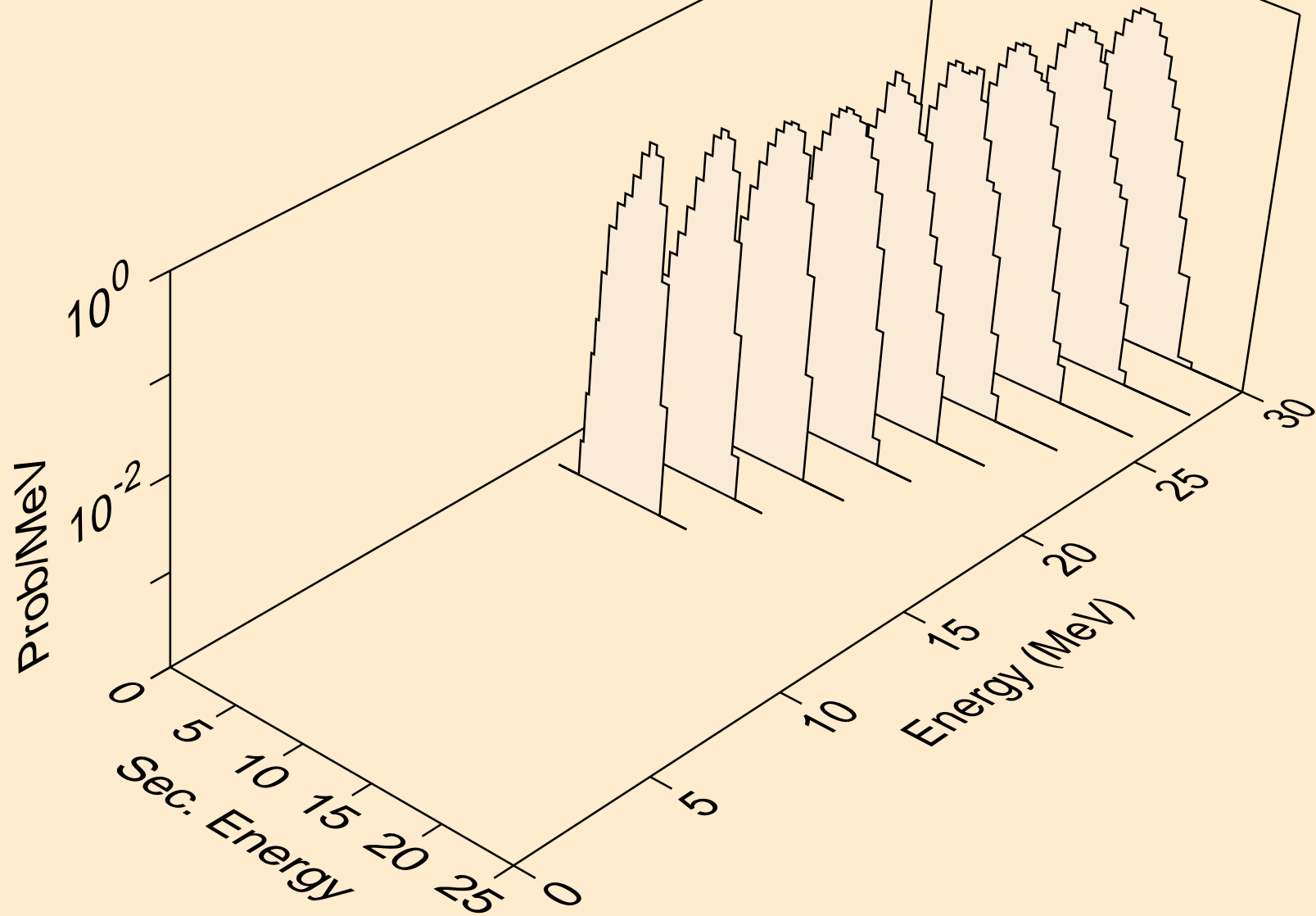

DB261 DEUTERON ACER TENDL-2021 LIBRARY; T=0.K
Deuteron emission for (d,da)

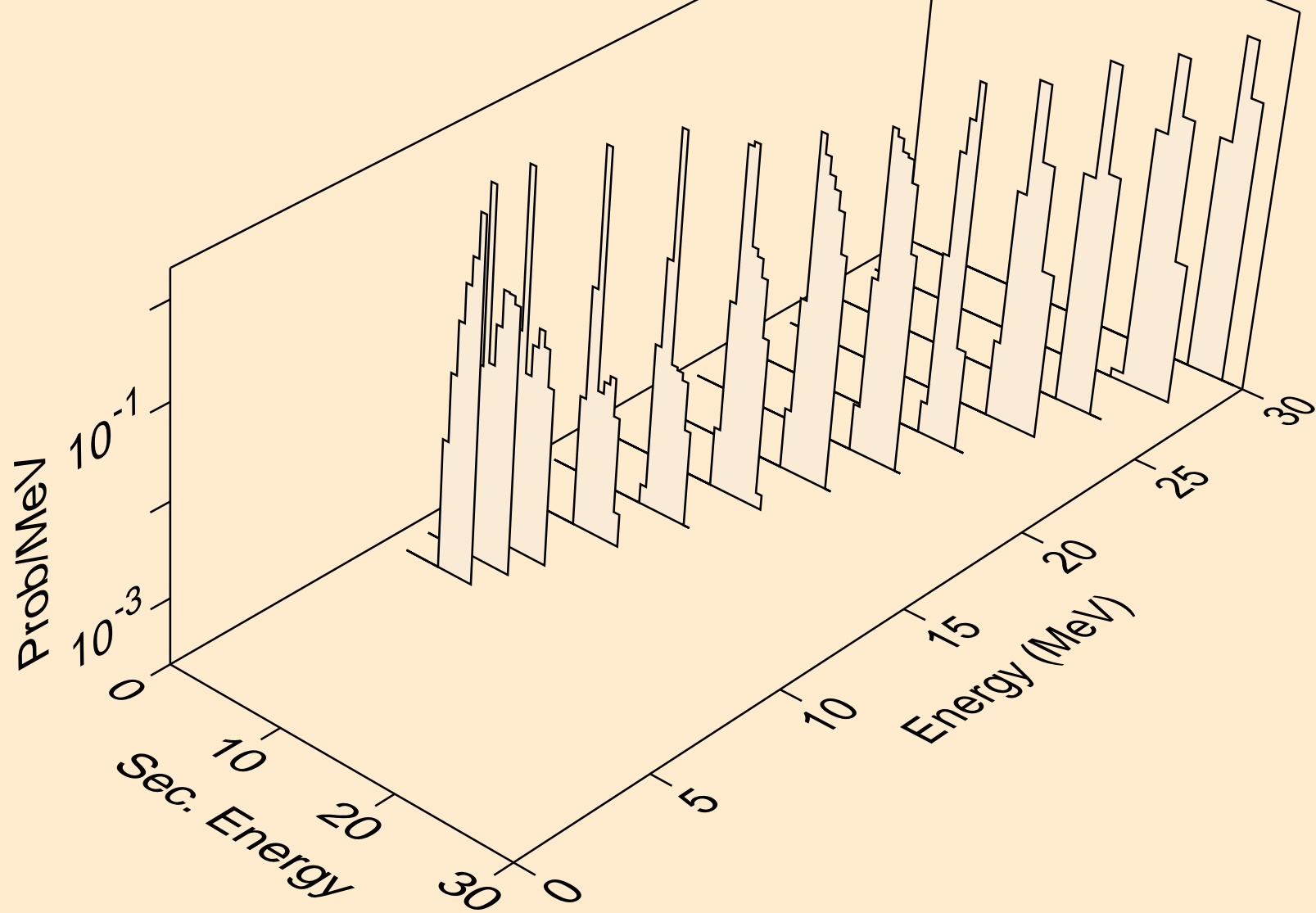

DB261 DEUTERON ACER TENDL-2021 LIBRARY; T=0.K
Photon emission for (z,n)

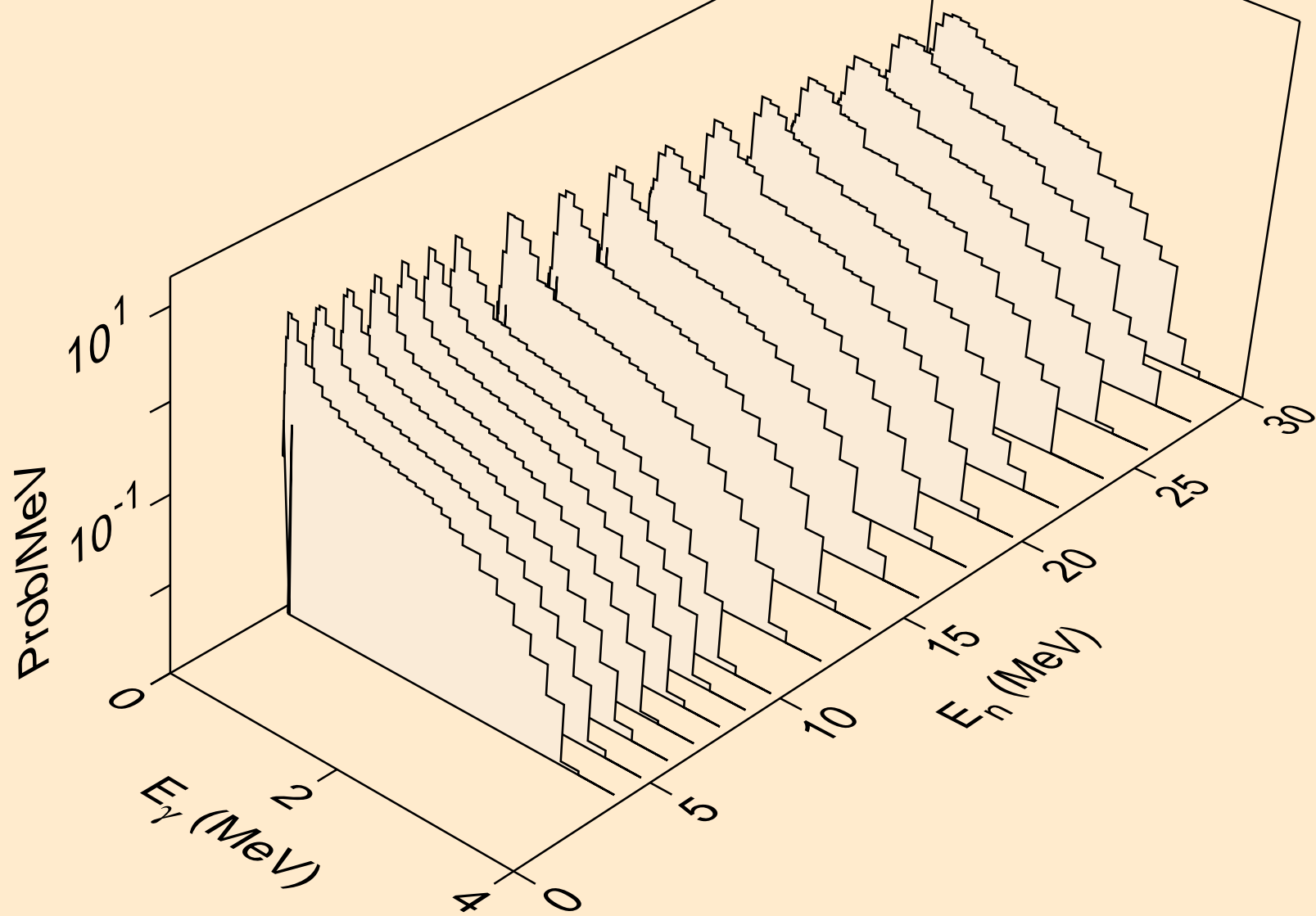

DB261 DEUTERON ACER TENDL-2021 LIBRARY; T=0.K
Photon emission for (n,x)

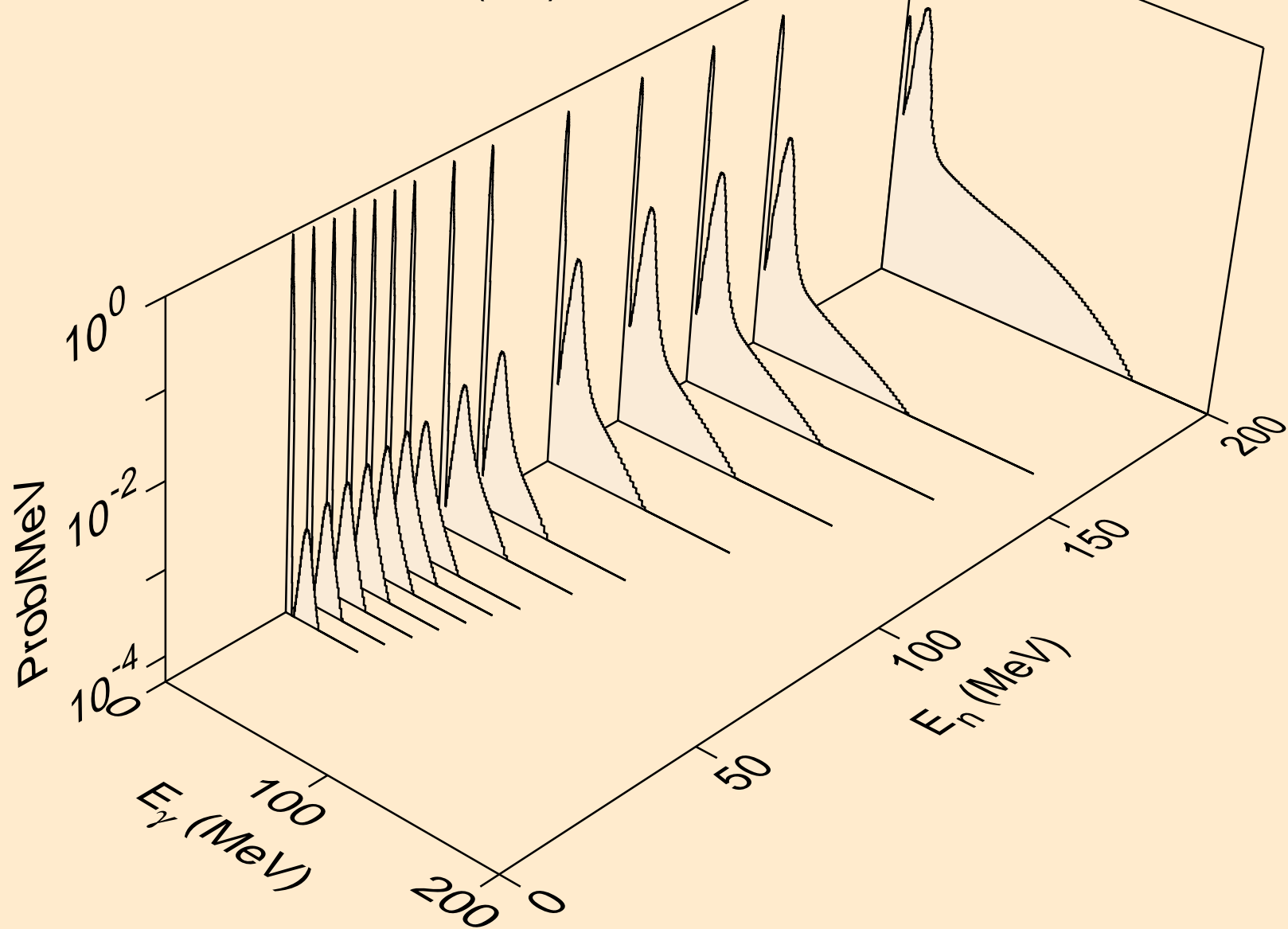

DB261 DEUTERON ACER TENDL-2021 LIBRARY; T=0.K
Photon emission for (n,2n)

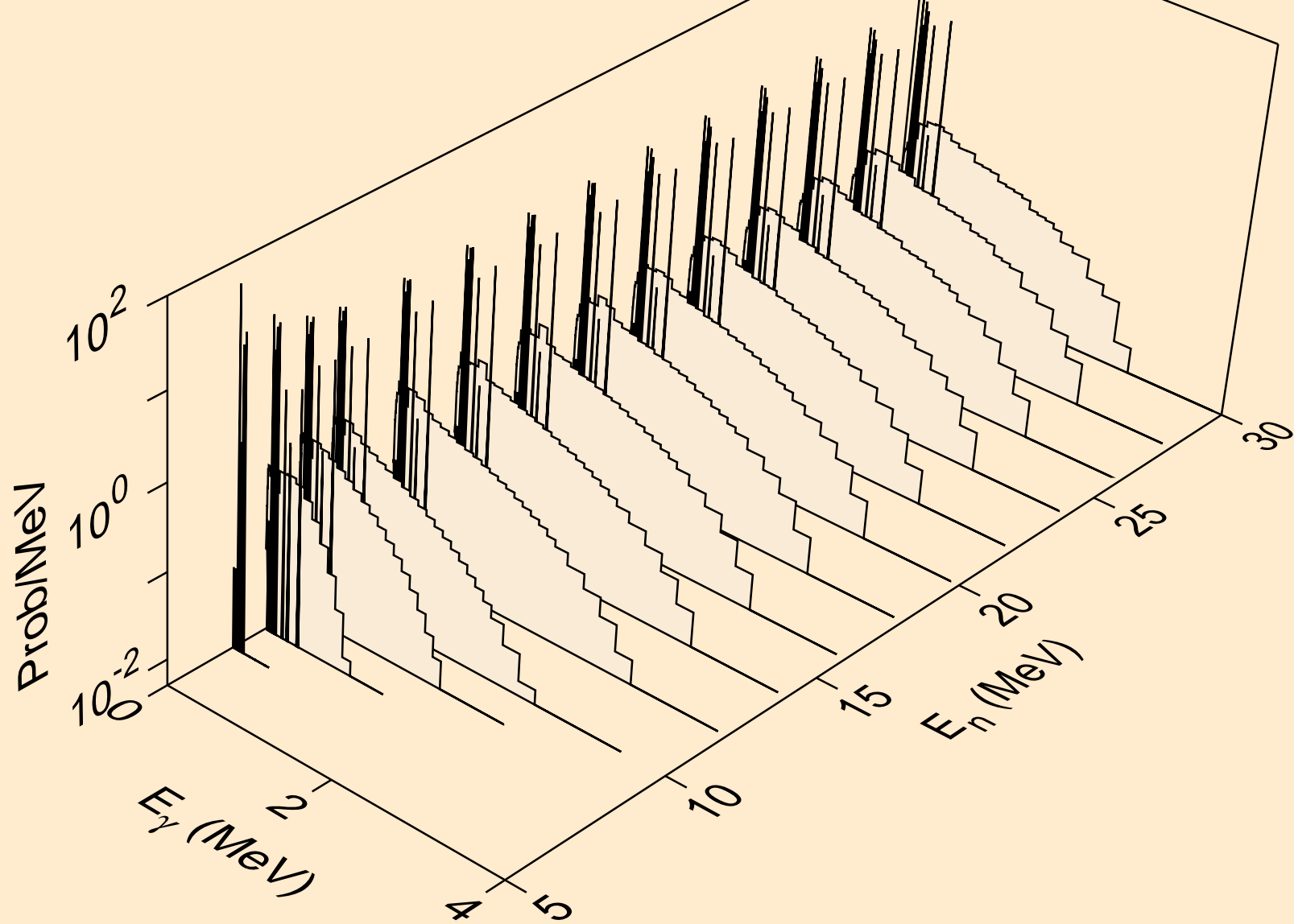

DB261 DEUTERON ACER TENDL-2021 LIBRARY; T=0.K
Photon emission for (n,3n)

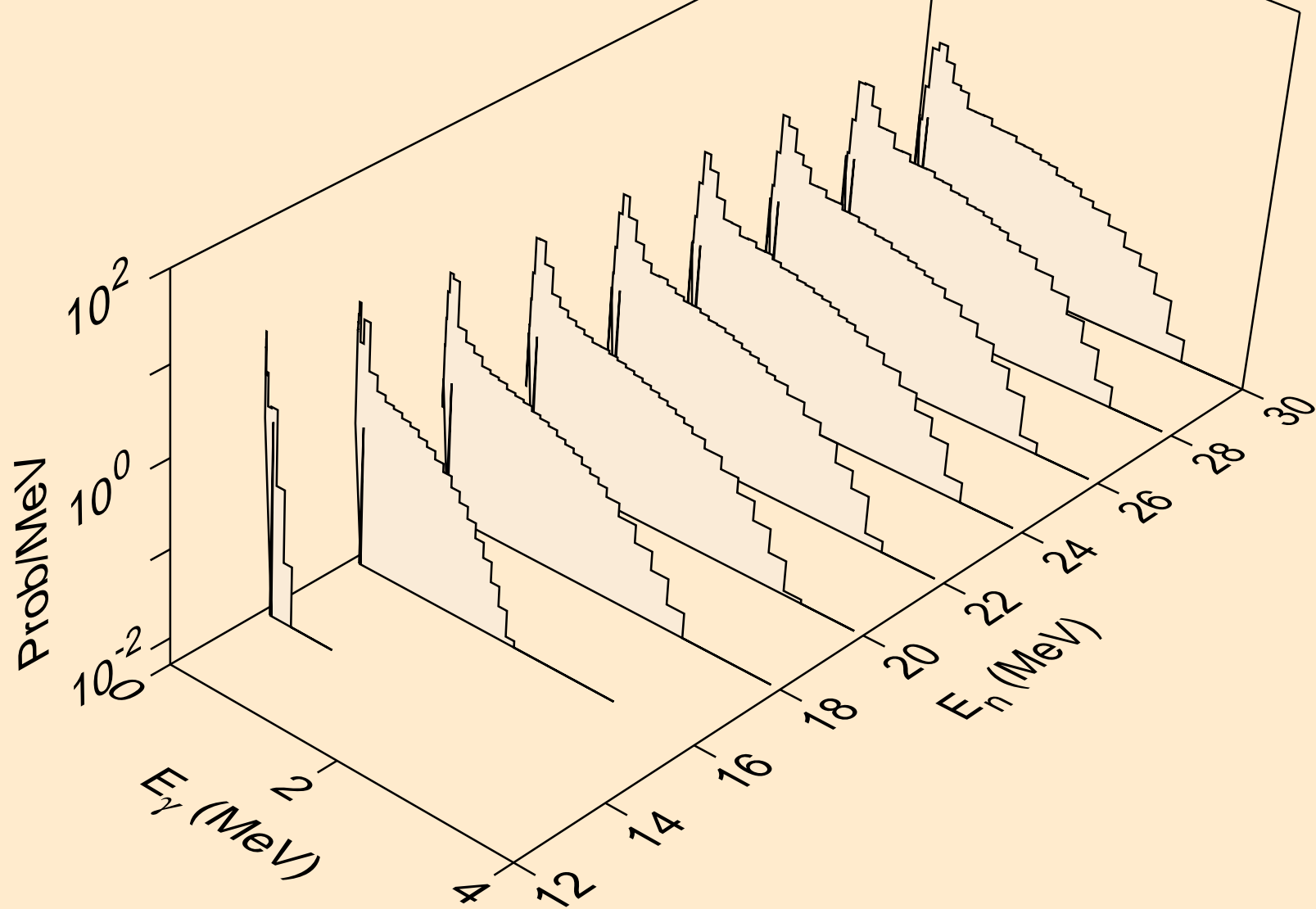

DB261 DEUTERON ACER TENDL-2021 LIBRARY; T=0.K
Photon emission for (n,n*)a

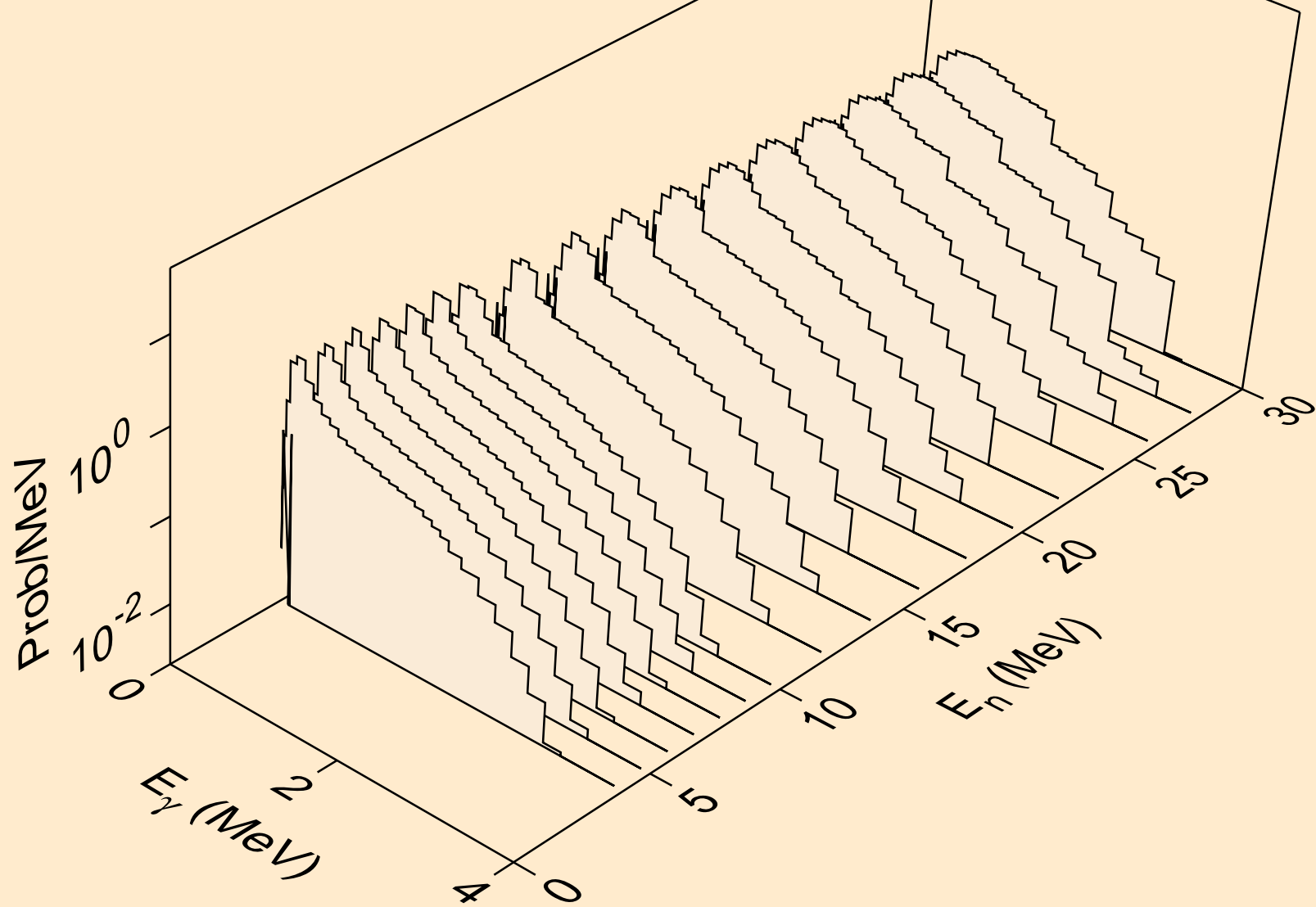

DB261 DEUTERON ACER TENDL-2021 LIBRARY; T=0.K
Photon emission for (n,2n)a

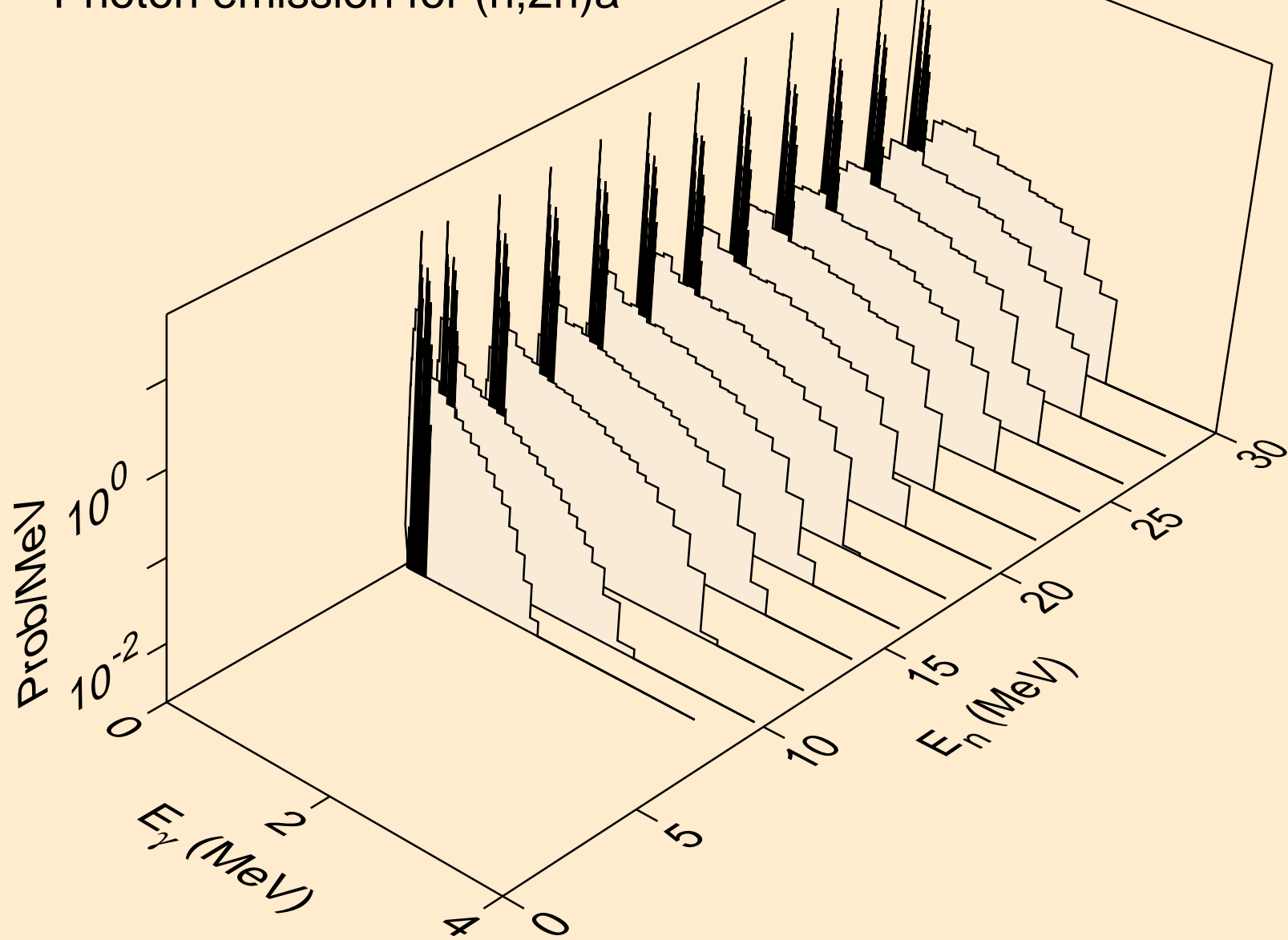

DB261 DEUTERON ACER TENDL-2021 LIBRARY; T=0.K
Photon emission for (n,3n)a

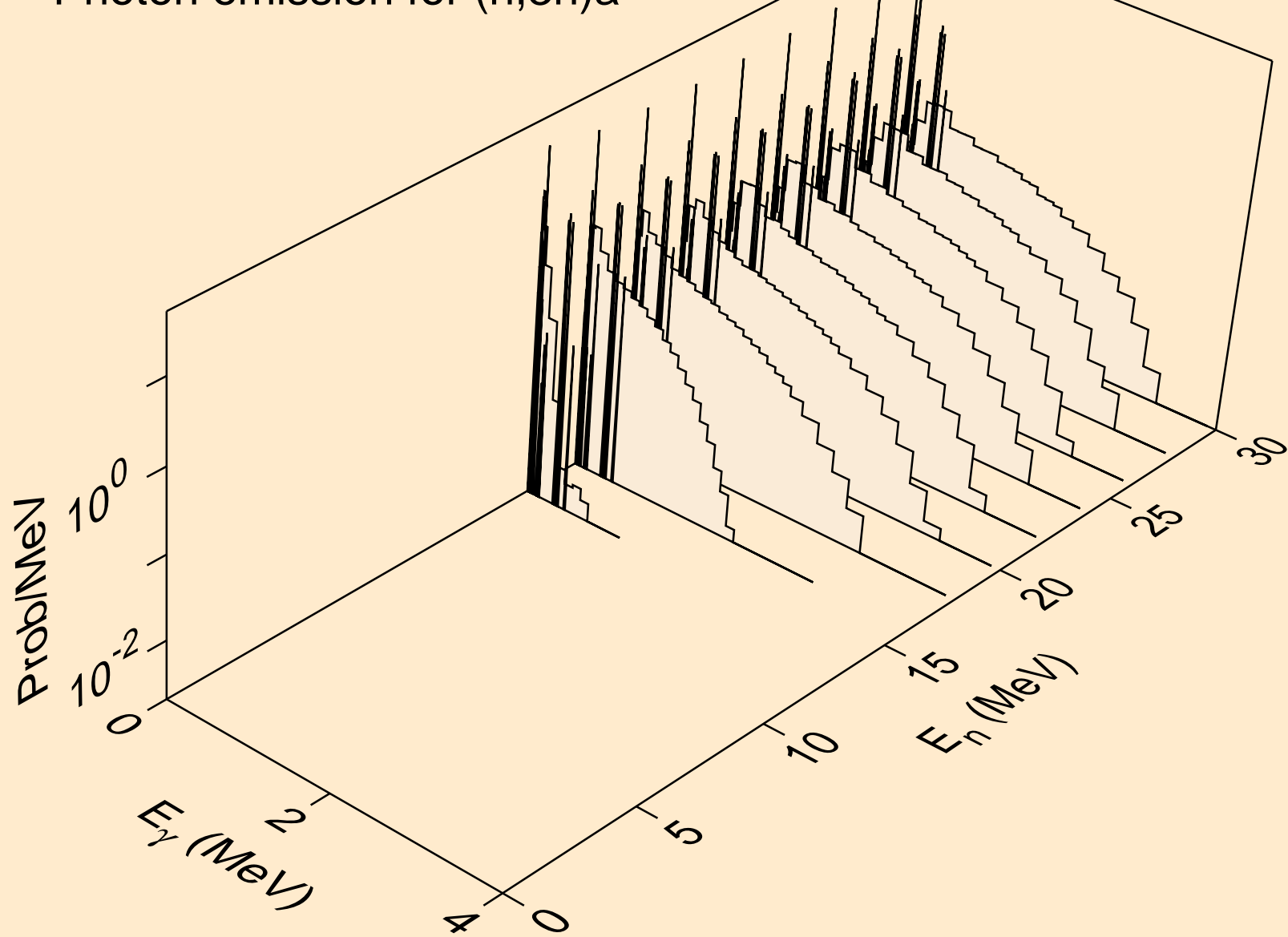

DB261 DEUTERON ACER TENDL-2021 LIBRARY; T=0.K
Photon emission for (n,n*)p

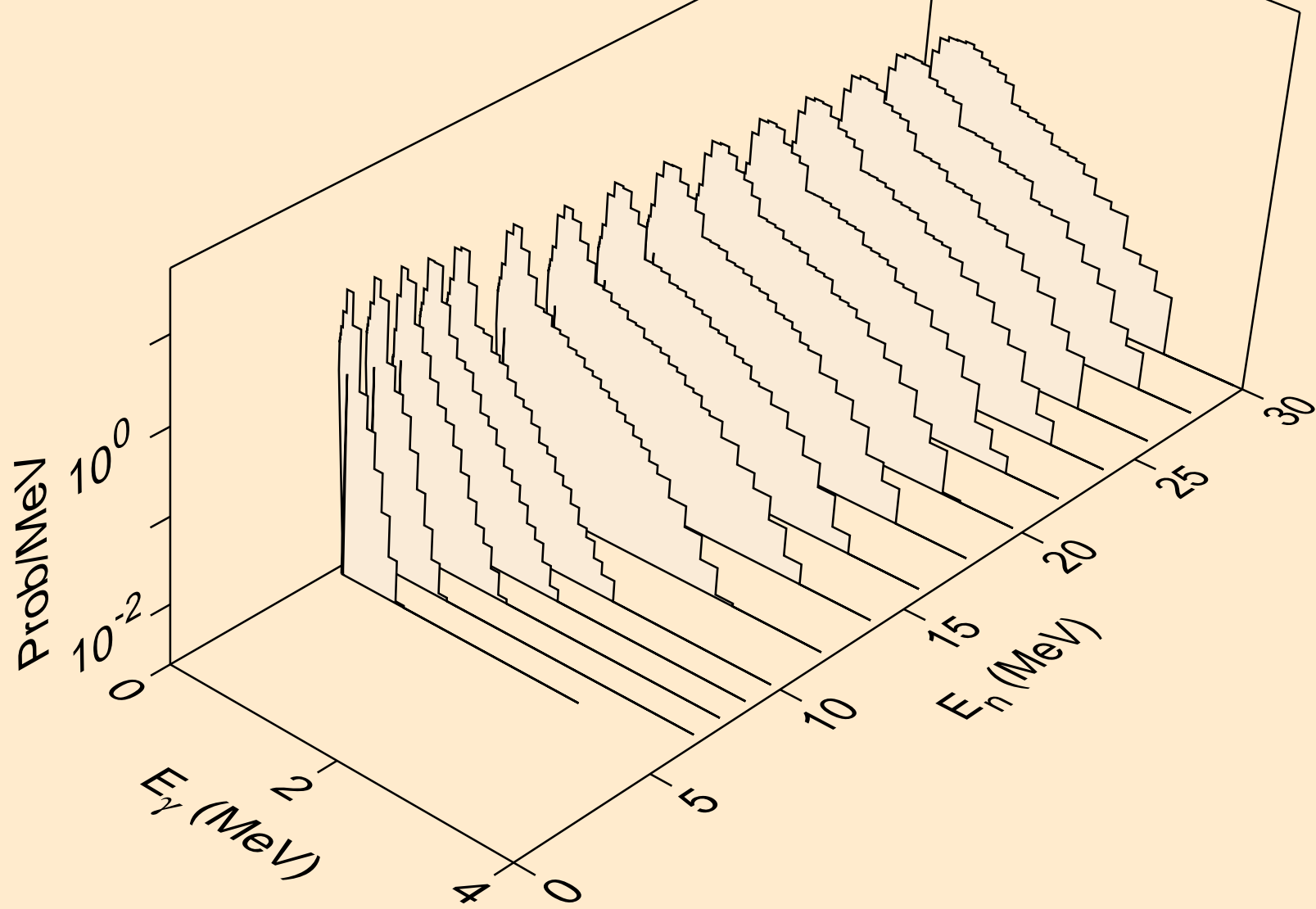

DB261 DEUTERON ACER TENDL-2021 LIBRARY; T=0.K
Photon emission for (n,n*)d

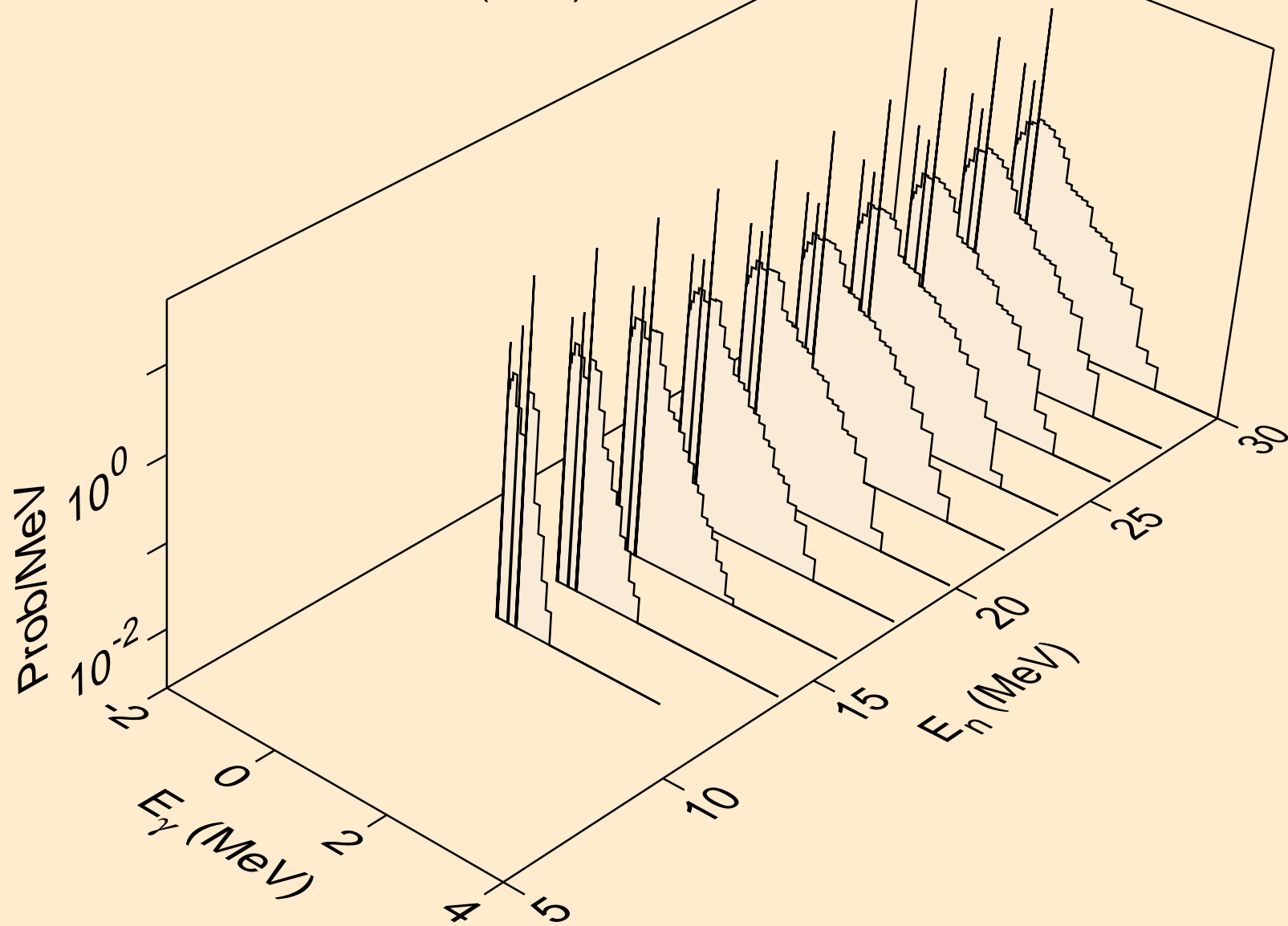

DB261 DEUTERON ACER TENDL-2021 LIBRARY; T=0.K
Photon emission for (n,n*)t

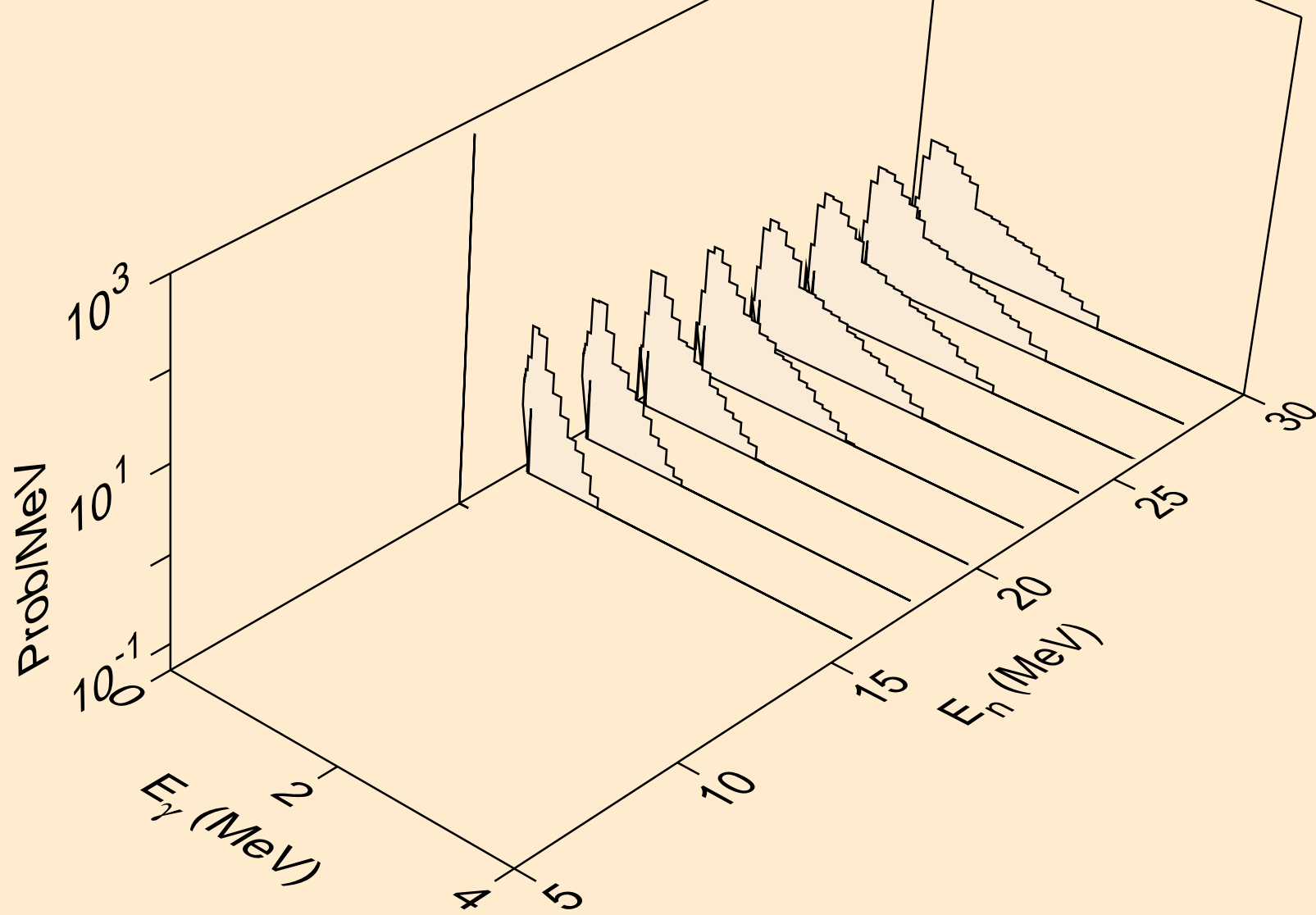

DB261 DEUTERON ACER TENDL-2021 LIBRARY; T=0.K
Photon emission for (n,n*)d2a

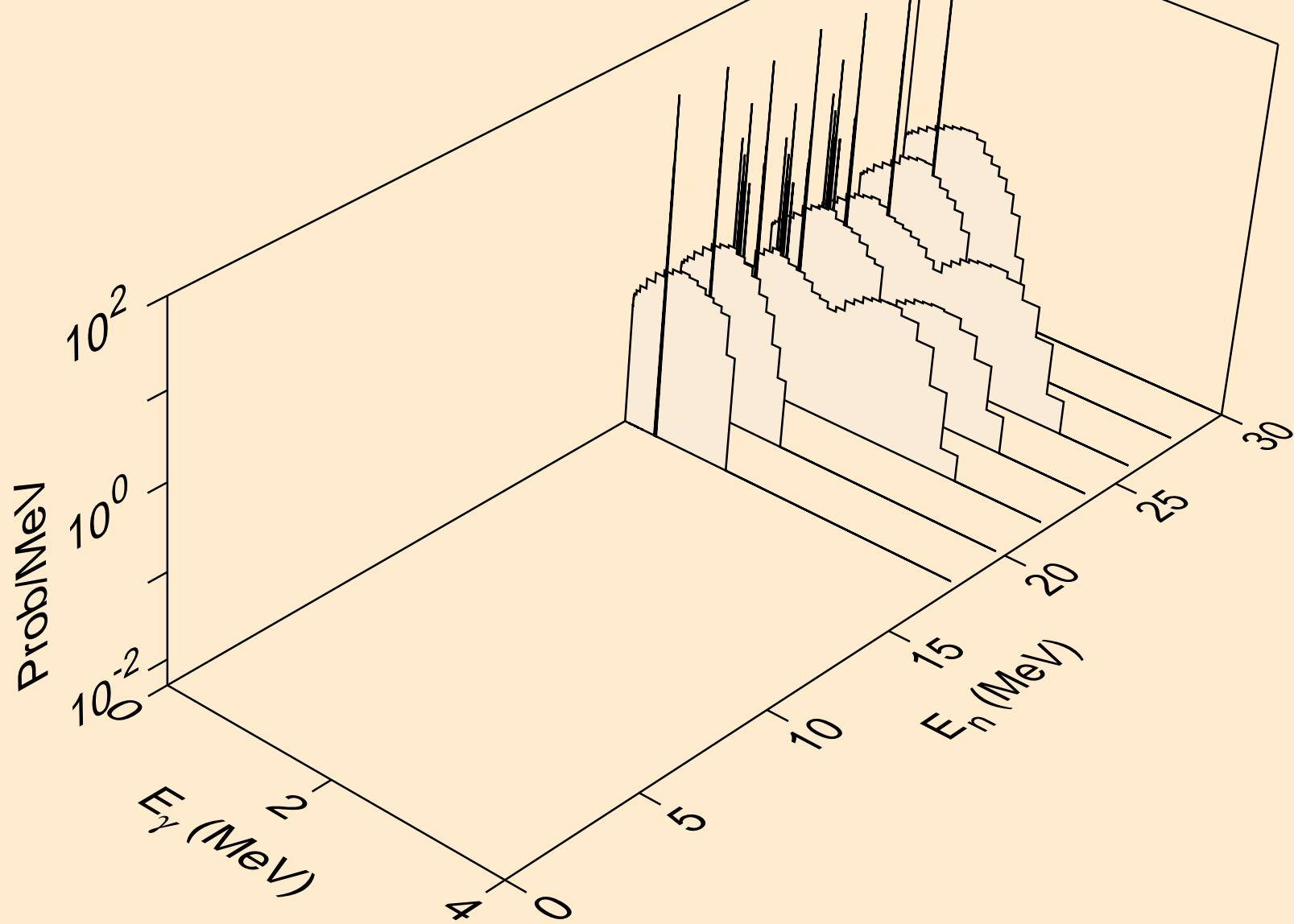

DB261 DEUTERON ACER TENDL-2021 LIBRARY; T=0.K
Photon emission for (n,4n)

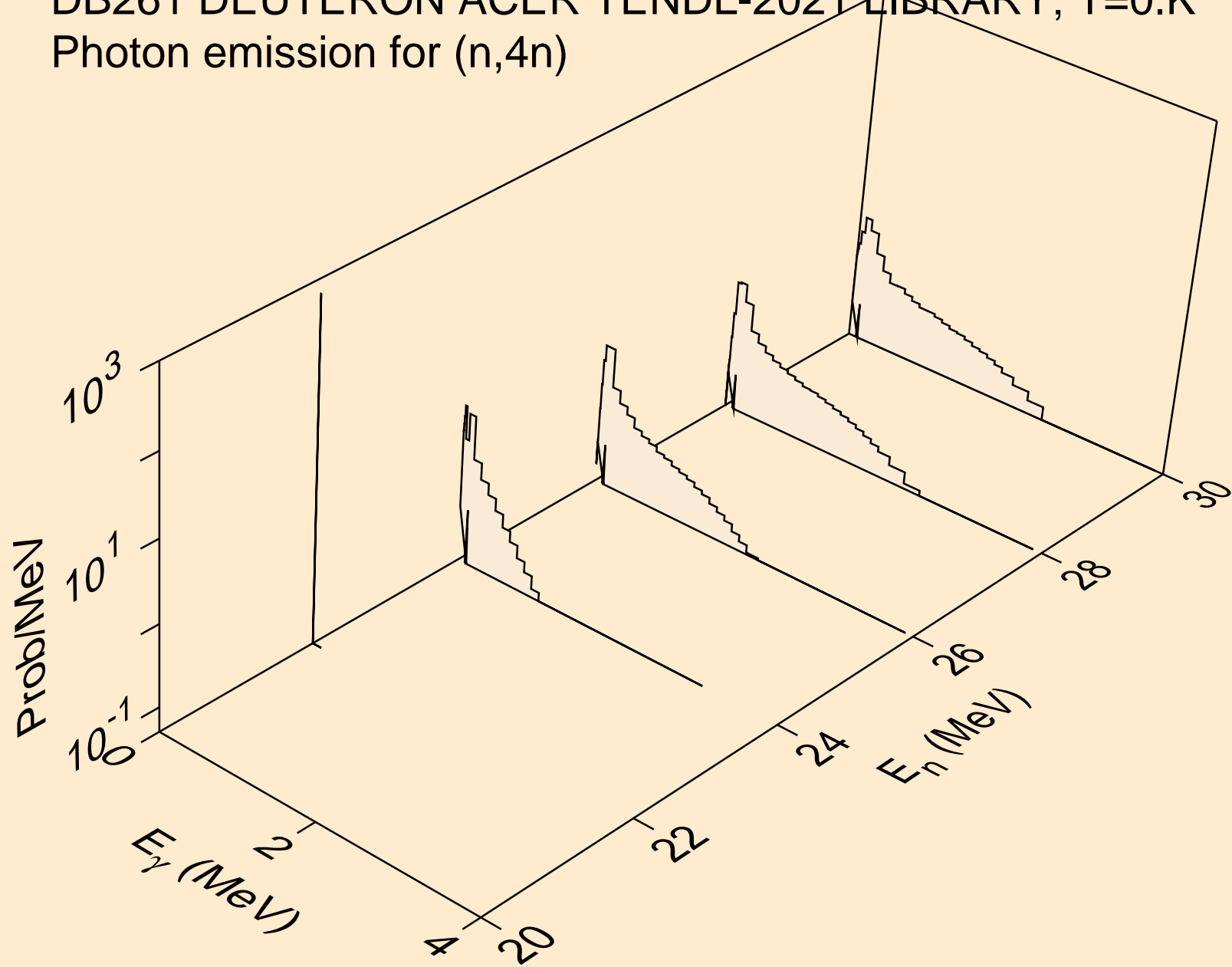

DB261 DEUTERON ACER TENDL-2021 LIBRARY; T=0.K
Photon emission for (n,2np)

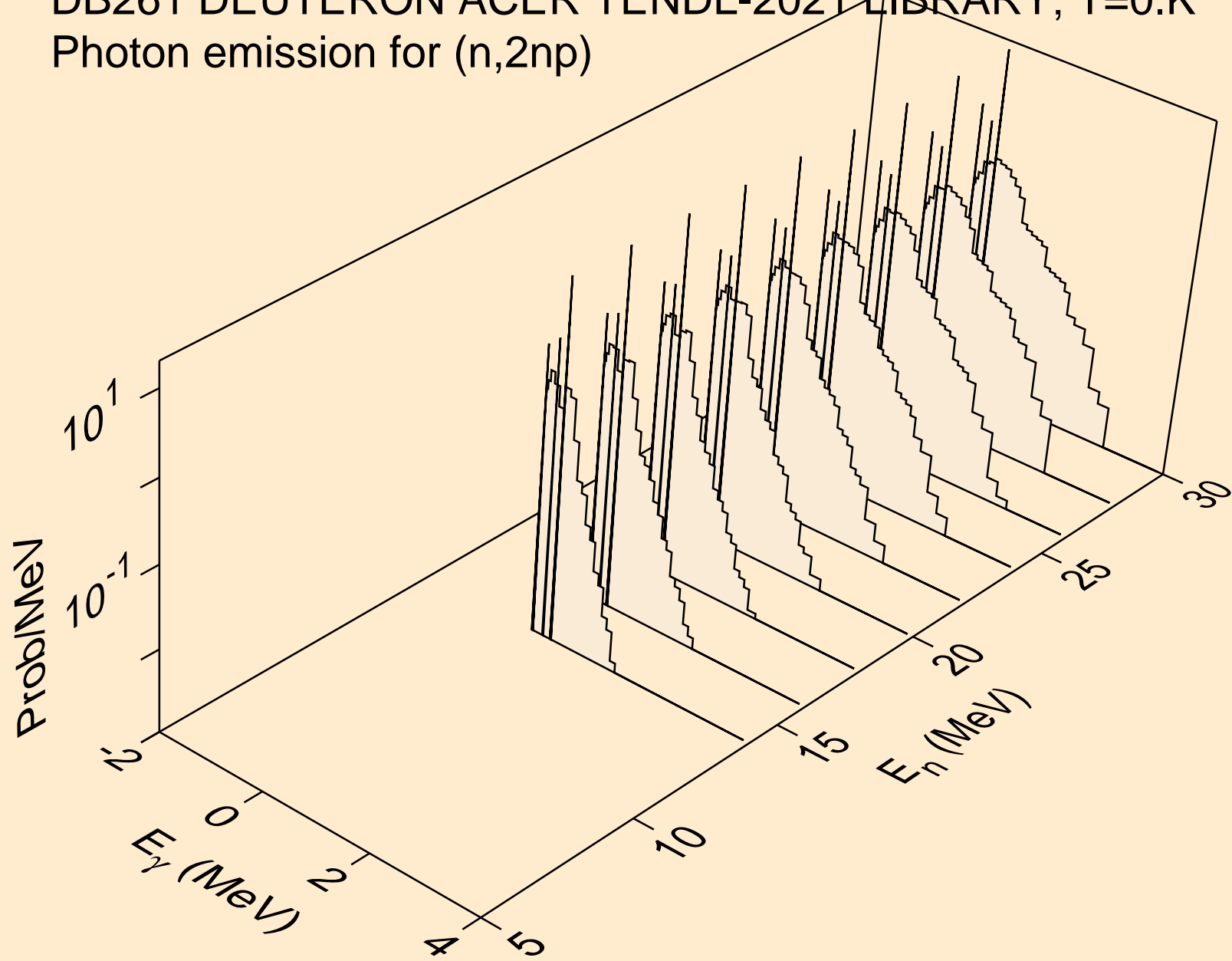

DB261 DEUTERON ACER TENDL-2021 LIBRARY; T=0.K
Photon emission for (n,2np)

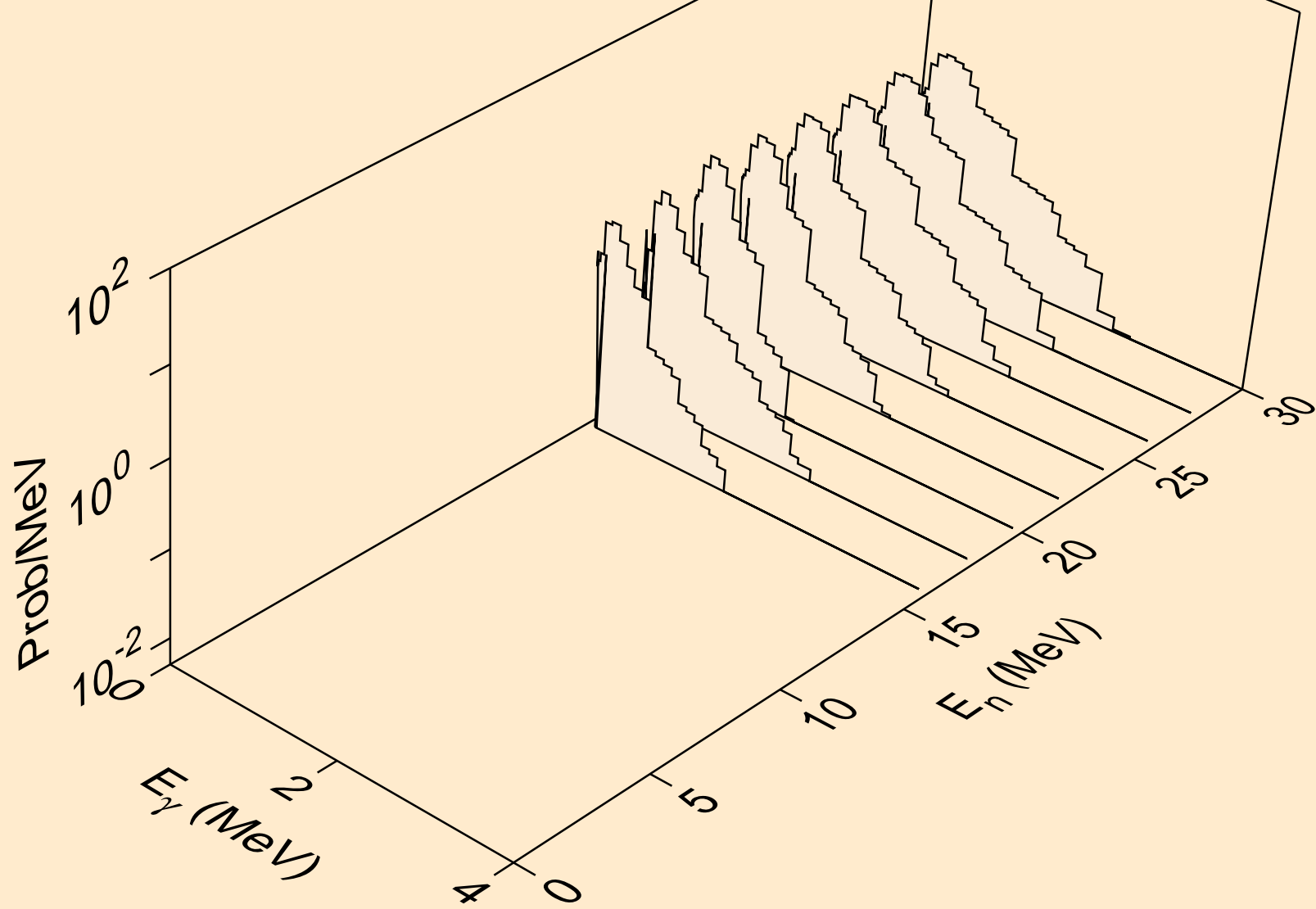

DB261 DEUTERON ACER TENDL-2021 LIBRARY; T=0.K
Photon emission for (n,npa)

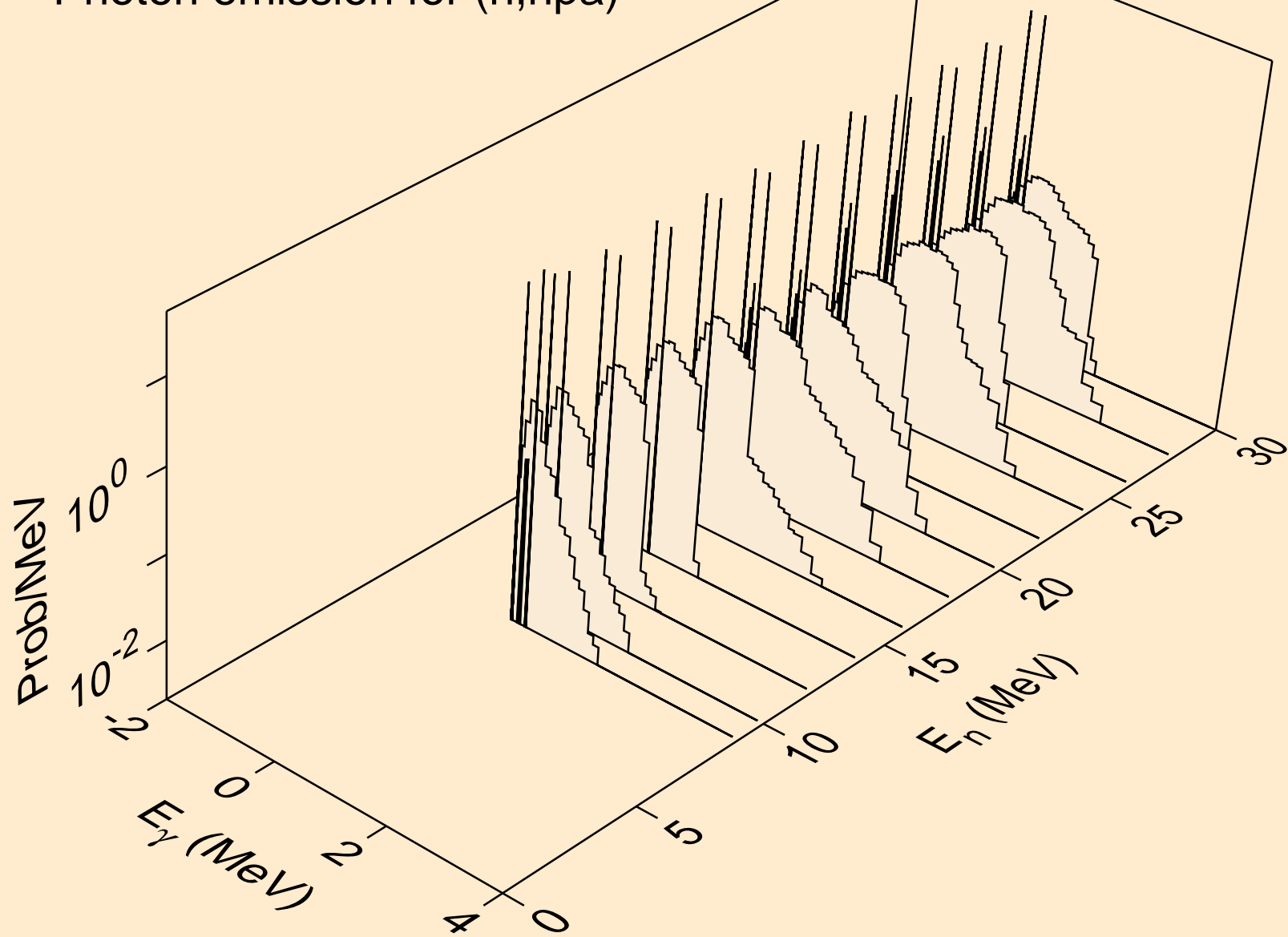

DB261 DEUTERON ACER TENDL-2021 LIBRARY; T=0.K
Photon emission for (n,p)

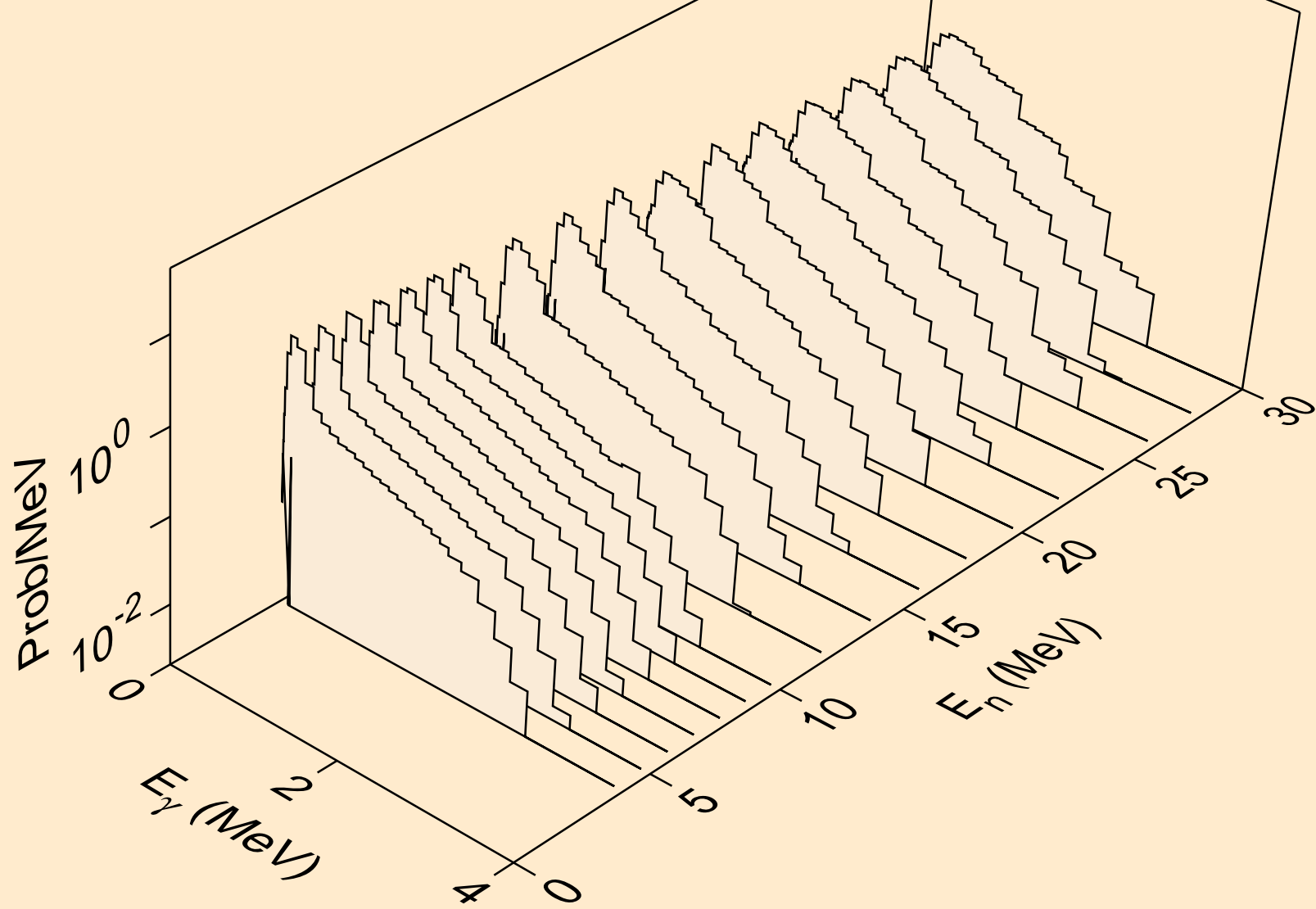

DB261 DEUTERON ACER TENDL-2021 LIBRARY; T=0.K
Photon emission for inelastic

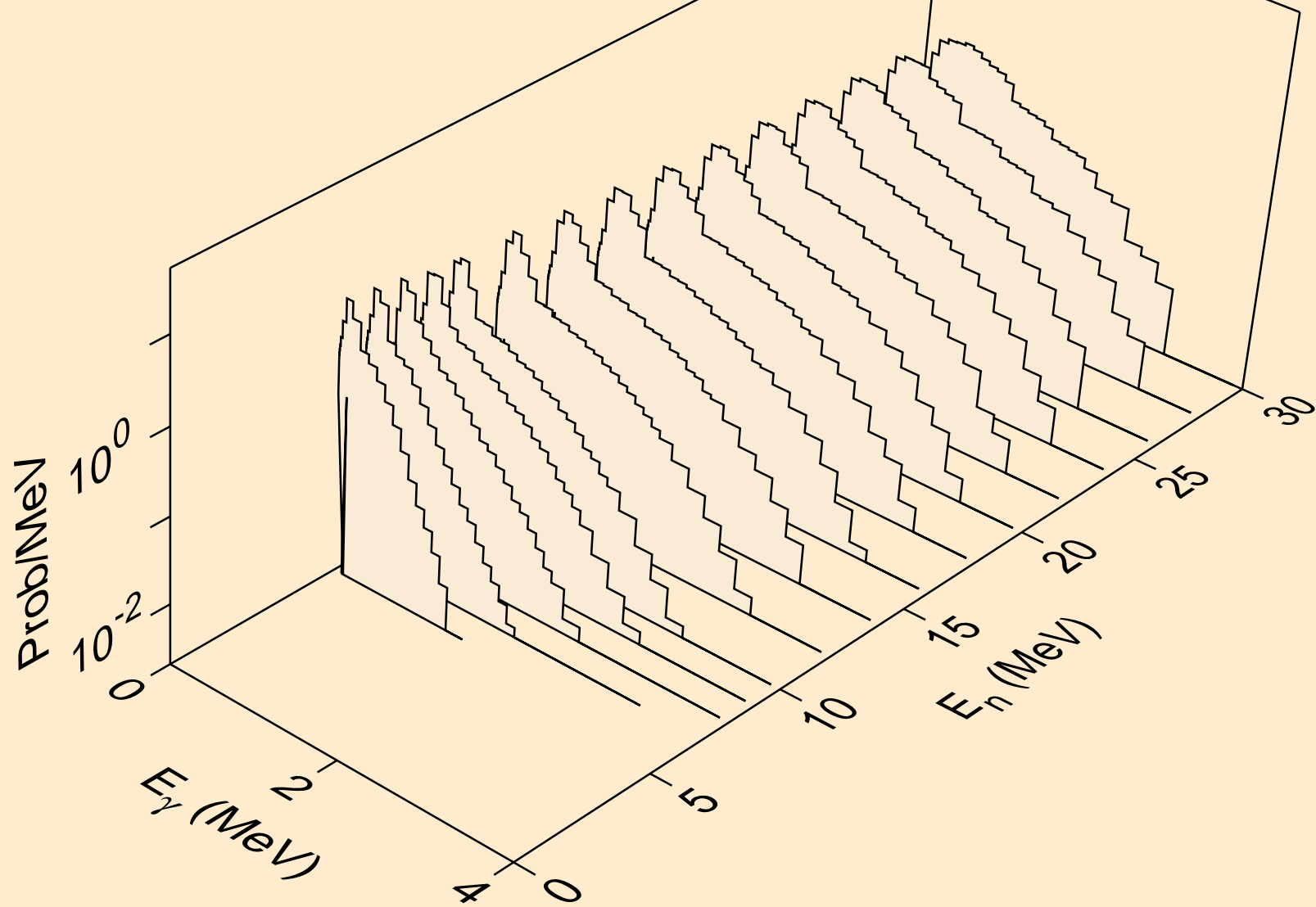

DB261 DEUTERON ACER TENDL-2021 LIBRARY; T=0.K
Photon emission for (n,t)

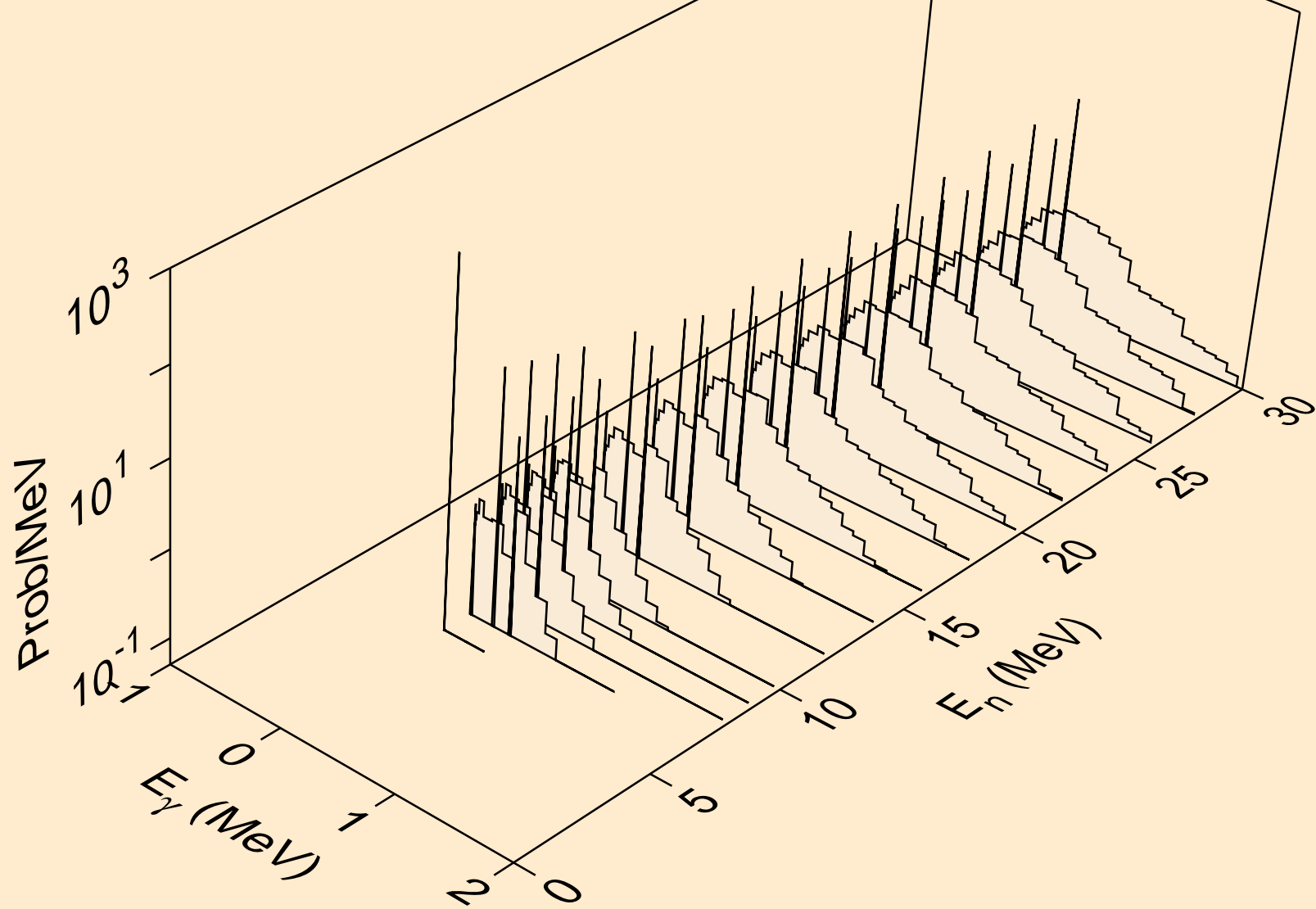

DB261 DEUTERON ACER TENDL-2021 LIBRARY; T=0.K
Photon emission for (n,he3)

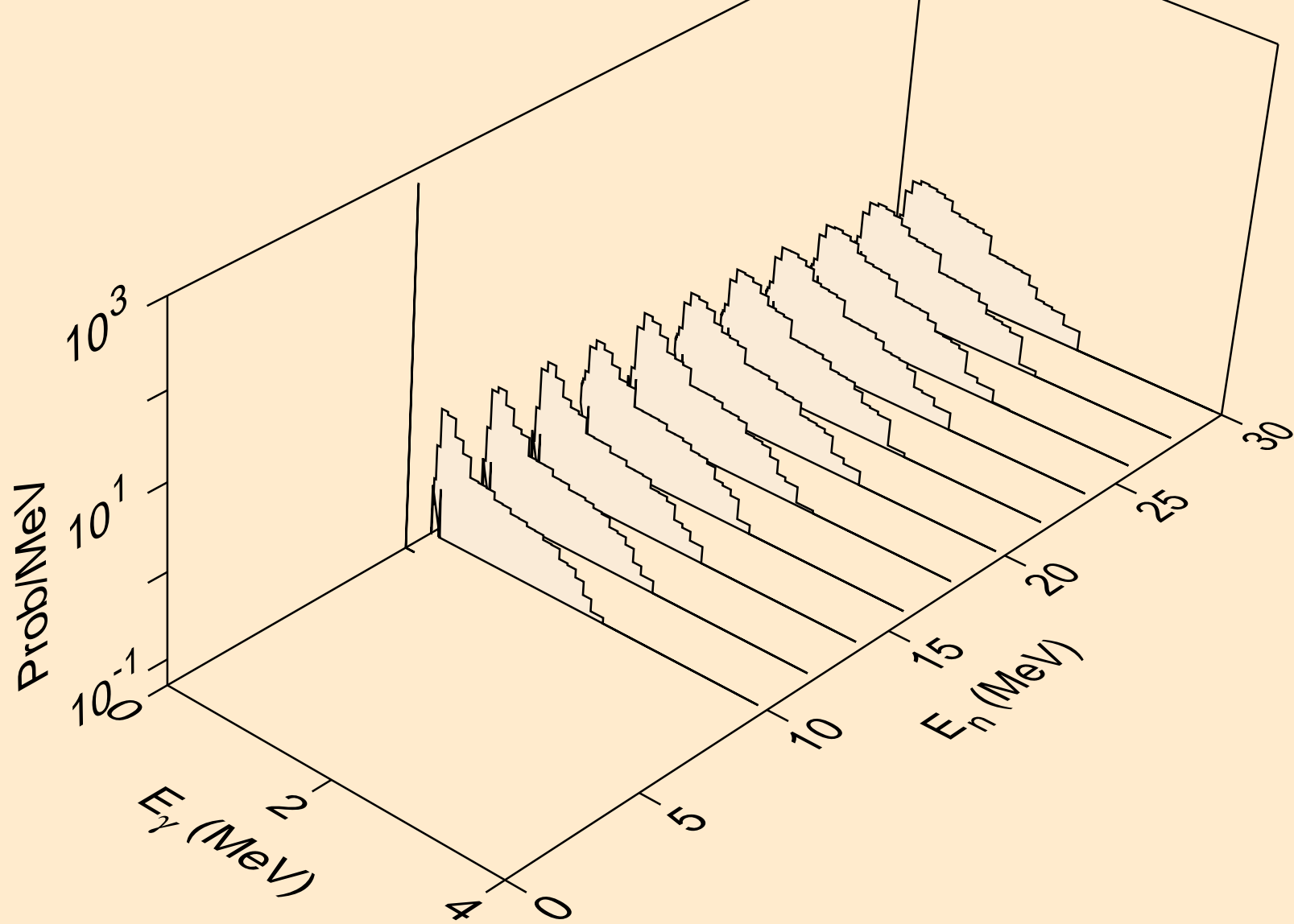

DB261 DEUTERON ACER TENDL-2021 LIBRARY; T=0.K
Photon emission for (n,a)

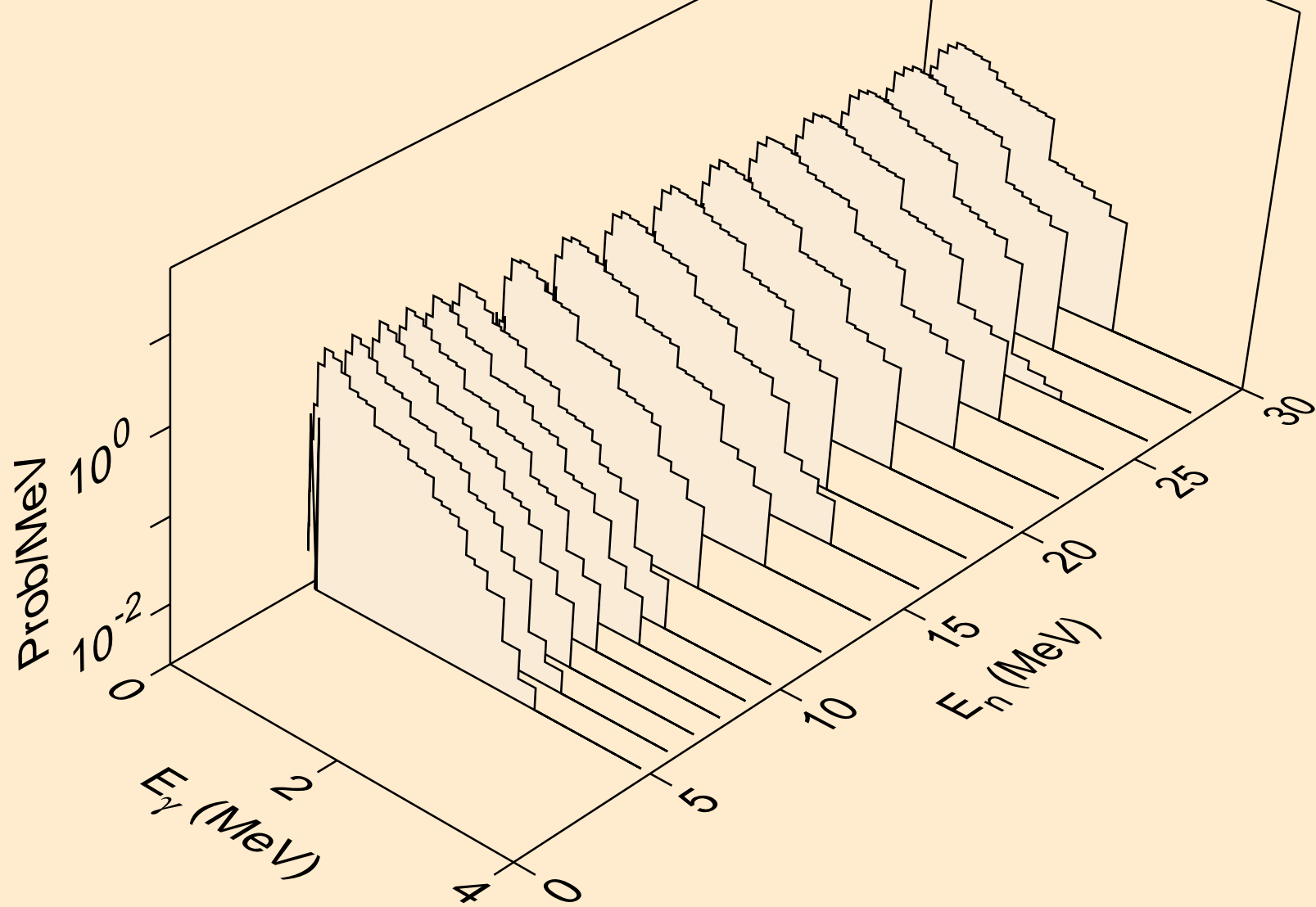

DB261 DEUTERON ACER TENDL-2021 LIBRARY; T=0.K
Photon emission for (n,2a)

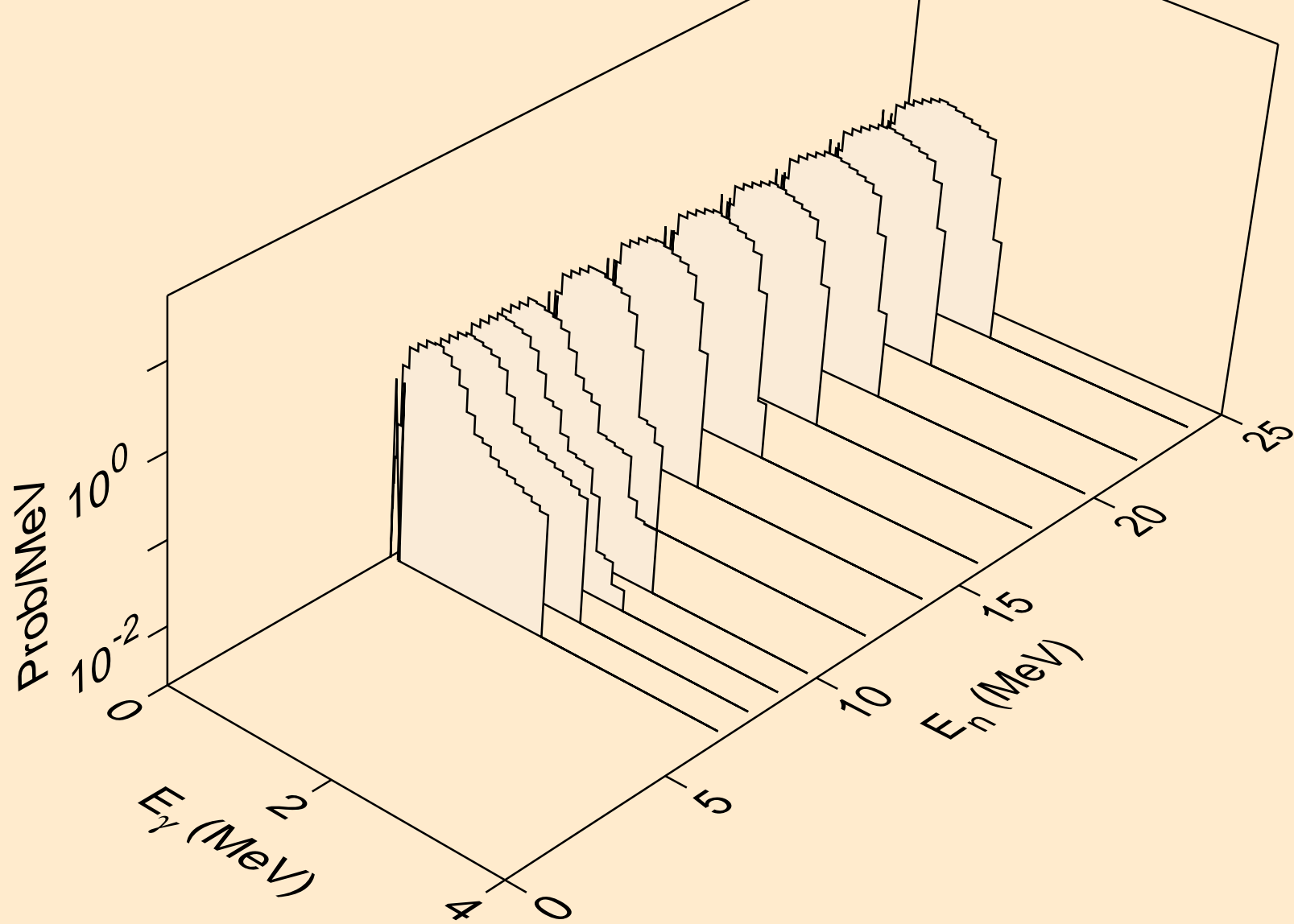

DB261 DEUTERON ACER TENDL-2021 LIBRARY; T=0.K
Photon emission for (n,2p)

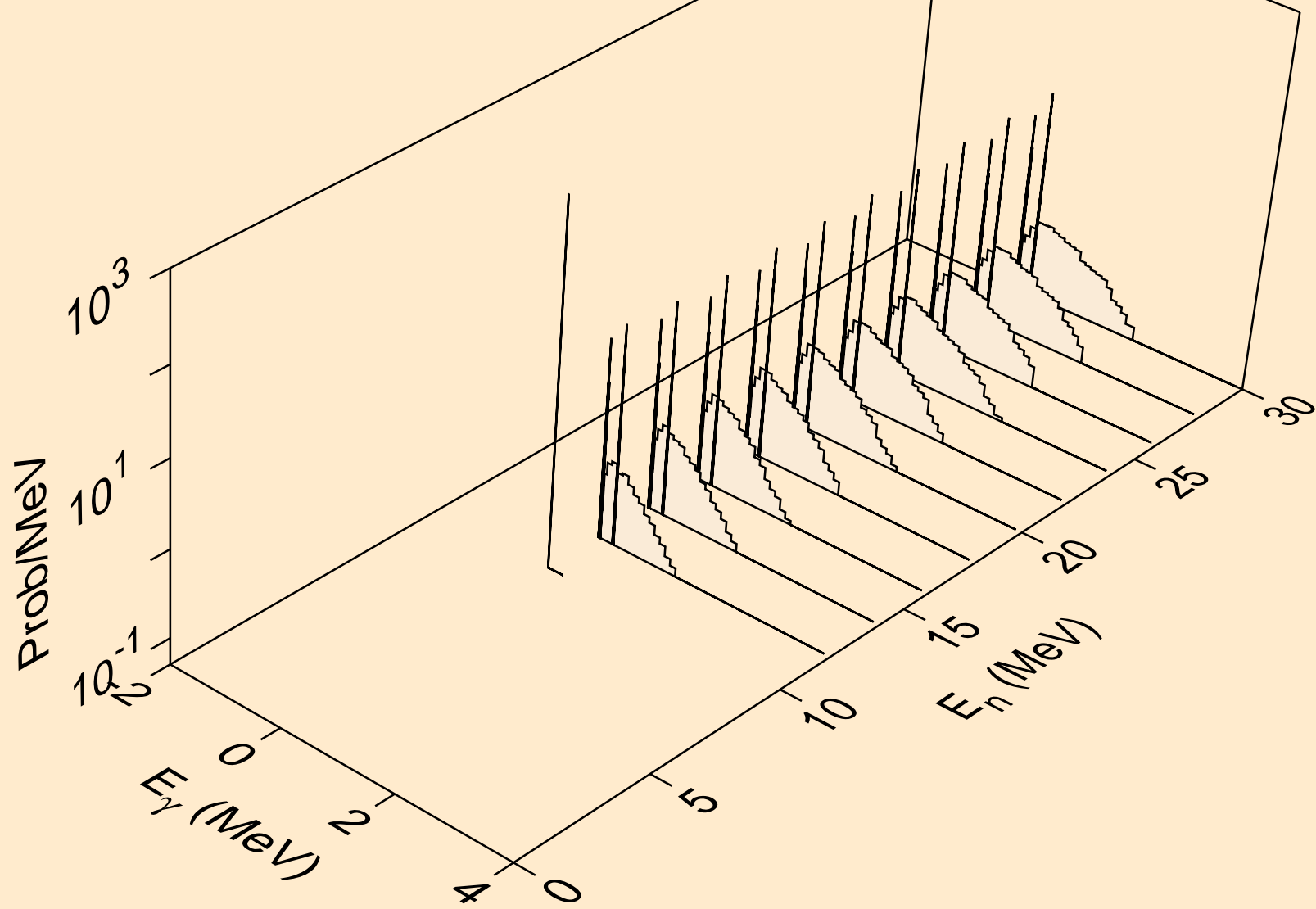

DB261 DEUTERON ACER TENDL-2021 LIBRARY; T=0.K
Photon emission for (n,p)

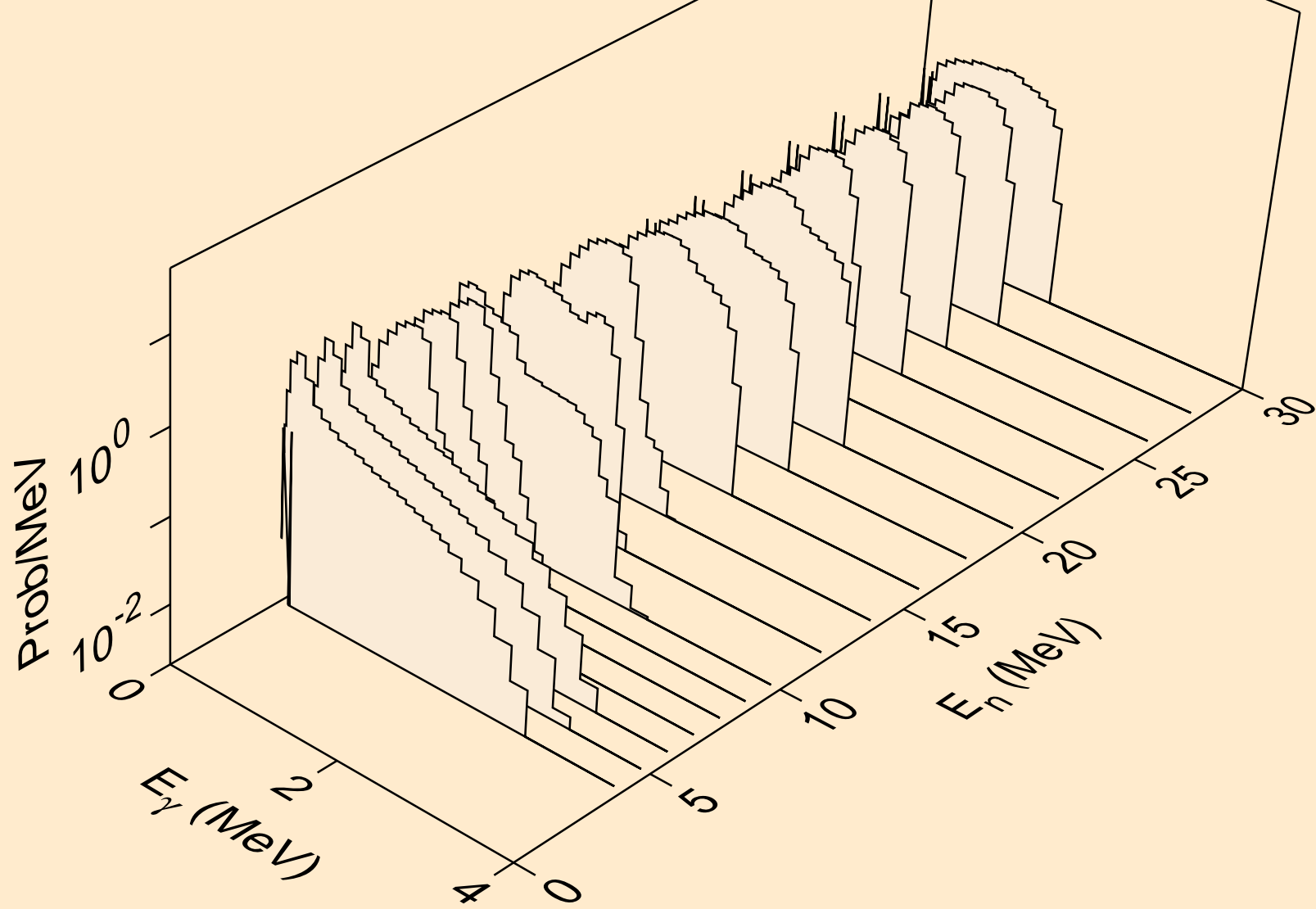

DB261 DEUTERON ACER TENDL-2021 LIBRARY; T=0.K
Photon emission for (n,t2a)

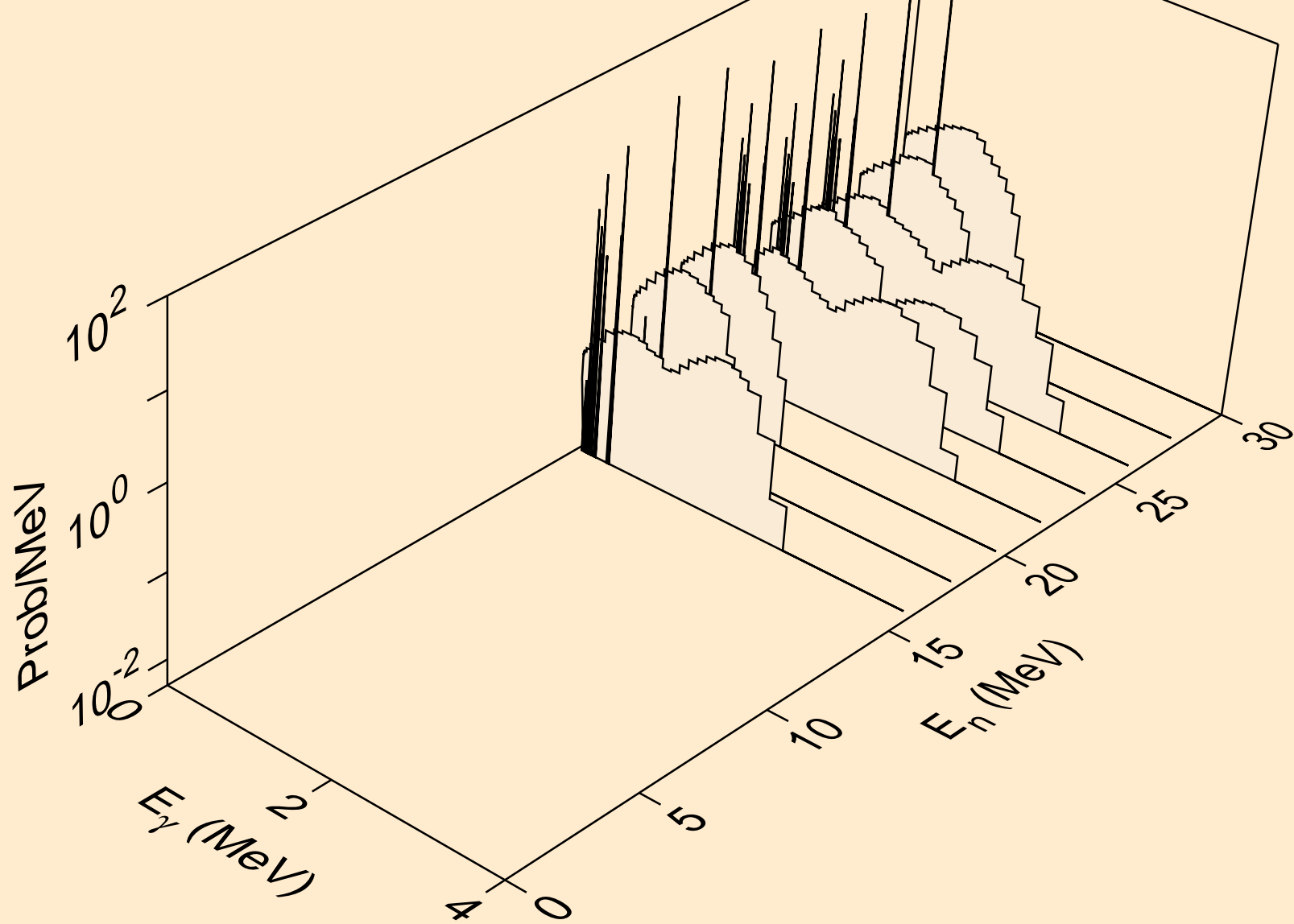

DB261 DEUTERON ACER TENDL-2021 LIBRARY; T=0.K
Photon emission for (n,d2a)

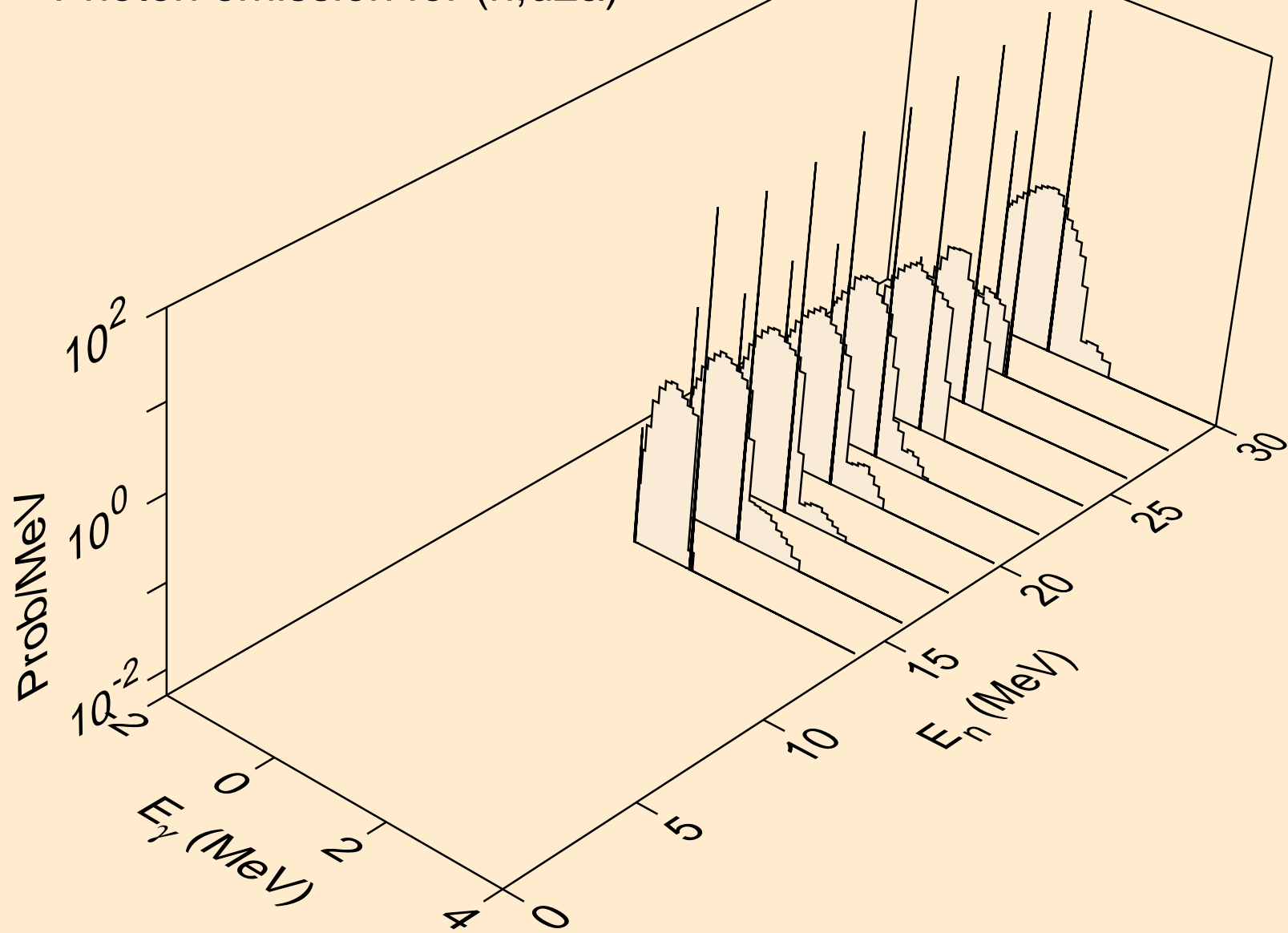

DB261 DEUTERON ACER TENDL-2021 LIBRARY; T=0.K
Photon emission for (n,pd)

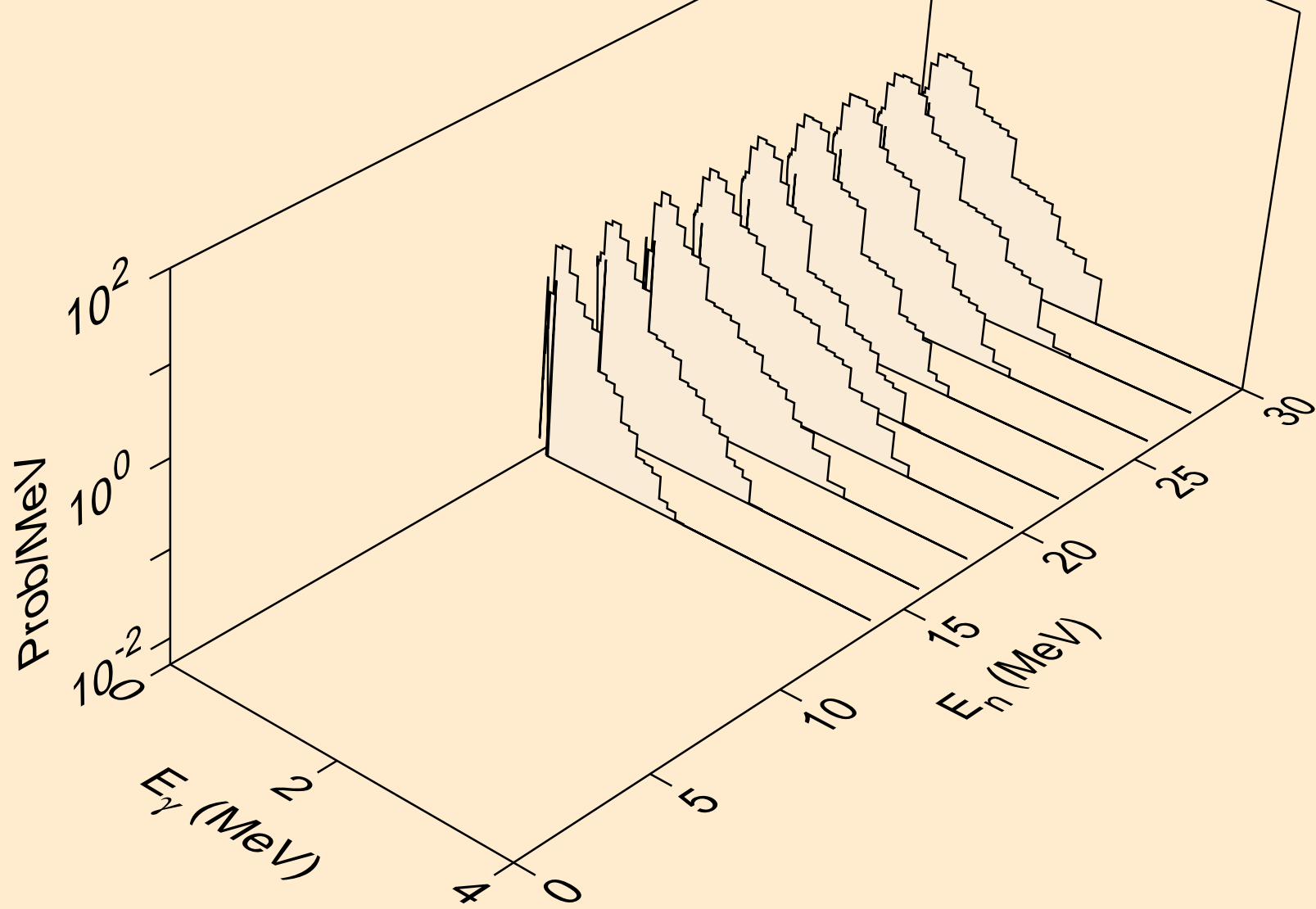

DB261 DEUTERON ACER TENDL-2021 LIBRARY; T=0.K
Photon emission for (n,da)

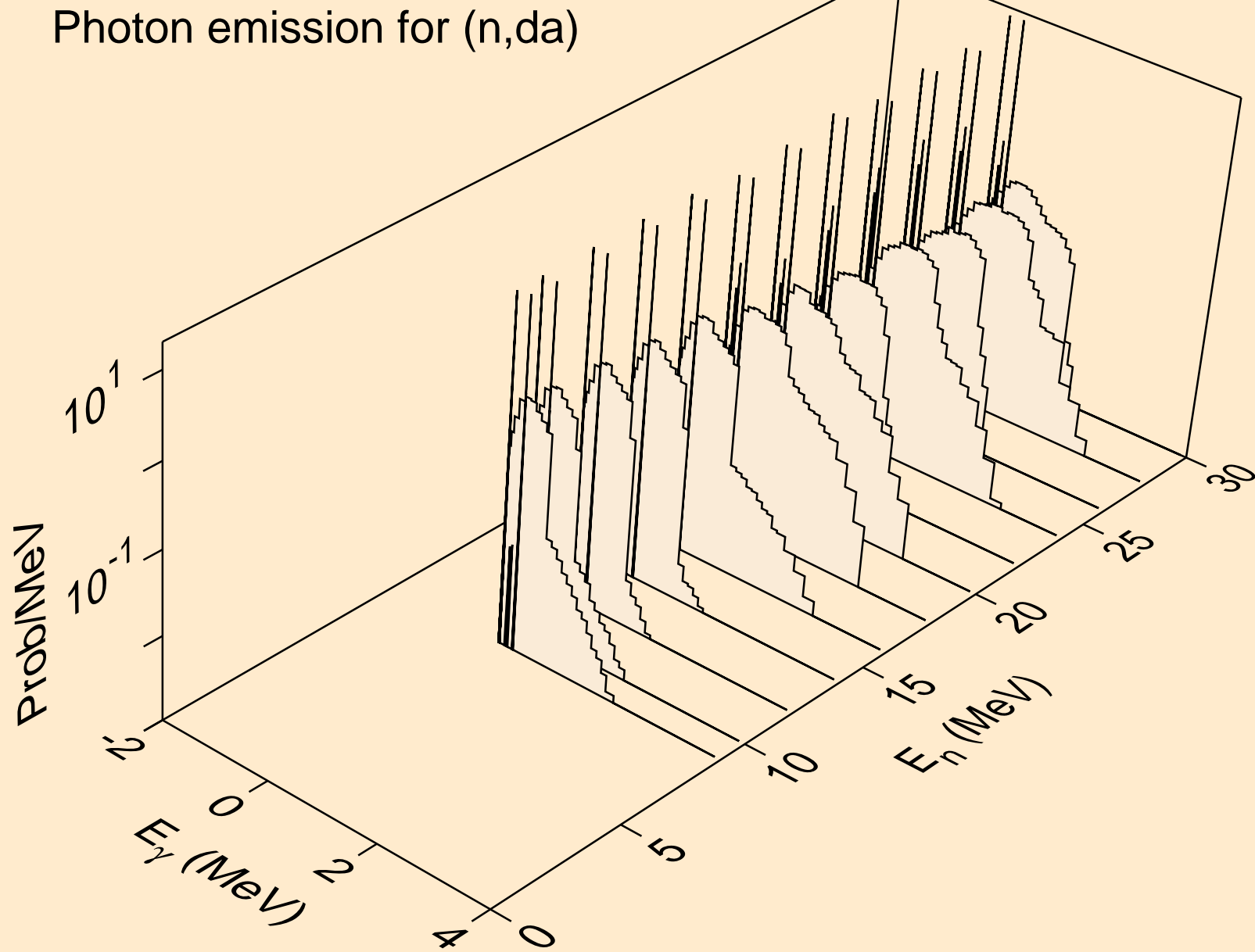

DB261 DEUTERON ACER TENDL-2021 LIBRARY; T=0.K
Particle heating contributions

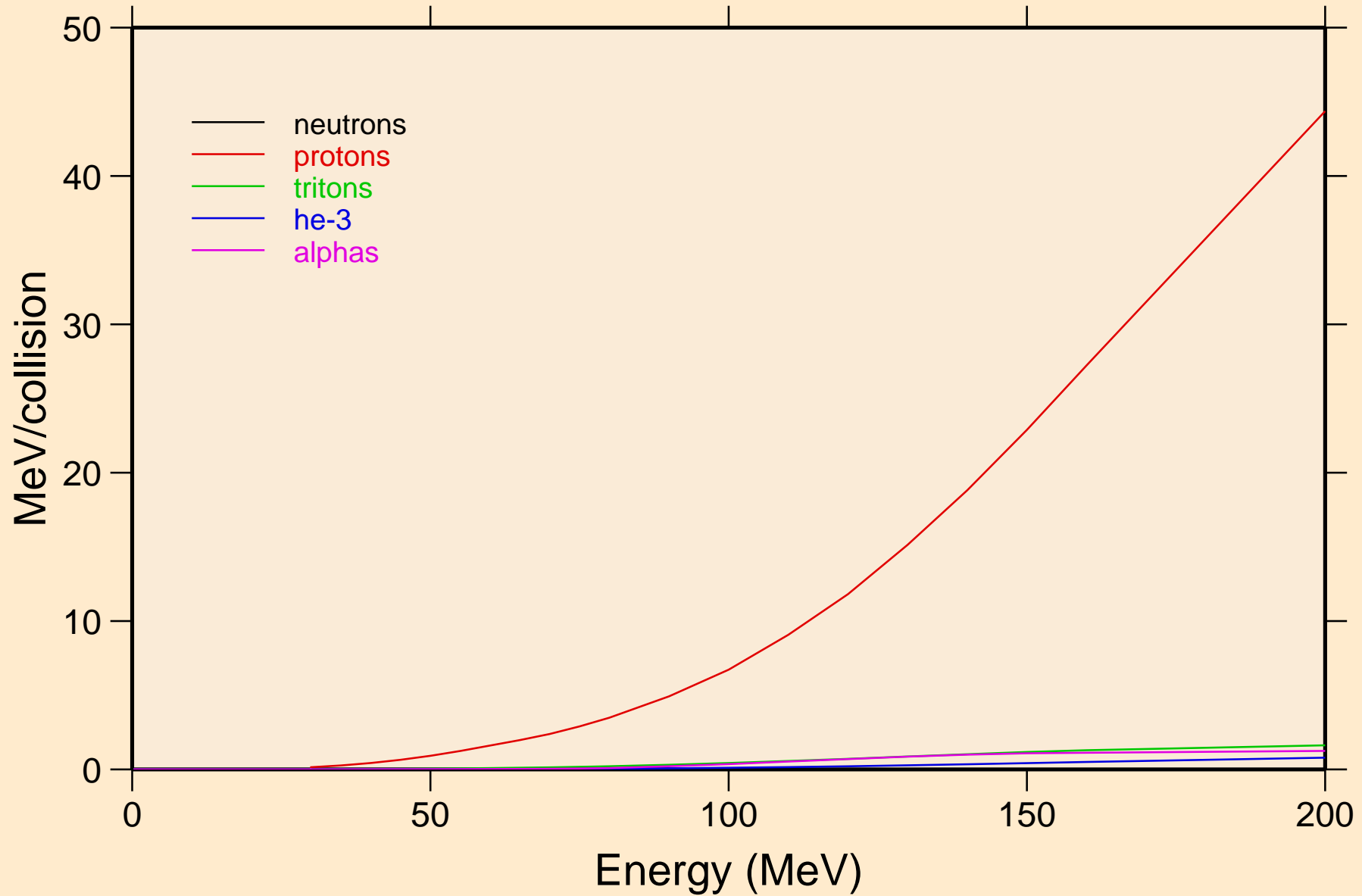

DB261 DEUTERON ACER TENDL-2021 LIBRARY; T=0.K
Recoil Heating

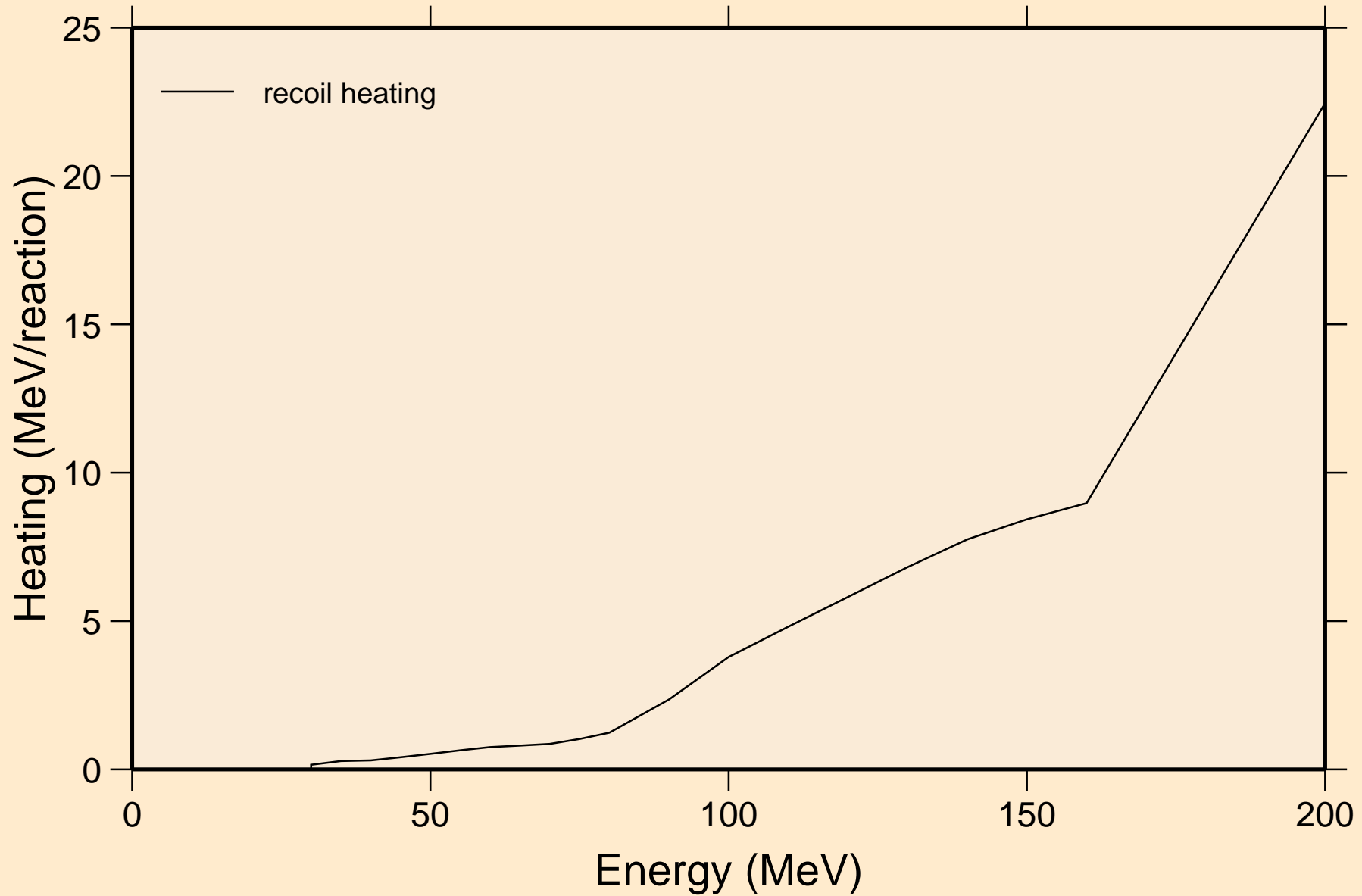

DB261 DEUTERON ACER TENDL-2021 LIBRARY; T=0.K
Particle production cross sections

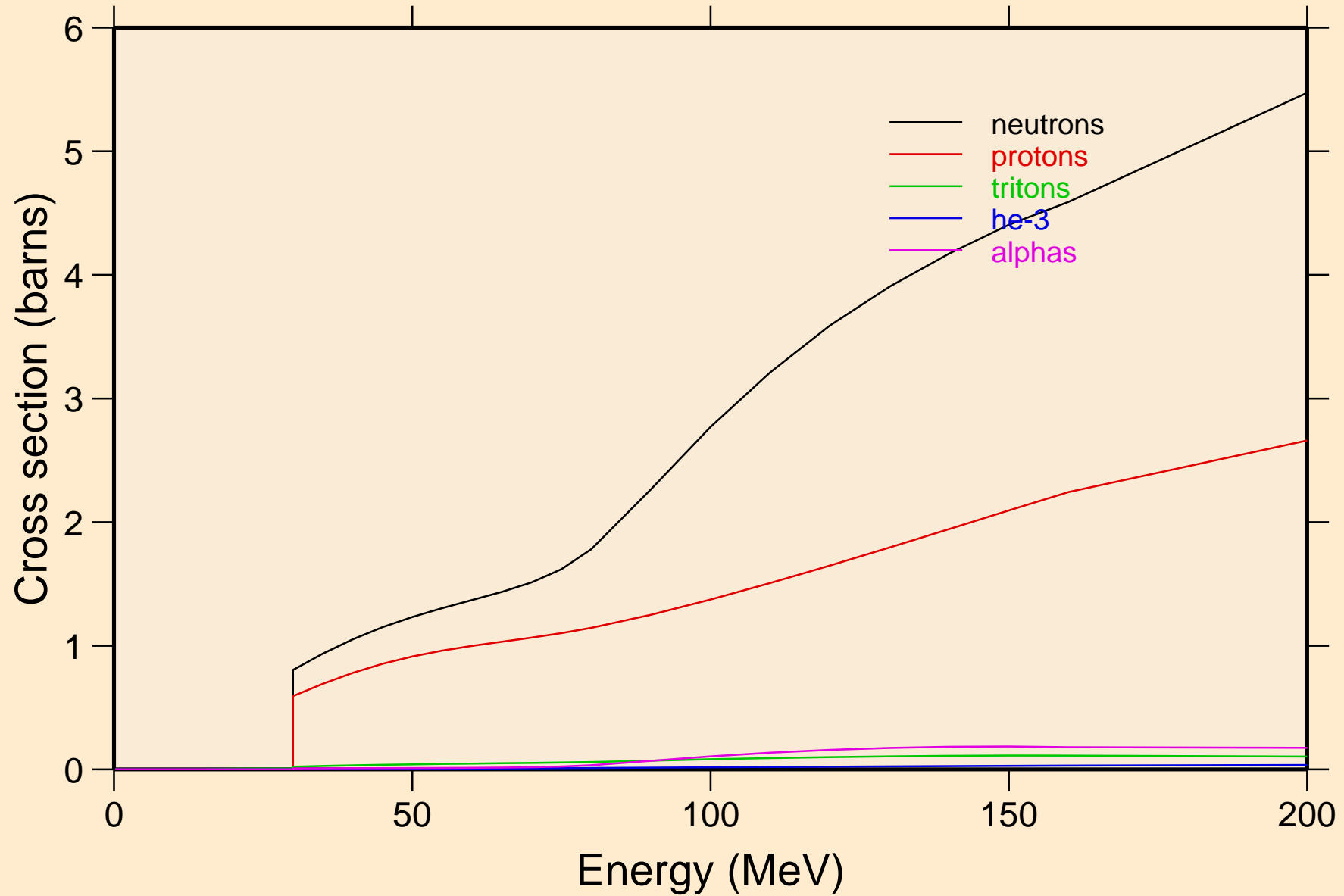

DB261 DEUTERON ACER TENDL-2021 LIBRARY; T=0.K
neutrons from (d,n)

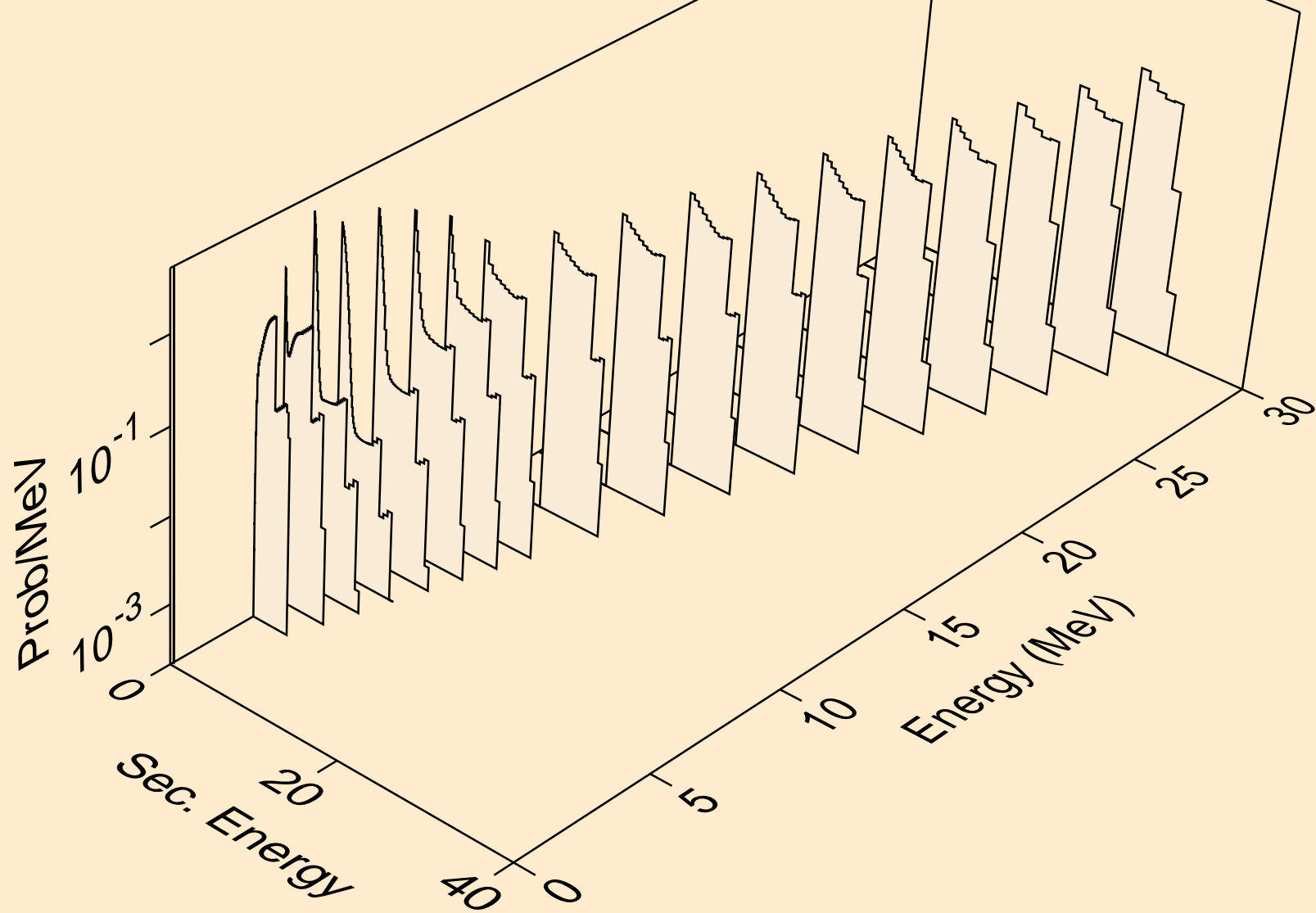

DB261 DEUTERON ACER TENDL-2021 LIBRARY; T=0.K
neutrons from (d,x)

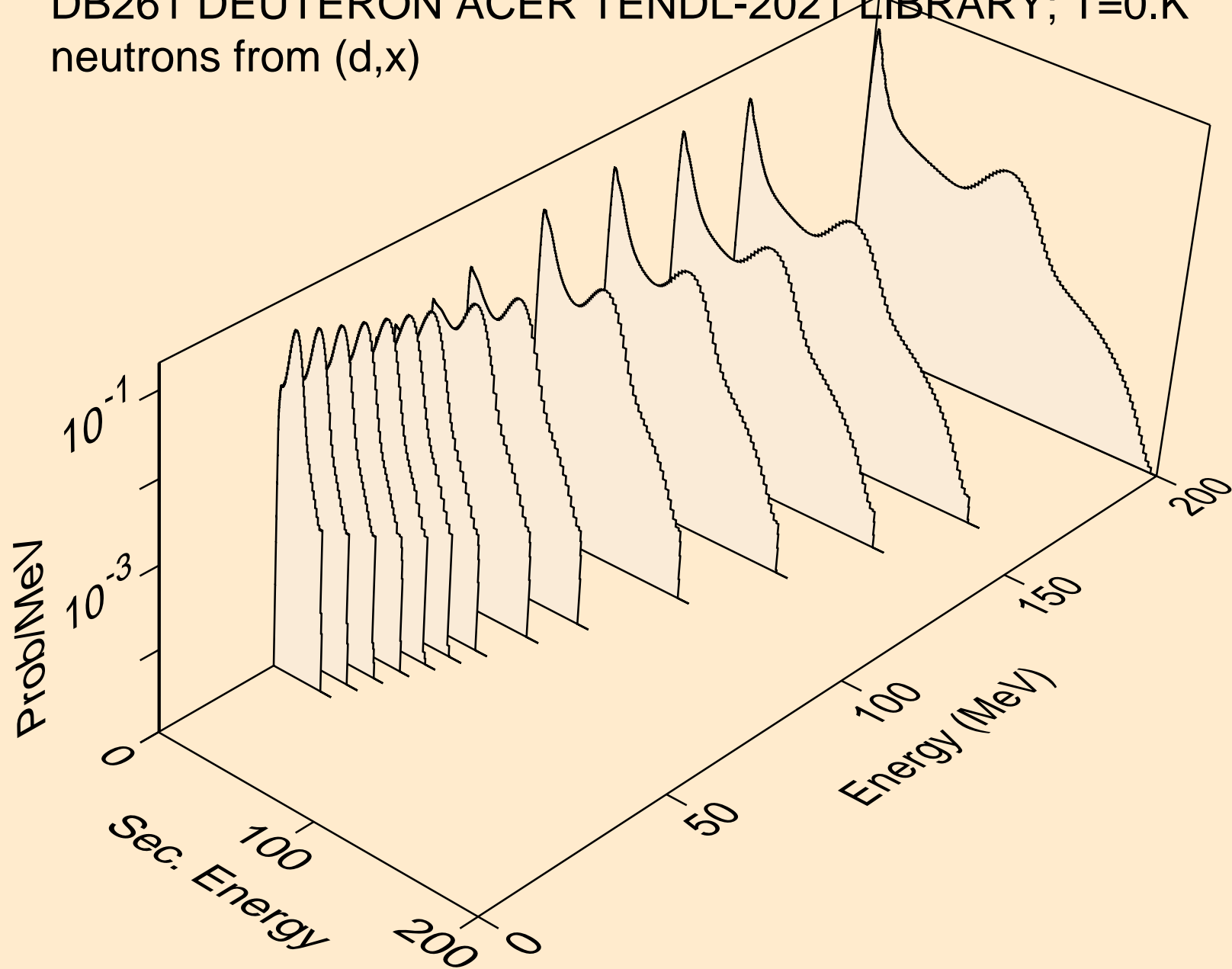

DB261 DEUTERON ACER TENDL-2021 LIBRARY; T=0.K
neutrons from (d,2n)

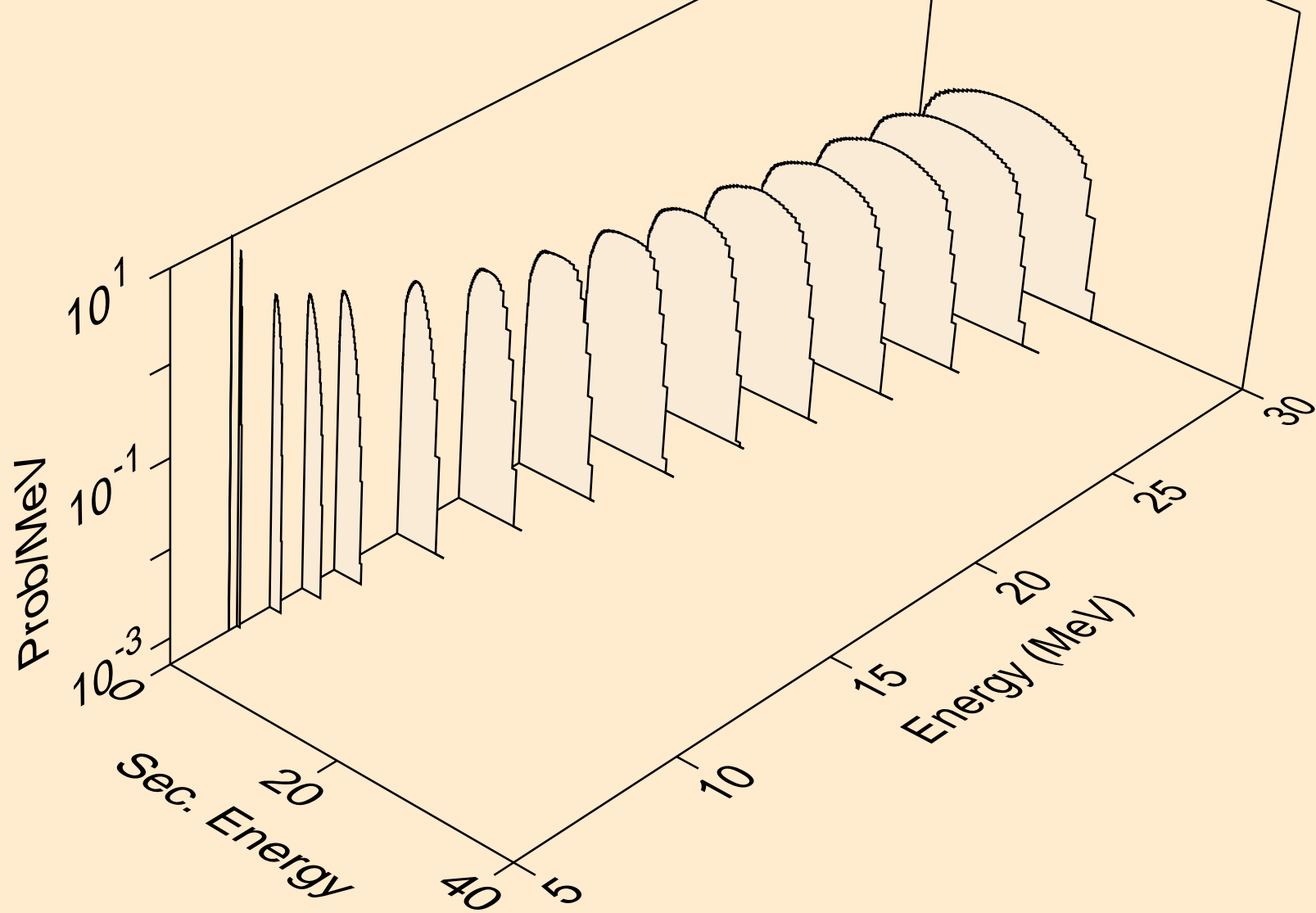

DB261 DEUTERON ACER TENDL-2021 LIBRARY; T=0.K
neutrons from (d,3n)

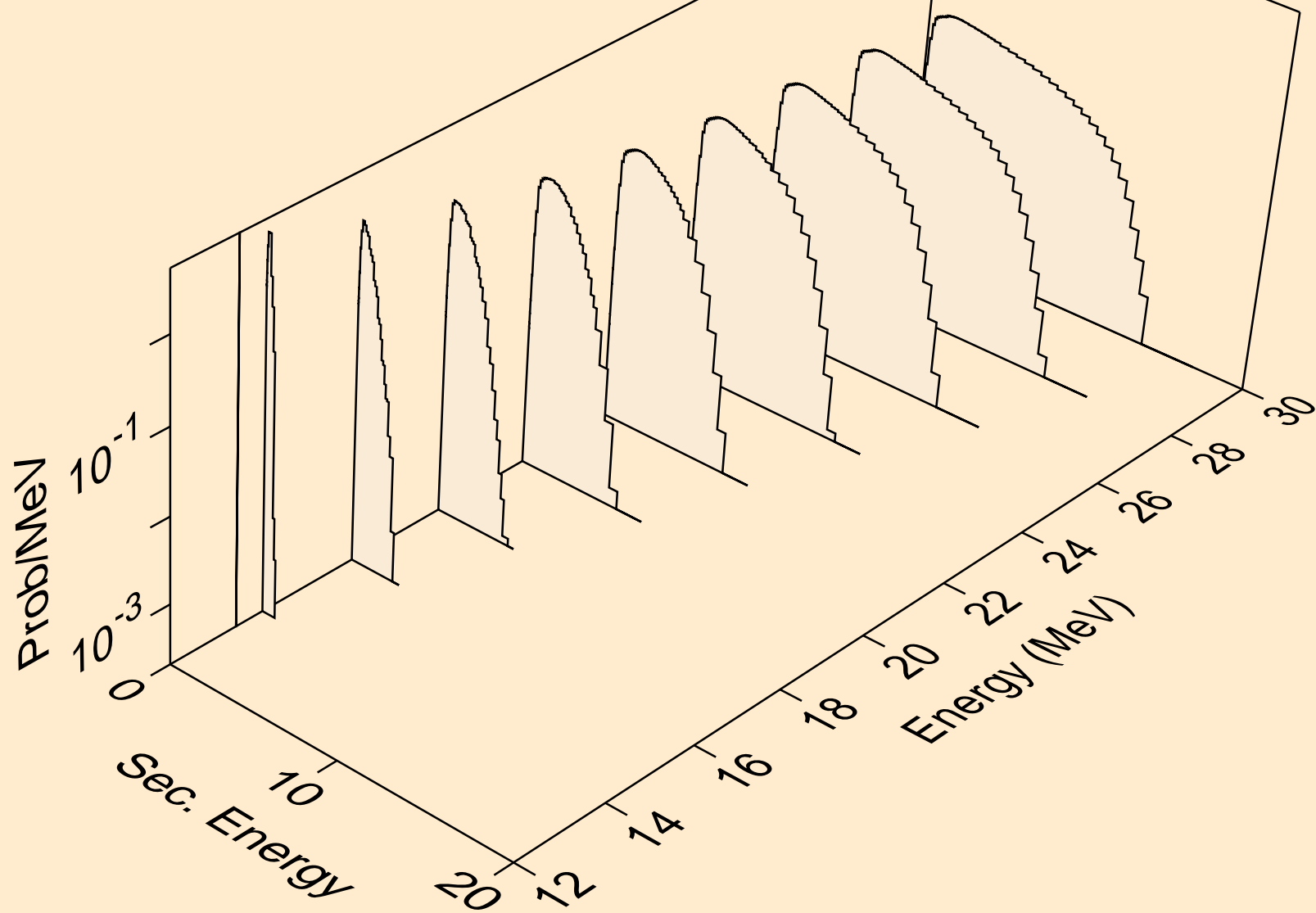

DB261 DEUTERON ACER TENDL-2021 LIBRARY; T=0.K
neutrons from (d,n*)a

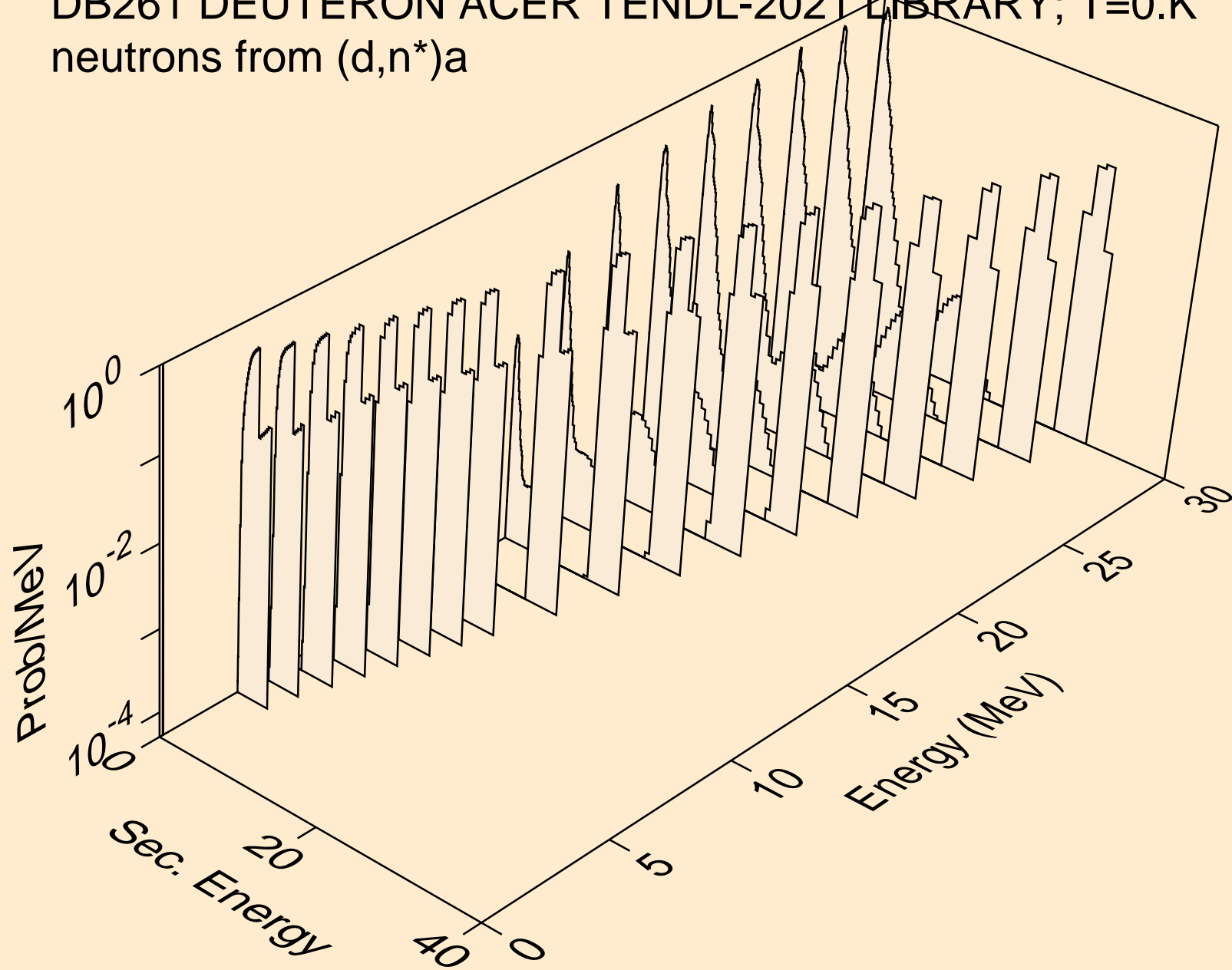

DB261 DEUTERON ACER TENDL-2021 LIBRARY; T=0.K
neutrons from (d,2n)a

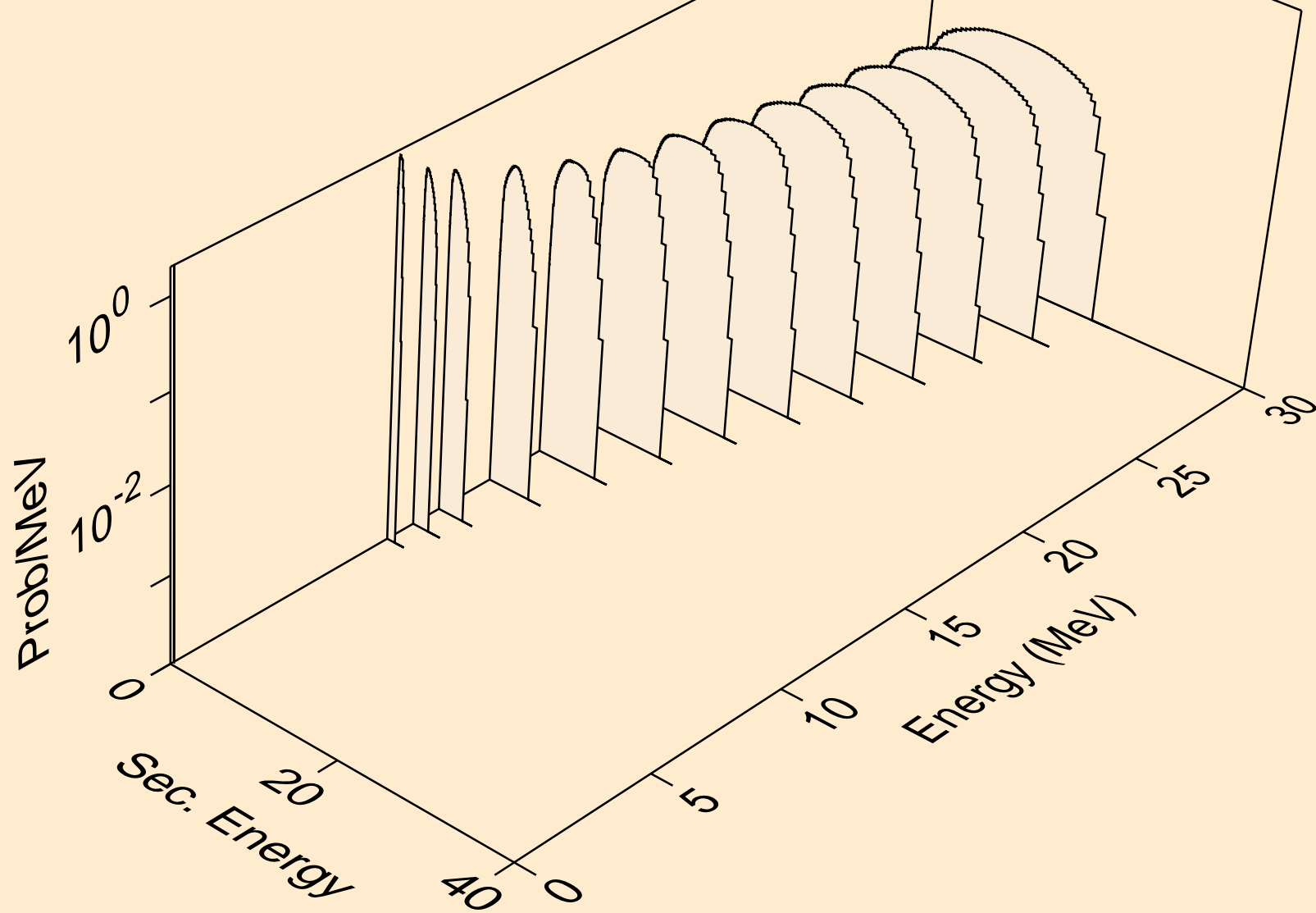

DB261 DEUTERON ACER TENDL-2021 LIBRARY; T=0.K
neutrons from (d,3n)a

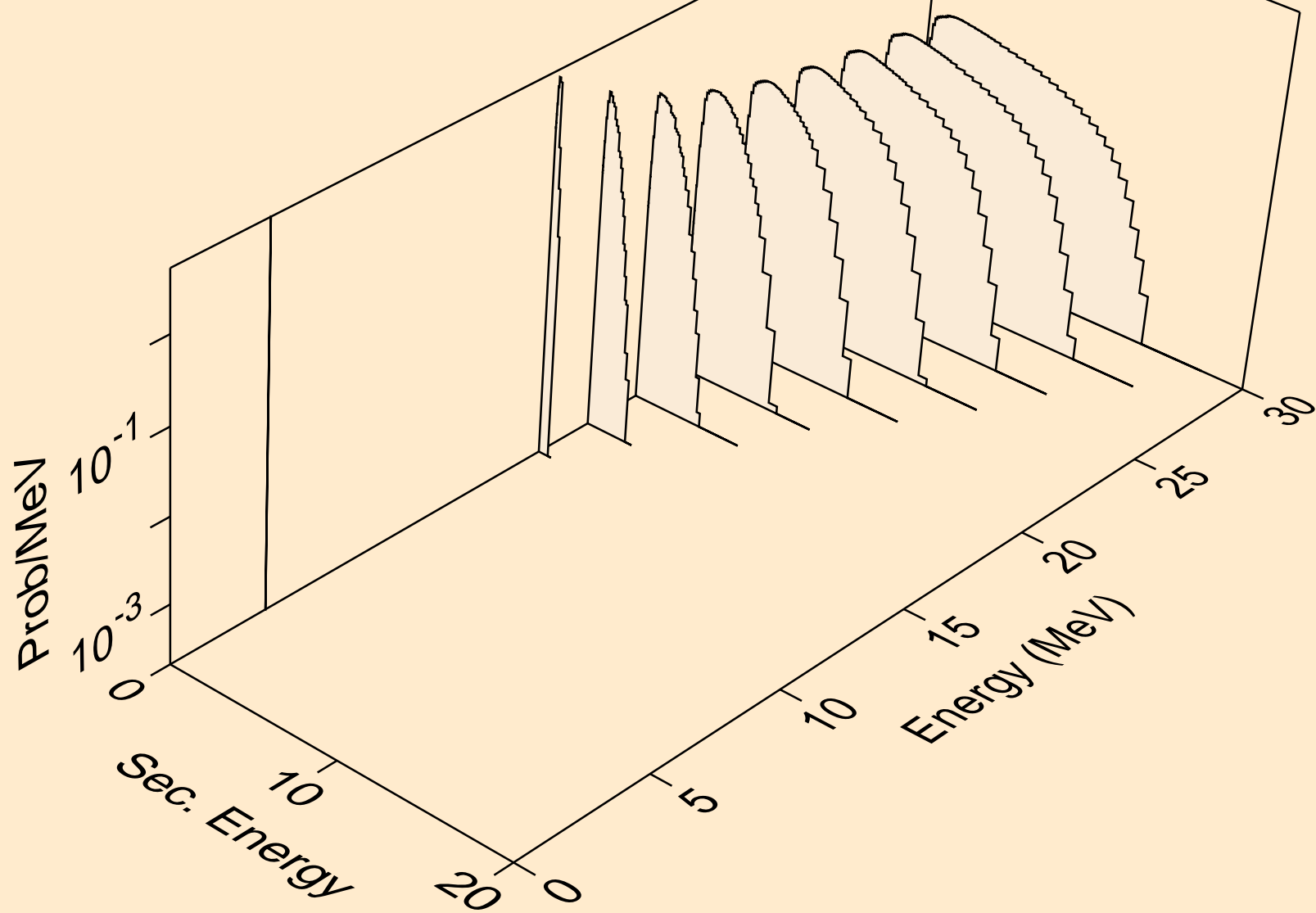

DB261 DEUTERON ACER TENDL-2021 LIBRARY; T=0.K
neutrons from (d,n*)p

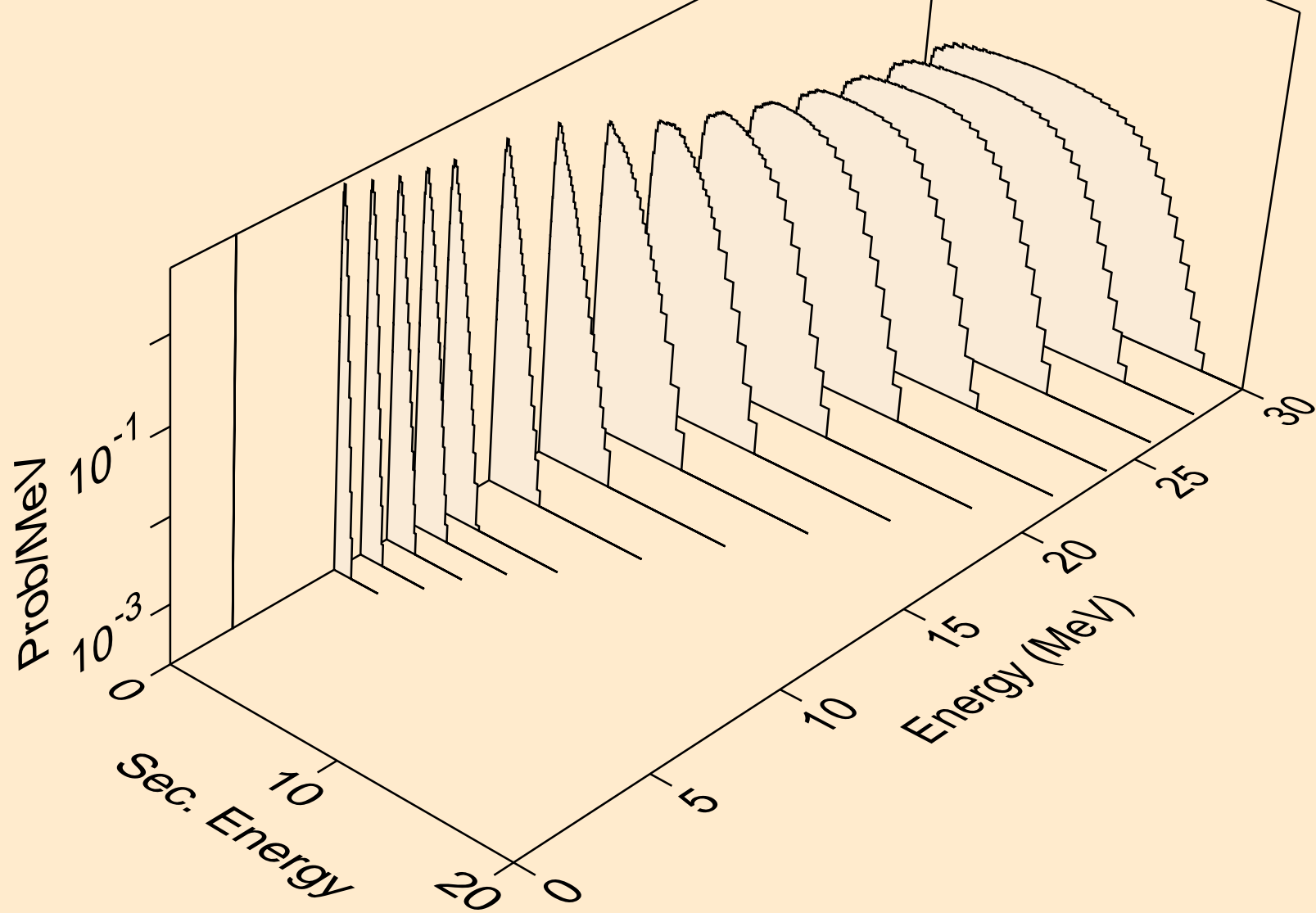

DB261 DEUTERON ACER TENDL-2021 LIBRARY; T=0.K
neutrons from (d,n*)d

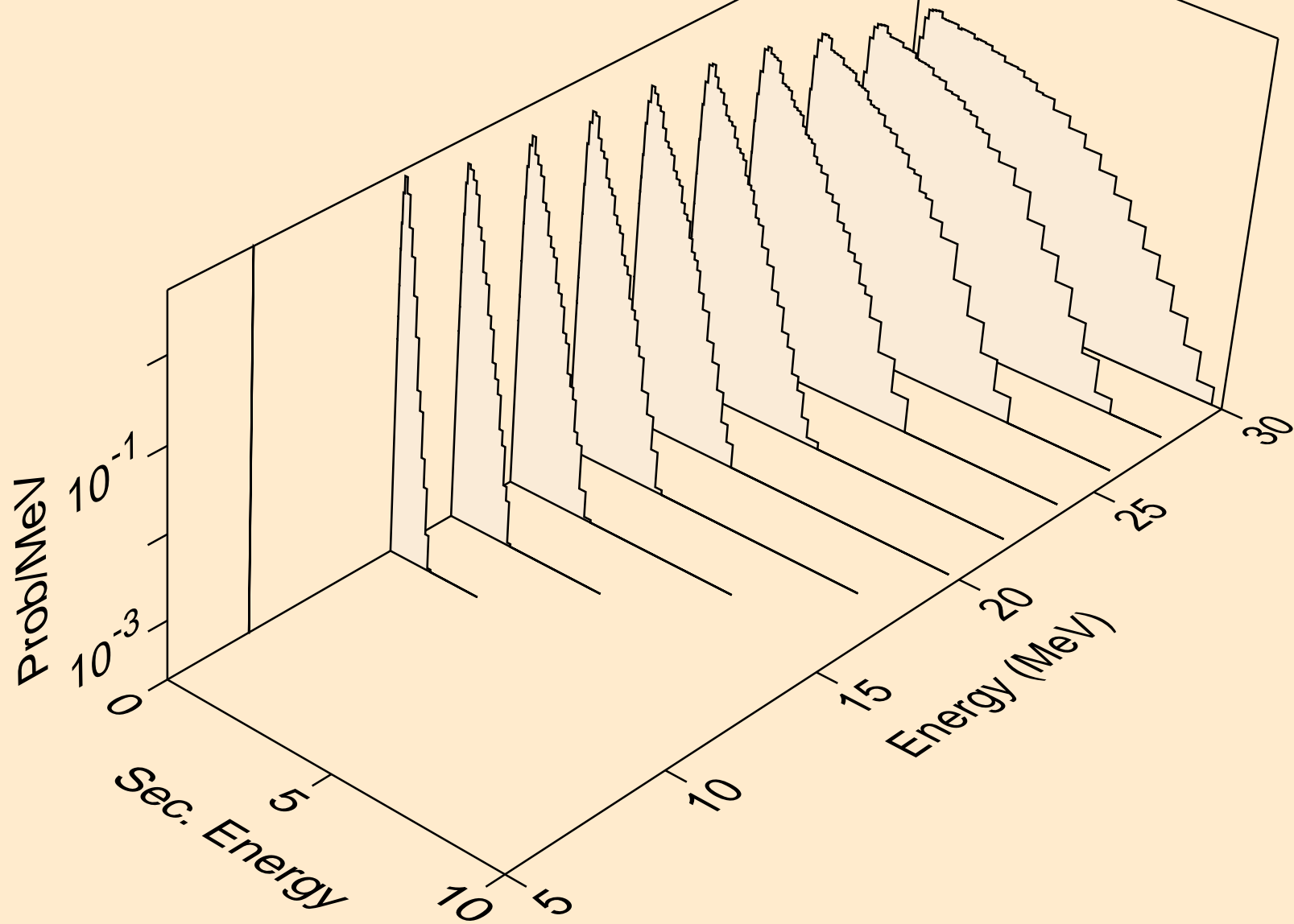

DB261 DEUTERON ACER TENDL-2021 LIBRARY; T=0.K
neutrons from (d,n*)t

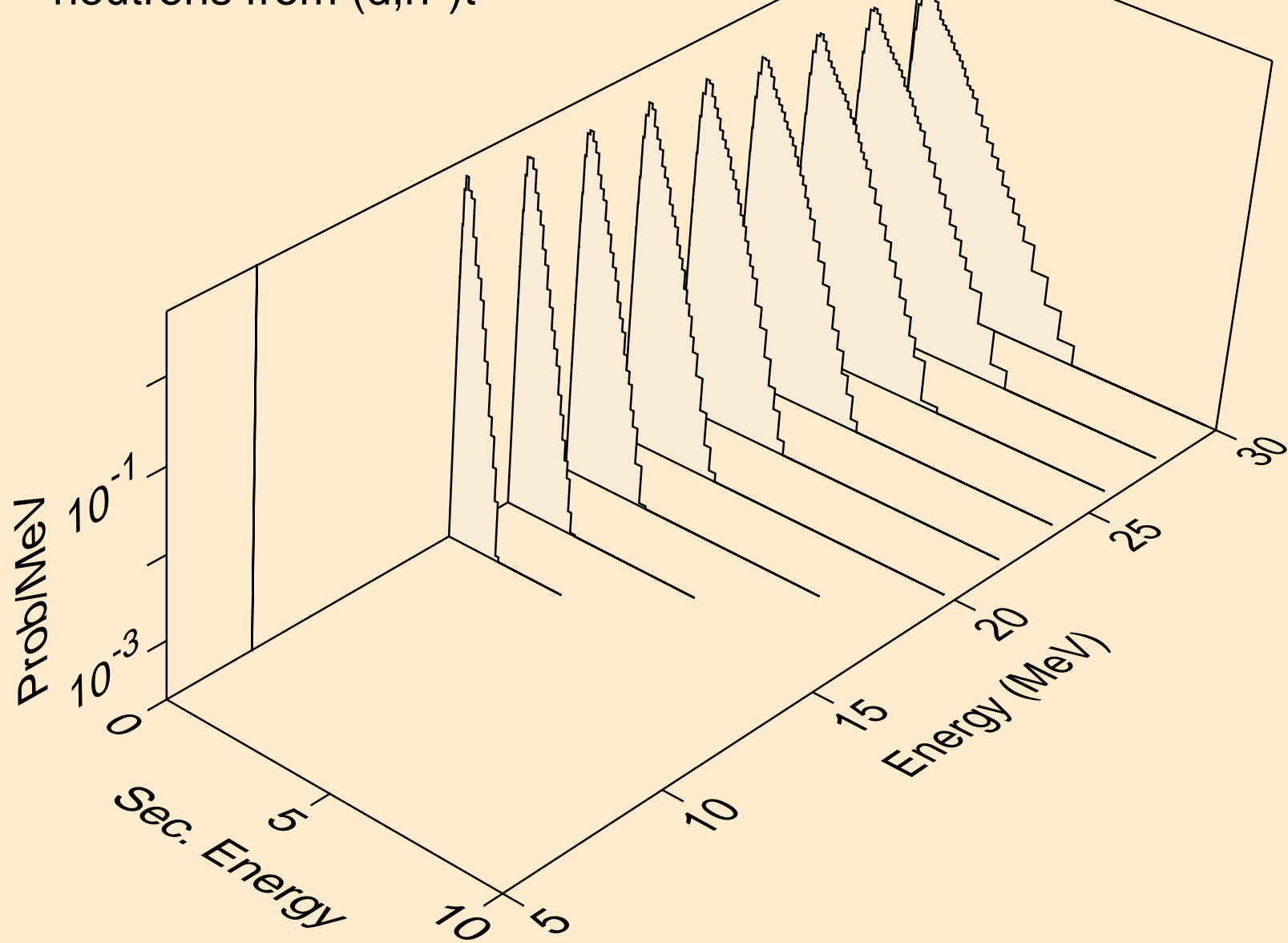

DB261 DEUTERON ACER TENDL-2021 LIBRARY; T=0.K
neutrons from (d,n*)d2a

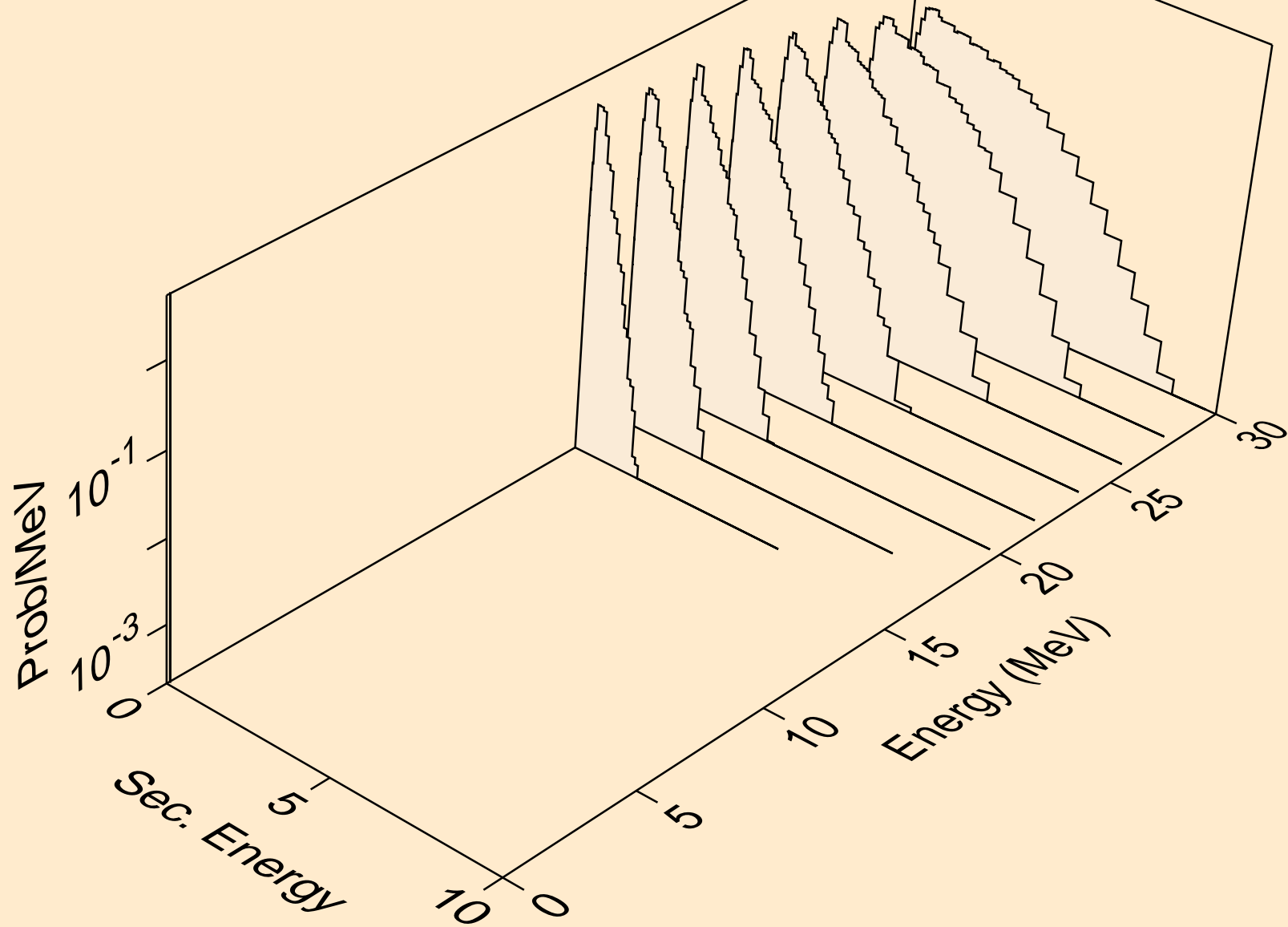

DB261 DEUTERON ACER TENDL-2021 LIBRARY; T=0.K
neutrons from (d,4n)

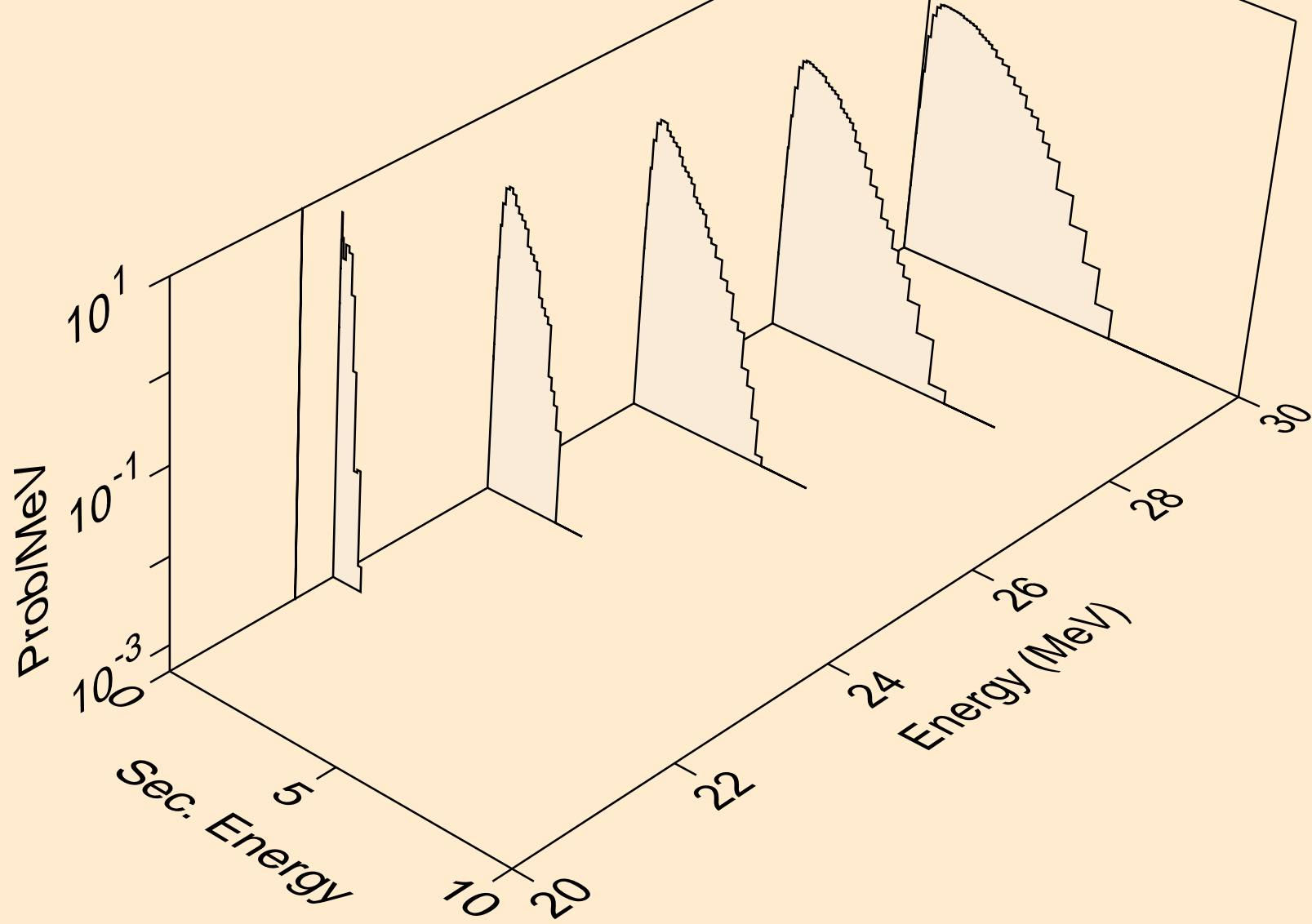

DB261 DEUTERON ACER TENDL-2021 LIBRARY; T=0.K
neutrons from (d,2np)

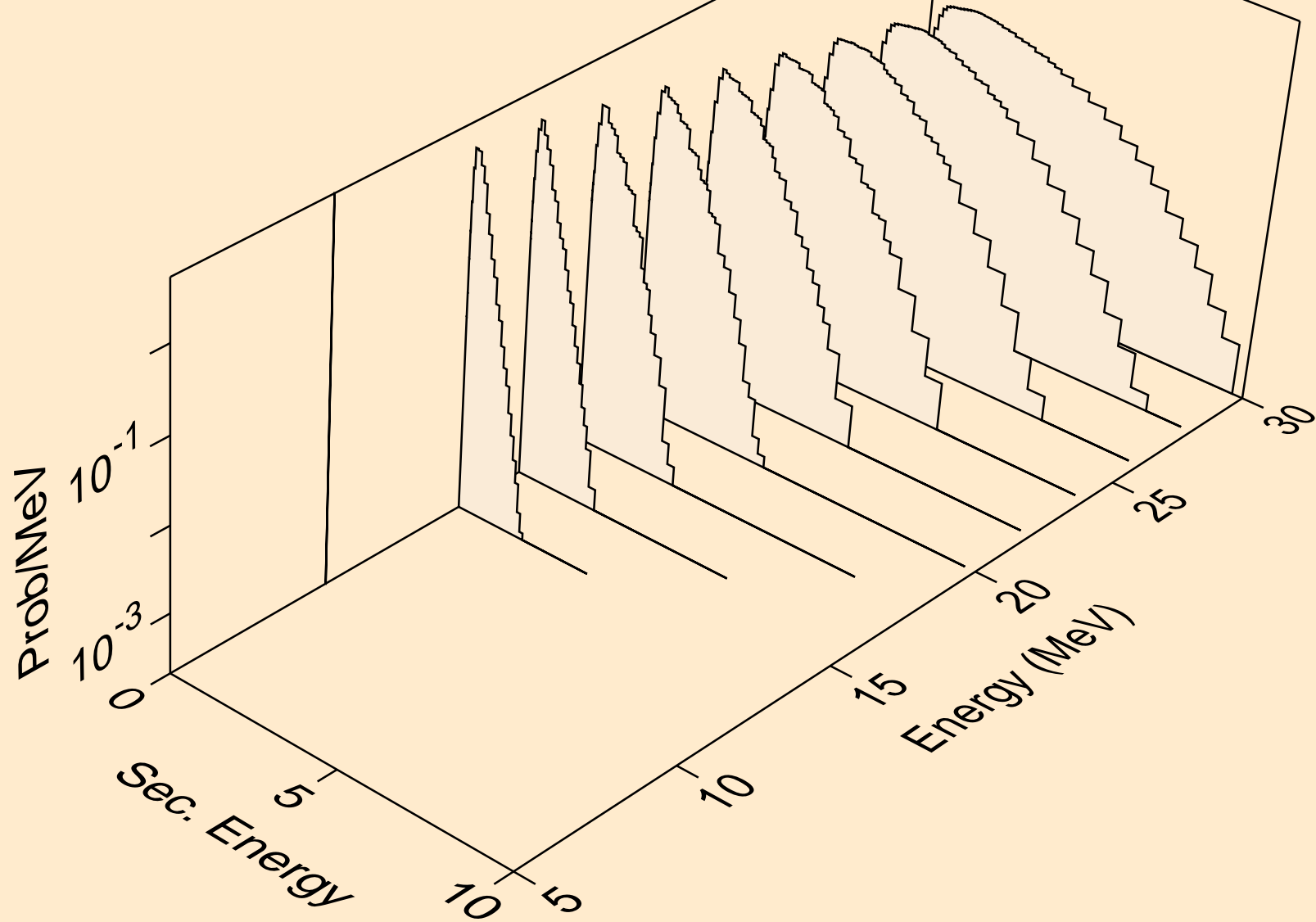

DB261 DEUTERON ACER TENDL-2021 LIBRARY; T=0.K
neutrons from (d,2np)

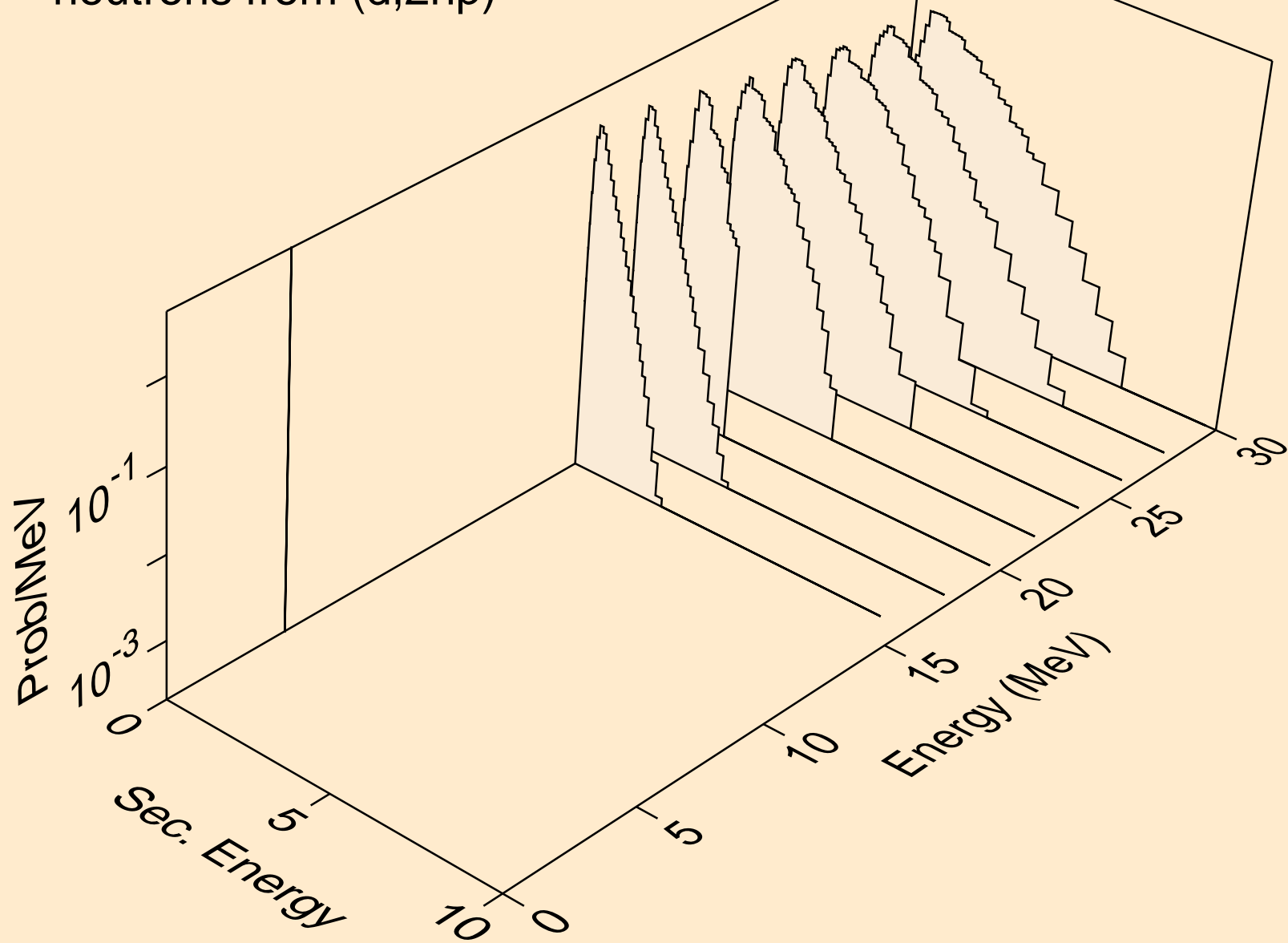

DB261 DEUTERON ACER TENDL-2021 LIBRARY; T=0.K
neutrons from (d,npa)

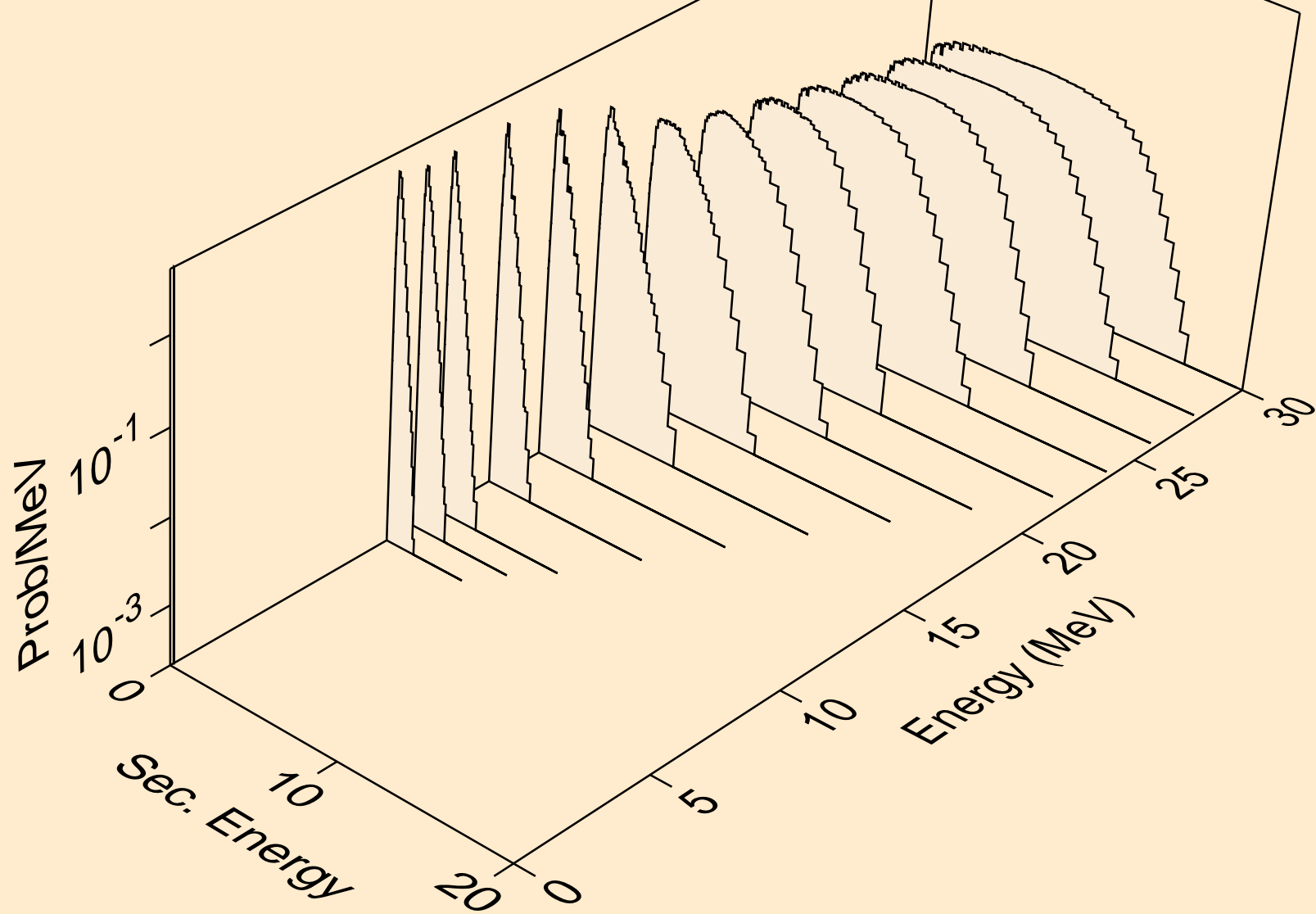

DB261 DEUTERON ACER TENDL-2021 LIBRARY; T=0.K
protons from (d,x)

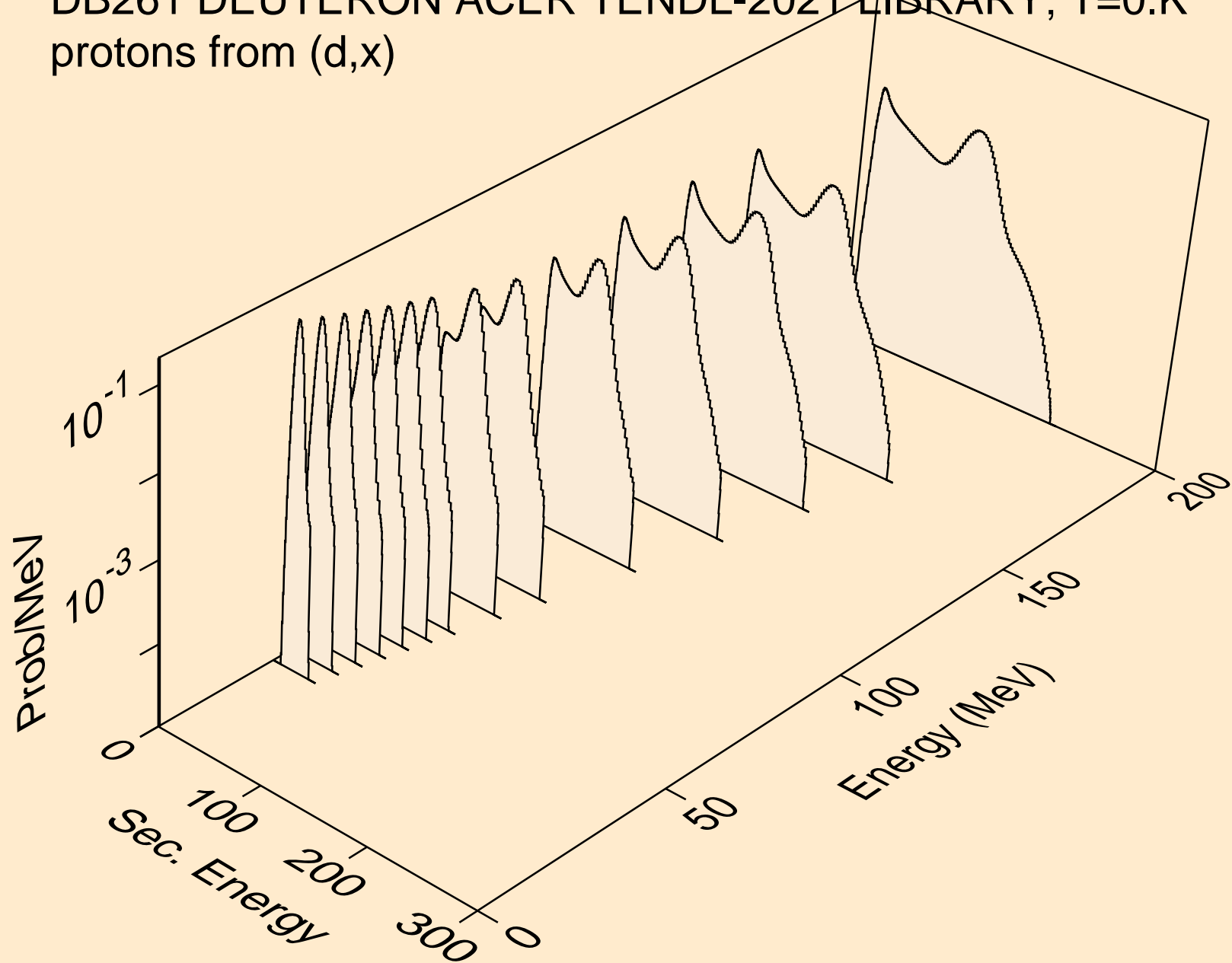

DB261 DEUTERON ACER TENDL-2021 LIBRARY; T=0.K
protons from (d,n*)p

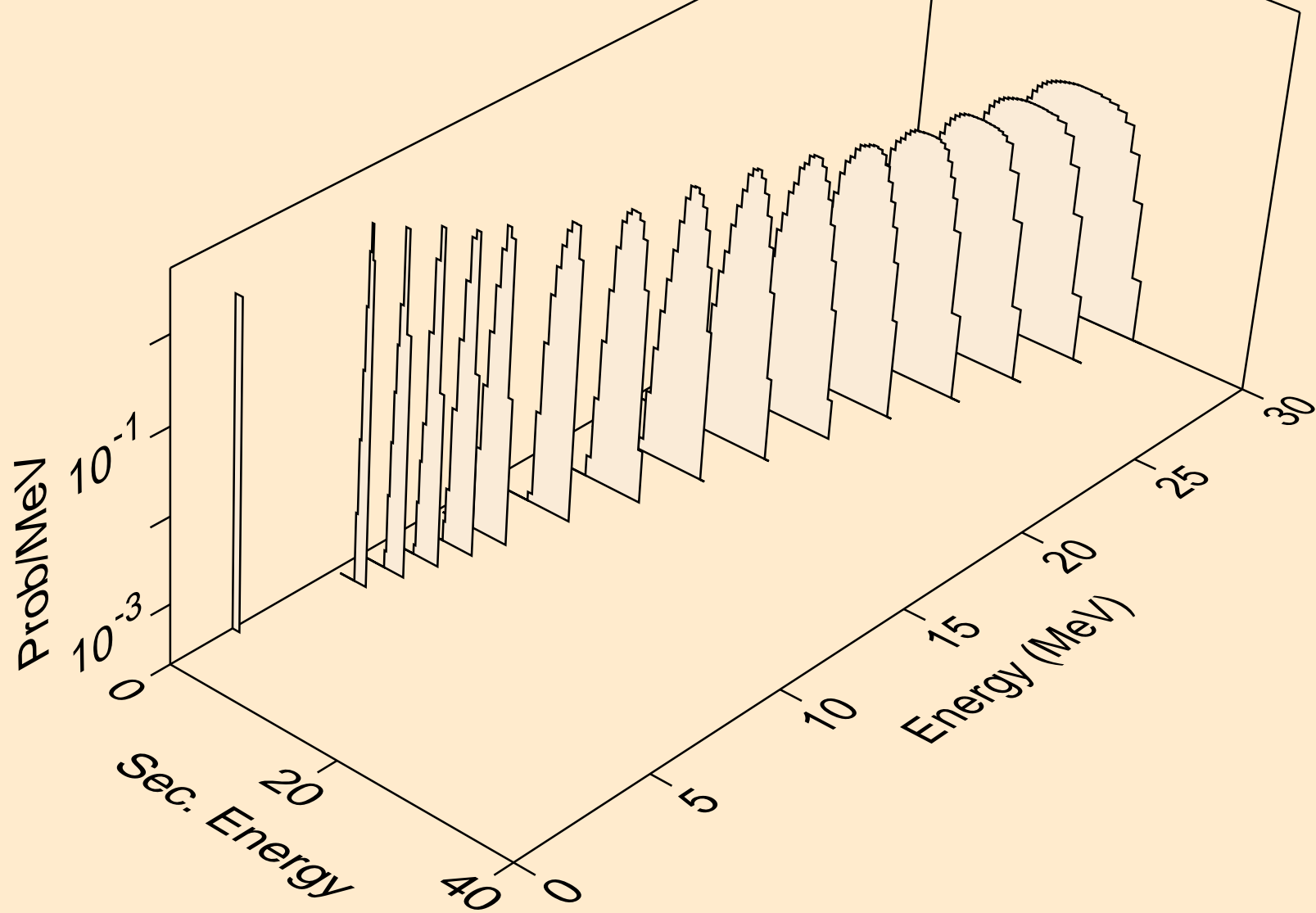

DB261 DEUTERON ACER TENDL-2021 LIBRARY; T=0.K
protons from (d,2np)

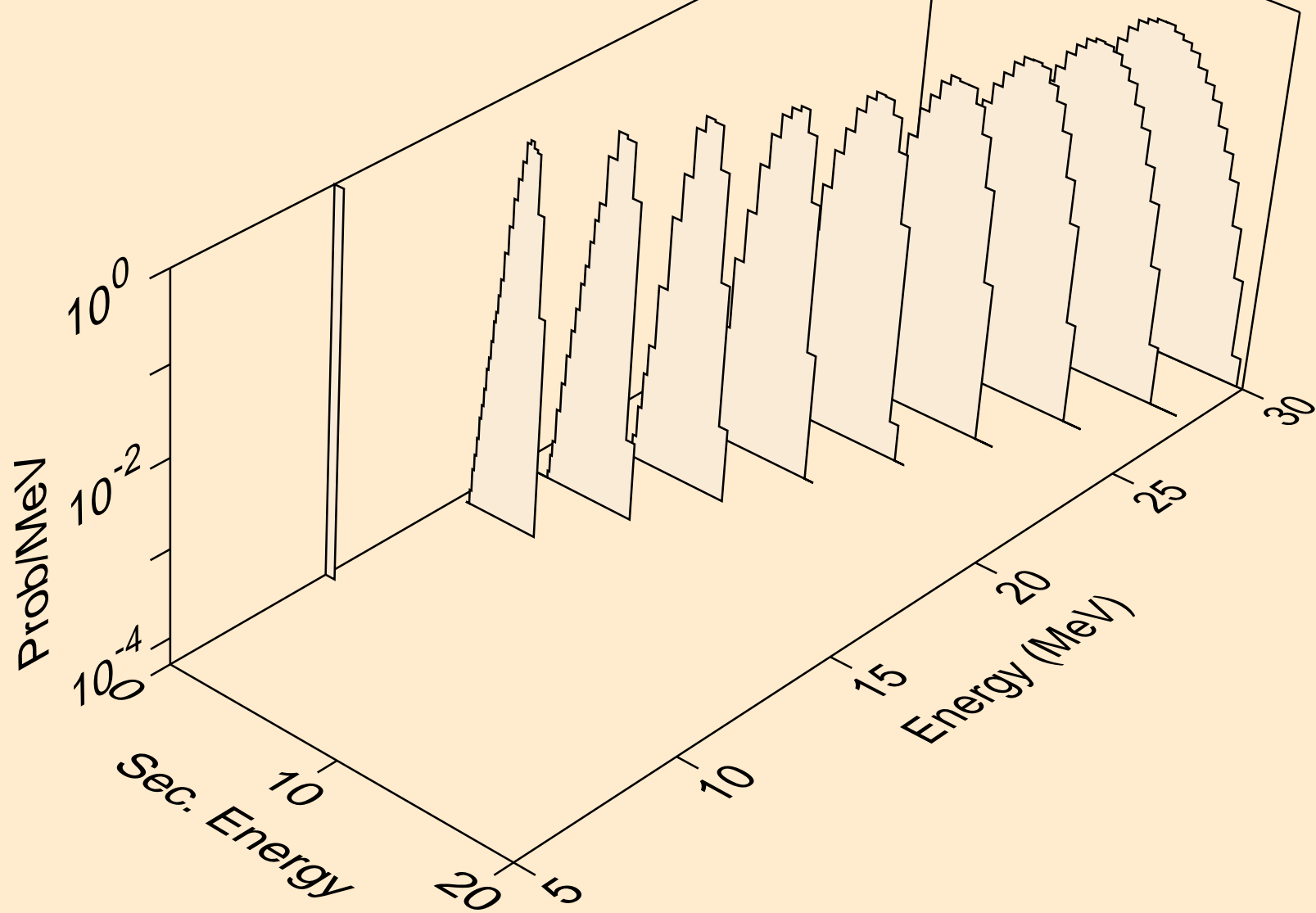

DB261 DEUTERON ACER TENDL-2021 LIBRARY; T=0.K
protons from (d,2np)

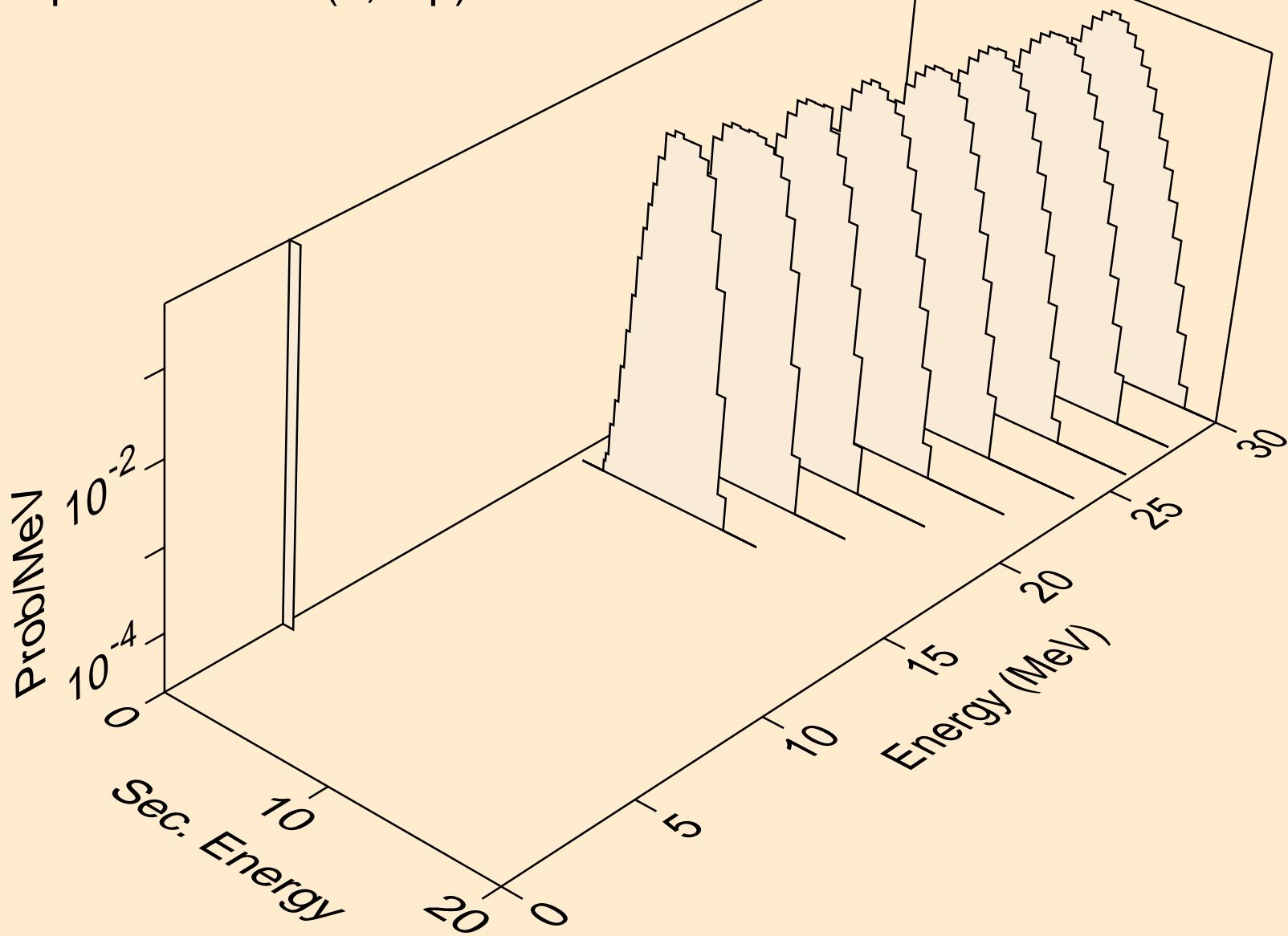

DB261 DEUTERON ACER TENDL-2021 LIBRARY; T=0.K
protons from (d,npa)

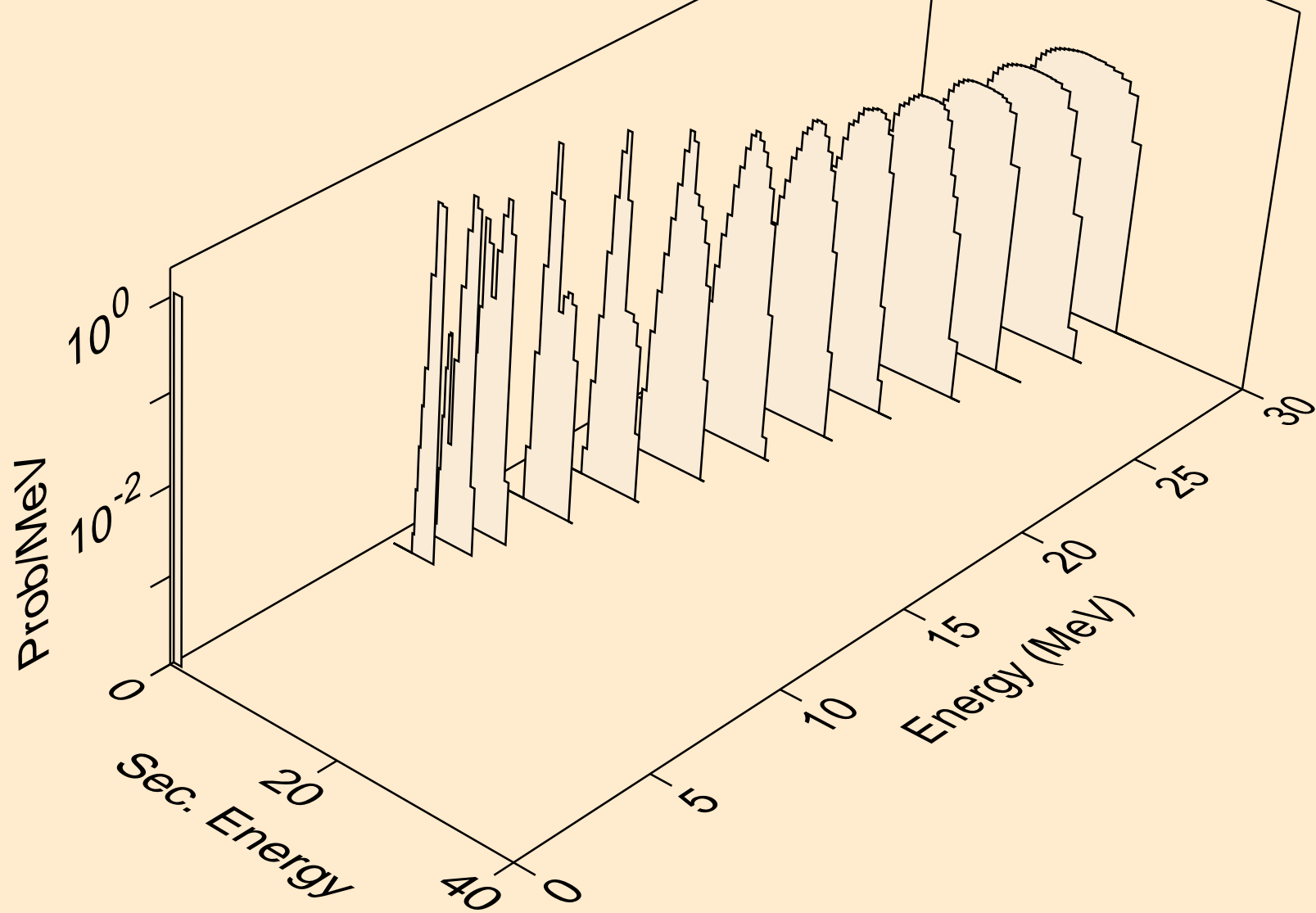

DB261 DEUTERON ACER TENDL-2021 LIBRARY; T=0.K
protons from (d,p)

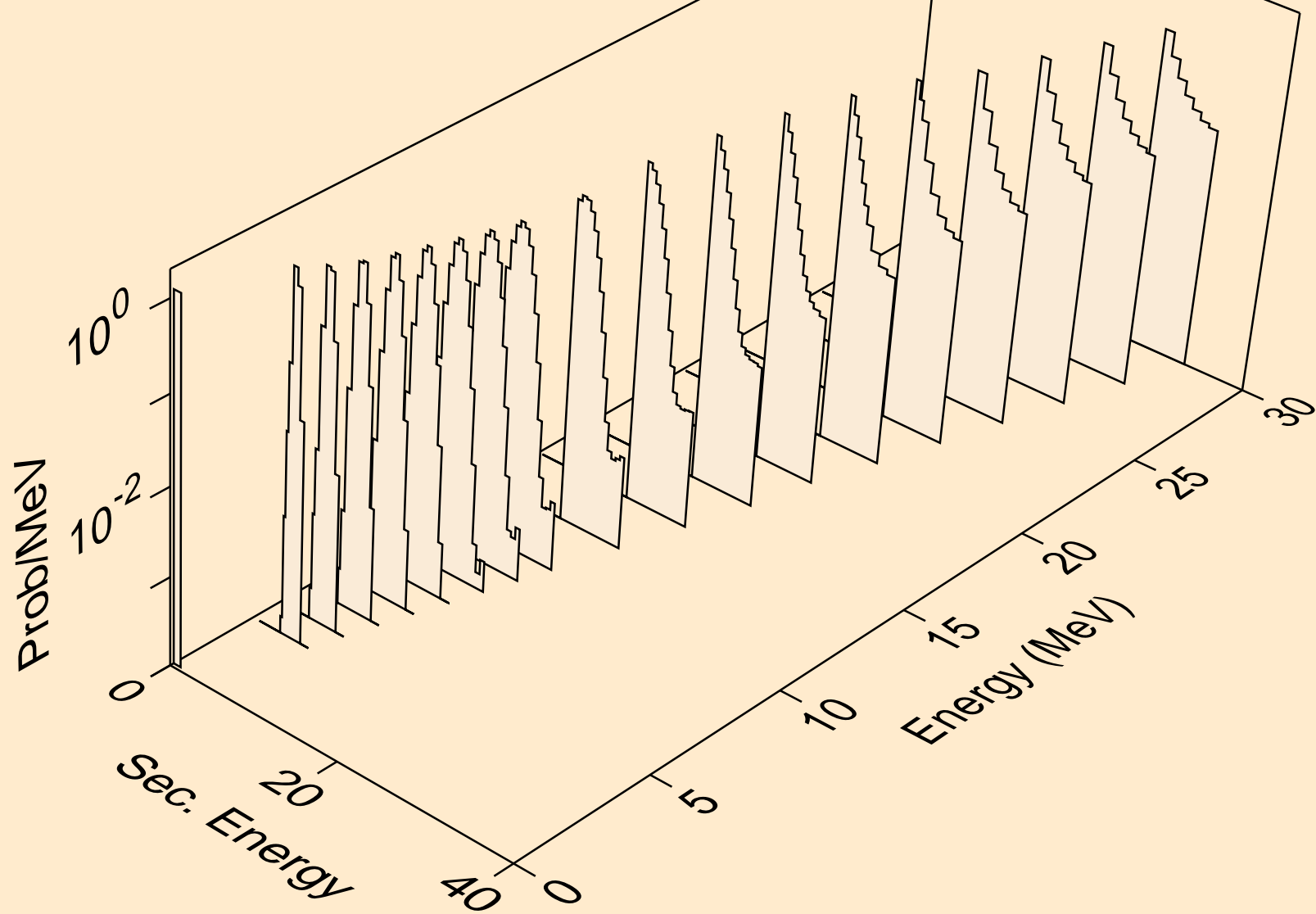

DB261 DEUTERON ACER TENDL-2021 LIBRARY; T=0.K
protons from (d,2p)

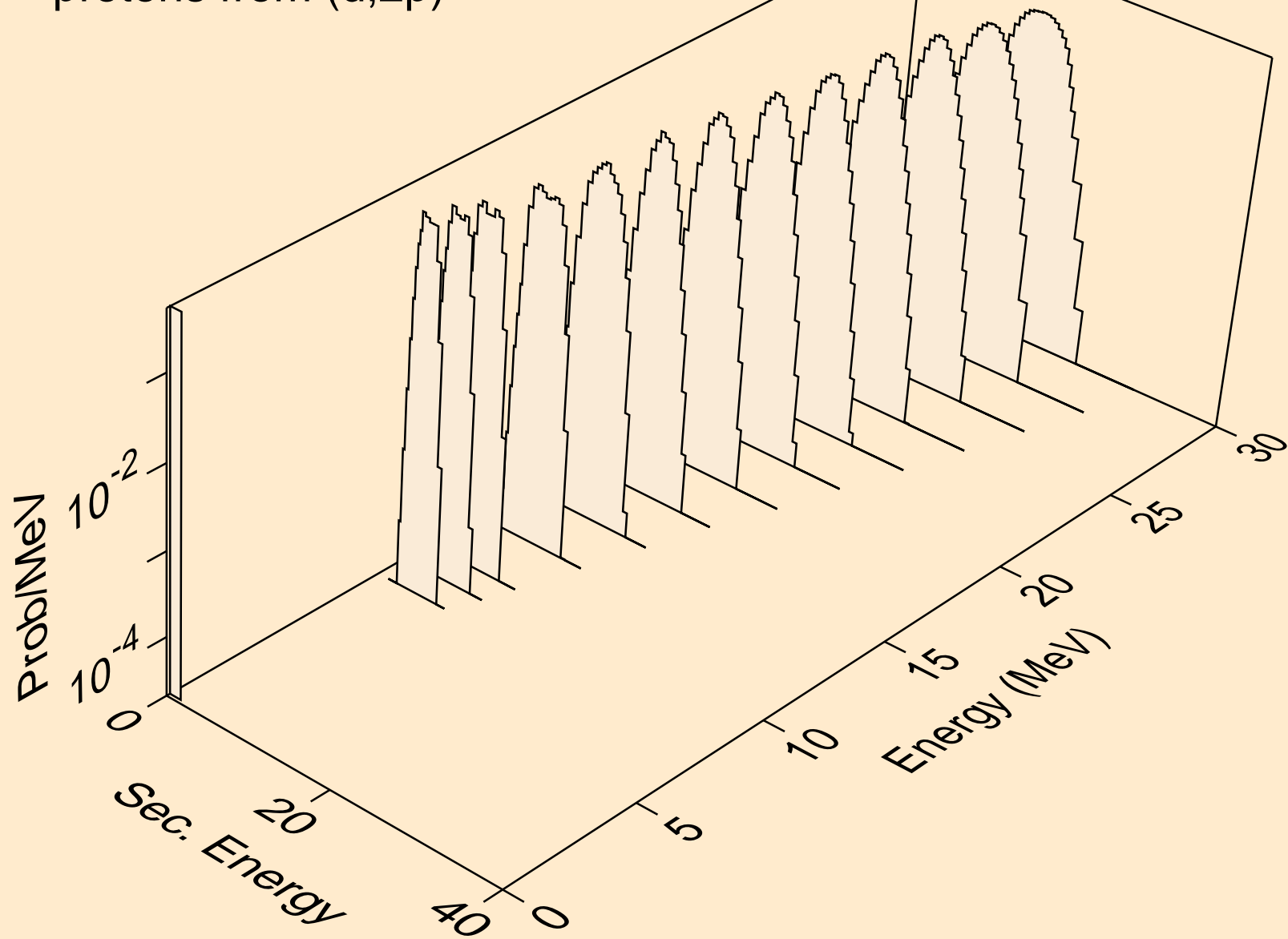

DB261 DEUTERON ACER TENDL-2021 LIBRARY; T=0.K
protons from (d,pa)

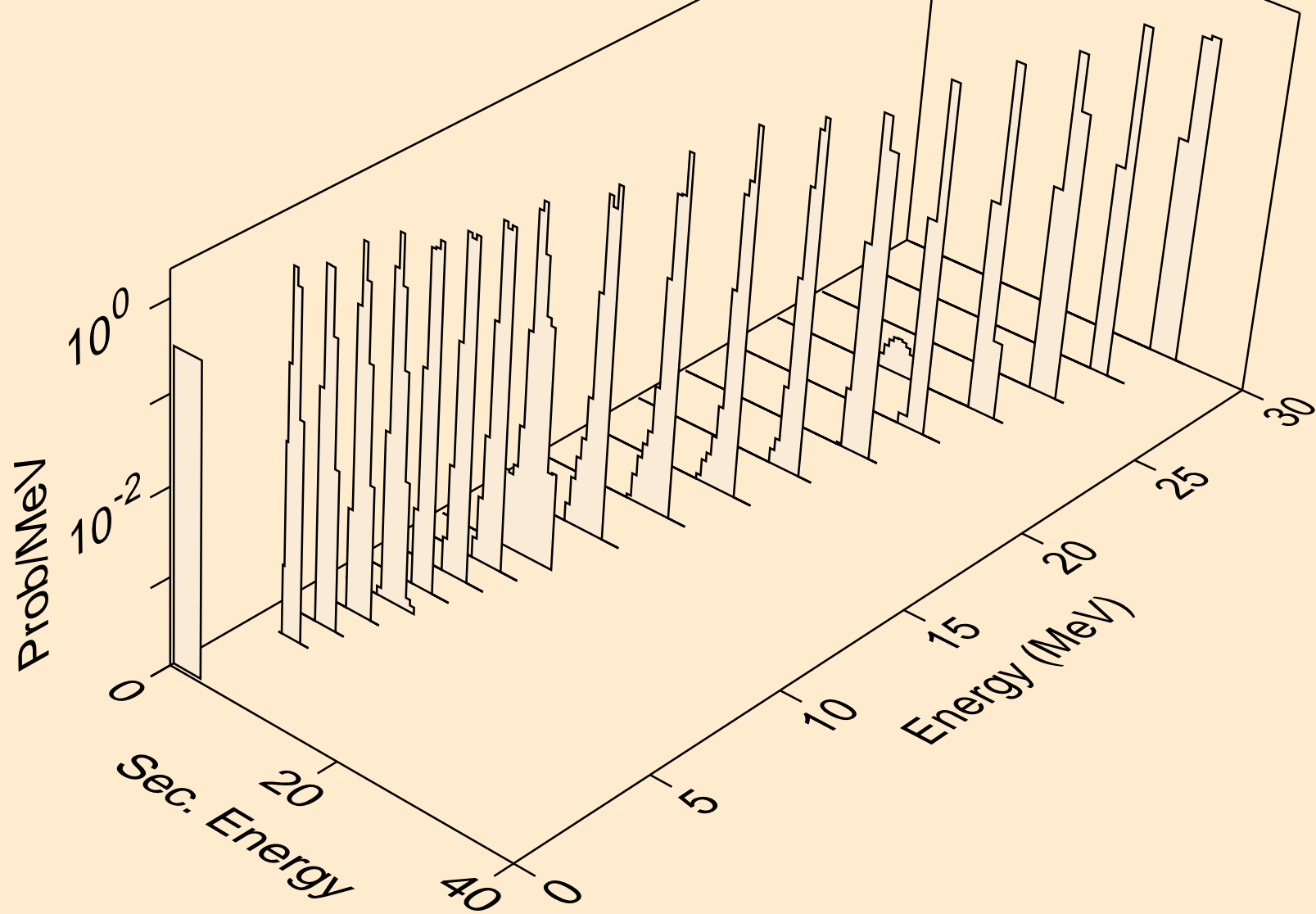

DB261 DEUTERON ACER TENDL-2021 LIBRARY; T=0.K
protons from (d,pd)

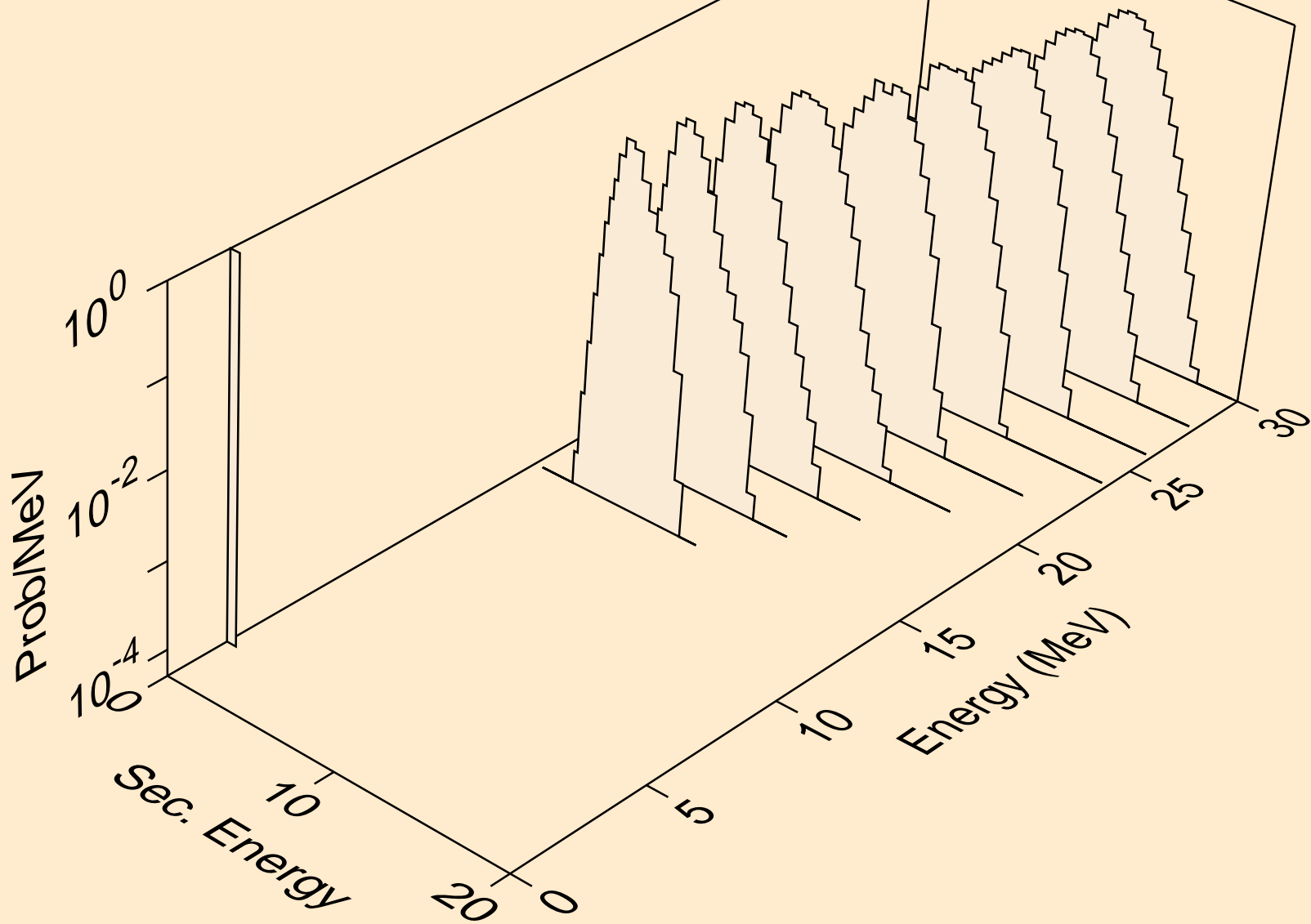

DB261 DEUTERON ACER TENDL-2021 LIBRARY; T=0.K
tritons from (d,x)

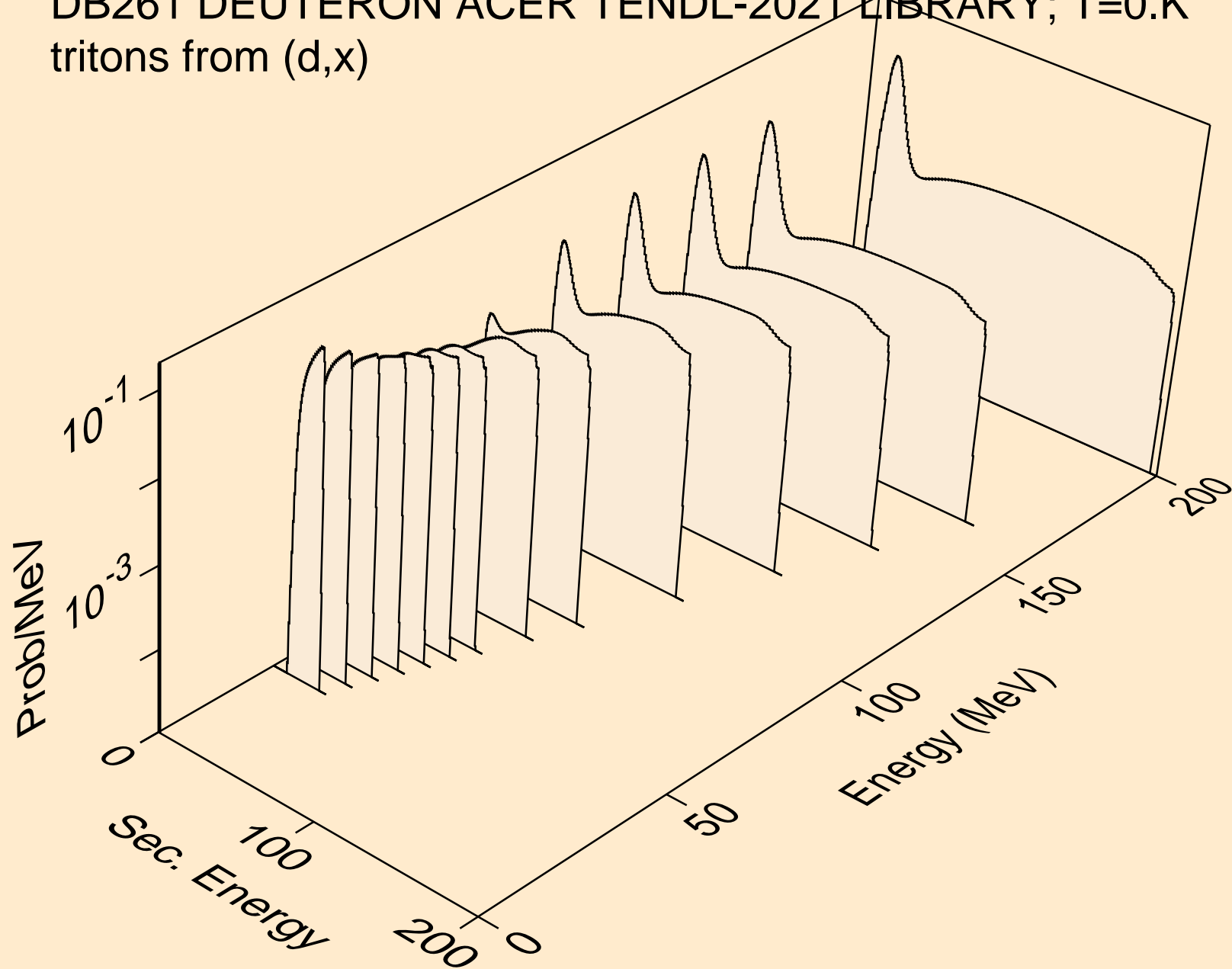

DB261 DEUTERON ACER TENDL-2021 LIBRARY; T=0.K
tritons from (d,n*)t

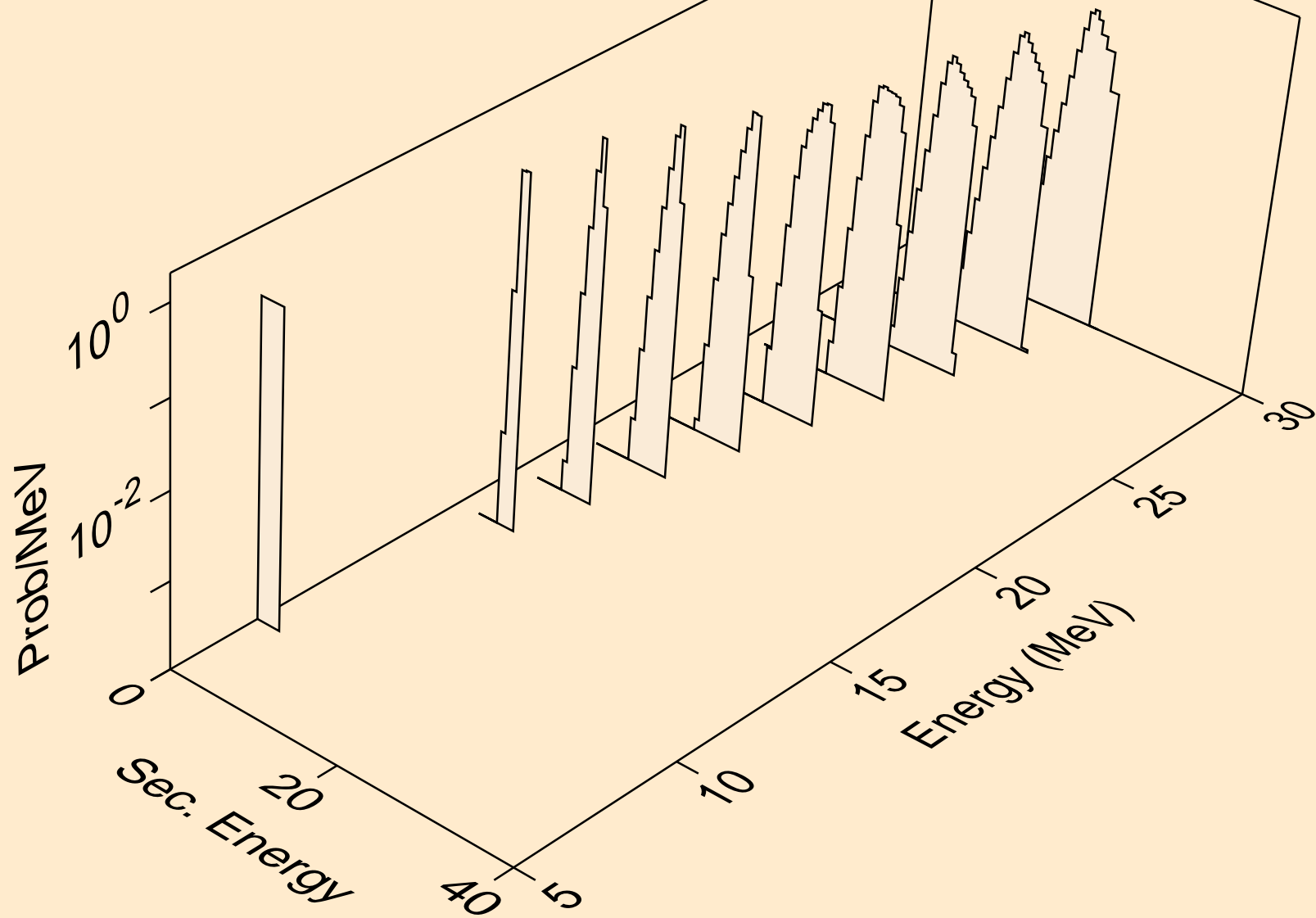

DB261 DEUTERON ACER TENDL-2021 LIBRARY; T=0.K
tritons from (d,t)

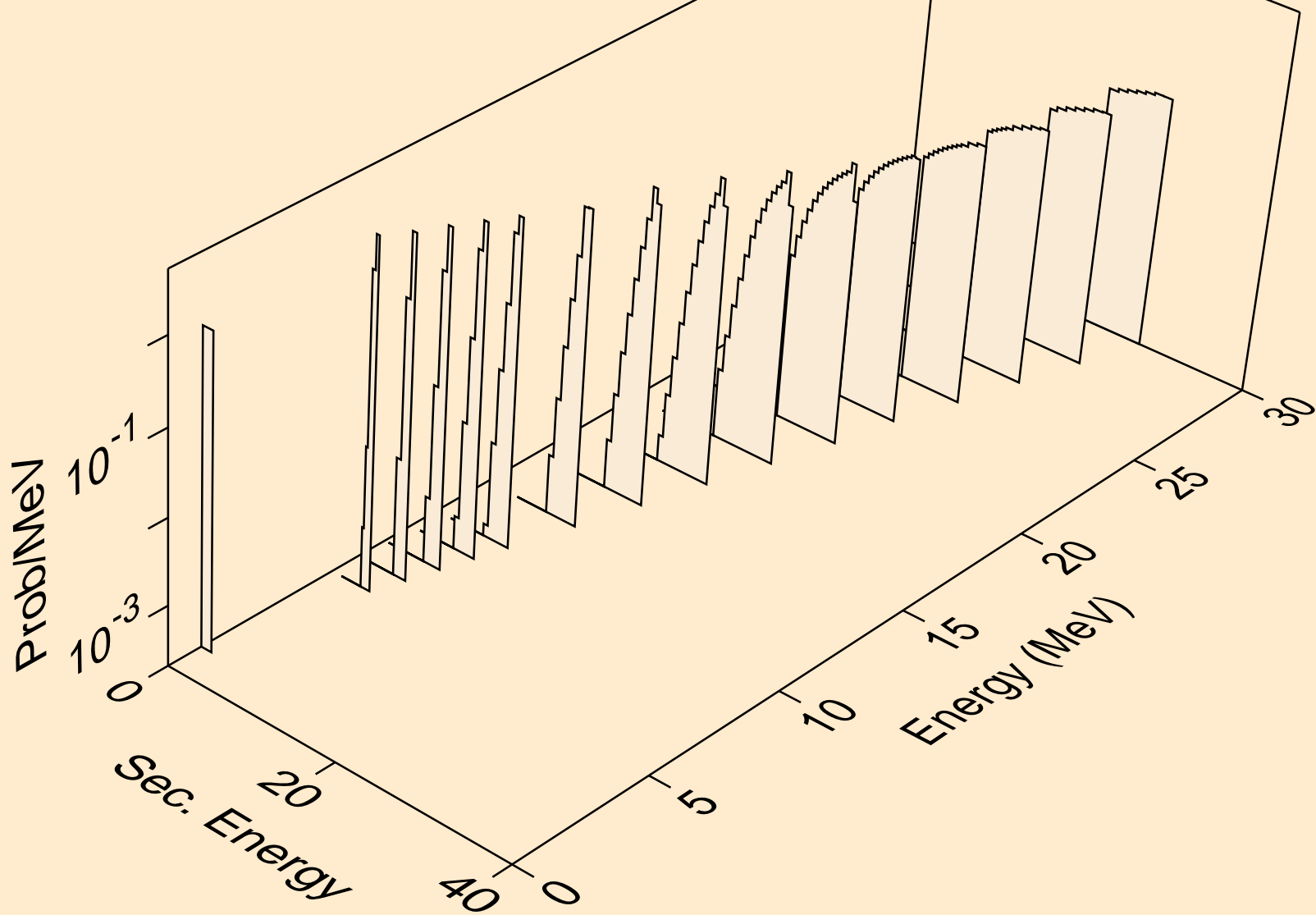

DB261 DEUTERON ACER TENDL-2021 LIBRARY; T=0.K
tritons from (d,t2a)

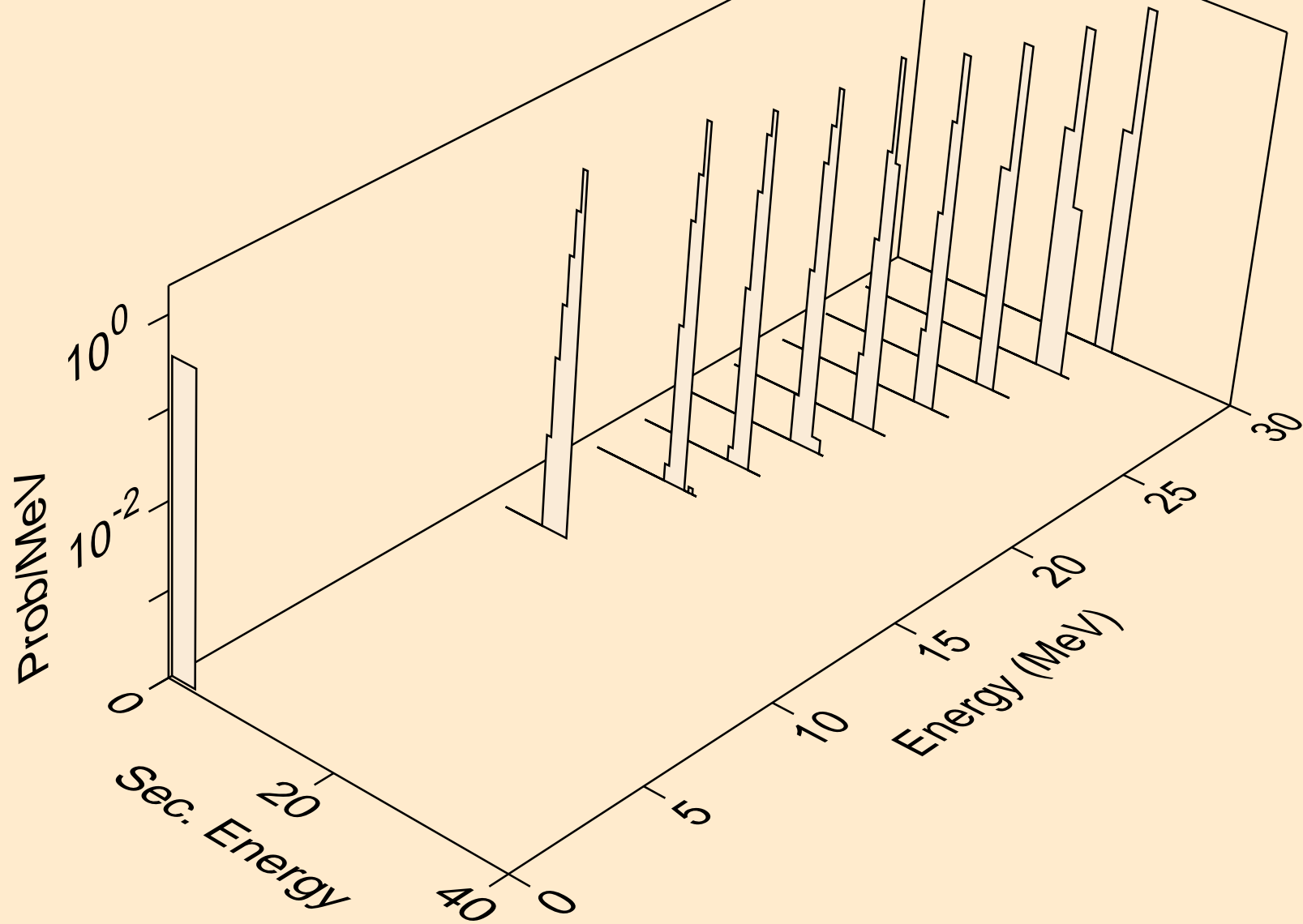

DB261 DEUTERON ACER TENDL-2021 LIBRARY; T=0.K
he3s from (d,x)

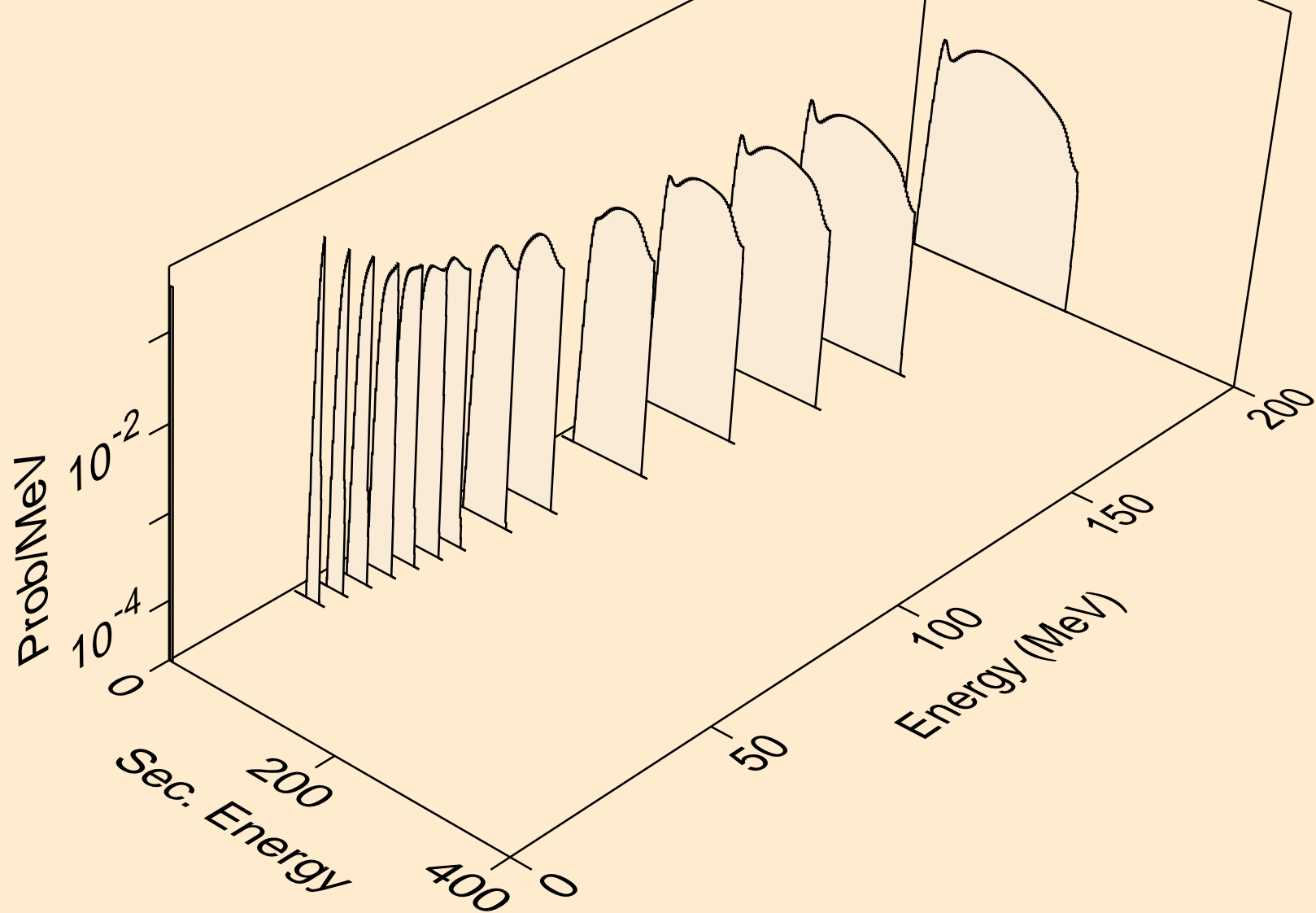

DB261 DEUTERON ACER TENDL-2021 LIBRARY; T=0.K
he3s from (d,he3)

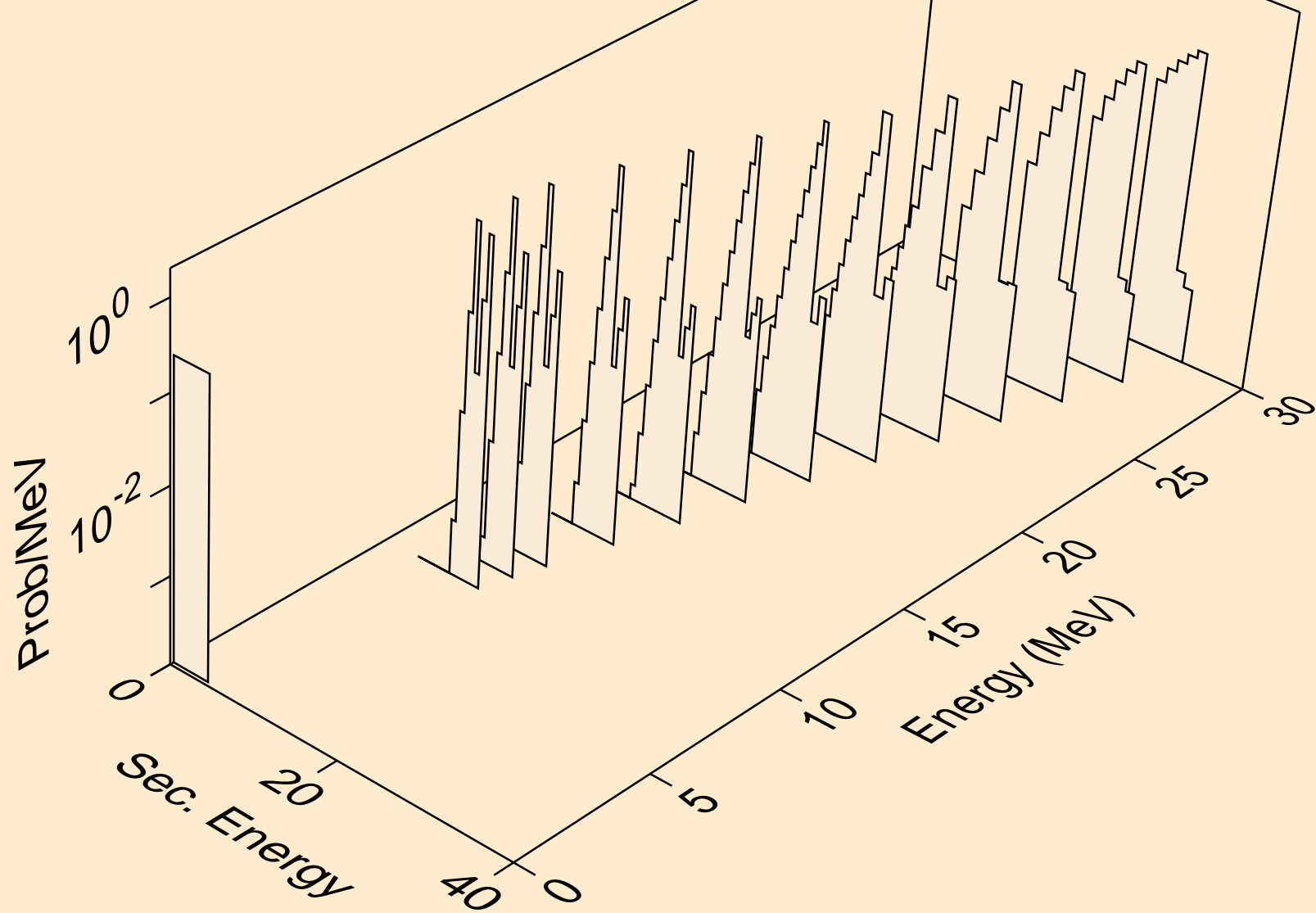

DB261 DEUTERON ACER TENDL-2021 LIBRARY; T=0.K
alphas from (d,x)

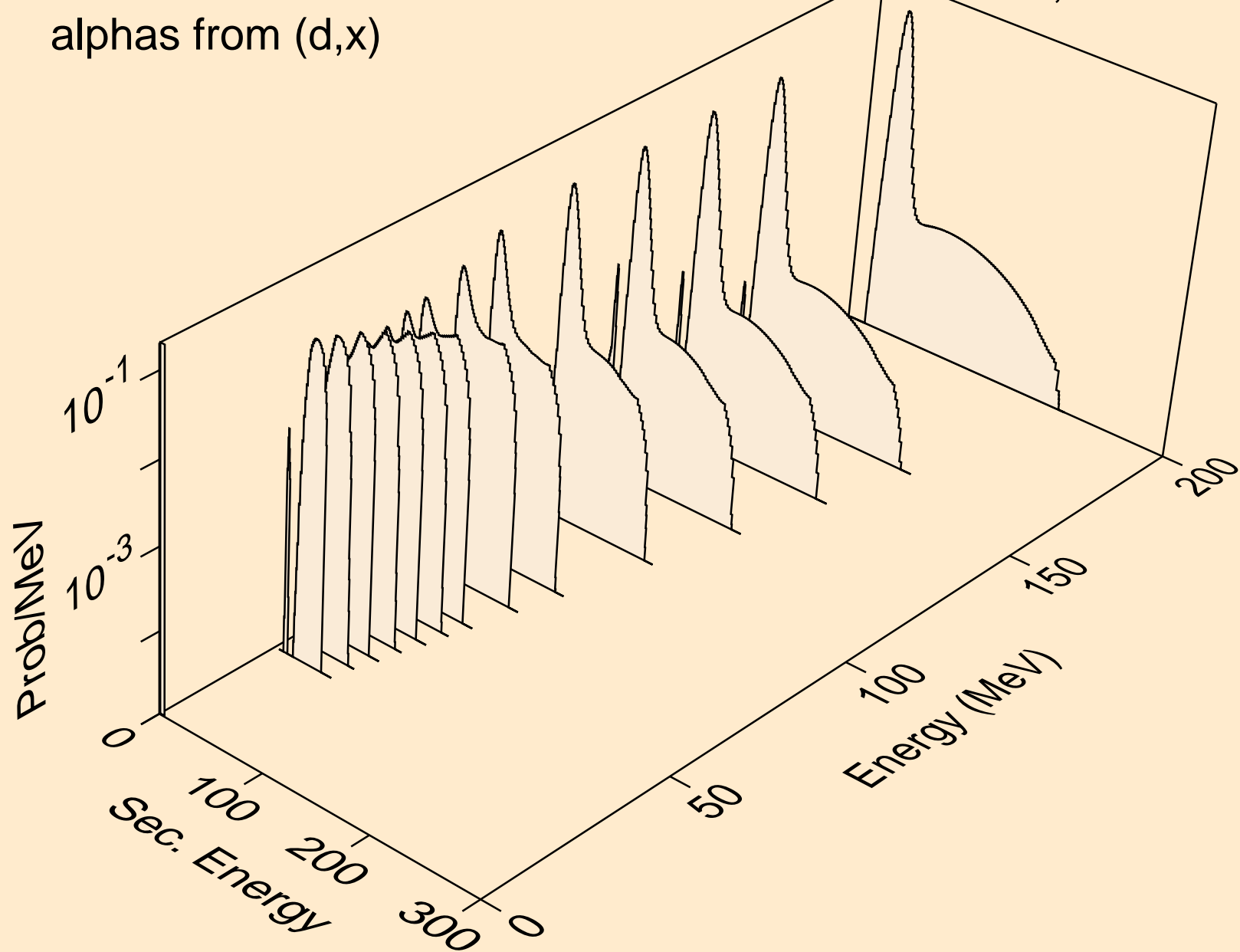

DB261 DEUTERON ACER TENDL-2021 LIBRARY; T=0.K
alphas from (d,n*)a

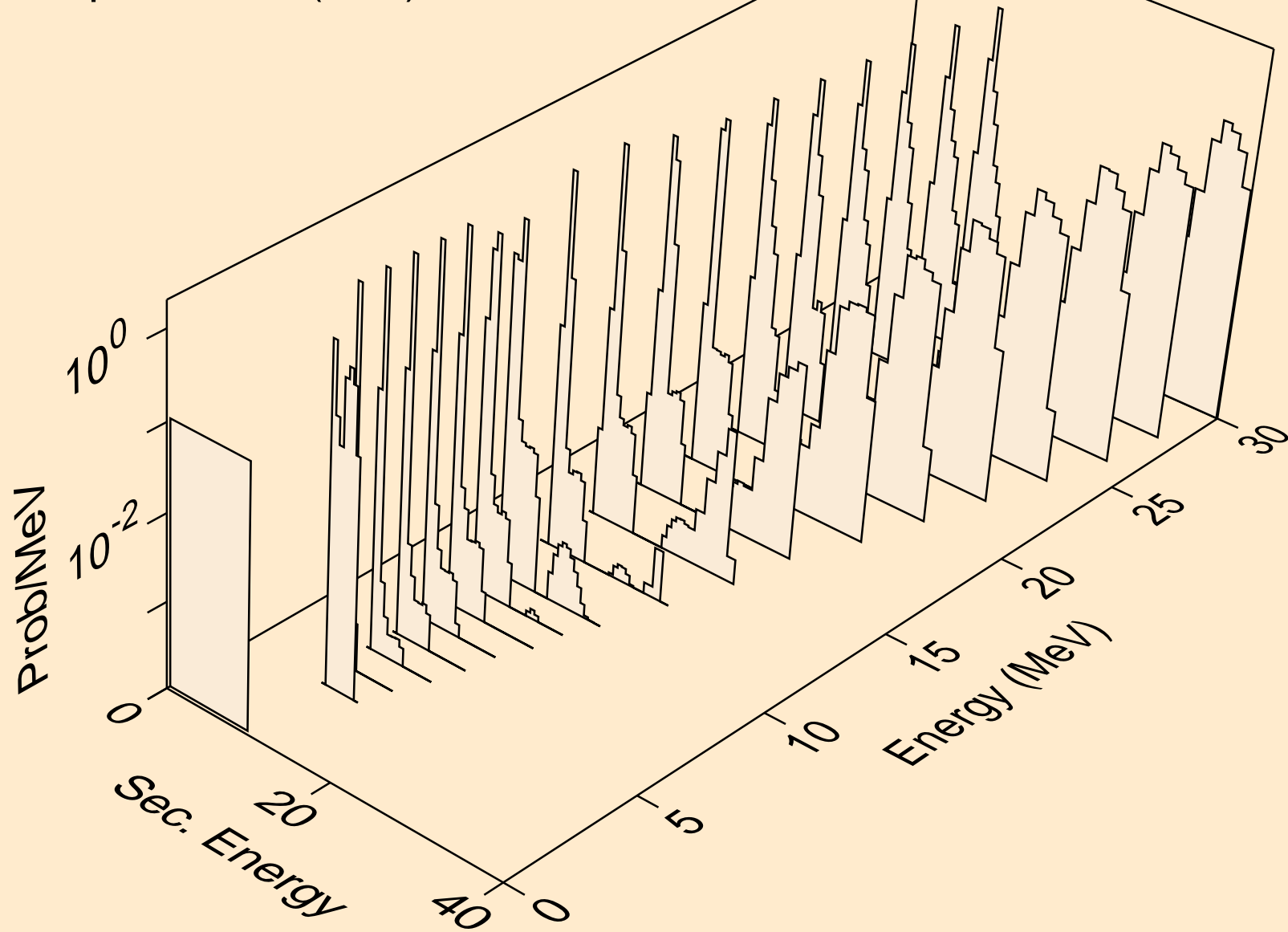

DB261 DEUTERON ACER TENDL-2021 LIBRARY; T=0.K
alphas from (d,2n)a

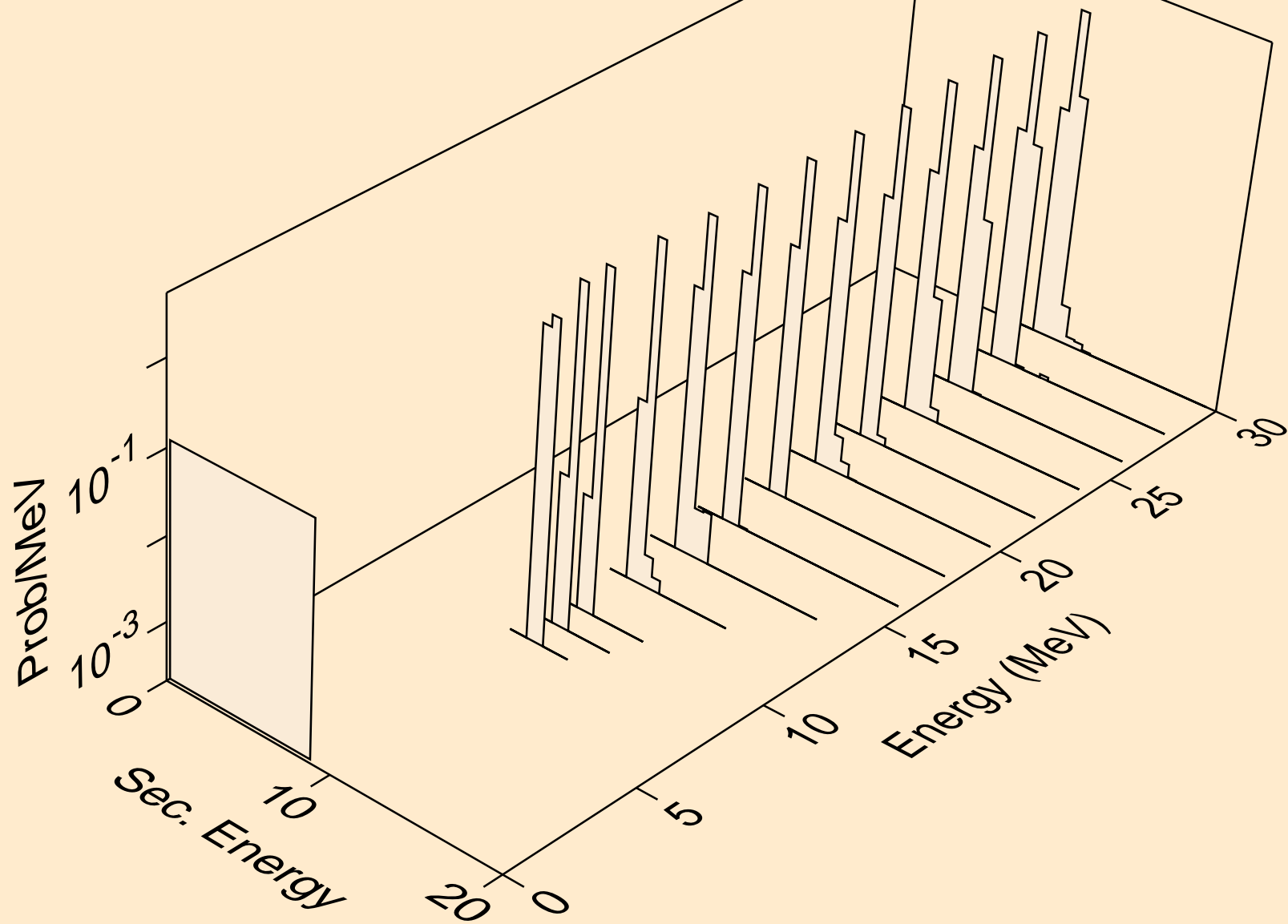

DB261 DEUTERON ACER TENDL-2021 LIBRARY; T=0.K
alphas from (d,3n)a

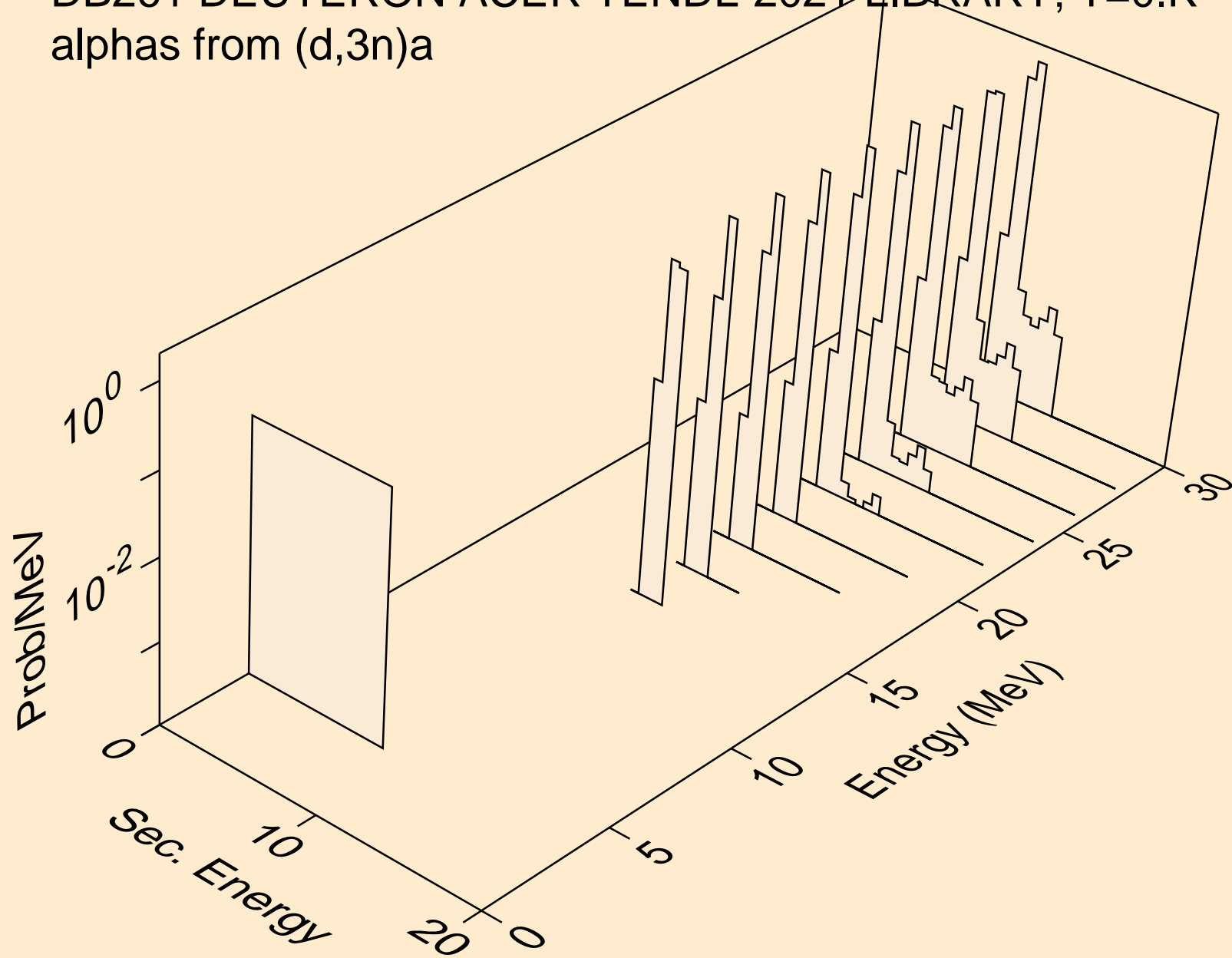

DB261 DEUTERON ACER TENDL-2021 LIBRARY; T=0.K
alphas from (d,n*)d2a

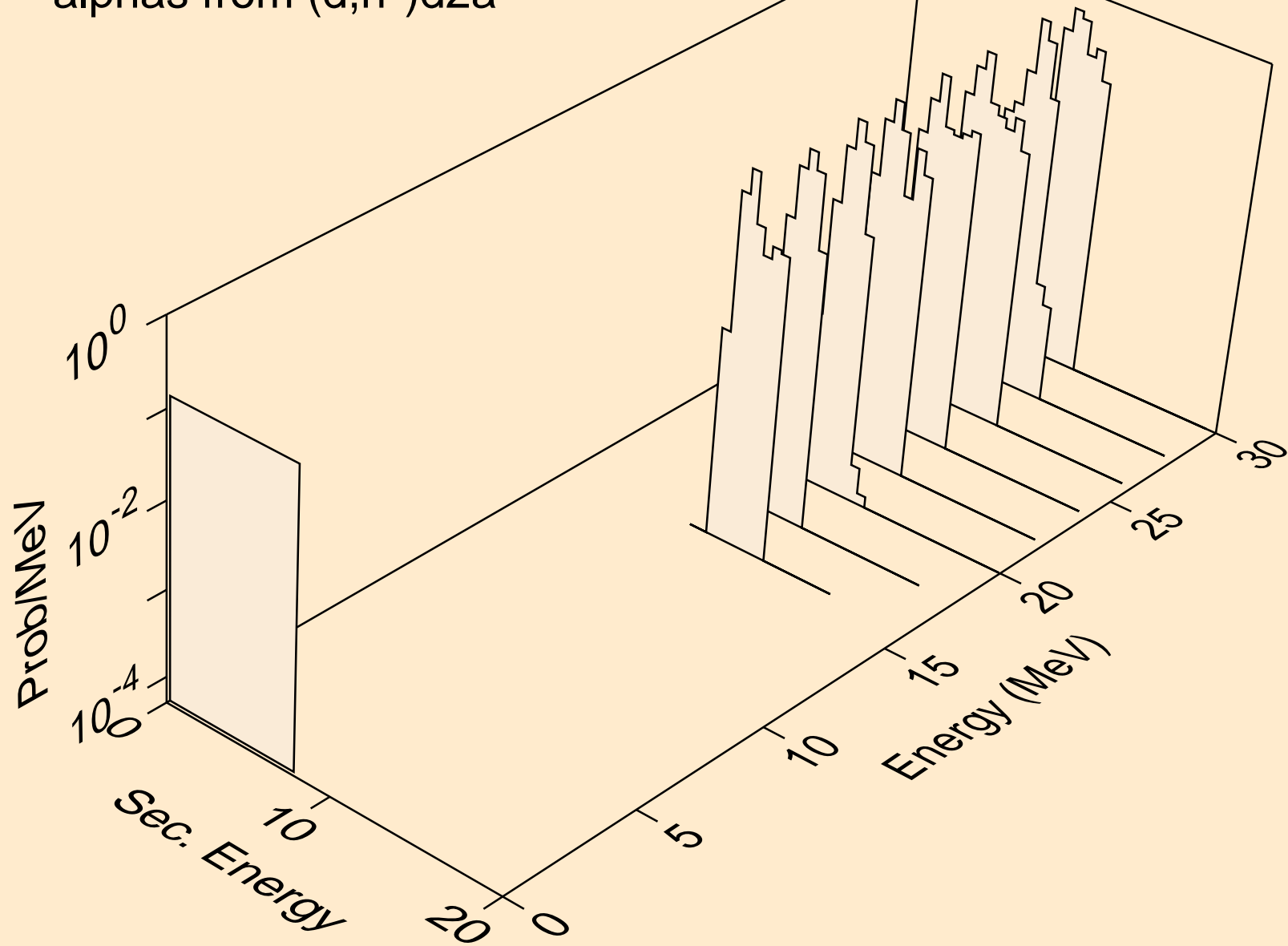

DB261 DEUTERON ACER TENDL-2021 LIBRARY; T=0.K
alphas from (d,npa)

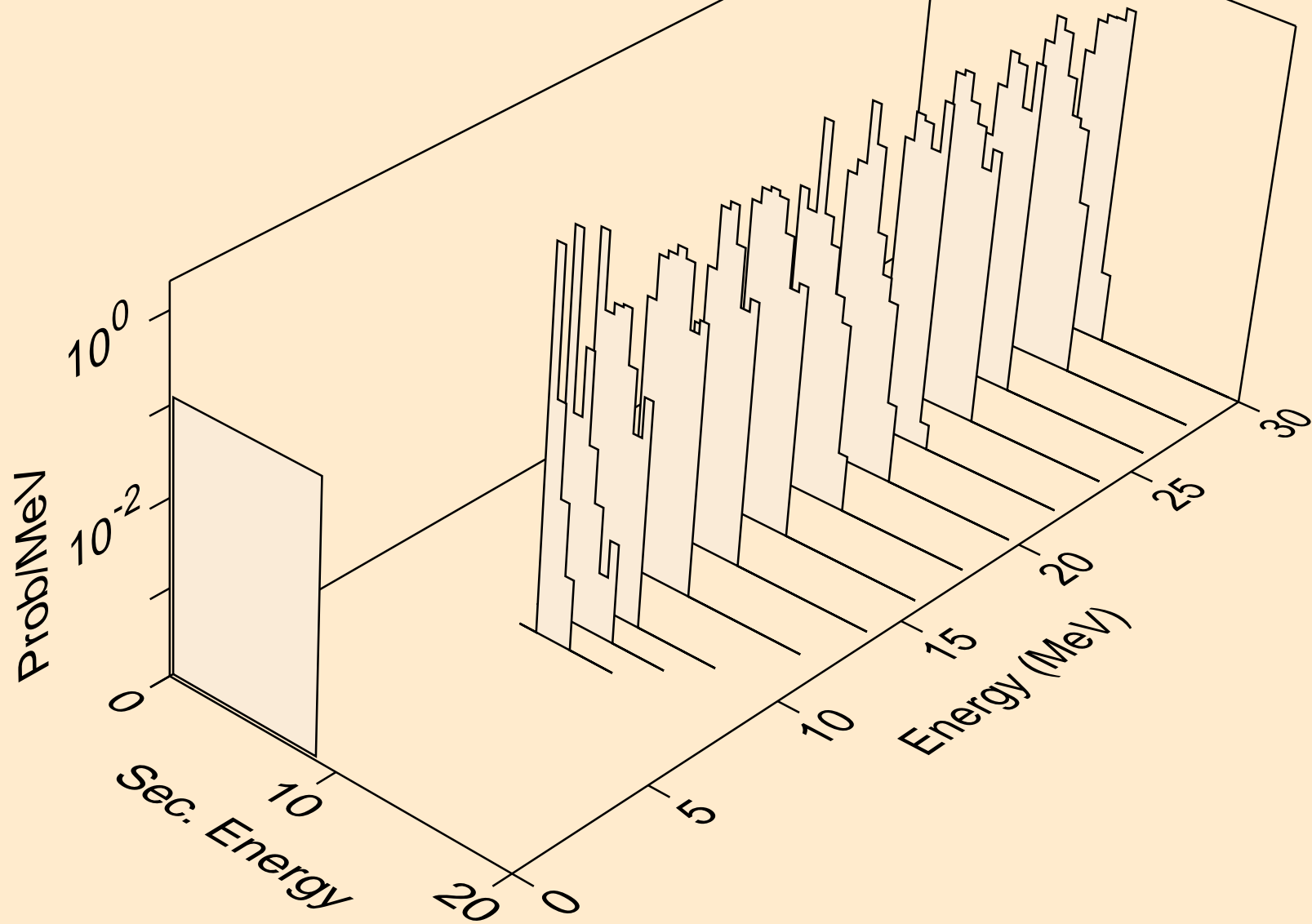

DB261 DEUTERON ACER TENDL-2021 LIBRARY; T=0.K
alphas from (d,a)

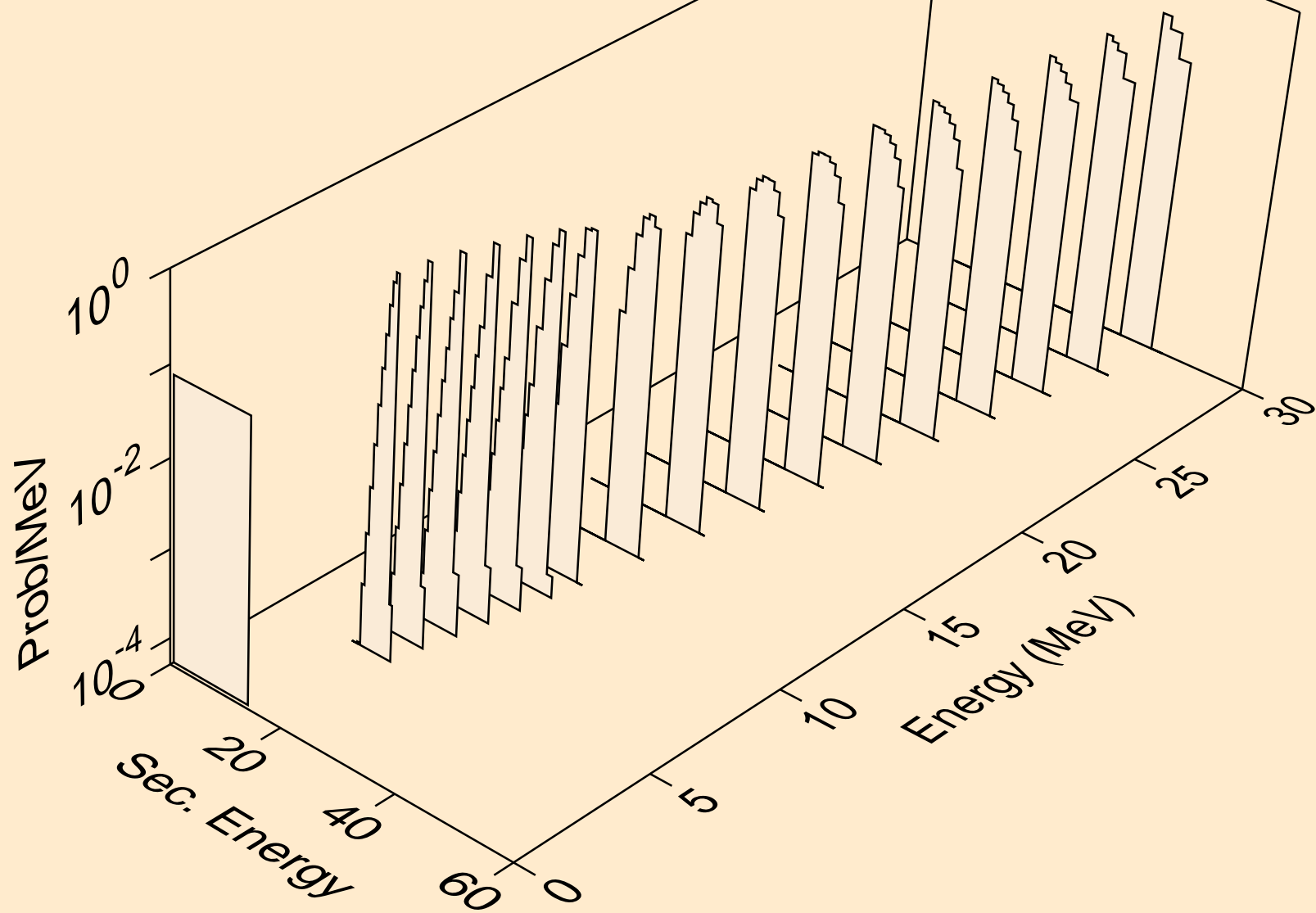

DB261 DEUTERON ACER TENDL-2021 LIBRARY; T=0.K
alphas from (d,2a)

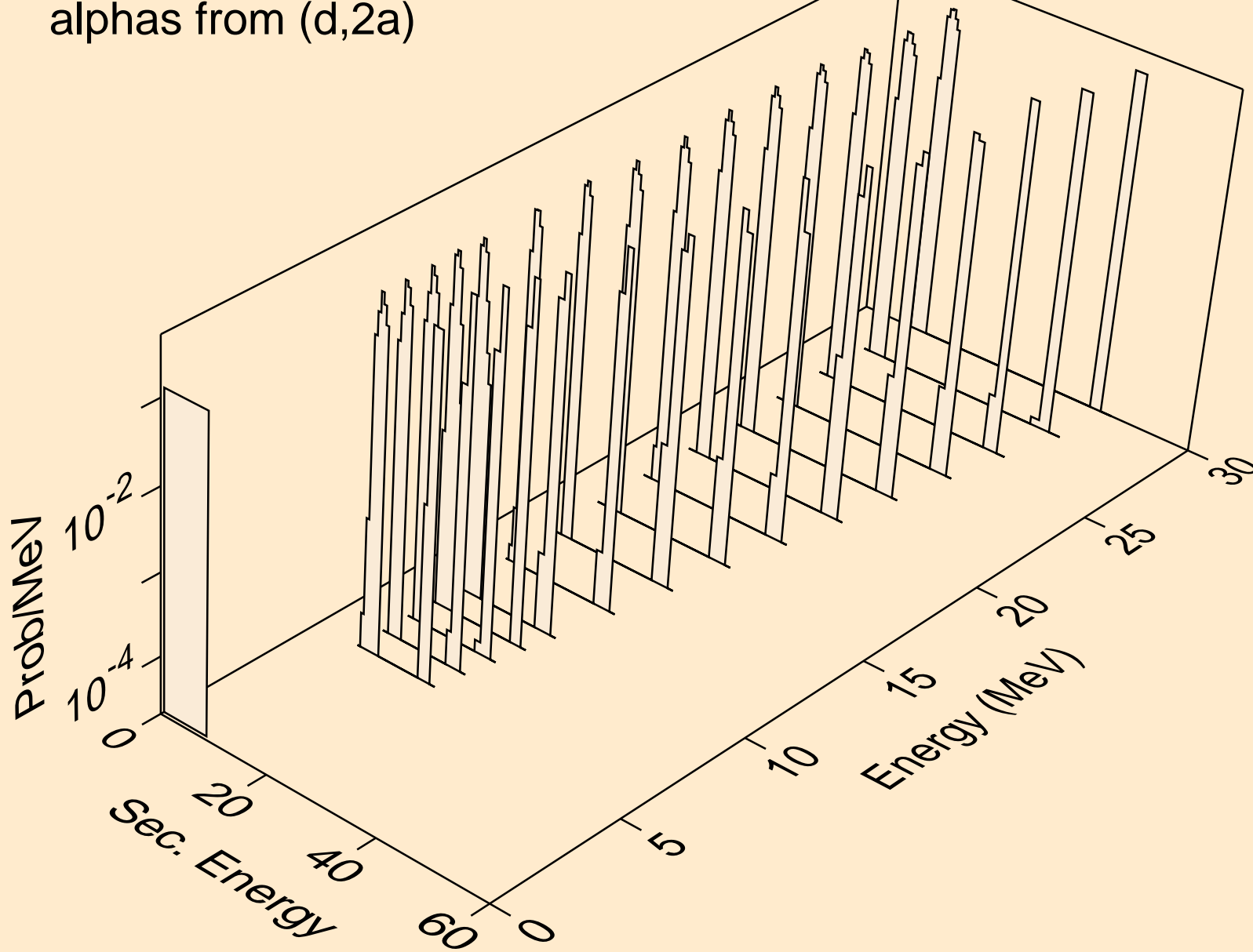

DB261 DEUTERON ACER TENDL-2021 LIBRARY; T=0.K
alphas from (d,pa)

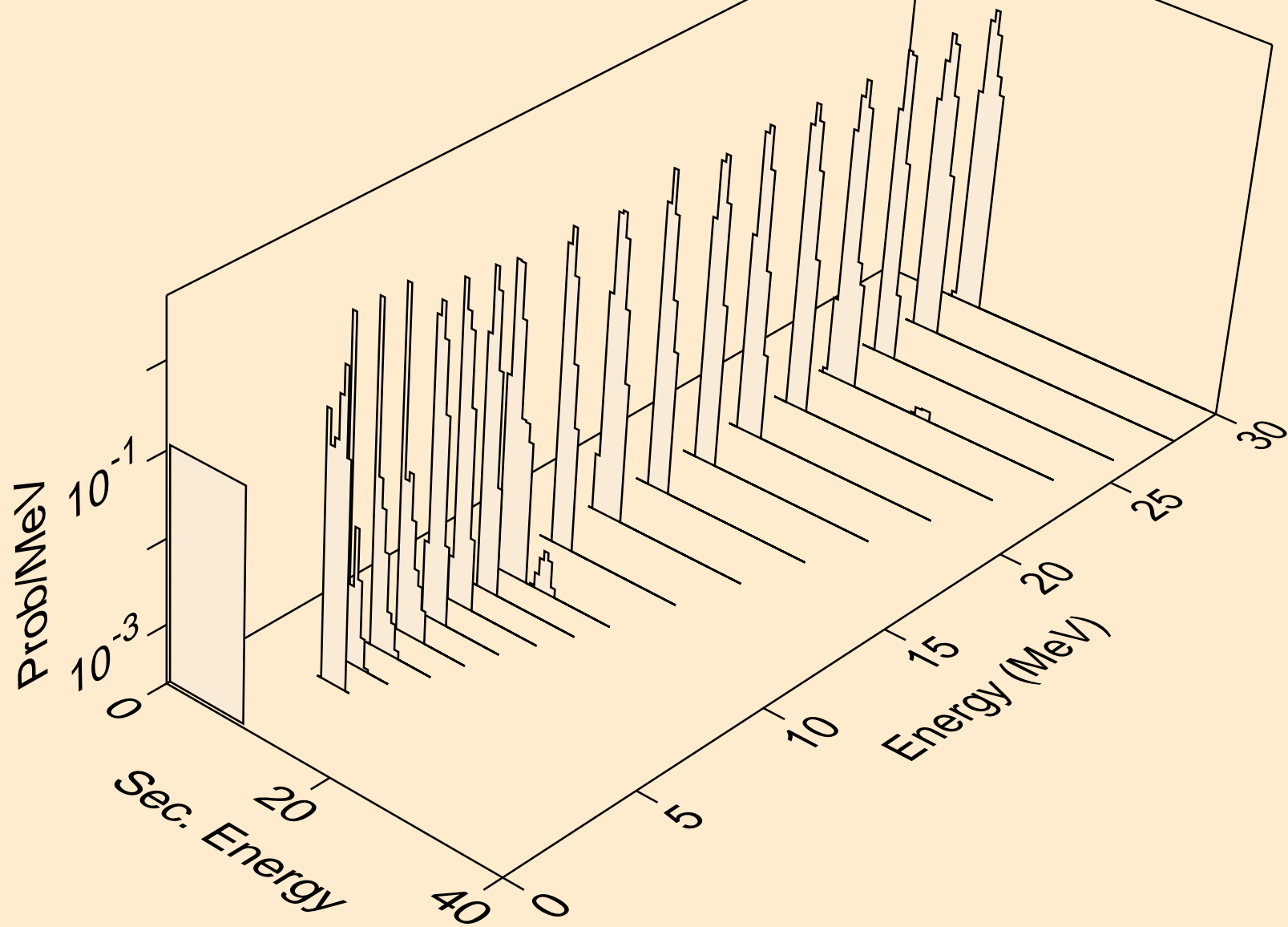

DB261 DEUTERON ACER TENDL-2021 LIBRARY; T=0.K
alphas from (d,t2a)

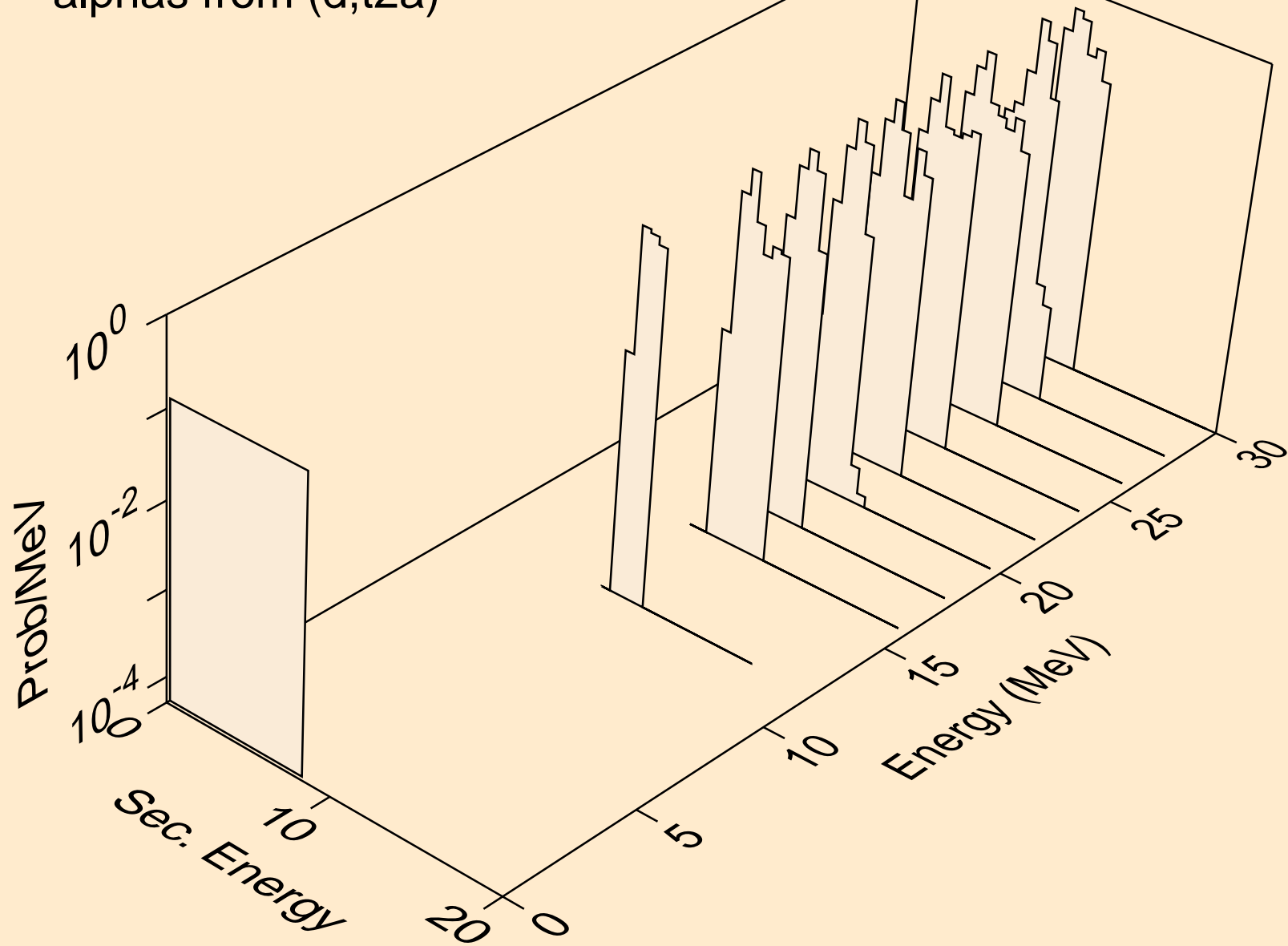

DB261 DEUTERON ACER TENDL-2021 LIBRARY; T=0.K
alphas from (d,d2a)

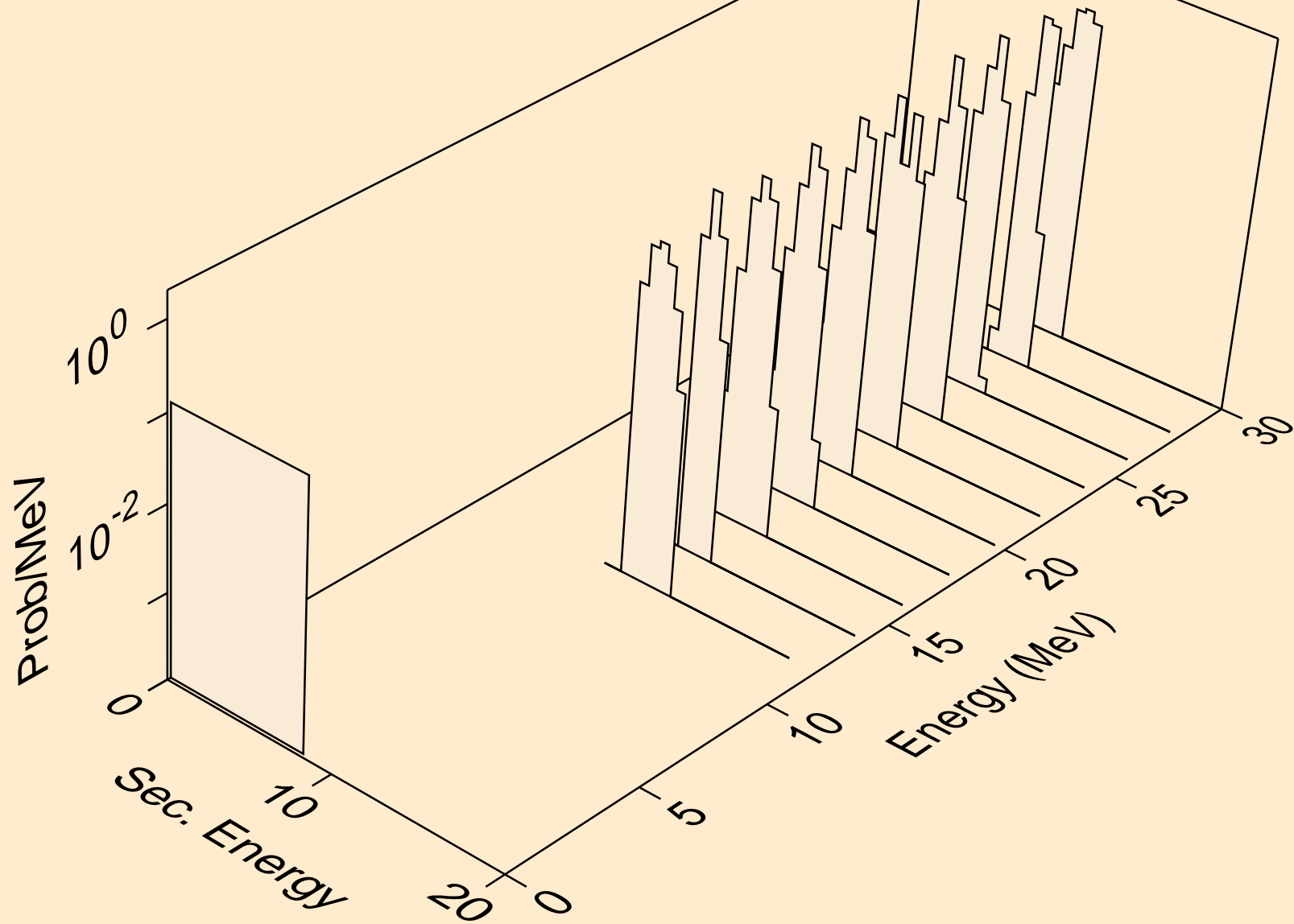

DB261 DEUTERON ACER TENDL-2021 LIBRARY; T=0.K
alphas from (d,da)

