

DB269 DEUTERON ACER TENDL-2021 LIBRARY; T=0.K  
Principal cross sections

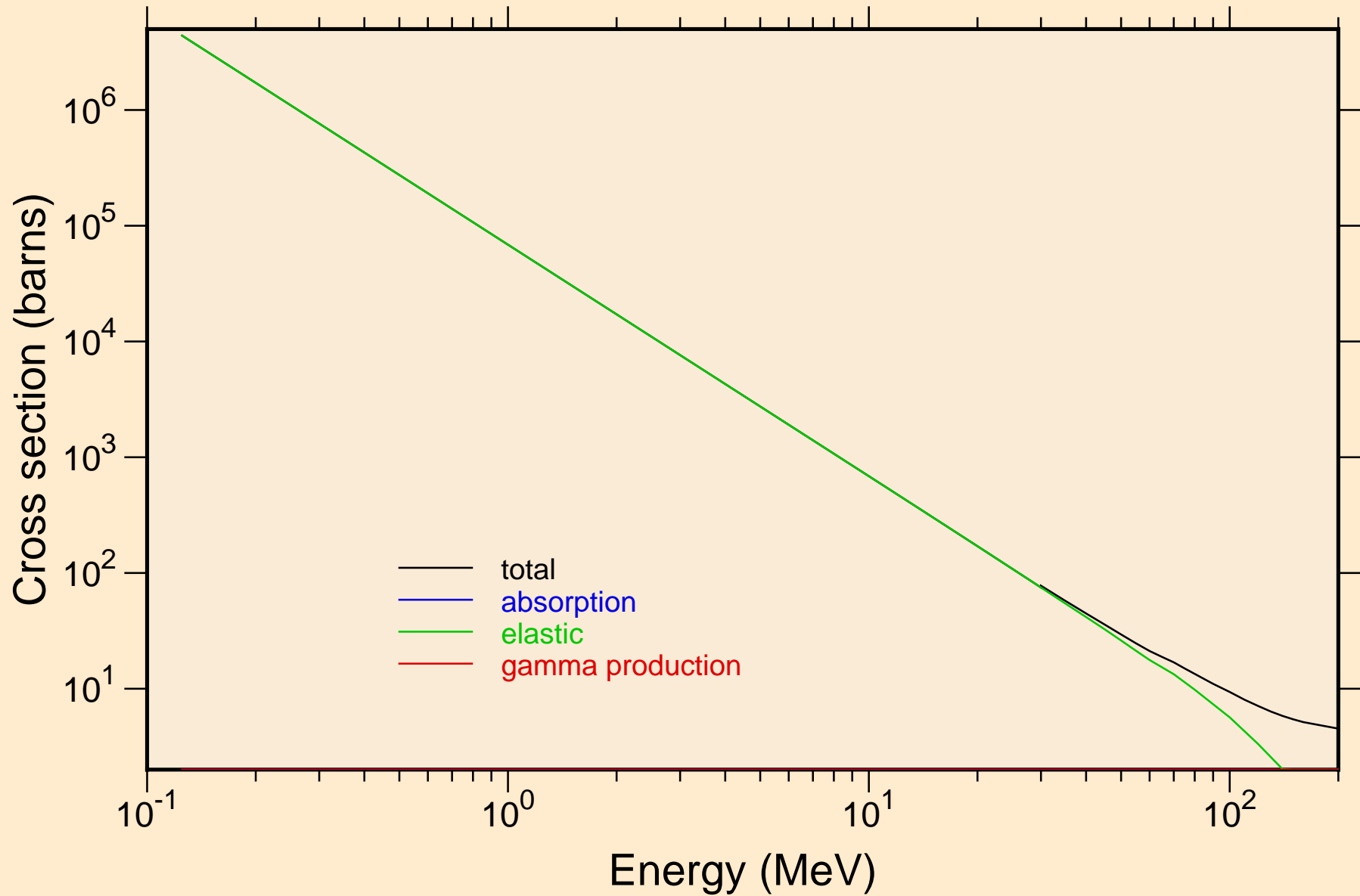

DB269 DEUTERON ACER TENDL-2021 LIBRARY; T=0.K  
Heating

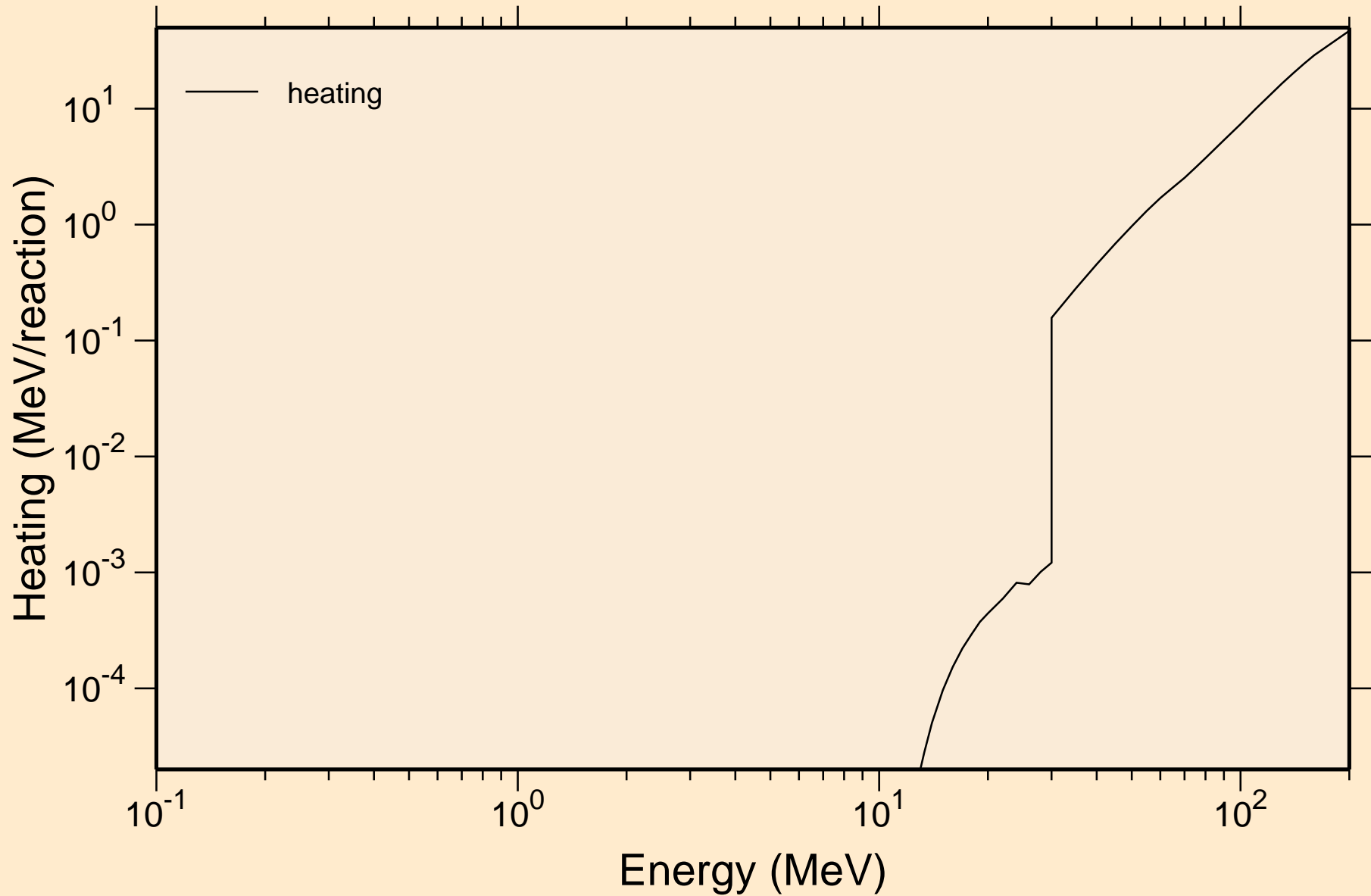

DB269 DEUTERON ACER TENDL-2021 LIBRARY; T=0.K  
Principal cross sections

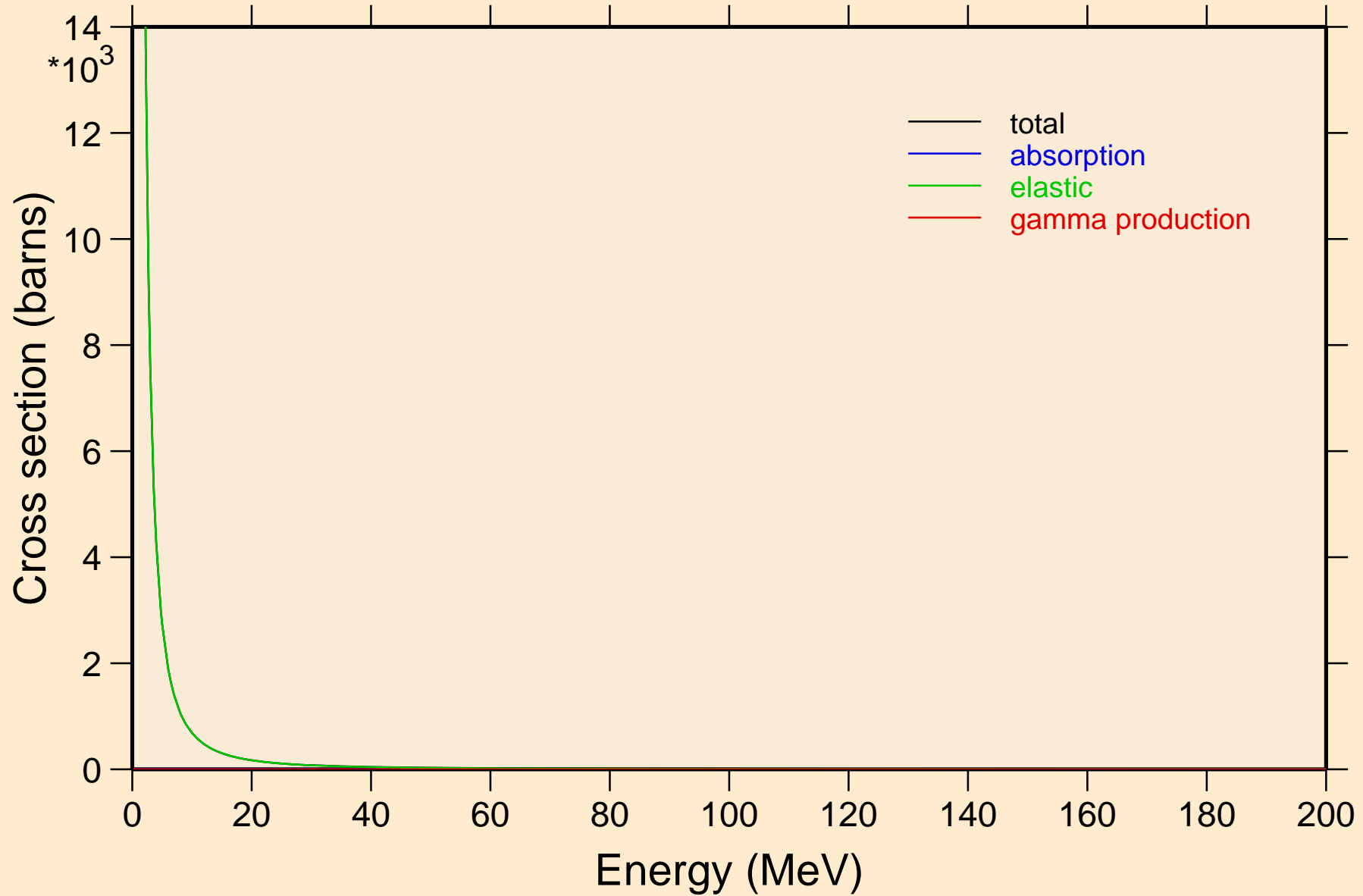

DB269 DEUTERON ACER TENDL-2021 LIBRARY; T=0.K

Heating

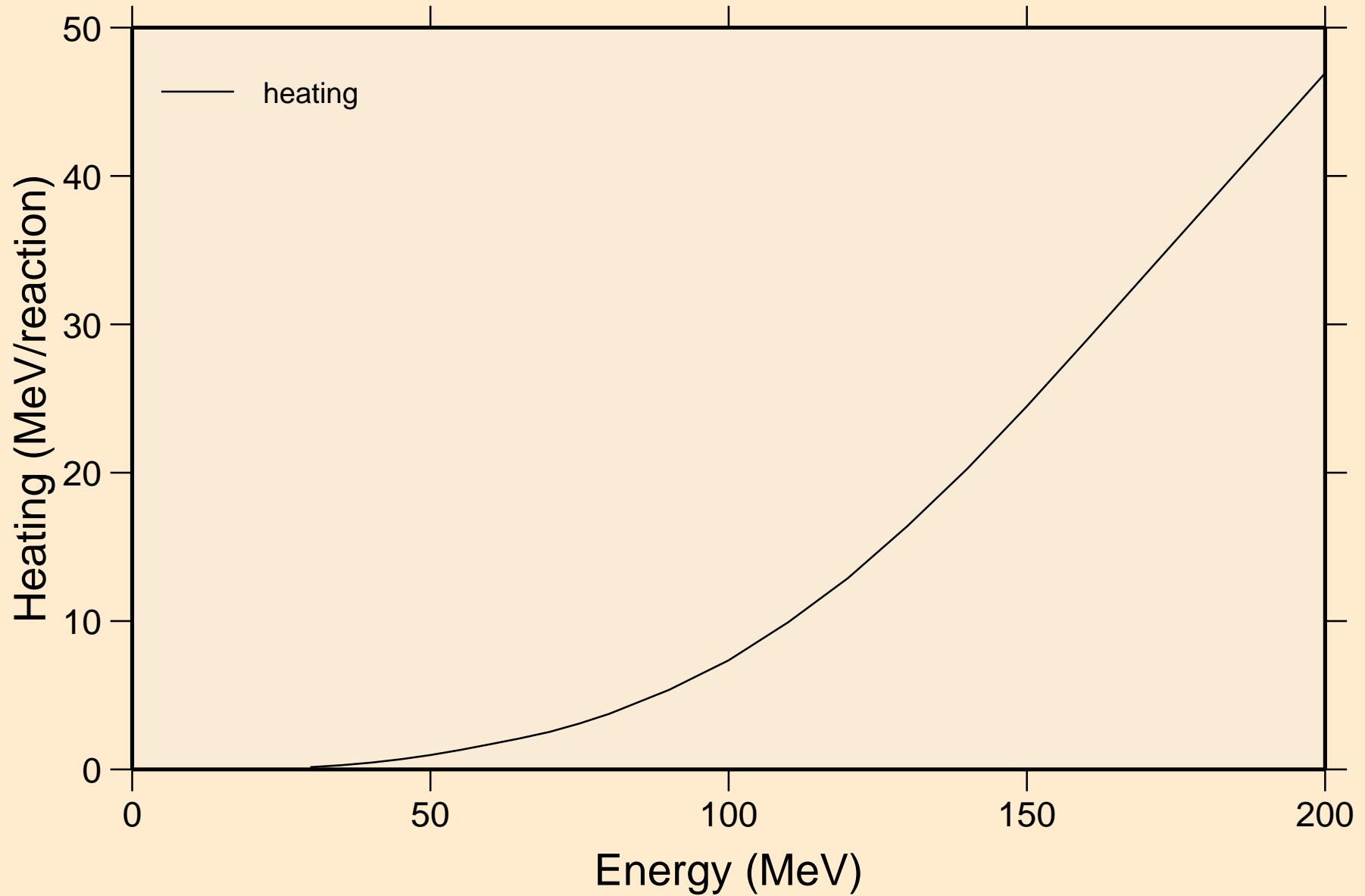

DB269 DEUTERON ACER TENDL-2021 LIBRARY; T=0.K  
Threshold reactions

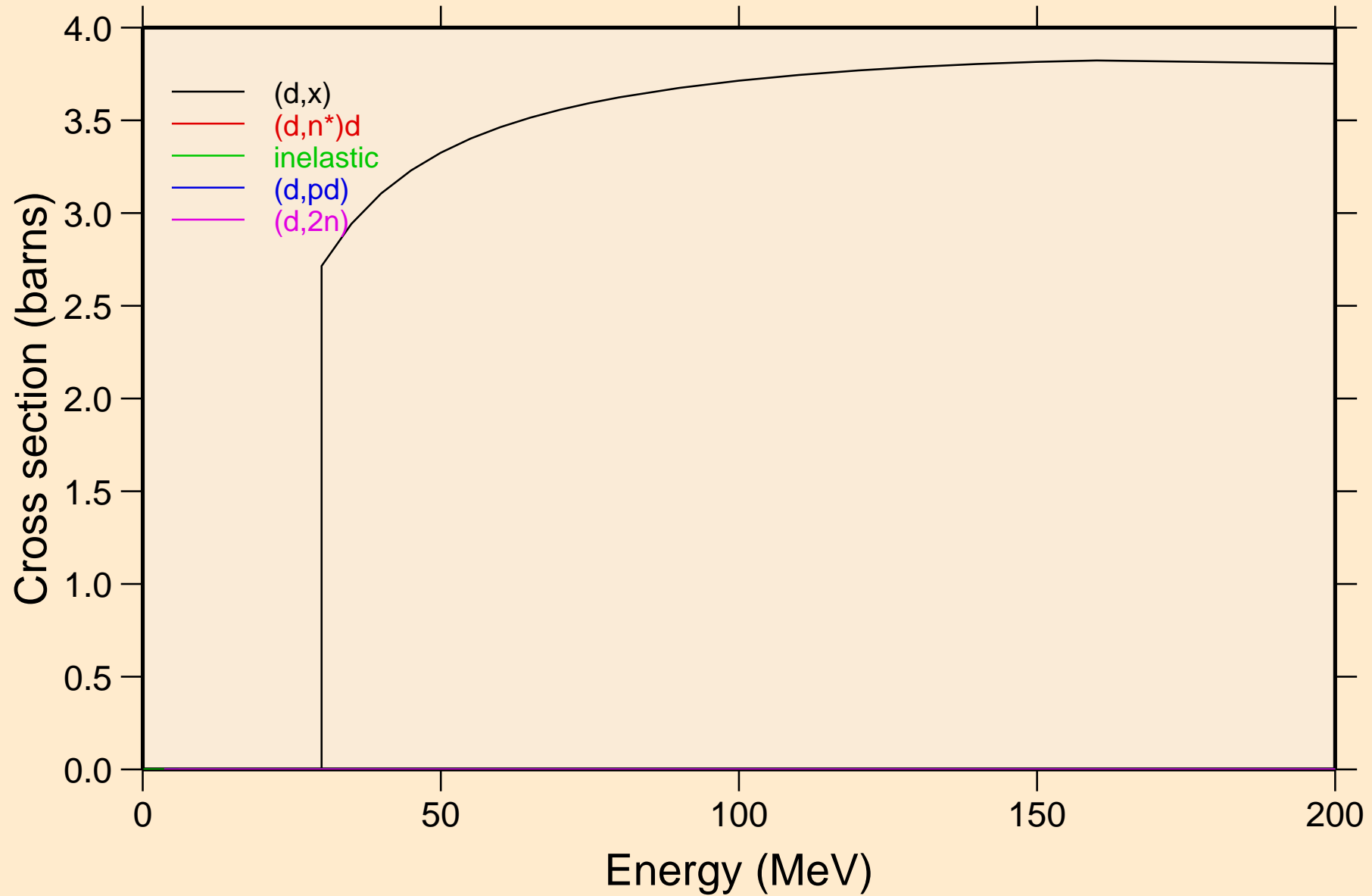

DB269 DEUTERON ACER TENDL-2021 LIBRARY; T=0.K  
Threshold reactions

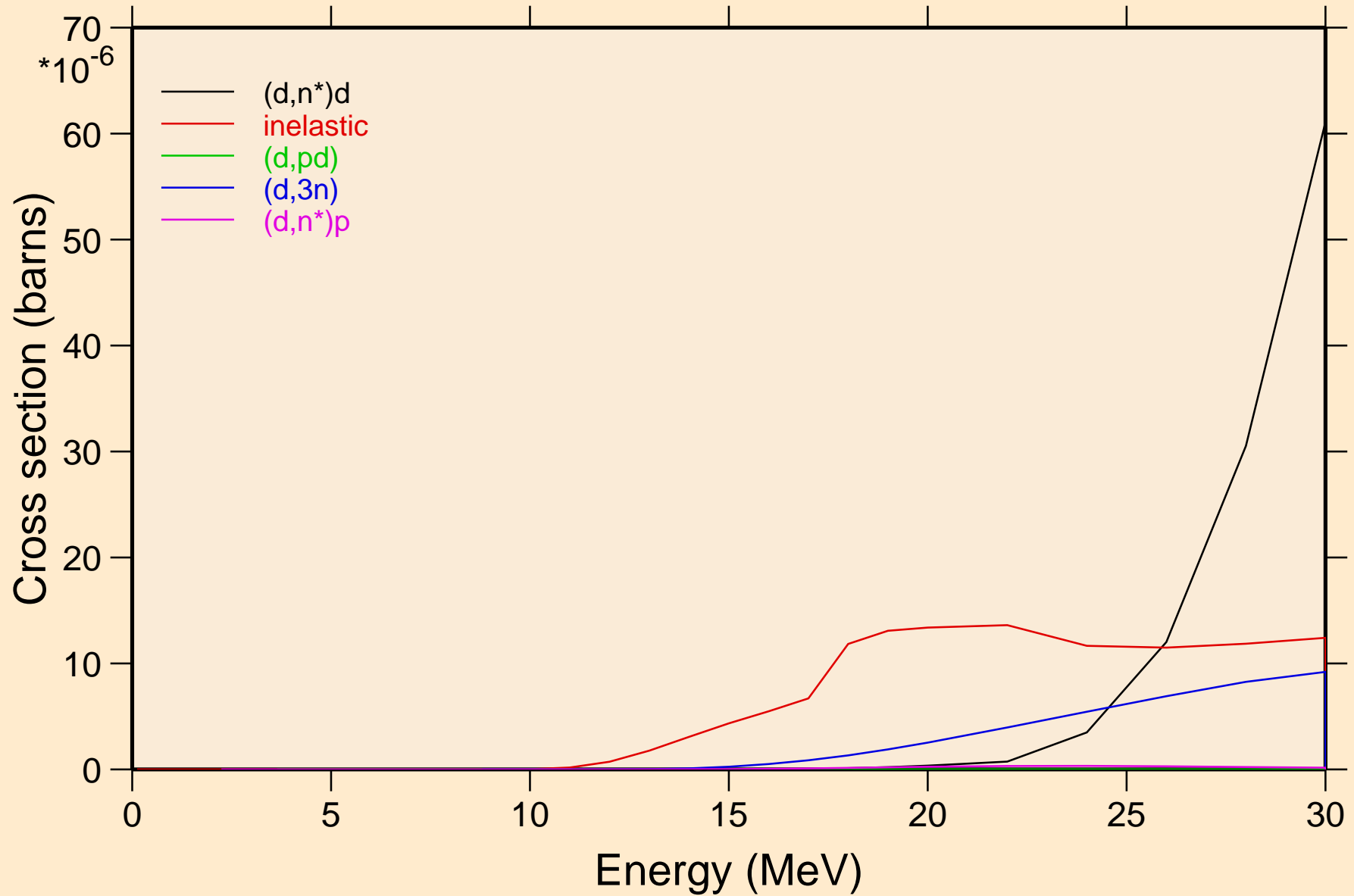

DB269 DEUTERON ACER TENDL-2021 LIBRARY; T=0.K  
Threshold reactions

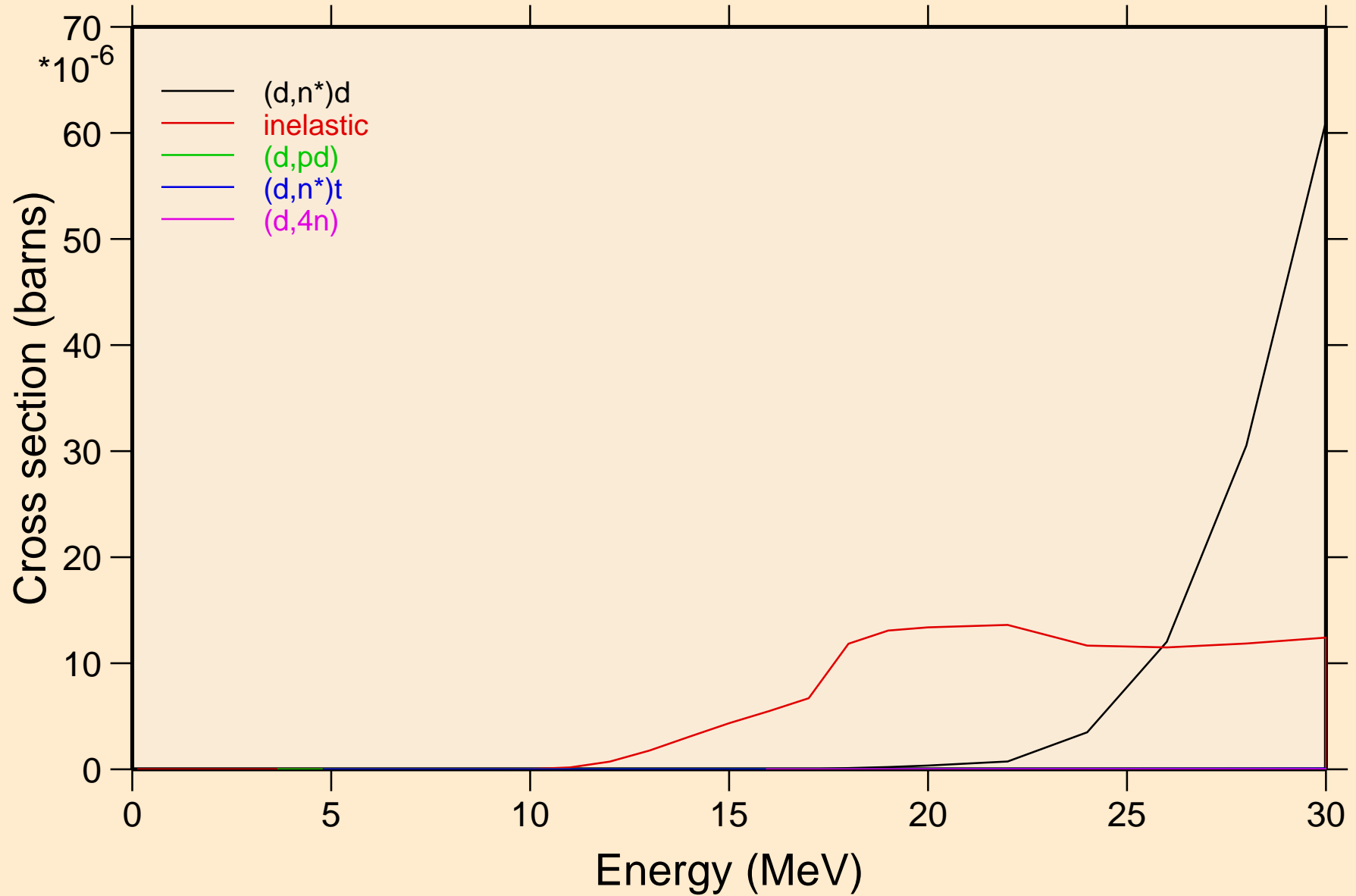

DB269 DEUTERON ACER TENDL-2021 LIBRARY; T=0.K  
Threshold reactions

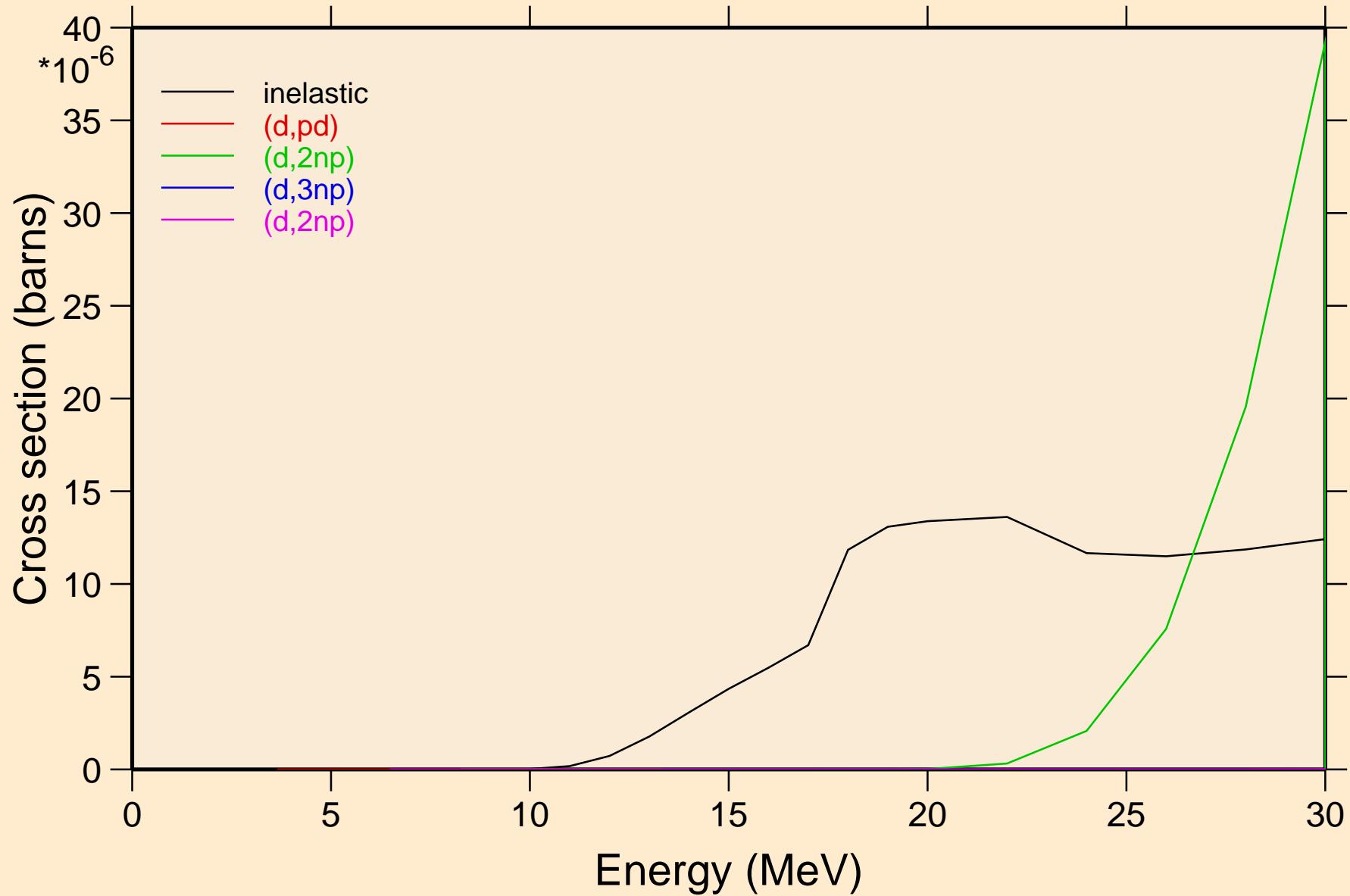



DB269 DEUTERON ACER TENDL-2021 LIBRARY; T=0.K  
Threshold reactions

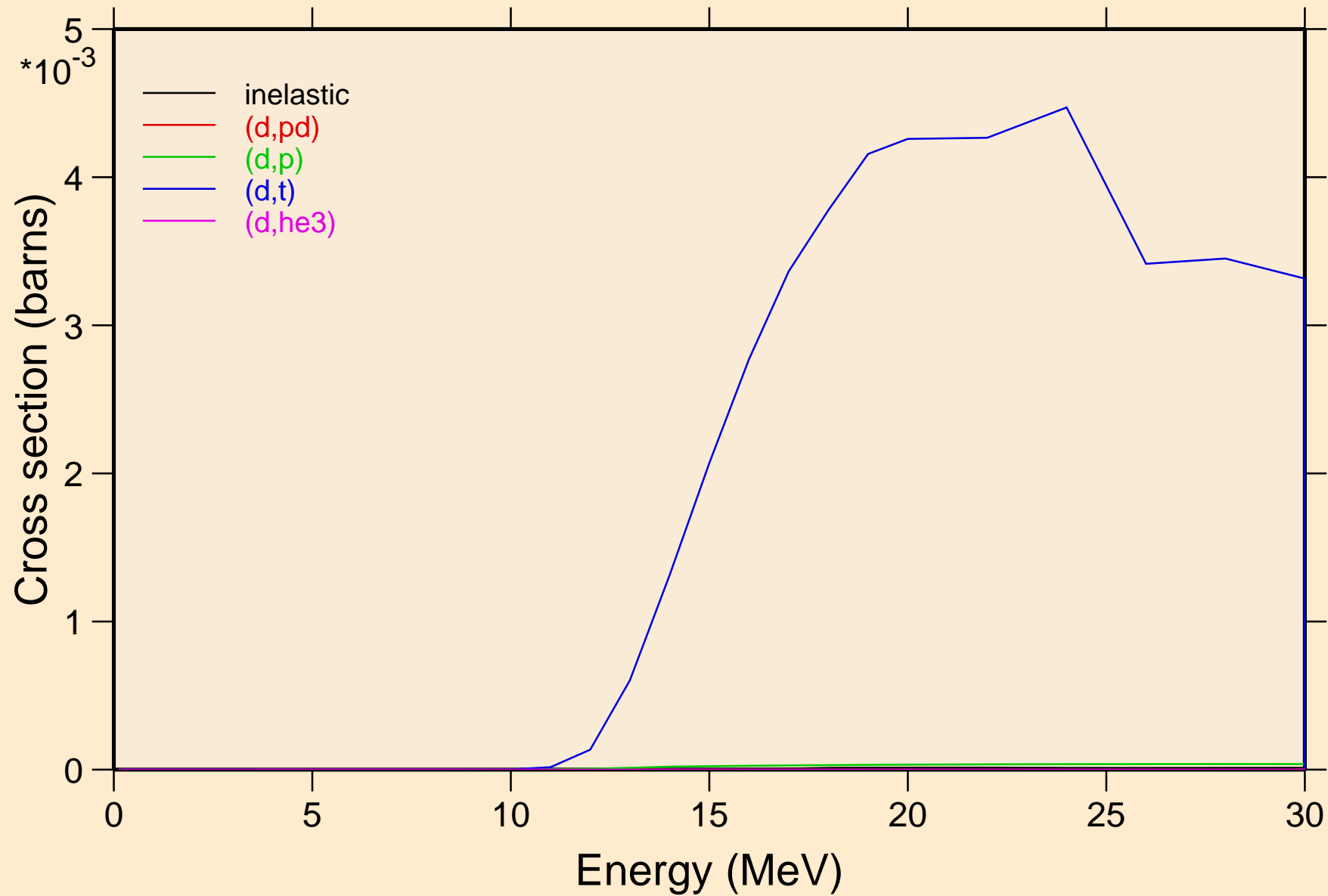

DB269 DEUTERON ACER TENDL-2021 LIBRARY; T=0.K  
Threshold reactions

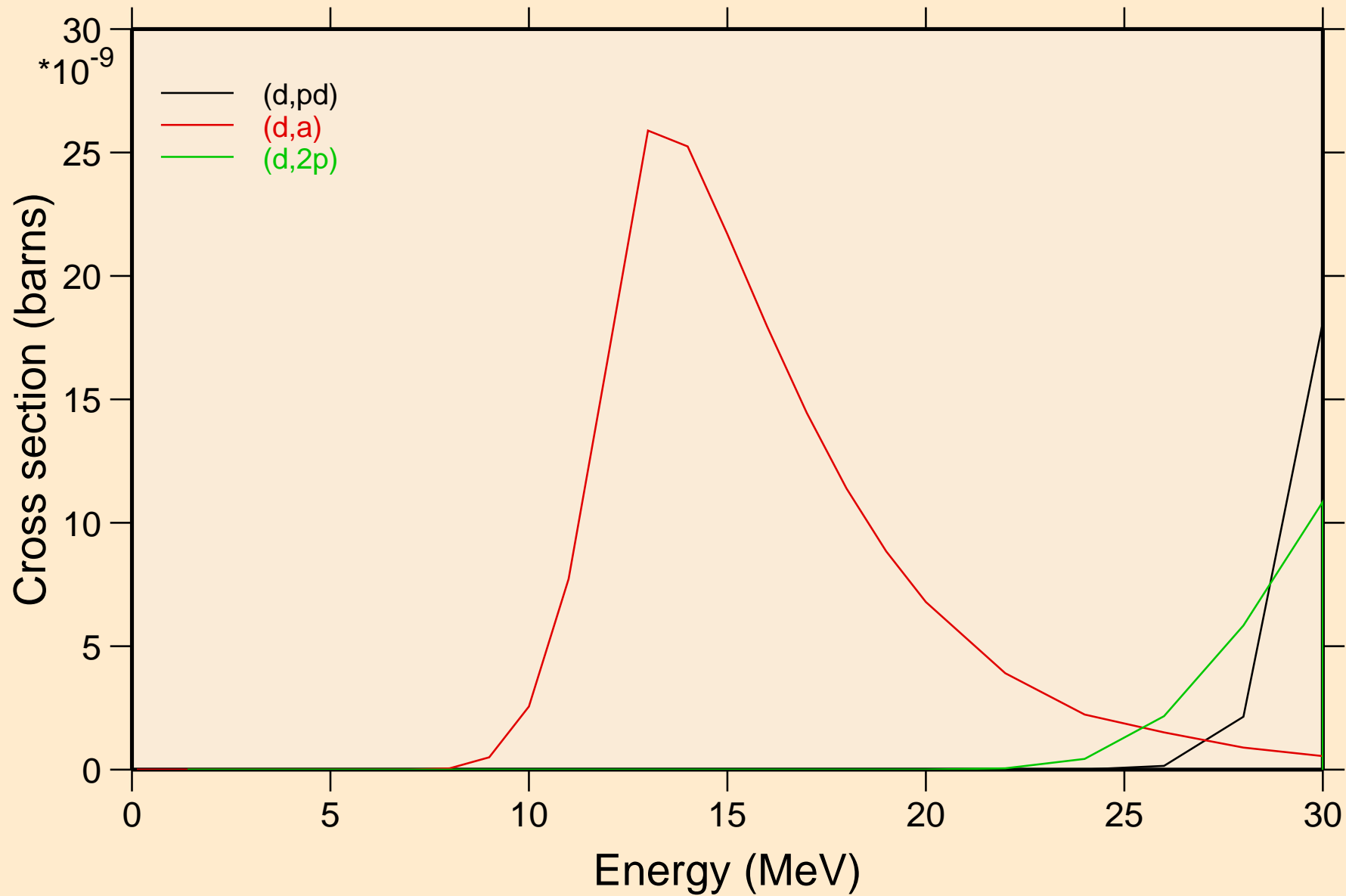

DB269 DEUTERON ACER TENDL-2021 LIBRARY; T=0.K  
Threshold reactions

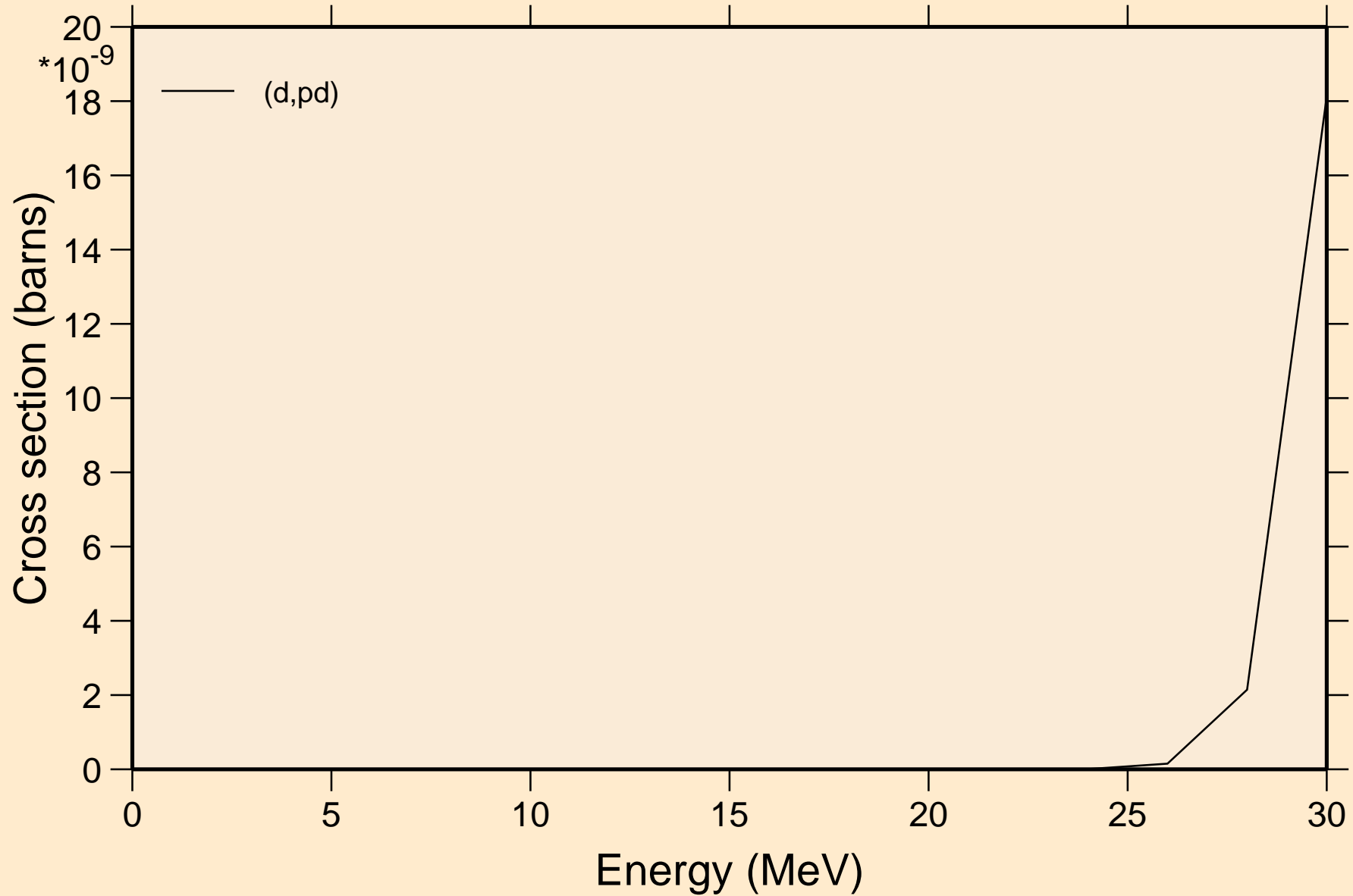

DB269 DEUTERON ACER TENDL-2021 LIBRARY; T=0.K  
angular distribution for elastic

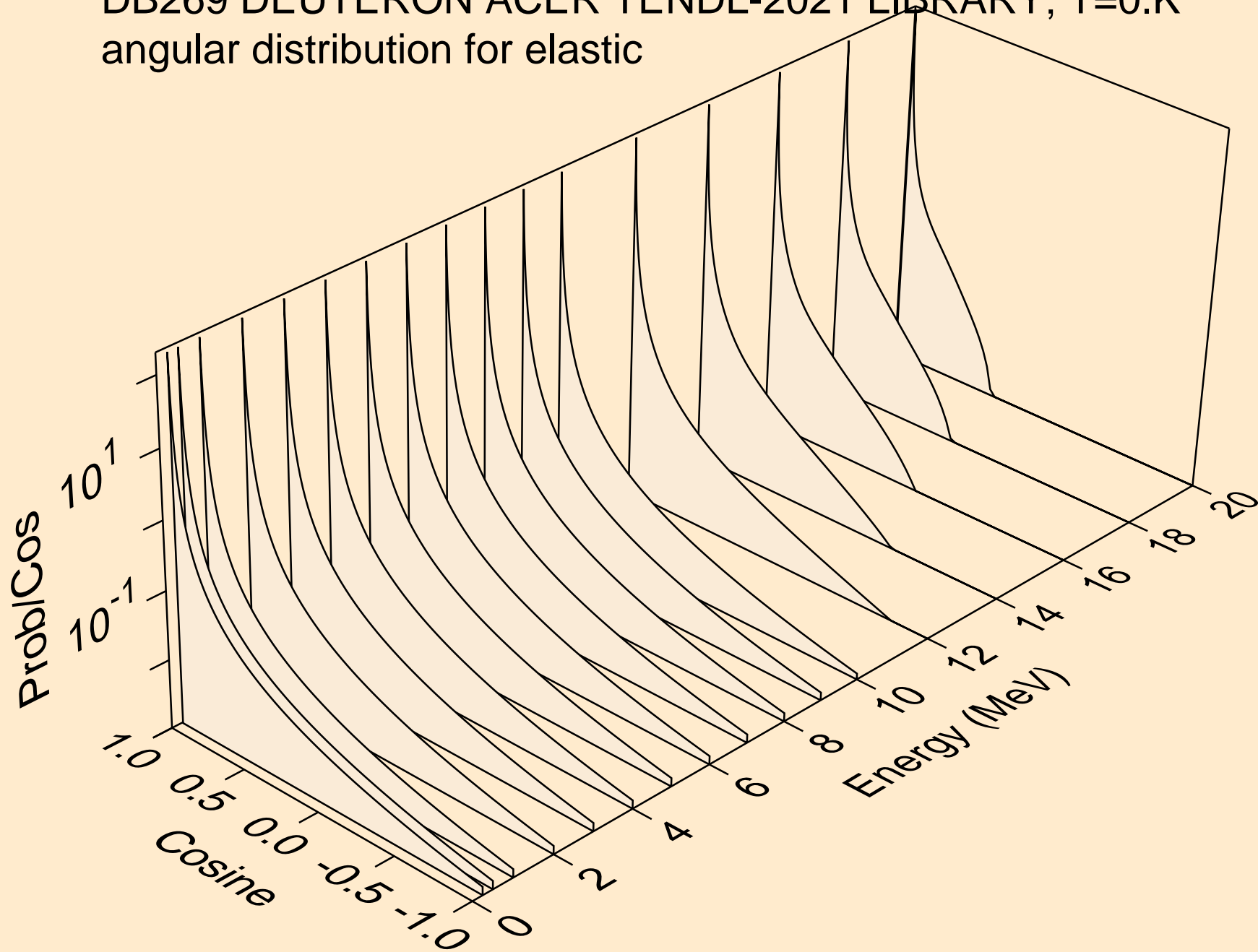

DB269 DEUTERON ACER TENDL-2021 LIBRARY; T=0.K  
angular distribution for elastic

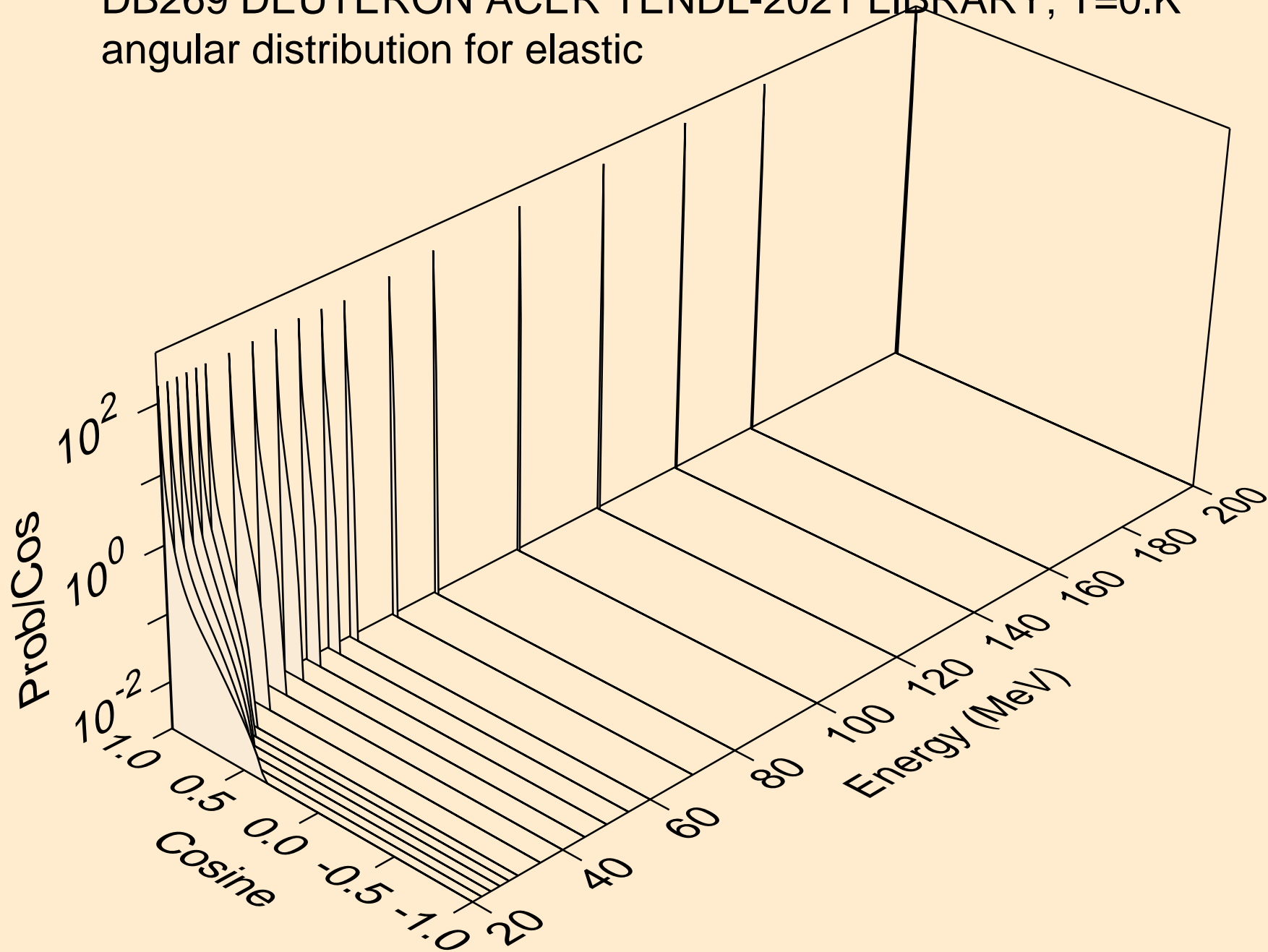

DB269 DEUTERON ACER TENDL-2021 LIBRARY; T=0.K  
Deuteron emission for (d,x)

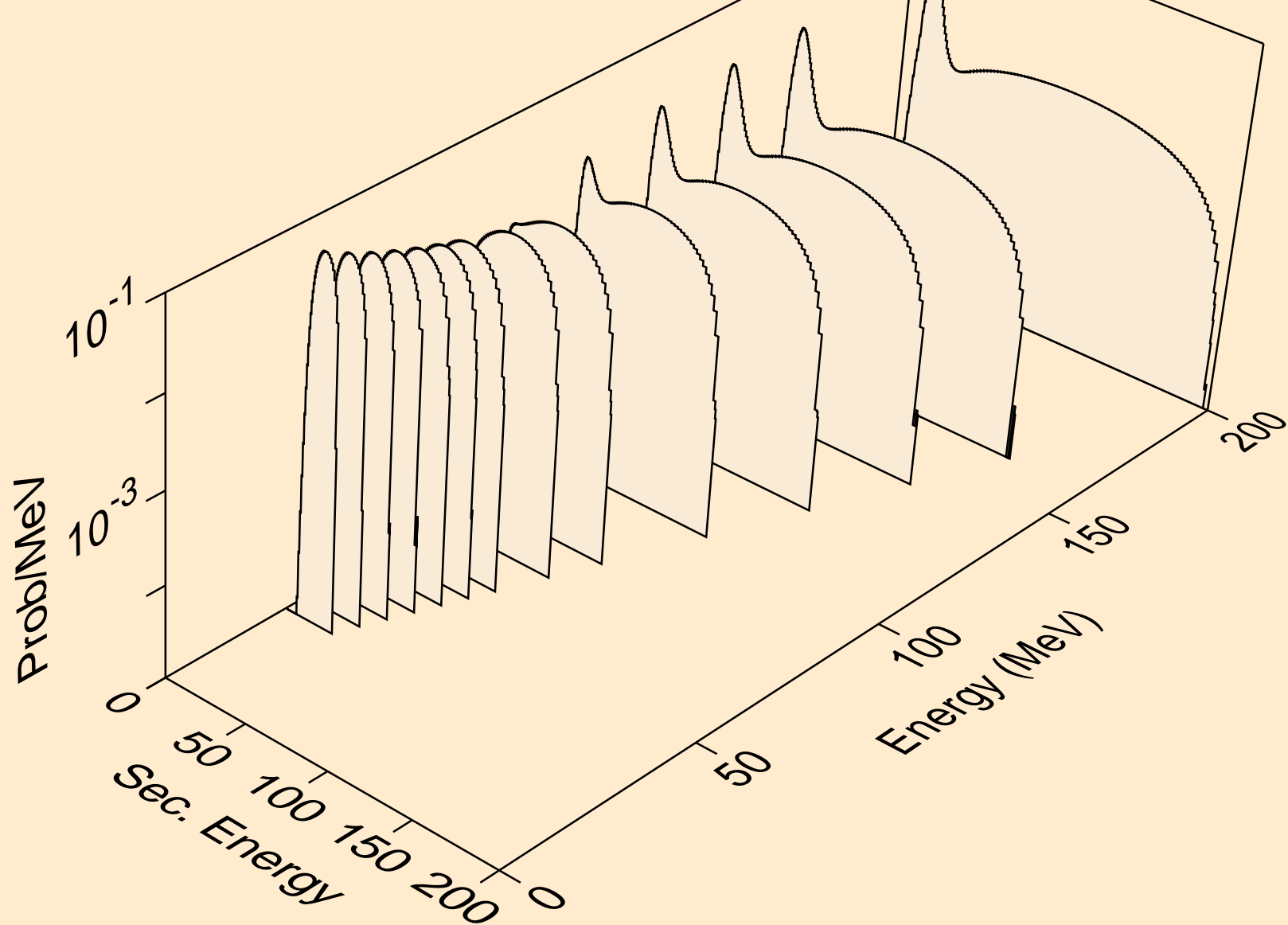

DB269 DEUTERON ACER TENDL-2021 LIBRARY; T=0.K  
Deuteron emission for (d,n\*)d

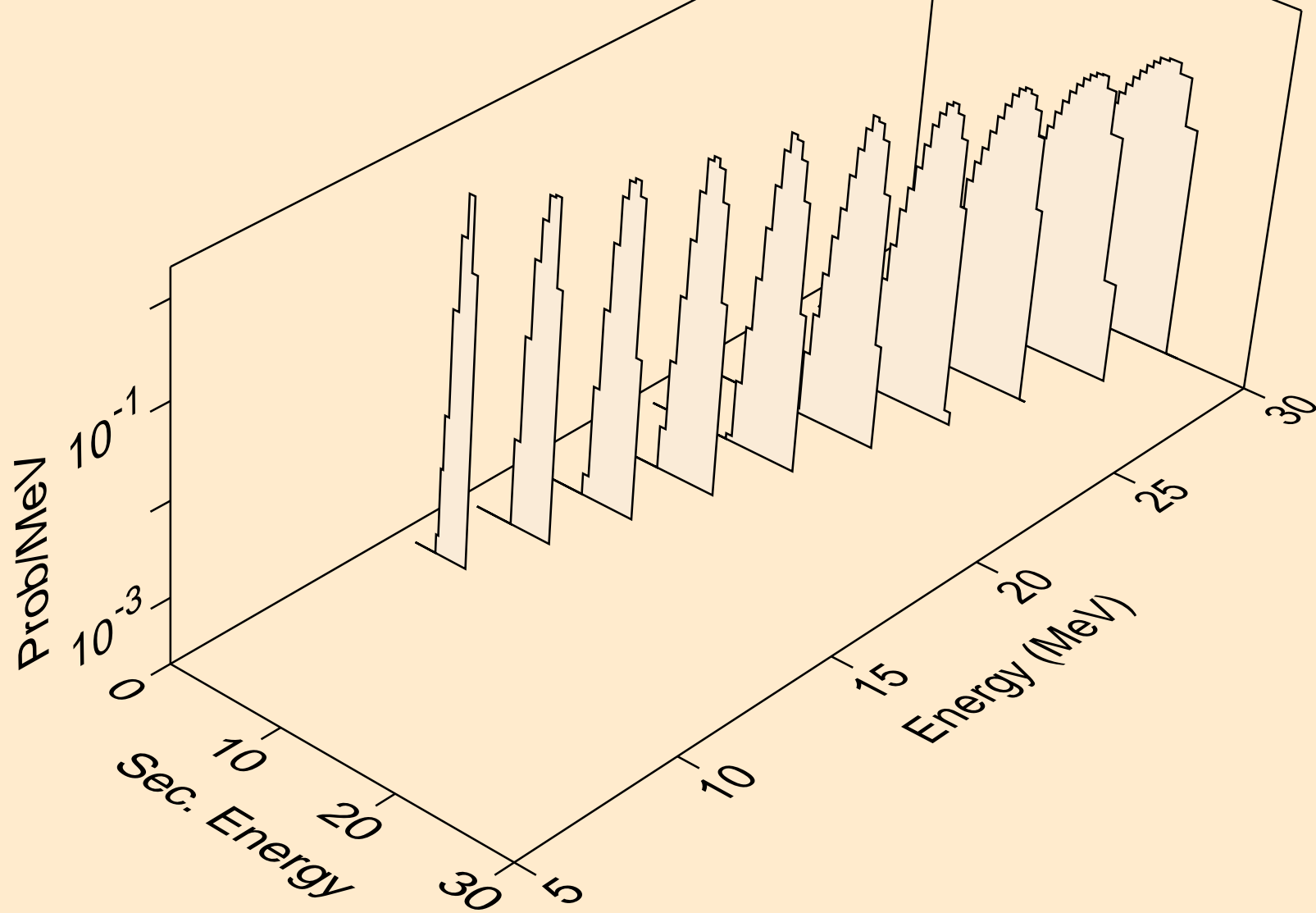

DB269 DEUTERON ACER TENDL-2021 LIBRARY; T=0.K  
Deuteron emission for inelastic

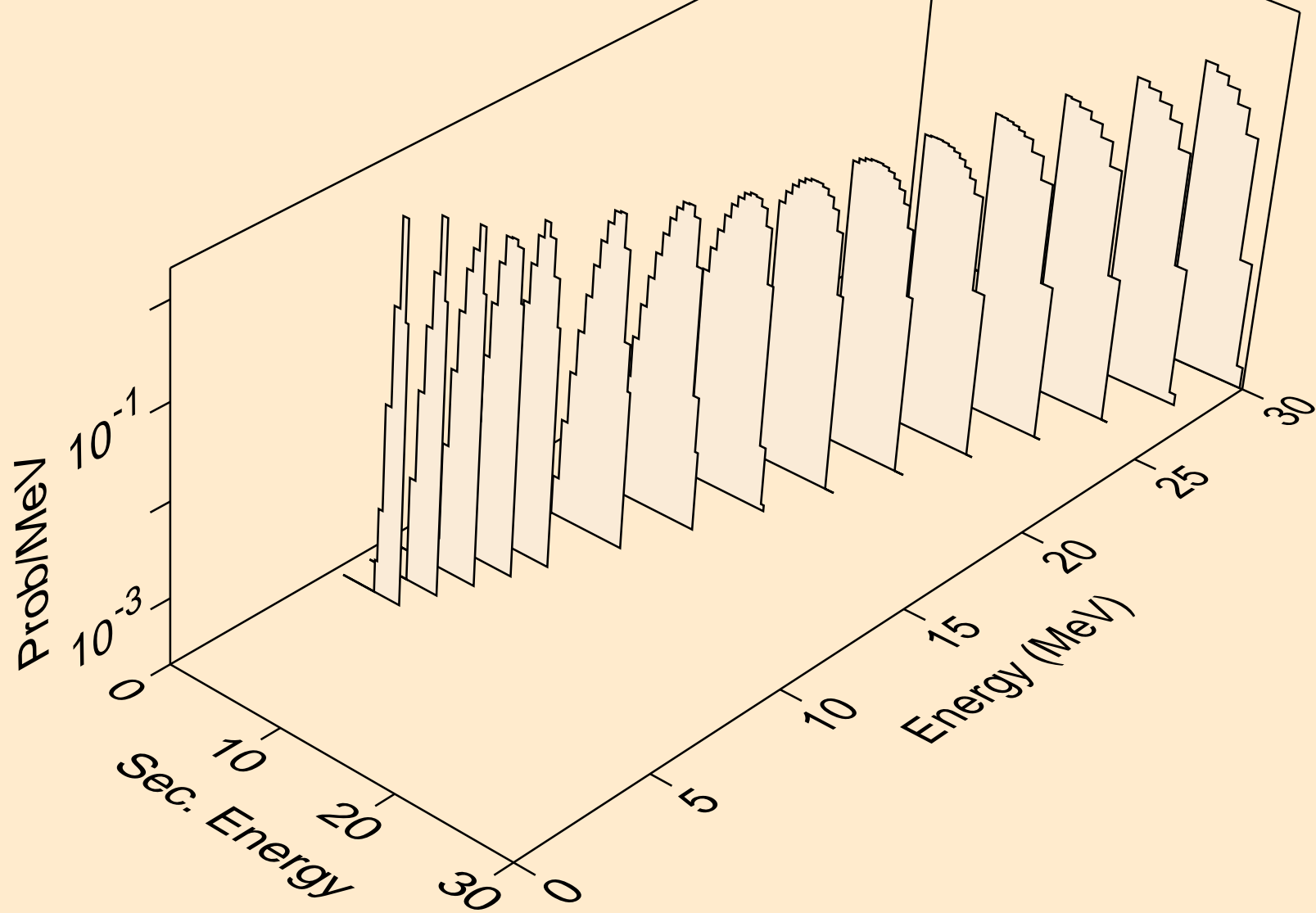



DB269 DEUTERON ACER TENDL-2021 LIBRARY; T=0.K  
Deuteron emission for (d,pd)

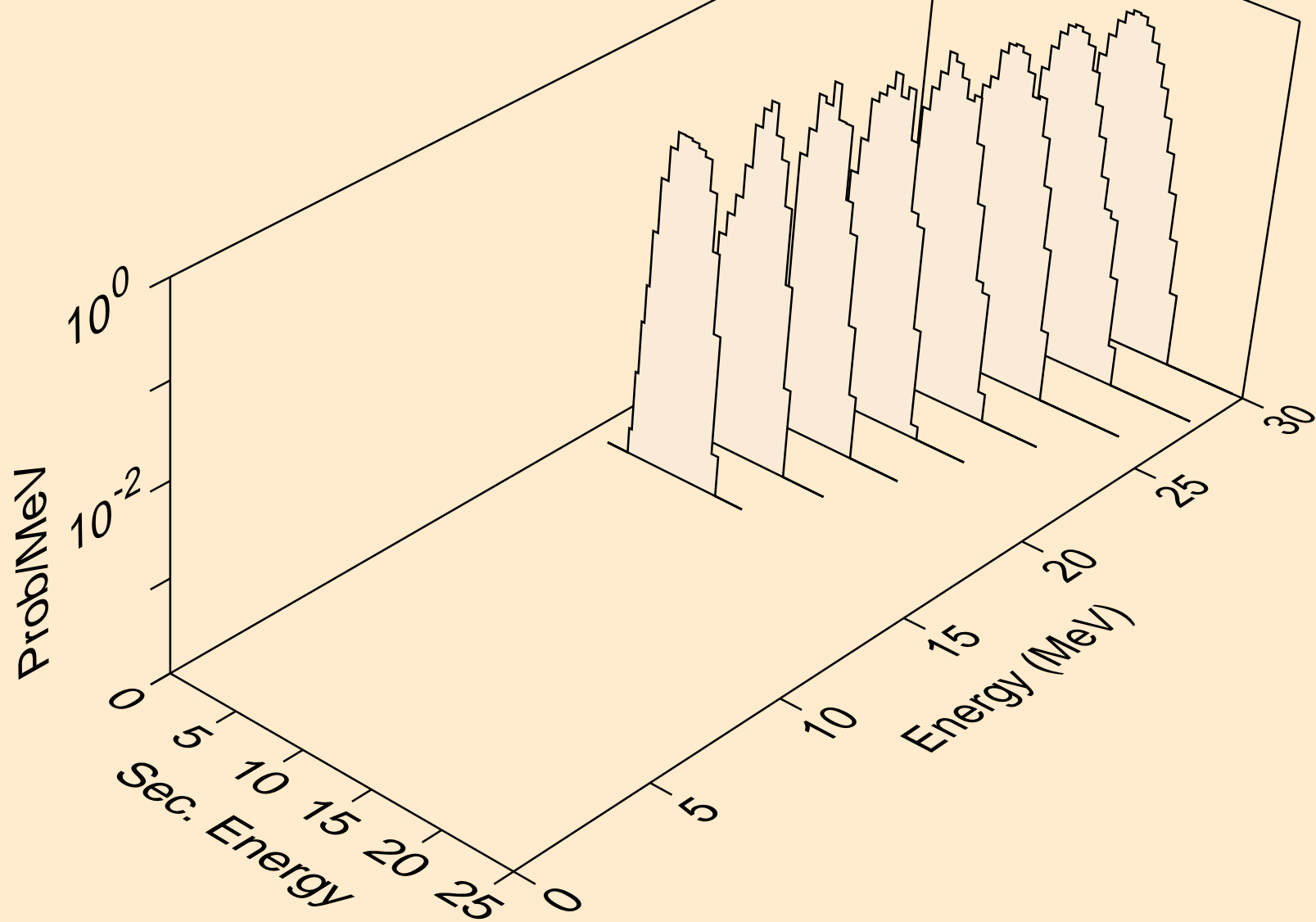

DB269 DEUTERON ACER TENDL-2021 LIBRARY; T=0.K  
Photon emission for (z,n)

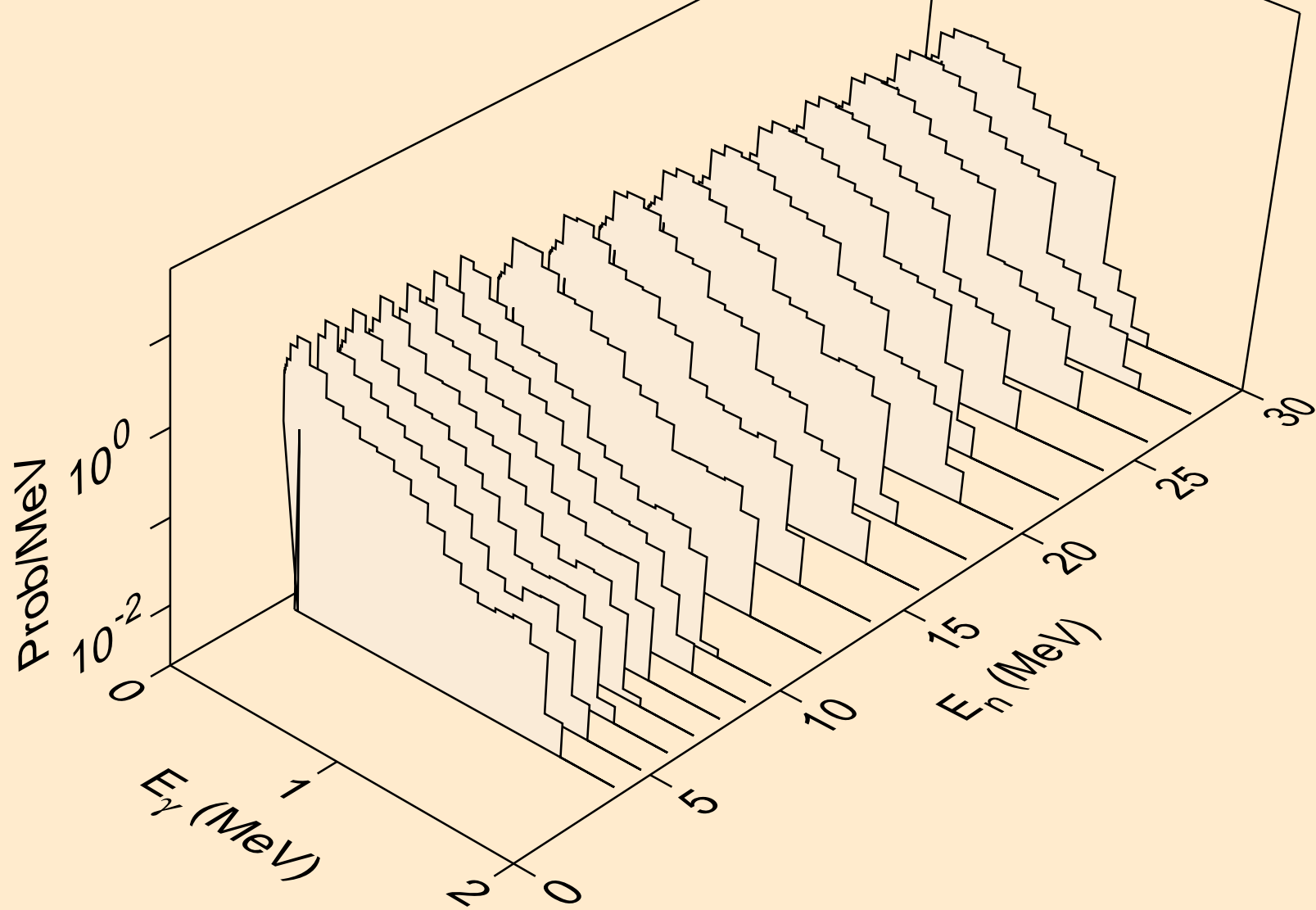

DB269 DEUTERON ACER TENDL-2021 LIBRARY; T=0.K  
Photon emission for (n,x)

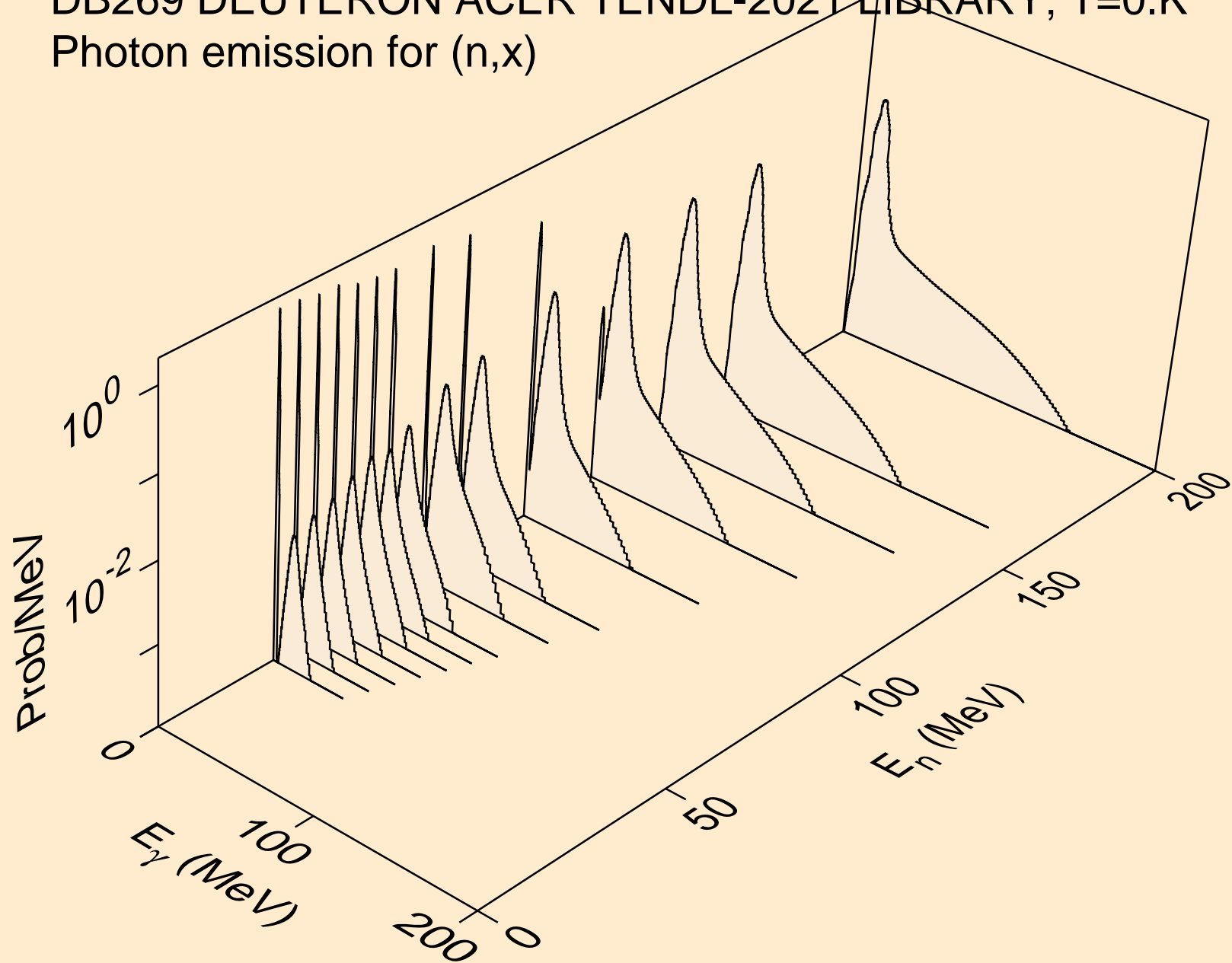

DB269 DEUTERON ACER TENDL-2021 LIBRARY; T=0.K  
Photon emission for (n,2n)

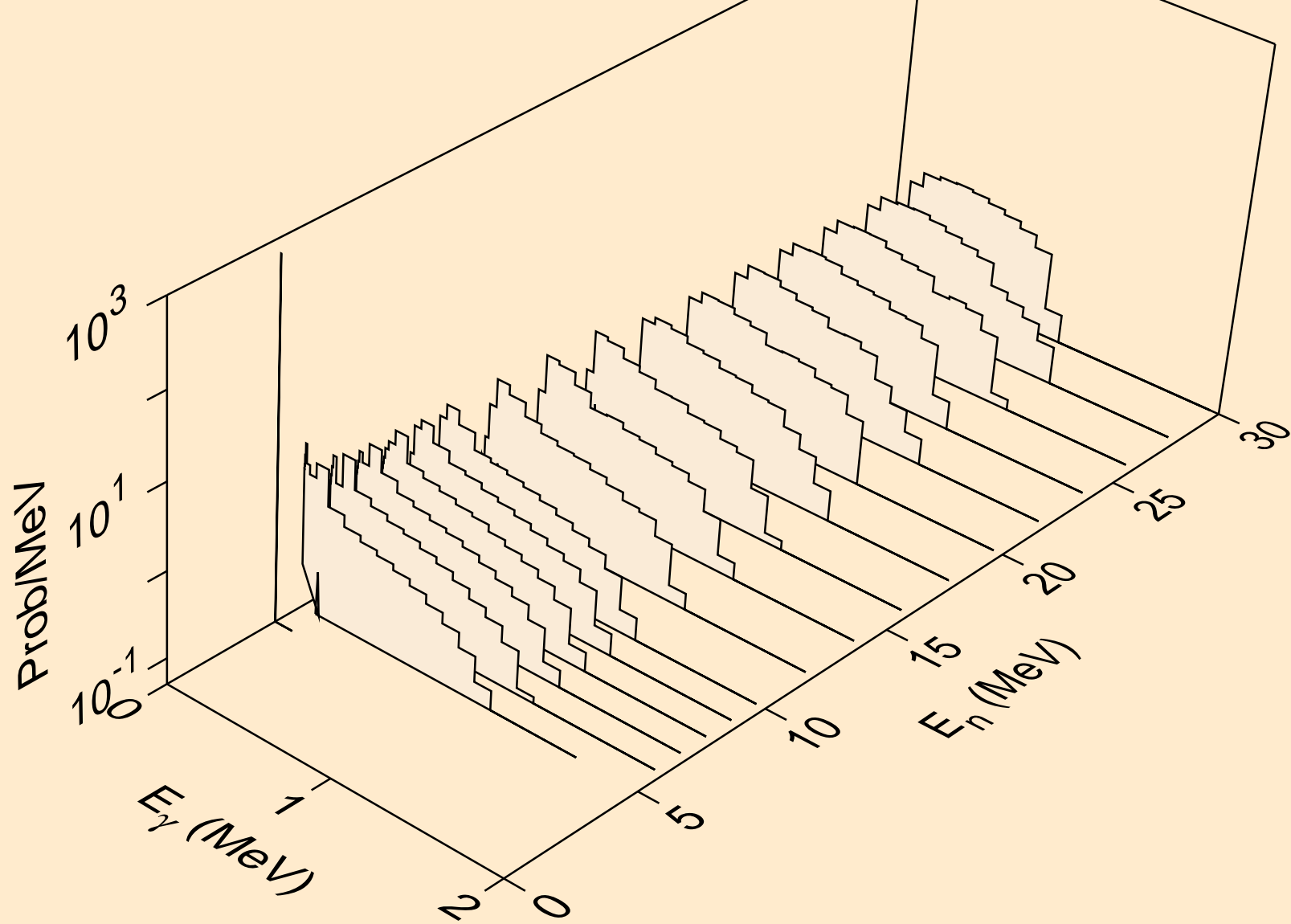

DB269 DEUTERON ACER TENDL-2021 LIBRARY; T=0.K  
Photon emission for (n,3n)

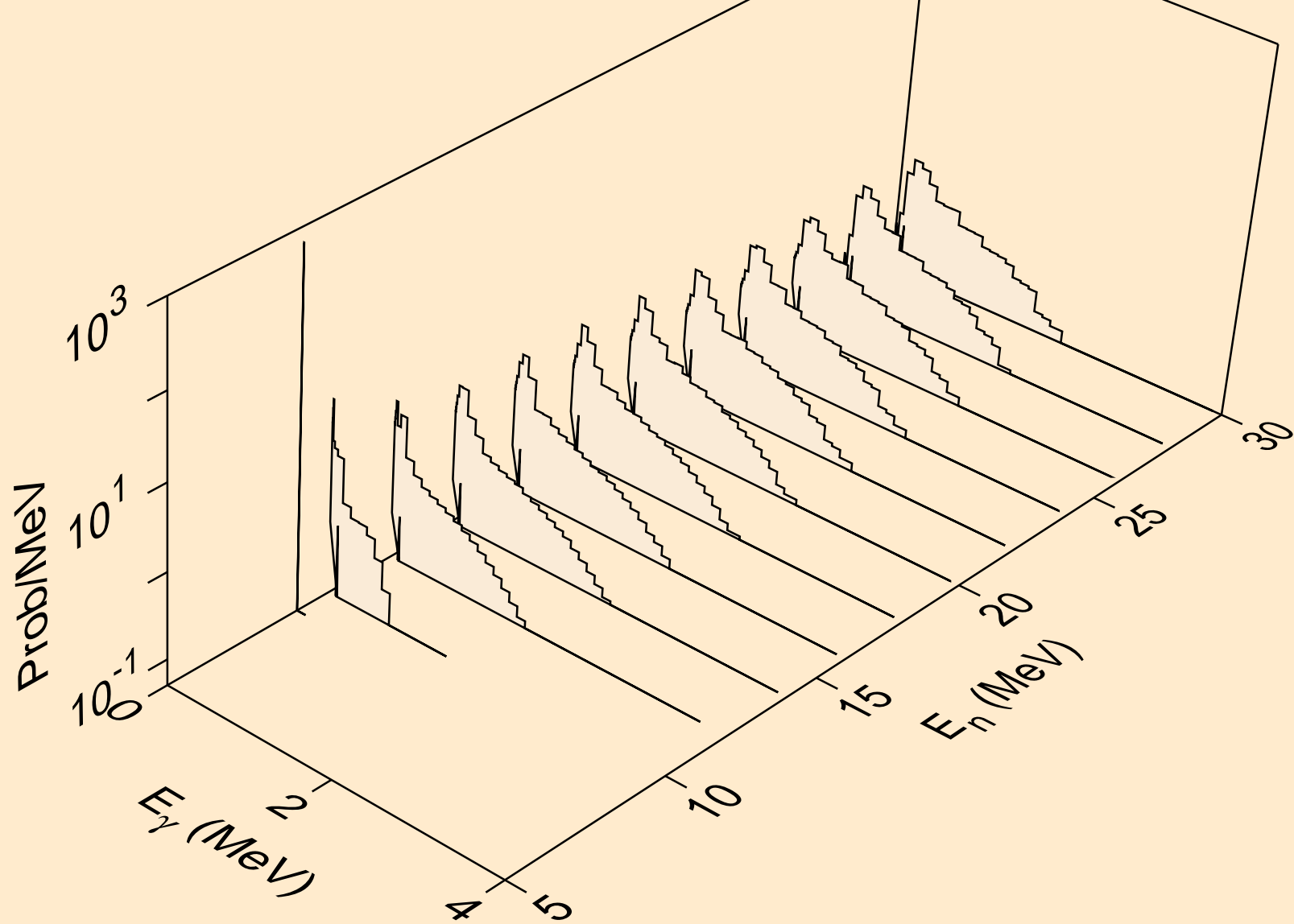

DB269 DEUTERON ACER TENDL-2021 LIBRARY; T=0.K  
Photon emission for (n,n\*)p

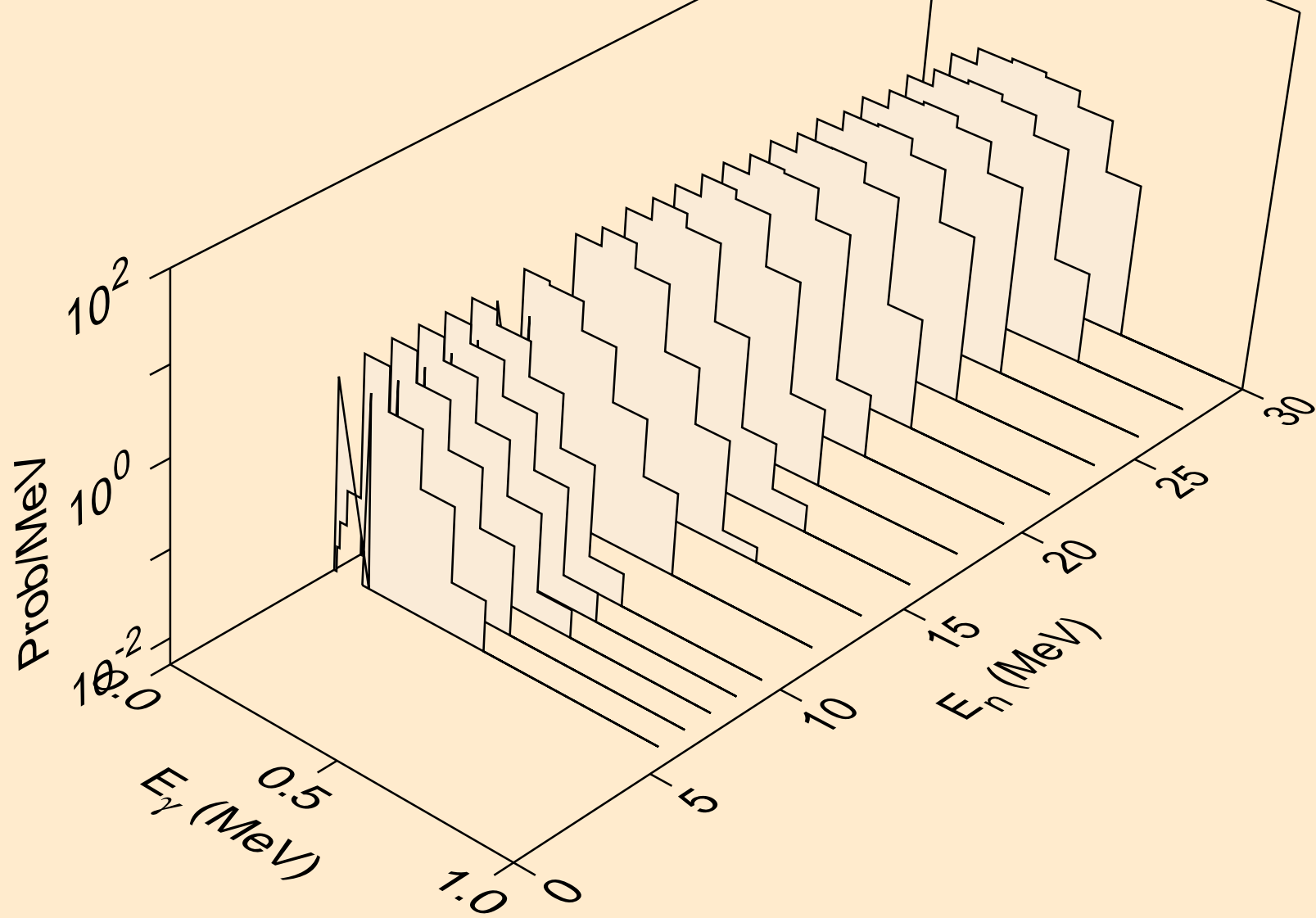

DB269 DEUTERON ACER TENDL-2021 LIBRARY; T=0.K  
Photon emission for (n,n\*)d

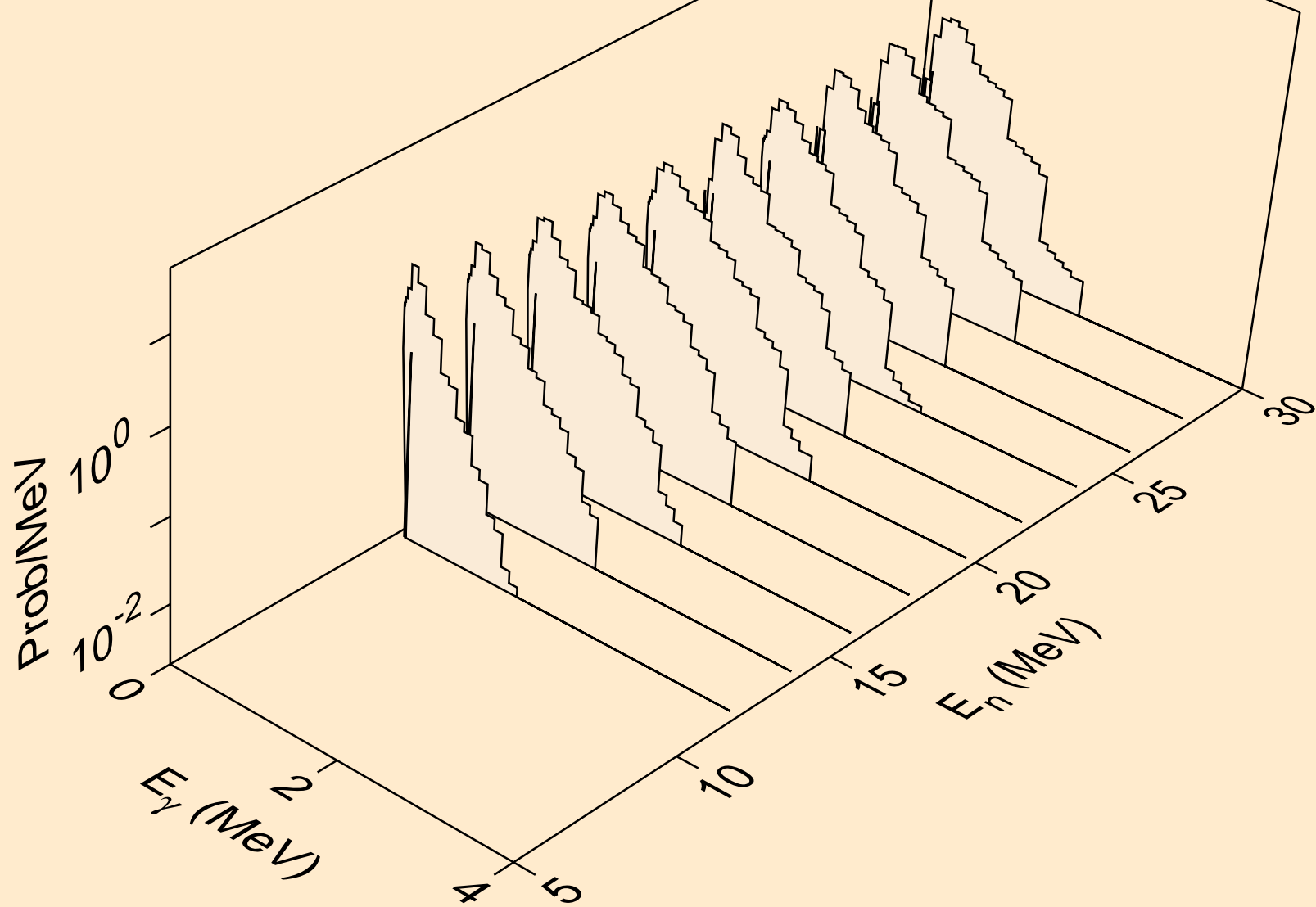

DB269 DEUTERON ACER TENDL-2021 LIBRARY; T=0.K  
Photon emission for (n,n\*)t

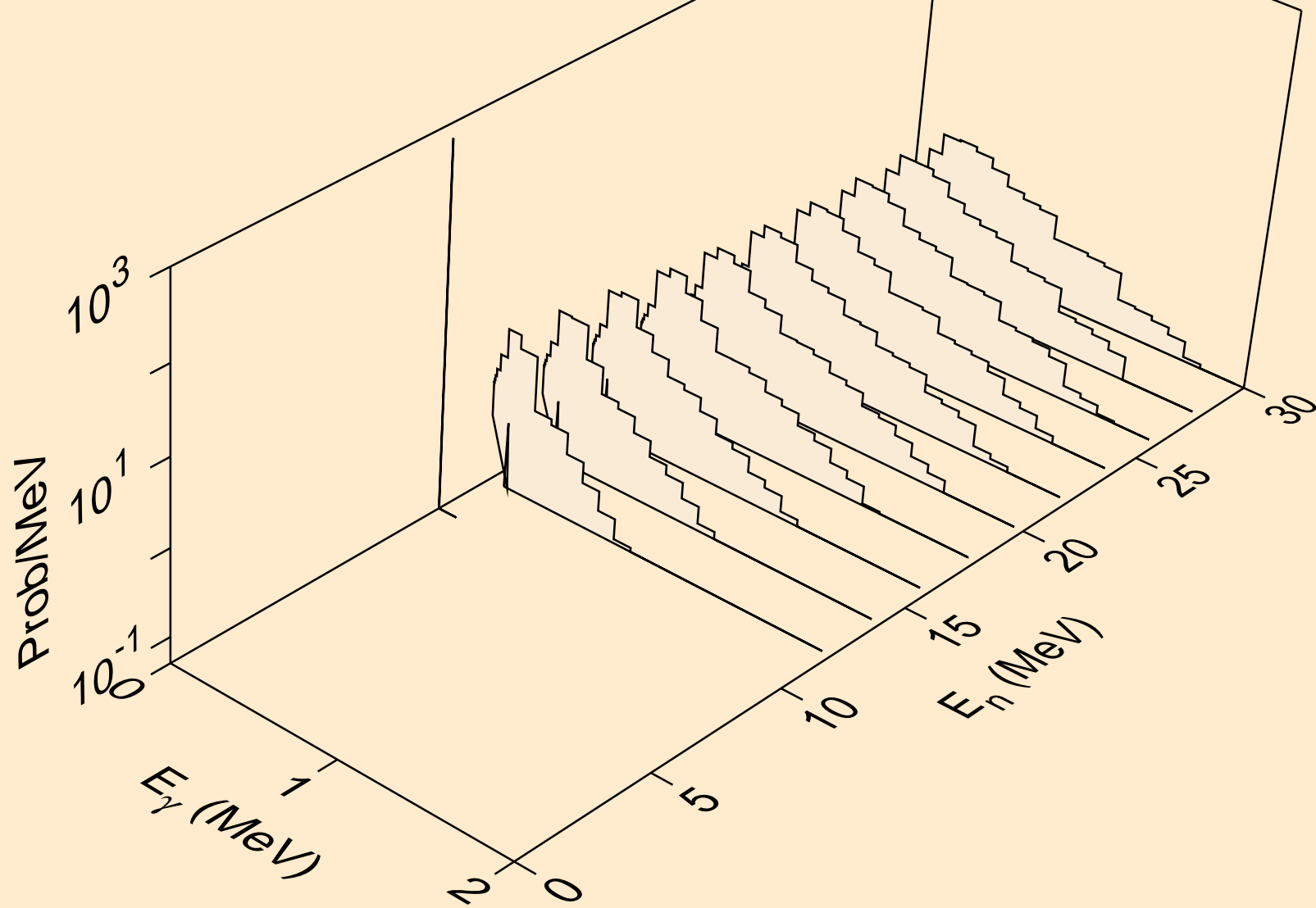



DB269 DEUTERON ACER TENDL-2021 LIBRARY; T=0.K  
Photon emission for (n,4n)

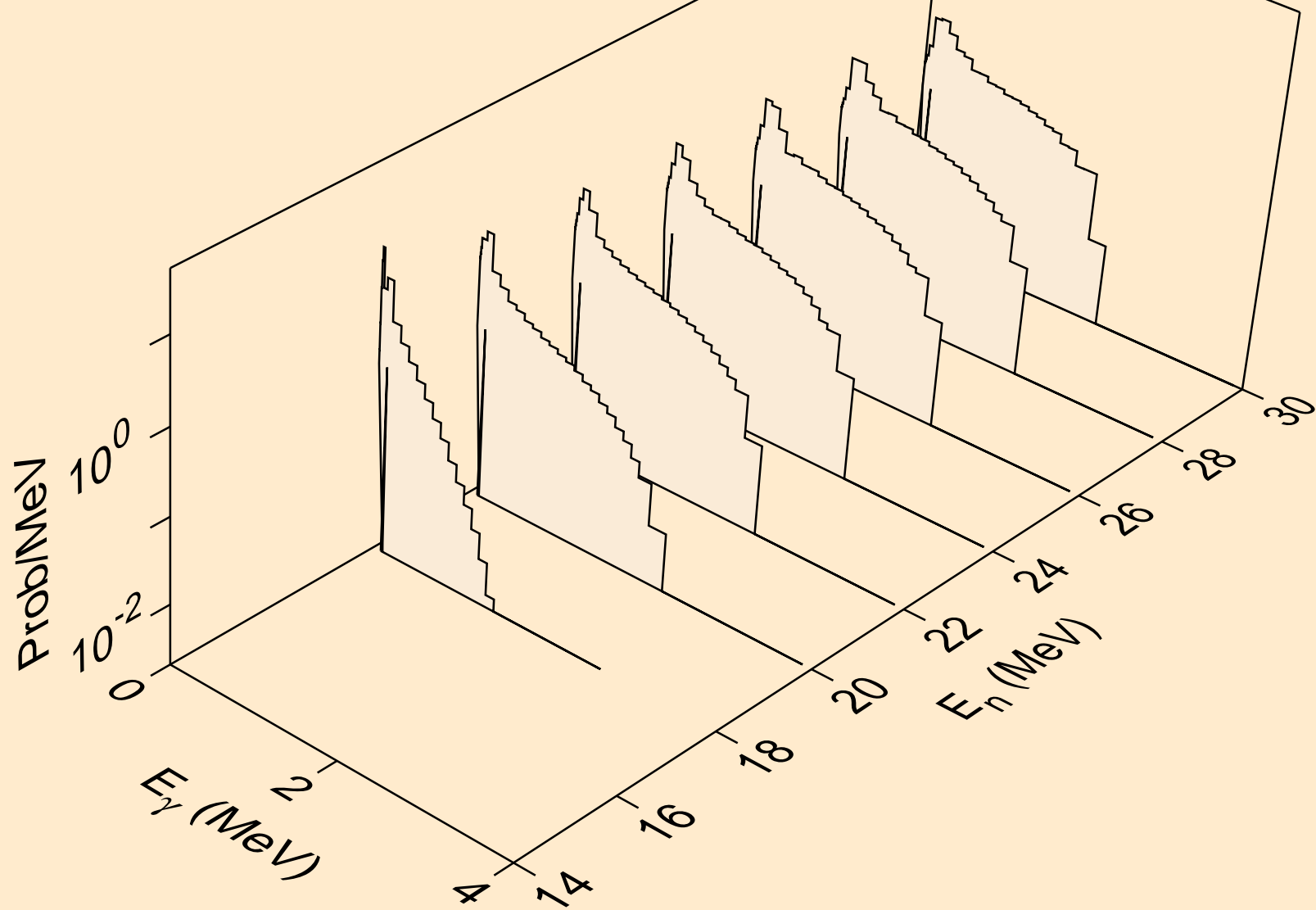

DB269 DEUTERON ACER TENDL-2021 LIBRARY; T=0.K  
Photon emission for (n,2np)

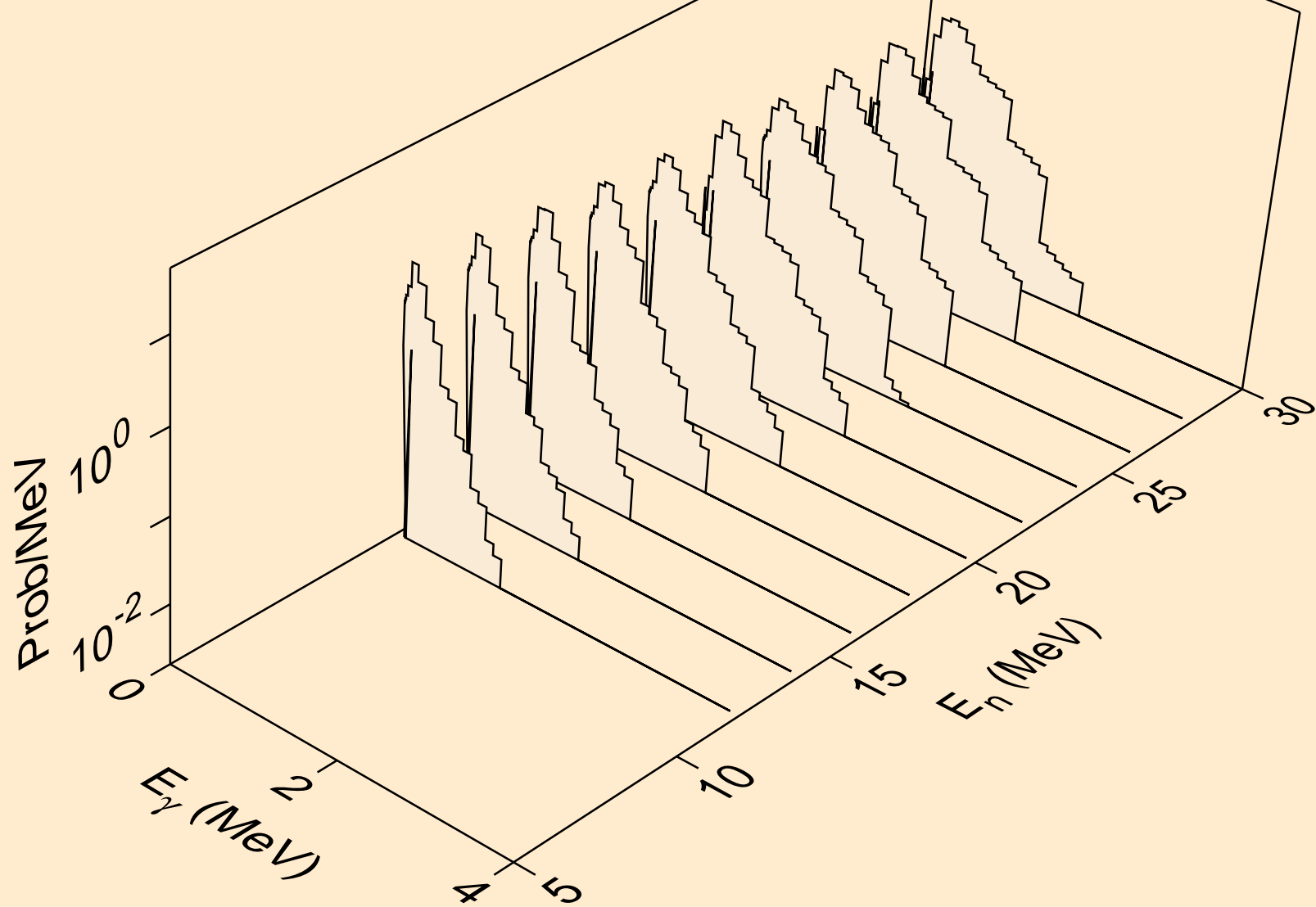

DB269 DEUTERON ACER TENDL-2021 LIBRARY; T=0.K  
Photon emission for (n,3np)

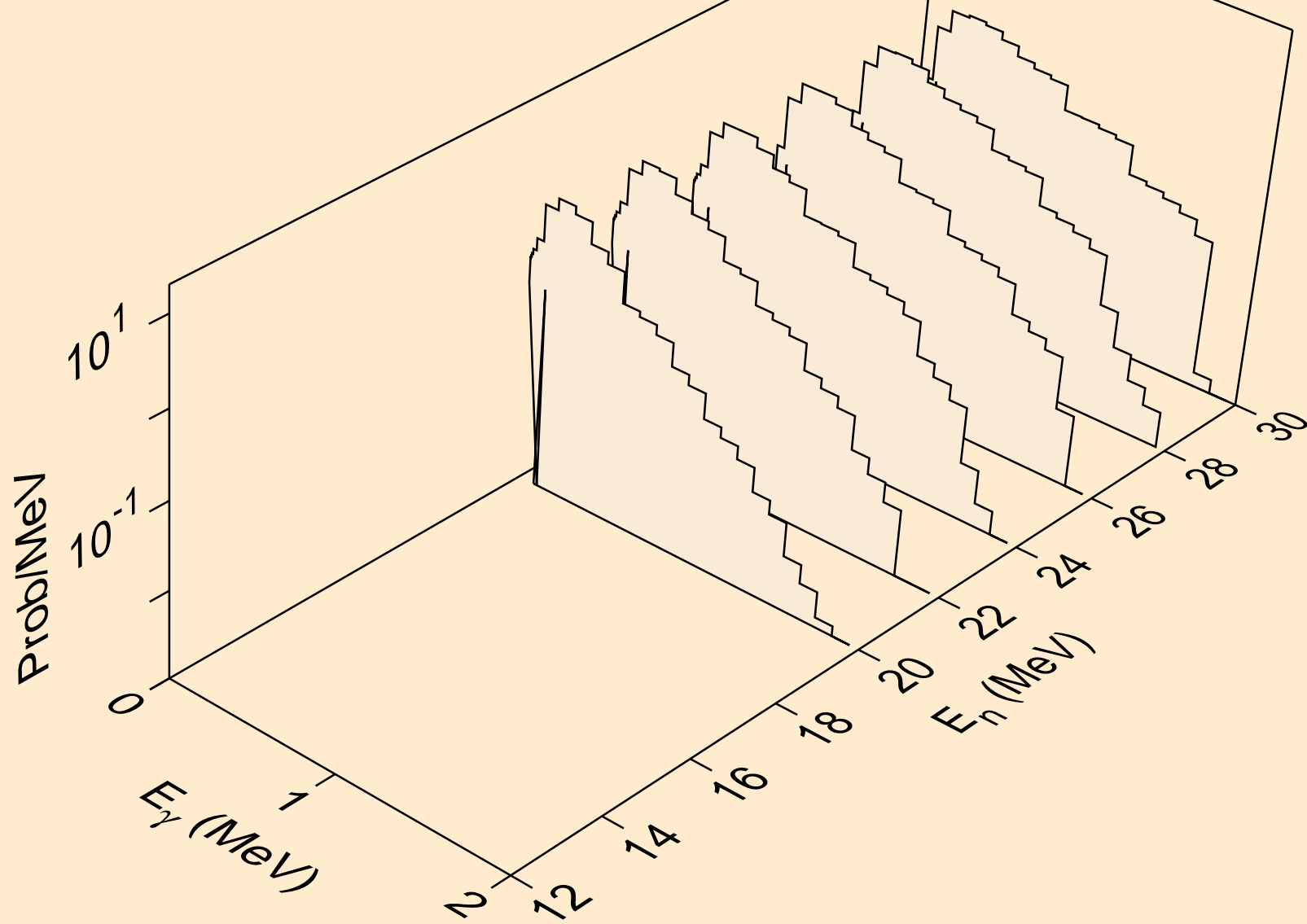

DB269 DEUTERON ACER TENDL-2021 LIBRARY; T=0.K  
Photon emission for (n,2np)

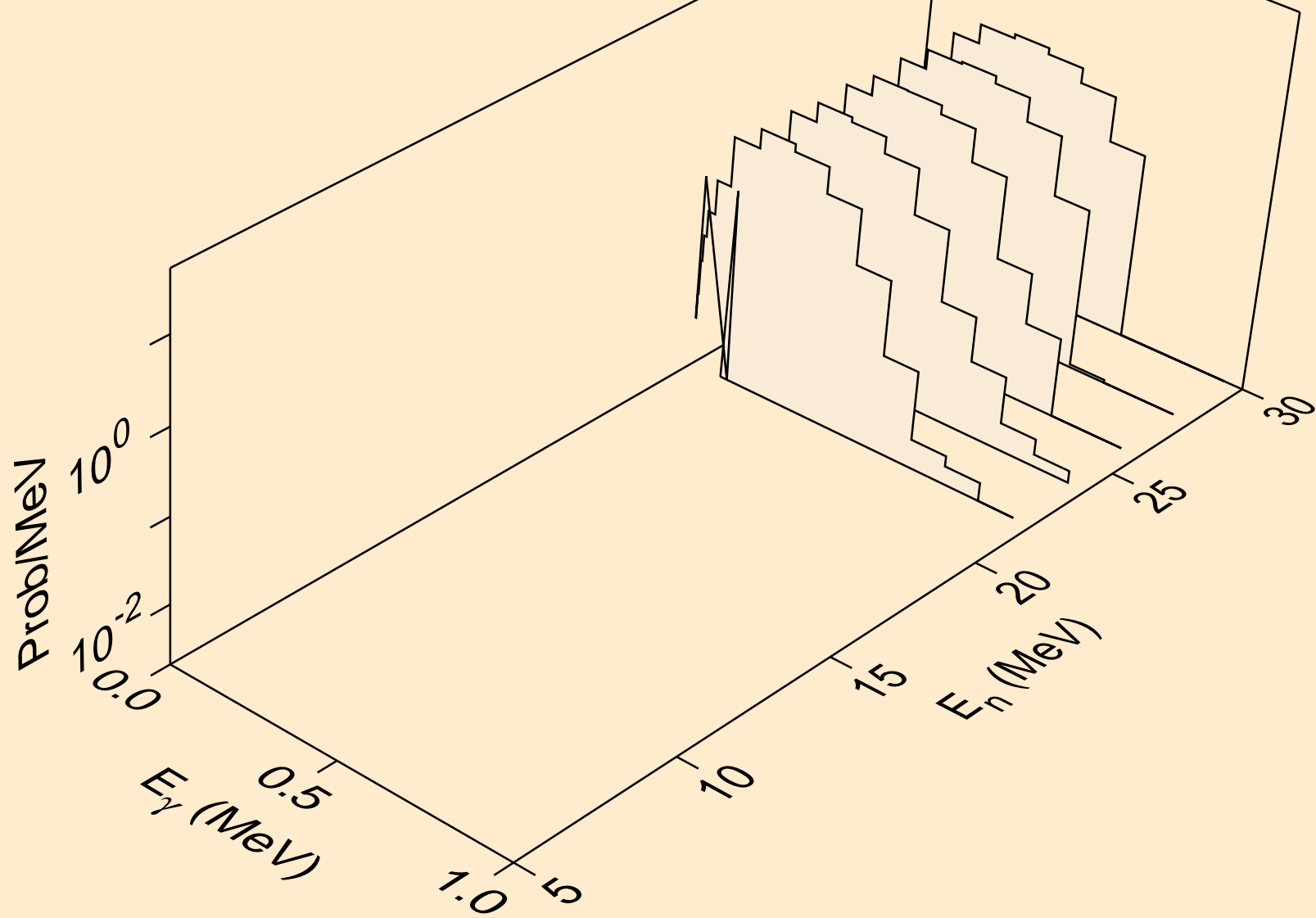

DB269 DEUTERON ACER TENDL-2021 LIBRARY; T=0.K  
Photon emission for (n,p)

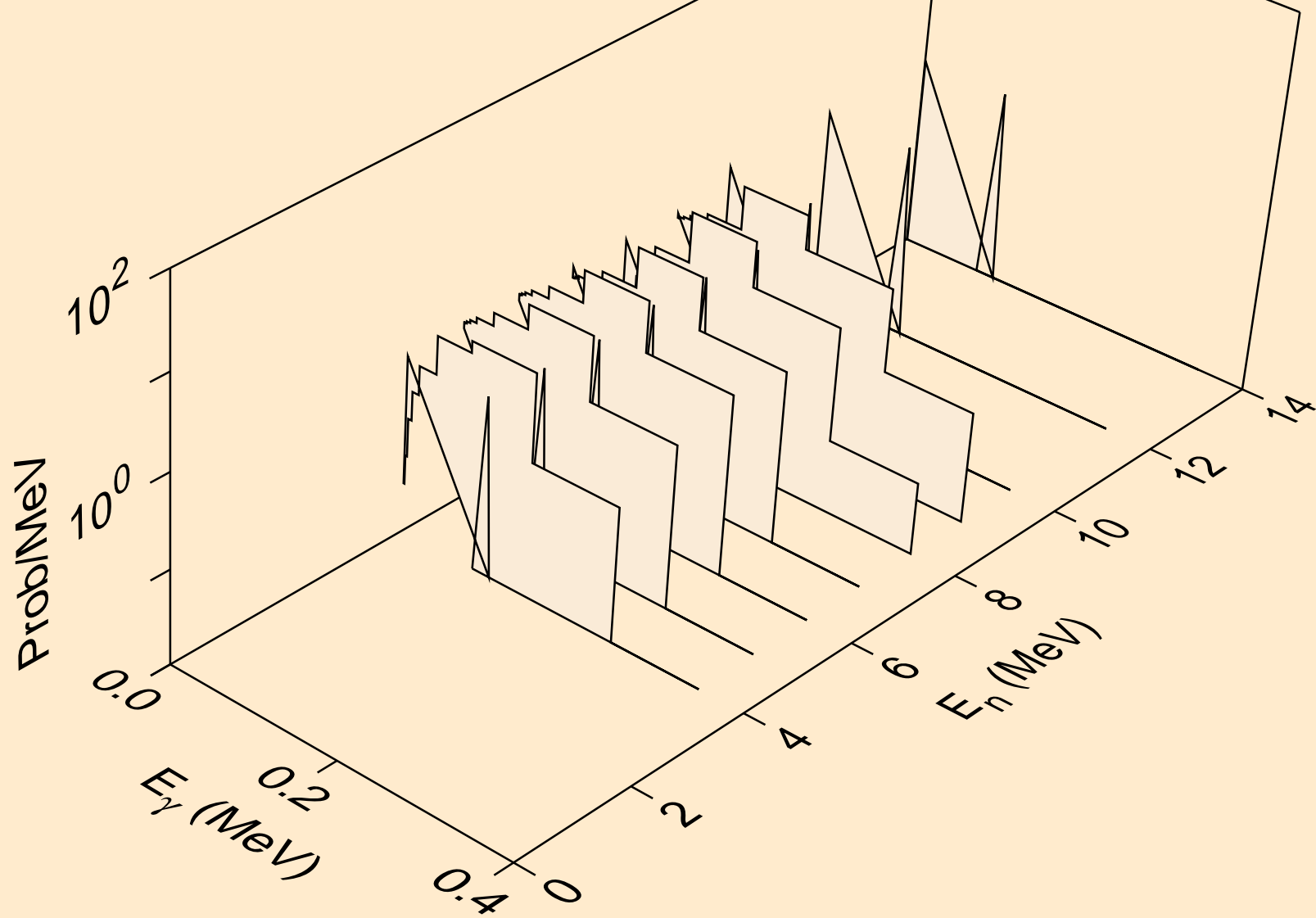

DB269 DEUTERON ACER TENDL-2021 LIBRARY; T=0.K  
Photon emission for inelastic

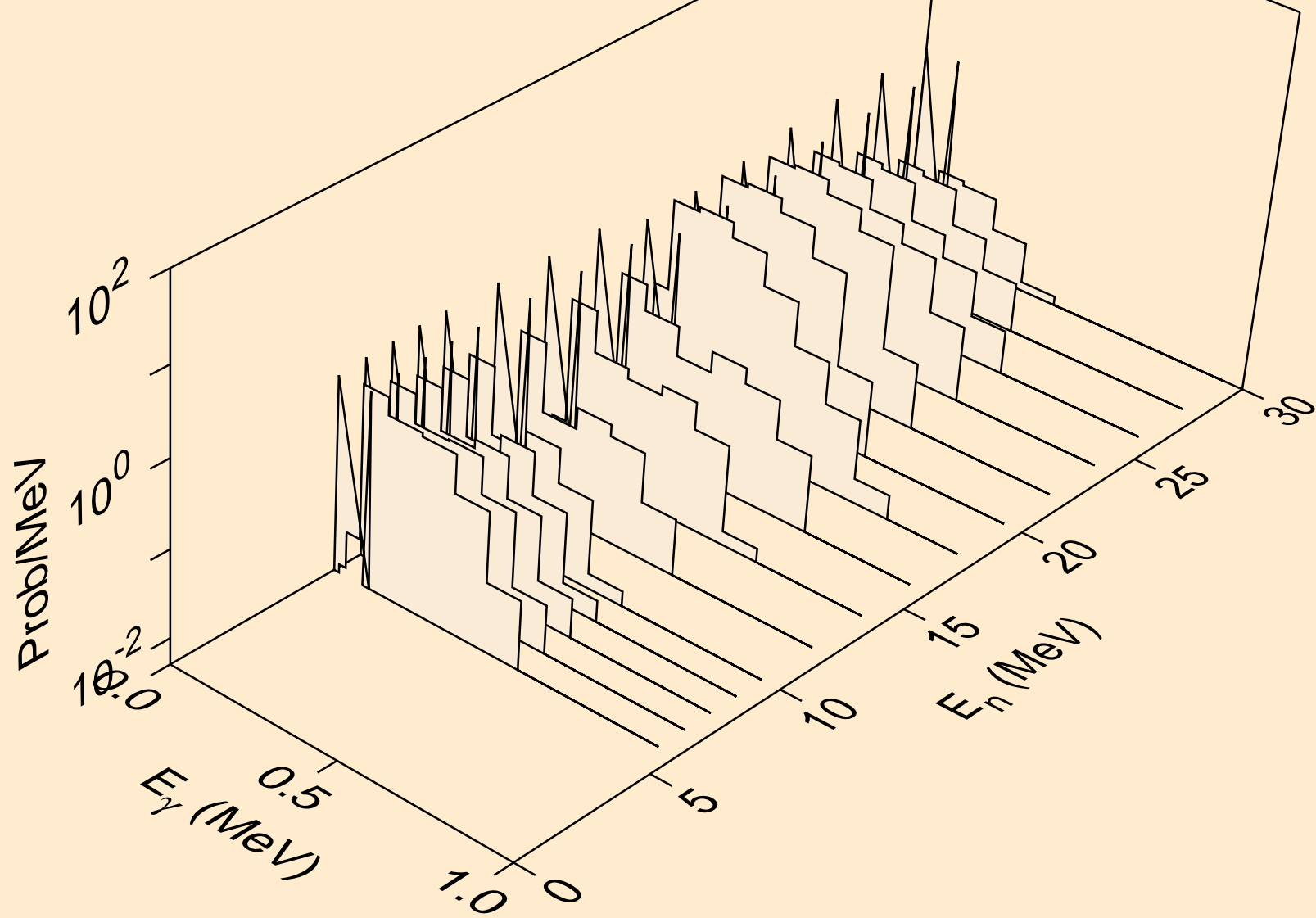

DB269 DEUTERON ACER TENDL-2021 LIBRARY; T=0.K  
Photon emission for (n,t)

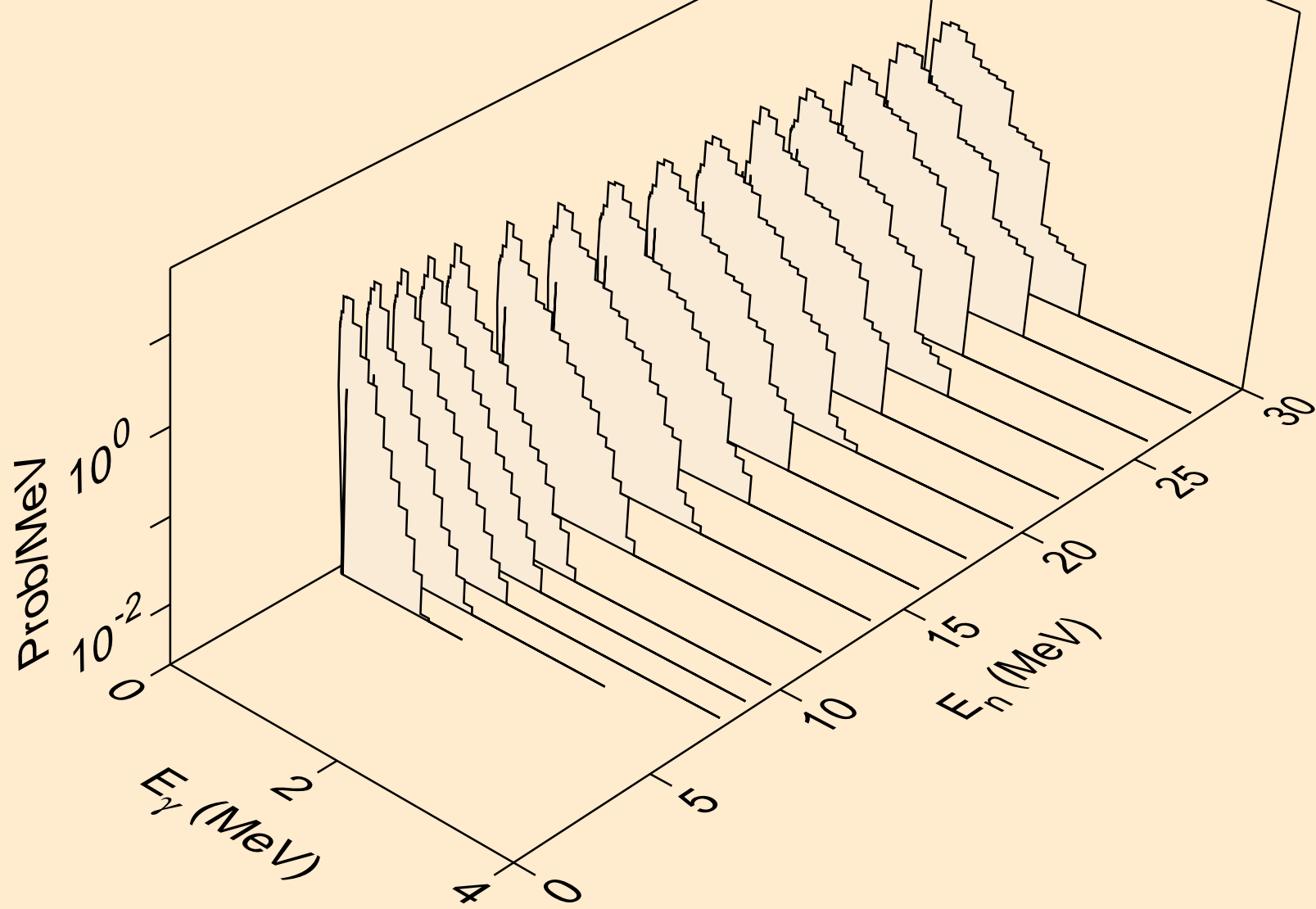

DB269 DEUTERON ACER TENDL-2021 LIBRARY; T=0.K  
Photon emission for (n,he3)

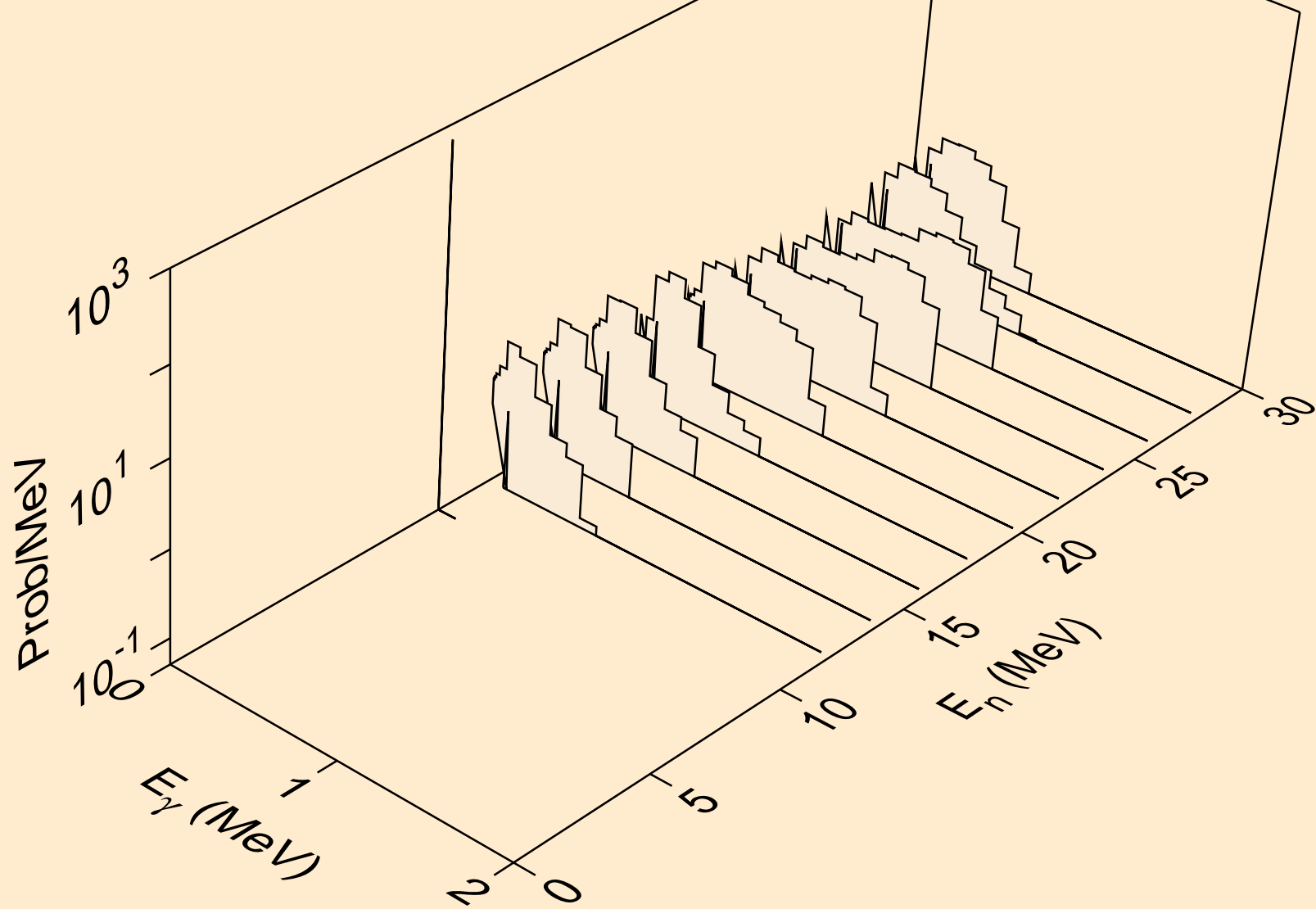



DB269 DEUTERON ACER TENDL-2021 LIBRARY; T=0.K  
Photon emission for (n,a)

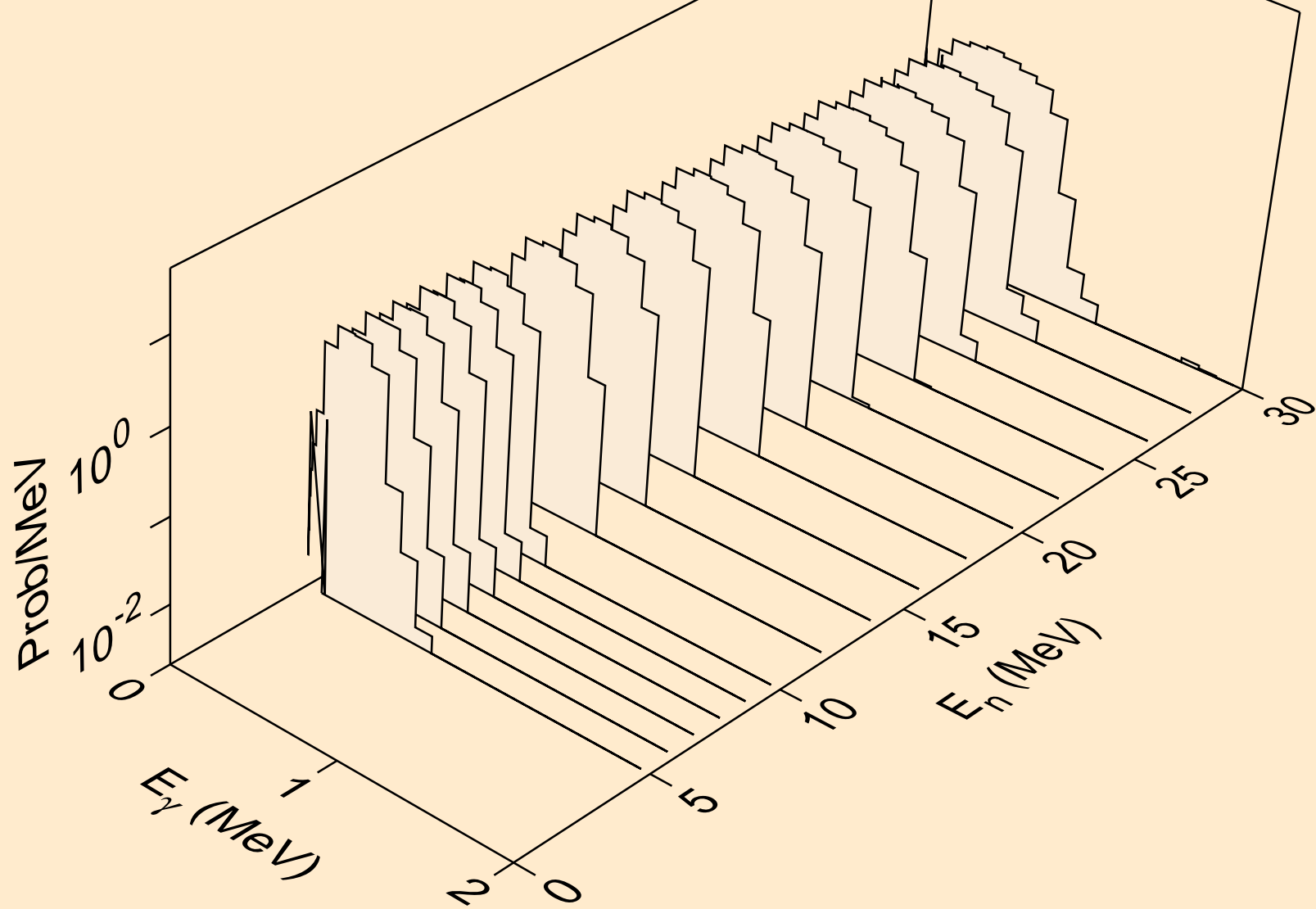

DB269 DEUTERON ACER TENDL-2021 LIBRARY; T=0.K  
Photon emission for (n,2p)

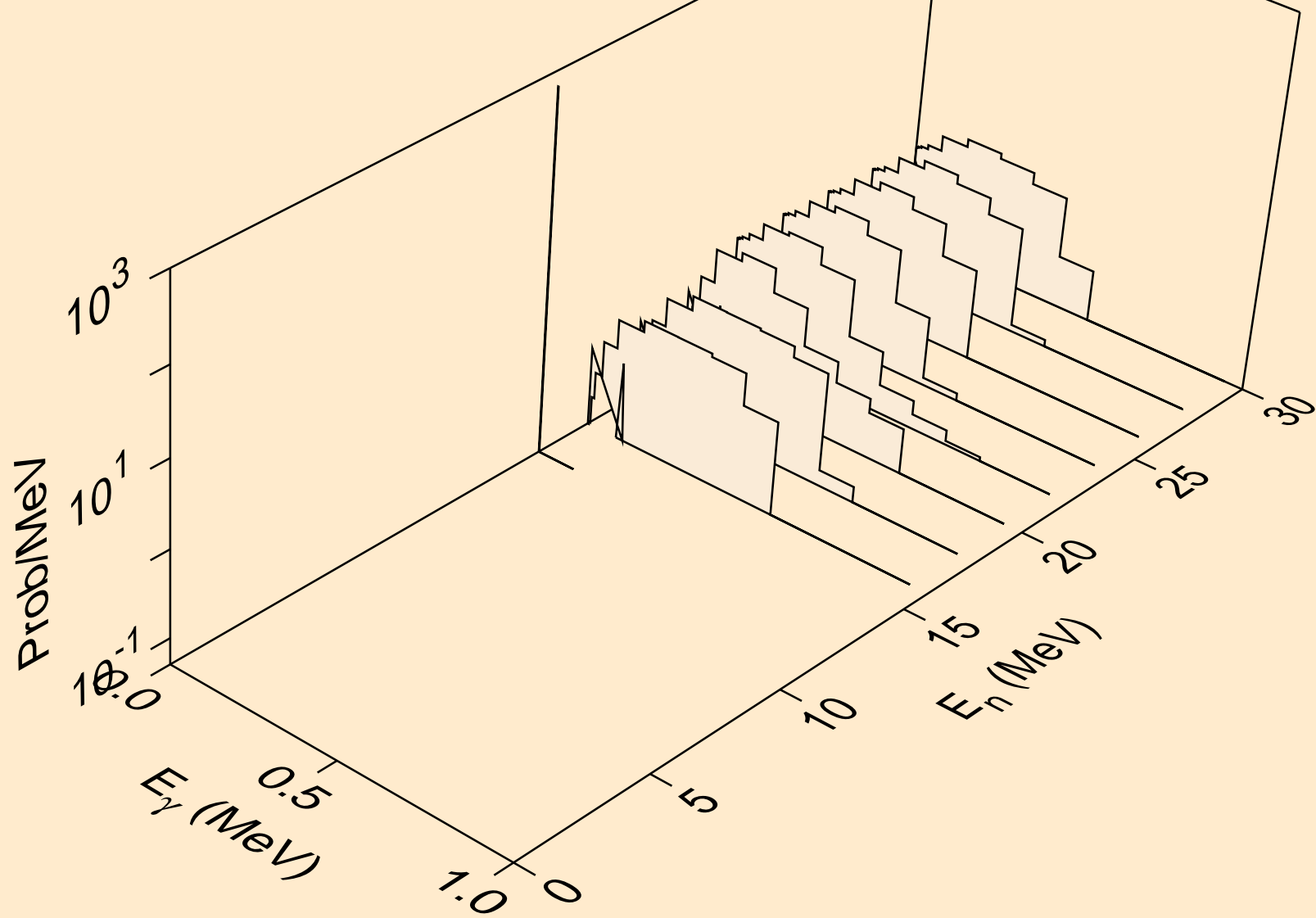

DB269 DEUTERON ACER TENDL-2021 LIBRARY; T=0.K  
Photon emission for (n,pd)

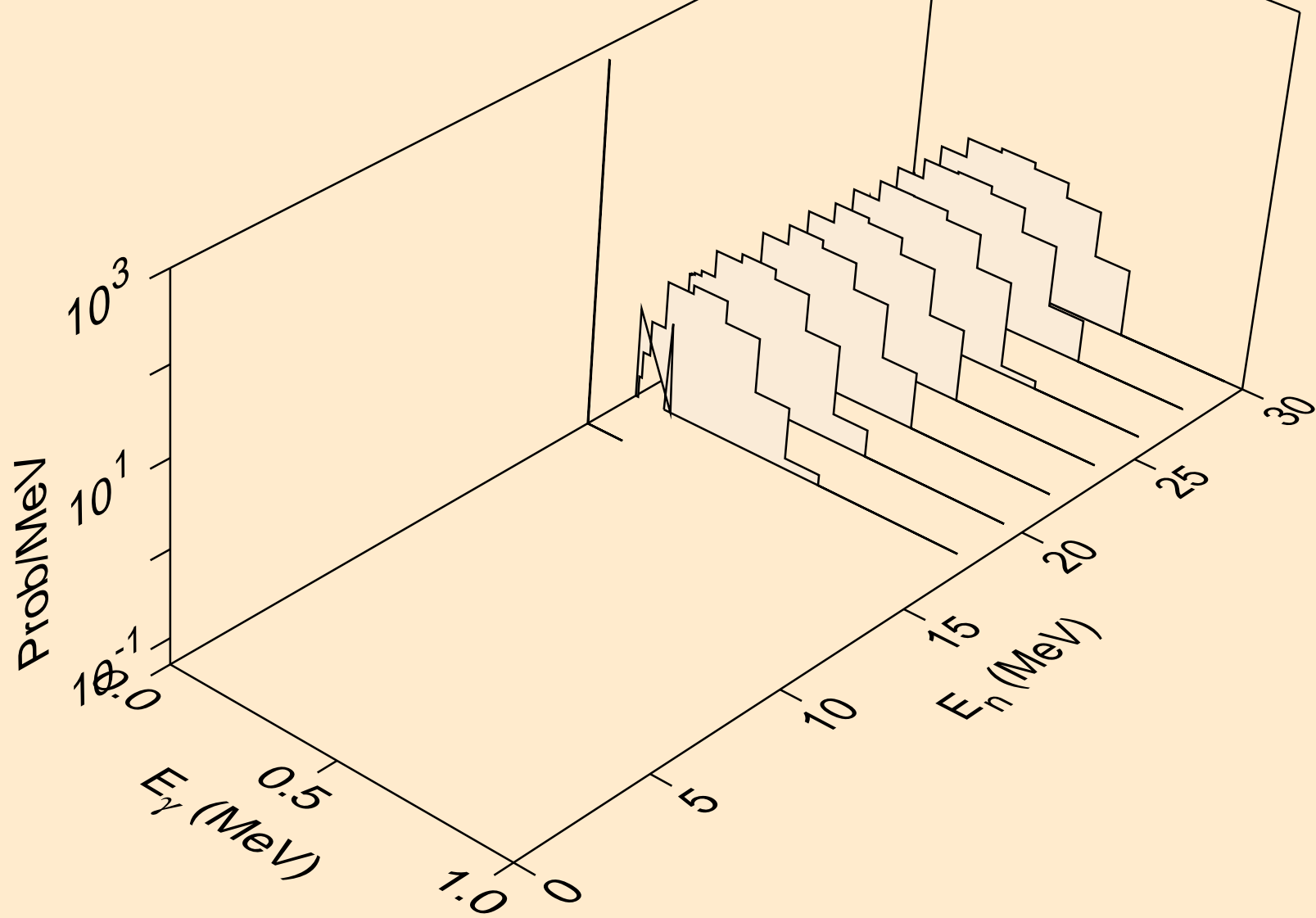

DB269 DEUTERON ACER TENDL-2021 LIBRARY; T=0.K  
Particle heating contributions

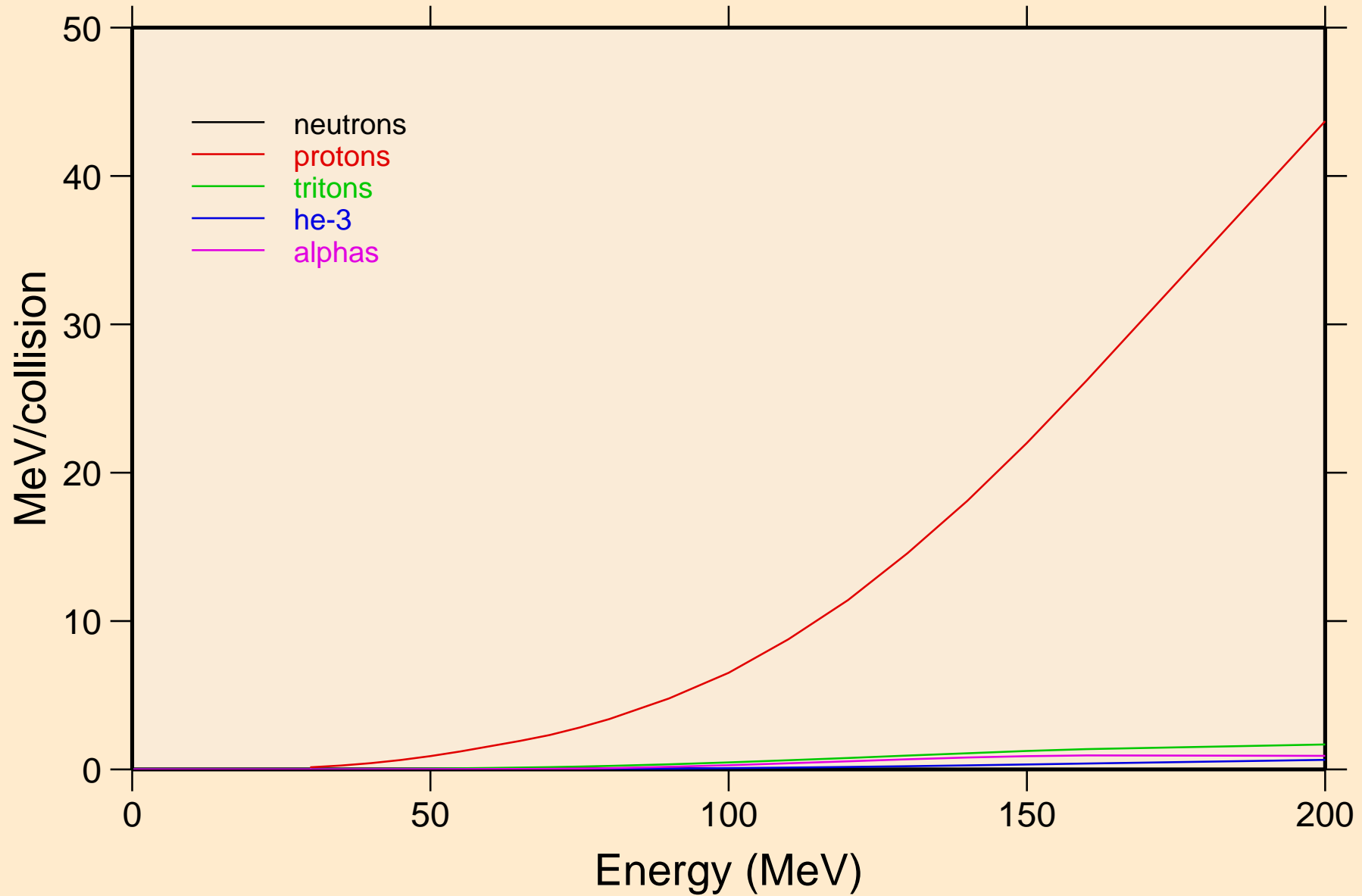

DB269 DEUTERON ACER TENDL-2021 LIBRARY; T=0.K  
Recoil Heating

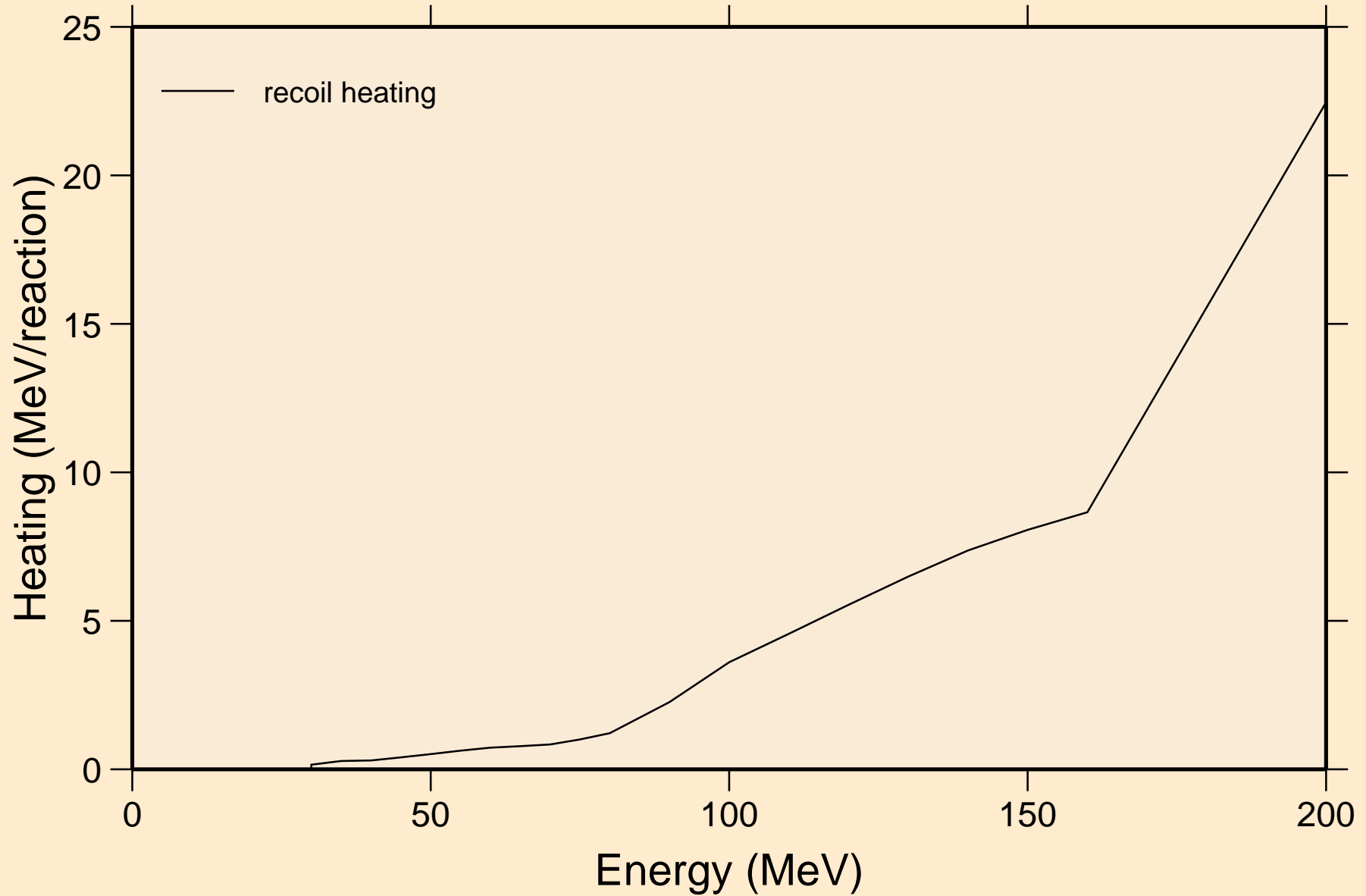

DB269 DEUTERON ACER TENDL-2021 LIBRARY; T=0.K  
Particle production cross sections

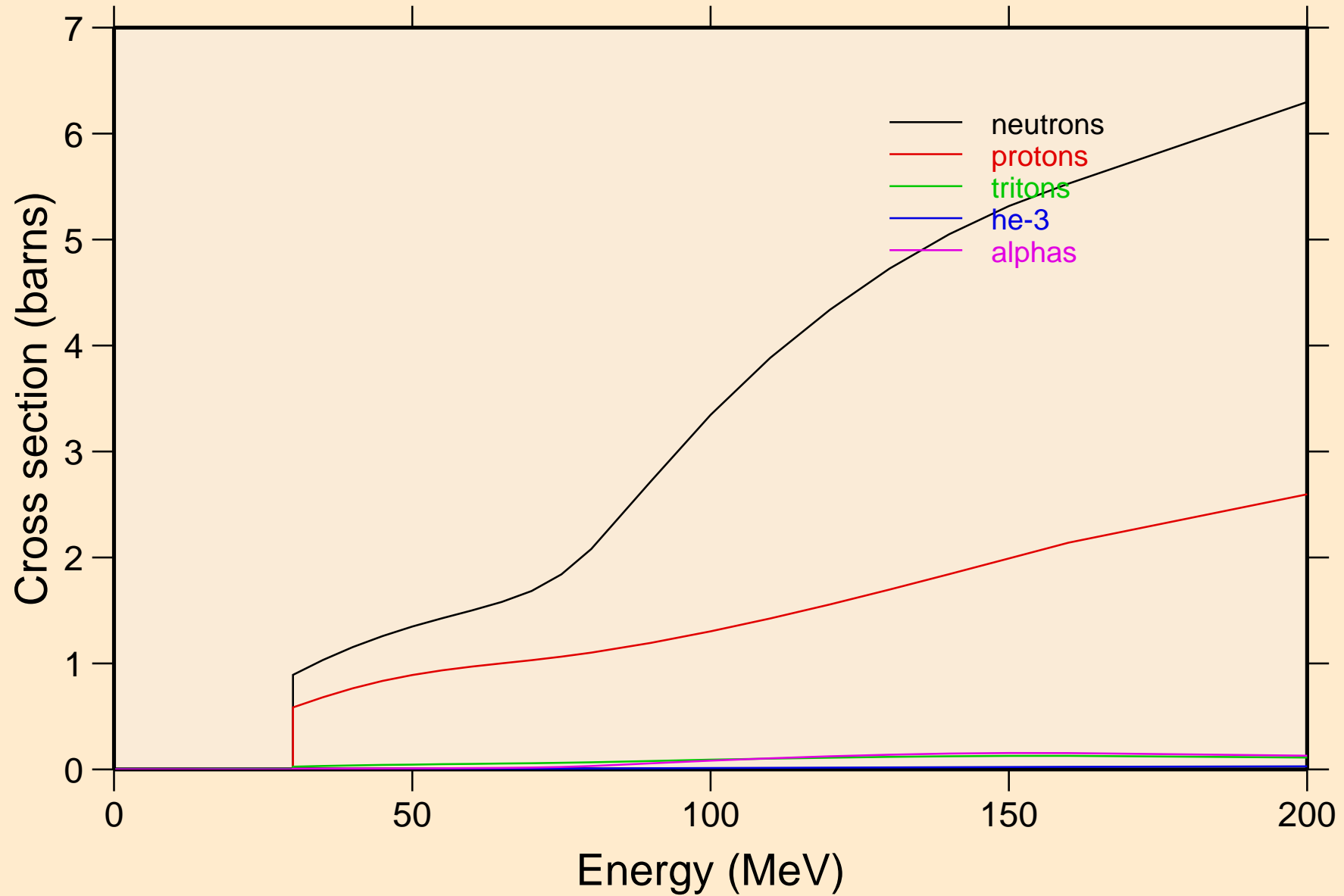

DB269 DEUTERON ACER TENDL-2021 LIBRARY; T=0.K  
neutrons from (d,n)

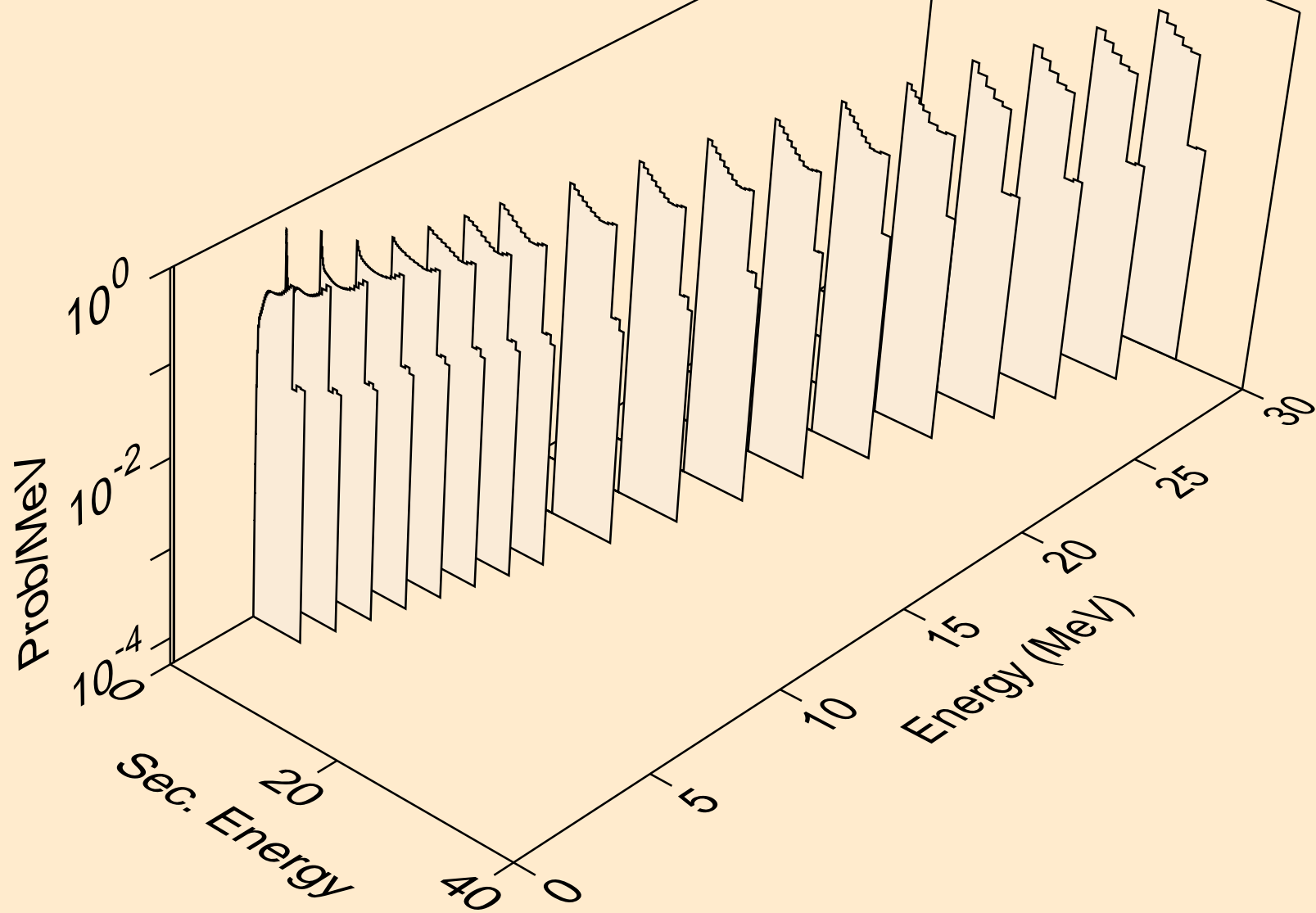

DB269 DEUTERON ACER TENDL-2021 LIBRARY; T=0.K  
neutrons from (d,x)

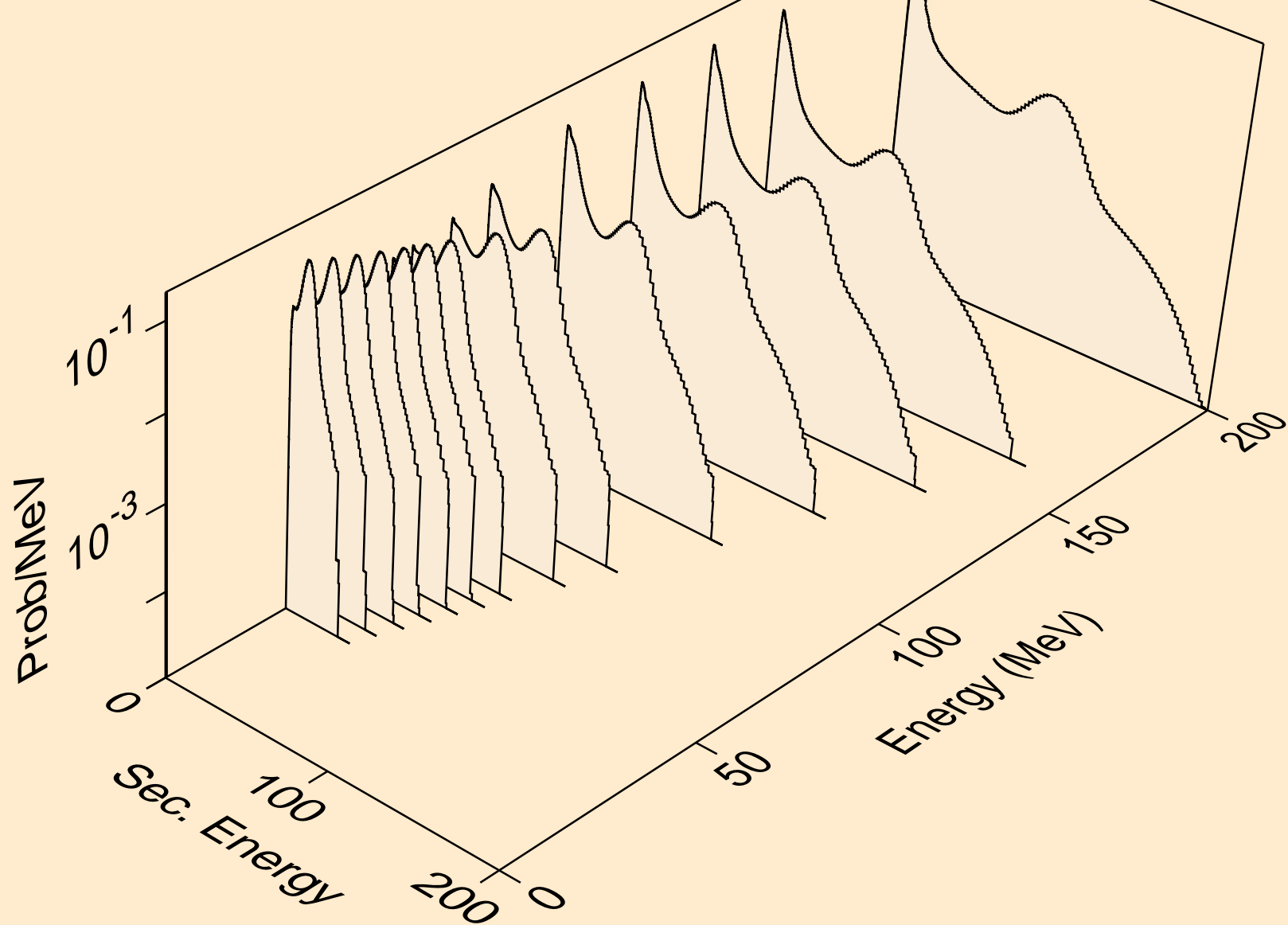



DB269 DEUTERON ACER TENDL-2021 LIBRARY; T=0.K  
neutrons from (d,2n)

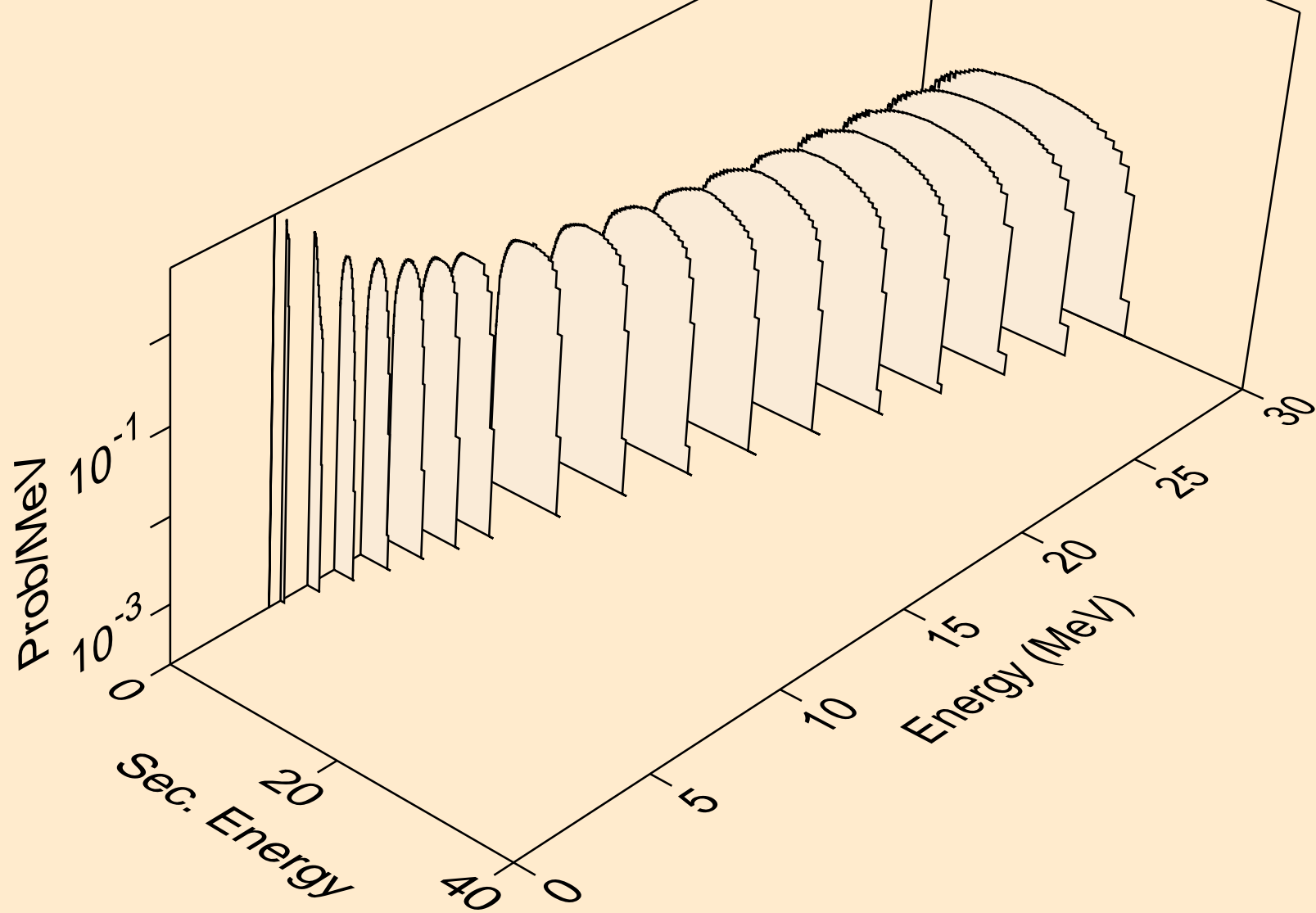

DB269 DEUTERON ACER TENDL-2021 LIBRARY; T=0.K  
neutrons from (d,3n)

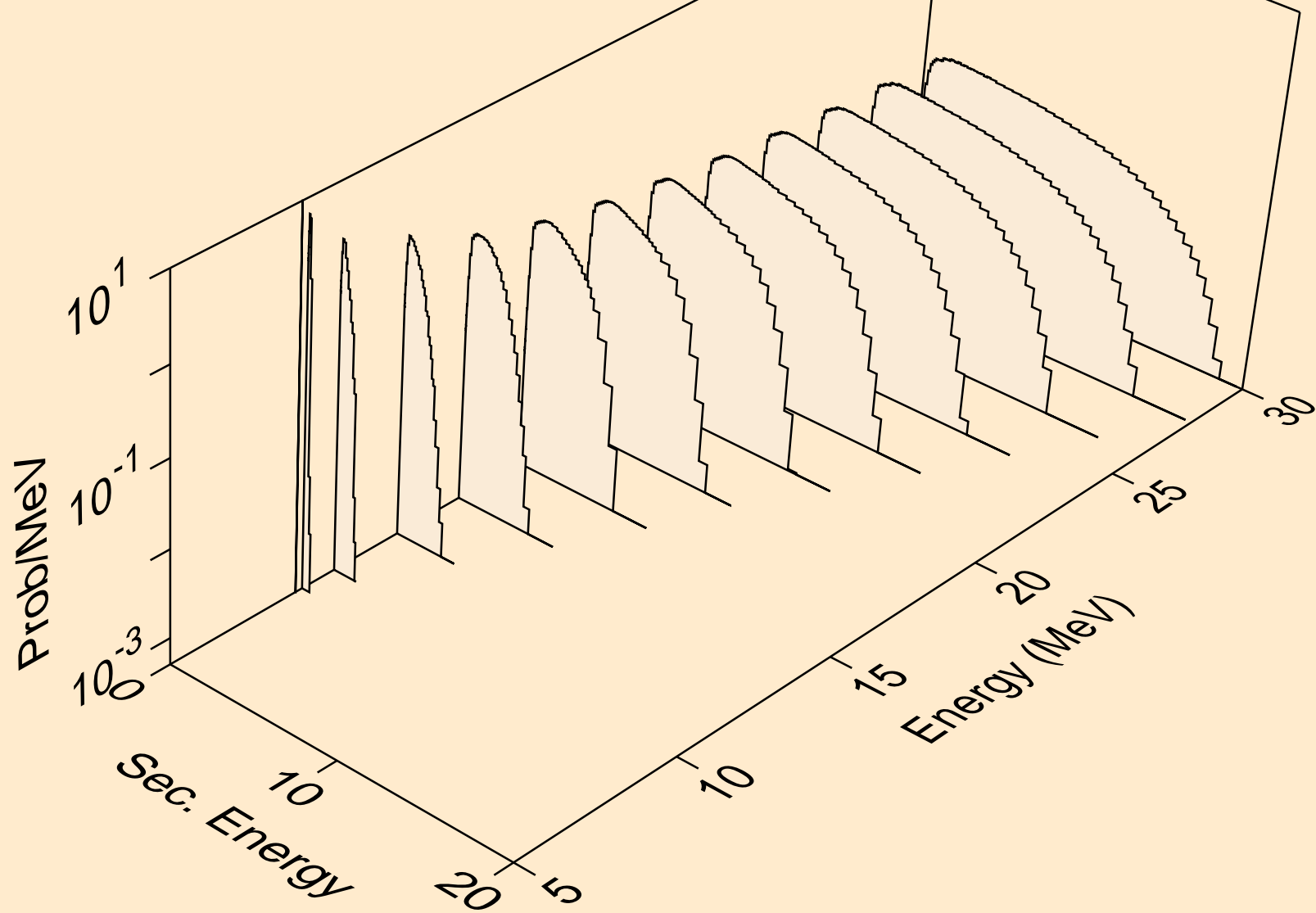

DB269 DEUTERON ACER TENDL-2021 LIBRARY; T=0.K  
neutrons from (d,n\*)p

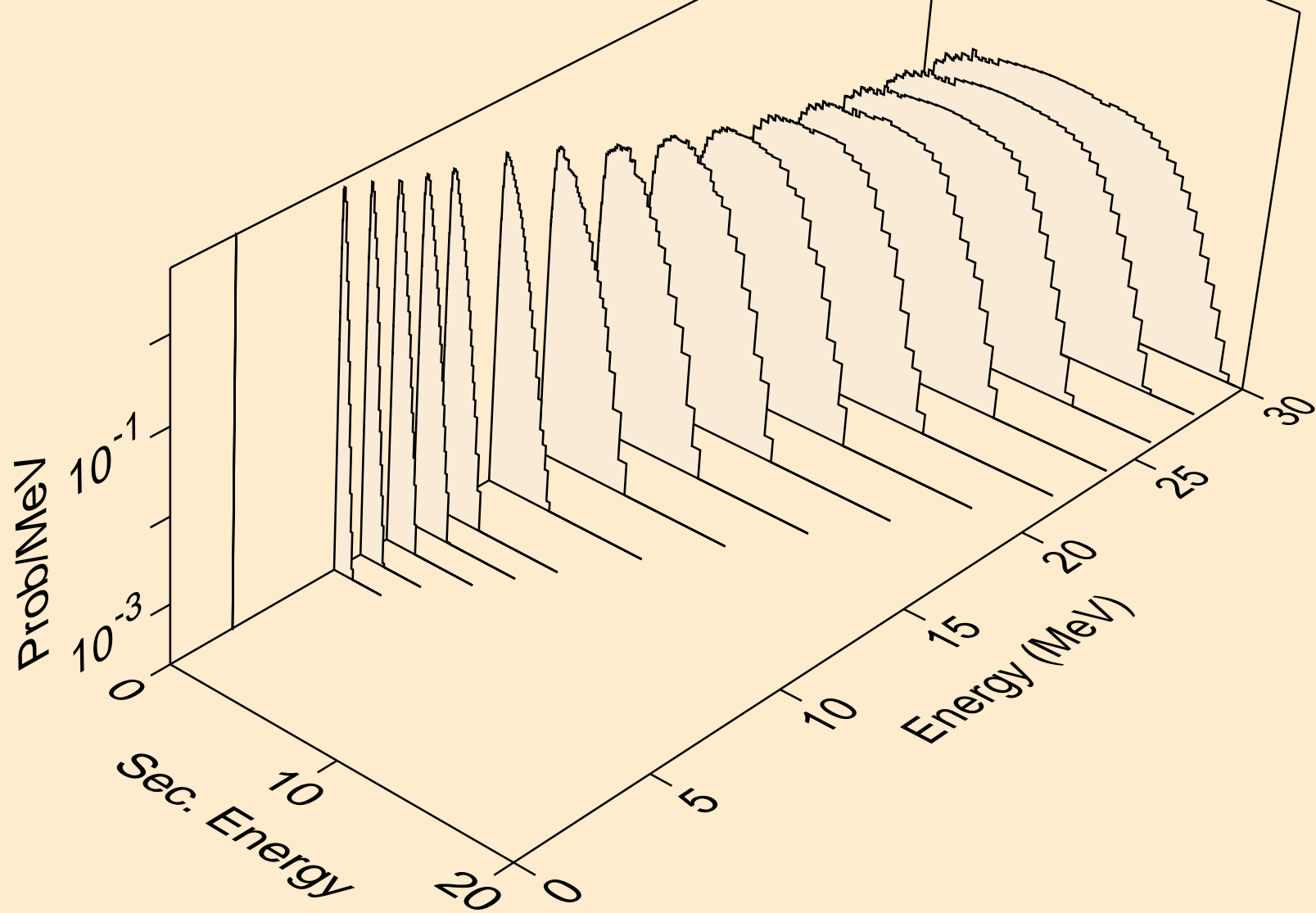

DB269 DEUTERON ACER TENDL-2021 LIBRARY; T=0.K  
neutrons from (d,n\*)d

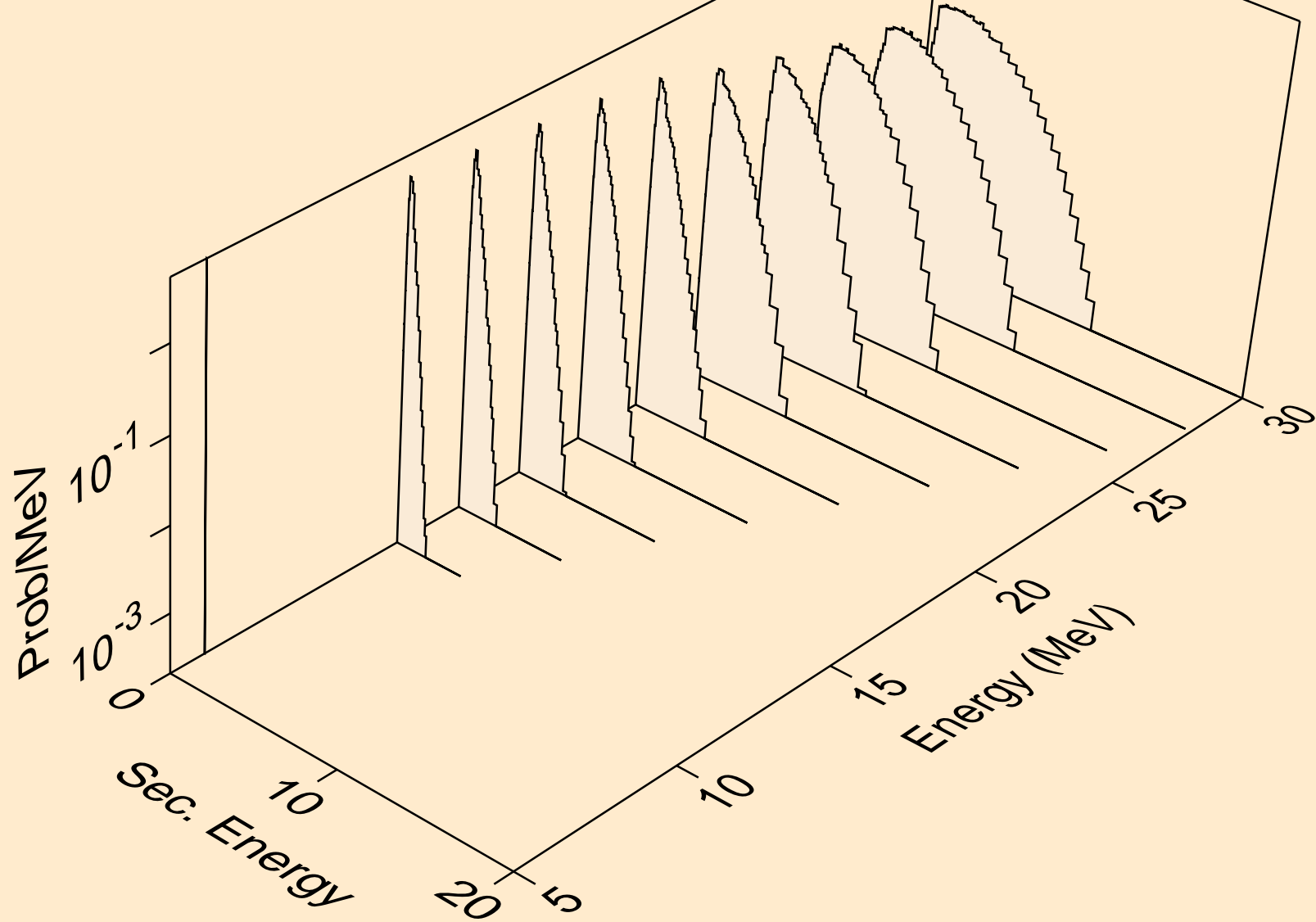

DB269 DEUTERON ACER TENDL-2021 LIBRARY; T=0.K  
neutrons from (d,n\*)t

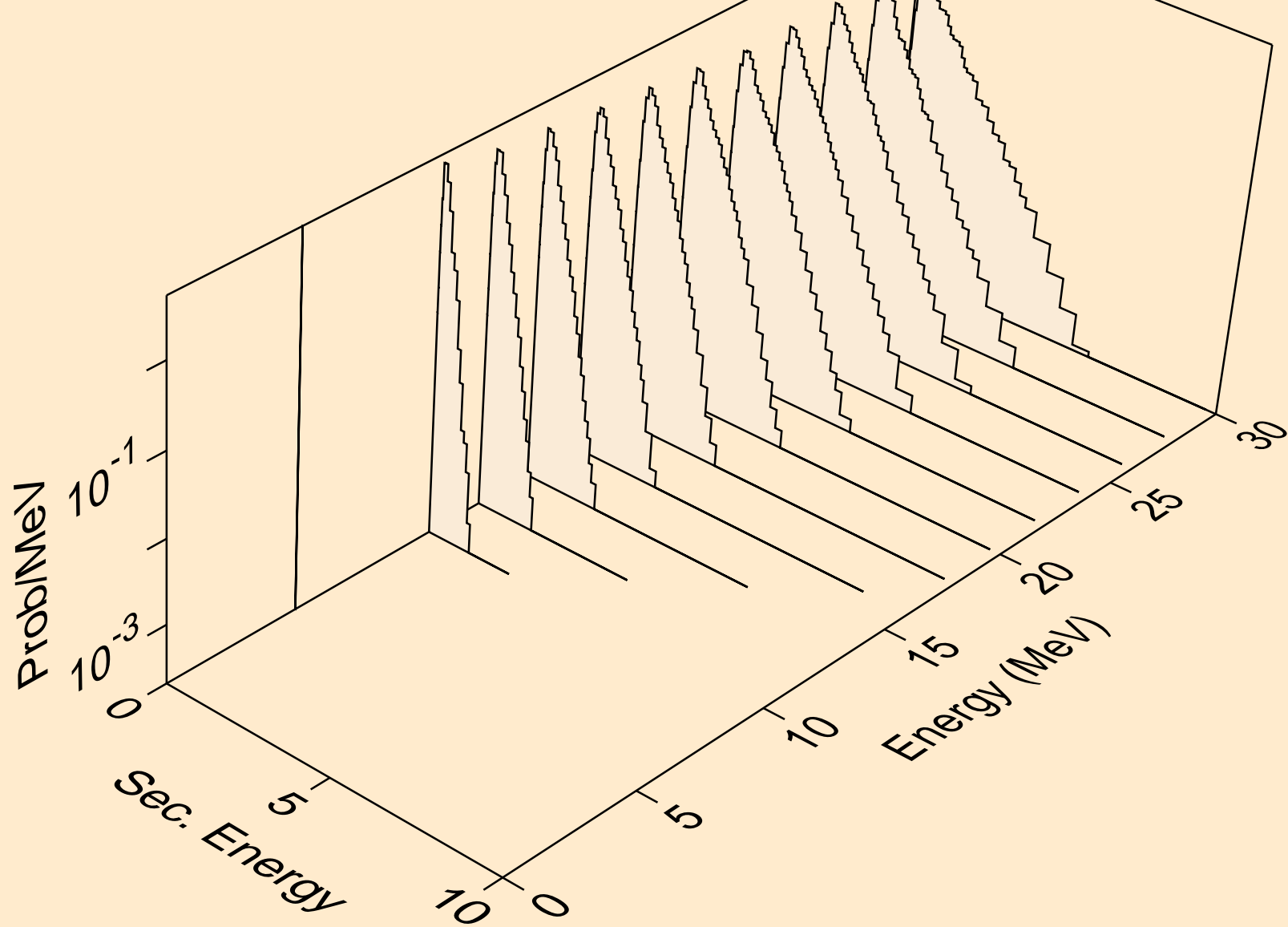

DB269 DEUTERON ACER TENDL-2021 LIBRARY; T=0.K  
neutrons from (d,4n)

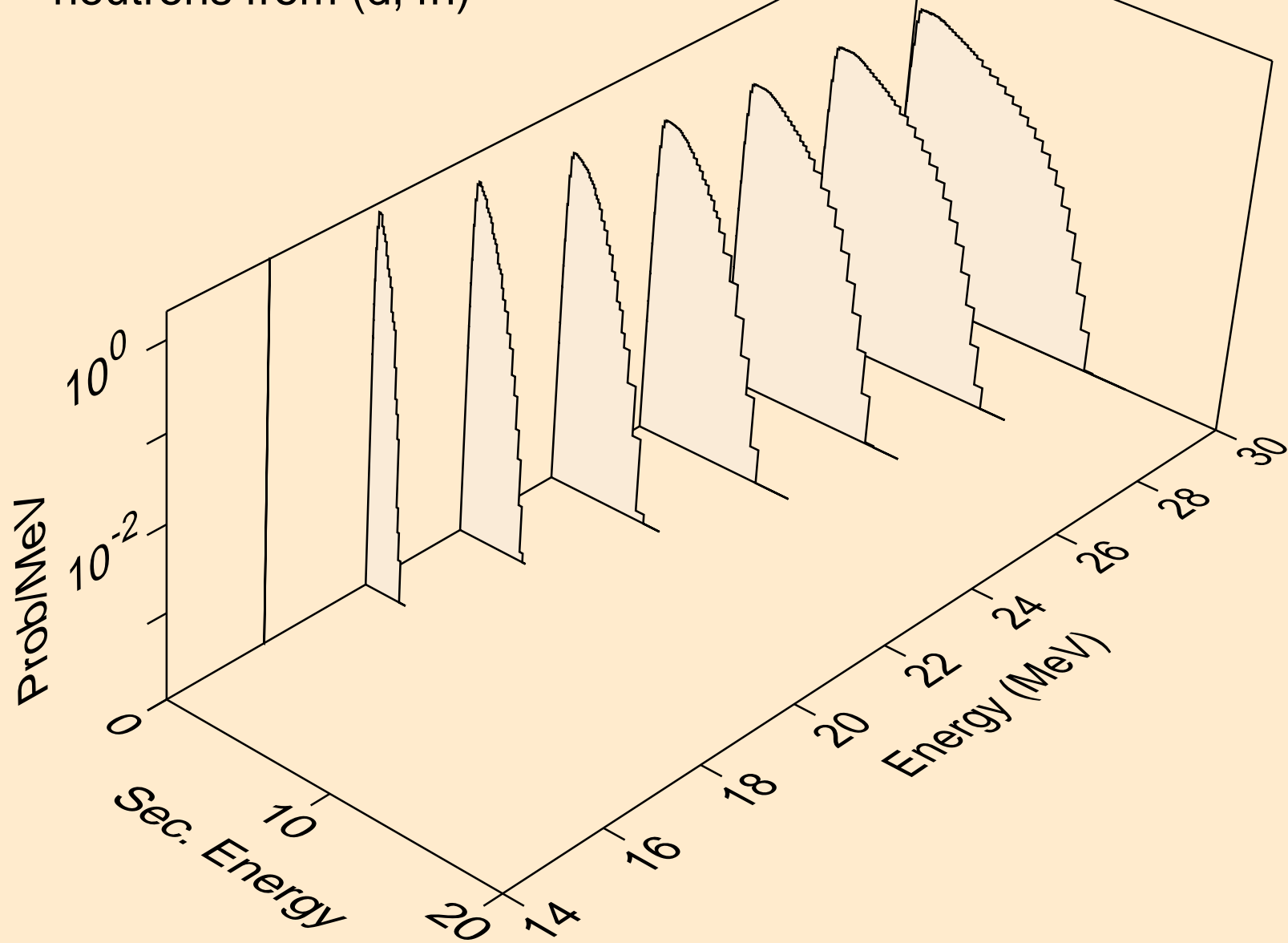

DB269 DEUTERON ACER TENDL-2021 LIBRARY; T=0.K  
neutrons from (d,2np)

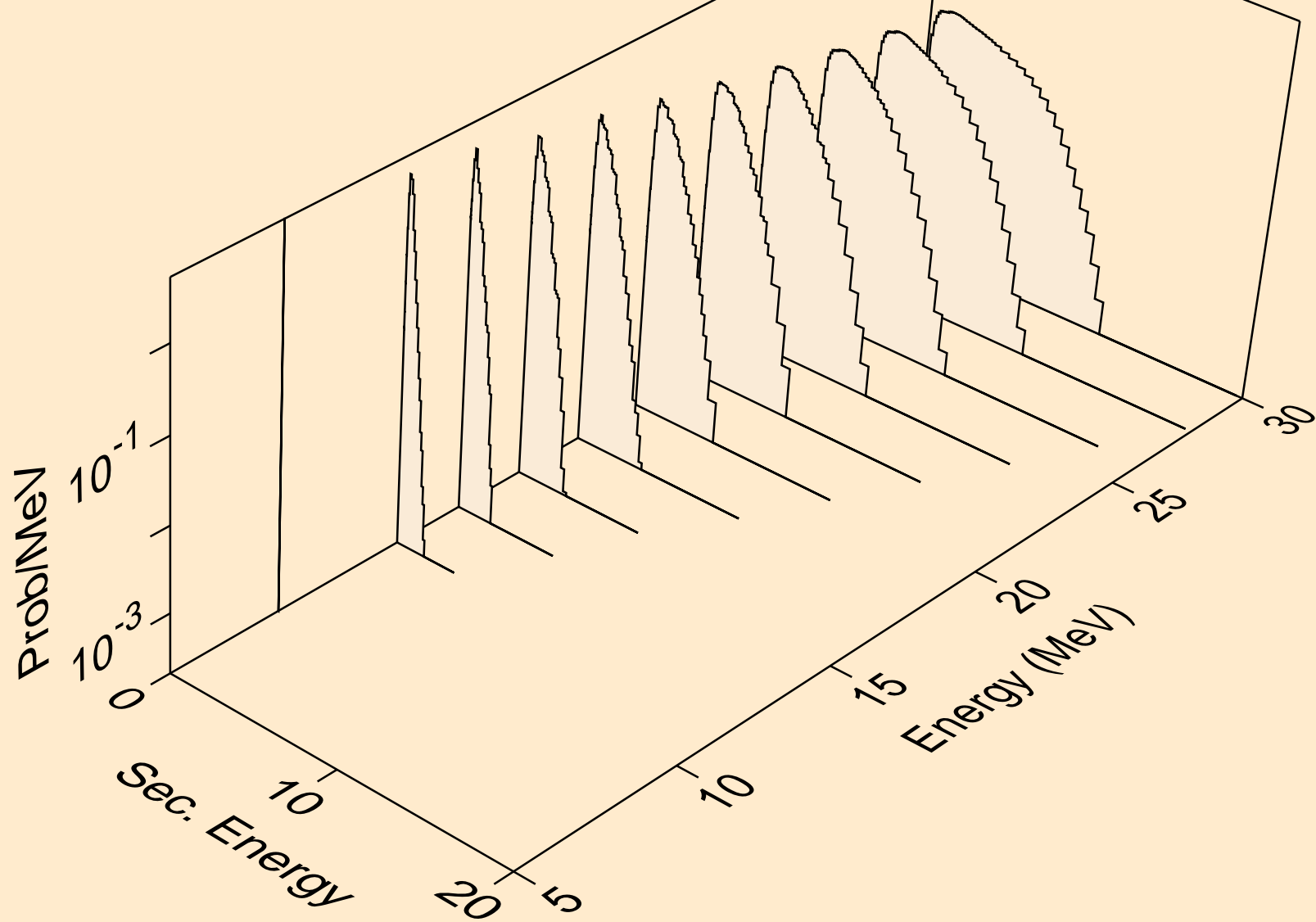

DB269 DEUTERON ACER TENDL-2021 LIBRARY; T=0.K  
neutrons from (d,3np)

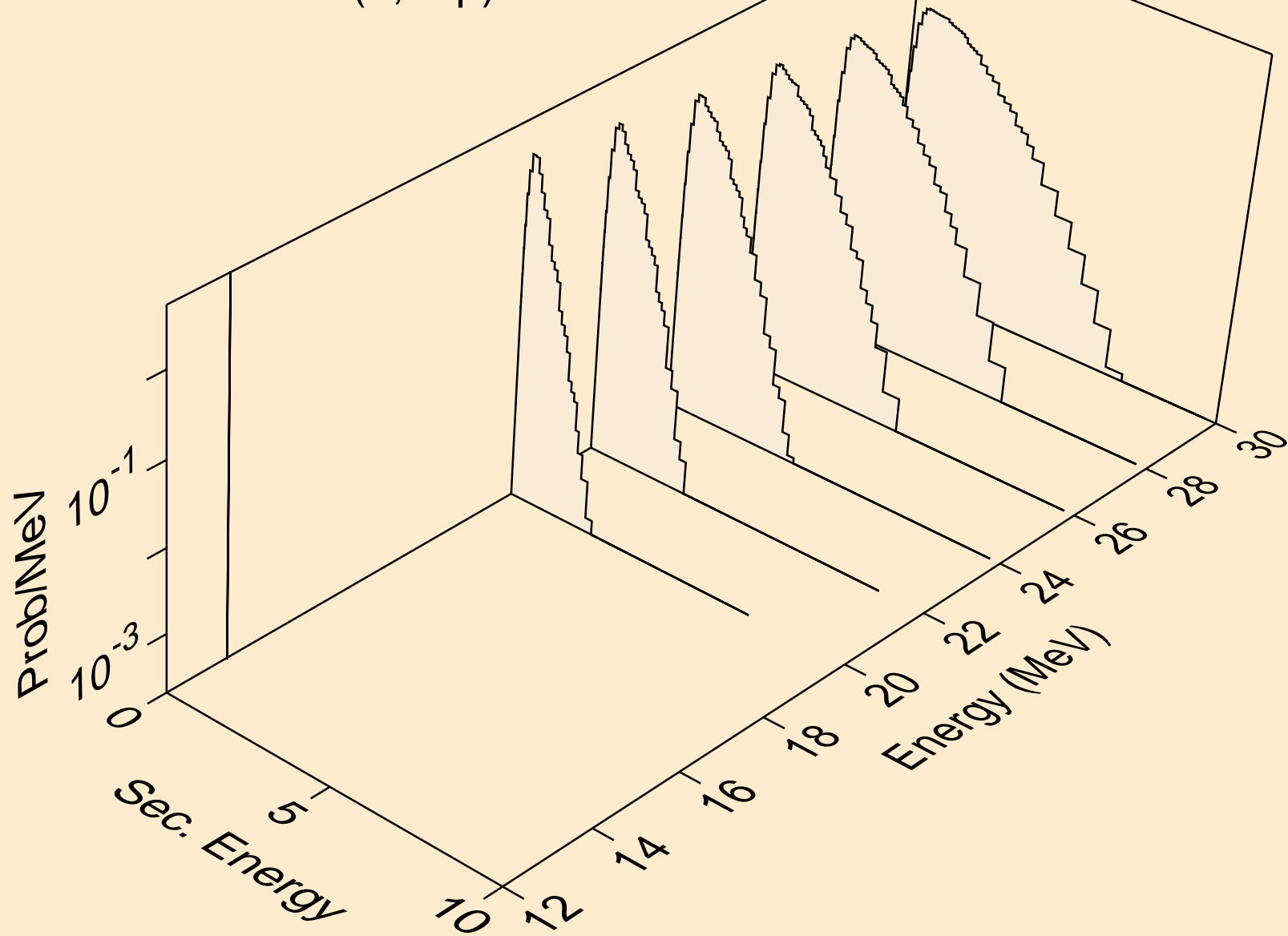



DB269 DEUTERON ACER TENDL-2021 LIBRARY; T=0.K  
neutrons from (d,2np)

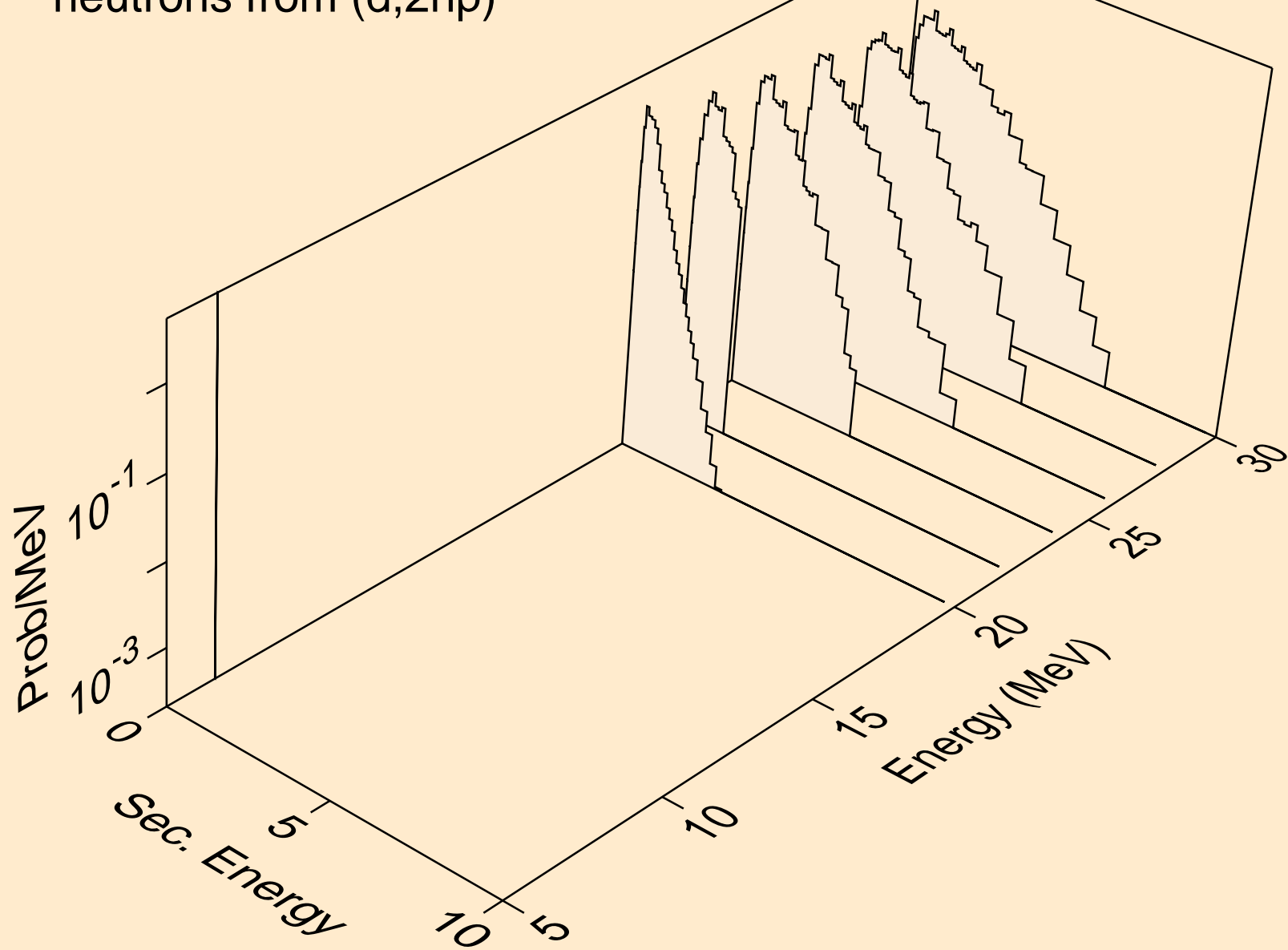

DB269 DEUTERON ACER TENDL-2021 LIBRARY; T=0.K  
protons from (d,x)

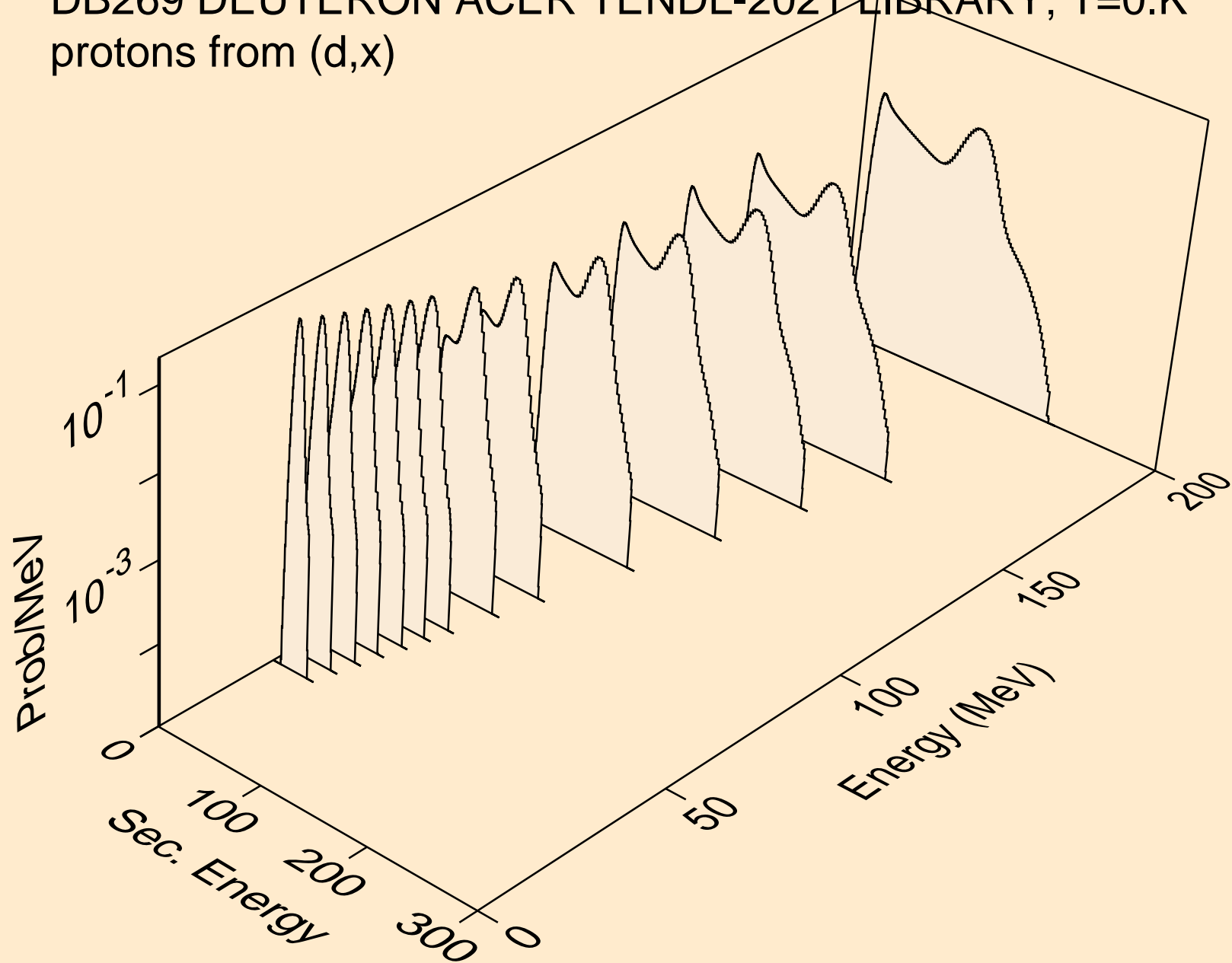

DB269 DEUTERON ACER TENDL-2021 LIBRARY; T=0.K  
protons from (d,n\*)p

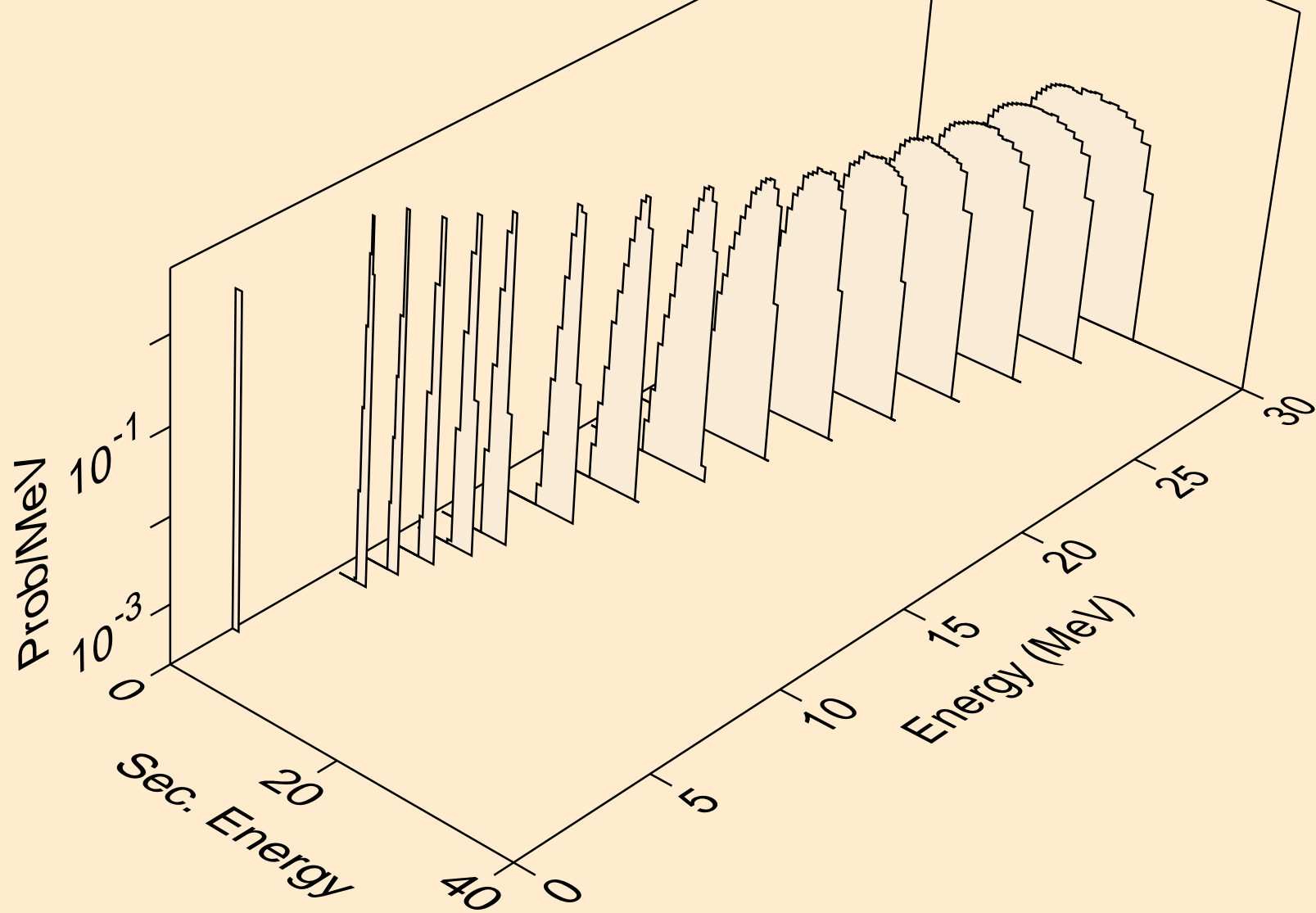

DB269 DEUTERON ACER TENDL-2021 LIBRARY; T=0.K  
protons from (d,2np)

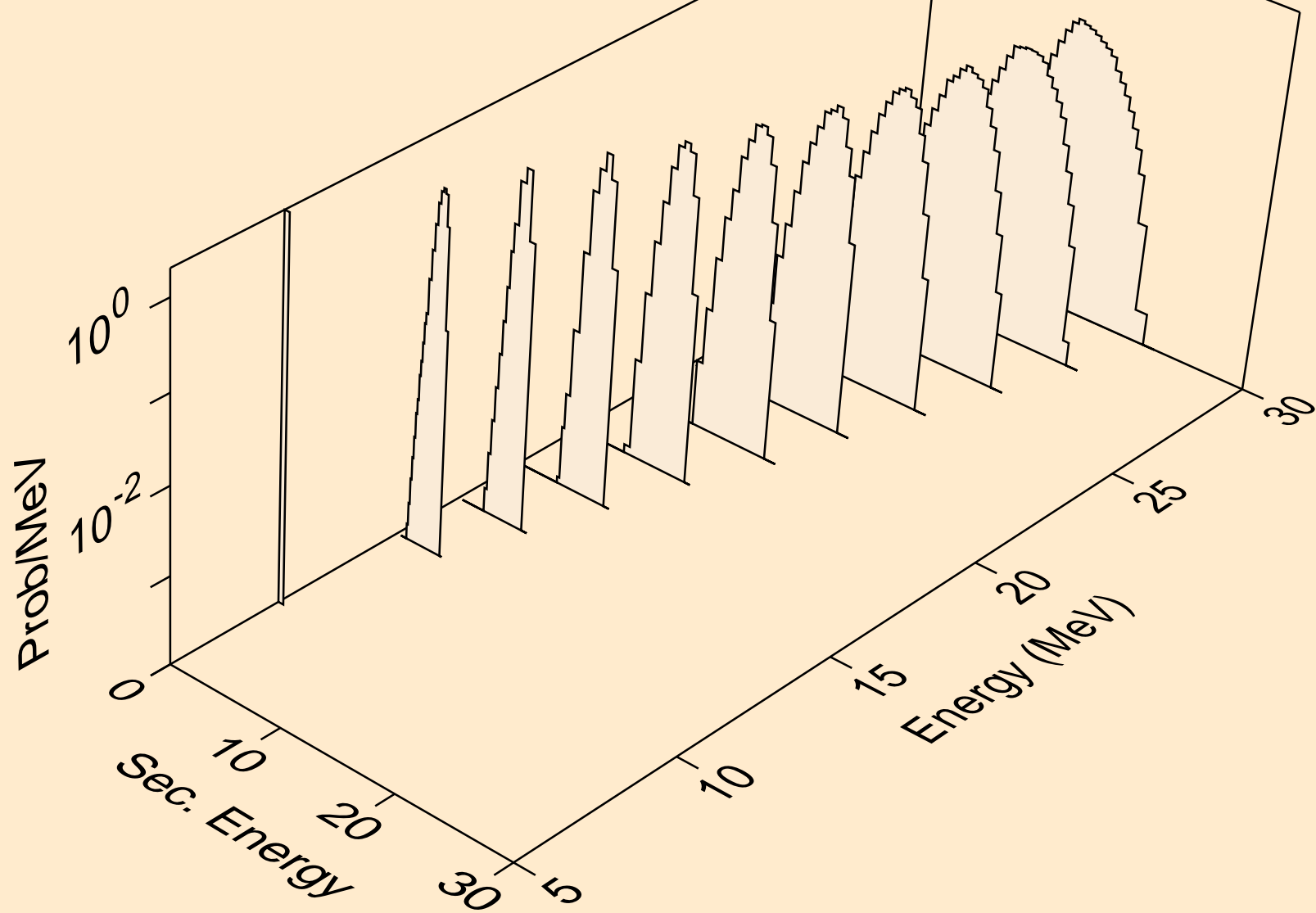

DB269 DEUTERON ACER TENDL-2021 LIBRARY; T=0.K  
protons from (d,3np)

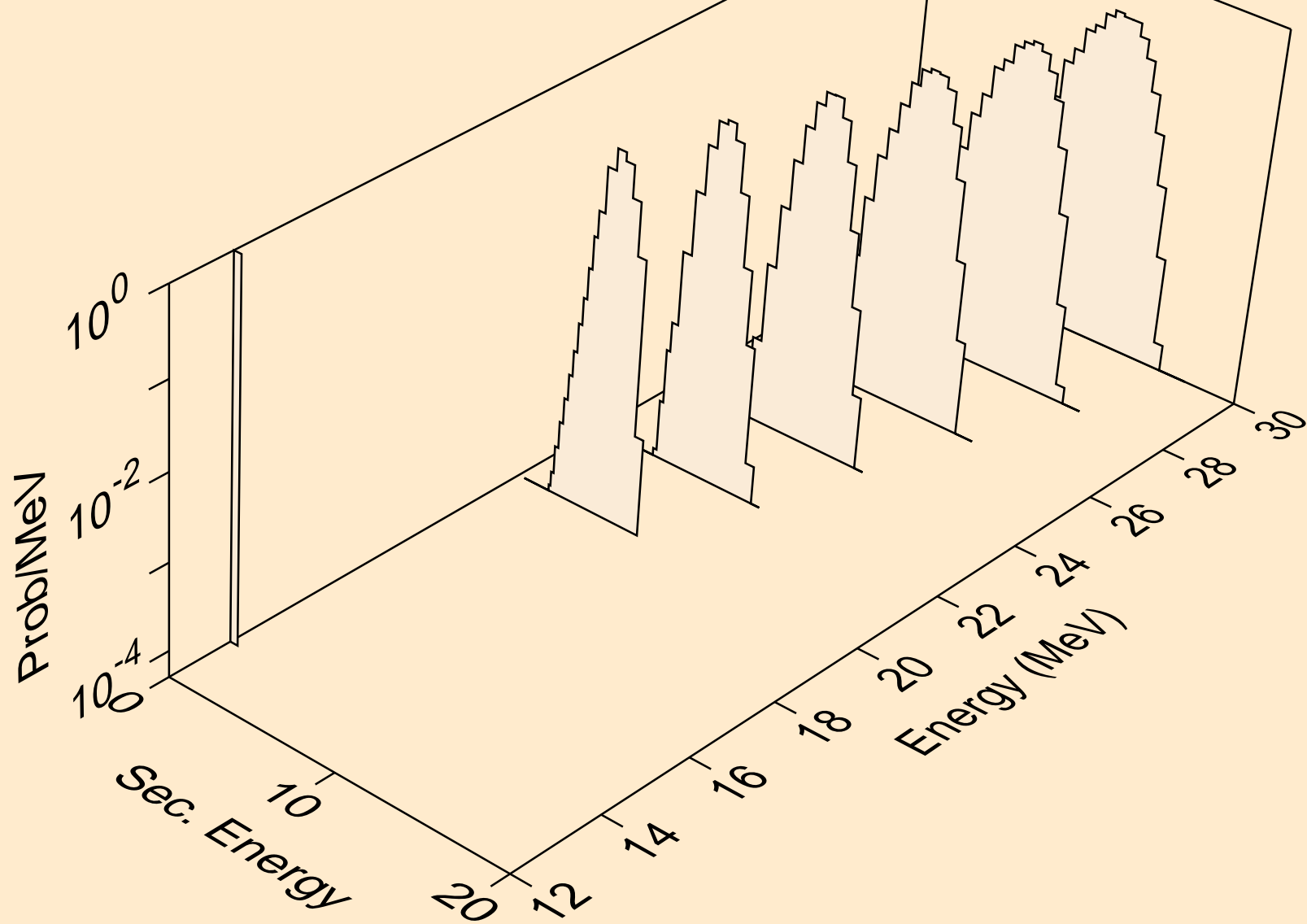

DB269 DEUTERON ACER TENDL-2021 LIBRARY; T=0.K  
protons from (d,2np)

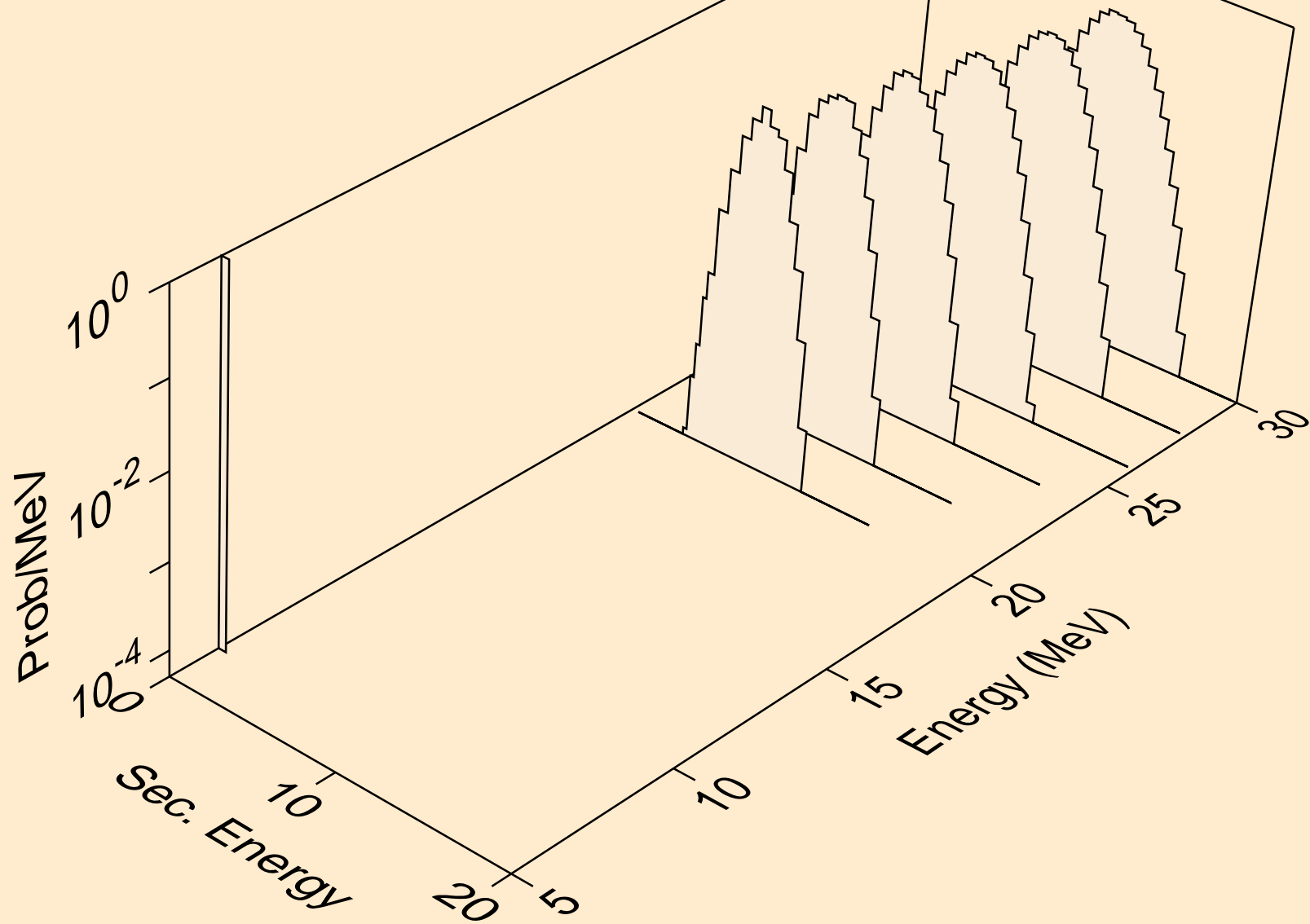

DB269 DEUTERON ACER TENDL-2021 LIBRARY; T=0.K  
protons from (d,p)

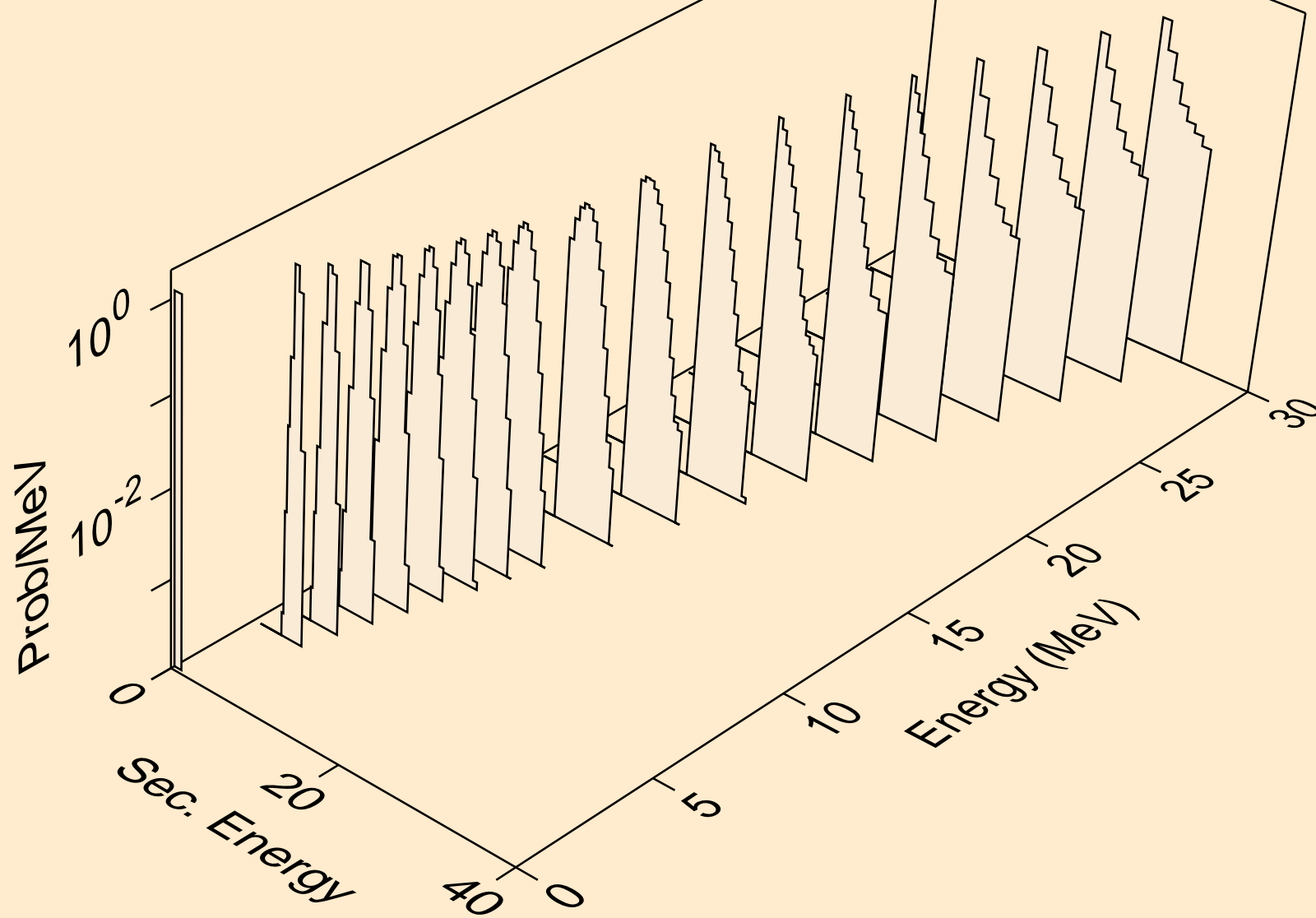

DB269 DEUTERON ACER TENDL-2021 LIBRARY; T=0.K  
protons from (d,2p)

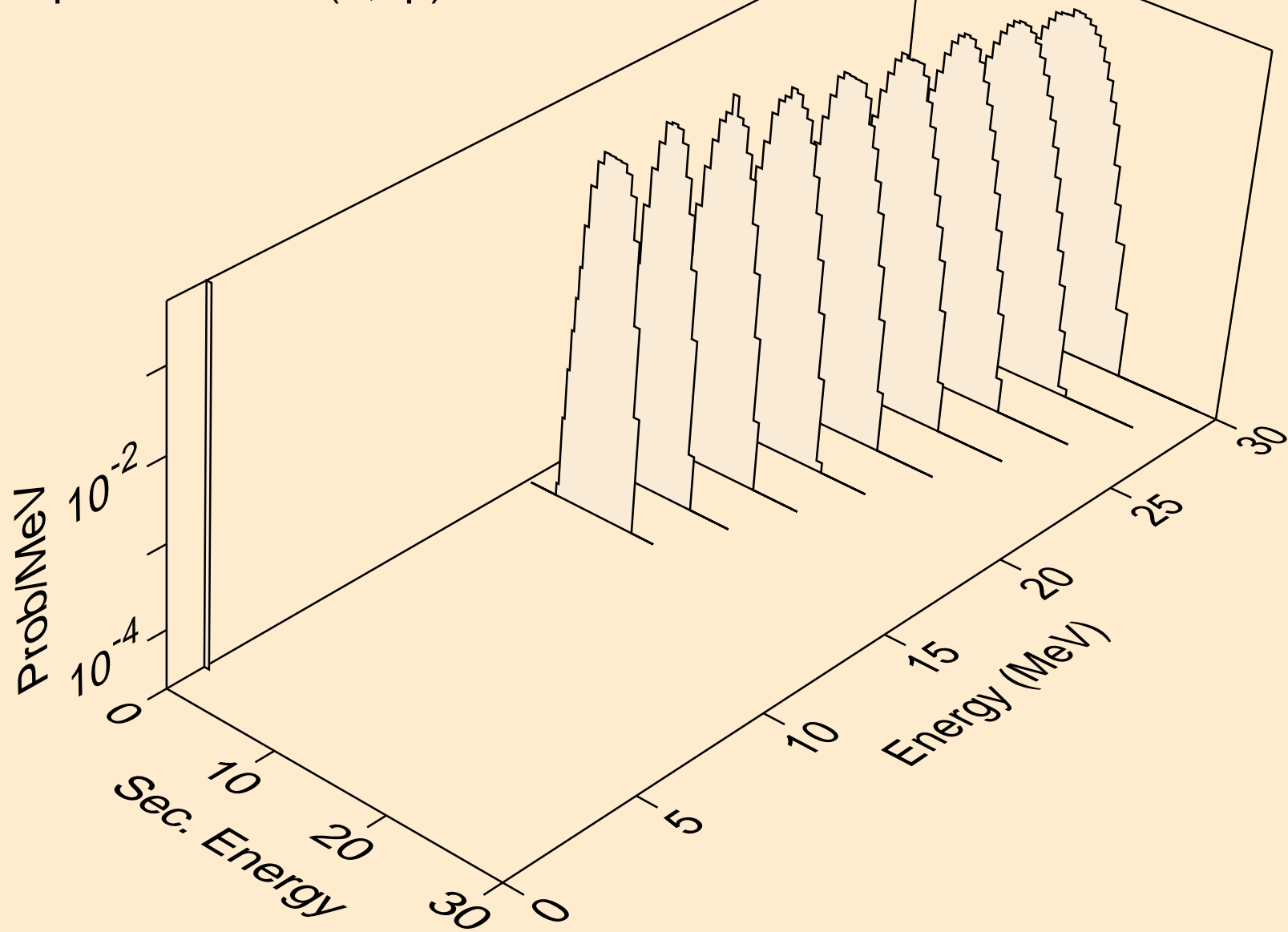



DB269 DEUTERON ACER TENDL-2021 LIBRARY; T=0.K  
protons from (d,pd)

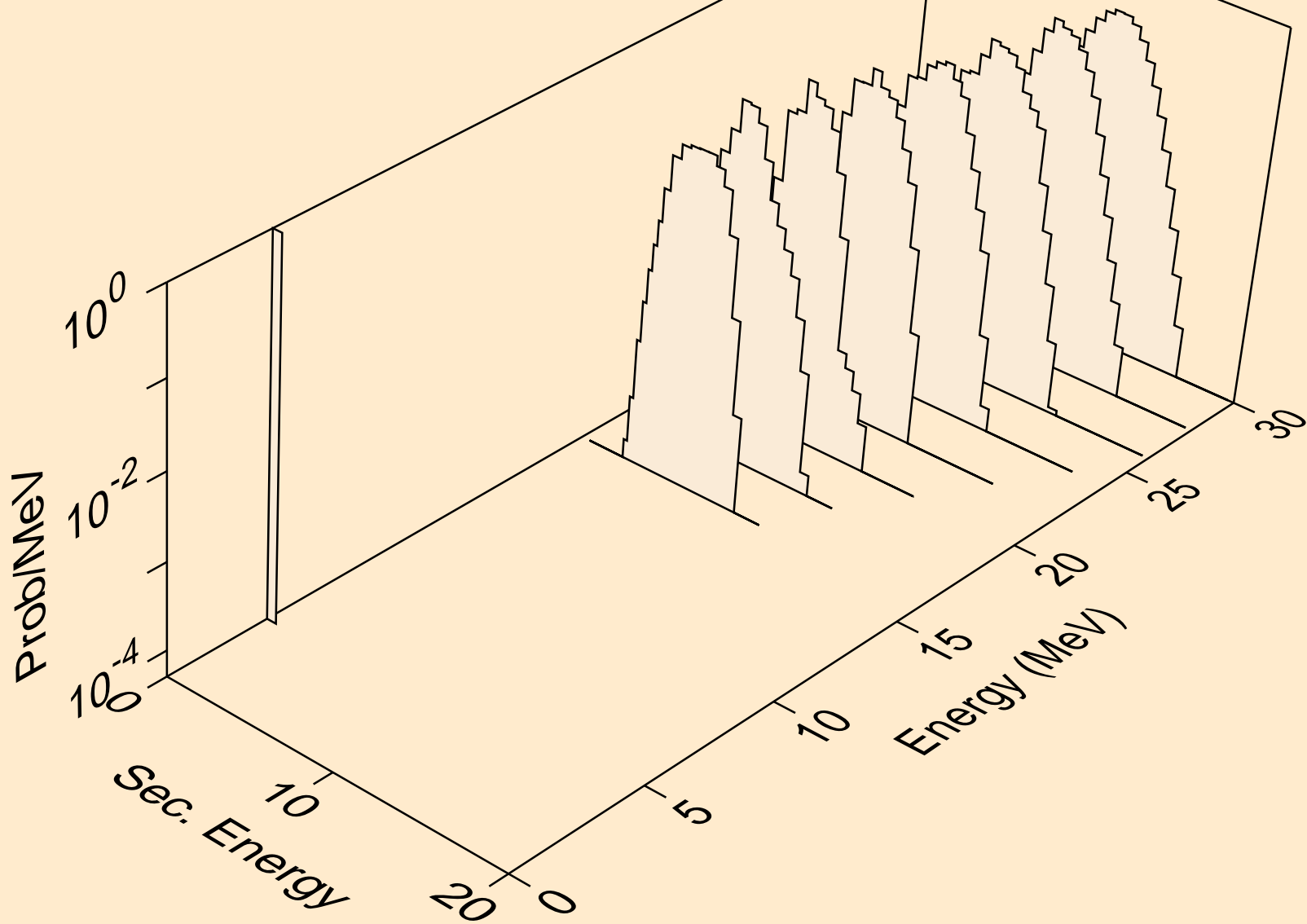

DB269 DEUTERON ACER TENDL-2021 LIBRARY; T=0.K  
tritons from (d,x)

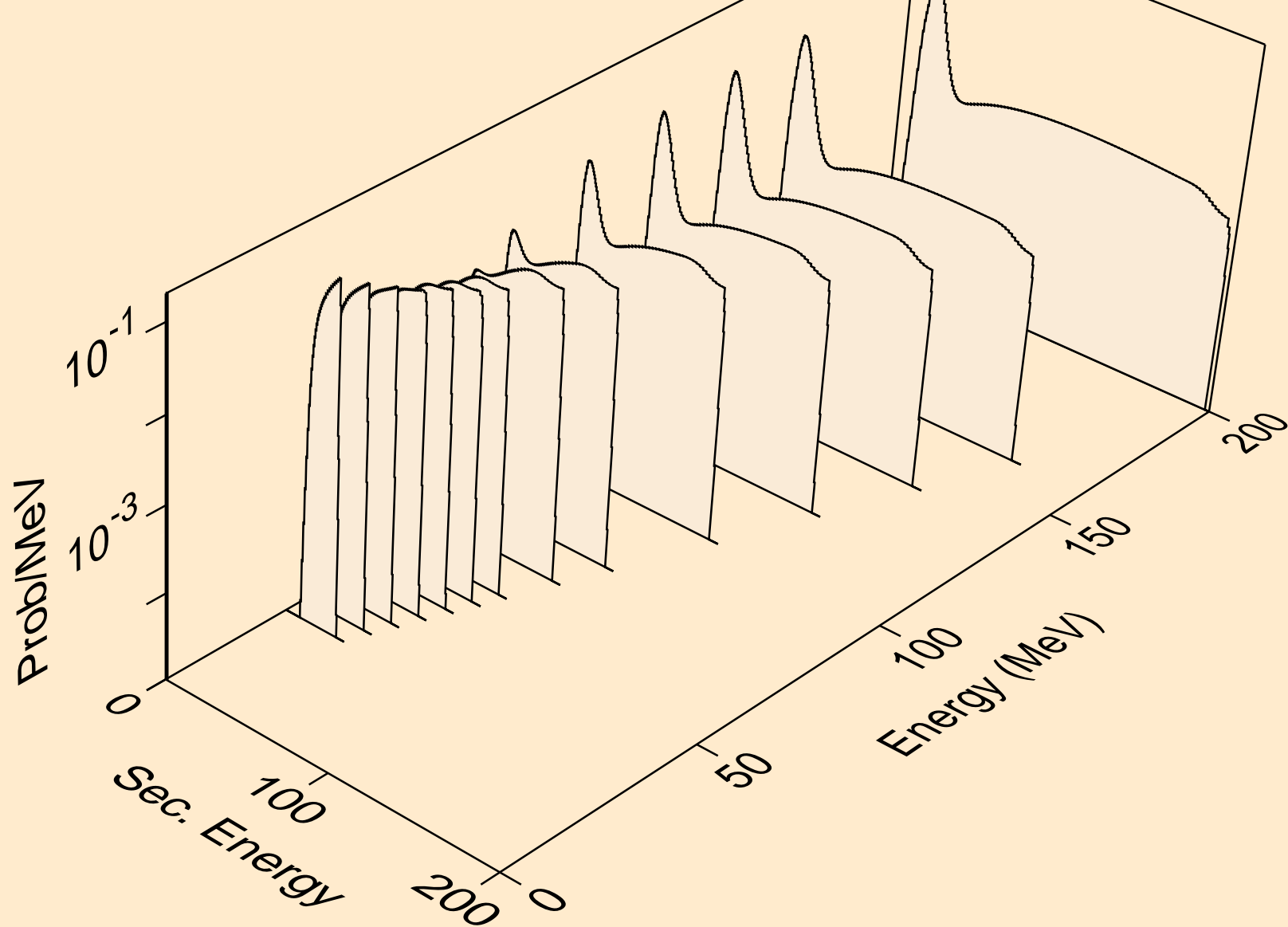

DB269 DEUTERON ACER TENDL-2021 LIBRARY; T=0.K  
tritons from (d,n\*)t

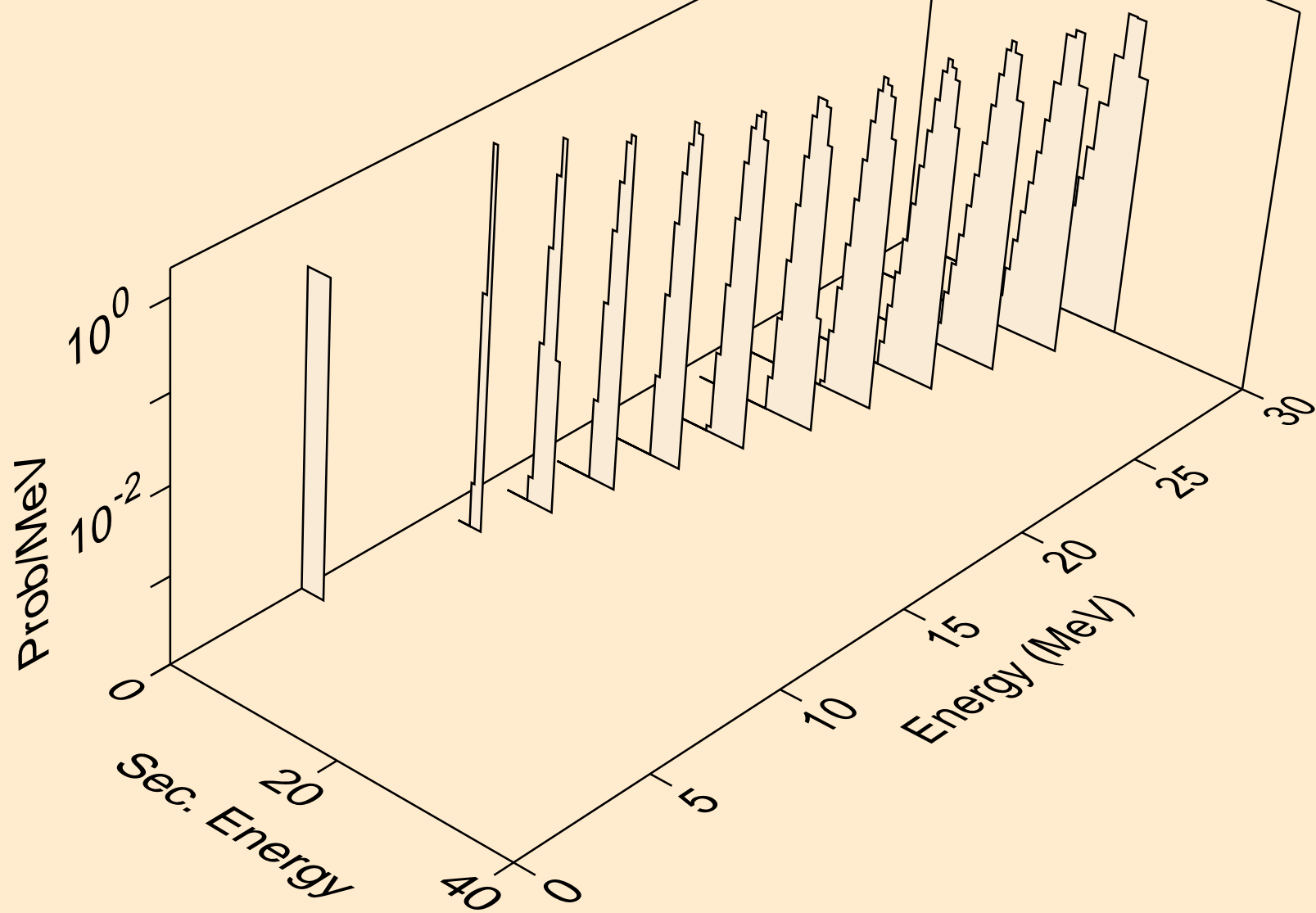

DB269 DEUTERON ACER TENDL-2021 LIBRARY; T=0.K  
tritons from (d,t)

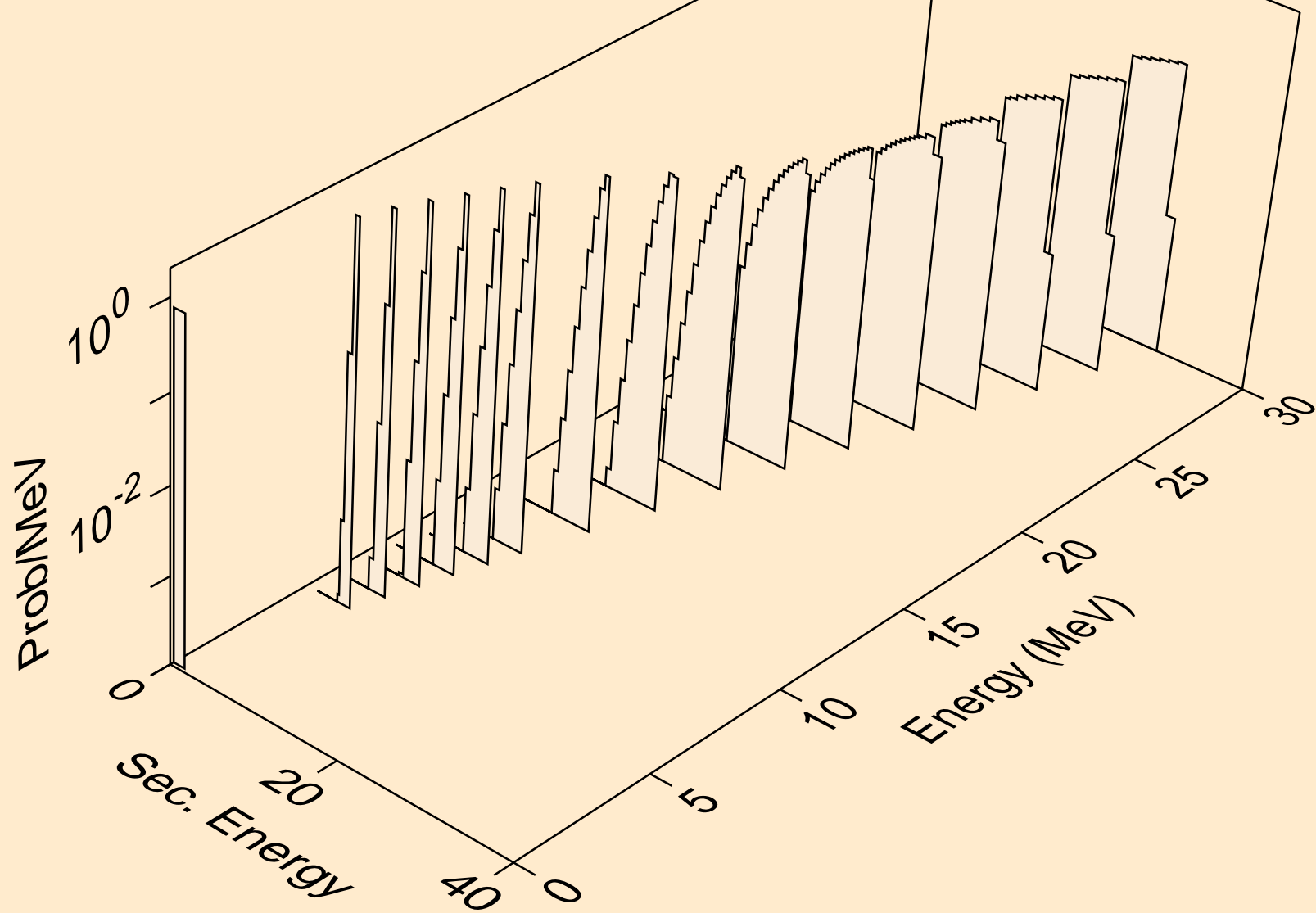

DB269 DEUTERON ACER TENDL-2021 LIBRARY; T=0.K  
he3s from (d,x)

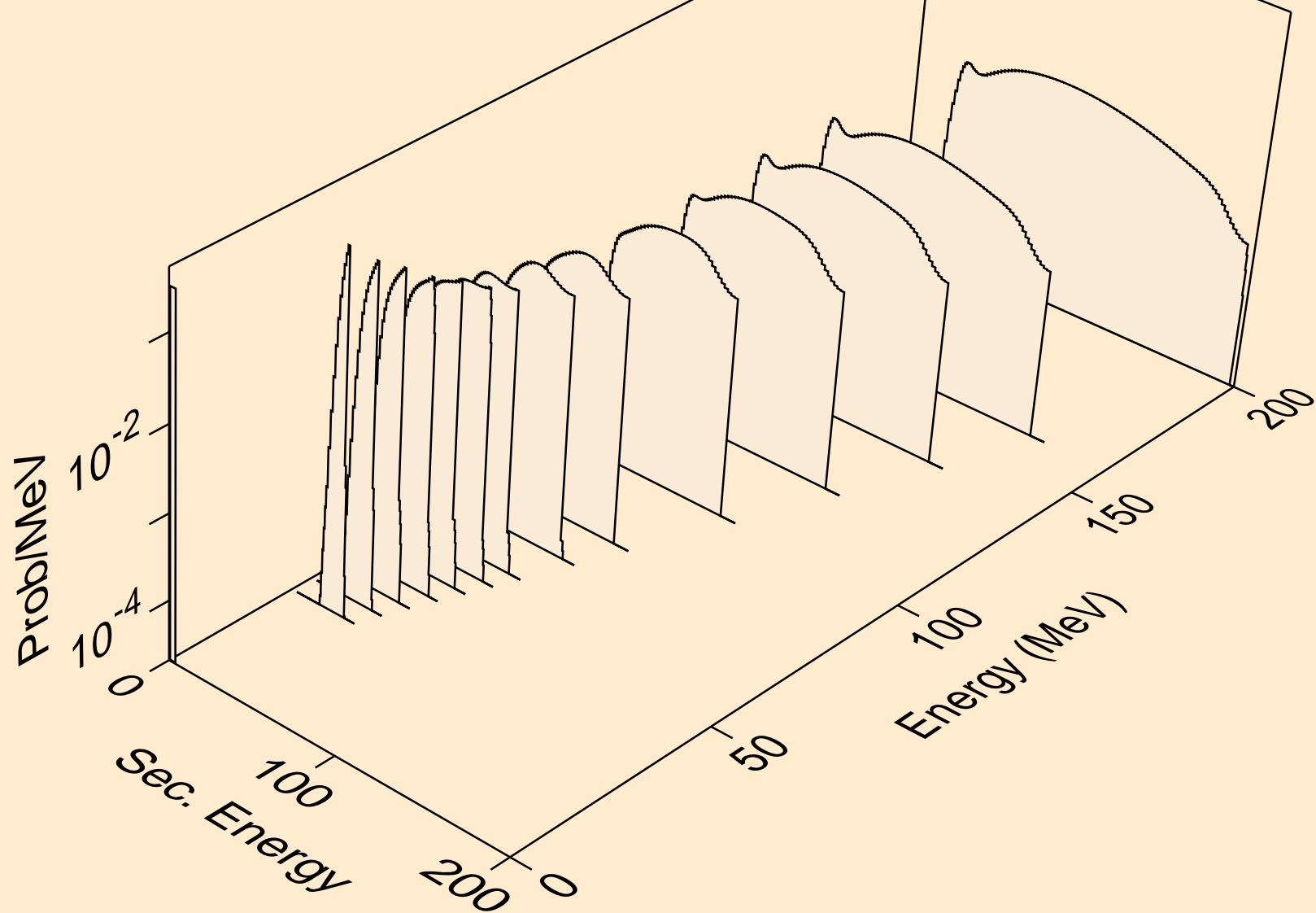

DB269 DEUTERON ACER TENDL-2021 LIBRARY; T=0.K  
he3s from (d,he3)

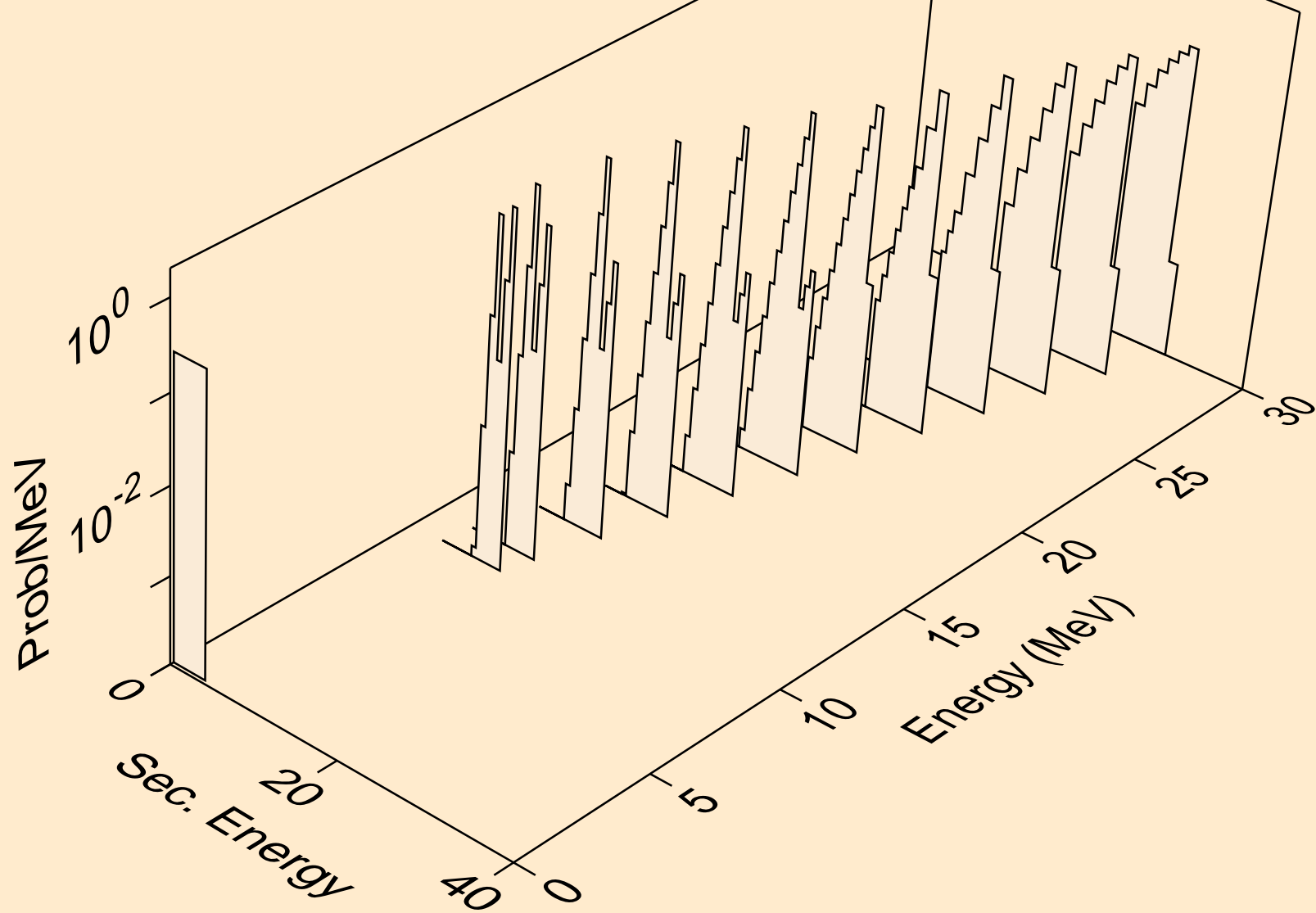

DB269 DEUTERON ACER TENDL-2021 LIBRARY; T=0.K  
alphas from (d,x)

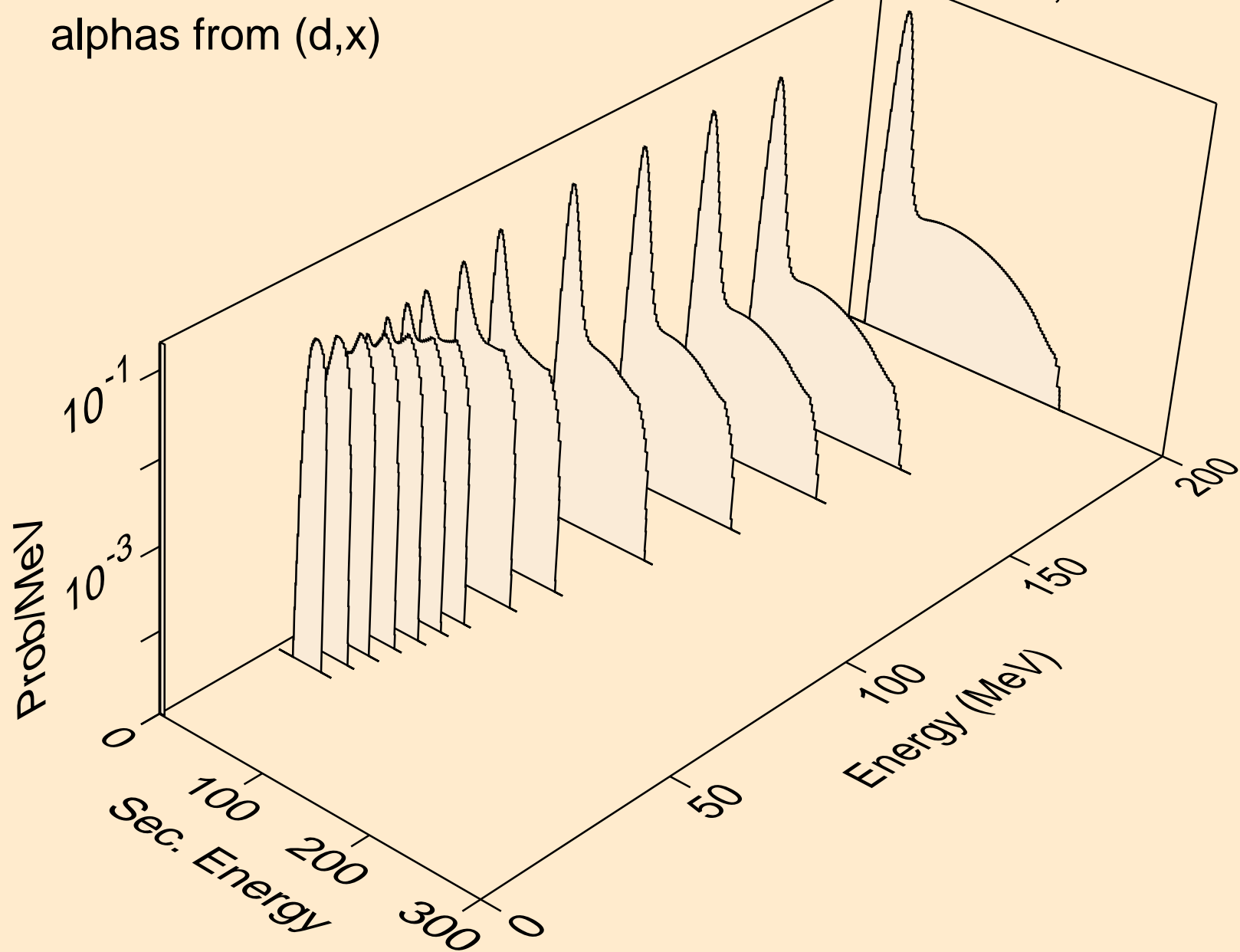

DB269 DEUTERON ACER TENDL-2021 LIBRARY; T=0.K  
alphas from (d,a)

