

# ES239 DEUTERON ACER TENDL-2021 LIBRARY; T=0.K

## Principal cross sections

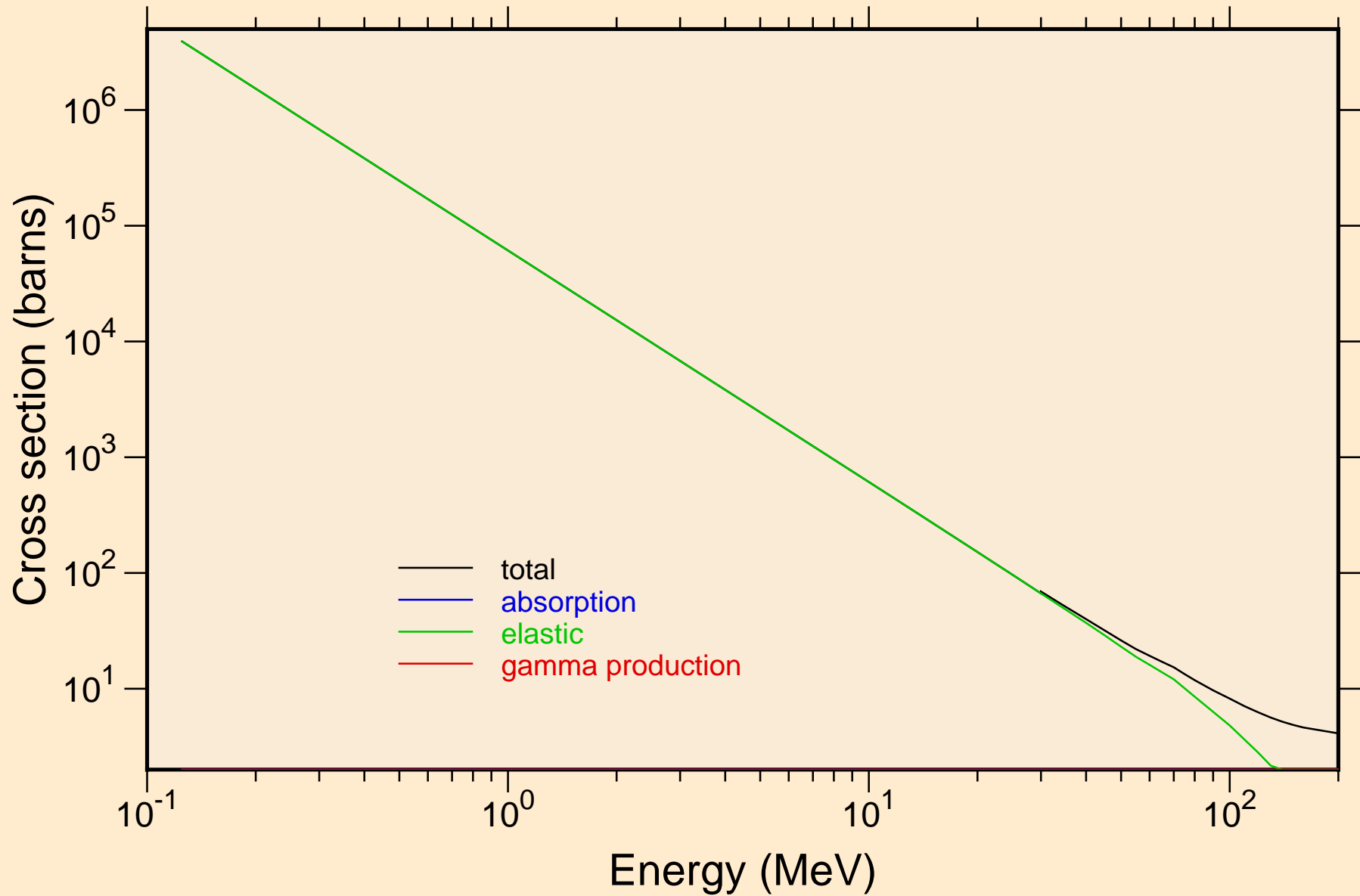

# ES239 DEUTERON ACER TENDL-2021 LIBRARY; T=0.K

## Heating

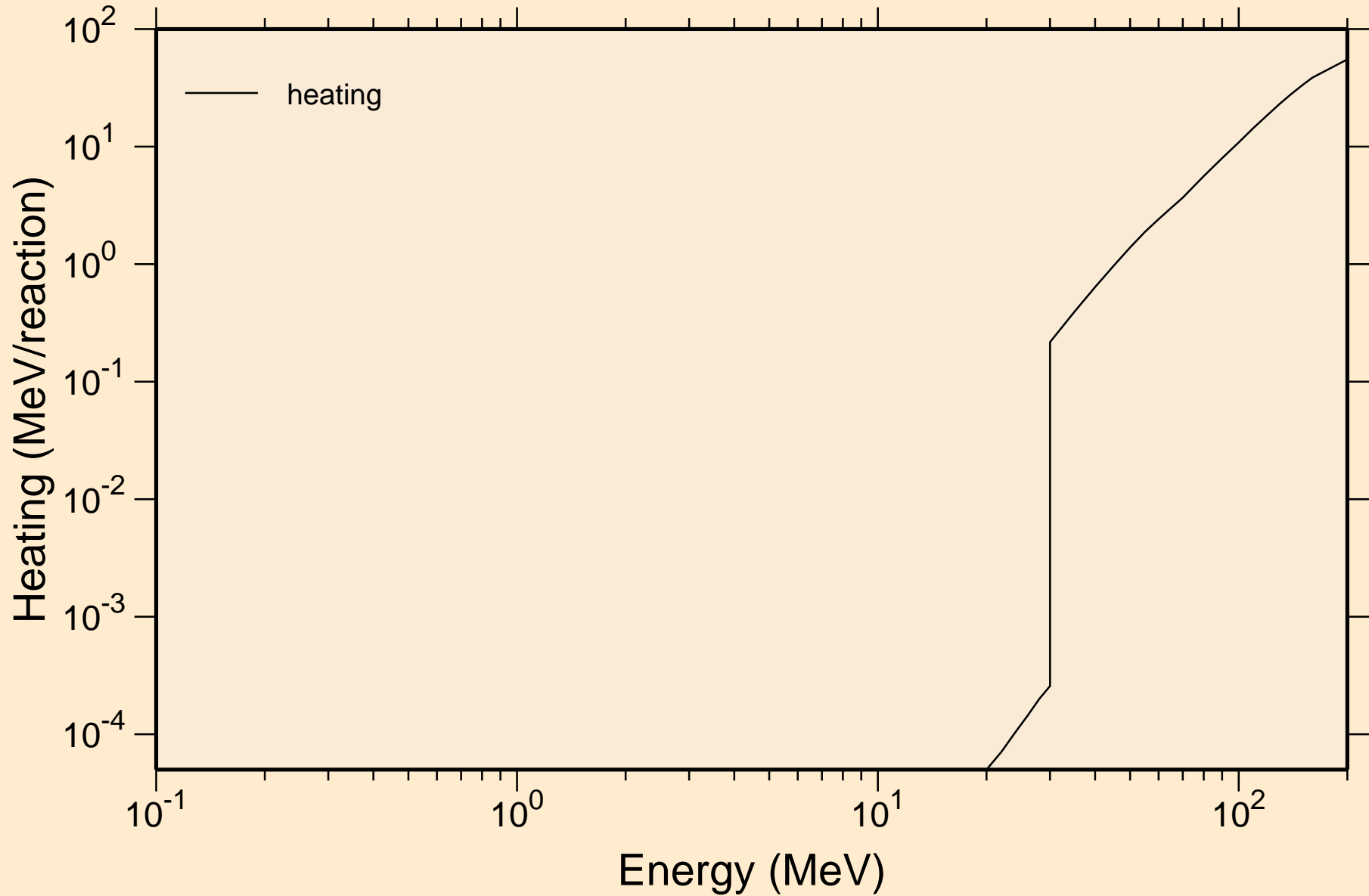

ES239 DEUTERON ACER TENDL-2021 LIBRARY; T=0.K  
Principal cross sections

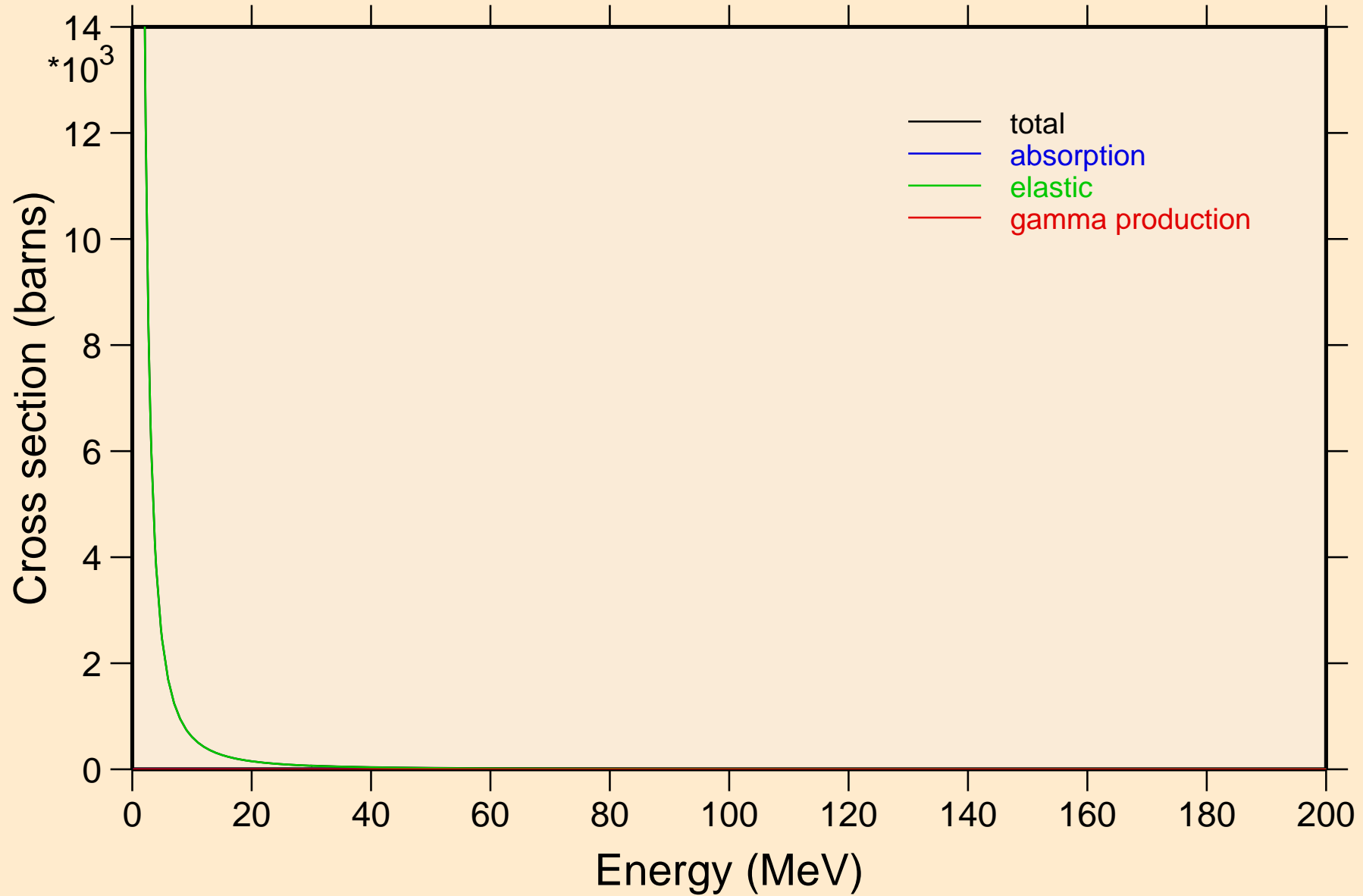

# ES239 DEUTERON ACER TENDL-2021 LIBRARY; T=0.K

## Heating

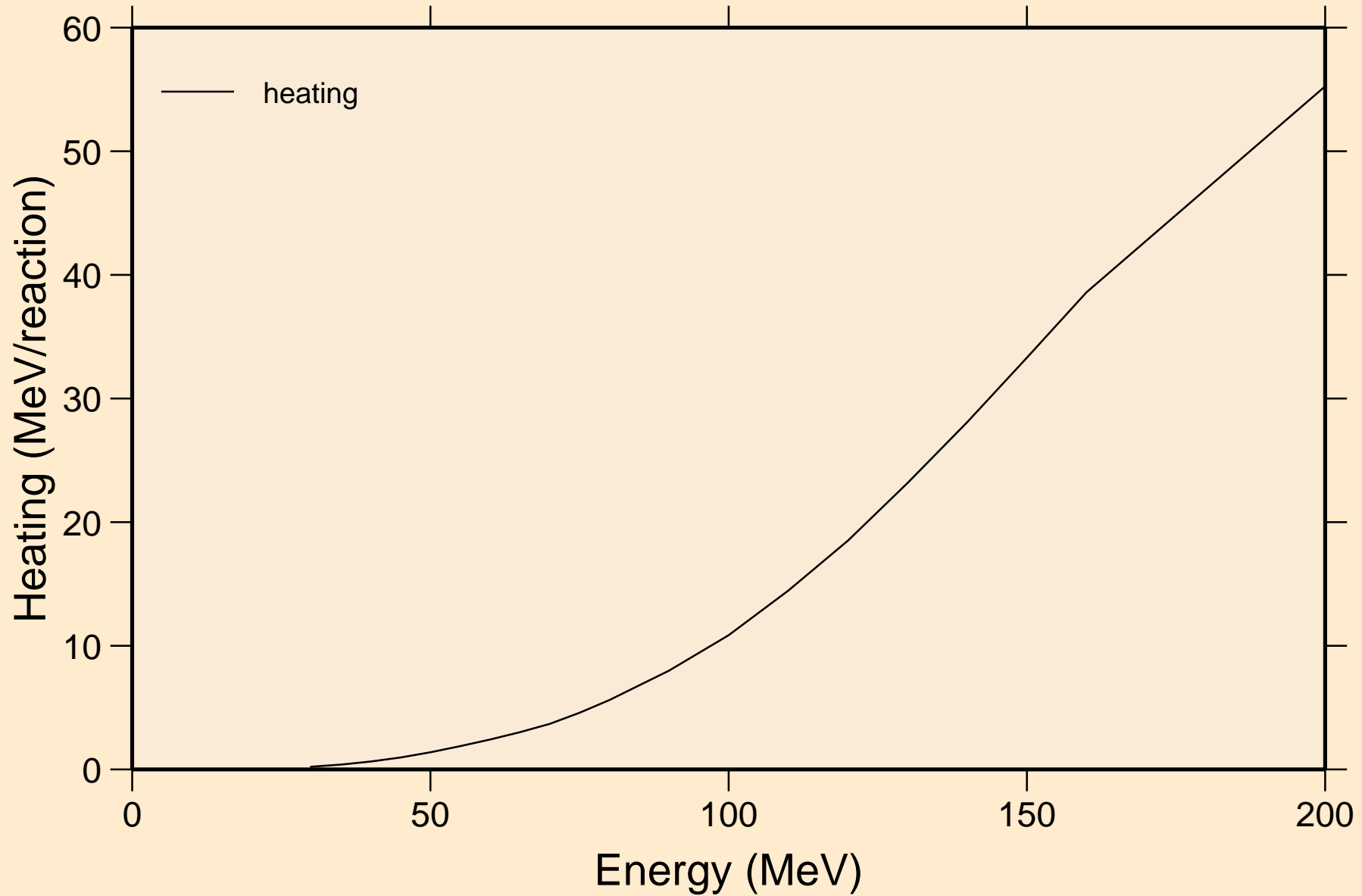

# ES239 DEUTERON ACER TENDL-2021 LIBRARY; T=0.K

## Threshold reactions

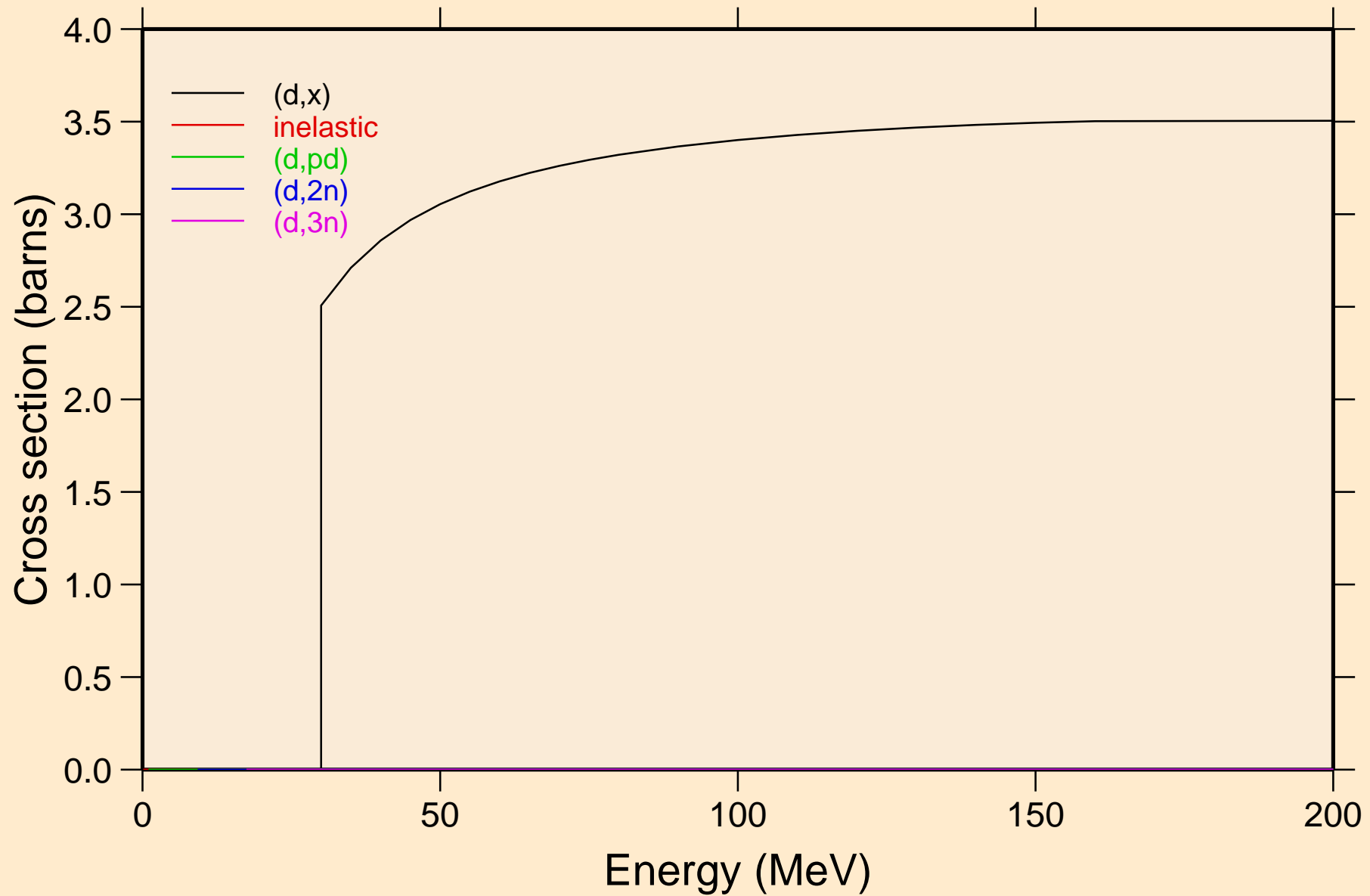

# ES239 DEUTERON ACER TENDL-2021 LIBRARY; T=0.K

## Threshold reactions

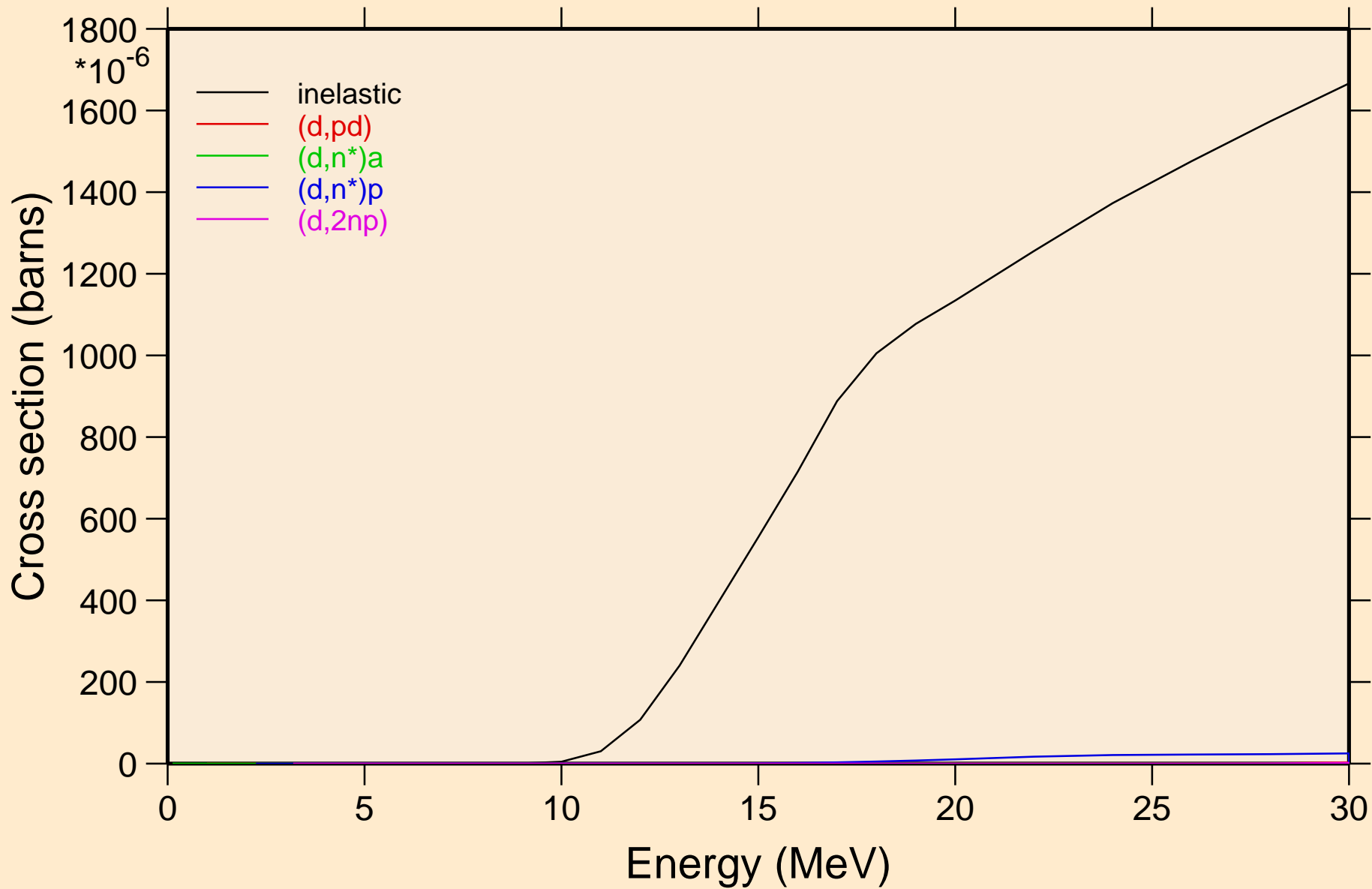

# ES239 DEUTERON ACER TENDL-2021 LIBRARY; T=0.K

## Threshold reactions

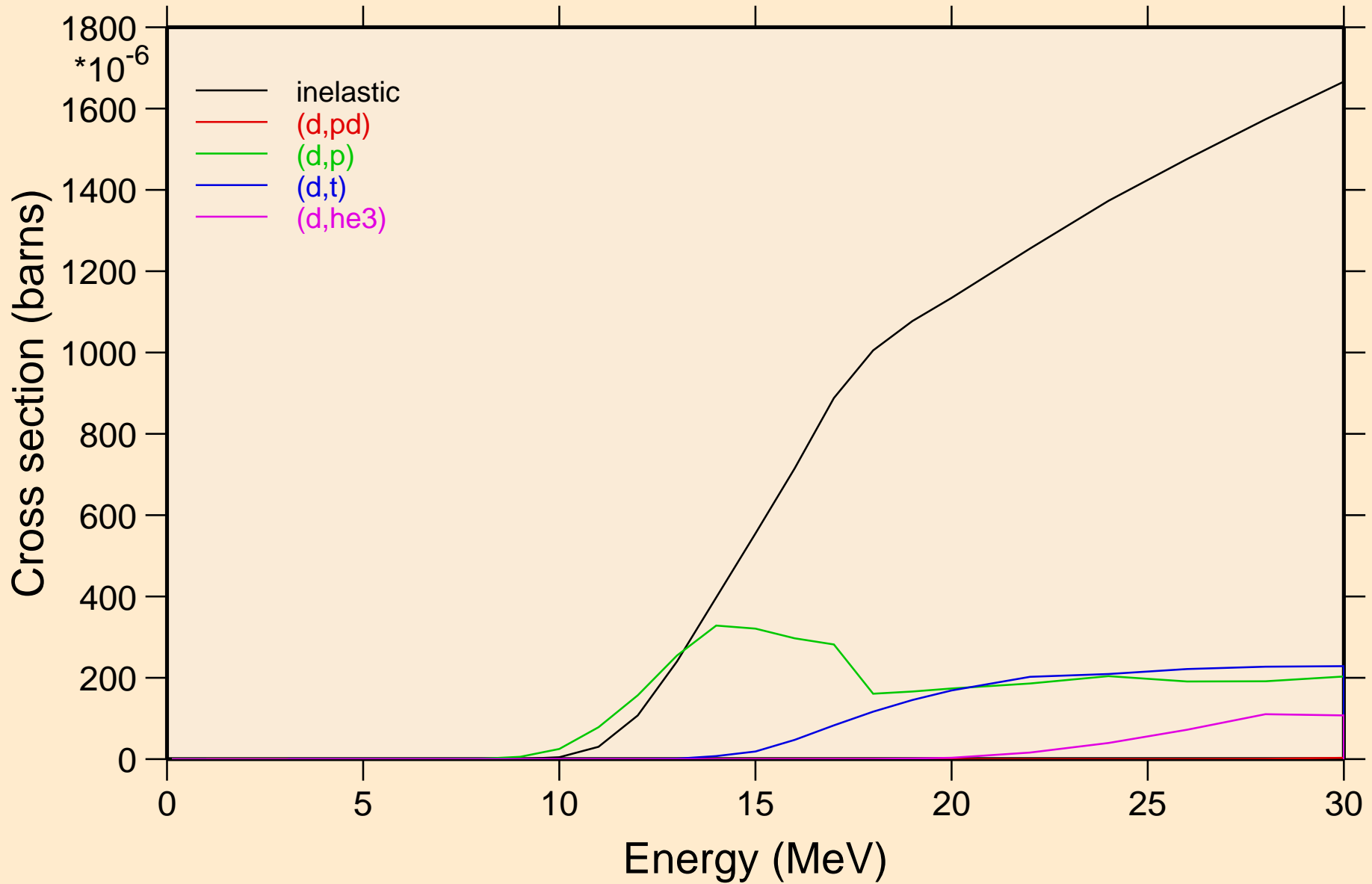

# ES239 DEUTERON ACER TENDL-2021 LIBRARY; T=0.K

## Threshold reactions

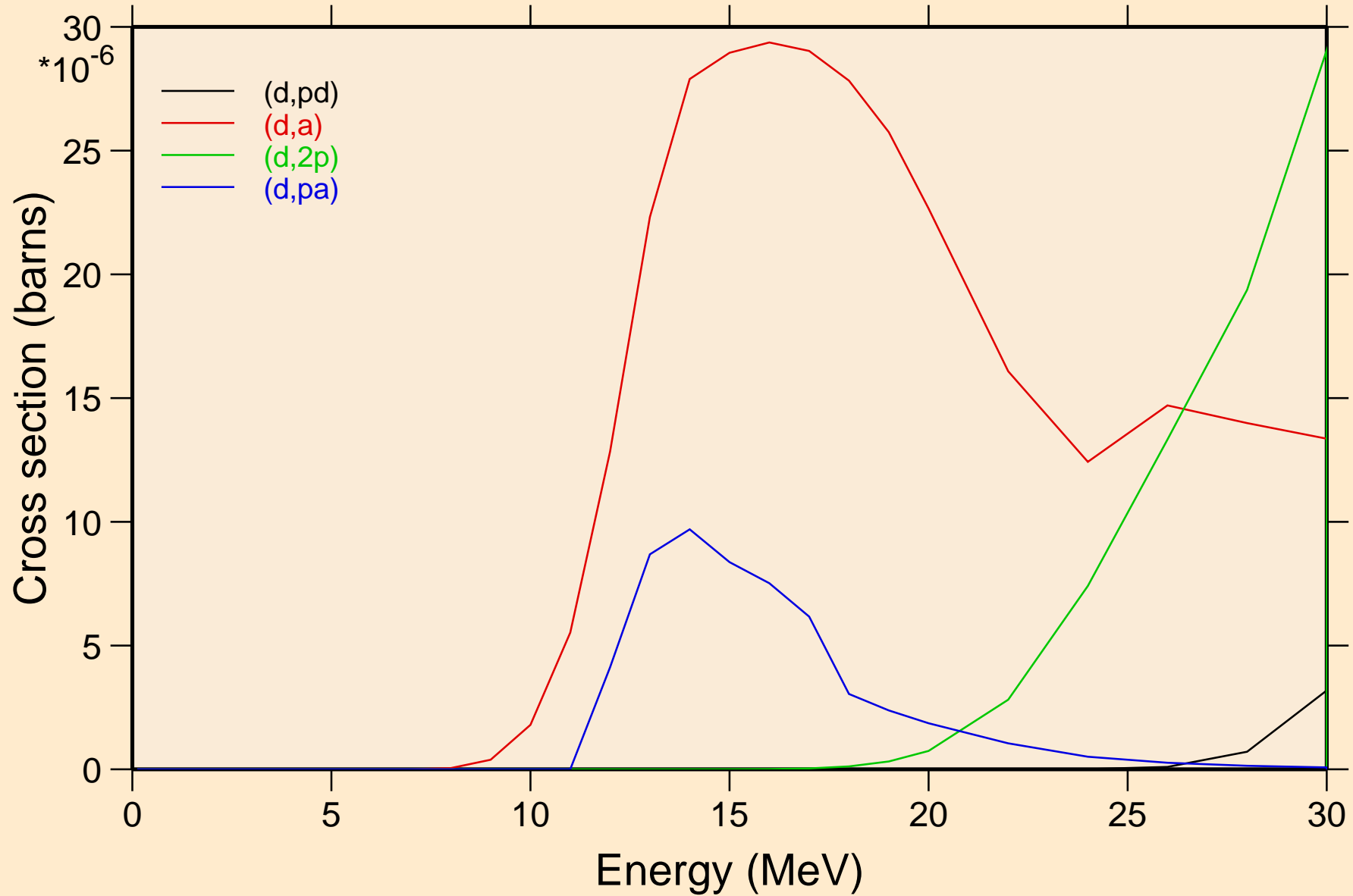



ES239 DEUTERON ACER TENDL-2021 LIBRARY; T=0.K  
Threshold reactions

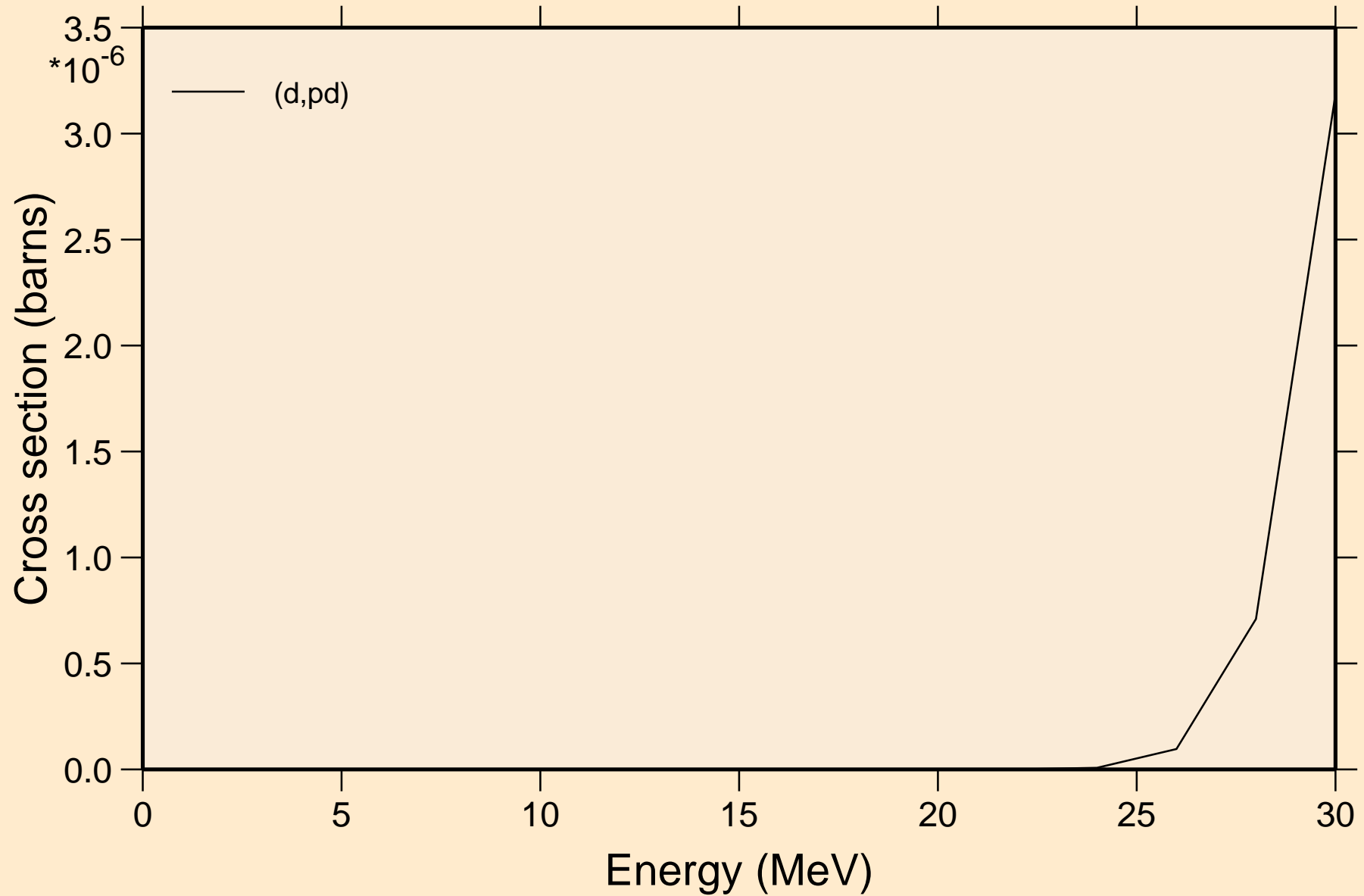

ES239 DEUTERON ACER TENDL-2021 LIBRARY; T=0.K  
angular distribution for elastic

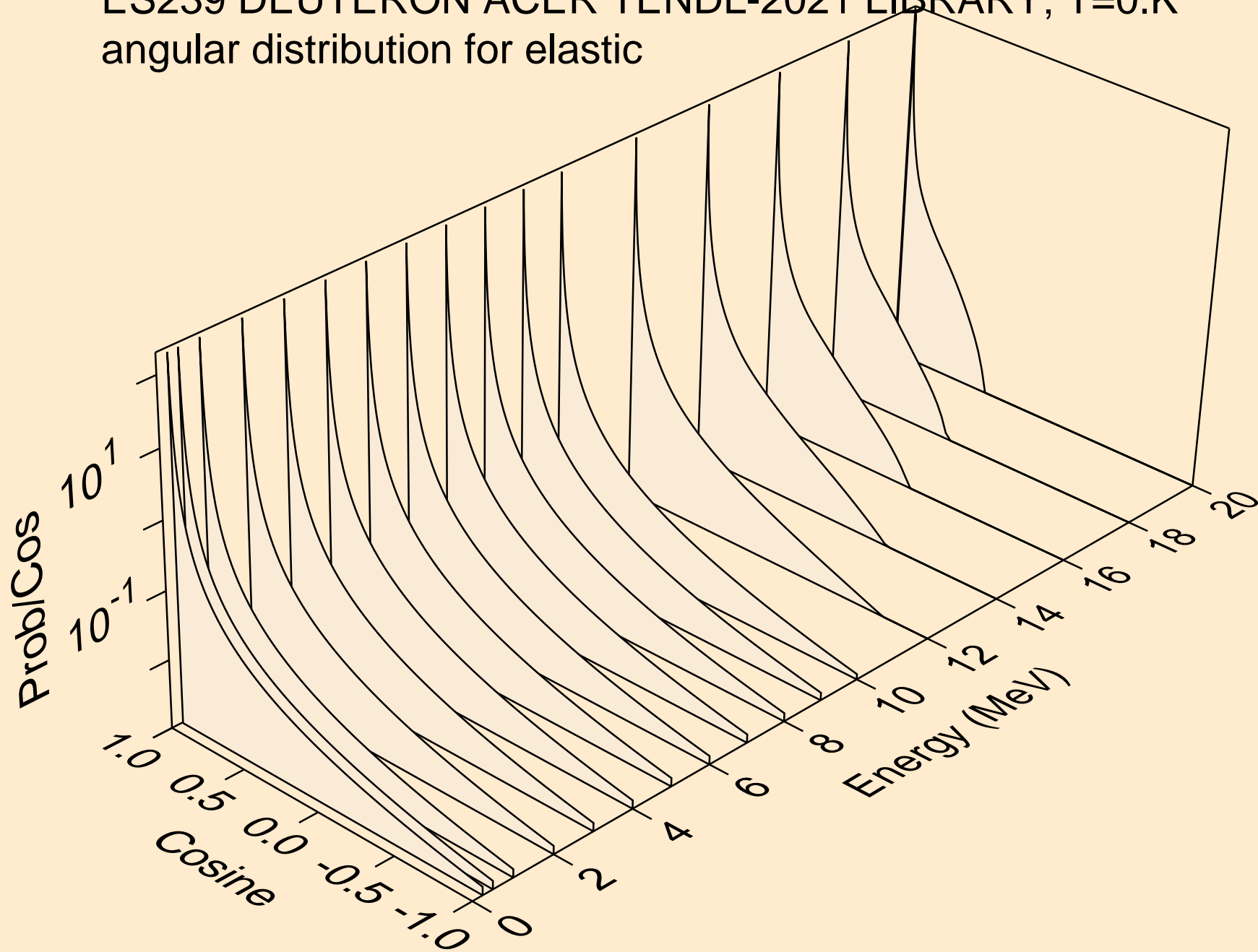

ES239 DEUTERON ACER TENDL-2021 LIBRARY; T=0.K  
angular distribution for elastic

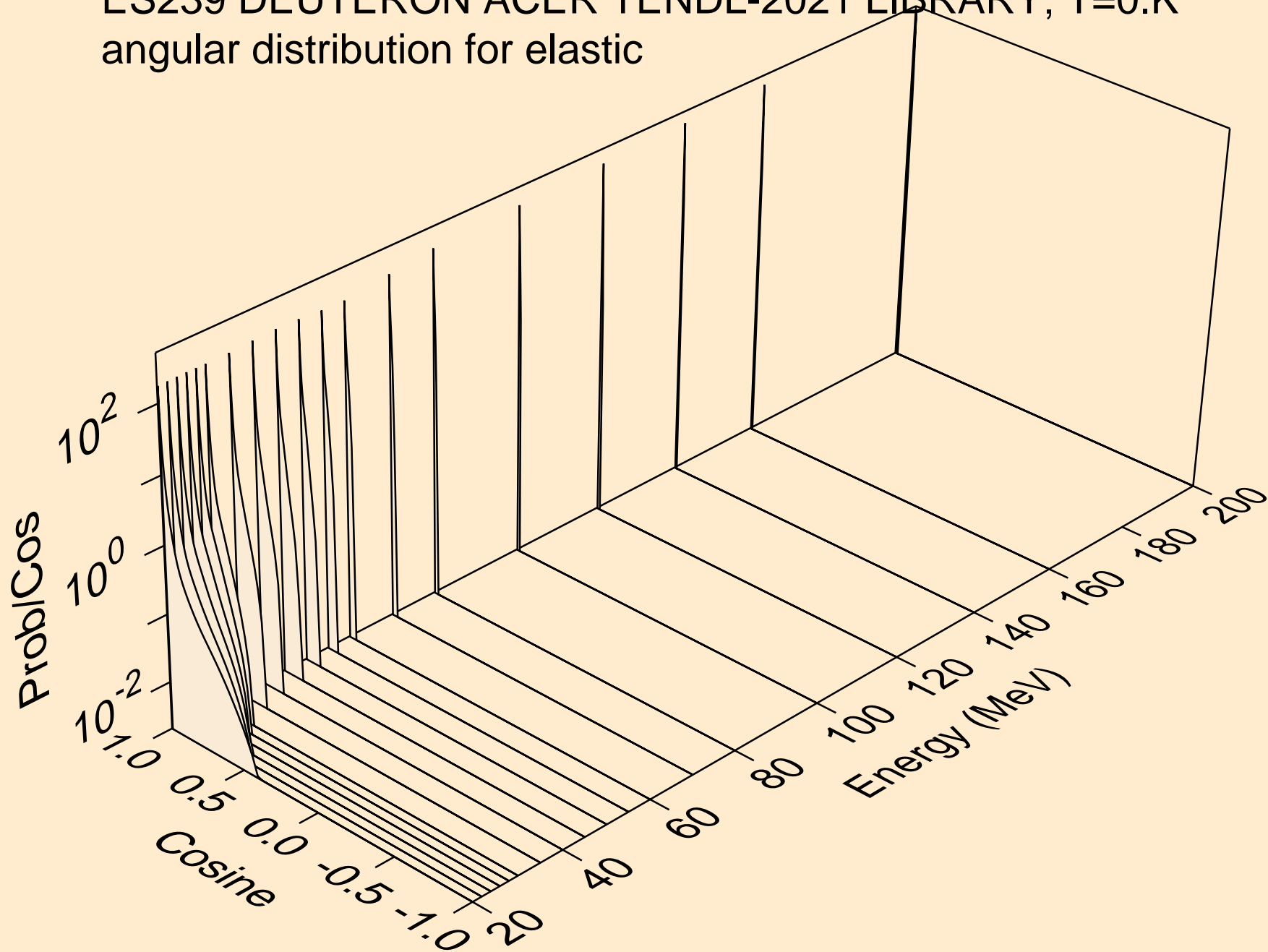

ES239 DEUTERON ACER TENDL-2021 LIBRARY; T=0.K  
Deuteron emission for (d,x)

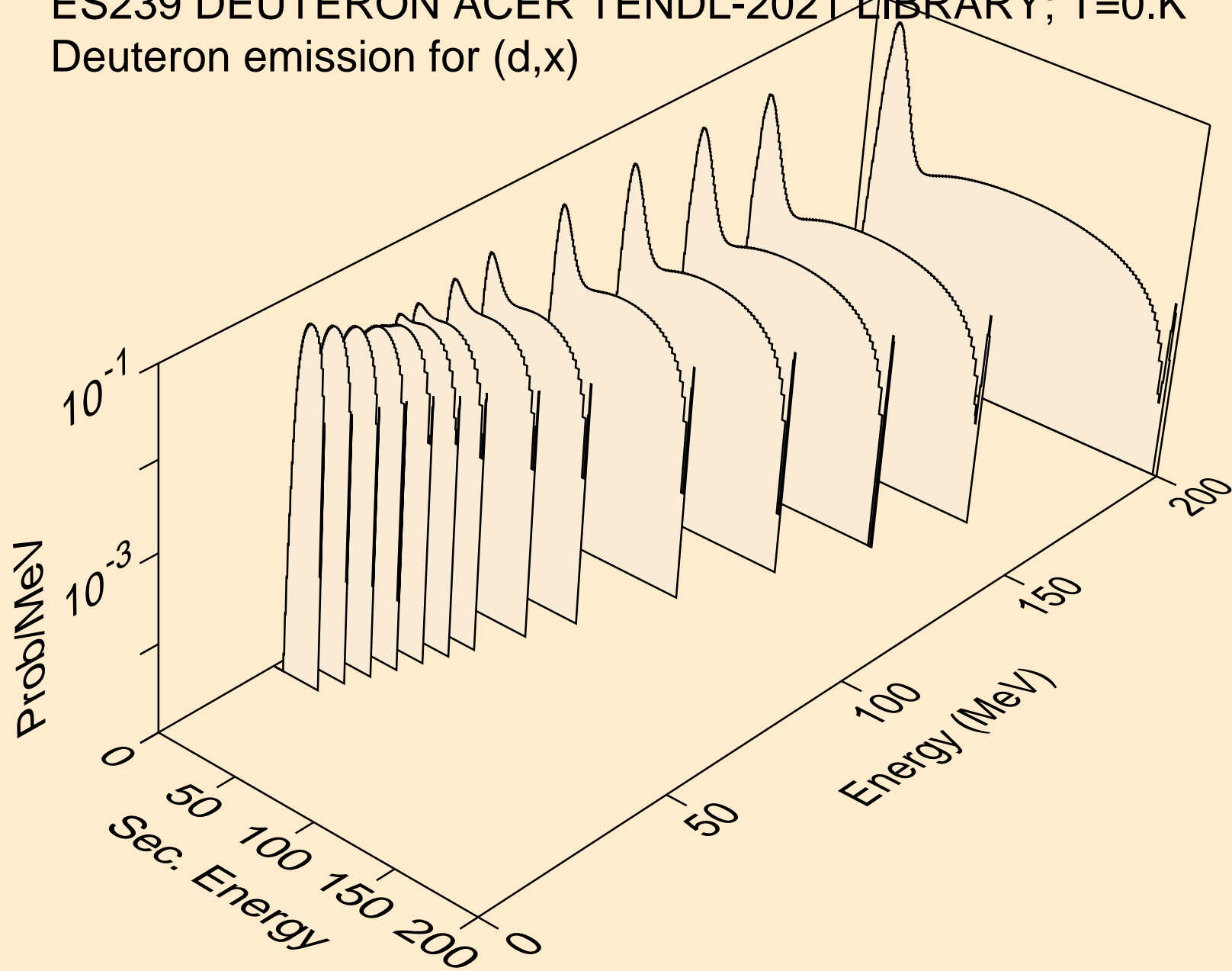

ES239 DEUTERON ACER TENDL-2021 LIBRARY; T=0.K  
Deuteron emission for inelastic

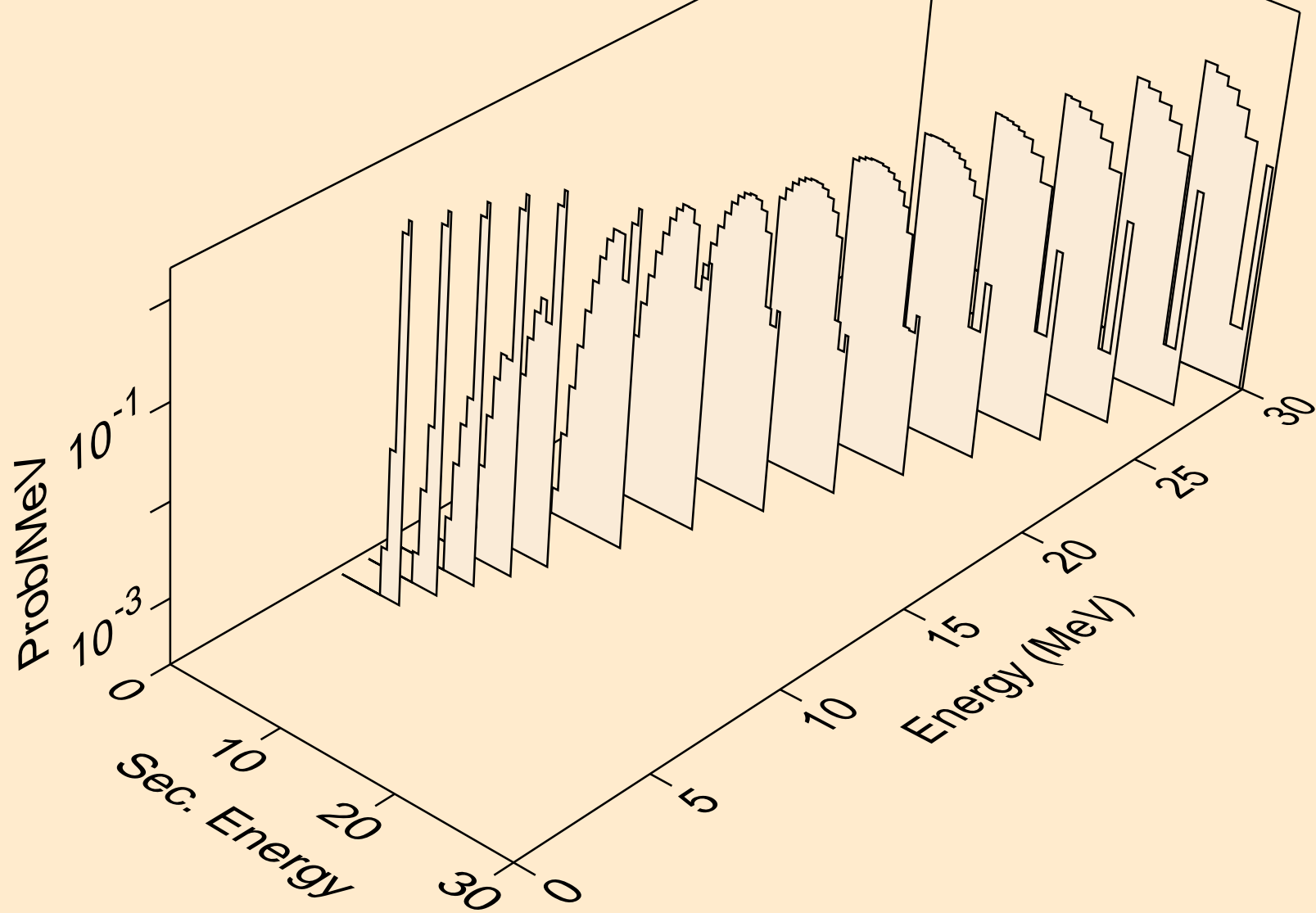

ES239 DEUTERON ACER TENDL-2021 LIBRARY; T=0.K  
Deuteron emission for (d,pd)

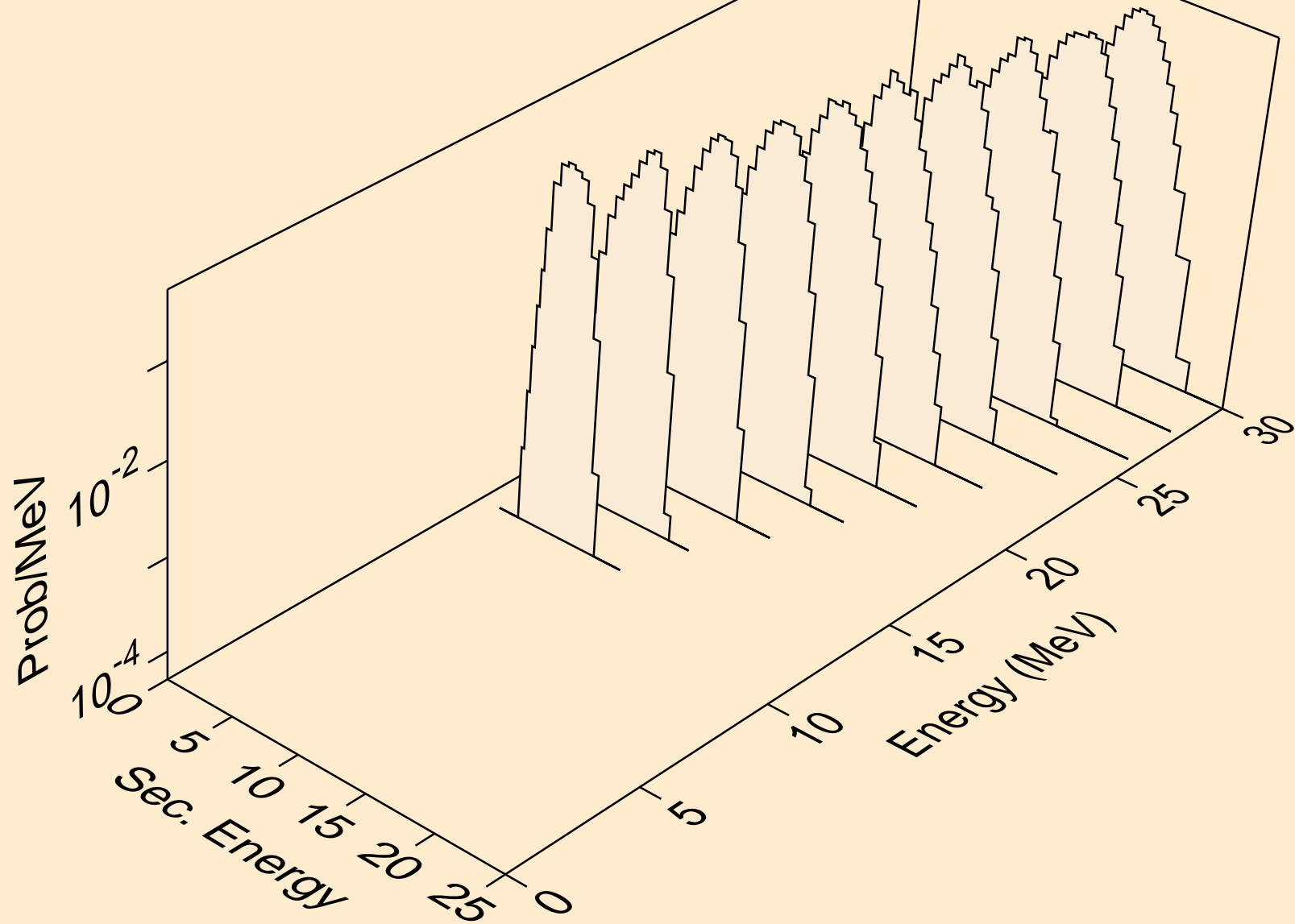

ES239 DEUTERON ACER TENDL-2021 LIBRARY; T=0.K  
Photon emission for (z,n)

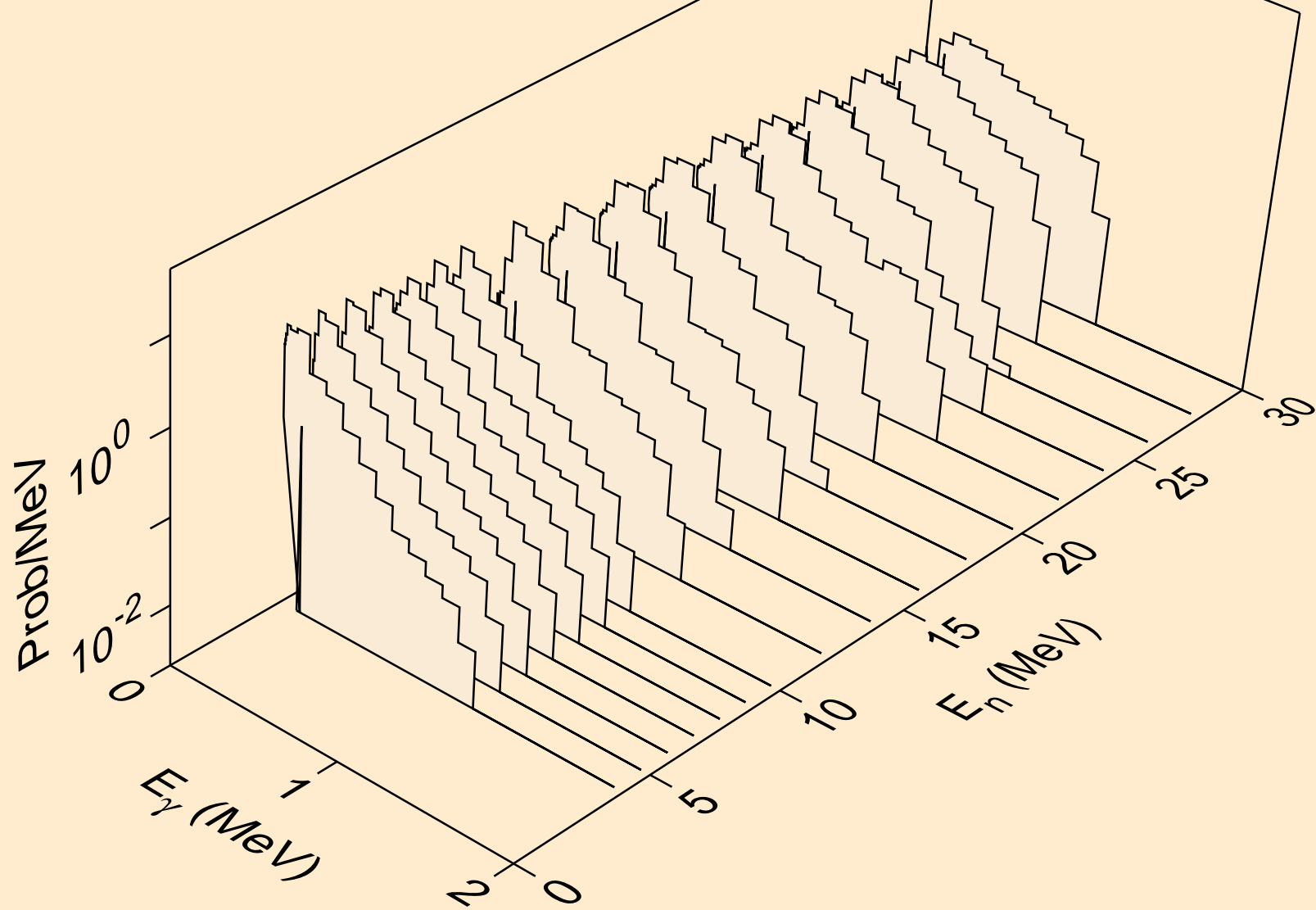

ES239 DEUTERON ACER TENDL-2021 LIBRARY; T=0.K  
Photon emission for (n,x)

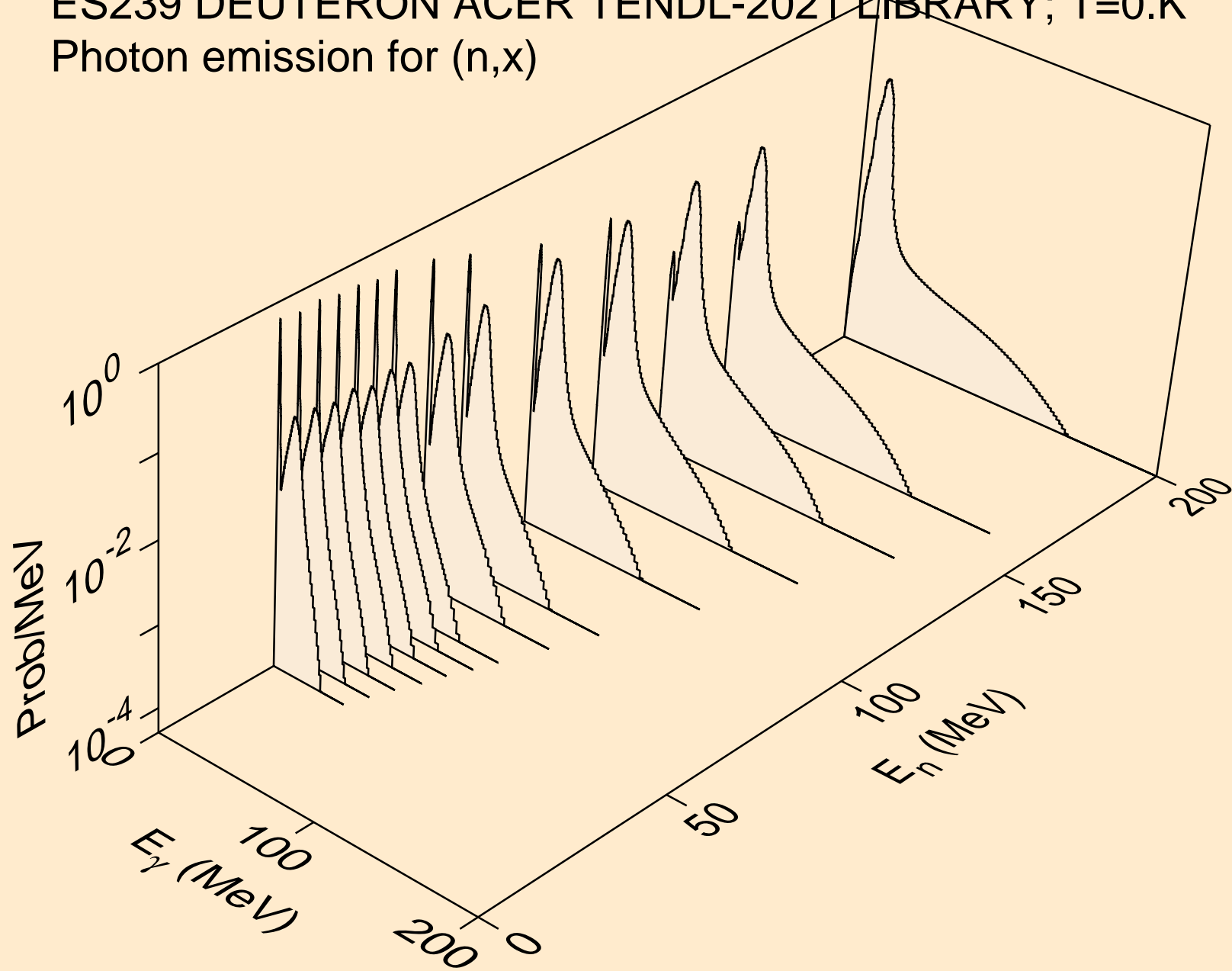



ES239 DEUTERON ACER TENDL-2021 LIBRARY; T=0.K  
Photon emission for (n,2n)

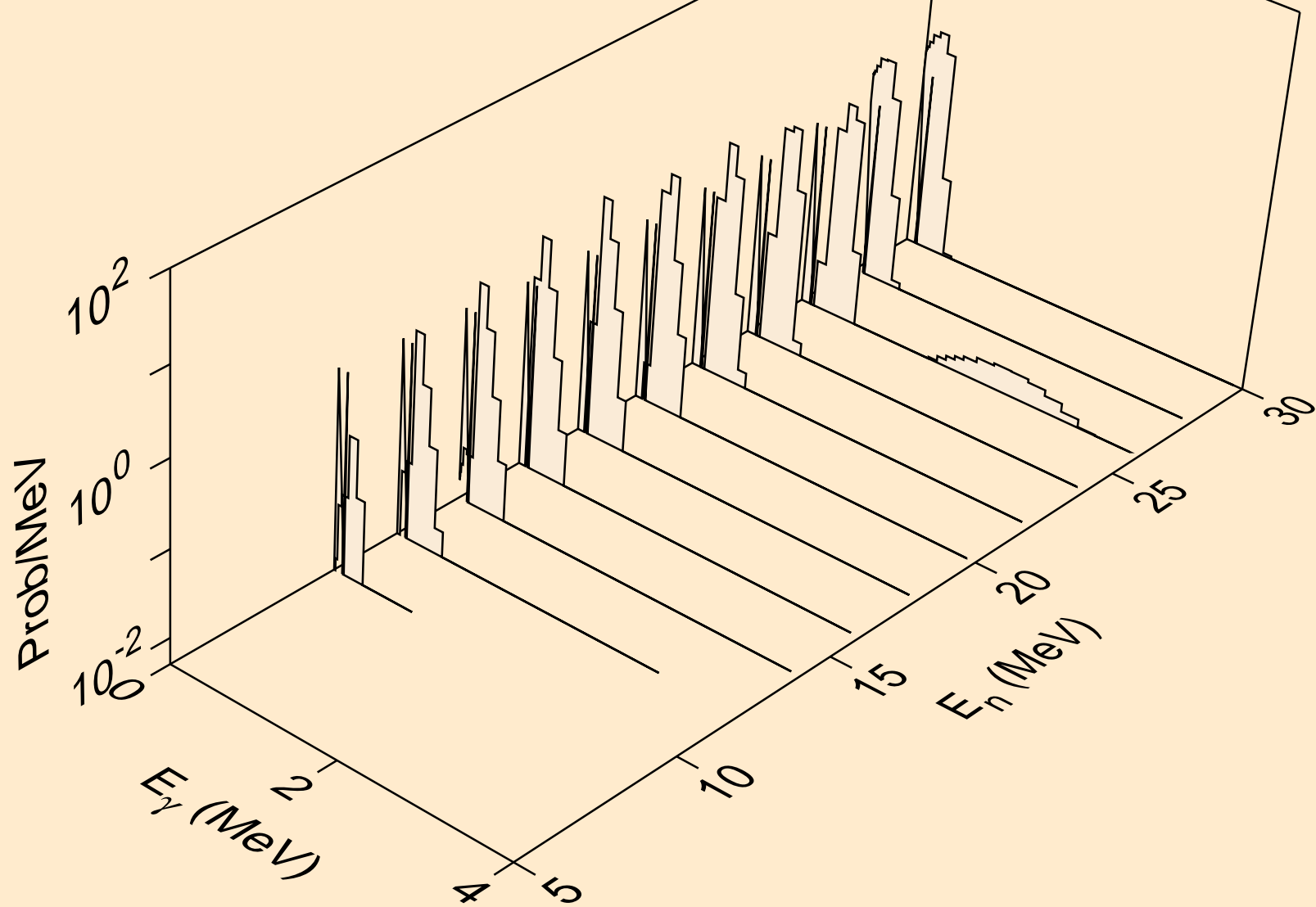

ES239 DEUTERON ACER TENDL-2021 LIBRARY; T=0.K  
Photon emission for (n,3n)

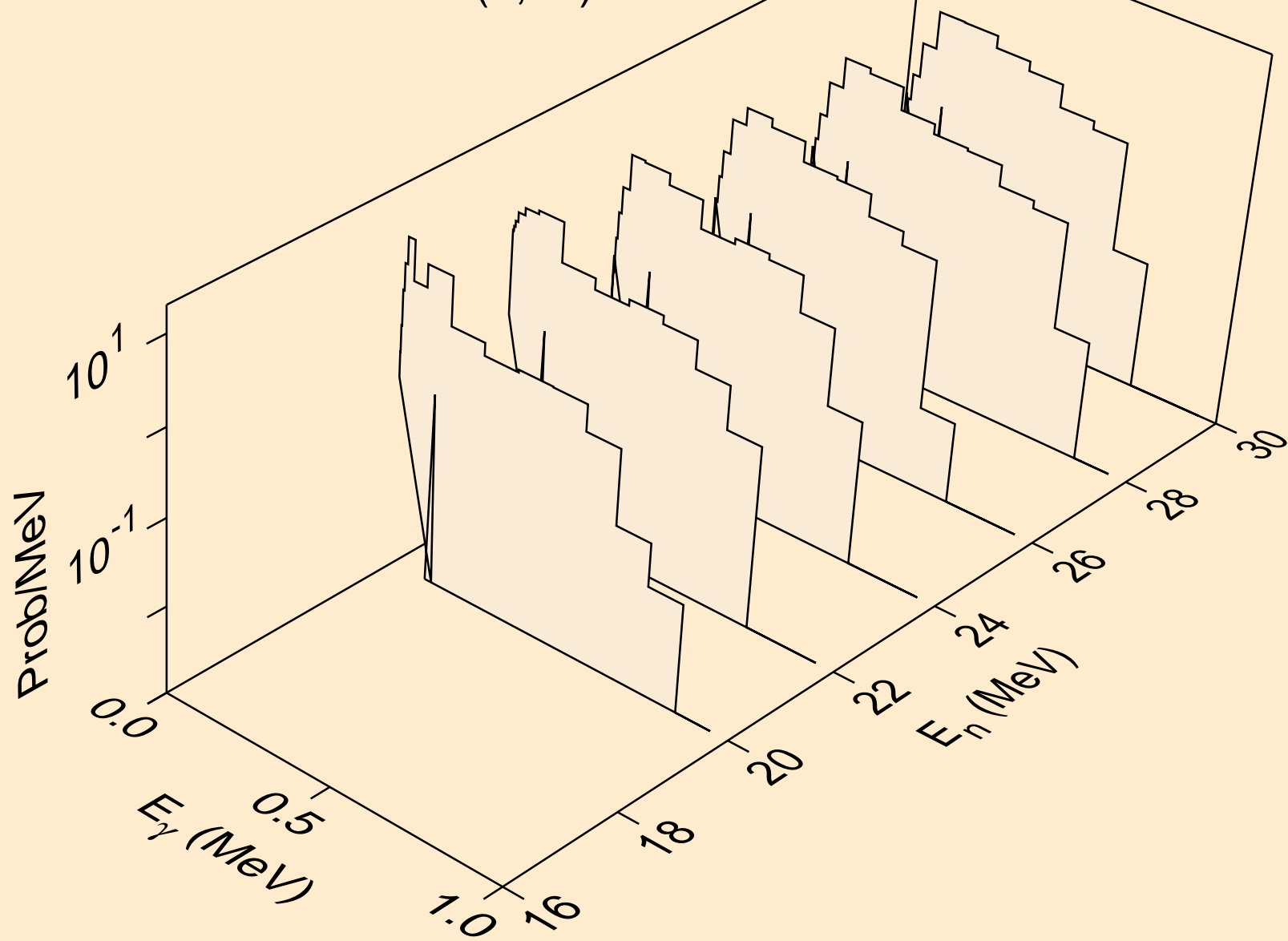

ES239 DEUTERON ACER TENDL-2021 LIBRARY; T=0.K  
Photon emission for (n,n\*)a

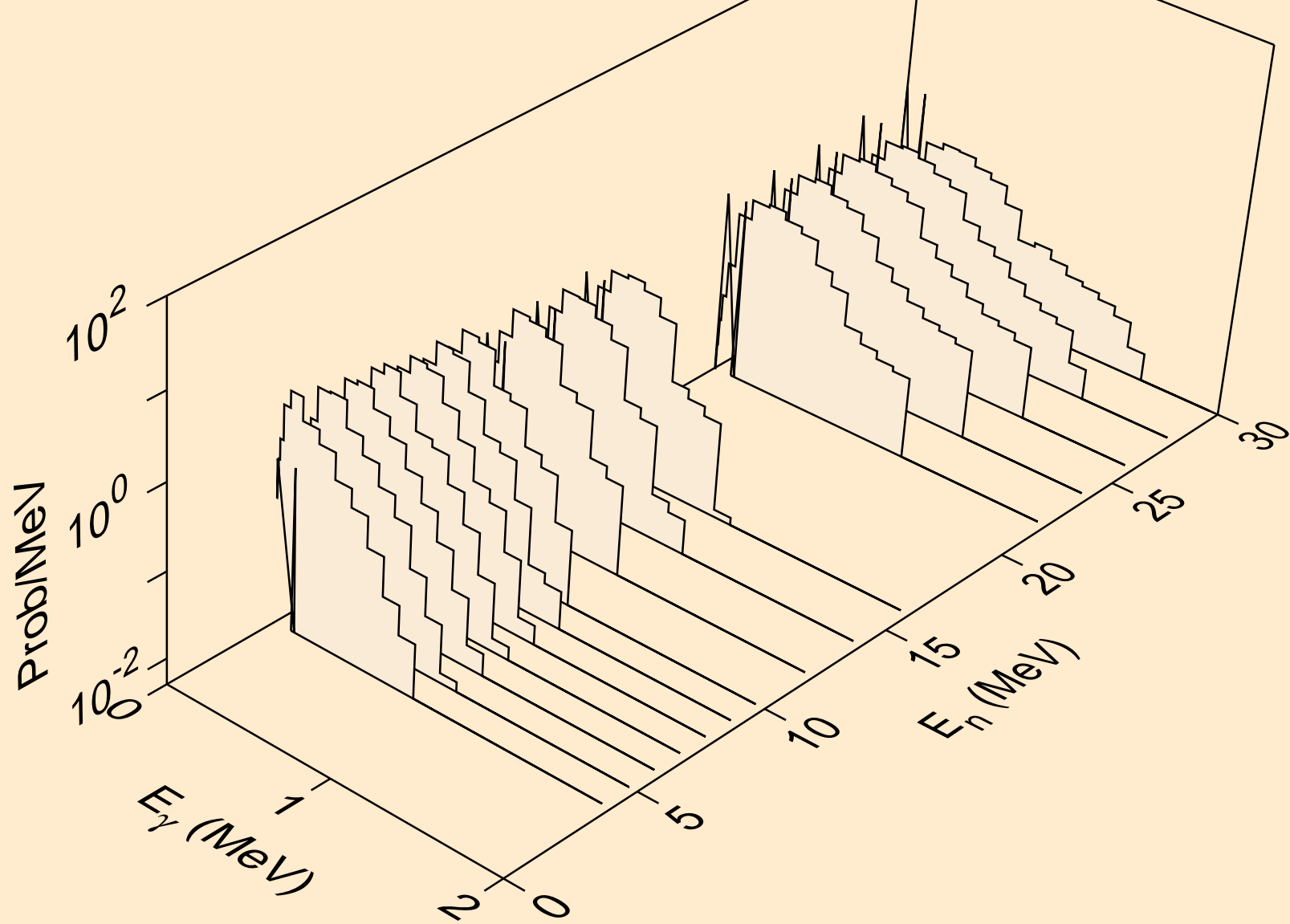

ES239 DEUTERON ACER TENDL-2021 LIBRARY; T=0.K  
Photon emission for (n,n\*)p

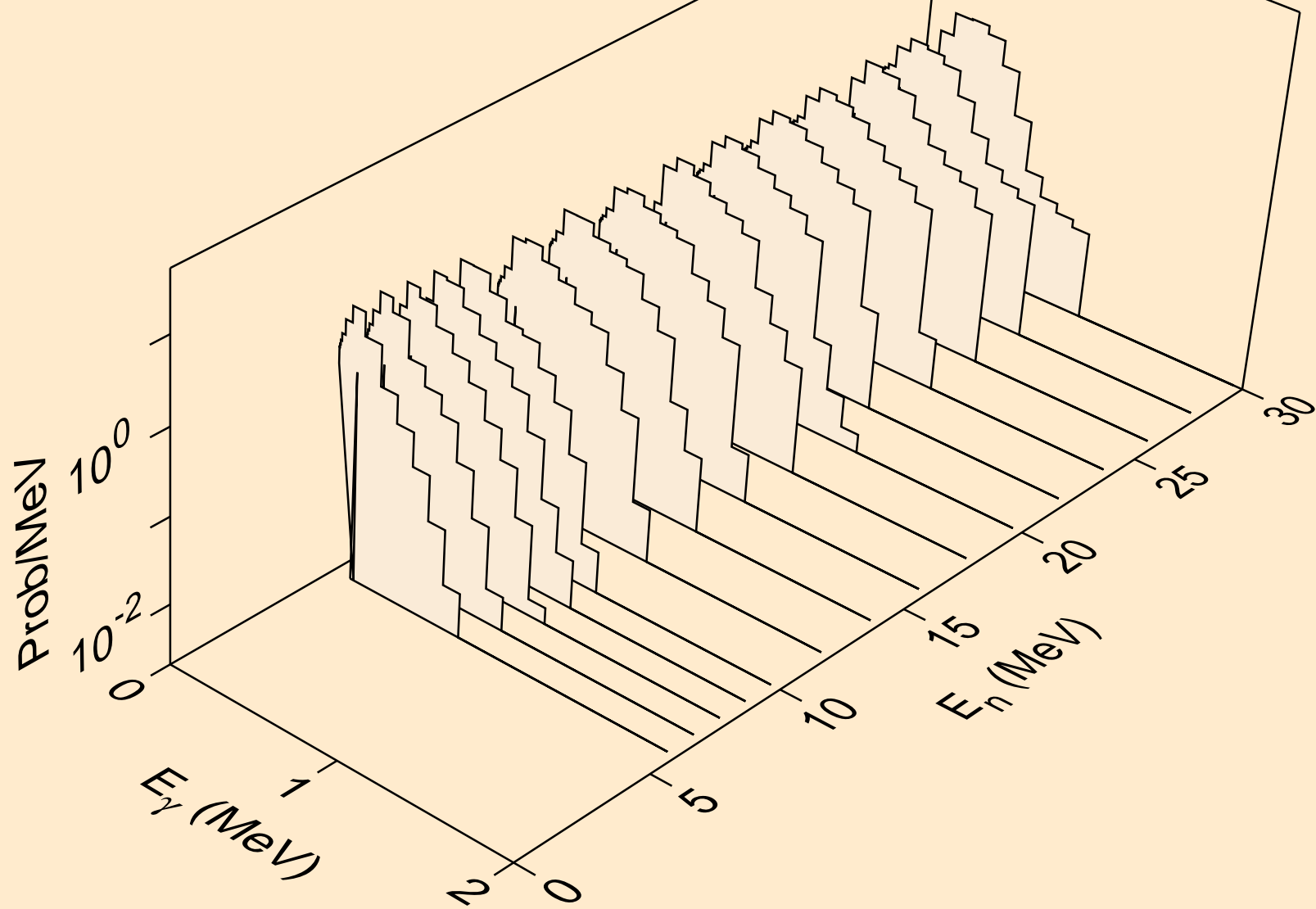

ES239 DEUTERON ACER TENDL-2021 LIBRARY; T=0.K  
Photon emission for (n,2np)

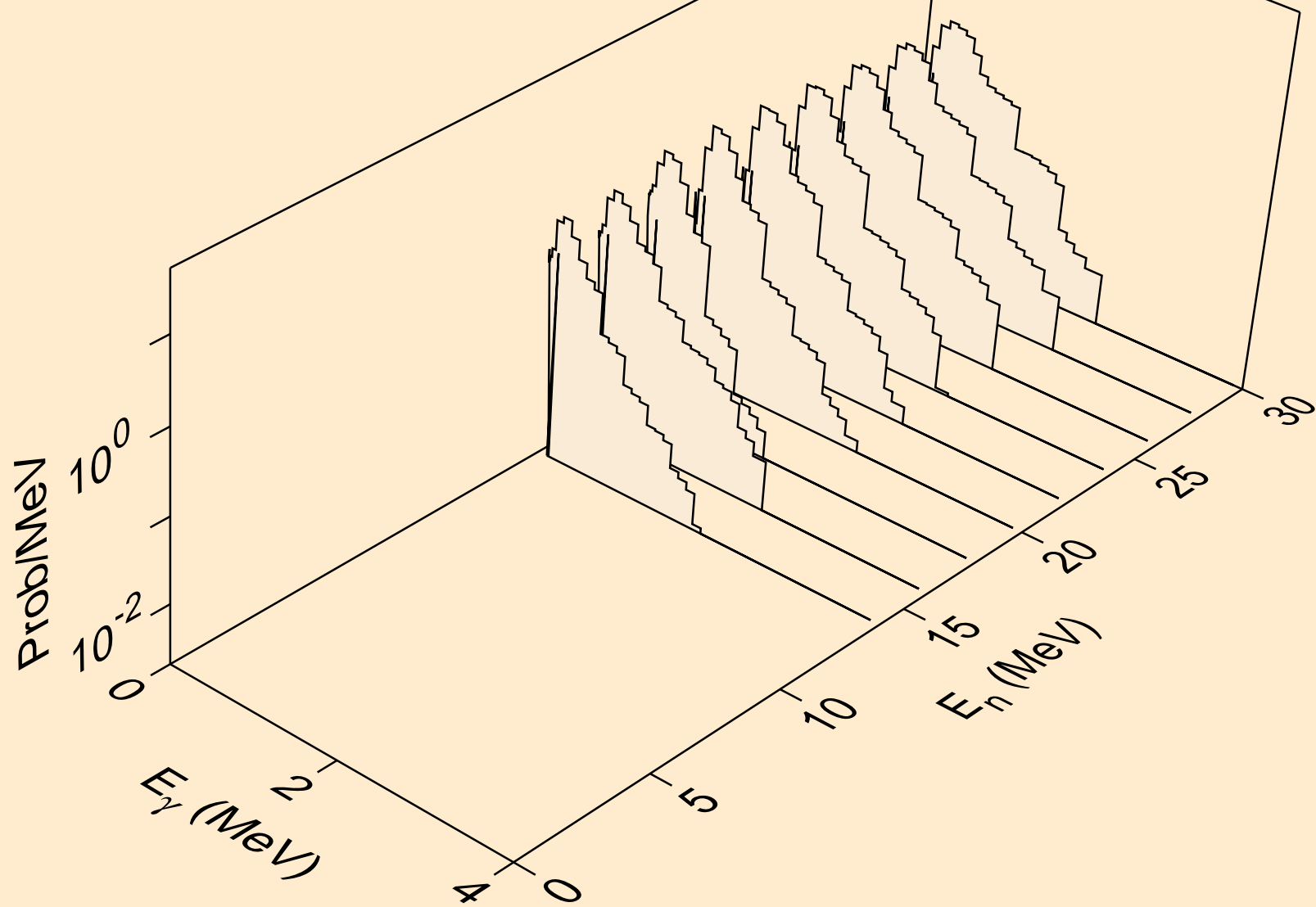

ES239 DEUTERON ACER TENDL-2021 LIBRARY; T=0.K  
Photon emission for (n,p)

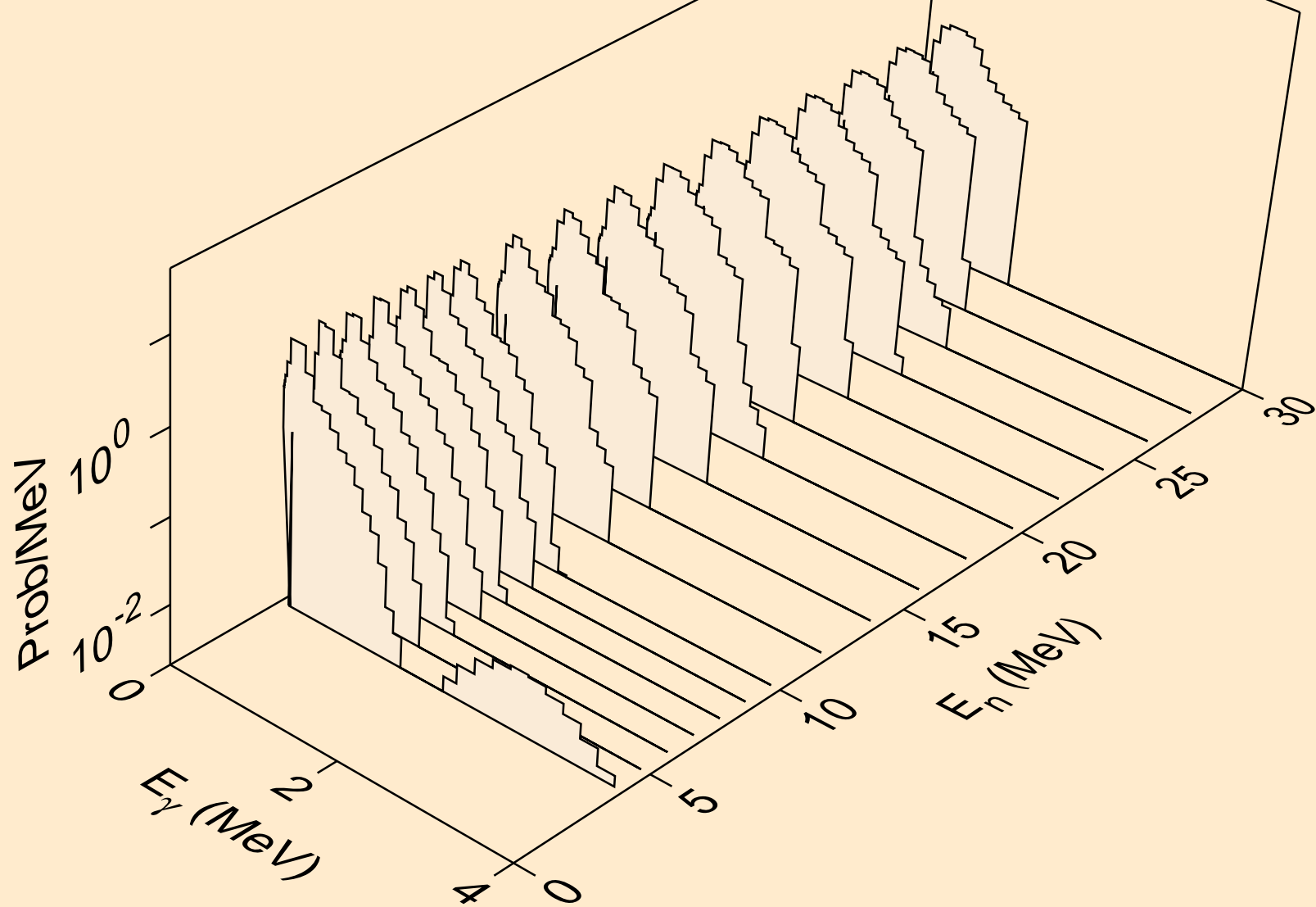

ES239 DEUTERON ACER TENDL-2021 LIBRARY; T=0.K  
Photon emission for inelastic

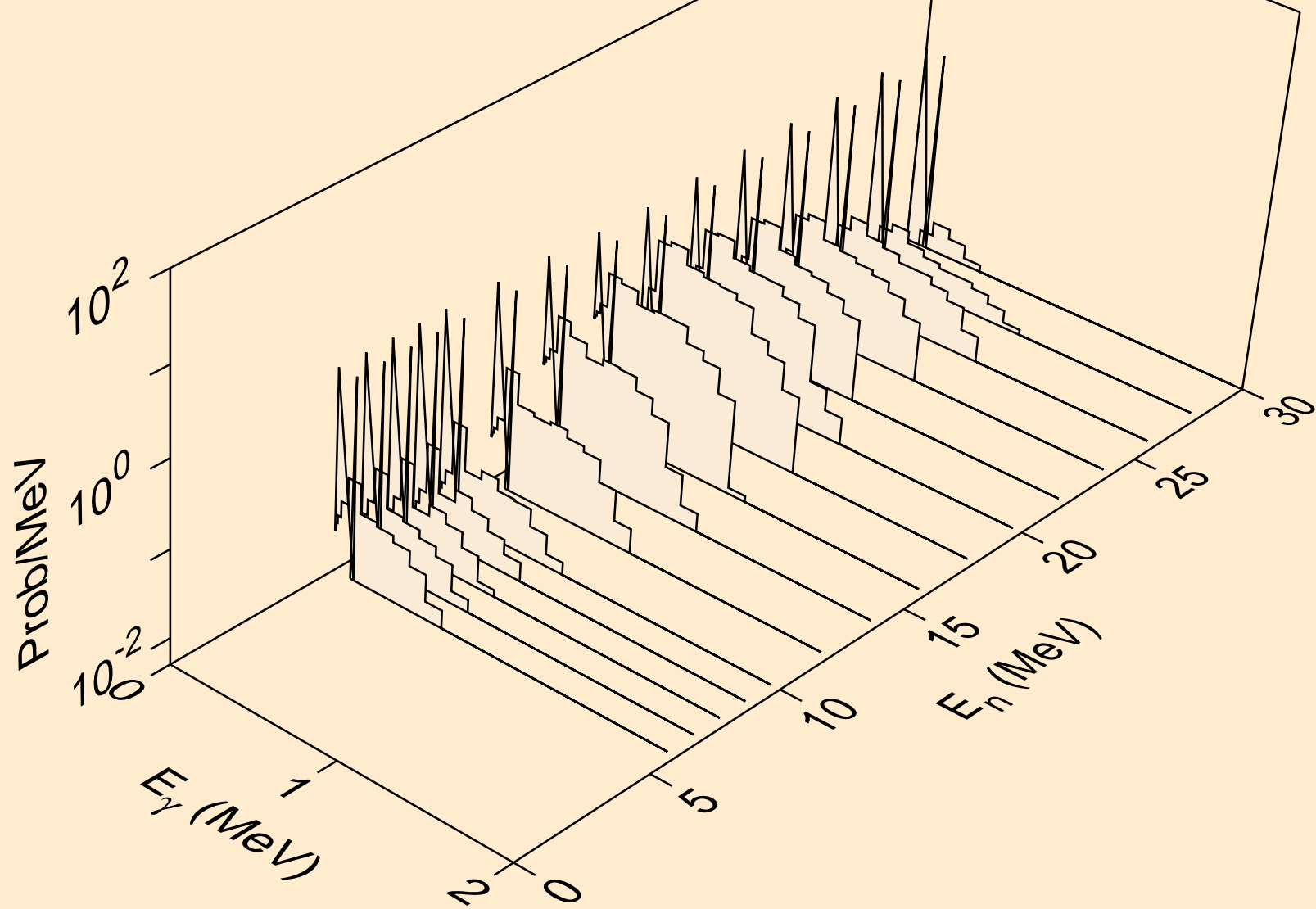

ES239 DEUTERON ACER TENDL-2021 LIBRARY; T=0.K  
Photon emission for (n,t)

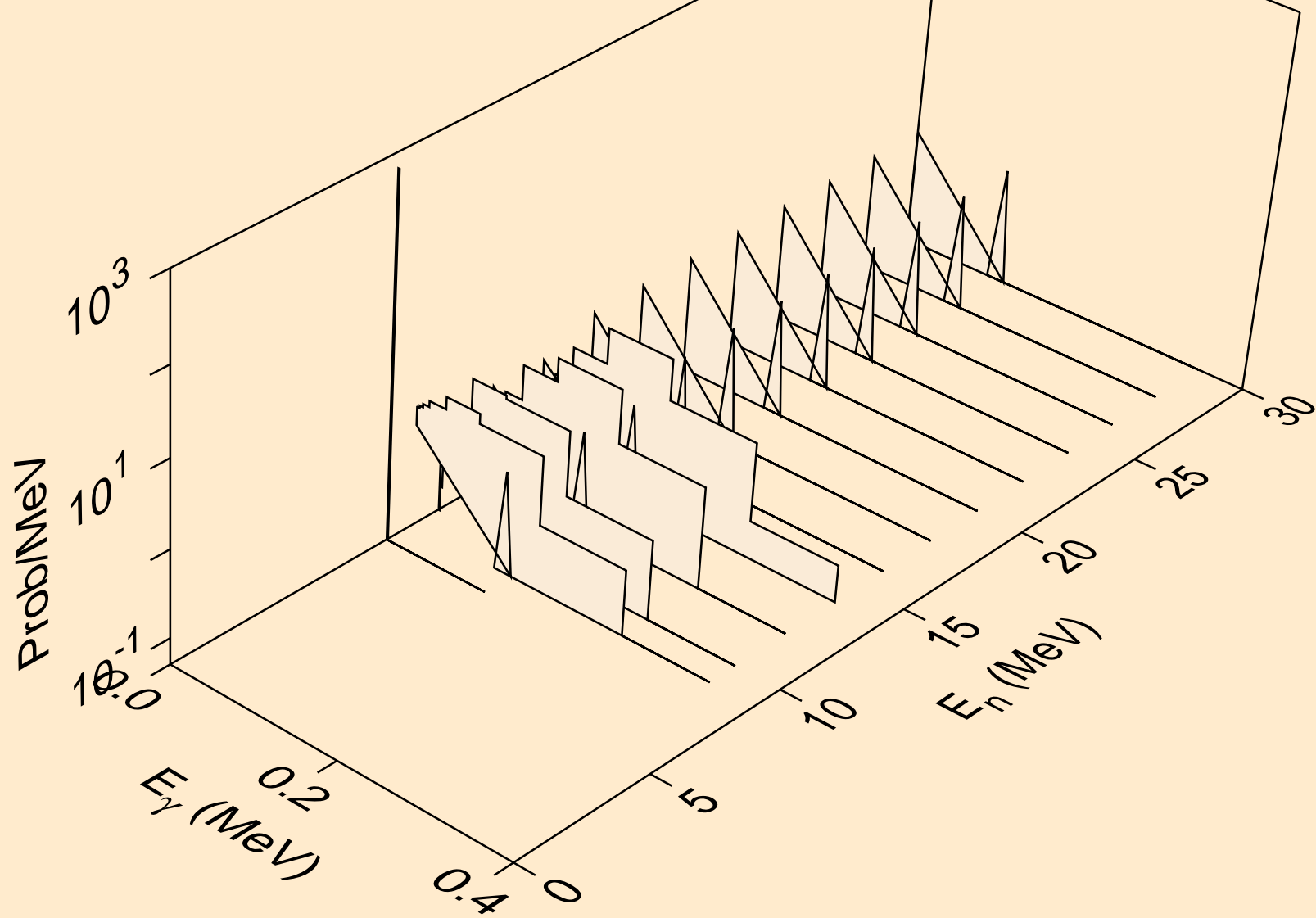



ES239 DEUTERON ACER TENDL-2021 LIBRARY; T=0.K  
Photon emission for (n,he3)

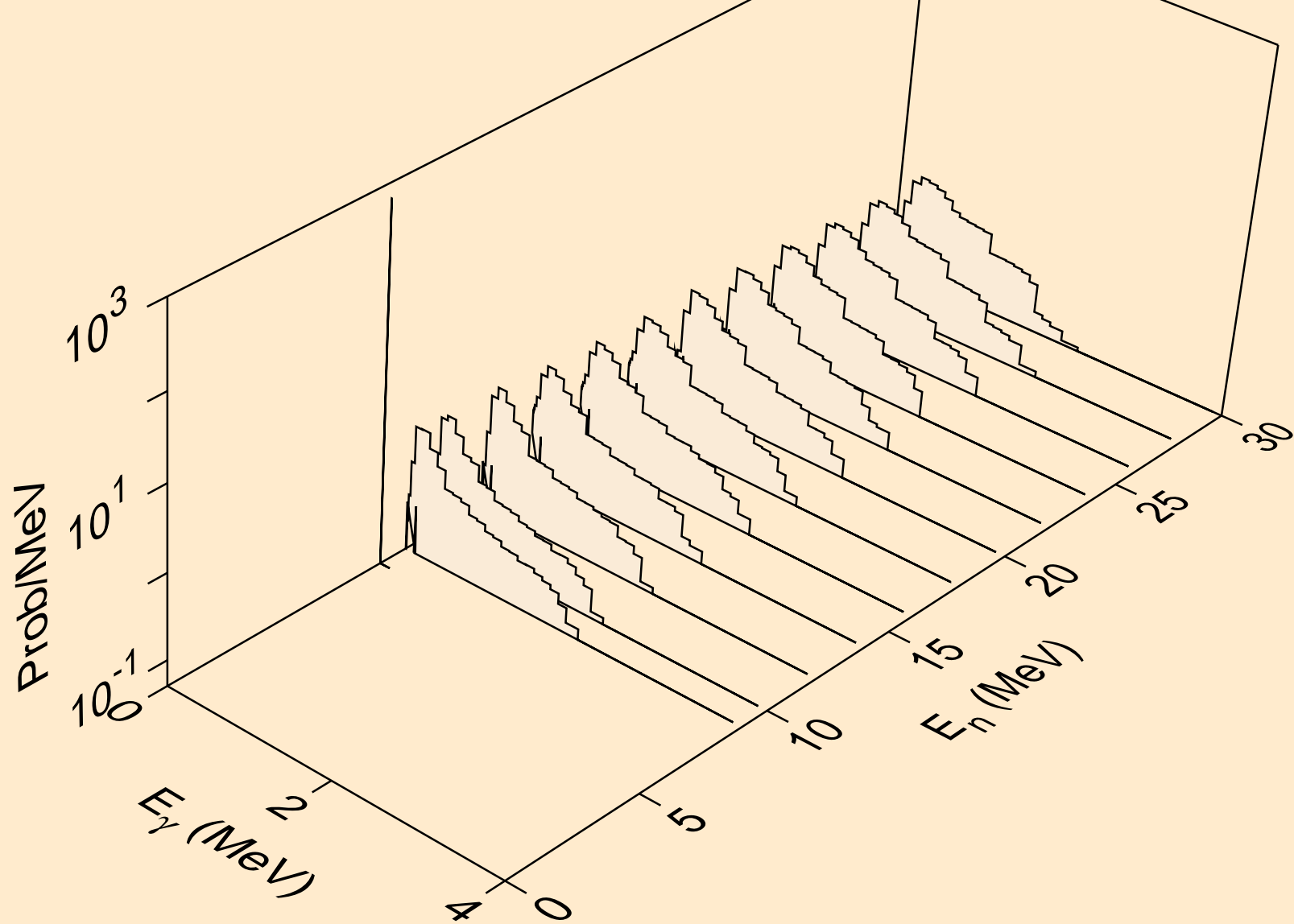

ES239 DEUTERON ACER TENDL-2021 LIBRARY; T=0.K  
Photon emission for (n,a)

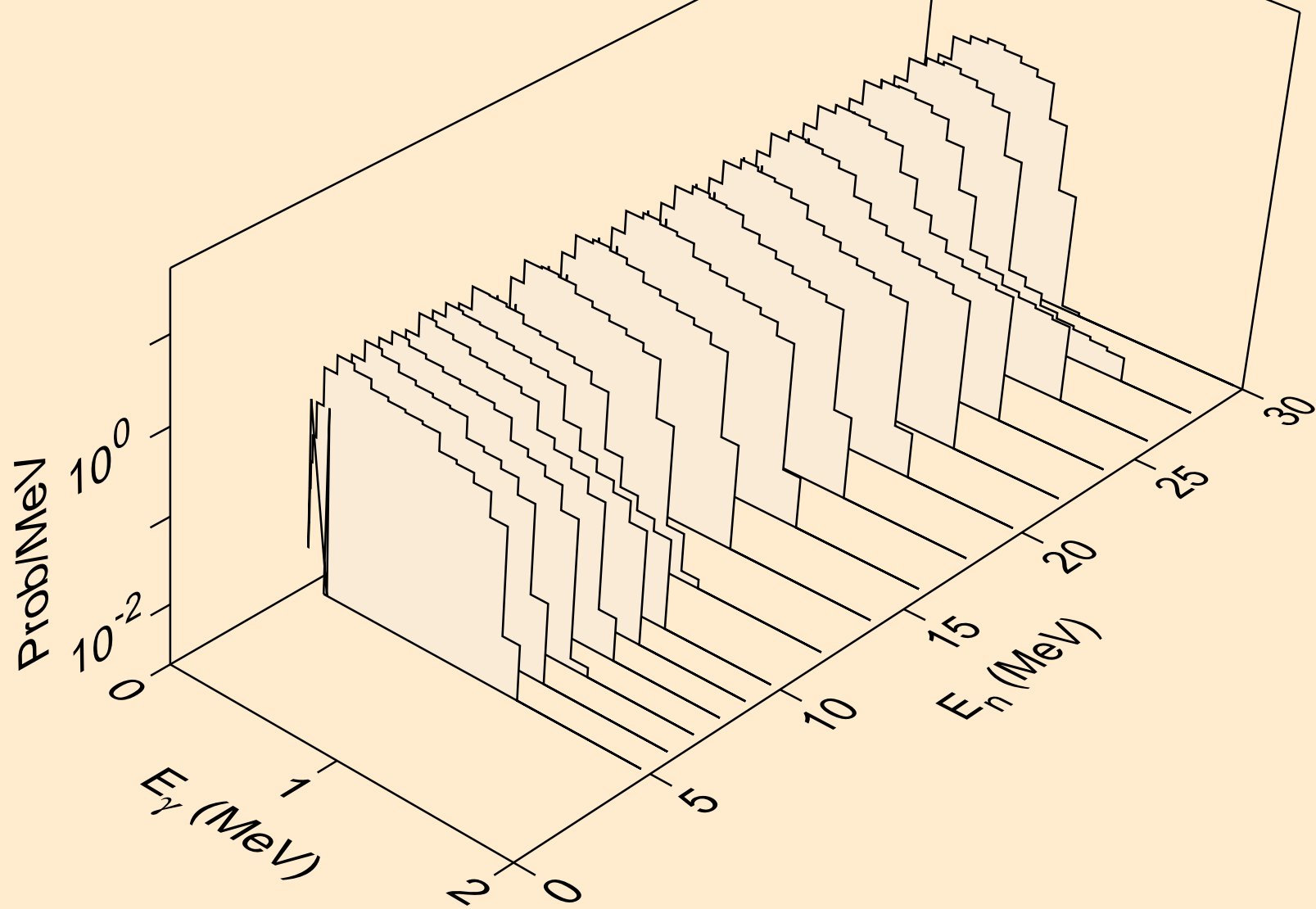

ES239 DEUTERON ACER TENDL-2021 LIBRARY; T=0.K  
Photon emission for (n,2p)

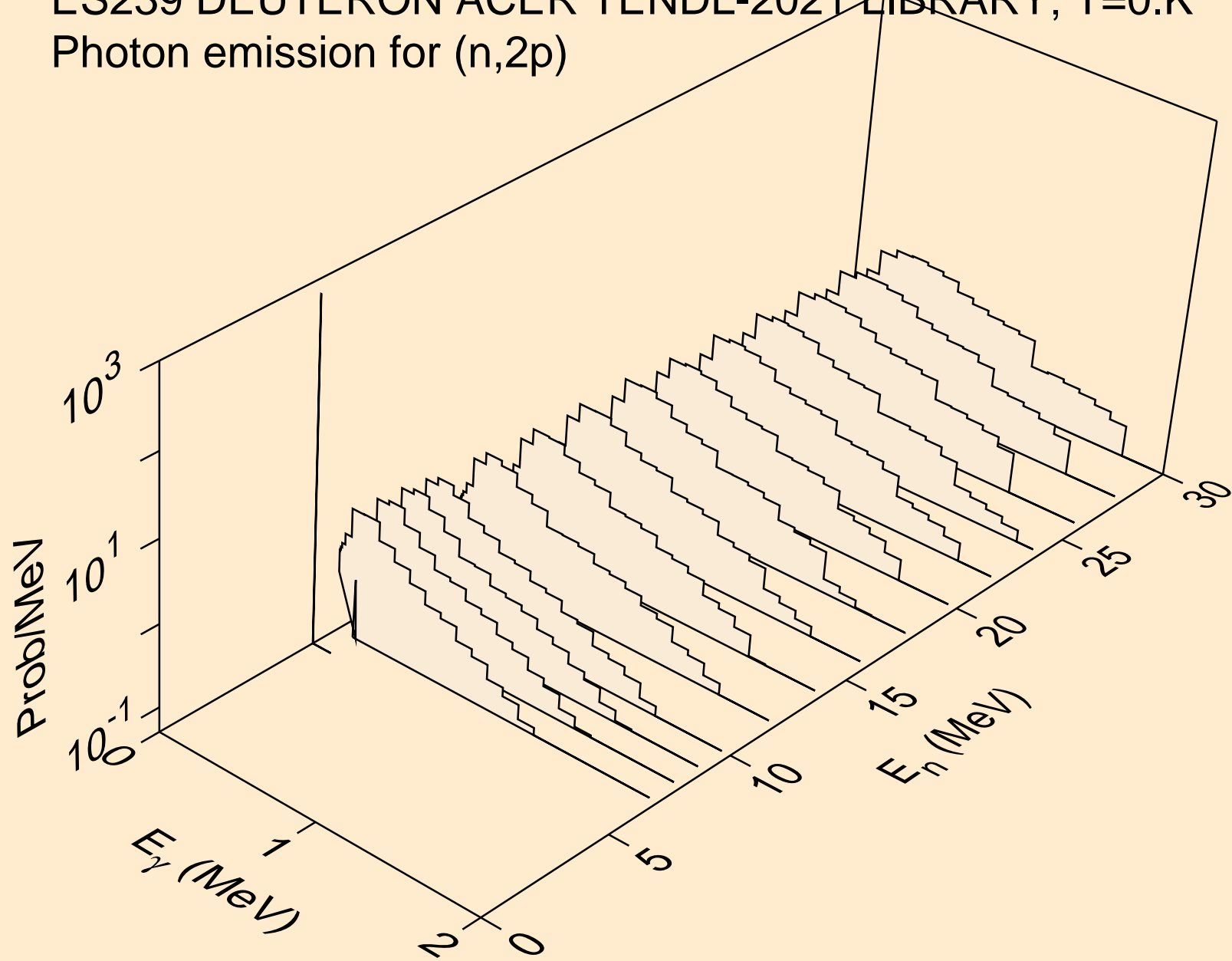

ES239 DEUTERON ACER TENDL-2021 LIBRARY; T=0.K  
Photon emission for (n,p)

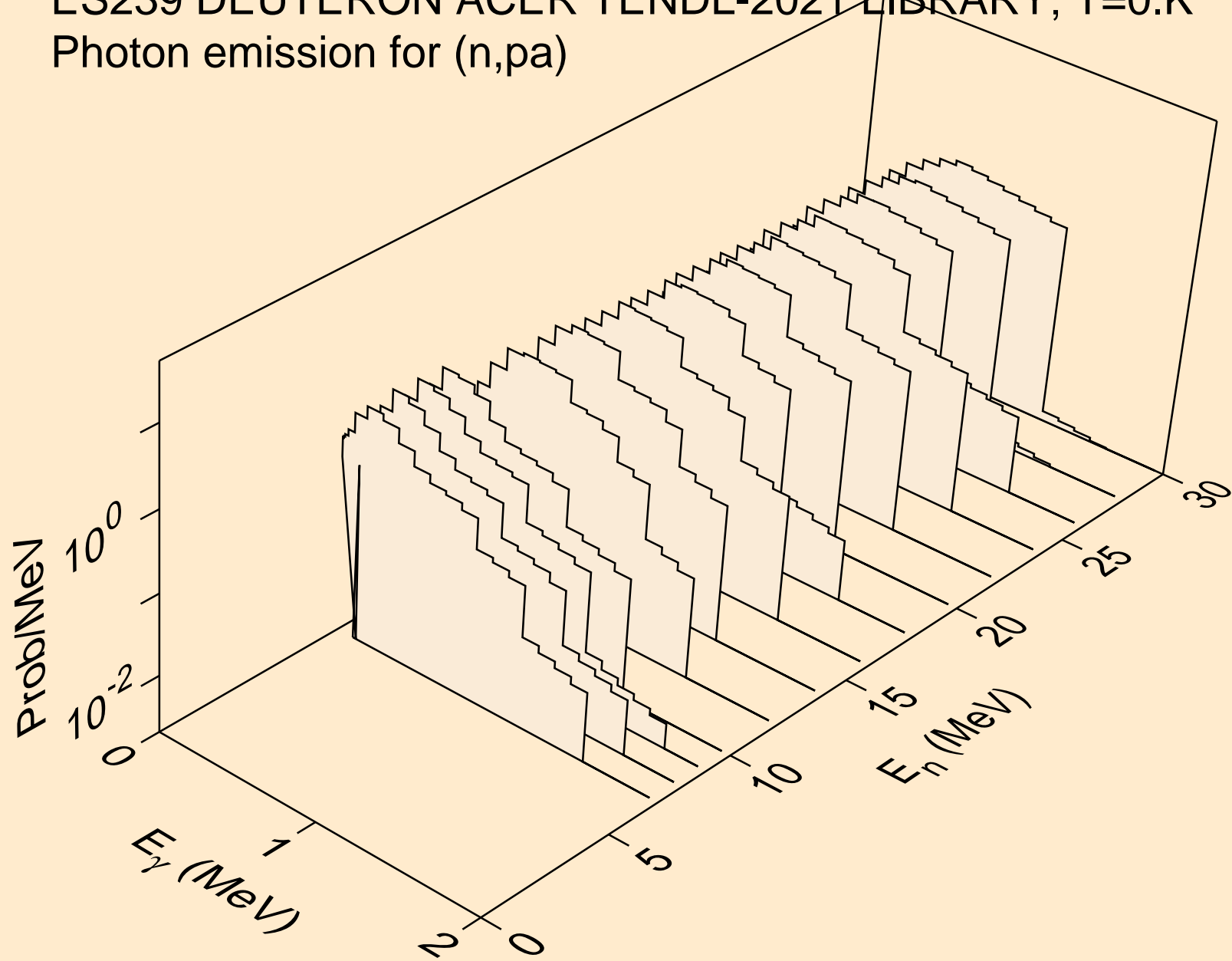

ES239 DEUTERON ACER TENDL-2021 LIBRARY; T=0.K  
Photon emission for (n,pd)

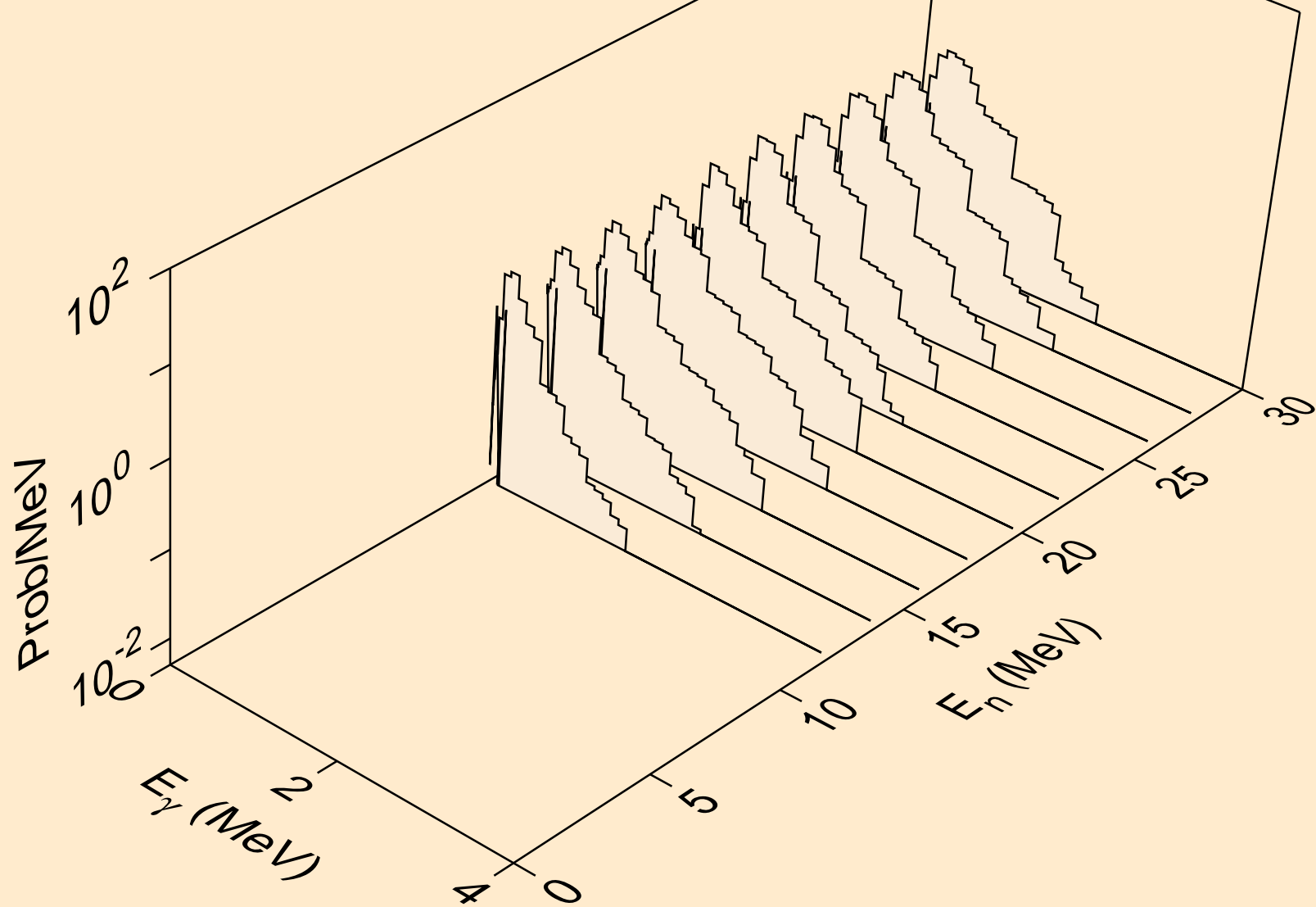

# ES239 DEUTERON ACER TENDL-2021 LIBRARY; T=0.K

## Particle heating contributions

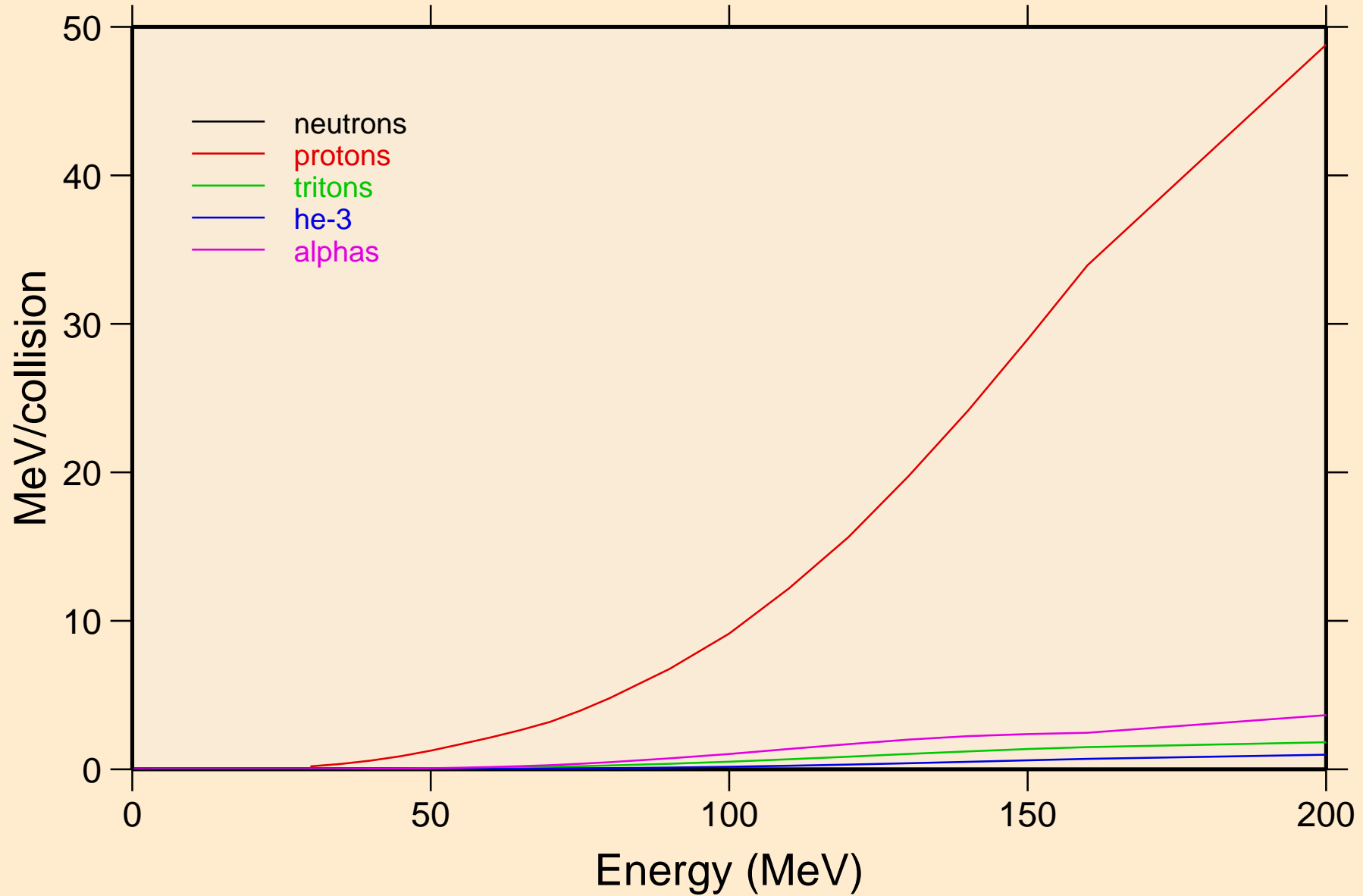

ES239 DEUTERON ACER TENDL-2021 LIBRARY; T=0.K  
Recoil Heating

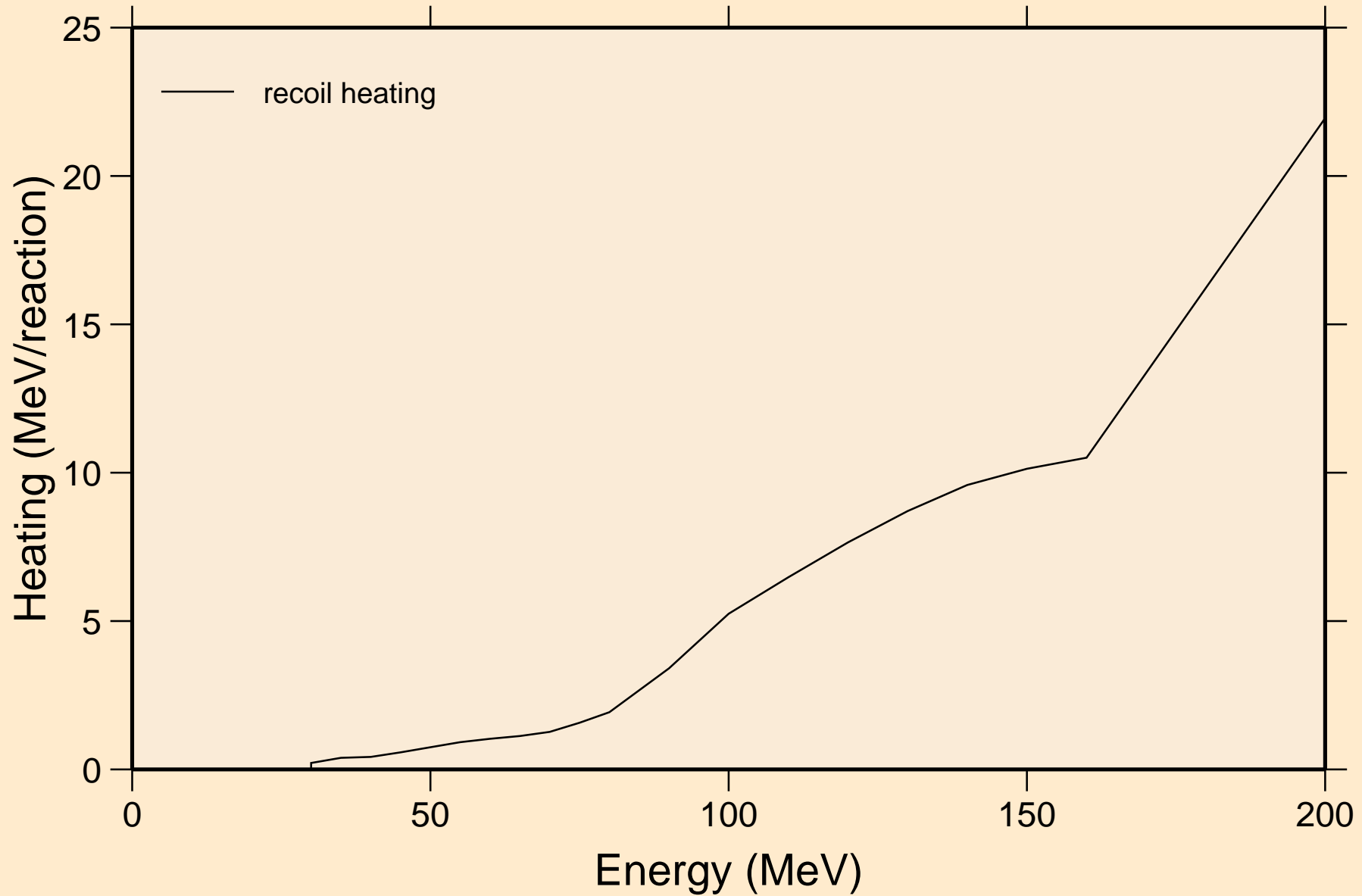

# ES239 DEUTERON ACER TENDL-2021 LIBRARY; T=0.K

## Particle production cross sections

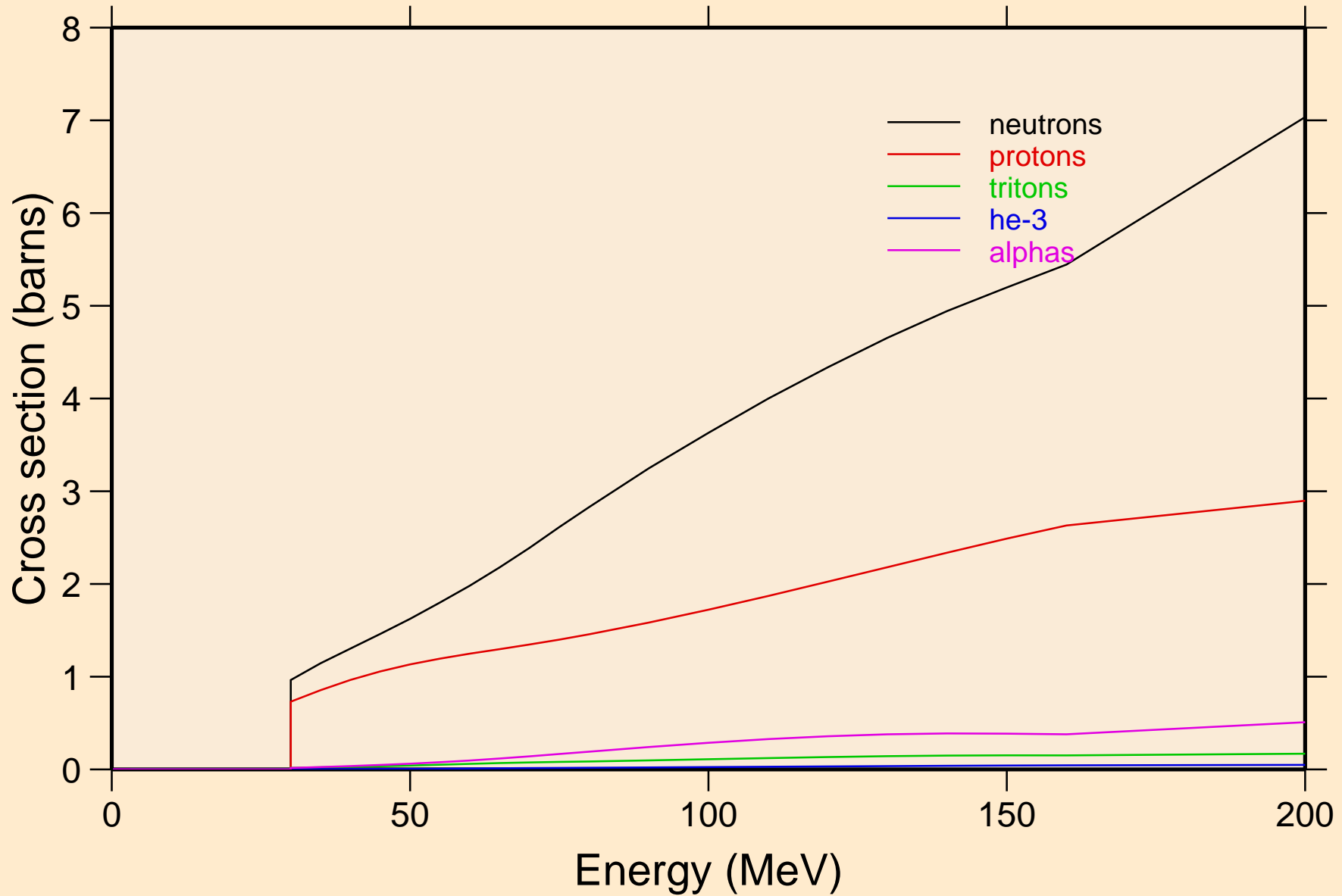



ES239 DEUTERON ACER TENDL-2021 LIBRARY; T=0.K  
neutrons from (d,n)

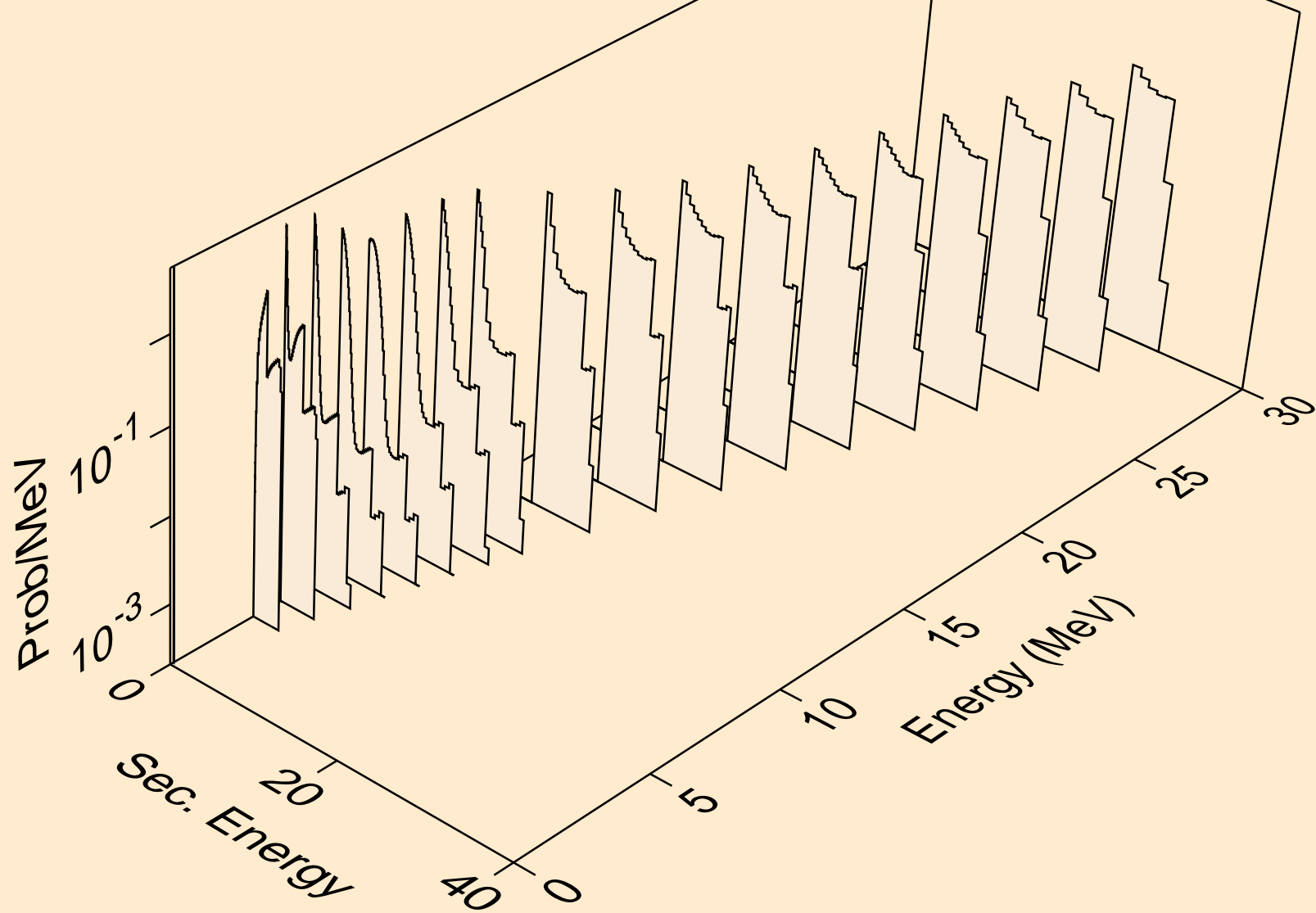

ES239 DEUTERON ACER TENDL-2021 LIBRARY; T=0.K  
neutrons from (d,x)

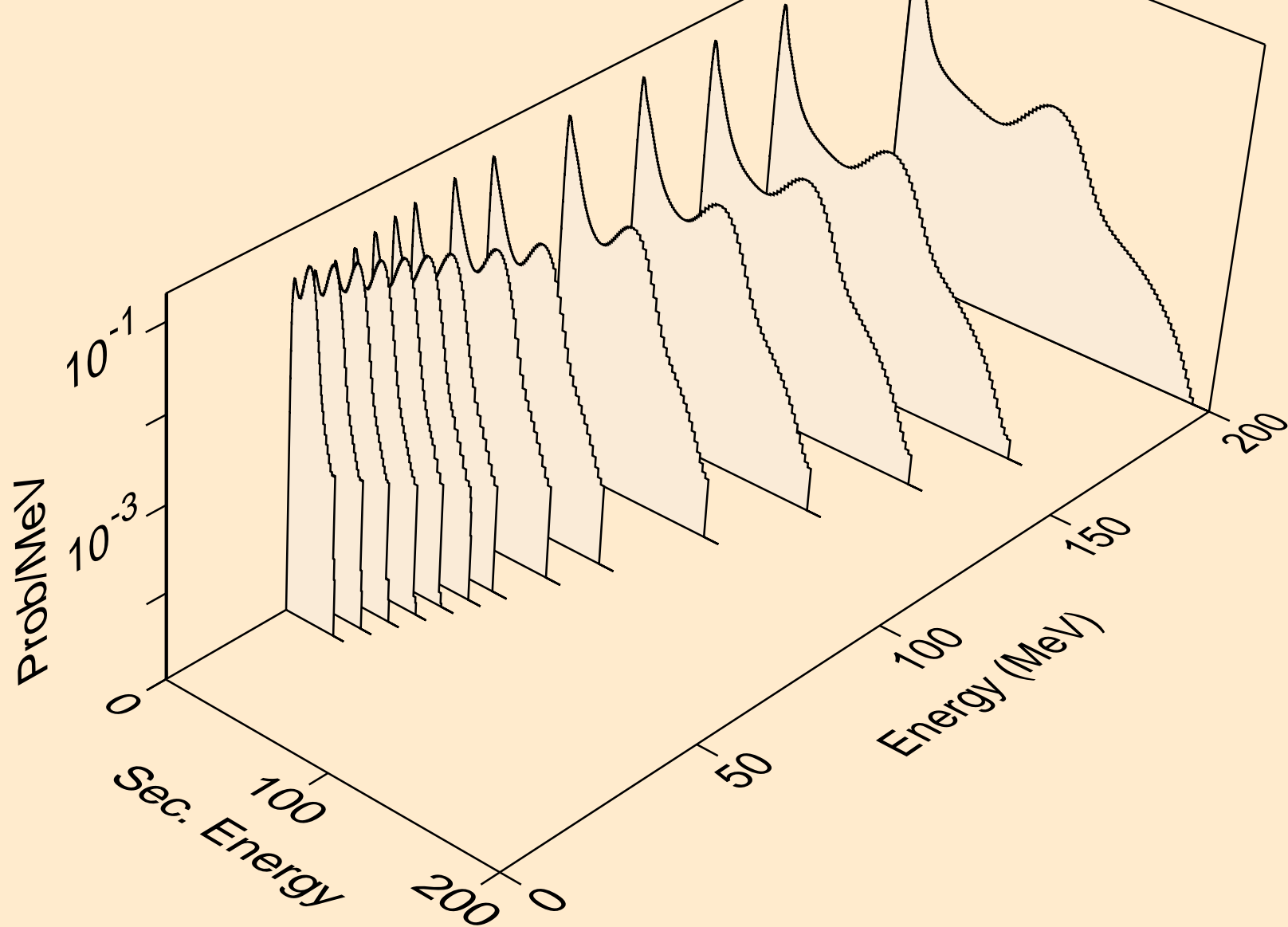

ES239 DEUTERON ACER TENDL-2021 LIBRARY; T=0.K  
neutrons from (d,2n)

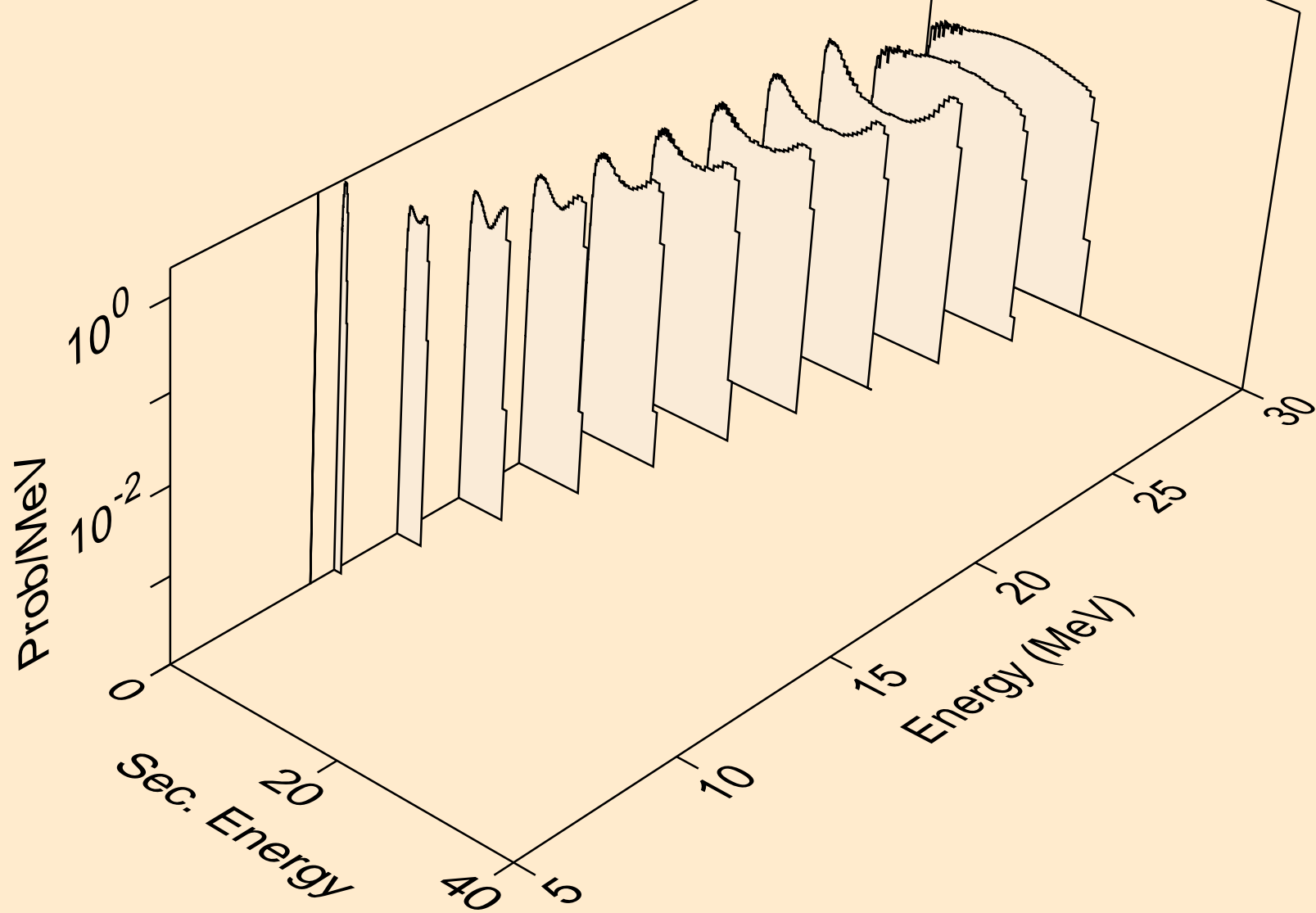

ES239 DEUTERON ACER TENDL-2021 LIBRARY; T=0.K  
neutrons from (d,3n)

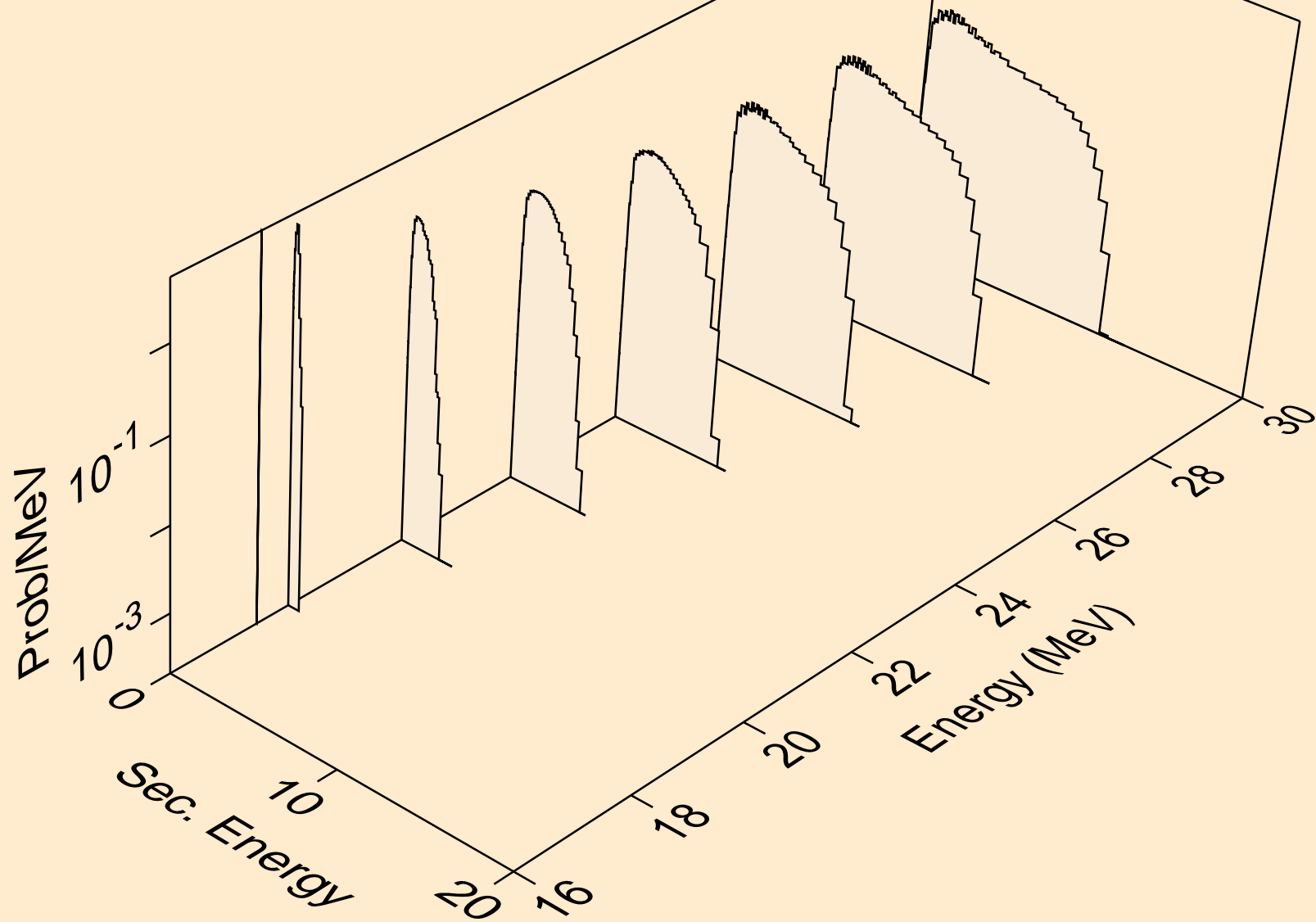

ES239 DEUTERON ACER TENDL-2021 LIBRARY; T=0.K  
neutrons from (d,n\*)a

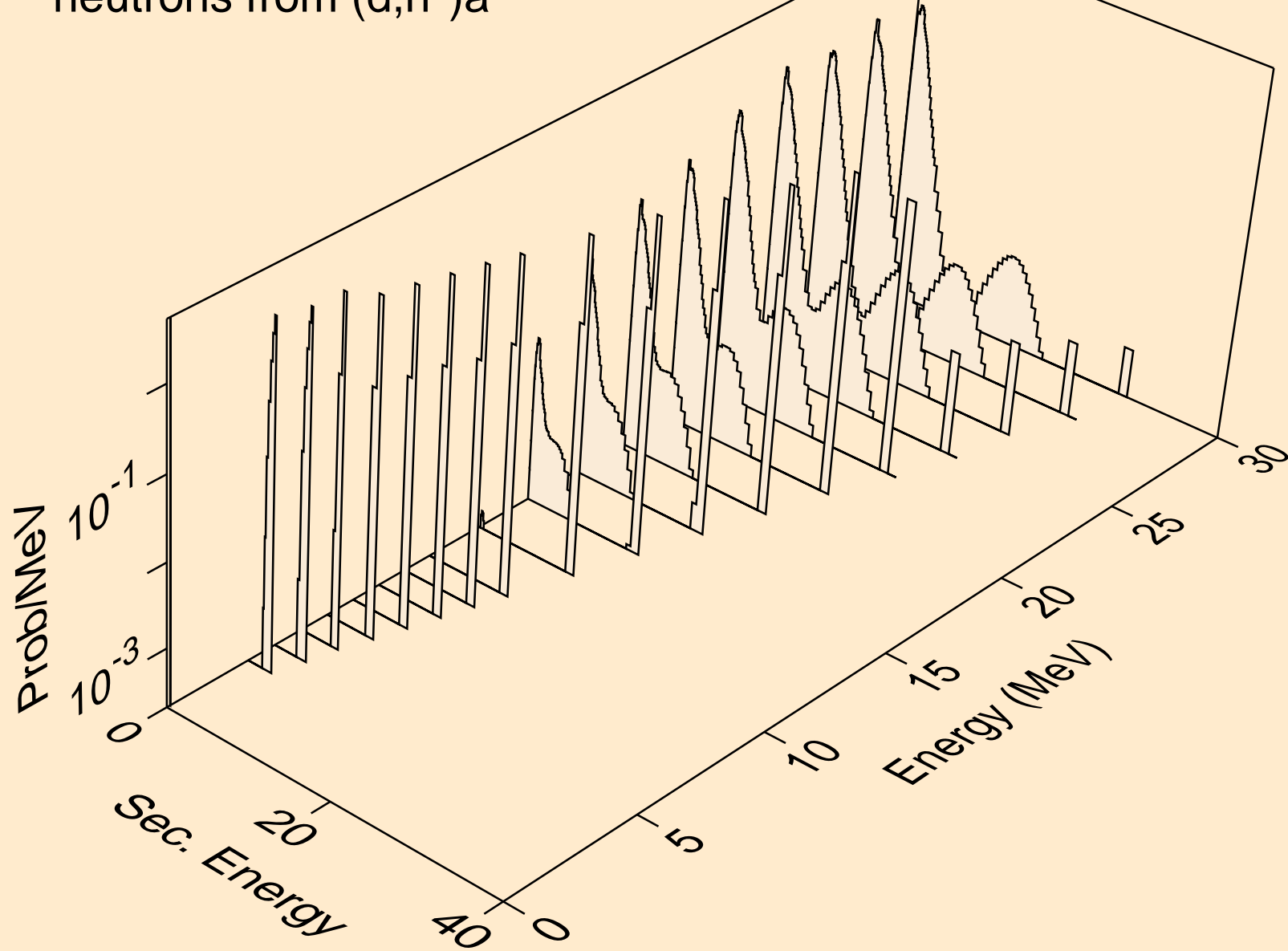

ES239 DEUTERON ACER TENDL-2021 LIBRARY; T=0.K  
neutrons from (d,n\*)p

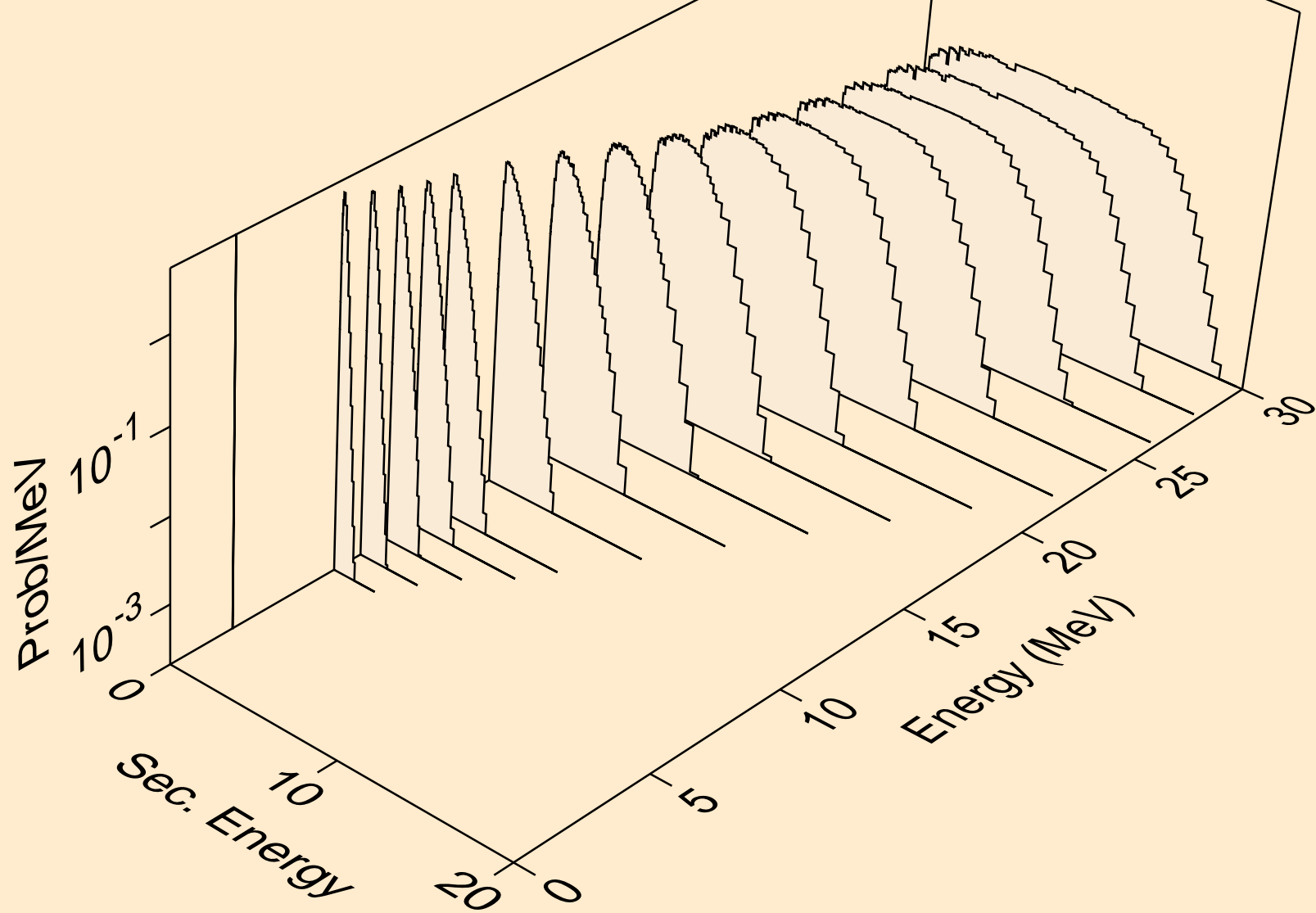

ES239 DEUTERON ACER TENDL-2021 LIBRARY; T=0.K  
neutrons from (d,2np)

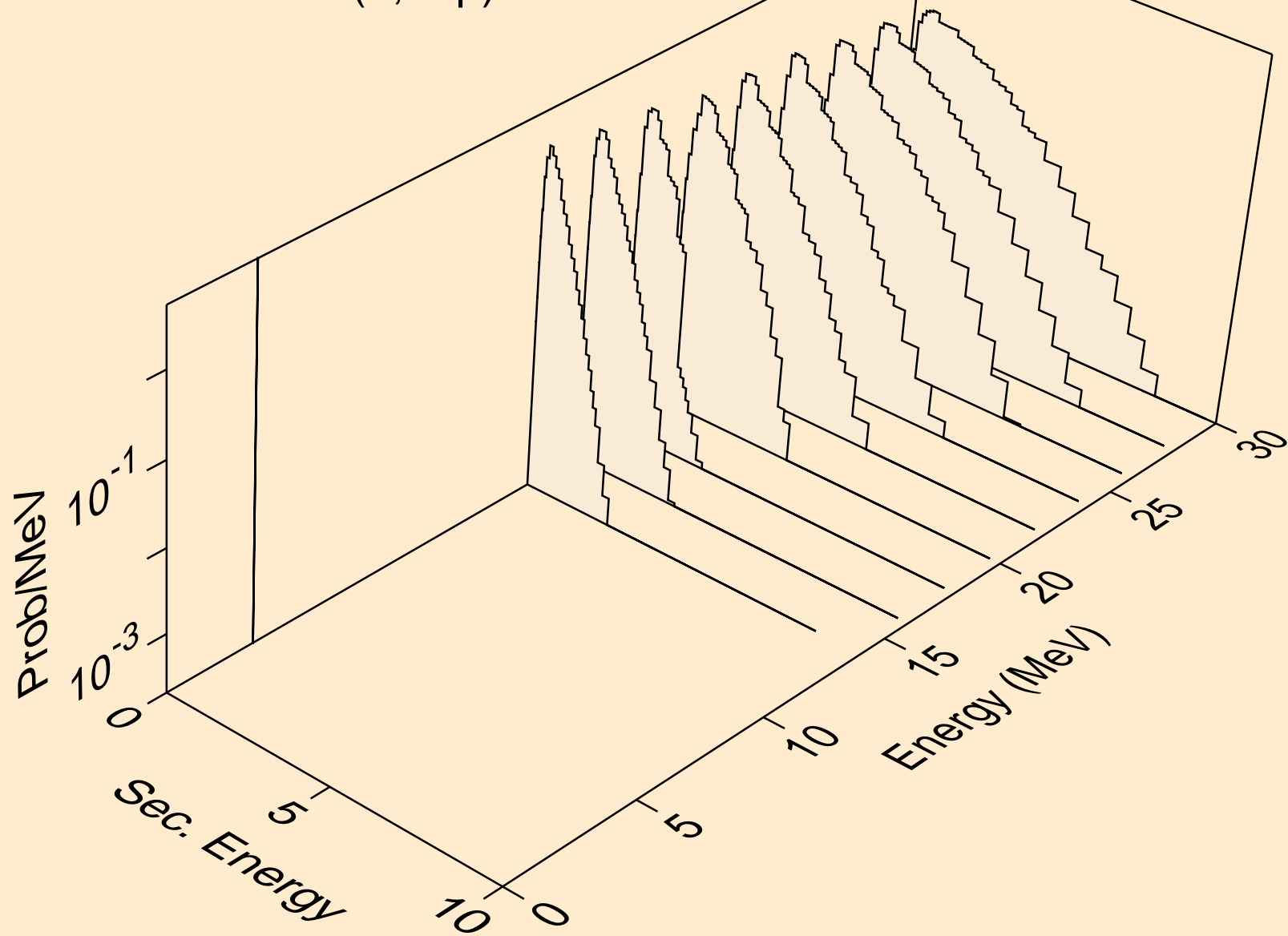

ES239 DEUTERON ACER TENDL-2021 LIBRARY; T=0.K  
protons from (d,x)

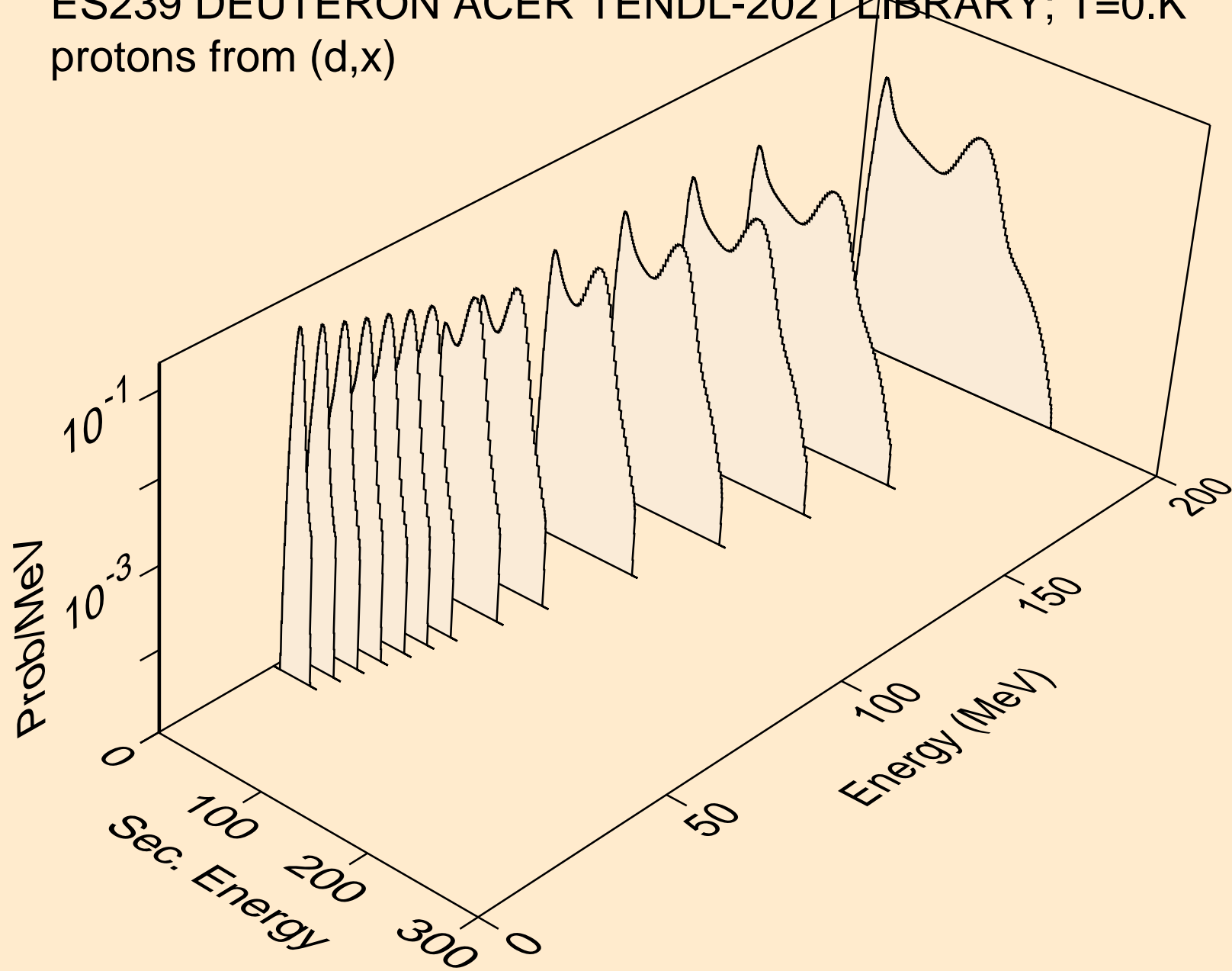



ES239 DEUTERON ACER TENDL-2021 LIBRARY; T=0.K  
protons from (d,n\*)p

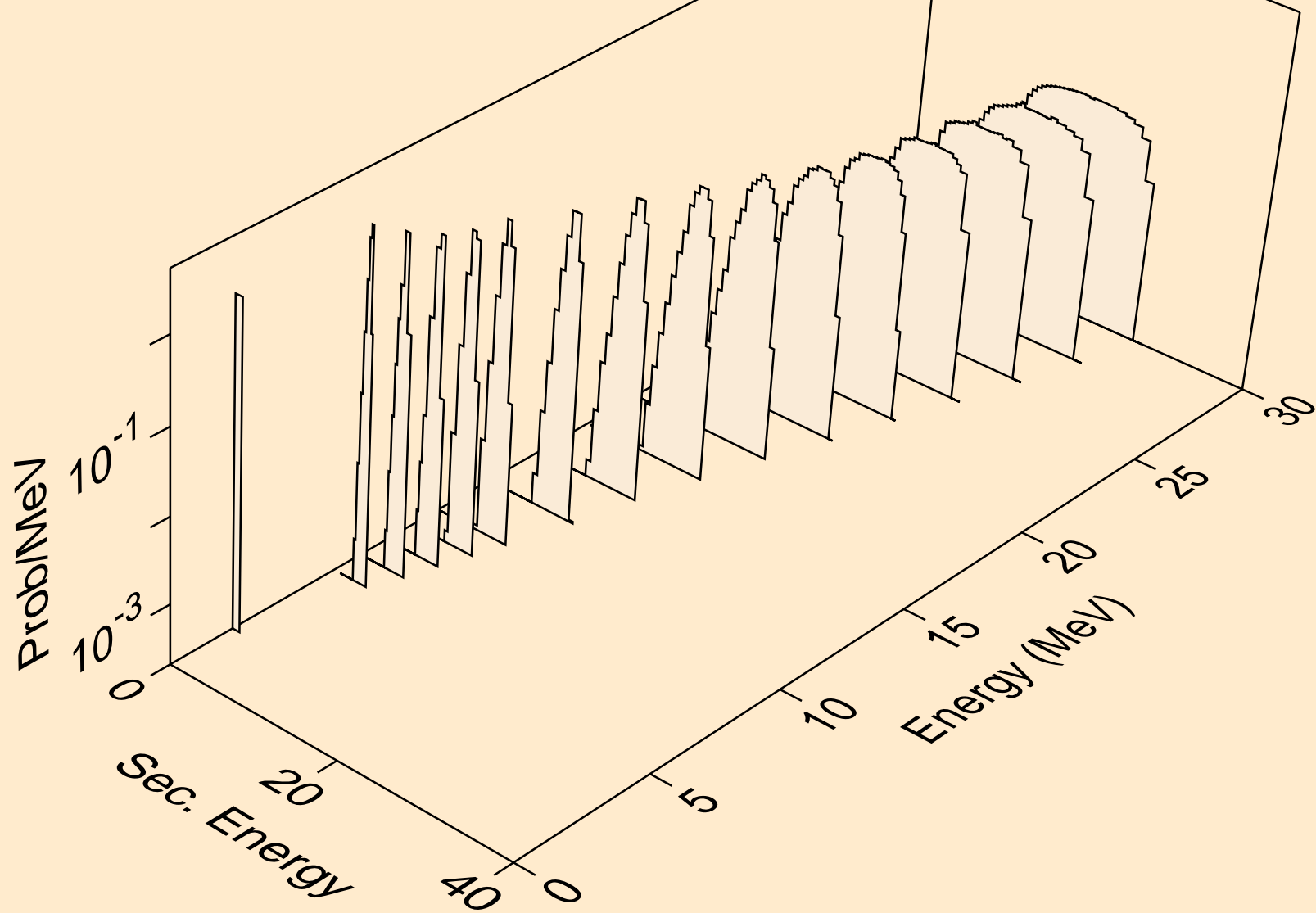

ES239 DEUTERON ACER TENDL-2021 LIBRARY; T=0.K  
protons from (d,2np)

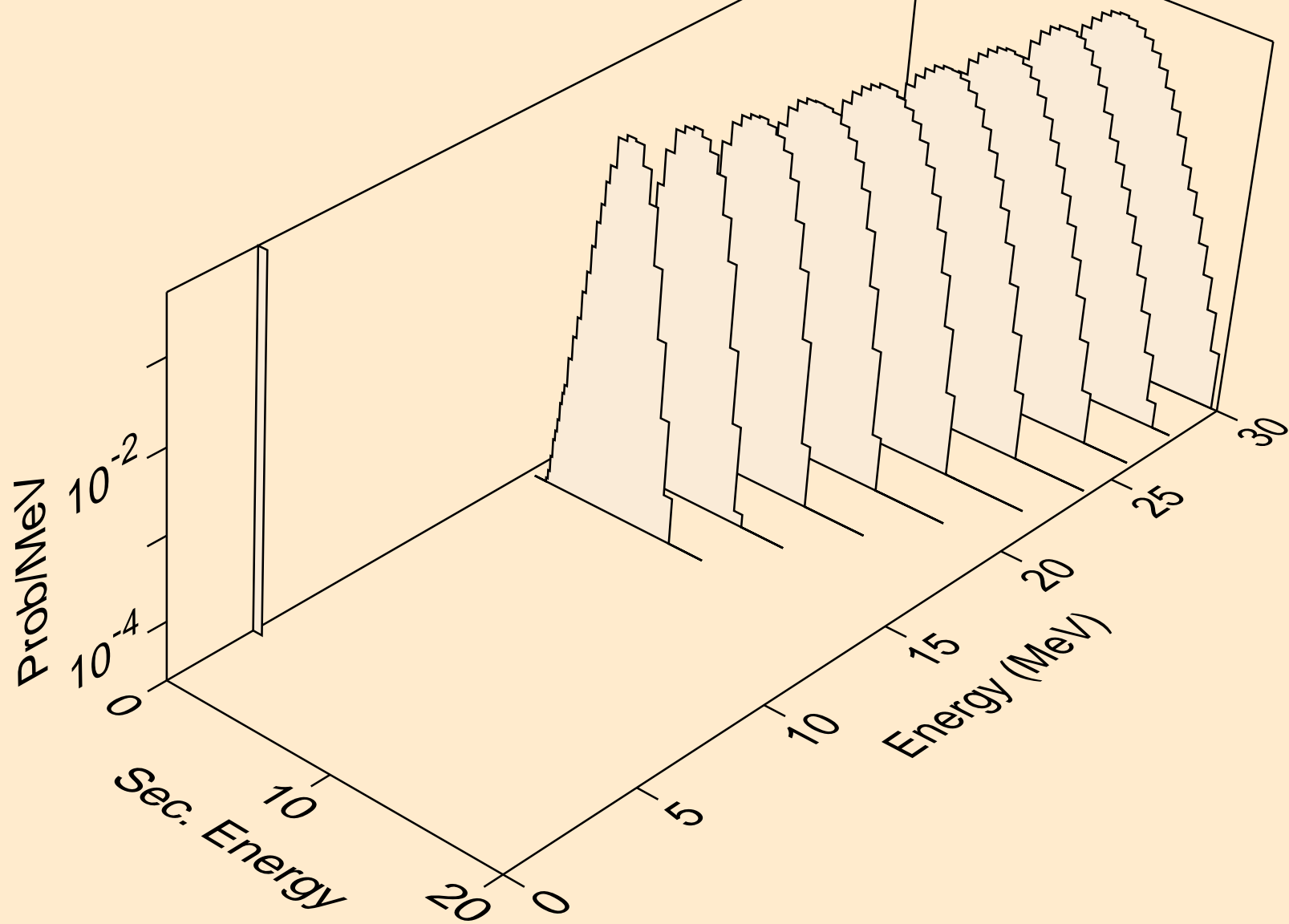

ES239 DEUTERON ACER TENDL-2021 LIBRARY; T=0.K  
protons from (d,p)

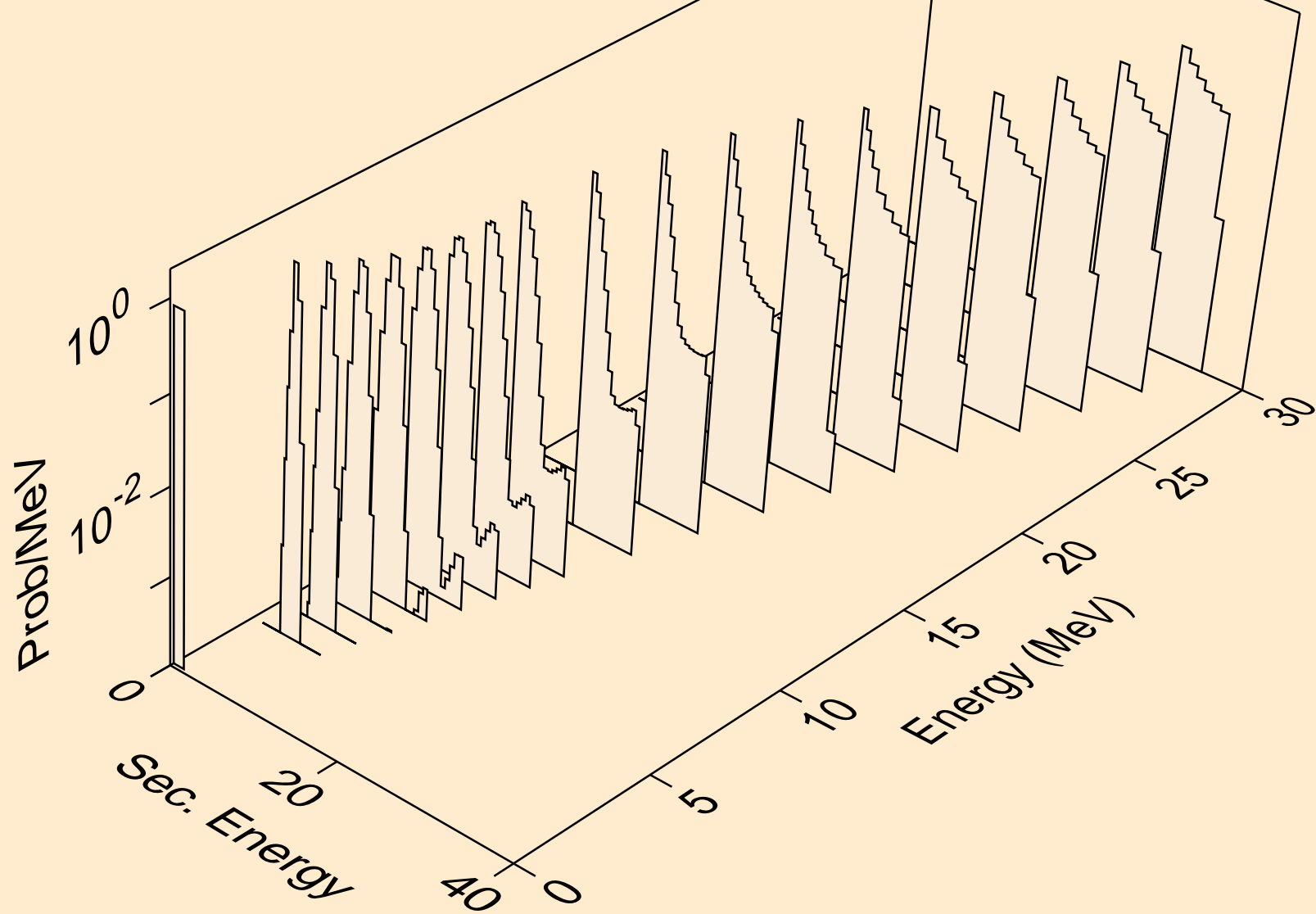

ES239 DEUTERON ACER TENDL-2021 LIBRARY; T=0.K  
protons from (d,2p)

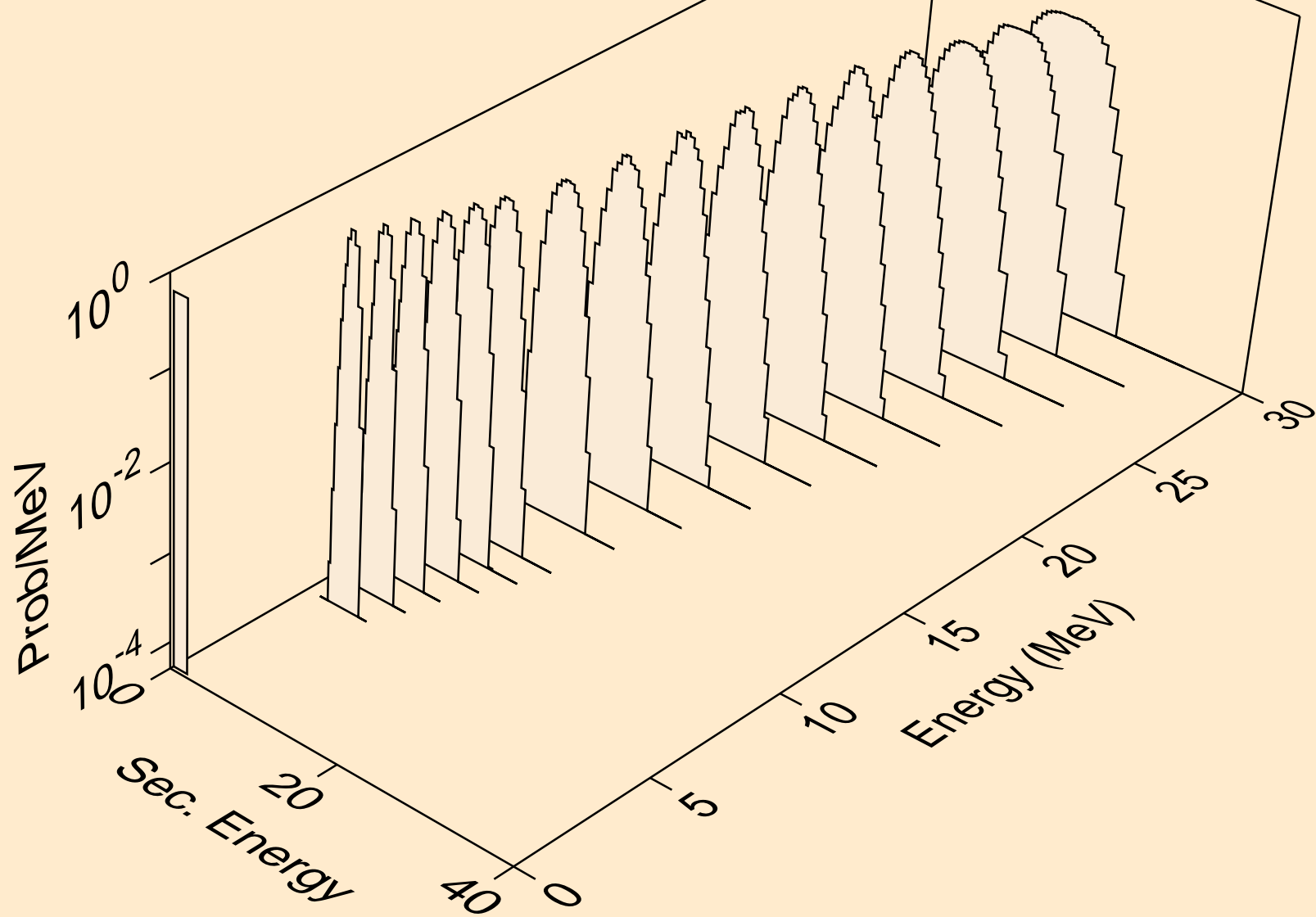

ES239 DEUTERON ACER TENDL-2021 LIBRARY; T=0.K  
protons from (d,pa)

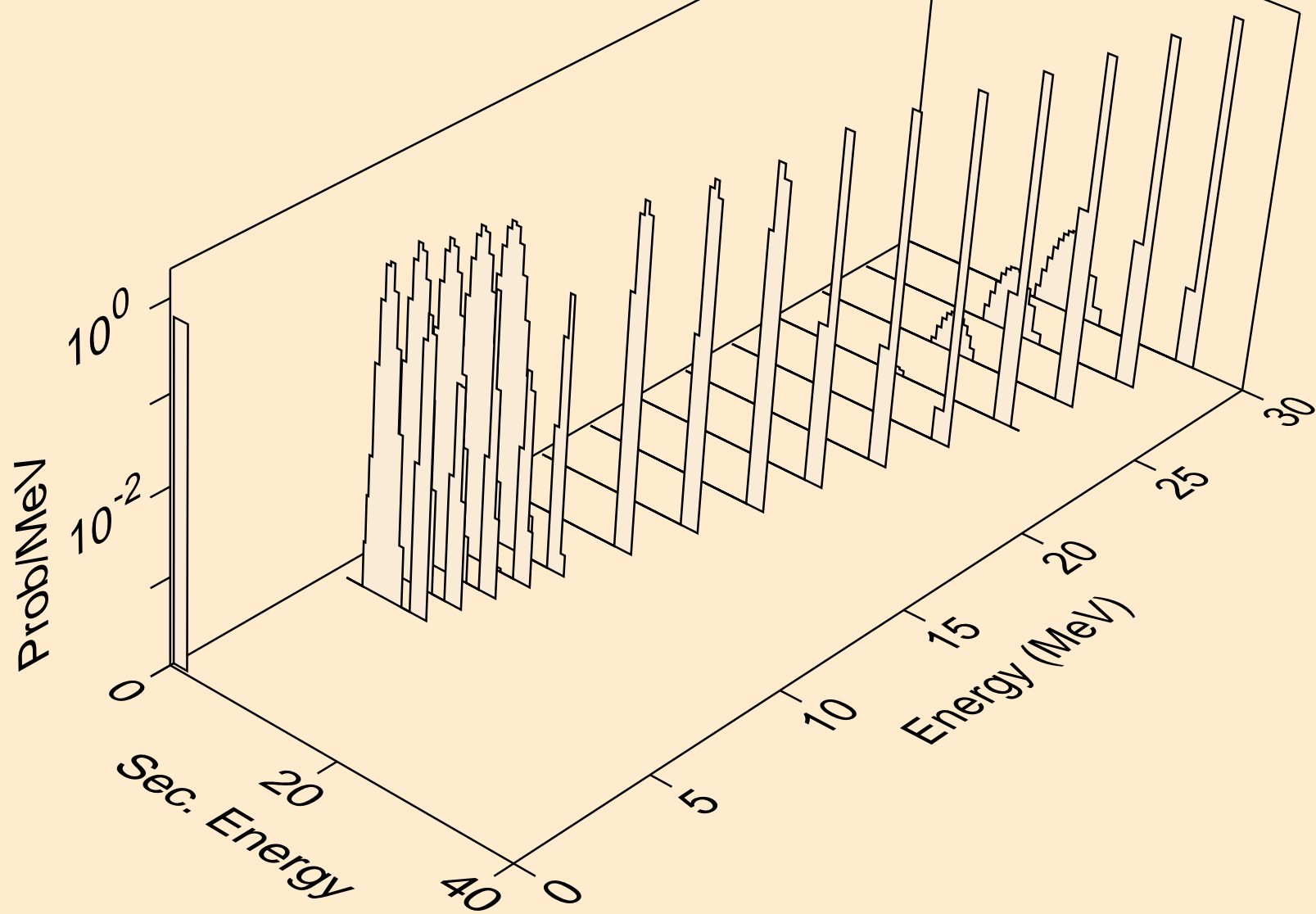

ES239 DEUTERON ACER TENDL-2021 LIBRARY; T=0.K  
protons from (d,pd)

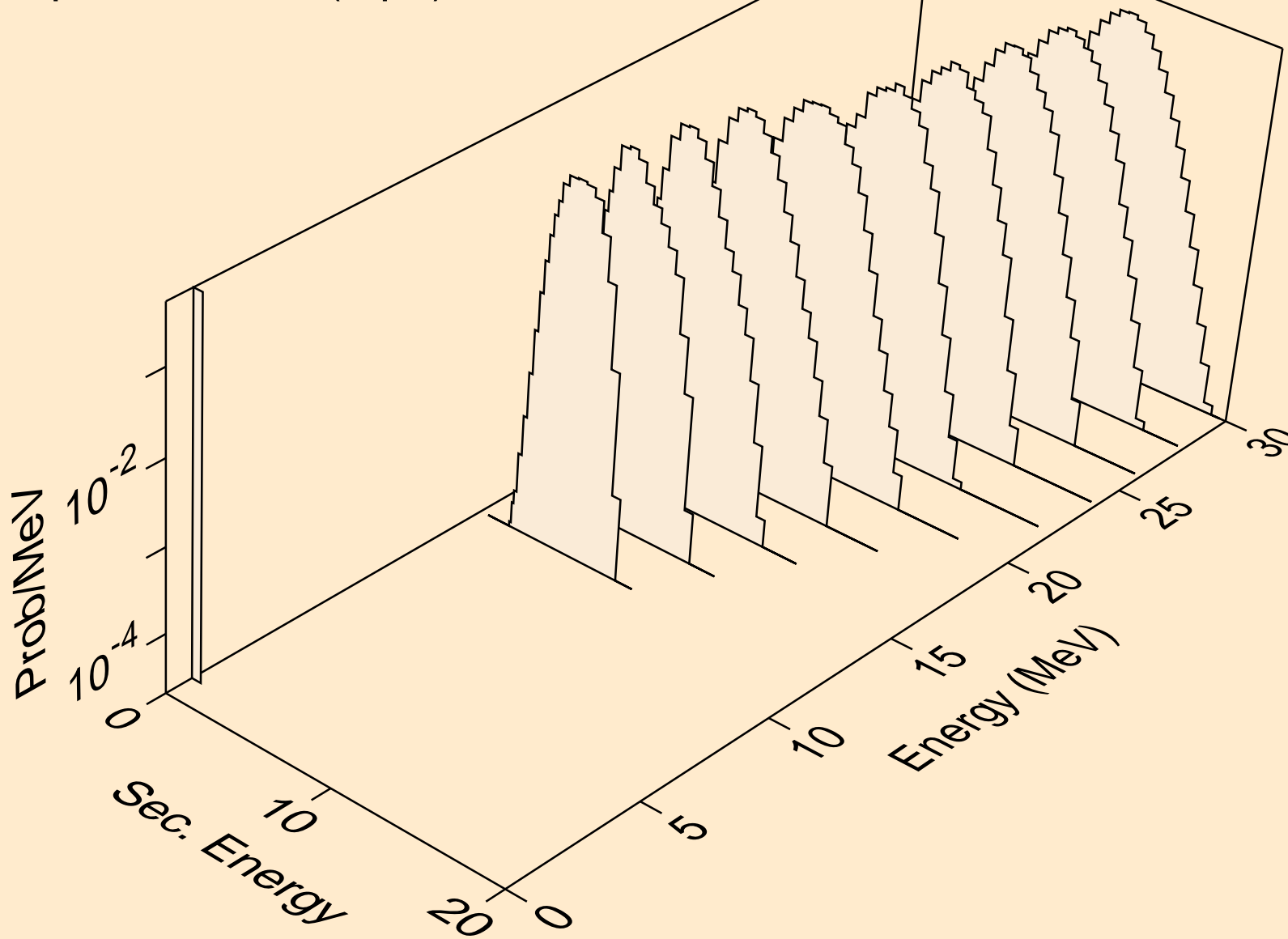

ES239 DEUTERON ACER TENDL-2021 LIBRARY; T=0.K  
tritons from (d,x)

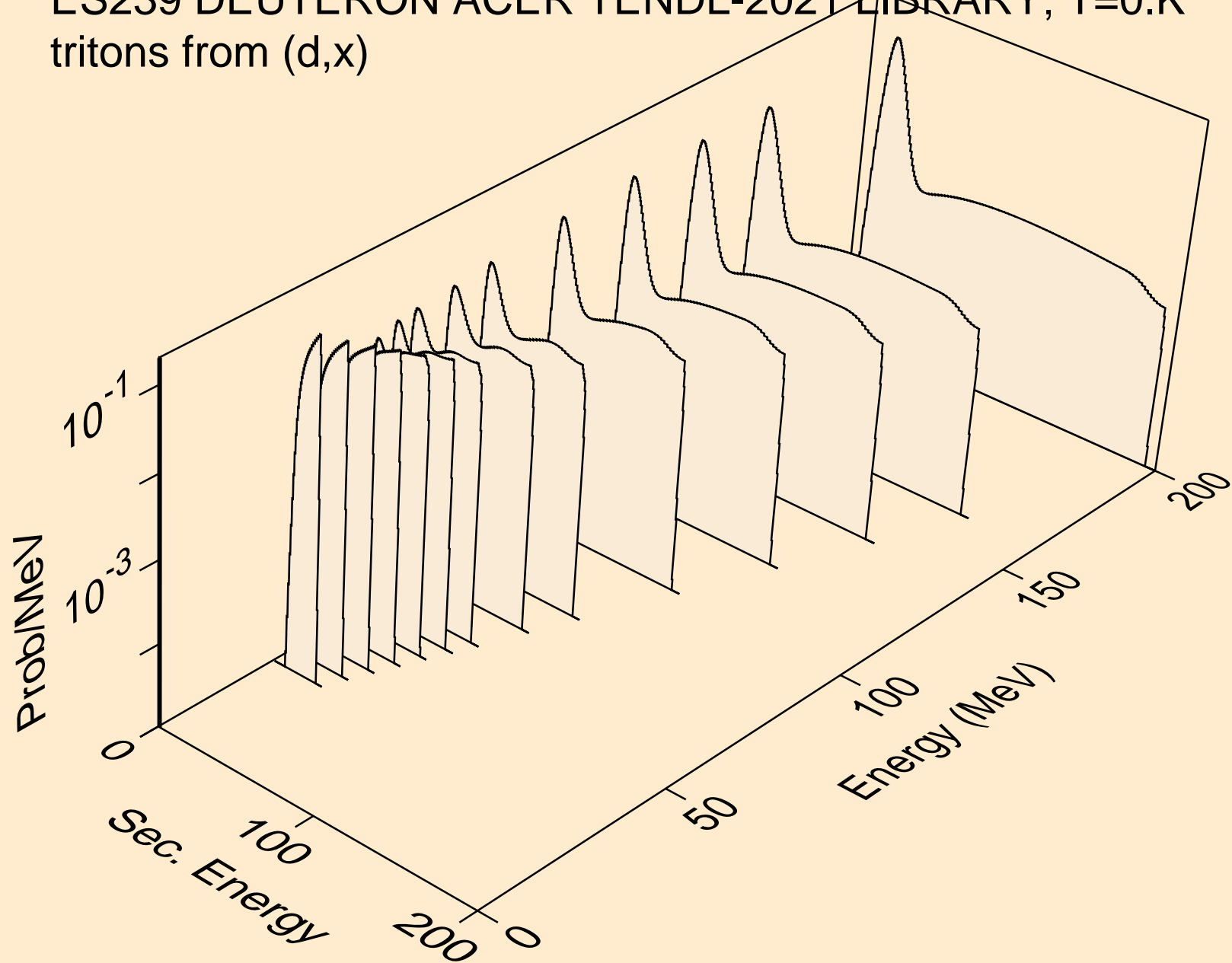

ES239 DEUTERON ACER TENDL-2021 LIBRARY; T=0.K  
tritons from (d,t)

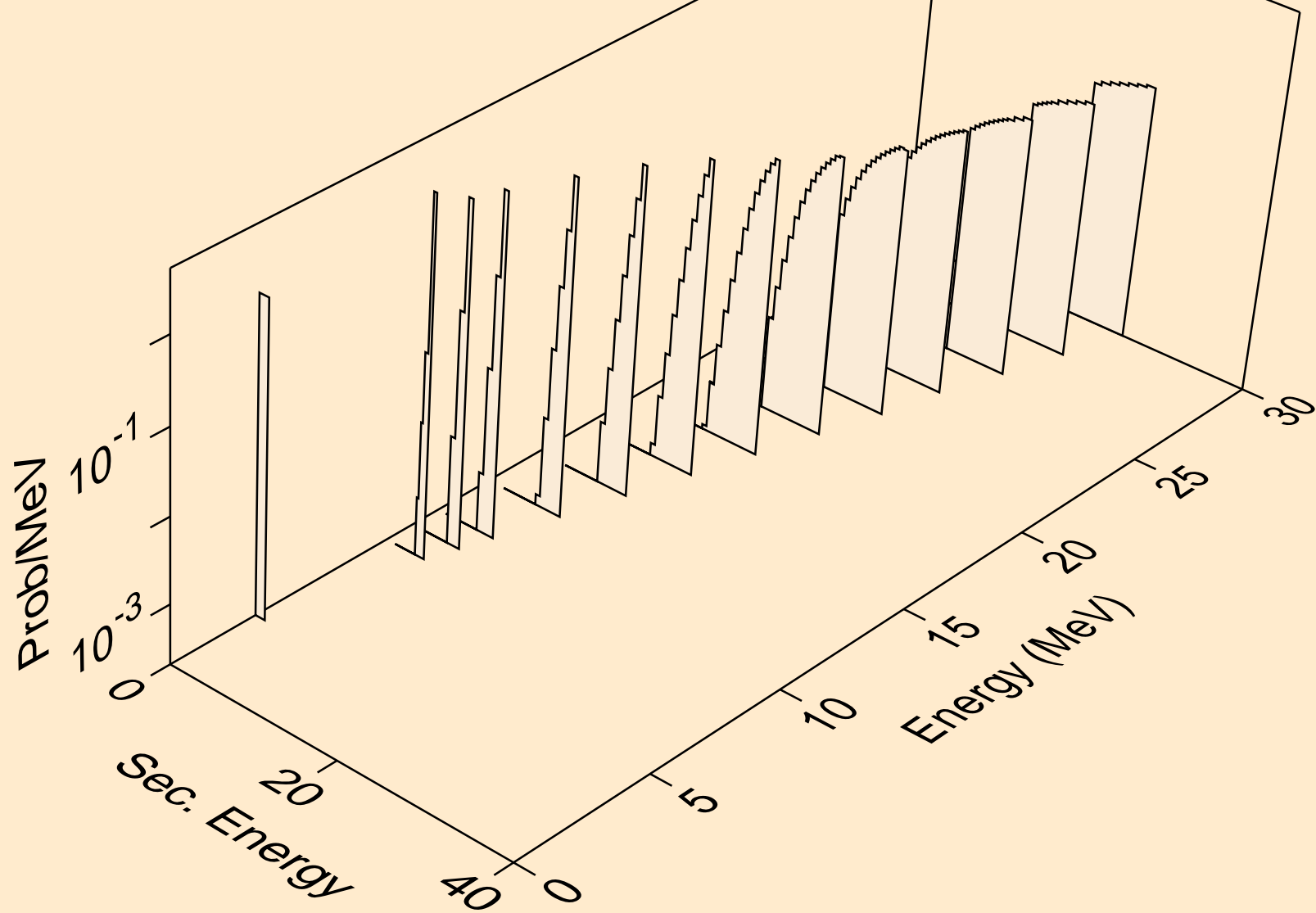



ES239 DEUTERON ACER TENDL-2021 LIBRARY; T=0.K  
he3s from (d,x)

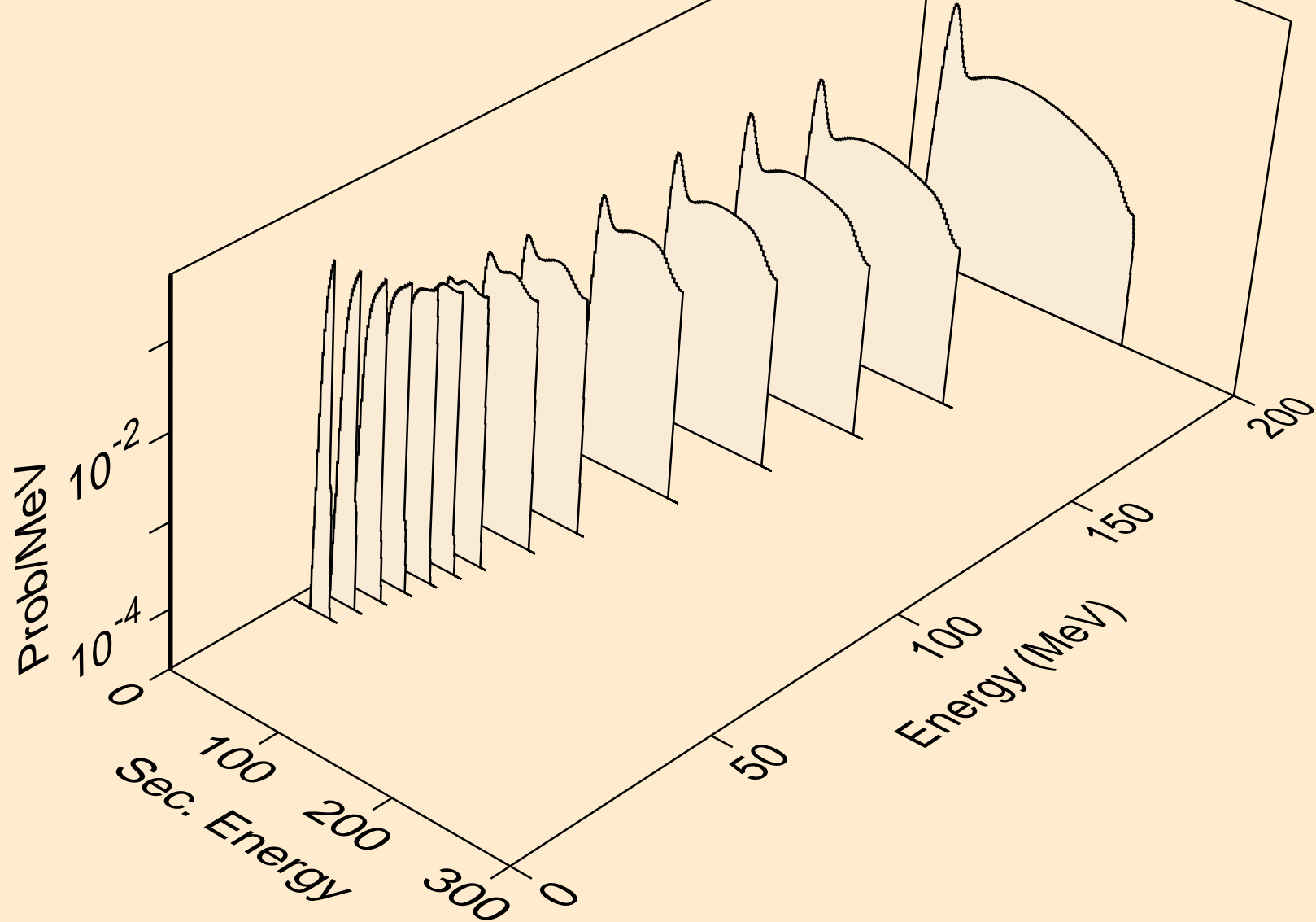

ES239 DEUTERON ACER TENDL-2021 LIBRARY; T=0.K  
he3s from (d,he3)

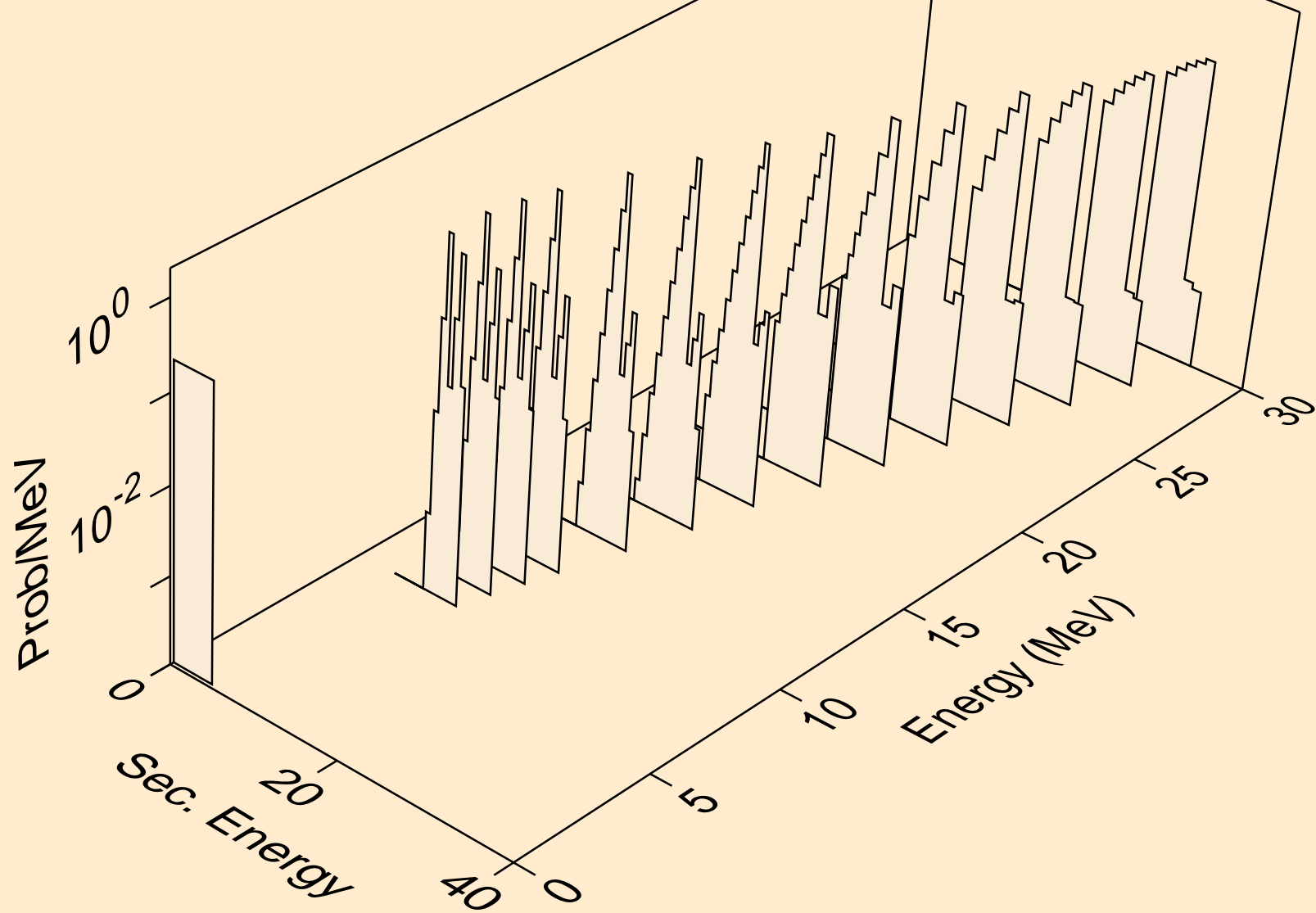

ES239 DEUTERON ACER TENDL-2021 LIBRARY; T=0.K  
alphas from (d,x)

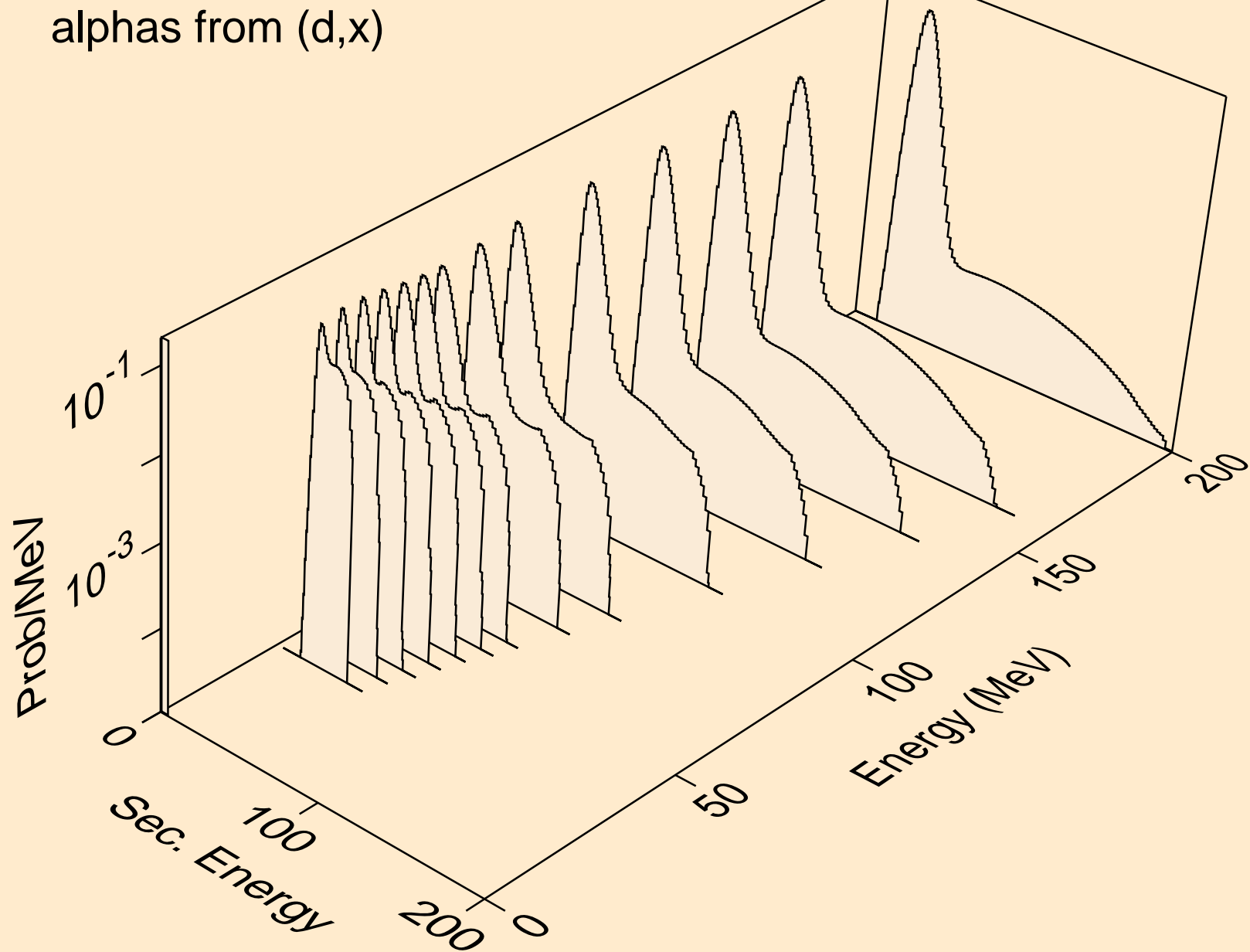

ES239 DEUTERON ACER TENDL-2021 LIBRARY; T=0.K  
alphas from (d,n\*)a

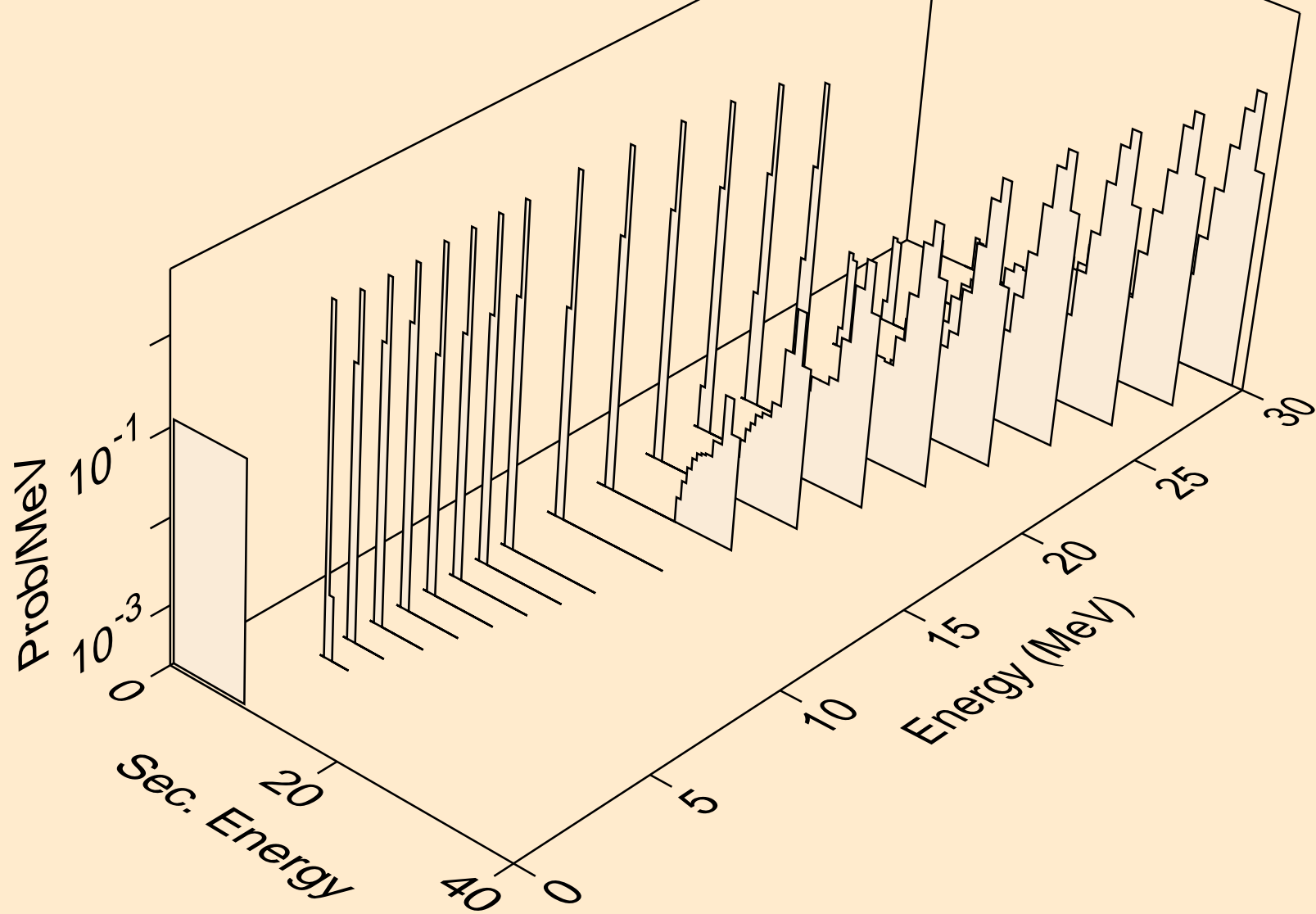

ES239 DEUTERON ACER TENDL-2021 LIBRARY; T=0.K  
alphas from (d,a)

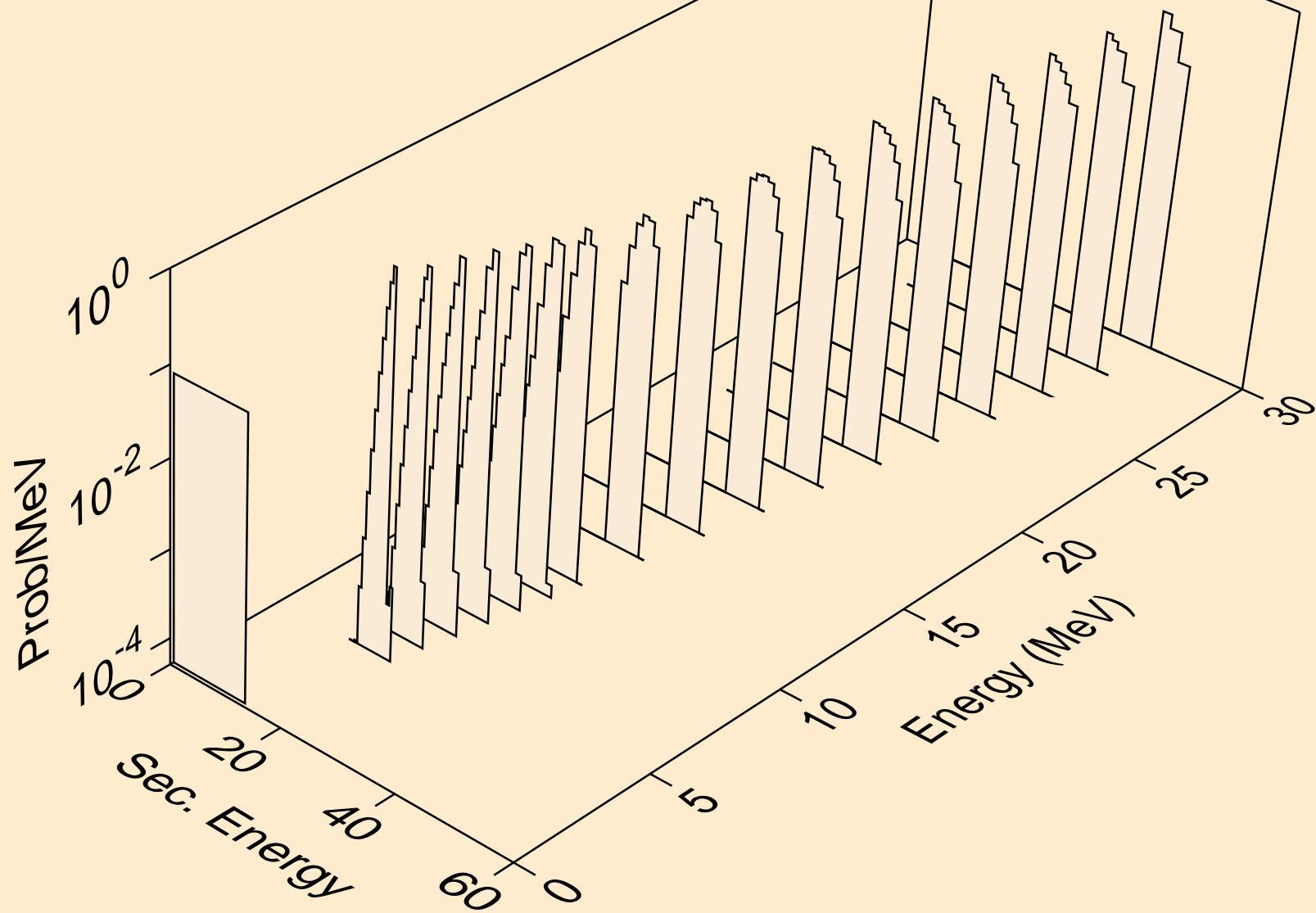

ES239 DEUTERON ACER TENDL-2021 LIBRARY; T=0.K  
alphas from (d,pa)

