

ES242 DEUTERON ACER TENDL-2021 LIBRARY; T=0.K

Principal cross sections

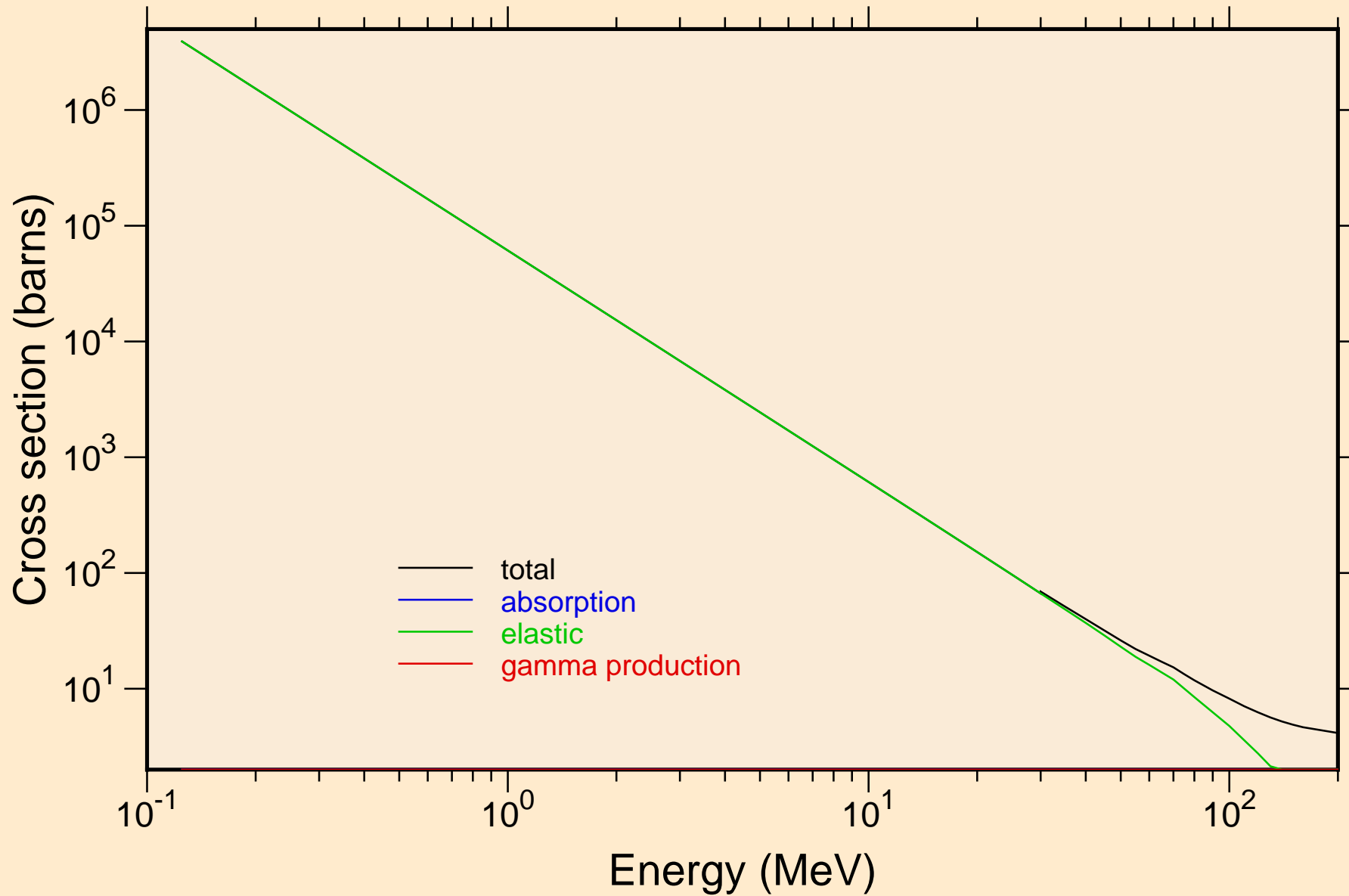

ES242 DEUTERON ACER TENDL-2021 LIBRARY; T=0.K

Heating

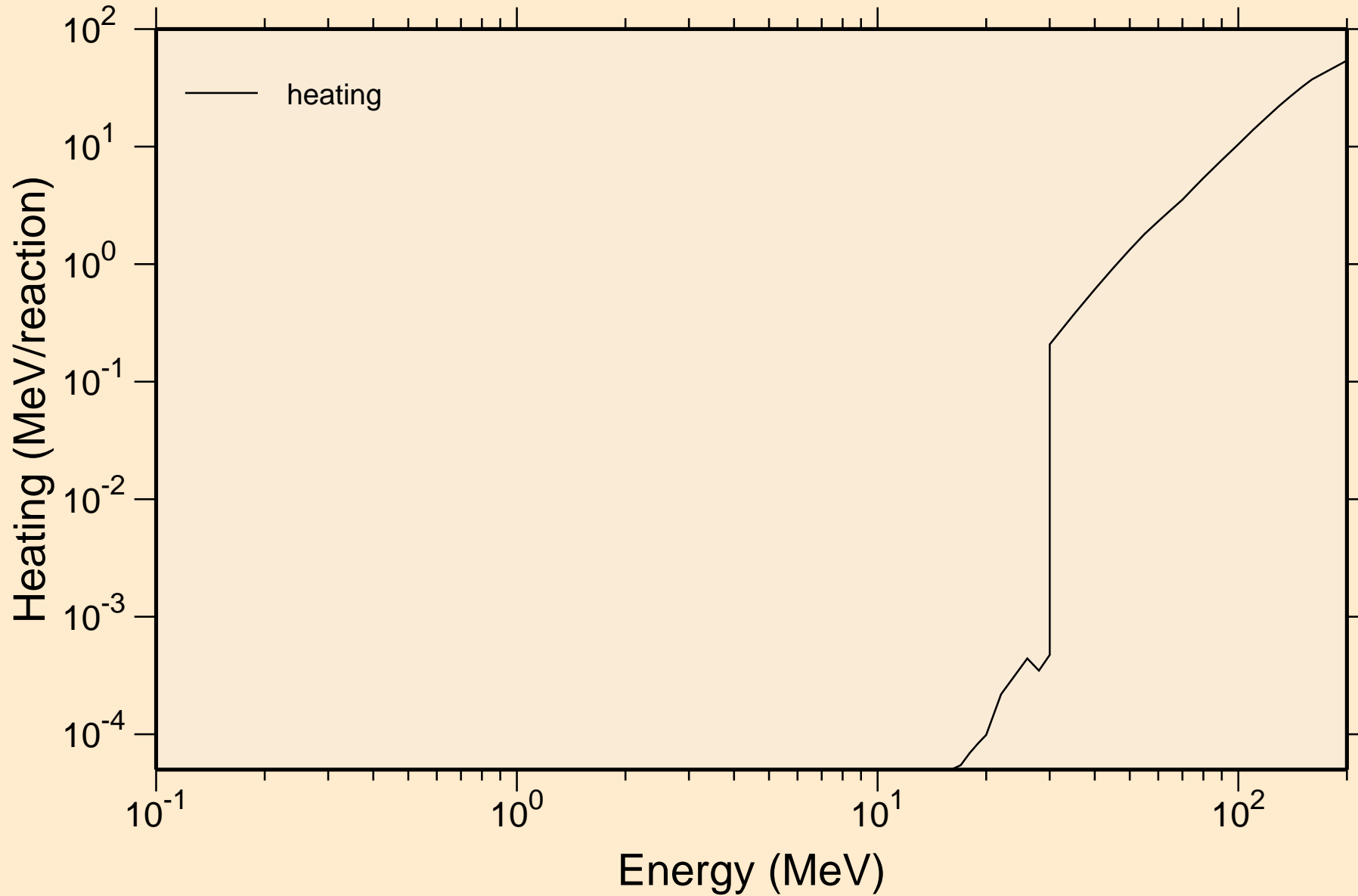

ES242 DEUTERON ACER TENDL-2021 LIBRARY; T=0.K
Principal cross sections

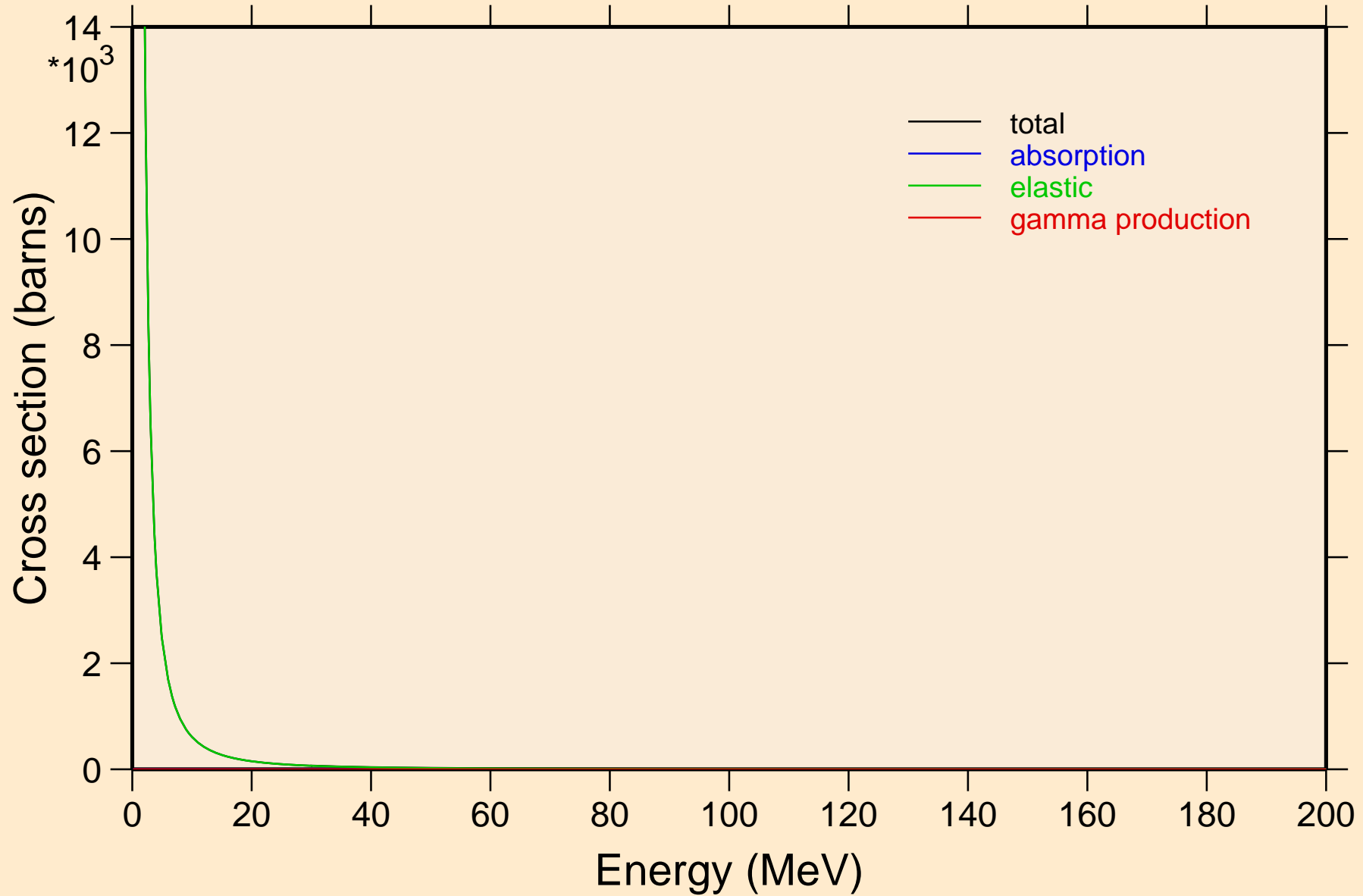

ES242 DEUTERON ACER TENDL-2021 LIBRARY; T=0.K

Heating

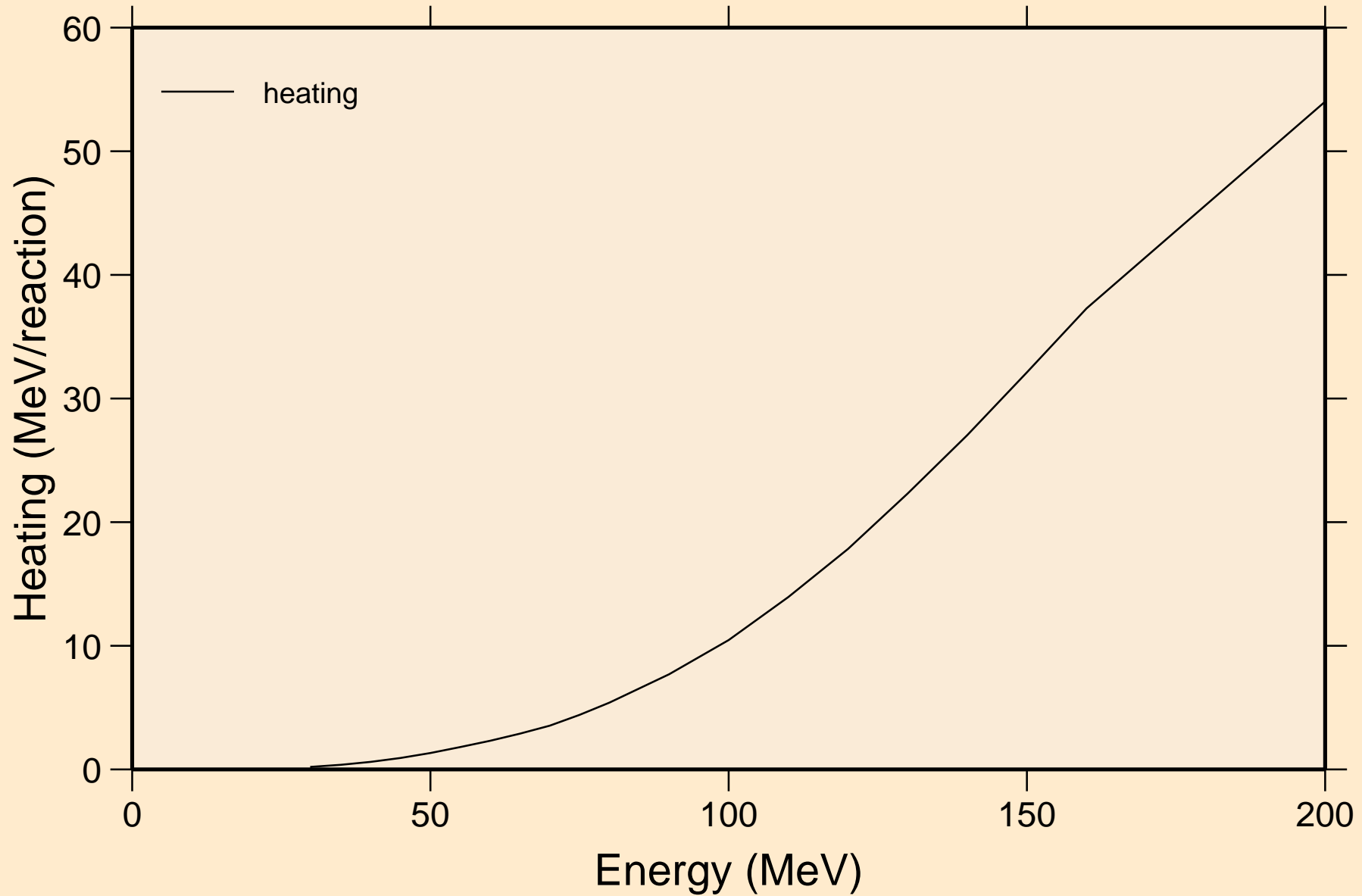

ES242 DEUTERON ACER TENDL-2021 LIBRARY; T=0.K

Threshold reactions

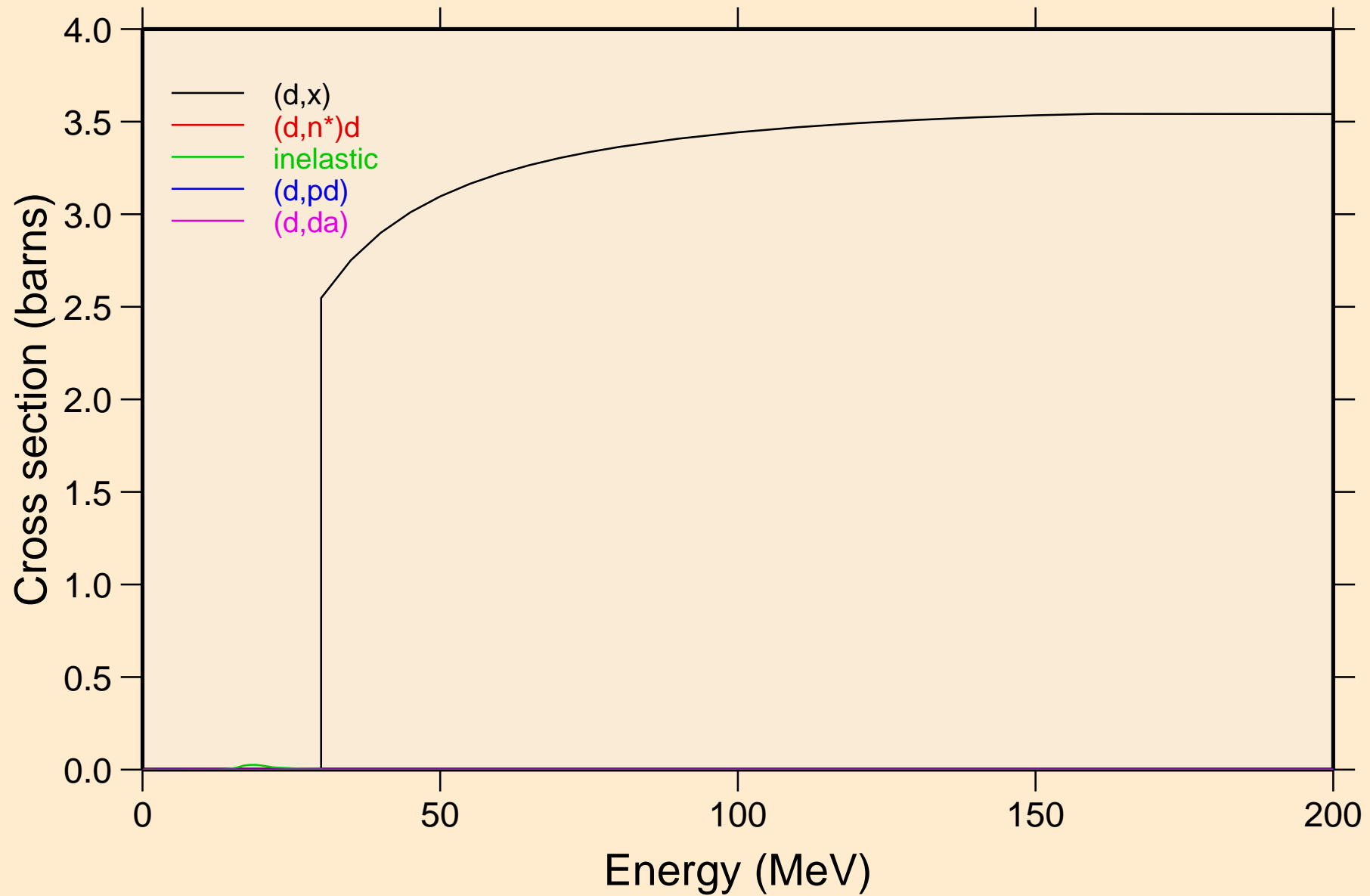

ES242 DEUTERON ACER TENDL-2021 LIBRARY; T=0.K
angular distribution for elastic

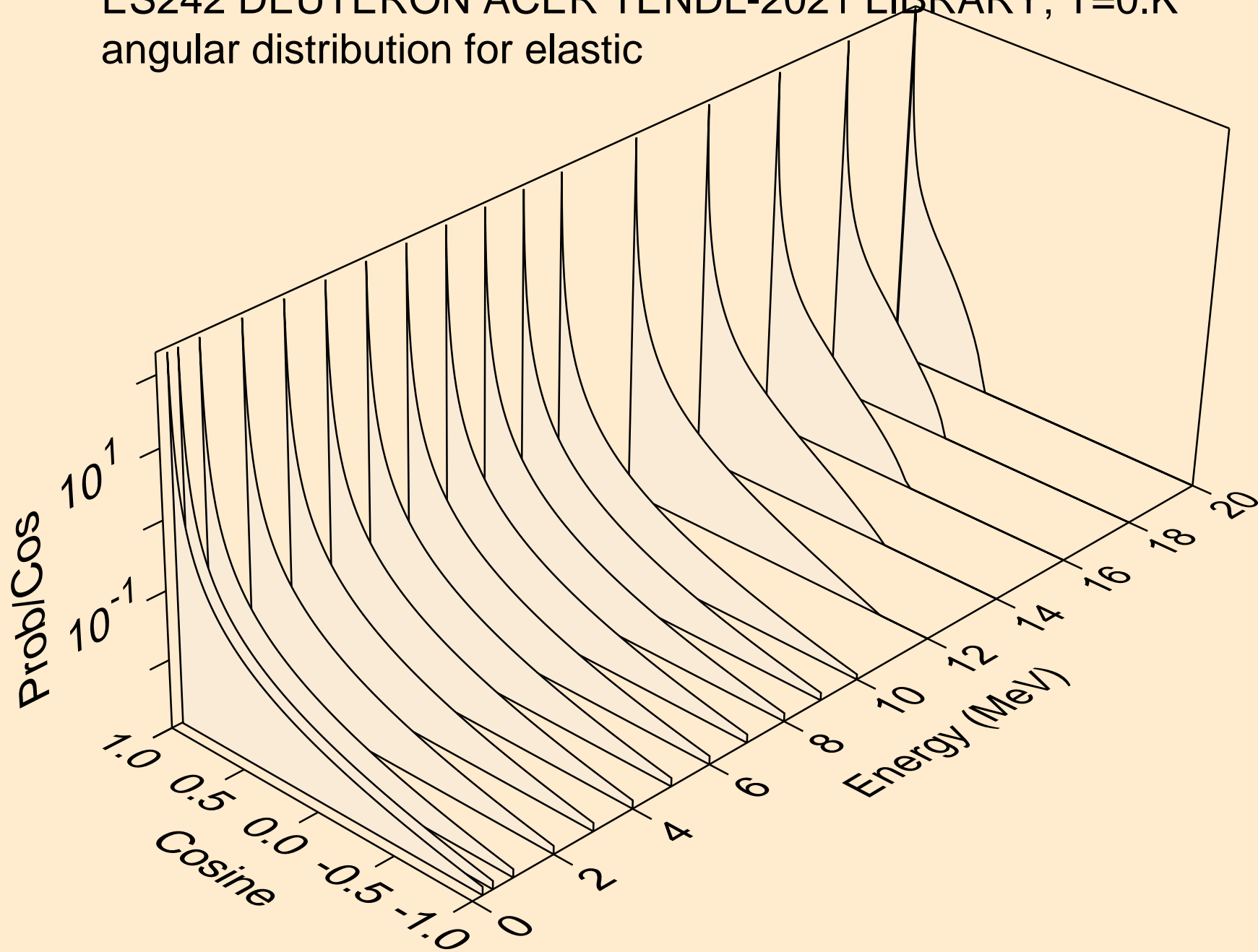

ES242 DEUTERON ACER TENDL-2021 LIBRARY; T=0.K
angular distribution for elastic

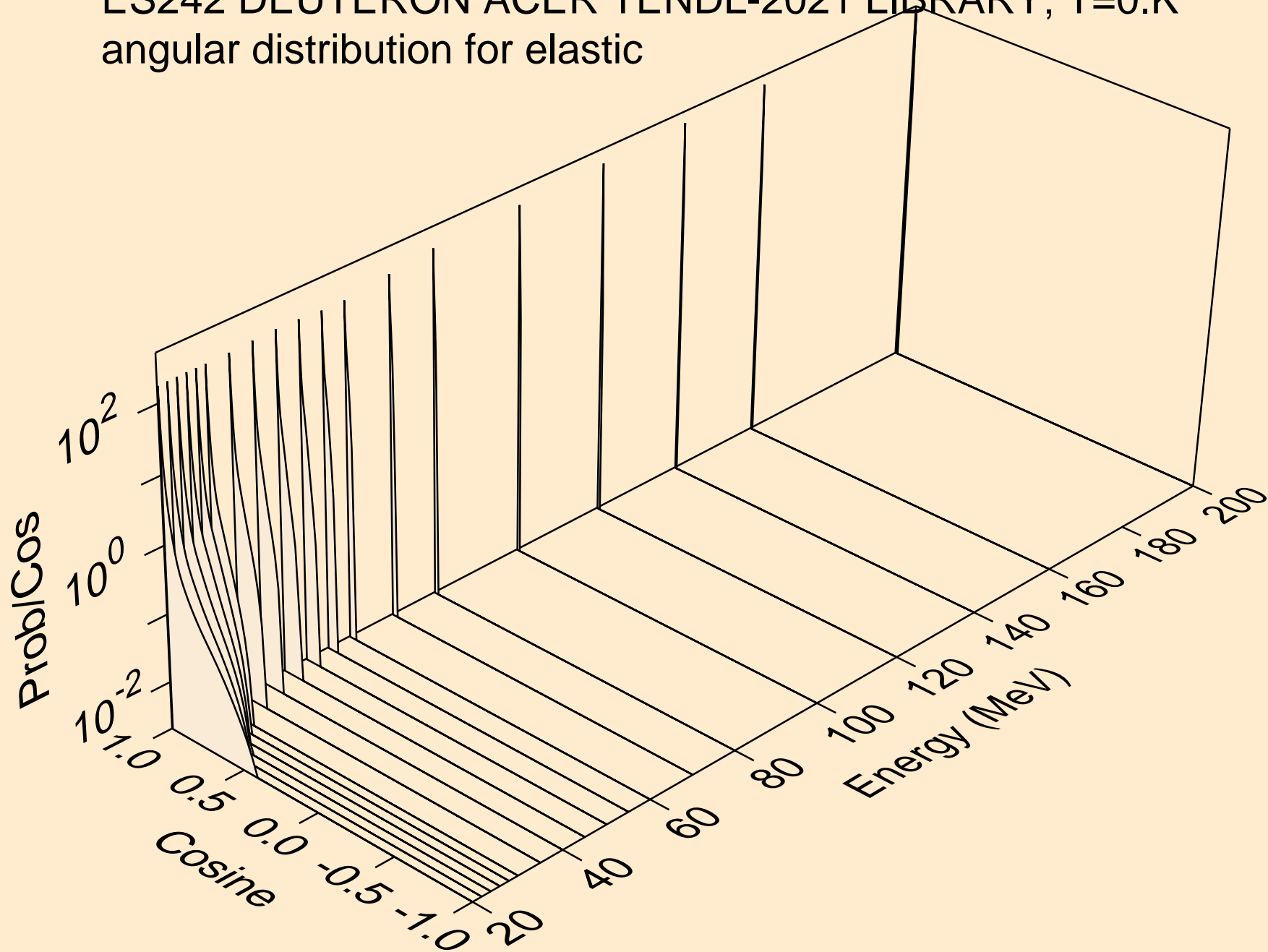

ES242 DEUTERON ACER TENDL-2021 LIBRARY; T=0.K
Deuteron emission for (d,x)

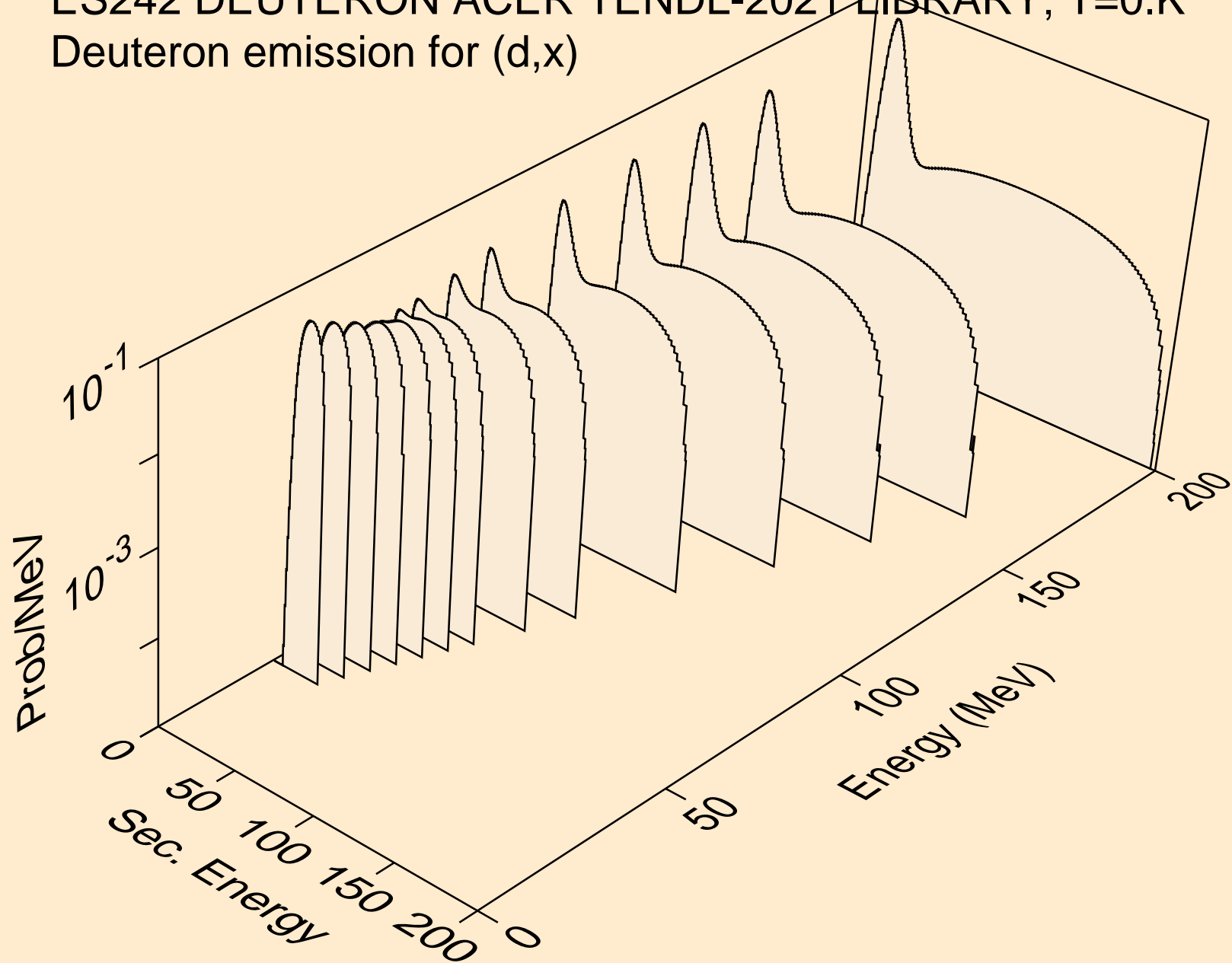

ES242 DEUTERON ACER TENDL-2021 LIBRARY; T=0.K
Deuteron emission for (d,n*)d

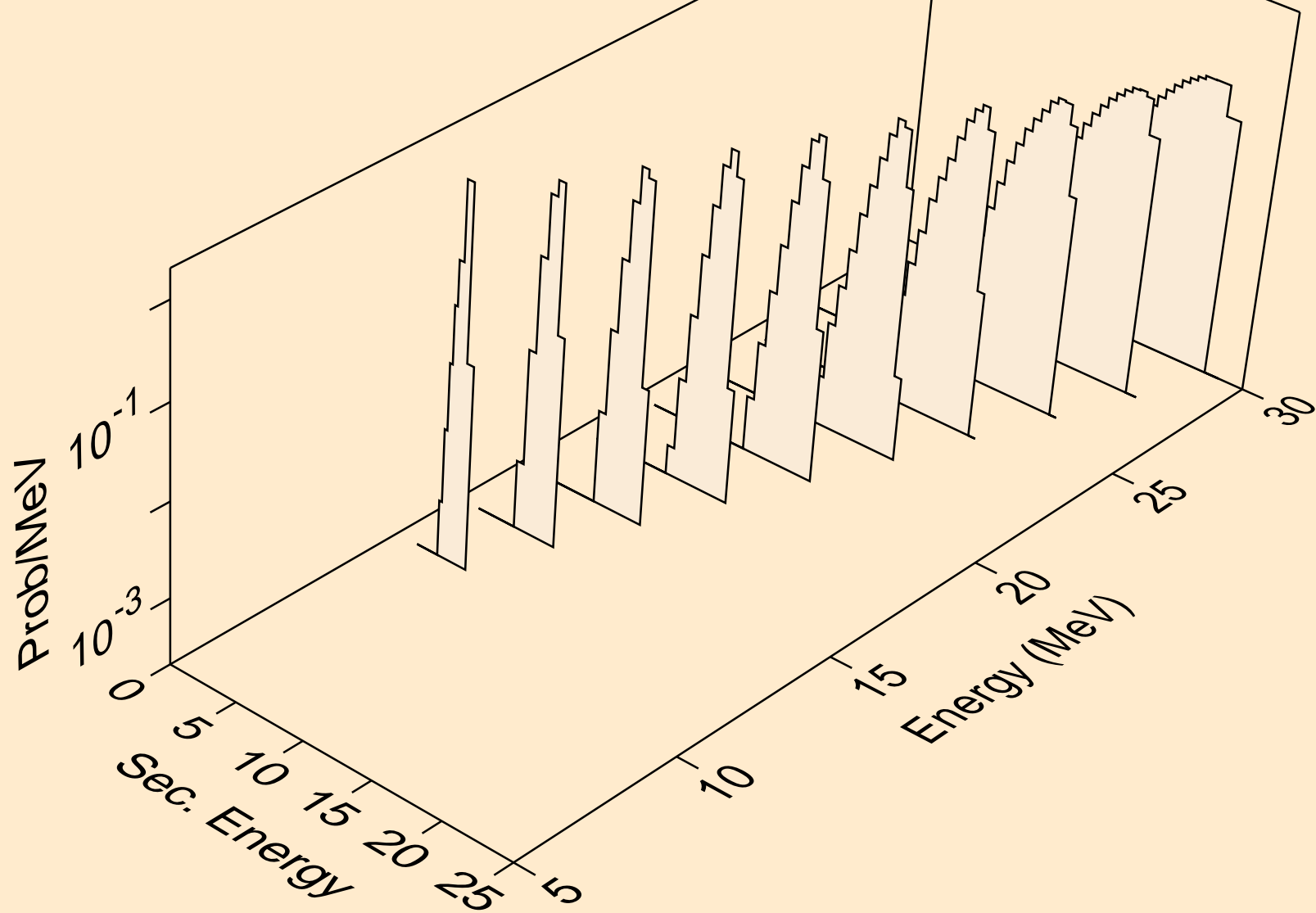

ES242 DEUTERON ACER TENDL-2021 LIBRARY; T=0.K
Deuteron emission for inelastic

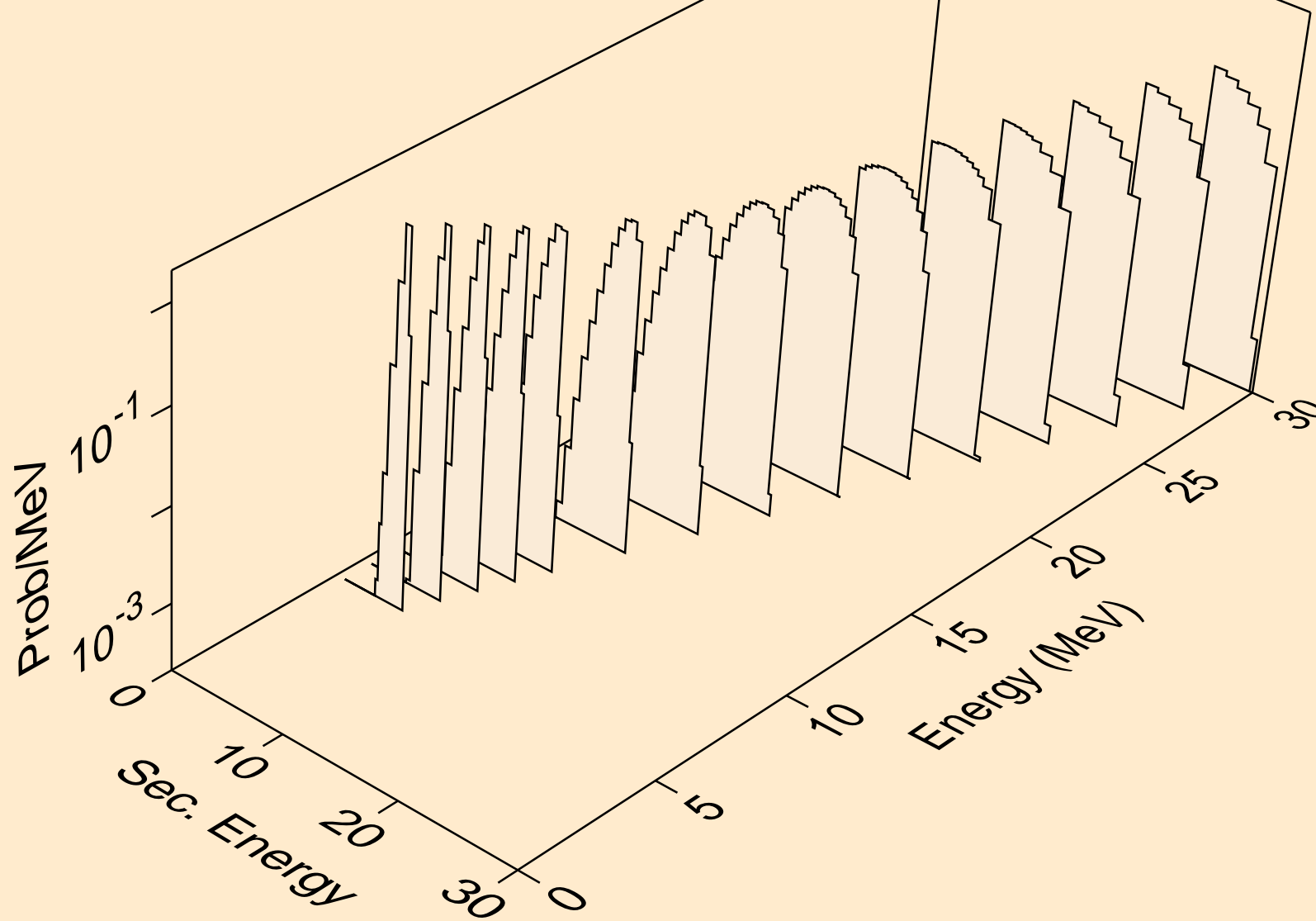

ES242 DEUTERON ACER TENDL-2021 LIBRARY; T=0.K
Deuteron emission for (d,pd)

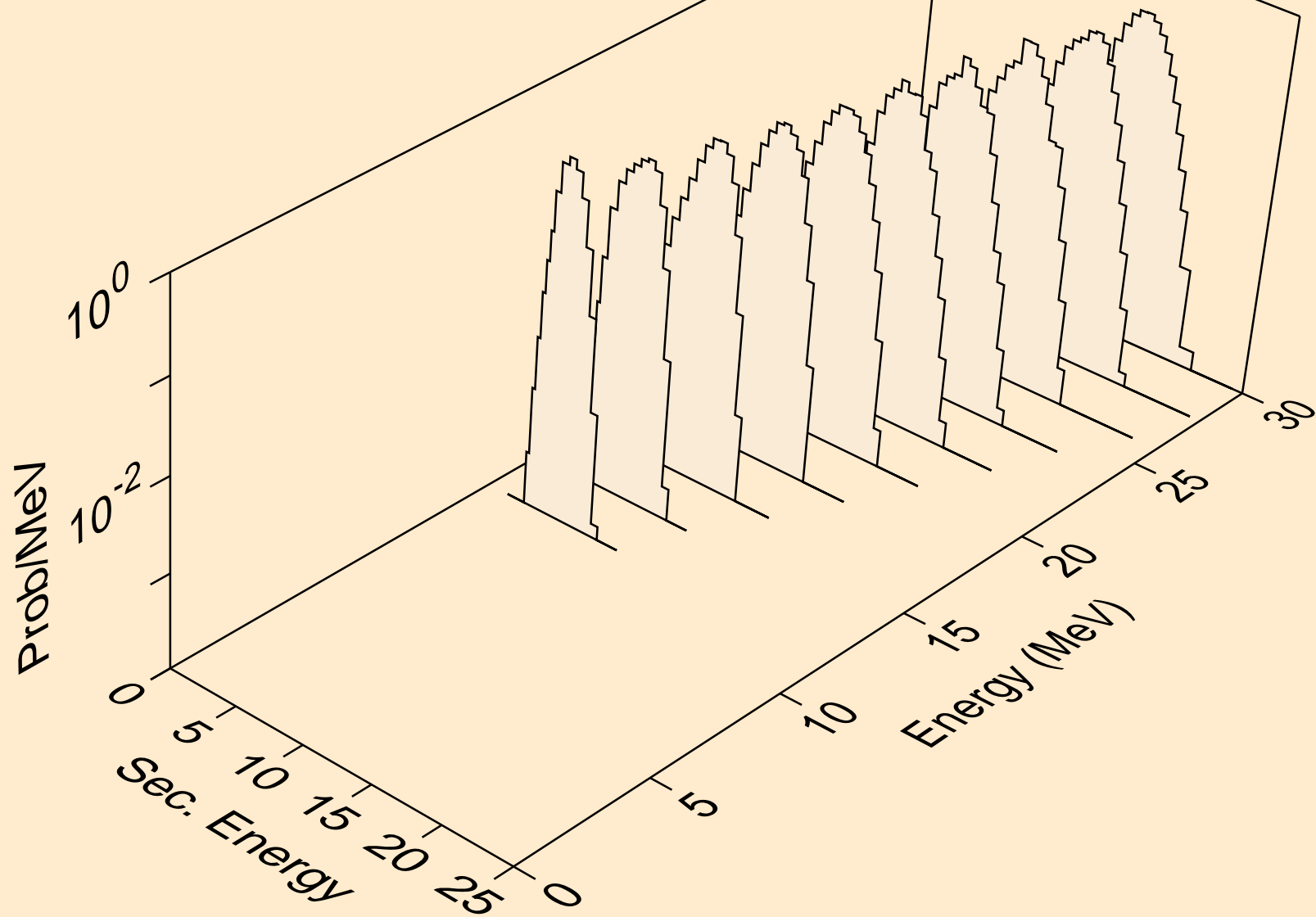

ES242 DEUTERON ACER TENDL-2021 LIBRARY; T=0.K
Deuteron emission for (d,da)

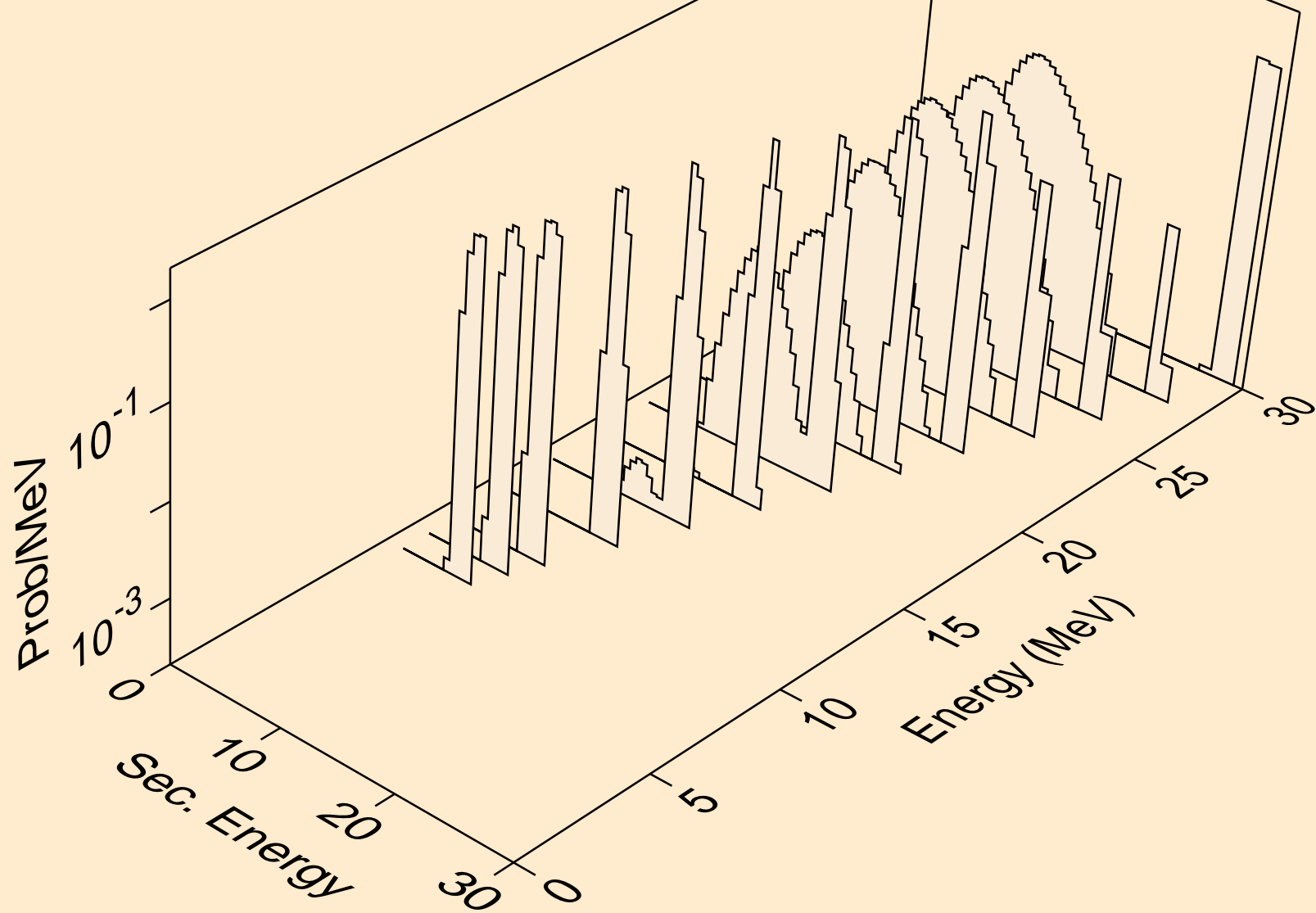

ES242 DEUTERON ACER TENDL-2021 LIBRARY; T=0.K
Photon emission for (z,n)

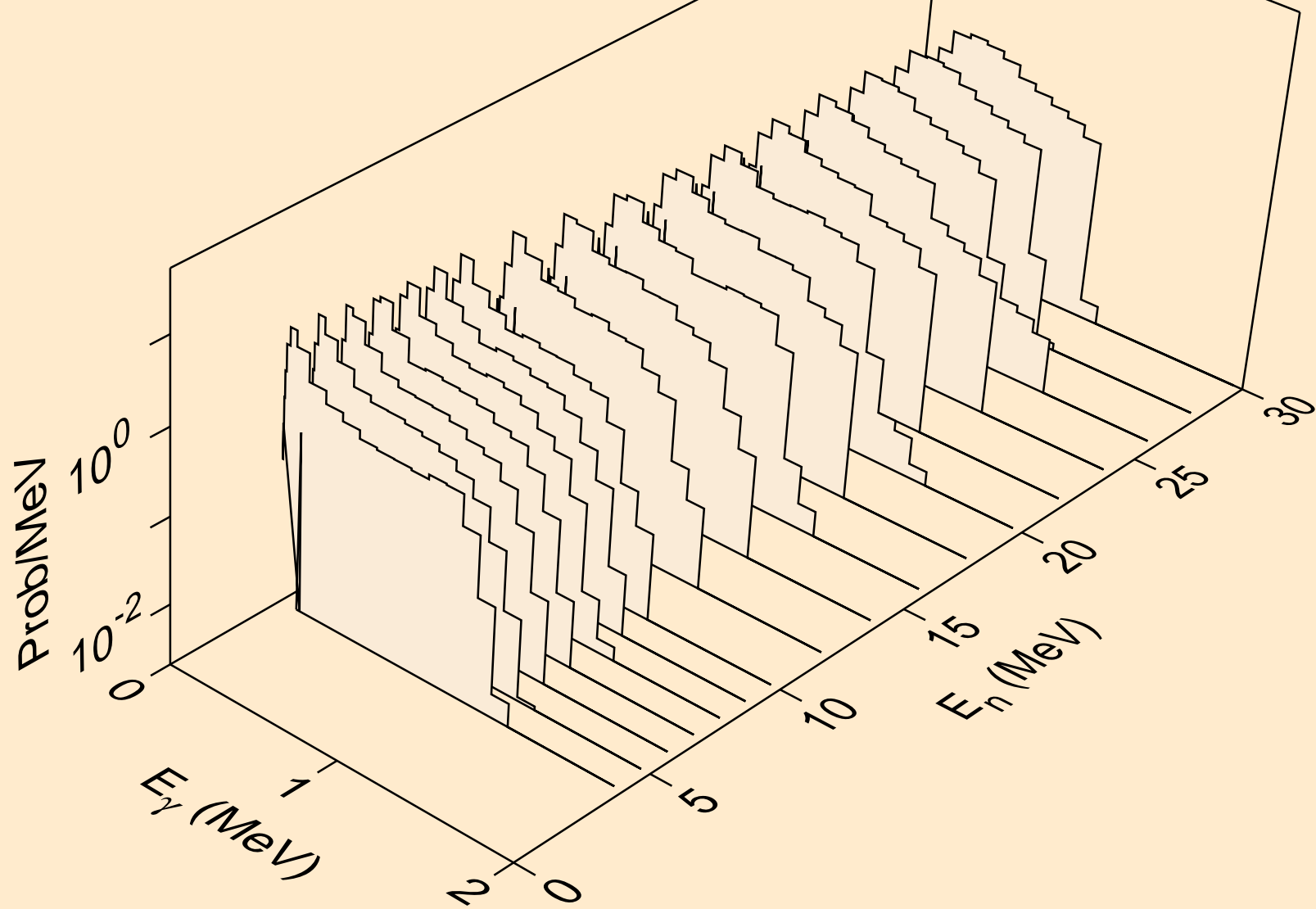

ES242 DEUTERON ACER TENDL-2021 LIBRARY; T=0.K
Photon emission for (n,x)

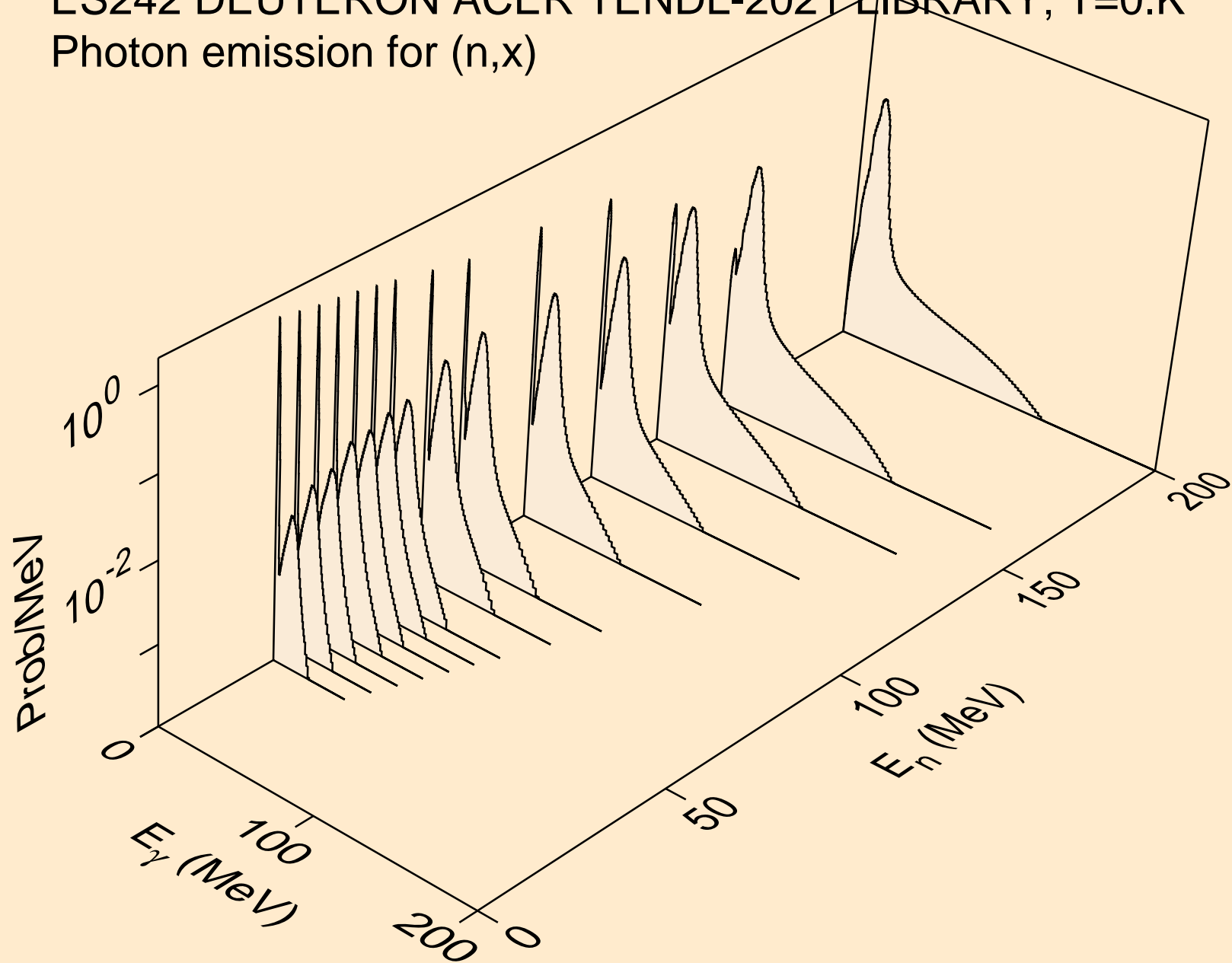

ES242 DEUTERON ACER TENDL-2021 LIBRARY; T=0.K
Photon emission for (n,2n)

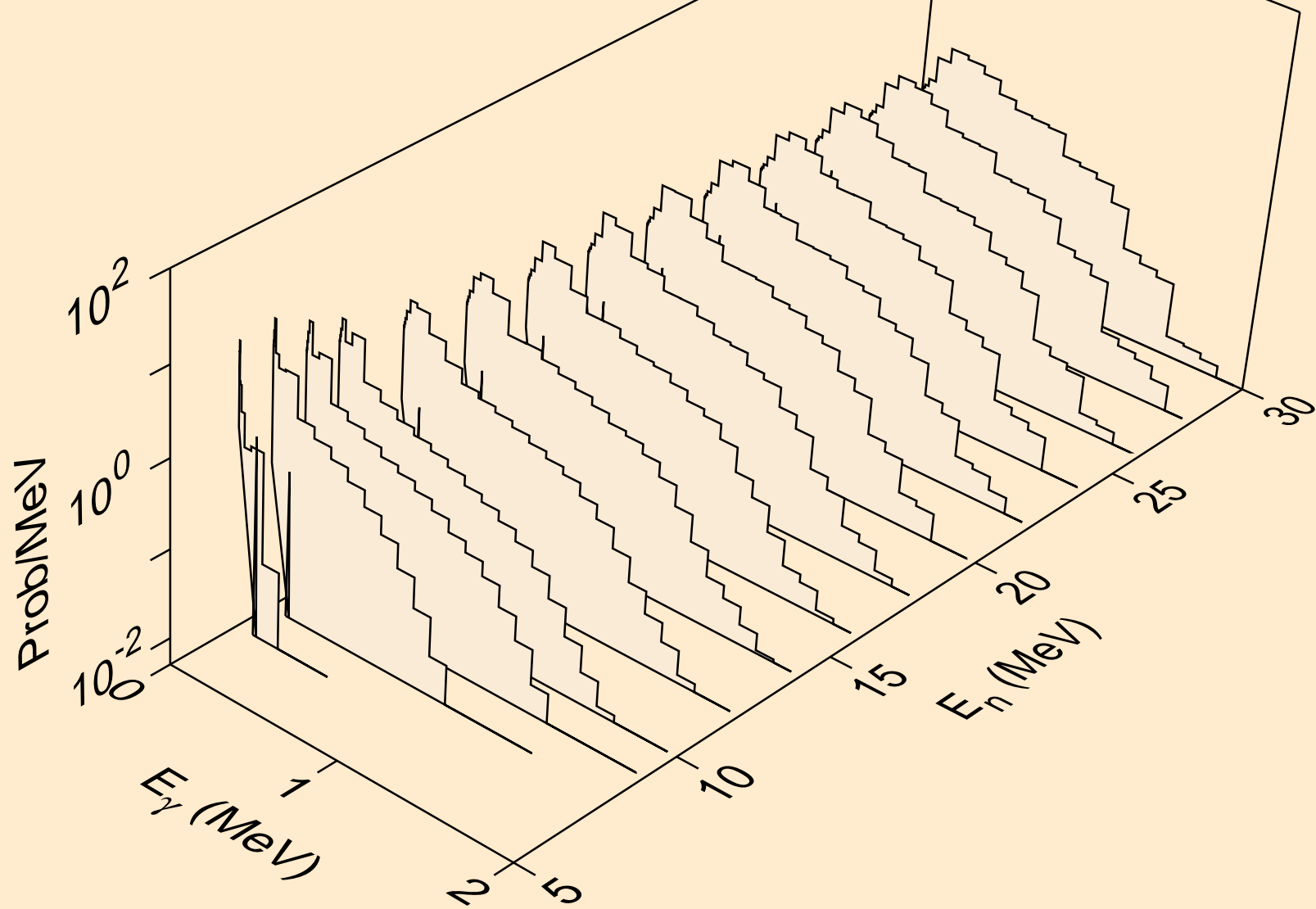

ES242 DEUTERON ACER TENDL-2021 LIBRARY; T=0.K
Photon emission for (n,3n)

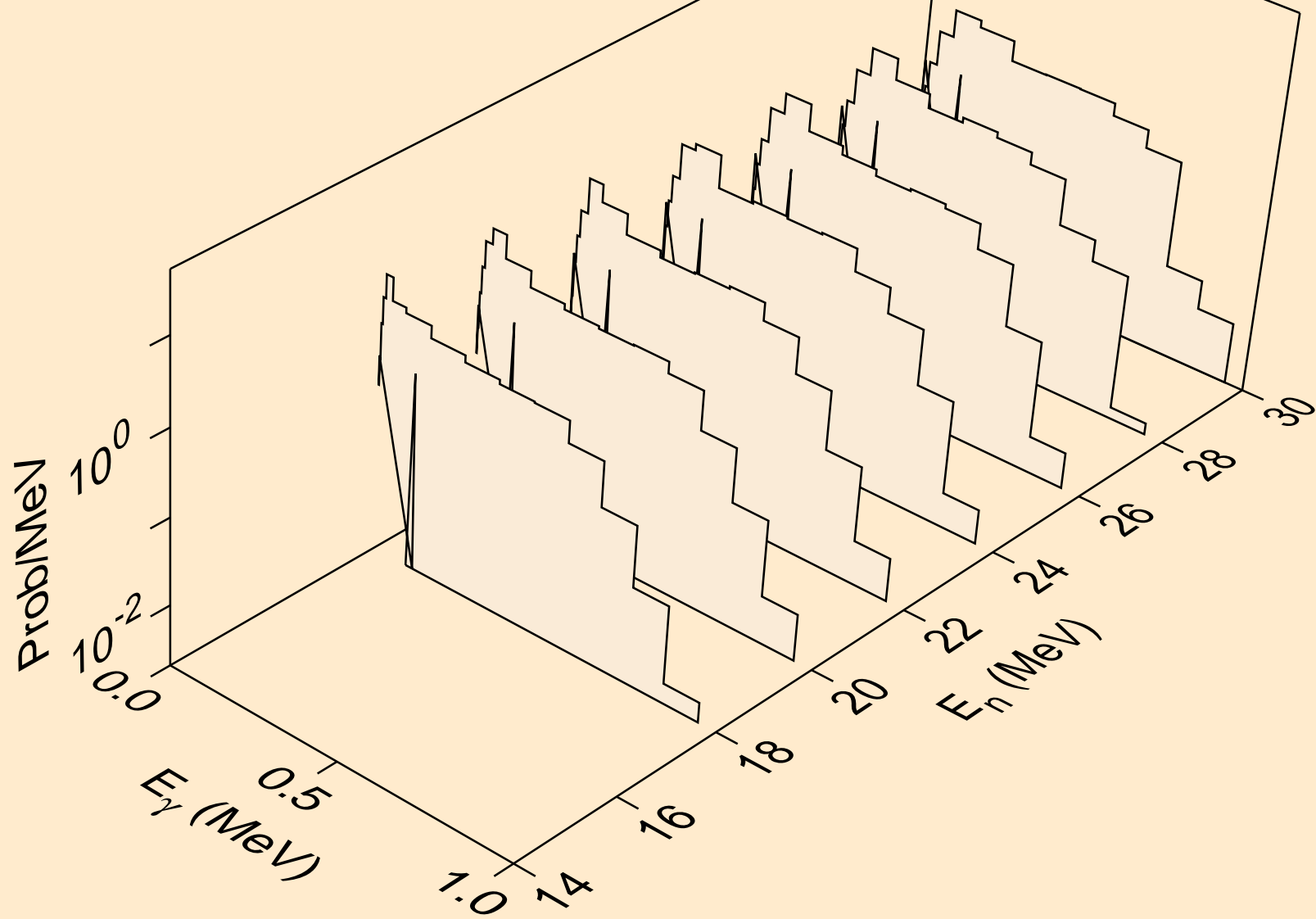

ES242 DEUTERON ACER TENDL-2021 LIBRARY; T=0.K
Photon emission for (n,n*)a

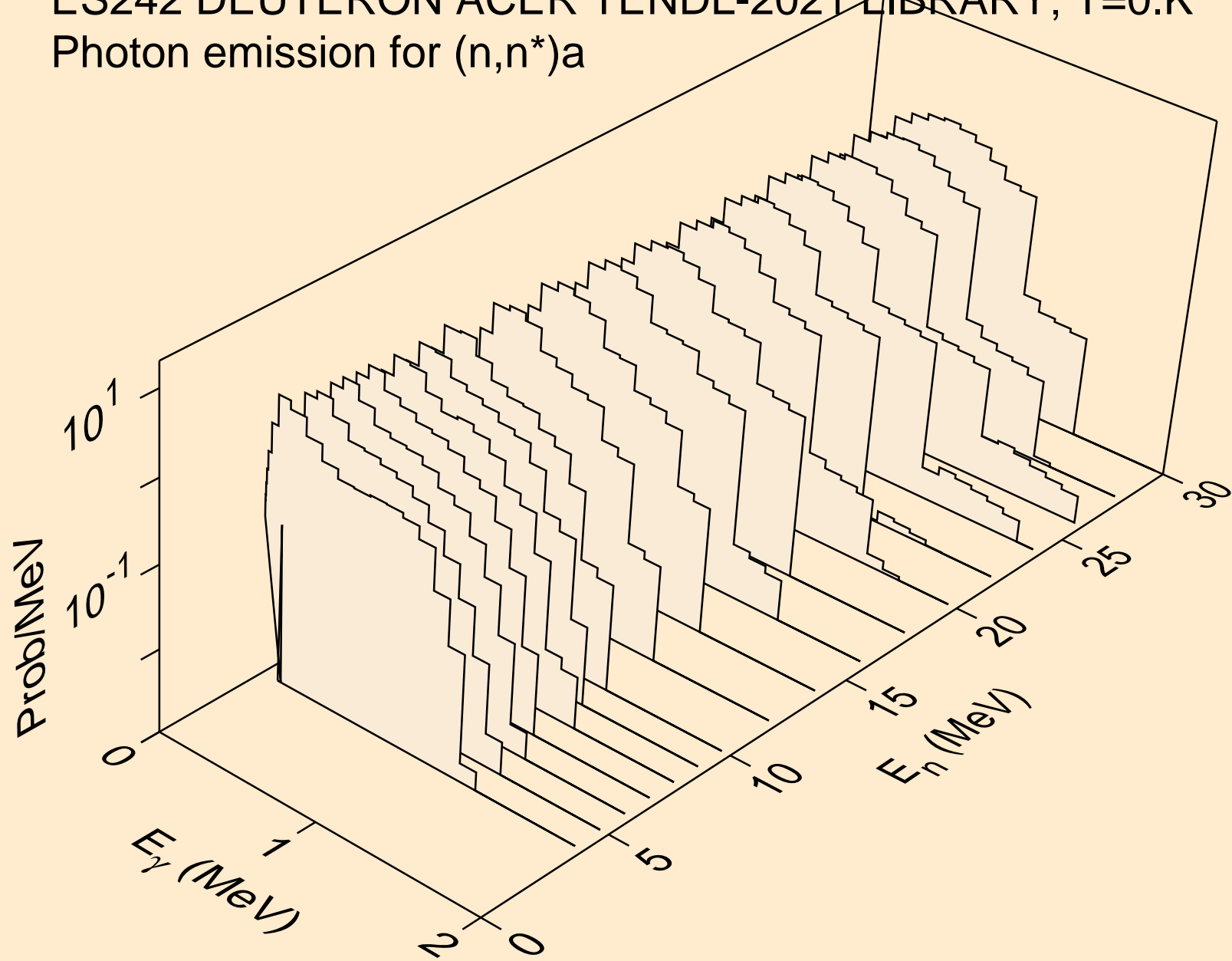

ES242 DEUTERON ACER TENDL-2021 LIBRARY; T=0.K
Photon emission for (n,2n)a

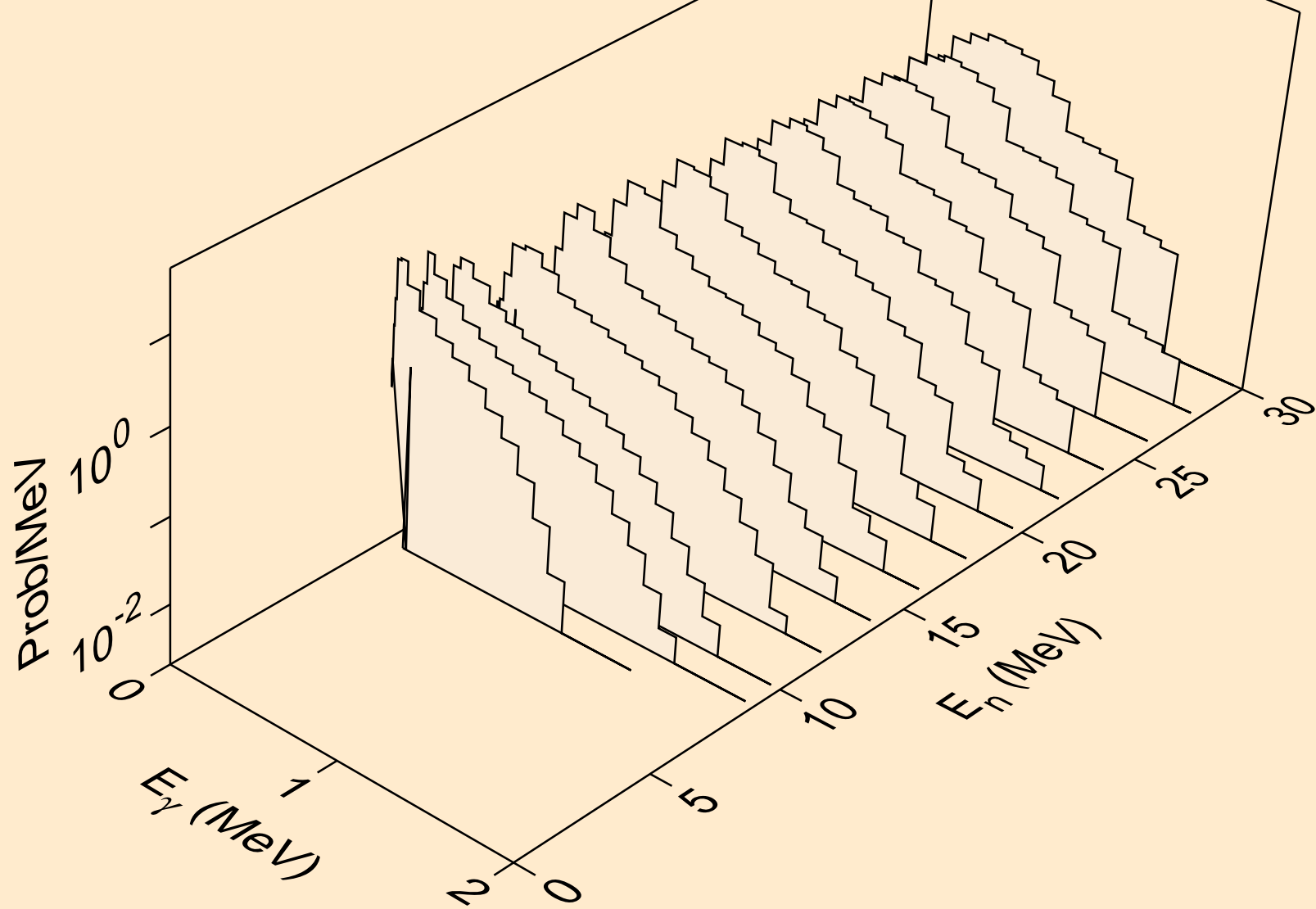

ES242 DEUTERON ACER TENDL-2021 LIBRARY; T=0.K
Photon emission for (n,n*)p

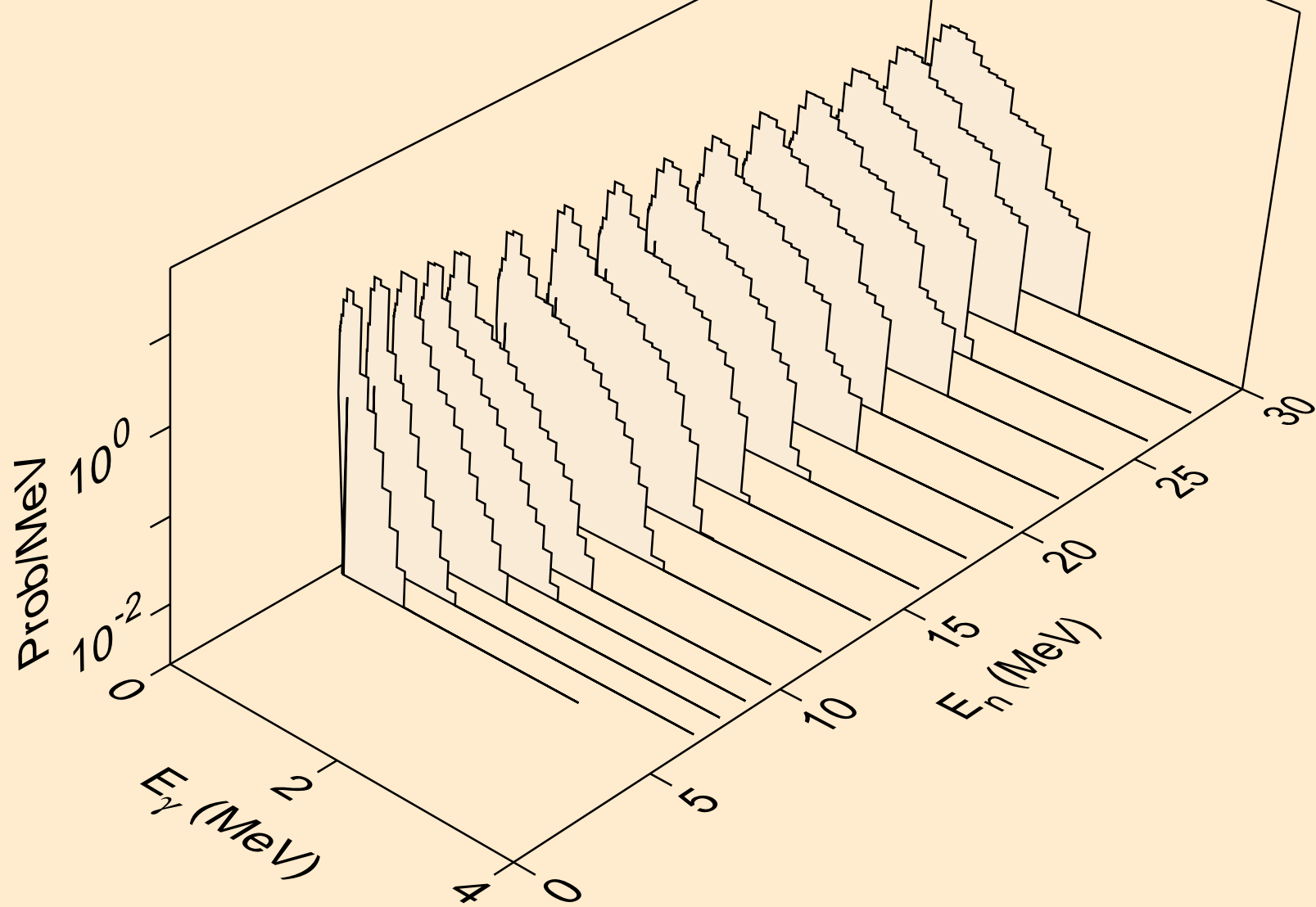

ES242 DEUTERON ACER TENDL-2021 LIBRARY; T=0.K
Photon emission for (n,n*)d

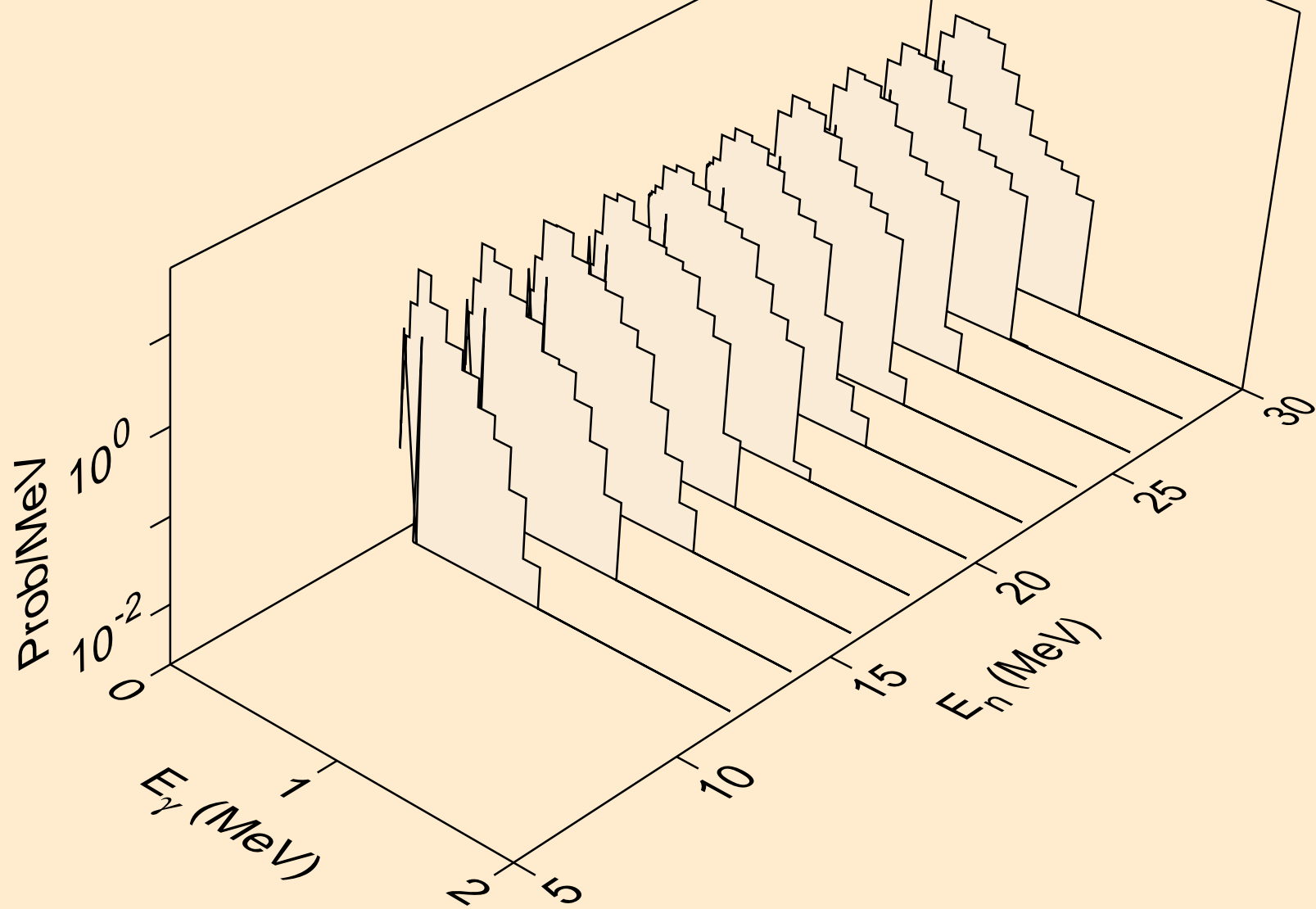

ES242 DEUTERON ACER TENDL-2021 LIBRARY; T=0.K
Photon emission for (n,n*)t

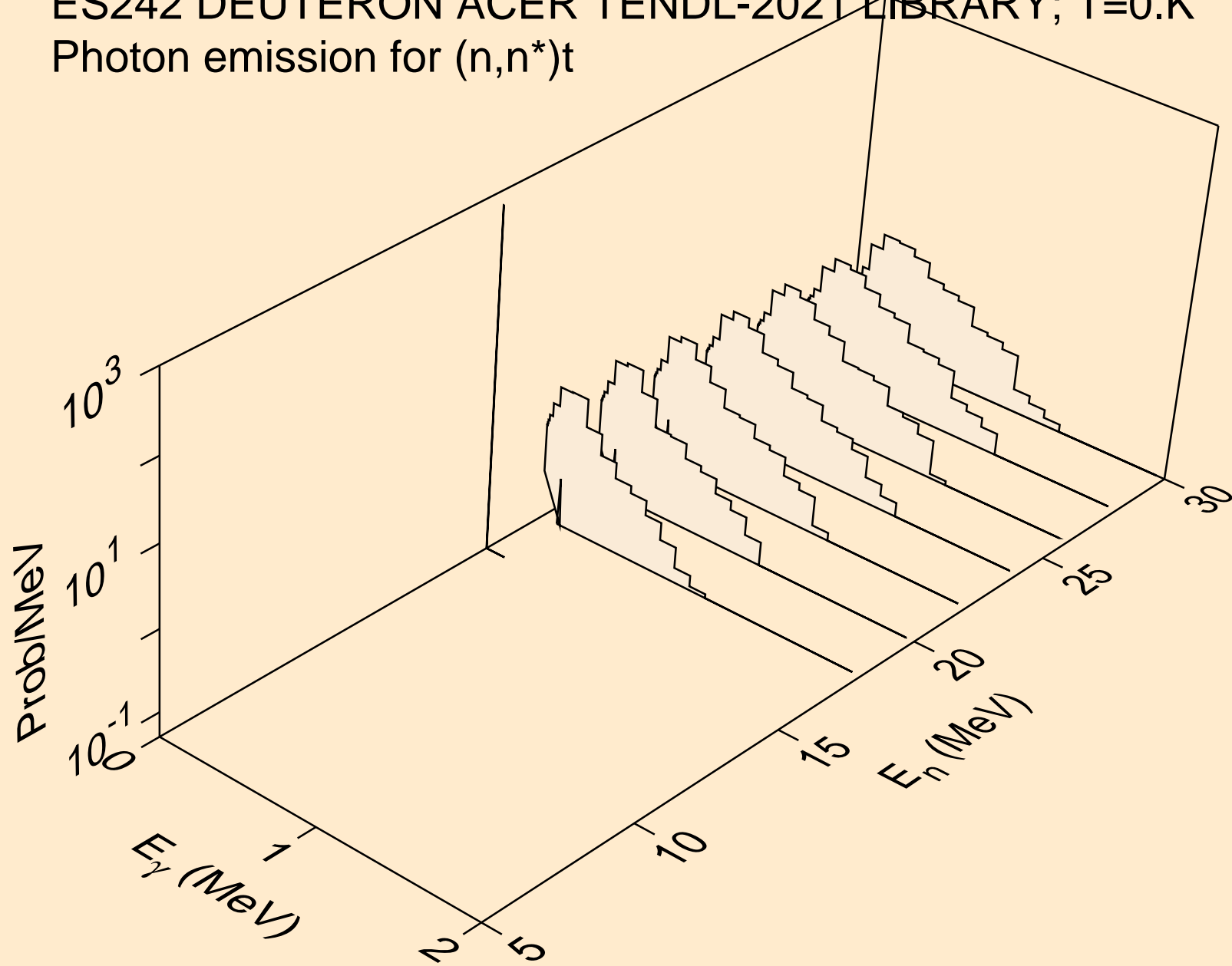

ES242 DEUTERON ACER TENDL-2021 LIBRARY; T=0.K
Photon emission for (n,n*)he3

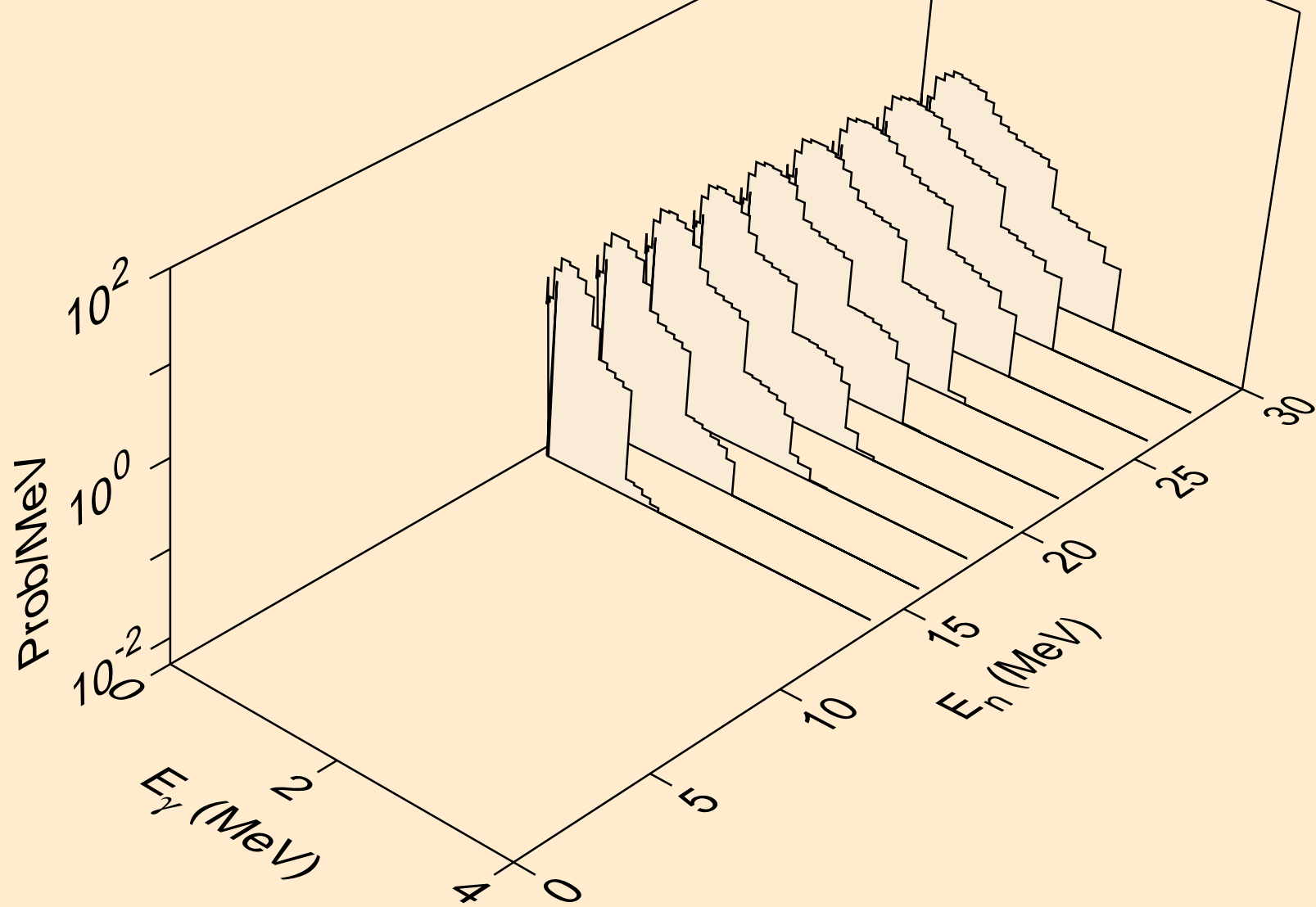

ES242 DEUTERON ACER TENDL-2021 LIBRARY; T=0.K
Photon emission for (n,2np)

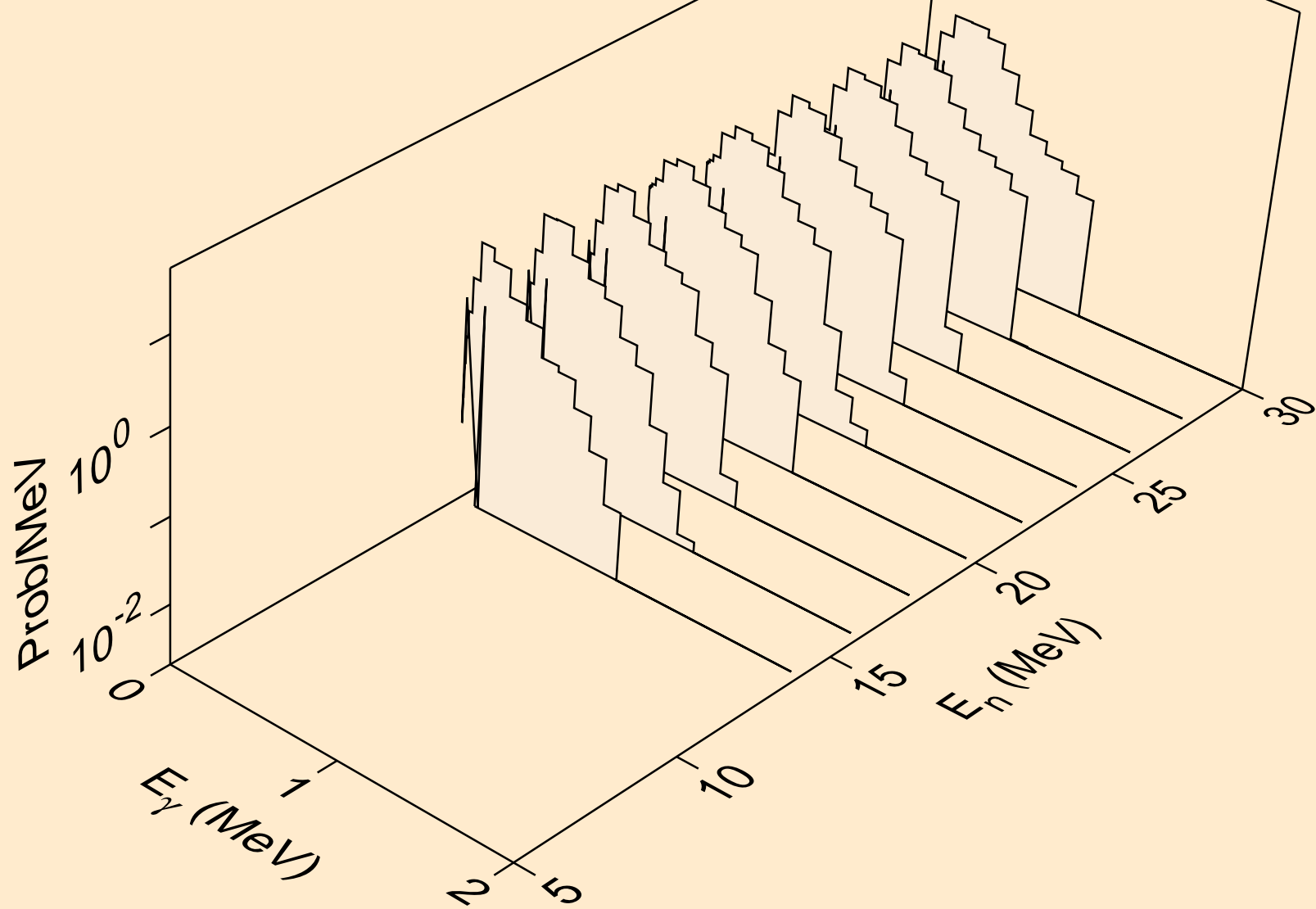

ES242 DEUTERON ACER TENDL-2021 LIBRARY; T=0.K
Photon emission for (n,2np)

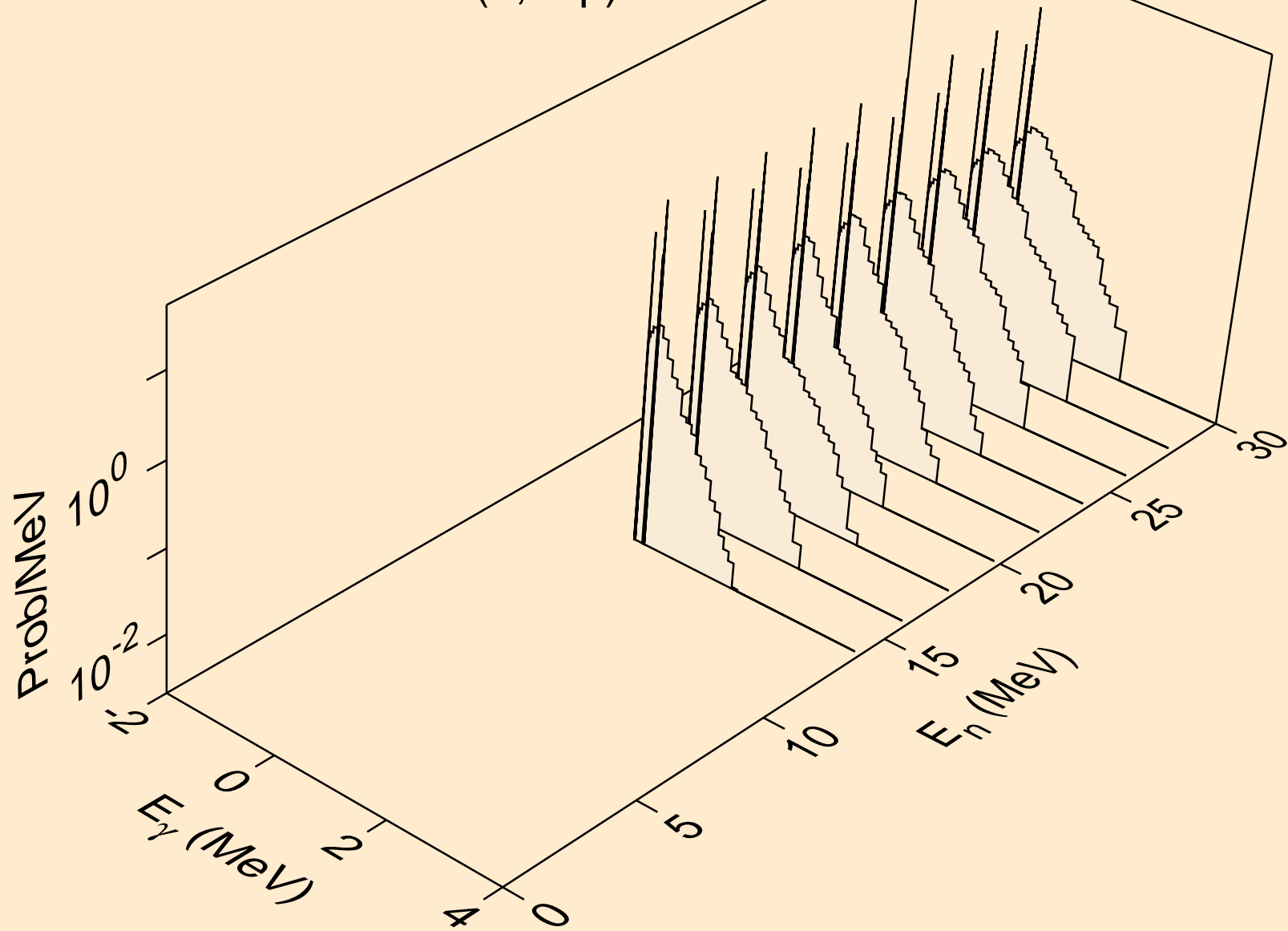

ES242 DEUTERON ACER TENDL-2021 LIBRARY; T=0.K
Photon emission for (n,npa)

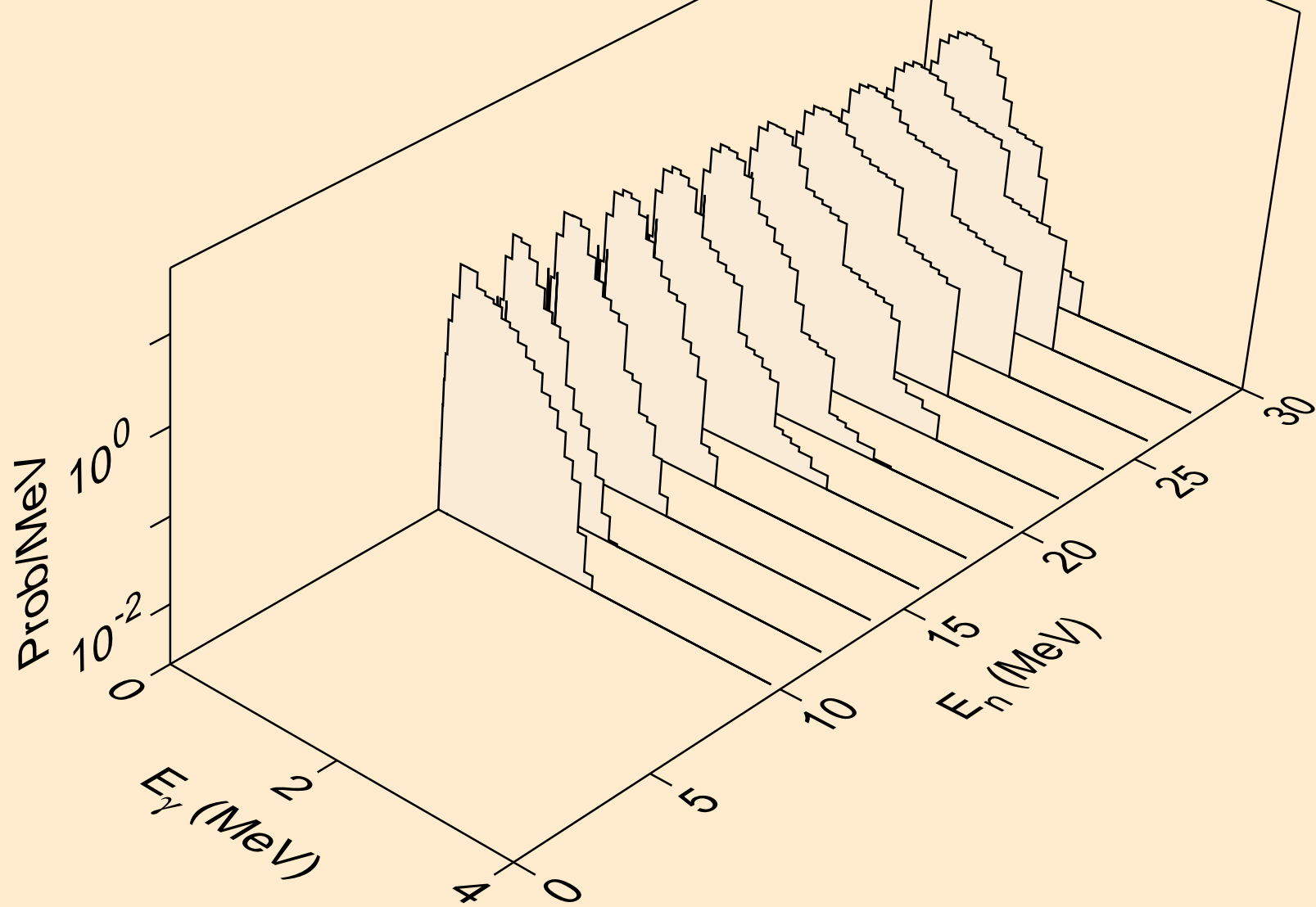

ES242 DEUTERON ACER TENDL-2021 LIBRARY; T=0.K
Photon emission for (n,p)

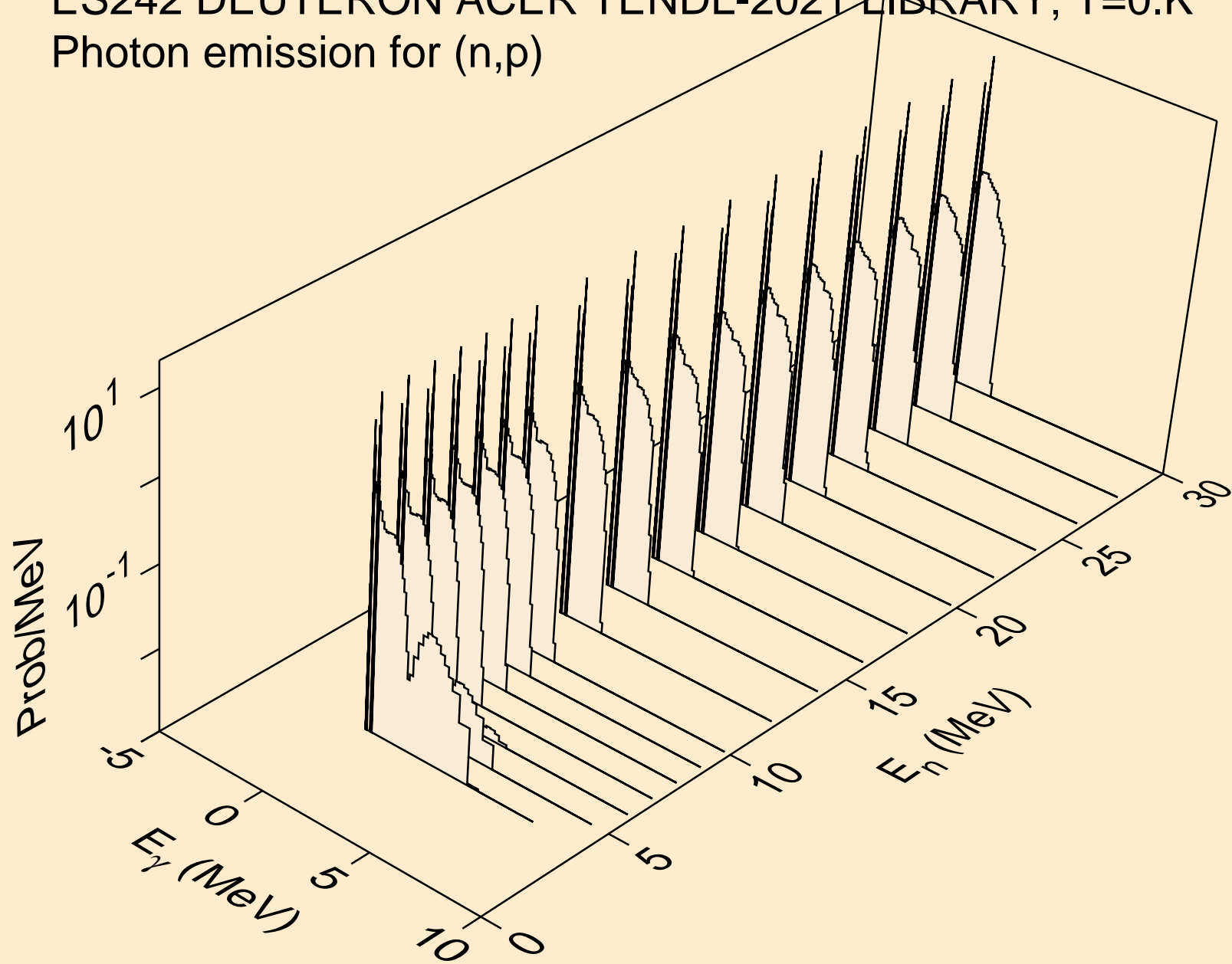

ES242 DEUTERON ACER TENDL-2021 LIBRARY; T=0.K
Photon emission for inelastic

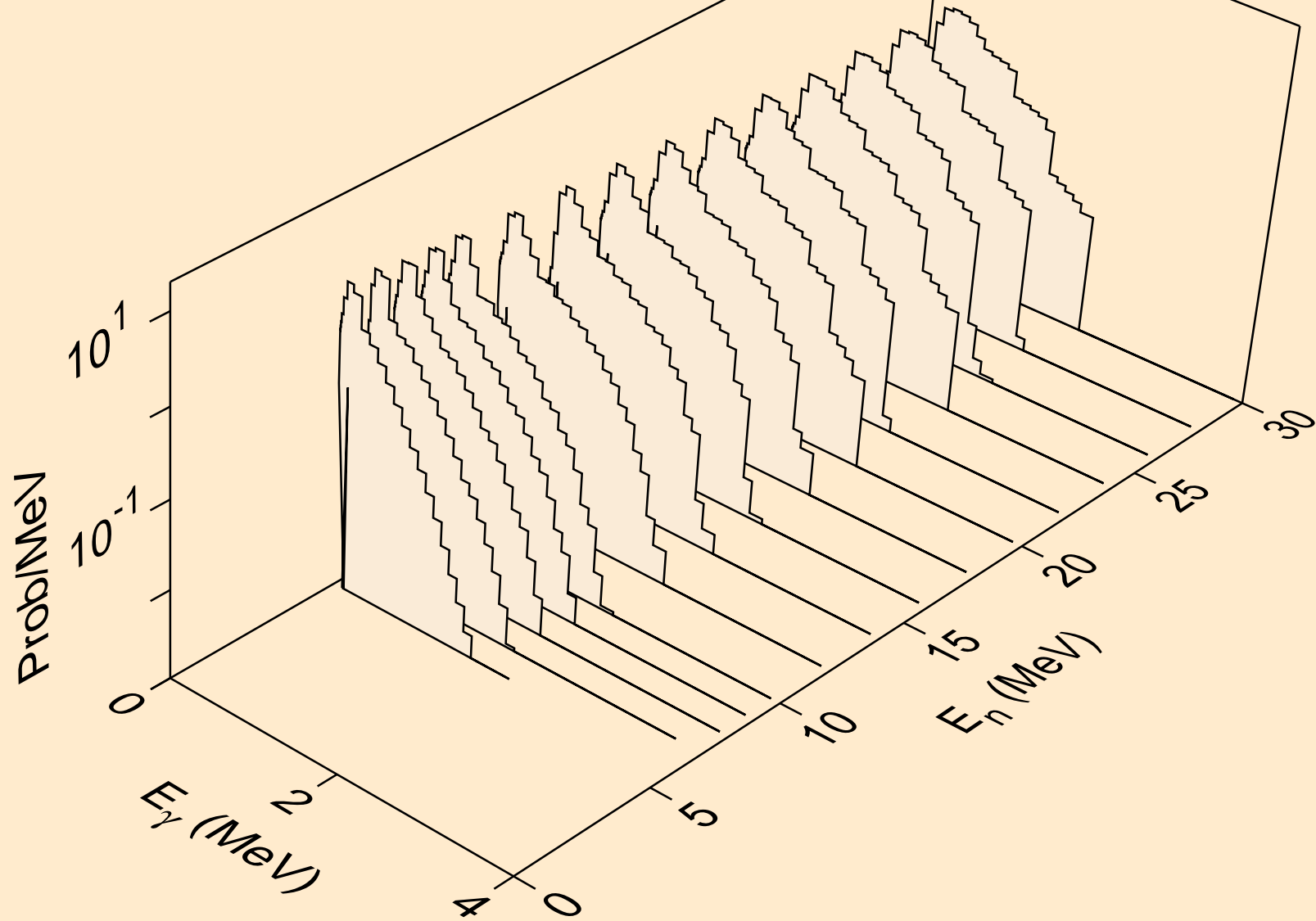

ES242 DEUTERON ACER TENDL-2021 LIBRARY; T=0.K
Photon emission for (n,t)

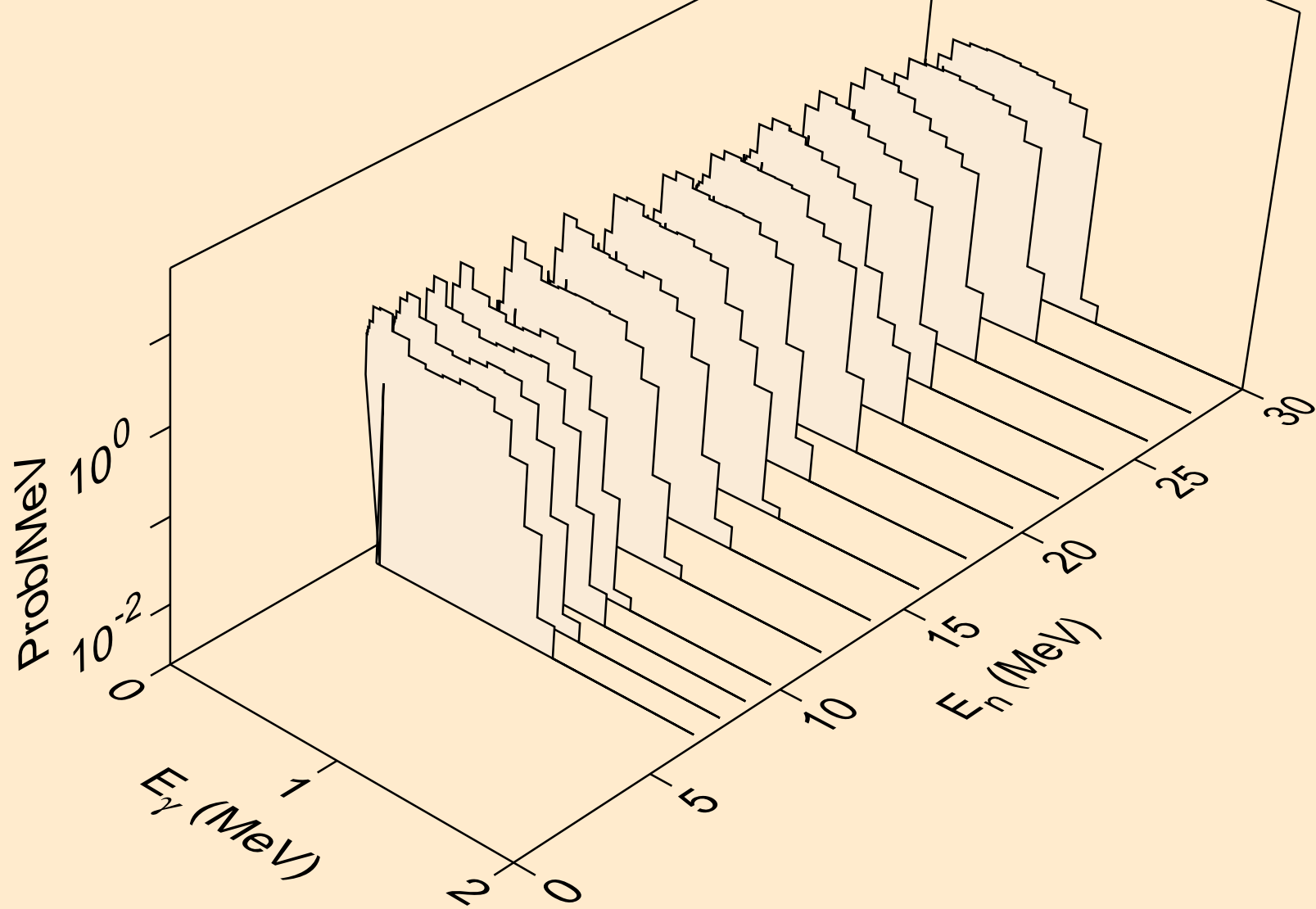

ES242 DEUTERON ACER TENDL-2021 LIBRARY; T=0.K
Photon emission for (n,he3)

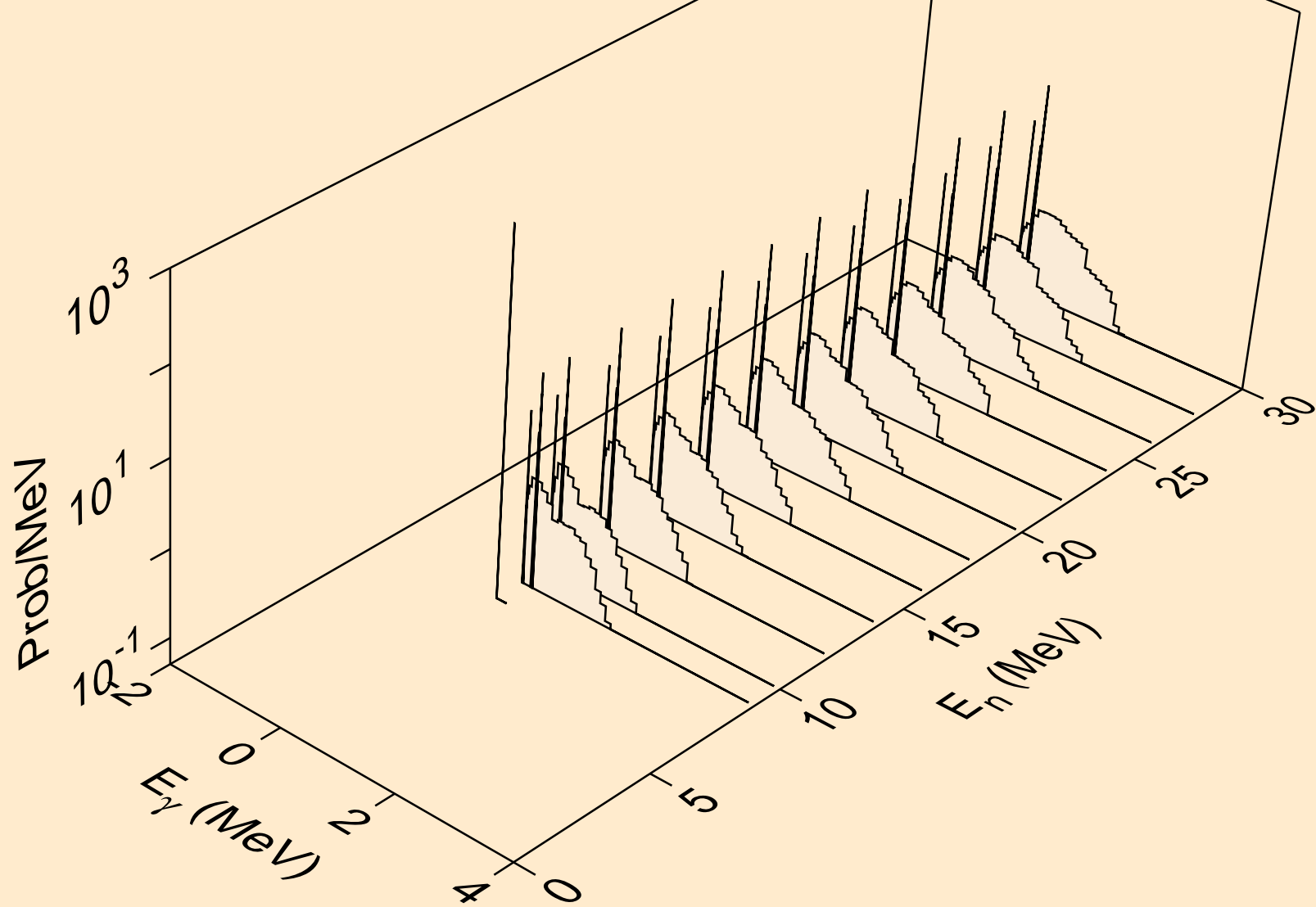

ES242 DEUTERON ACER TENDL-2021 LIBRARY; T=0.K
Photon emission for (n,a)

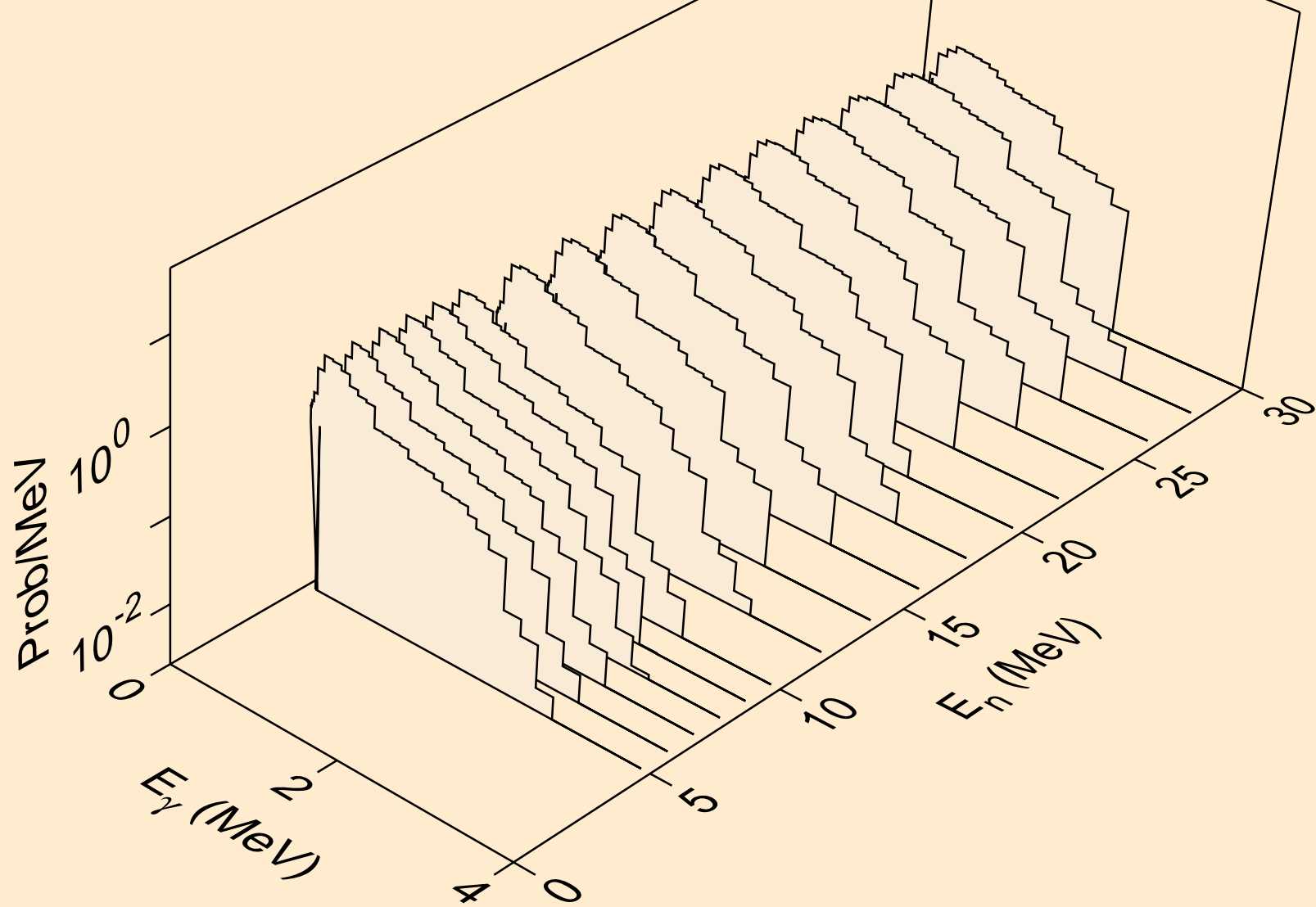

ES242 DEUTERON ACER TENDL-2021 LIBRARY; T=0.K
Photon emission for (n,2p)

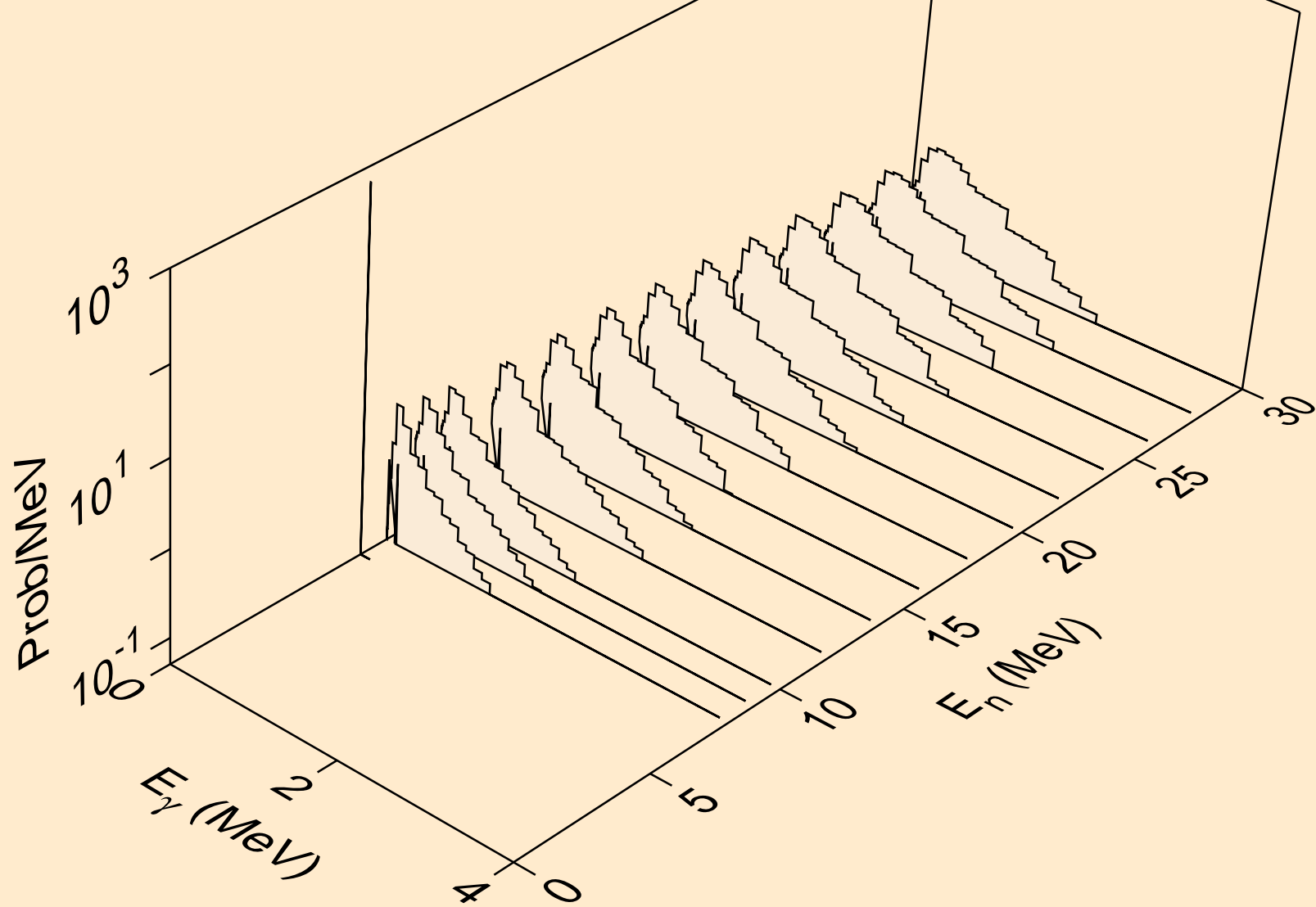

ES242 DEUTERON ACER TENDL-2021 LIBRARY; T=0.K
Photon emission for (n,p)

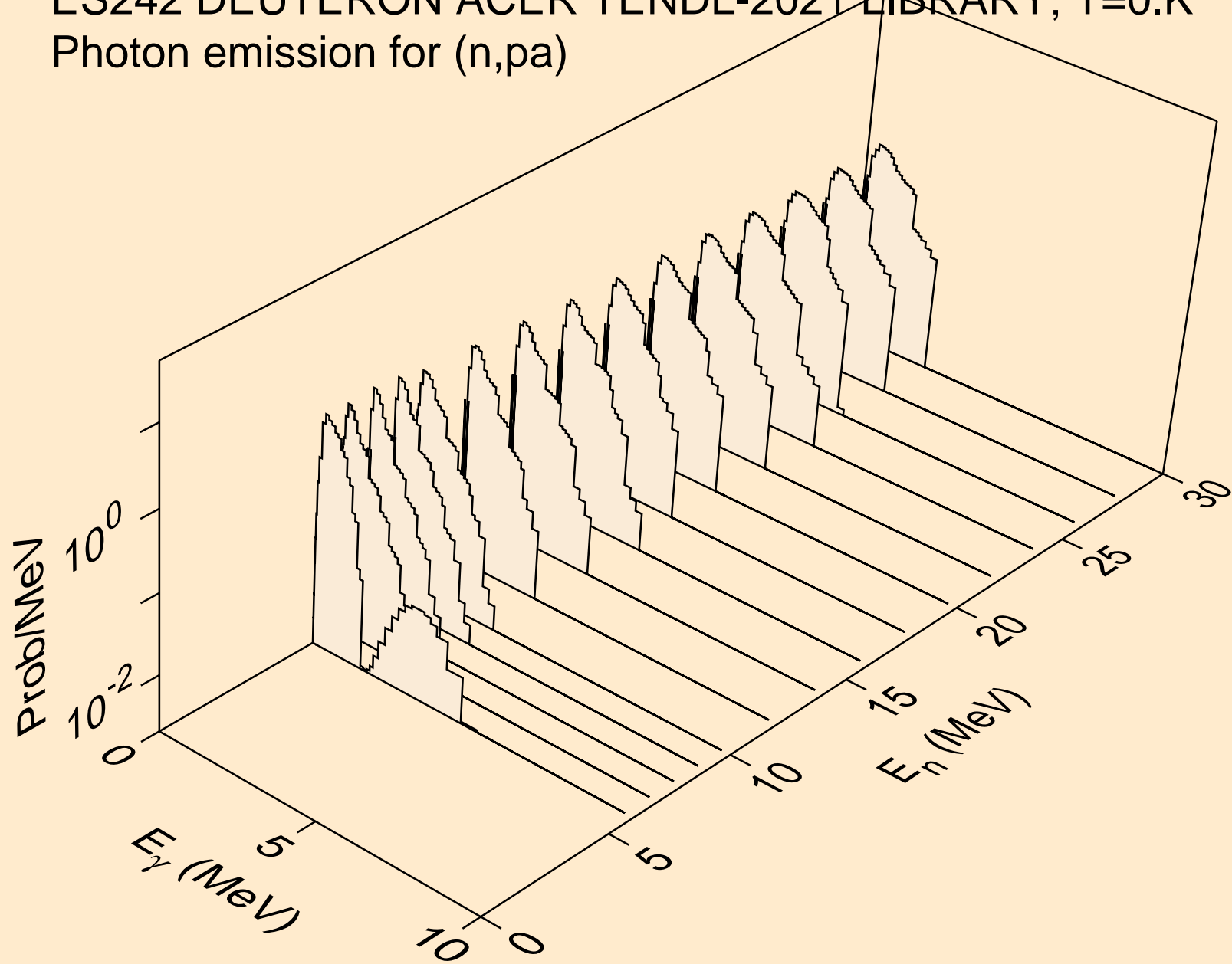

ES242 DEUTERON ACER TENDL-2021 LIBRARY; T=0.K
Photon emission for (n,pd)

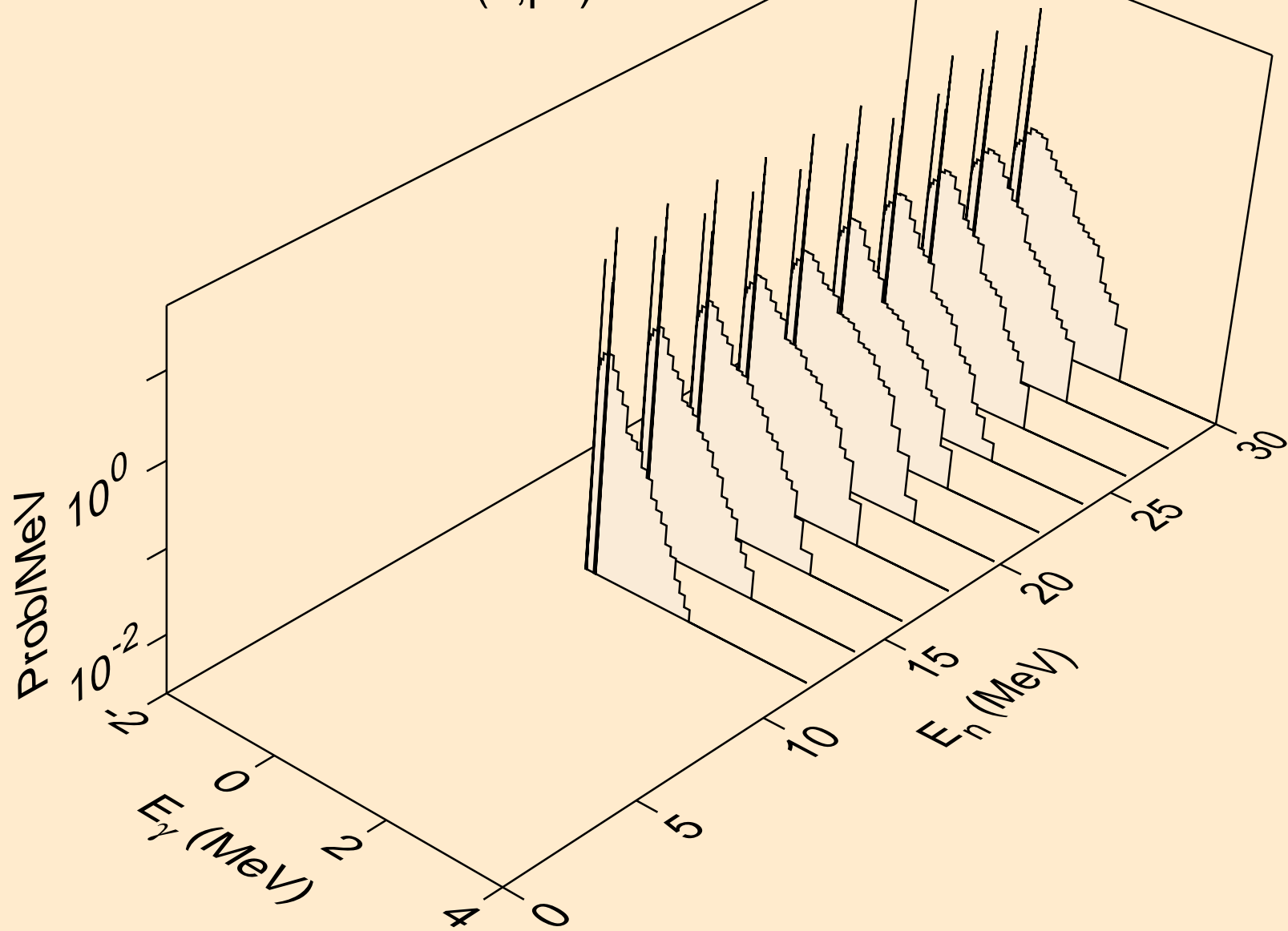

ES242 DEUTERON ACER TENDL-2021 LIBRARY; T=0.K
Photon emission for (n,da)

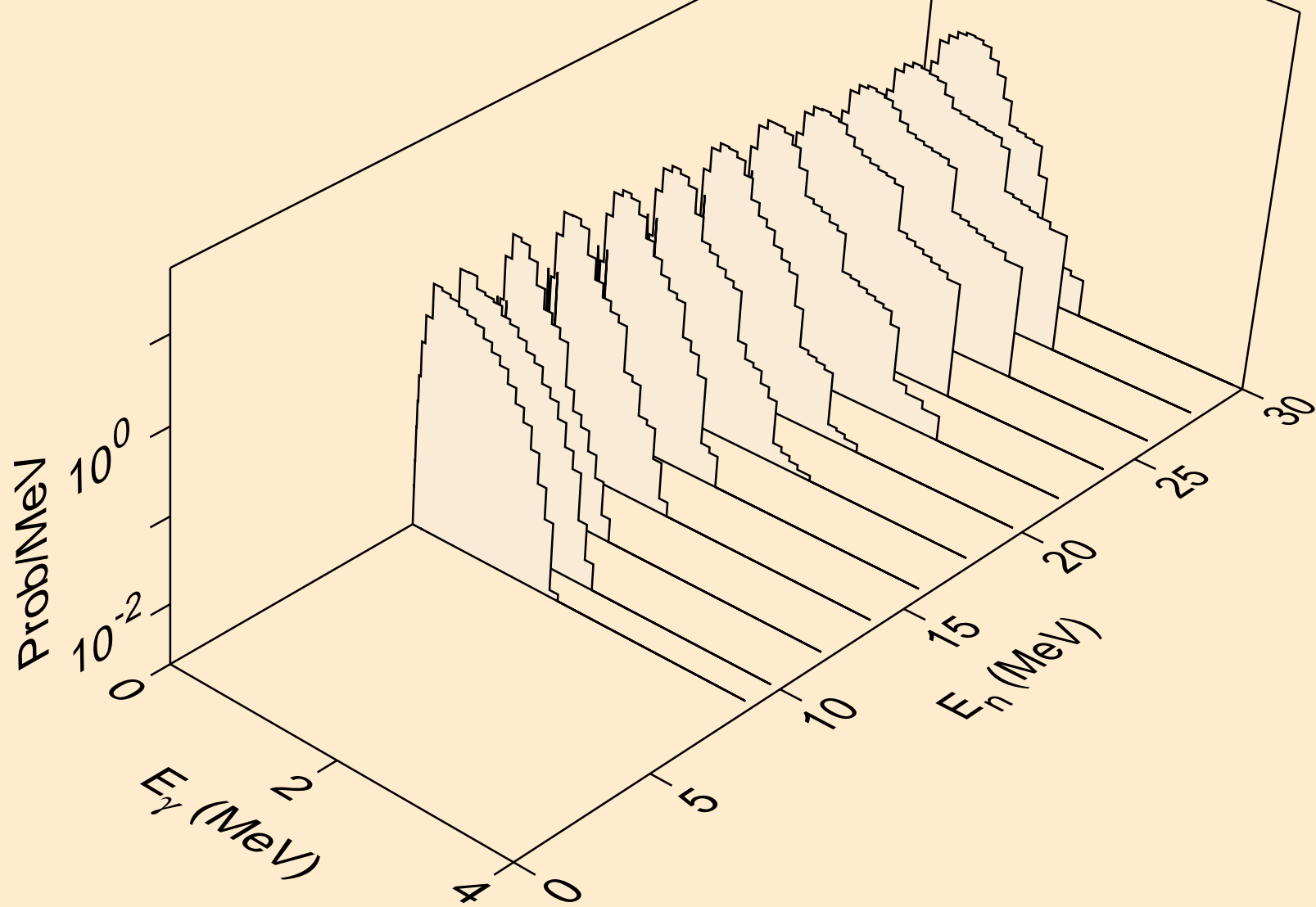

ES242 DEUTERON ACER TENDL-2021 LIBRARY; T=0.K

Particle heating contributions

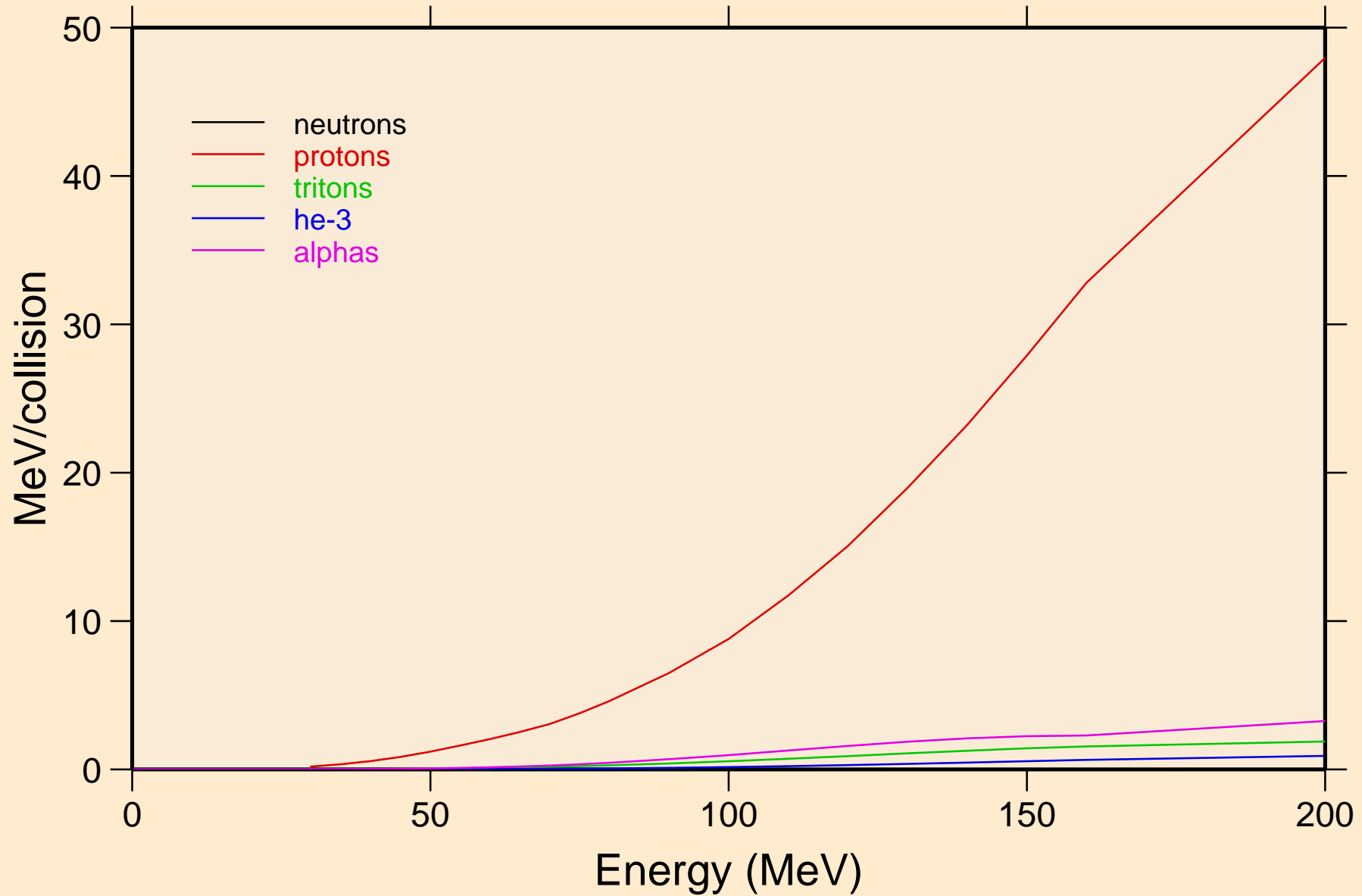

ES242 DEUTERON ACER TENDL-2021 LIBRARY; T=0.K
Recoil Heating

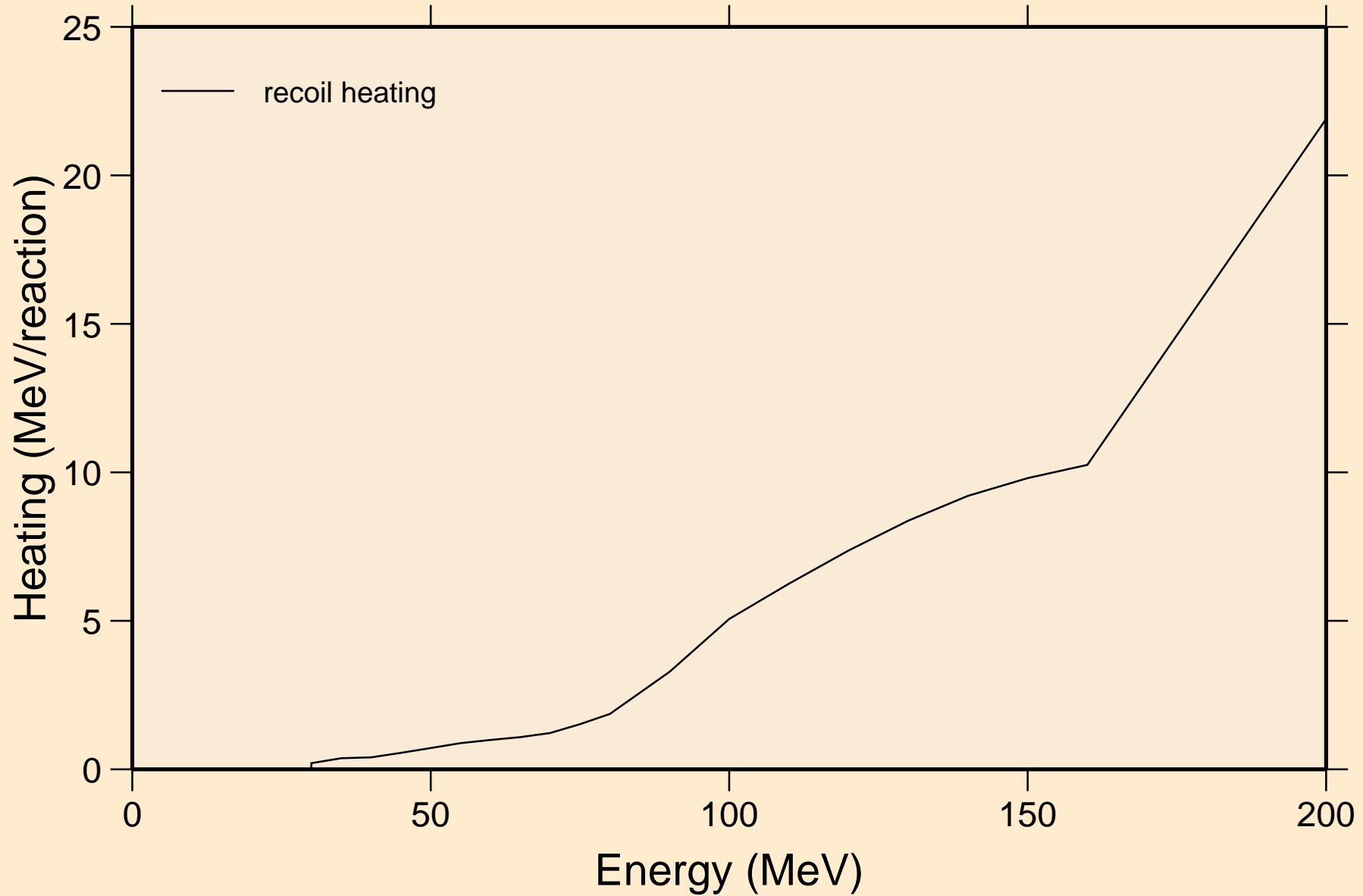

ES242 DEUTERON ACER TENDL-2021 LIBRARY; T=0.K
Particle production cross sections

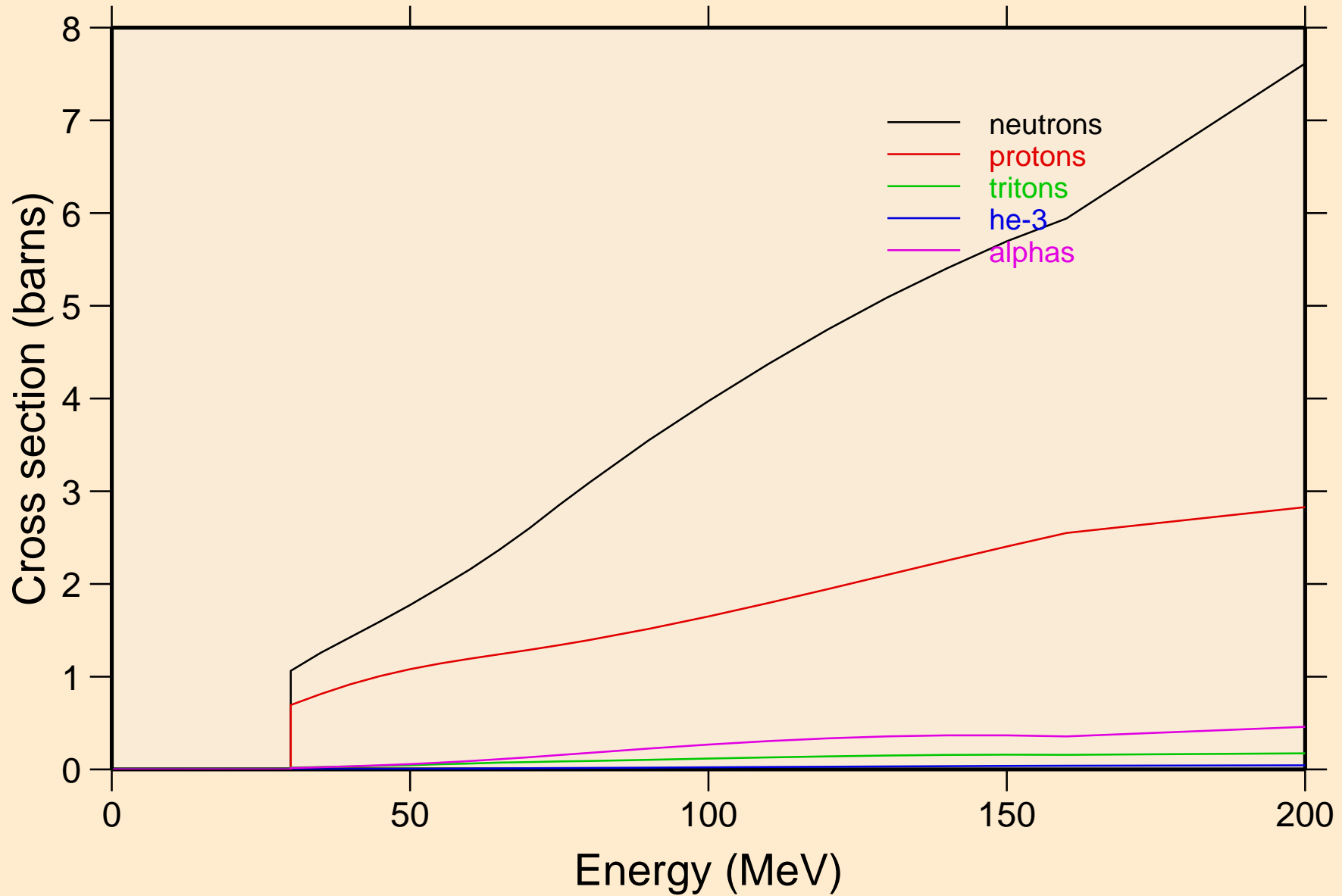

ES242 DEUTERON ACER TENDL-2021 LIBRARY; T=0.K
neutrons from (d,n)

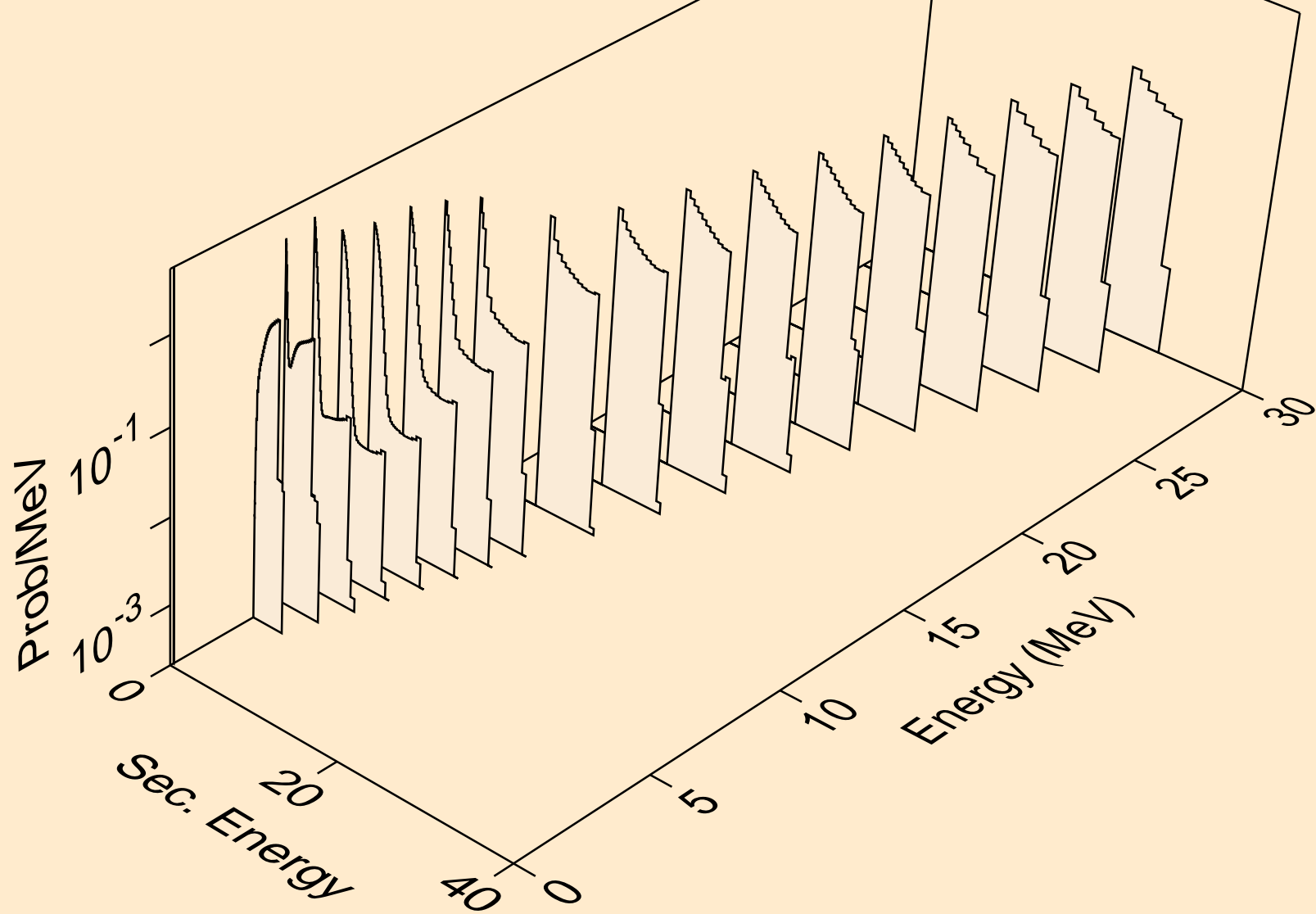

ES242 DEUTERON ACER TENDL-2021 LIBRARY; T=0.K
neutrons from (d,x)

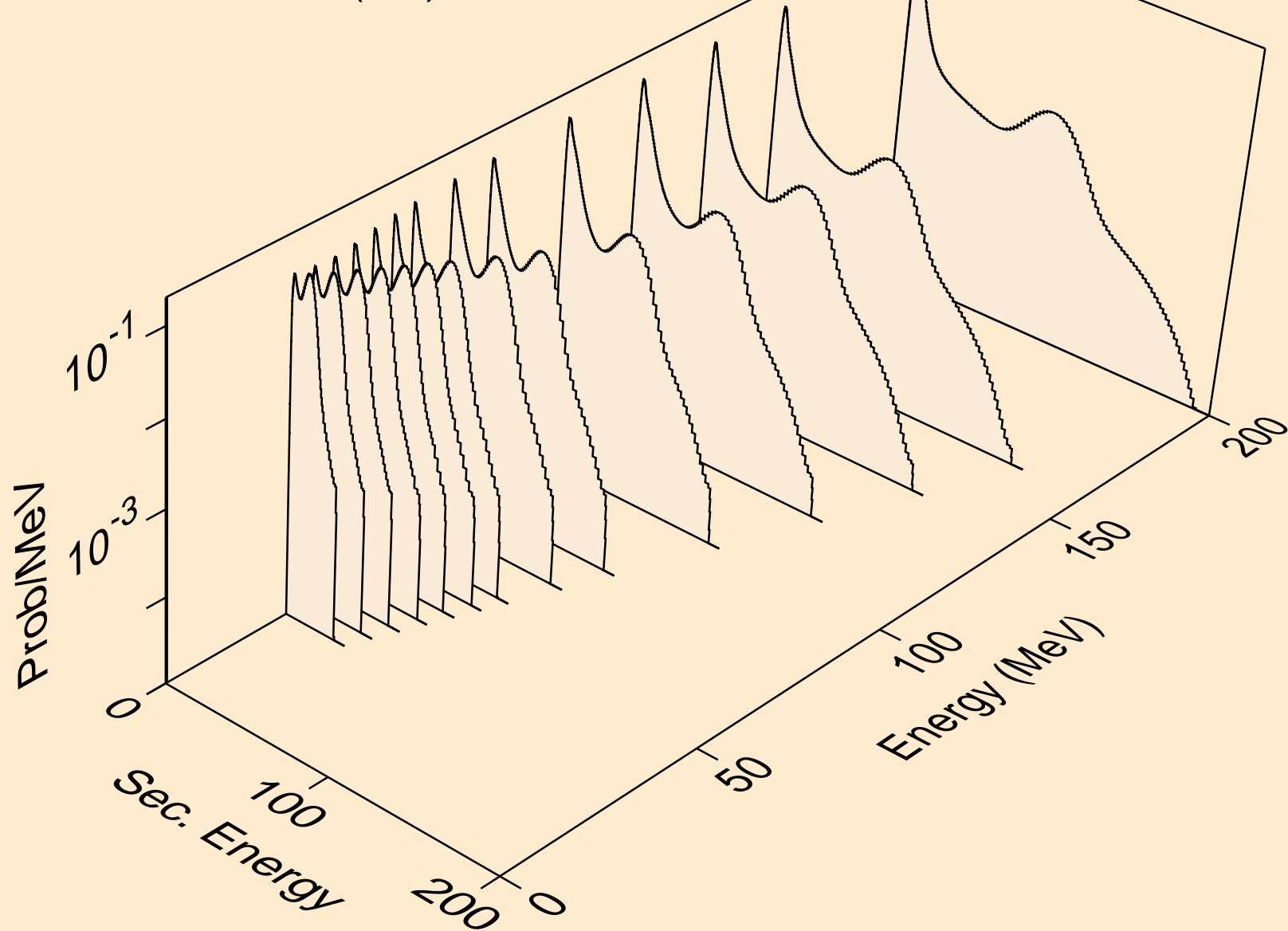

ES242 DEUTERON ACER TENDL-2021 LIBRARY; T=0.K
neutrons from (d,2n)

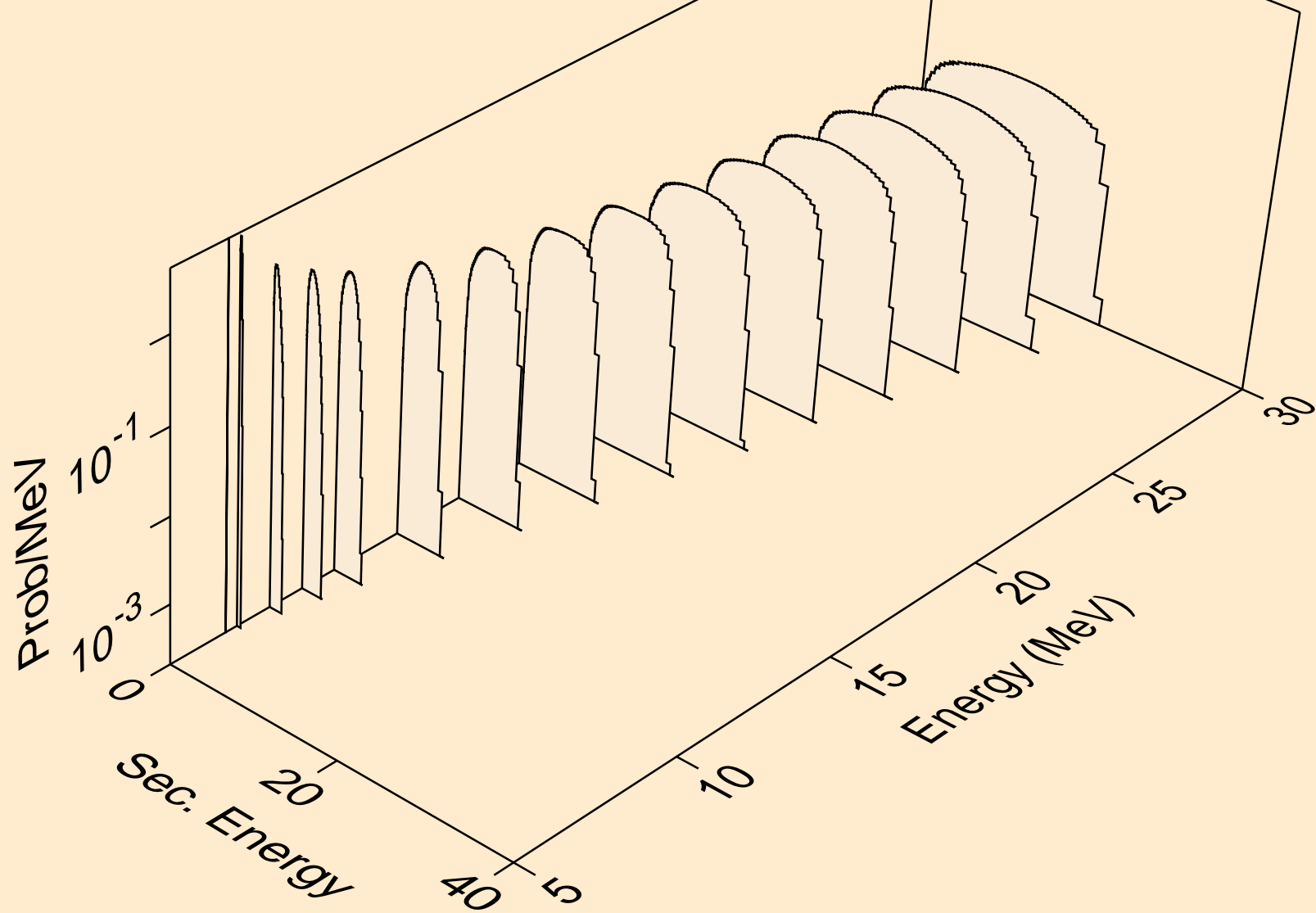

ES242 DEUTERON ACER TENDL-2021 LIBRARY; T=0.K
neutrons from (d,3n)

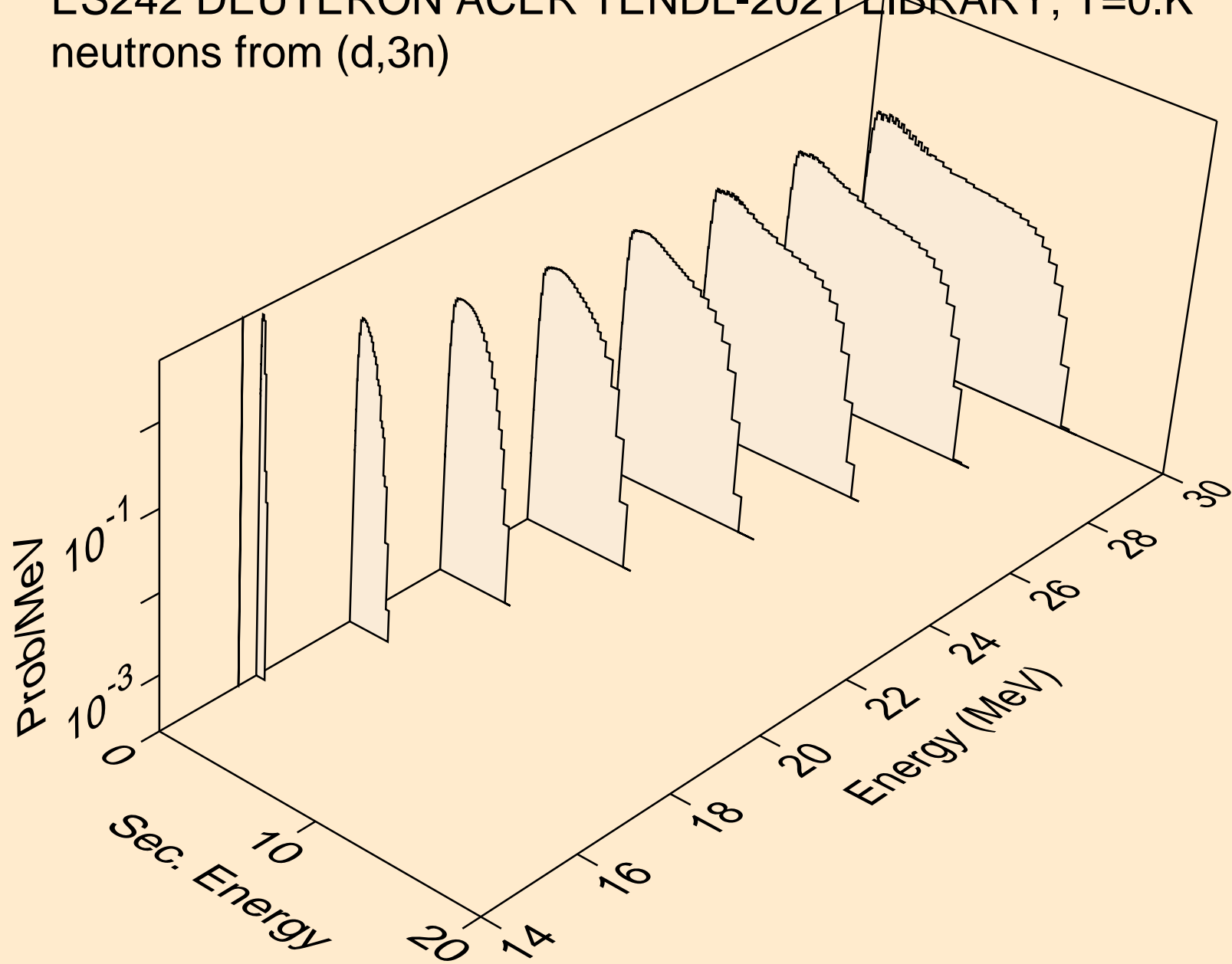

ES242 DEUTERON ACER TENDL-2021 LIBRARY; T=0.K
neutrons from (d,n*)a

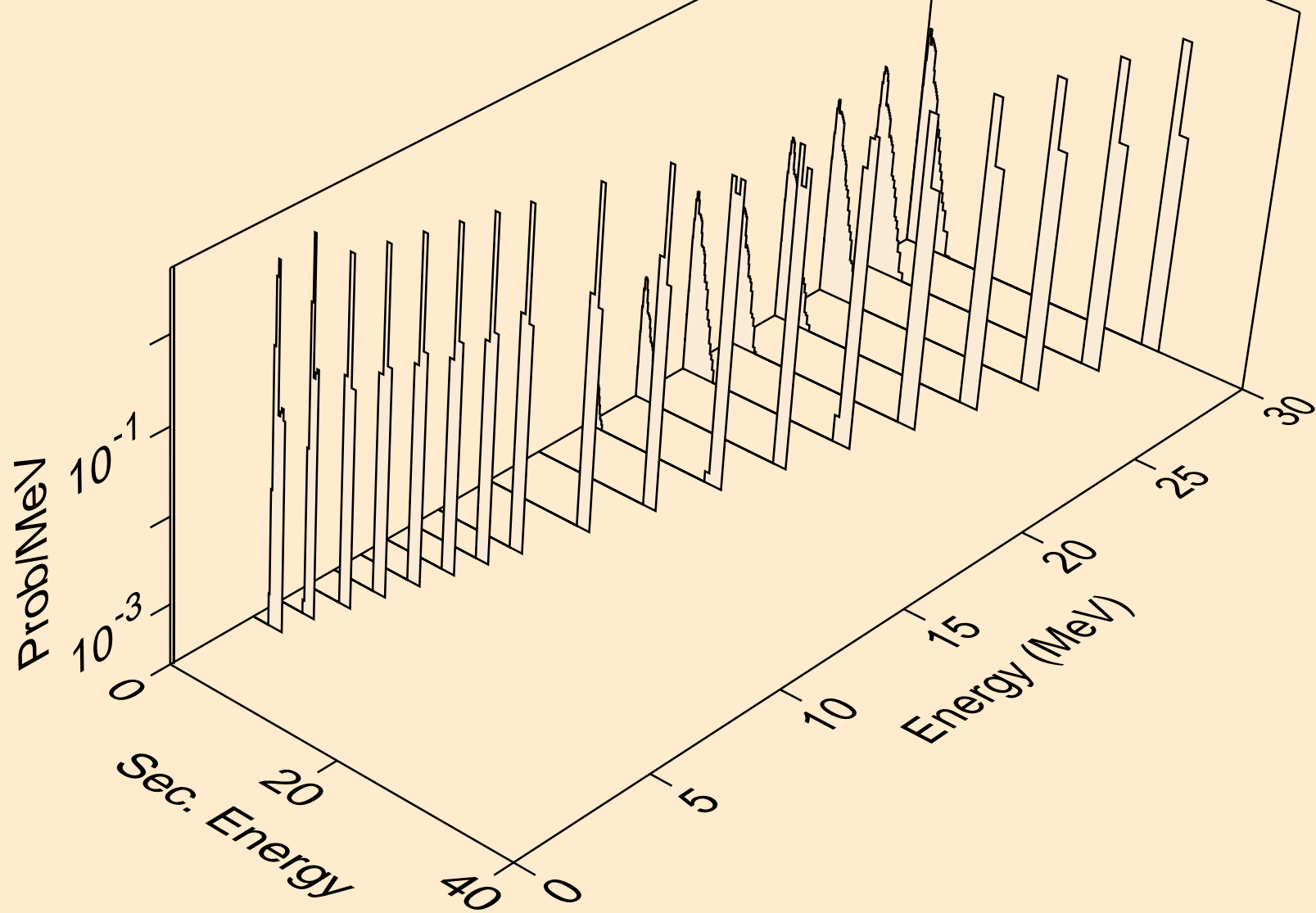

ES242 DEUTERON ACER TENDL-2021 LIBRARY; T=0.K
neutrons from (d,2n)a

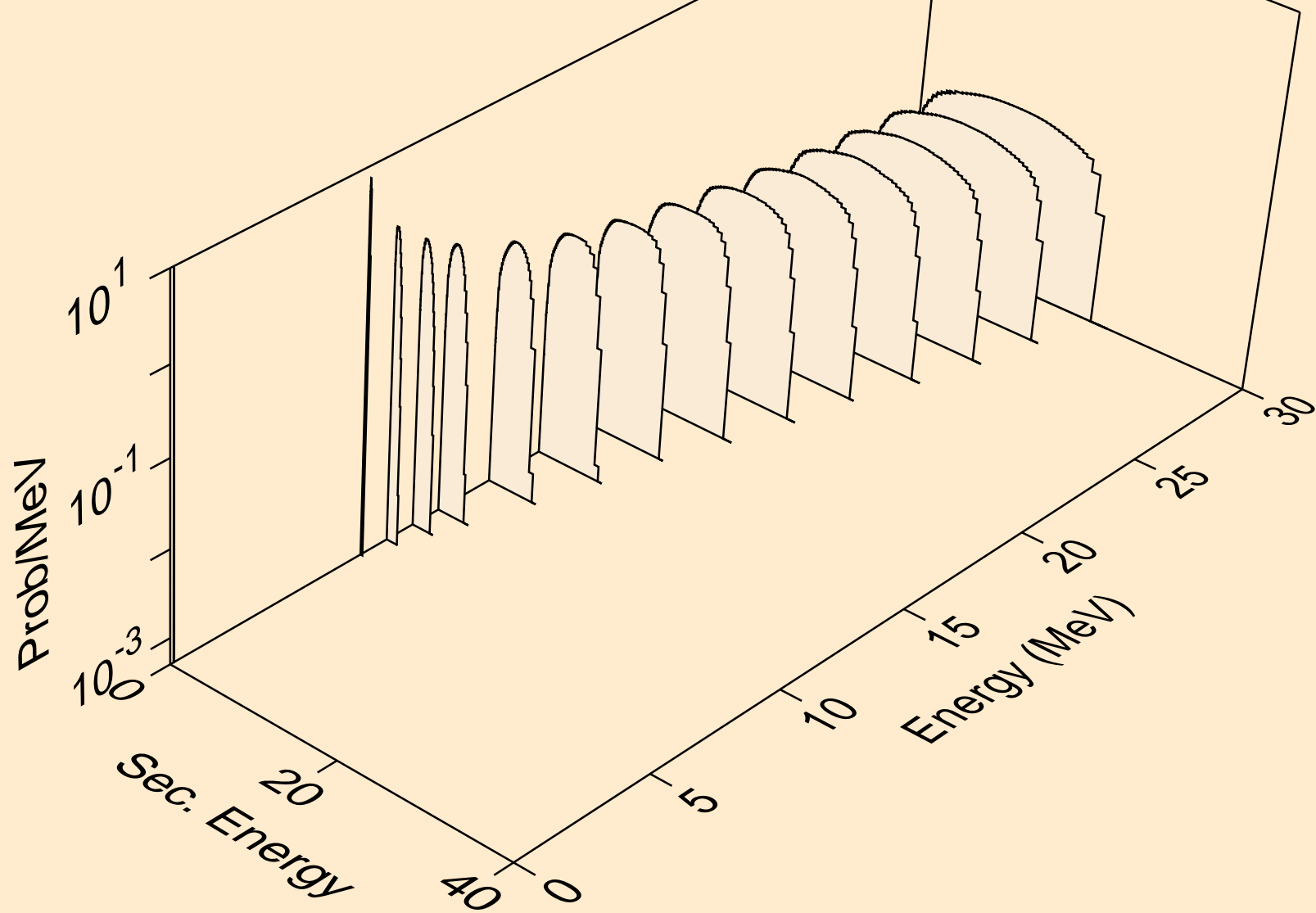

ES242 DEUTERON ACER TENDL-2021 LIBRARY; T=0.K
neutrons from (d,n*)p

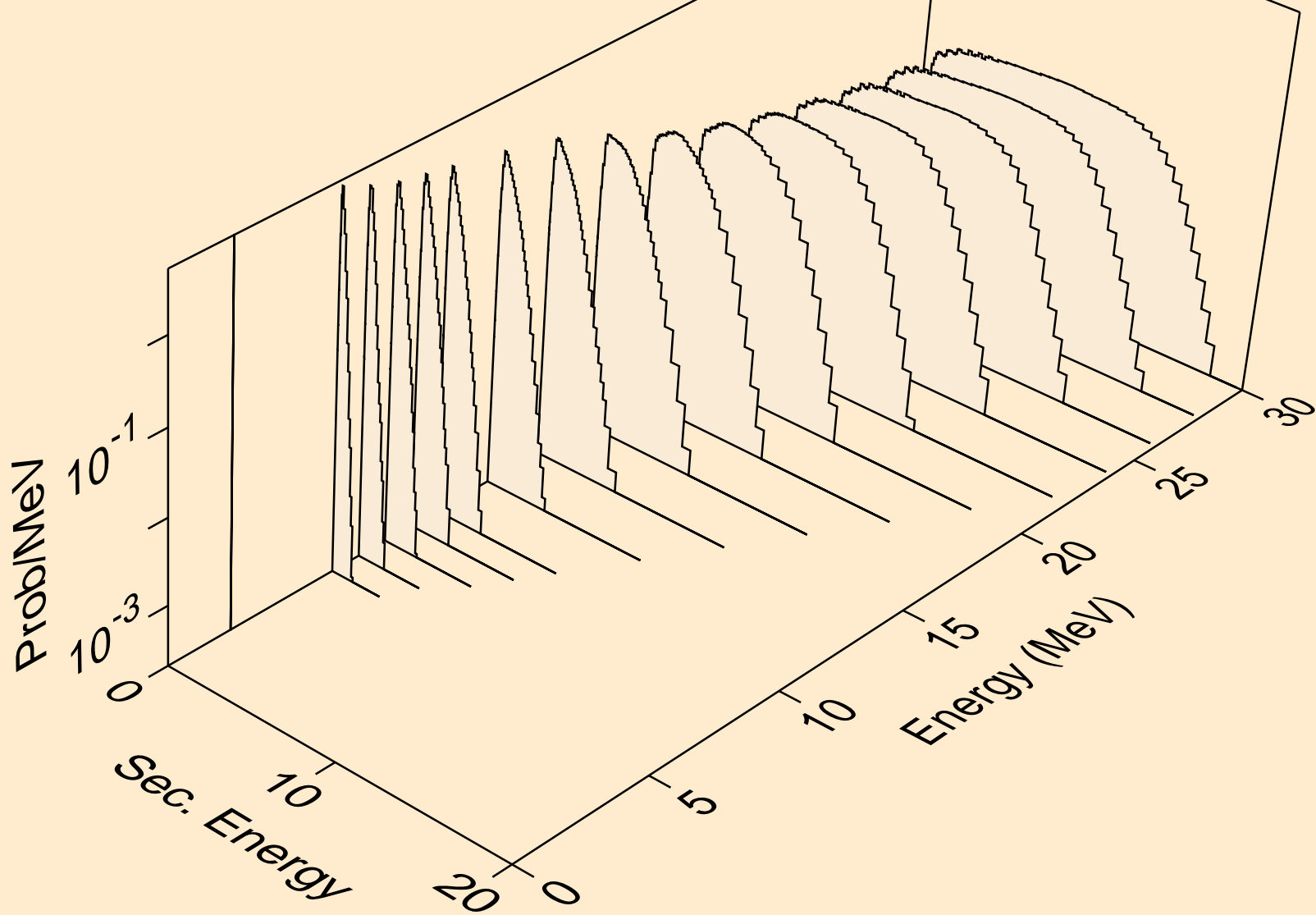

ES242 DEUTERON ACER TENDL-2021 LIBRARY; T=0.K
neutrons from (d,n*)d

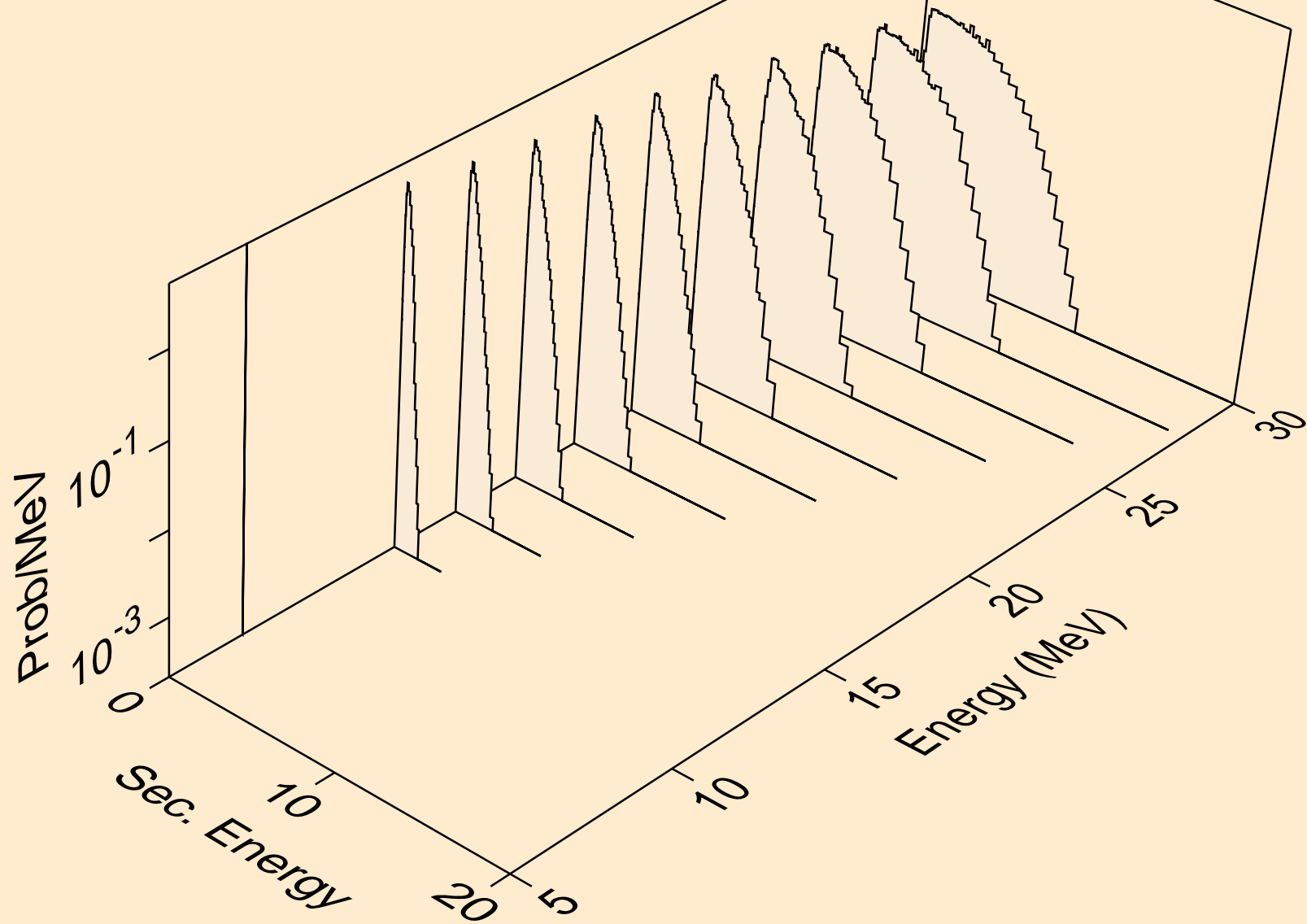

ES242 DEUTERON ACER TENDL-2021 LIBRARY; T=0.K
neutrons from (d,n*)t

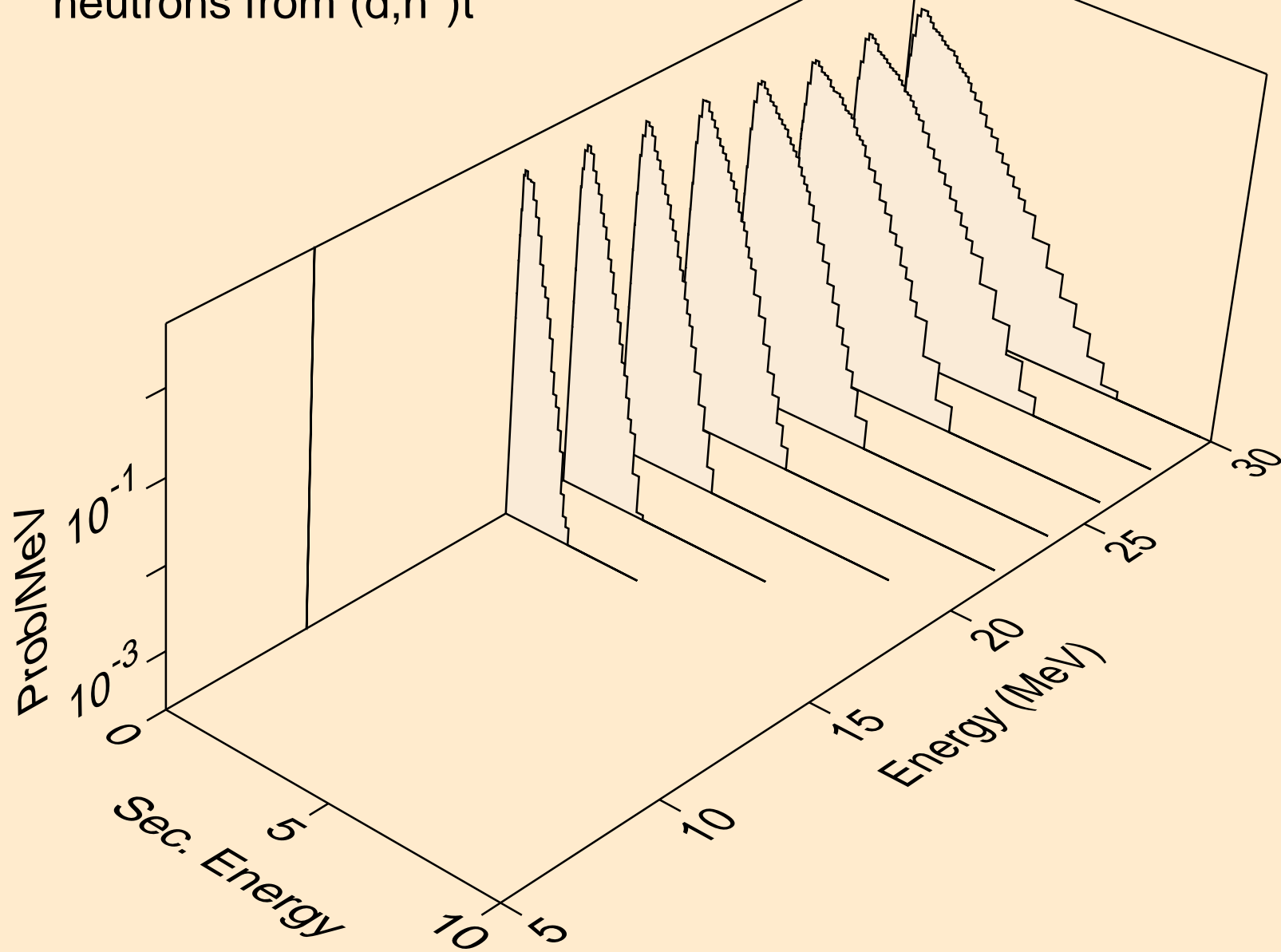

ES242 DEUTERON ACER TENDL-2021 LIBRARY; T=0.K
neutrons from (d,n*)he3

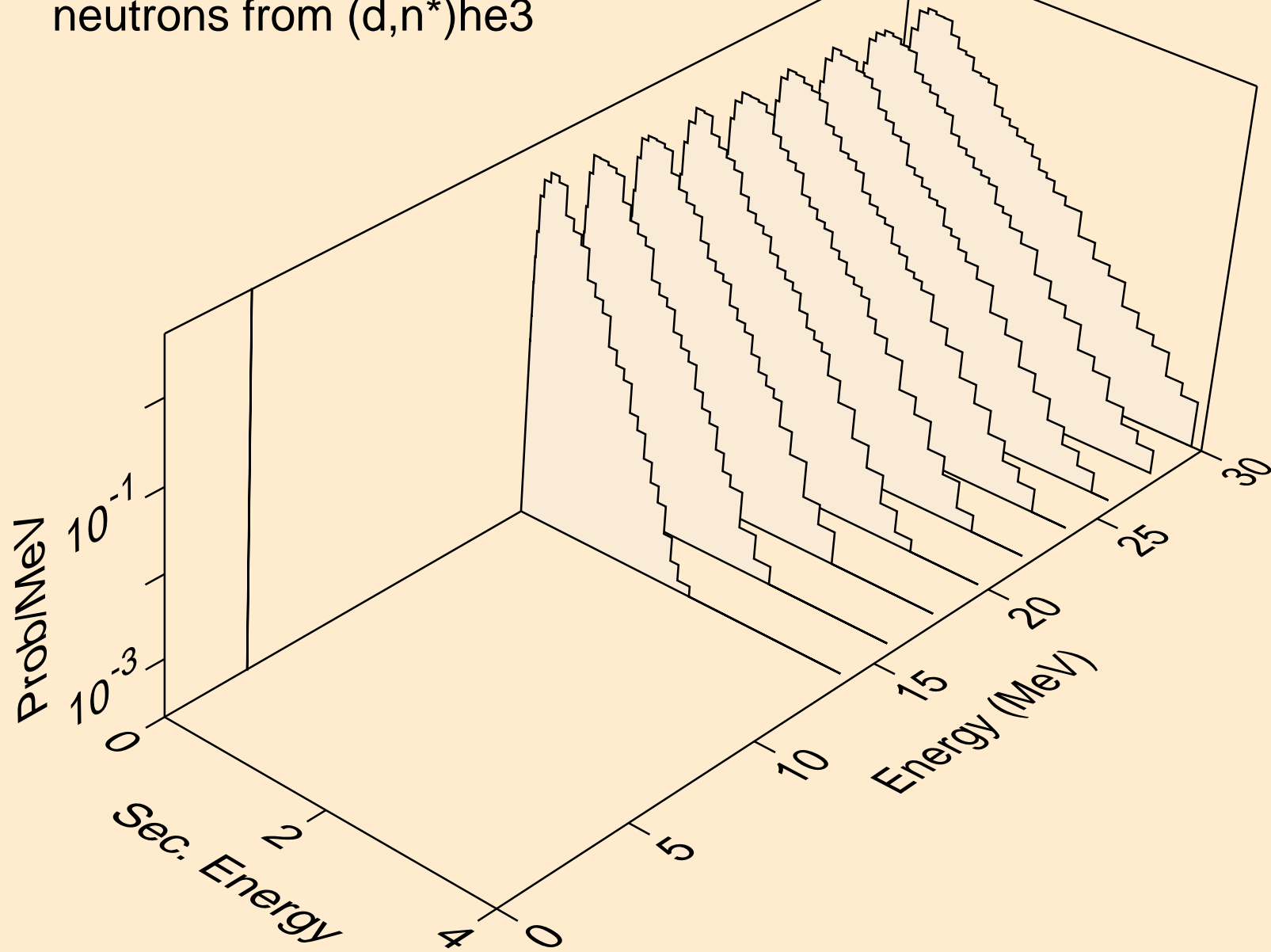

ES242 DEUTERON ACER TENDL-2021 LIBRARY; T=0.K
neutrons from (d,2np)

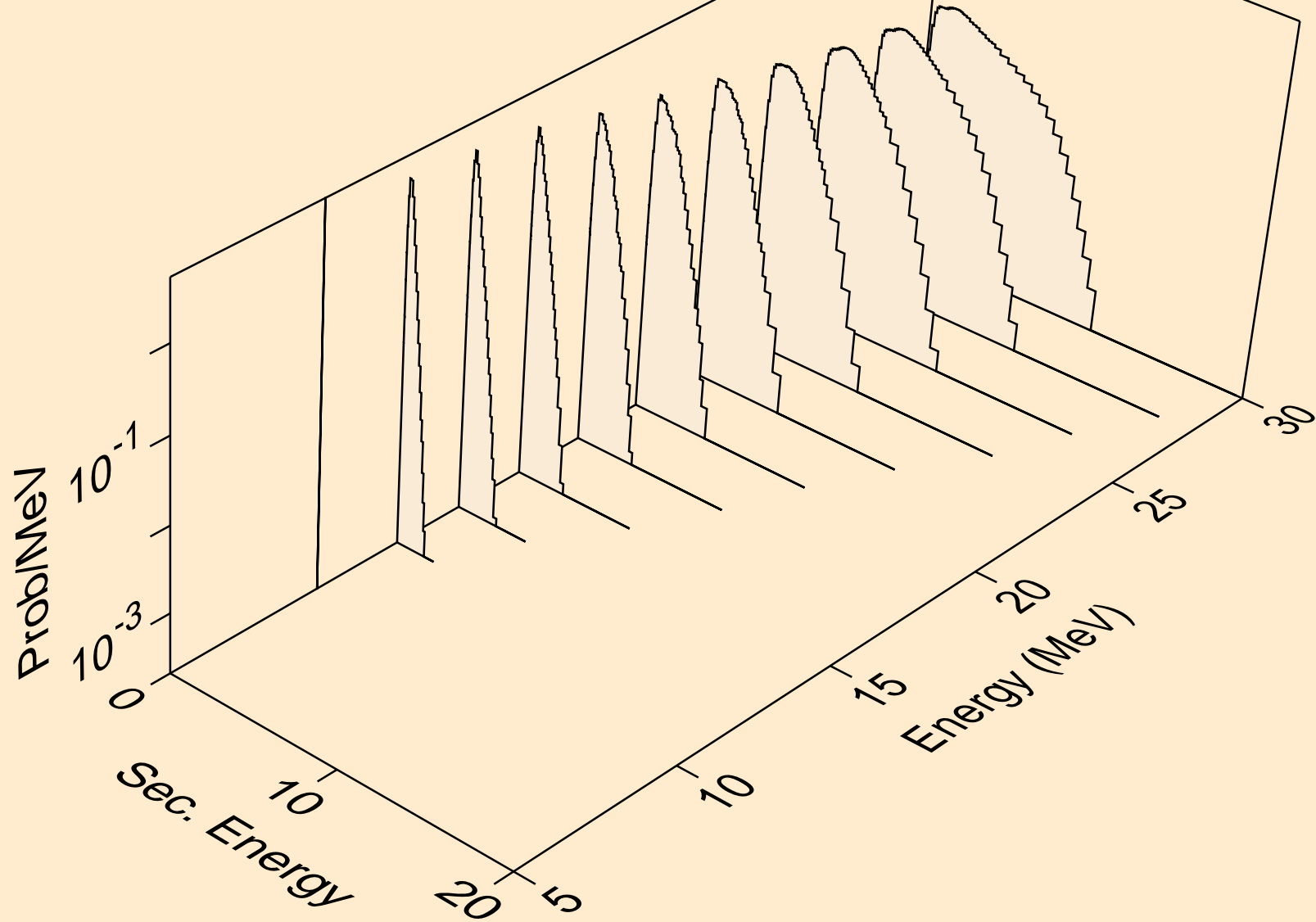

ES242 DEUTERON ACER TENDL-2021 LIBRARY; T=0.K
neutrons from (d,2np)

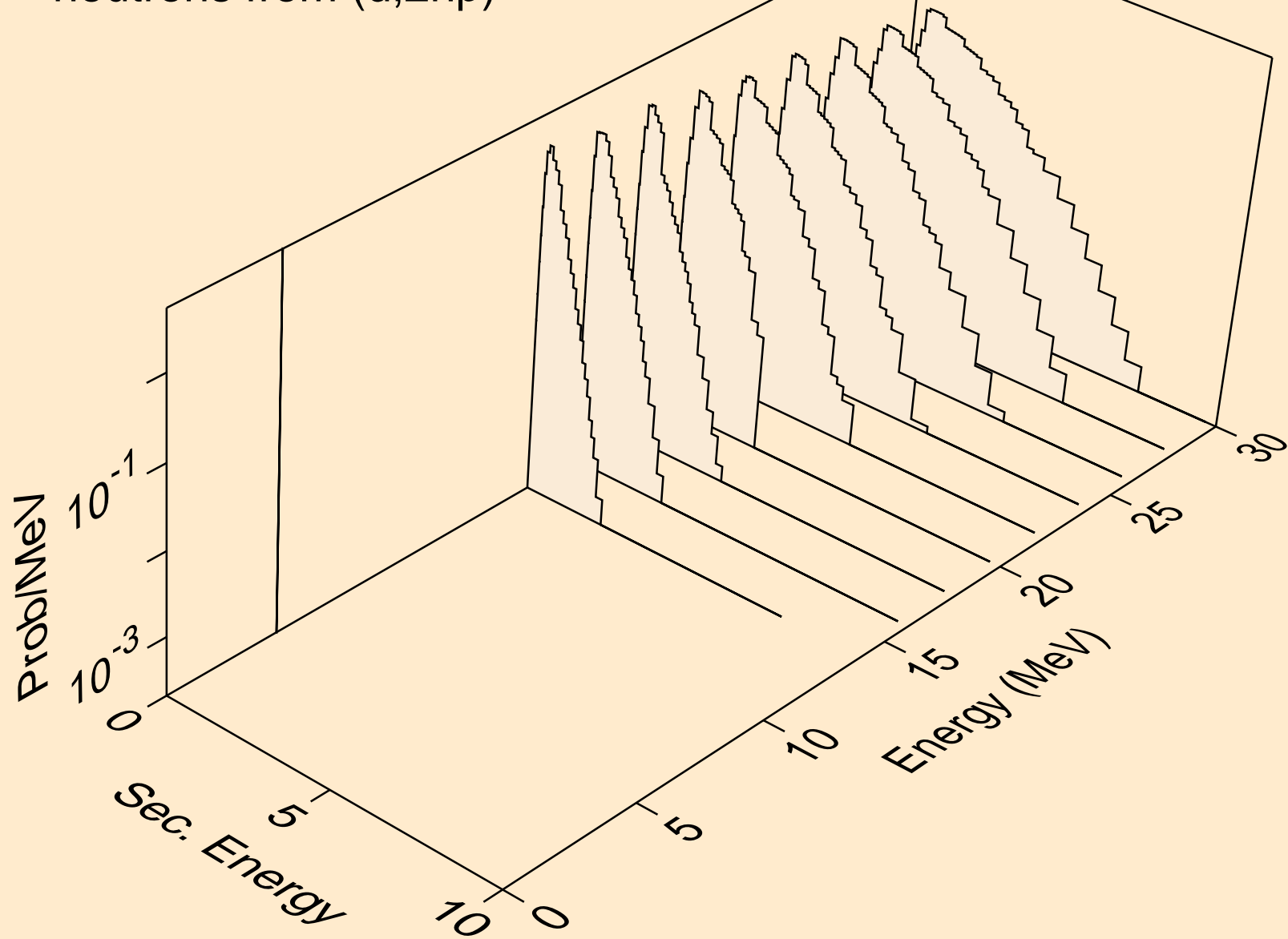

ES242 DEUTERON ACER TENDL-2021 LIBRARY; T=0.K
neutrons from (d,npa)

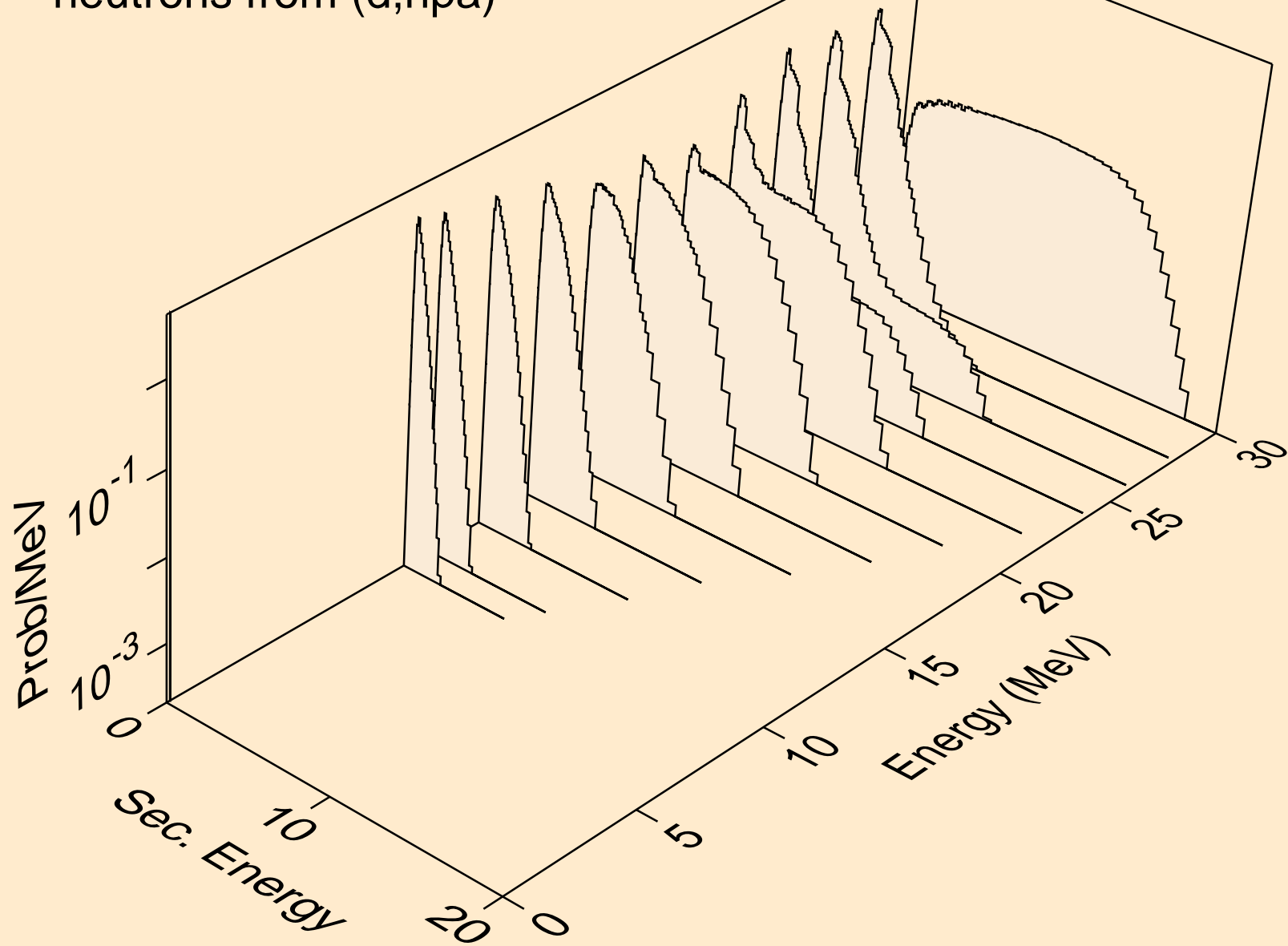

ES242 DEUTERON ACER TENDL-2021 LIBRARY; T=0.K
protons from (d,x)

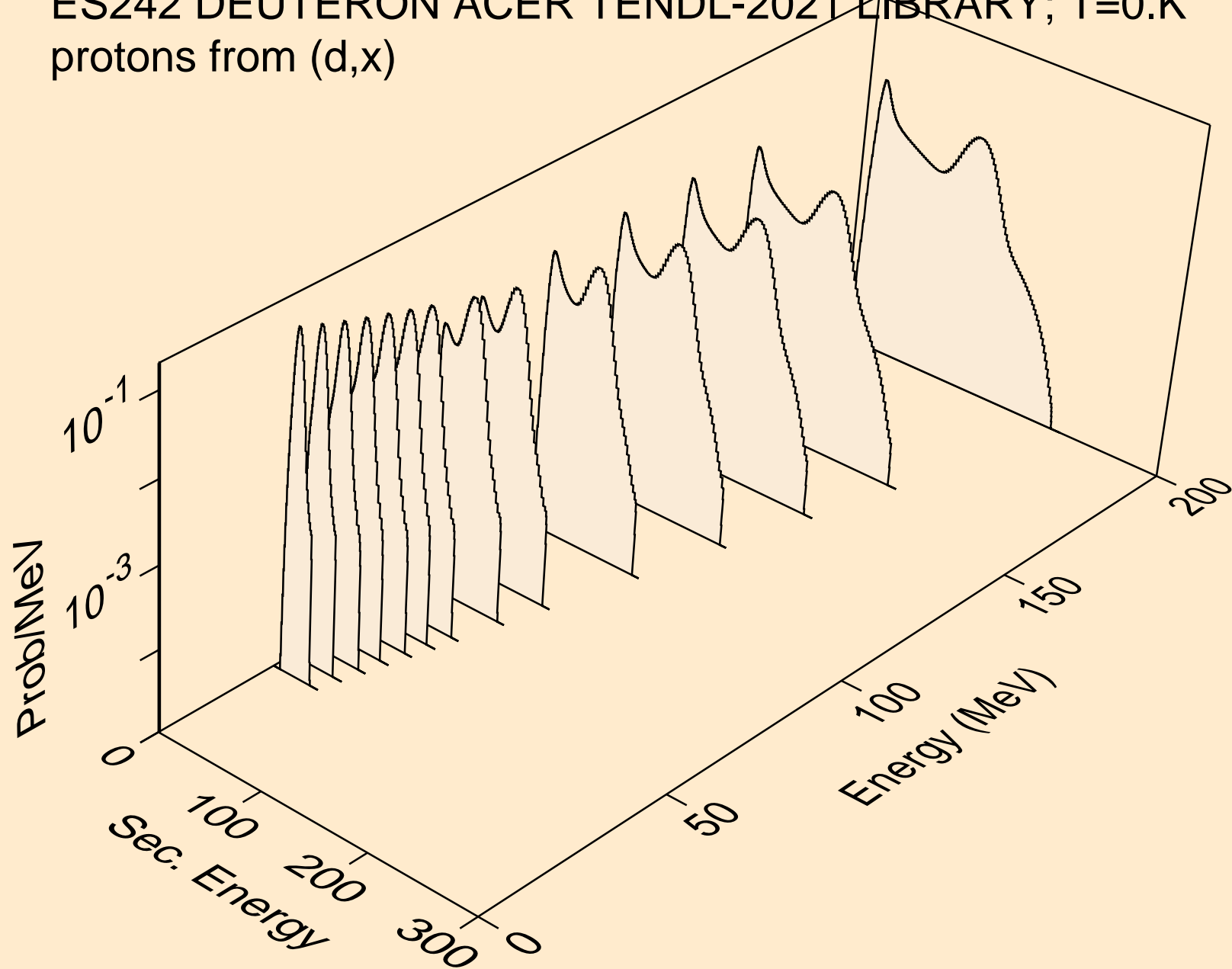

ES242 DEUTERON ACER TENDL-2021 LIBRARY; T=0.K
protons from (d,n*)p

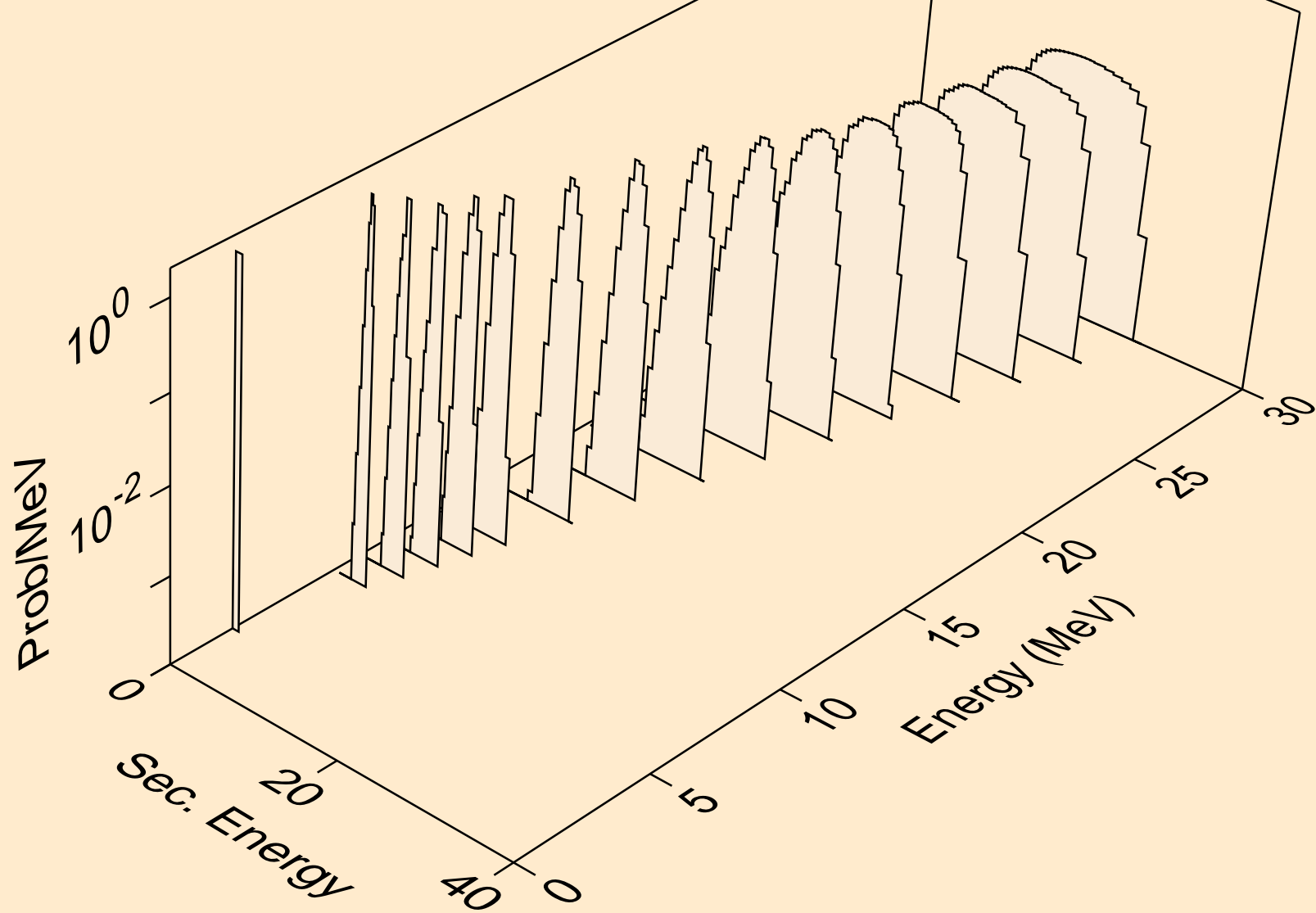

ES242 DEUTERON ACER TENDL-2021 LIBRARY; T=0.K
protons from (d,2np)

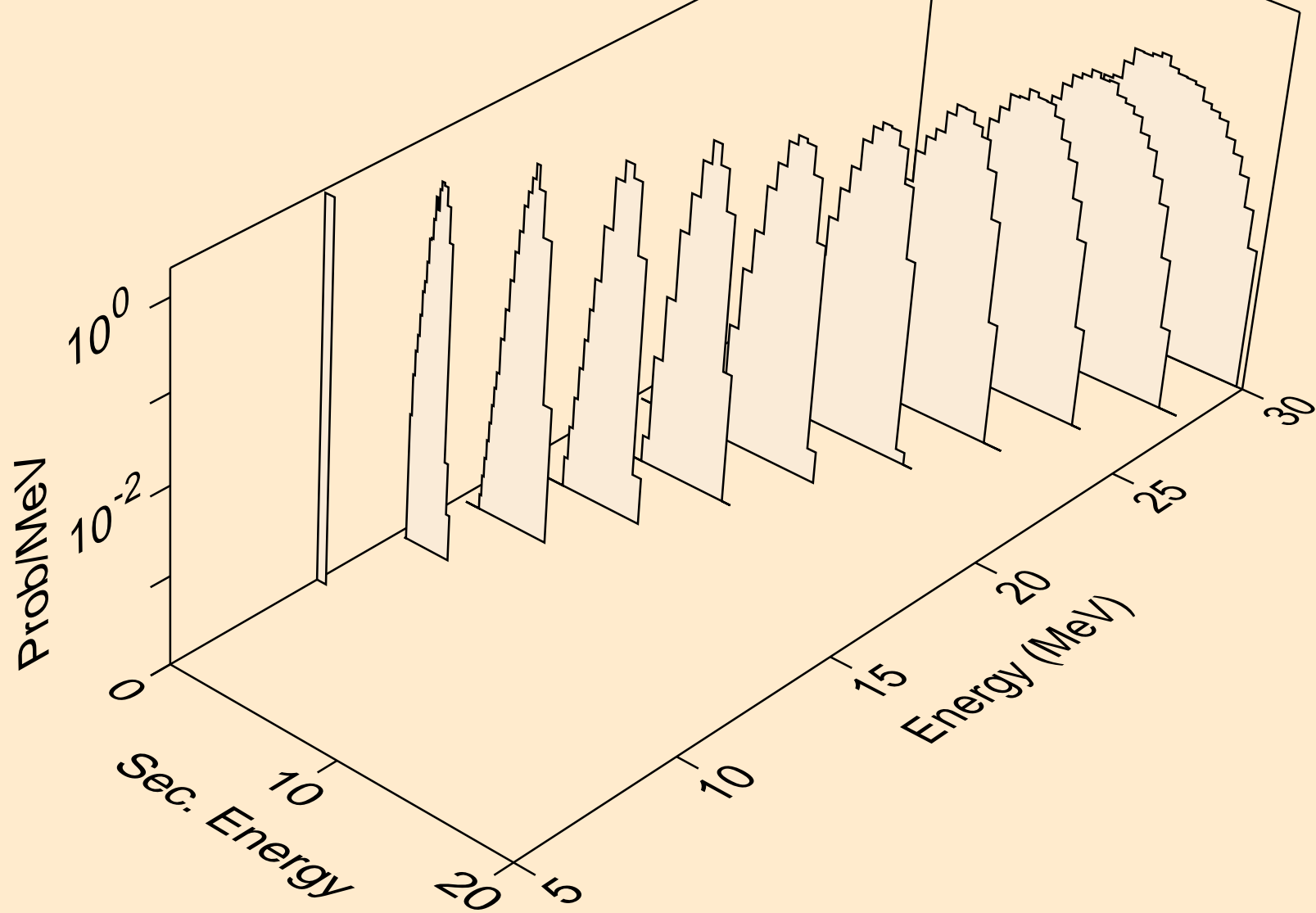

ES242 DEUTERON ACER TENDL-2021 LIBRARY; T=0.K
protons from (d,2np)

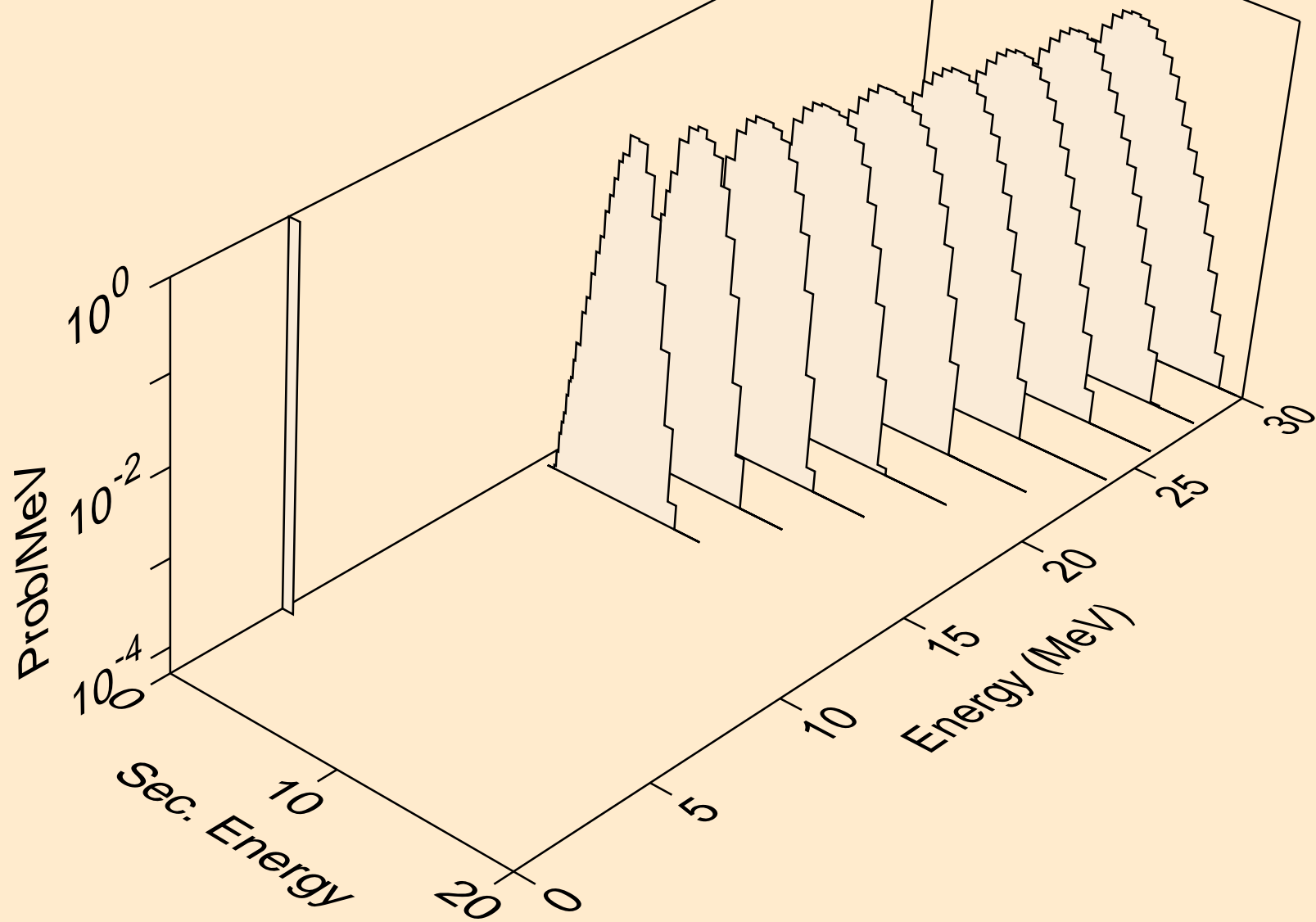

ES242 DEUTERON ACER TENDL-2021 LIBRARY; T=0.K
protons from (d,npa)

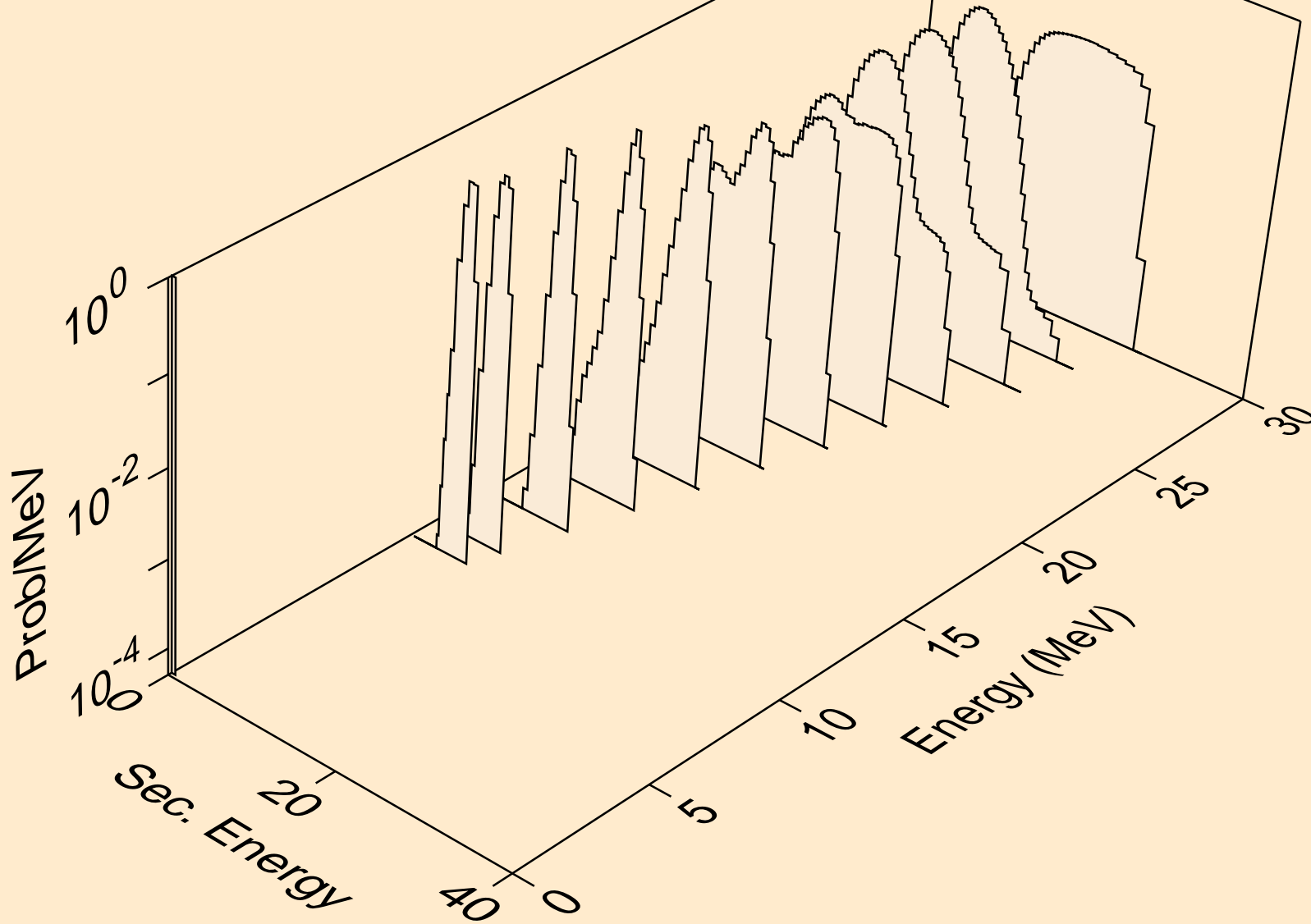

ES242 DEUTERON ACER TENDL-2021 LIBRARY; T=0.K
protons from (d,p)

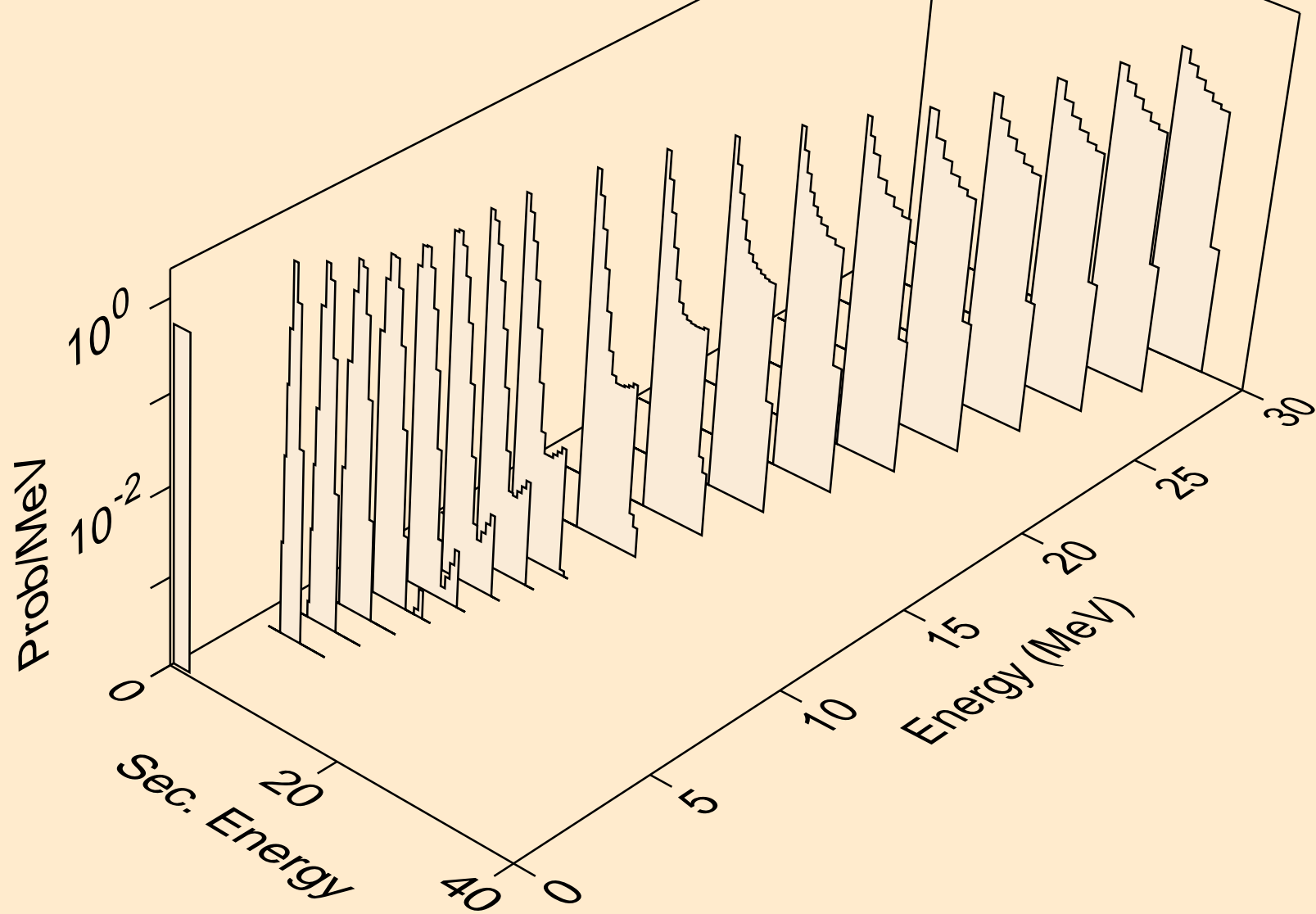

ES242 DEUTERON ACER TENDL-2021 LIBRARY; T=0.K
protons from (d,2p)

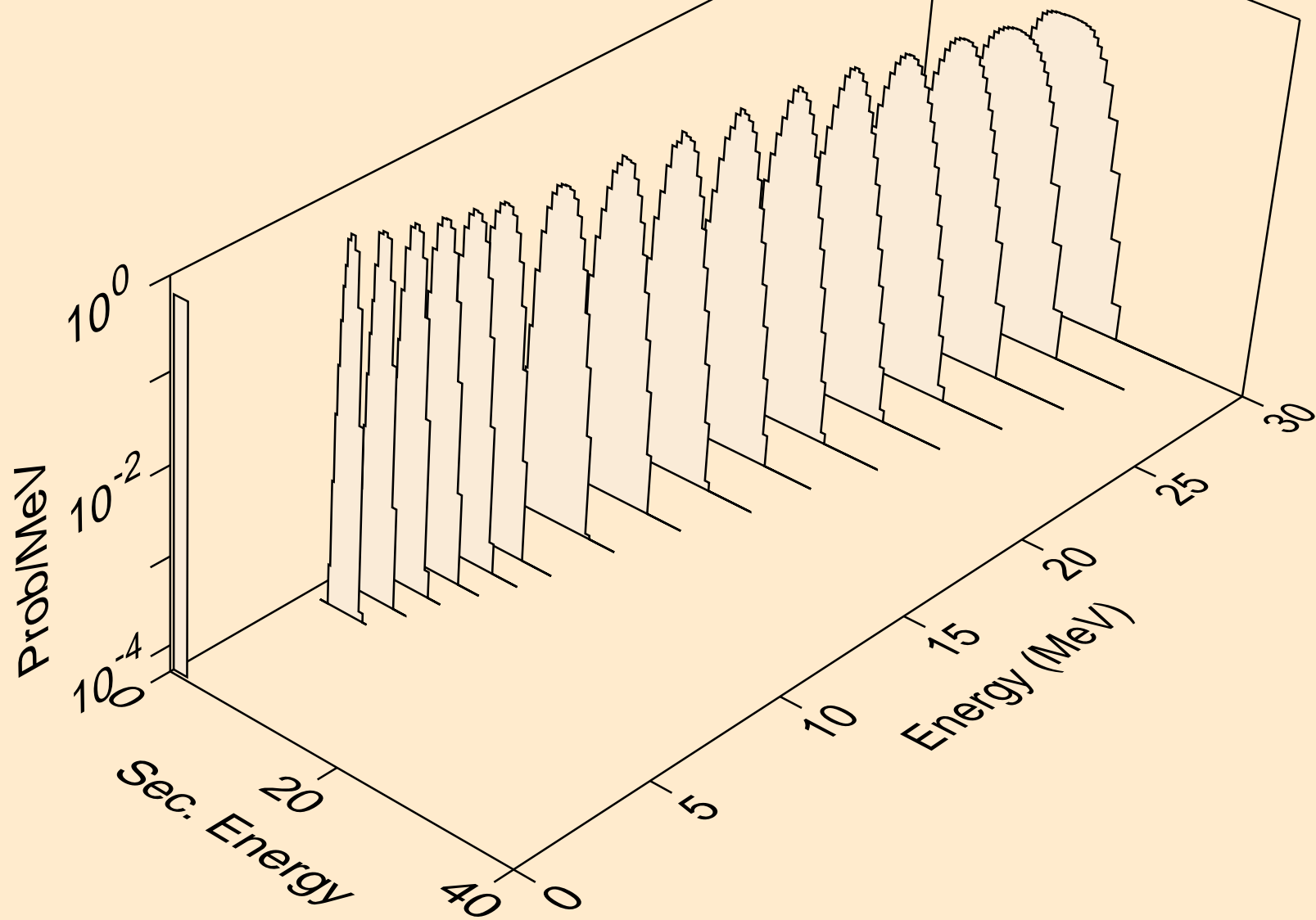

ES242 DEUTERON ACER TENDL-2021 LIBRARY; T=0.K
protons from (d,pa)

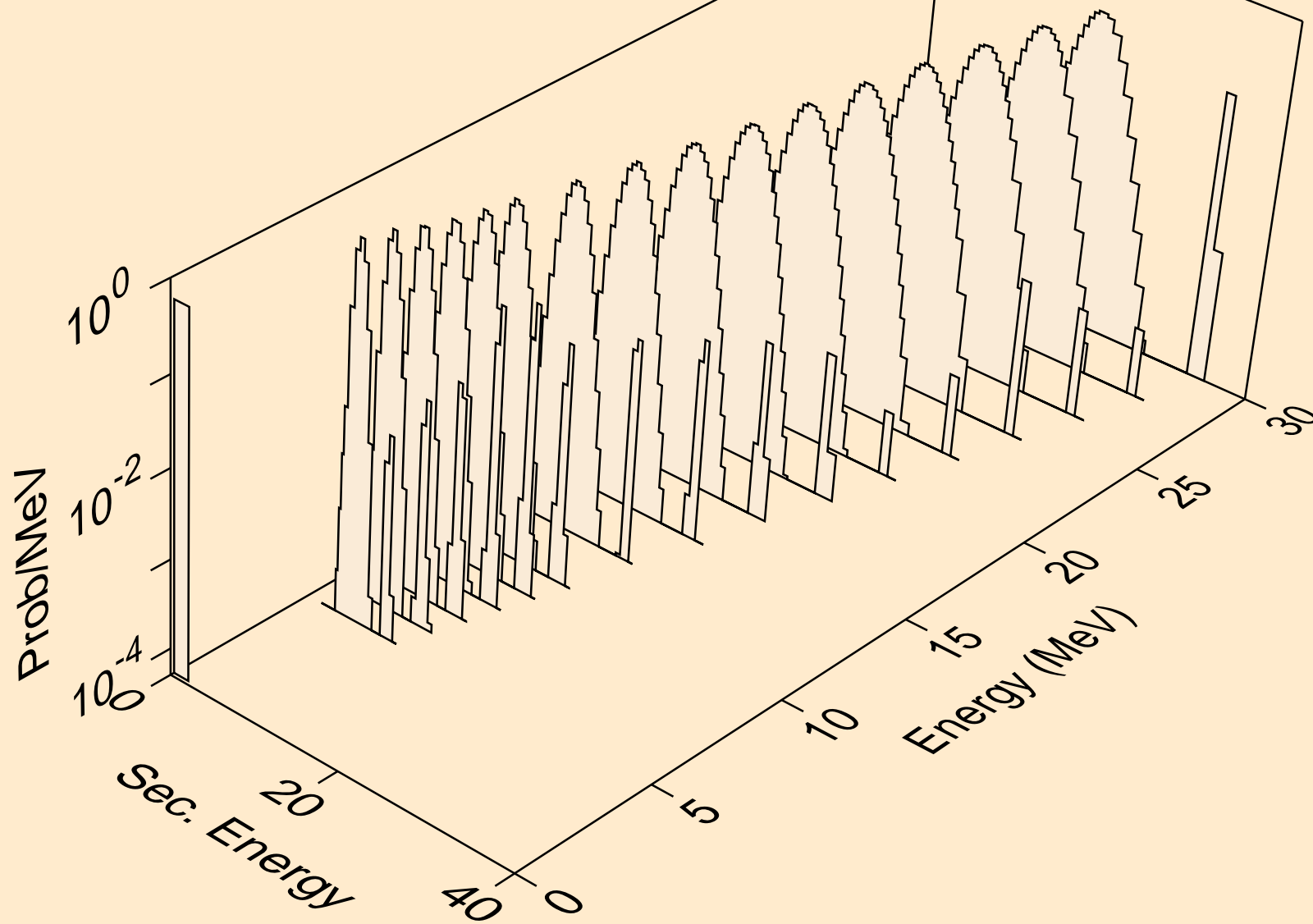

ES242 DEUTERON ACER TENDL-2021 LIBRARY; T=0.K
protons from (d,pd)

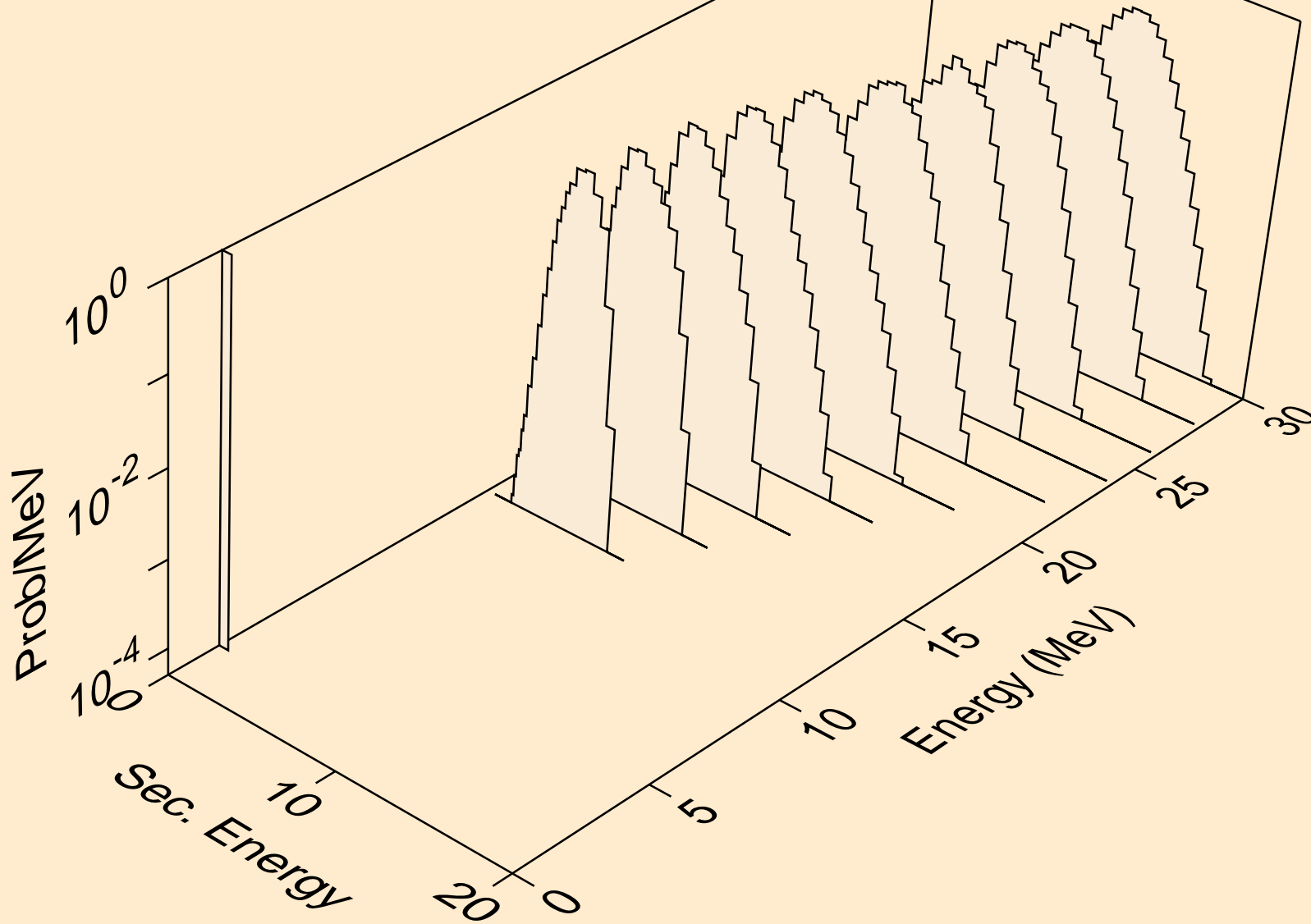

ES242 DEUTERON ACER TENDL-2021 LIBRARY; T=0.K
tritons from (d,x)

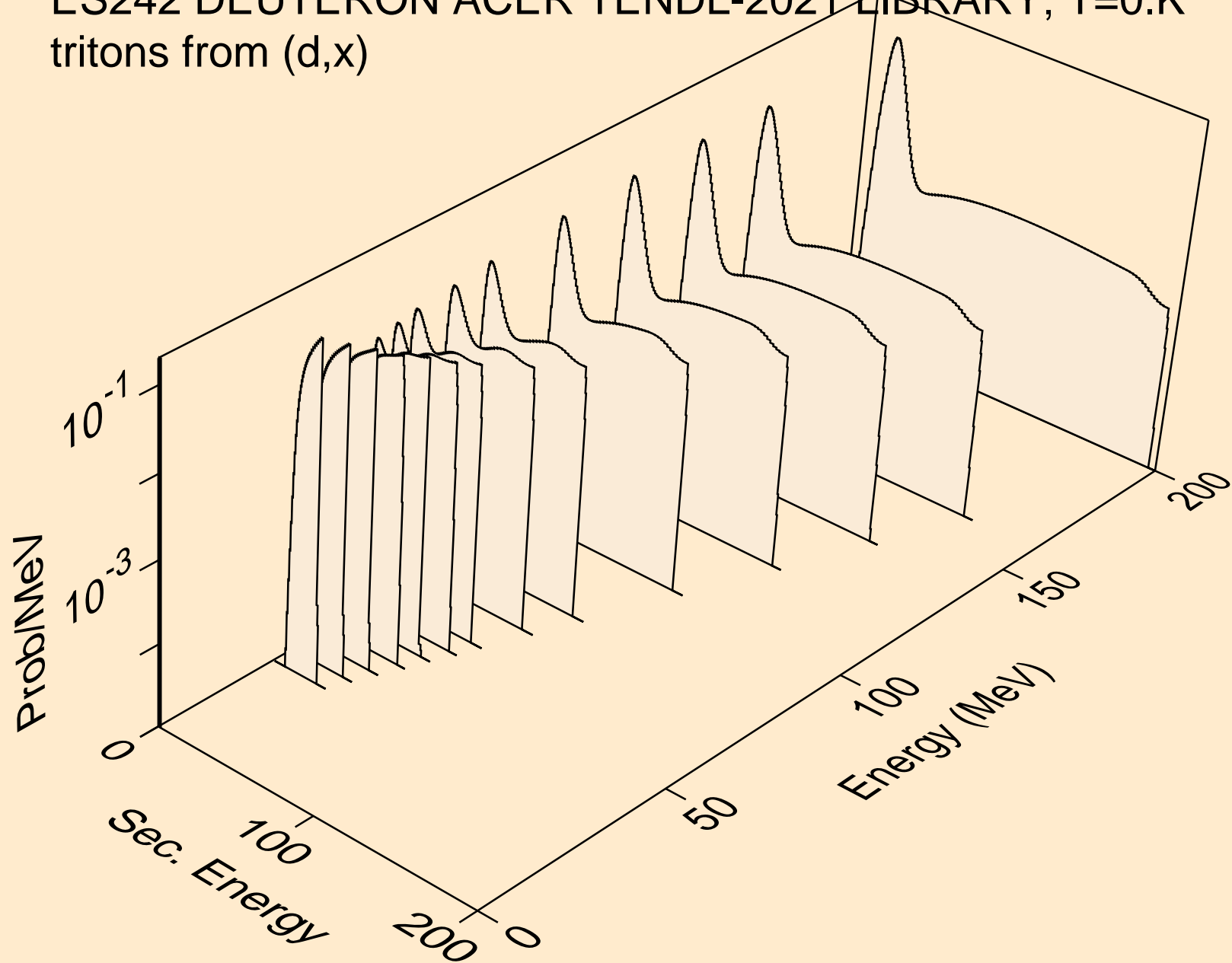

ES242 DEUTERON ACER TENDL-2021 LIBRARY; T=0.K
tritons from (d,n*)t

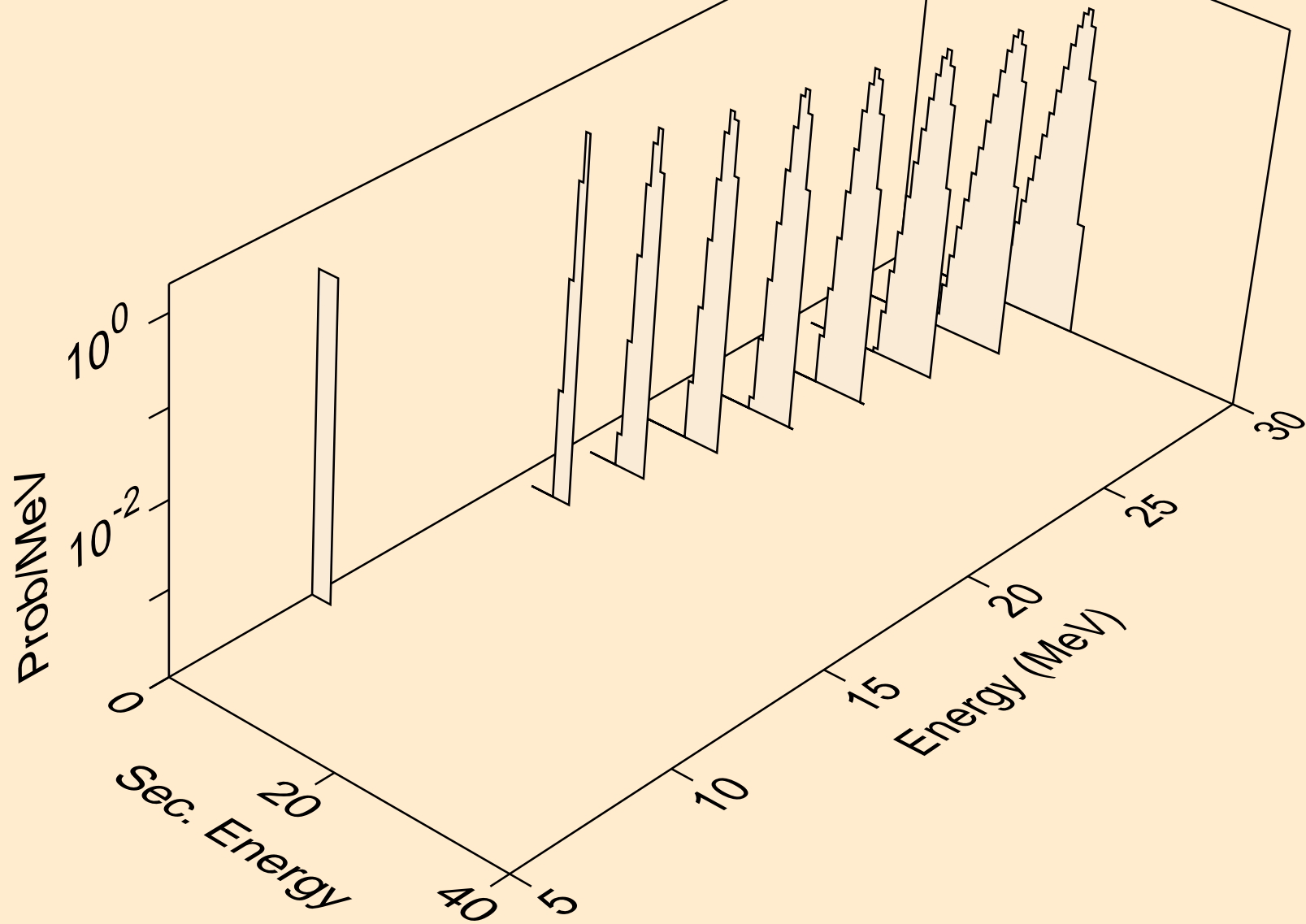

ES242 DEUTERON ACER TENDL-2021 LIBRARY; T=0.K
tritons from (d,t)

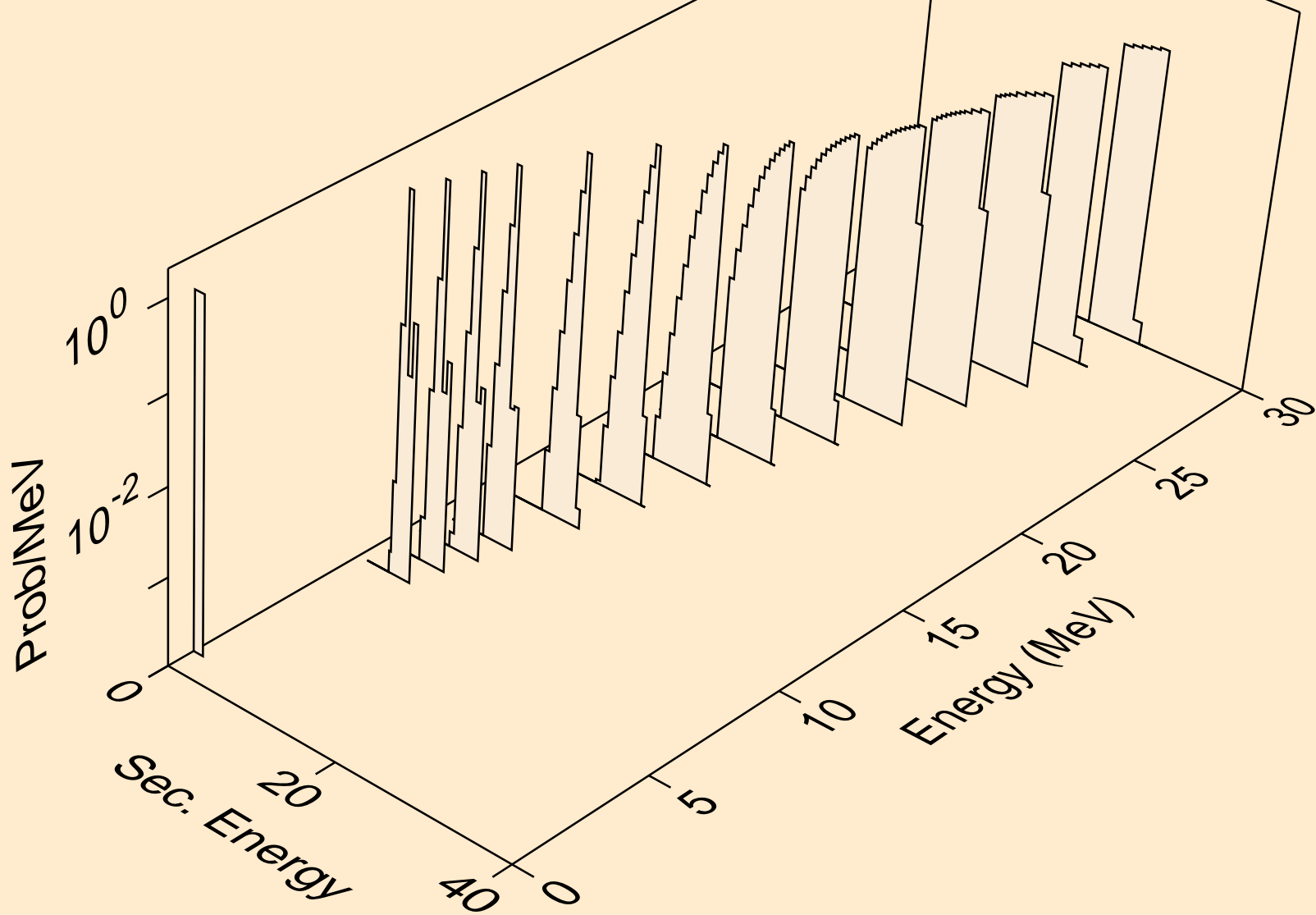

ES242 DEUTERON ACER TENDL-2021 LIBRARY; T=0.K
he3s from (d,x)

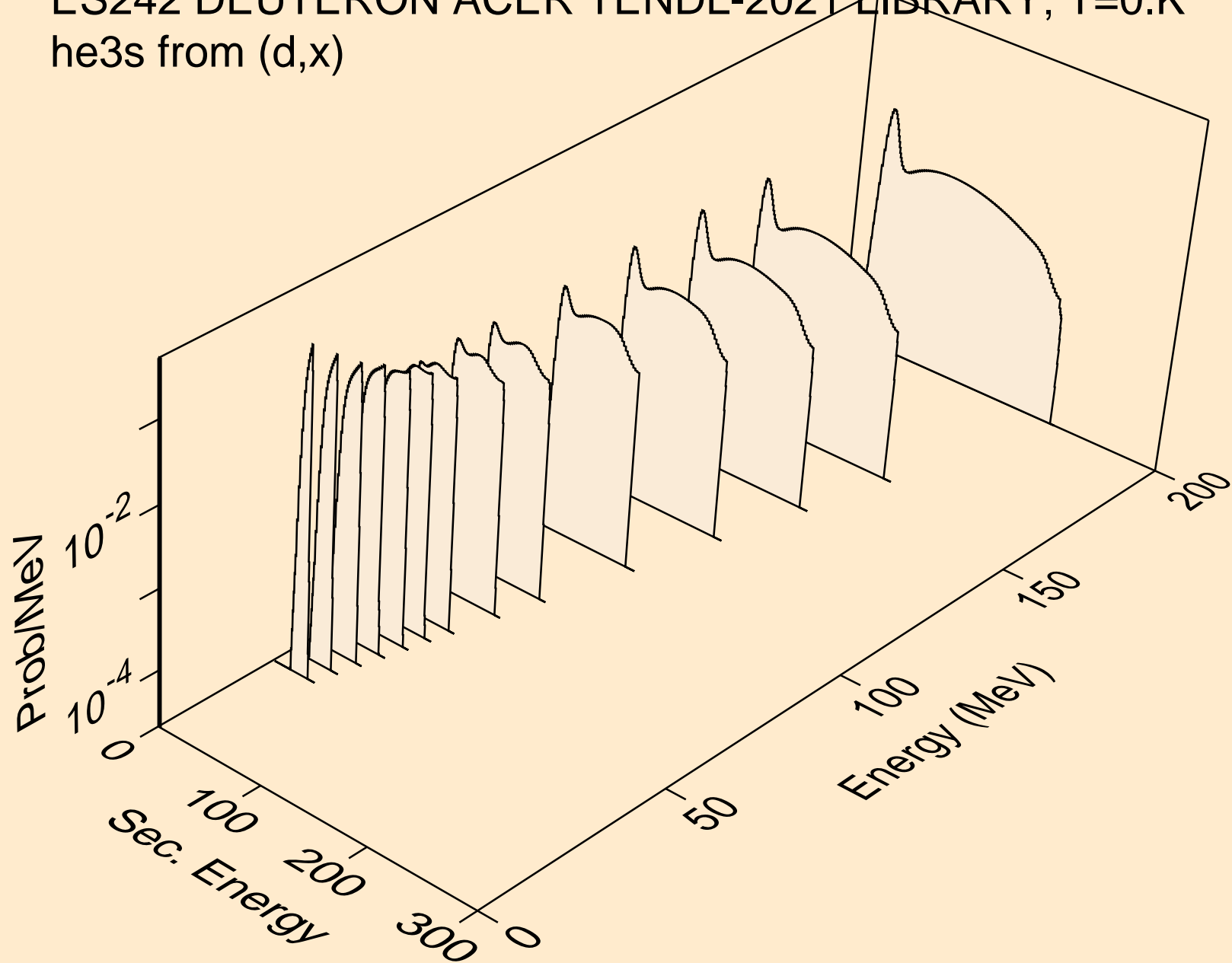

ES242 DEUTERON ACER TENDL-2021 LIBRARY; T=0.K
he3s from (d,n*)he3

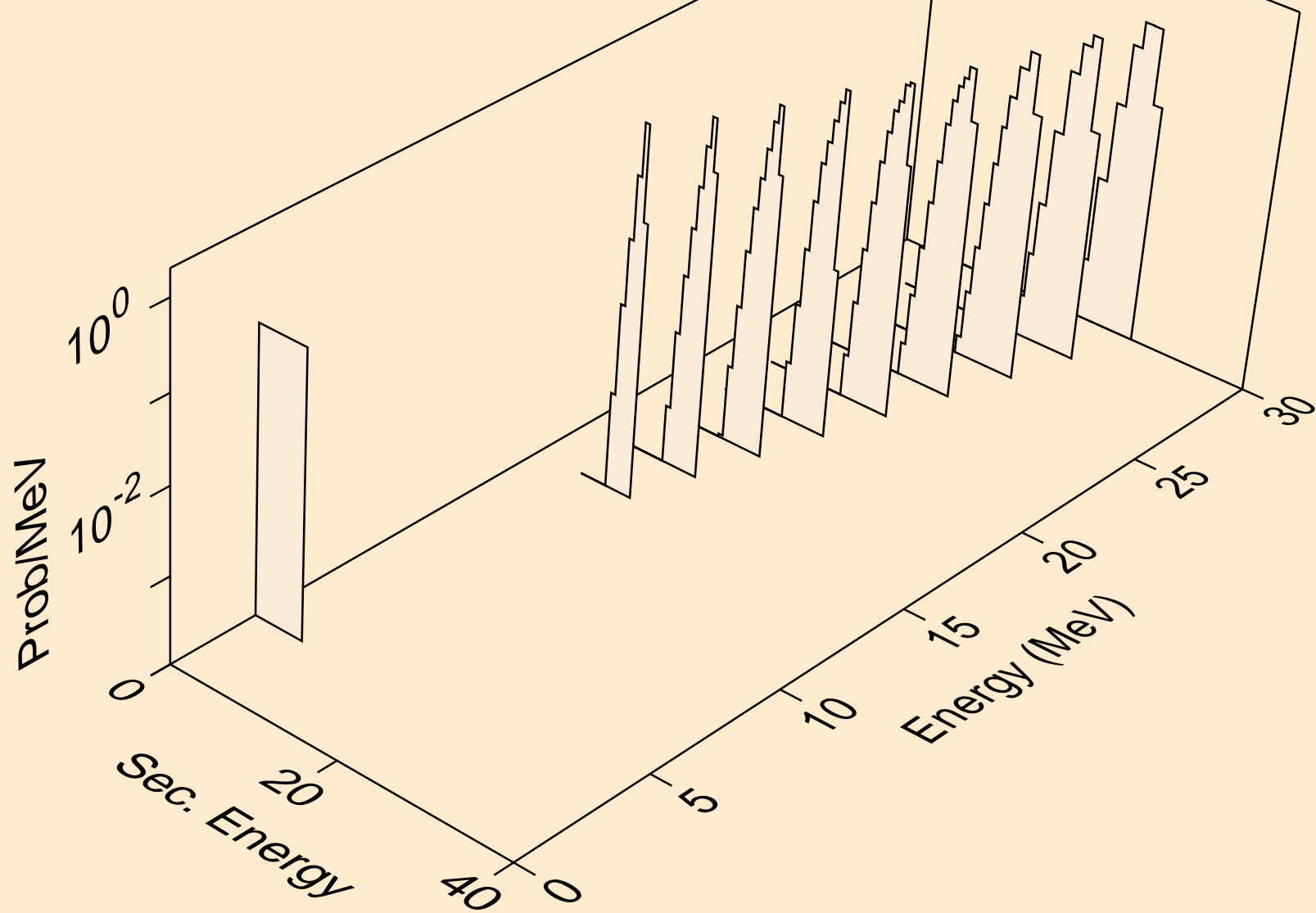

ES242 DEUTERON ACER TENDL-2021 LIBRARY; T=0.K
he3s from (d,he3)

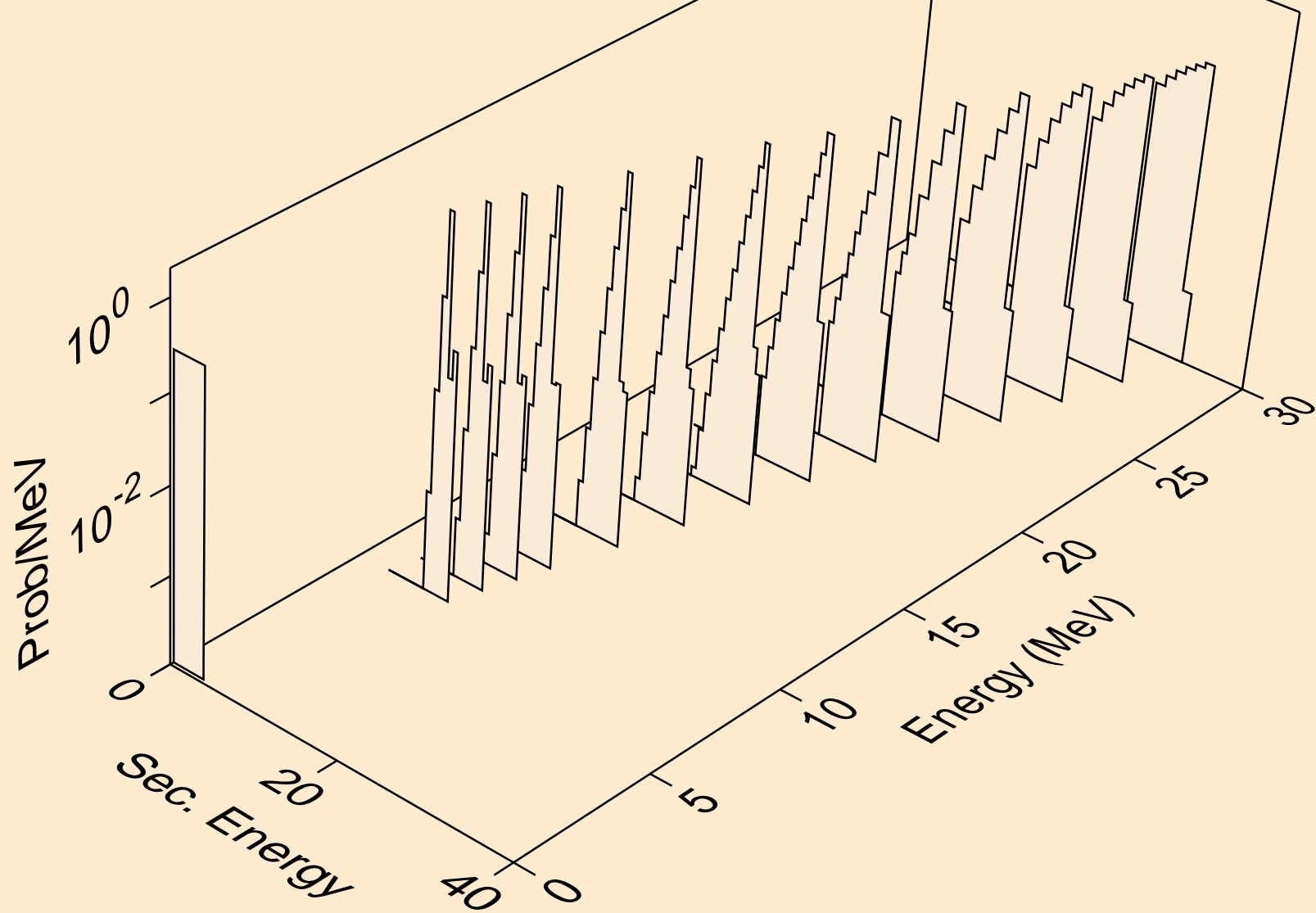

ES242 DEUTERON ACER TENDL-2021 LIBRARY; T=0.K
alphas from (d,x)

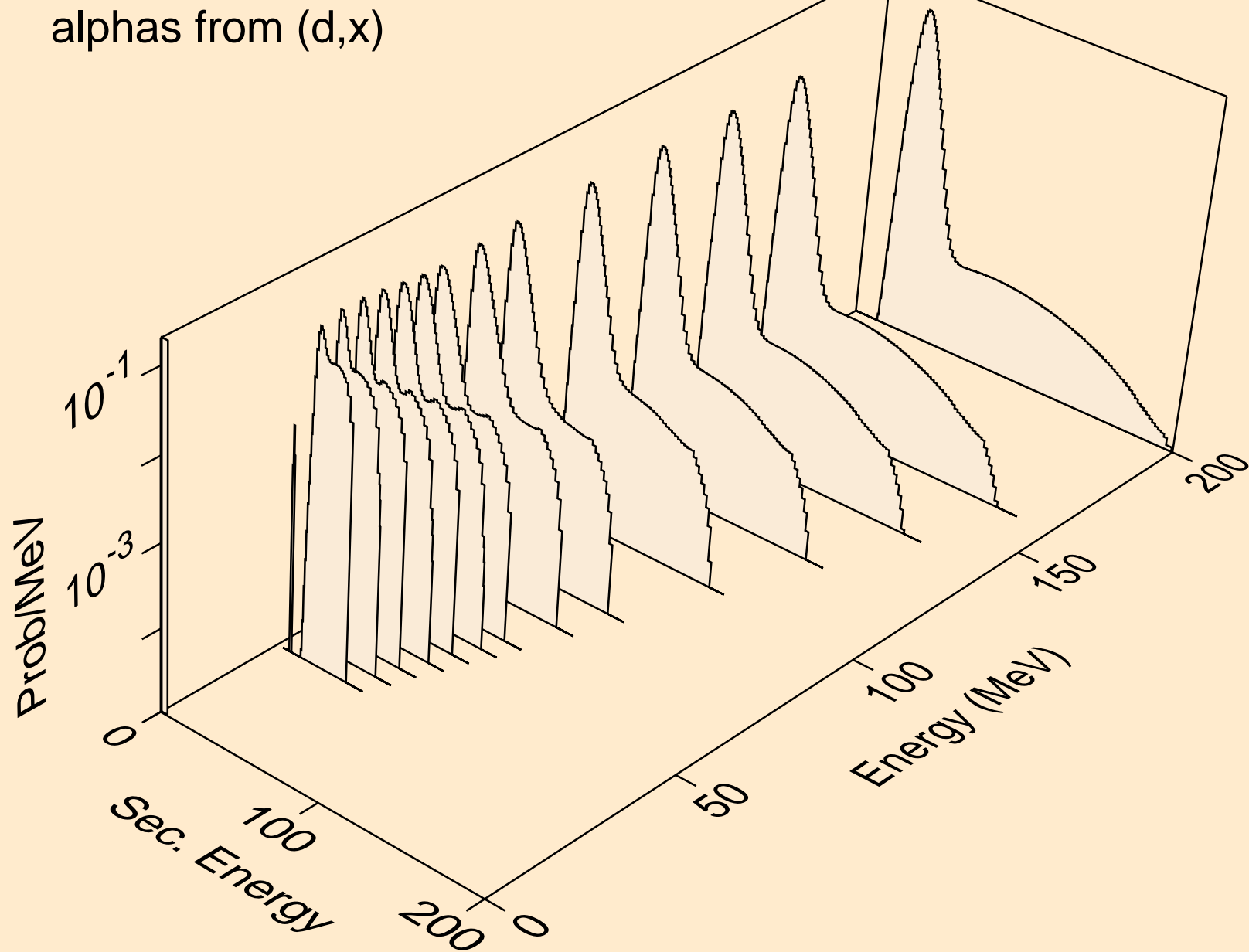

ES242 DEUTERON ACER TENDL-2021 LIBRARY; T=0.K
alphas from (d,n*)a

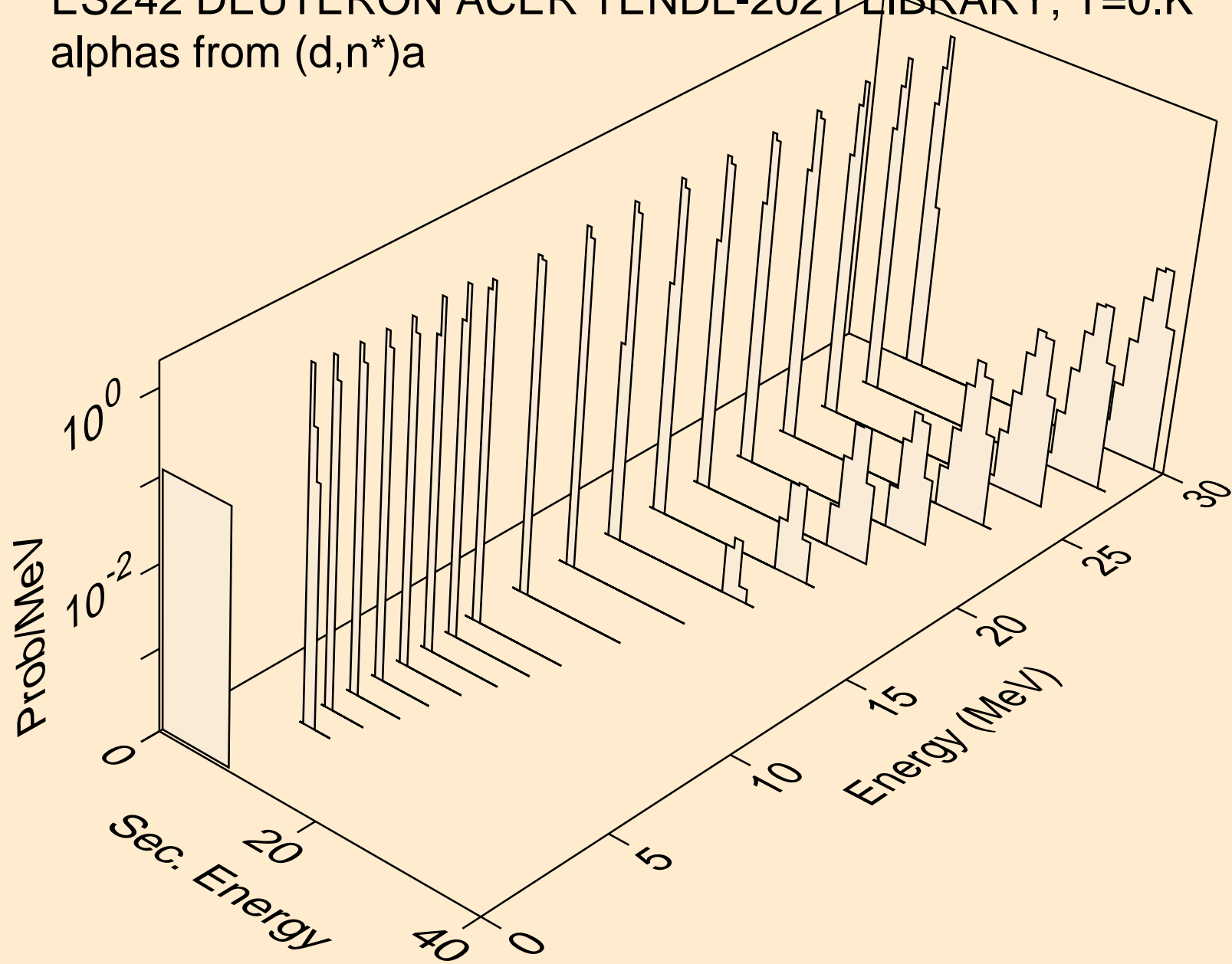

ES242 DEUTERON ACER TENDL-2021 LIBRARY; T=0.K
alphas from (d,2n)a

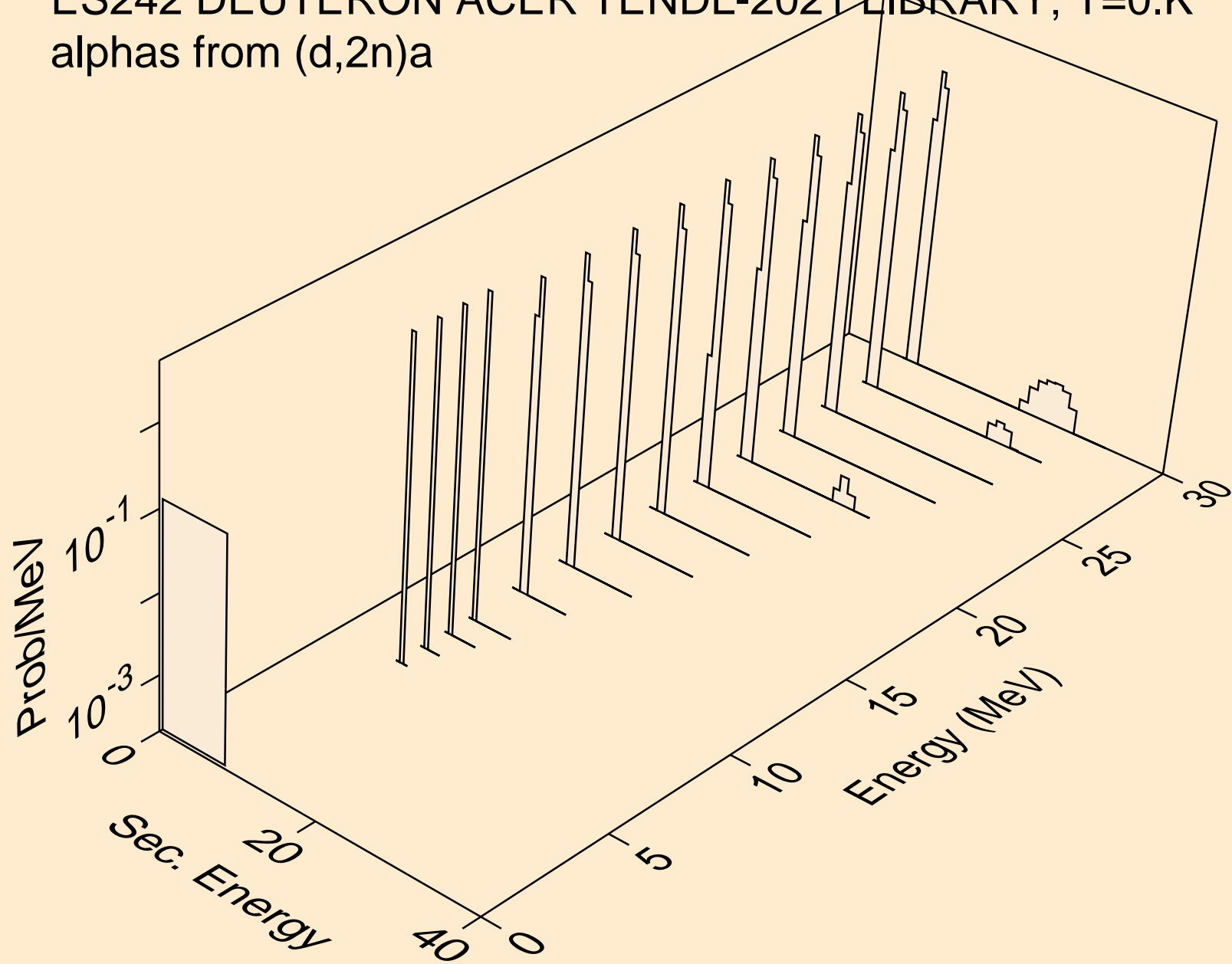

ES242 DEUTERON ACER TENDL-2021 LIBRARY; T=0.K
alphas from (d,npa)

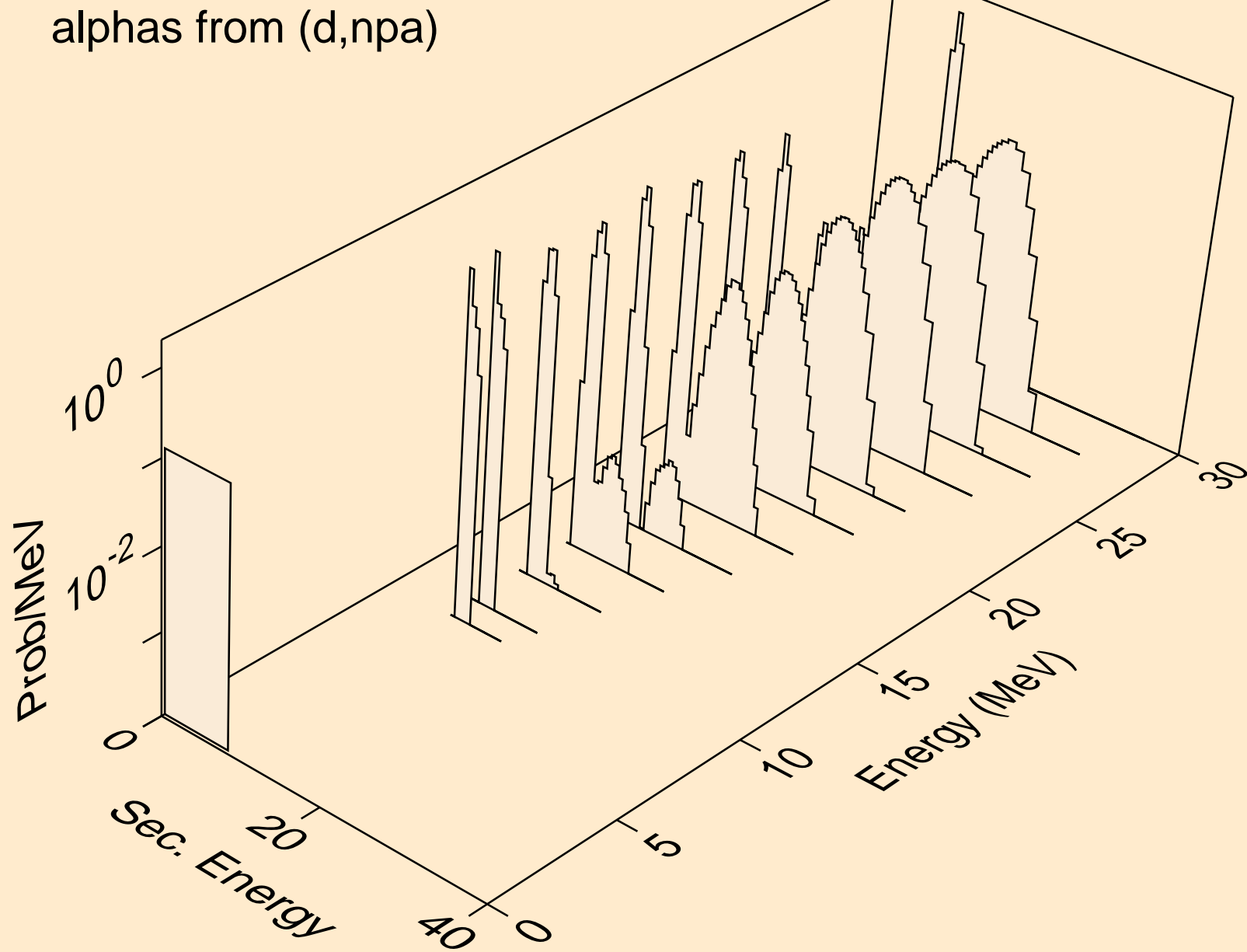

ES242 DEUTERON ACER TENDL-2021 LIBRARY; T=0.K
alphas from (d,a)

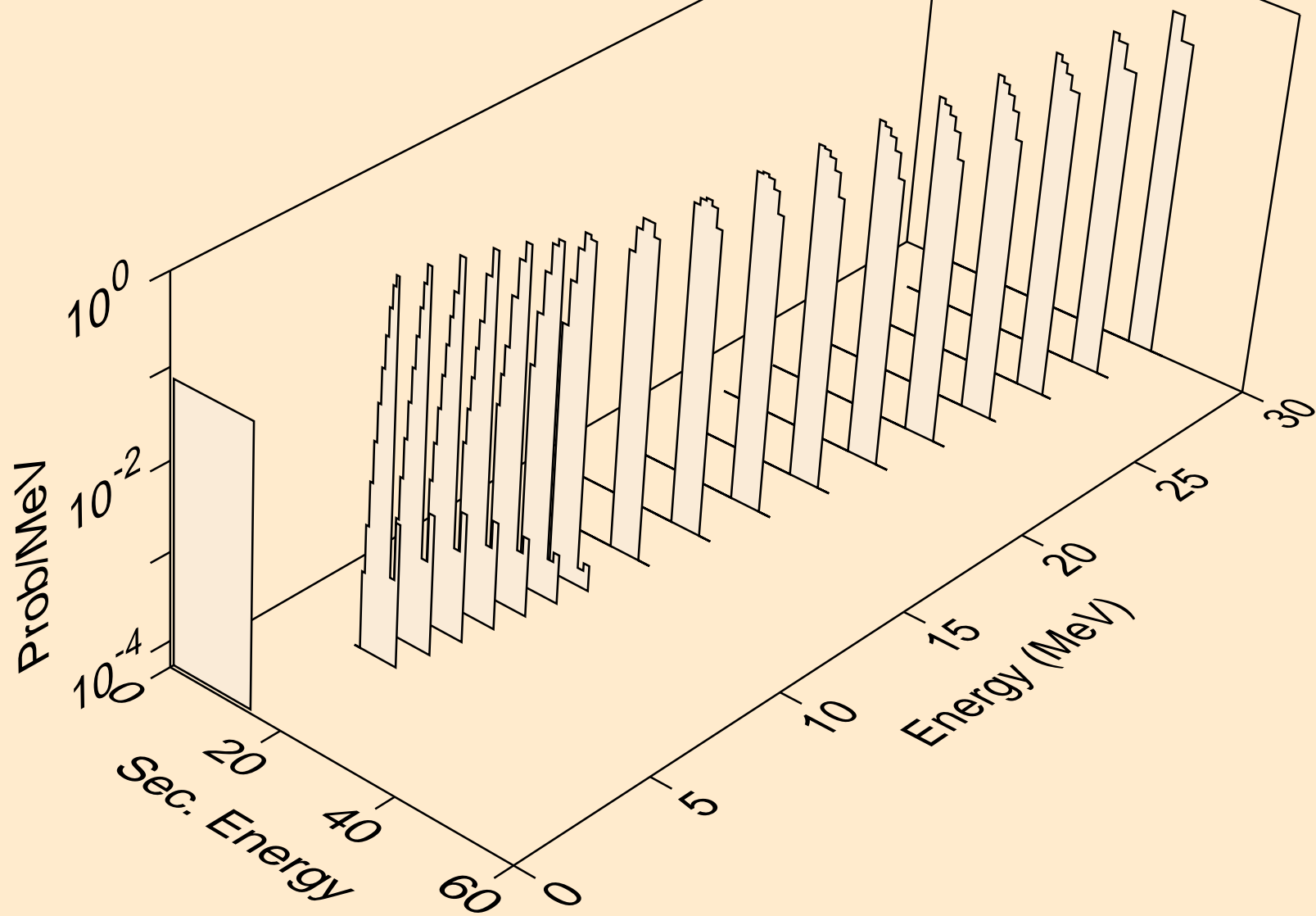

ES242 DEUTERON ACER TENDL-2021 LIBRARY; T=0.K
alphas from (d,pa)

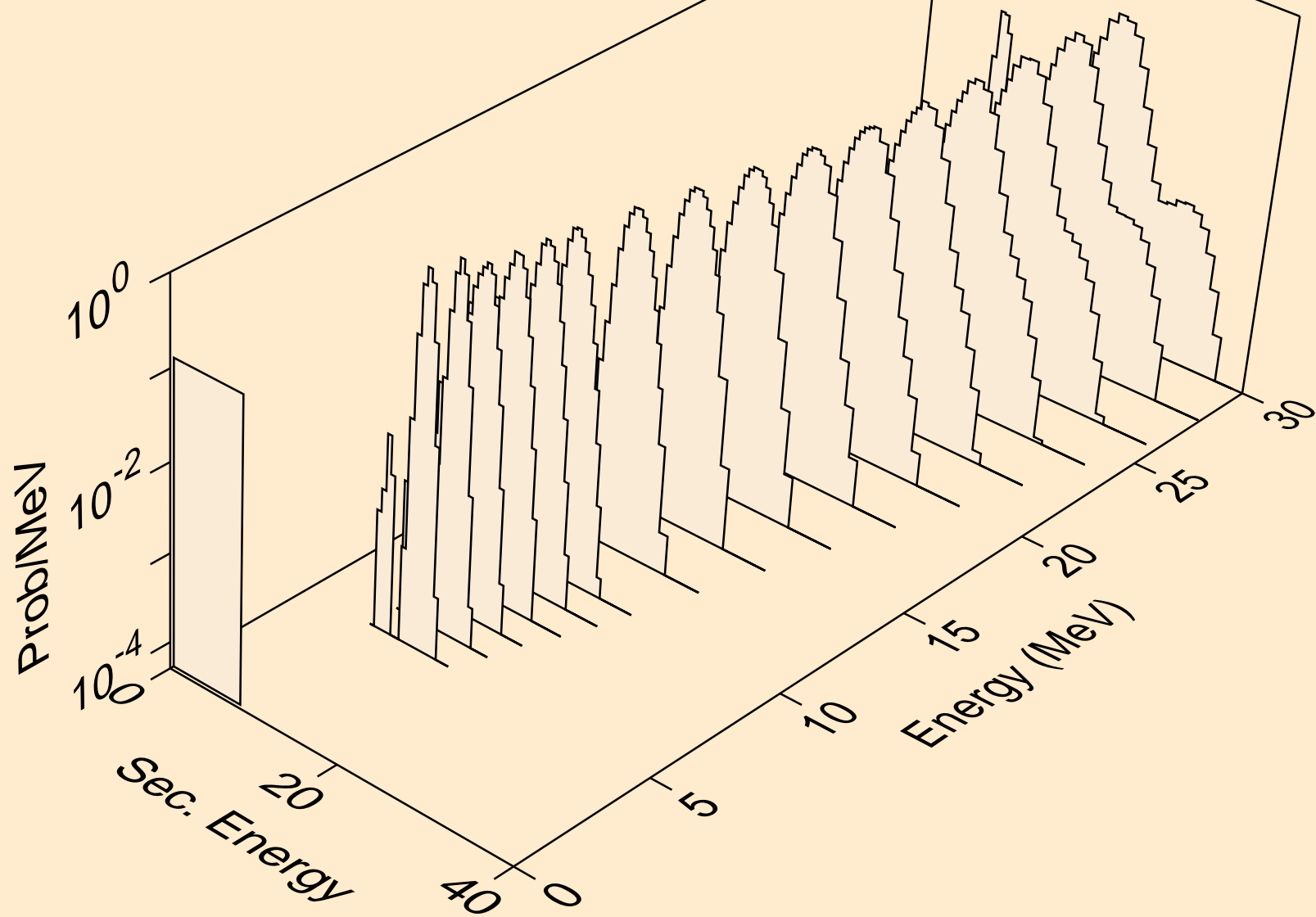

ES242 DEUTERON ACER TENDL-2021 LIBRARY; T=0.K
alphas from (d,da)

