

FM247 DEUTERON ACER TENDL-2021 LIBRARY; T=0.K

Principal cross sections

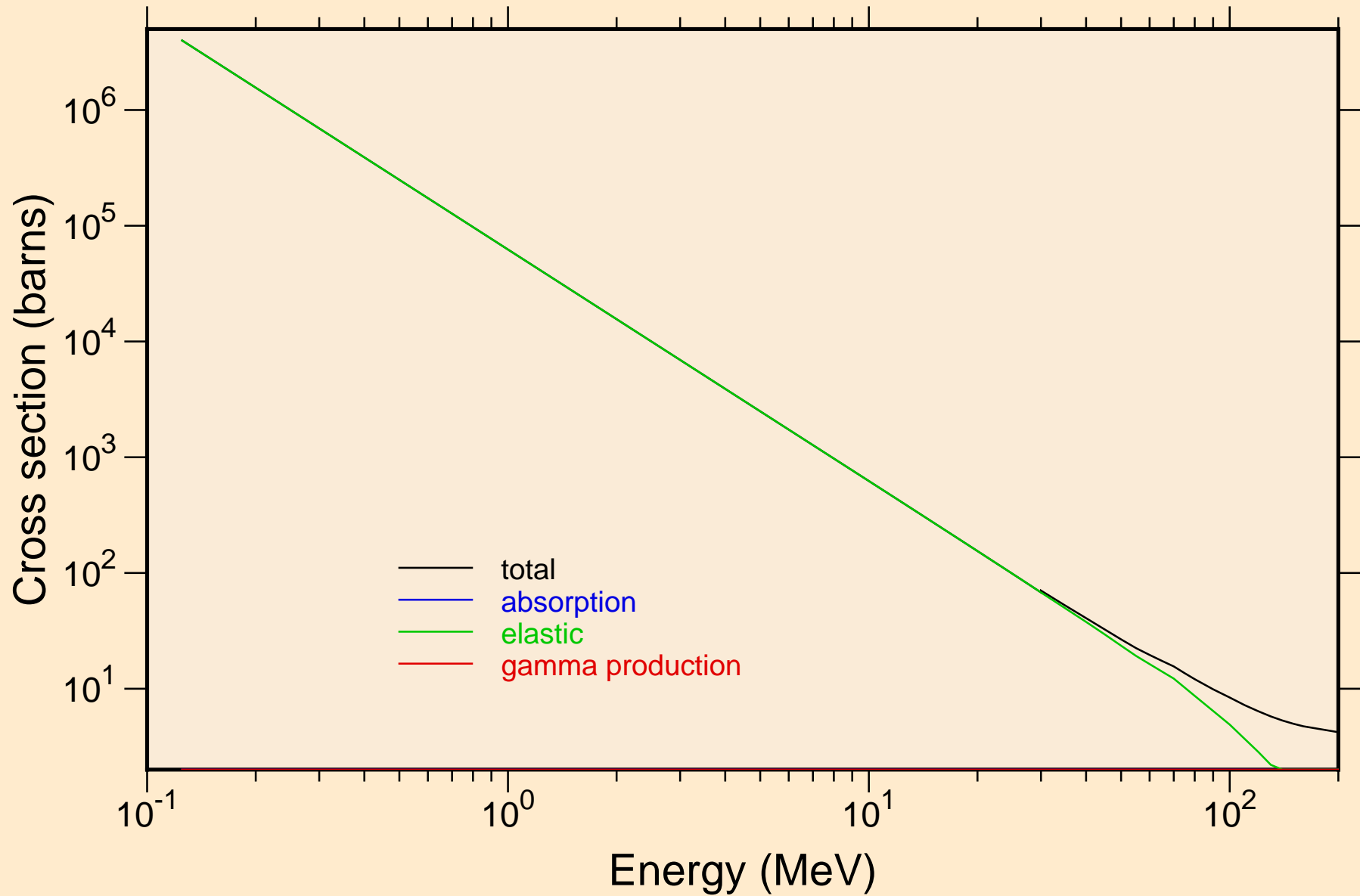

FM247 DEUTERON ACER TENDL-2021 LIBRARY; T=0.K
Heating

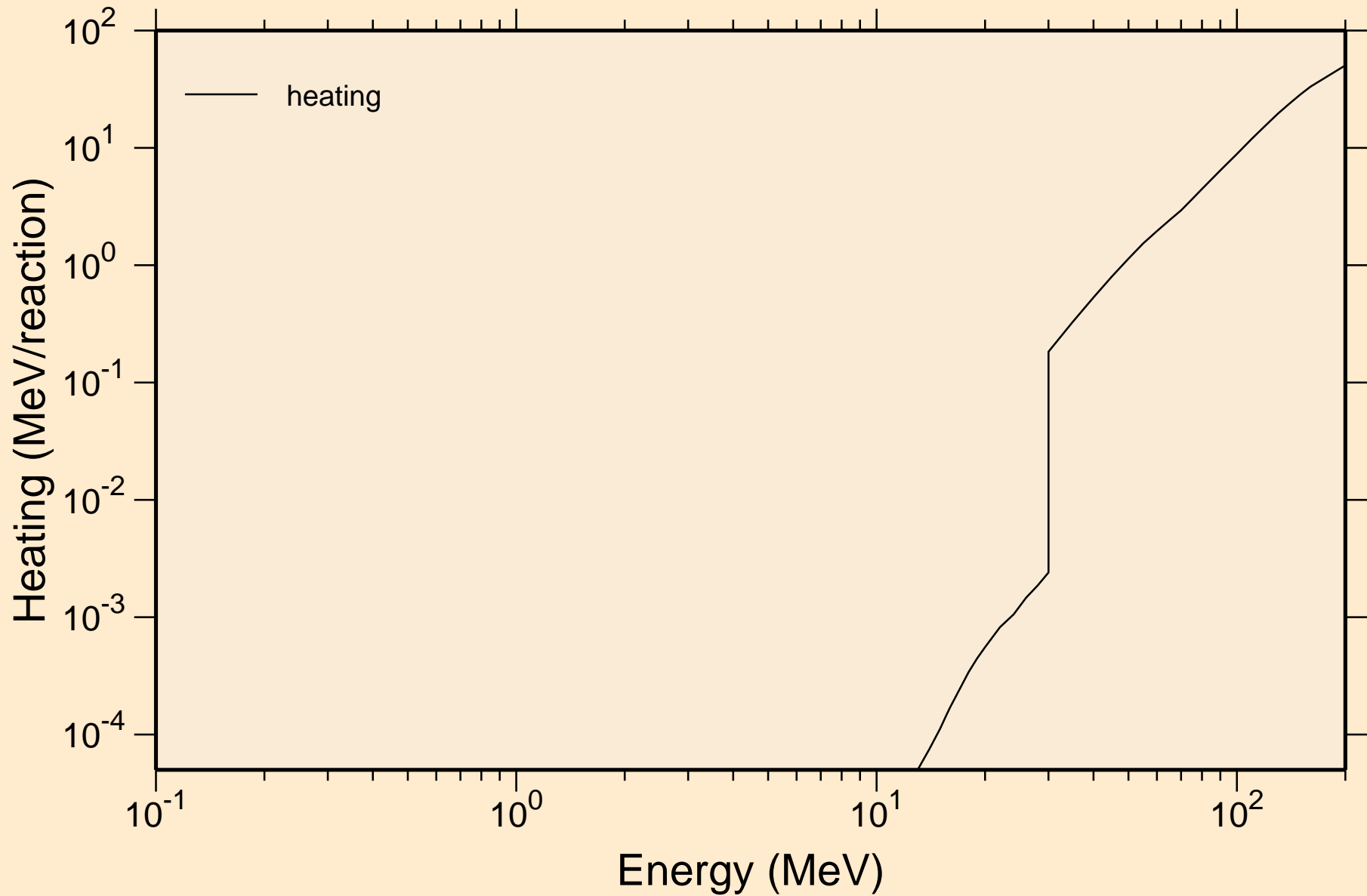

FM247 DEUTERON ACER TENDL-2021 LIBRARY; T=0.K
Principal cross sections

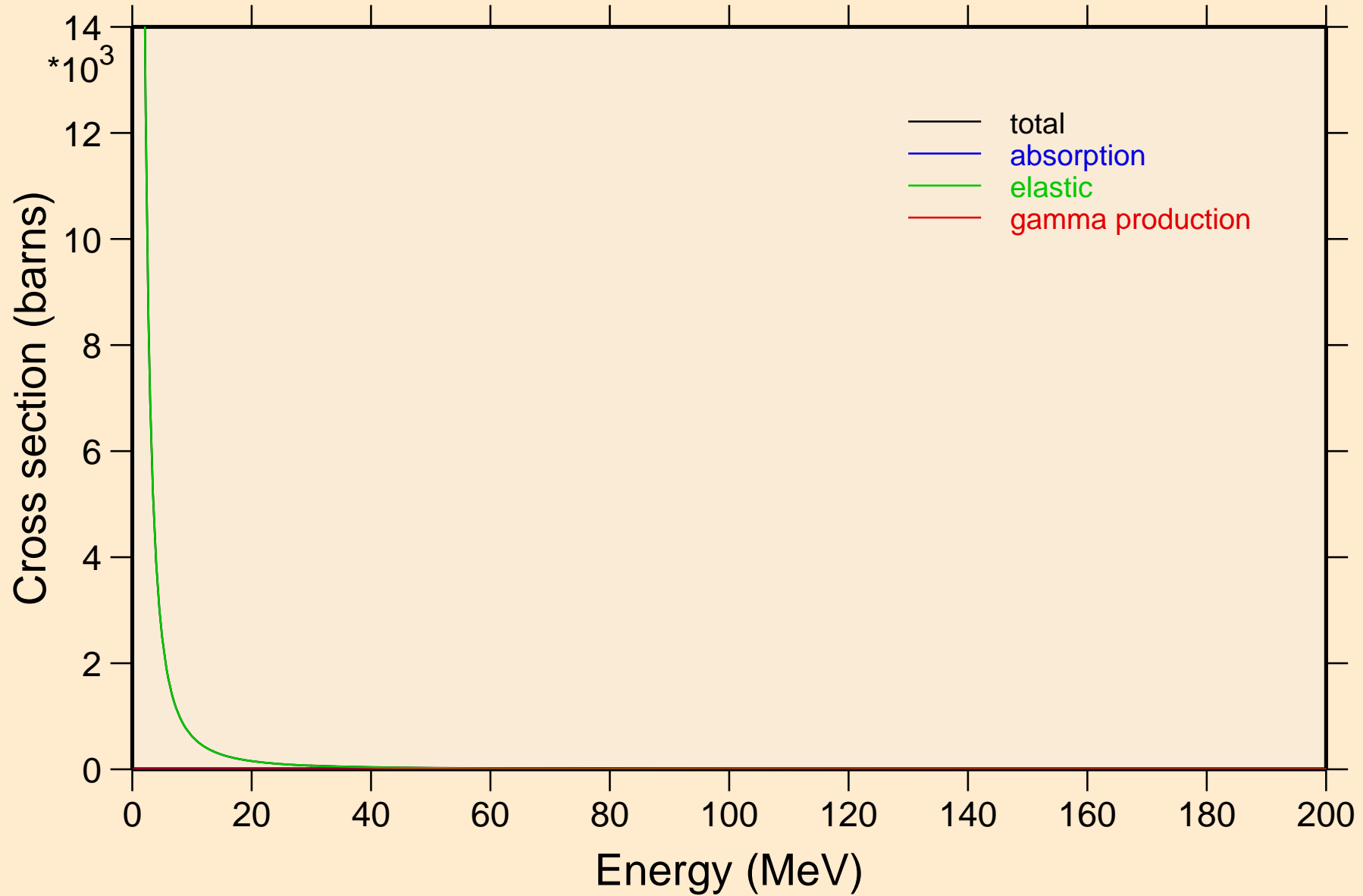

FM247 DEUTERON ACER TENDL-2021 LIBRARY; T=0.K

Heating

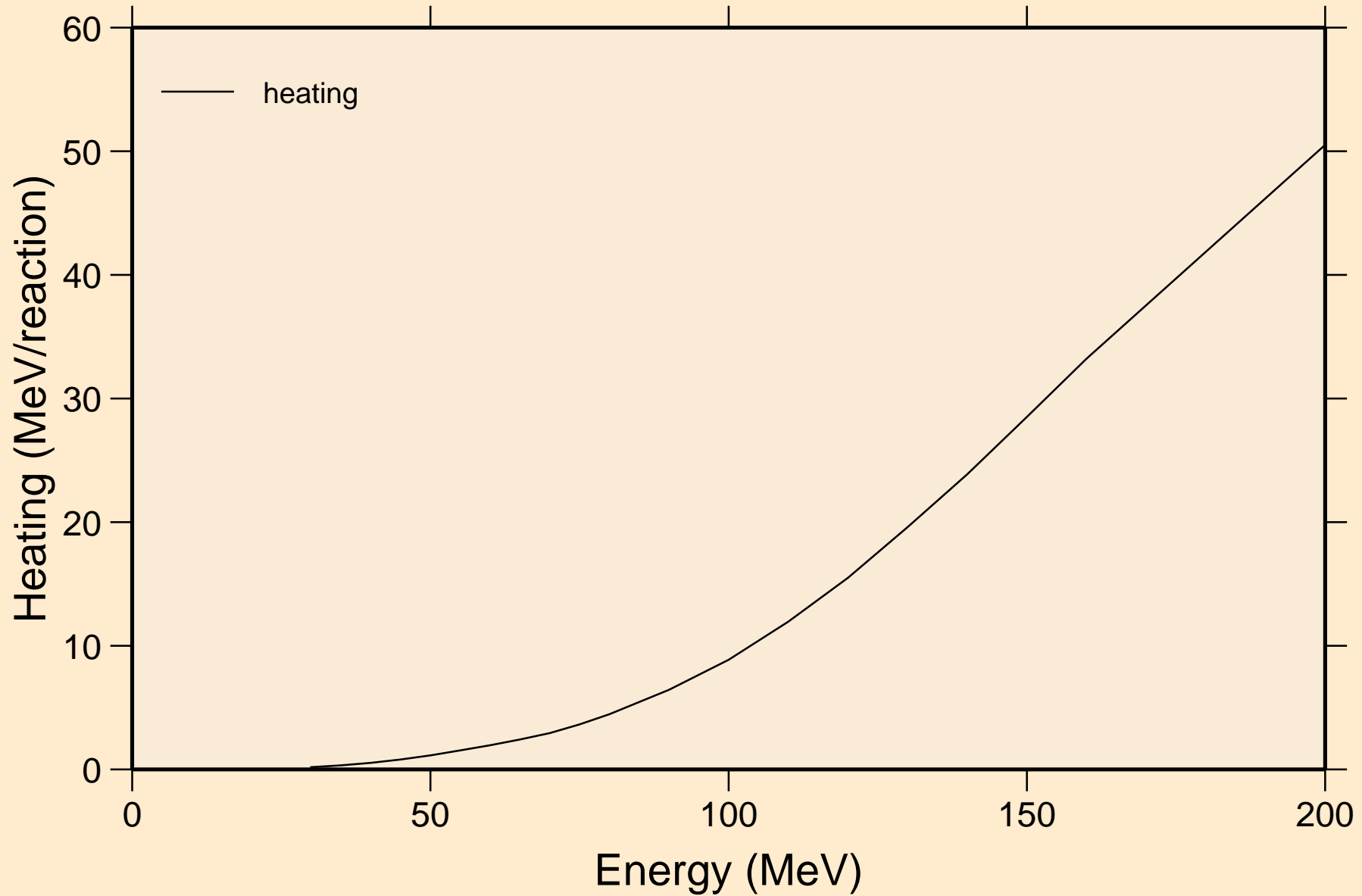

FM247 DEUTERON ACER TENDL-2021 LIBRARY; T=0.K

Threshold reactions

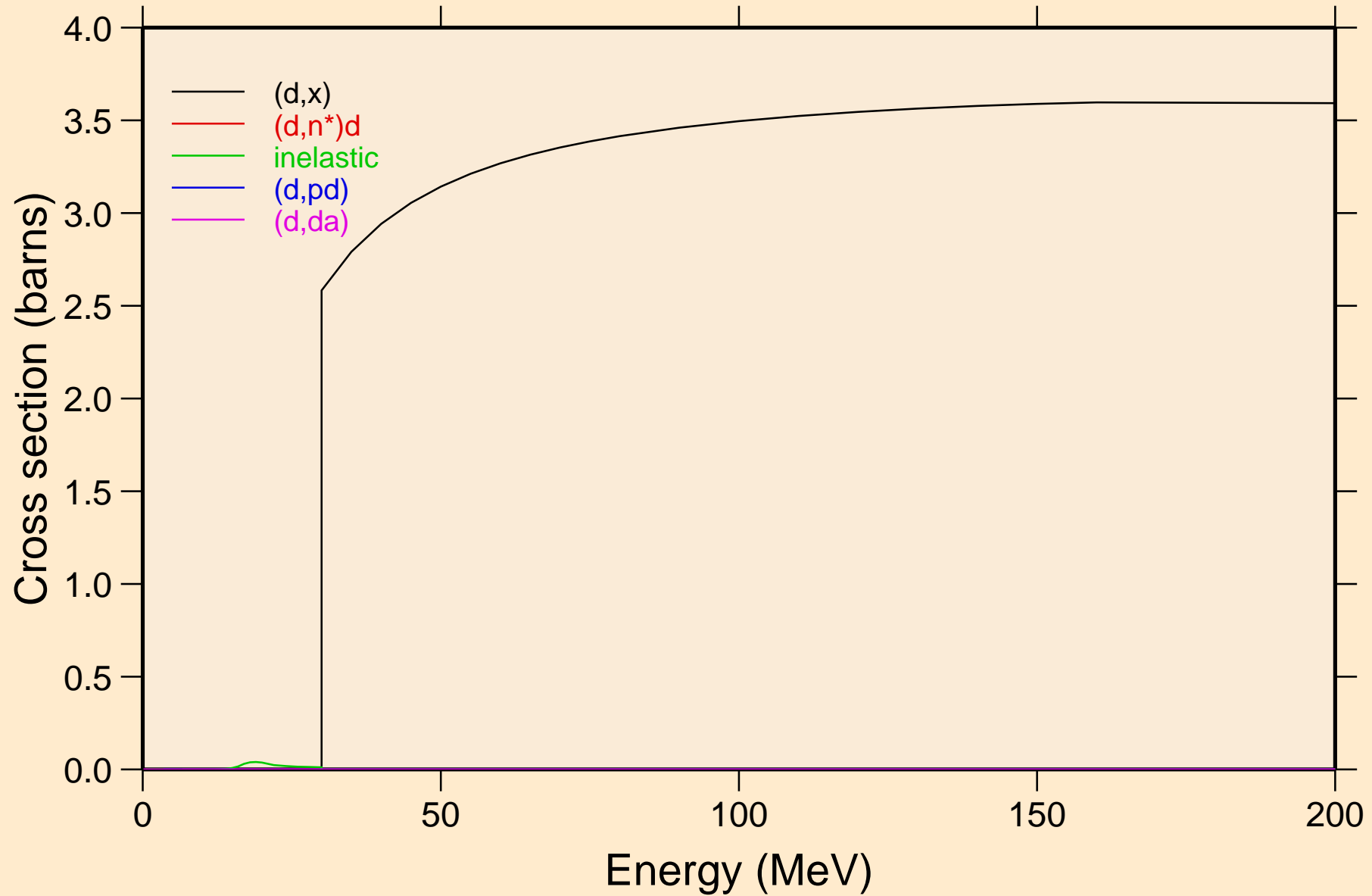

FM247 DEUTERON ACER TENDL-2021 LIBRARY; T=0.K
angular distribution for elastic

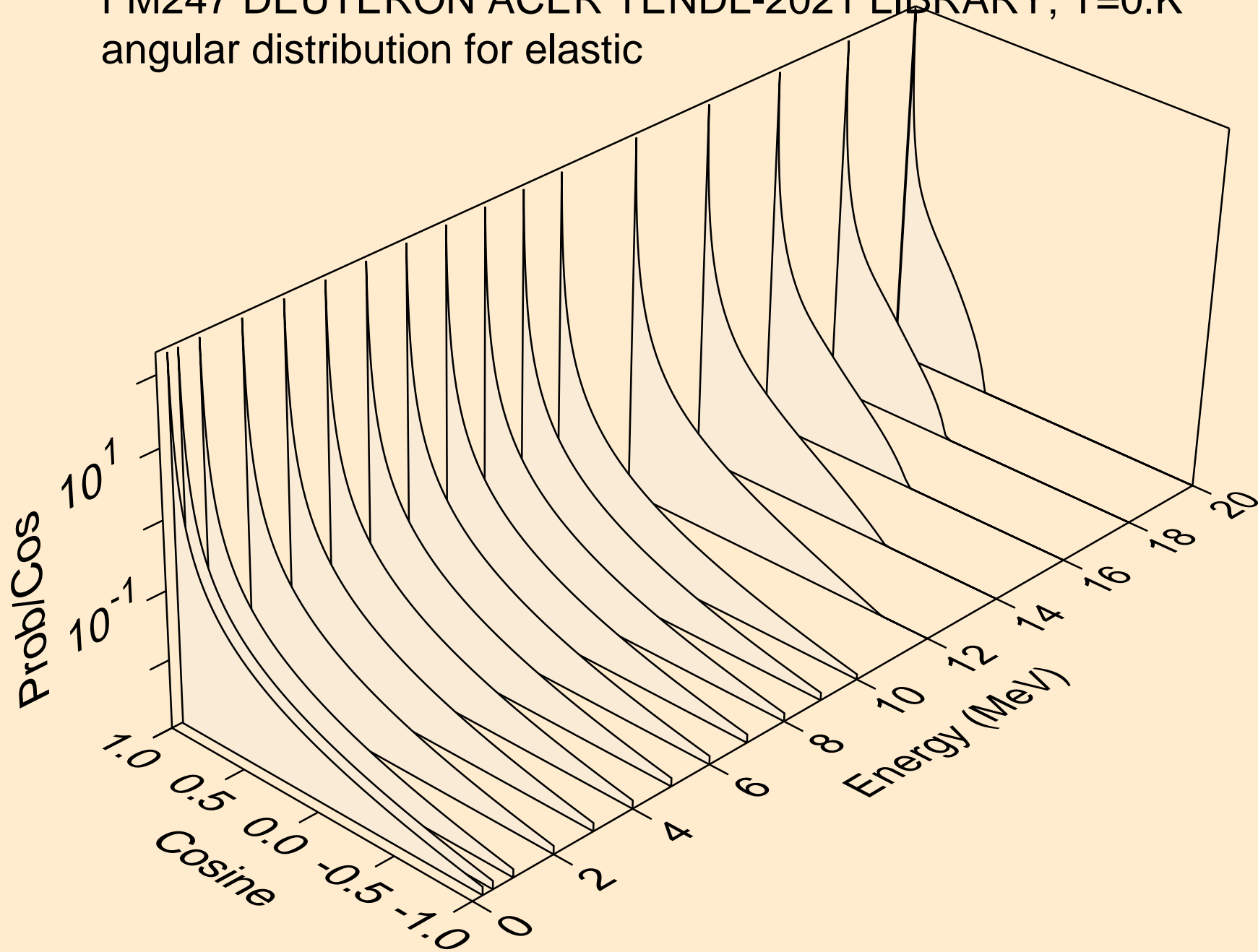

FM247 DEUTERON ACER TENDL-2021 LIBRARY; T=0.K
angular distribution for elastic

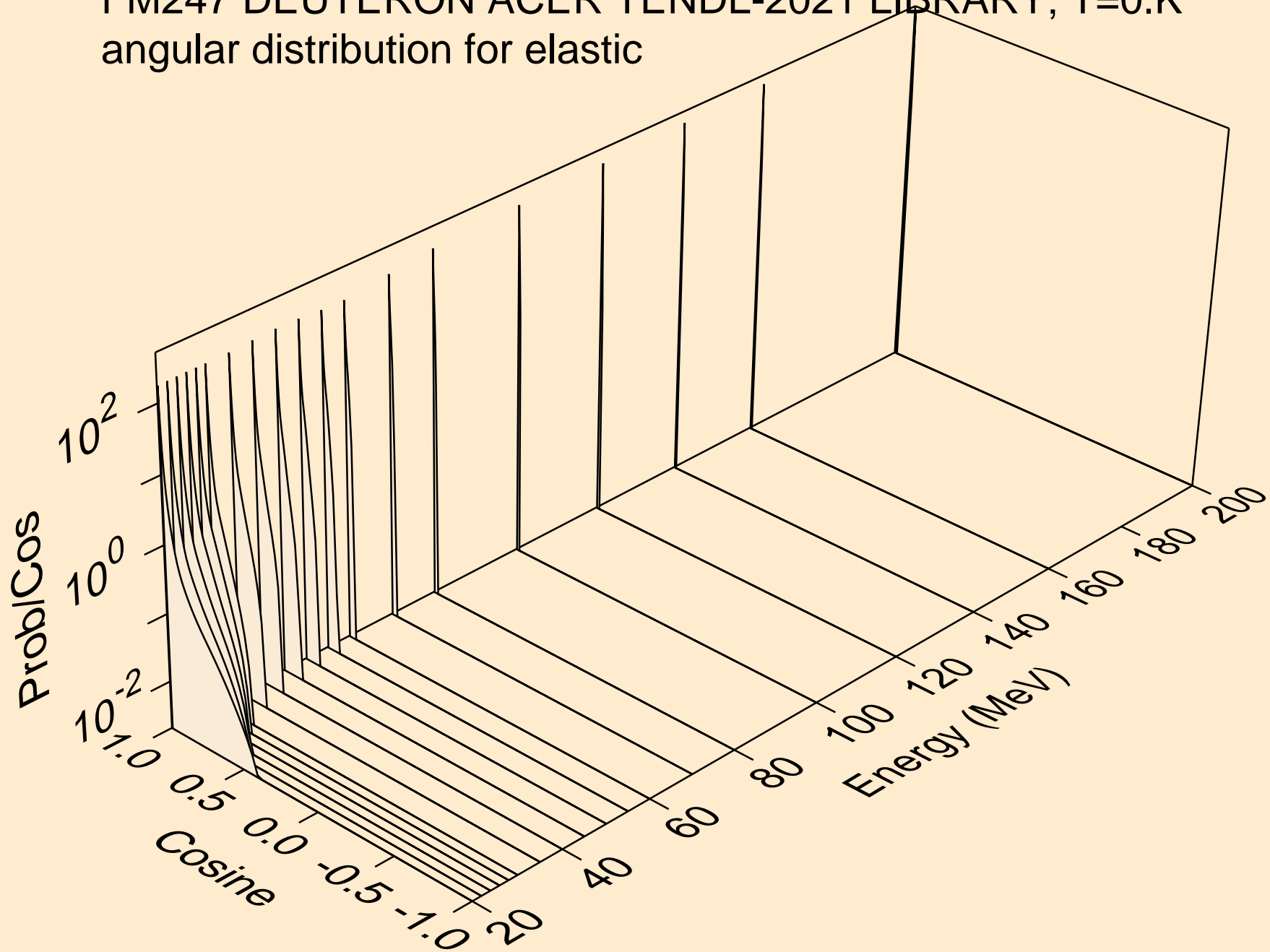

FM247 DEUTERON ACER TENDL-2021 LIBRARY; T=0.K
Deuteron emission for (d,x)

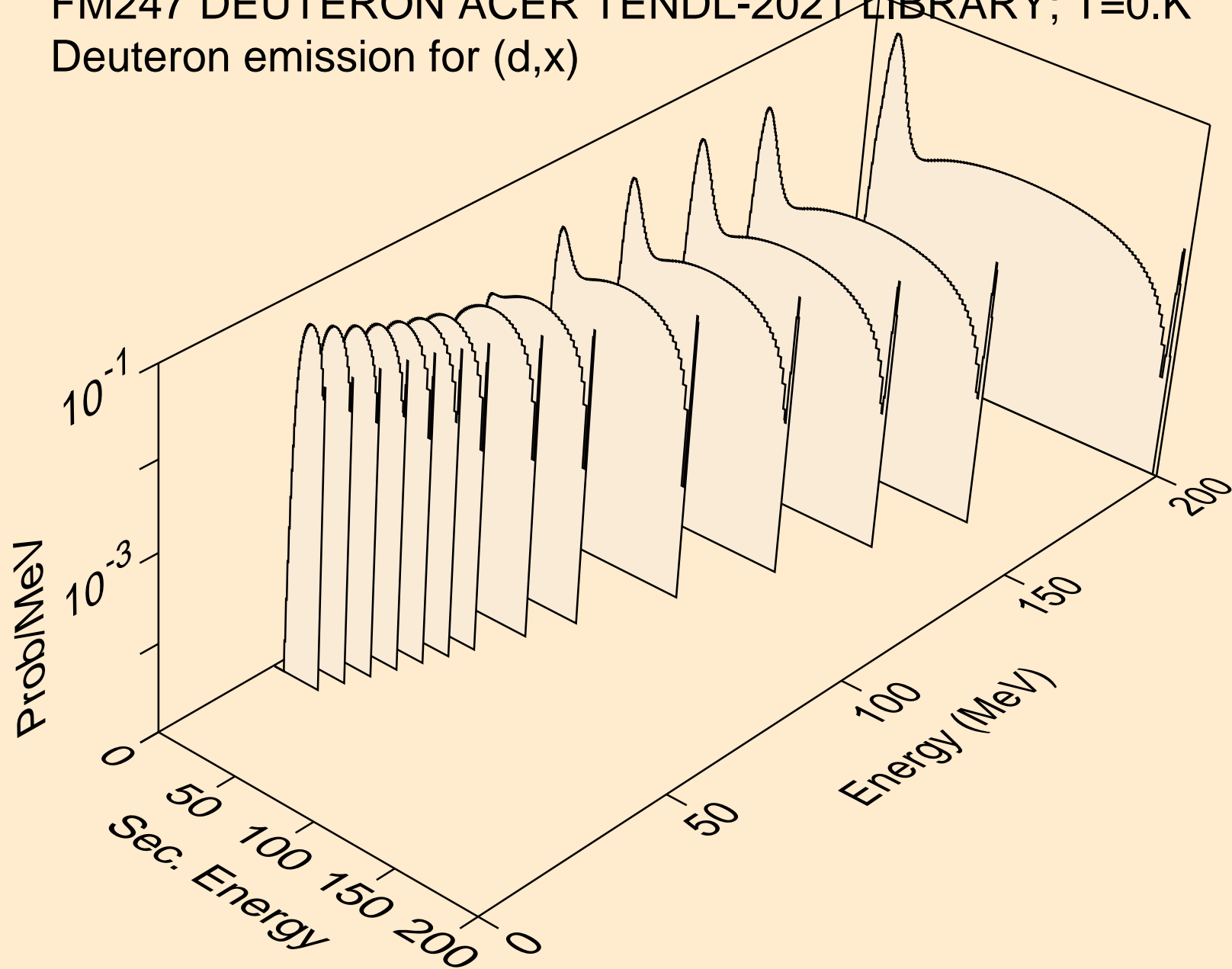

FM247 DEUTERON ACER TENDL-2021 LIBRARY; T=0.K
Deuteron emission for (d,n*)d

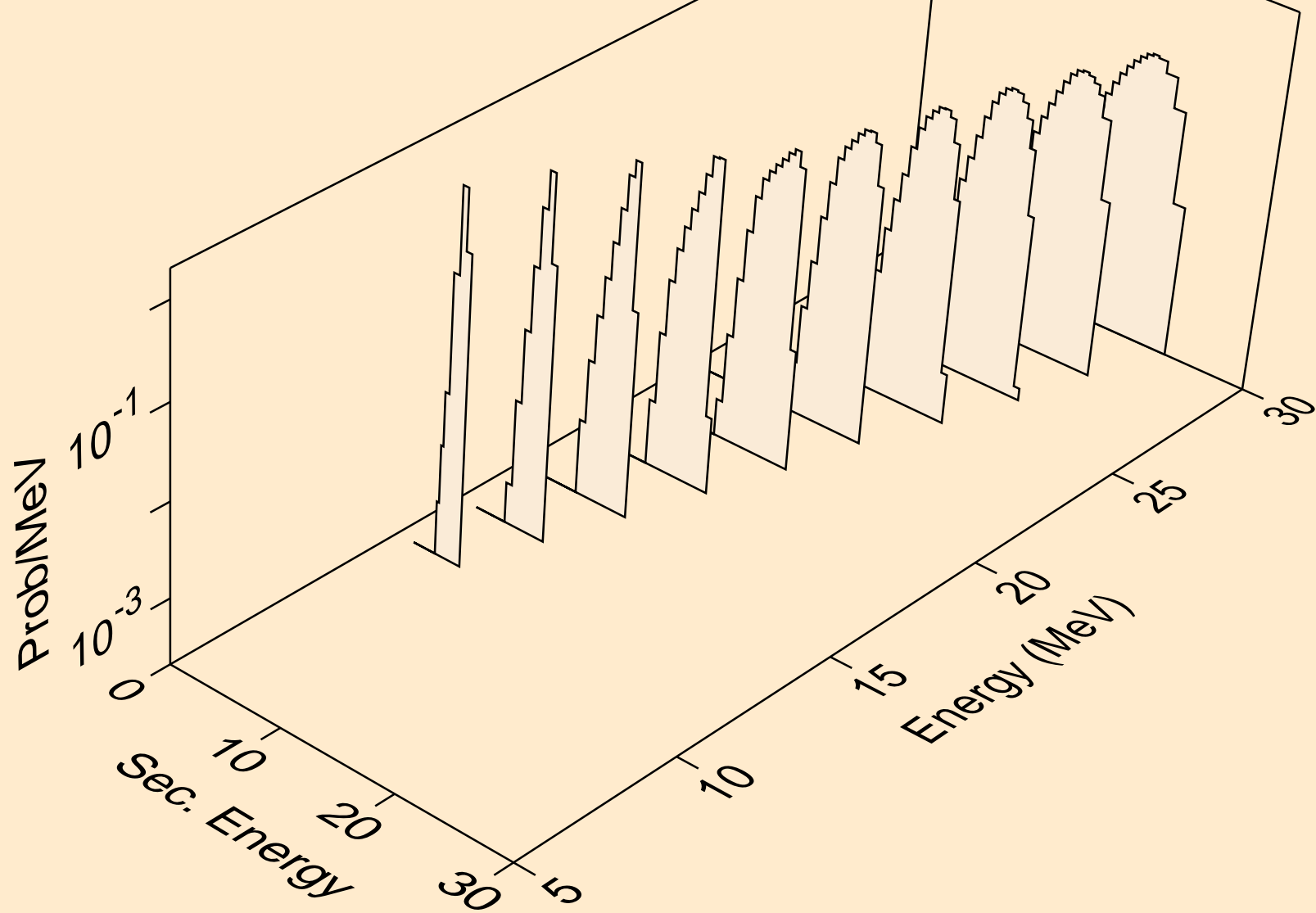

FM247 DEUTERON ACER TENDL-2021 LIBRARY; T=0.K
Deuteron emission for inelastic

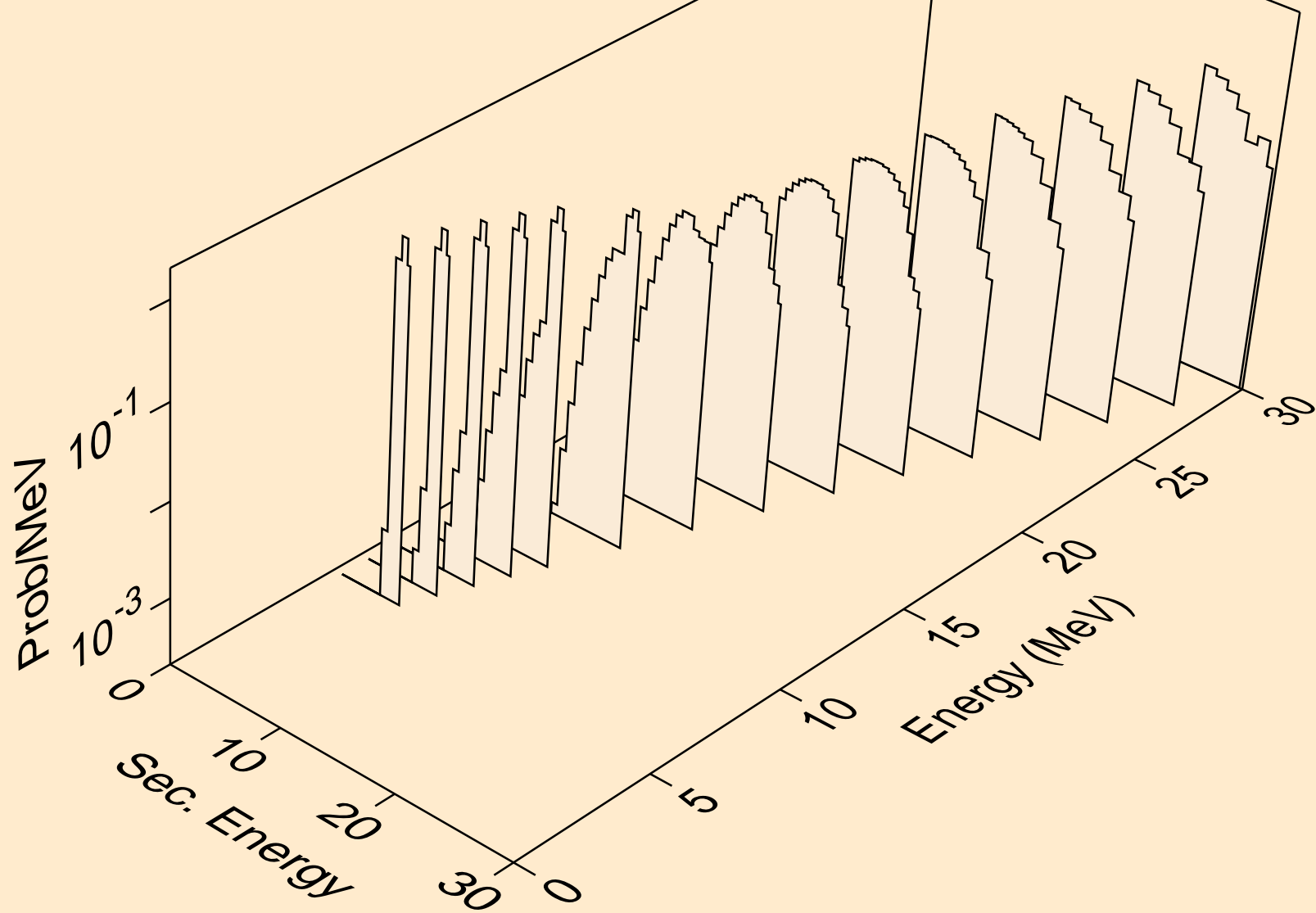

FM247 DEUTERON ACER TENDL-2021 LIBRARY; T=0.K
Deuteron emission for (d,pd)

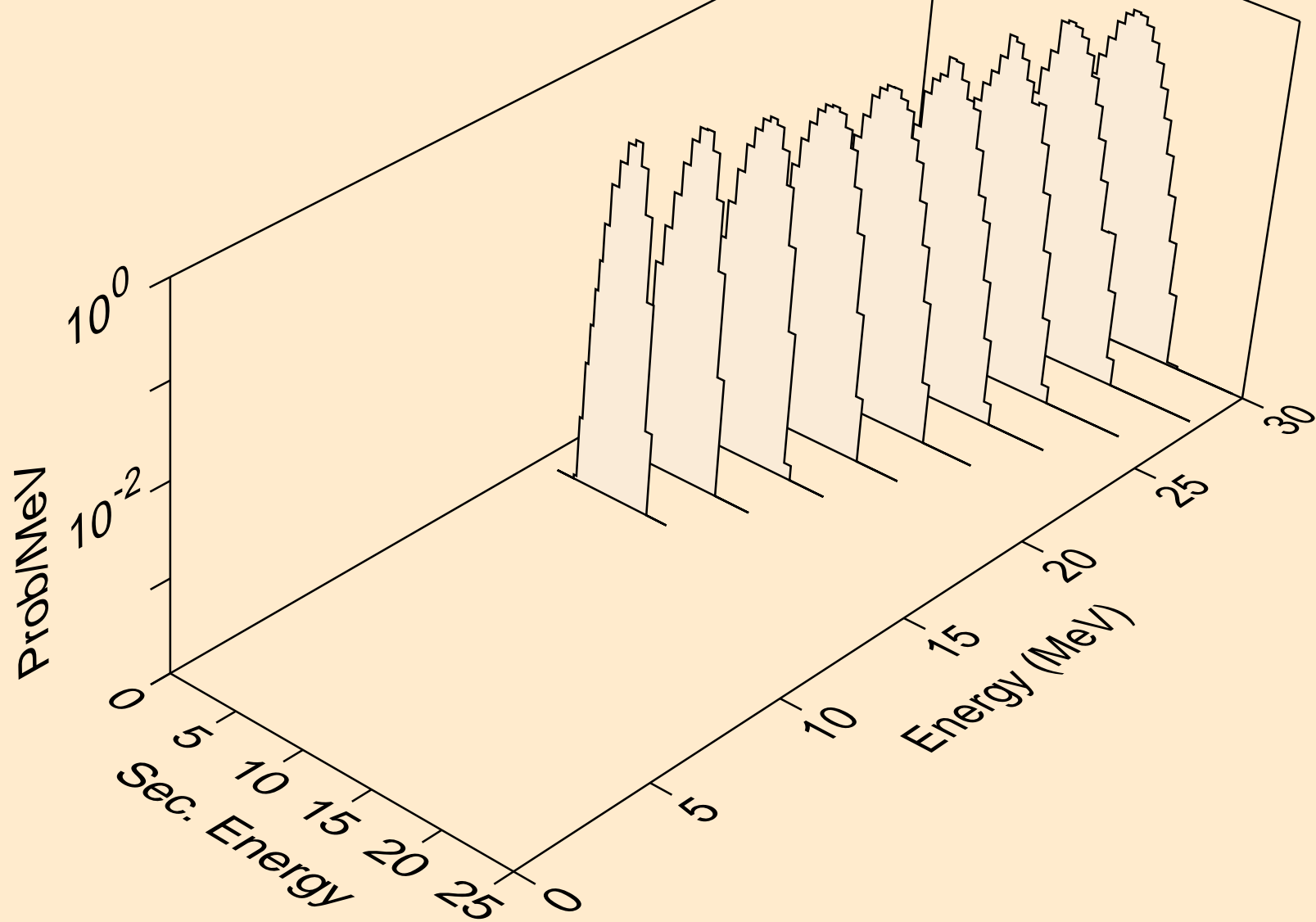

FM247 DEUTERON ACER TENDL-2021 LIBRARY; T=0.K
Deuteron emission for (d,da)

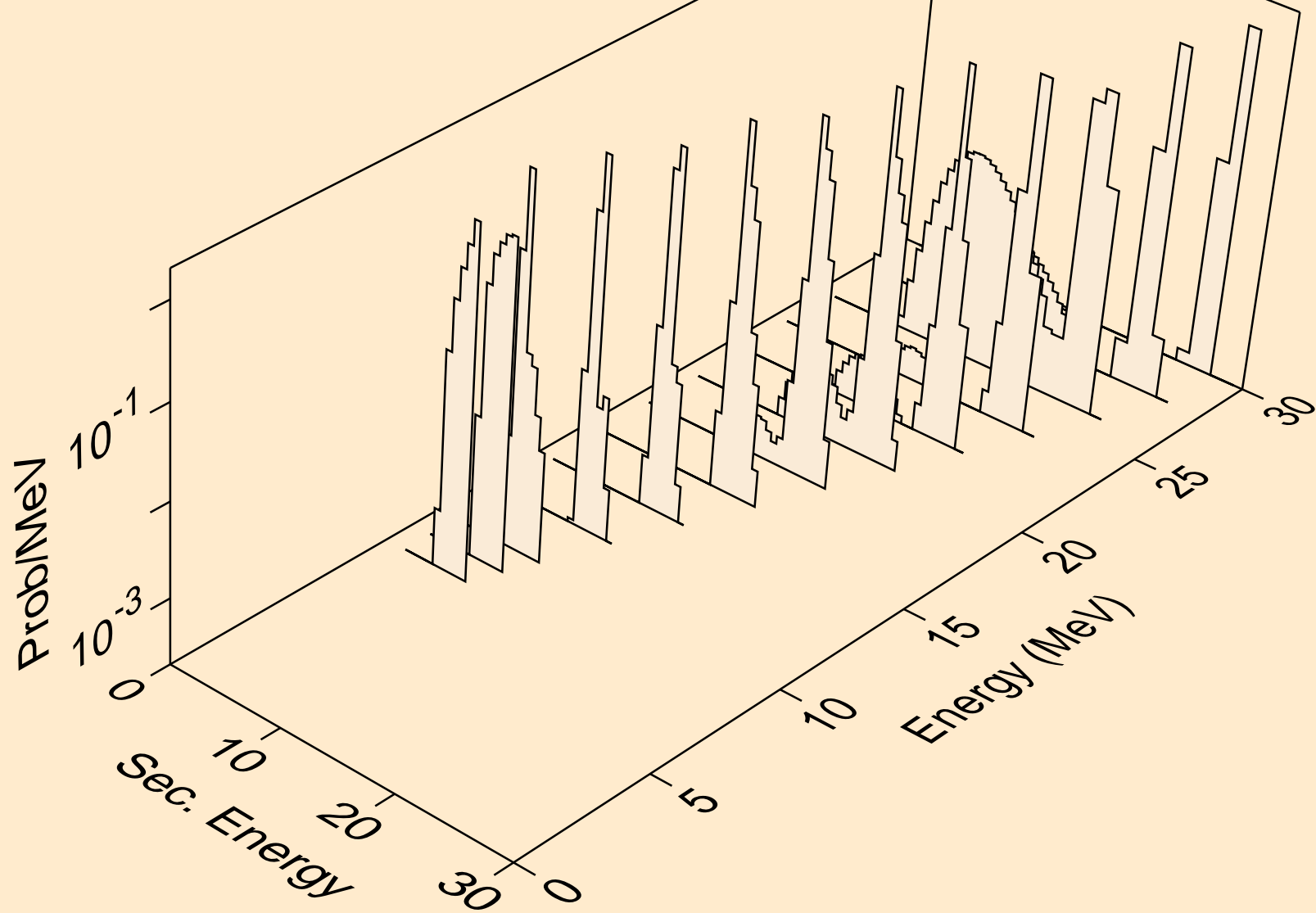

FM247 DEUTERON ACER TENDL-2021 LIBRARY; T=0.K
Photon emission for (z,n)

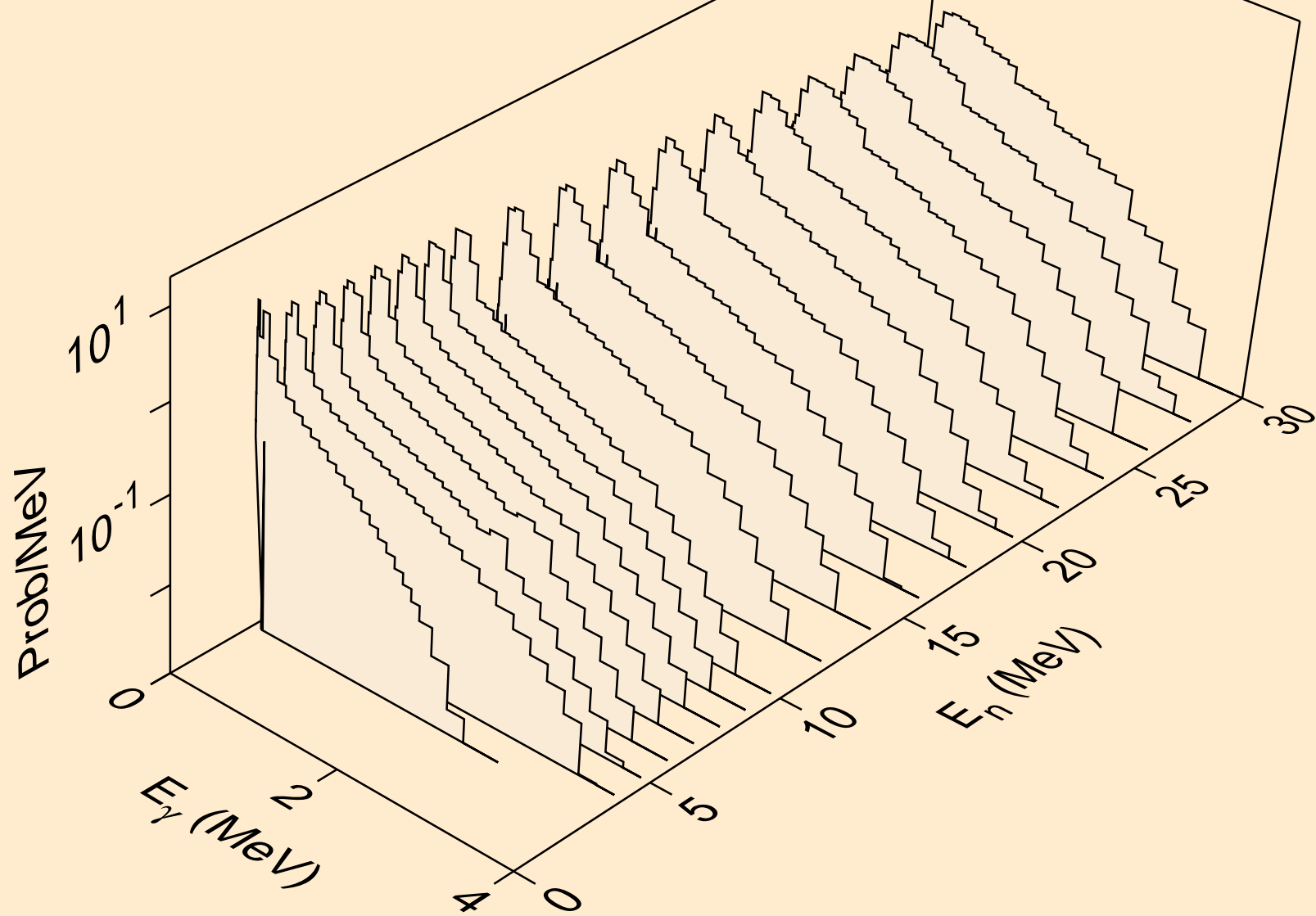

FM247 DEUTERON ACER TENDL-2021 LIBRARY; T=0.K
Photon emission for (n,x)

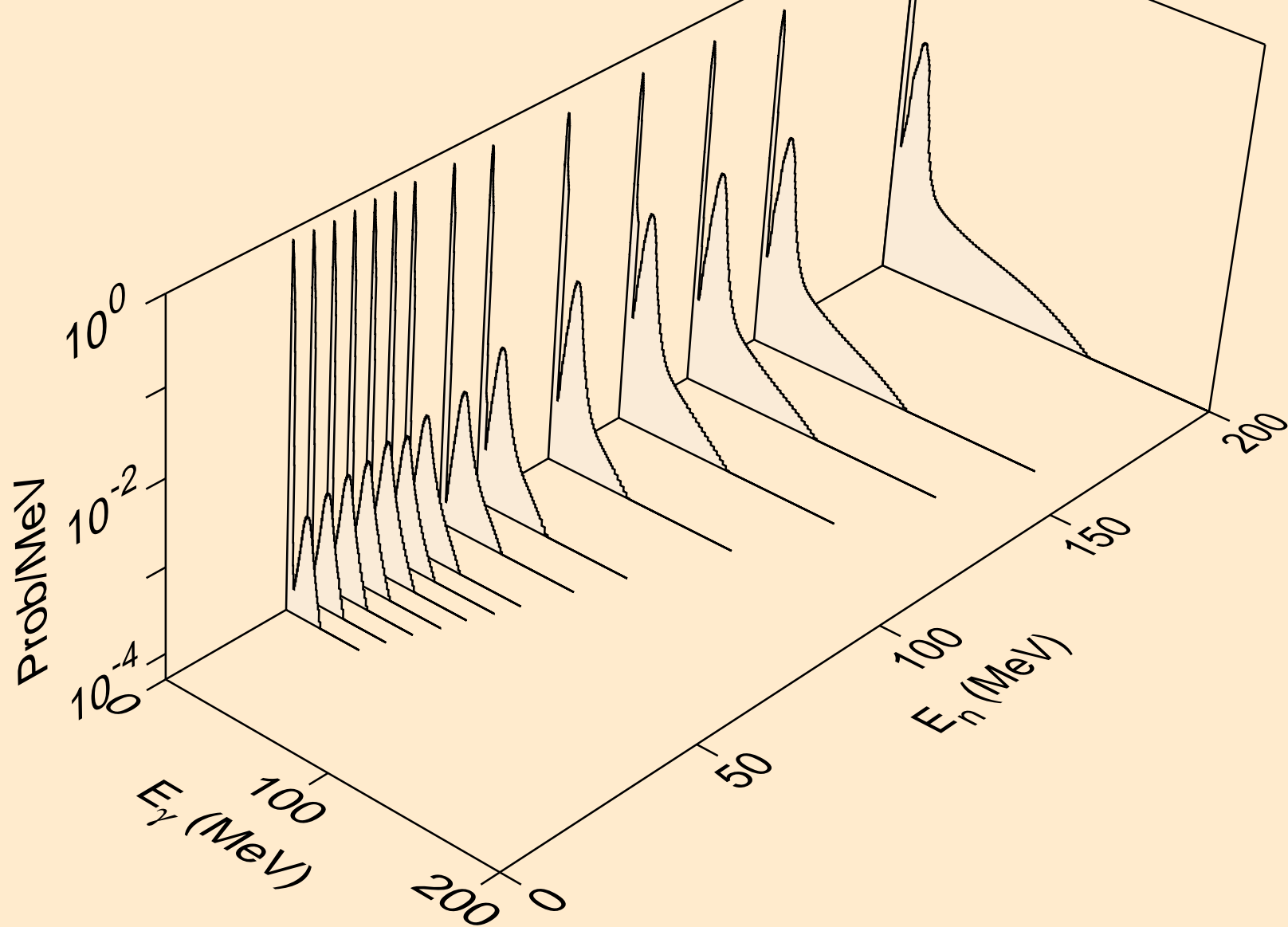

FM247 DEUTERON ACER TENDL-2021 LIBRARY; T=0.K
Photon emission for (n,2n)

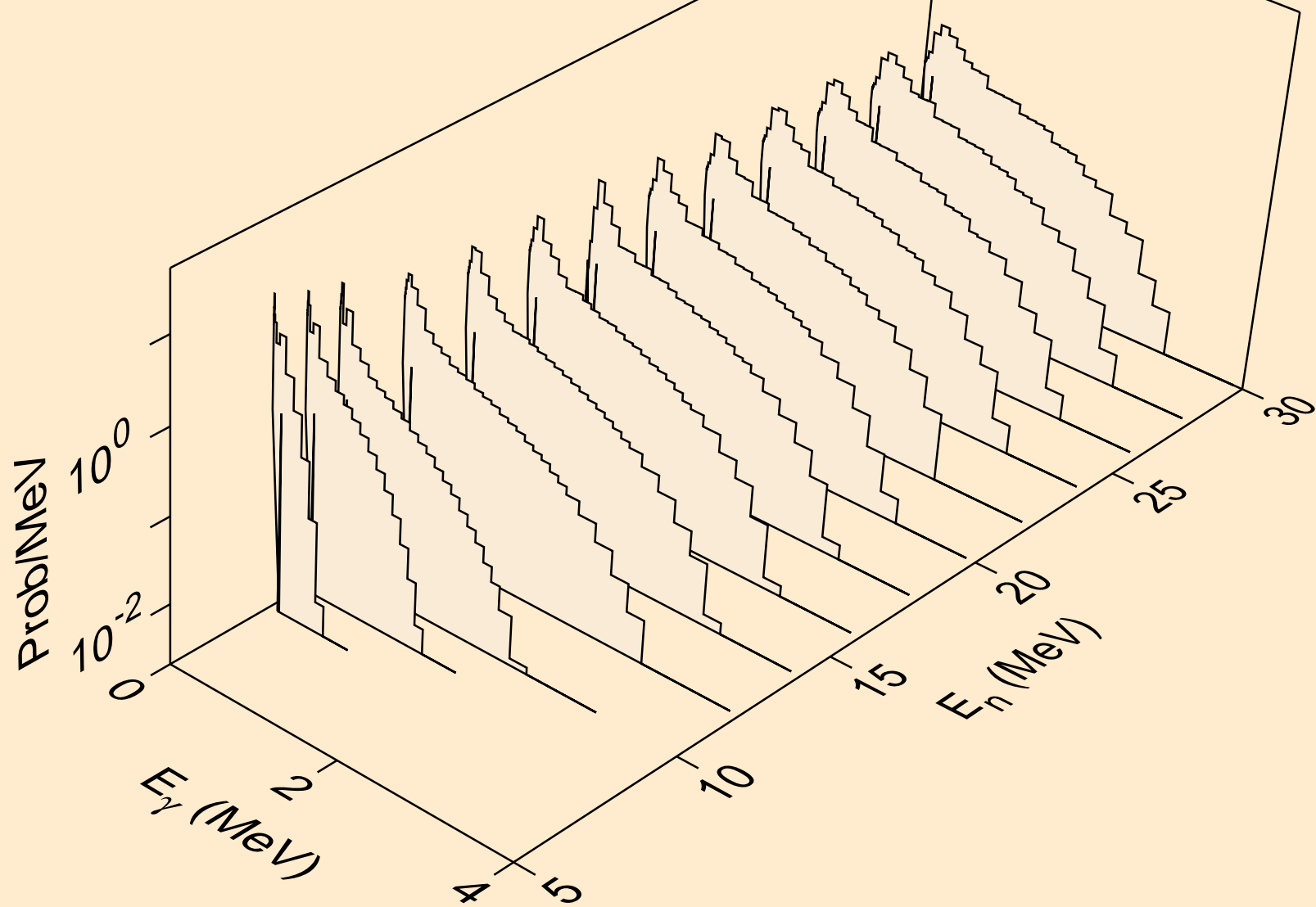

FM247 DEUTERON ACER TENDL-2021 LIBRARY; T=0.K
Photon emission for (n,3n)

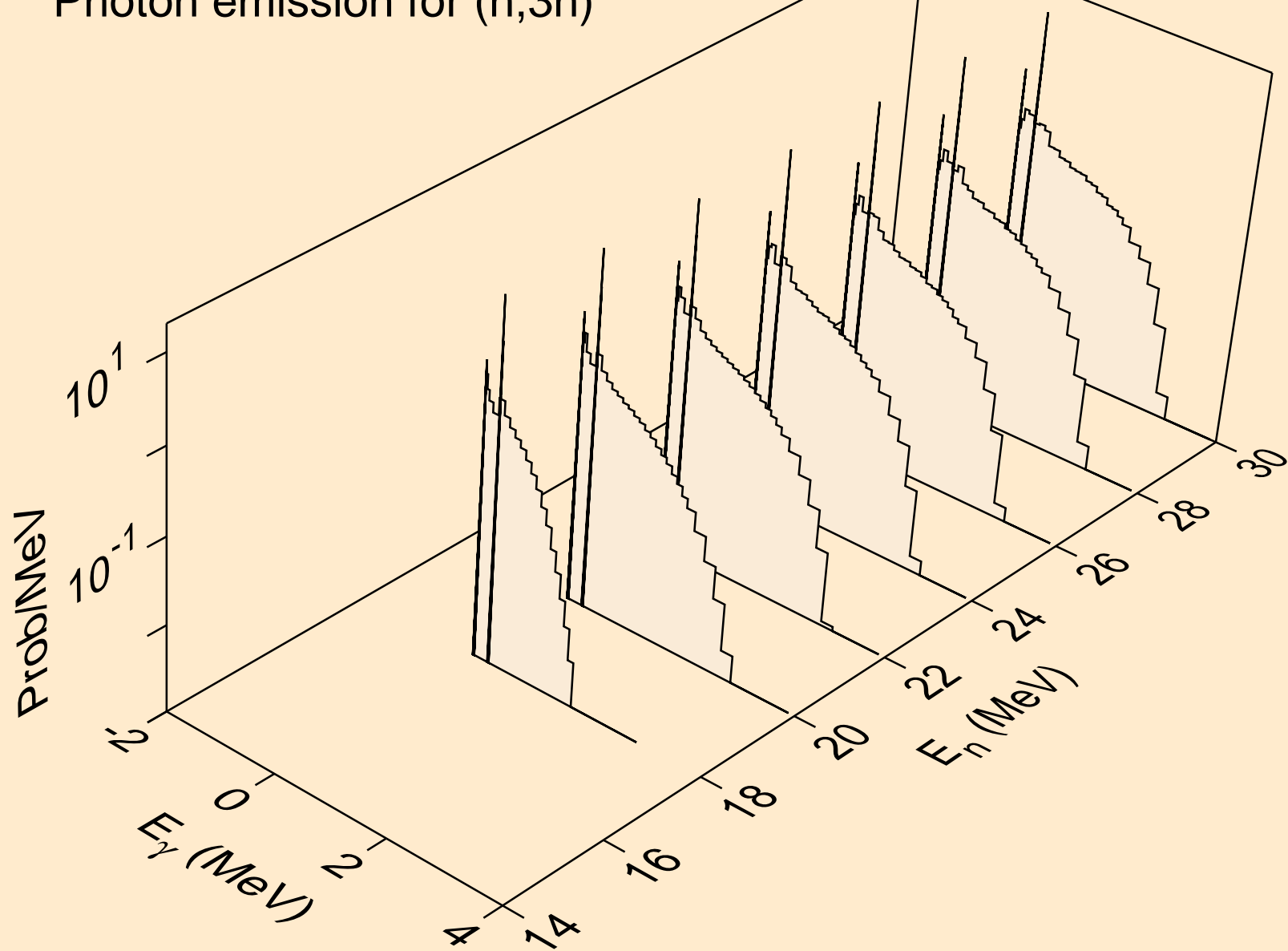

FM247 DEUTERON ACER TENDL-2021 LIBRARY; T=0.K
Photon emission for (n,n*)a

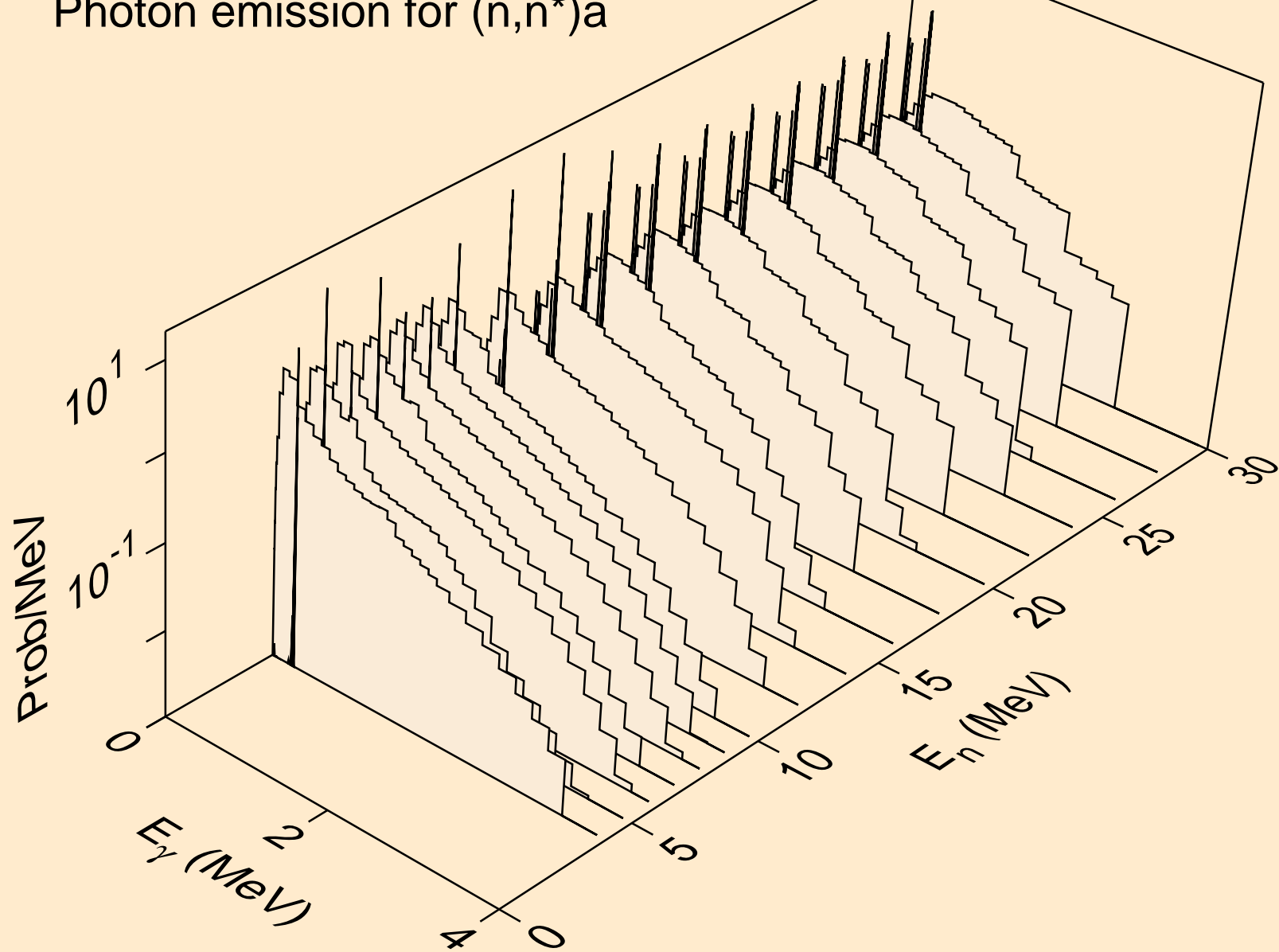

FM247 DEUTERON ACER TENDL-2021 LIBRARY; T=0.K
Photon emission for (n,2n)a

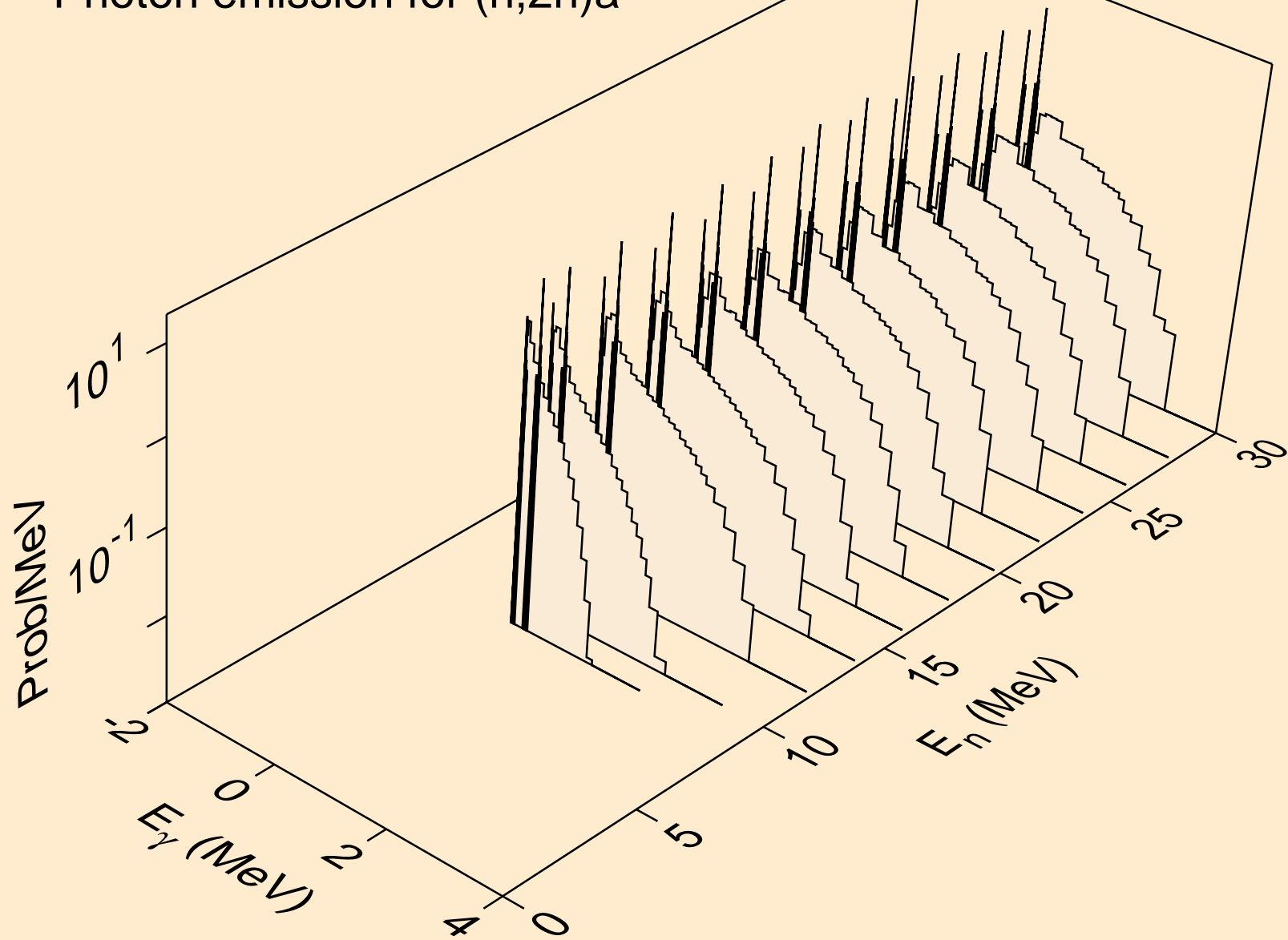

FM247 DEUTERON ACER TENDL-2021 LIBRARY; T=0.K
Photon emission for (n,n*)p

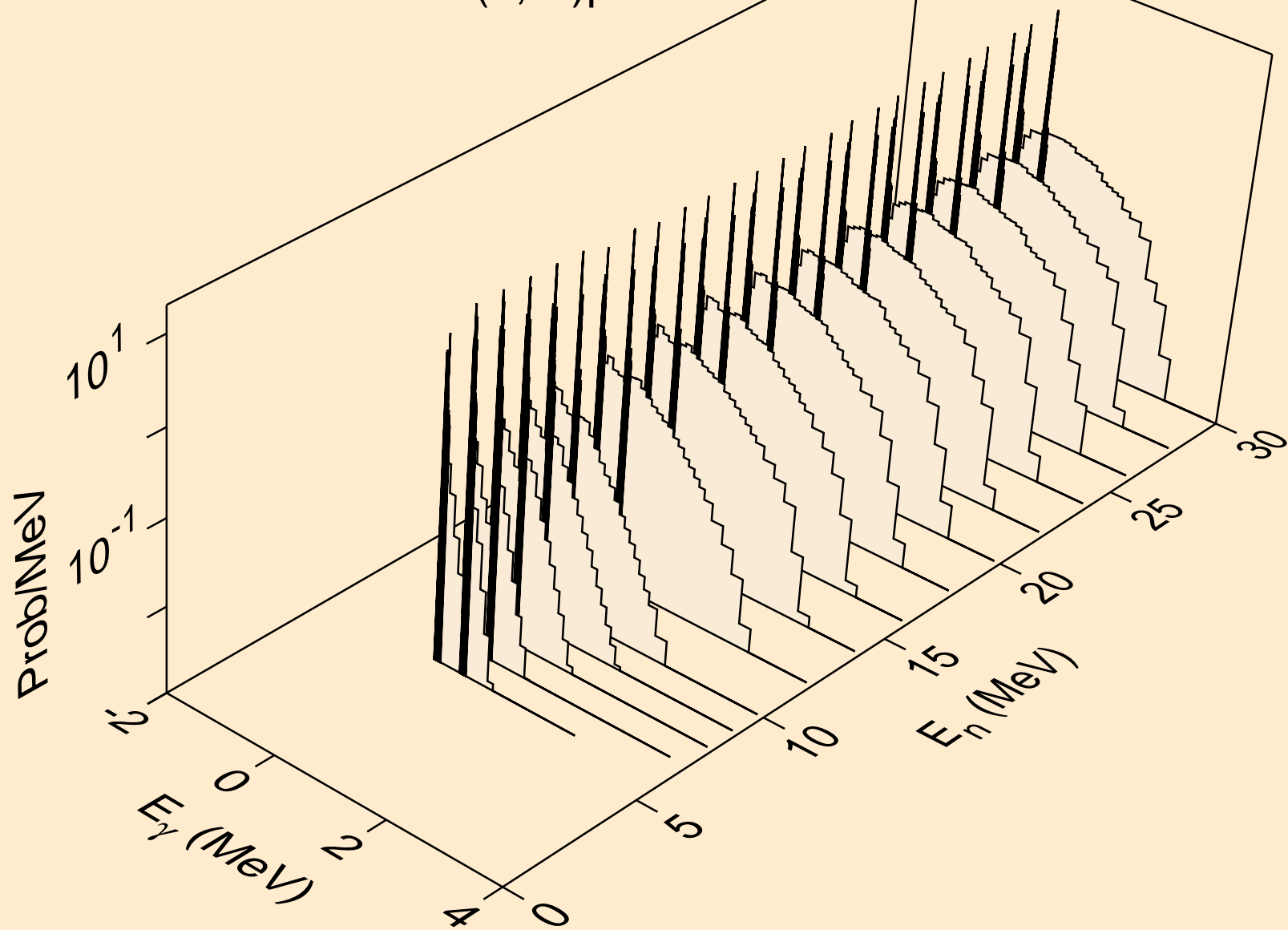

FM247 DEUTERON ACER TENDL-2021 LIBRARY; T=0.K
Photon emission for (n,n*)2a

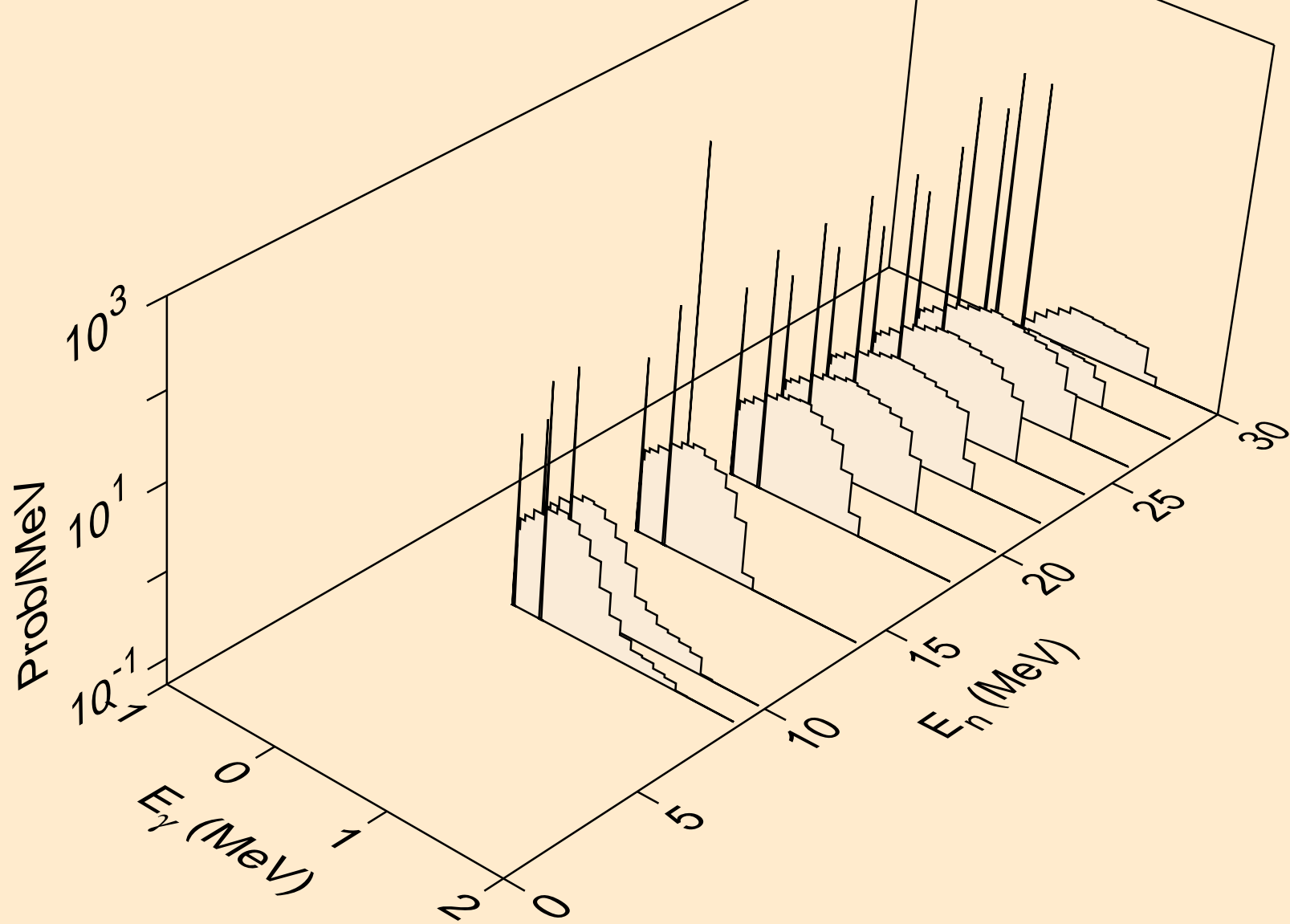

FM247 DEUTERON ACER TENDL-2021 LIBRARY; T=0.K
Photon emission for (n,n*)d

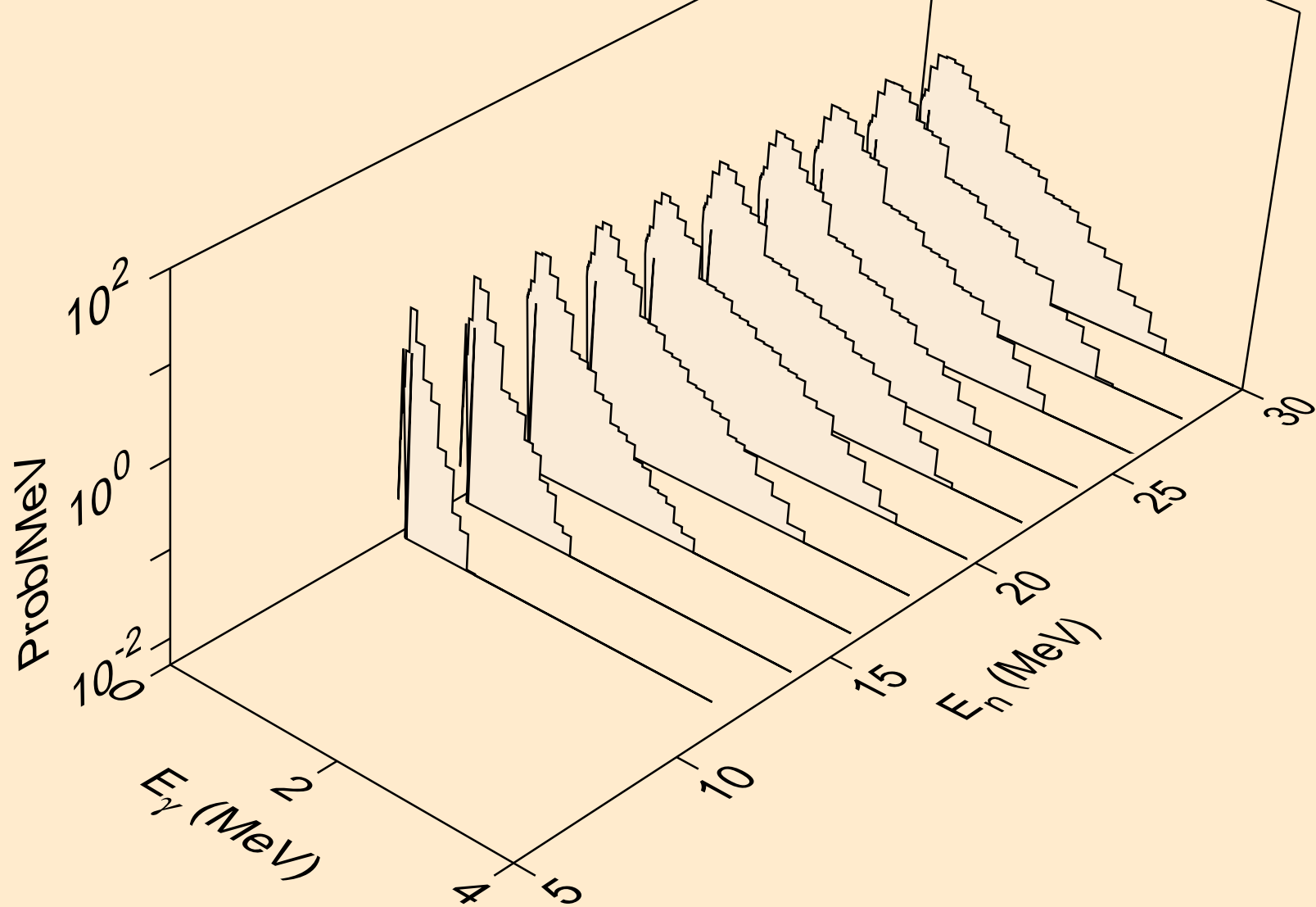

FM247 DEUTERON ACER TENDL-2021 LIBRARY; T=0.K
Photon emission for (n,n*)t

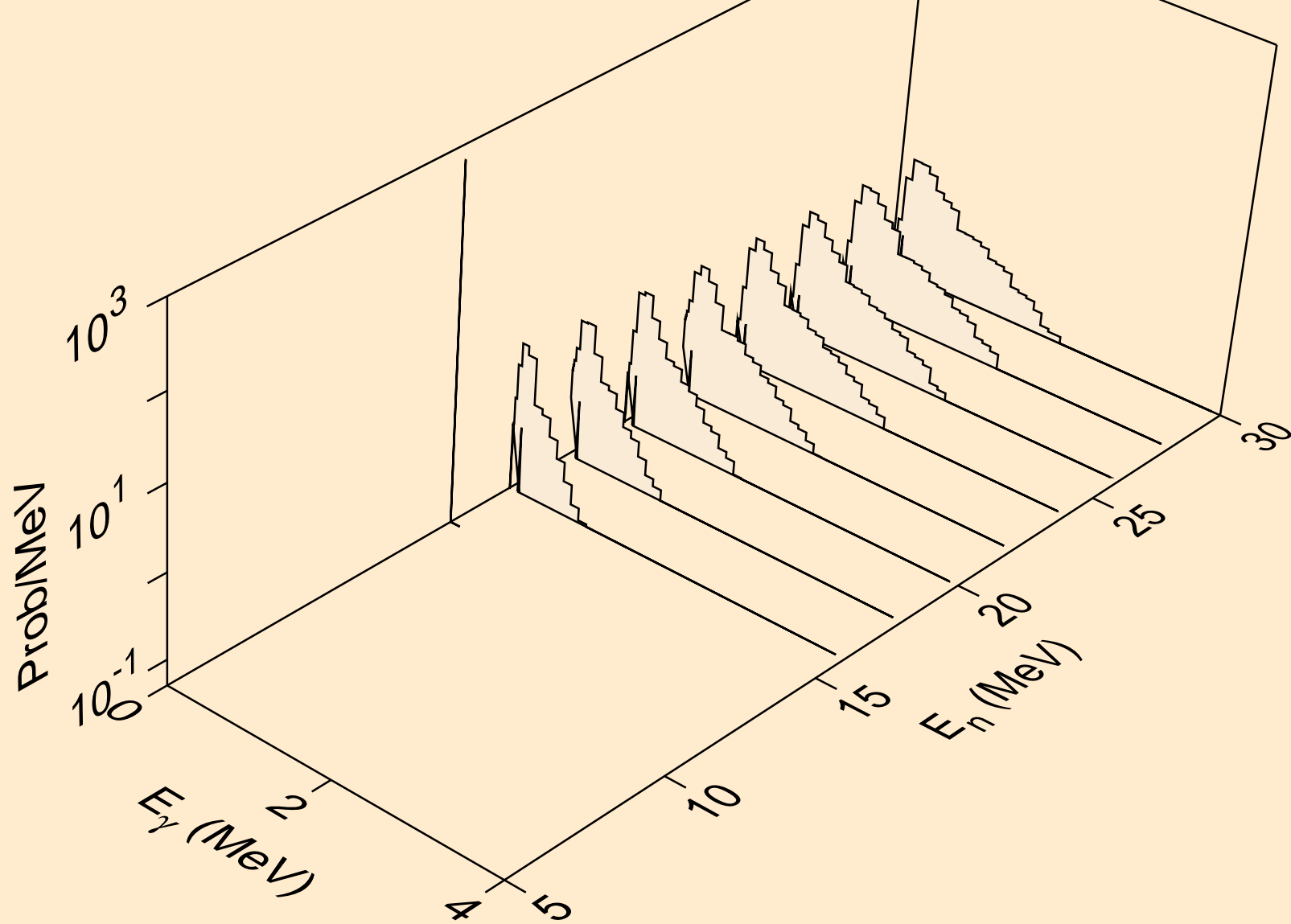

FM247 DEUTERON ACER TENDL-2021 LIBRARY; T=0.K
Photon emission for (n,n*)he3

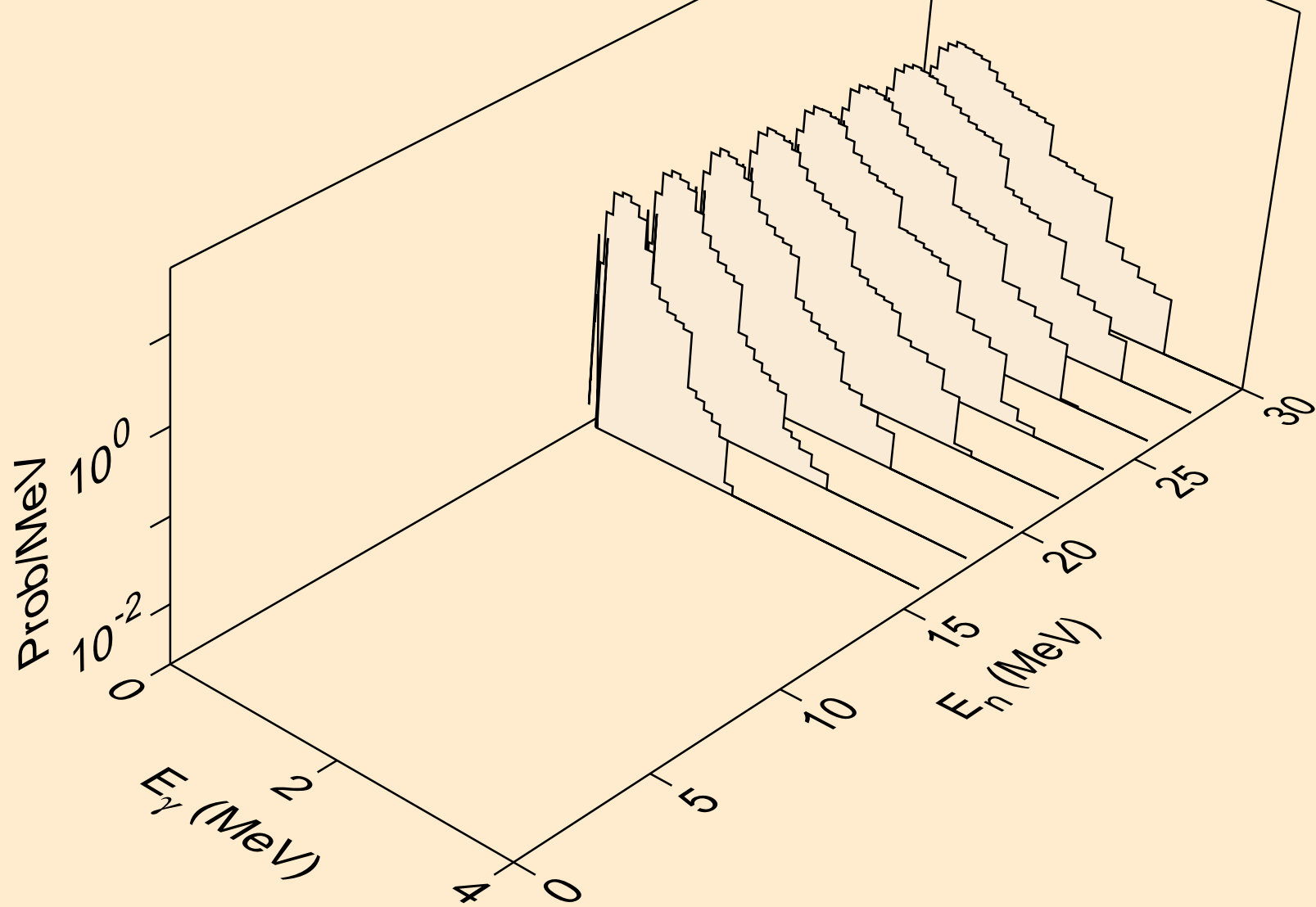

FM247 DEUTERON ACER TENDL-2021 LIBRARY; T=0.K
Photon emission for (n,2np)

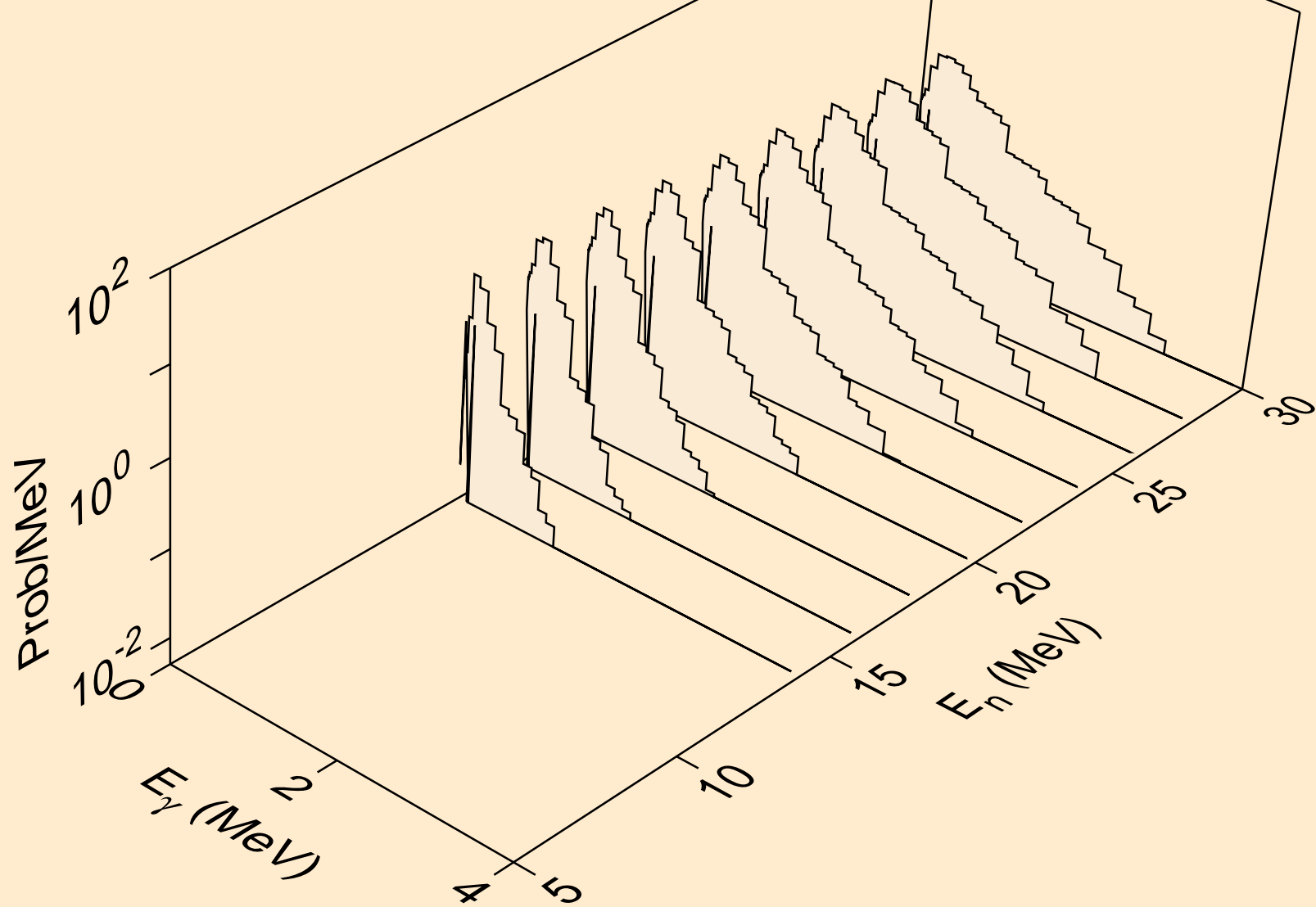

FM247 DEUTERON ACER TENDL-2021 LIBRARY; T=0.K
Photon emission for (n,2np)

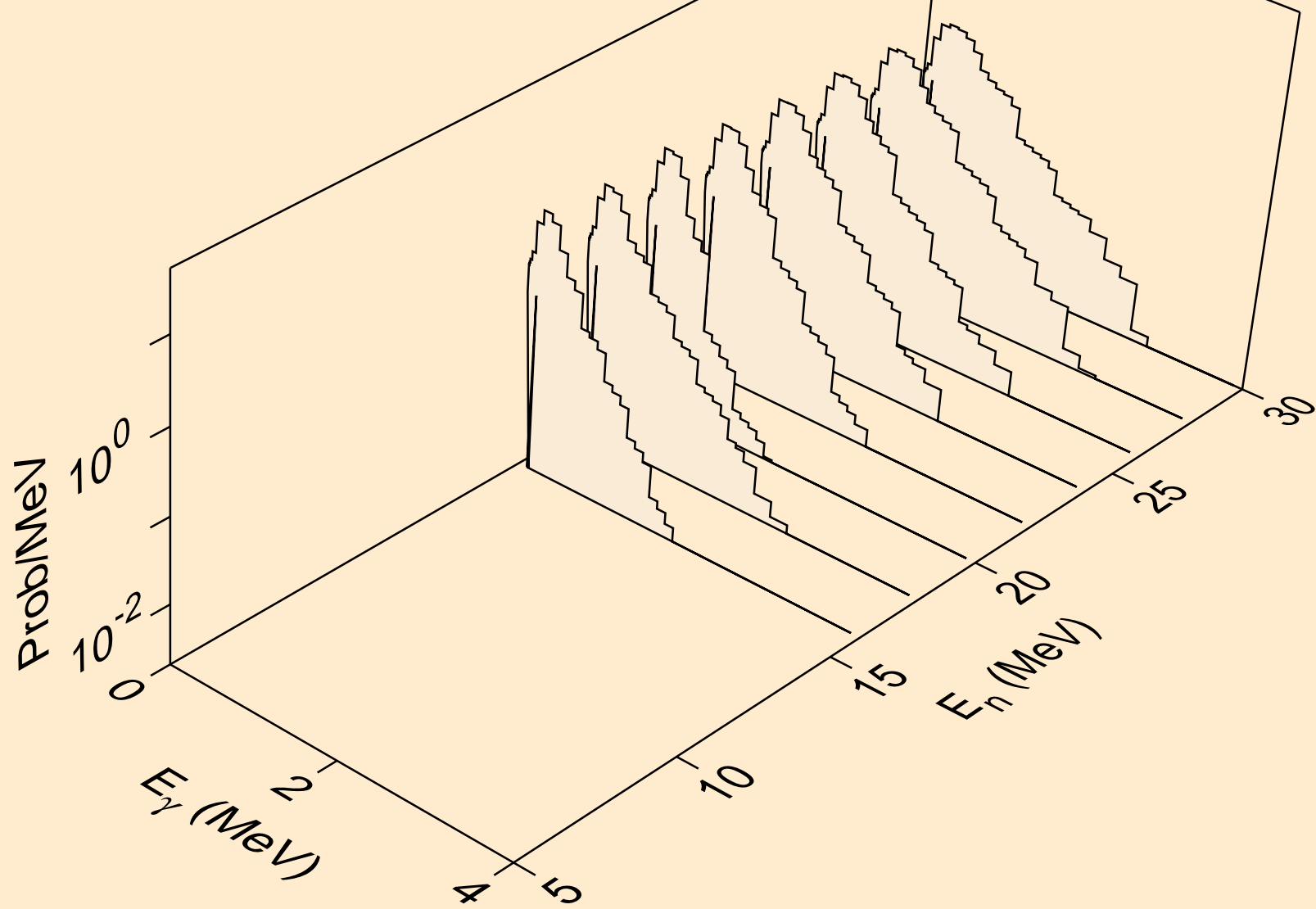

FM247 DEUTERON ACER TENDL-2021 LIBRARY; T=0.K
Photon emission for (n,npa)

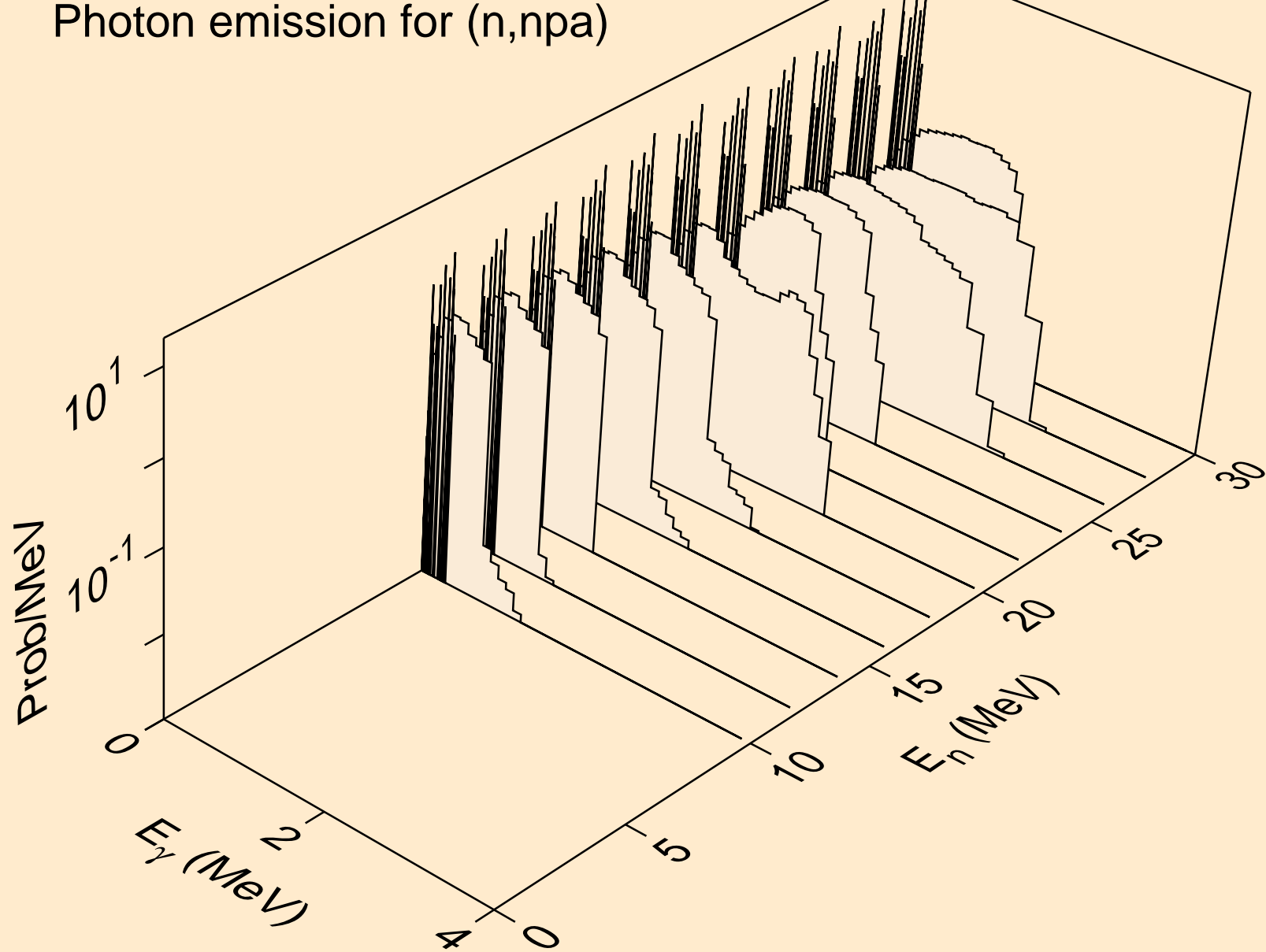

FM247 DEUTERON ACER TENDL-2021 LIBRARY; T=0.K
Photon emission for (n,gma)

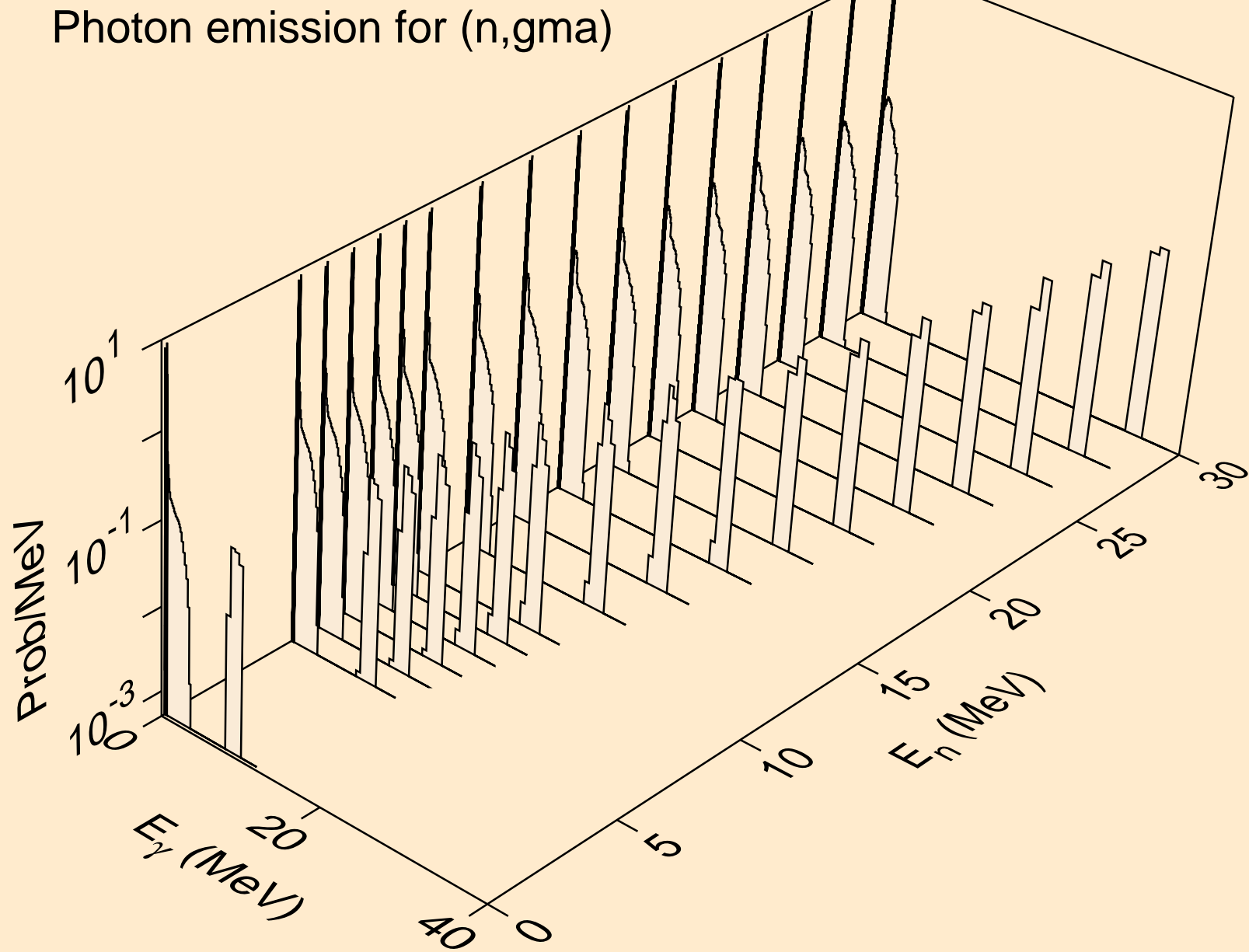

FM247 DEUTERON ACER TENDL-2021 LIBRARY; T=0.K
Photon emission for (n,p)

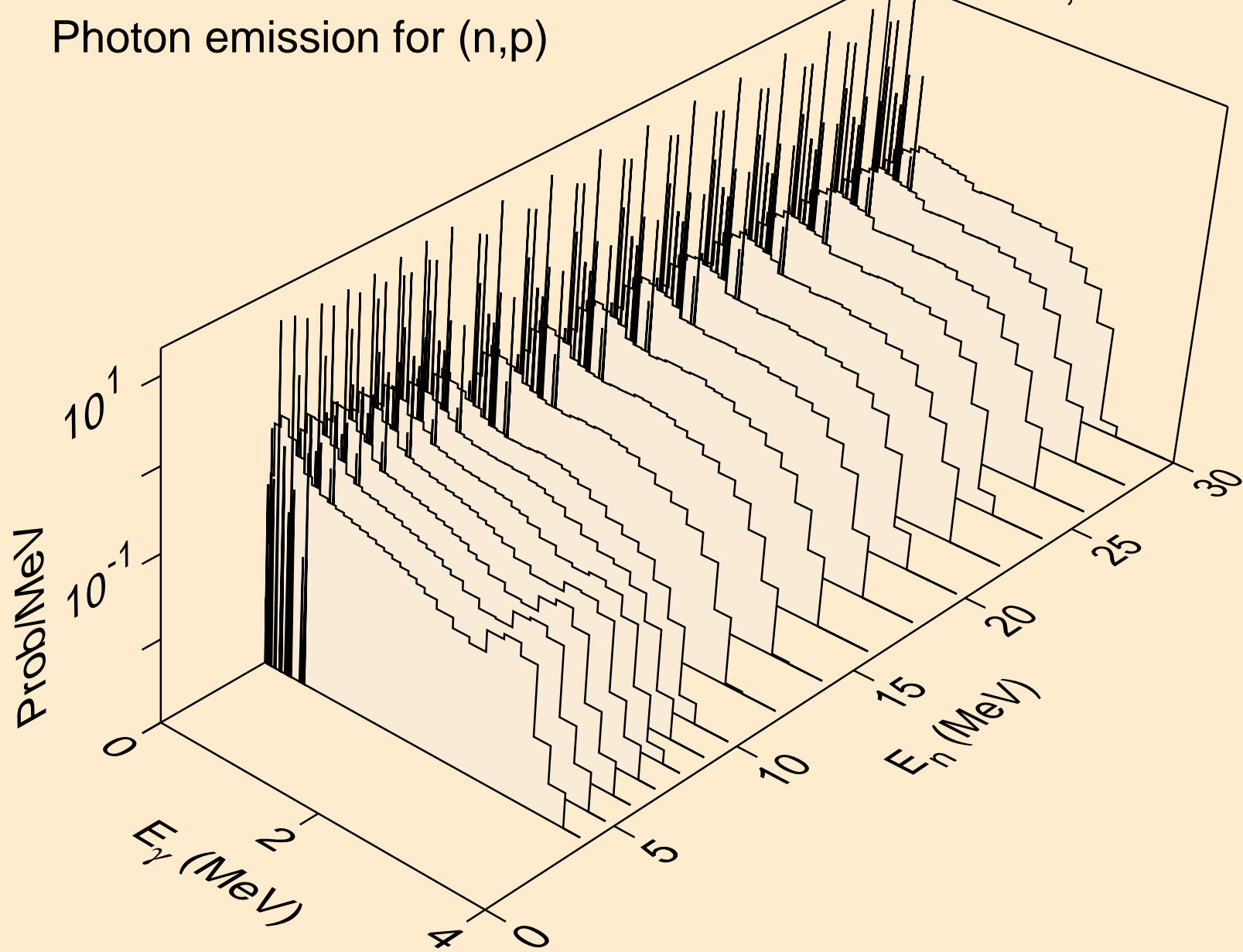

FM247 DEUTERON ACER TENDL-2021 LIBRARY; T=0.K
Photon emission for inelastic

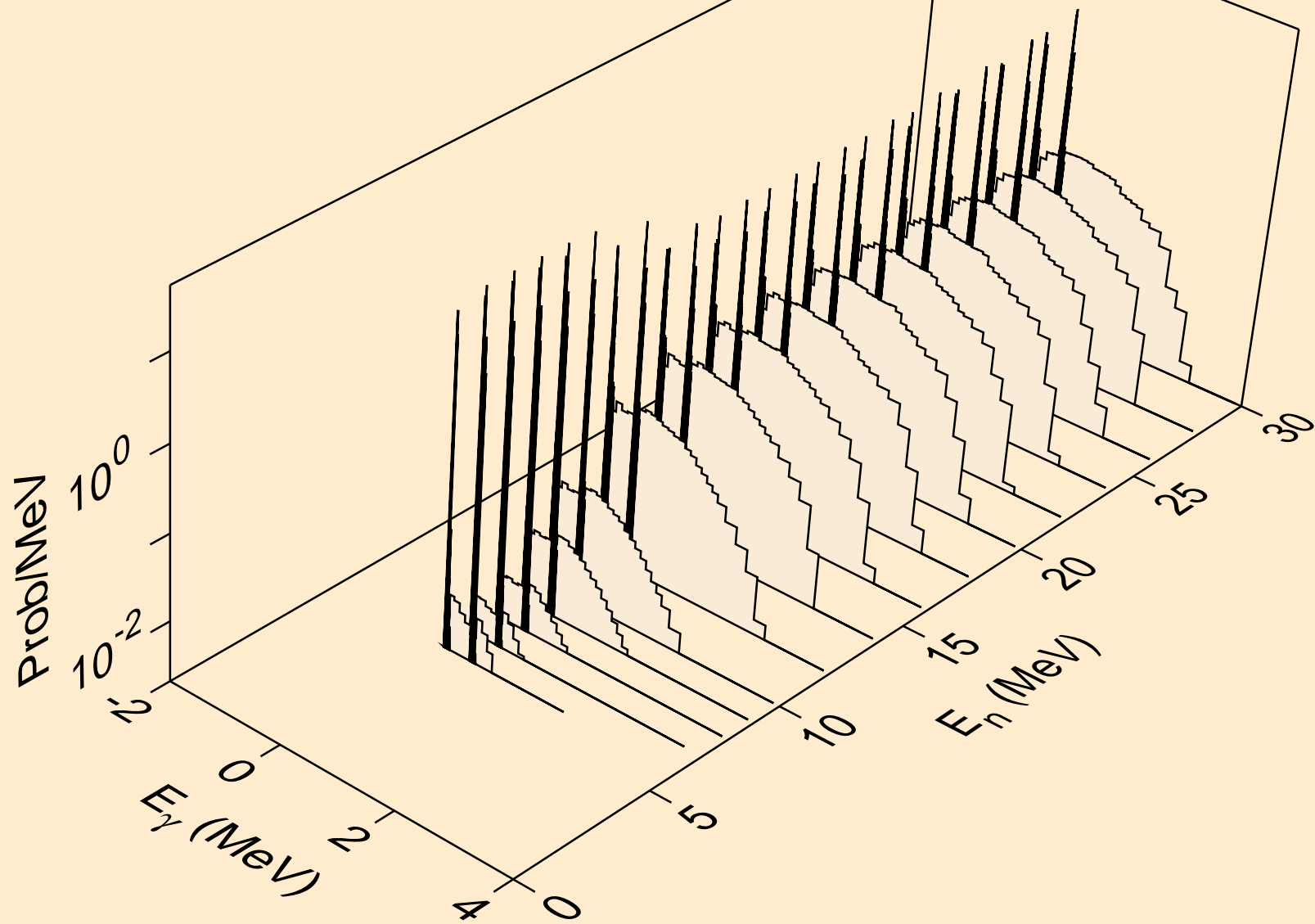

FM247 DEUTERON ACER TENDL-2021 LIBRARY; T=0.K
Photon emission for (n,t)

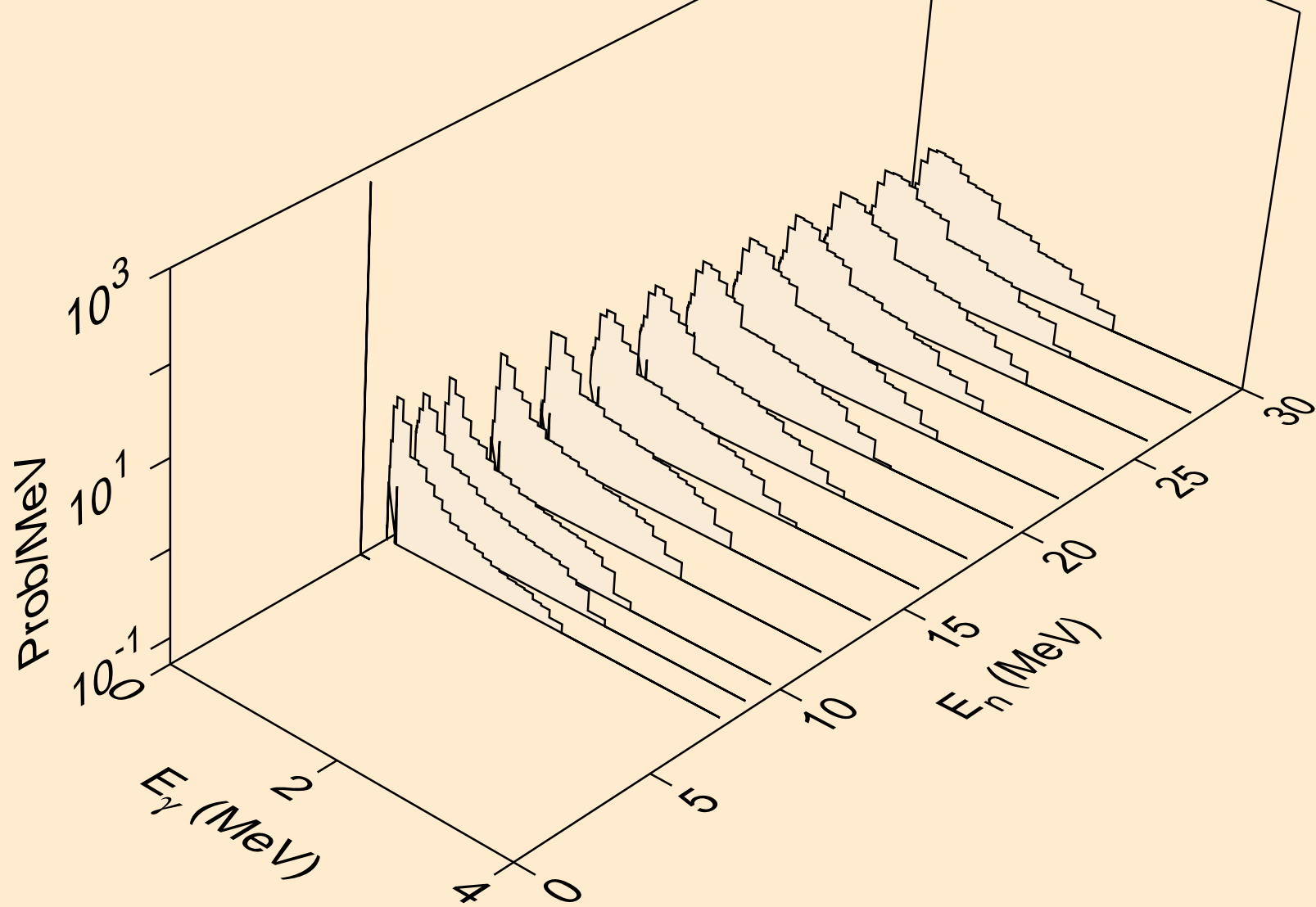

FM247 DEUTERON ACER TENDL-2021 LIBRARY; T=0.K
Photon emission for (n,he3)

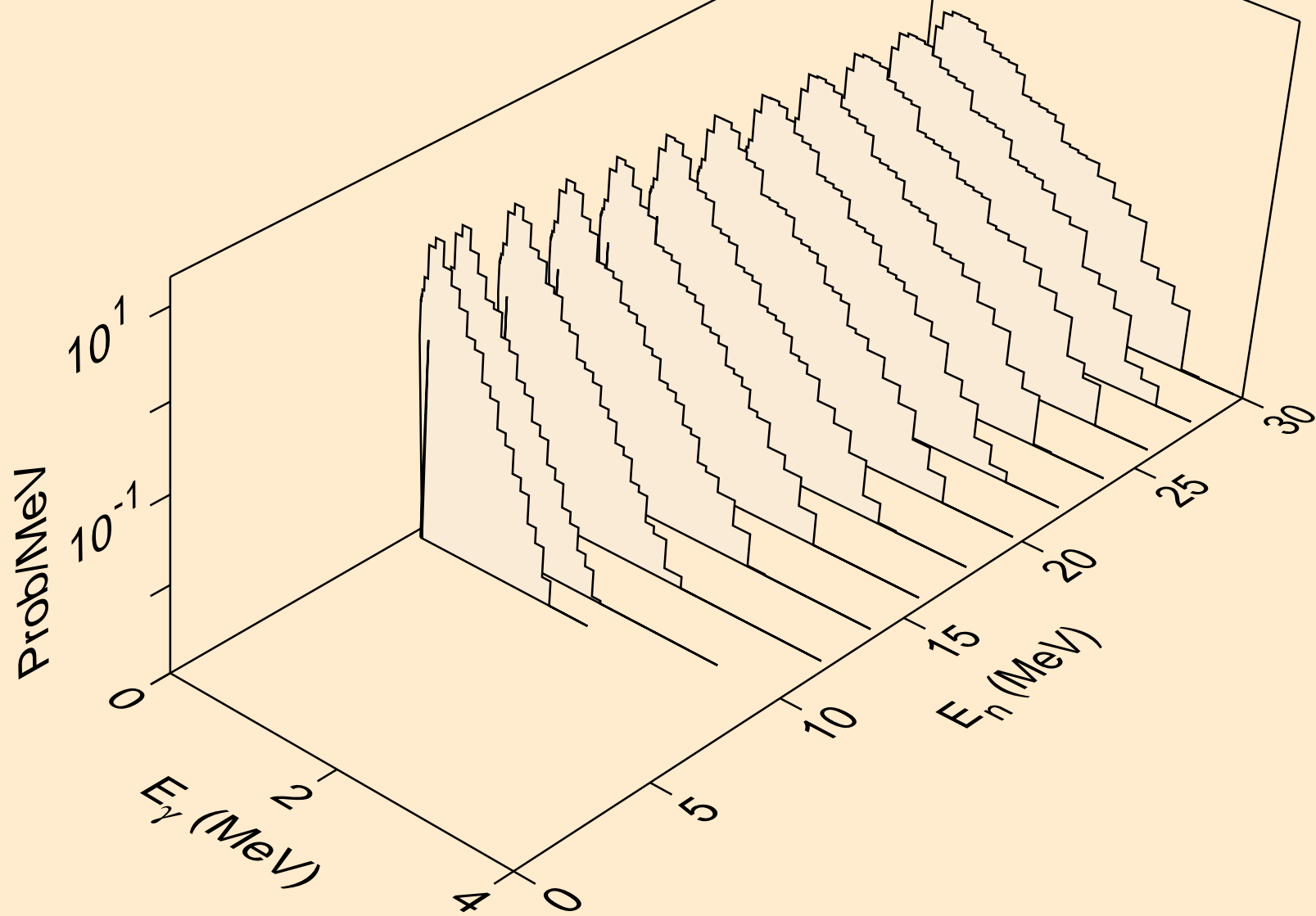

FM247 DEUTERON ACER TENDL-2021 LIBRARY; T=0.K
Photon emission for (n,a)

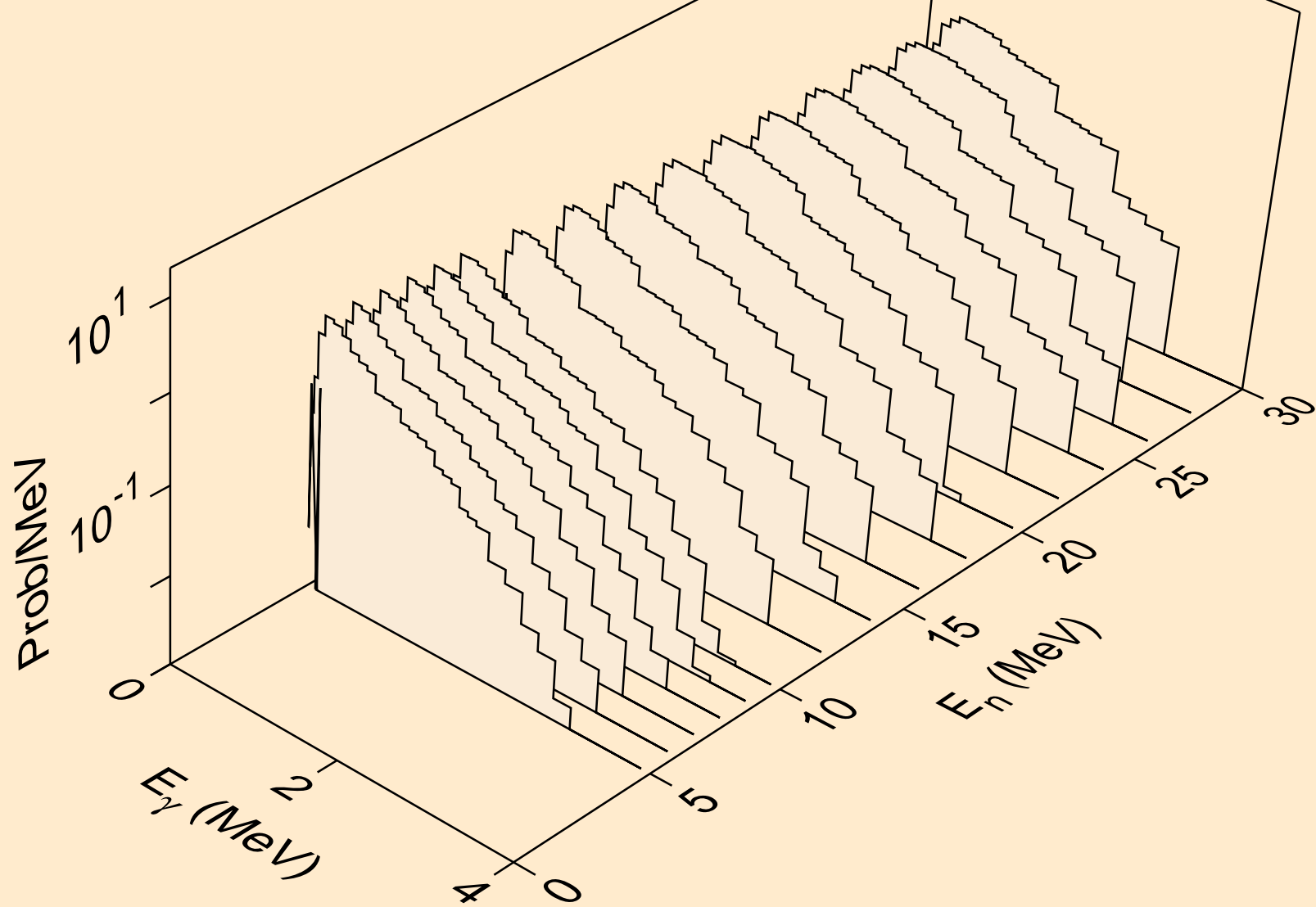

FM247 DEUTERON ACER TENDL-2021 LIBRARY; T=0.K
Photon emission for (n,2a)

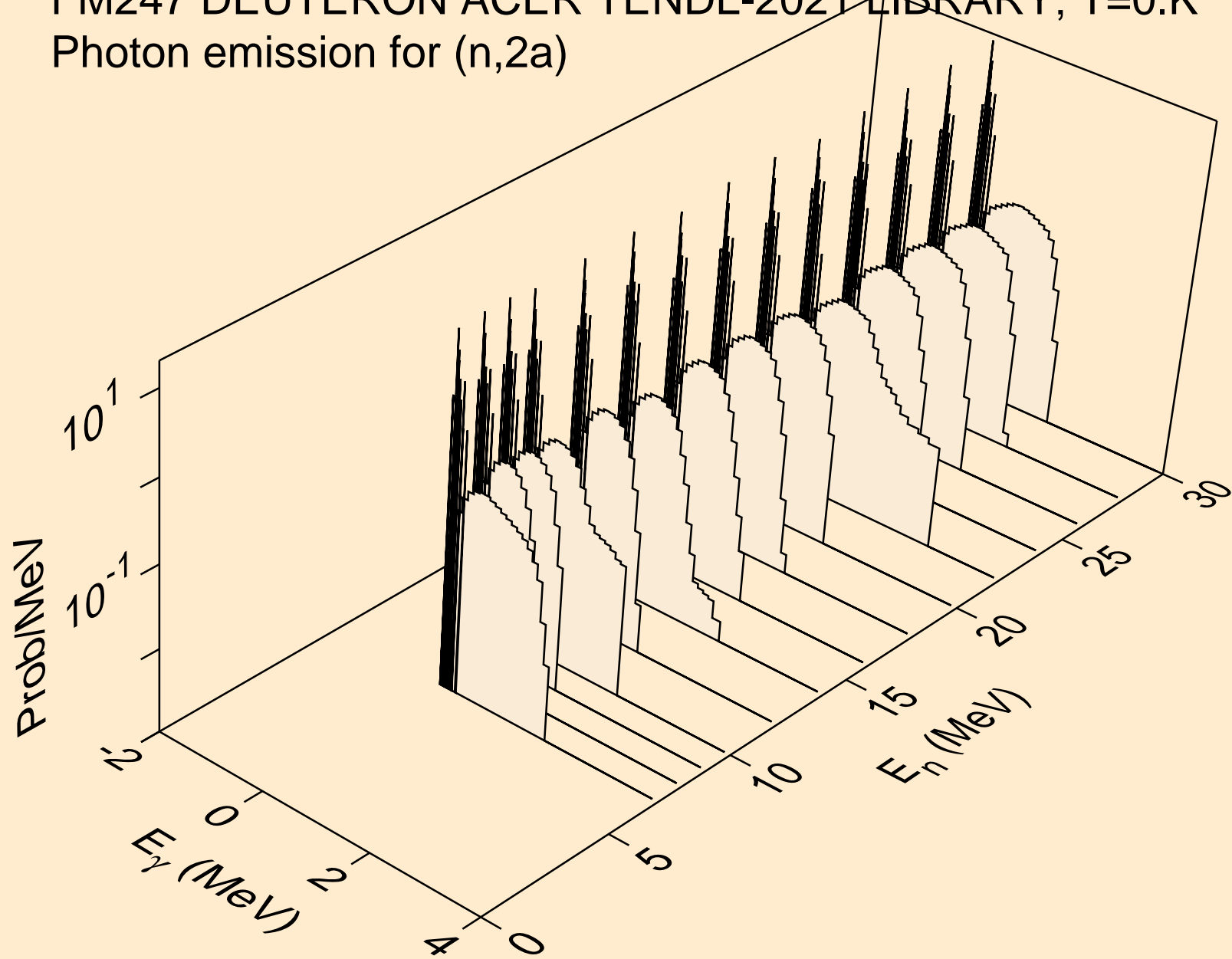

FM247 DEUTERON ACER TENDL-2021 LIBRARY; T=0.K
Photon emission for (n,2p)

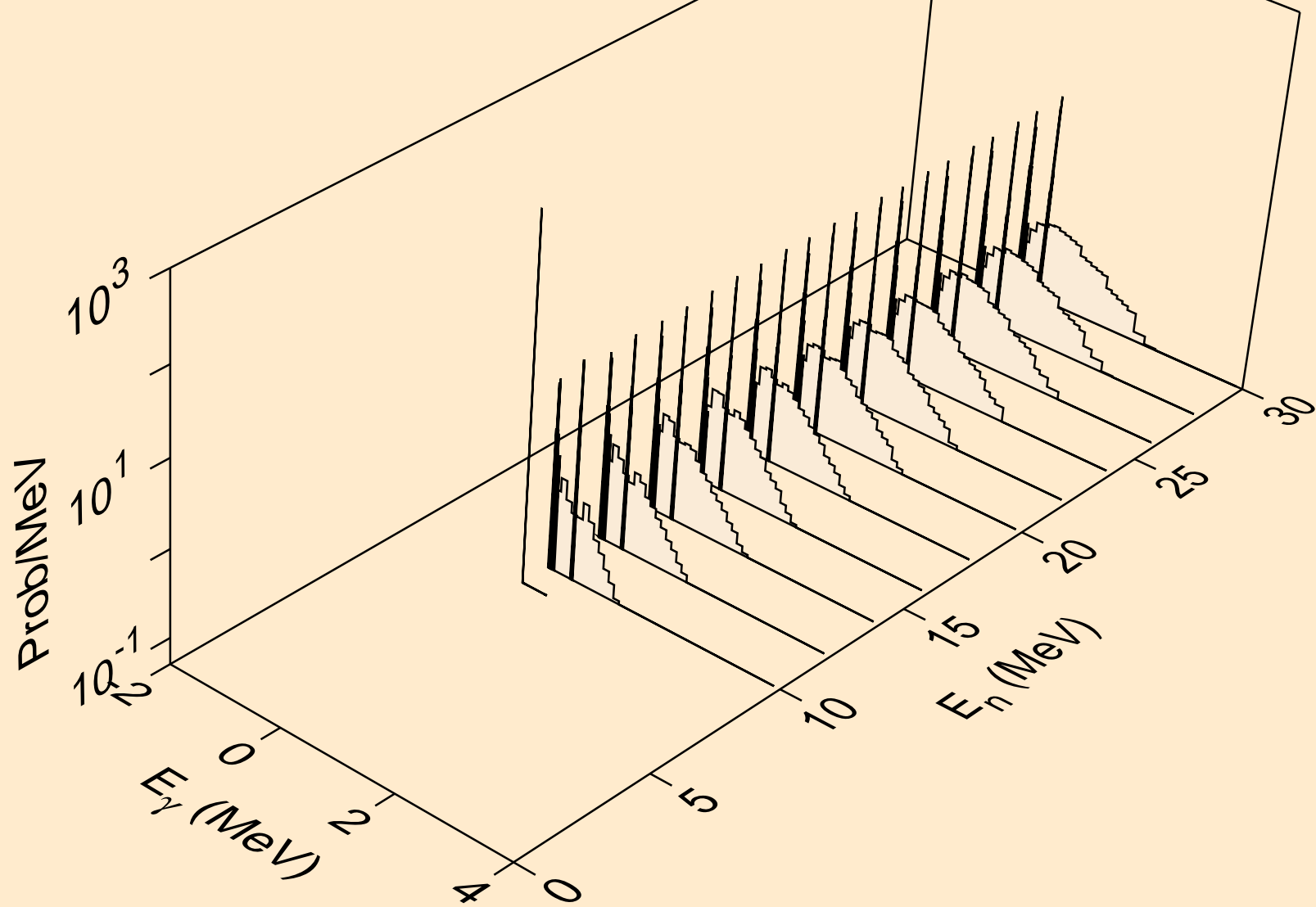

FM247 DEUTERON ACER TENDL-2021 LIBRARY; T=0.K
Photon emission for (n,pd)

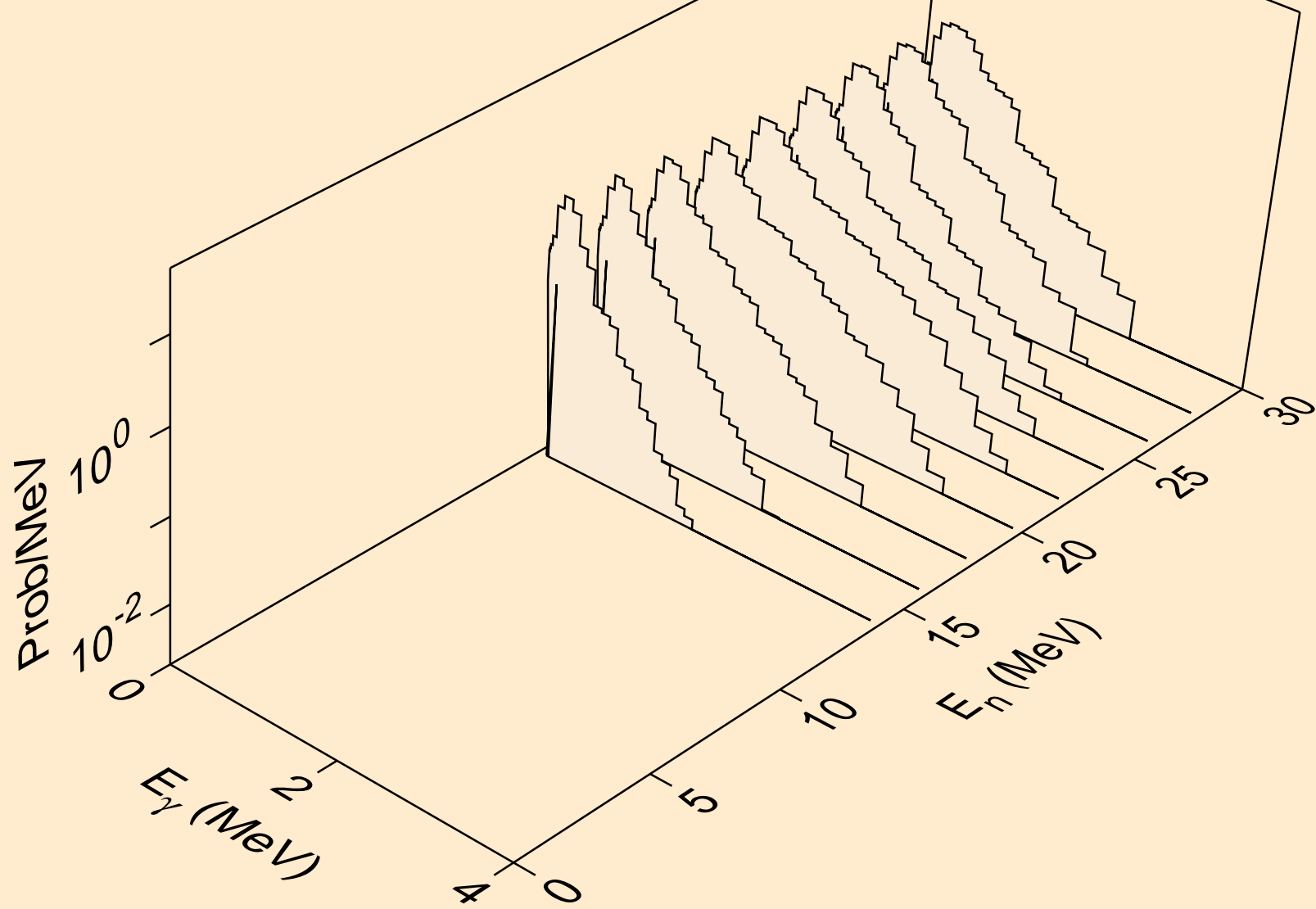

FM247 DEUTERON ACER TENDL-2021 LIBRARY; T=0.K
Photon emission for (n,da)

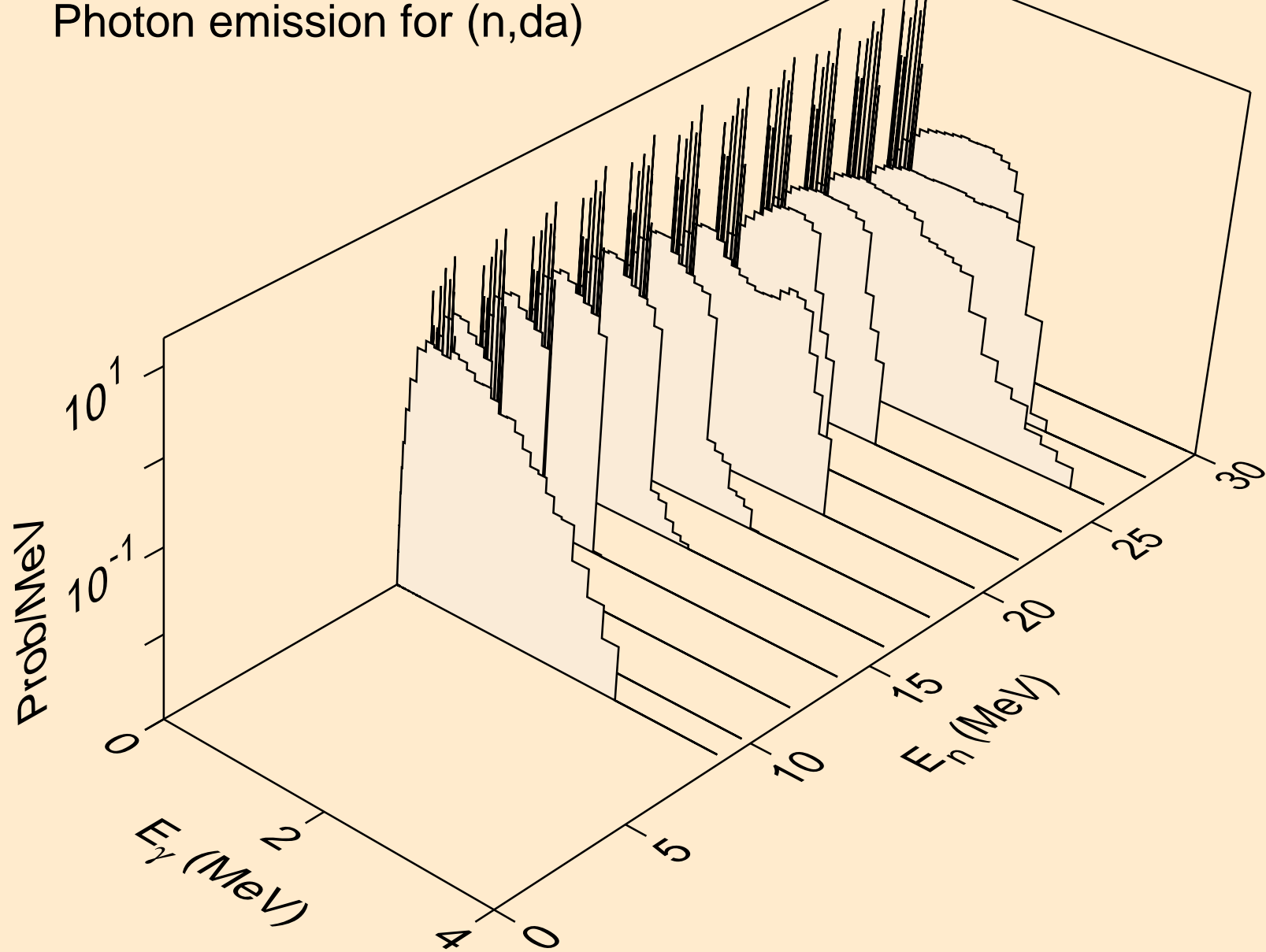

FM247 DEUTERON ACER TENDL-2021 LIBRARY; T=0.K

Particle heating contributions

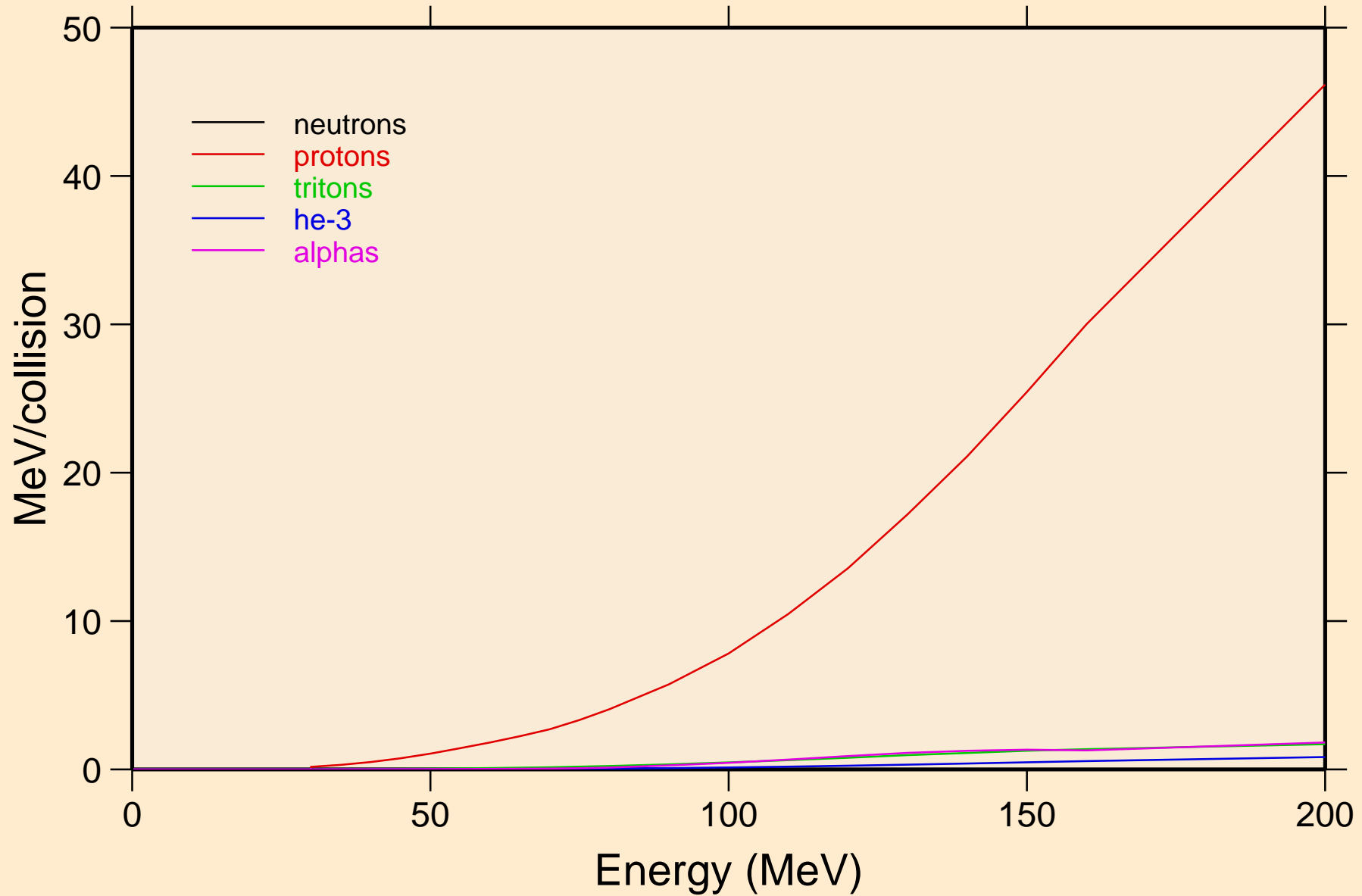

FM247 DEUTERON ACER TENDL-2021 LIBRARY; T=0.K
Recoil Heating

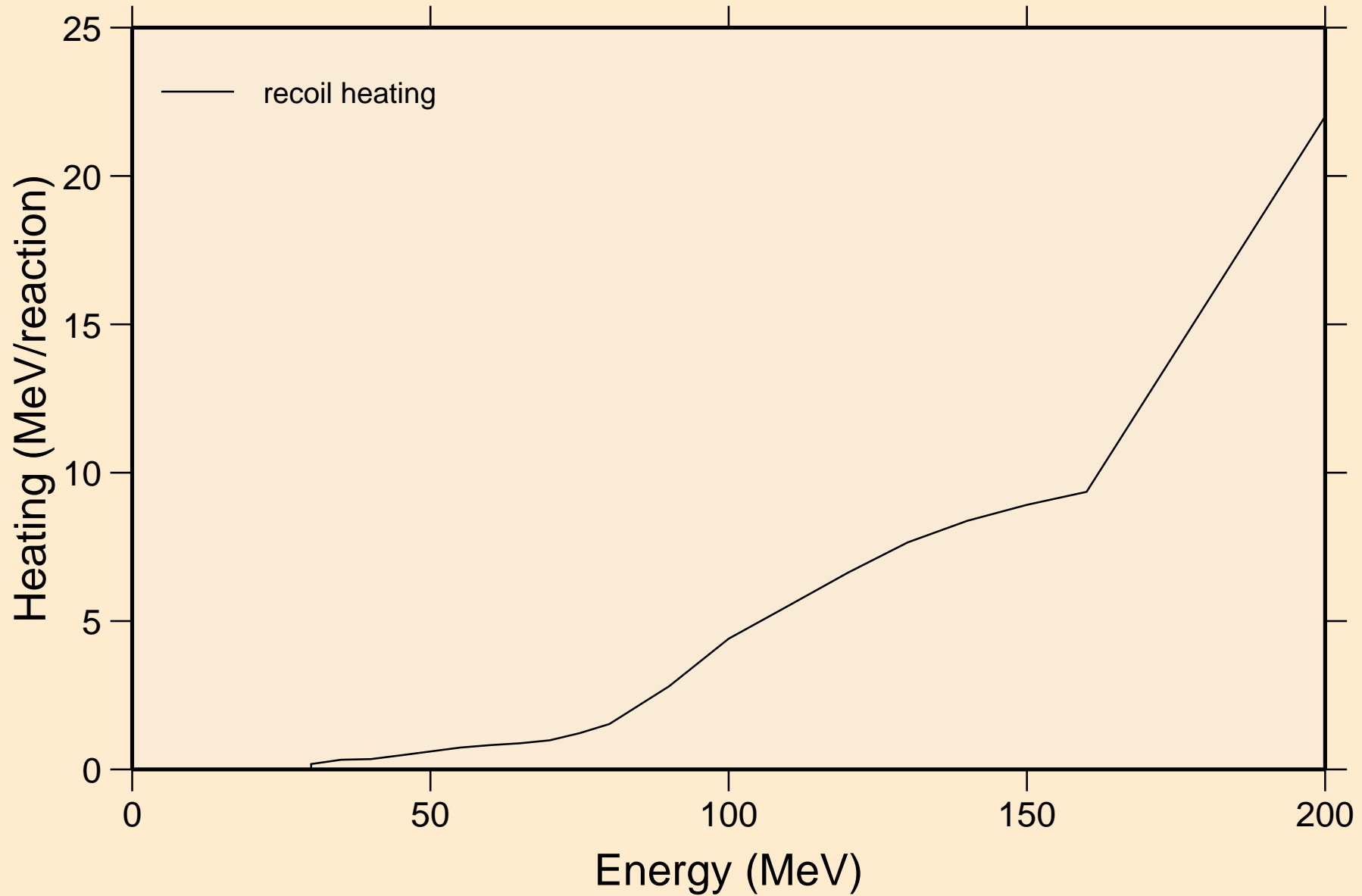

FM247 DEUTERON ACER TENDL-2021 LIBRARY; T=0.K
Particle production cross sections

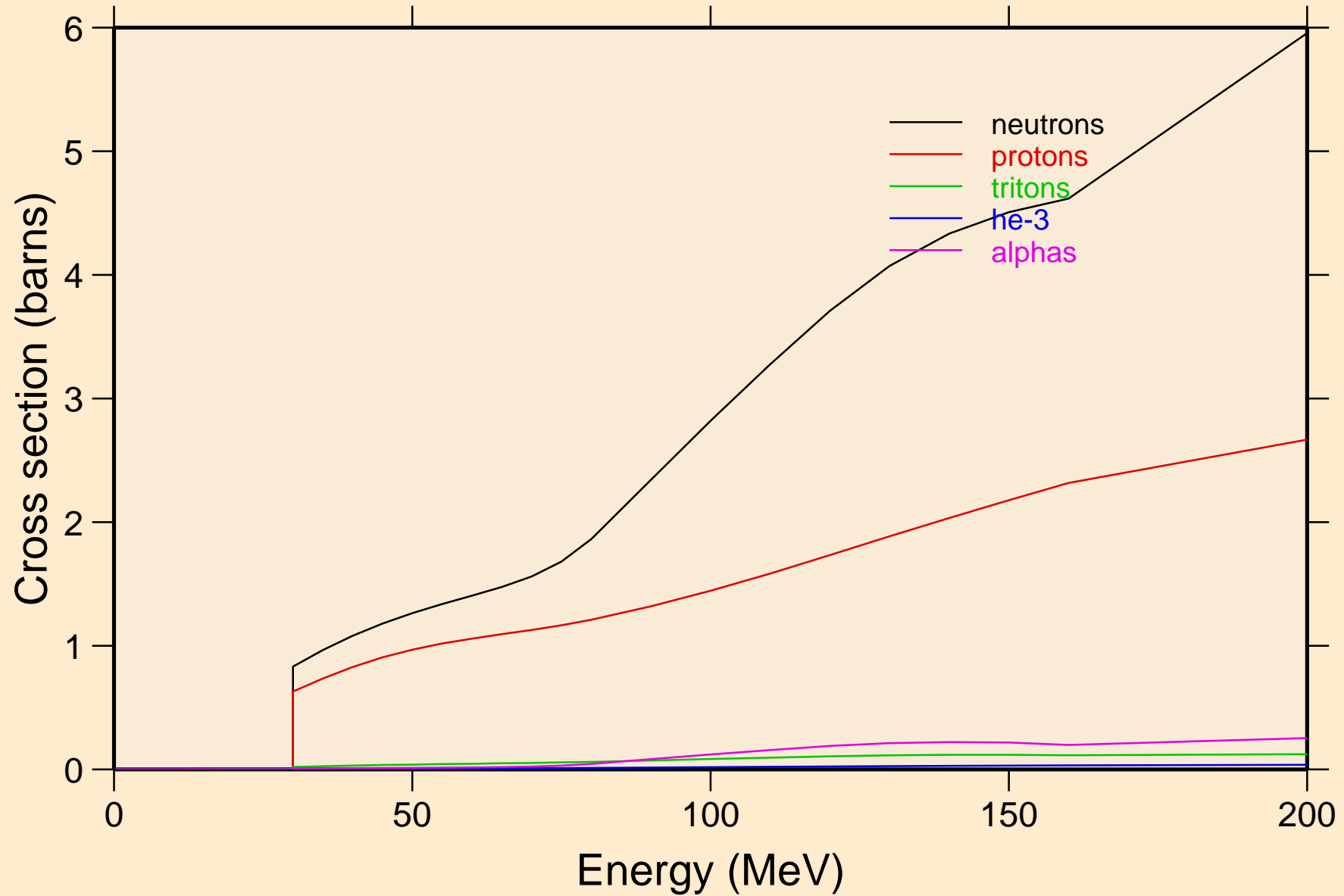

FM247 DEUTERON ACER TENDL-2021 LIBRARY; T=0.K
neutrons from (d,n)

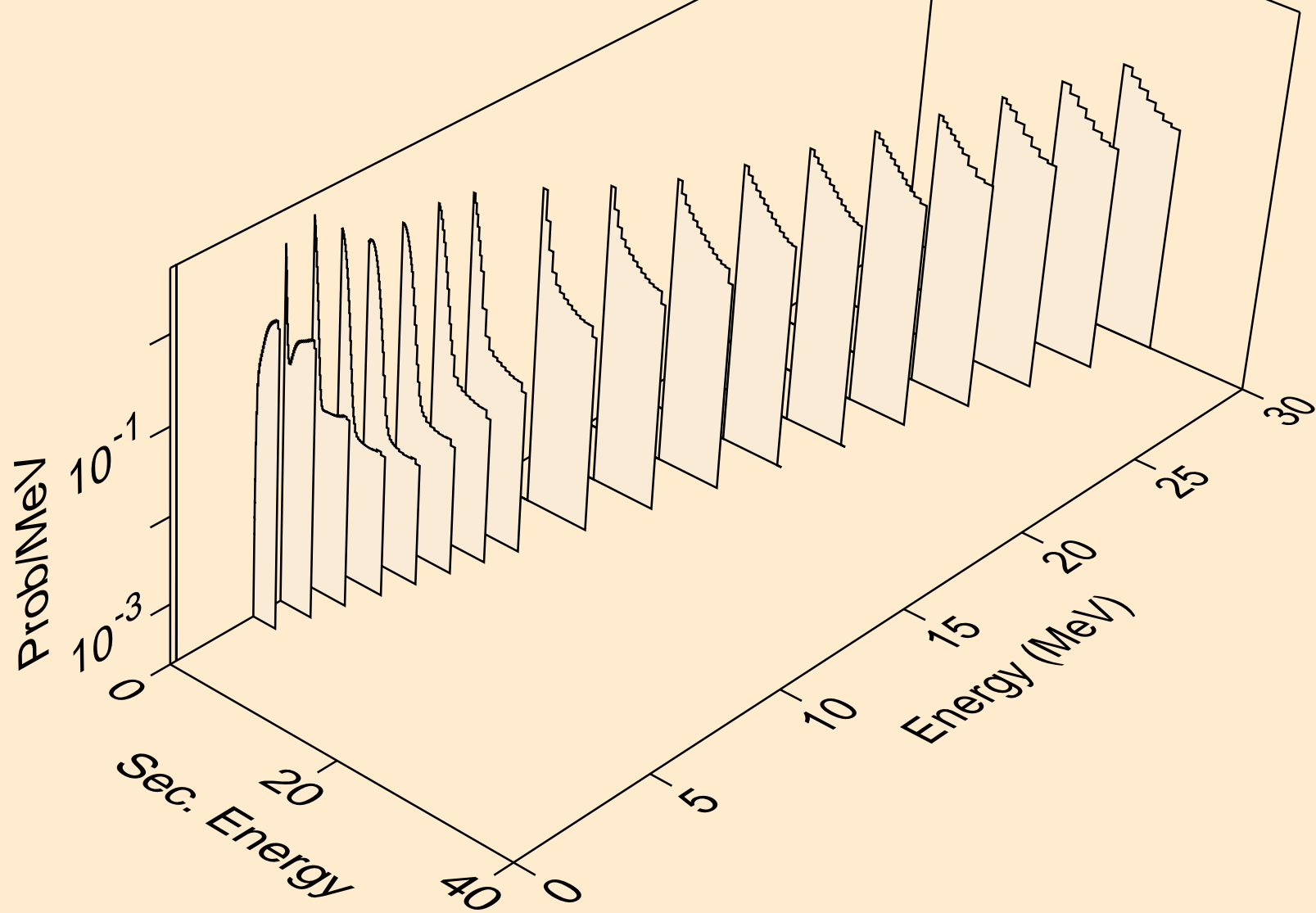

FM247 DEUTERON ACER TENDL-2021 LIBRARY; T=0.K
neutrons from (d,x)

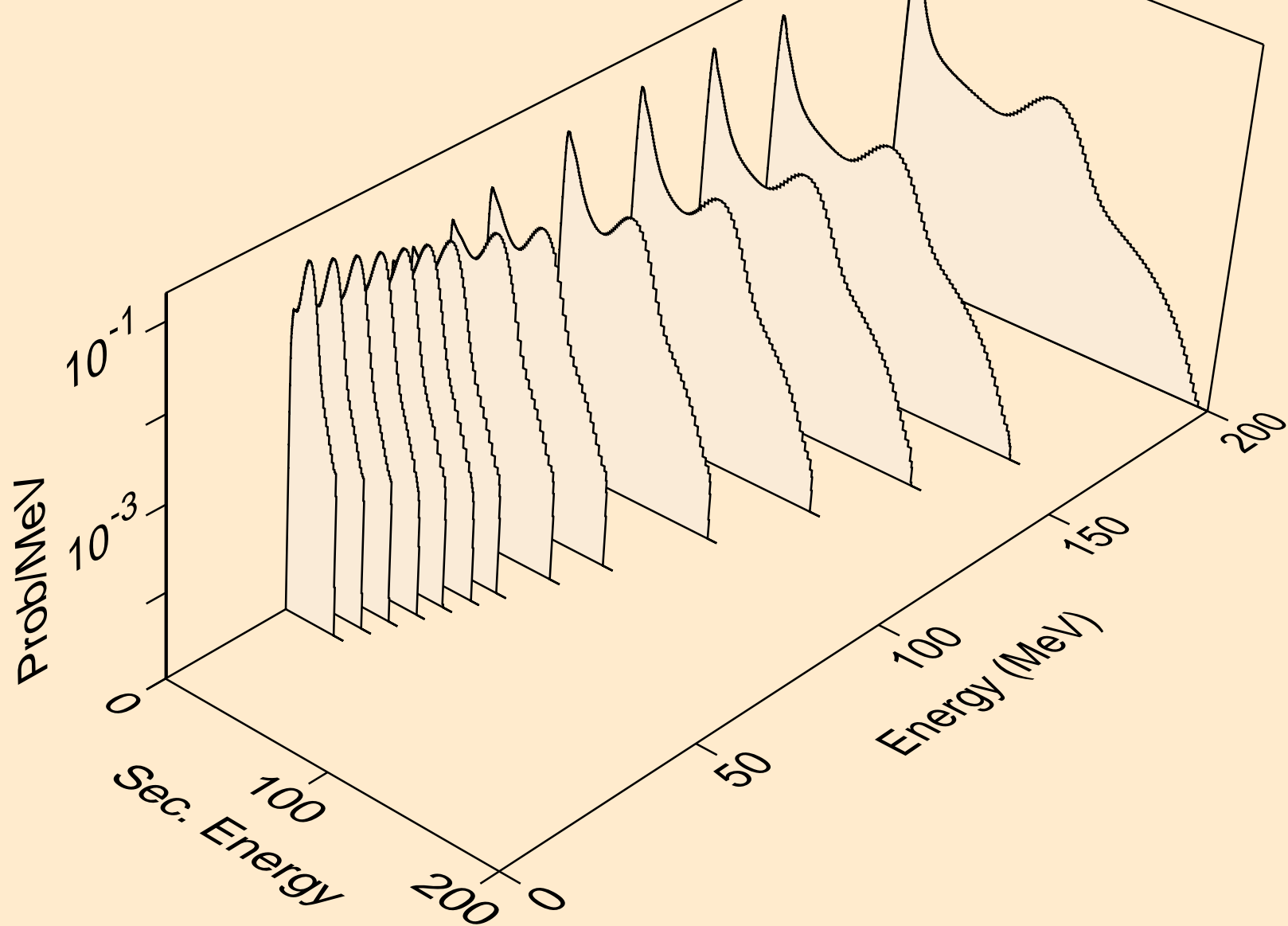

FM247 DEUTERON ACER TENDL-2021 LIBRARY; T=0.K
neutrons from (d,2n)

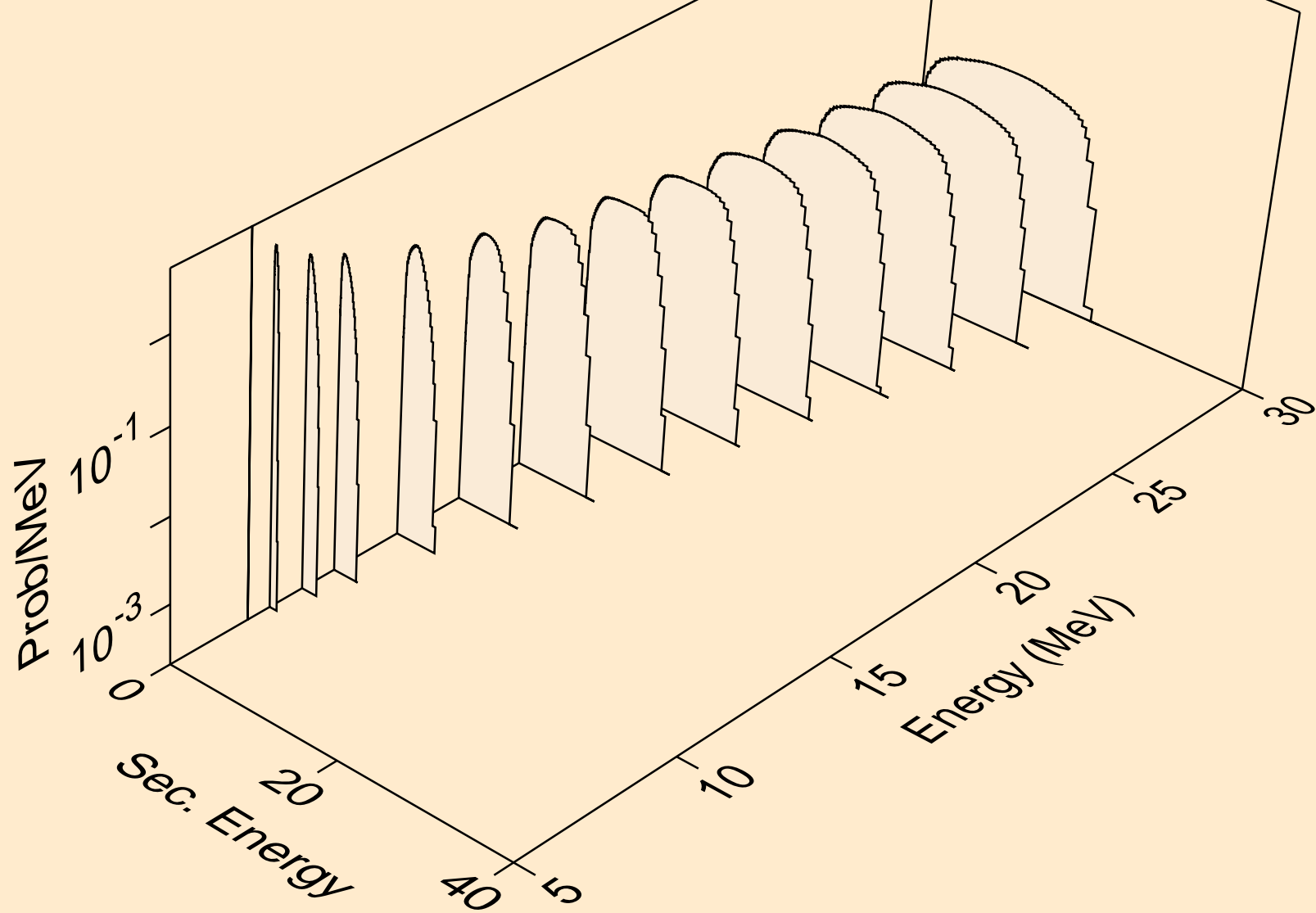

FM247 DEUTERON ACER TENDL-2021 LIBRARY; T=0.K
neutrons from (d,3n)

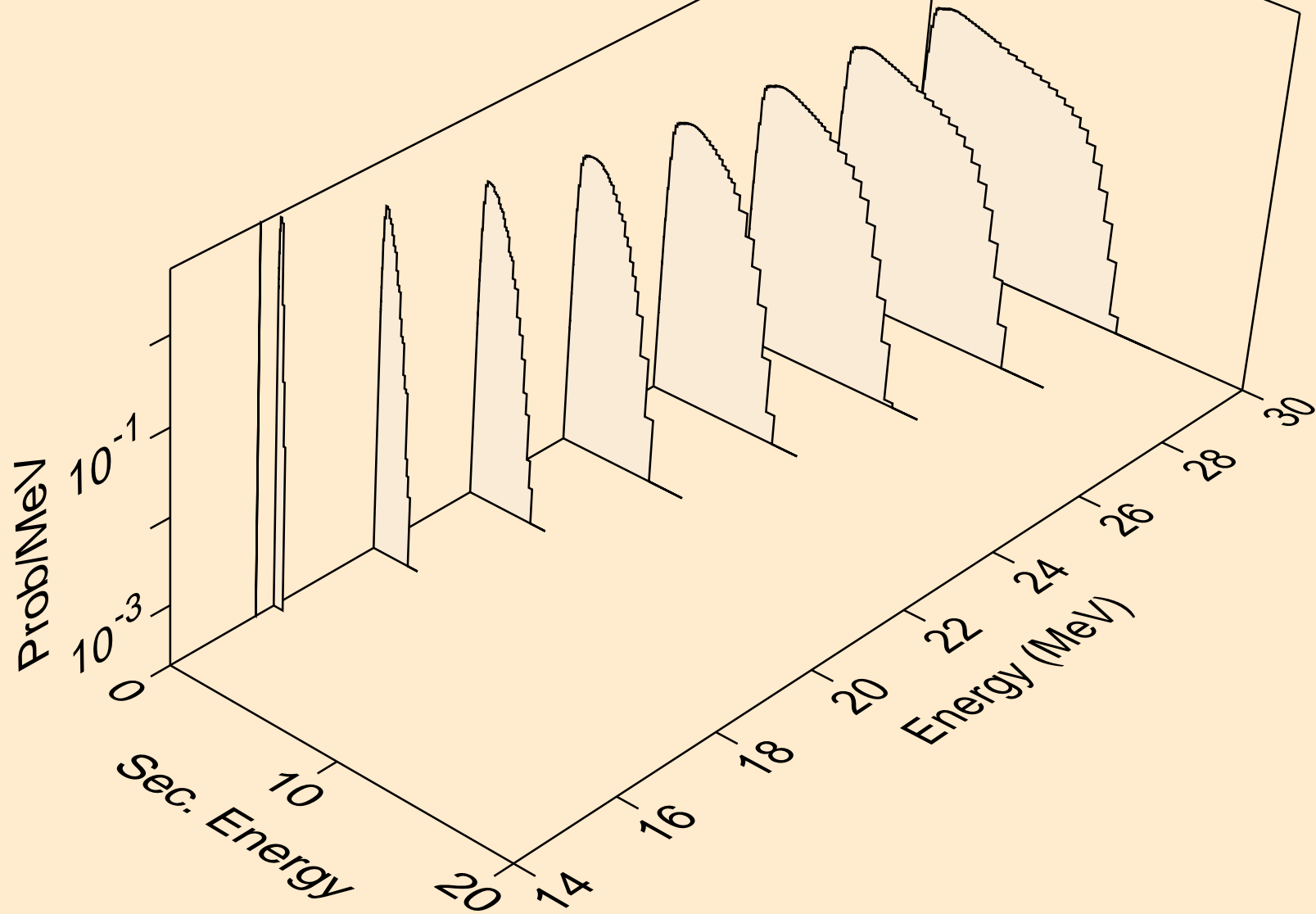

FM247 DEUTERON ACER TENDL-2021 LIBRARY; T=0.K
neutrons from (d,n*)a

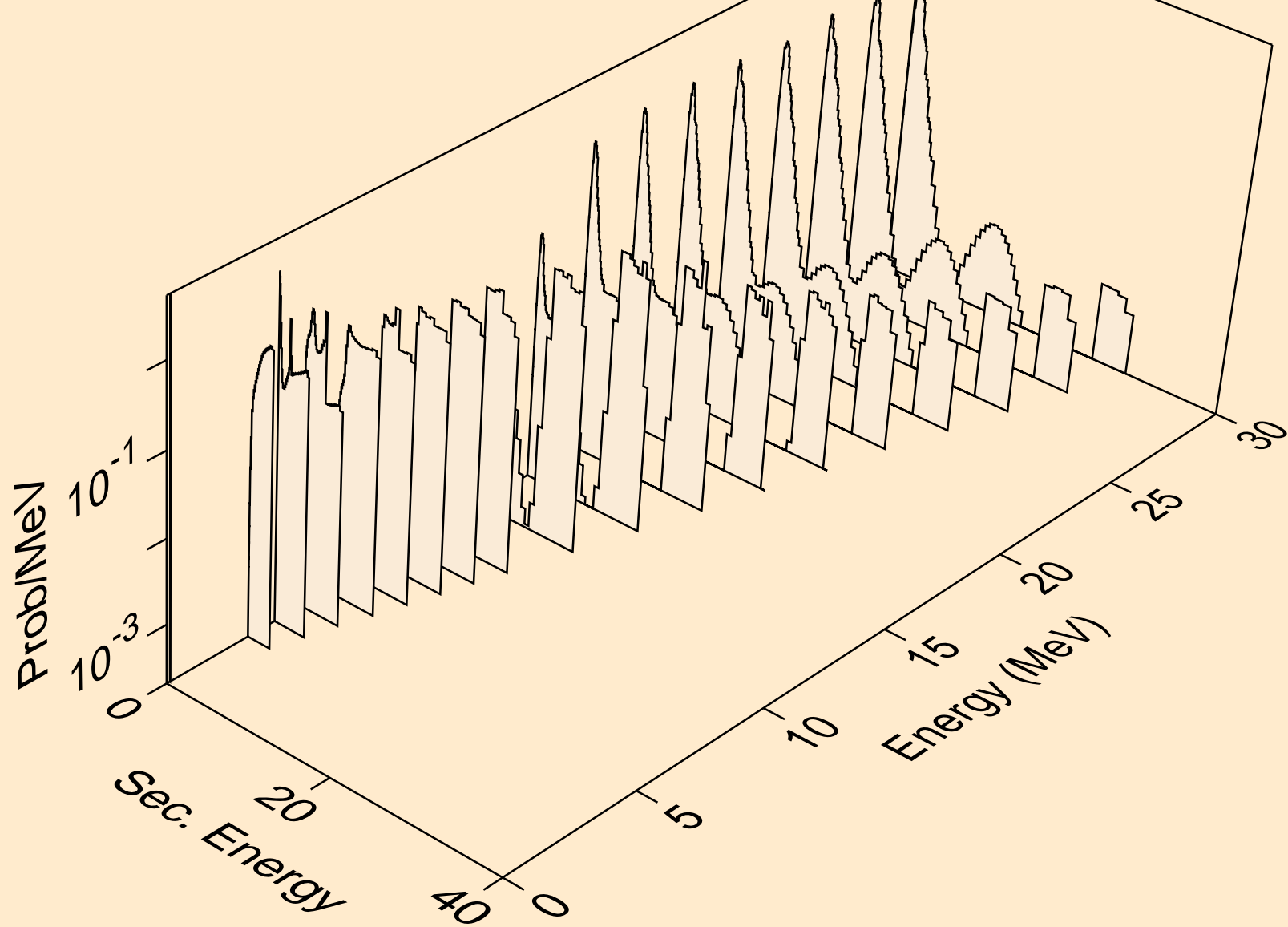

FM247 DEUTERON ACER TENDL-2021 LIBRARY; T=0.K
neutrons from (d,2n)a

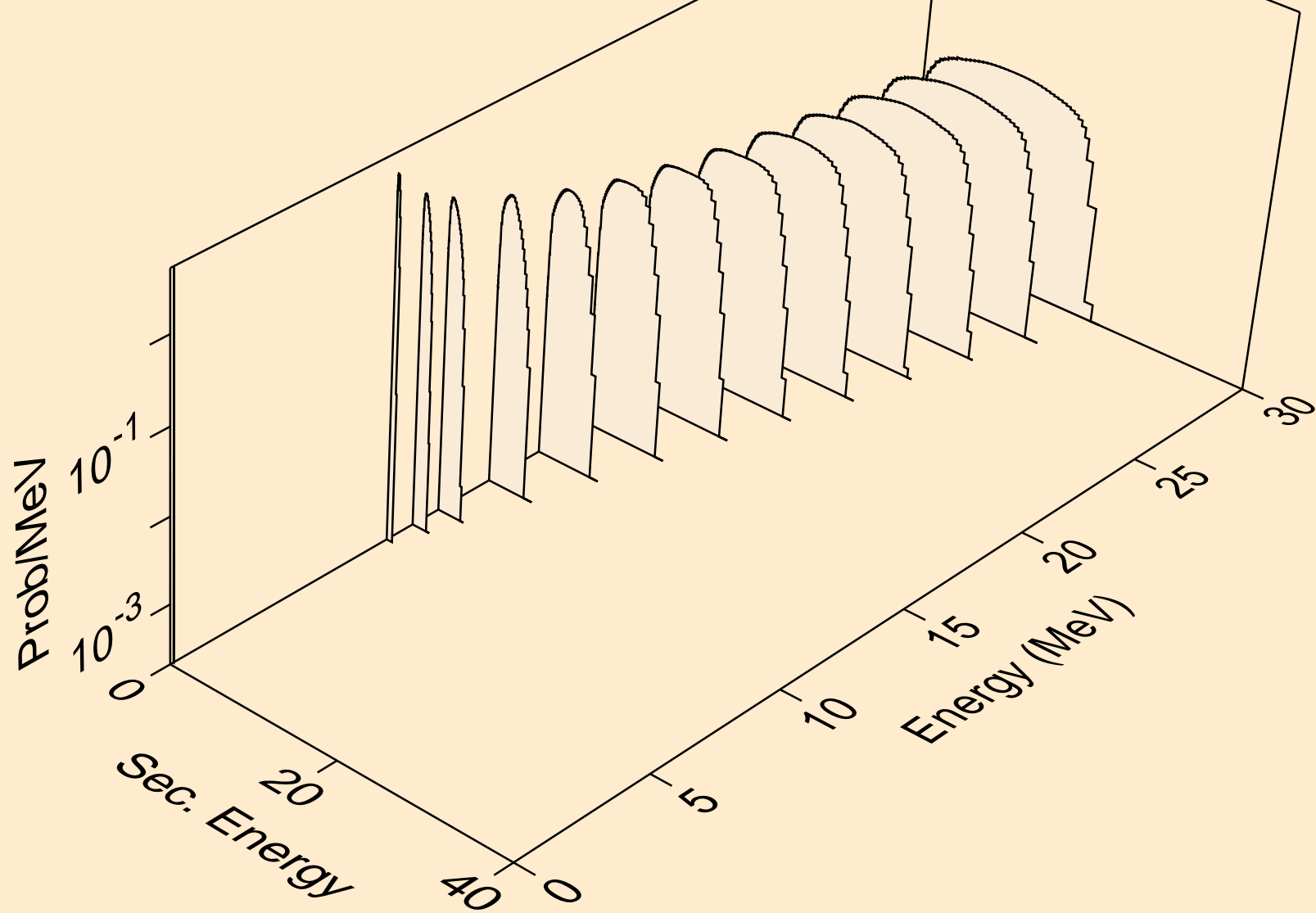

FM247 DEUTERON ACER TENDL-2021 LIBRARY; T=0.K
neutrons from (d,n*)p

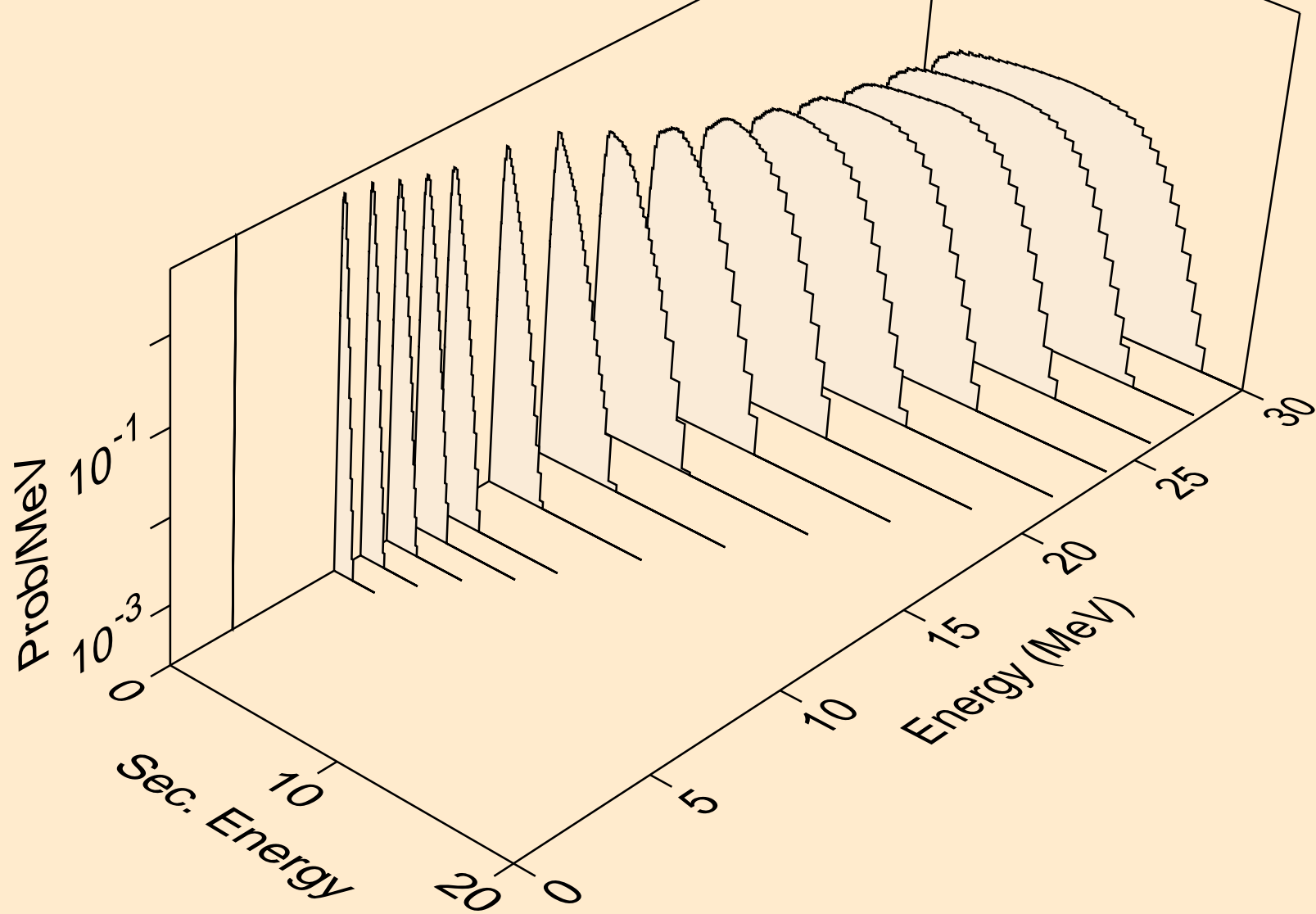

FM247 DEUTERON ACER TENDL-2021 LIBRARY; T=0.K
neutrons from (d,n*)2a

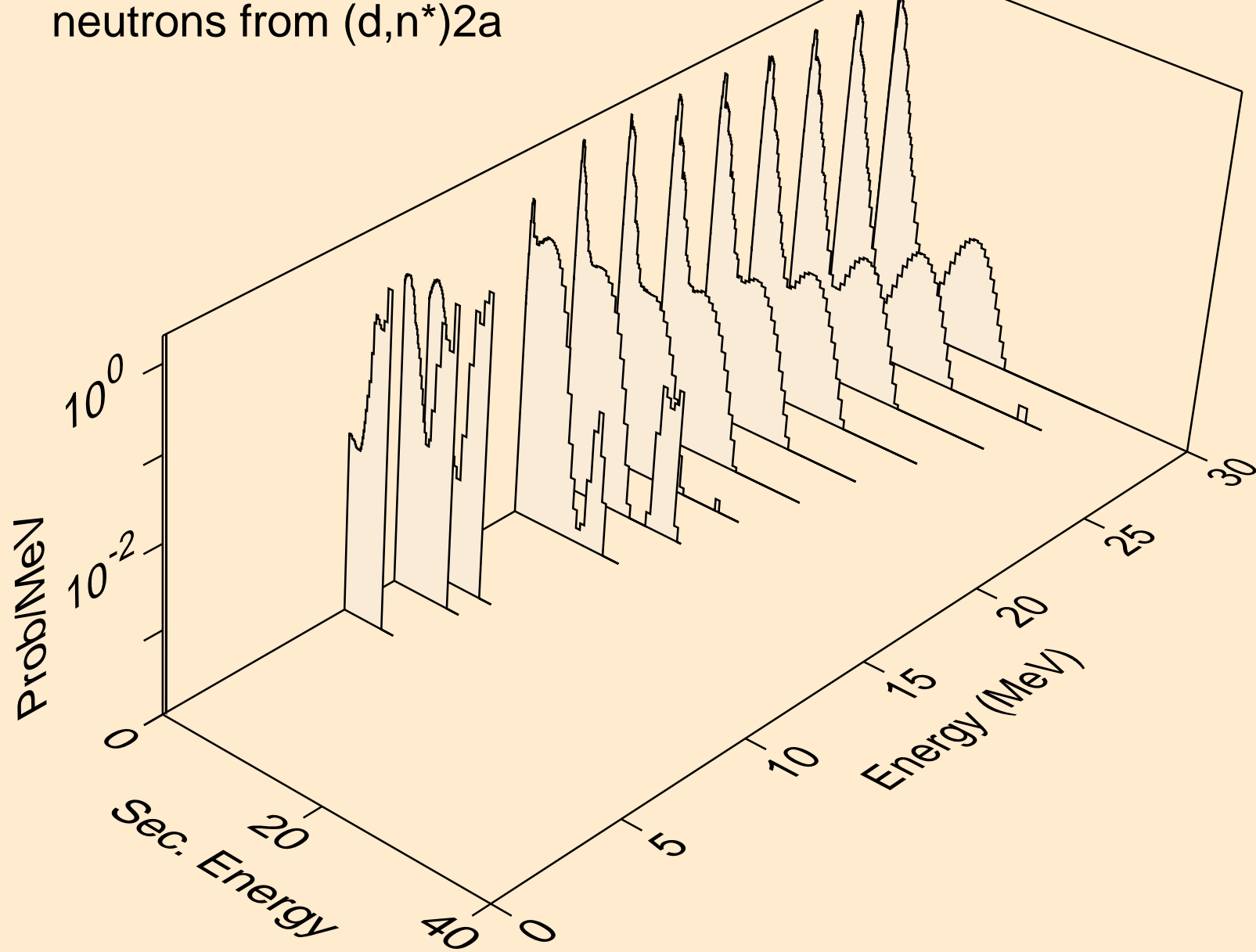

FM247 DEUTERON ACER TENDL-2021 LIBRARY; T=0.K
neutrons from (d,n*)d

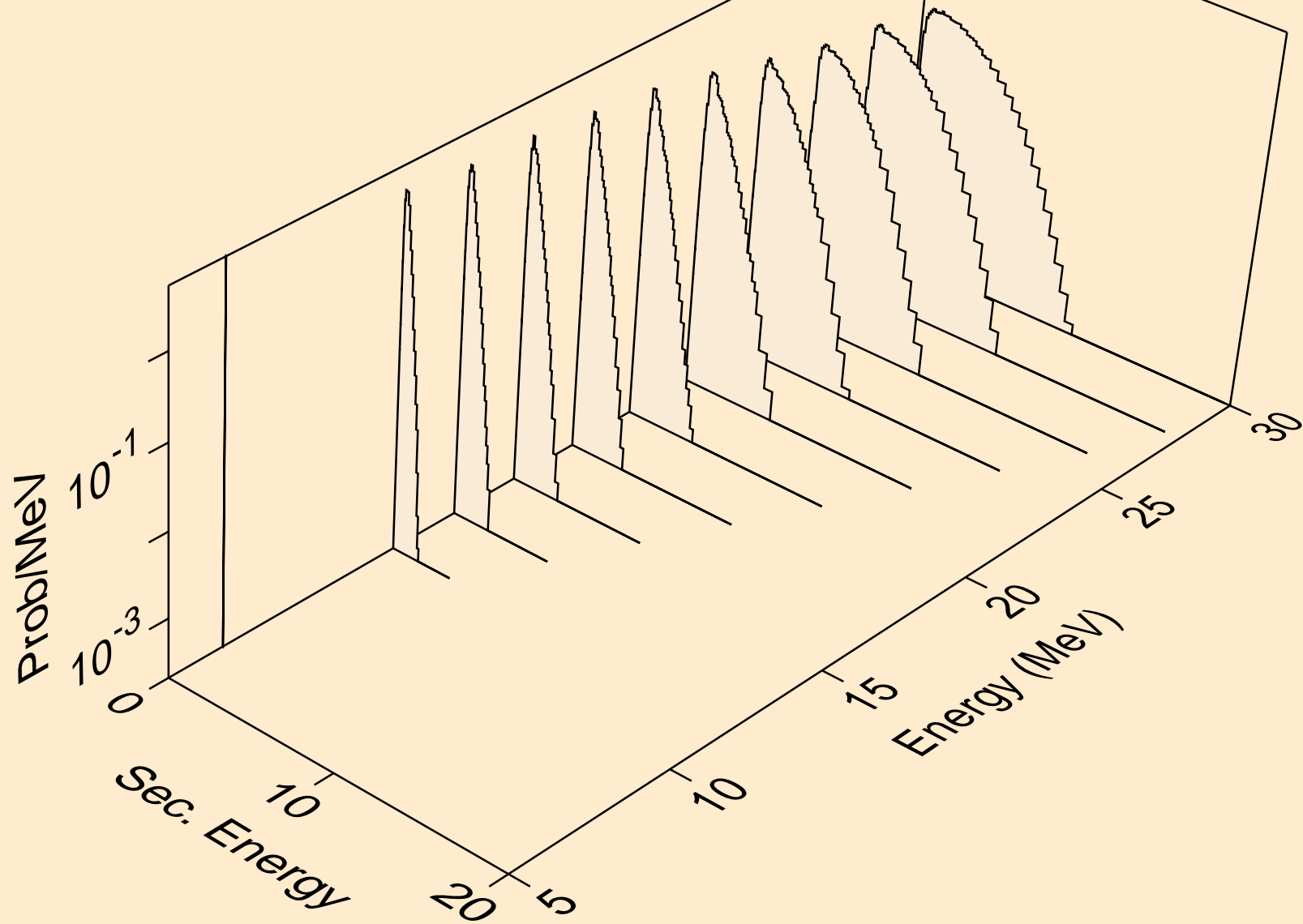

FM247 DEUTERON ACER TENDL-2021 LIBRARY; T=0.K
neutrons from (d,n*)t

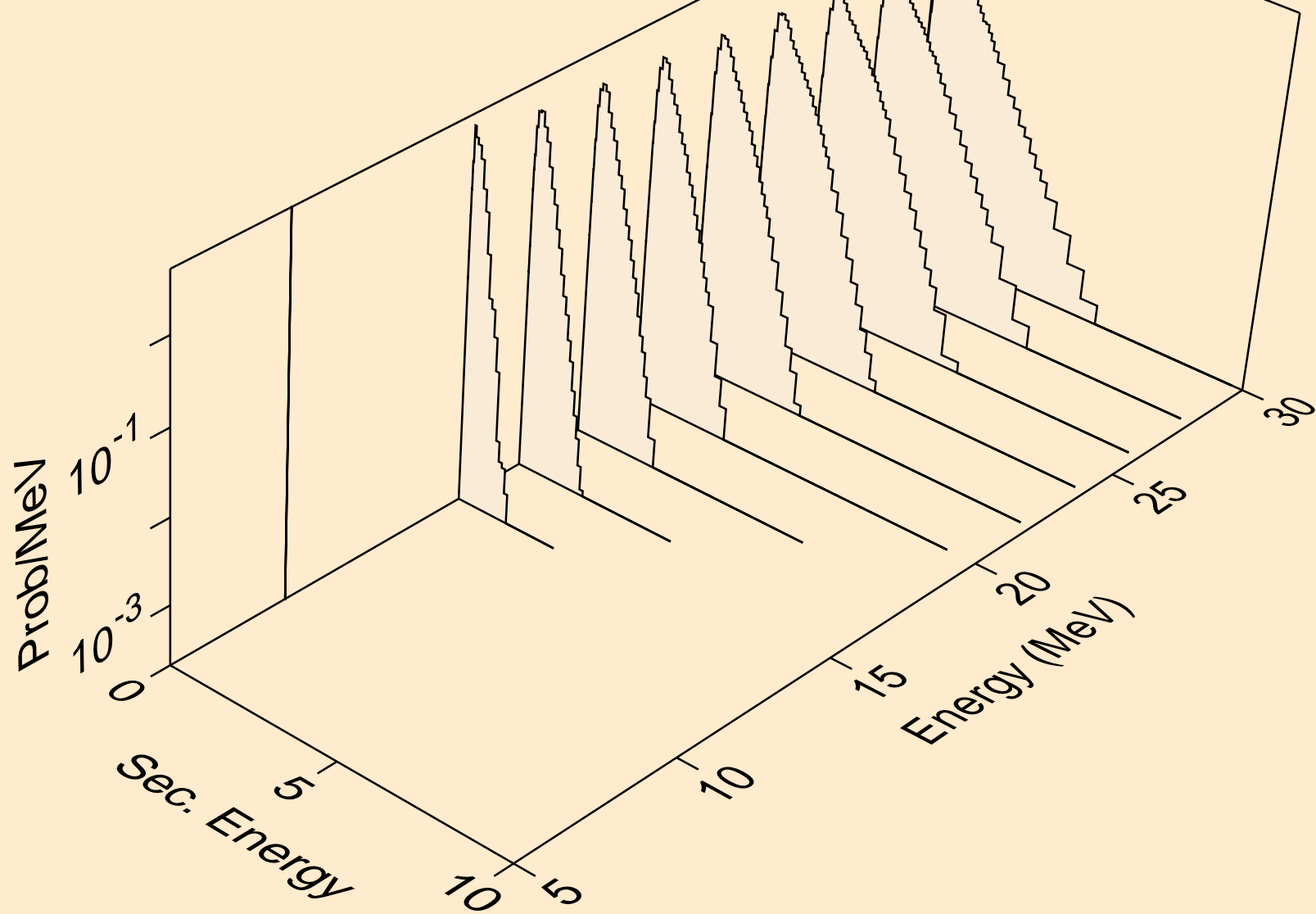

FM247 DEUTERON ACER TENDL-2021 LIBRARY; T=0.K
neutrons from (d,n*)he3

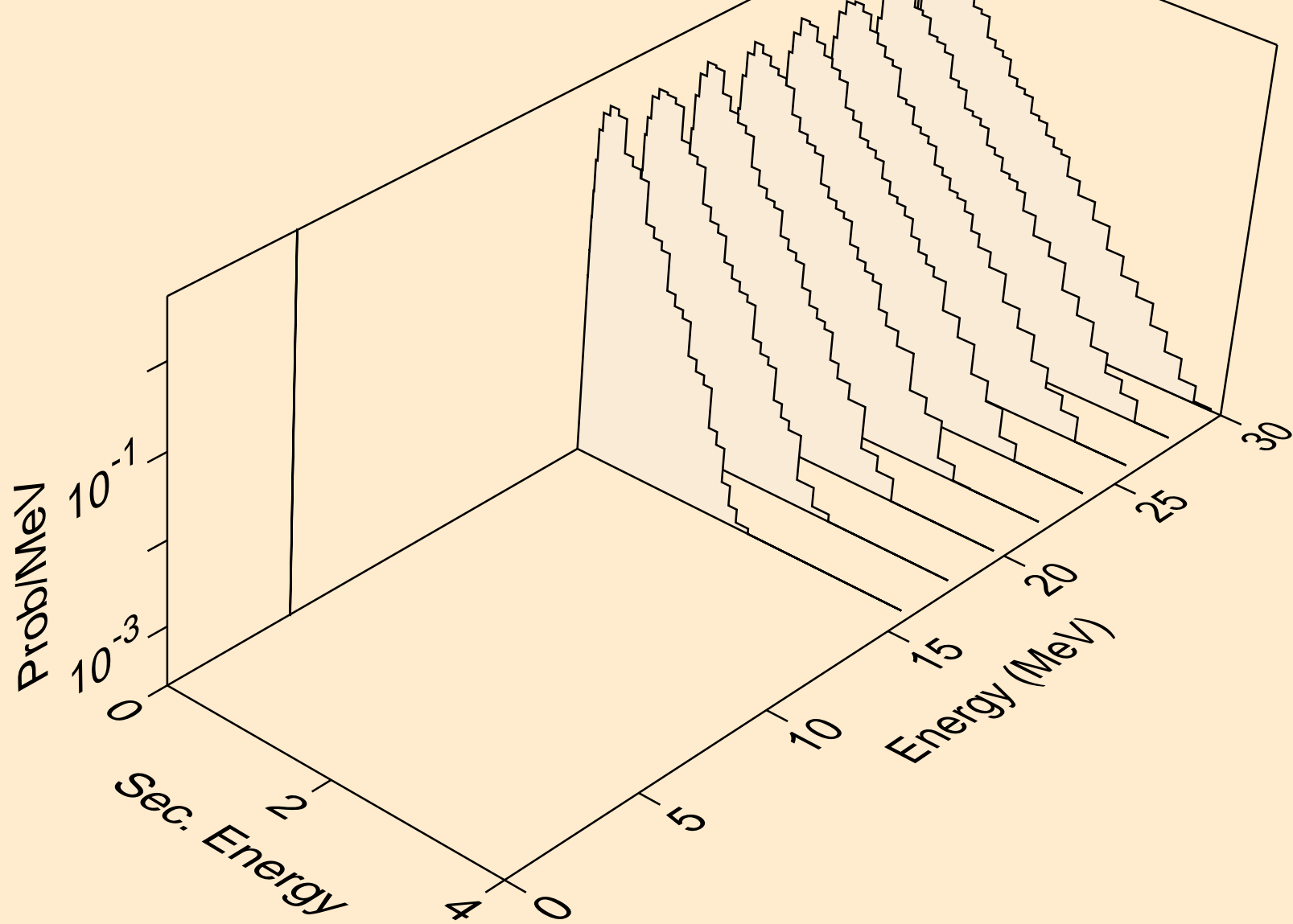

FM247 DEUTERON ACER TENDL-2021 LIBRARY; T=0.K
neutrons from (d,2np)

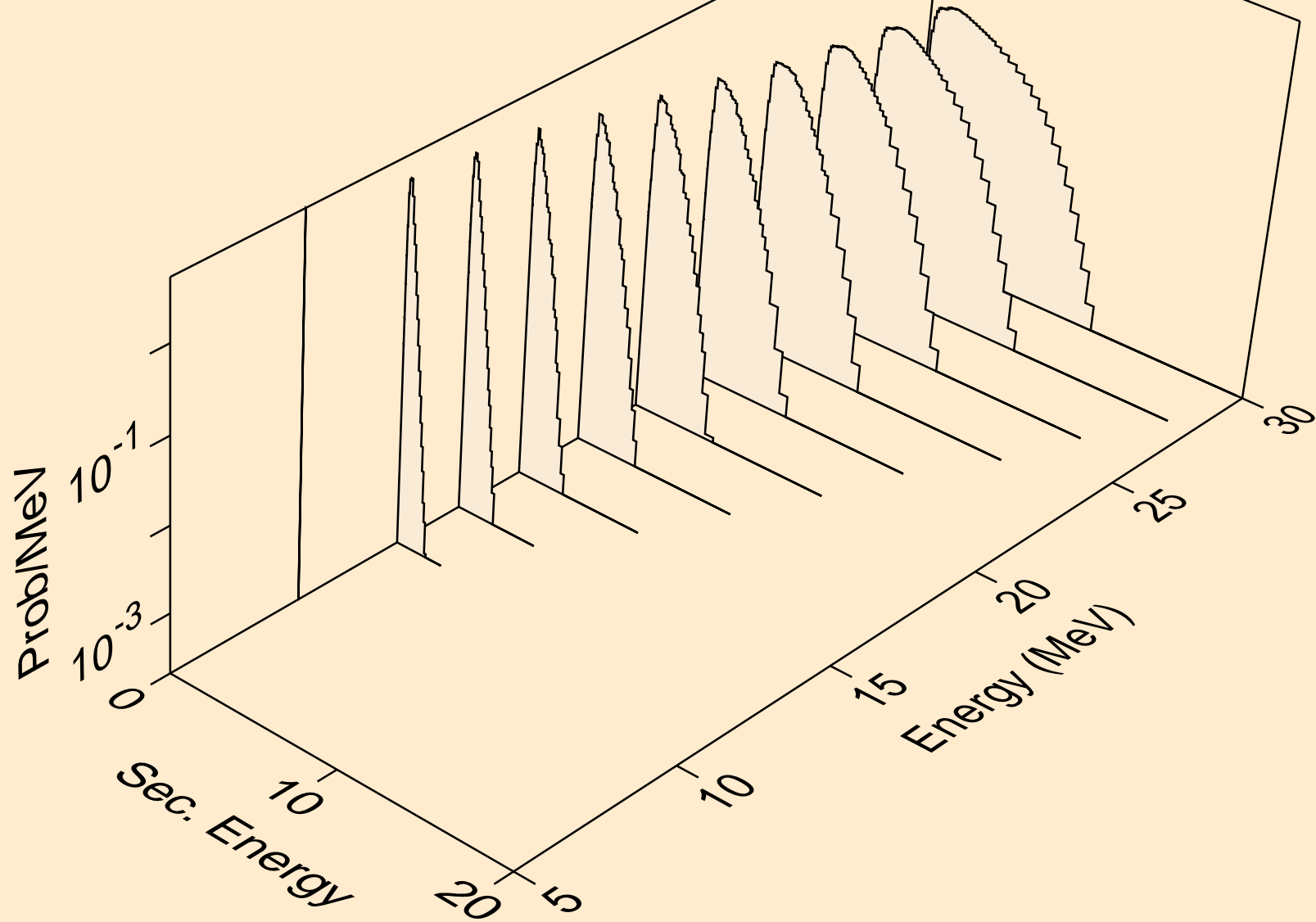

FM247 DEUTERON ACER TENDL-2021 LIBRARY; T=0.K
neutrons from (d,2np)

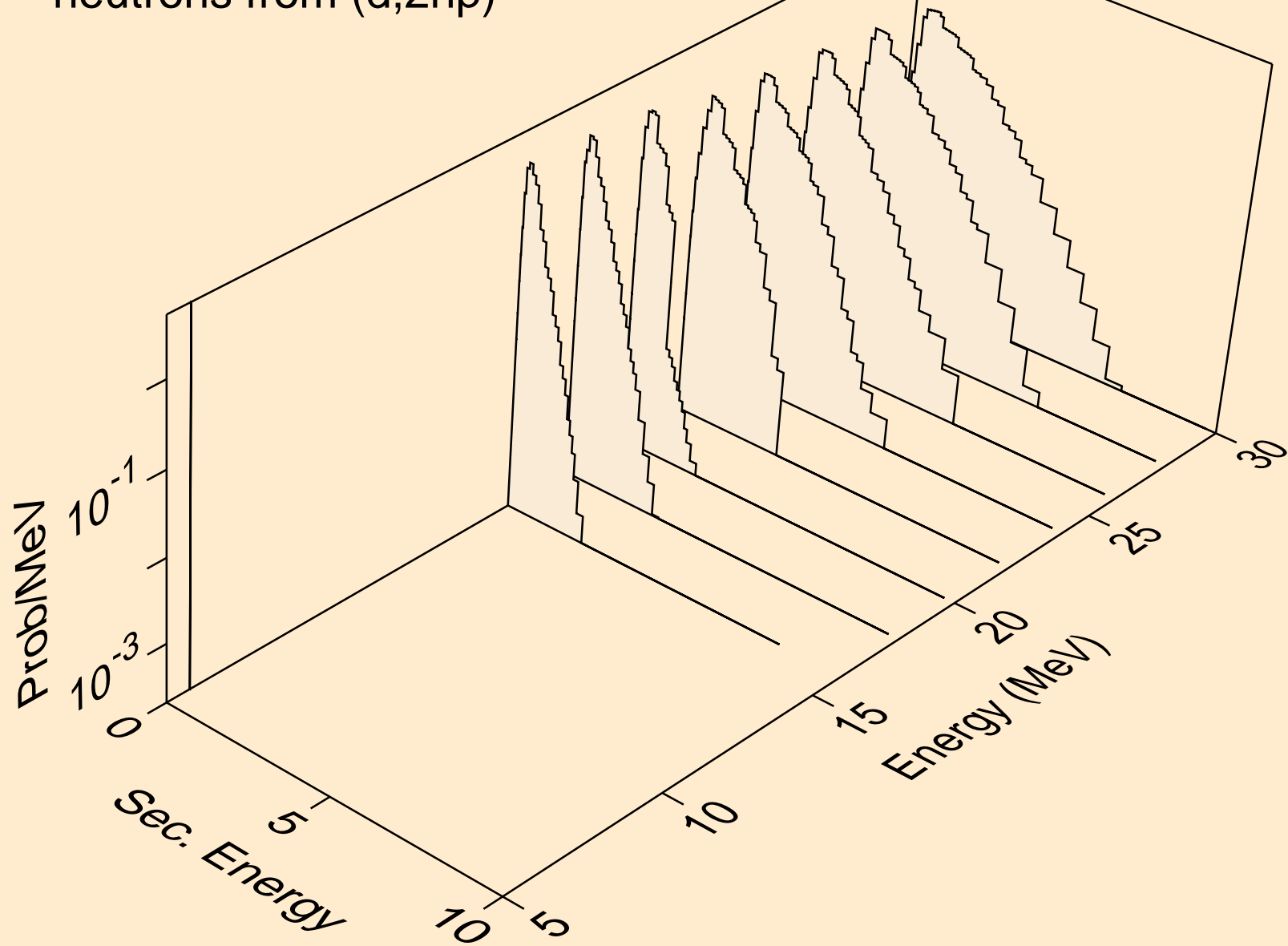

FM247 DEUTERON ACER TENDL-2021 LIBRARY; T=0.K
neutrons from (d,npa)

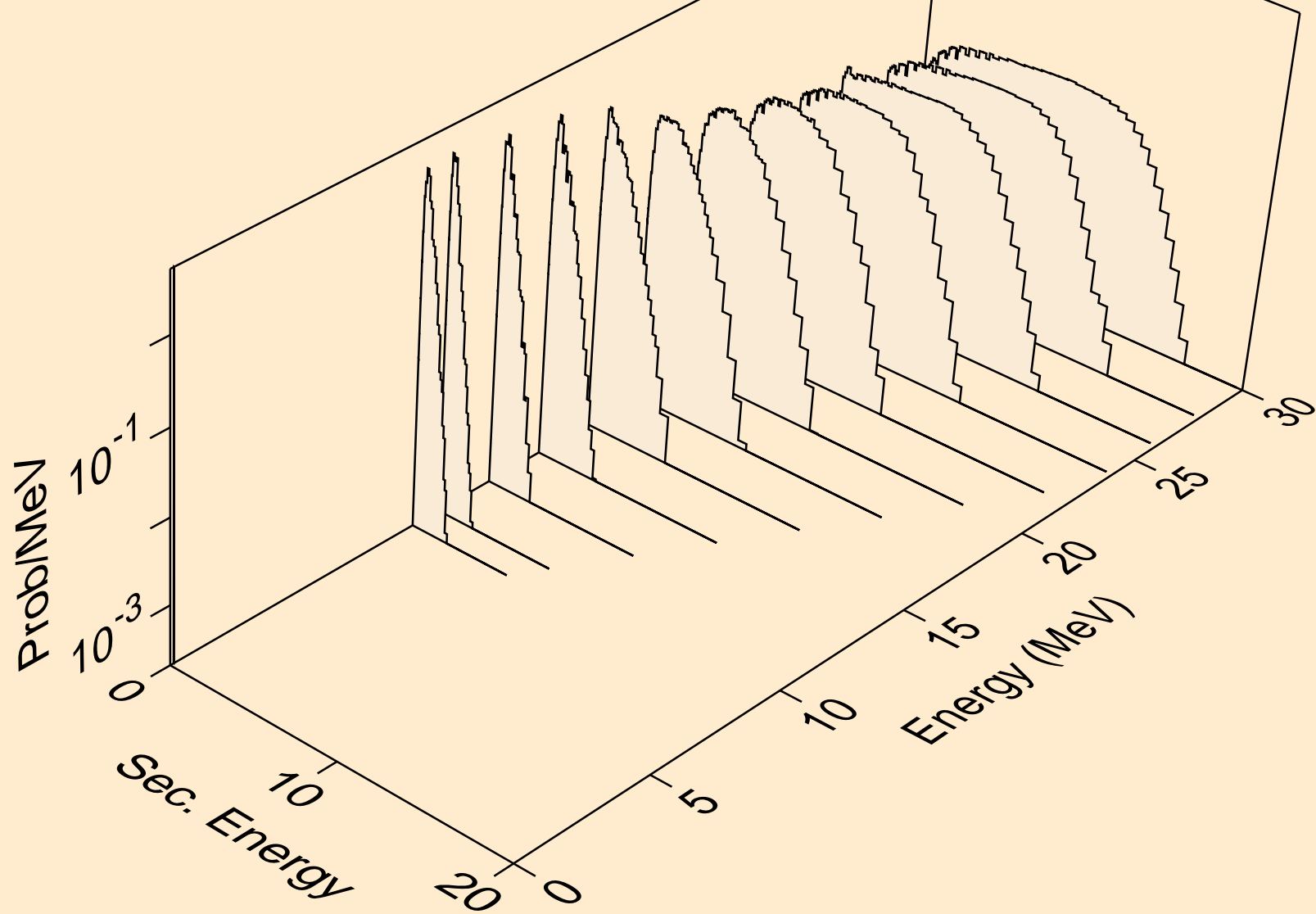

FM247 DEUTERON ACER TENDL-2021 LIBRARY; T=0.K
protons from (d,x)

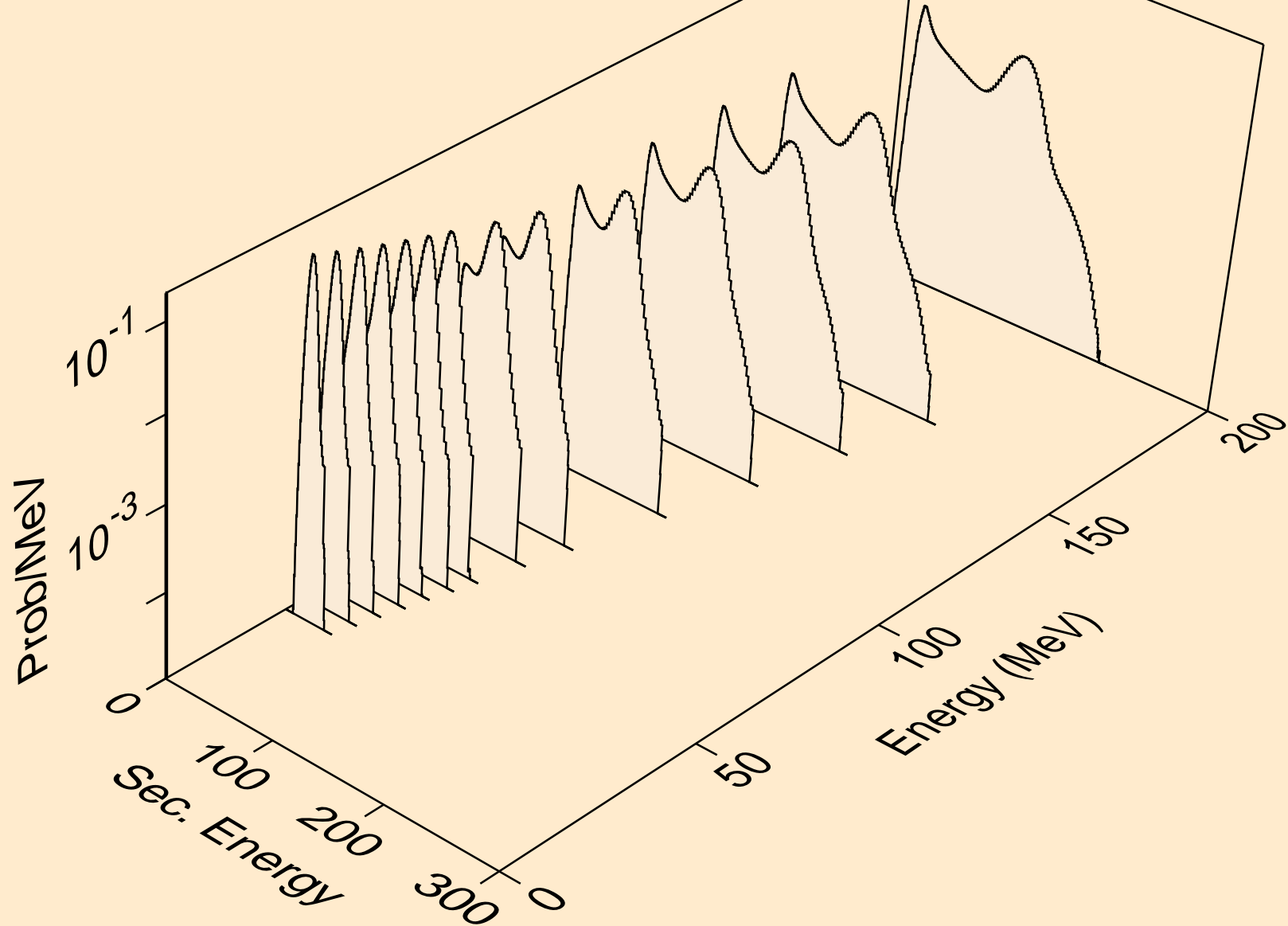

FM247 DEUTERON ACER TENDL-2021 LIBRARY; T=0.K
protons from (d,n*)p

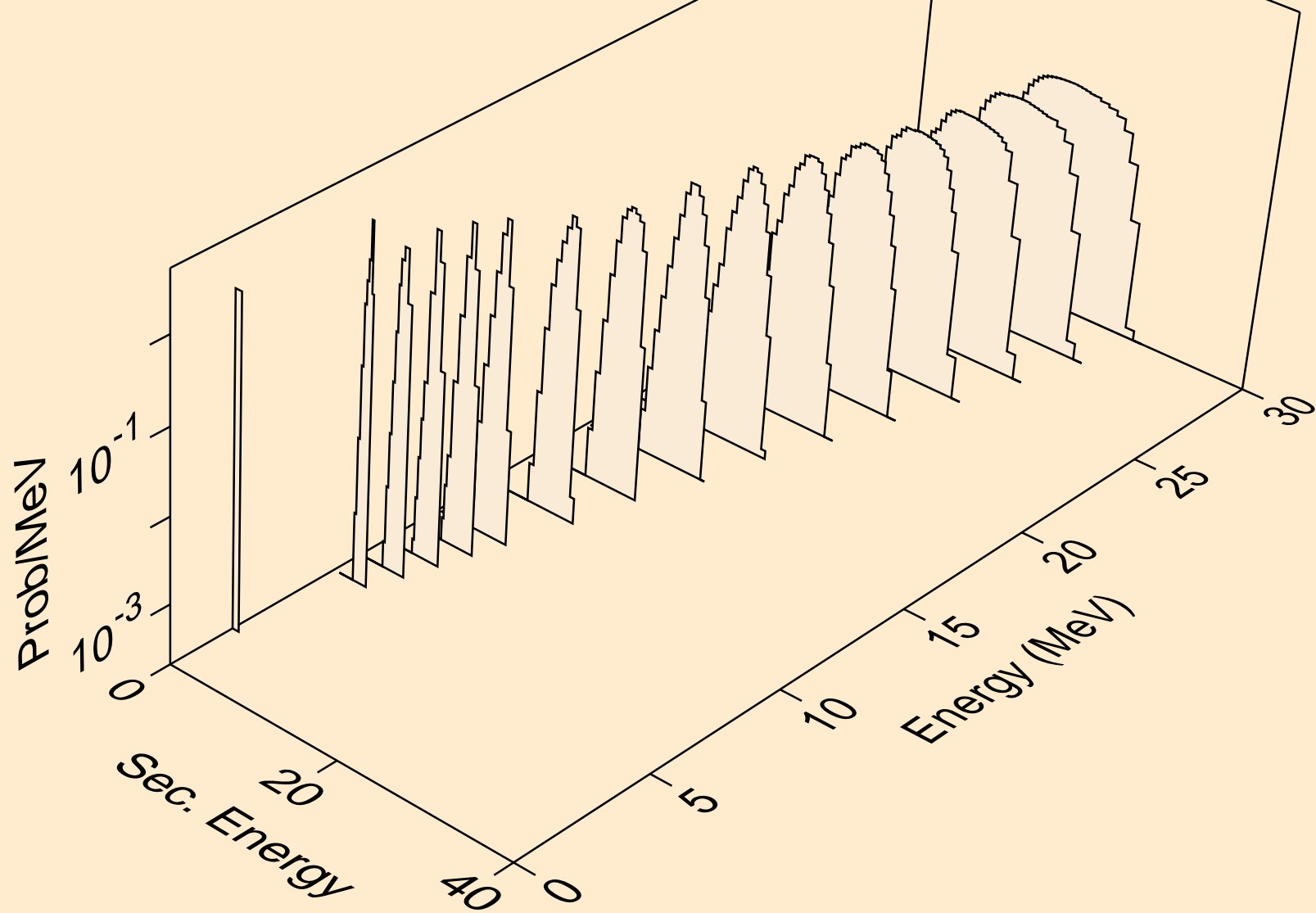

FM247 DEUTERON ACER TENDL-2021 LIBRARY; T=0.K
protons from (d,2np)

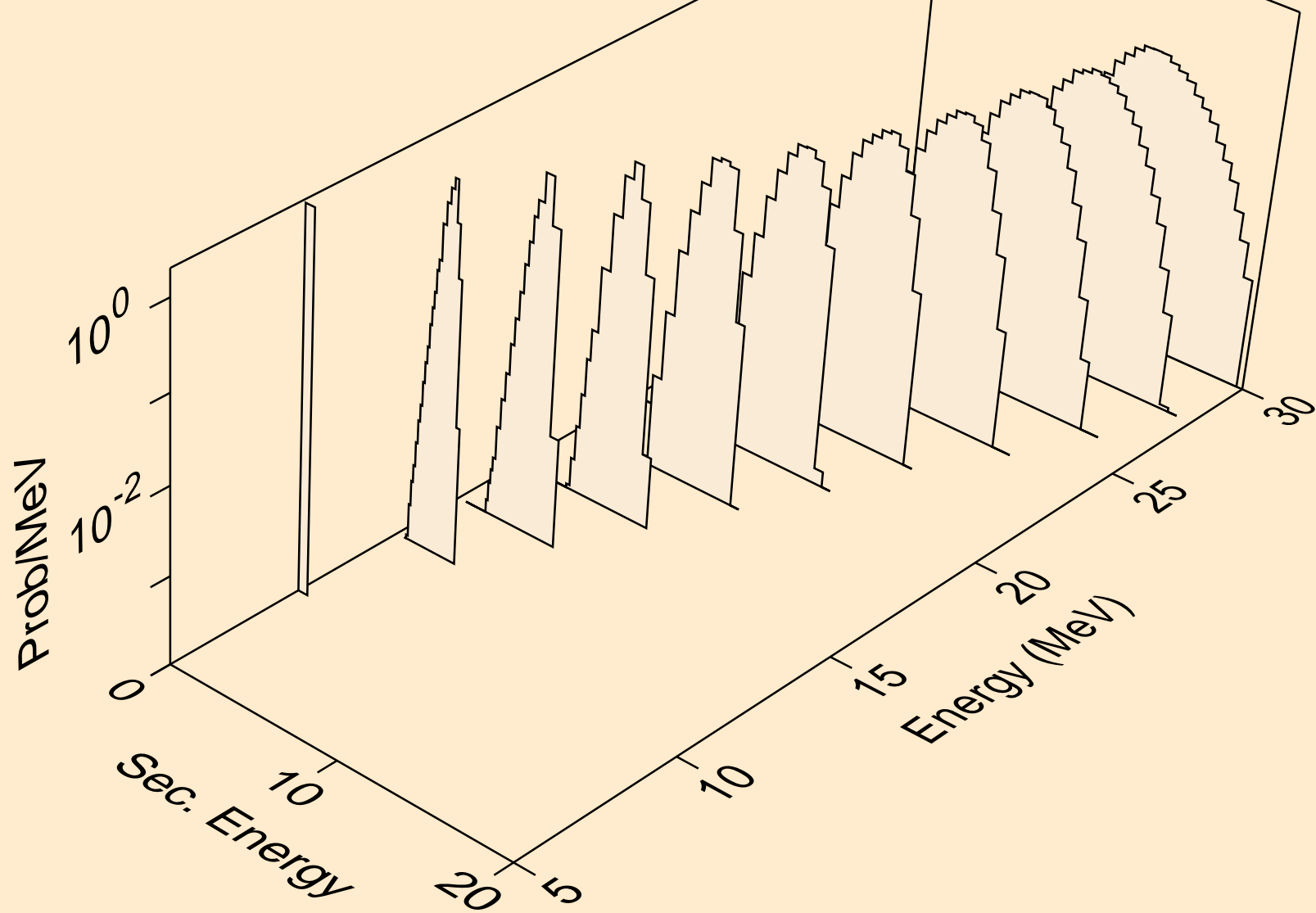

FM247 DEUTERON ACER TENDL-2021 LIBRARY; T=0.K
protons from (d,2np)

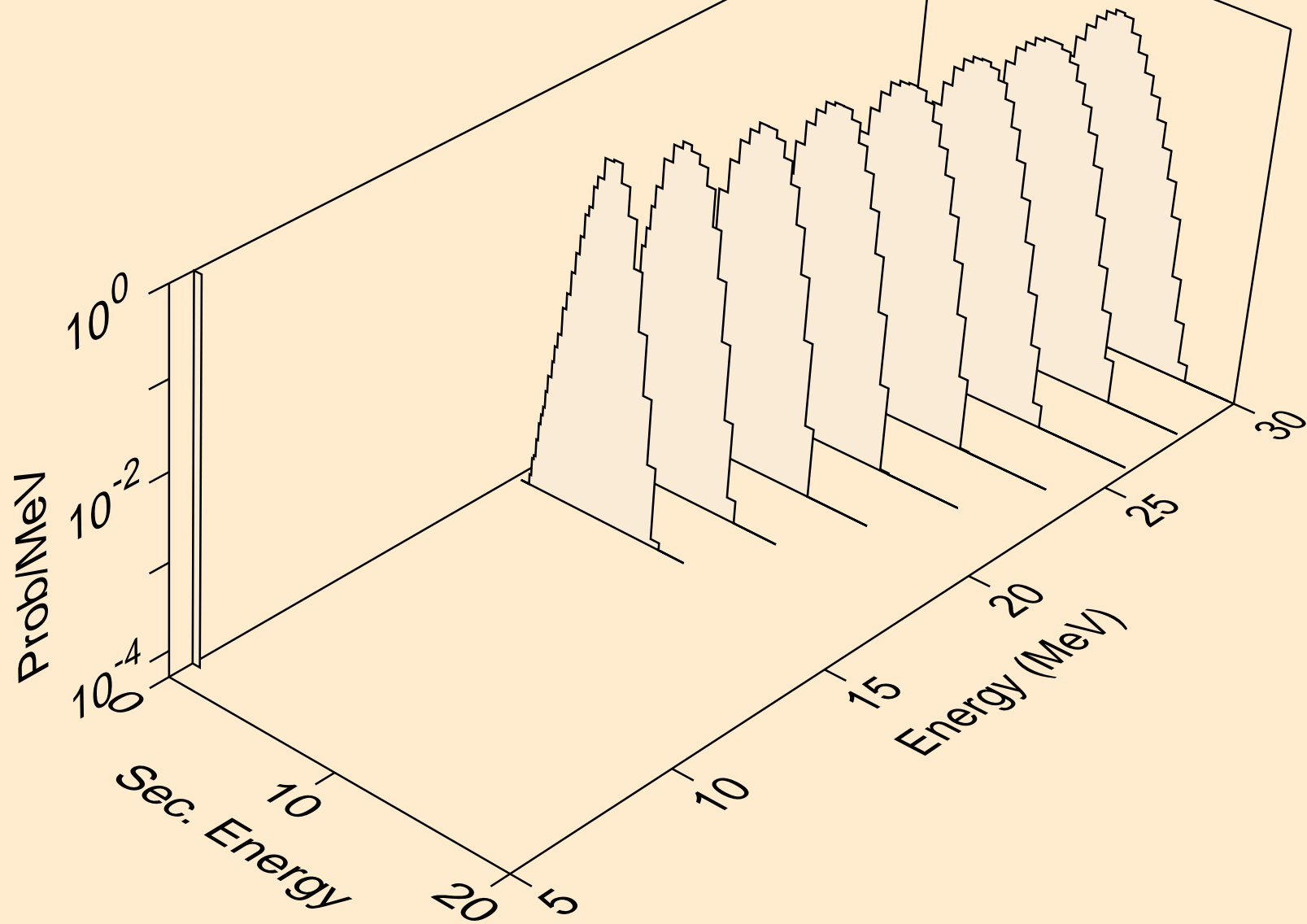

FM247 DEUTERON ACER TENDL-2021 LIBRARY; T=0.K
protons from (d,npa)

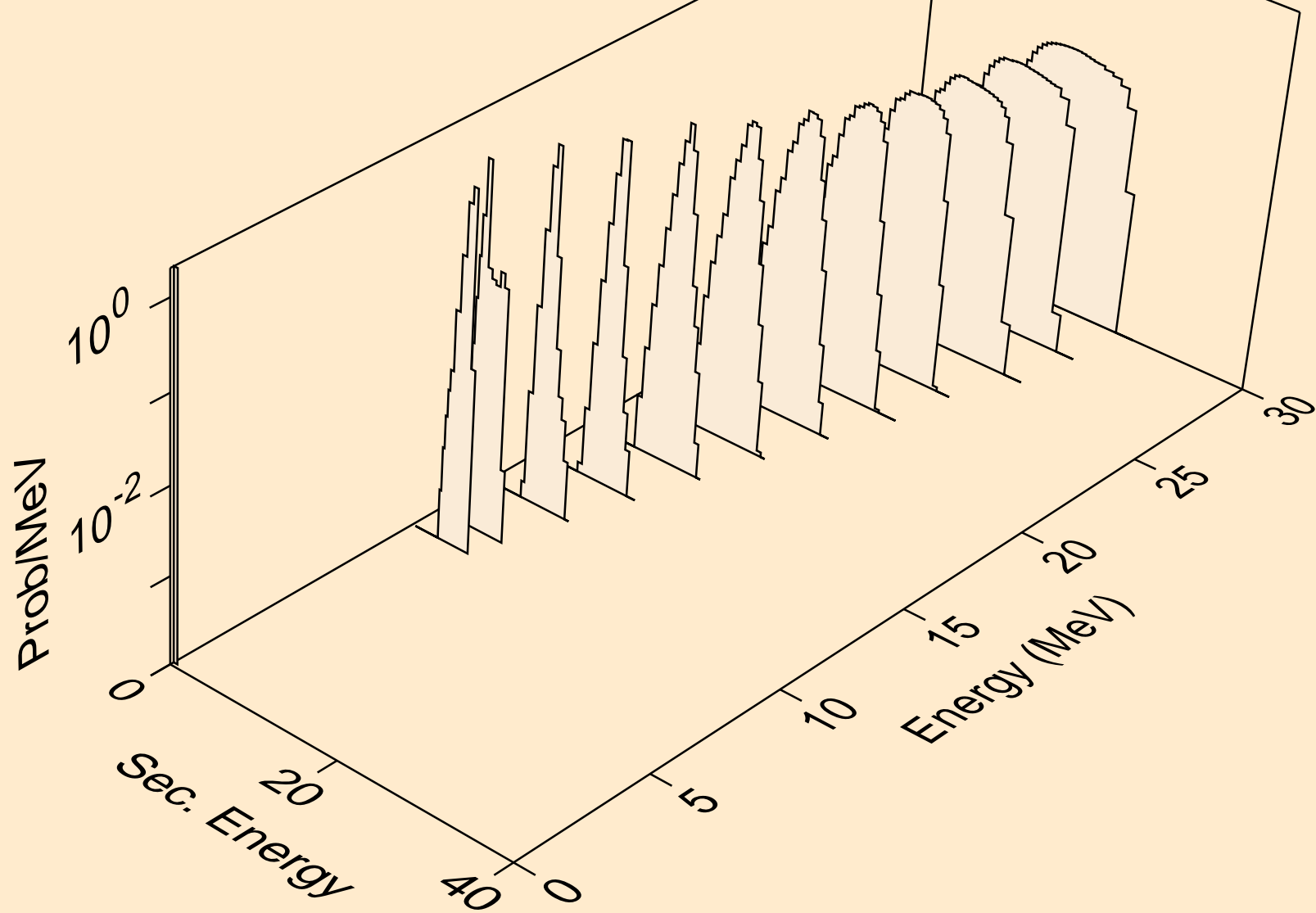

FM247 DEUTERON ACER TENDL-2021 LIBRARY; T=0.K
protons from (d,p)

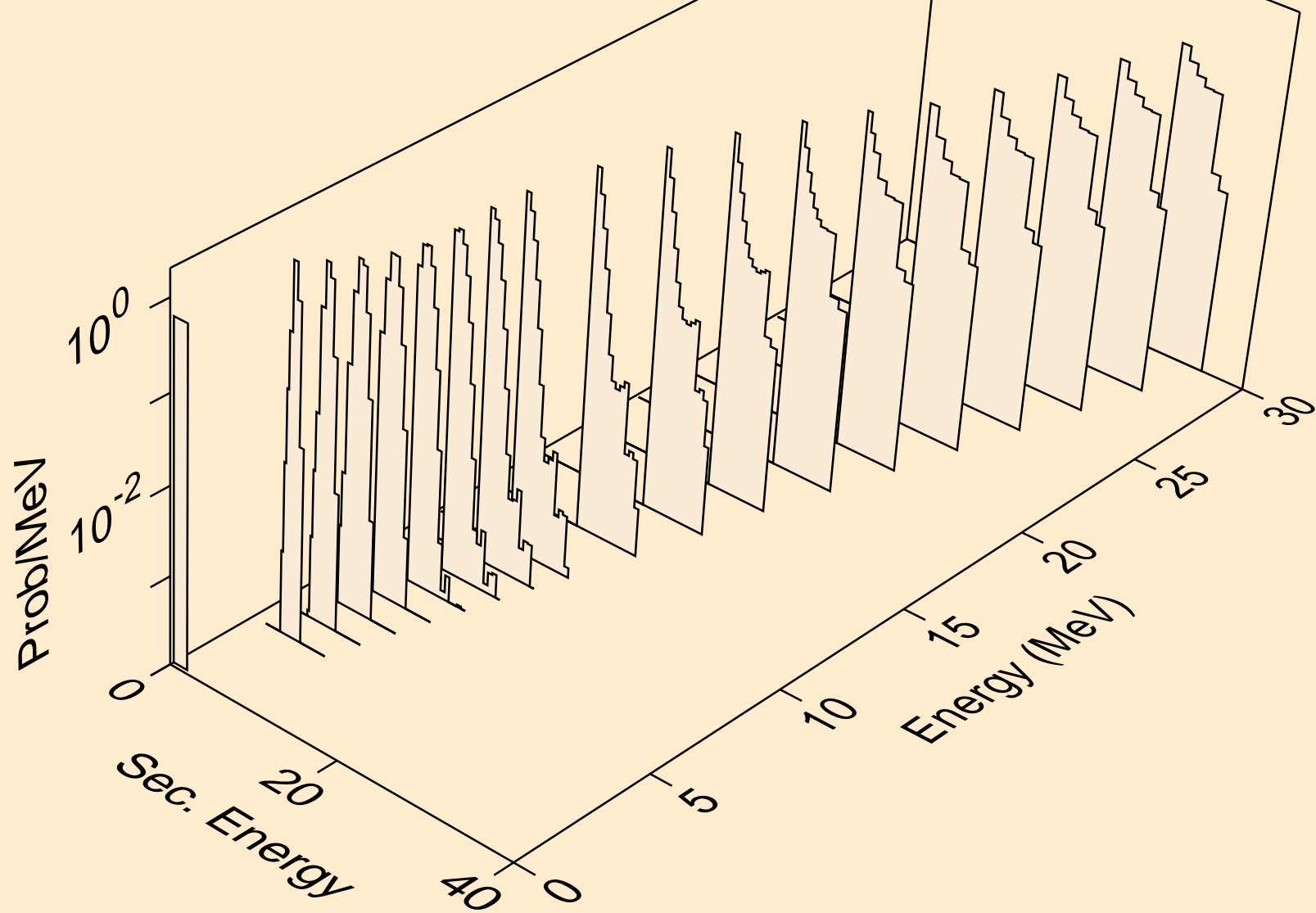

FM247 DEUTERON ACER TENDL-2021 LIBRARY; T=0.K
protons from (d,2p)

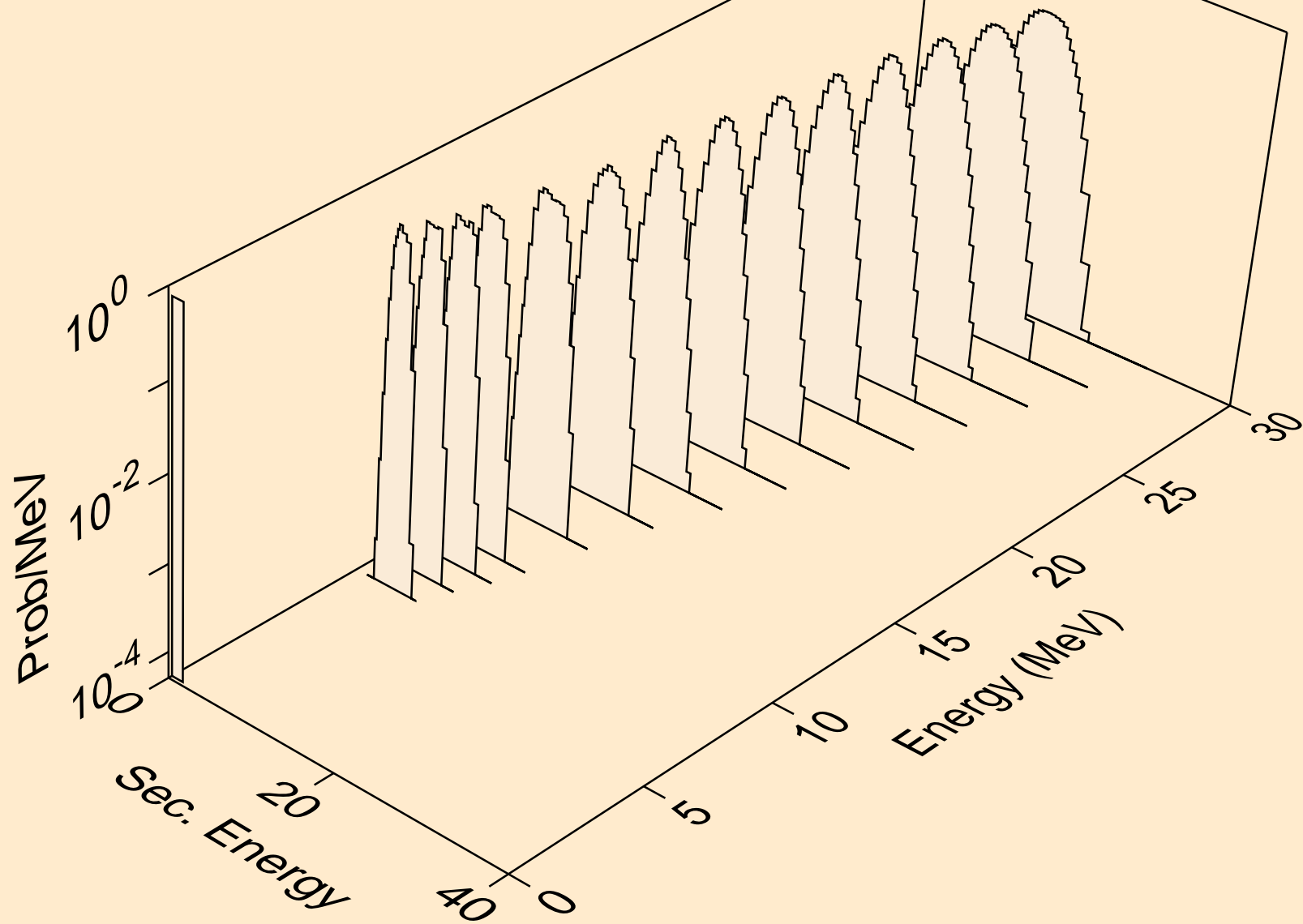

FM247 DEUTERON ACER TENDL-2021 LIBRARY; T=0.K
protons from (d,pd)

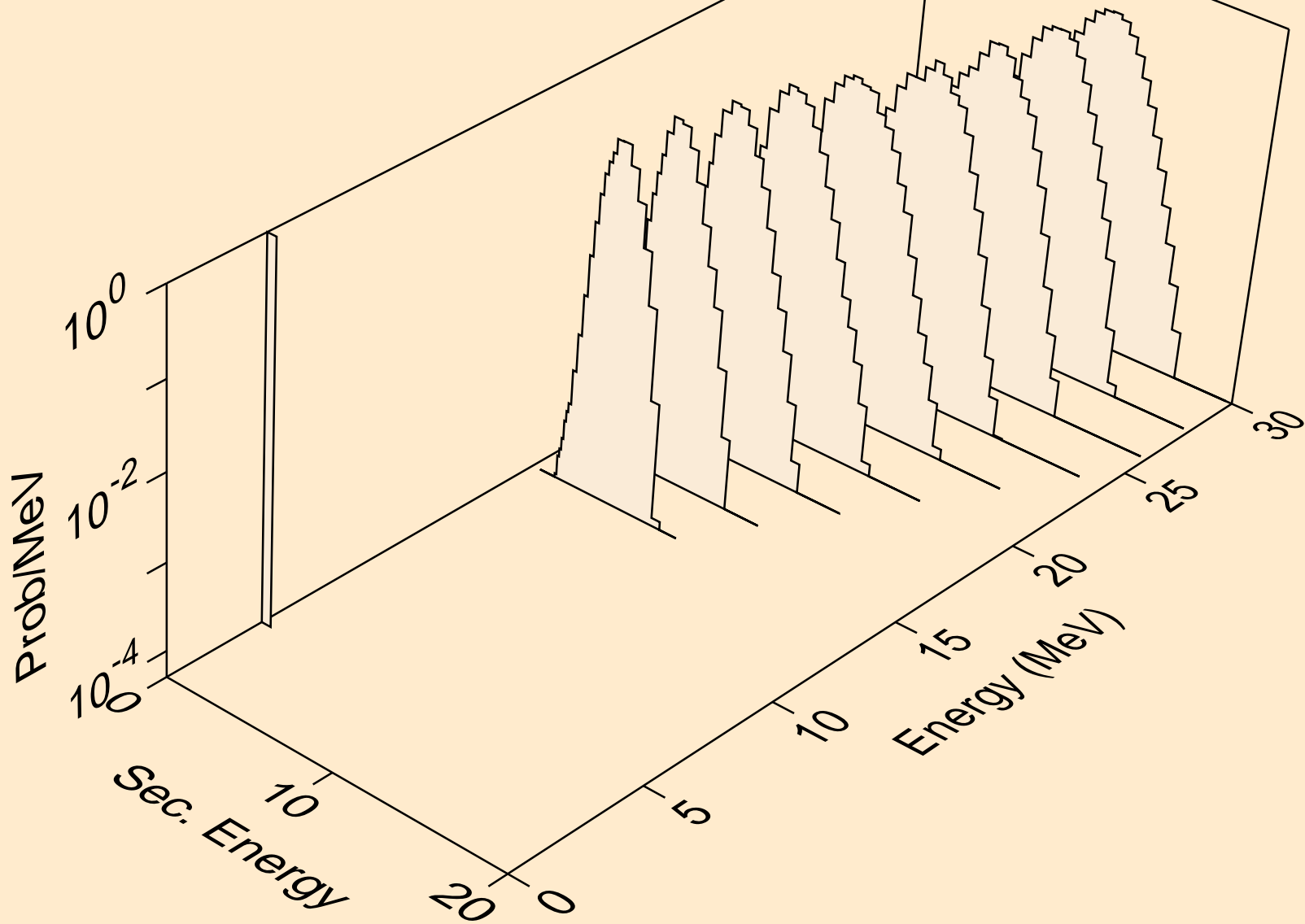

FM247 DEUTERON ACER TENDL-2021 LIBRARY; T=0.K
tritons from (d,x)

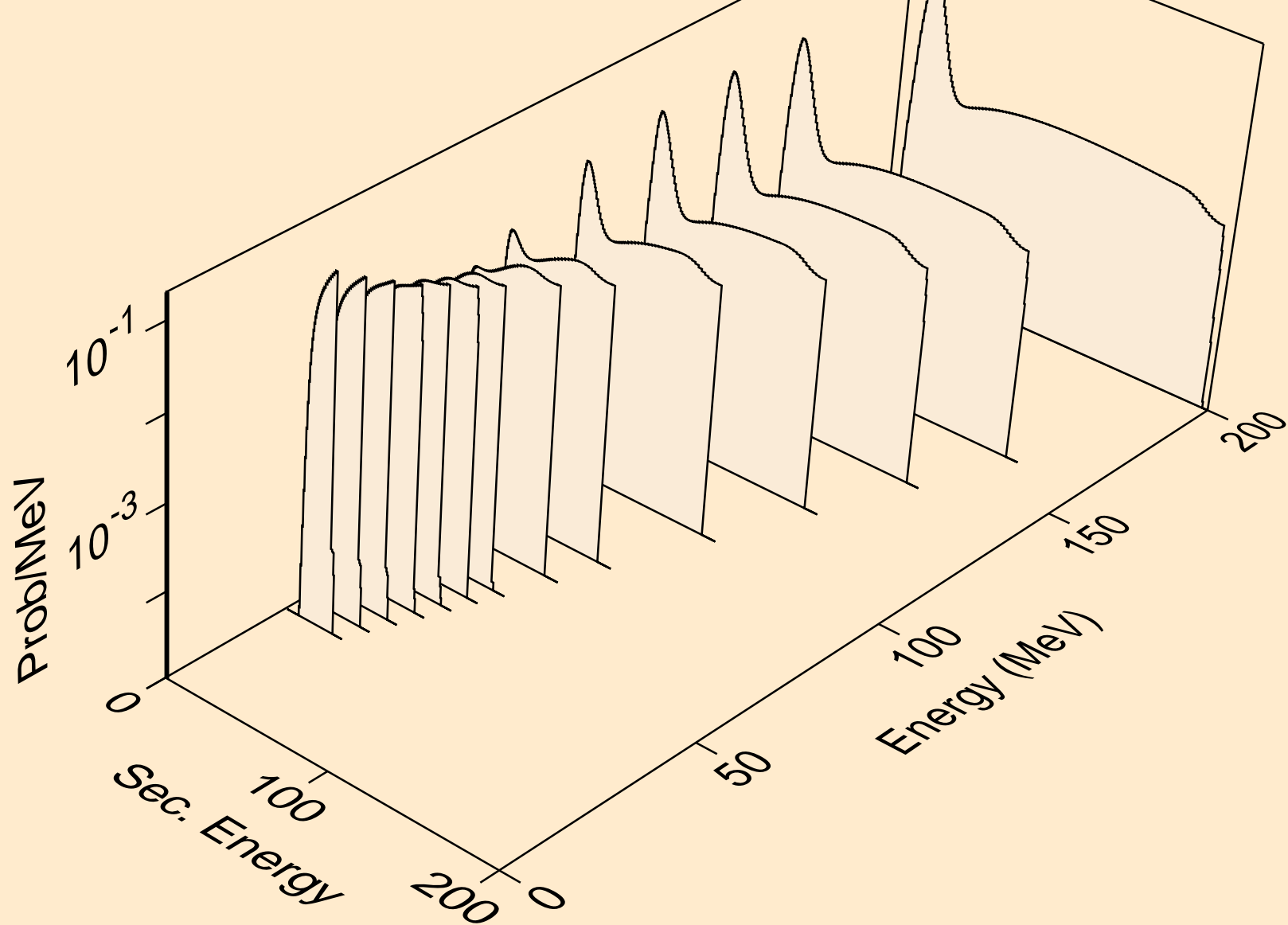

FM247 DEUTERON ACER TENDL-2021 LIBRARY; T=0.K
tritons from (d,n*)t

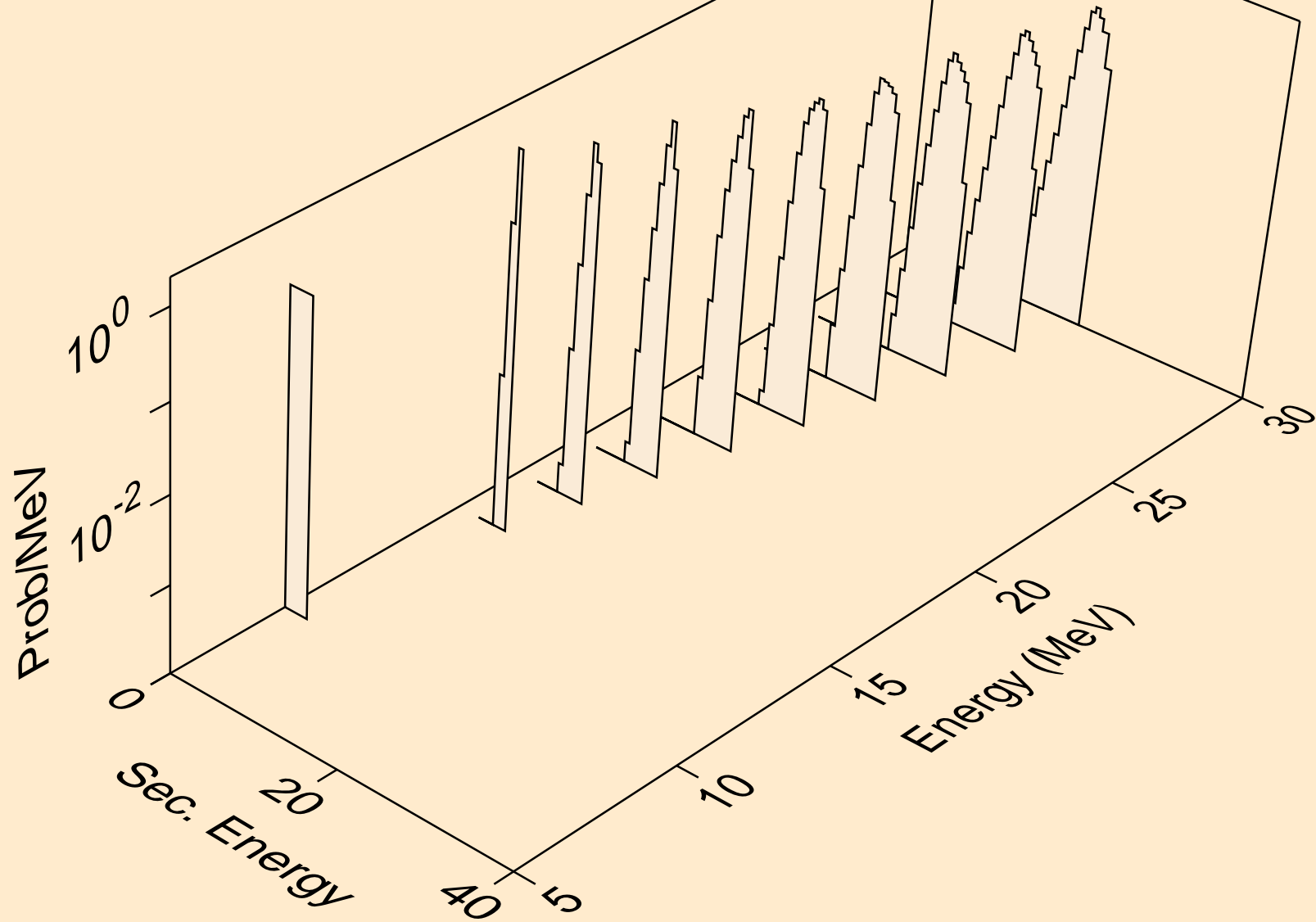

FM247 DEUTERON ACER TENDL-2021 LIBRARY; T=0.K
tritons from (d,t)

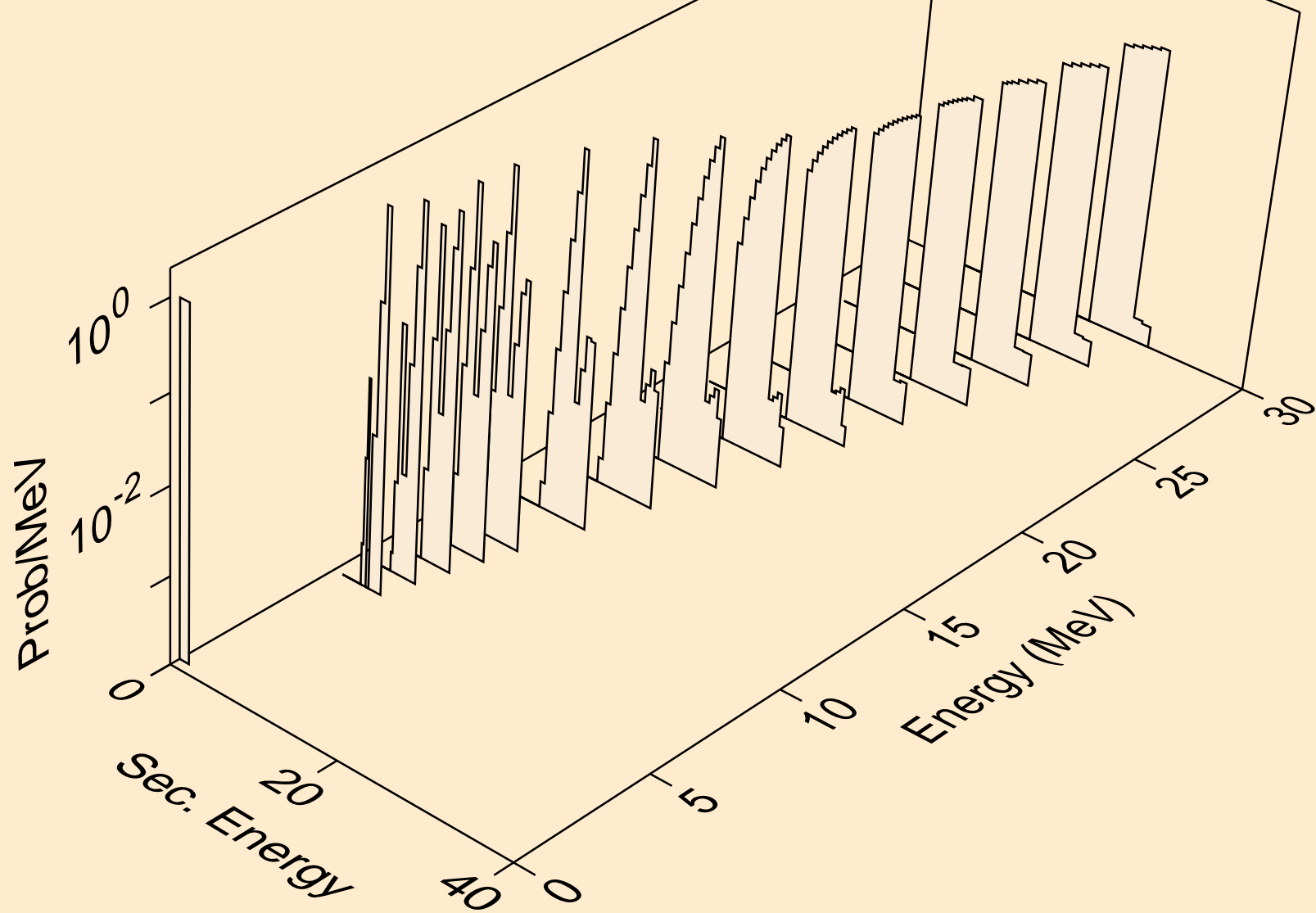

FM247 DEUTERON ACER TENDL-2021 LIBRARY; T=0.K
he3s from (d,x)

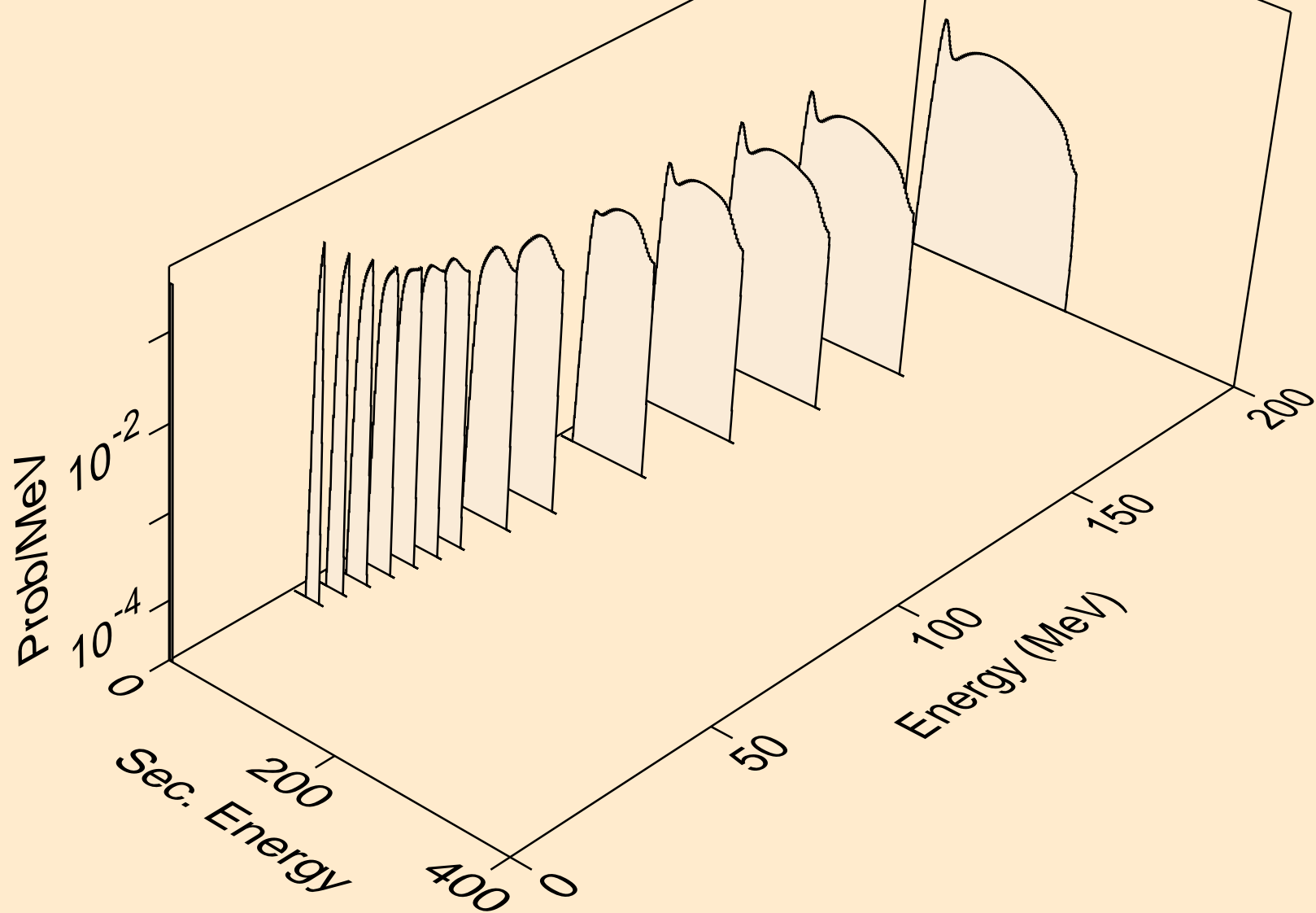

FM247 DEUTERON ACER TENDL-2021 LIBRARY; T=0.K
he3s from (d,n*)he3

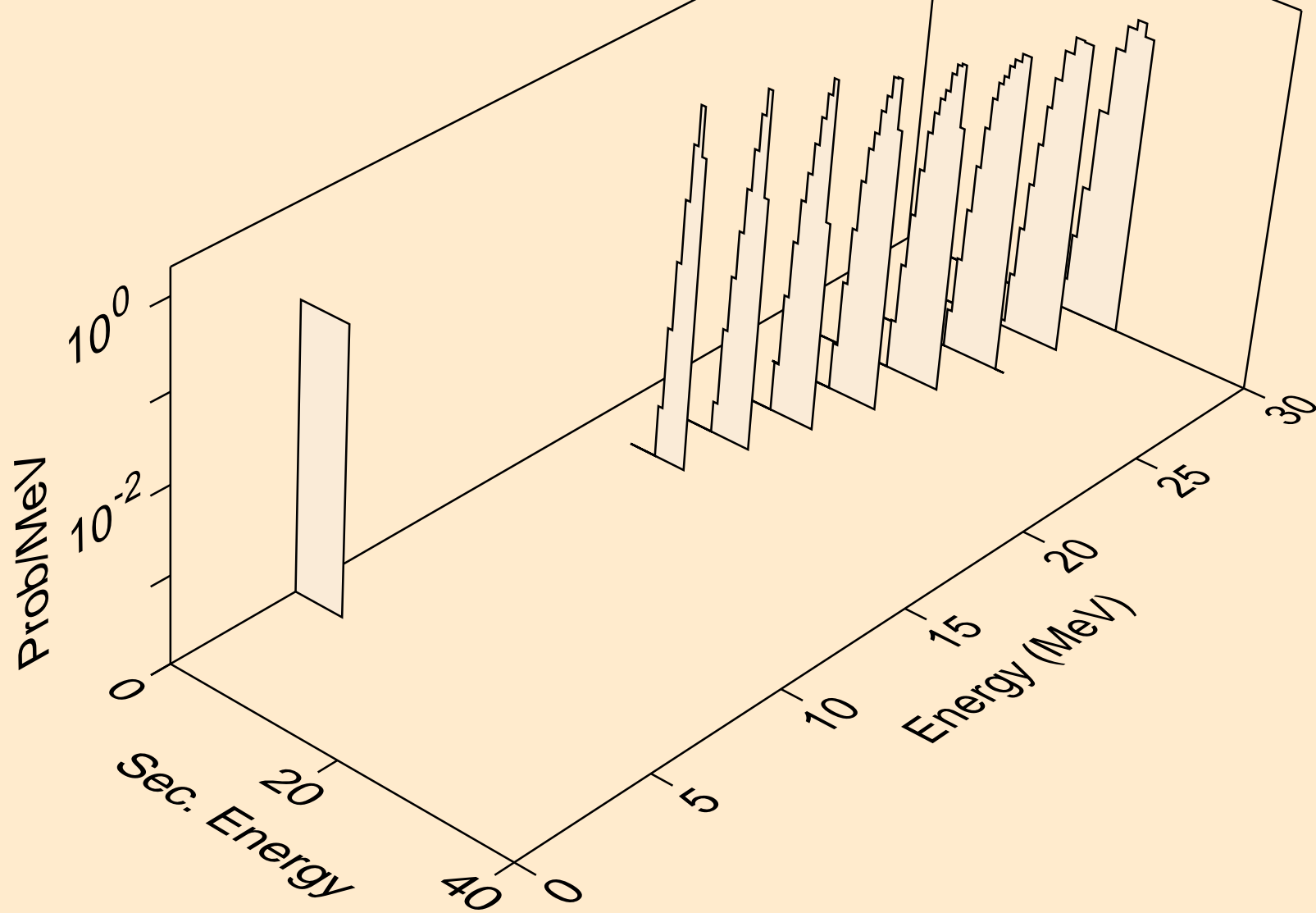

FM247 DEUTERON ACER TENDL-2021 LIBRARY; T=0.K
he3s from (d,he3)

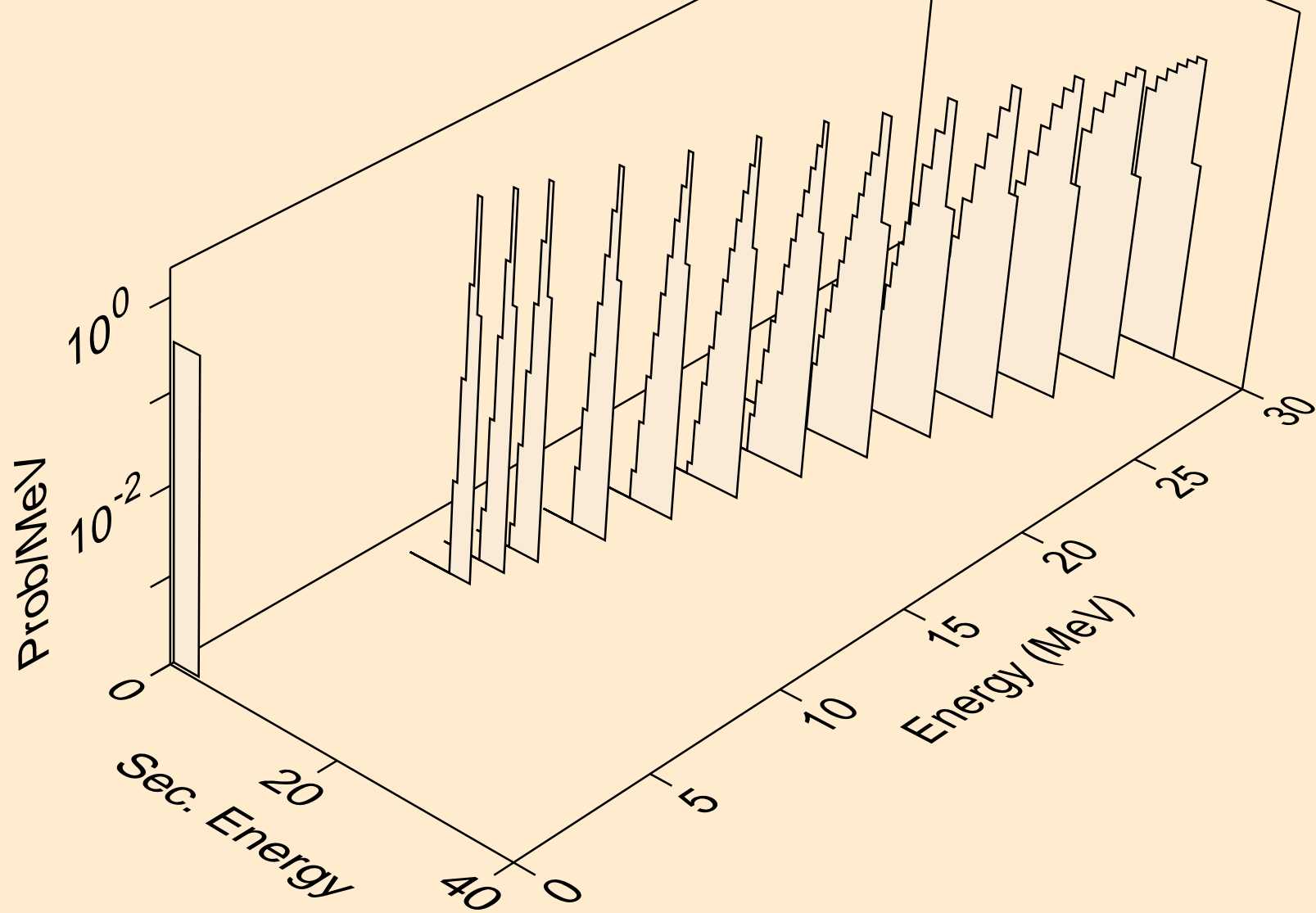

FM247 DEUTERON ACER TENDL-2021 LIBRARY; T=0.K
alphas from (d,x)

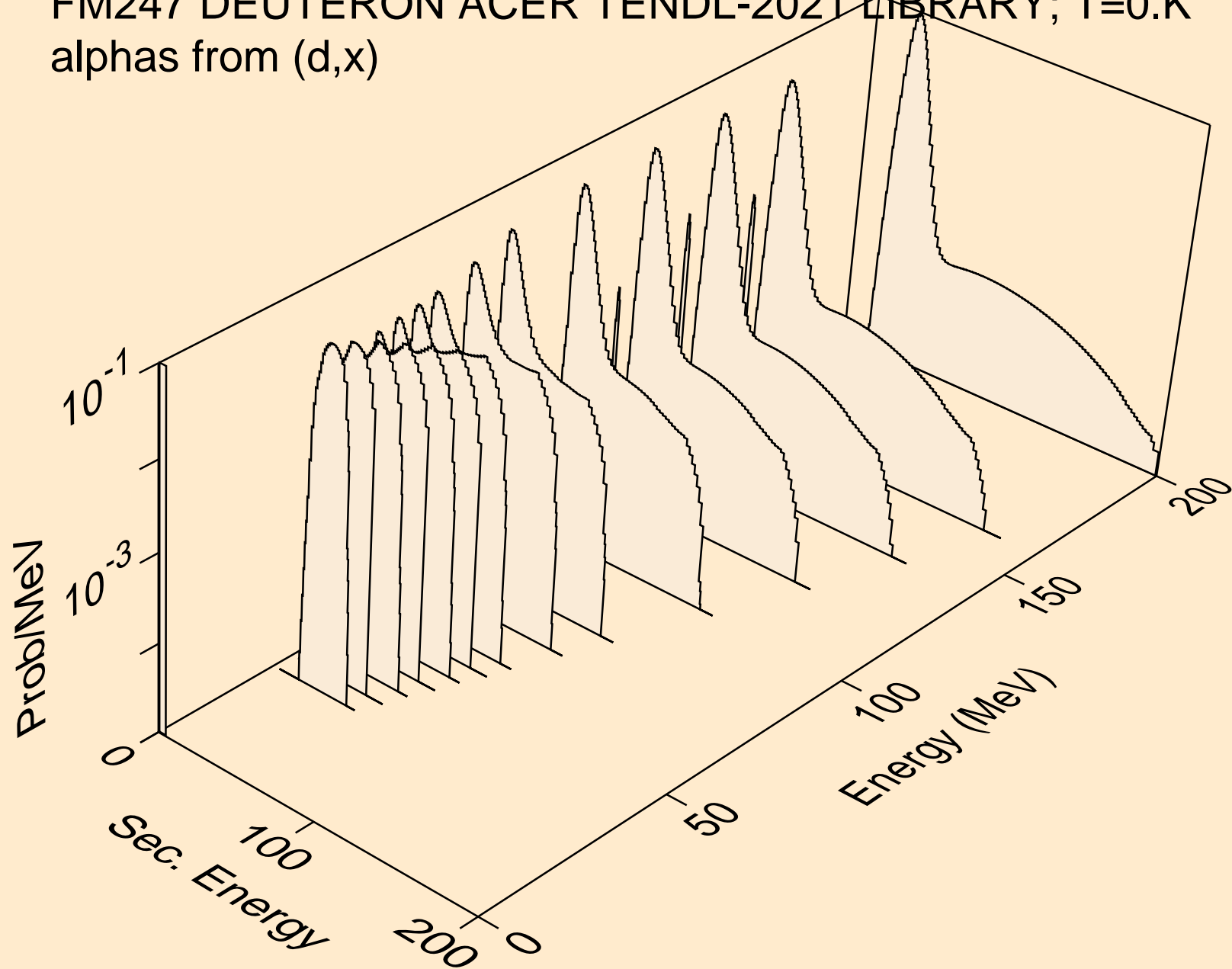

FM247 DEUTERON ACER TENDL-2021 LIBRARY; T=0.K
alphas from (d,n*)a

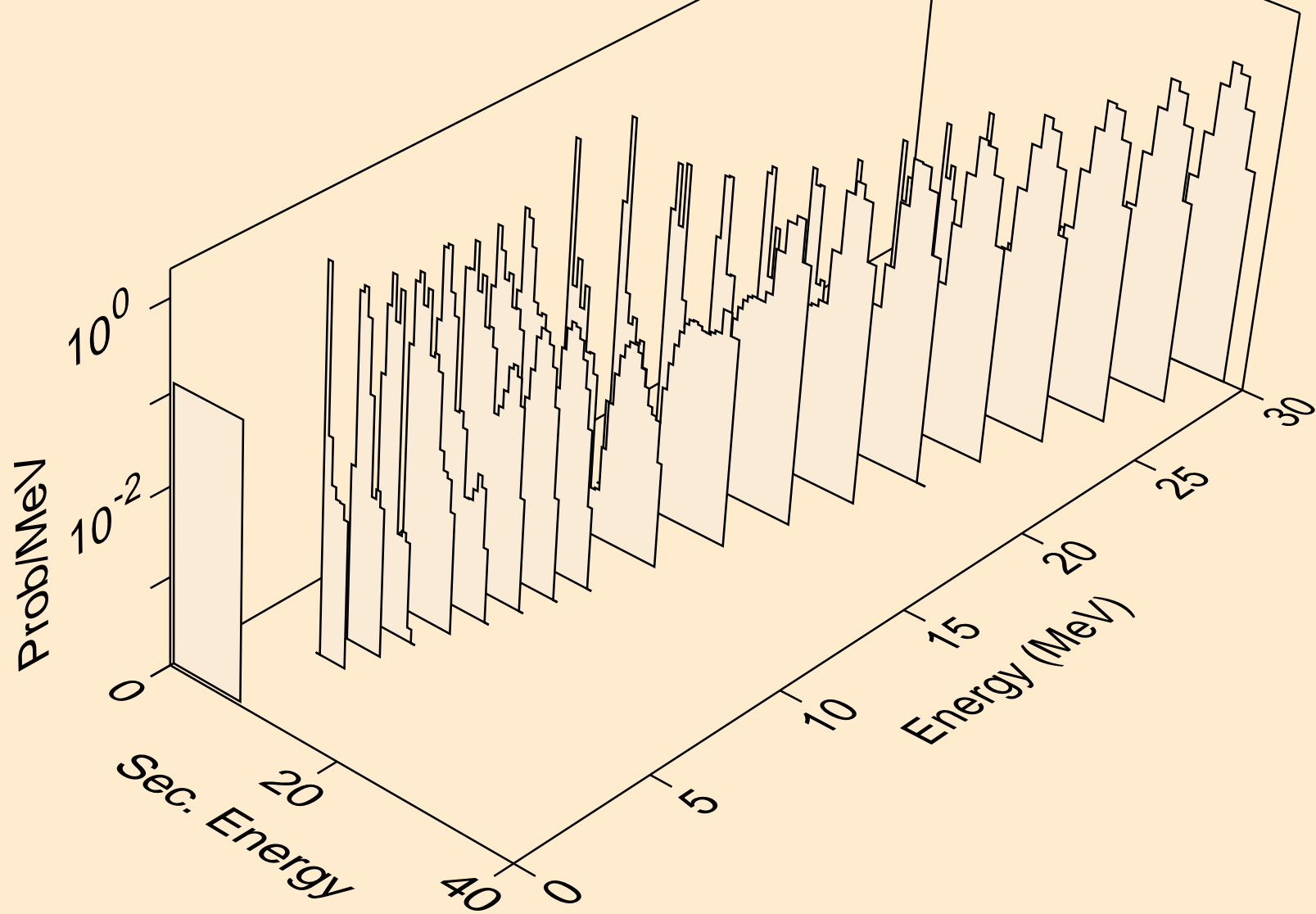

FM247 DEUTERON ACER TENDL-2021 LIBRARY; T=0.K
alphas from (d,2n)a

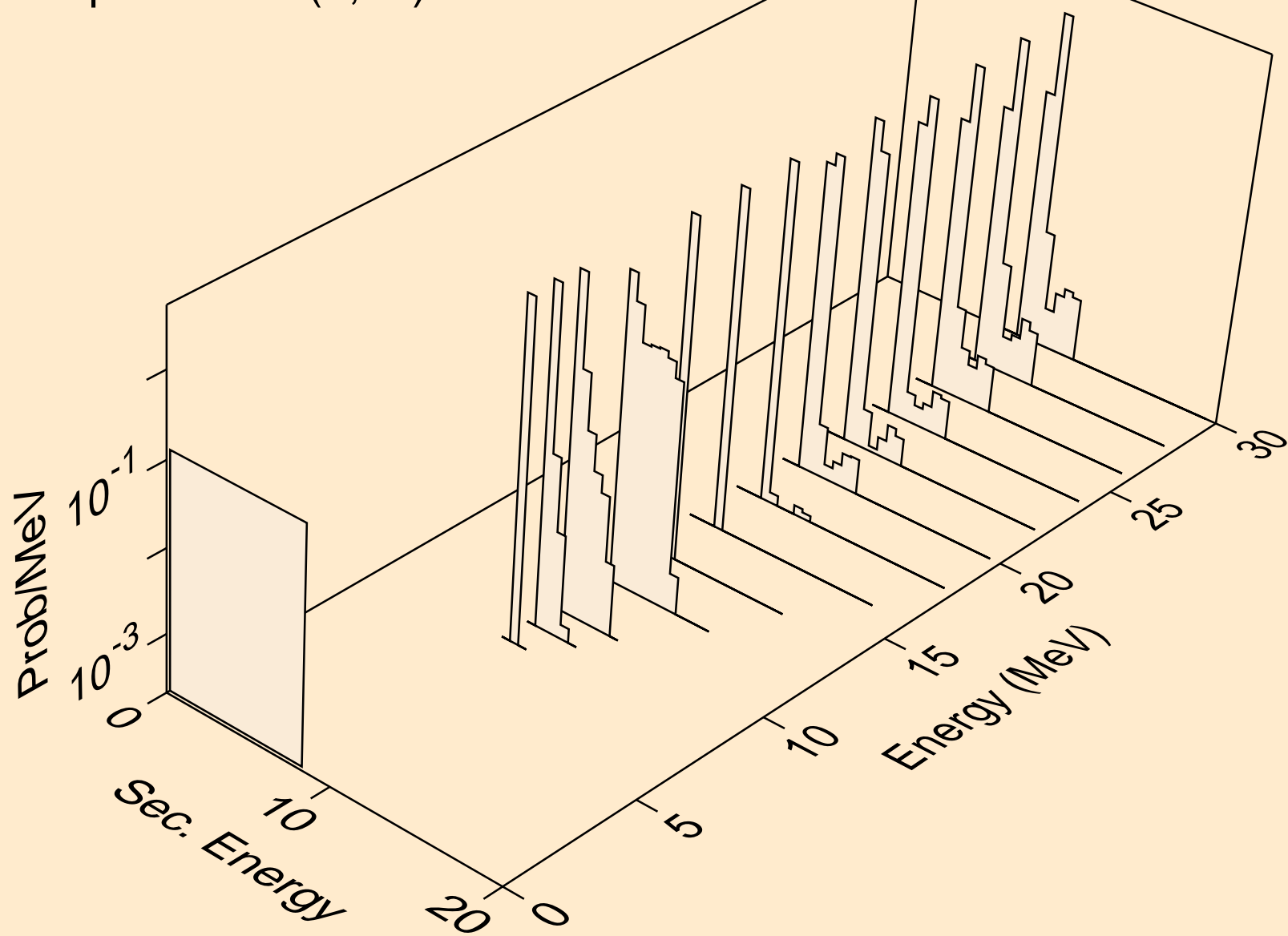

FM247 DEUTERON ACER TENDL-2021 LIBRARY; T=0.K
alphas from (d,n*)2a

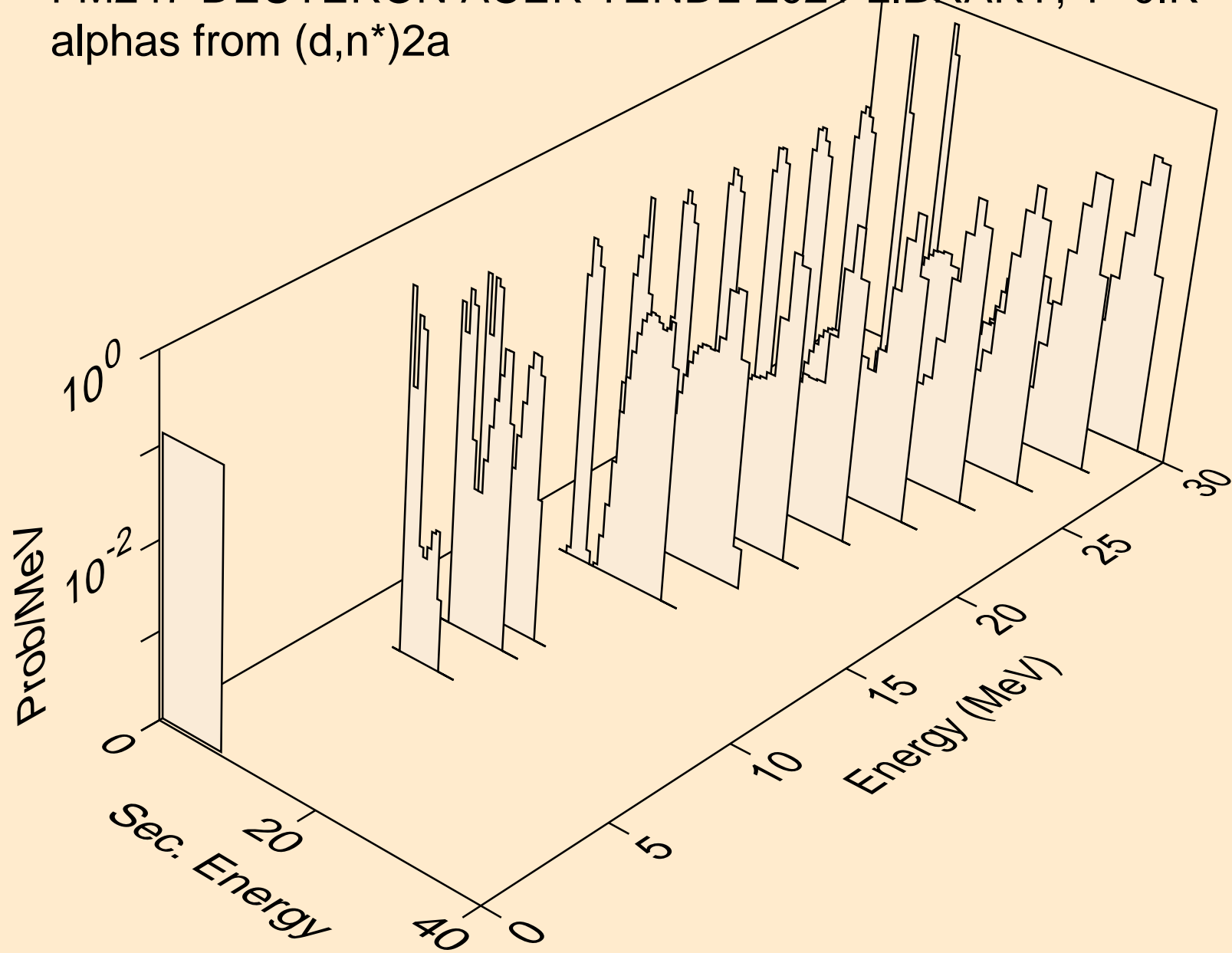

FM247 DEUTERON ACER TENDL-2021 LIBRARY; T=0.K
alphas from (d,npa)

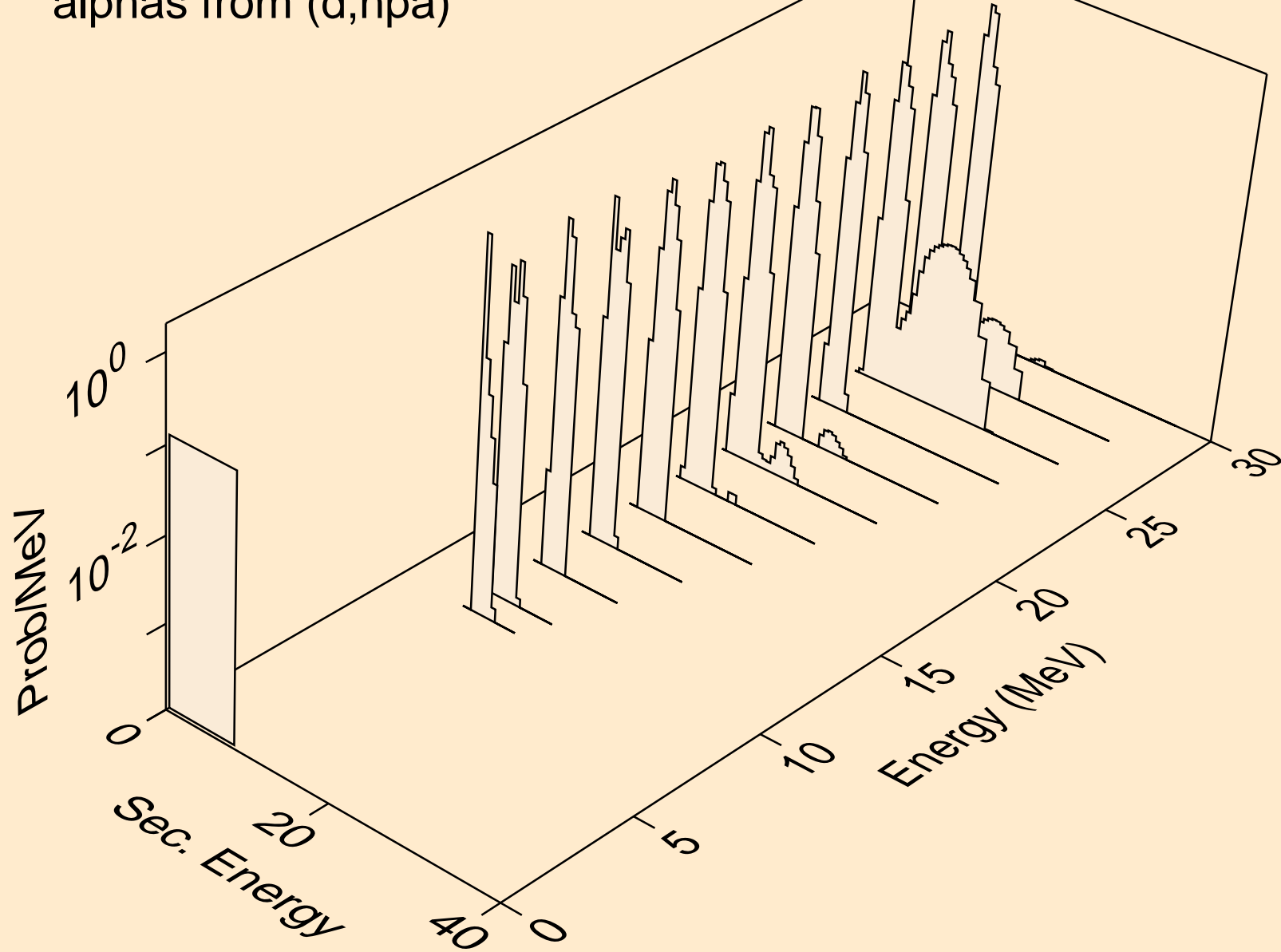

FM247 DEUTERON ACER TENDL-2021 LIBRARY; T=0.K
alphas from (d,a)

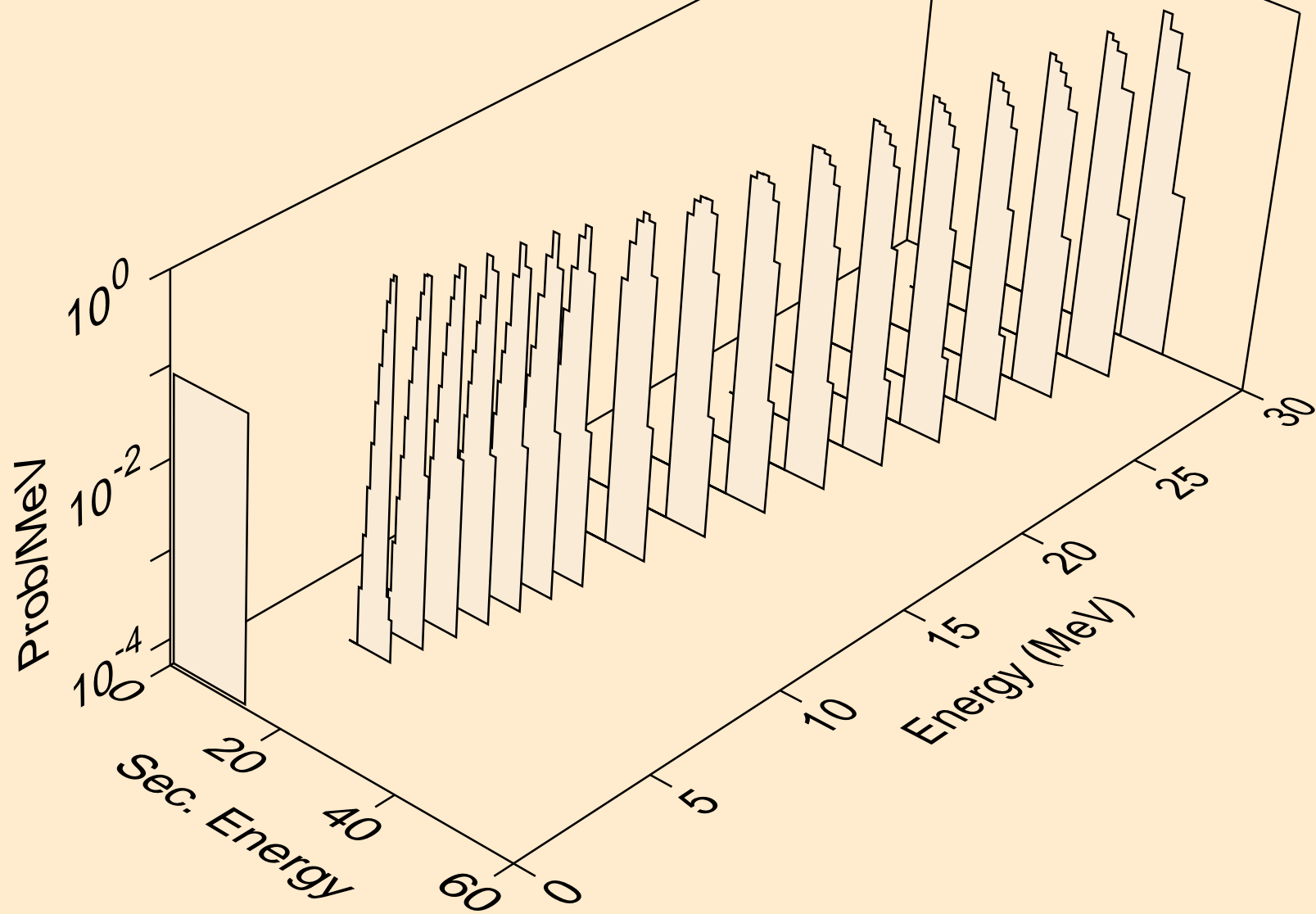

FM247 DEUTERON ACER TENDL-2021 LIBRARY; T=0.K
alphas from (d,2a)

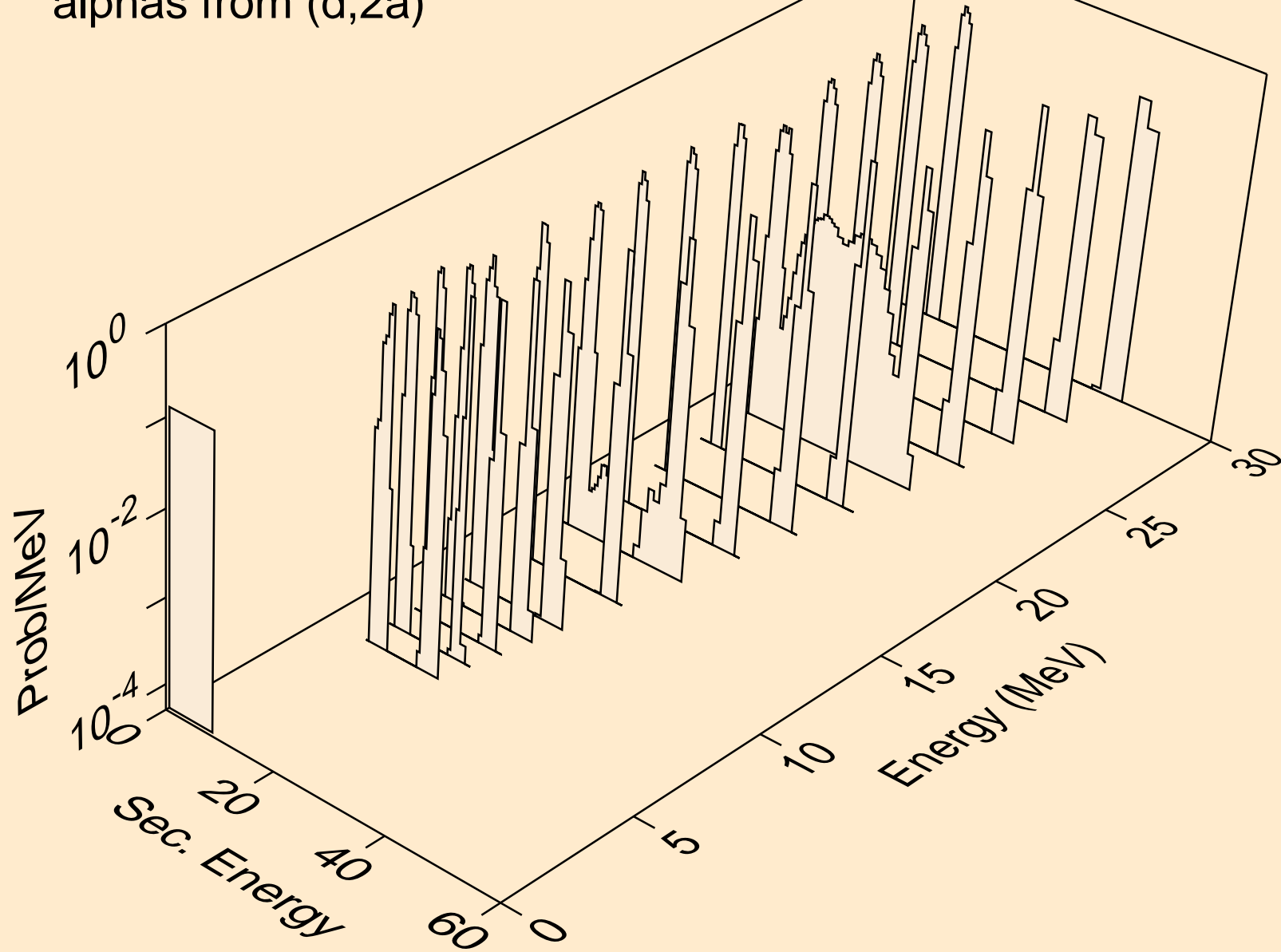

FM247 DEUTERON ACER TENDL-2021 LIBRARY; T=0.K
alphas from (d,da)

