

FR225 DEUTERON ACER TENDL-2021 LIBRARY; T=0.K

Principal cross sections

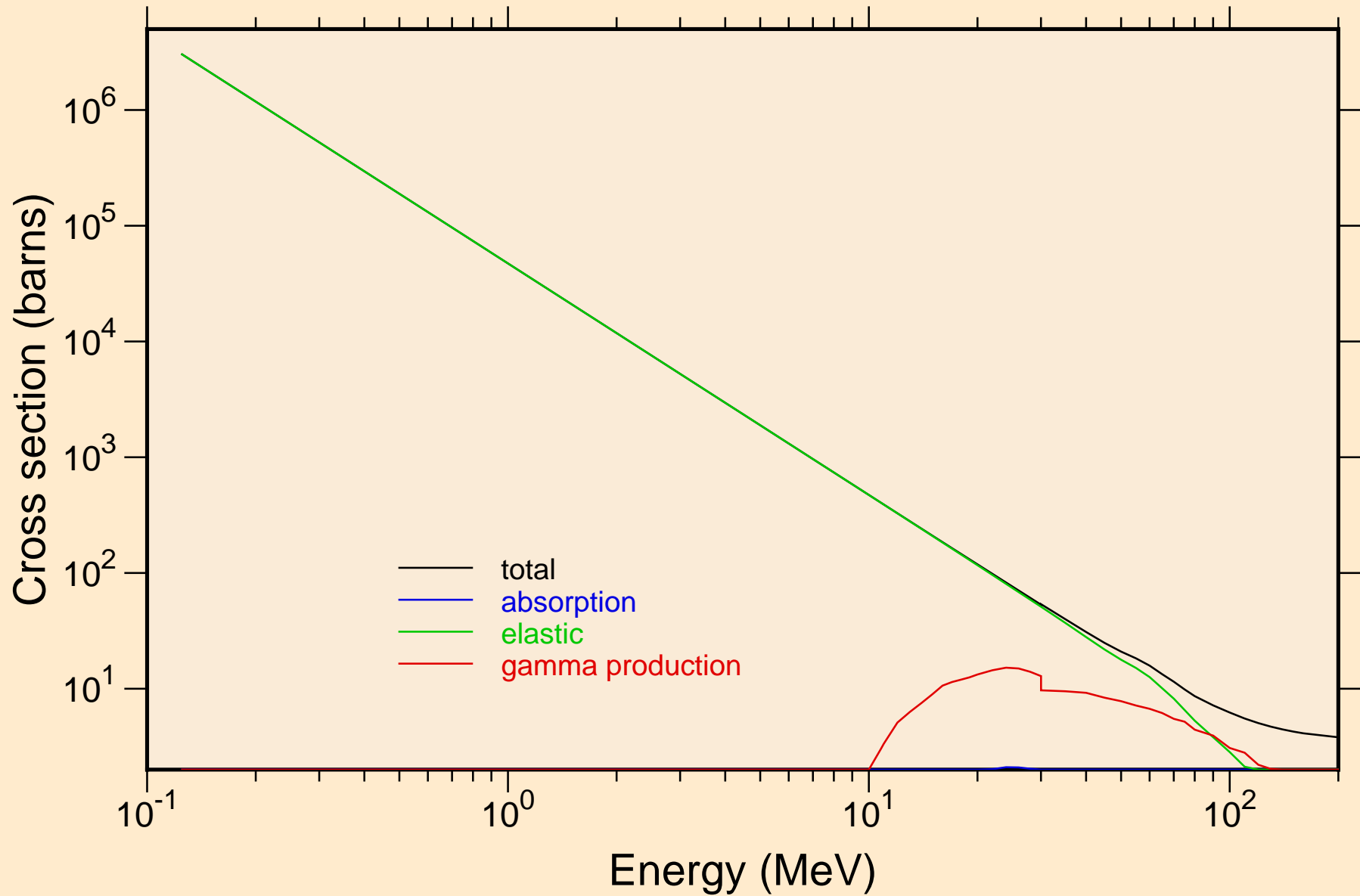

FR225 DEUTERON ACER TENDL-2021 LIBRARY; T=0.K
Heating

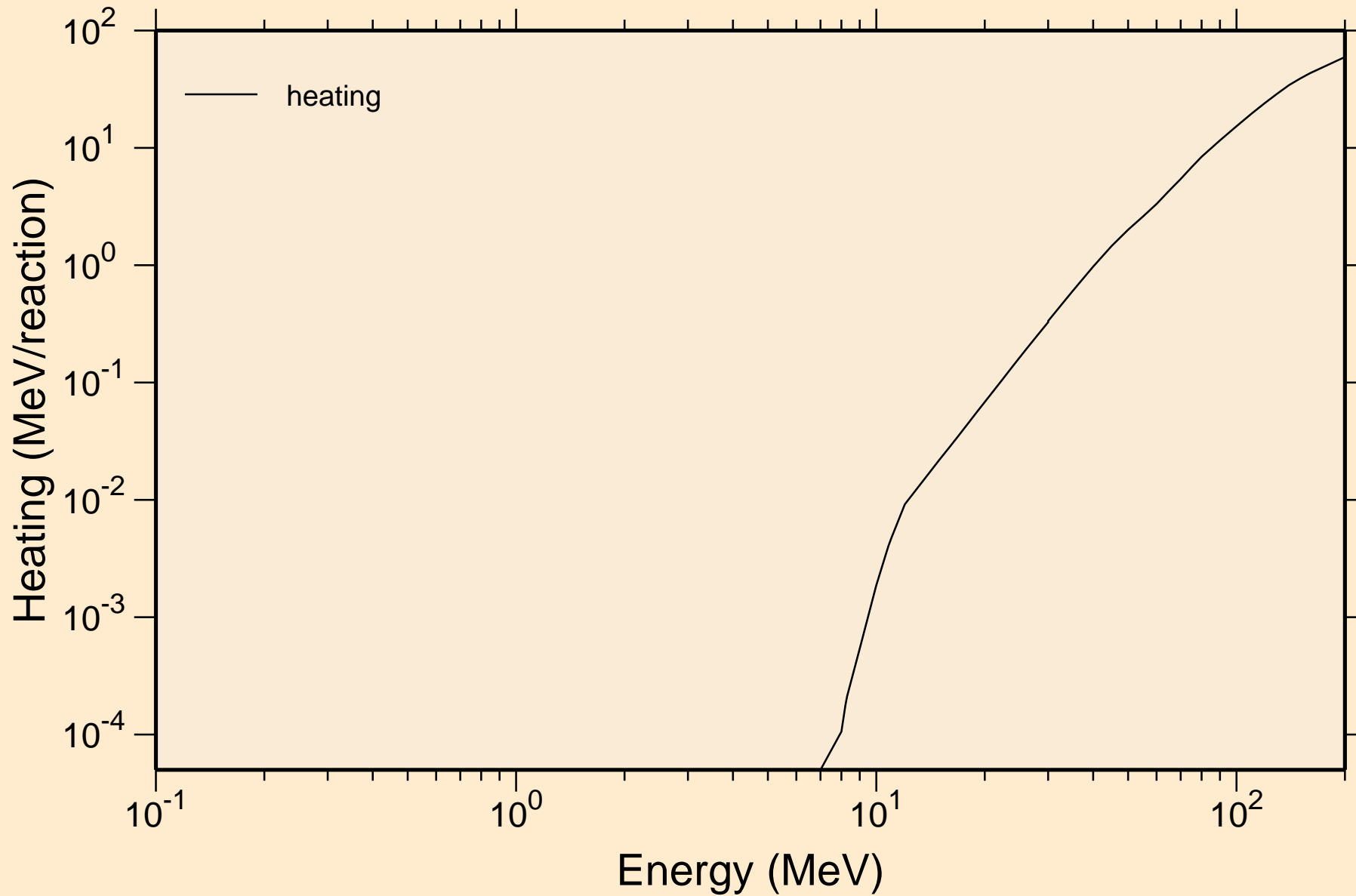

FR225 DEUTERON ACER TENDL-2021 LIBRARY; T=0.K
Principal cross sections

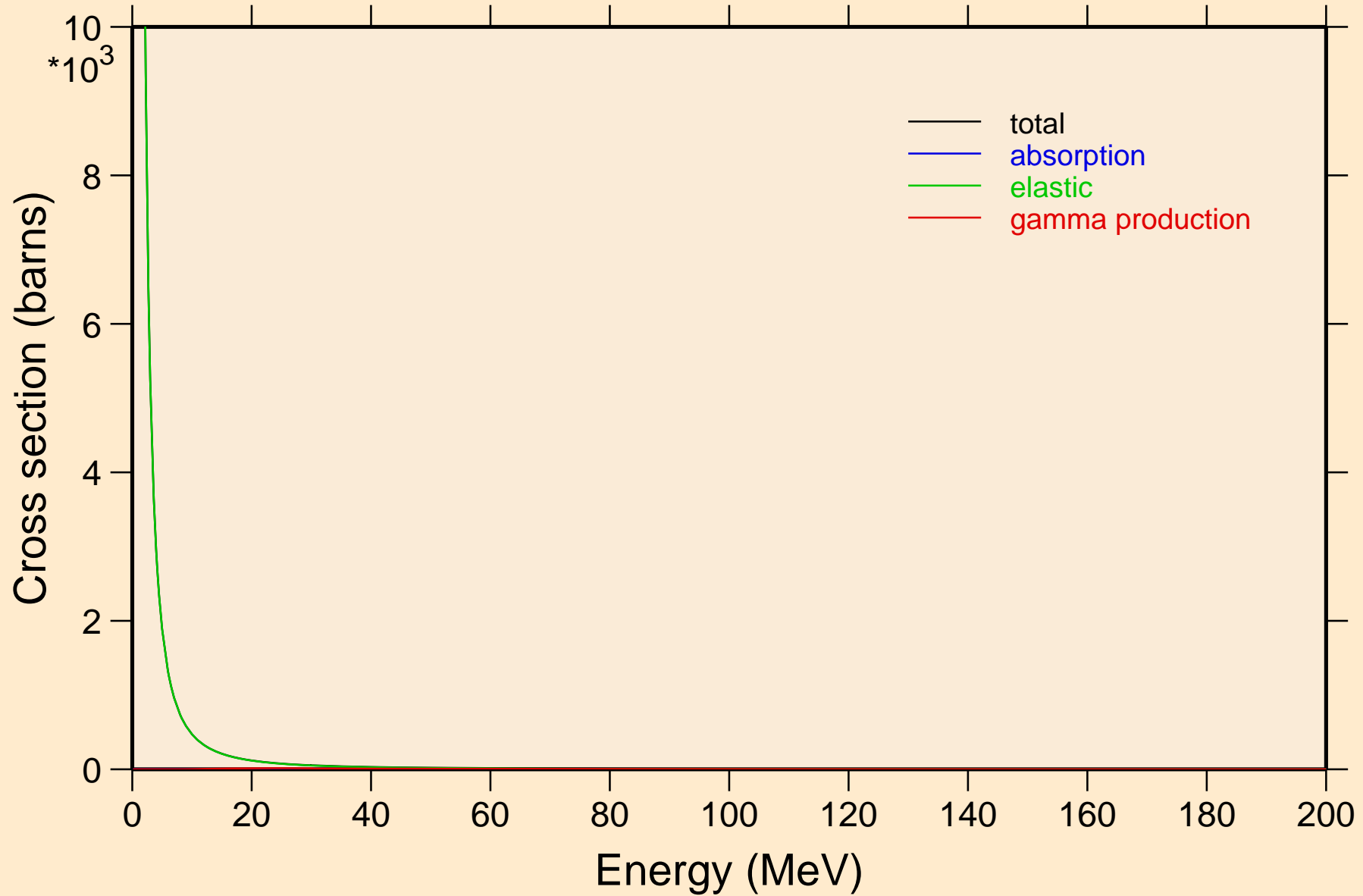

FR225 DEUTERON ACER TENDL-2021 LIBRARY; T=0.K
Heating

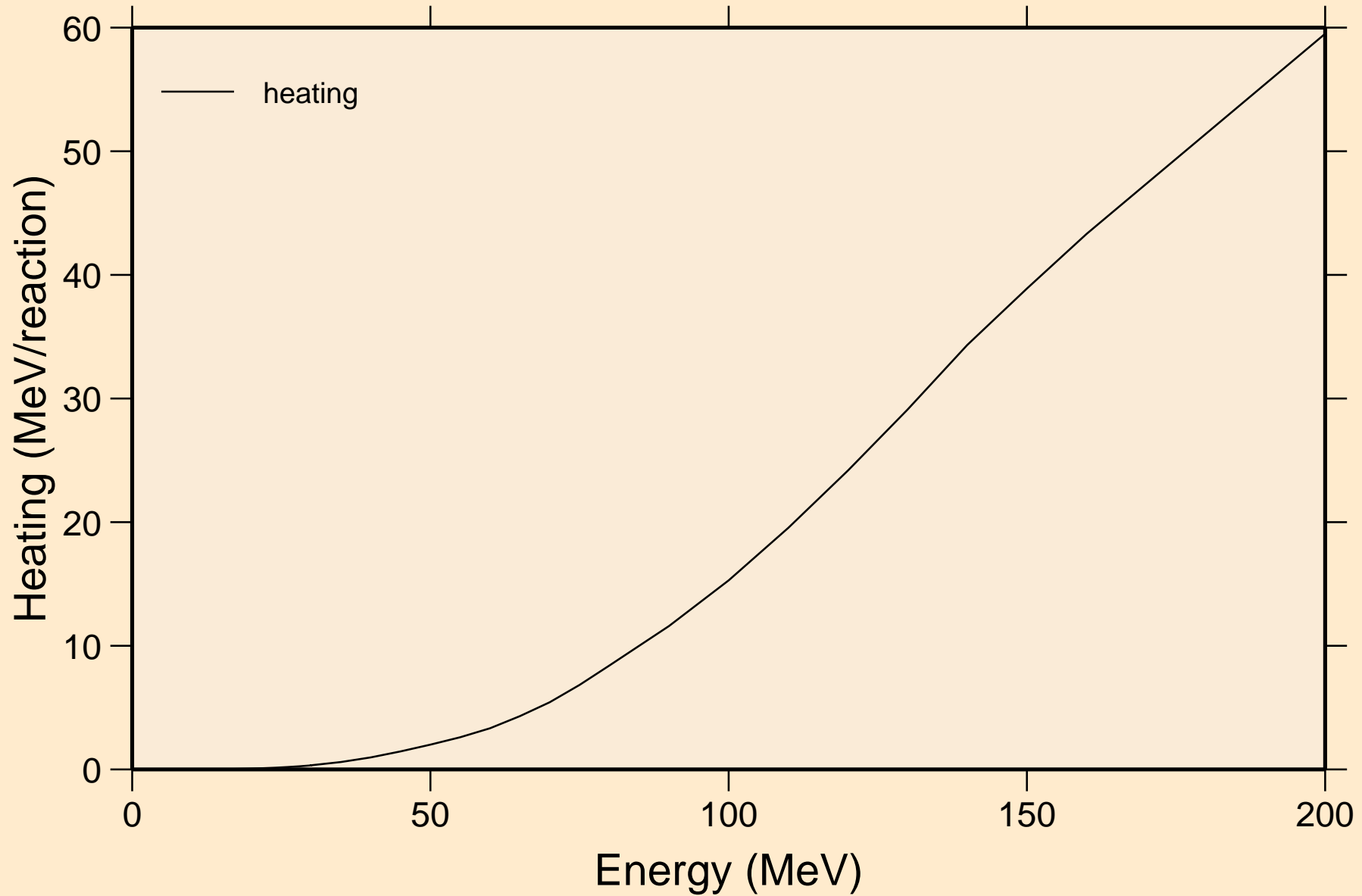

FR225 DEUTERON ACER TENDL-2021 LIBRARY; T=0.K
Threshold reactions

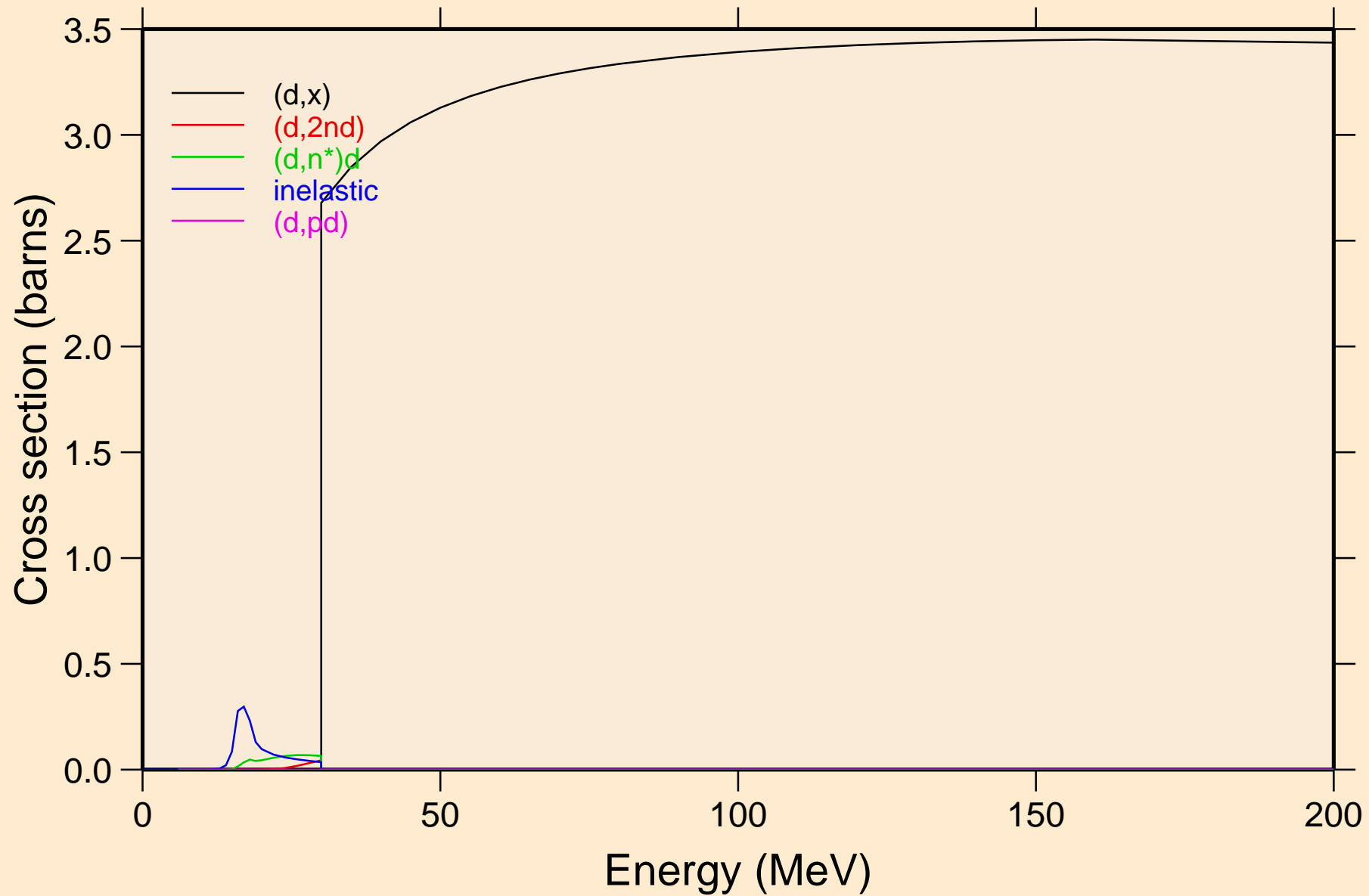

FR225 DEUTERON ACER TENDL-2021 LIBRARY; T=0.K
Threshold reactions

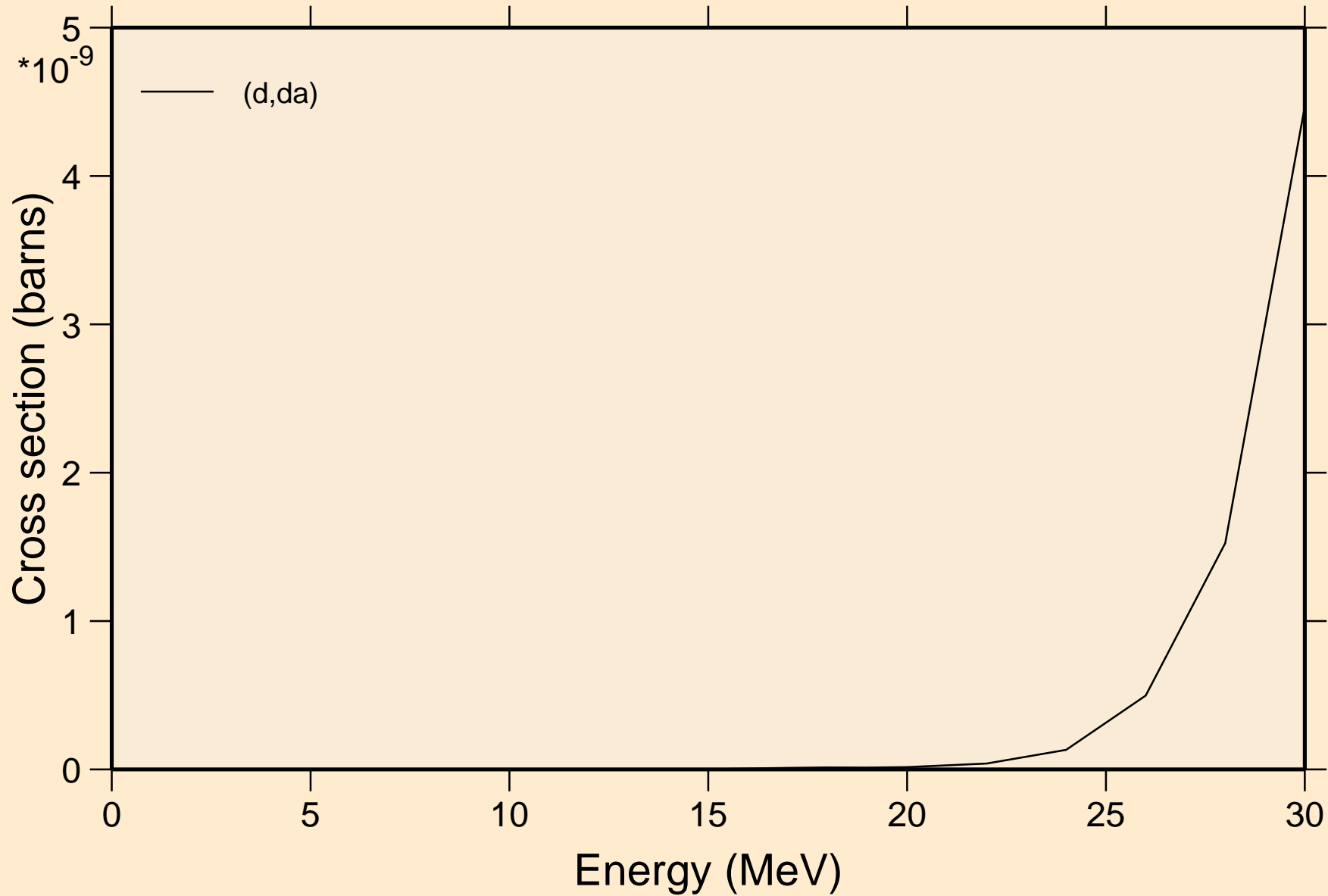

FR225 DEUTERON ACER TENDL-2021 LIBRARY; T=0.K
angular distribution for elastic

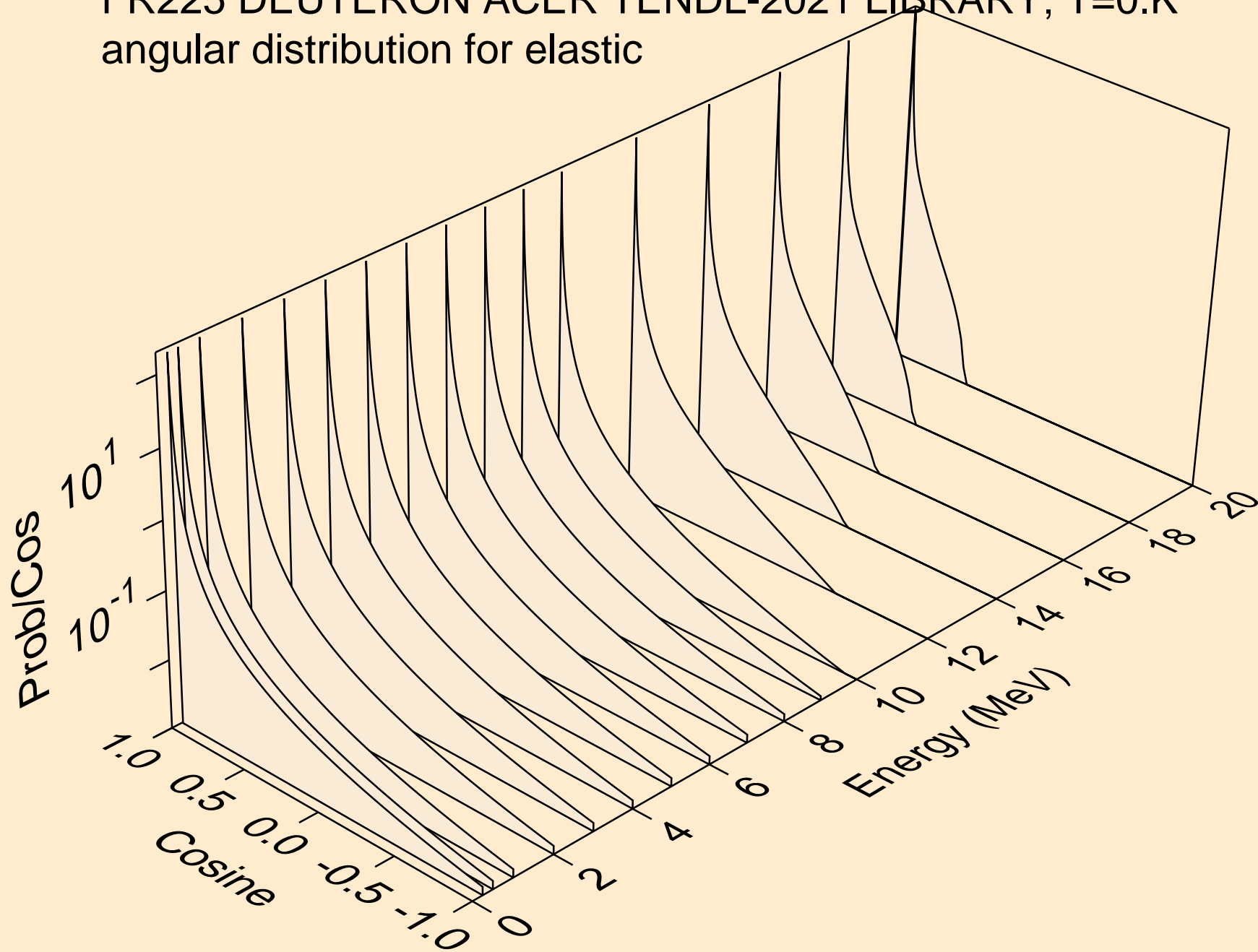

FR225 DEUTERON ACER TENDL-2021 LIBRARY; T=0.K
angular distribution for elastic

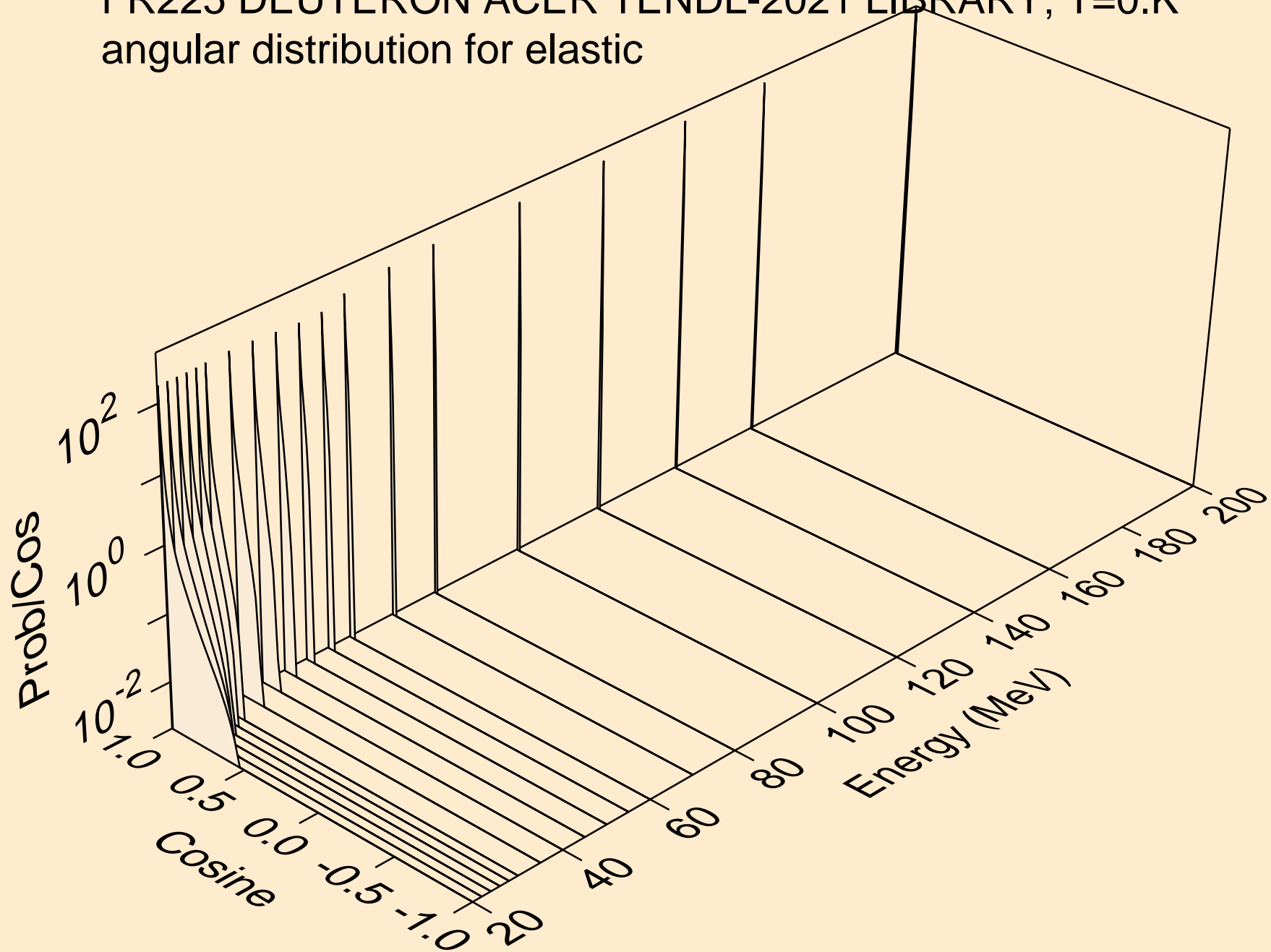

FR225 DEUTERON ACER TENDL-2021 LIBRARY; T=0.K
Deuteron emission for (d,x)

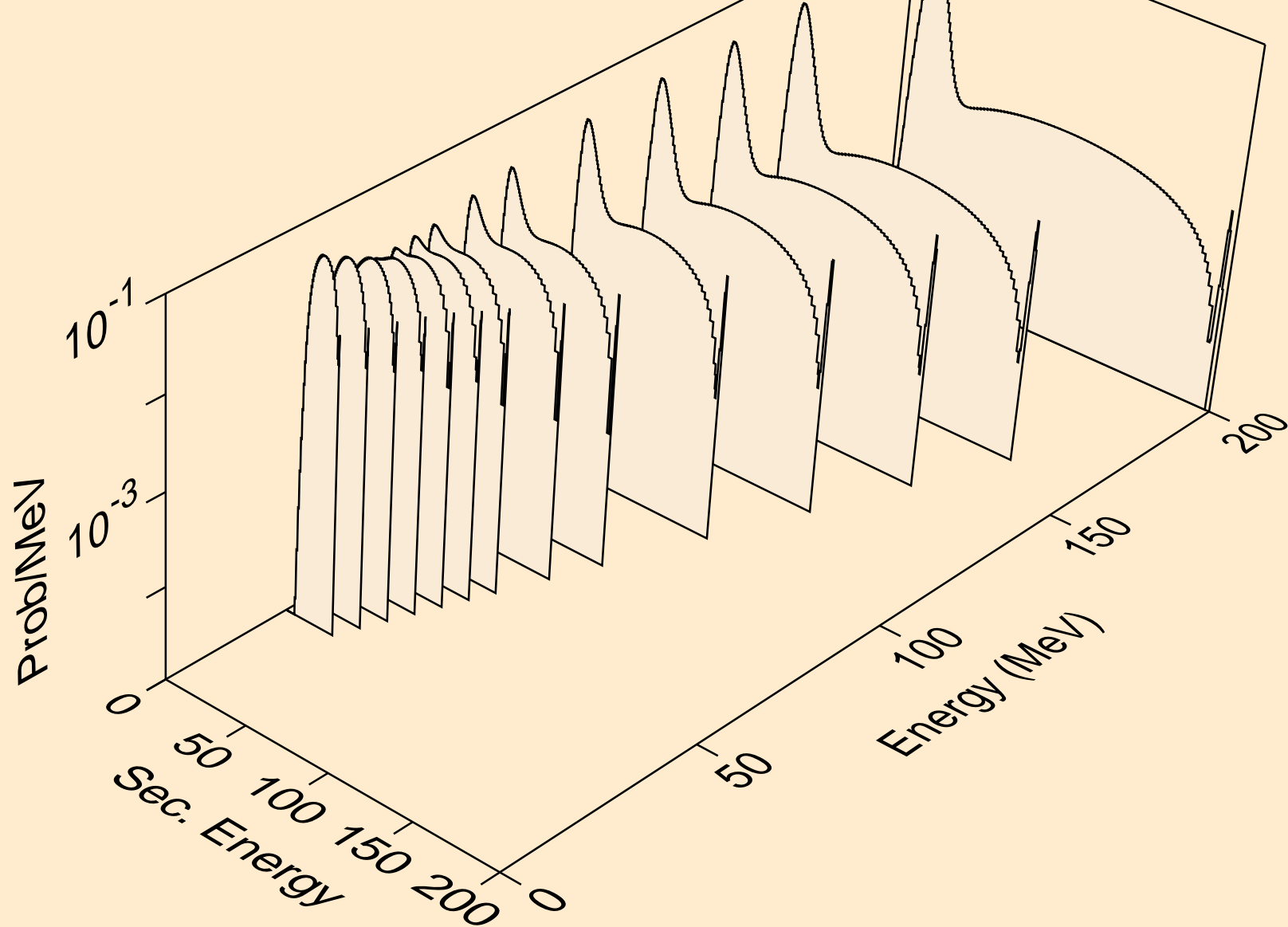

FR225 DEUTERON ACER TENDL-2021 LIBRARY; T=0.K
Deuteron emission for (d,2nd)

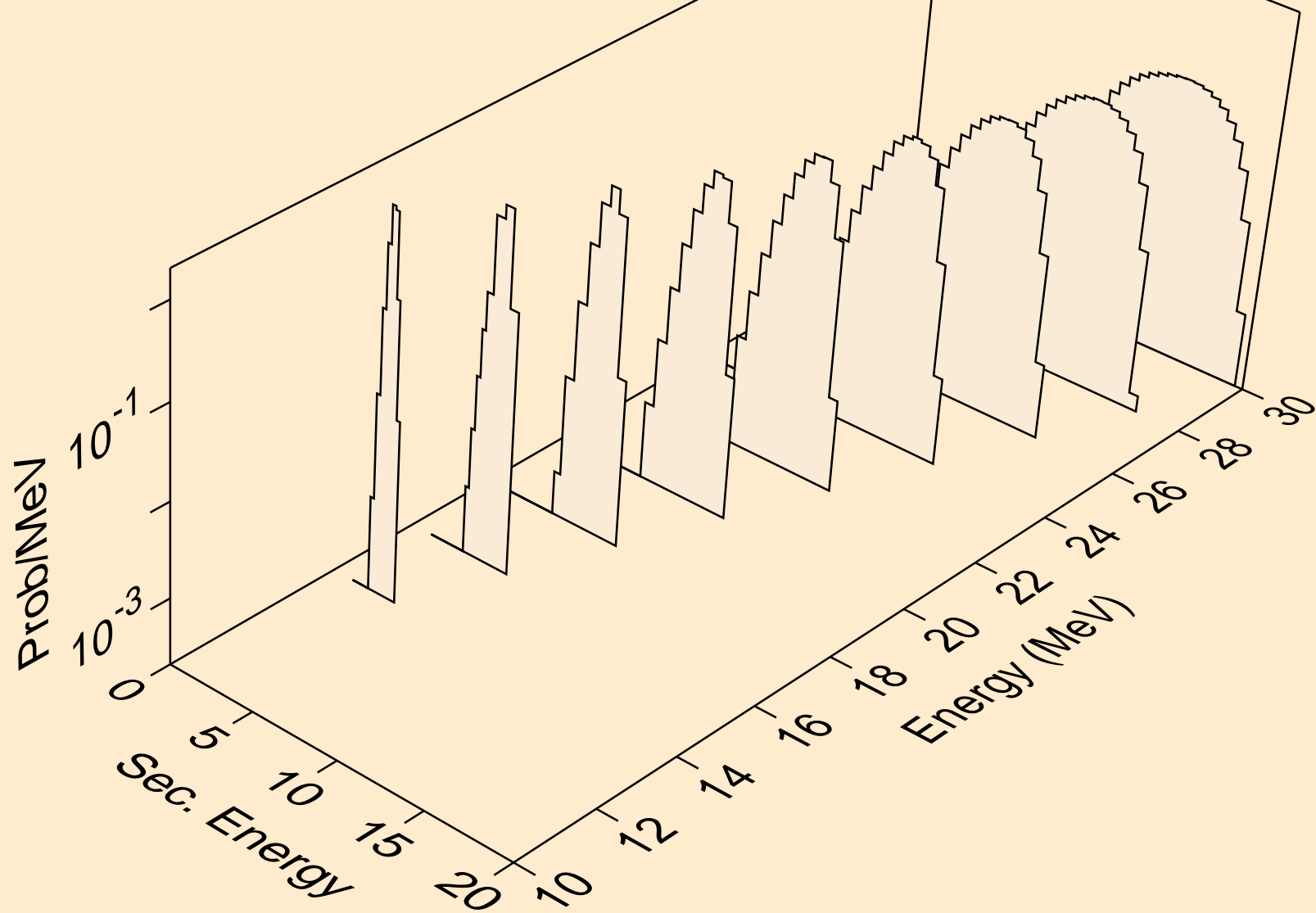

FR225 DEUTERON ACER TENDL-2021 LIBRARY; T=0.K
Deuteron emission for (d,n*)d

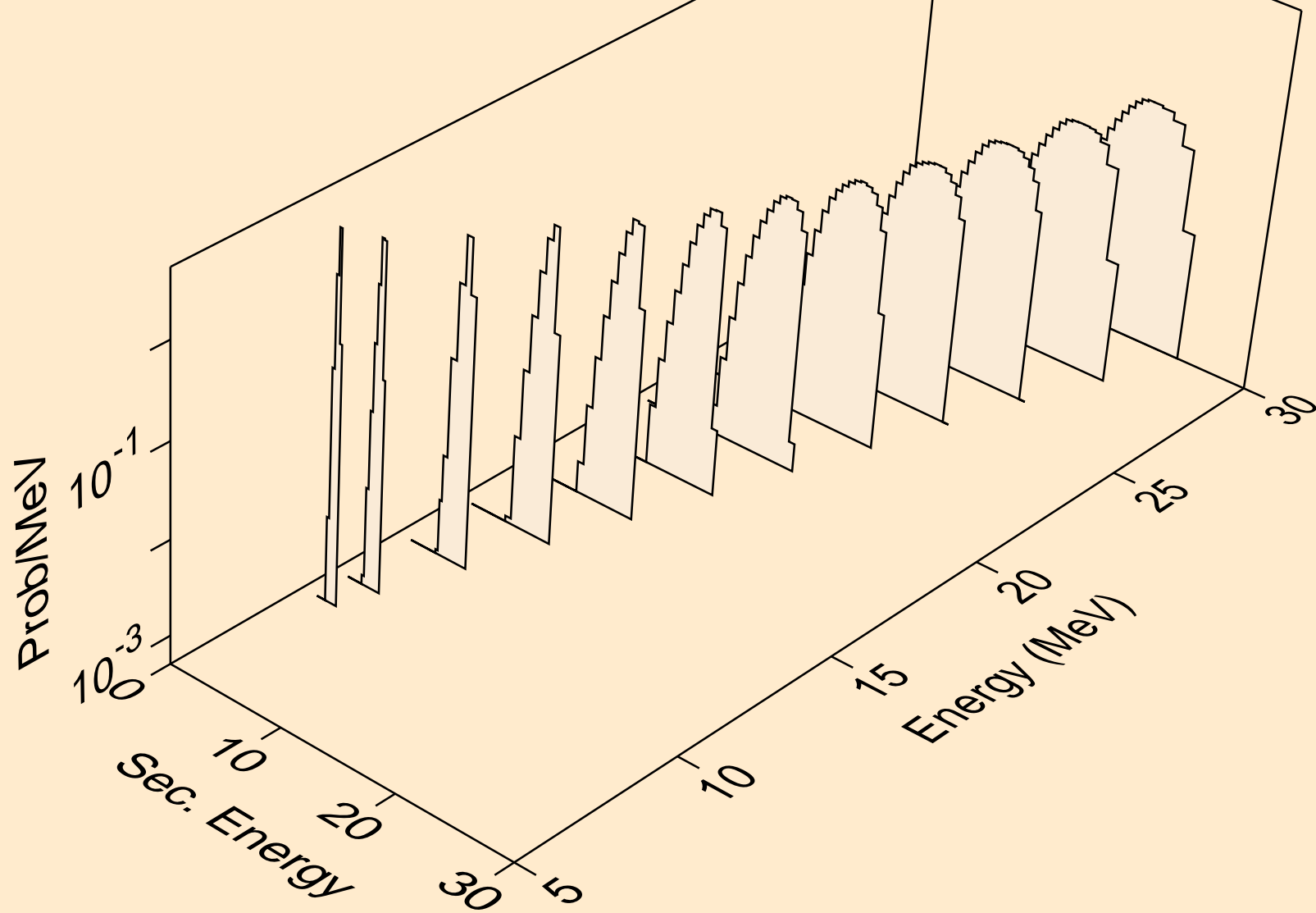

FR225 DEUTERON ACER TENDL-2021 LIBRARY; T=0.K
Deuteron emission for inelastic

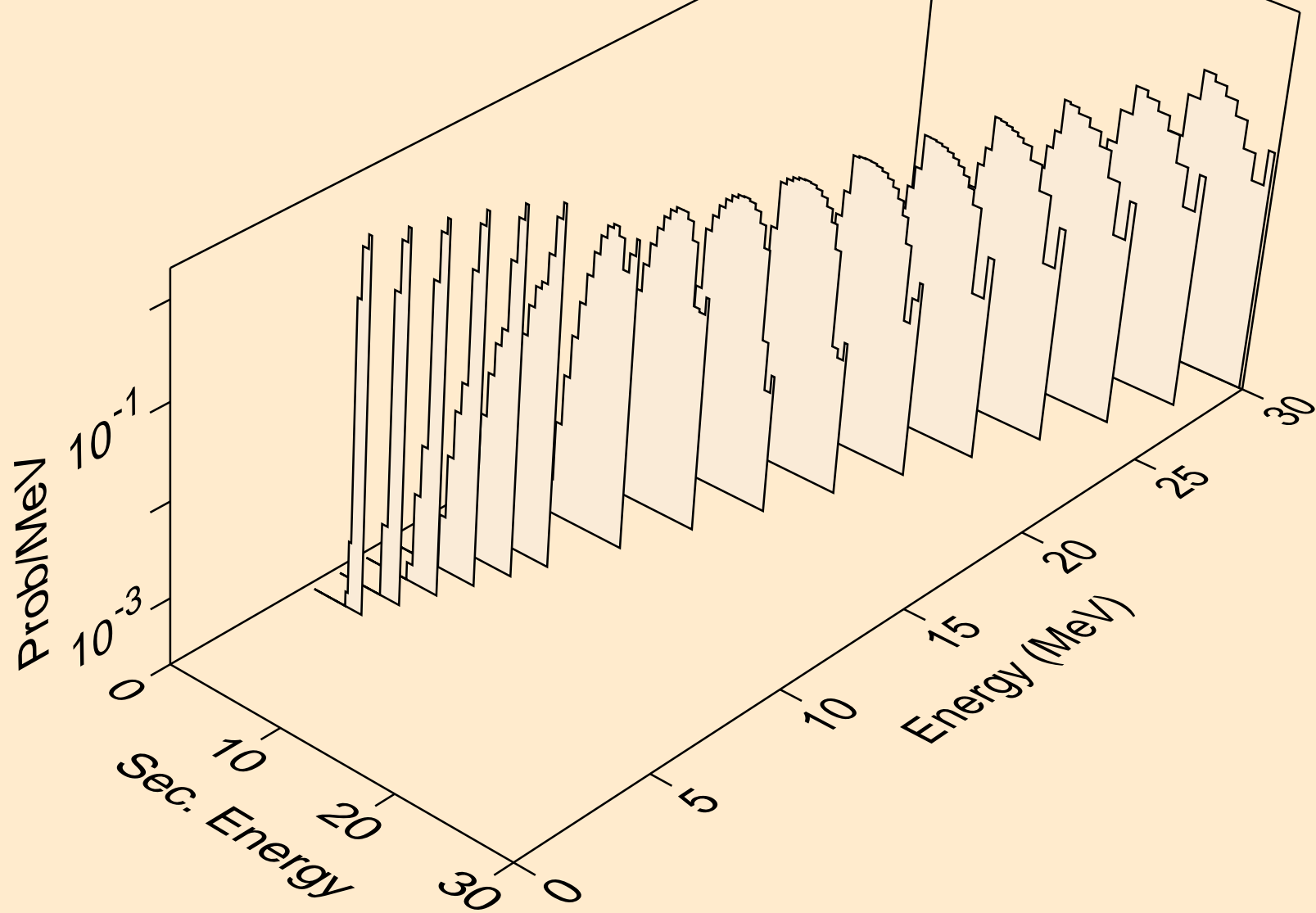

FR225 DEUTERON ACER TENDL-2021 LIBRARY; T=0.K
Deuteron emission for (d,pd)

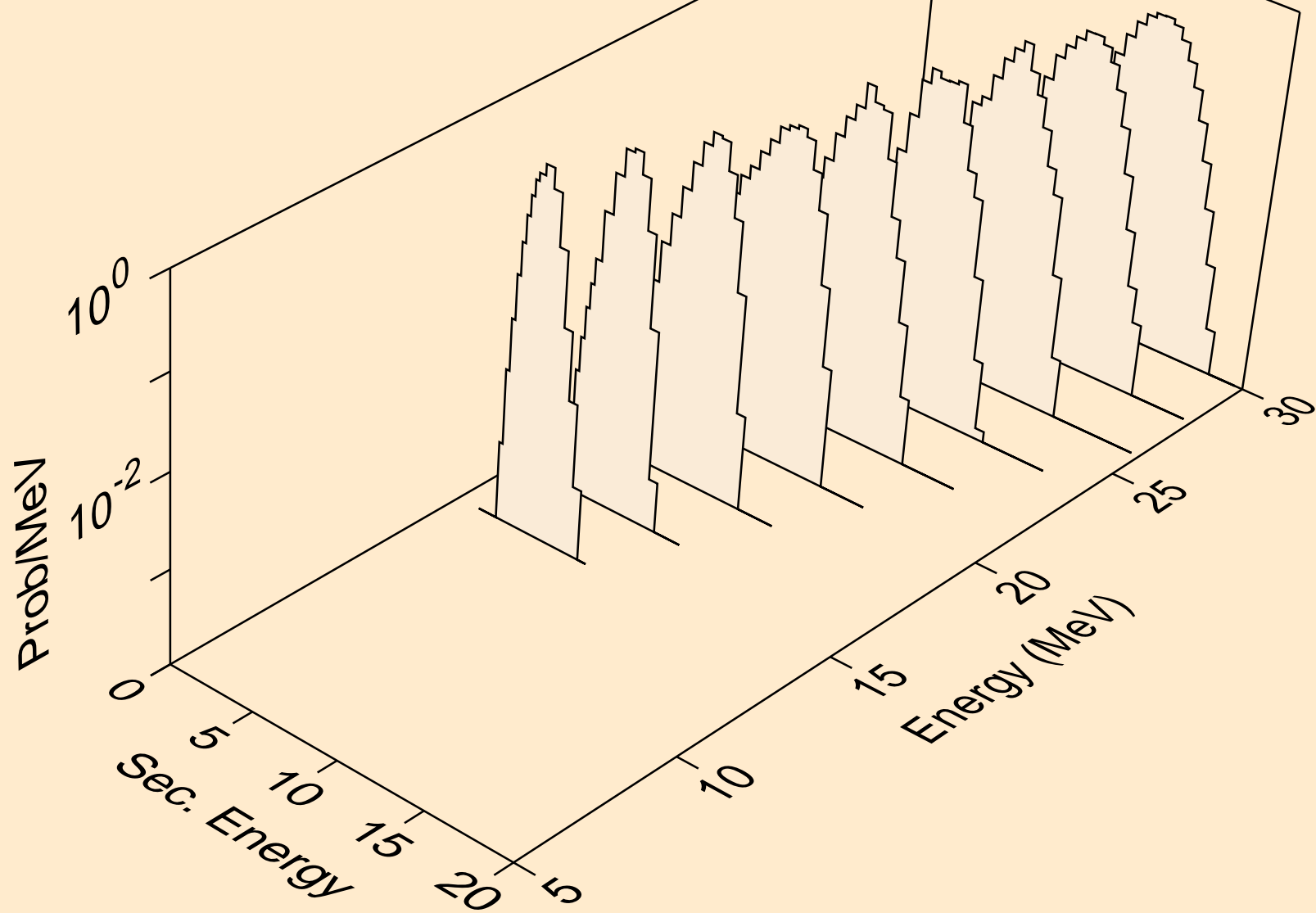

FR225 DEUTERON ACER TENDL-2021 LIBRARY; T=0.K
Deuteron emission for (d,da)

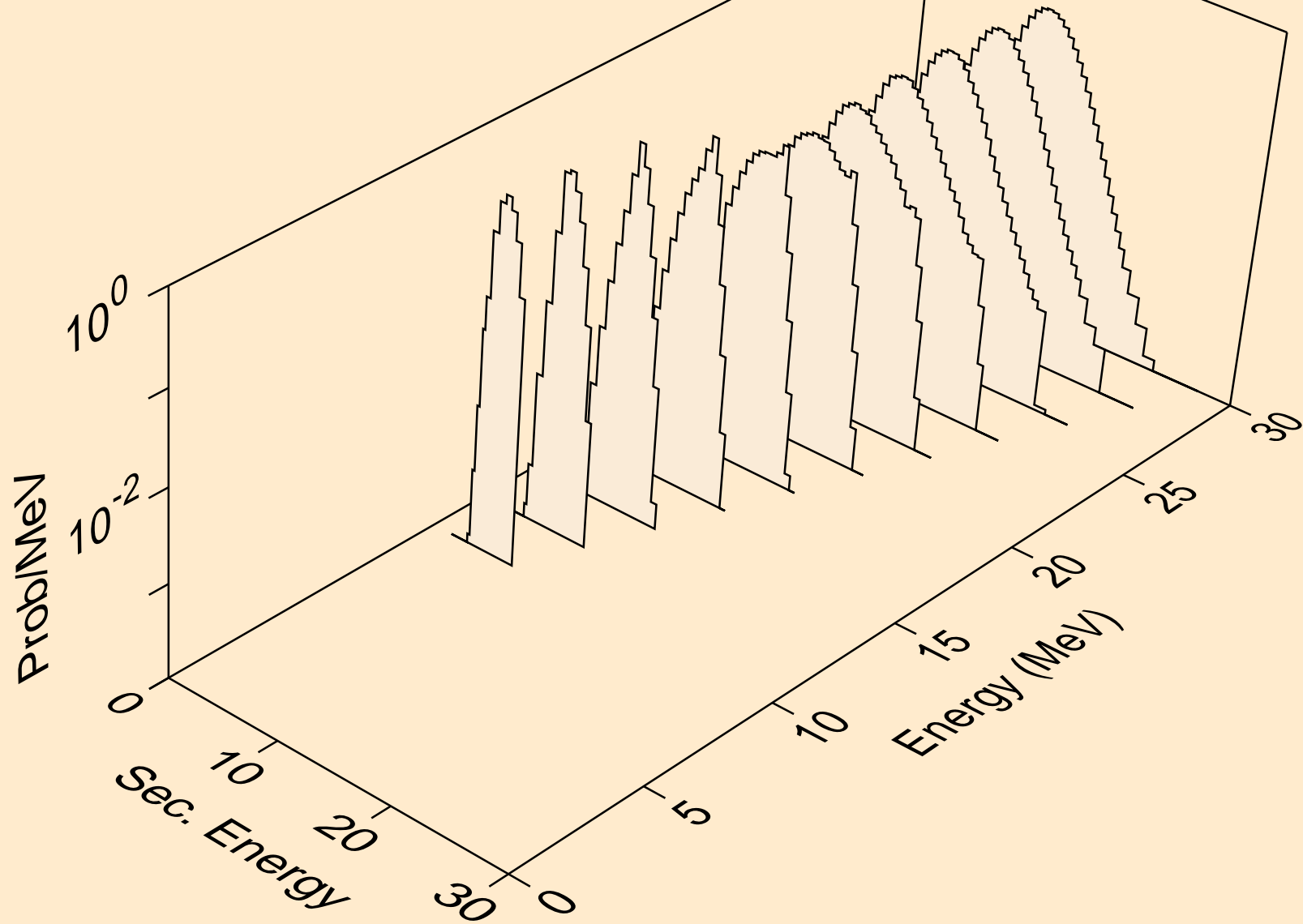

FR225 DEUTERON ACER TENDL-2021 LIBRARY; T=0.K
Photon emission for (z,n)

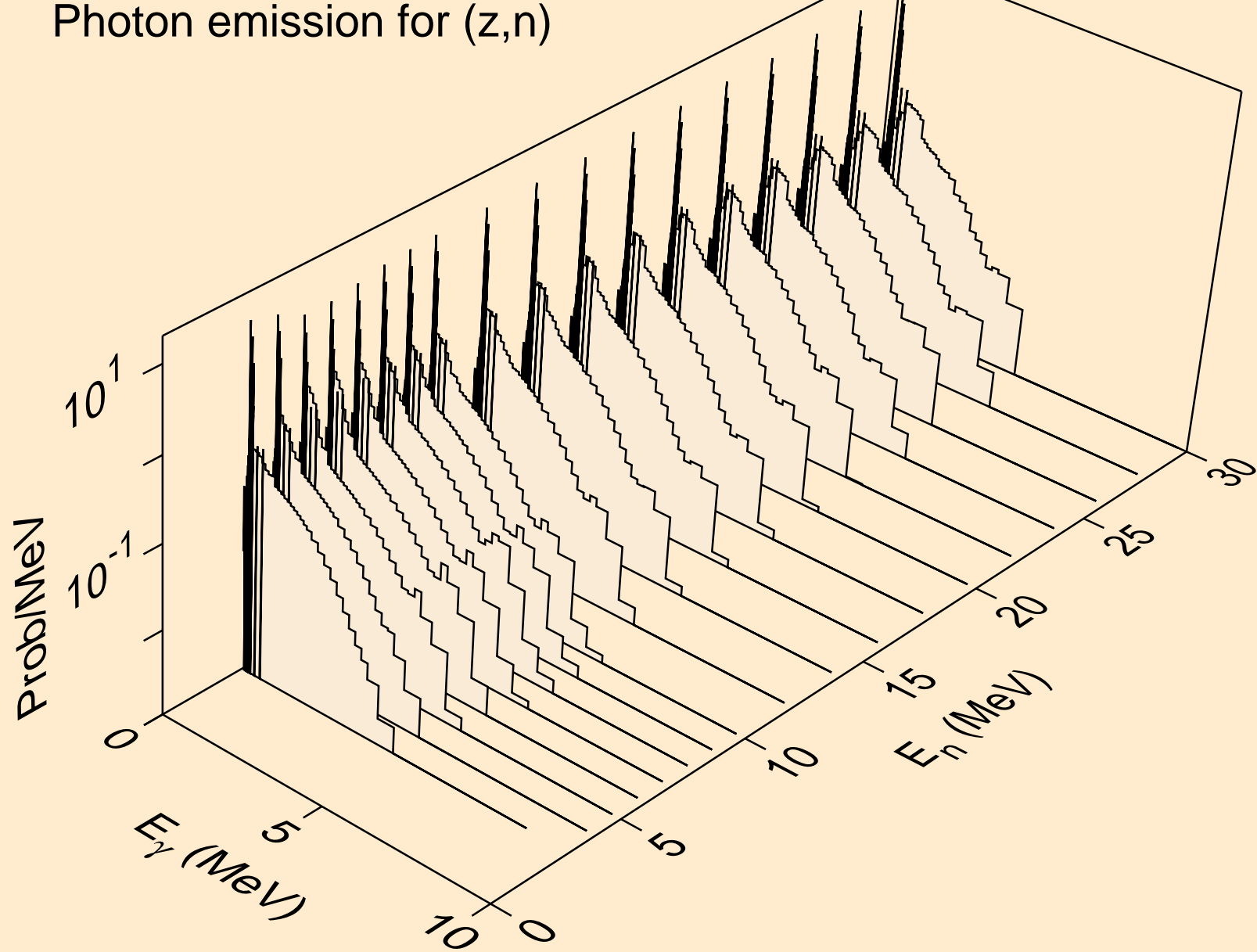

FR225 DEUTERON ACER TENDL-2021 LIBRARY; T=0.K
Photon emission for (n,x)

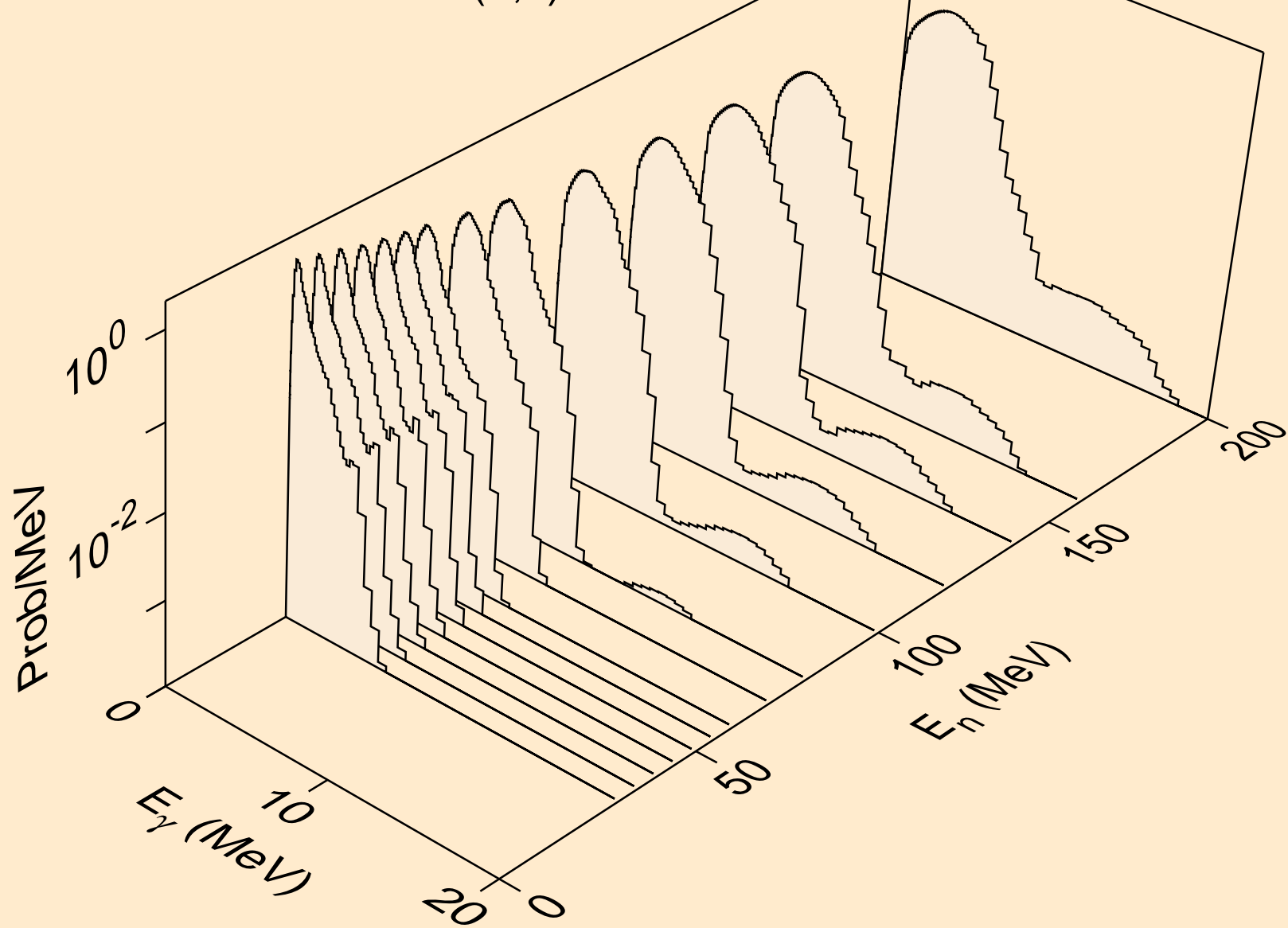

FR225 DEUTERON ACER TENDL-2021 LIBRARY; T=0.K
Photon emission for (n,2nd)

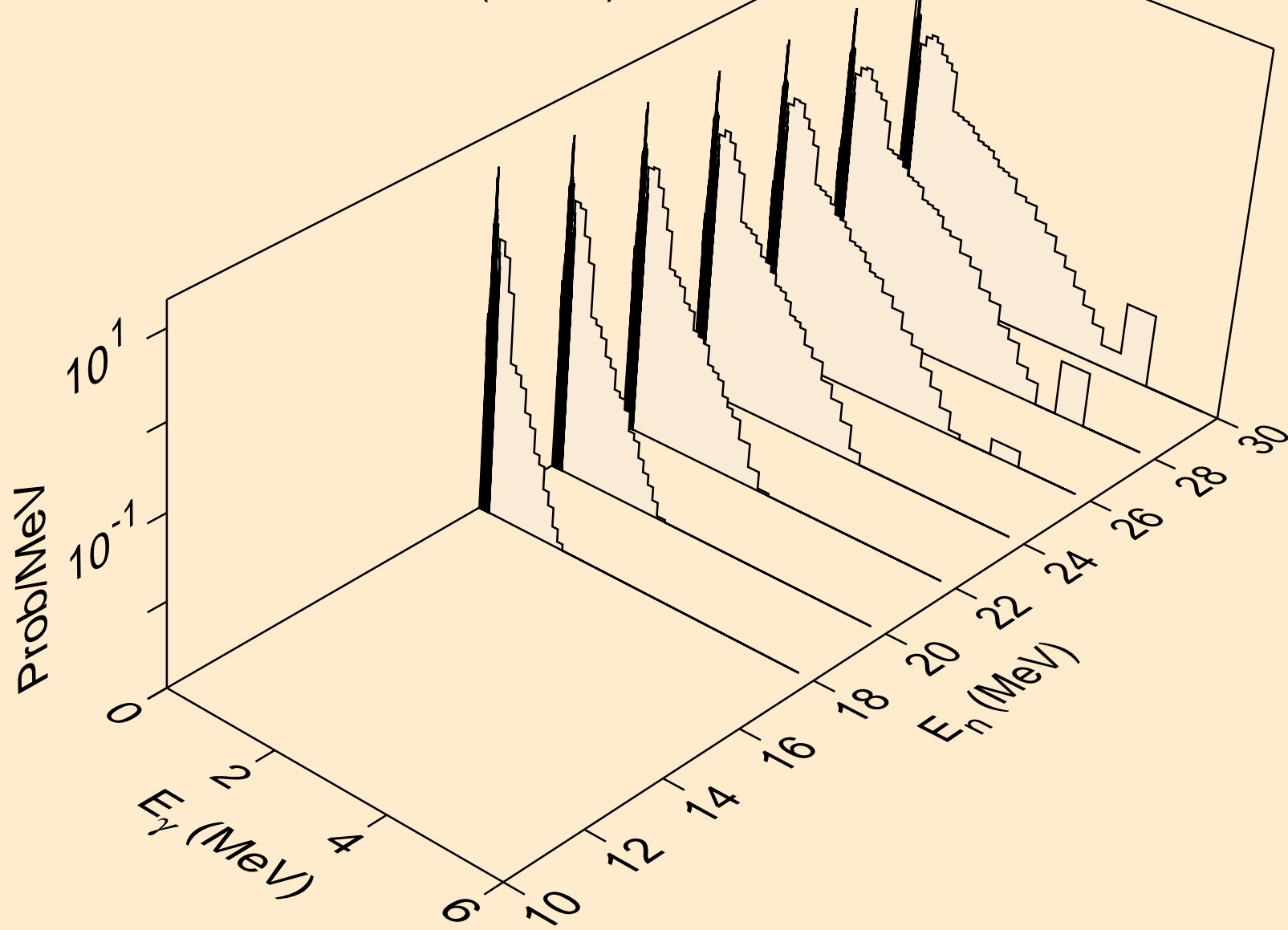

FR225 DEUTERON ACER TENDL-2021 LIBRARY; T=0.K
Photon emission for (n,2n)

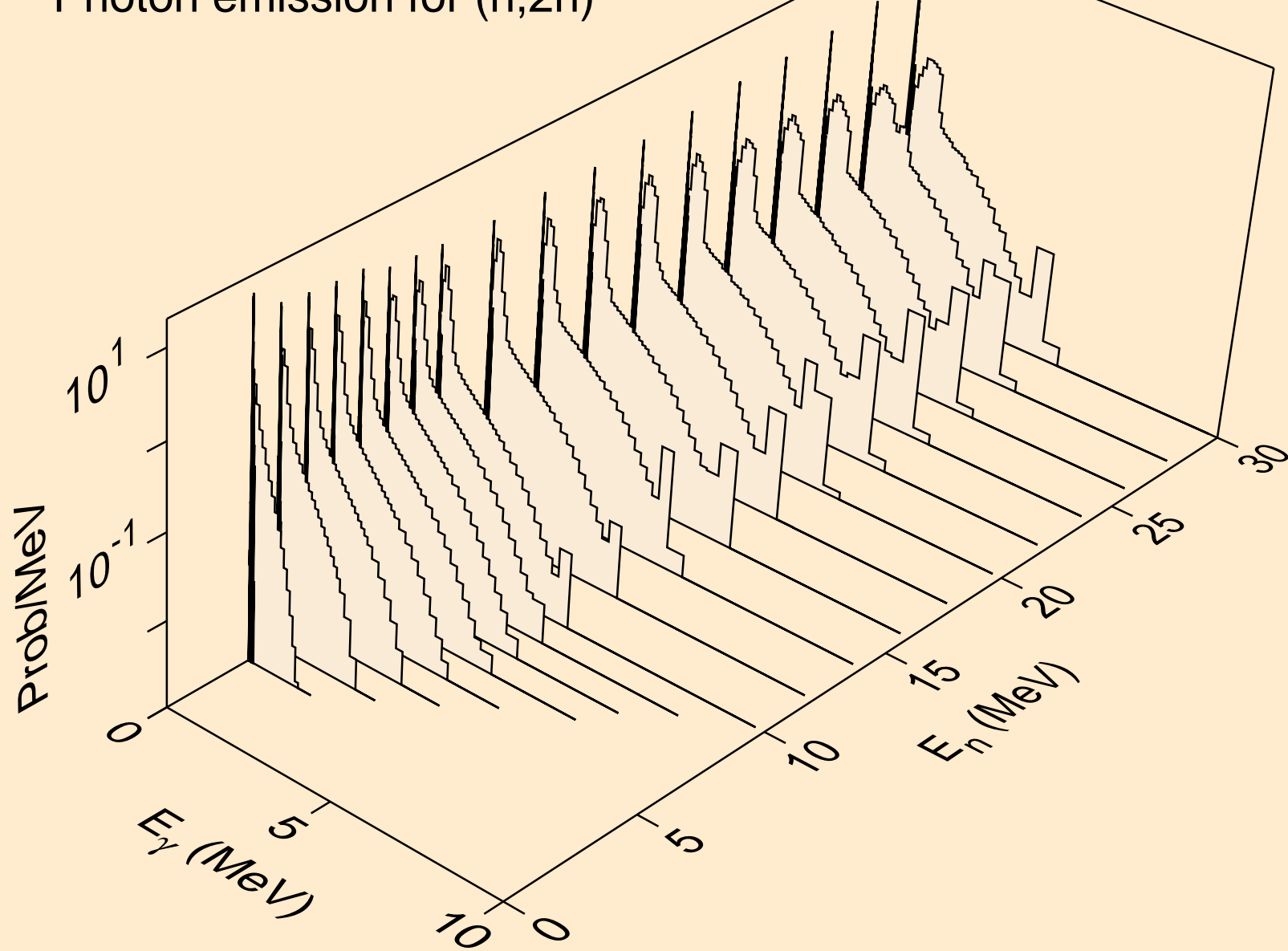

FR225 DEUTERON ACER TENDL-2021 LIBRARY; T=0.K
Photon emission for (n,3n)

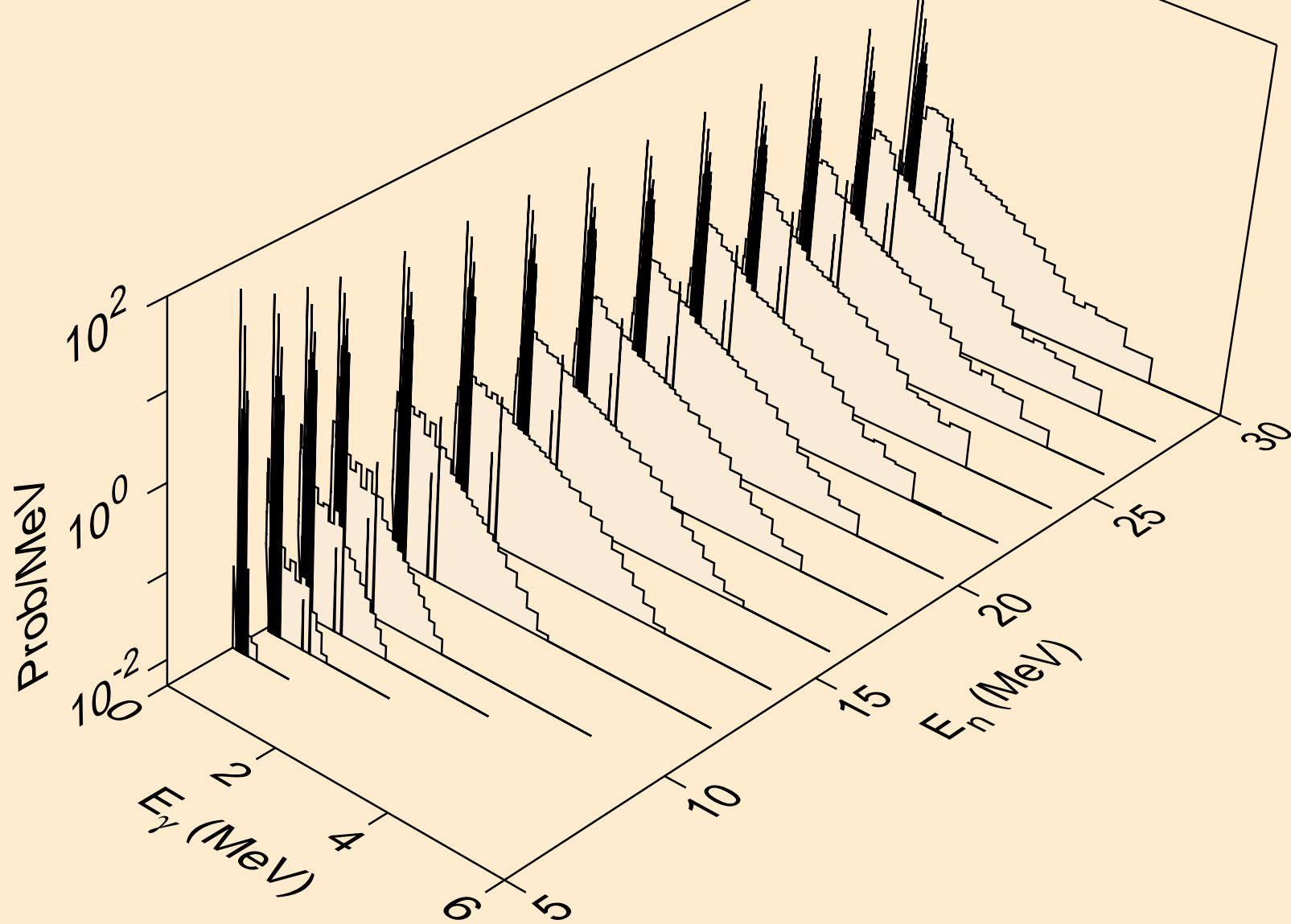

FR225 DEUTERON ACER TENDL-2021 LIBRARY; T=0.K
Photon emission for (n,n*)a

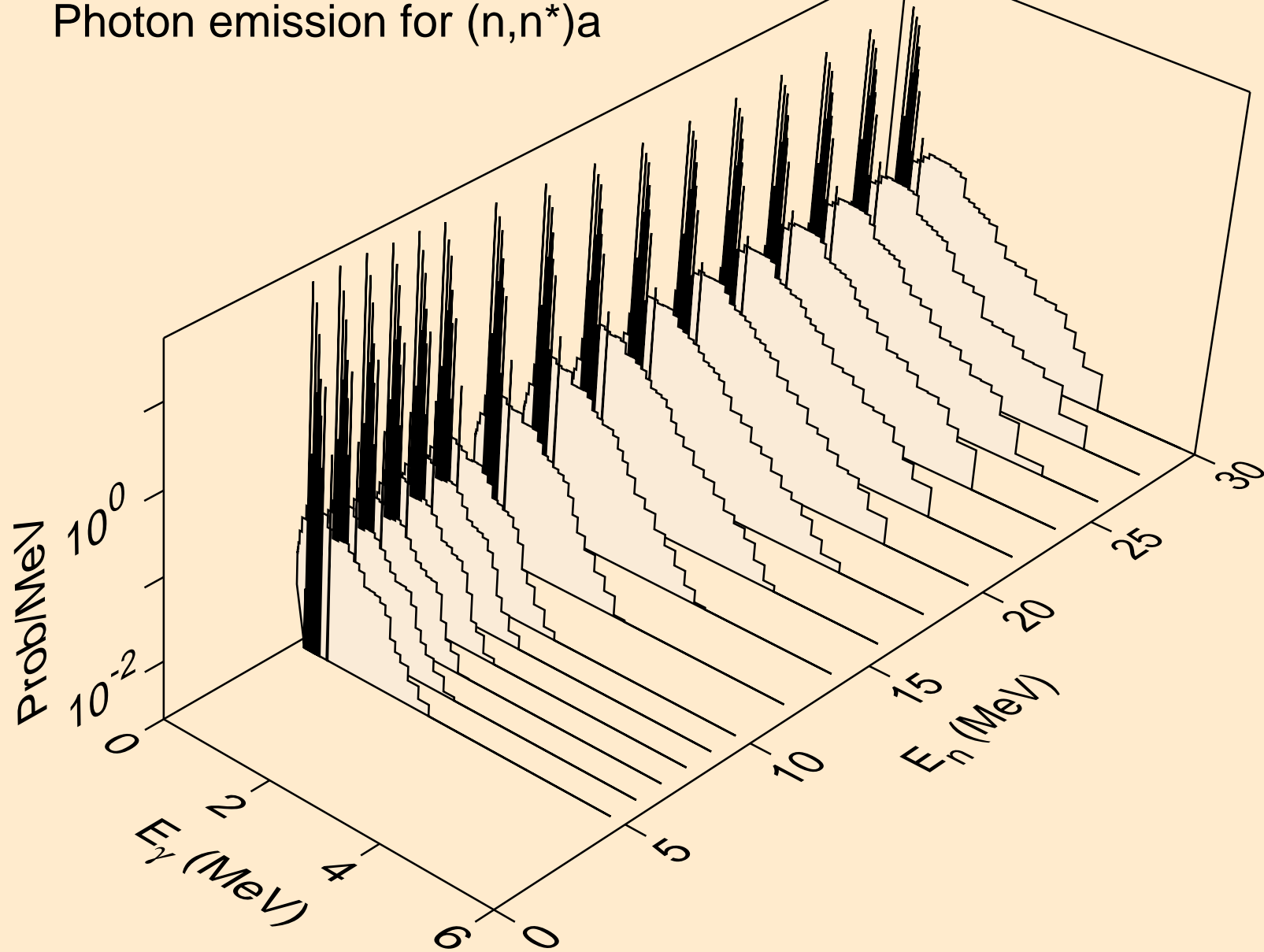

FR225 DEUTERON ACER TENDL-2021 LIBRARY; T=0.K
Photon emission for (n,2n) α

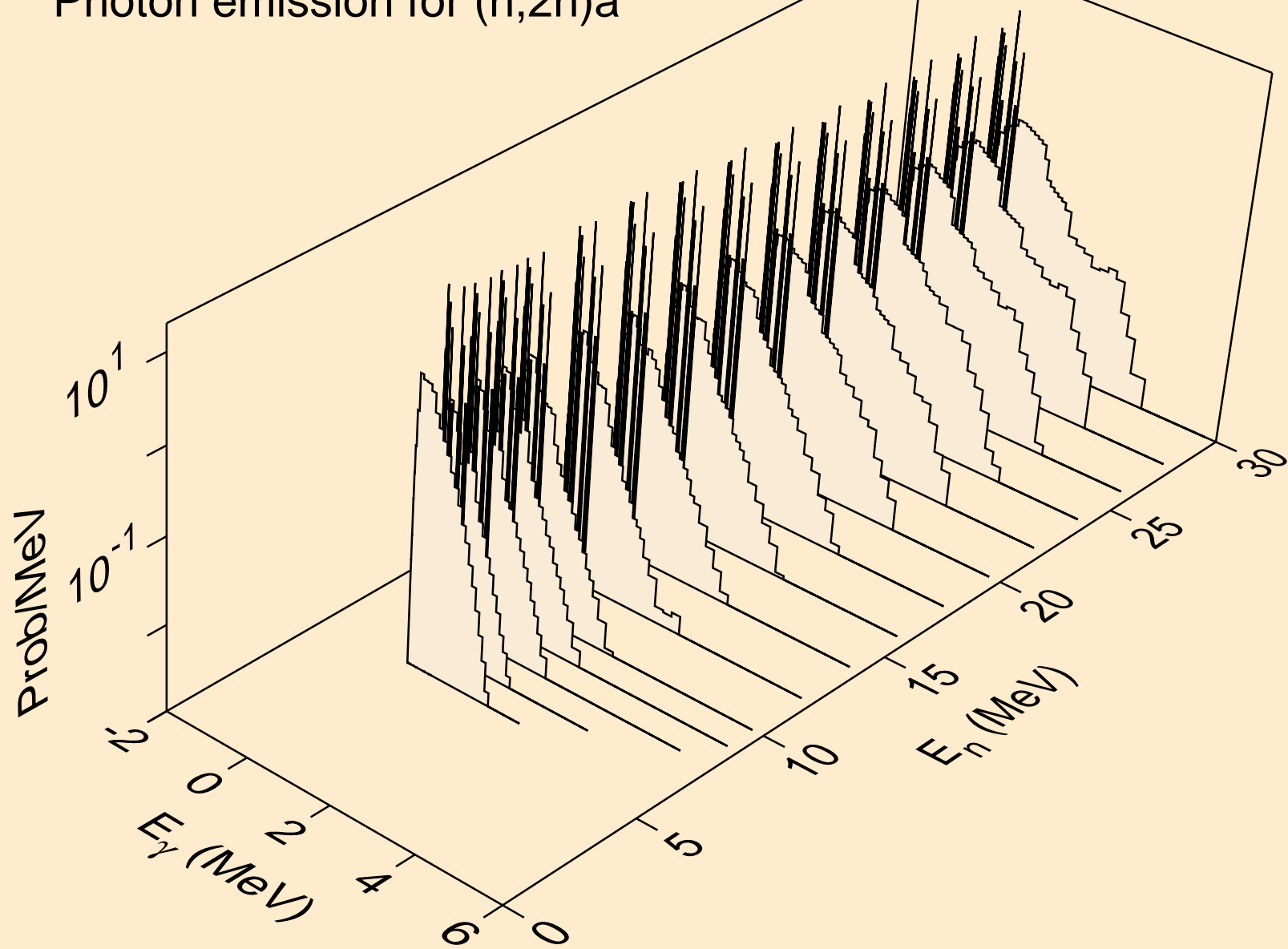

FR225 DEUTERON ACER TENDL-2021 LIBRARY; T=0.K
Photon emission for (n,3n)a

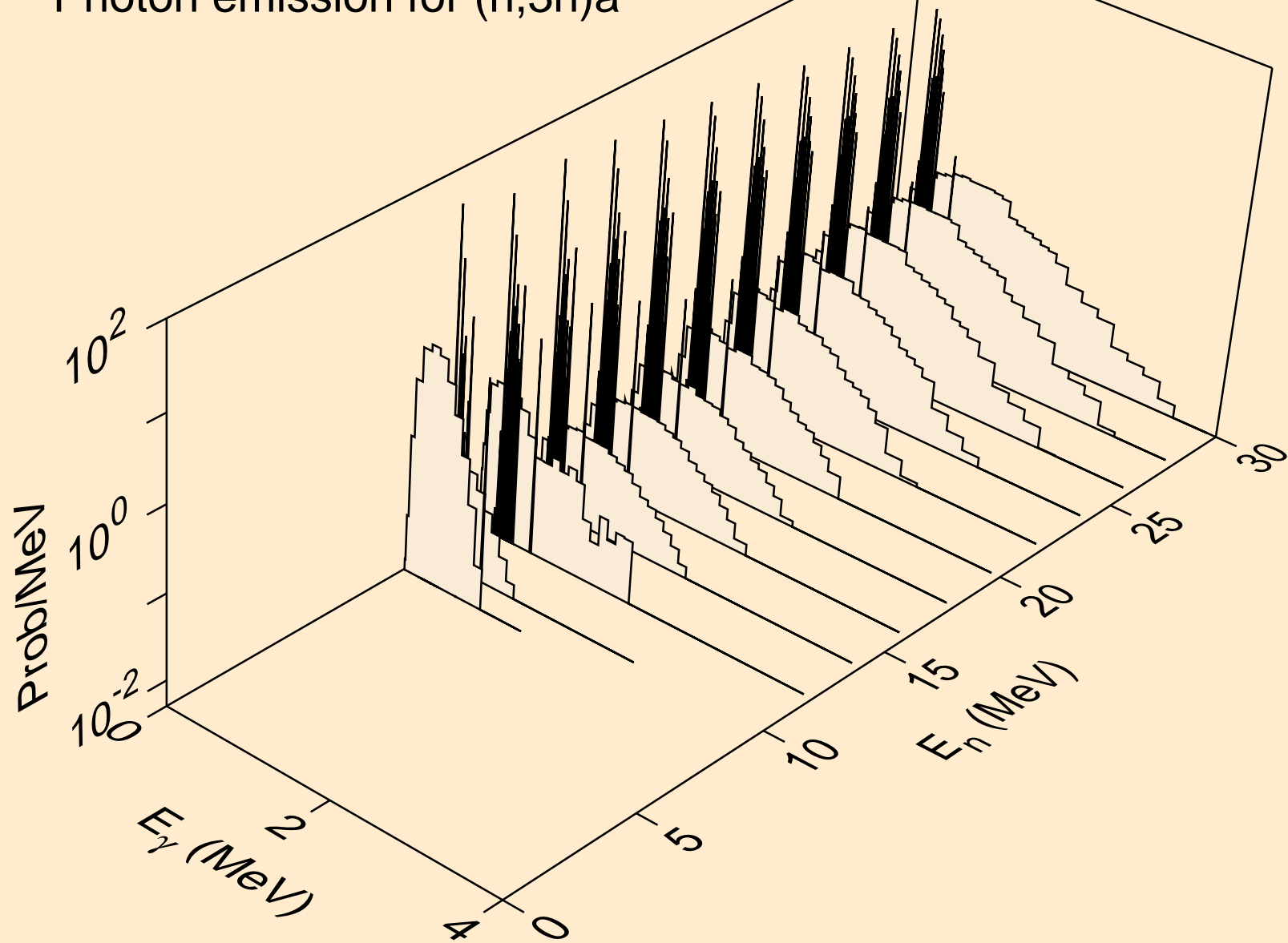

FR225 DEUTERON ACER TENDL-2021 LIBRARY; T=0.K
Photon emission for (n,n*)p

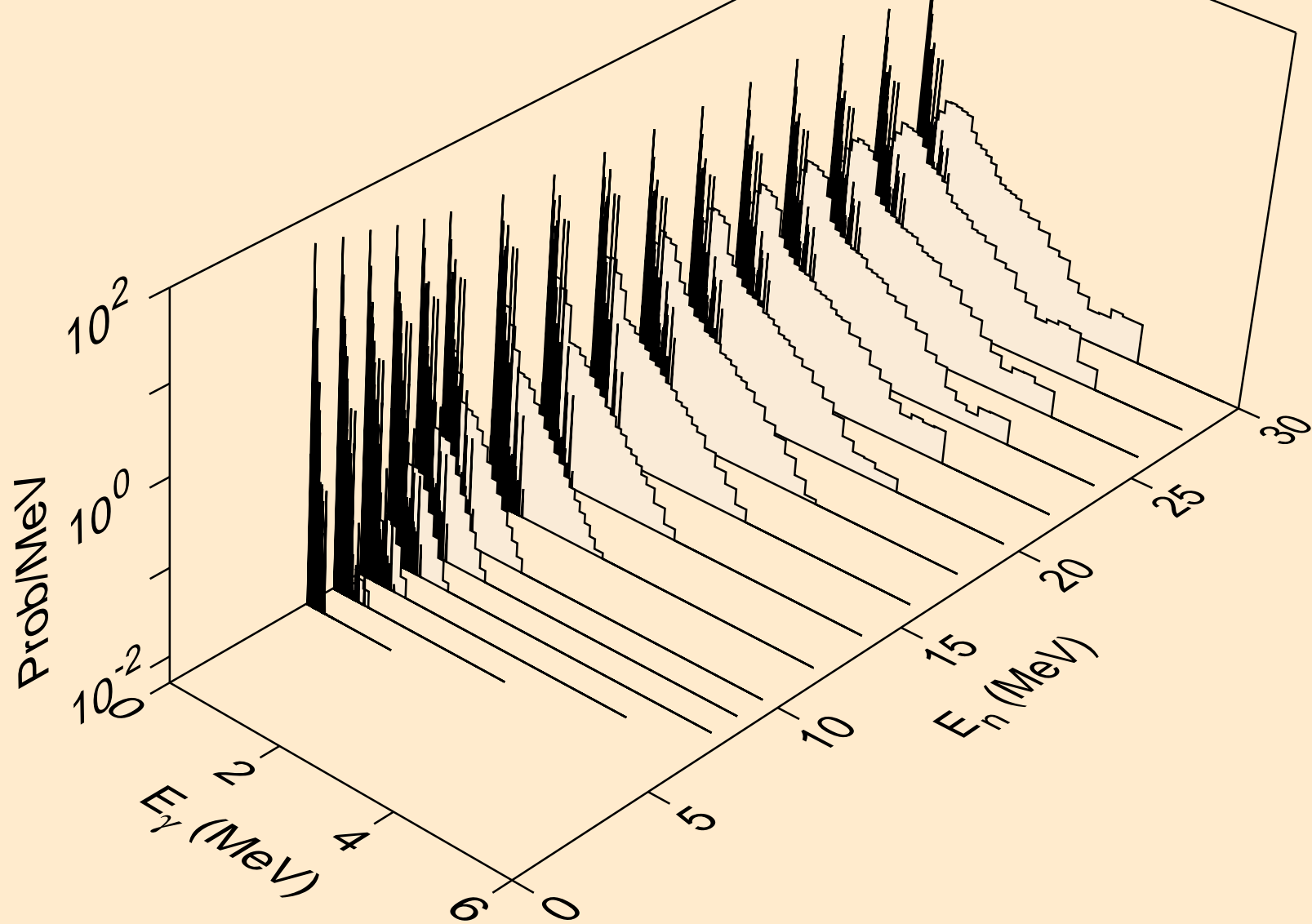

FR225 DEUTERON ACER TENDL-2021 LIBRARY; T=0.K
Photon emission for (n,n*)2a

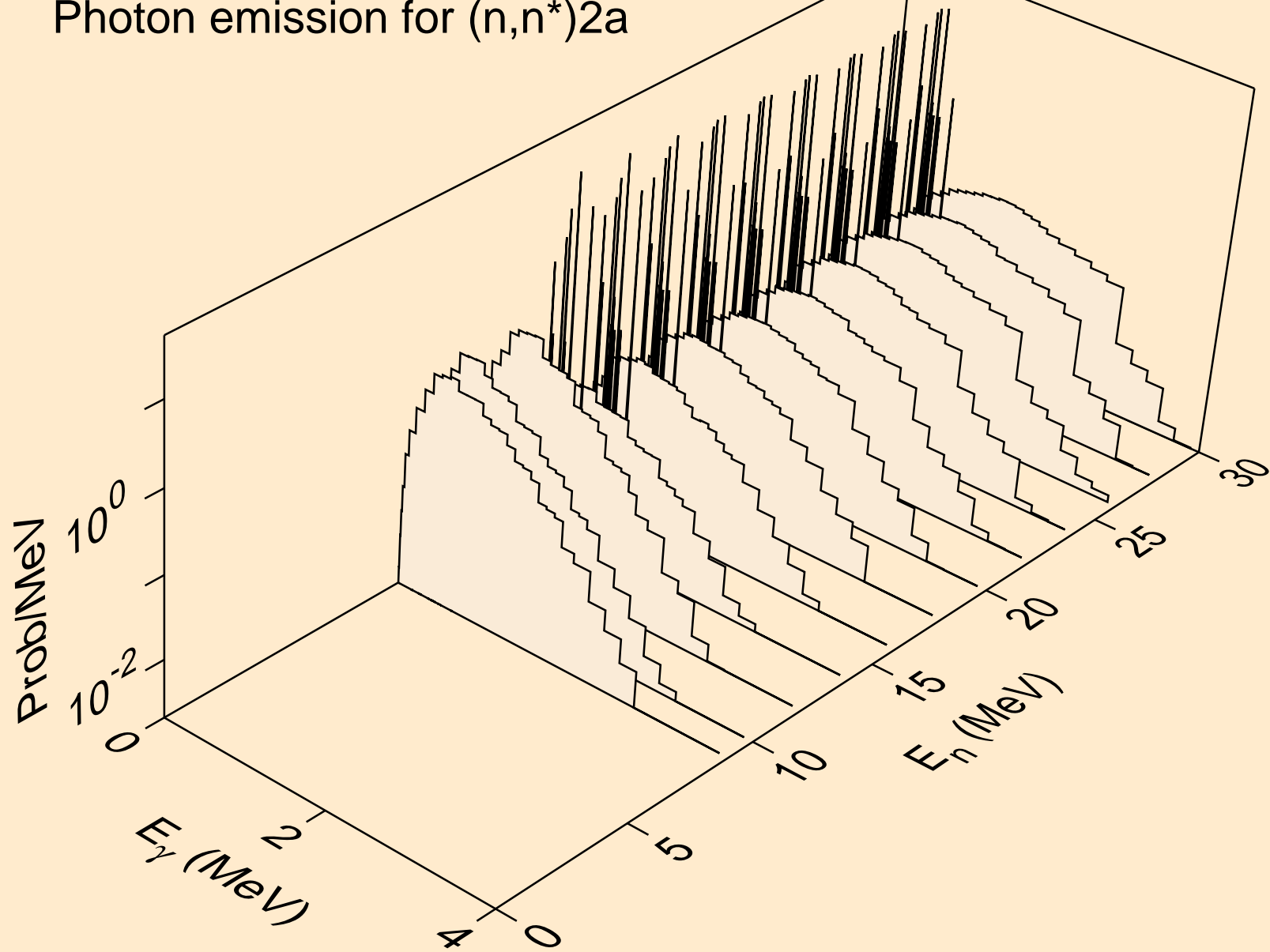

FR225 DEUTERON ACER TENDL-2021 LIBRARY; T=0.K
Photon emission for (n,2n)2a

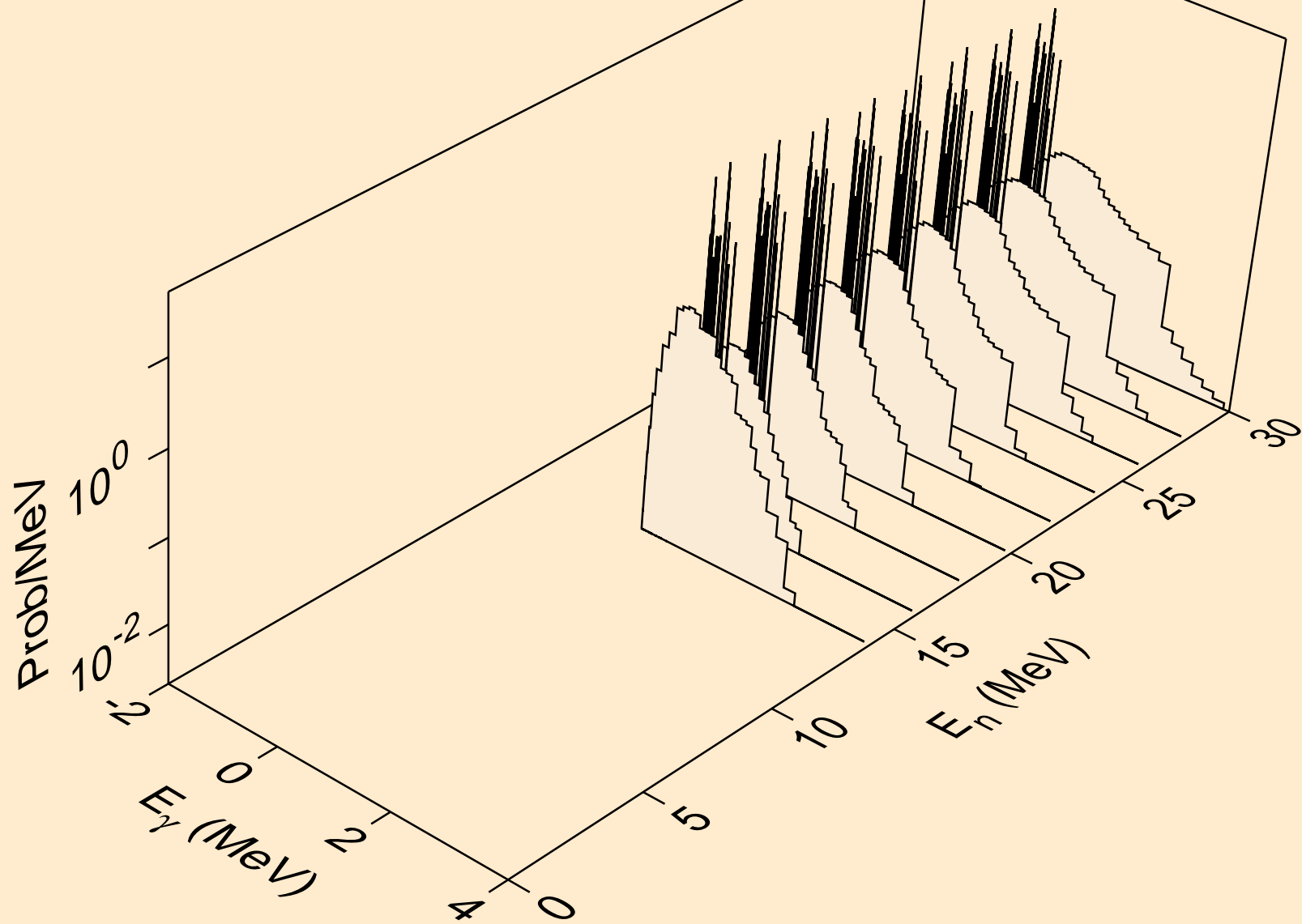

FR225 DEUTERON ACER TENDL-2021 LIBRARY; T=0.K
Photon emission for (n,n*)d

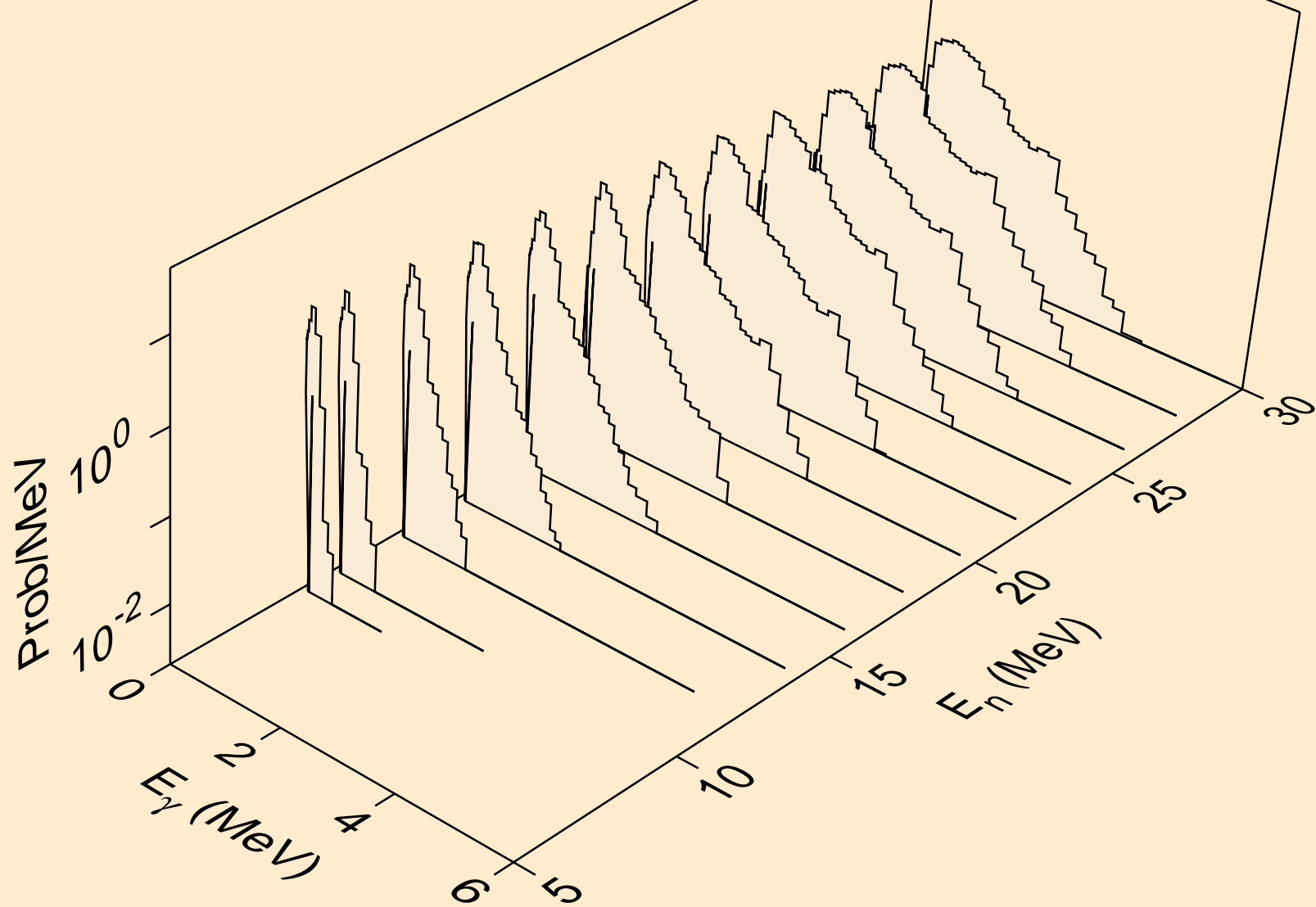

FR225 DEUTERON ACER TENDL-2021 LIBRARY; T=0.K
Photon emission for (n,n*)t

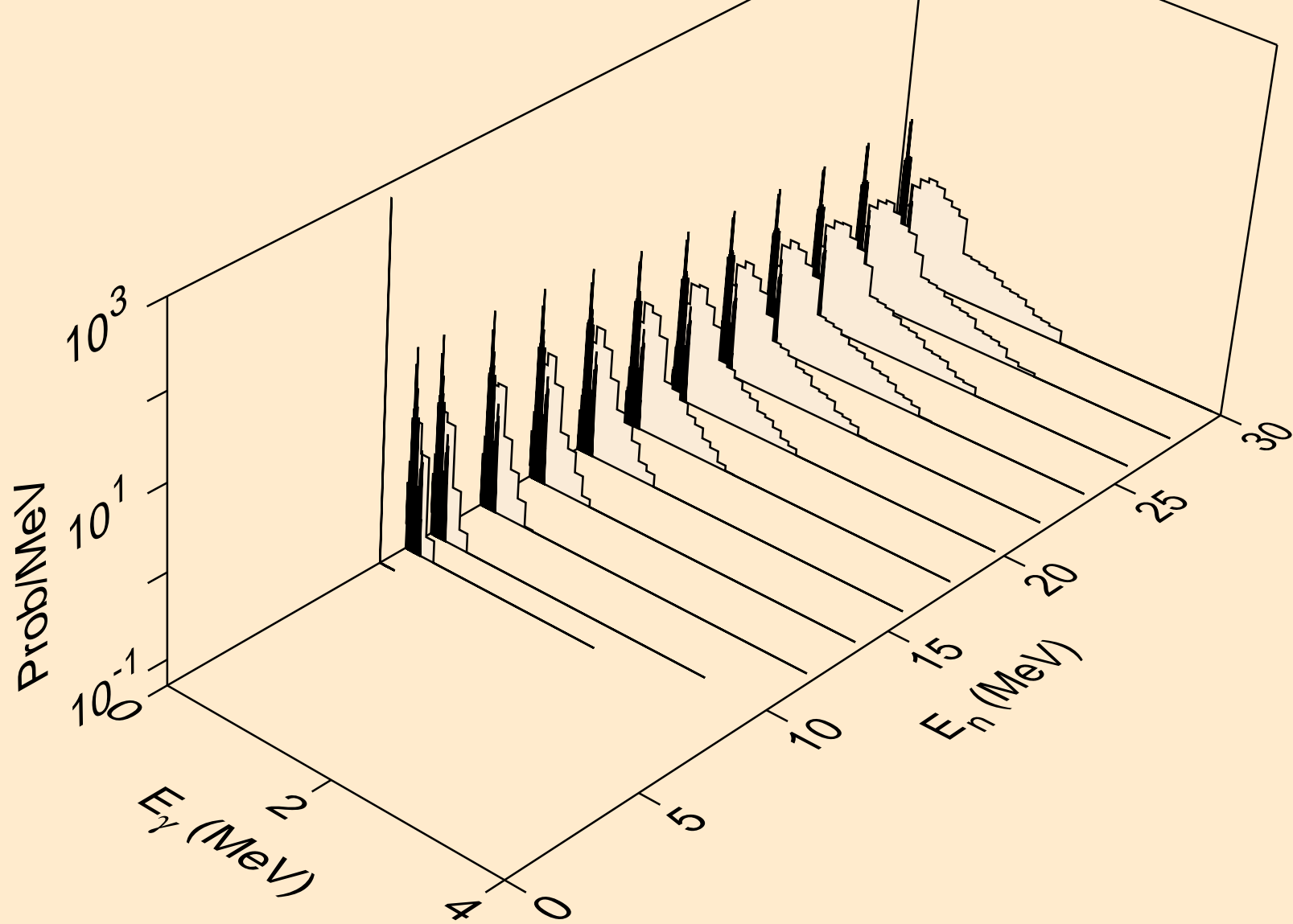

FR225 DEUTERON ACER TENDL-2021 LIBRARY; T=0.K
Photon emission for (n,n*)he3

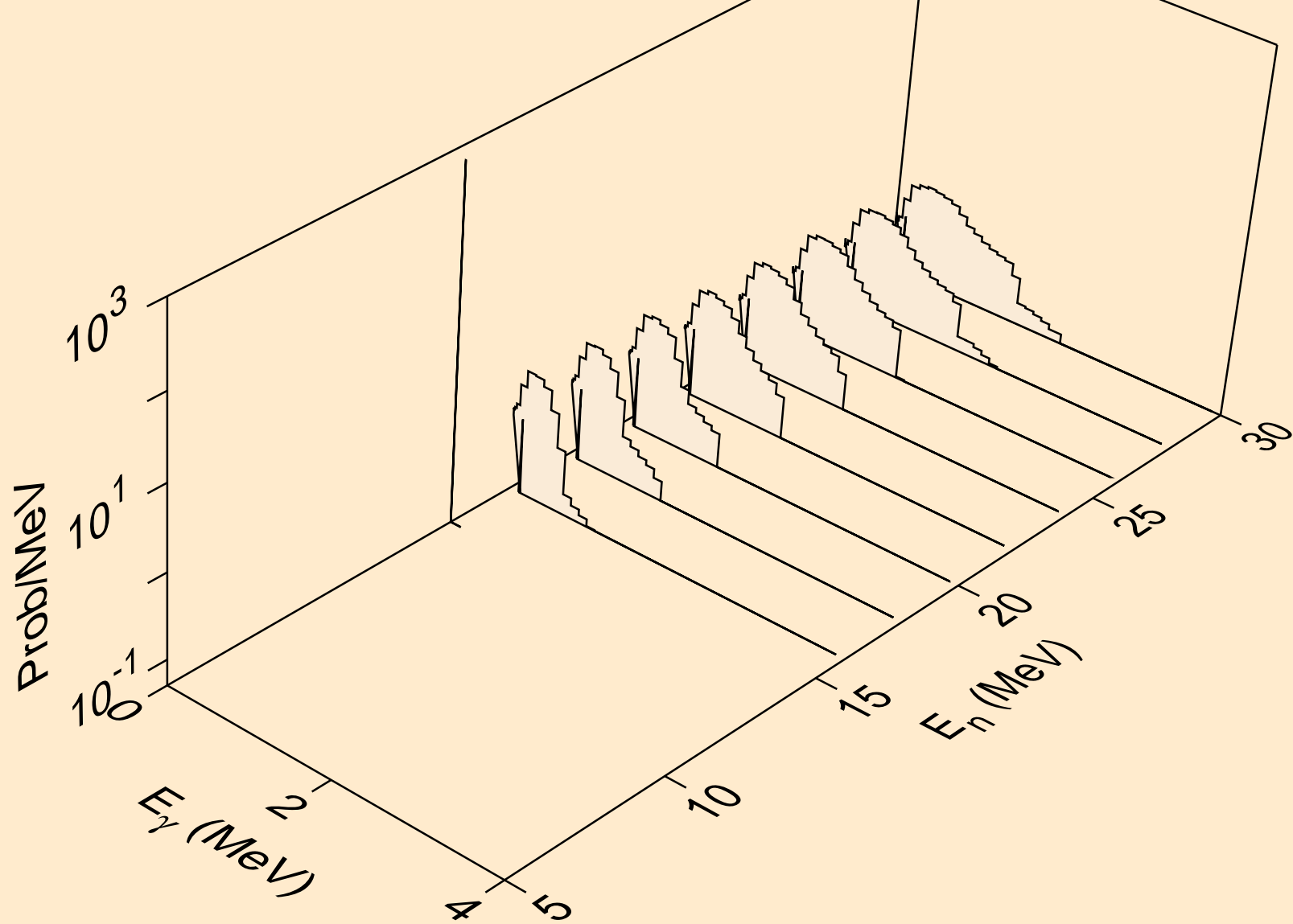

FR225 DEUTERON ACER TENDL-2021 LIBRARY; T=0.K
Photon emission for (n,4n)

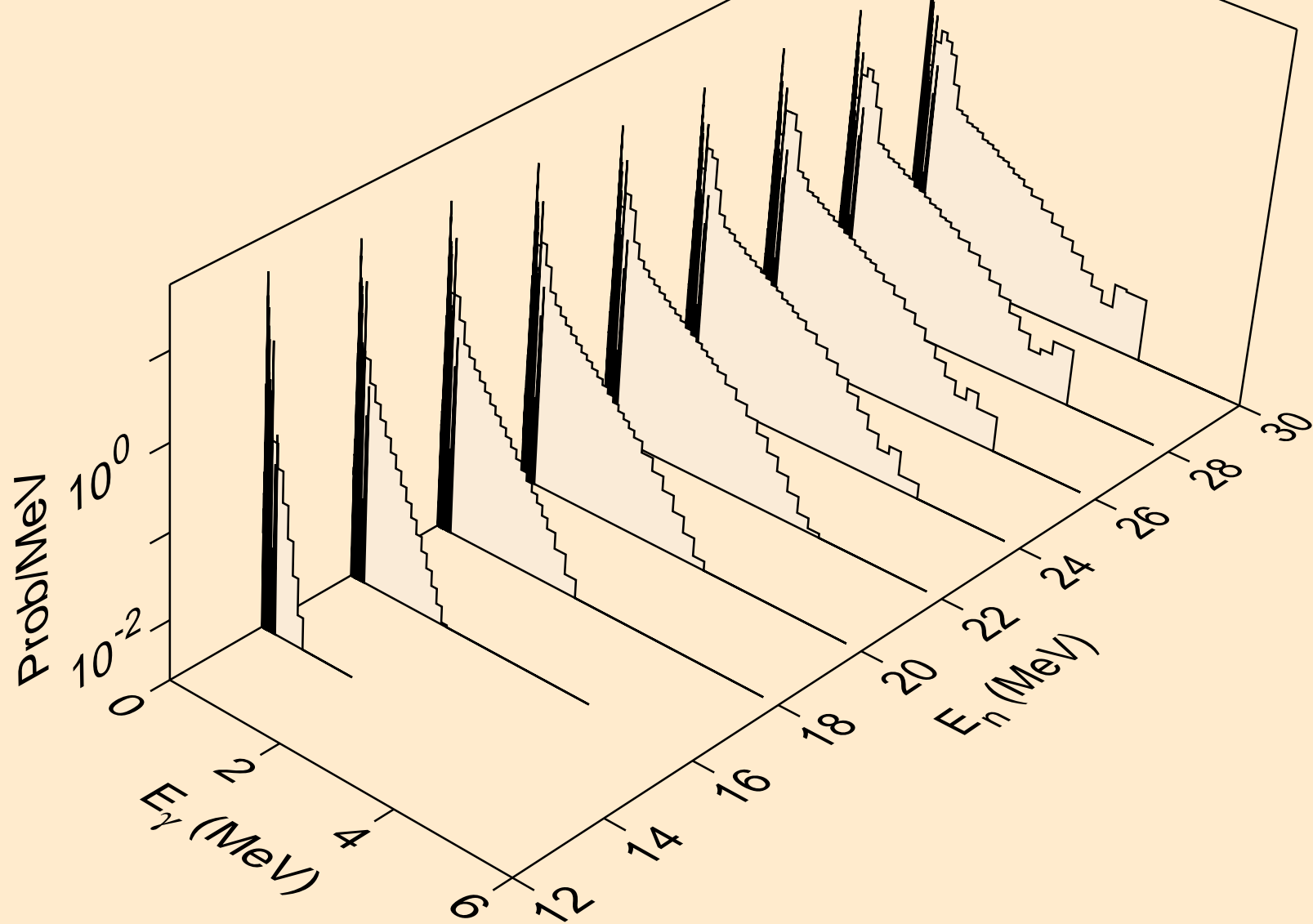

FR225 DEUTERON ACER TENDL-2021 LIBRARY; T=0.K
Photon emission for (n,2np)

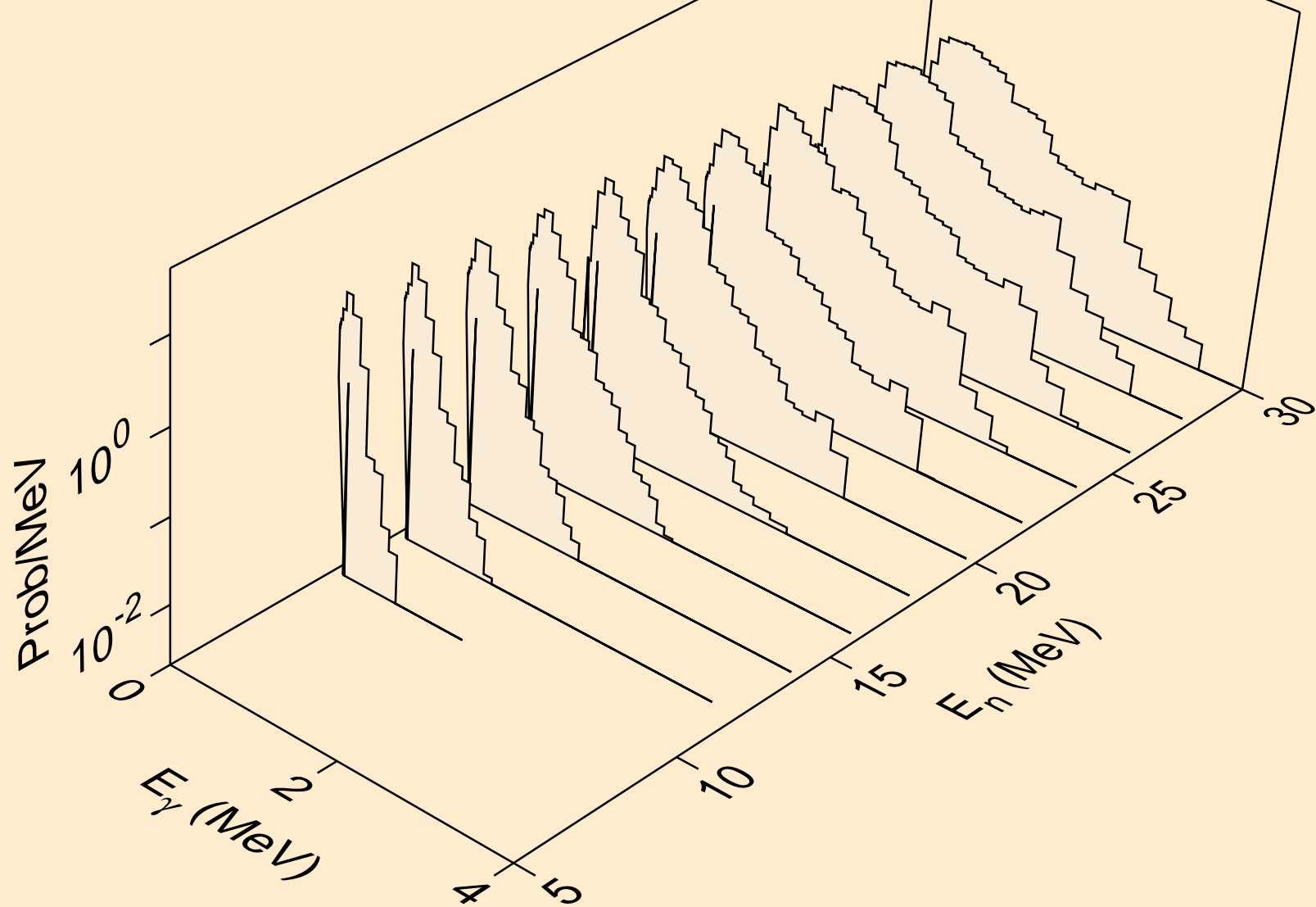

FR225 DEUTERON ACER TENDL-2021 LIBRARY; T=0.K
Photon emission for (n,3np)

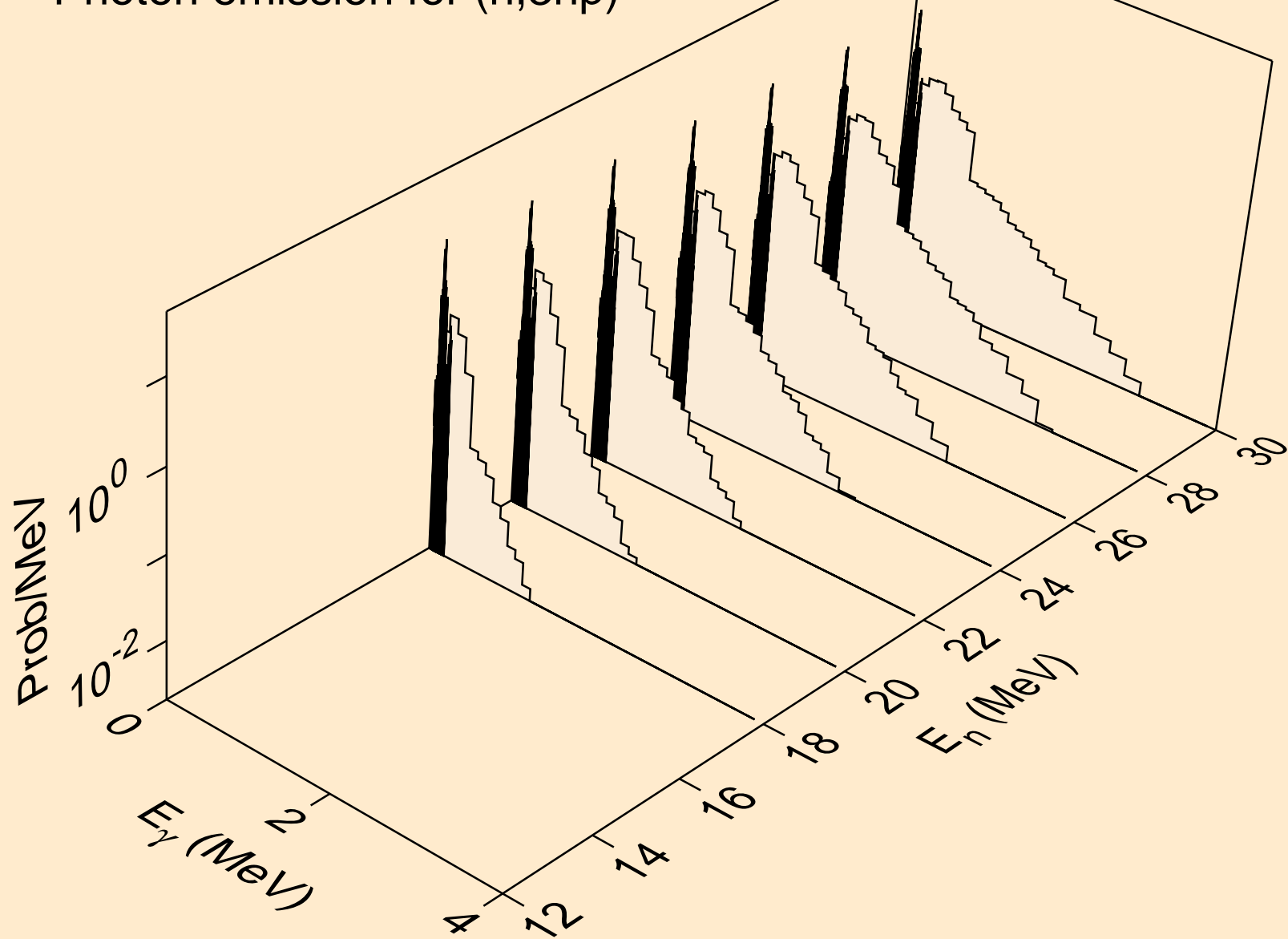

FR225 DEUTERON ACER TENDL-2021 LIBRARY; T=0.K
Photon emission for (n,2np)

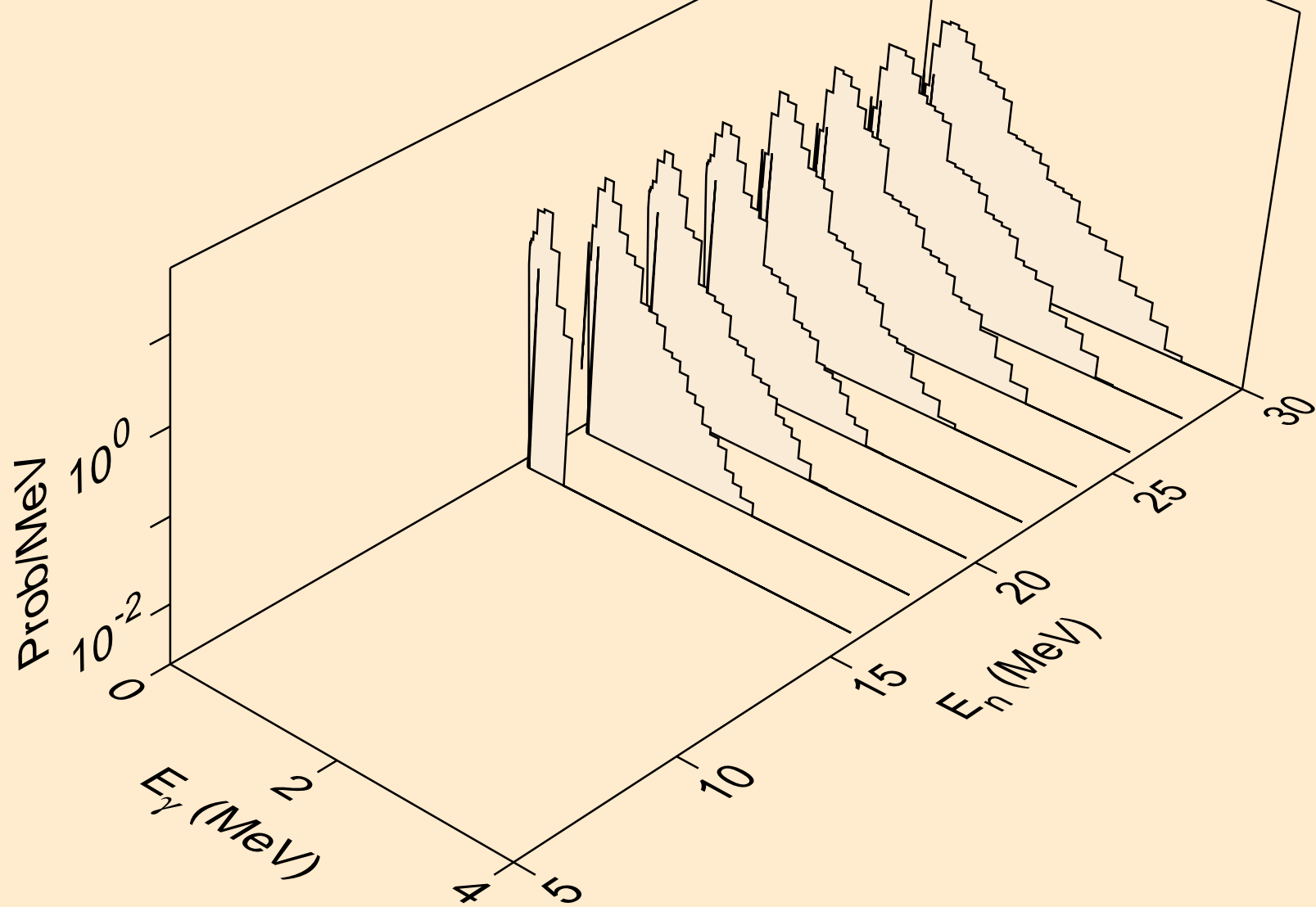

FR225 DEUTERON ACER TENDL-2021 LIBRARY; T=0.K
Photon emission for (n,npa)

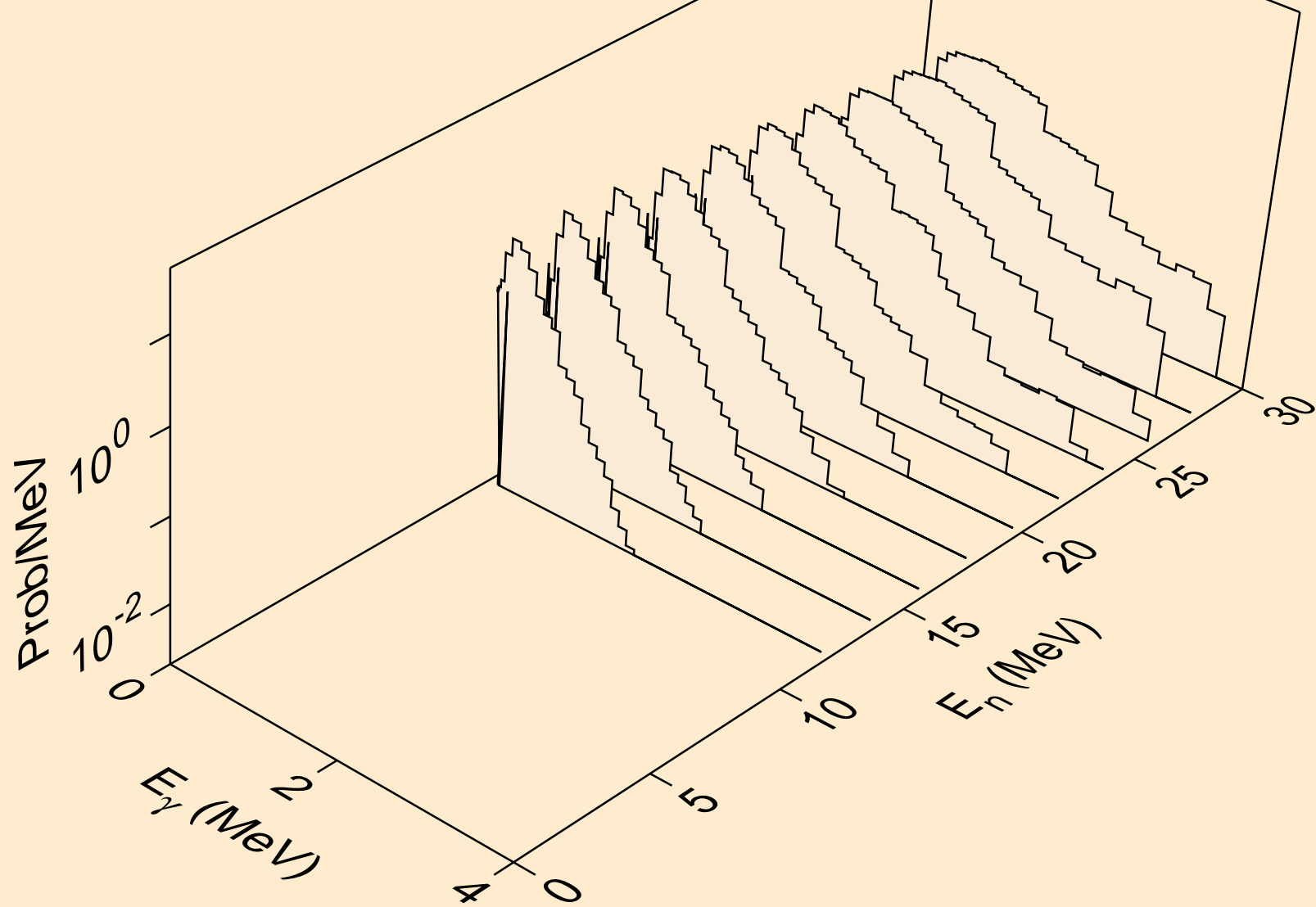

FR225 DEUTERON ACER TENDL-2021 LIBRARY; T=0.K
Photon emission for (n,gma)

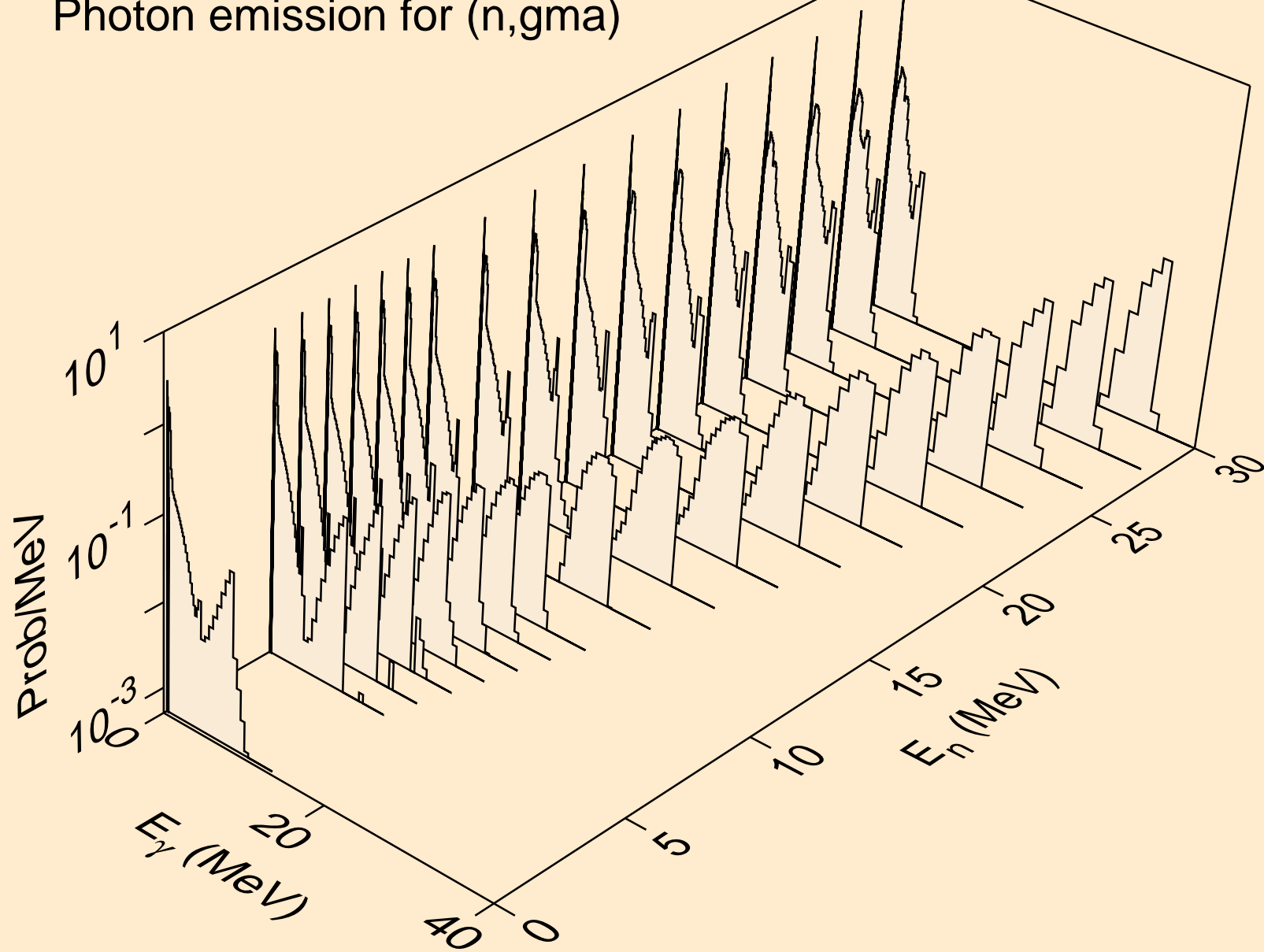

FR225 DEUTERON ACER TENDL-2021 LIBRARY; T=0.K
Photon emission for (n,p)

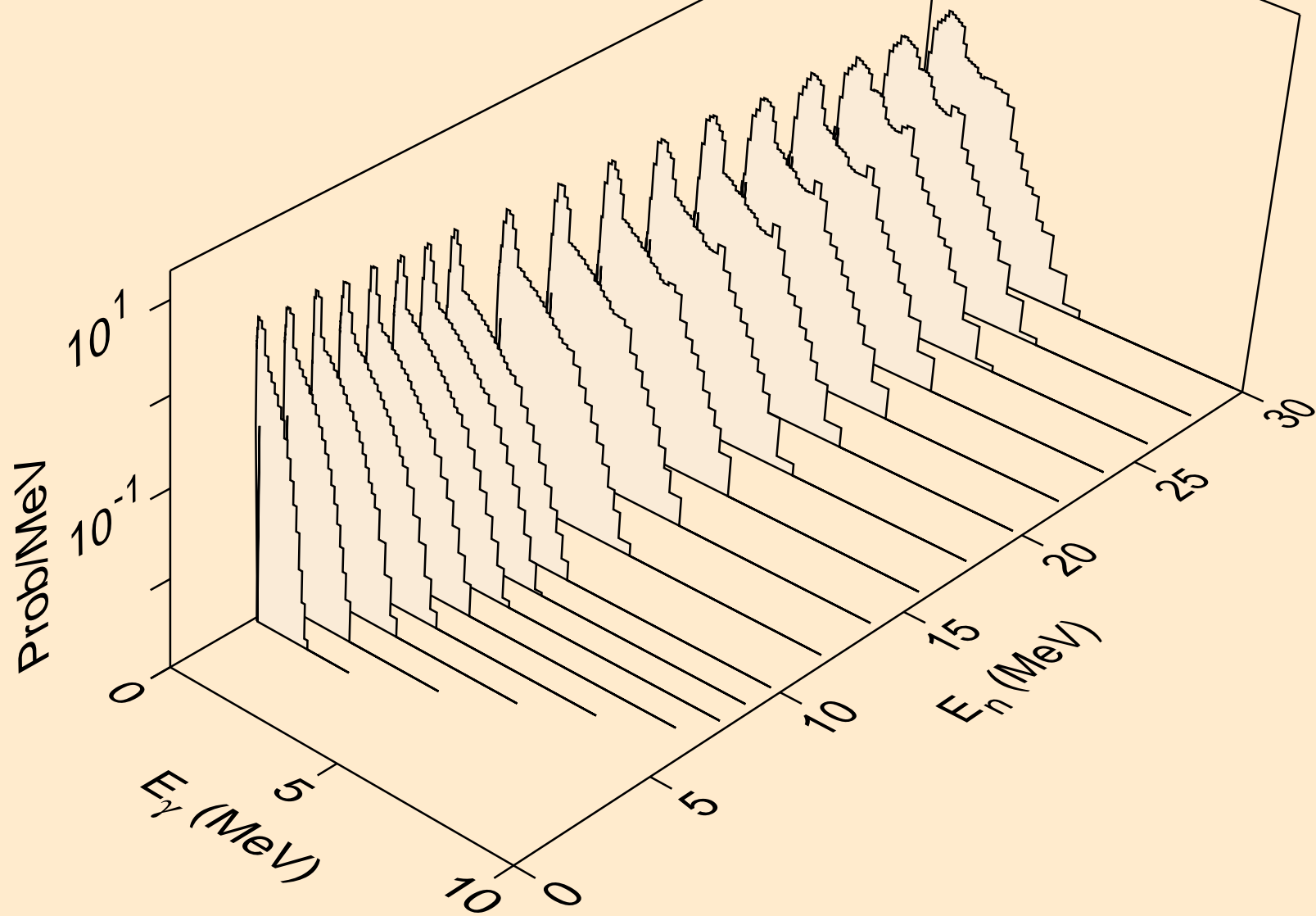

FR225 DEUTERON ACER TENDL-2021 LIBRARY; T=0.K
Photon emission for inelastic

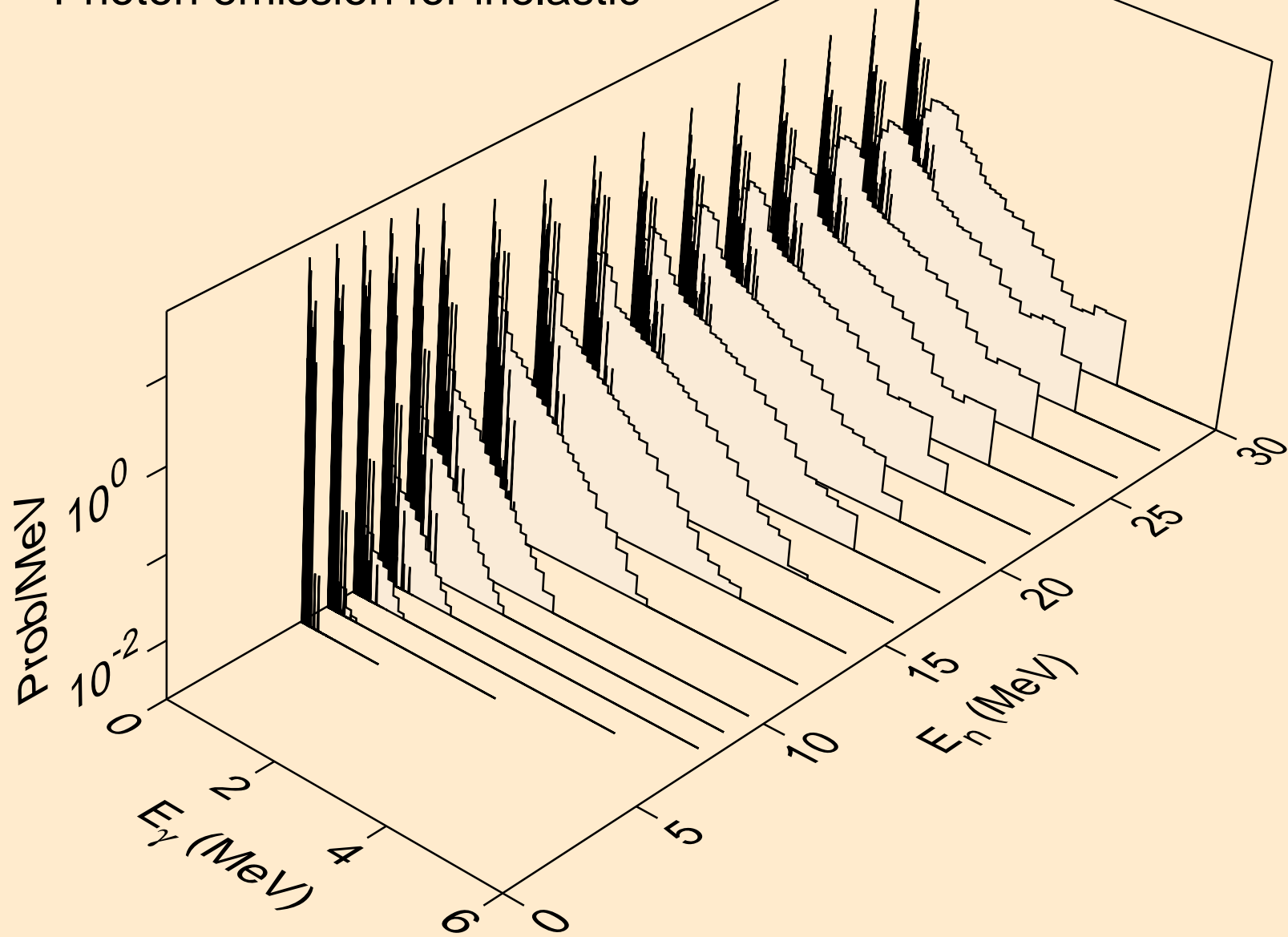

FR225 DEUTERON ACER TENDL-2021 LIBRARY; T=0.K
Photon emission for (n,t)

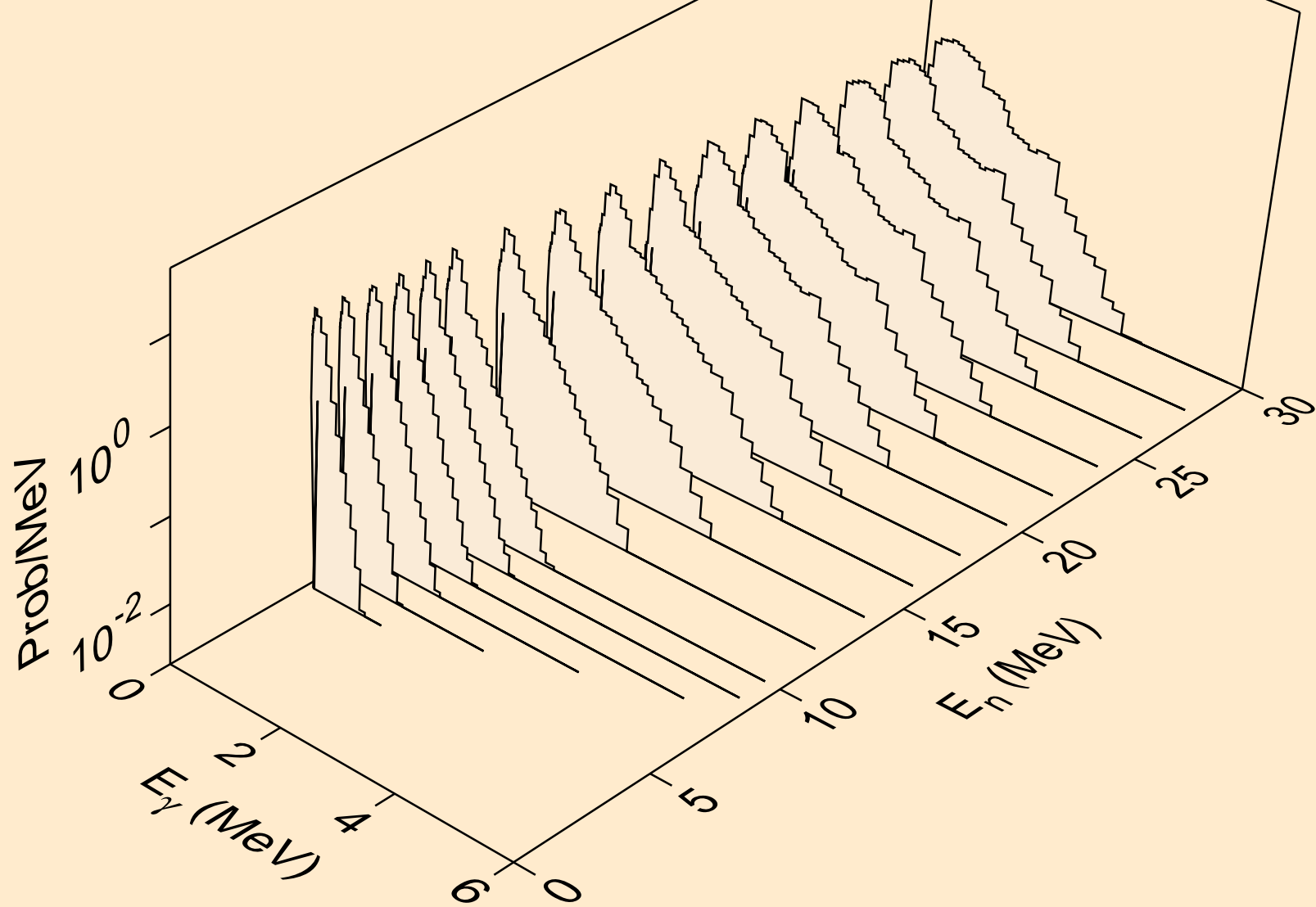

FR225 DEUTERON ACER TENDL-2021 LIBRARY; T=0.K
Photon emission for (n,he3)

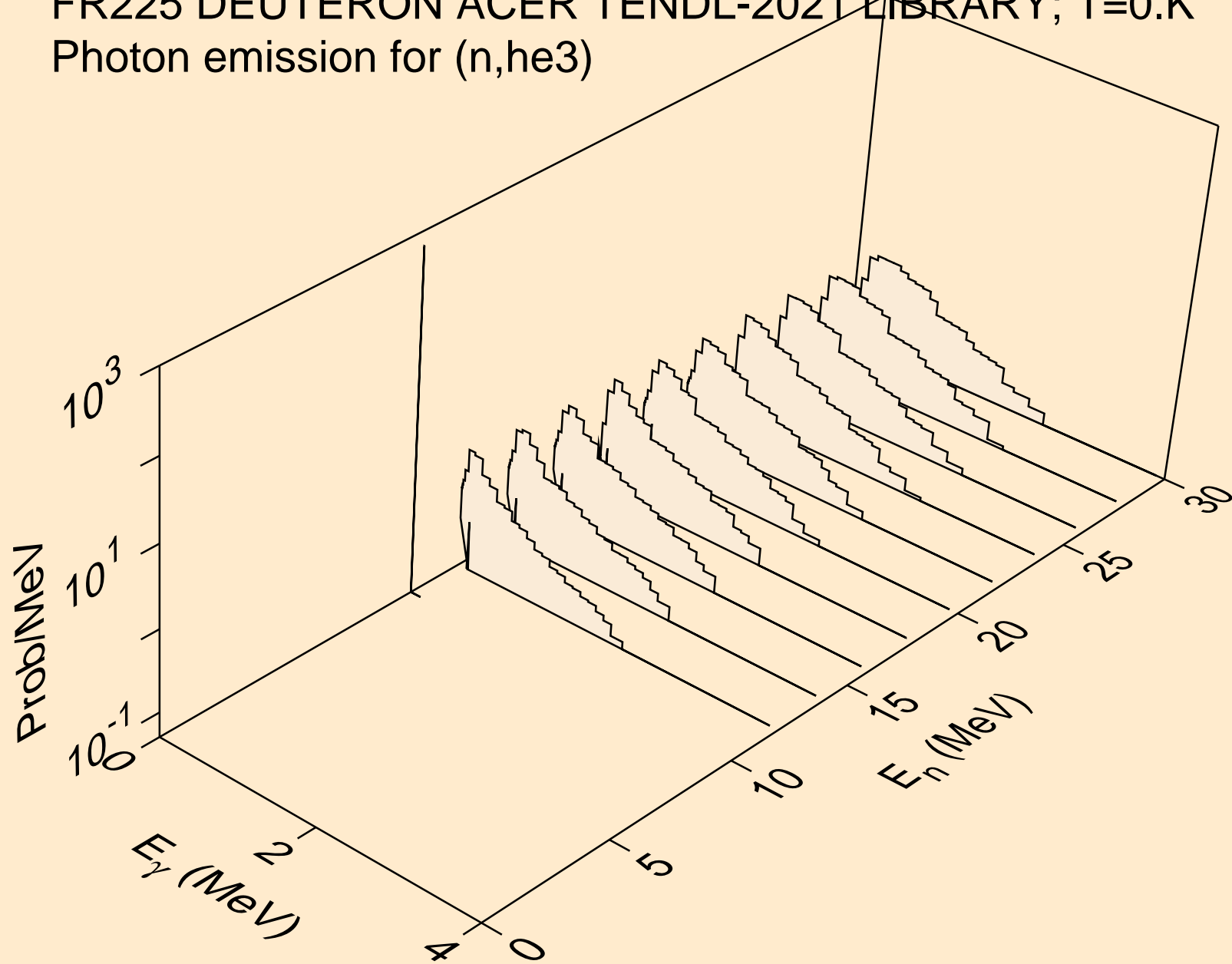

FR225 DEUTERON ACER TENDL-2021 LIBRARY; T=0.K
Photon emission for (n,a)

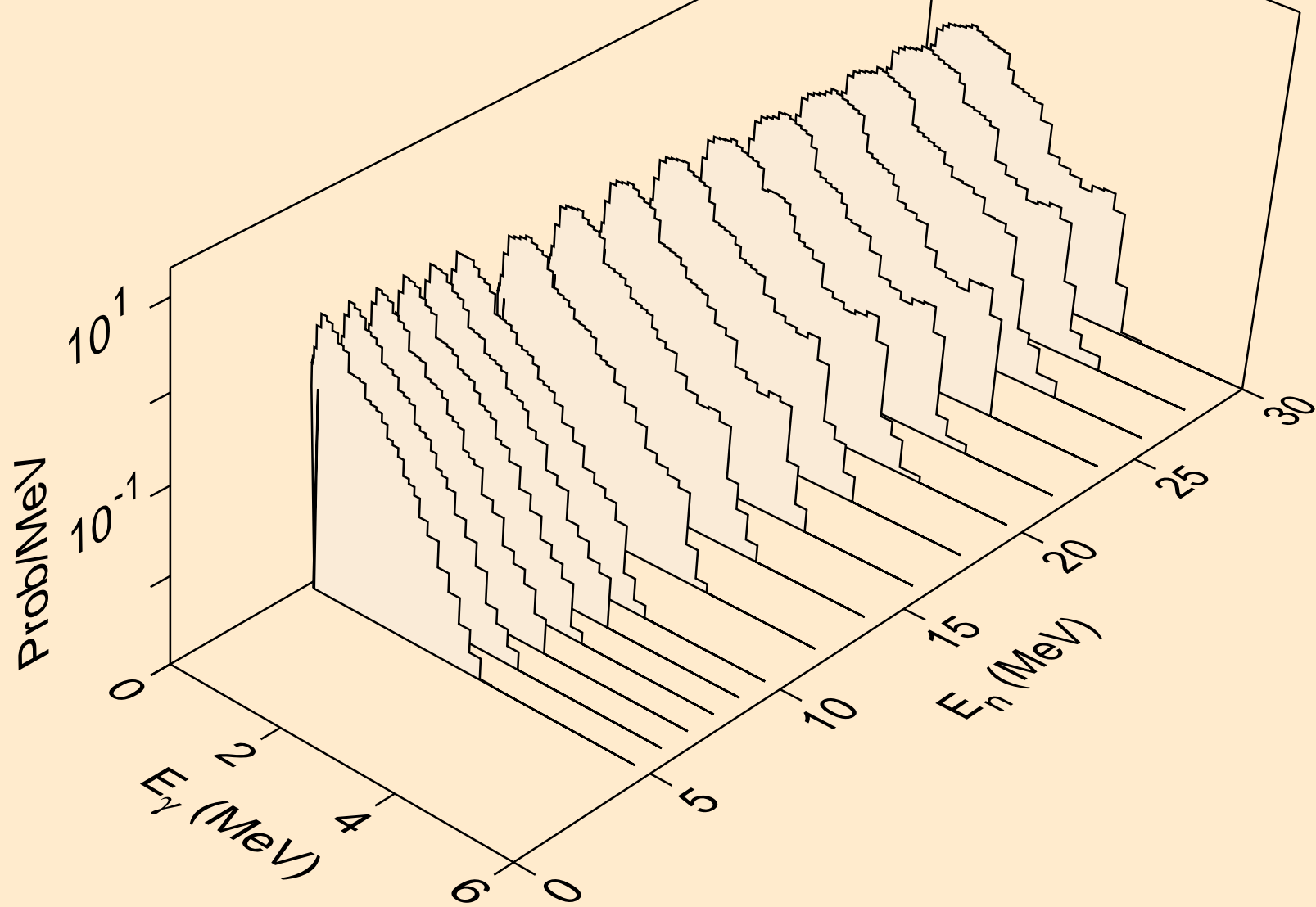

FR225 DEUTERON ACER TENDL-2021 LIBRARY; T=0.K
Photon emission for (n,2a)

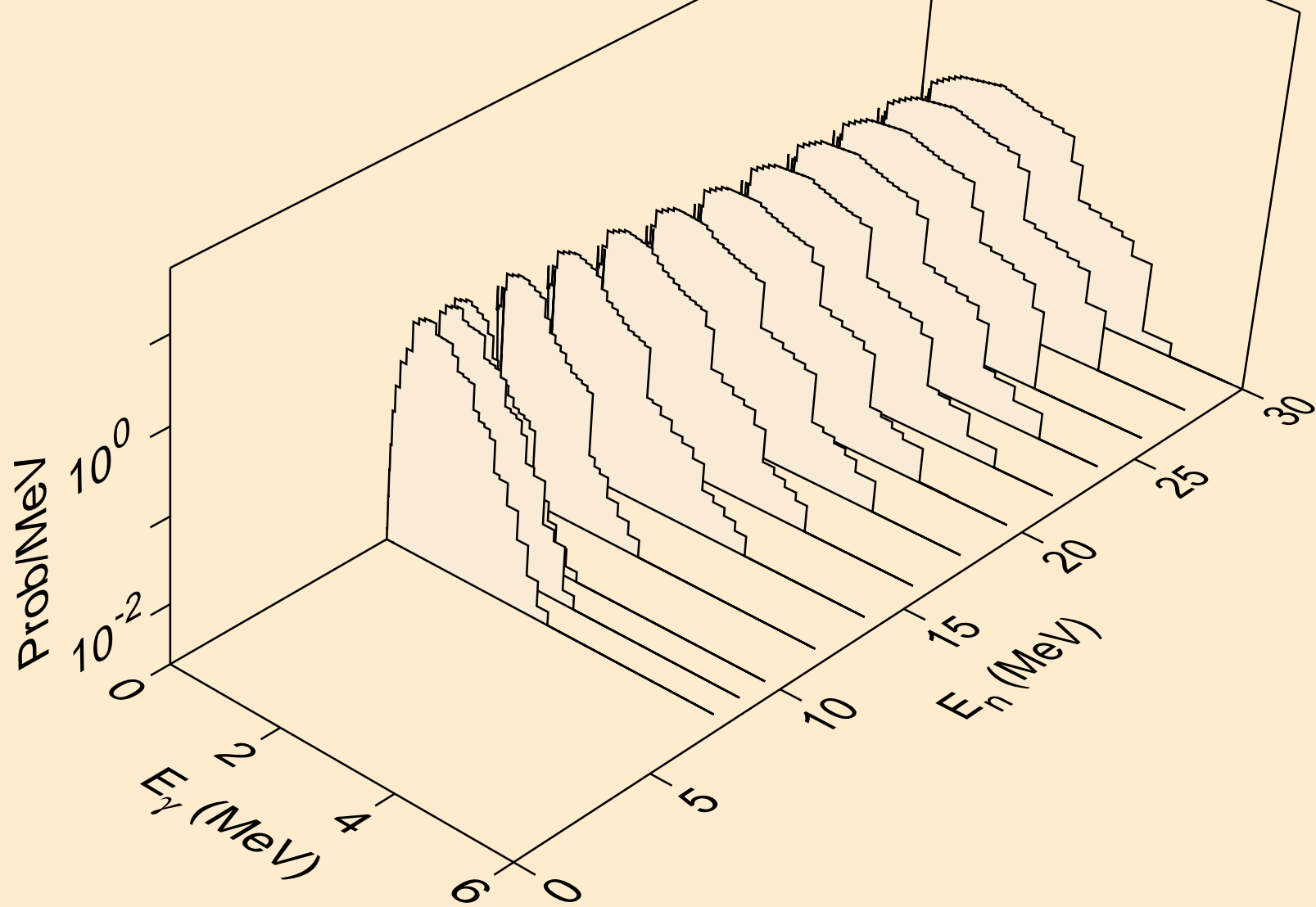

FR225 DEUTERON ACER TENDL-2021 LIBRARY; T=0.K
Photon emission for (n,2p)

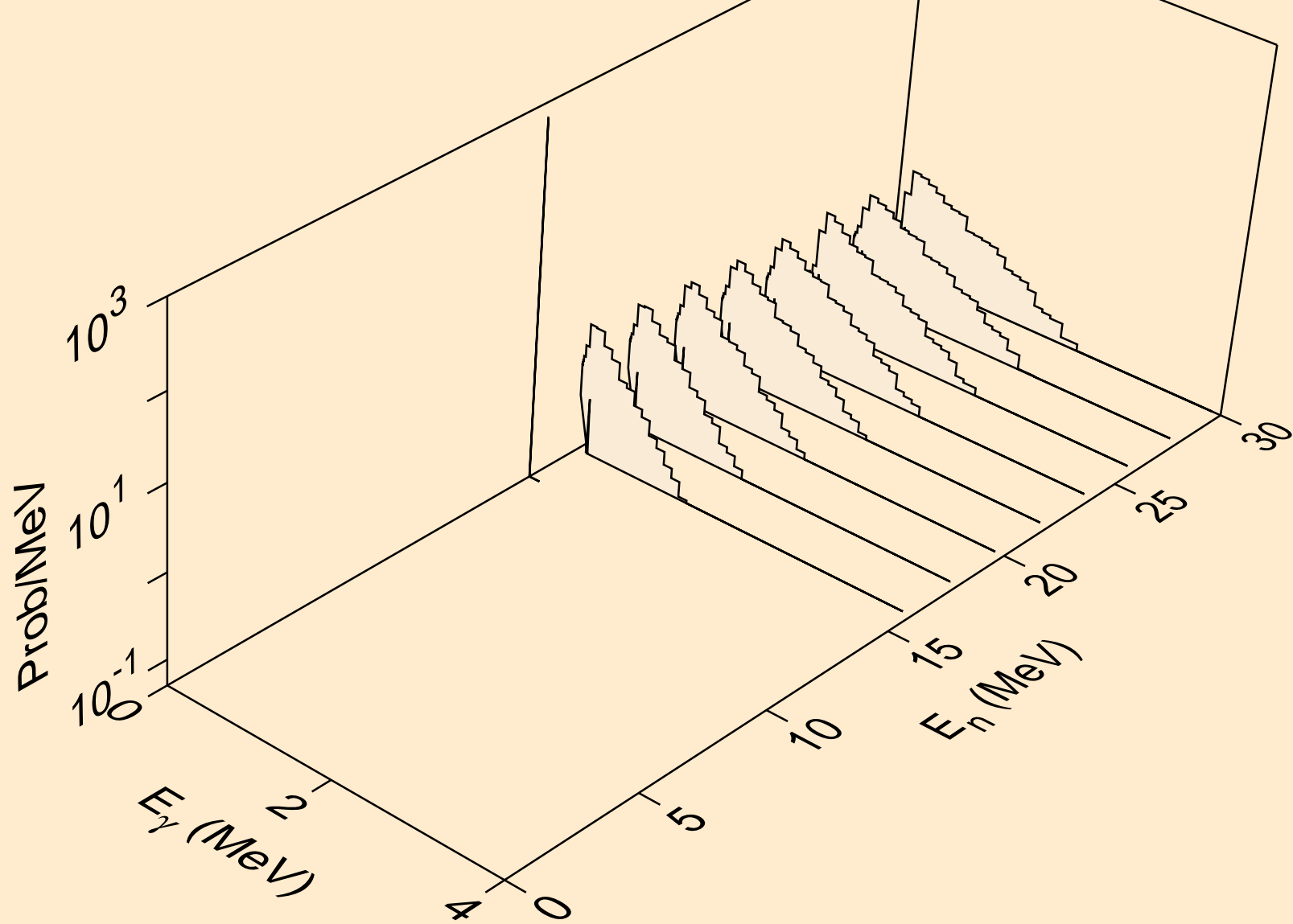

FR225 DEUTERON ACER TENDL-2021 LIBRARY; T=0.K
Photon emission for (n,p)

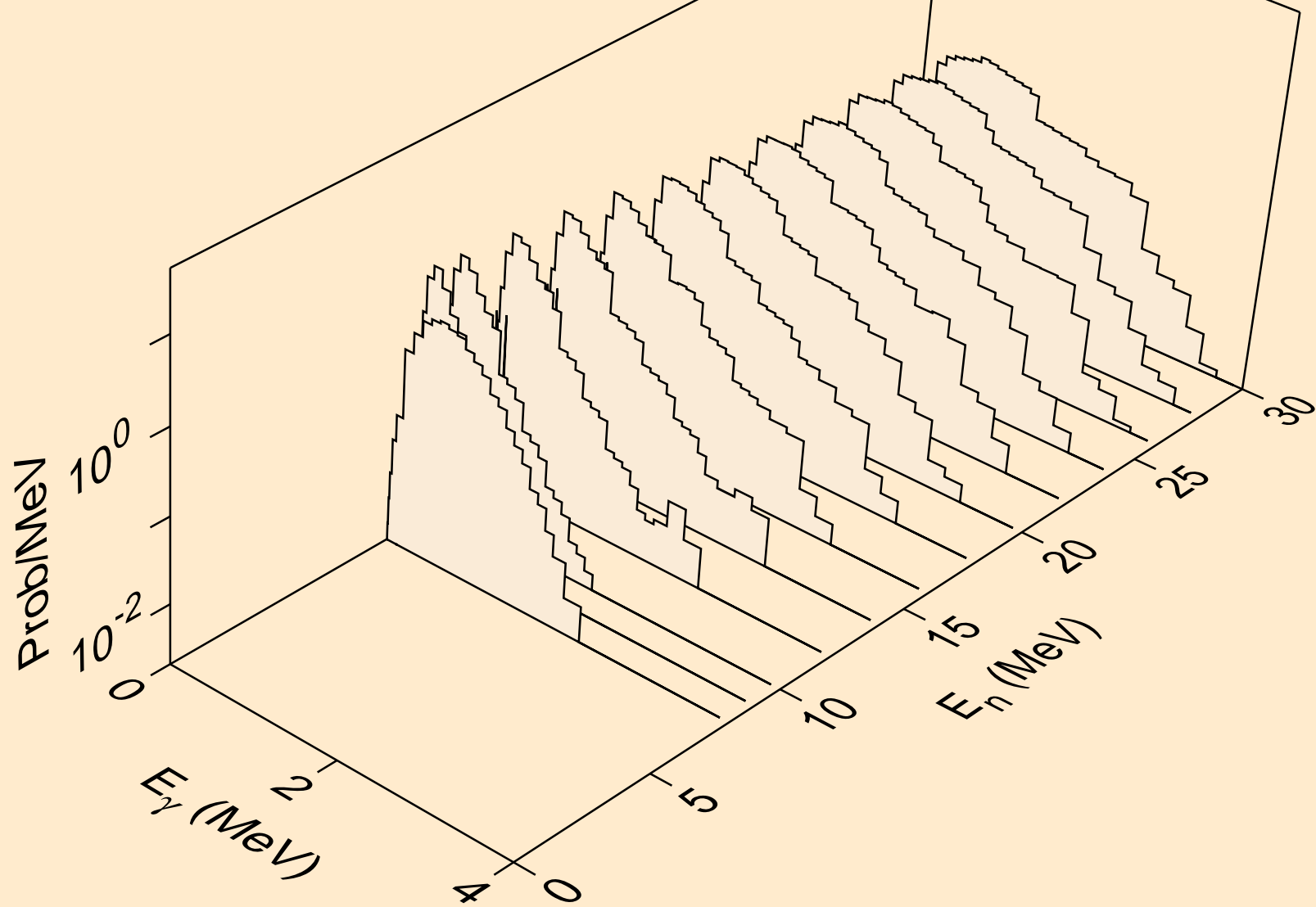

FR225 DEUTERON ACER TENDL-2021 LIBRARY; T=0.K
Photon emission for (n,pd)

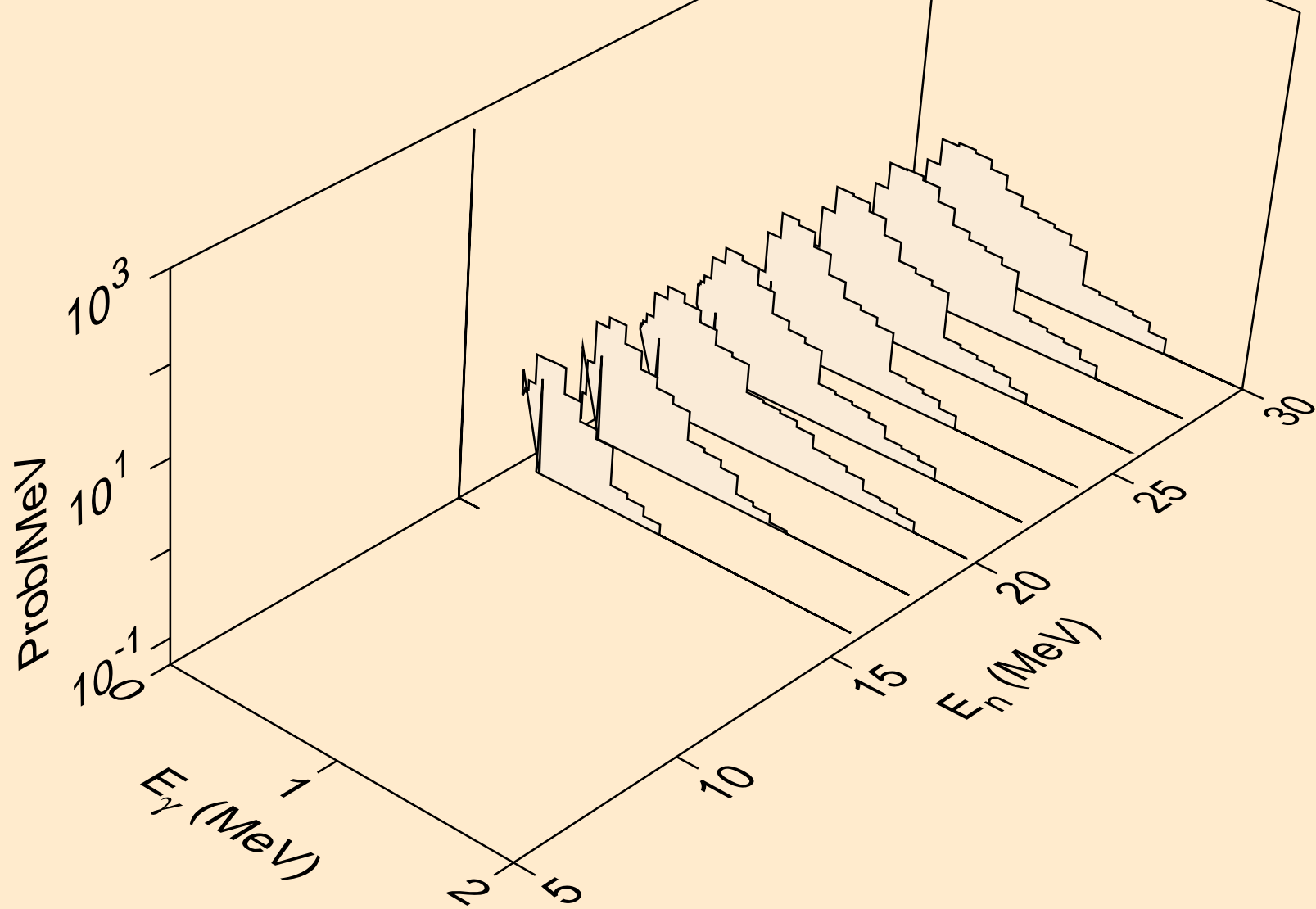

FR225 DEUTERON ACER TENDL-2021 LIBRARY; T=0.K
Photon emission for (n,da)

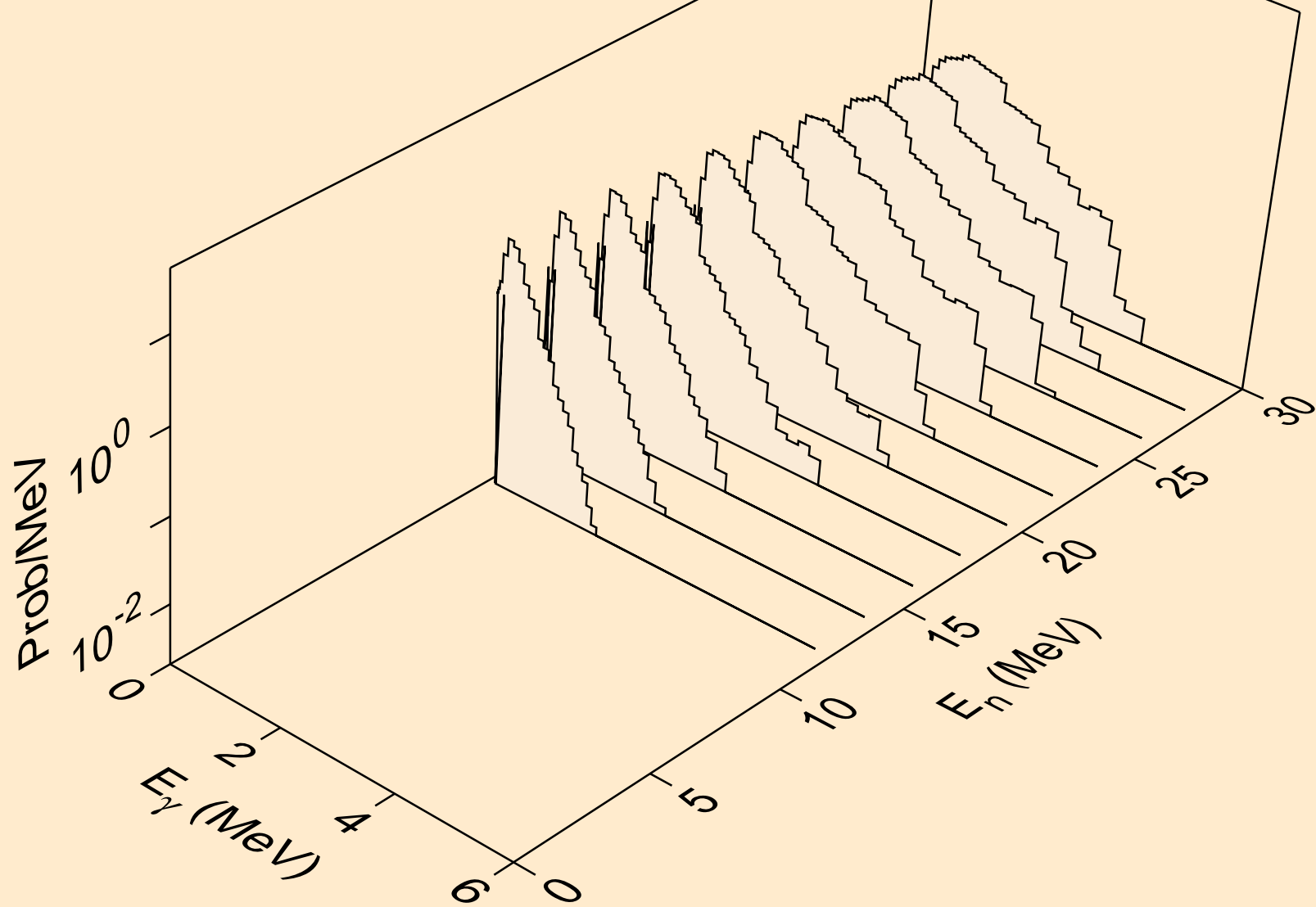

FR225 DEUTERON ACER TENDL-2021 LIBRARY; T=0.K
Particle heating contributions

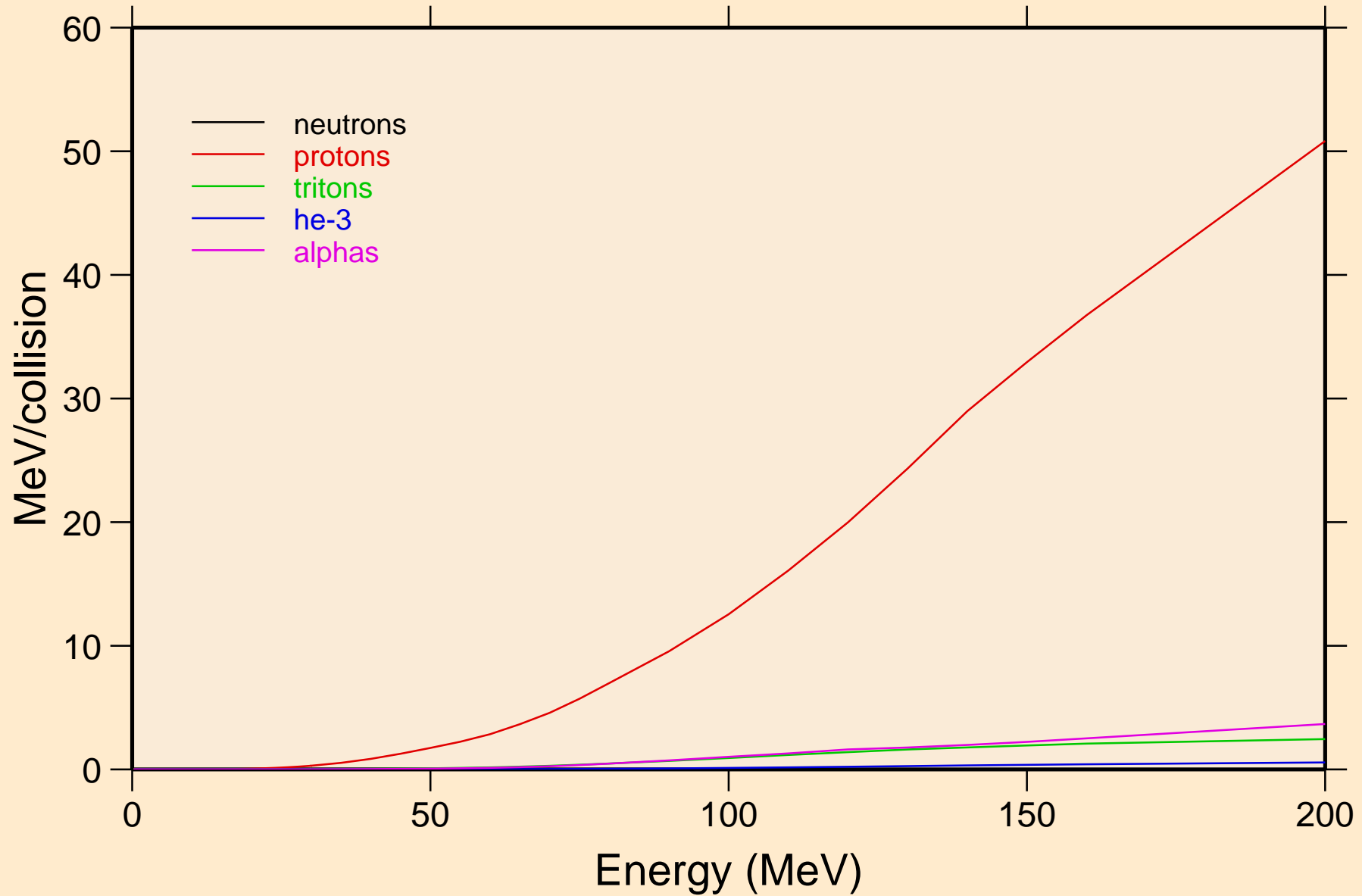

FR225 DEUTERON ACER TENDL-2021 LIBRARY; T=0.K
Recoil Heating

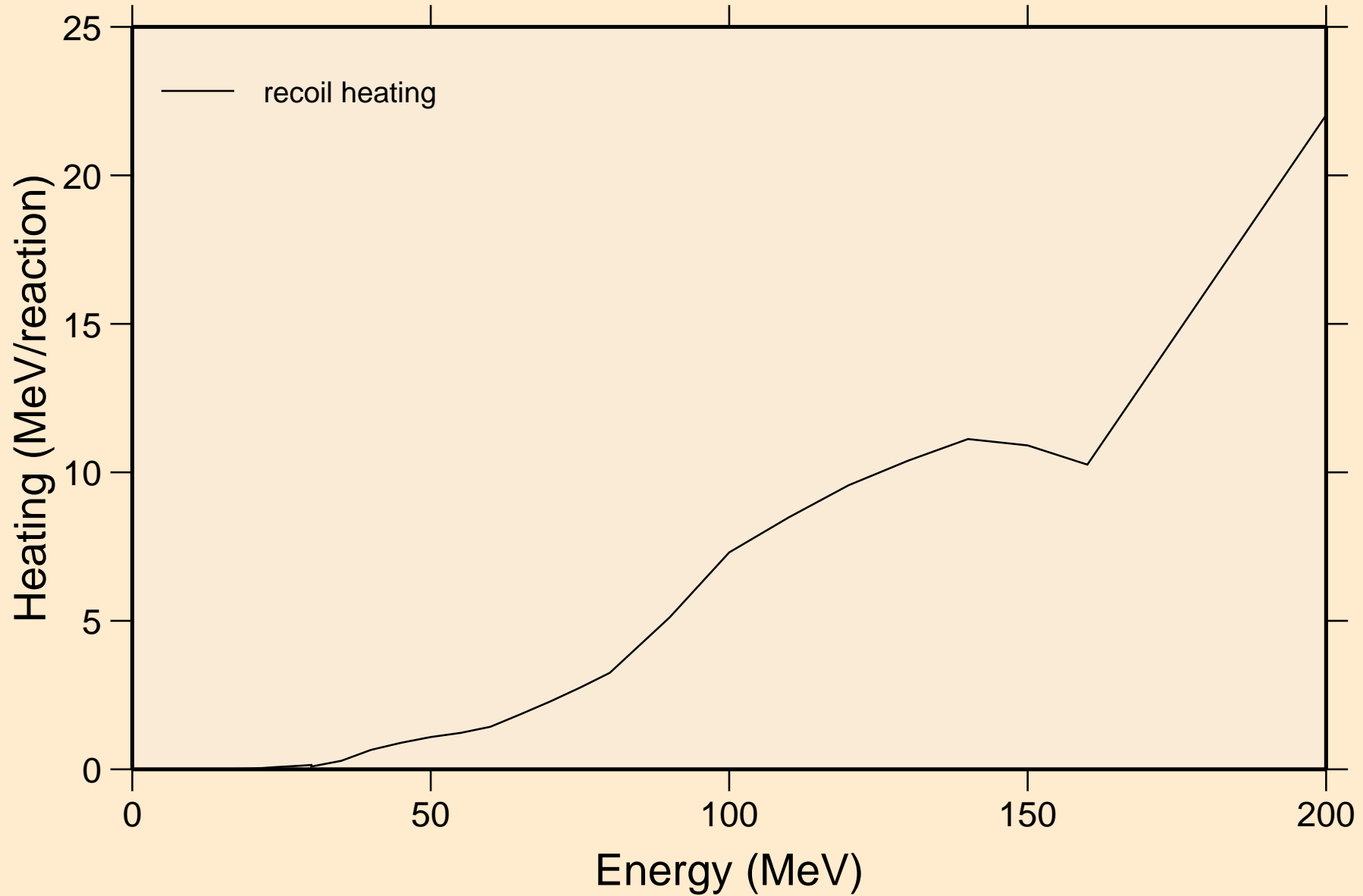

FR225 DEUTERON ACER TENDL-2021 LIBRARY; T=0.K
Particle production cross sections

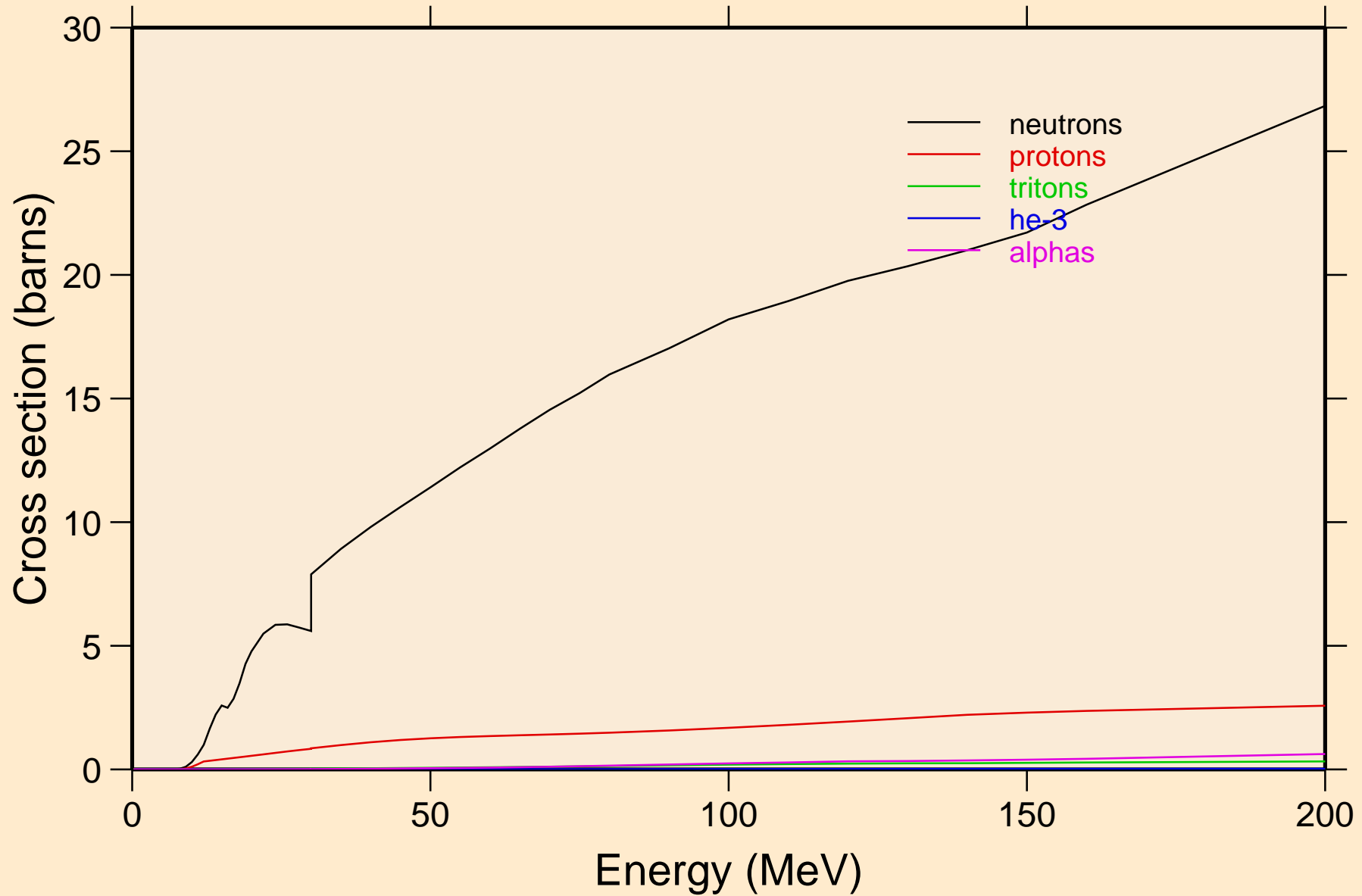

FR225 DEUTERON ACER TENDL-2021 LIBRARY; T=0.K
neutrons from (d,n)

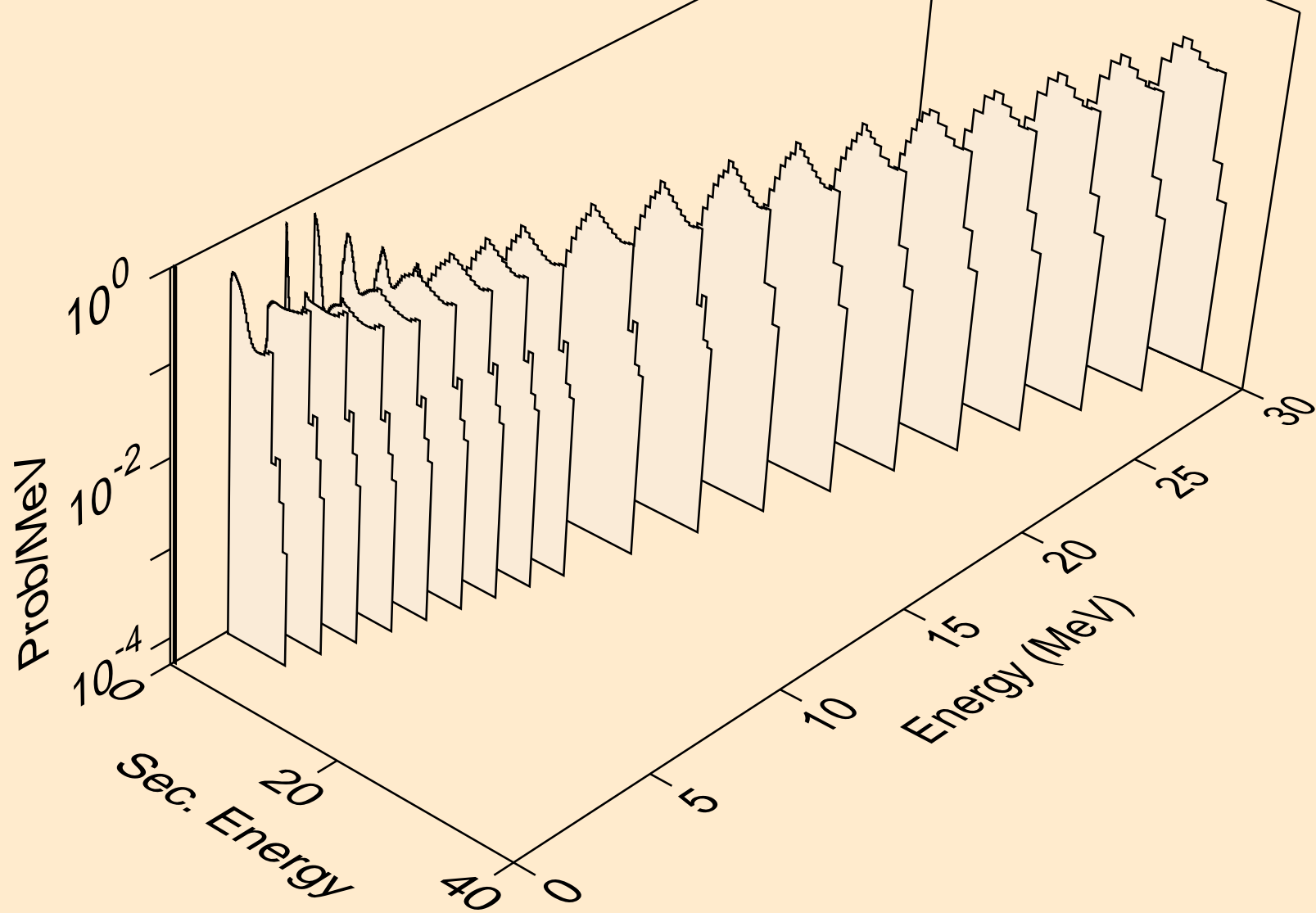

FR225 DEUTERON ACER TENDL-2021 LIBRARY; T=0.K
neutrons from (d,x)

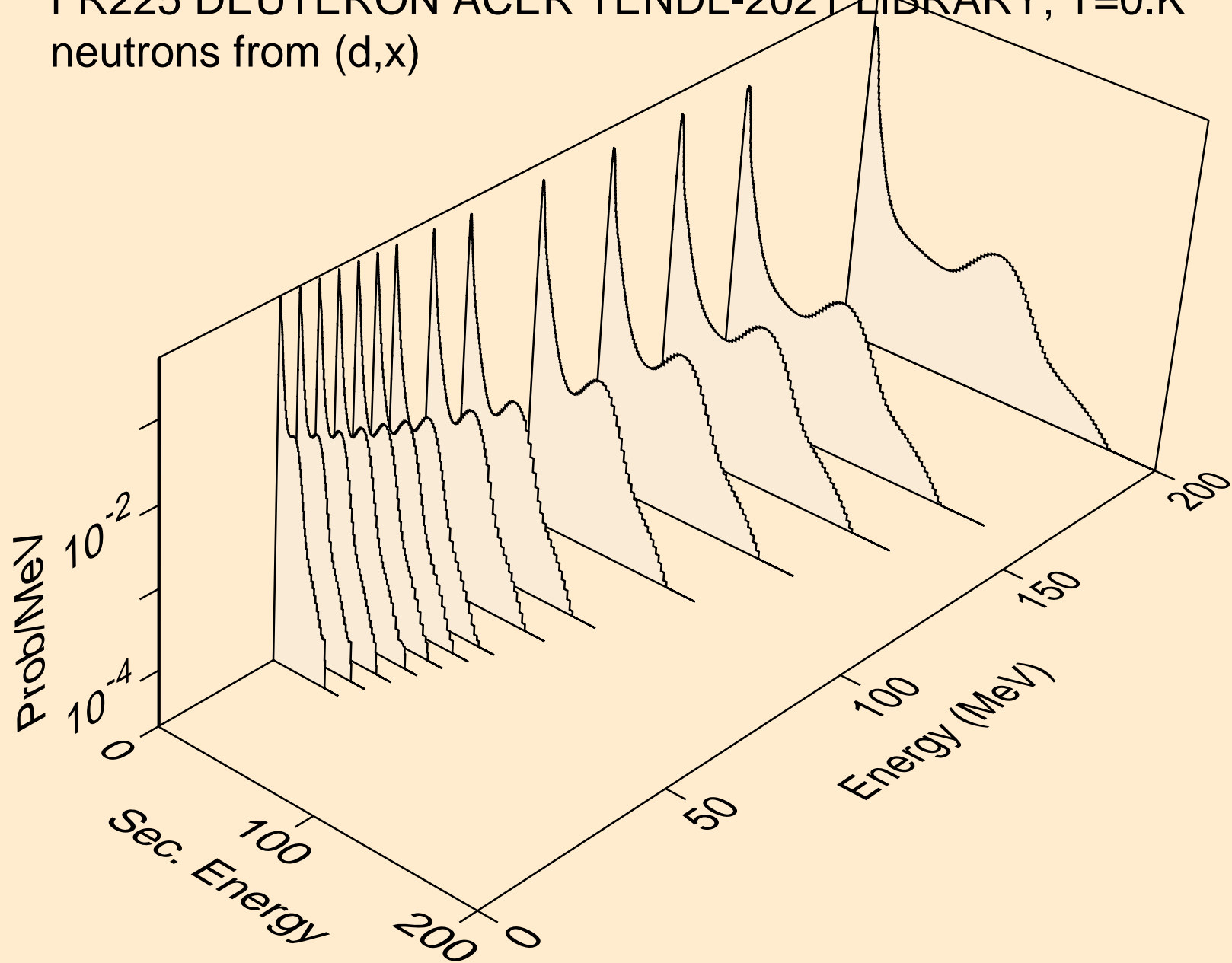

FR225 DEUTERON ACER TENDL-2021 LIBRARY; T=0.K
neutrons from (d,2nd)

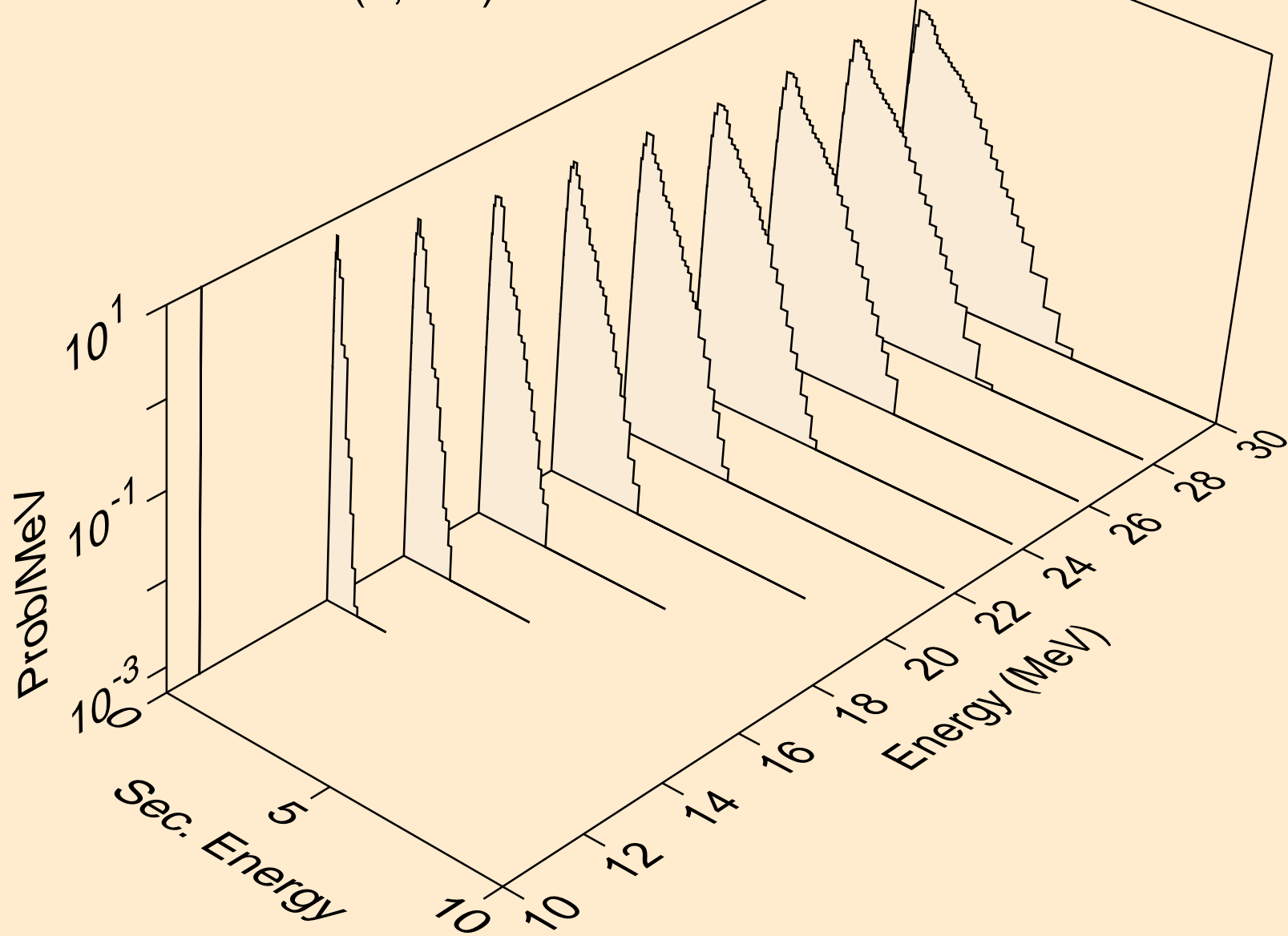

FR225 DEUTERON ACER TENDL-2021 LIBRARY; T=0.K
neutrons from (d,2n)

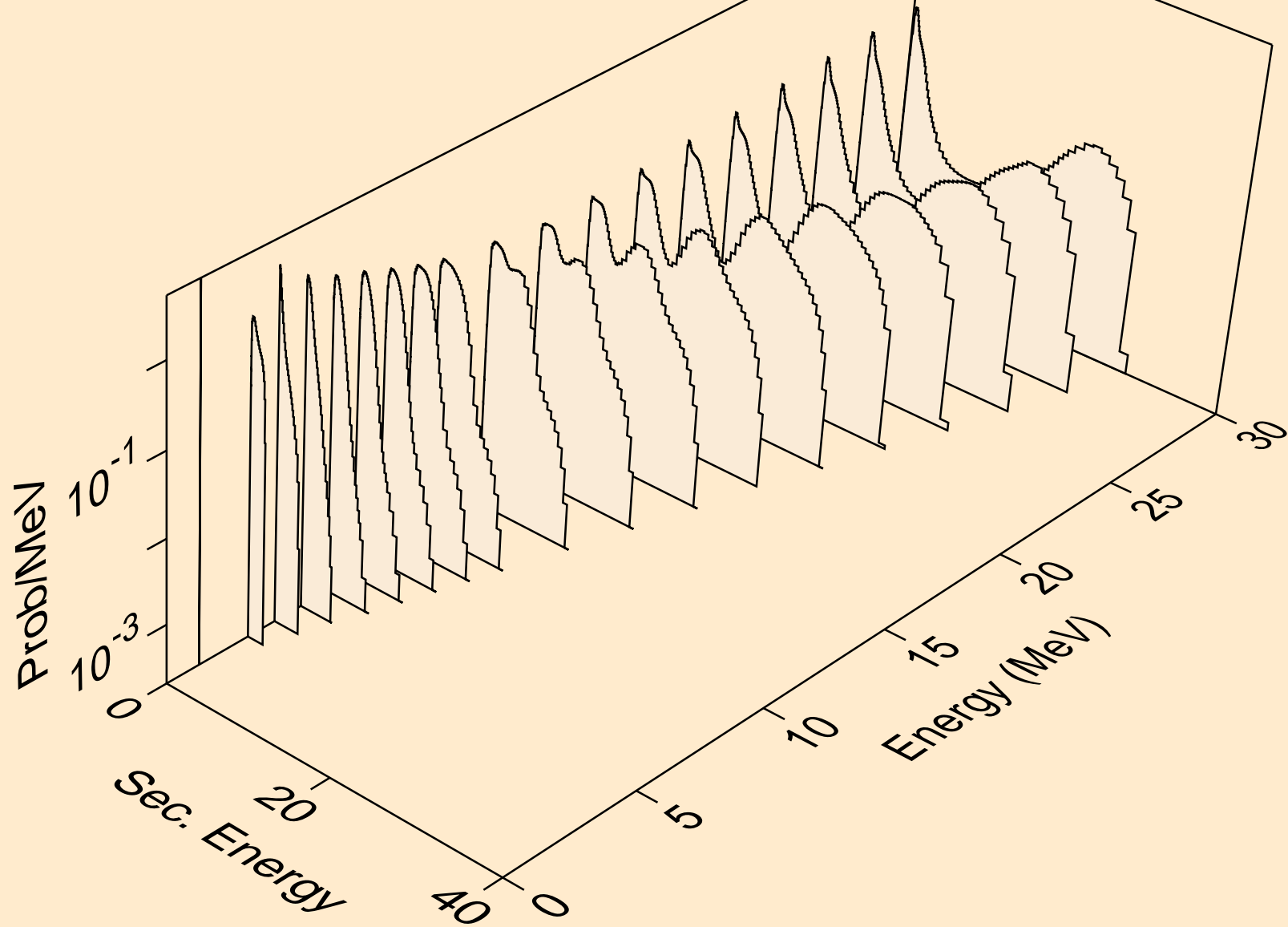

FR225 DEUTERON ACER TENDL-2021 LIBRARY; T=0.K
neutrons from (d,3n)

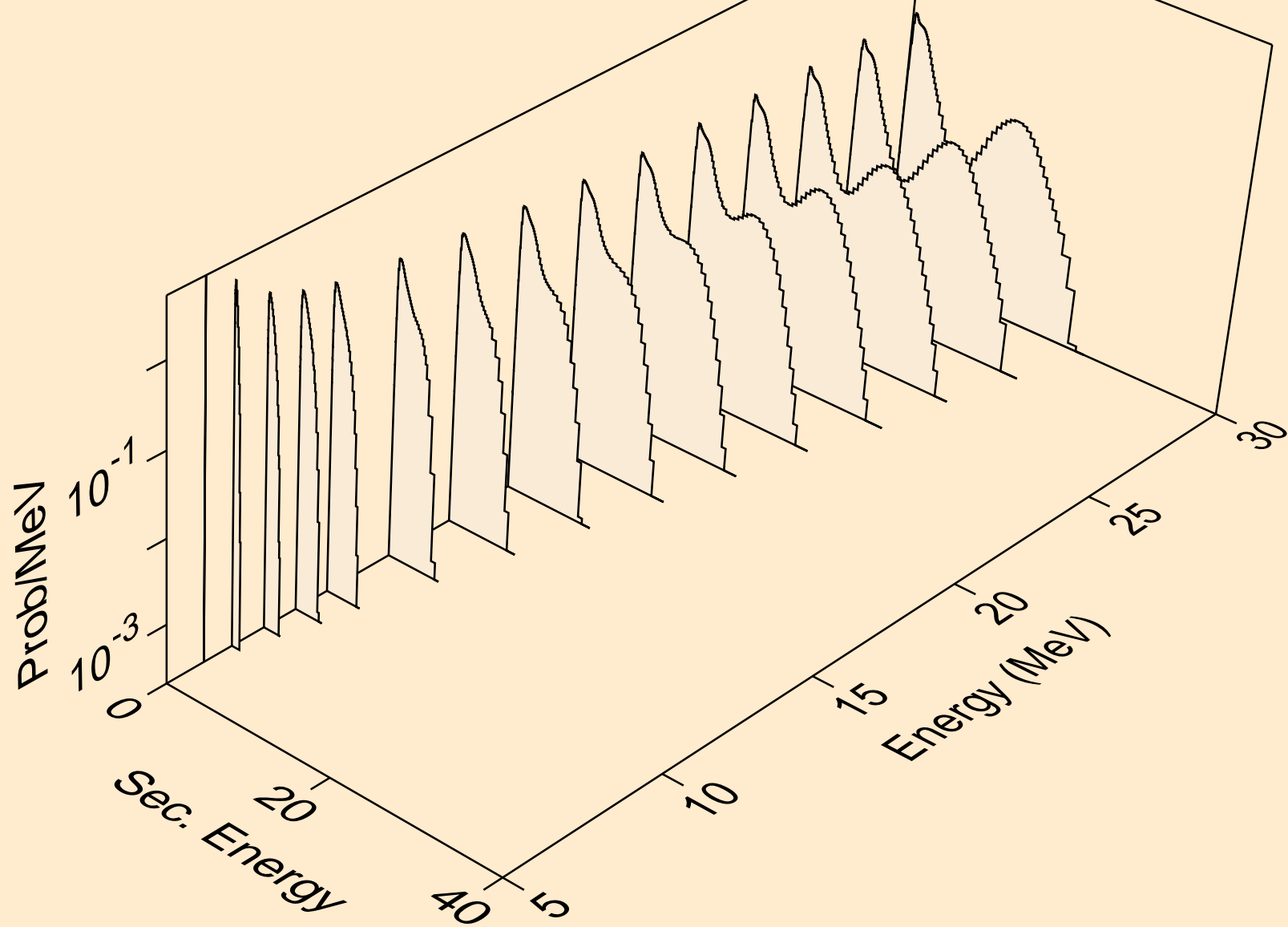

FR225 DEUTERON ACER TENDL-2021 LIBRARY; T=0.K
neutrons from (d,n*)a

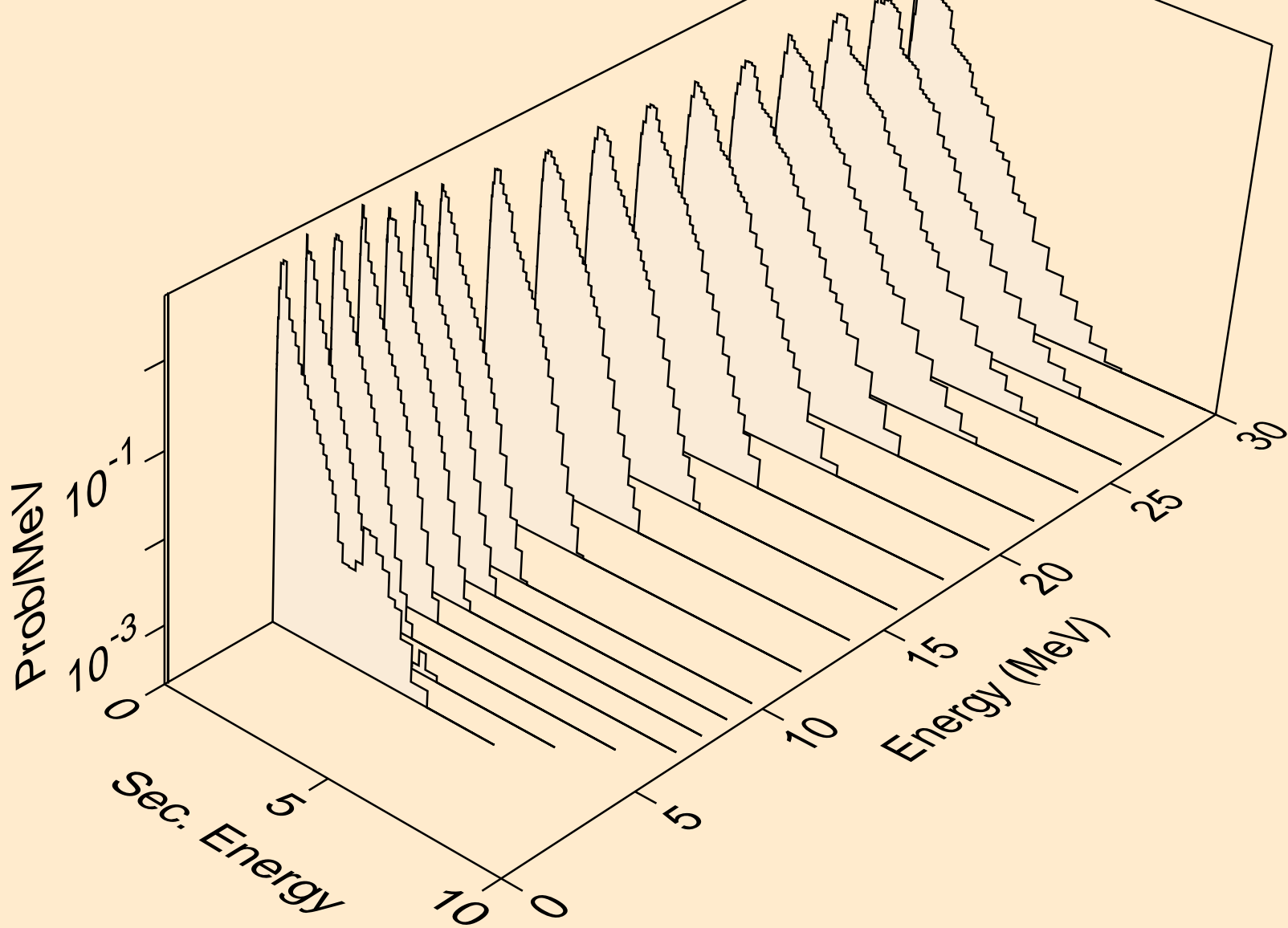

FR225 DEUTERON ACER TENDL-2021 LIBRARY; T=0.K
neutrons from (d,2n)a

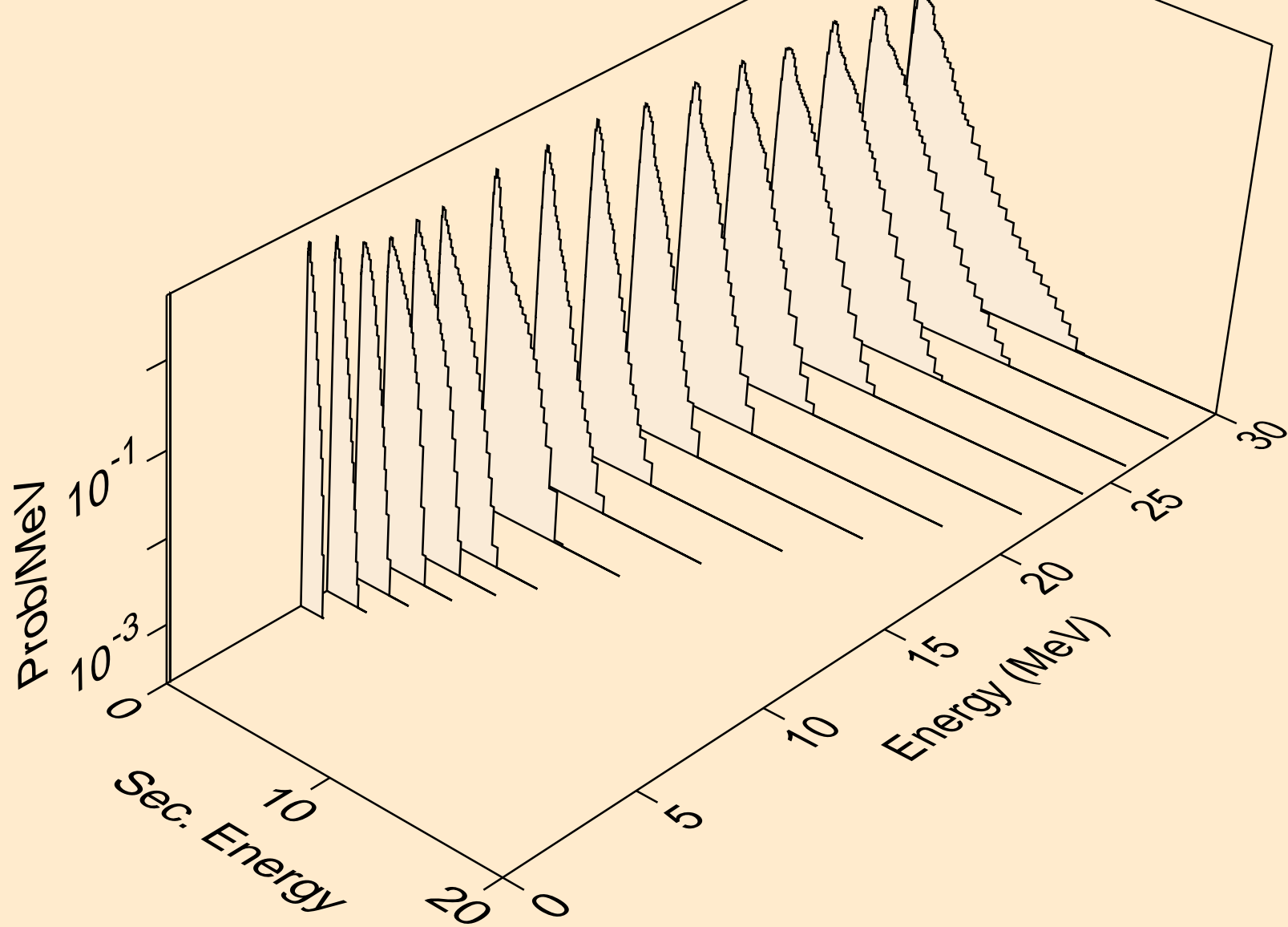

FR225 DEUTERON ACER TENDL-2021 LIBRARY; T=0.K
neutrons from (d,3n)a

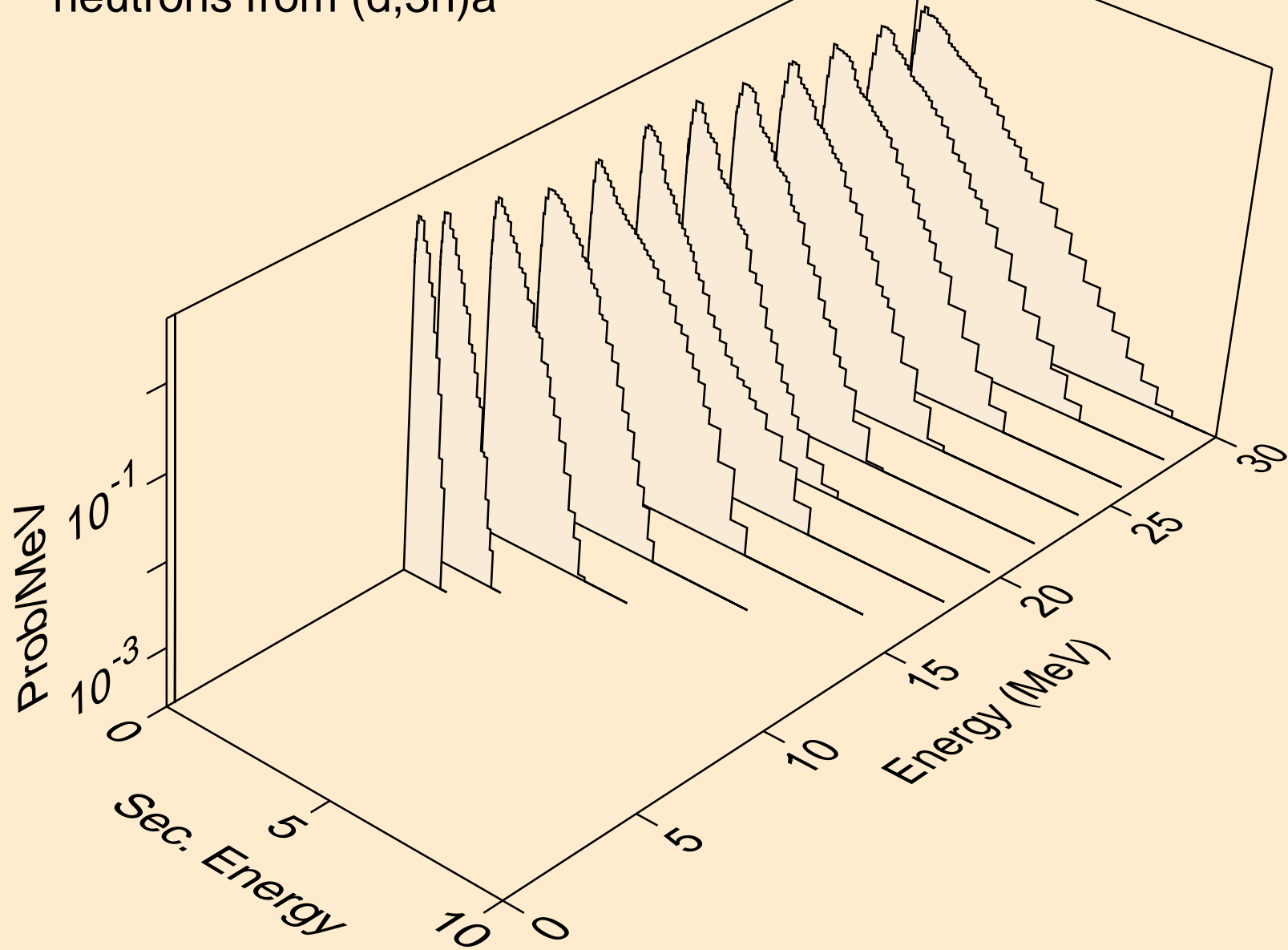

FR225 DEUTERON ACER TENDL-2021 LIBRARY; T=0.K
neutrons from (d,n*)p

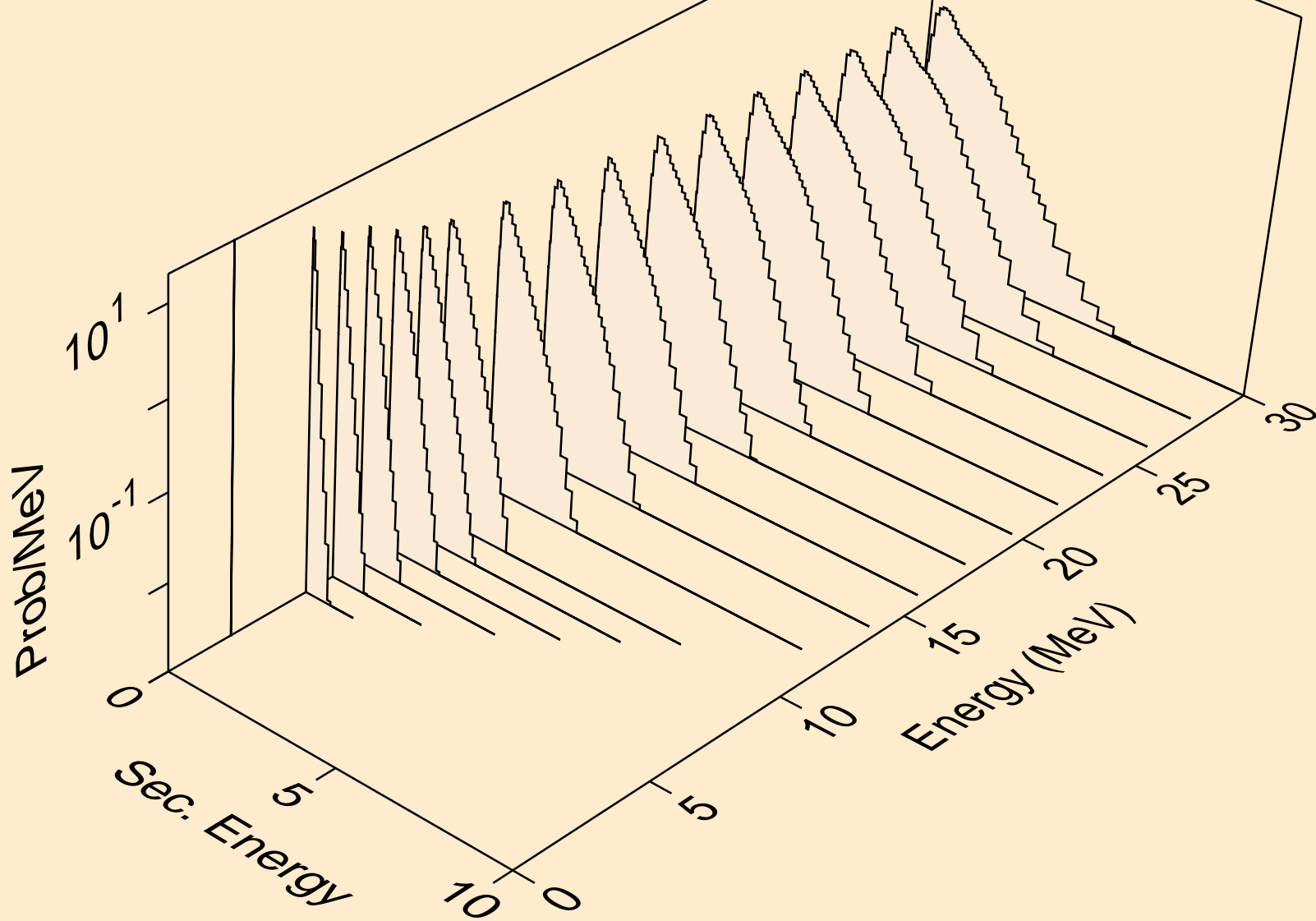

FR225 DEUTERON ACER TENDL-2021 LIBRARY; T=0.K
neutrons from (d,n*)2a

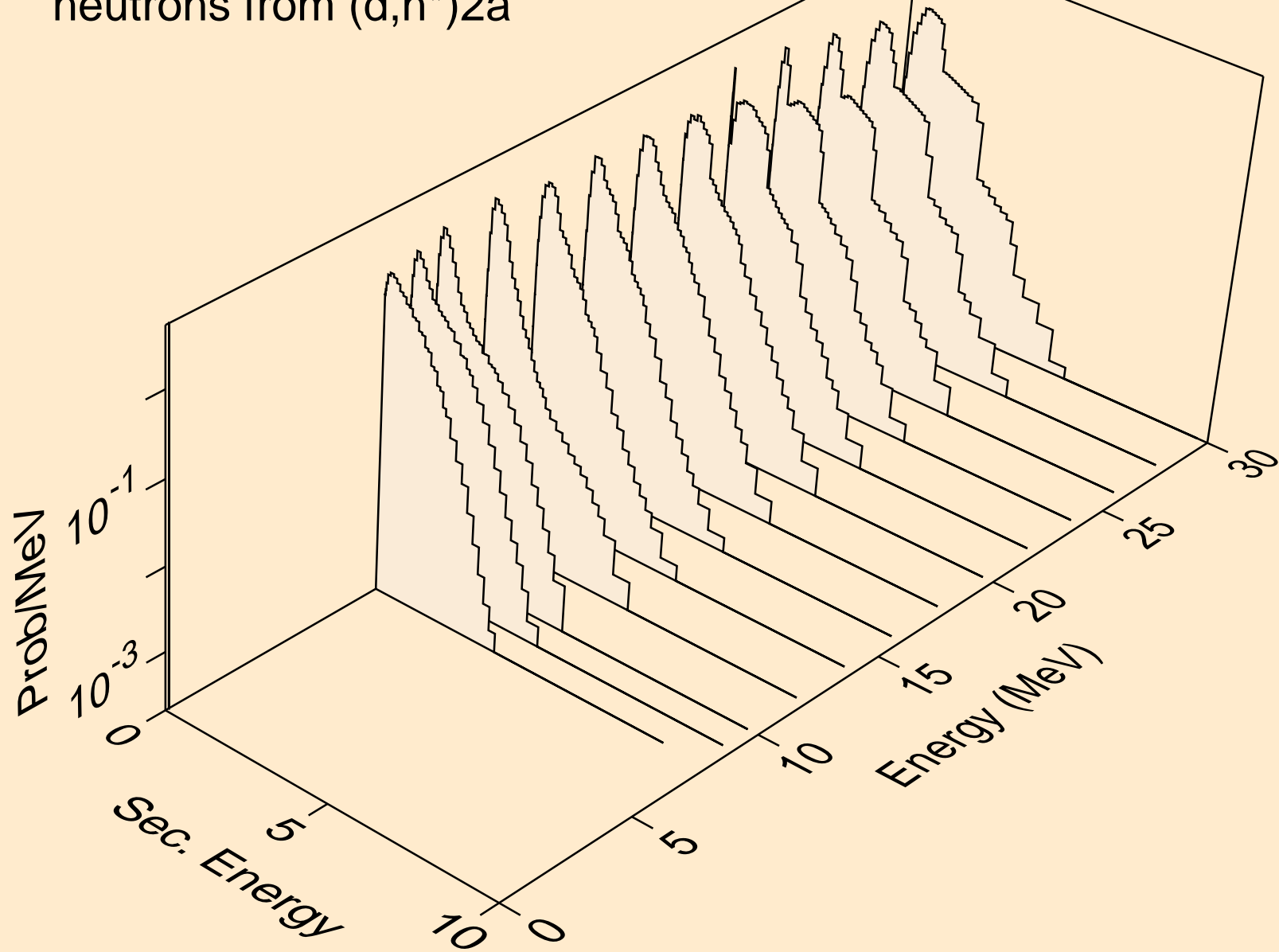

FR225 DEUTERON ACER TENDL-2021 LIBRARY; T=0.K
neutrons from (d,2n)2a

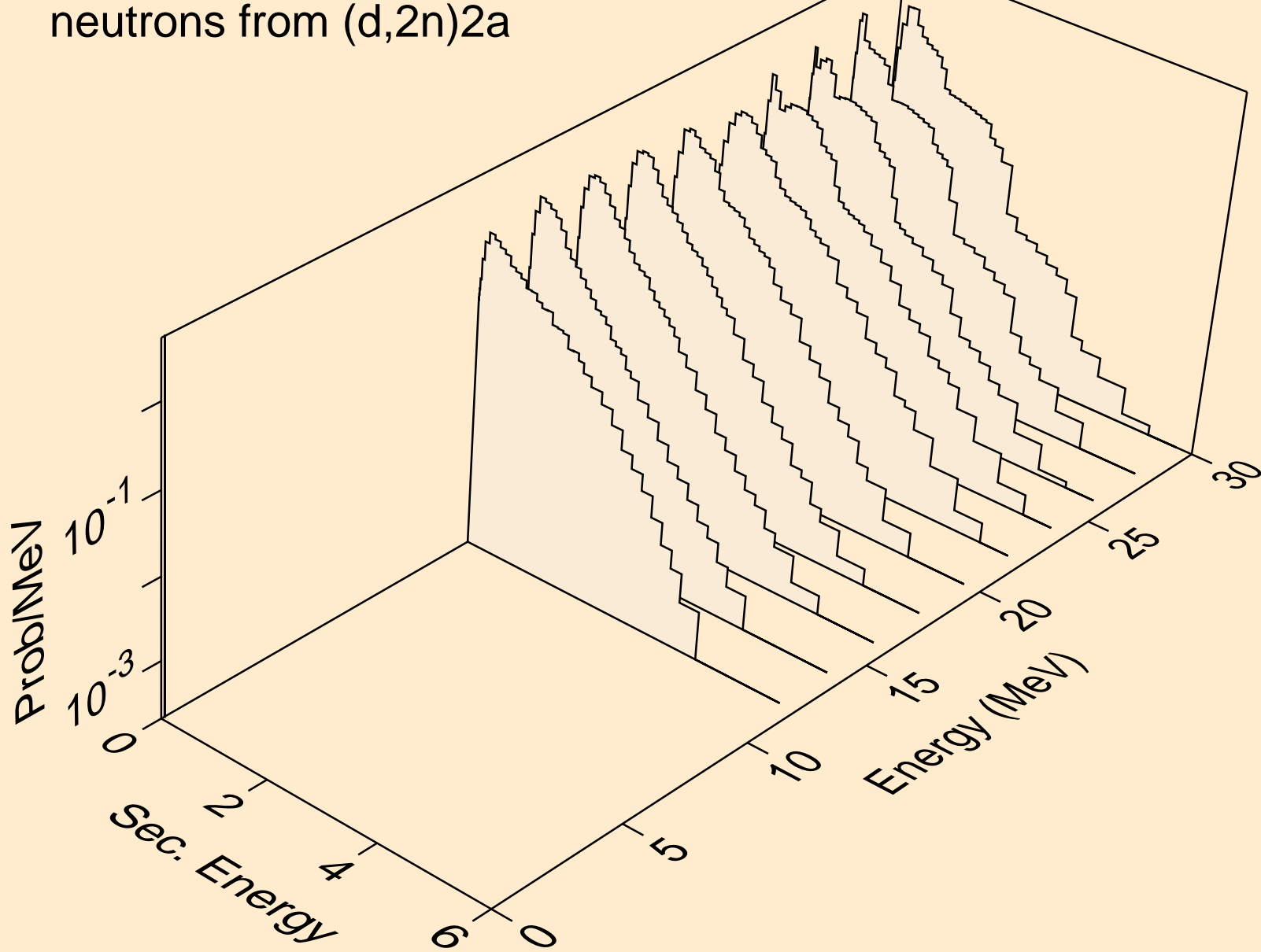

FR225 DEUTERON ACER TENDL-2021 LIBRARY; T=0.K
neutrons from (d,n*)d

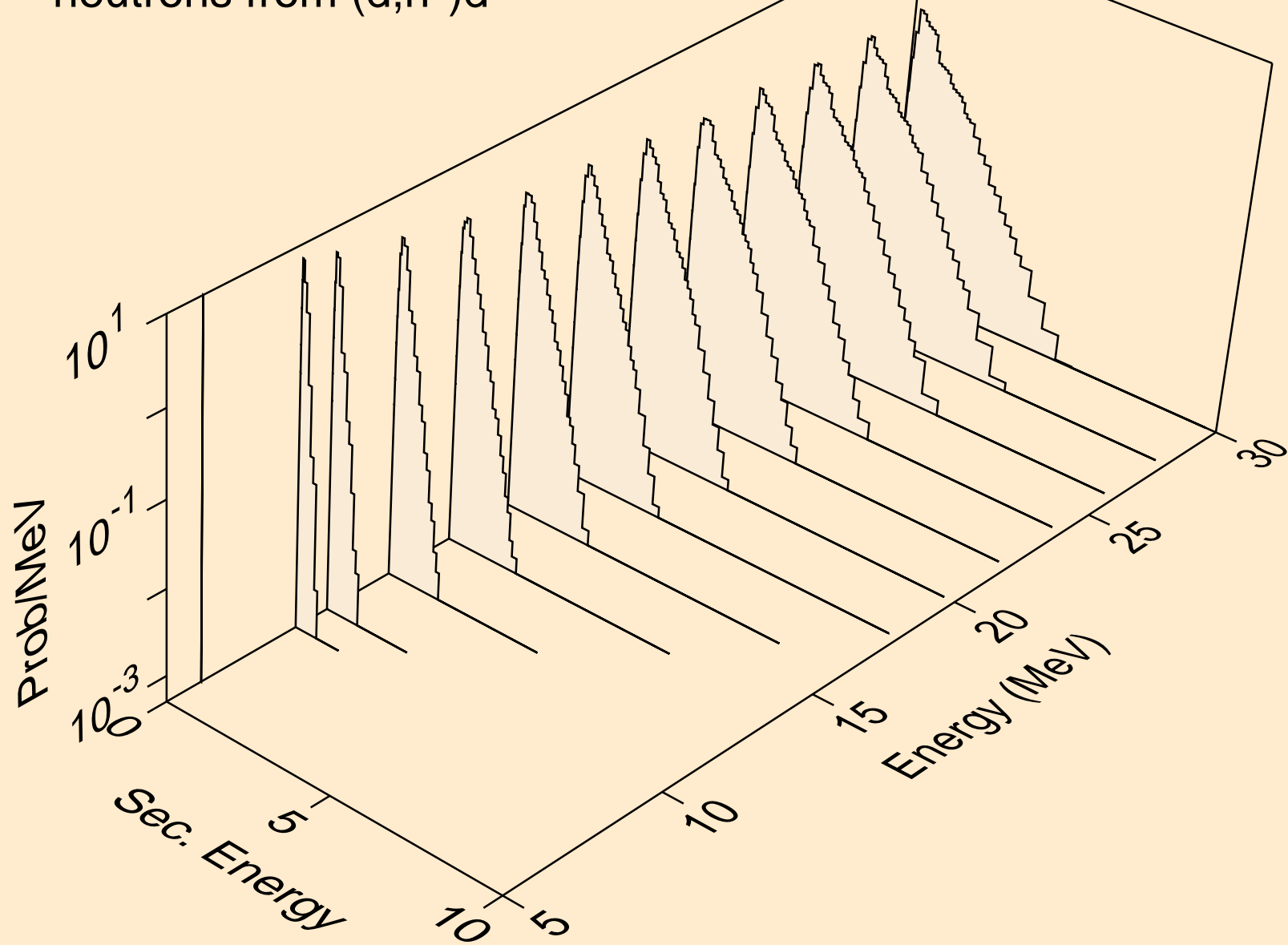

FR225 DEUTERON ACER TENDL-2021 LIBRARY; T=0.K
neutrons from (d,n*)t

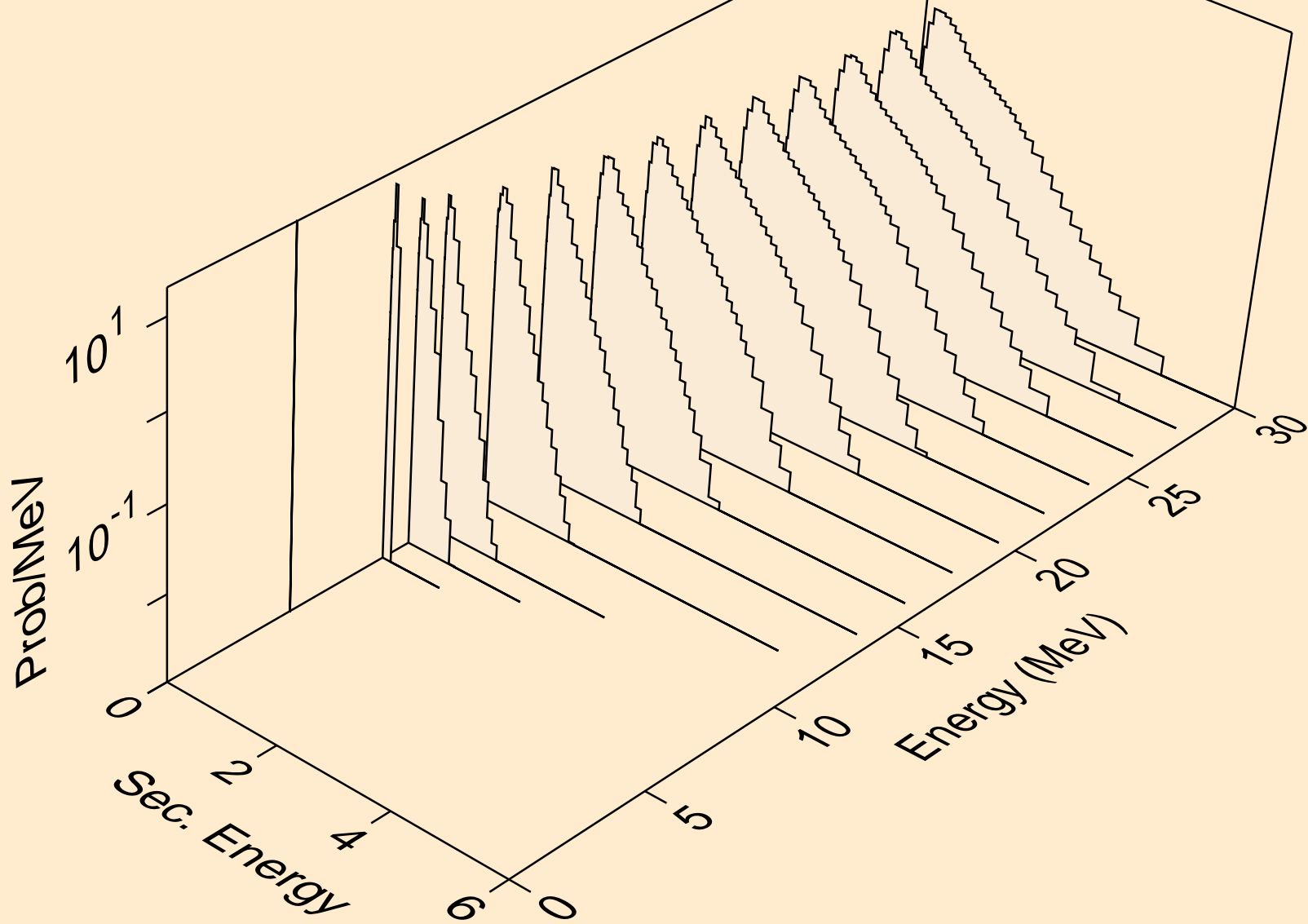

FR225 DEUTERON ACER TENDL-2021 LIBRARY; T=0.K
neutrons from (d,n*)he3

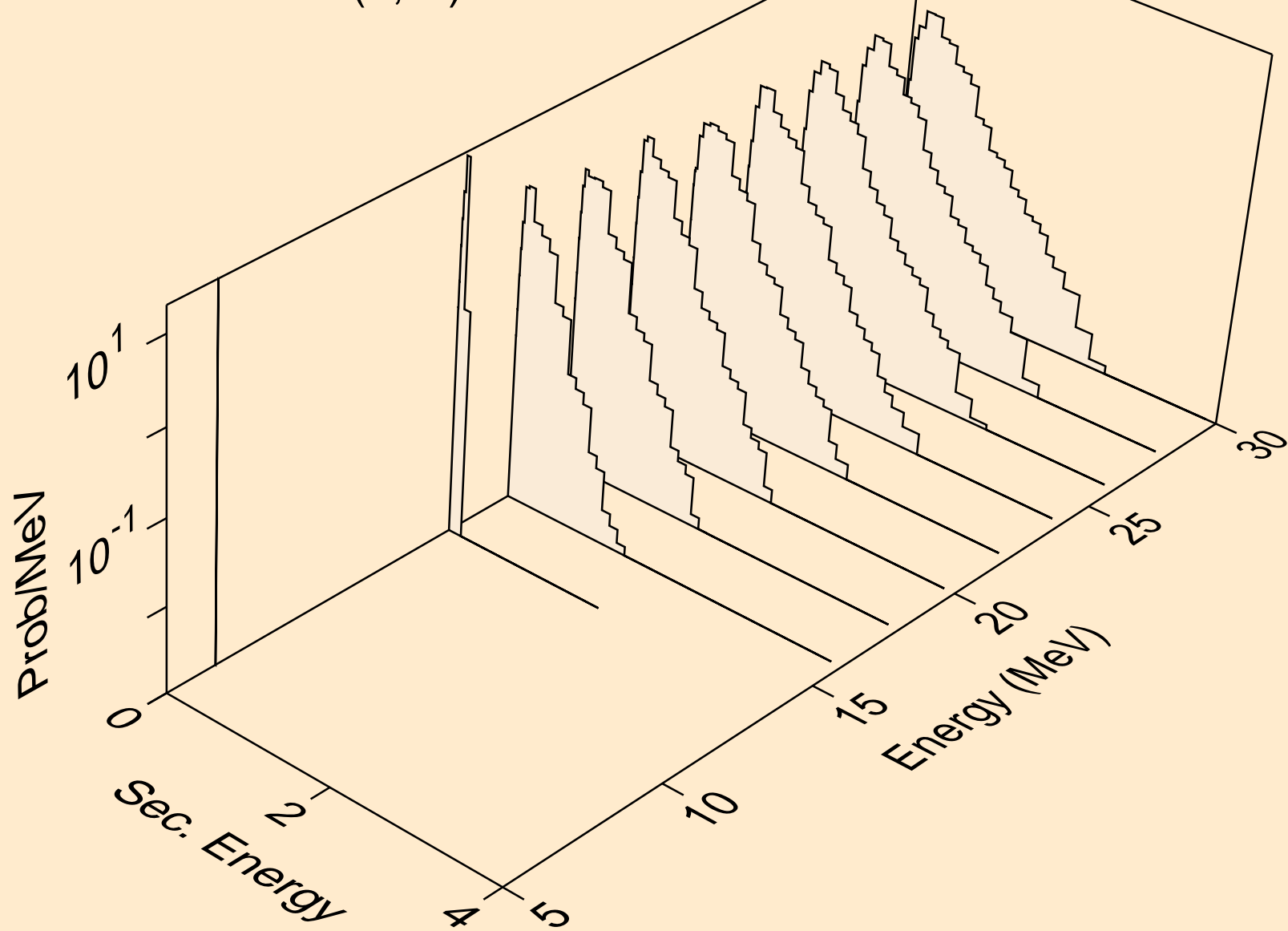

FR225 DEUTERON ACER TENDL-2021 LIBRARY; T=0.K
neutrons from (d,4n)

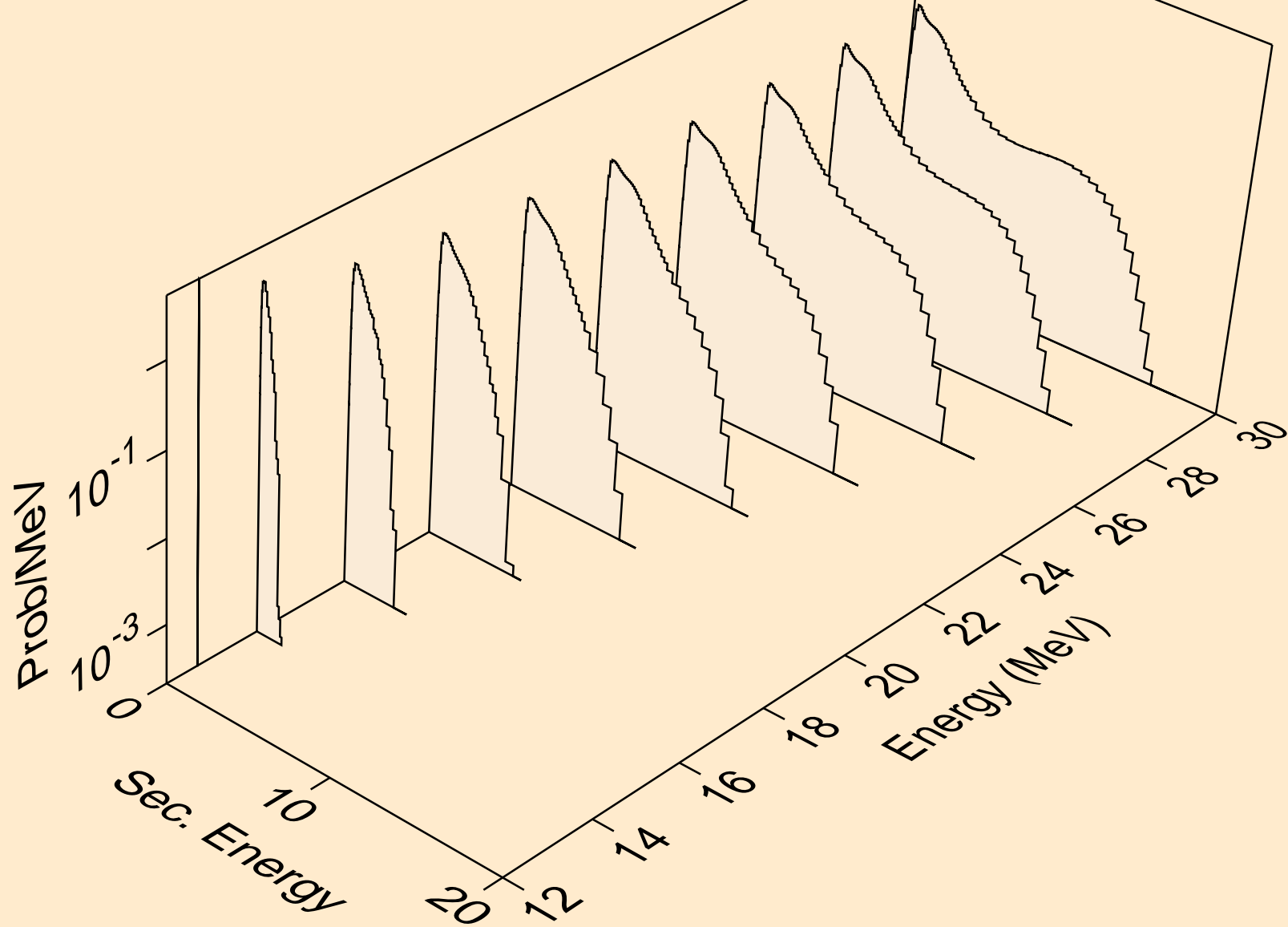

FR225 DEUTERON ACER TENDL-2021 LIBRARY; T=0.K
neutrons from (d,2np)

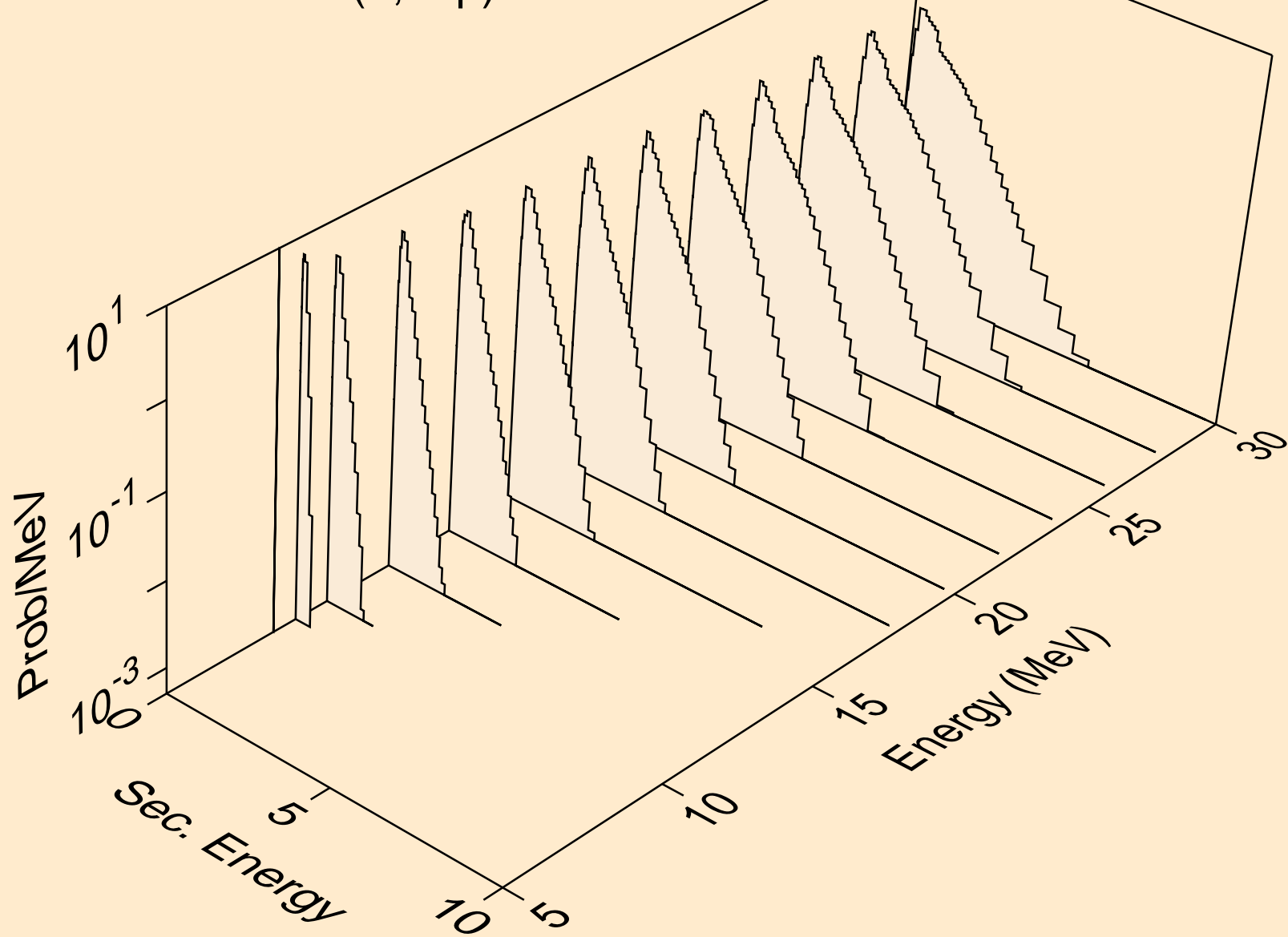

FR225 DEUTERON ACER TENDL-2021 LIBRARY; T=0.K
neutrons from (d,3np)

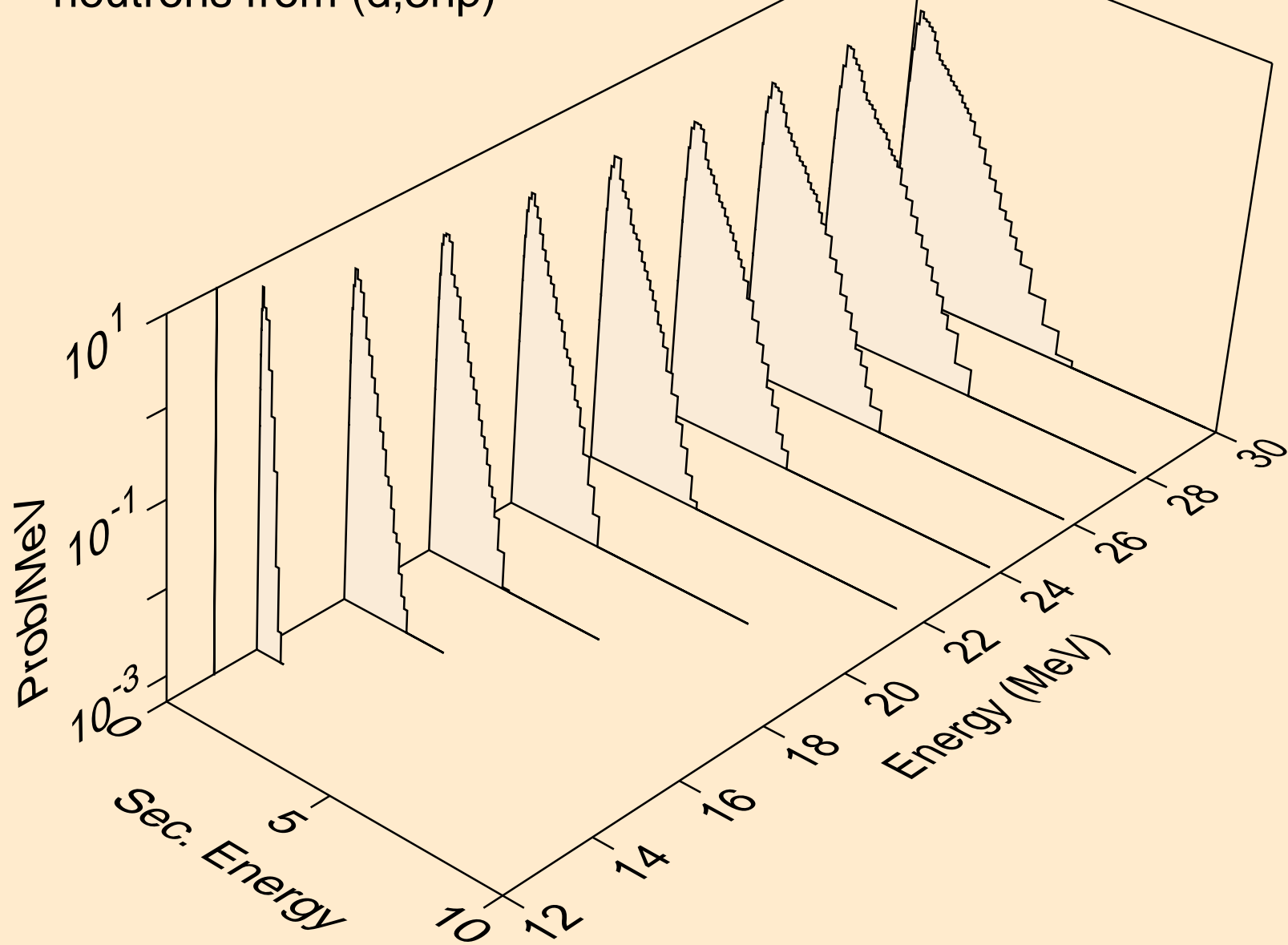

FR225 DEUTERON ACER TENDL-2021 LIBRARY; T=0.K
neutrons from (d,2np)

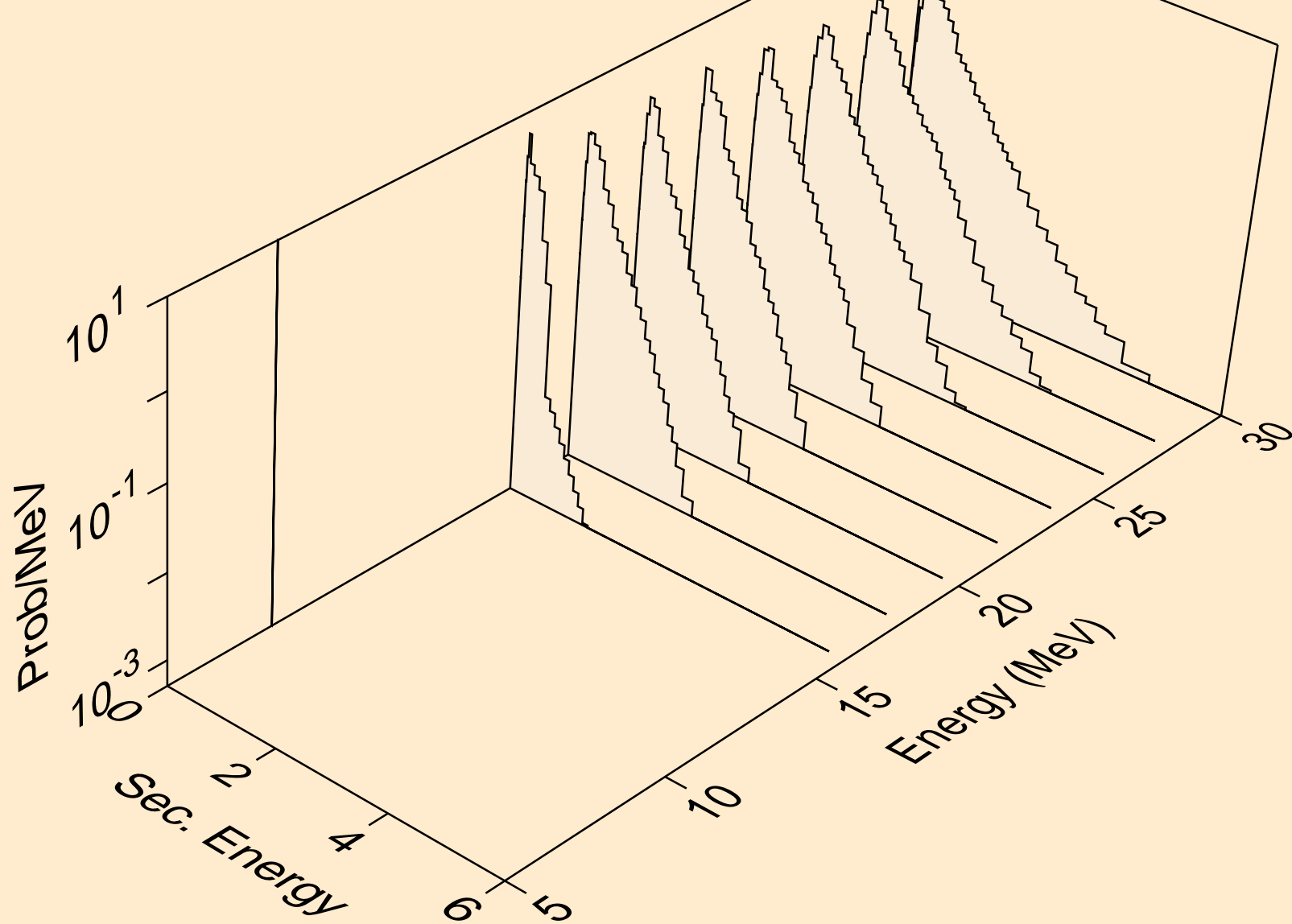

FR225 DEUTERON ACER TENDL-2021 LIBRARY; T=0.K
neutrons from (d,npa)

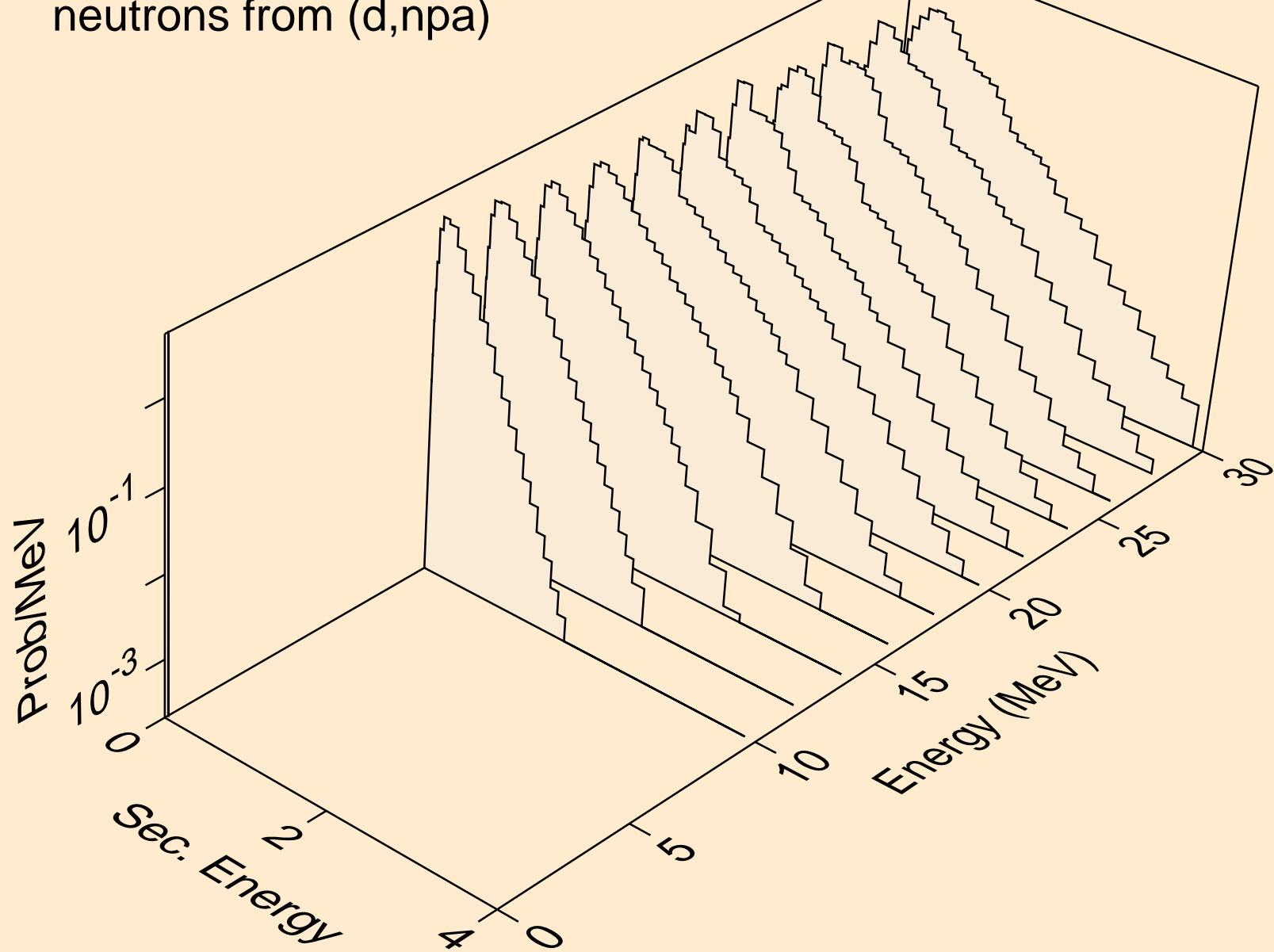

FR225 DEUTERON ACER TENDL-2021 LIBRARY; T=0.K
protons from (d,x)

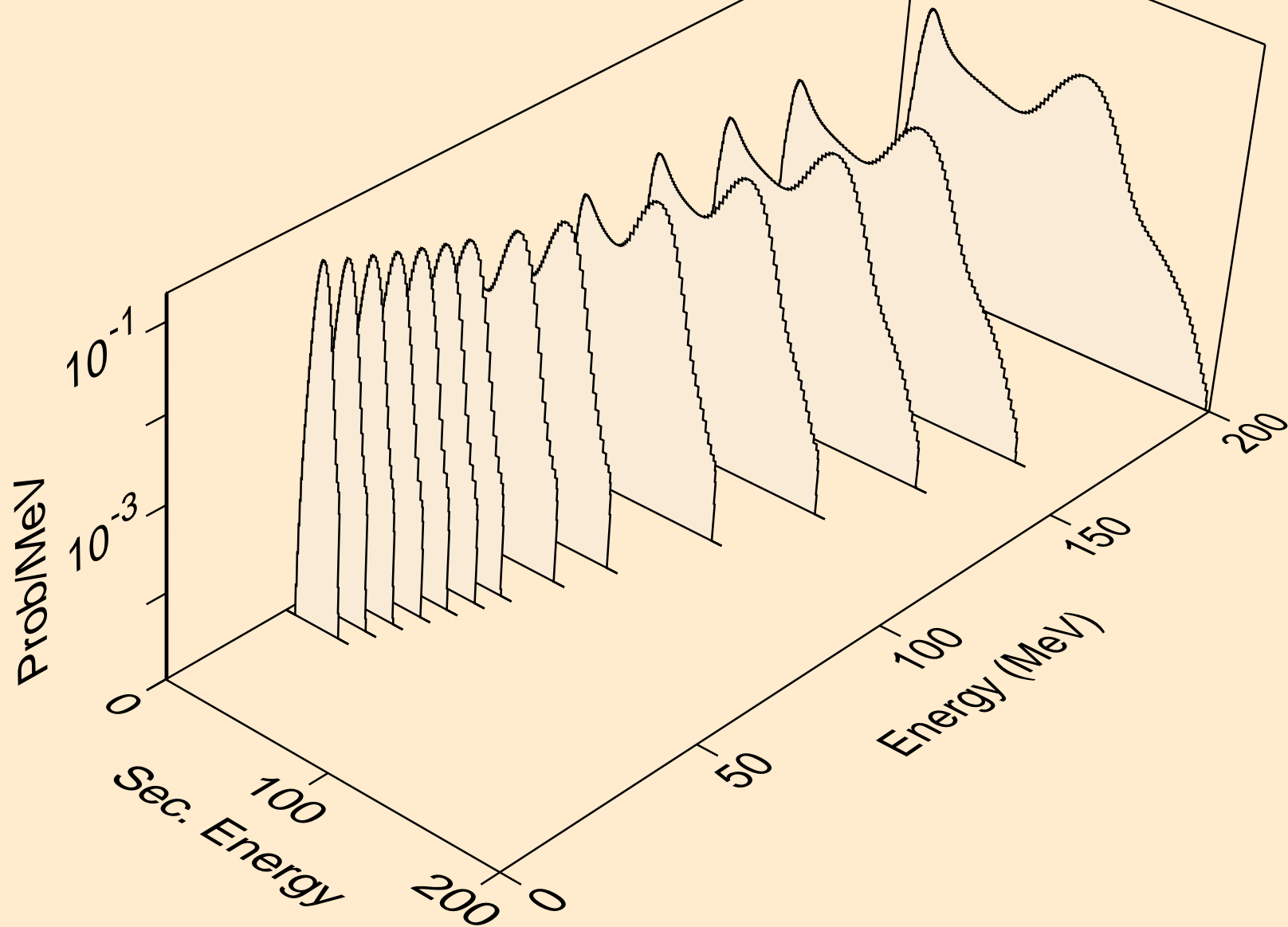

FR225 DEUTERON ACER TENDL-2021 LIBRARY; T=0.K
protons from (d,n*)p

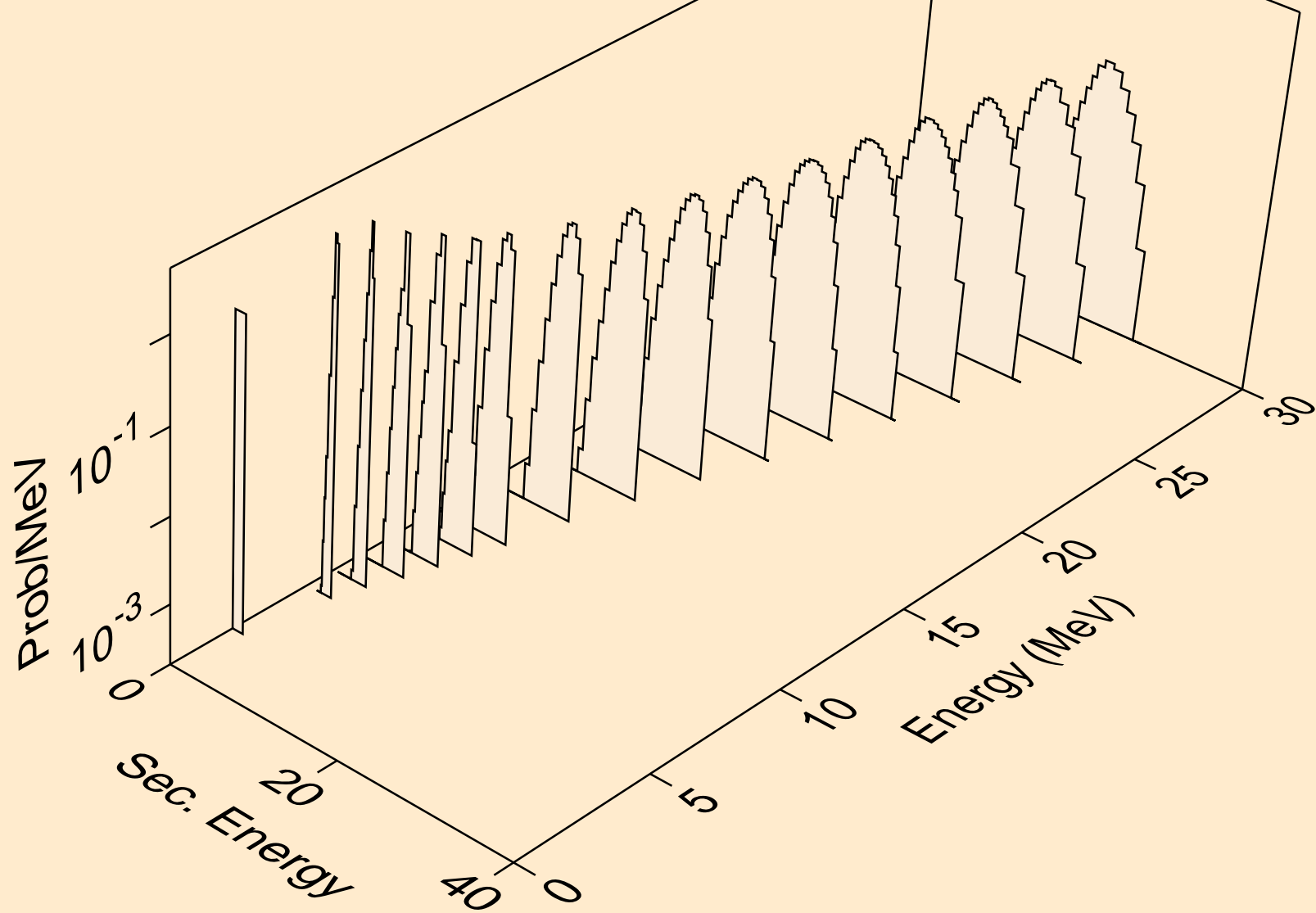

FR225 DEUTERON ACER TENDL-2021 LIBRARY; T=0.K
protons from (d,2np)

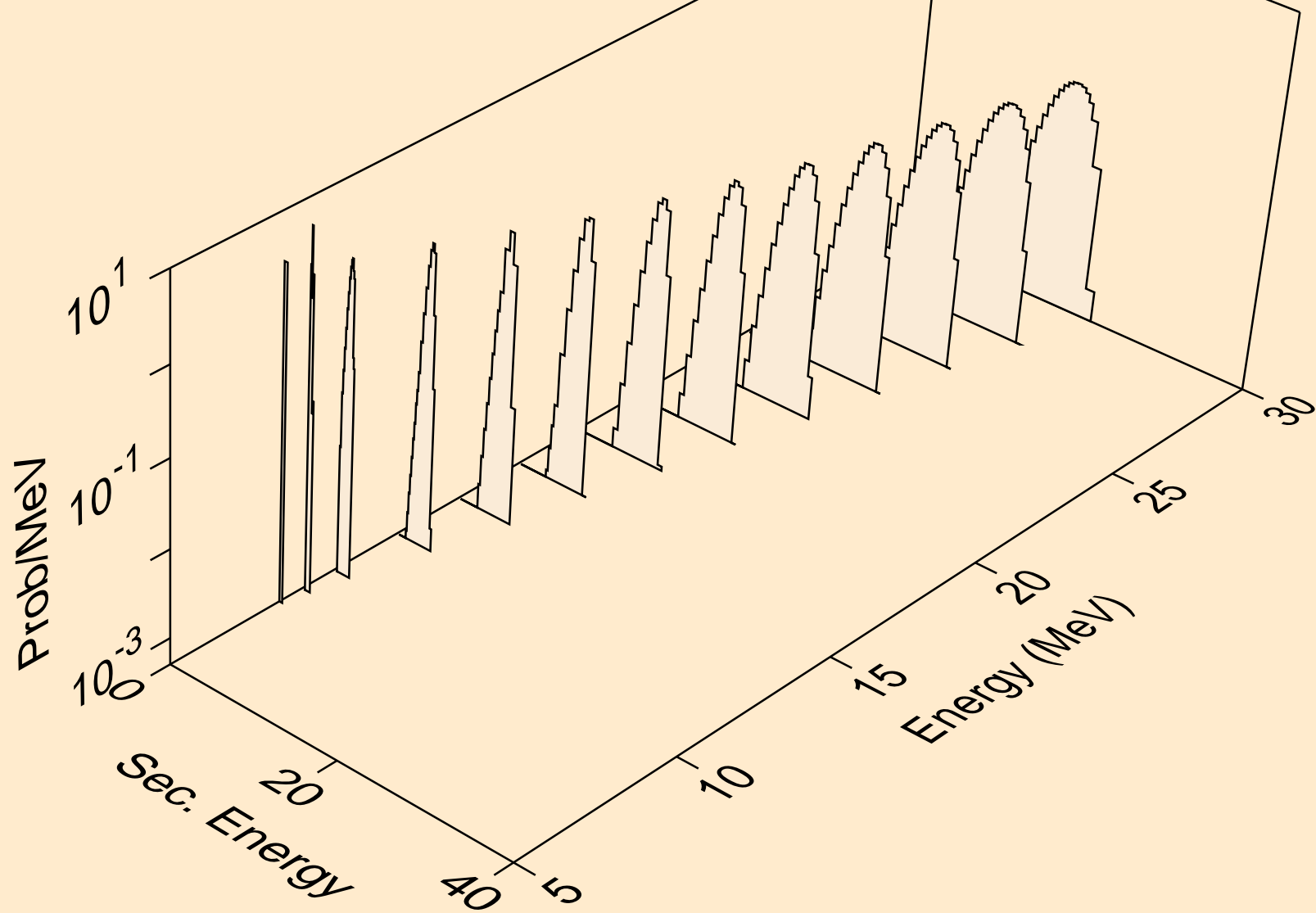

FR225 DEUTERON ACER TENDL-2021 LIBRARY; T=0.K
protons from (d,3np)

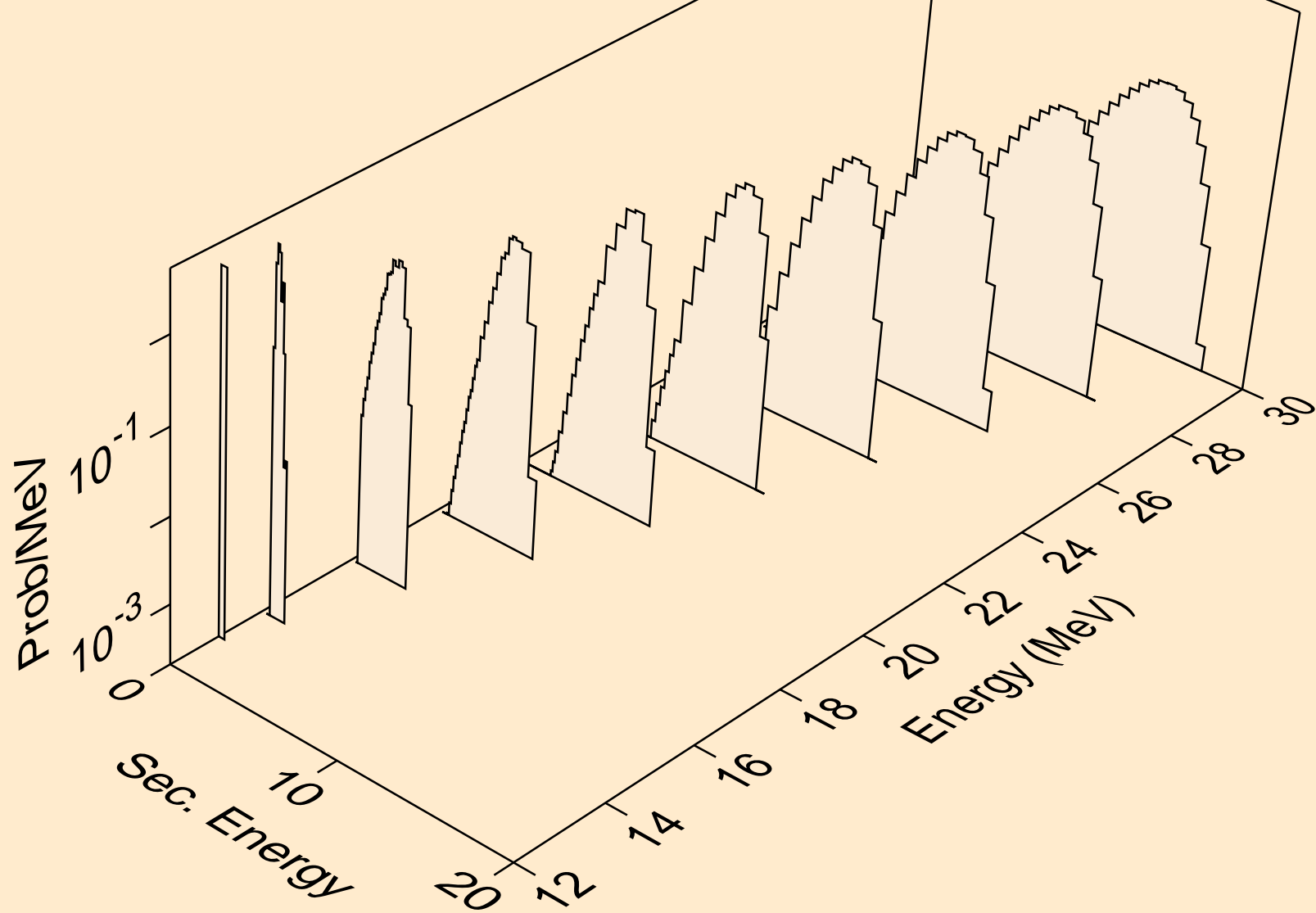

FR225 DEUTERON ACER TENDL-2021 LIBRARY; T=0.K
protons from (d,2np)

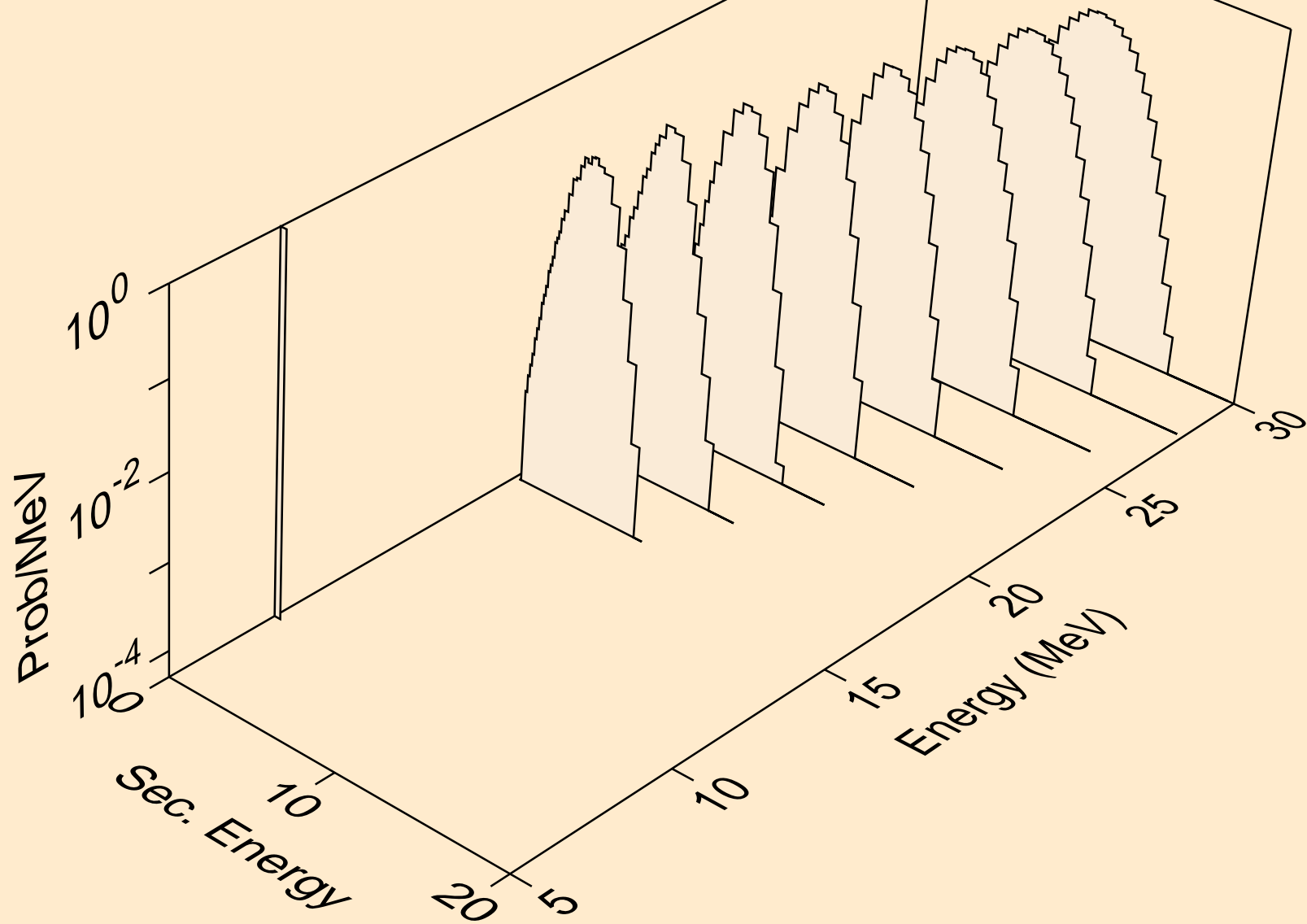

FR225 DEUTERON ACER TENDL-2021 LIBRARY; T=0.K
protons from (d,npa)

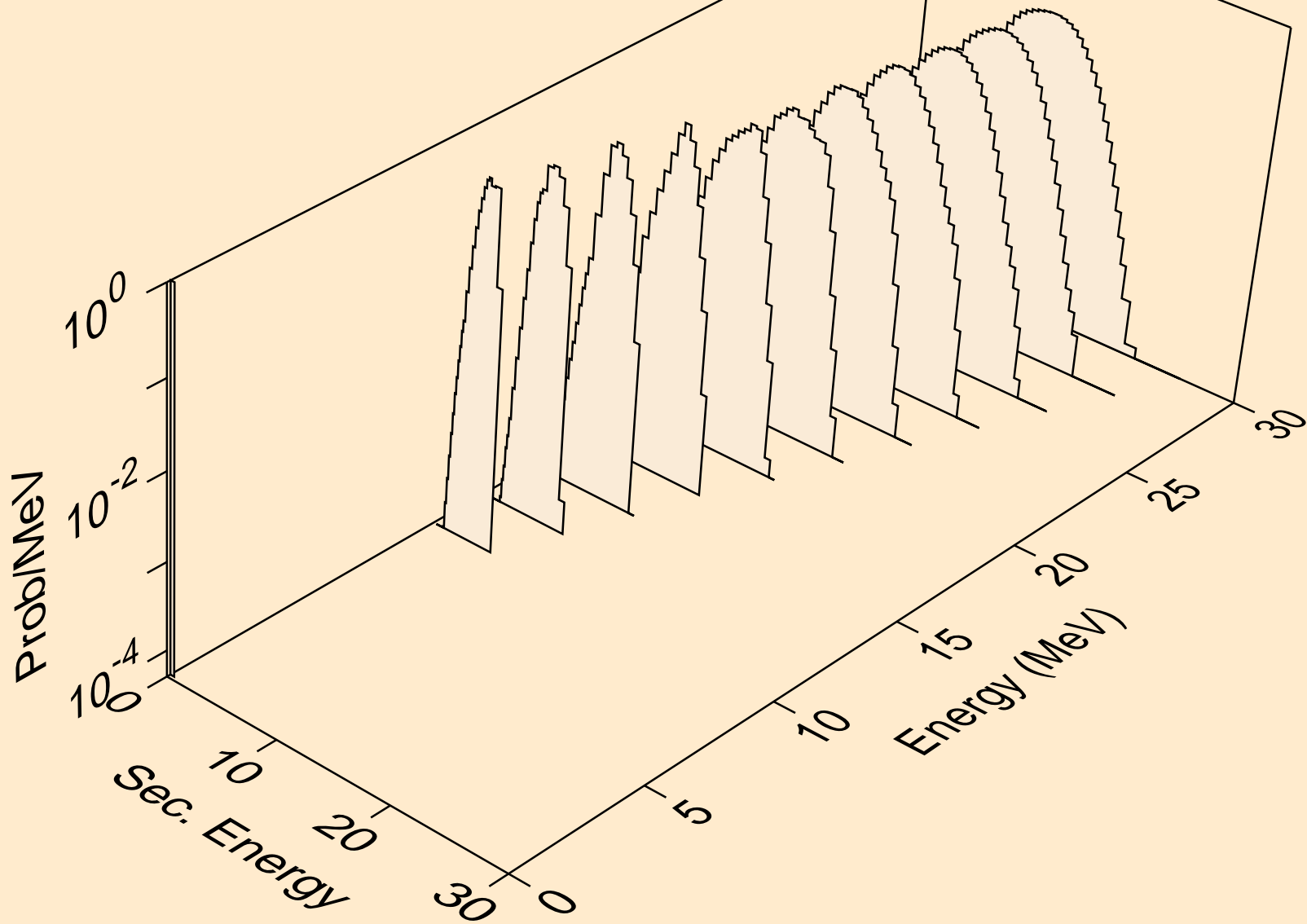

FR225 DEUTERON ACER TENDL-2021 LIBRARY; T=0.K
protons from (d,p)

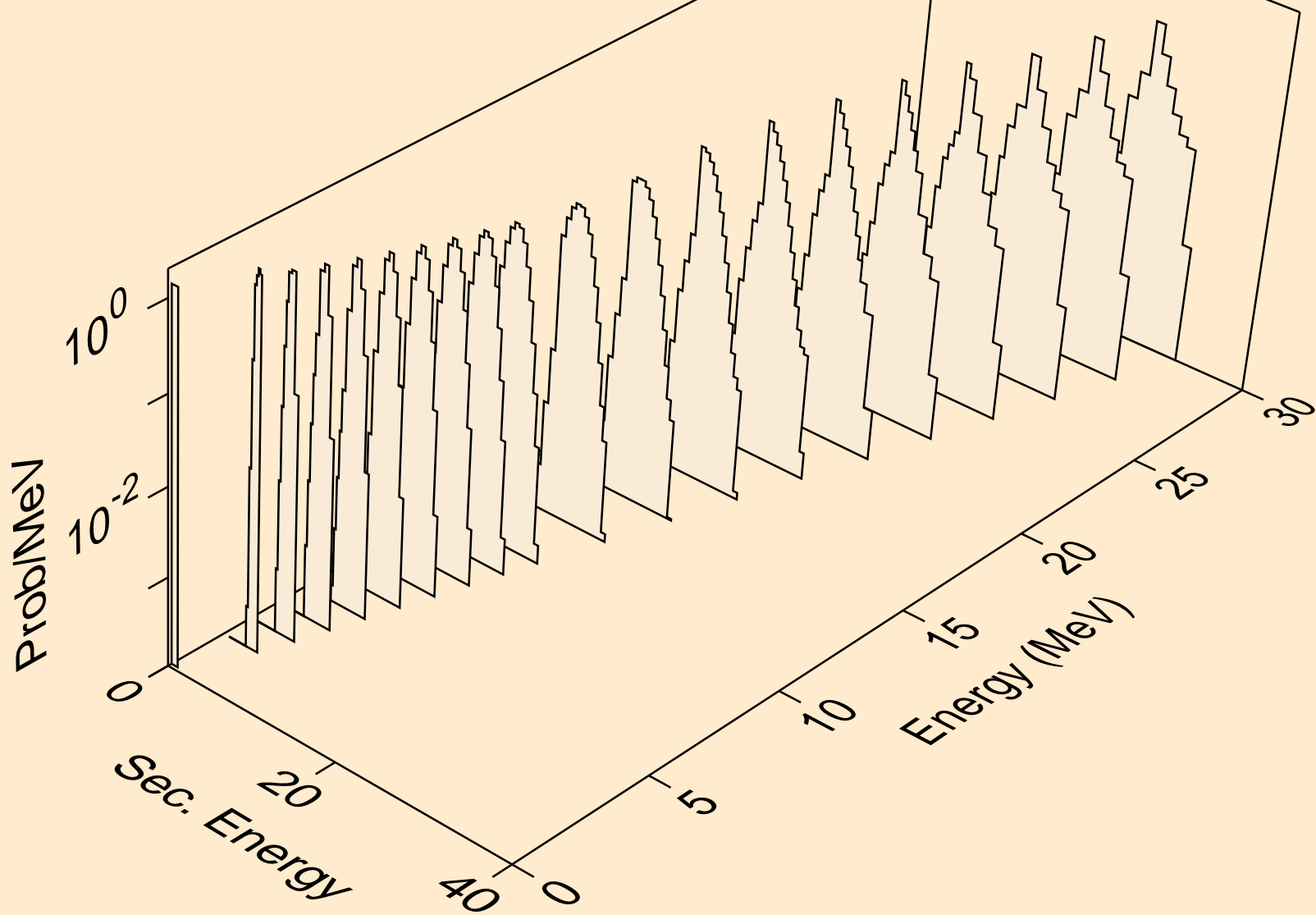

FR225 DEUTERON ACER TENDL-2021 LIBRARY; T=0.K
protons from (d,2p)

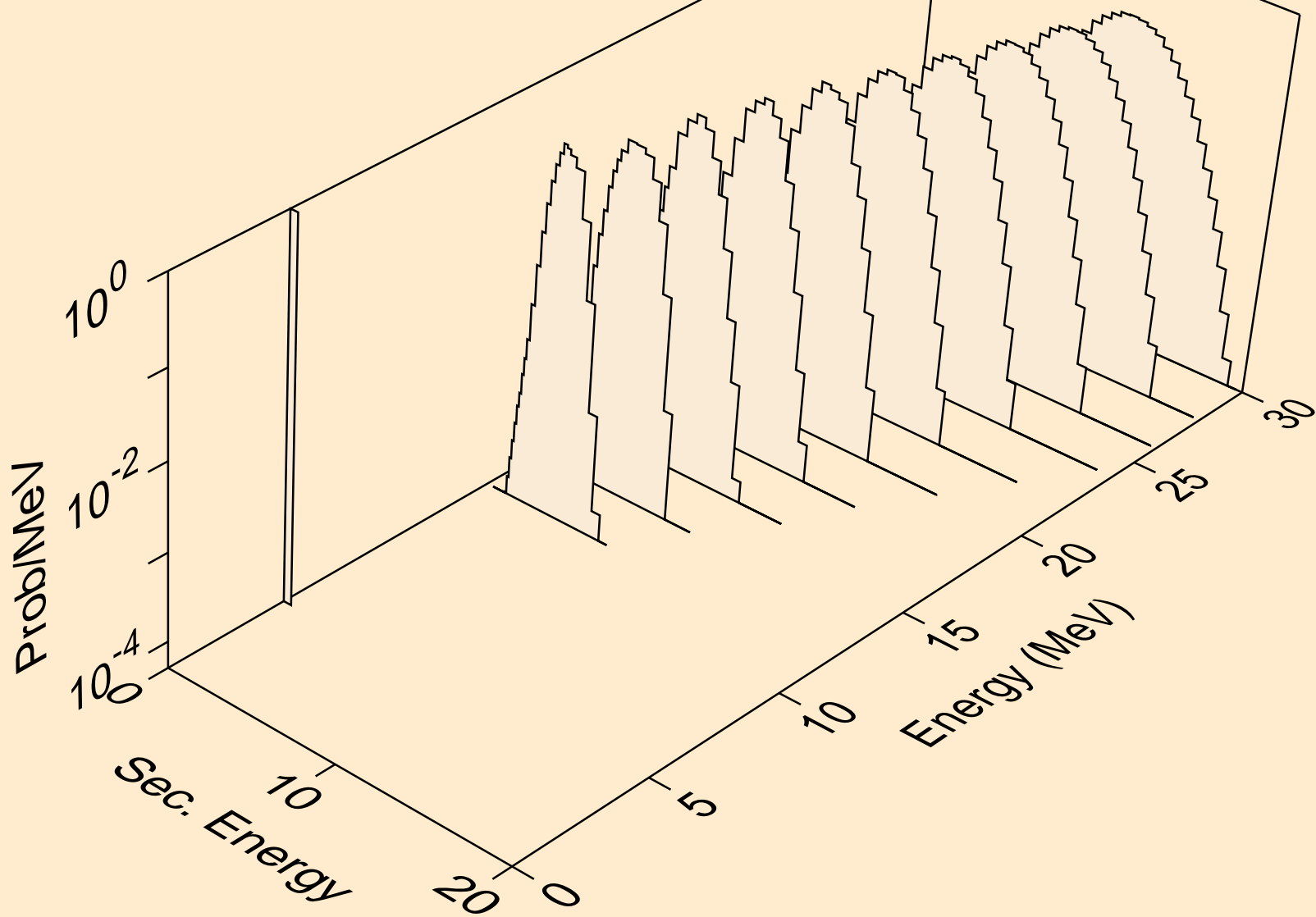

FR225 DEUTERON ACER TENDL-2021 LIBRARY; T=0.K
protons from (d,pa)

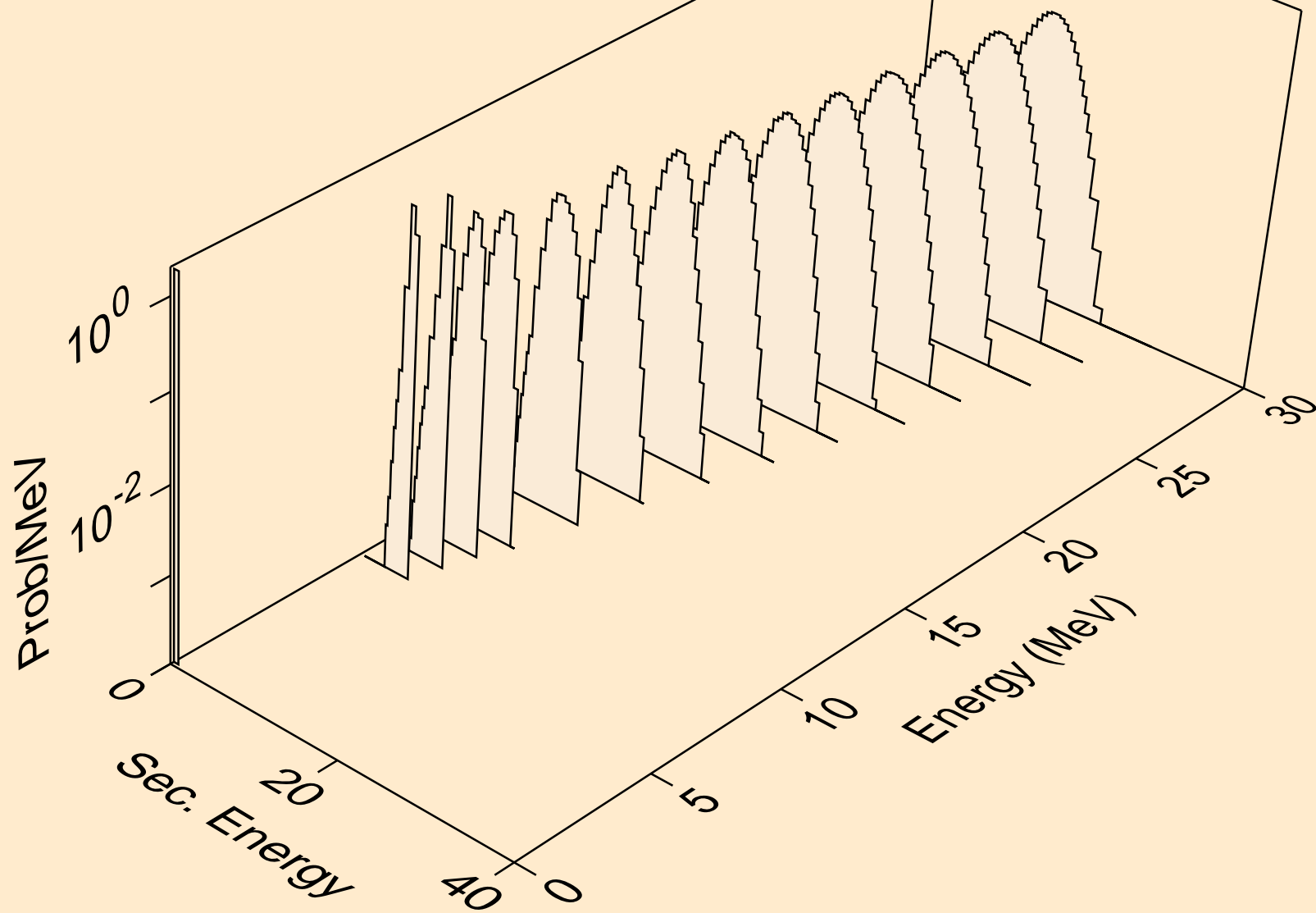

FR225 DEUTERON ACER TENDL-2021 LIBRARY; T=0.K
protons from (d,pd)

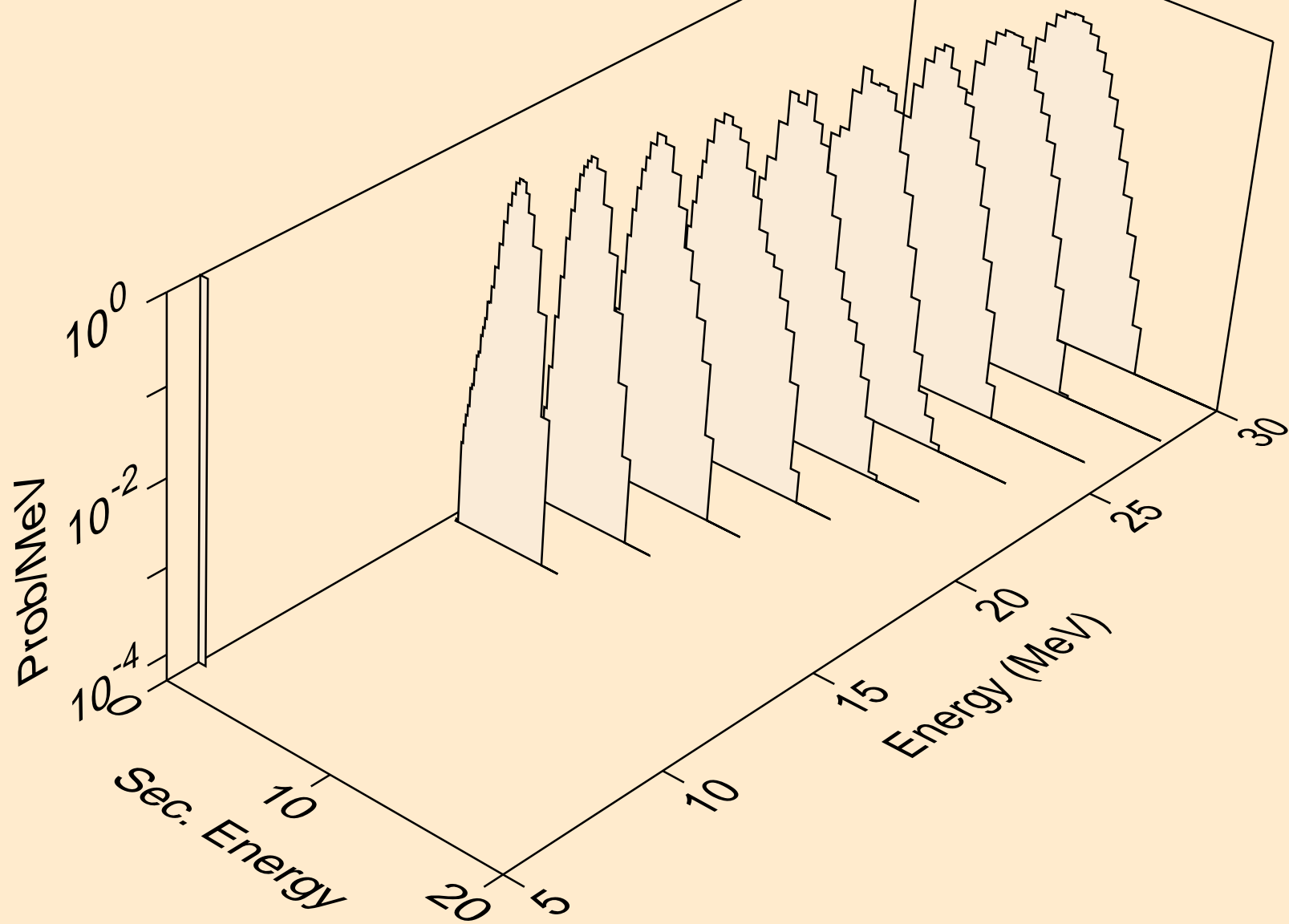

FR225 DEUTERON ACER TENDL-2021 LIBRARY; T=0.K
tritons from (d,x)

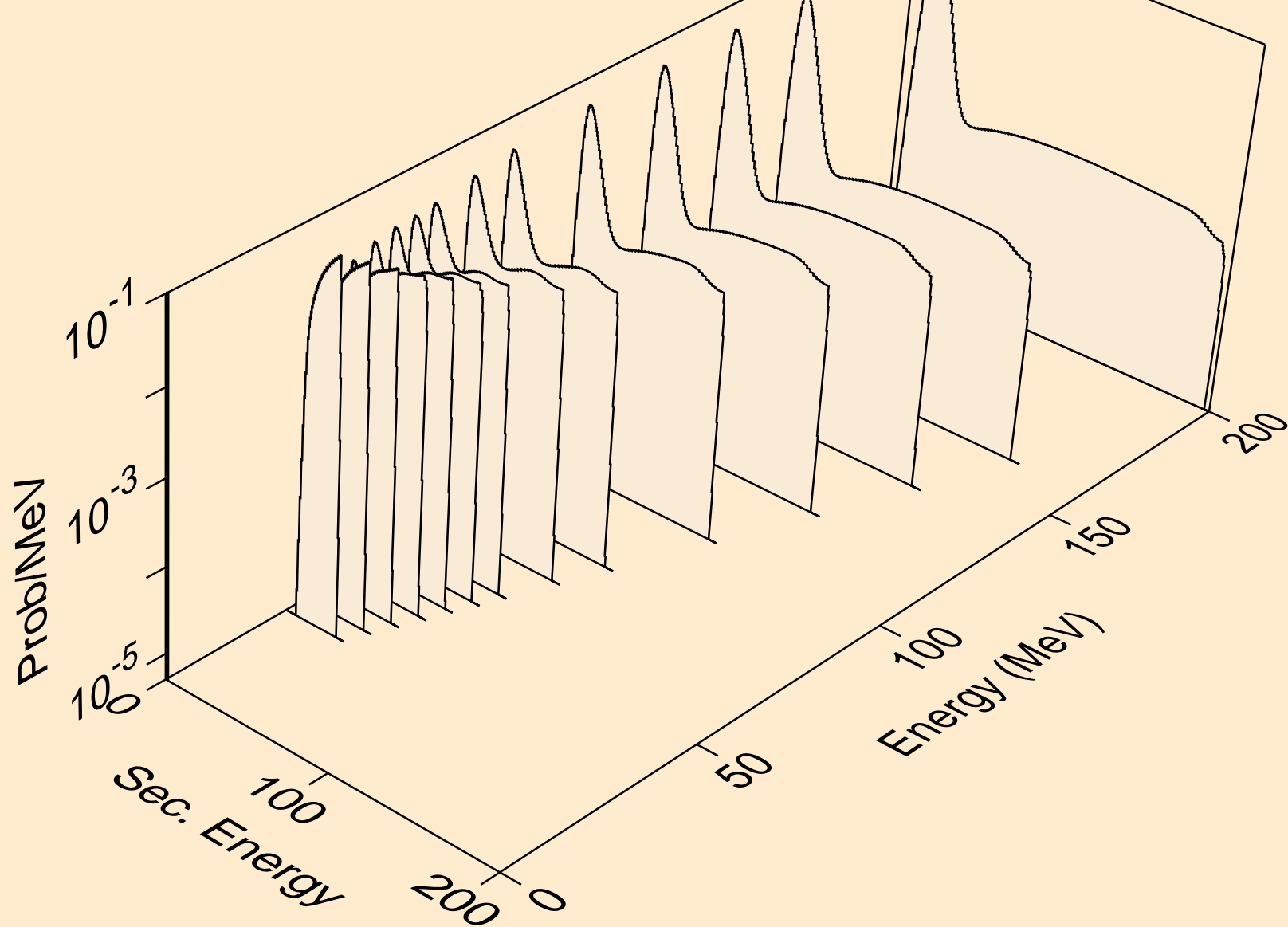

FR225 DEUTERON ACER TENDL-2021 LIBRARY; T=0.K
tritons from (d,n*)t

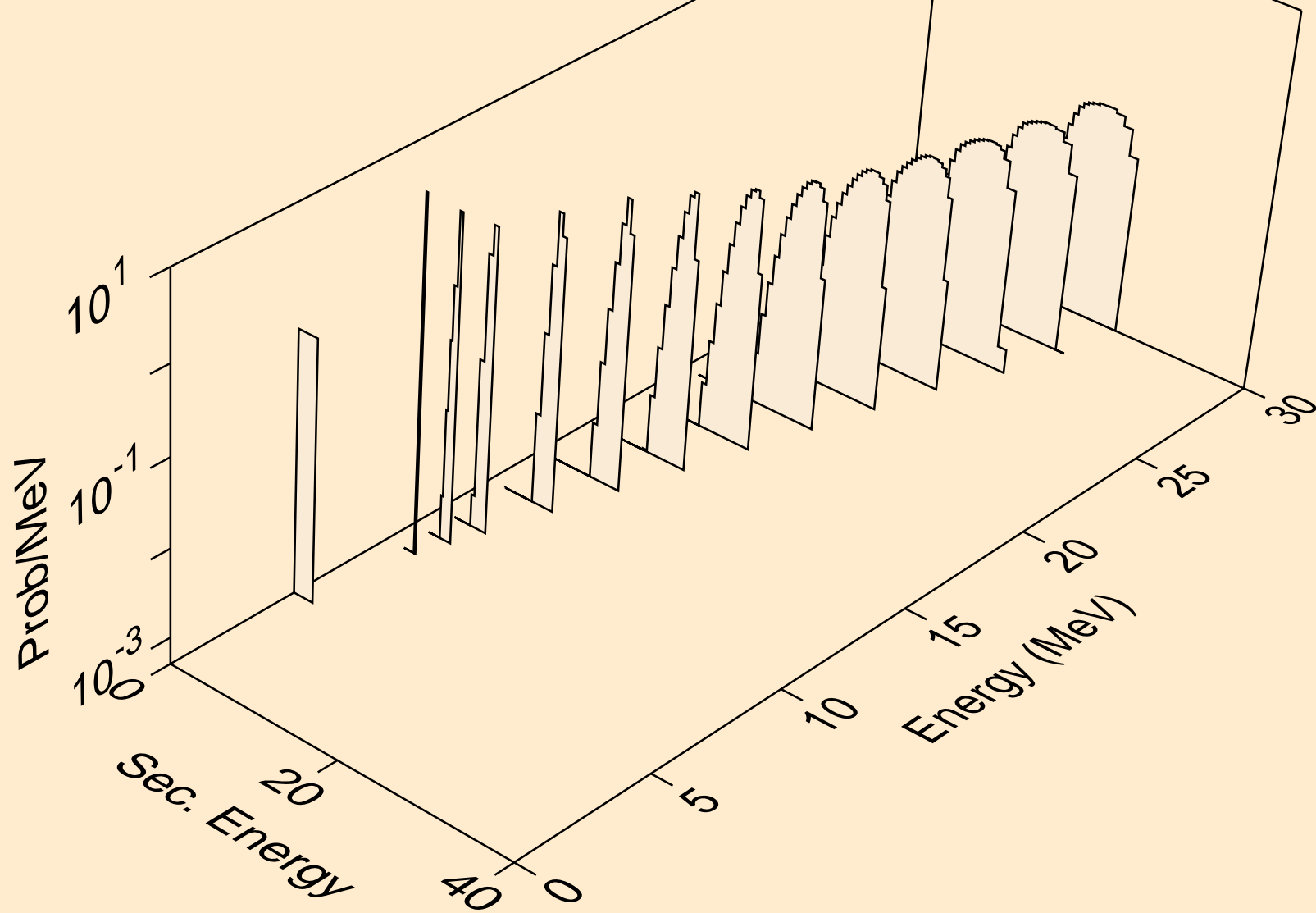

FR225 DEUTERON ACER TENDL-2021 LIBRARY; T=0.K
tritons from (d,t)

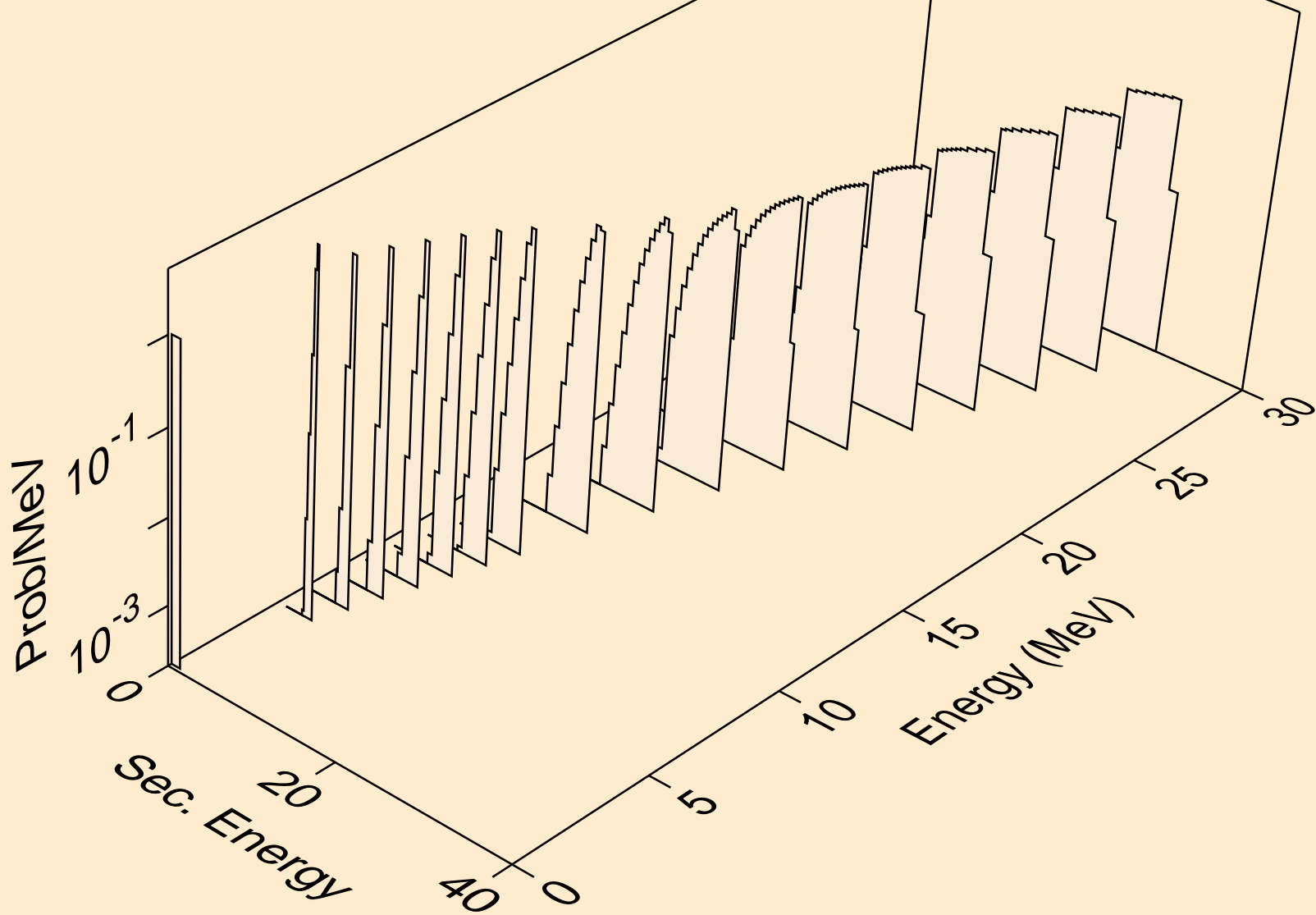

FR225 DEUTERON ACER TENDL-2021 LIBRARY; T=0.K
he3s from (d,x)

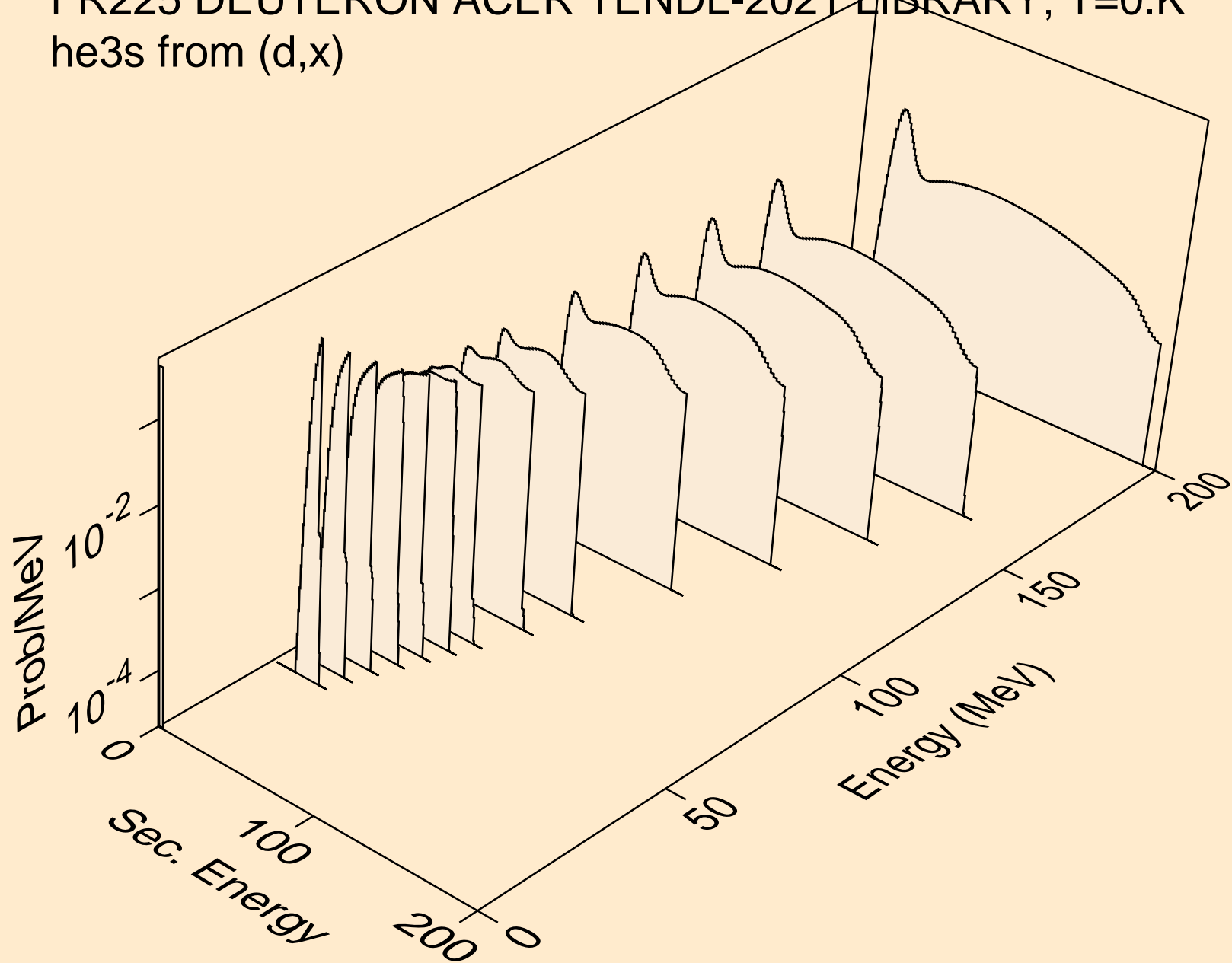

FR225 DEUTERON ACER TENDL-2021 LIBRARY; T=0.K
he3s from (d,n*)he3

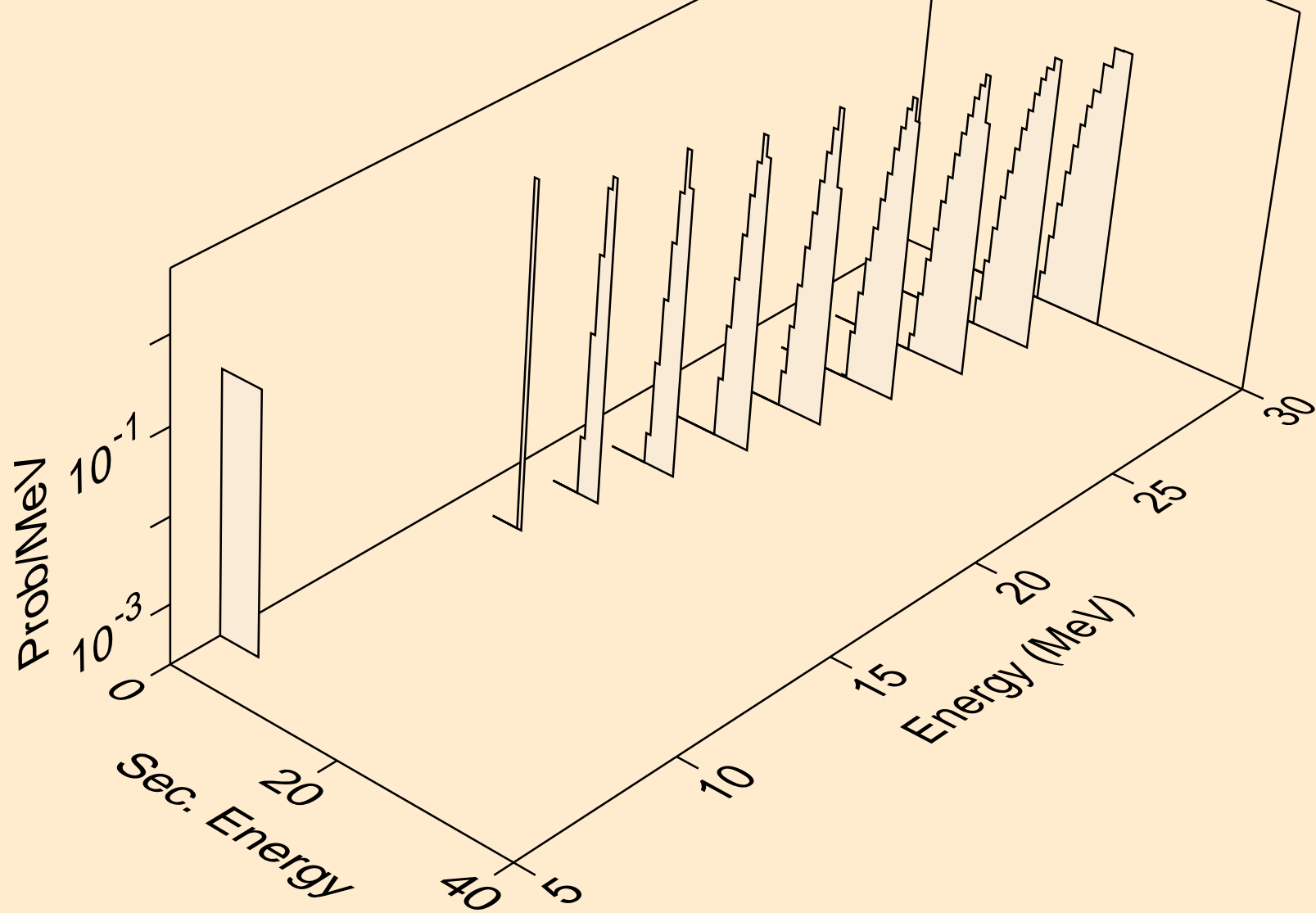

FR225 DEUTERON ACER TENDL-2021 LIBRARY; T=0.K
he3s from (d,he3)

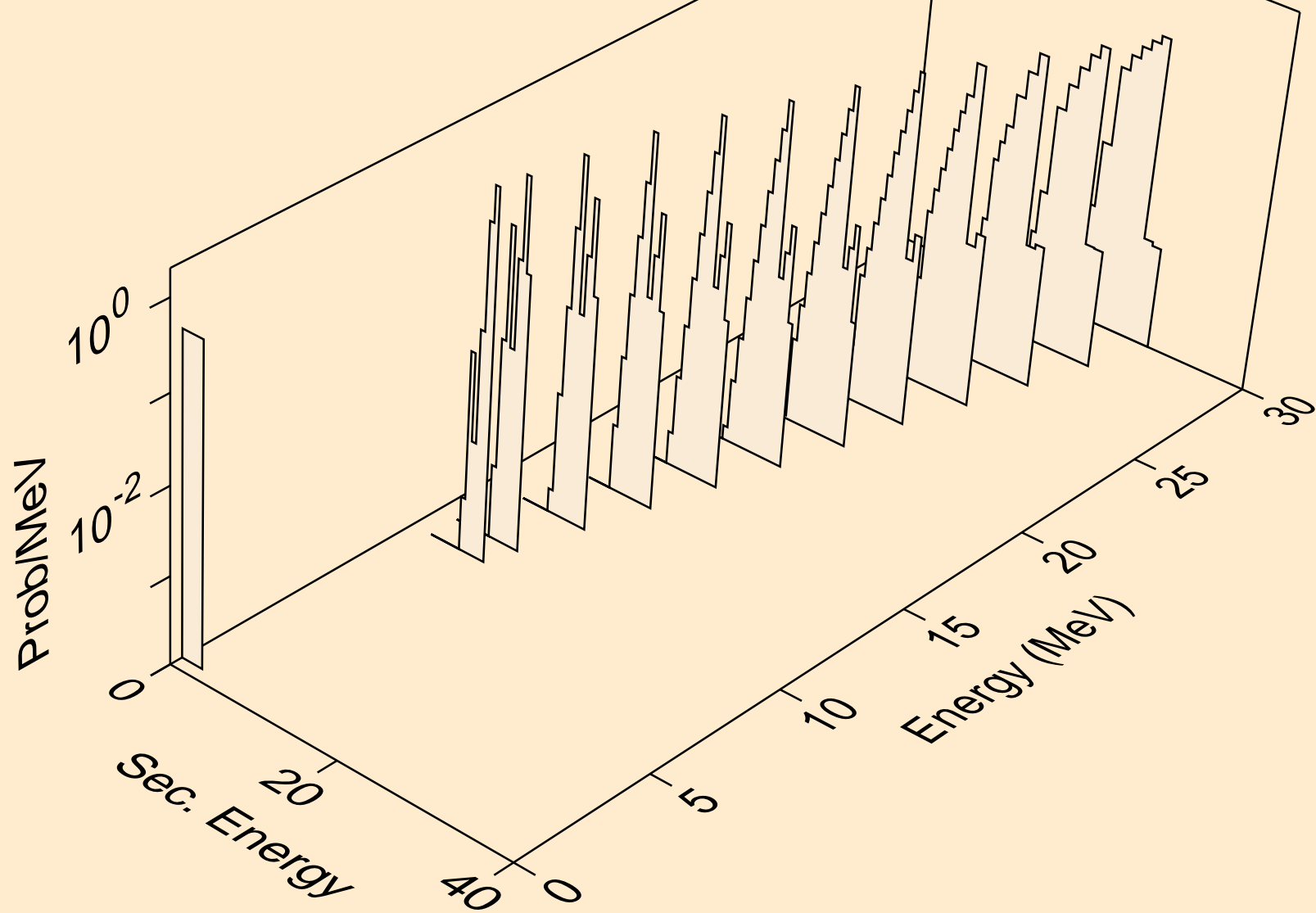

FR225 DEUTERON ACER TENDL-2021 LIBRARY; T=0.K
alphas from (d,x)

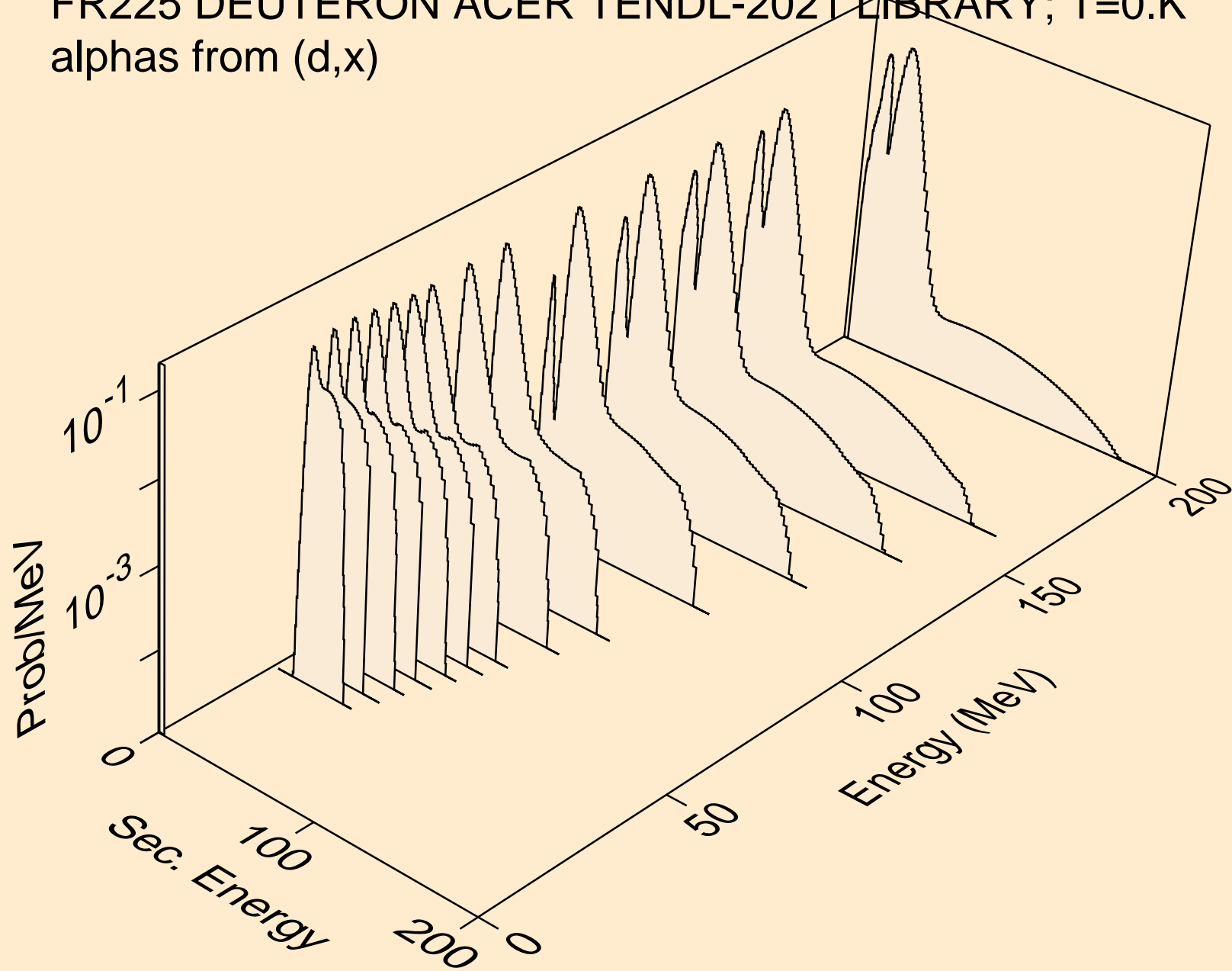

FR225 DEUTERON ACER TENDL-2021 LIBRARY; T=0.K
alphas from (d,n*)a

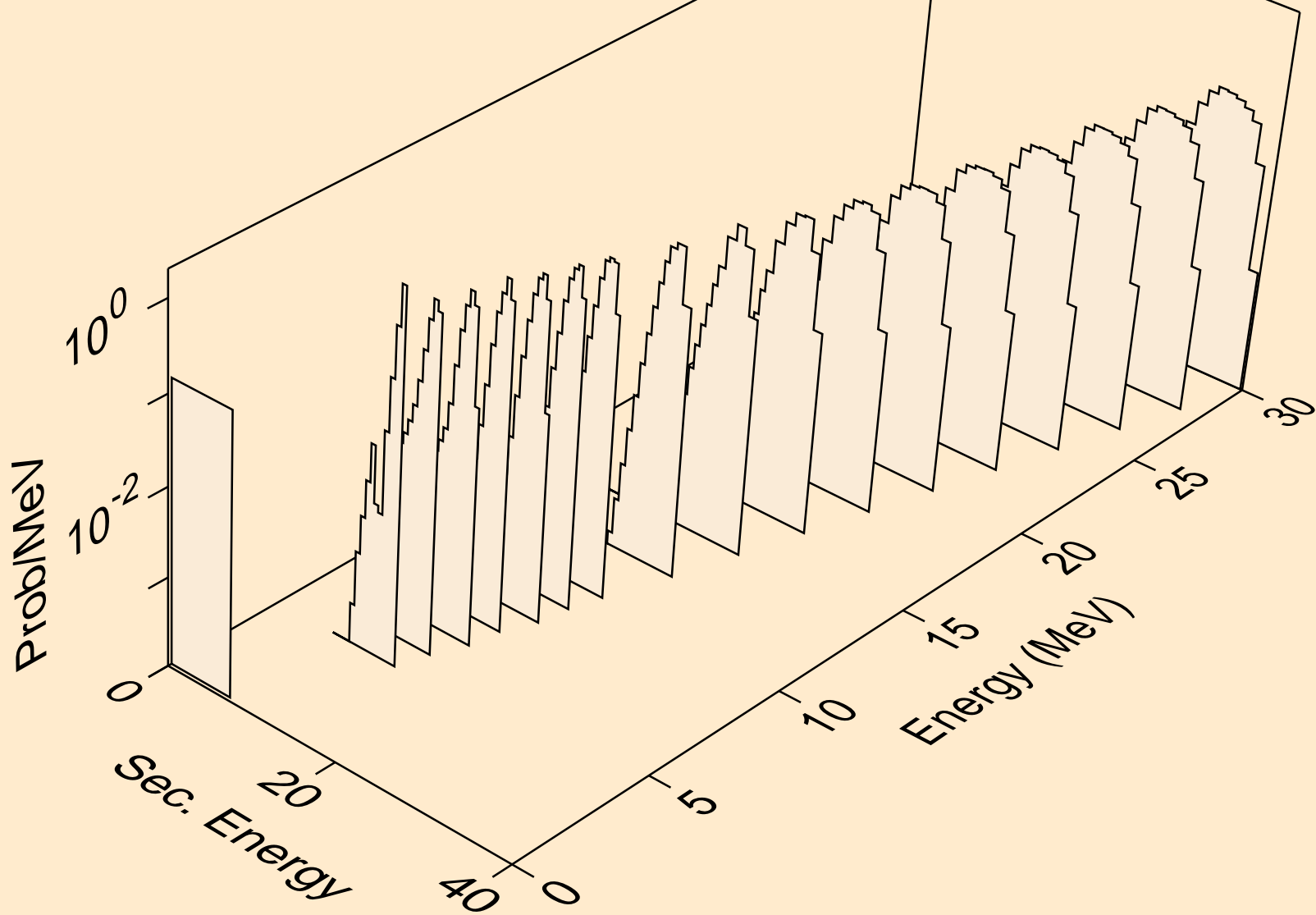

FR225 DEUTERON ACER TENDL-2021 LIBRARY; T=0.K
alphas from (d,2n)a

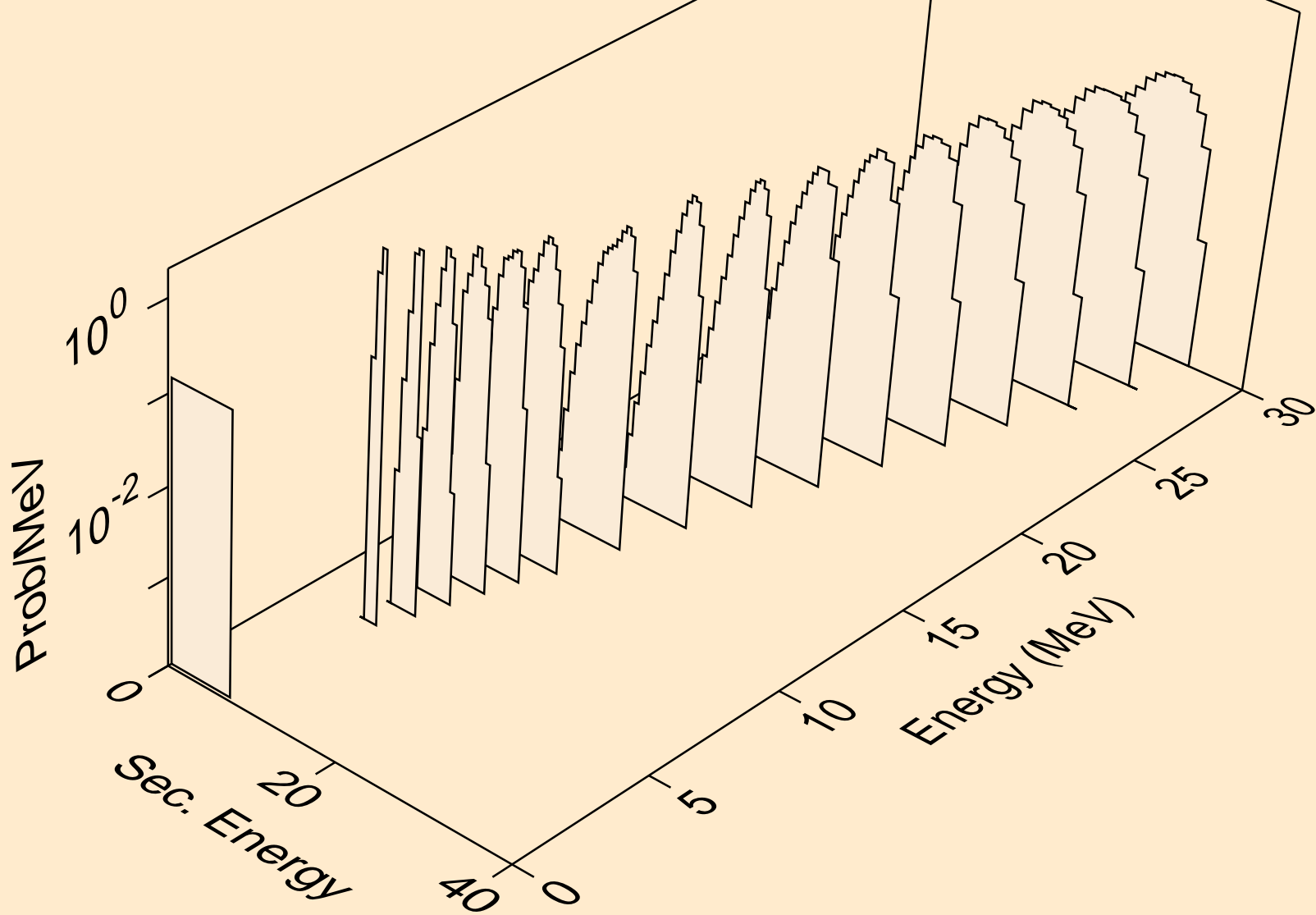

FR225 DEUTERON ACER TENDL-2021 LIBRARY; T=0.K
alphas from (d,3n)a

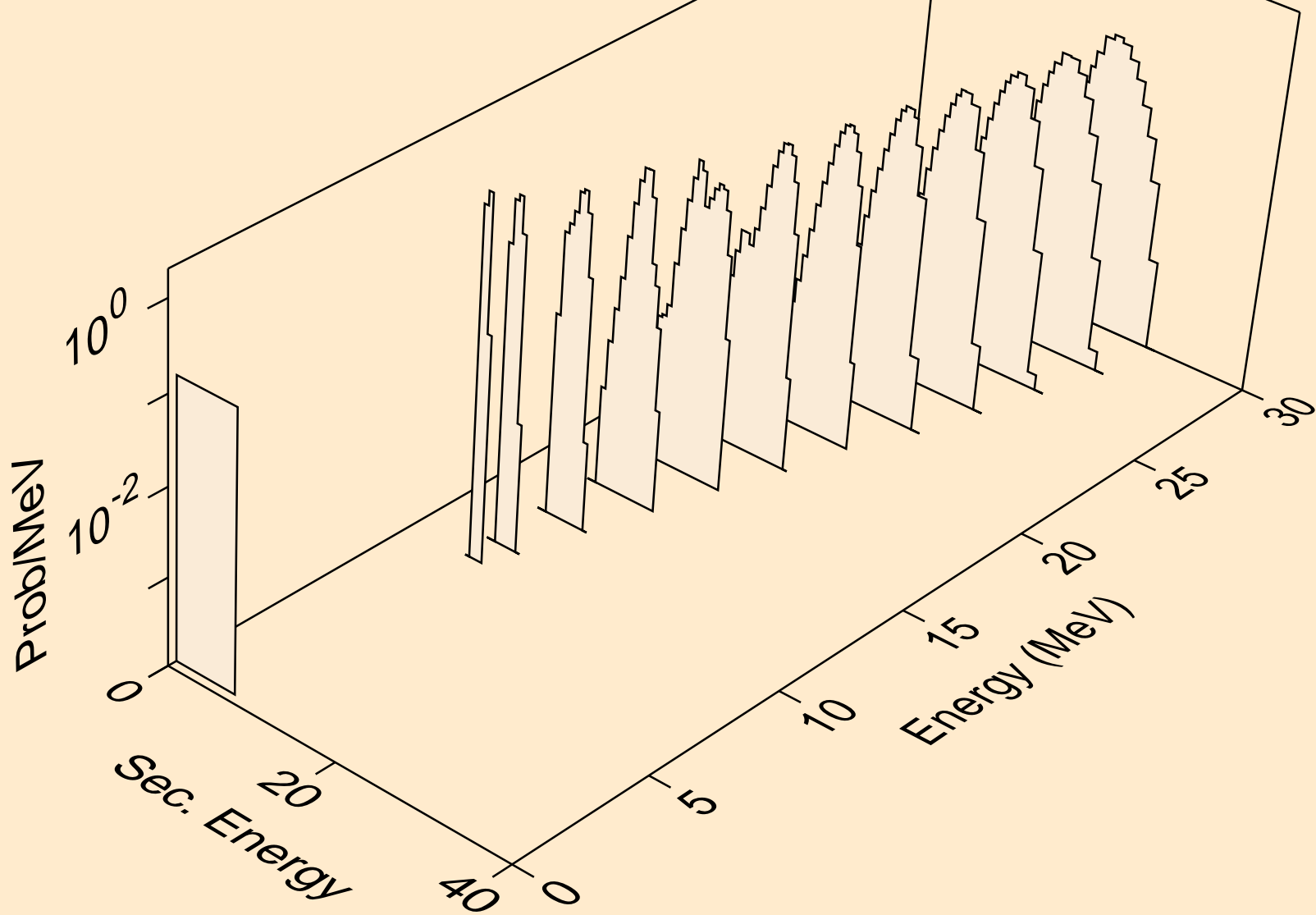

FR225 DEUTERON ACER TENDL-2021 LIBRARY; T=0.K
alphas from (d,n*)2a

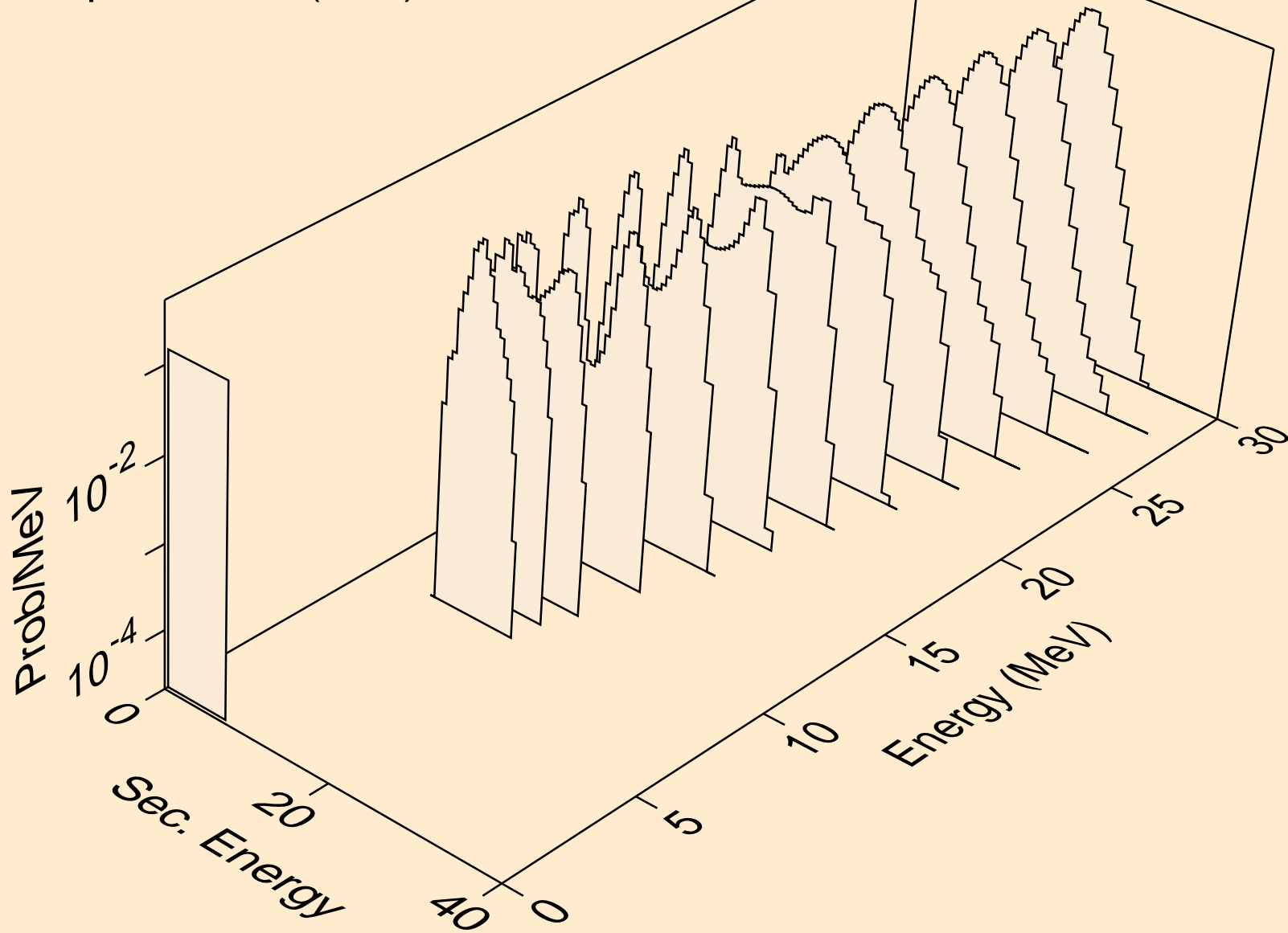

FR225 DEUTERON ACER TENDL-2021 LIBRARY; T=0.K
alphas from (d,2n)2a

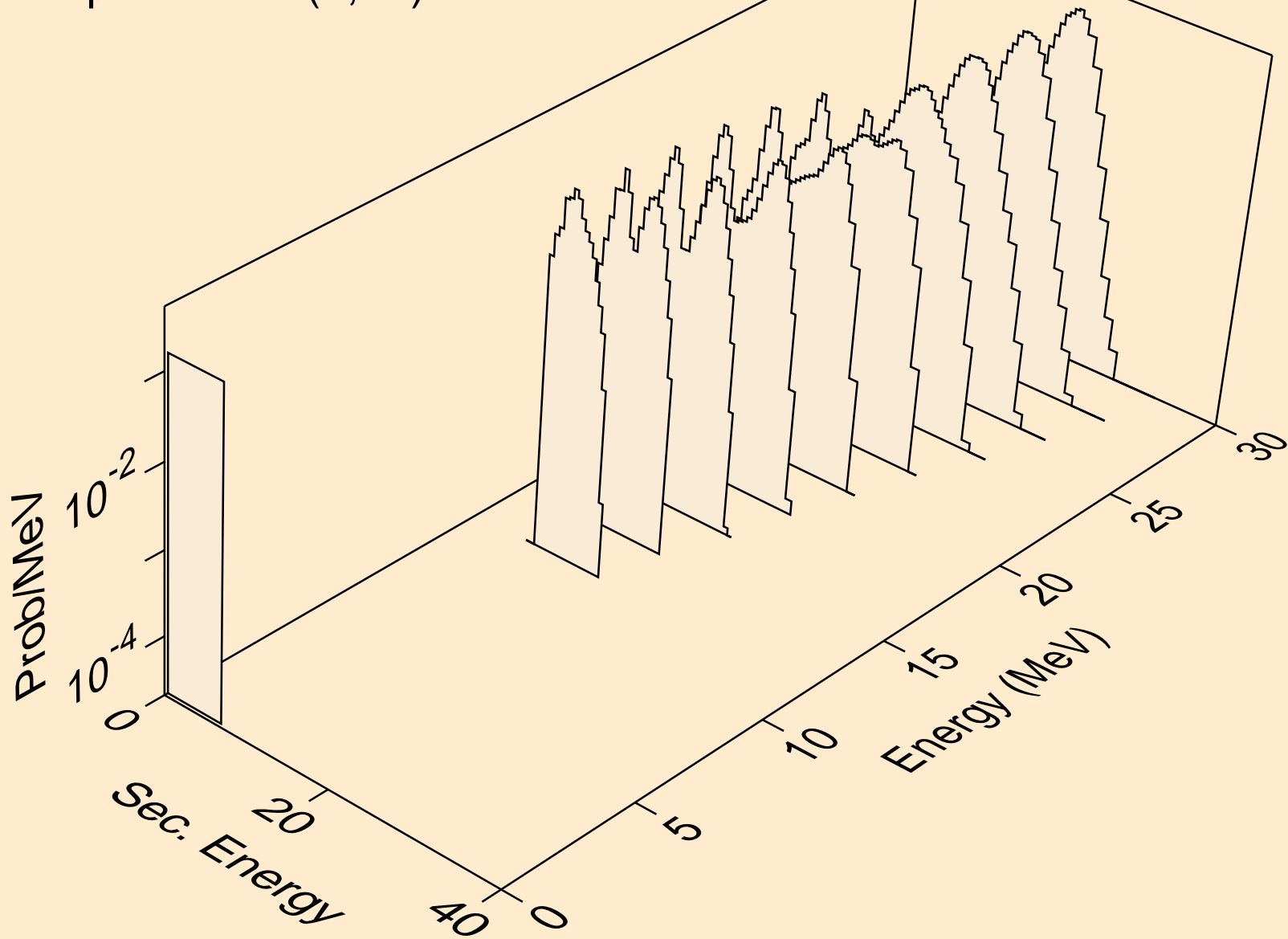

FR225 DEUTERON ACER TENDL-2021 LIBRARY; T=0.K
alphas from (d,npa)

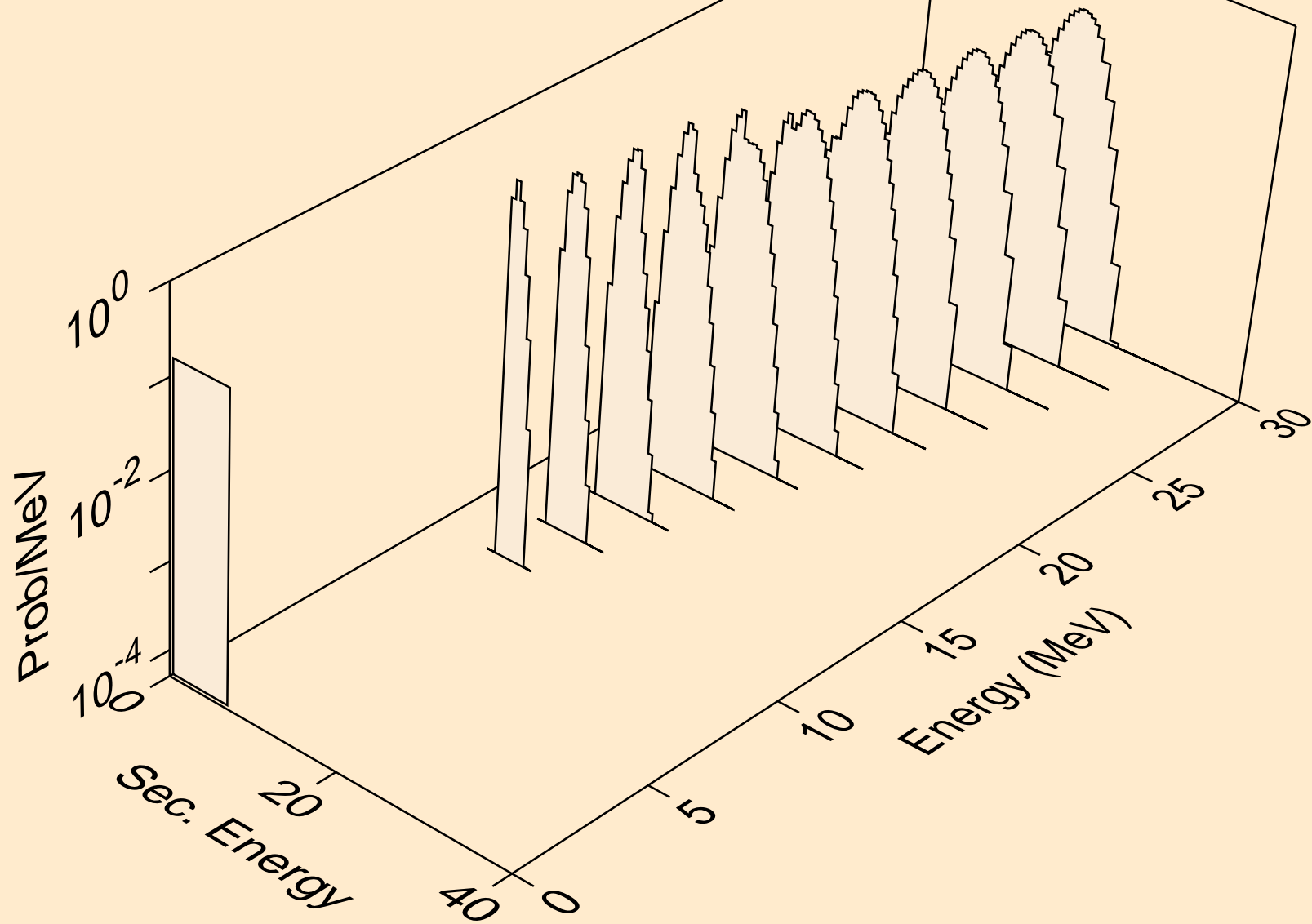

FR225 DEUTERON ACER TENDL-2021 LIBRARY; T=0.K
alphas from (d,a)

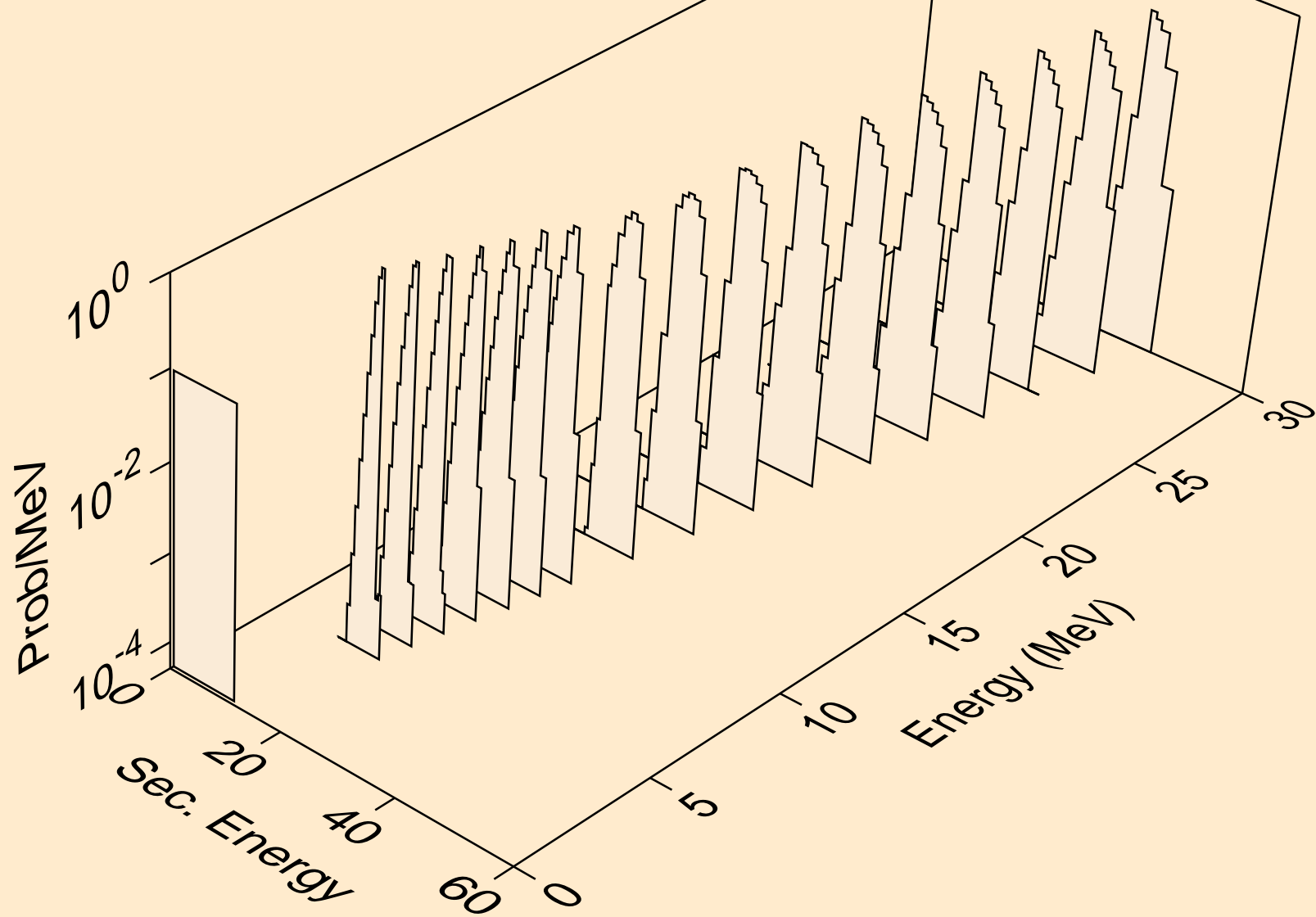

FR225 DEUTERON ACER TENDL-2021 LIBRARY; T=0.K
alphas from (d,2a)

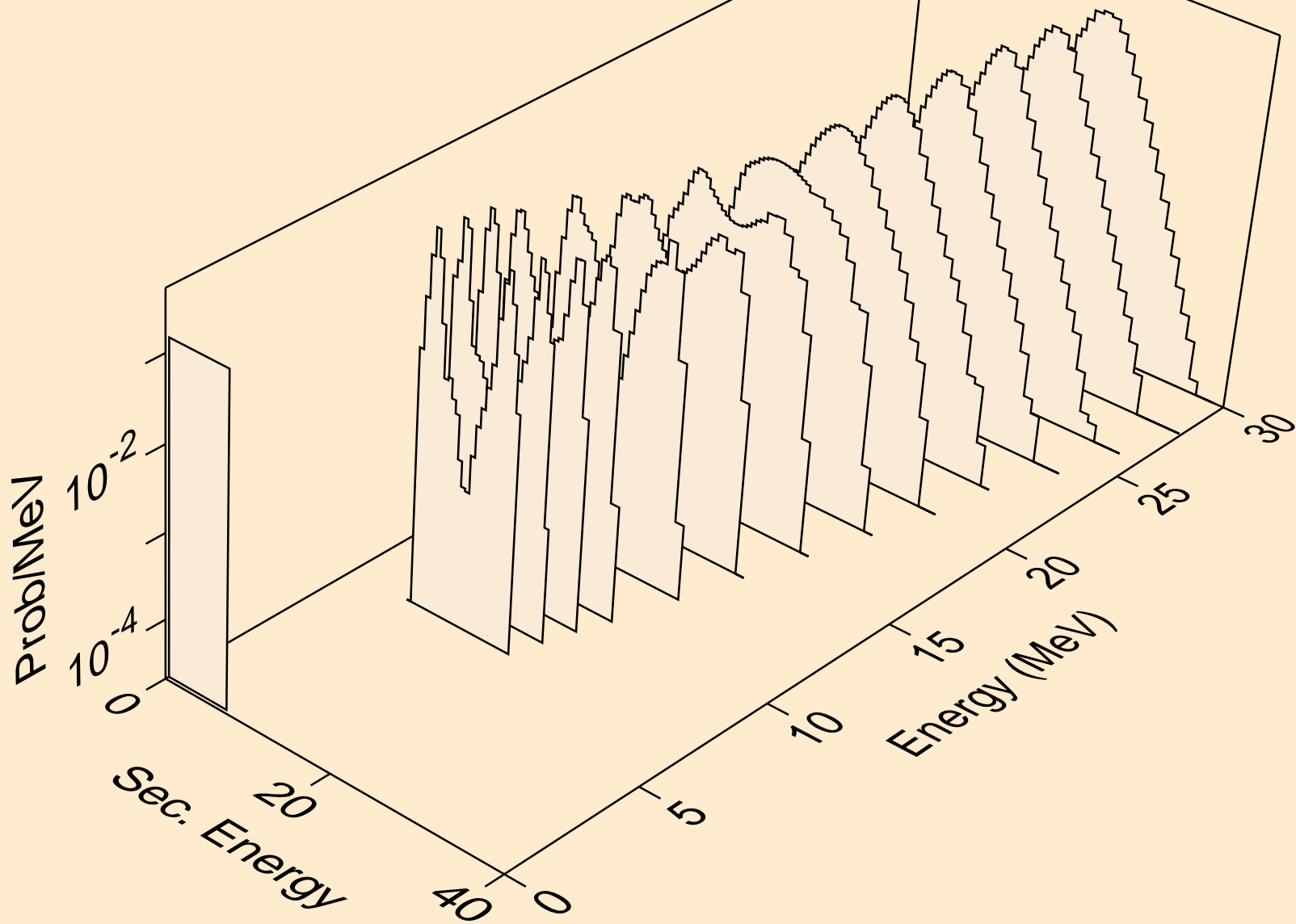

FR225 DEUTERON ACER TENDL-2021 LIBRARY; T=0.K
alphas from (d,pa)

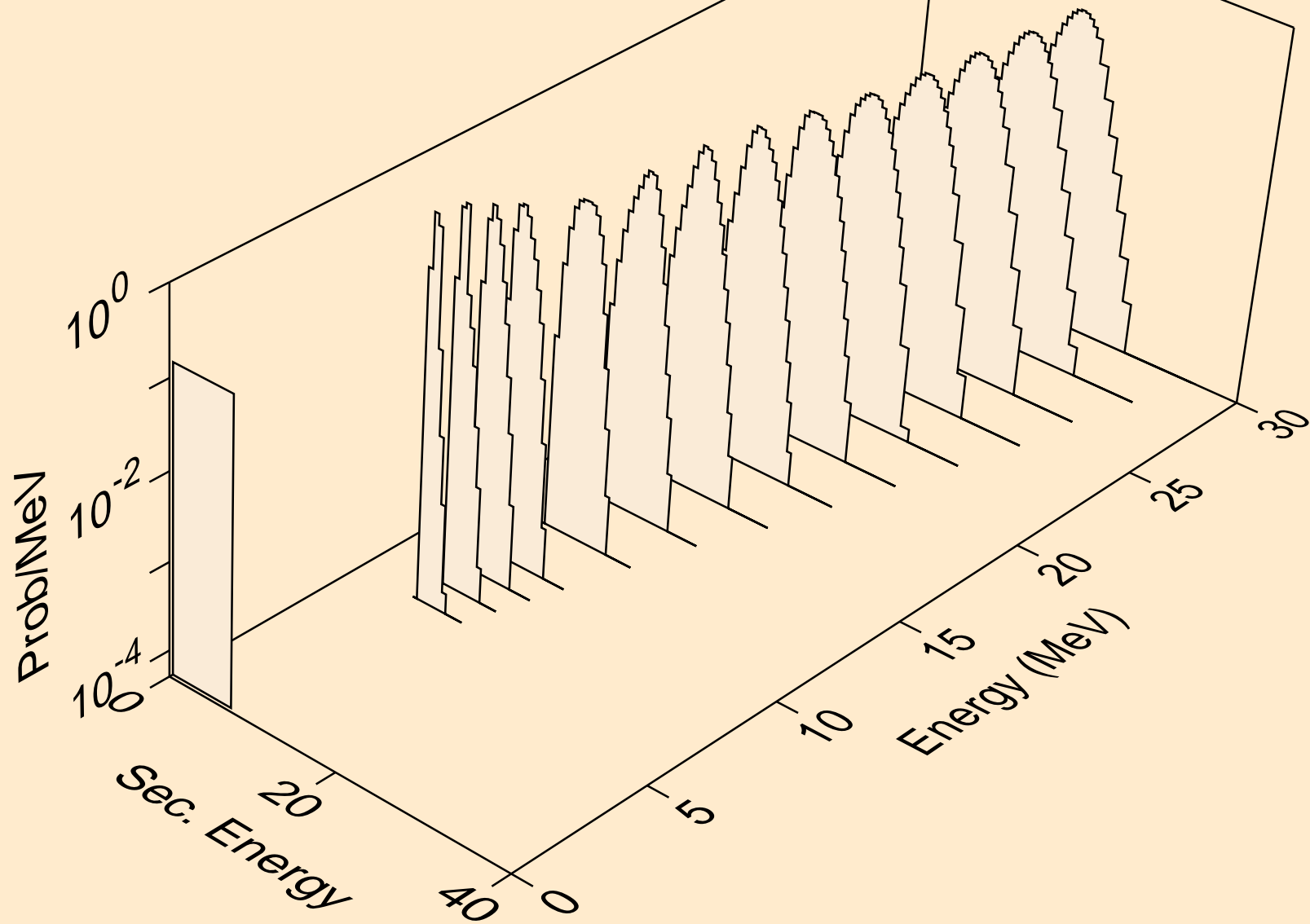

FR225 DEUTERON ACER TENDL-2021 LIBRARY; T=0.K
alphas from (d,da)

