

# GD137 DEUTERON ACER TENDL-2021 LIBRARY; T=0.K

## Principal cross sections

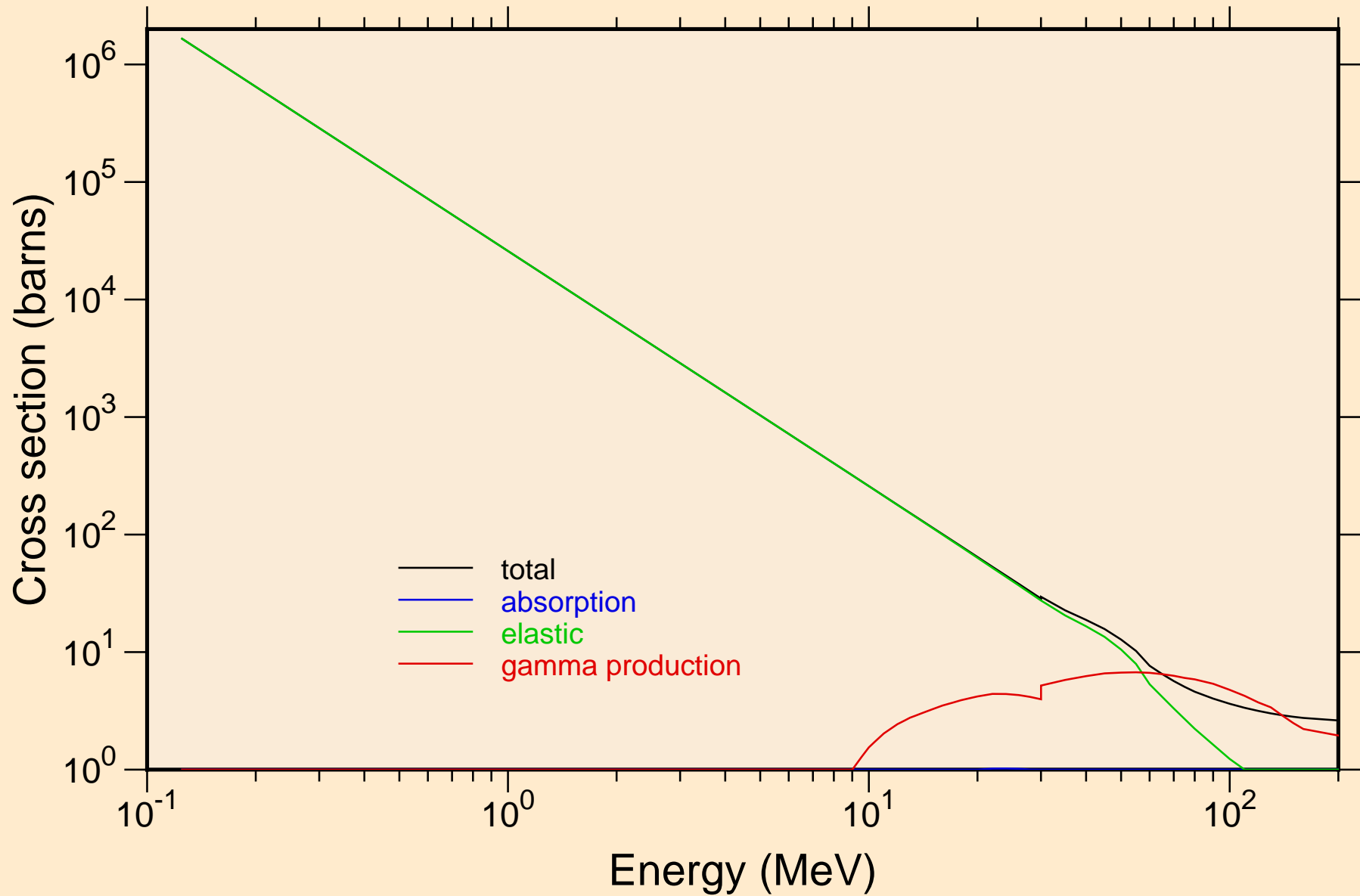

# GD137 DEUTERON ACER TENDL-2021 LIBRARY; T=0.K

## Heating

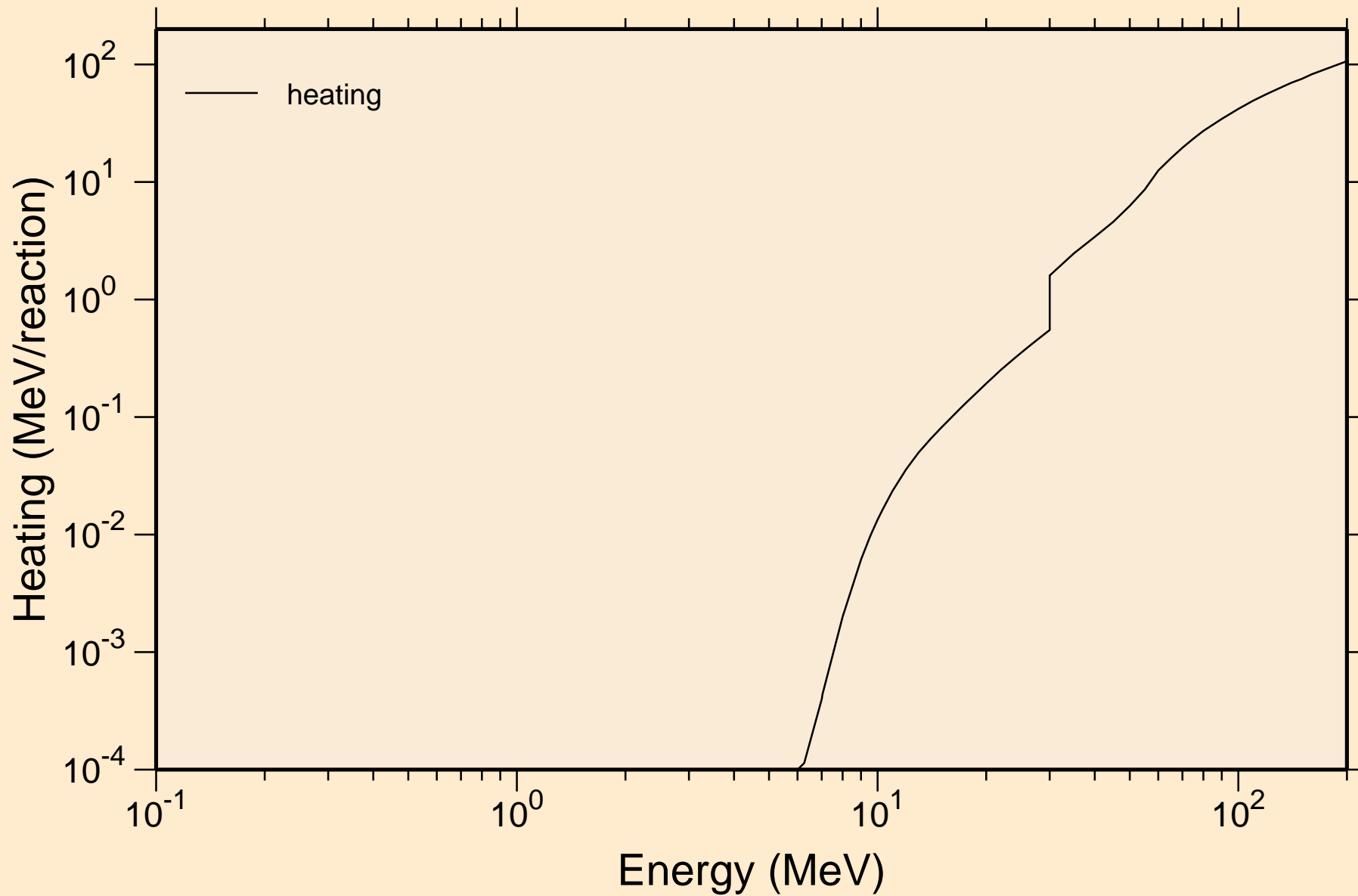

# GD137 DEUTERON ACER TENDL-2021 LIBRARY; T=0.K

## Principal cross sections

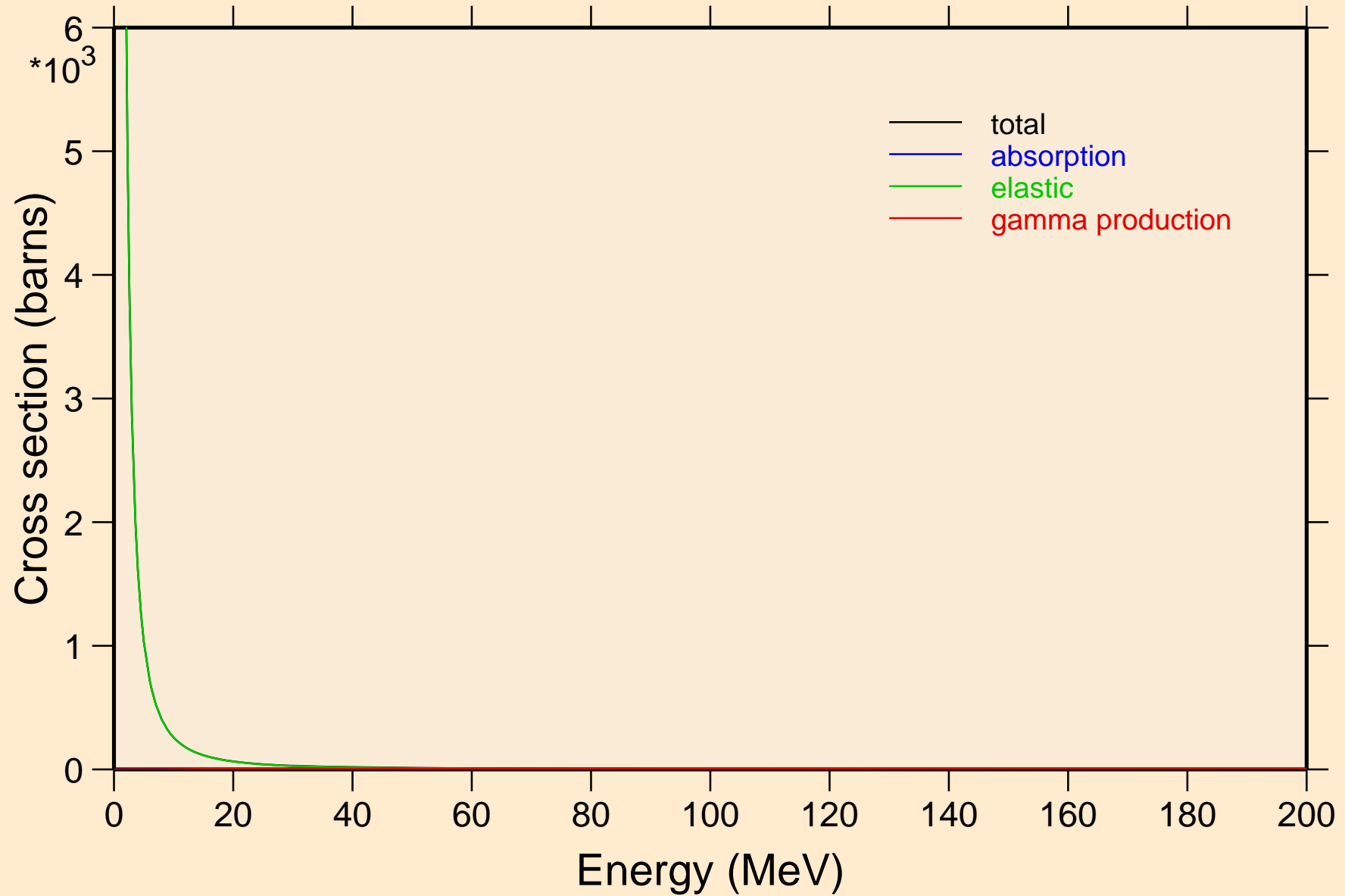

GD137 DEUTERON ACER TENDL-2021 LIBRARY; T=0.K  
Heating

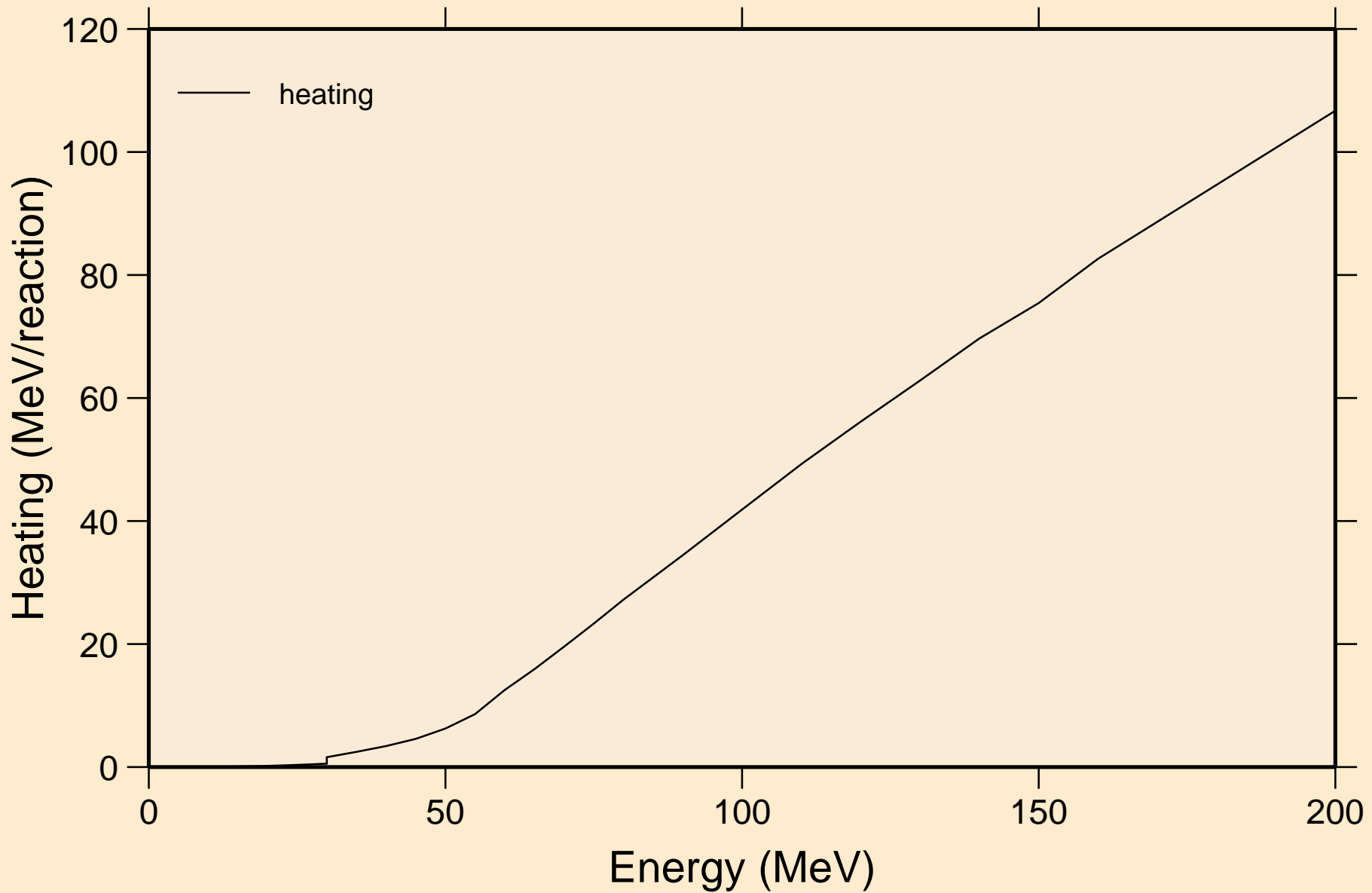

# GD137 DEUTERON ACER TENDL-2021 LIBRARY; T=0.K

## Threshold reactions

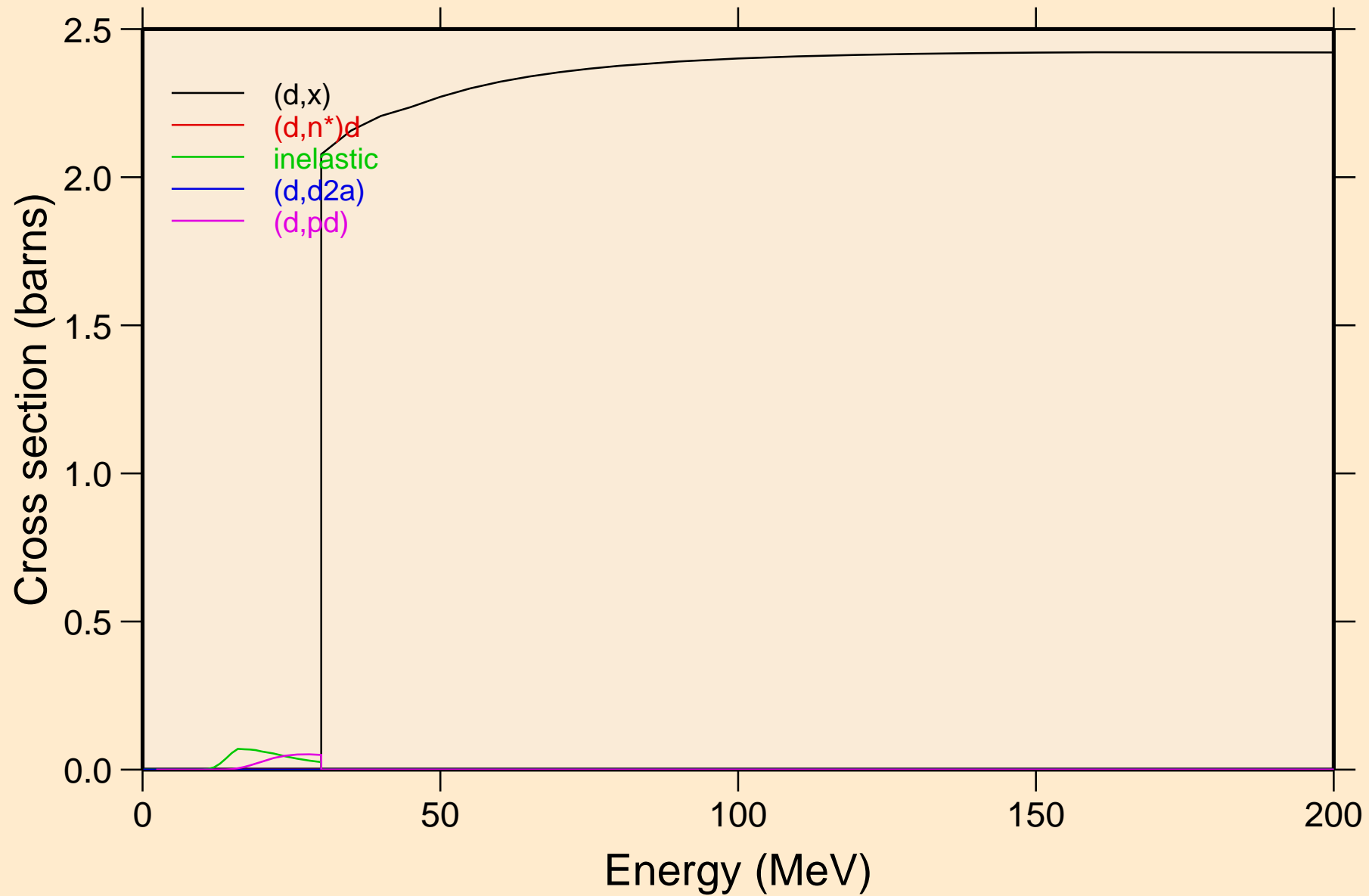

# GD137 DEUTERON ACER TENDL-2021 LIBRARY; T=0.K

## Threshold reactions

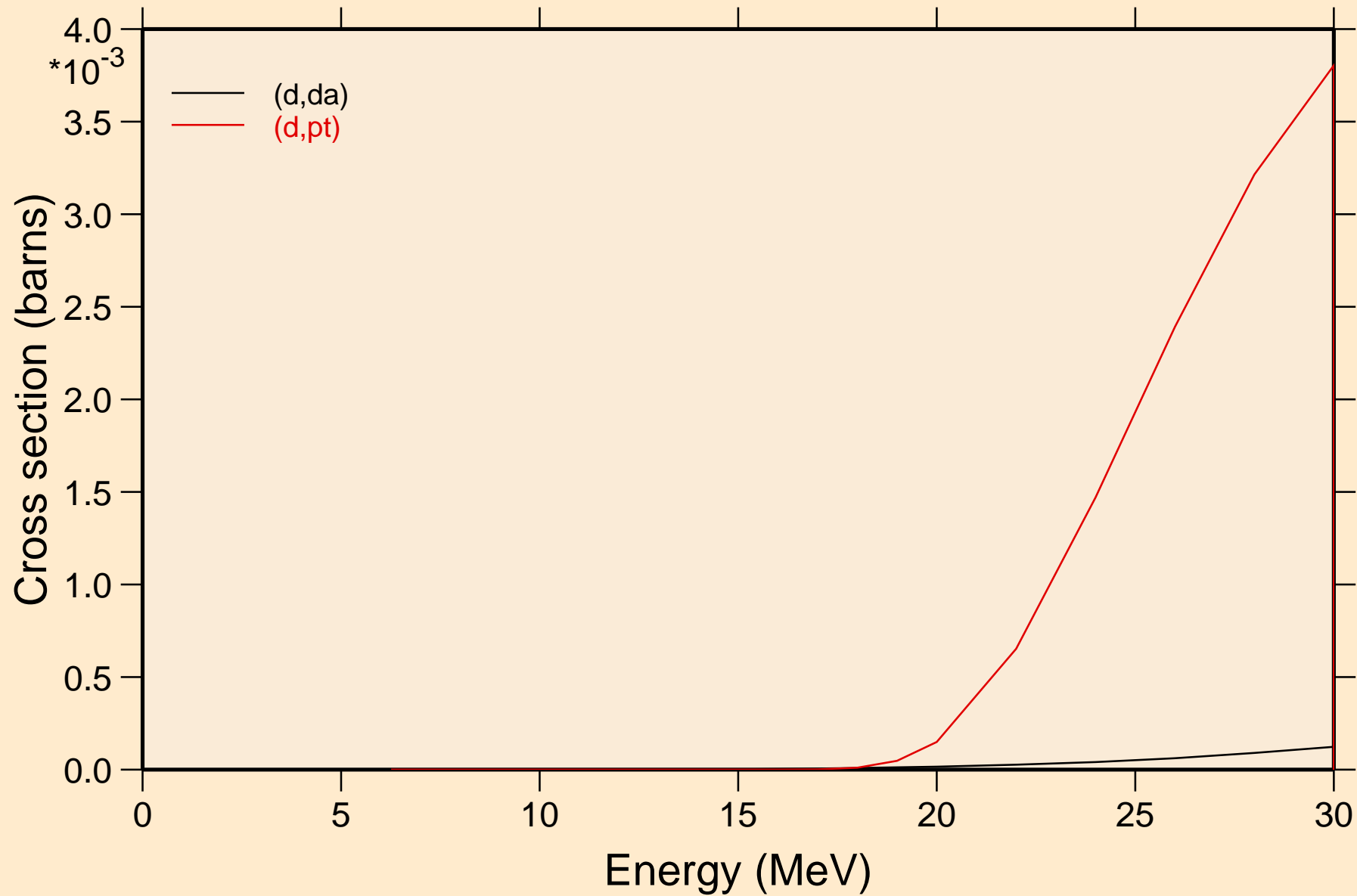

GD137 DEUTERON ACER TENDL-2021 LIBRARY; T=0.K  
Threshold reactions

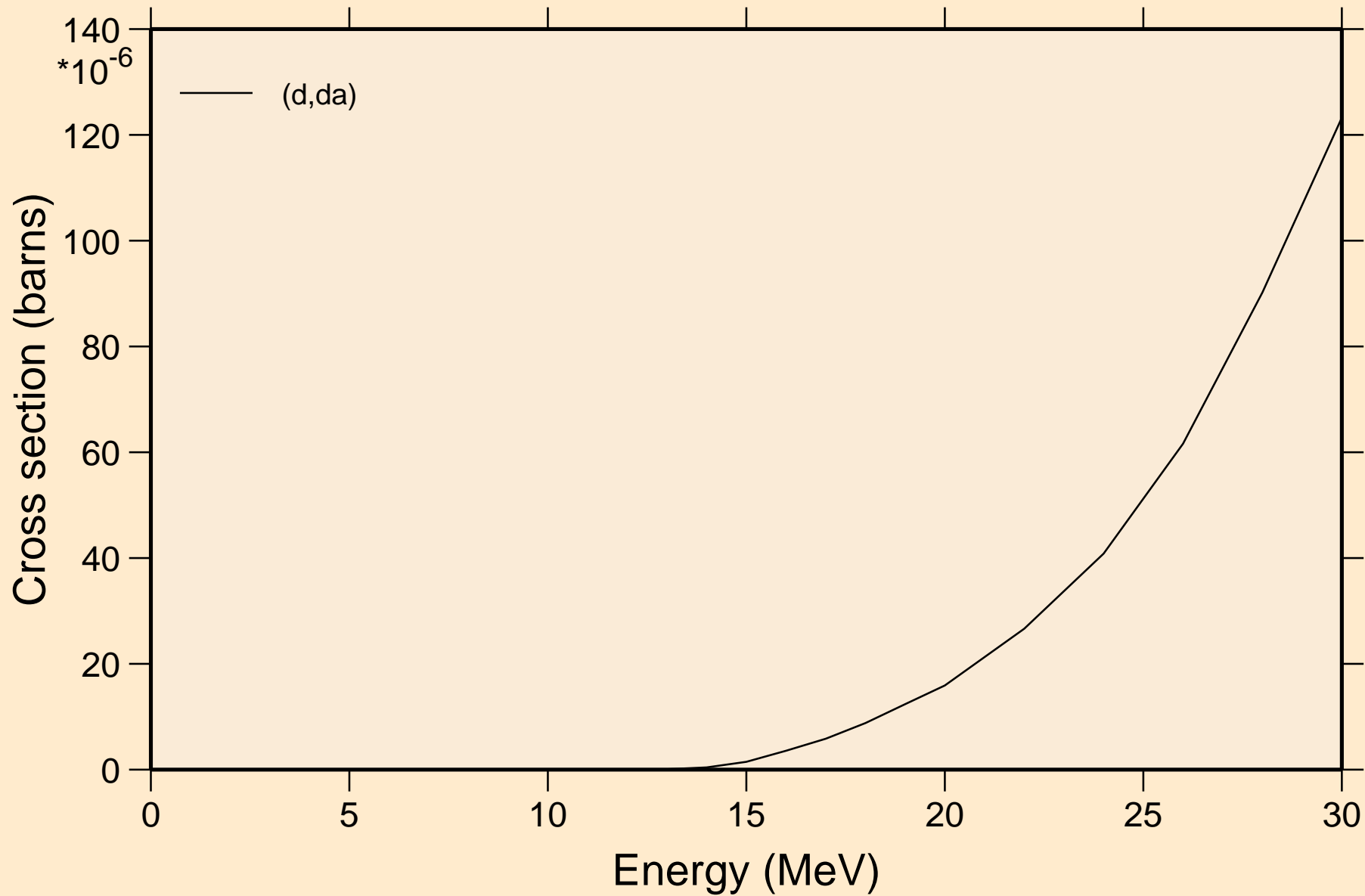

GD137 DEUTERON ACER TENDL-2021 LIBRARY; T=0.K  
angular distribution for elastic

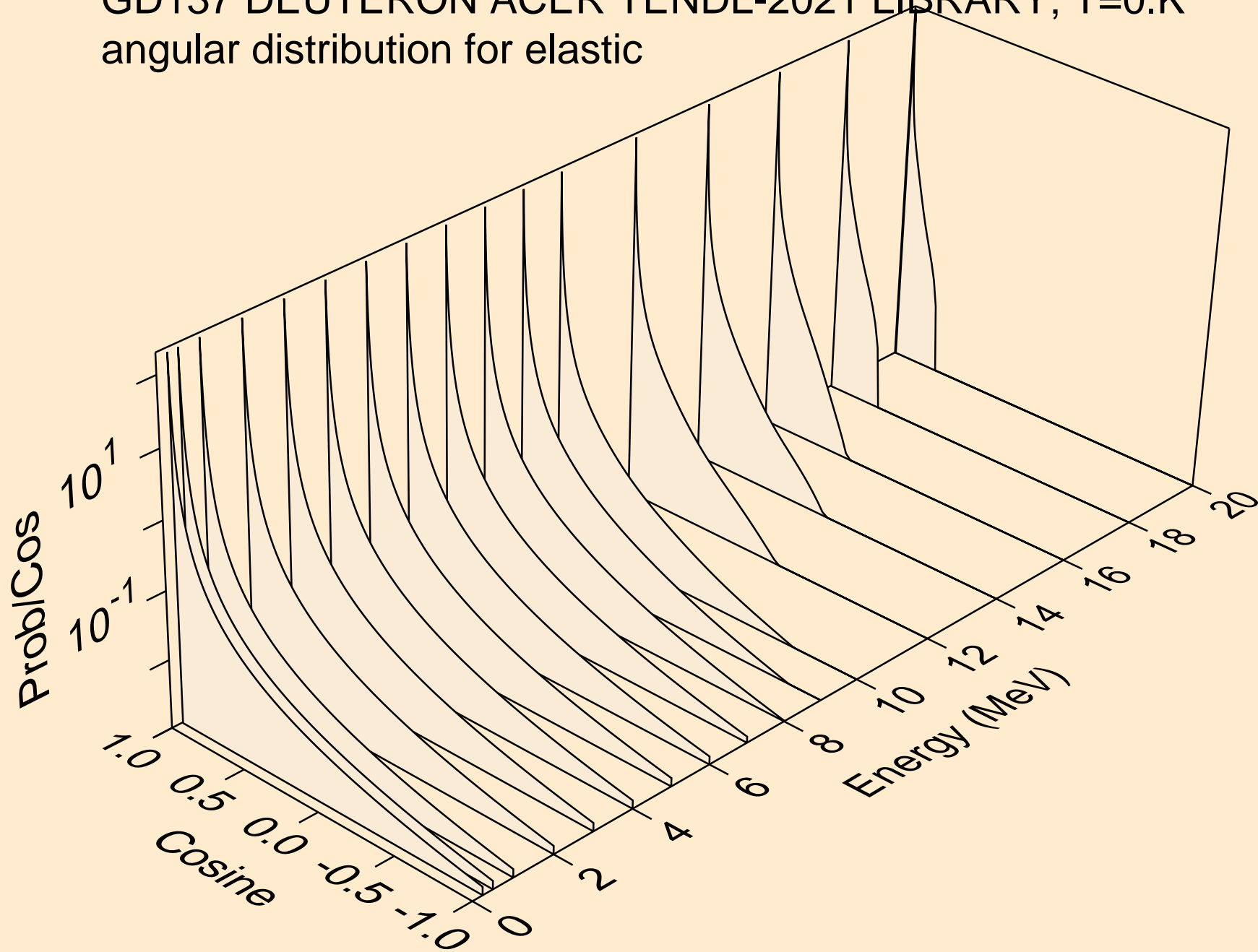



GD137 DEUTERON ACER TENDL-2021 LIBRARY; T=0.K  
angular distribution for elastic

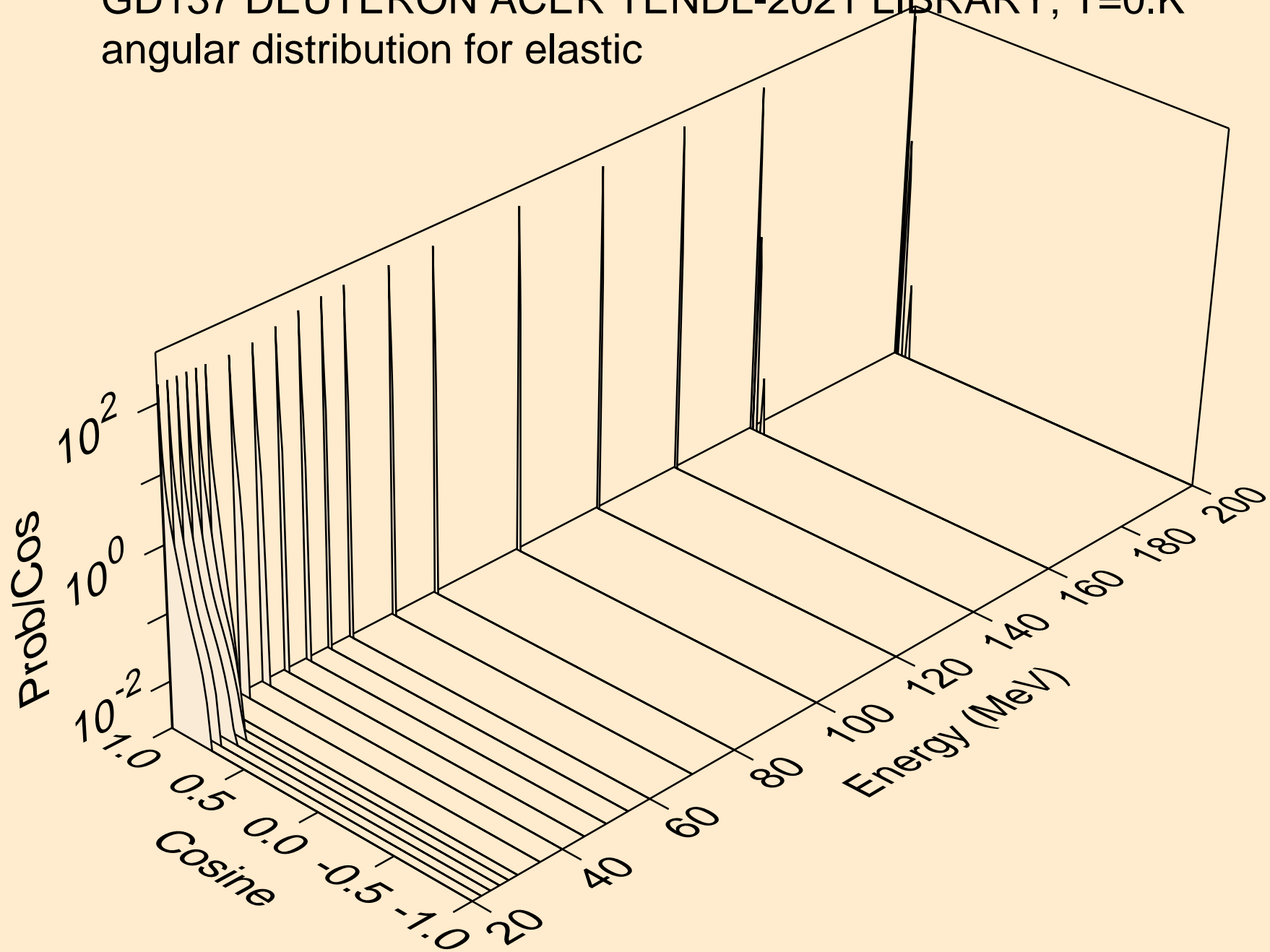

GD137 DEUTERON ACER TENDL-2021 LIBRARY; T=0.K  
Deuteron emission for (d,x)

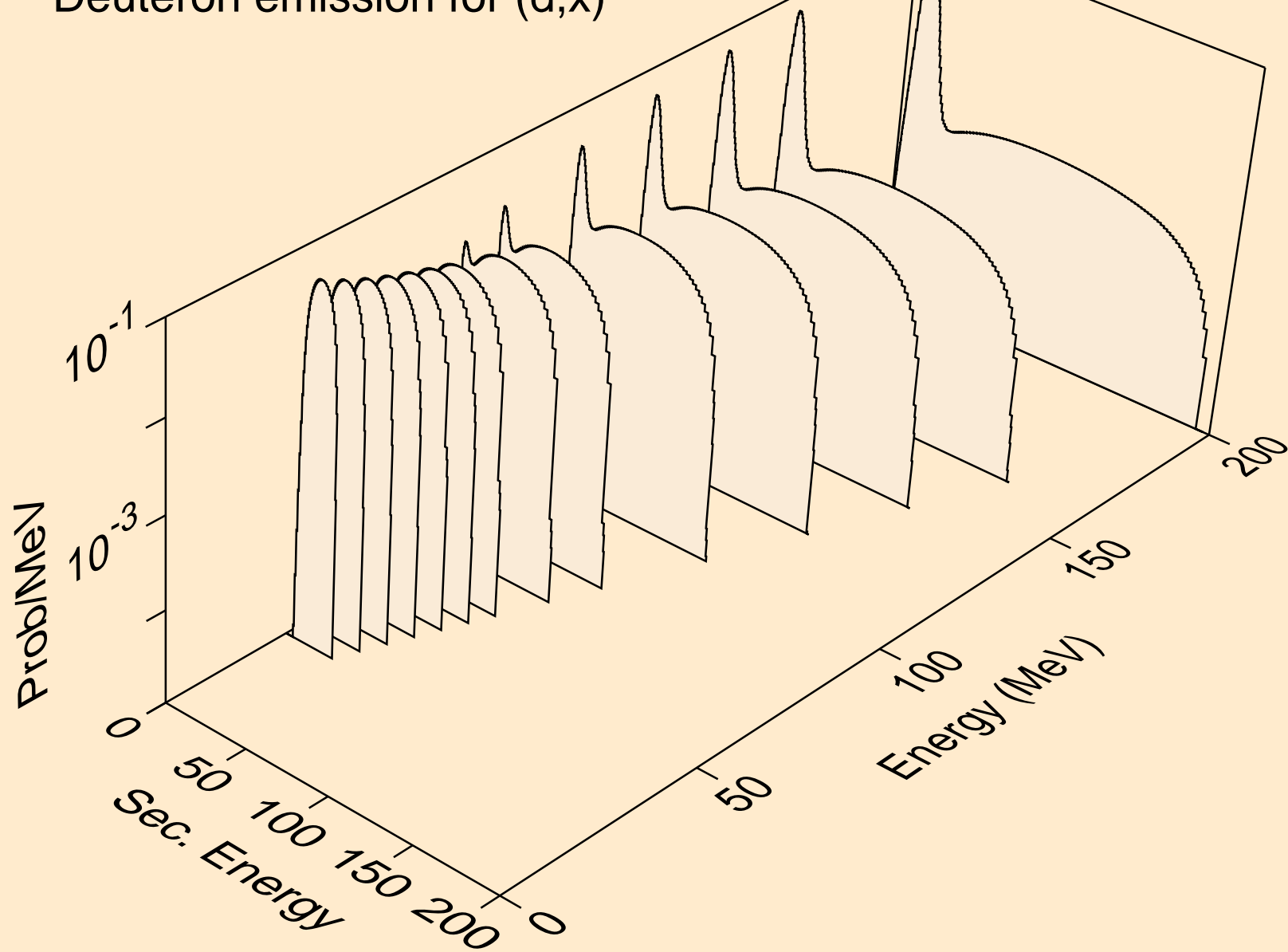

GD137 DEUTERON ACER TENDL-2021 LIBRARY; T=0.K  
Deuteron emission for (d,n\*)d

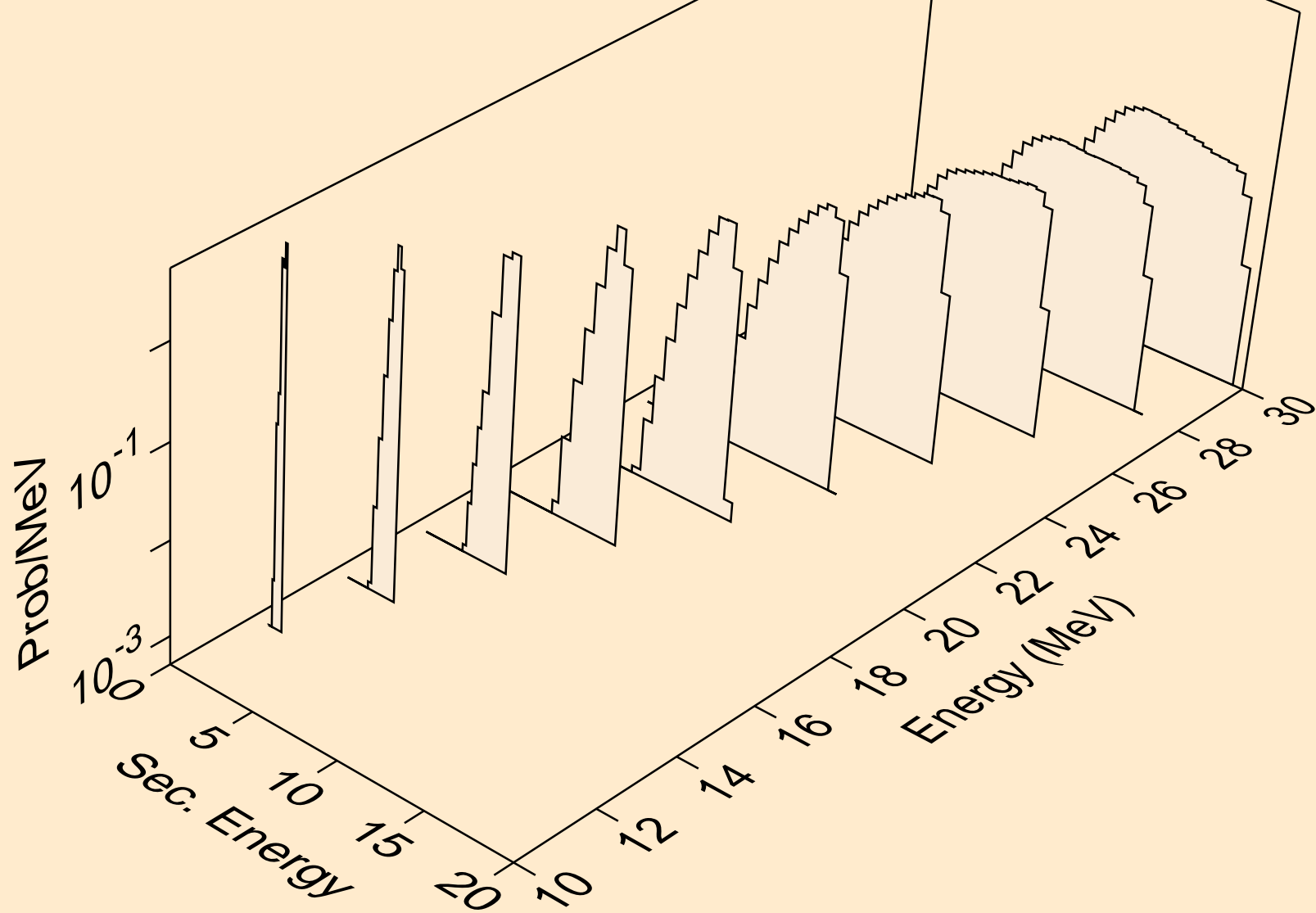

GD137 DEUTERON ACER TENDL-2021 LIBRARY; T=0.K  
Deuteron emission for inelastic

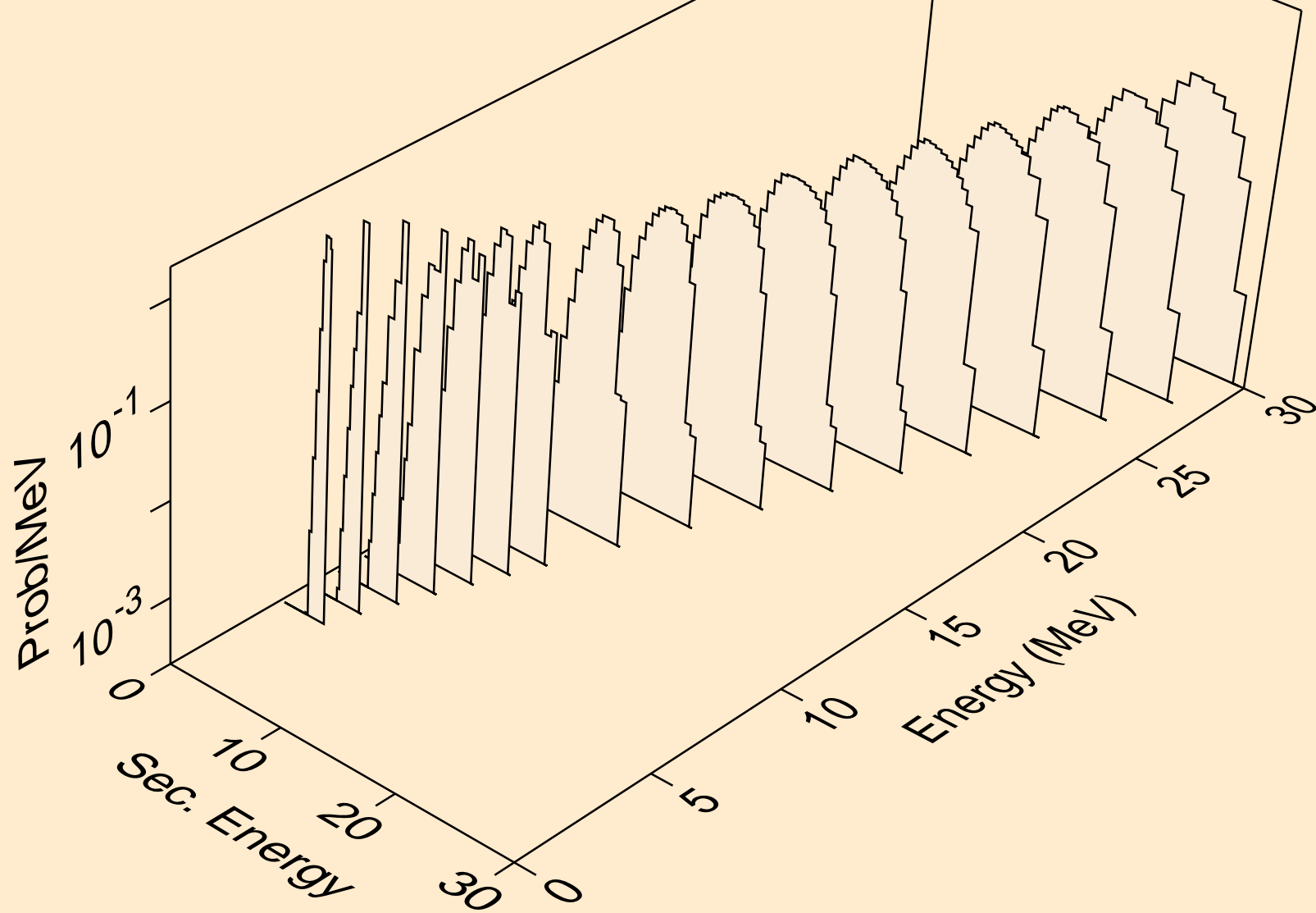

GD137 DEUTERON ACER TENDL-2021 LIBRARY; T=0.K  
Deuteron emission for (d,d2a)

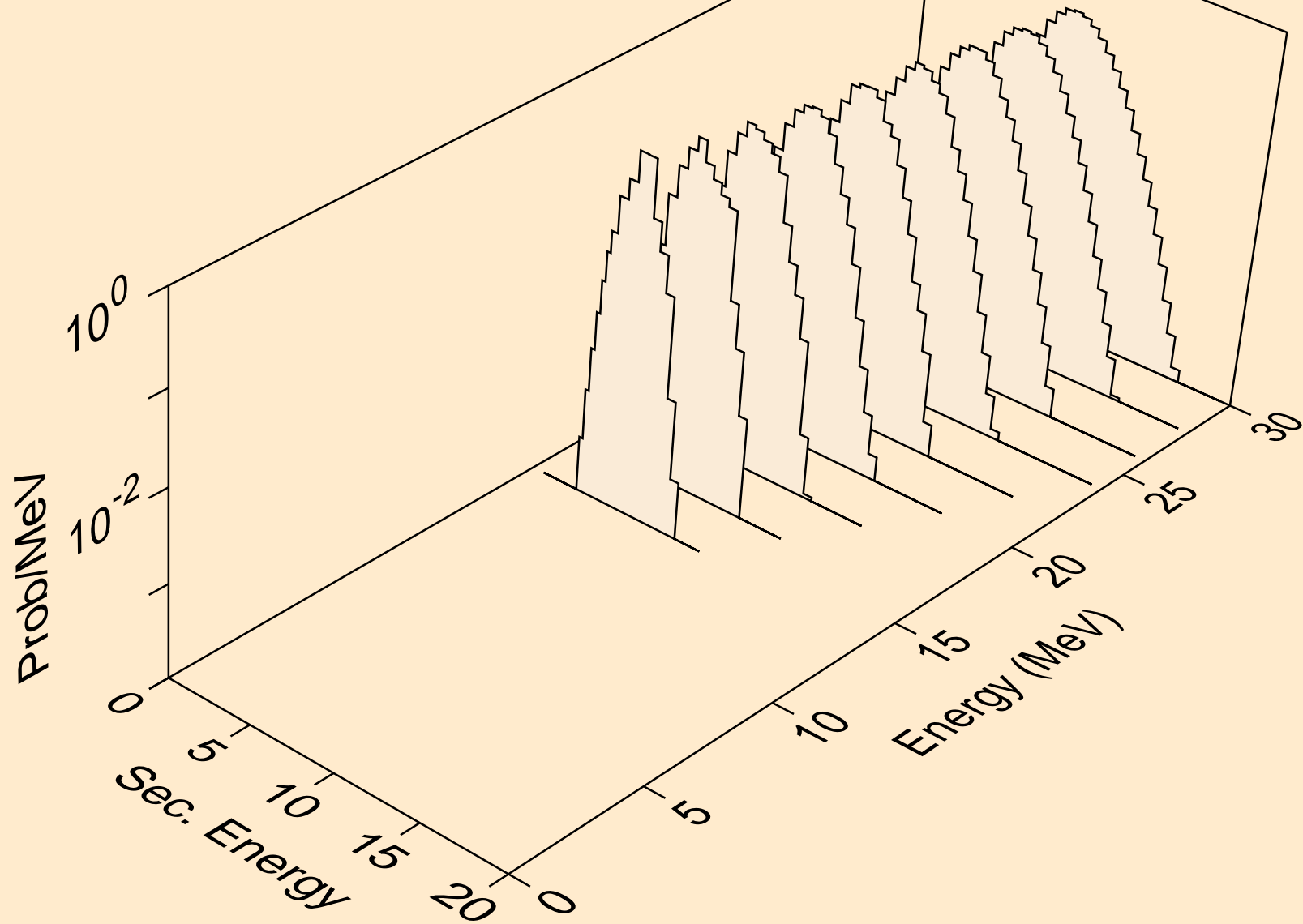

GD137 DEUTERON ACER TENDL-2021 LIBRARY; T=0.K  
Deuteron emission for (d,pd)

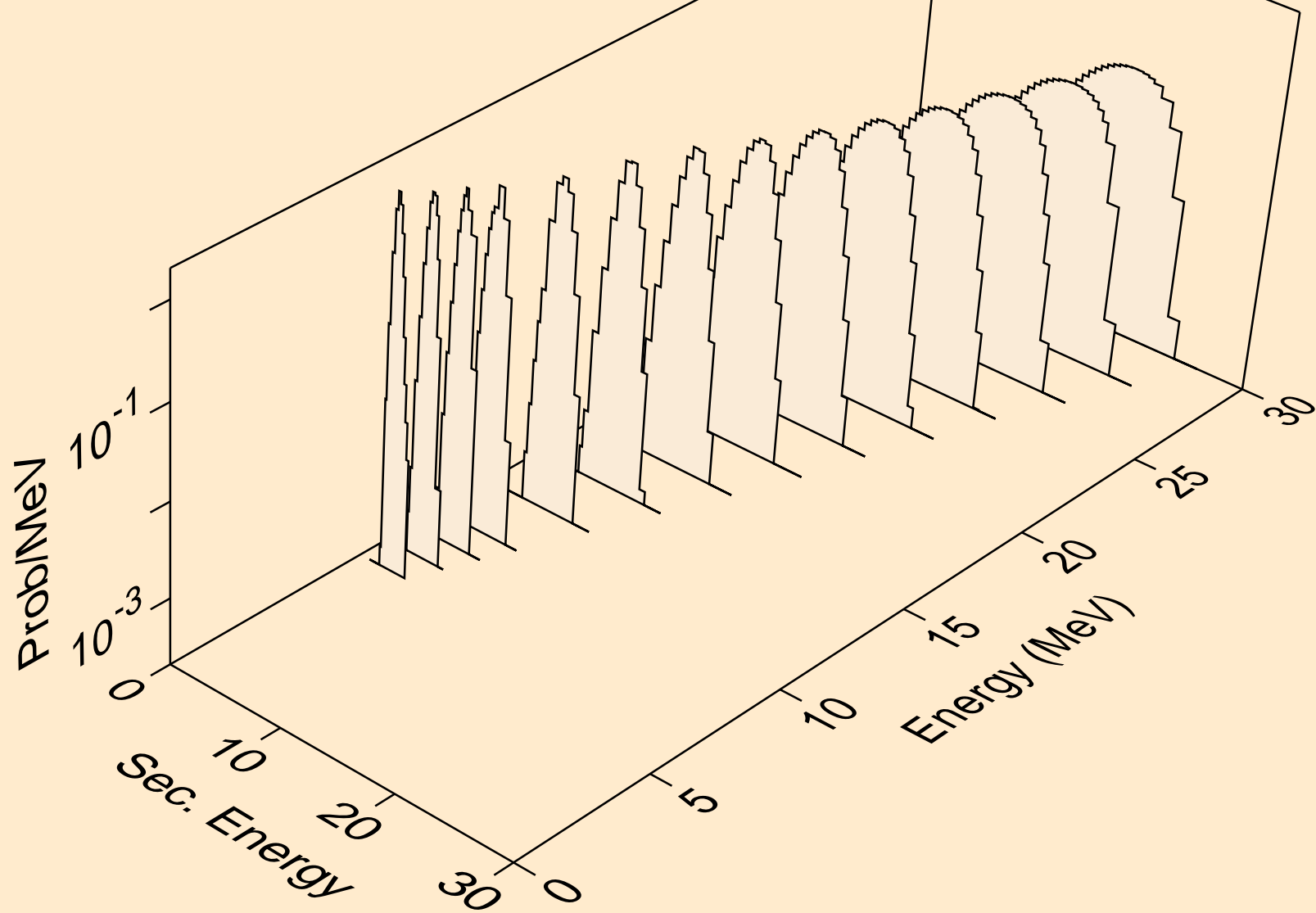

GD137 DEUTERON ACER TENDL-2021 LIBRARY; T=0.K  
Deuteron emission for (d,da)

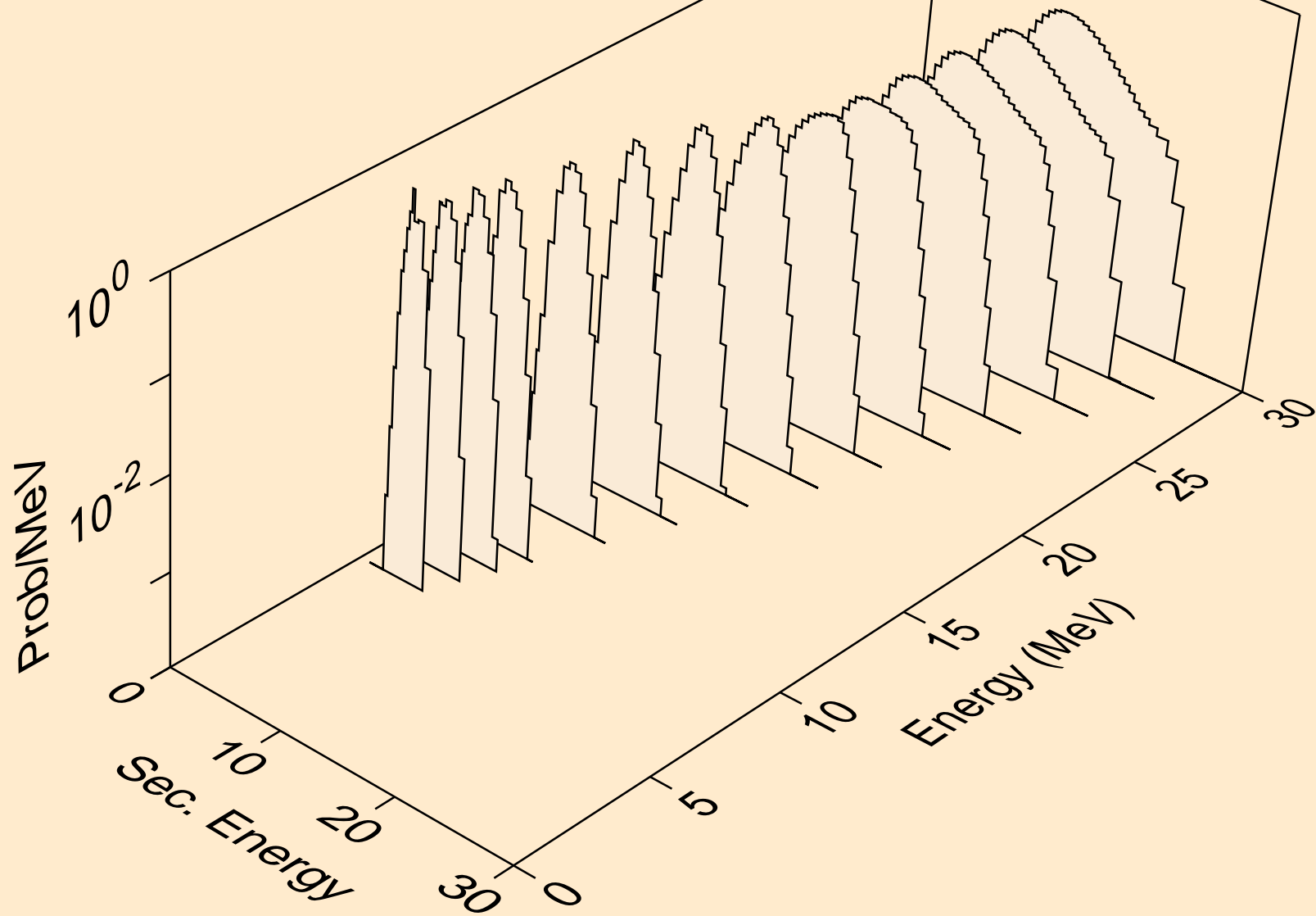

GD137 DEUTERON ACER TENDL-2021 LIBRARY; T=0.K  
Photon emission for (z,n)

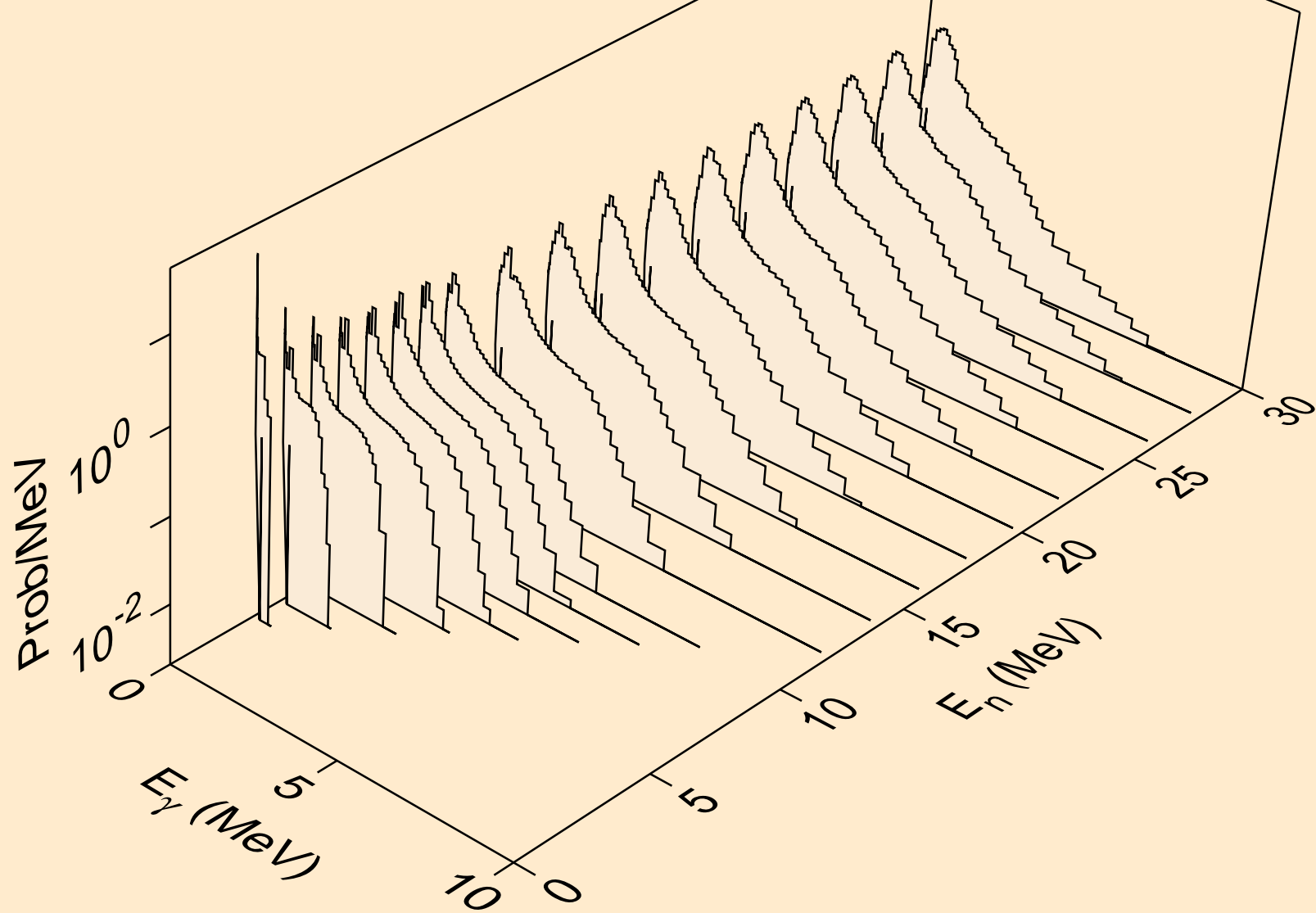



GD137 DEUTERON ACER TENDL-2021 LIBRARY; T=0.K  
Photon emission for (n,x)

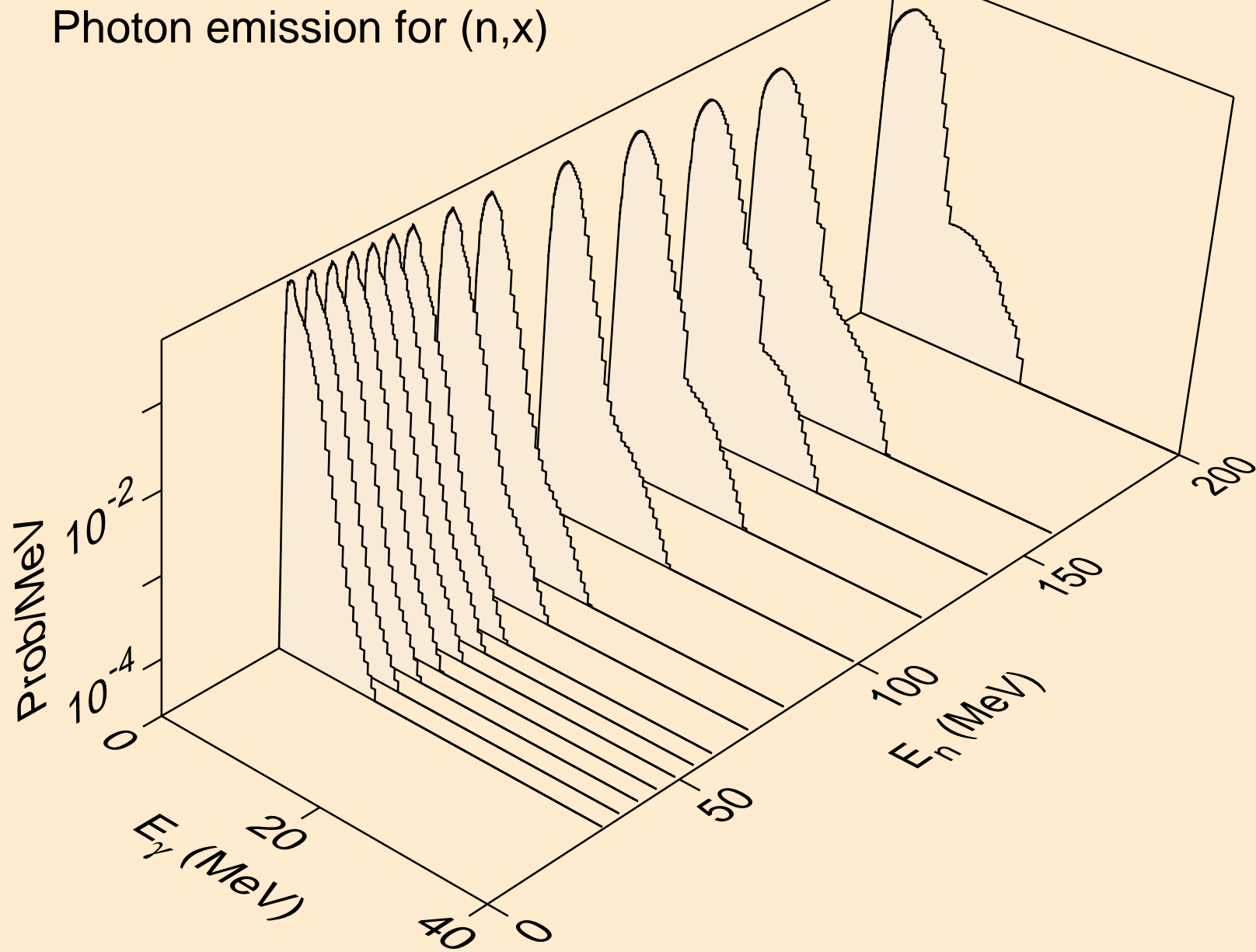

GD137 DEUTERON ACER TENDL-2021 LIBRARY; T=0.K  
Photon emission for (n,2n)

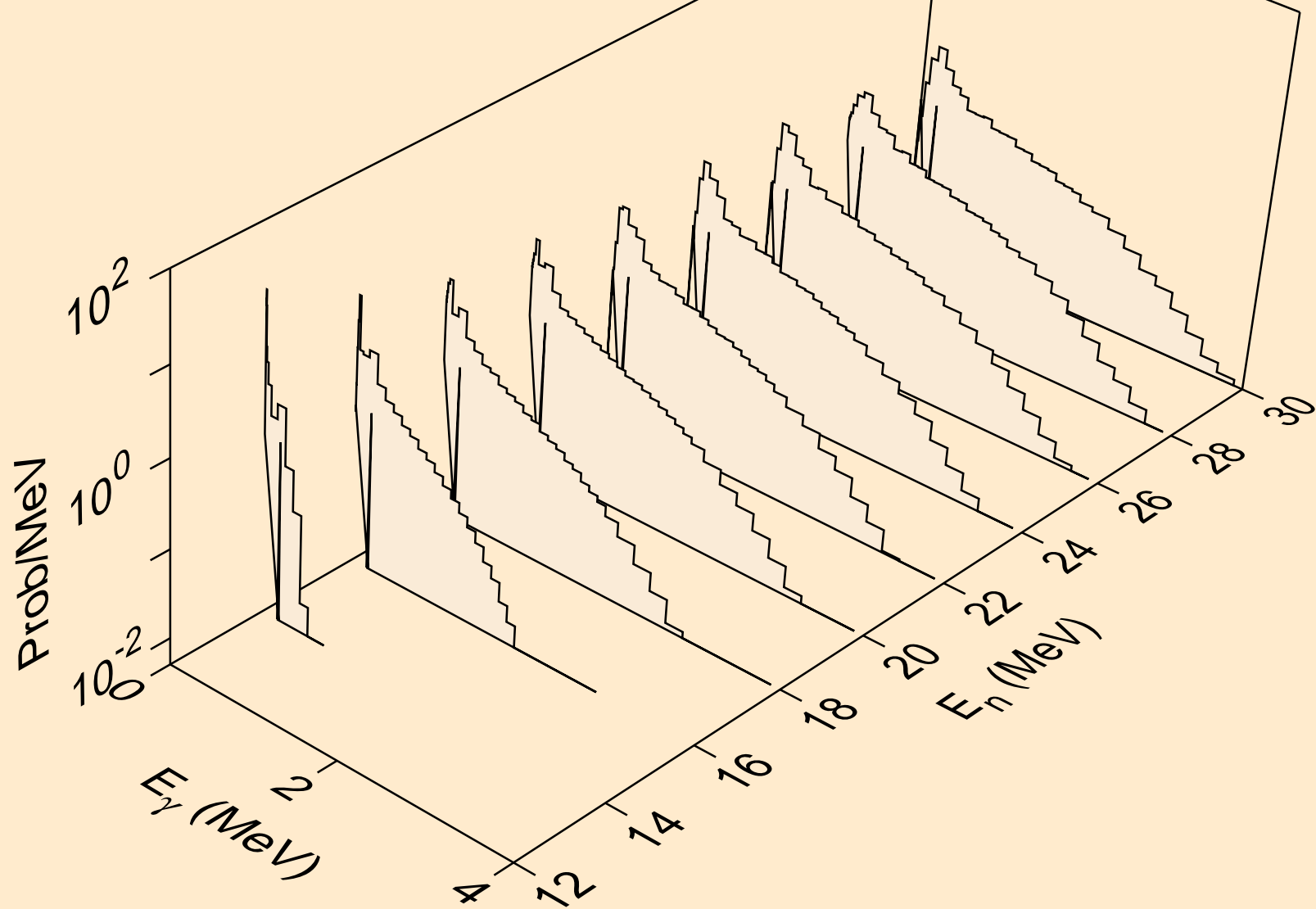

GD137 DEUTERON ACER TENDL-2021 LIBRARY; T=0.K  
Photon emission for (n,3n)

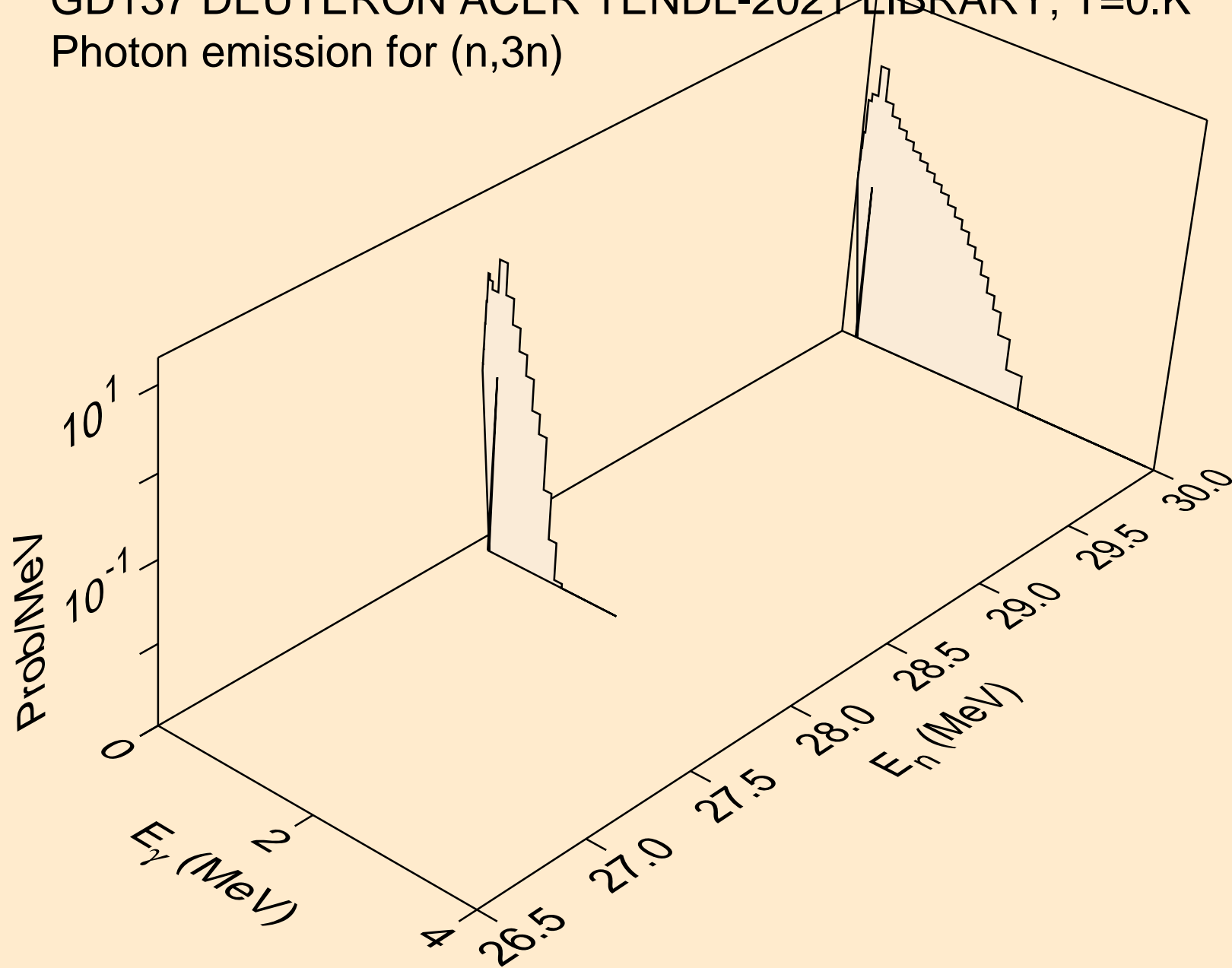

GD137 DEUTERON ACER TENDL-2021 LIBRARY; T=0.K  
Photon emission for (n,n\*)a

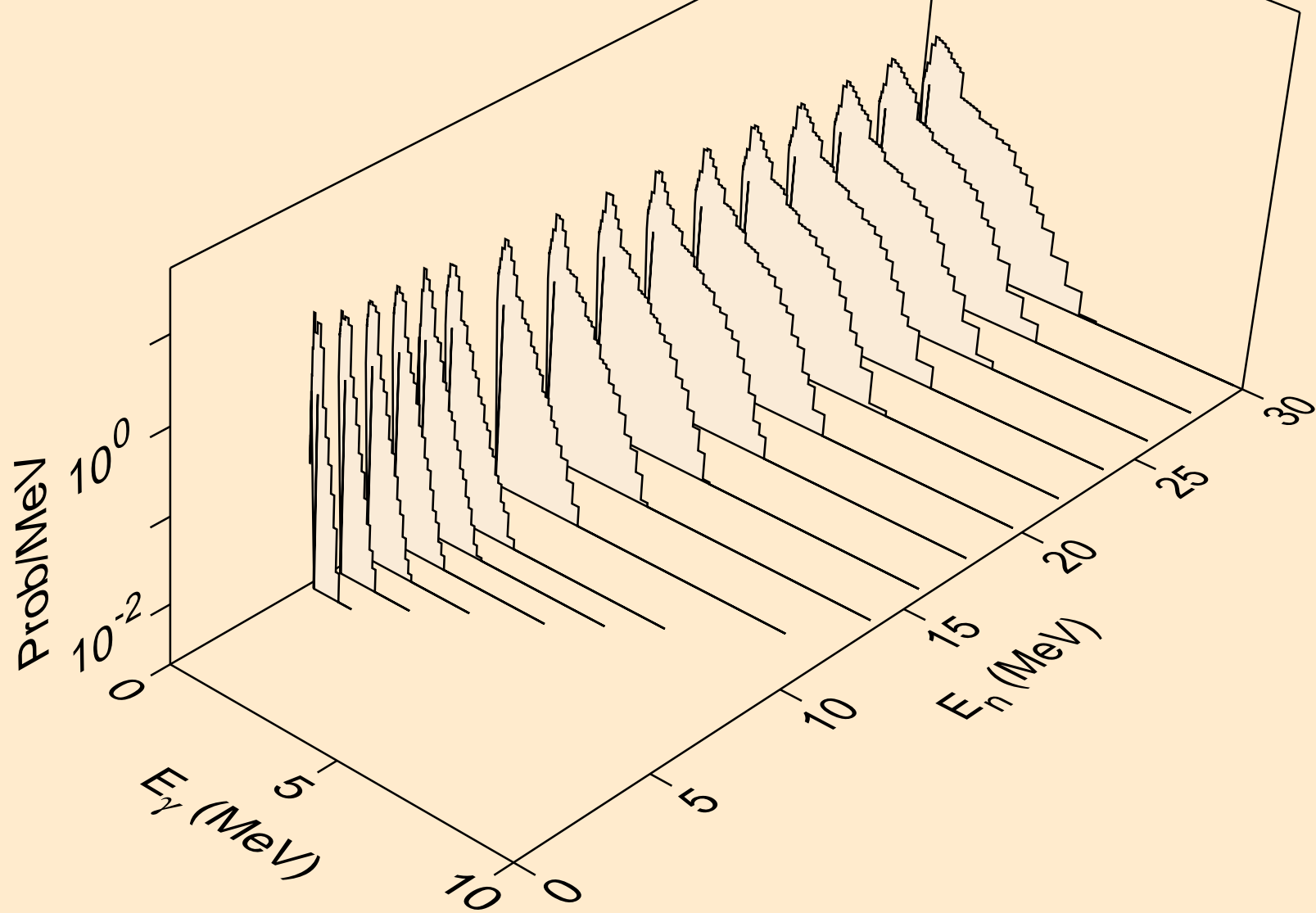

GD137 DEUTERON ACER TENDL-2021 LIBRARY; T=0.K  
Photon emission for (n,2n)a

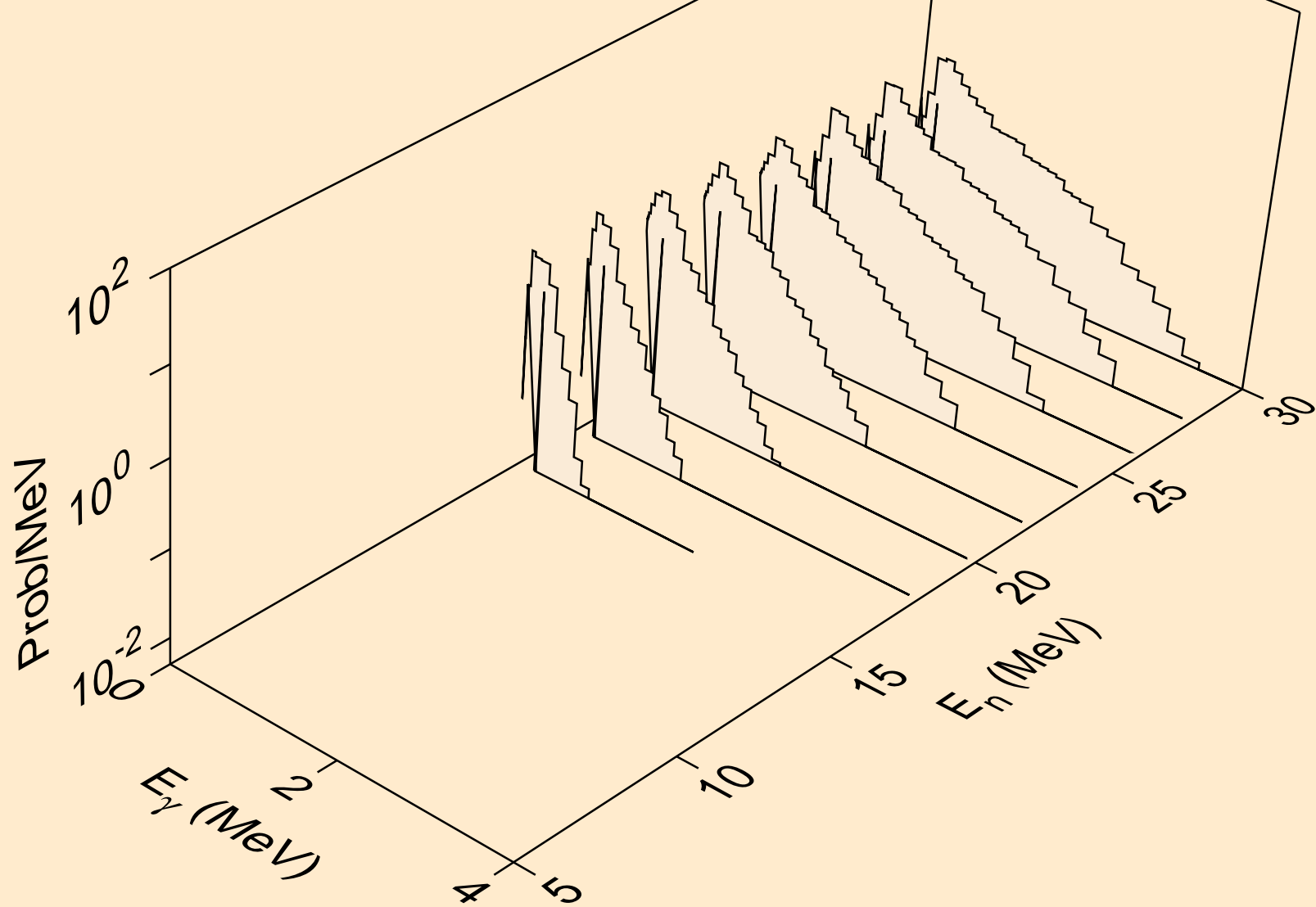

GD137 DEUTERON ACER TENDL-2021 LIBRARY; T=0.K  
Photon emission for (n,n\*)p

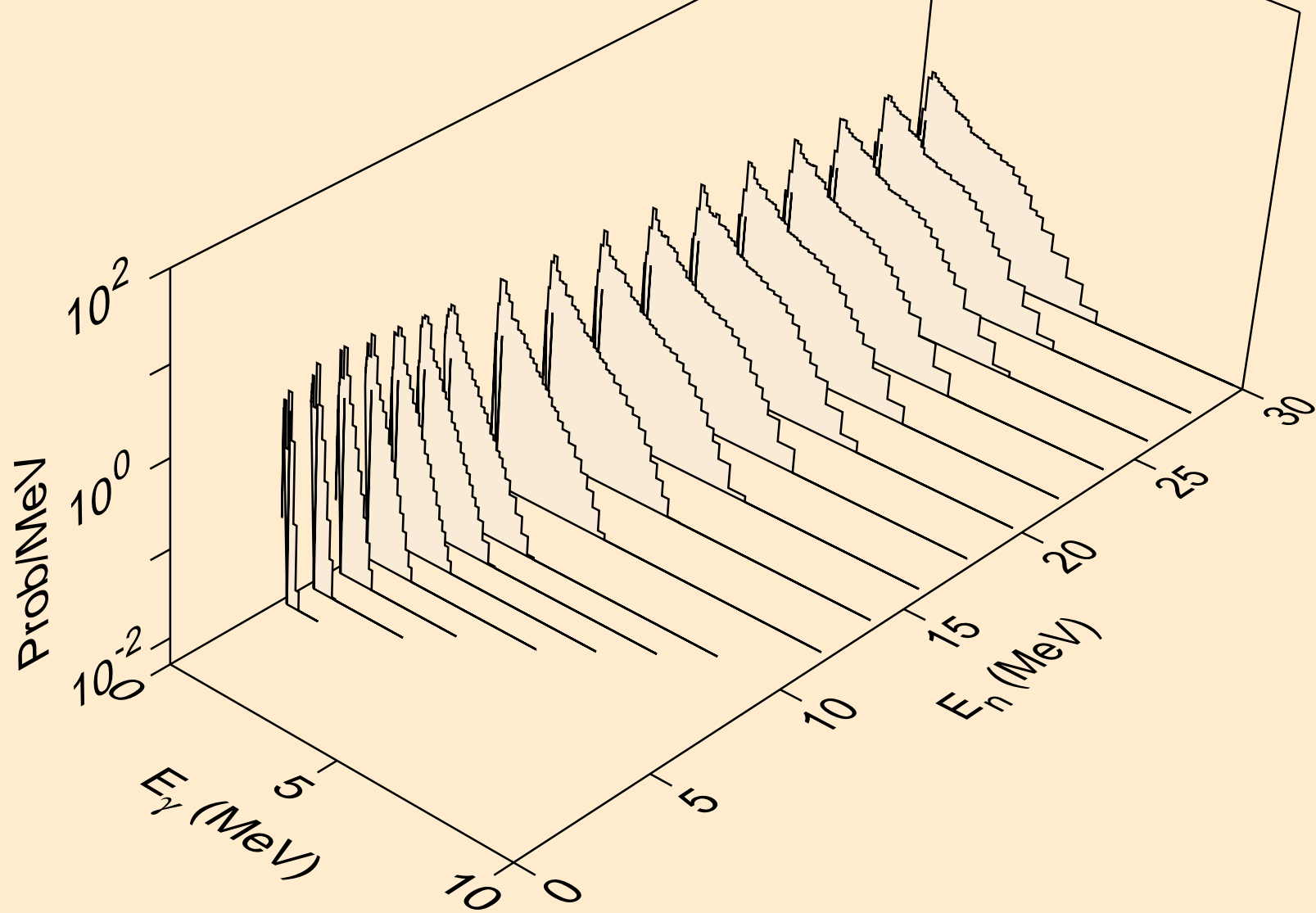

GD137 DEUTERON ACER TENDL-2021 LIBRARY; T=0.K  
Photon emission for (n,n\*)2a

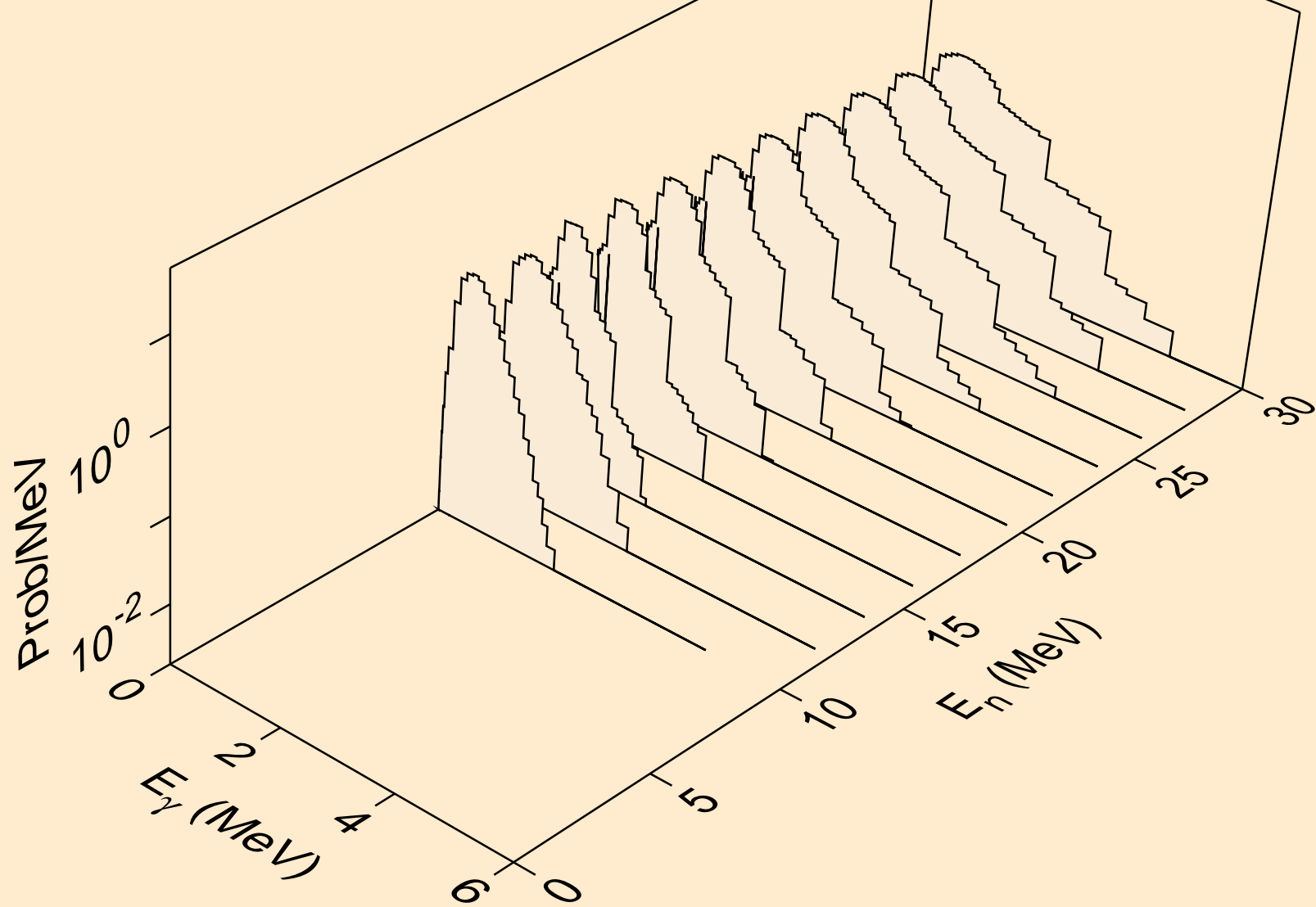

GD137 DEUTERON ACER TENDL-2021 LIBRARY; T=0.K  
Photon emission for (n,n\*)d

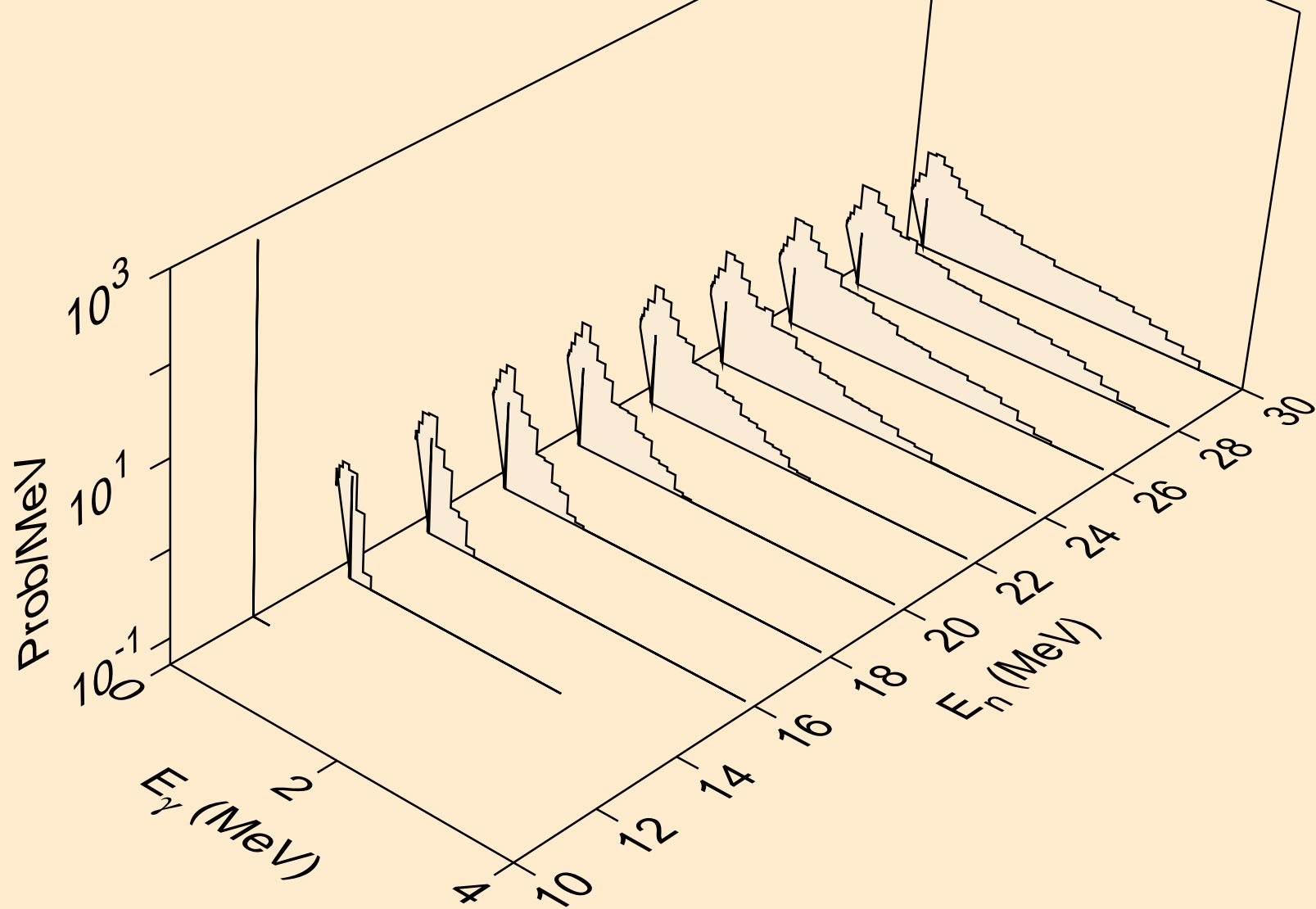



GD137 DEUTERON ACER TENDL-2021 LIBRARY; T=0.K  
Photon emission for (n,n\*)t

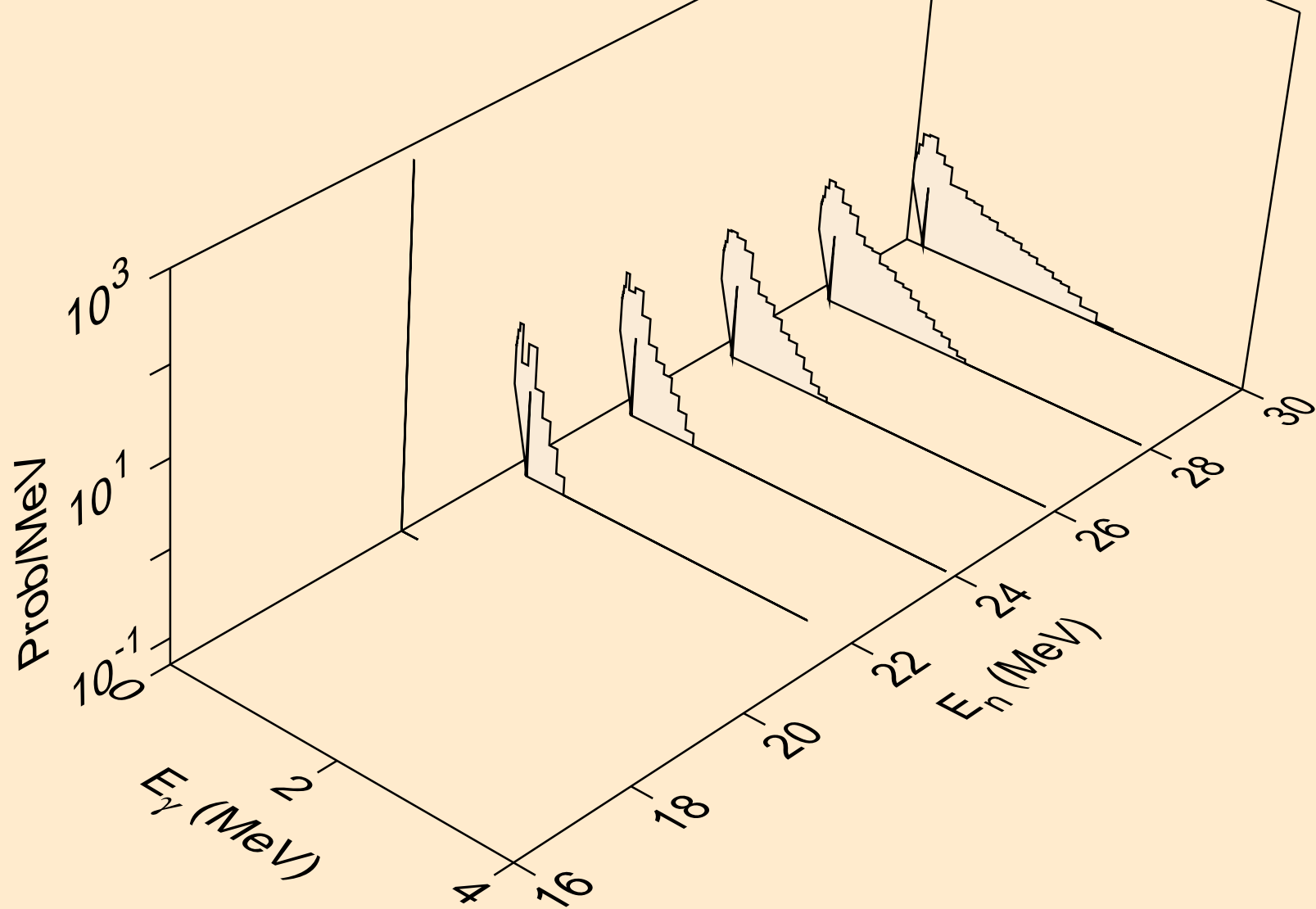

GD137 DEUTERON ACER TENDL-2021 LIBRARY; T=0.K  
Photon emission for (n,n\*)he3

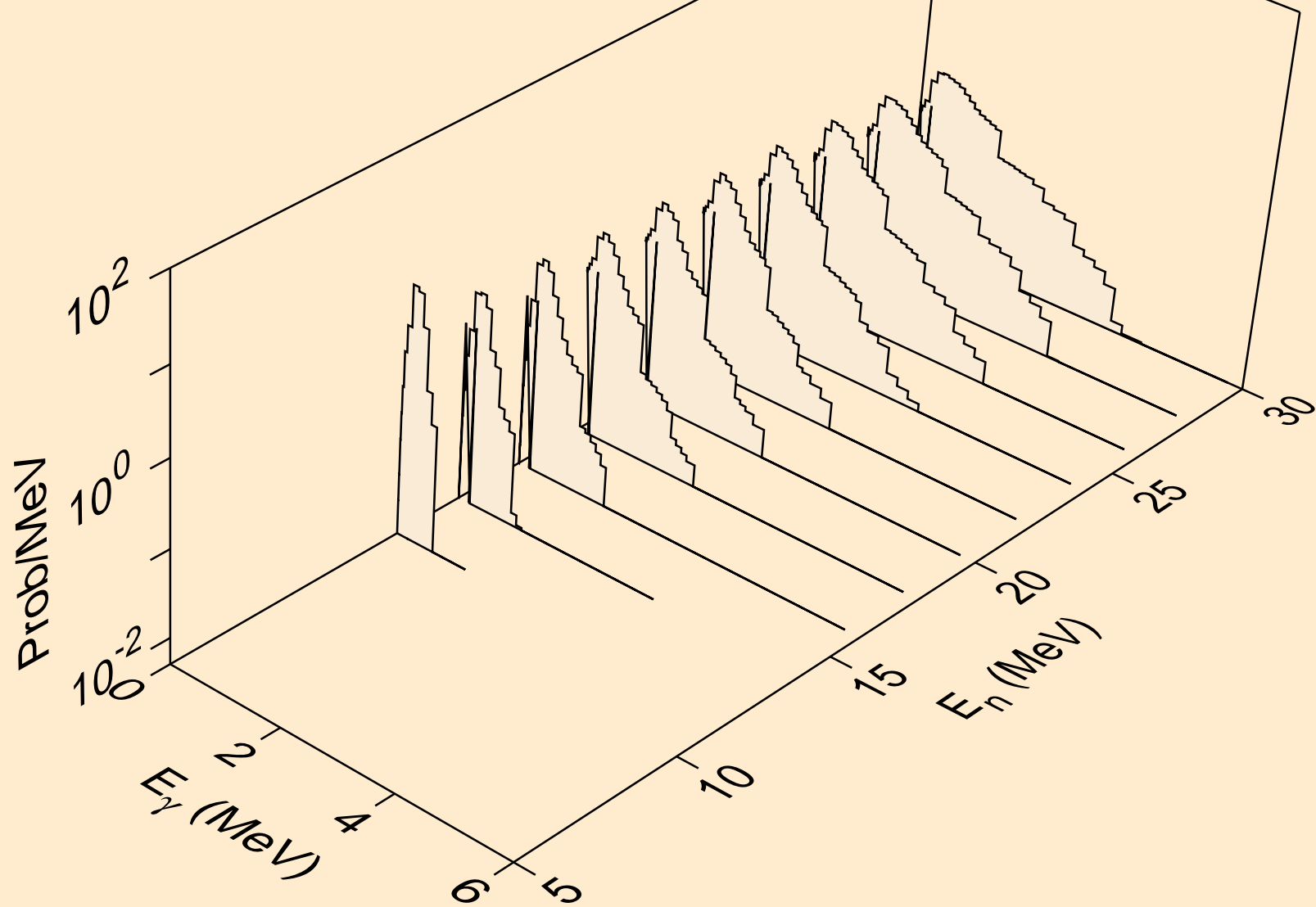

GD137 DEUTERON ACER TENDL-2021 LIBRARY; T=0.K  
Photon emission for (n,2np)

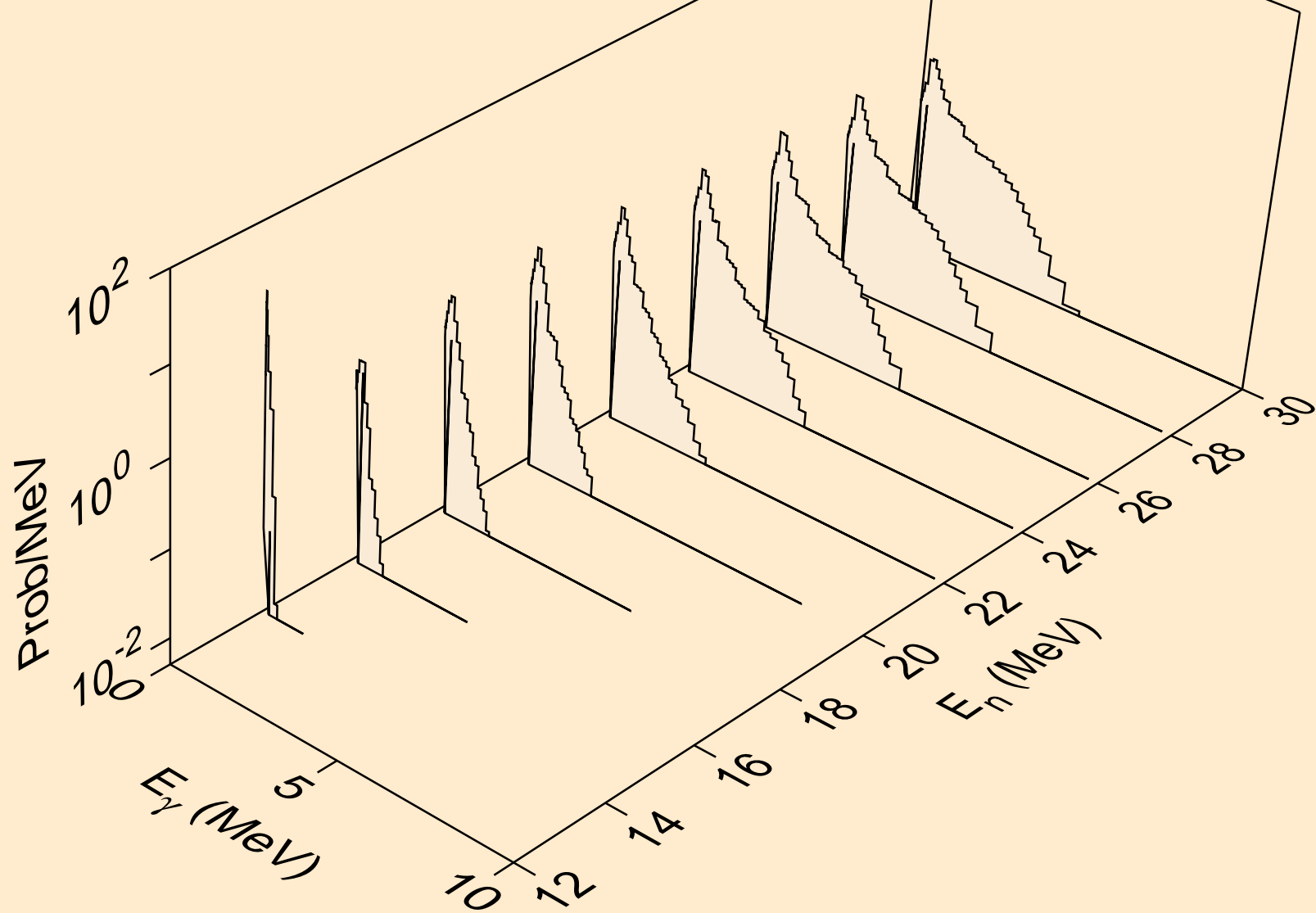

GD137 DEUTERON ACER TENDL-2021 LIBRARY; T=0.K  
Photon emission for (n,3np)

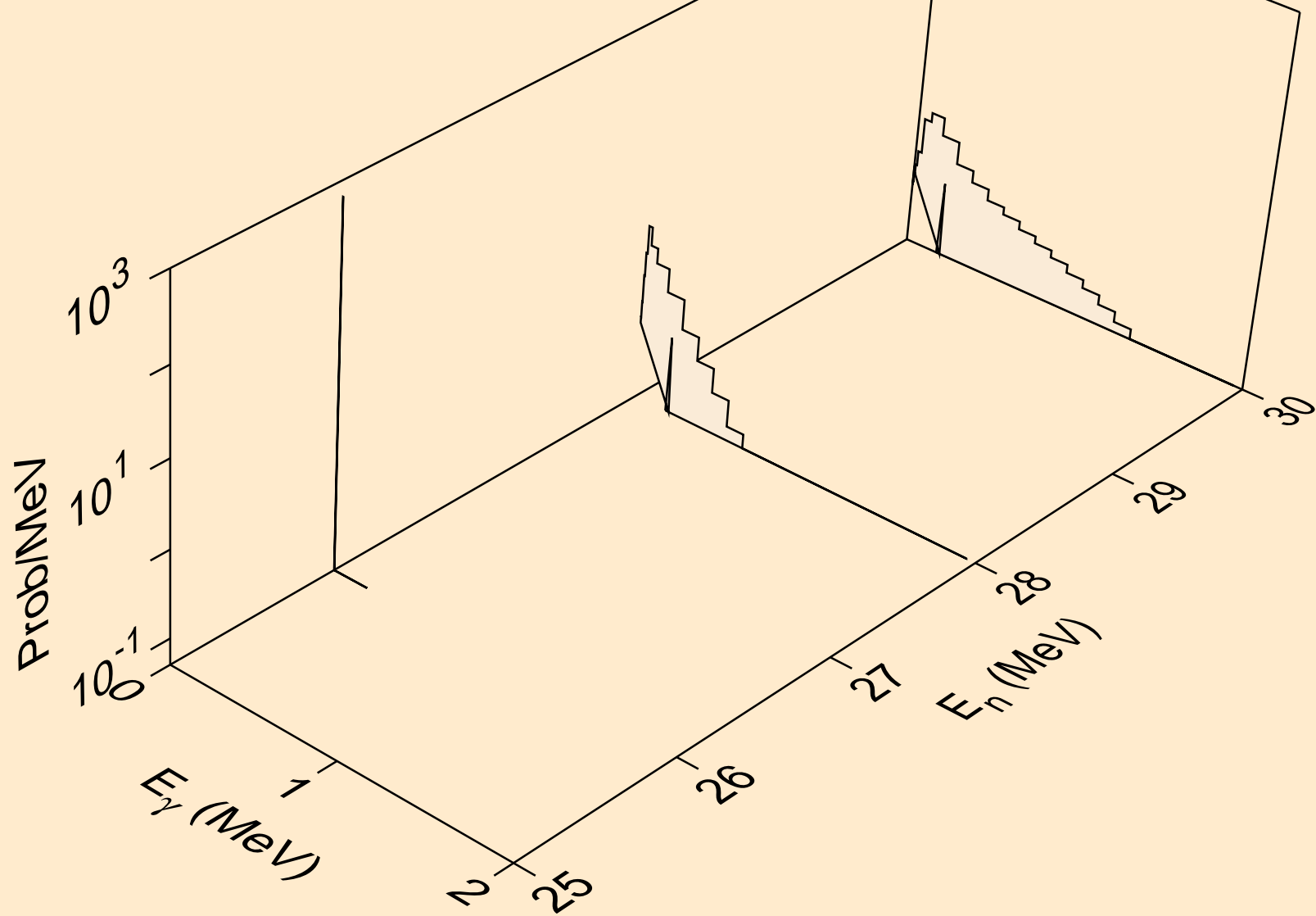

GD137 DEUTERON ACER TENDL-2021 LIBRARY; T=0.K  
Photon emission for (n,2np)

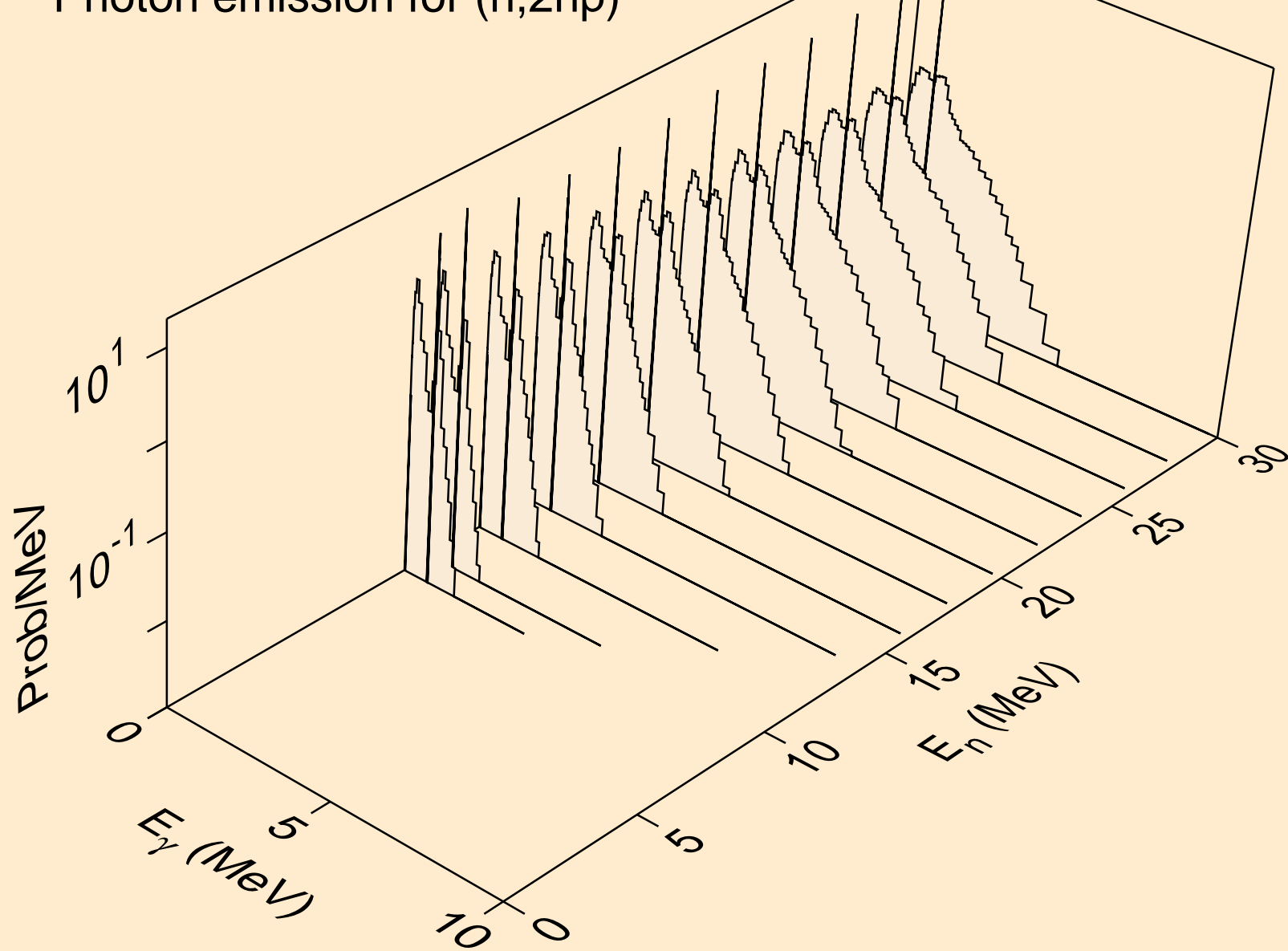

GD137 DEUTERON ACER TENDL-2021 LIBRARY; T=0.K  
Photon emission for (n,npa)

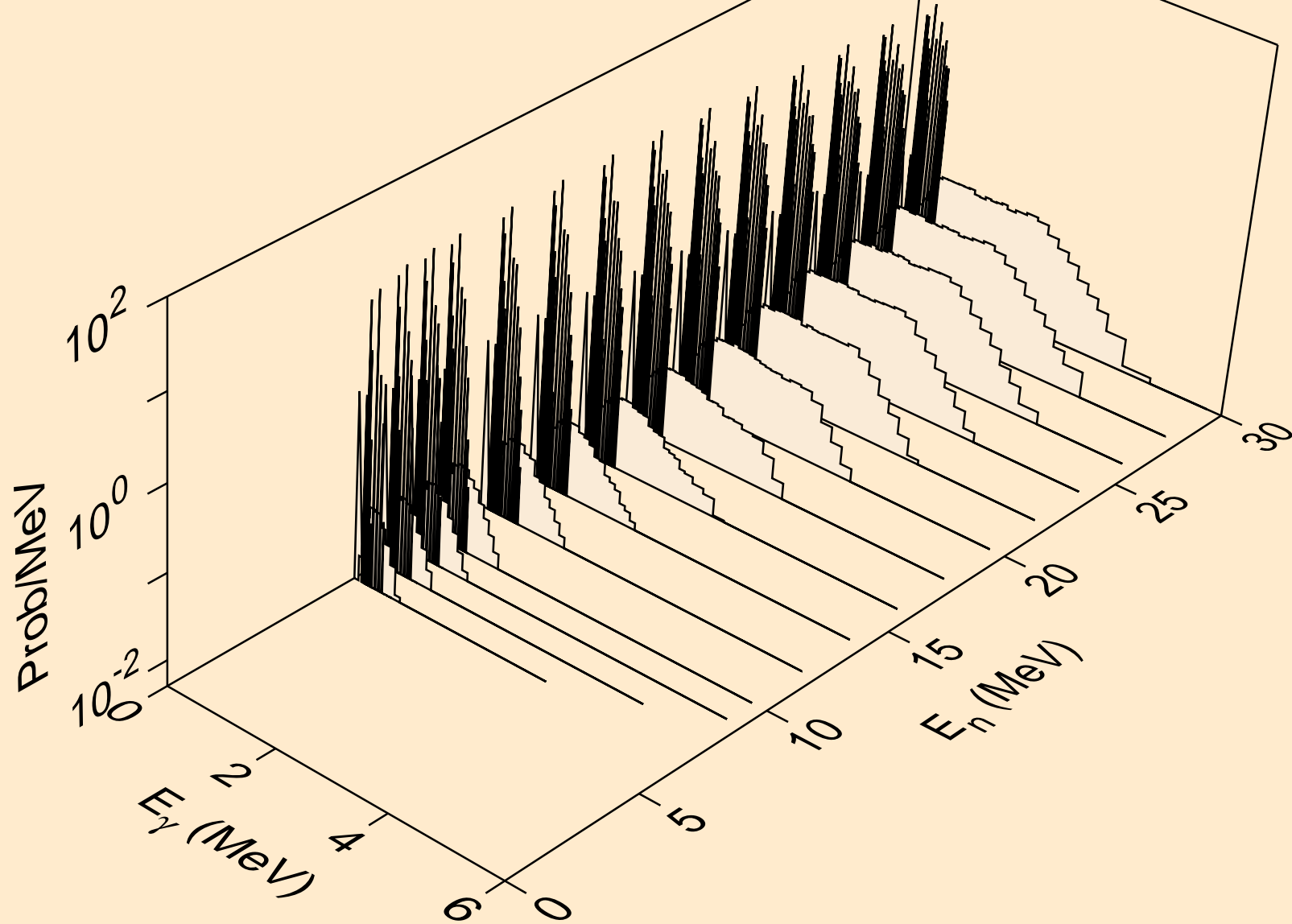

GD137 DEUTERON ACER TENDL-2021 LIBRARY; T=0.K  
Photon emission for (n,gma)

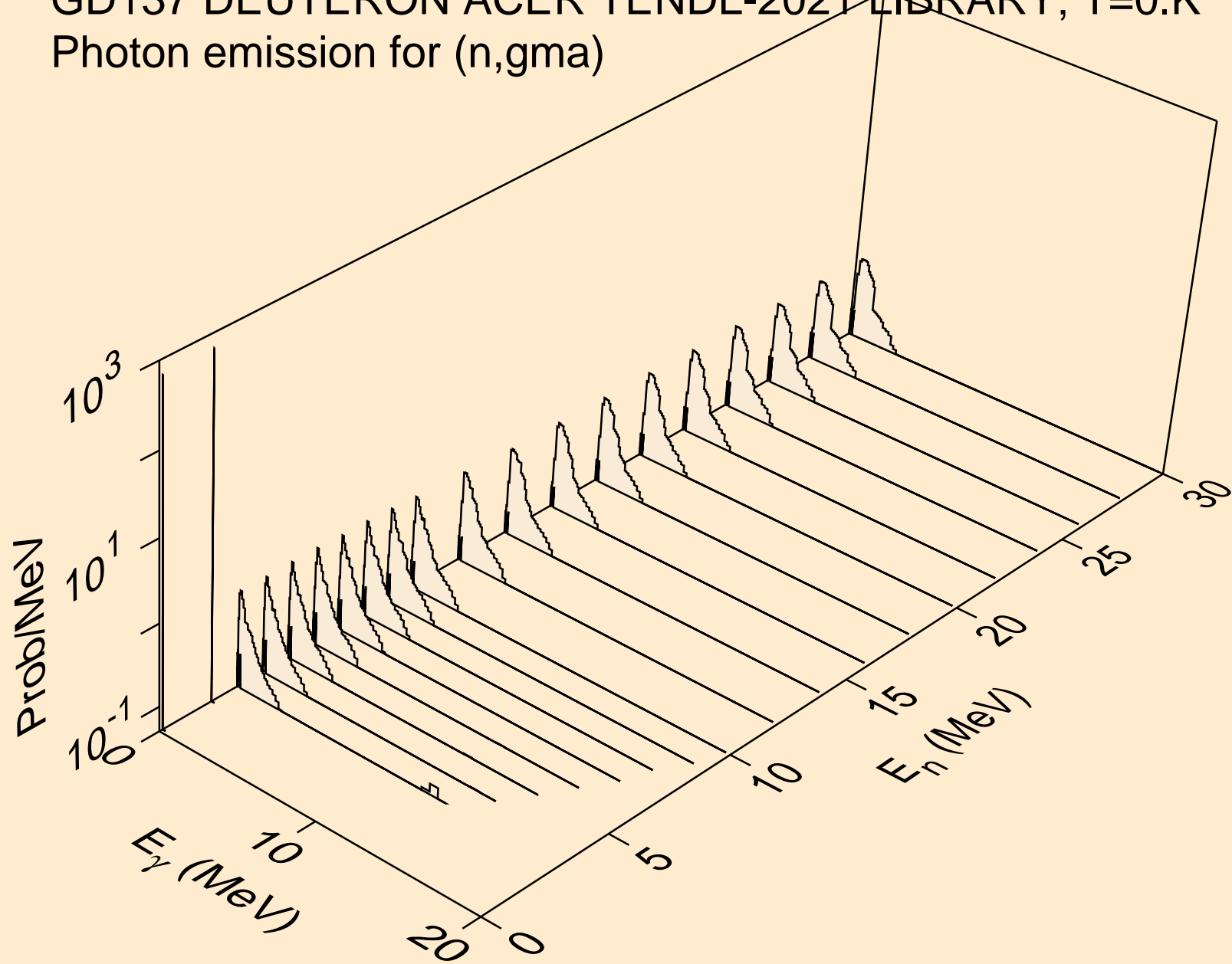

GD137 DEUTERON ACER TENDL-2021 LIBRARY; T=0.K  
Photon emission for (n,p)

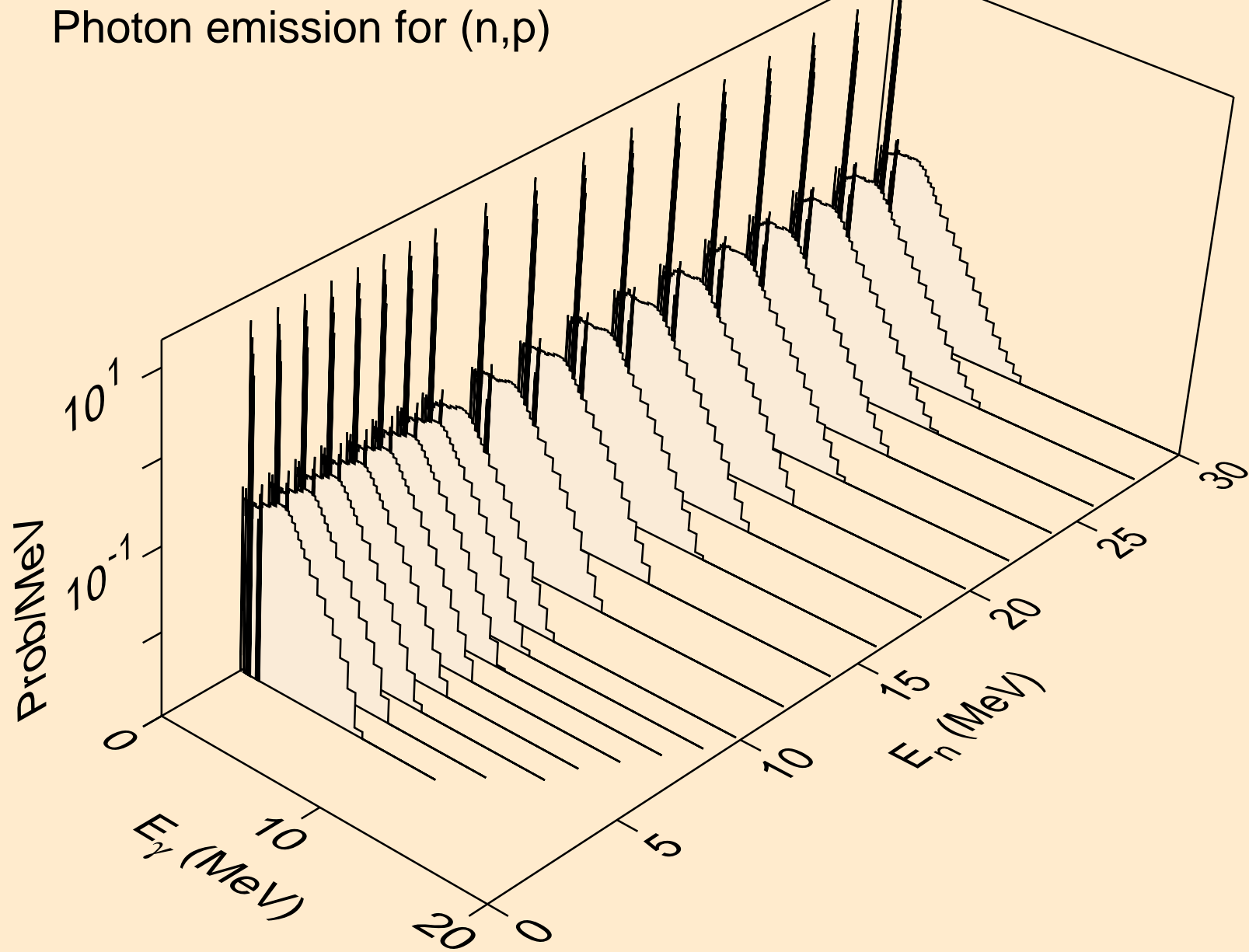



GD137 DEUTERON ACER TENDL-2021 LIBRARY; T=0.K  
Photon emission for inelastic

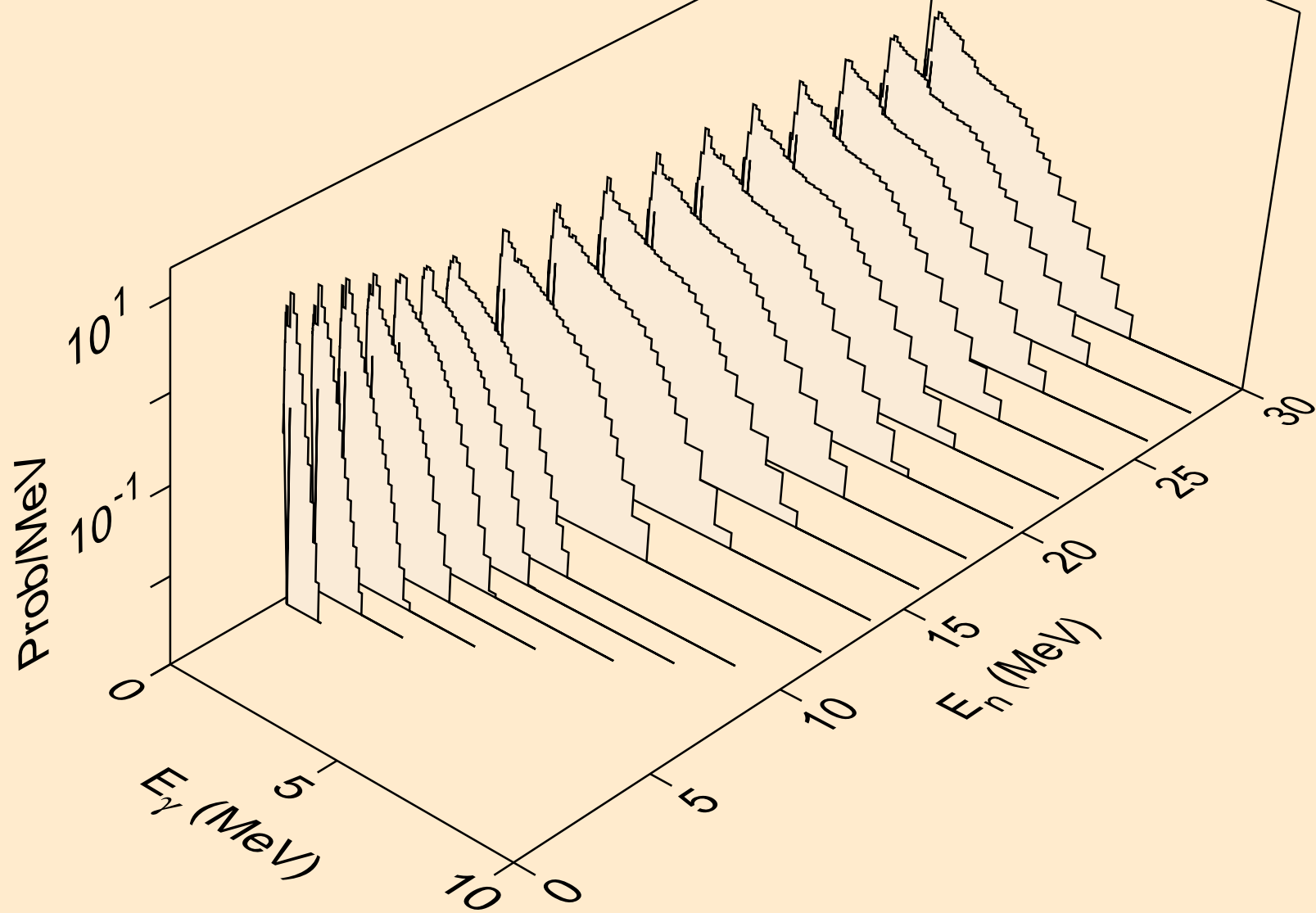

GD137 DEUTERON ACER TENDL-2021 LIBRARY; T=0.K  
Photon emission for (n,t)

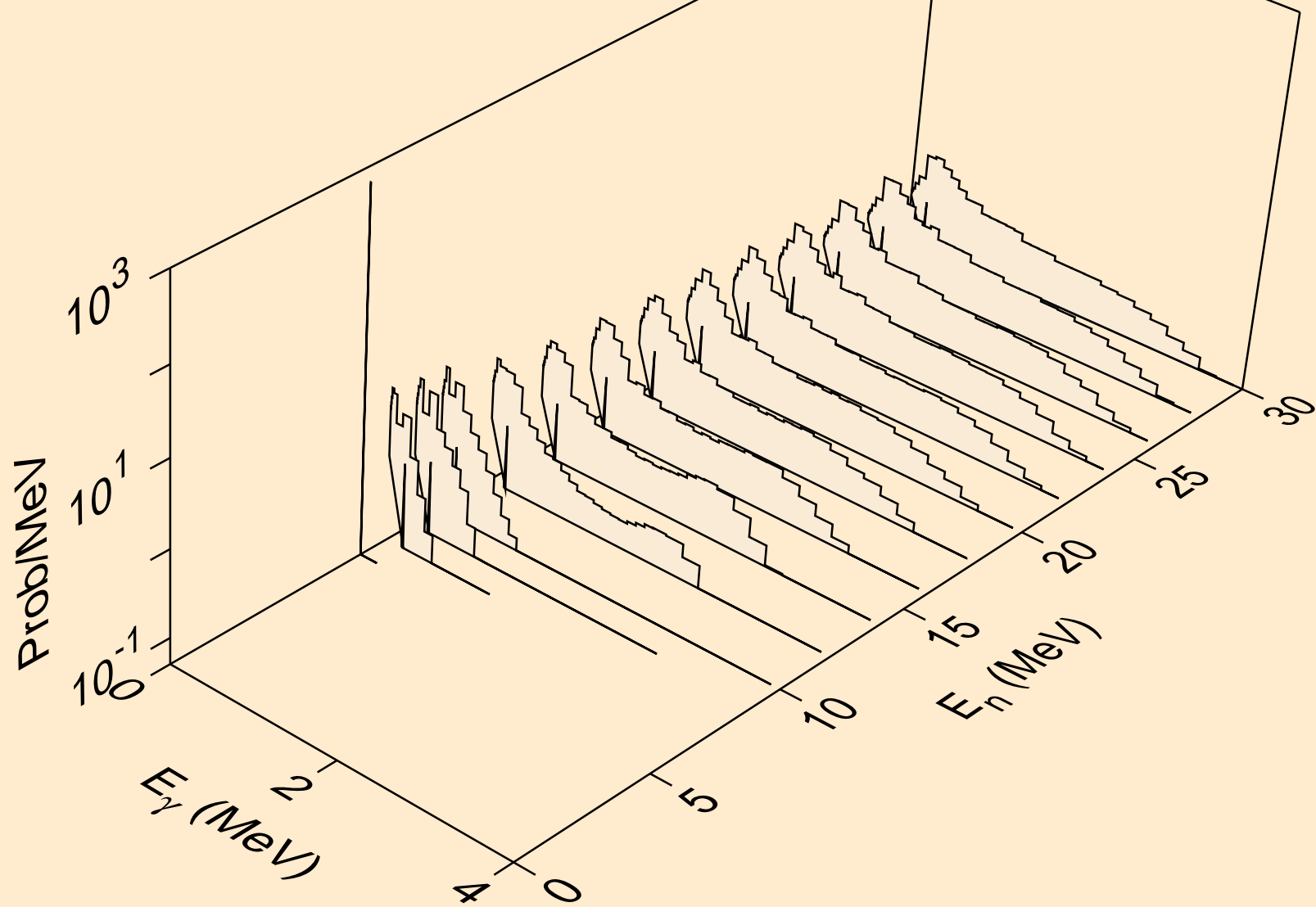

GD137 DEUTERON ACER TENDL-2021 LIBRARY; T=0.K  
Photon emission for (n,he3)

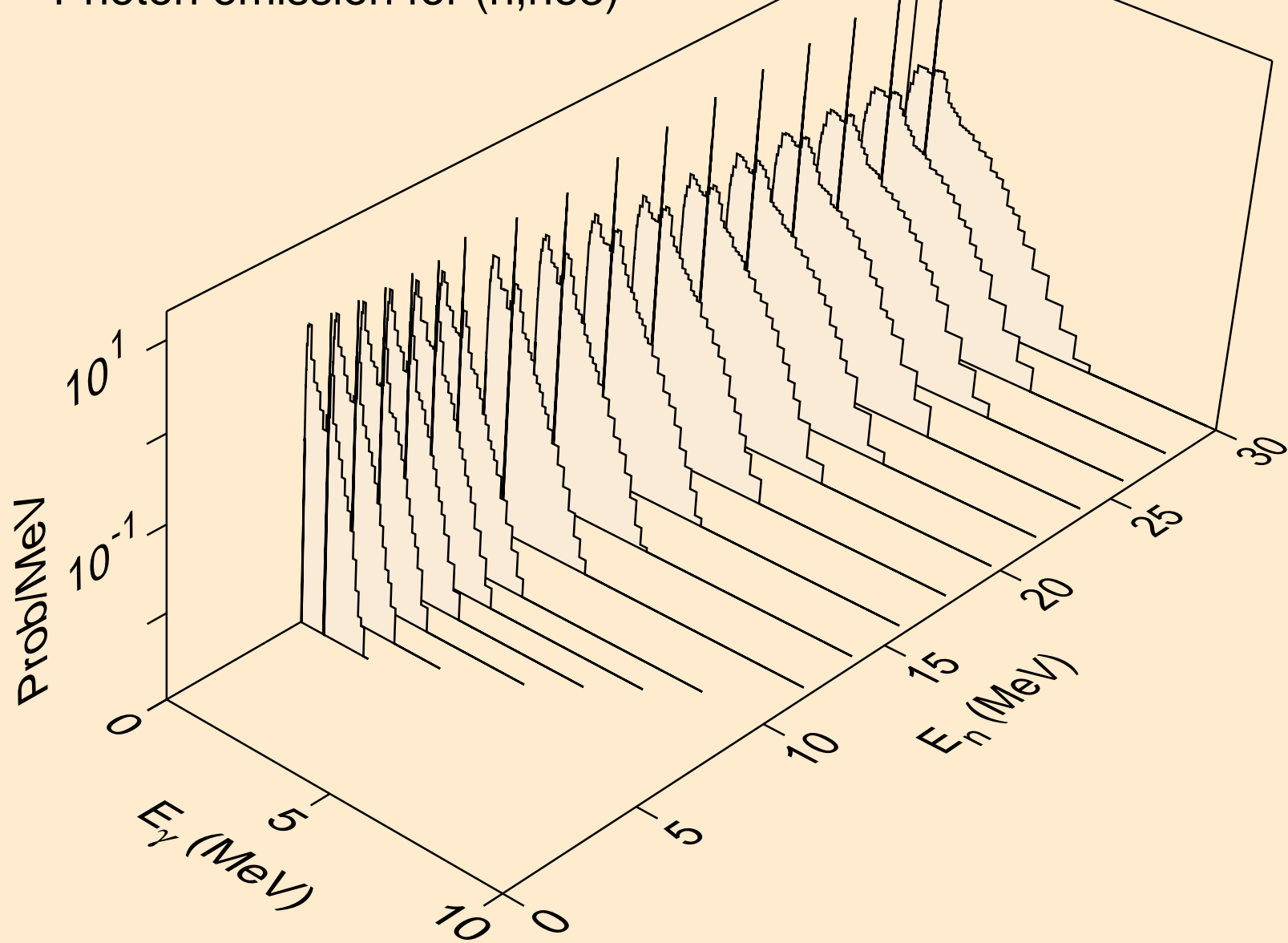

GD137 DEUTERON ACER TENDL-2021 LIBRARY; T=0.K  
Photon emission for (n,a)

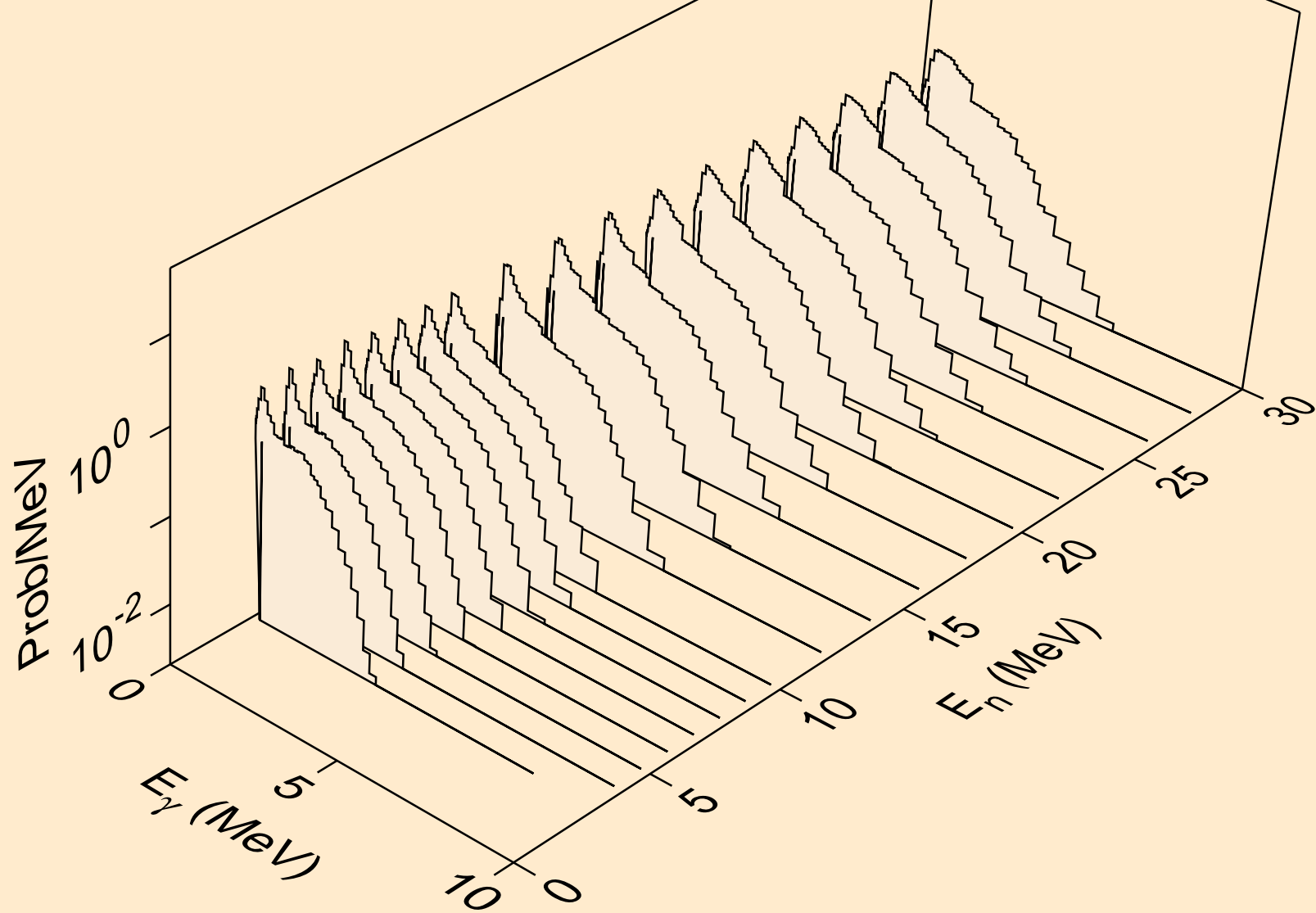

GD137 DEUTERON ACER TENDL-2021 LIBRARY; T=0.K  
Photon emission for (n,2a)

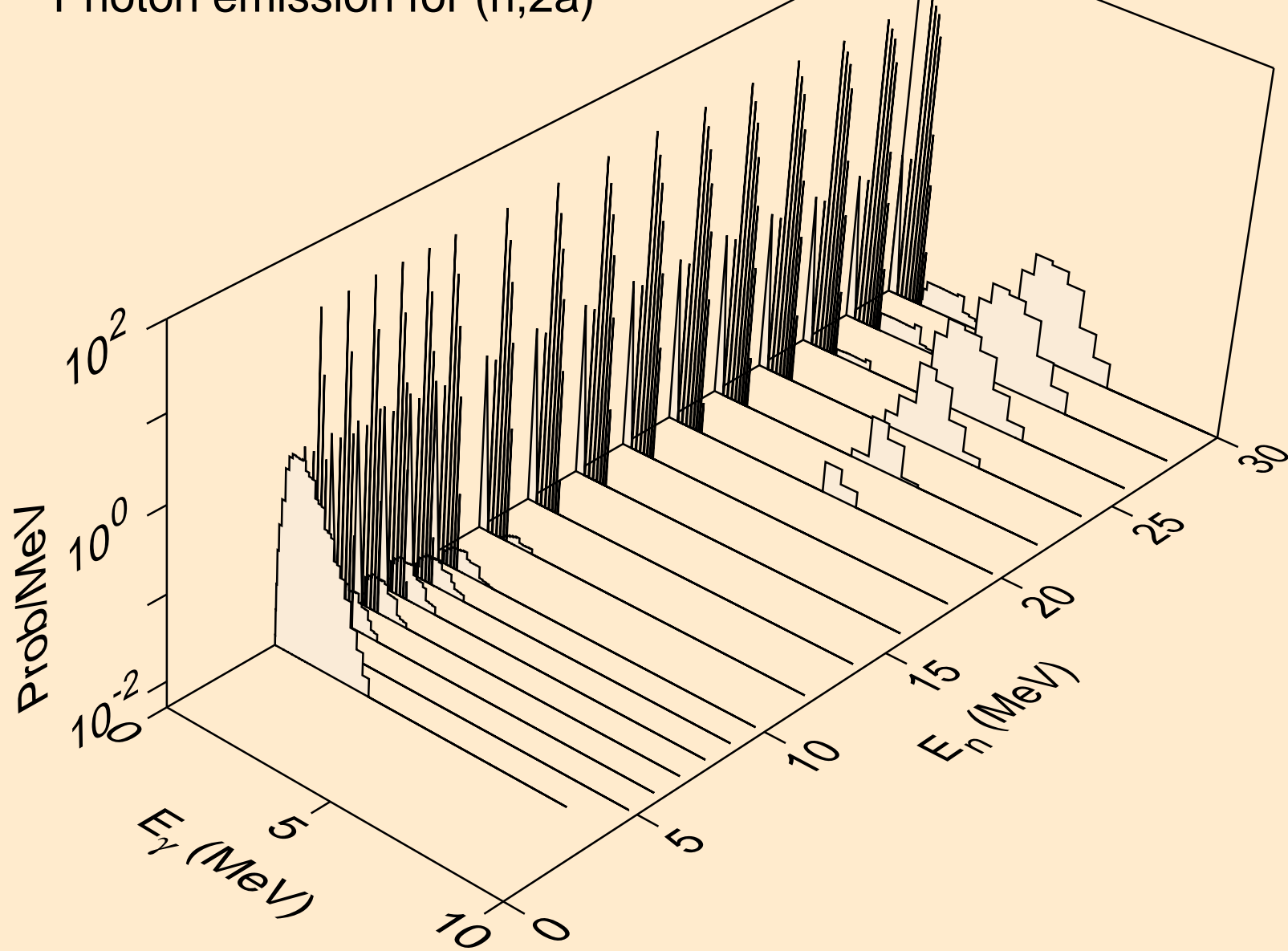

GD137 DEUTERON ACER TENDL-2021 LIBRARY; T=0.K  
Photon emission for (n,3a)

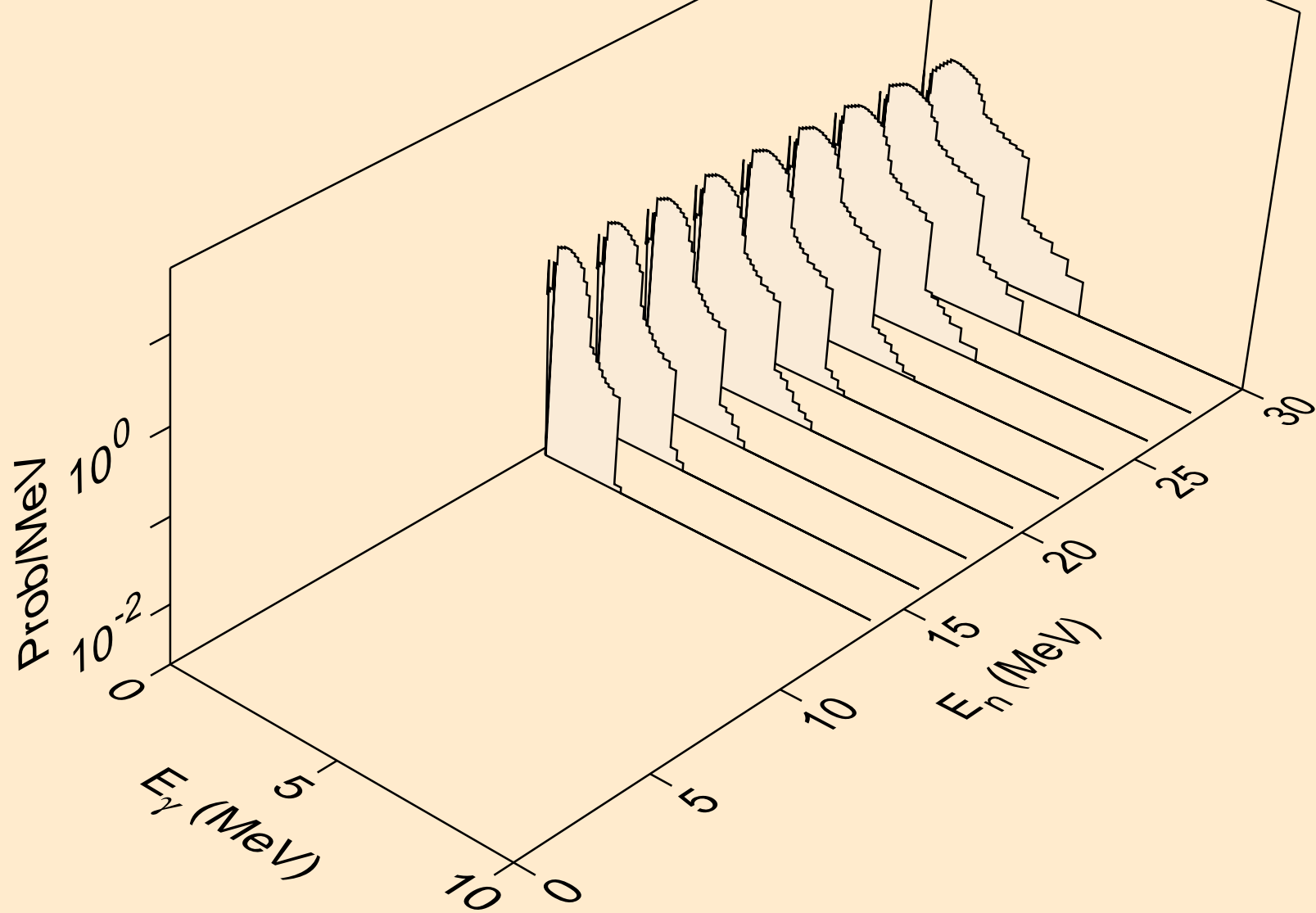

GD137 DEUTERON ACER TENDL-2021 LIBRARY; T=0.K  
Photon emission for (n,2p)

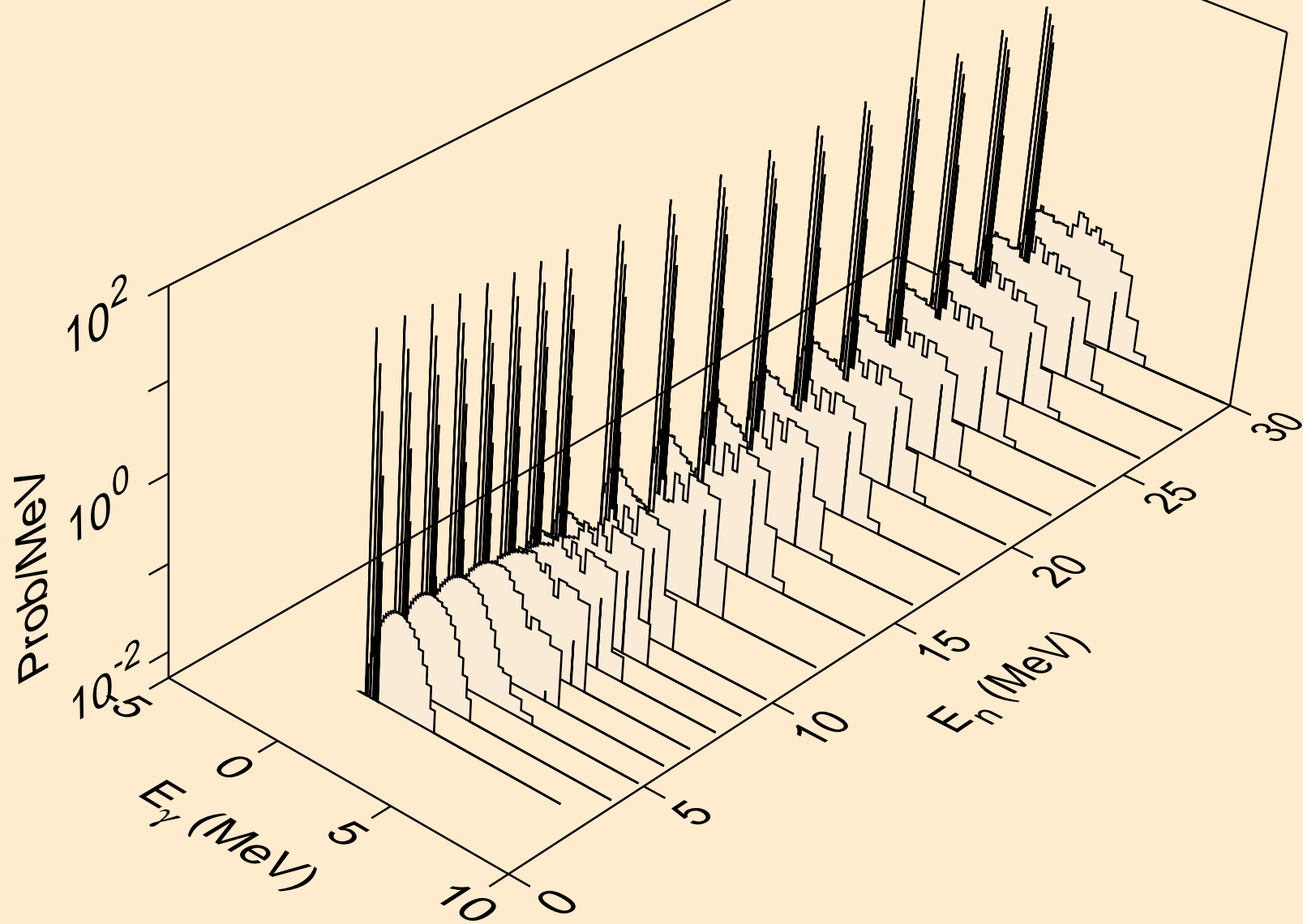

GD137 DEUTERON ACER TENDL-2021 LIBRARY; T=0.K  
Photon emission for (n,p)

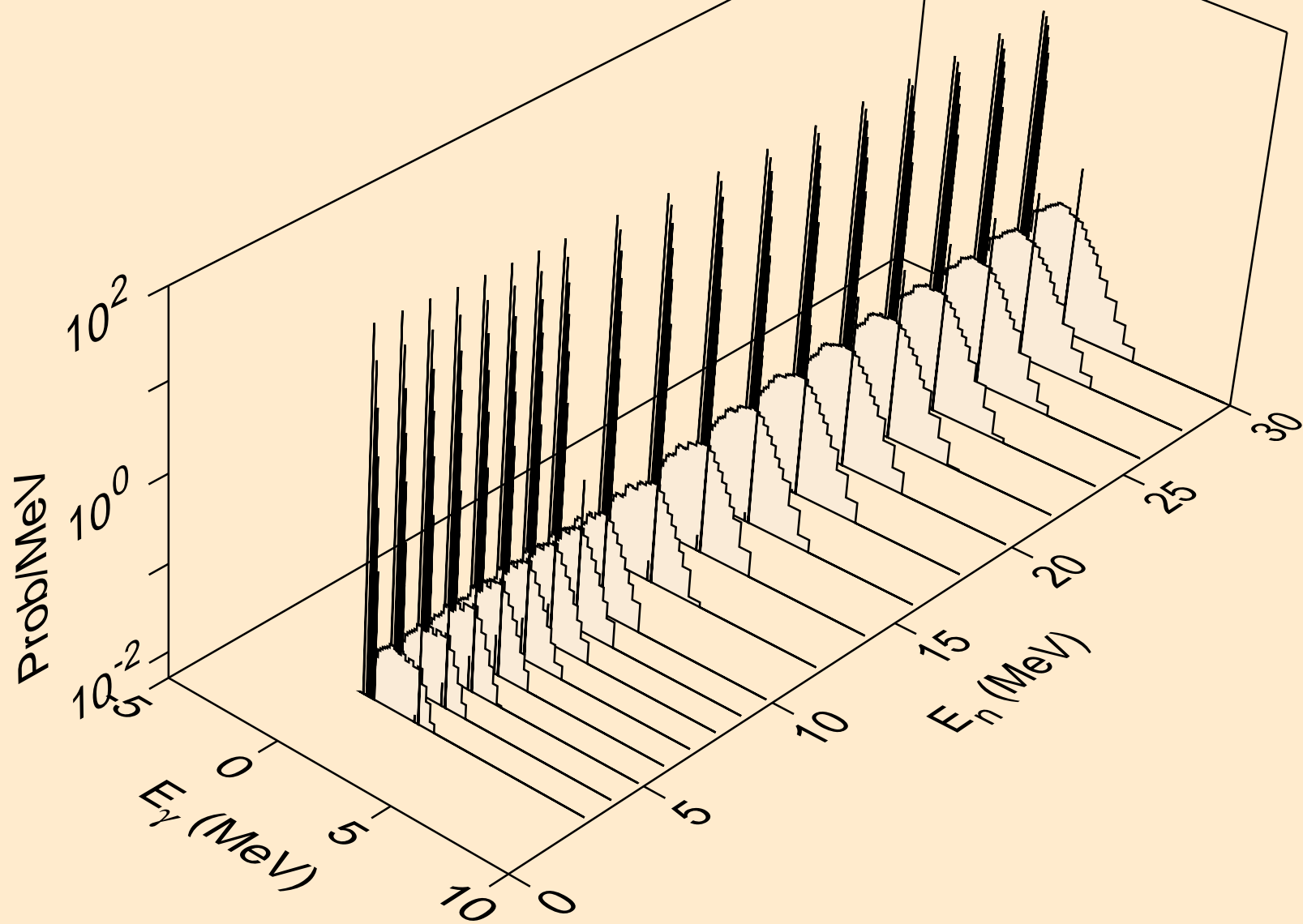



GD137 DEUTERON ACER TENDL-2021 LIBRARY; T=0.K  
Photon emission for (n,d2a)

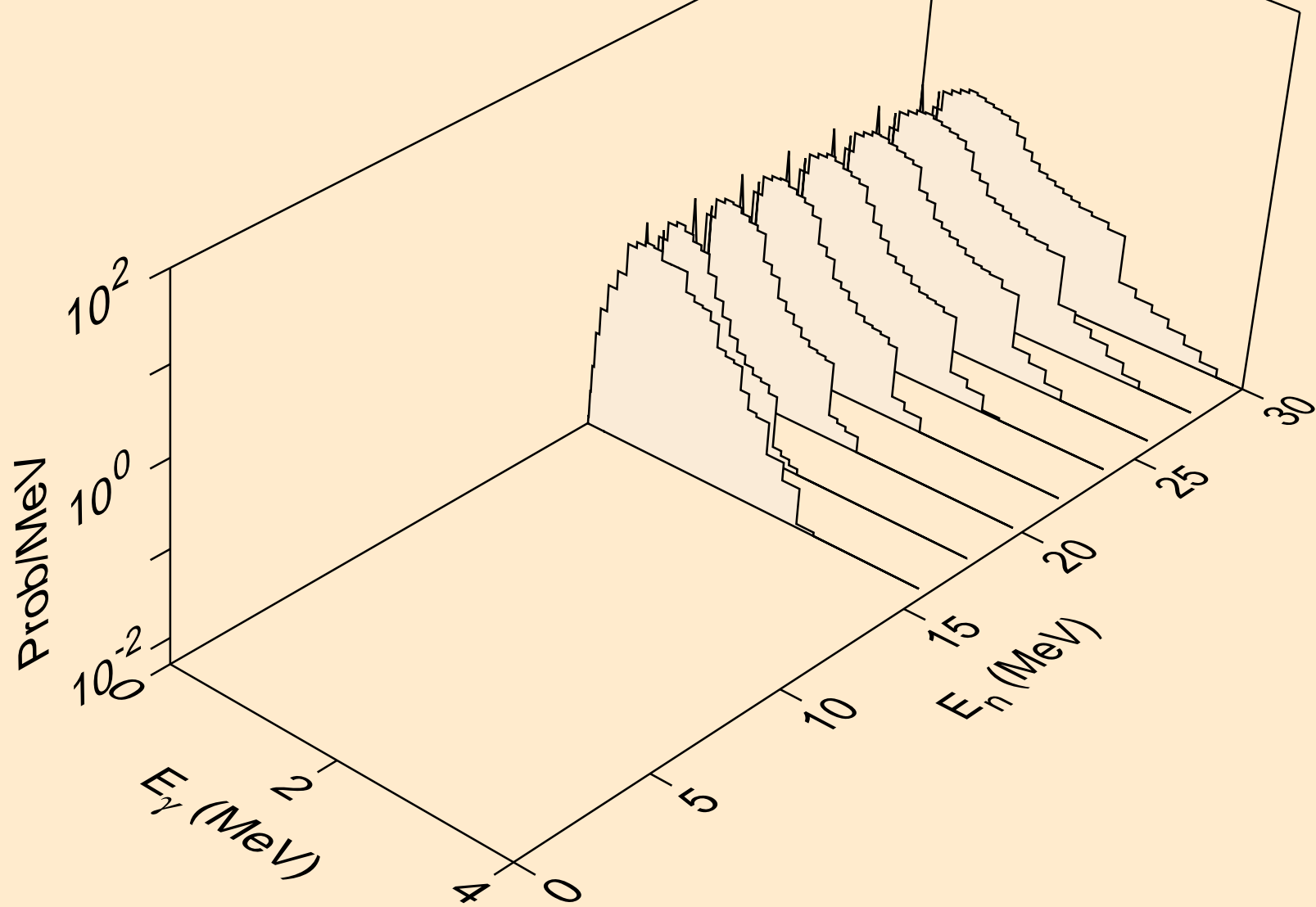

GD137 DEUTERON ACER TENDL-2021 LIBRARY; T=0.K  
Photon emission for (n,pd)

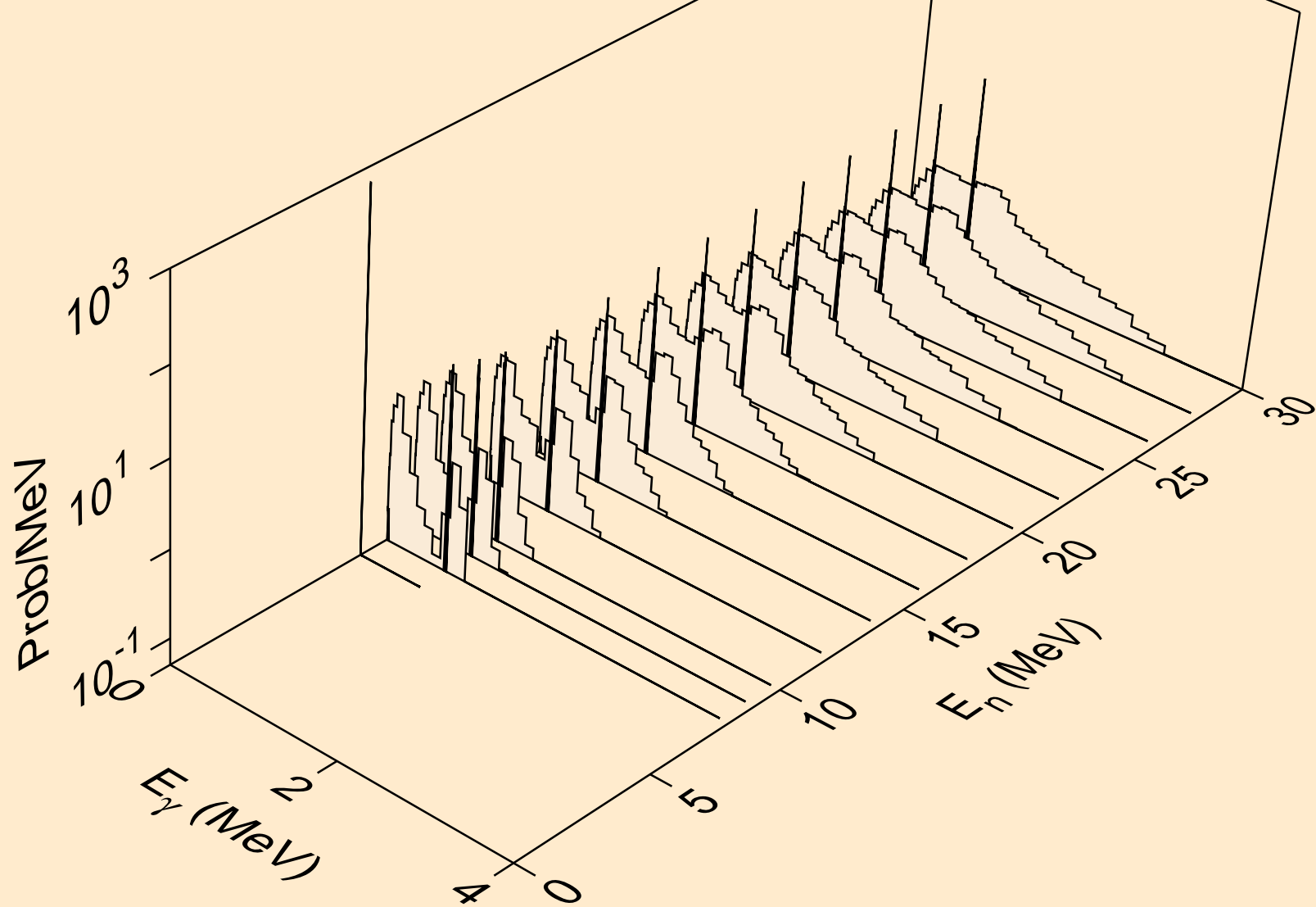

GD137 DEUTERON ACER TENDL-2021 LIBRARY; T=0.K  
Photon emission for (n,pt)

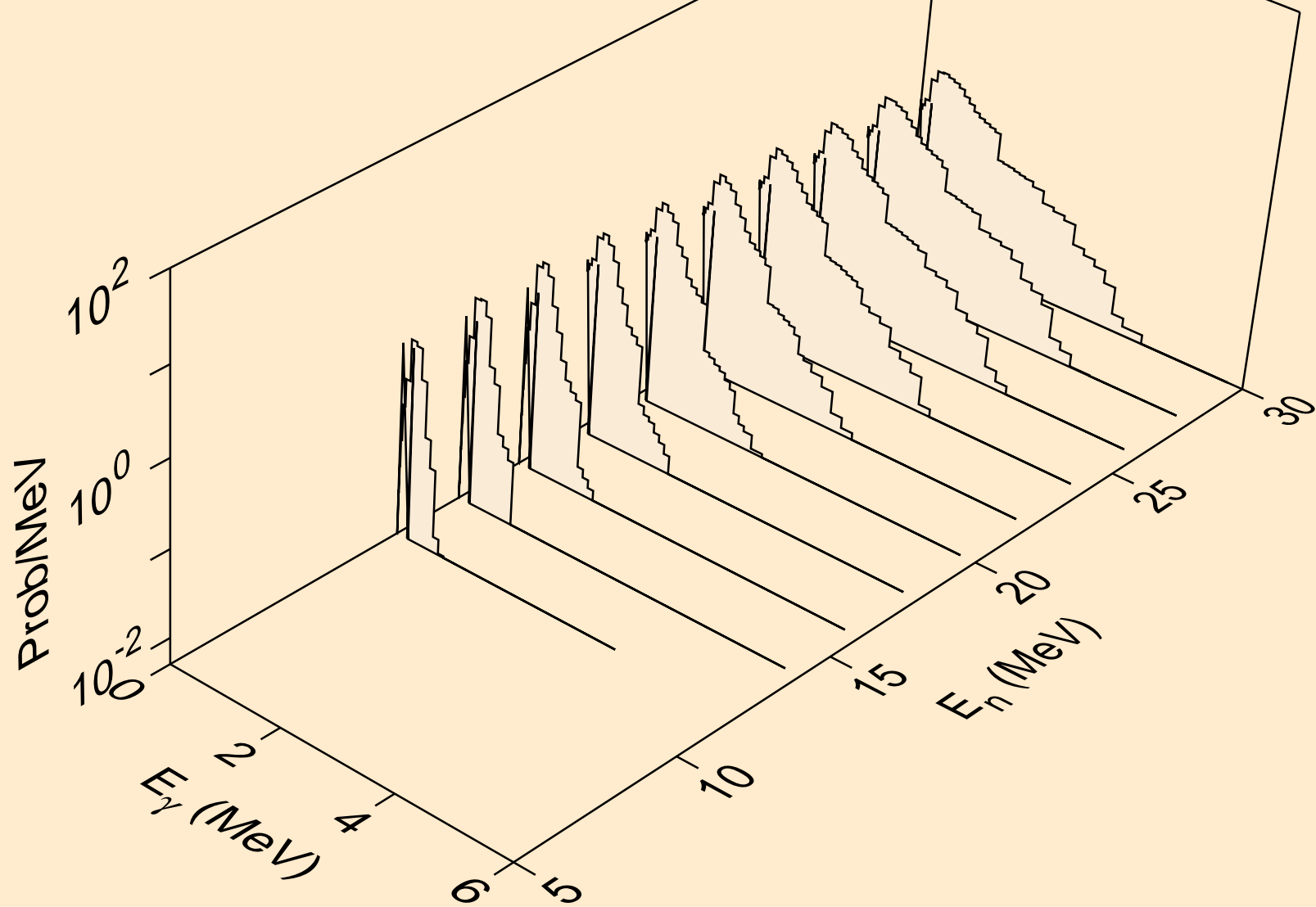

GD137 DEUTERON ACER TENDL-2021 LIBRARY; T=0.K  
Photon emission for (n,da)

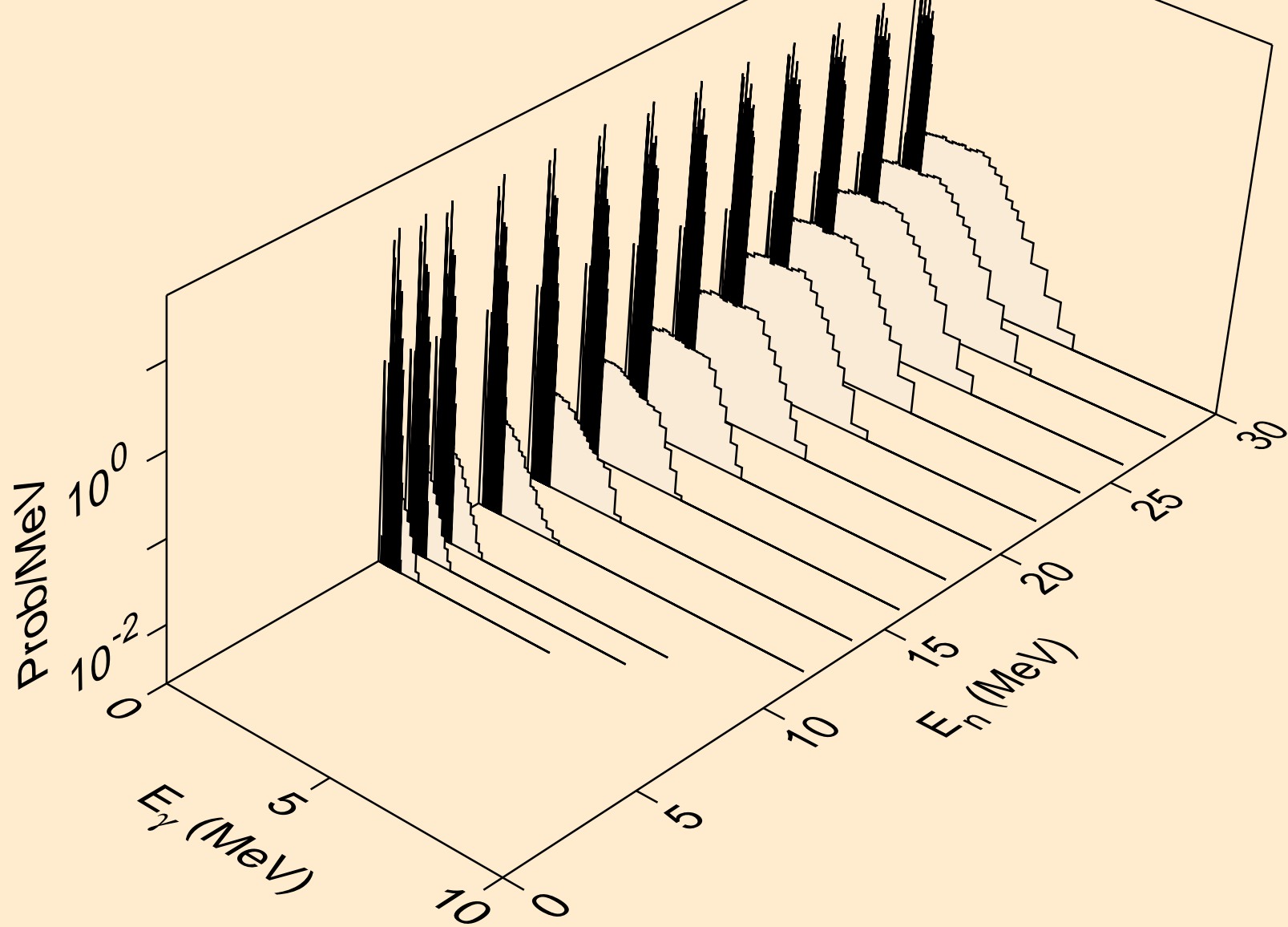

# GD137 DEUTERON ACER TENDL-2021 LIBRARY; T=0.K

## Particle heating contributions

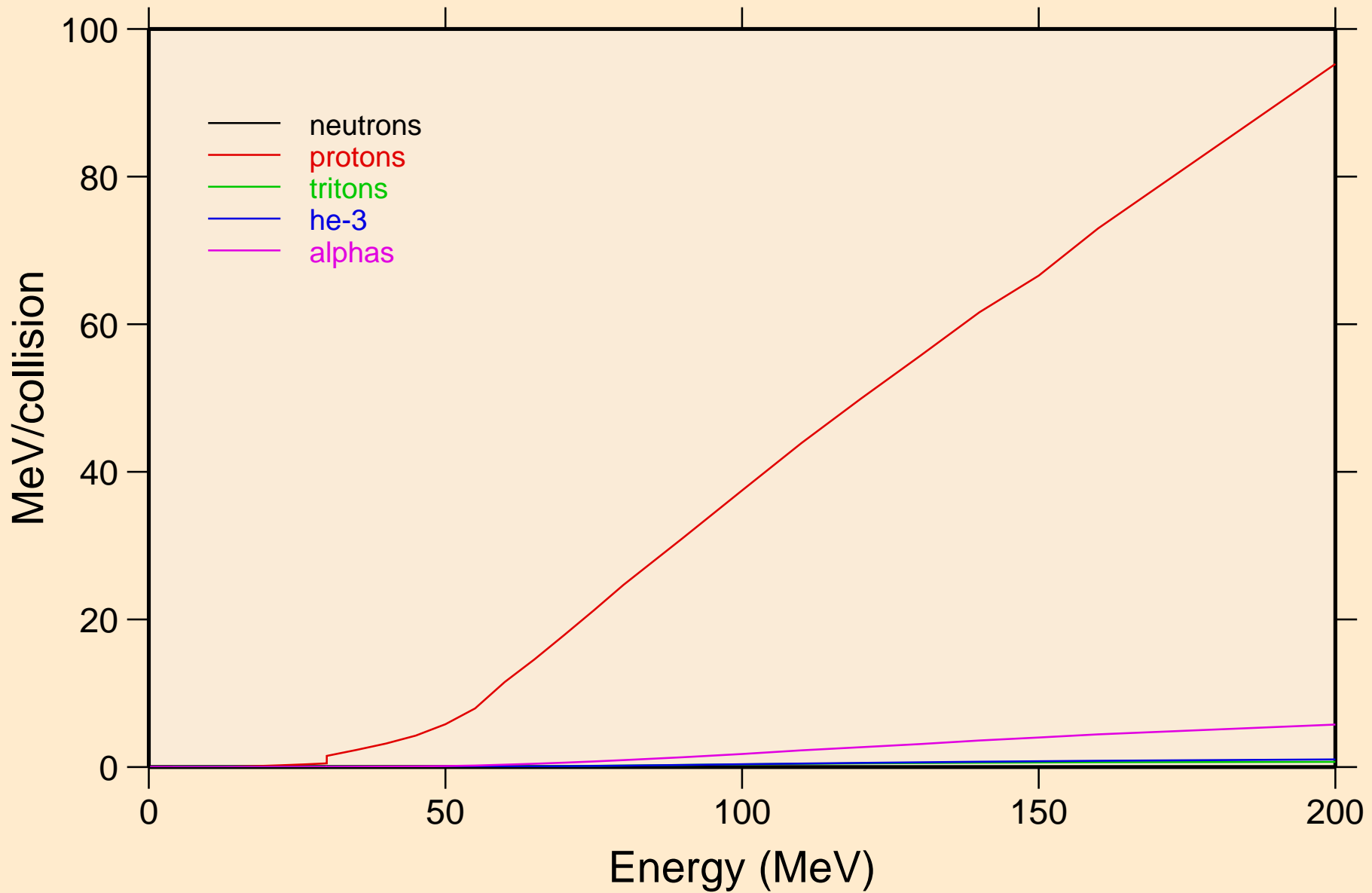

GD137 DEUTERON ACER TENDL-2021 LIBRARY; T=0.K  
Recoil Heating

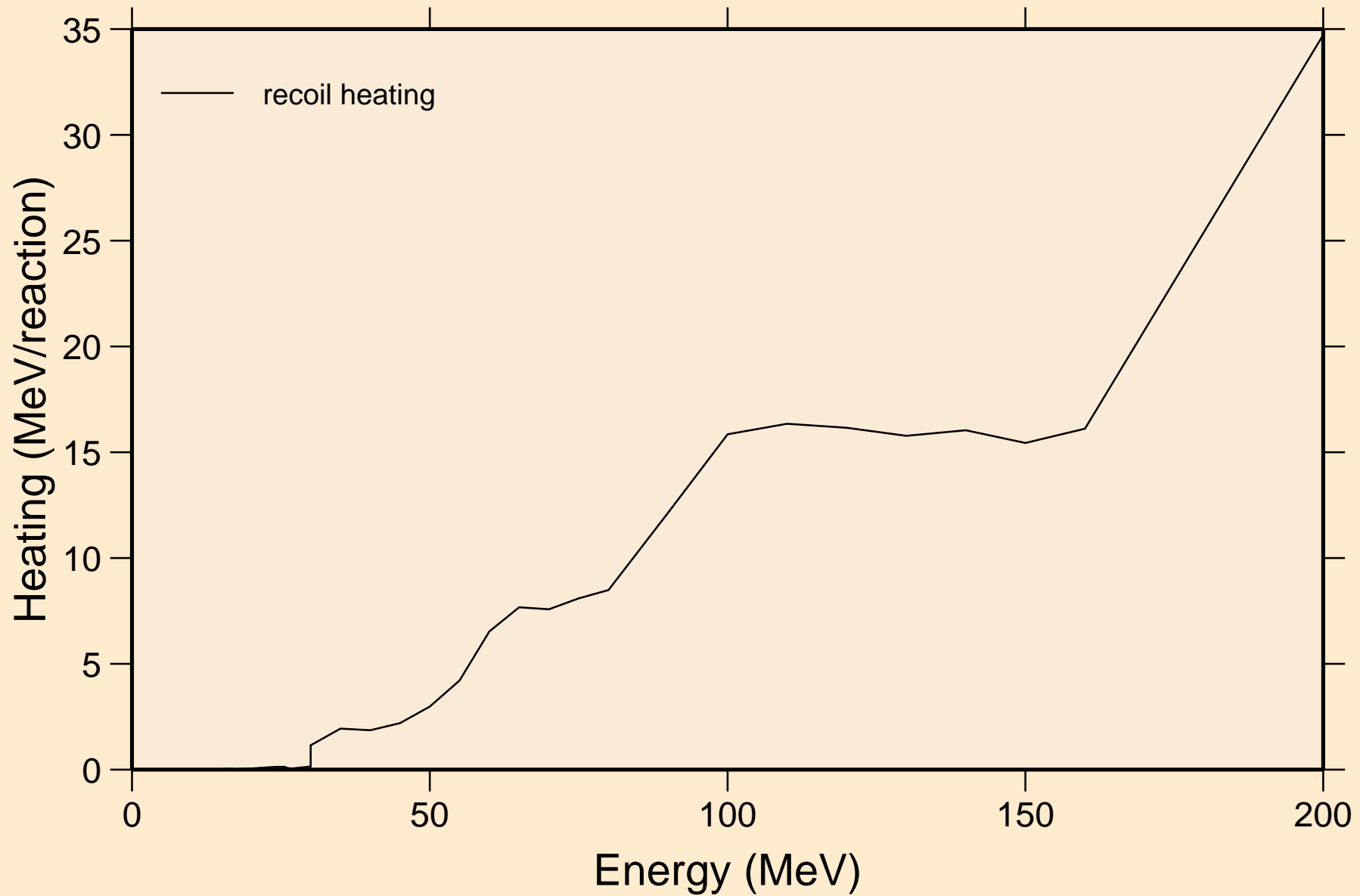

# GD137 DEUTERON ACER TENDL-2021 LIBRARY; T=0.K

## Particle production cross sections

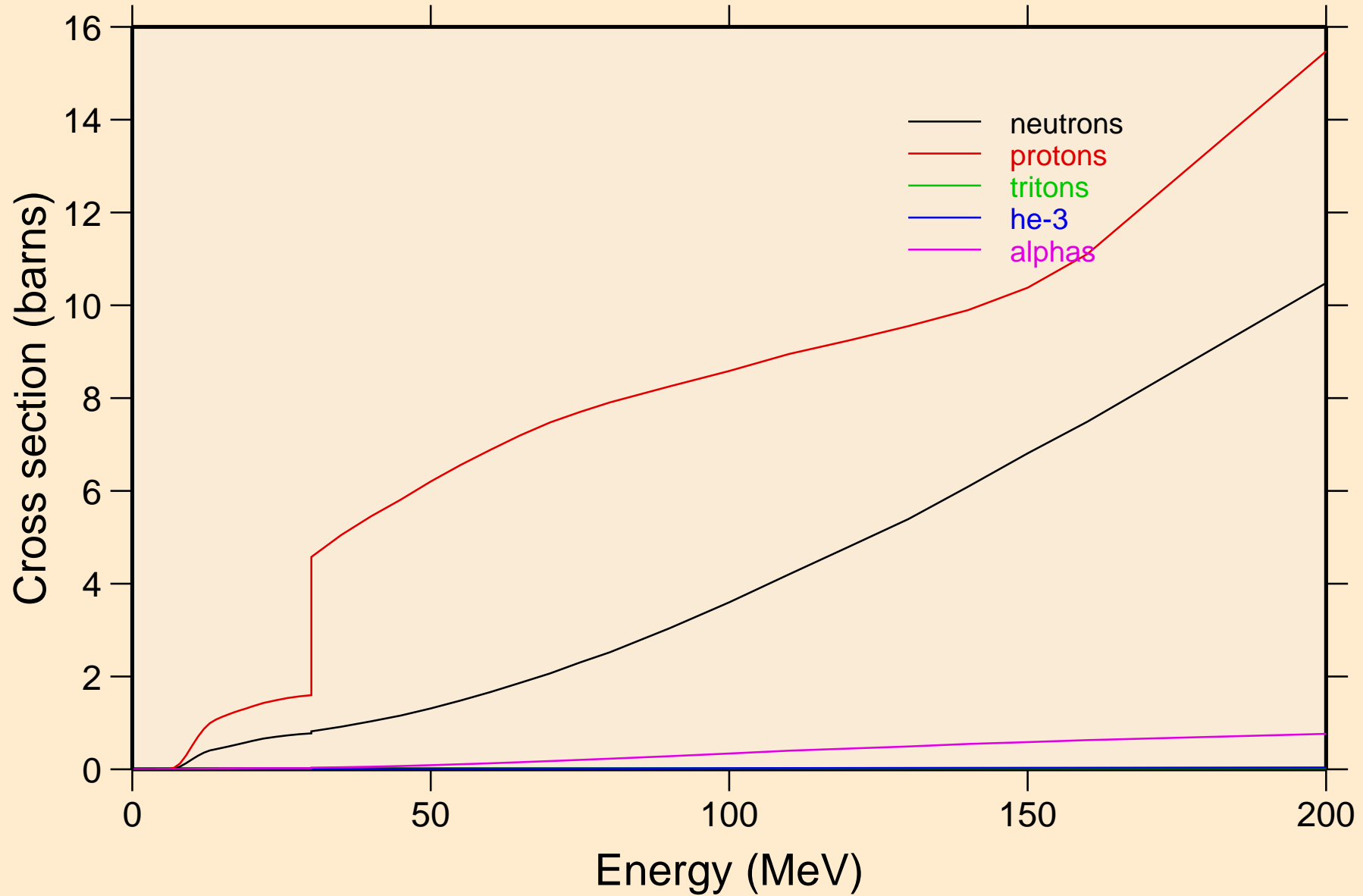

GD137 DEUTERON ACER TENDL-2021 LIBRARY; T=0.K  
neutrons from (d,n)

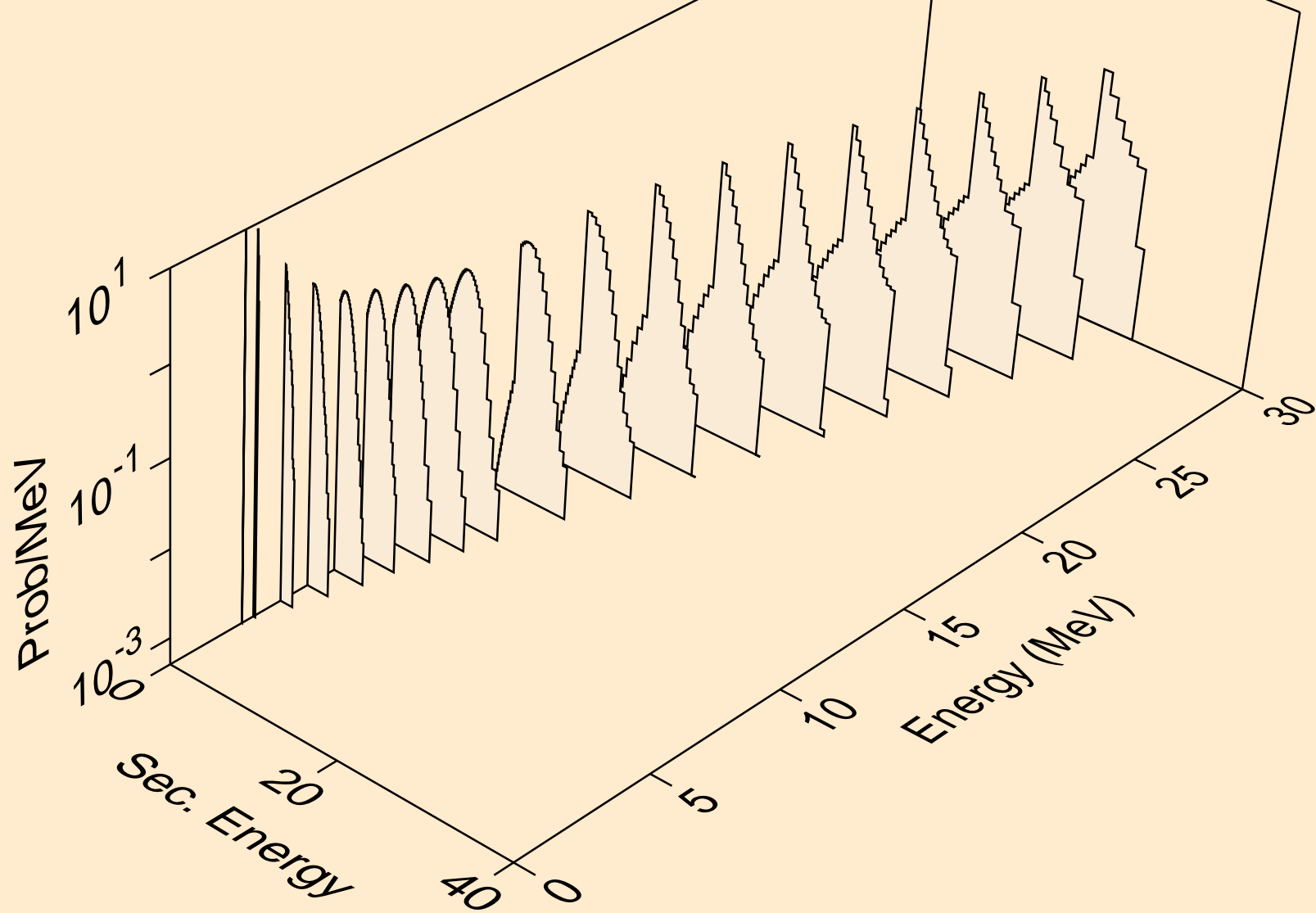



GD137 DEUTERON ACER TENDL-2021 LIBRARY; T=0.K  
neutrons from (d,x)

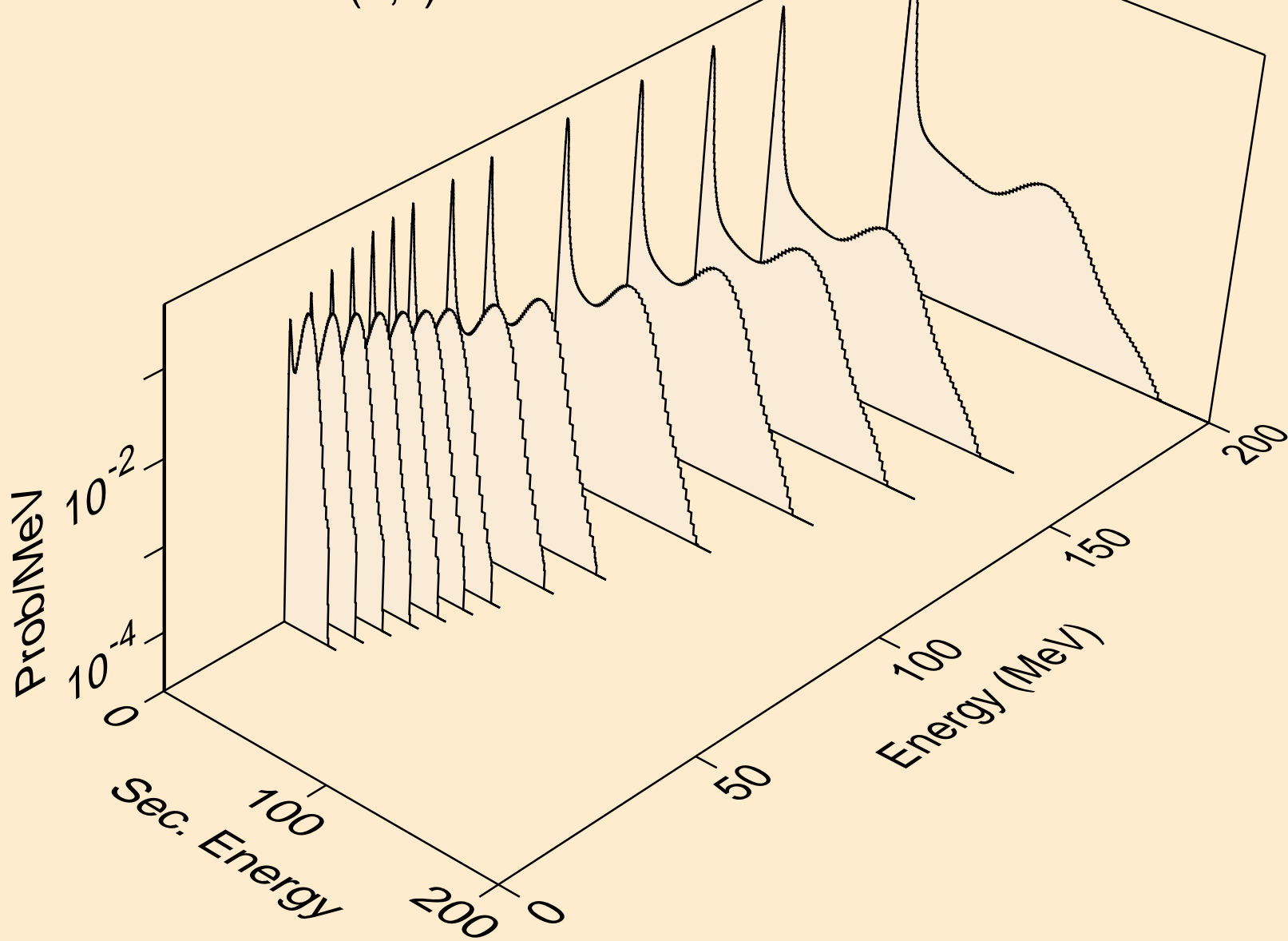

GD137 DEUTERON ACER TENDL-2021 LIBRARY; T=0.K  
neutrons from (d,2n)

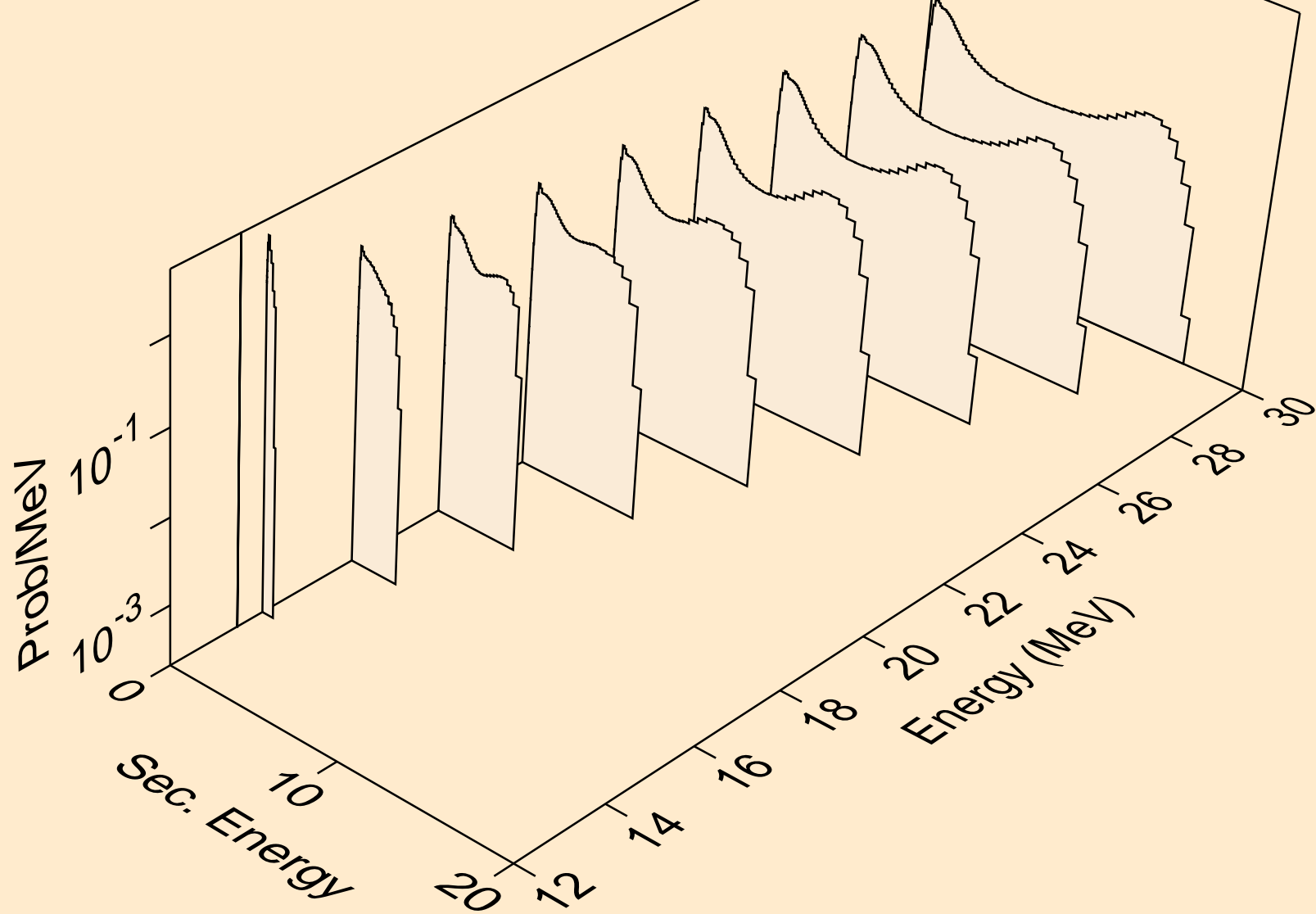

GD137 DEUTERON ACER TENDL-2021 LIBRARY; T=0.K  
neutrons from (d,3n)

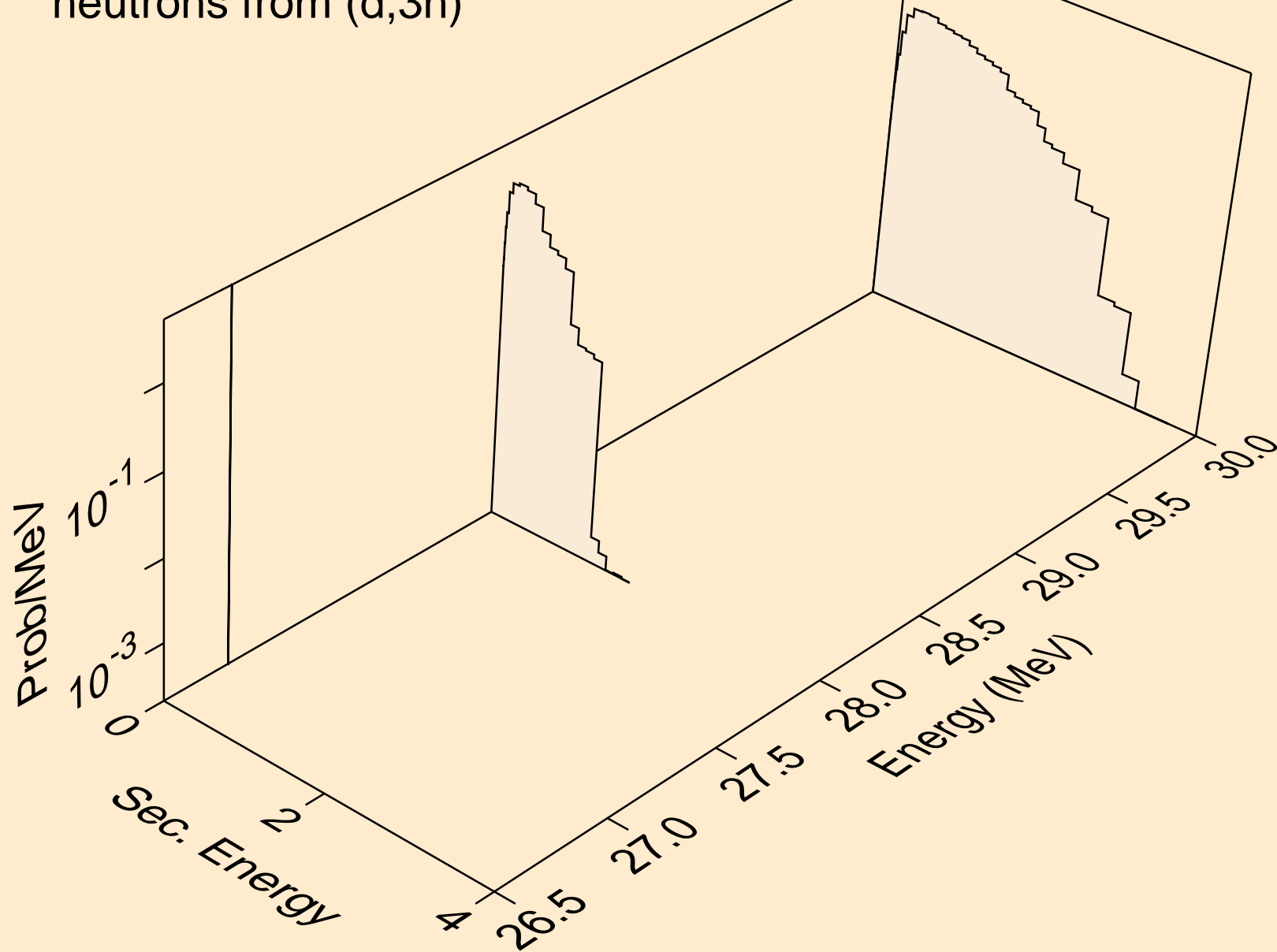

GD137 DEUTERON ACER TENDL-2021 LIBRARY; T=0.K  
neutrons from (d,n\*)a

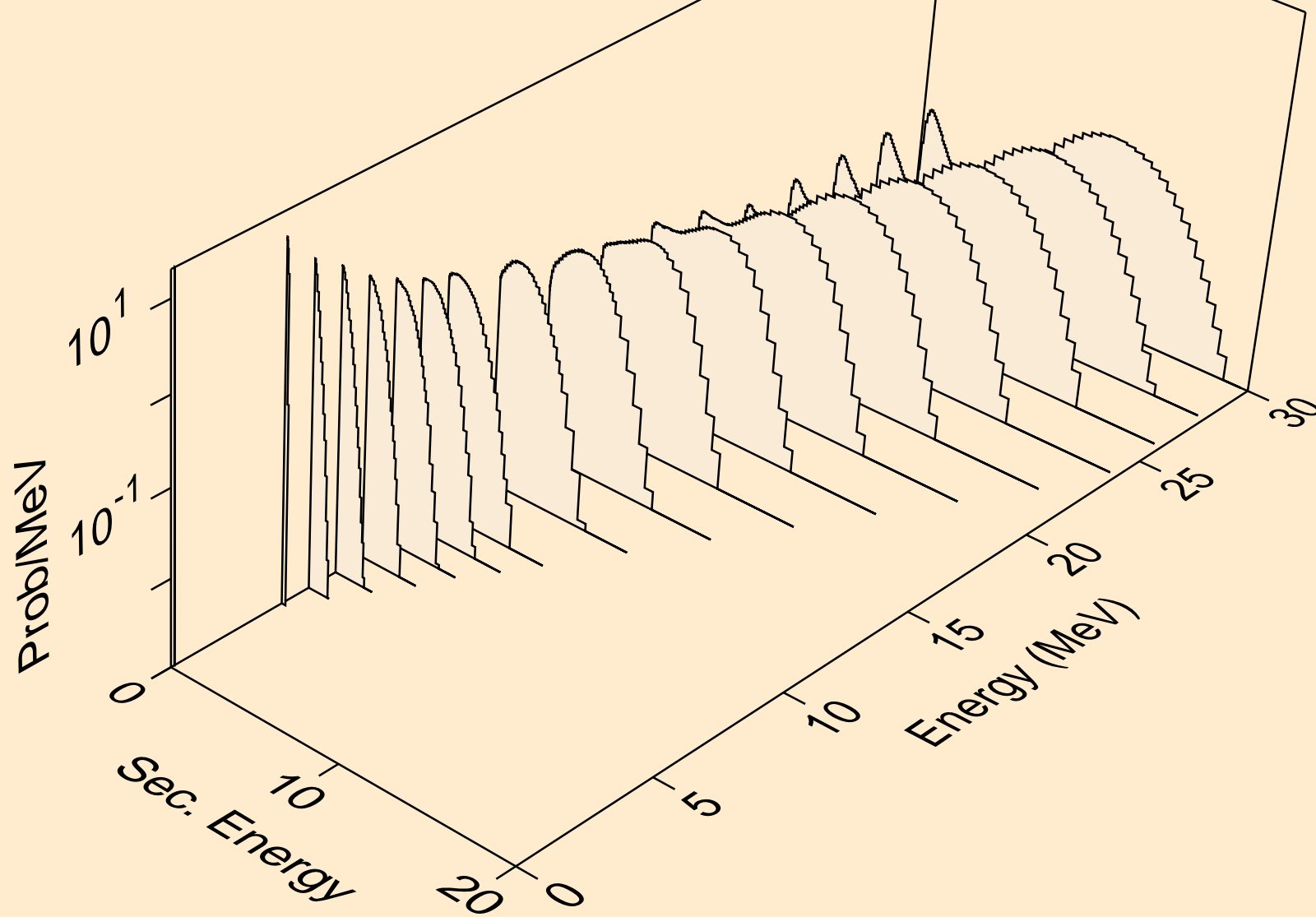

GD137 DEUTERON ACER TENDL-2021 LIBRARY; T=0.K  
neutrons from (d,2n)a

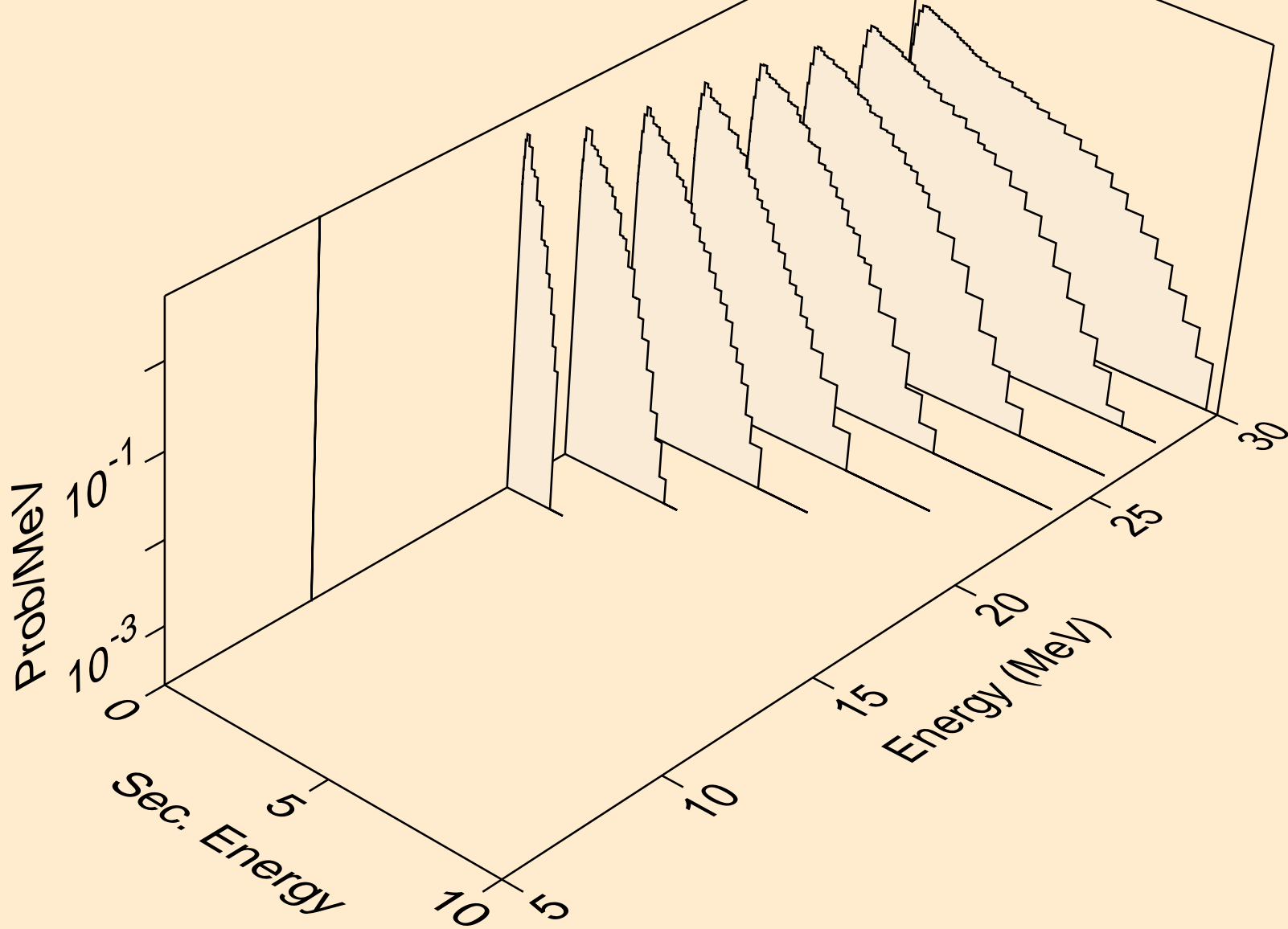

GD137 DEUTERON ACER TENDL-2021 LIBRARY; T=0.K  
neutrons from (d,n\*)p

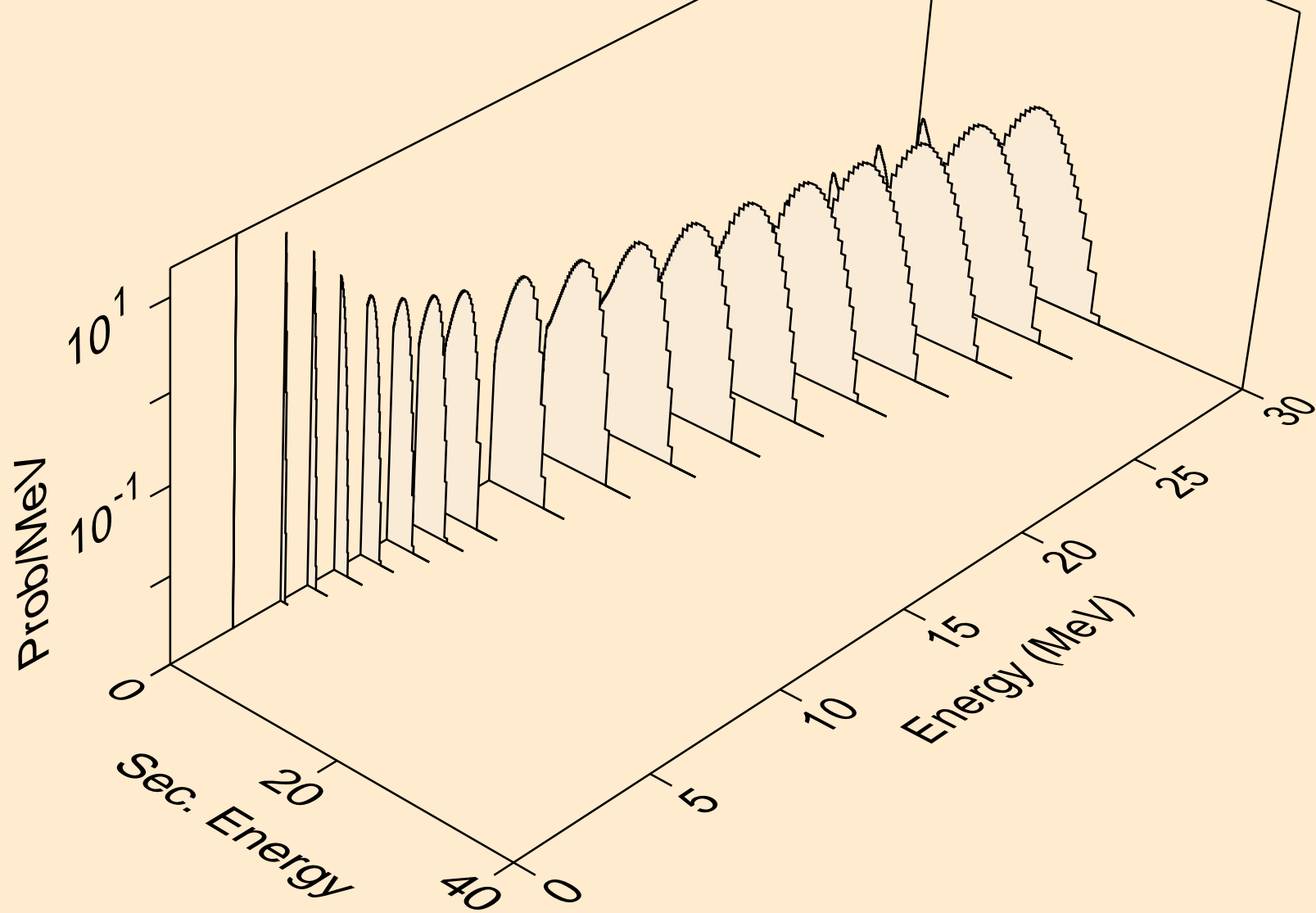

GD137 DEUTERON ACER TENDL-2021 LIBRARY; T=0.K  
neutrons from (d,n\*)2a

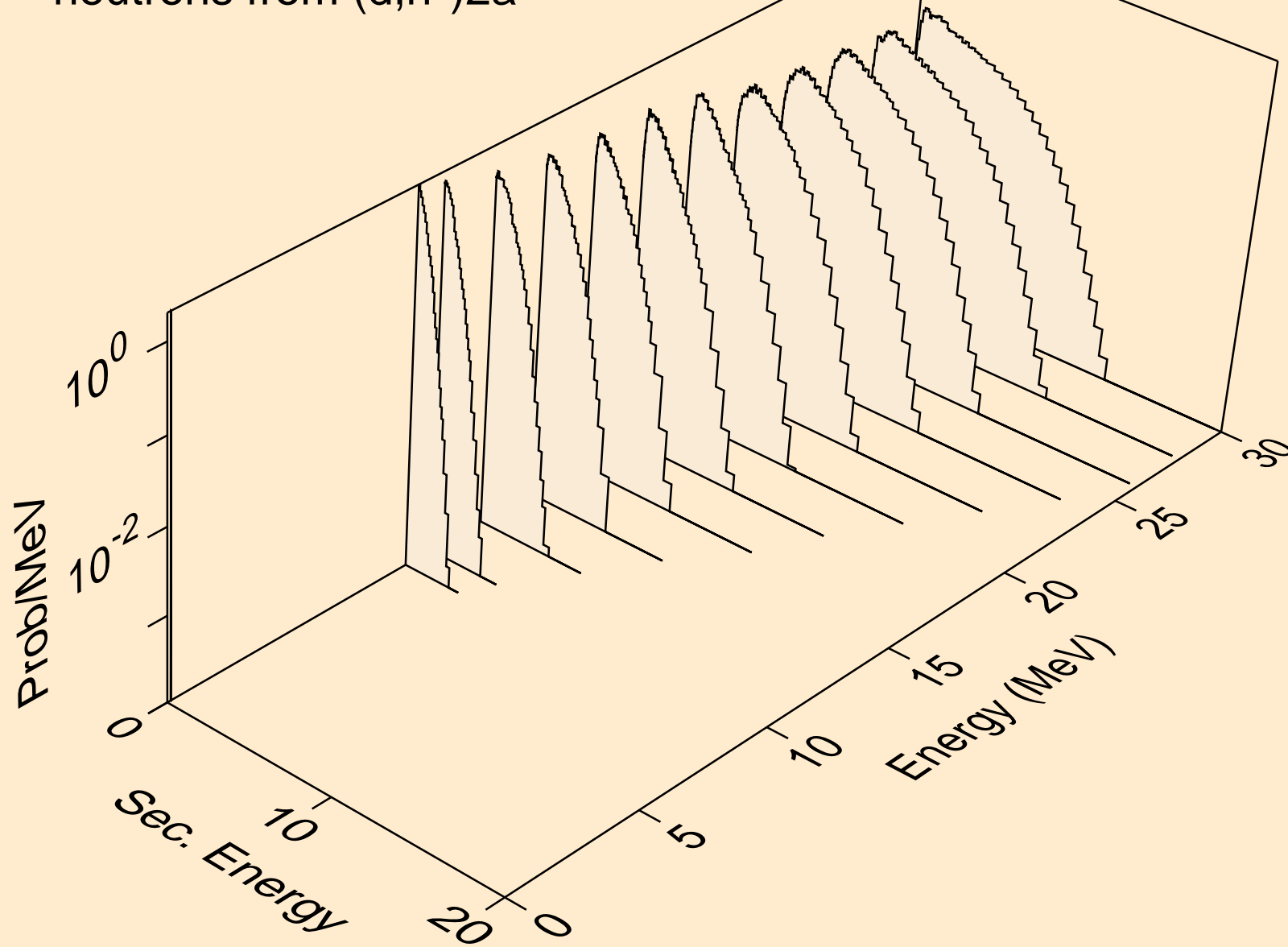

GD137 DEUTERON ACER TENDL-2021 LIBRARY; T=0.K  
neutrons from (d,n\*)d

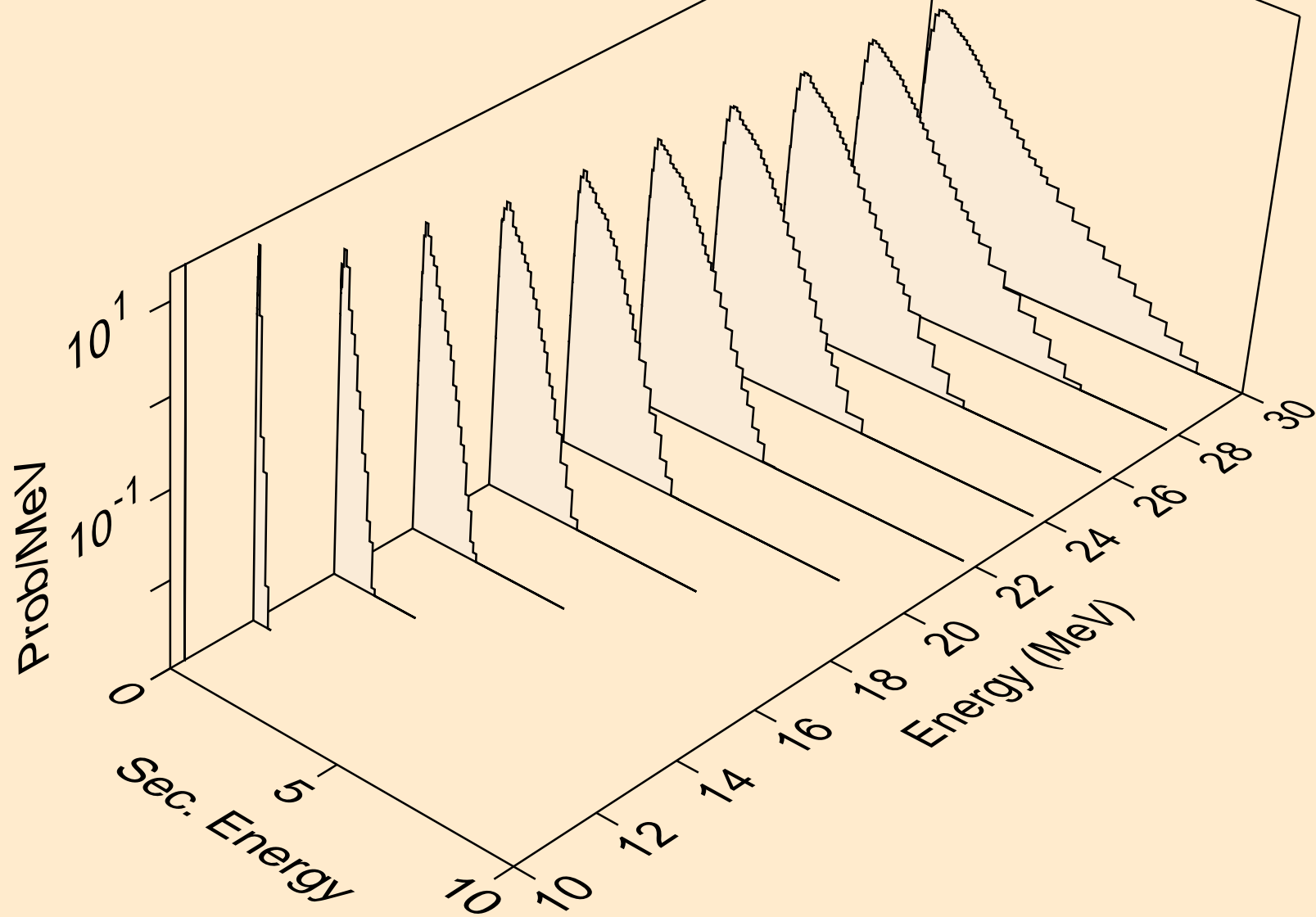



GD137 DEUTERON ACER TENDL-2021 LIBRARY; T=0.K  
neutrons from (d,n\*)t

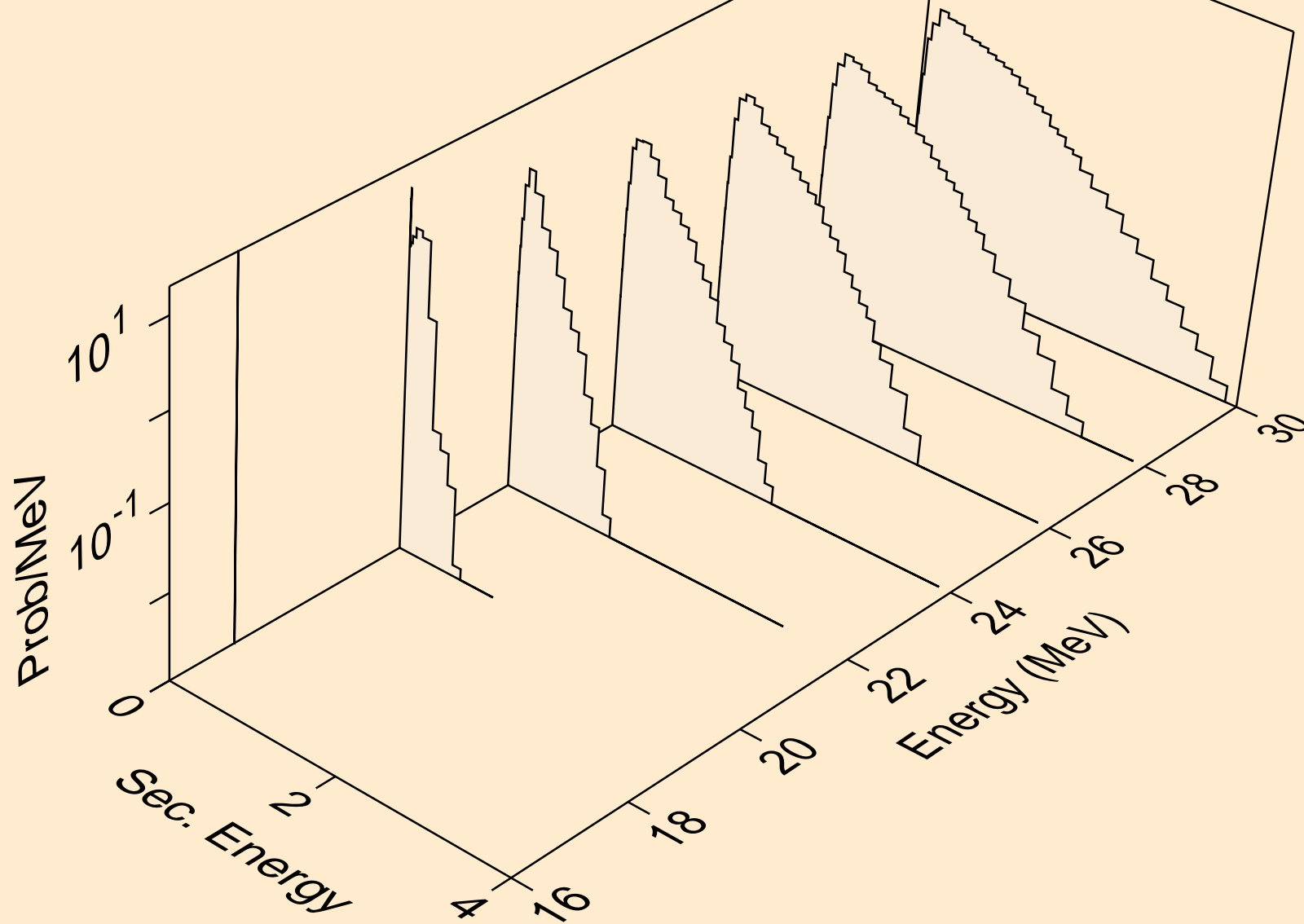

GD137 DEUTERON ACER TENDL-2021 LIBRARY; T=0.K  
neutrons from (d,n\*)he3

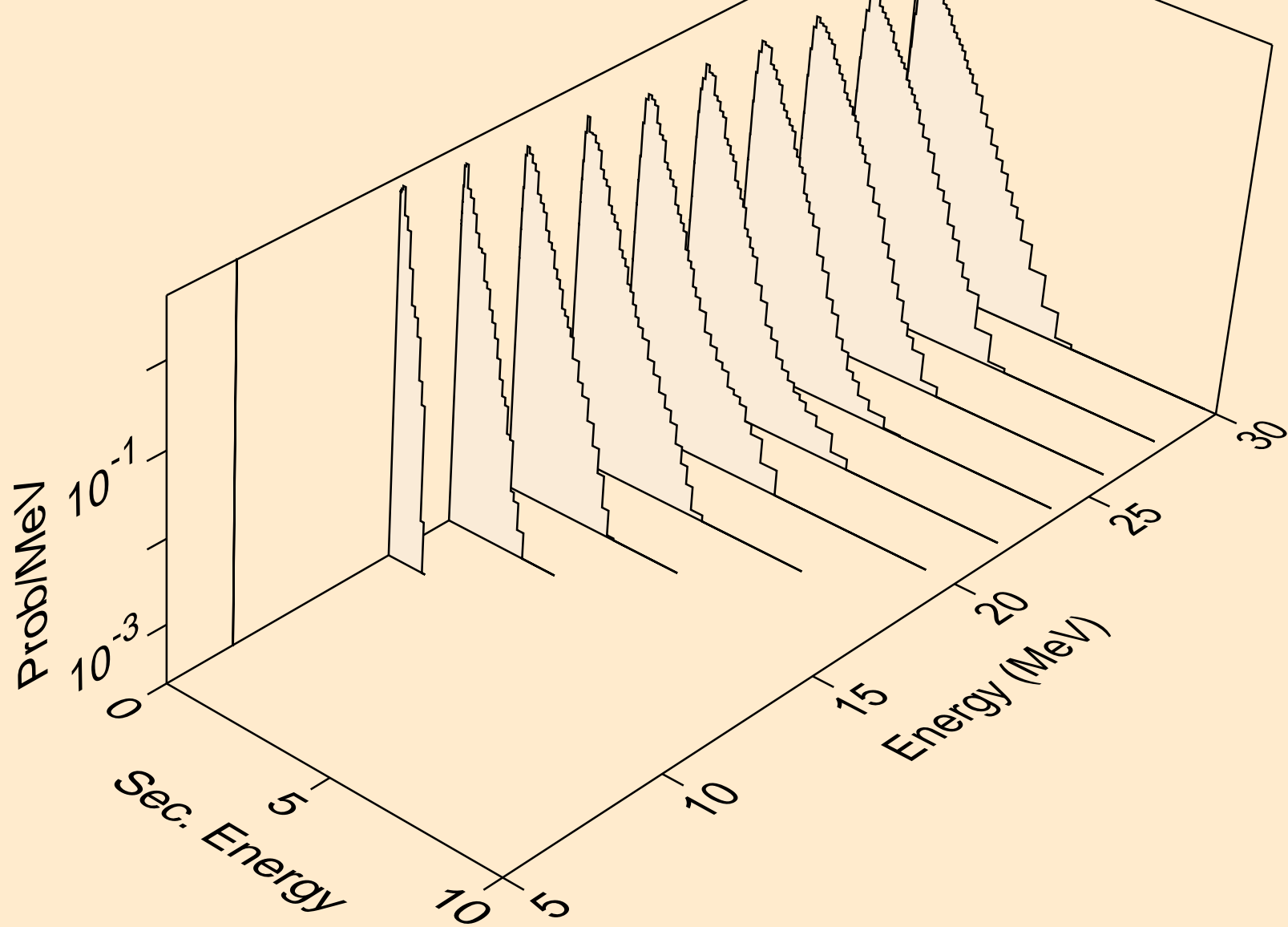

GD137 DEUTERON ACER TENDL-2021 LIBRARY; T=0.K  
neutrons from (d,2np)

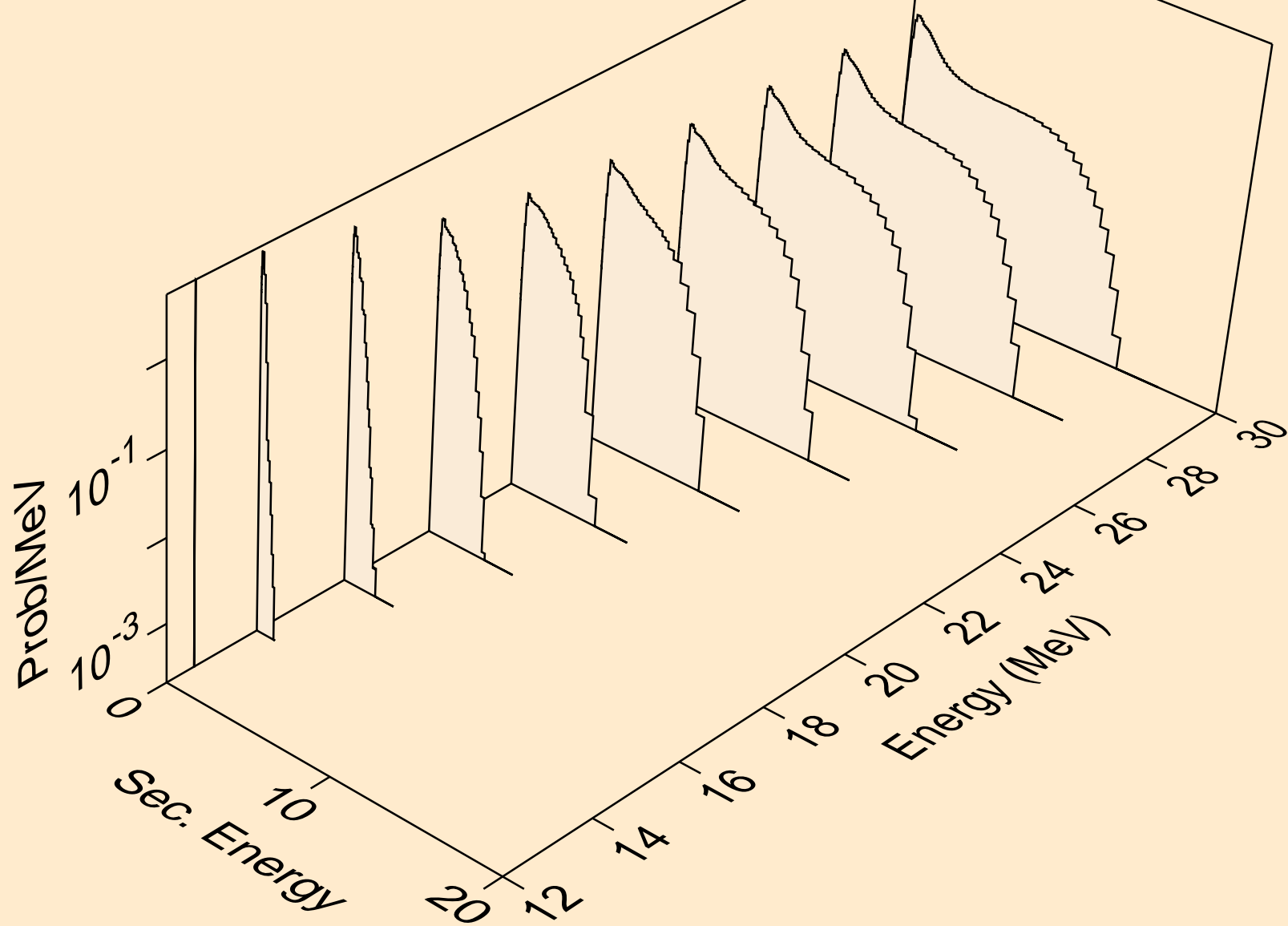

GD137 DEUTERON ACER TENDL-2021 LIBRARY; T=0.K  
neutrons from (d,3np)

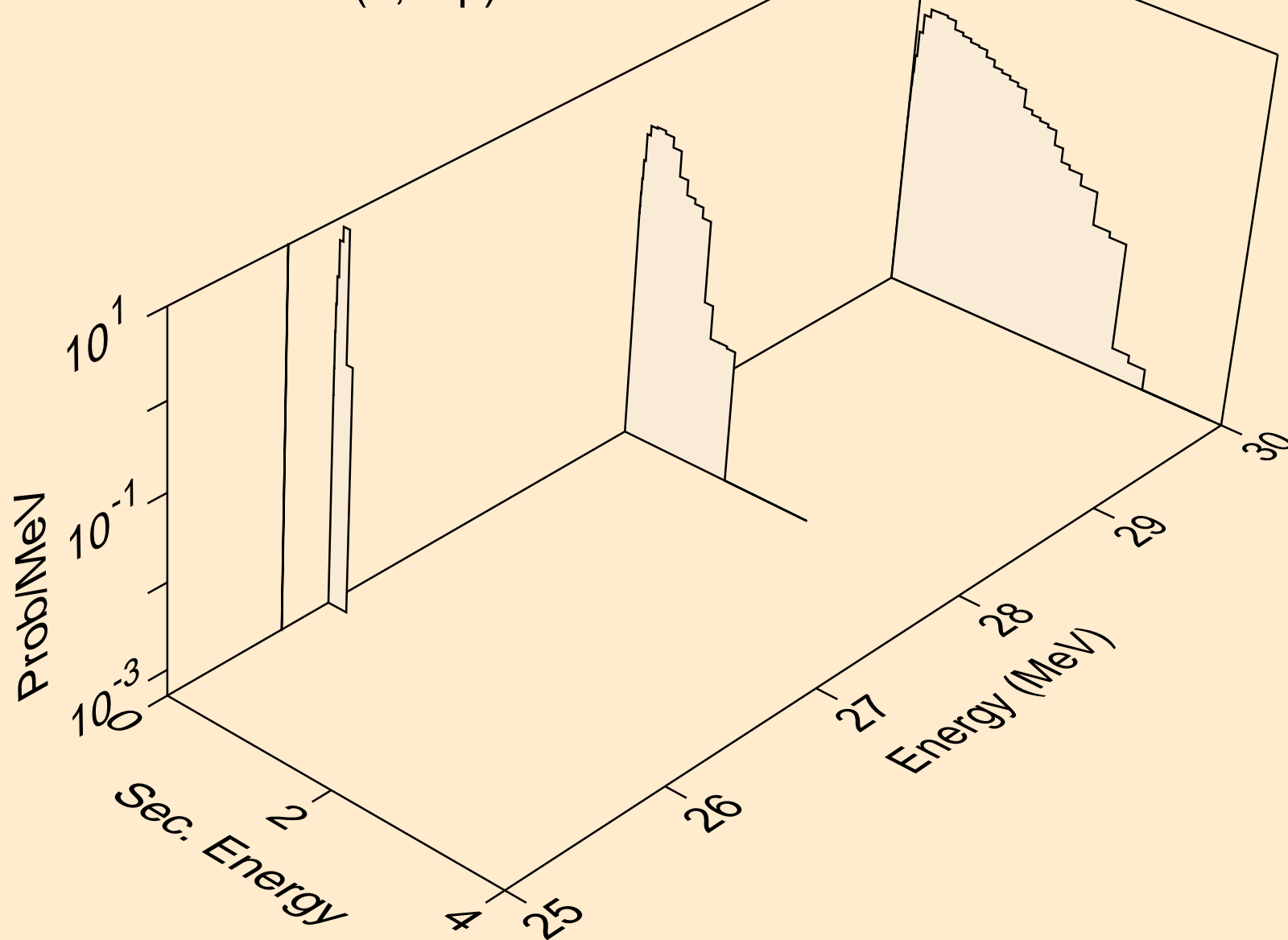

GD137 DEUTERON ACER TENDL-2021 LIBRARY; T=0.K  
neutrons from (d,2np)

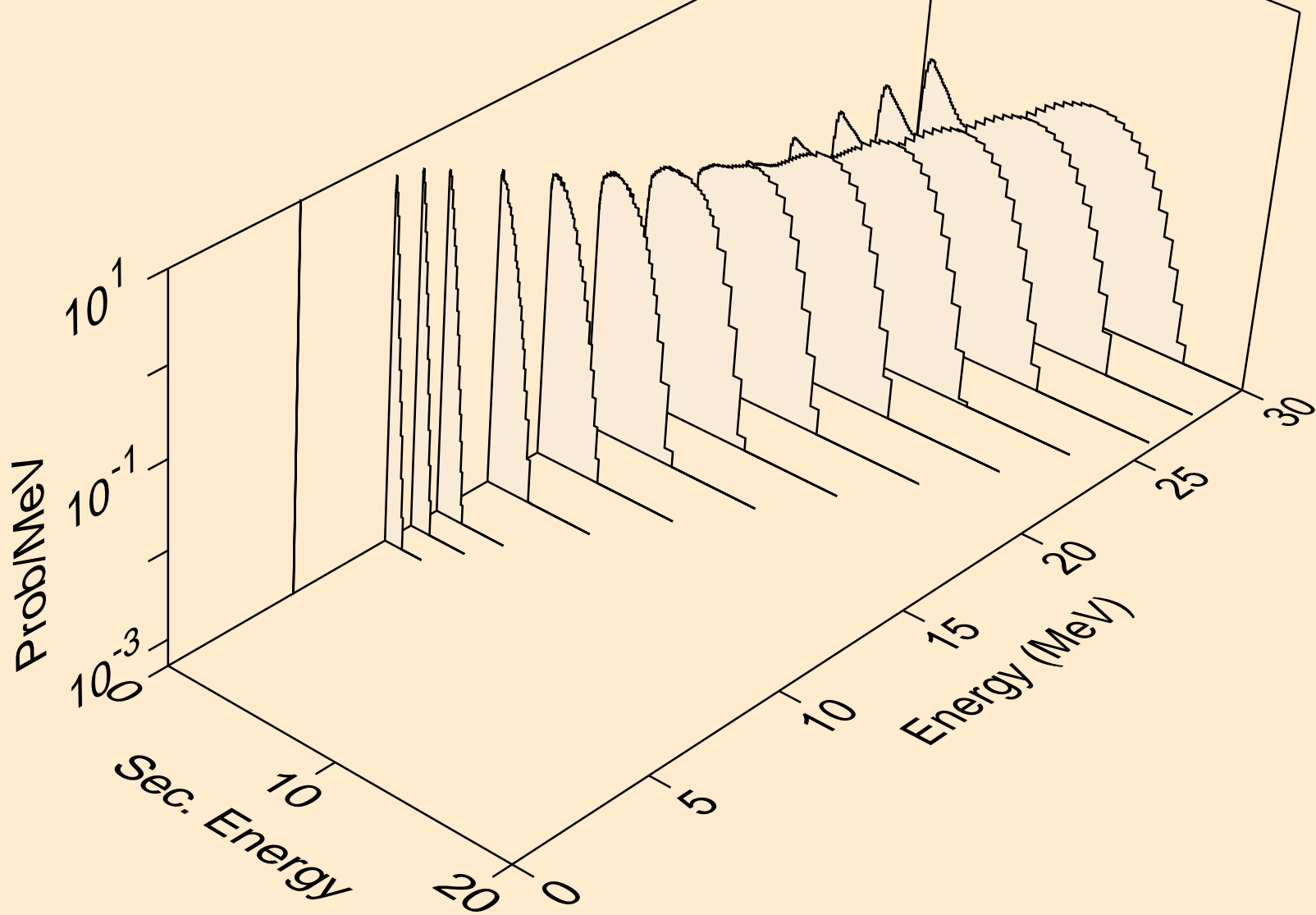

GD137 DEUTERON ACER TENDL-2021 LIBRARY; T=0.K  
neutrons from (d,npa)

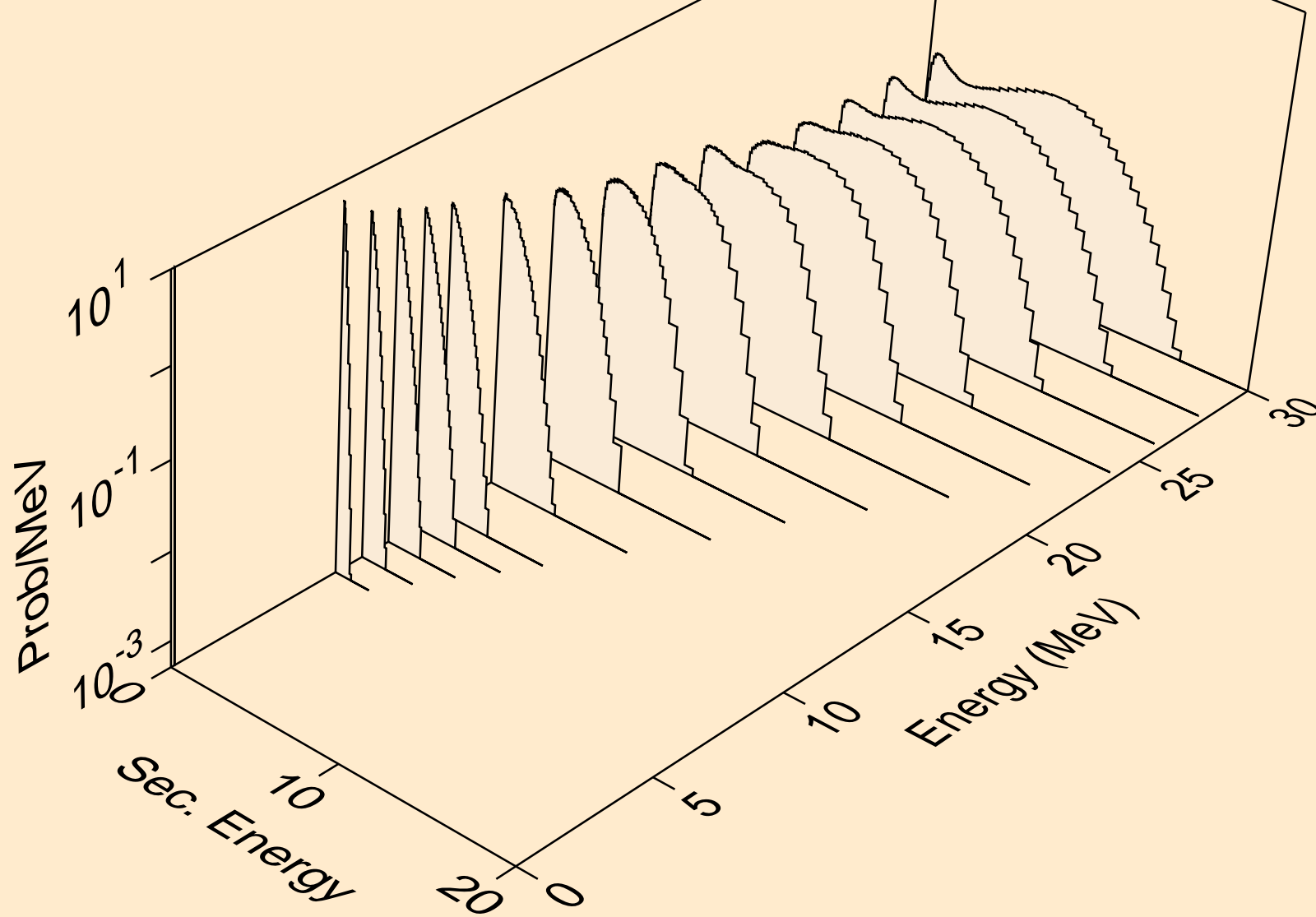

GD137 DEUTERON ACER TENDL-2021 LIBRARY; T=0.K  
protons from (d,x)

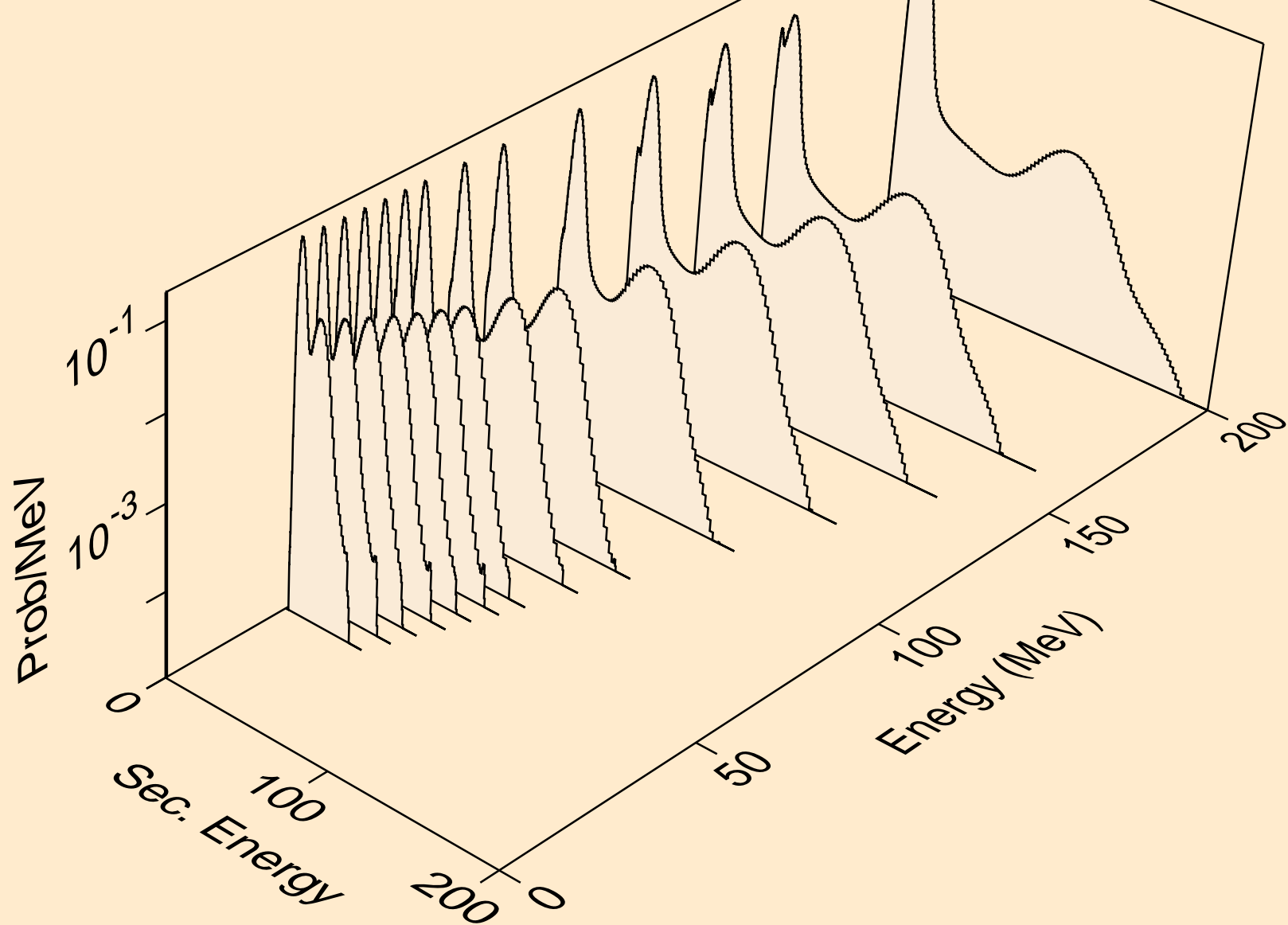

GD137 DEUTERON ACER TENDL-2021 LIBRARY; T=0.K  
protons from (d,n\*)p

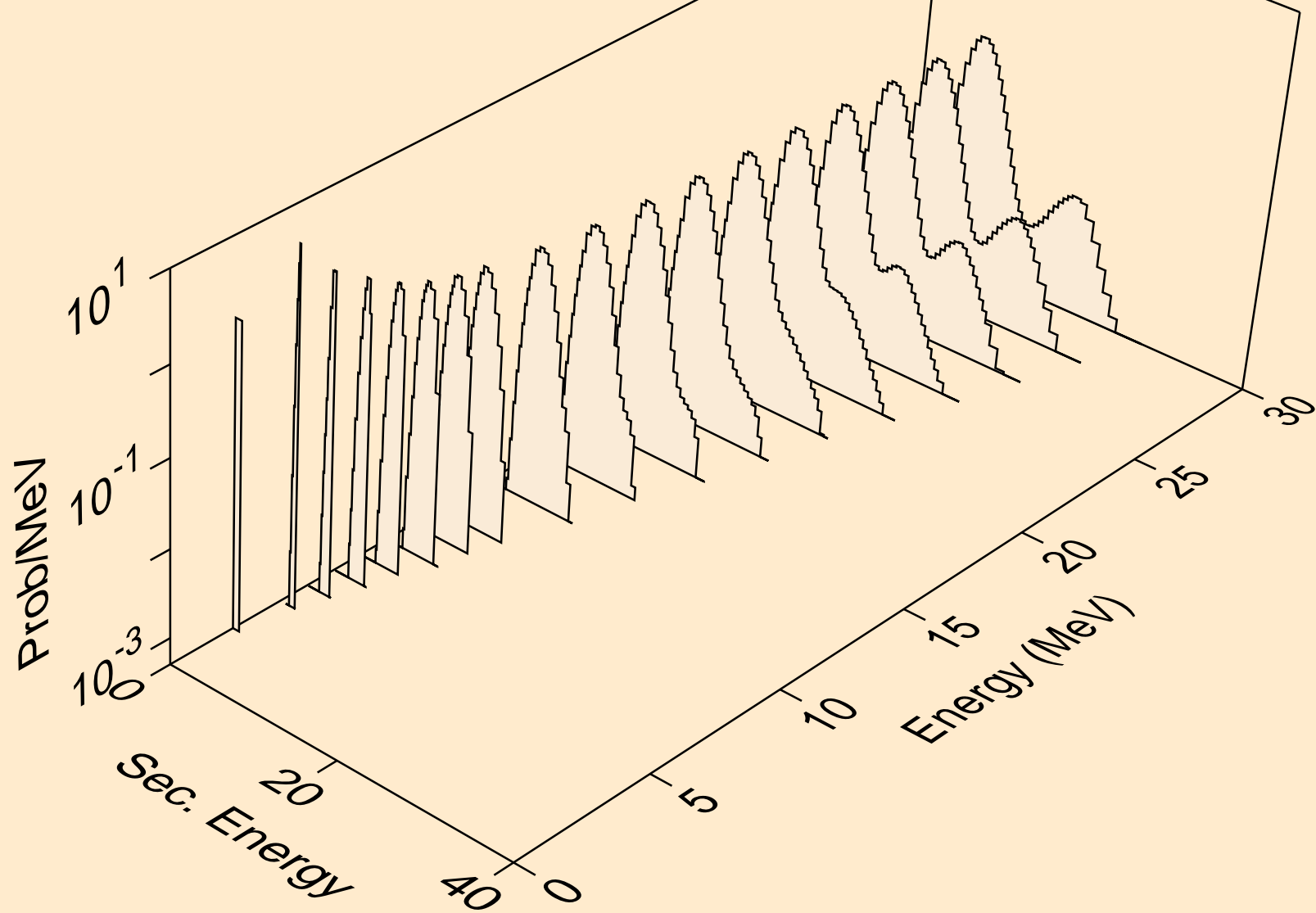



GD137 DEUTERON ACER TENDL-2021 LIBRARY; T=0.K  
protons from (d,2np)

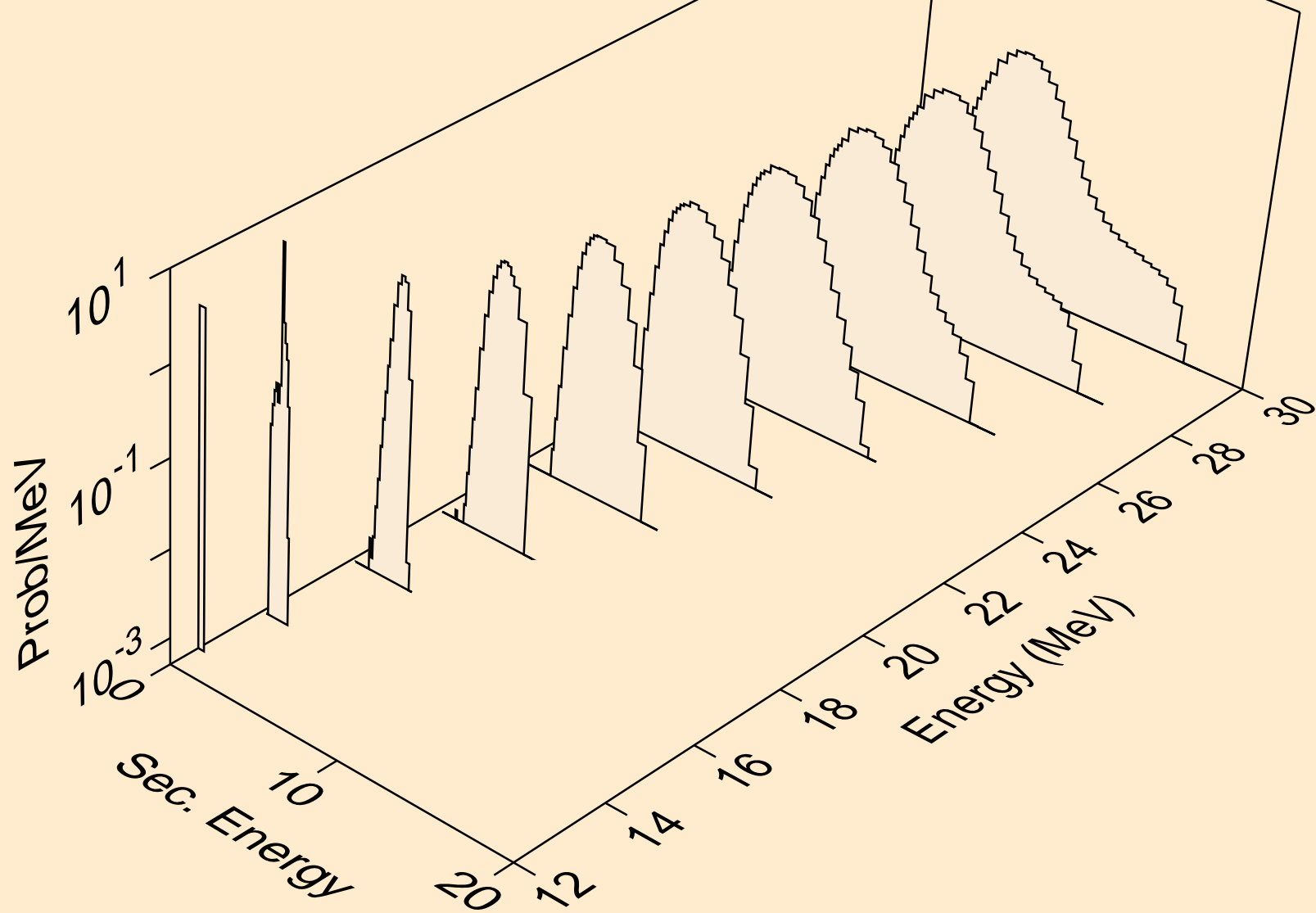

GD137 DEUTERON ACER TENDL-2021 LIBRARY; T=0.K  
protons from (d,3np)

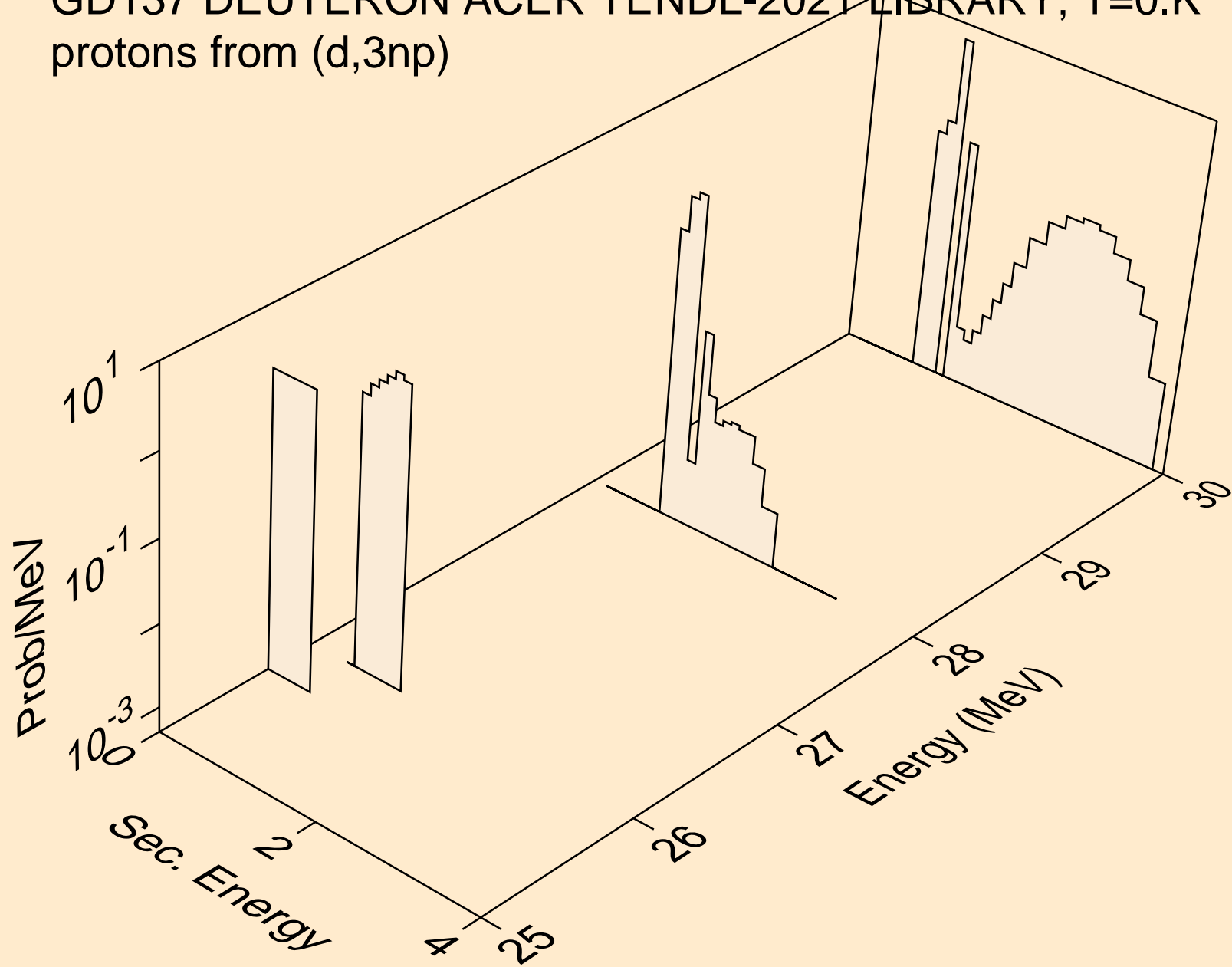

GD137 DEUTERON ACER TENDL-2021 LIBRARY; T=0.K  
protons from (d,2np)

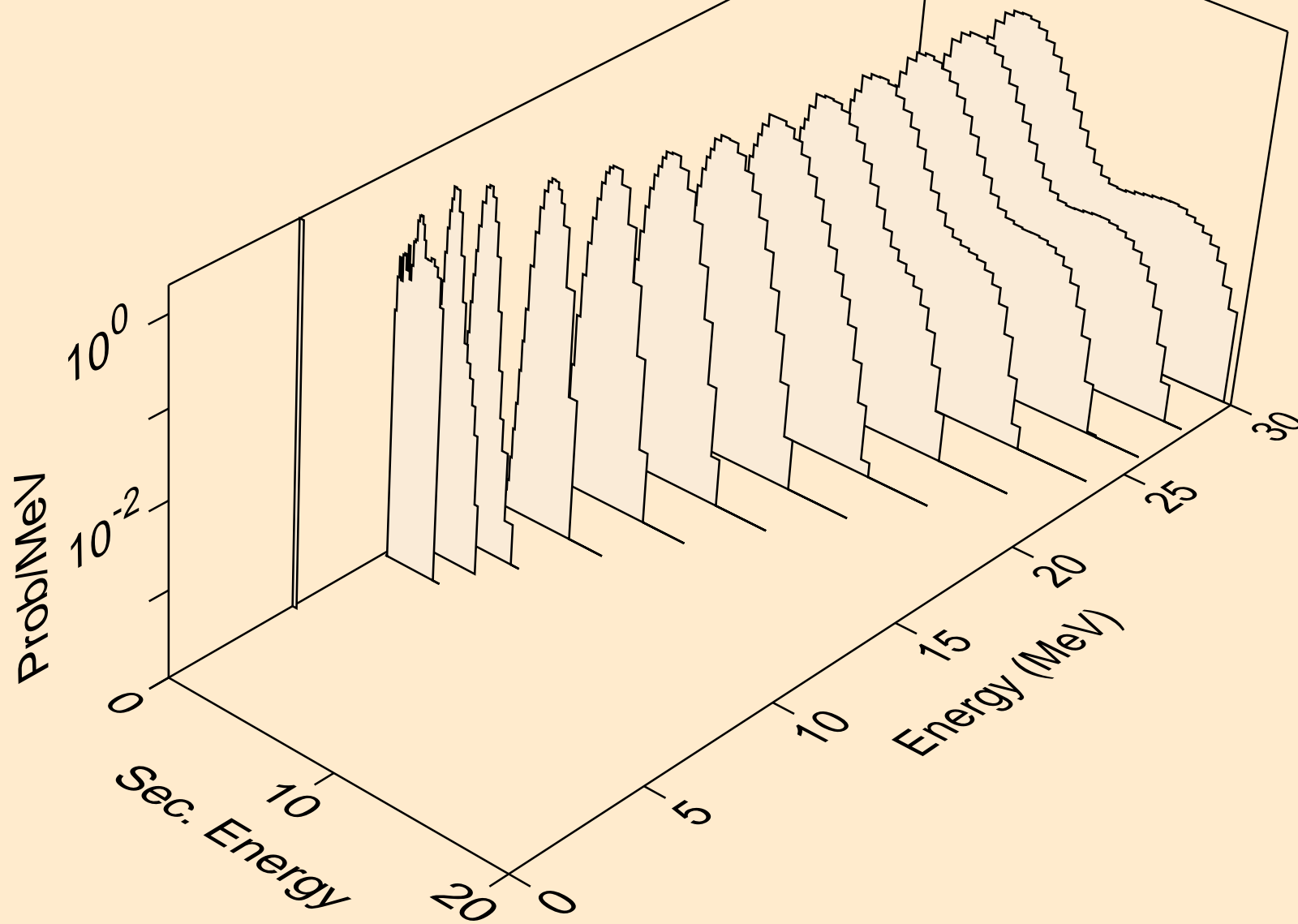

GD137 DEUTERON ACER TENDL-2021 LIBRARY; T=0.K  
protons from (d,npa)

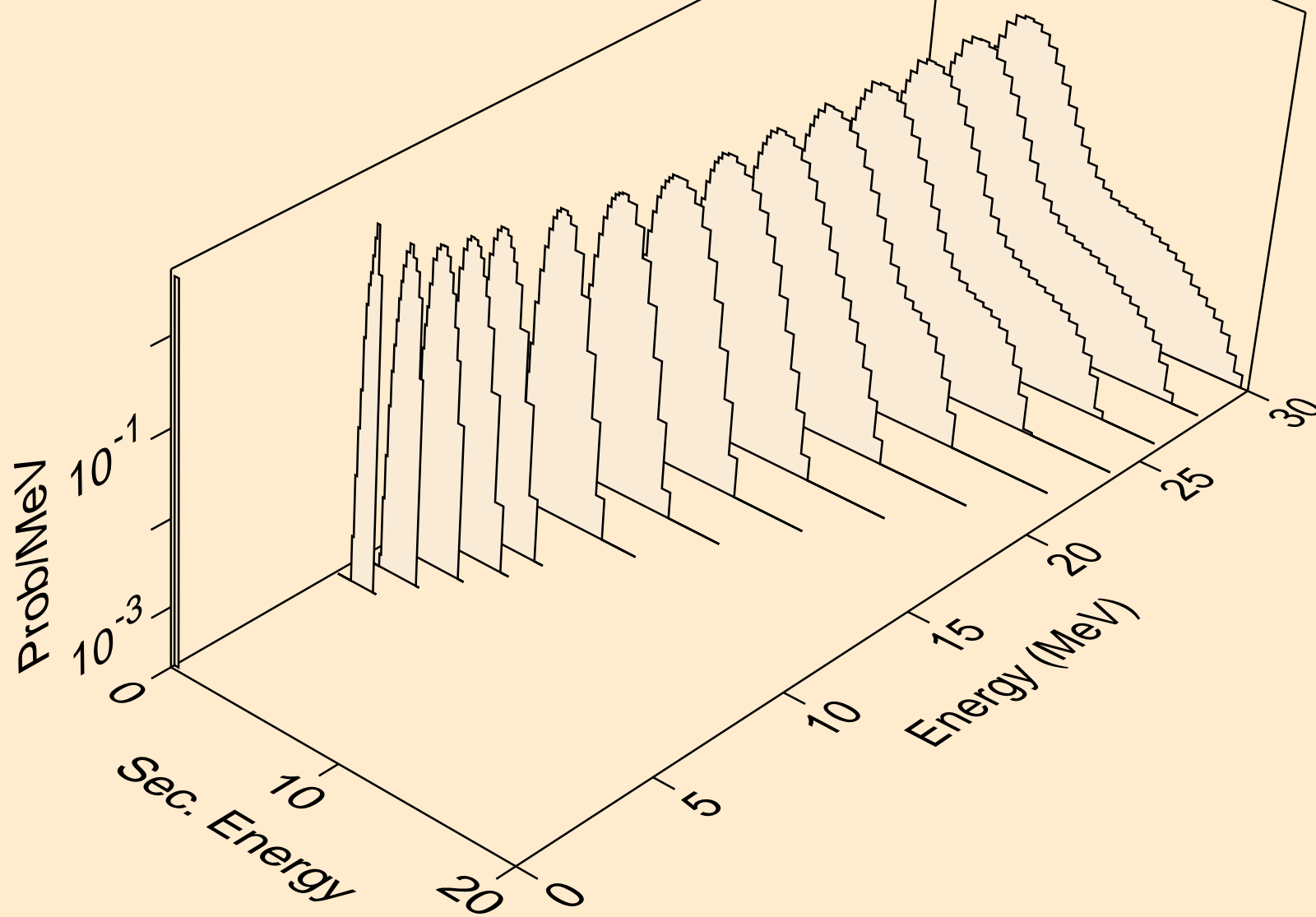

GD137 DEUTERON ACER TENDL-2021 LIBRARY; T=0.K  
protons from (d,p)

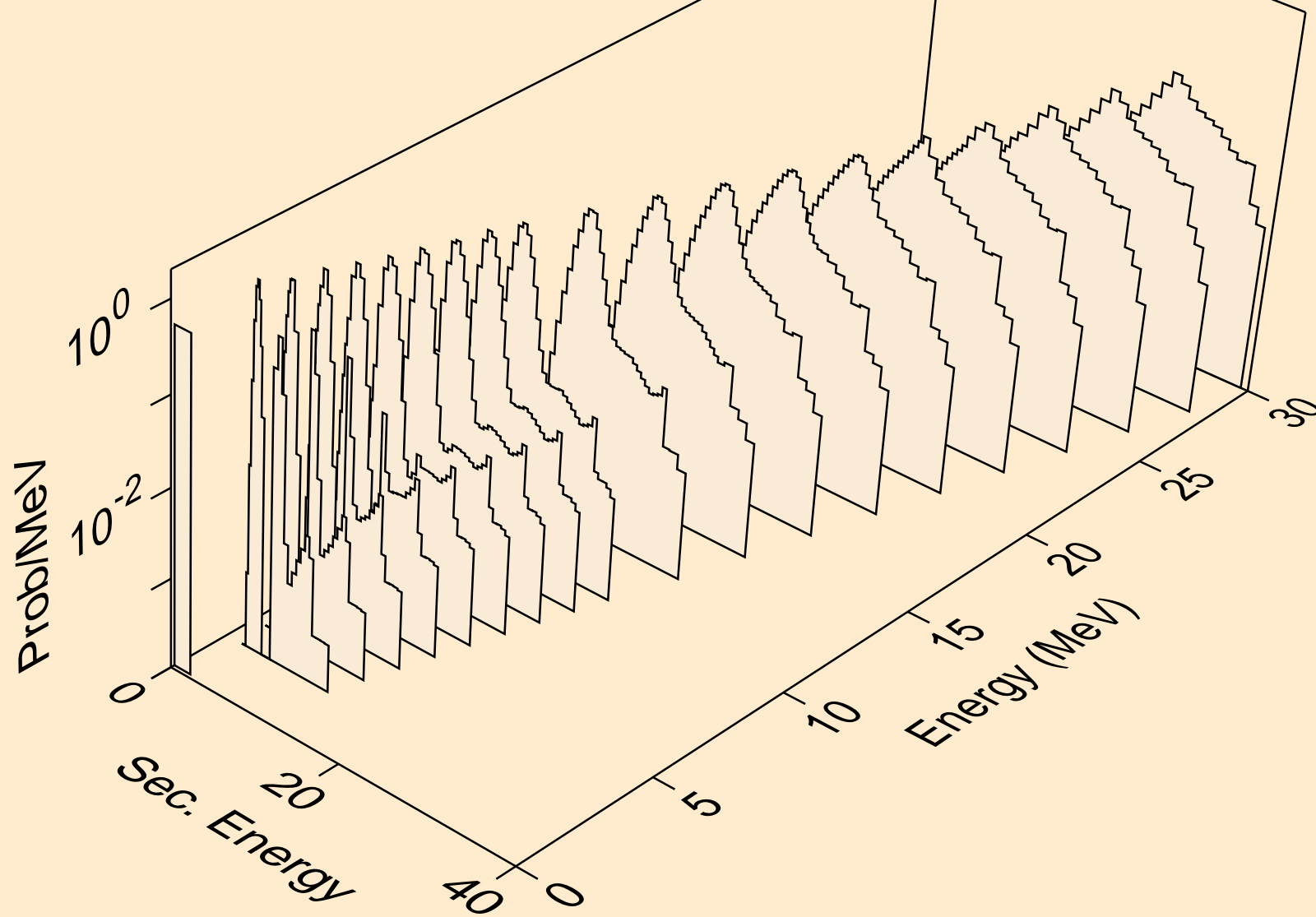

GD137 DEUTERON ACER TENDL-2021 LIBRARY; T=0.K  
protons from (d,2p)

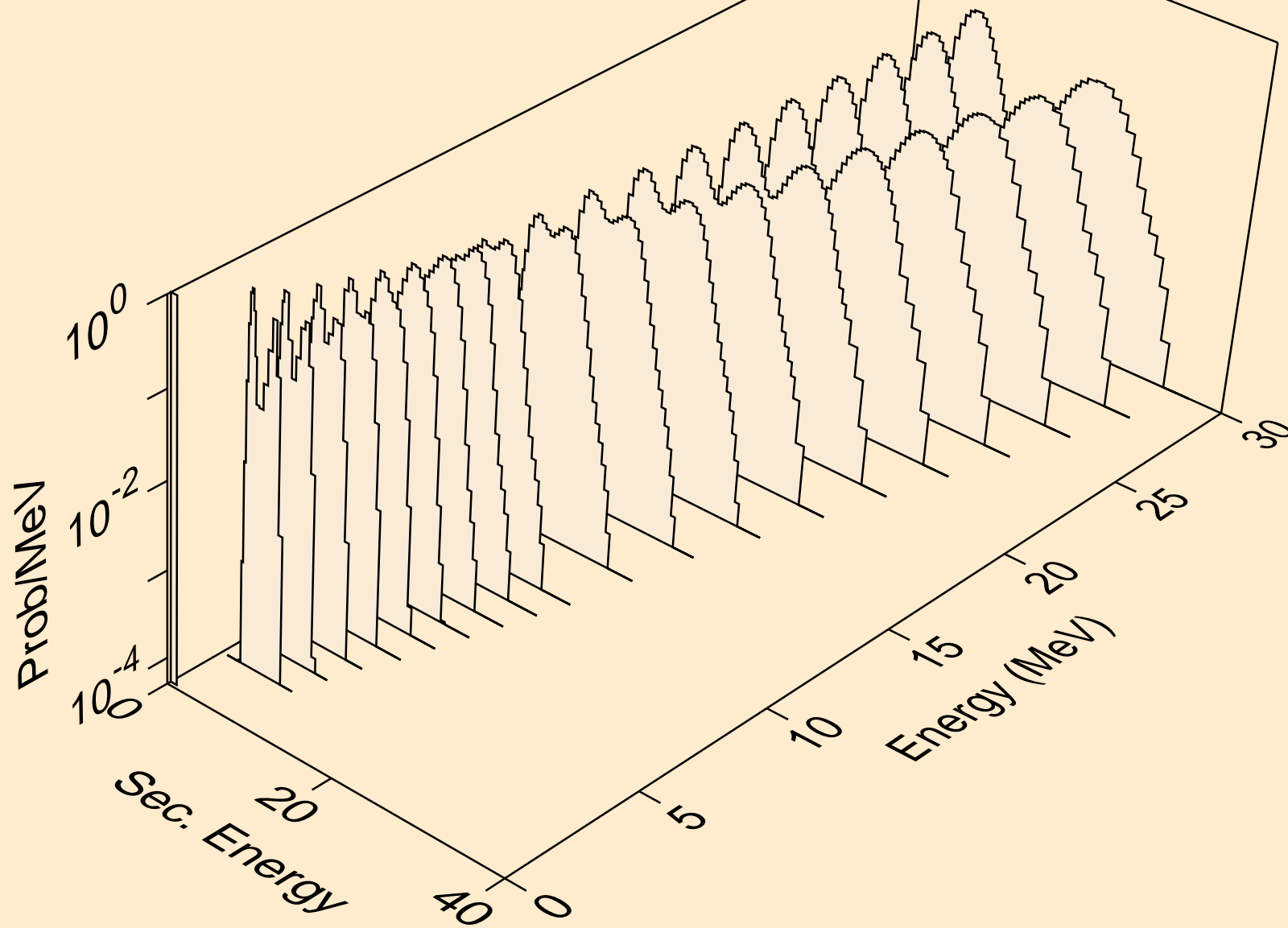

GD137 DEUTERON ACER TENDL-2021 LIBRARY; T=0.K  
protons from (d,pa)

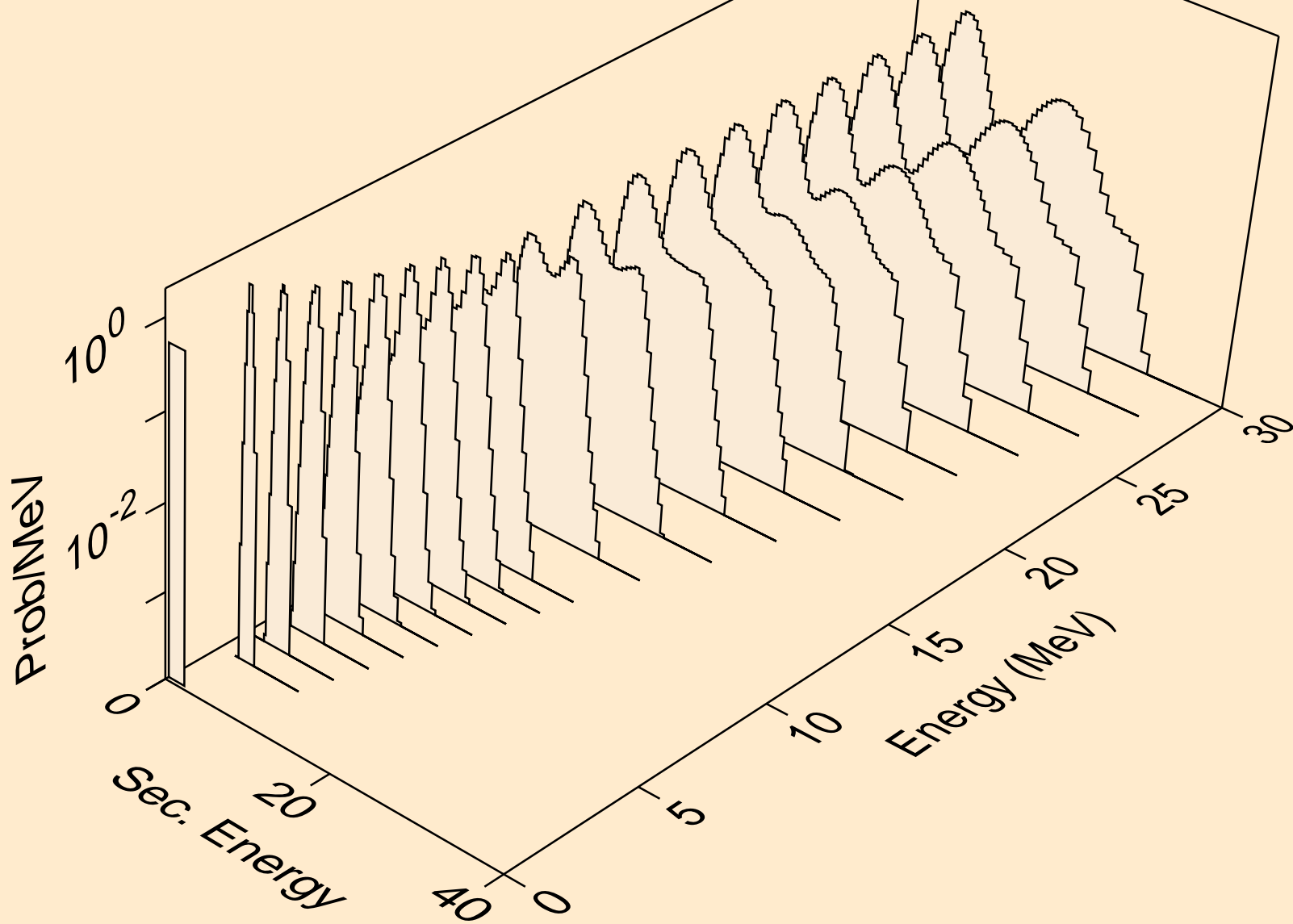

GD137 DEUTERON ACER TENDL-2021 LIBRARY; T=0.K  
protons from (d,pd)

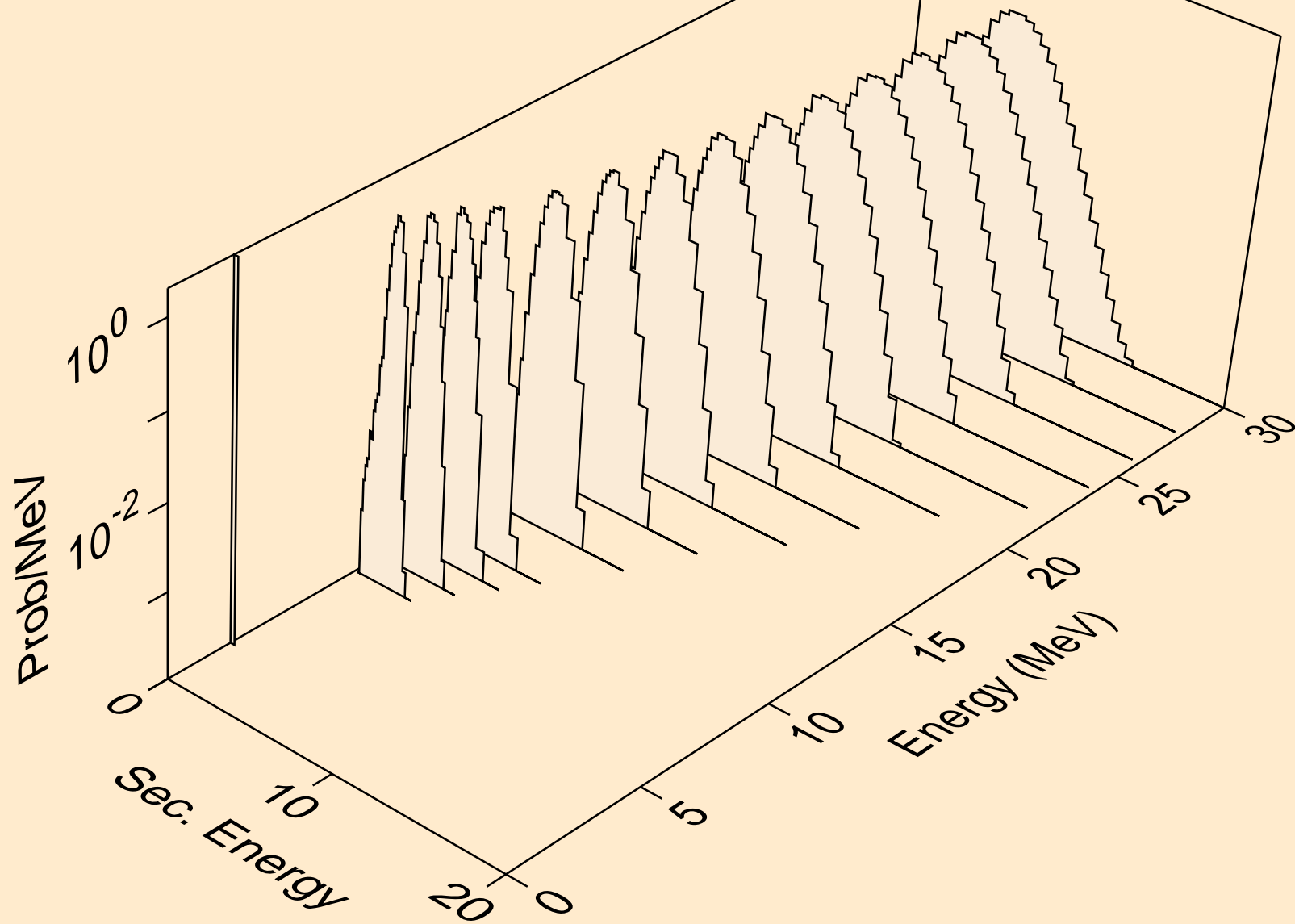



GD137 DEUTERON ACER TENDL-2021 LIBRARY; T=0.K  
protons from (d,pt)

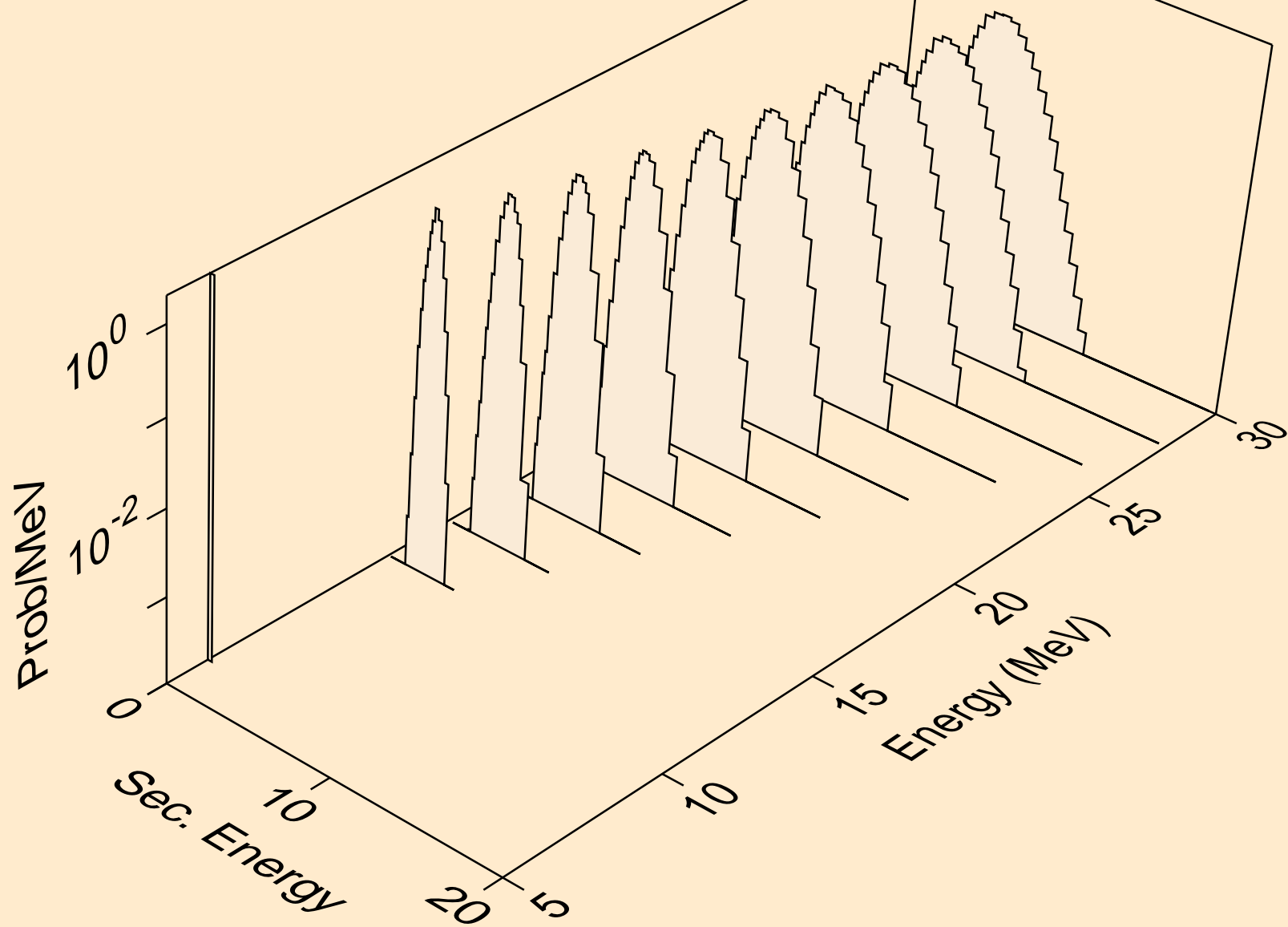

GD137 DEUTERON ACER TENDL-2021 LIBRARY; T=0.K  
tritons from (d,x)

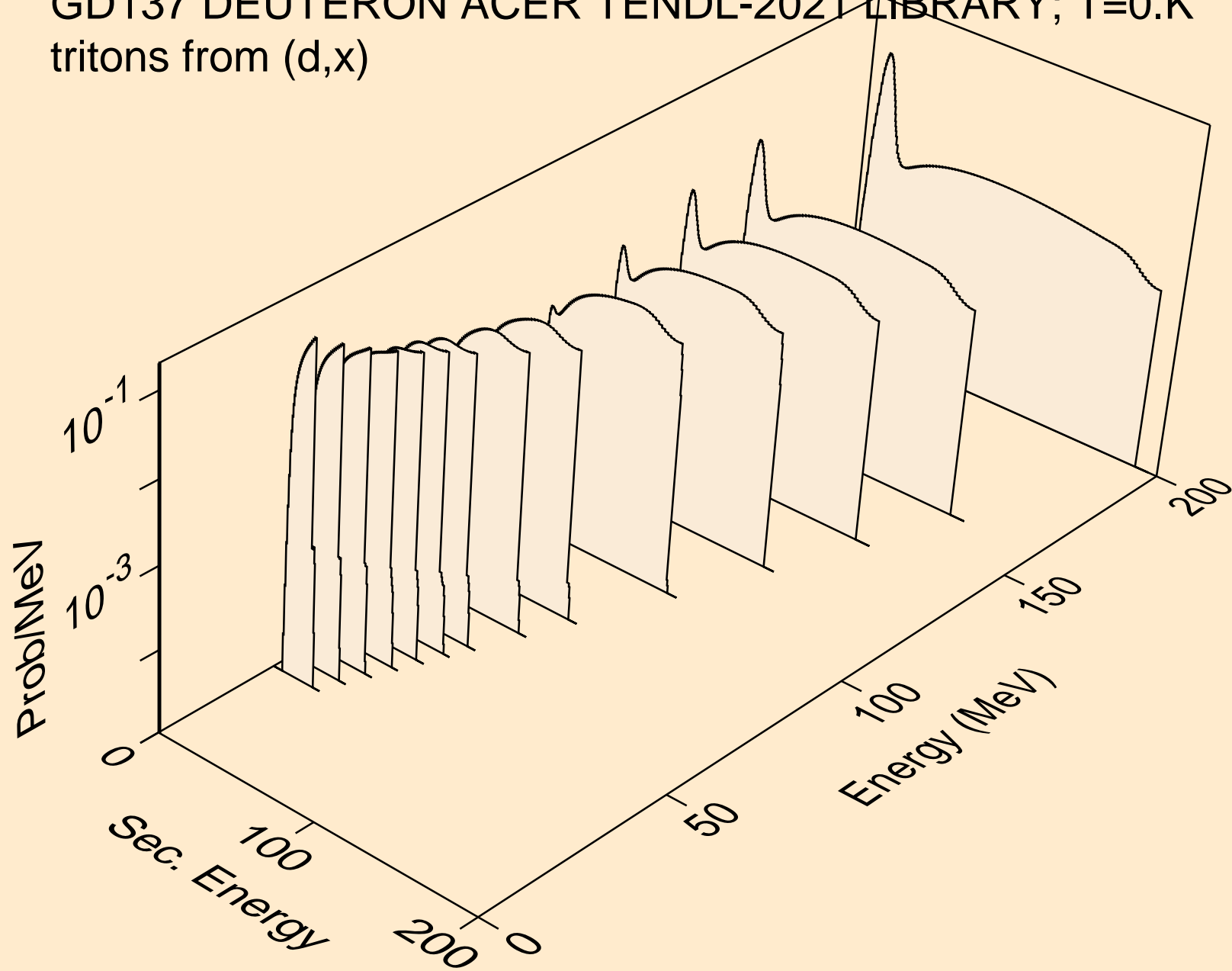

GD137 DEUTERON ACER TENDL-2021 LIBRARY; T=0.K  
tritons from (d,n\*)t

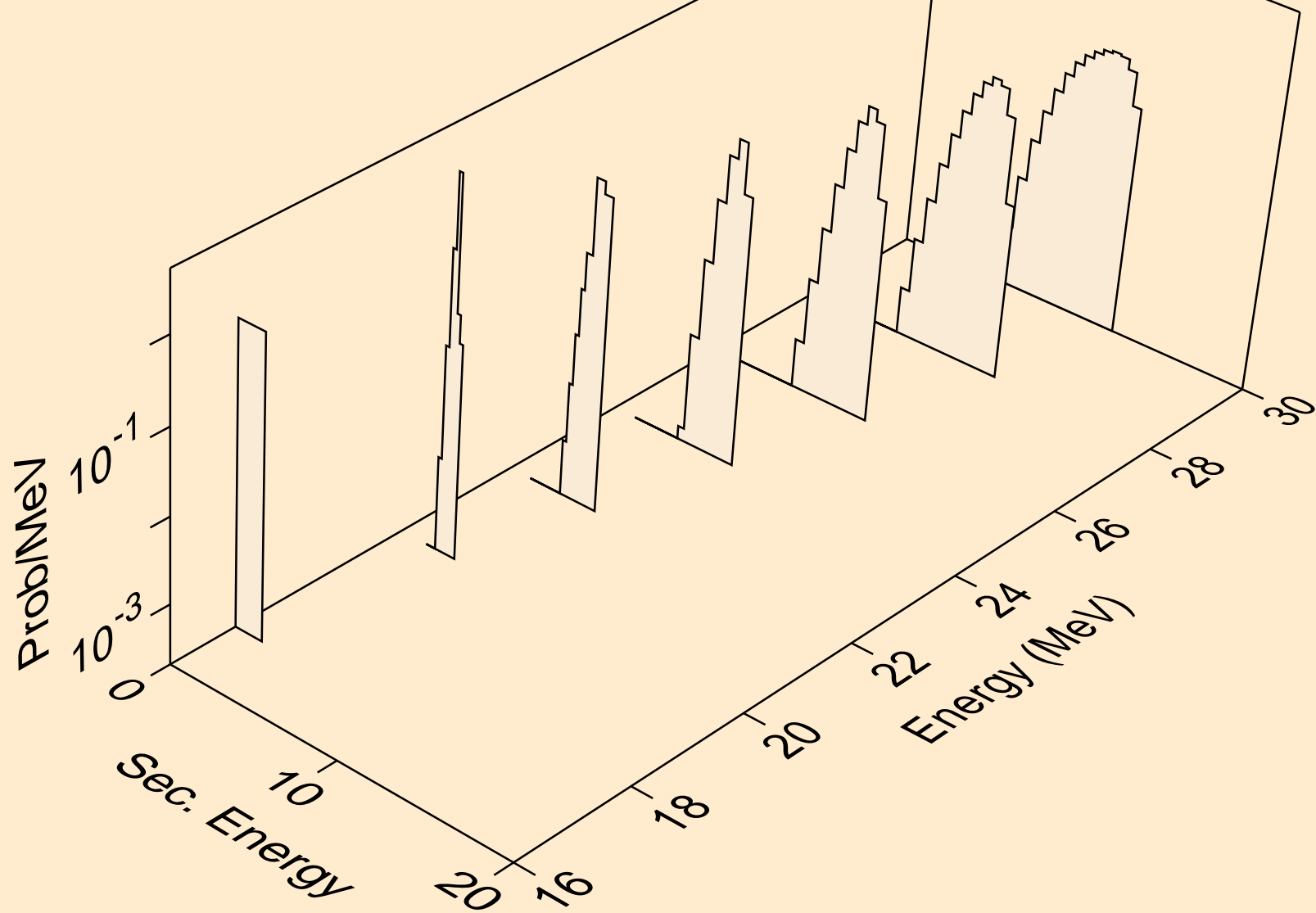

GD137 DEUTERON ACER TENDL-2021 LIBRARY; T=0.K  
tritons from (d,t)

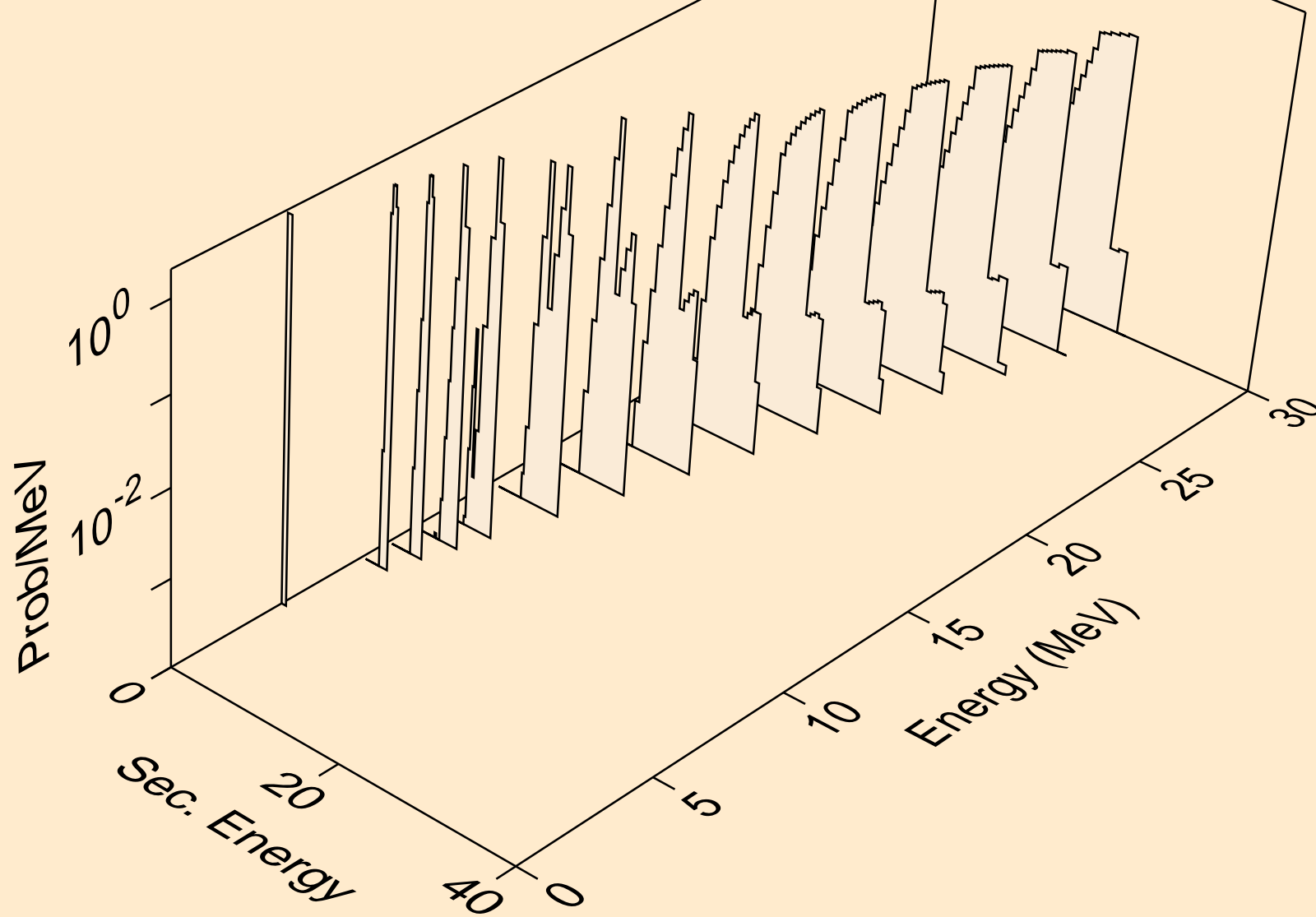

GD137 DEUTERON ACER TENDL-2021 LIBRARY; T=0.K  
tritons from (d,pt)

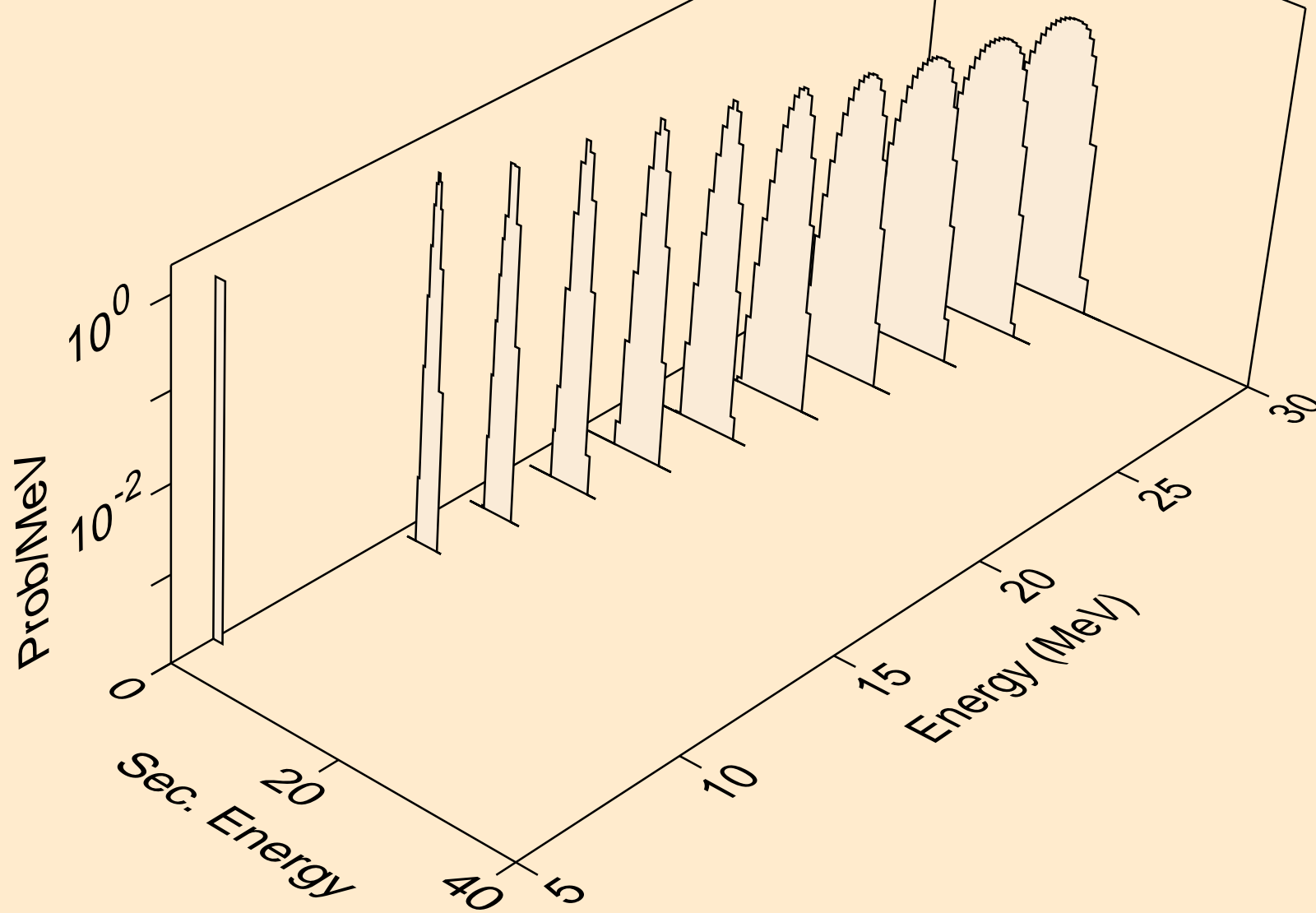

GD137 DEUTERON ACER TENDL-2021 LIBRARY; T=0.K  
he3s from (d,x)

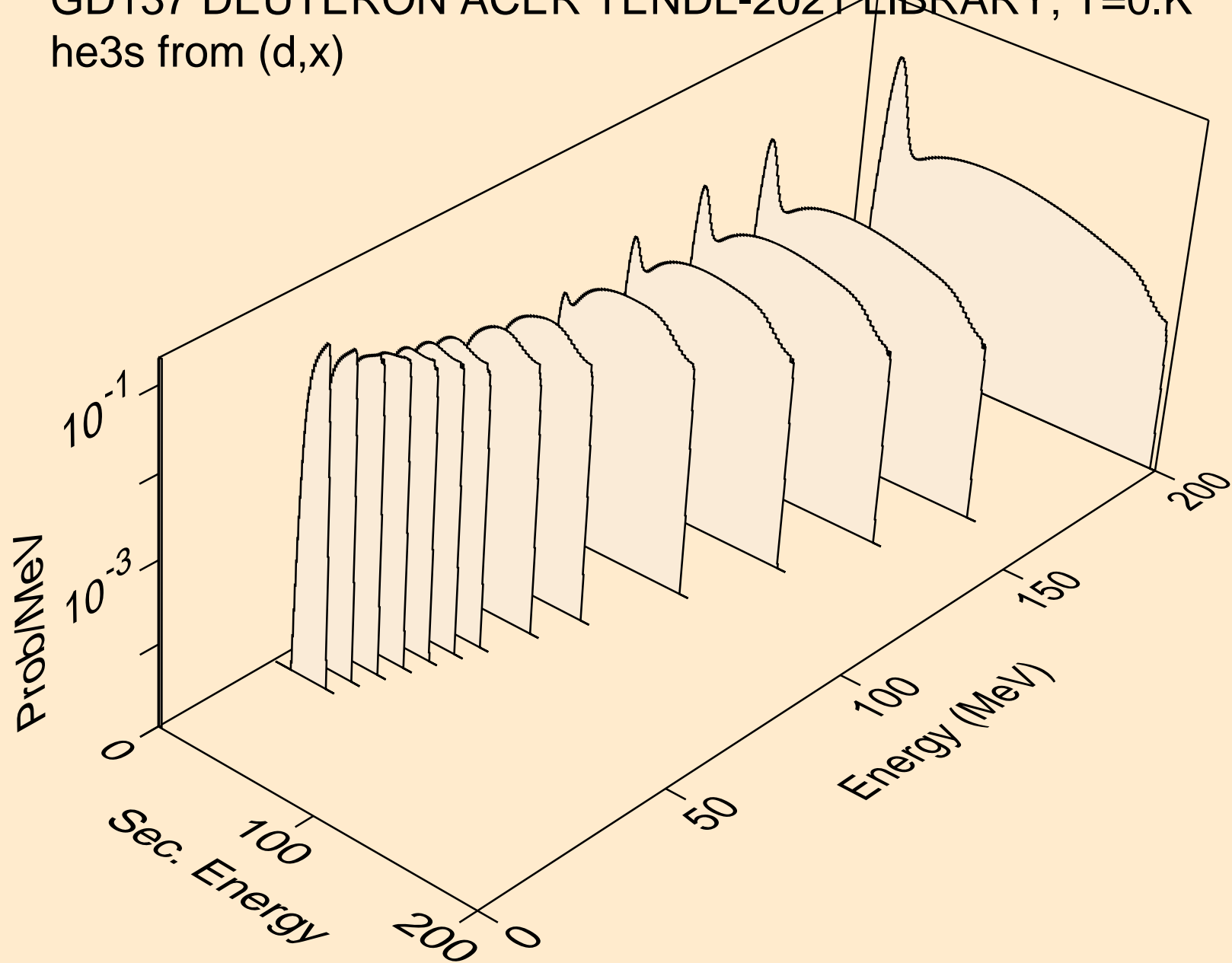

GD137 DEUTERON ACER TENDL-2021 LIBRARY; T=0.K  
he3s from (d,n\*)he3

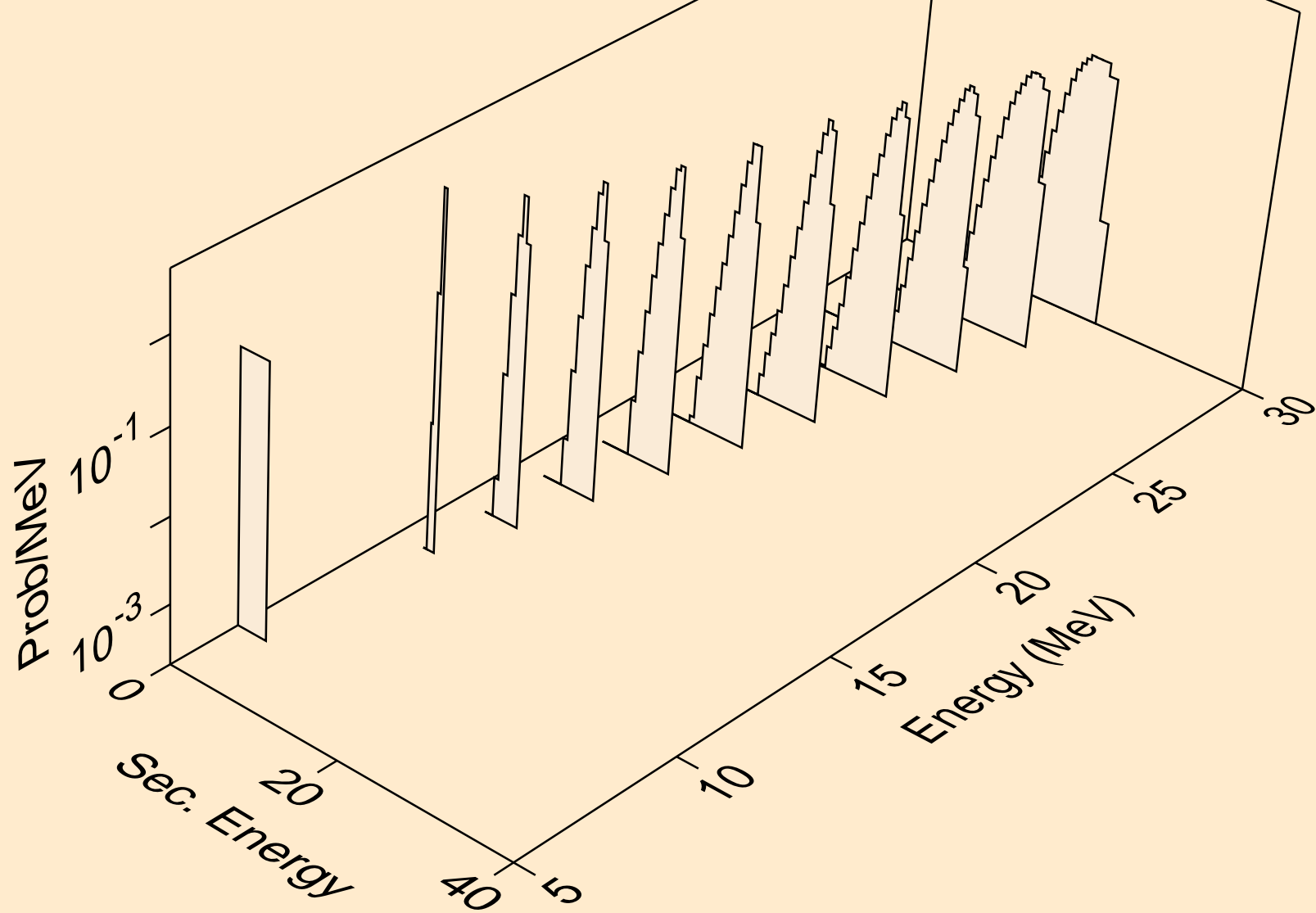

GD137 DEUTERON ACER TENDL-2021 LIBRARY; T=0.K  
he3s from (d,he3)

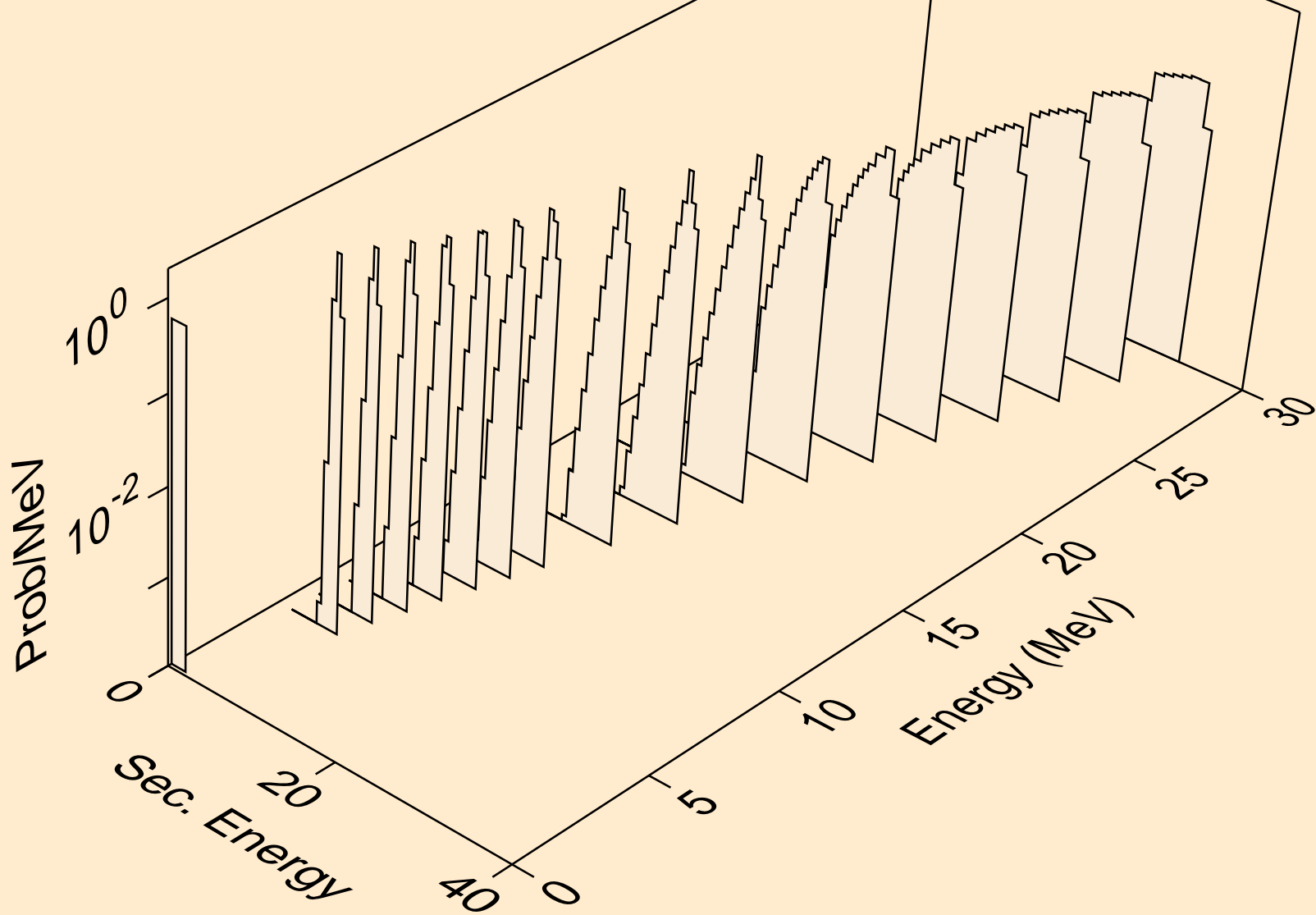



GD137 DEUTERON ACER TENDL-2021 LIBRARY; T=0.K  
alphas from (d,x)

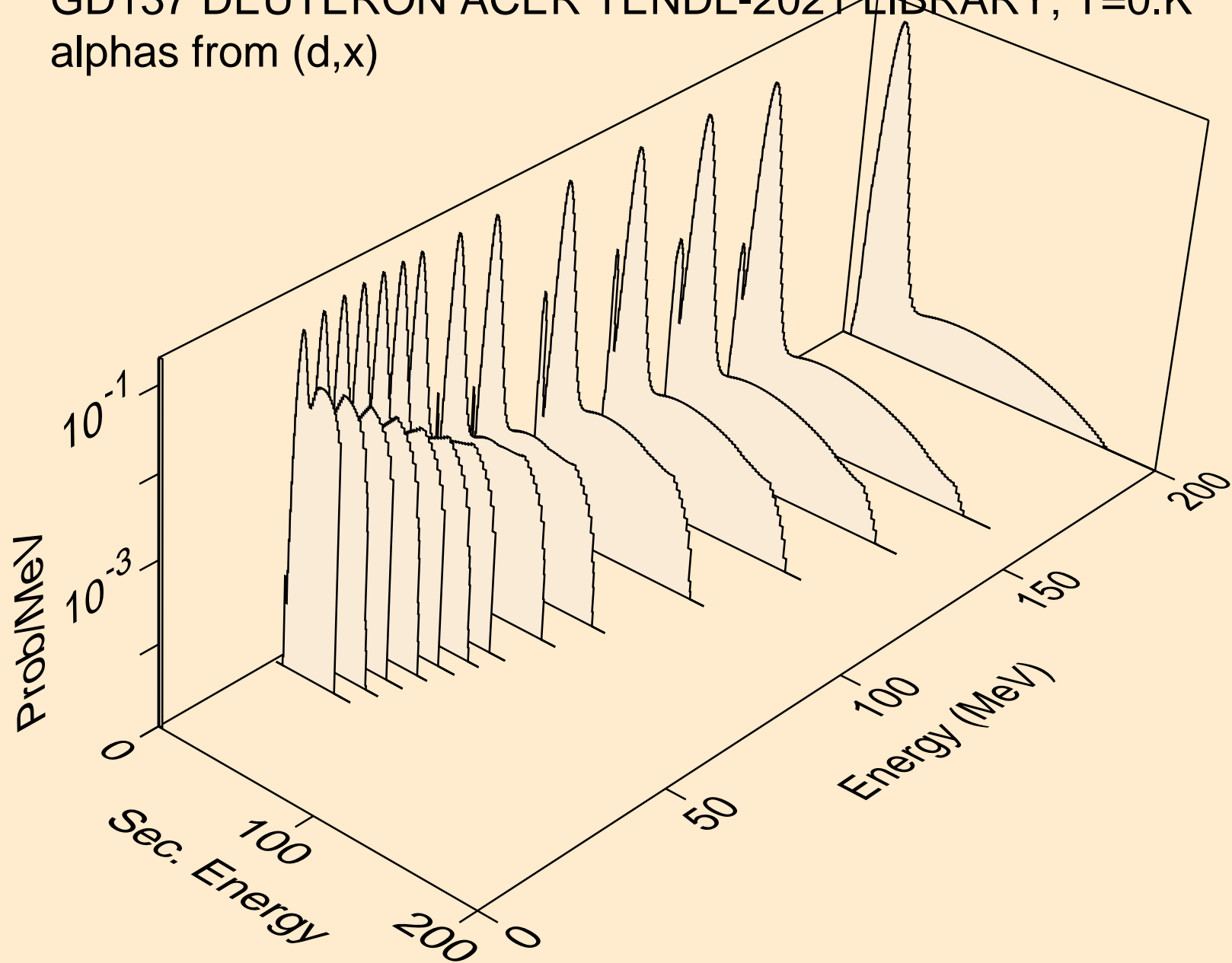

GD137 DEUTERON ACER TENDL-2021 LIBRARY; T=0.K  
alphas from (d,n\*)a

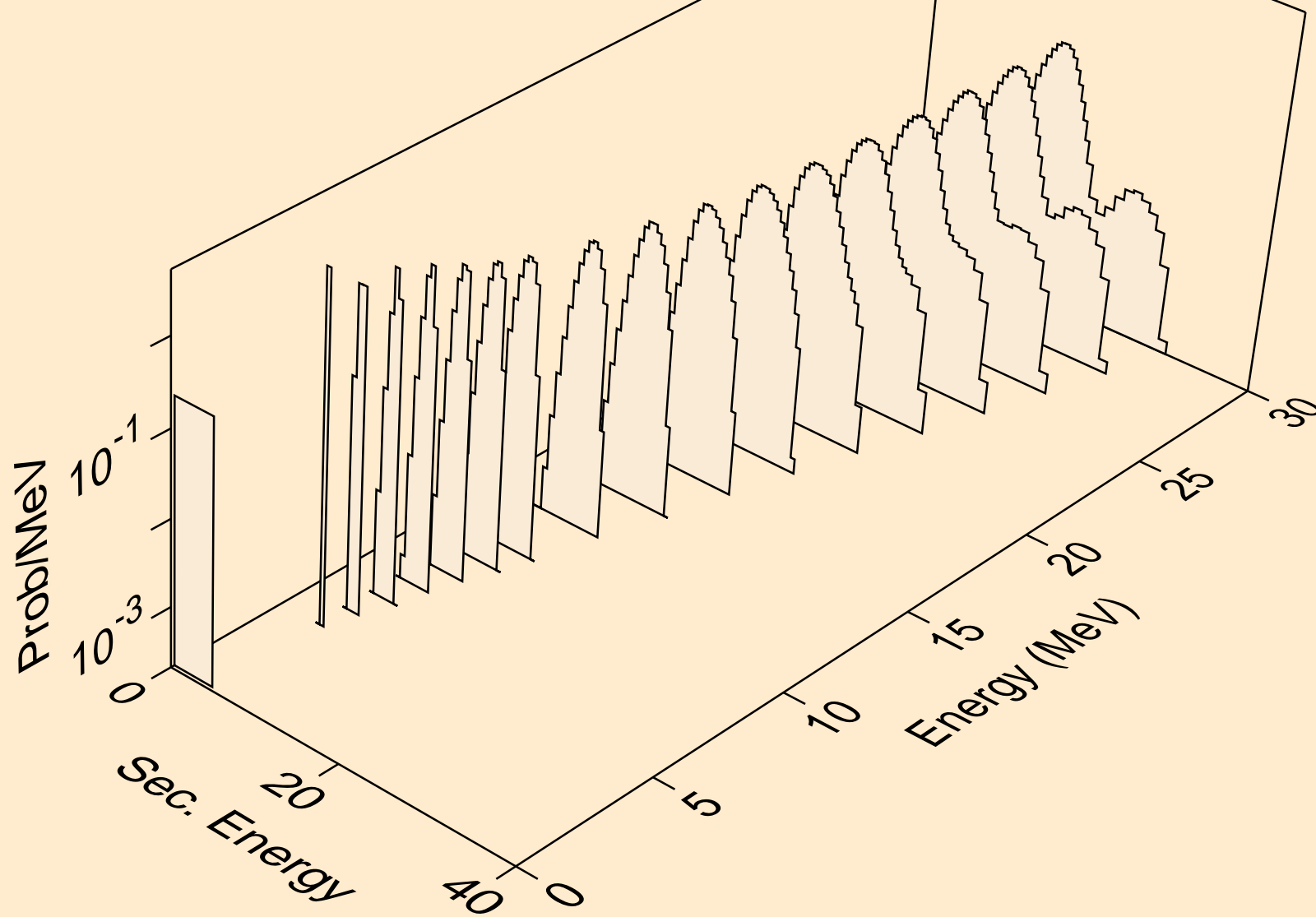

GD137 DEUTERON ACER TENDL-2021 LIBRARY; T=0.K  
alphas from (d,2n)a

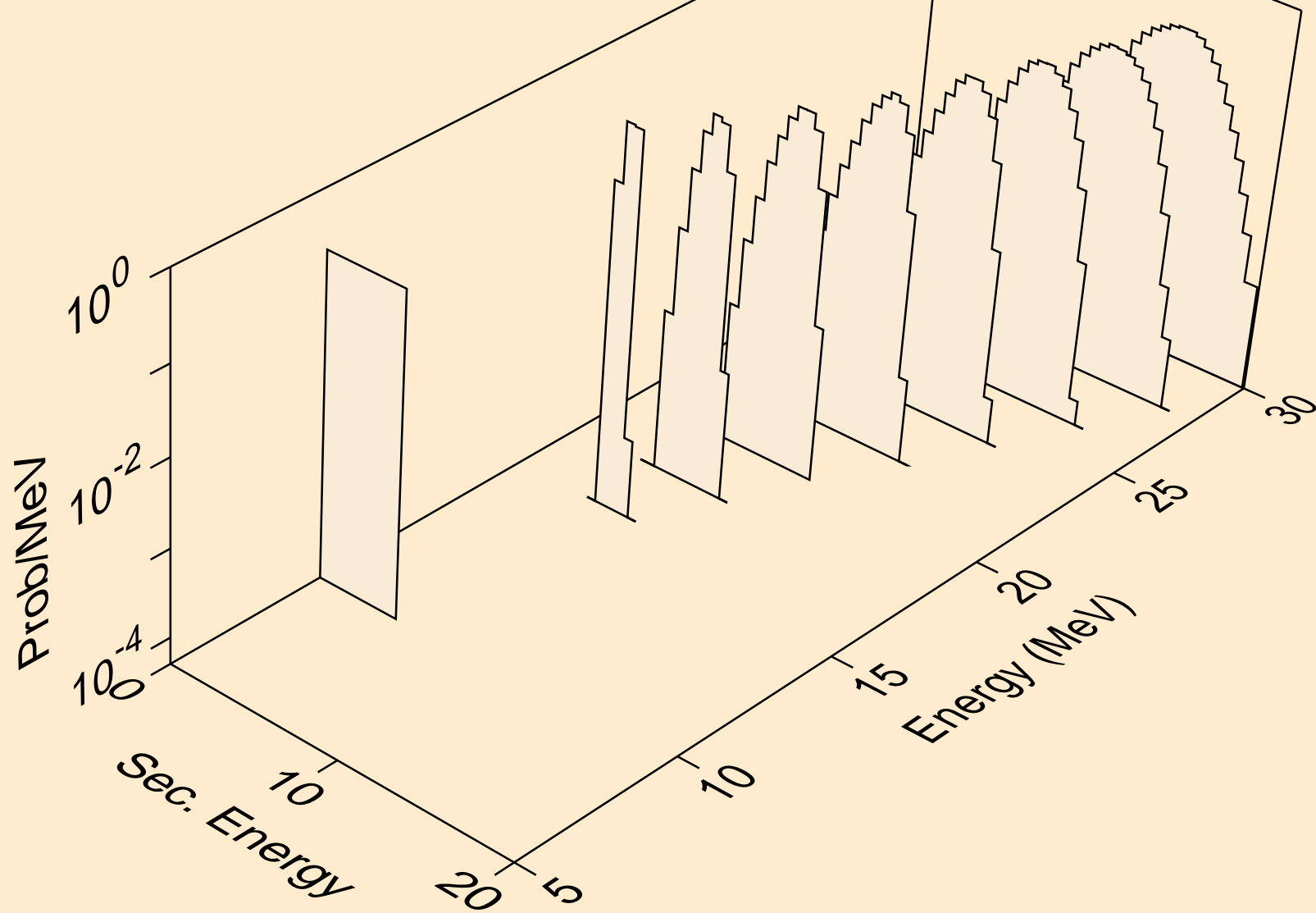

GD137 DEUTERON ACER TENDL-2021 LIBRARY; T=0.K  
alphas from (d,n\*)2a

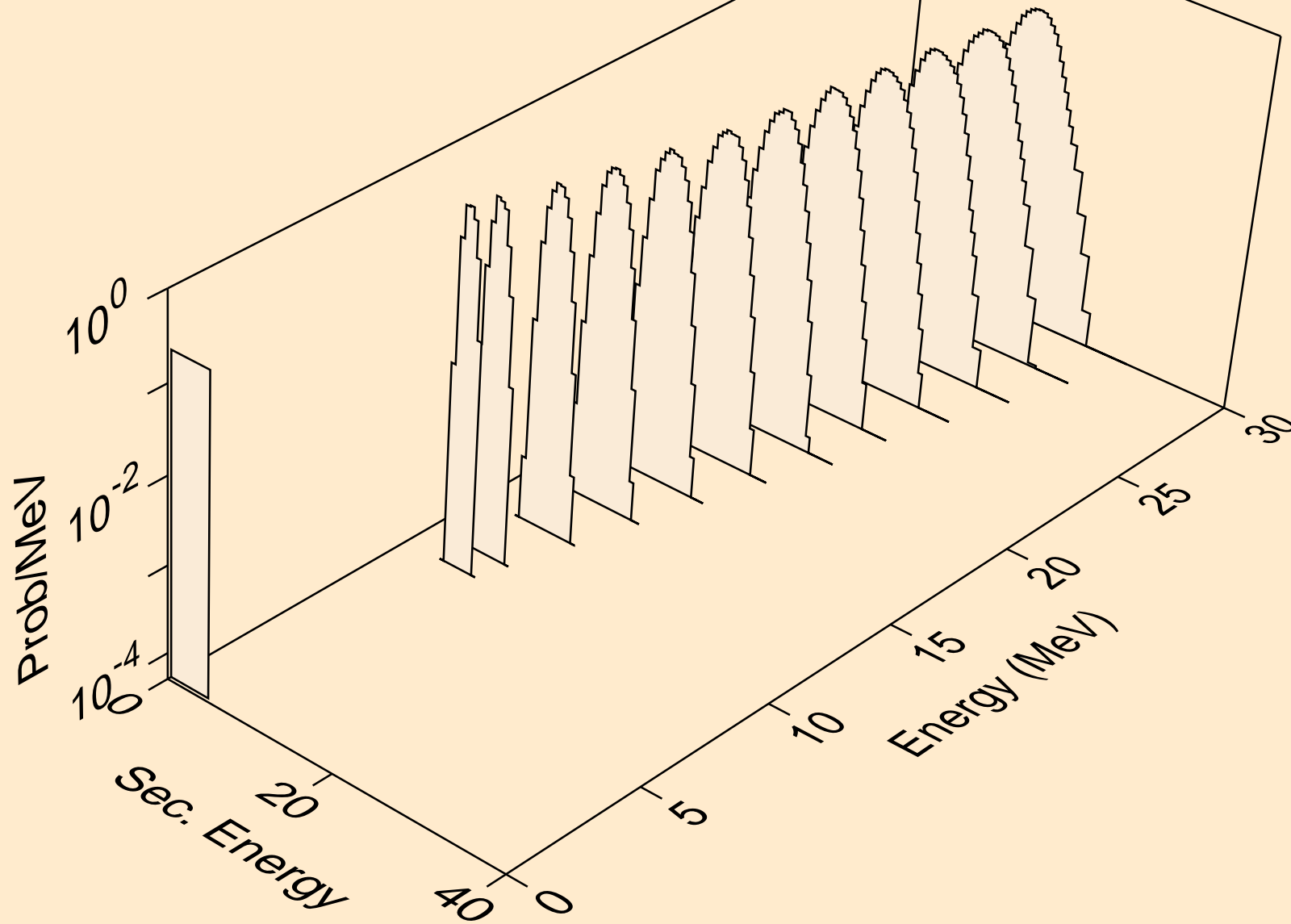

GD137 DEUTERON ACER TENDL-2021 LIBRARY; T=0.K  
alphas from (d,npa)

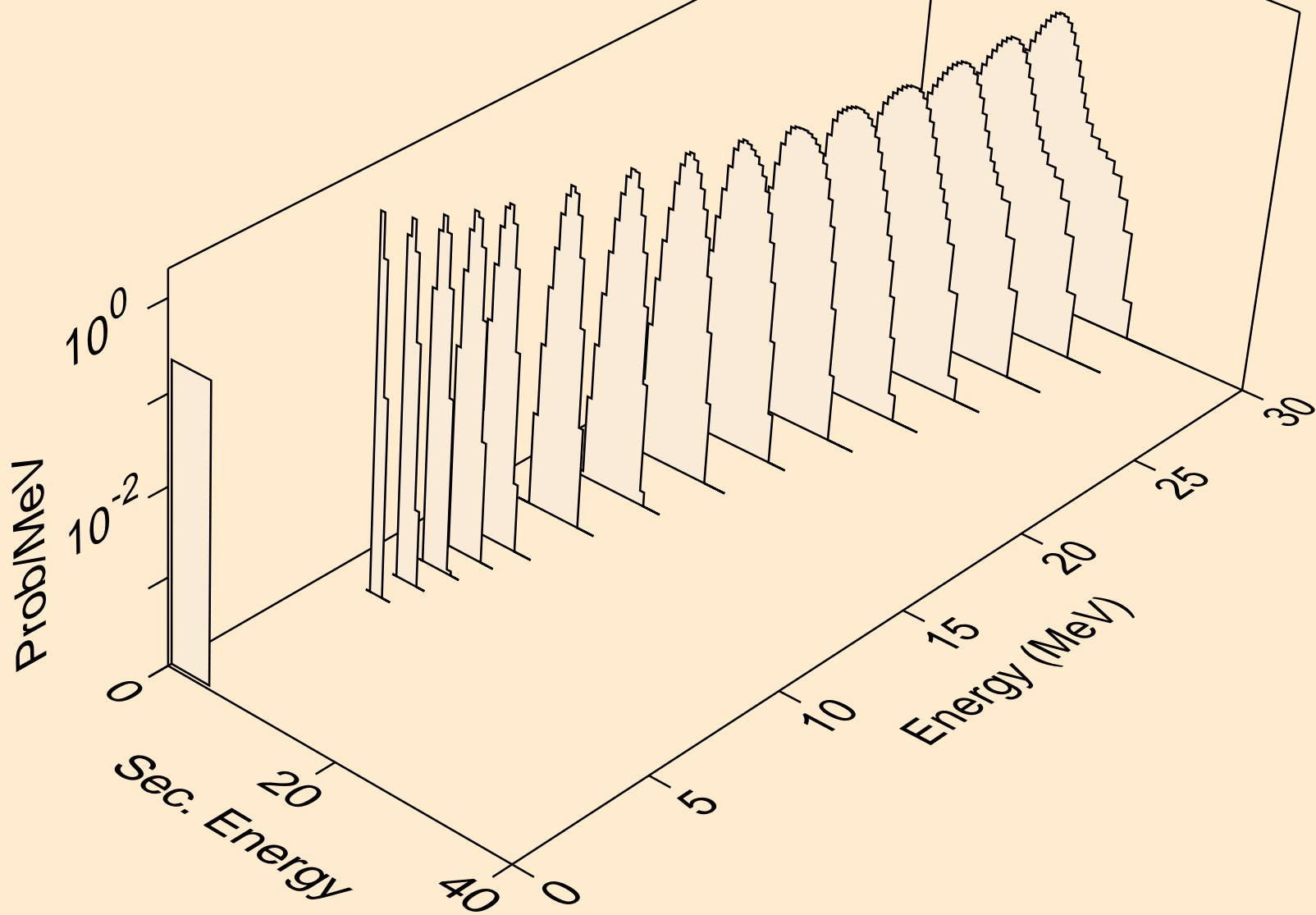

GD137 DEUTERON ACER TENDL-2021 LIBRARY; T=0.K  
alphas from (d,a)

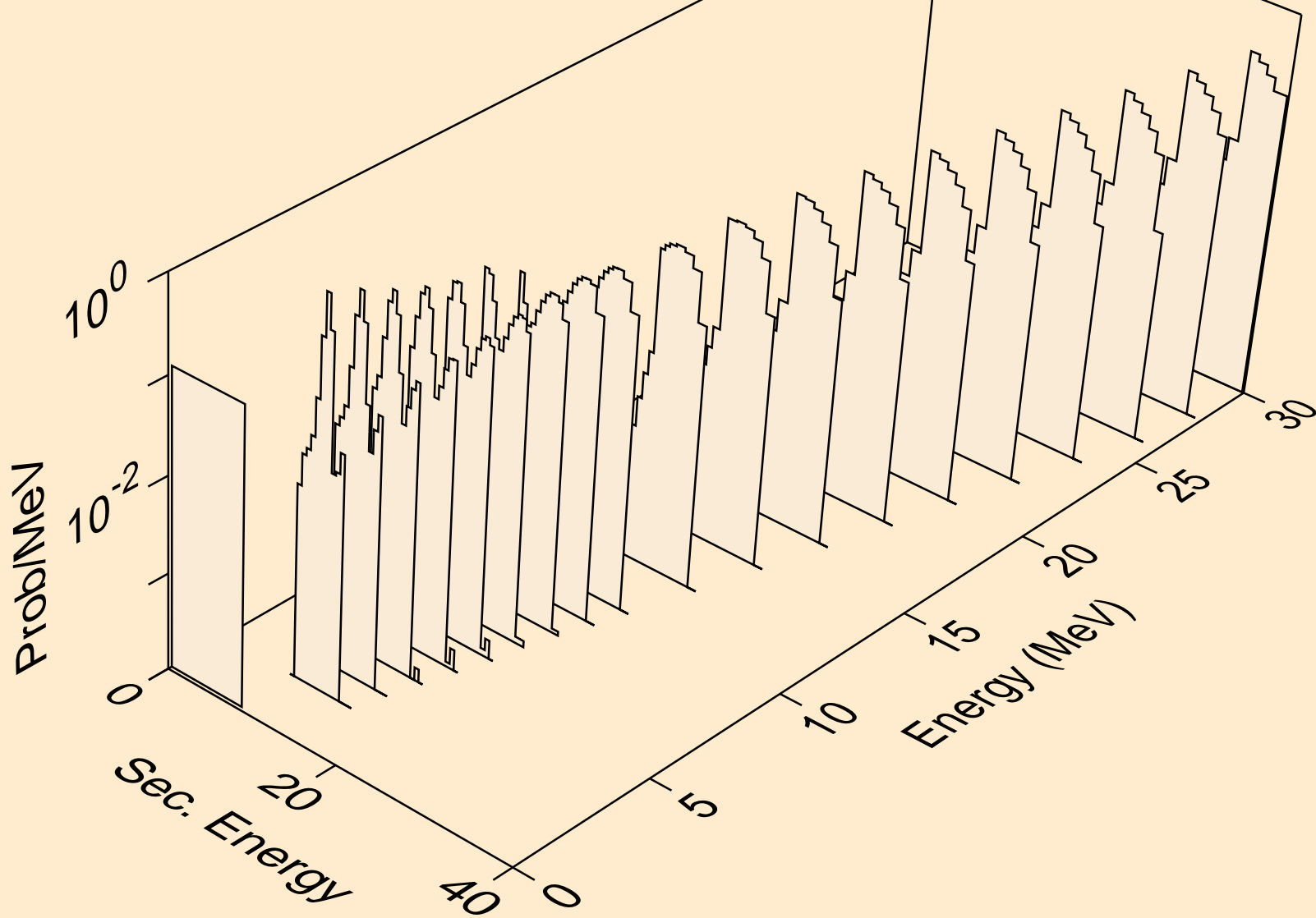

GD137 DEUTERON ACER TENDL-2021 LIBRARY; T=0.K  
alphas from (d,2a)

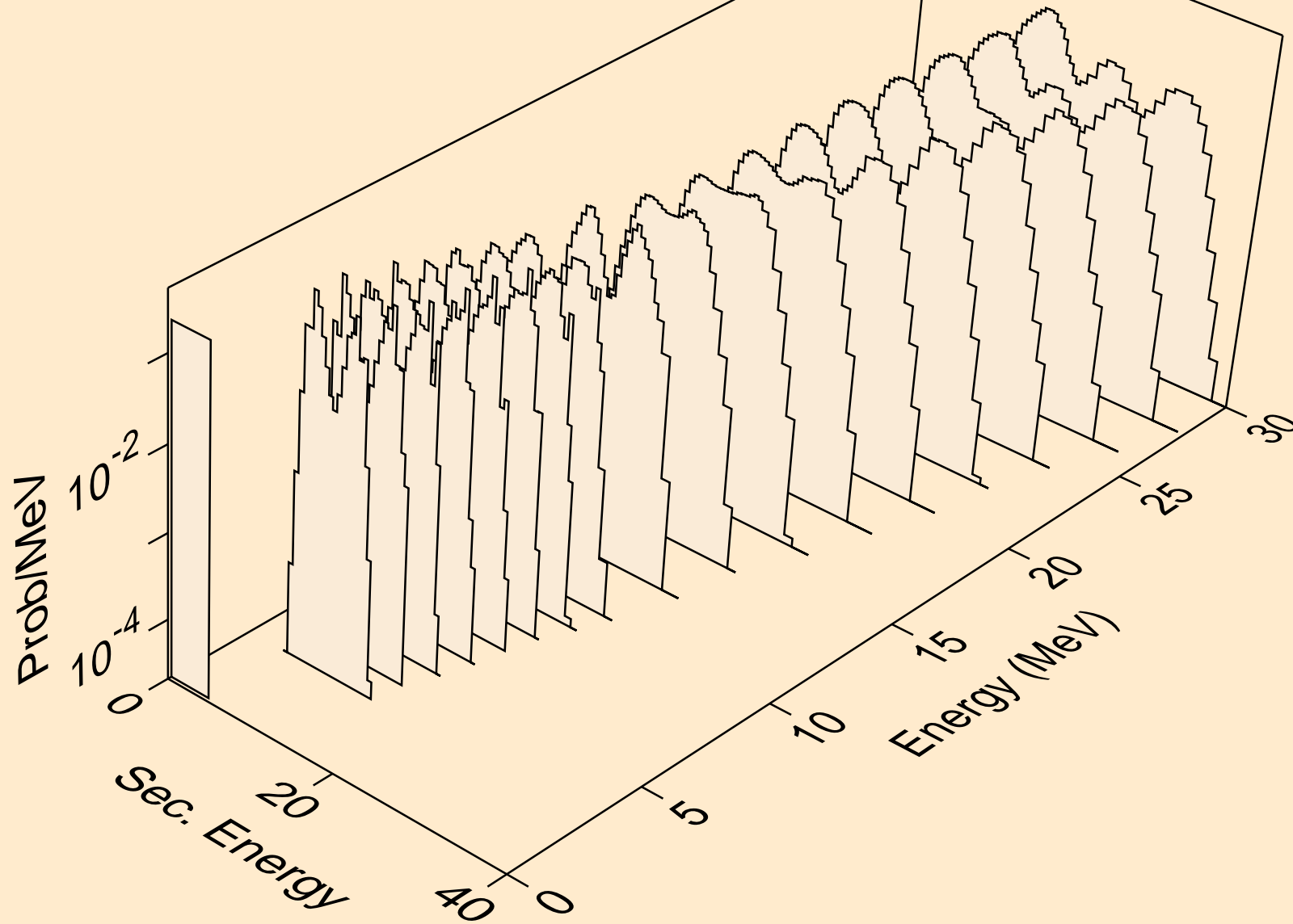

GD137 DEUTERON ACER TENDL-2021 LIBRARY; T=0.K  
alphas from (d,3a)

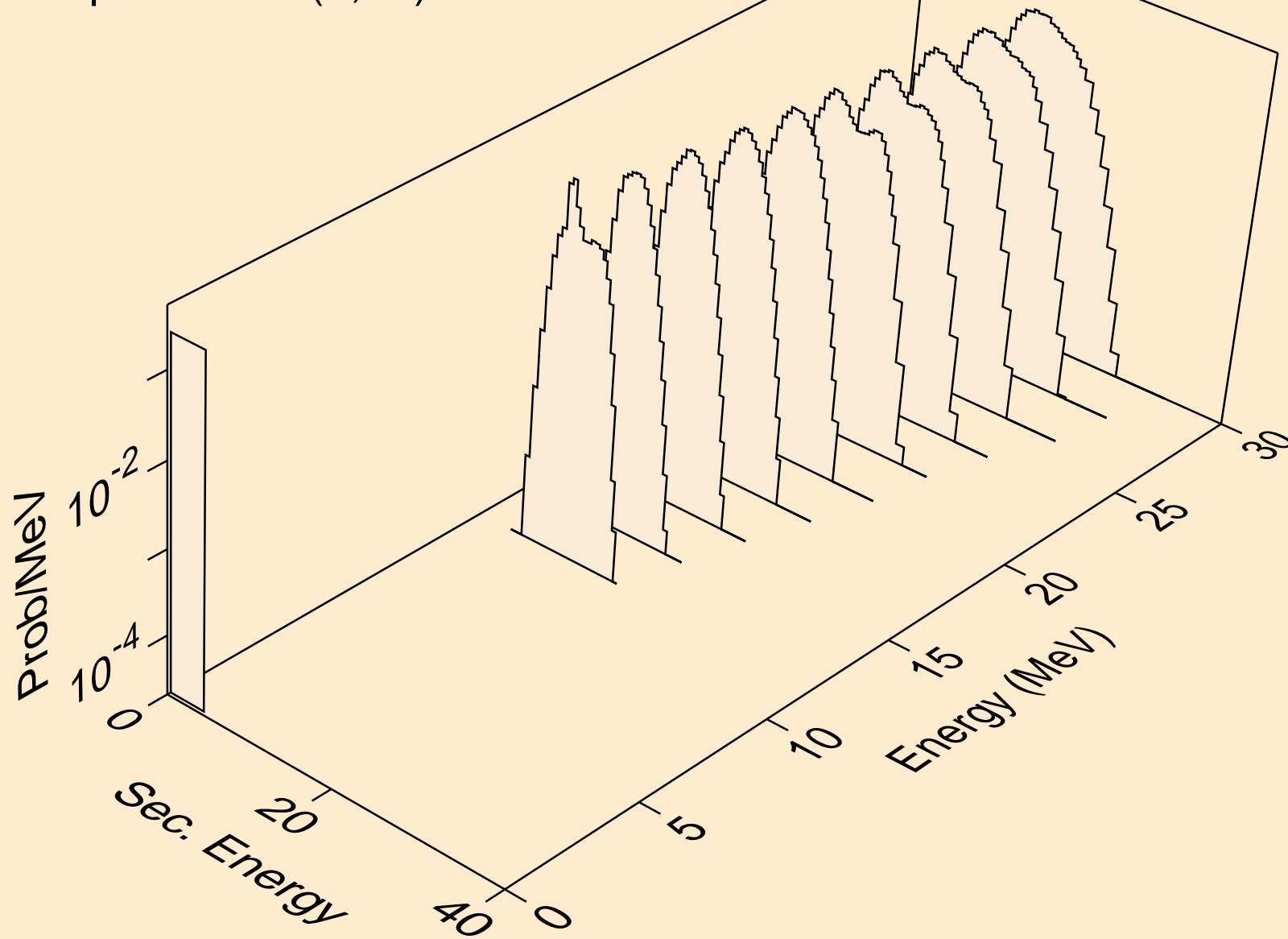



GD137 DEUTERON ACER TENDL-2021 LIBRARY; T=0.K  
alphas from (d,pa)

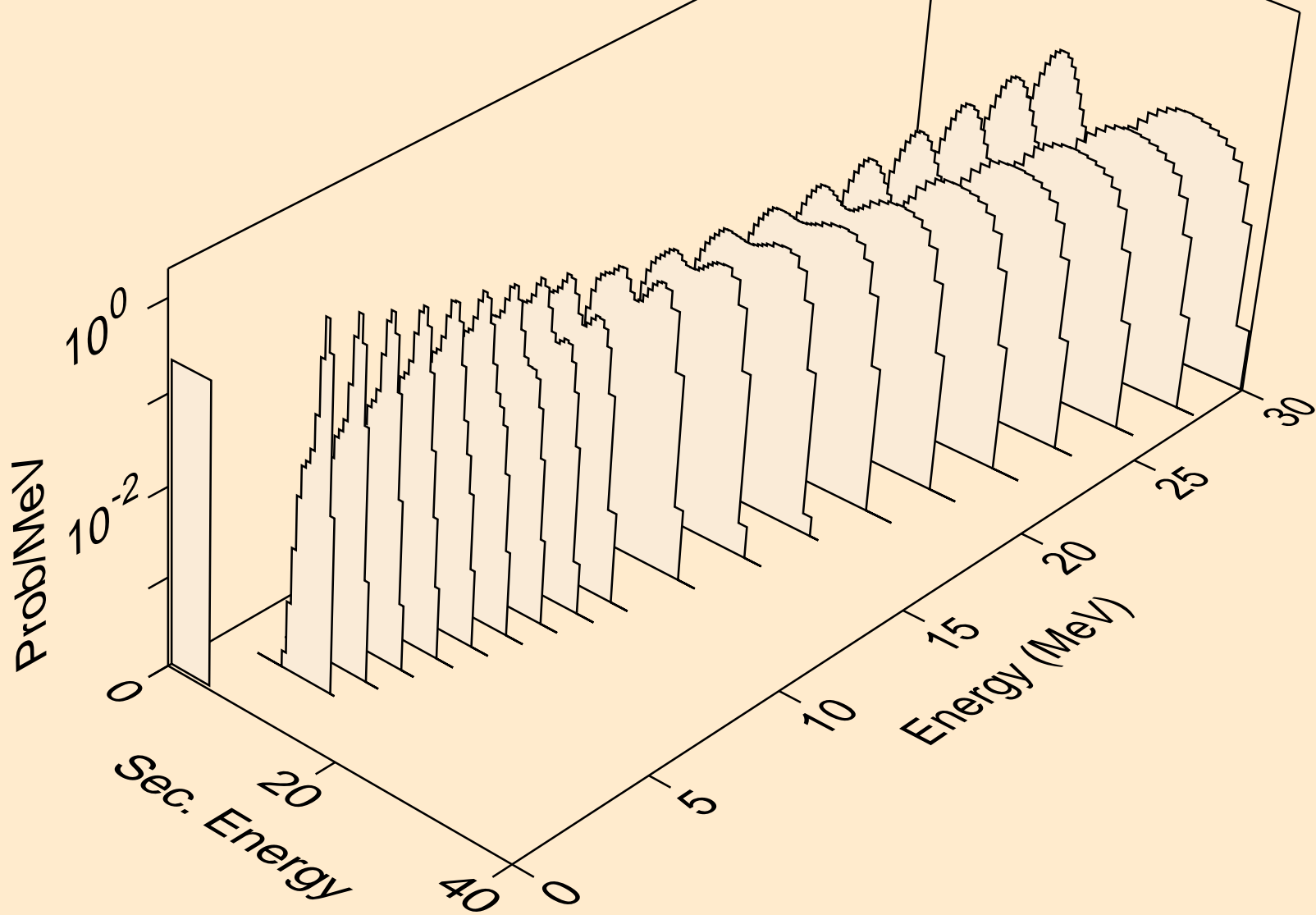

GD137 DEUTERON ACER TENDL-2021 LIBRARY; T=0.K  
alphas from (d,d2a)

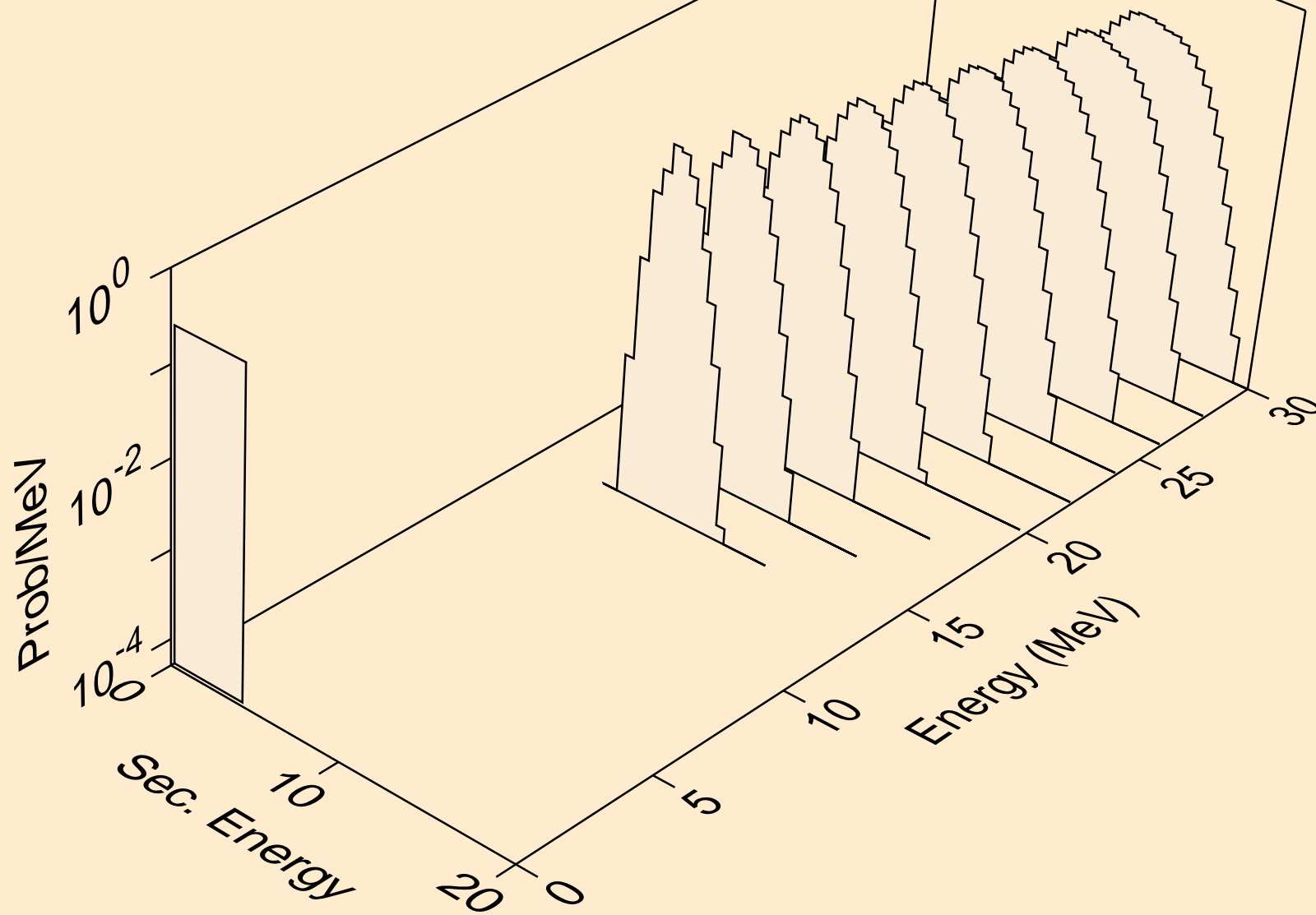

GD137 DEUTERON ACER TENDL-2021 LIBRARY; T=0.K  
alphas from (d,da)

