

HF186 DEUTERON ACER TENDL-2021 LIBRARY; T=0.K

Principal cross sections

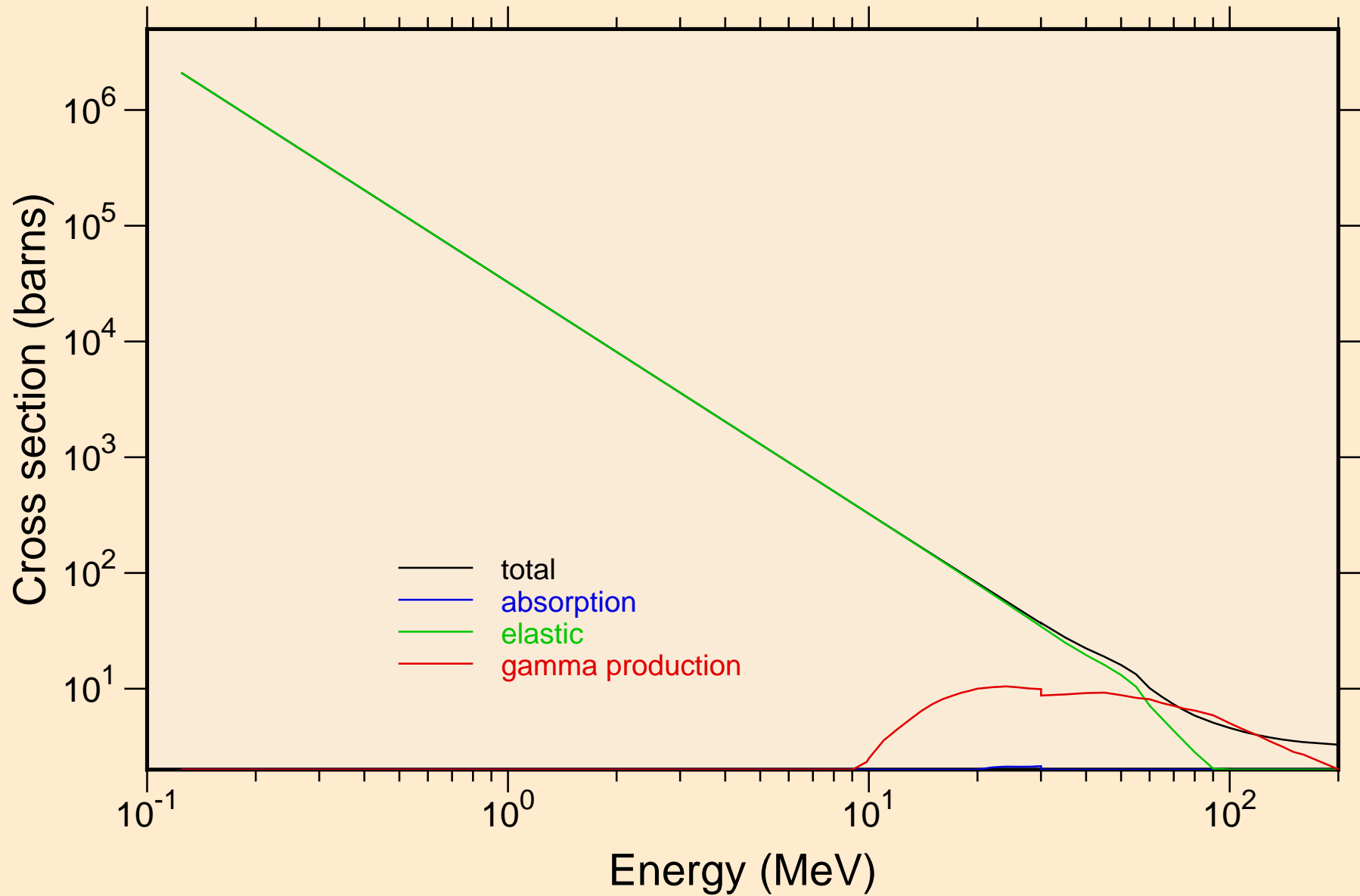

HF186 DEUTERON ACER TENDL-2021 LIBRARY; T=0.K
Heating

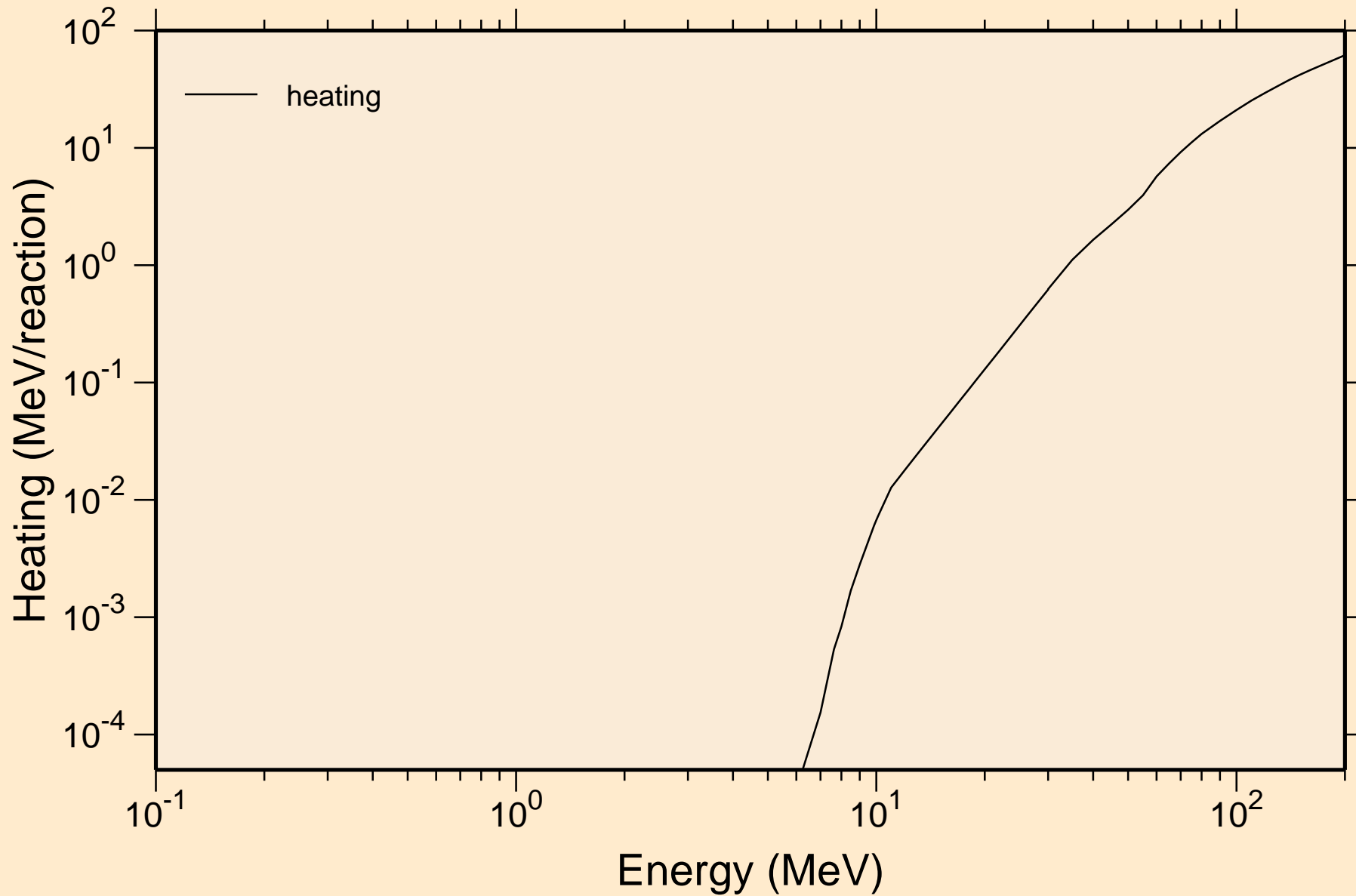

HF186 DEUTERON ACER TENDL-2021 LIBRARY; T=0.K

Principal cross sections

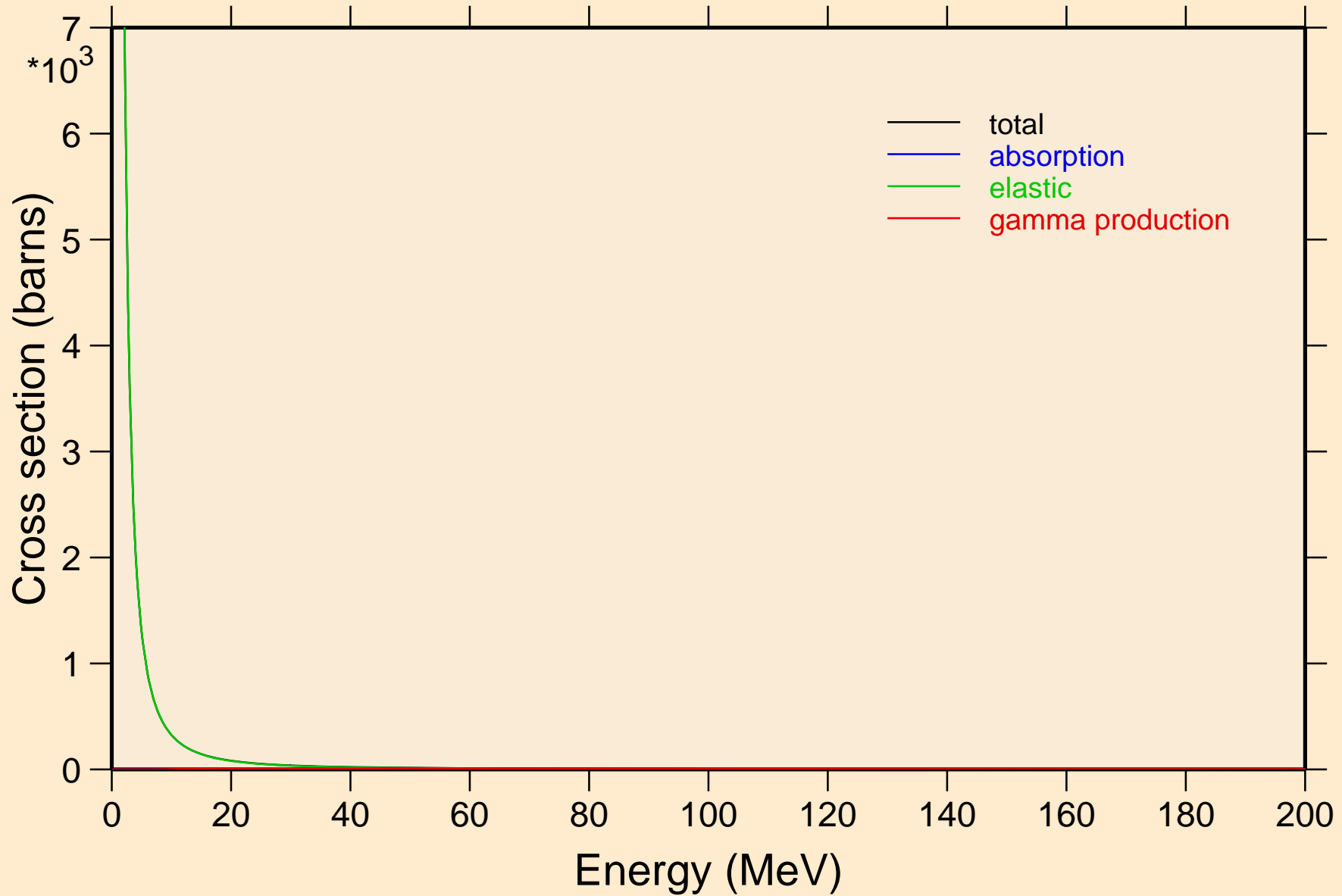

HF186 DEUTERON ACER TENDL-2021 LIBRARY; T=0.K
Heating

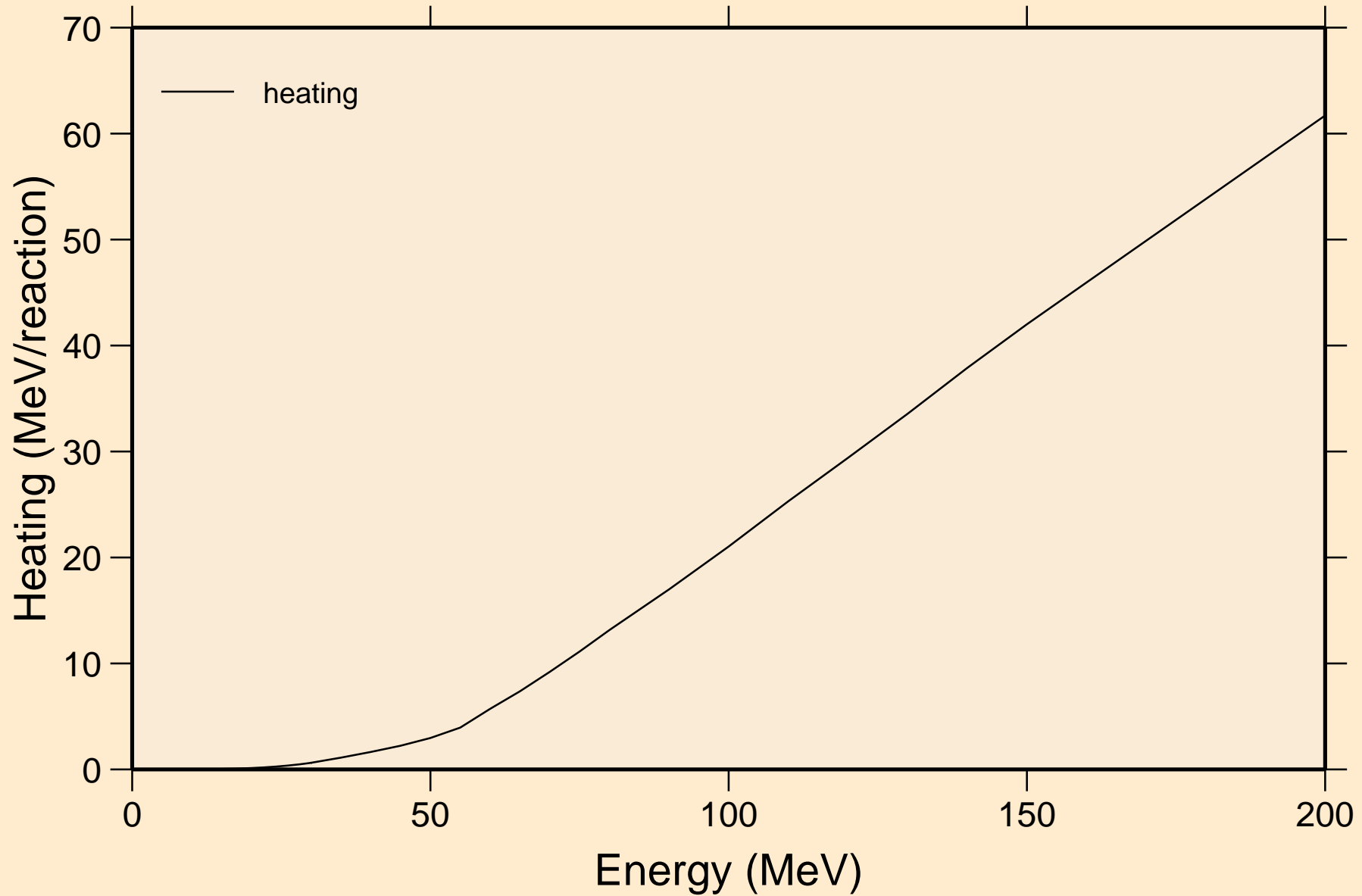

HF186 DEUTERON ACER TENDL-2021 LIBRARY; T=0.K

Threshold reactions

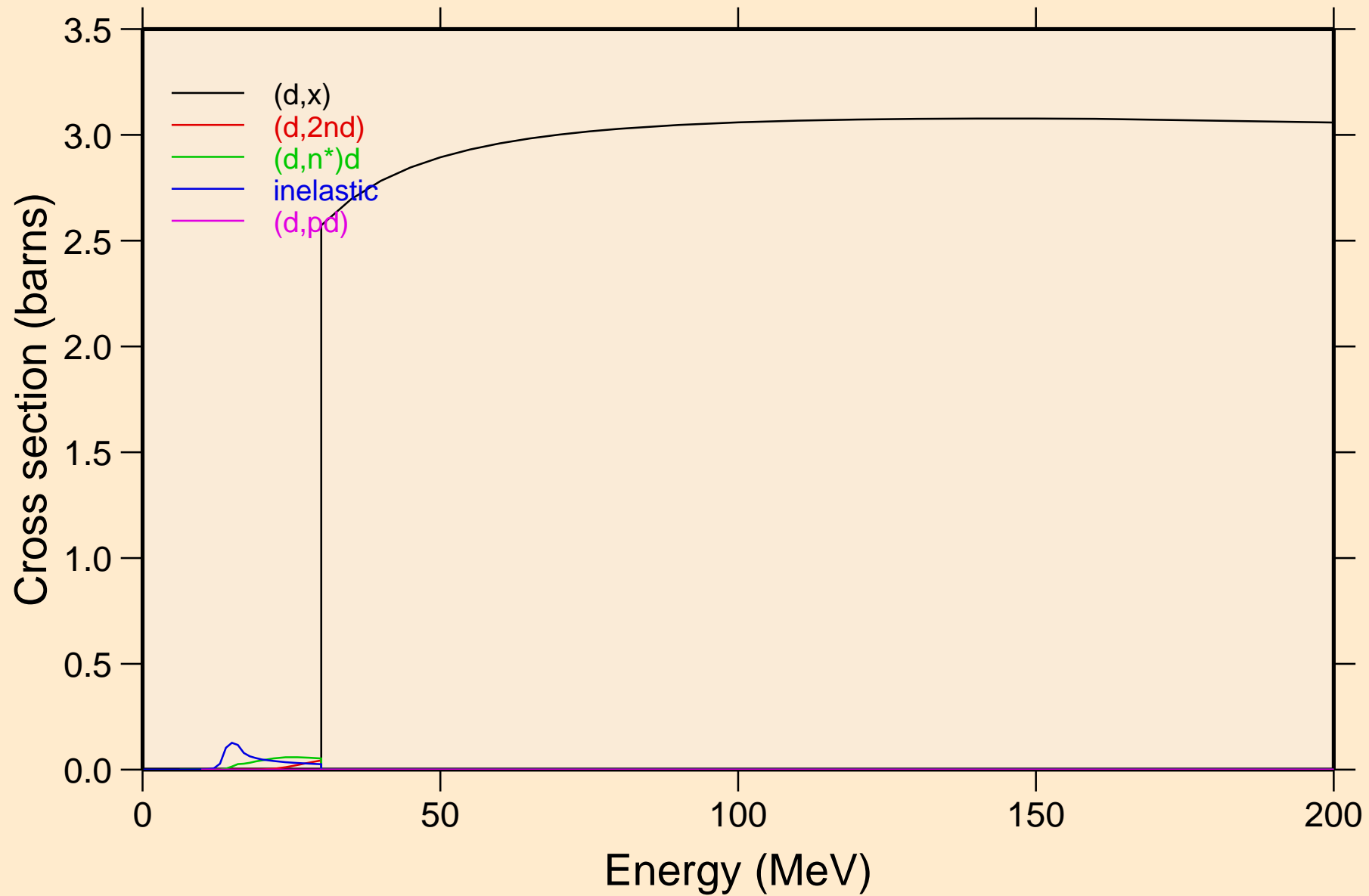

HF186 DEUTERON ACER TENDL-2021 LIBRARY; T=0.K
angular distribution for elastic

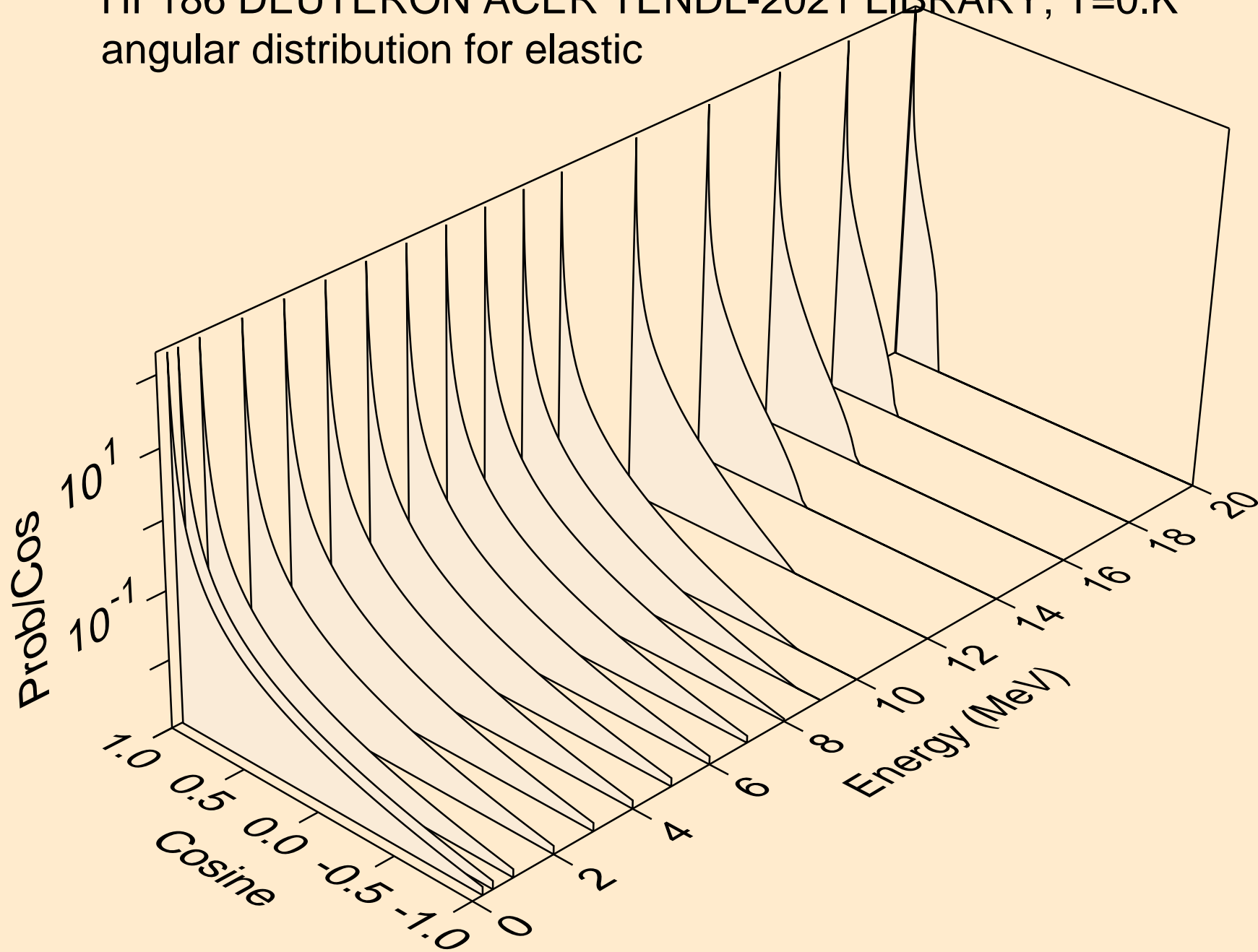

HF186 DEUTERON ACER TENDL-2021 LIBRARY; T=0.K
angular distribution for elastic

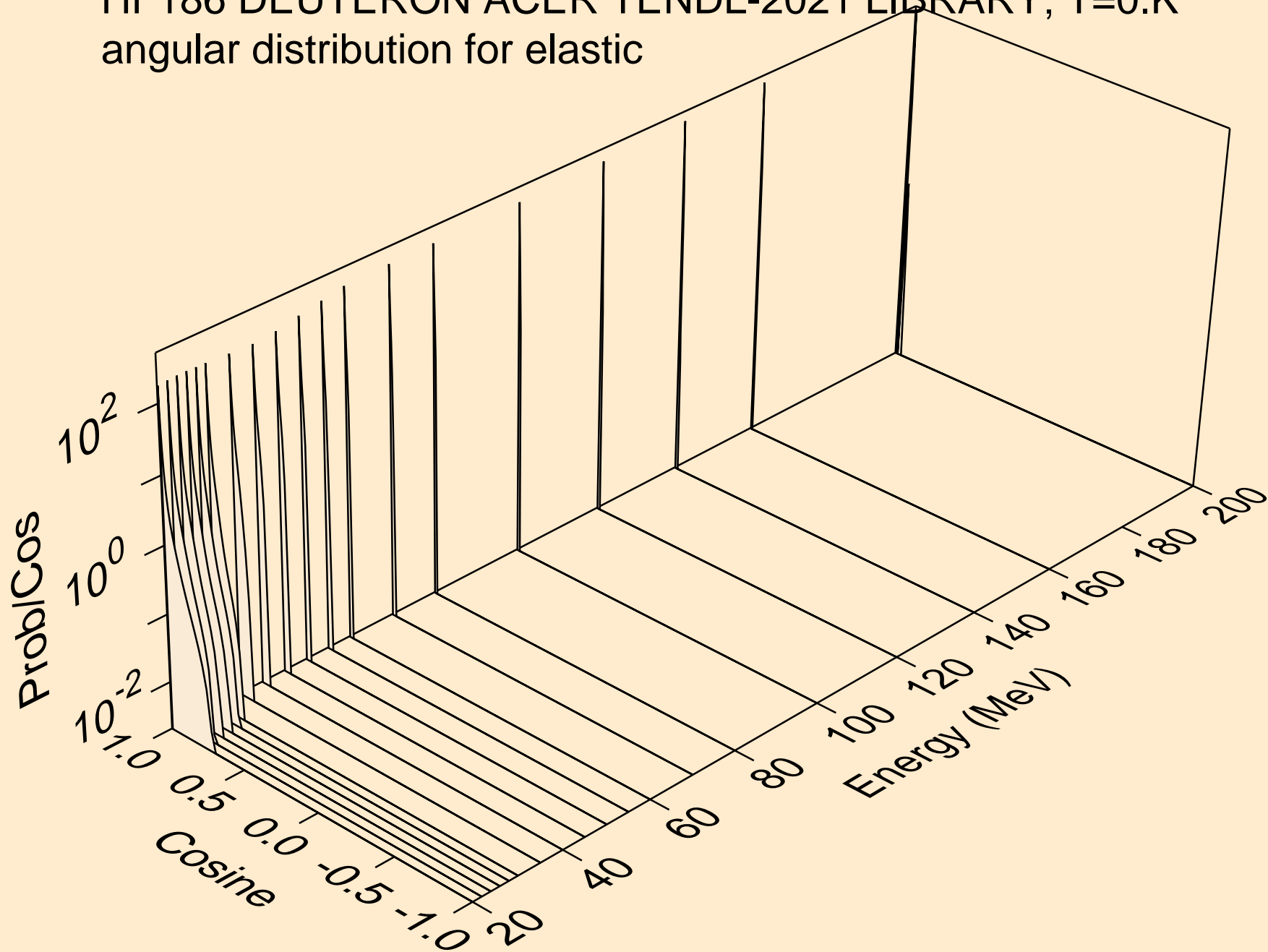

HF186 DEUTERON ACER TENDL-2021 LIBRARY; T=0.K
Deuteron emission for (d,x)

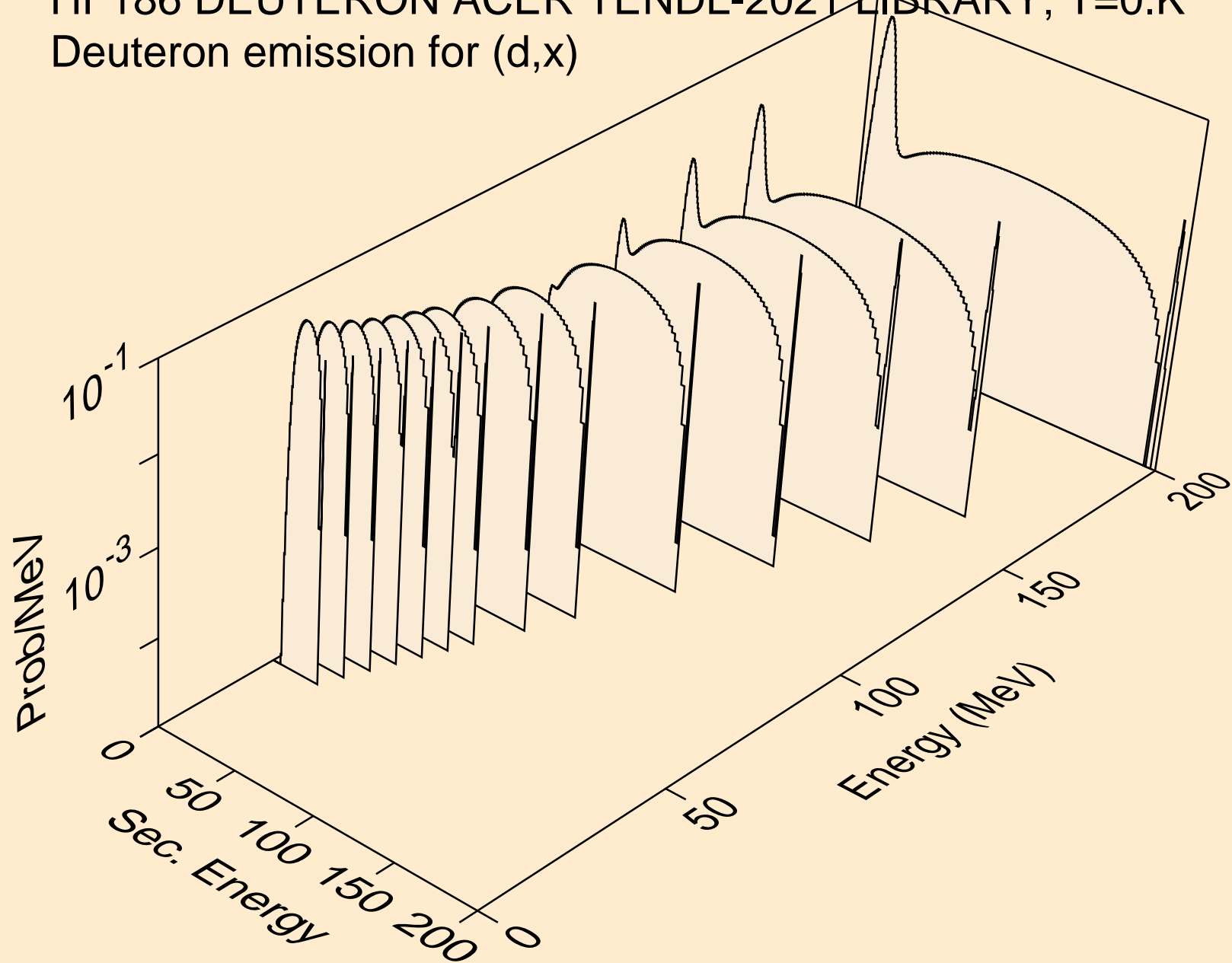

HF186 DEUTERON ACER TENDL-2021 LIBRARY; T=0.K
Deuteron emission for (d,2nd)

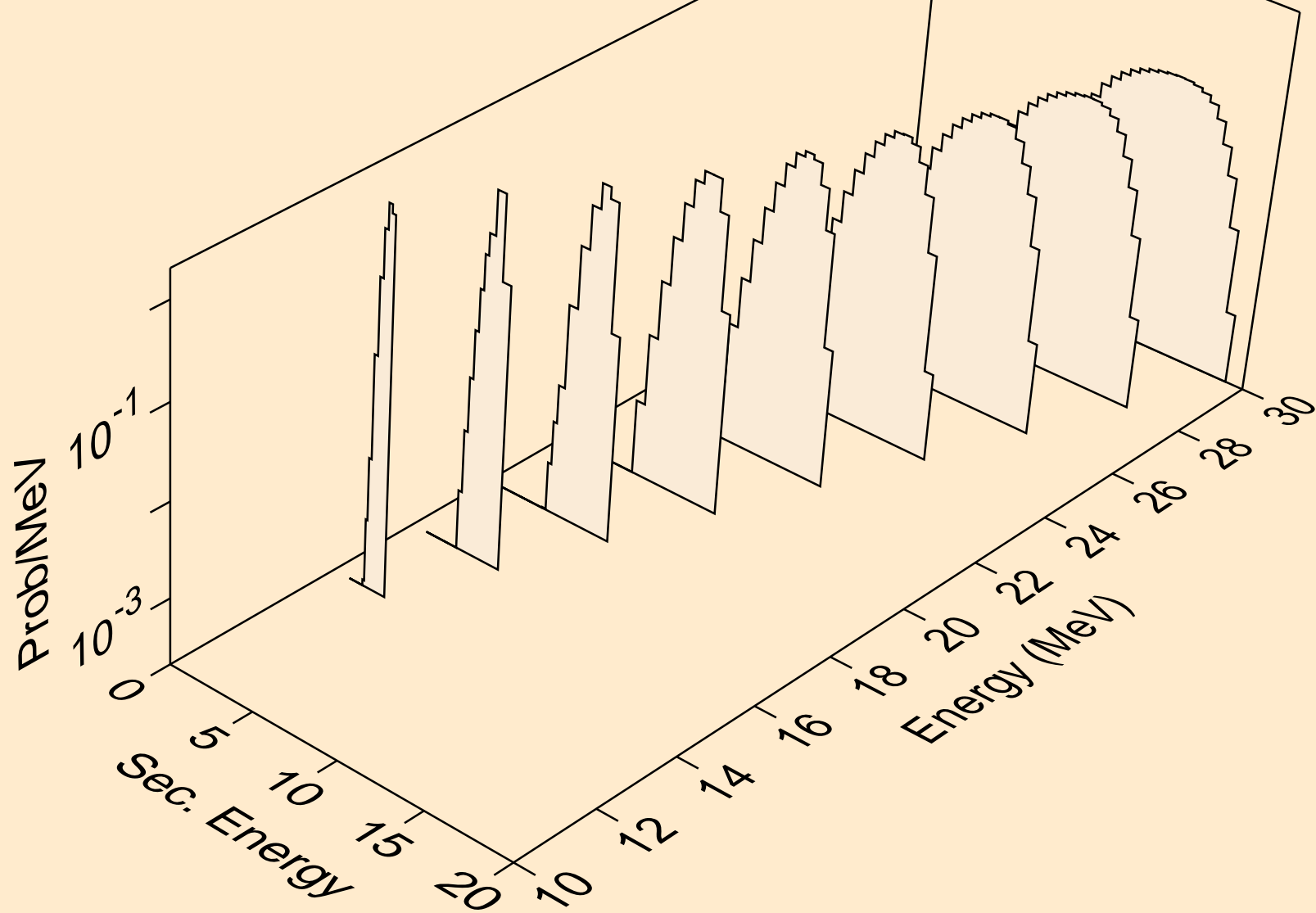

HF186 DEUTERON ACER TENDL-2021 LIBRARY; T=0.K
Deuteron emission for (d,n*)d

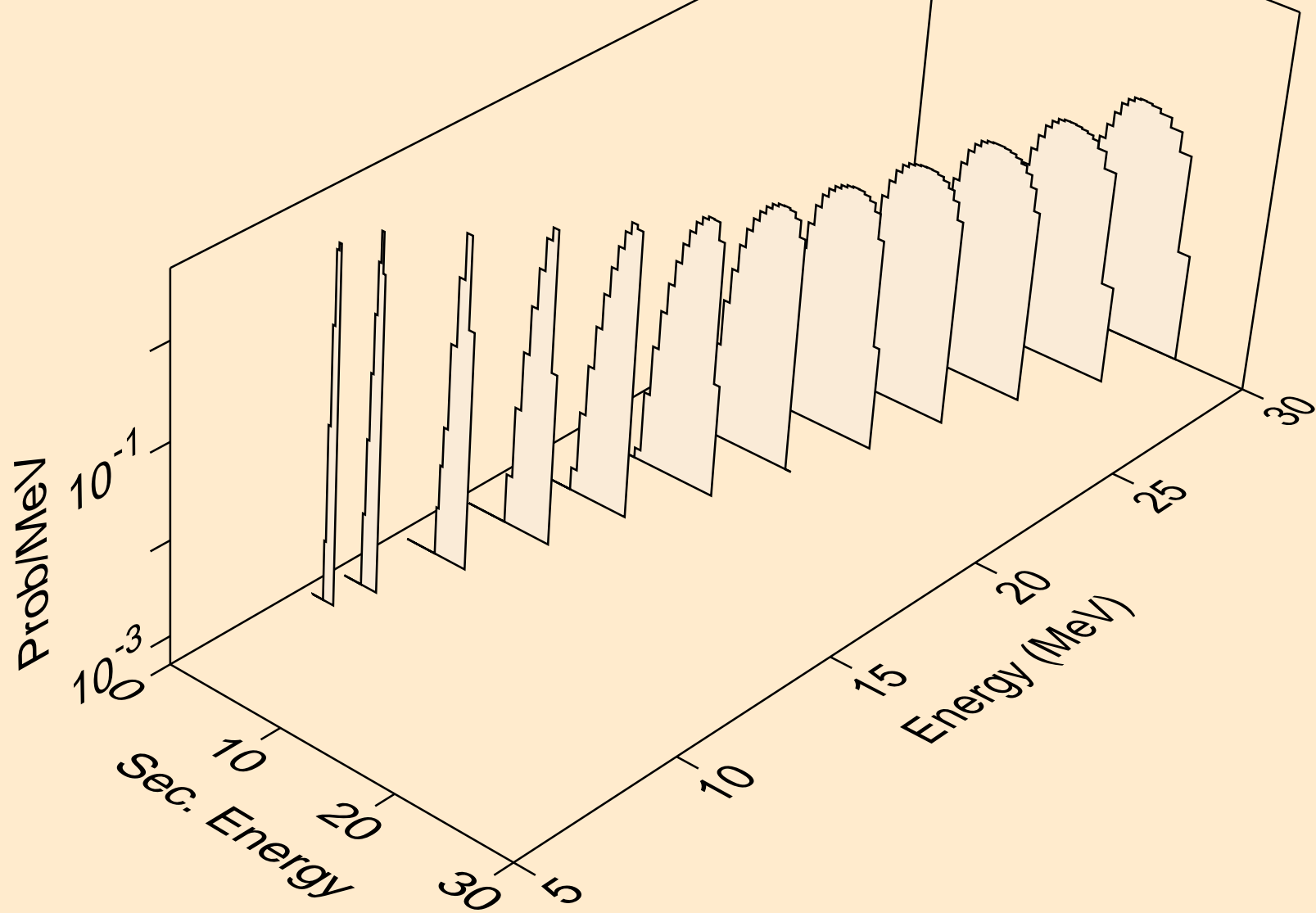

HF186 DEUTERON ACER TENDL-2021 LIBRARY; T=0.K
Deuteron emission for inelastic

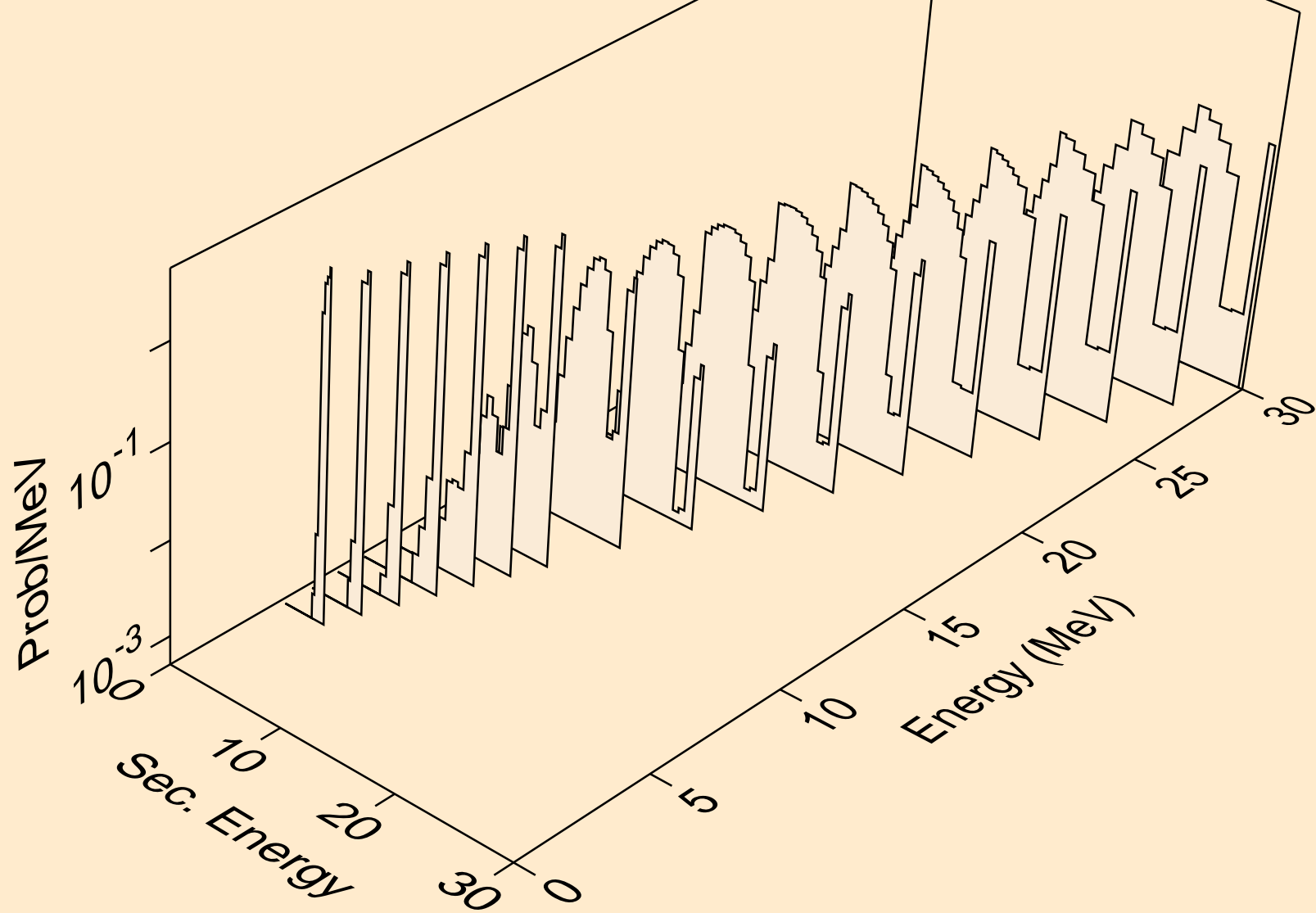

HF186 DEUTERON ACER TENDL-2021 LIBRARY; T=0.K
Deuteron emission for (d,pd)

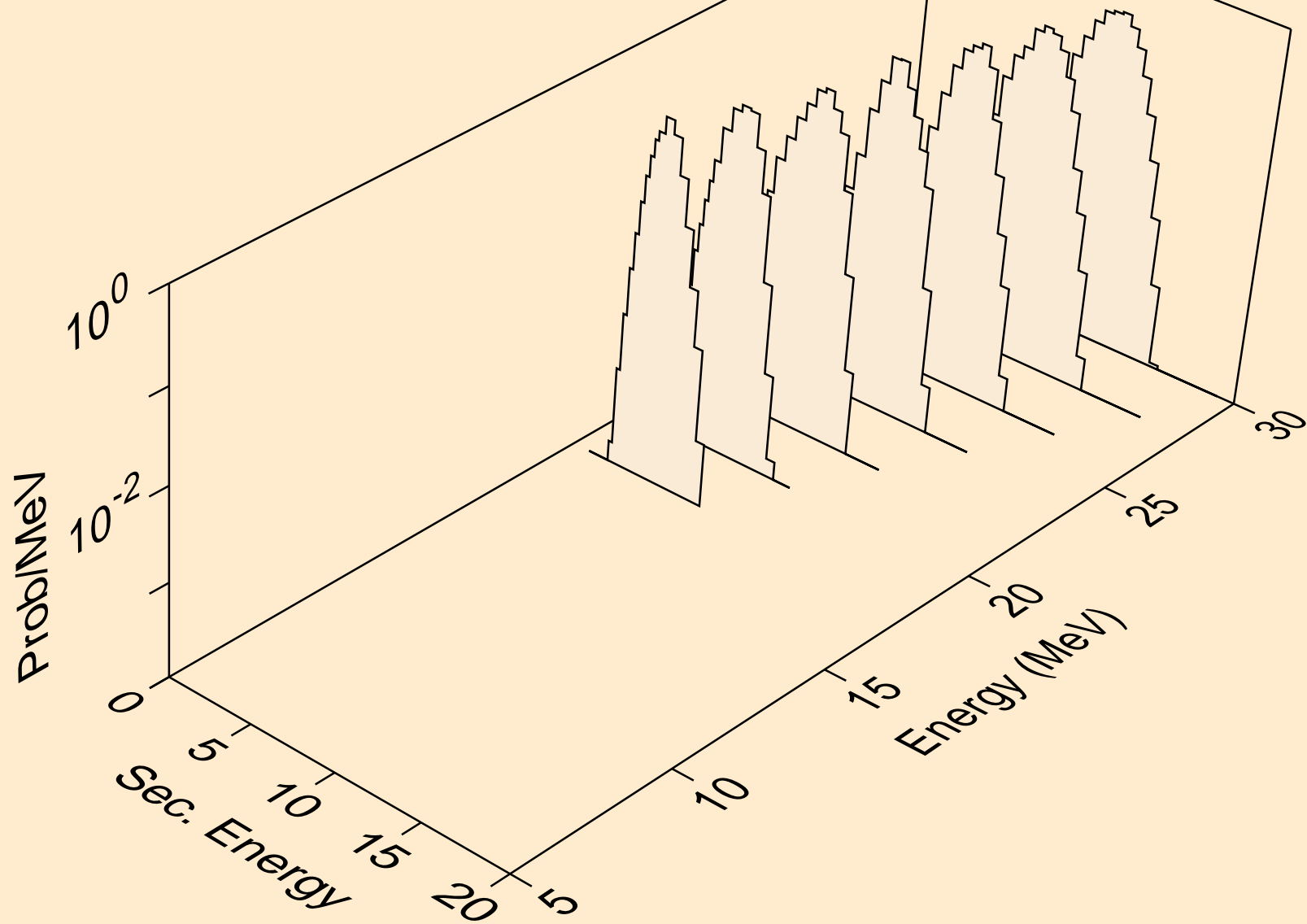

HF186 DEUTERON ACER TENDL-2021 LIBRARY; T=0.K
Photon emission for (z,n)

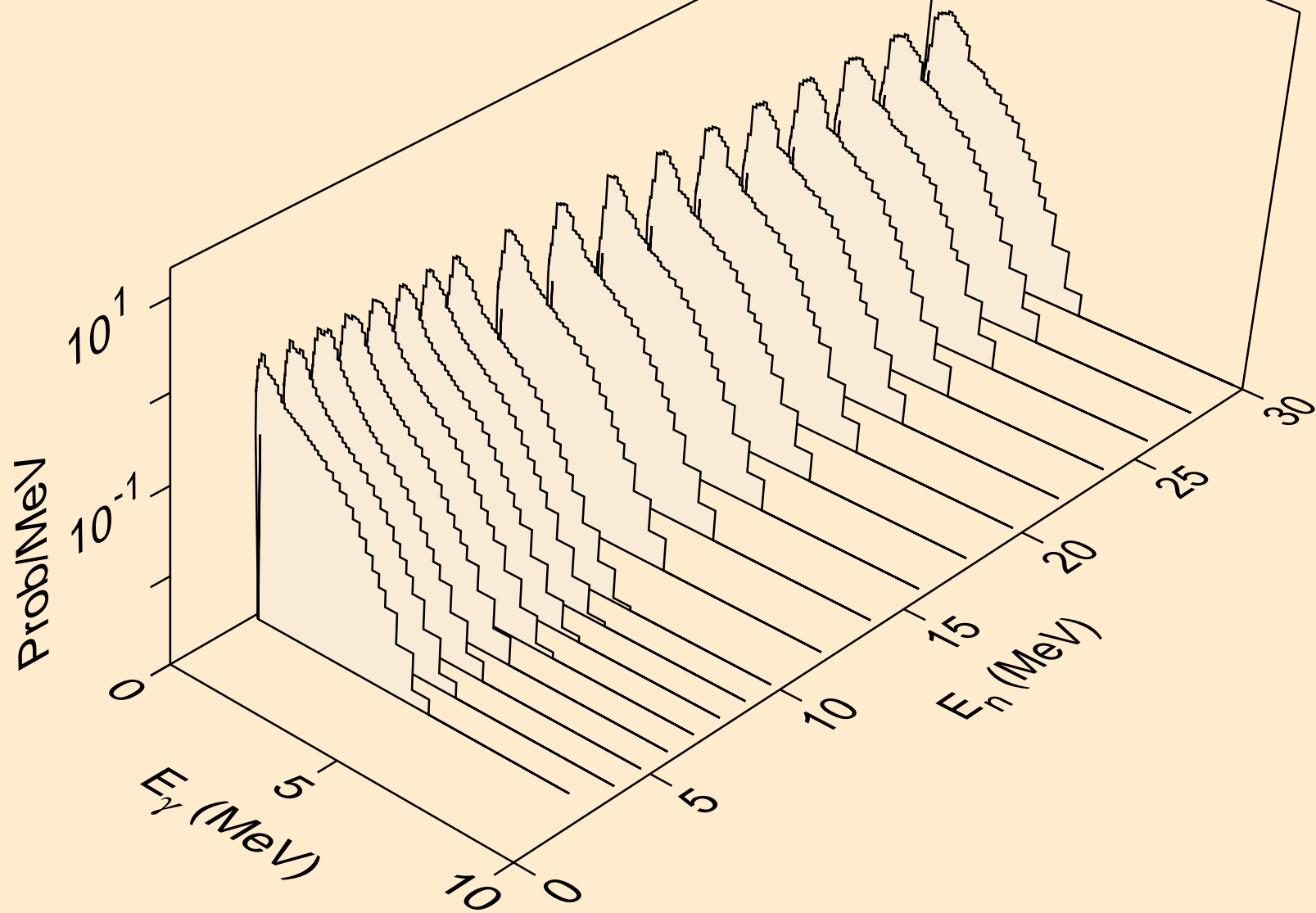

HF186 DEUTERON ACER TENDL-2021 LIBRARY; T=0.K
Photon emission for (n,x)

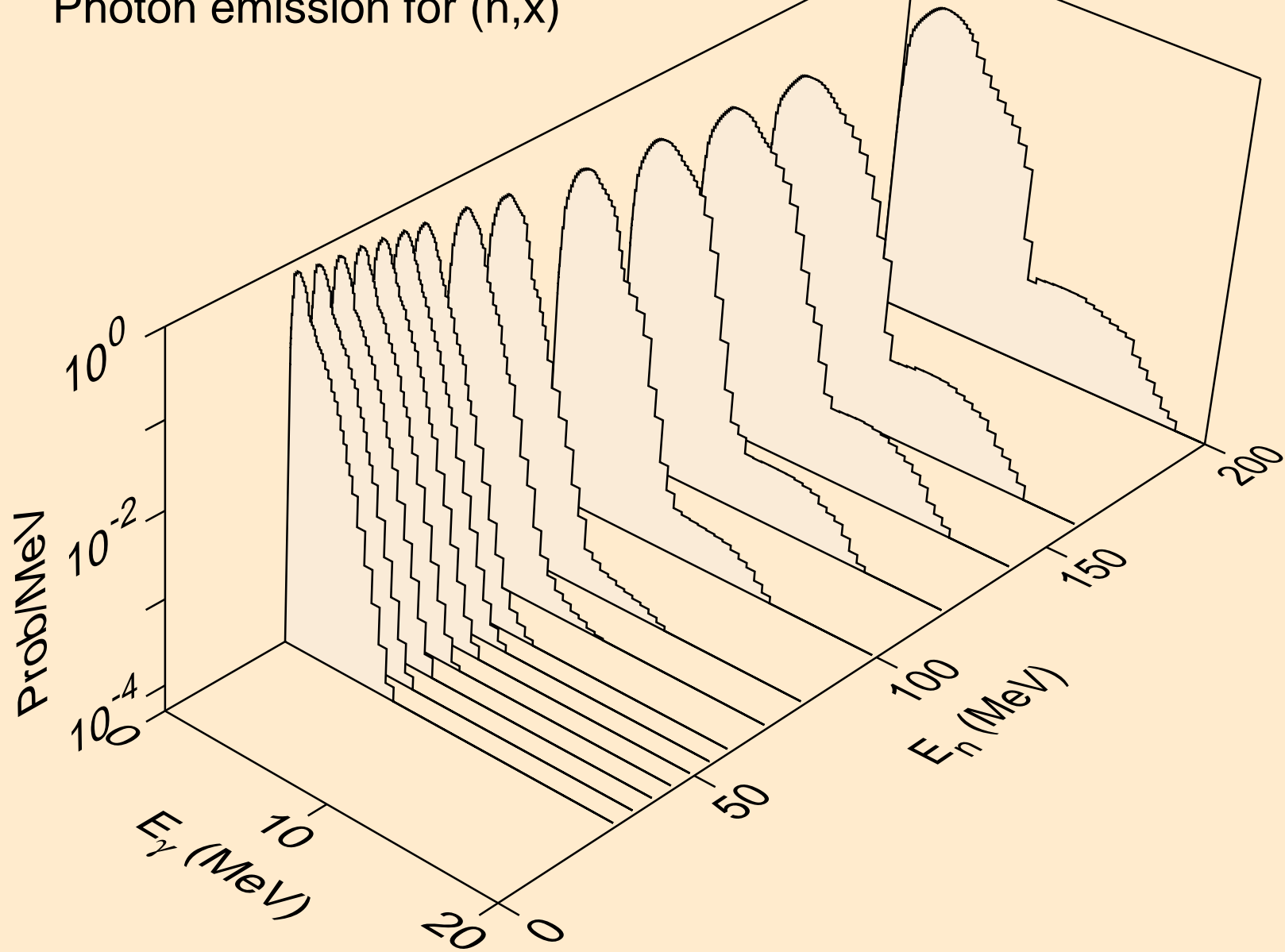

HF186 DEUTERON ACER TENDL-2021 LIBRARY; T=0.K
Photon emission for (n,2nd)

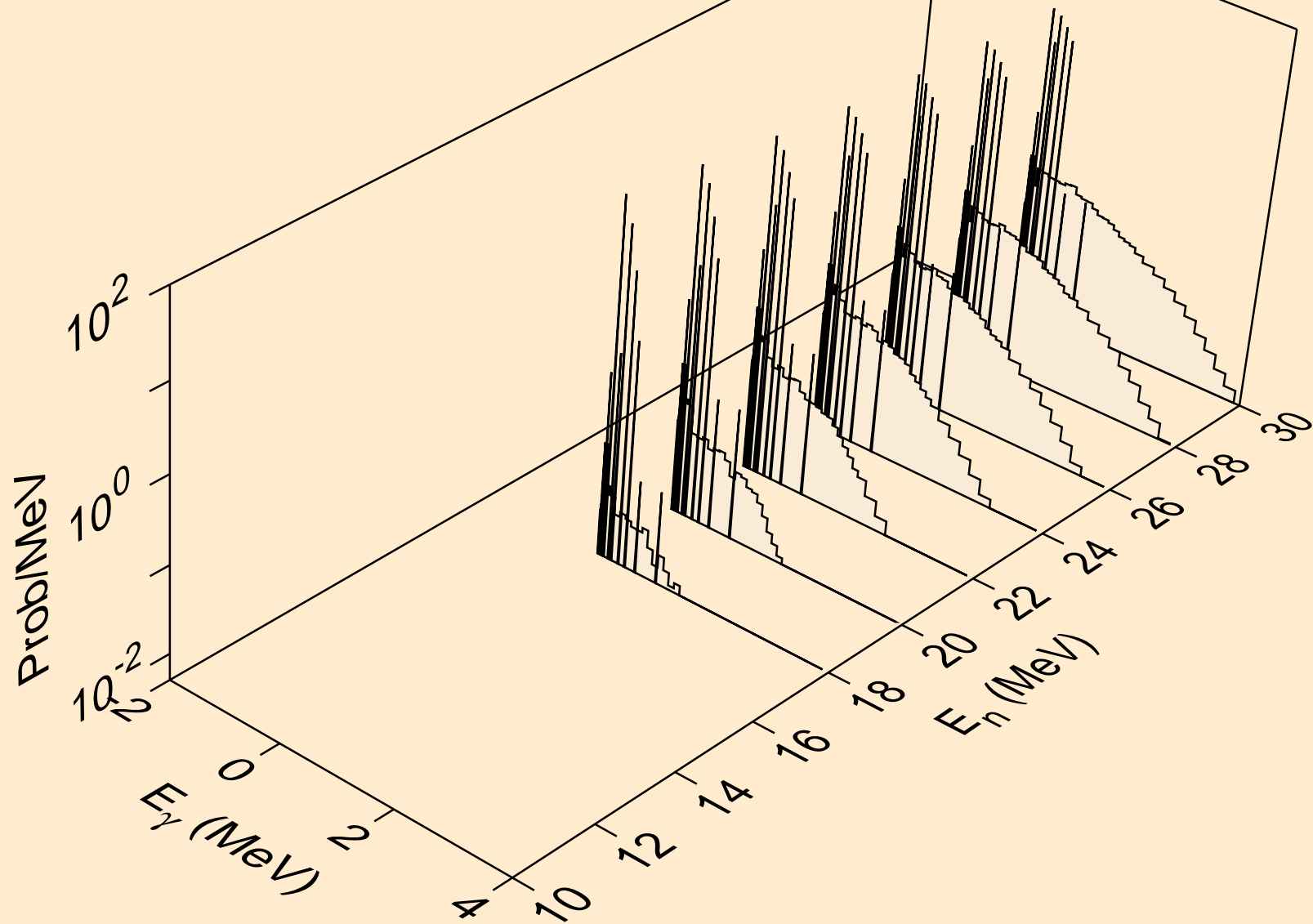

HF186 DEUTERON ACER TENDL-2021 LIBRARY; T=0.K
Photon emission for (n,2n)

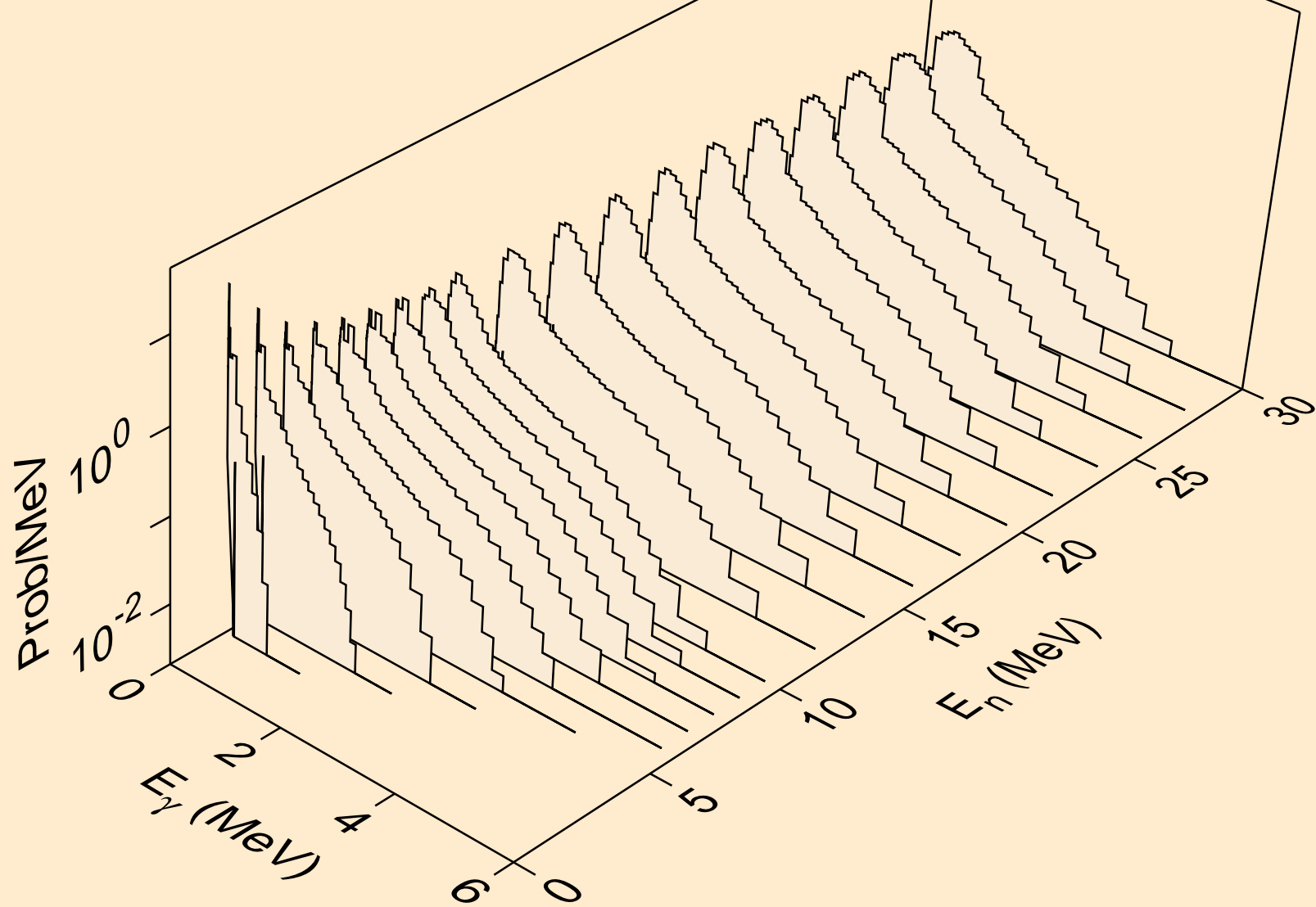

HF186 DEUTERON ACER TENDL-2021 LIBRARY; T=0.K
Photon emission for (n,3n)

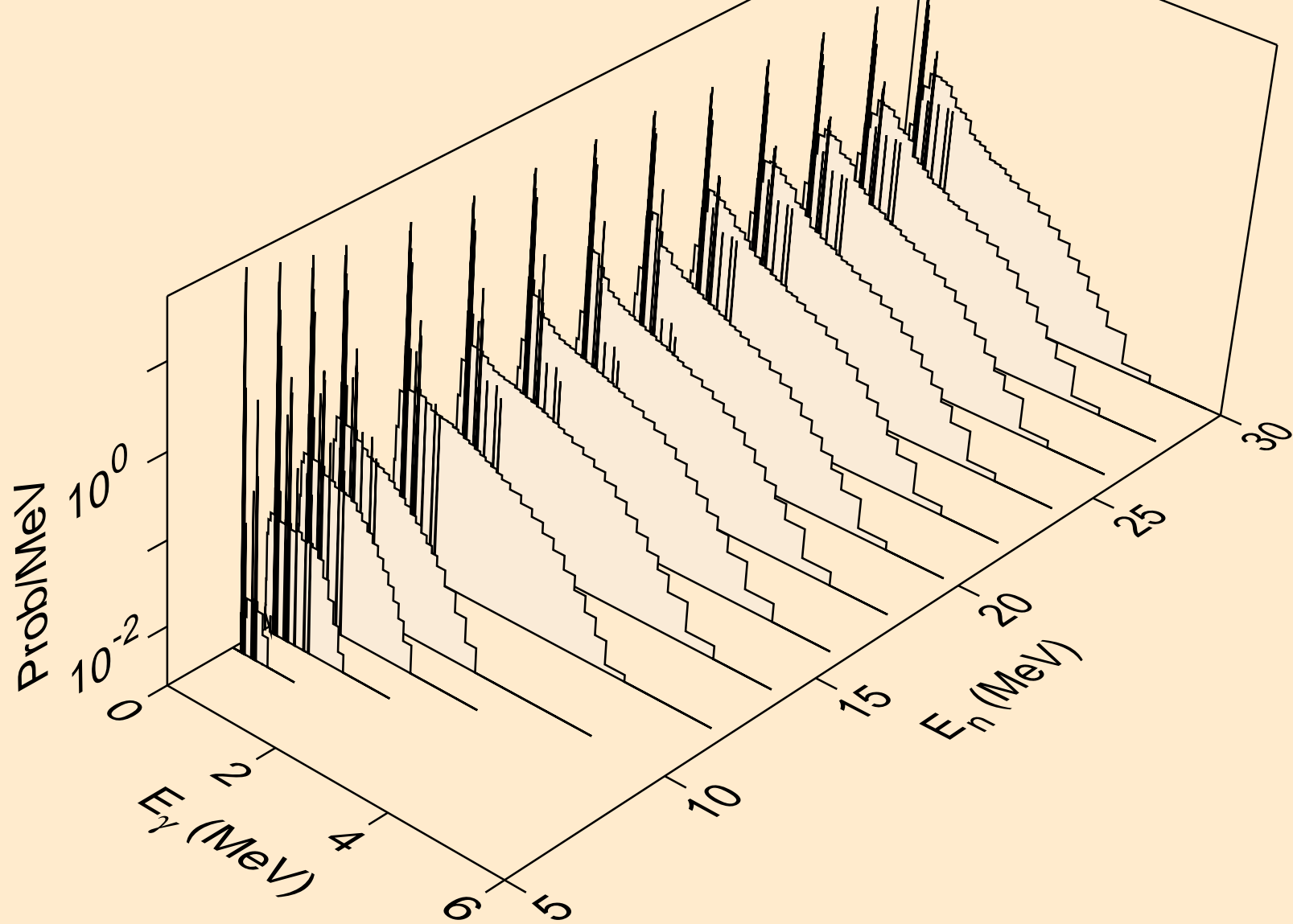

HF186 DEUTERON ACER TENDL-2021 LIBRARY; T=0.K
Photon emission for (n,n*)a

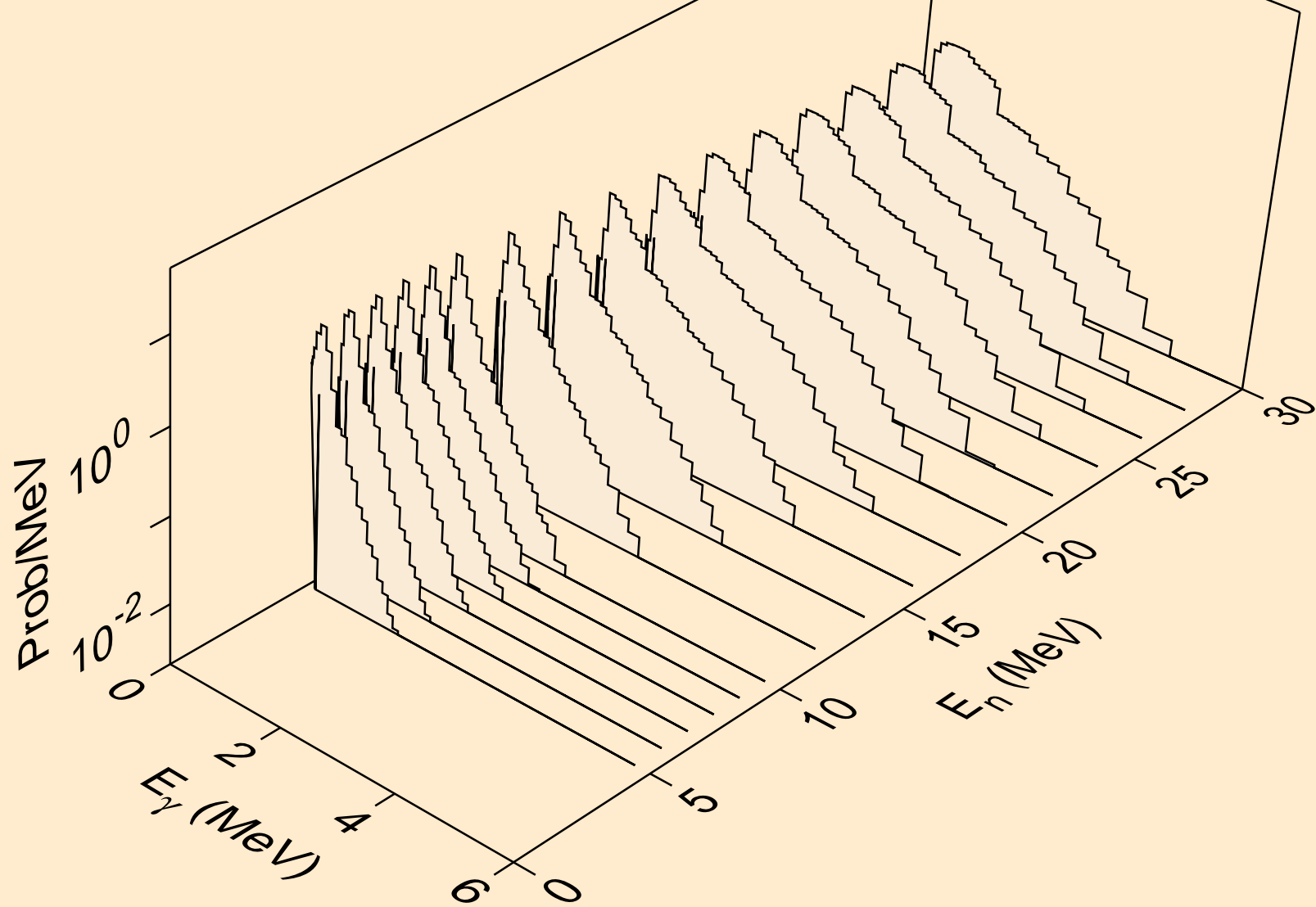

HF186 DEUTERON ACER TENDL-2021 LIBRARY; T=0.K
Photon emission for (n,2n)a

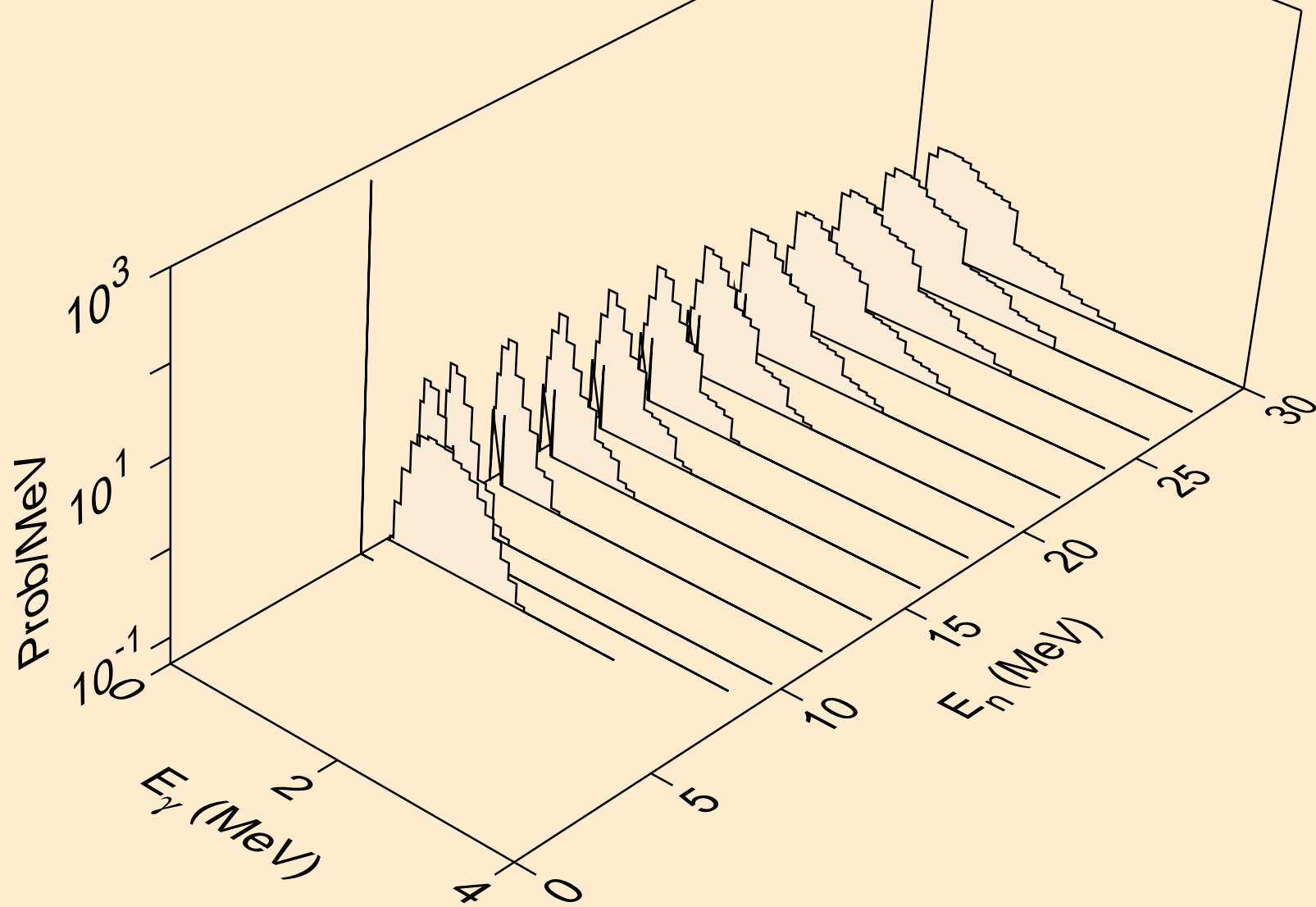

HF186 DEUTERON ACER TENDL-2021 LIBRARY; T=0.K
Photon emission for (n,3n)a

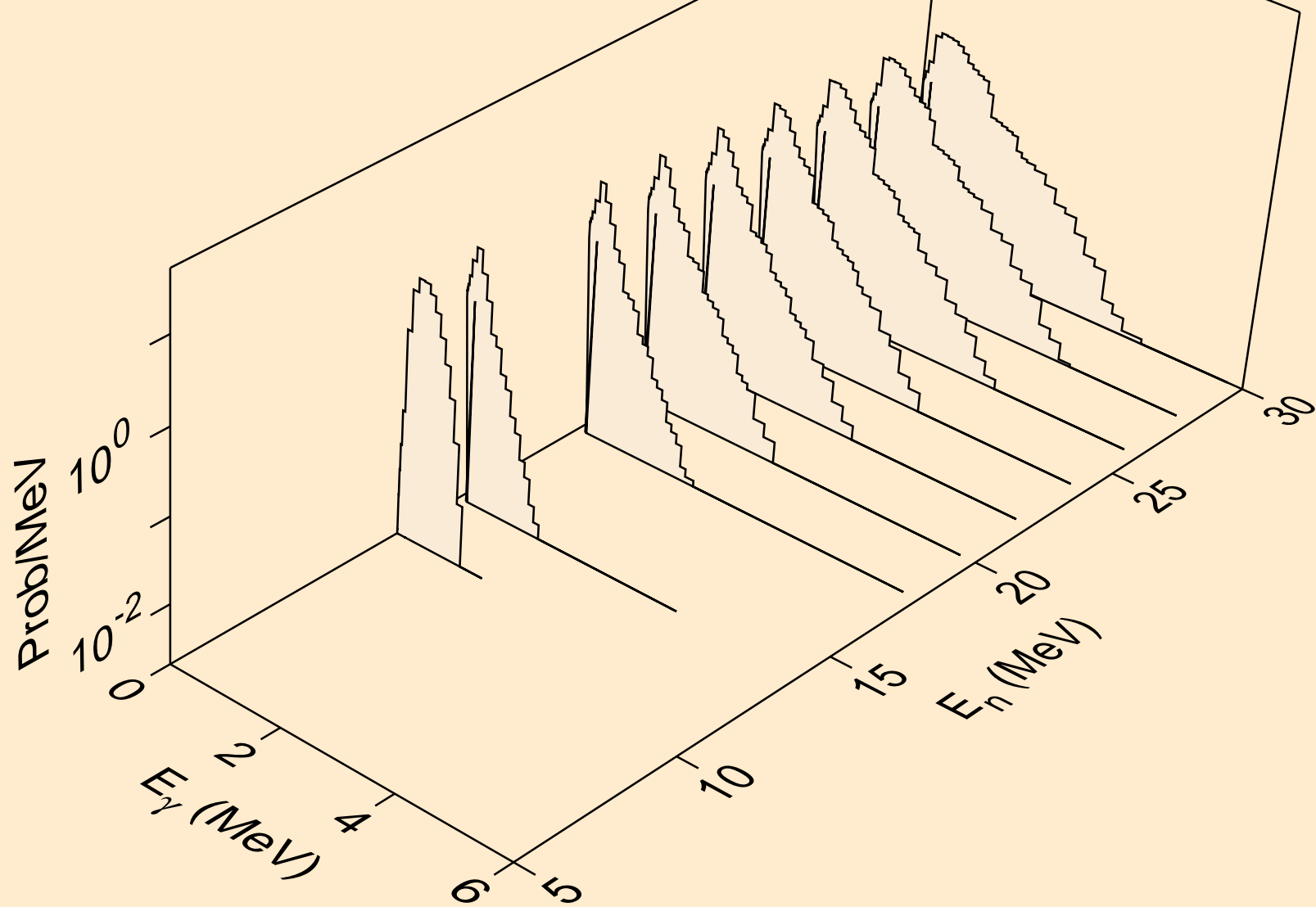

HF186 DEUTERON ACER TENDL-2021 LIBRARY; T=0.K
Photon emission for (n,n*)p

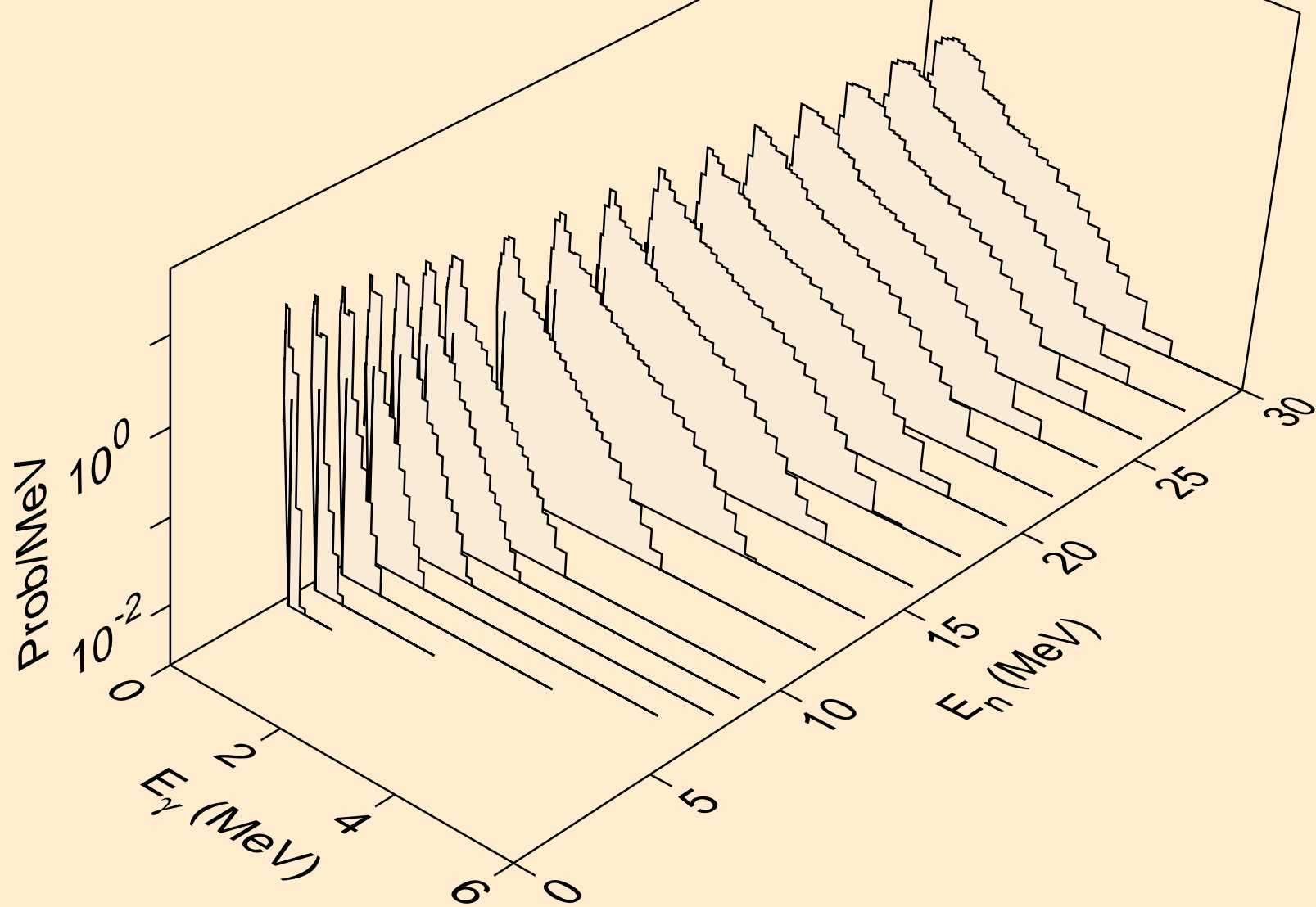

HF186 DEUTERON ACER TENDL-2021 LIBRARY; T=0.K
Photon emission for (n,n*)d

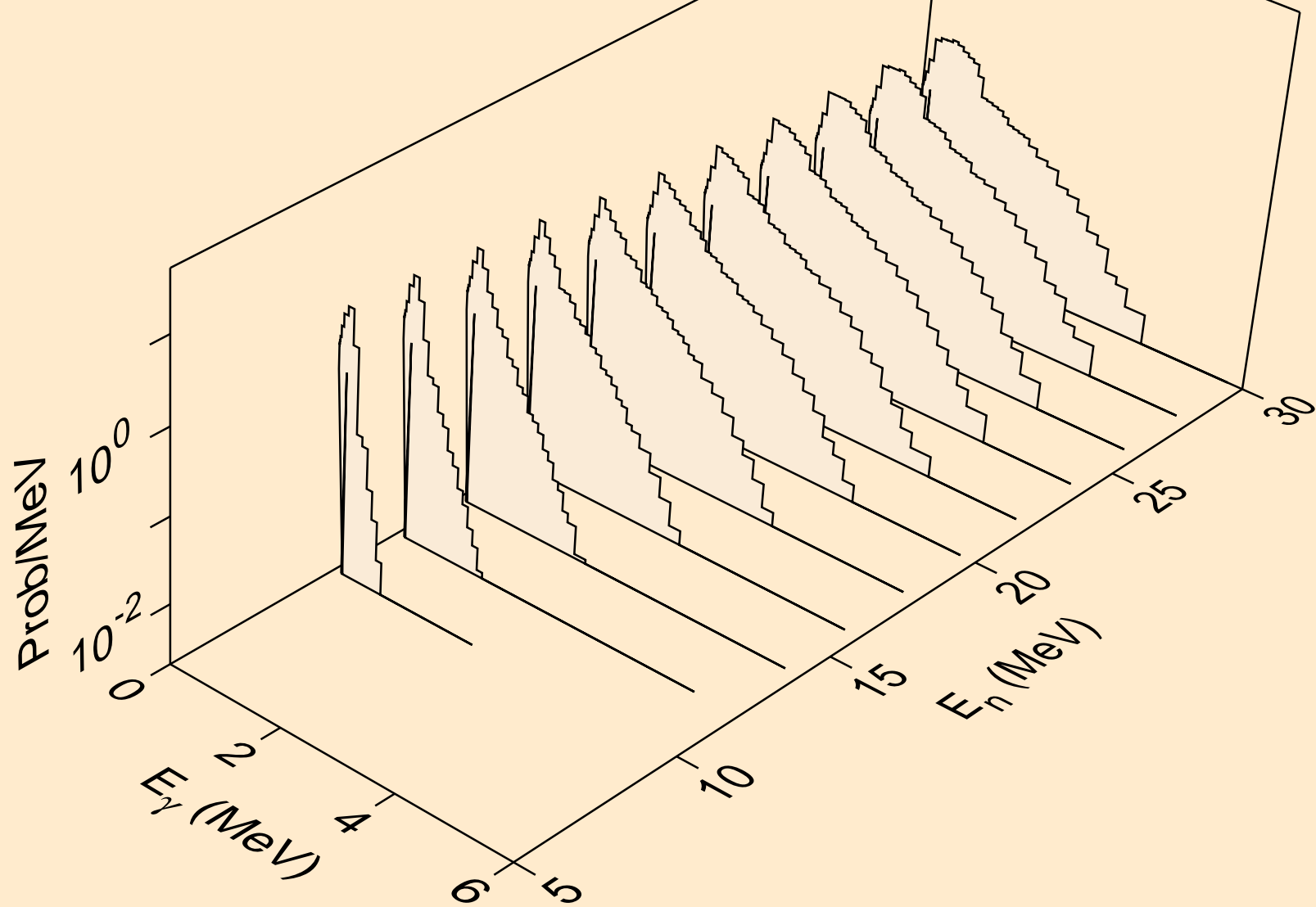

HF186 DEUTERON ACER TENDL-2021 LIBRARY; T=0.K
Photon emission for (n,n*)t

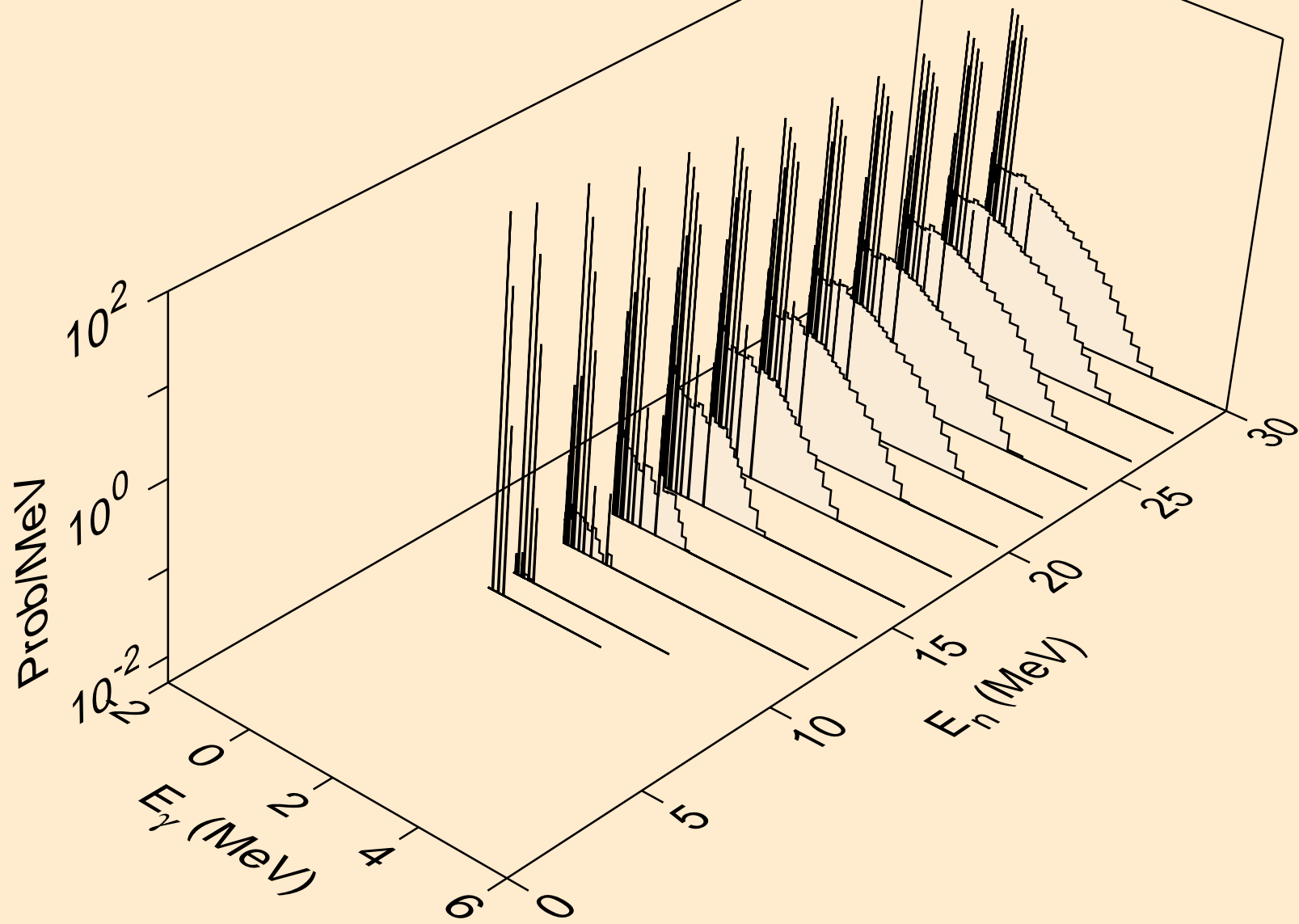

HF186 DEUTERON ACER TENDL-2021 LIBRARY; T=0.K
Photon emission for (n,n*)he3

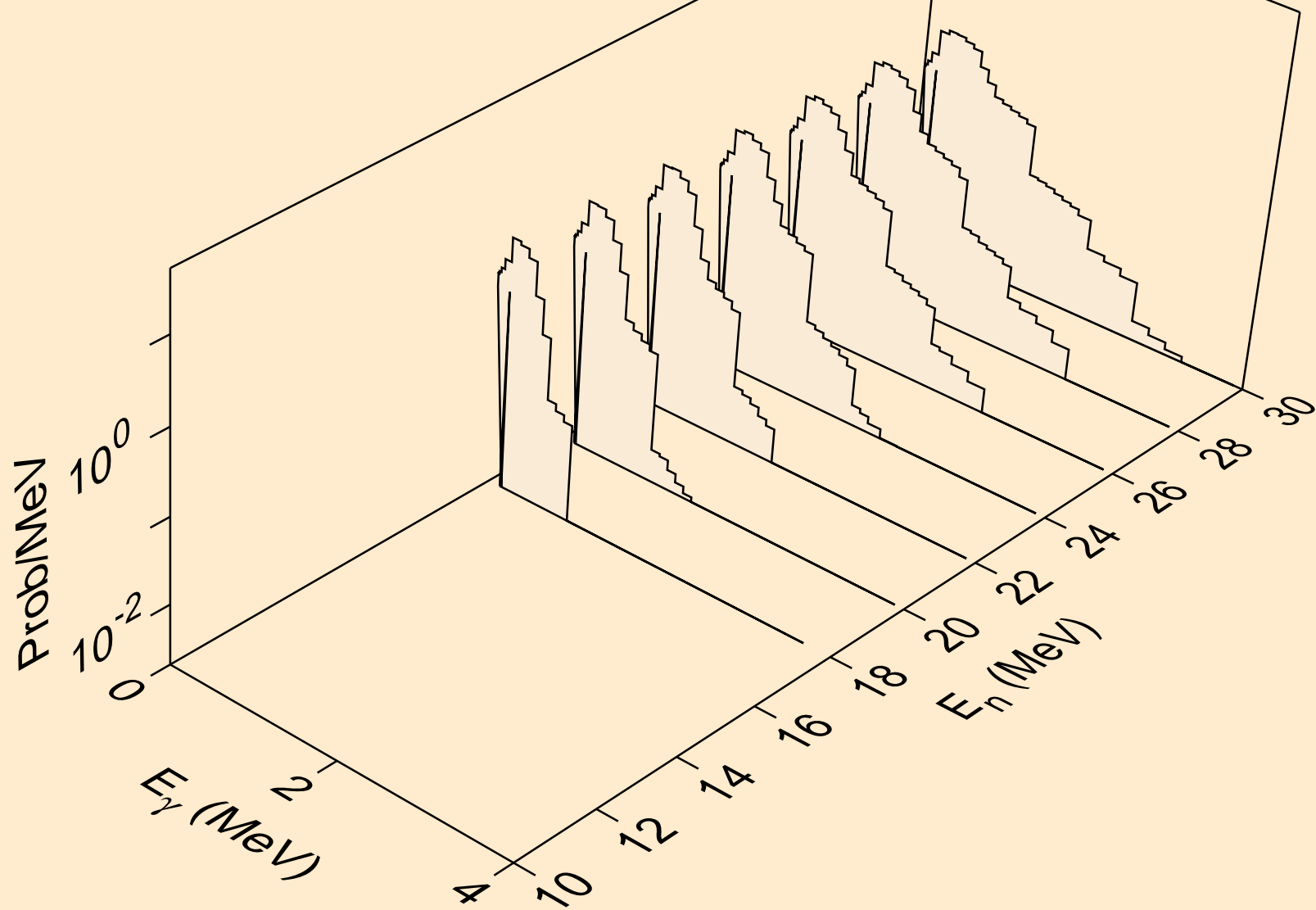

HF186 DEUTERON ACER TENDL-2021 LIBRARY; T=0.K
Photon emission for (n,4n)

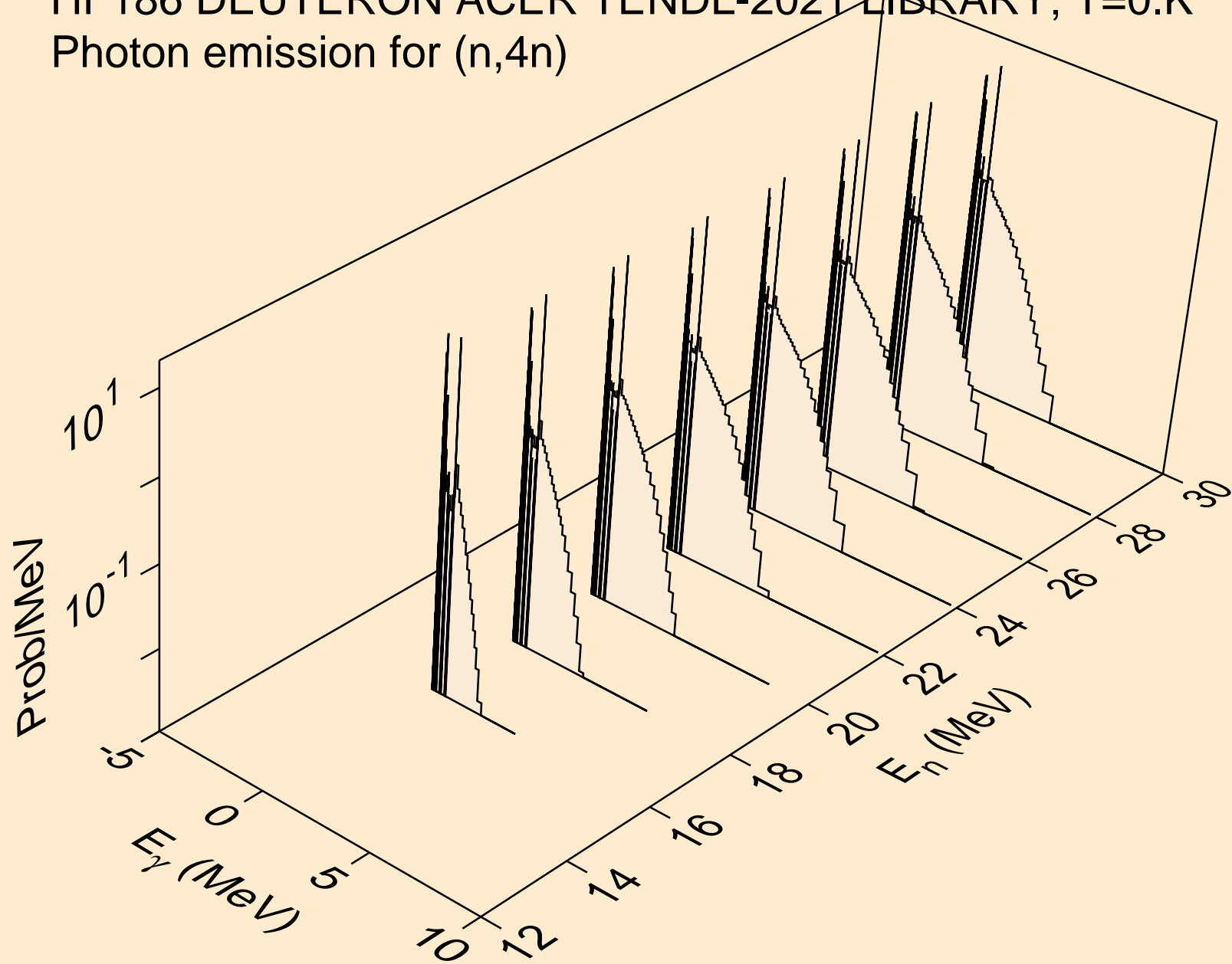

HF186 DEUTERON ACER TENDL-2021 LIBRARY; T=0.K
Photon emission for (n,2np)

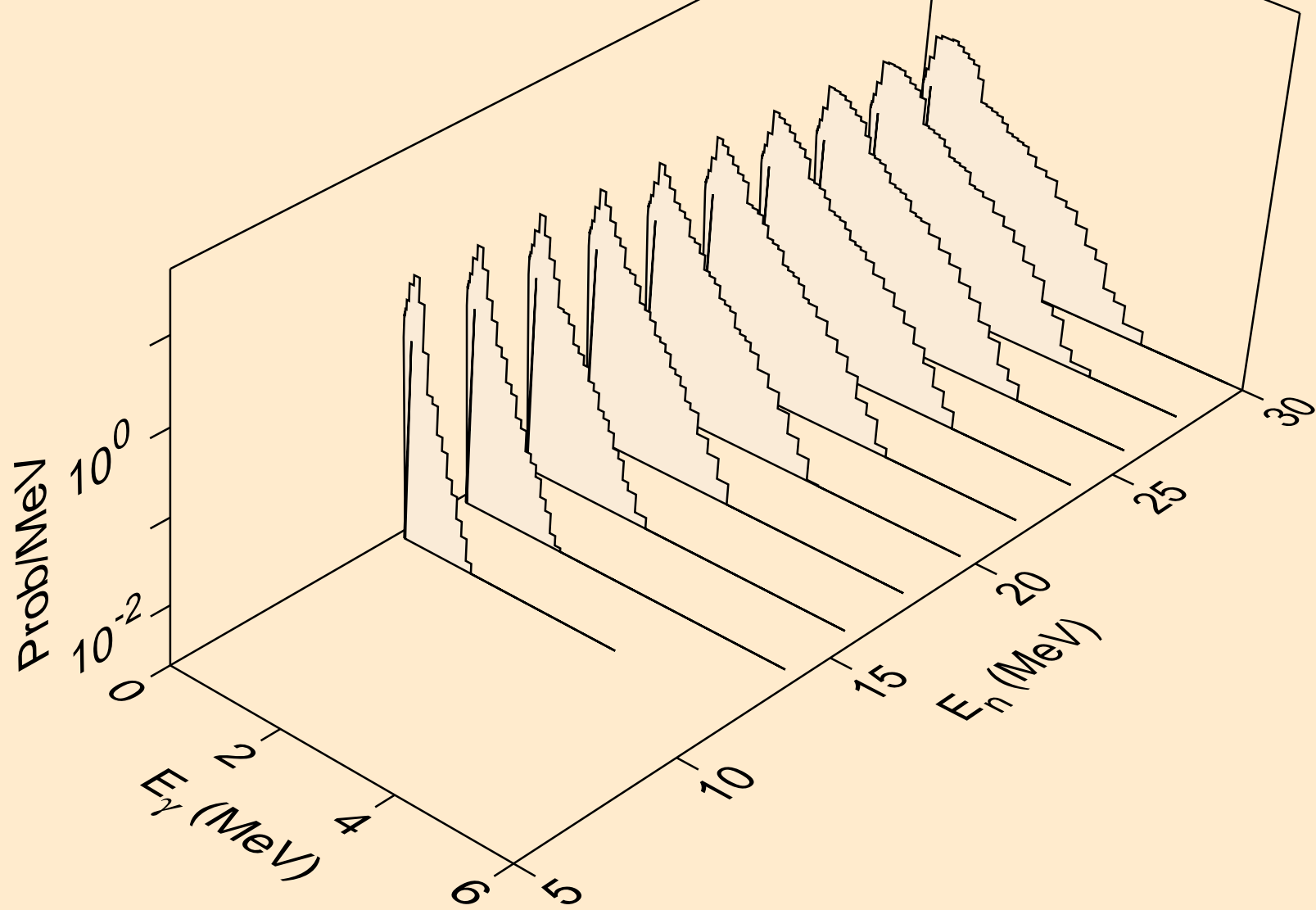

HF186 DEUTERON ACER TENDL-2021 LIBRARY; T=0.K
Photon emission for (n,3np)

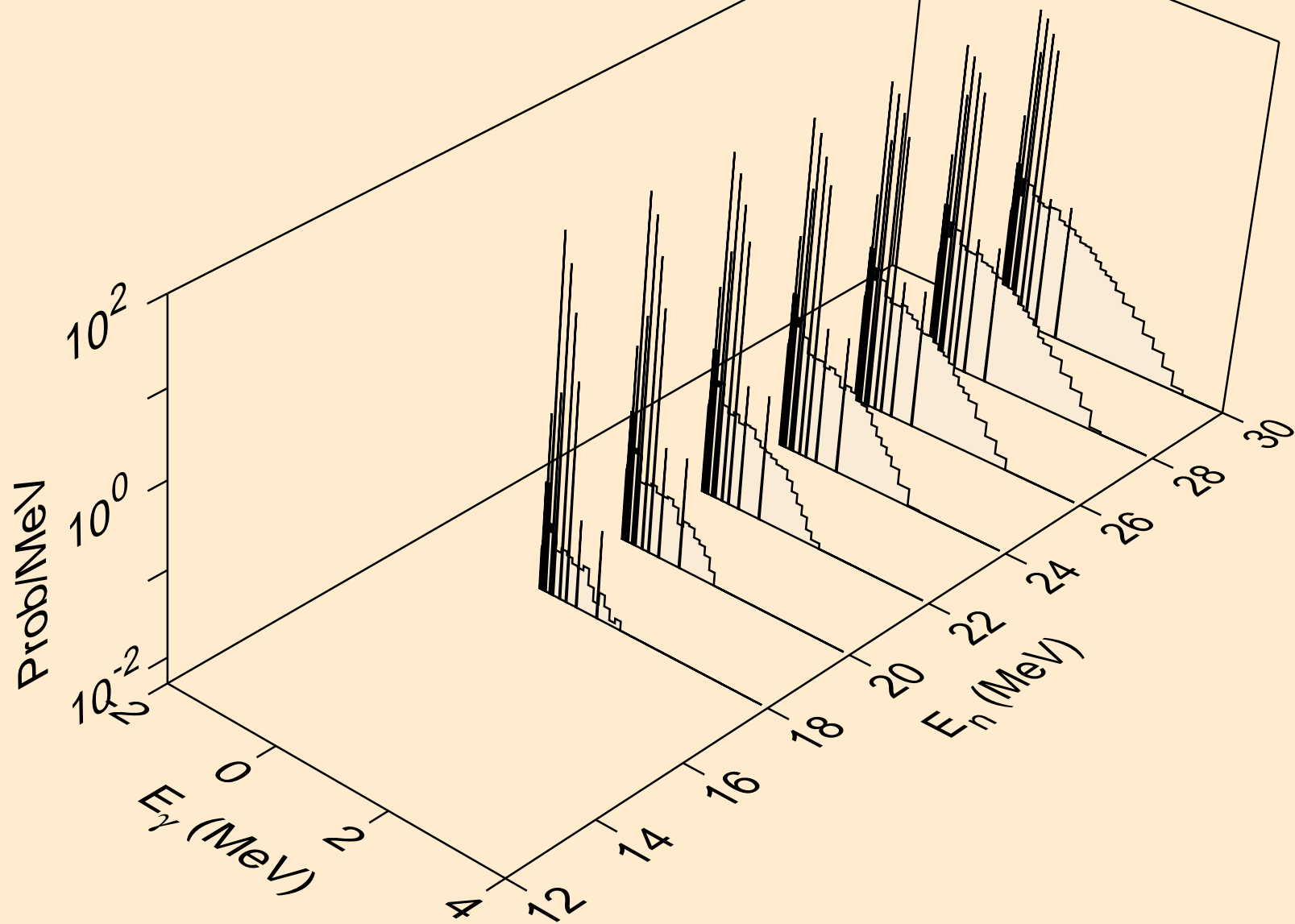

HF186 DEUTERON ACER TENDL-2021 LIBRARY; T=0.K
Photon emission for (n,2np)

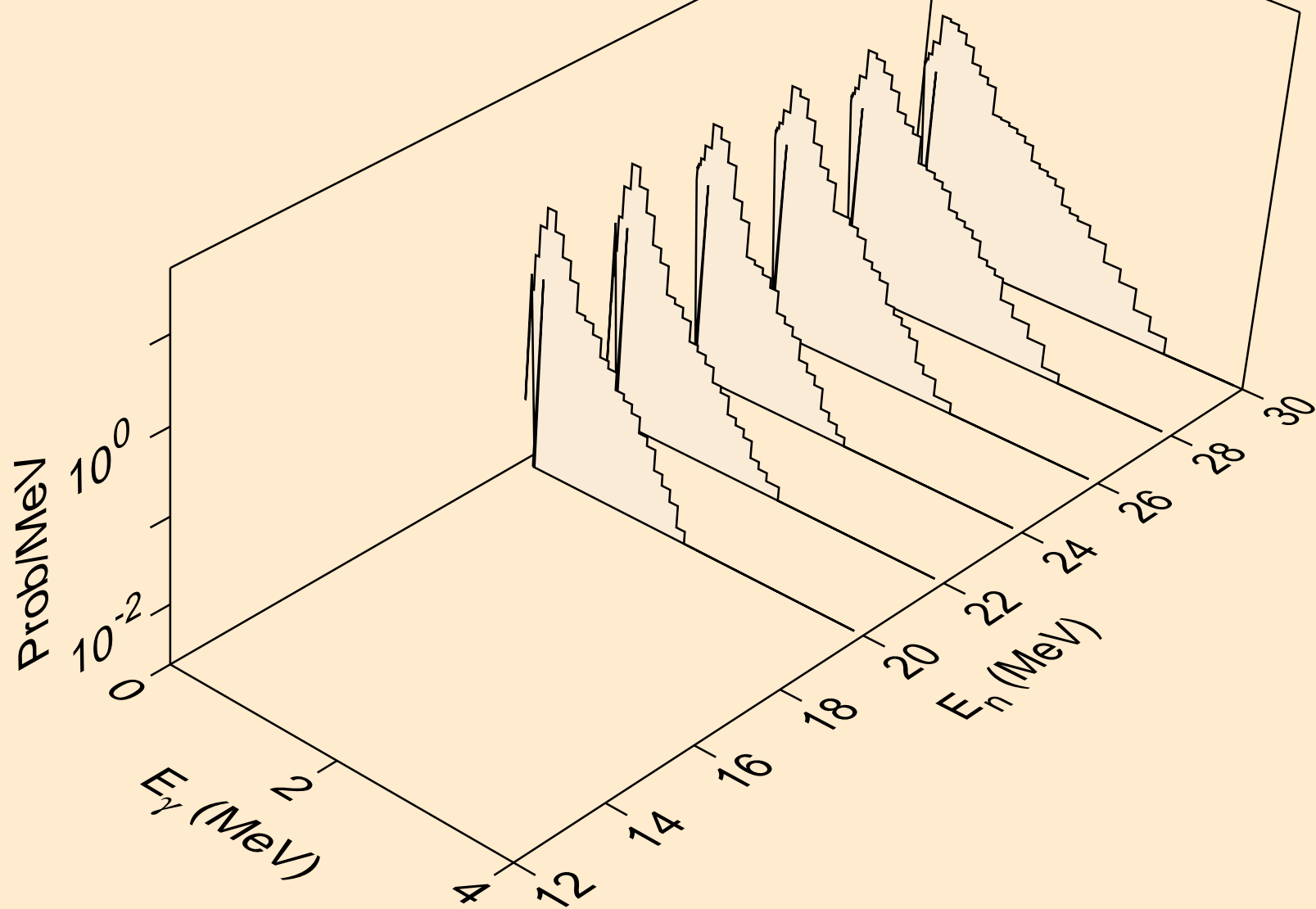

HF186 DEUTERON ACER TENDL-2021 LIBRARY; T=0.K
Photon emission for (n,npa)

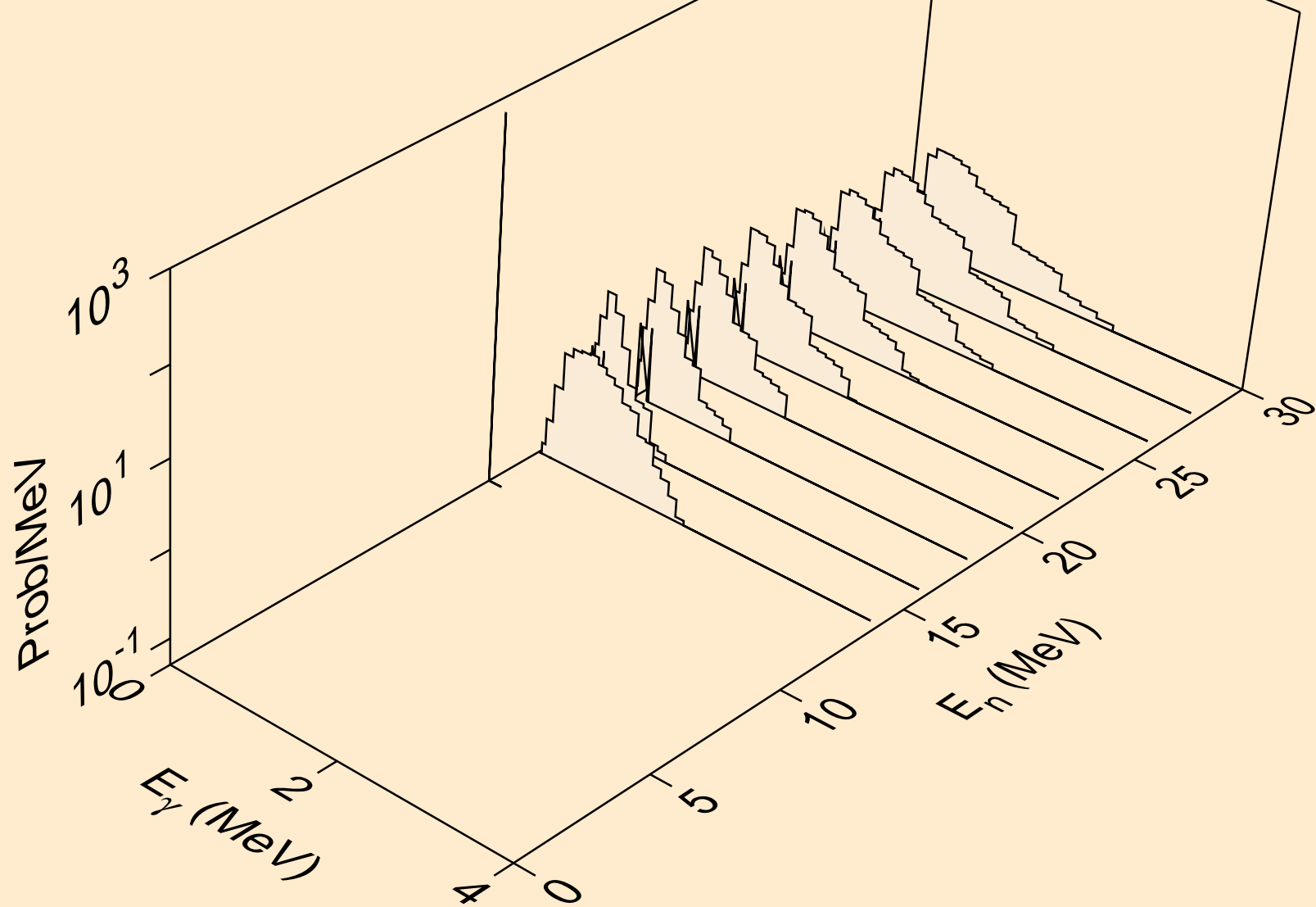

HF186 DEUTERON ACER TENDL-2021 LIBRARY; T=0.K
Photon emission for (n,gma)

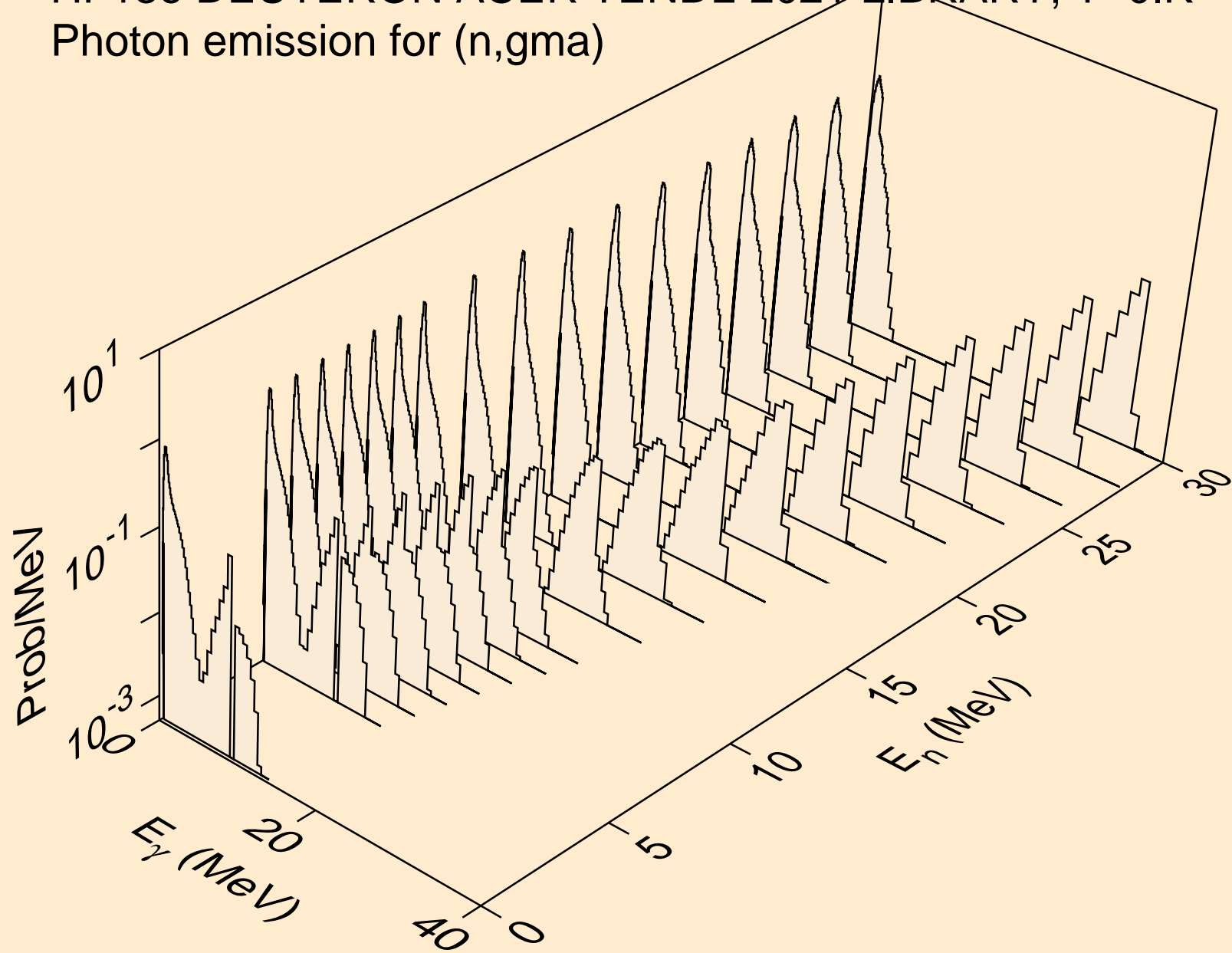

HF186 DEUTERON ACER TENDL-2021 LIBRARY; T=0.K
Photon emission for (n,p)

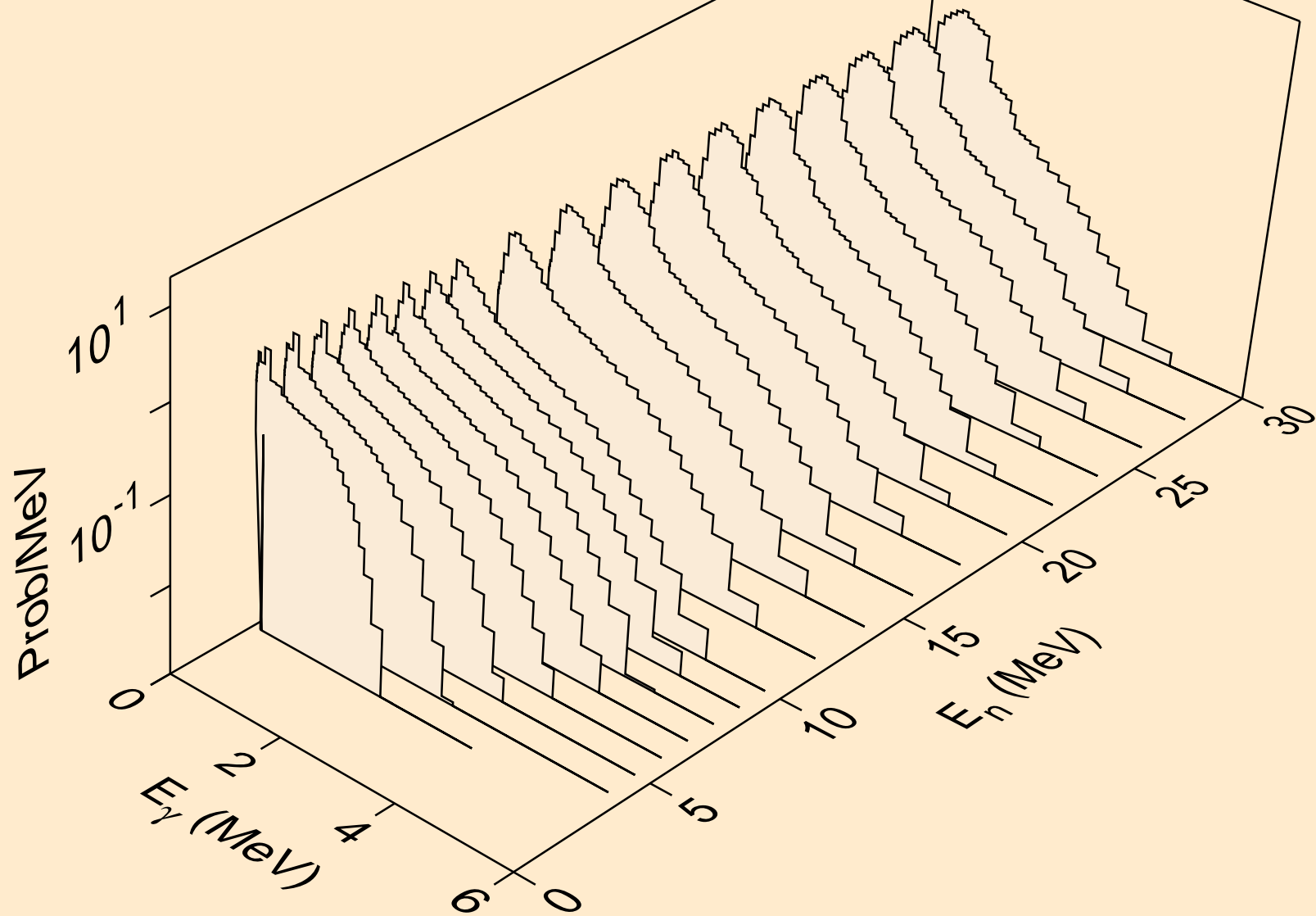

HF186 DEUTERON ACER TENDL-2021 LIBRARY; T=0.K
Photon emission for inelastic

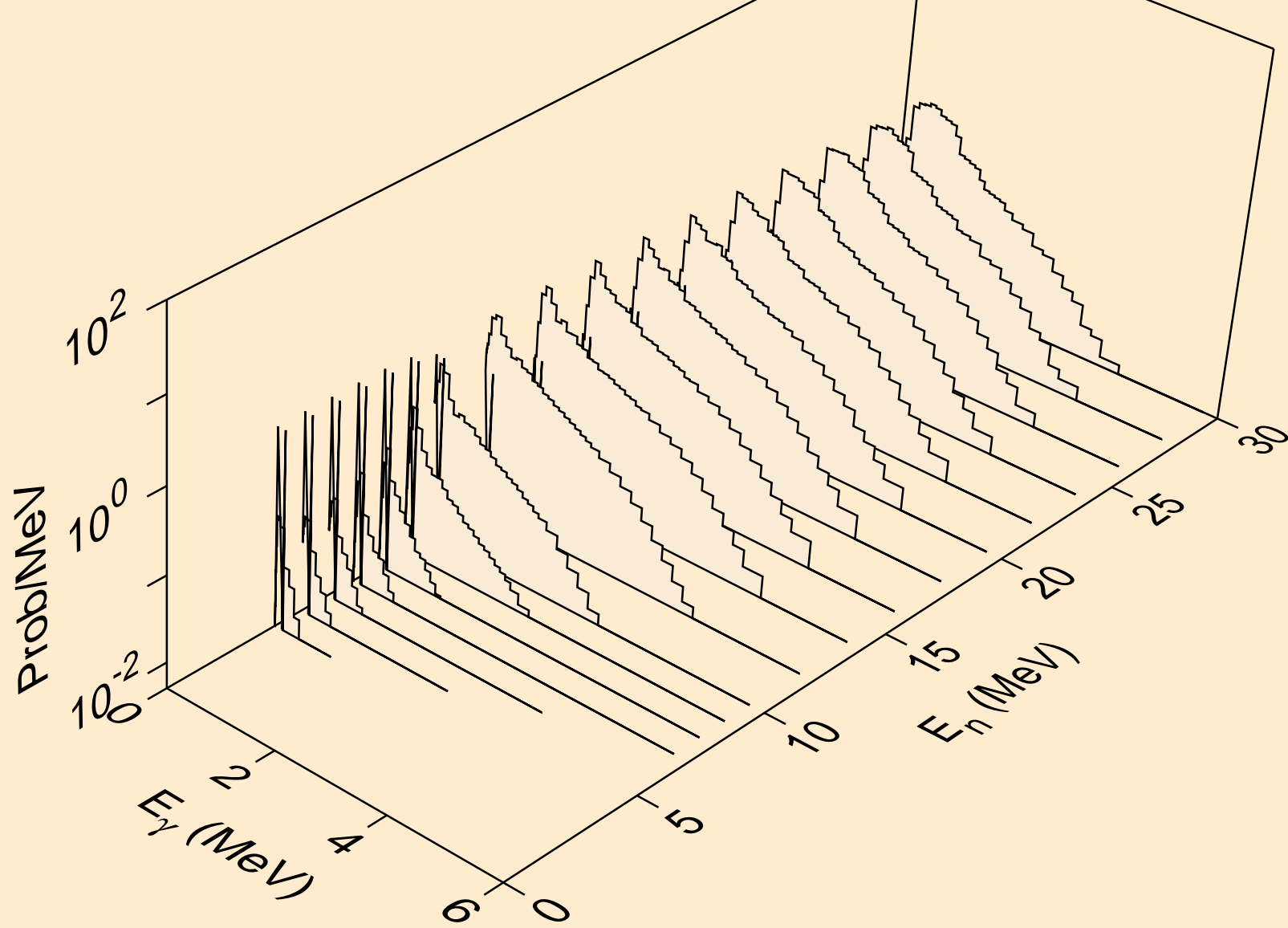

HF186 DEUTERON ACER TENDL-2021 LIBRARY; T=0.K
Photon emission for (n,t)

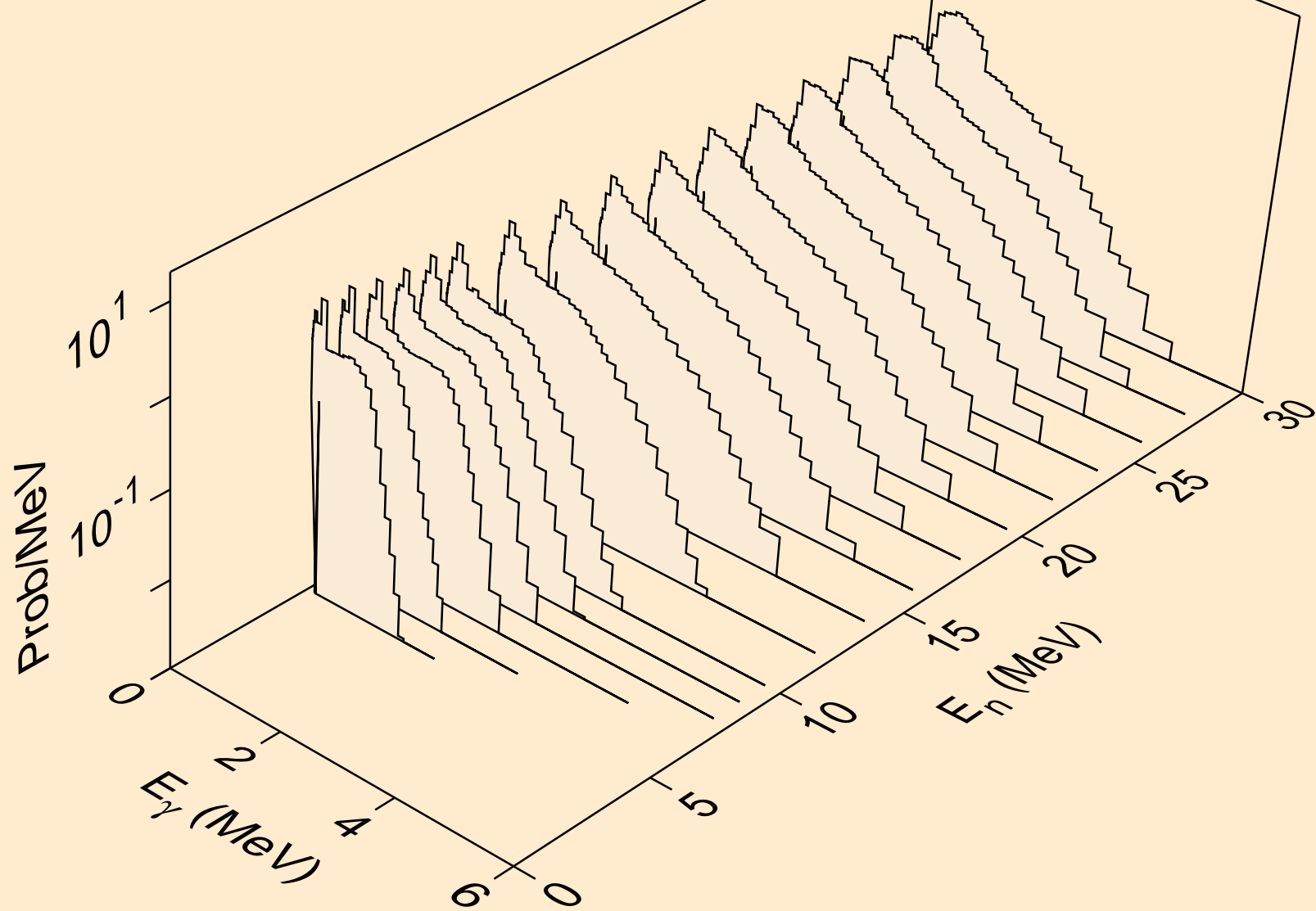

HF186 DEUTERON ACER TENDL-2021 LIBRARY; T=0.K
Photon emission for (n,he3)

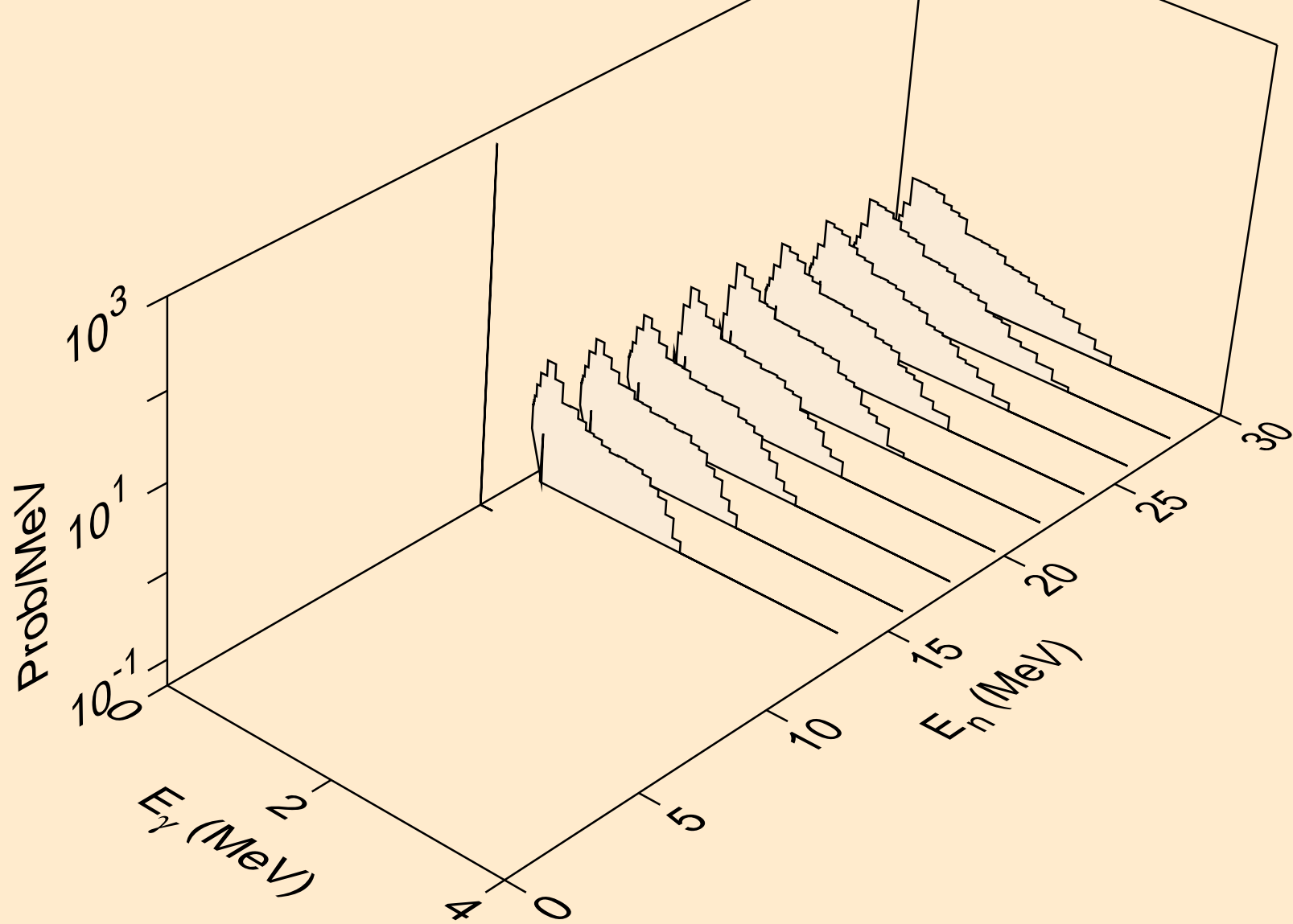

HF186 DEUTERON ACER TENDL-2021 LIBRARY; T=0.K
Photon emission for (n,a)

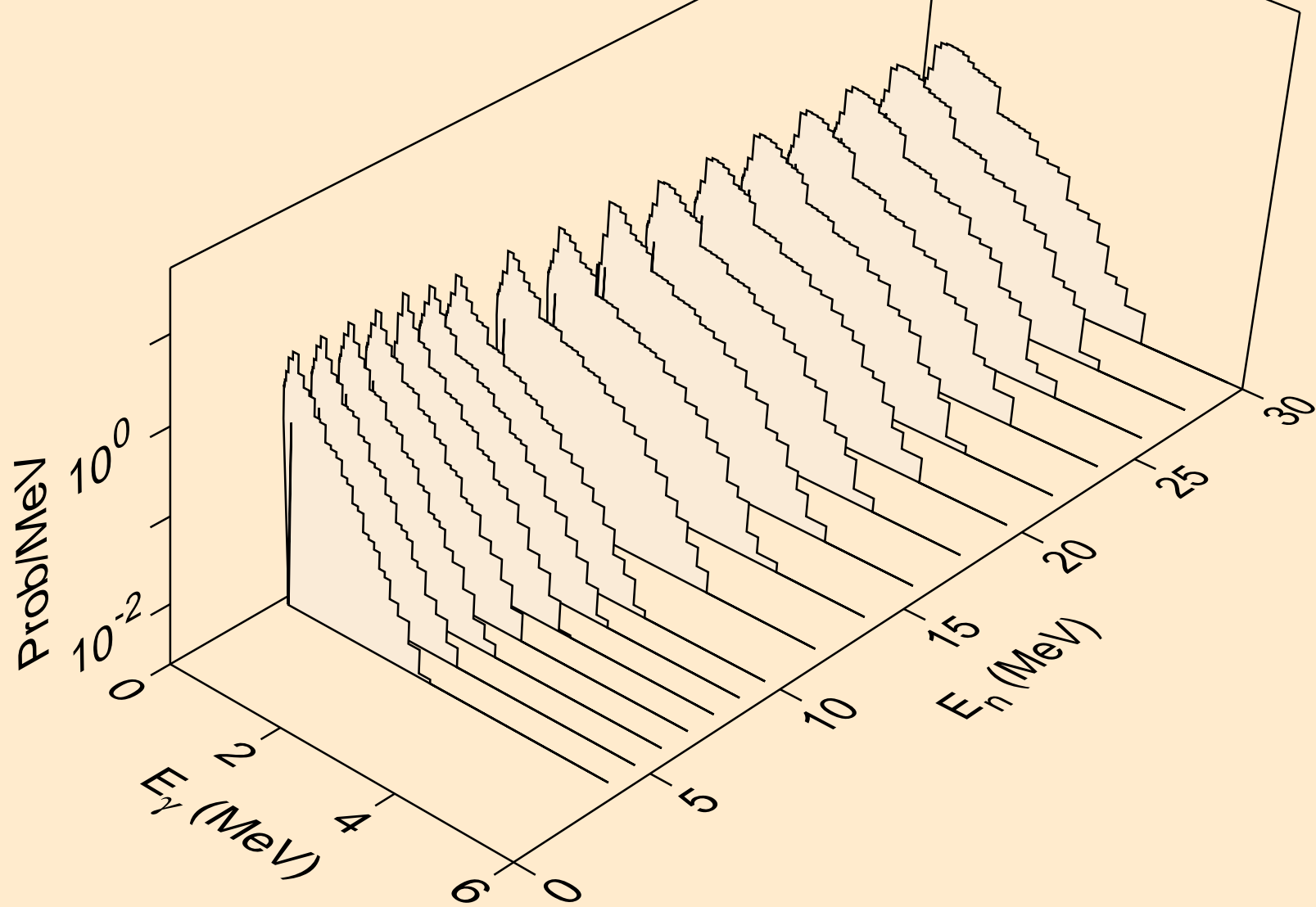

HF186 DEUTERON ACER TENDL-2021 LIBRARY; T=0.K
Photon emission for (n,2p)

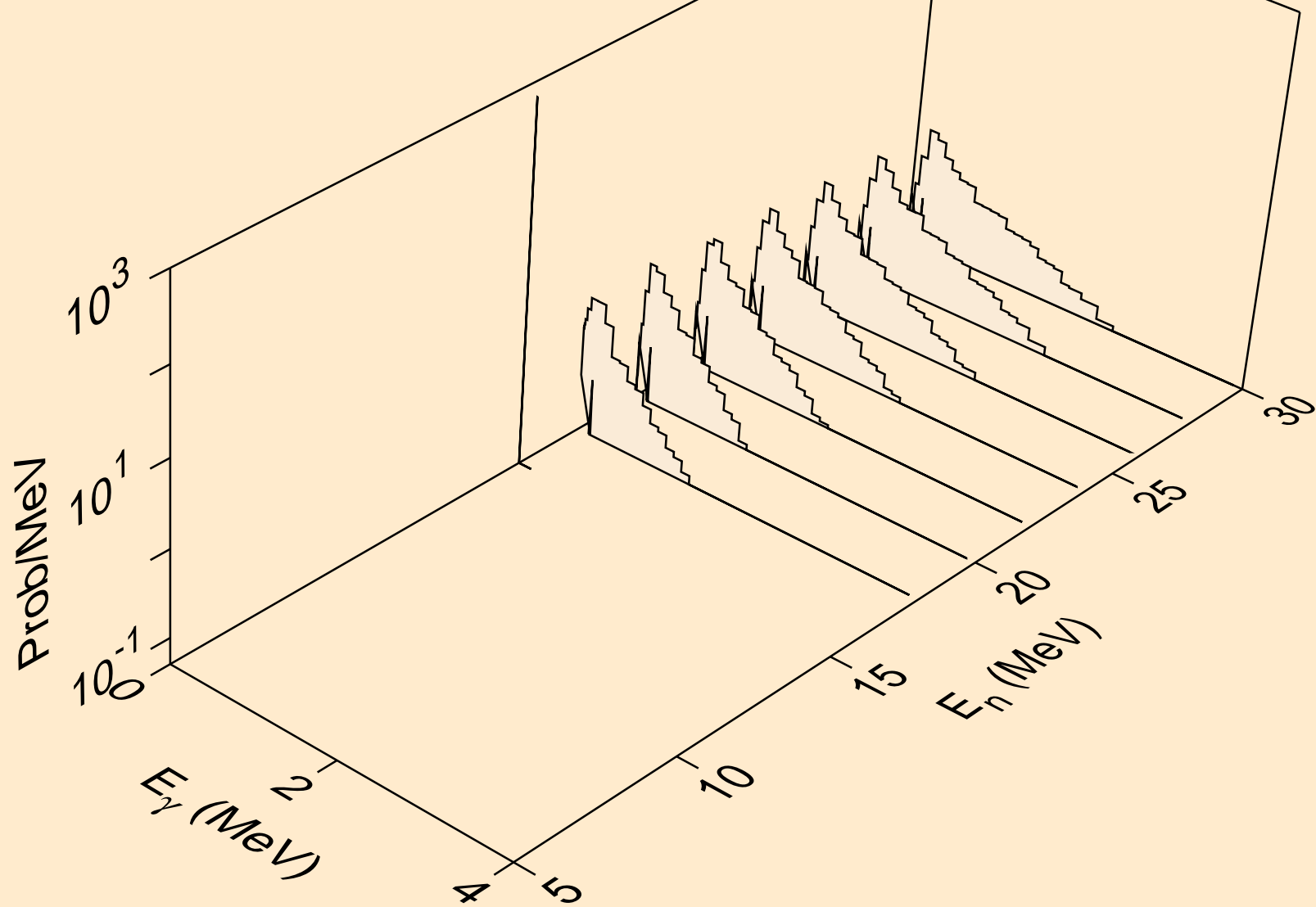

HF186 DEUTERON ACER TENDL-2021 LIBRARY; T=0.K
Photon emission for (n,p)

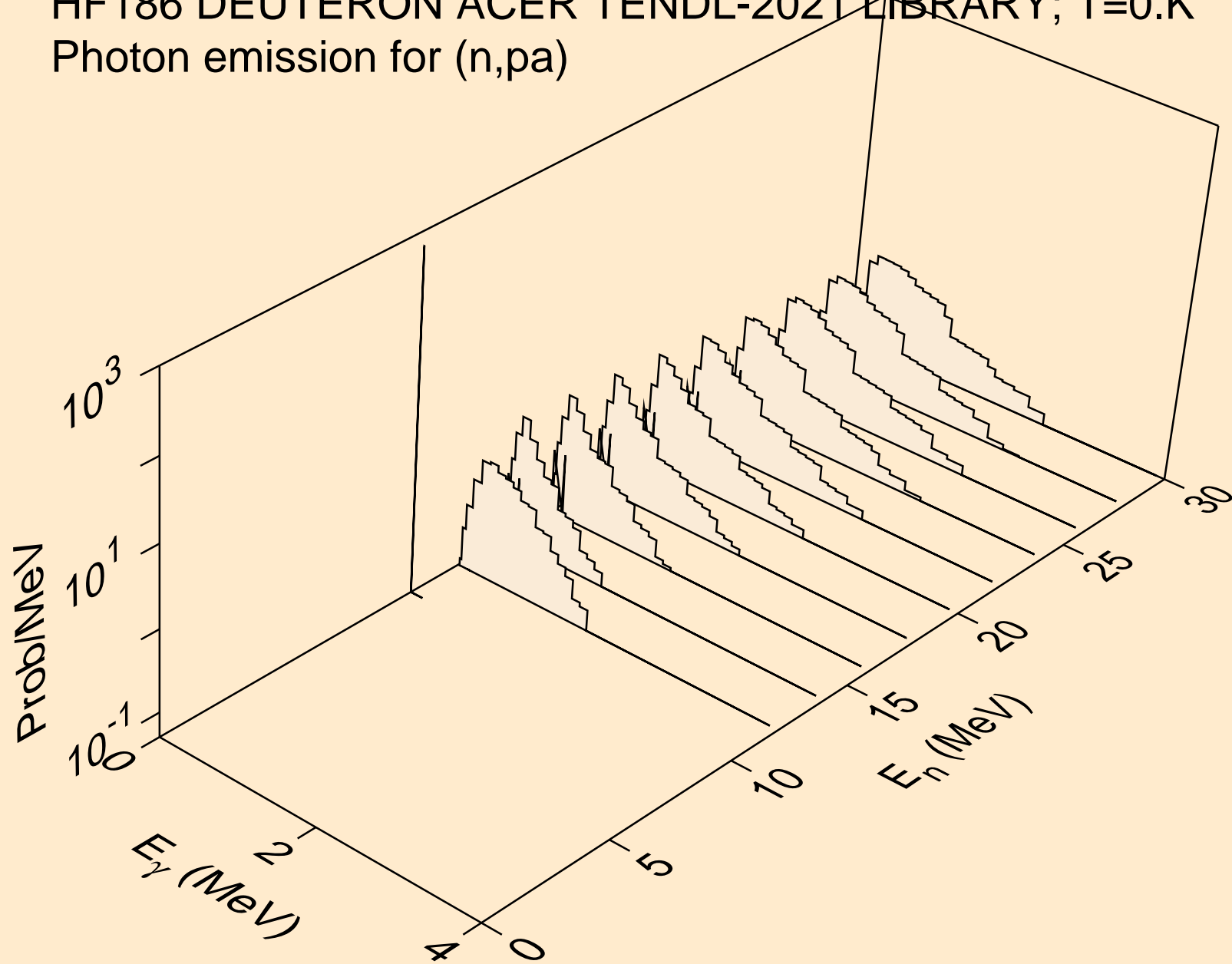

HF186 DEUTERON ACER TENDL-2021 LIBRARY; T=0.K
Photon emission for (n,pd)

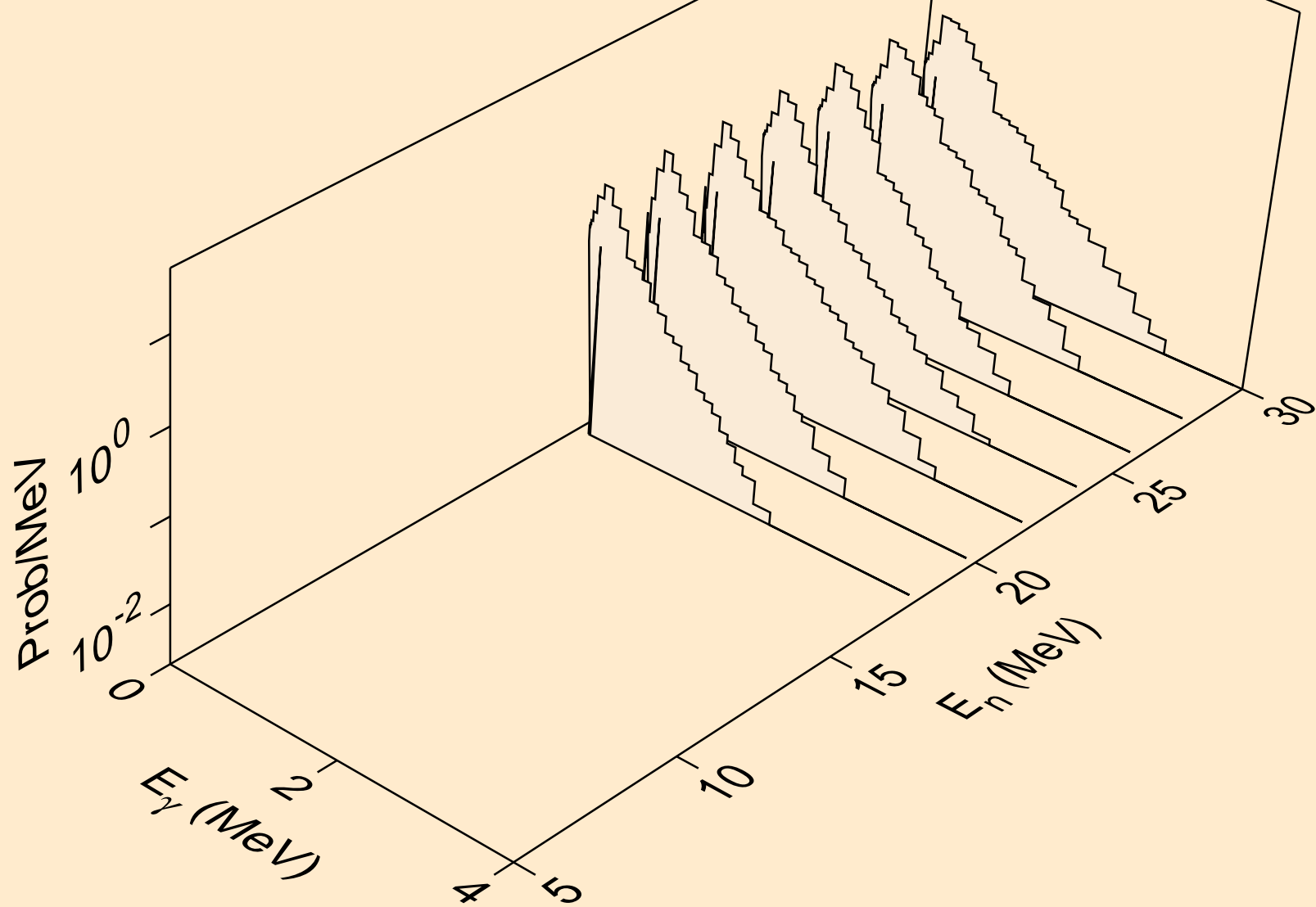

HF186 DEUTERON ACER TENDL-2021 LIBRARY; T=0.K

Particle heating contributions

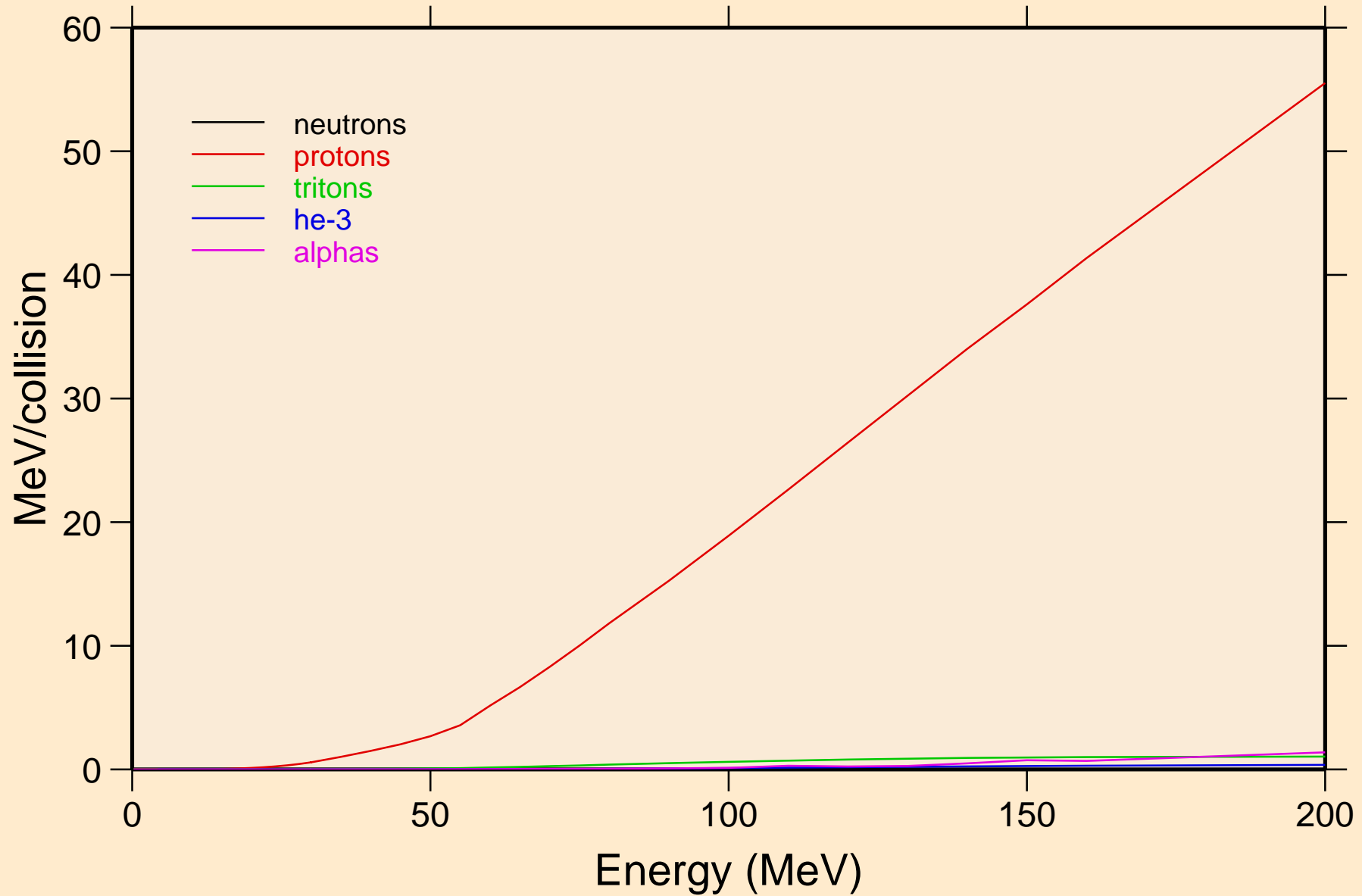

HF186 DEUTERON ACER TENDL-2021 LIBRARY; T=0.K
Recoil Heating

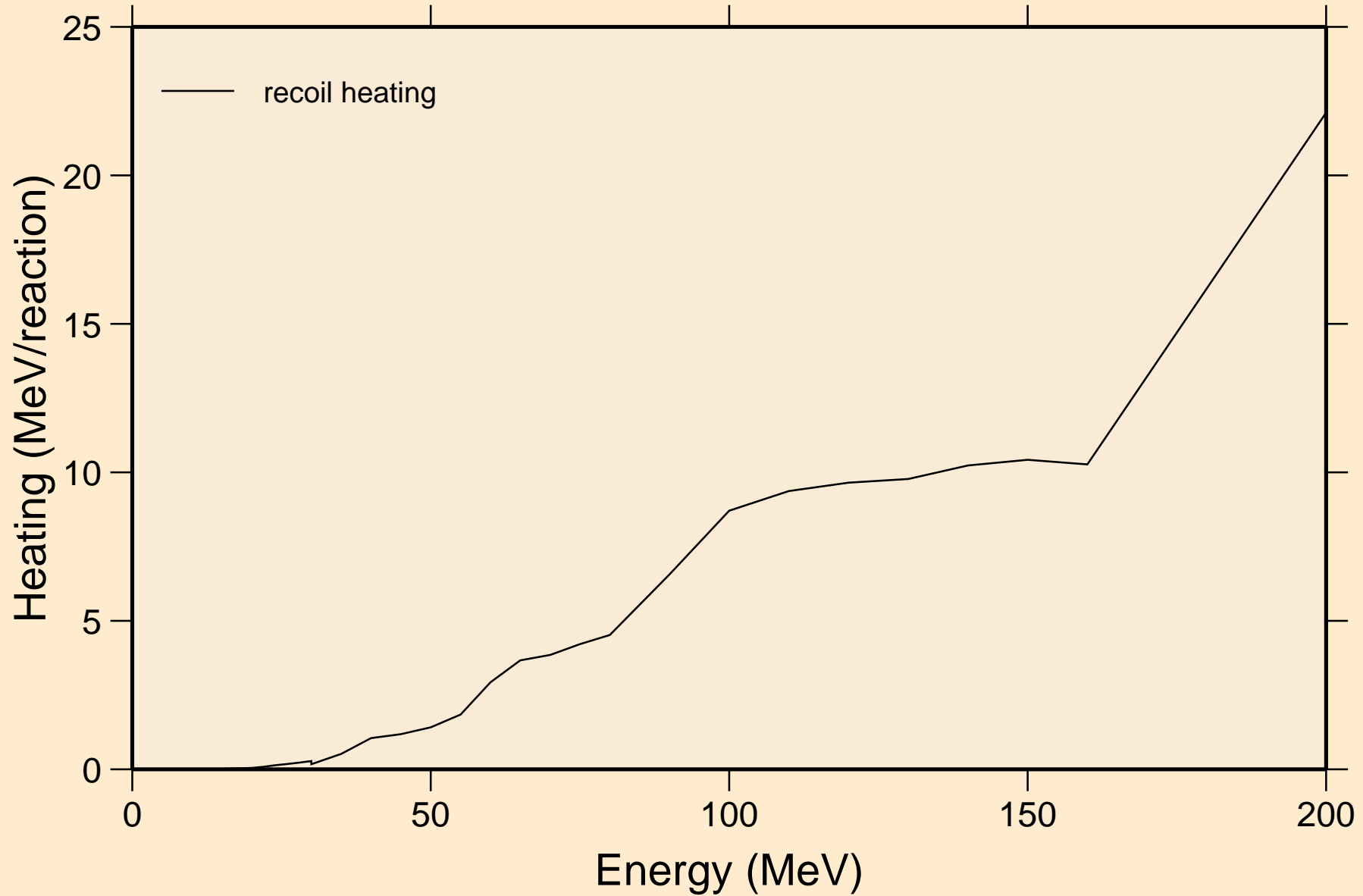

HF186 DEUTERON ACER TENDL-2021 LIBRARY; T=0.K

Particle production cross sections

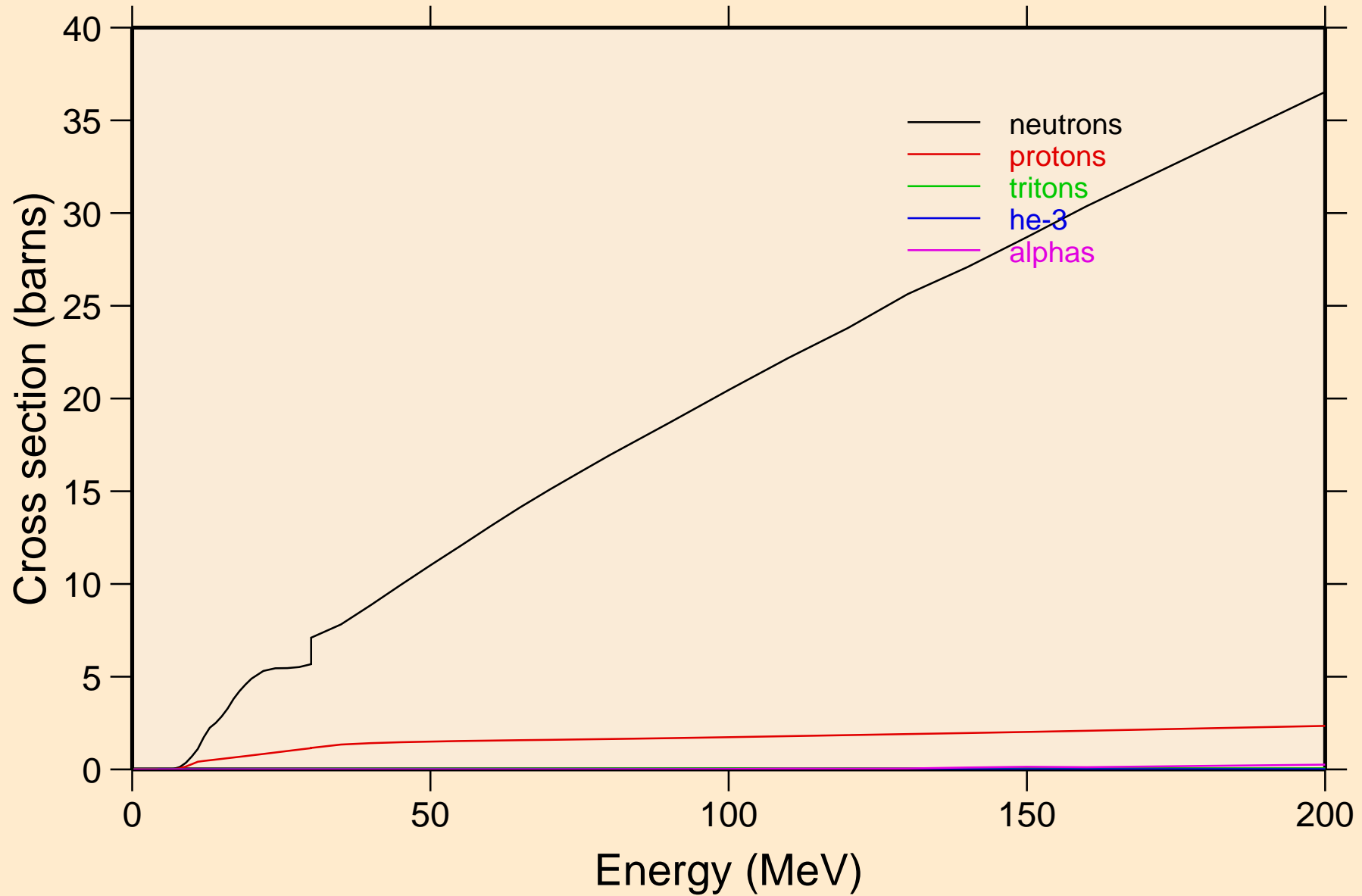

HF186 DEUTERON ACER TENDL-2021 LIBRARY; T=0.K
neutrons from (d,n)

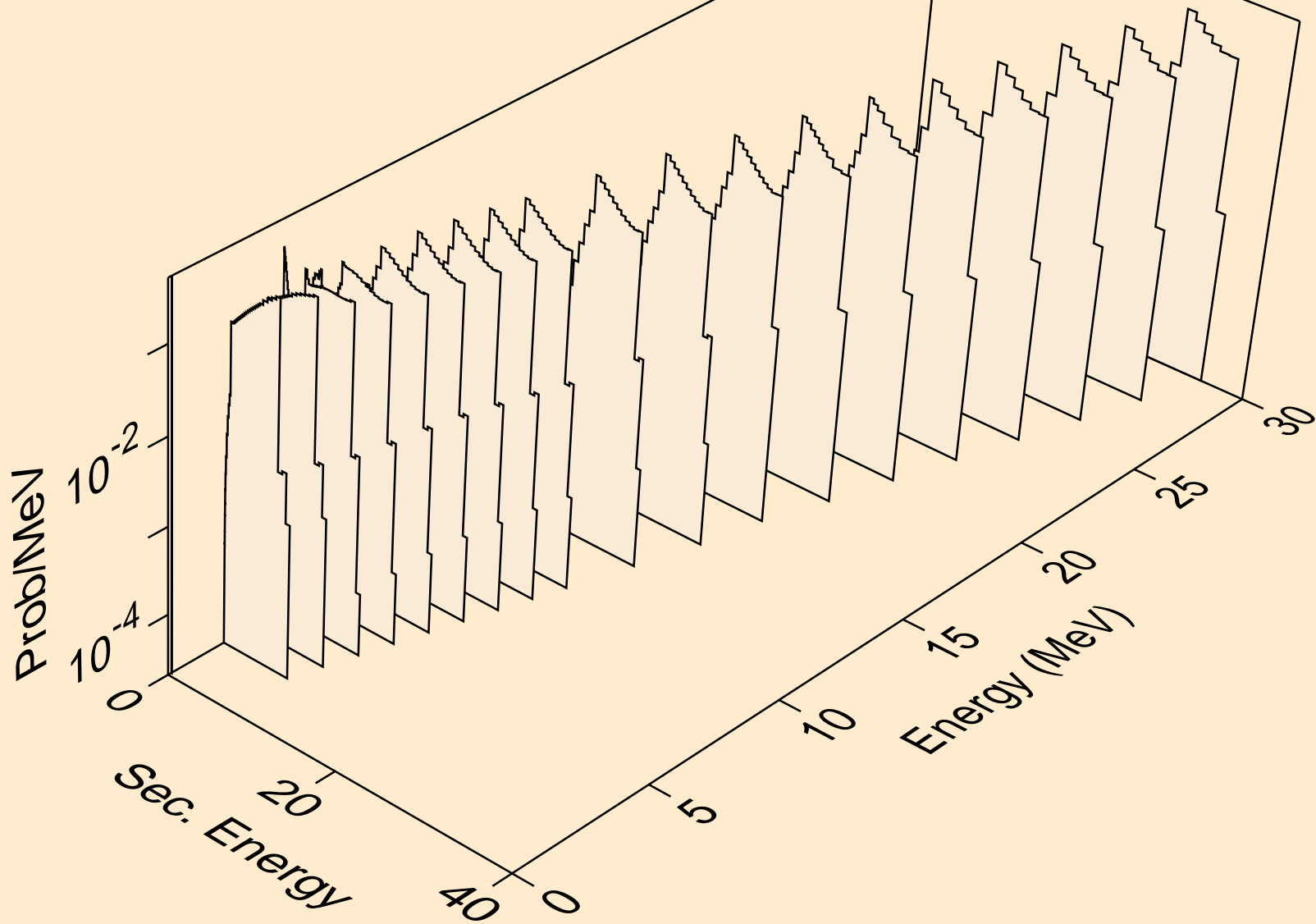

HF186 DEUTERON ACER TENDL-2021 LIBRARY; T=0.K
neutrons from (d,x)

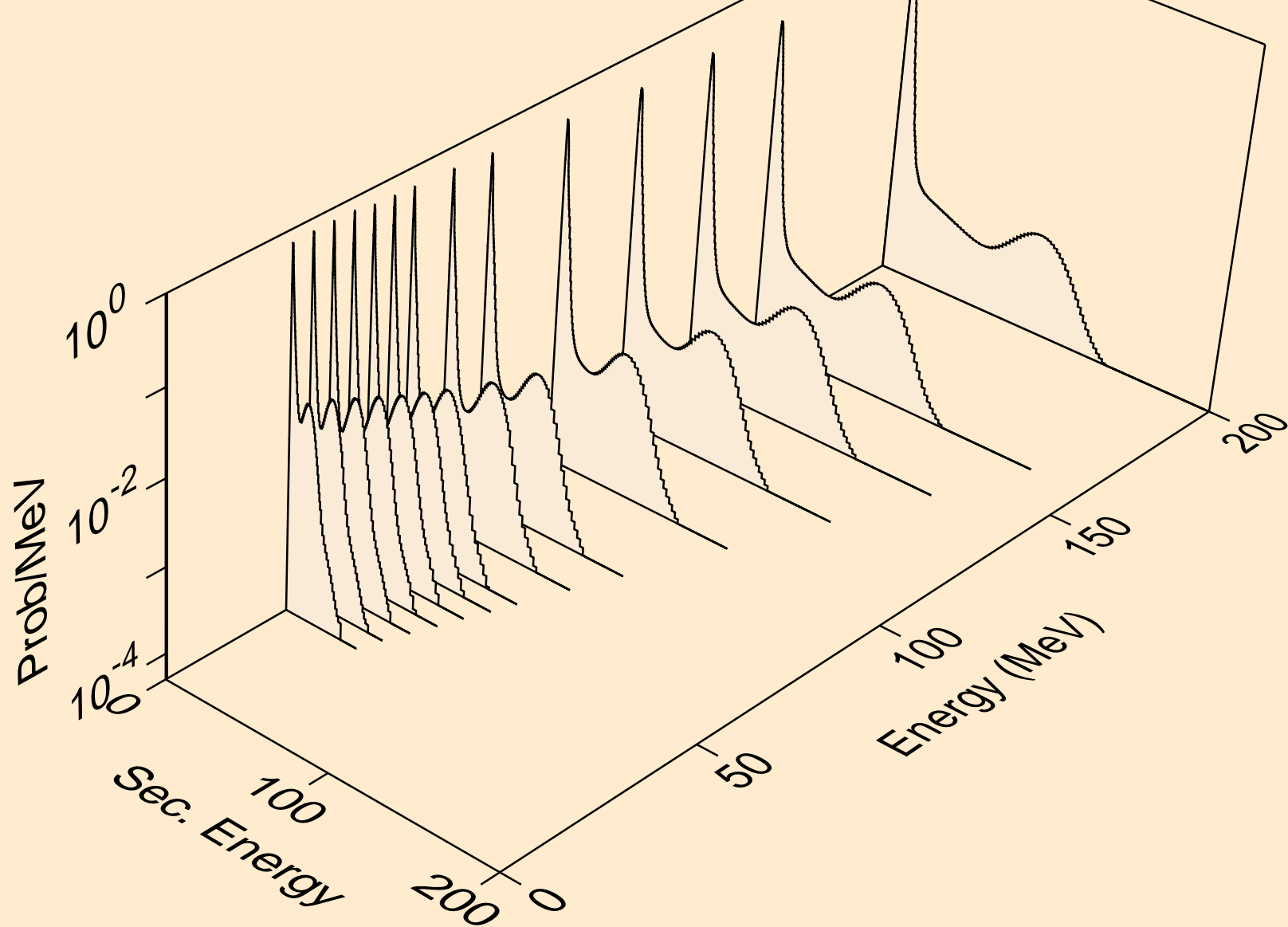

HF186 DEUTERON ACER TENDL-2021 LIBRARY; T=0.K
neutrons from (d,2nd)

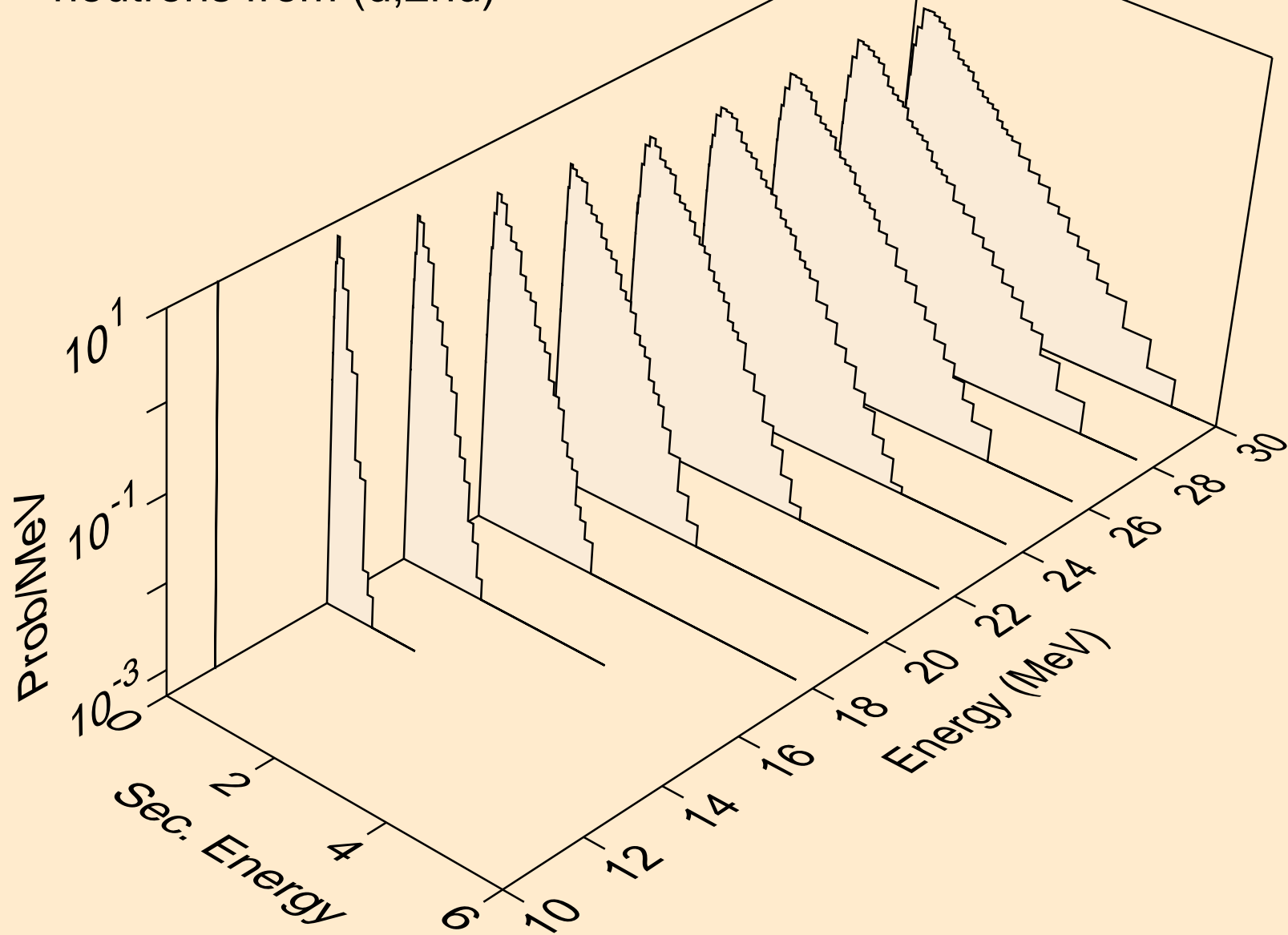

HF186 DEUTERON ACER TENDL-2021 LIBRARY; T=0.K
neutrons from (d,2n)

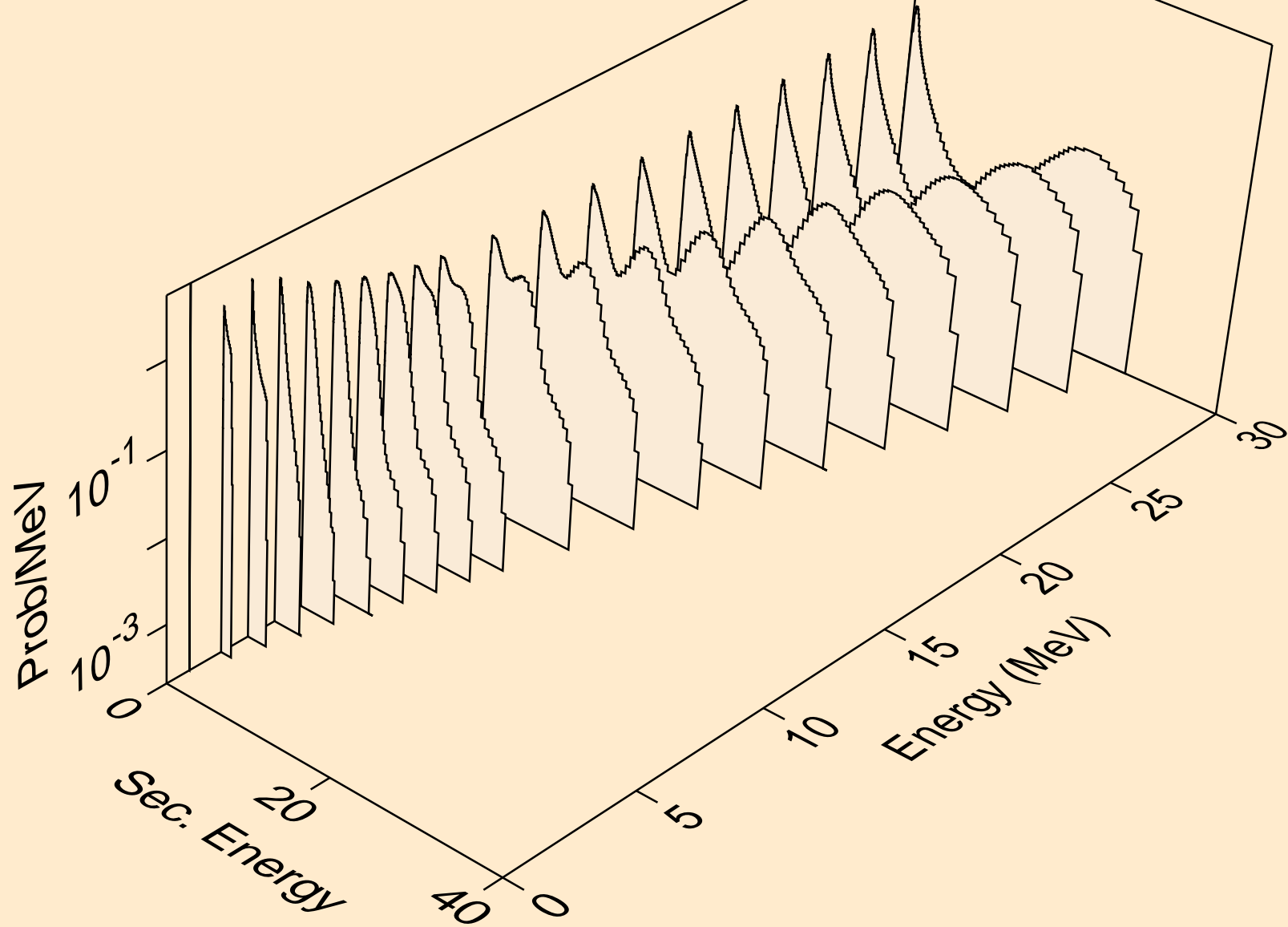

HF186 DEUTERON ACER TENDL-2021 LIBRARY; T=0.K
neutrons from (d,3n)

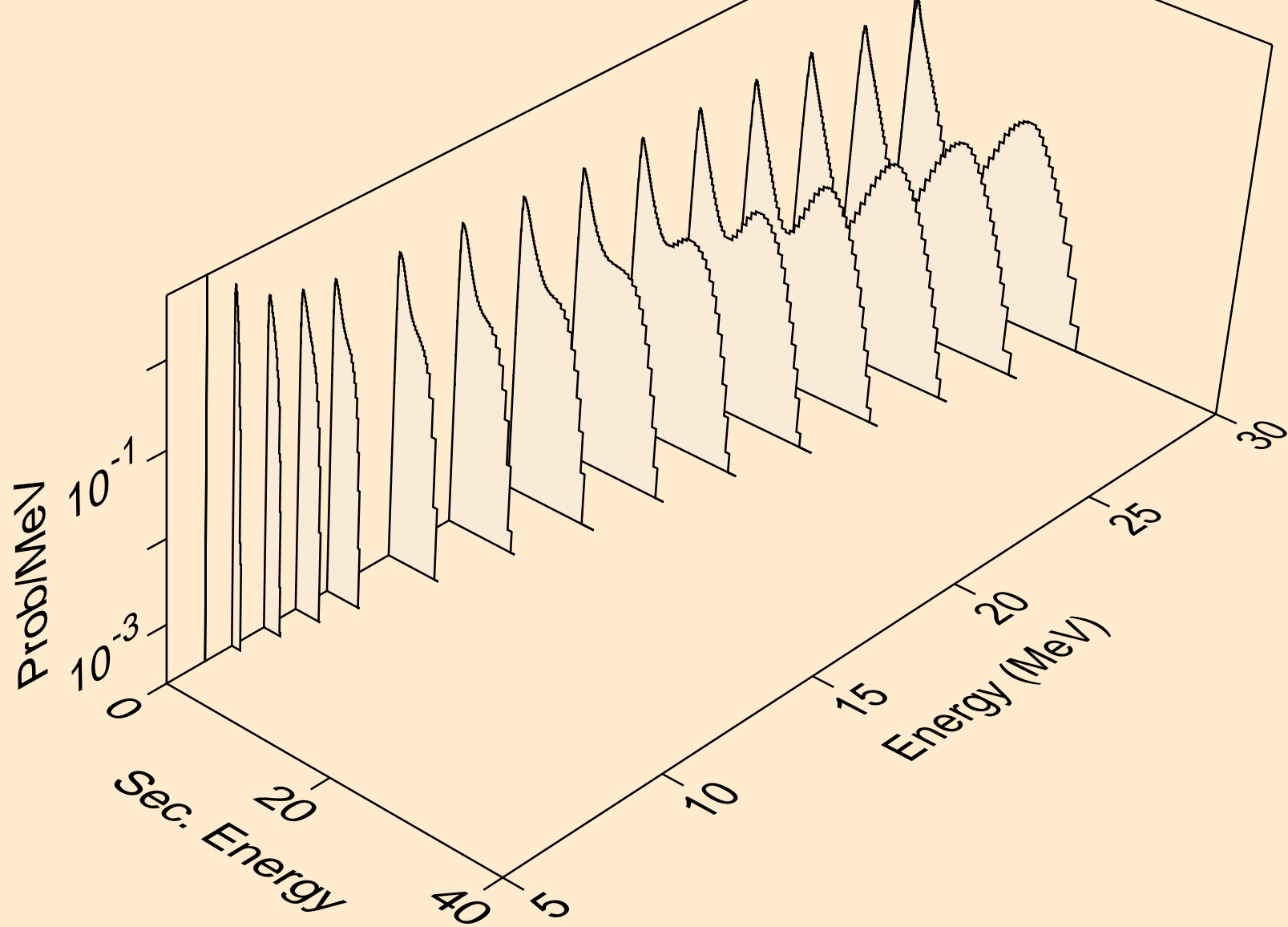

HF186 DEUTERON ACER TENDL-2021 LIBRARY; T=0.K
neutrons from (d,n*)a

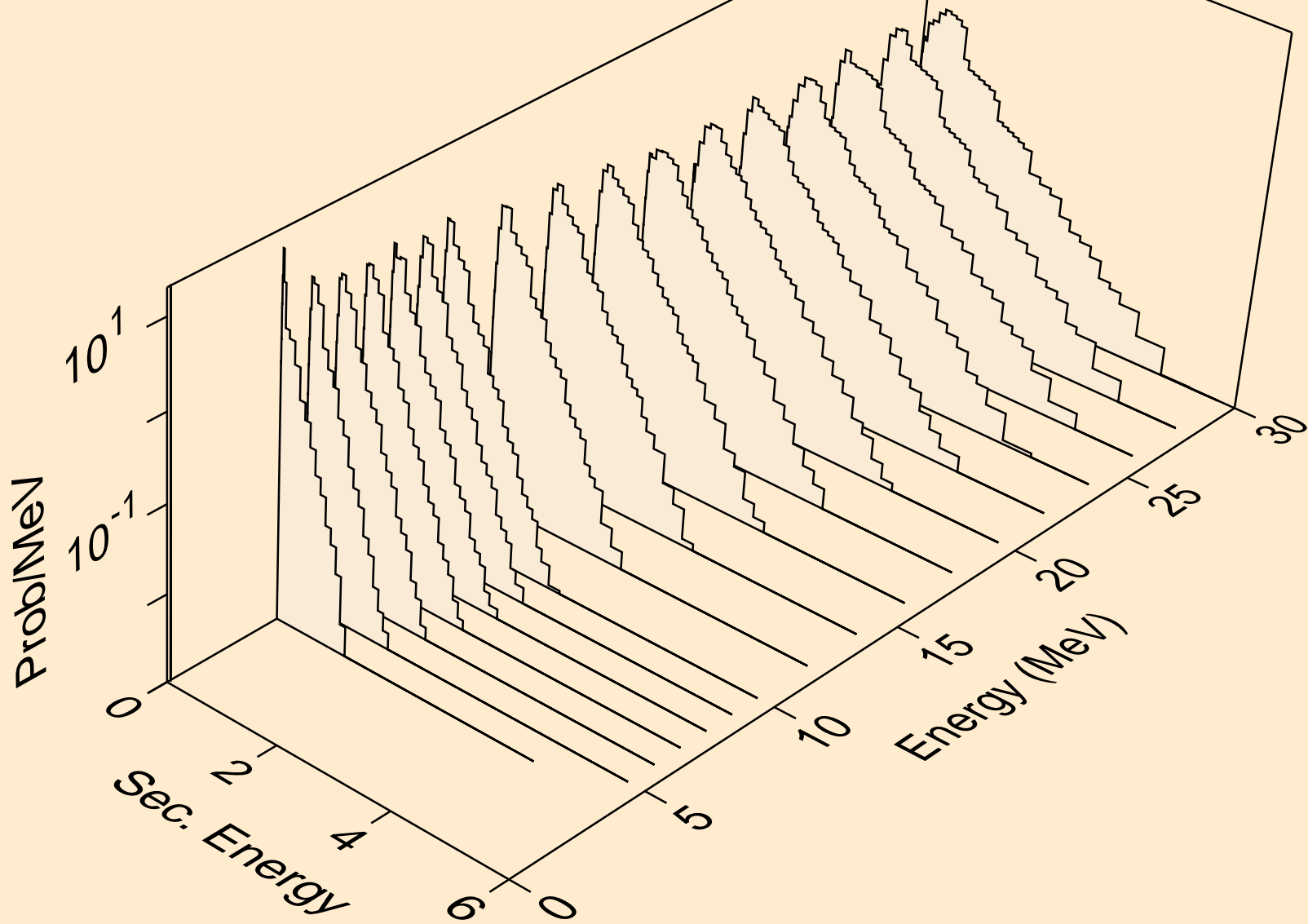

HF186 DEUTERON ACER TENDL-2021 LIBRARY; T=0.K
neutrons from (d,2n)a

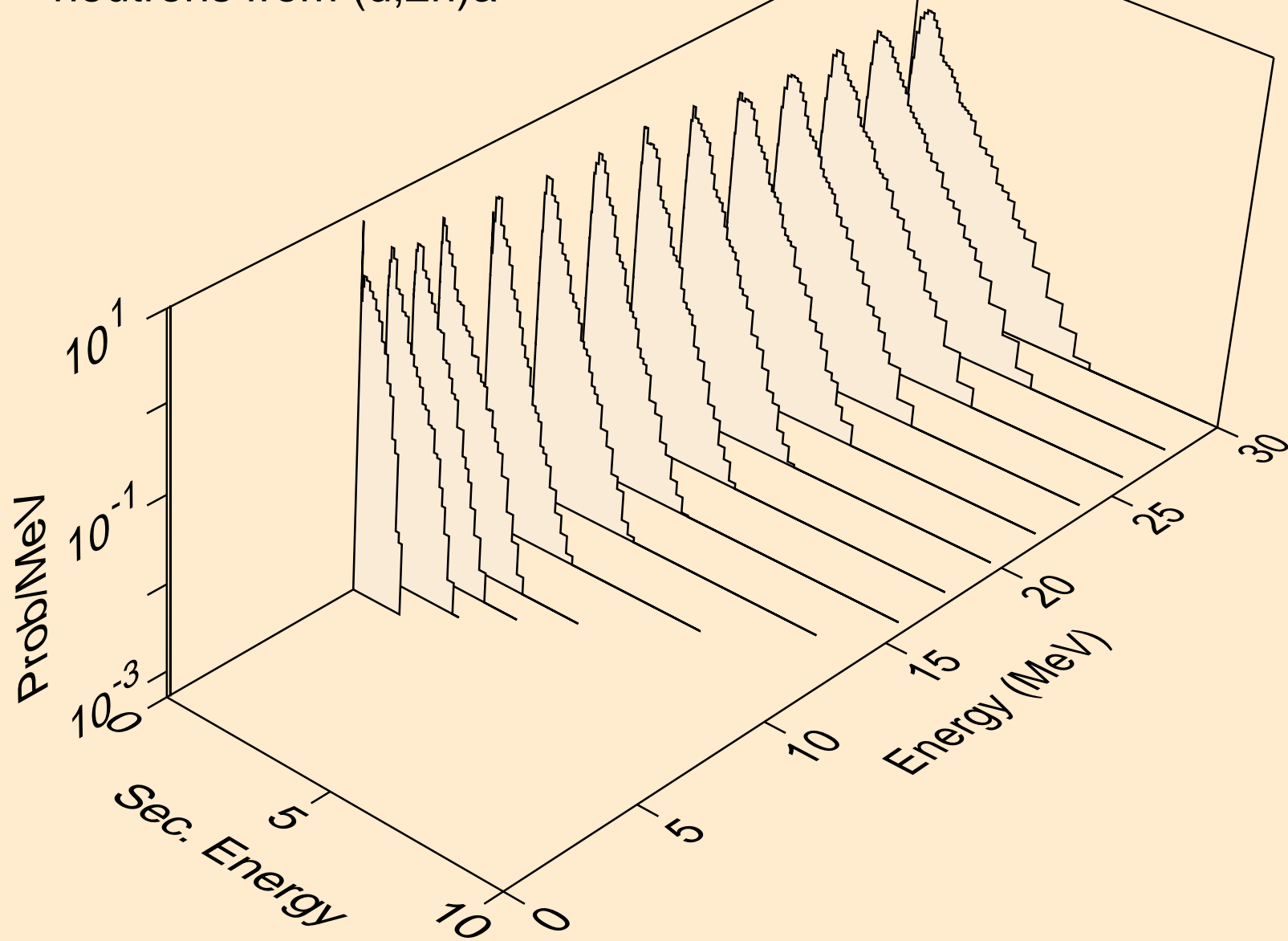

HF186 DEUTERON ACER TENDL-2021 LIBRARY; T=0.K
neutrons from (d,3n)a

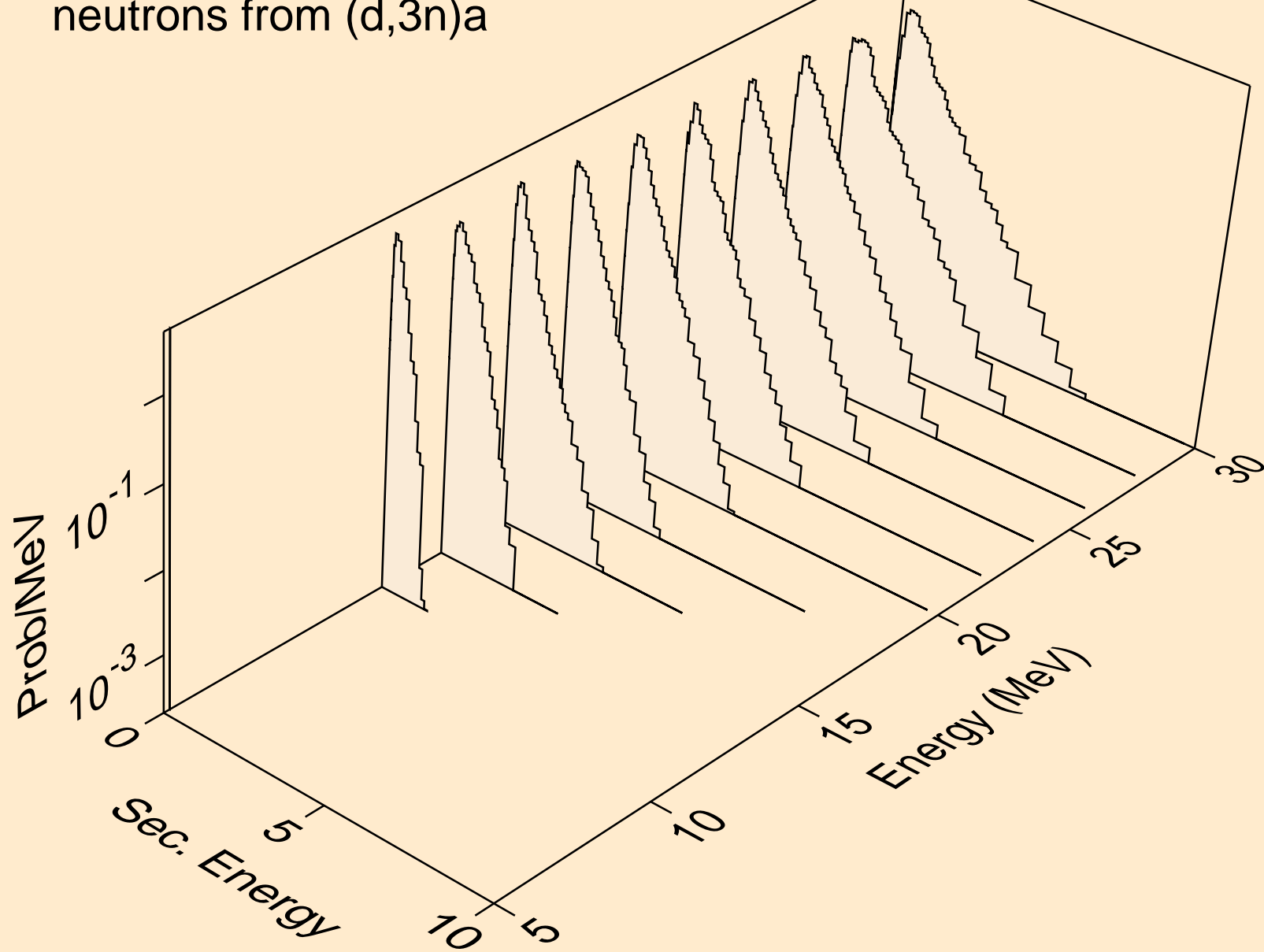

HF186 DEUTERON ACER TENDL-2021 LIBRARY; T=0.K
neutrons from (d,n*)p

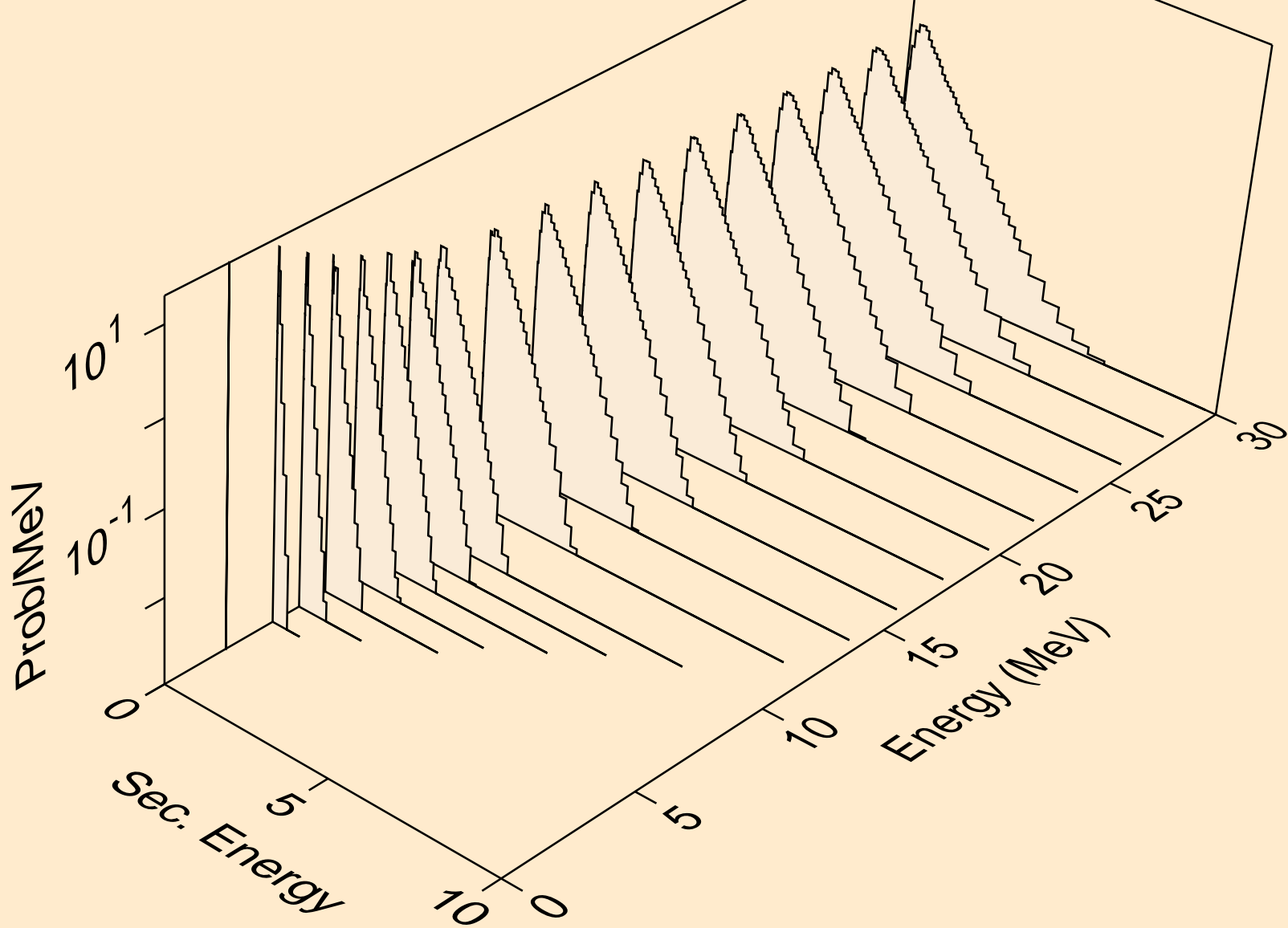

HF186 DEUTERON ACER TENDL-2021 LIBRARY; T=0.K
neutrons from (d,n*)d

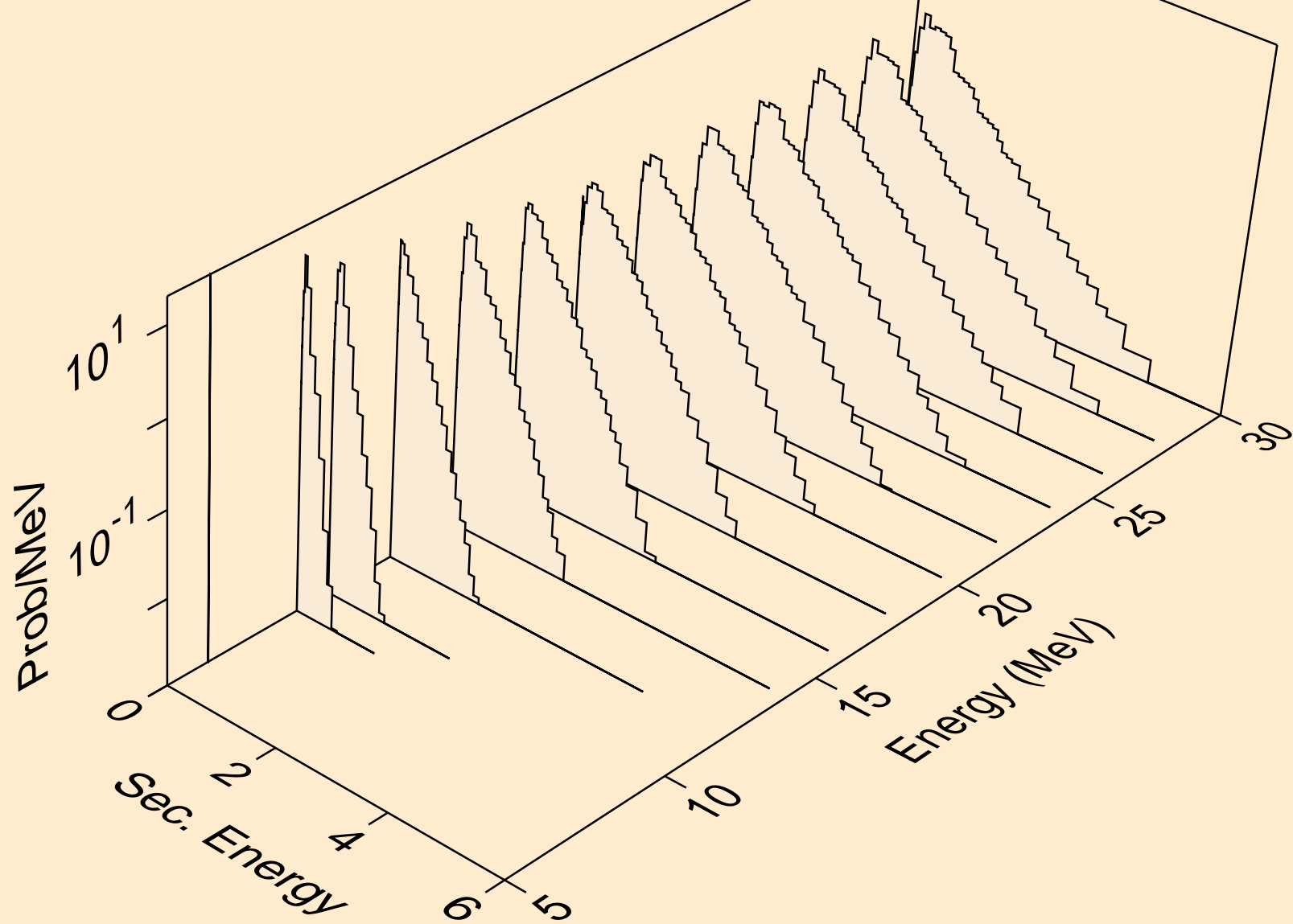

HF186 DEUTERON ACER TENDL-2021 LIBRARY; T=0.K
neutrons from (d,n*)t

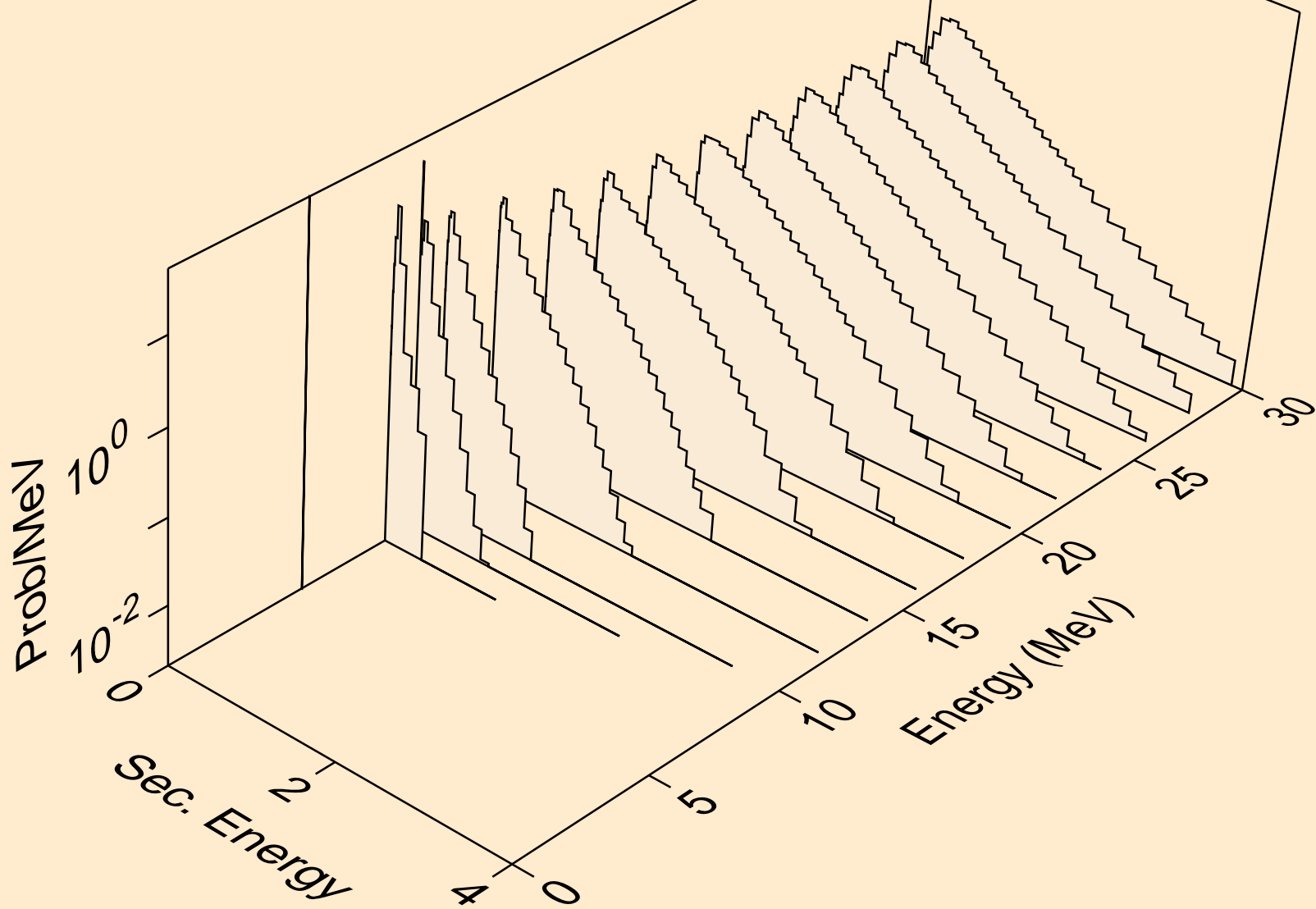

HF186 DEUTERON ACER TENDL-2021 LIBRARY; T=0.K
neutrons from (d,n*)he3

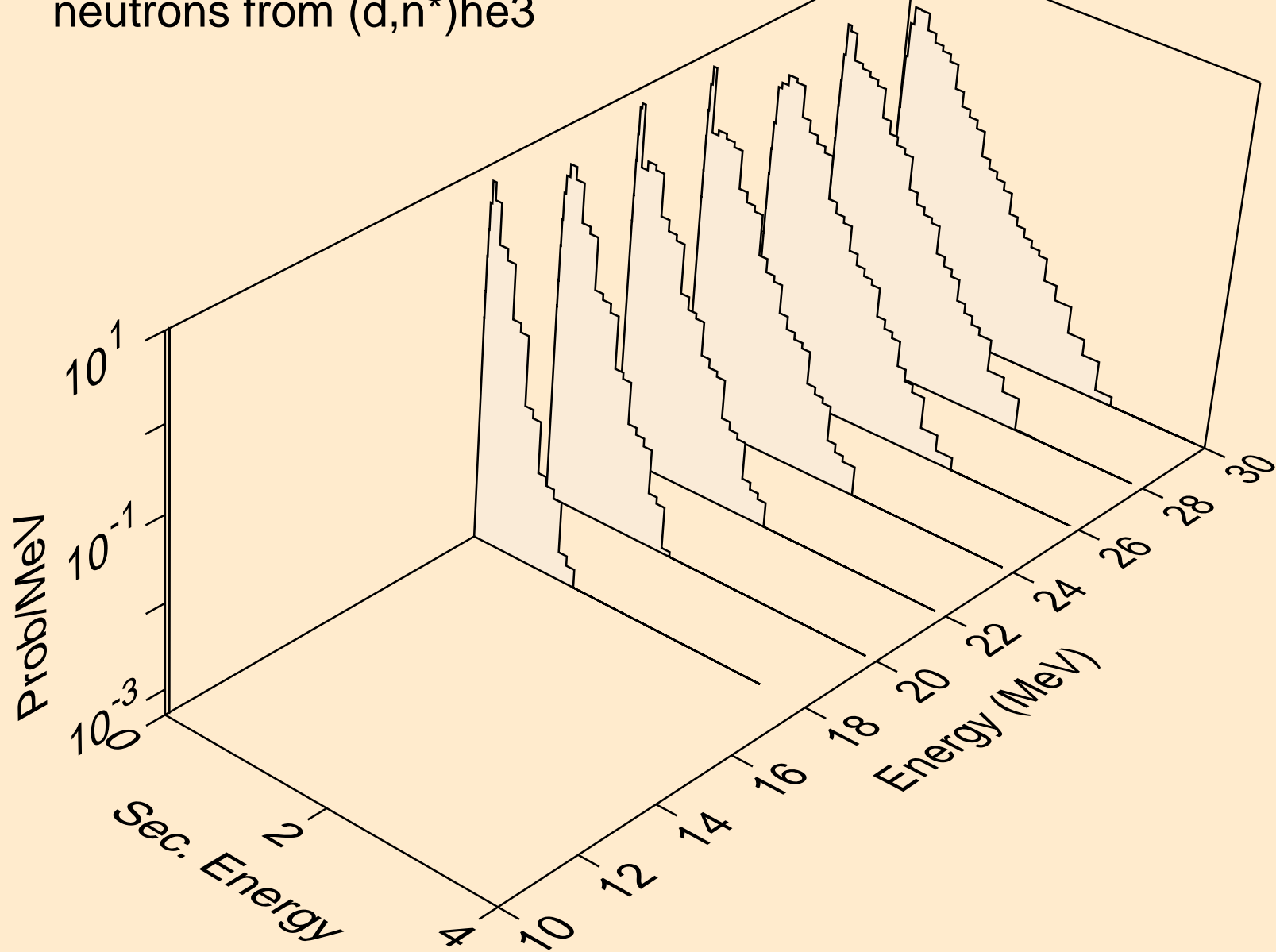

HF186 DEUTERON ACER TENDL-2021 LIBRARY; T=0.K
neutrons from (d,4n)

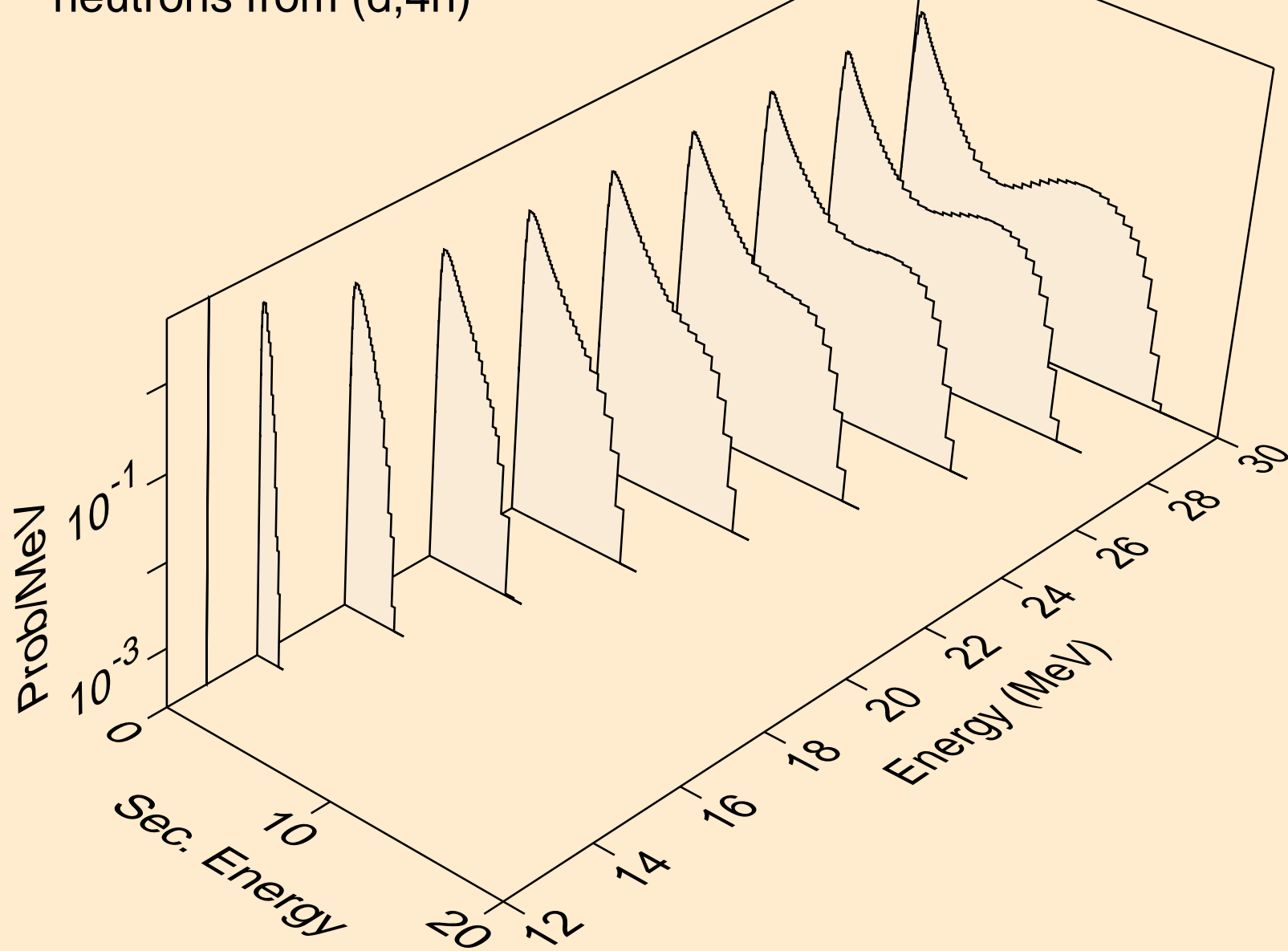

HF186 DEUTERON ACER TENDL-2021 LIBRARY; T=0.K
neutrons from (d,2np)

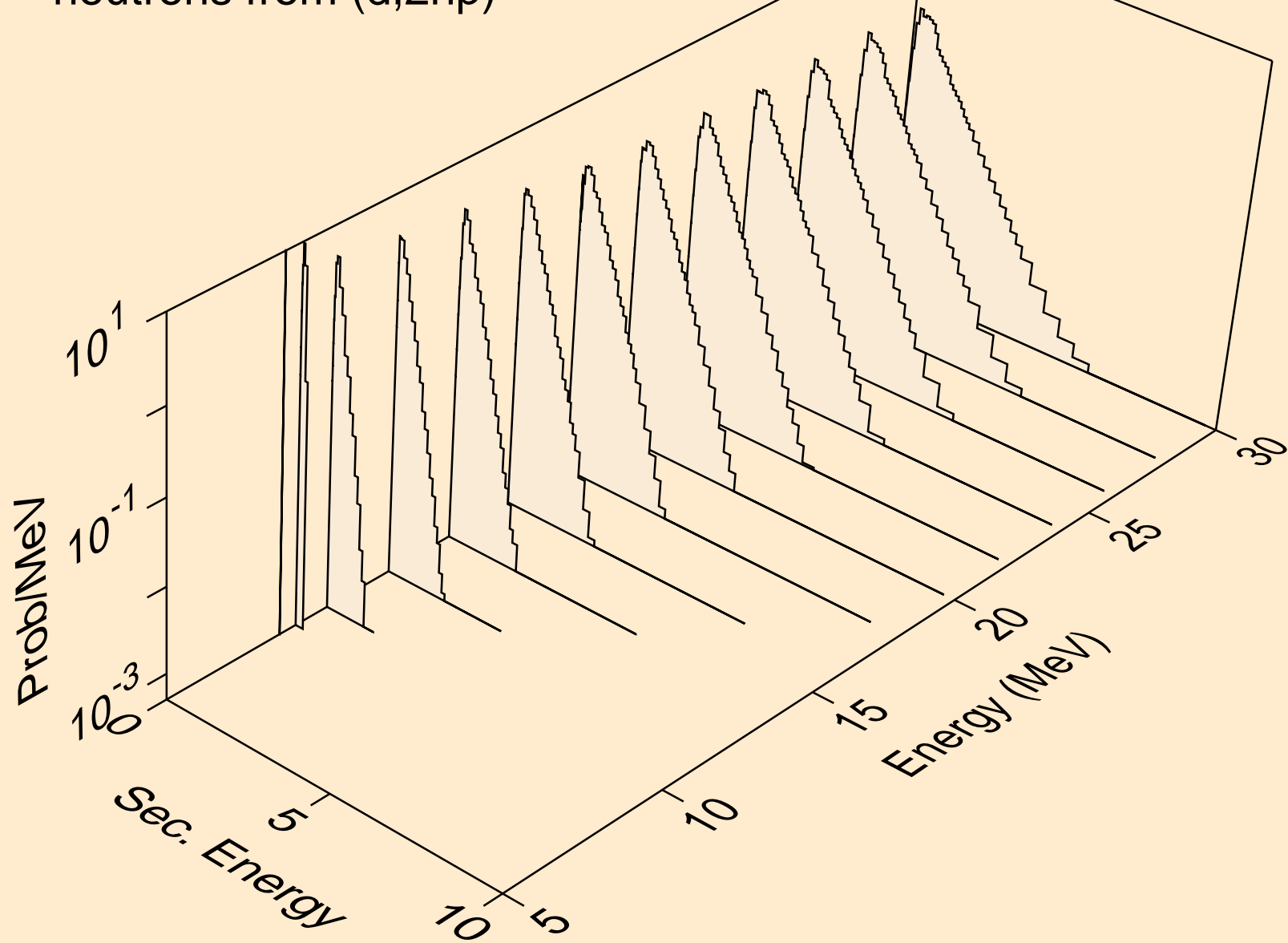

HF186 DEUTERON ACER TENDL-2021 LIBRARY; T=0.K
neutrons from (d,3np)

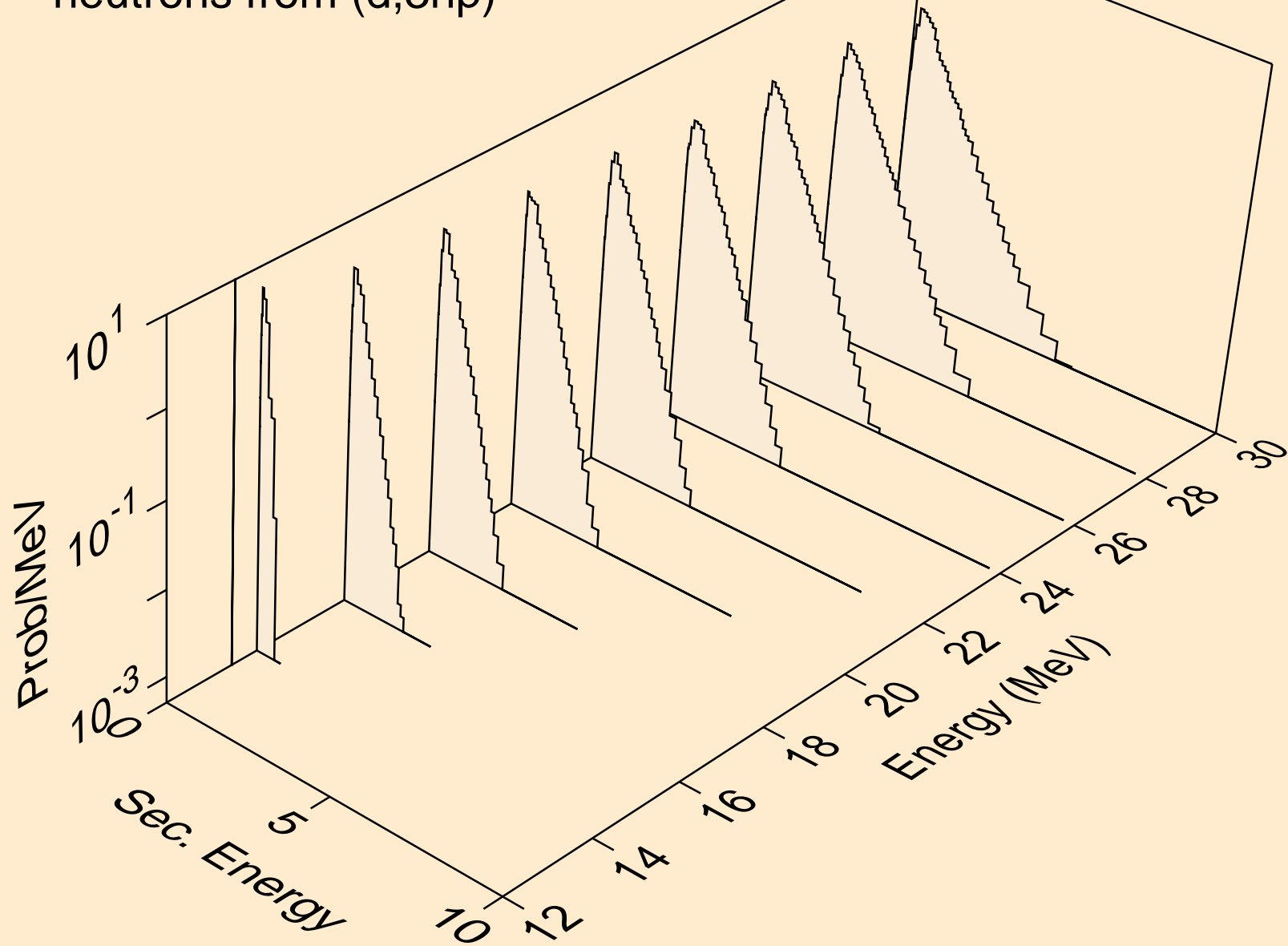

HF186 DEUTERON ACER TENDL-2021 LIBRARY; T=0.K
neutrons from (d,2np)

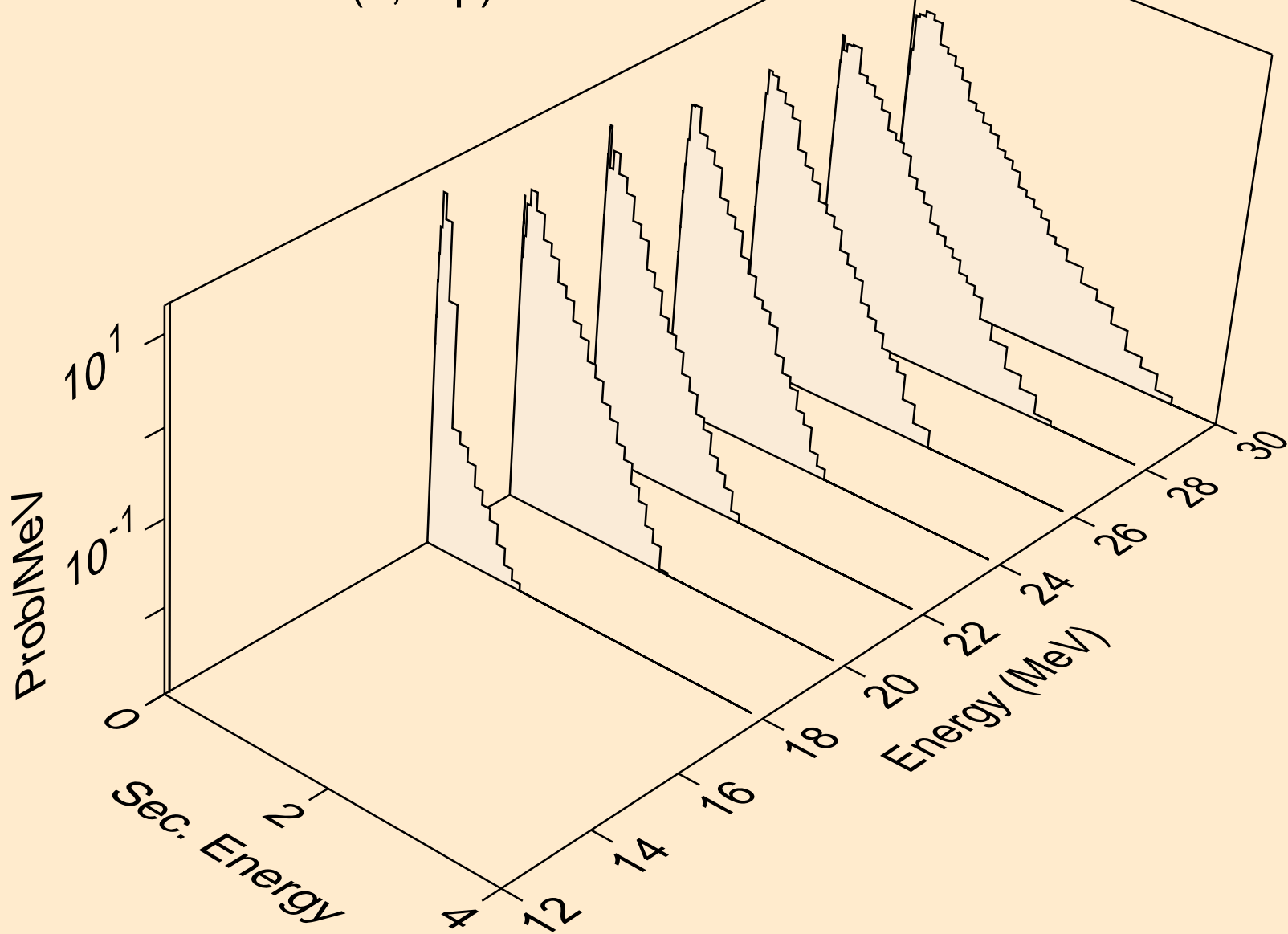

HF186 DEUTERON ACER TENDL-2021 LIBRARY; T=0.K
neutrons from (d,npa)

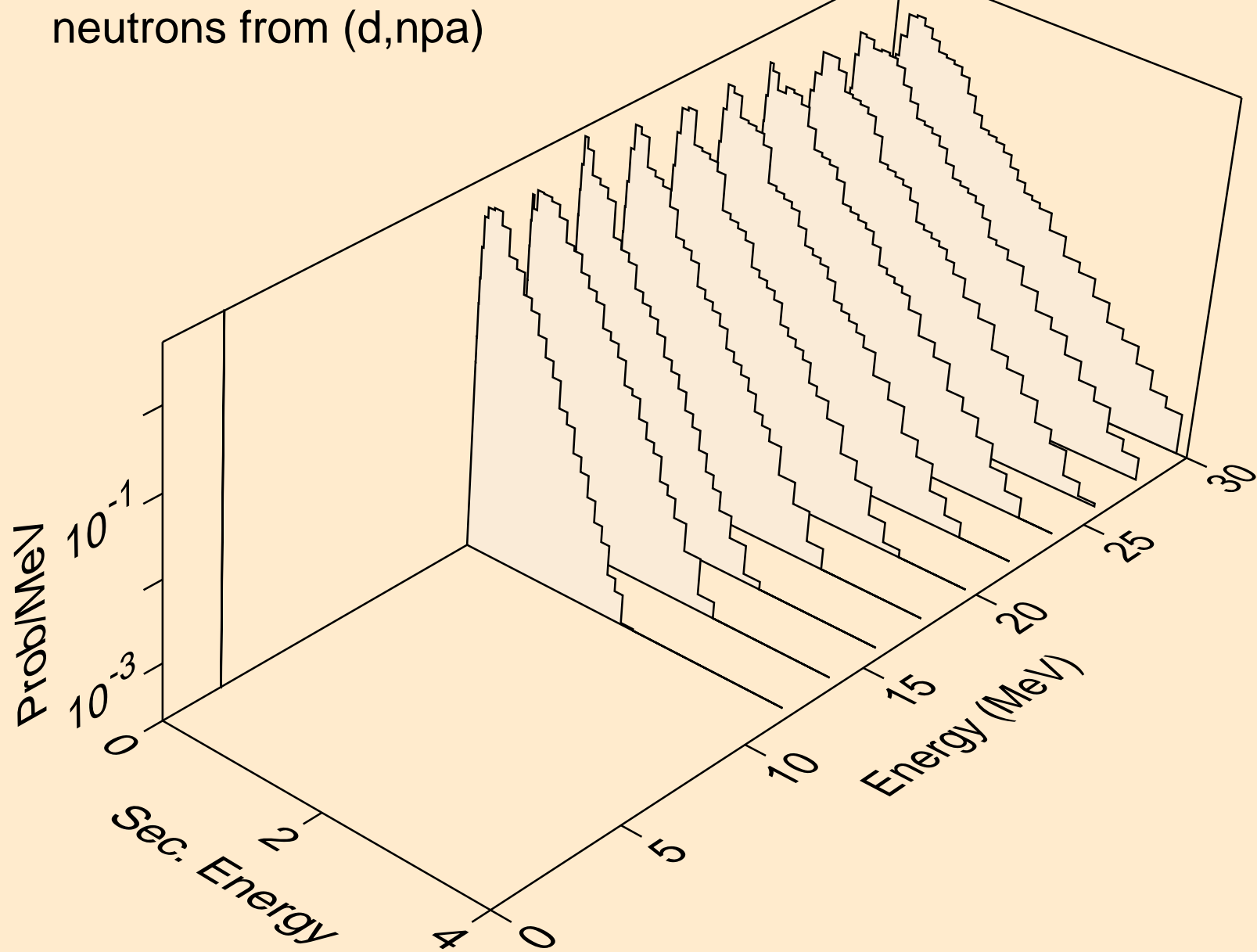

HF186 DEUTERON ACER TENDL-2021 LIBRARY; T=0.K
protons from (d,x)

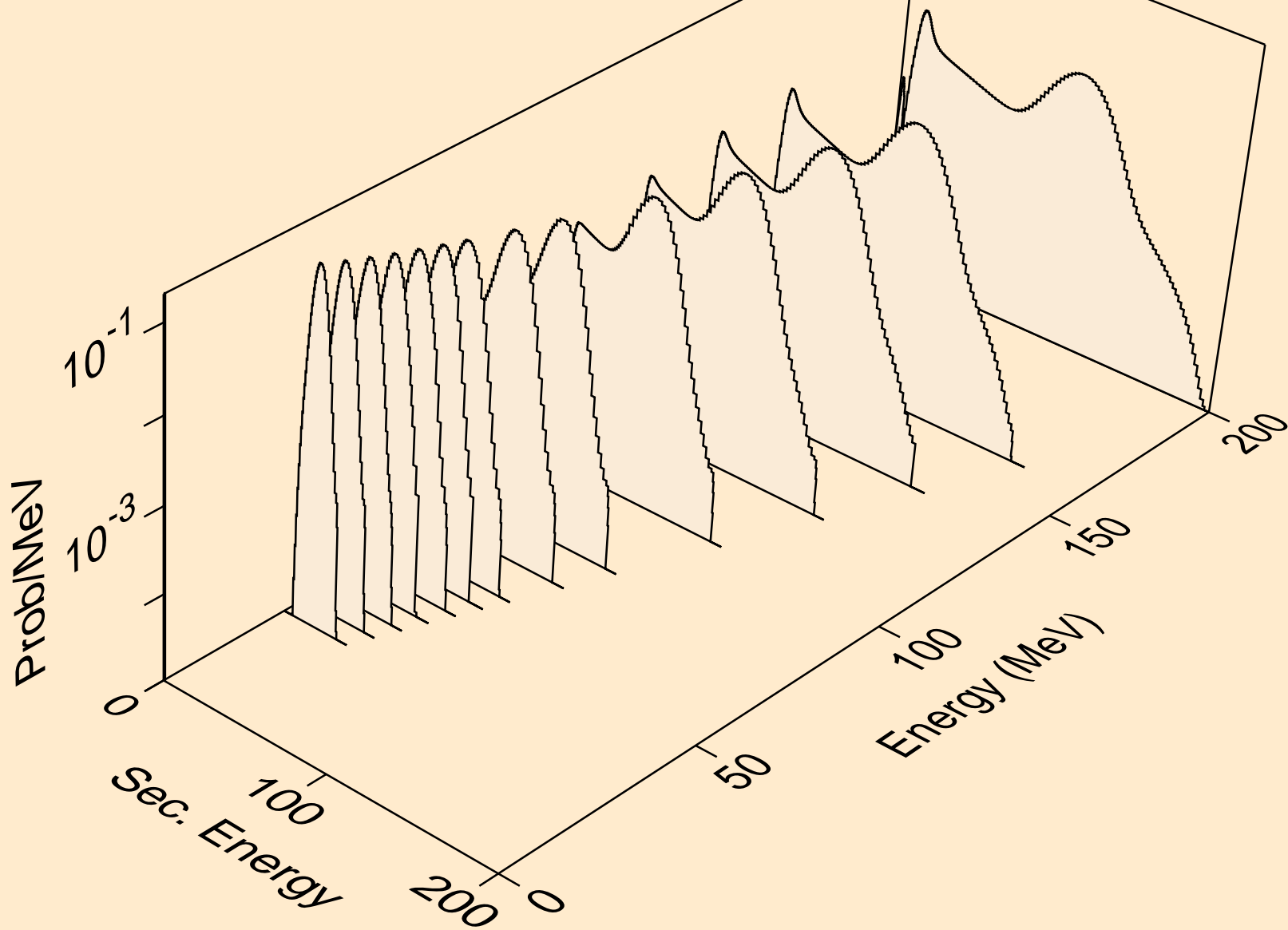

HF186 DEUTERON ACER TENDL-2021 LIBRARY; T=0.K
protons from (d,n*)p

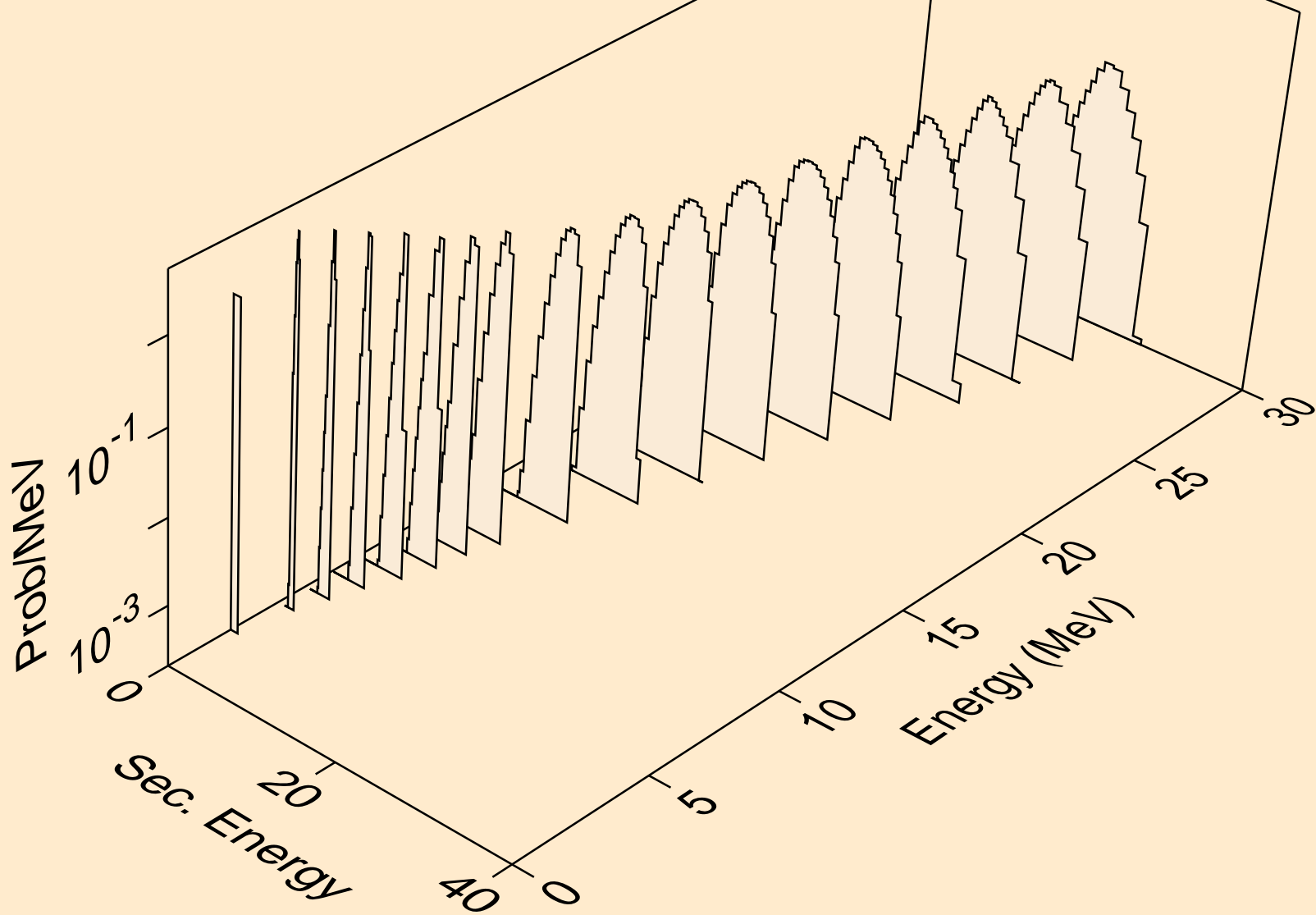

HF186 DEUTERON ACER TENDL-2021 LIBRARY; T=0.K
protons from (d,2np)

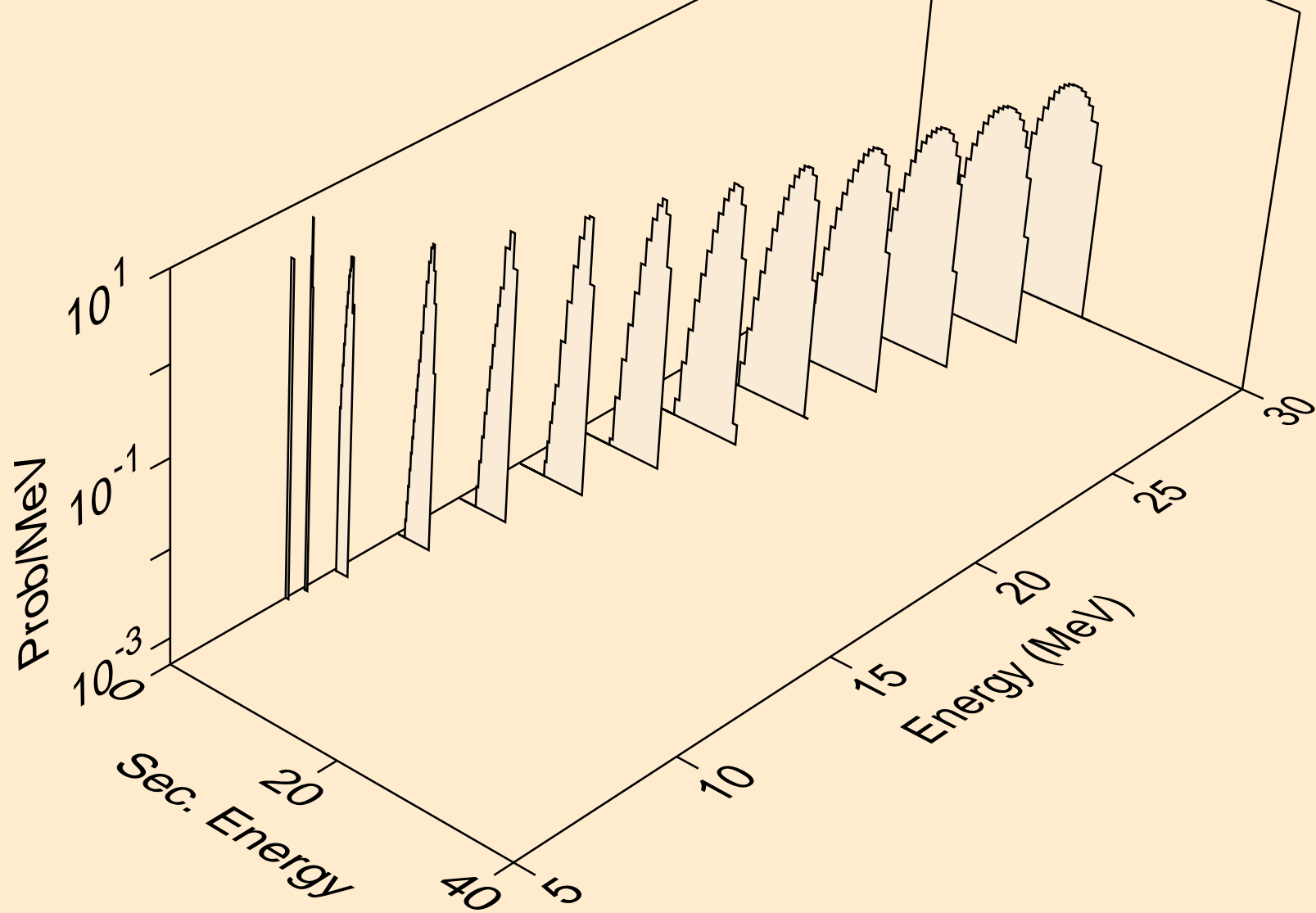

HF186 DEUTERON ACER TENDL-2021 LIBRARY; T=0.K
protons from (d,3np)

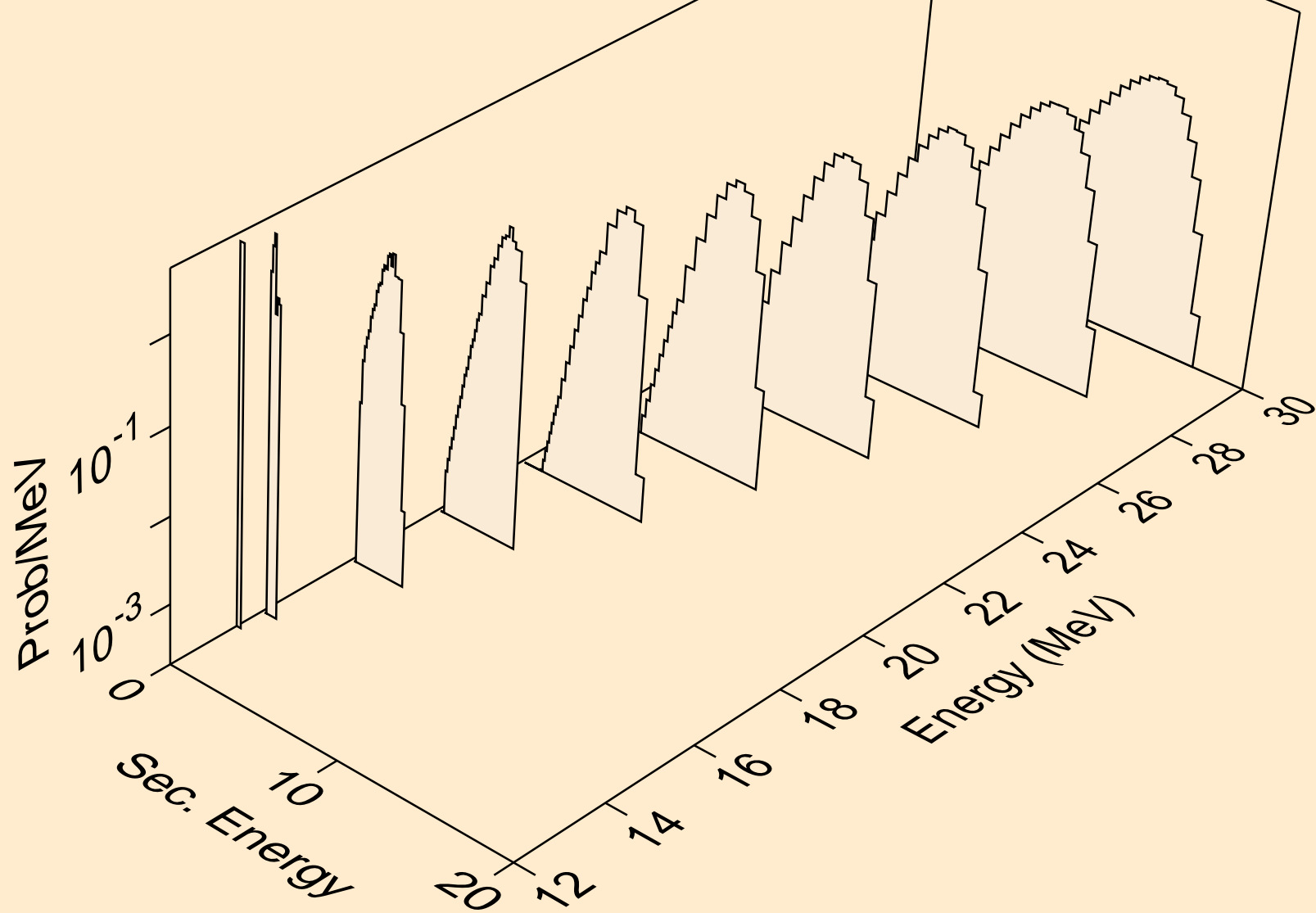

HF186 DEUTERON ACER TENDL-2021 LIBRARY; T=0.K
protons from (d,2np)

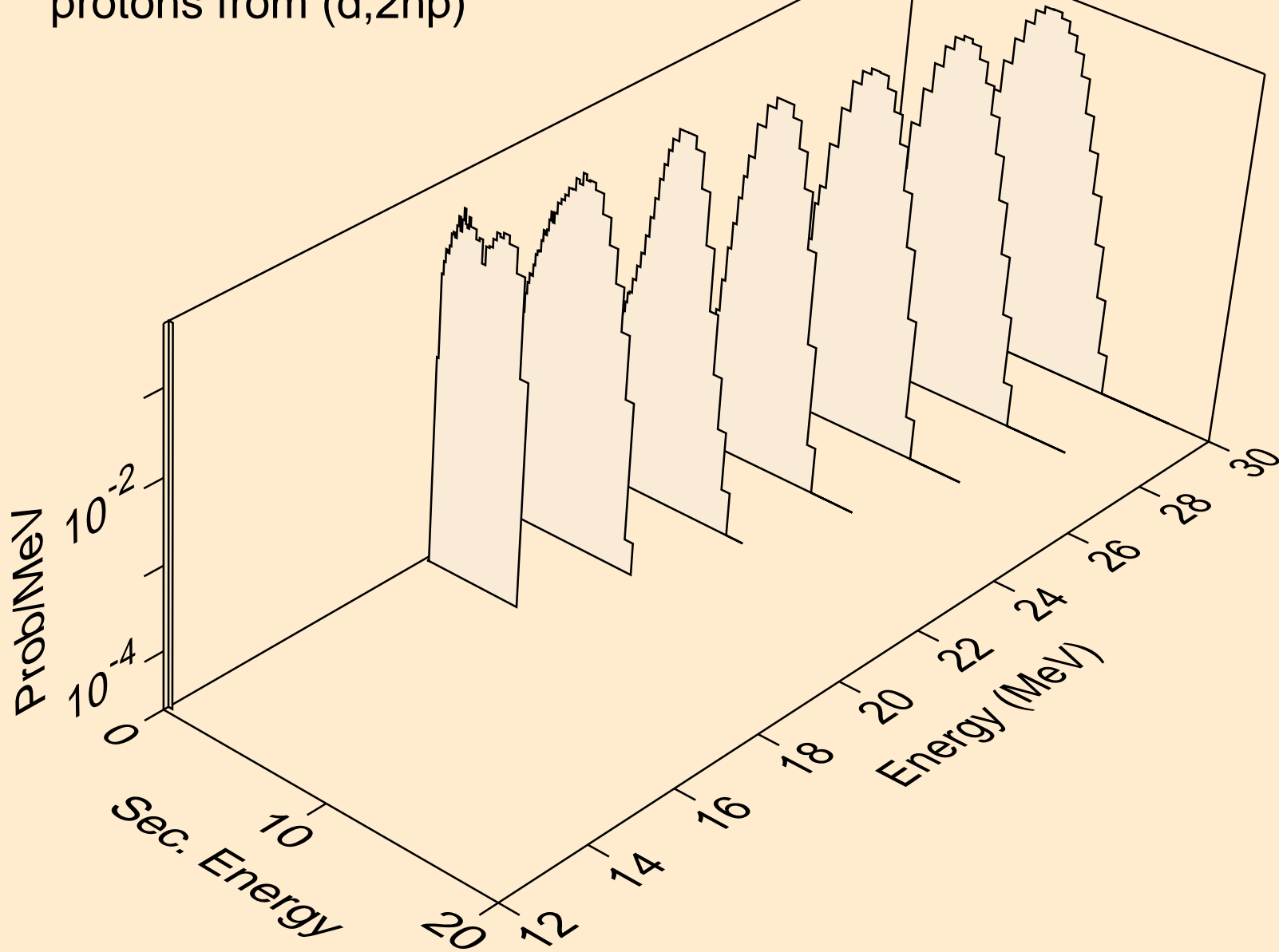

HF186 DEUTERON ACER TENDL-2021 LIBRARY; T=0.K
protons from (d,npa)

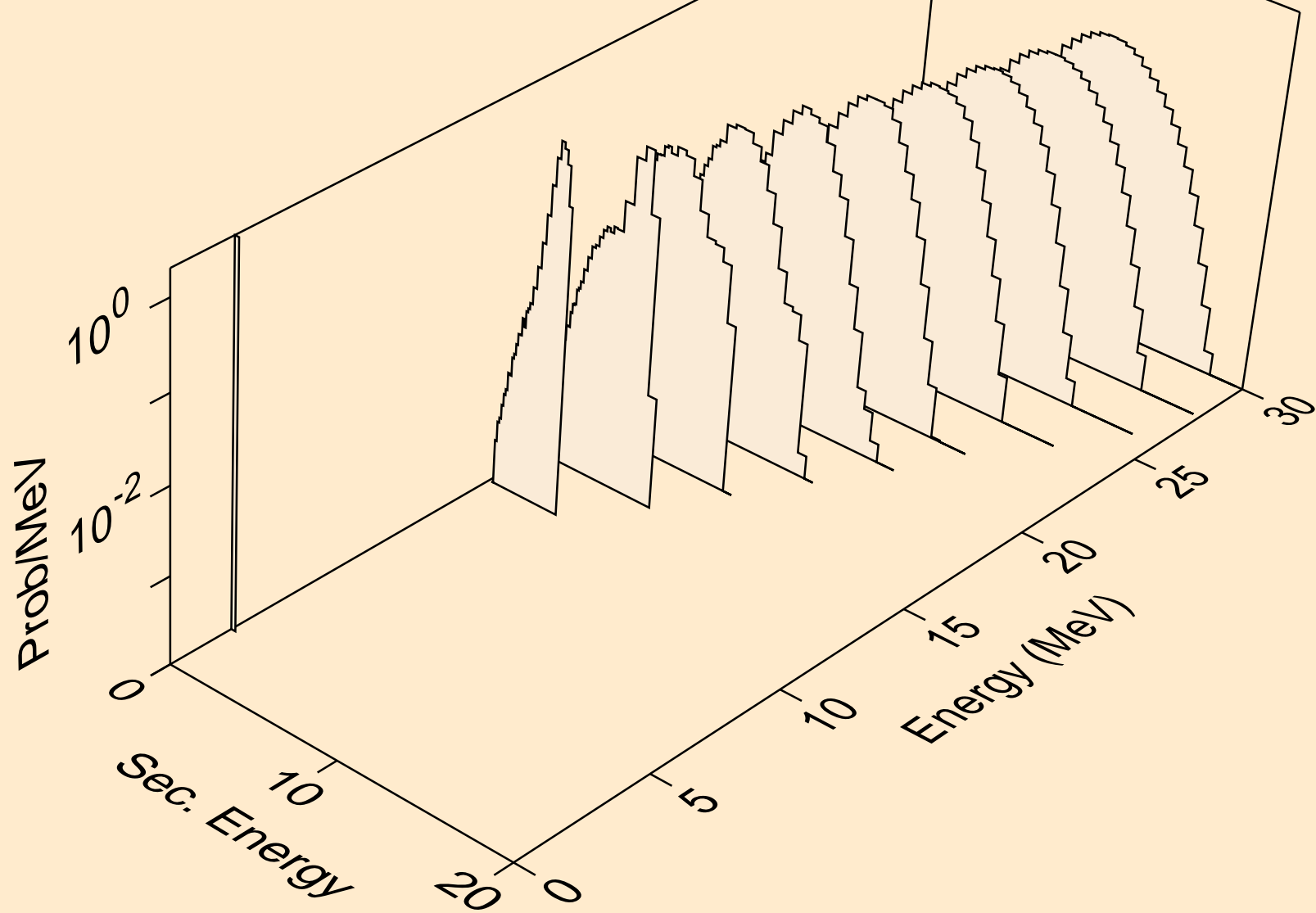

HF186 DEUTERON ACER TENDL-2021 LIBRARY; T=0.K
protons from (d,p)

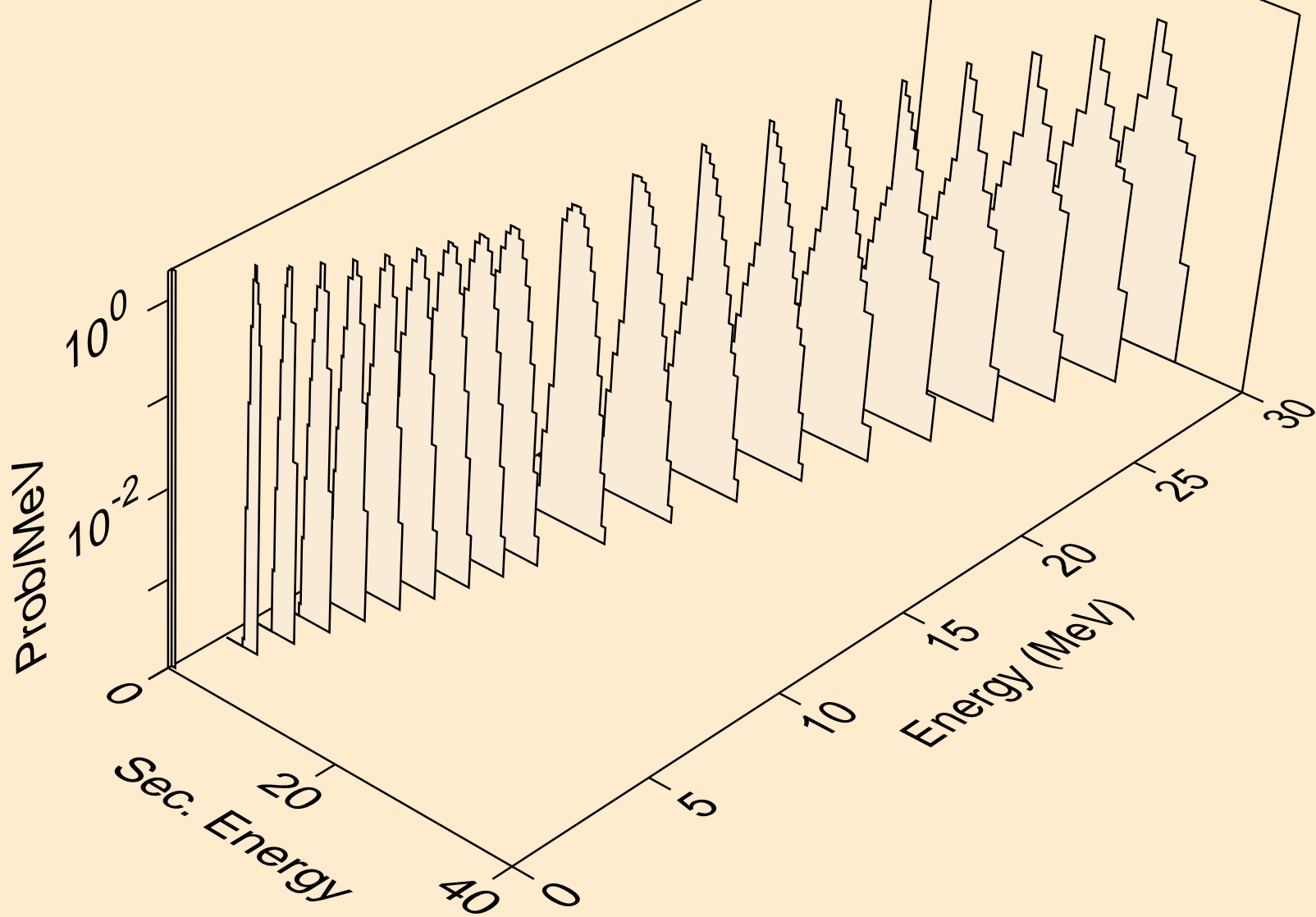

HF186 DEUTERON ACER TENDL-2021 LIBRARY; T=0.K
protons from (d,2p)

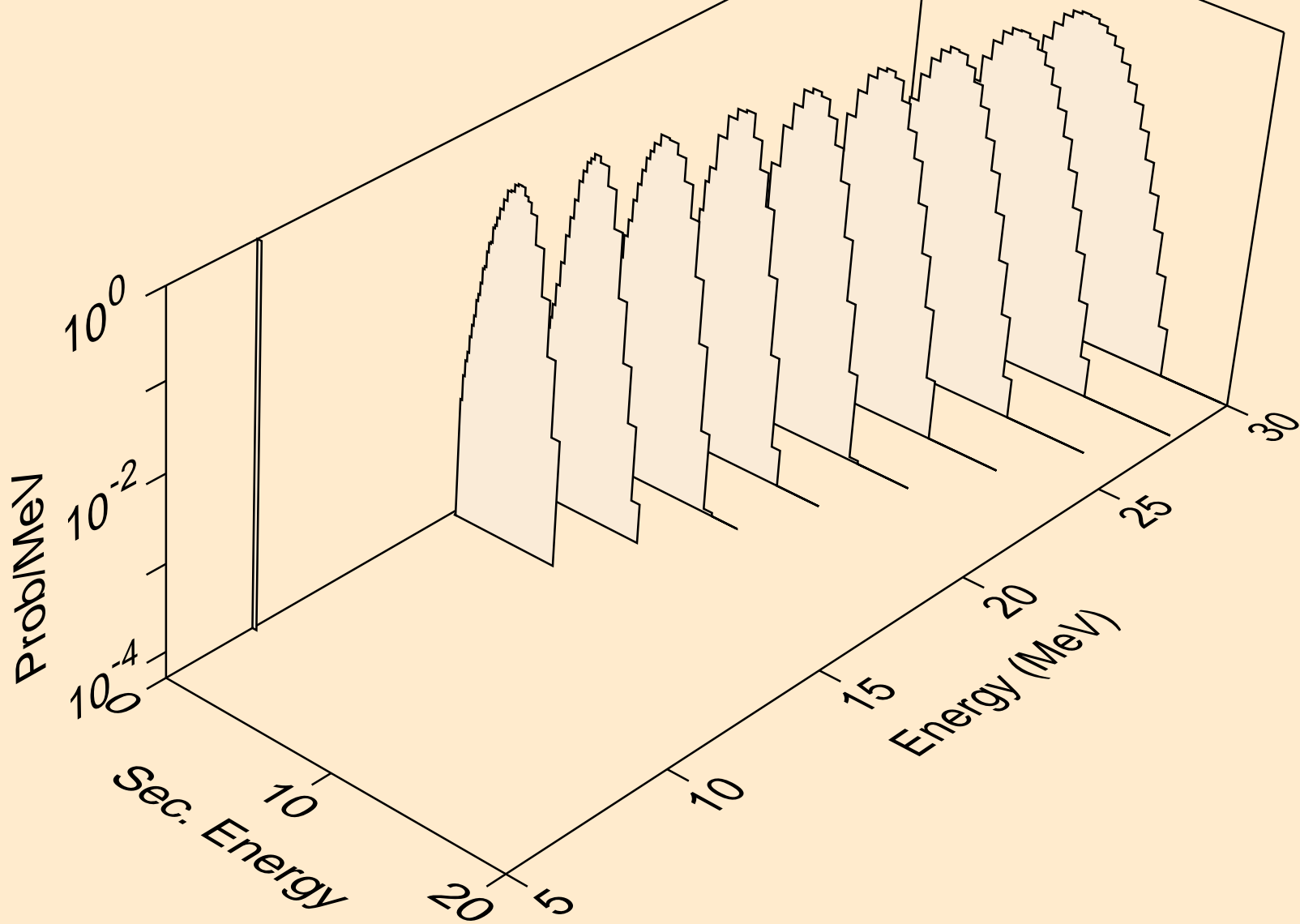

HF186 DEUTERON ACER TENDL-2021 LIBRARY; T=0.K
protons from (d,pa)

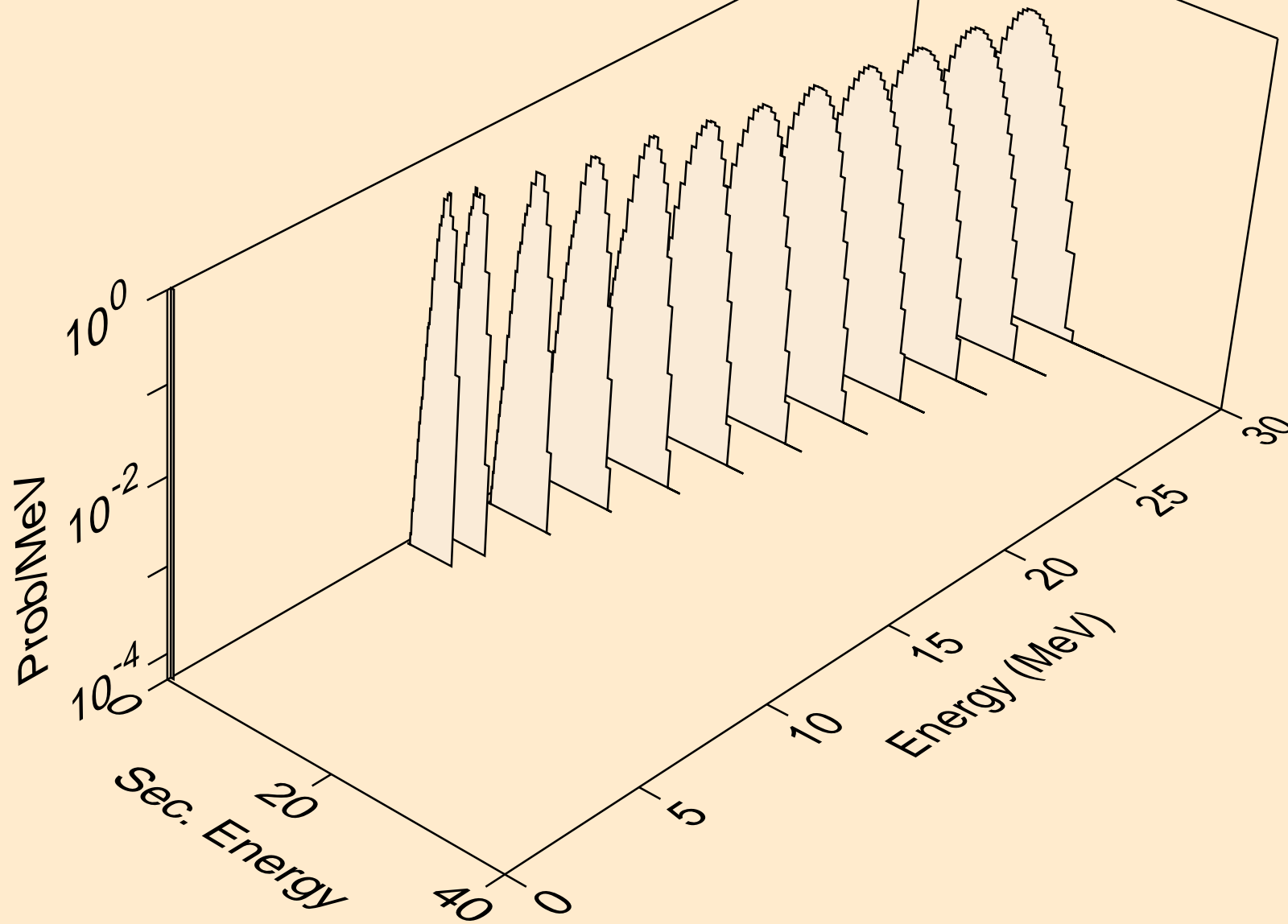

HF186 DEUTERON ACER TENDL-2021 LIBRARY; T=0.K
protons from (d,pd)

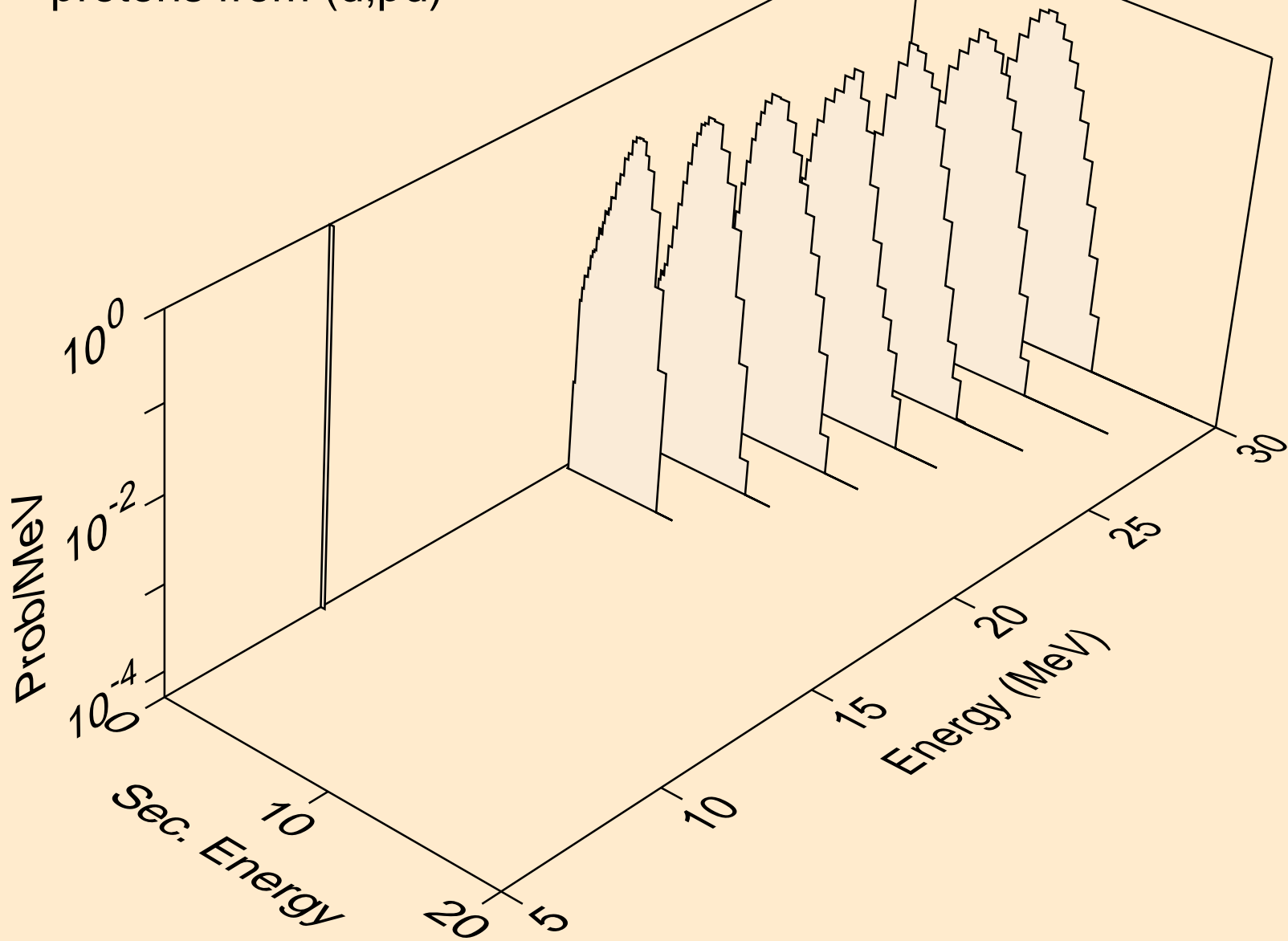

HF186 DEUTERON ACER TENDL-2021 LIBRARY; T=0.K
tritons from (d,x)

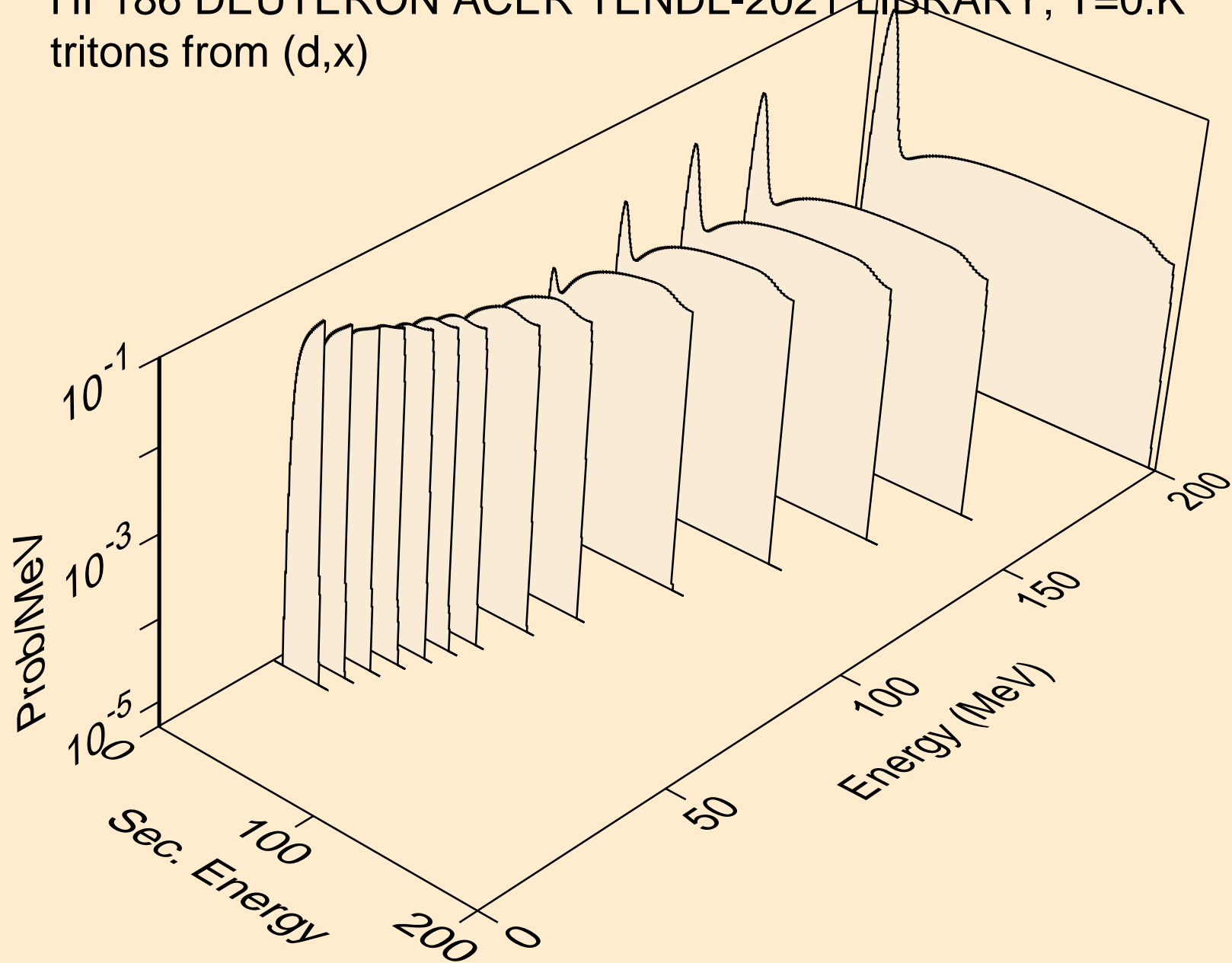

HF186 DEUTERON ACER TENDL-2021 LIBRARY; T=0.K
tritons from (d,n*)t

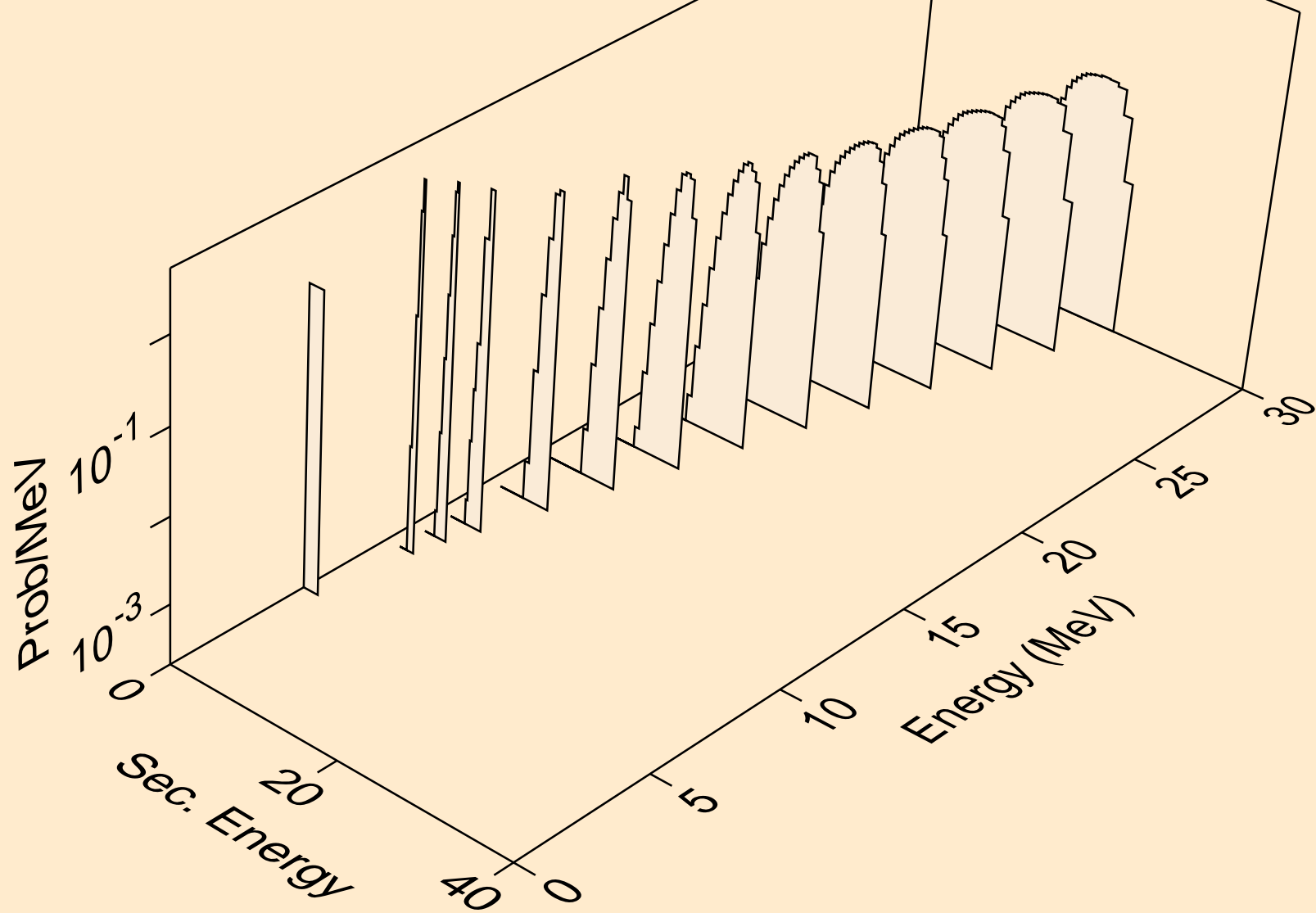

HF186 DEUTERON ACER TENDL-2021 LIBRARY; T=0.K
tritons from (d,t)

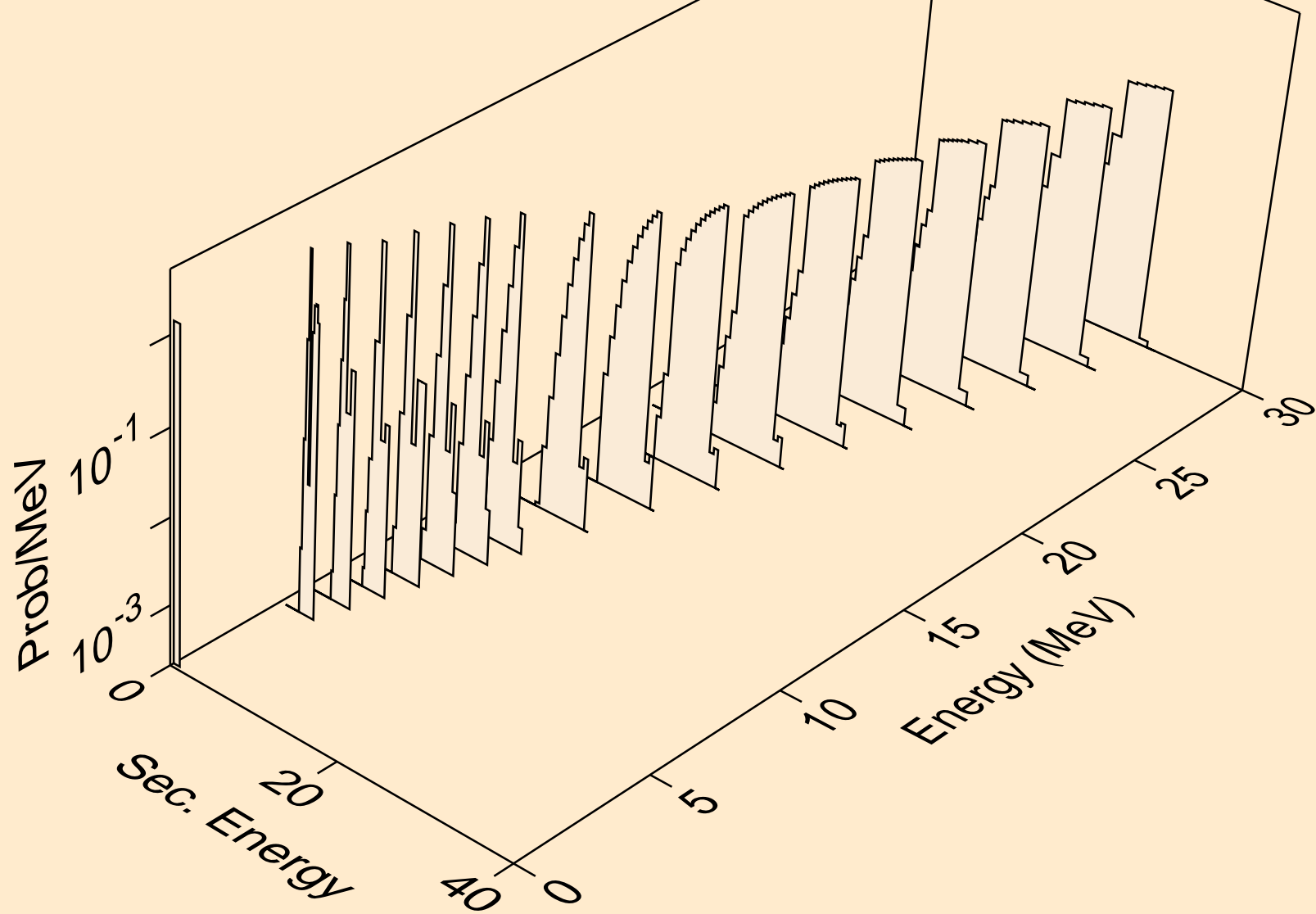

HF186 DEUTERON ACER TENDL-2021 LIBRARY; T=0.K
he3s from (d,x)

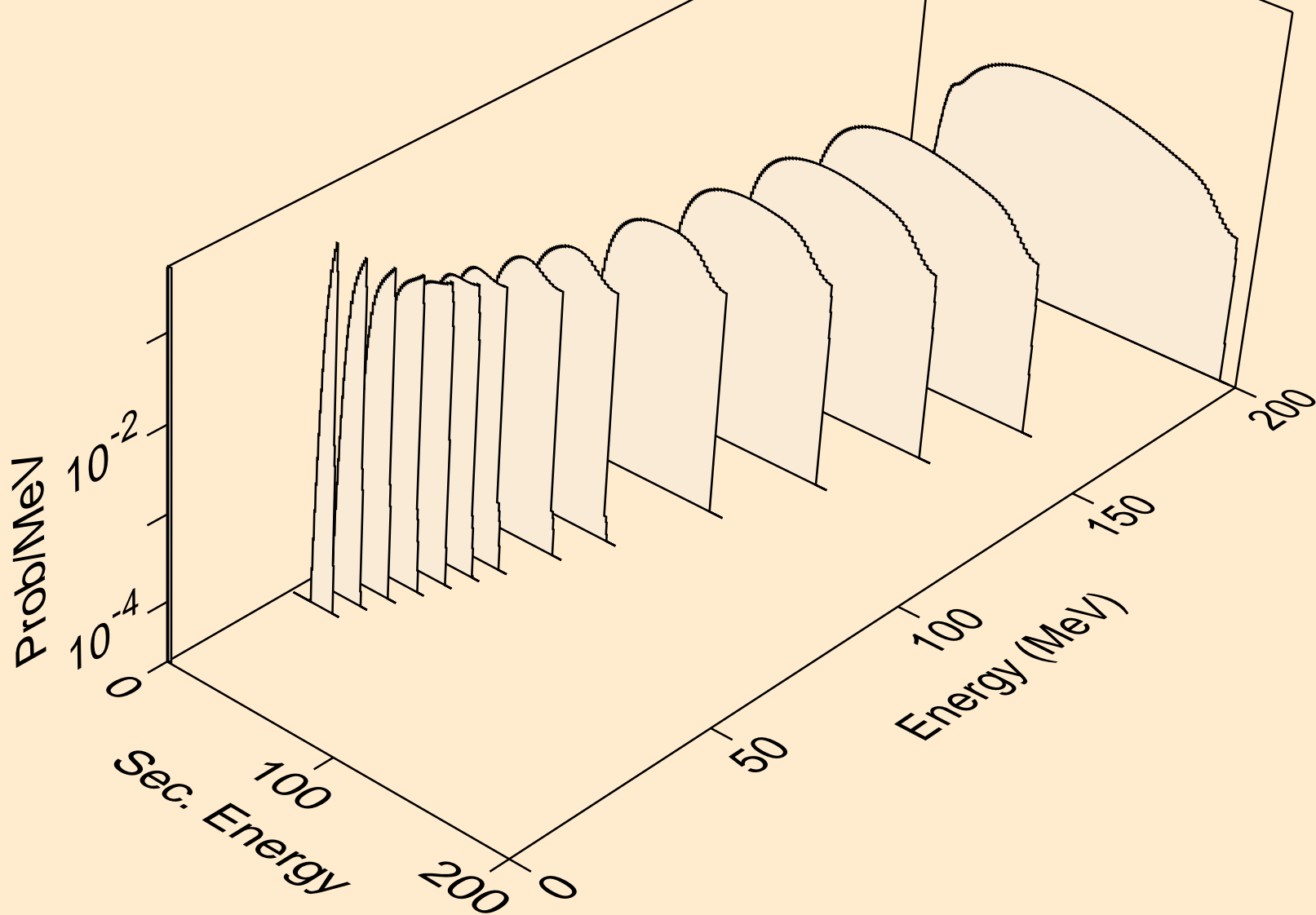

HF186 DEUTERON ACER TENDL-2021 LIBRARY; T=0.K
he3s from (d,n*)he3

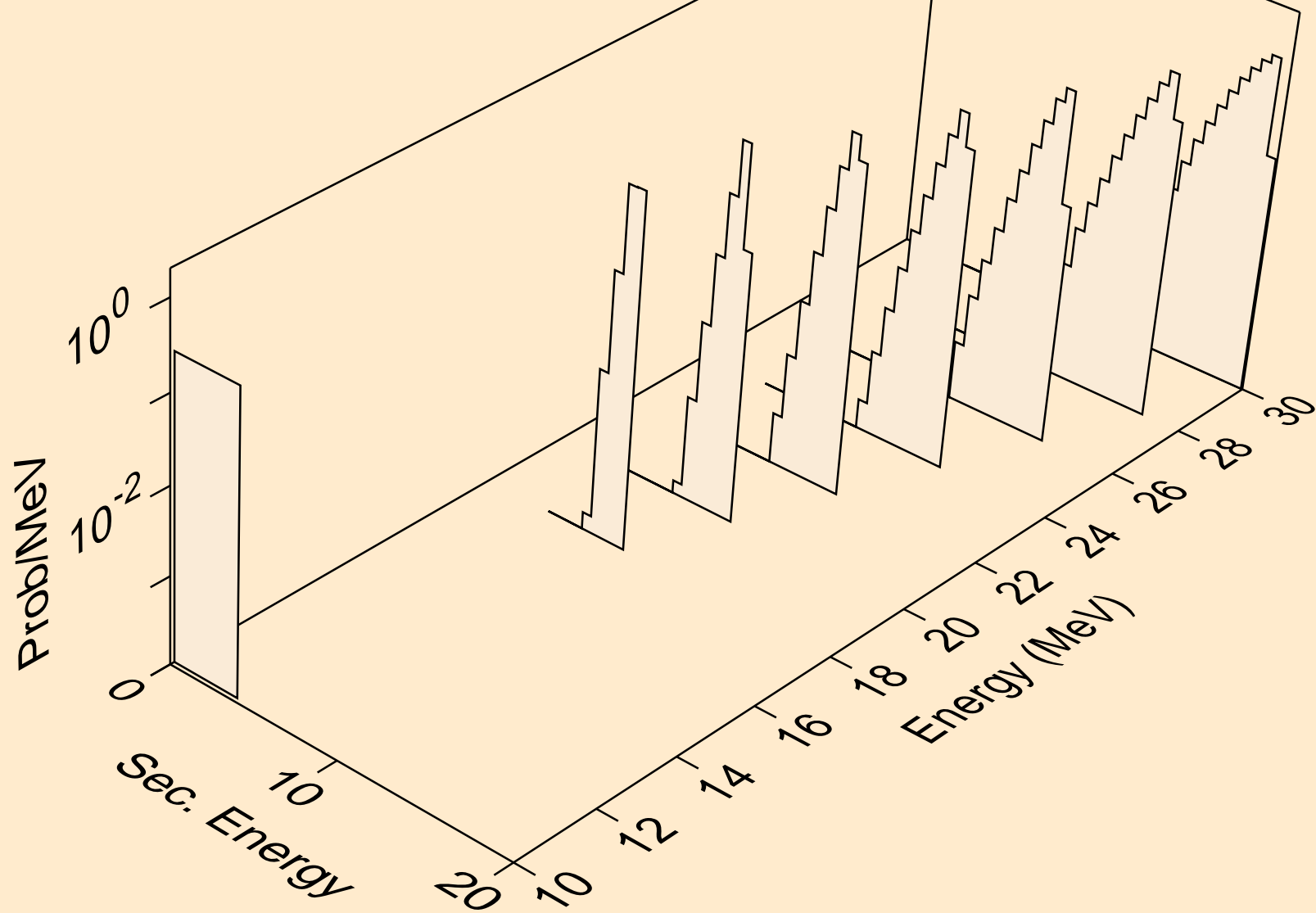

HF186 DEUTERON ACER TENDL-2021 LIBRARY; T=0.K
he3s from (d,he3)

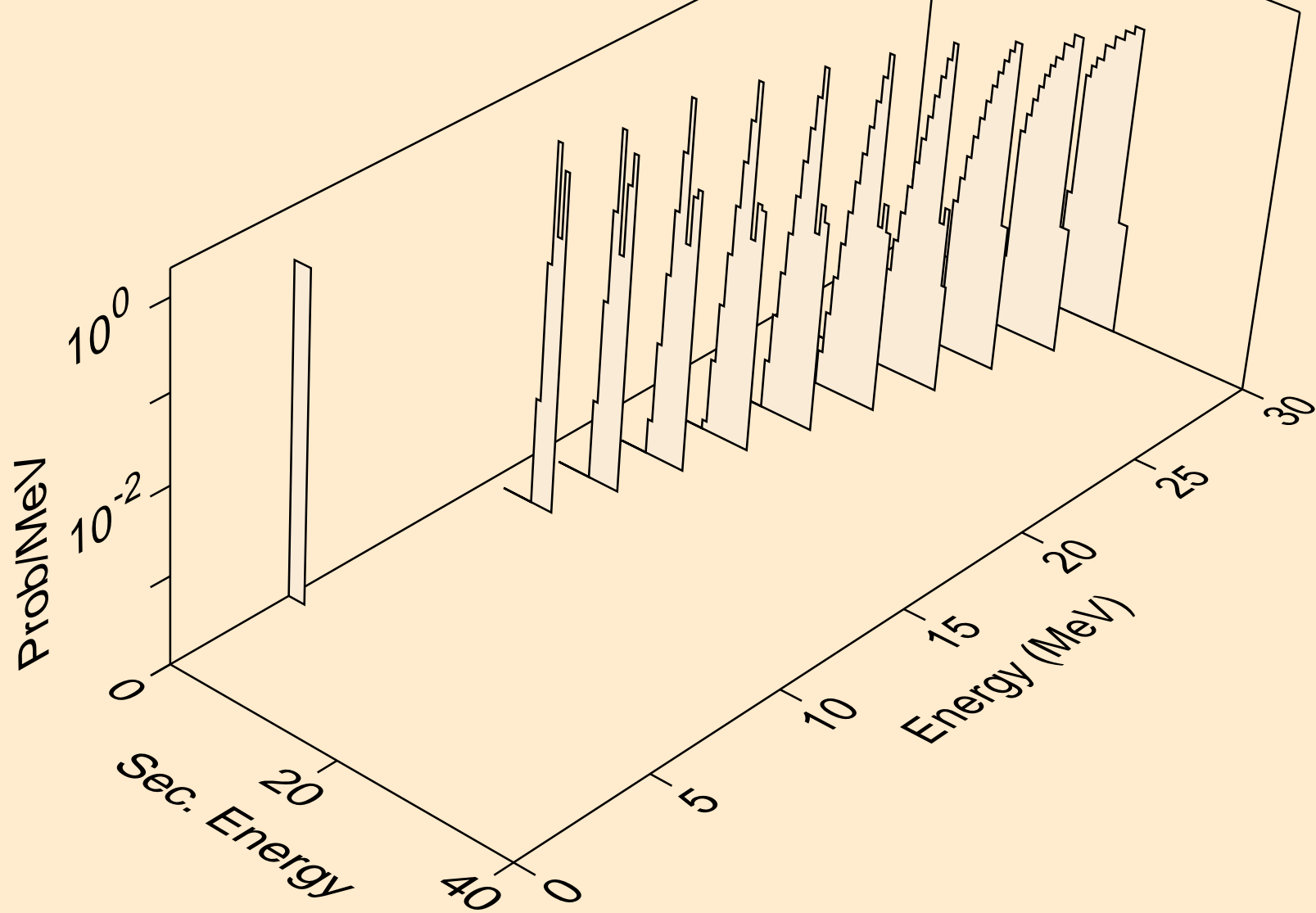

HF186 DEUTERON ACER TENDL-2021 LIBRARY; T=0.K
alphas from (d,x)

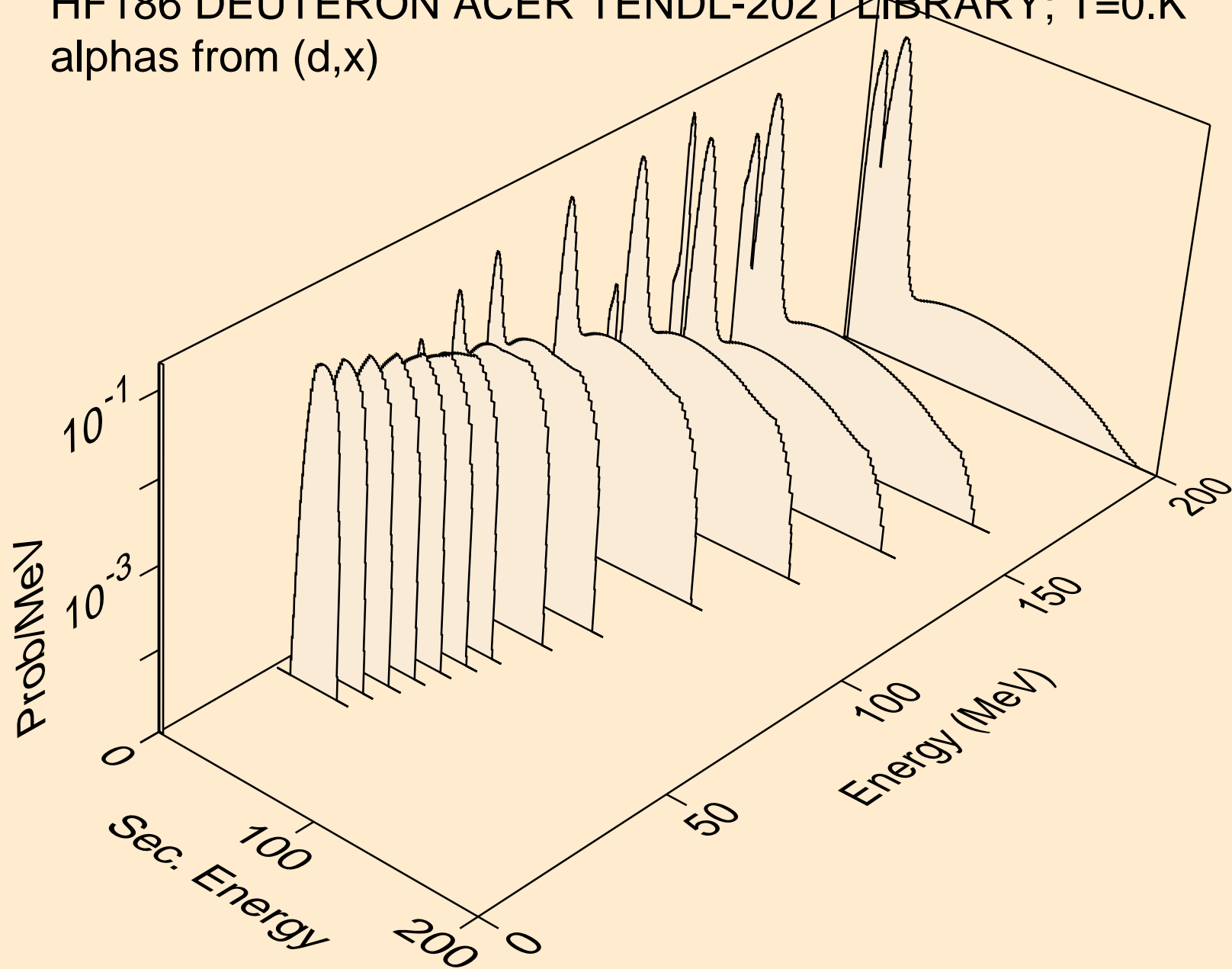

HF186 DEUTERON ACER TENDL-2021 LIBRARY; T=0.K
alphas from (d,n*)a

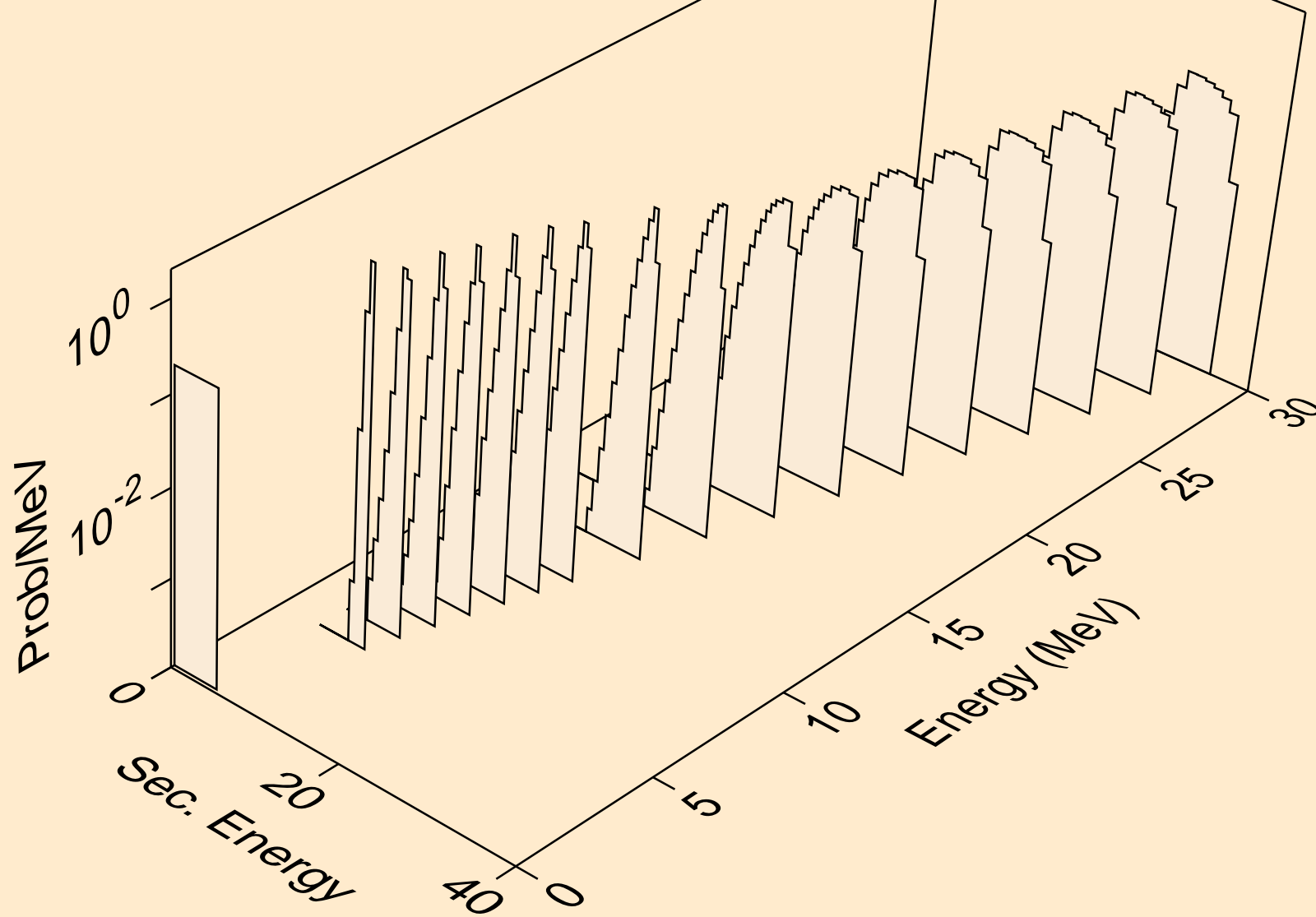

HF186 DEUTERON ACER TENDL-2021 LIBRARY; T=0.K
alphas from (d,2n)a

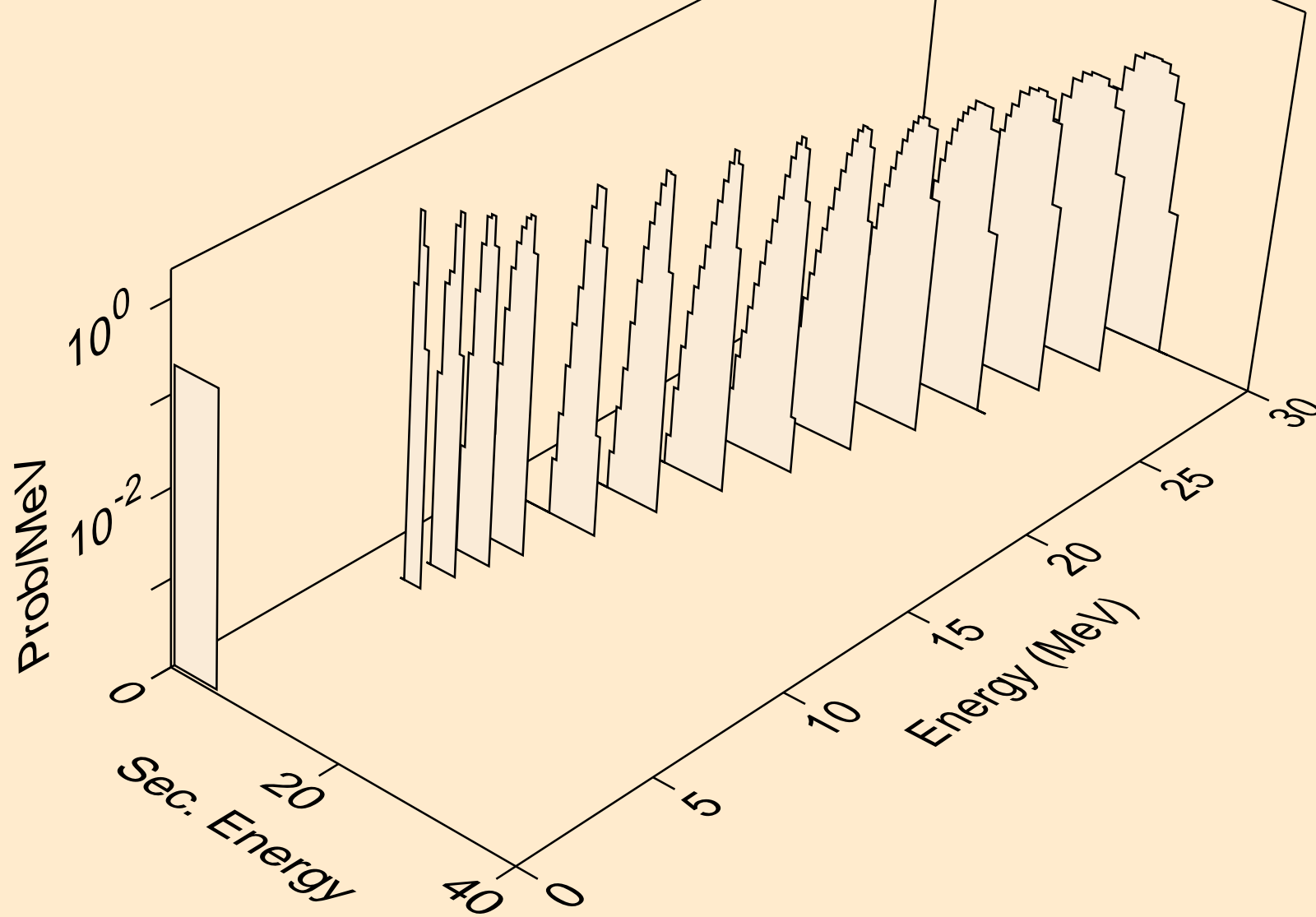

HF186 DEUTERON ACER TENDL-2021 LIBRARY; T=0.K
alphas from (d,3n)a

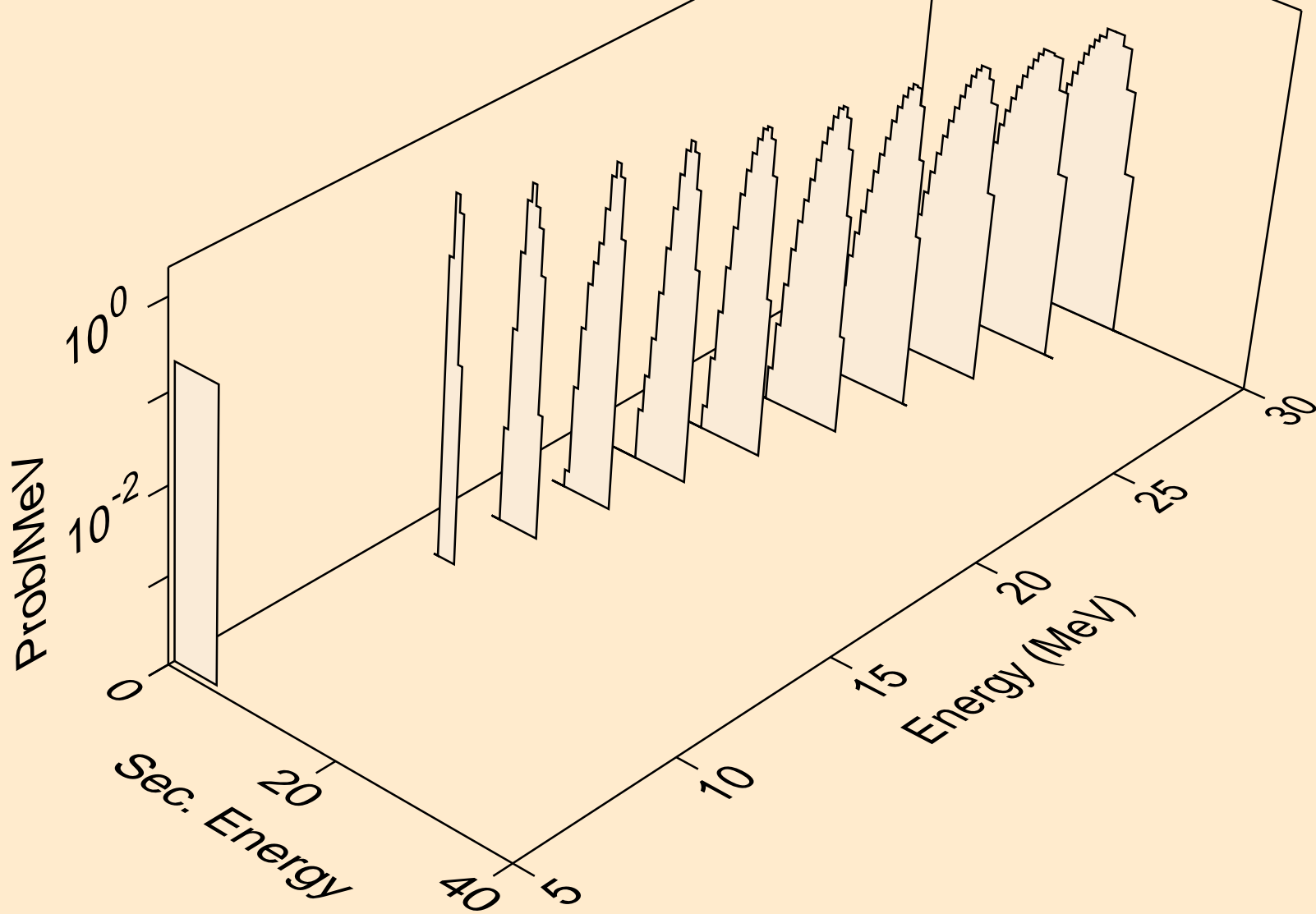

HF186 DEUTERON ACER TENDL-2021 LIBRARY; T=0.K
alphas from (d,npa)

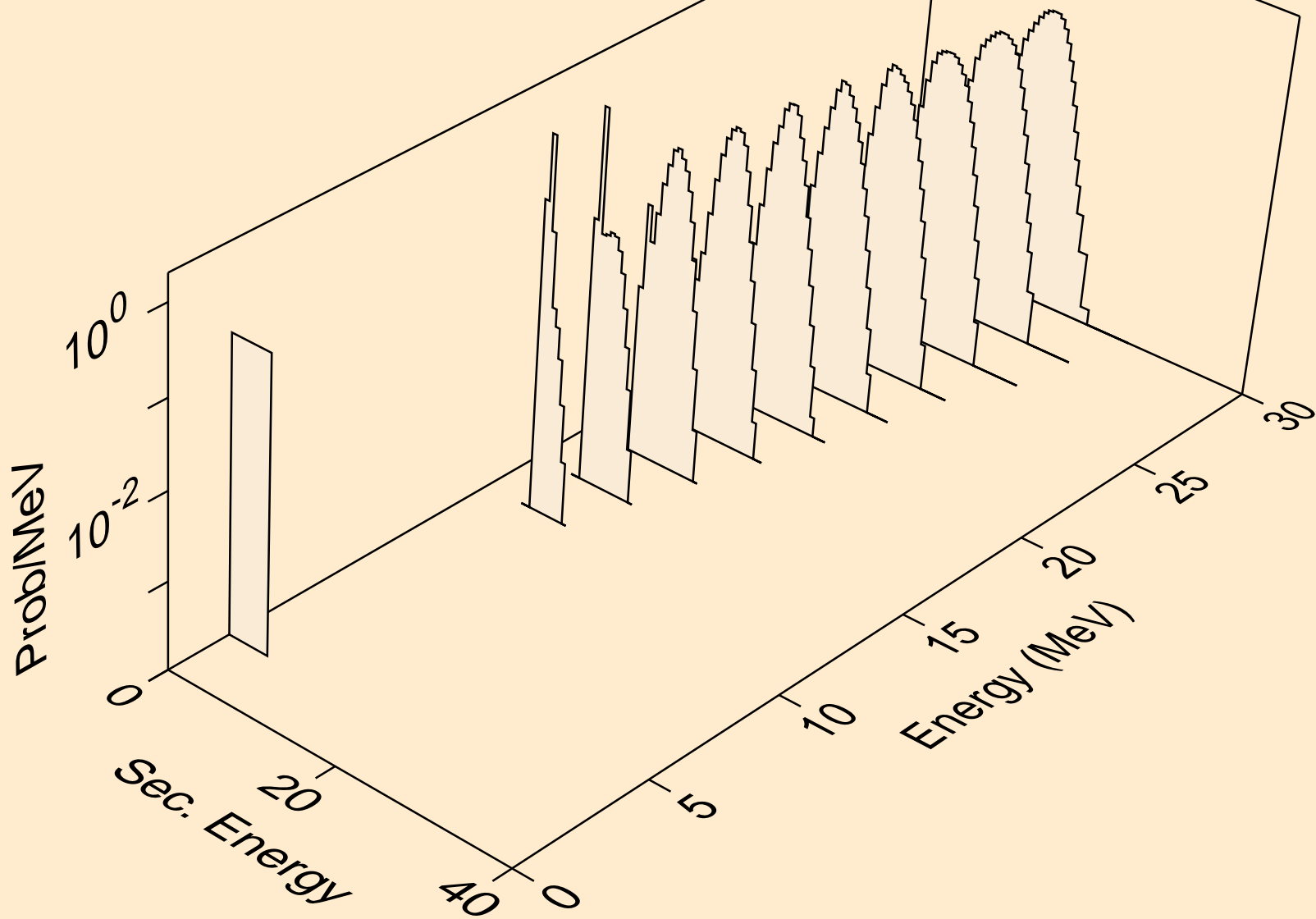

HF186 DEUTERON ACER TENDL-2021 LIBRARY; T=0.K
alphas from (d,a)

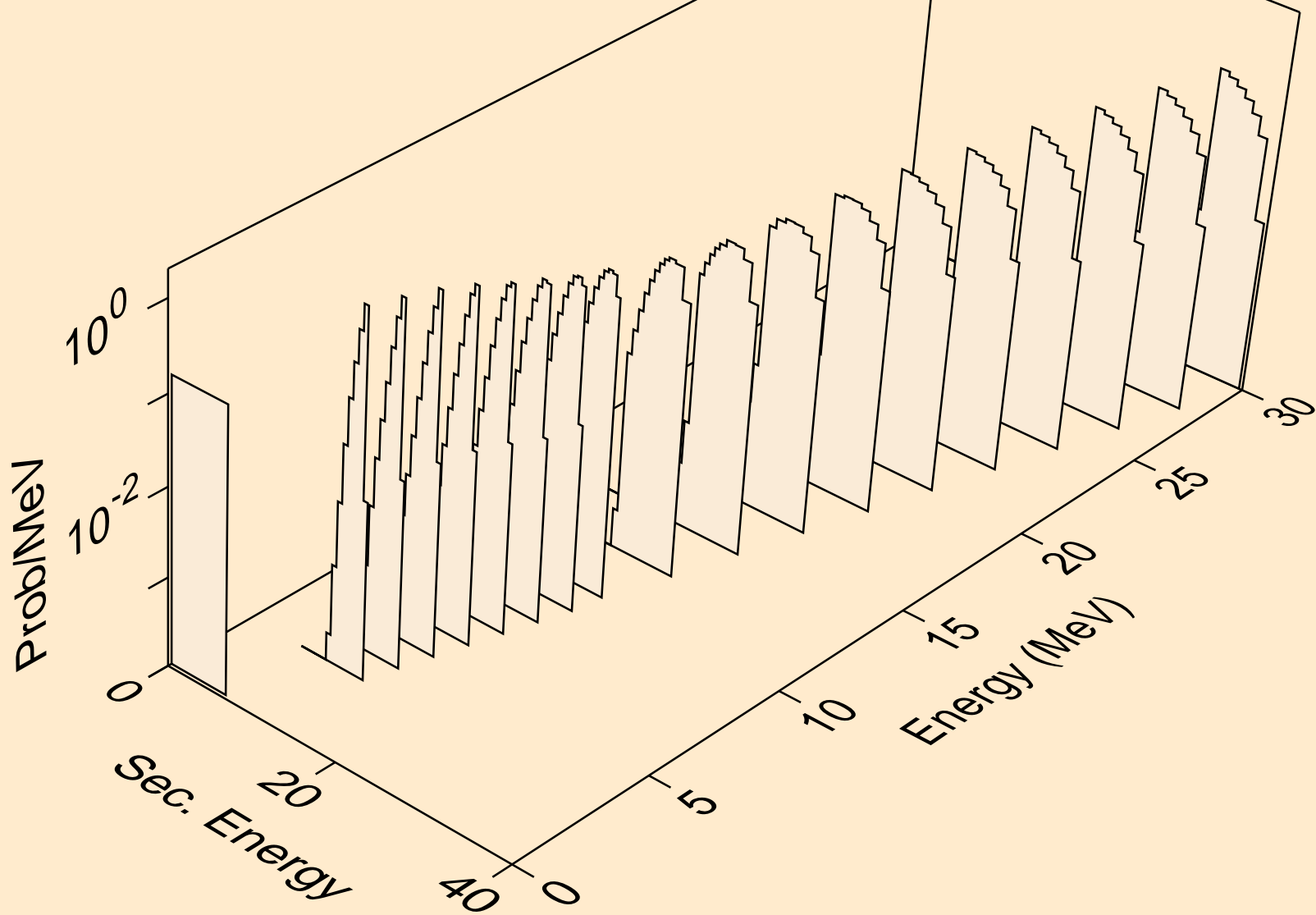

HF186 DEUTERON ACER TENDL-2021 LIBRARY; T=0.K
alphas from (d,pa)

