

HS272 DEUTERON ACER TENDL-2021 LIBRARY; T=0.K

Principal cross sections

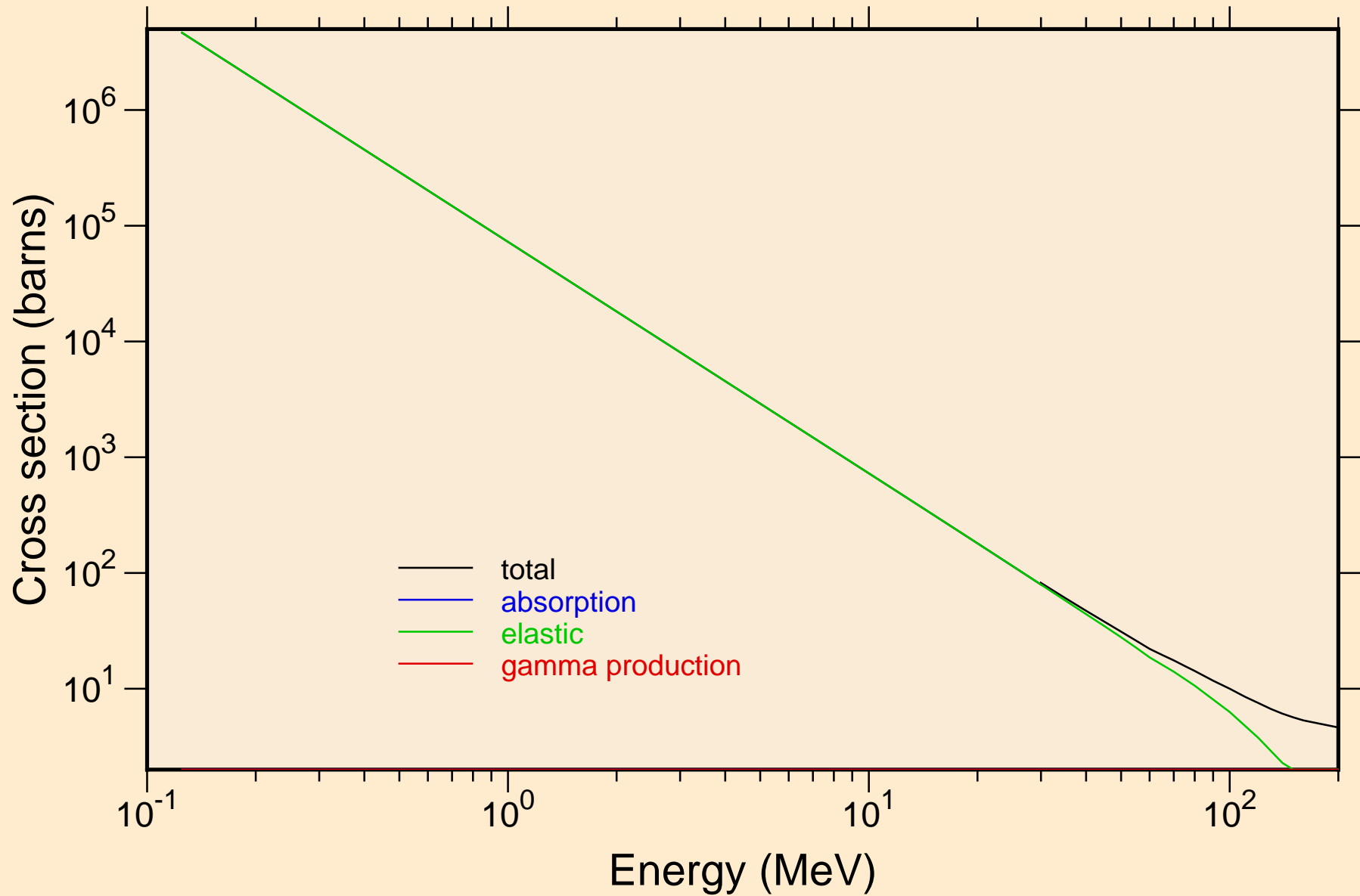

HS272 DEUTERON ACER TENDL-2021 LIBRARY; T=0.K
Heating

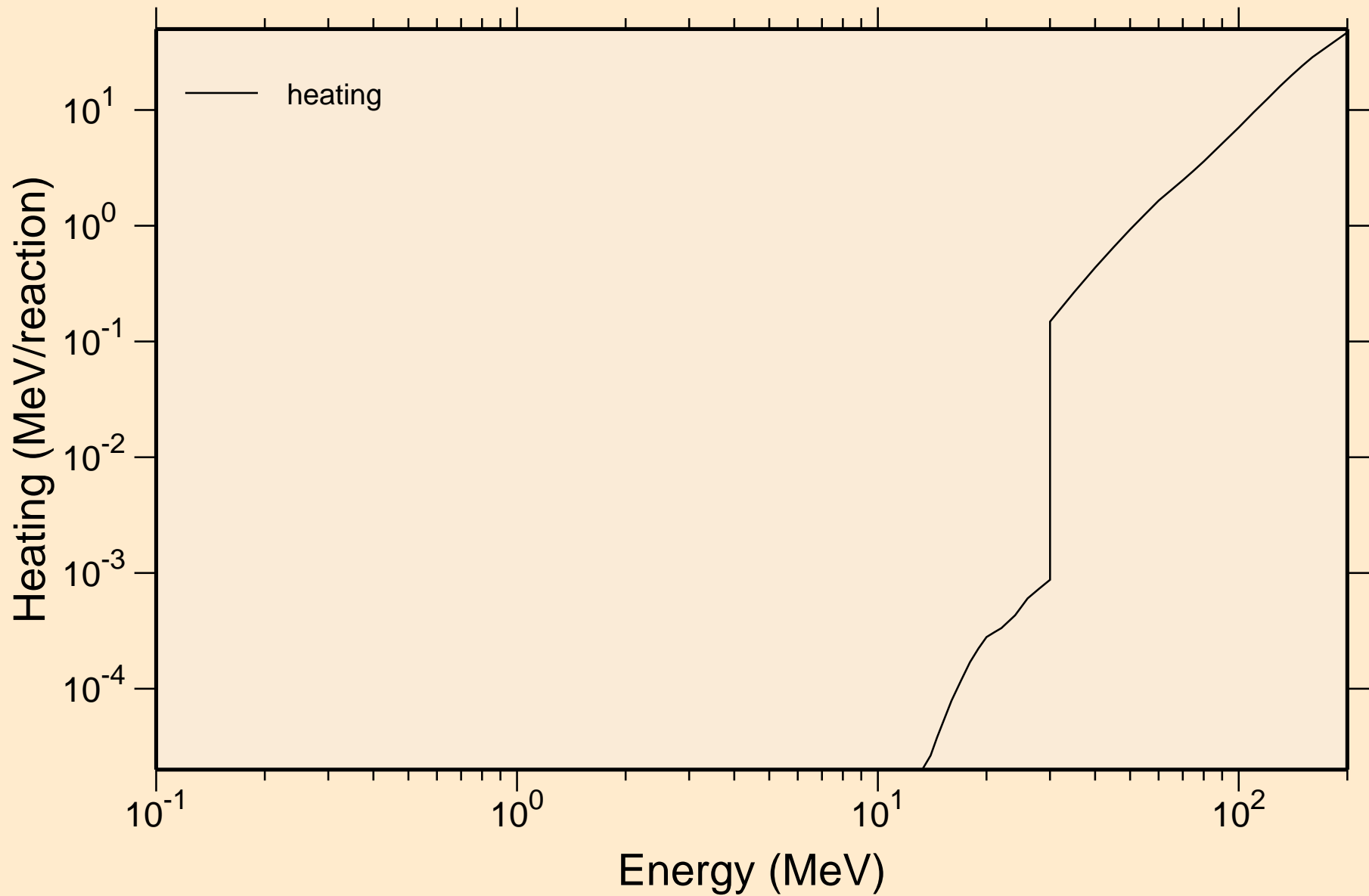

HS272 DEUTERON ACER TENDL-2021 LIBRARY; T=0.K

Principal cross sections

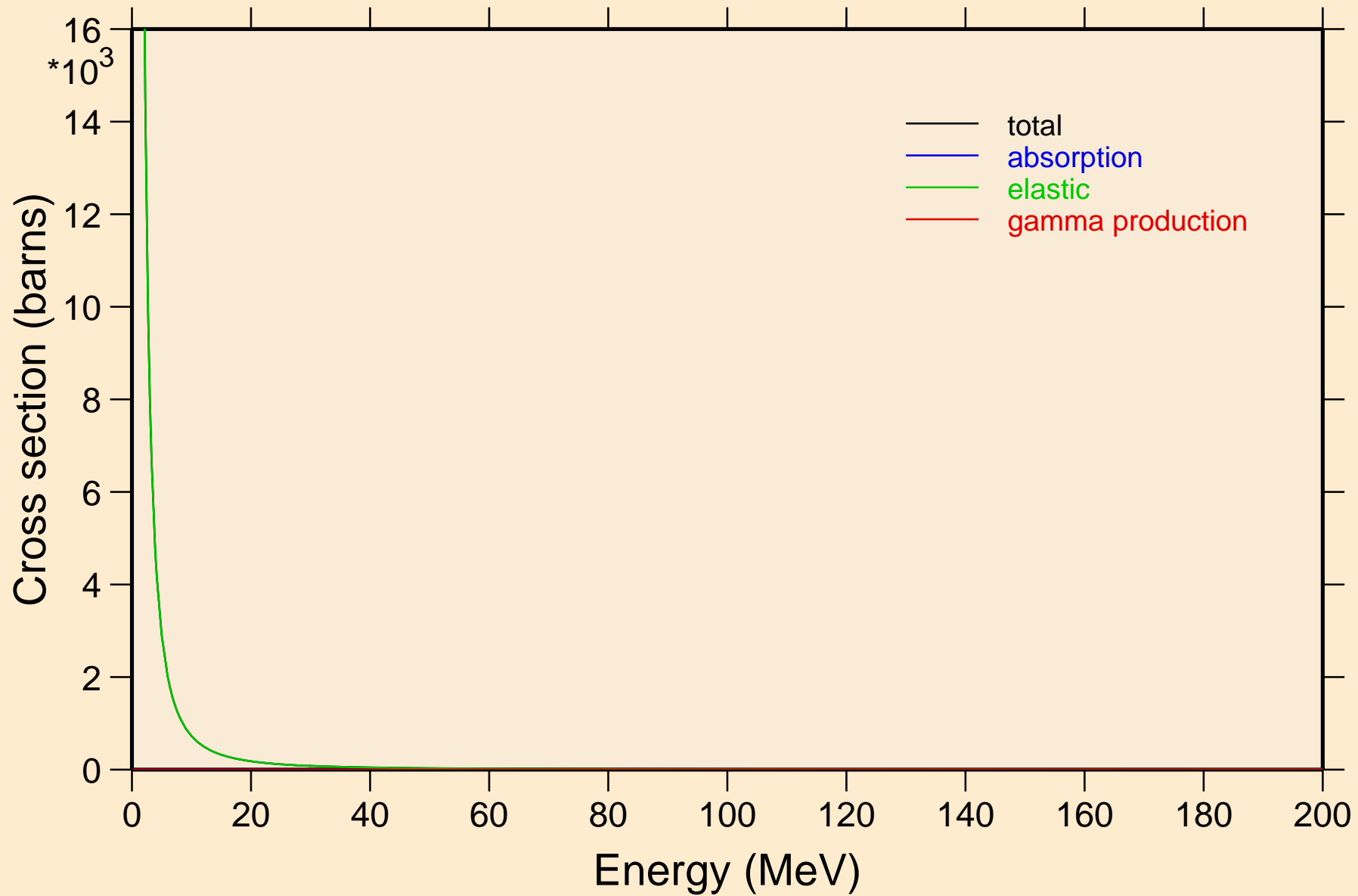

HS272 DEUTERON ACER TENDL-2021 LIBRARY; T=0.K

Heating

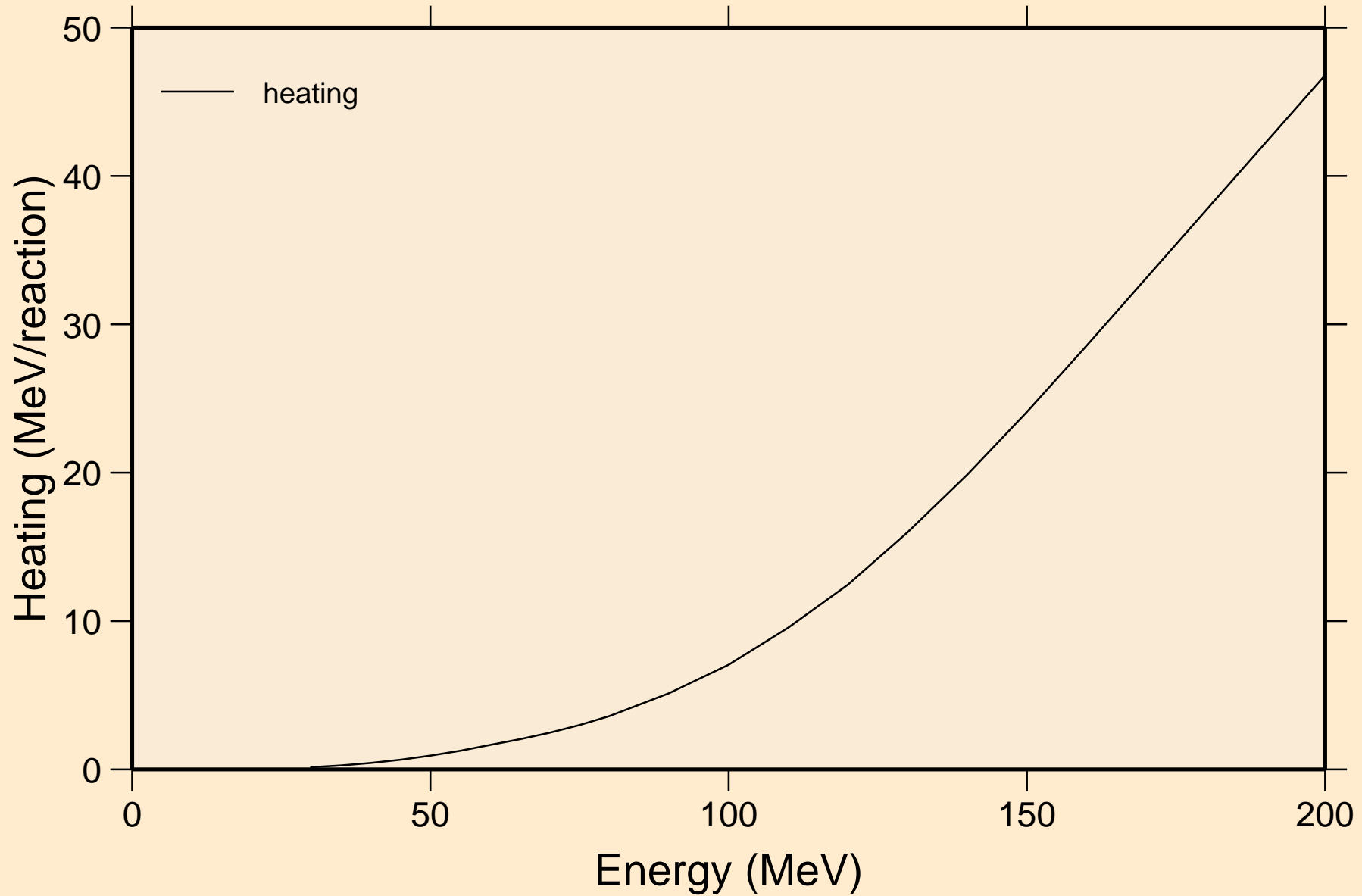

HS272 DEUTERON ACER TENDL-2021 LIBRARY; T=0.K

Threshold reactions

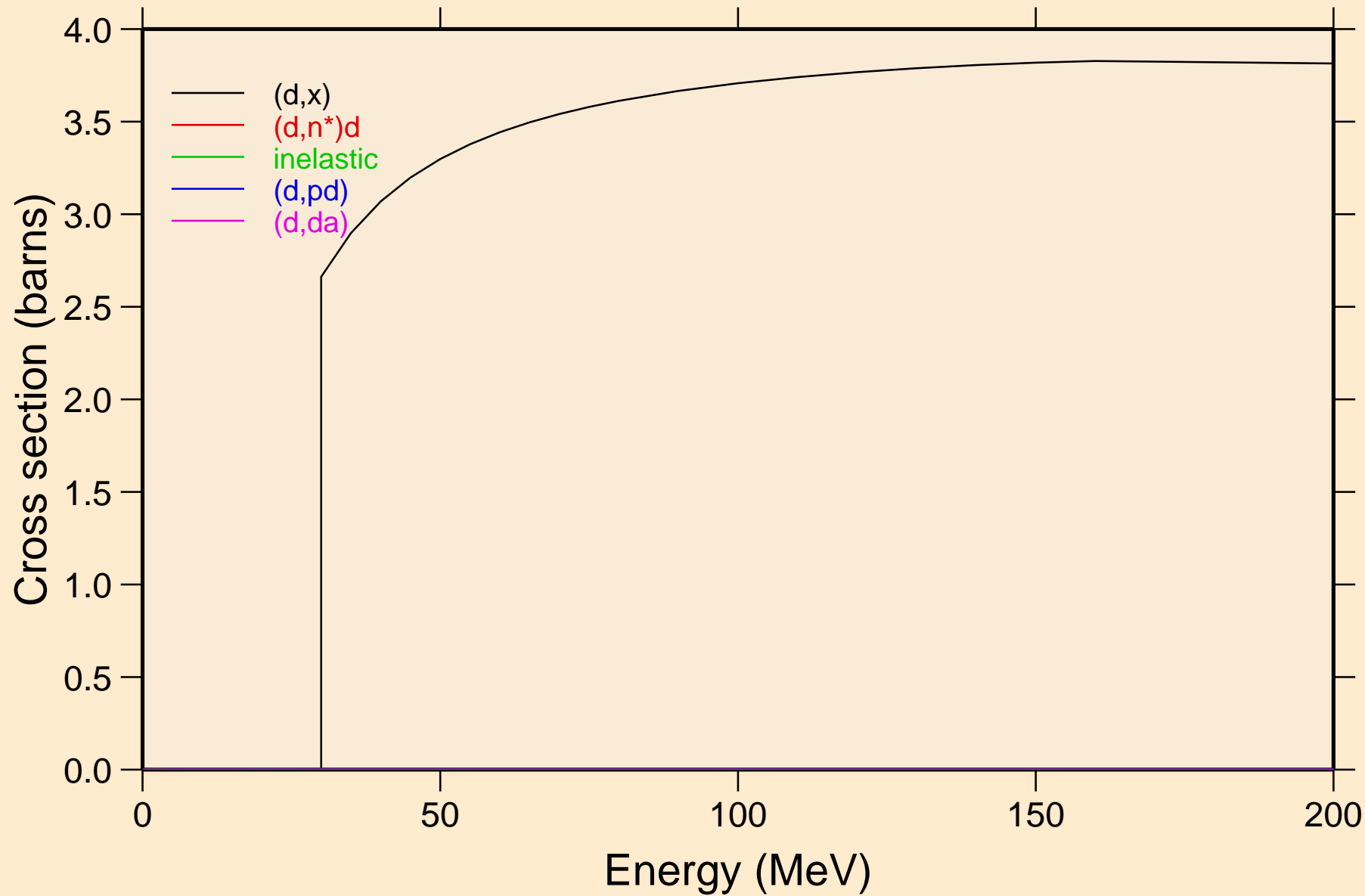

HS272 DEUTERON ACER TENDL-2021 LIBRARY; T=0.K
angular distribution for elastic

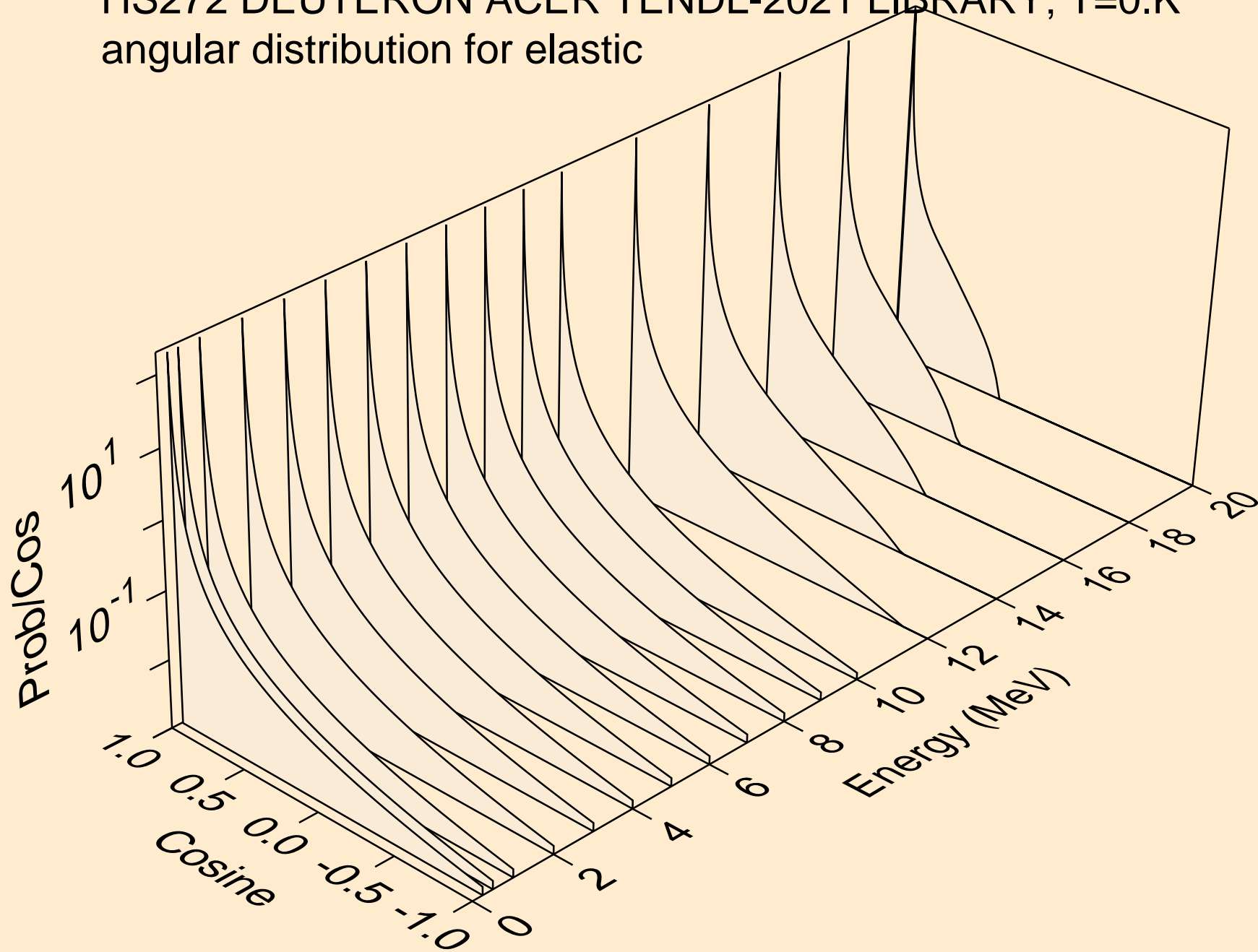

HS272 DEUTERON ACER TENDL-2021 LIBRARY; T=0.K
angular distribution for elastic

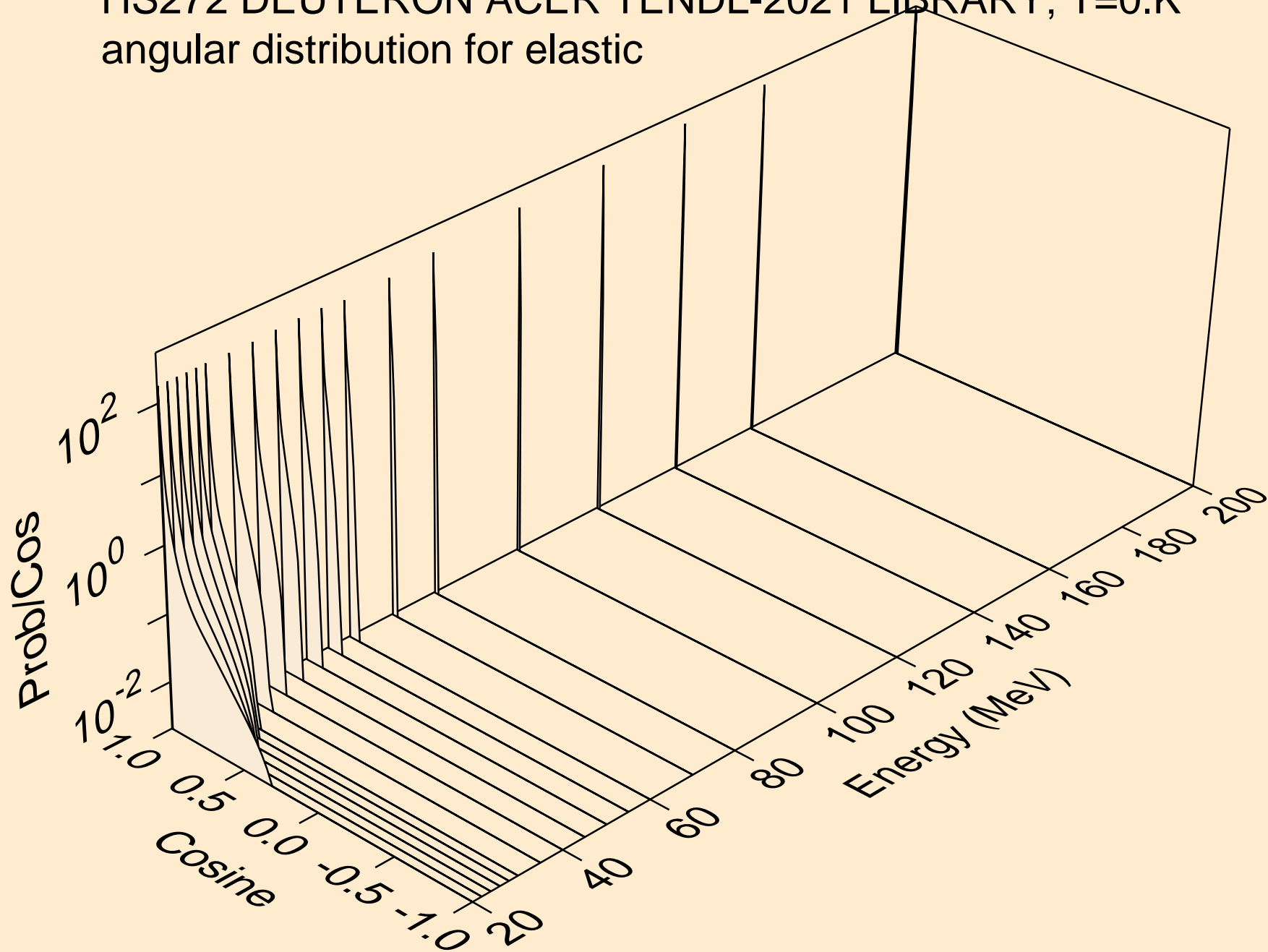

HS272 DEUTERON ACER TENDL-2021 LIBRARY; T=0.K
Deuteron emission for (d,x)

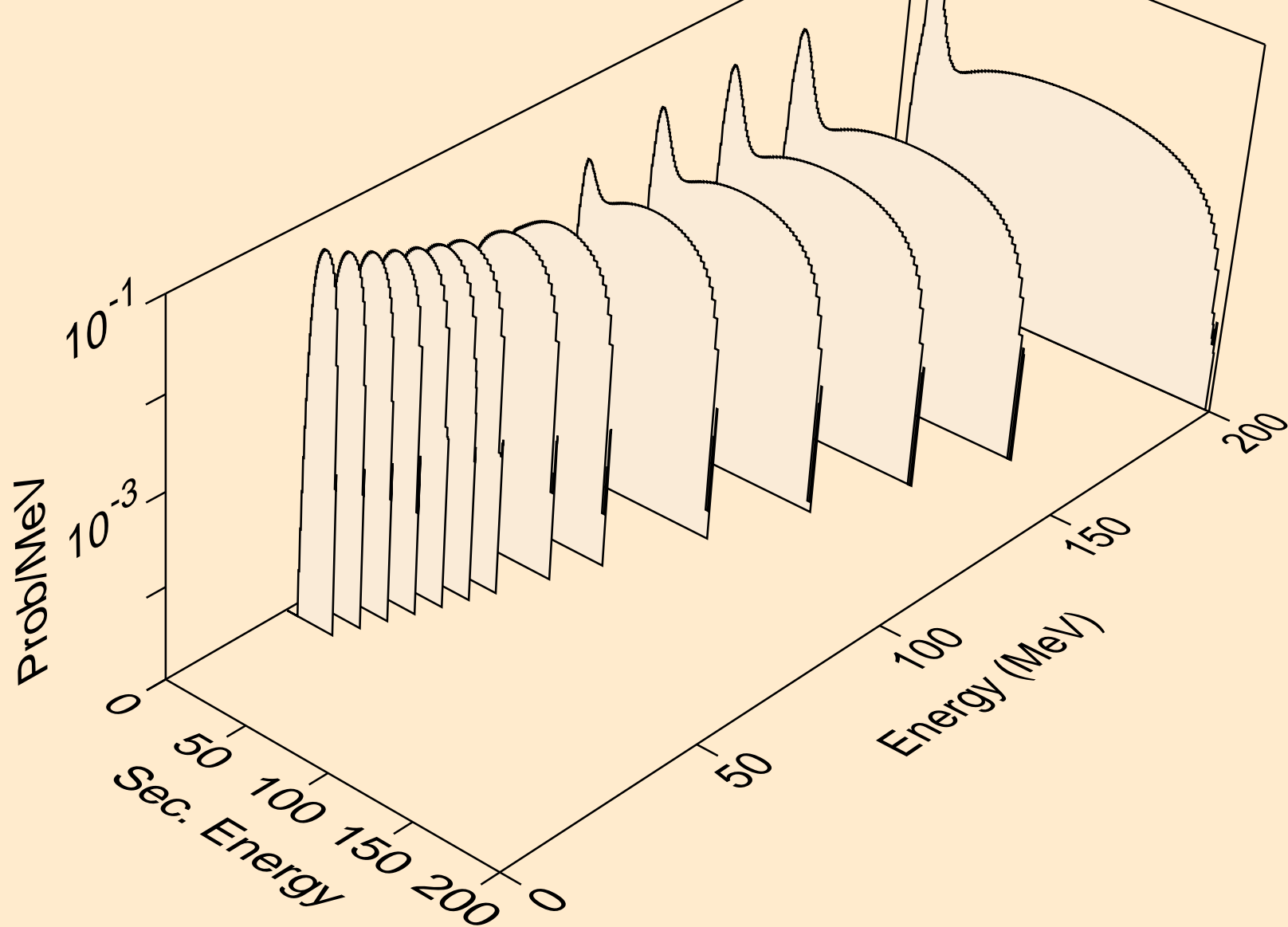

HS272 DEUTERON ACER TENDL-2021 LIBRARY; T=0.K
Deuteron emission for (d,n*)d

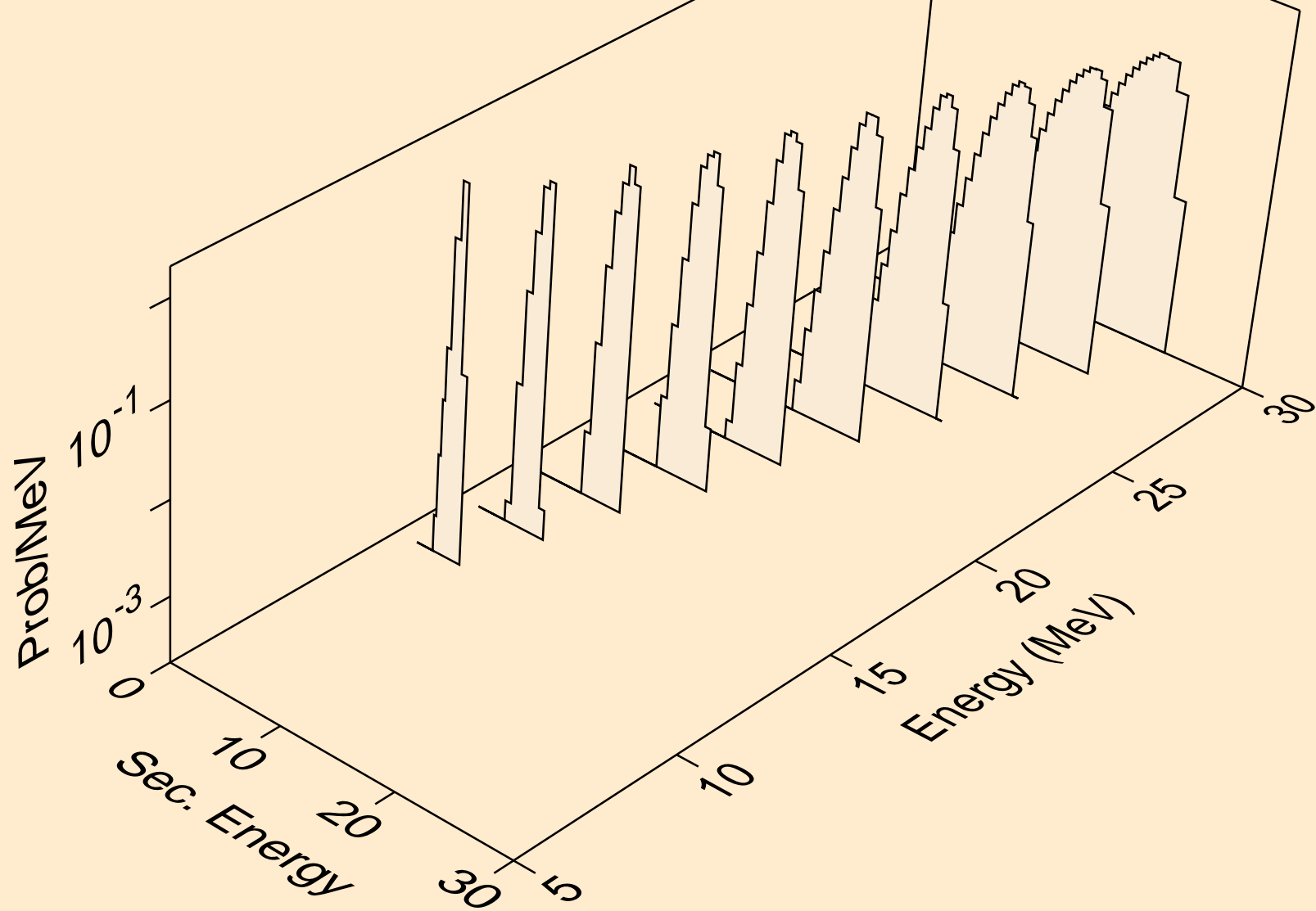

HS272 DEUTERON ACER TENDL-2021 LIBRARY; T=0.K
Deuteron emission for inelastic

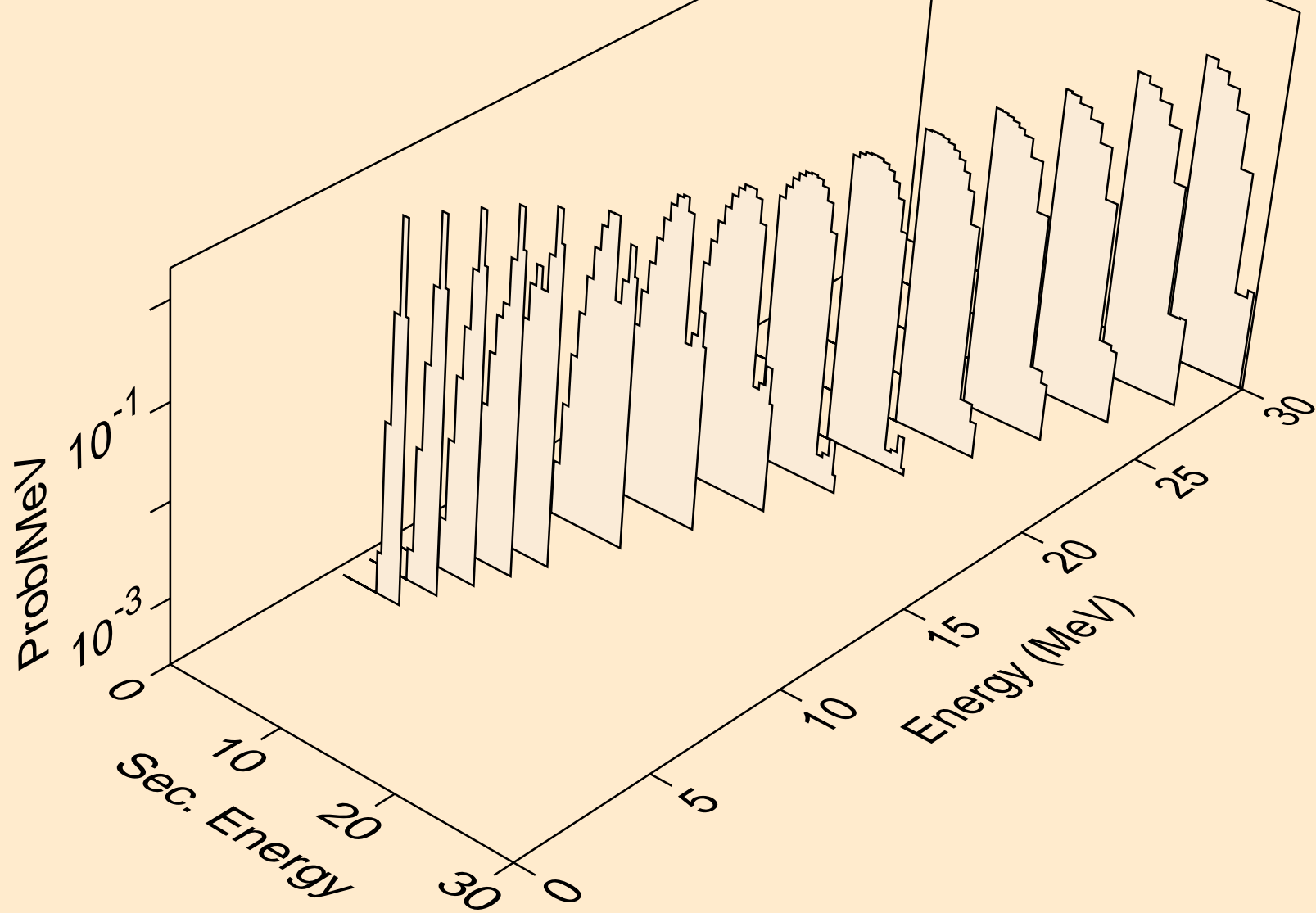

HS272 DEUTERON ACER TENDL-2021 LIBRARY; T=0.K
Deuteron emission for (d,pd)

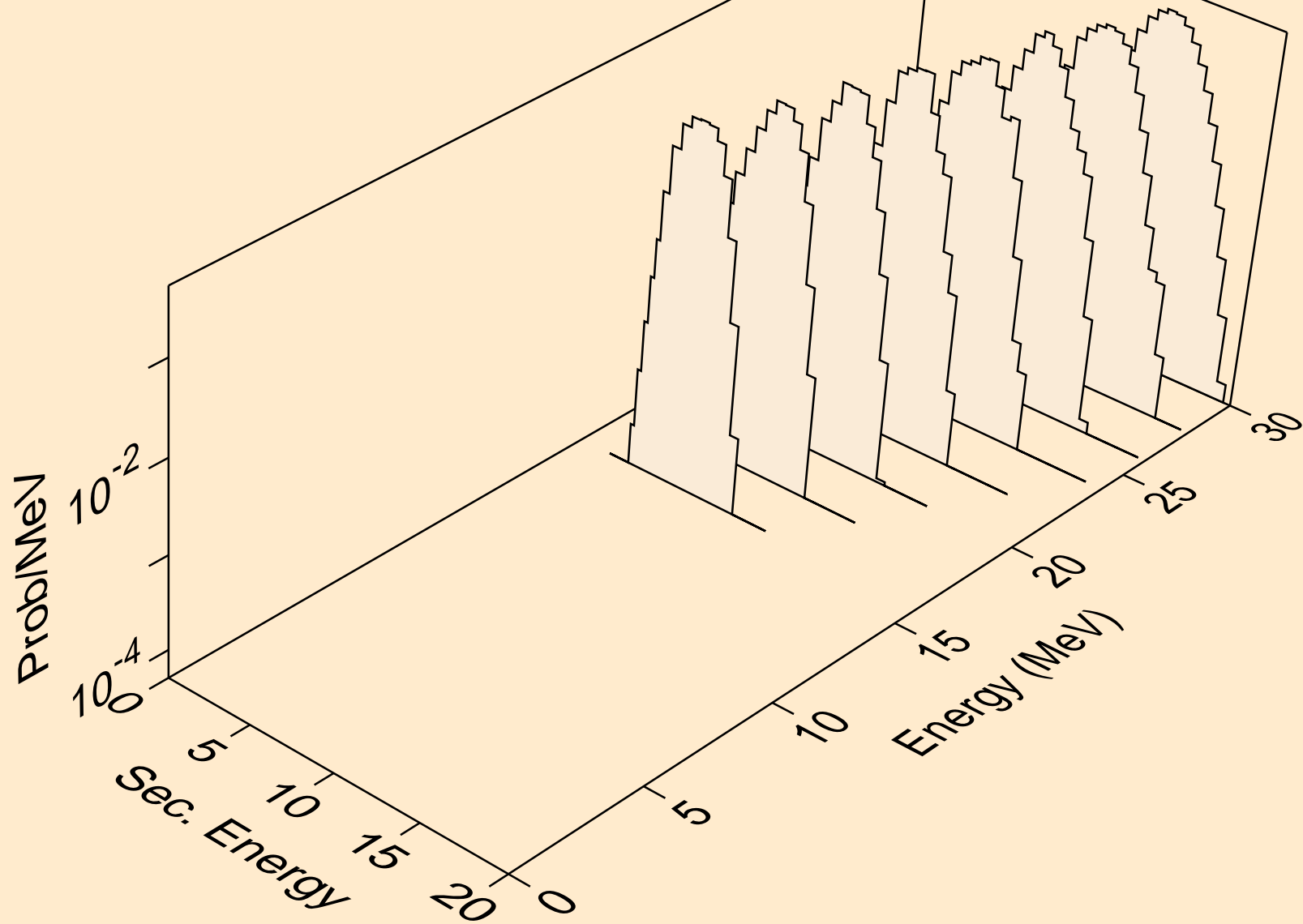

HS272 DEUTERON ACER TENDL-2021 LIBRARY; T=0.K
Deuteron emission for (d,da)

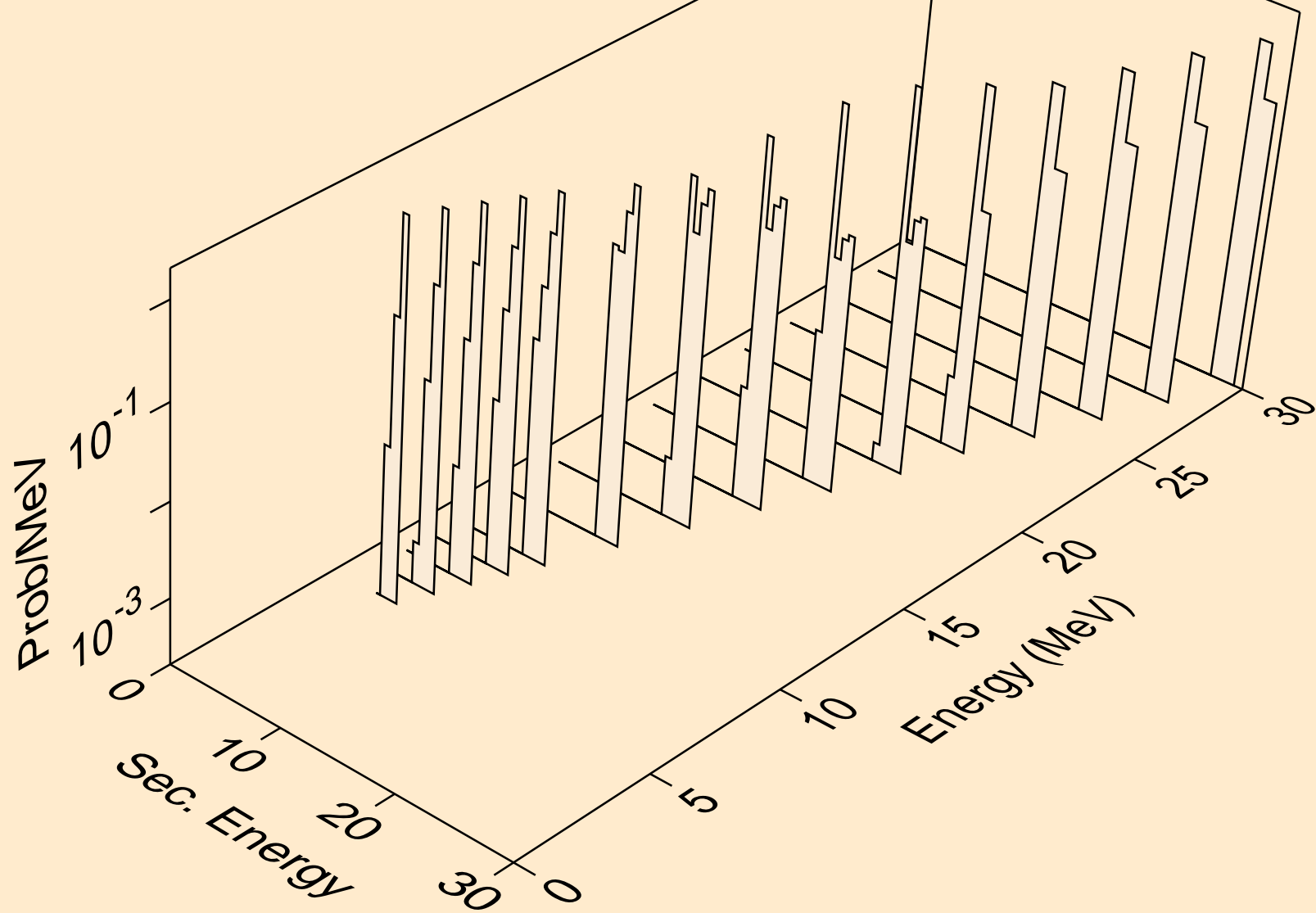

HS272 DEUTERON ACER TENDL-2021 LIBRARY; T=0.K
Photon emission for (z,n)

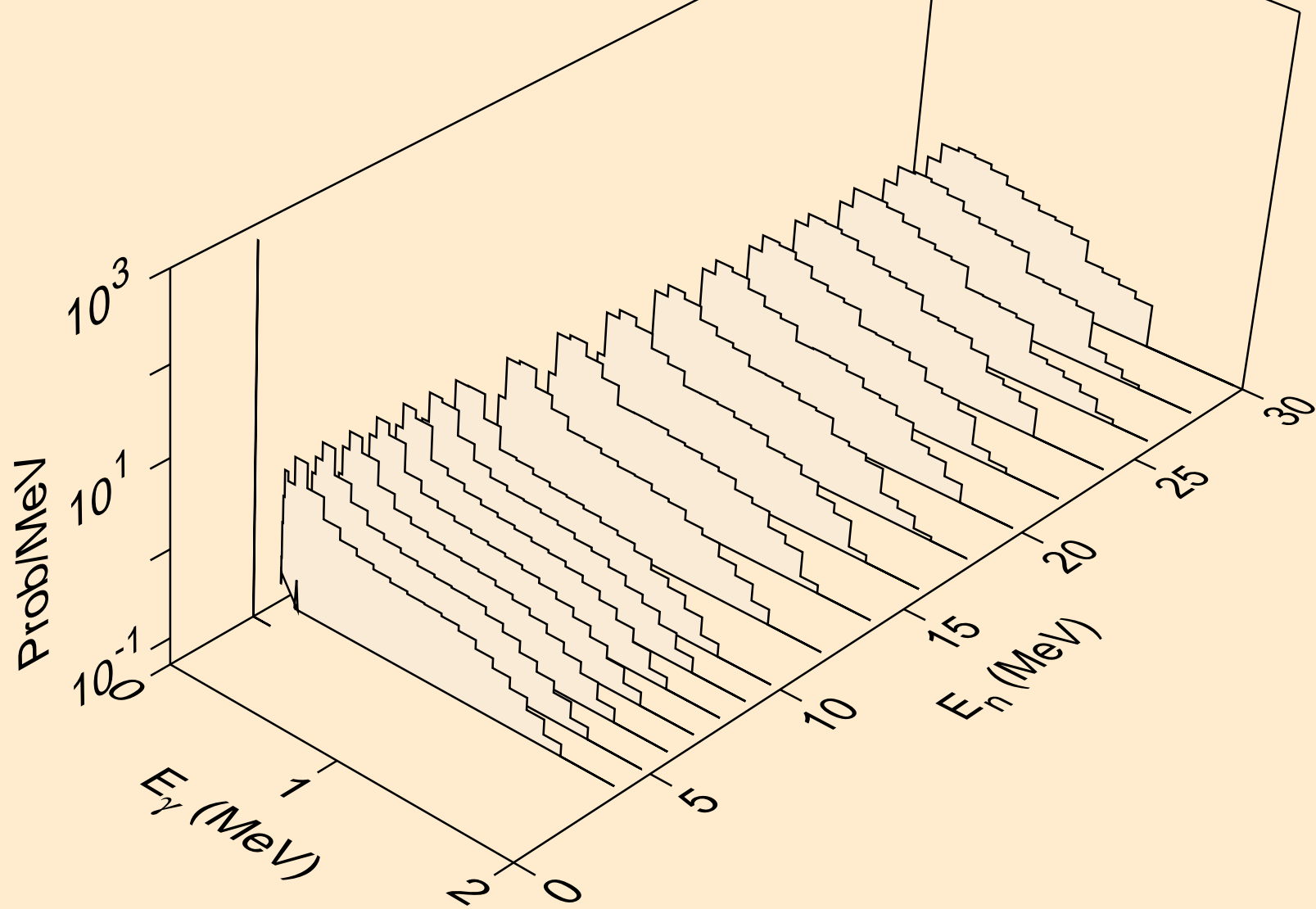

HS272 DEUTERON ACER TENDL-2021 LIBRARY; T=0.K
Photon emission for (n,x)

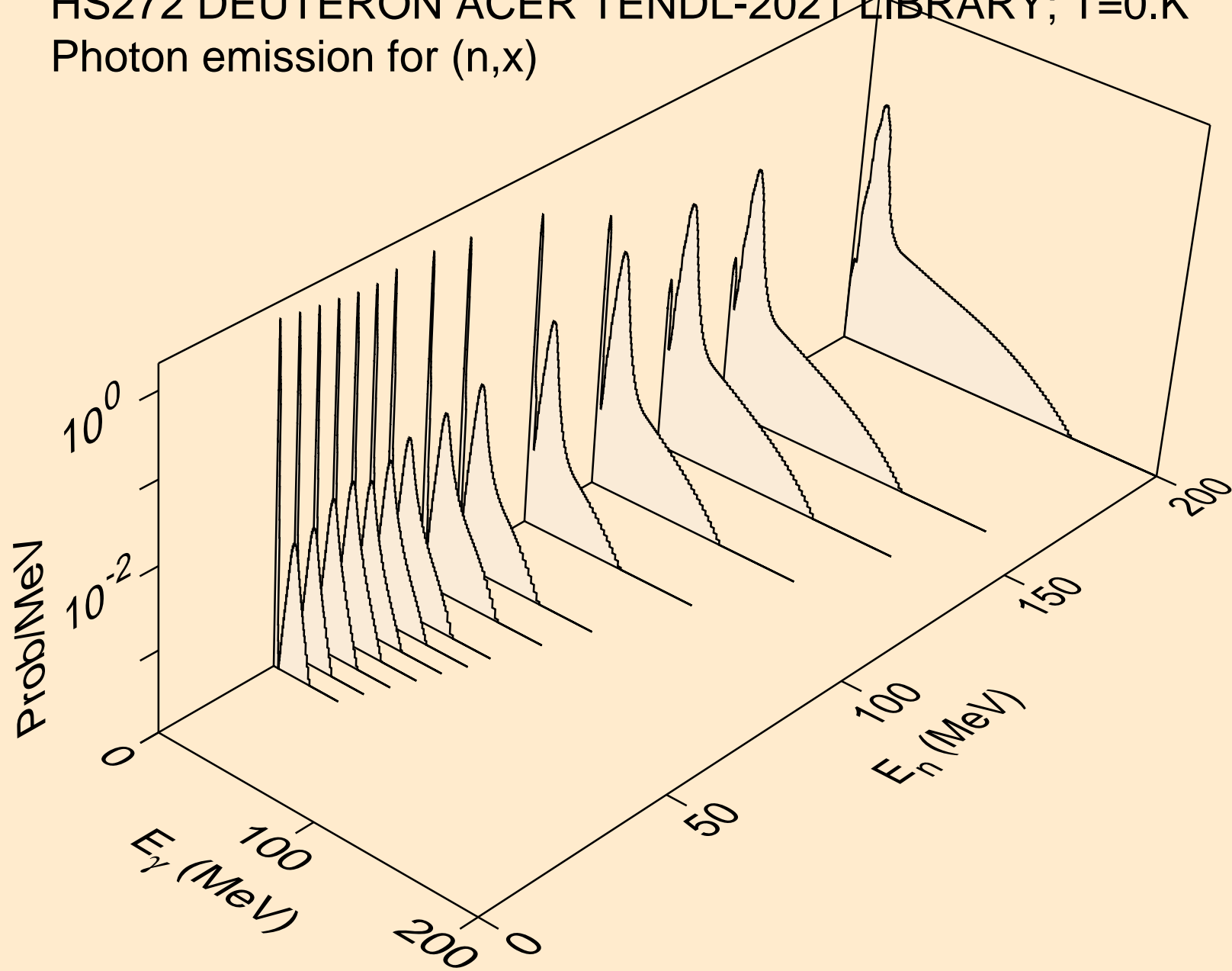

HS272 DEUTERON ACER TENDL-2021 LIBRARY; T=0.K
Photon emission for (n,2n)

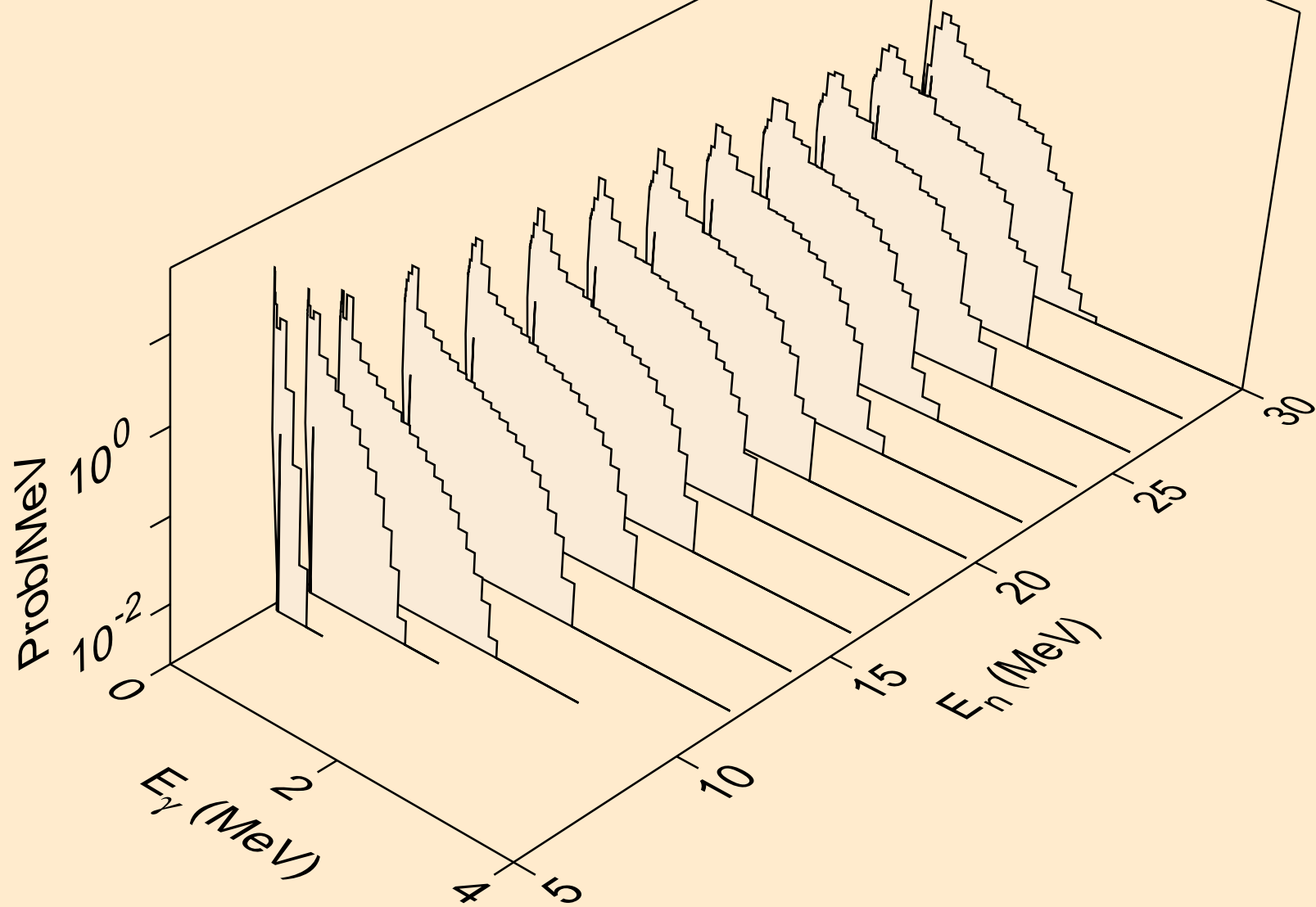

HS272 DEUTERON ACER TENDL-2021 LIBRARY; T=0.K
Photon emission for (n,3n)

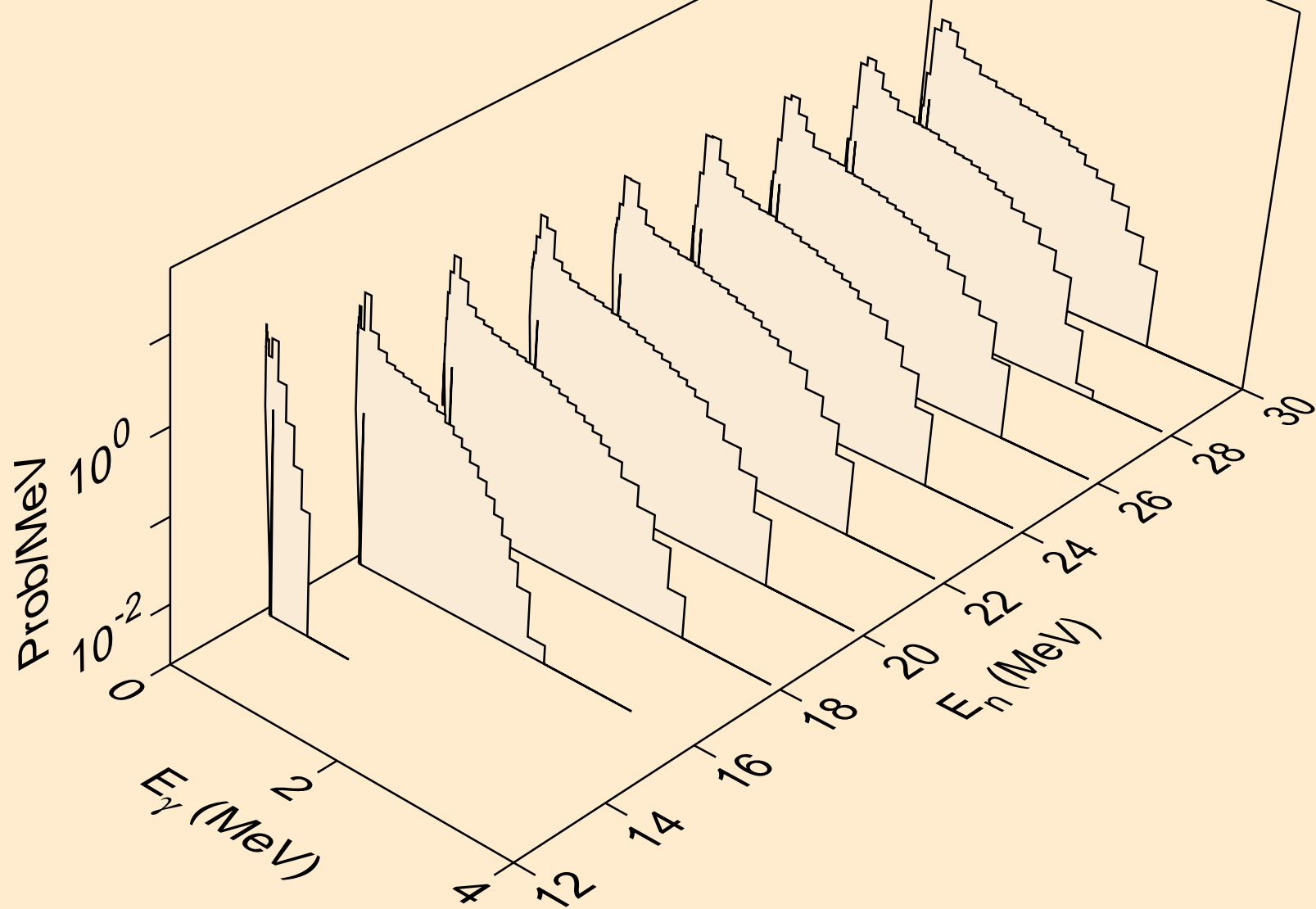

HS272 DEUTERON ACER TENDL-2021 LIBRARY; T=0.K
Photon emission for (n,n*)a

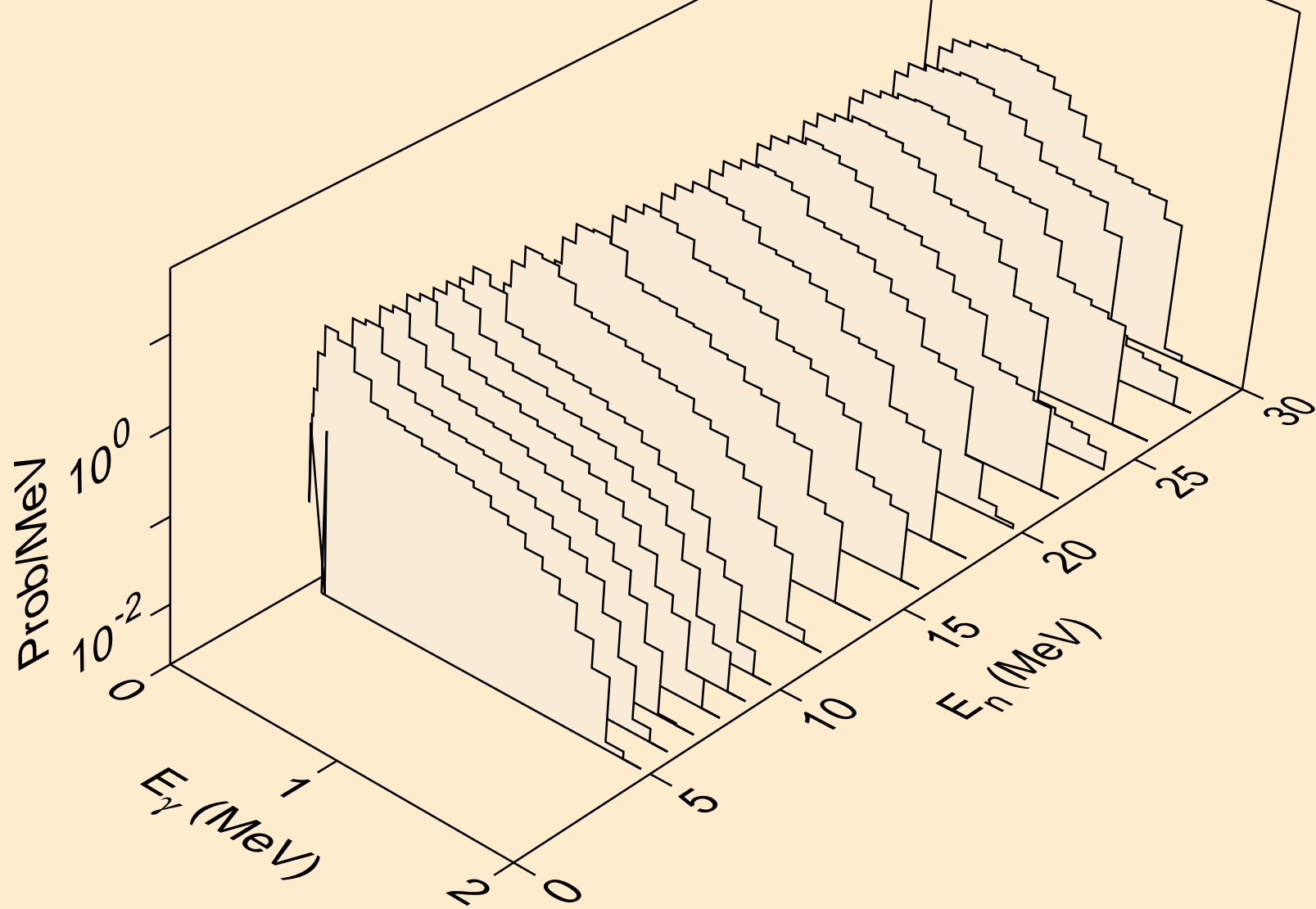

HS272 DEUTERON ACER TENDL-2021 LIBRARY; T=0.K
Photon emission for (n,2n)a

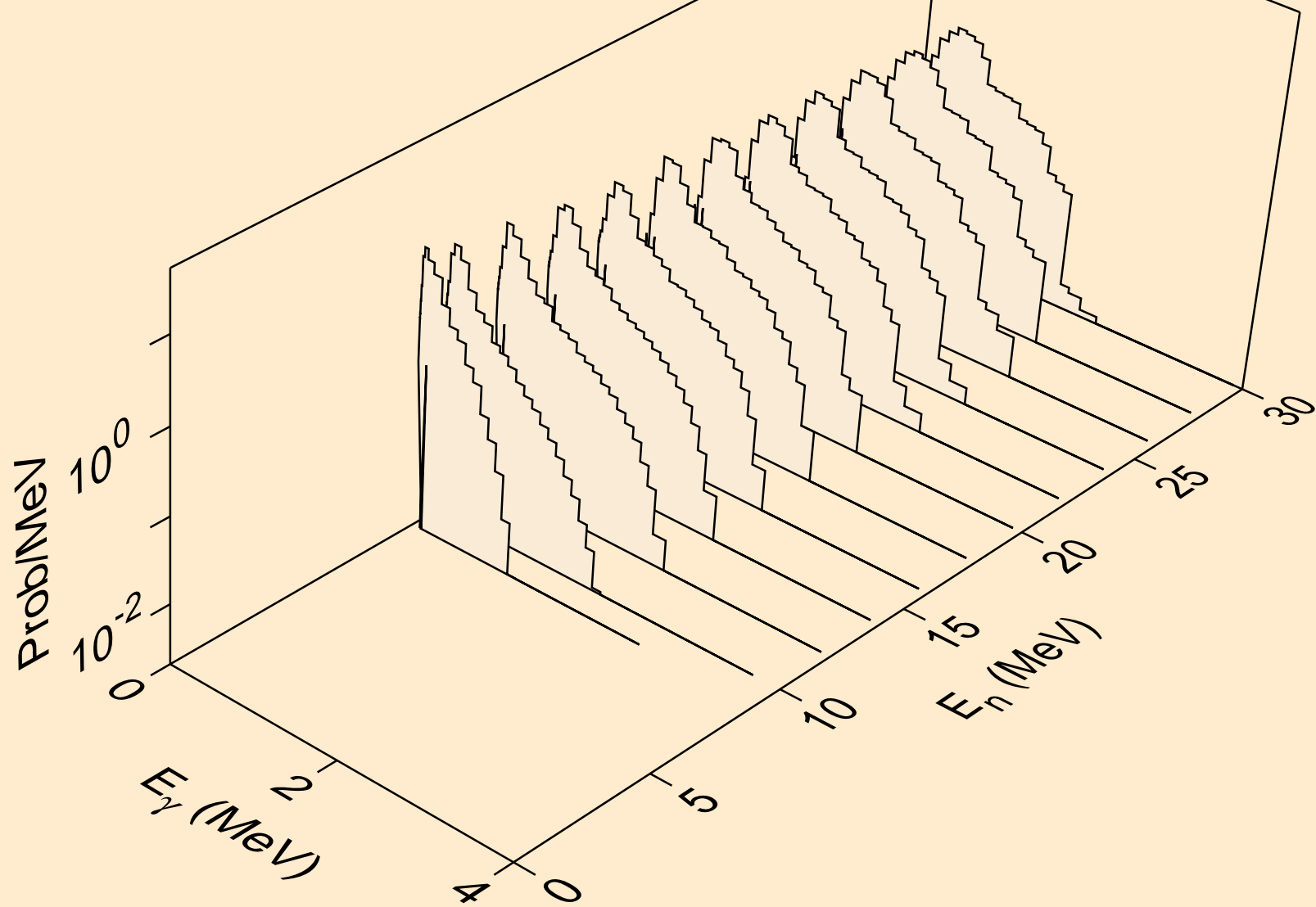

HS272 DEUTERON ACER TENDL-2021 LIBRARY; T=0.K
Photon emission for (n,3n)a

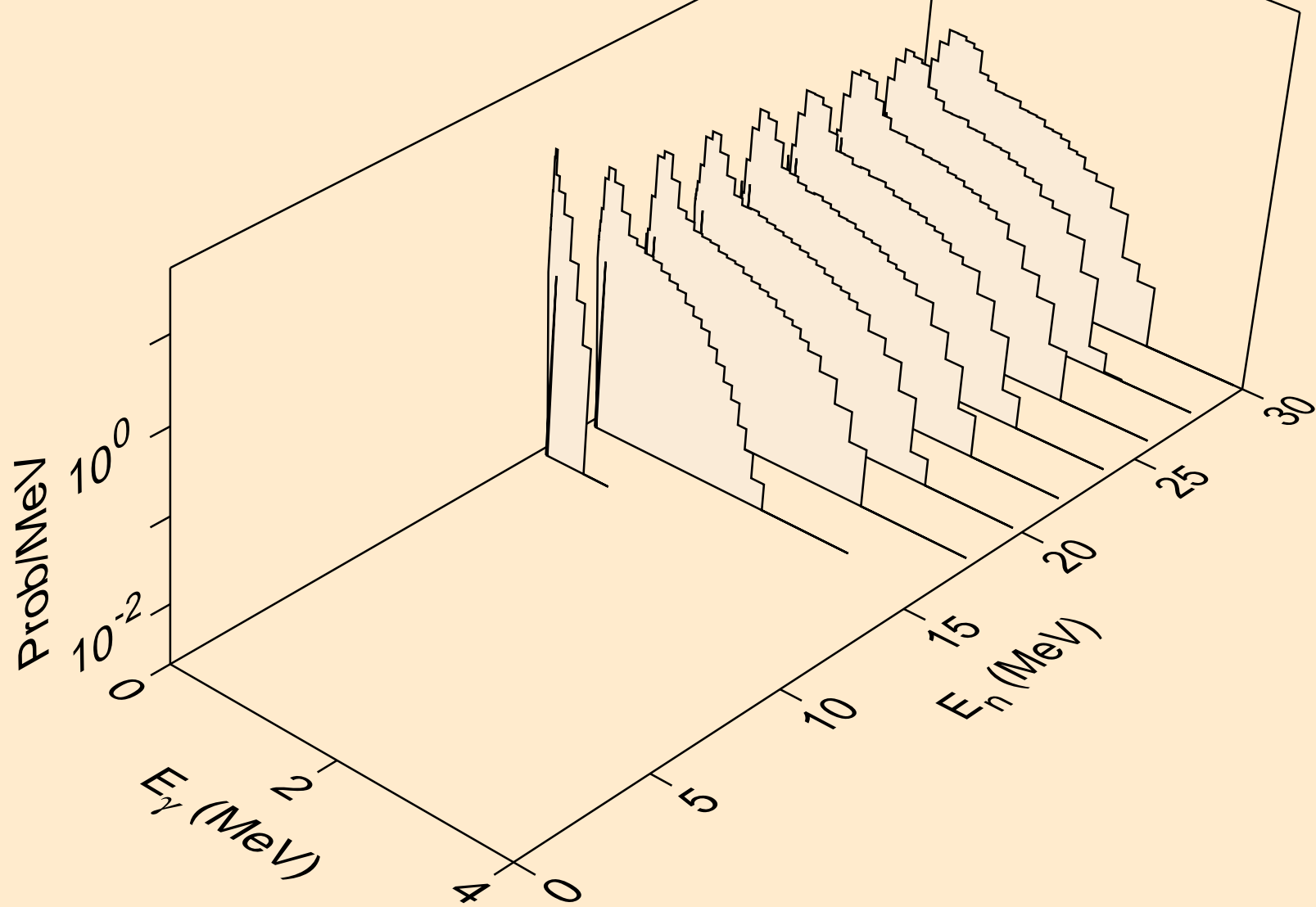

HS272 DEUTERON ACER TENDL-2021 LIBRARY; T=0.K
Photon emission for (n,n*)p

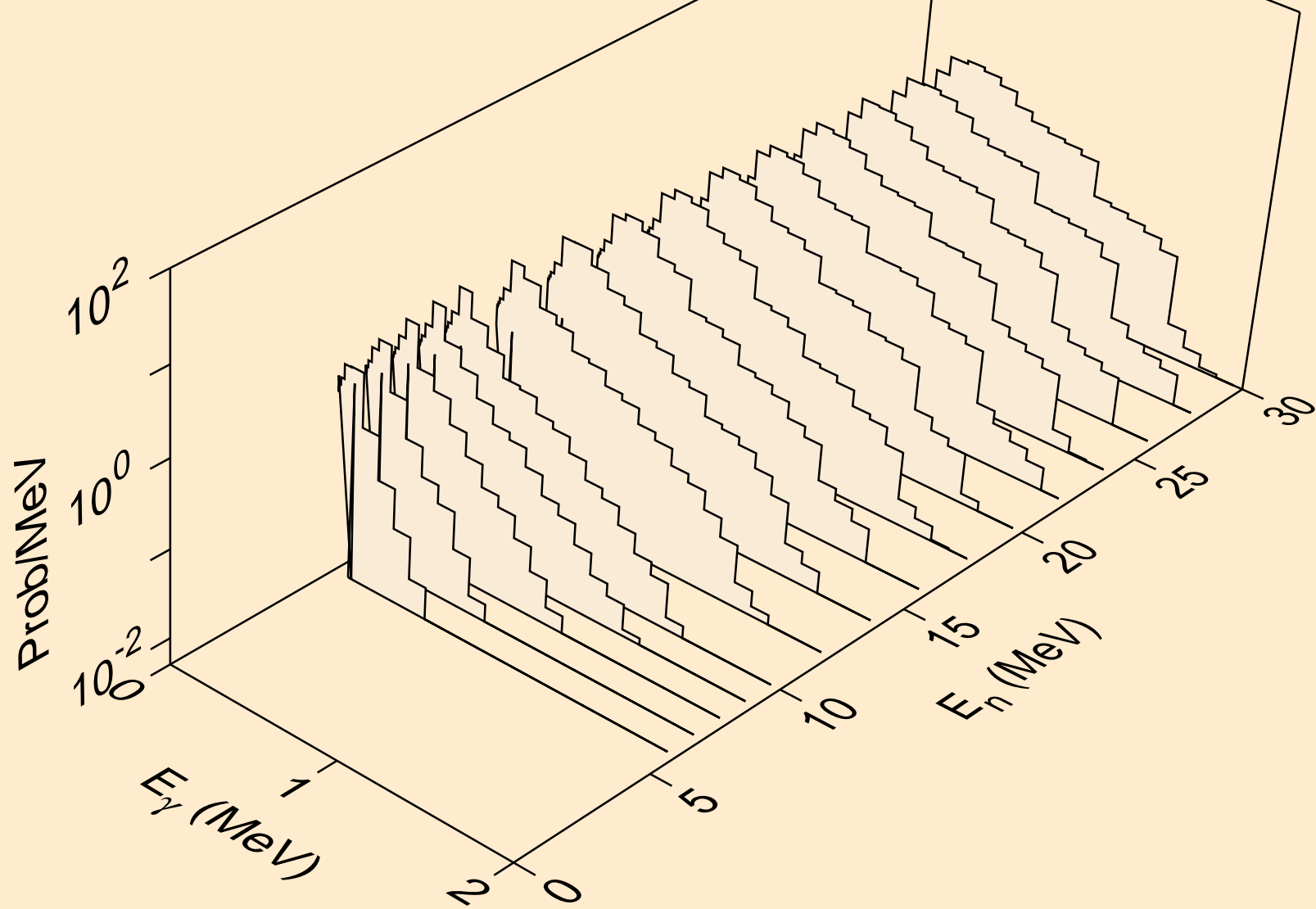

HS272 DEUTERON ACER TENDL-2021 LIBRARY; T=0.K
Photon emission for (n,n*)d

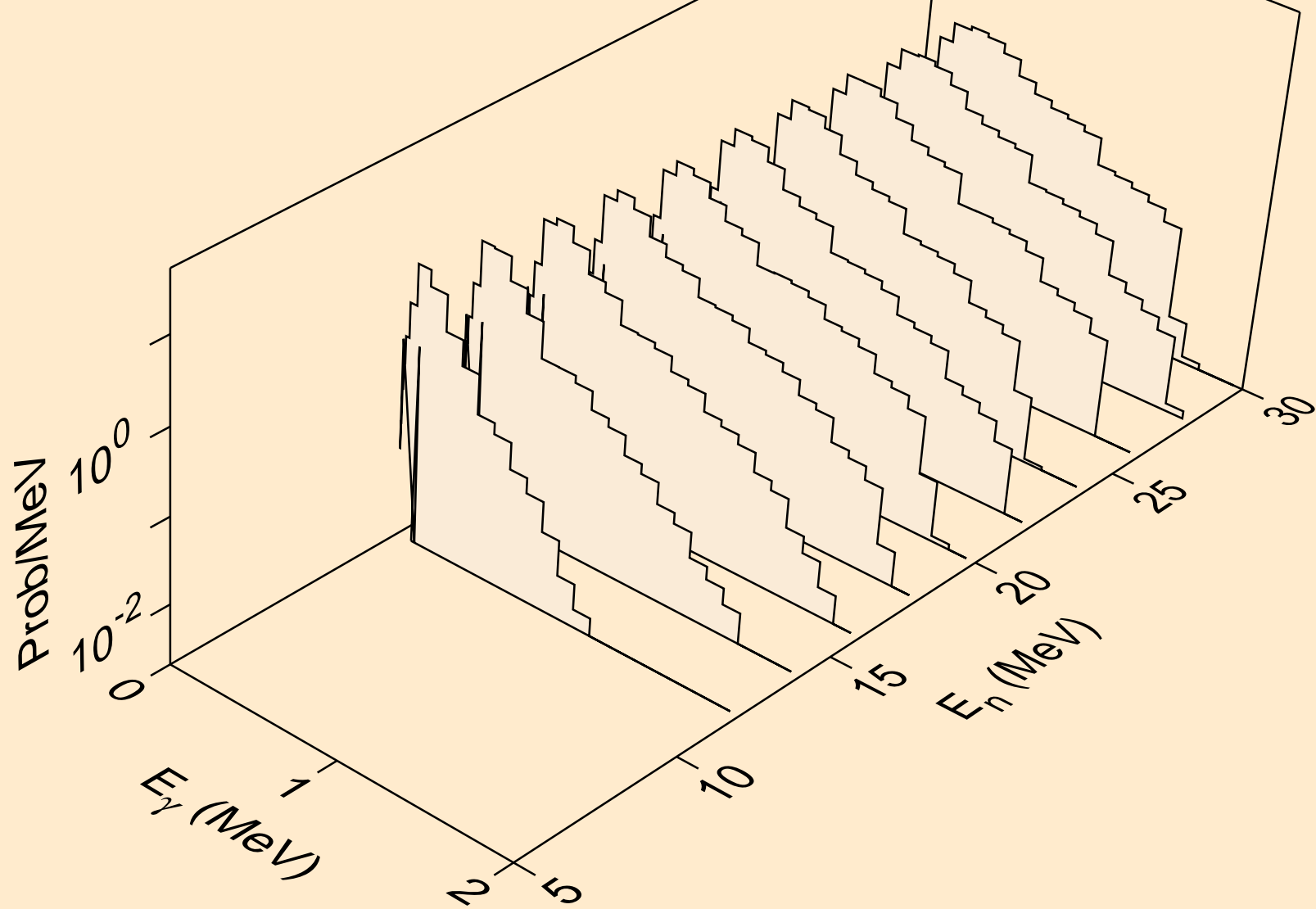

HS272 DEUTERON ACER TENDL-2021 LIBRARY; T=0.K
Photon emission for (n,n*)t

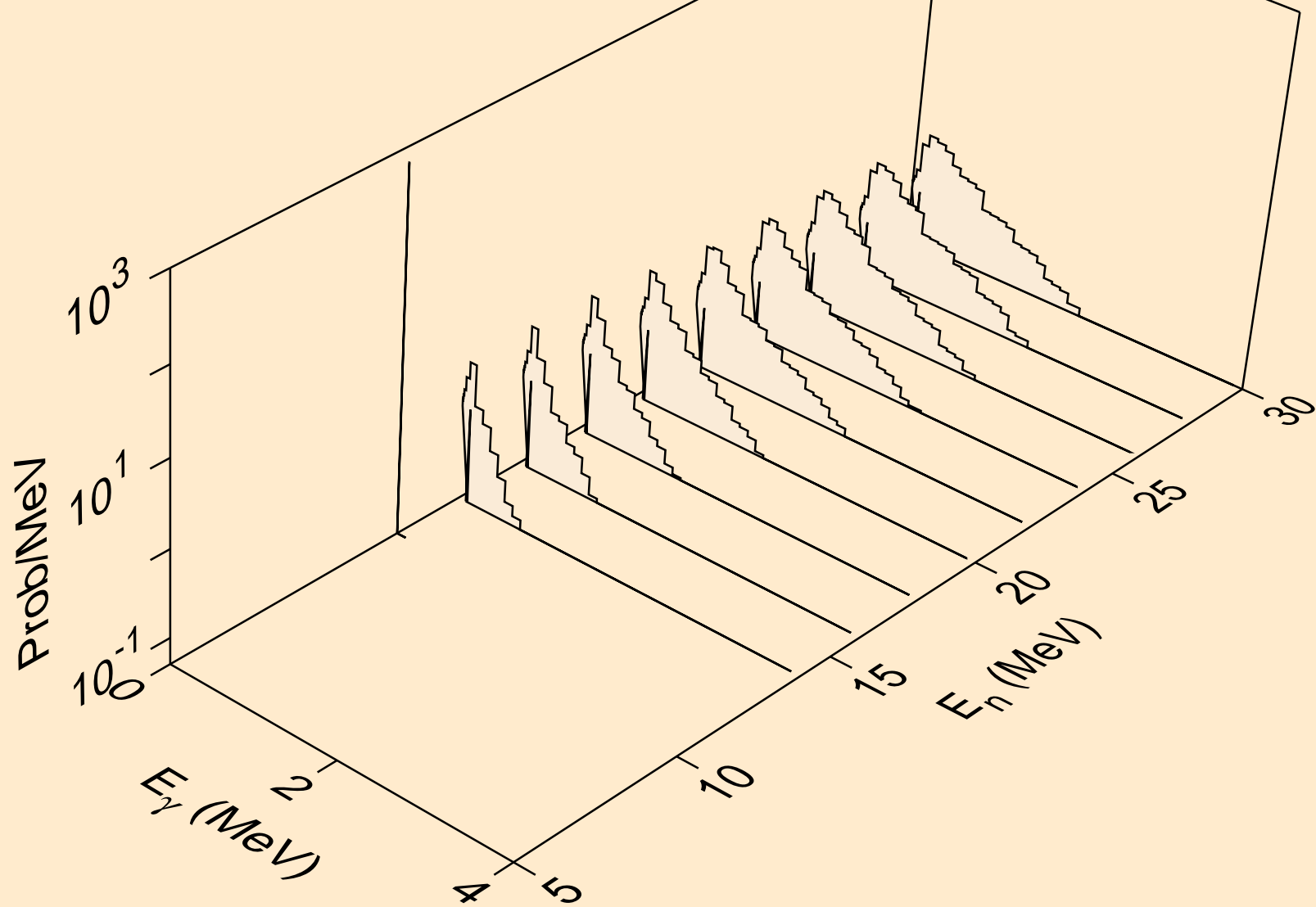

HS272 DEUTERON ACER TENDL-2021 LIBRARY; T=0.K
Photon emission for (n,4n)

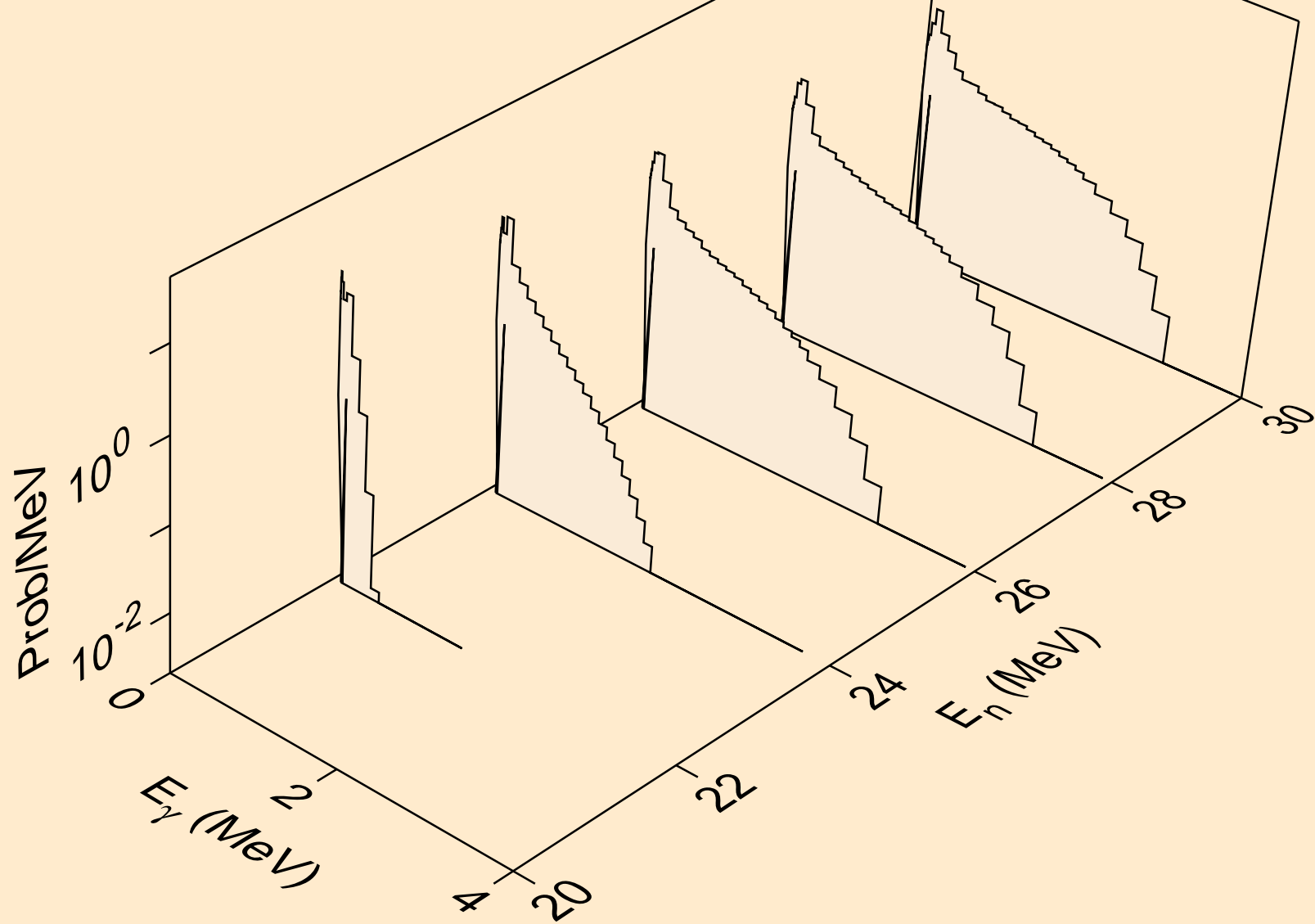

HS272 DEUTERON ACER TENDL-2021 LIBRARY; T=0.K
Photon emission for (n,2np)

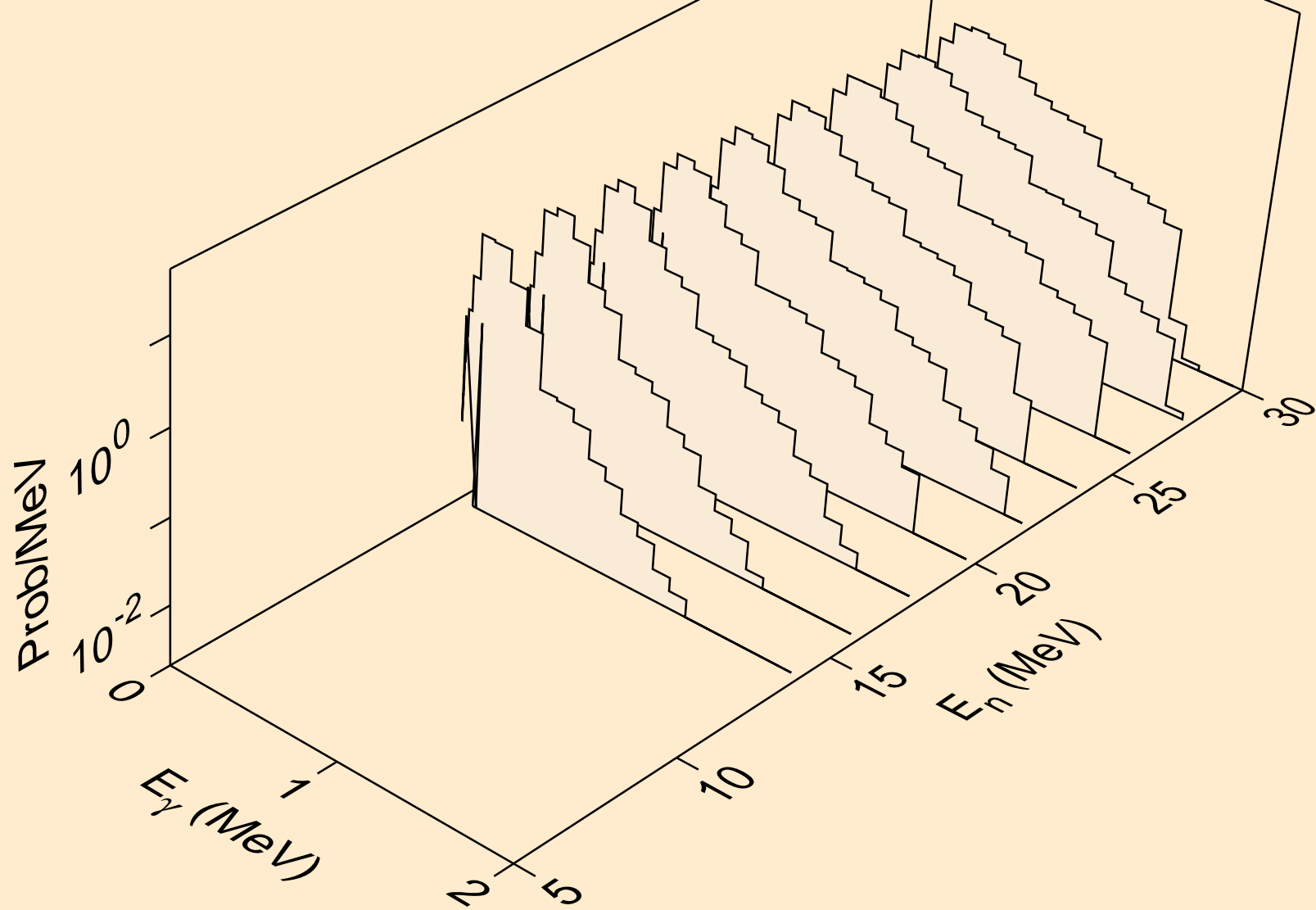

HS272 DEUTERON ACER TENDL-2021 LIBRARY; T=0.K
Photon emission for (n,3np)

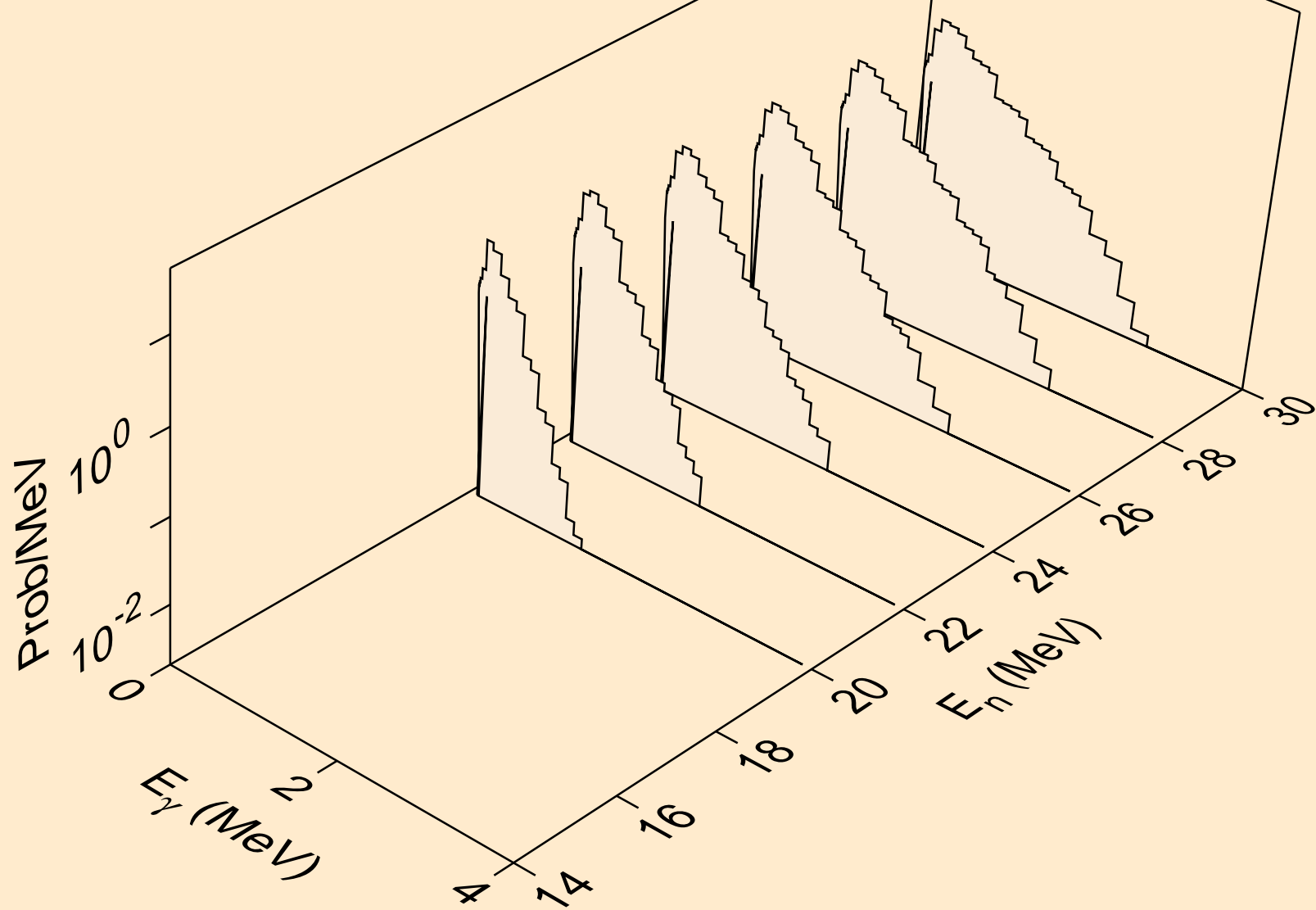

HS272 DEUTERON ACER TENDL-2021 LIBRARY; T=0.K
Photon emission for (n,2np)

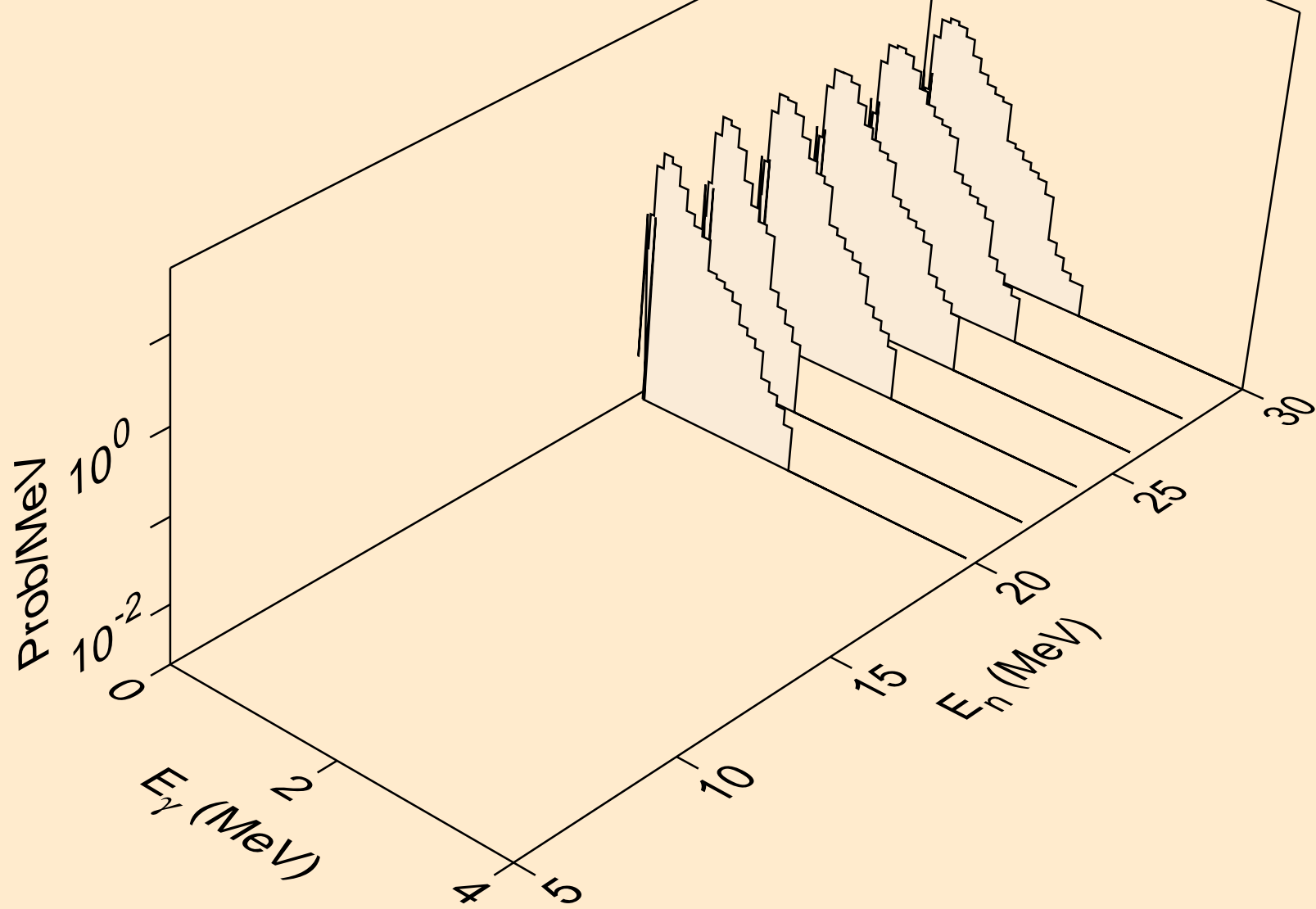

HS272 DEUTERON ACER TENDL-2021 LIBRARY; T=0.K
Photon emission for (n,npa)

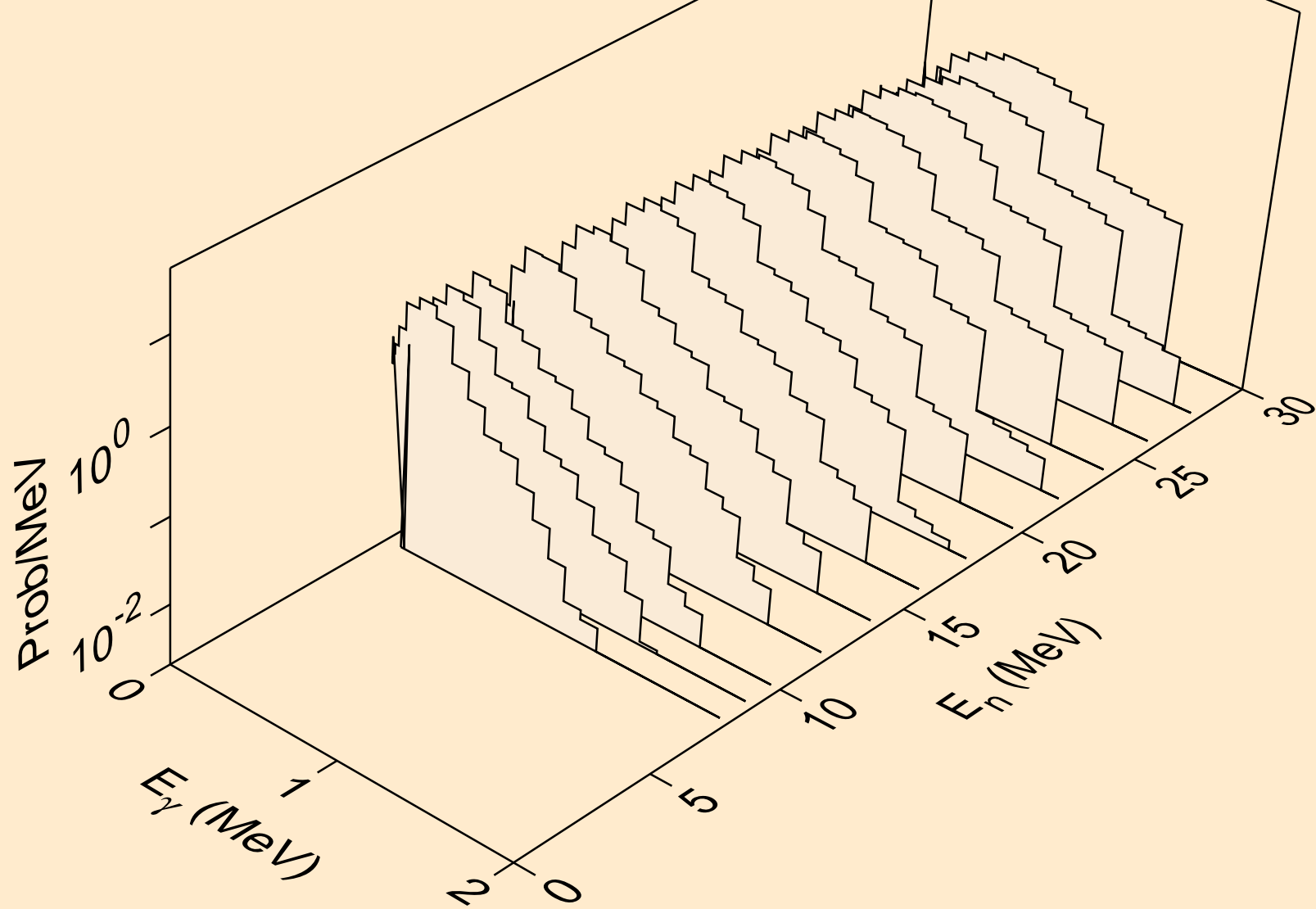

HS272 DEUTERON ACER TENDL-2021 LIBRARY; T=0.K
Photon emission for (n,p)

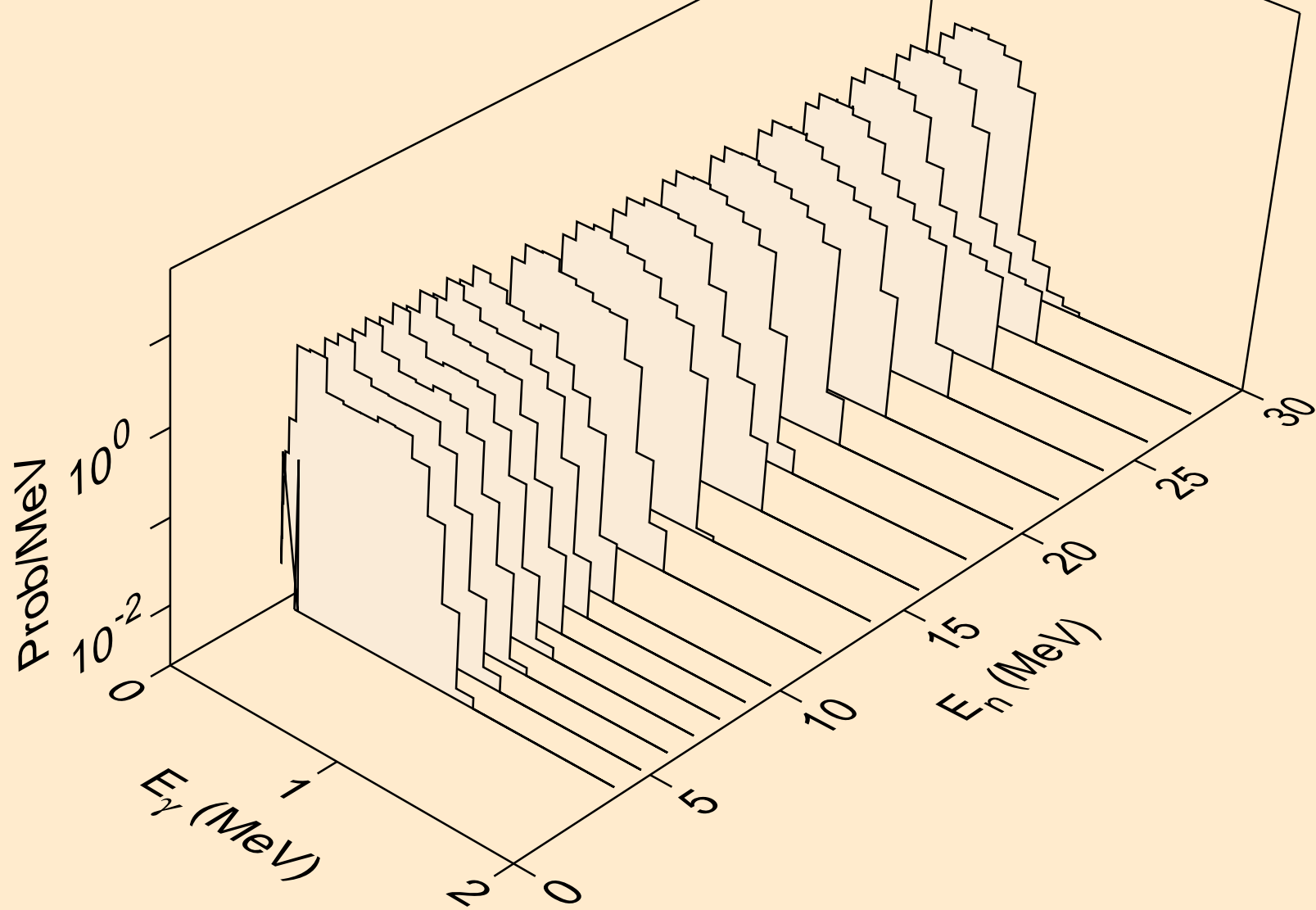

HS272 DEUTERON ACER TENDL-2021 LIBRARY; T=0.K
Photon emission for inelastic

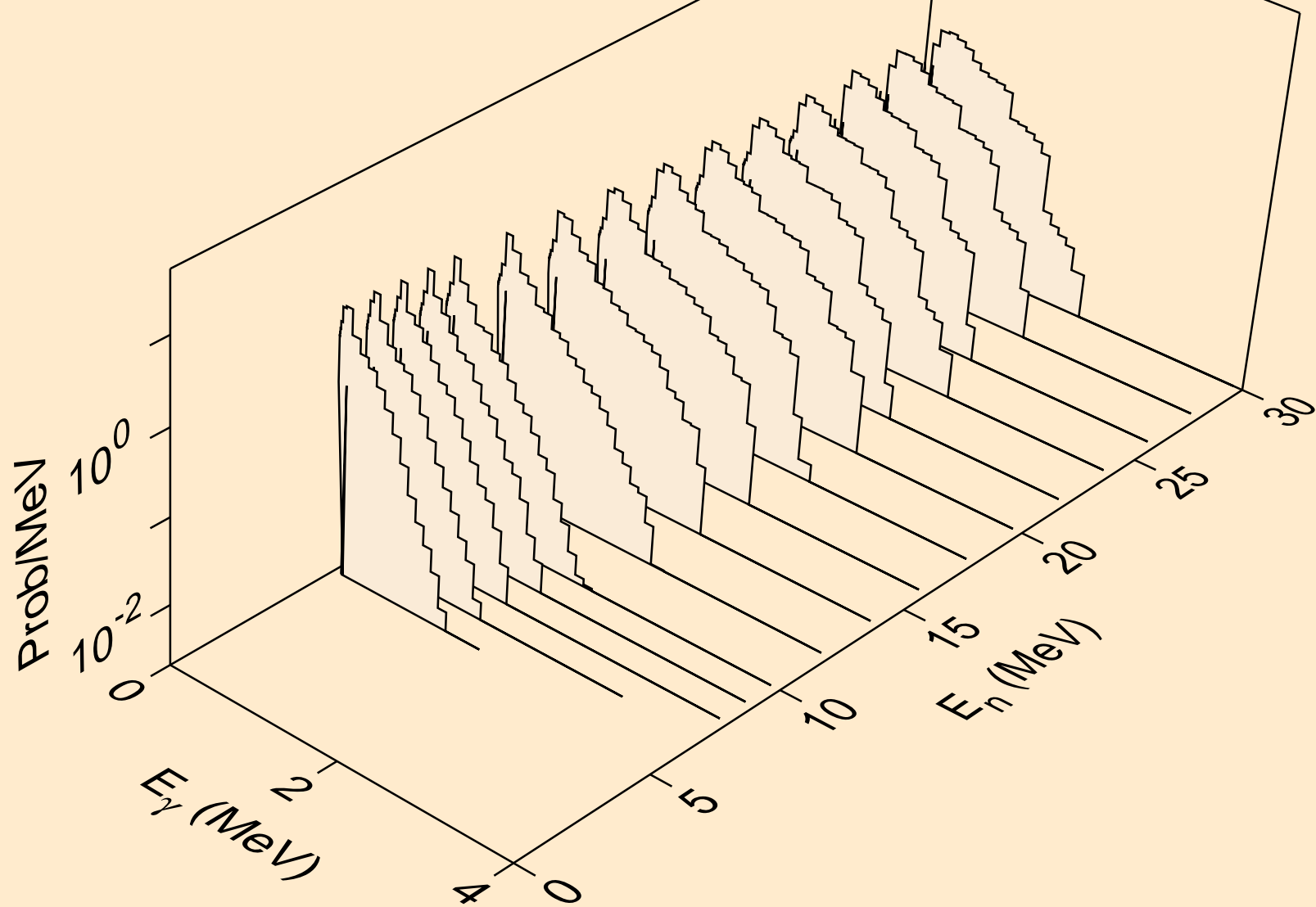

HS272 DEUTERON ACER TENDL-2021 LIBRARY; T=0.K
Photon emission for (n,t)

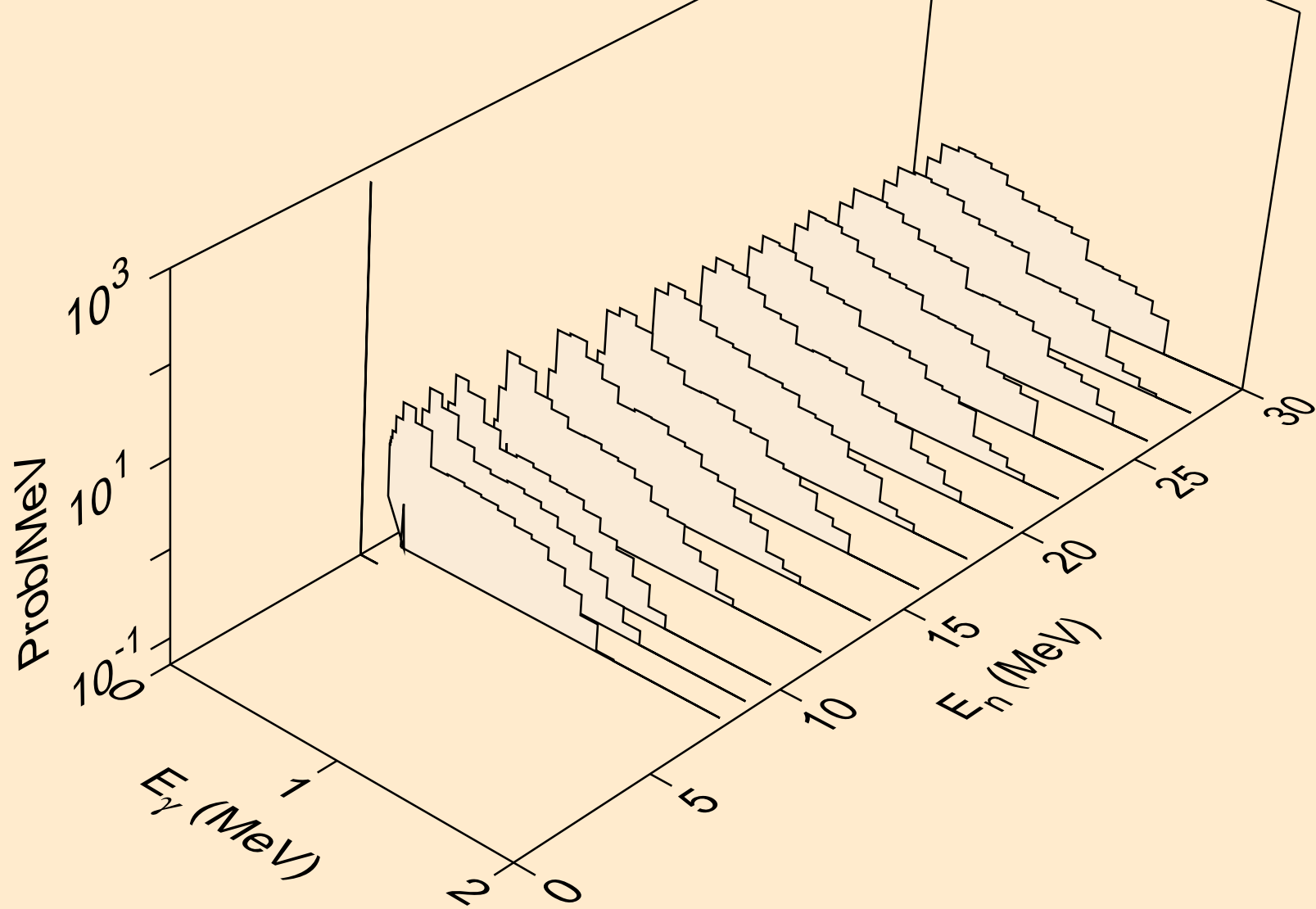

HS272 DEUTERON ACER TENDL-2021 LIBRARY; T=0.K
Photon emission for (n,he3)

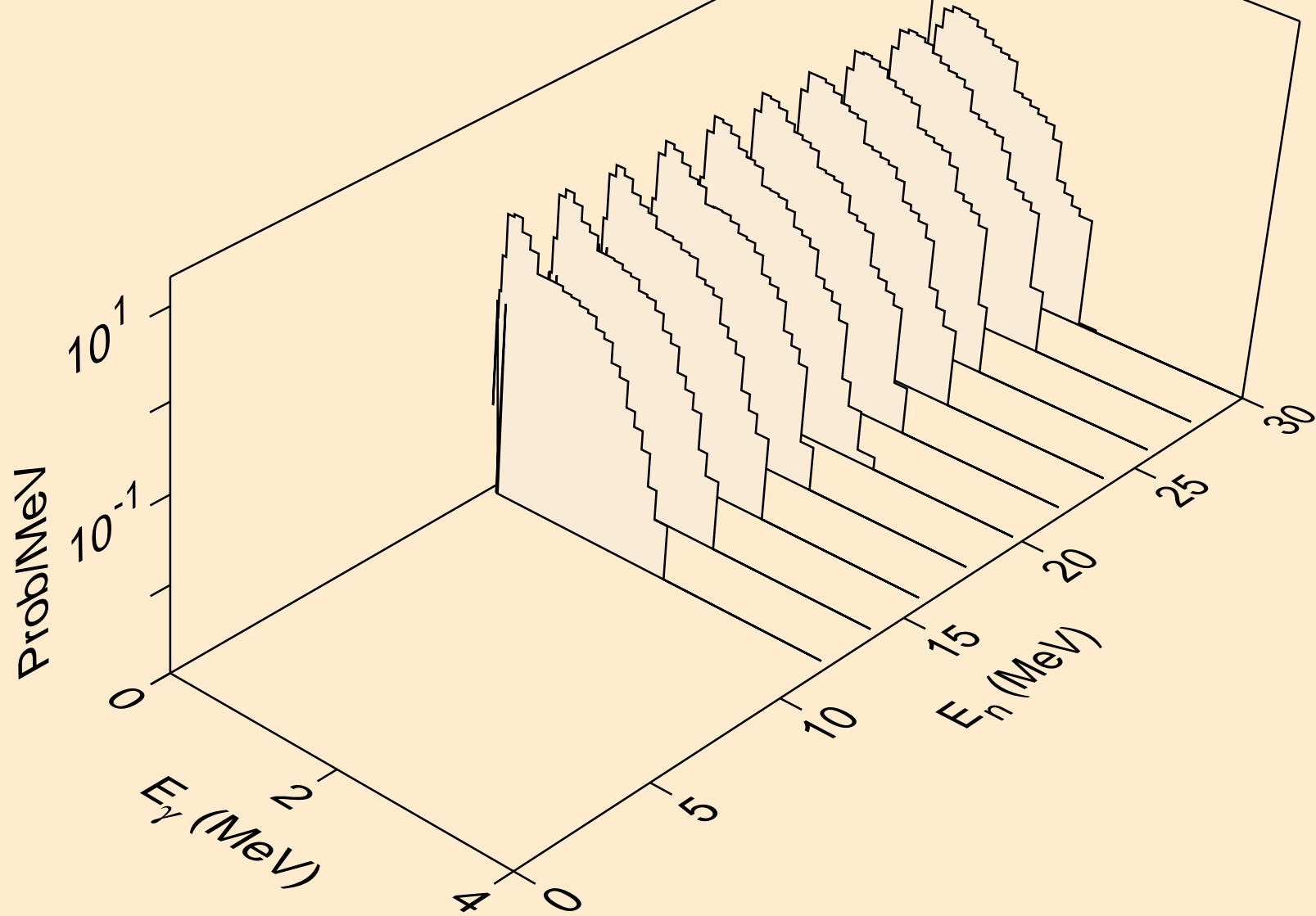

HS272 DEUTERON ACER TENDL-2021 LIBRARY; T=0.K
Photon emission for (n,a)

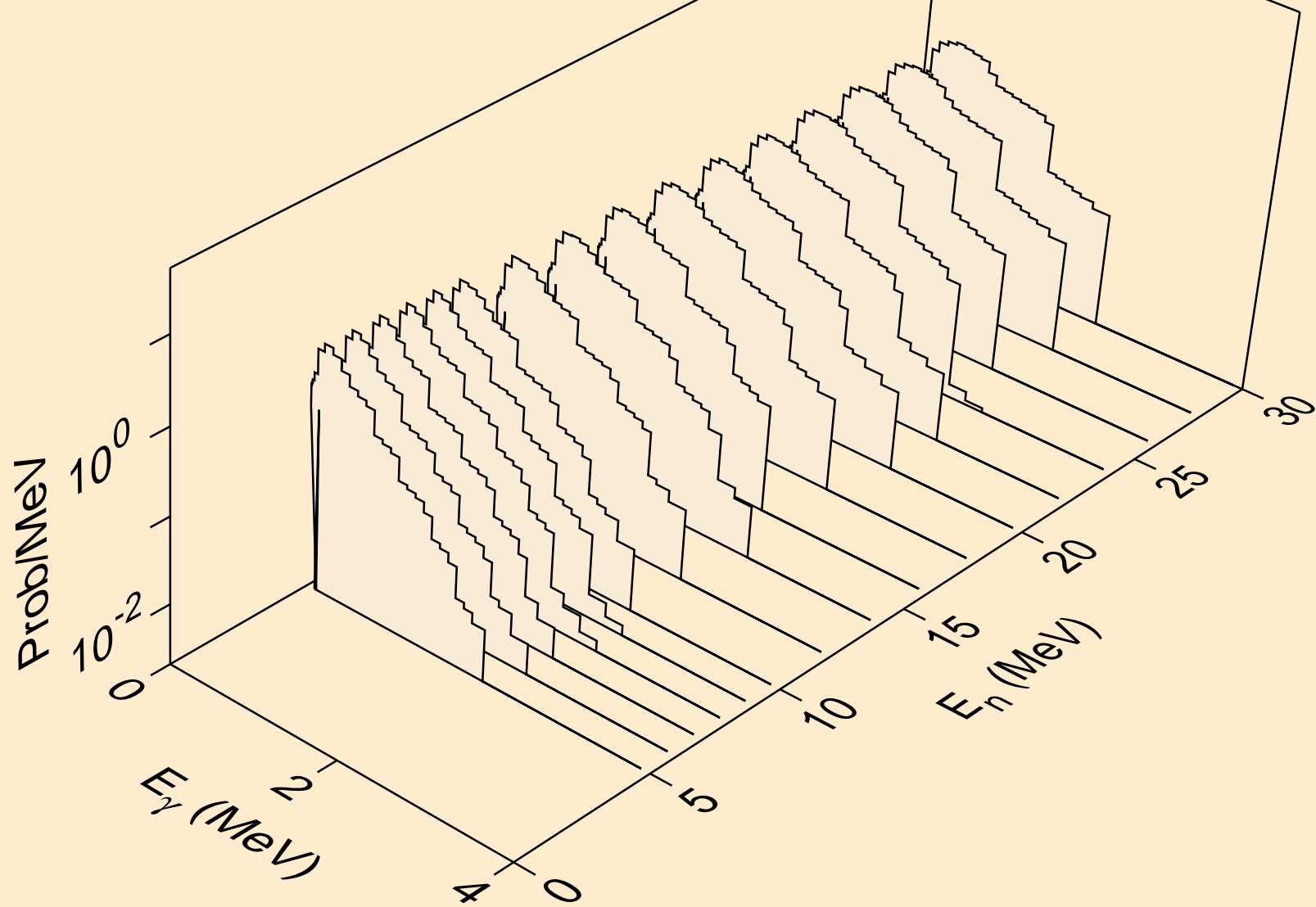

HS272 DEUTERON ACER TENDL-2021 LIBRARY; T=0.K
Photon emission for (n,2a)

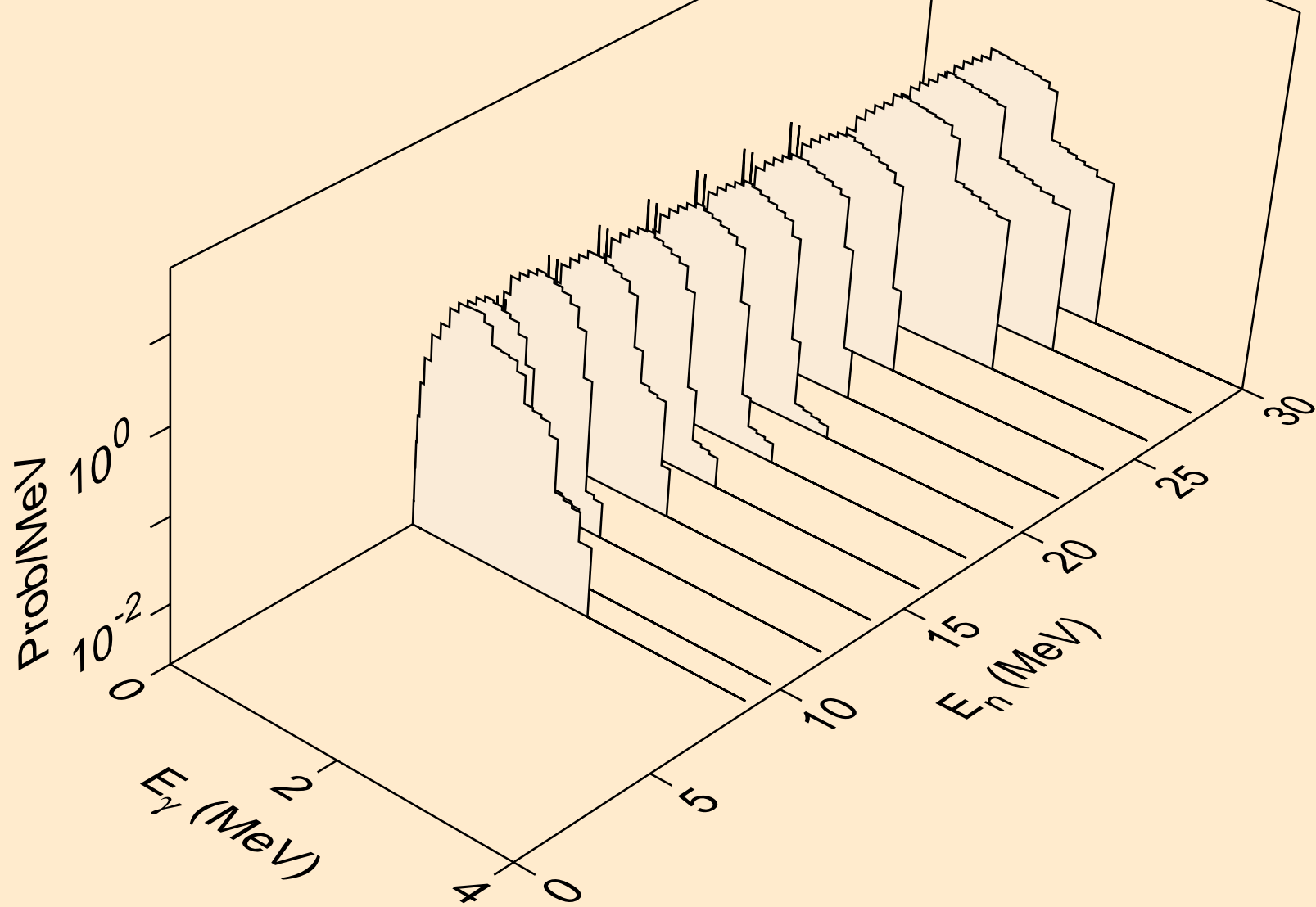

HS272 DEUTERON ACER TENDL-2021 LIBRARY; T=0.K
Photon emission for (n,2p)

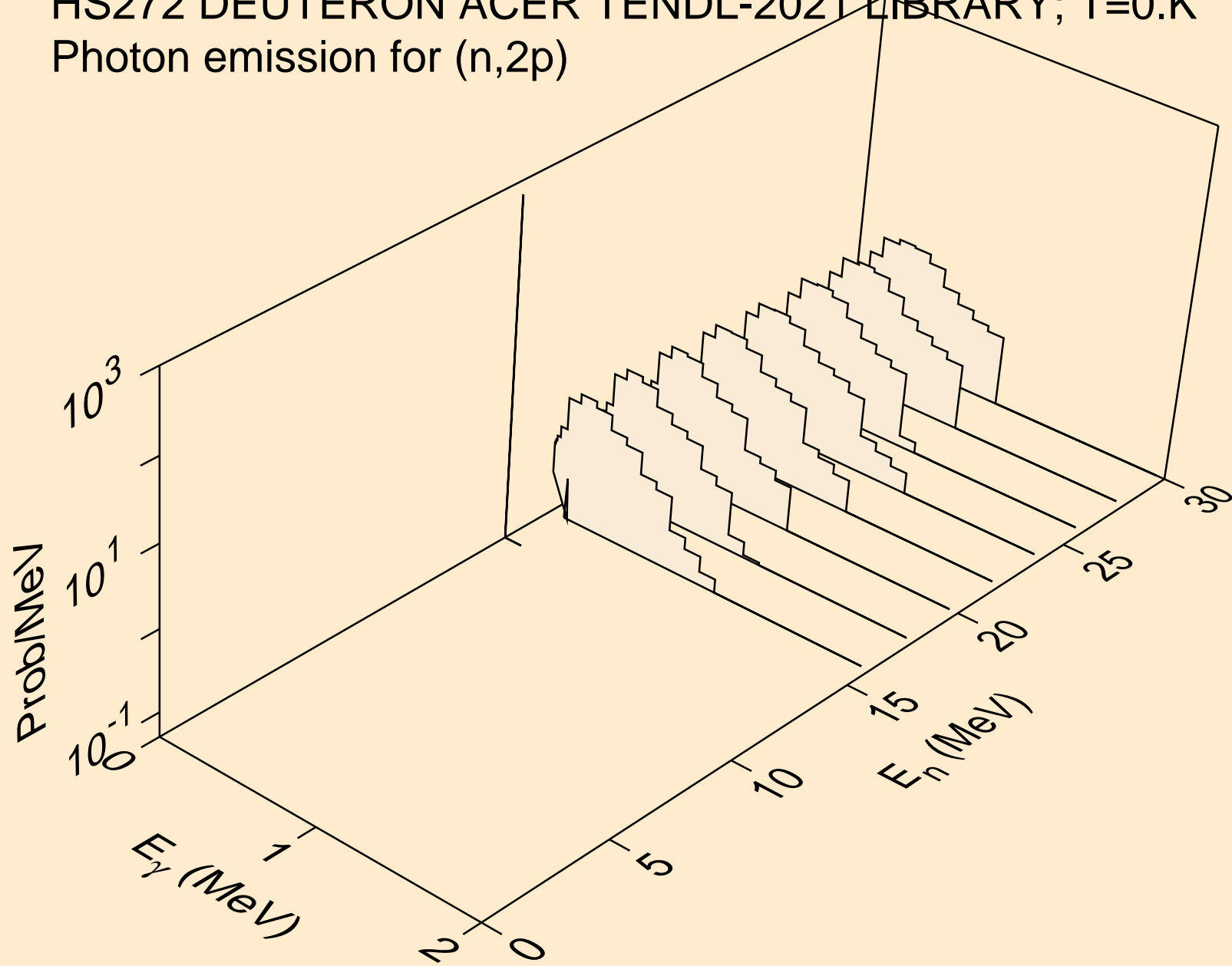

HS272 DEUTERON ACER TENDL-2021 LIBRARY; T=0.K
Photon emission for (n,p)

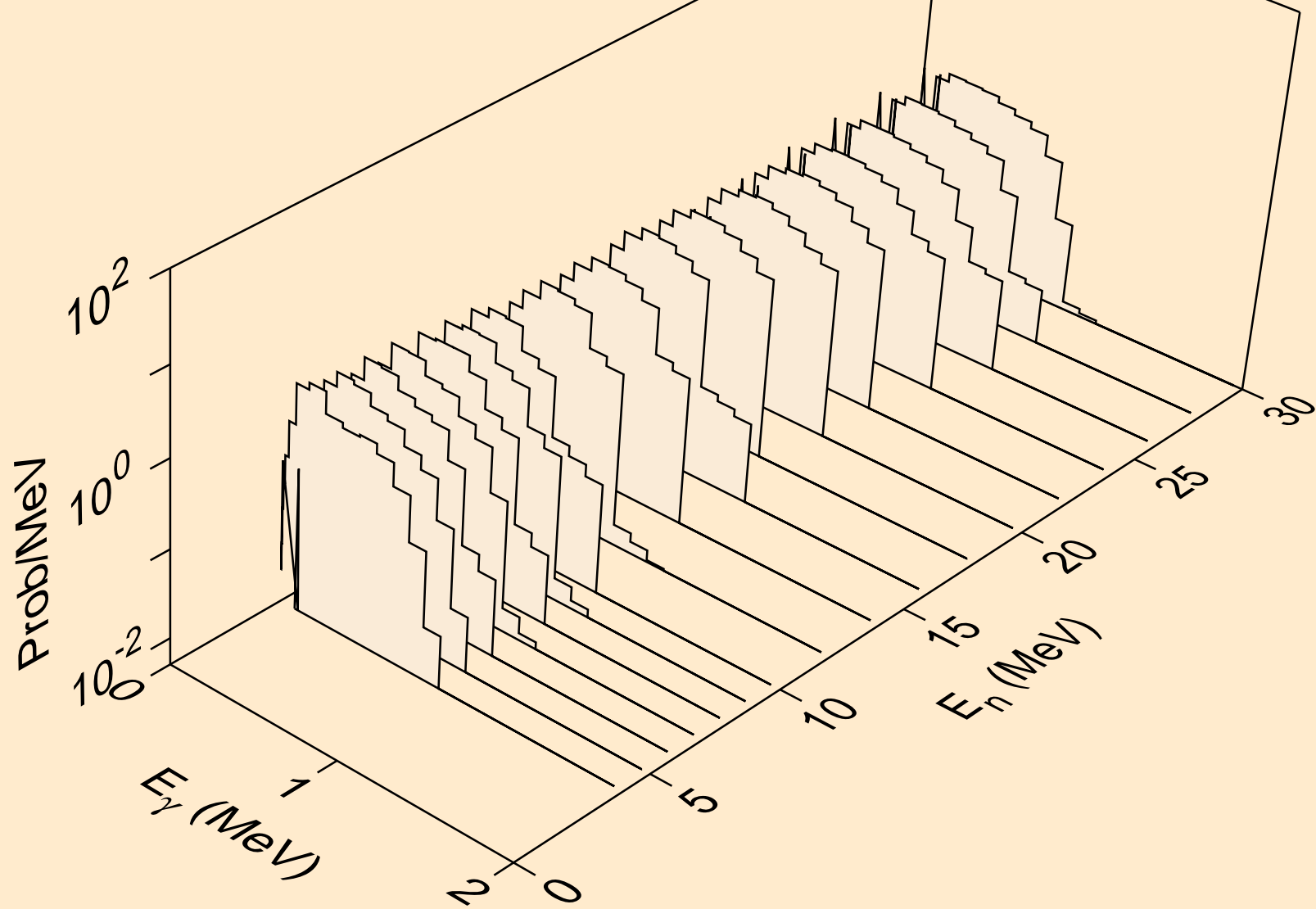

HS272 DEUTERON ACER TENDL-2021 LIBRARY; T=0.K
Photon emission for (n,pd)

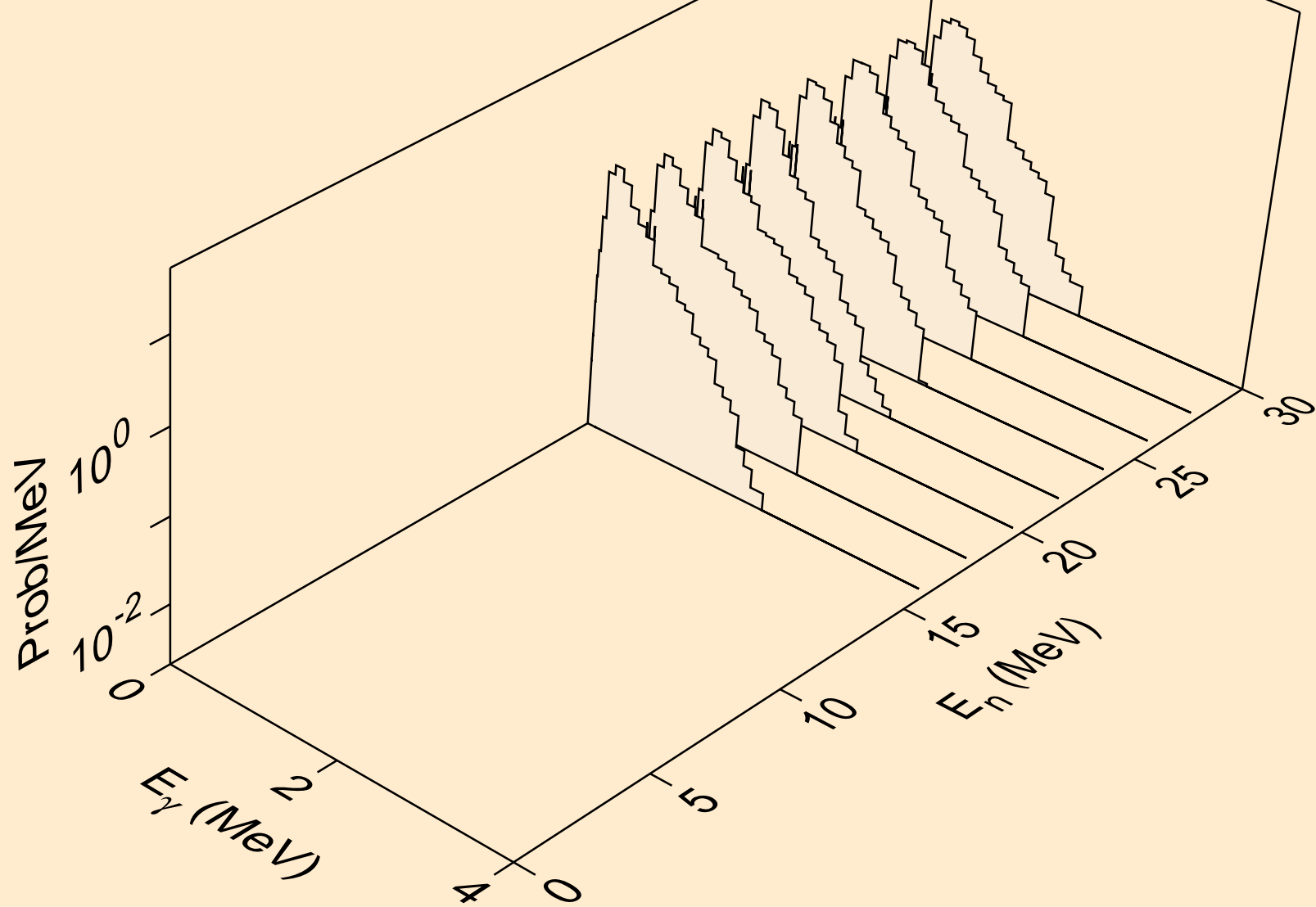

HS272 DEUTERON ACER TENDL-2021 LIBRARY; T=0.K
Photon emission for (n,da)

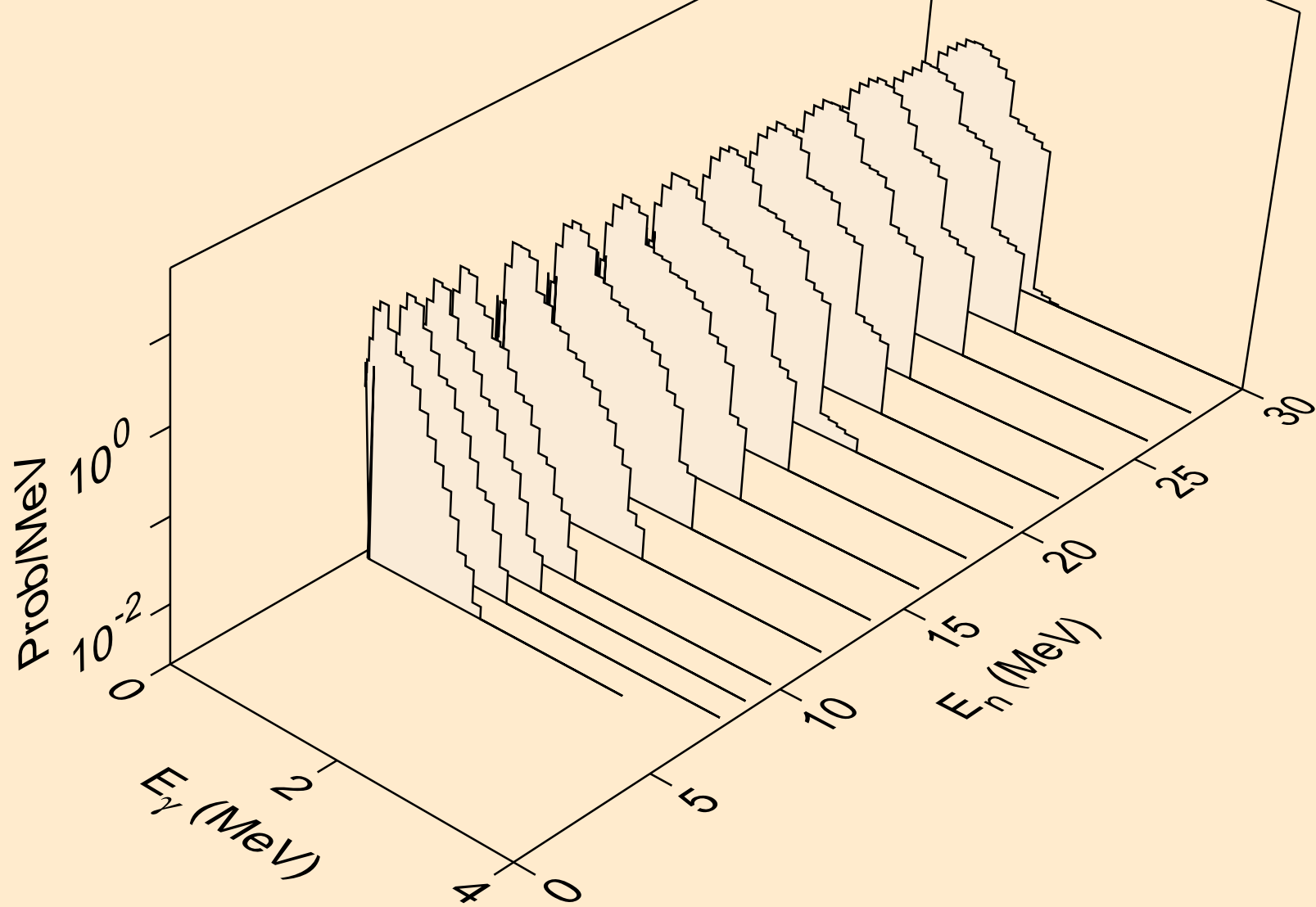

HS272 DEUTERON ACER TENDL-2021 LIBRARY; T=0.K

Particle heating contributions

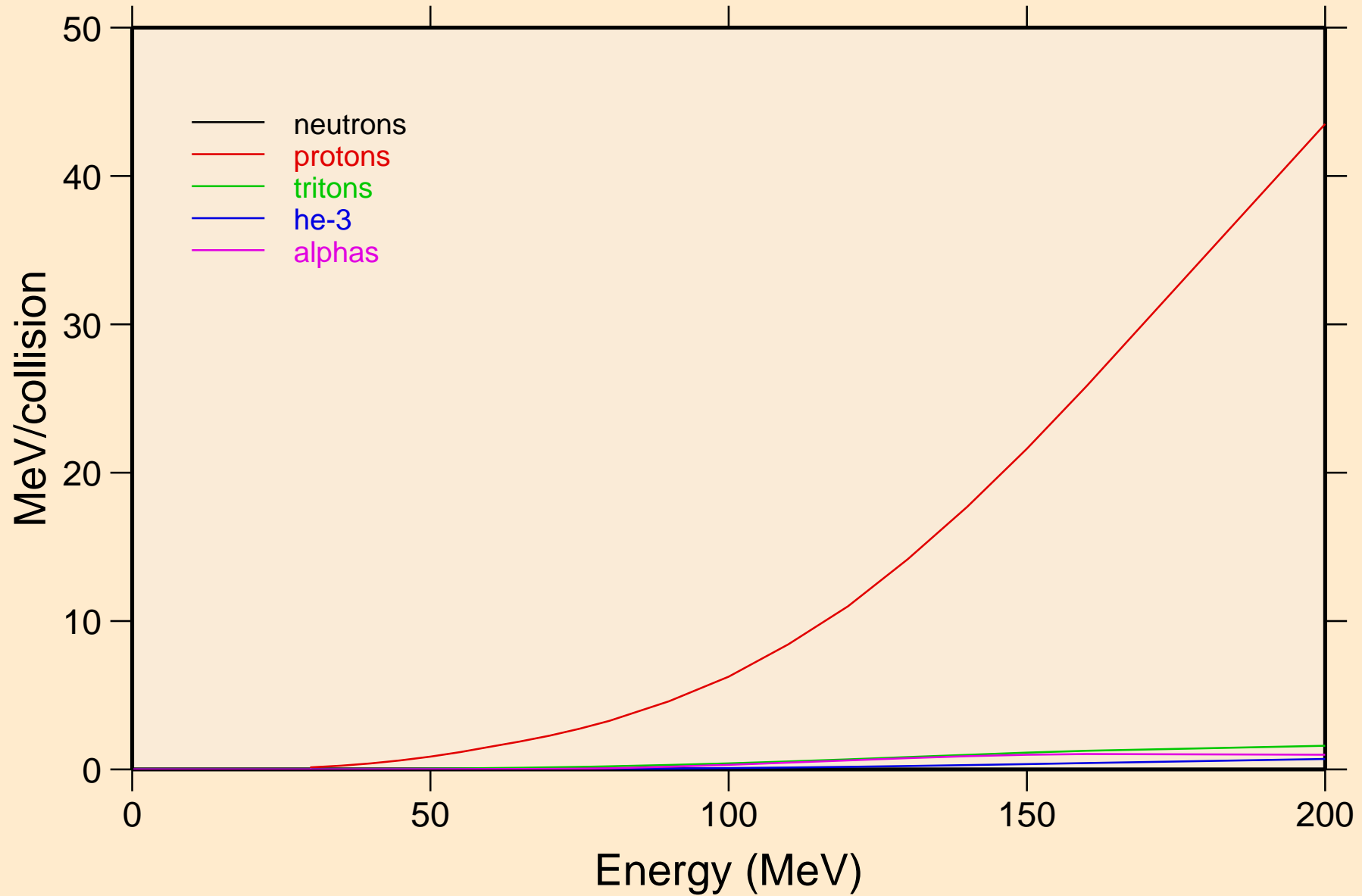

HS272 DEUTERON ACER TENDL-2021 LIBRARY; T=0.K
Recoil Heating

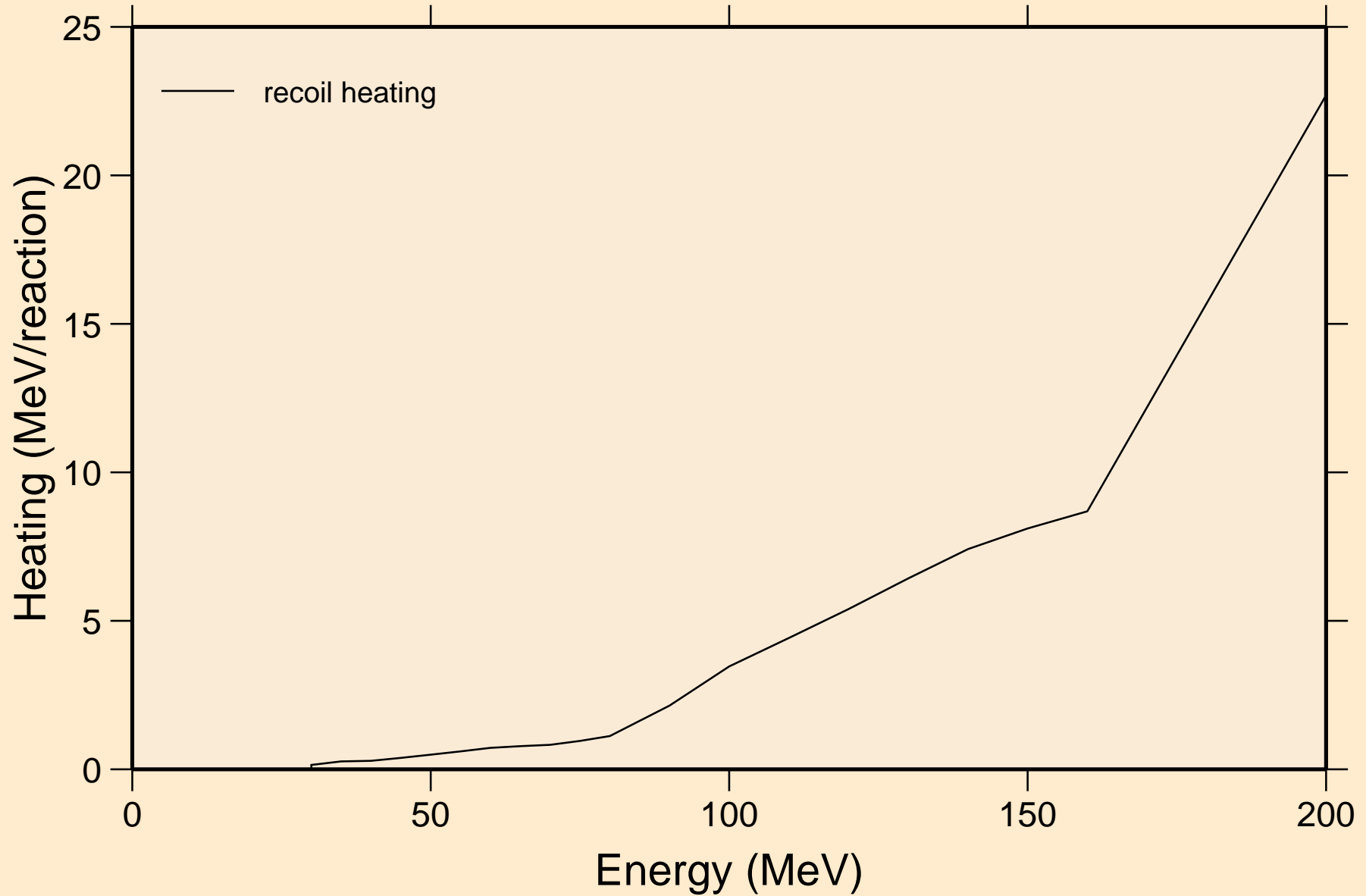

HS272 DEUTERON ACER TENDL-2021 LIBRARY; T=0.K
Particle production cross sections

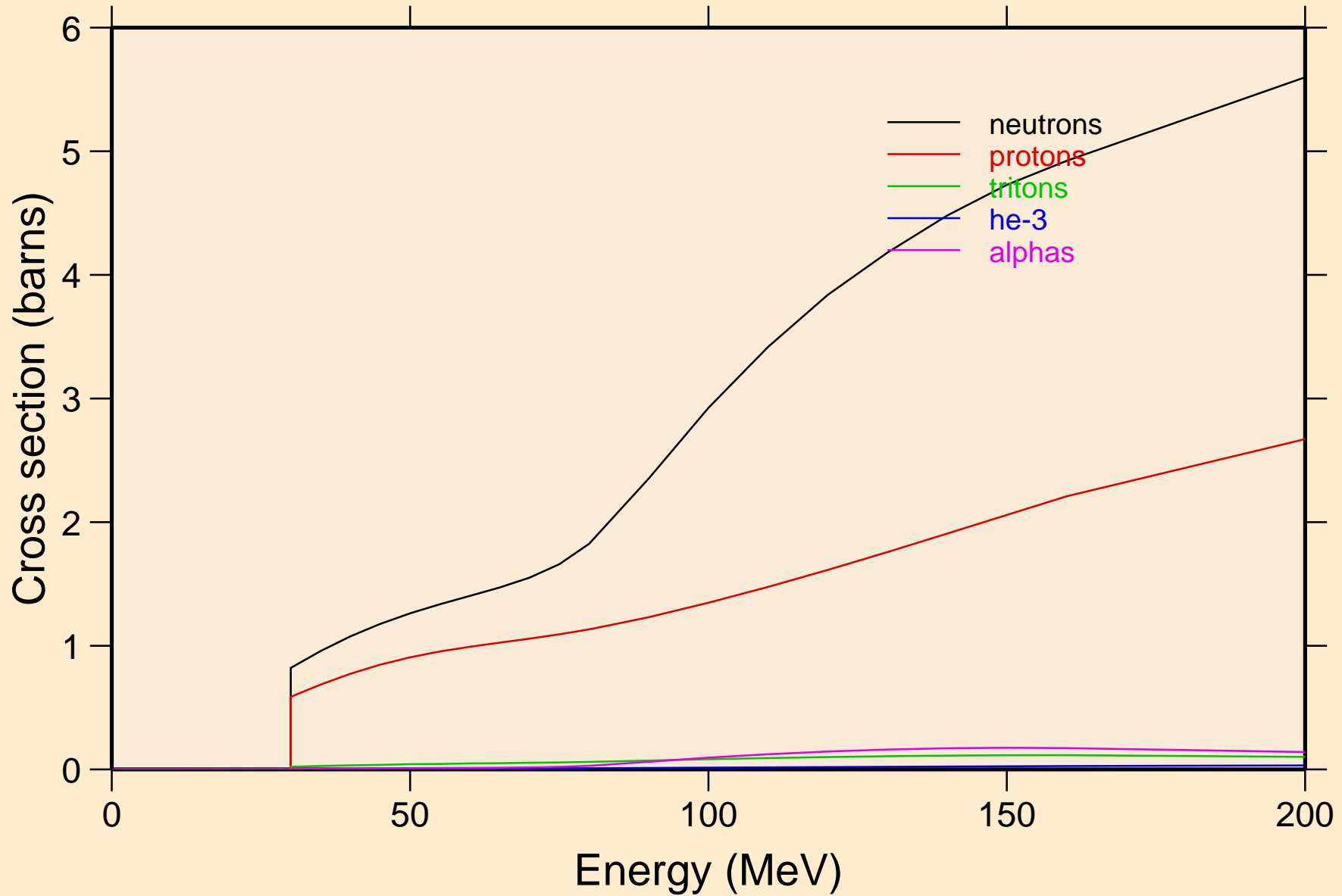

HS272 DEUTERON ACER TENDL-2021 LIBRARY; T=0.K
neutrons from (d,n)

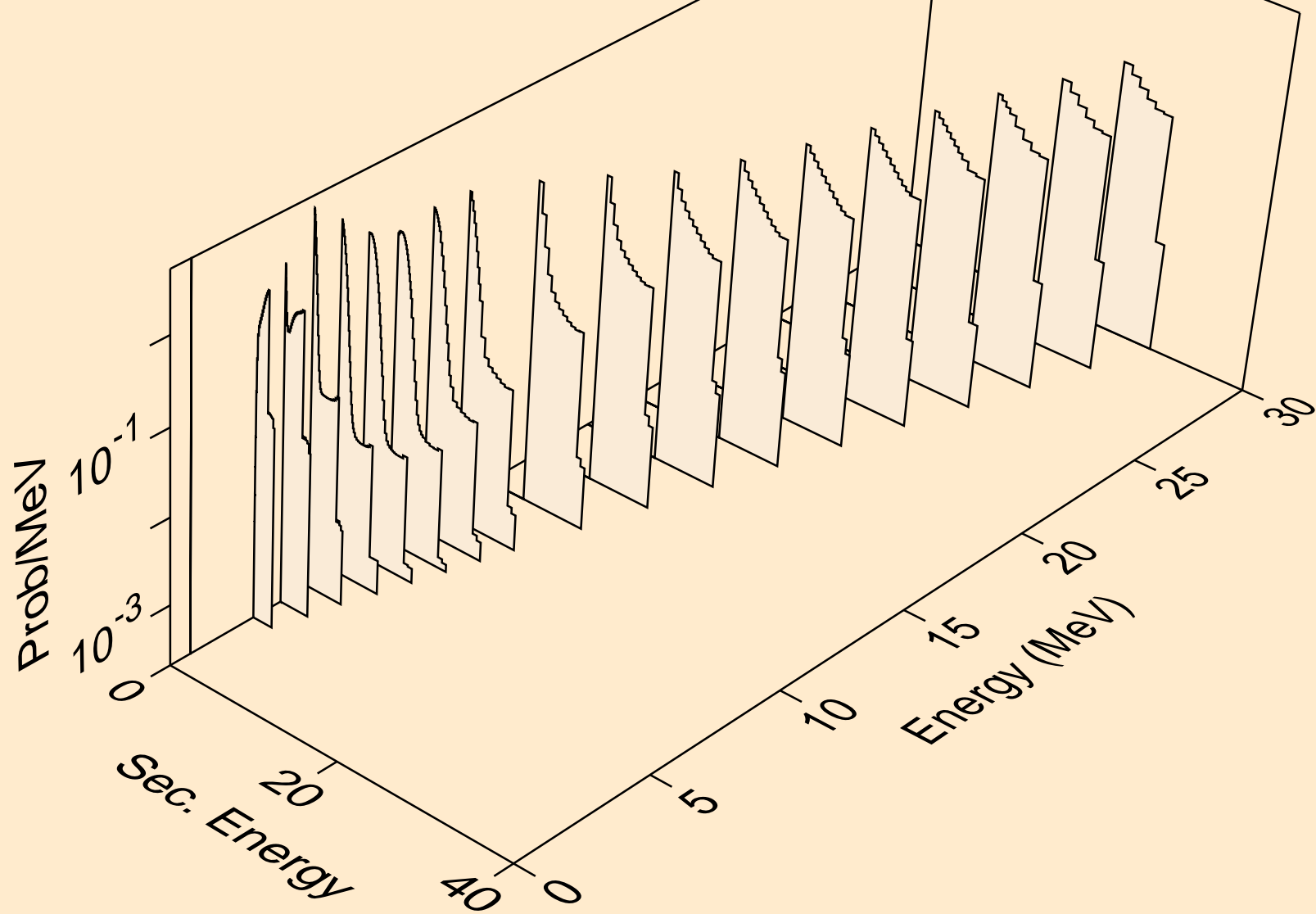

HS272 DEUTERON ACER TENDL-2021 LIBRARY; T=0.K
neutrons from (d,x)

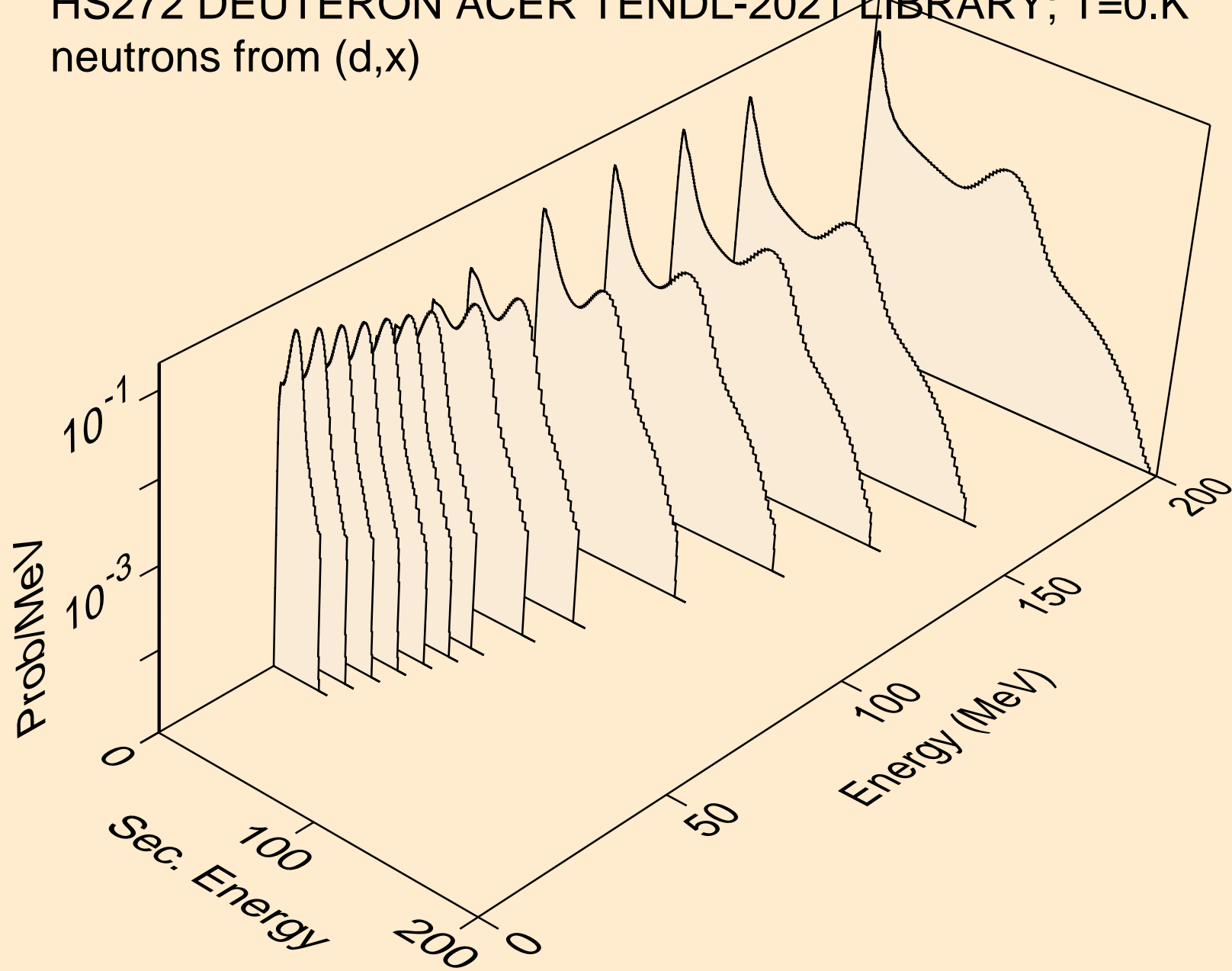

HS272 DEUTERON ACER TENDL-2021 LIBRARY; T=0.K
neutrons from (d,2n)

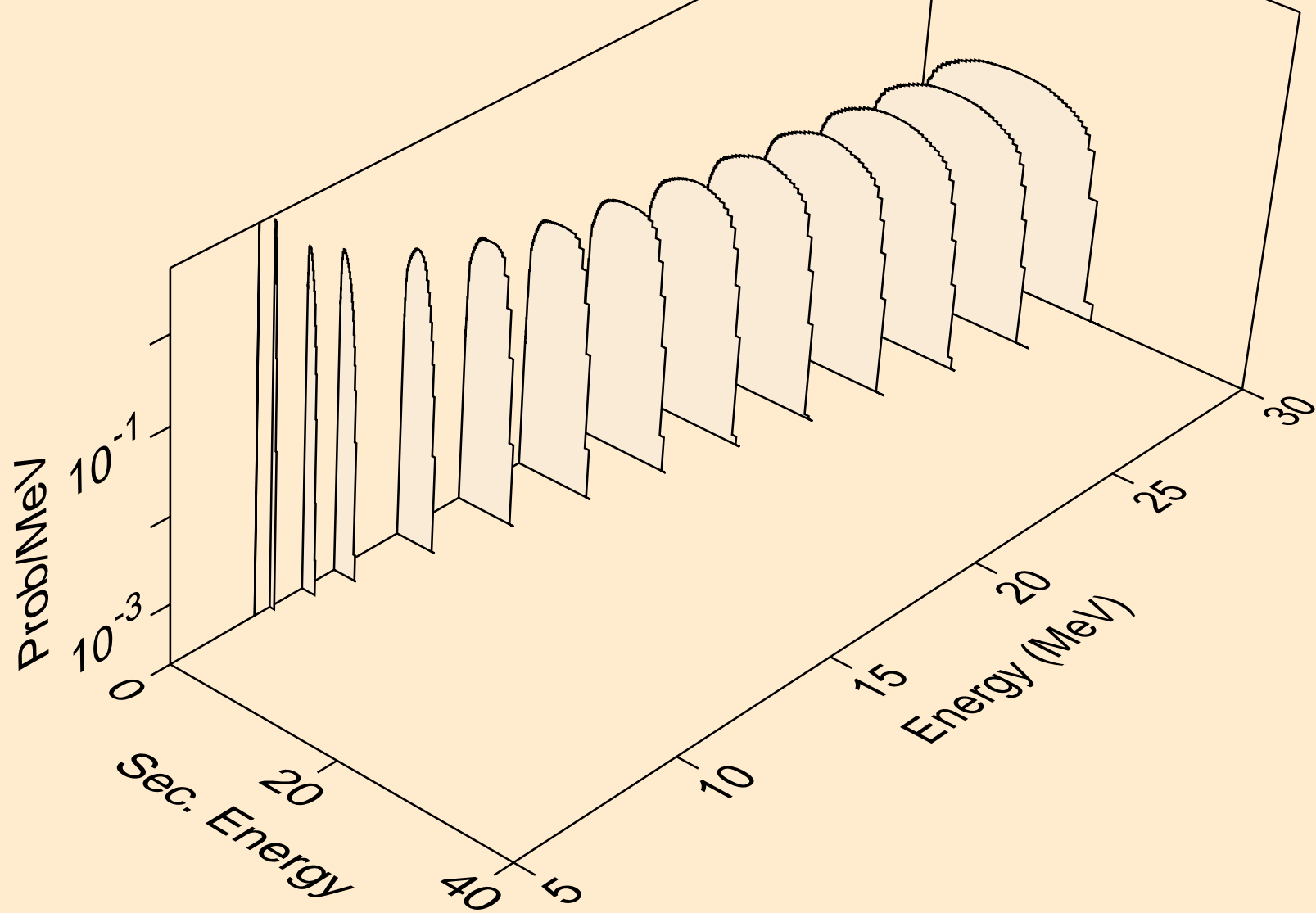

HS272 DEUTERON ACER TENDL-2021 LIBRARY; T=0.K
neutrons from (d,3n)

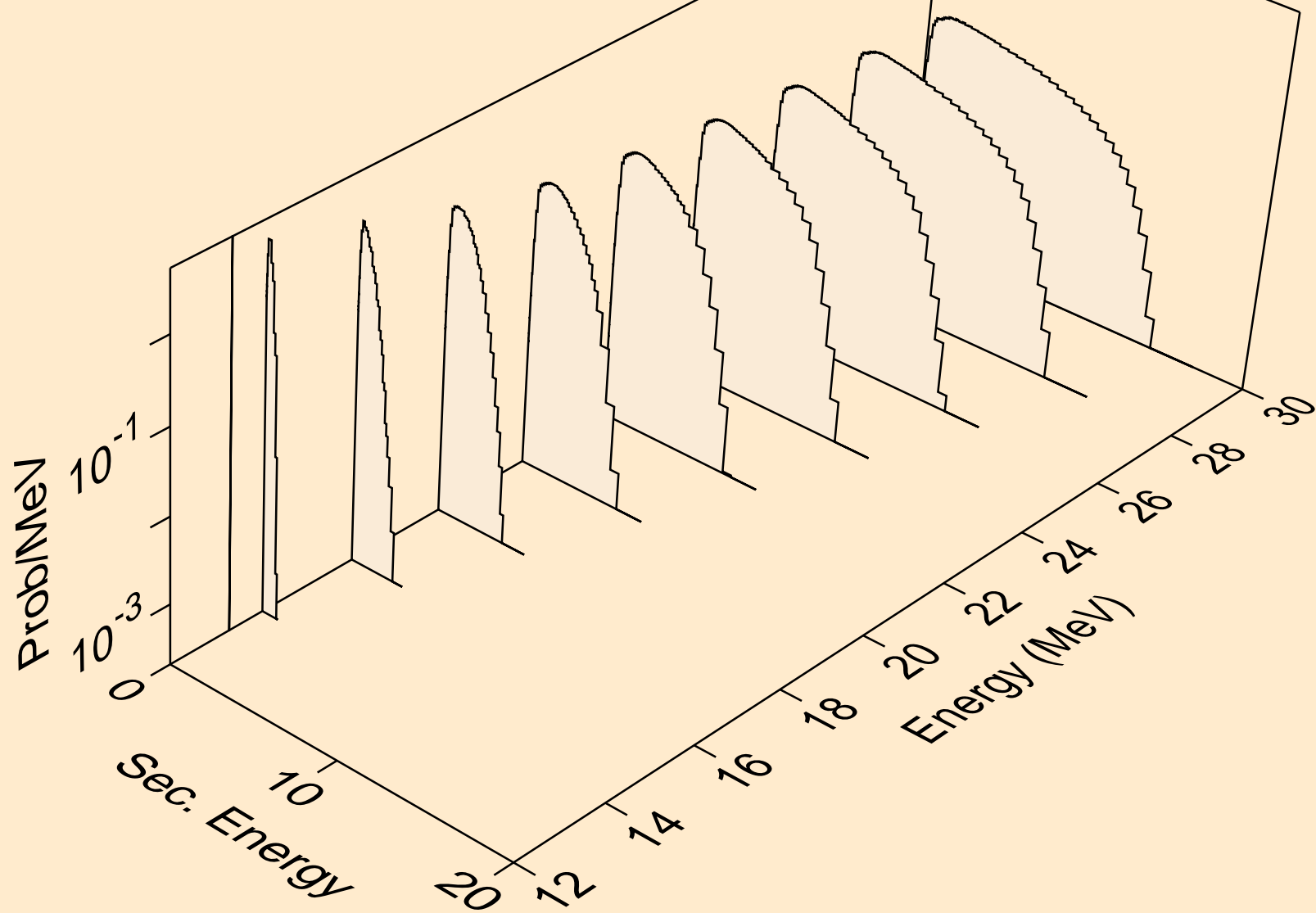

HS272 DEUTERON ACER TENDL-2021 LIBRARY; T=0.K
neutrons from (d,n*)a

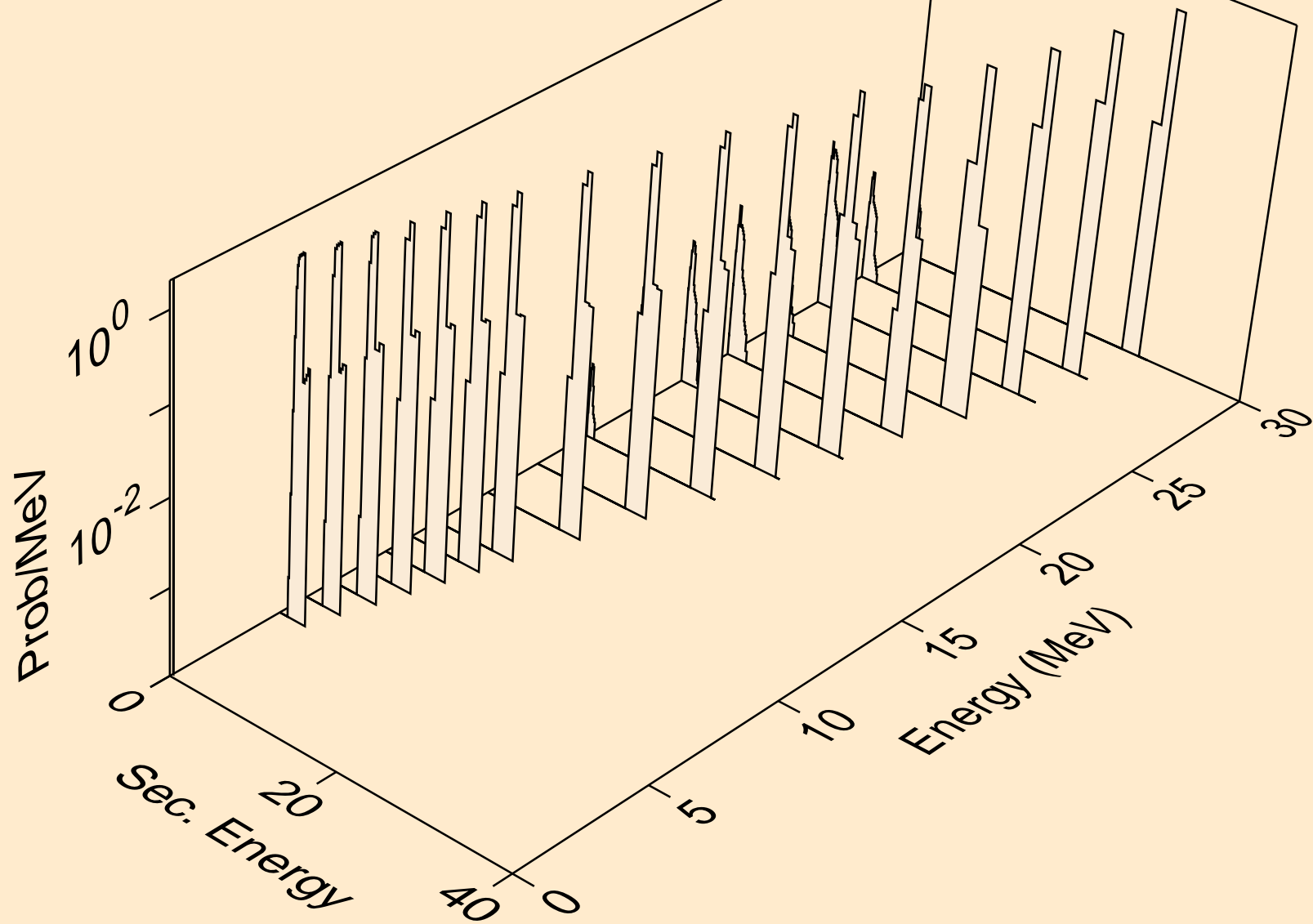

HS272 DEUTERON ACER TENDL-2021 LIBRARY; T=0.K
neutrons from (d,2n)a

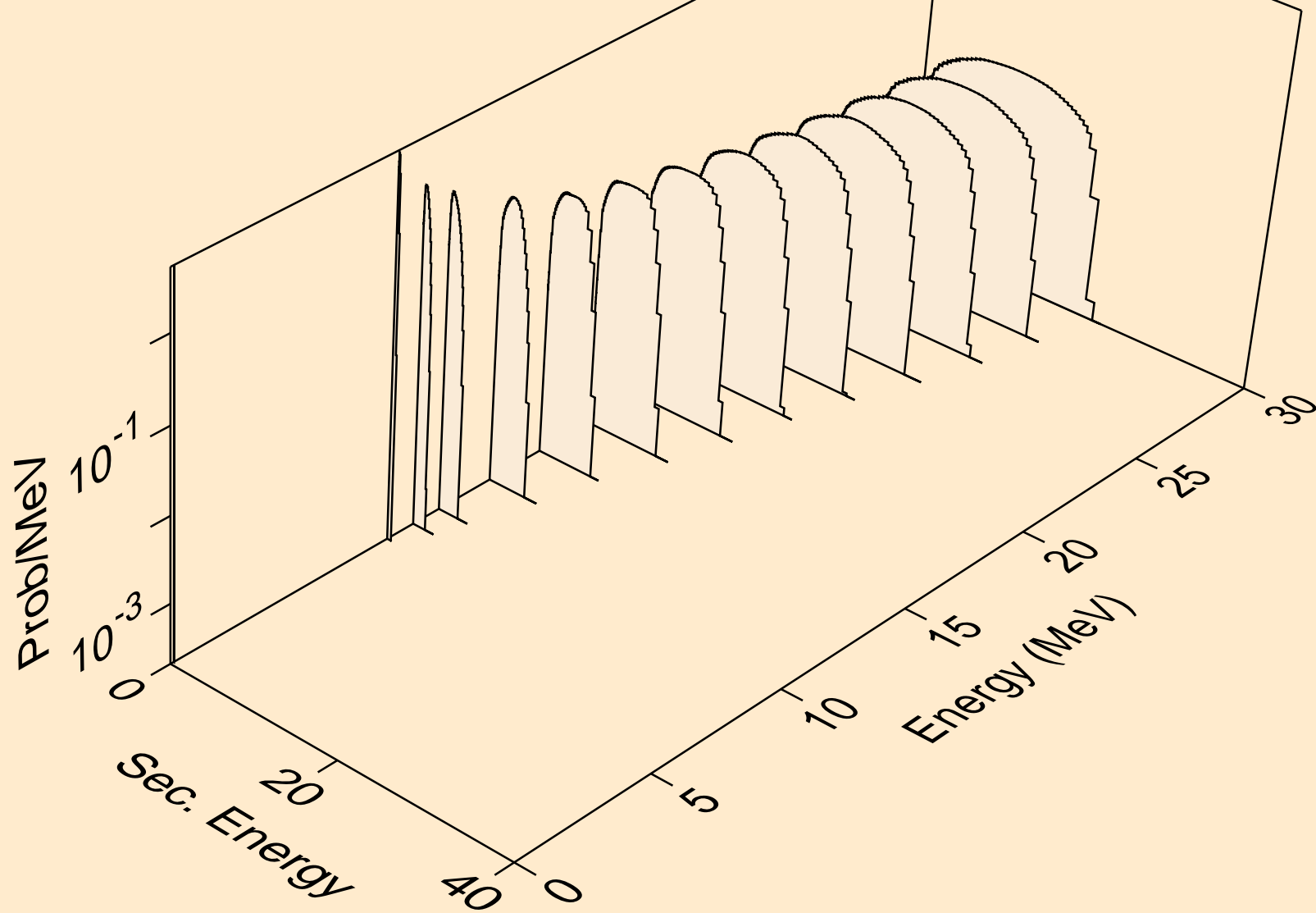

HS272 DEUTERON ACER TENDL-2021 LIBRARY; T=0.K
neutrons from (d,3n)a

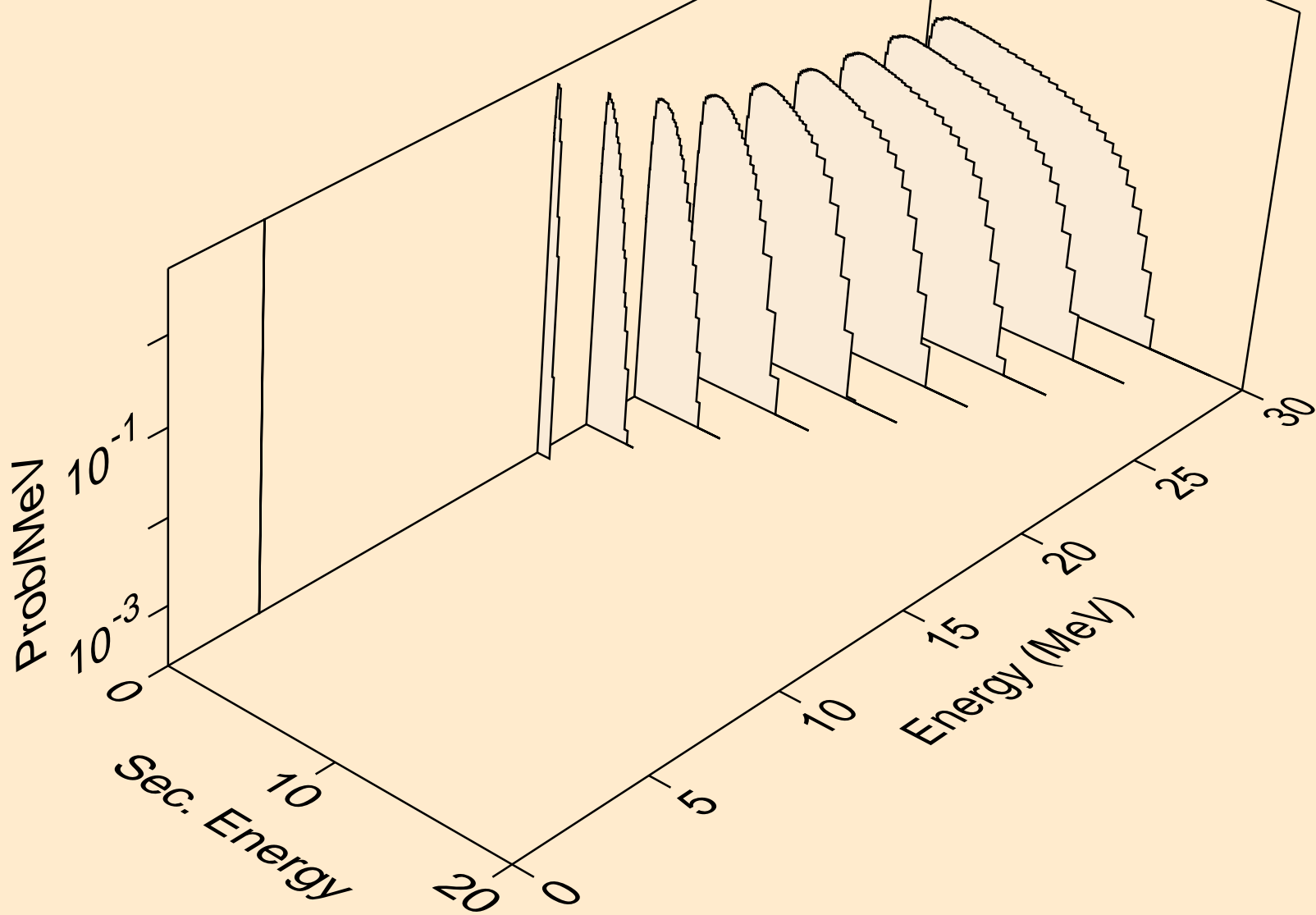

HS272 DEUTERON ACER TENDL-2021 LIBRARY; T=0.K
neutrons from (d,n*)p

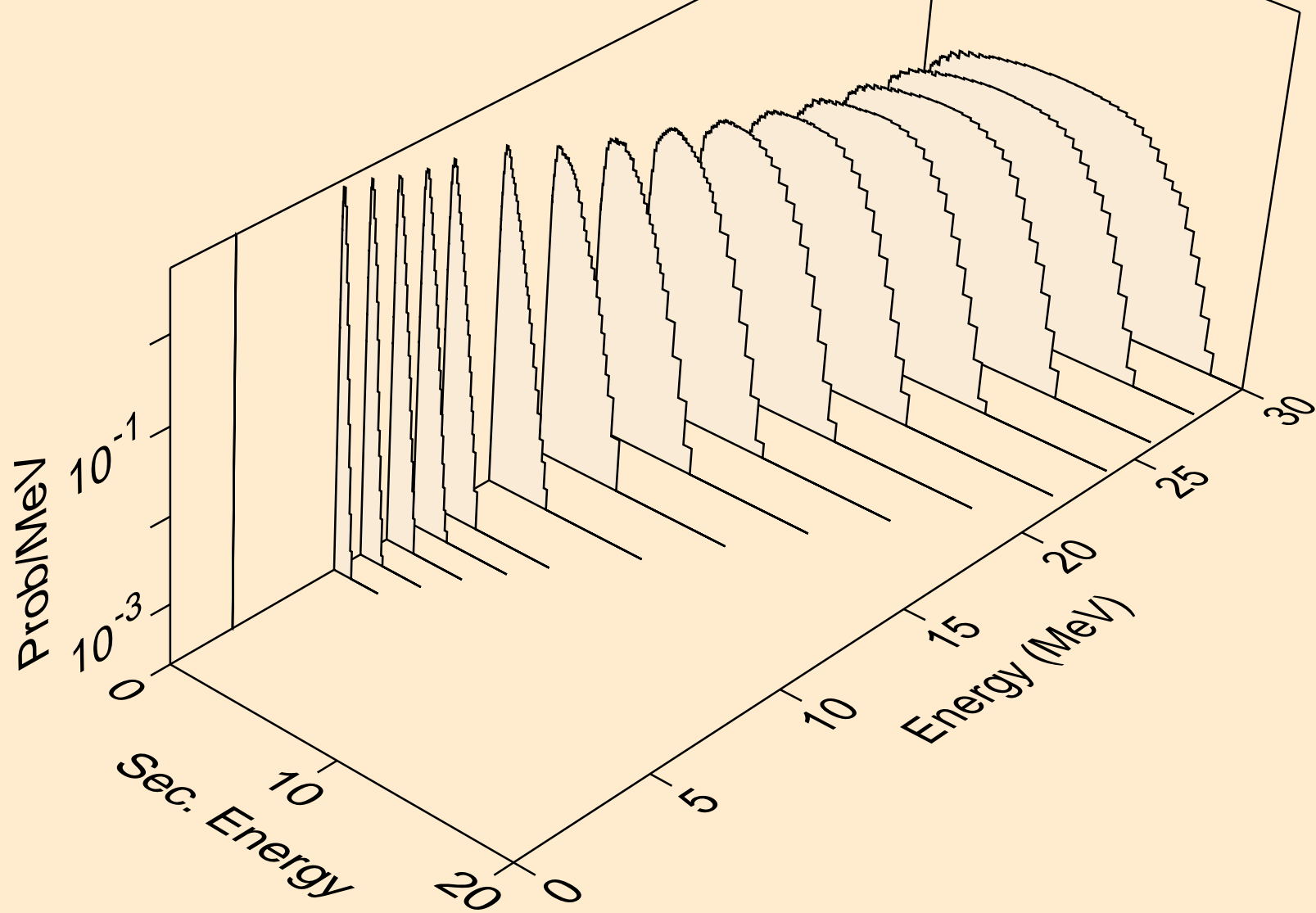

HS272 DEUTERON ACER TENDL-2021 LIBRARY; T=0.K
neutrons from (d,n*)d

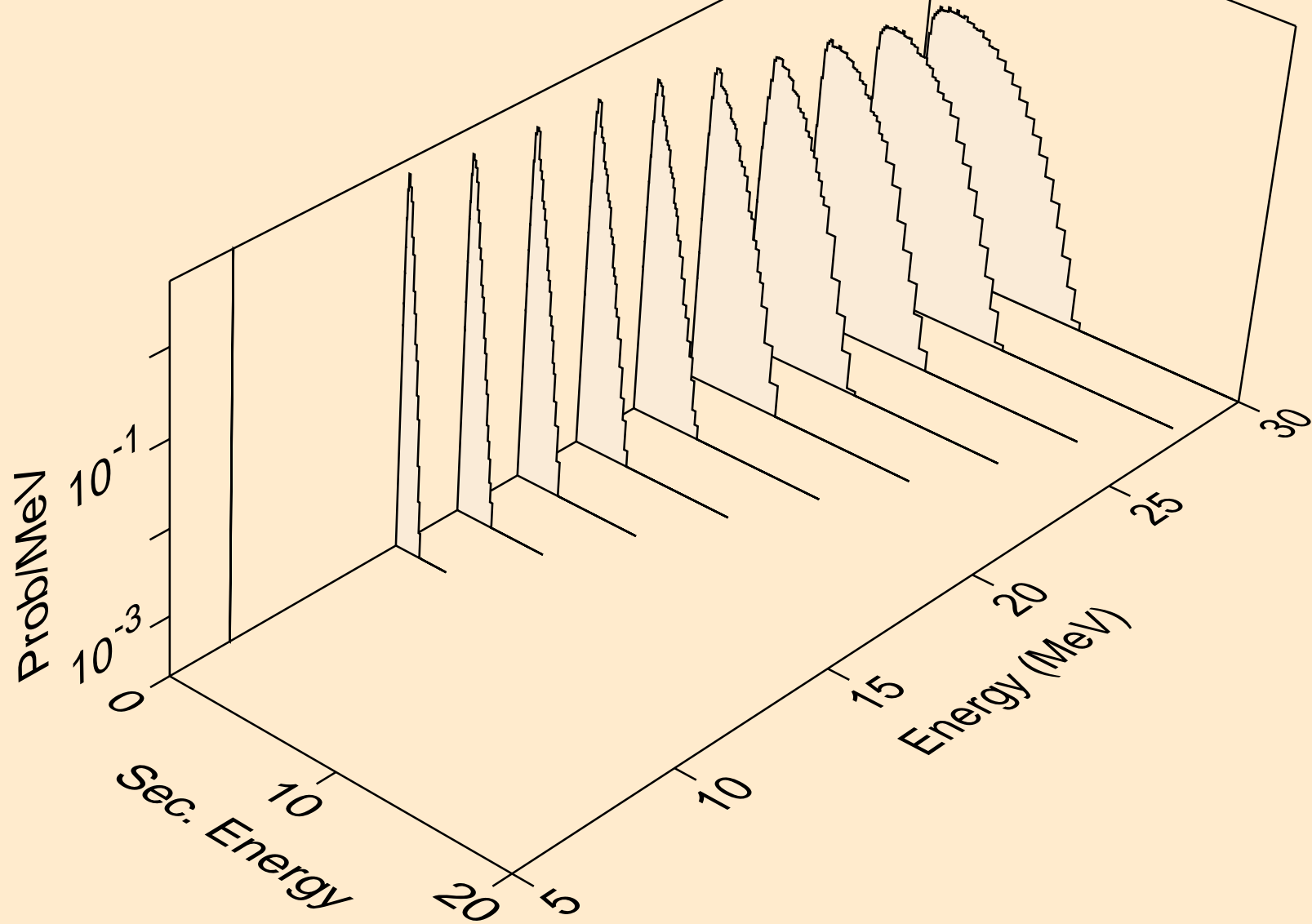

HS272 DEUTERON ACER TENDL-2021 LIBRARY; T=0.K
neutrons from (d,n*)t

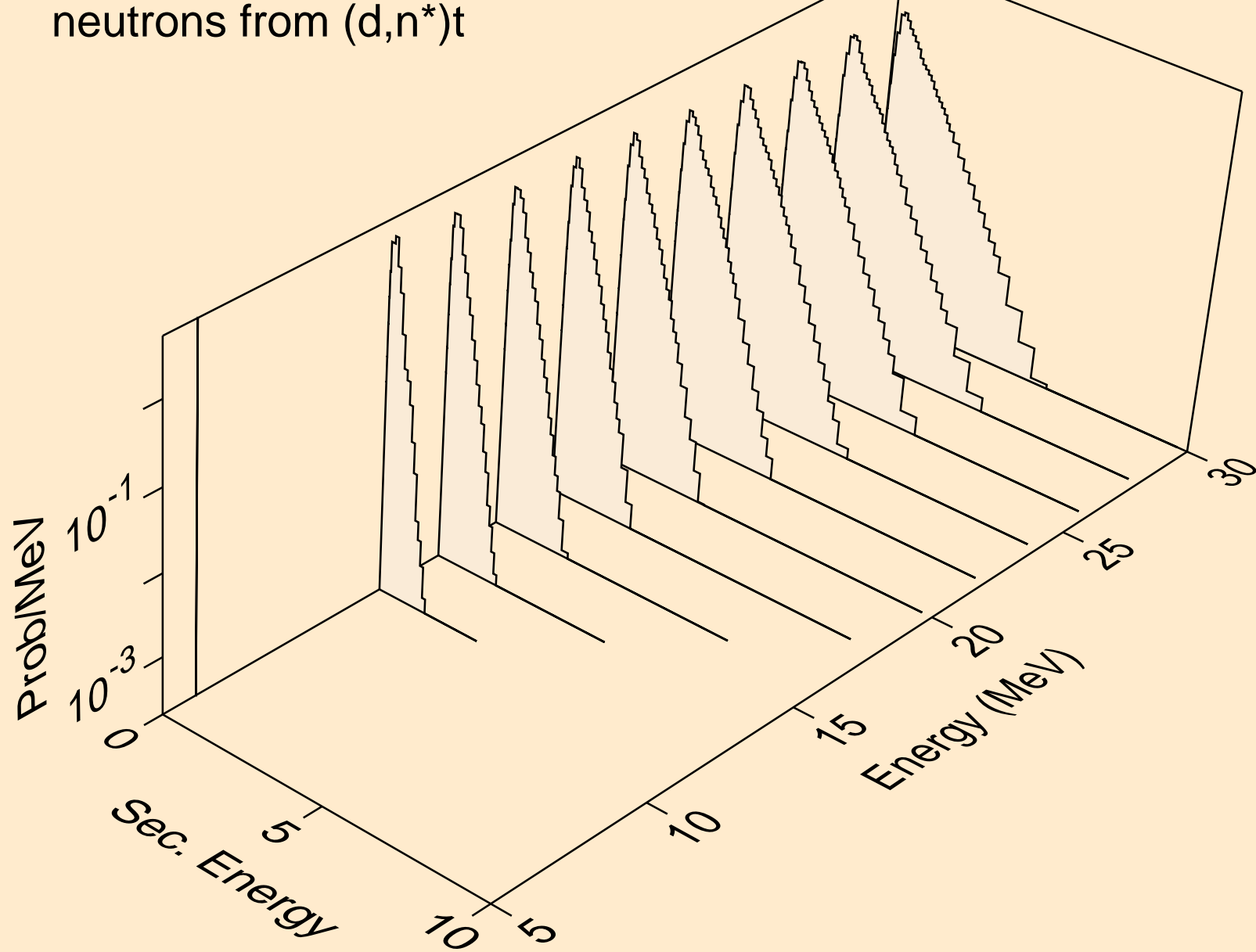

HS272 DEUTERON ACER TENDL-2021 LIBRARY; T=0.K
neutrons from (d,4n)

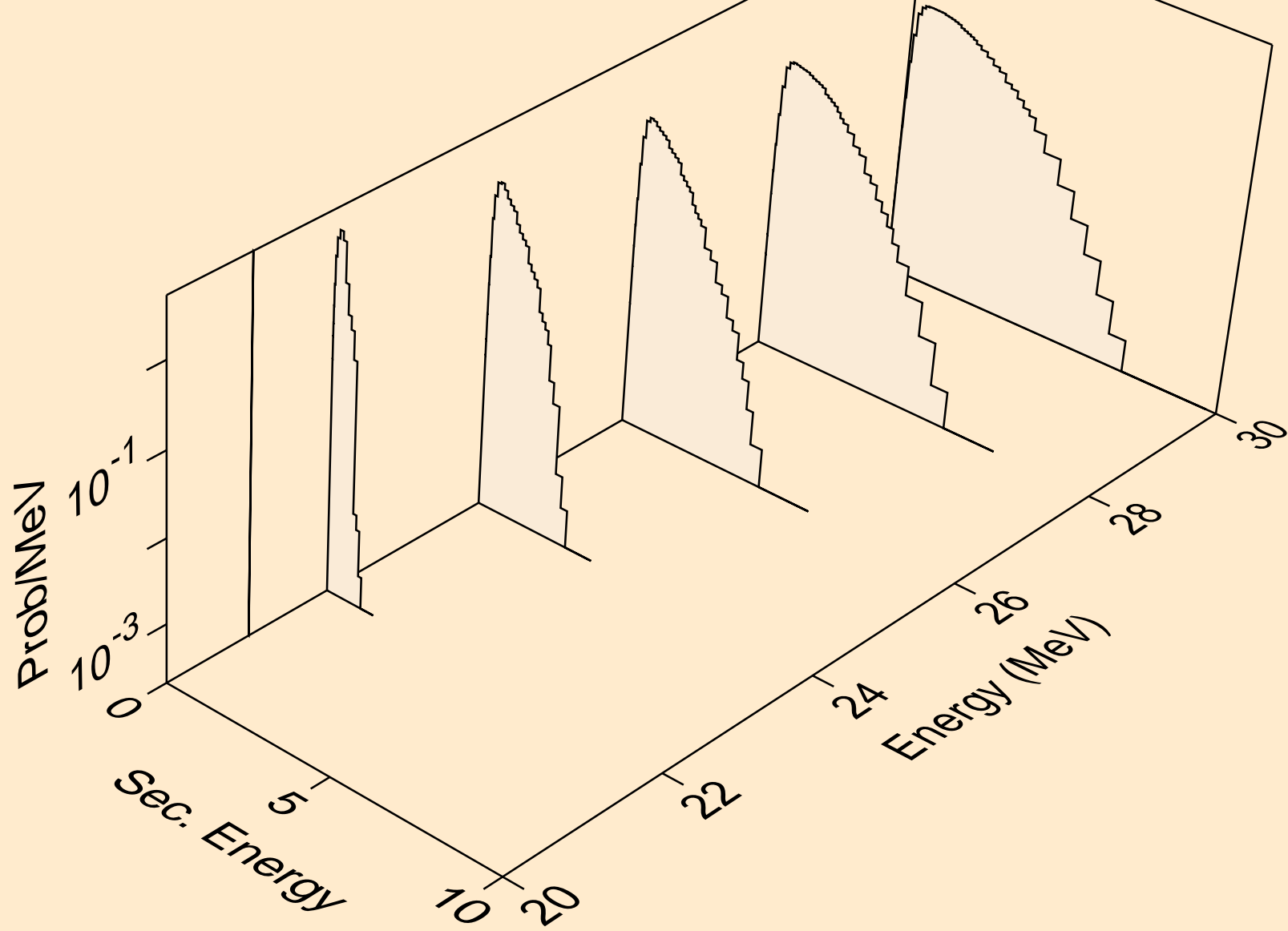

HS272 DEUTERON ACER TENDL-2021 LIBRARY; T=0.K
neutrons from (d,2np)

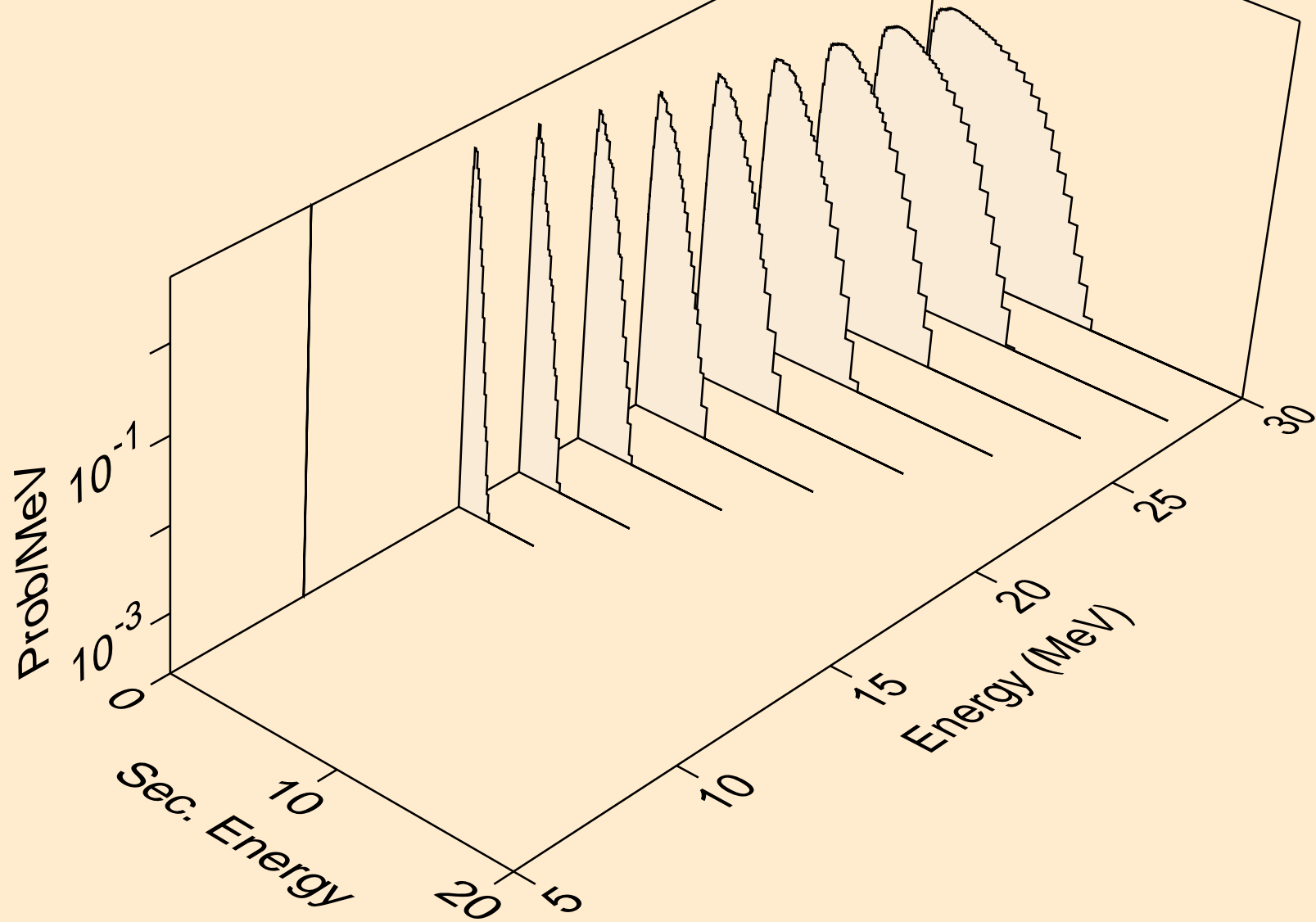

HS272 DEUTERON ACER TENDL-2021 LIBRARY; T=0.K
neutrons from (d,3np)

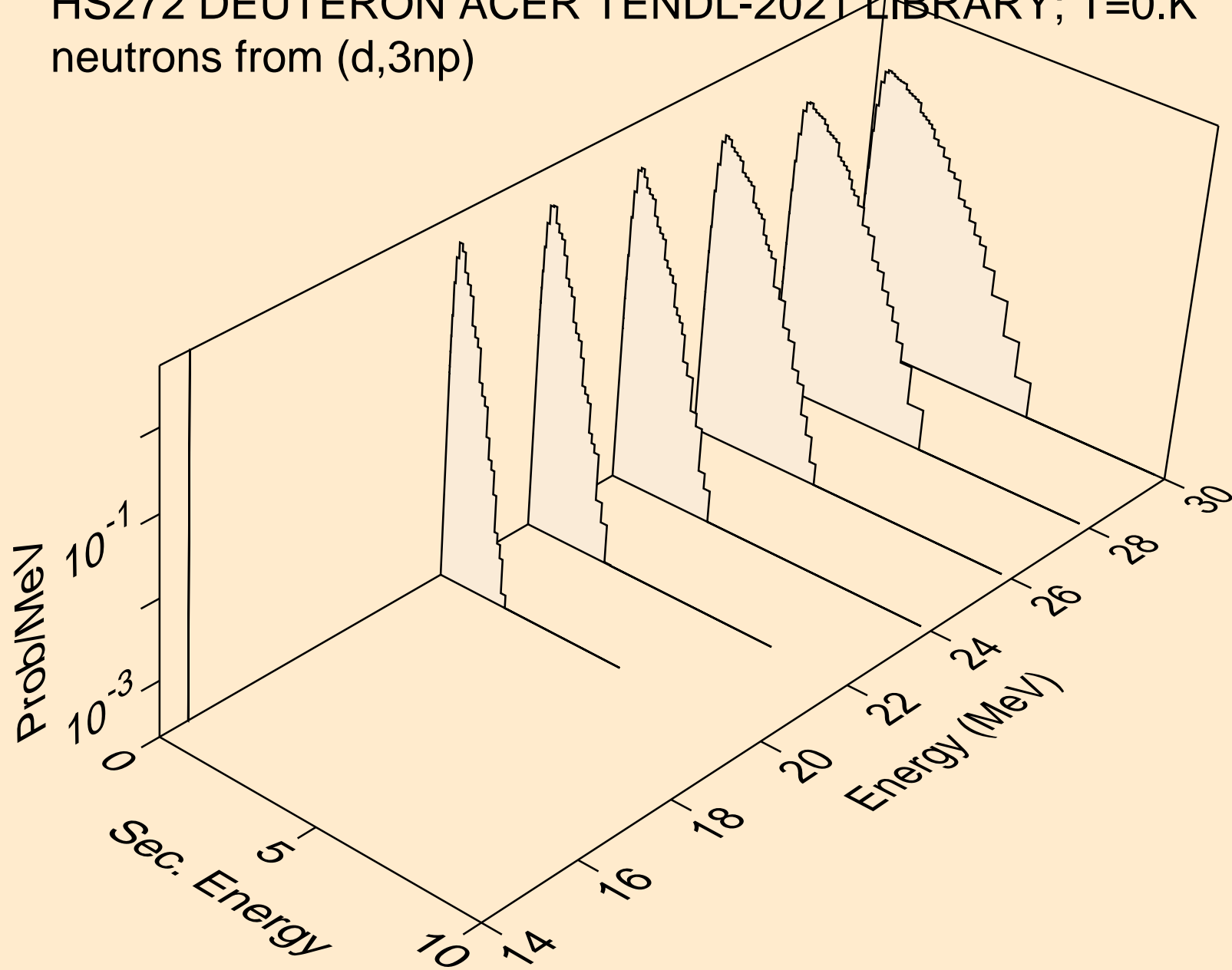

HS272 DEUTERON ACER TENDL-2021 LIBRARY; T=0.K
neutrons from (d,2np)

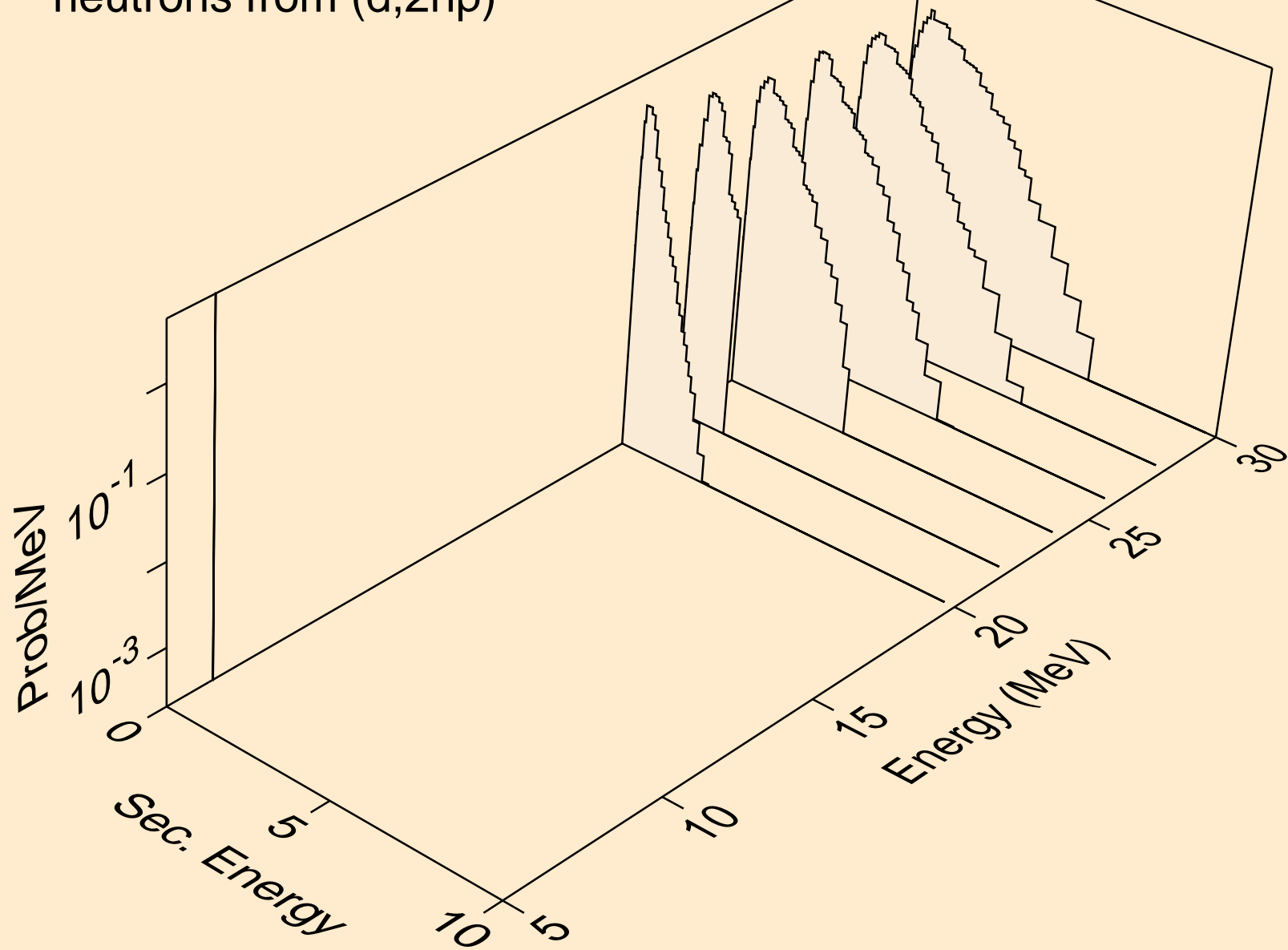

HS272 DEUTERON ACER TENDL-2021 LIBRARY; T=0.K
neutrons from (d,npa)

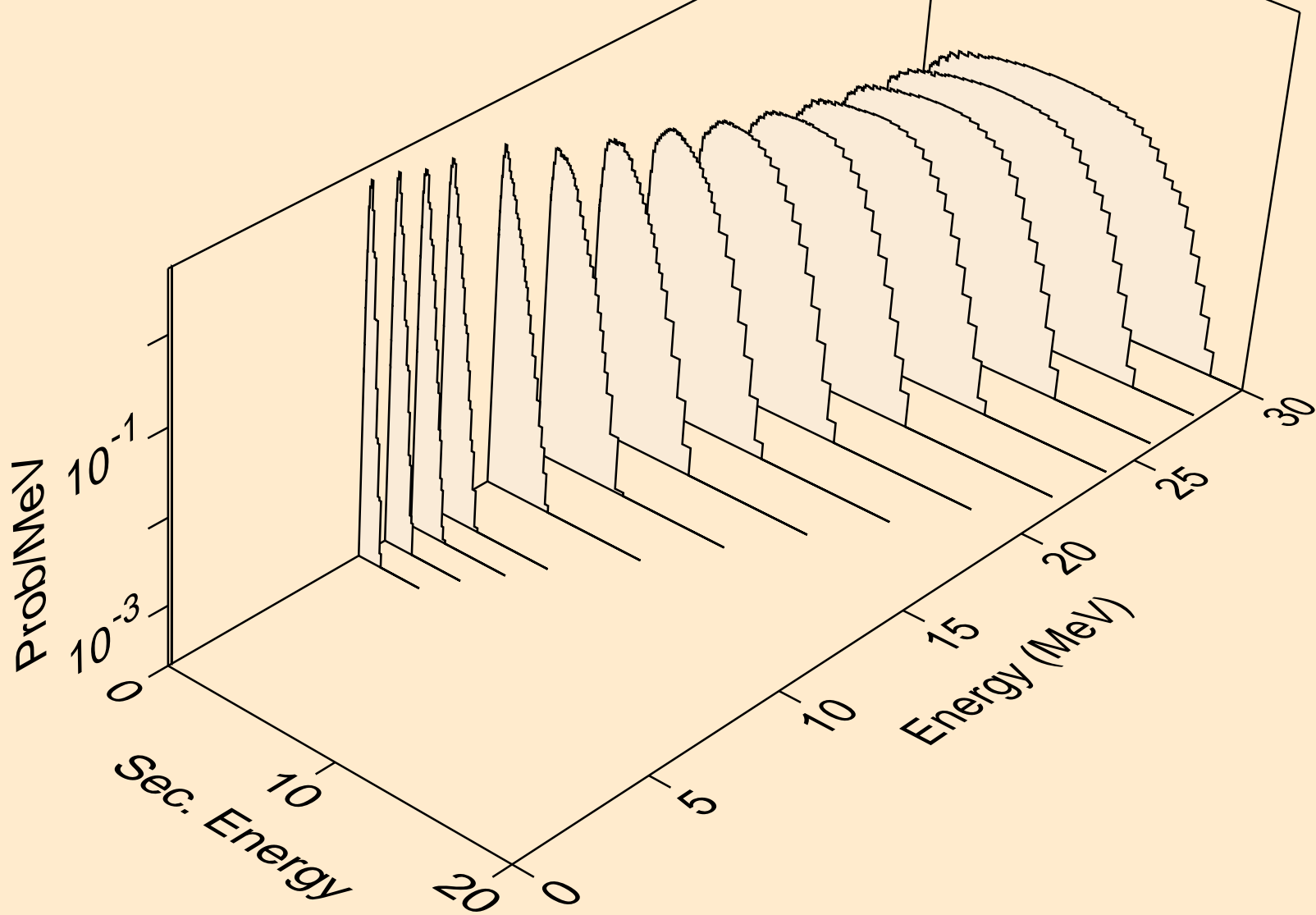

HS272 DEUTERON ACER TENDL-2021 LIBRARY; T=0.K
protons from (d,x)

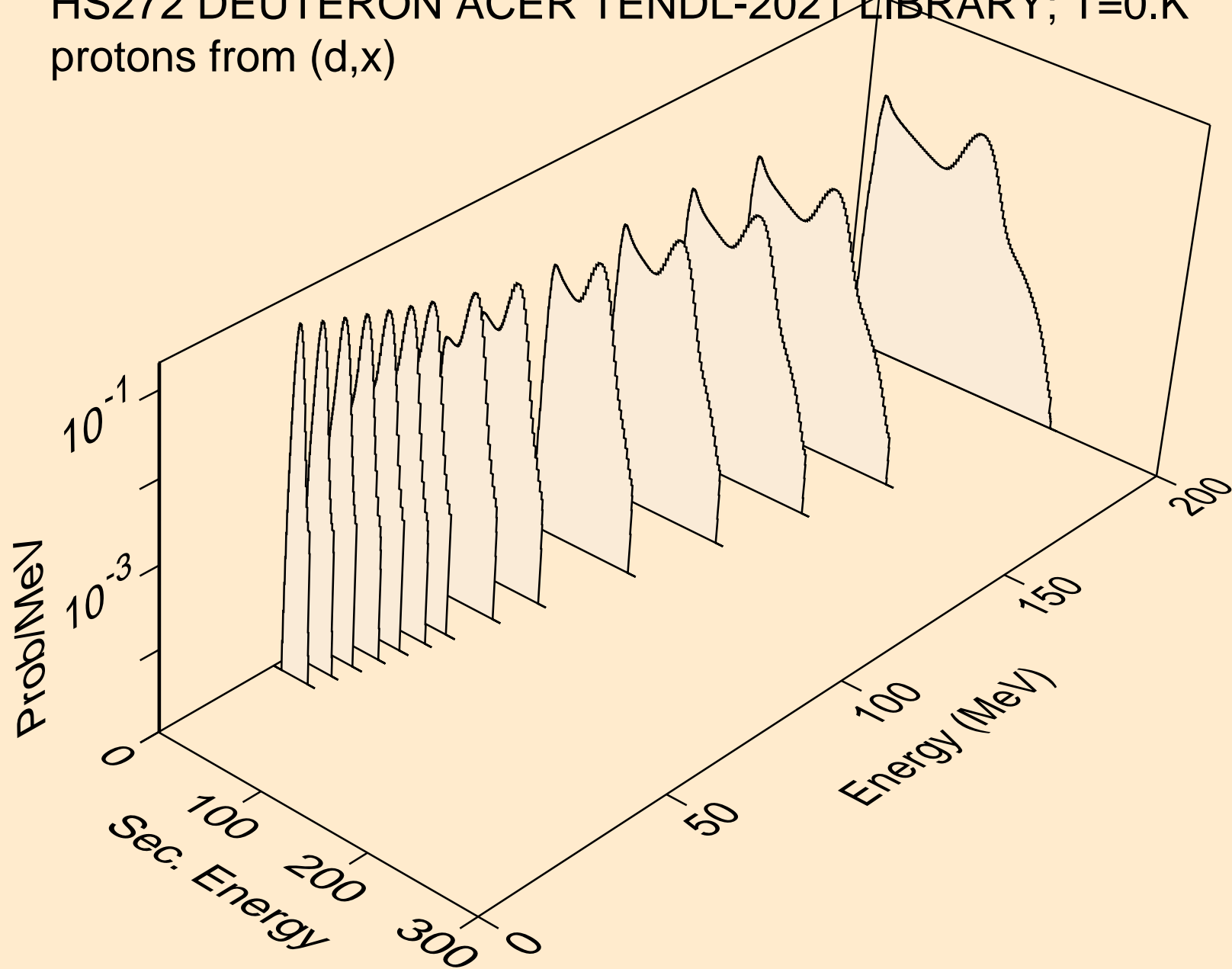

HS272 DEUTERON ACER TENDL-2021 LIBRARY; T=0.K
protons from (d,n*)p

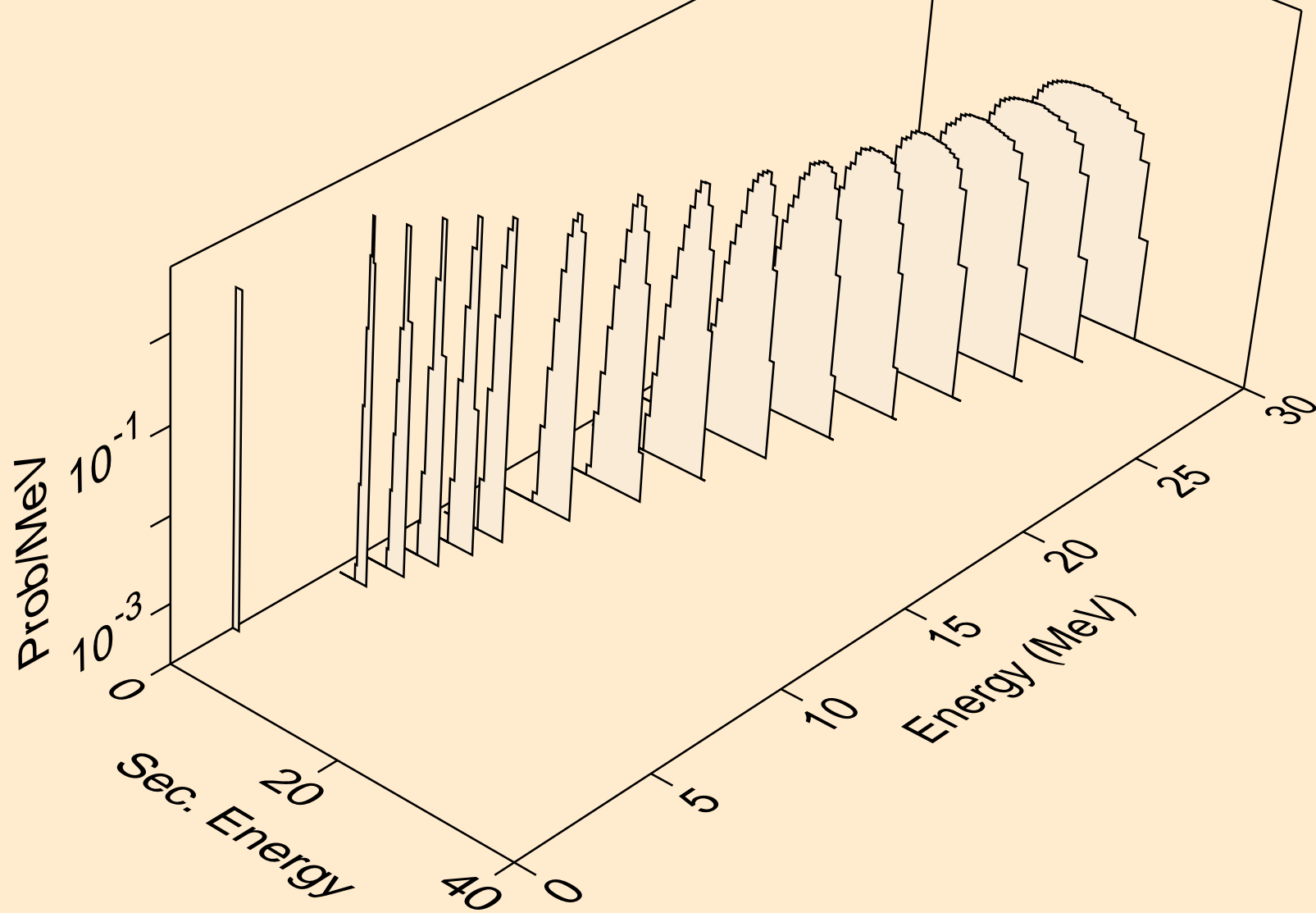

HS272 DEUTERON ACER TENDL-2021 LIBRARY; T=0.K
protons from (d,2np)

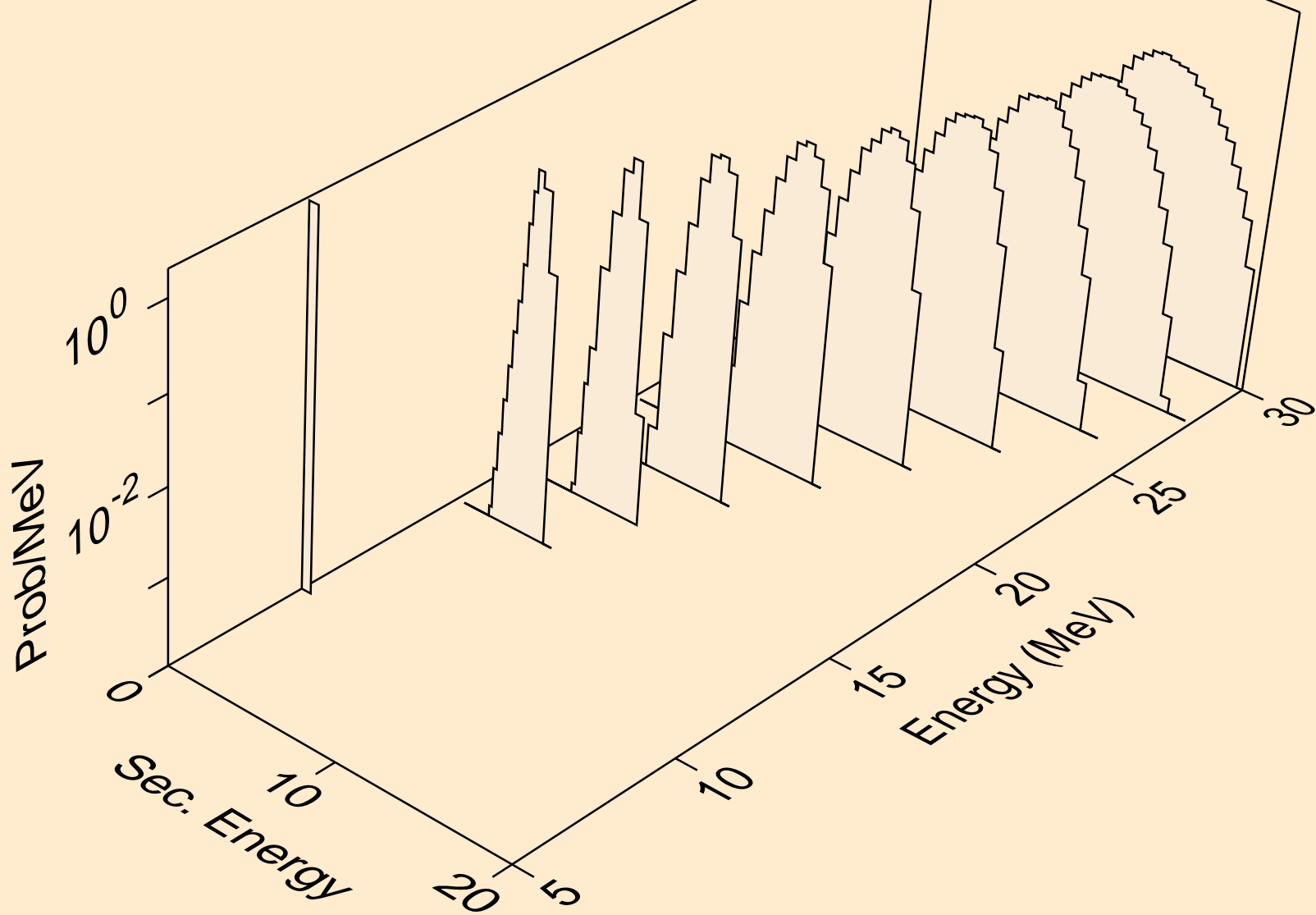

HS272 DEUTERON ACER TENDL-2021 LIBRARY; T=0.K
protons from (d,3np)

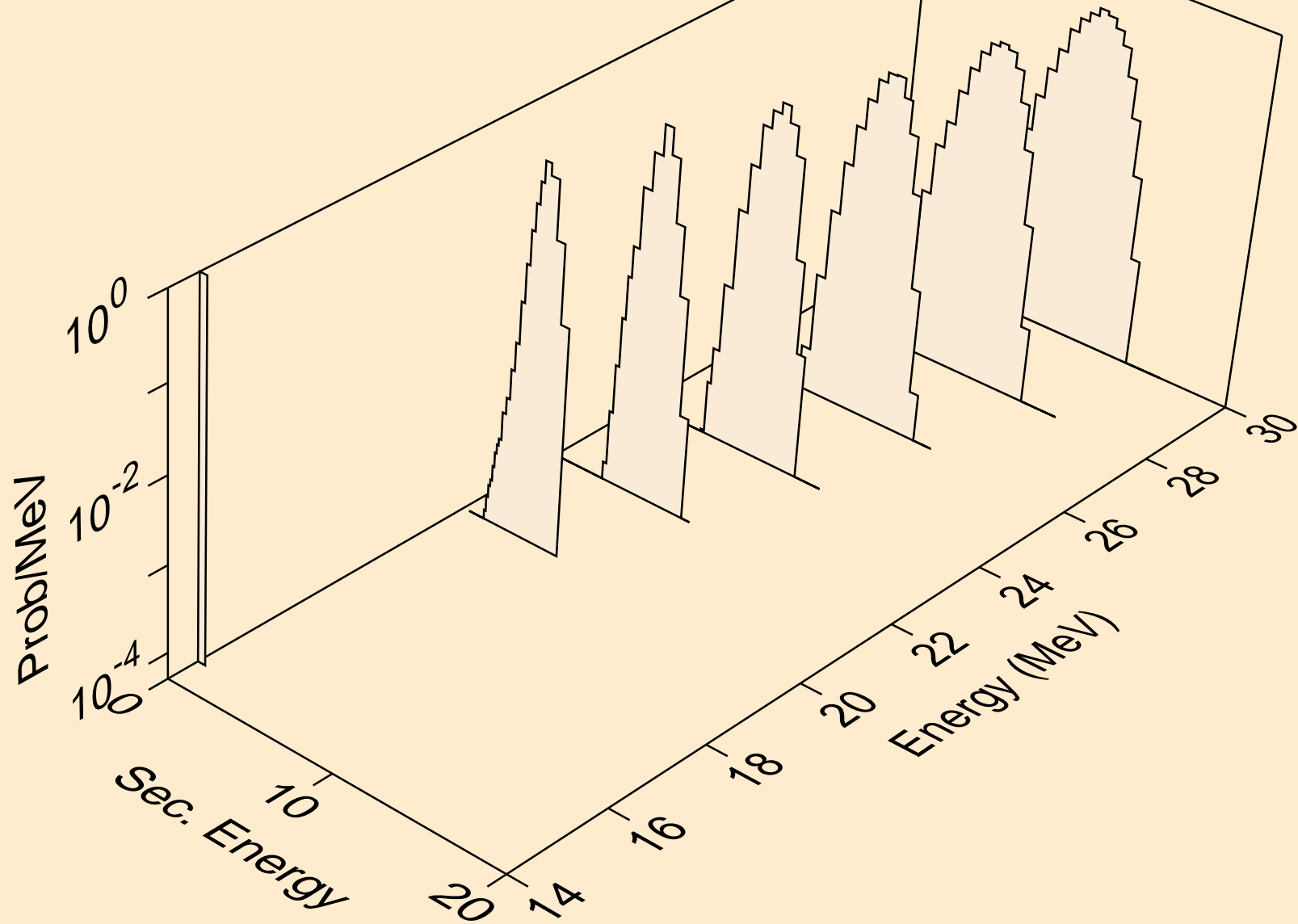

HS272 DEUTERON ACER TENDL-2021 LIBRARY; T=0.K
protons from (d,2np)

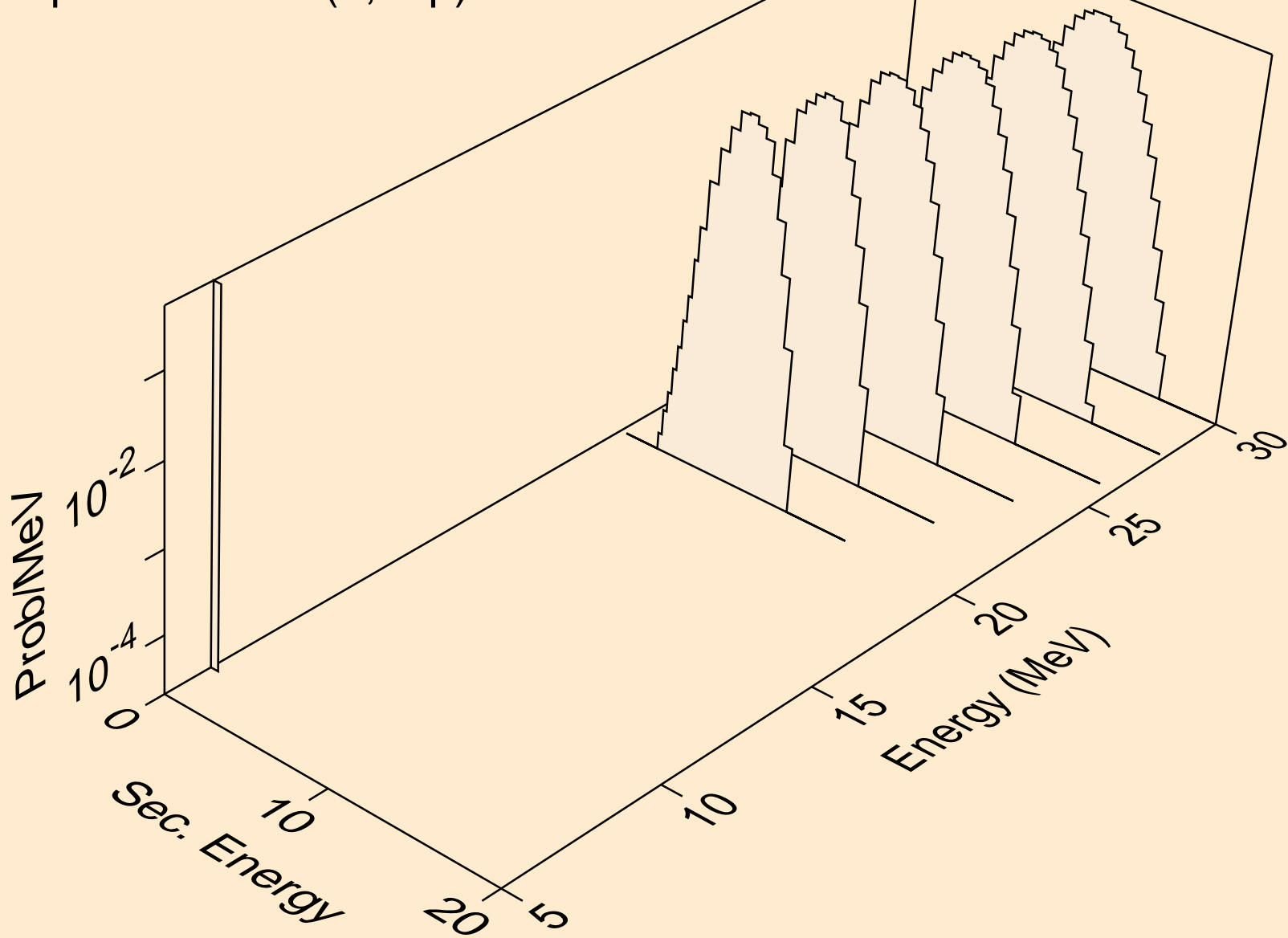

HS272 DEUTERON ACER TENDL-2021 LIBRARY; T=0.K
protons from (d,npa)

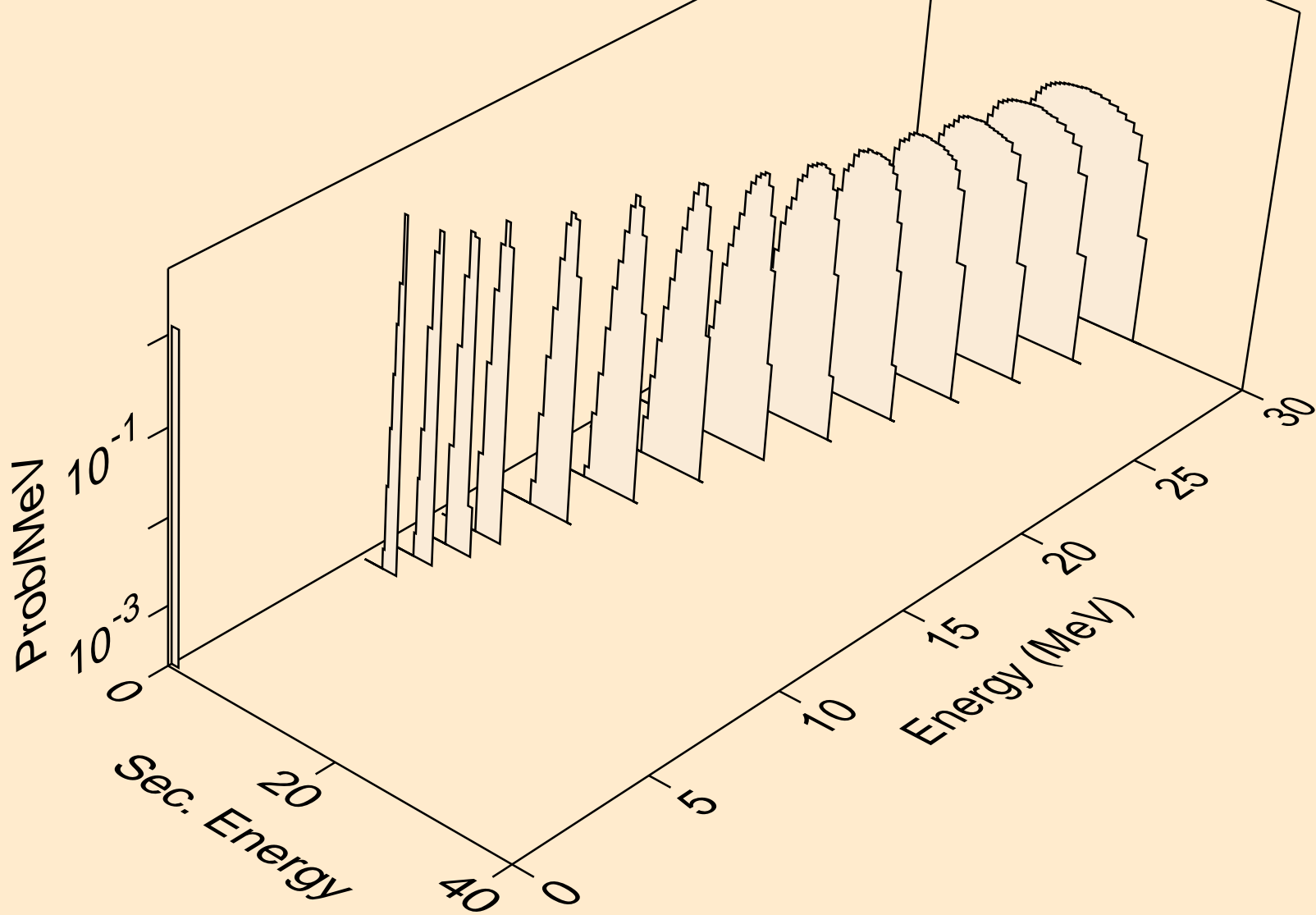

HS272 DEUTERON ACER TENDL-2021 LIBRARY; T=0.K
protons from (d,p)

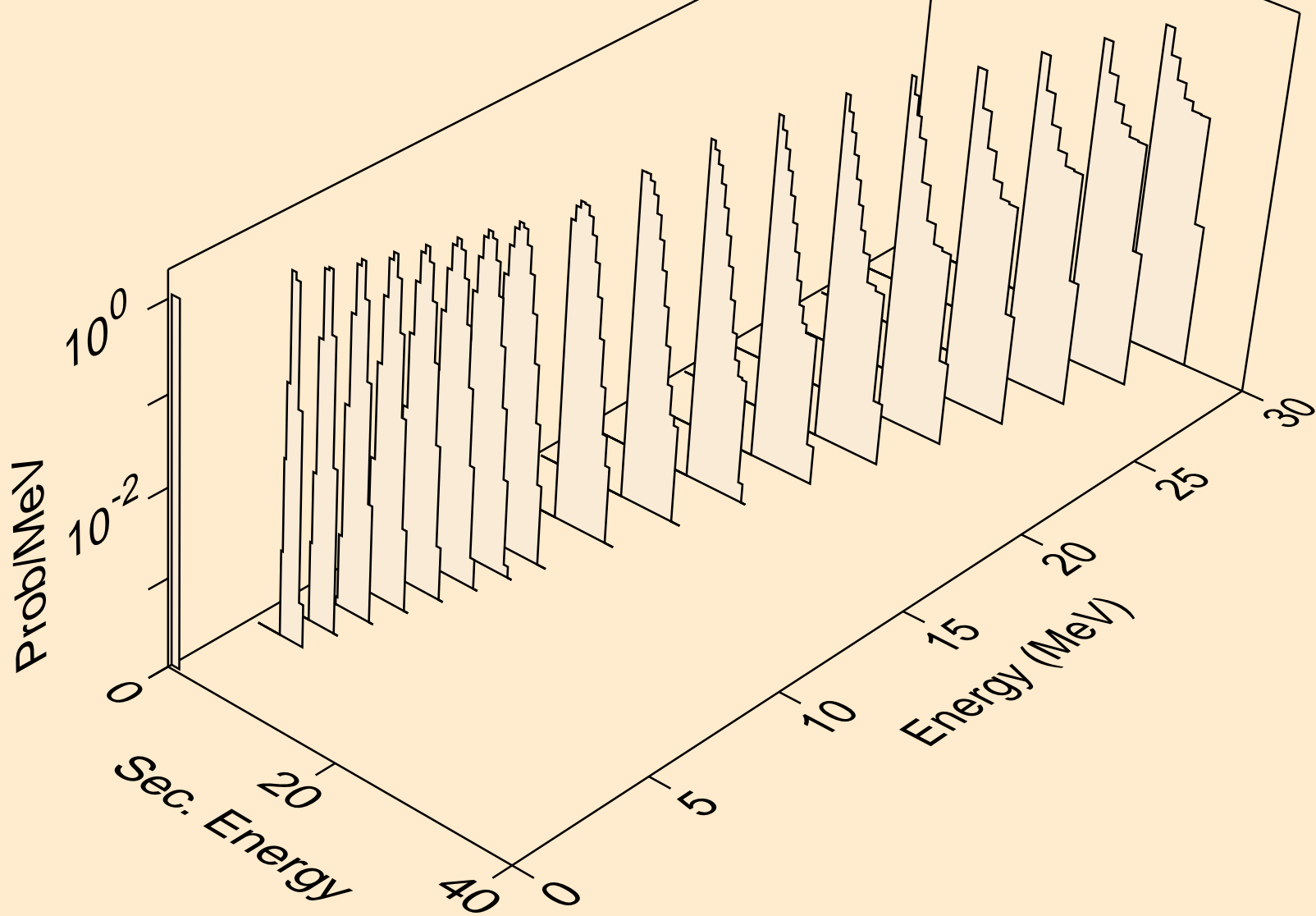

HS272 DEUTERON ACER TENDL-2021 LIBRARY; T=0.K
protons from (d,2p)

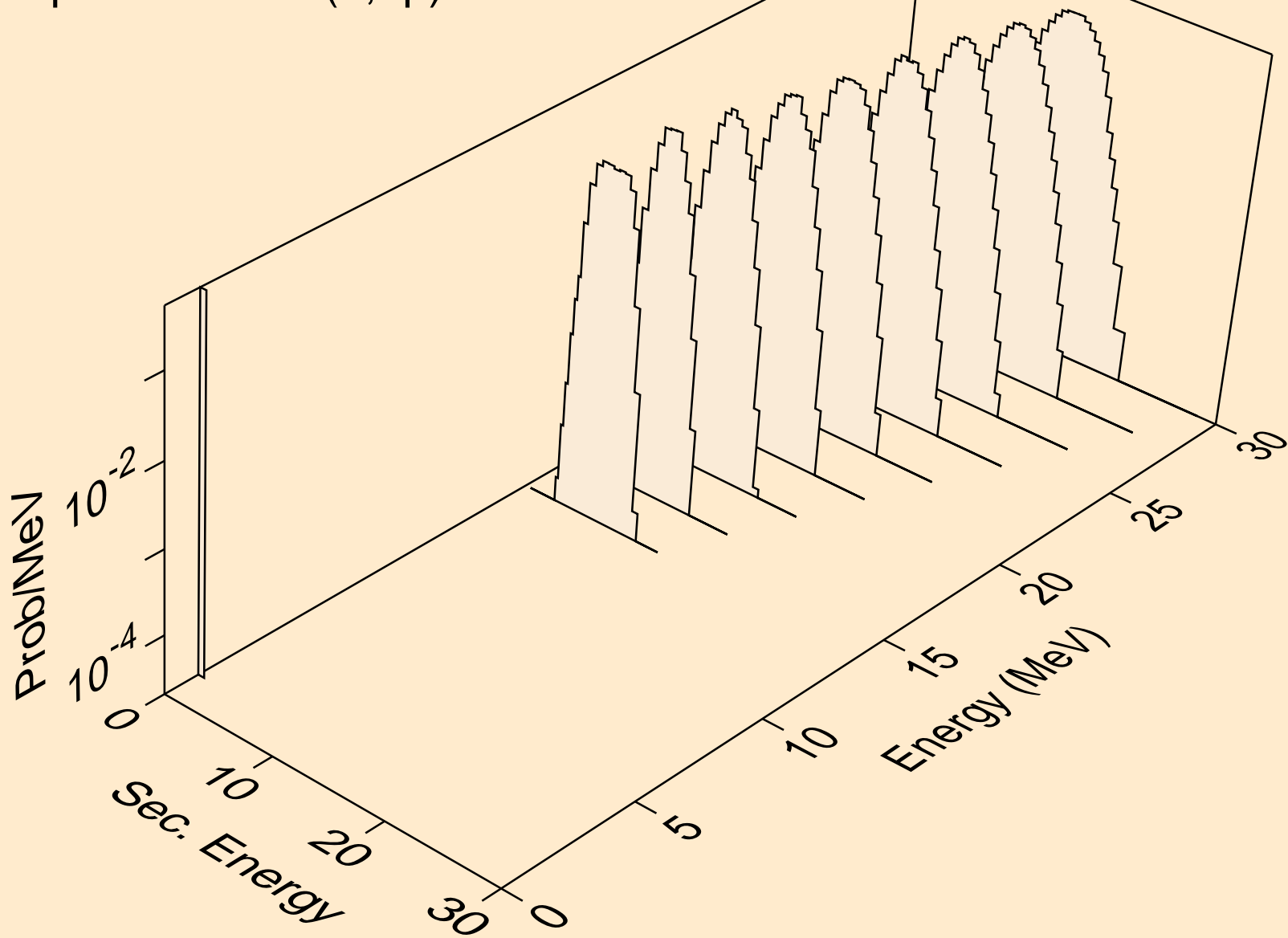

HS272 DEUTERON ACER TENDL-2021 LIBRARY; T=0.K
protons from (d,pa)

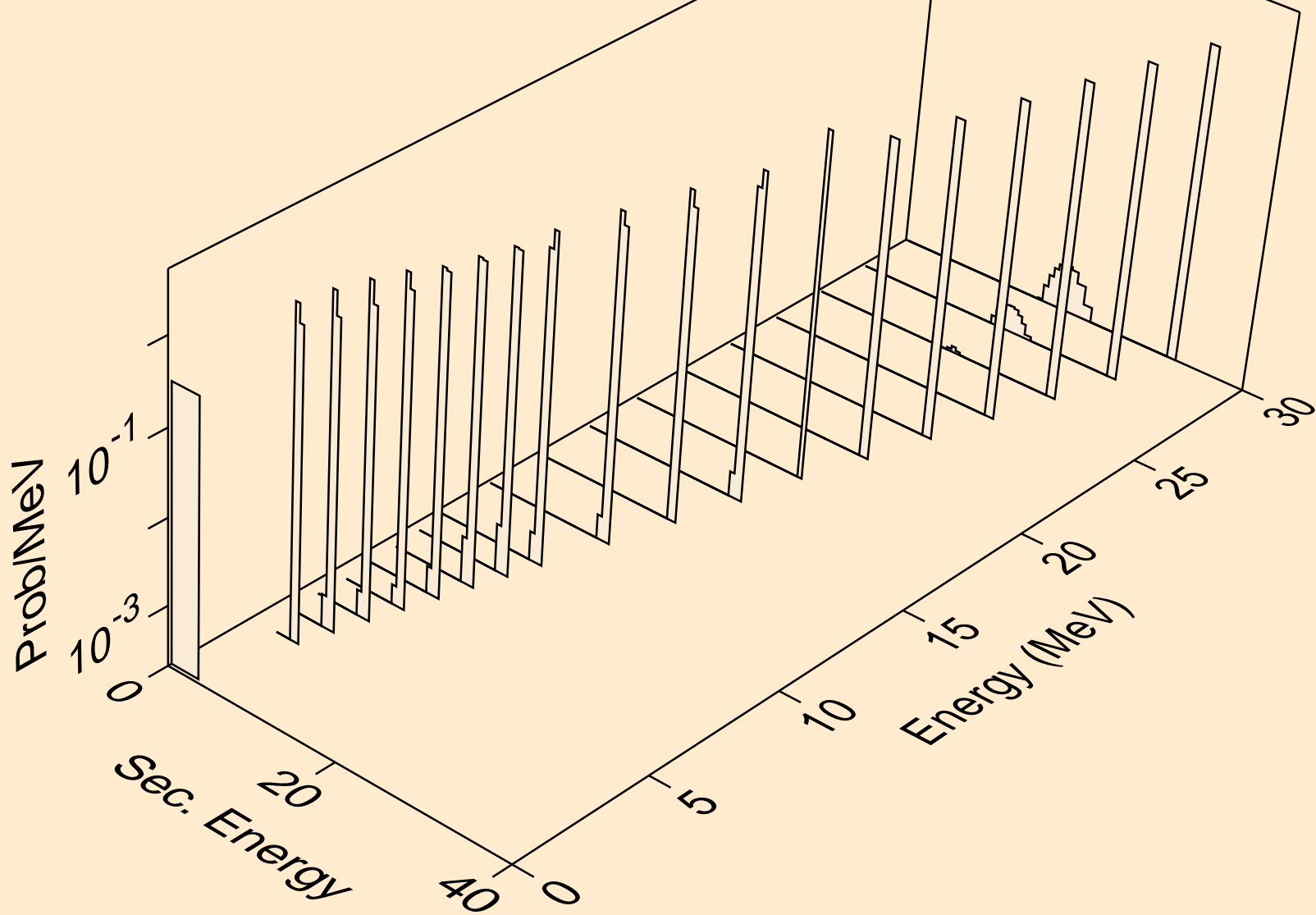

HS272 DEUTERON ACER TENDL-2021 LIBRARY; T=0.K
protons from (d,pd)

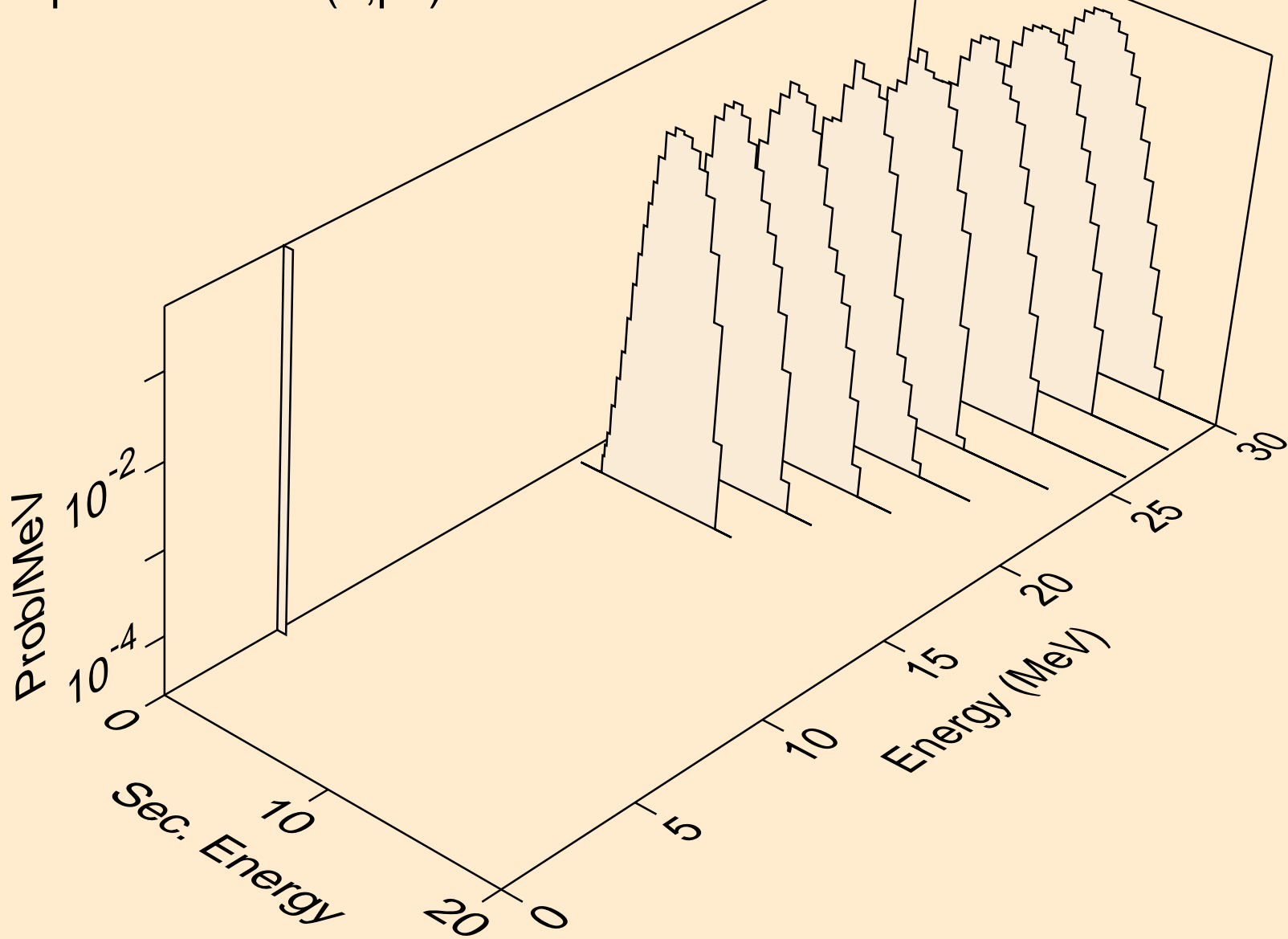

HS272 DEUTERON ACER TENDL-2021 LIBRARY; T=0.K
tritons from (d,x)

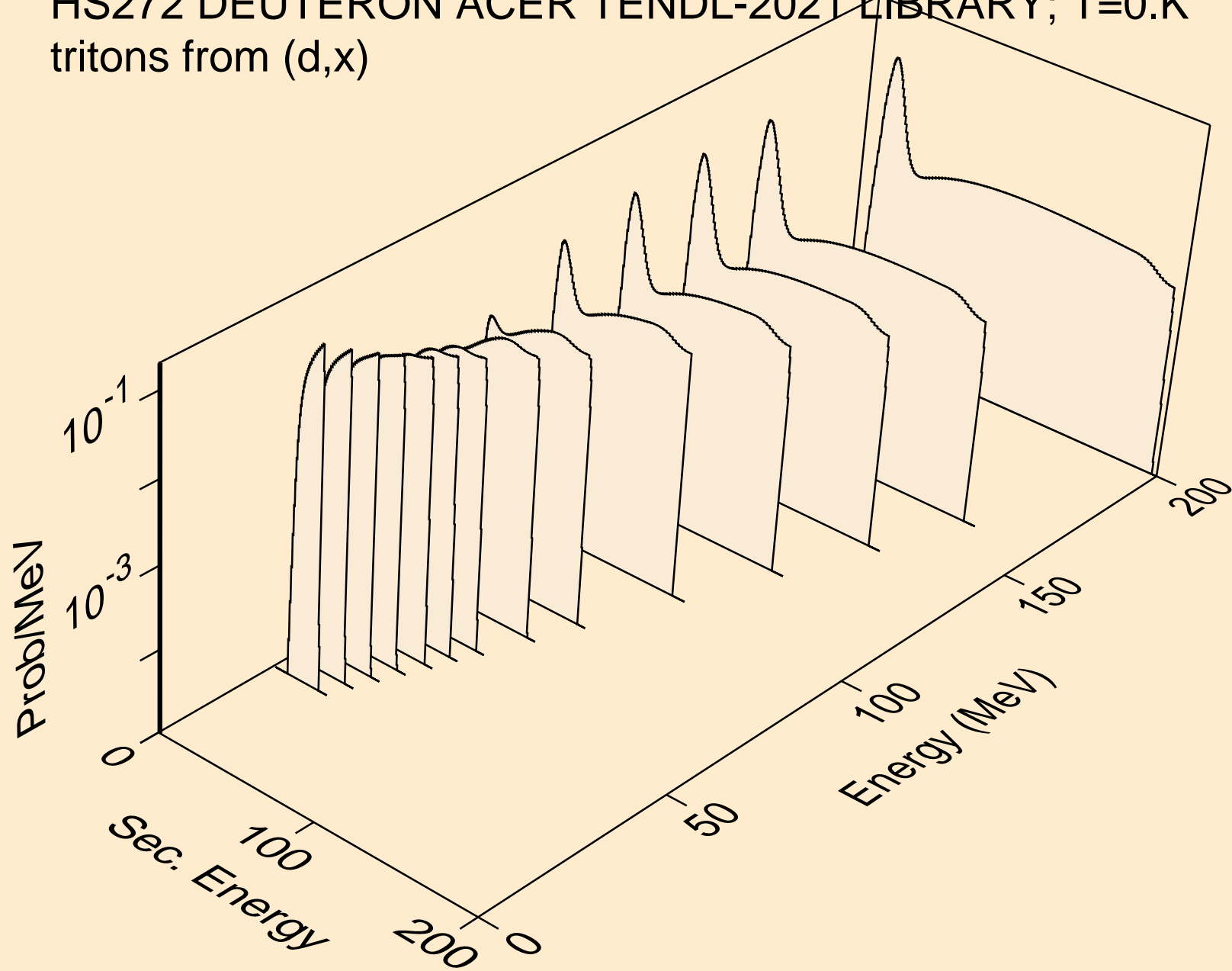

HS272 DEUTERON ACER TENDL-2021 LIBRARY; T=0.K
tritons from (d,n*)t

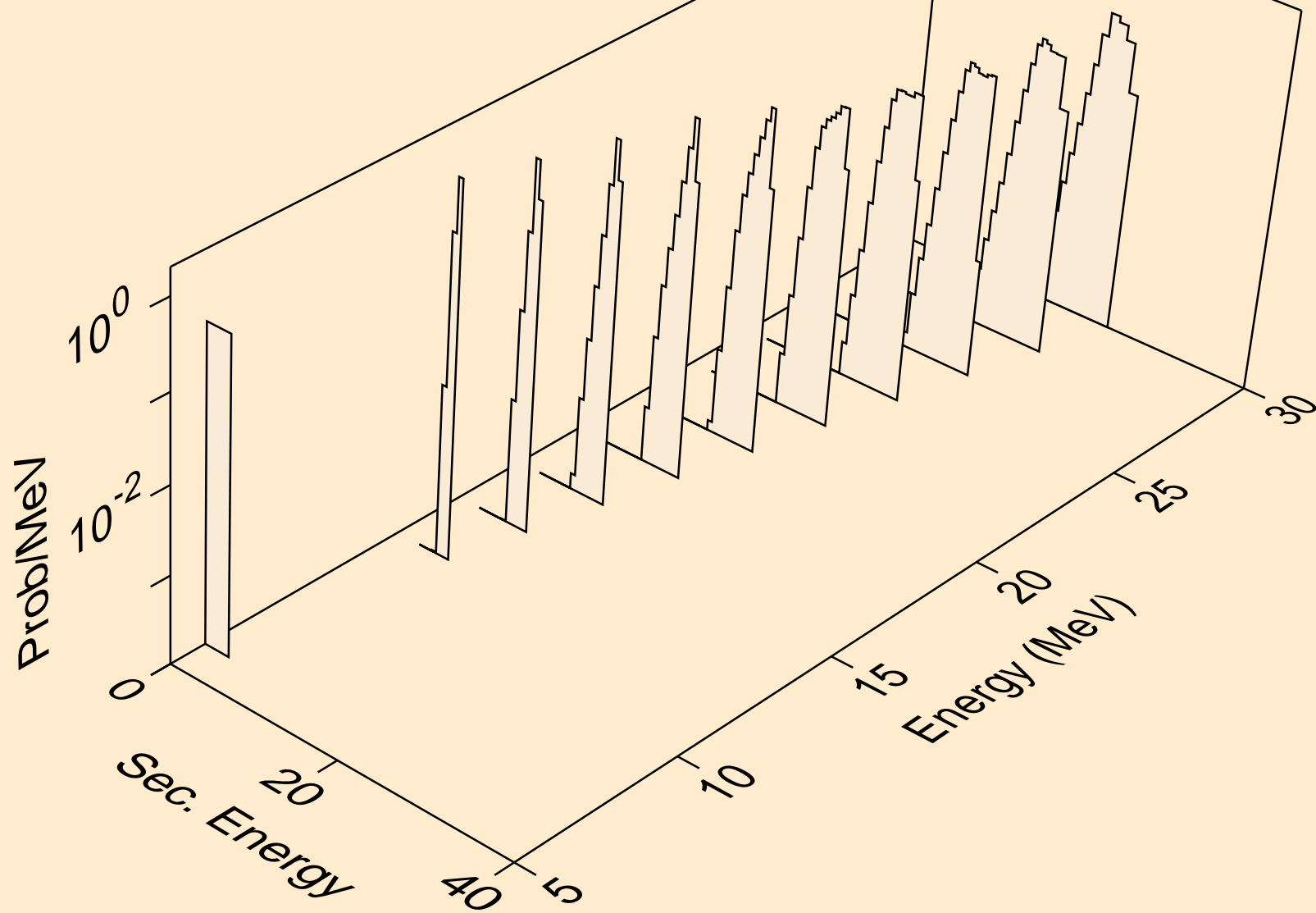

HS272 DEUTERON ACER TENDL-2021 LIBRARY; T=0.K
tritons from (d,t)

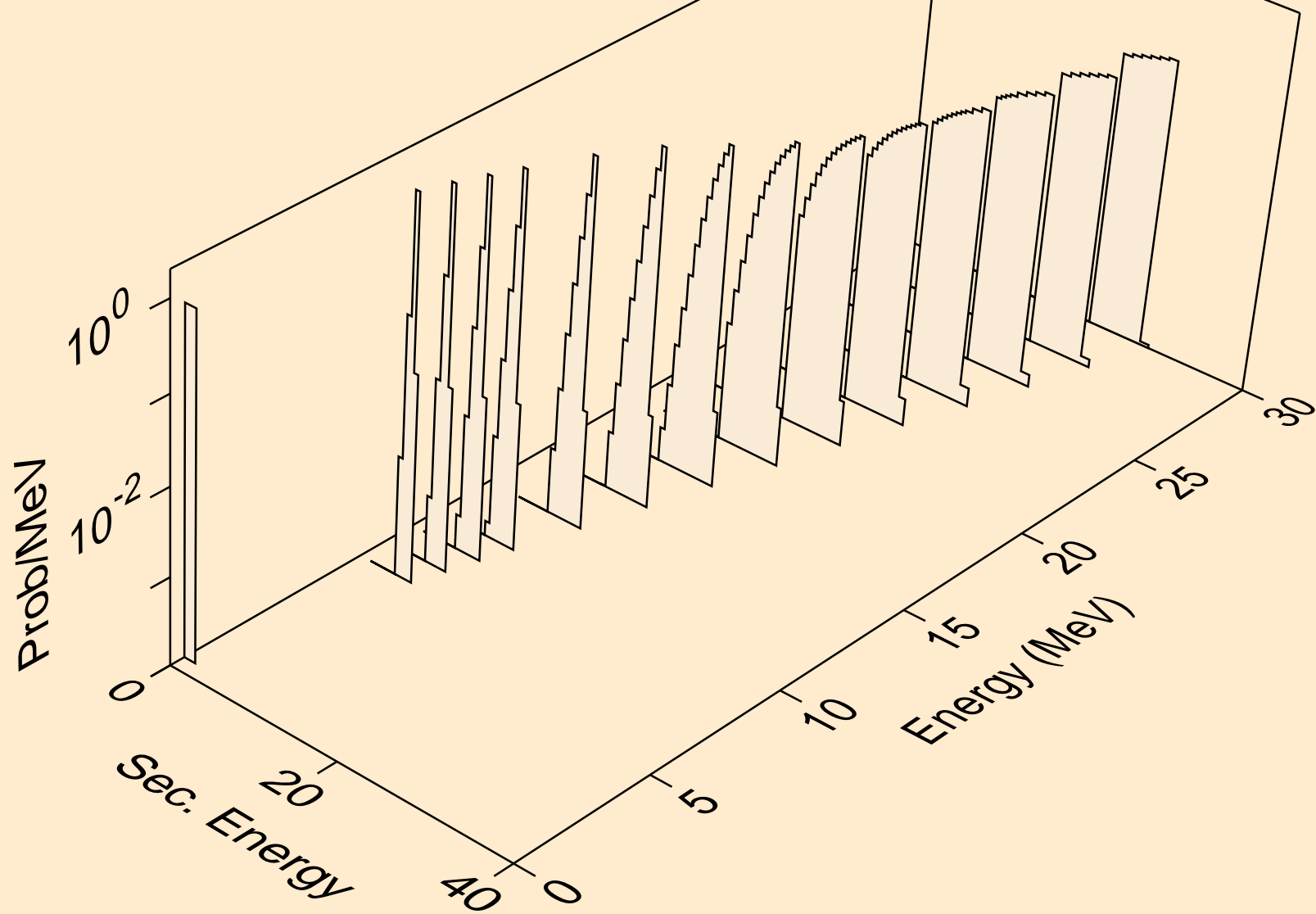

HS272 DEUTERON ACER TENDL-2021 LIBRARY; T=0.K
he3s from (d,x)

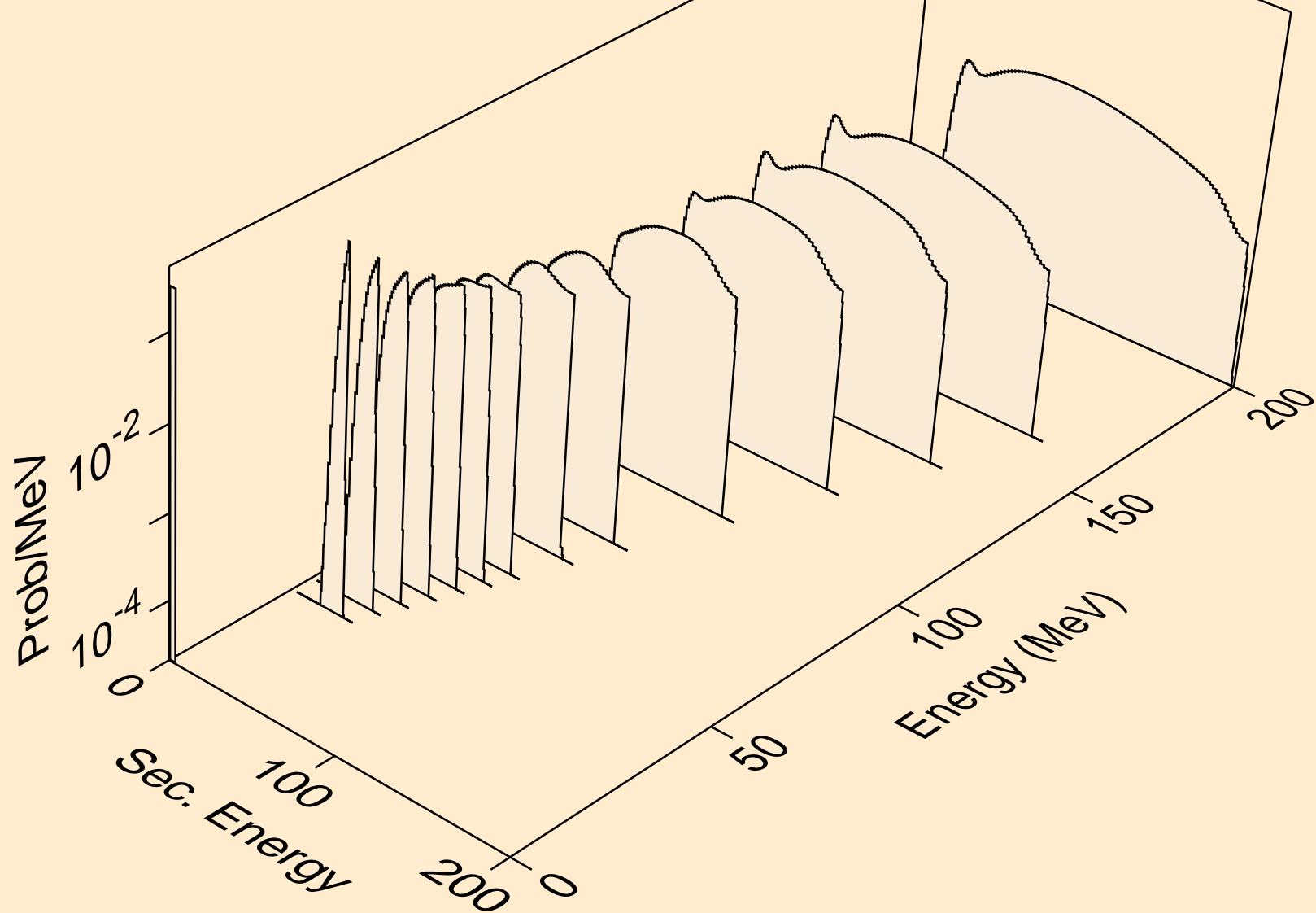

HS272 DEUTERON ACER TENDL-2021 LIBRARY; T=0.K
he3s from (d,he3)

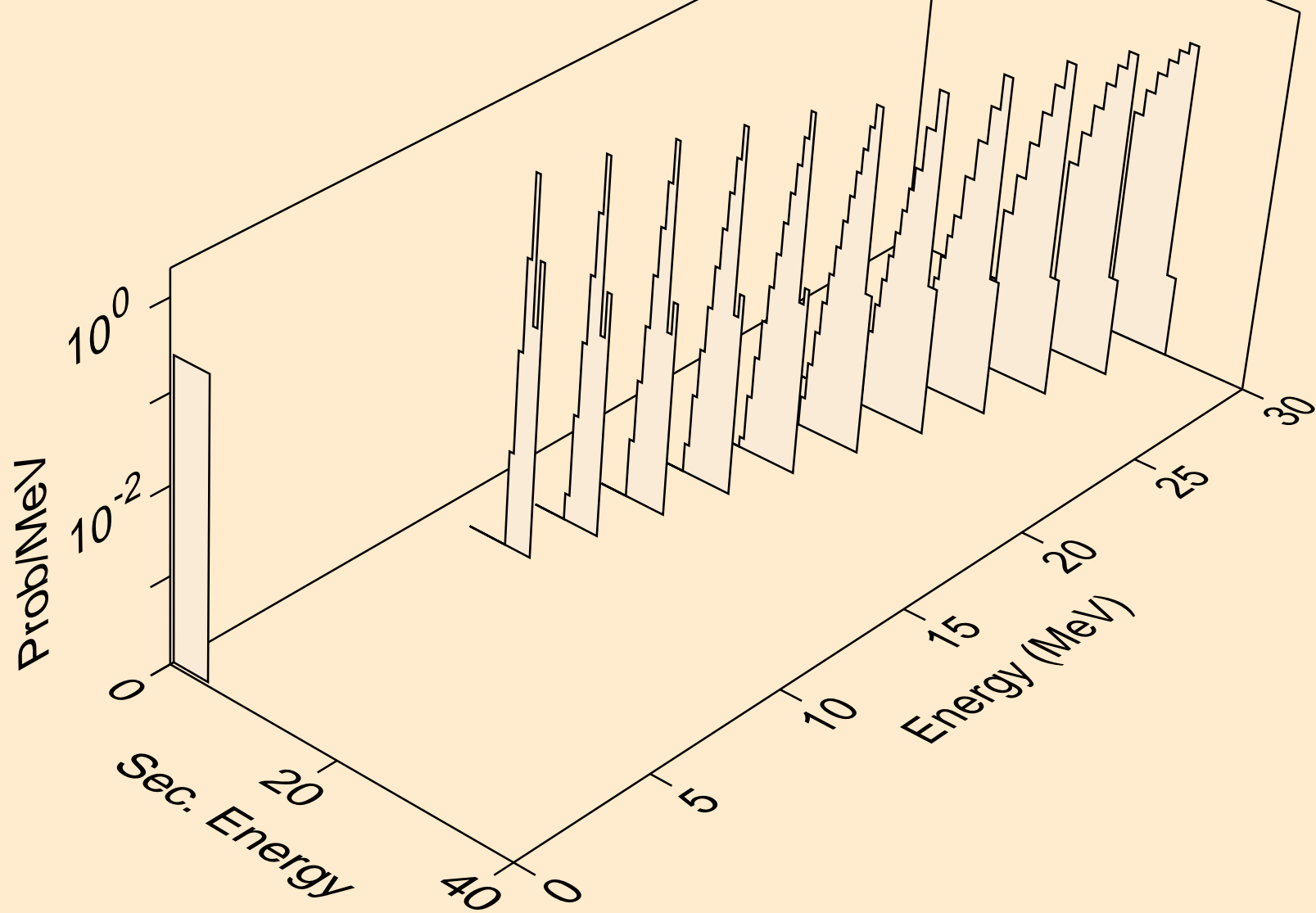

HS272 DEUTERON ACER TENDL-2021 LIBRARY; T=0.K
alphas from (d,x)

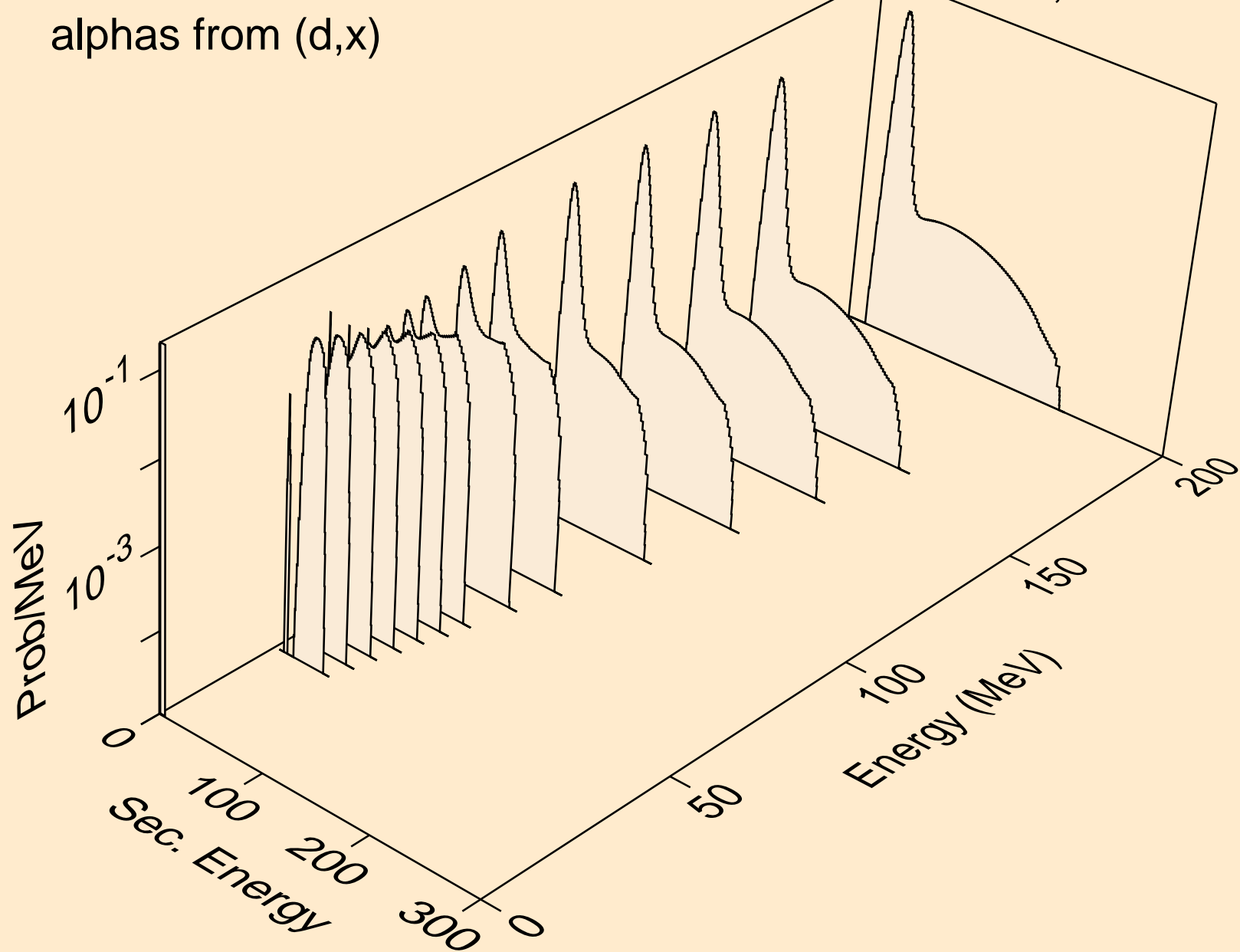

HS272 DEUTERON ACER TENDL-2021 LIBRARY; T=0.K
alphas from (d,n*)a

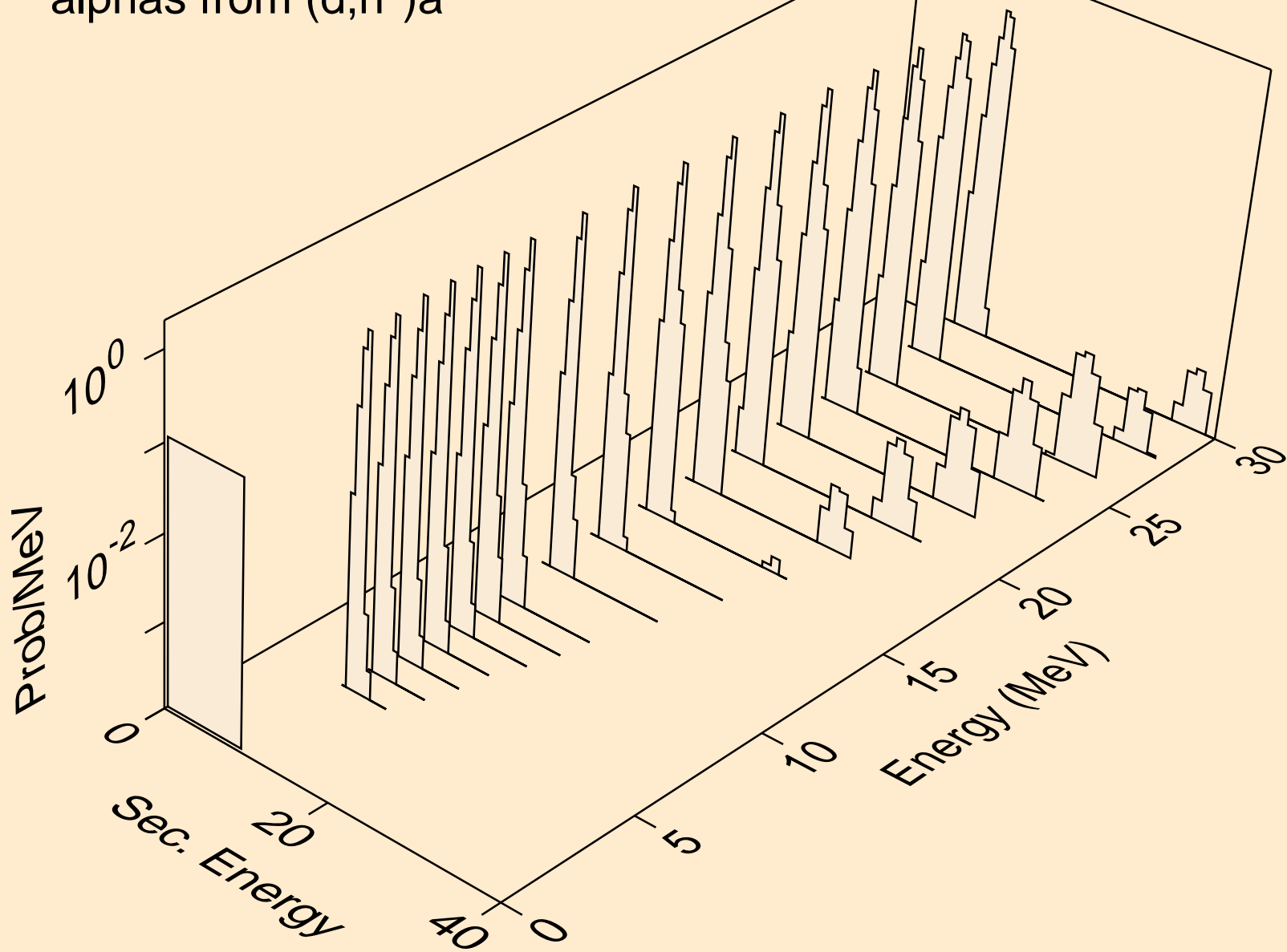

HS272 DEUTERON ACER TENDL-2021 LIBRARY; T=0.K
alphas from (d,2n)a

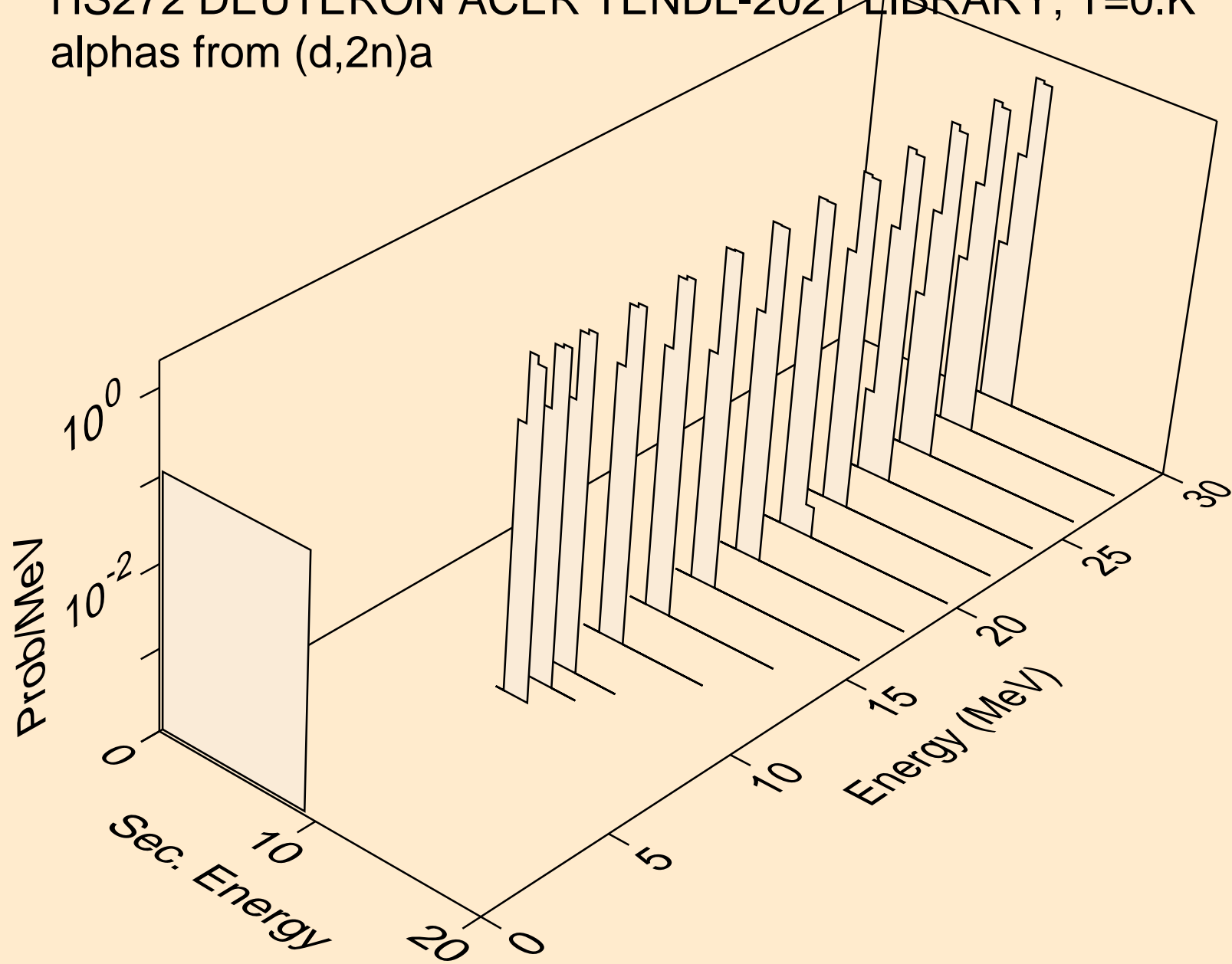

HS272 DEUTERON ACER TENDL-2021 LIBRARY; T=0.K
alphas from (d,3n)a

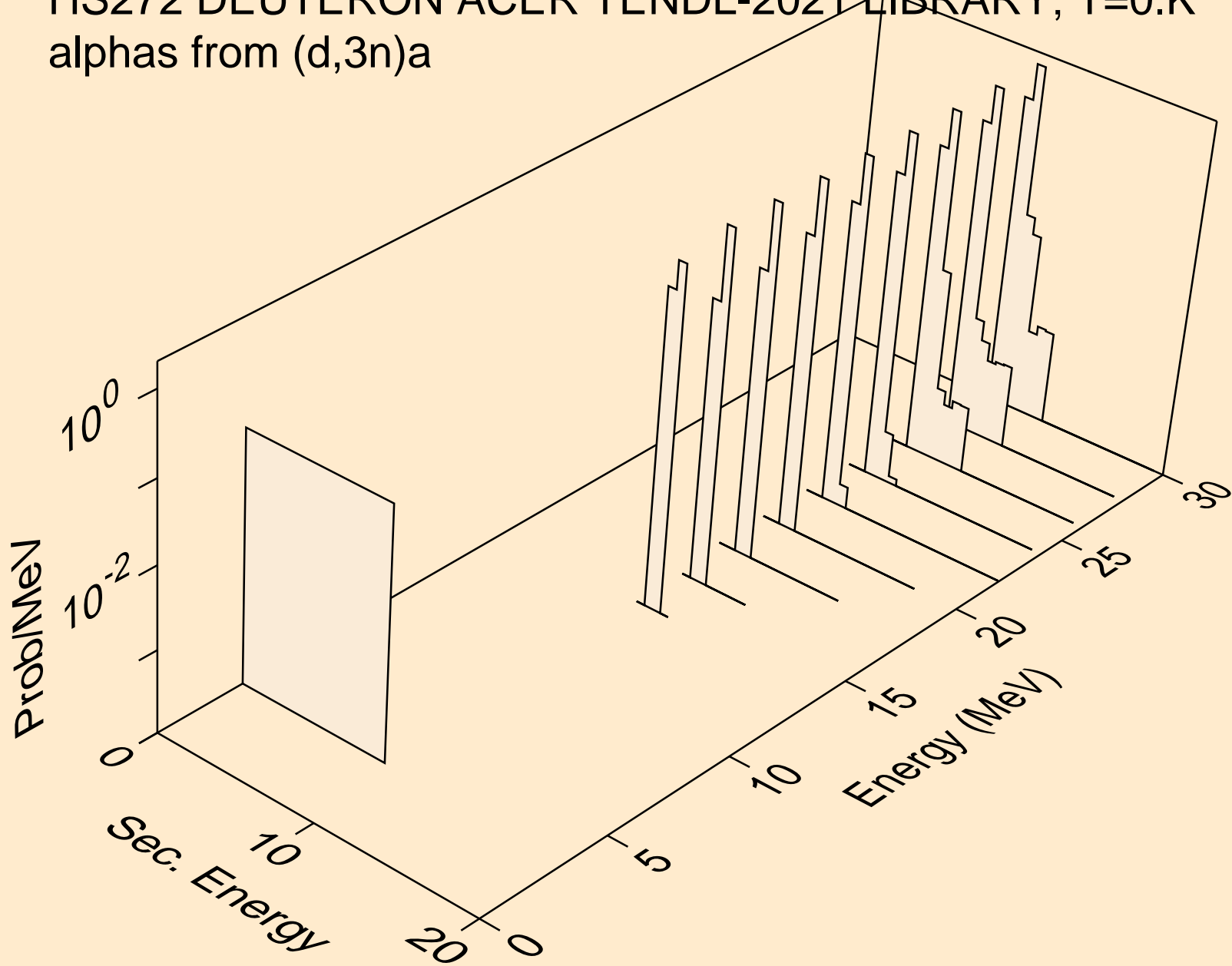

HS272 DEUTERON ACER TENDL-2021 LIBRARY; T=0.K
alphas from (d,npa)

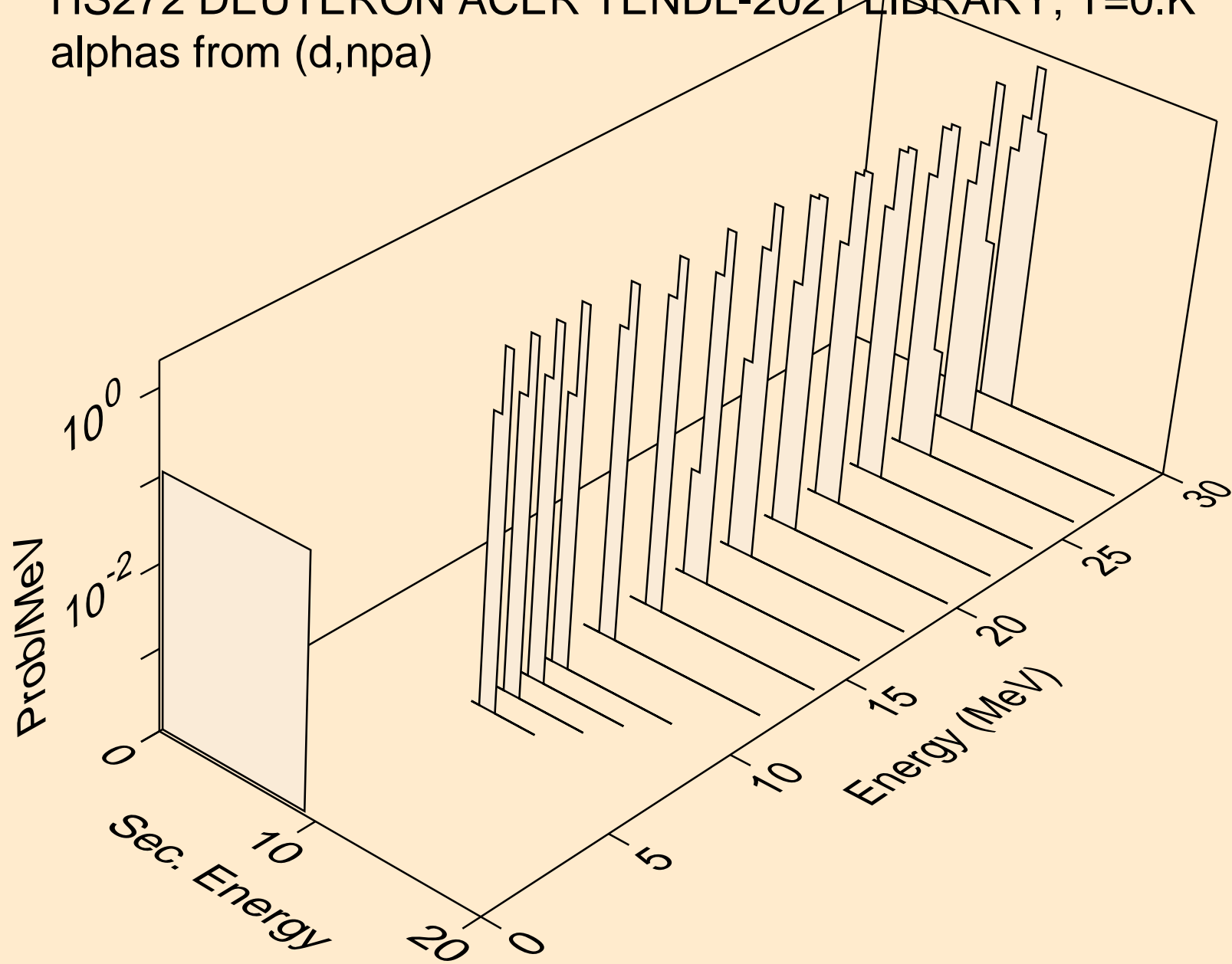

HS272 DEUTERON ACER TENDL-2021 LIBRARY; T=0.K
alphas from (d,a)

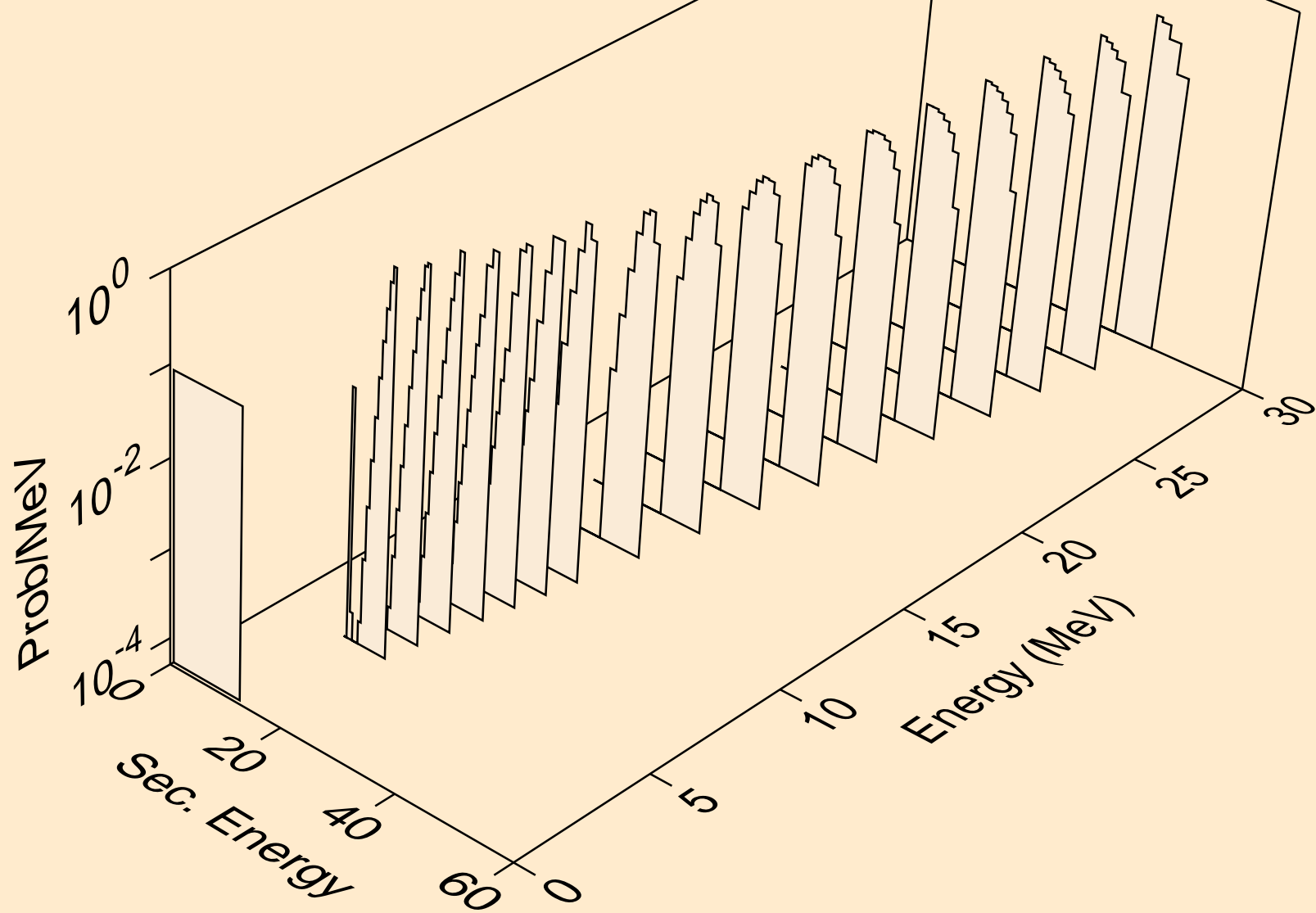

HS272 DEUTERON ACER TENDL-2021 LIBRARY; T=0.K
alphas from (d,2a)

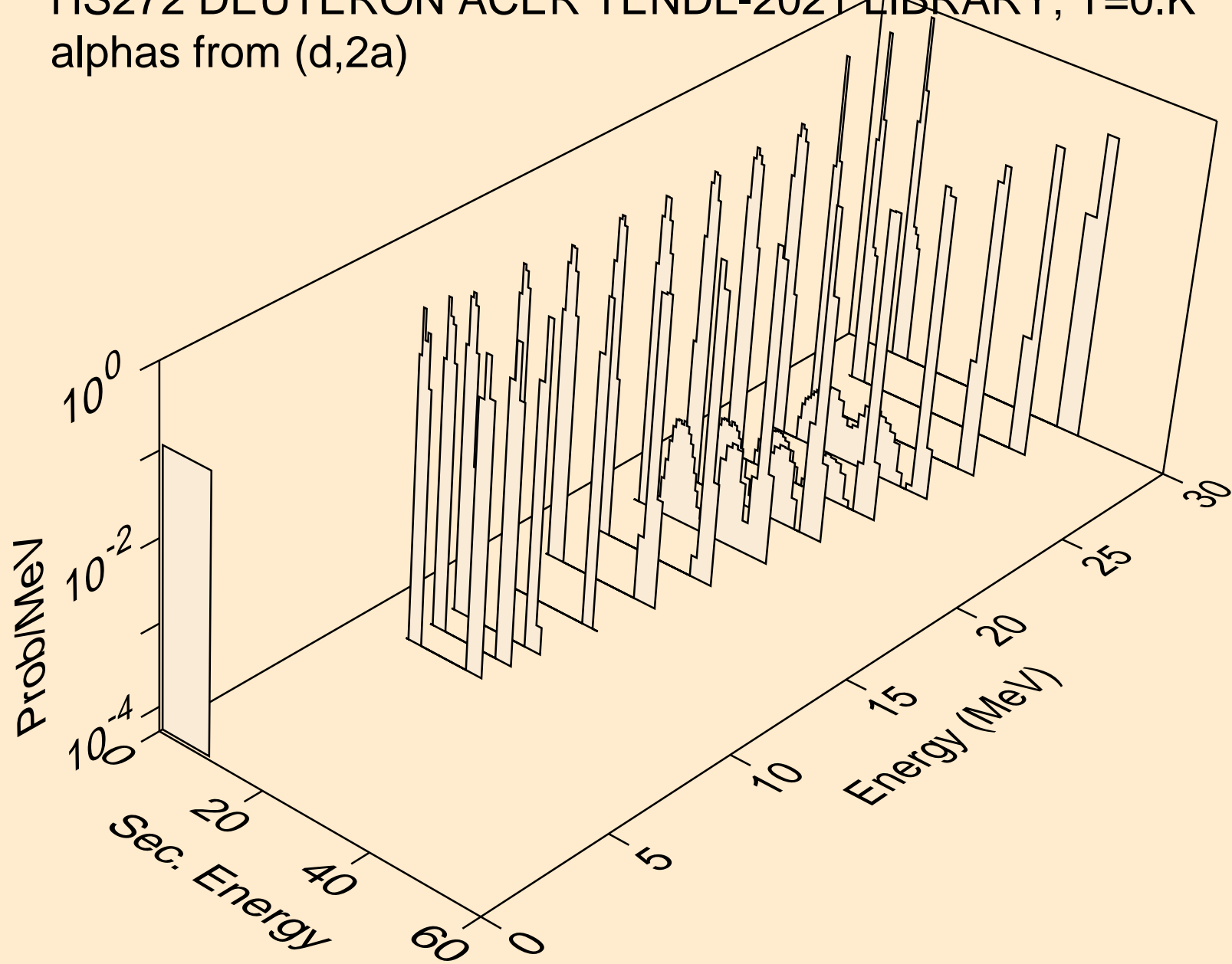

HS272 DEUTERON ACER TENDL-2021 LIBRARY; T=0.K
alphas from (d,pa)

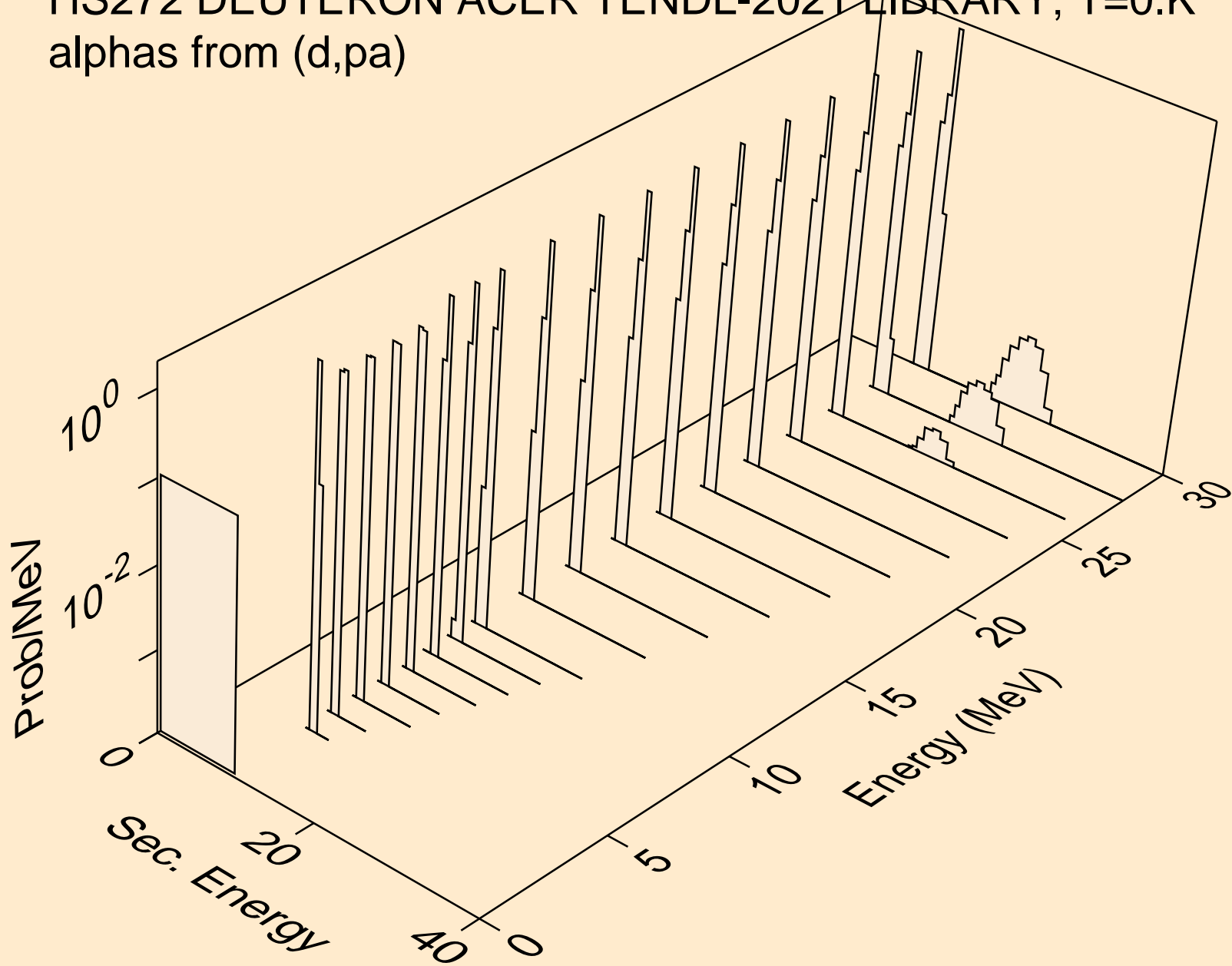

HS272 DEUTERON ACER TENDL-2021 LIBRARY; T=0.K
alphas from (d,da)

