

LA119 DEUTERON ACER TENDL-2021 LIBRARY; T=0.K
Principal cross sections

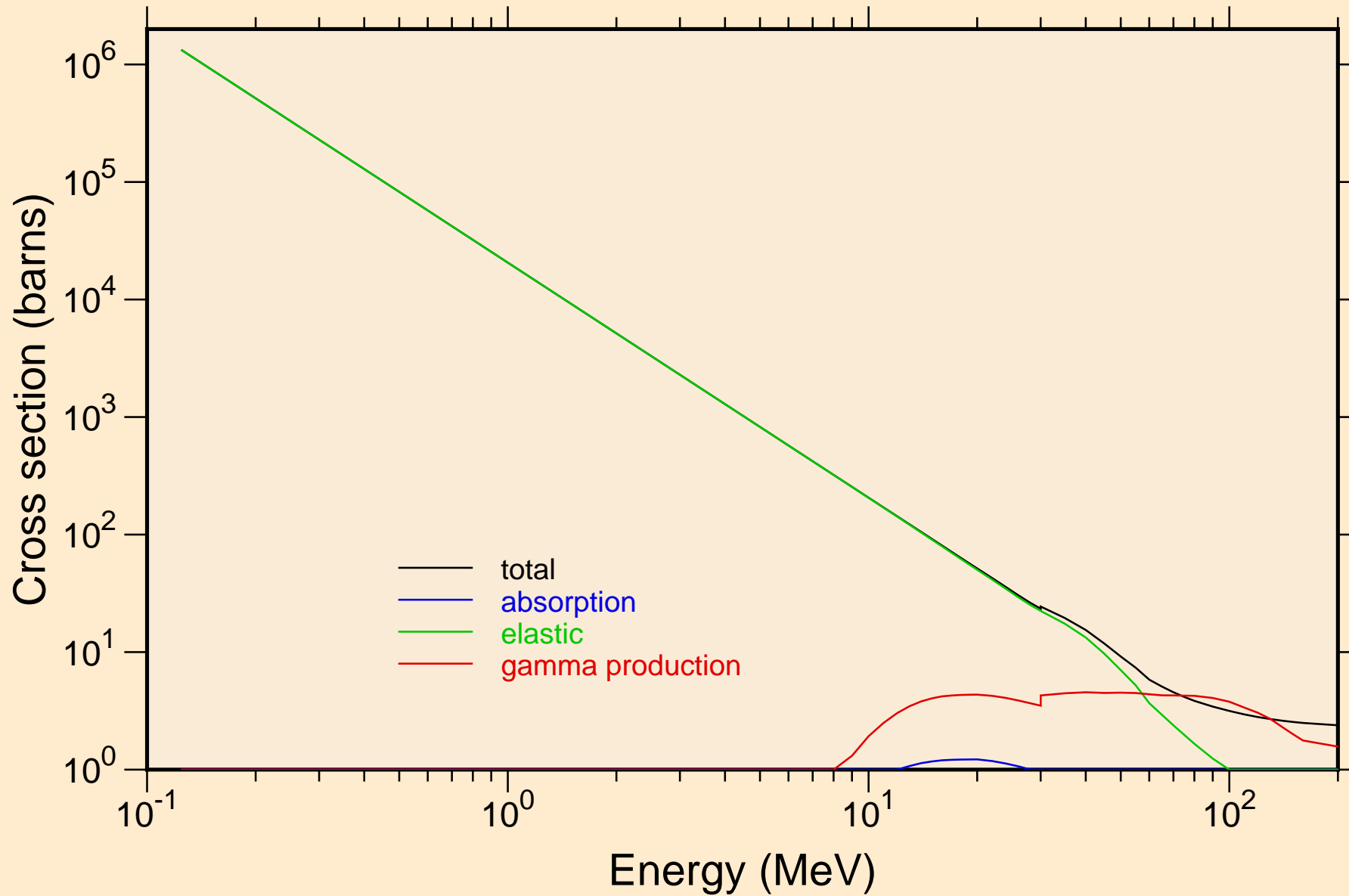

LA119 DEUTERON ACER TENDL-2021 LIBRARY; T=0.K
Heating

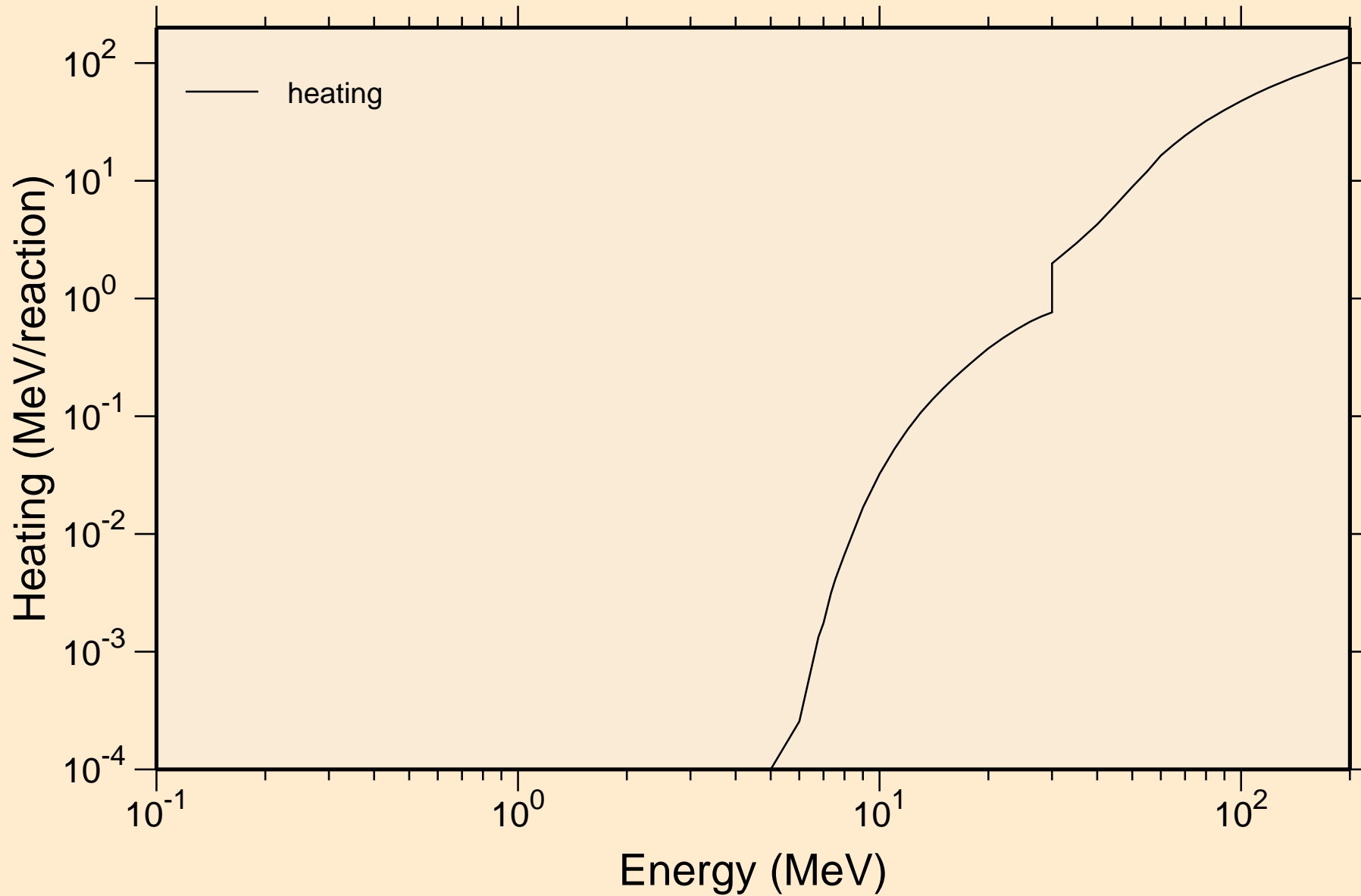

LA119 DEUTERON ACER TENDL-2021 LIBRARY; T=0.K
Principal cross sections

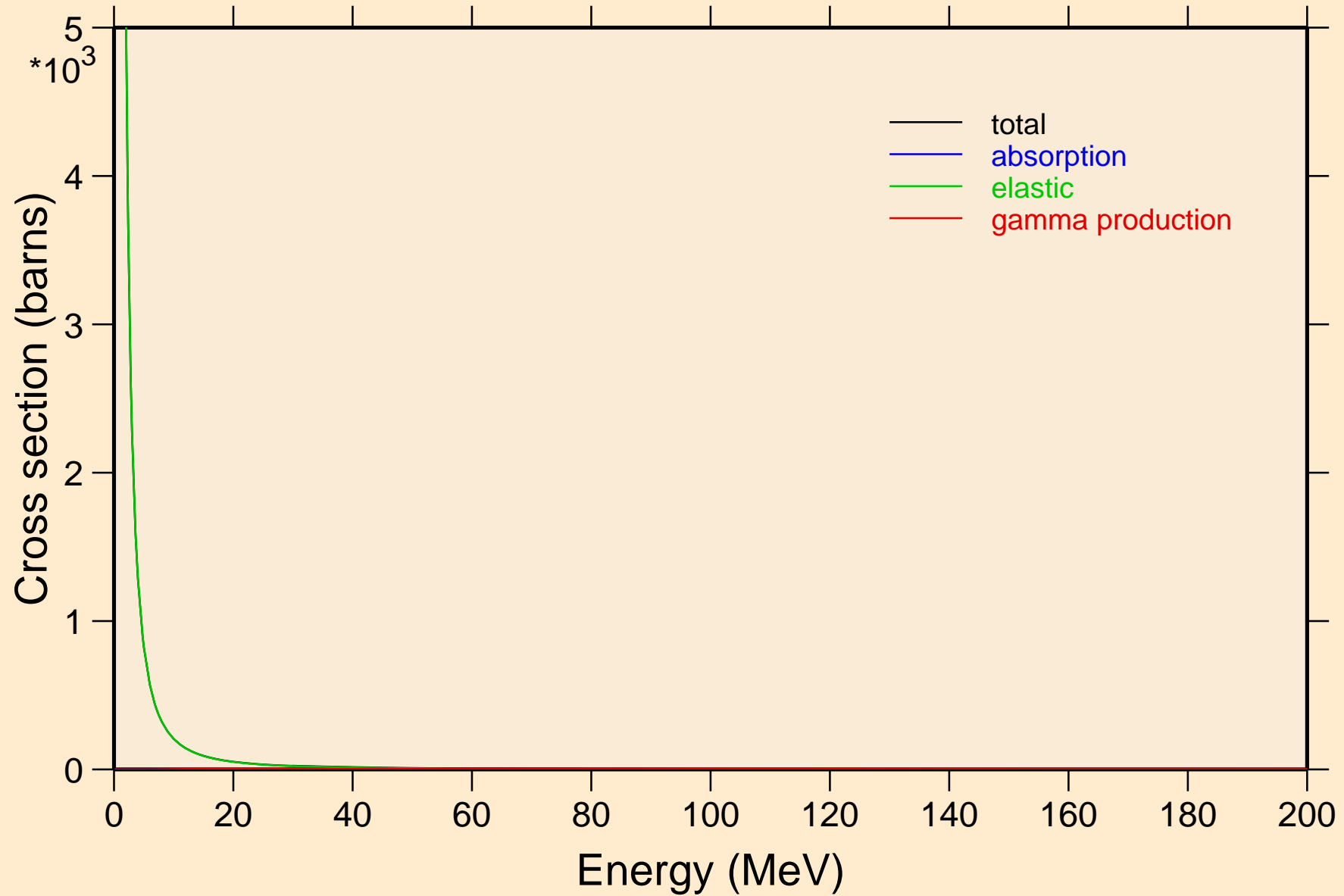

LA119 DEUTERON ACER TENDL-2021 LIBRARY; T=0.K
Heating

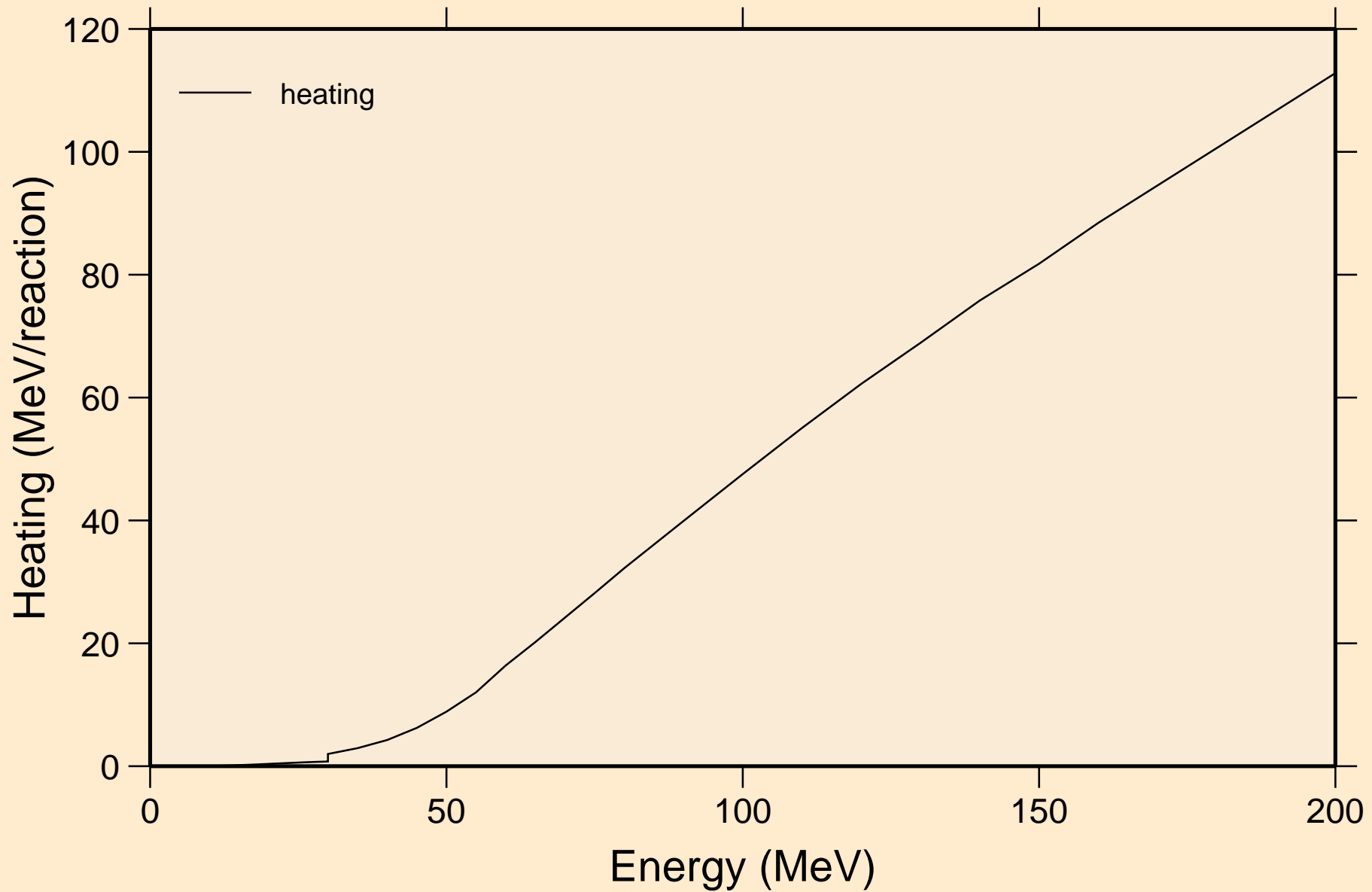

LA119 DEUTERON ACER TENDL-2021 LIBRARY; T=0.K
Threshold reactions

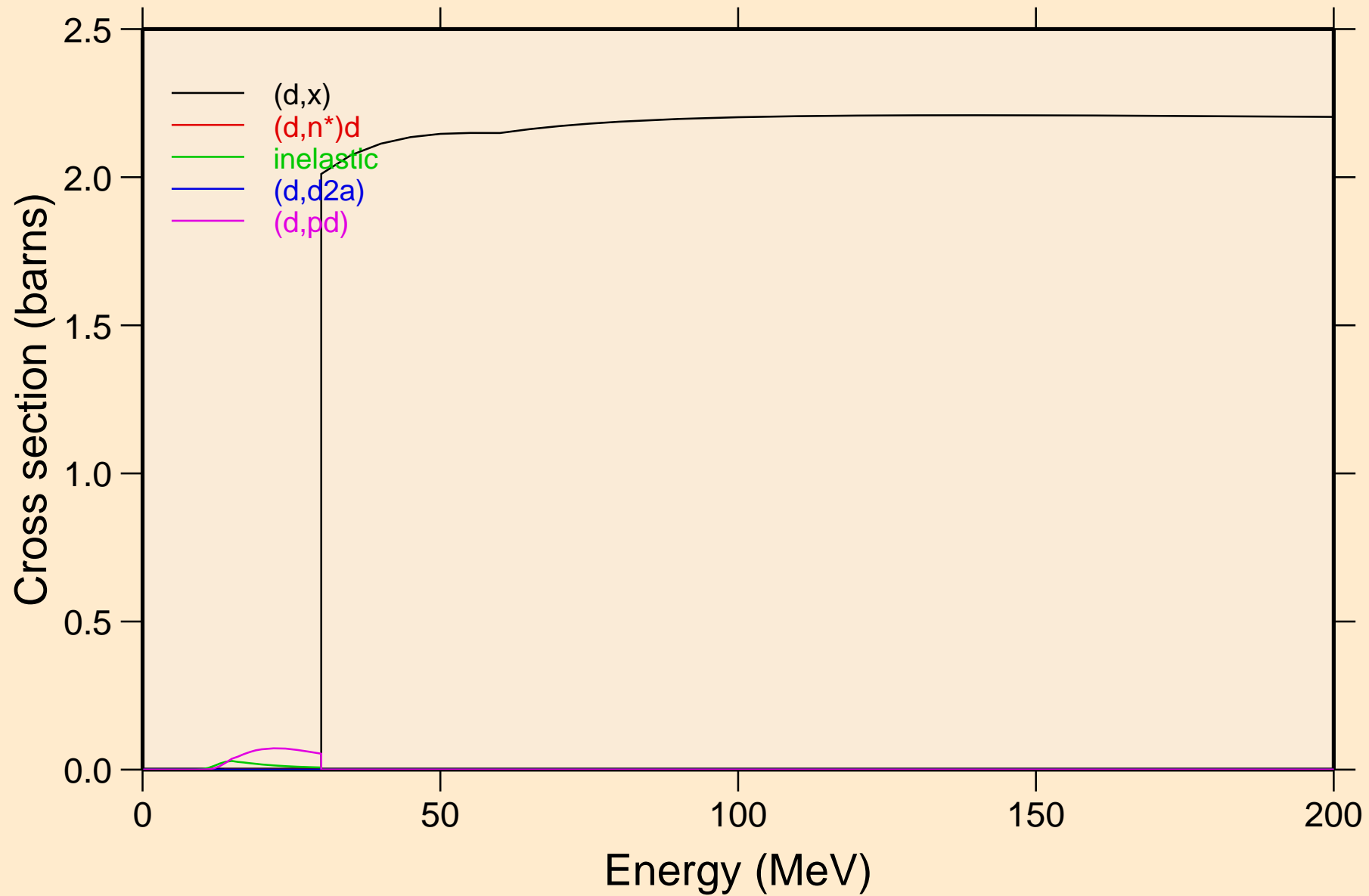

LA119 DEUTERON ACER TENDL-2021 LIBRARY; T=0.K
Threshold reactions

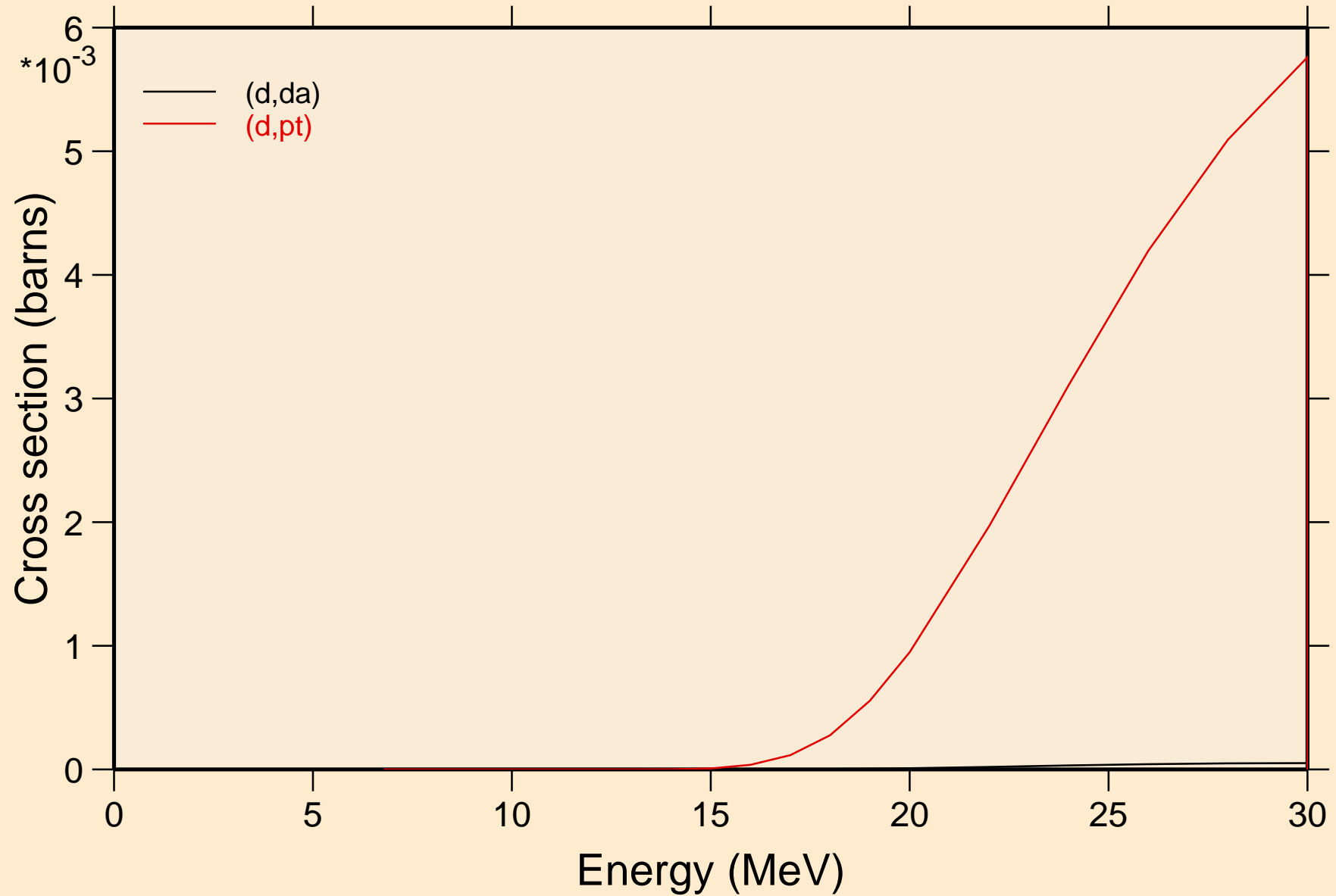

LA119 DEUTERON ACER TENDL-2021 LIBRARY; T=0.K
Threshold reactions

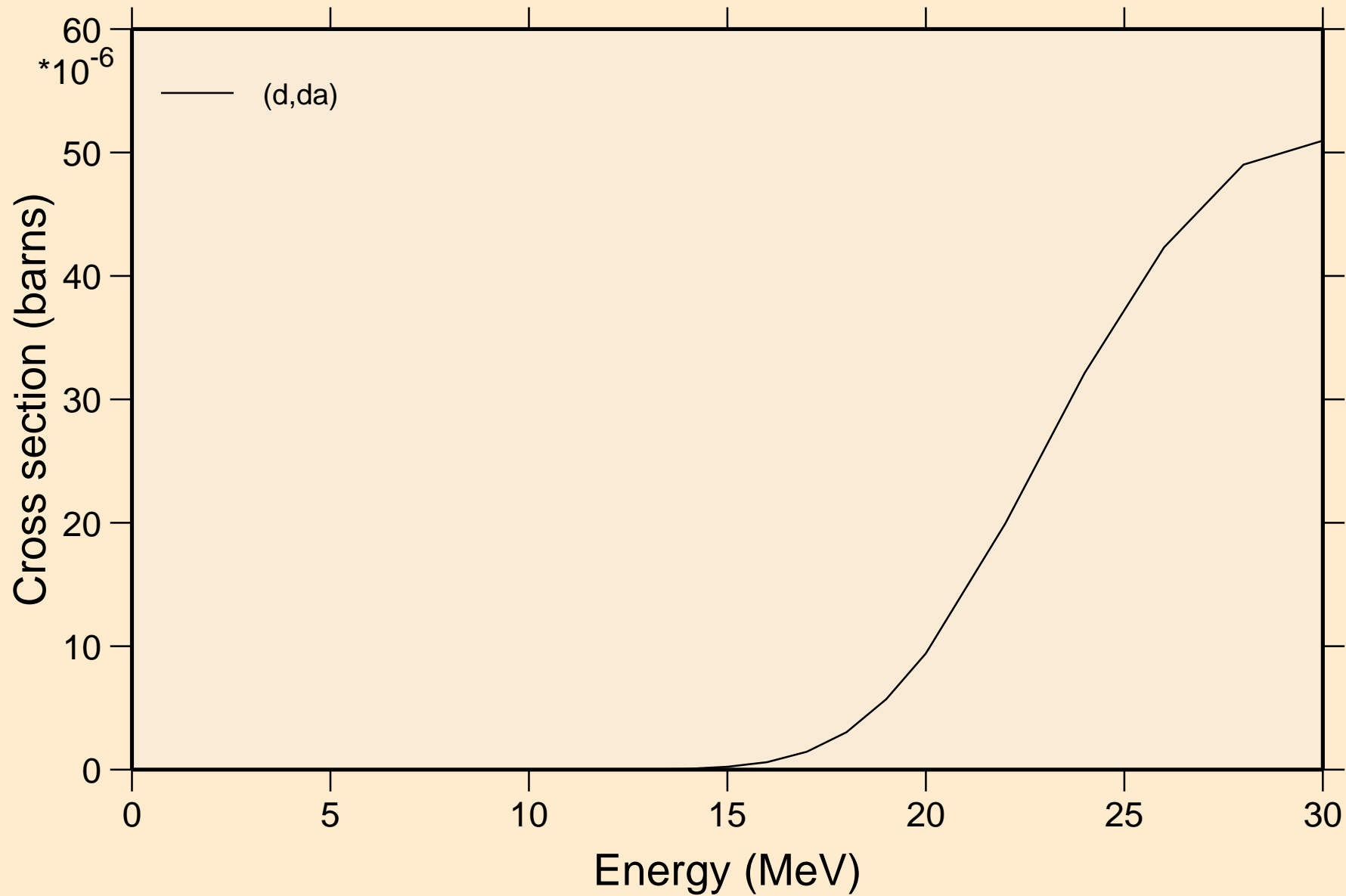

LA119 DEUTERON ACER TENDL-2021 LIBRARY; T=0.K
angular distribution for elastic

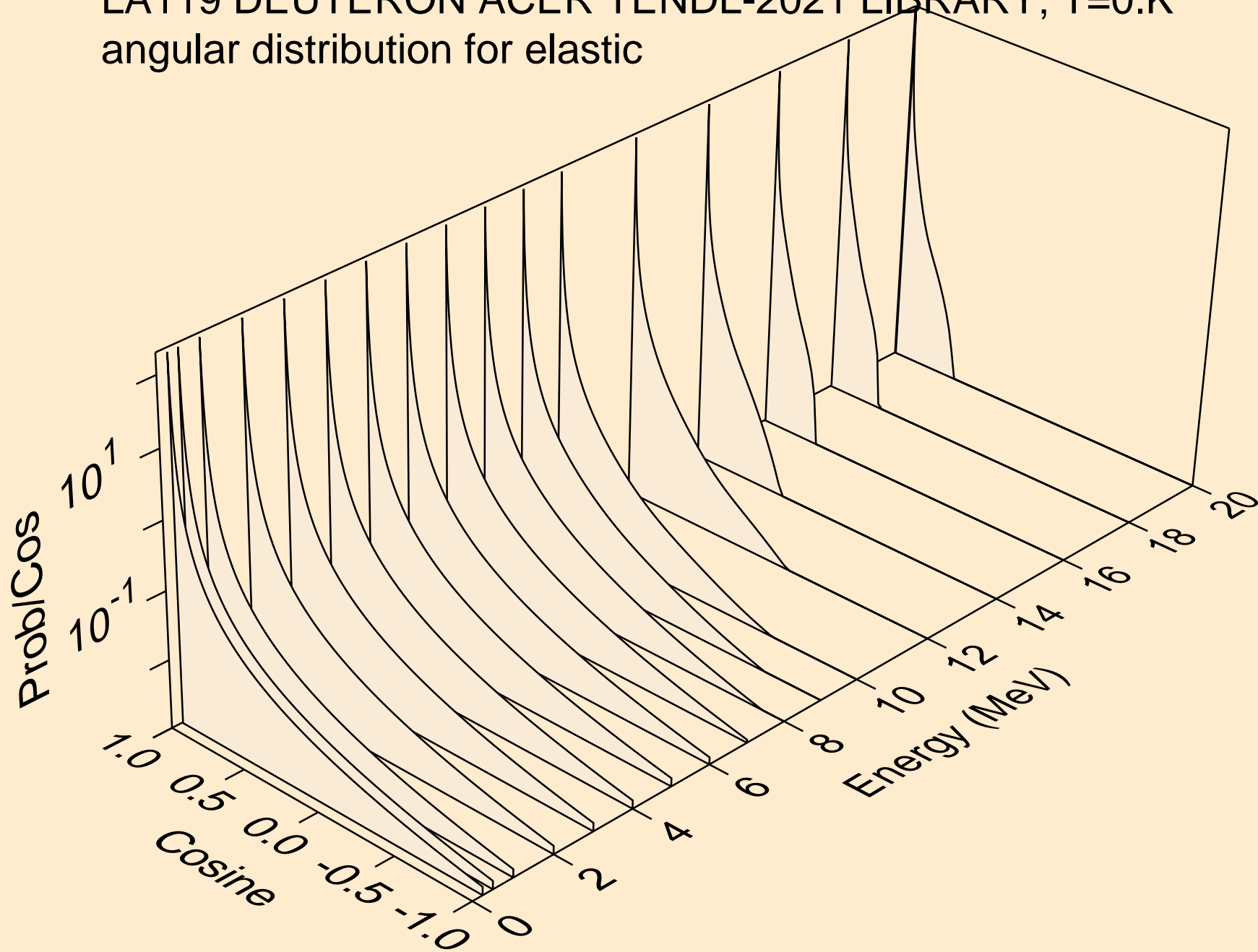

LA119 DEUTERON ACER TENDL-2021 LIBRARY; T=0.K
angular distribution for elastic

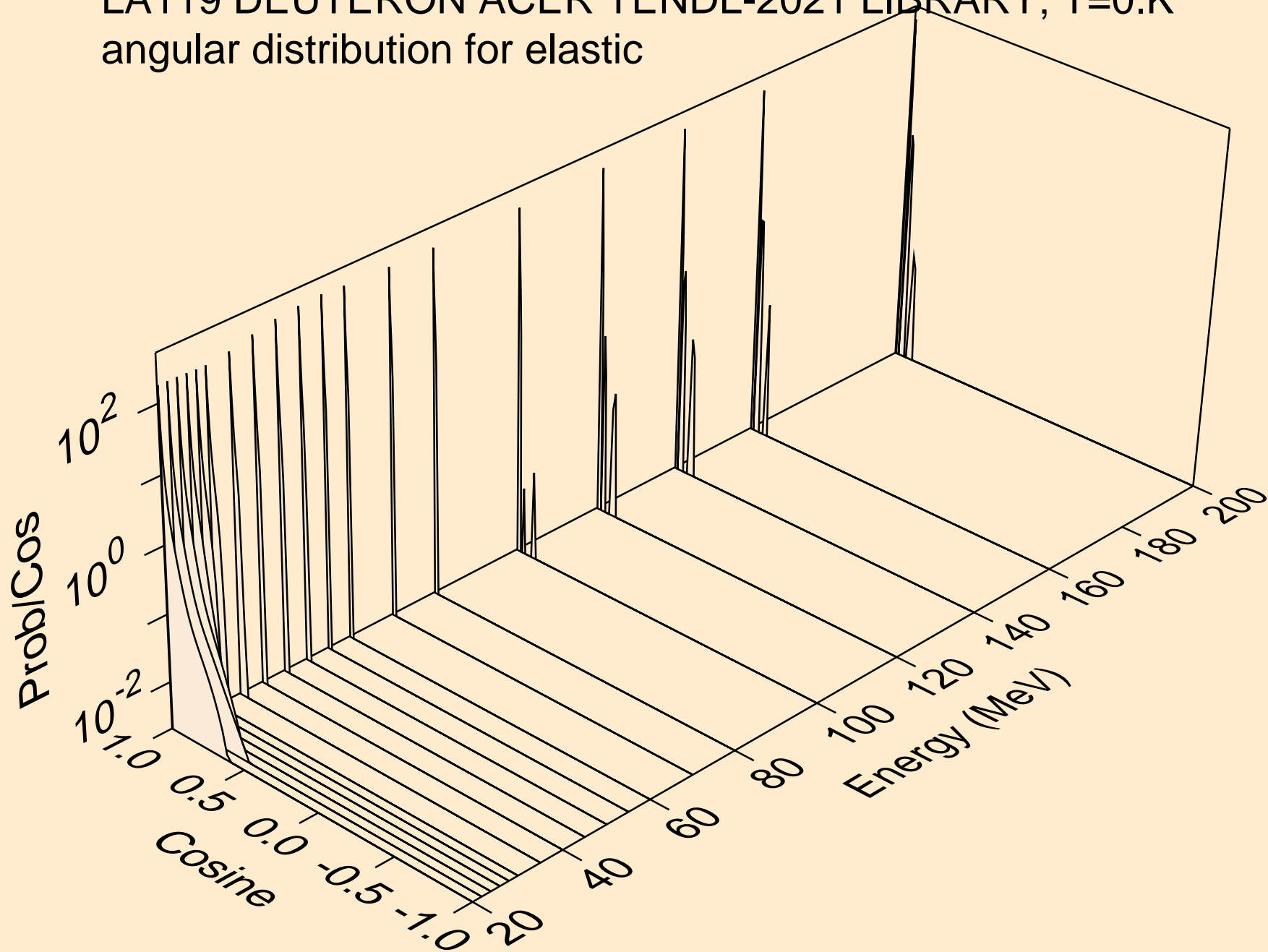

LA119 DEUTERON ACER TENDL-2021 LIBRARY; T=0.K
Deuteron emission for (d,x)

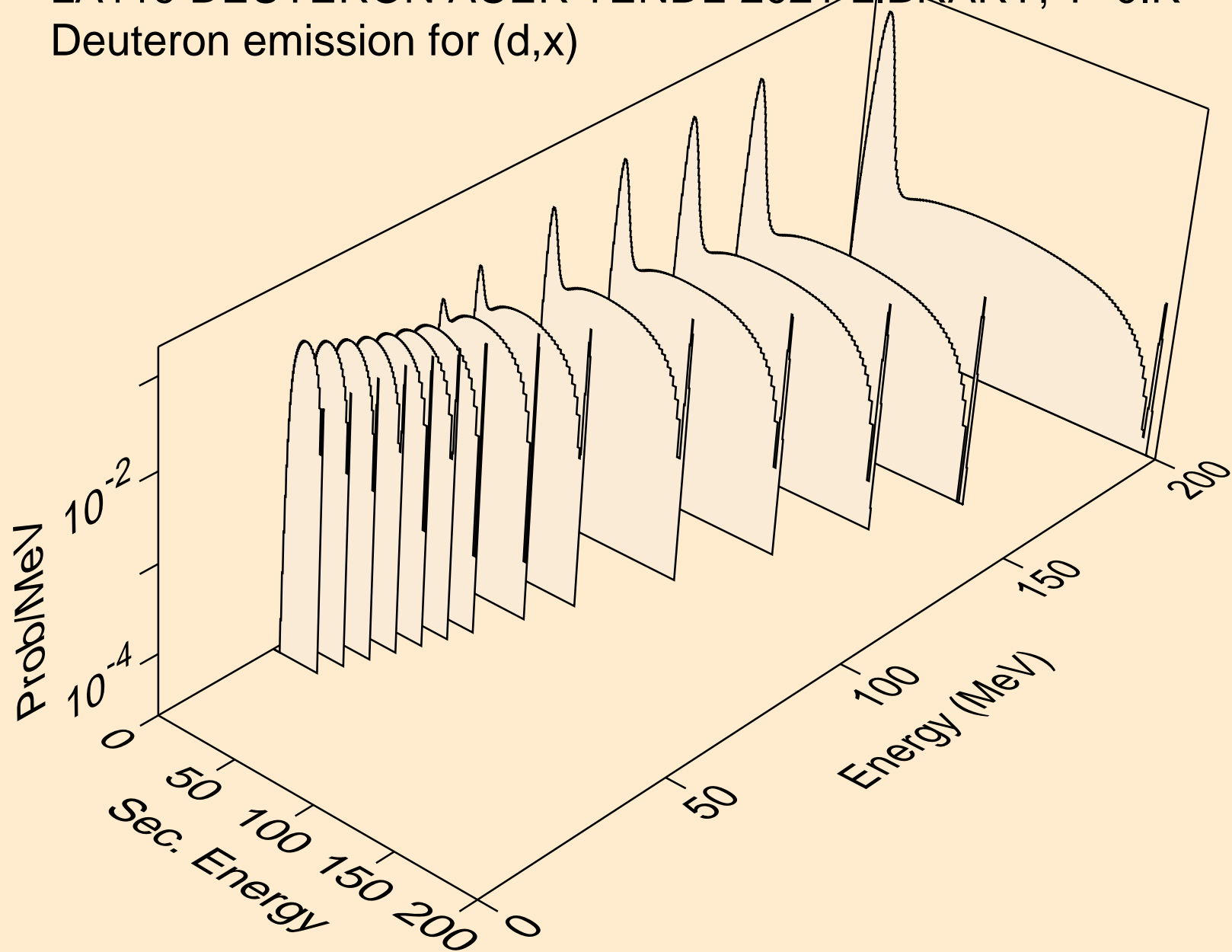

LA119 DEUTERON ACER TENDL-2021 LIBRARY; T=0.K
Deuteron emission for (d,n*)d

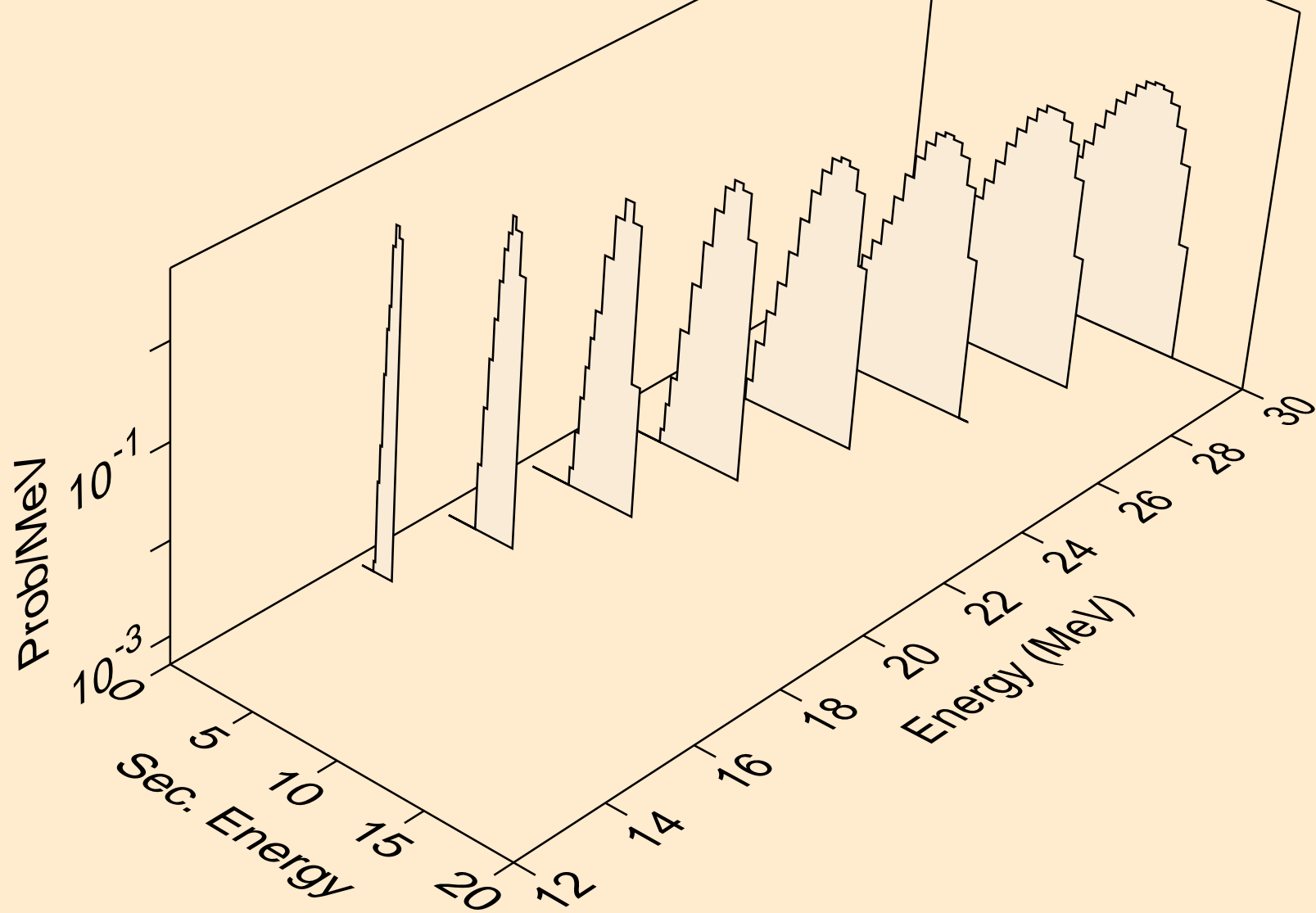

LA119 DEUTERON ACER TENDL-2021 LIBRARY; T=0.K
Deuteron emission for inelastic

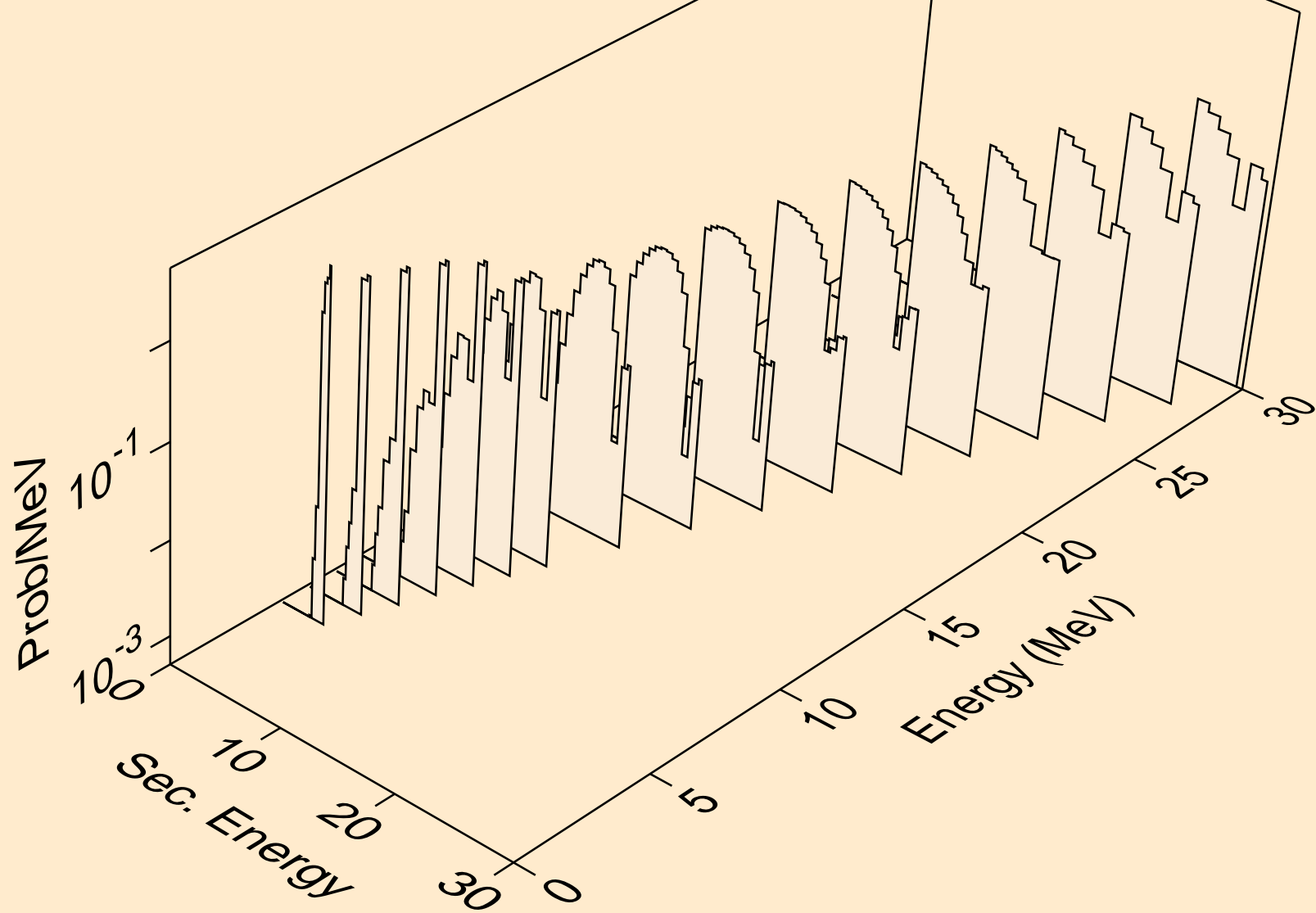

LA119 DEUTERON ACER TENDL-2021 LIBRARY; T=0.K
Deuteron emission for (d,d2a)

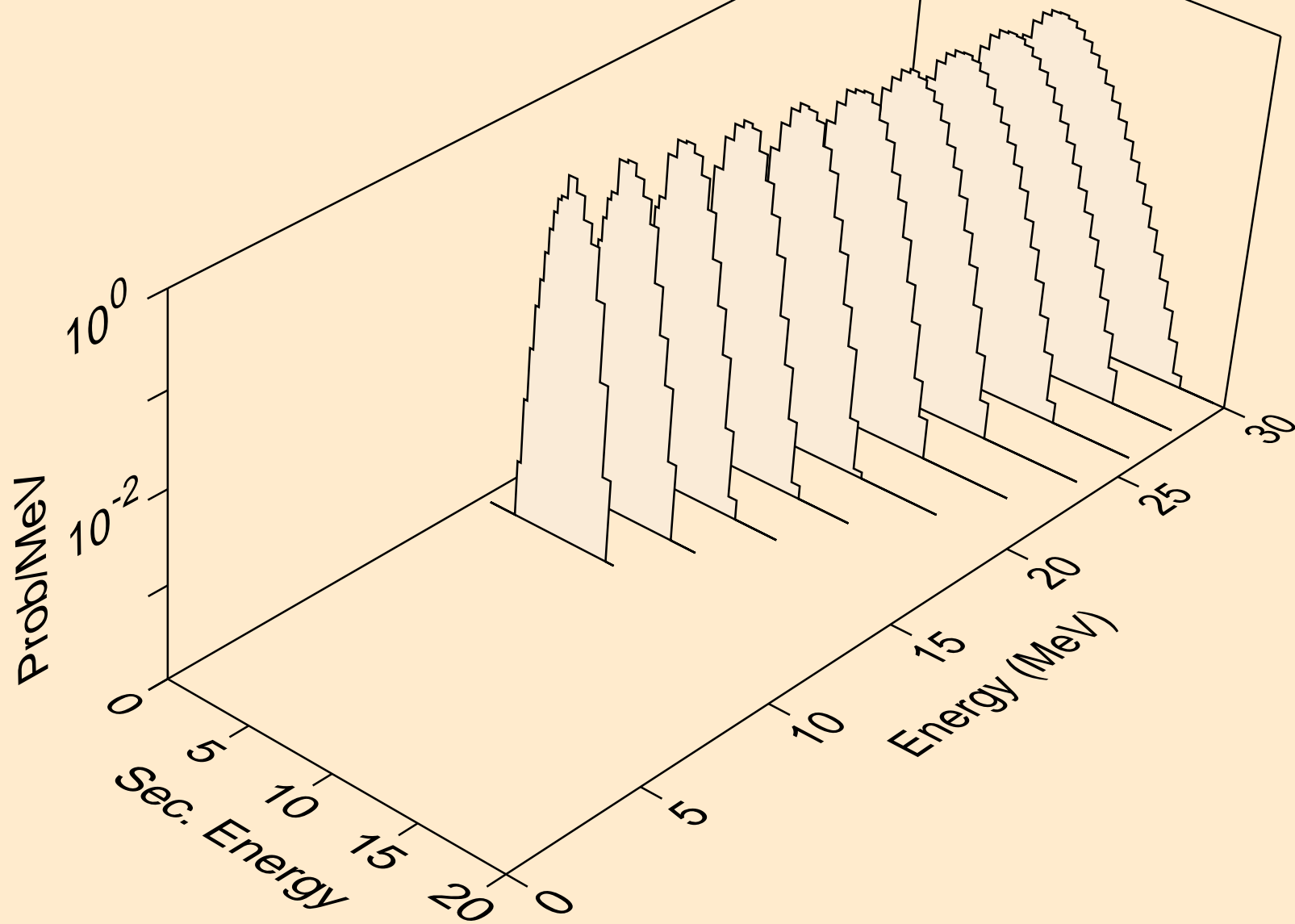

LA119 DEUTERON ACER TENDL-2021 LIBRARY; T=0.K
Deuteron emission for (d,pd)

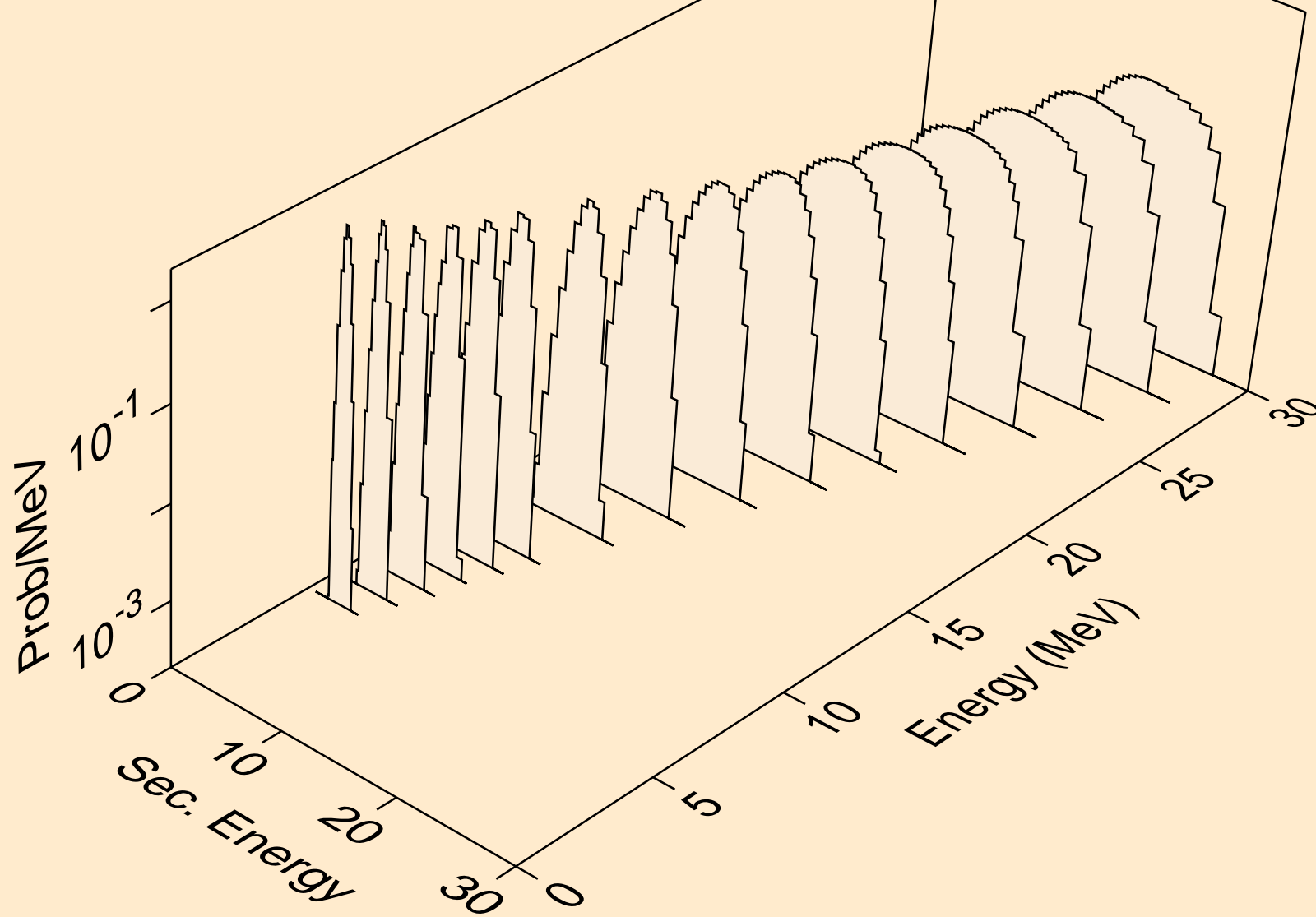

LA119 DEUTERON ACER TENDL-2021 LIBRARY; T=0.K
Deuteron emission for (d,da)

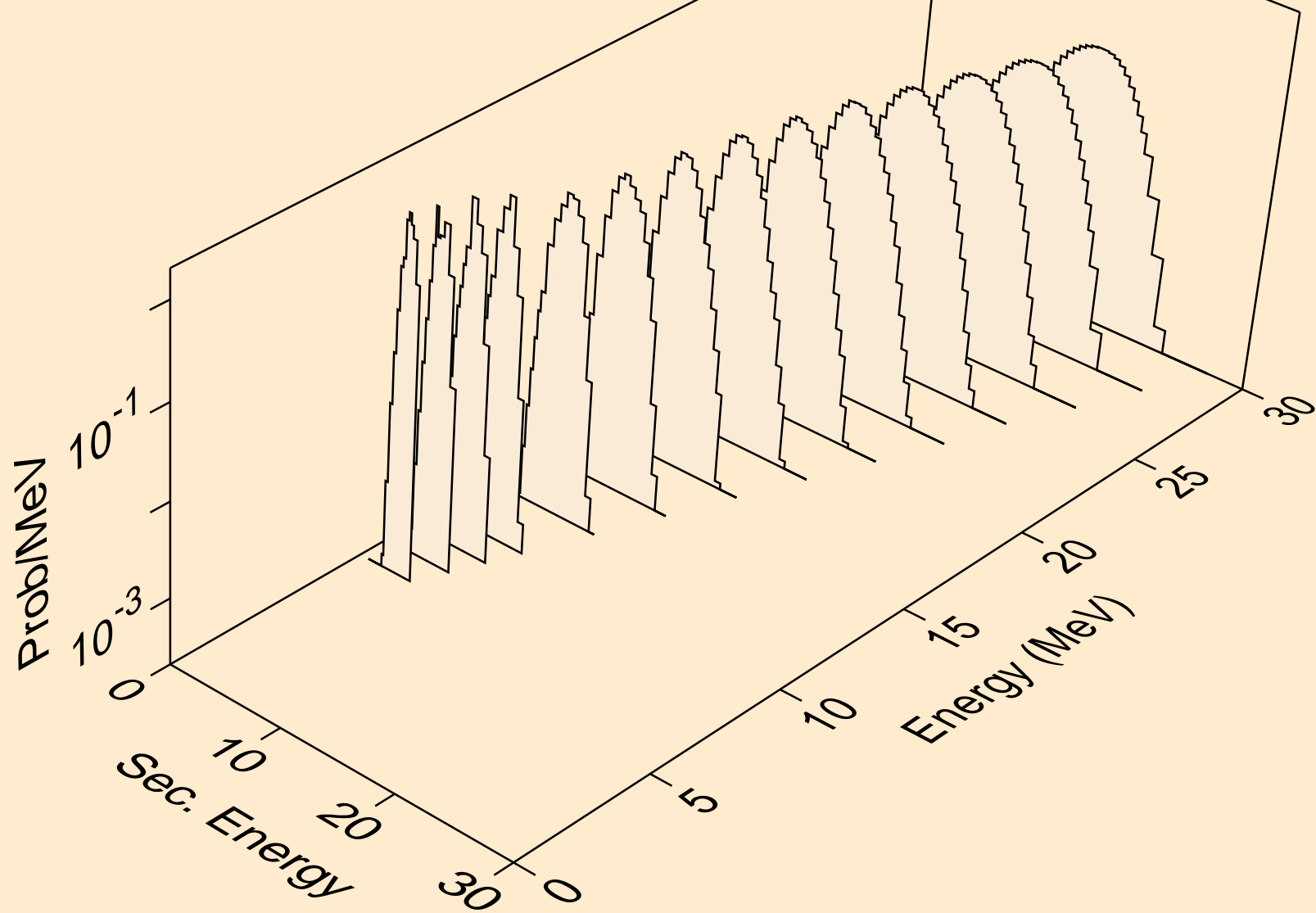

LA119 DEUTERON ACER TENDL-2021 LIBRARY; T=0.K
Photon emission for (z,n)

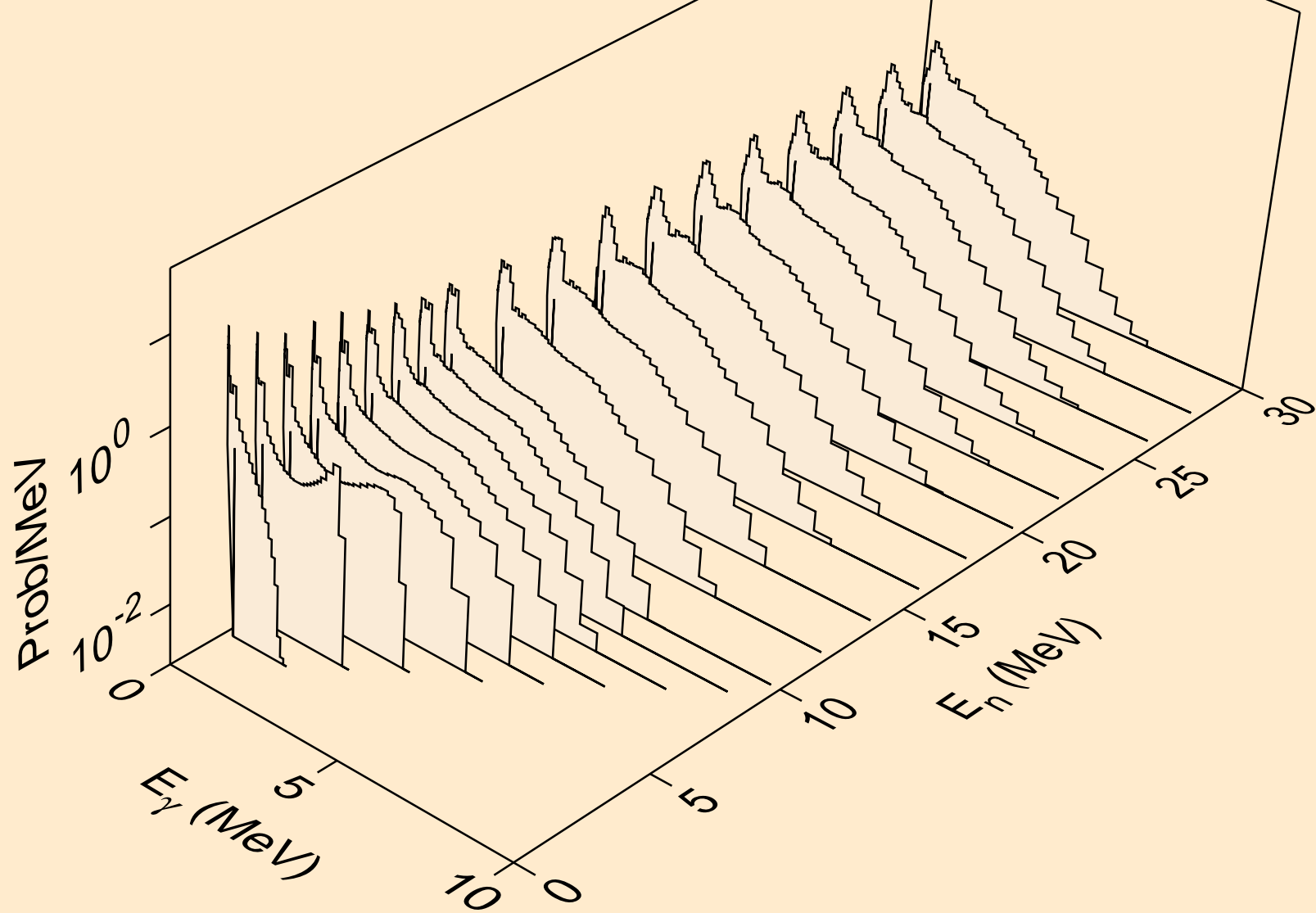

LA119 DEUTERON ACER TENDL-2021 LIBRARY; T=0.K
Photon emission for (n,x)

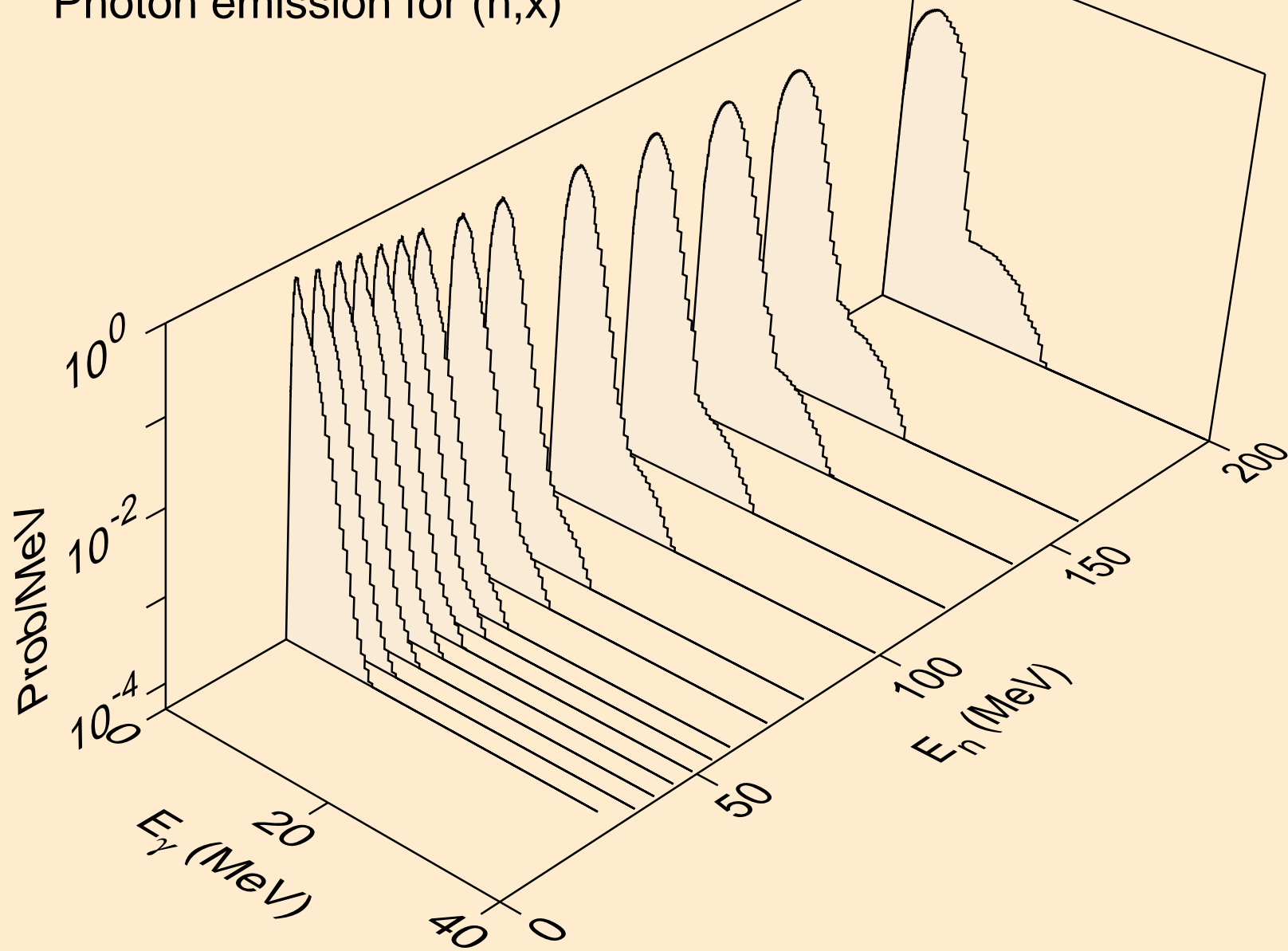

LA119 DEUTERON ACER TENDL-2021 LIBRARY; T=0.K
Photon emission for (n,2n)

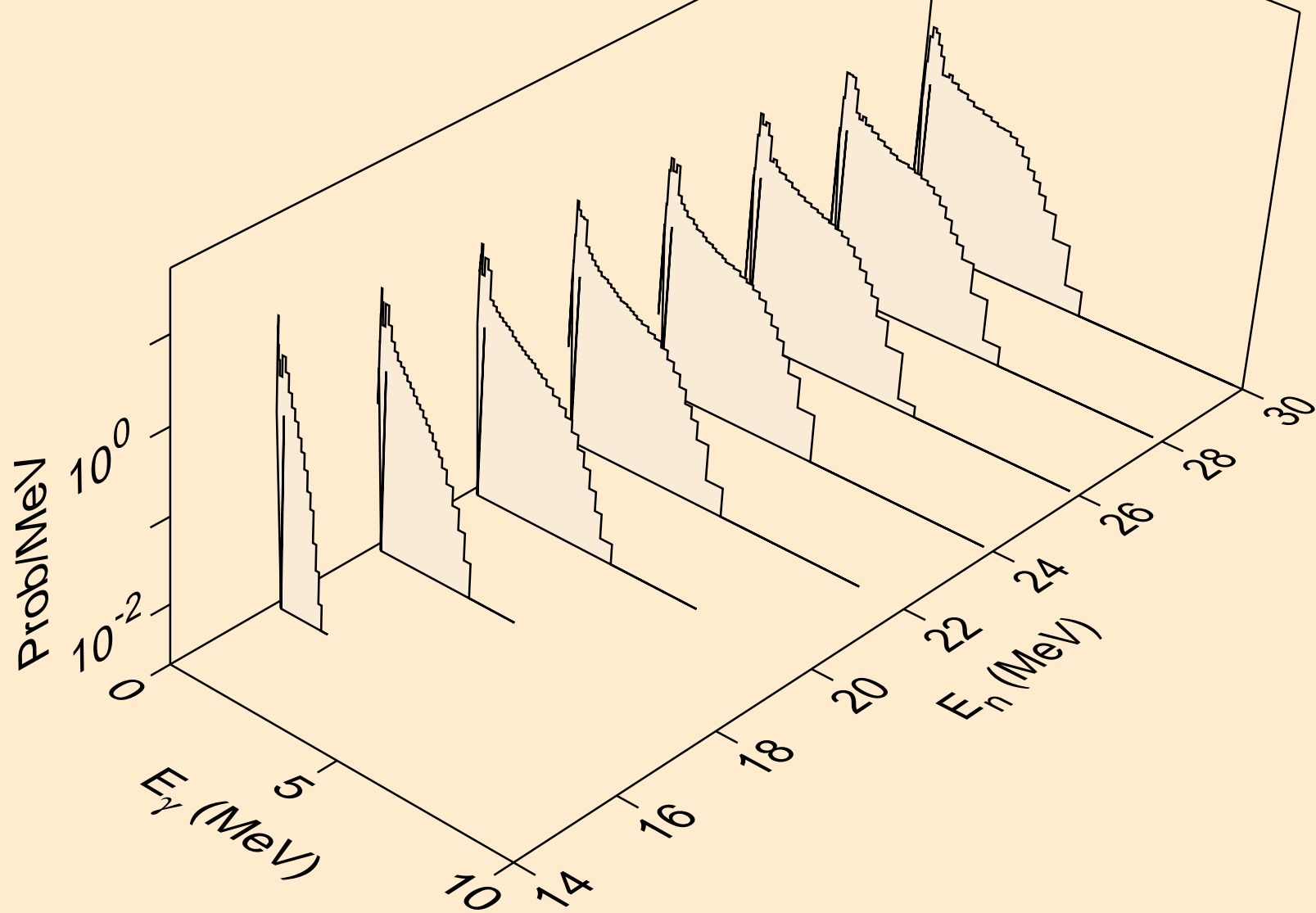

LA119 DEUTERON ACER TENDL-2021 LIBRARY; T=0.K
Photon emission for (n,3n)

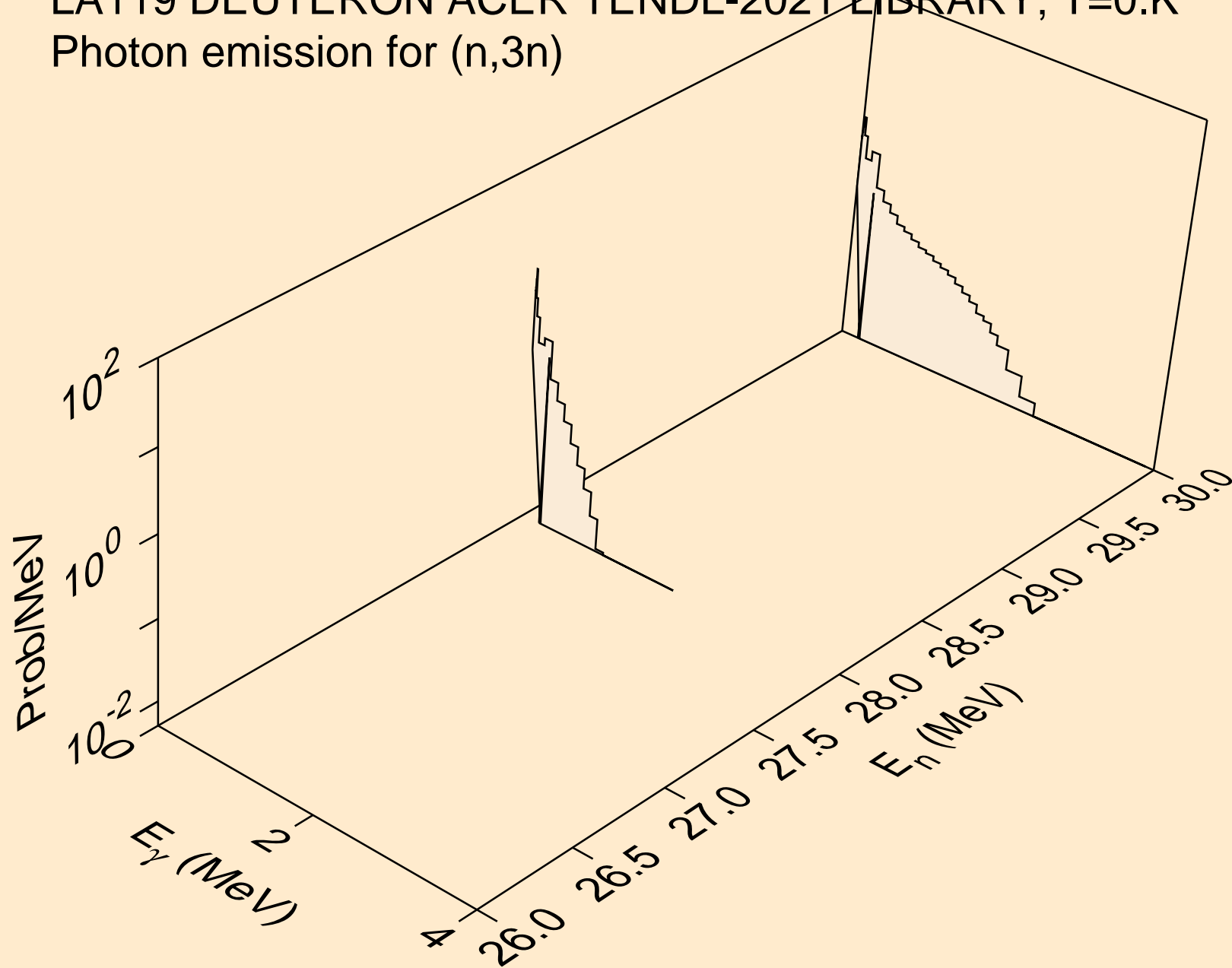

LA119 DEUTERON ACER TENDL-2021 LIBRARY; T=0.K
Photon emission for (n,n*)a

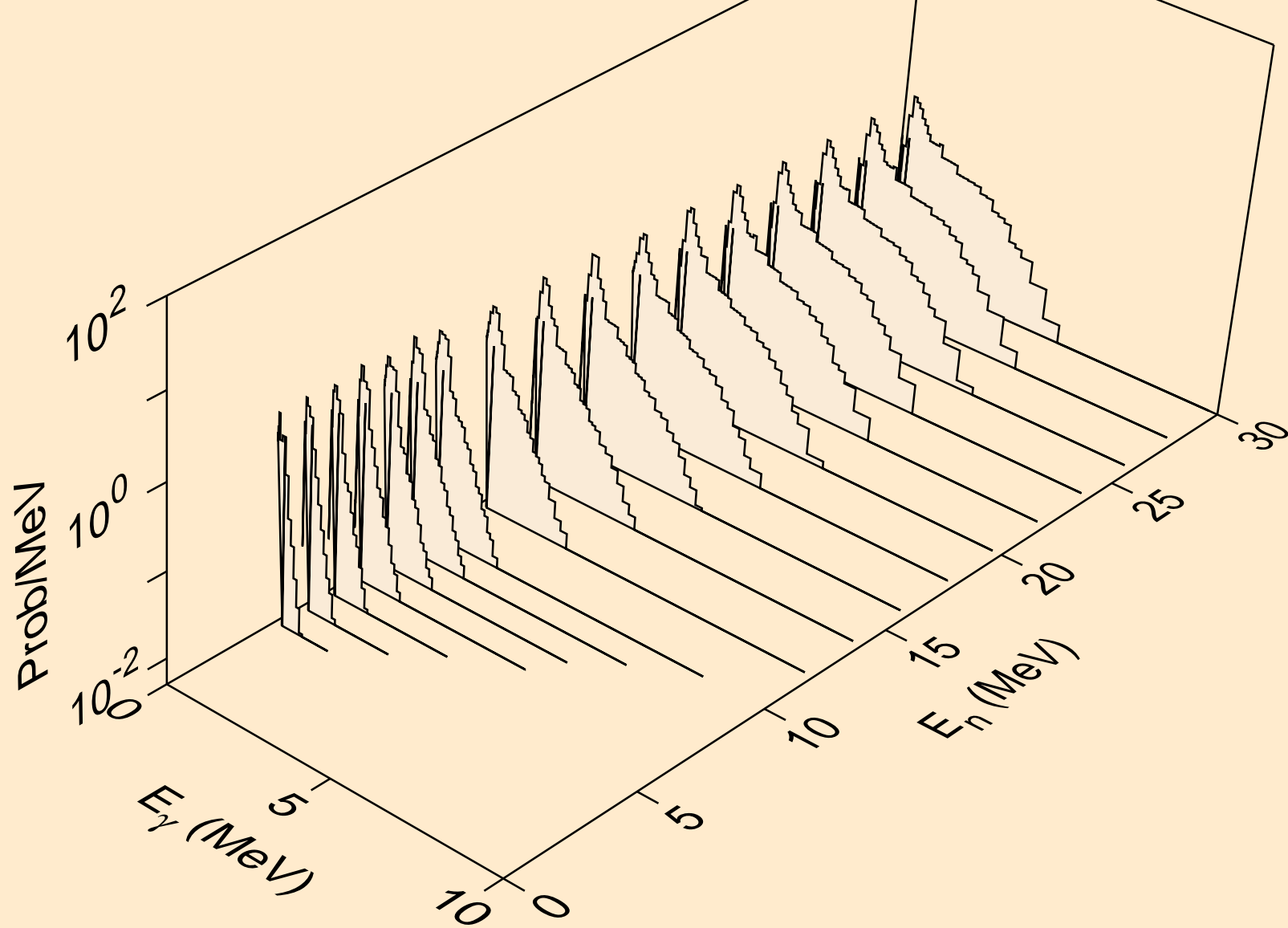

LA119 DEUTERON ACER TENDL-2021 LIBRARY; T=0.K
Photon emission for (n,2n)a

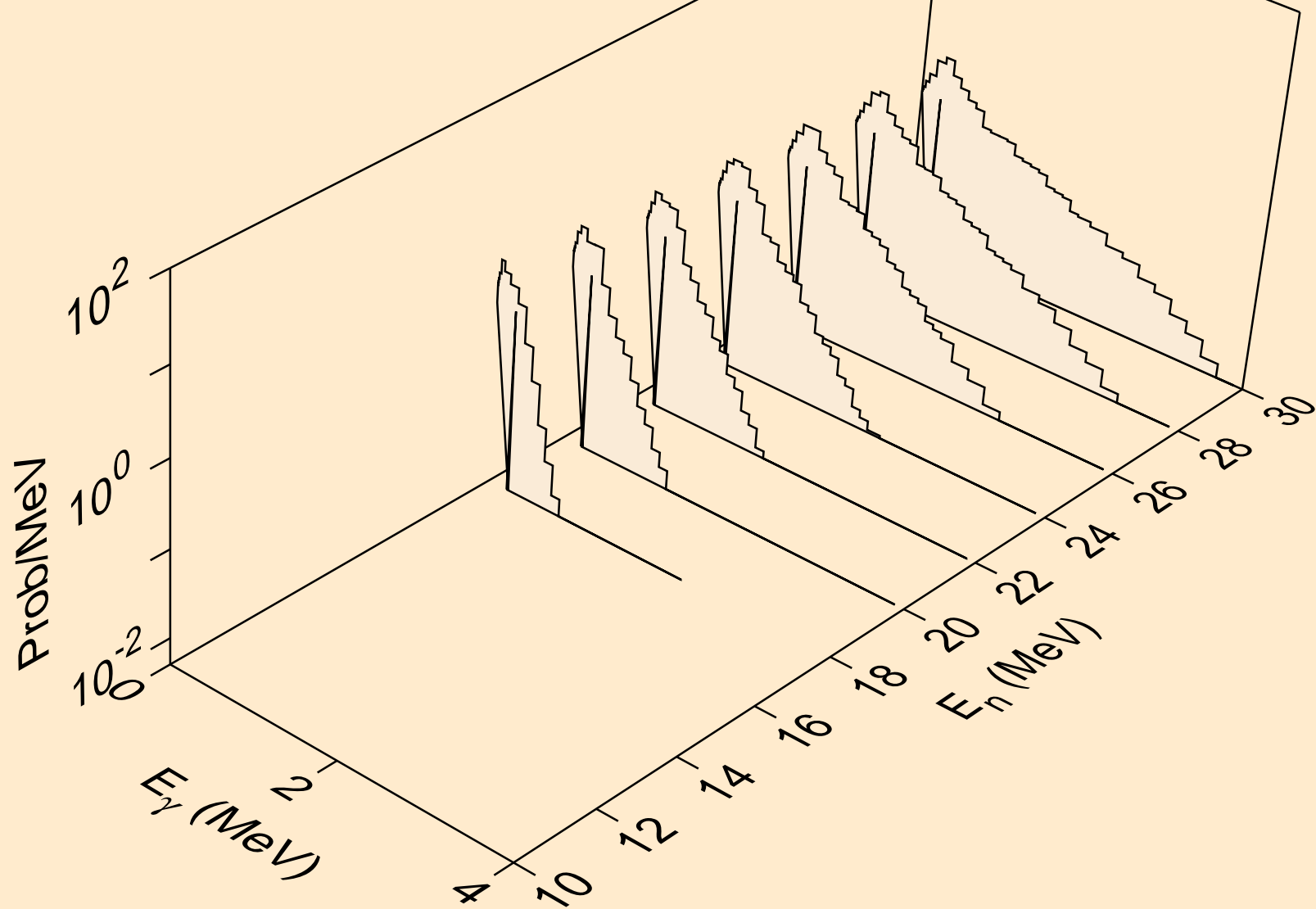

LA119 DEUTERON ACER TENDL-2021 LIBRARY; T=0.K
Photon emission for (n,n*)p

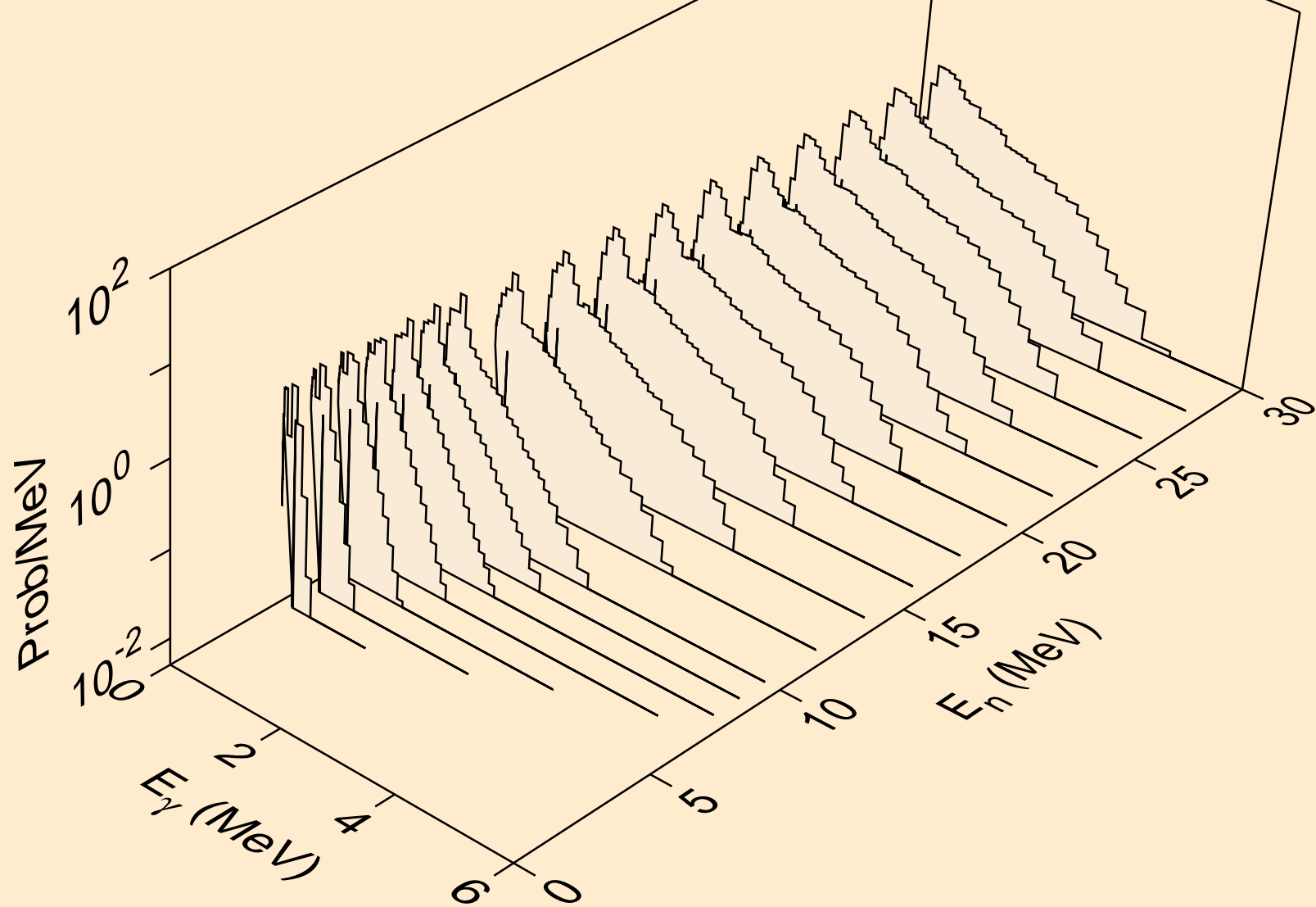

LA119 DEUTERON ACER TENDL-2021 LIBRARY; T=0.K
Photon emission for (n,n*)2a

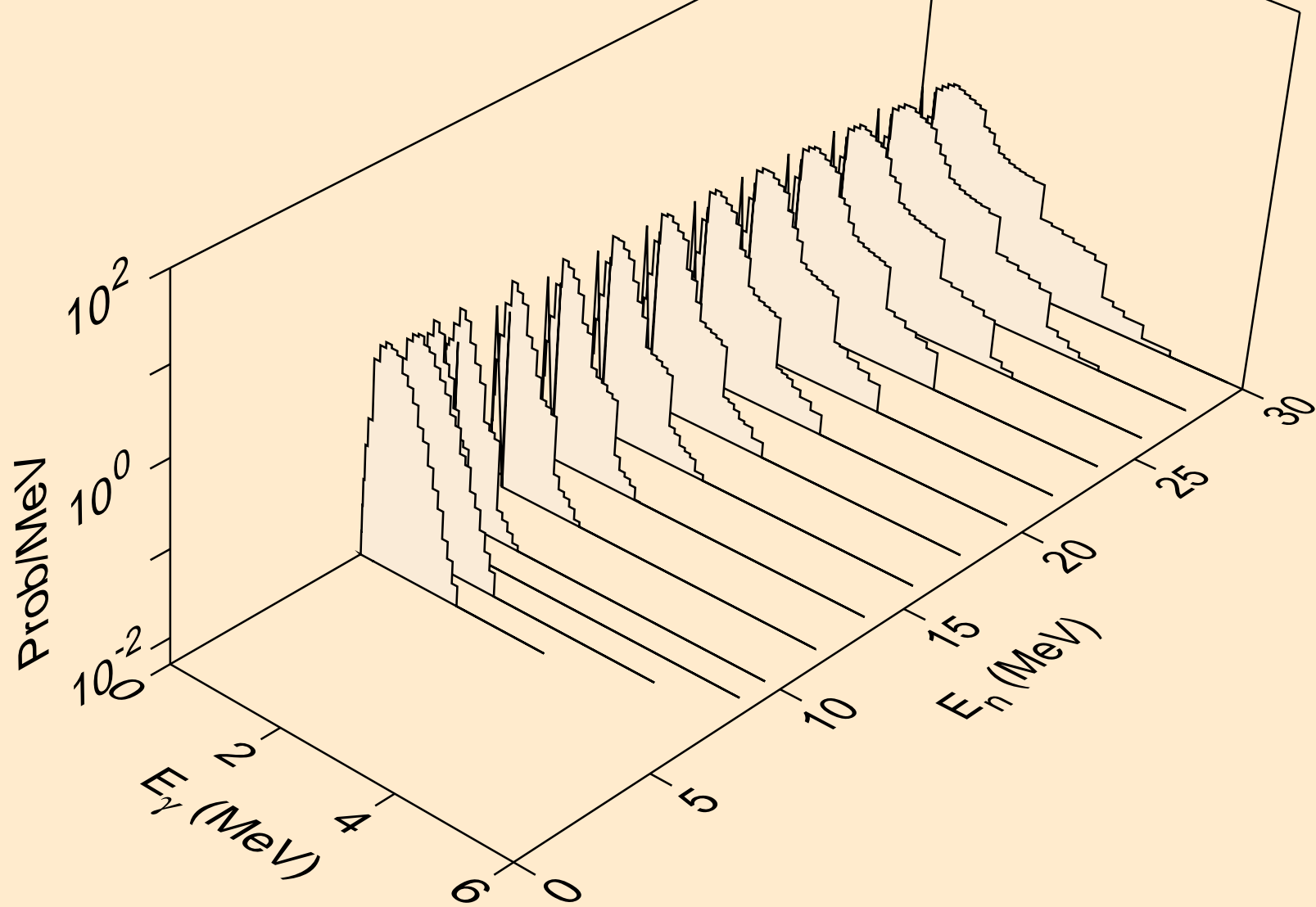

LA119 DEUTERON ACER TENDL-2021 LIBRARY; T=0.K
Photon emission for (n,n*)d

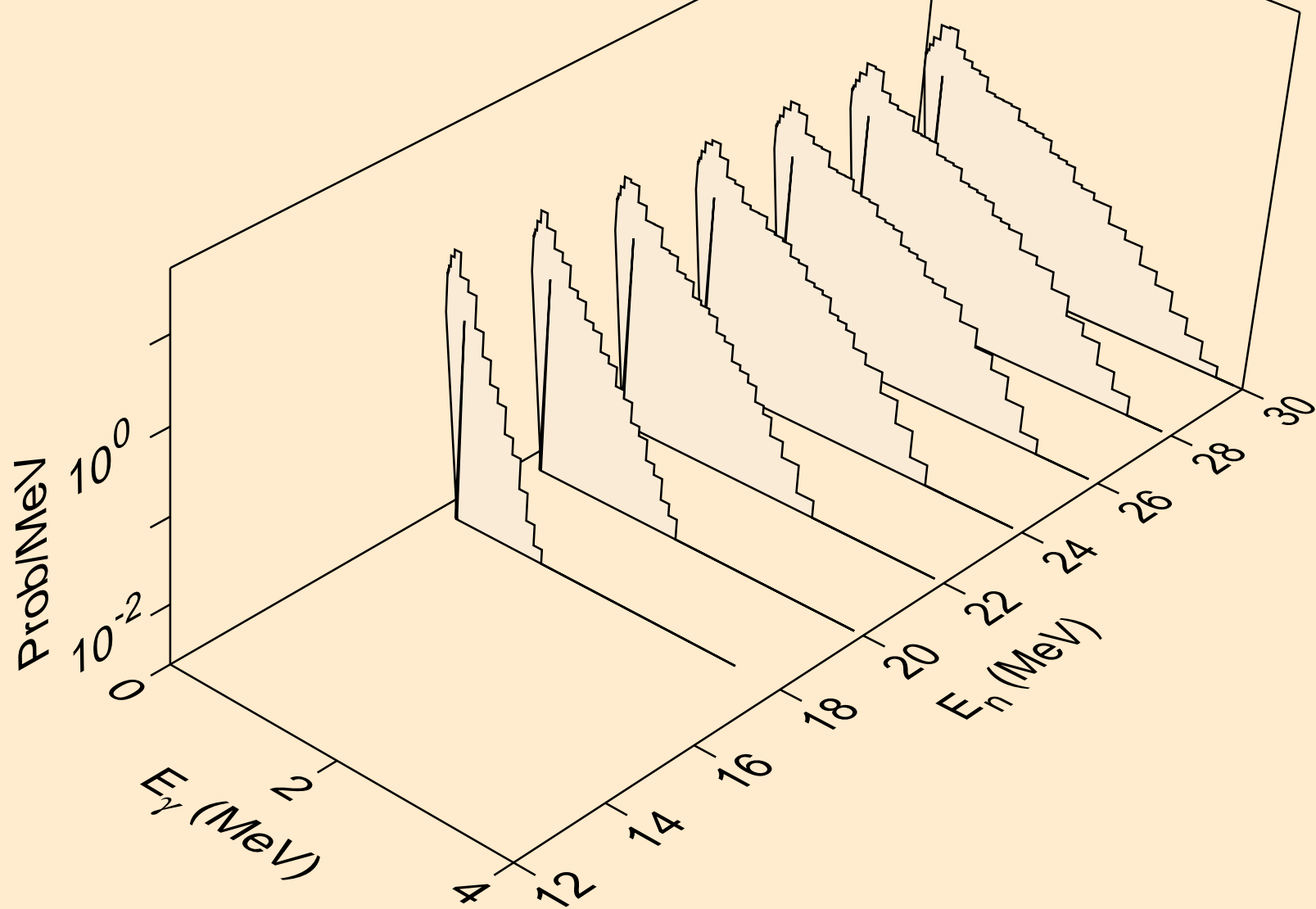

LA119 DEUTERON ACER TENDL-2021 LIBRARY; T=0.K
Photon emission for (n,n*)t

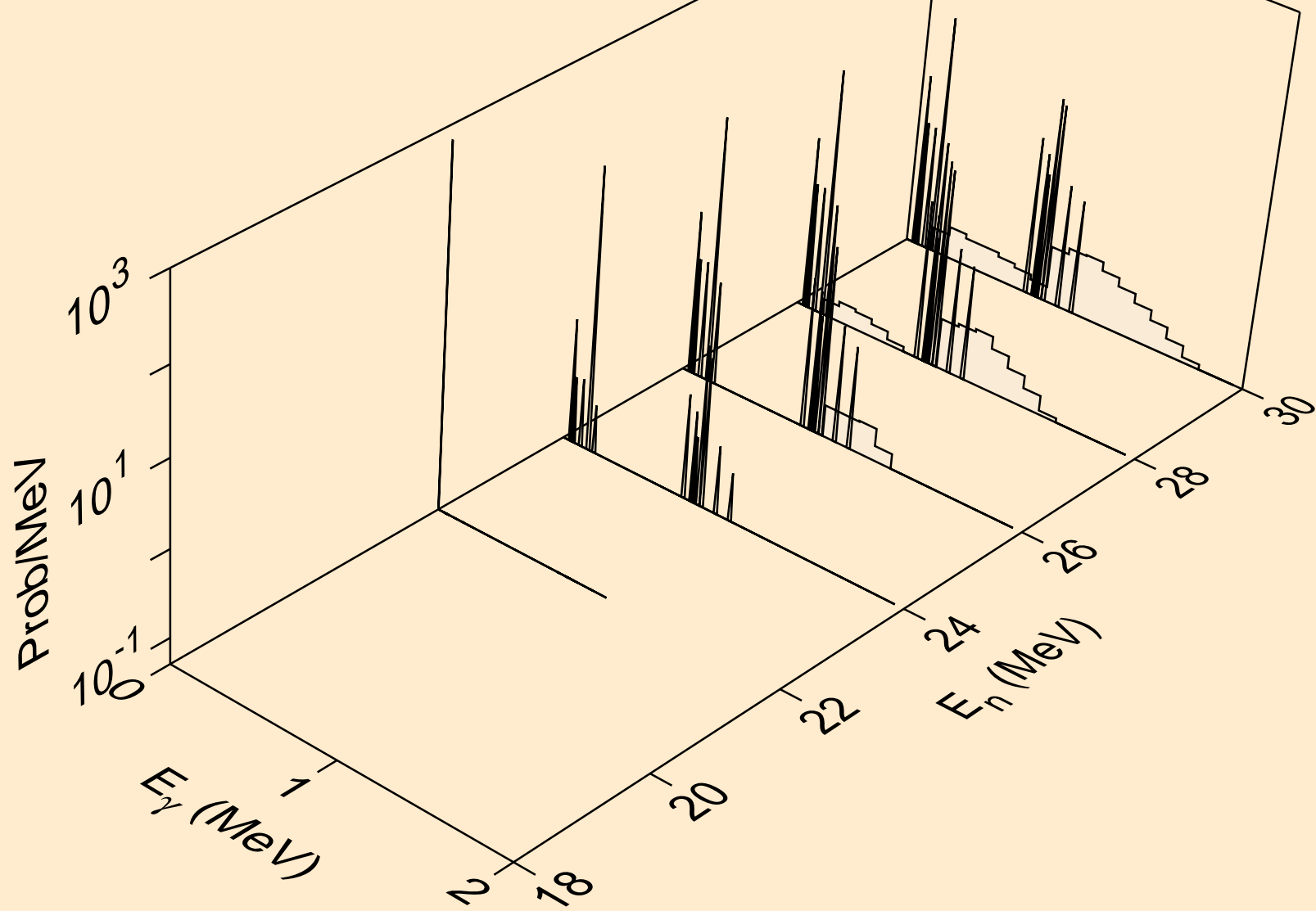

LA119 DEUTERON ACER TENDL-2021 LIBRARY; T=0.K
Photon emission for (n,n*)he3

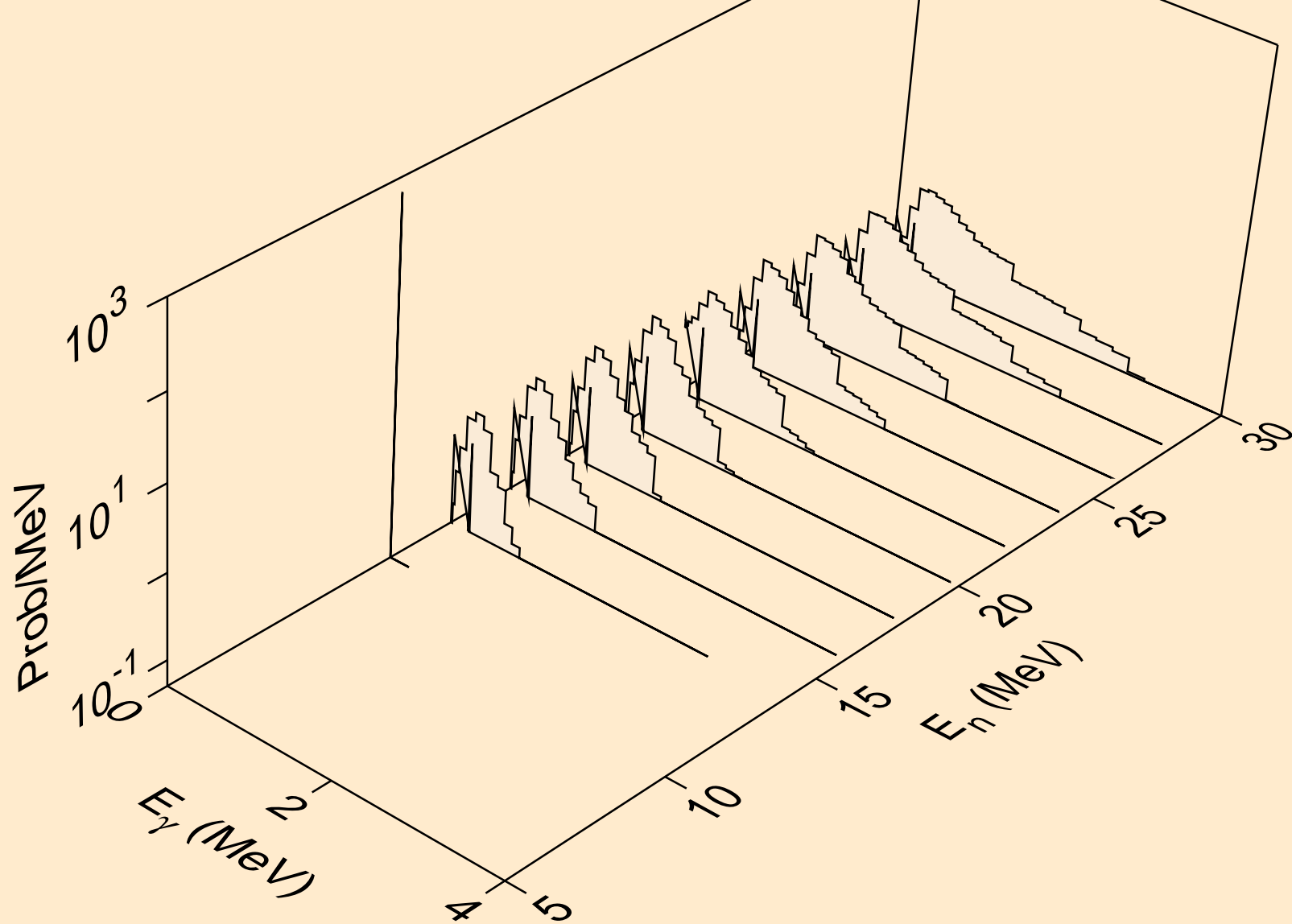

LA119 DEUTERON ACER TENDL-2021 LIBRARY; T=0.K
Photon emission for (n,2np)

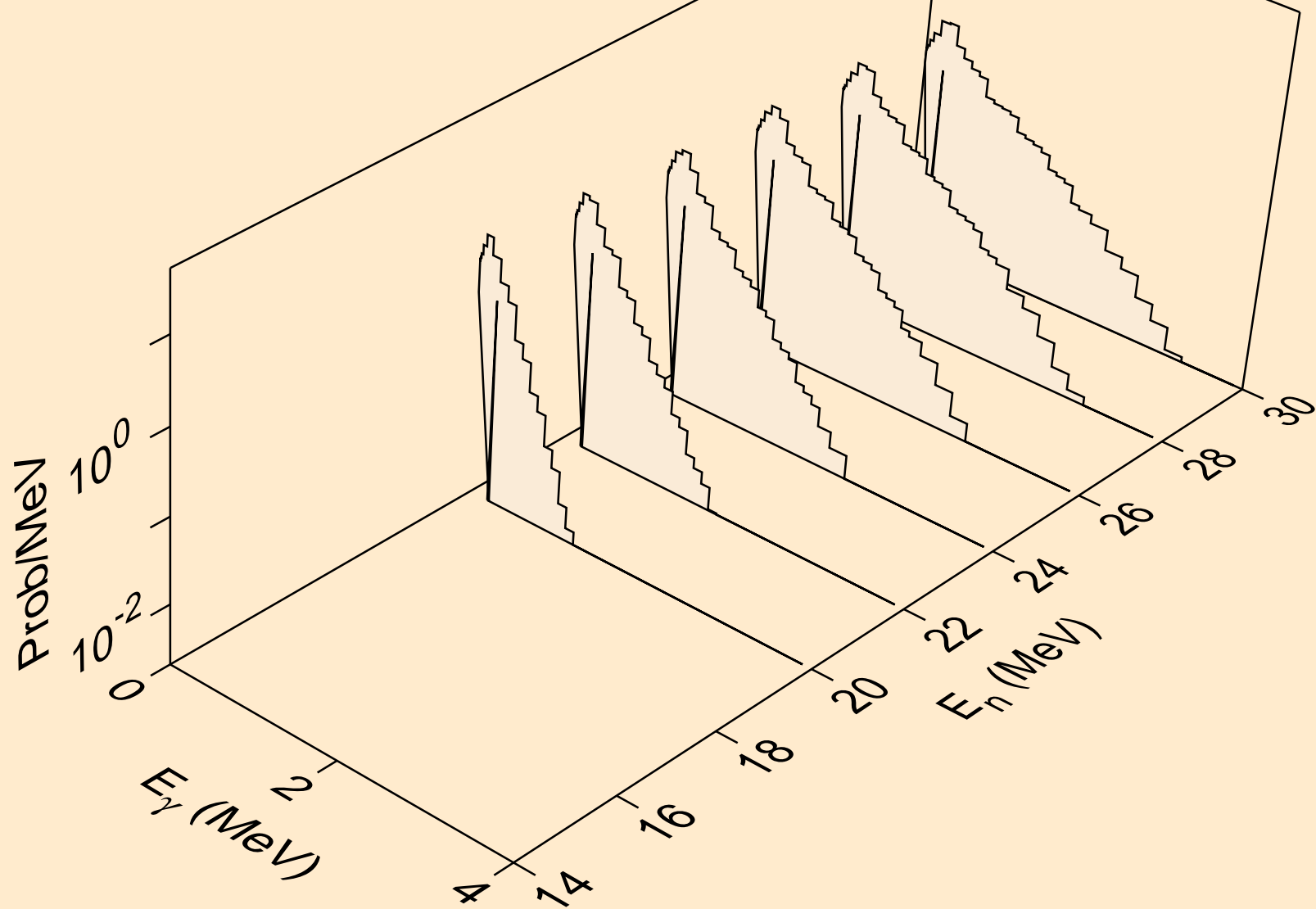

LA119 DEUTERON ACER TENDL-2021 LIBRARY; T=0.K
Photon emission for (n,2np)

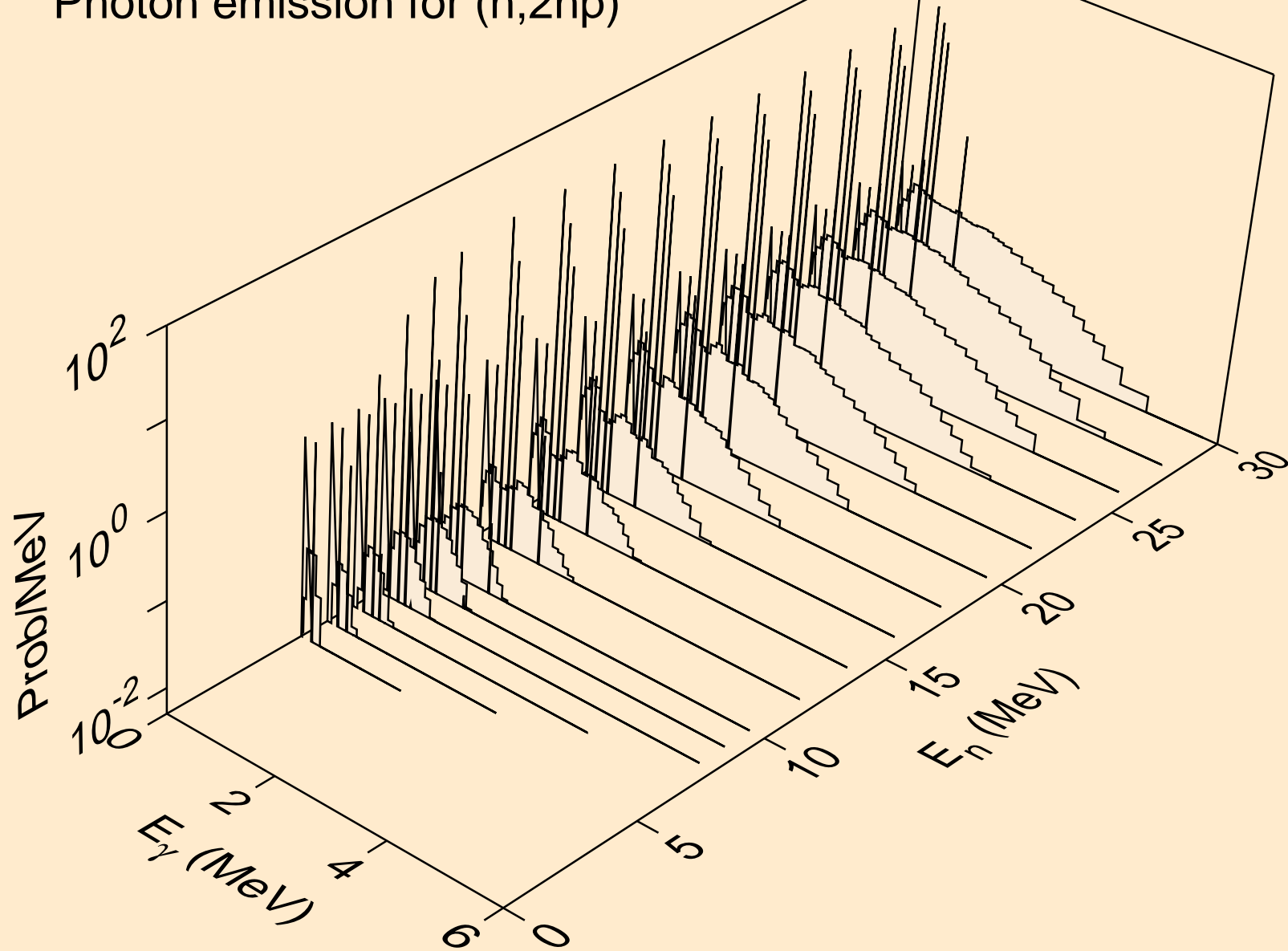

LA119 DEUTERON ACER TENDL-2021 LIBRARY; T=0.K
Photon emission for (n,npa)

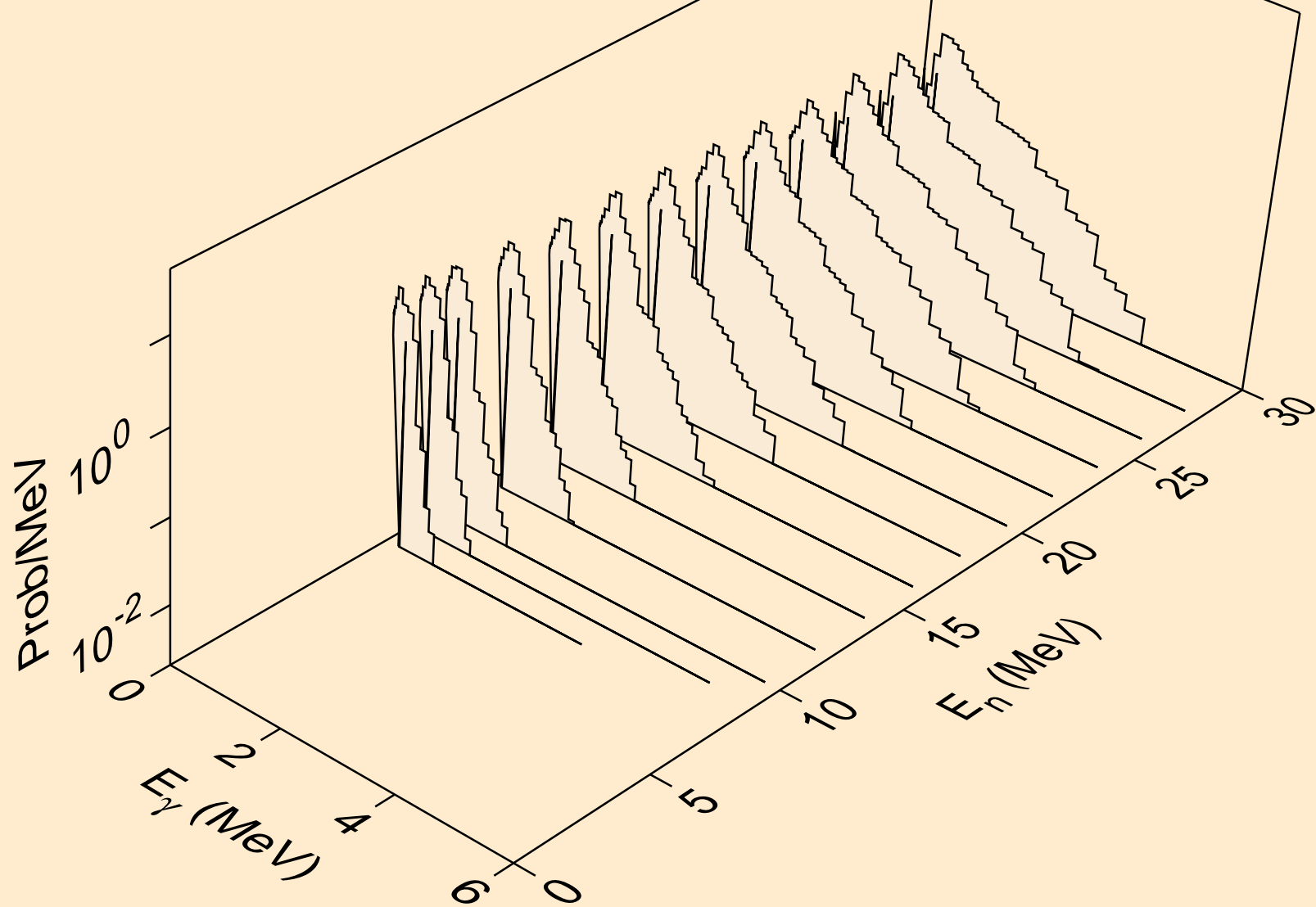

LA119 DEUTERON ACER TENDL-2021 LIBRARY; T=0.K
Photon emission for (n,gma)

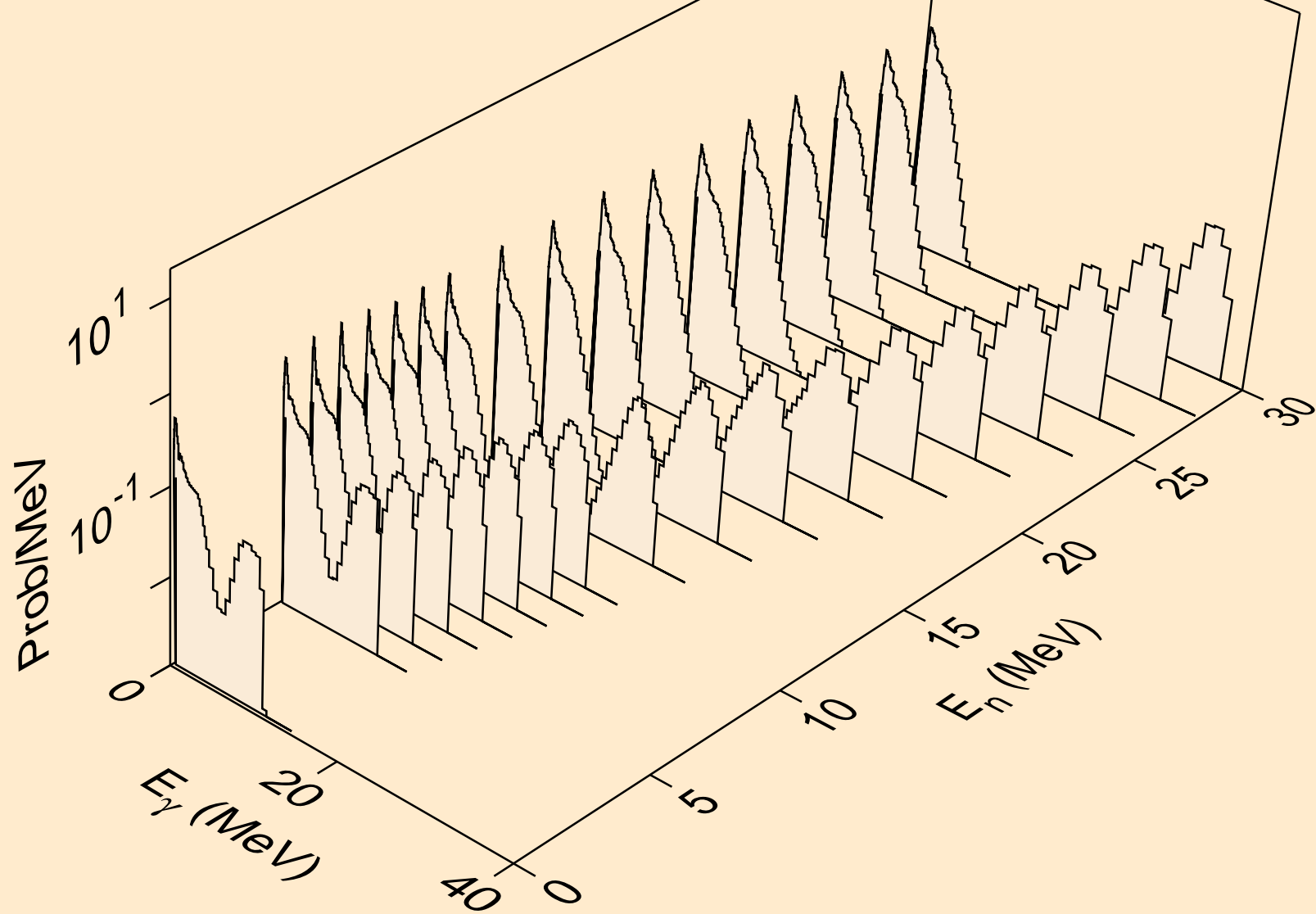

LA119 DEUTERON ACER TENDL-2021 LIBRARY; T=0.K
Photon emission for (n,p)

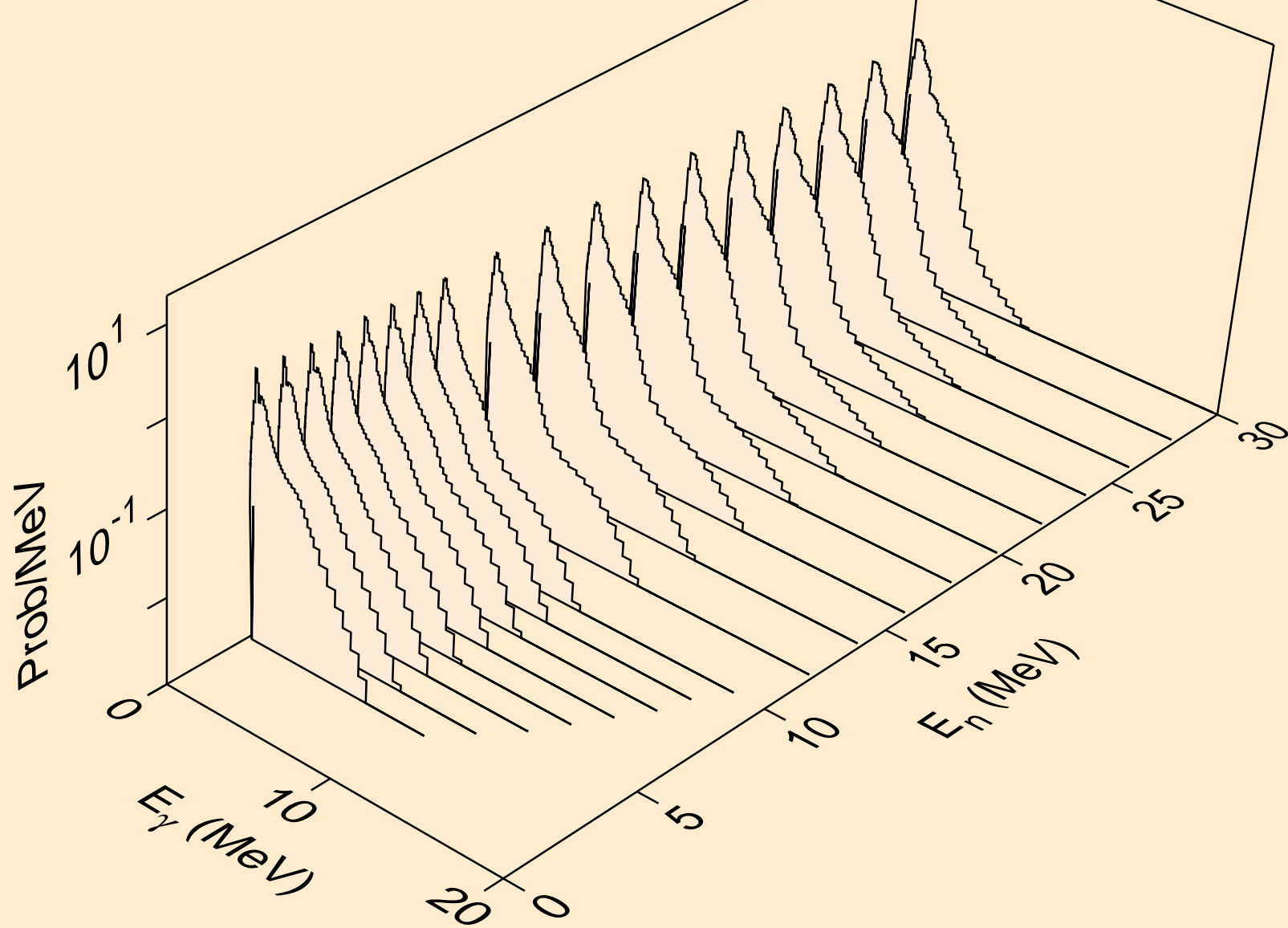

LA119 DEUTERON ACER TENDL-2021 LIBRARY; T=0.K
Photon emission for inelastic

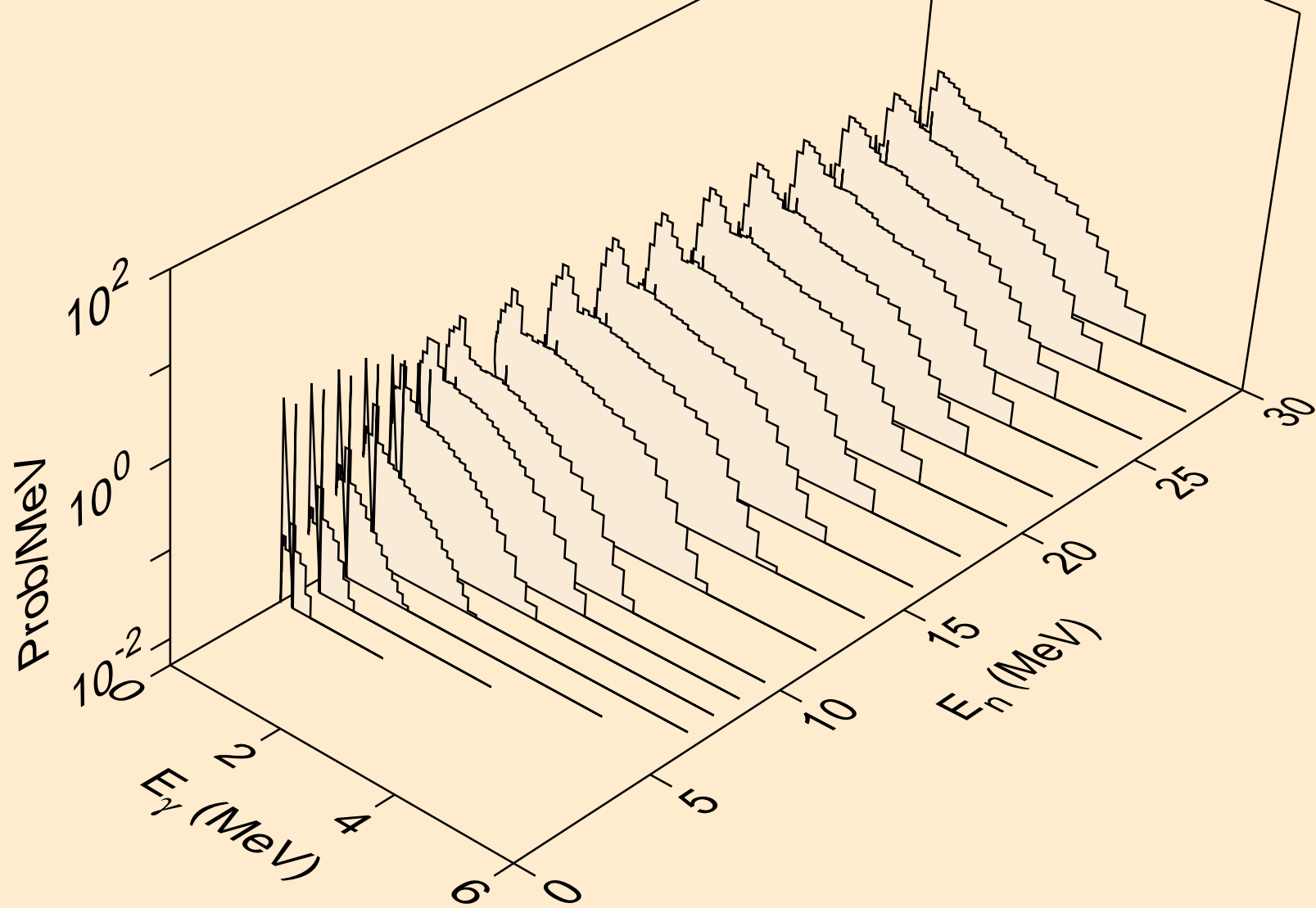

LA119 DEUTERON ACER TENDL-2021 LIBRARY; T=0.K
Photon emission for (n,t)

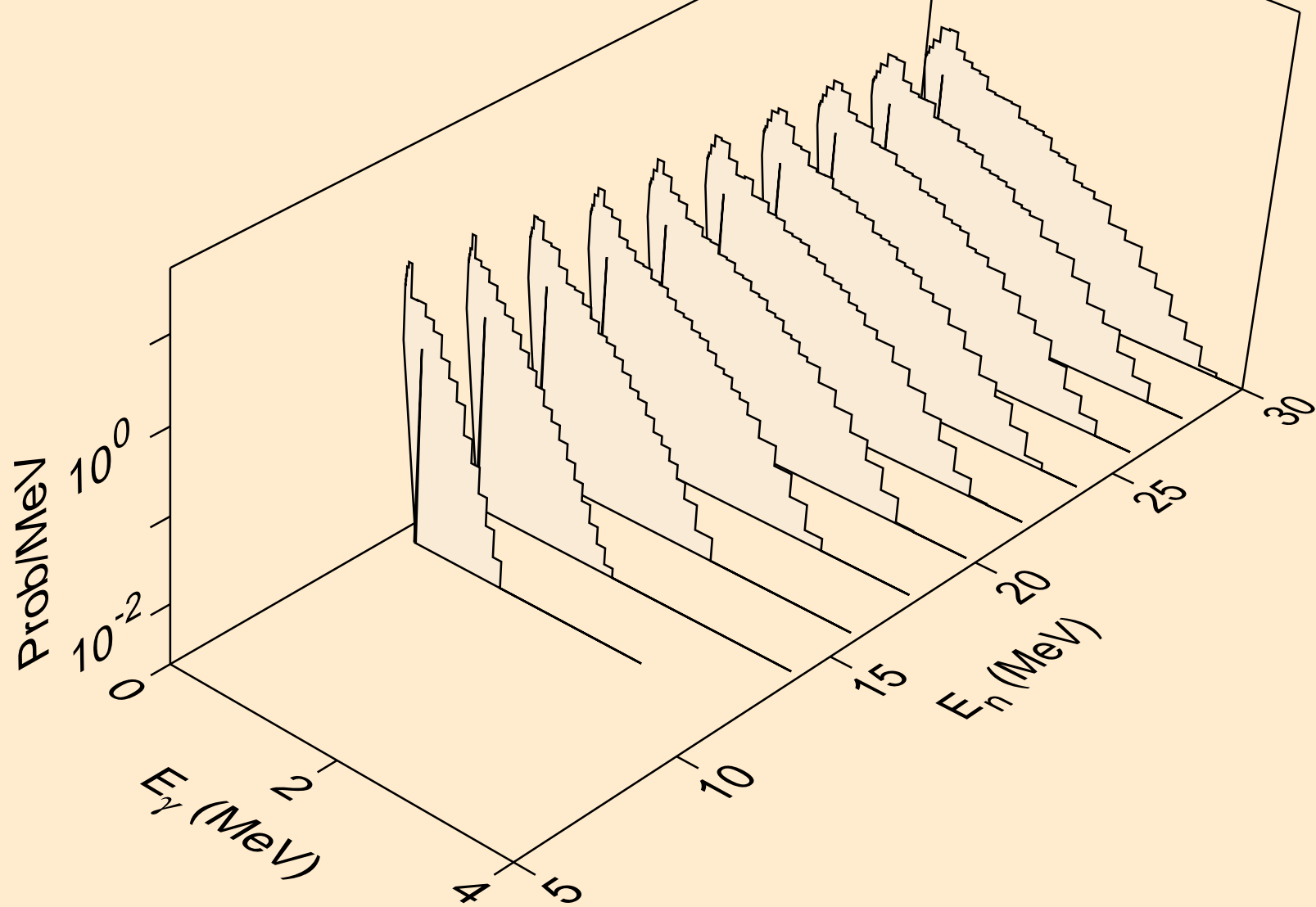

LA119 DEUTERON ACER TENDL-2021 LIBRARY; T=0.K
Photon emission for (n,he3)

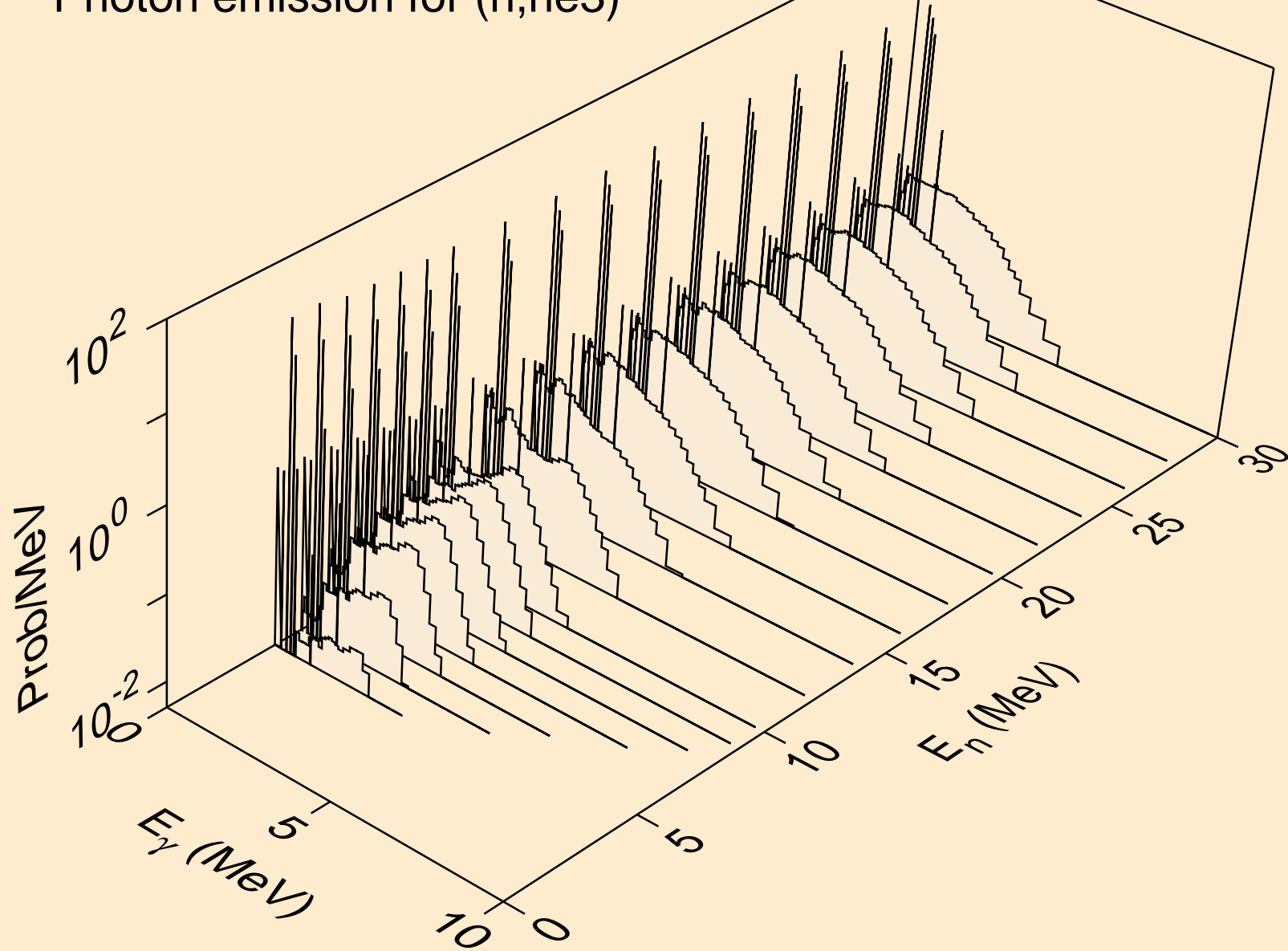

LA119 DEUTERON ACER TENDL-2021 LIBRARY; T=0.K
Photon emission for (n,a)

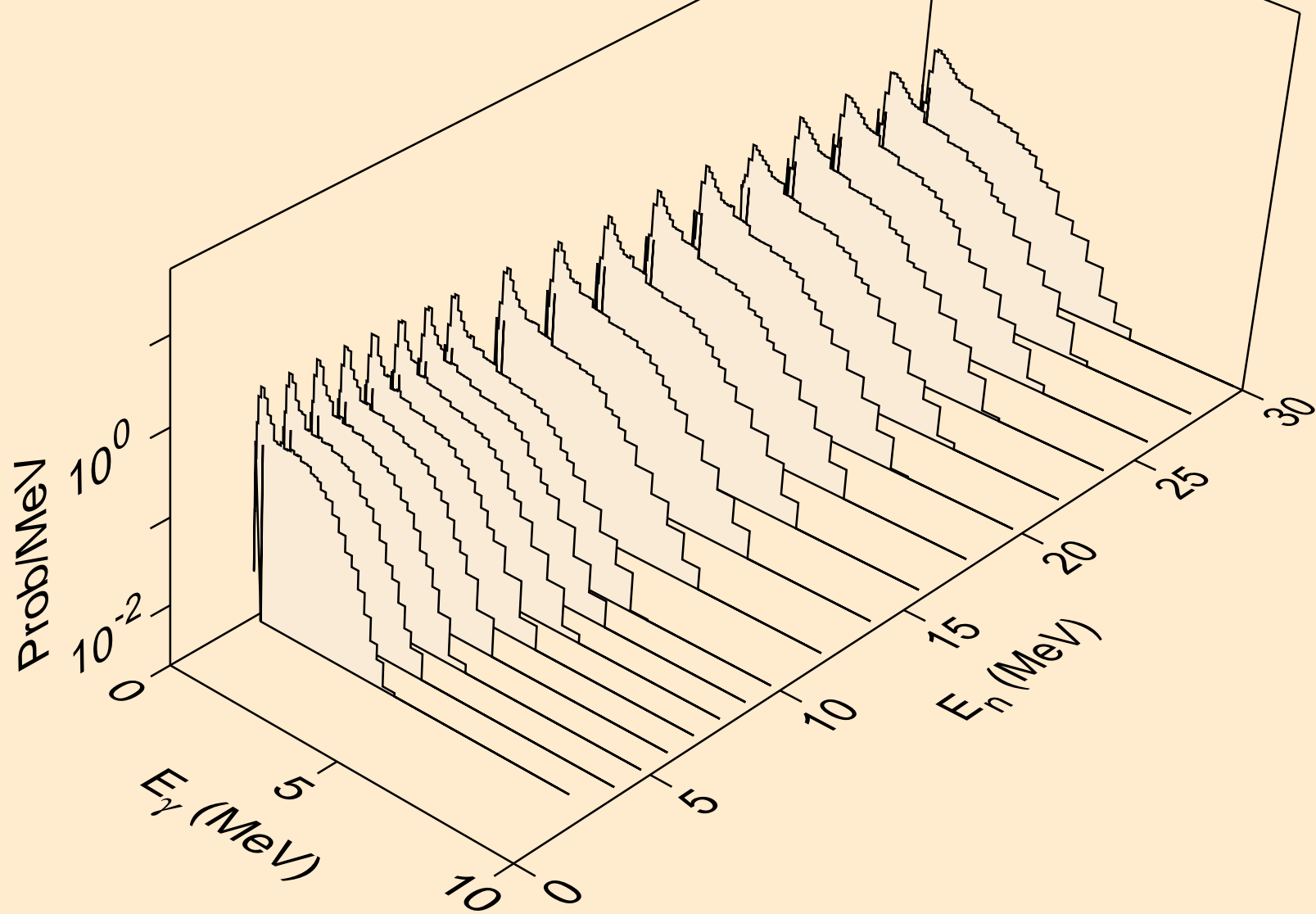

LA119 DEUTERON ACER TENDL-2021 LIBRARY; T=0.K
Photon emission for (n,2a)

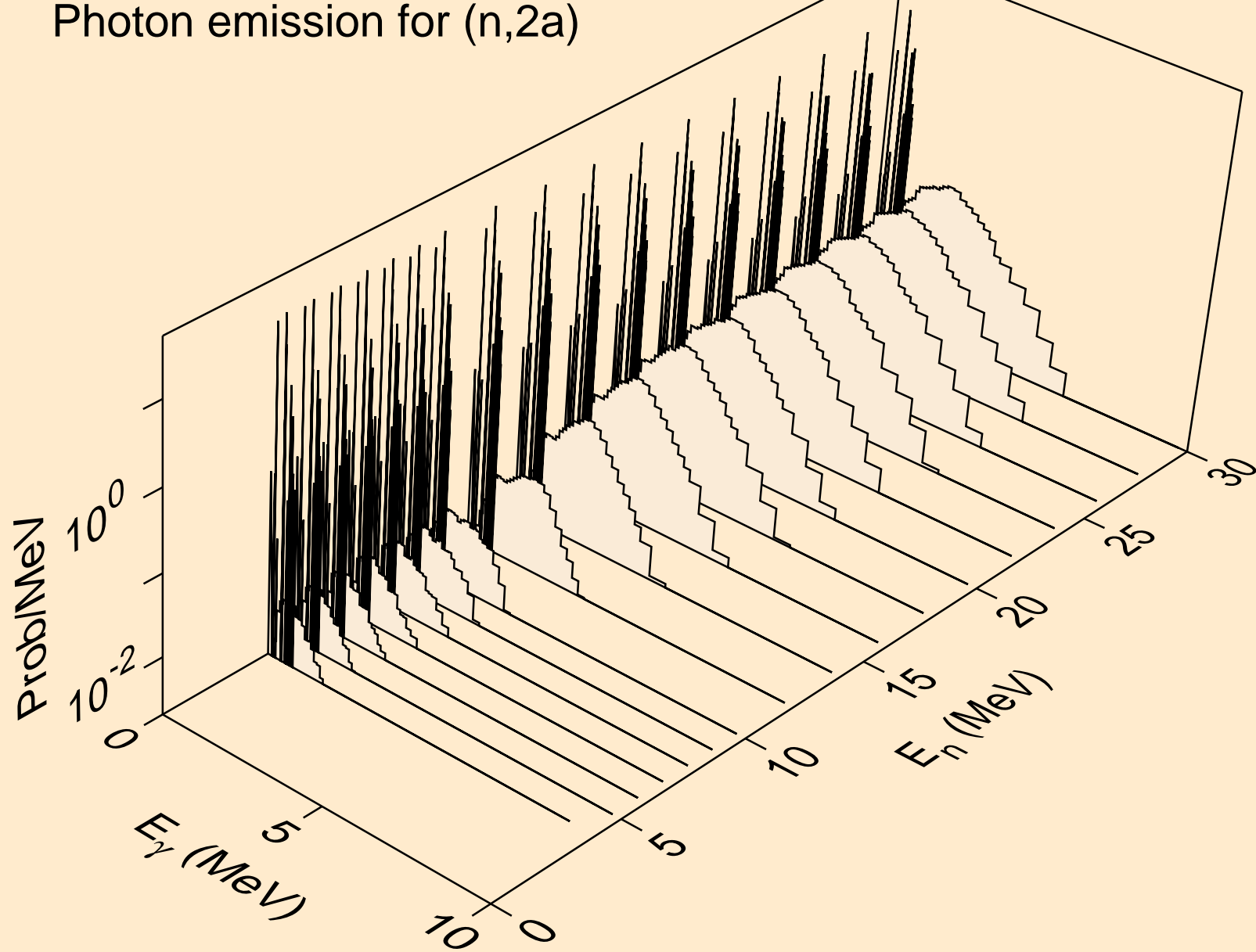

LA119 DEUTERON ACER TENDL-2021 LIBRARY; T=0.K
Photon emission for (n,3a)

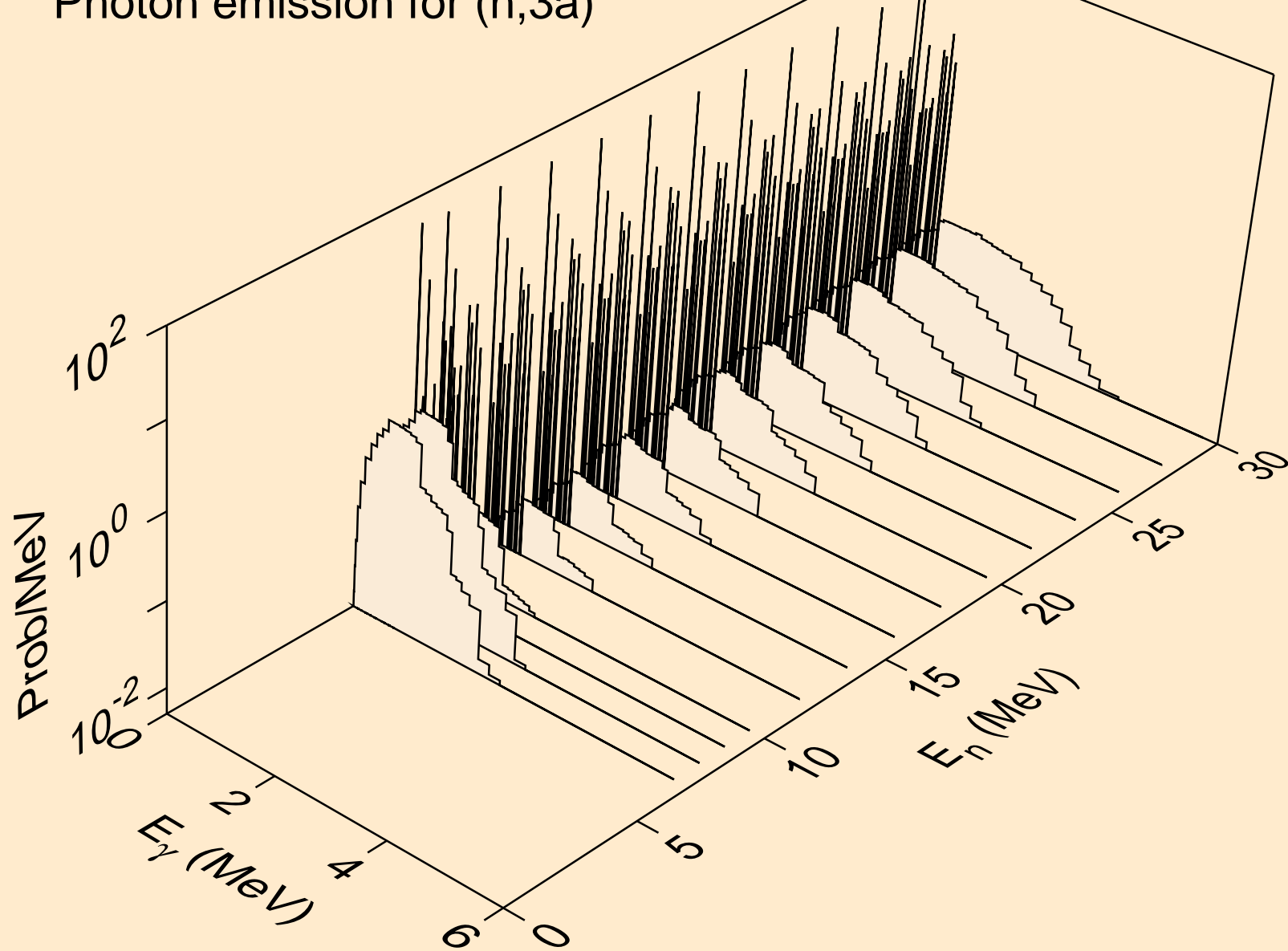

LA119 DEUTERON ACER TENDL-2021 LIBRARY; T=0.K
Photon emission for (n,2p)

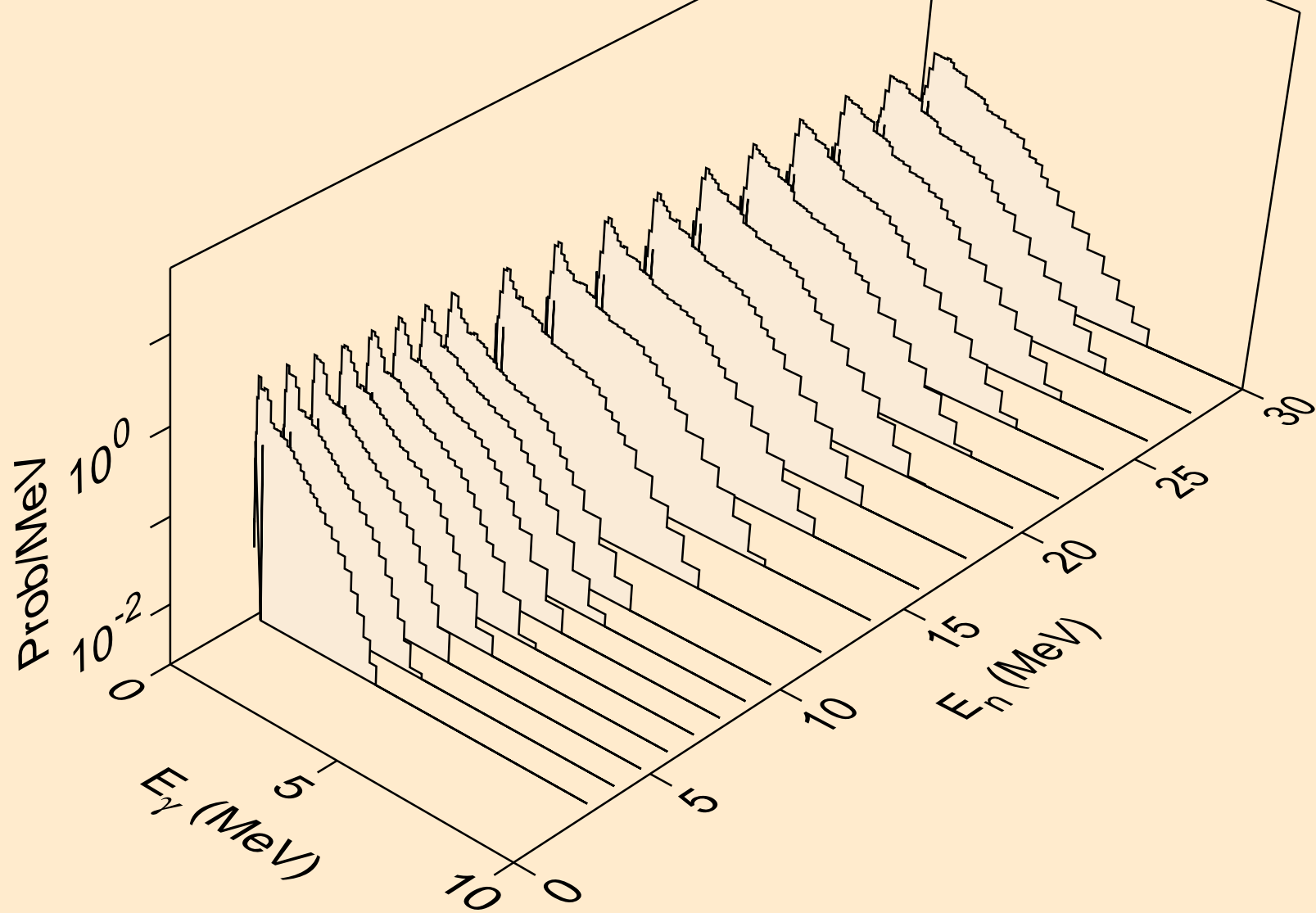

LA119 DEUTERON ACER TENDL-2021 LIBRARY; T=0.K
Photon emission for (n,p)

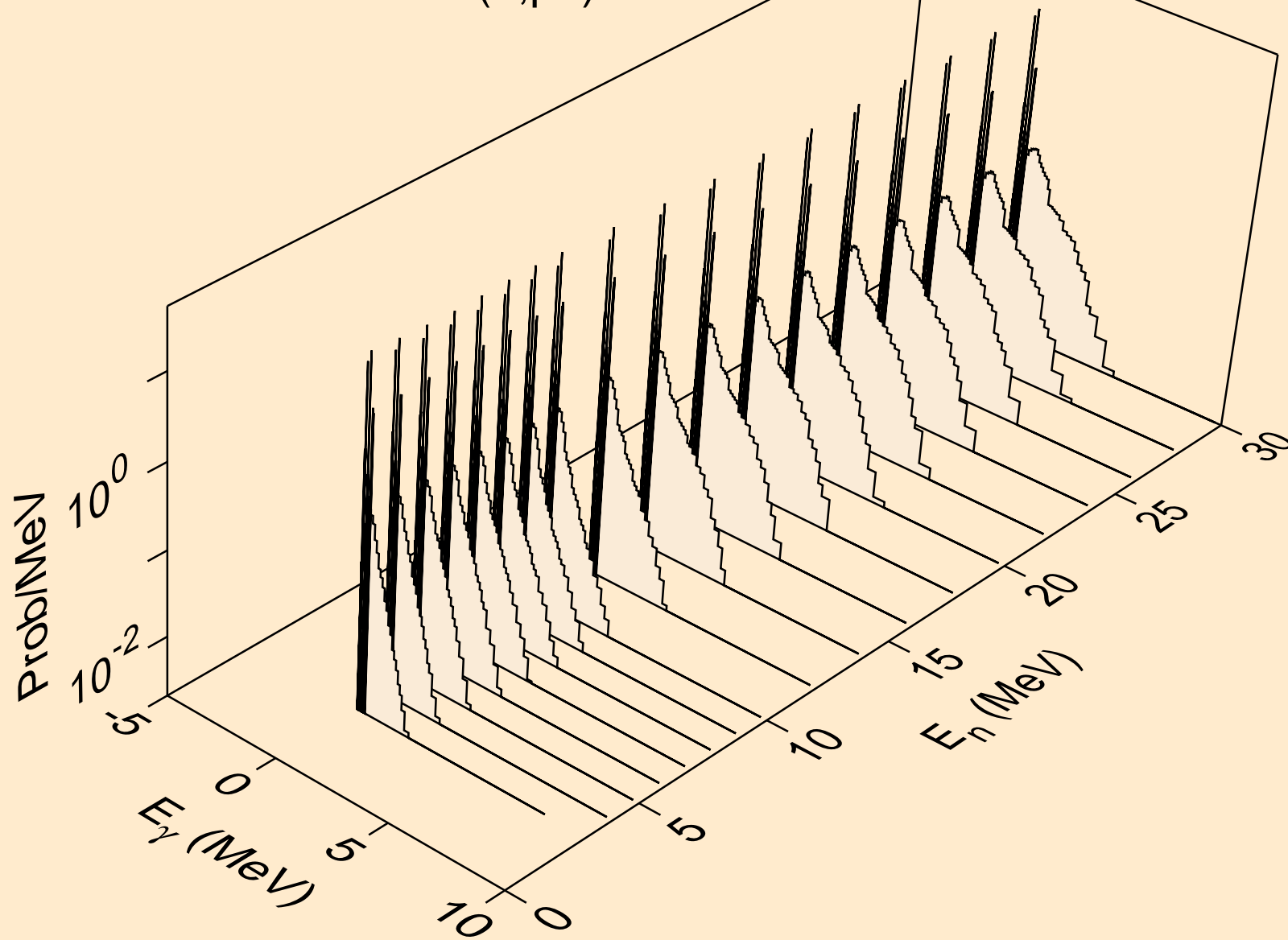

LA119 DEUTERON ACER TENDL-2021 LIBRARY; T=0.K
Photon emission for (n,d2a)

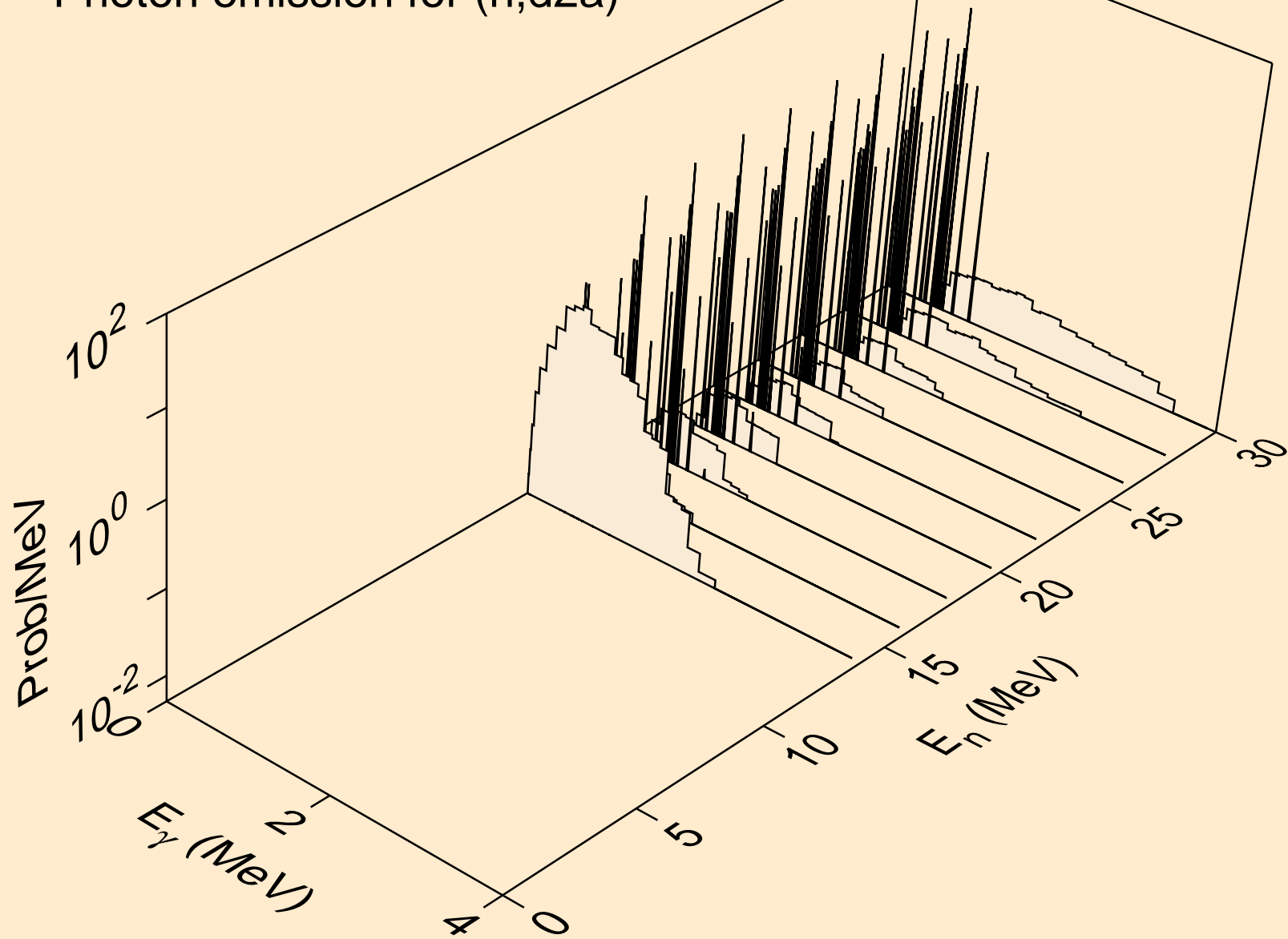

LA119 DEUTERON ACER TENDL-2021 LIBRARY; T=0.K
Photon emission for (n,pd)

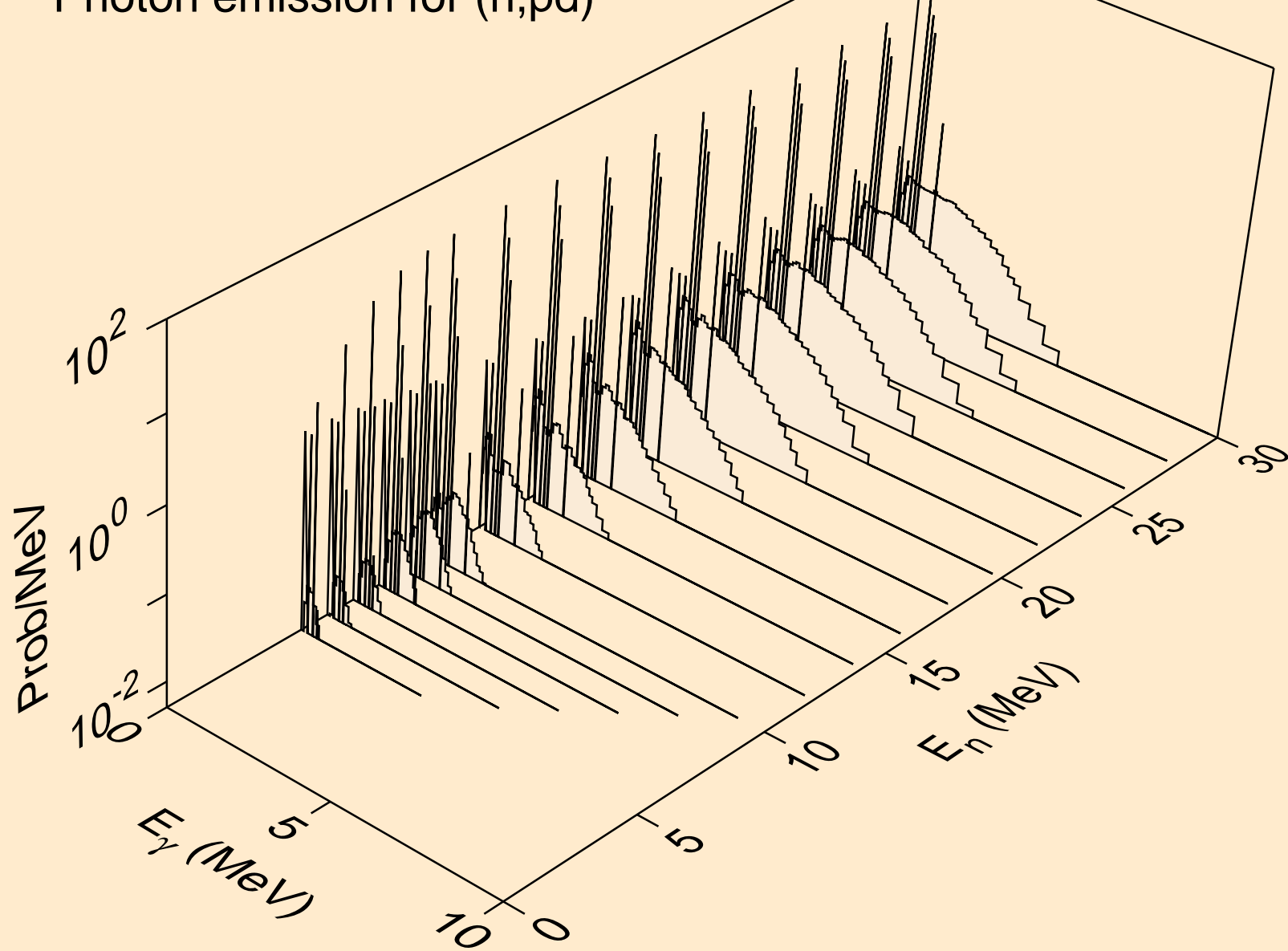

LA119 DEUTERON ACER TENDL-2021 LIBRARY; T=0.K
Photon emission for (n,pt)

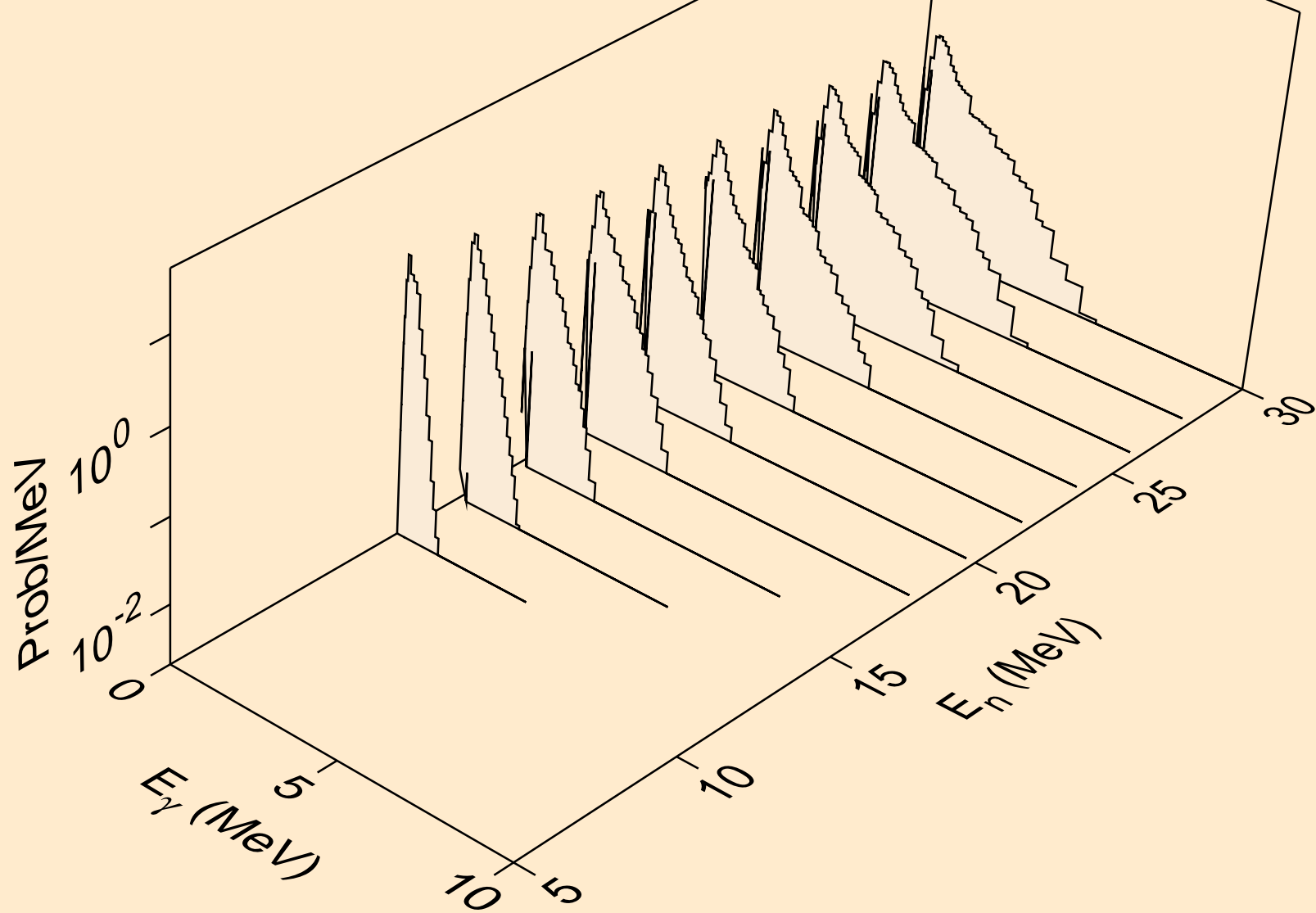

LA119 DEUTERON ACER TENDL-2021 LIBRARY; T=0.K
Photon emission for (n,da)

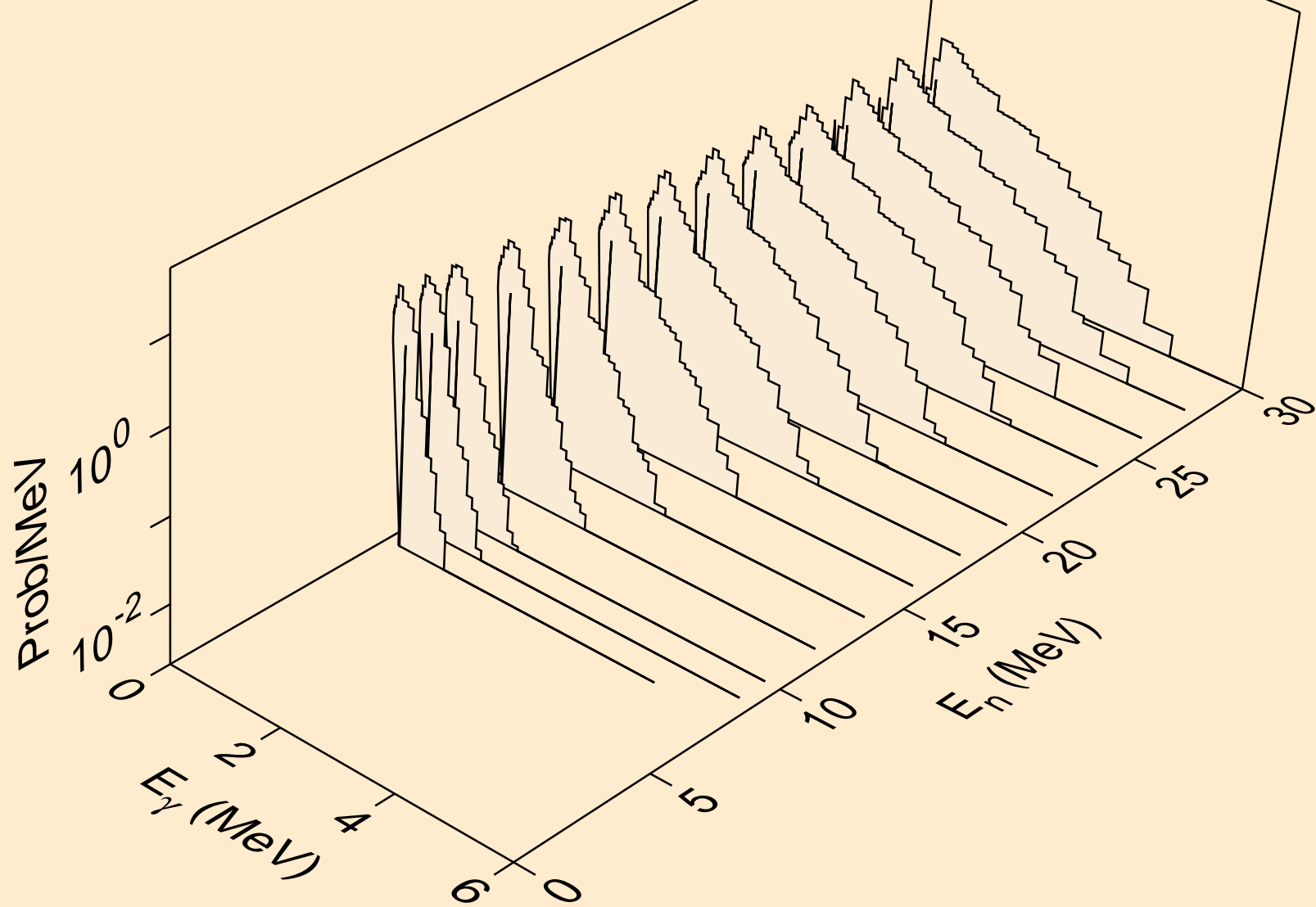

LA119 DEUTERON ACER TENDL-2021 LIBRARY; T=0.K
Particle heating contributions

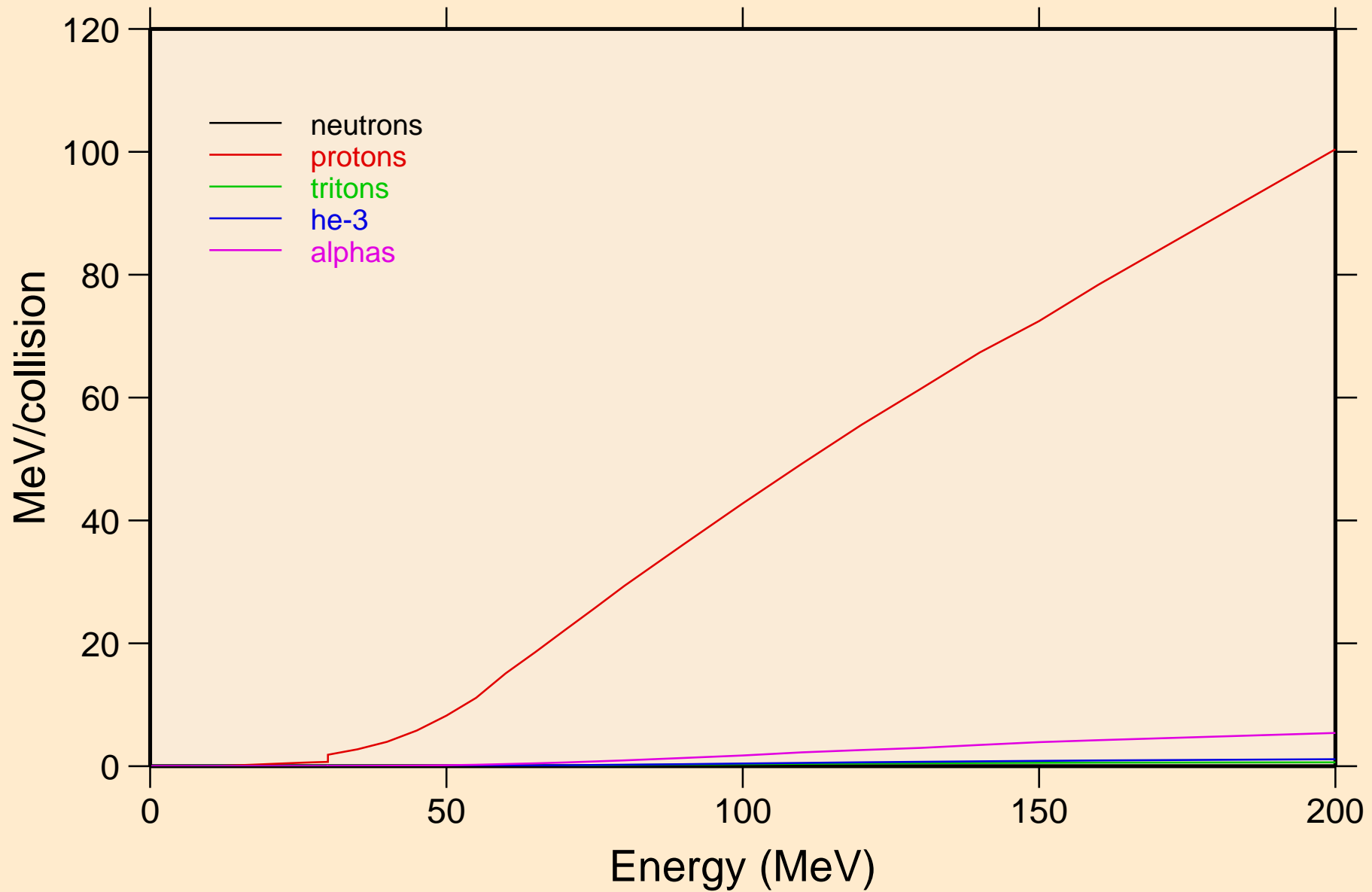

LA119 DEUTERON ACER TENDL-2021 LIBRARY; T=0.K
Recoil Heating

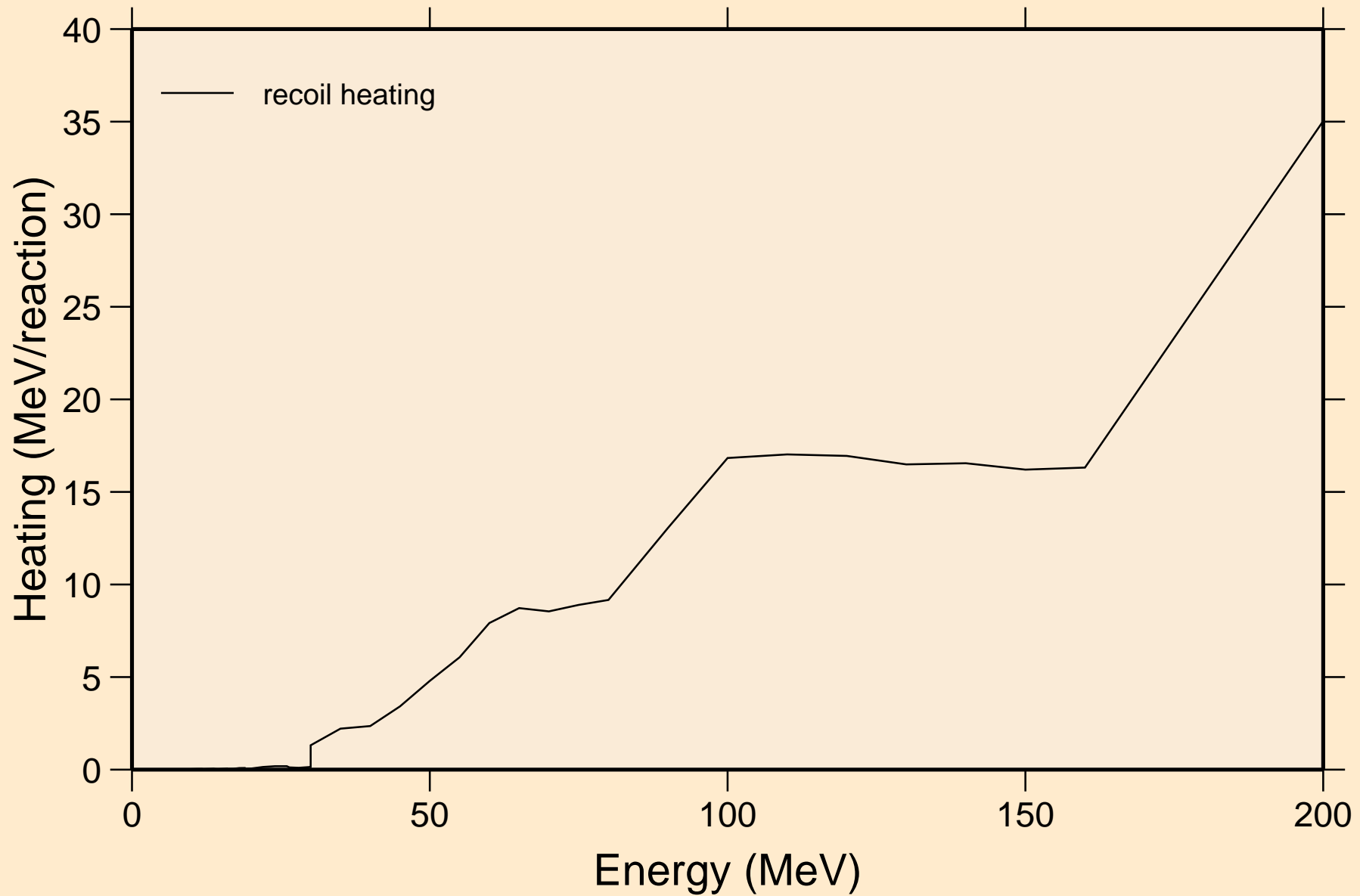

LA119 DEUTERON ACER TENDL-2021 LIBRARY; T=0.K
Particle production cross sections

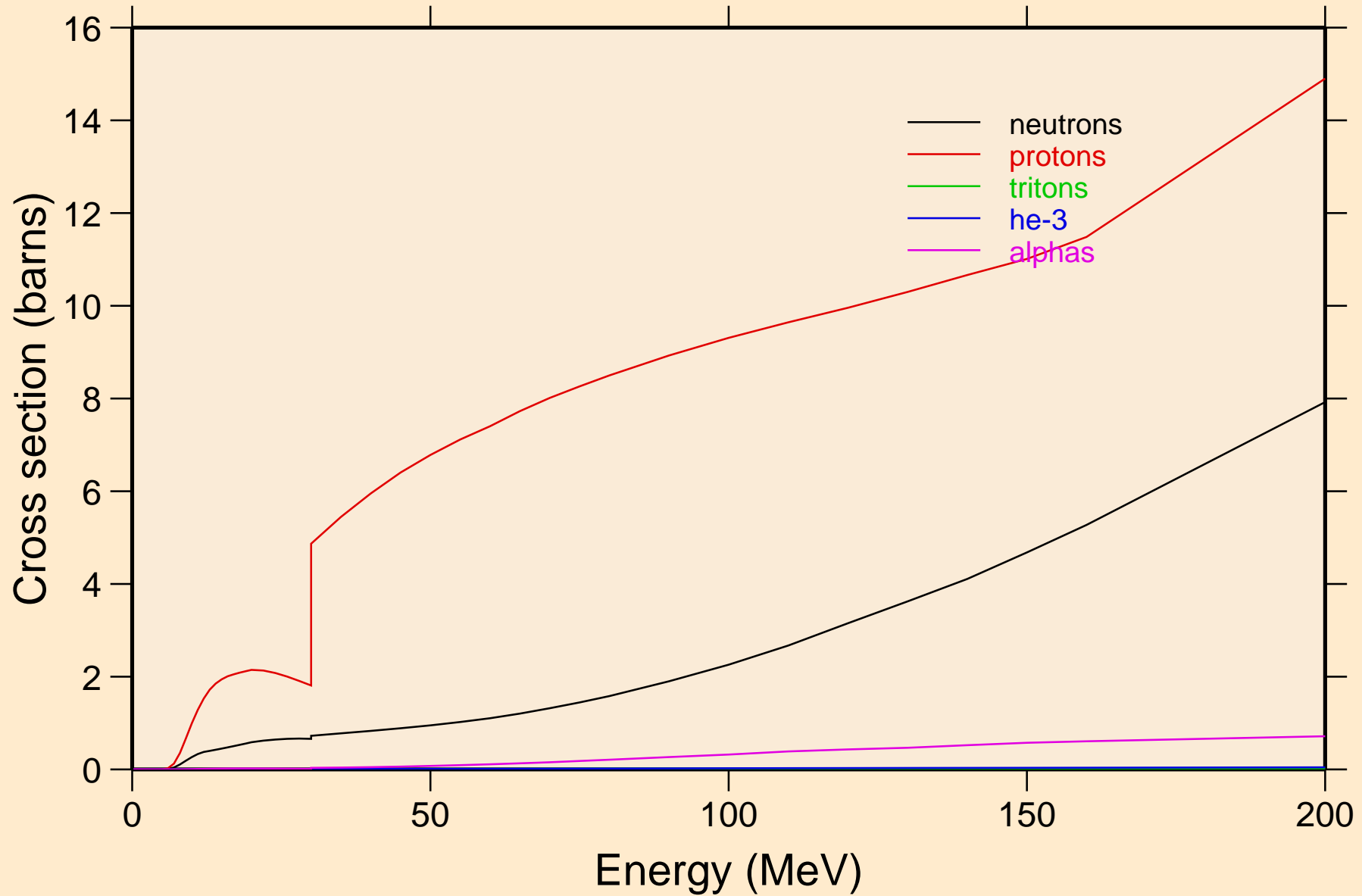

LA119 DEUTERON ACER TENDL-2021 LIBRARY; T=0.K
neutrons from (d,n)

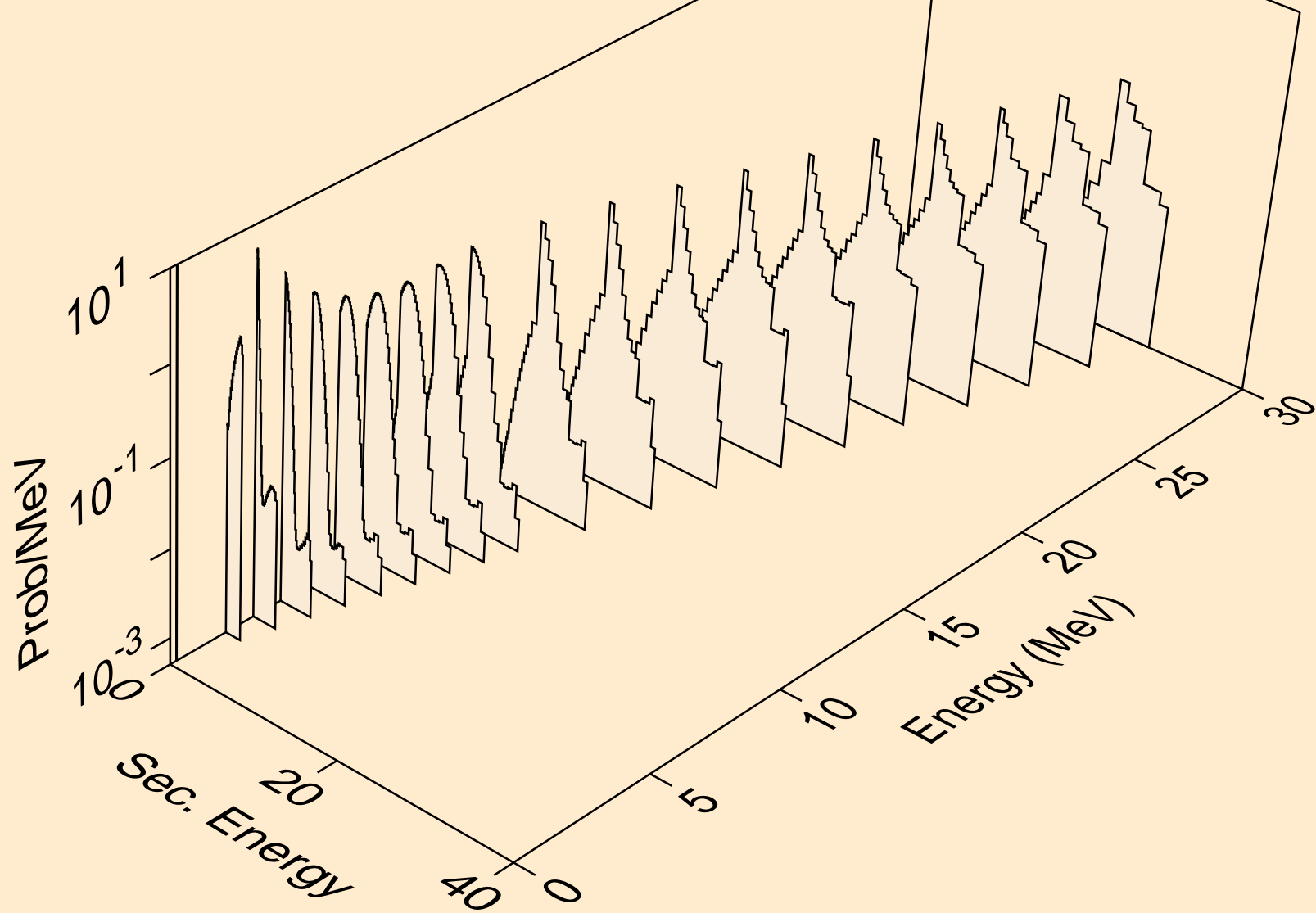

LA119 DEUTERON ACER TENDL-2021 LIBRARY; T=0.K
neutrons from (d,x)

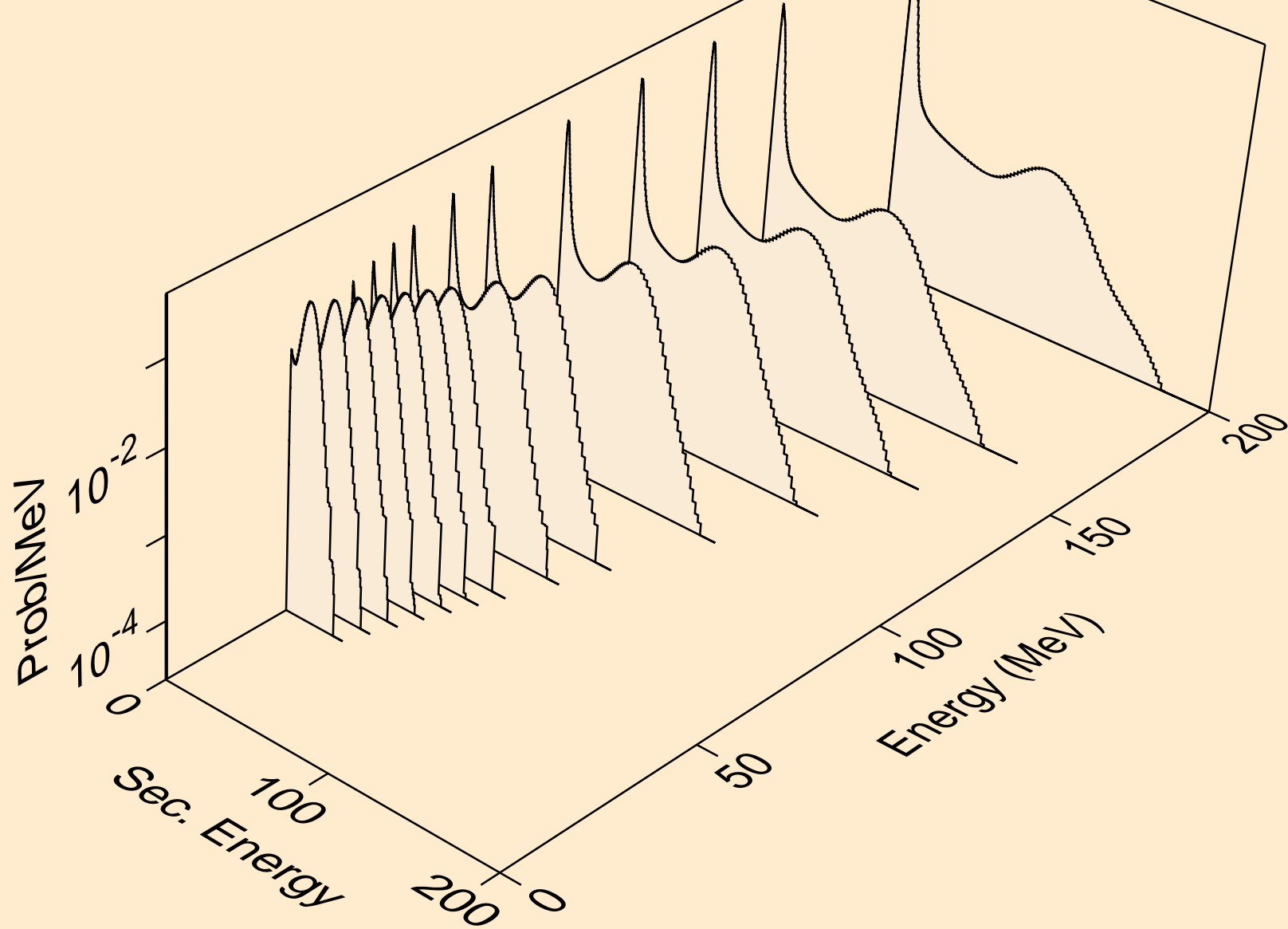

LA119 DEUTERON ACER TENDL-2021 LIBRARY; T=0.K
neutrons from (d,2n)

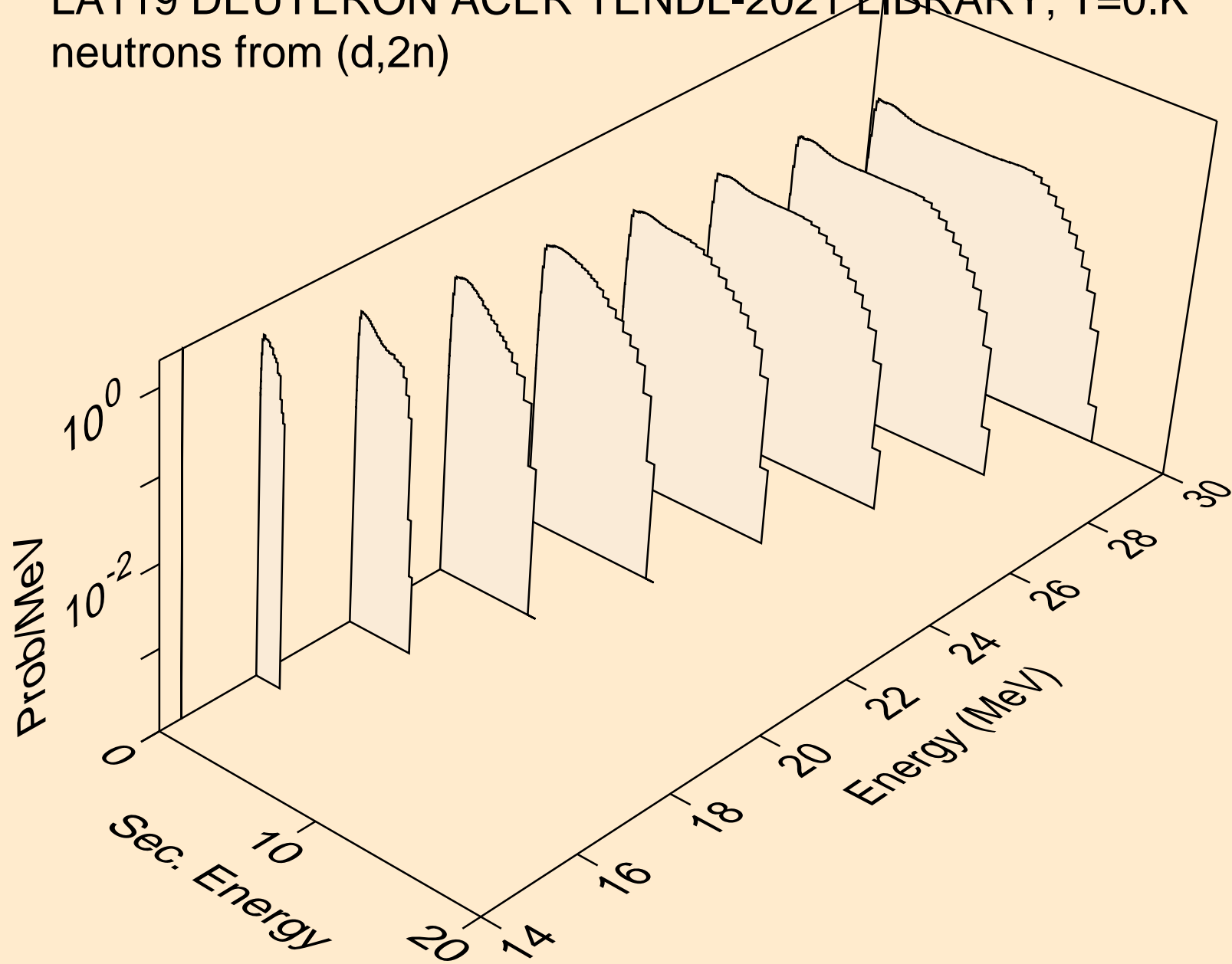

LA119 DEUTERON ACER TENDL-2021 LIBRARY; T=0.K
neutrons from (d,3n)

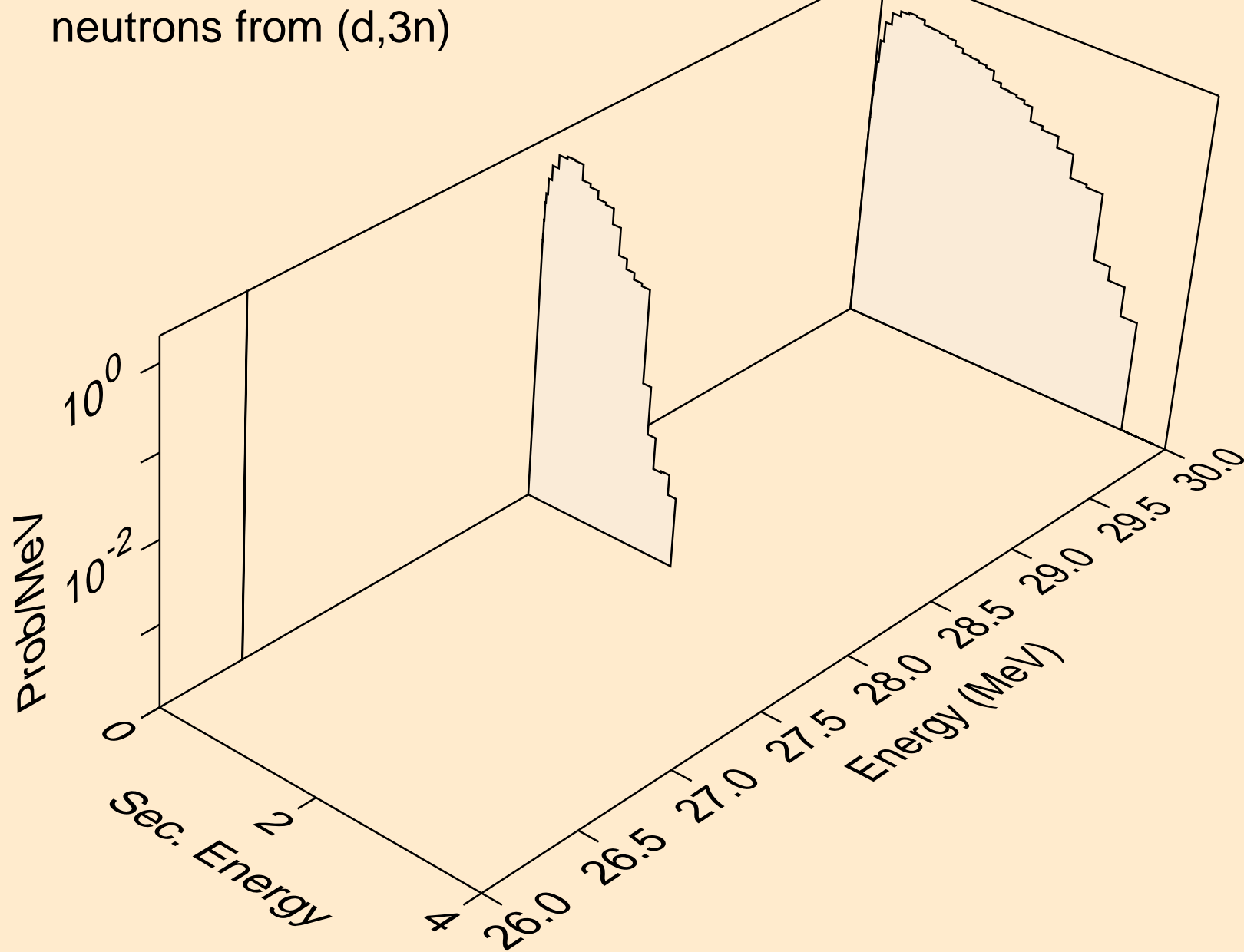

LA119 DEUTERON ACER TENDL-2021 LIBRARY; T=0.K
neutrons from (d,n*)a

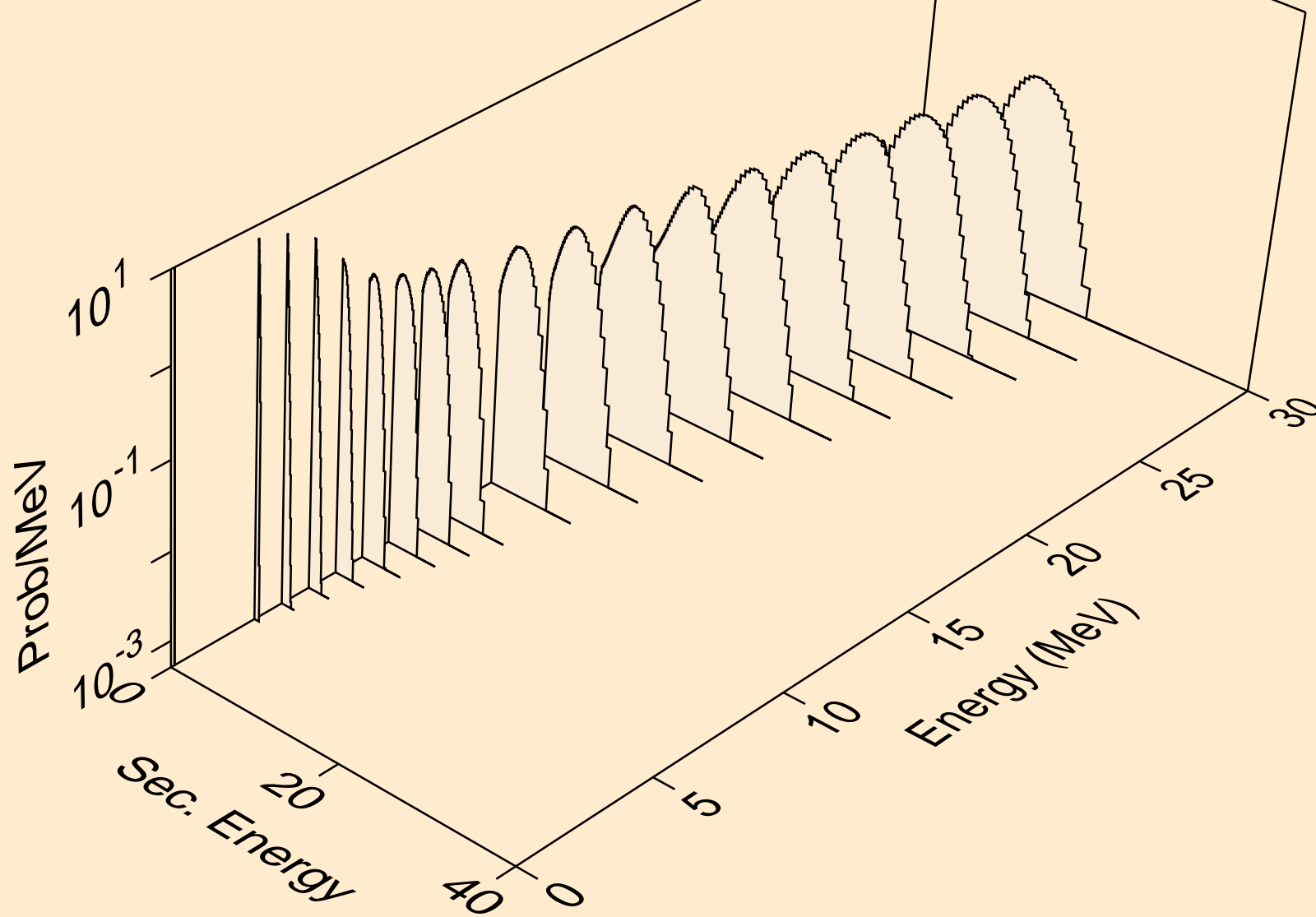

LA119 DEUTERON ACER TENDL-2021 LIBRARY; T=0.K
neutrons from (d,2n)a

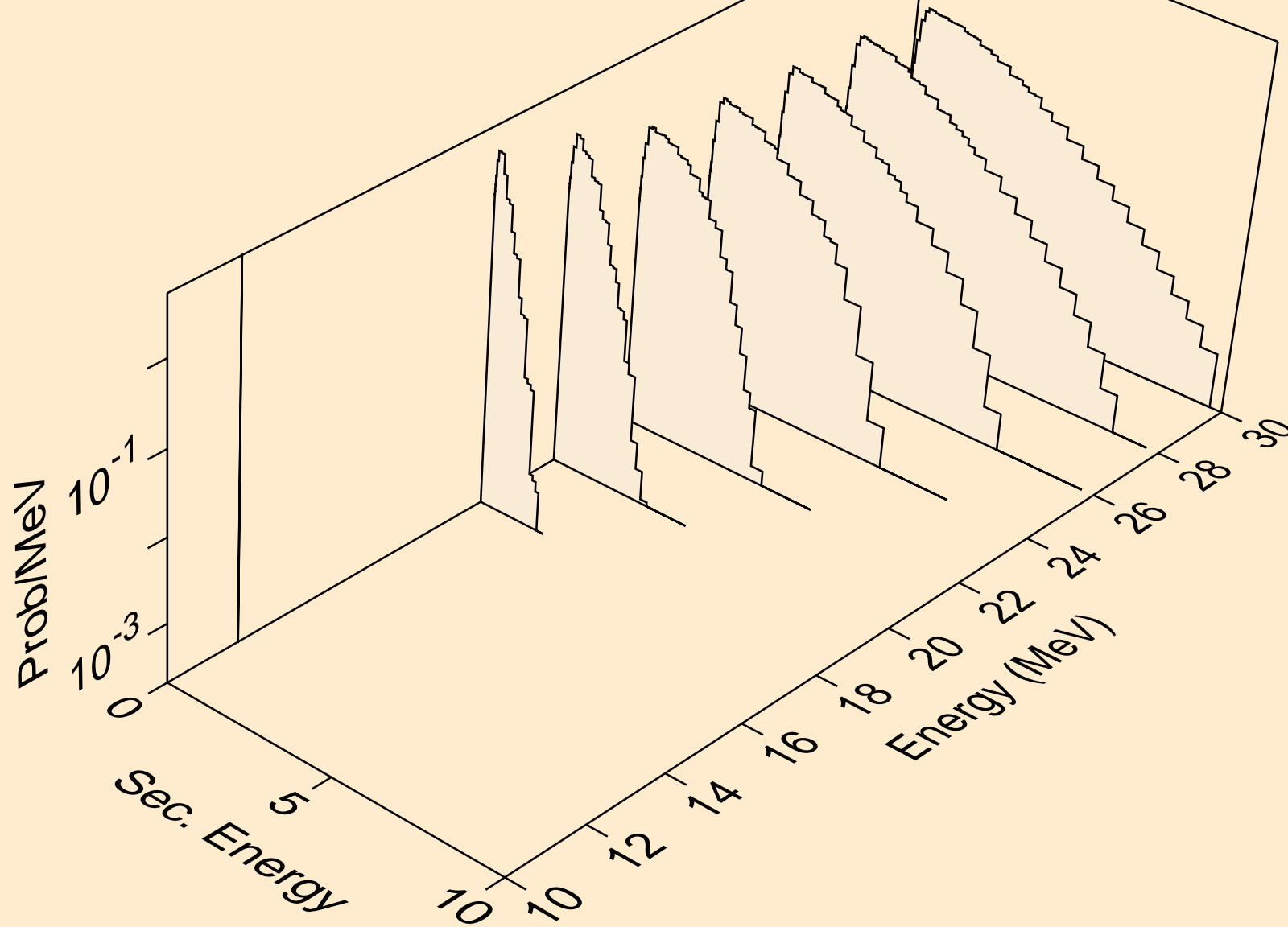

LA119 DEUTERON ACER TENDL-2021 LIBRARY; T=0.K
neutrons from (d,n*)p

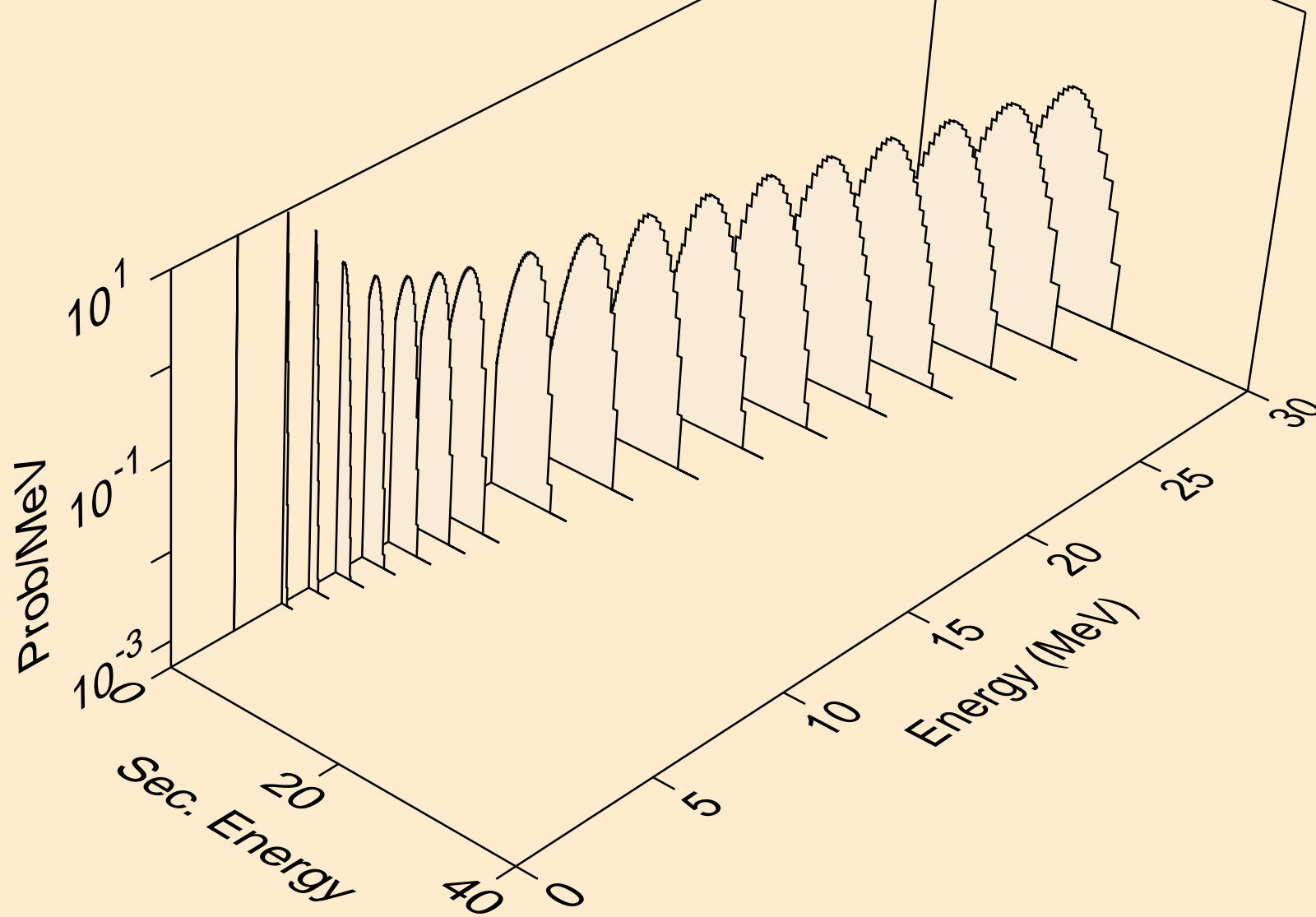

LA119 DEUTERON ACER TENDL-2021 LIBRARY; T=0.K
neutrons from (d,n*)2a

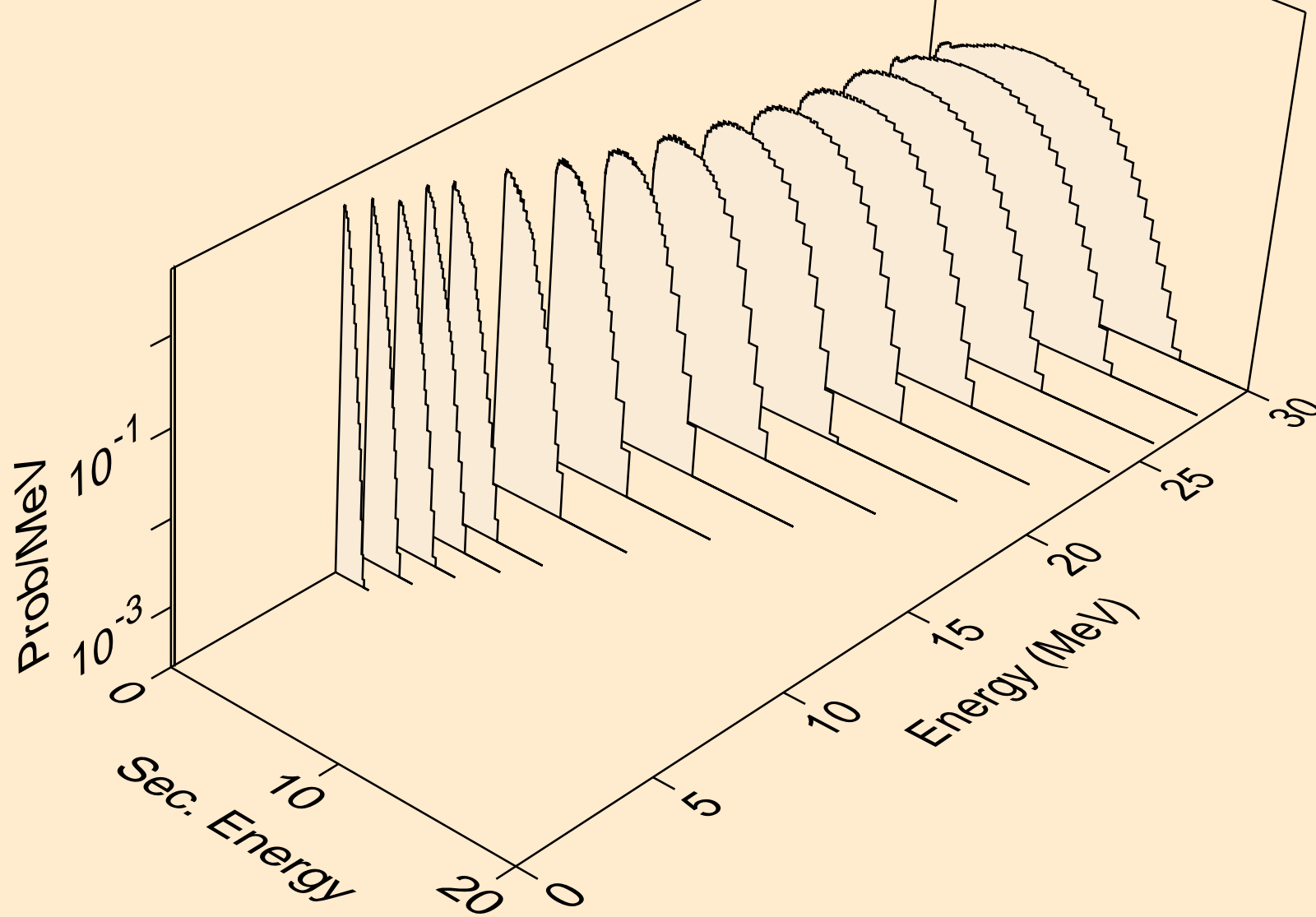

LA119 DEUTERON ACER TENDL-2021 LIBRARY; T=0.K
neutrons from (d,n*)d

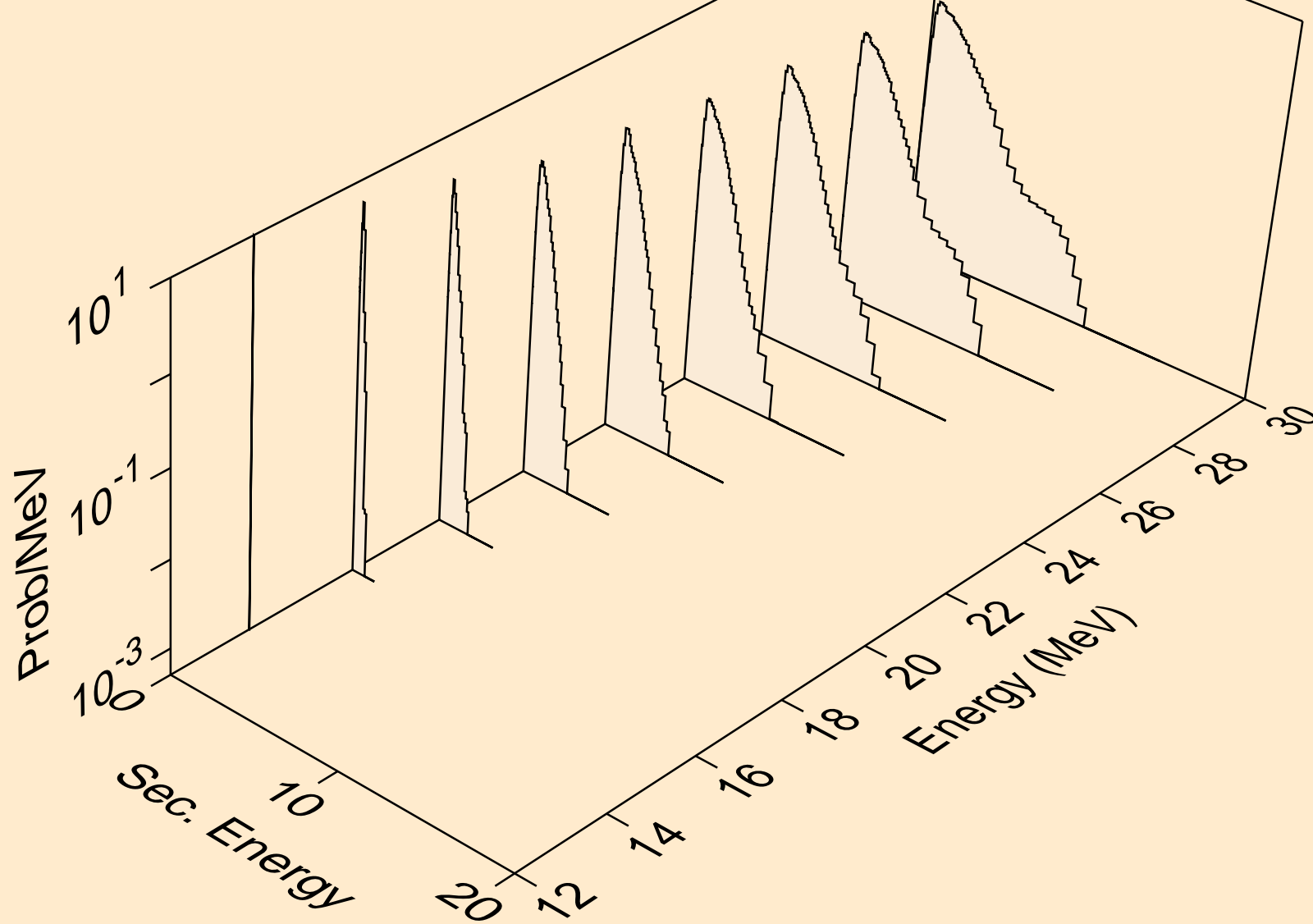

LA119 DEUTERON ACER TENDL-2021 LIBRARY; T=0.K
neutrons from (d,n*)t

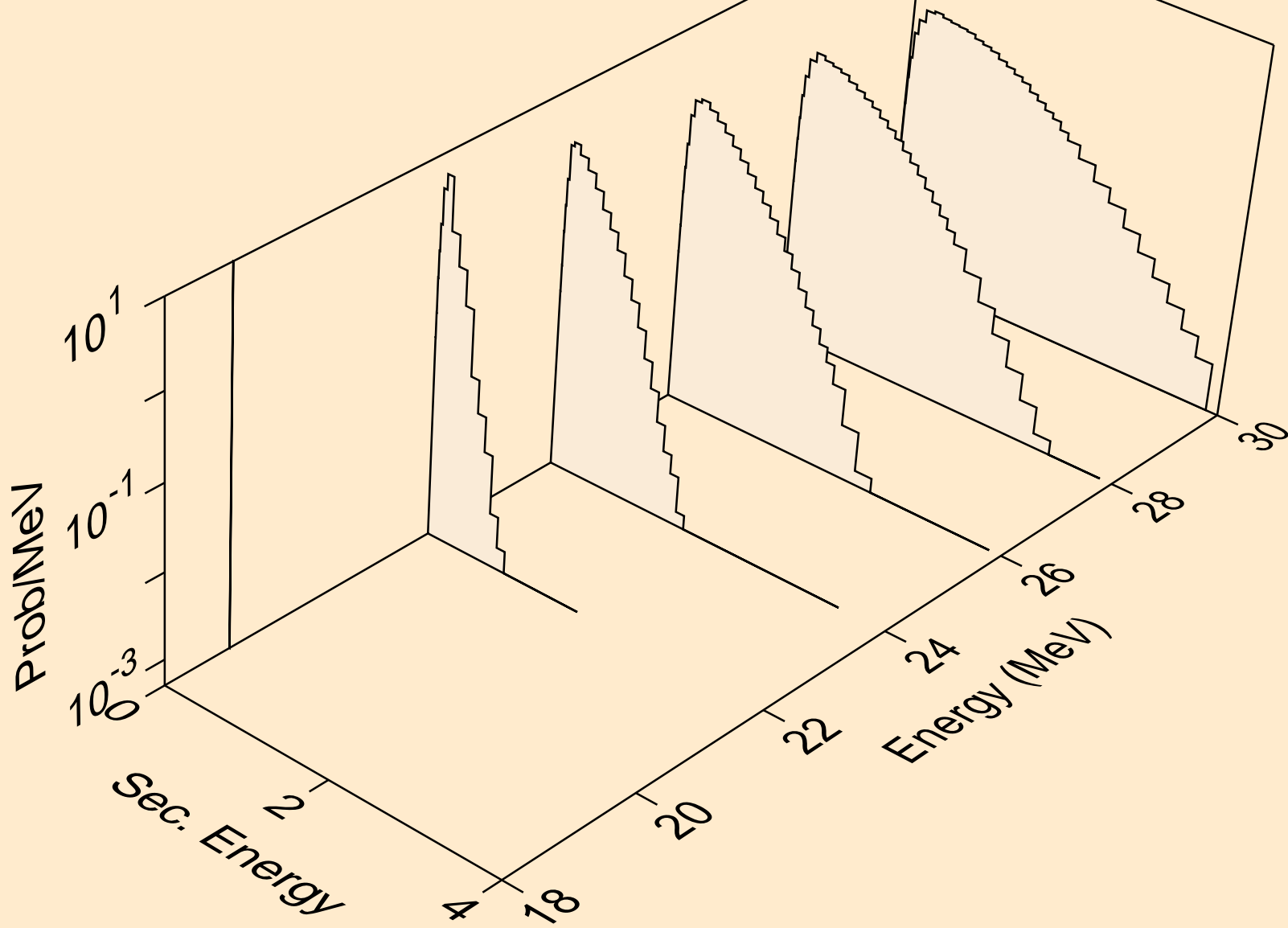

LA119 DEUTERON ACER TENDL-2021 LIBRARY; T=0.K
neutrons from (d,n*)he3

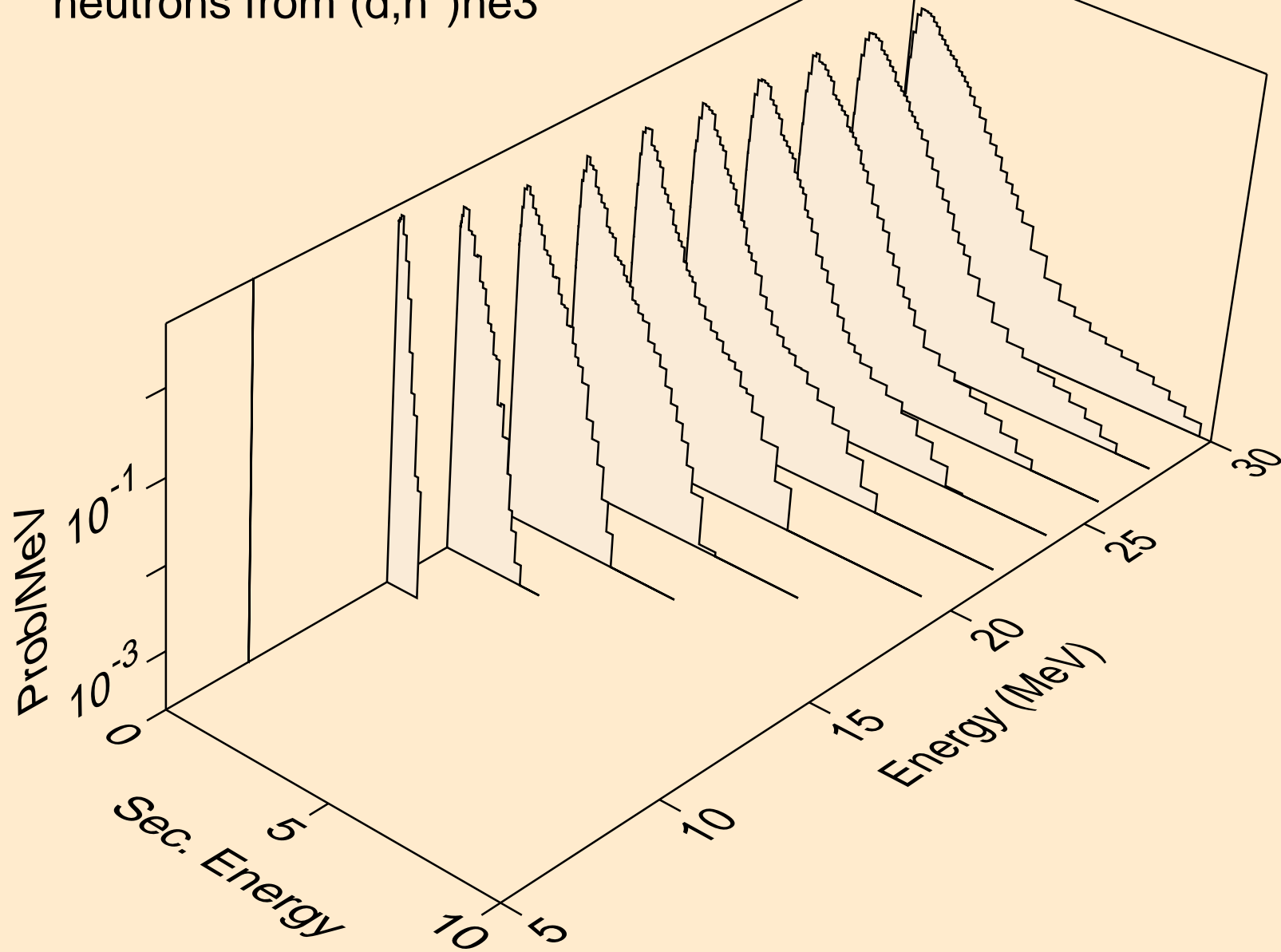

LA119 DEUTERON ACER TENDL-2021 LIBRARY; T=0.K
neutrons from (d,2np)

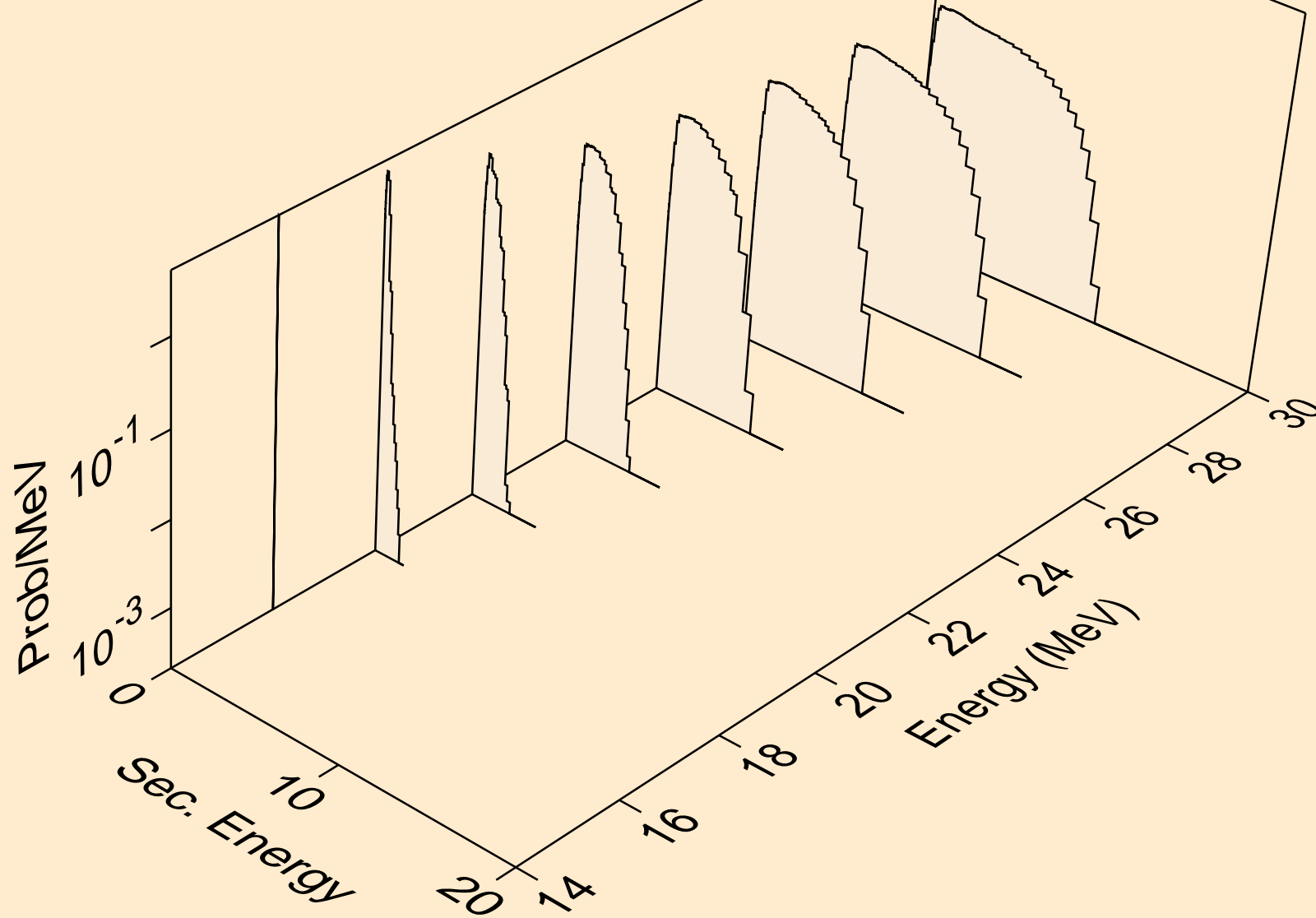

LA119 DEUTERON ACER TENDL-2021 LIBRARY; T=0.K
neutrons from (d,2np)

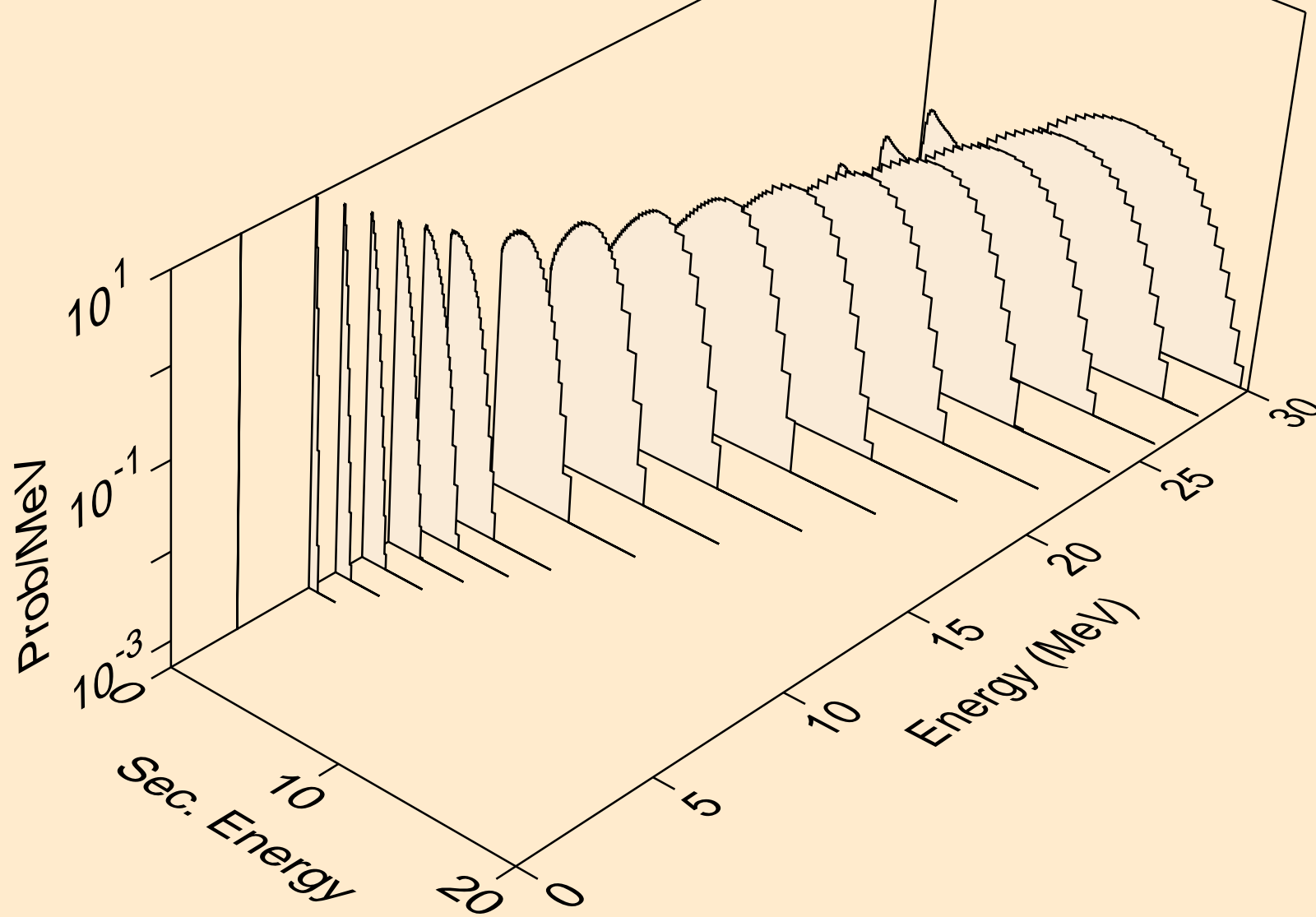

LA119 DEUTERON ACER TENDL-2021 LIBRARY; T=0.K
neutrons from (d,npa)

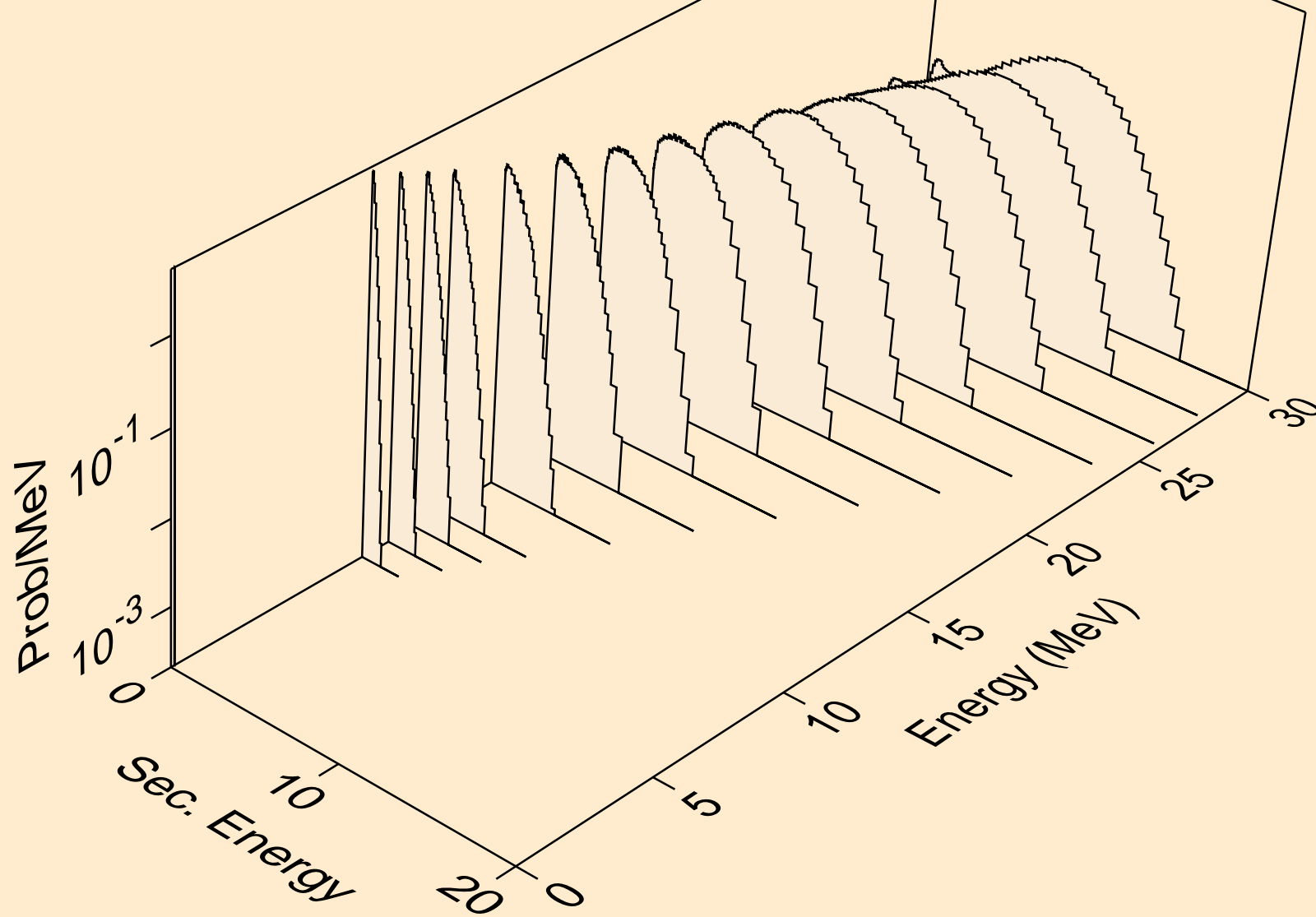

LA119 DEUTERON ACER TENDL-2021 LIBRARY; T=0.K
protons from (d,x)

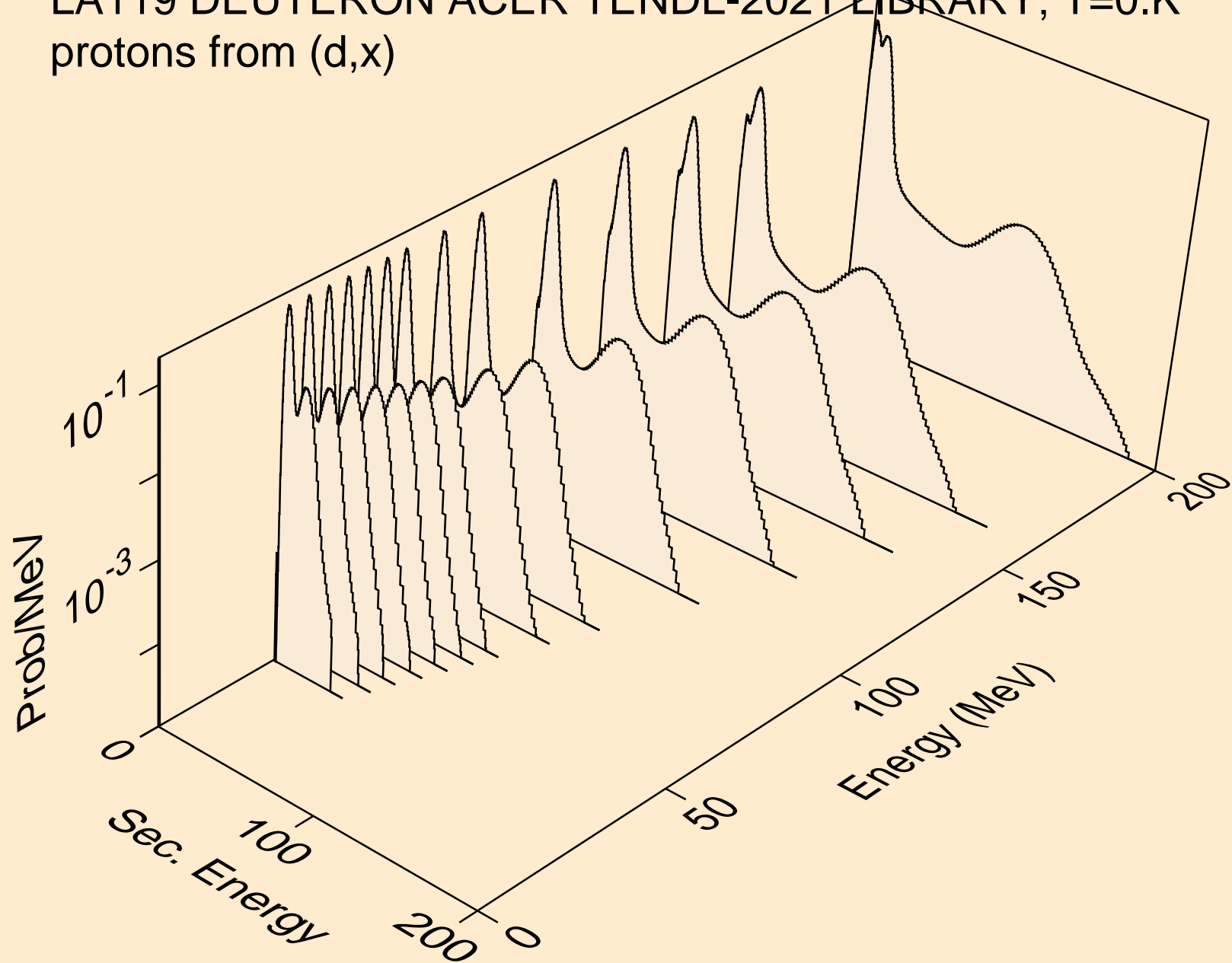

LA119 DEUTERON ACER TENDL-2021 LIBRARY; T=0.K
protons from (d,n*)p

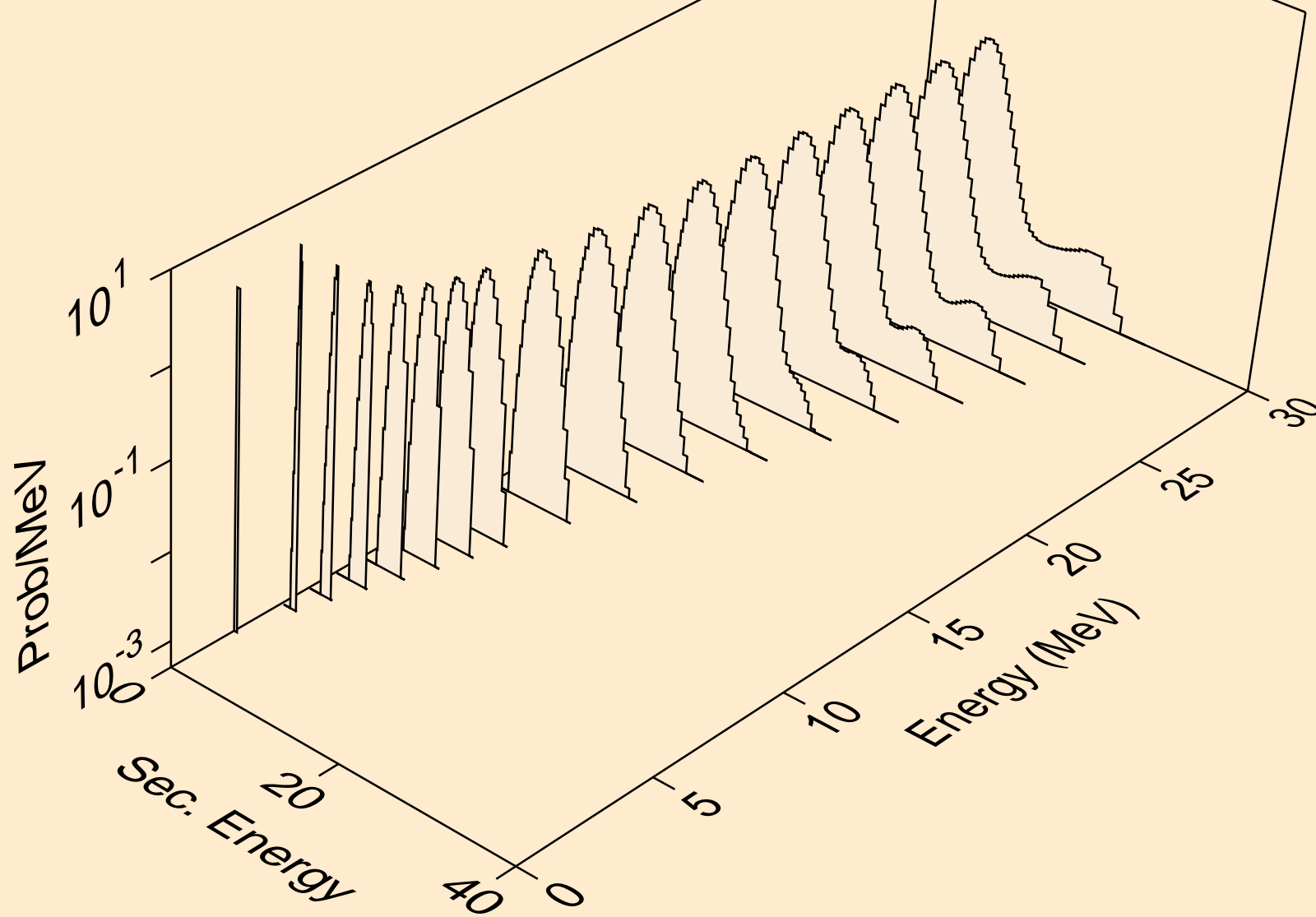

LA119 DEUTERON ACER TENDL-2021 LIBRARY; T=0.K
protons from (d,2np)

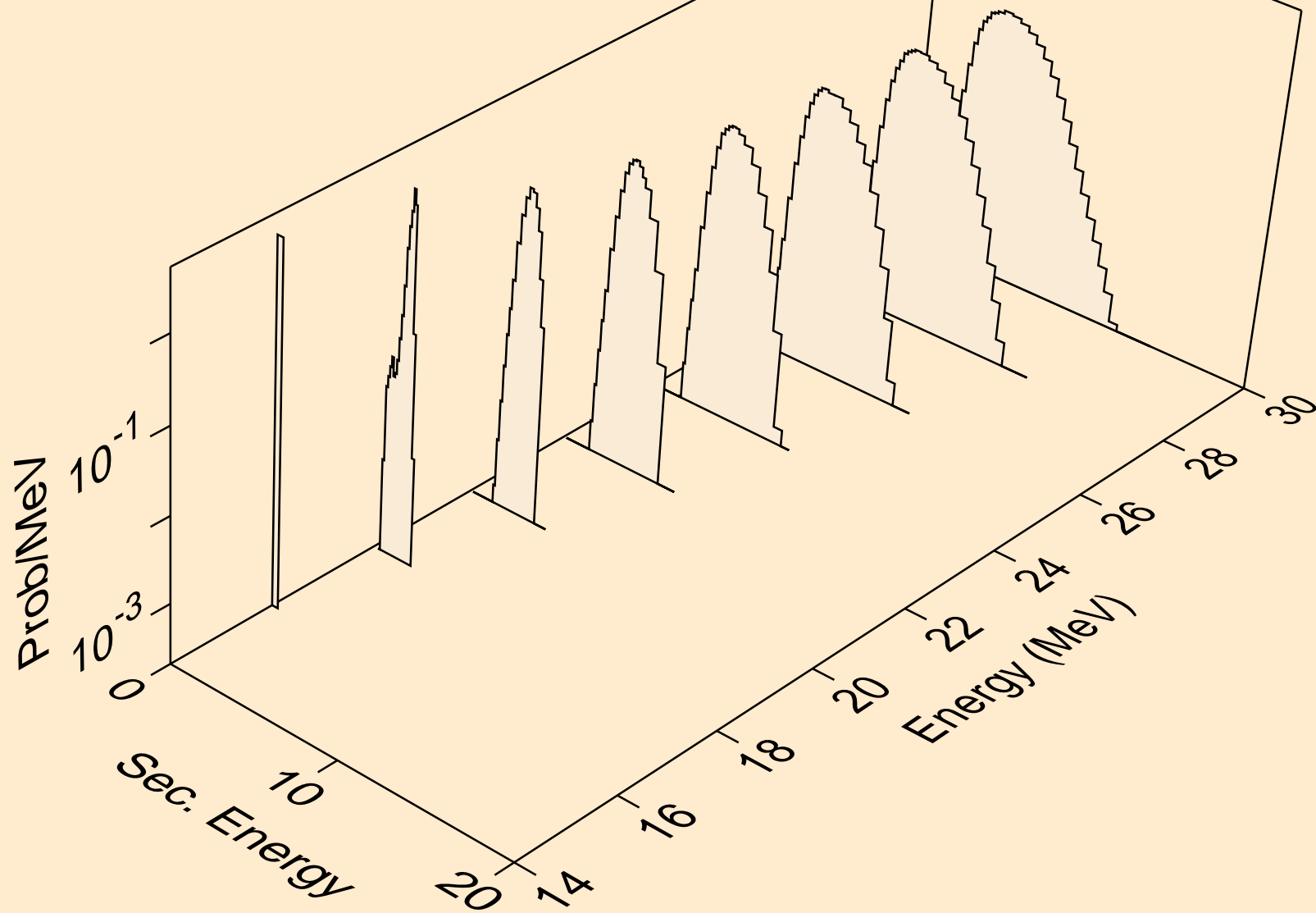

LA119 DEUTERON ACER TENDL-2021 LIBRARY; T=0.K
protons from (d,2np)

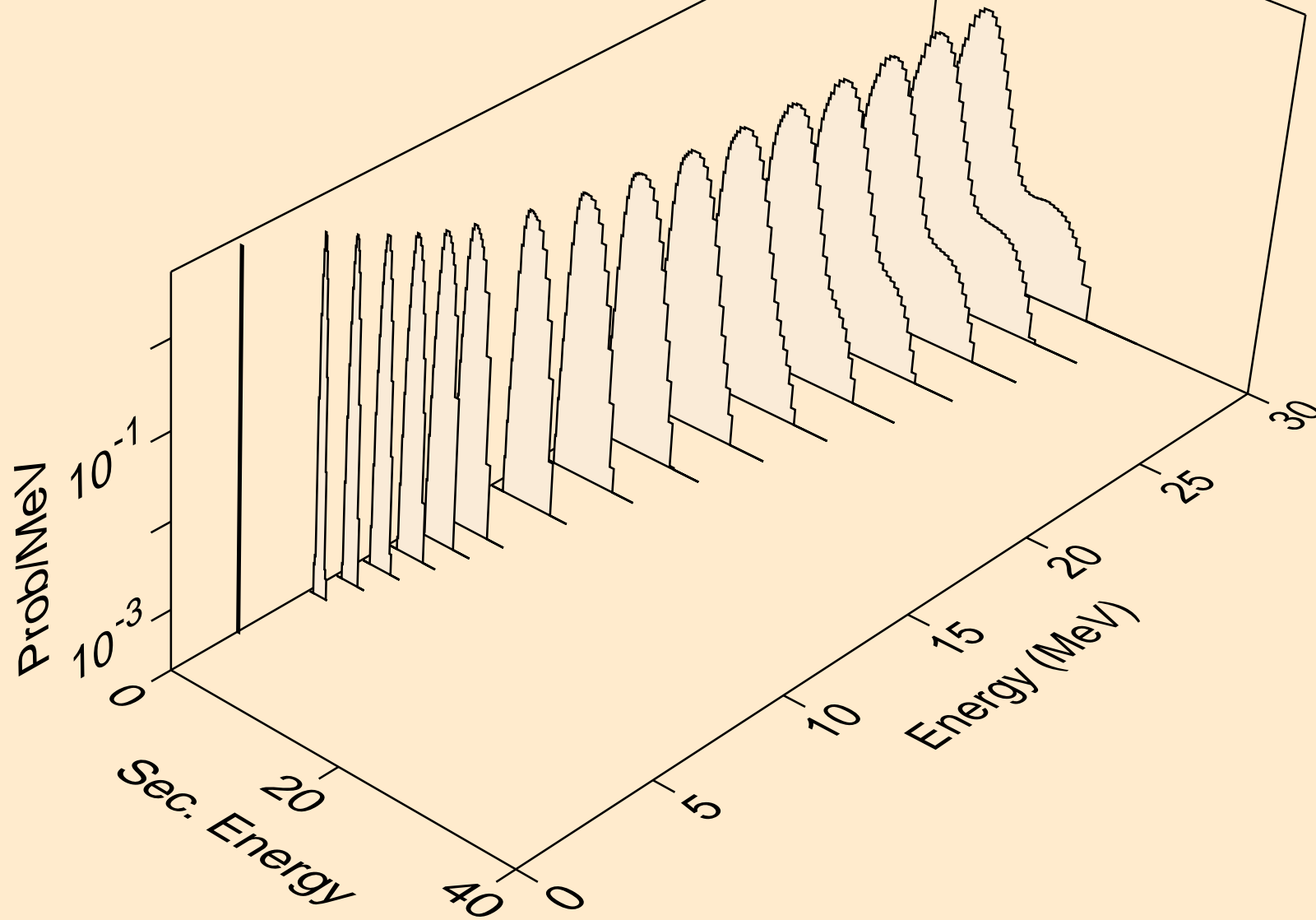

LA119 DEUTERON ACER TENDL-2021 LIBRARY; T=0.K
protons from (d,npa)

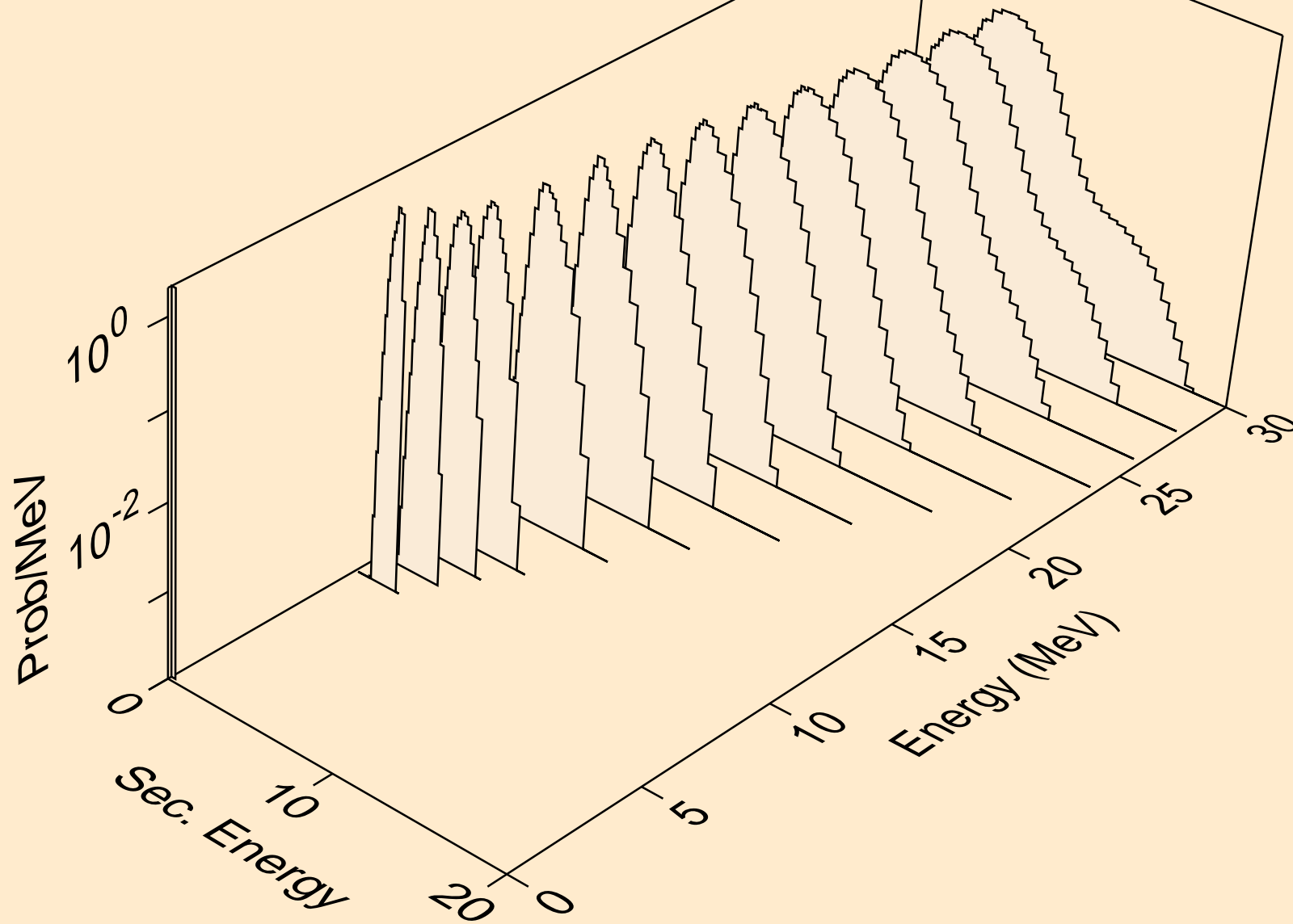

LA119 DEUTERON ACER TENDL-2021 LIBRARY; T=0.K
protons from (d,p)

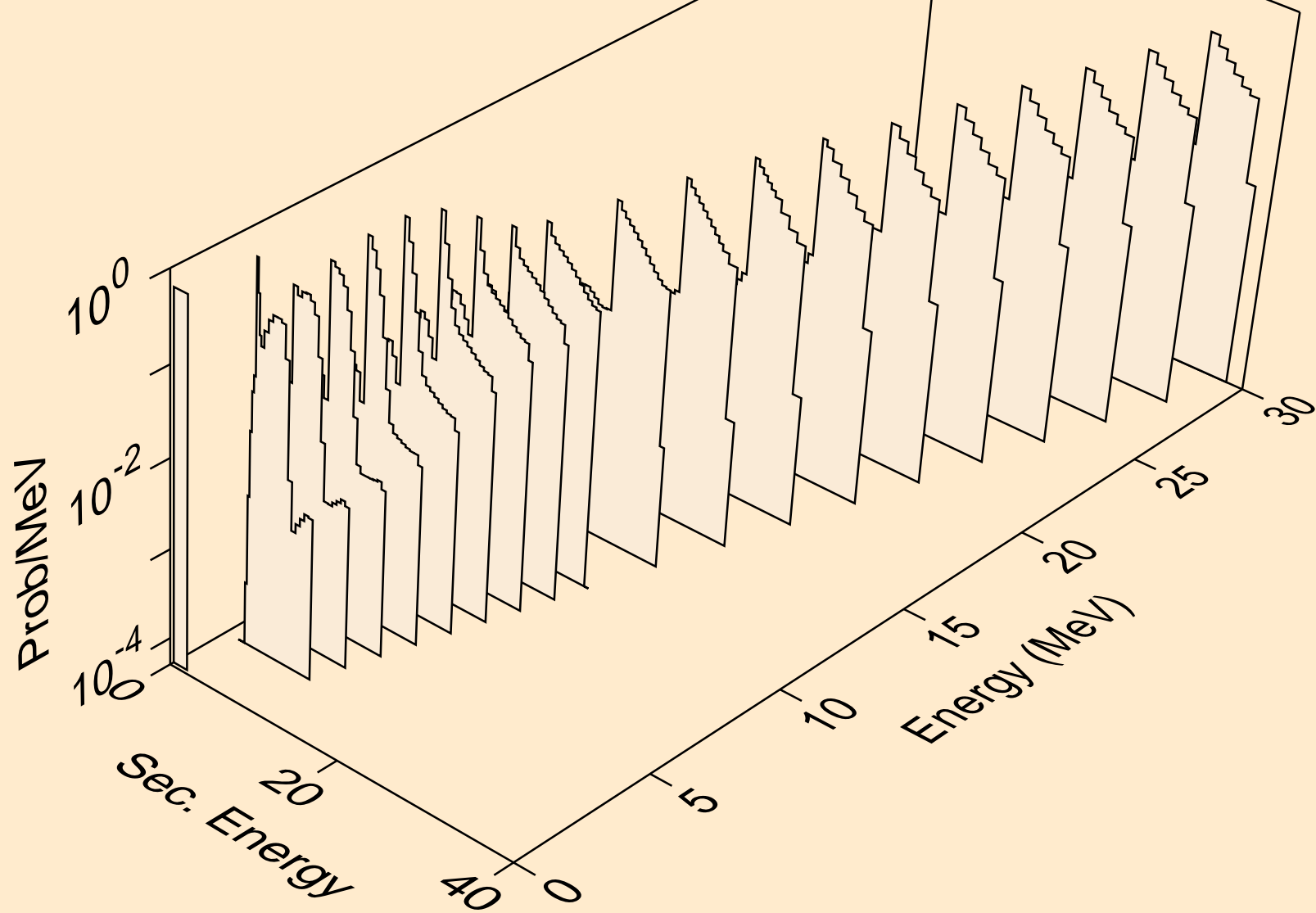

LA119 DEUTERON ACER TENDL-2021 LIBRARY; T=0.K
protons from (d,2p)

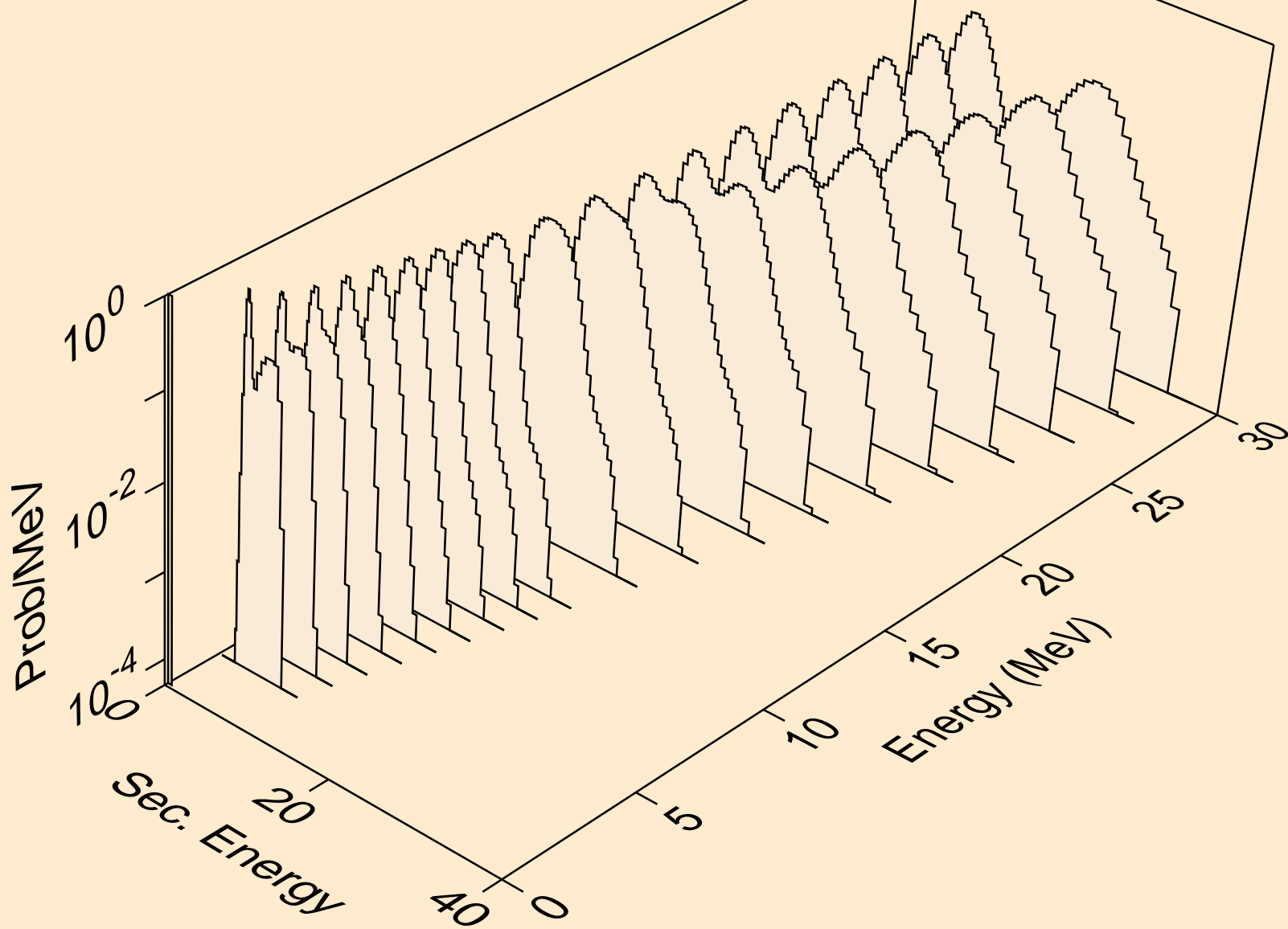

LA119 DEUTERON ACER TENDL-2021 LIBRARY; T=0.K
protons from (d,pa)

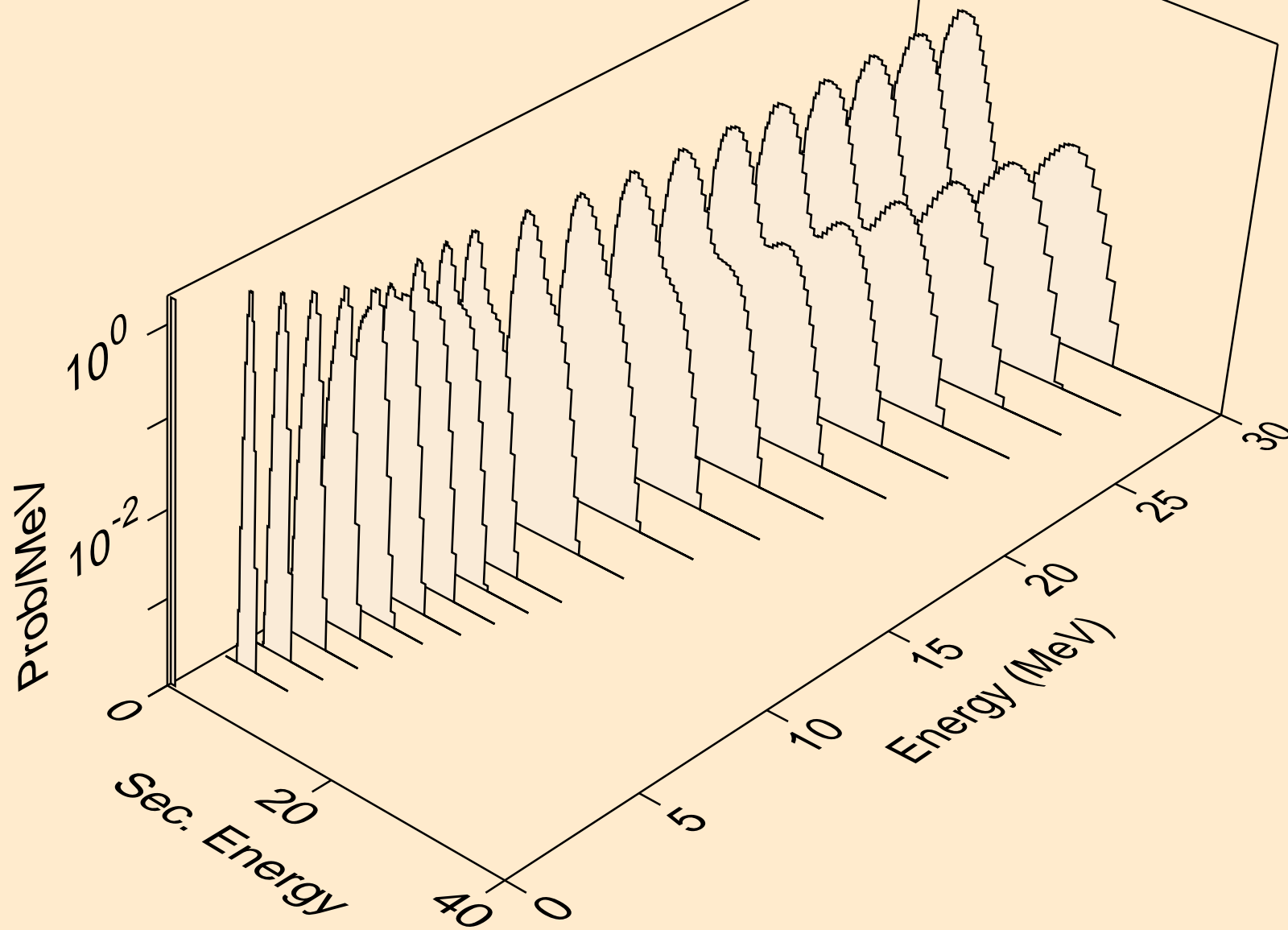

LA119 DEUTERON ACER TENDL-2021 LIBRARY; T=0.K
protons from (d,pd)

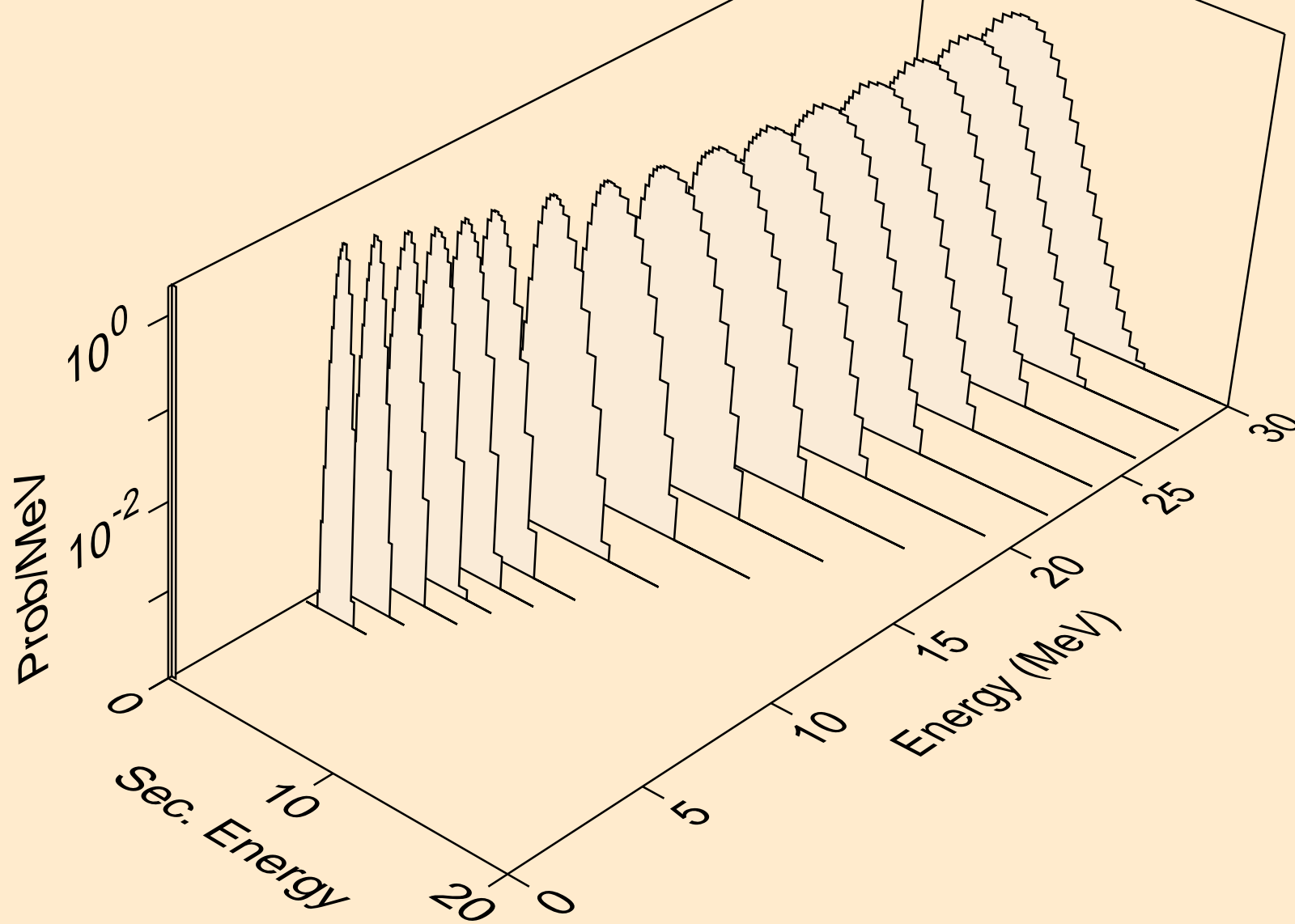

LA119 DEUTERON ACER TENDL-2021 LIBRARY; T=0.K
protons from (d,pt)

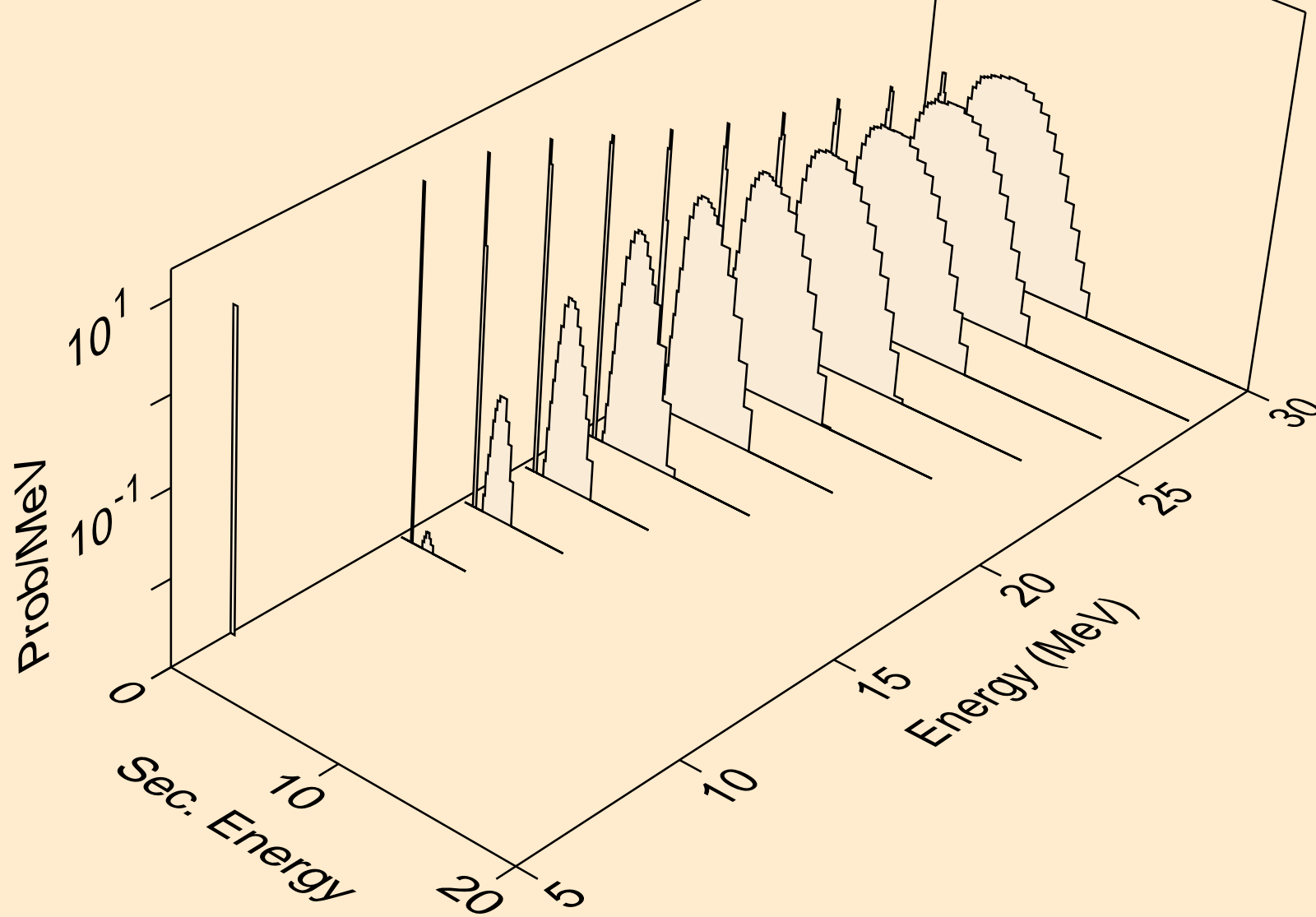

LA119 DEUTERON ACER TENDL-2021 LIBRARY; T=0.K
tritons from (d,x)

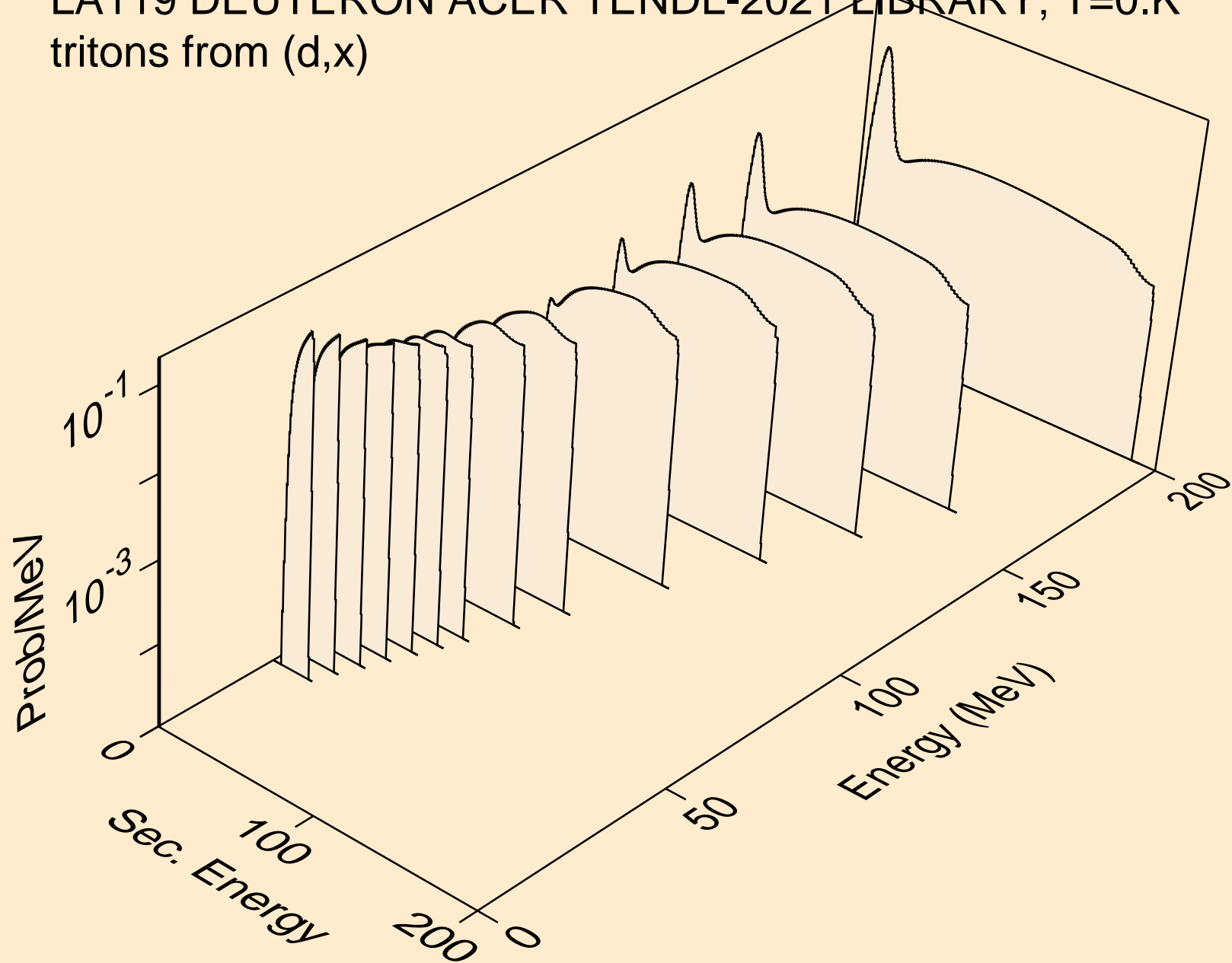

LA119 DEUTERON ACER TENDL-2021 LIBRARY; T=0.K
tritons from (d,n*)t

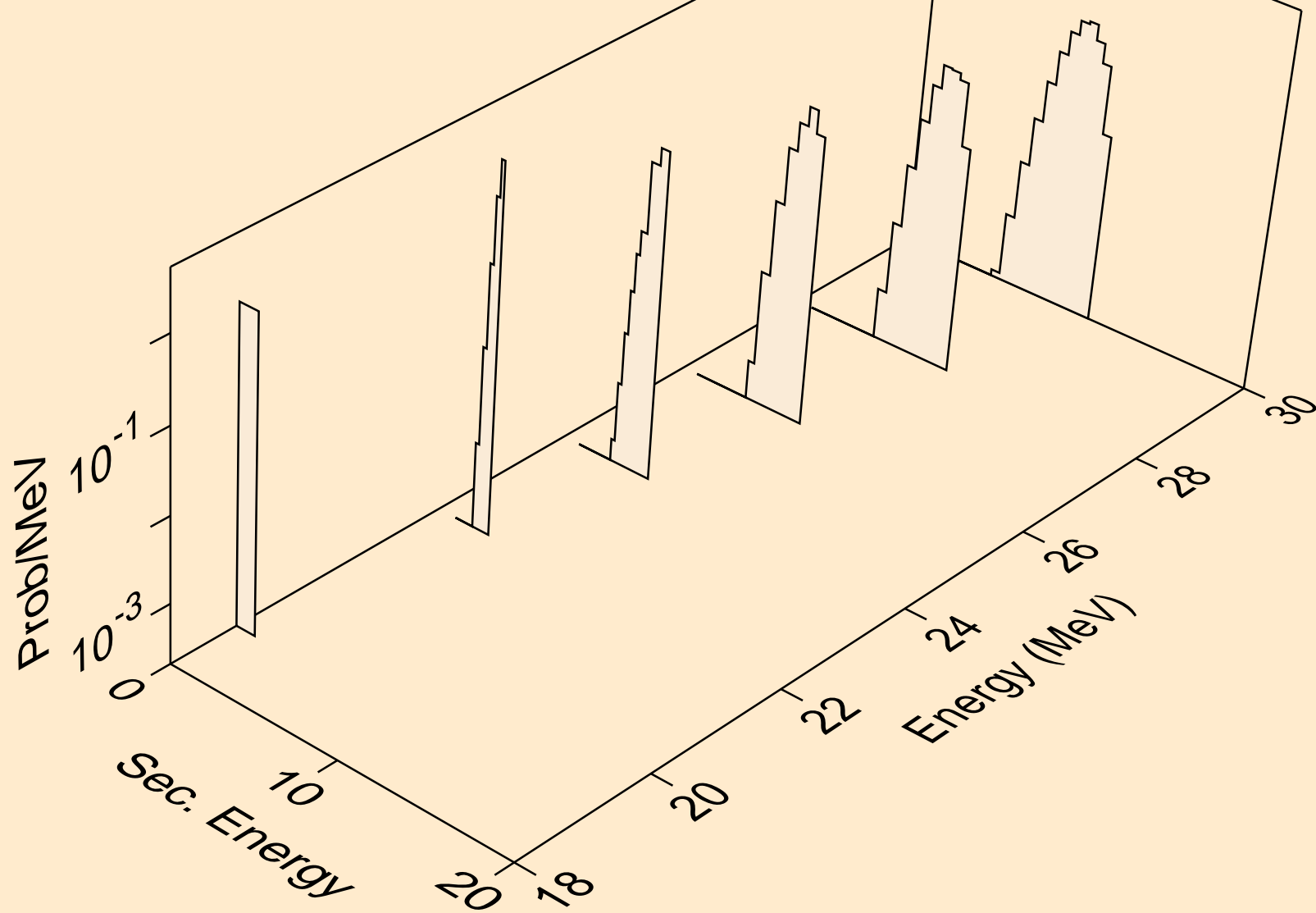

LA119 DEUTERON ACER TENDL-2021 LIBRARY; T=0.K
tritons from (d,t)

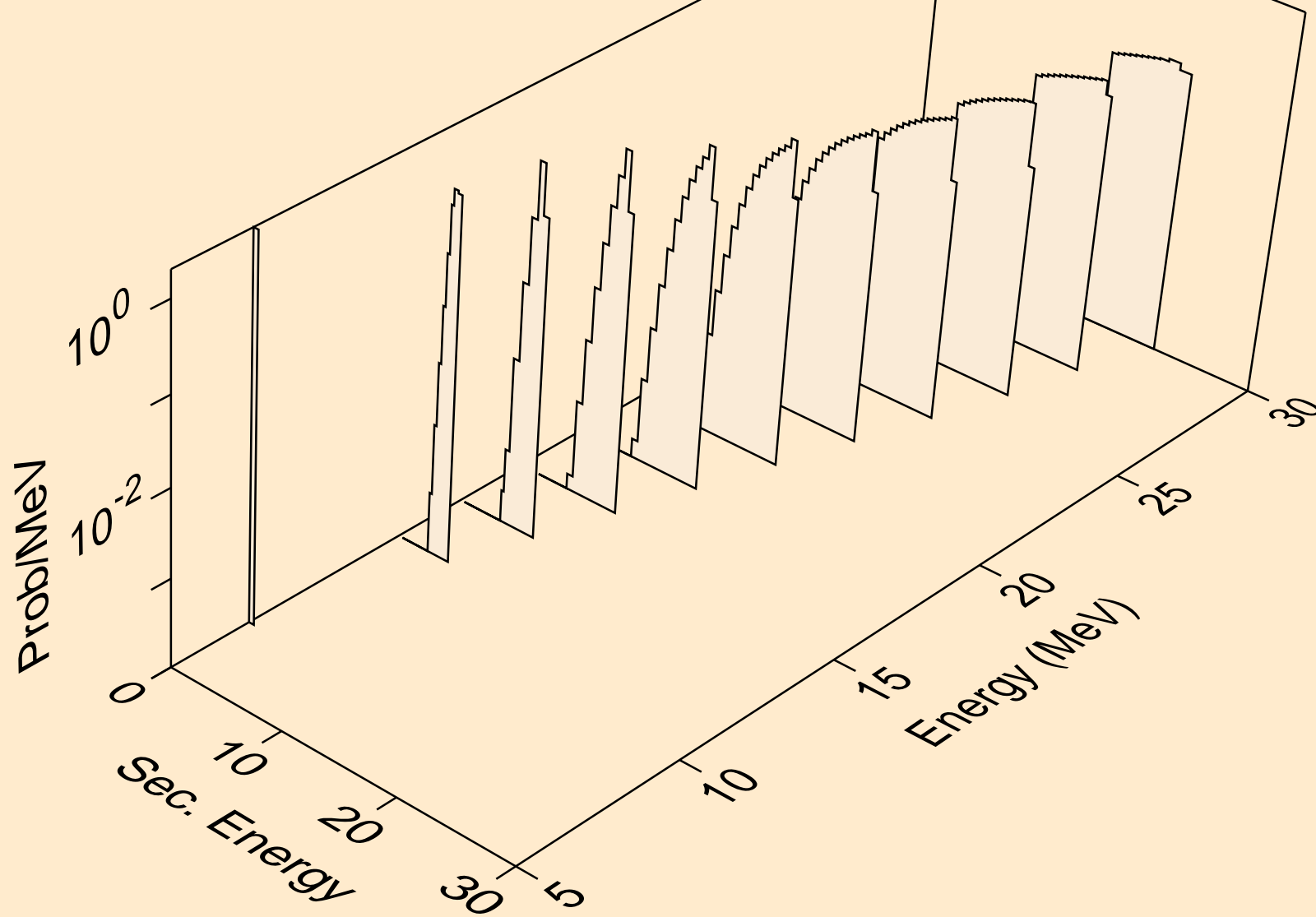

LA119 DEUTERON ACER TENDL-2021 LIBRARY; T=0.K
tritons from (d,pt)

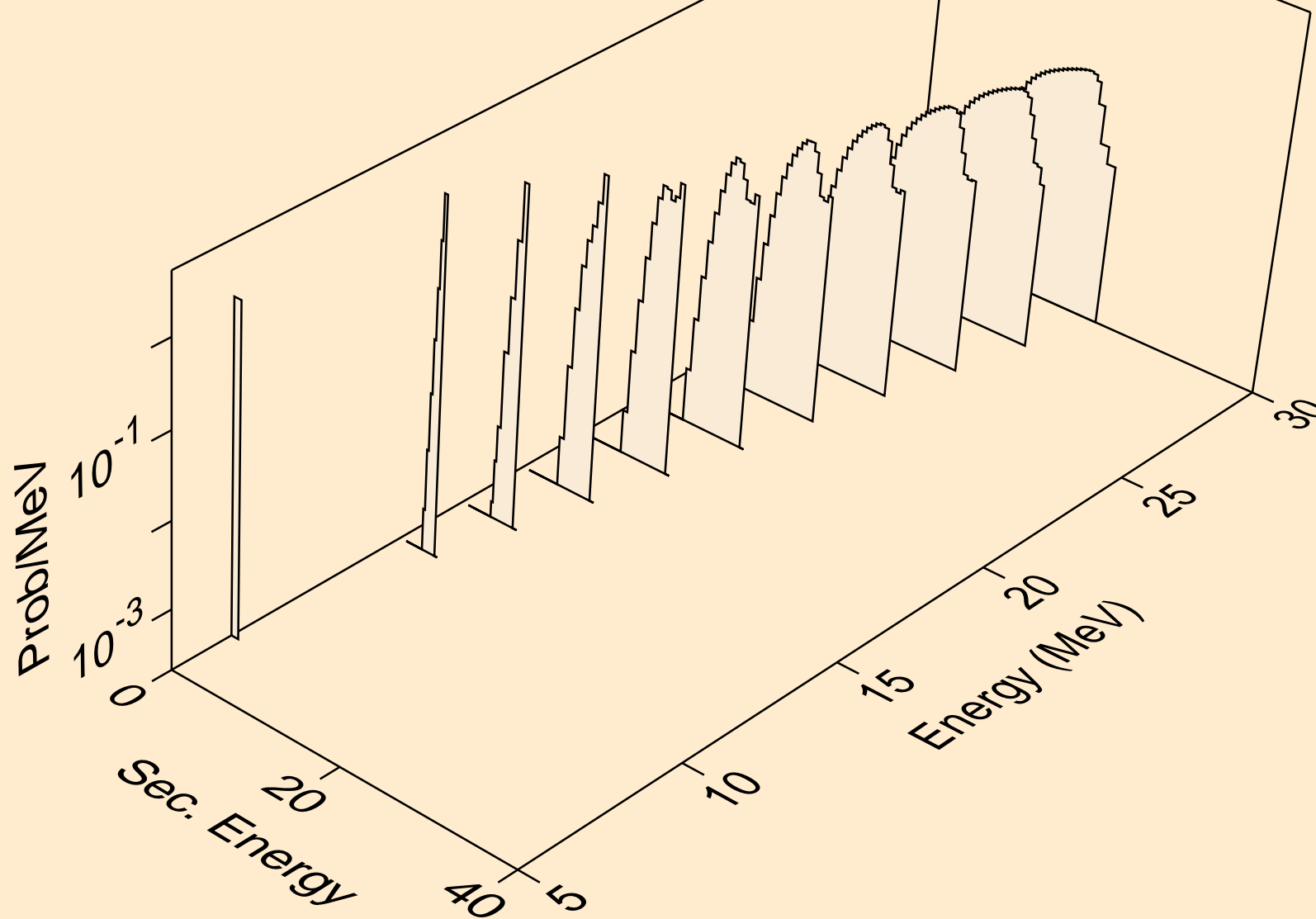

LA119 DEUTERON ACER TENDL-2021 LIBRARY; T=0.K
he3s from (d,x)

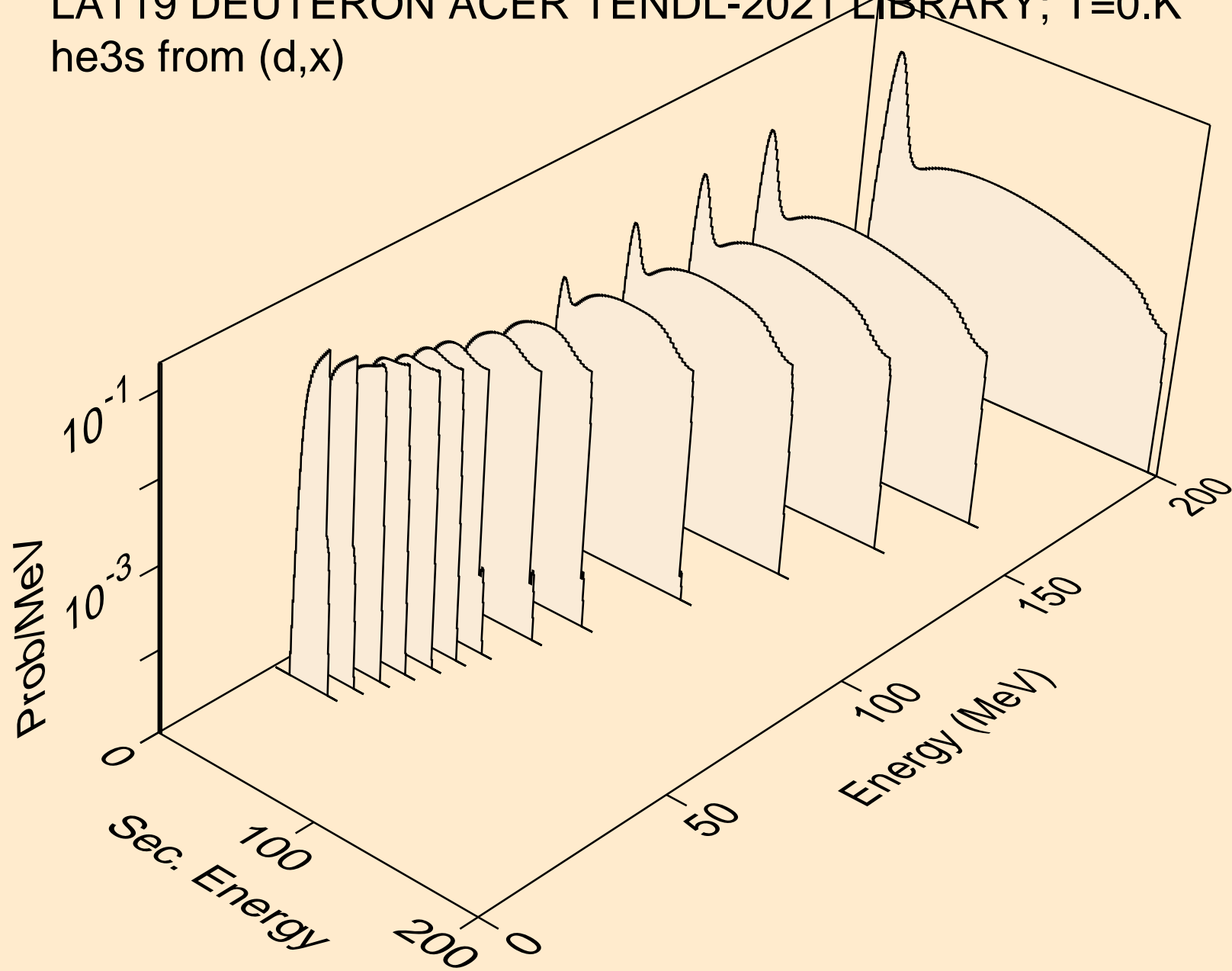

LA119 DEUTERON ACER TENDL-2021 LIBRARY; T=0.K
he3s from (d,n*)he3

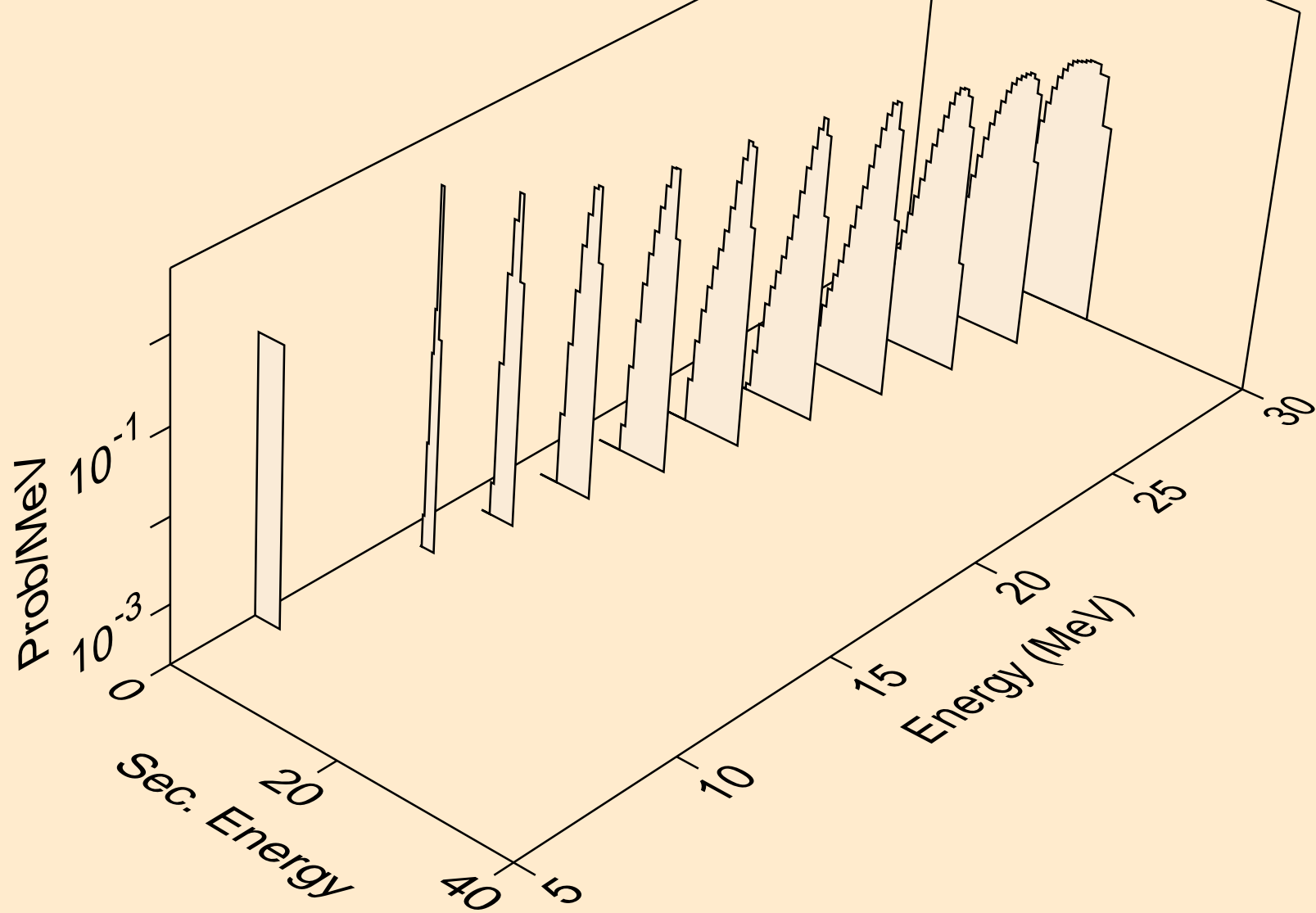

LA119 DEUTERON ACER TENDL-2021 LIBRARY; T=0.K
he3s from (d,he3)

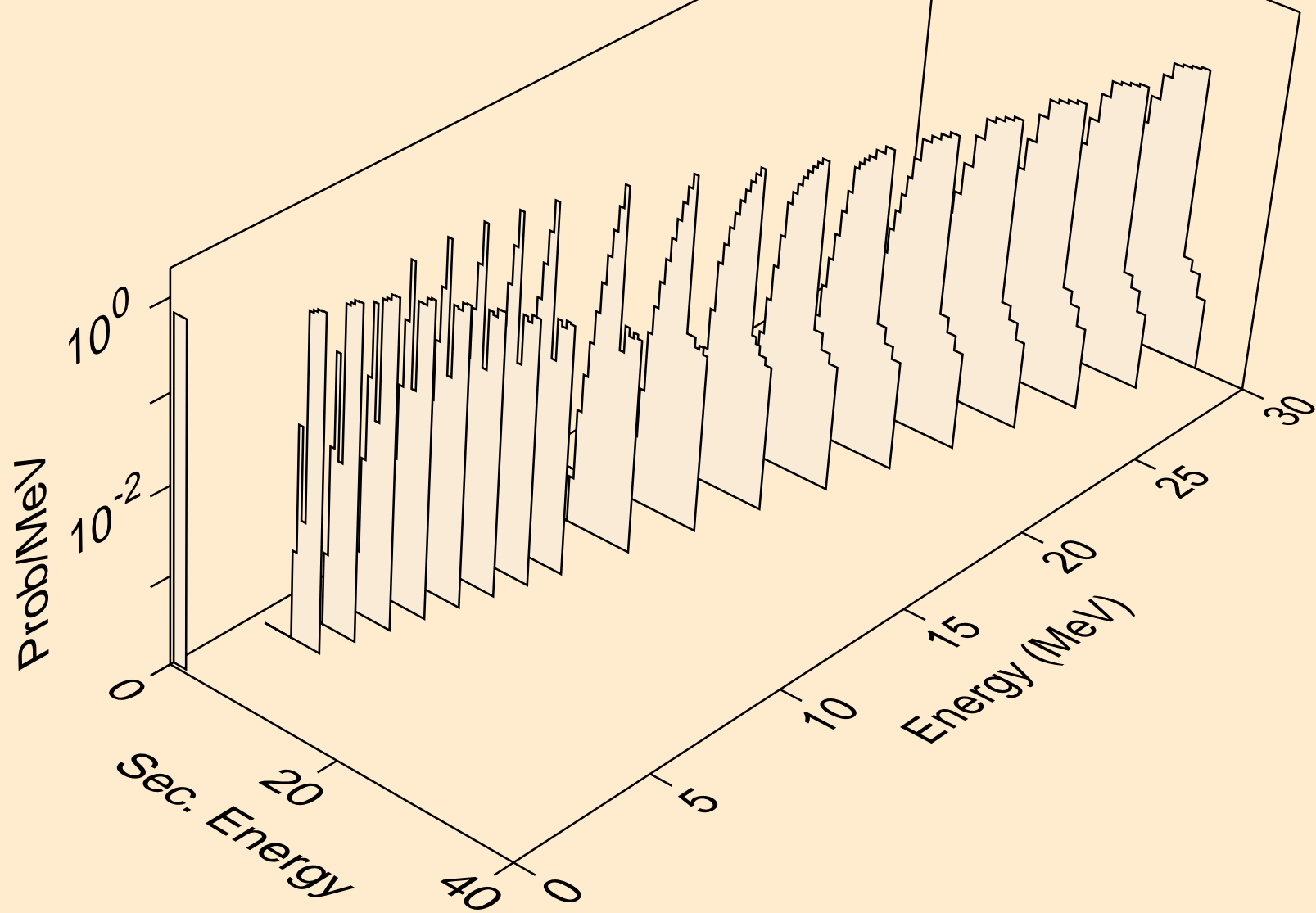

LA119 DEUTERON ACER TENDL-2021 LIBRARY; T=0.K
alphas from (d,x)

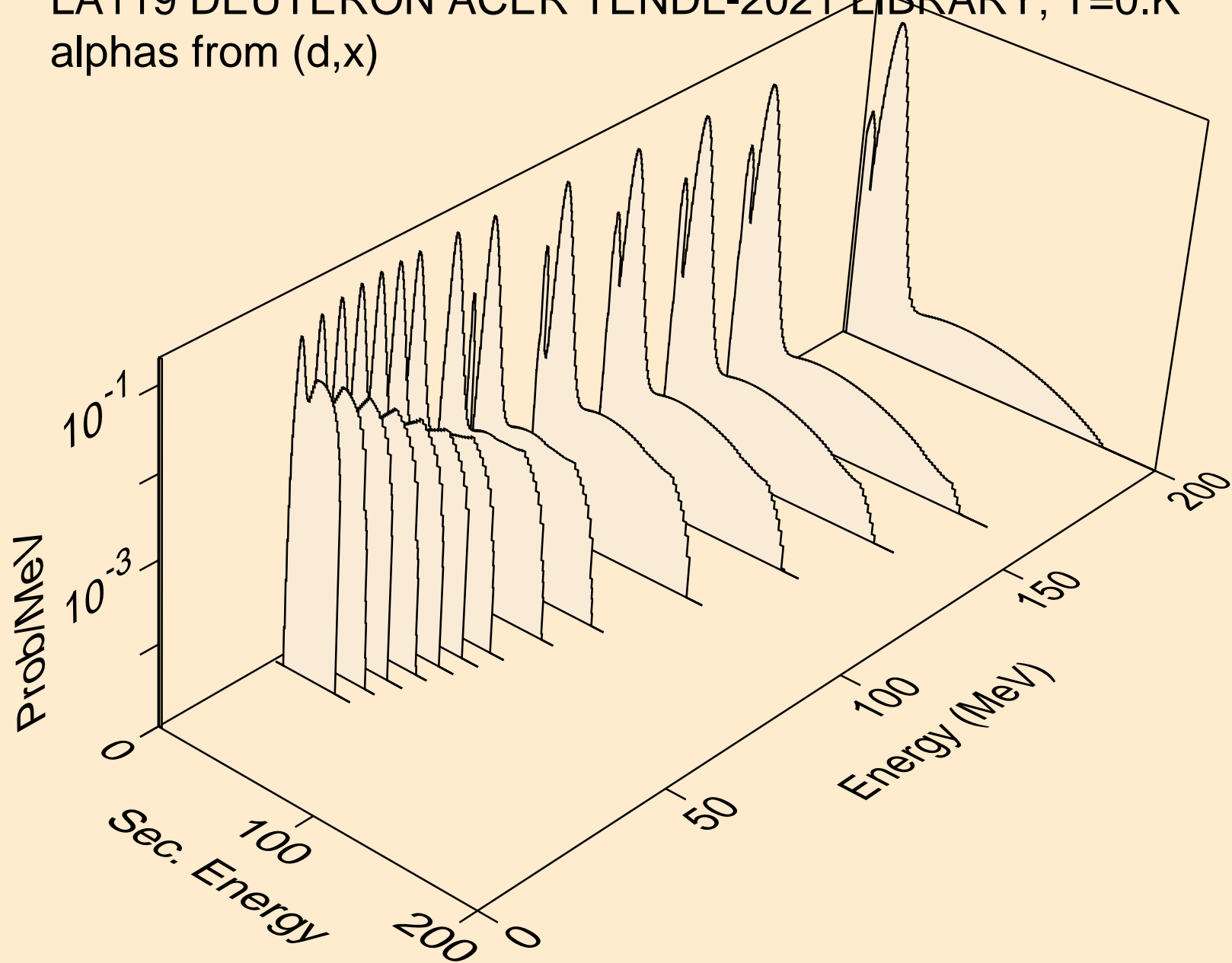

LA119 DEUTERON ACER TENDL-2021 LIBRARY; T=0.K
alphas from (d,n*)a

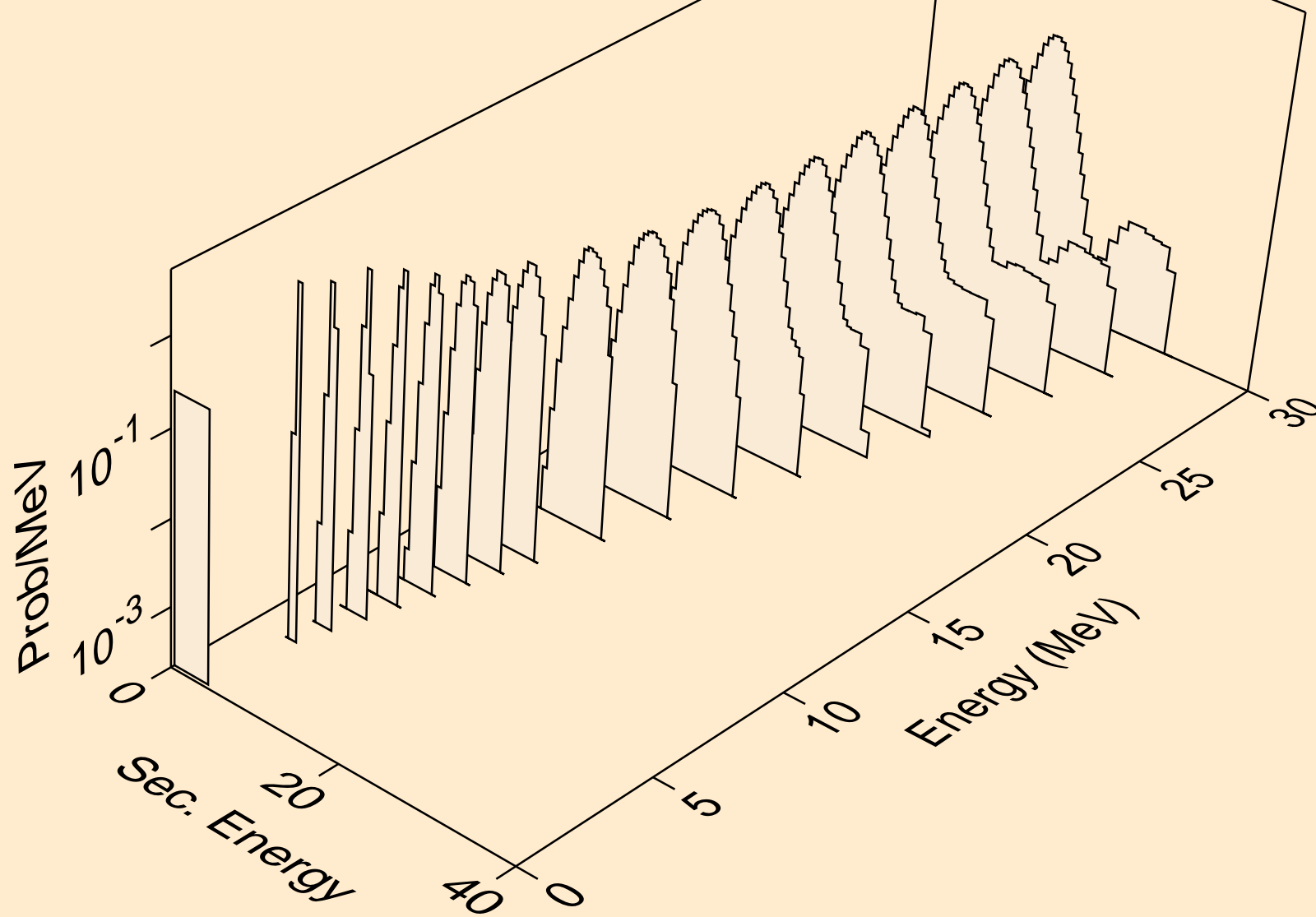

LA119 DEUTERON ACER TENDL-2021 LIBRARY; T=0.K
alphas from (d,2n)a

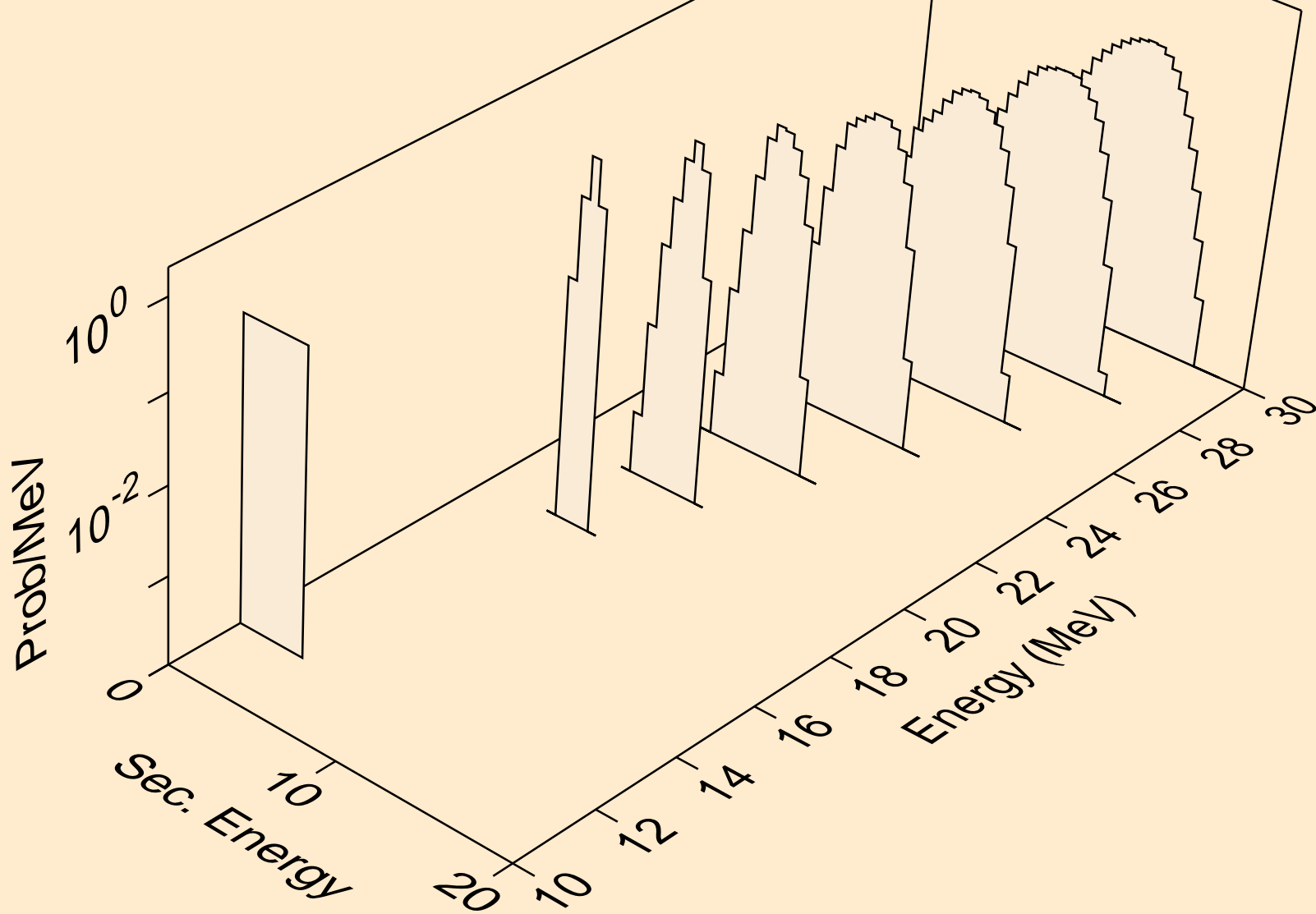

LA119 DEUTERON ACER TENDL-2021 LIBRARY; T=0.K
alphas from (d,n*)2a

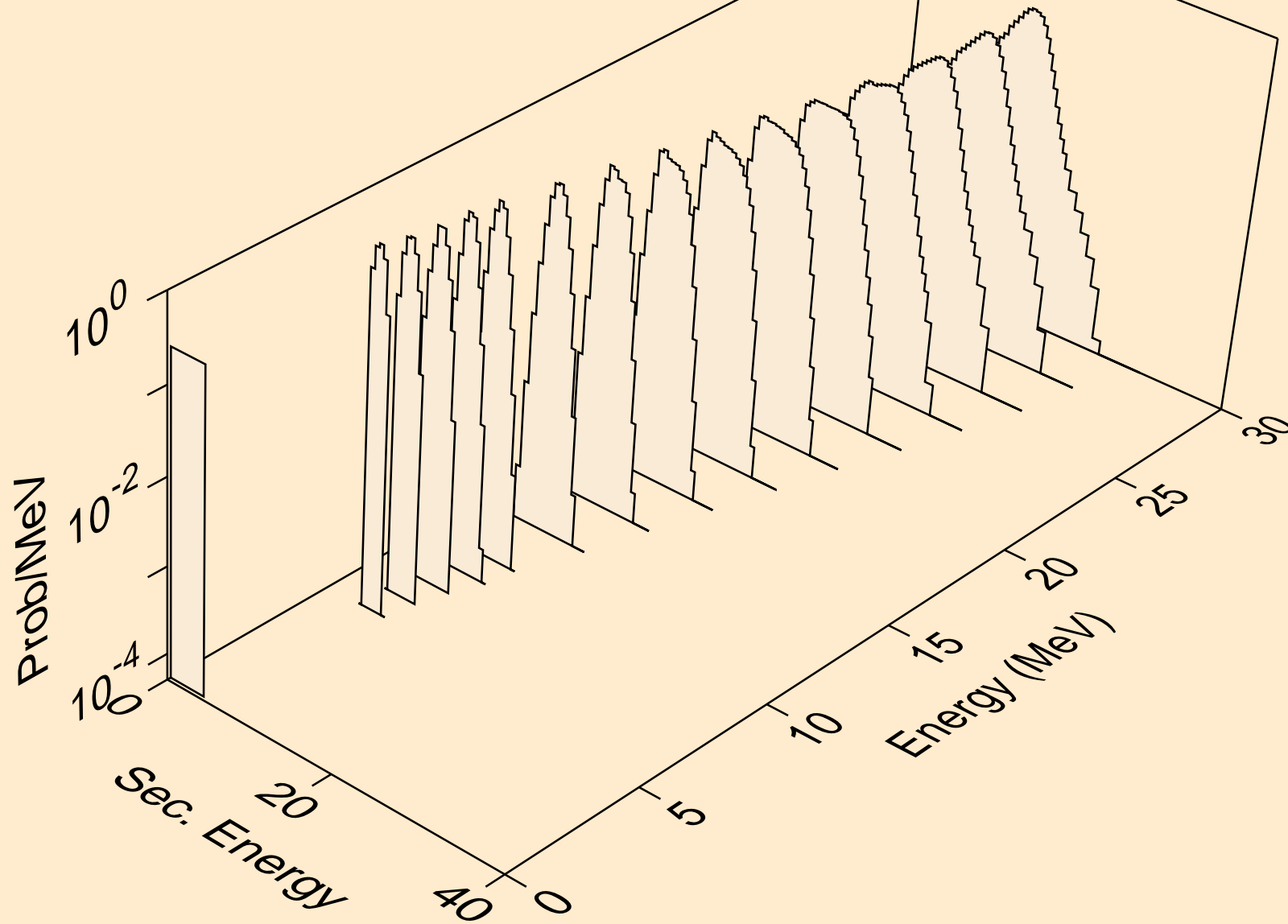

LA119 DEUTERON ACER TENDL-2021 LIBRARY; T=0.K
alphas from (d,npa)

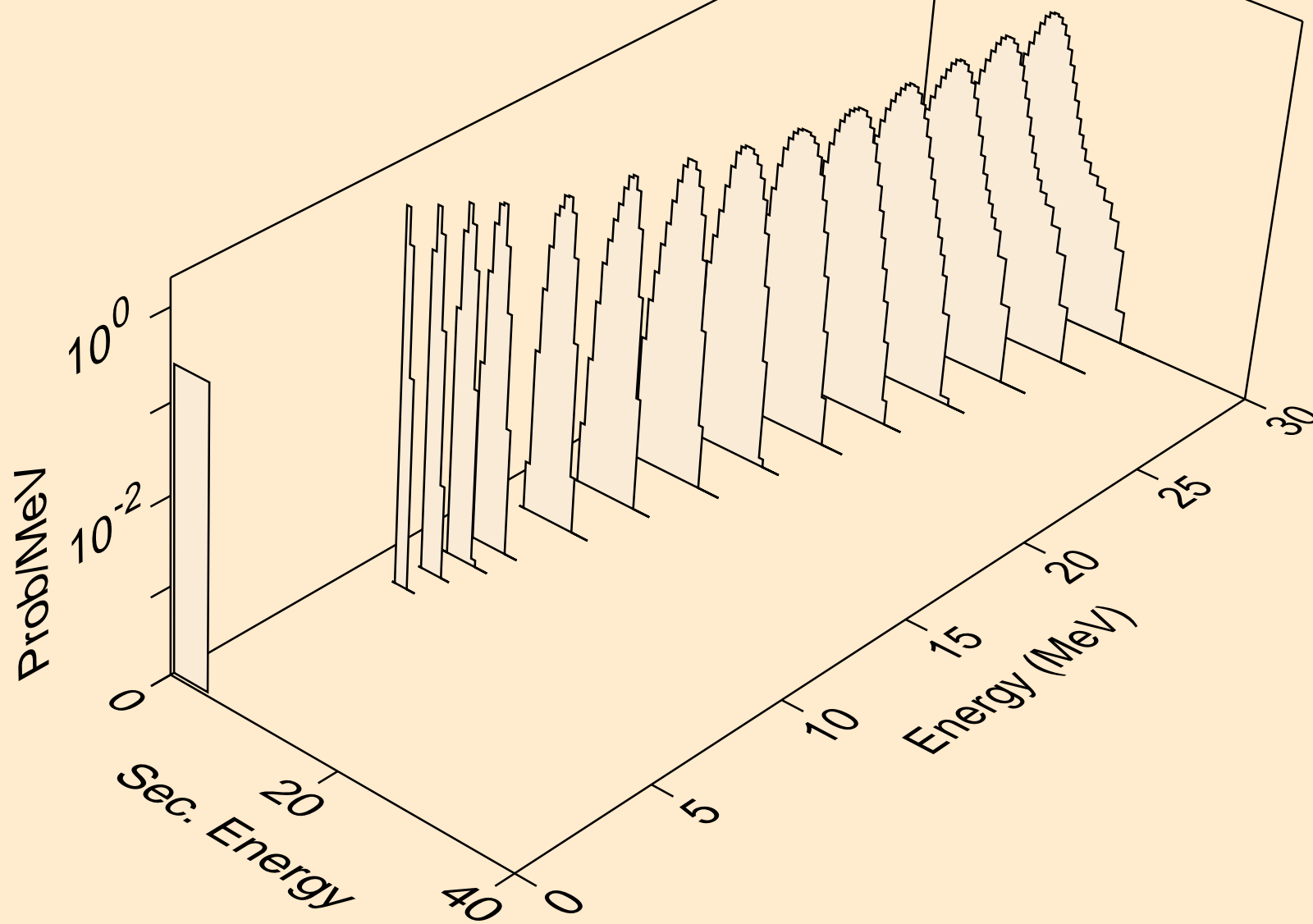

LA119 DEUTERON ACER TENDL-2021 LIBRARY; T=0.K
alphas from (d,a)

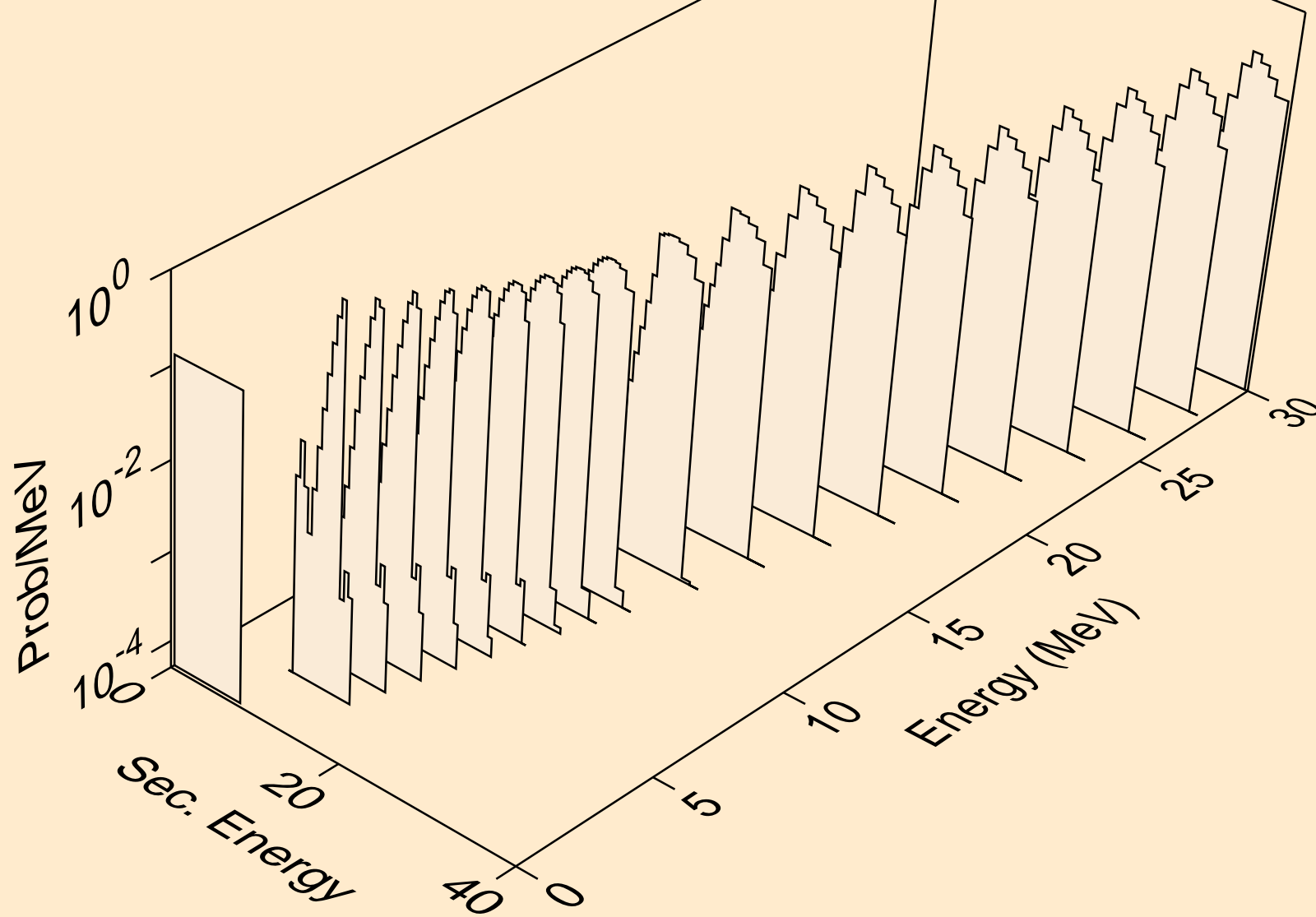

LA119 DEUTERON ACER TENDL-2021 LIBRARY; T=0.K
alphas from (d,2a)

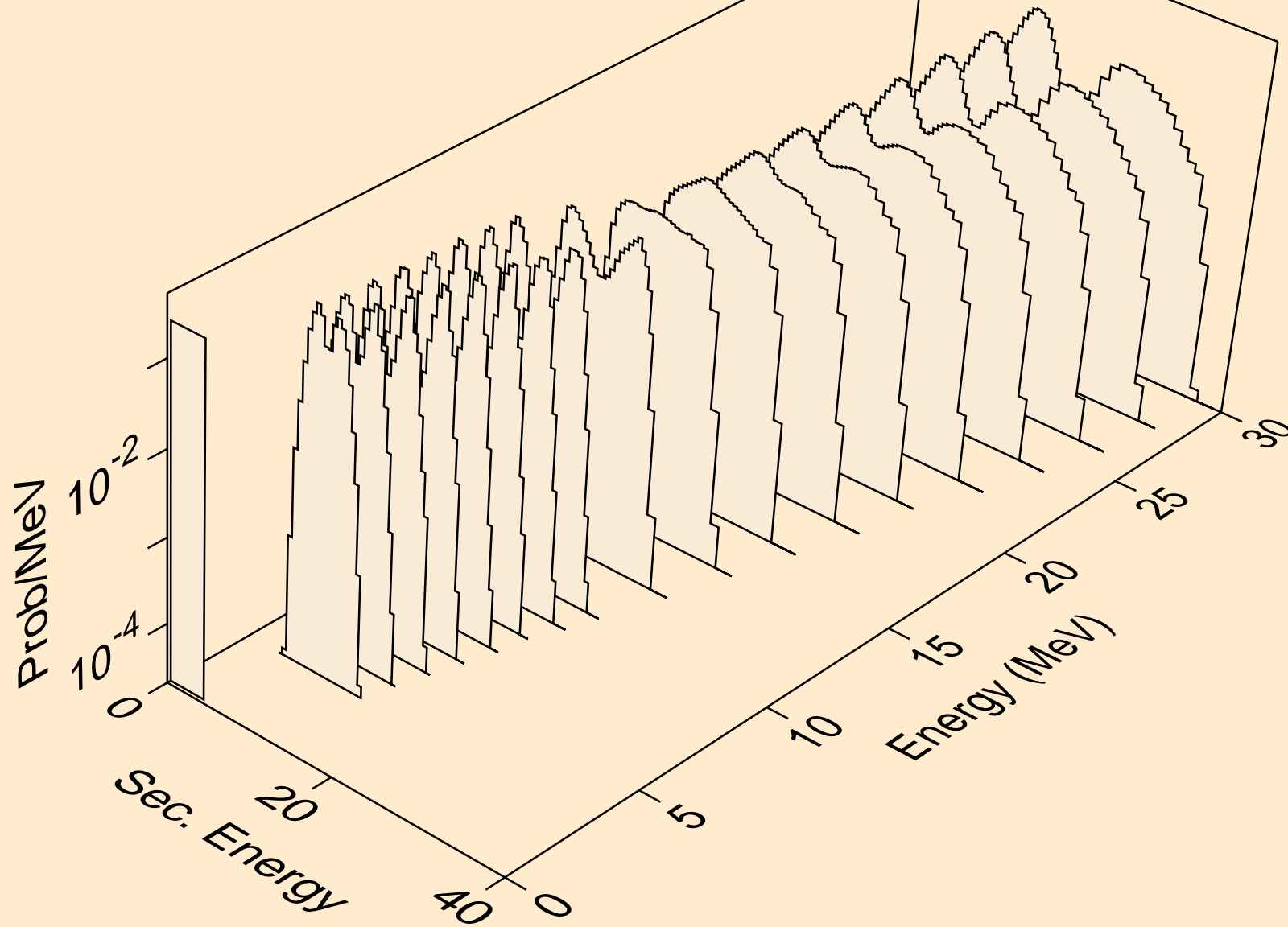

LA119 DEUTERON ACER TENDL-2021 LIBRARY; T=0.K
alphas from (d,3a)

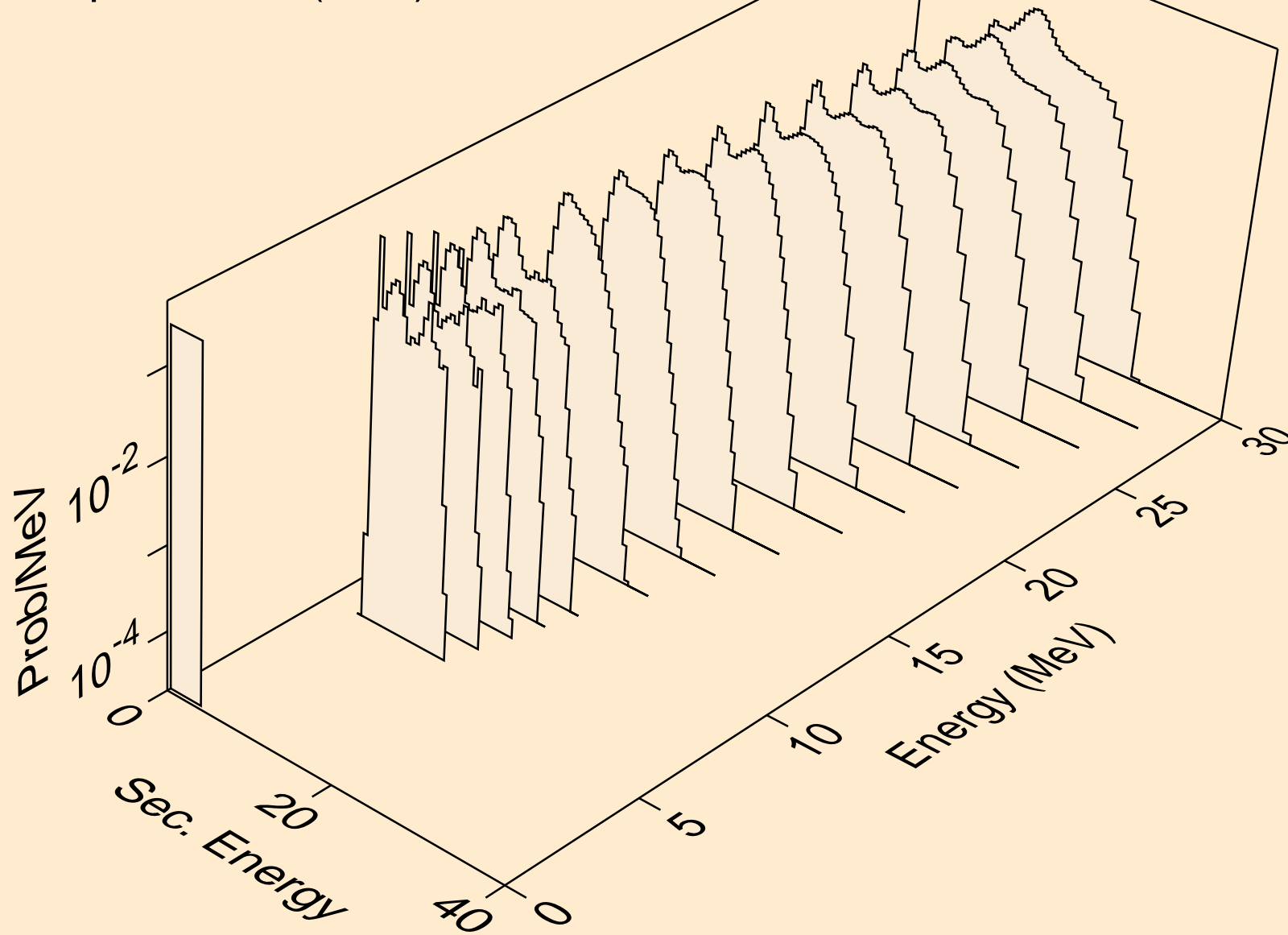

LA119 DEUTERON ACER TENDL-2021 LIBRARY; T=0.K
alphas from (d,pa)

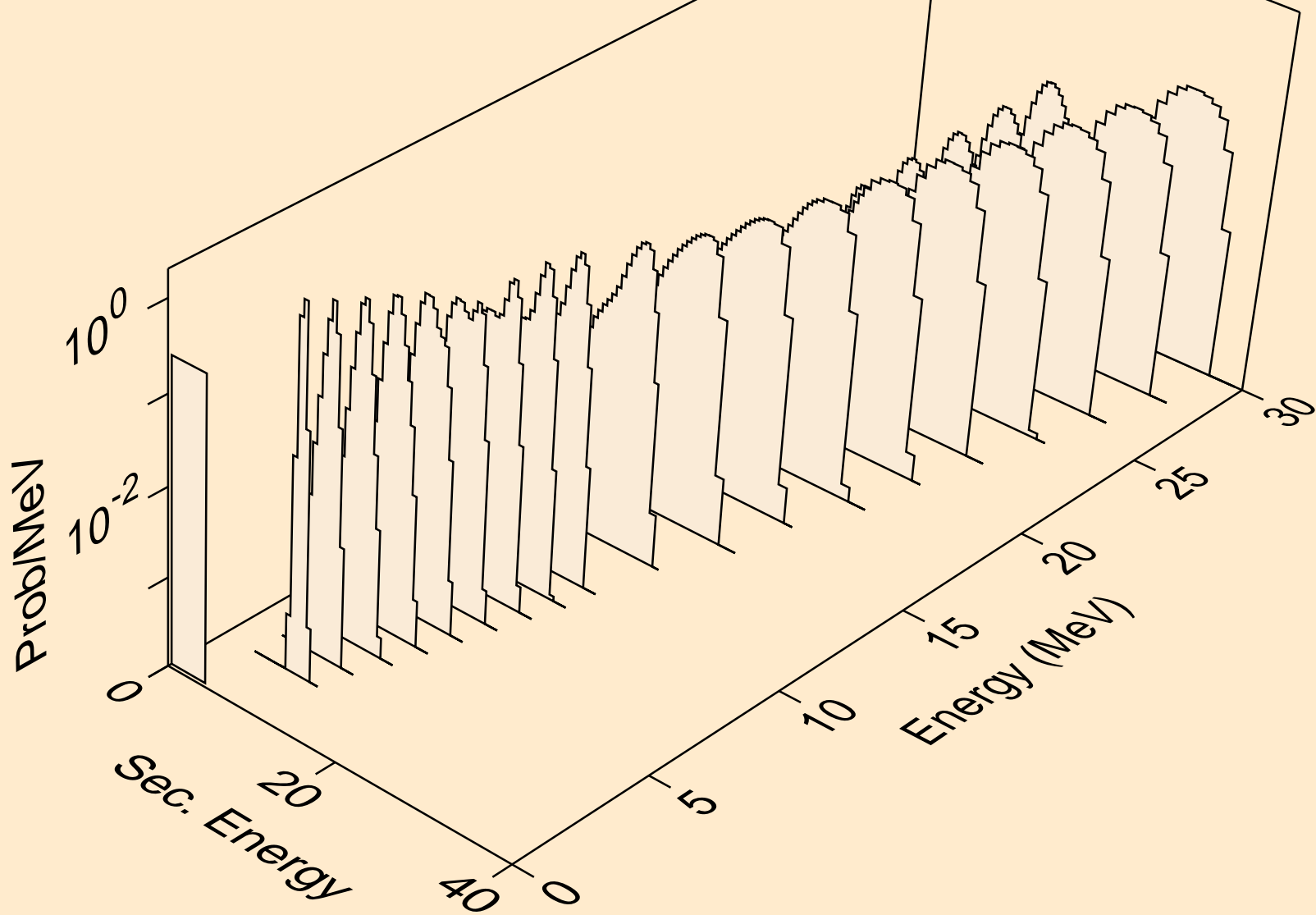

LA119 DEUTERON ACER TENDL-2021 LIBRARY; T=0.K
alphas from (d,d2a)

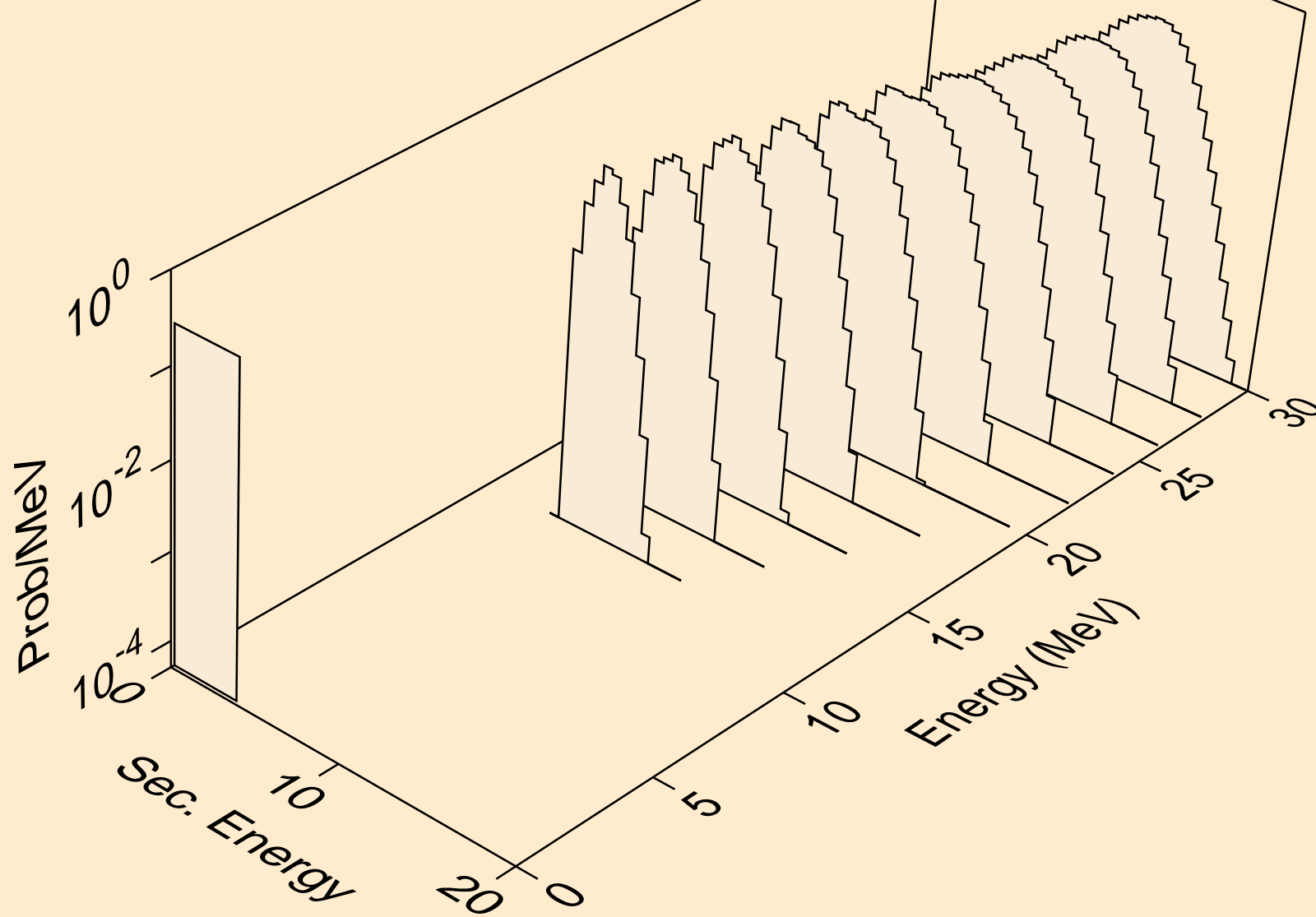

LA119 DEUTERON ACER TENDL-2021 LIBRARY; T=0.K
alphas from (d,da)

