

LR265 DEUTERON ACER TENDL-2021 LIBRARY; T=0.K  
Principal cross sections

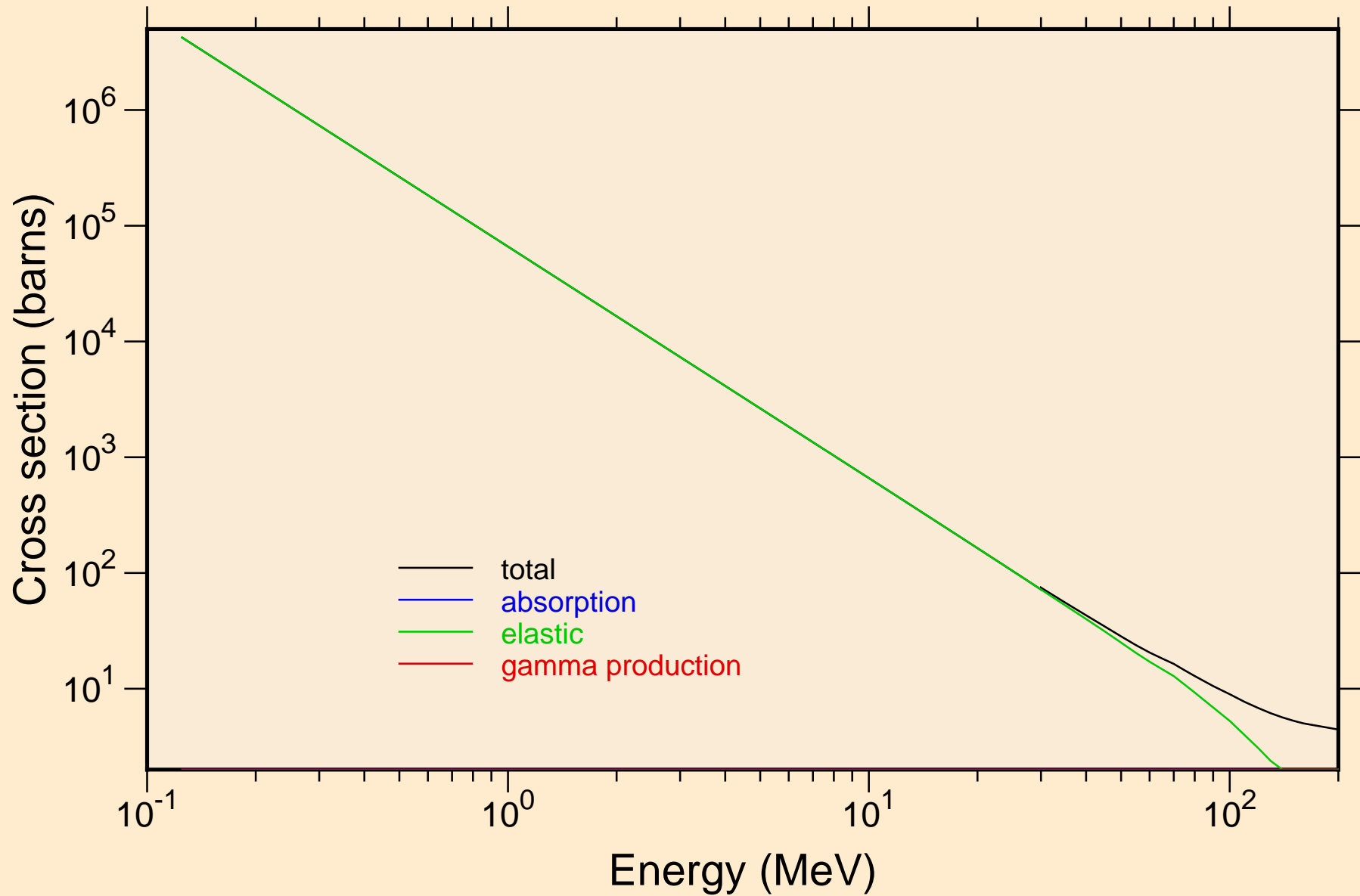

LR265 DEUTERON ACER TENDL-2021 LIBRARY; T=0.K  
Heating

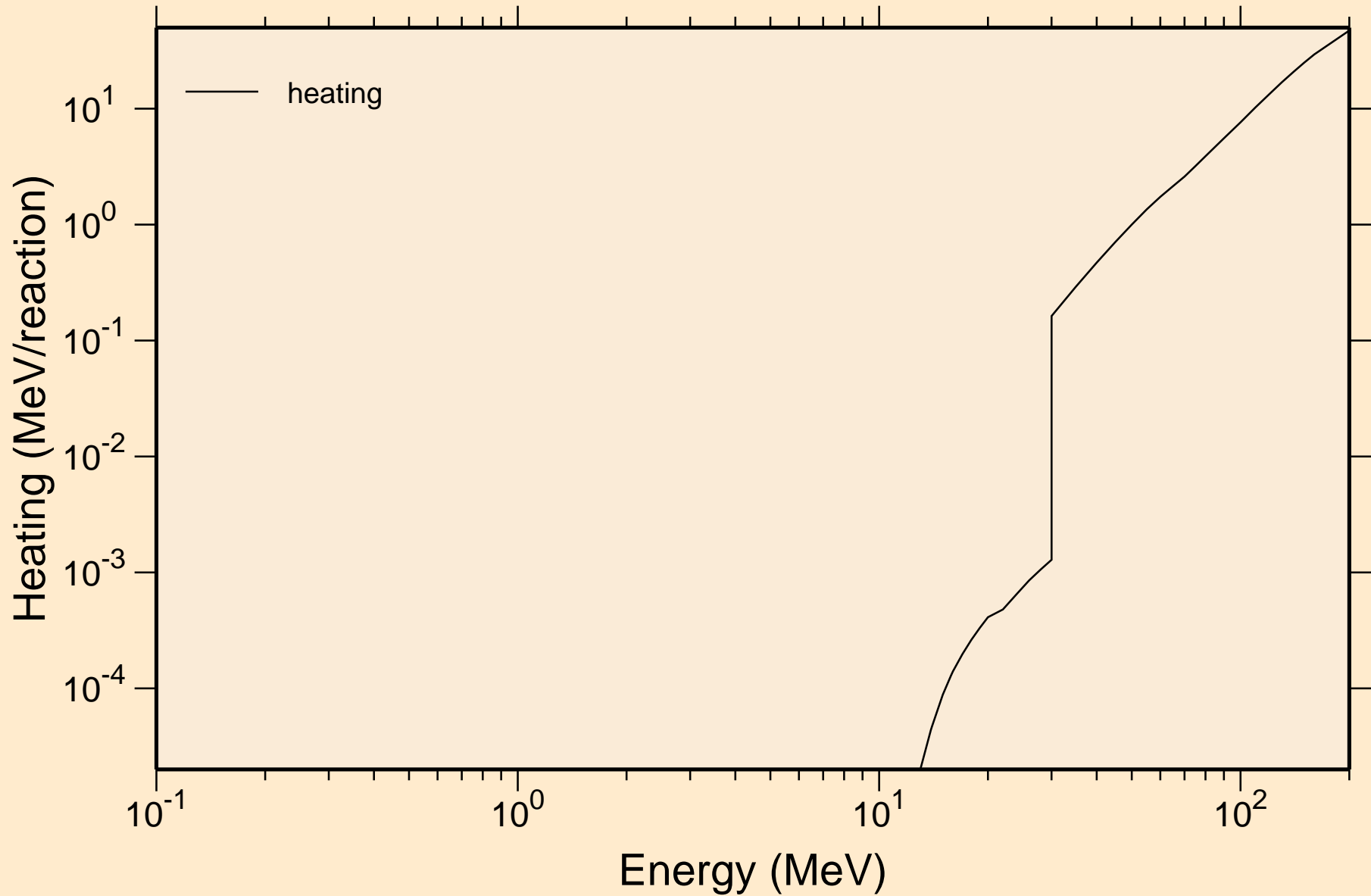

LR265 DEUTERON ACER TENDL-2021 LIBRARY; T=0.K  
Principal cross sections

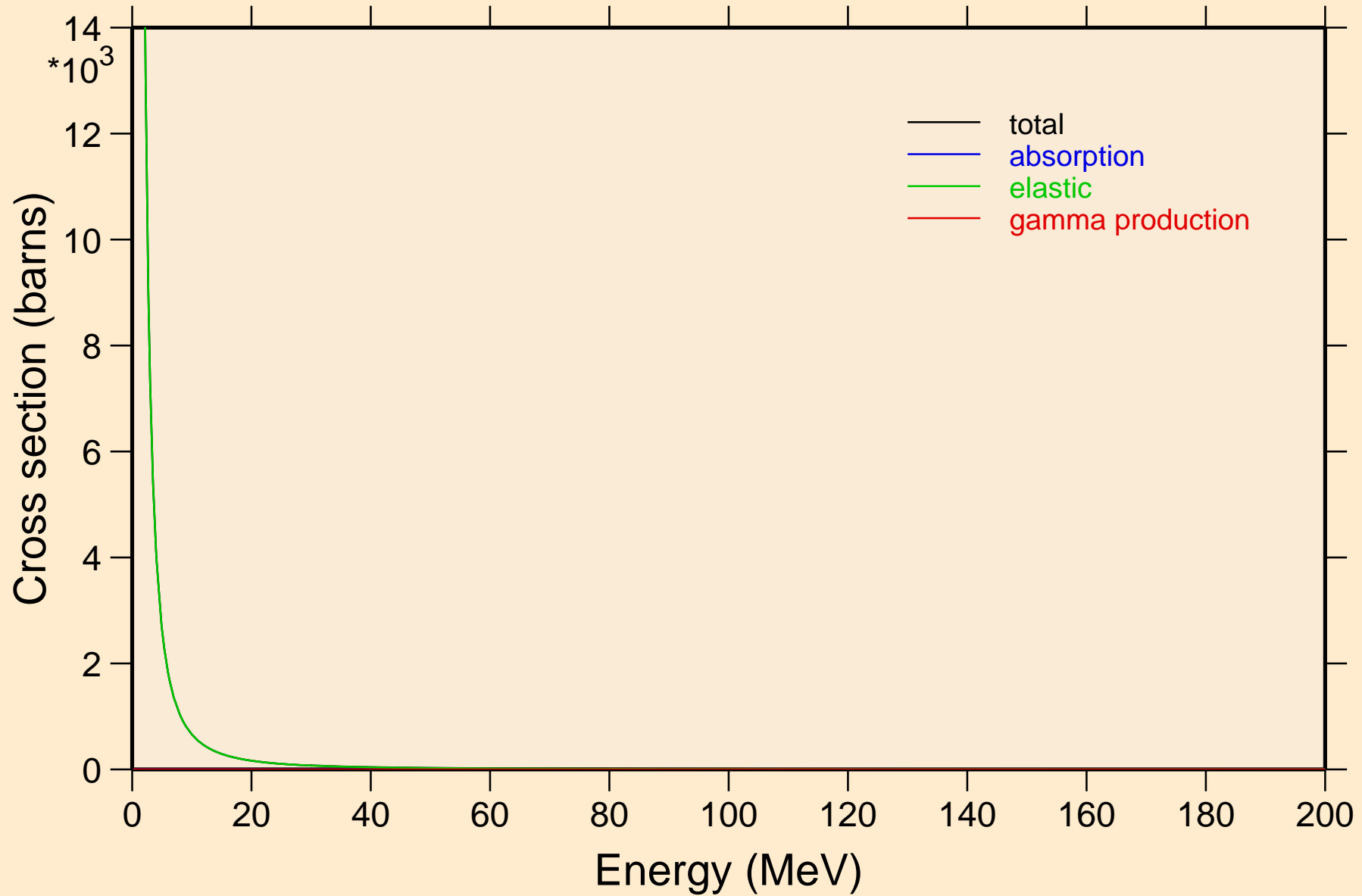

LR265 DEUTERON ACER TENDL-2021 LIBRARY; T=0.K

Heating

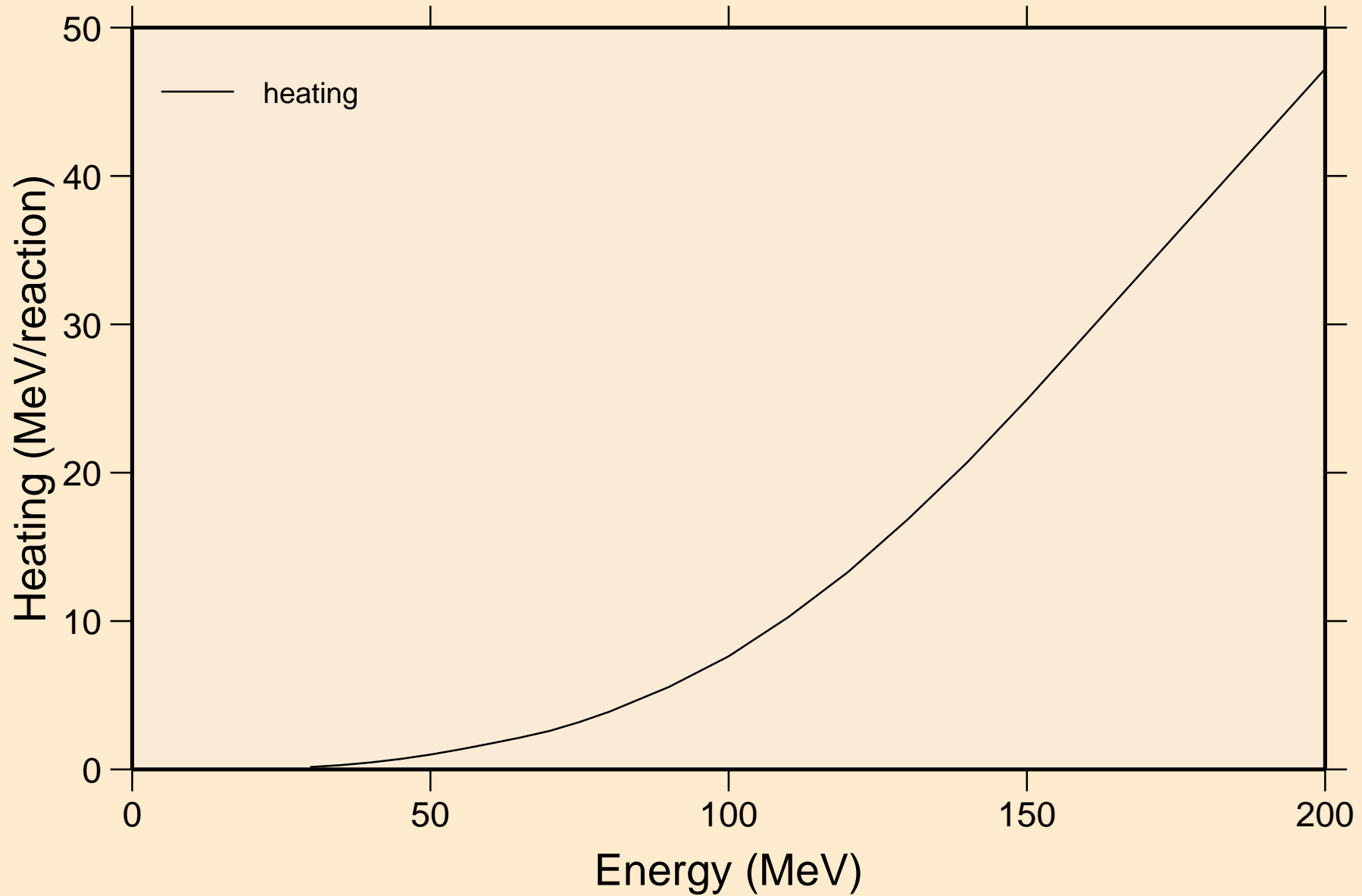

# LR265 DEUTERON ACER TENDL-2021 LIBRARY; T=0.K

## Threshold reactions

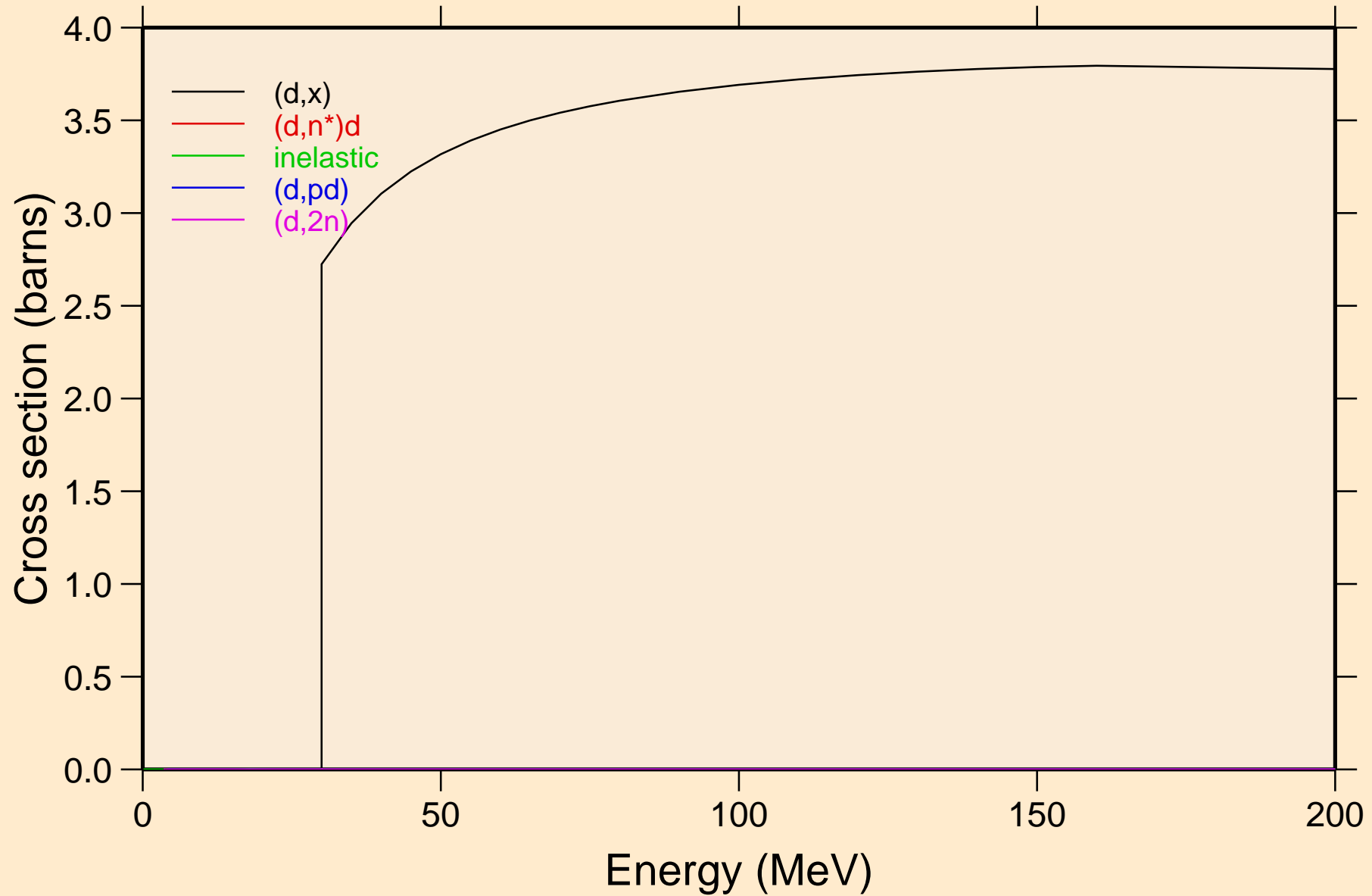

# LR265 DEUTERON ACER TENDL-2021 LIBRARY; T=0.K

## Threshold reactions

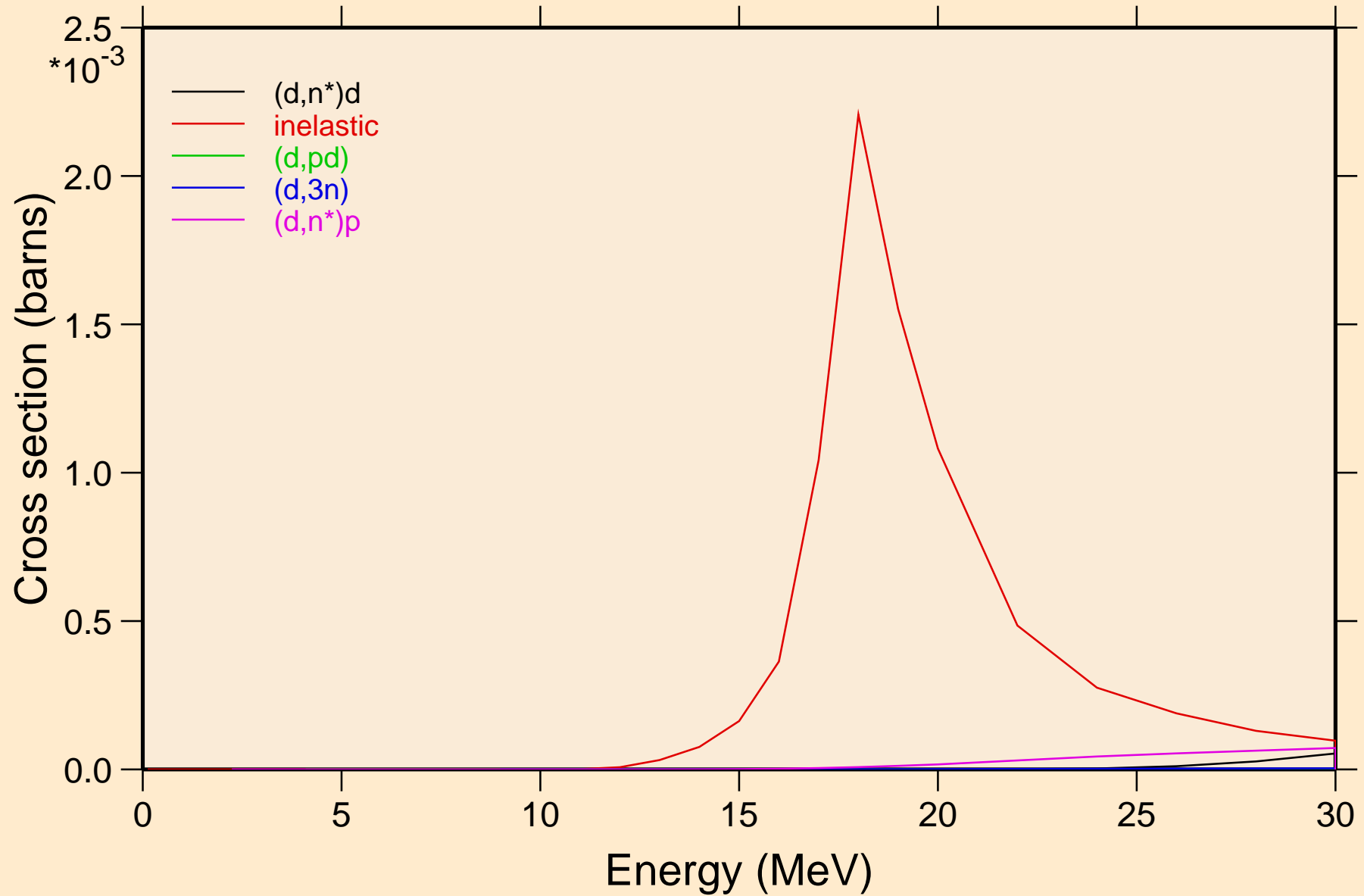

LR265 DEUTERON ACER TENDL-2021 LIBRARY; T=0.K  
Threshold reactions

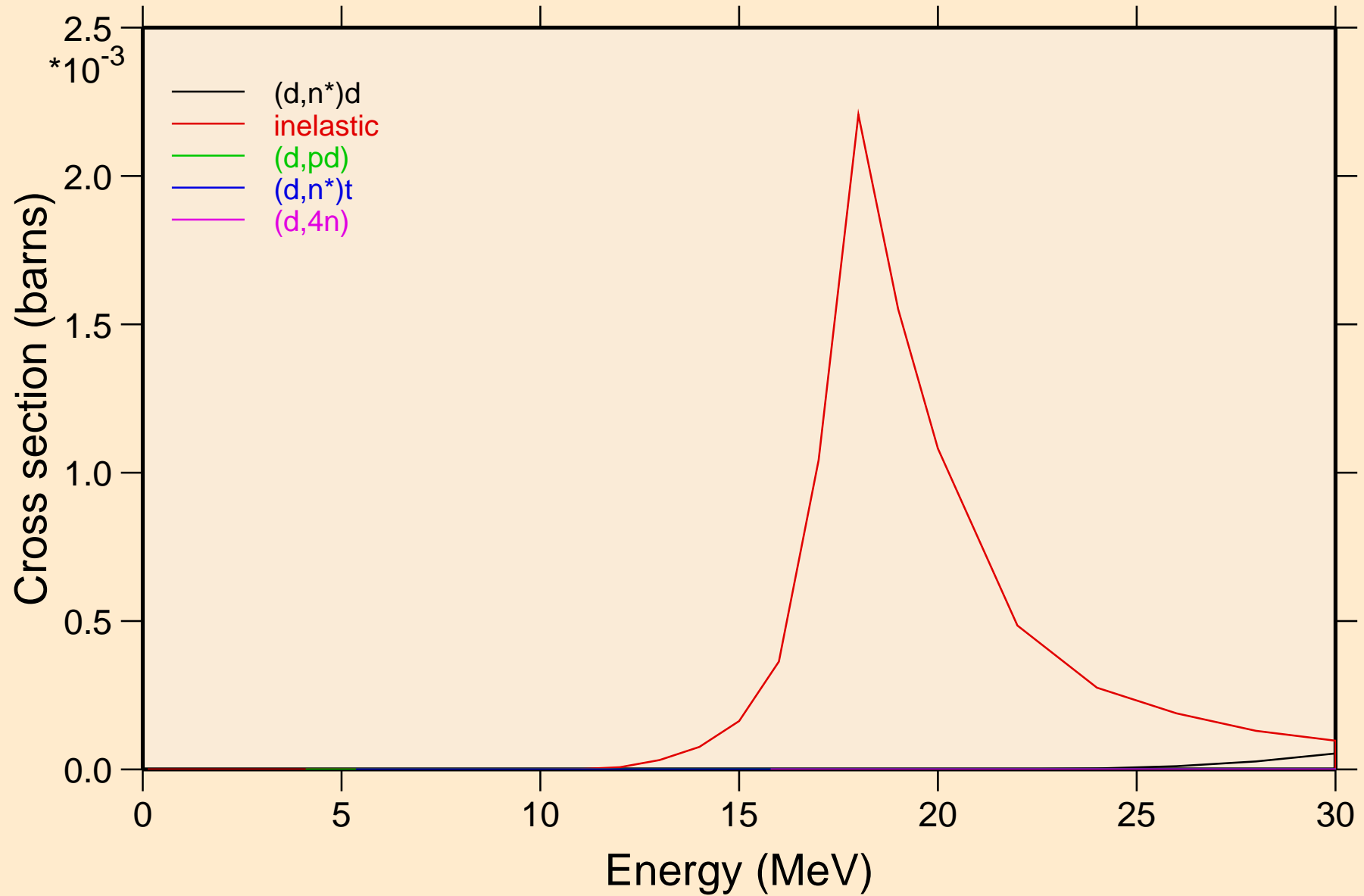

LR265 DEUTERON ACER TENDL-2021 LIBRARY; T=0.K  
Threshold reactions

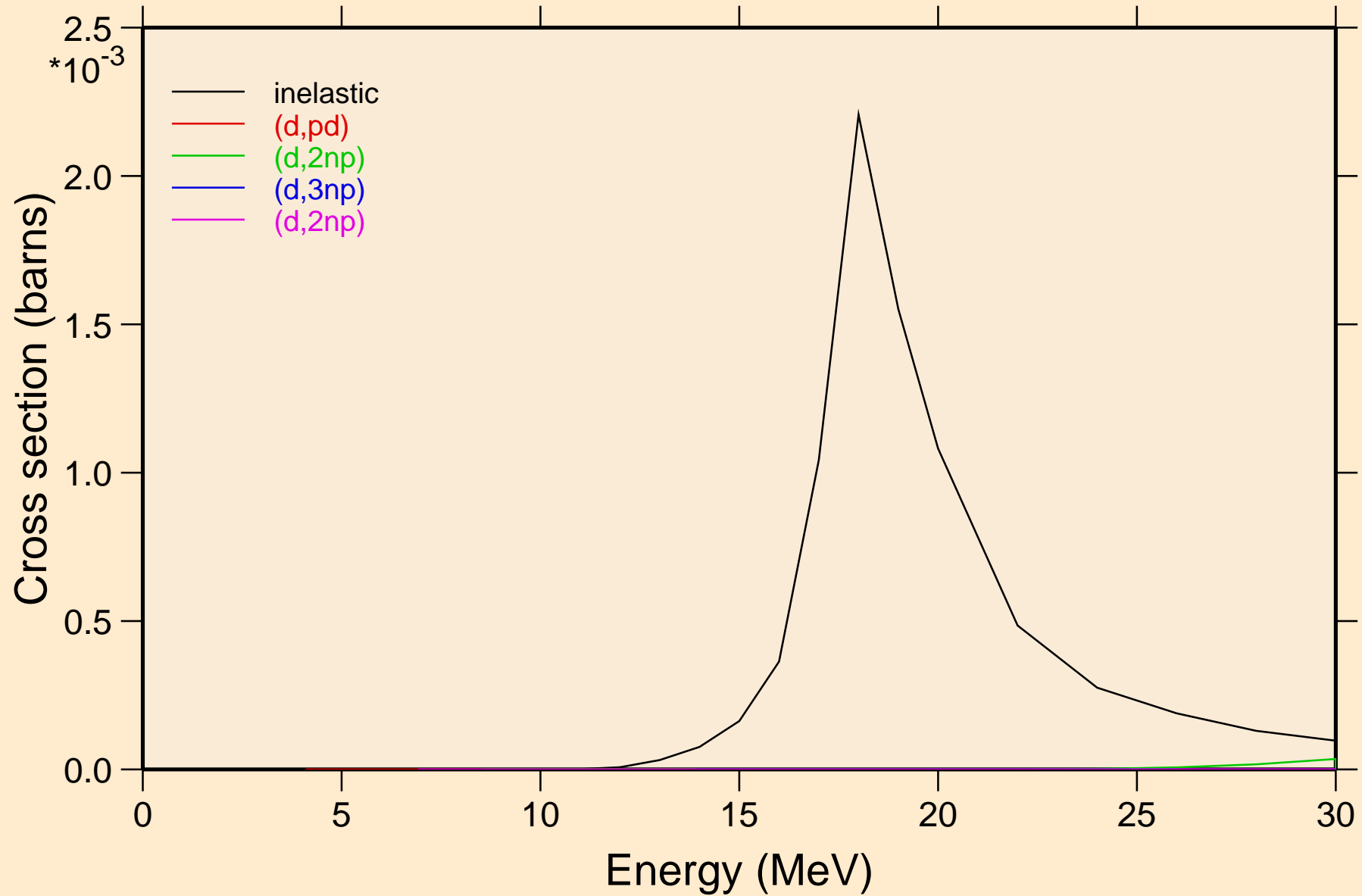



# LR265 DEUTERON ACER TENDL-2021 LIBRARY; T=0.K

## Threshold reactions

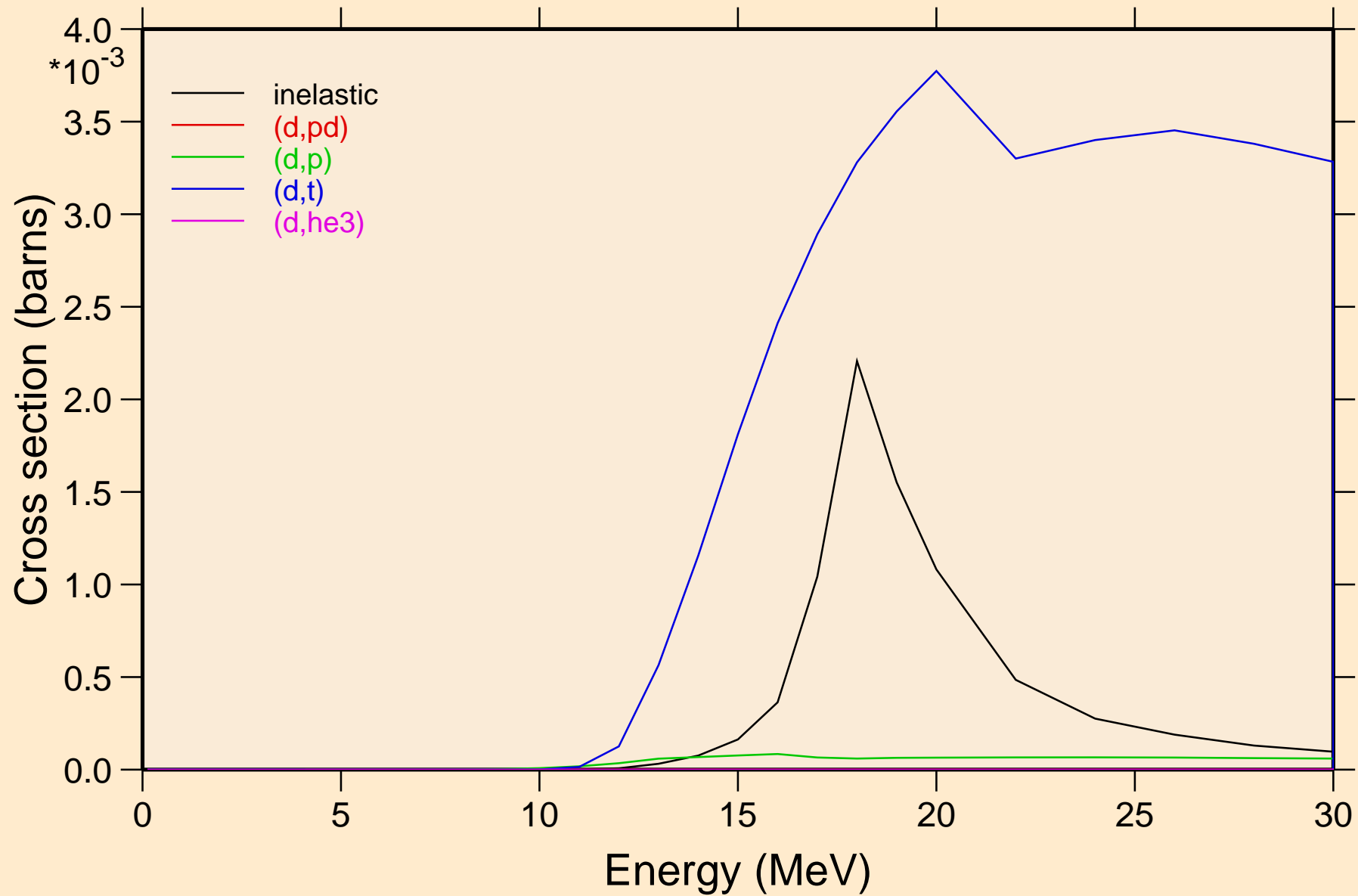

LR265 DEUTERON ACER TENDL-2021 LIBRARY; T=0.K  
Threshold reactions

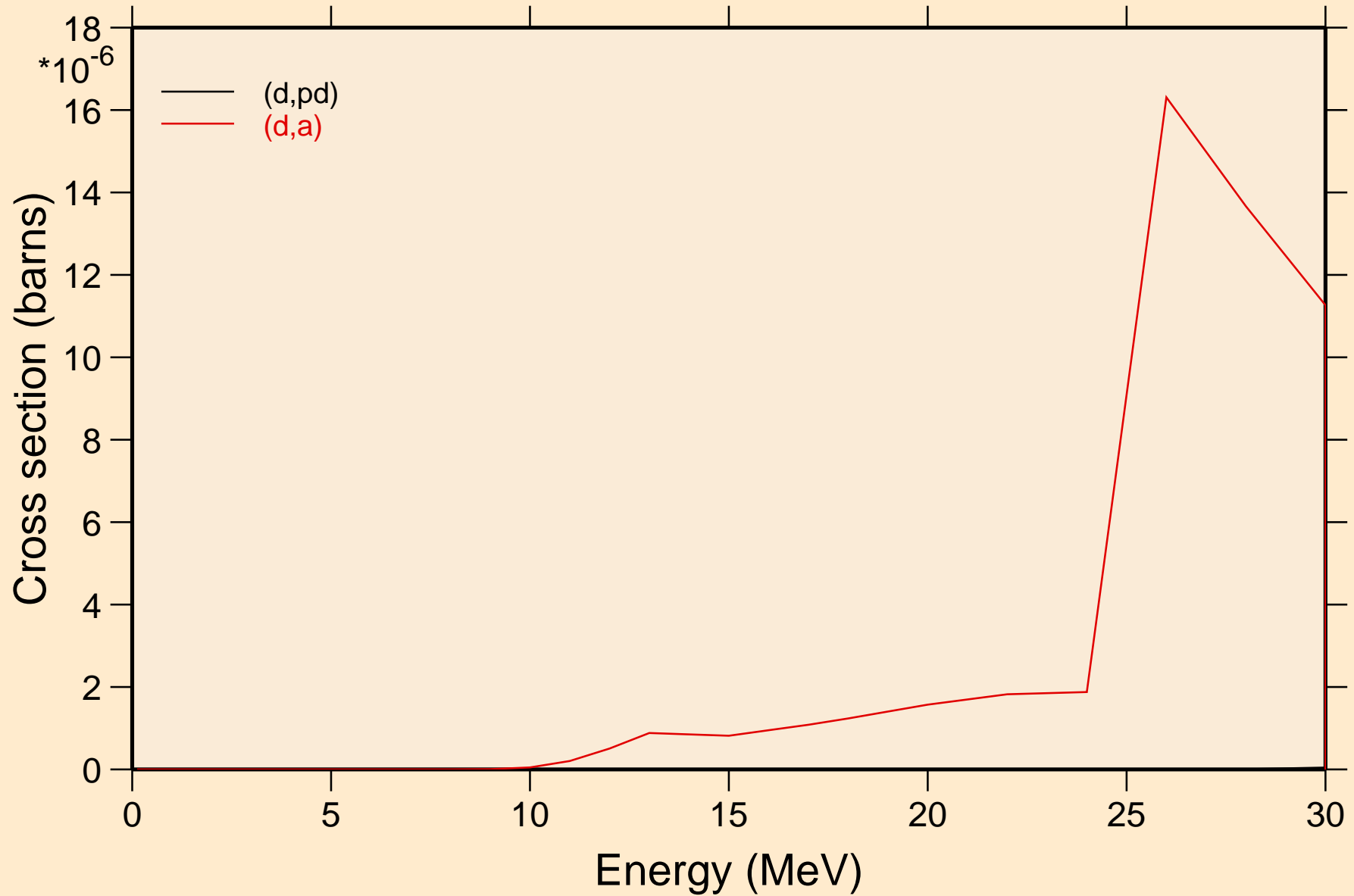

LR265 DEUTERON ACER TENDL-2021 LIBRARY; T=0.K  
Threshold reactions

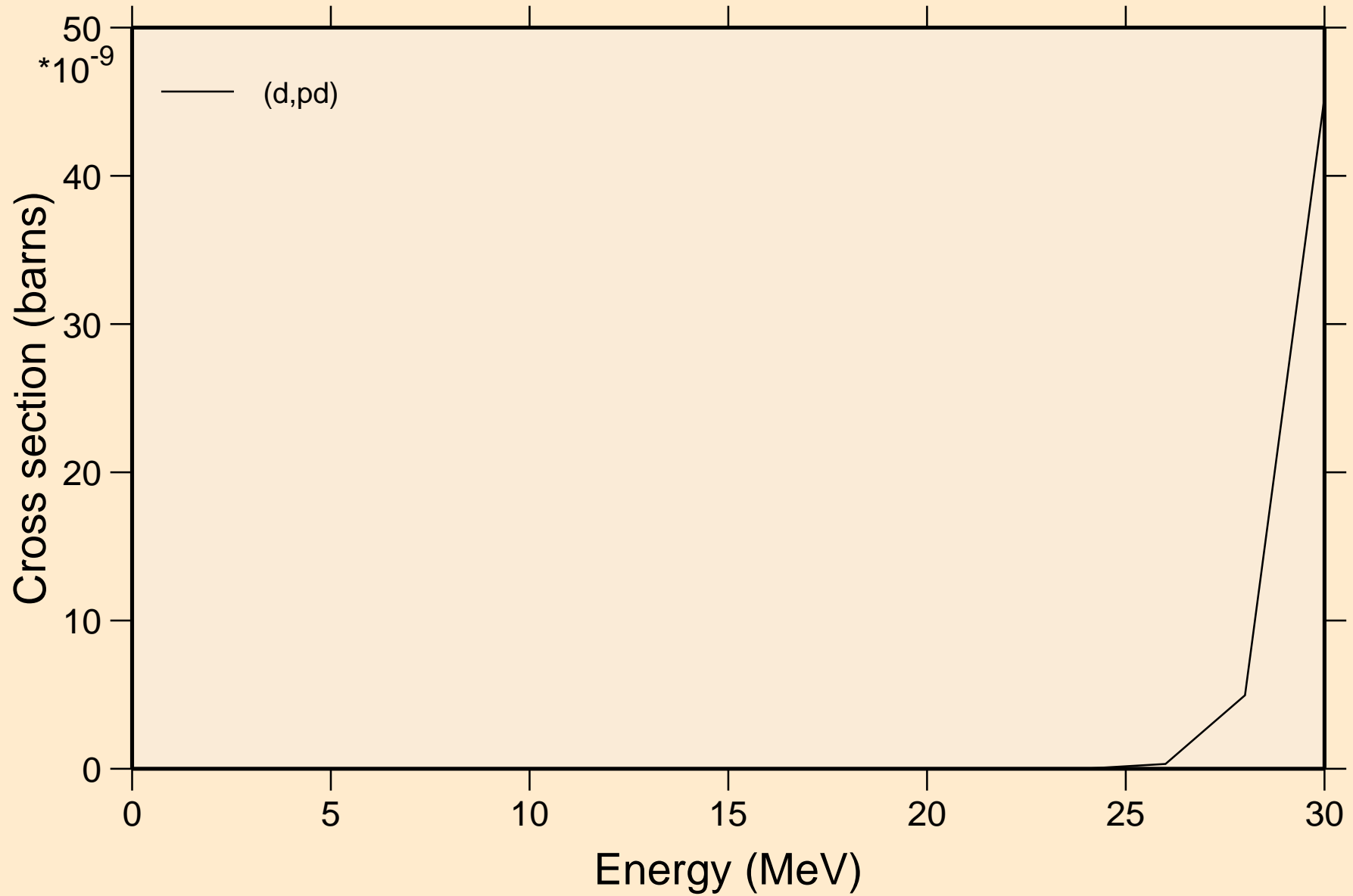

LR265 DEUTERON ACER TENDL-2021 LIBRARY; T=0.K  
angular distribution for elastic

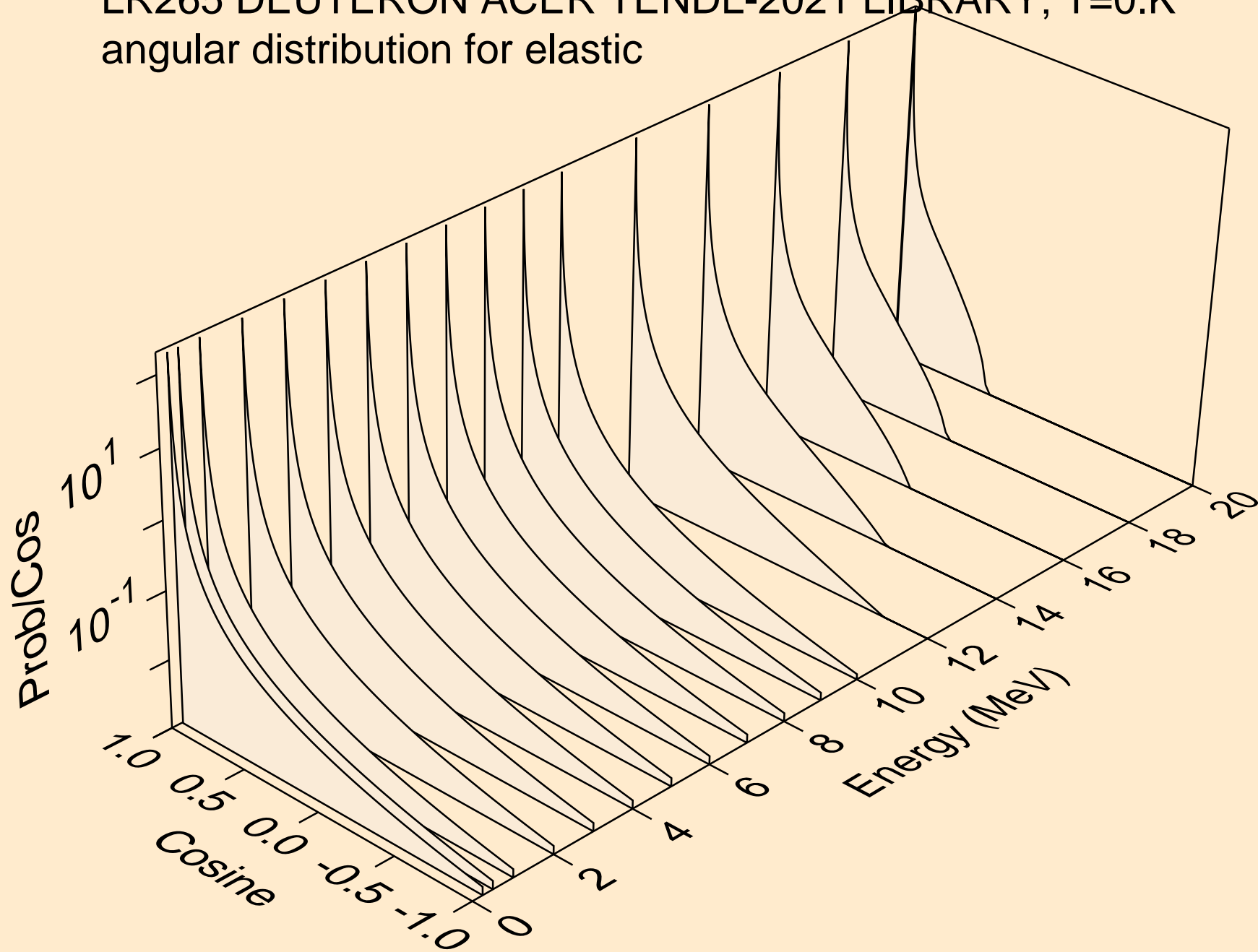

LR265 DEUTERON ACER TENDL-2021 LIBRARY; T=0.K  
angular distribution for elastic

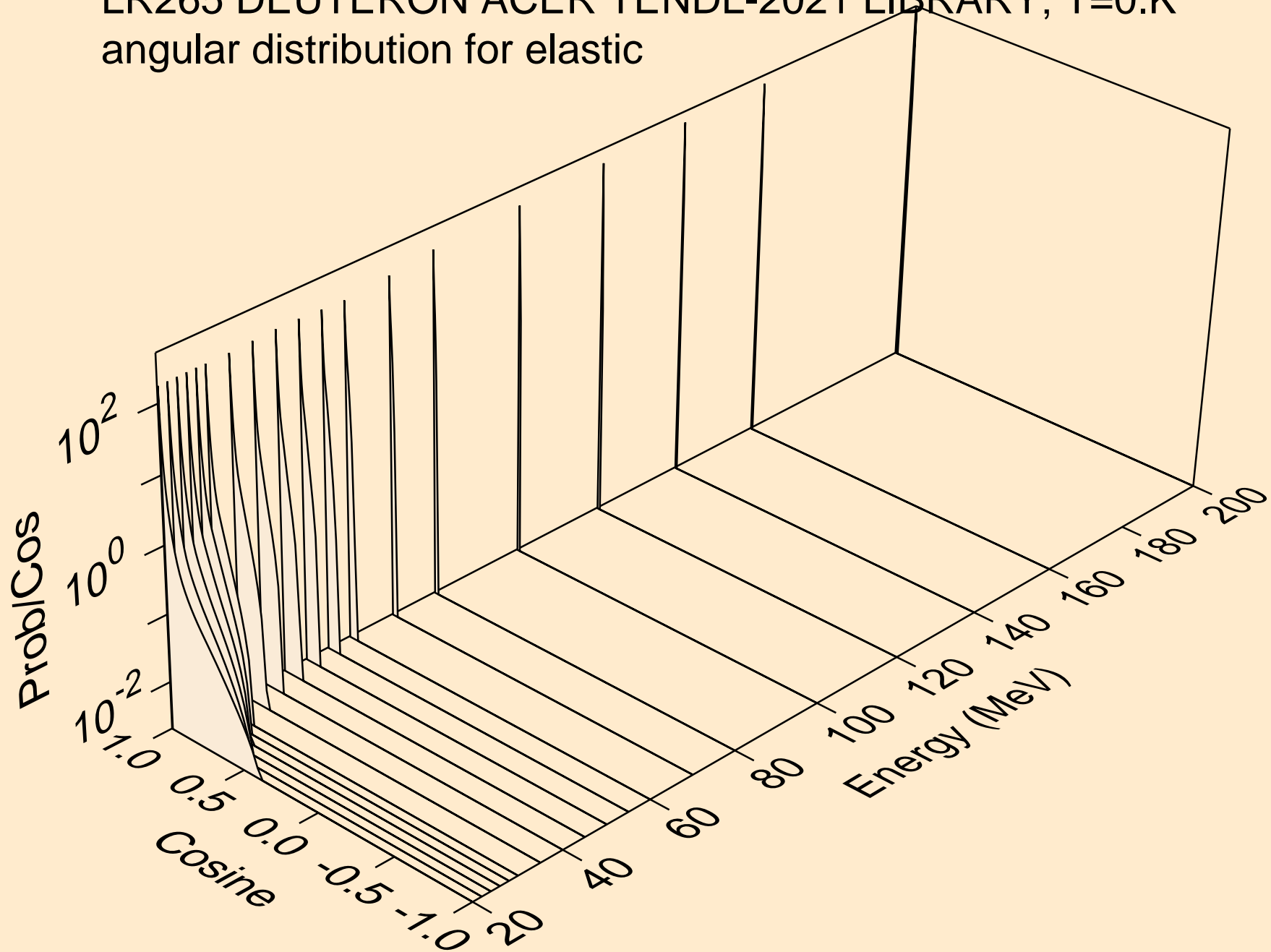

LR265 DEUTERON ACER TENDL-2021 LIBRARY; T=0.K  
Deuteron emission for (d,x)

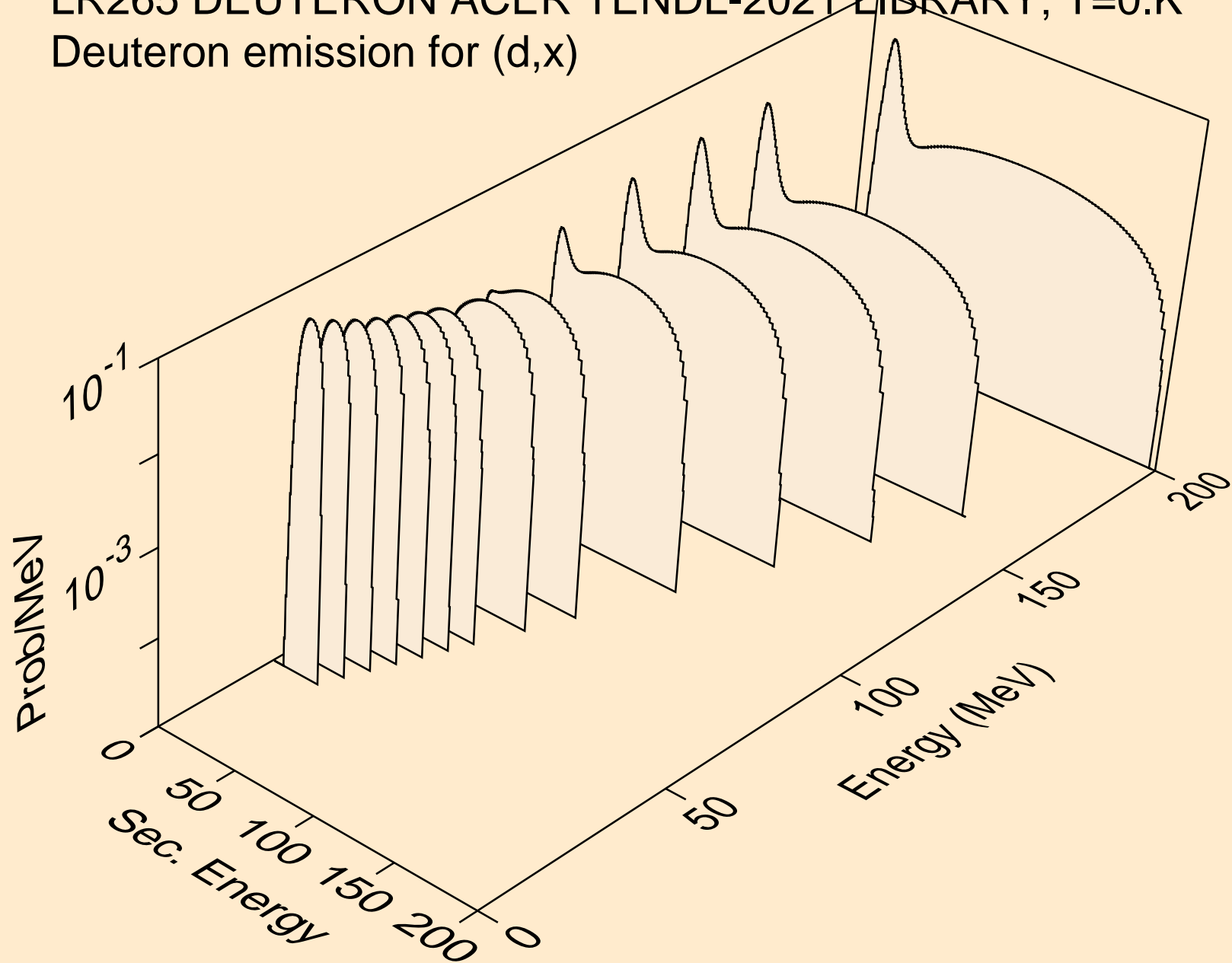

LR265 DEUTERON ACER TENDL-2021 LIBRARY; T=0.K  
Deuteron emission for (d,n\*)d

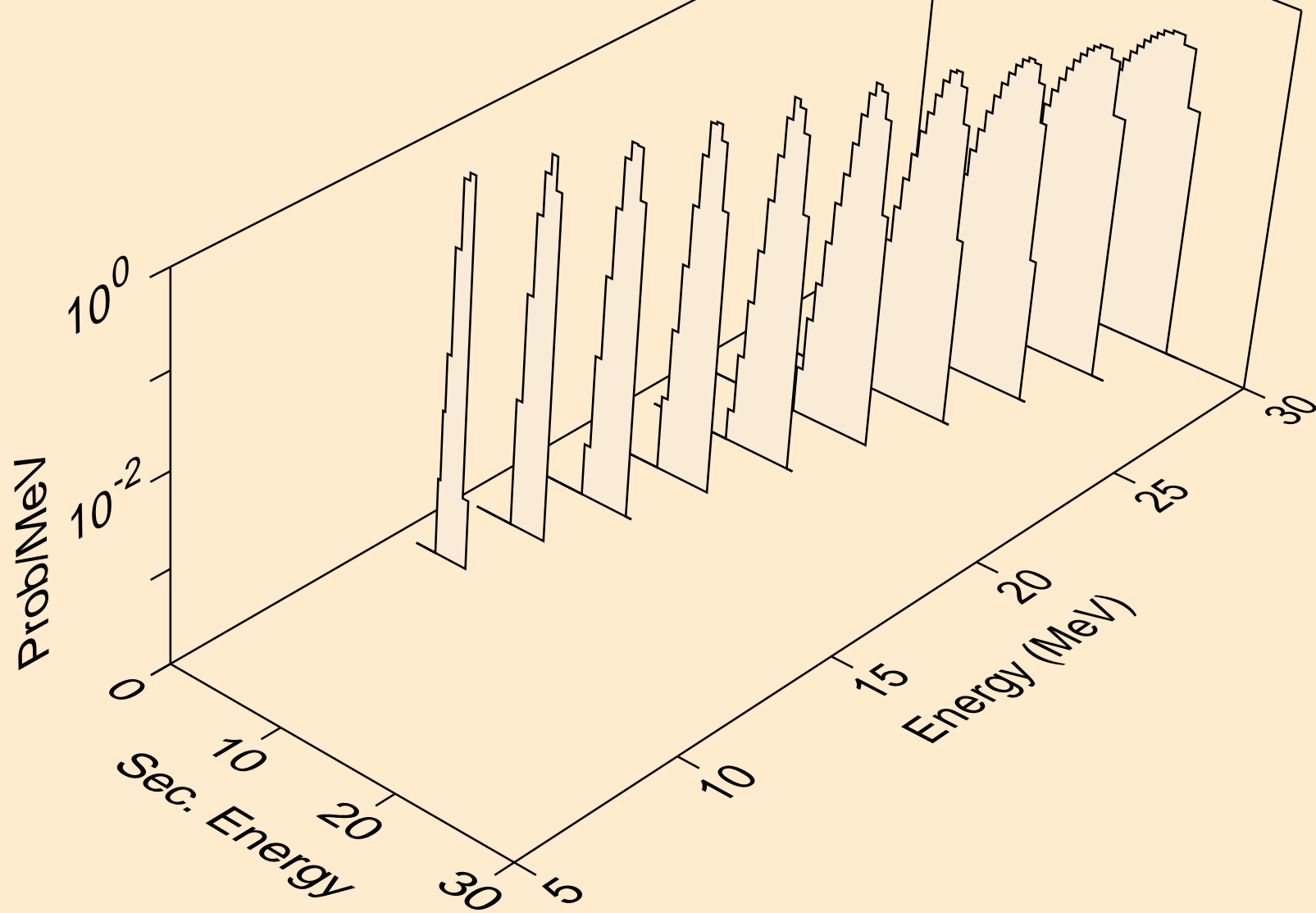

LR265 DEUTERON ACER TENDL-2021 LIBRARY; T=0.K  
Deuteron emission for inelastic

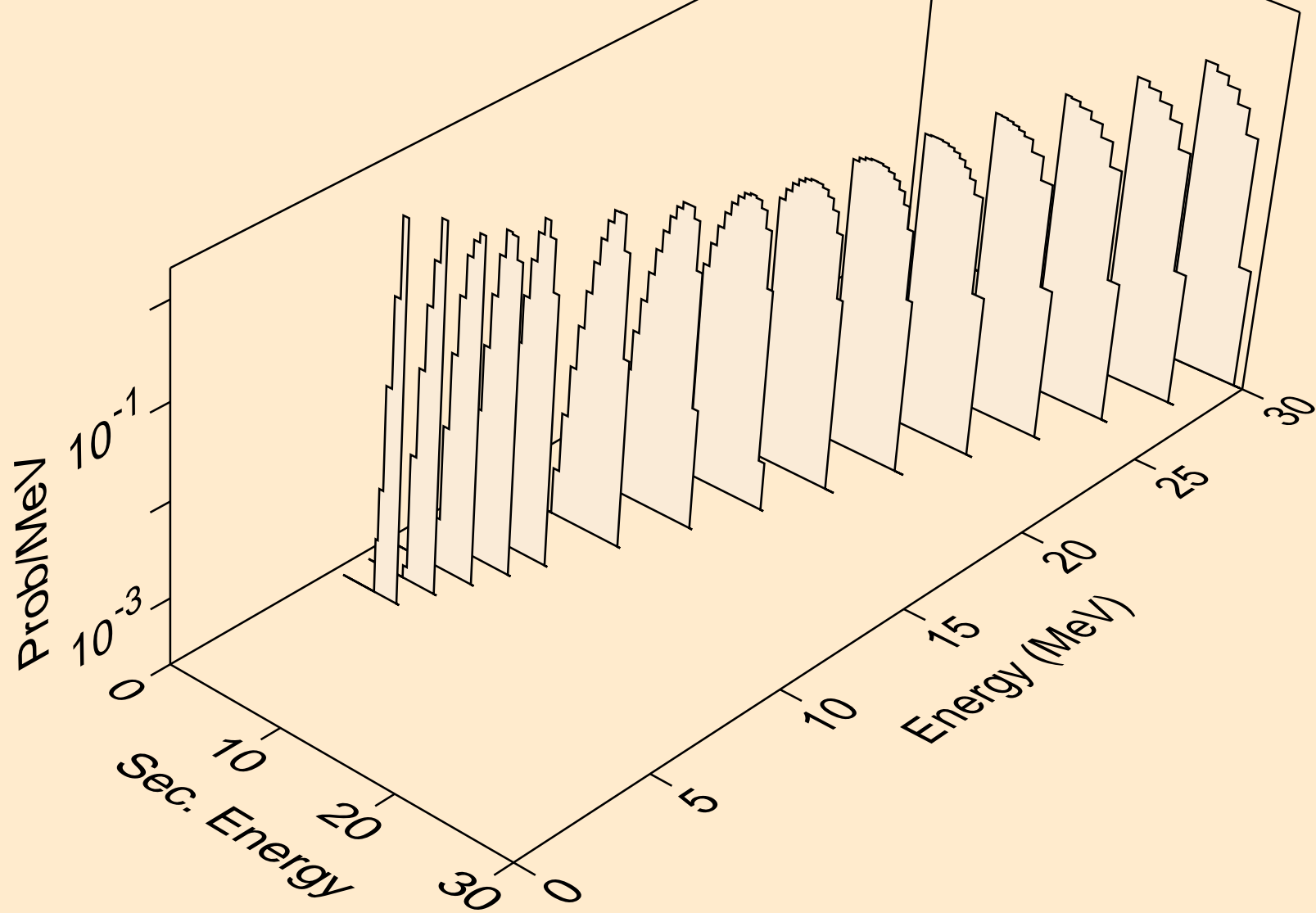



LR265 DEUTERON ACER TENDL-2021 LIBRARY; T=0.K  
Deuteron emission for (d,pd)

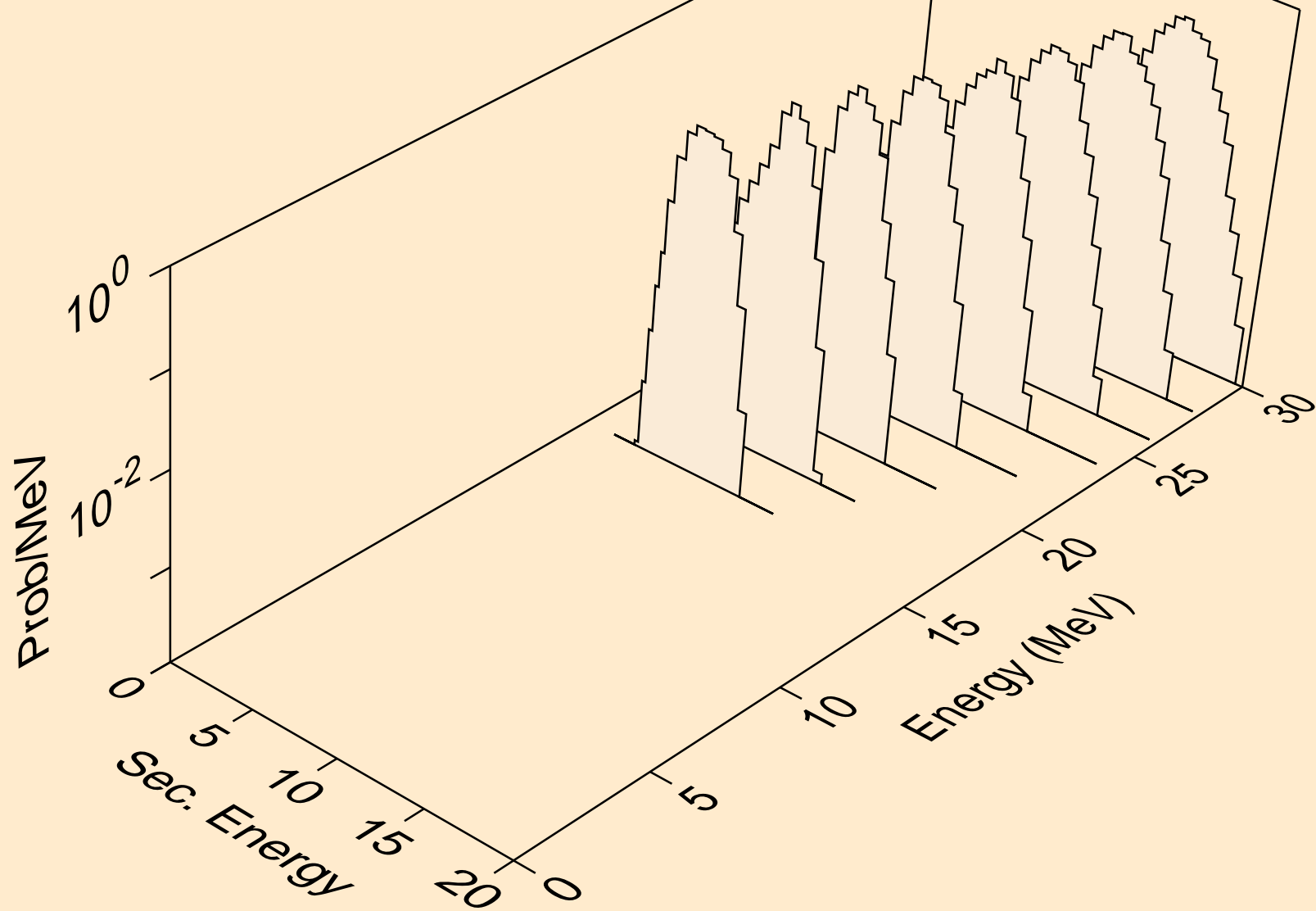

LR265 DEUTERON ACER TENDL-2021 LIBRARY; T=0.K  
Photon emission for (z,n)

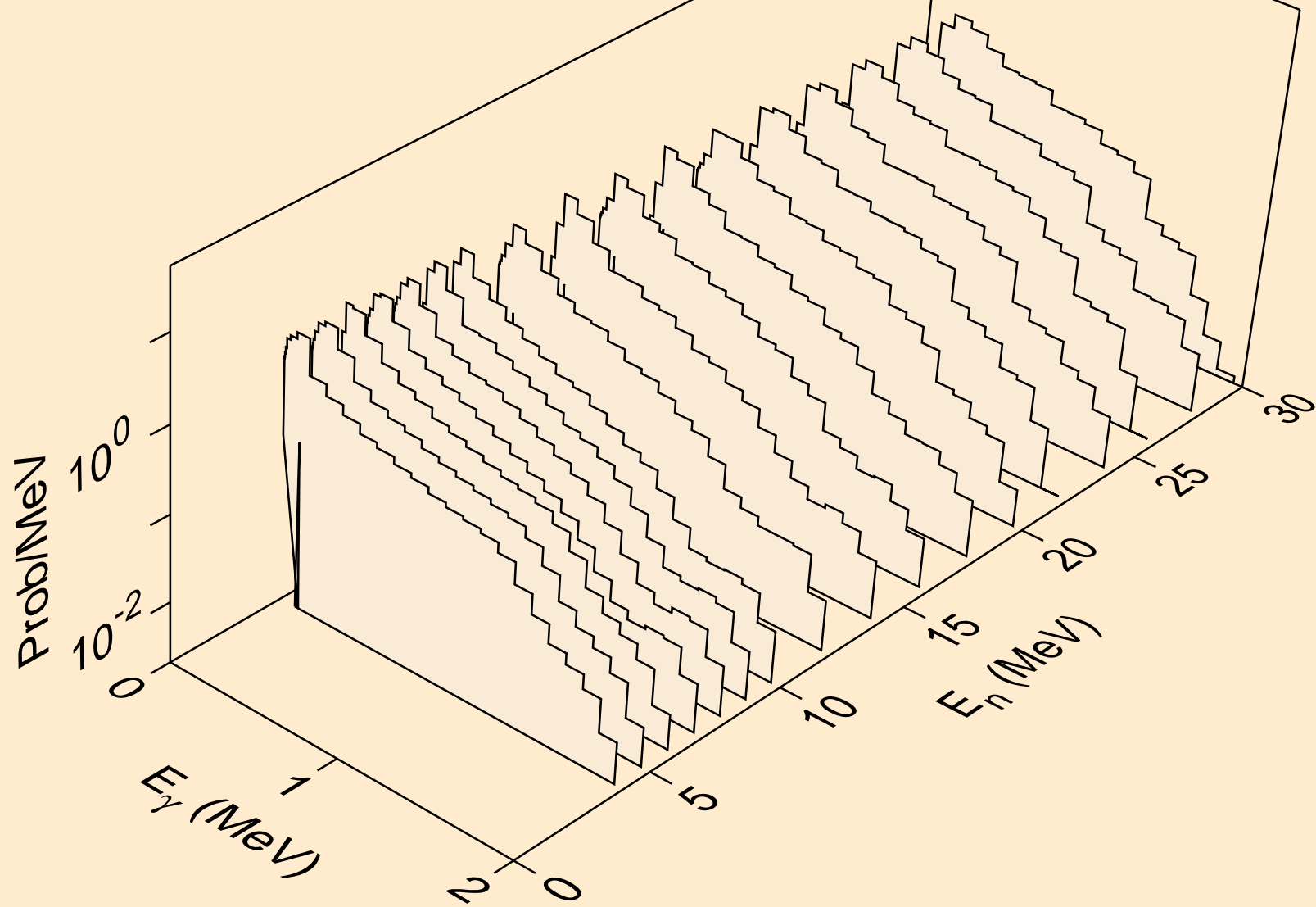

LR265 DEUTERON ACER TENDL-2021 LIBRARY; T=0.K  
Photon emission for (n,x)

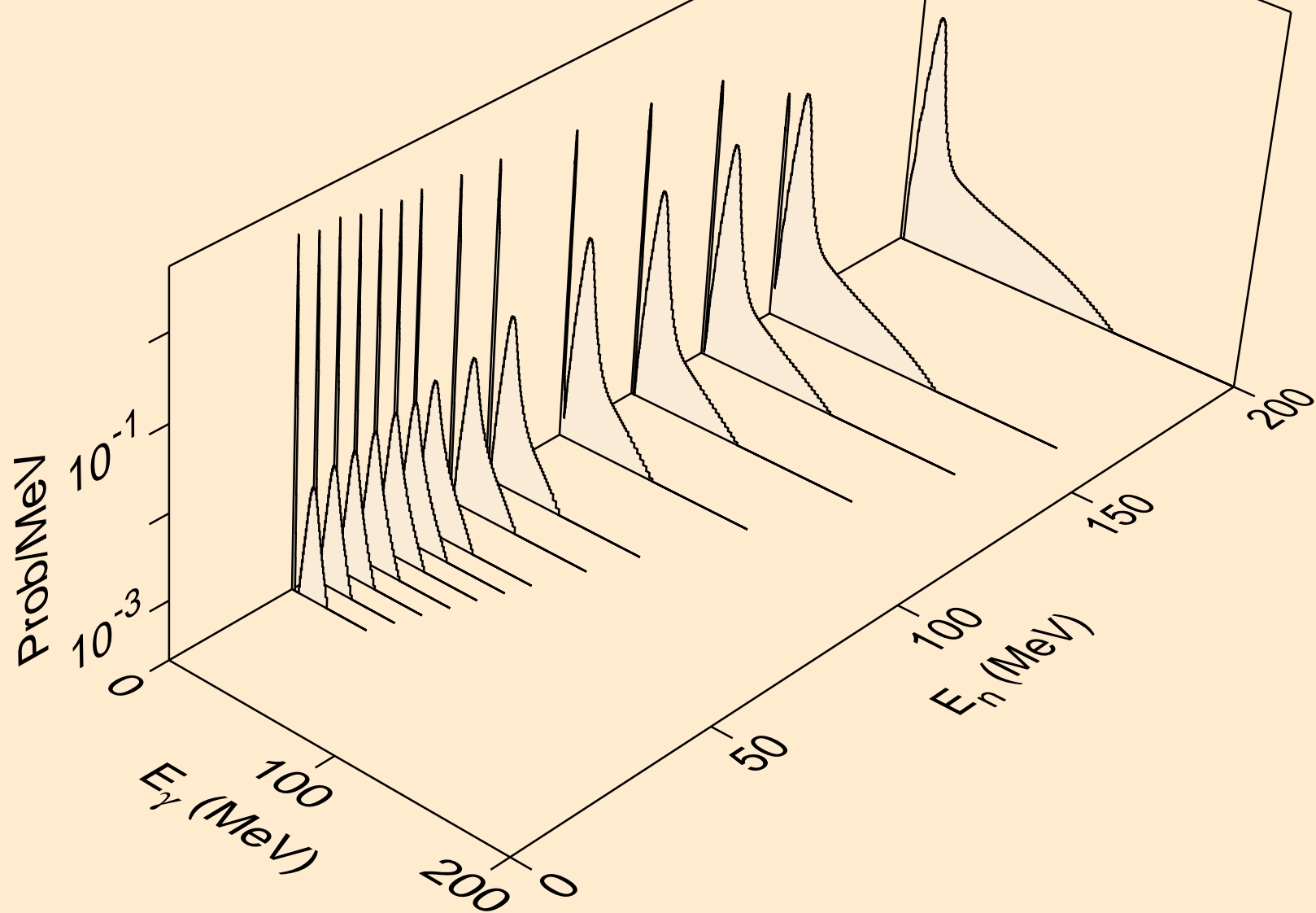

LR265 DEUTERON ACER TENDL-2021 LIBRARY; T=0.K  
Photon emission for (n,2n)

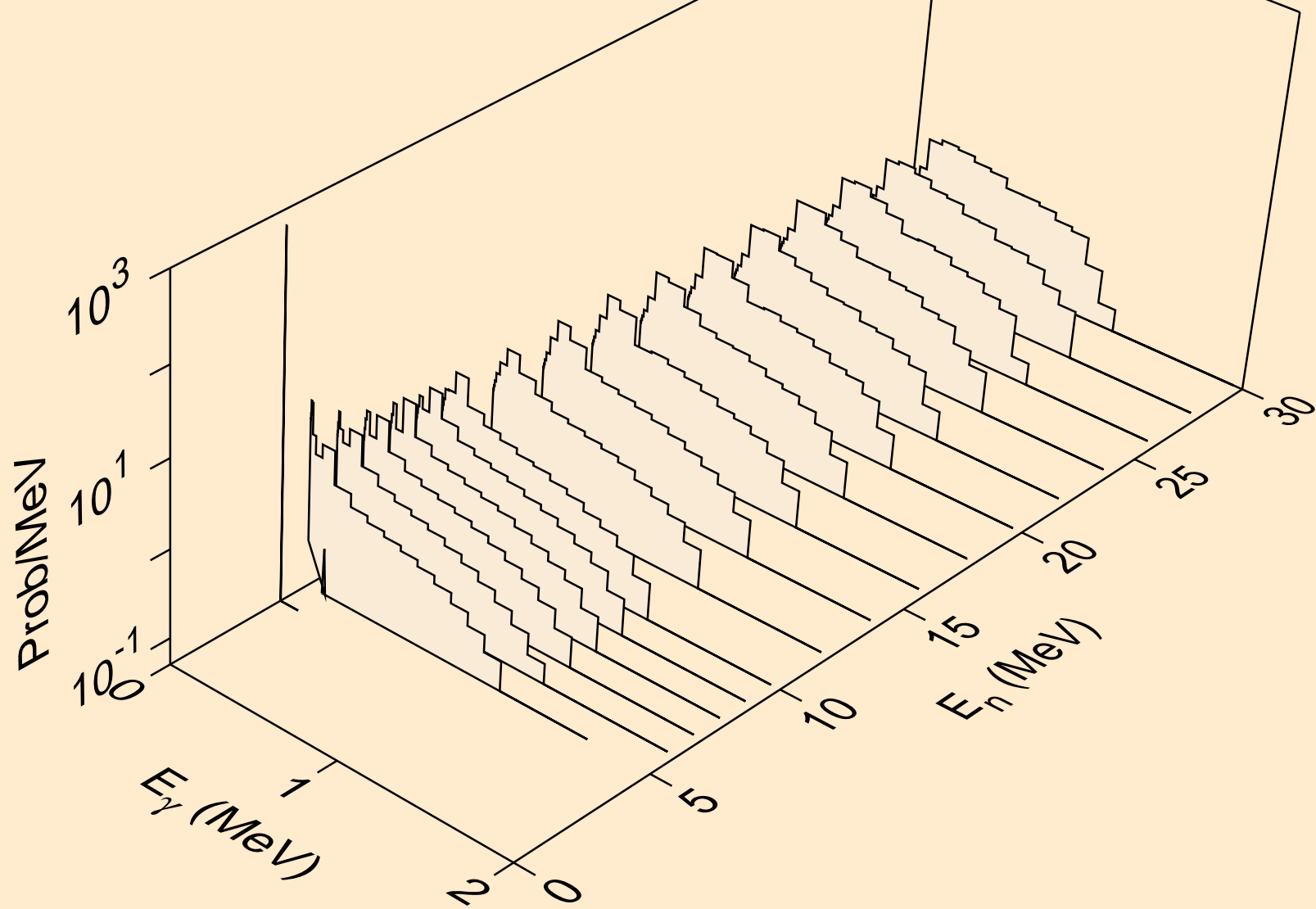

LR265 DEUTERON ACER TENDL-2021 LIBRARY; T=0.K  
Photon emission for (n,3n)

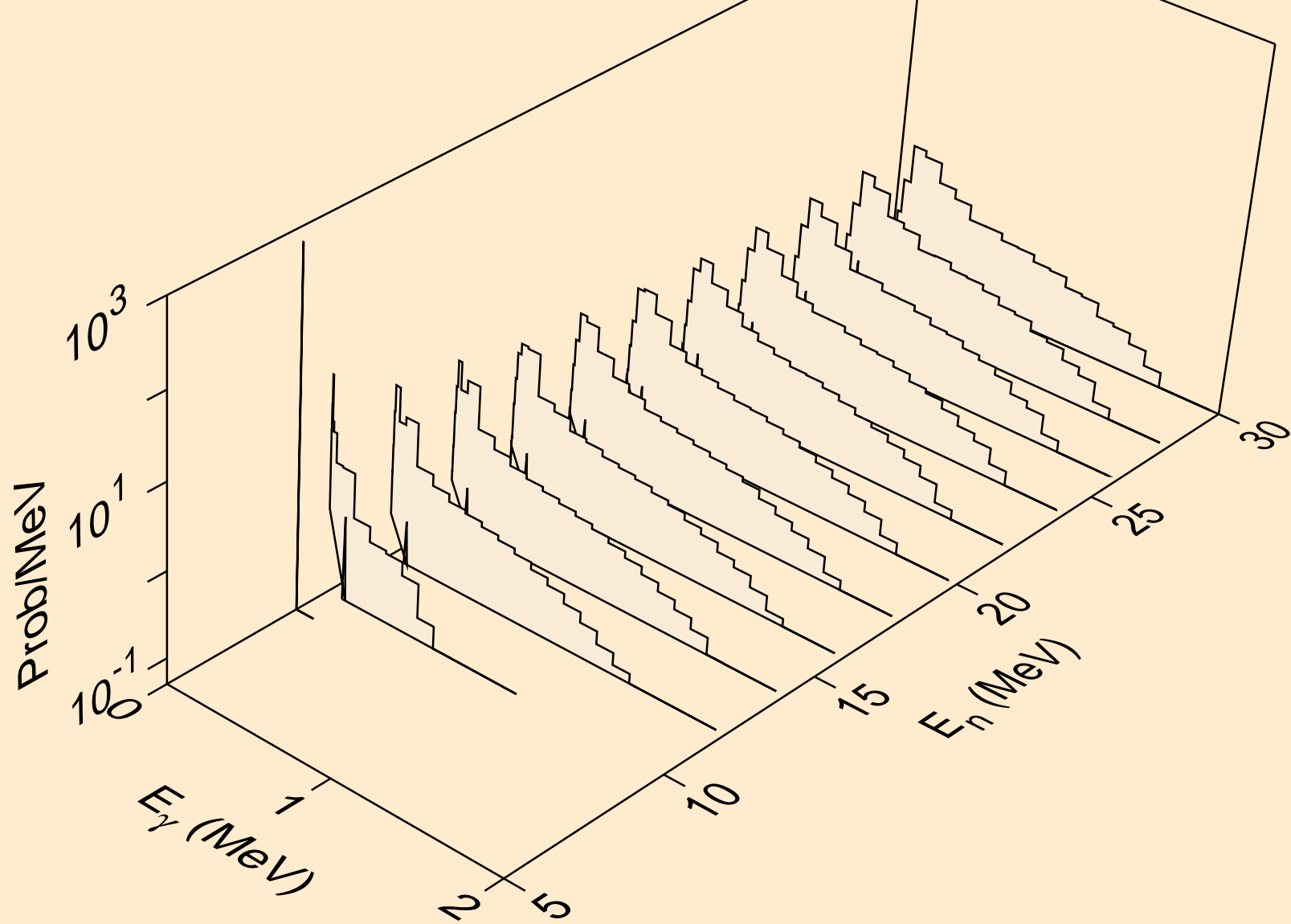

LR265 DEUTERON ACER TENDL-2021 LIBRARY; T=0.K  
Photon emission for (n,n\*)p

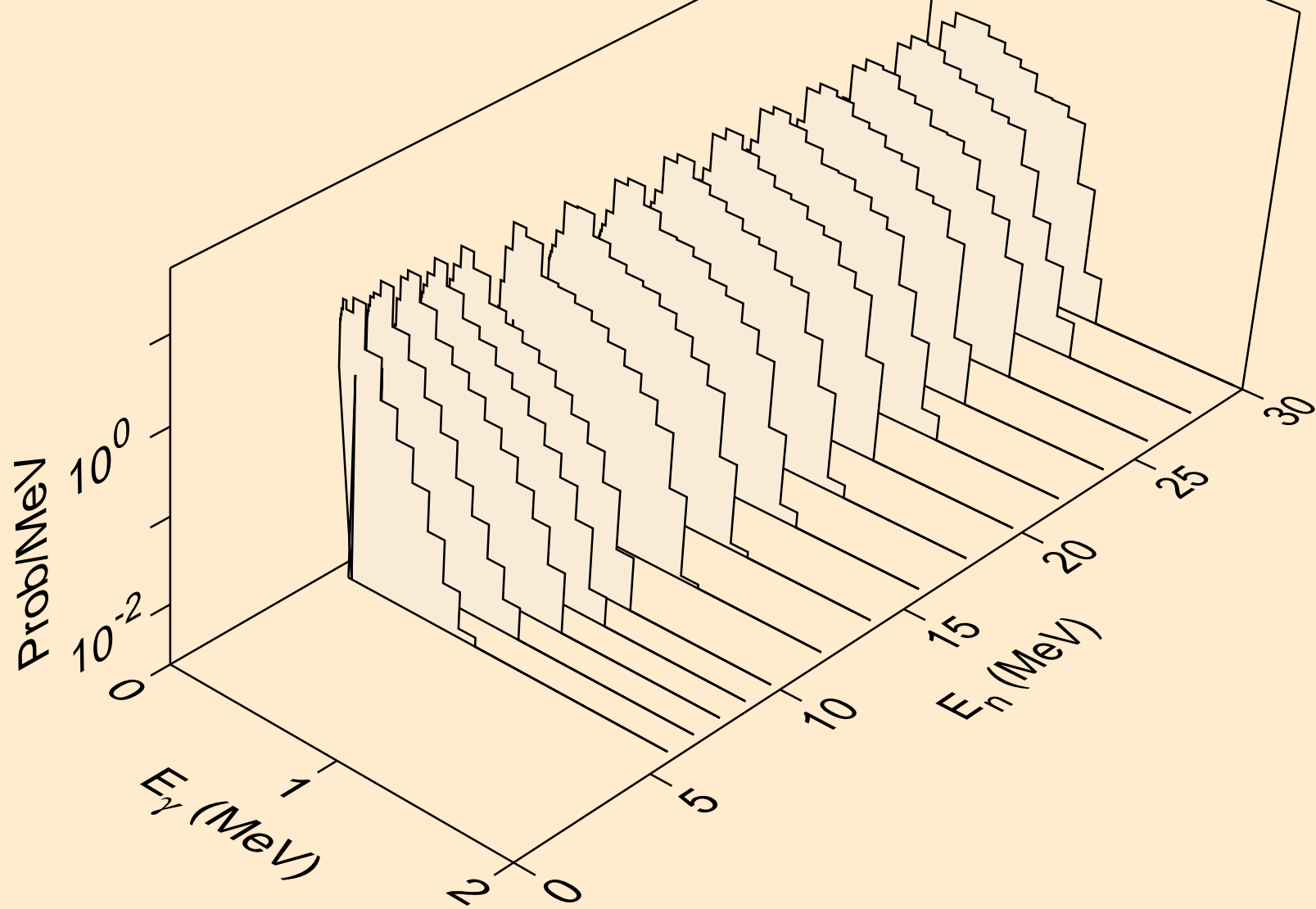

LR265 DEUTERON ACER TENDL-2021 LIBRARY; T=0.K  
Photon emission for (n,n\*)d

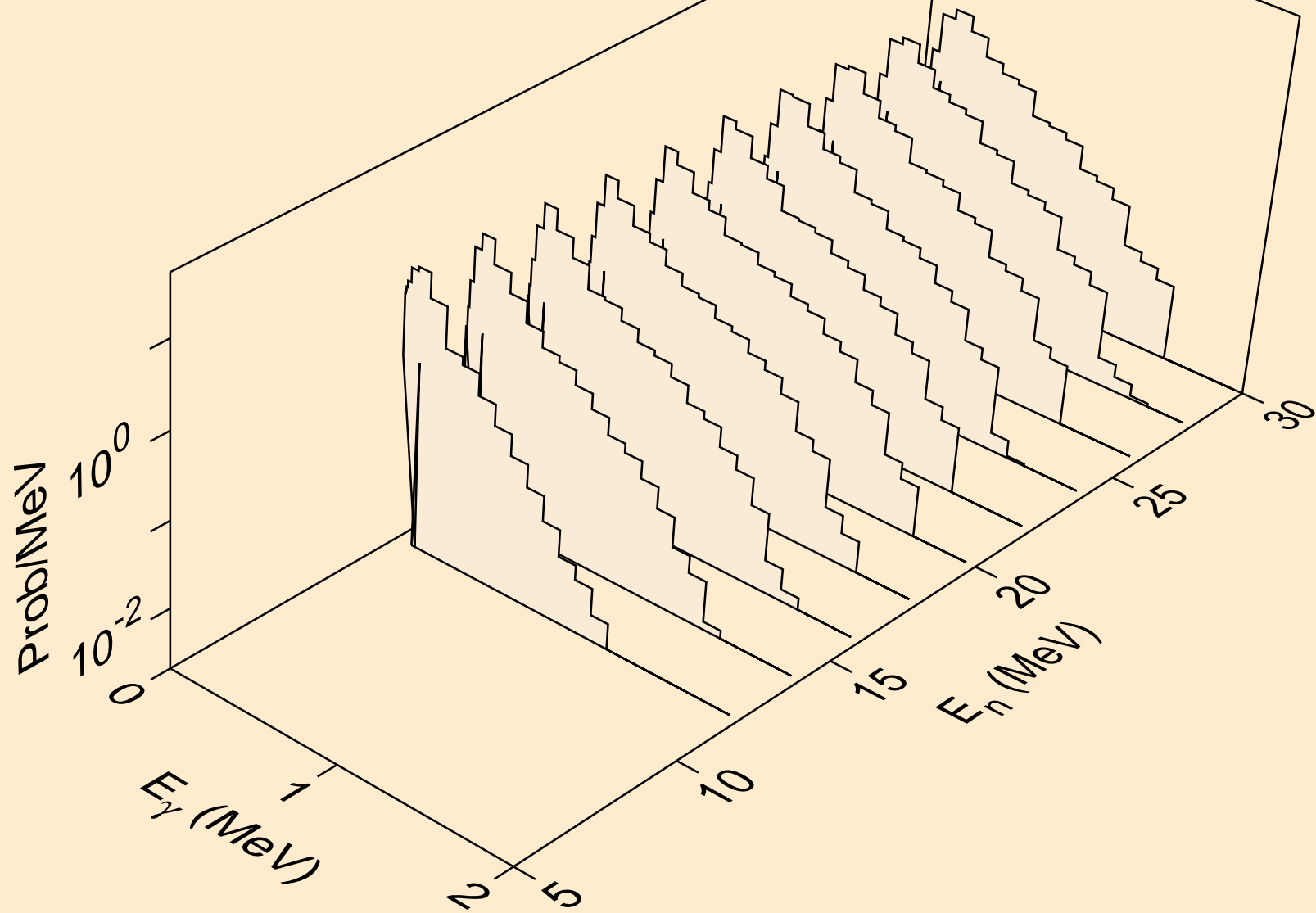

LR265 DEUTERON ACER TENDL-2021 LIBRARY; T=0.K  
Photon emission for (n,n\*)t

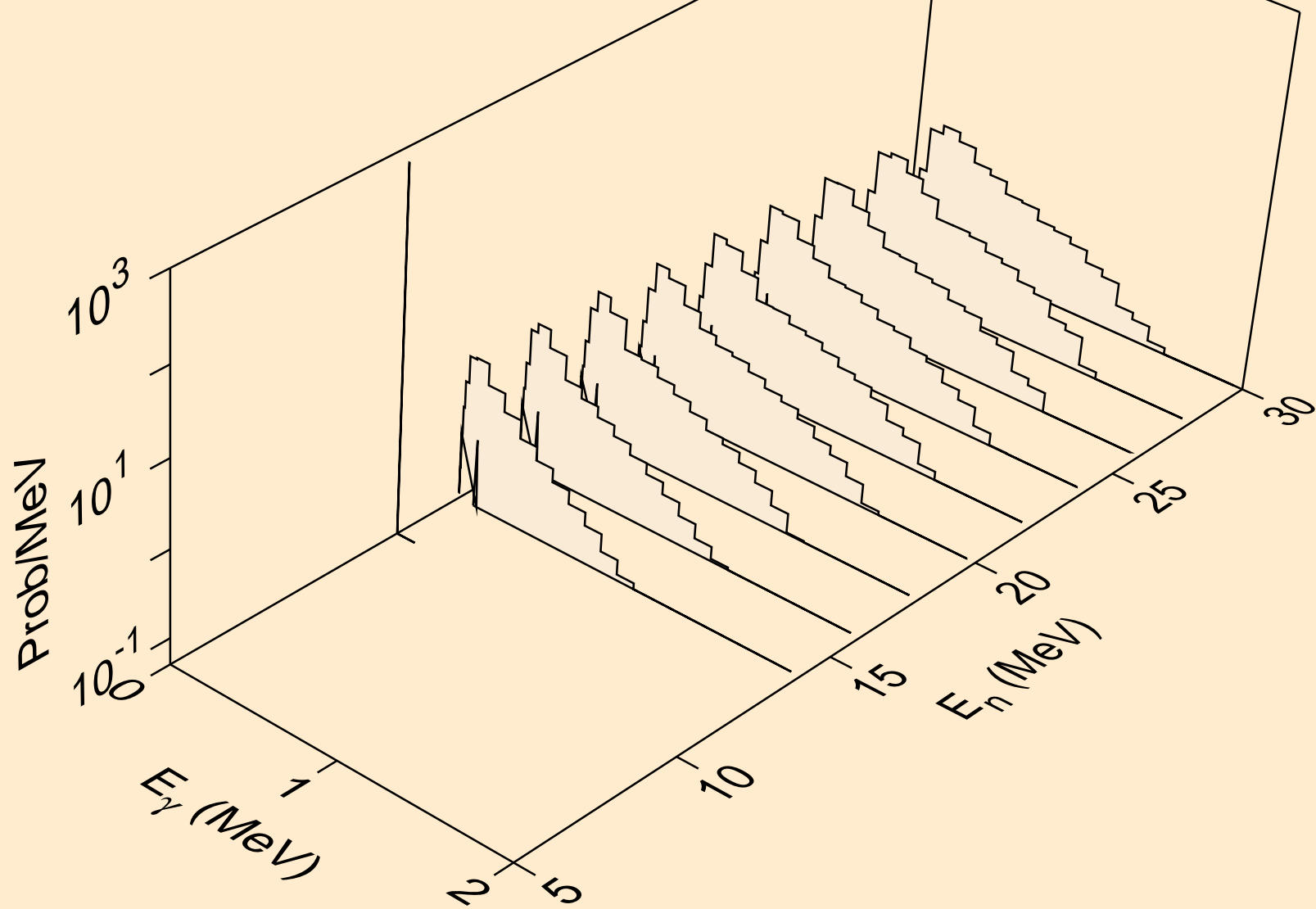



LR265 DEUTERON ACER TENDL-2021 LIBRARY; T=0.K  
Photon emission for (n,4n)

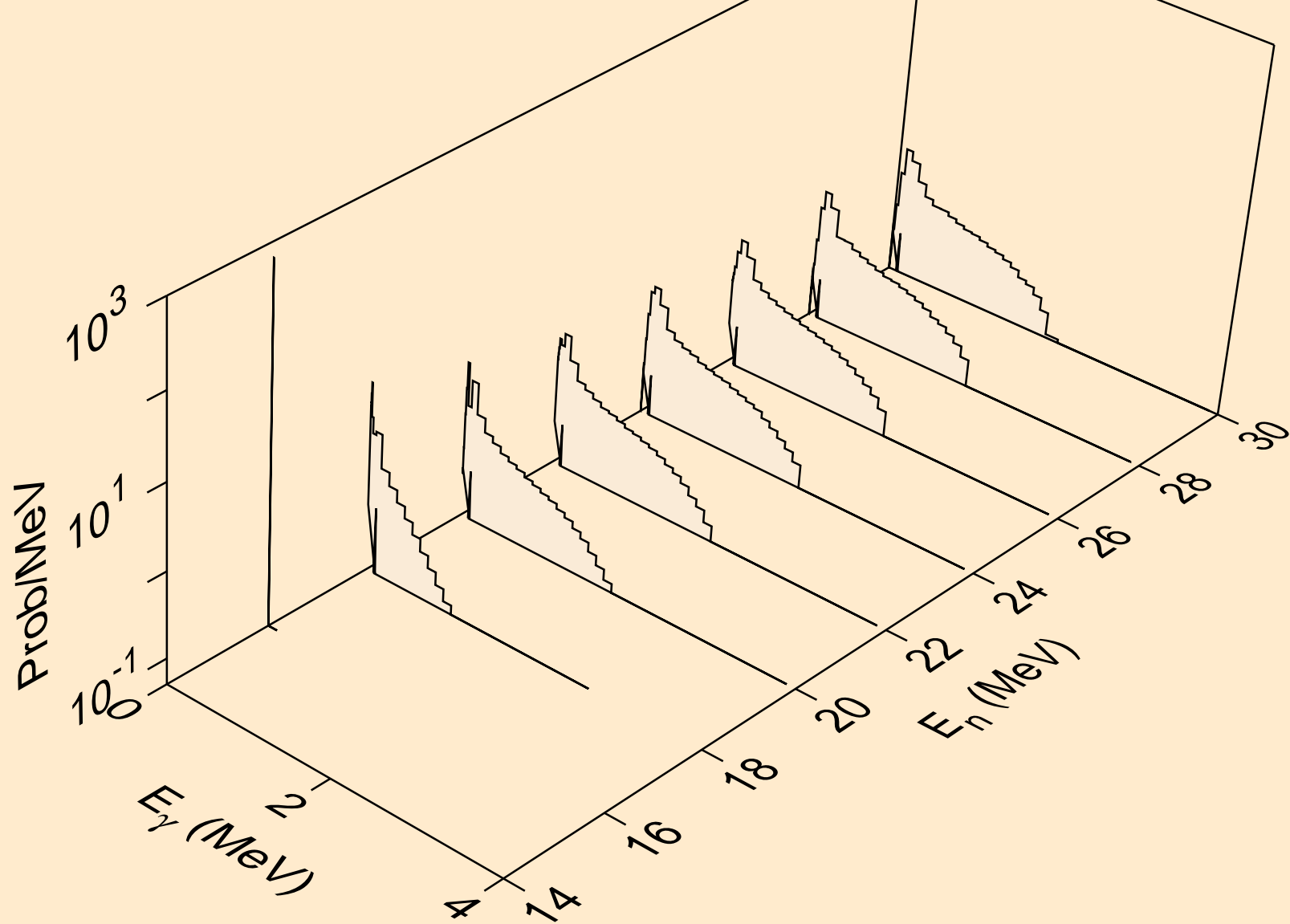

LR265 DEUTERON ACER TENDL-2021 LIBRARY; T=0.K  
Photon emission for (n,2np)

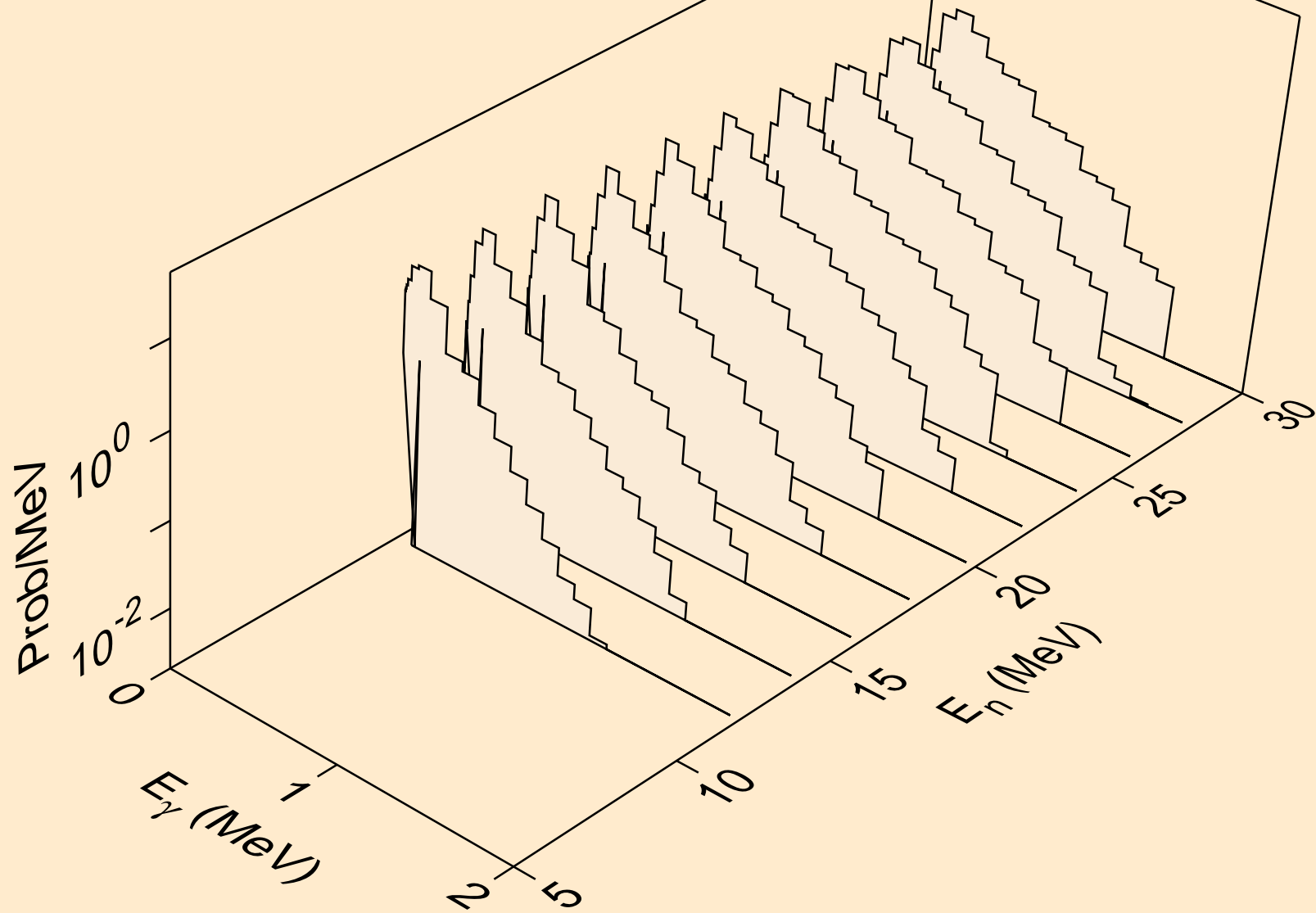

LR265 DEUTERON ACER TENDL-2021 LIBRARY; T=0.K  
Photon emission for (n,3np)

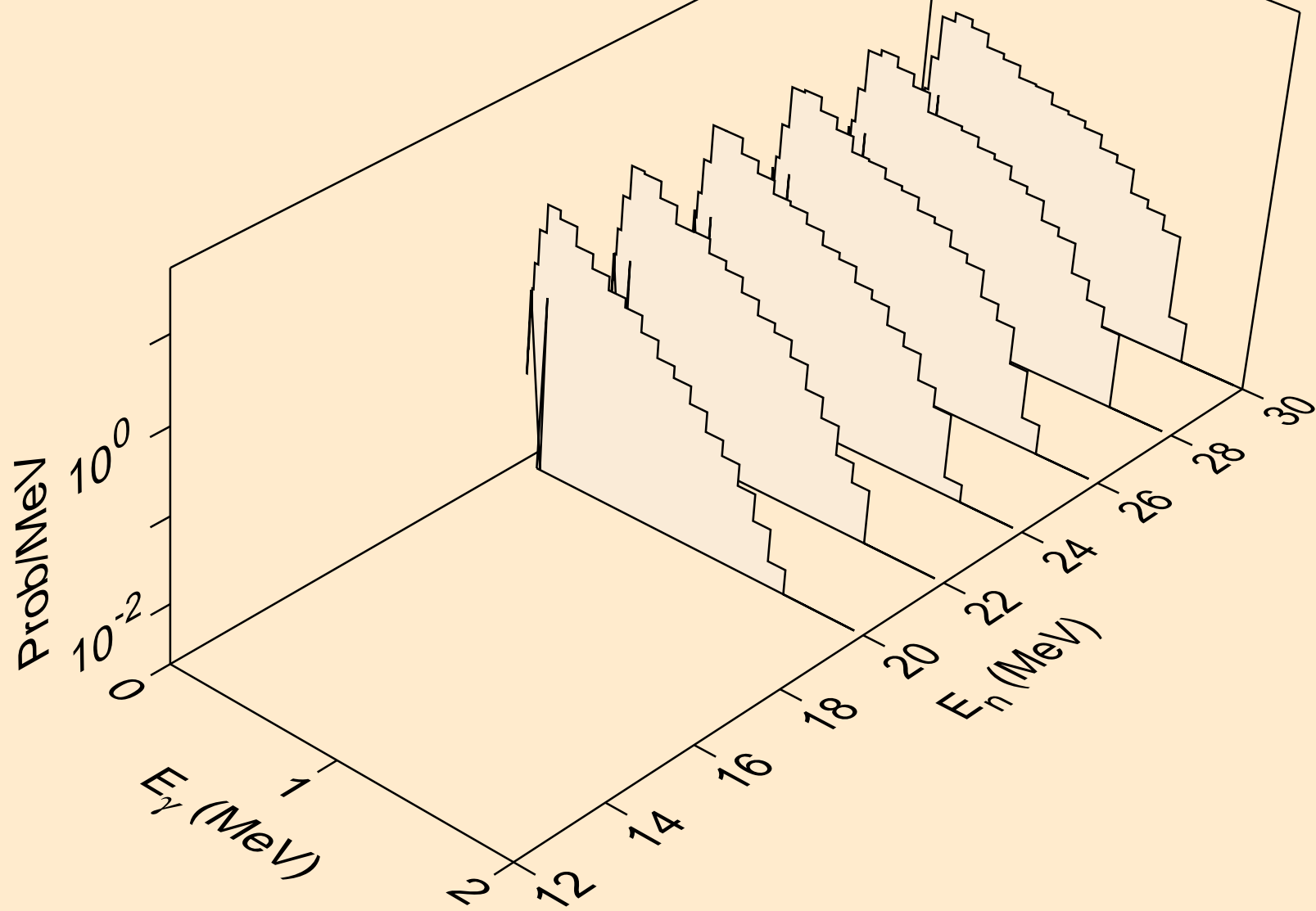

LR265 DEUTERON ACER TENDL-2021 LIBRARY; T=0.K  
Photon emission for (n,2np)

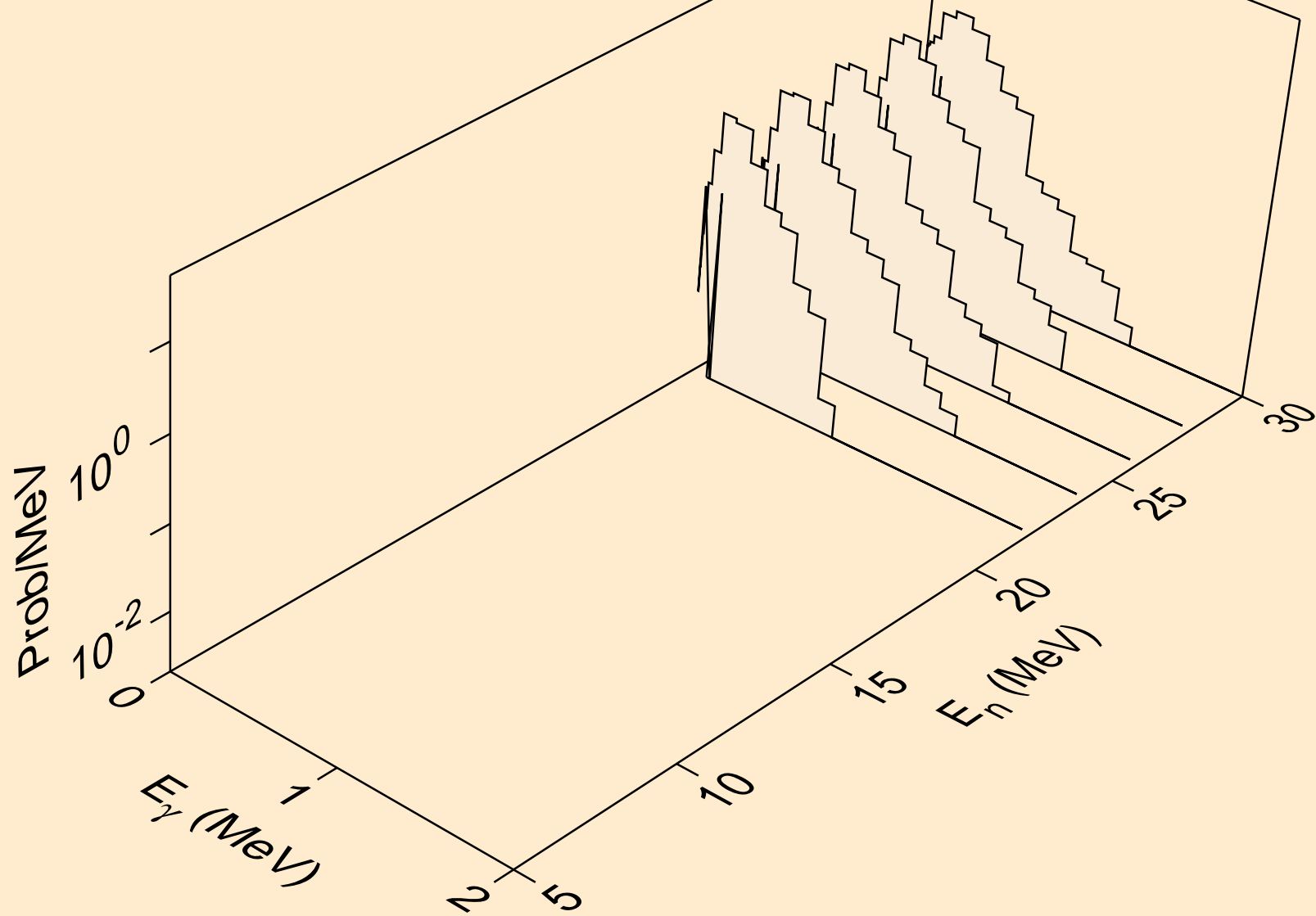

LR265 DEUTERON ACER TENDL-2021 LIBRARY; T=0.K  
Photon emission for (n,p)

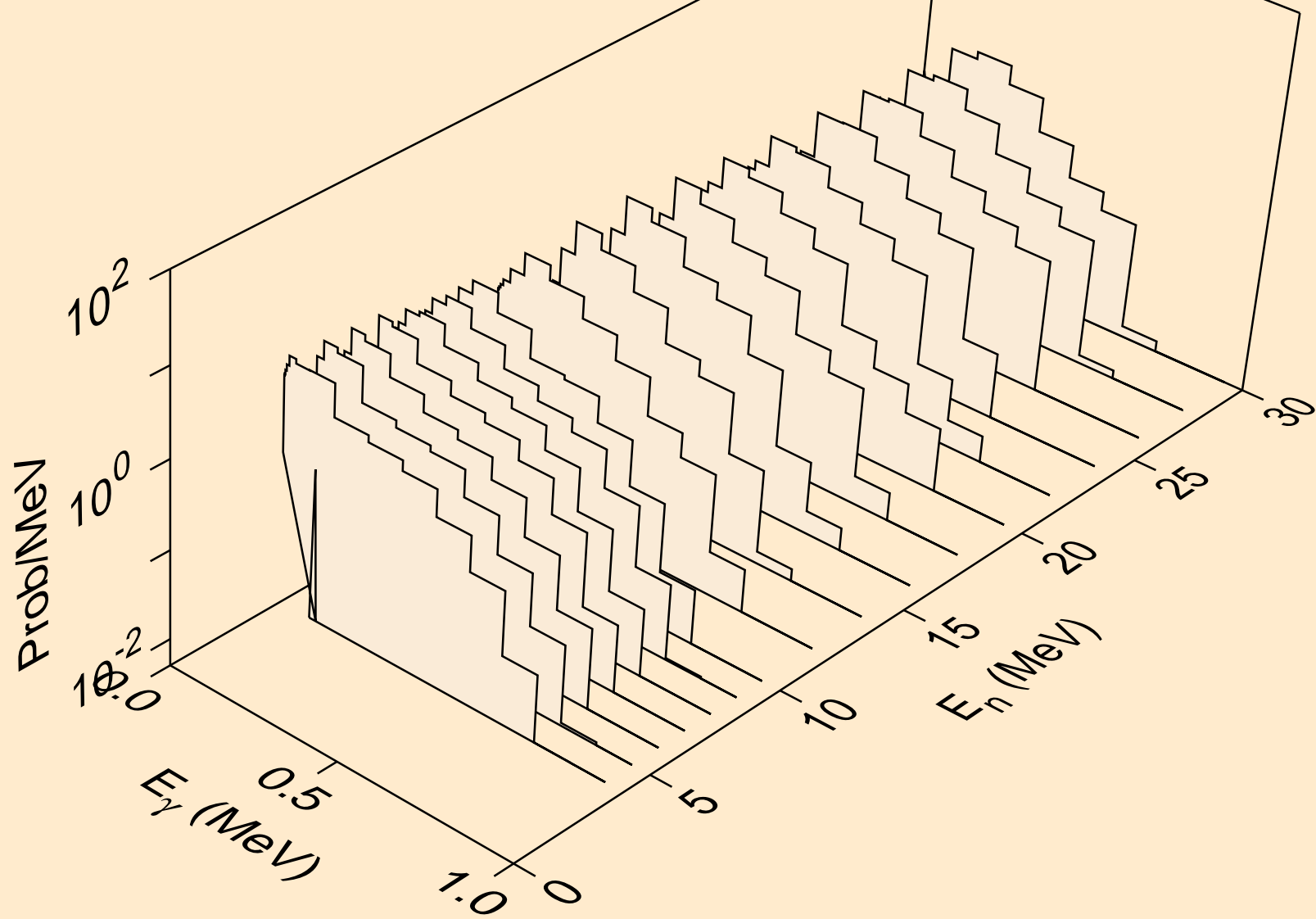

LR265 DEUTERON ACER TENDL-2021 LIBRARY; T=0.K  
Photon emission for inelastic

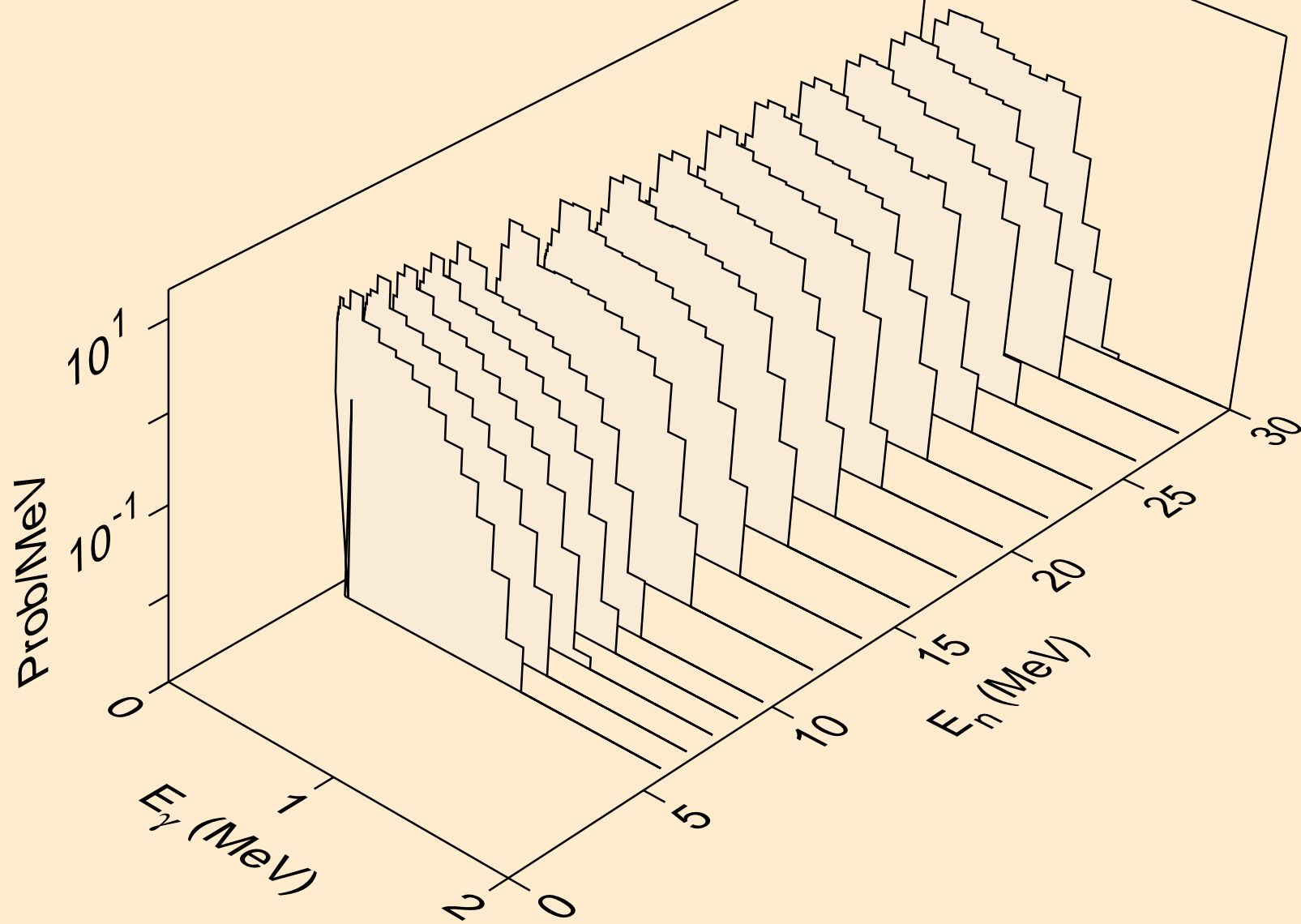

LR265 DEUTERON ACER TENDL-2021 LIBRARY; T=0.K  
Photon emission for (n,t)

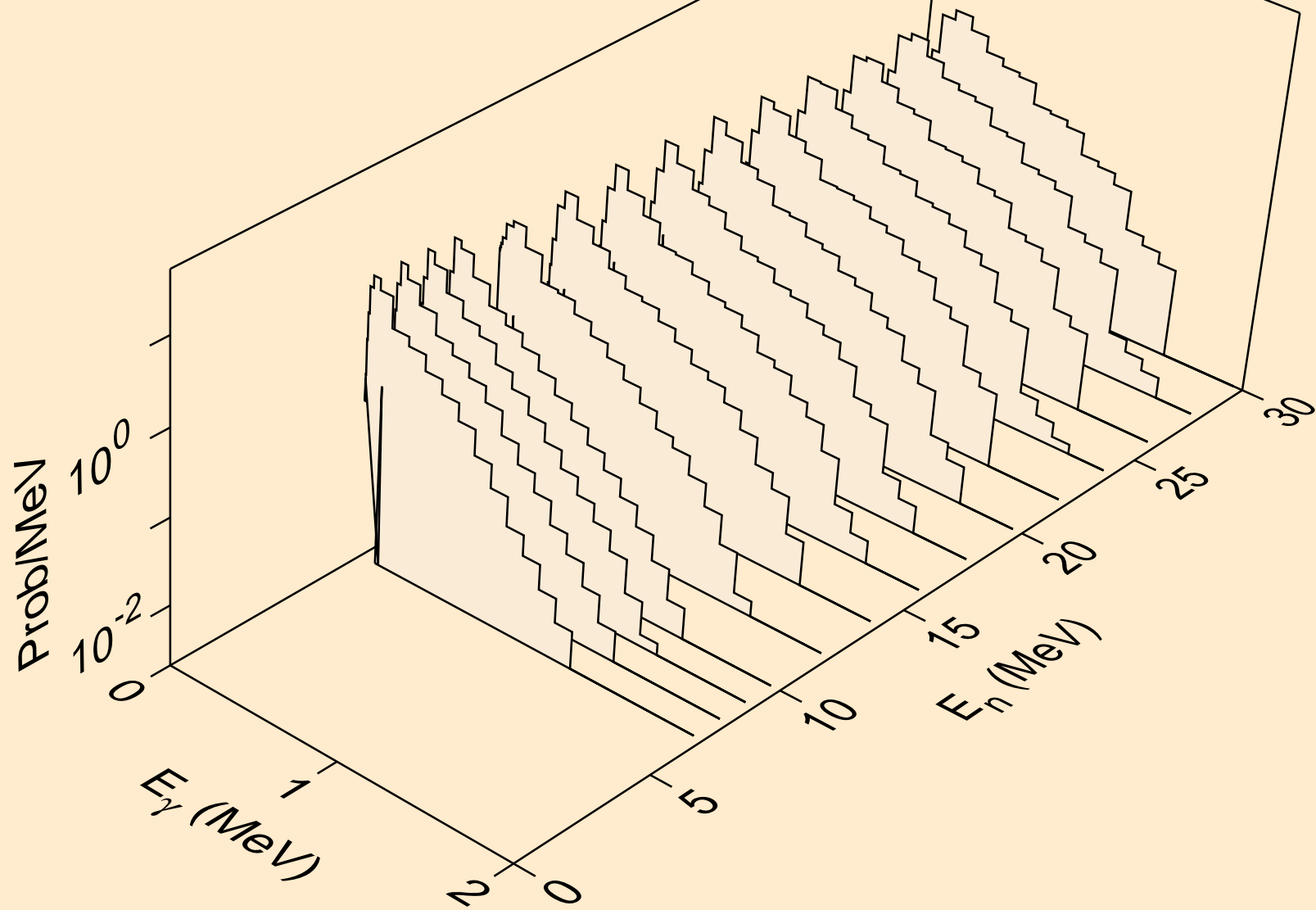

LR265 DEUTERON ACER TENDL-2021 LIBRARY; T=0.K  
Photon emission for (n,he3)

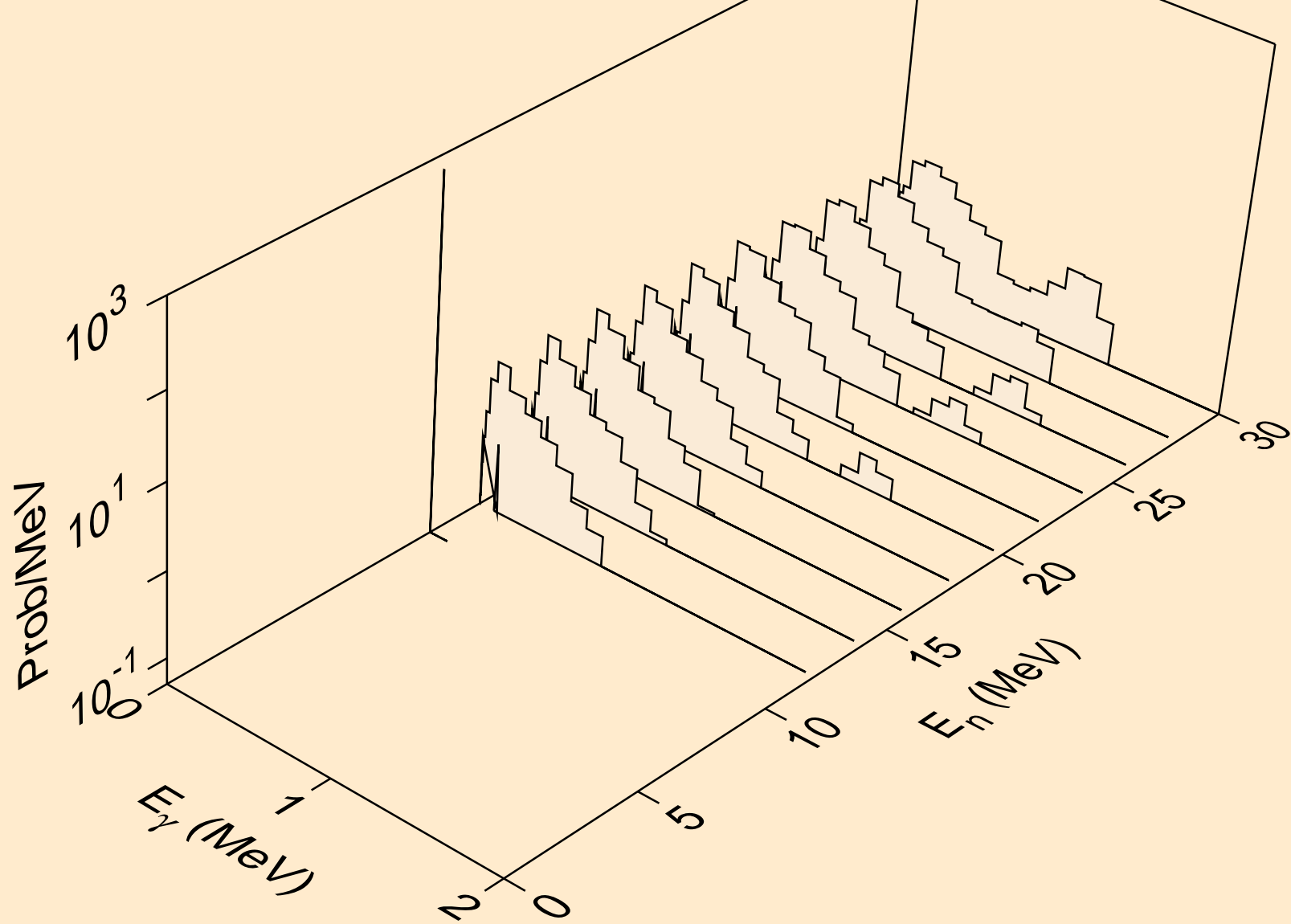



LR265 DEUTERON ACER TENDL-2021 LIBRARY; T=0.K  
Photon emission for (n,a)

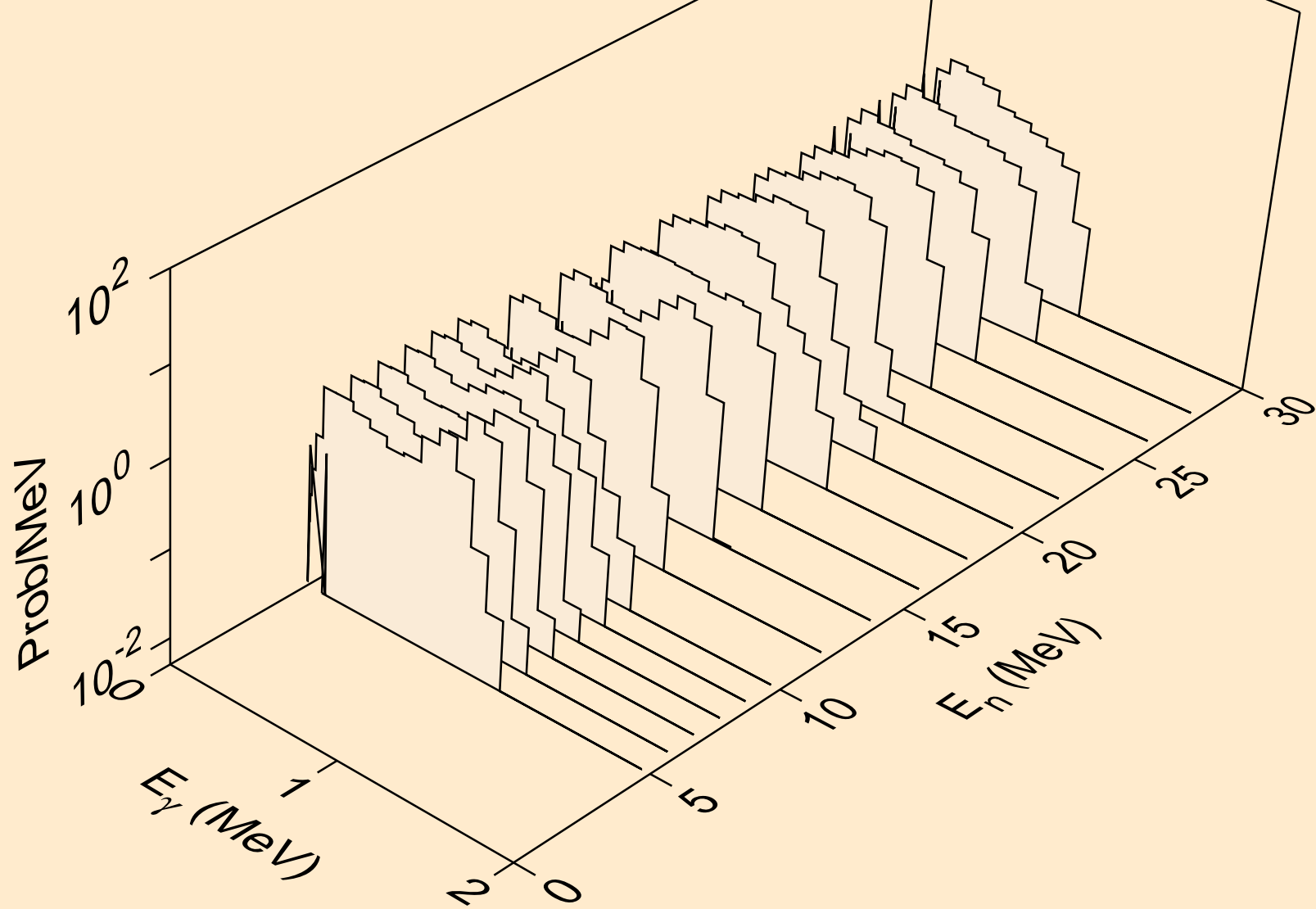

LR265 DEUTERON ACER TENDL-2021 LIBRARY; T=0.K  
Photon emission for (n,pd)

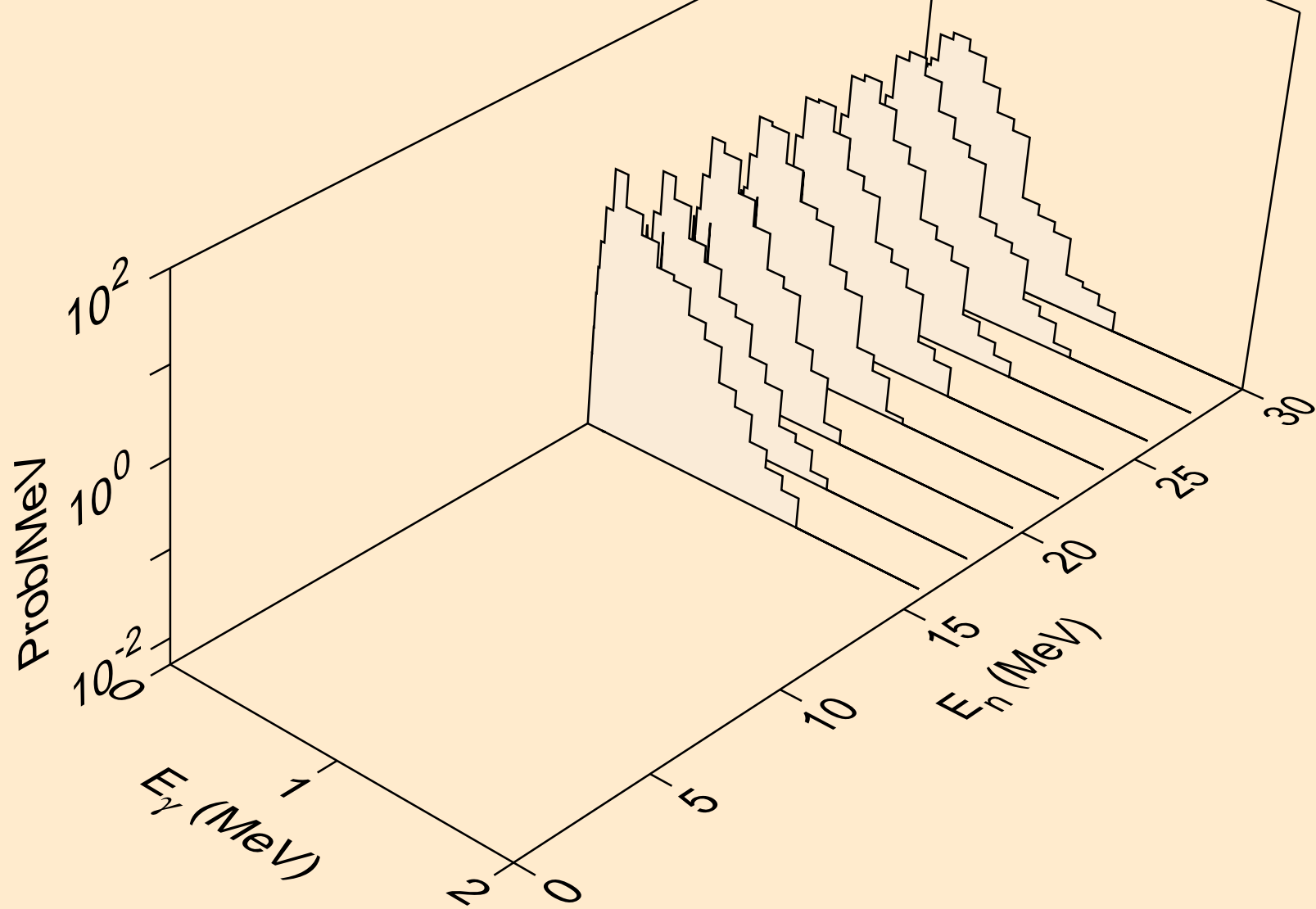

LR265 DEUTERON ACER TENDL-2021 LIBRARY; T=0.K  
Particle heating contributions

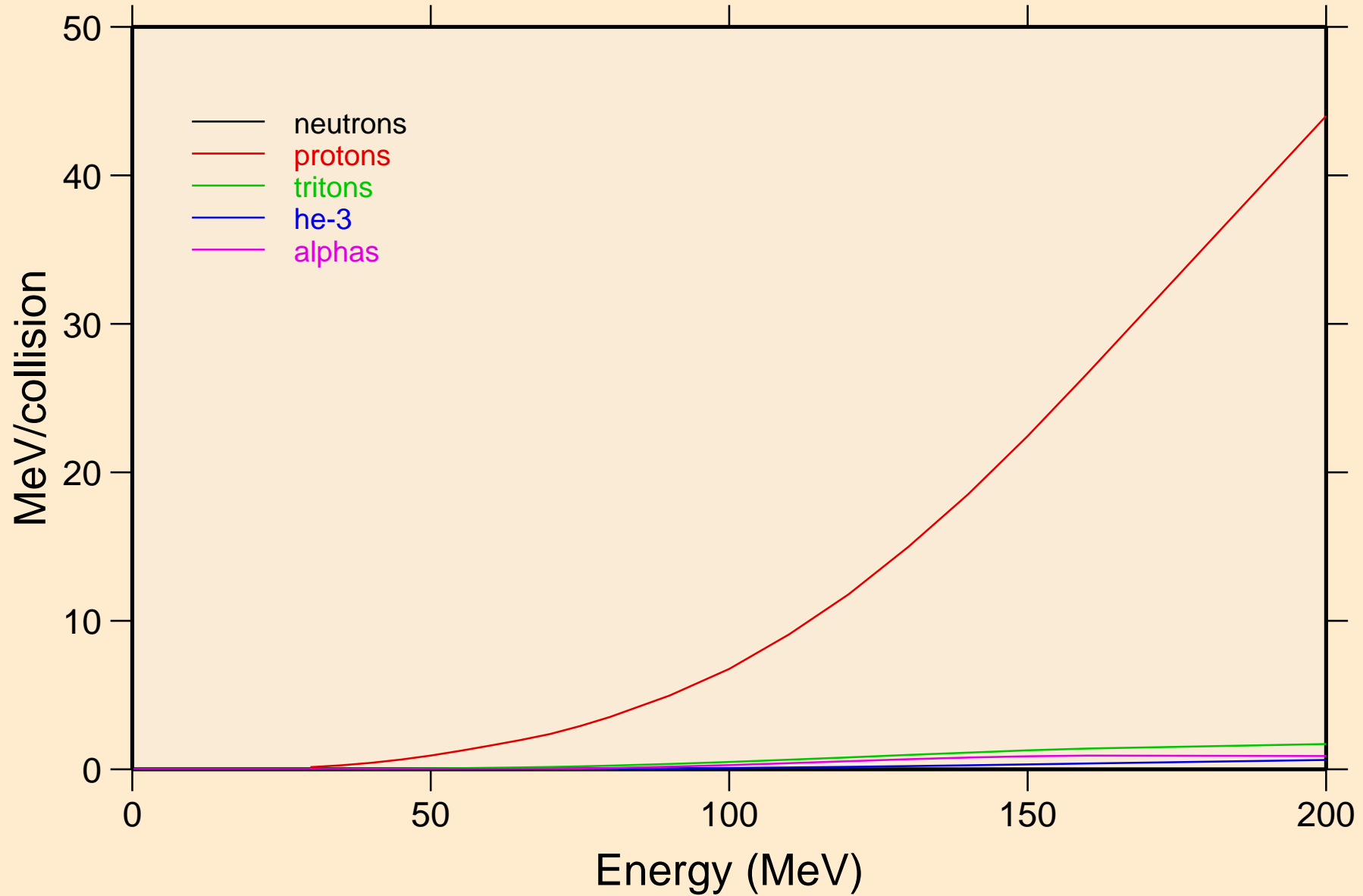

LR265 DEUTERON ACER TENDL-2021 LIBRARY; T=0.K  
Recoil Heating

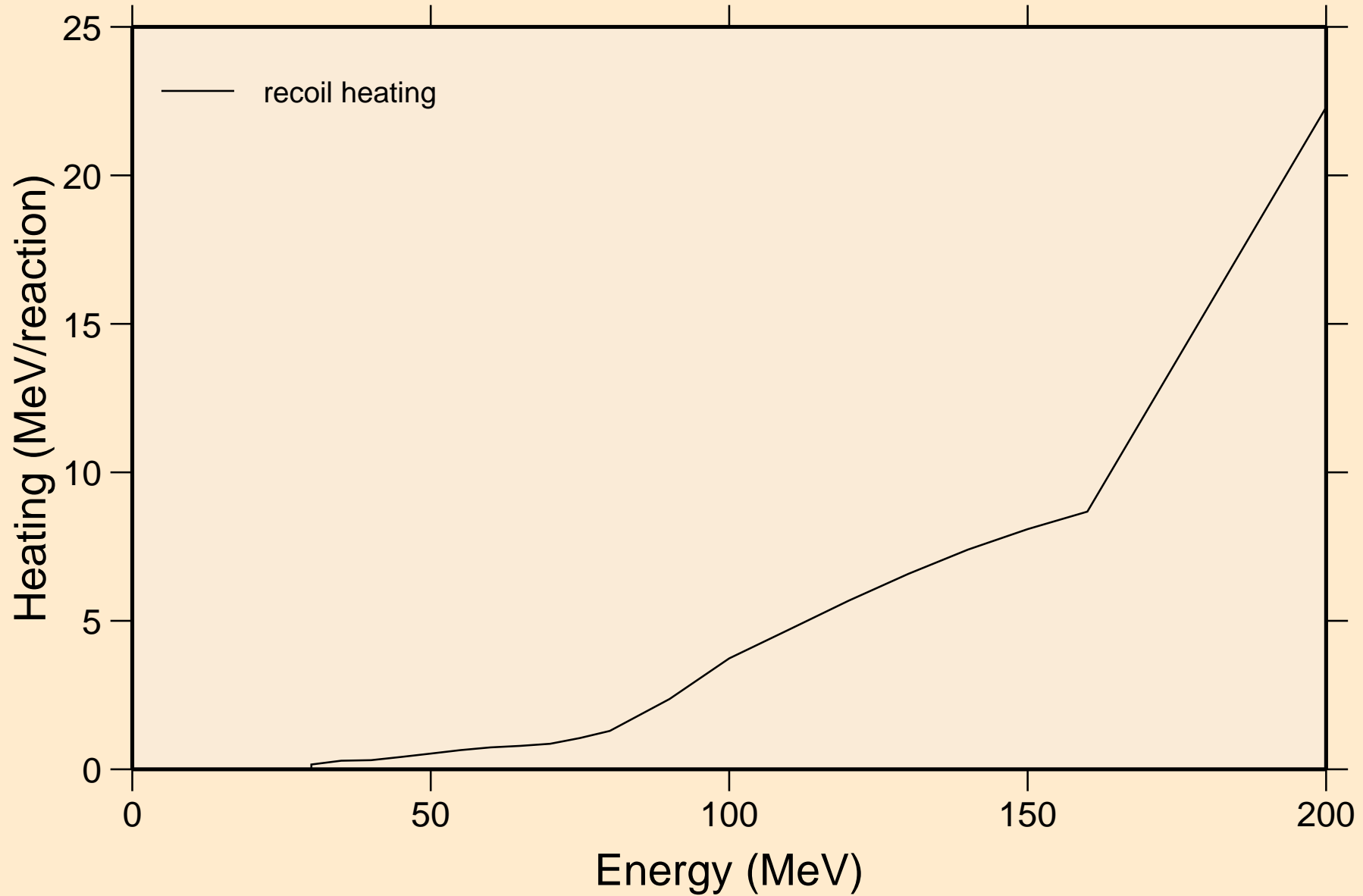

LR265 DEUTERON ACER TENDL-2021 LIBRARY; T=0.K  
Particle production cross sections

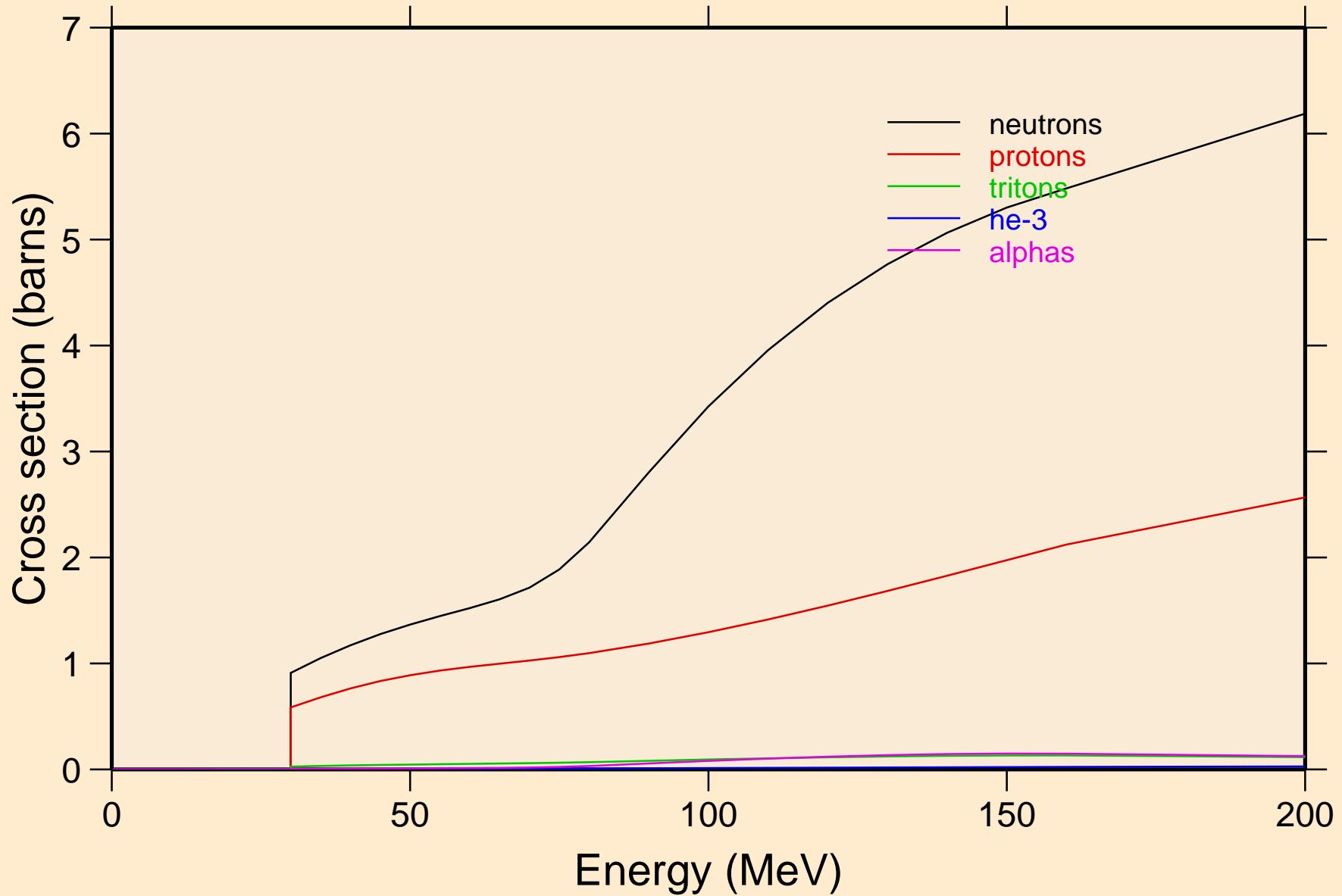

LR265 DEUTERON ACER TENDL-2021 LIBRARY; T=0.K  
neutrons from (d,n)

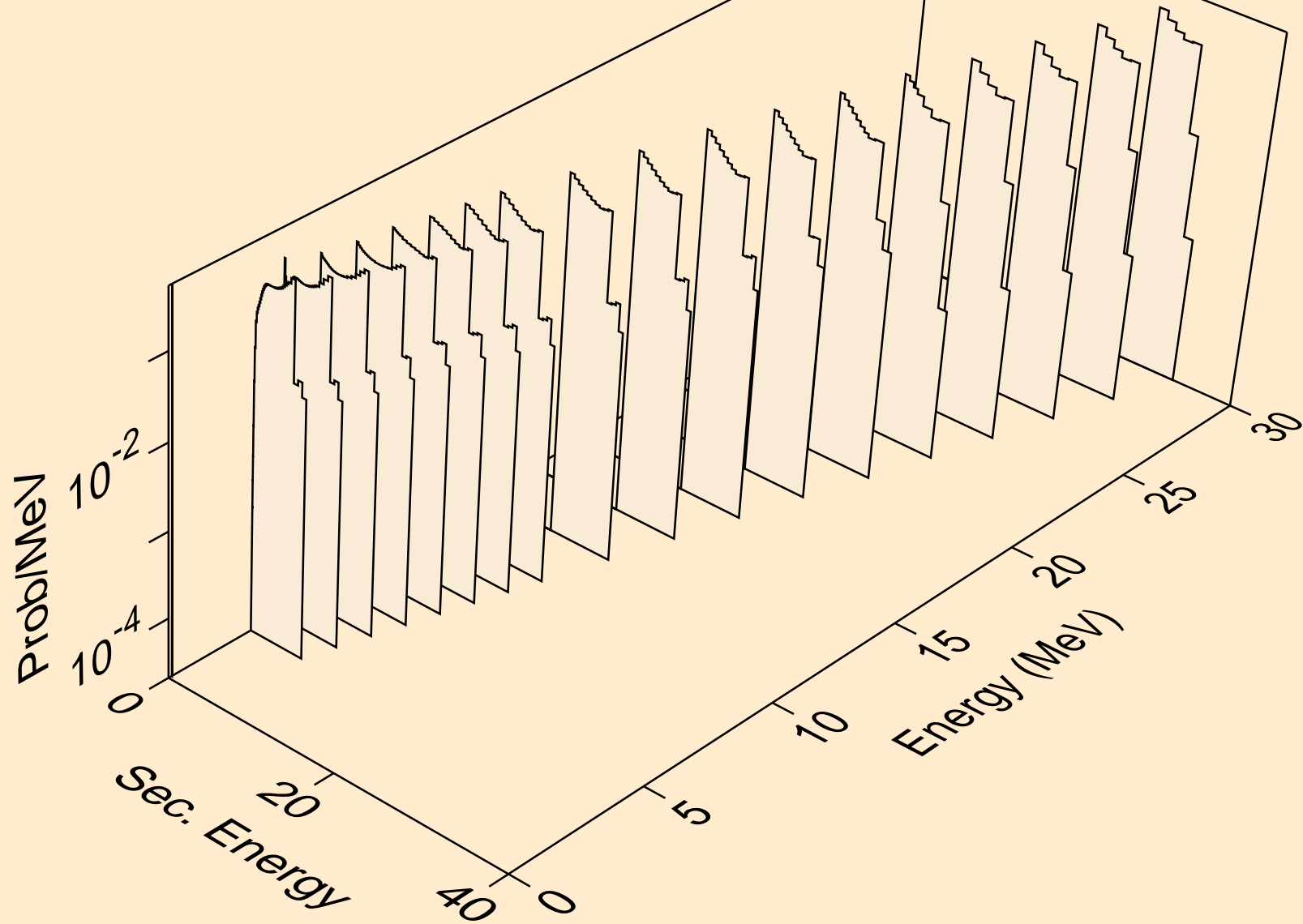

LR265 DEUTERON ACER TENDL-2021 LIBRARY; T=0.K  
neutrons from (d,x)

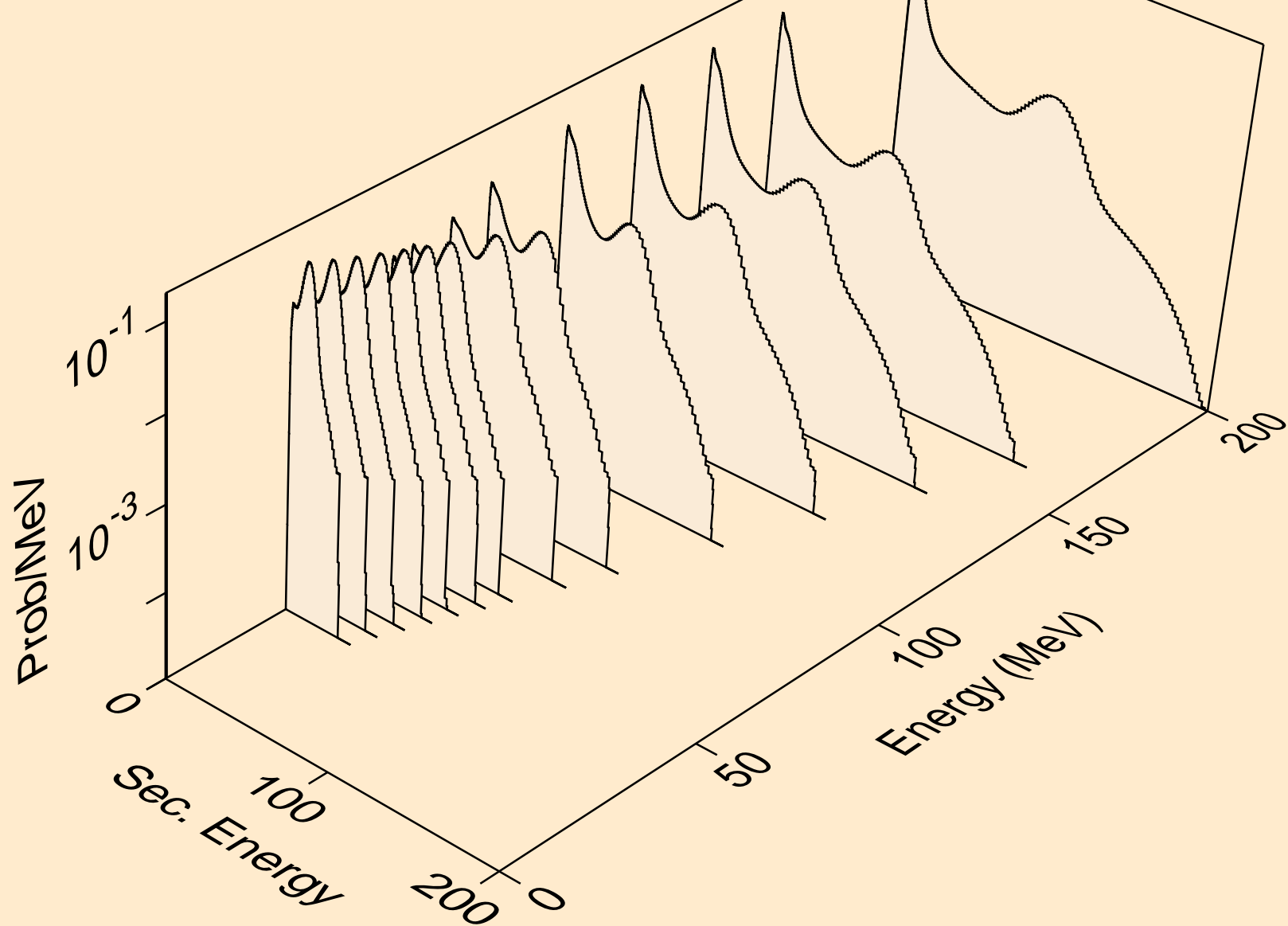

LR265 DEUTERON ACER TENDL-2021 LIBRARY; T=0.K  
neutrons from (d,2n)

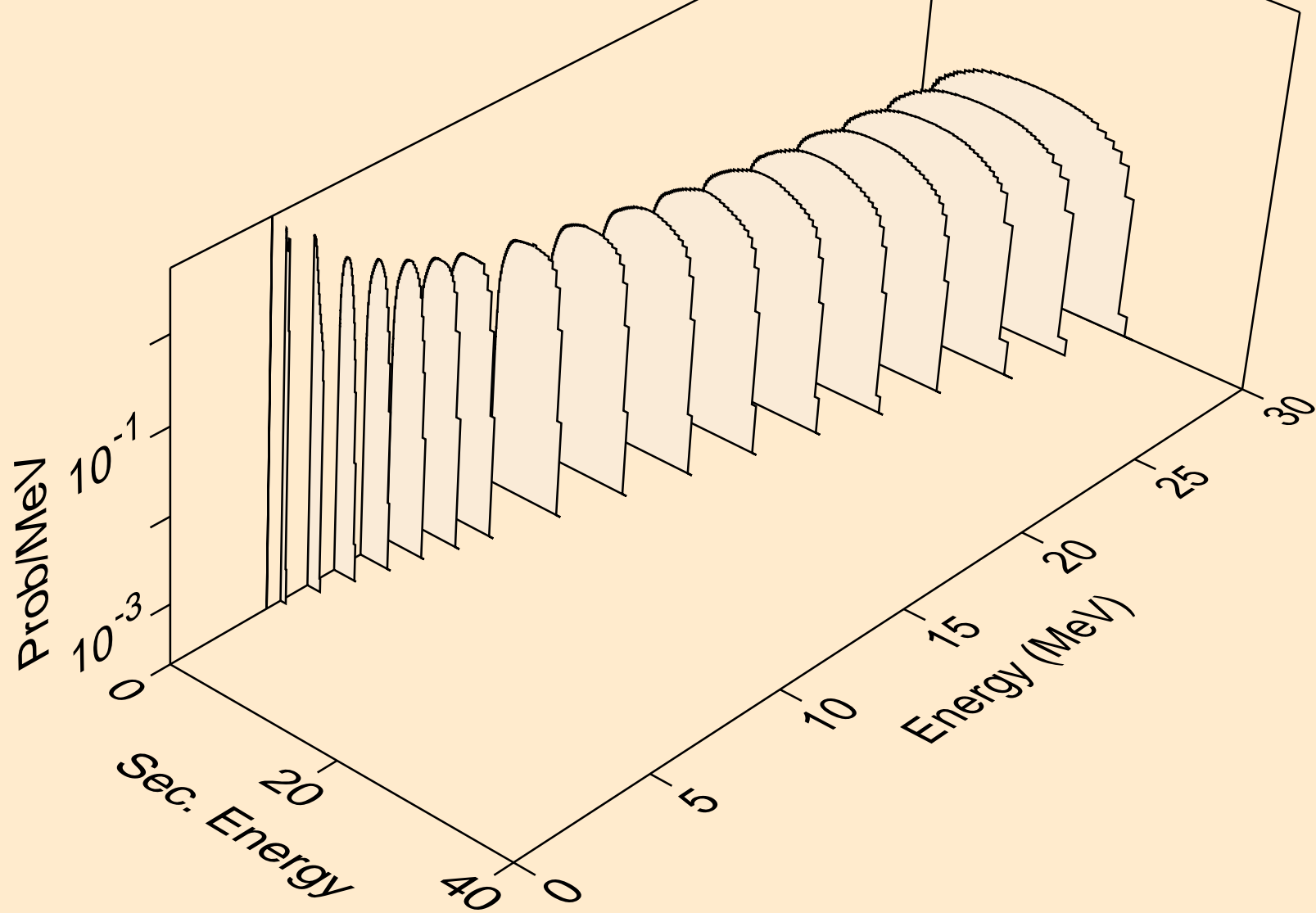



LR265 DEUTERON ACER TENDL-2021 LIBRARY; T=0.K  
neutrons from (d,3n)

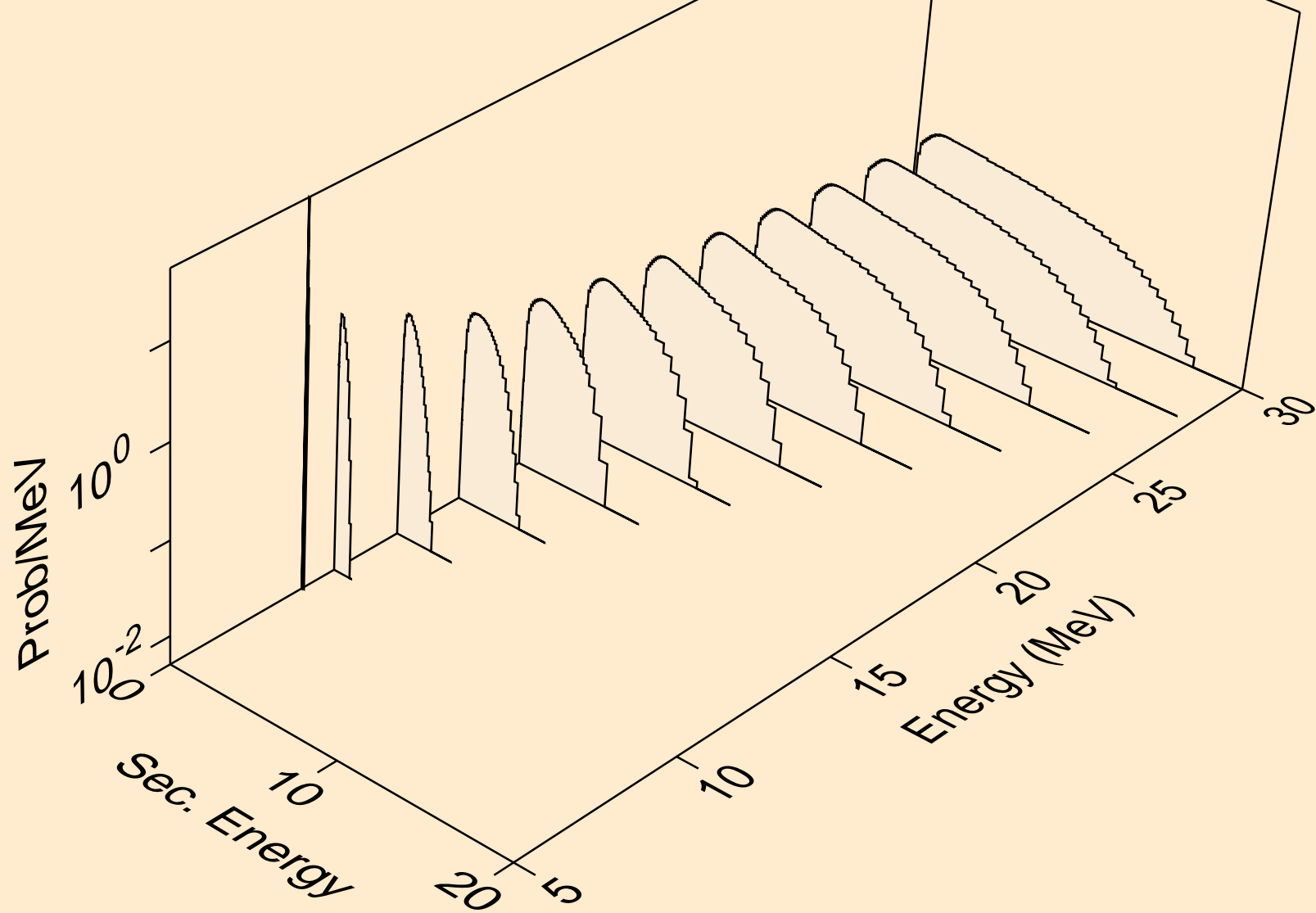

LR265 DEUTERON ACER TENDL-2021 LIBRARY; T=0.K  
neutrons from (d,n\*)p

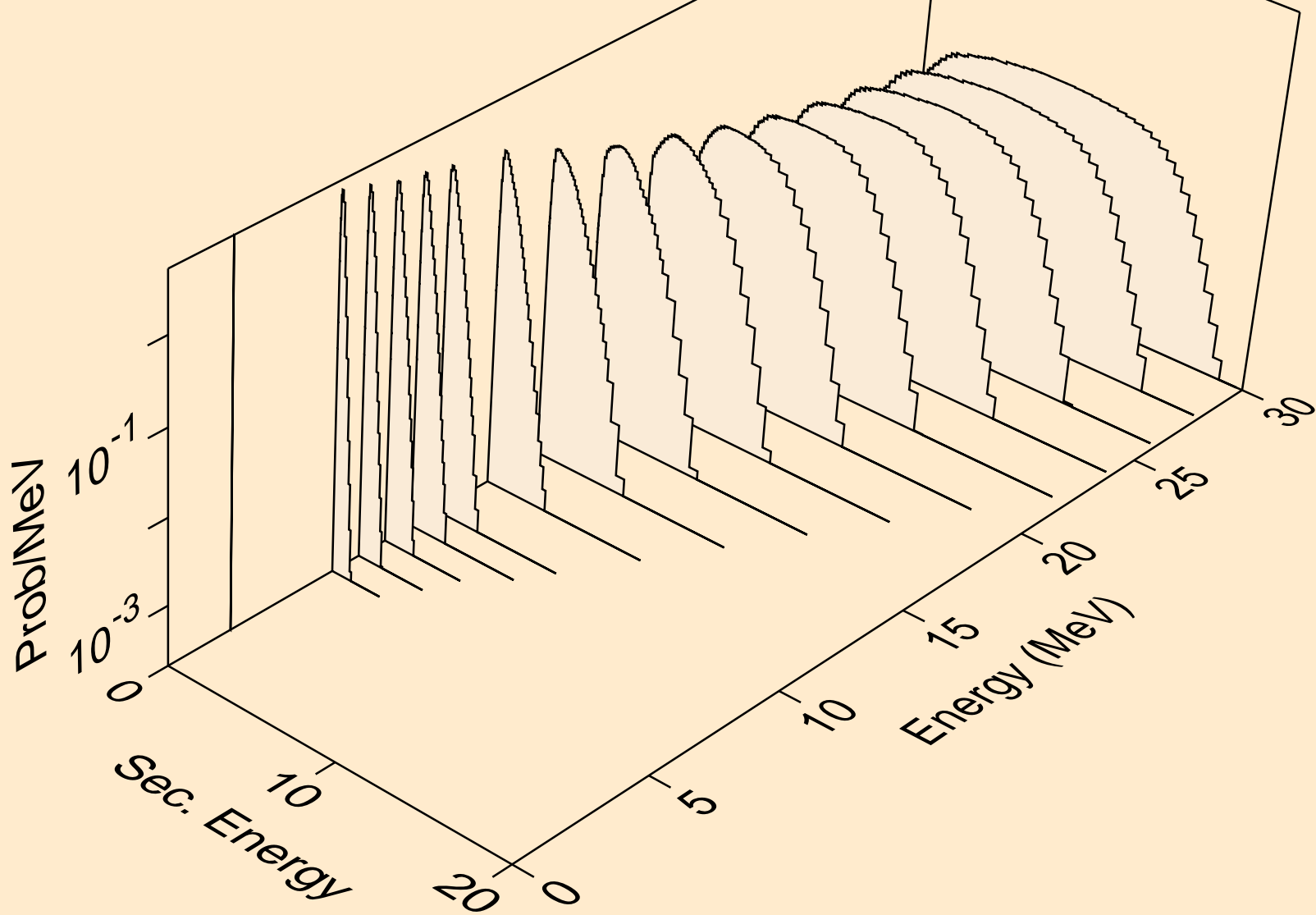

LR265 DEUTERON ACER TENDL-2021 LIBRARY; T=0.K  
neutrons from (d,n\*)d

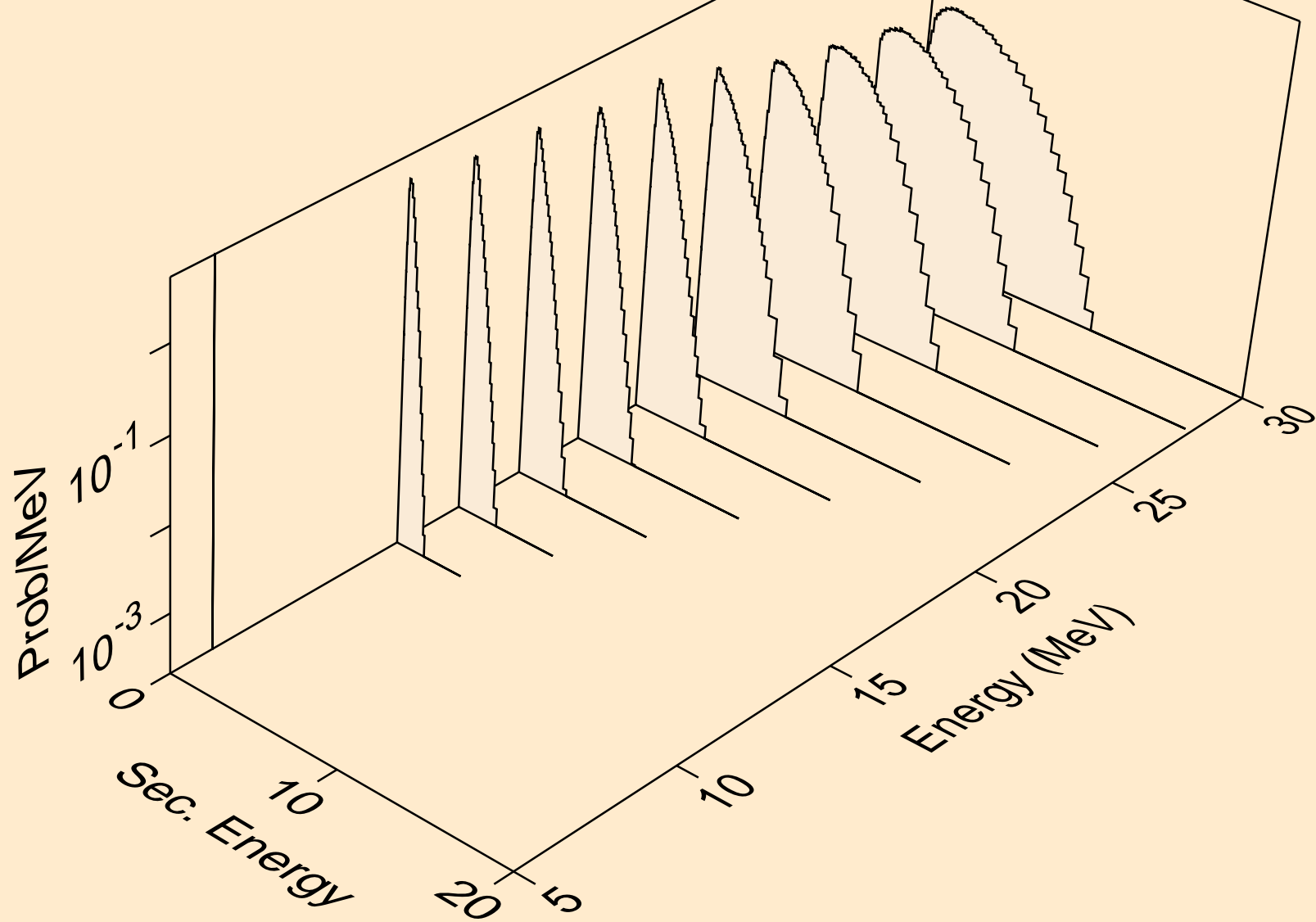

LR265 DEUTERON ACER TENDL-2021 LIBRARY; T=0.K  
neutrons from (d,n\*)t

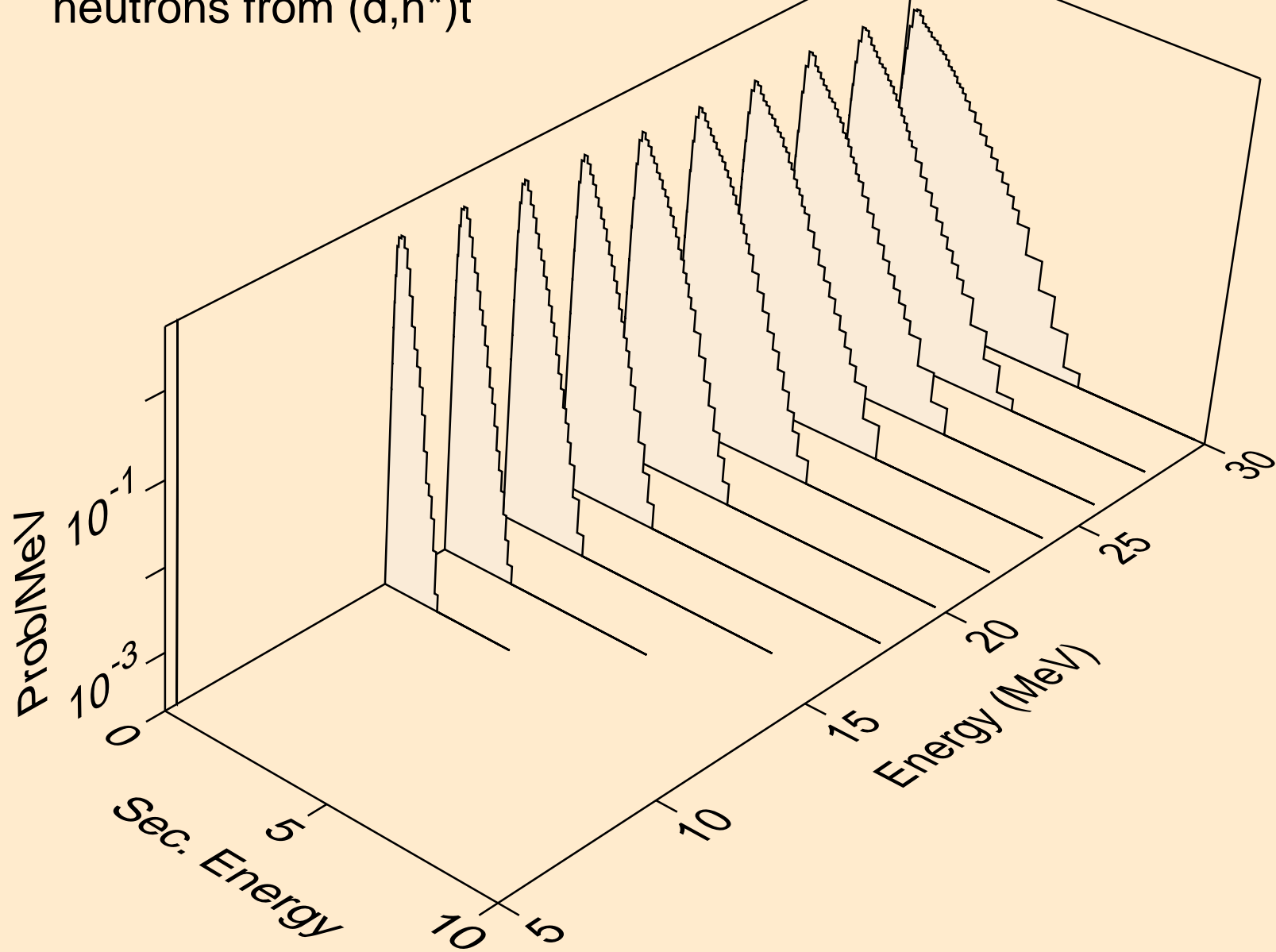

LR265 DEUTERON ACER TENDL-2021 LIBRARY; T=0.K  
neutrons from (d,4n)

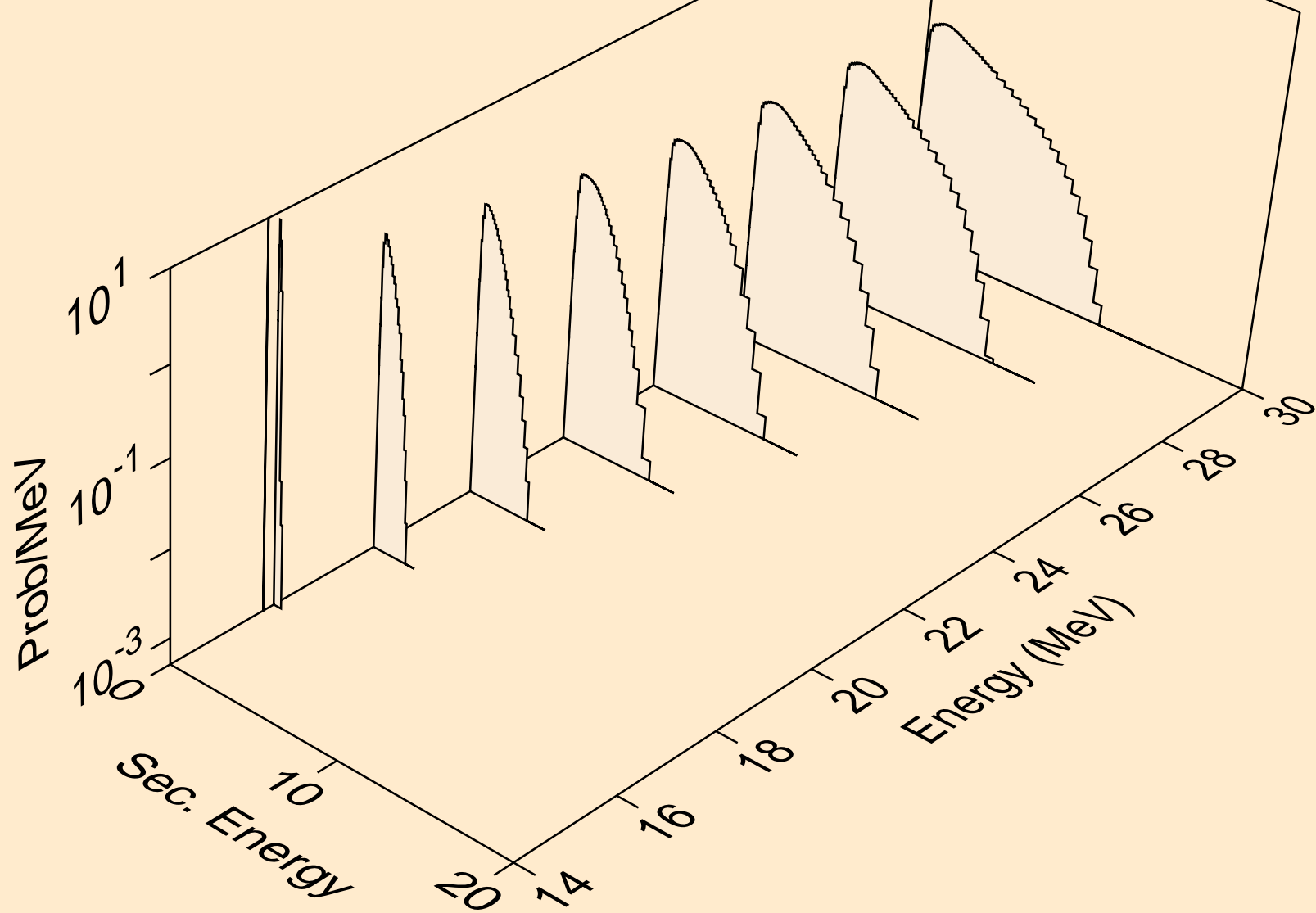

LR265 DEUTERON ACER TENDL-2021 LIBRARY; T=0.K  
neutrons from (d,2np)

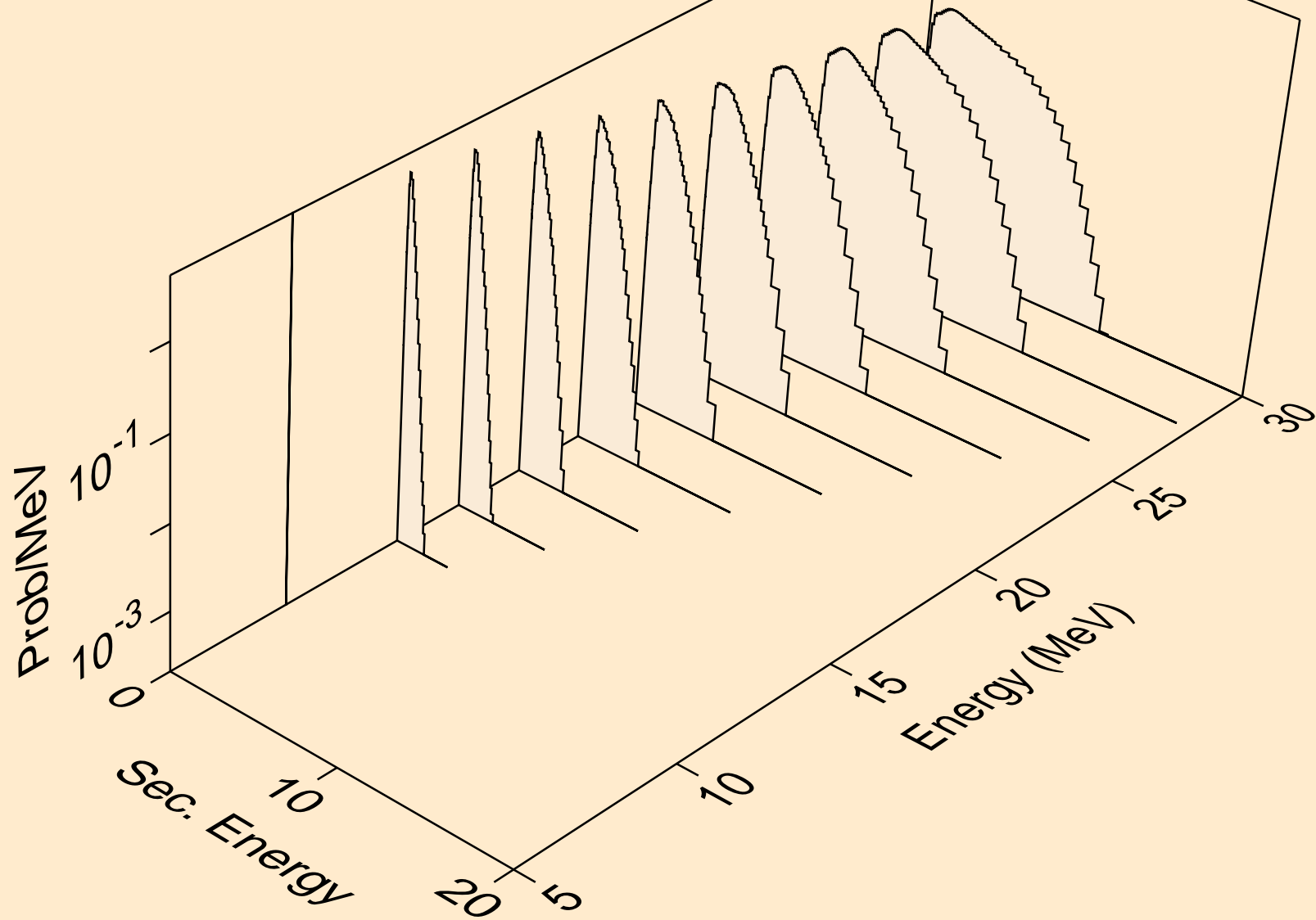

LR265 DEUTERON ACER TENDL-2021 LIBRARY; T=0.K  
neutrons from (d,3np)

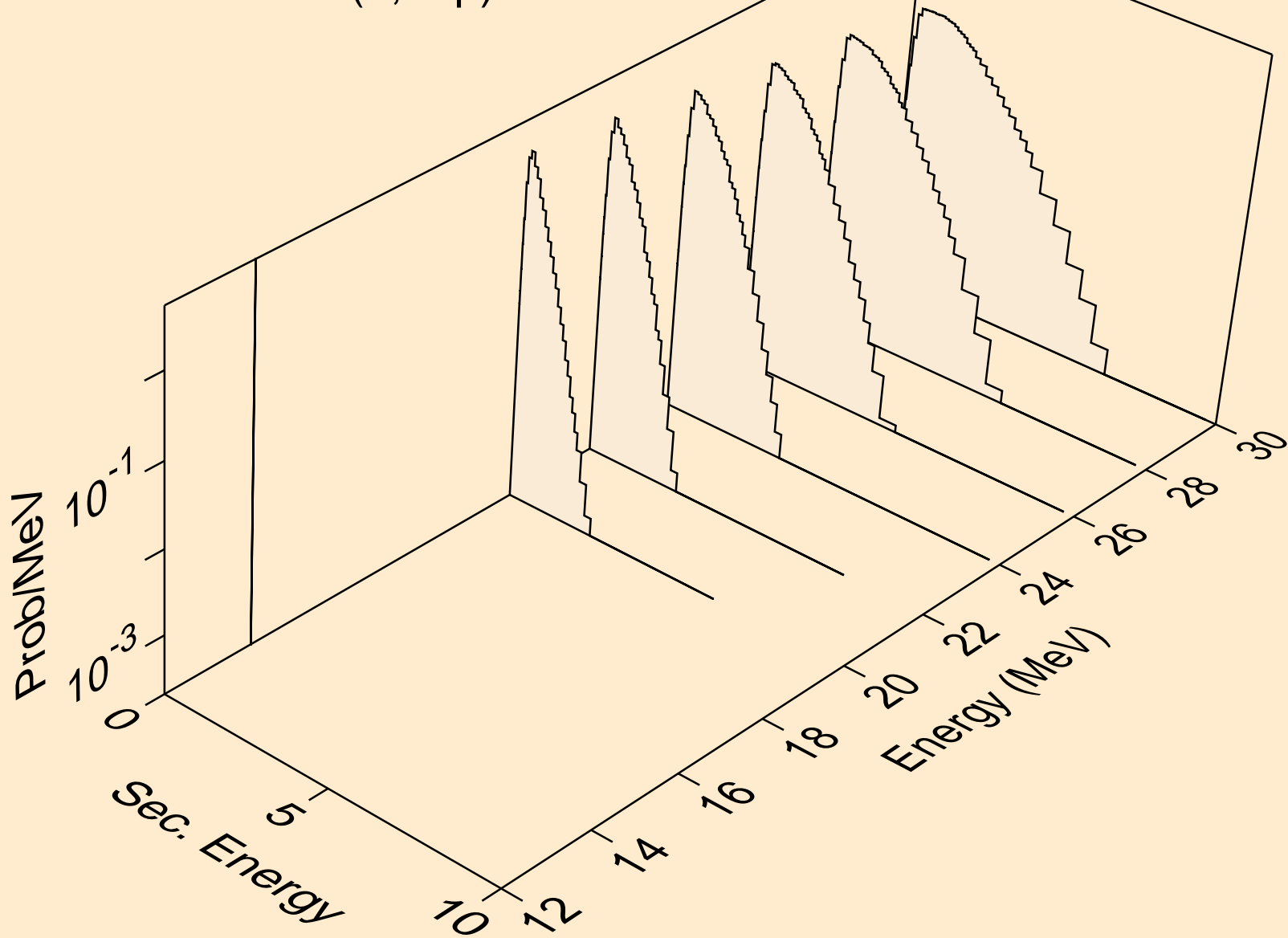

LR265 DEUTERON ACER TENDL-2021 LIBRARY; T=0.K  
neutrons from (d,2np)

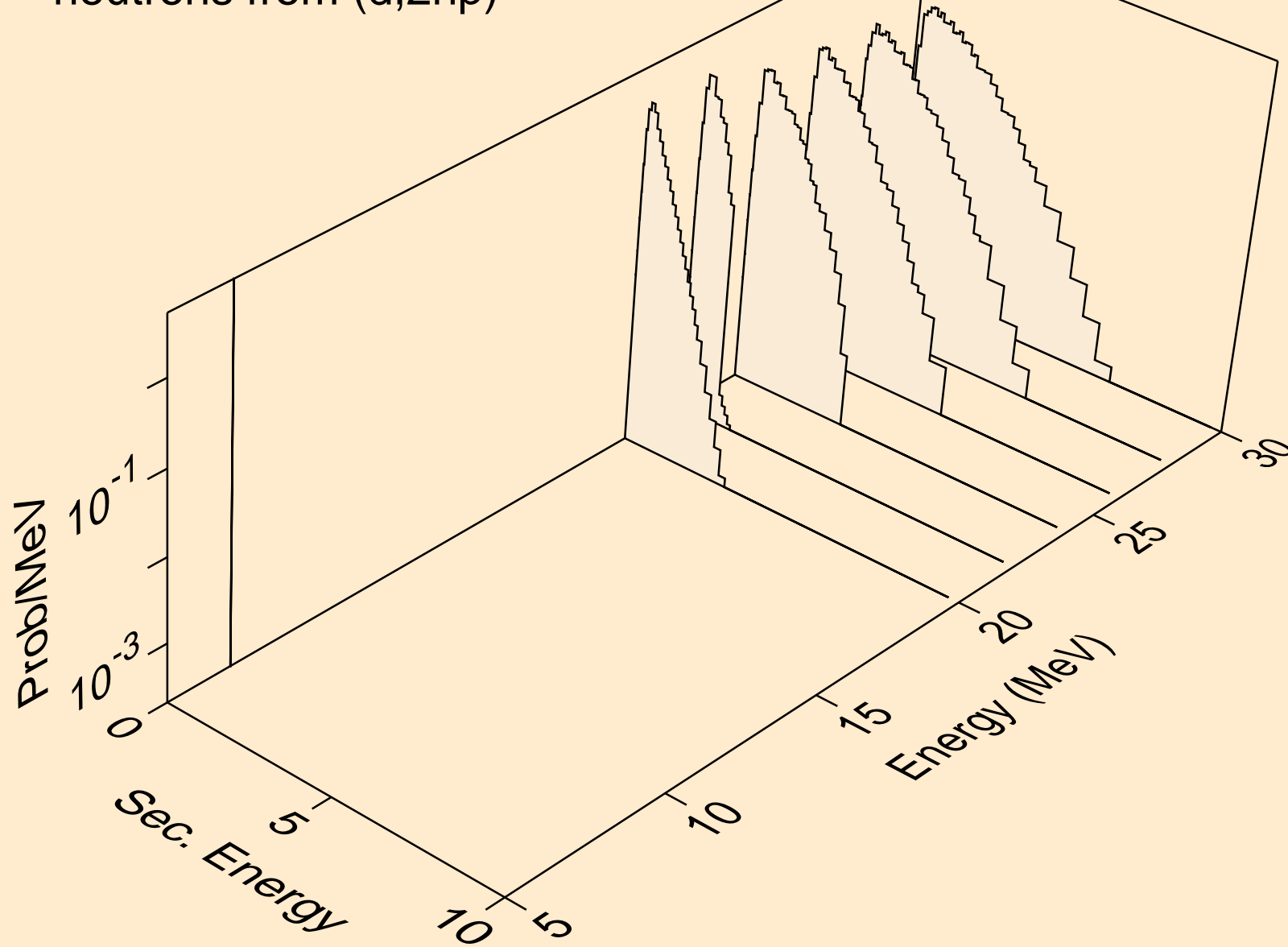



LR265 DEUTERON ACER TENDL-2021 LIBRARY; T=0.K  
protons from (d,x)

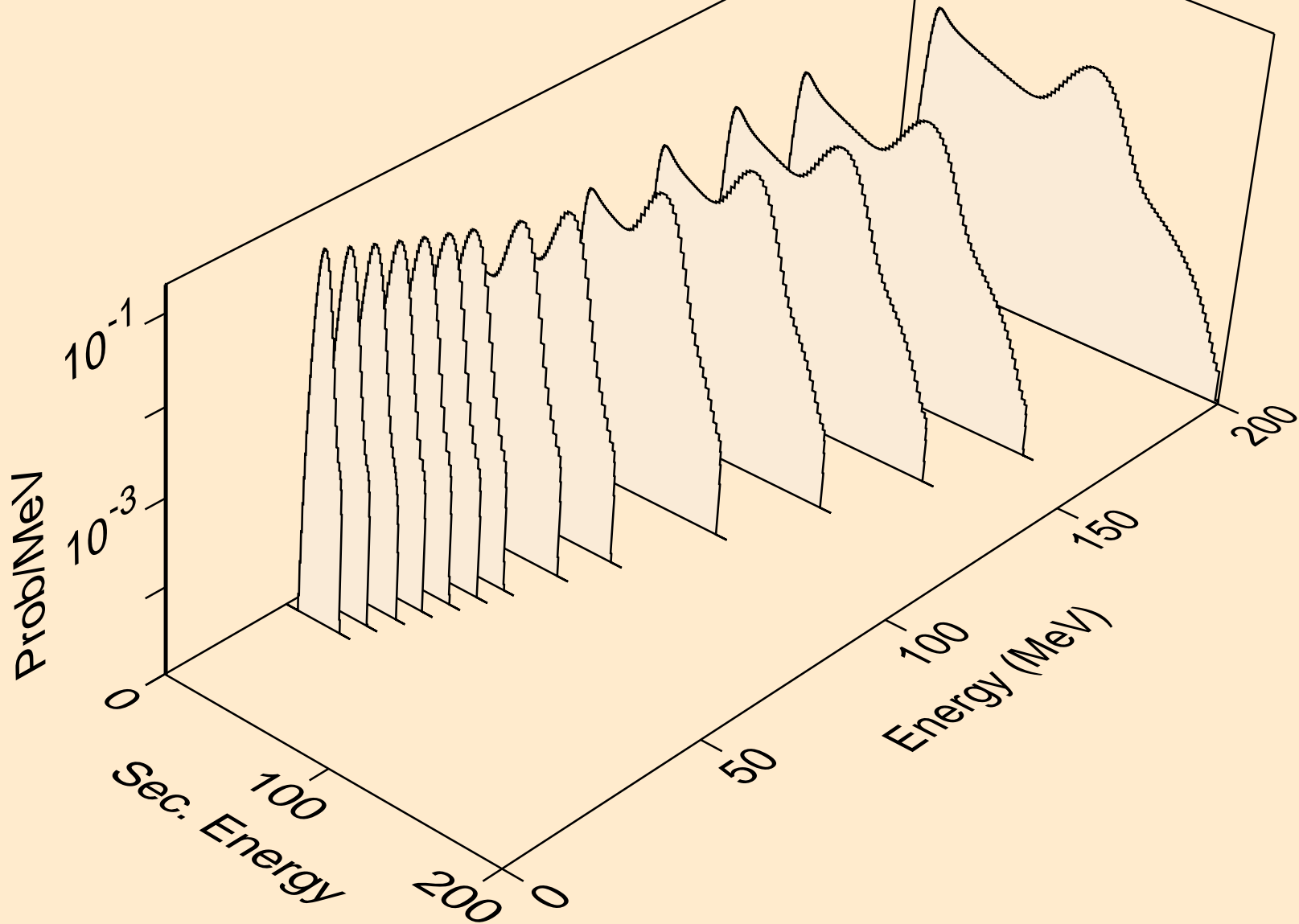

LR265 DEUTERON ACER TENDL-2021 LIBRARY; T=0.K  
protons from (d,n\*)p

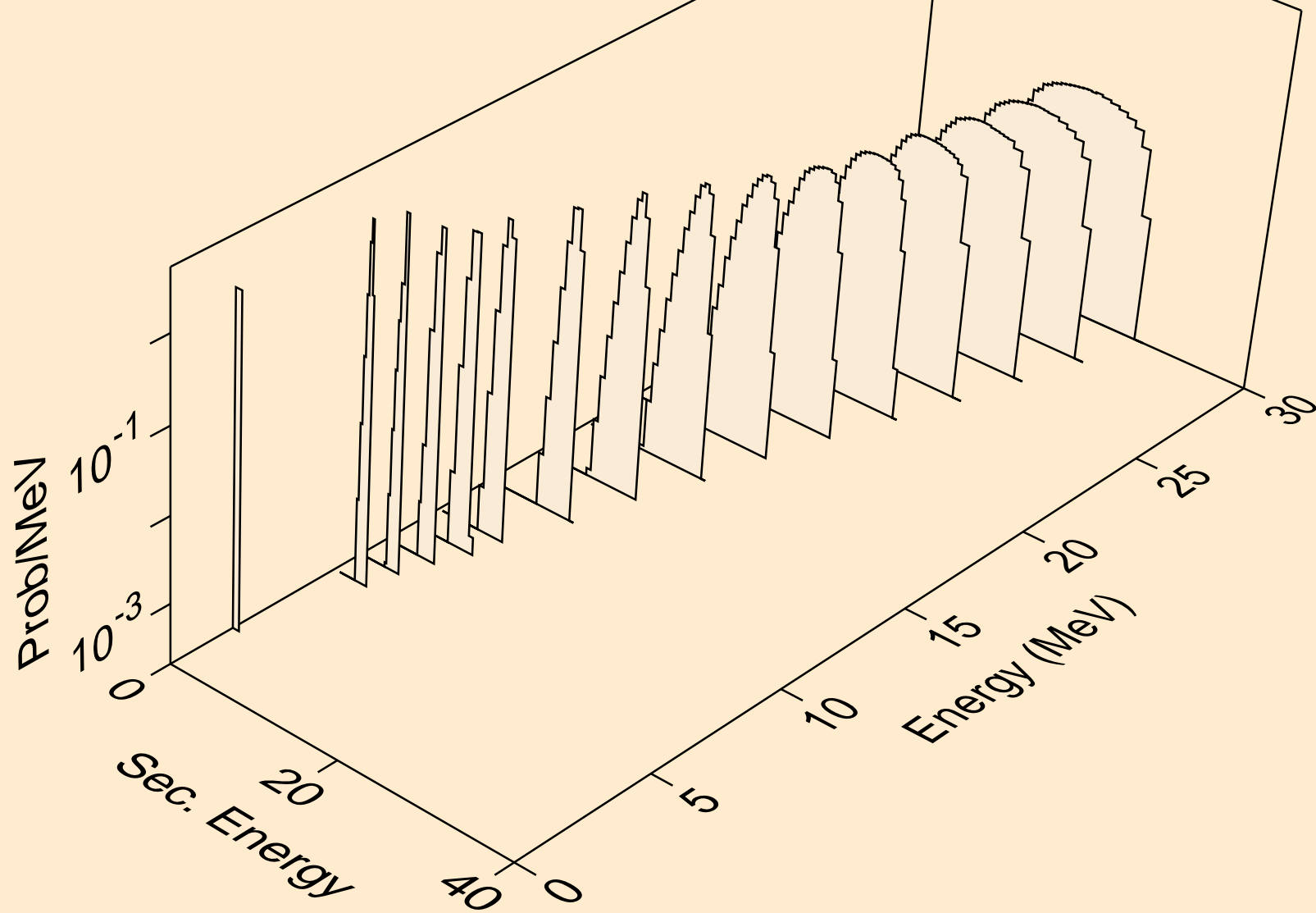

LR265 DEUTERON ACER TENDL-2021 LIBRARY; T=0.K  
protons from (d,2np)

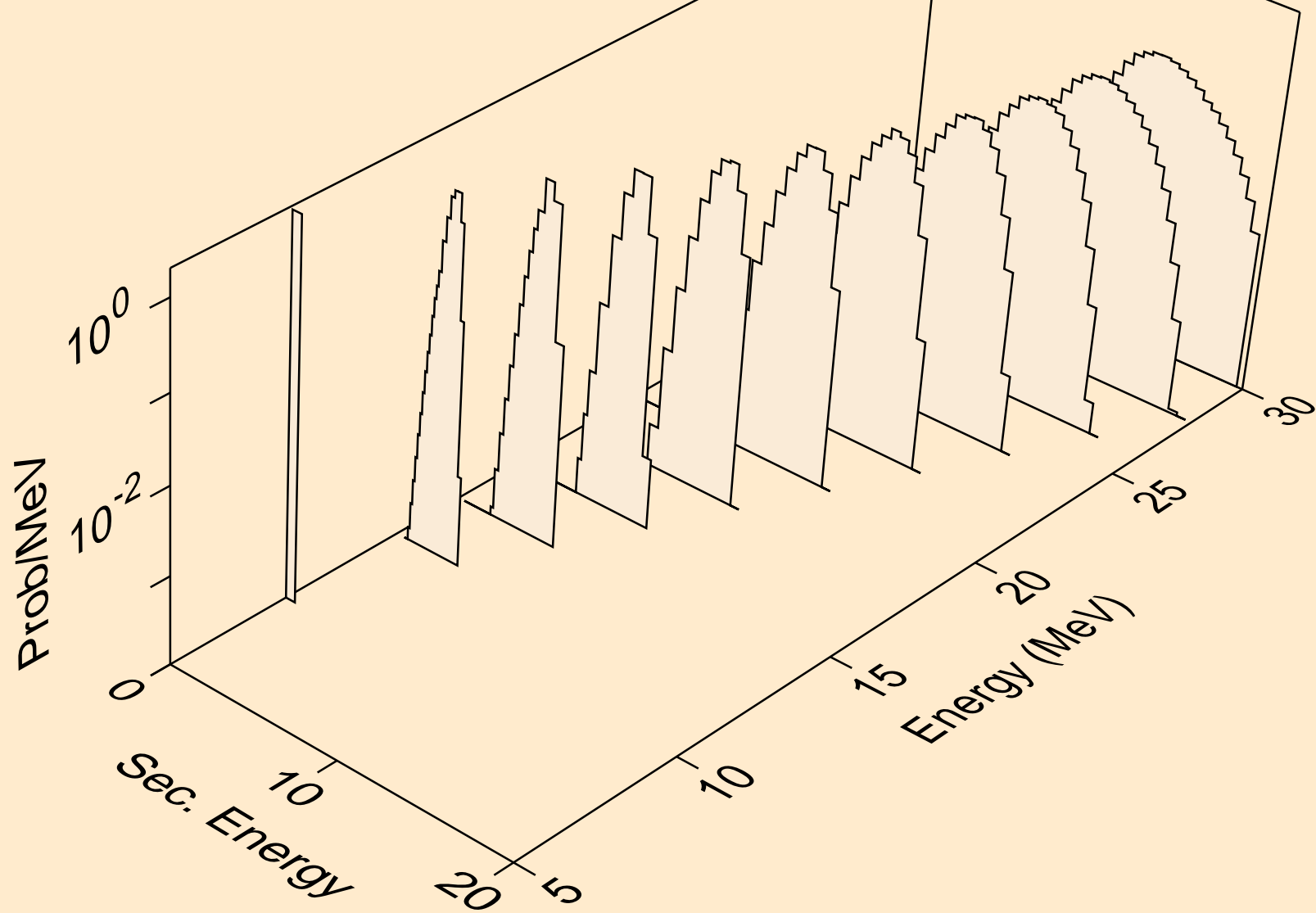

LR265 DEUTERON ACER TENDL-2021 LIBRARY; T=0.K  
protons from (d,3np)

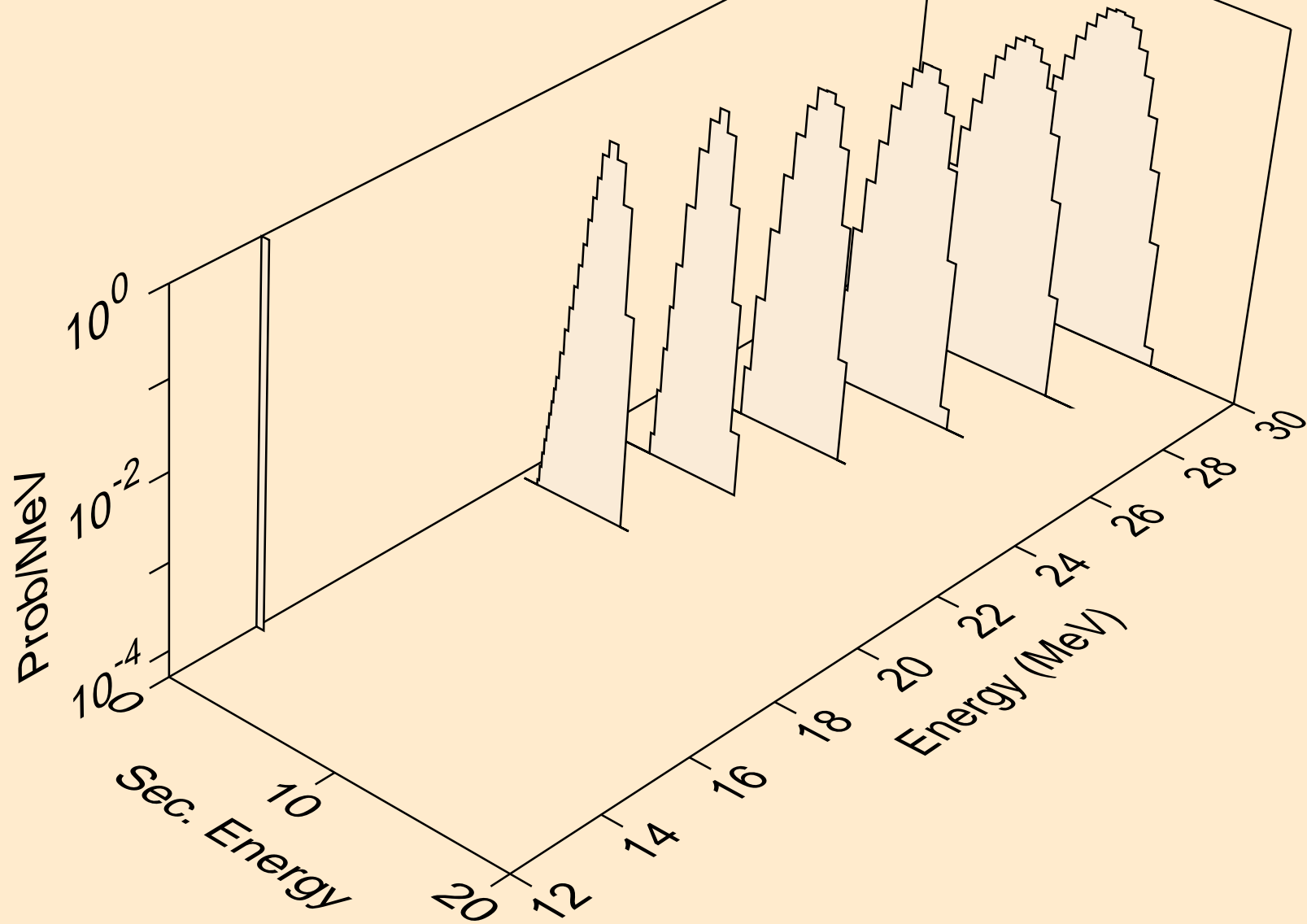

LR265 DEUTERON ACER TENDL-2021 LIBRARY; T=0.K  
protons from (d,2np)

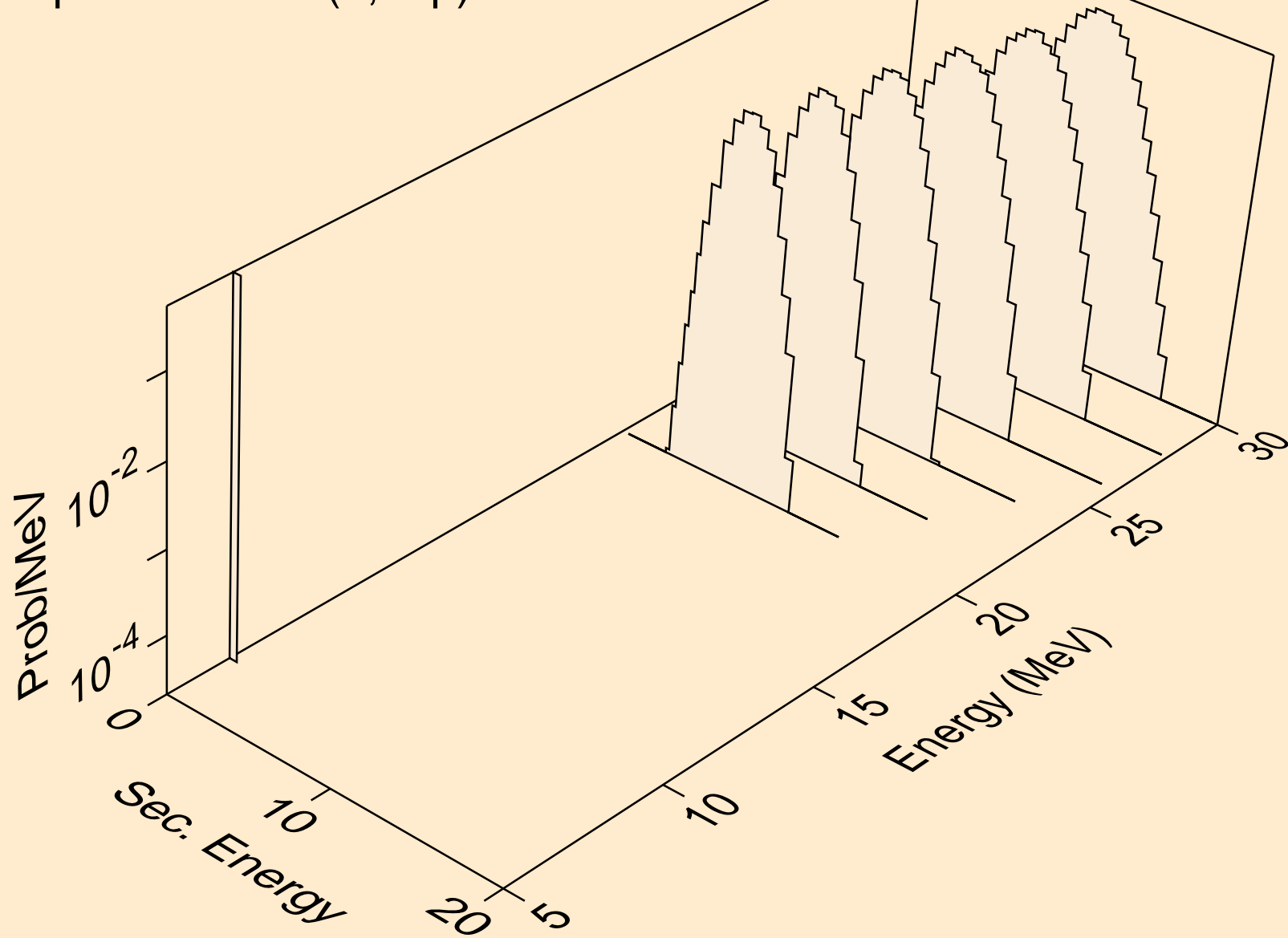

LR265 DEUTERON ACER TENDL-2021 LIBRARY; T=0.K  
protons from (d,p)

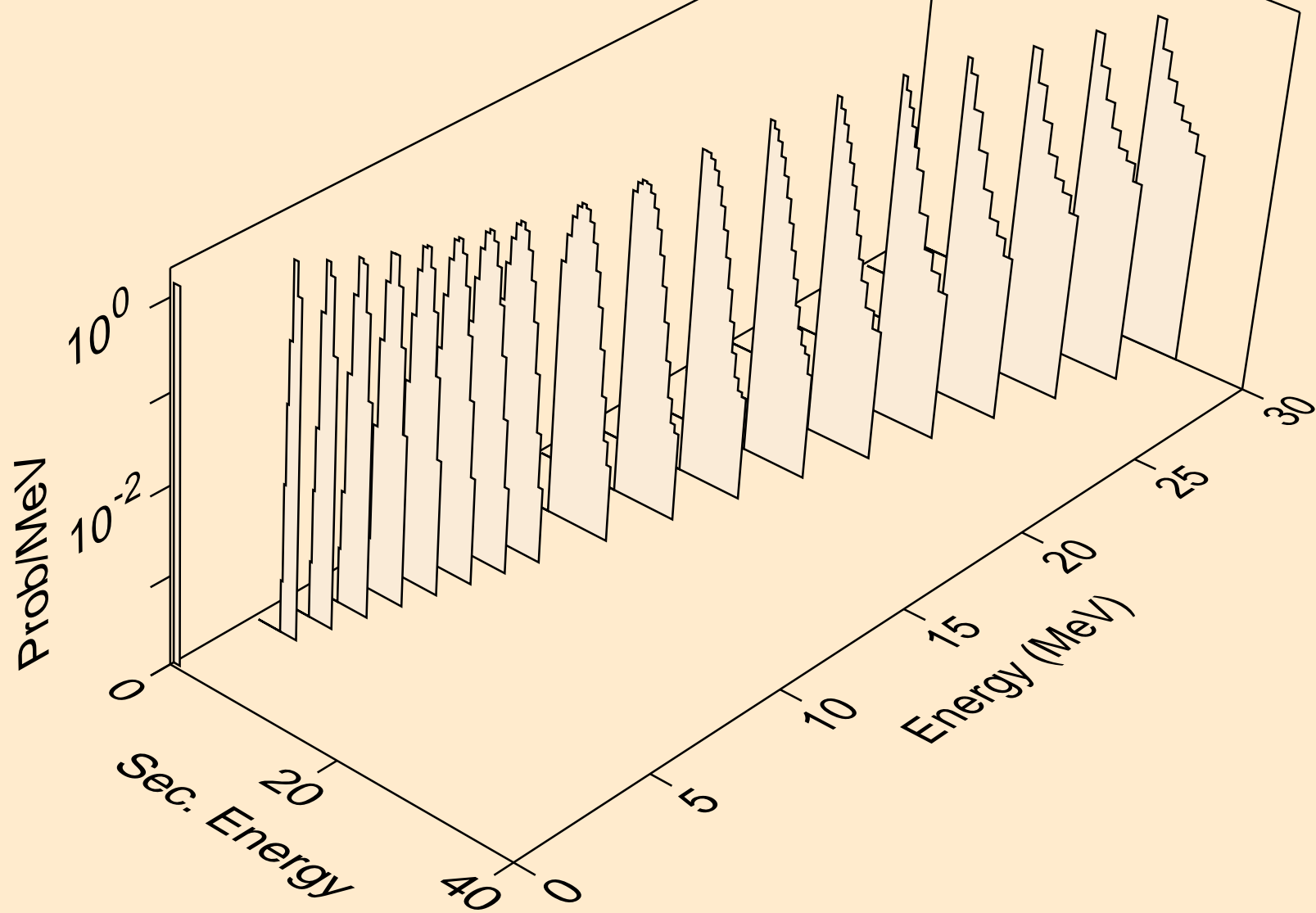

LR265 DEUTERON ACER TENDL-2021 LIBRARY; T=0.K  
protons from (d,pd)

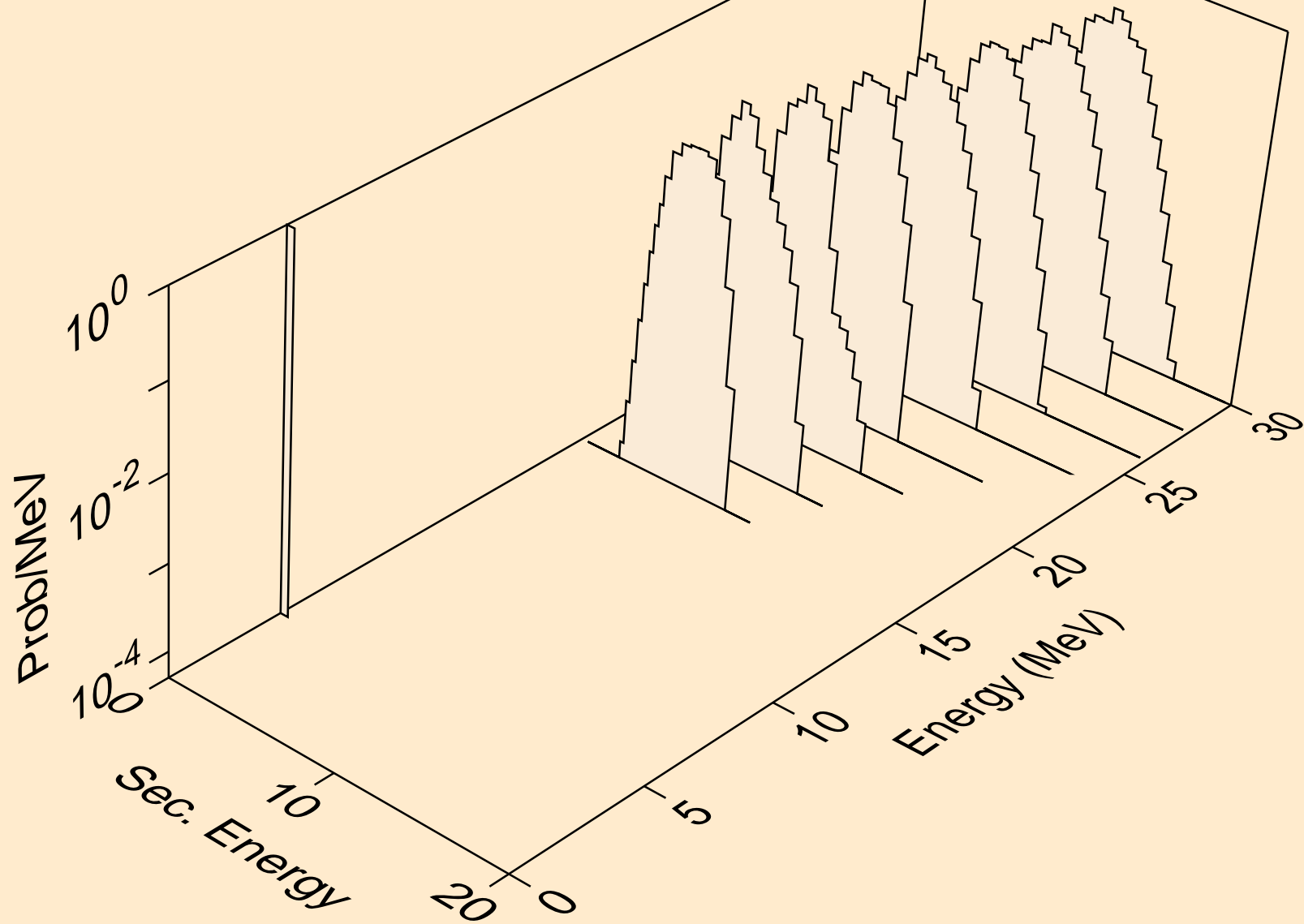

LR265 DEUTERON ACER TENDL-2021 LIBRARY; T=0.K  
tritons from (d,x)

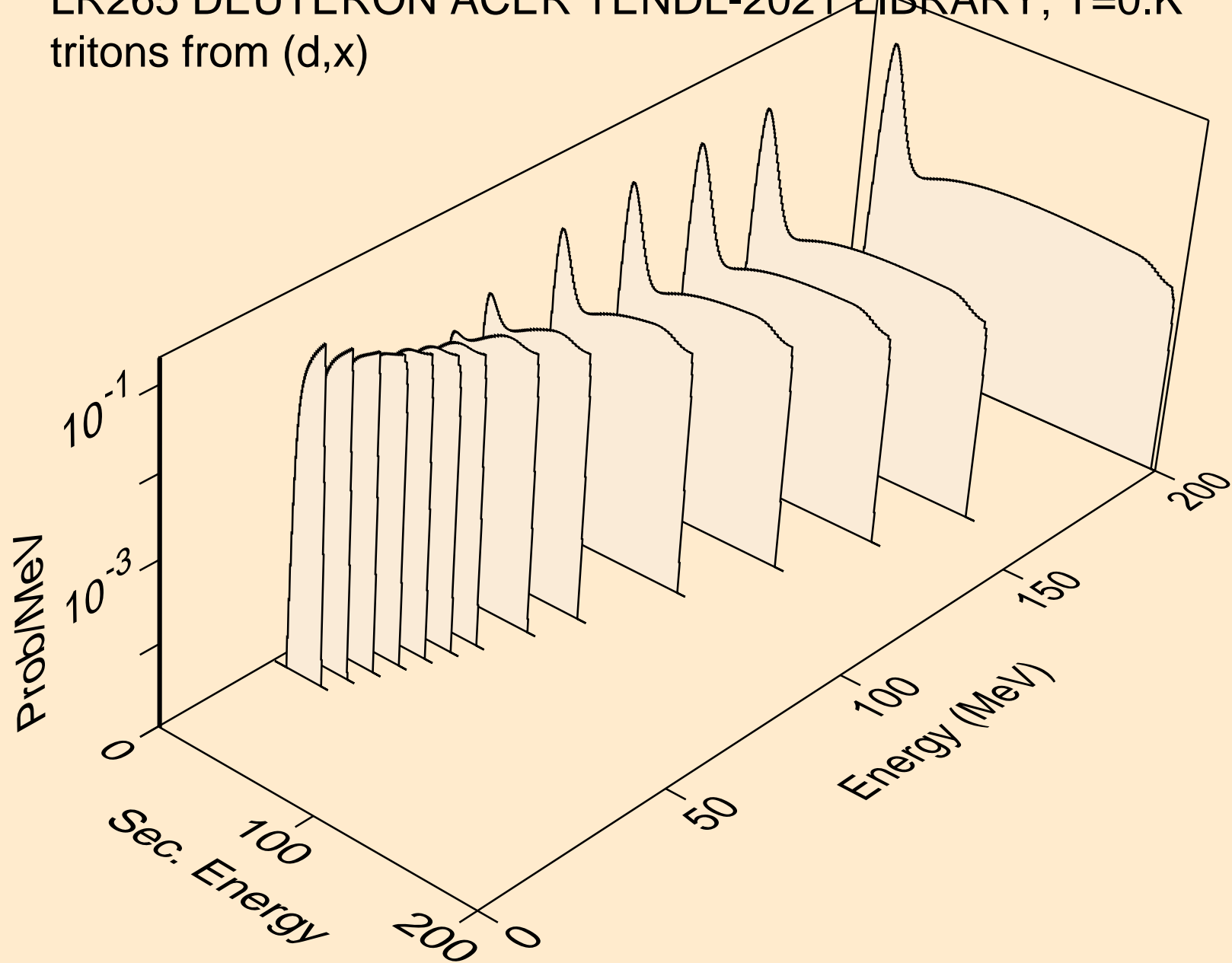



LR265 DEUTERON ACER TENDL-2021 LIBRARY; T=0.K  
tritons from (d,n\*)t

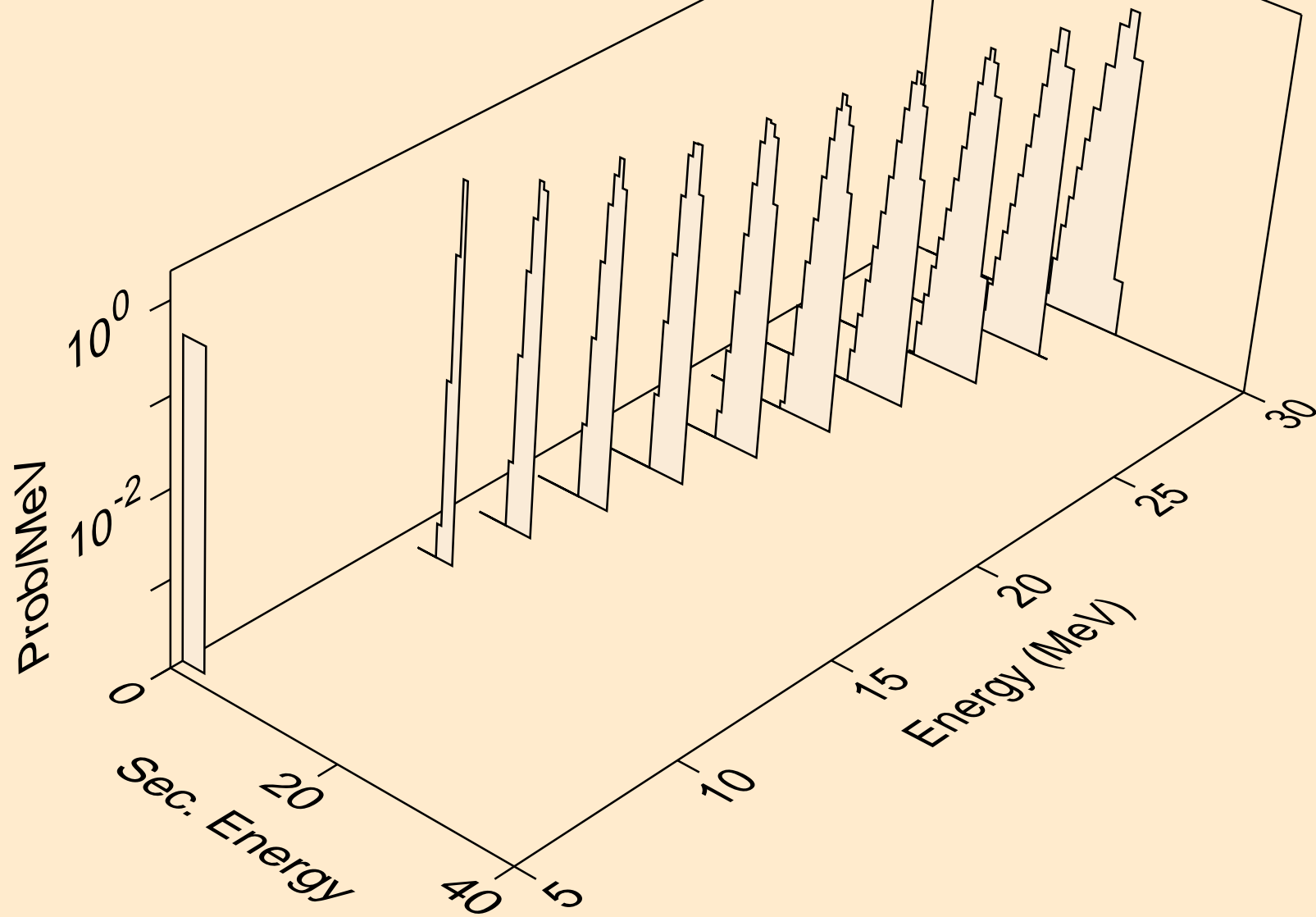

LR265 DEUTERON ACER TENDL-2021 LIBRARY; T=0.K  
tritons from (d,t)

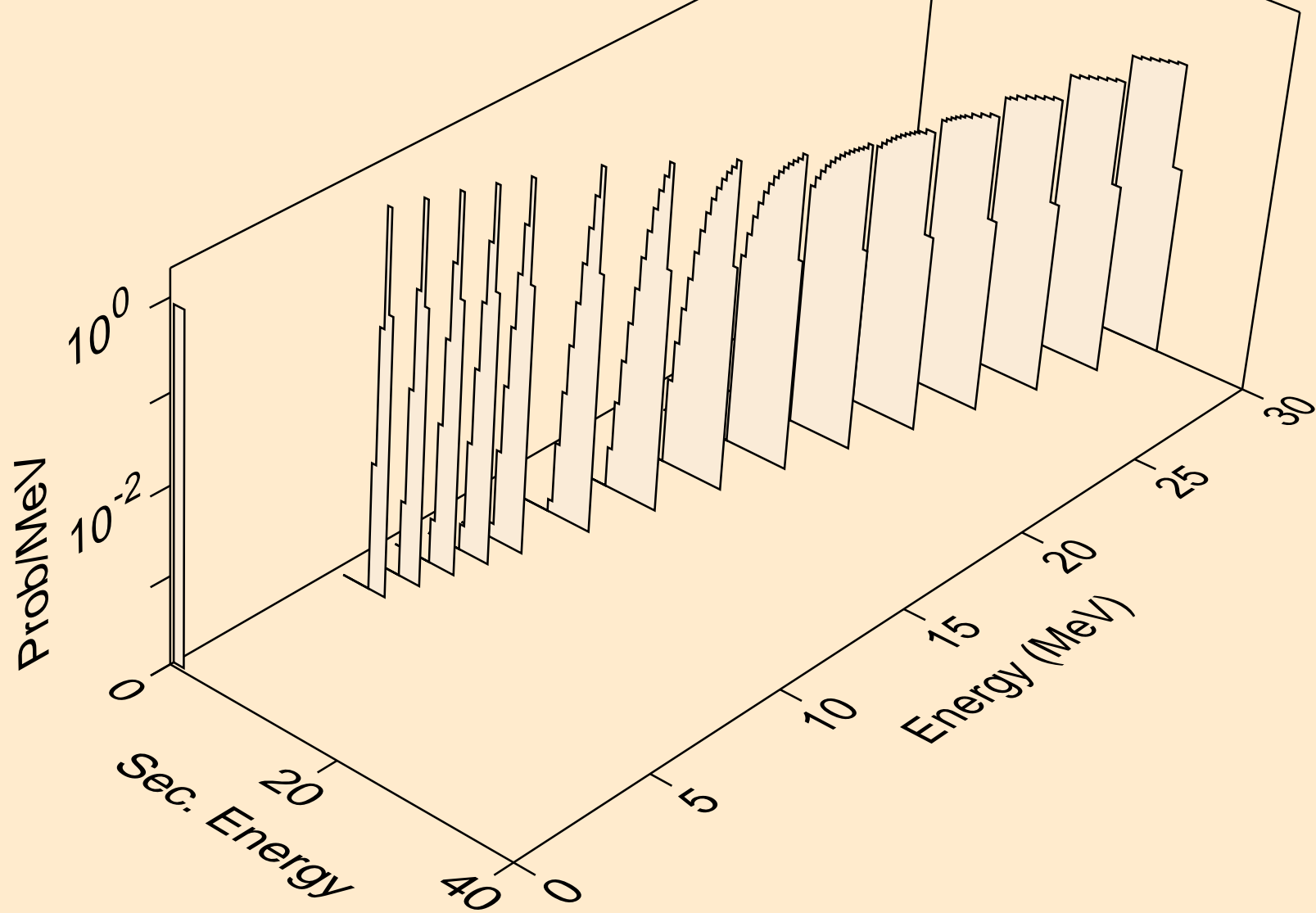

LR265 DEUTERON ACER TENDL-2021 LIBRARY; T=0.K  
he3s from (d,x)

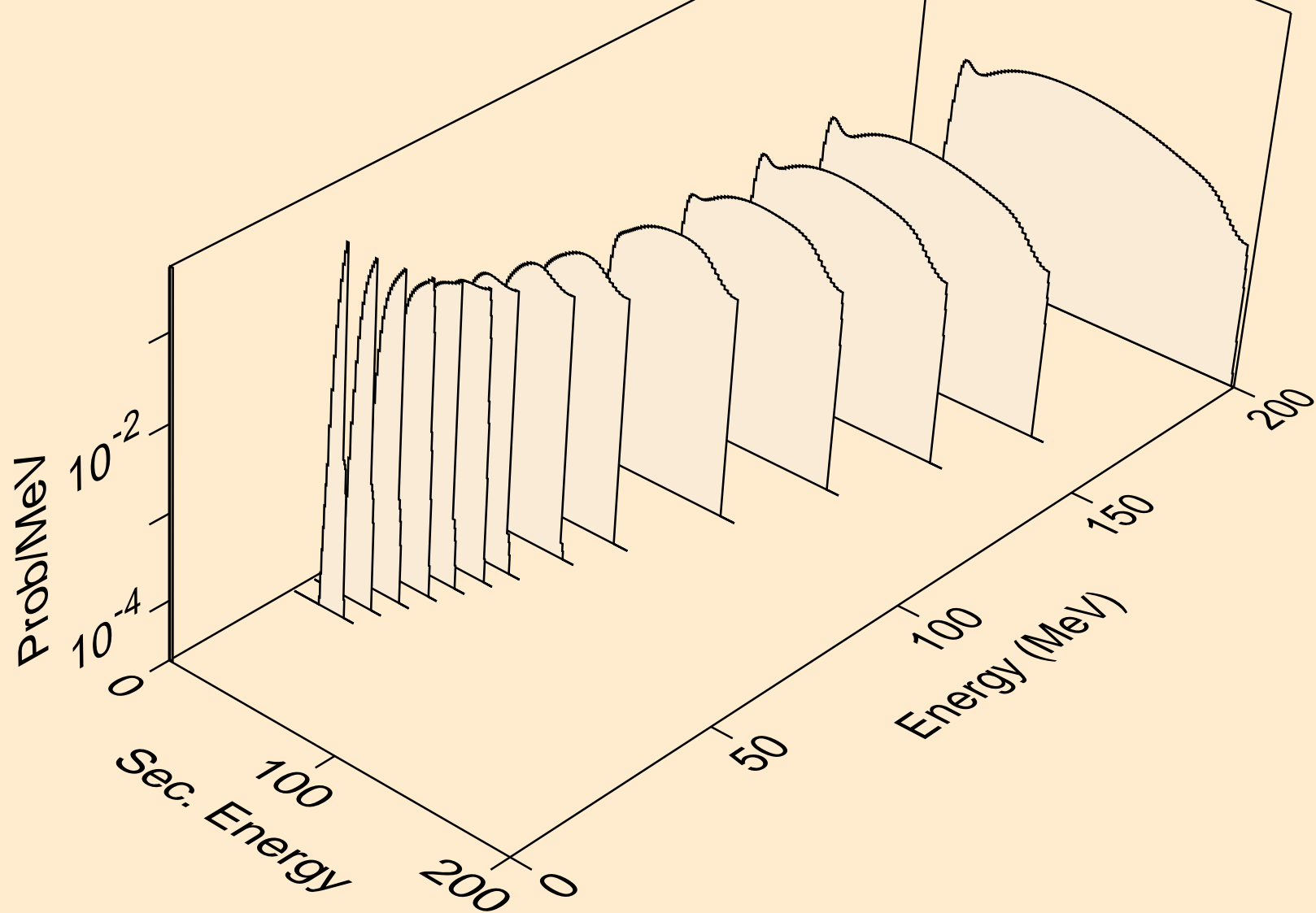

LR265 DEUTERON ACER TENDL-2021 LIBRARY; T=0.K  
he3s from (d,he3)

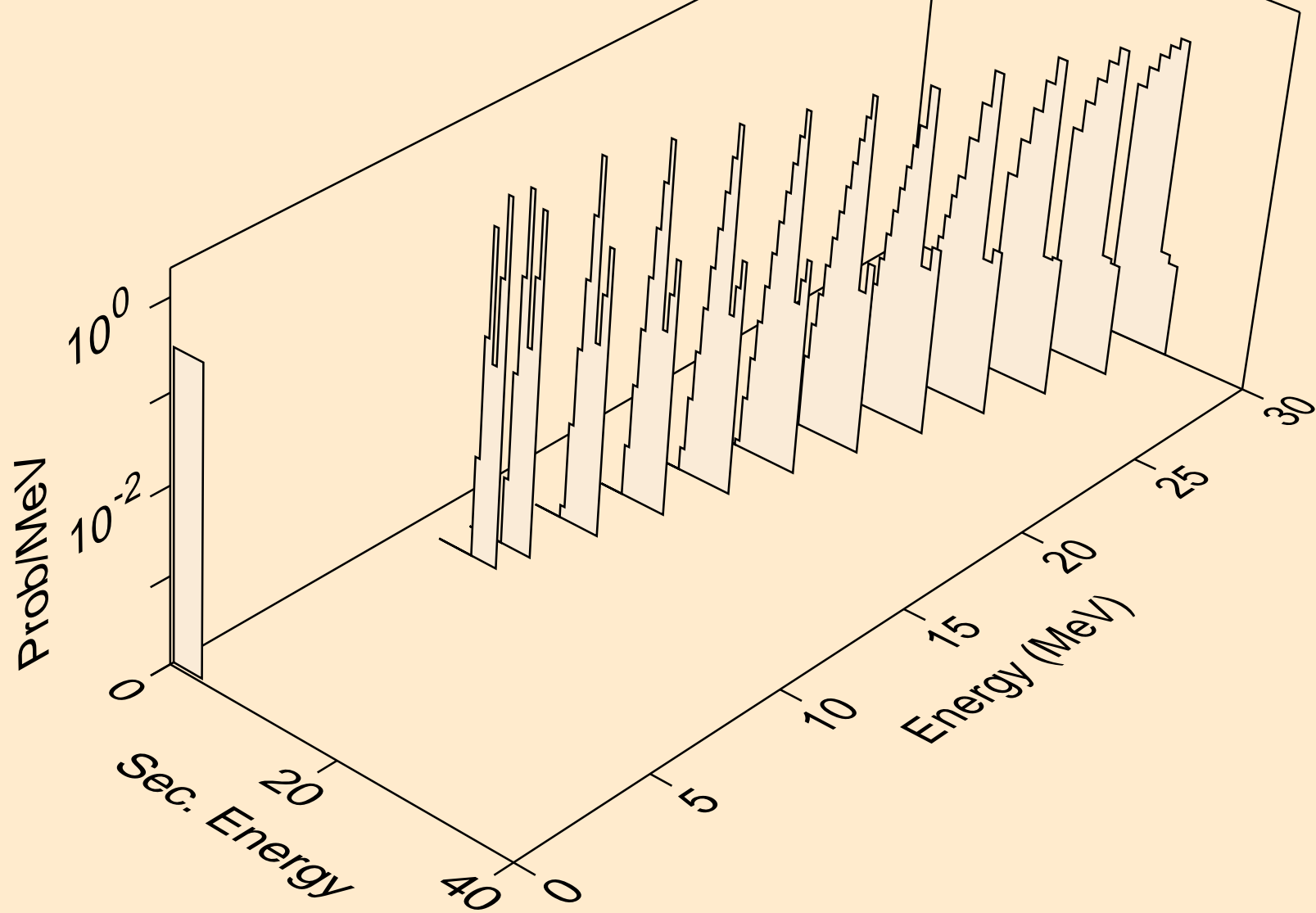

LR265 DEUTERON ACER TENDL-2021 LIBRARY; T=0.K  
alphas from (d,x)

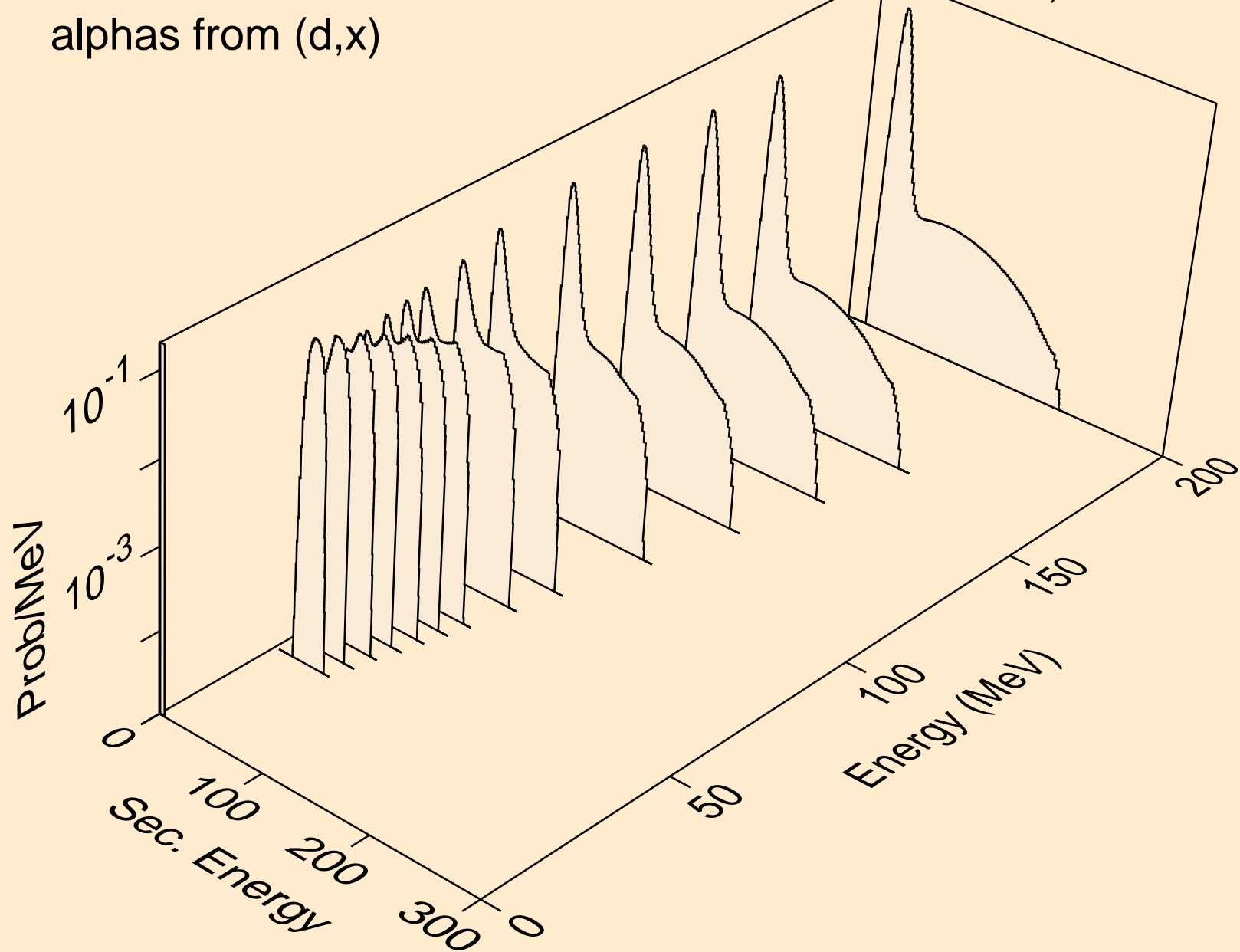

LR265 DEUTERON ACER TENDL-2021 LIBRARY; T=0.K  
alphas from (d,a)

