

LU166 DEUTERON ACER TENDL-2021 LIBRARY; T=0.K  
Principal cross sections

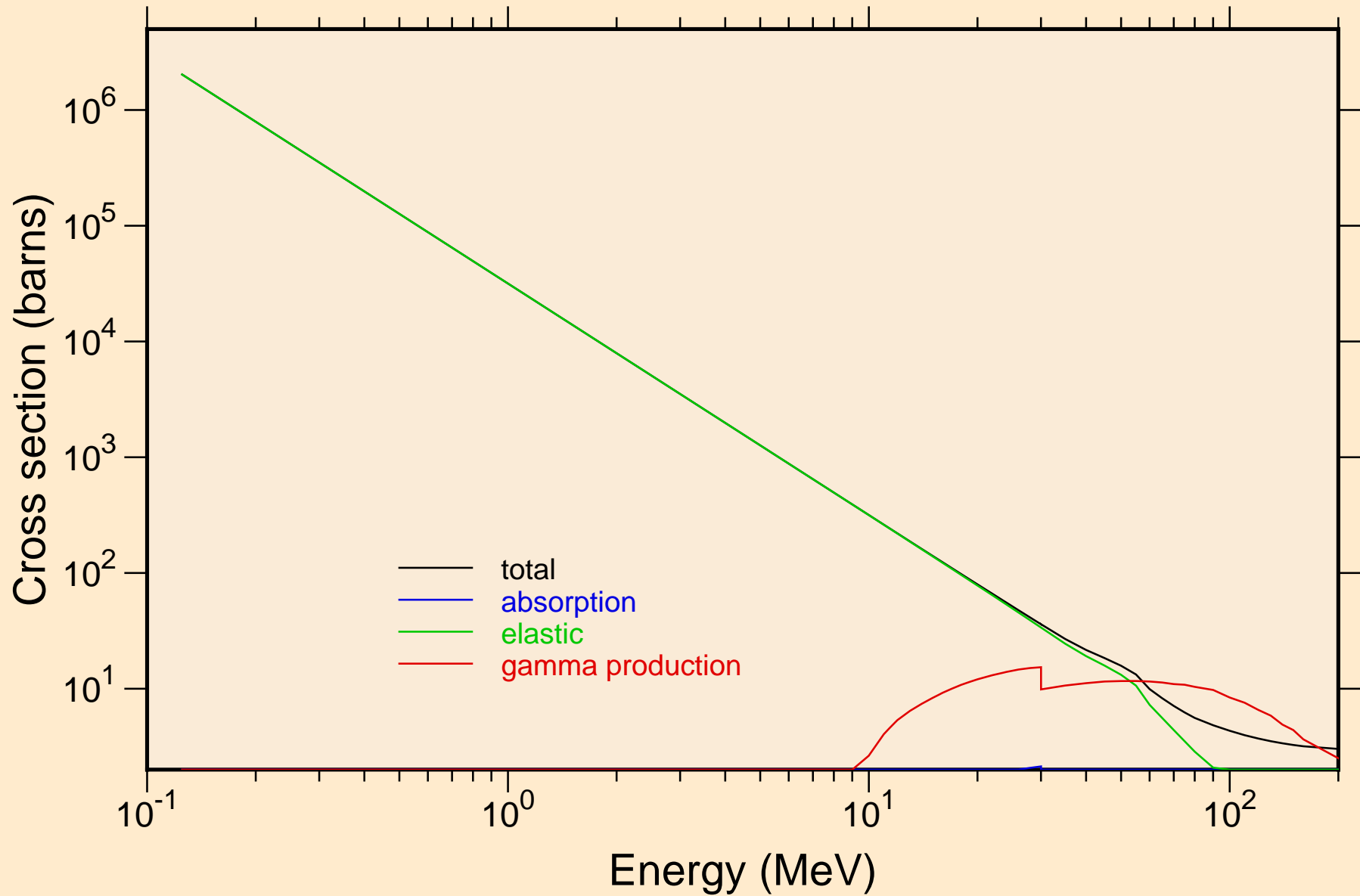

LU166 DEUTERON ACER TENDL-2021 LIBRARY; T=0.K  
Heating

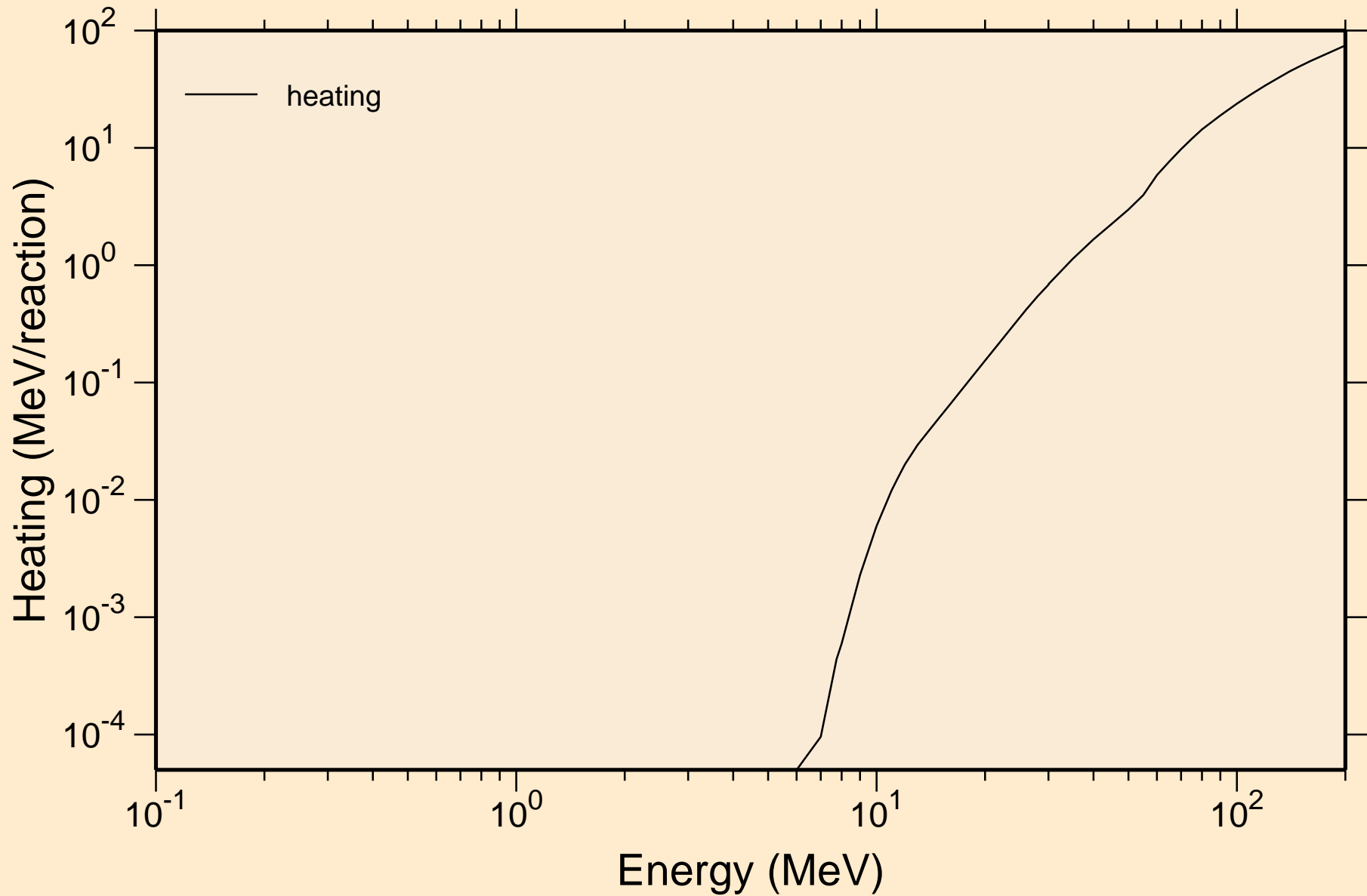

LU166 DEUTERON ACER TENDL-2021 LIBRARY; T=0.K  
Principal cross sections

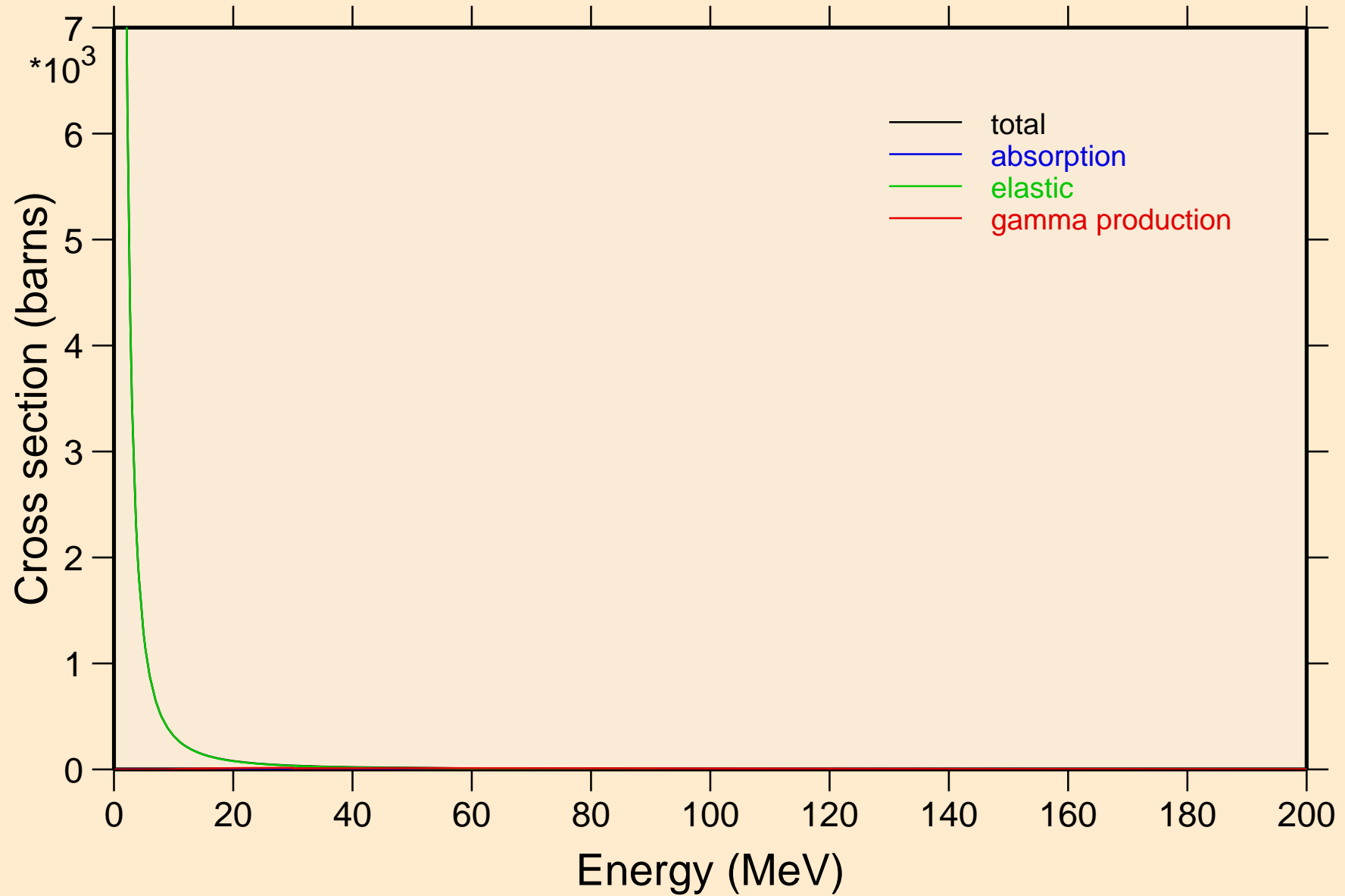

# LU166 DEUTERON ACER TENDL-2021 LIBRARY; T=0.K

## Heating

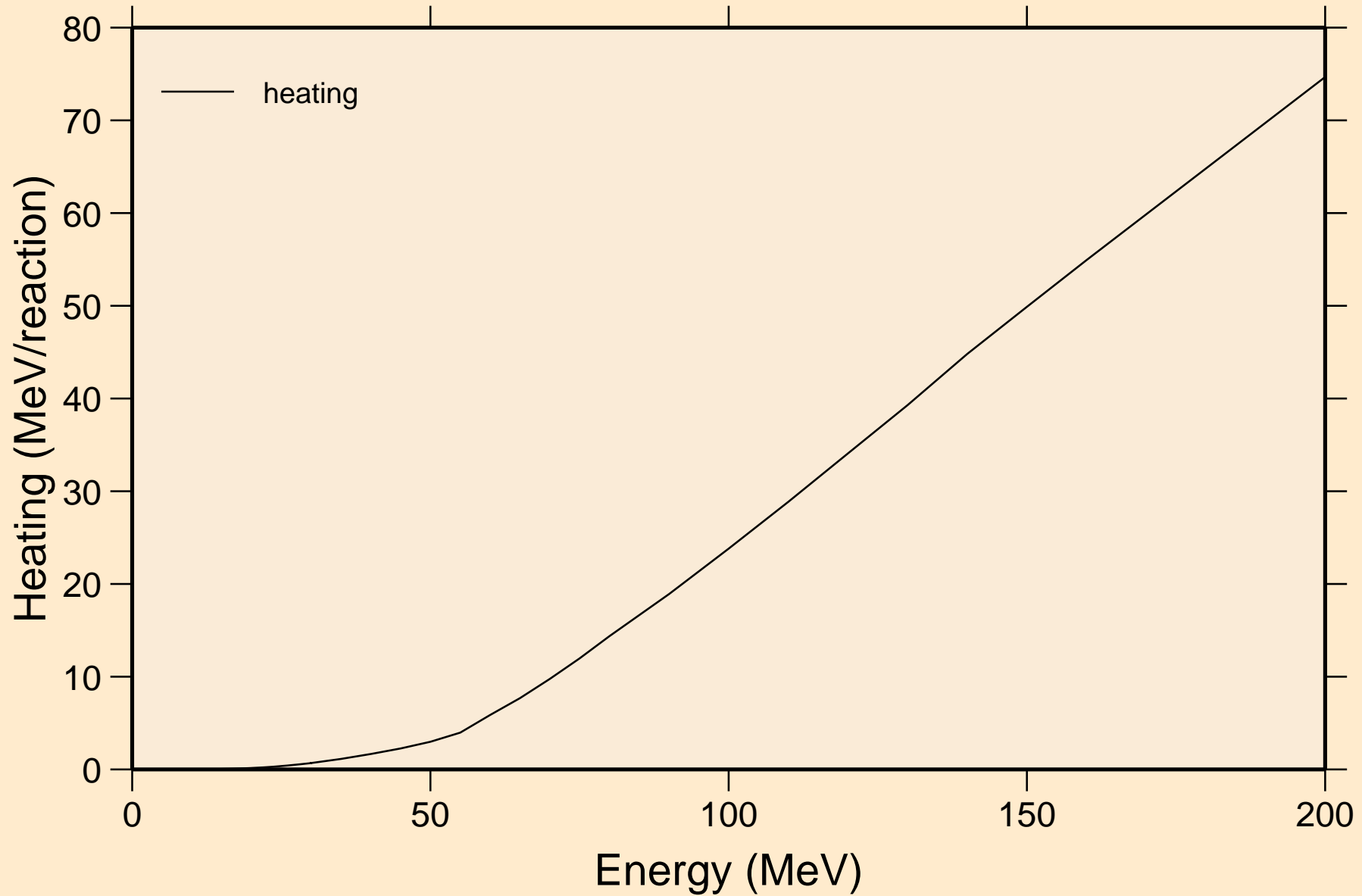

LU166 DEUTERON ACER TENDL-2021 LIBRARY; T=0.K  
Threshold reactions

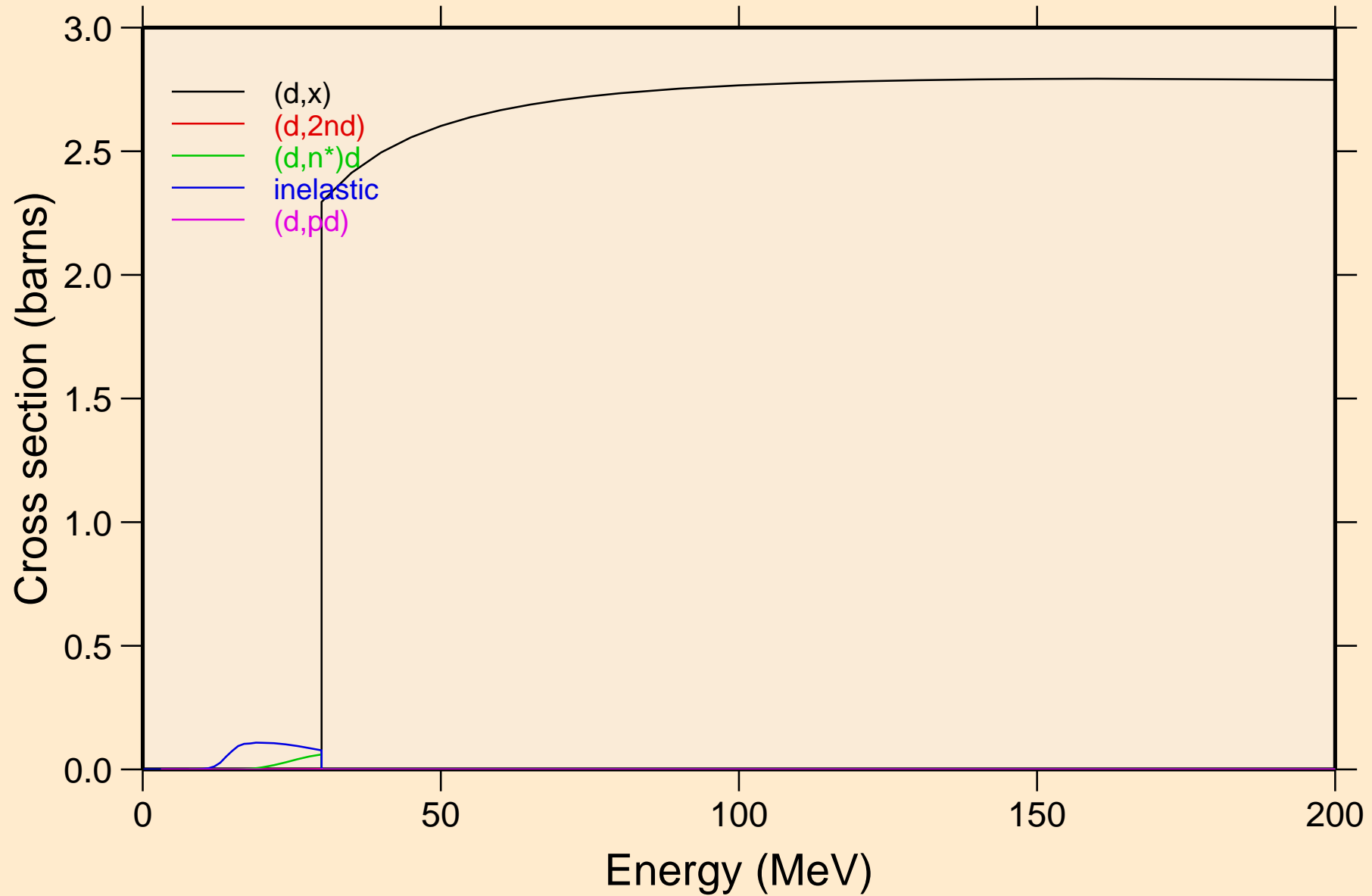

LU166 DEUTERON ACER TENDL-2021 LIBRARY; T=0.K  
Threshold reactions

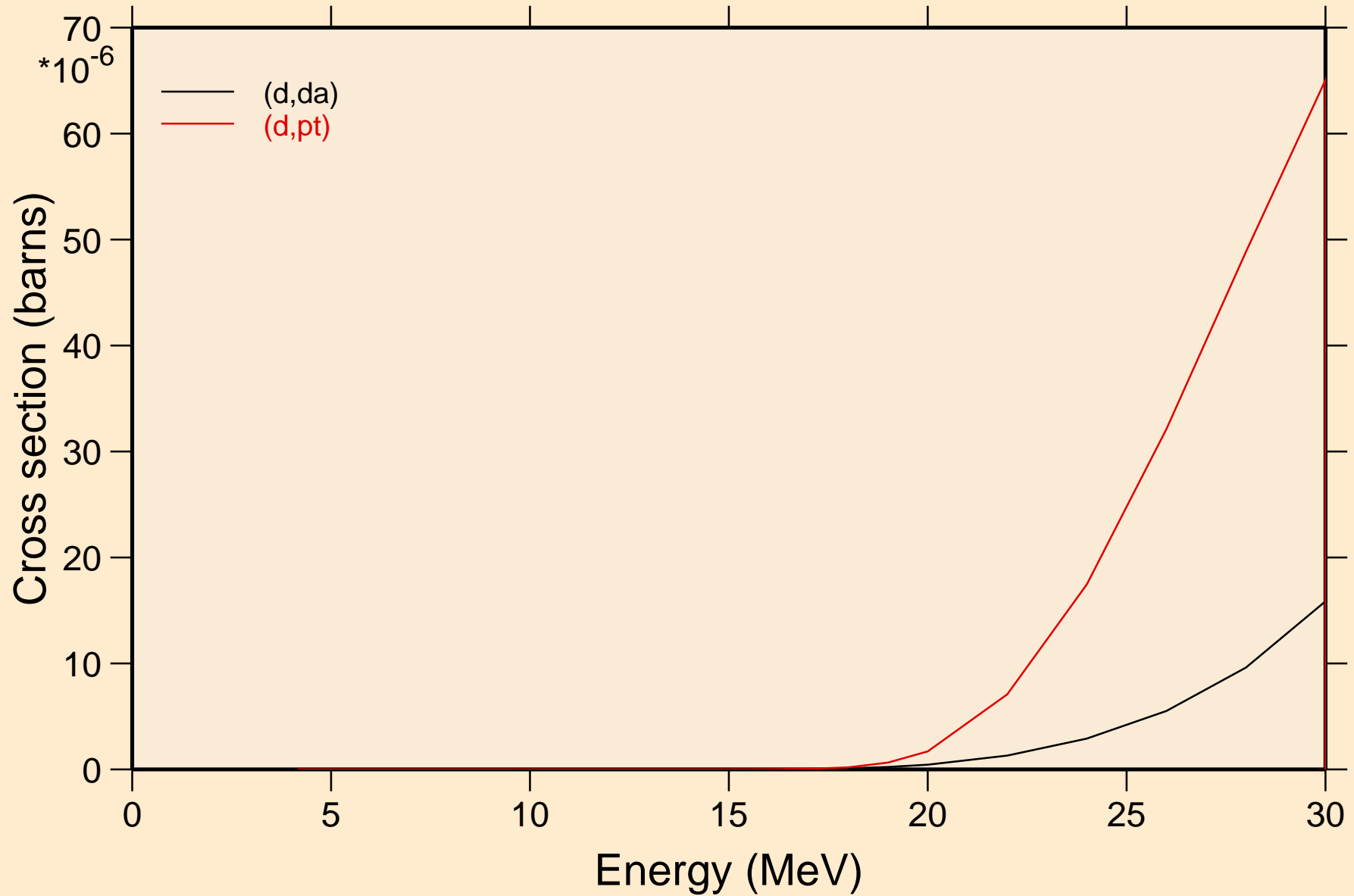

LU166 DEUTERON ACER TENDL-2021 LIBRARY; T=0.K  
Threshold reactions

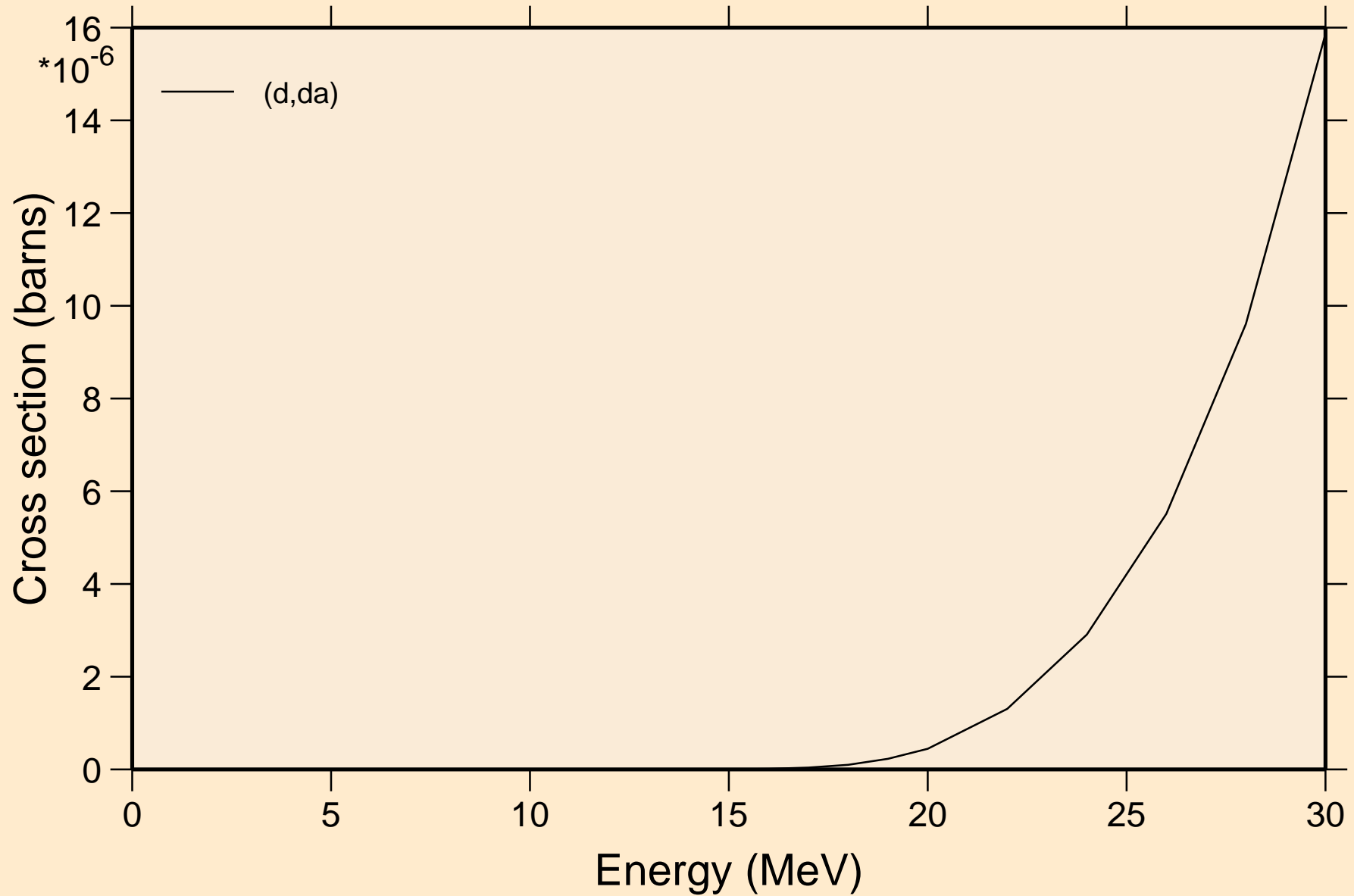

LU166 DEUTERON ACER TENDL-2021 LIBRARY; T=0.K  
angular distribution for elastic

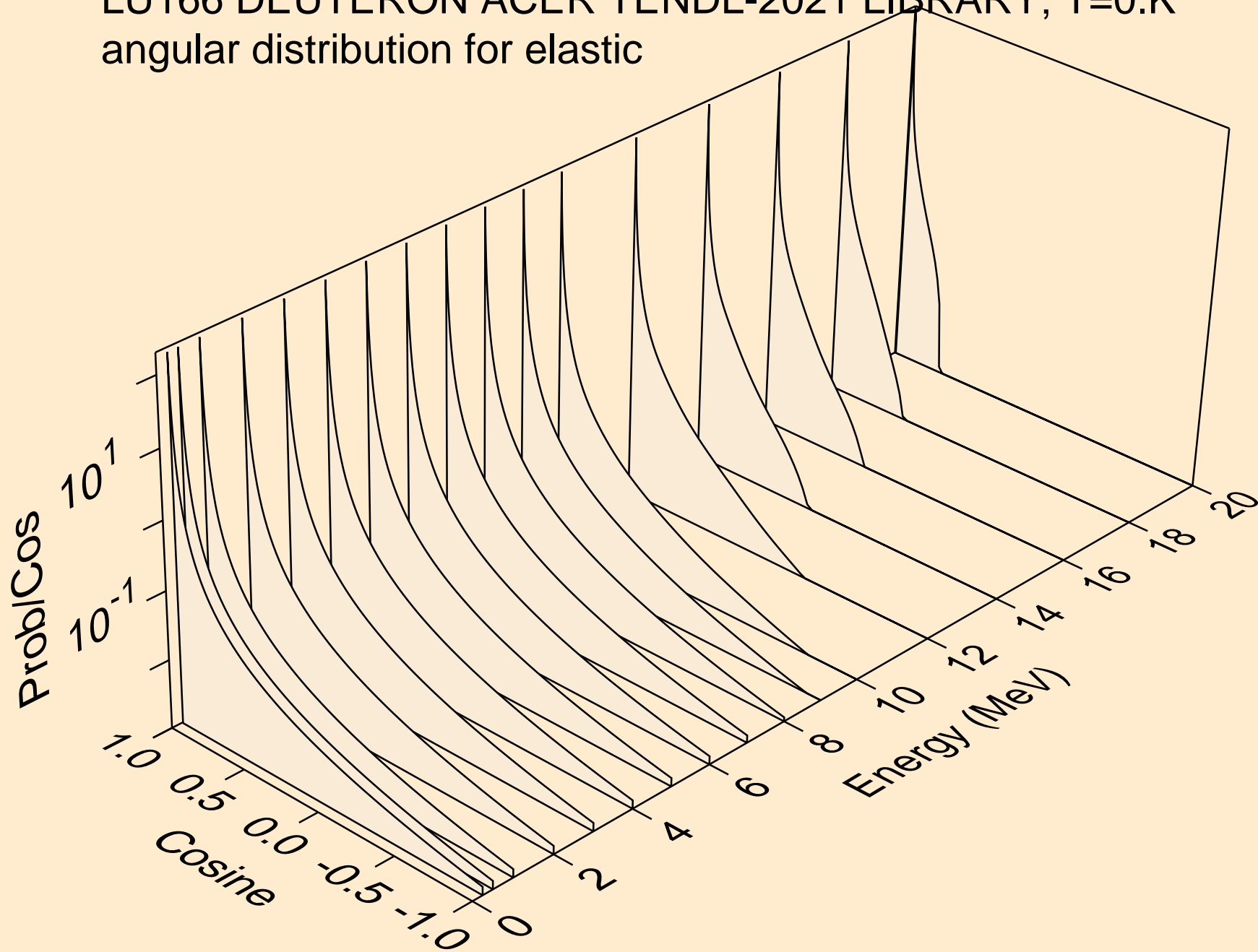



LU166 DEUTERON ACER TENDL-2021 LIBRARY; T=0.K  
angular distribution for elastic

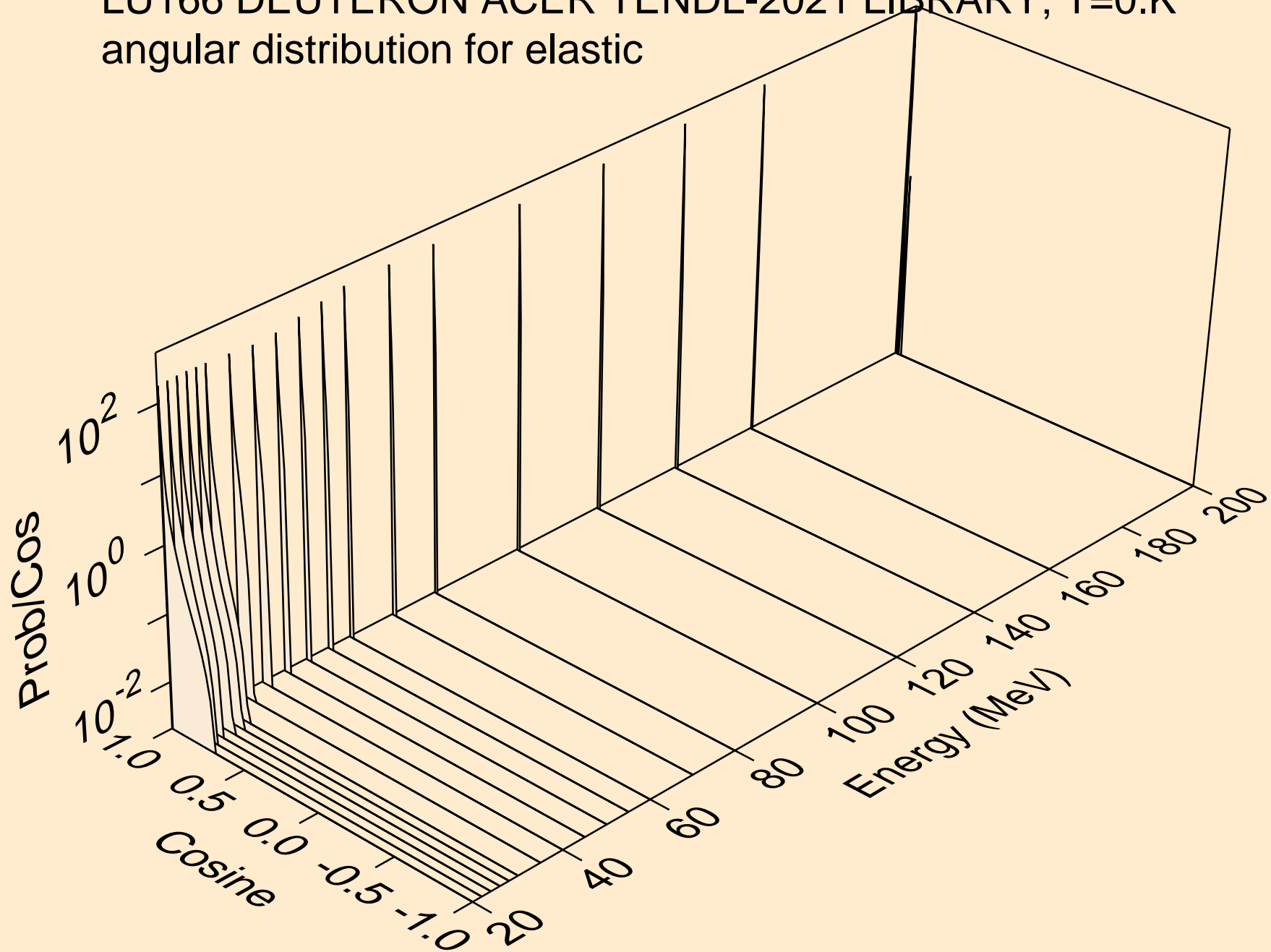

LU166 DEUTERON ACER TENDL-2021 LIBRARY; T=0.K  
Deuteron emission for (d,x)

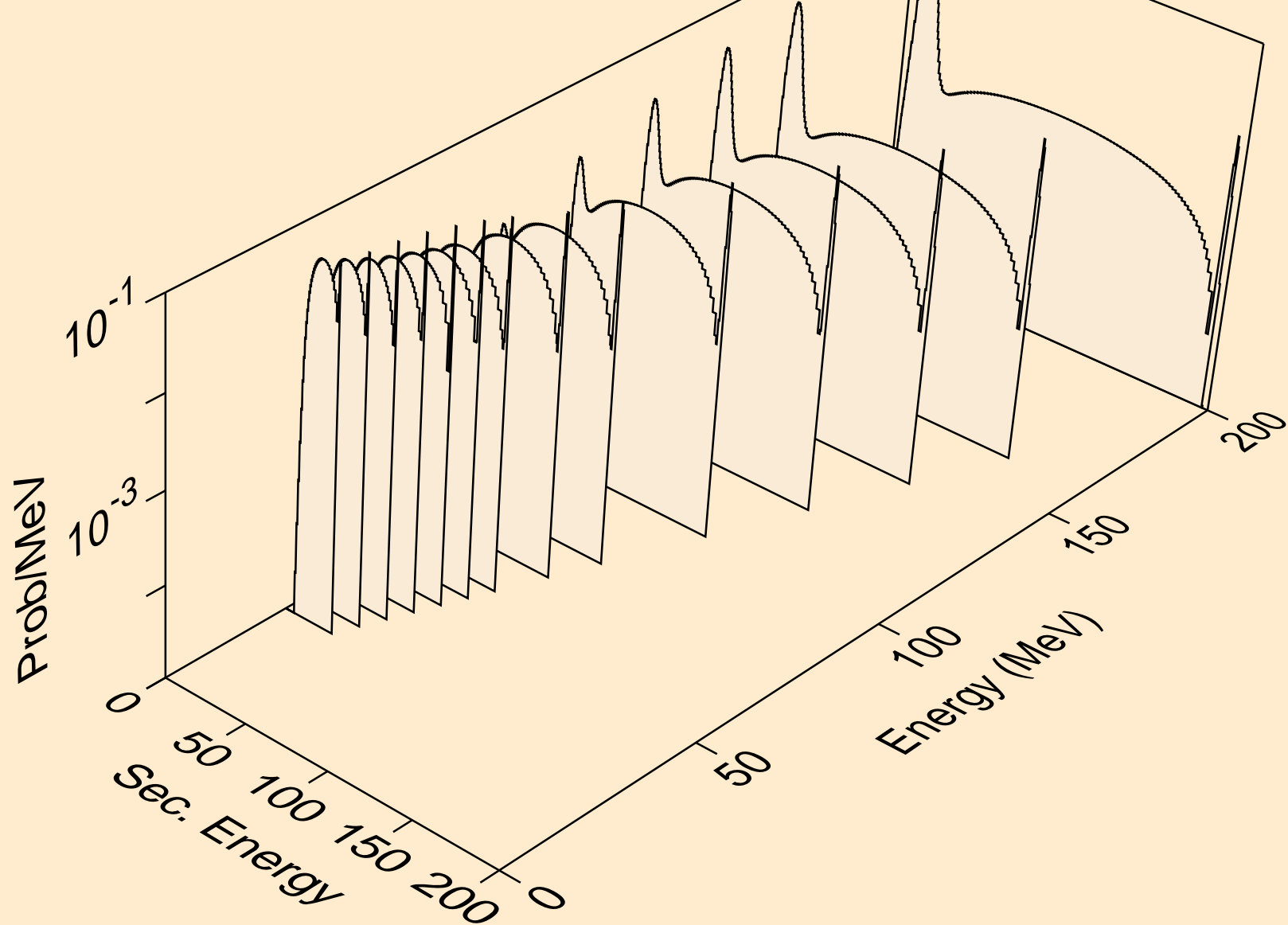

LU166 DEUTERON ACER TENDL-2021 LIBRARY; T=0.K  
Deuteron emission for (d,2nd)

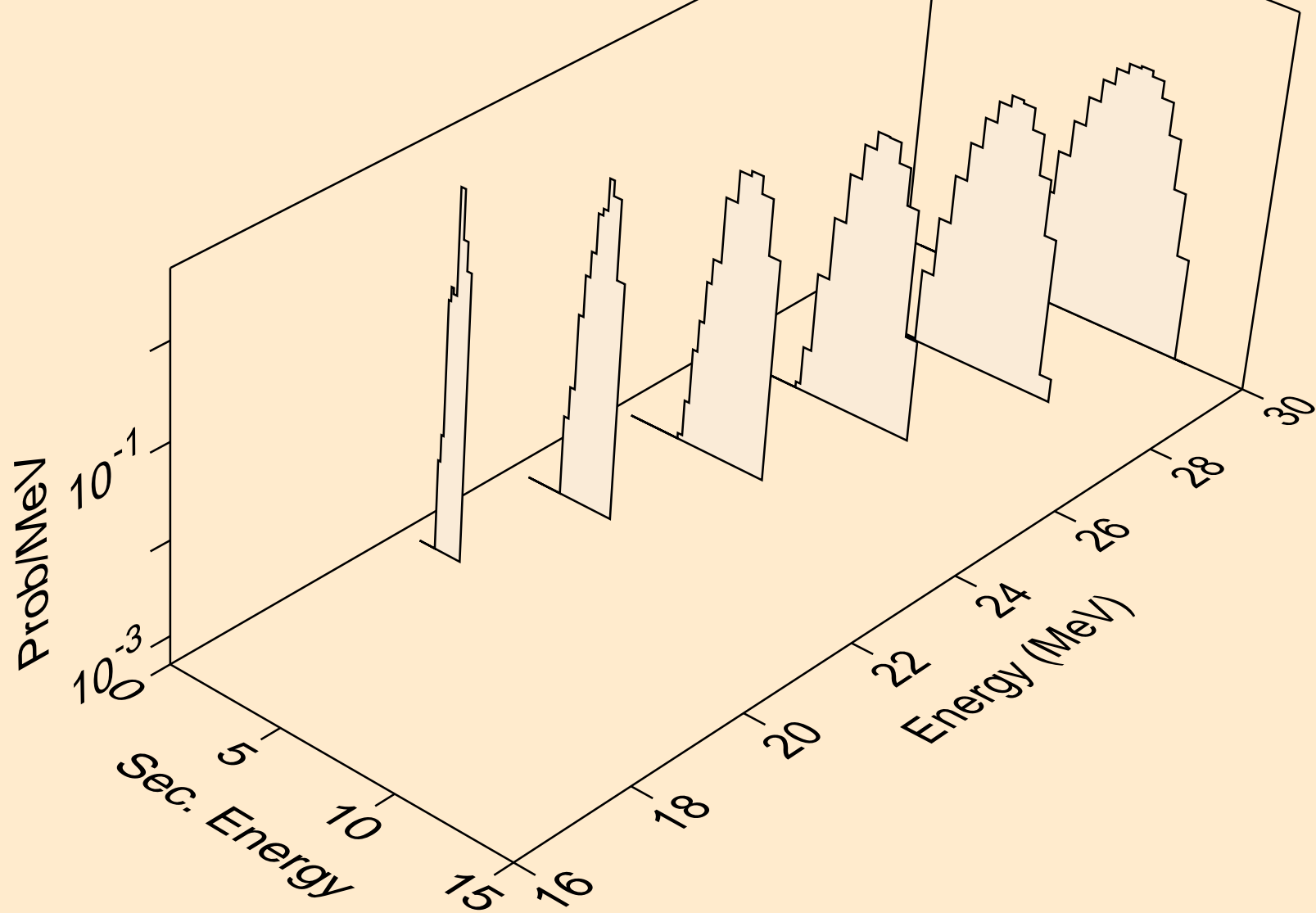

LU166 DEUTERON ACER TENDL-2021 LIBRARY; T=0.K  
Deuteron emission for (d,n\*)d

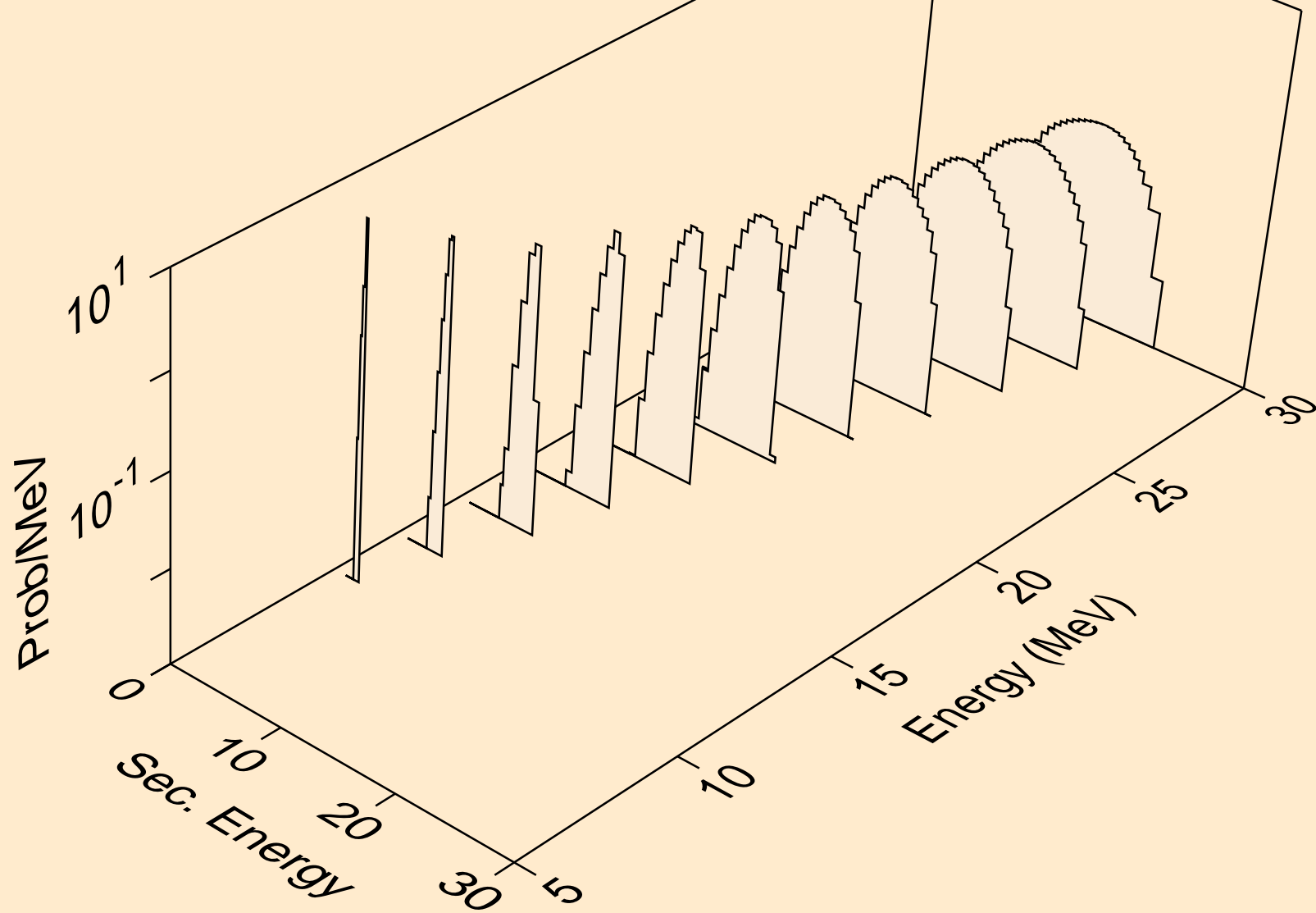

LU166 DEUTERON ACER TENDL-2021 LIBRARY; T=0.K  
Deuteron emission for inelastic

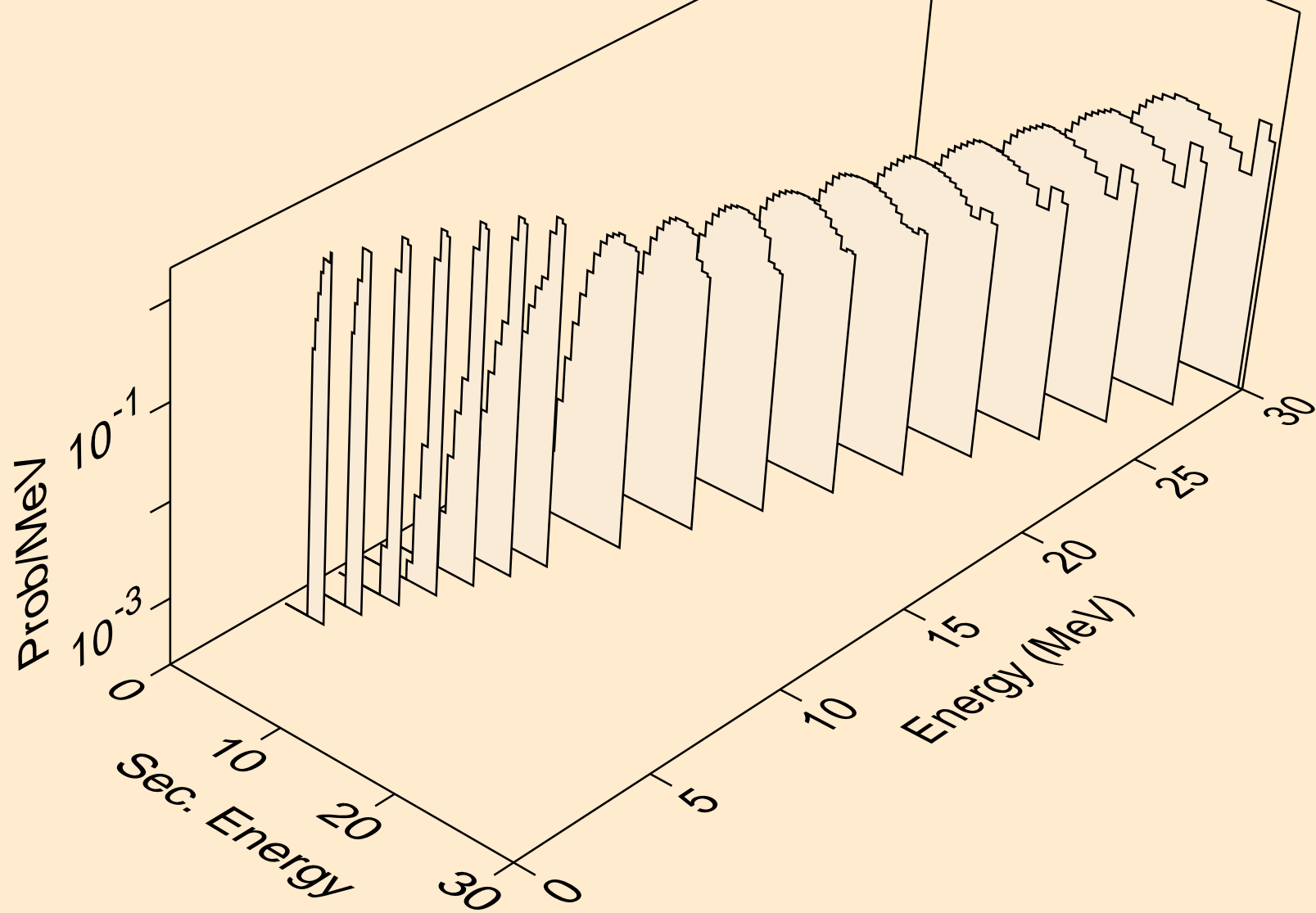

LU166 DEUTERON ACER TENDL-2021 LIBRARY; T=0.K  
Deuteron emission for (d,pd)

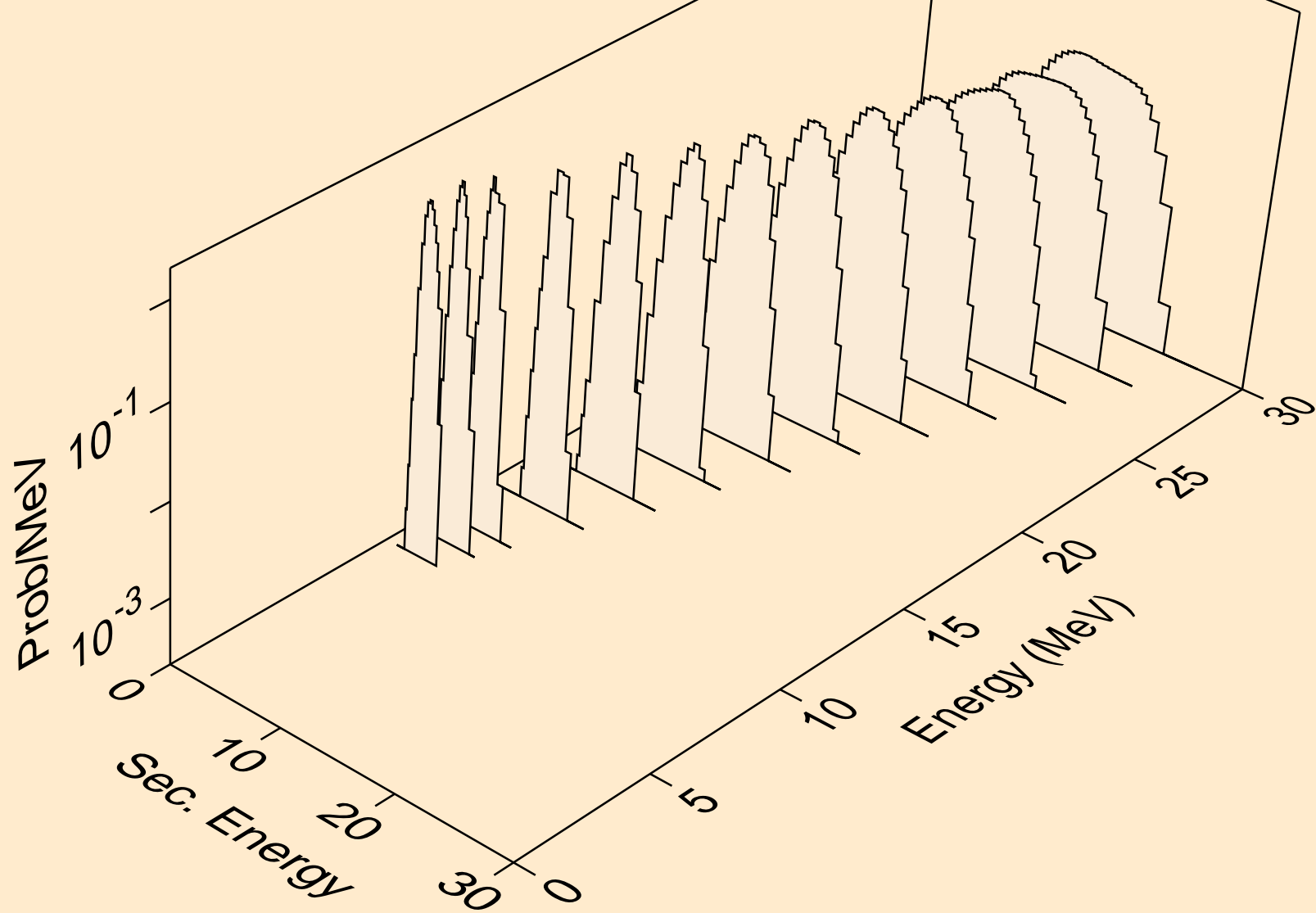

LU166 DEUTERON ACER TENDL-2021 LIBRARY; T=0.K  
Deuteron emission for (d,da)

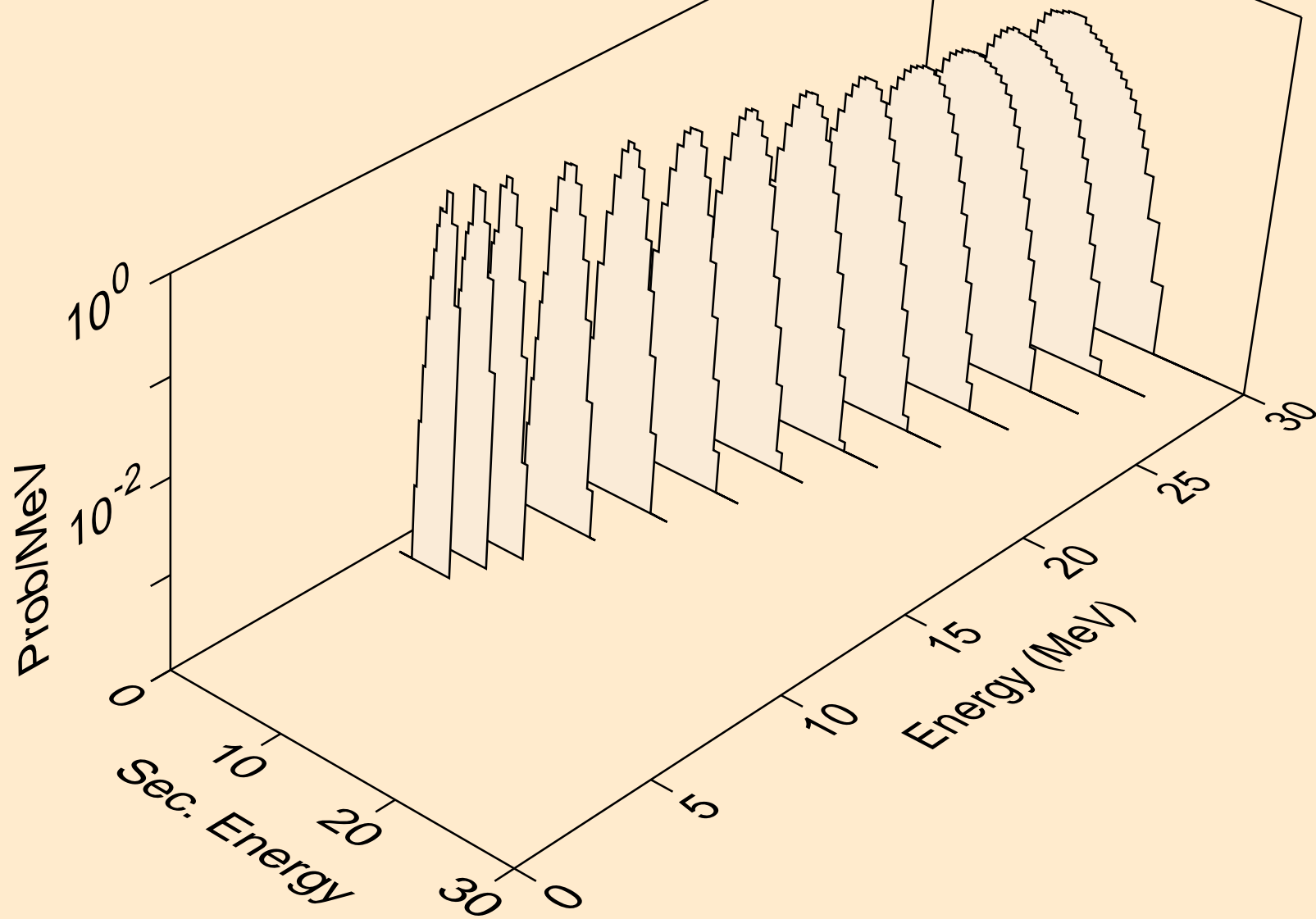

LU166 DEUTERON ACER TENDL-2021 LIBRARY; T=0.K  
Photon emission for (z,n)

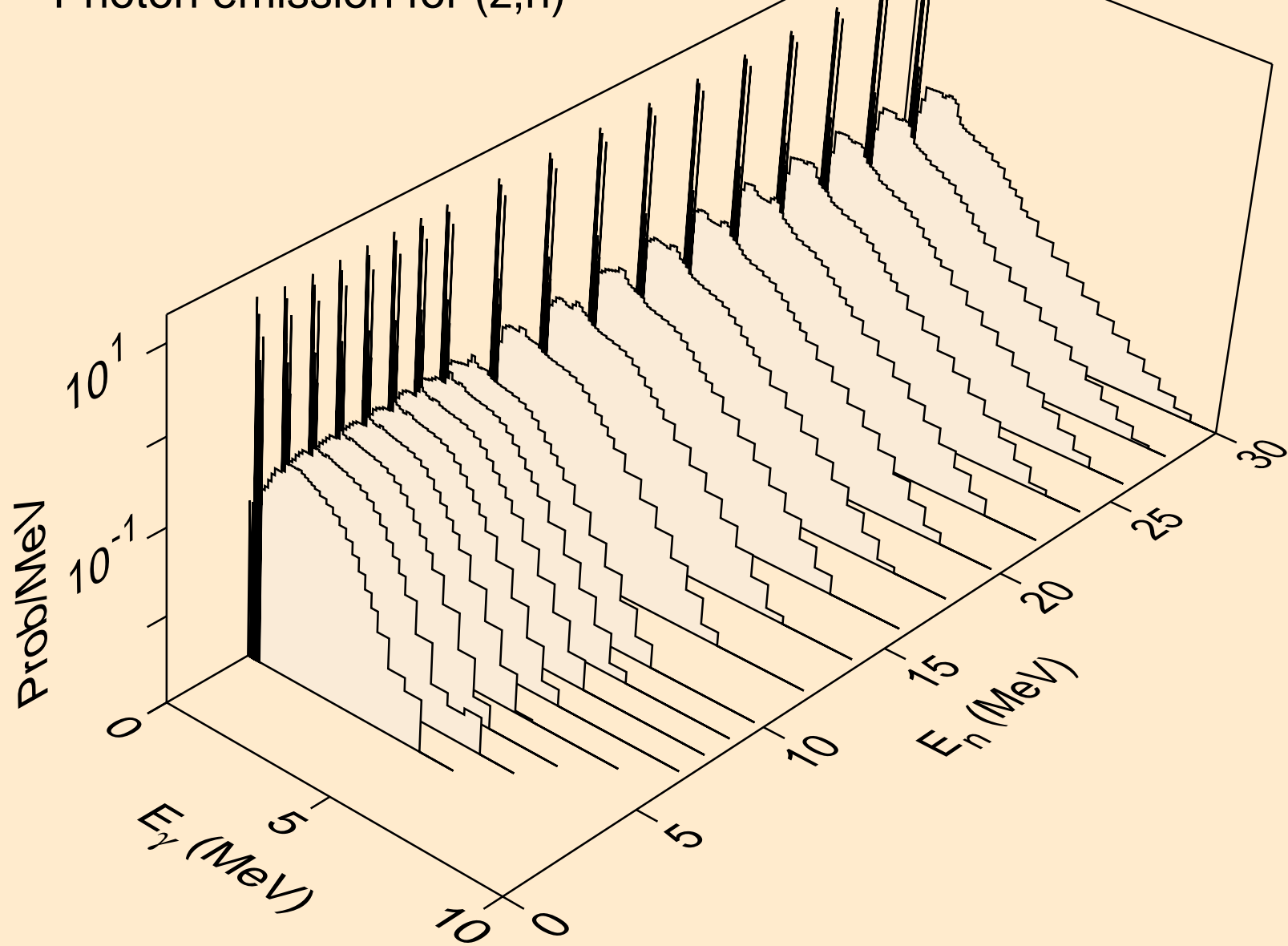



LU166 DEUTERON ACER TENDL-2021 LIBRARY; T=0.K  
Photon emission for (n,x)

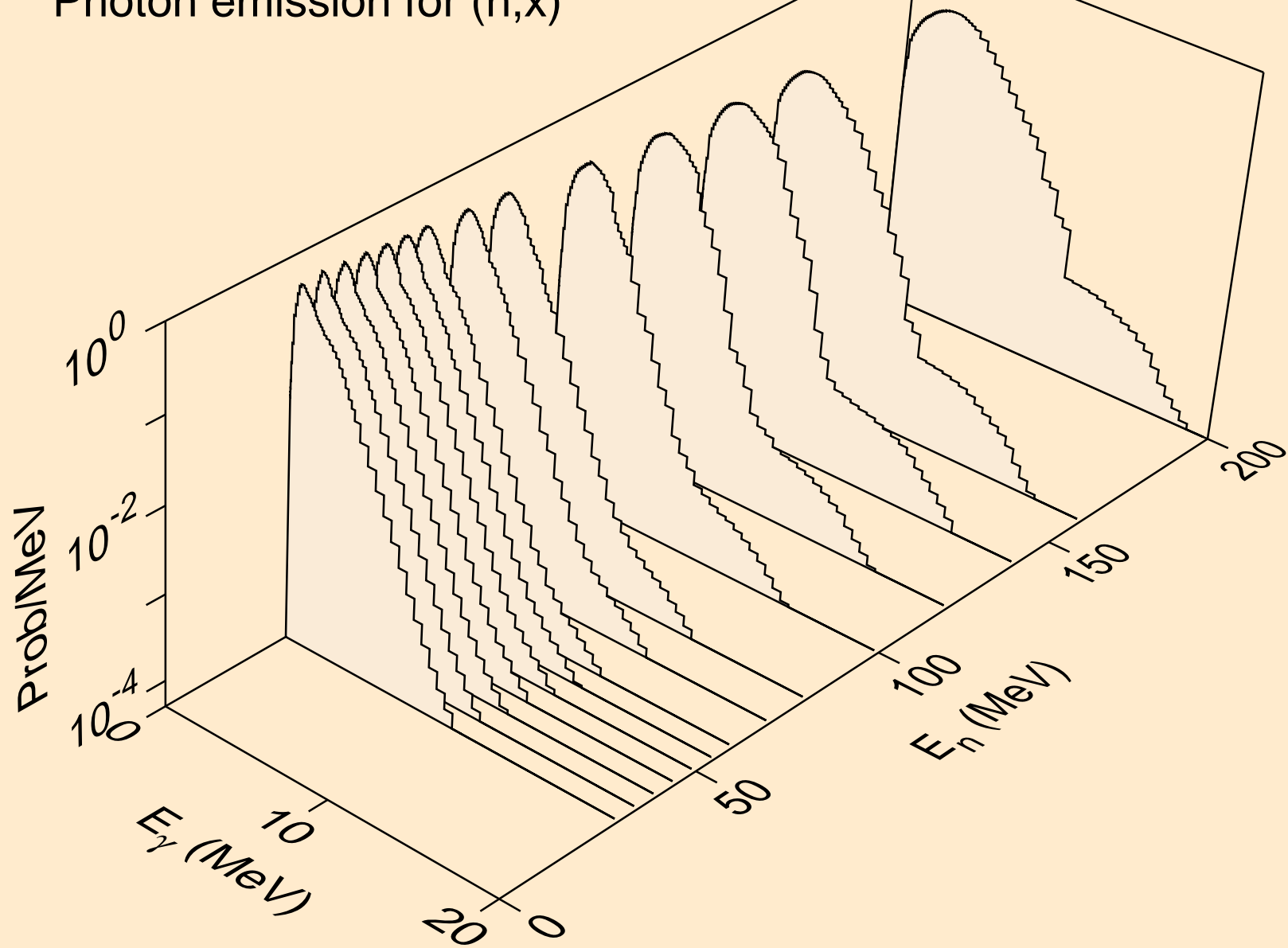

LU166 DEUTERON ACER TENDL-2021 LIBRARY; T=0.K  
Photon emission for (n,2nd)

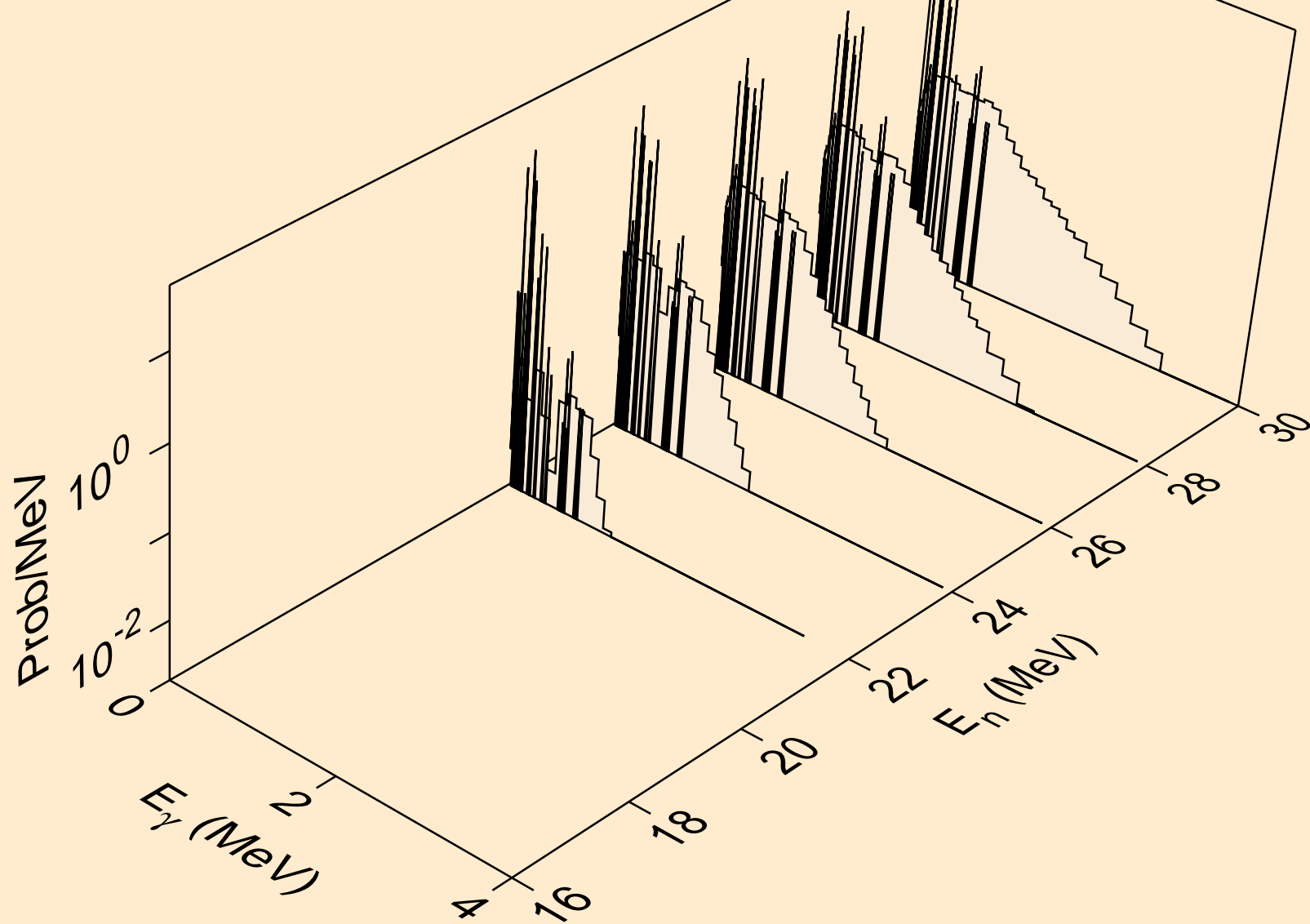

LU166 DEUTERON ACER TENDL-2021 LIBRARY; T=0.K  
Photon emission for (n,2n)

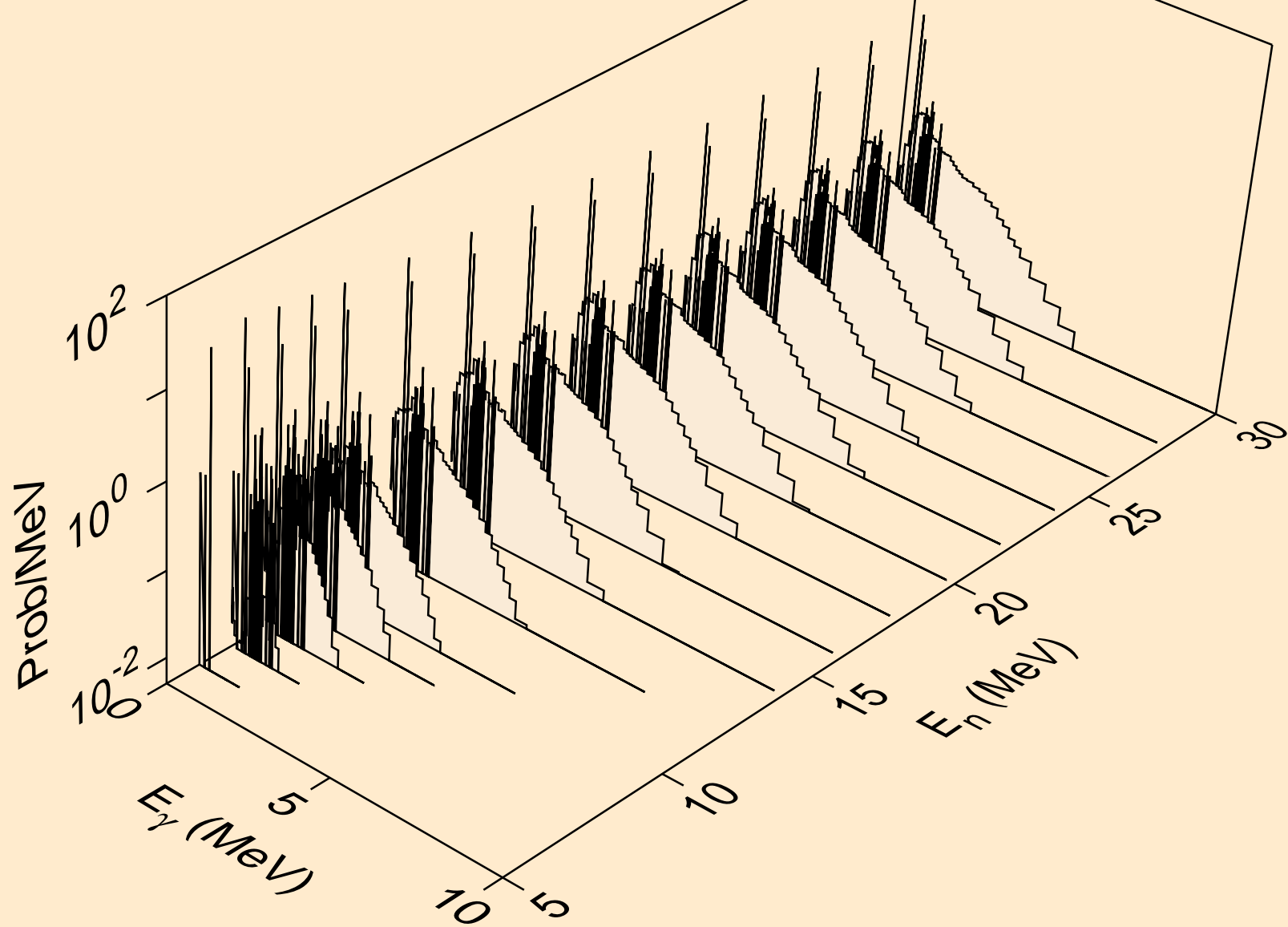

LU166 DEUTERON ACER TENDL-2021 LIBRARY; T=0.K  
Photon emission for (n,3n)

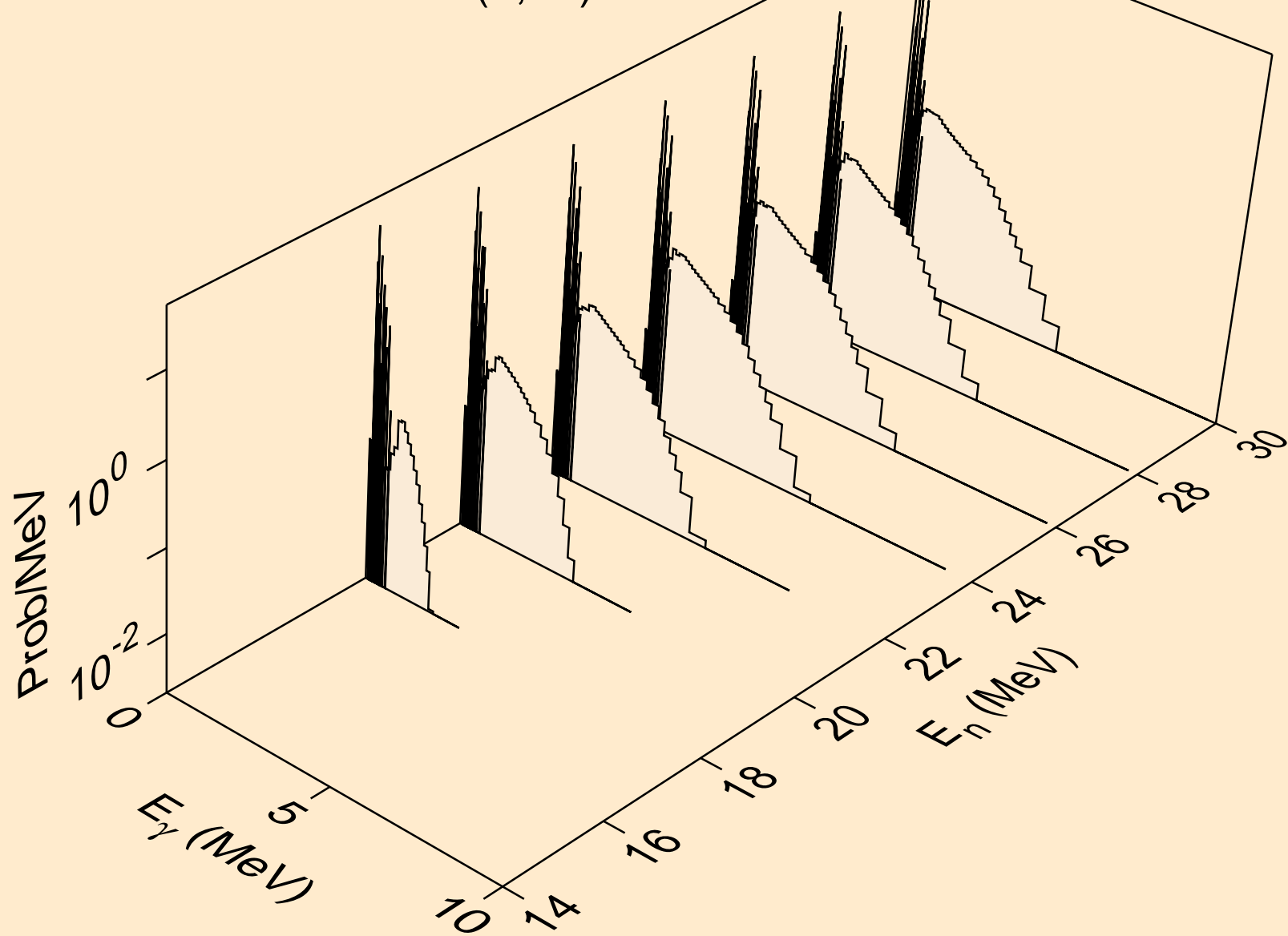

LU166 DEUTERON ACER TENDL-2021 LIBRARY; T=0.K  
Photon emission for (n,n\*)a

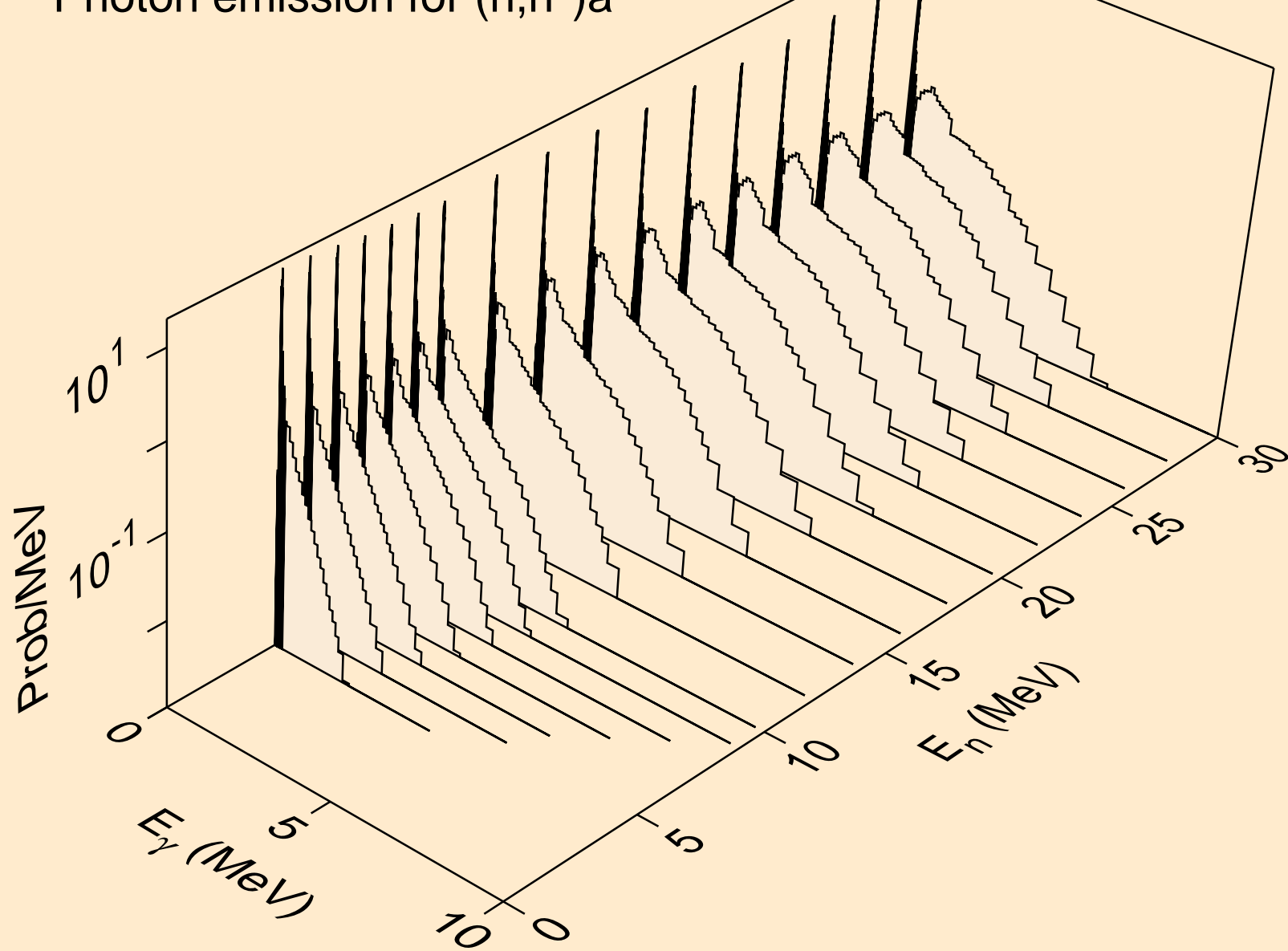

LU166 DEUTERON ACER TENDL-2021 LIBRARY; T=0.K  
Photon emission for (n,2n)a

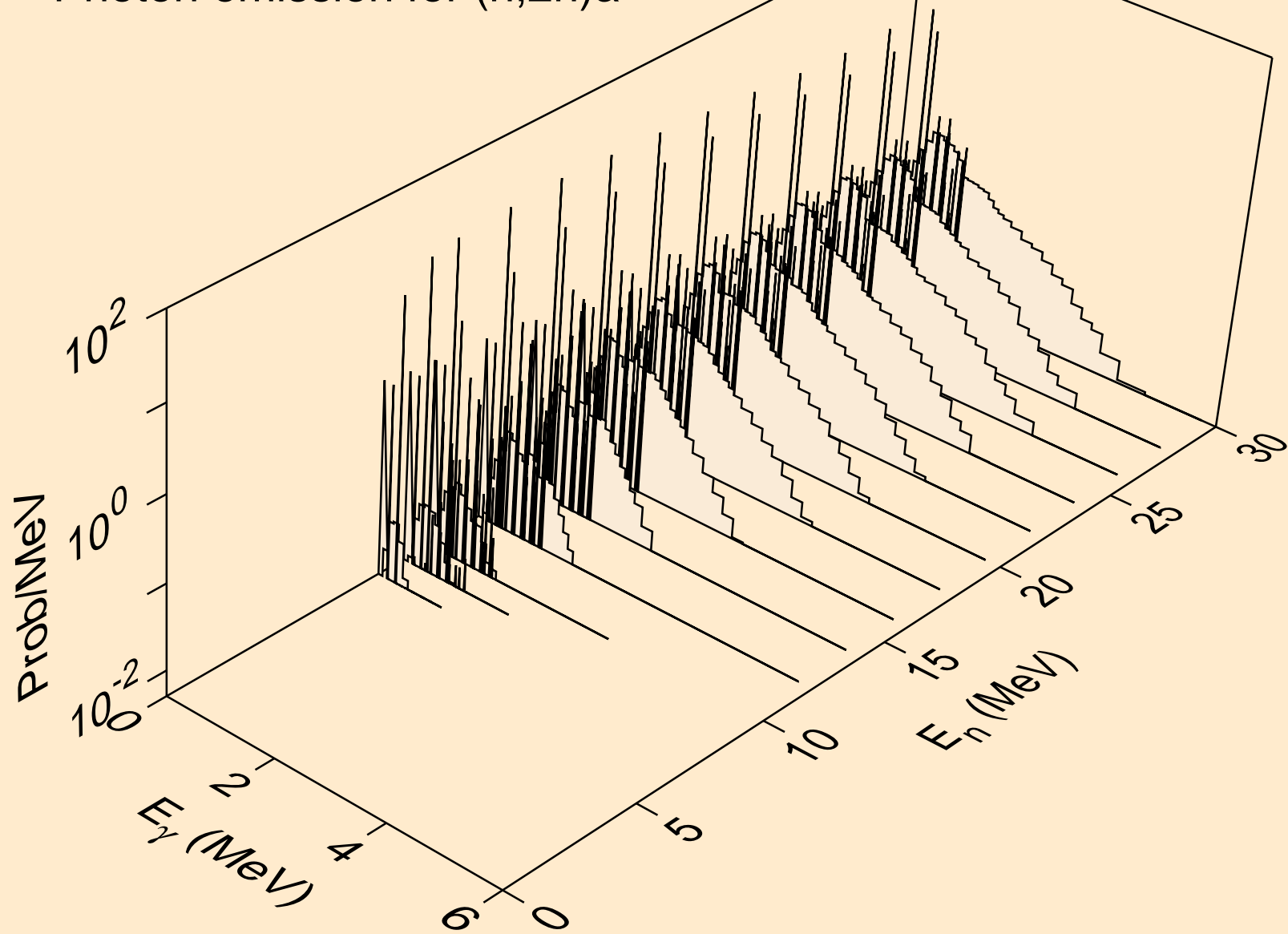

LU166 DEUTERON ACER TENDL-2021 LIBRARY; T=0.K  
Photon emission for (n,3n)a

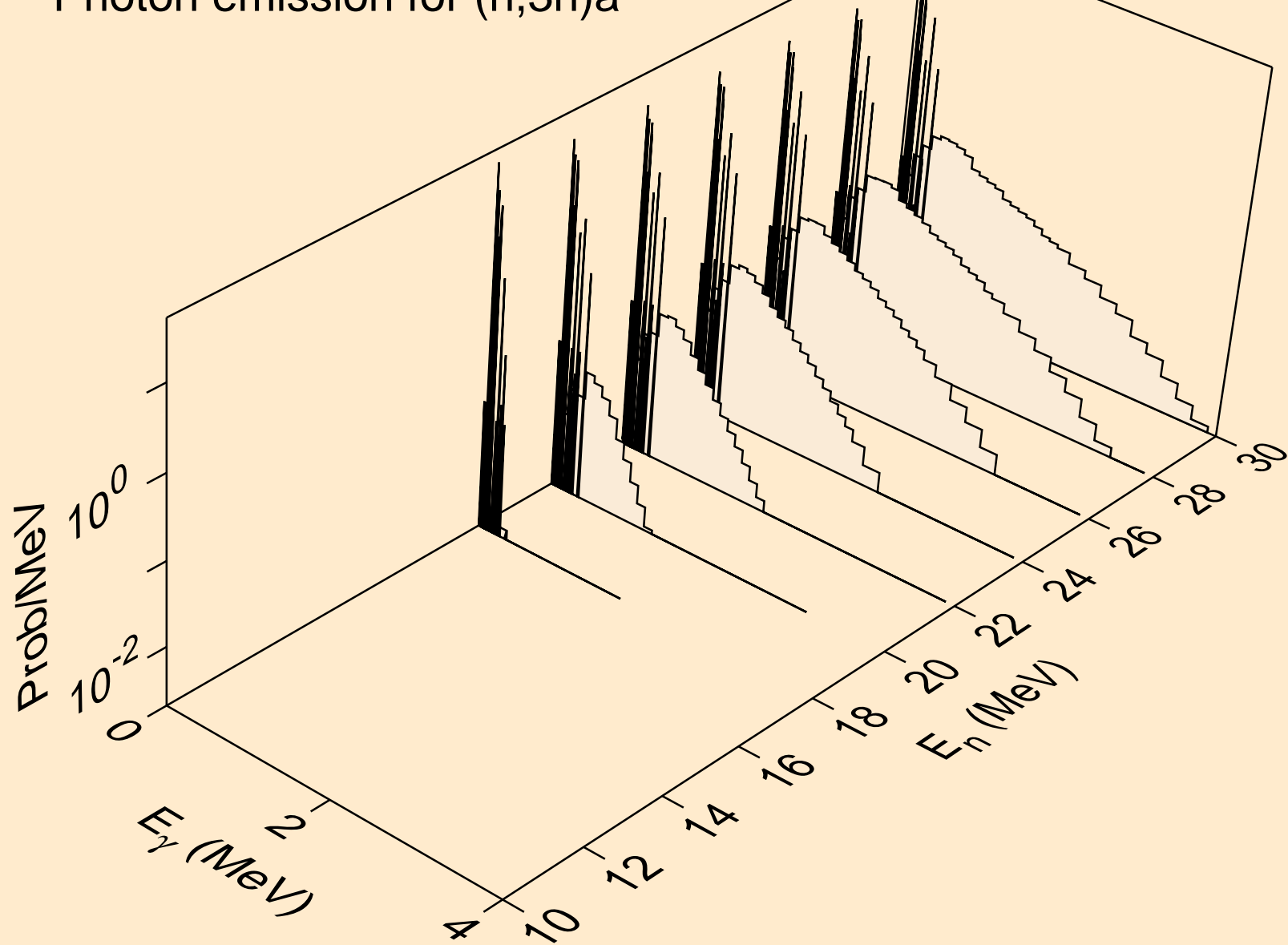

LU166 DEUTERON ACER TENDL-2021 LIBRARY; T=0.K  
Photon emission for (n,n\*)p

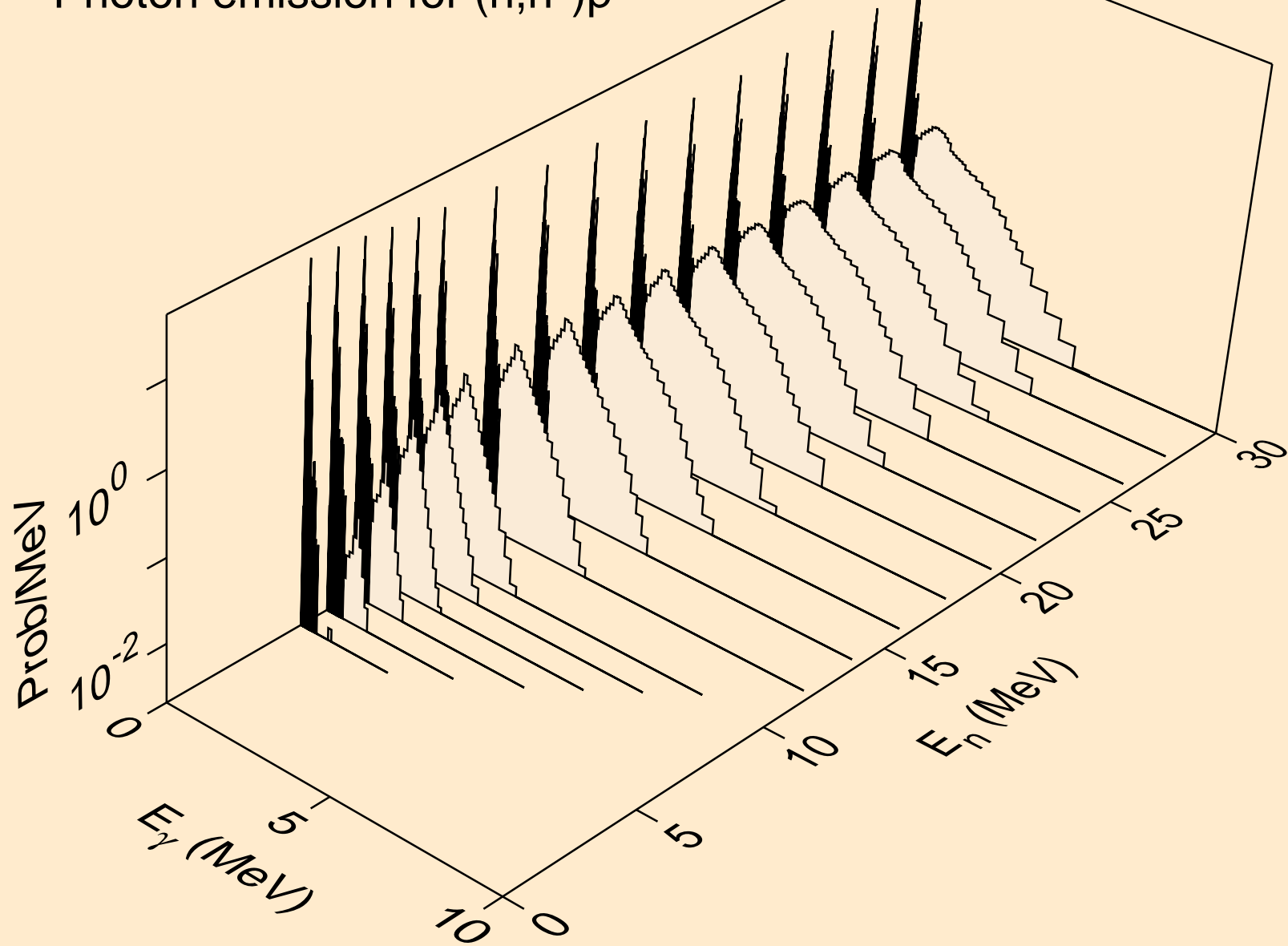



LU166 DEUTERON ACER TENDL-2021 LIBRARY; T=0.K  
Photon emission for (n,n\*)2a

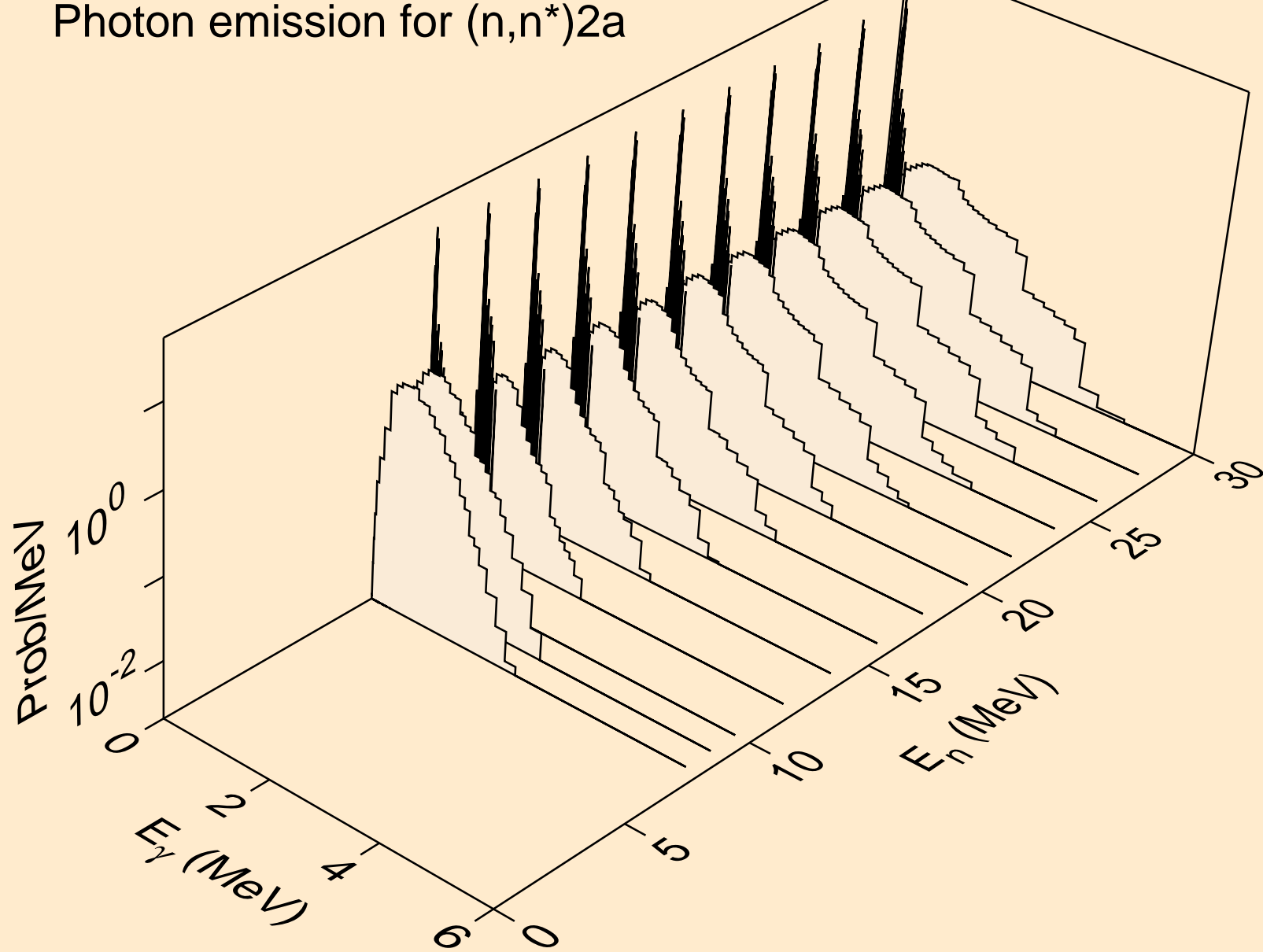

LU166 DEUTERON ACER TENDL-2021 LIBRARY; T=0.K  
Photon emission for (n,2n)2a

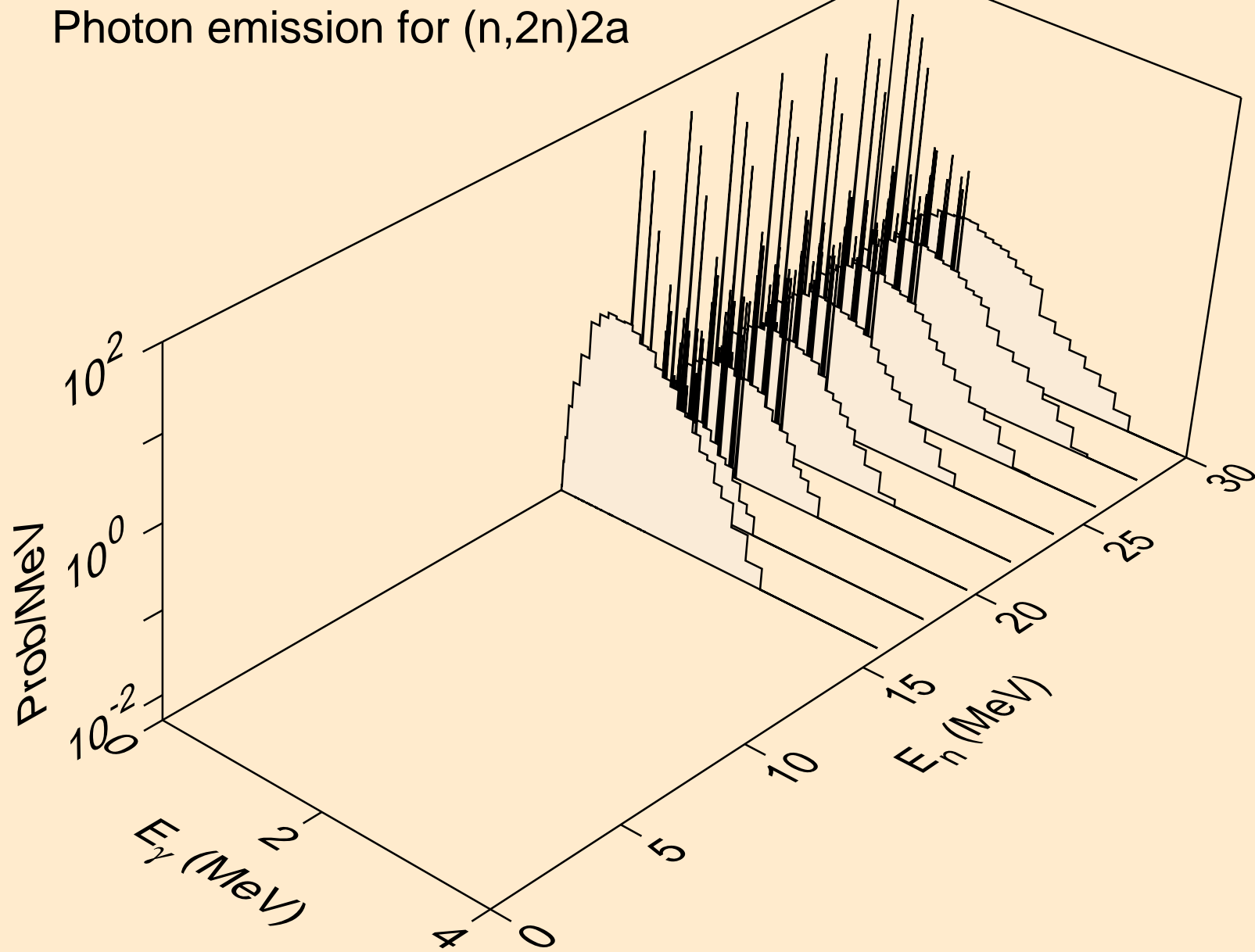

LU166 DEUTERON ACER TENDL-2021 LIBRARY; T=0.K  
Photon emission for (n,n\*)d

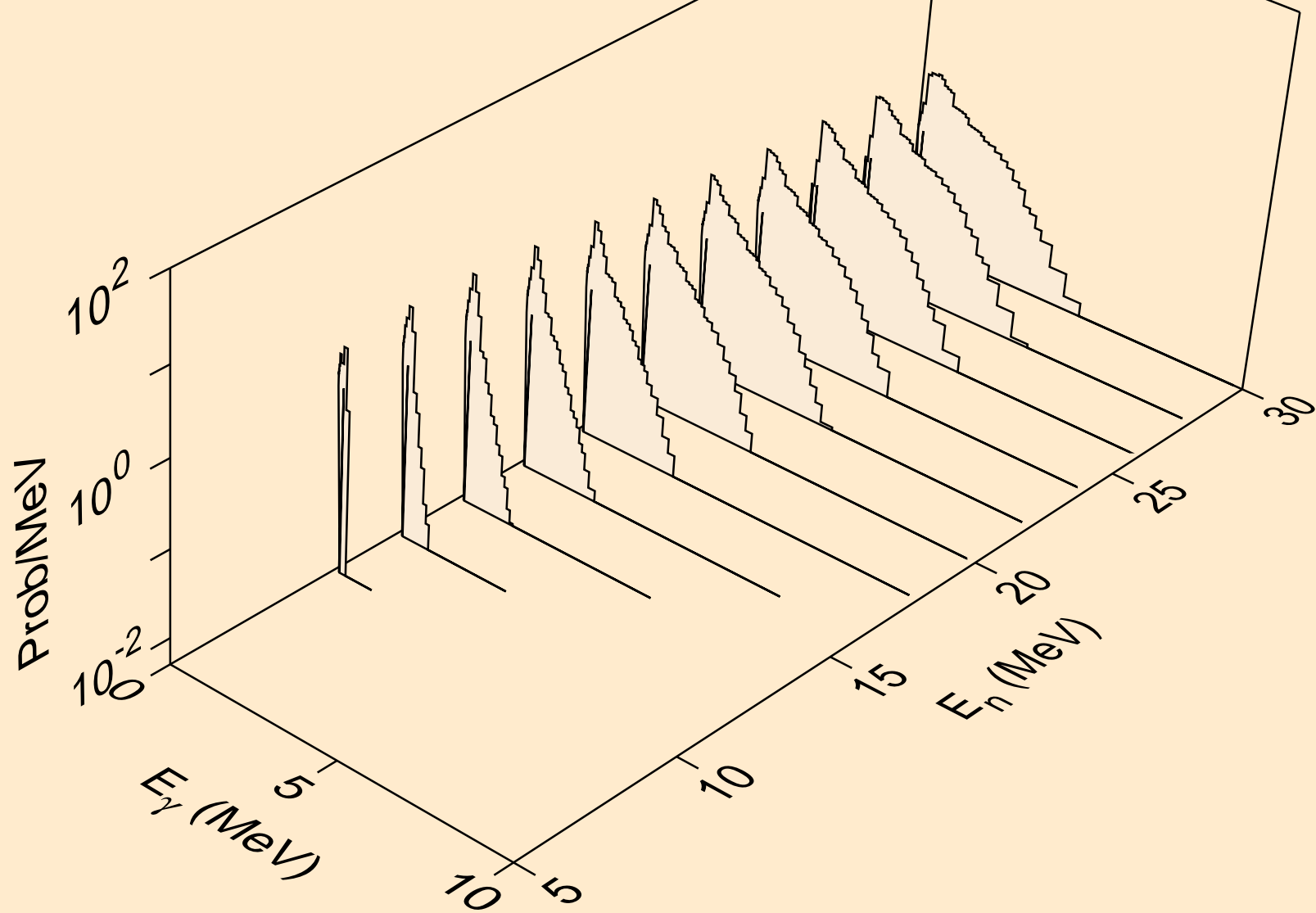

LU166 DEUTERON ACER TENDL-2021 LIBRARY; T=0.K  
Photon emission for (n,n\*)t

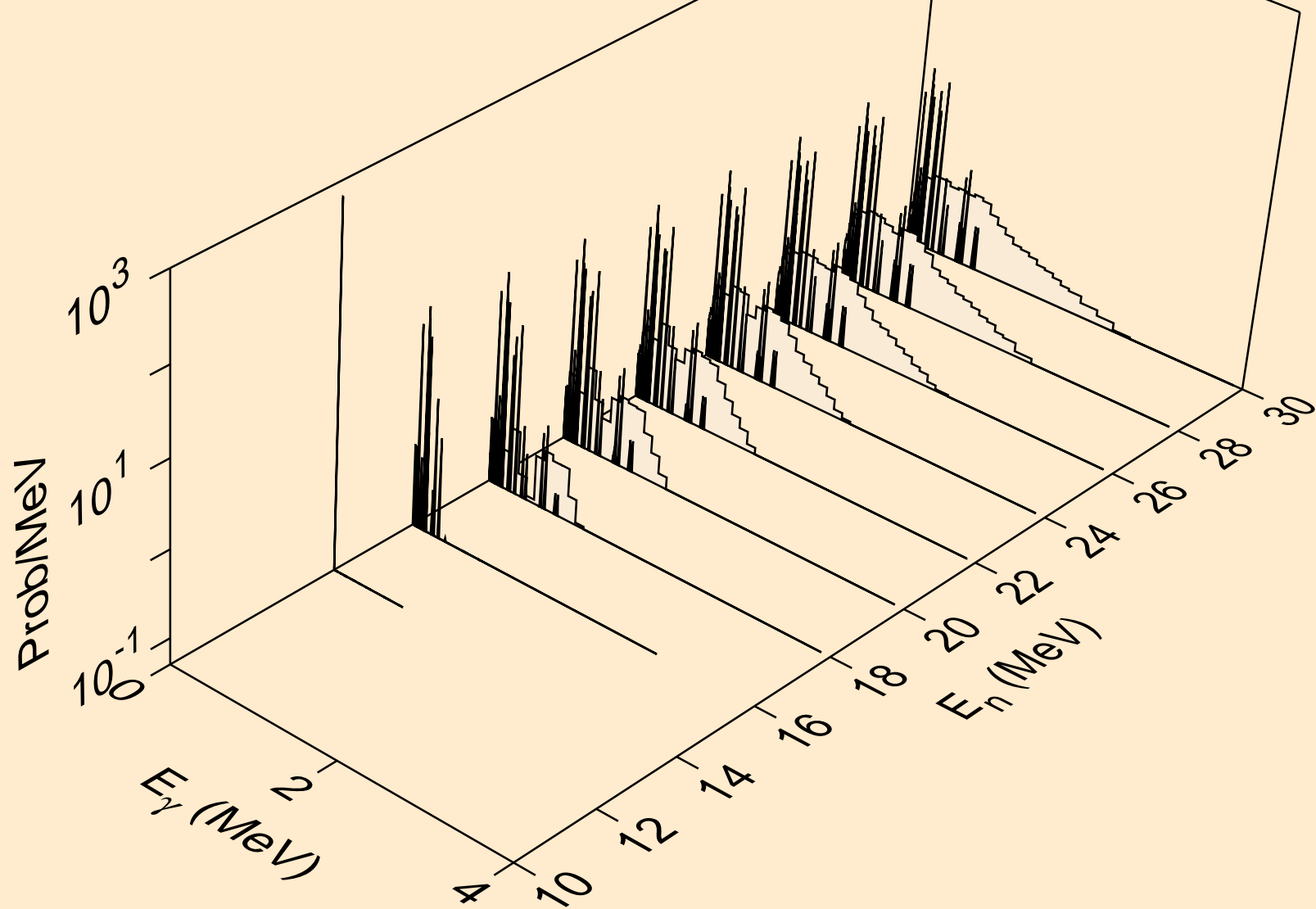

LU166 DEUTERON ACER TENDL-2021 LIBRARY; T=0.K  
Photon emission for (n,n\*)he3

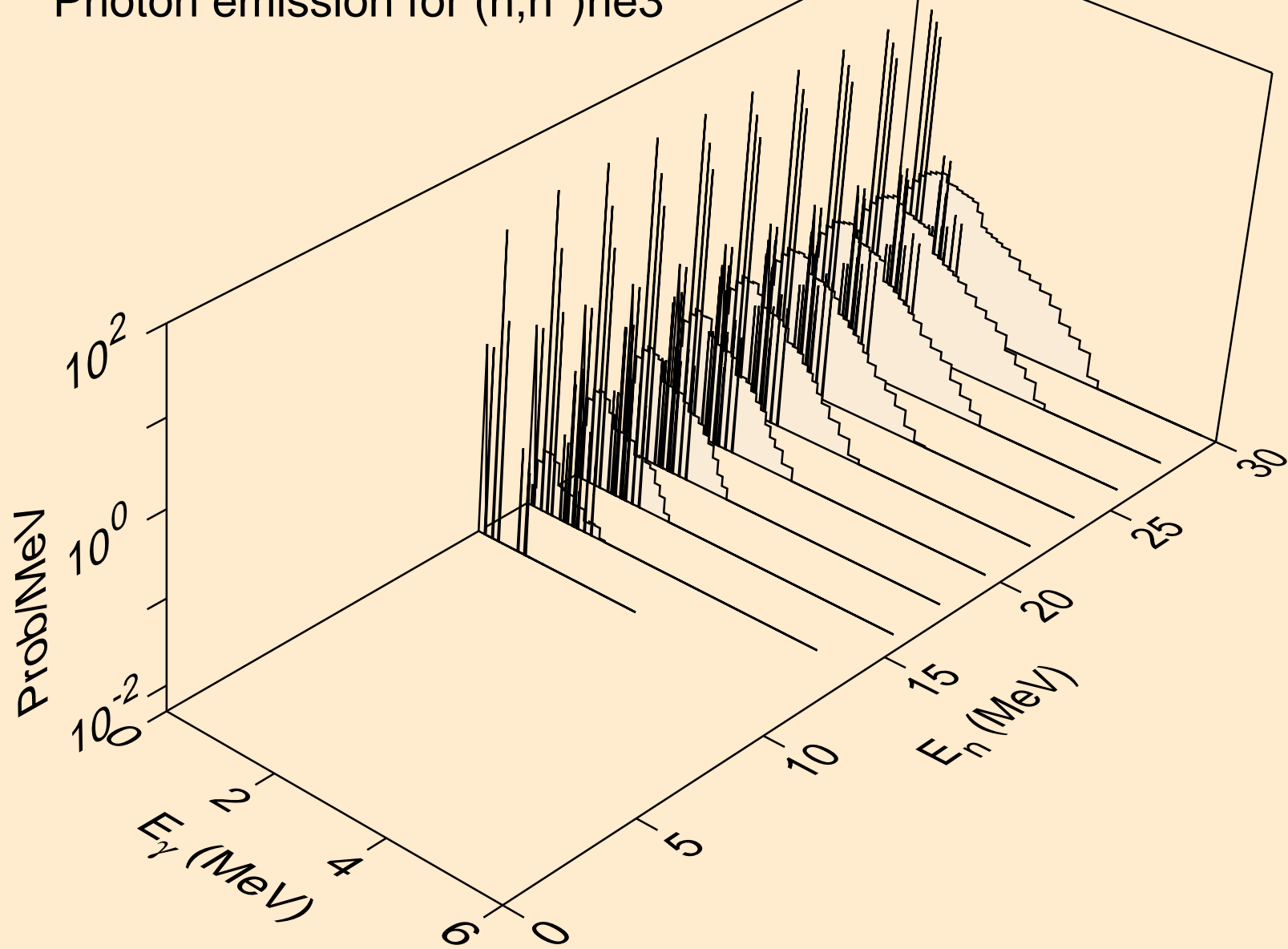

LU166 DEUTERON ACER TENDL-2021 LIBRARY; T=0.K  
Photon emission for (n,4n)

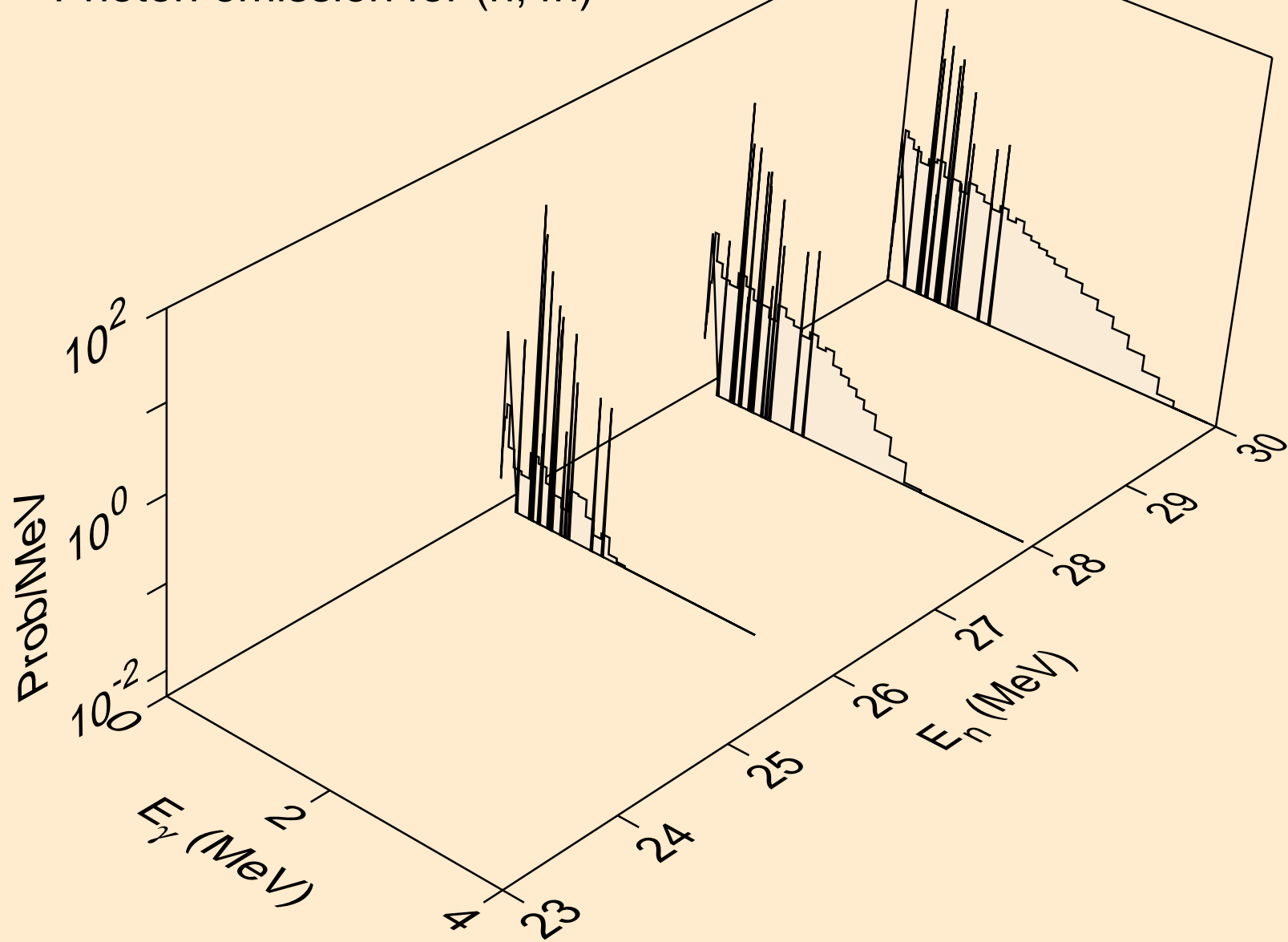

LU166 DEUTERON ACER TENDL-2021 LIBRARY; T=0.K  
Photon emission for (n,2np)

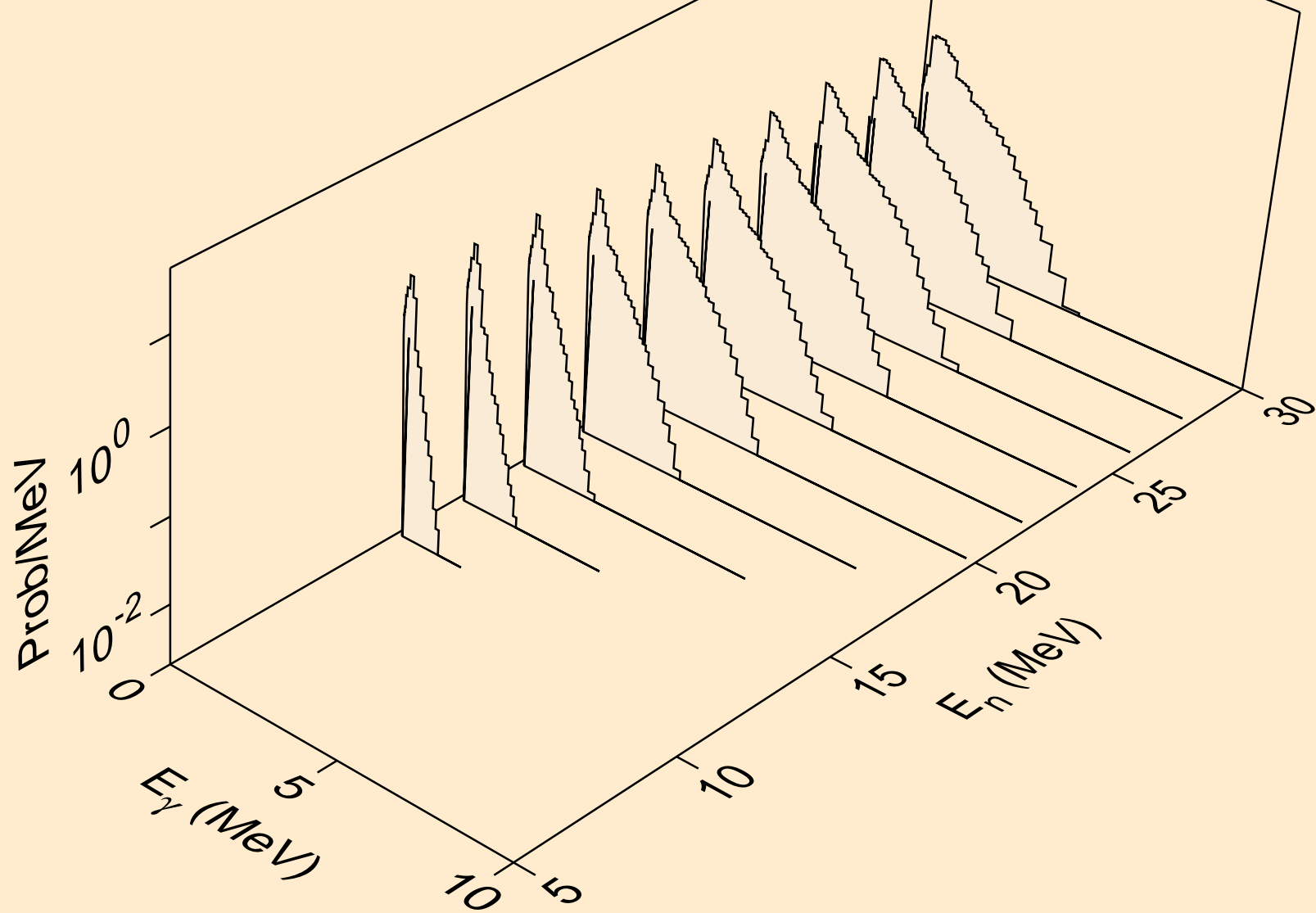

LU166 DEUTERON ACER TENDL-2021 LIBRARY; T=0.K  
Photon emission for (n,3np)

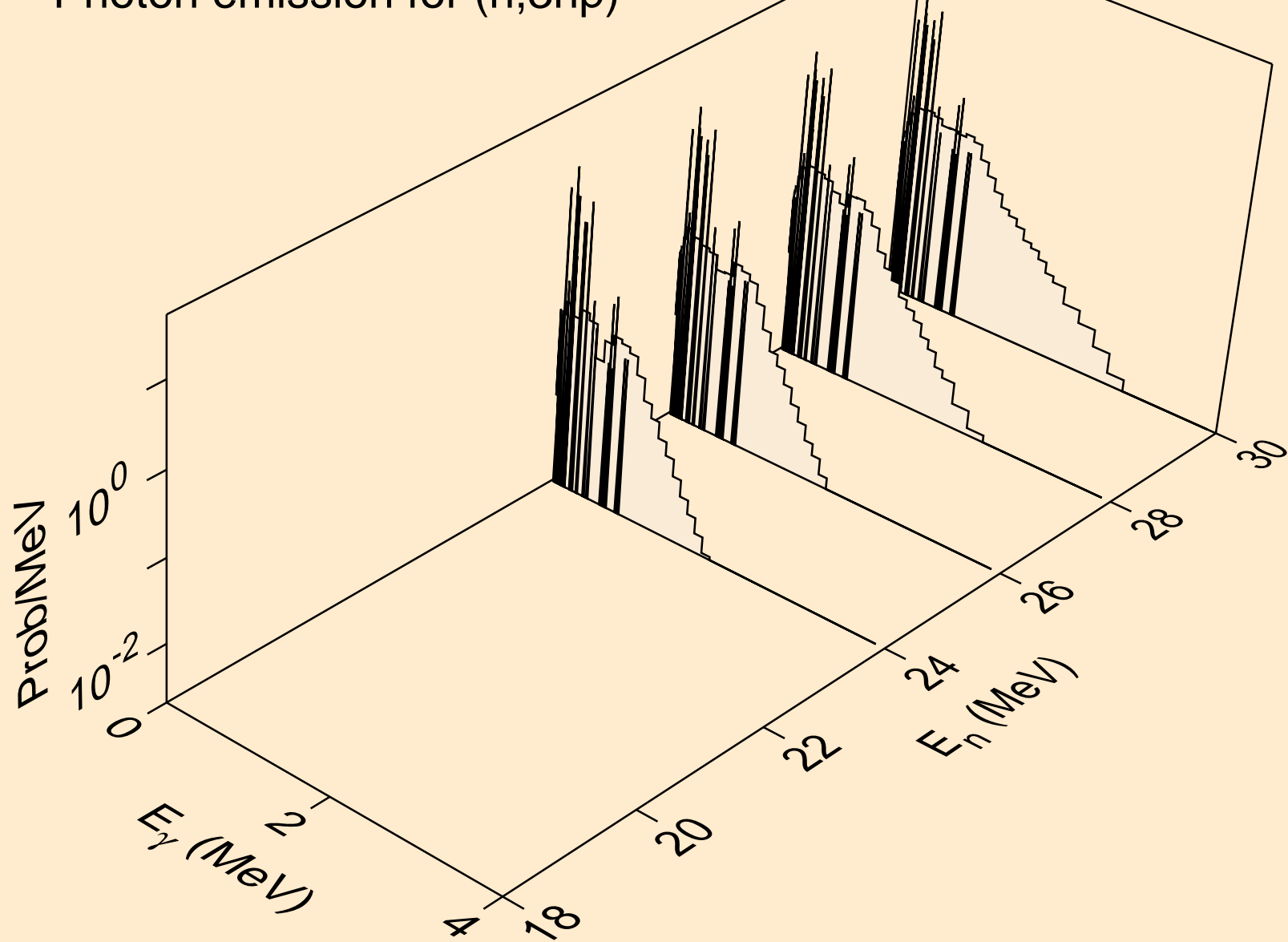



LU166 DEUTERON ACER TENDL-2021 LIBRARY; T=0.K  
Photon emission for (n,2np)

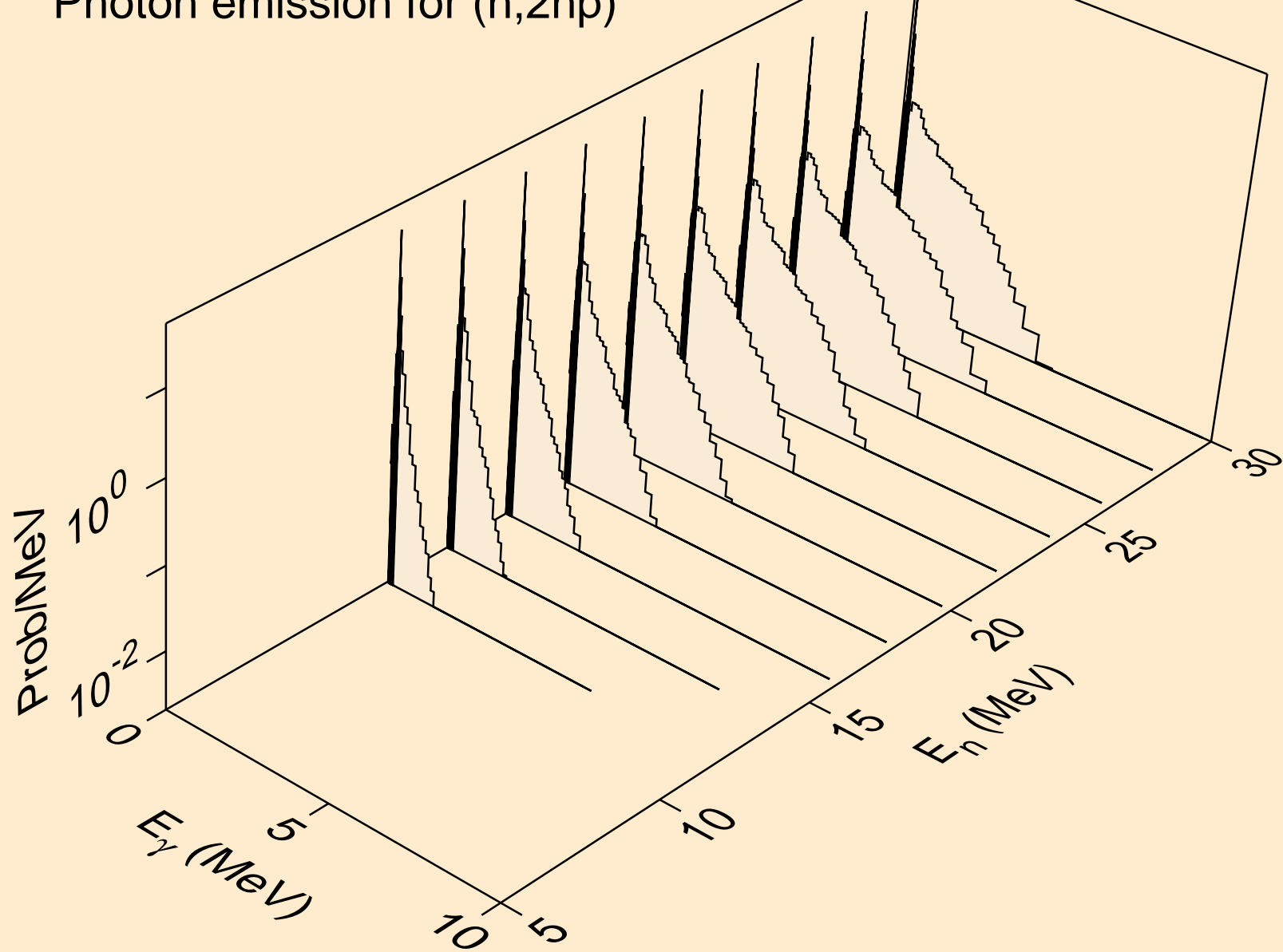

LU166 DEUTERON ACER TENDL-2021 LIBRARY; T=0.K  
Photon emission for (n,npa)

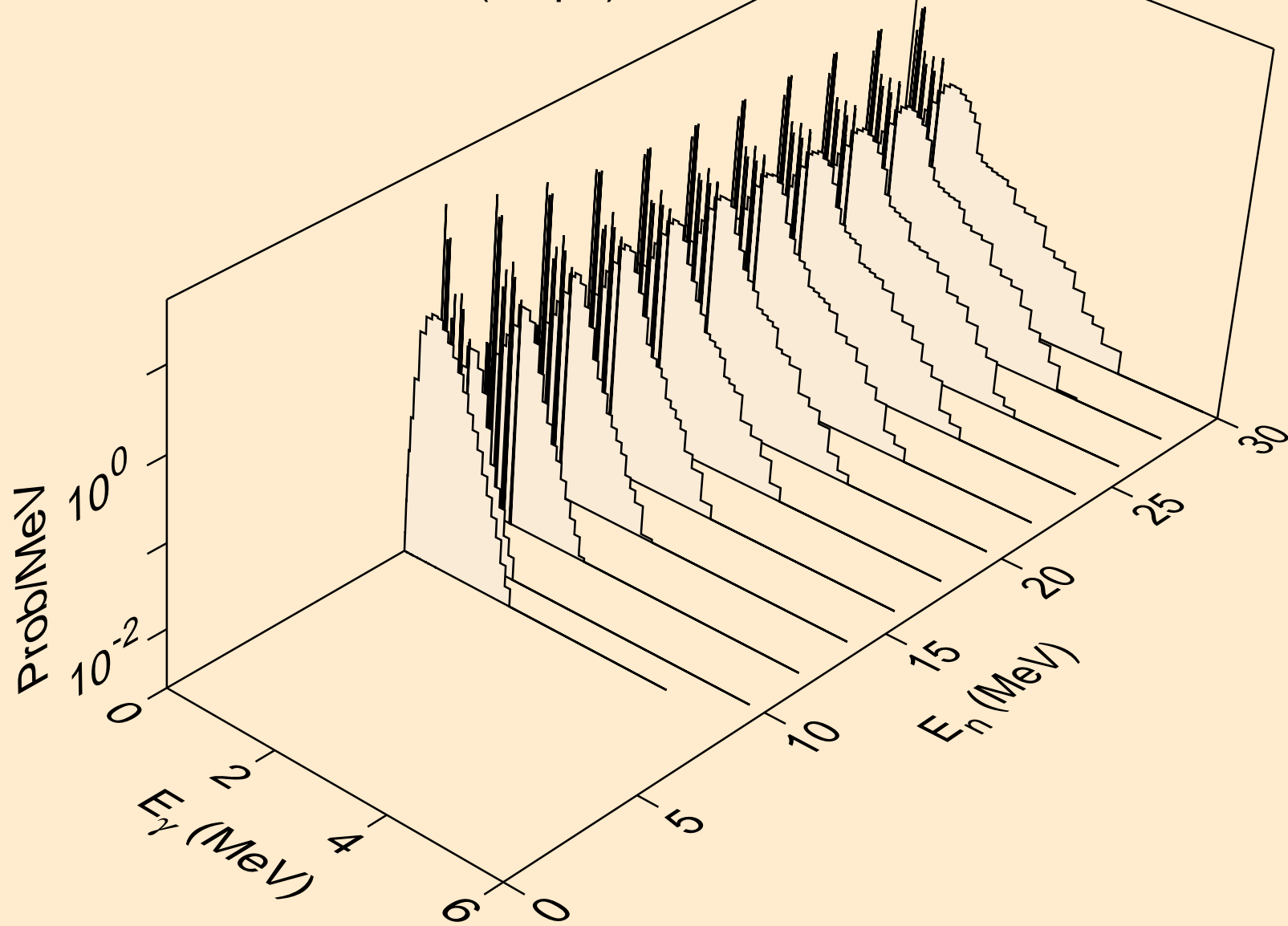

LU166 DEUTERON ACER TENDL-2021 LIBRARY; T=0.K  
Photon emission for (n,gma)

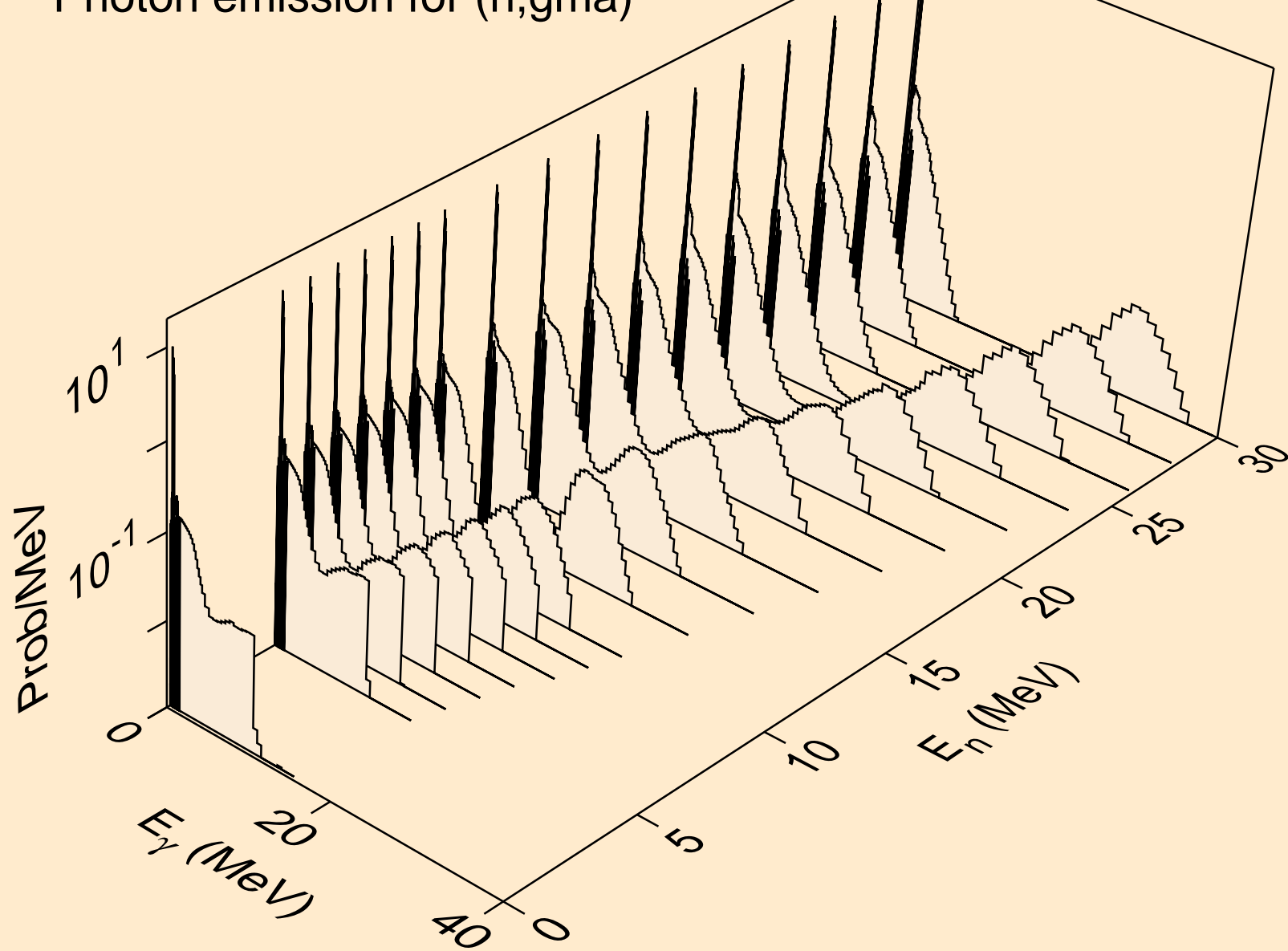

LU166 DEUTERON ACER TENDL-2021 LIBRARY; T=0.K  
Photon emission for (n,p)

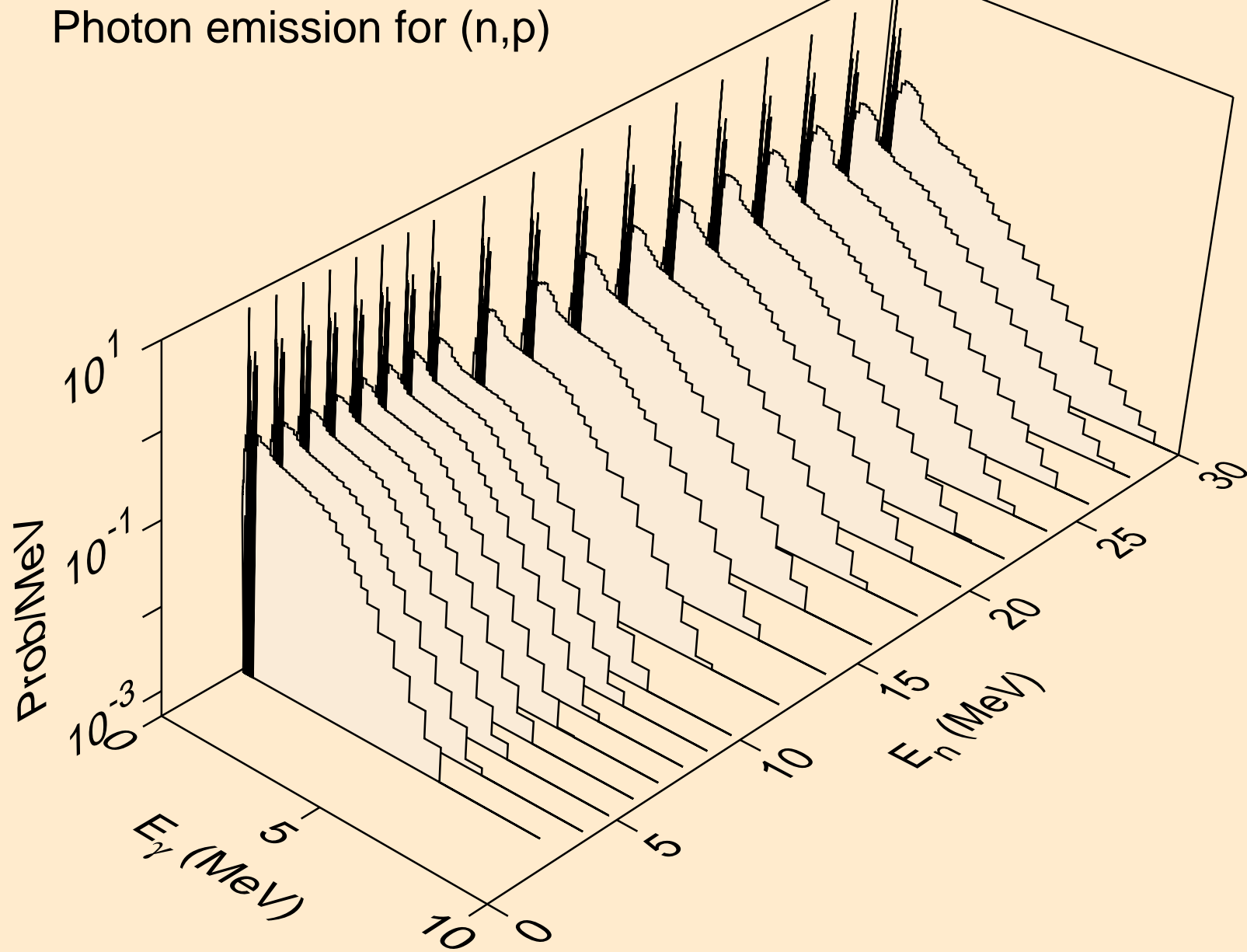

LU166 DEUTERON ACER TENDL-2021 LIBRARY; T=0.K  
Photon emission for inelastic

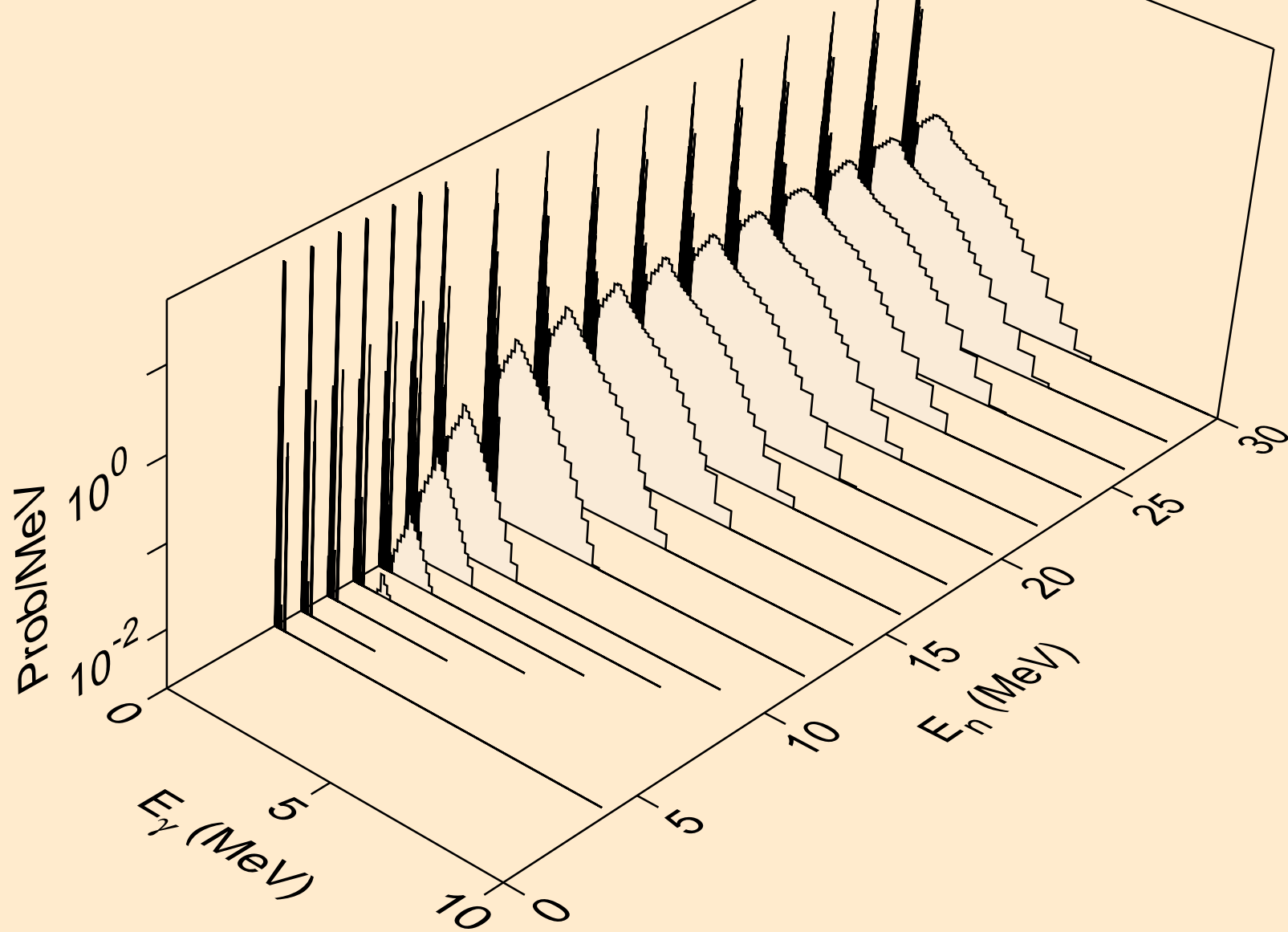

LU166 DEUTERON ACER TENDL-2021 LIBRARY; T=0.K  
Photon emission for (n,t)

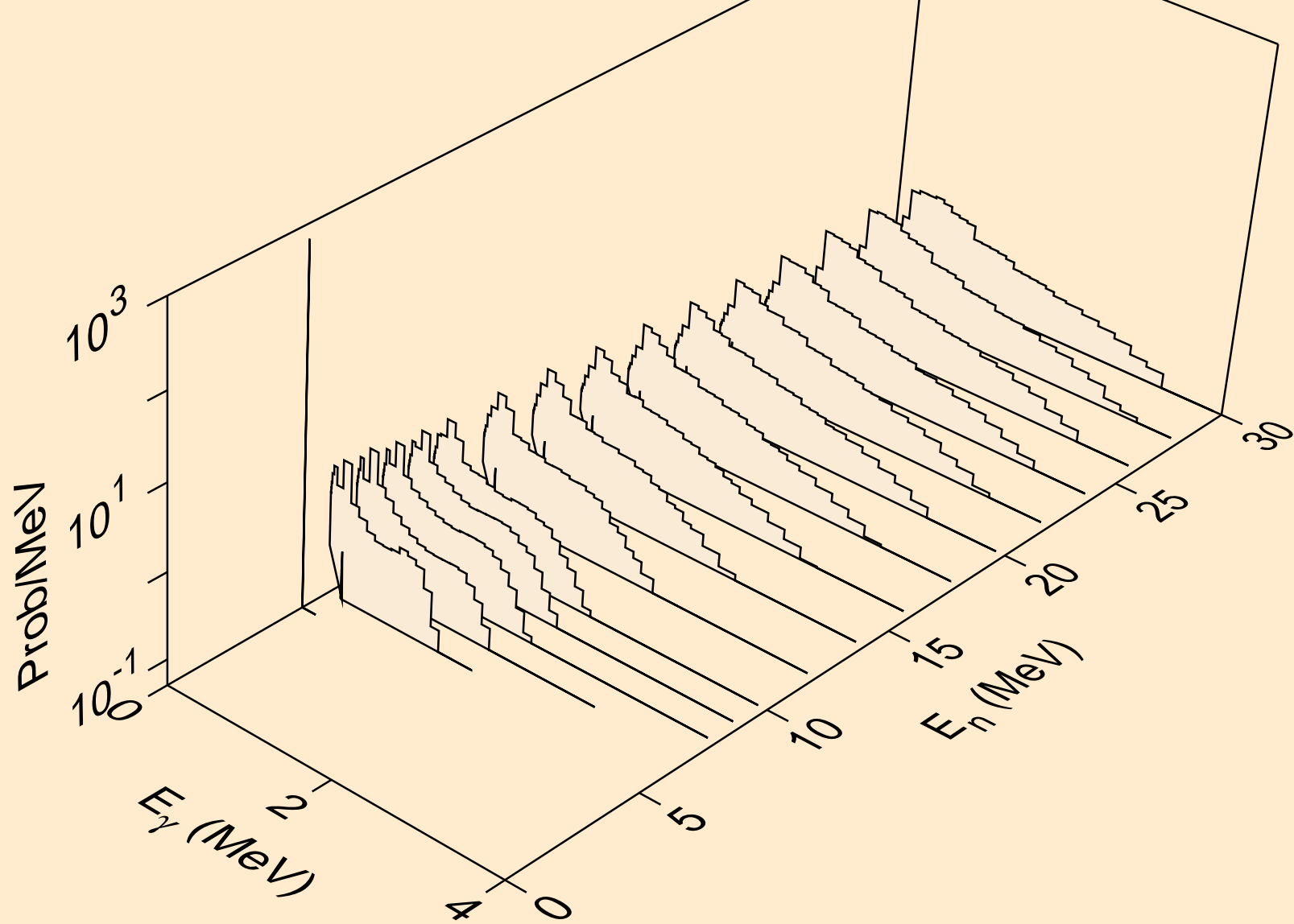

LU166 DEUTERON ACER TENDL-2021 LIBRARY; T=0.K  
Photon emission for (n,he3)

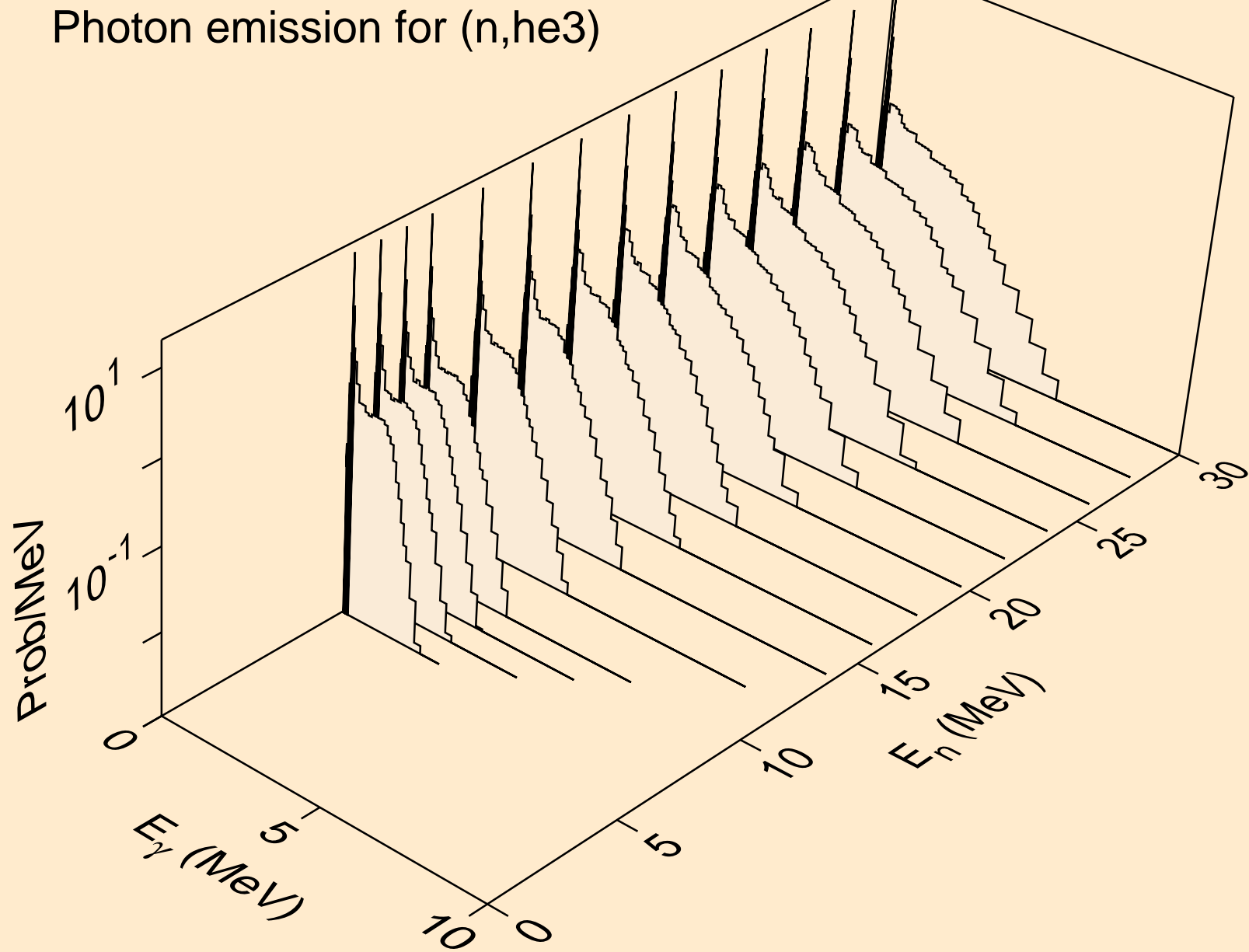

LU166 DEUTERON ACER TENDL-2021 LIBRARY; T=0.K  
Photon emission for (n,a)

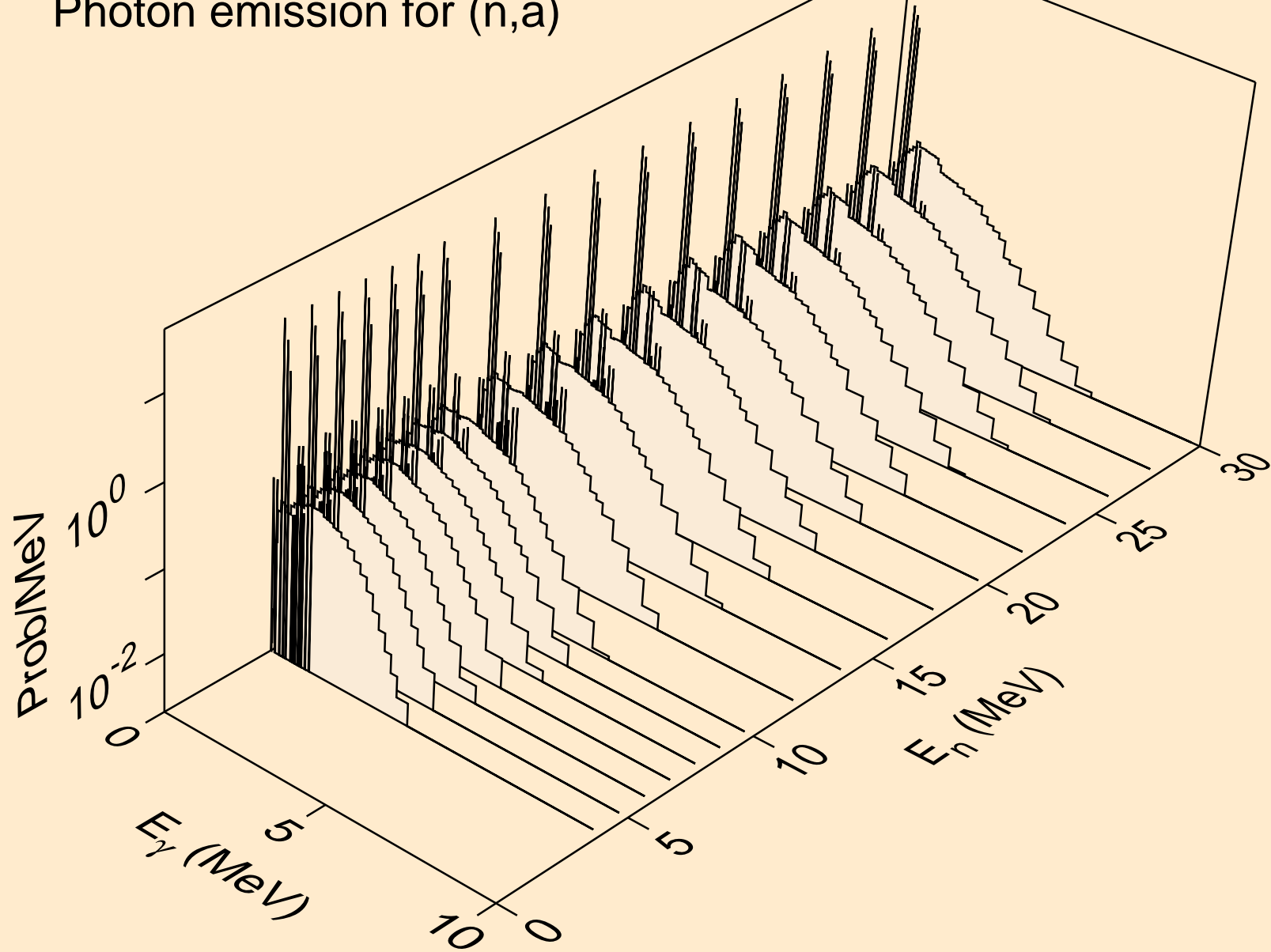



LU166 DEUTERON ACER TENDL-2021 LIBRARY; T=0.K  
Photon emission for (n,2a)

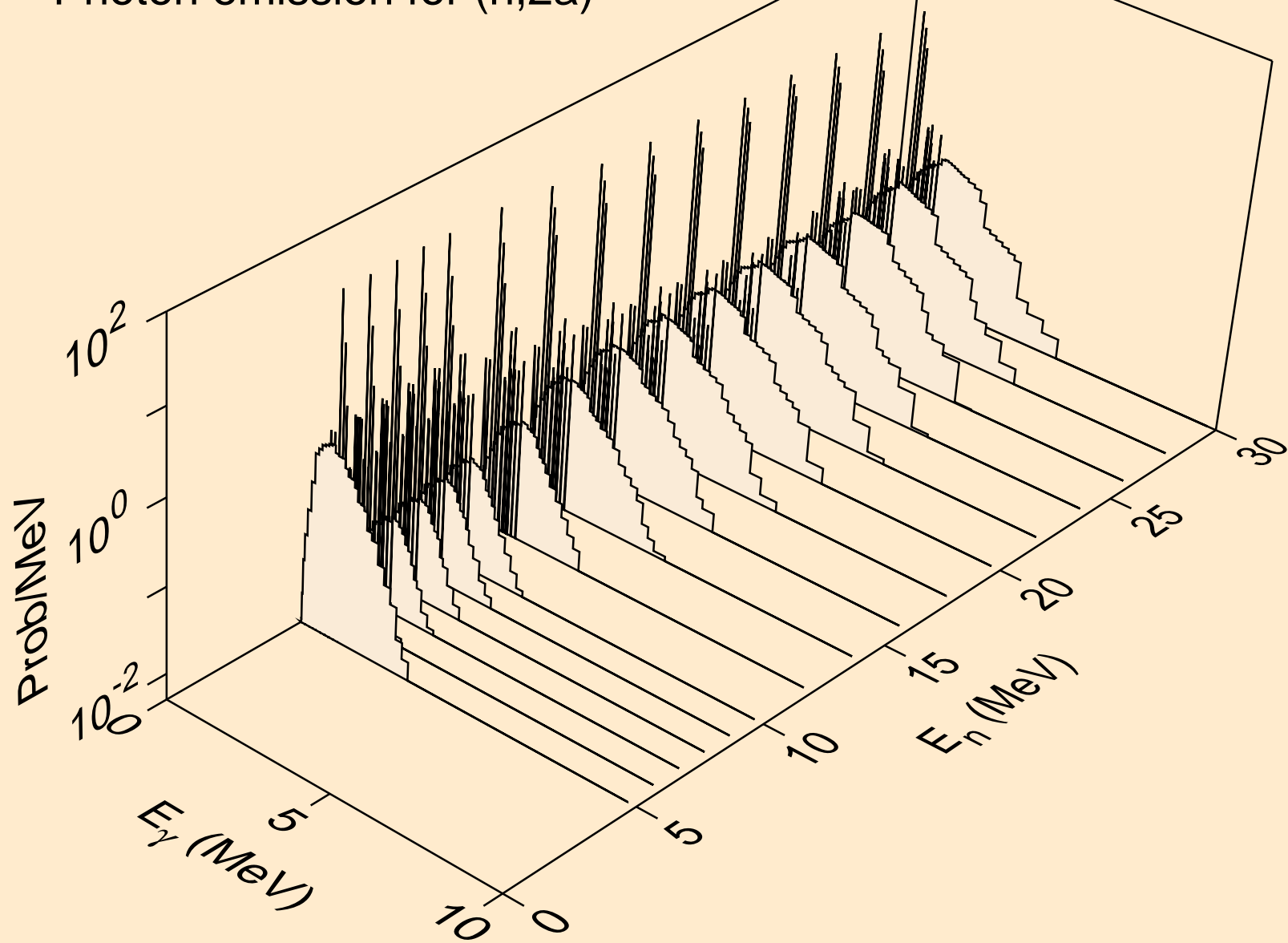

LU166 DEUTERON ACER TENDL-2021 LIBRARY; T=0.K  
Photon emission for (n,2p)

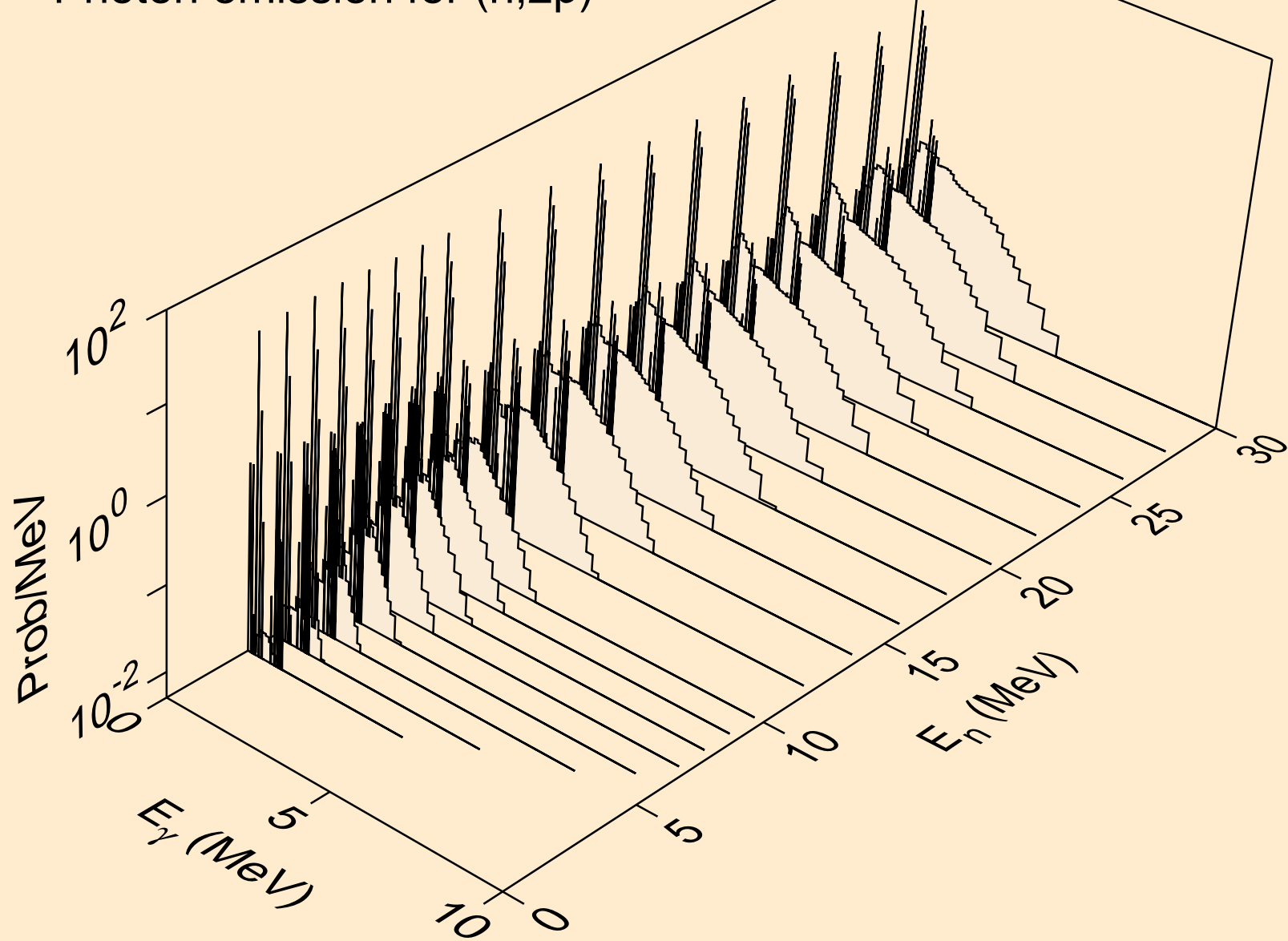

LU166 DEUTERON ACER TENDL-2021 LIBRARY; T=0.K  
Photon emission for (n,p)

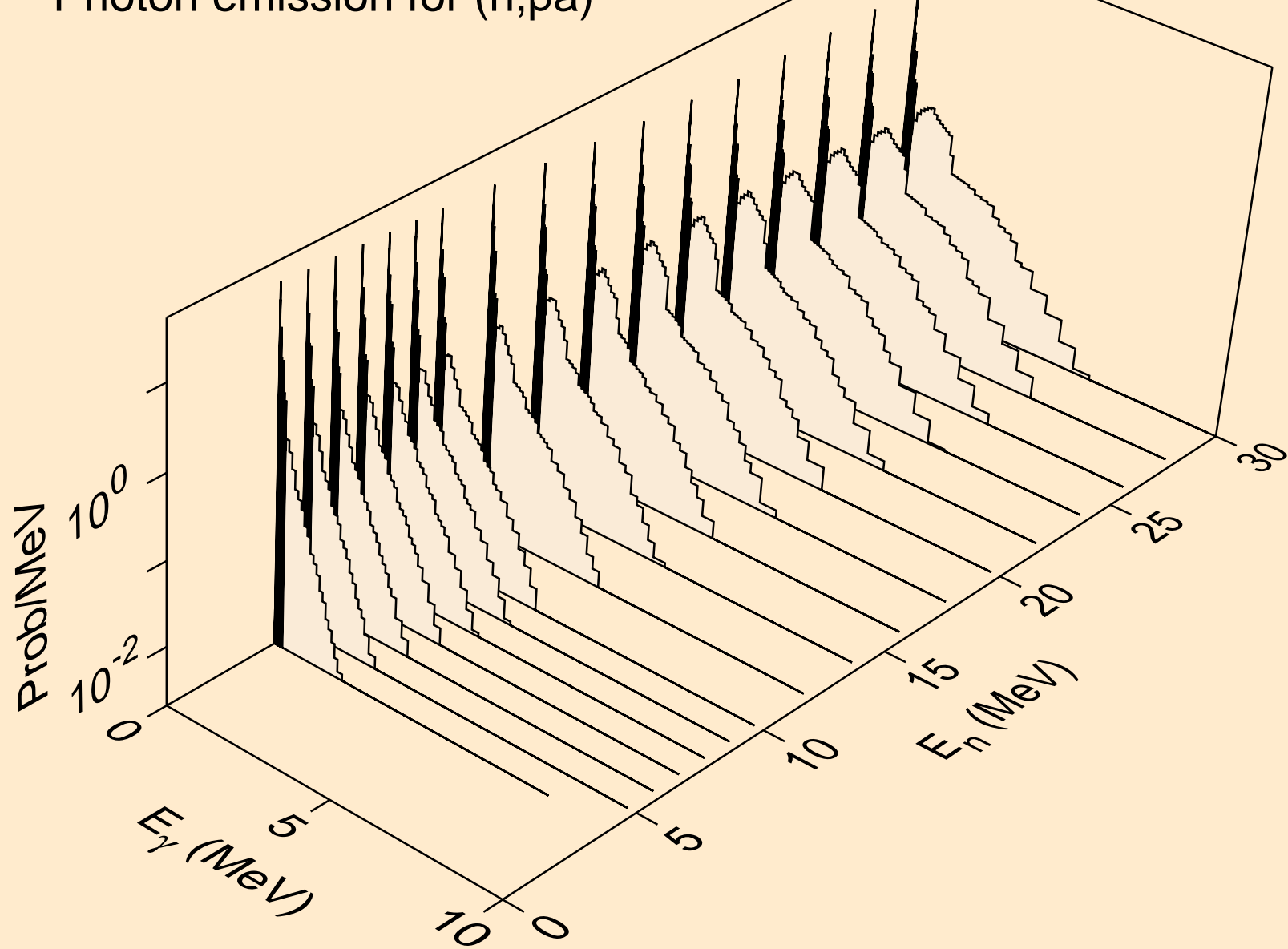

LU166 DEUTERON ACER TENDL-2021 LIBRARY; T=0.K  
Photon emission for (n,pd)

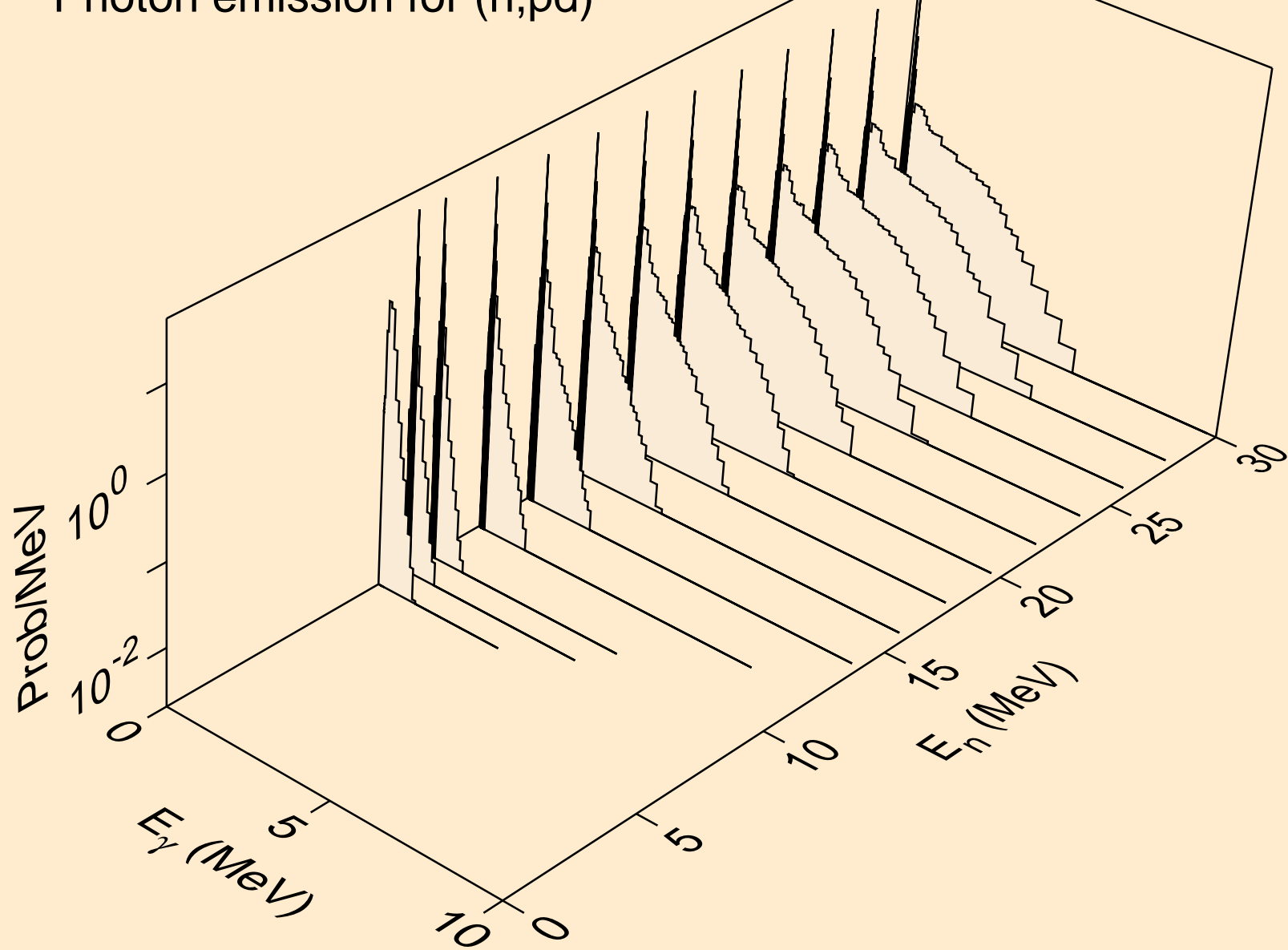

LU166 DEUTERON ACER TENDL-2021 LIBRARY; T=0.K  
Photon emission for (n,pt)

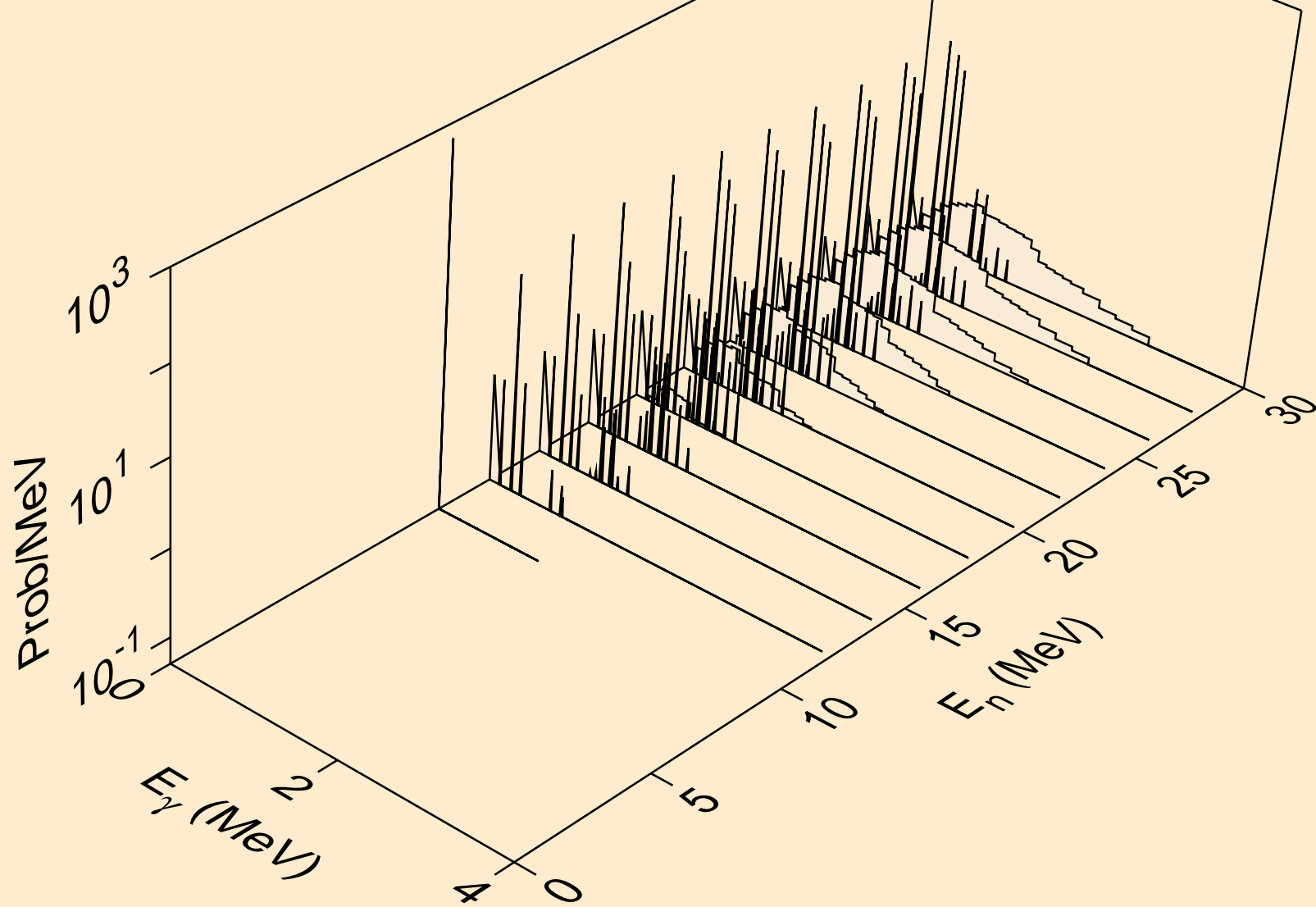

LU166 DEUTERON ACER TENDL-2021 LIBRARY; T=0.K  
Photon emission for (n,da)

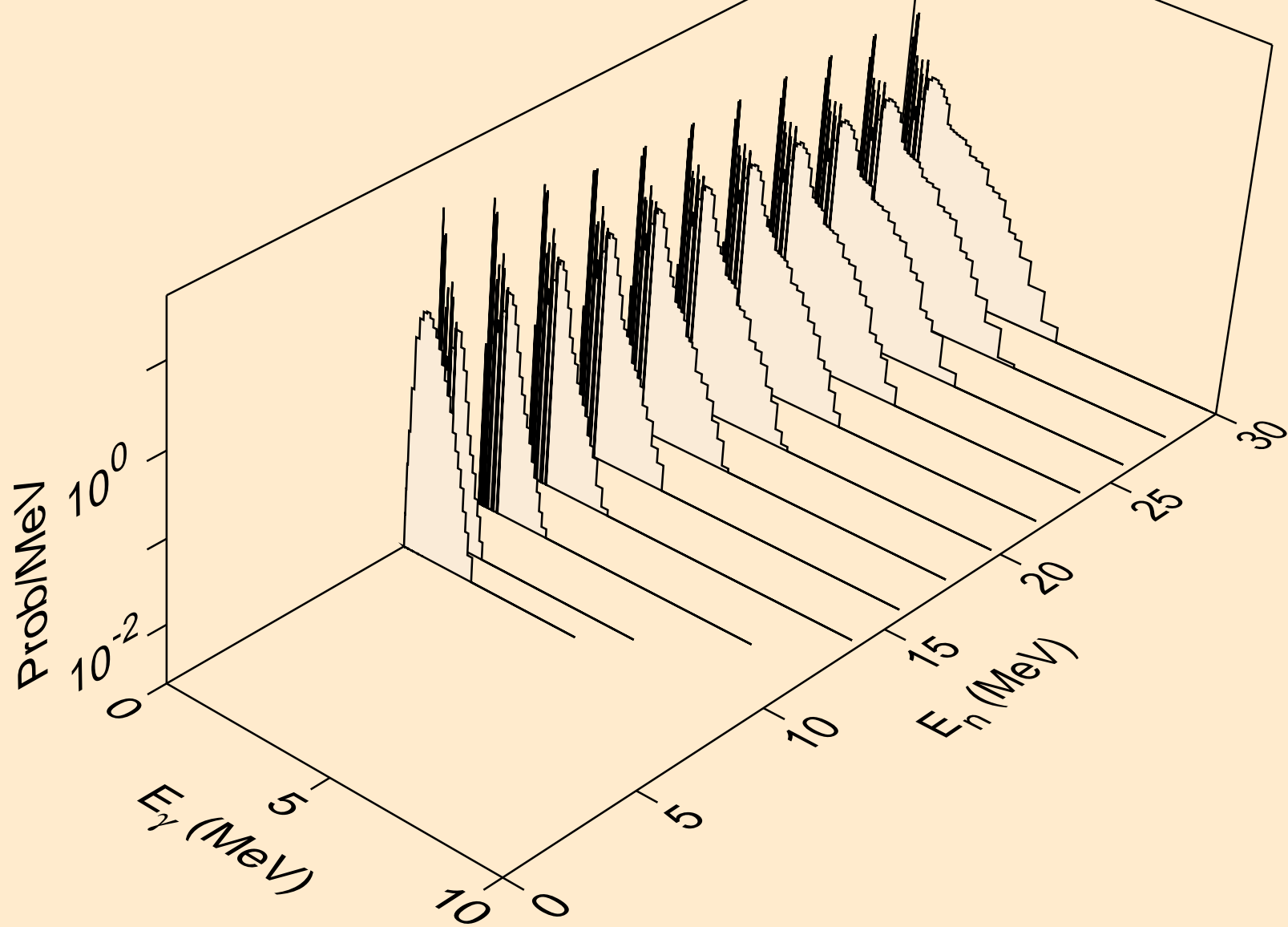

# LU166 DEUTERON ACER TENDL-2021 LIBRARY; T=0.K

## Particle heating contributions

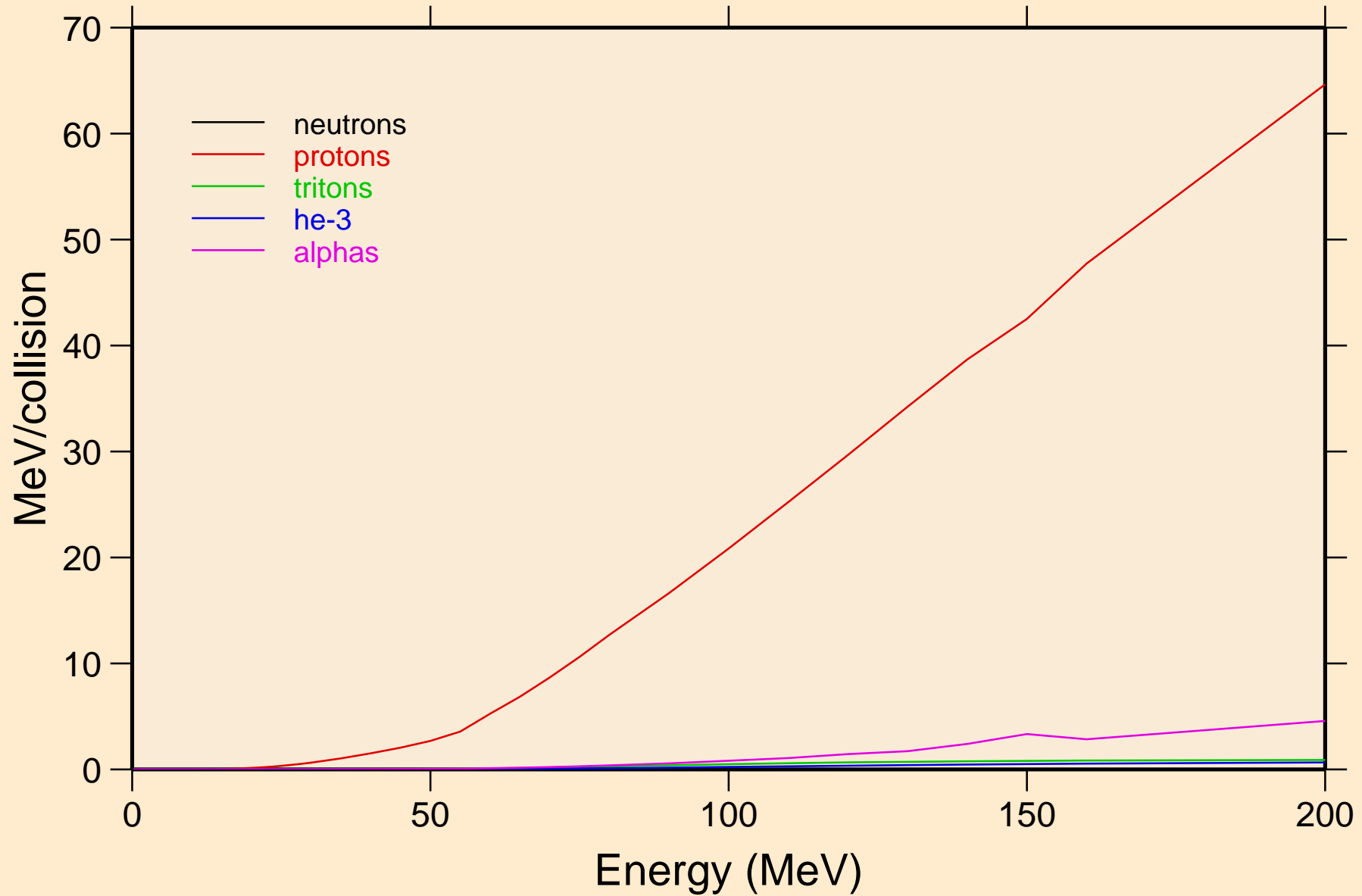

LU166 DEUTERON ACER TENDL-2021 LIBRARY; T=0.K  
Recoil Heating

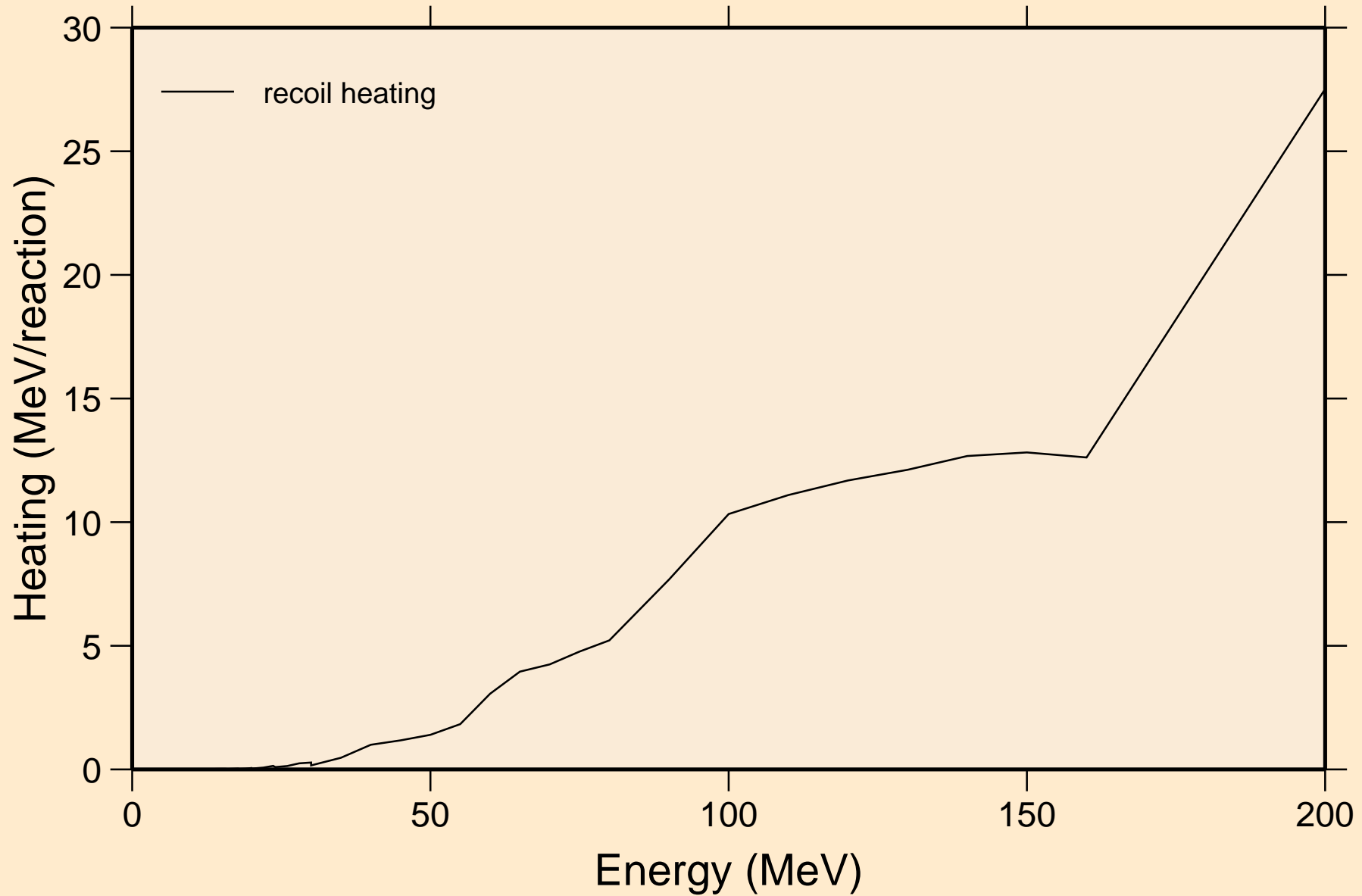



LU166 DEUTERON ACER TENDL-2021 LIBRARY; T=0.K  
Particle production cross sections

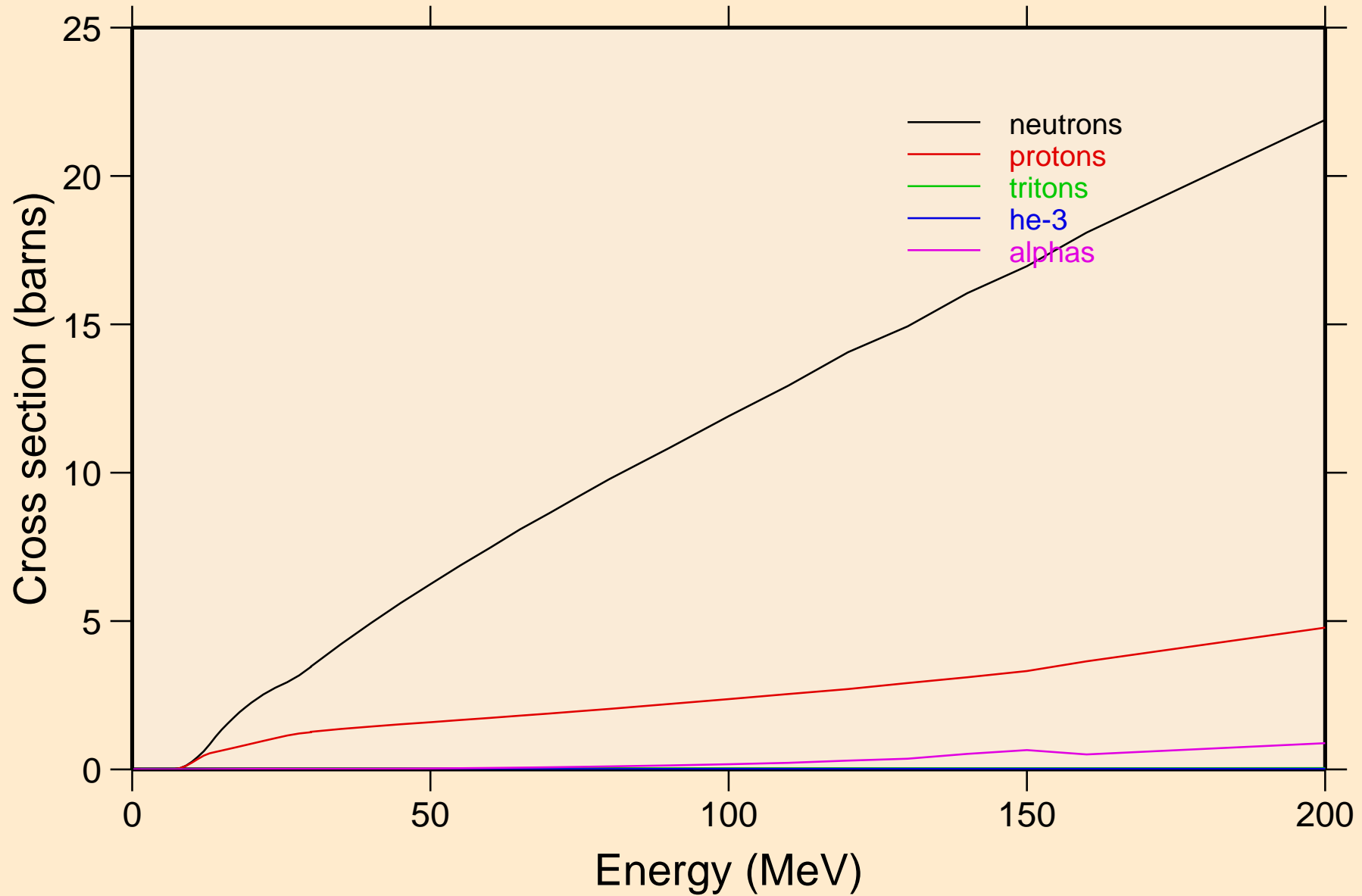

LU166 DEUTERON ACER TENDL-2021 LIBRARY; T=0.K  
neutrons from (d,n)

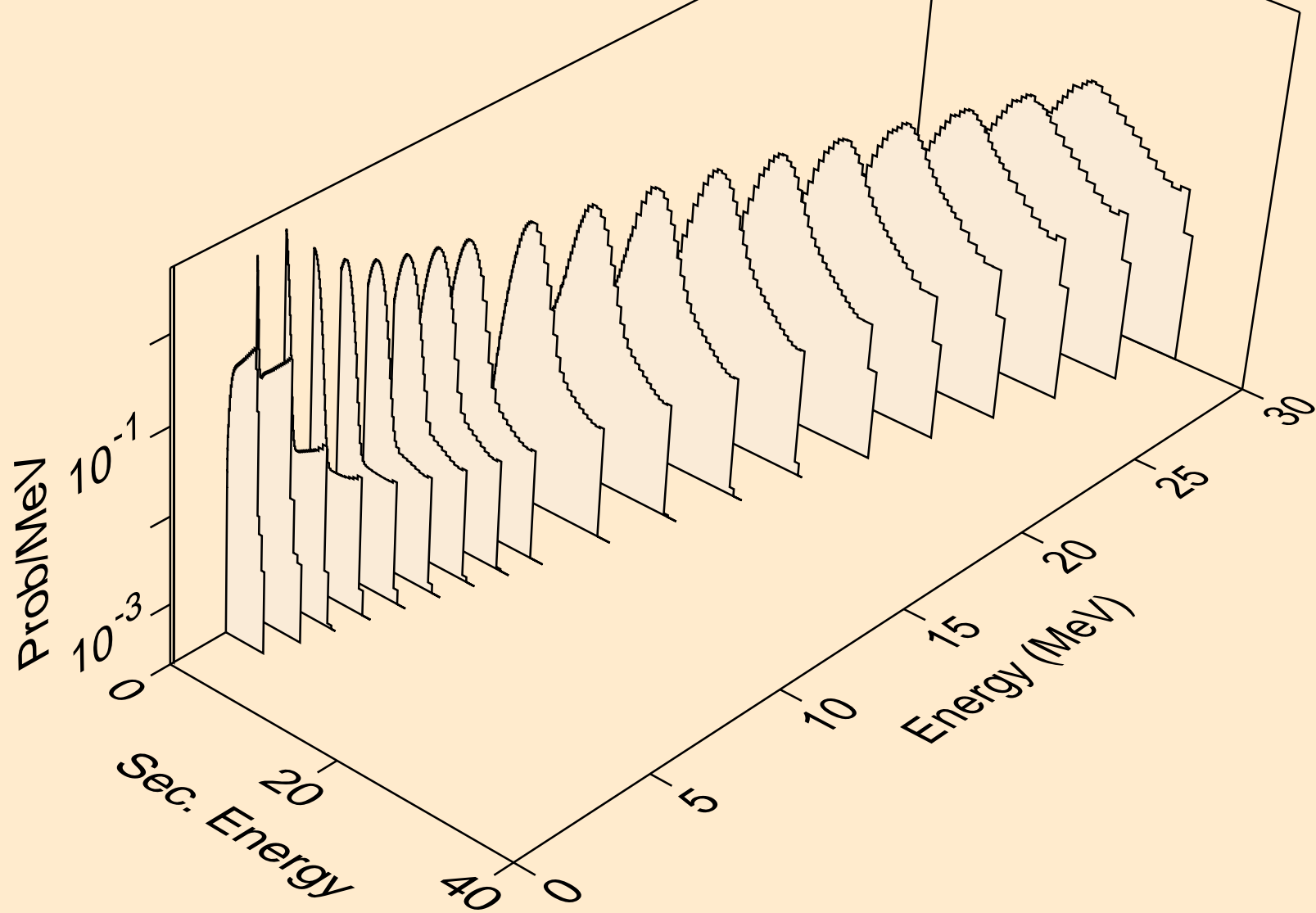

LU166 DEUTERON ACER TENDL-2021 LIBRARY; T=0.K  
neutrons from (d,x)

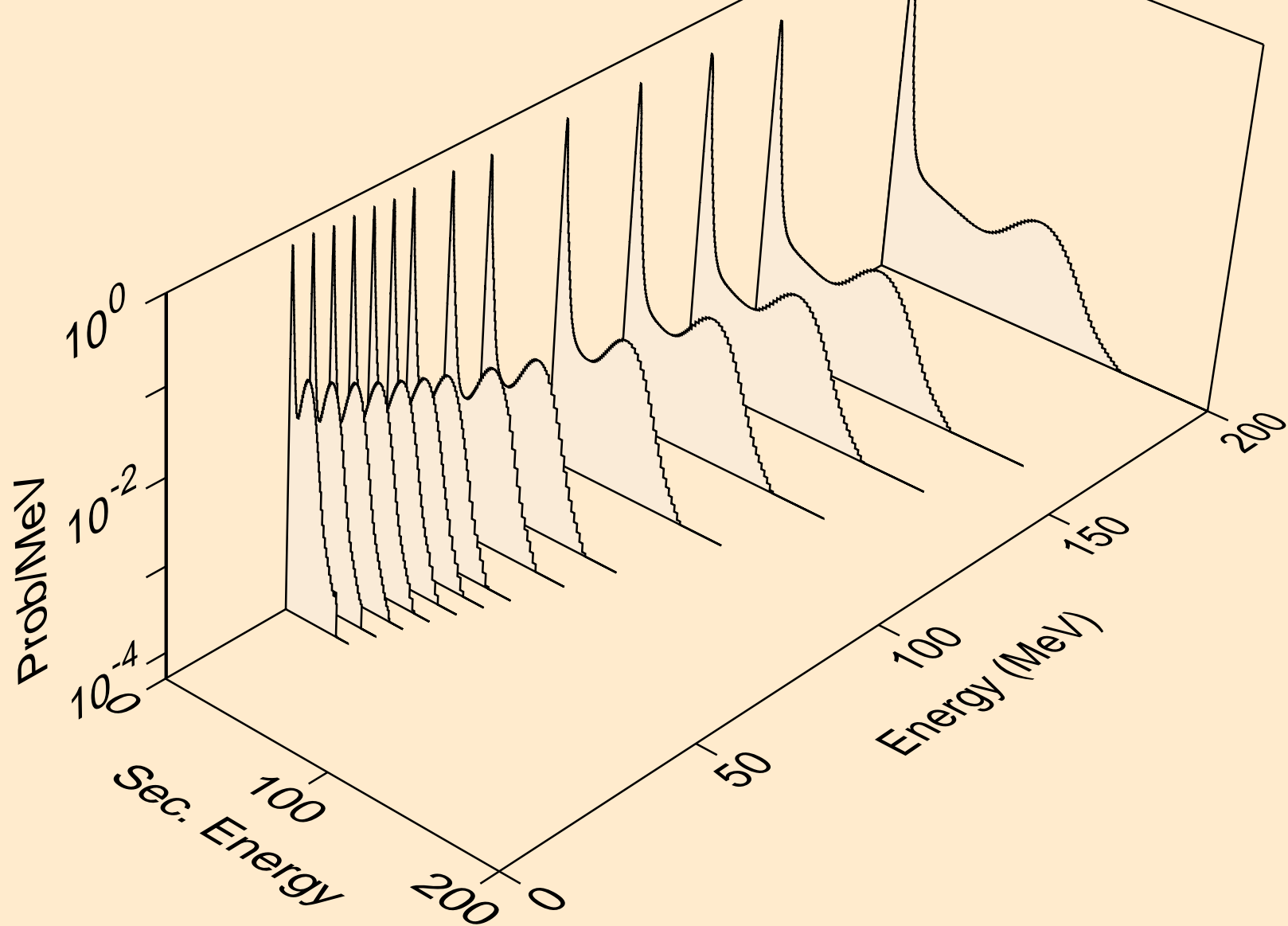

LU166 DEUTERON ACER TENDL-2021 LIBRARY; T=0.K  
neutrons from (d,2nd)

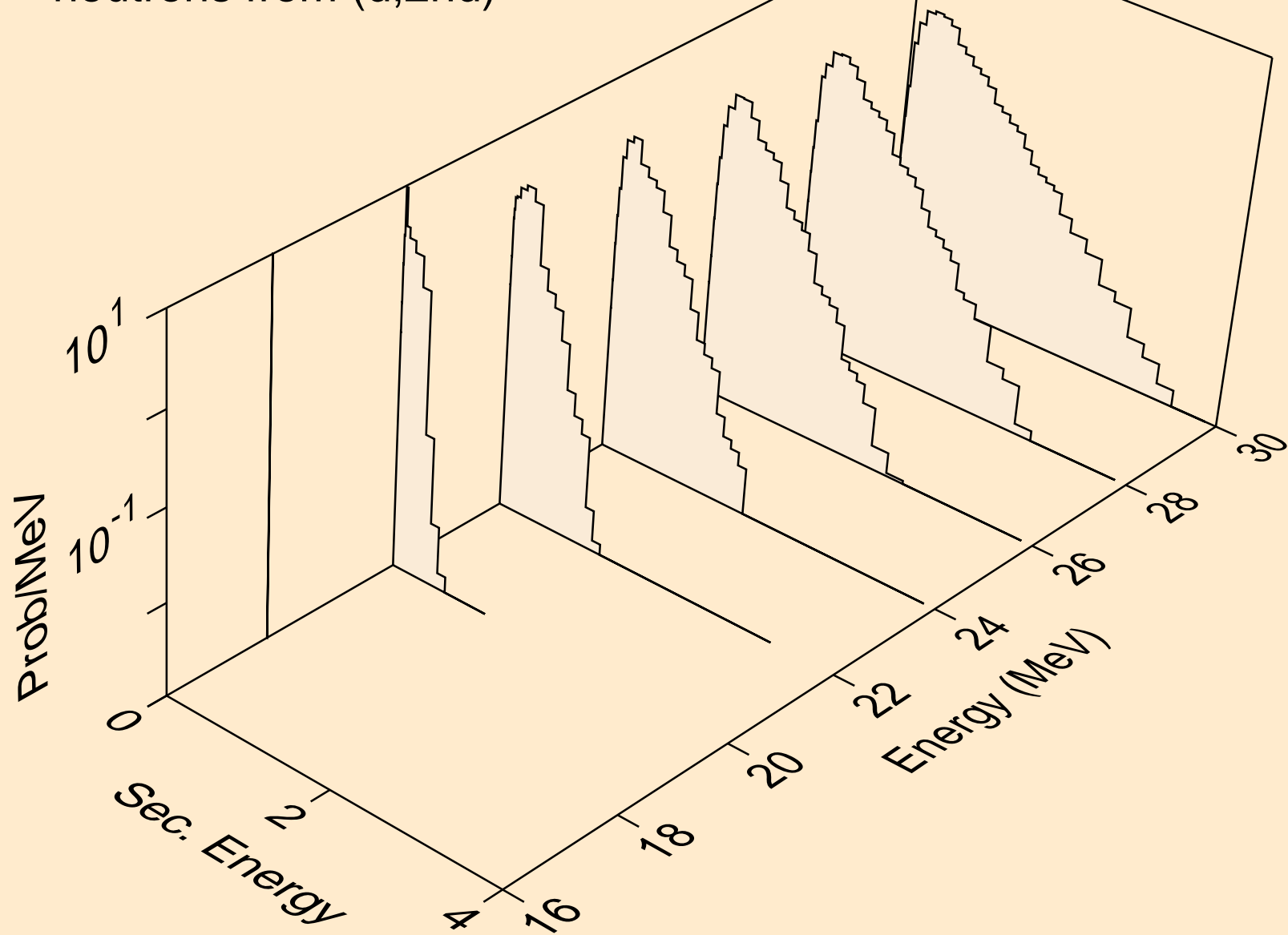

LU166 DEUTERON ACER TENDL-2021 LIBRARY; T=0.K  
neutrons from (d,2n)

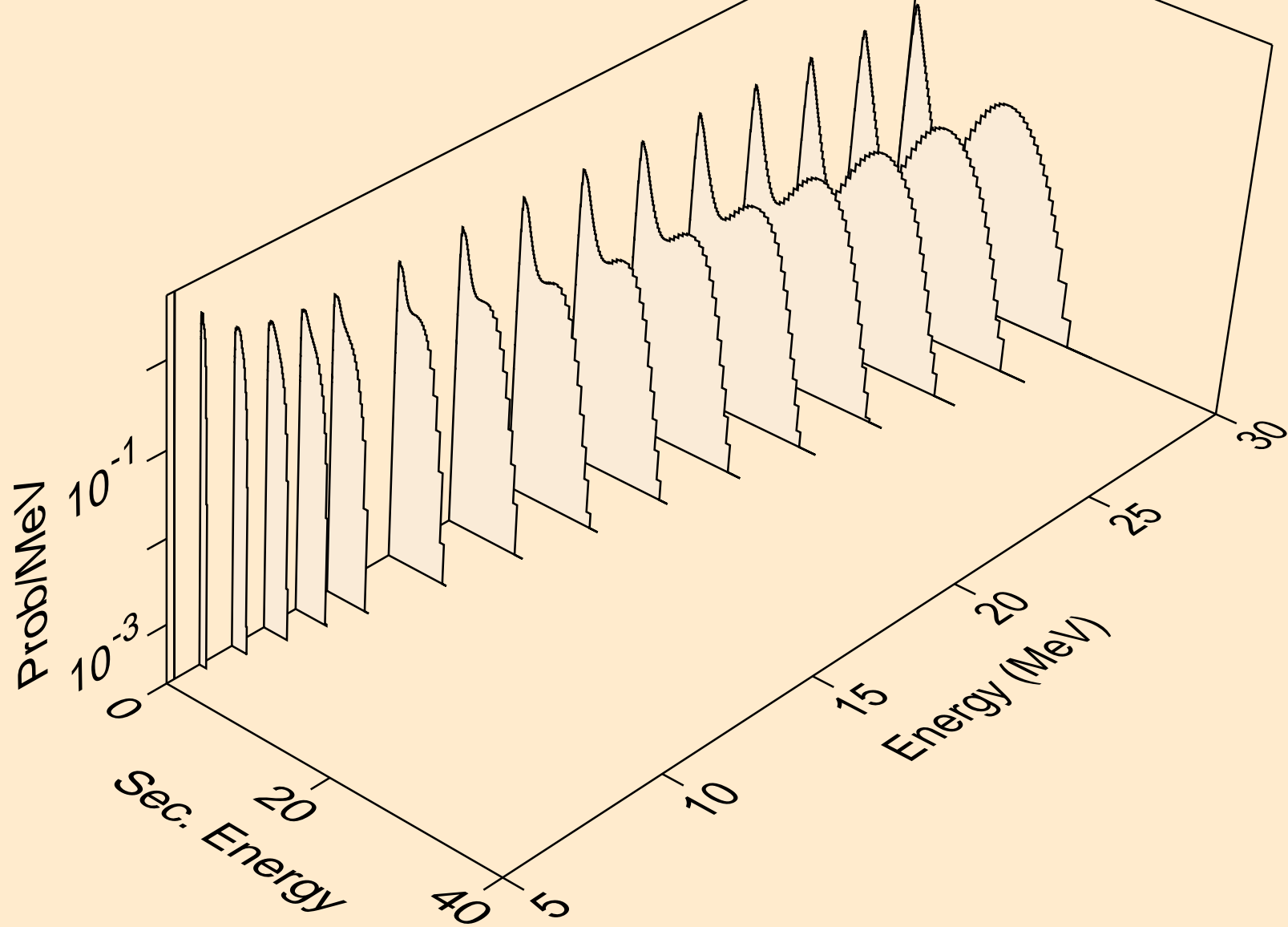

LU166 DEUTERON ACER TENDL-2021 LIBRARY; T=0.K  
neutrons from (d,3n)

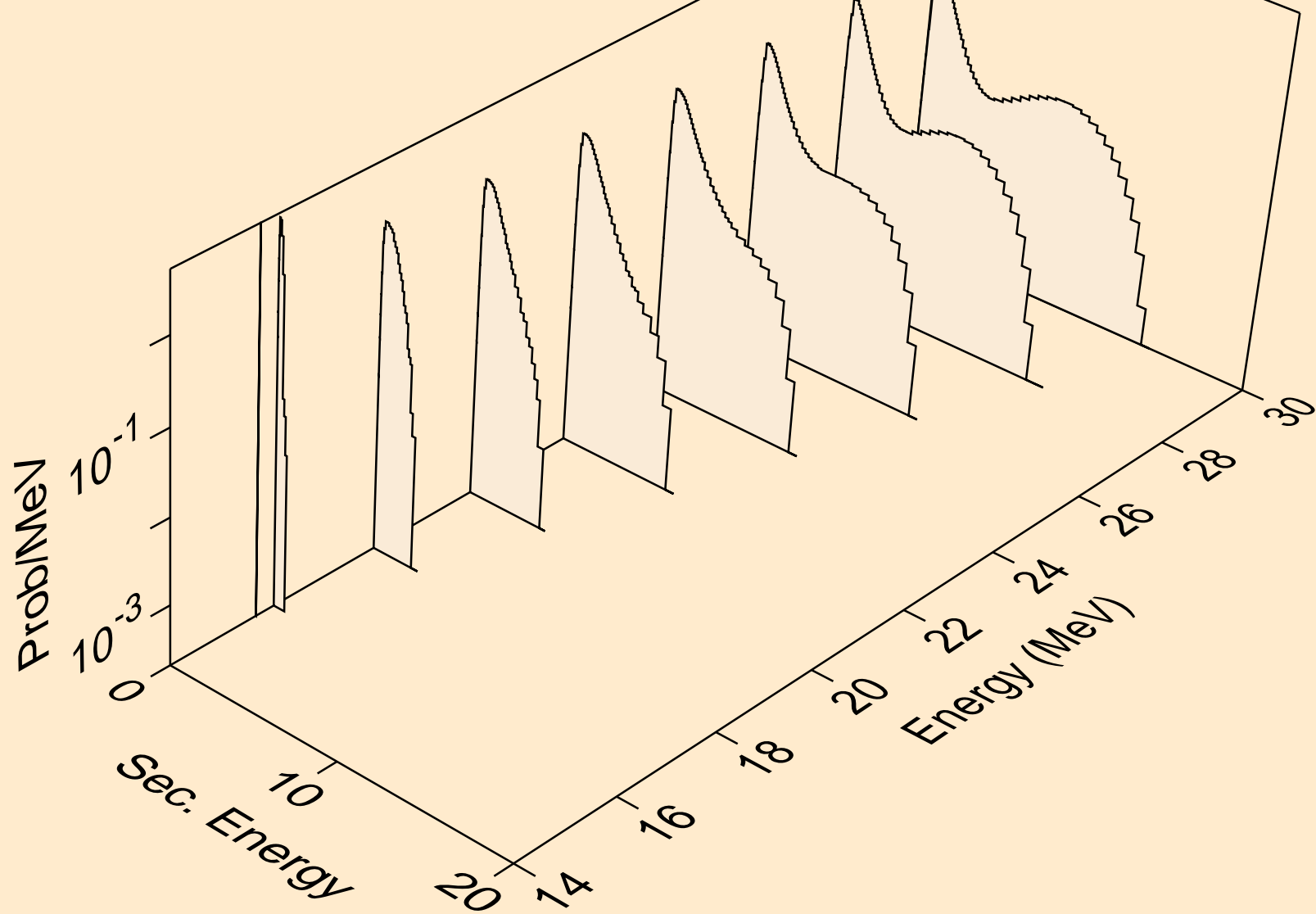

LU166 DEUTERON ACER TENDL-2021 LIBRARY; T=0.K  
neutrons from (d,n\*)a

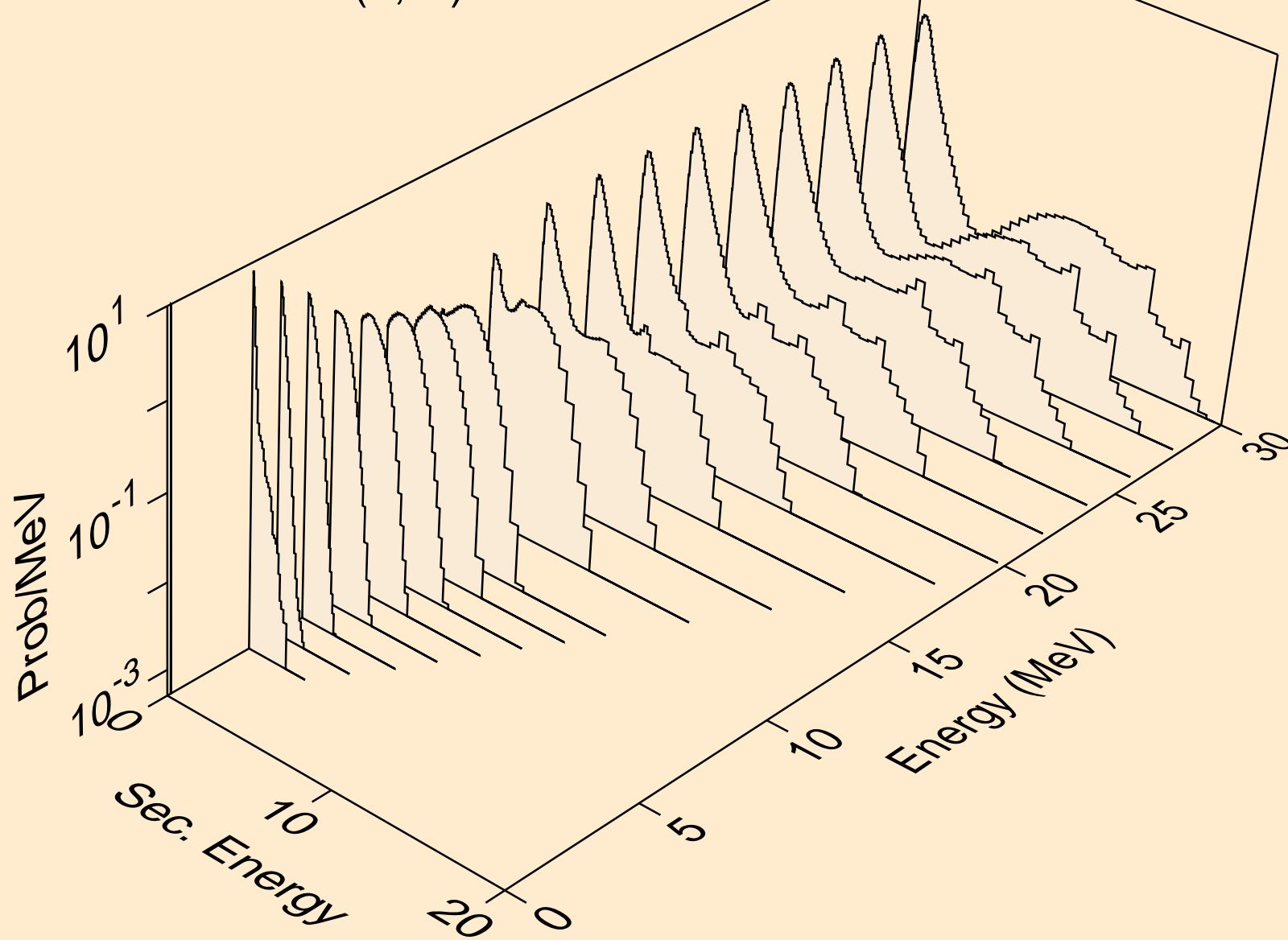

LU166 DEUTERON ACER TENDL-2021 LIBRARY; T=0.K  
neutrons from (d,2n)a

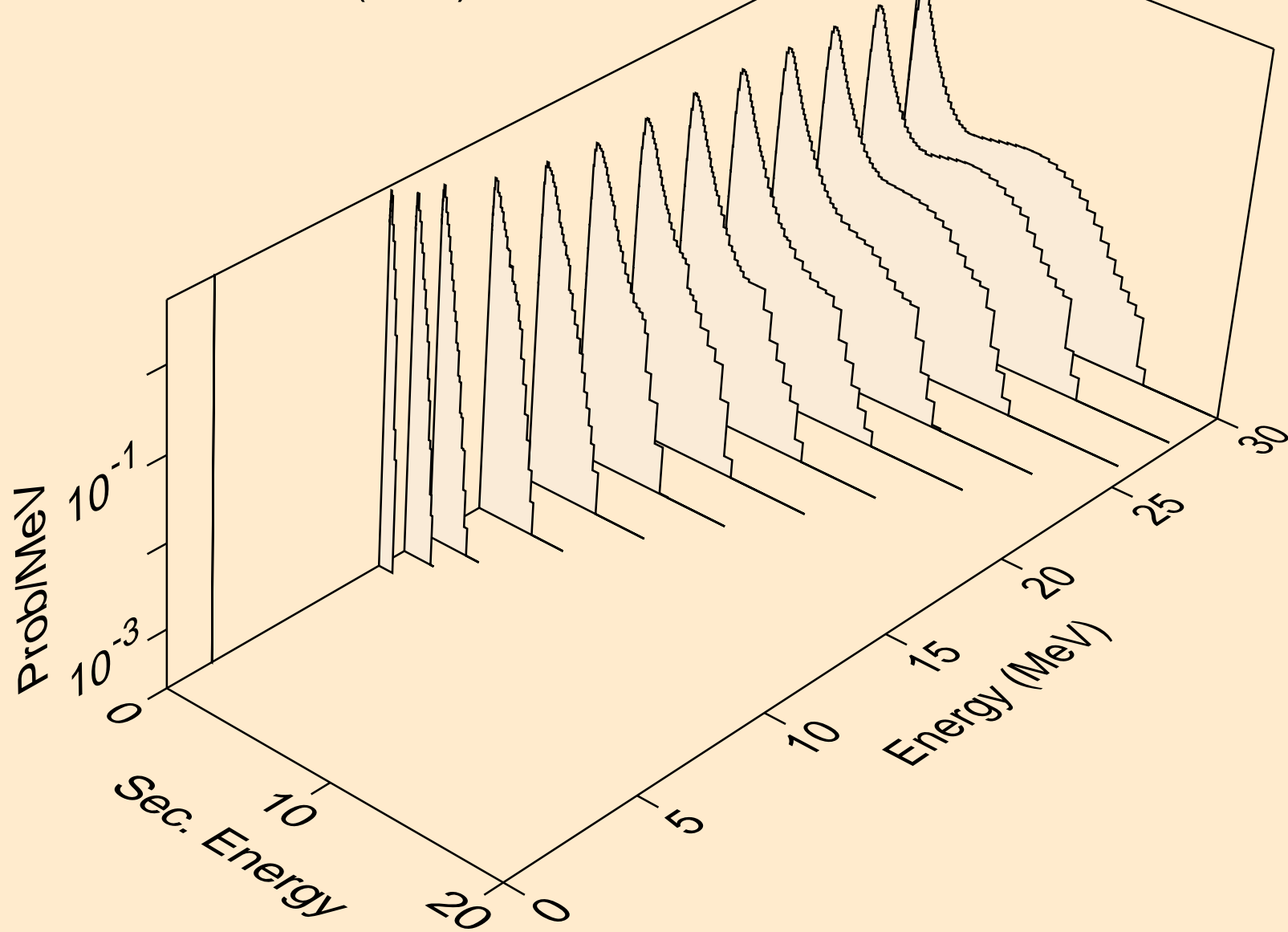



LU166 DEUTERON ACER TENDL-2021 LIBRARY; T=0.K  
neutrons from (d,3n)a

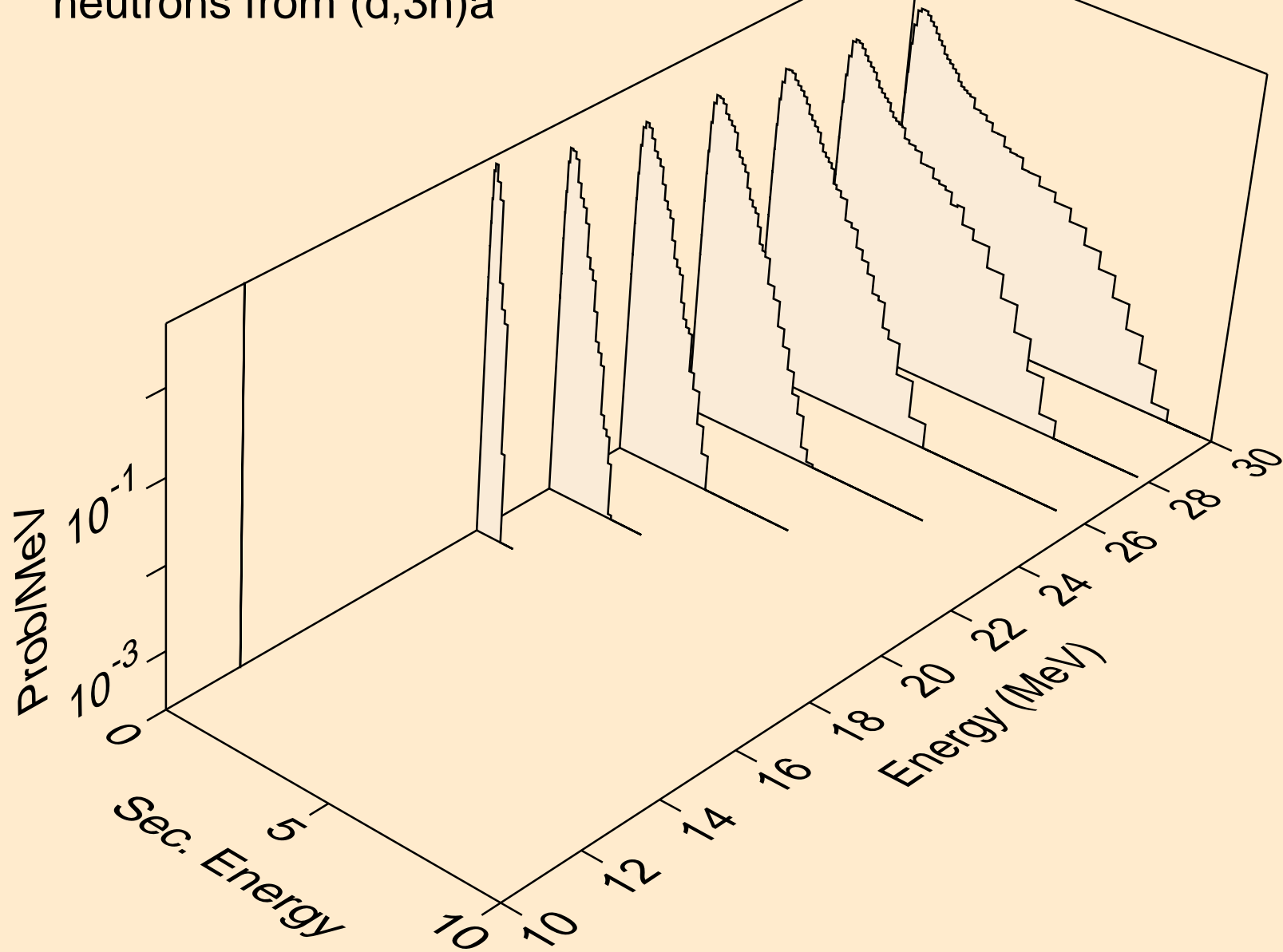

LU166 DEUTERON ACER TENDL-2021 LIBRARY; T=0.K  
neutrons from (d,n\*)p

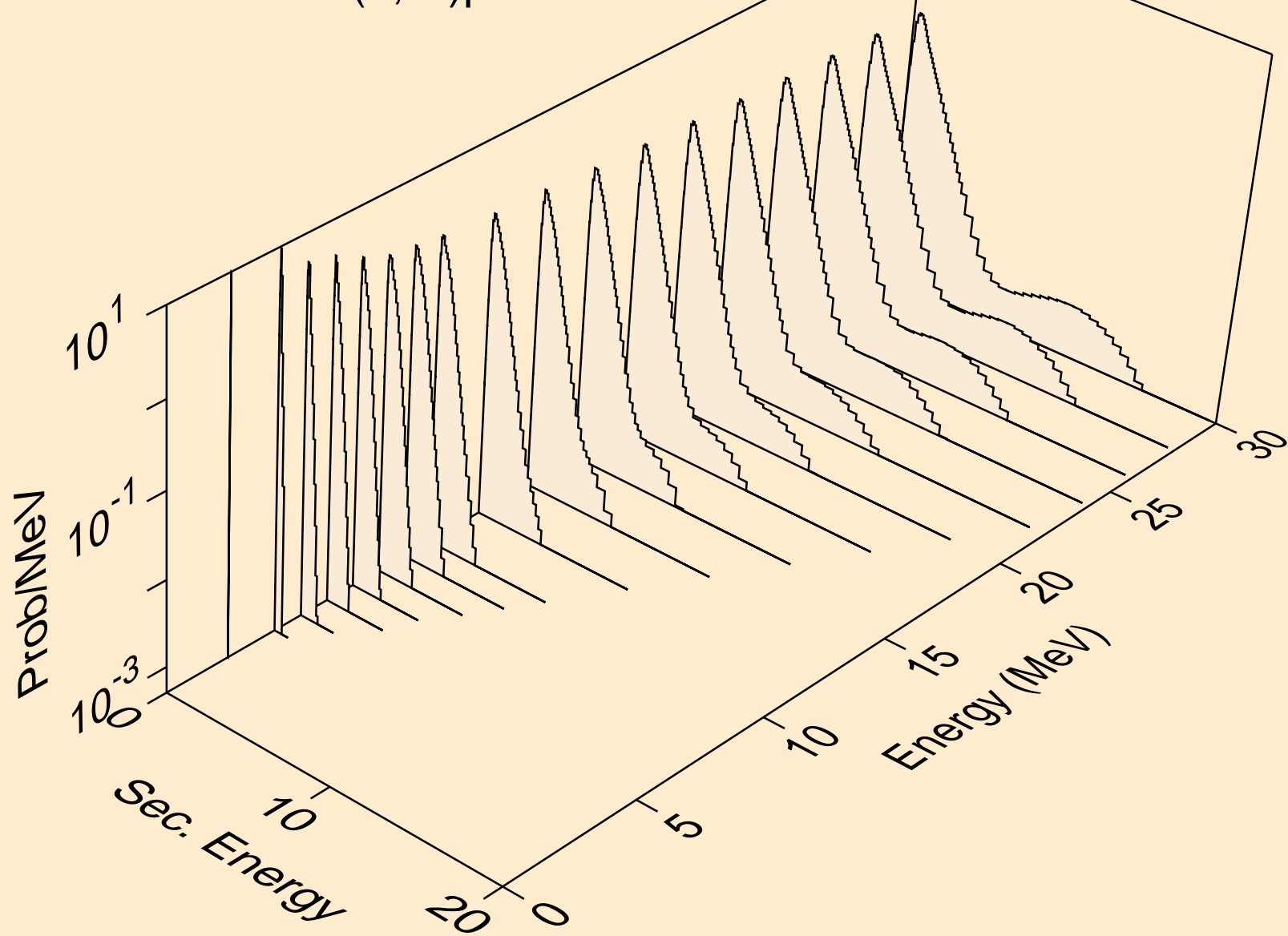

LU166 DEUTERON ACER TENDL-2021 LIBRARY; T=0.K  
neutrons from (d,n\*)2a

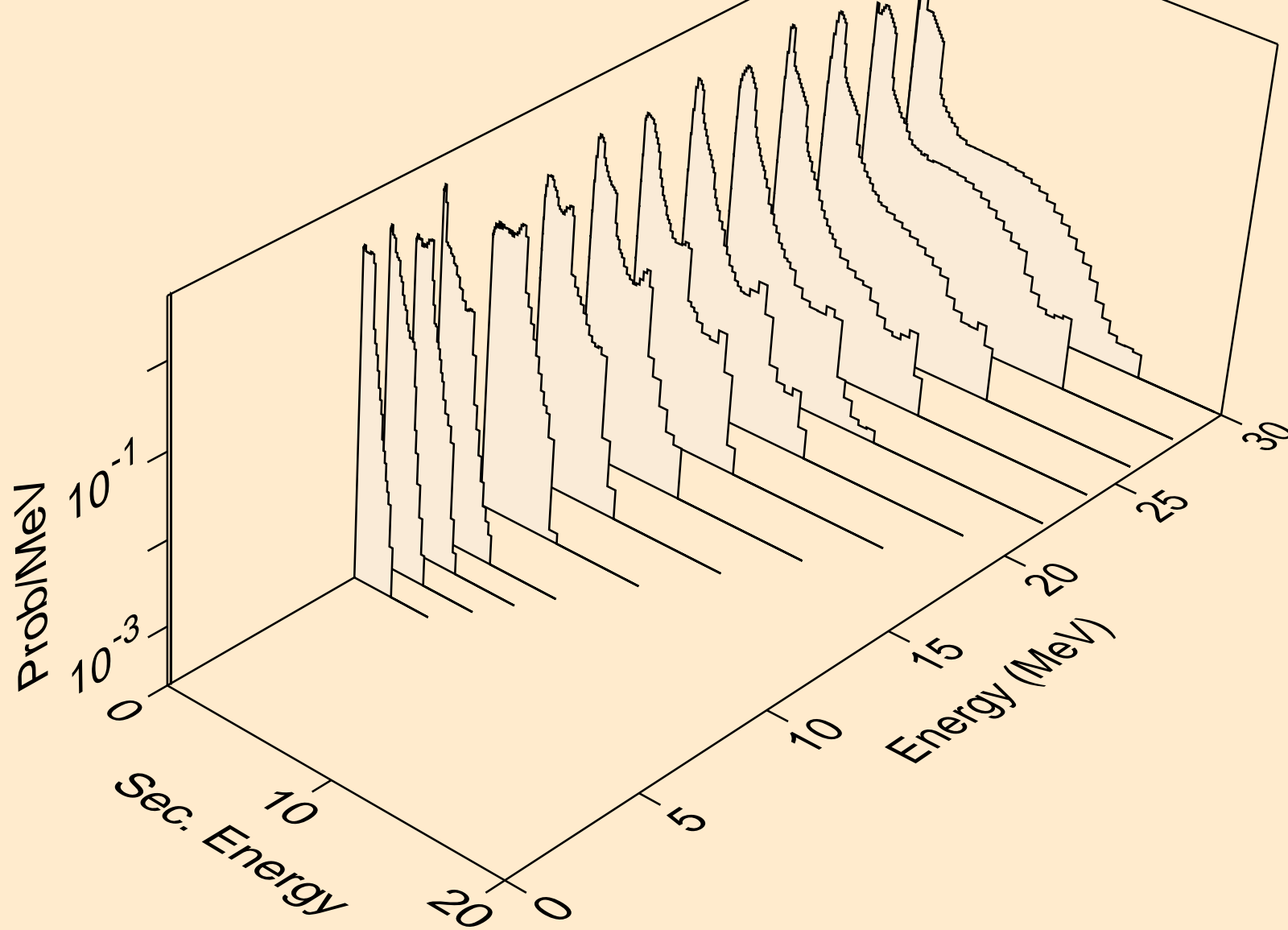

LU166 DEUTERON ACER TENDL-2021 LIBRARY; T=0.K  
neutrons from (d,2n)2a

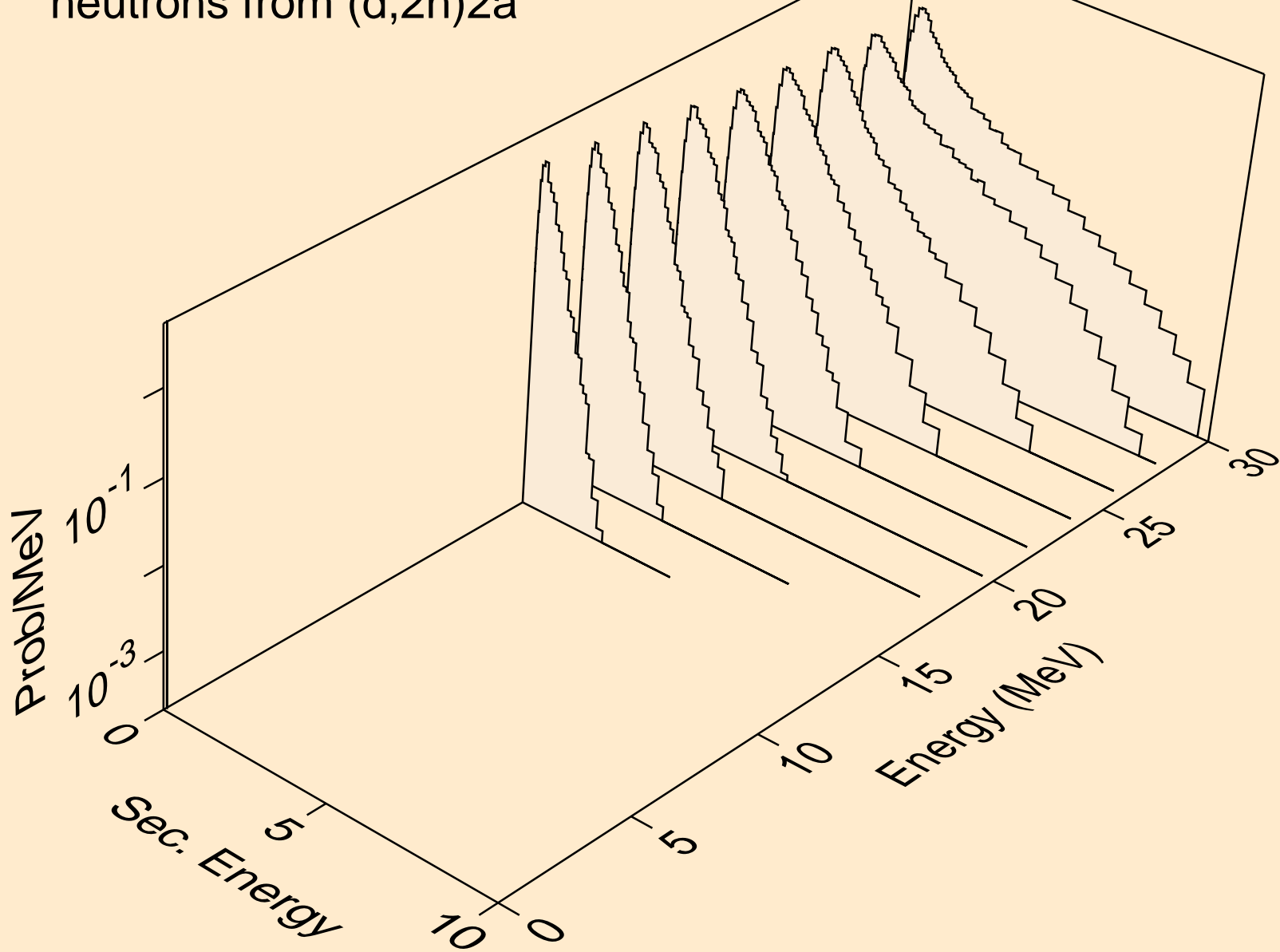

LU166 DEUTERON ACER TENDL-2021 LIBRARY; T=0.K  
neutrons from (d,n\*)d

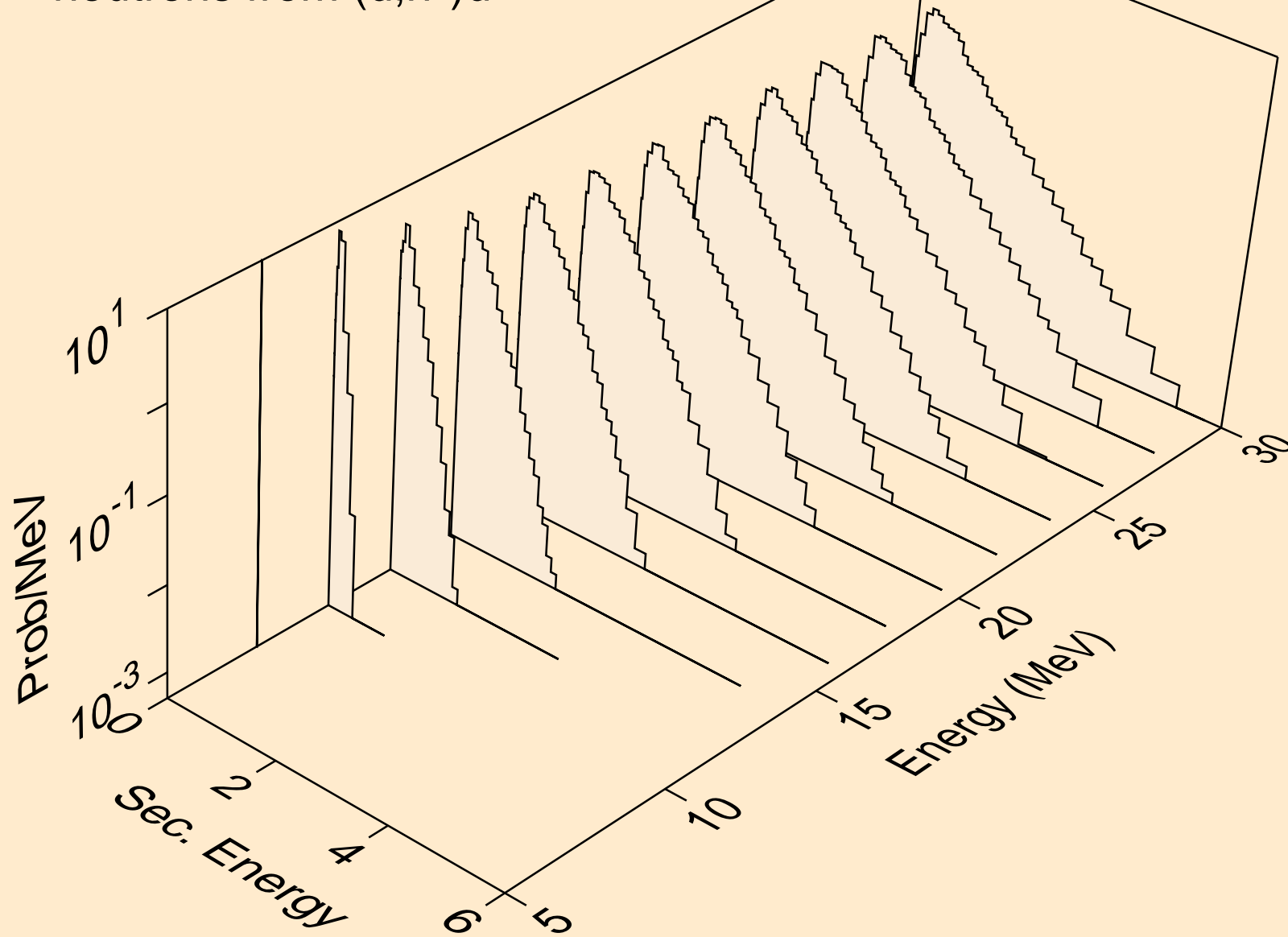

LU166 DEUTERON ACER TENDL-2021 LIBRARY; T=0.K  
neutrons from (d,n\*)t

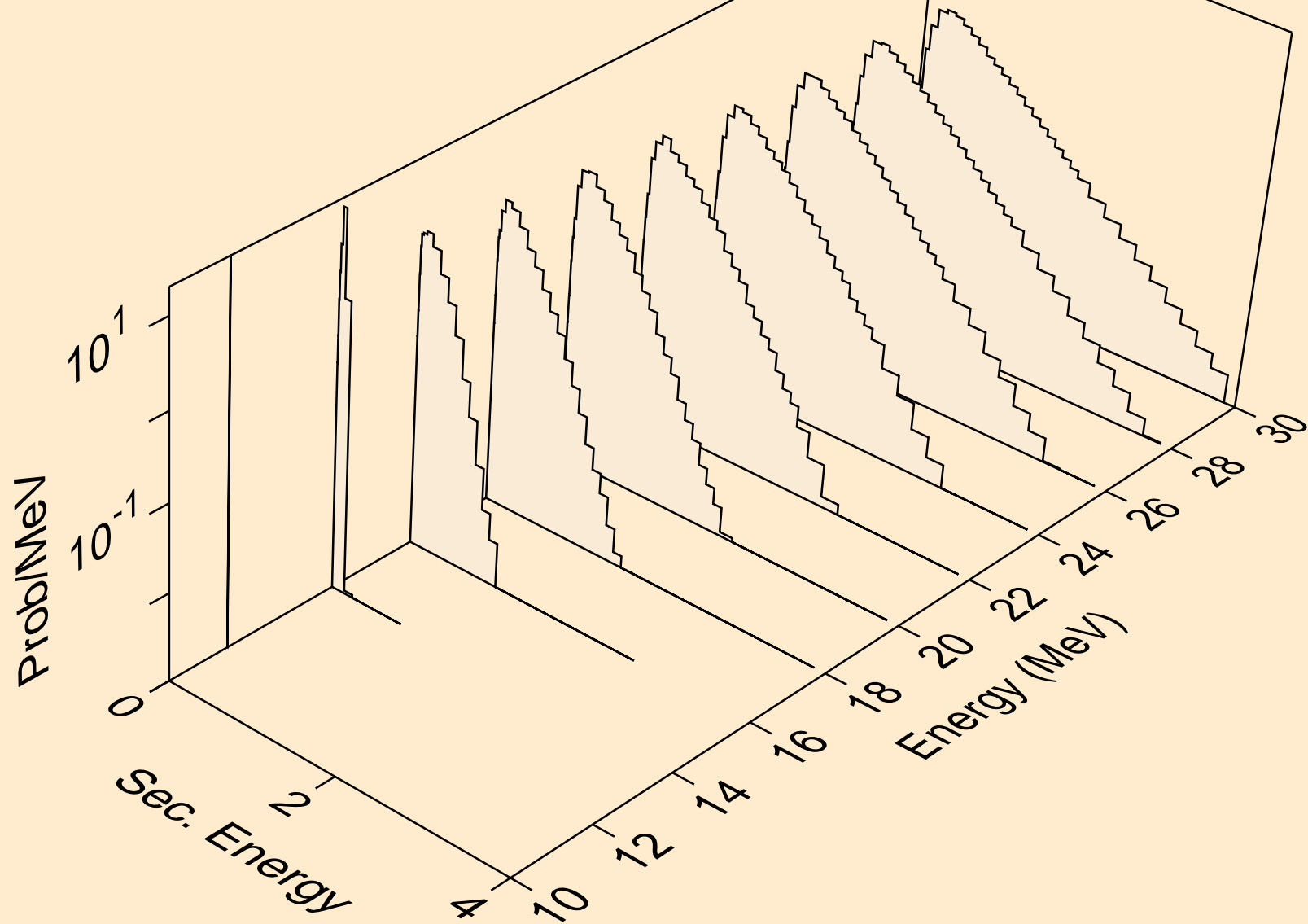

LU166 DEUTERON ACER TENDL-2021 LIBRARY; T=0.K  
neutrons from (d,n\*)he3

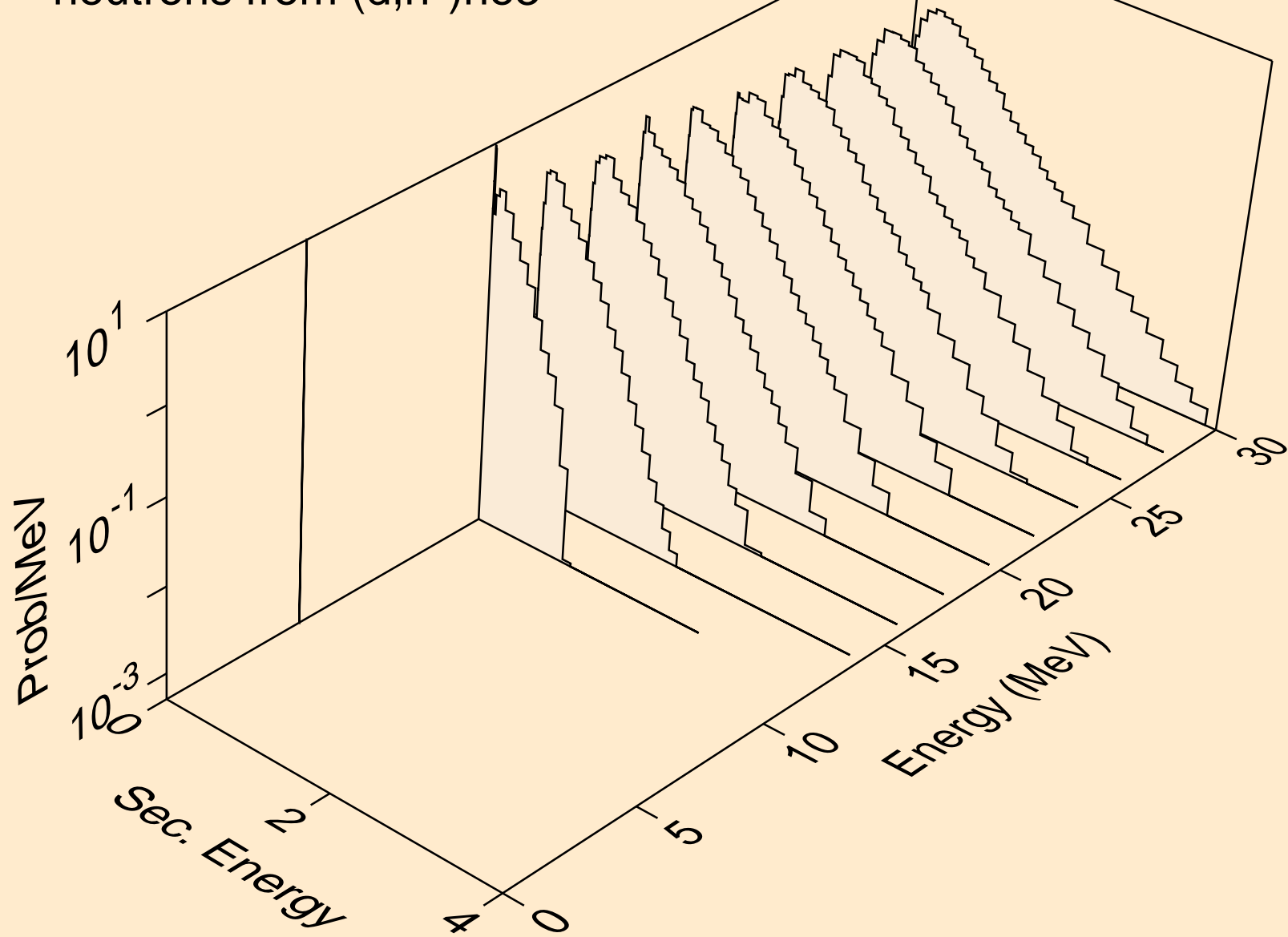

LU166 DEUTERON ACER TENDL-2021 LIBRARY; T=0.K  
neutrons from (d,4n)

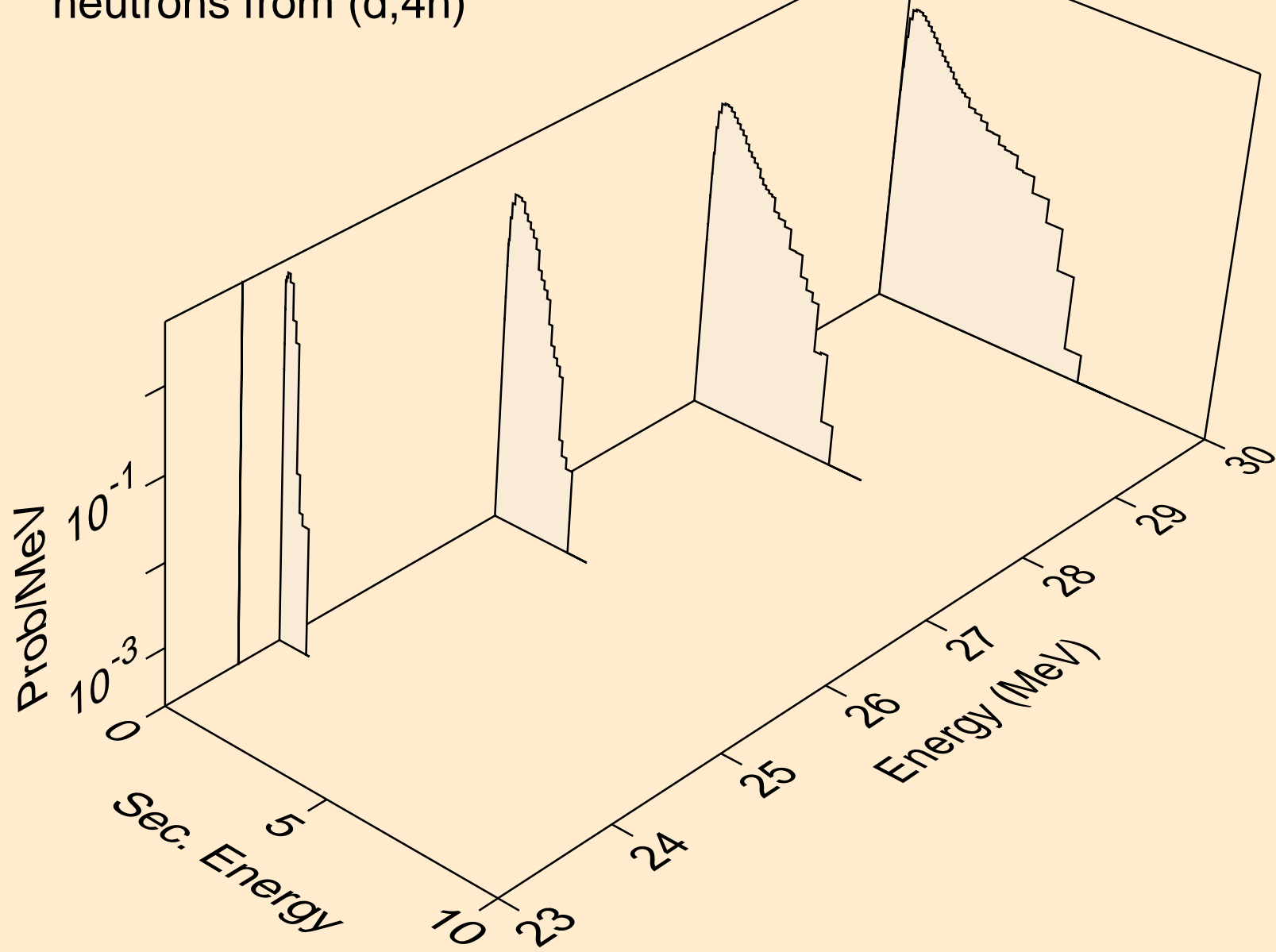



LU166 DEUTERON ACER TENDL-2021 LIBRARY; T=0.K  
neutrons from (d,2np)

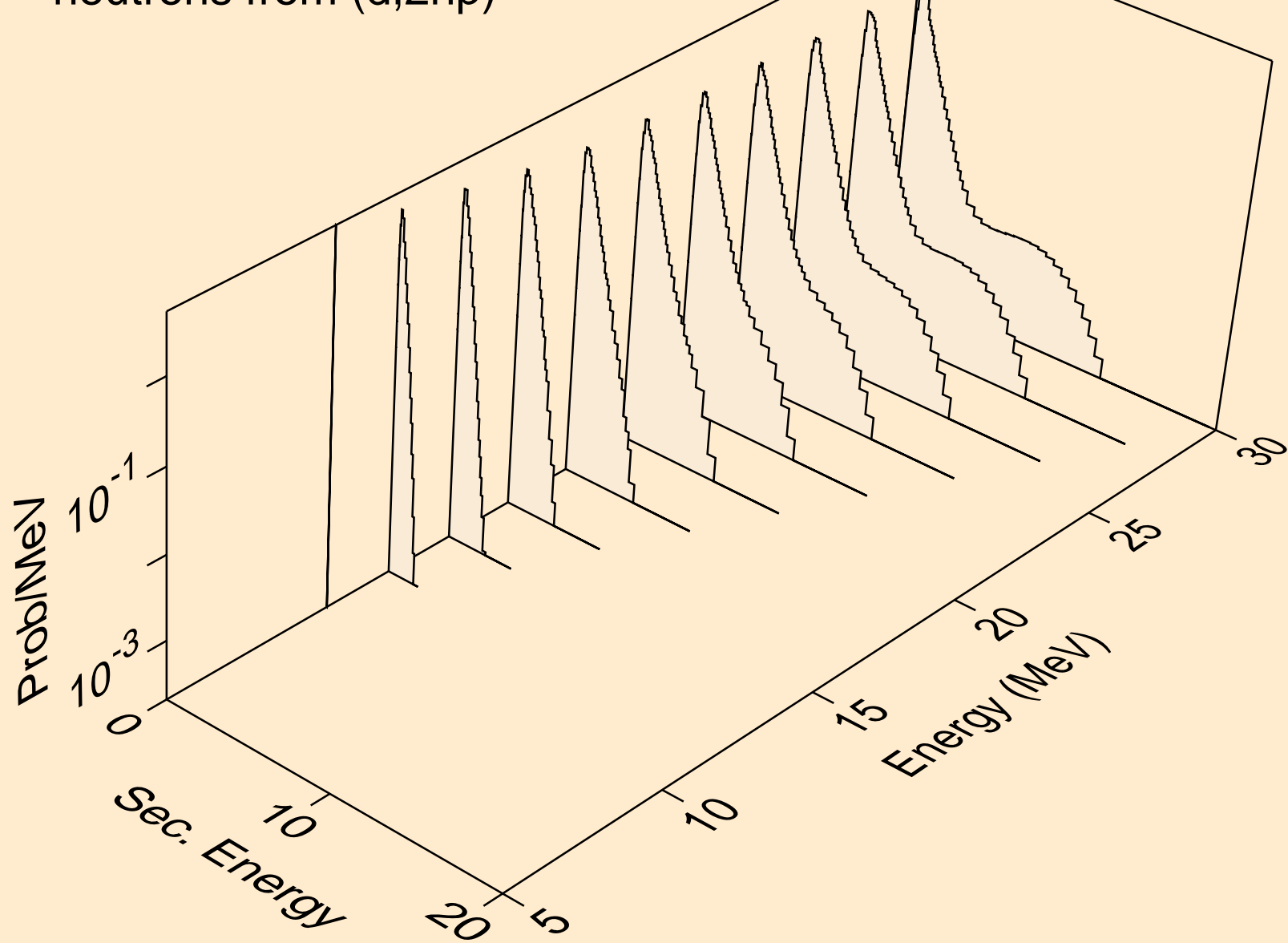

LU166 DEUTERON ACER TENDL-2021 LIBRARY; T=0.K  
neutrons from (d,3np)

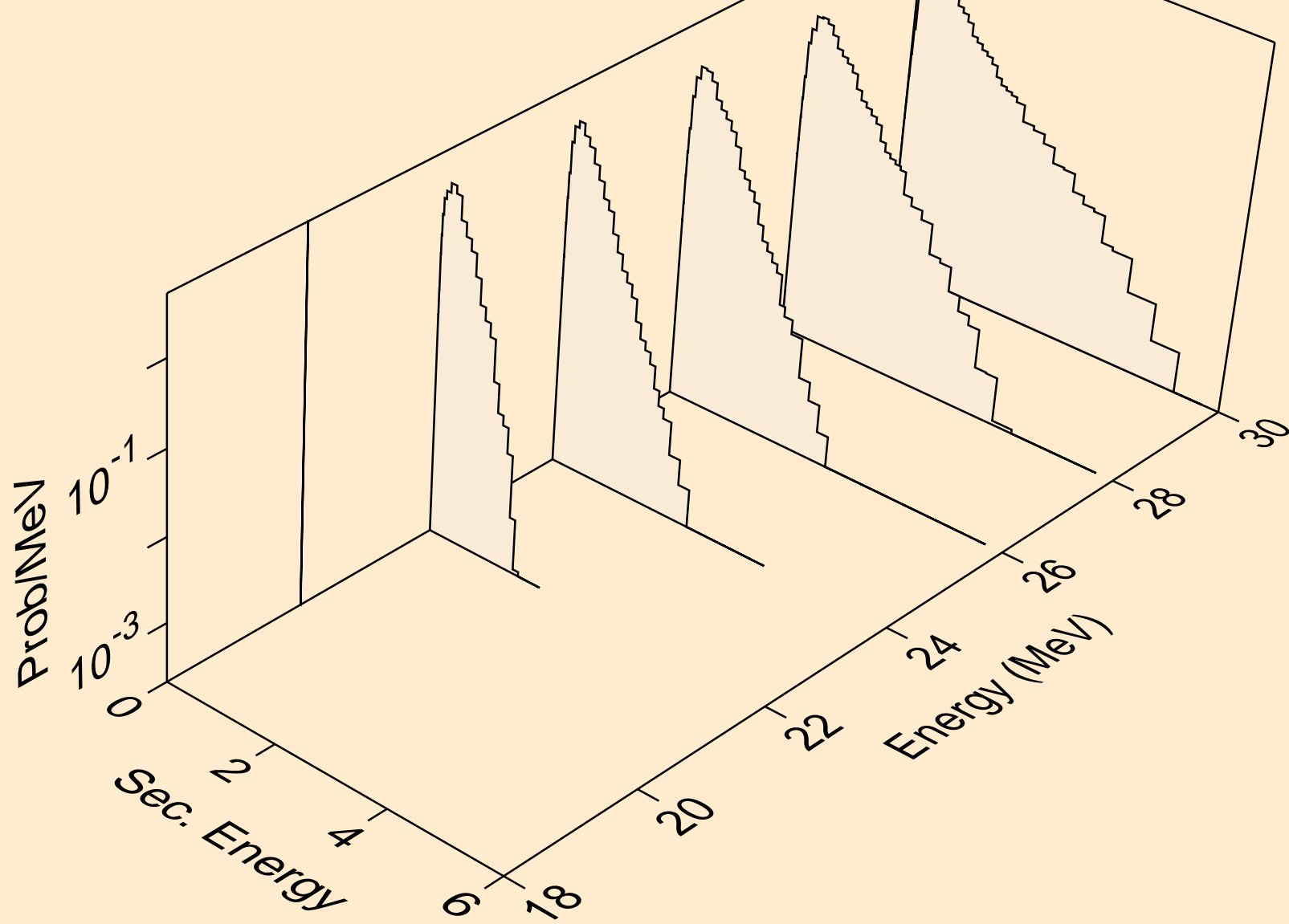

LU166 DEUTERON ACER TENDL-2021 LIBRARY; T=0.K  
neutrons from (d,2np)

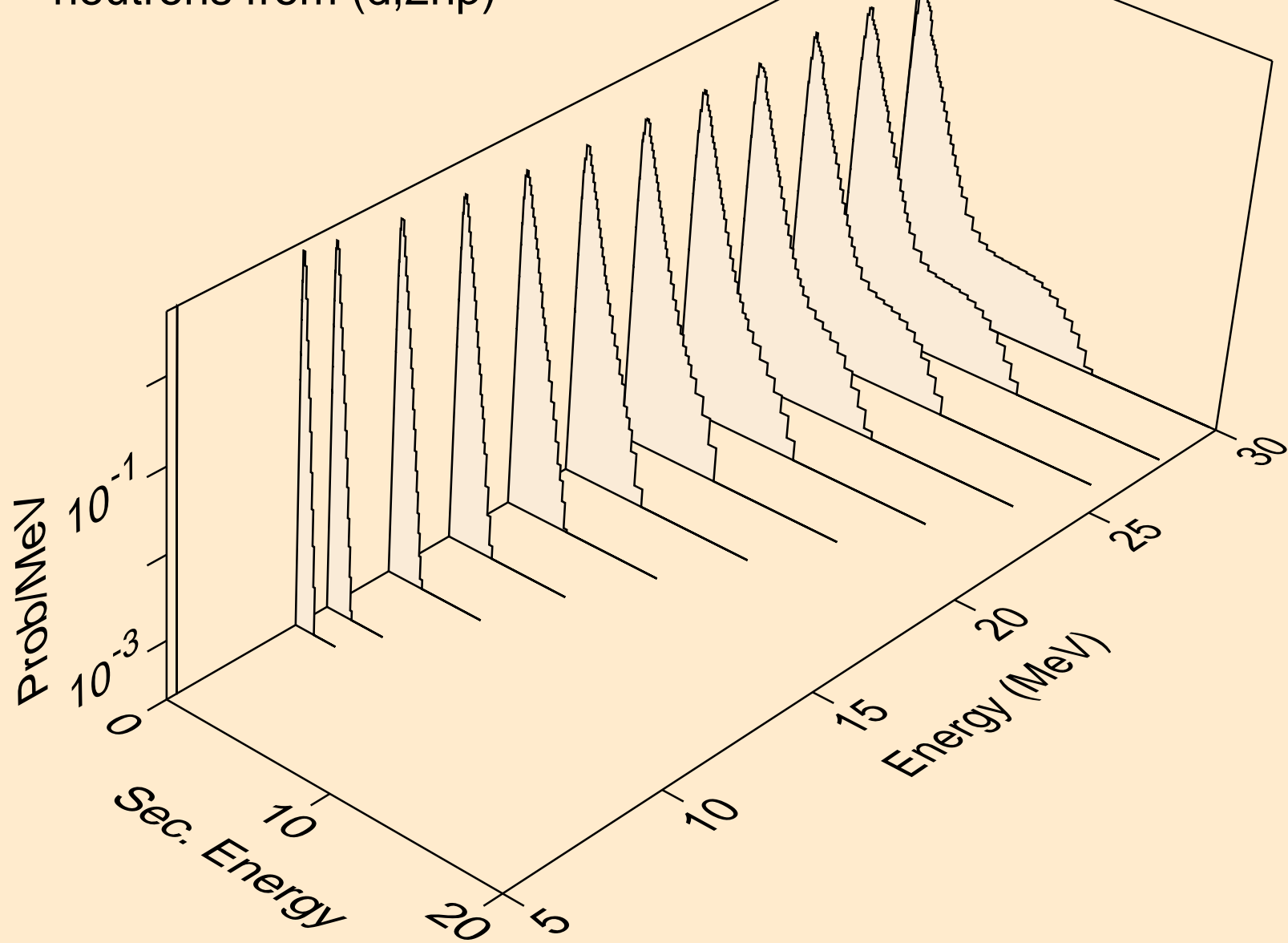

LU166 DEUTERON ACER TENDL-2021 LIBRARY; T=0.K  
neutrons from (d,npa)

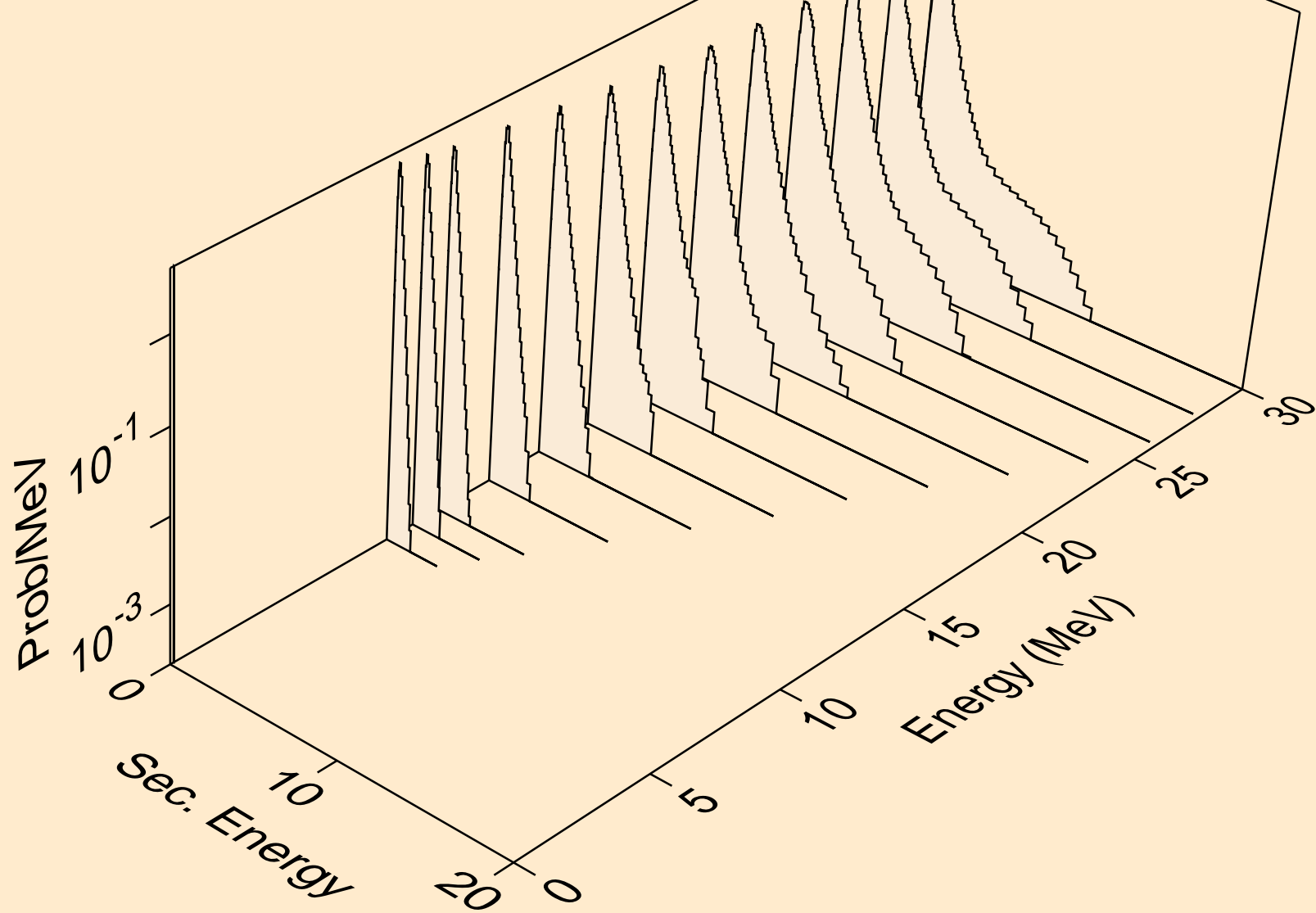

LU166 DEUTERON ACER TENDL-2021 LIBRARY; T=0.K  
protons from (d,x)

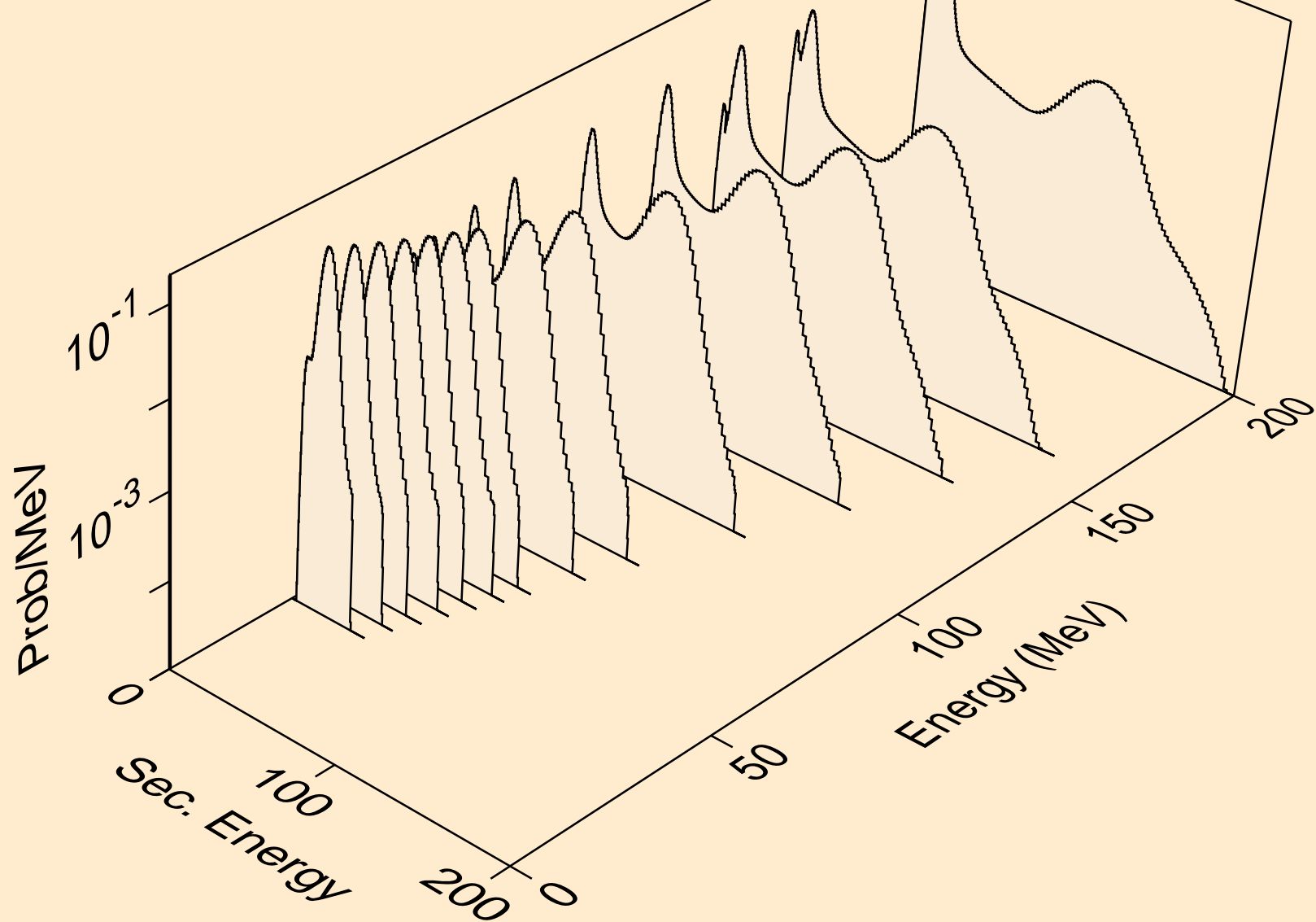

LU166 DEUTERON ACER TENDL-2021 LIBRARY; T=0.K  
protons from (d,n\*)p

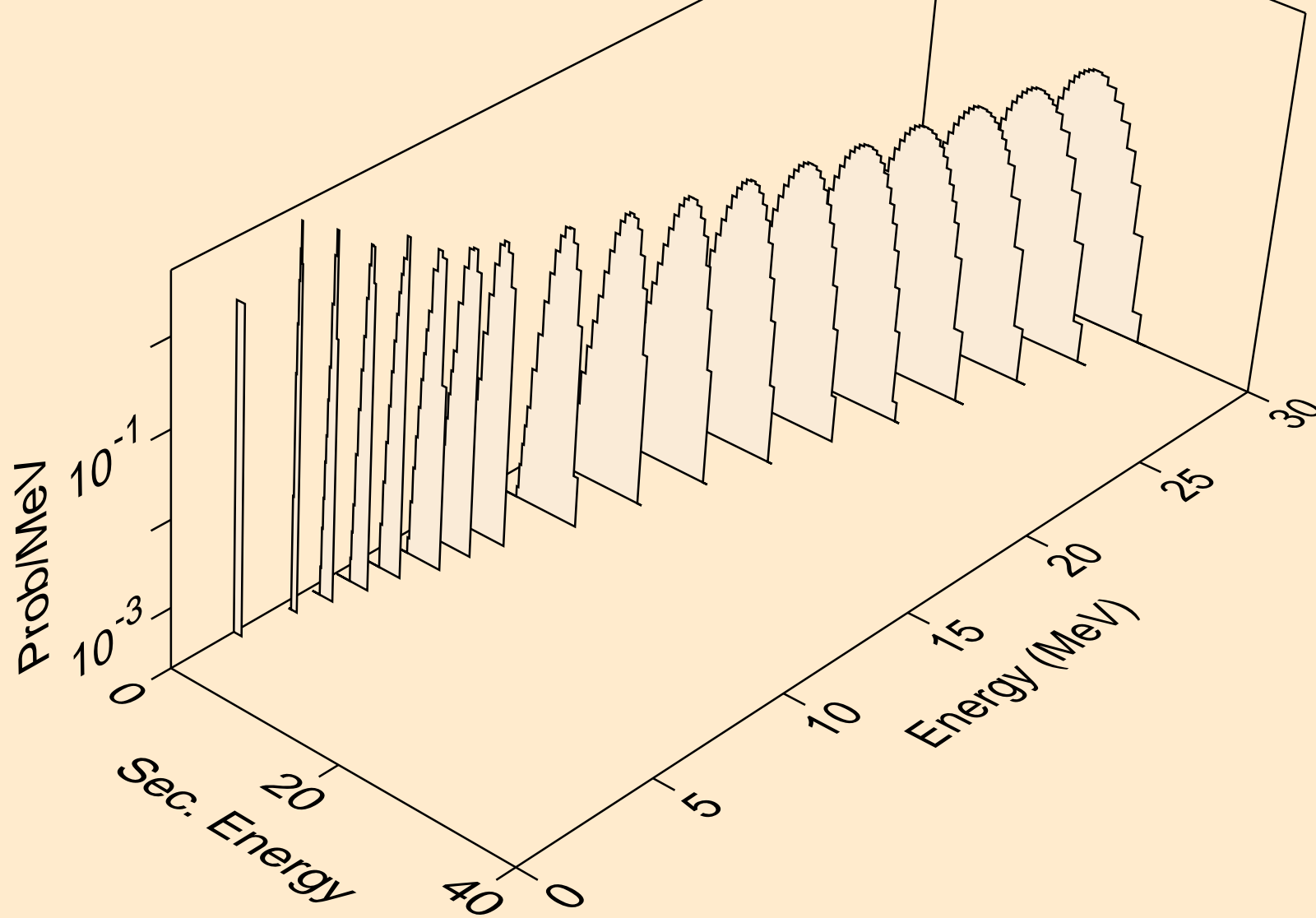

LU166 DEUTERON ACER TENDL-2021 LIBRARY; T=0.K  
protons from (d,2np)

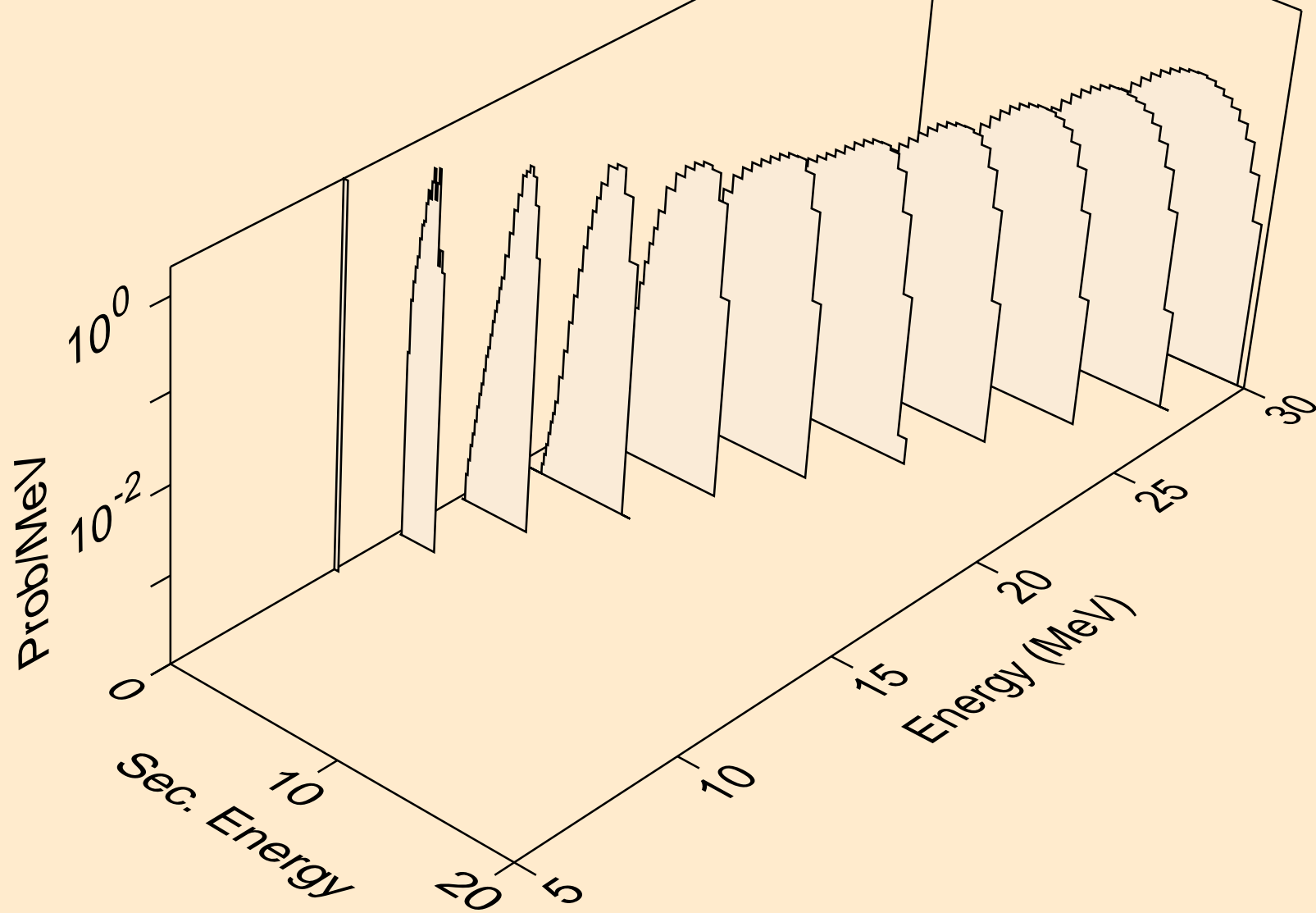

LU166 DEUTERON ACER TENDL-2021 LIBRARY; T=0.K  
protons from (d,3np)

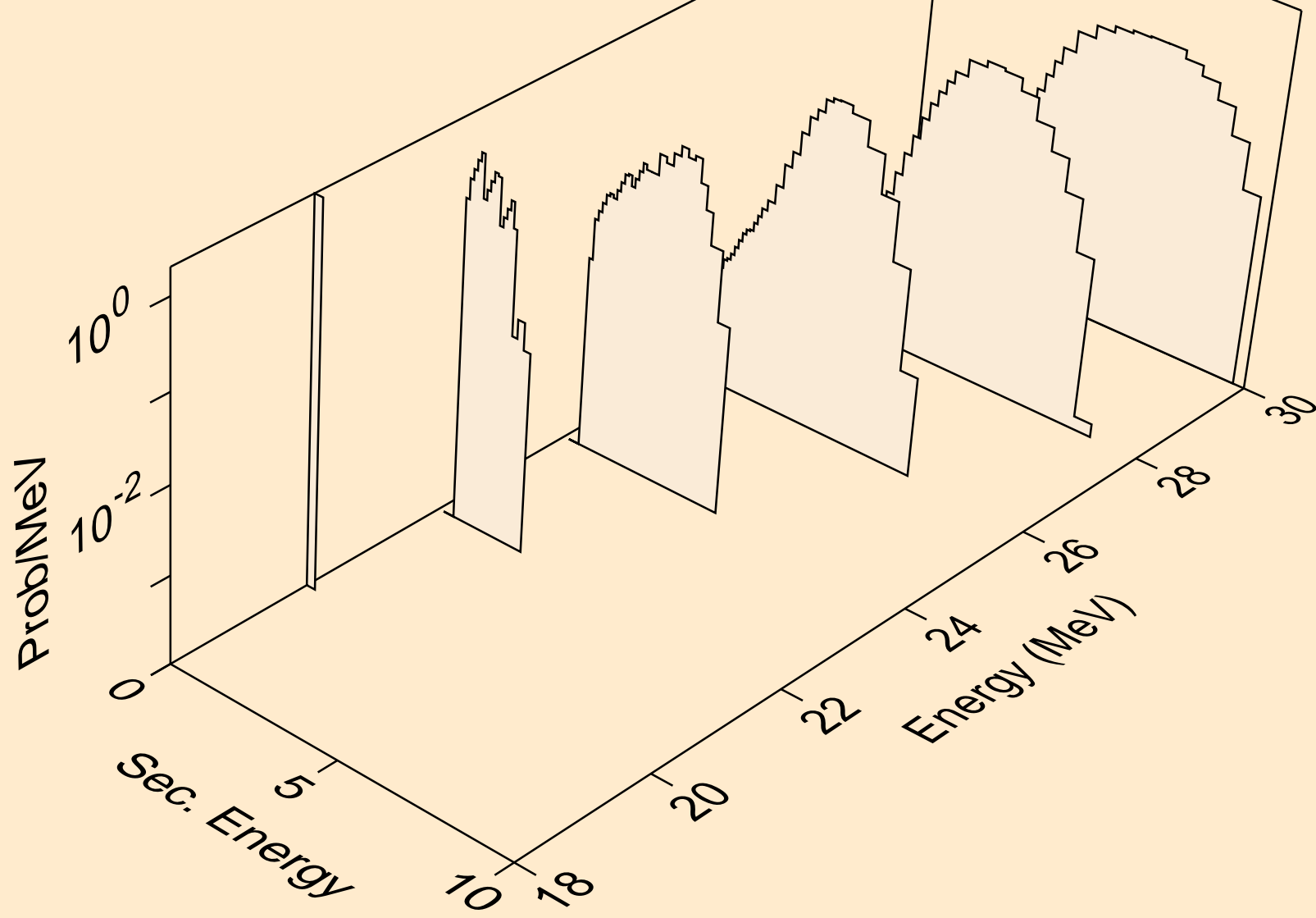



LU166 DEUTERON ACER TENDL-2021 LIBRARY; T=0.K  
protons from (d,2np)

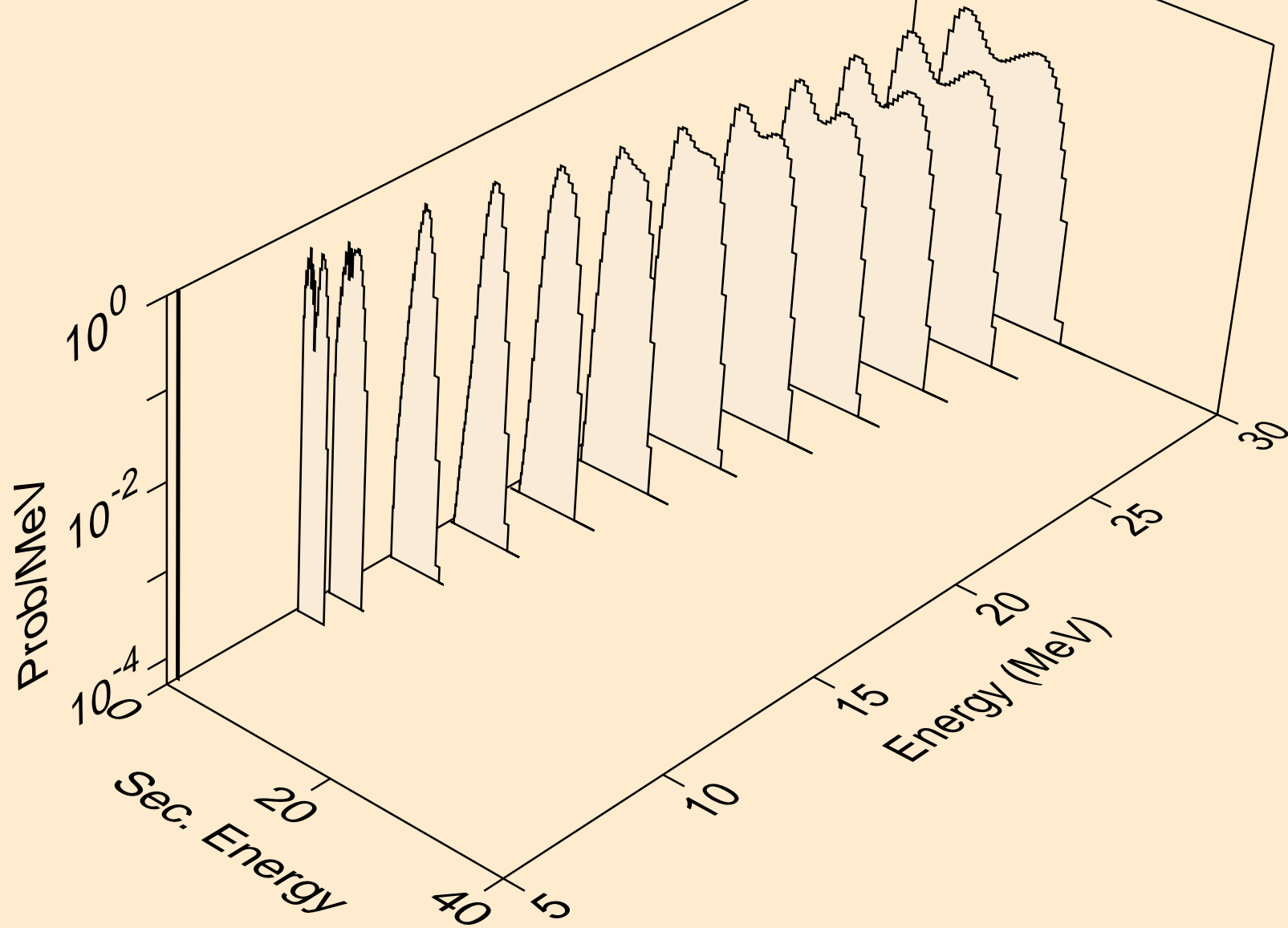

LU166 DEUTERON ACER TENDL-2021 LIBRARY; T=0.K  
protons from (d,npa)

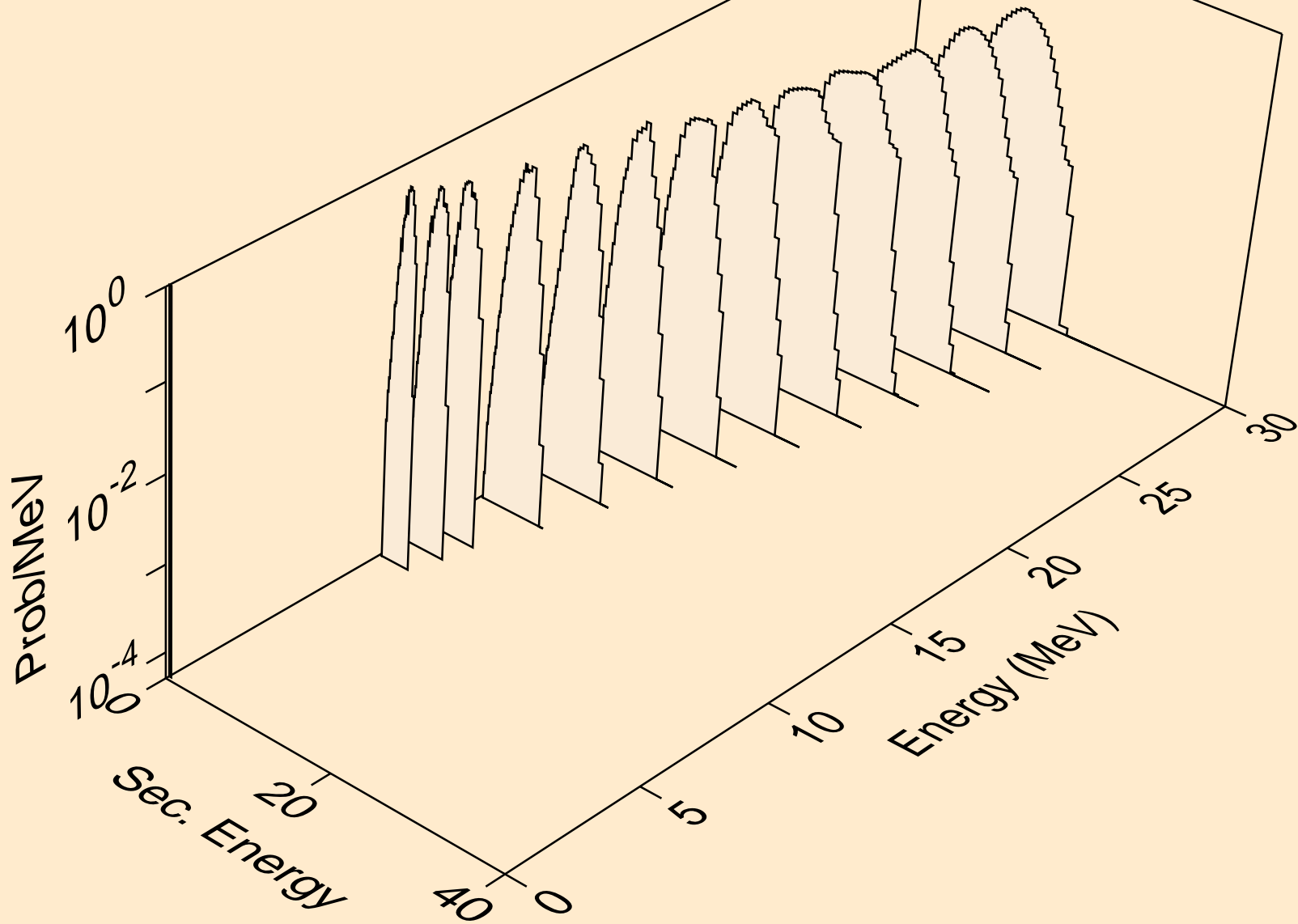

LU166 DEUTERON ACER TENDL-2021 LIBRARY; T=0.K  
protons from (d,p)

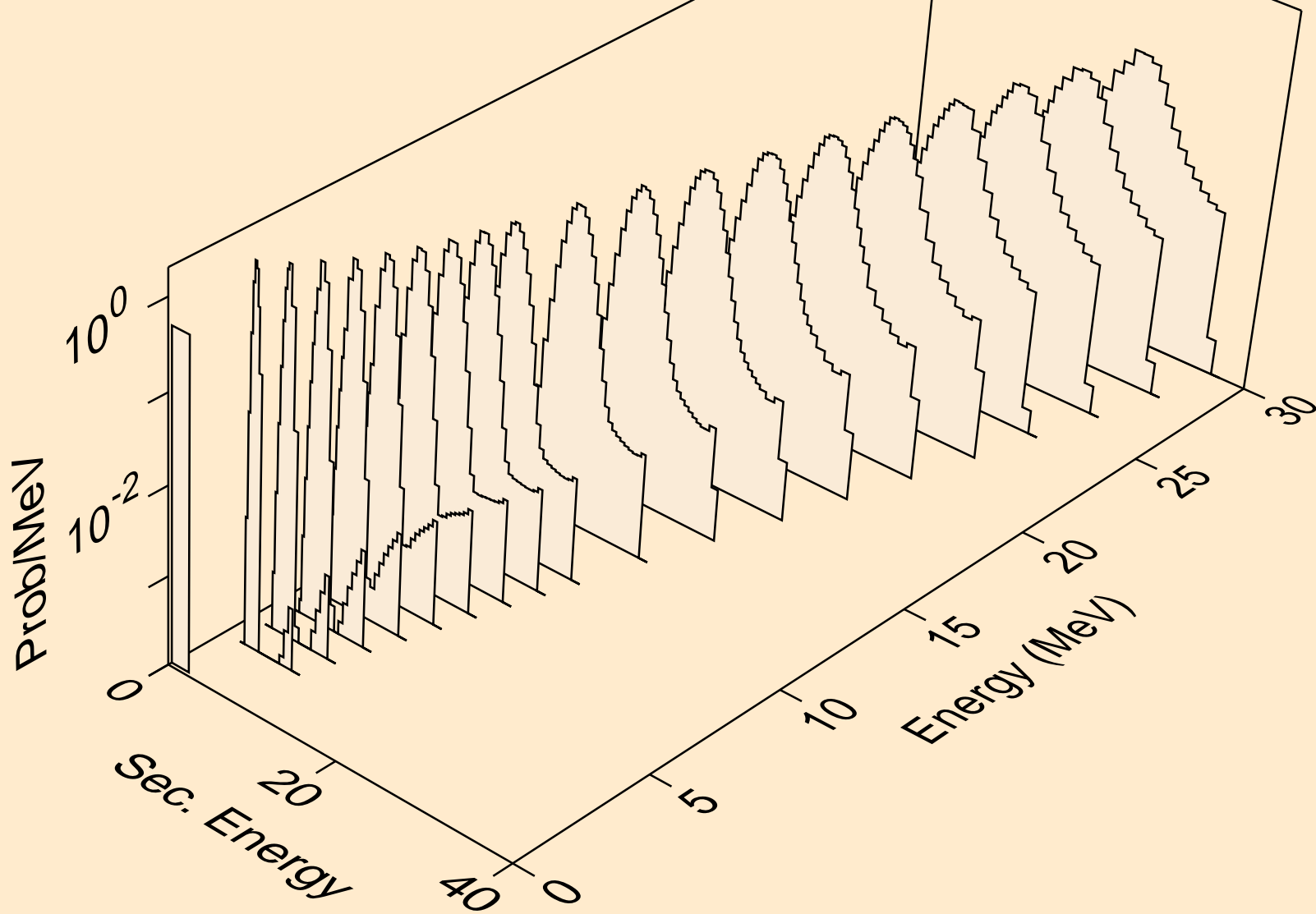

LU166 DEUTERON ACER TENDL-2021 LIBRARY; T=0.K  
protons from (d,2p)

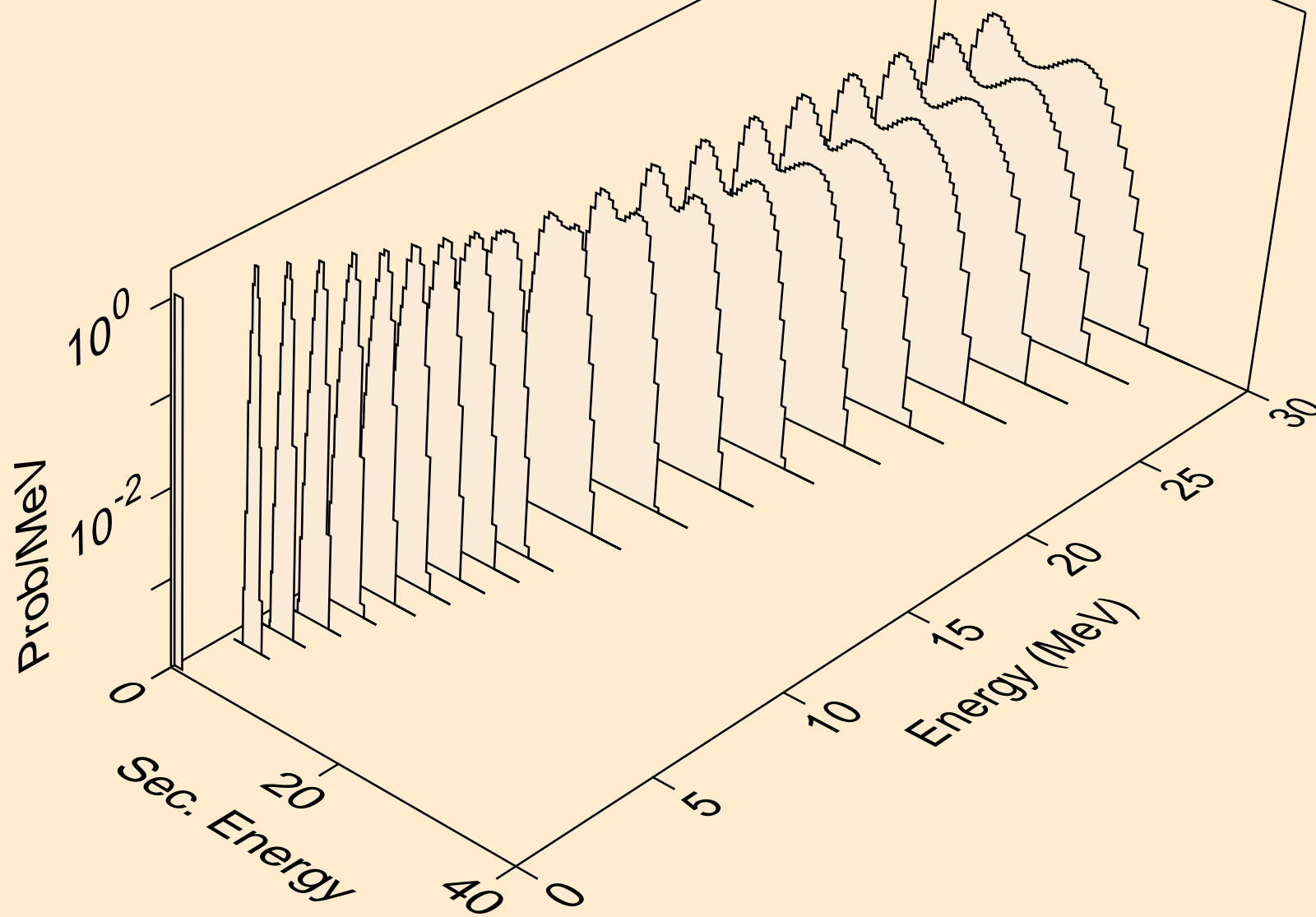

LU166 DEUTERON ACER TENDL-2021 LIBRARY; T=0.K  
protons from (d,pa)

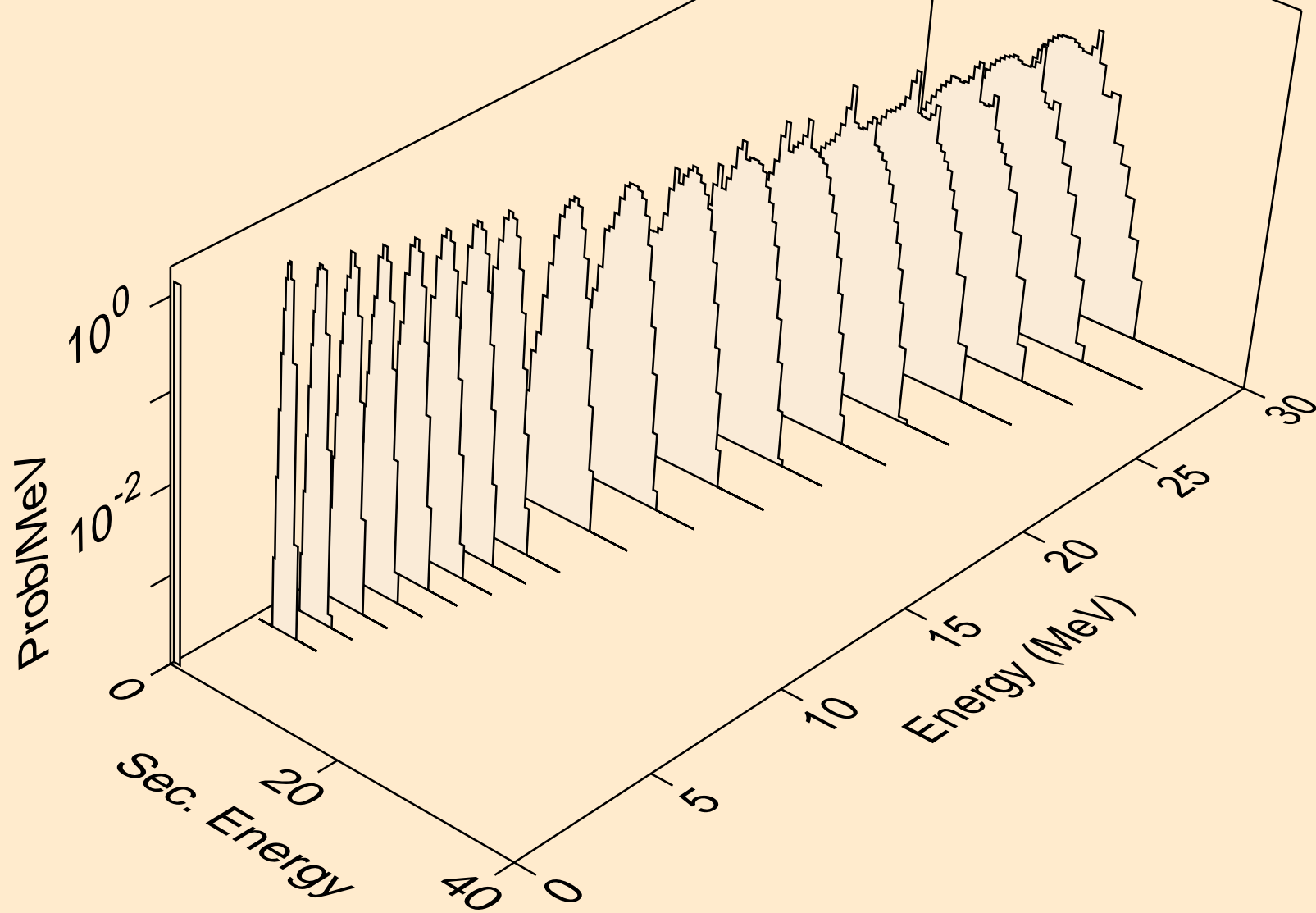

LU166 DEUTERON ACER TENDL-2021 LIBRARY; T=0.K  
protons from (d,pd)

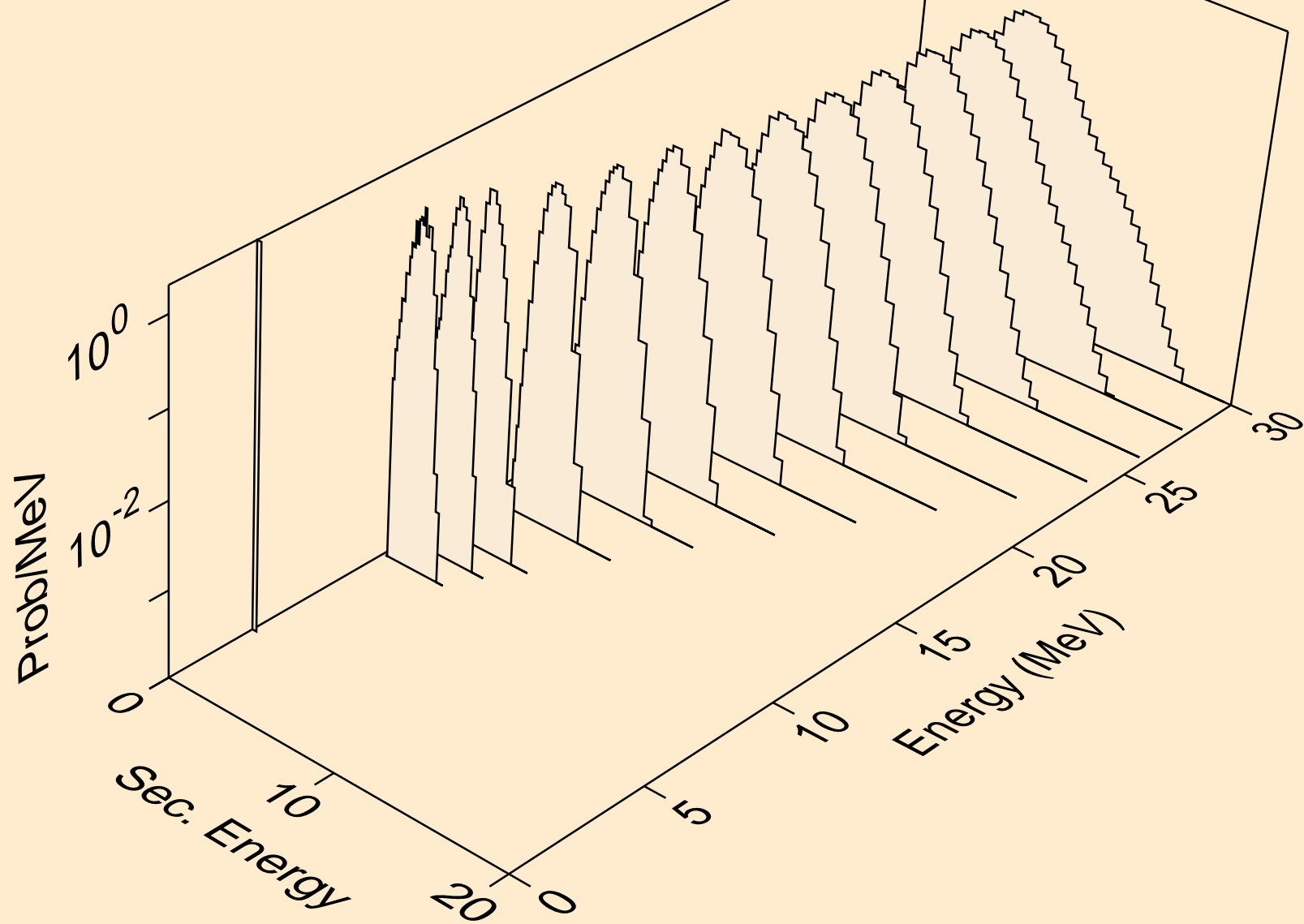

LU166 DEUTERON ACER TENDL-2021 LIBRARY; T=0.K  
protons from (d,pt)

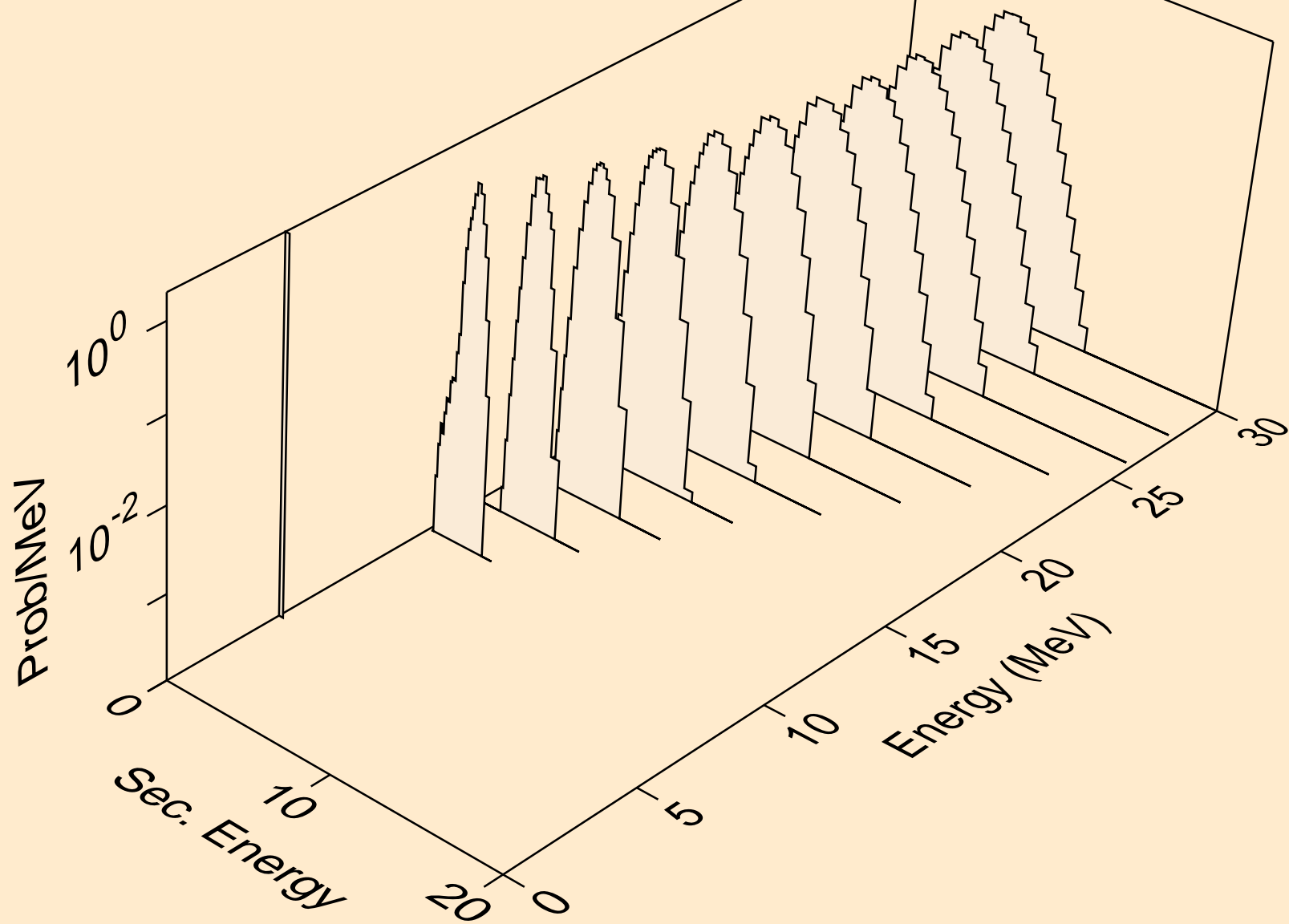

LU166 DEUTERON ACER TENDL-2021 LIBRARY; T=0.K  
tritons from (d,x)

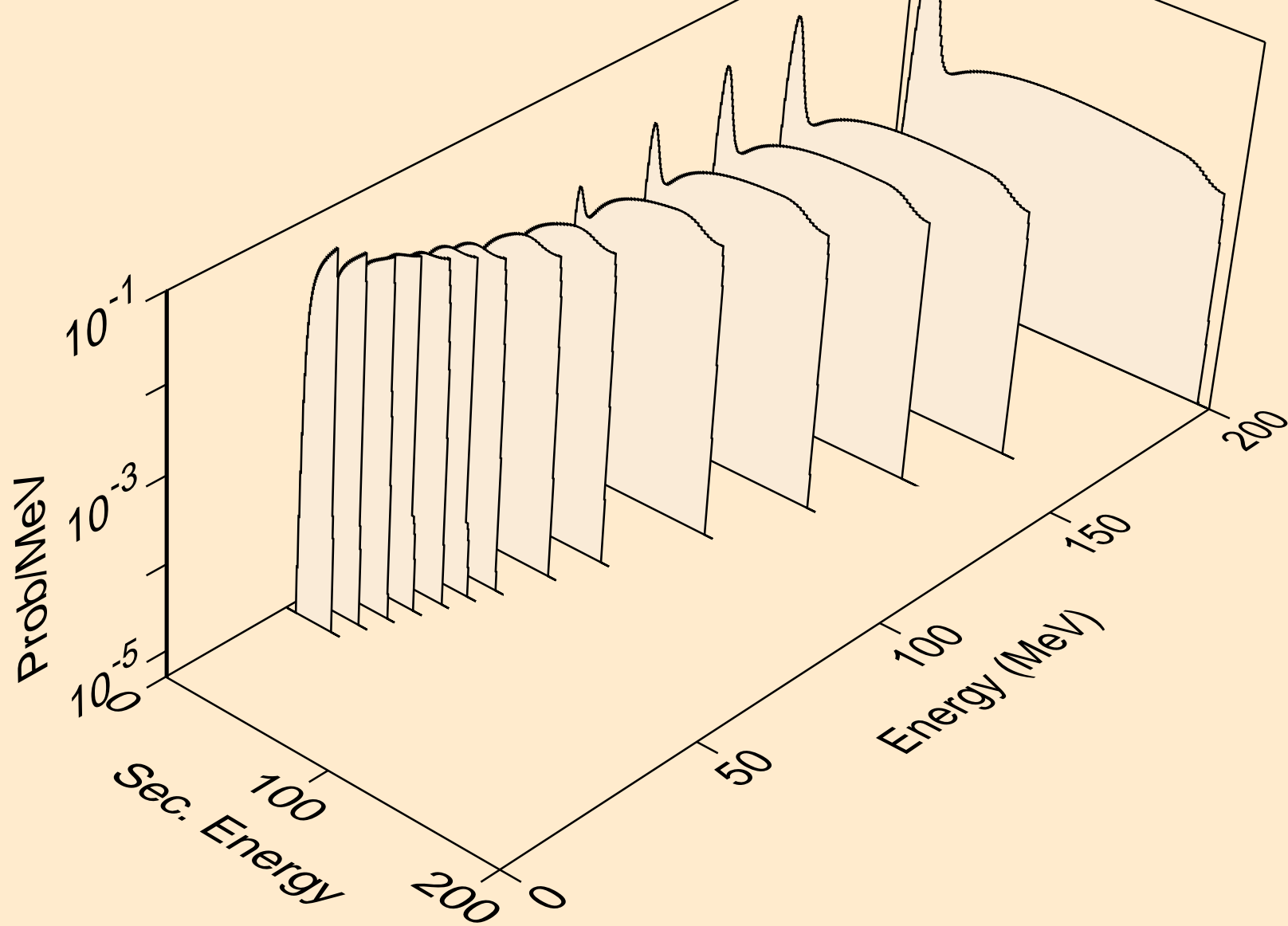



LU166 DEUTERON ACER TENDL-2021 LIBRARY; T=0.K  
tritons from (d,n\*)t

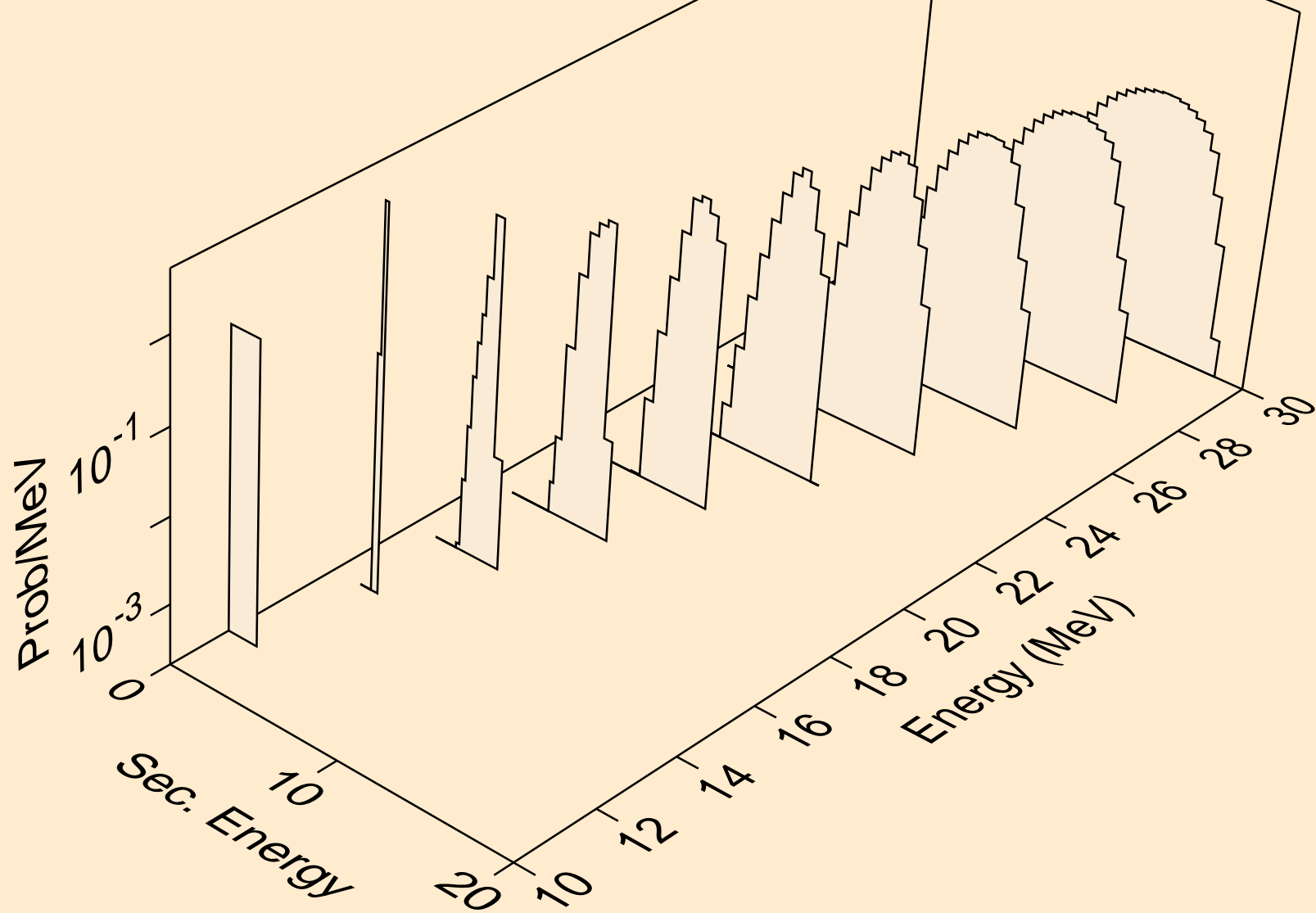

LU166 DEUTERON ACER TENDL-2021 LIBRARY; T=0.K  
tritons from (d,t)

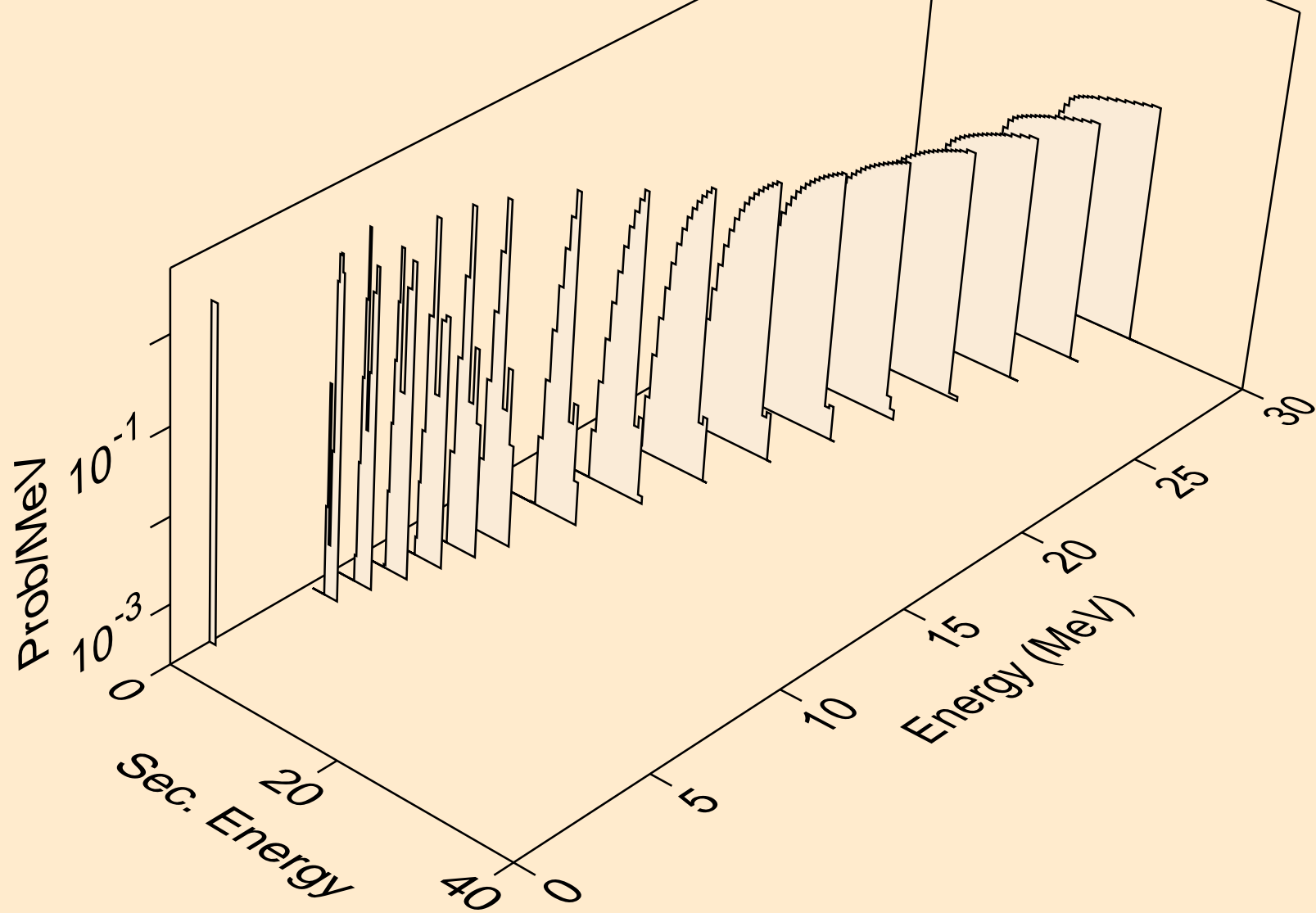

LU166 DEUTERON ACER TENDL-2021 LIBRARY; T=0.K  
tritons from (d,pt)

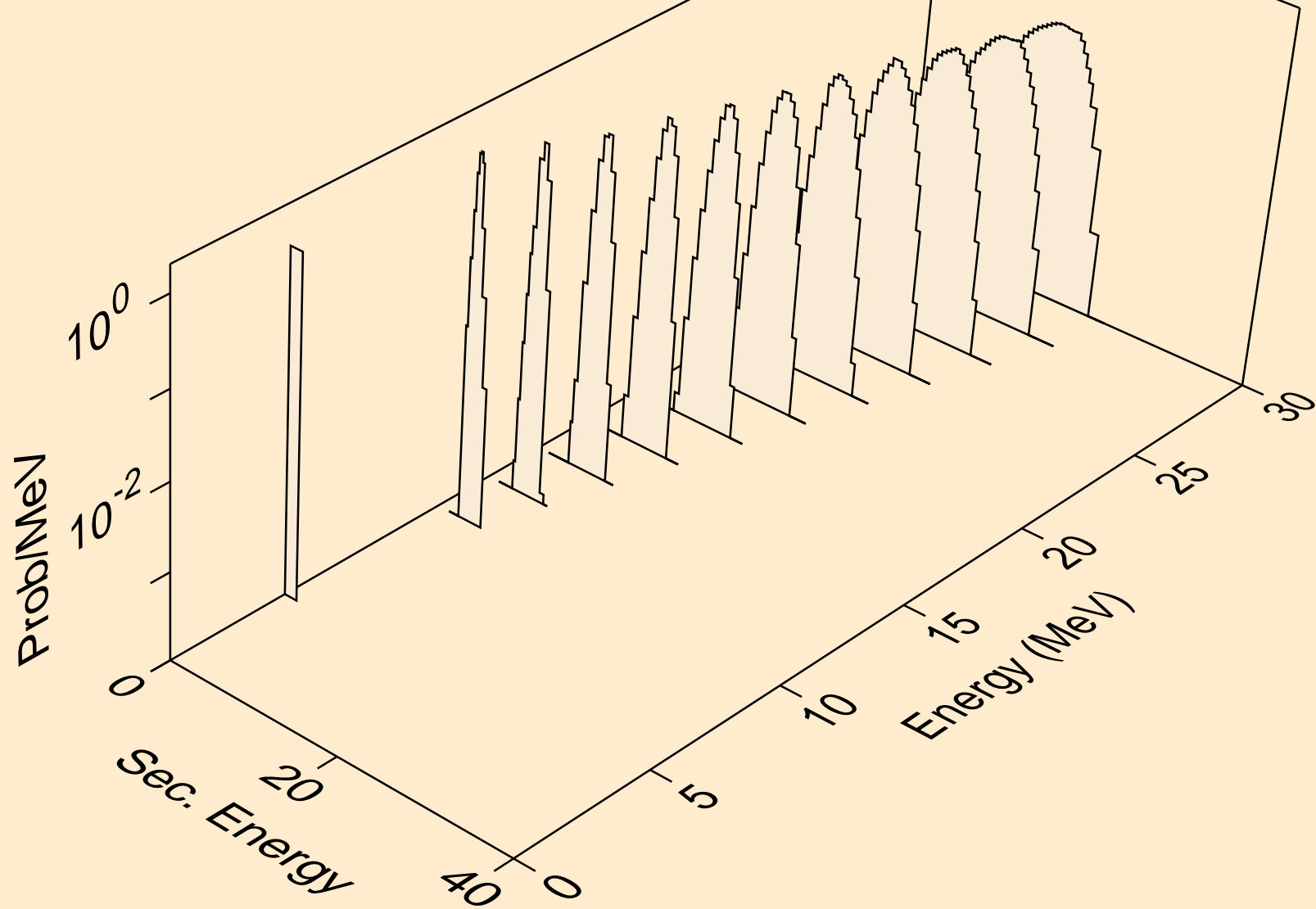

LU166 DEUTERON ACER TENDL-2021 LIBRARY; T=0.K  
he3s from (d,x)

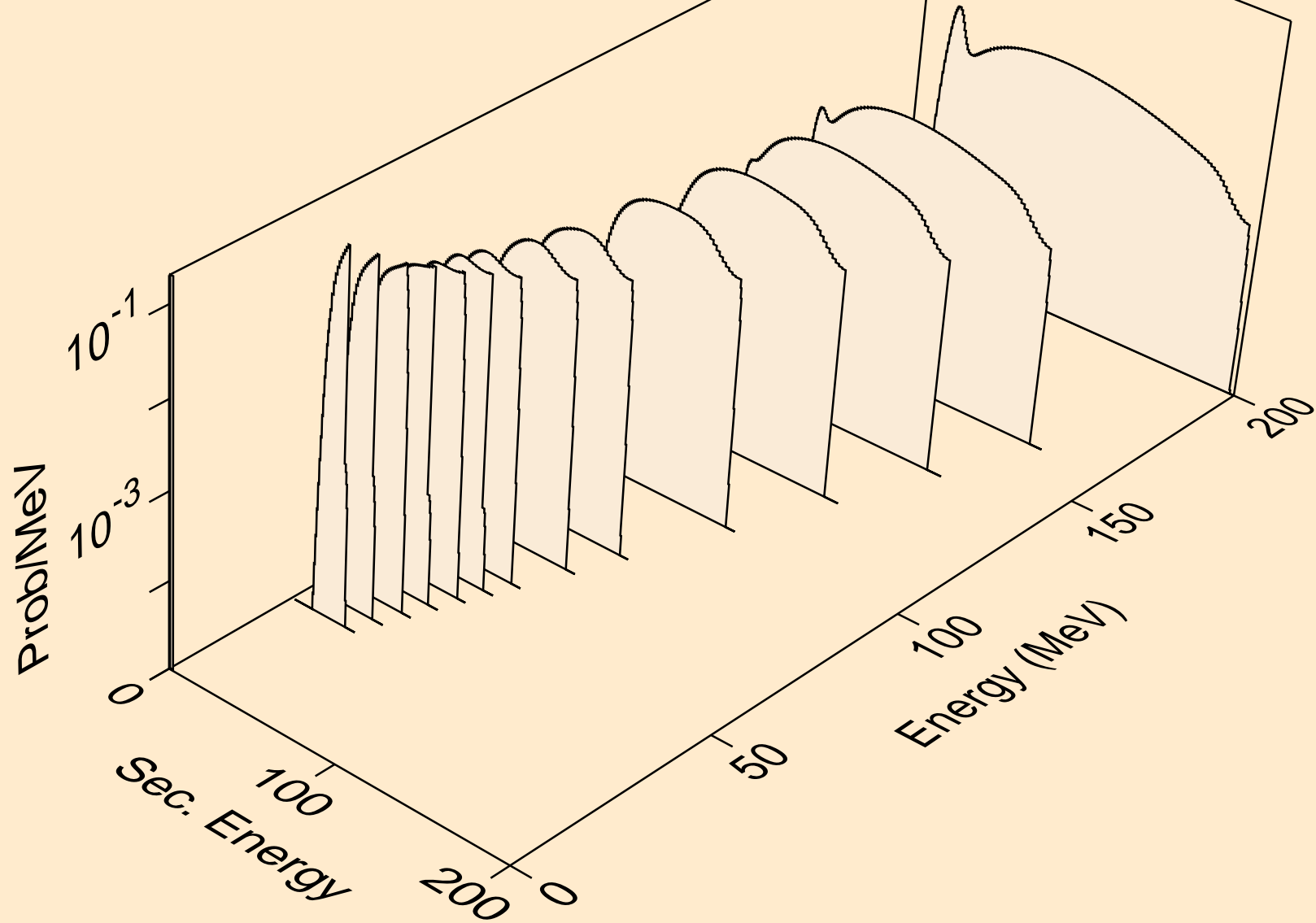

LU166 DEUTERON ACER TENDL-2021 LIBRARY; T=0.K  
he3s from (d,n\*)he3

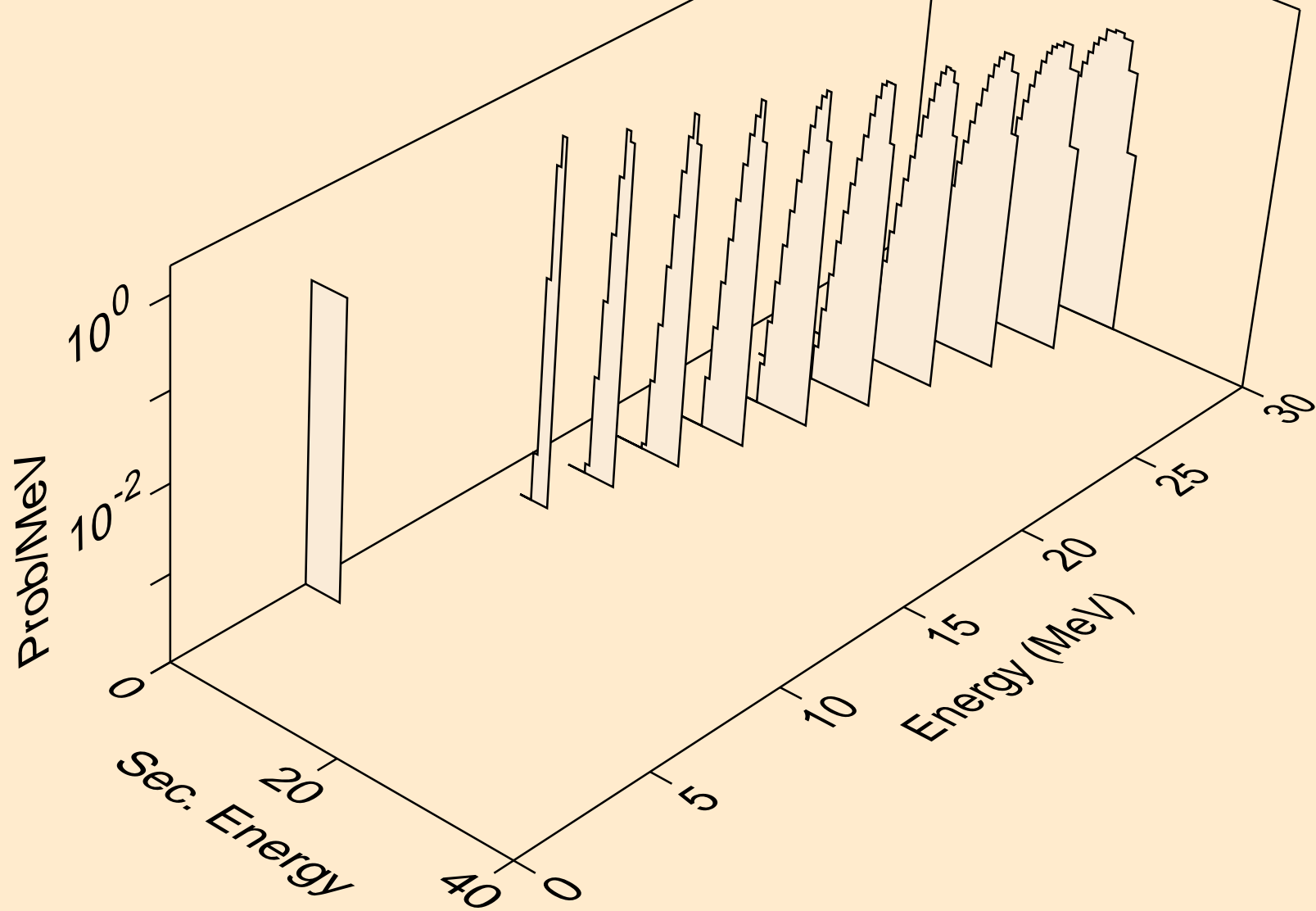

LU166 DEUTERON ACER TENDL-2021 LIBRARY; T=0.K  
he3s from (d,he3)

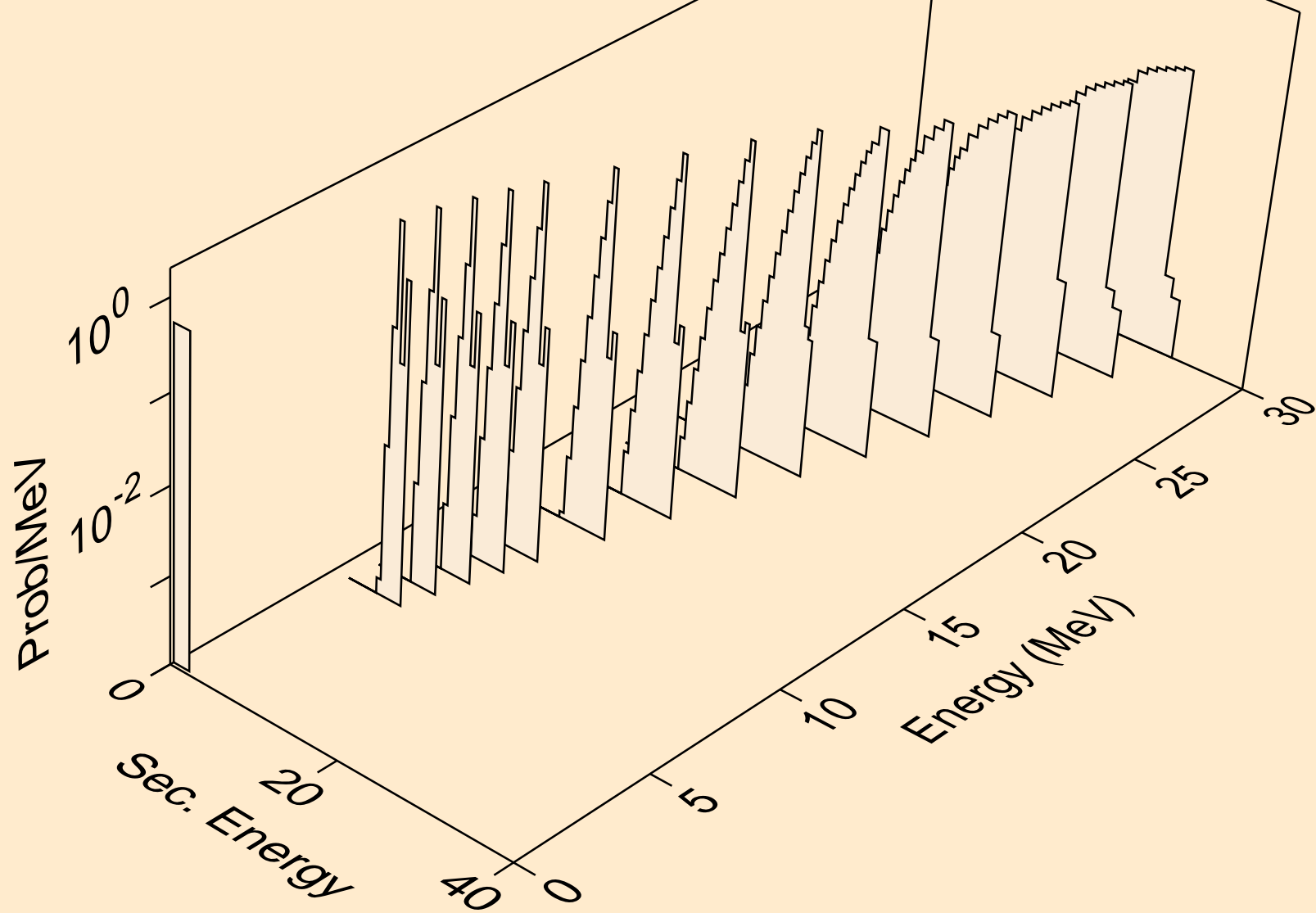

LU166 DEUTERON ACER TENDL-2021 LIBRARY; T=0.K  
alphas from (d,x)

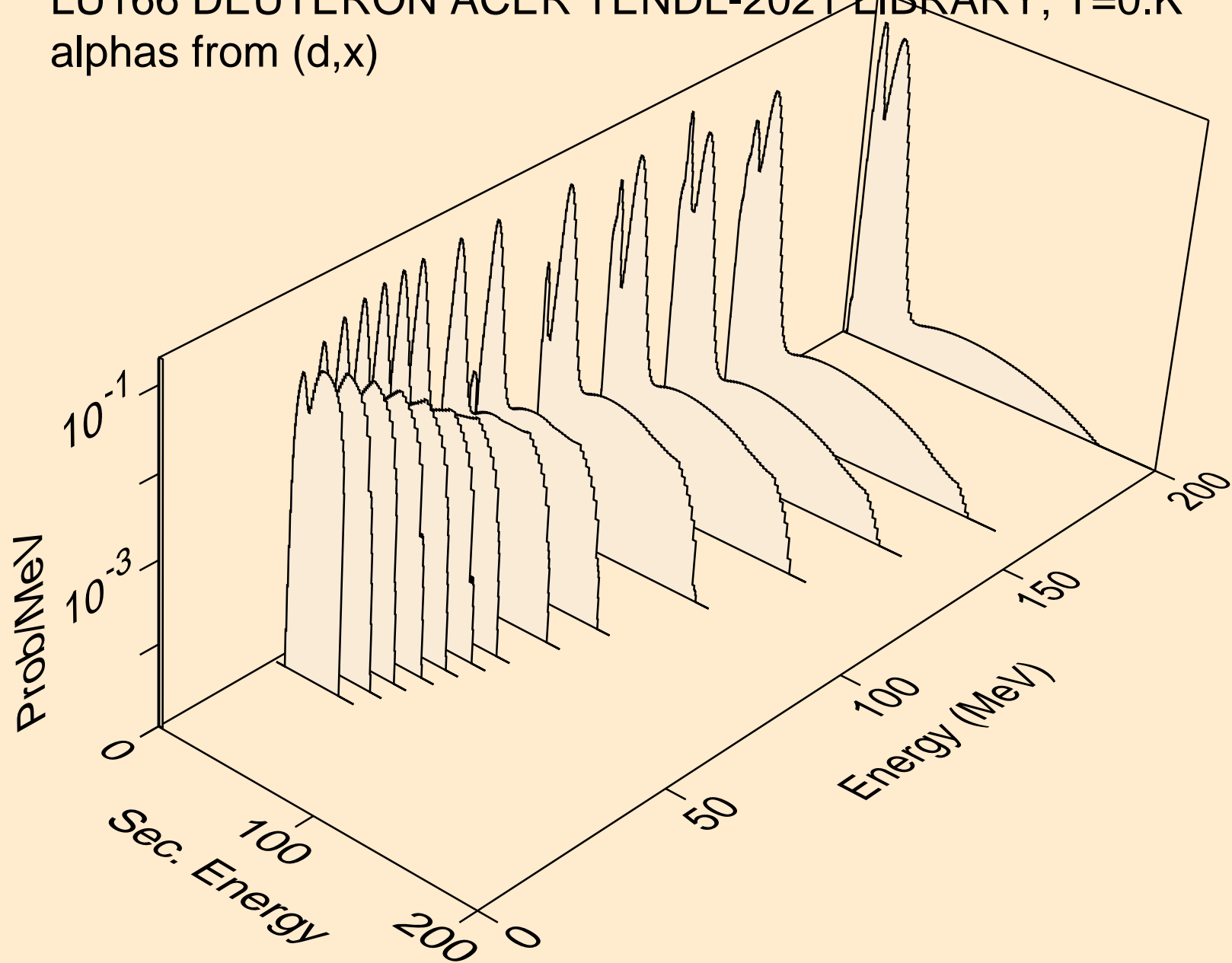

LU166 DEUTERON ACER TENDL-2021 LIBRARY; T=0.K  
alphas from (d,n\*)a

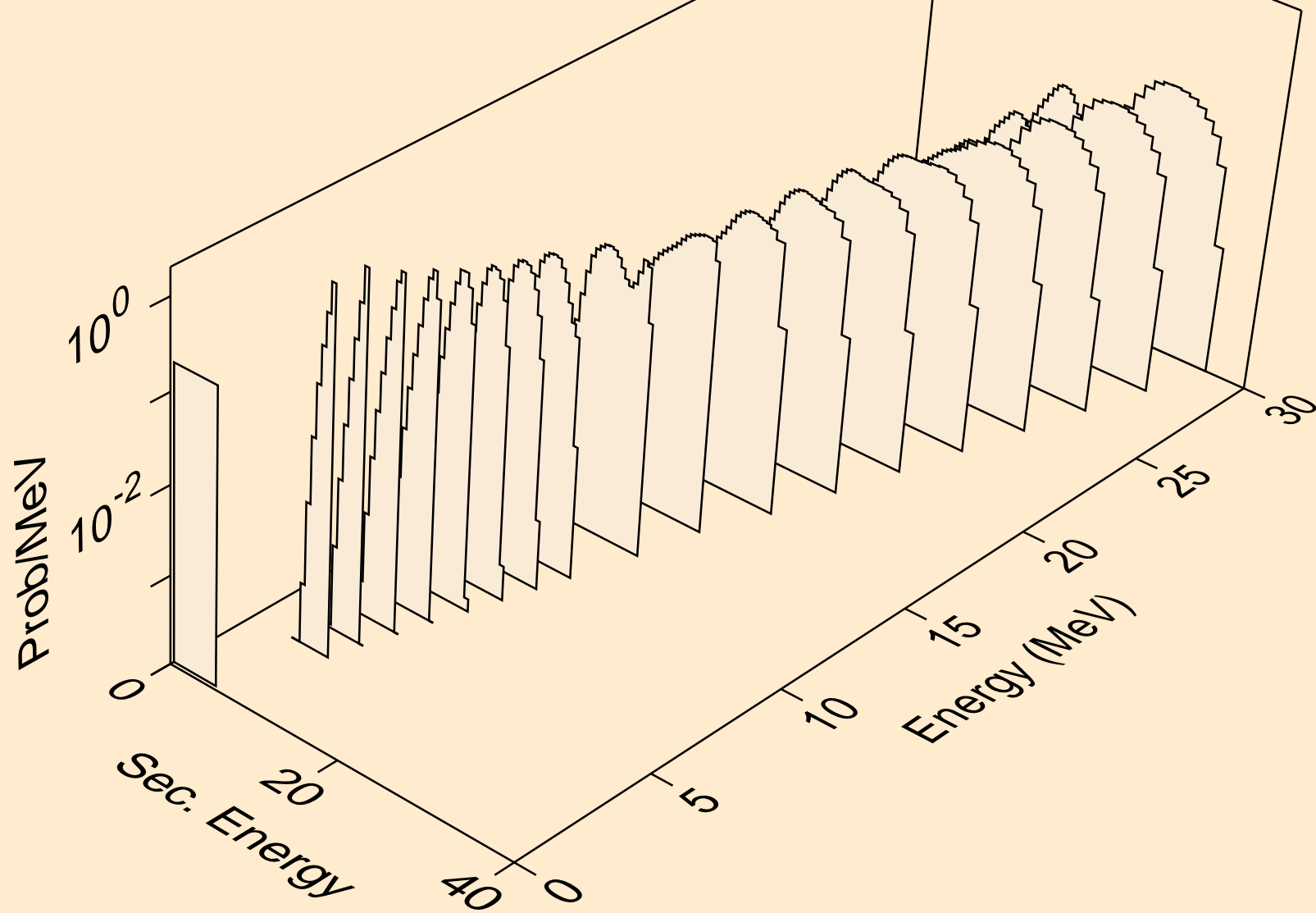



LU166 DEUTERON ACER TENDL-2021 LIBRARY; T=0.K  
alphas from (d,2n)a

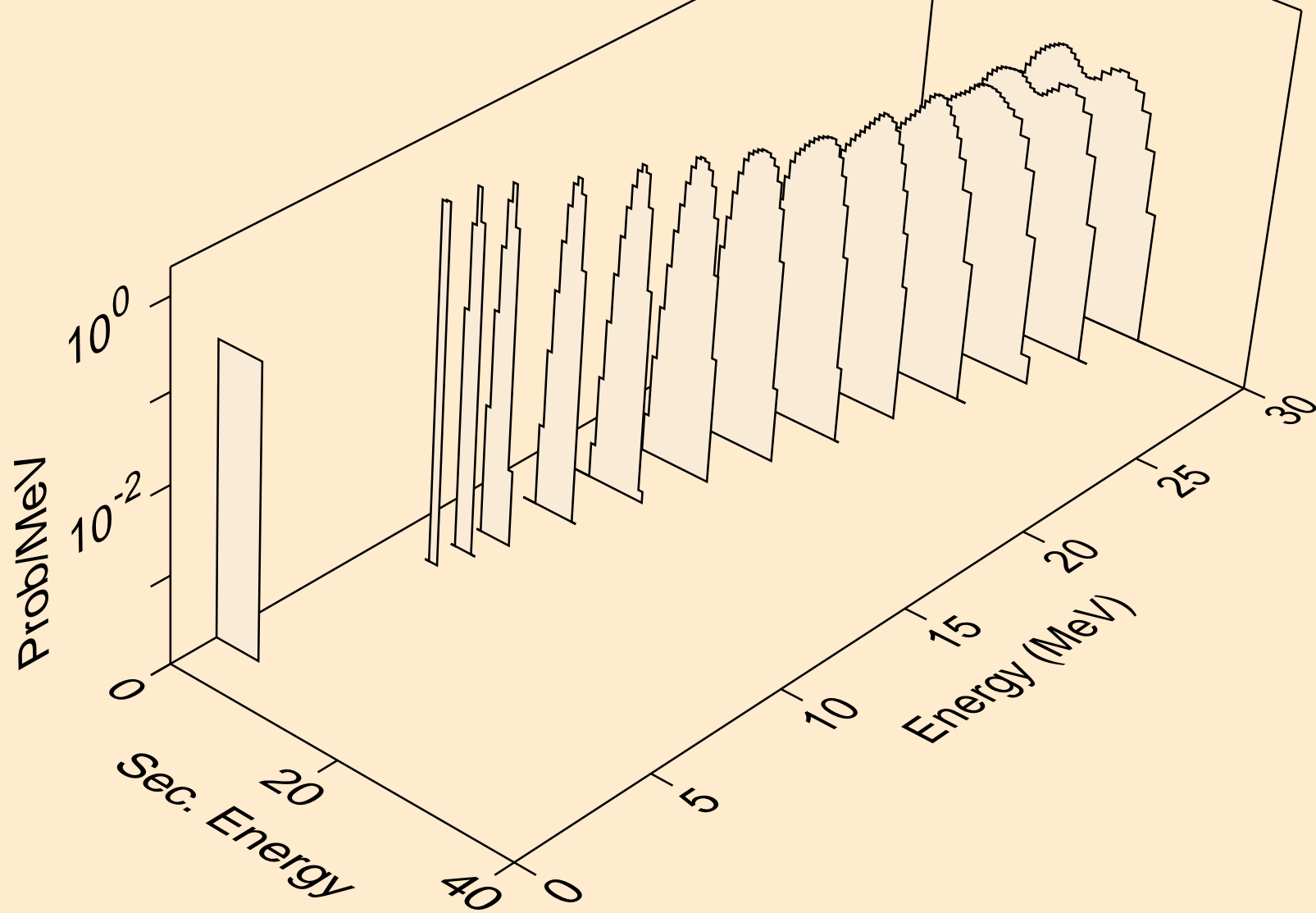

LU166 DEUTERON ACER TENDL-2021 LIBRARY; T=0.K  
alphas from (d,3n)a

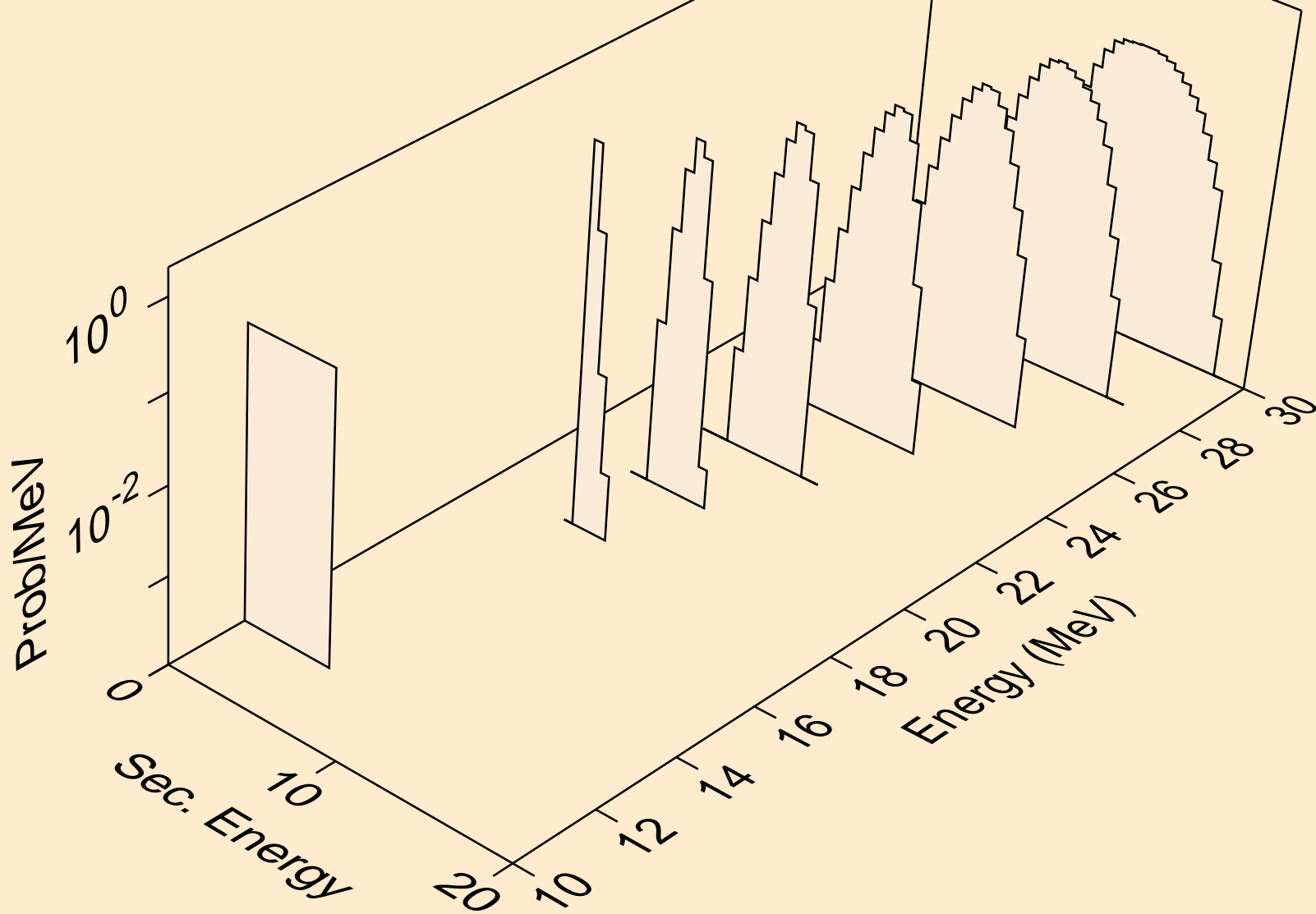

LU166 DEUTERON ACER TENDL-2021 LIBRARY; T=0.K  
alphas from (d,n\*)2a

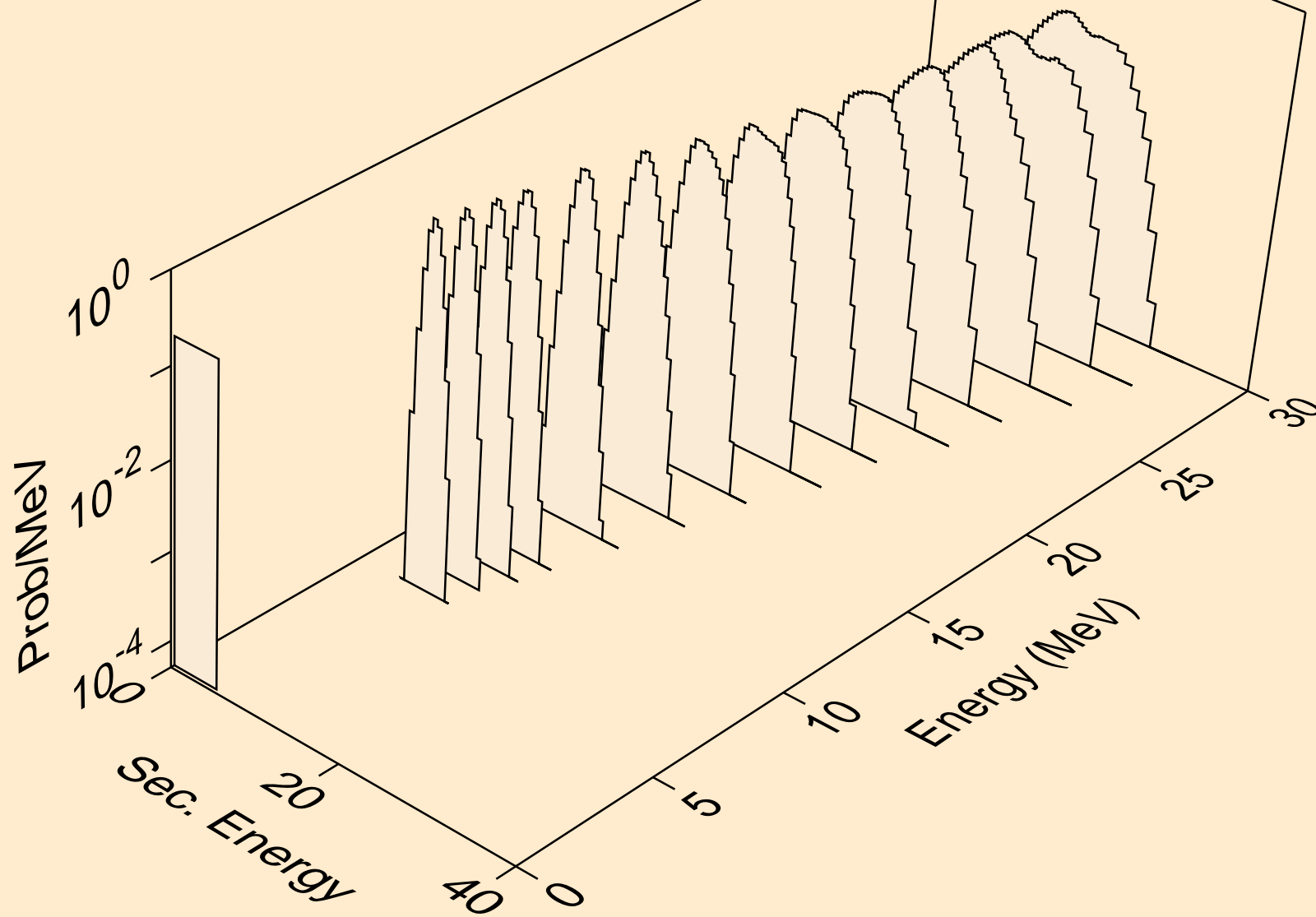

LU166 DEUTERON ACER TENDL-2021 LIBRARY; T=0.K  
alphas from (d,2n)2a

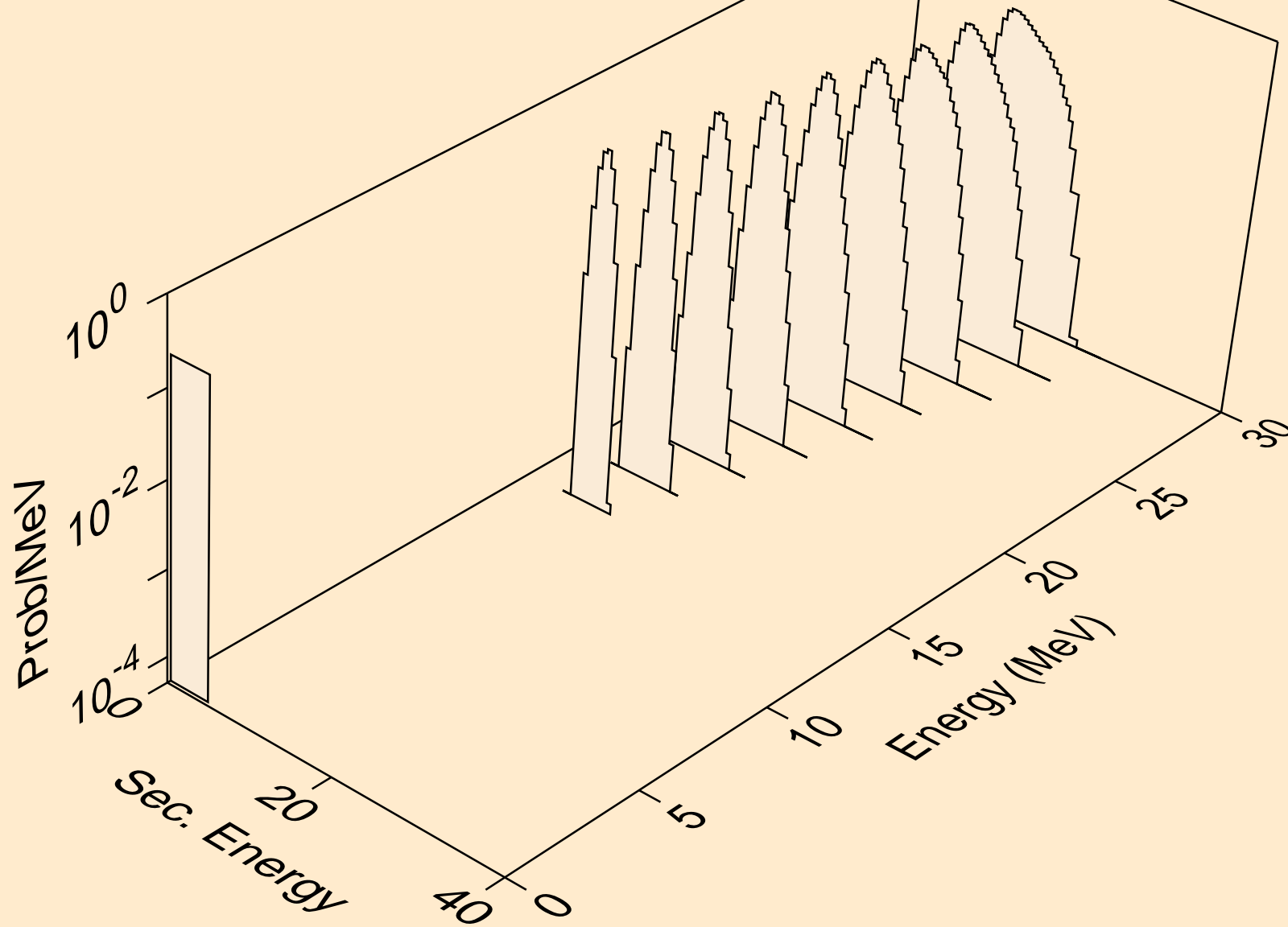

LU166 DEUTERON ACER TENDL-2021 LIBRARY; T=0.K  
alphas from (d,npa)

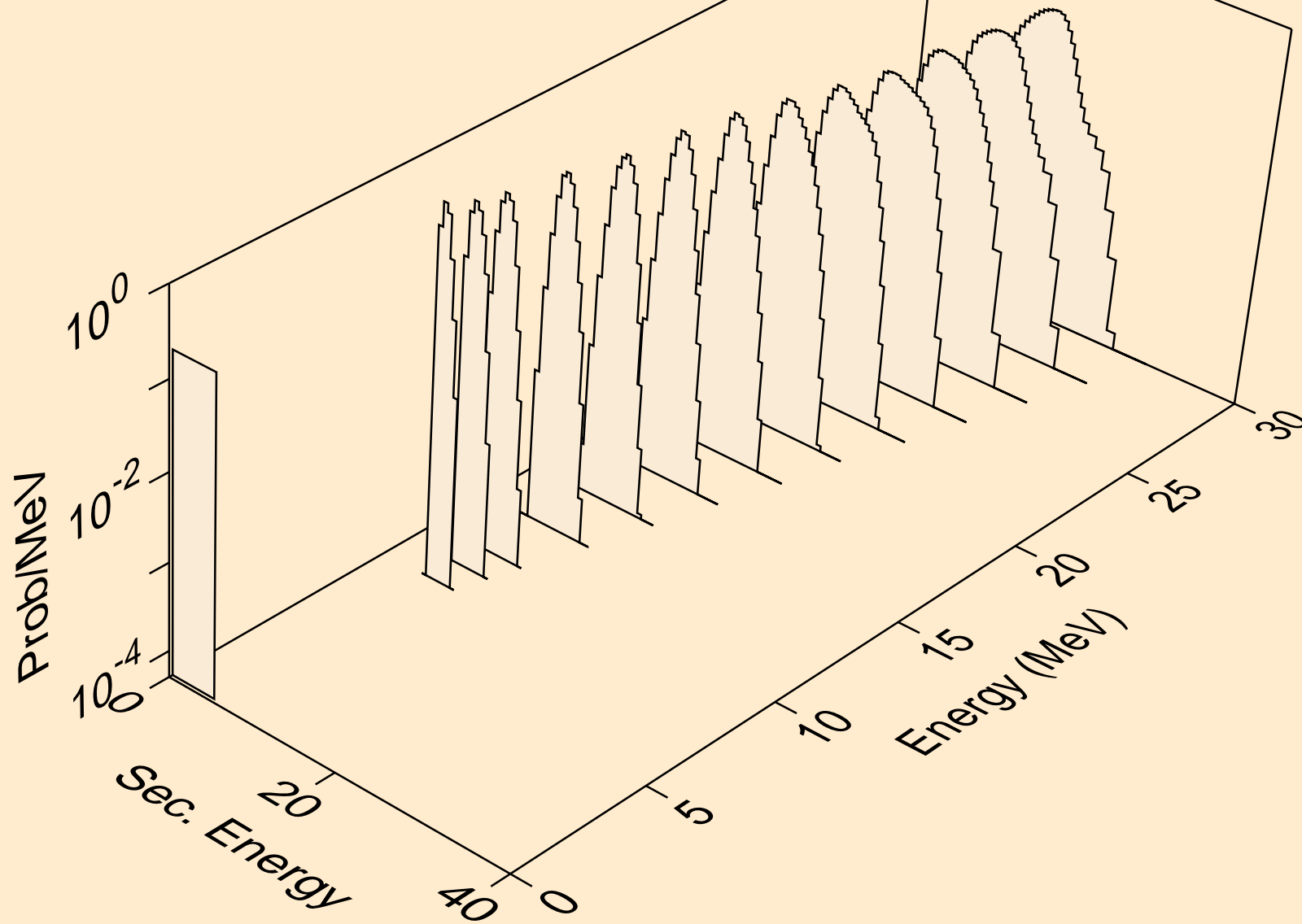

LU166 DEUTERON ACER TENDL-2021 LIBRARY; T=0.K  
alphas from (d,a)

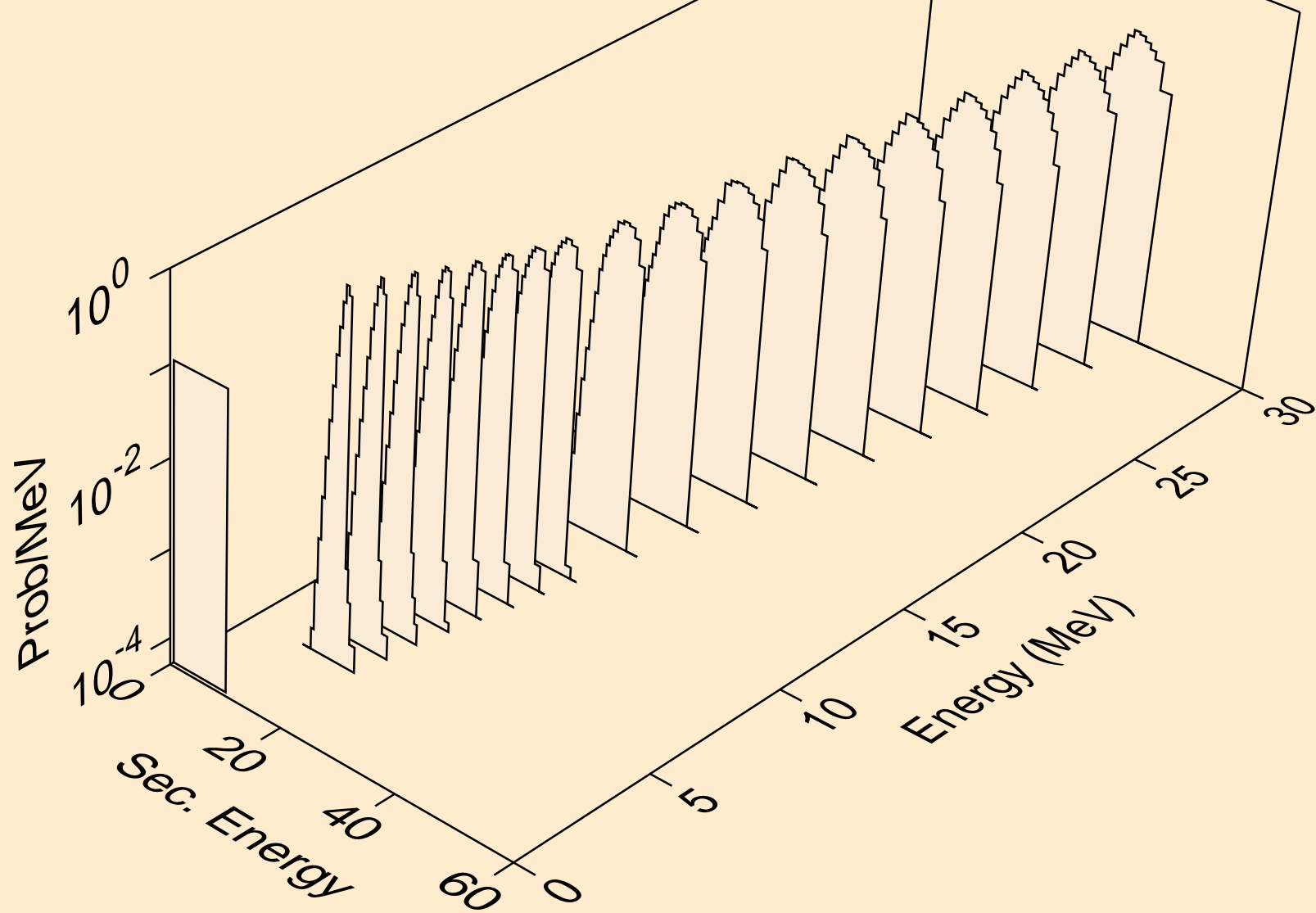

LU166 DEUTERON ACER TENDL-2021 LIBRARY; T=0.K  
alphas from (d,2a)

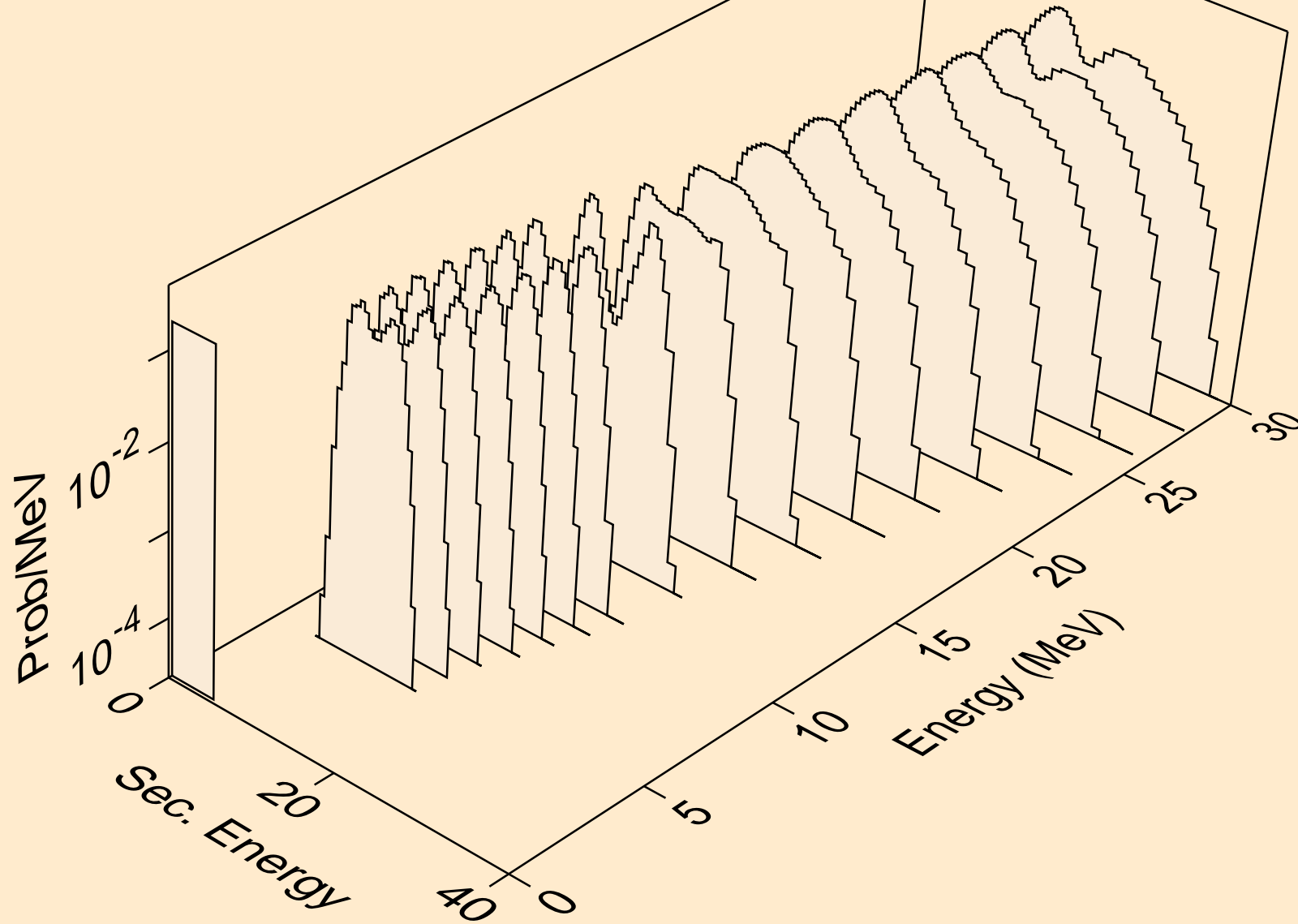

LU166 DEUTERON ACER TENDL-2021 LIBRARY; T=0.K  
alphas from (d,pa)

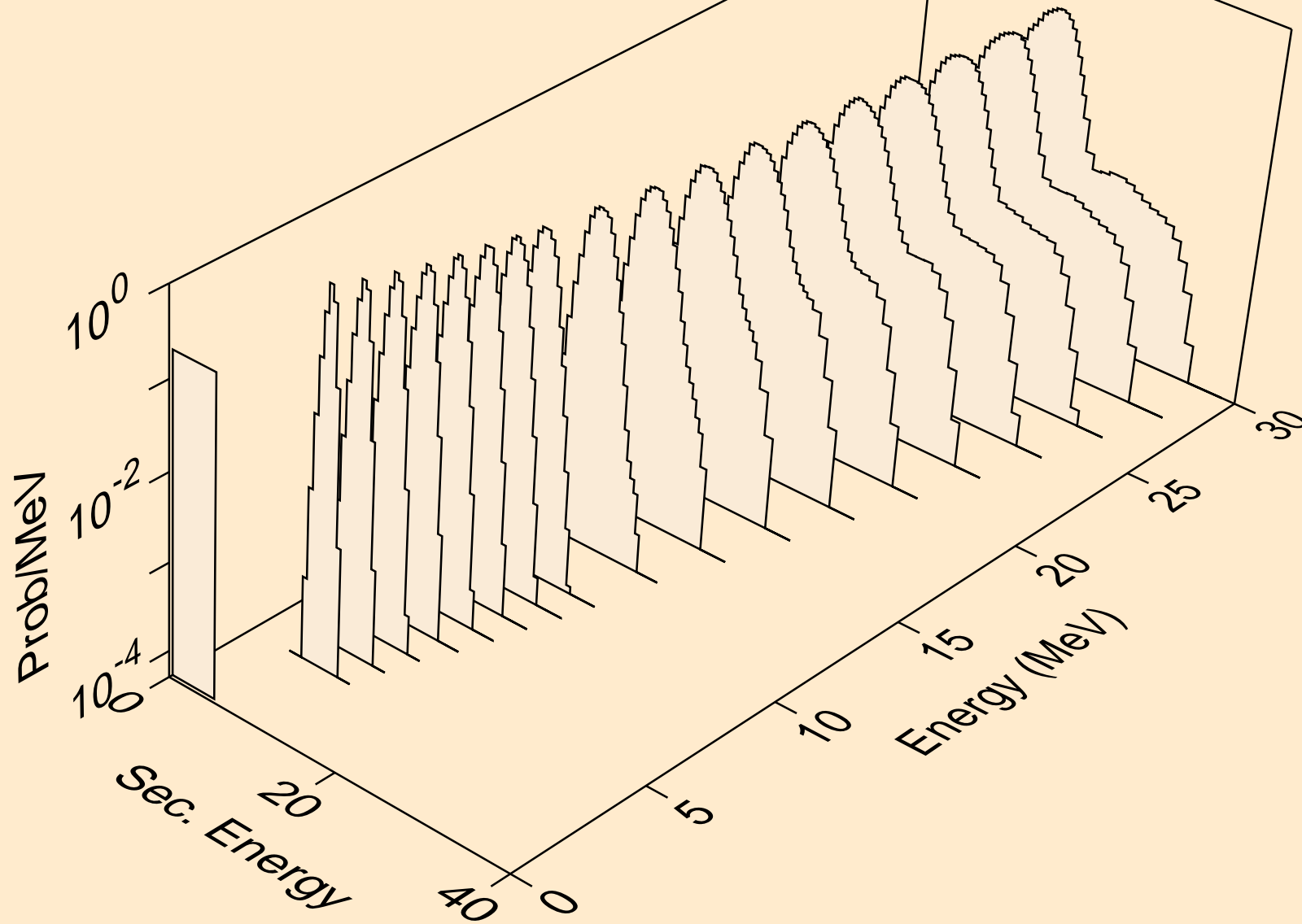



LU166 DEUTERON ACER TENDL-2021 LIBRARY; T=0.K  
alphas from (d,da)

