

MD248 DEUTERON ACER TENDL-2021 LIBRARY; T=0.K  
Principal cross sections

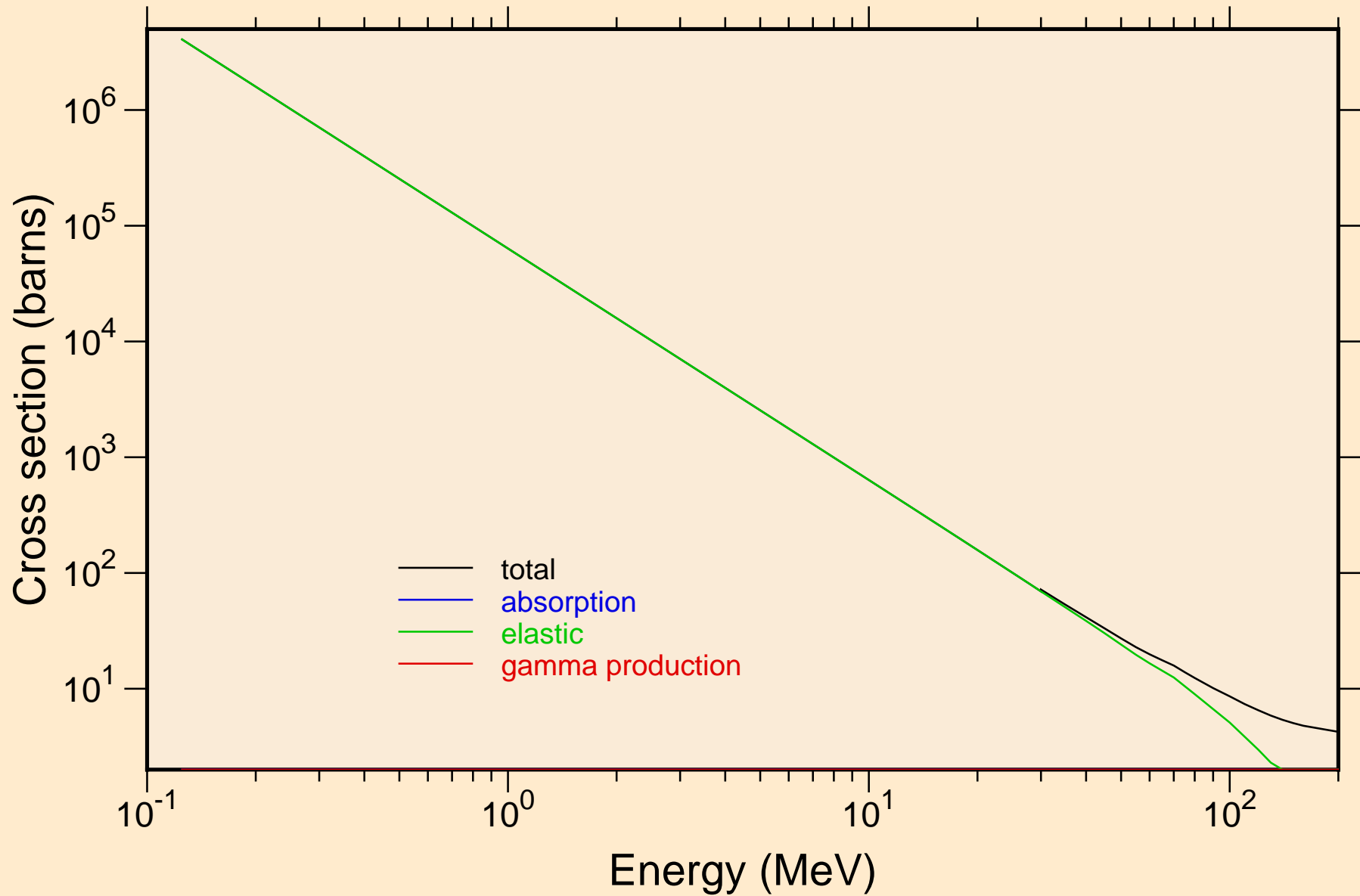

MD248 DEUTERON ACER TENDL-2021 LIBRARY; T=0.K  
Heating

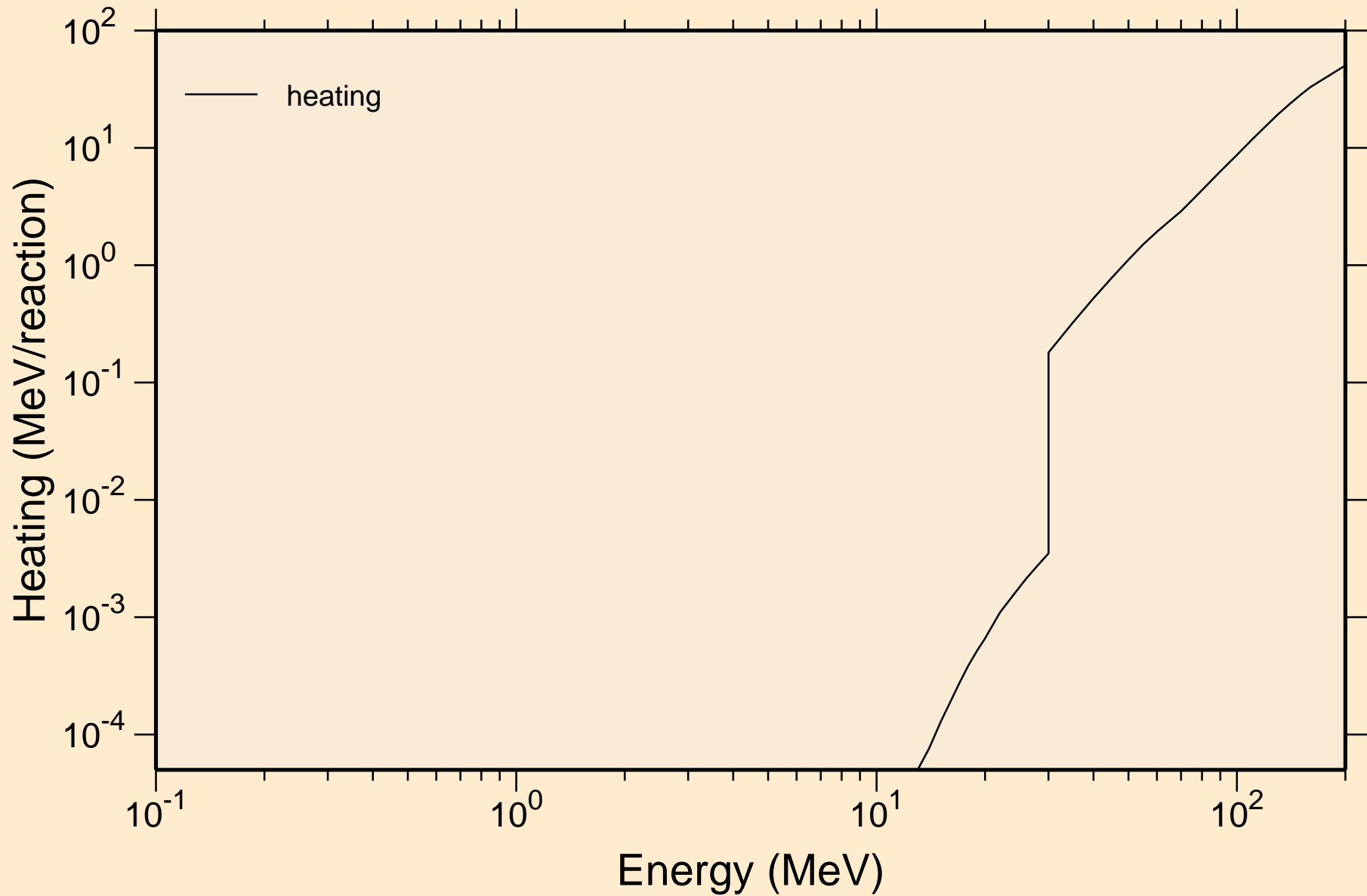

MD248 DEUTERON ACER TENDL-2021 LIBRARY; T=0.K  
Principal cross sections

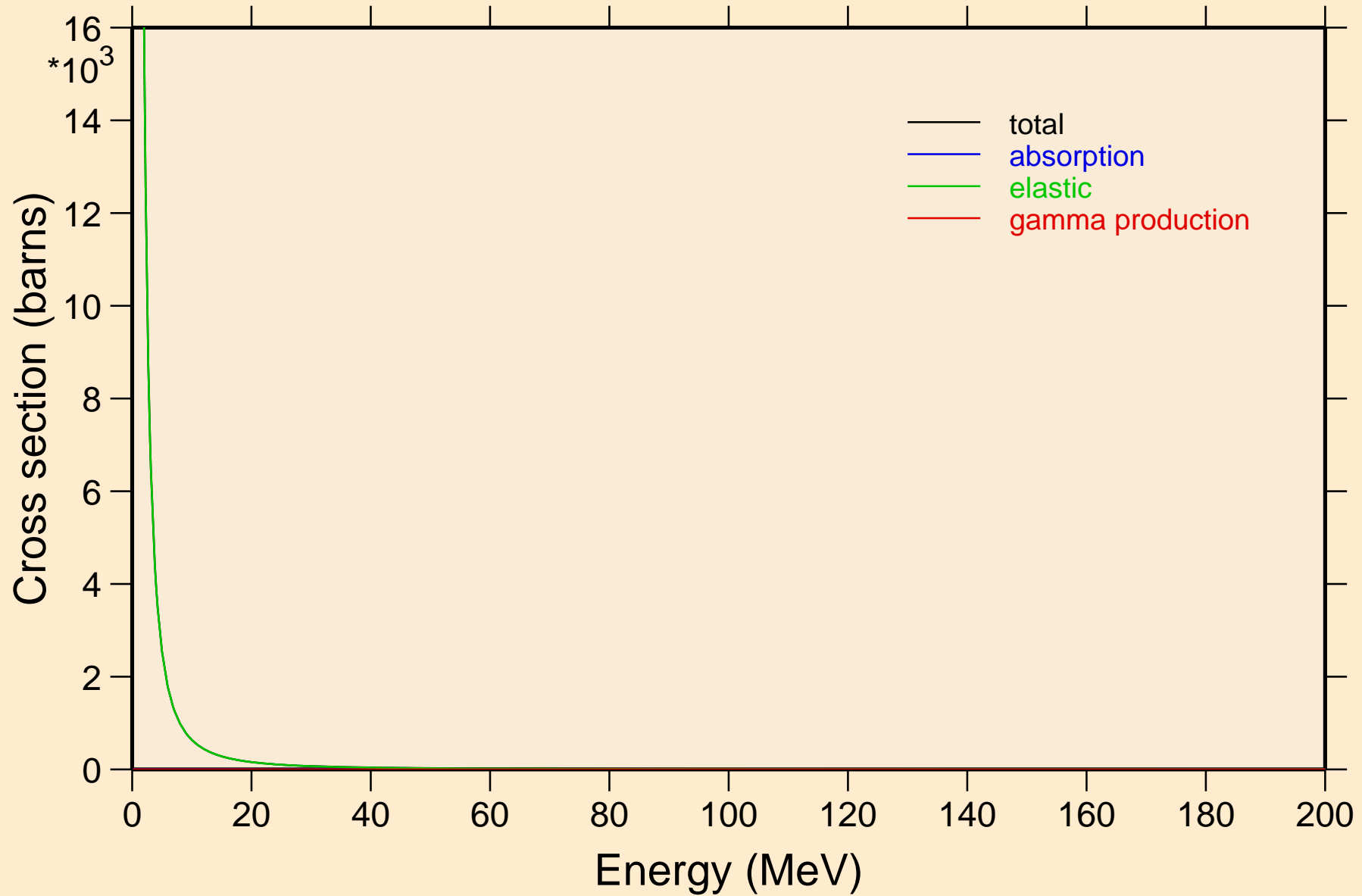

# MD248 DEUTERON ACER TENDL-2021 LIBRARY; T=0.K

## Heating

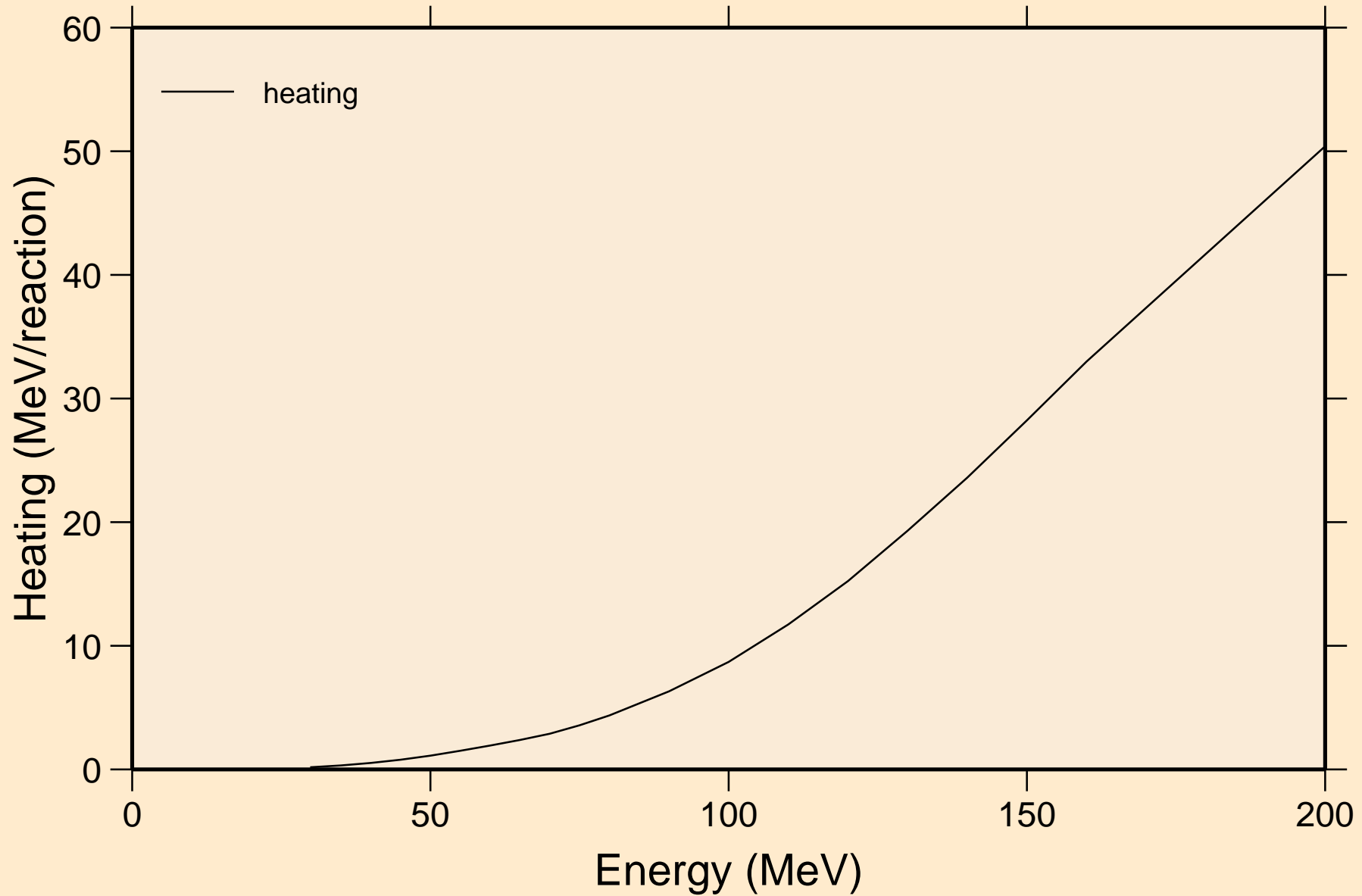

# MD248 DEUTERON ACER TENDL-2021 LIBRARY; T=0.K

## Threshold reactions

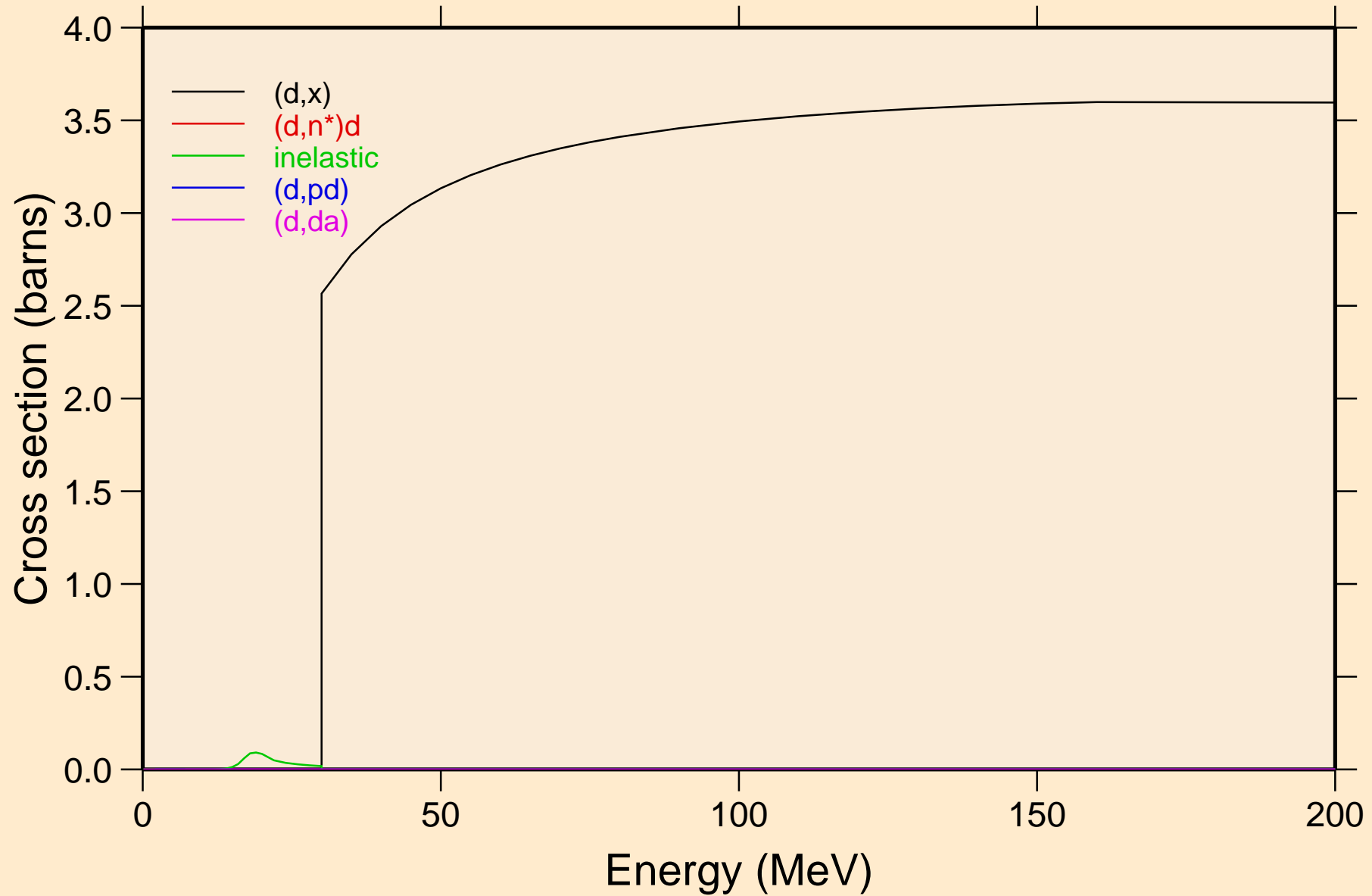

MD248 DEUTERON ACER TENDL-2021 LIBRARY; T=0.K  
angular distribution for elastic

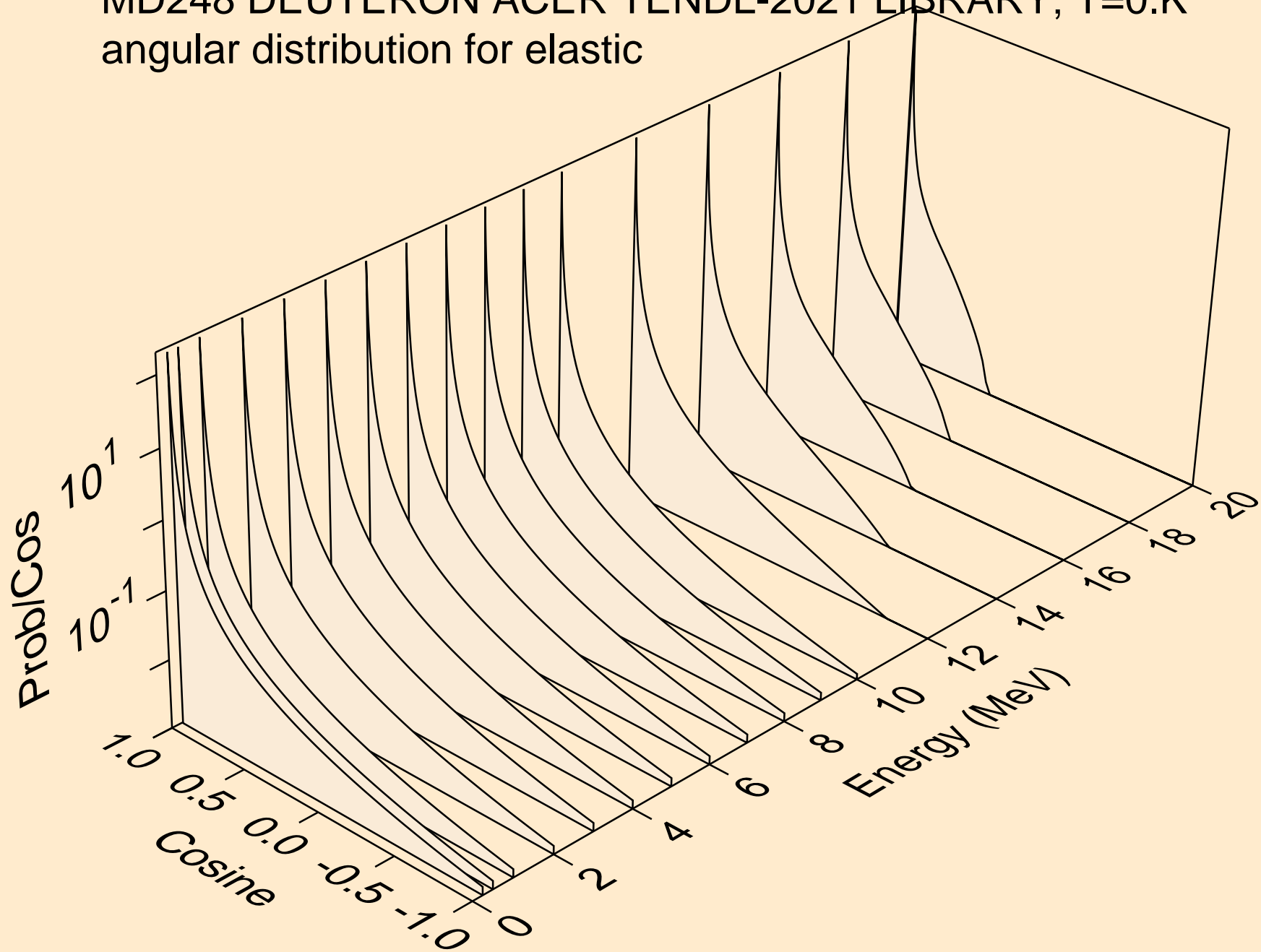

MD248 DEUTERON ACER TENDL-2021 LIBRARY; T=0.K  
angular distribution for elastic

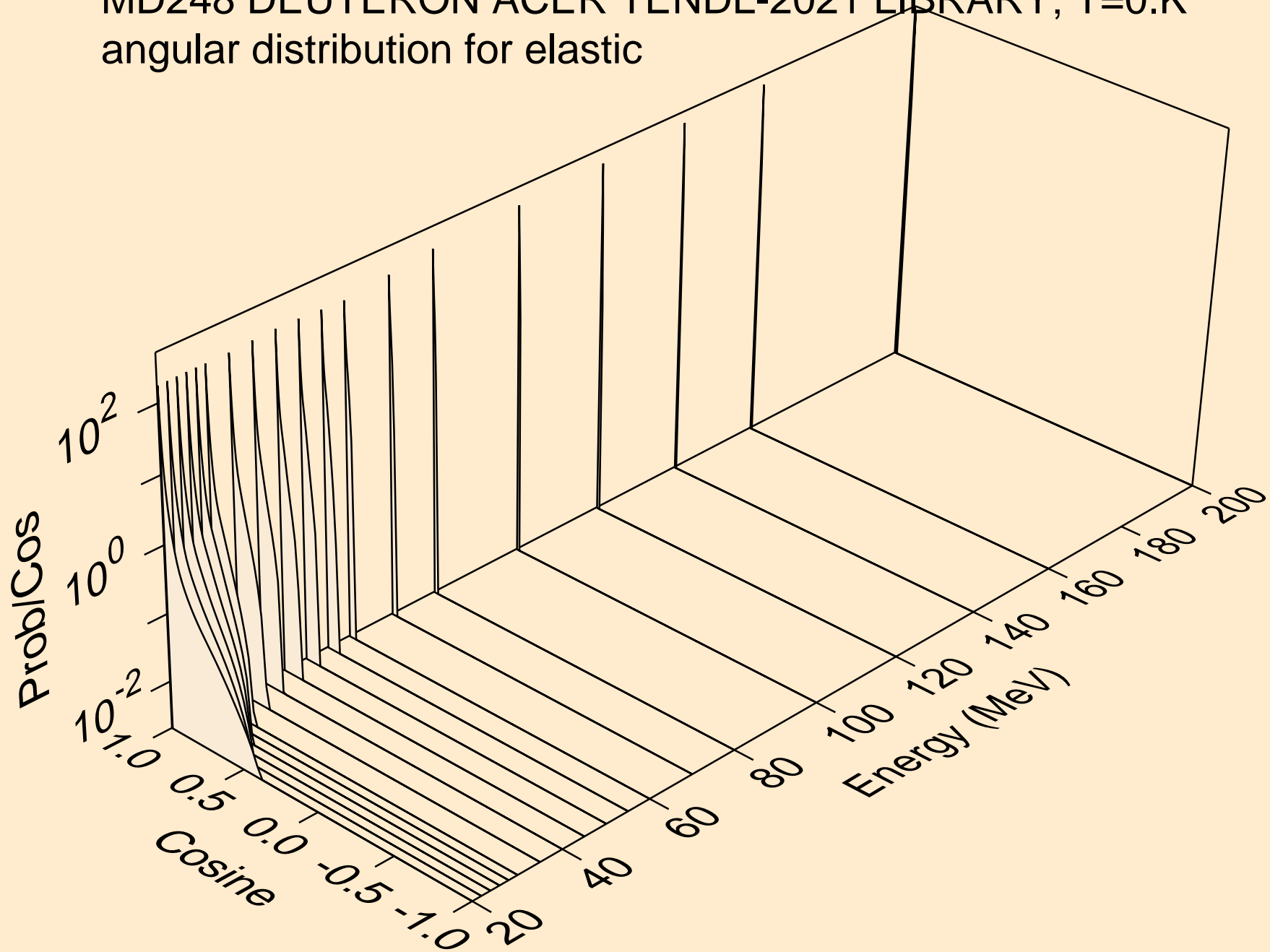

MD248 DEUTERON ACER TENDL-2021 LIBRARY; T=0.K  
Deuteron emission for (d,x)

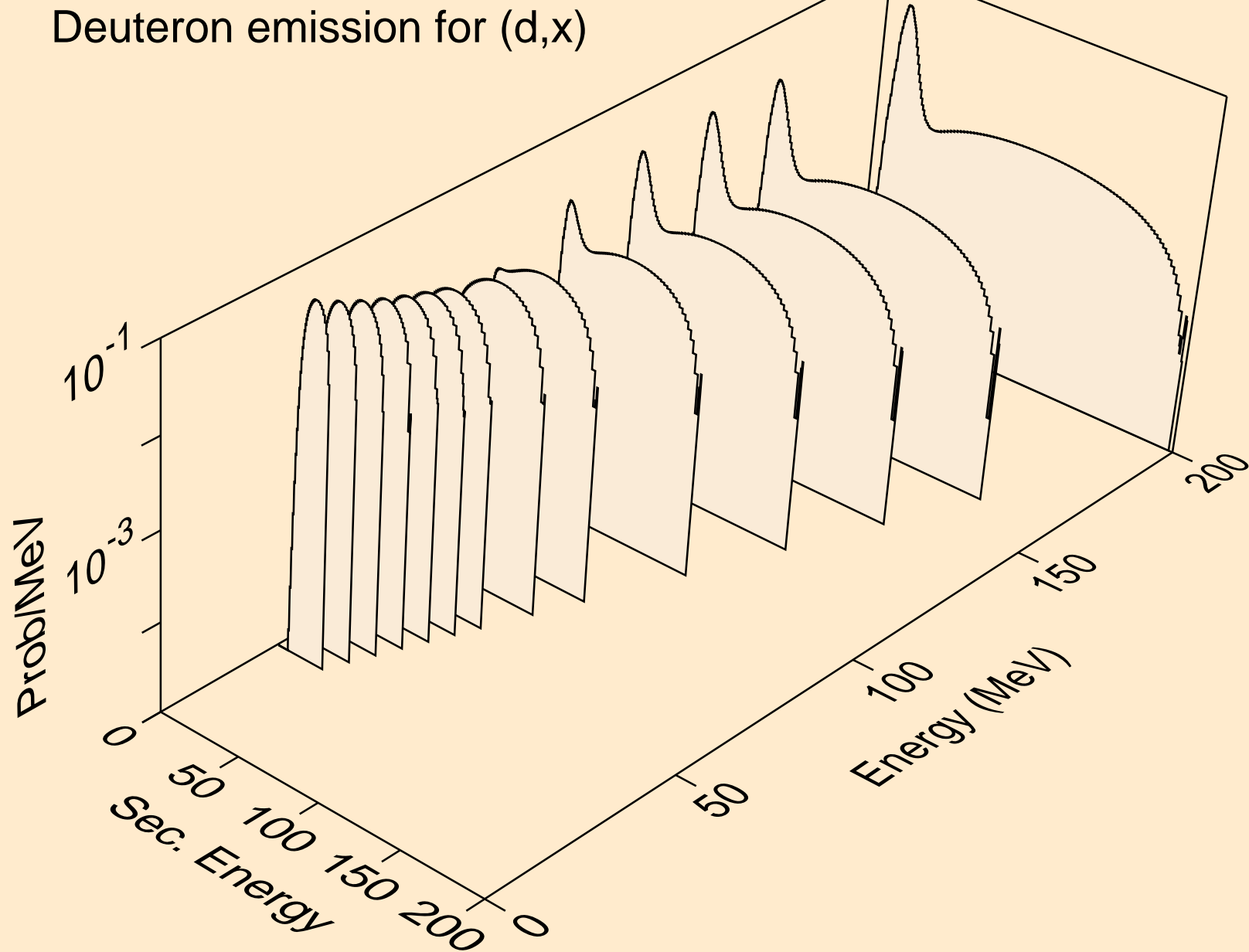



MD248 DEUTERON ACER TENDL-2021 LIBRARY; T=0.K  
Deuteron emission for (d,n\*)d

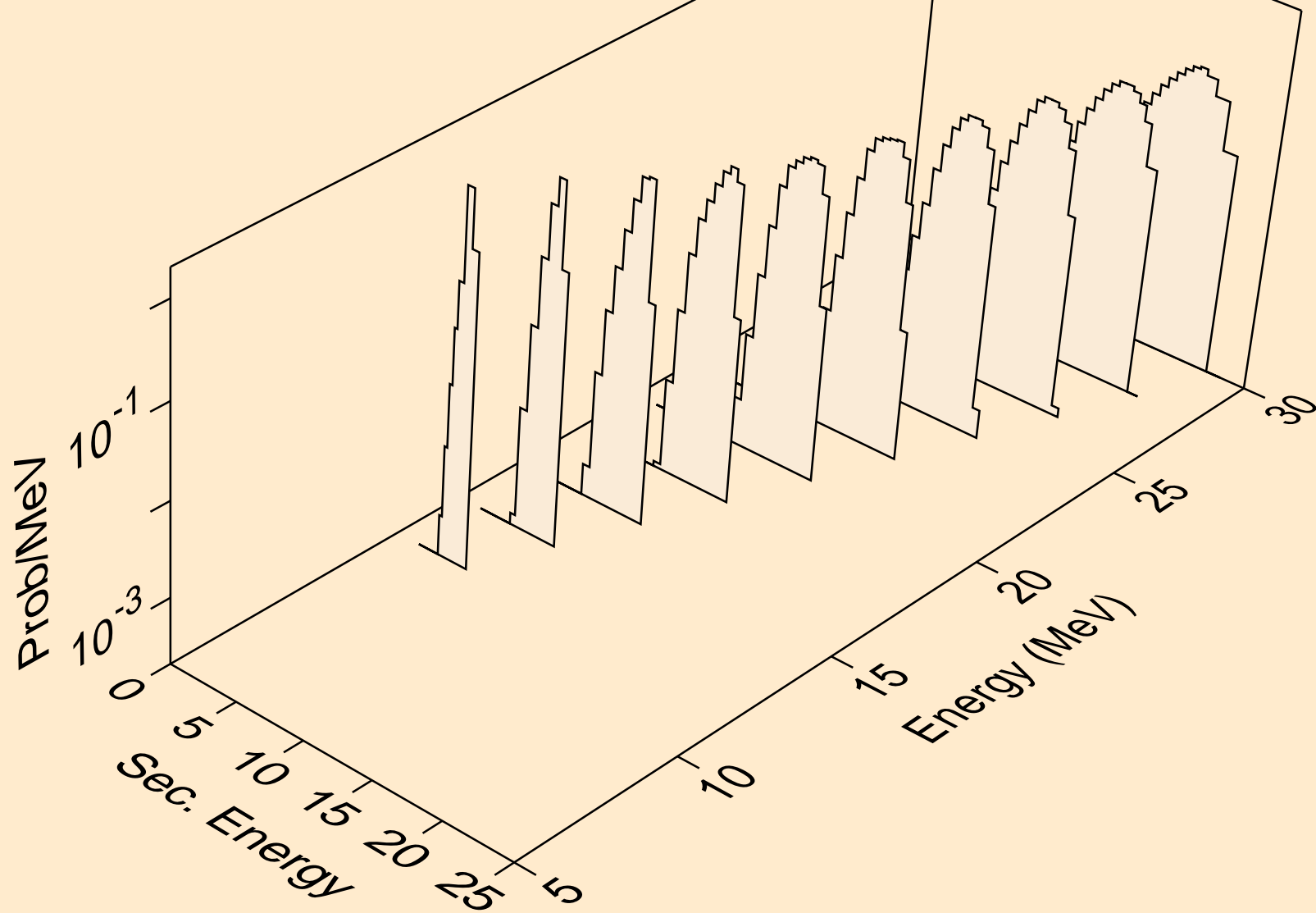

MD248 DEUTERON ACER TENDL-2021 LIBRARY; T=0.K  
Deuteron emission for inelastic

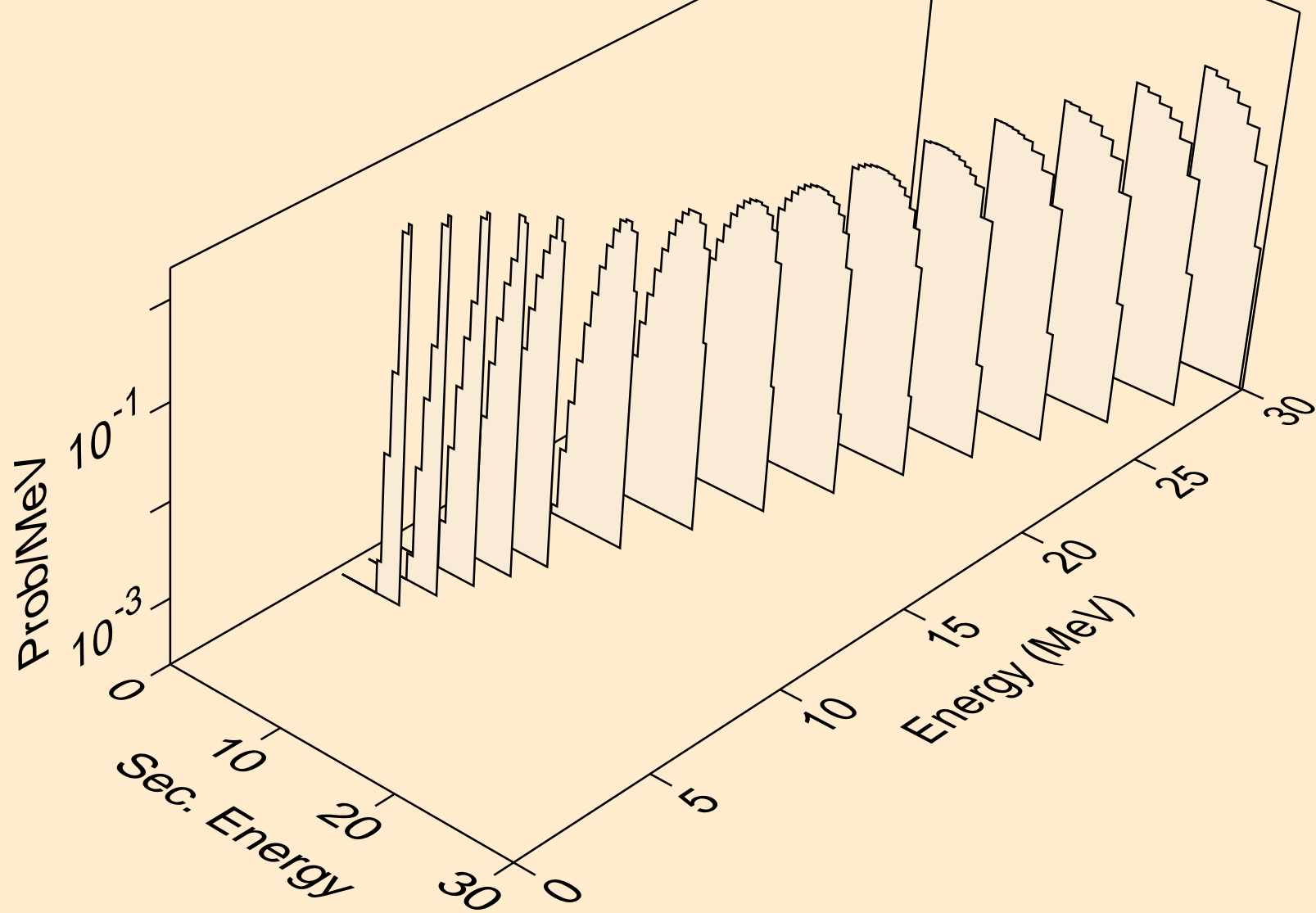

MD248 DEUTERON ACER TENDL-2021 LIBRARY; T=0.K  
Deuteron emission for (d,pd)

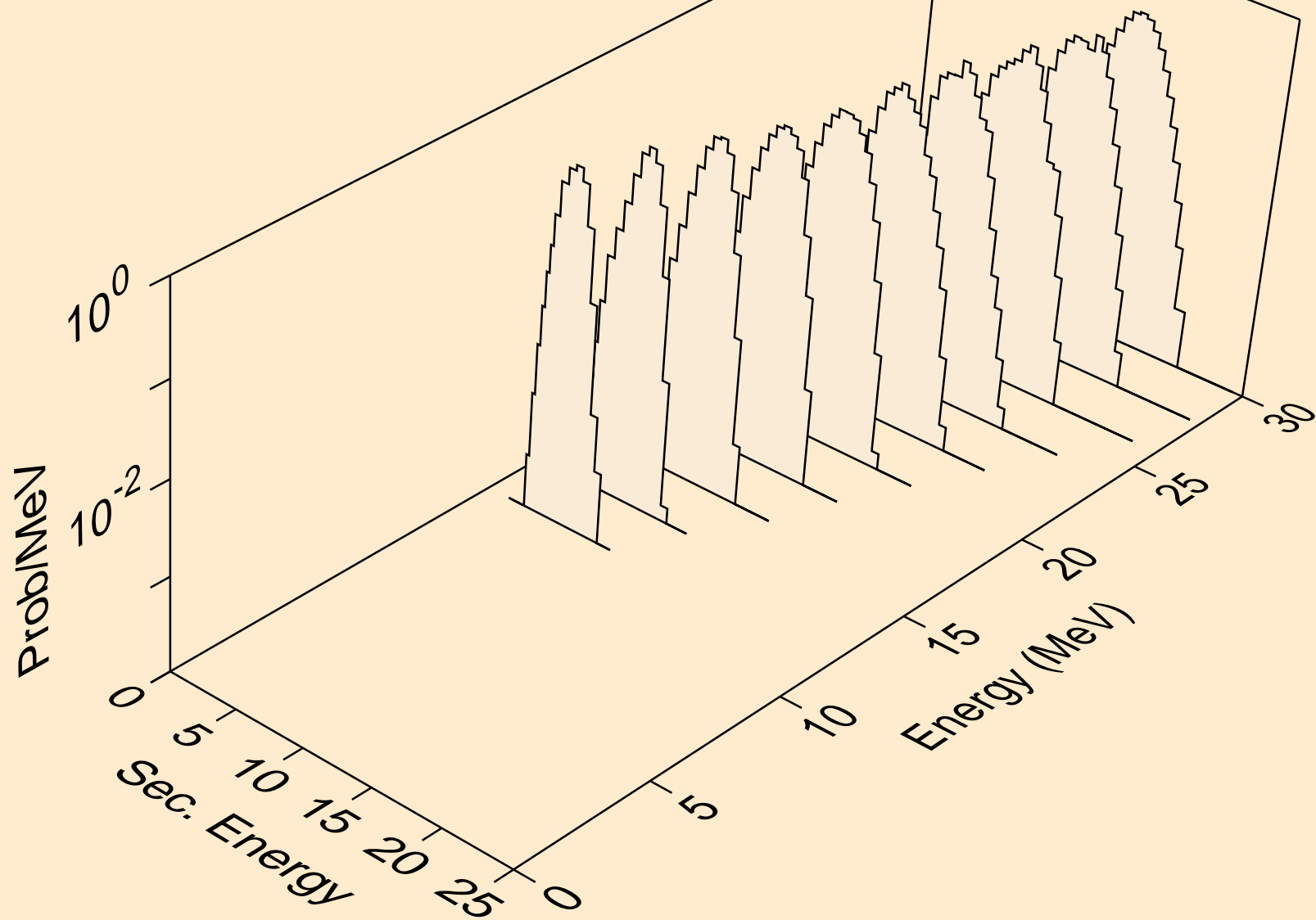

MD248 DEUTERON ACER TENDL-2021 LIBRARY; T=0.K  
Deuteron emission for (d,da)

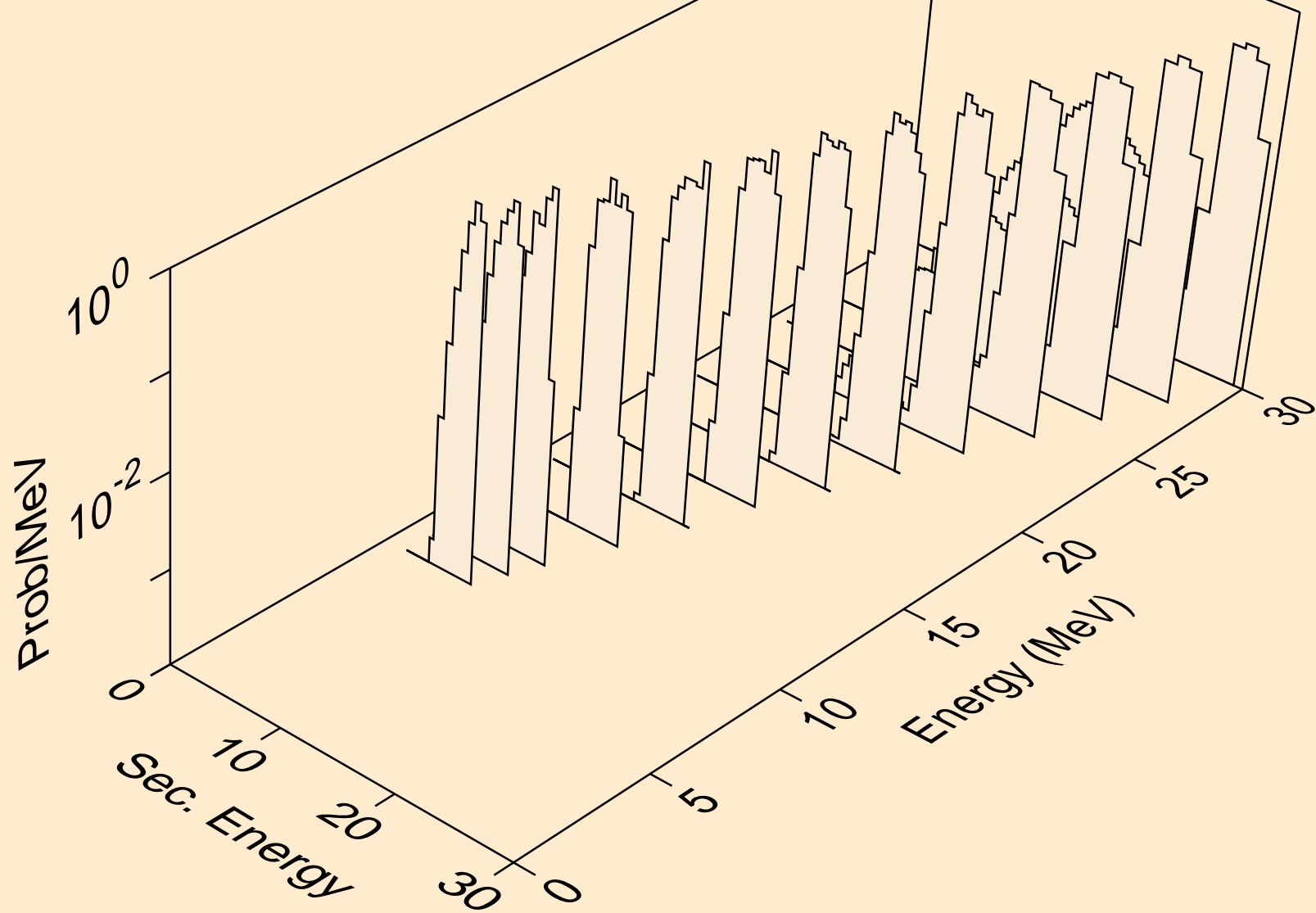

MD248 DEUTERON ACER TENDL-2021 LIBRARY; T=0.K  
Photon emission for (z,n)

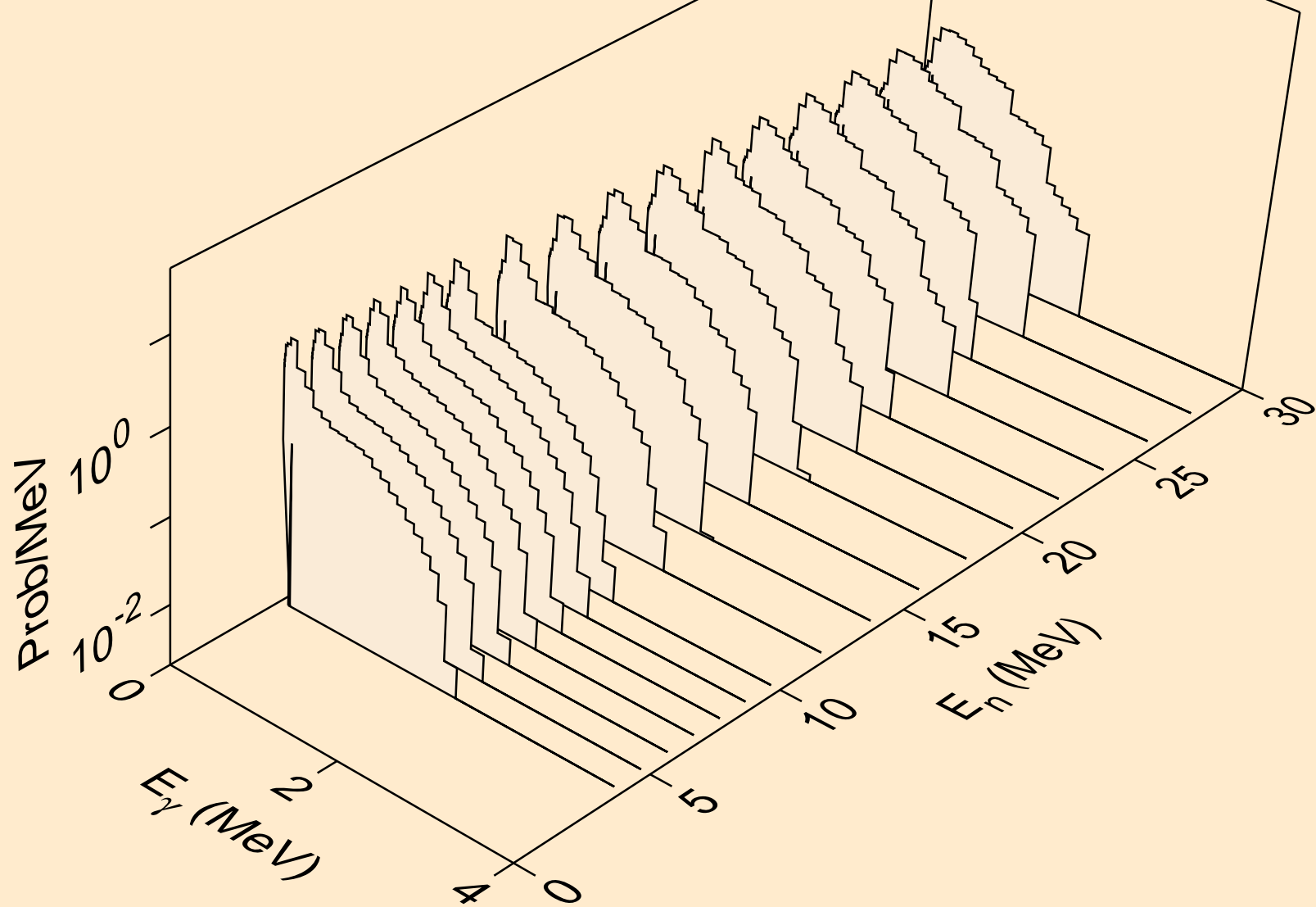

MD248 DEUTERON ACER TENDL-2021 LIBRARY; T=0.K  
Photon emission for (n,x)

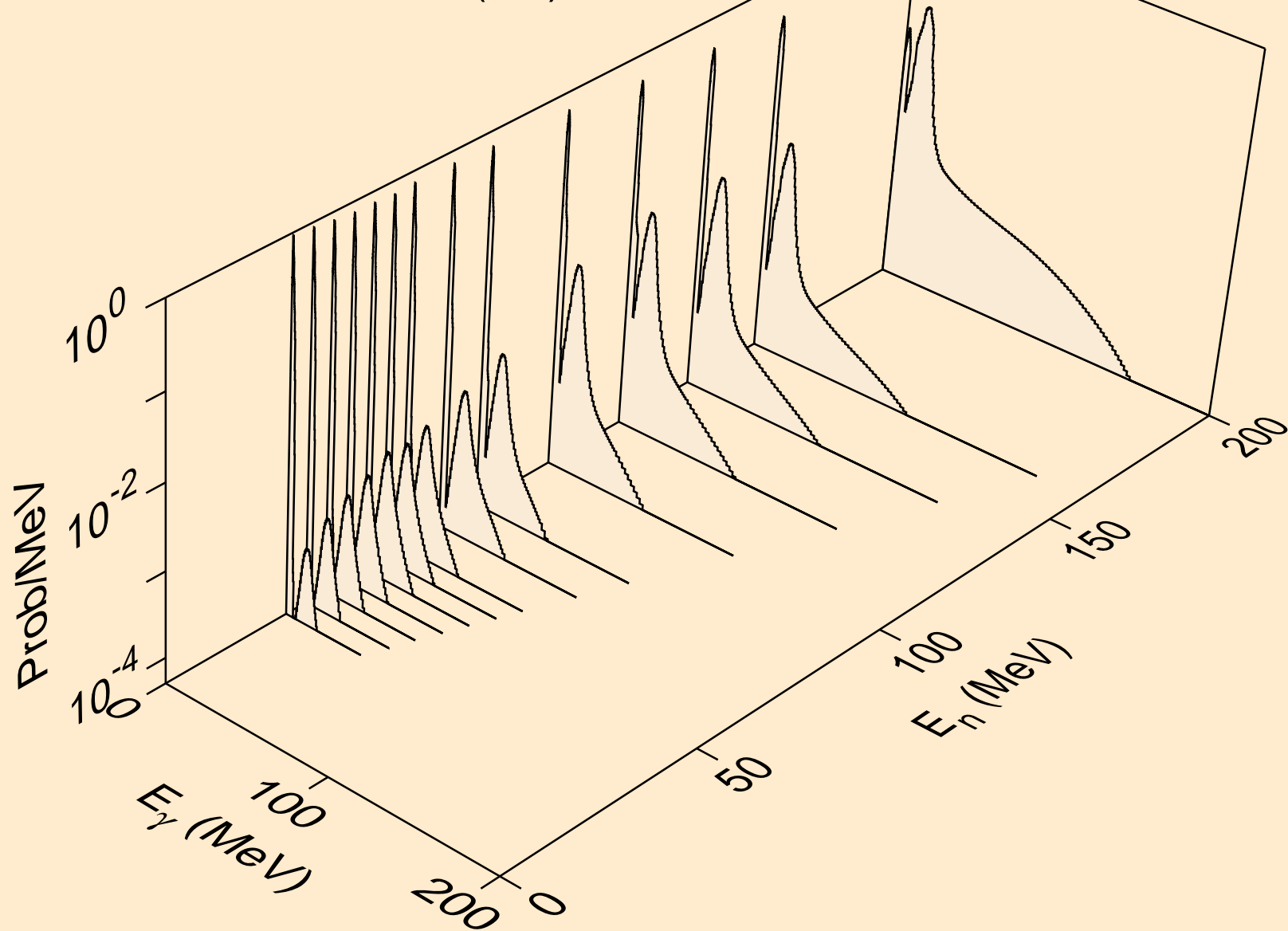

MD248 DEUTERON ACER TENDL-2021 LIBRARY; T=0.K  
Photon emission for (n,2n)

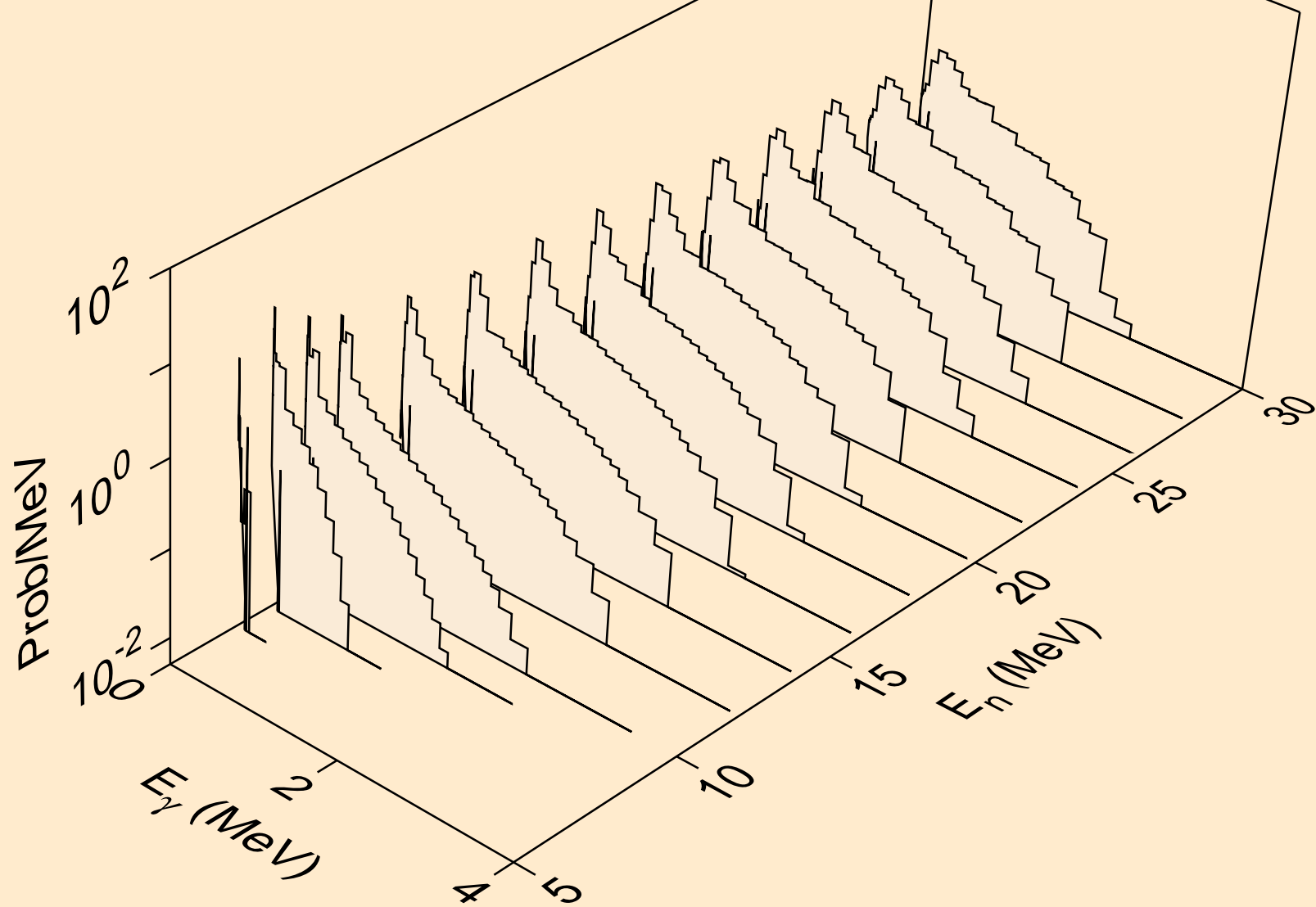

MD248 DEUTERON ACER TENDL-2021 LIBRARY; T=0.K  
Photon emission for (n,3n)

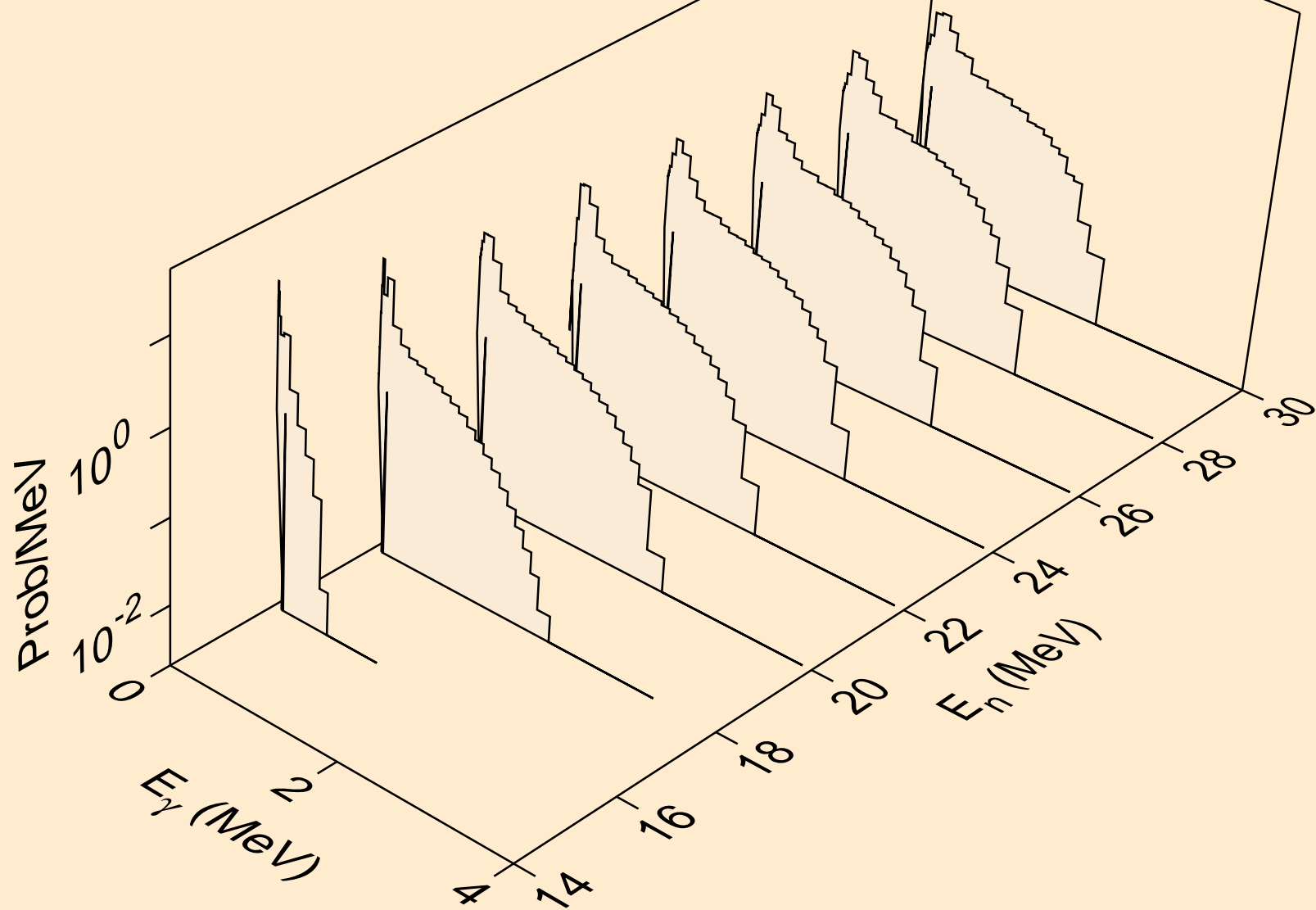



MD248 DEUTERON ACER TENDL-2021 LIBRARY; T=0.K  
Photon emission for (n,n\*)a

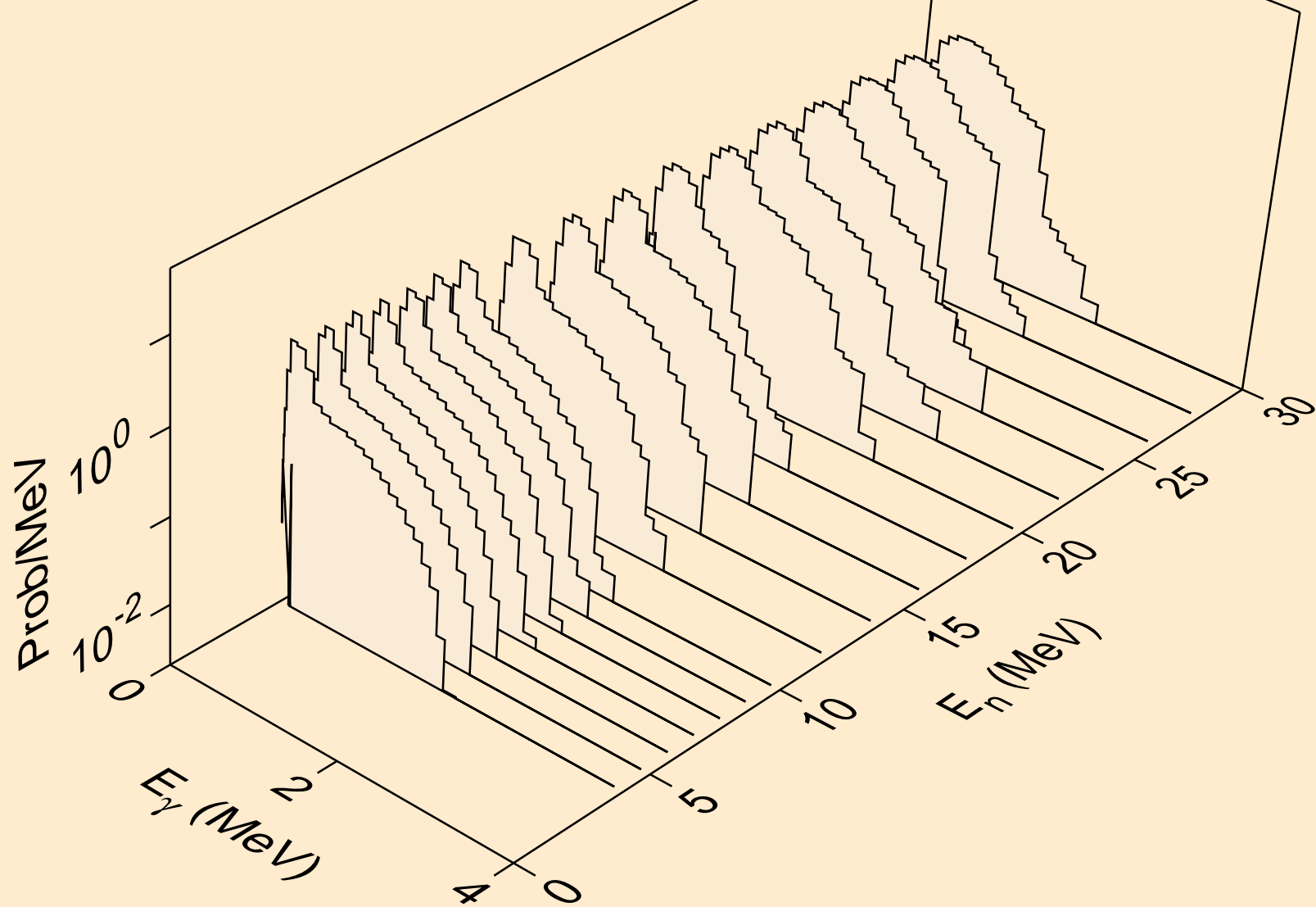

MD248 DEUTERON ACER TENDL-2021 LIBRARY; T=0.K  
Photon emission for (n,2n)a

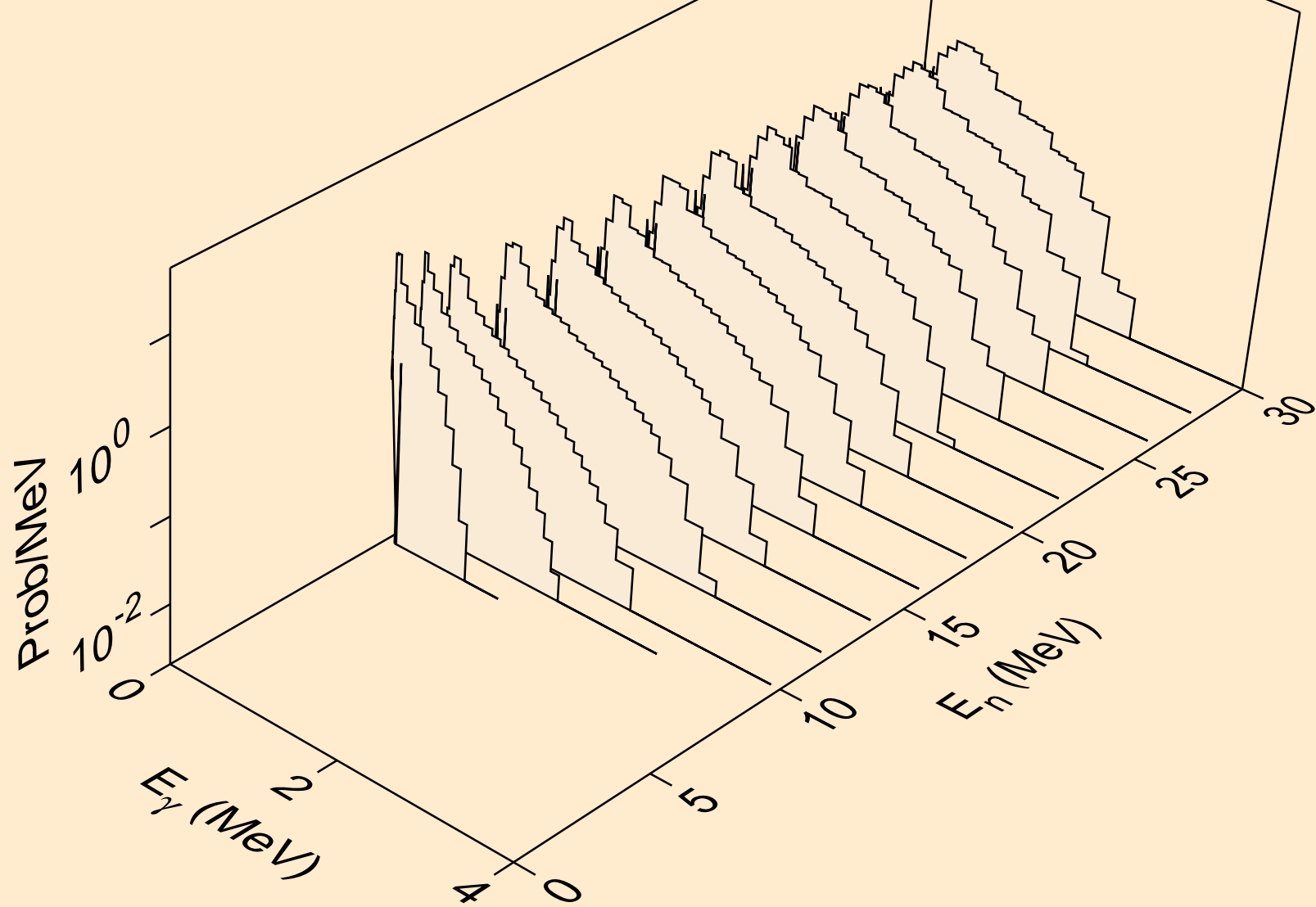

MD248 DEUTERON ACER TENDL-2021 LIBRARY; T=0.K  
Photon emission for (n,3n)a

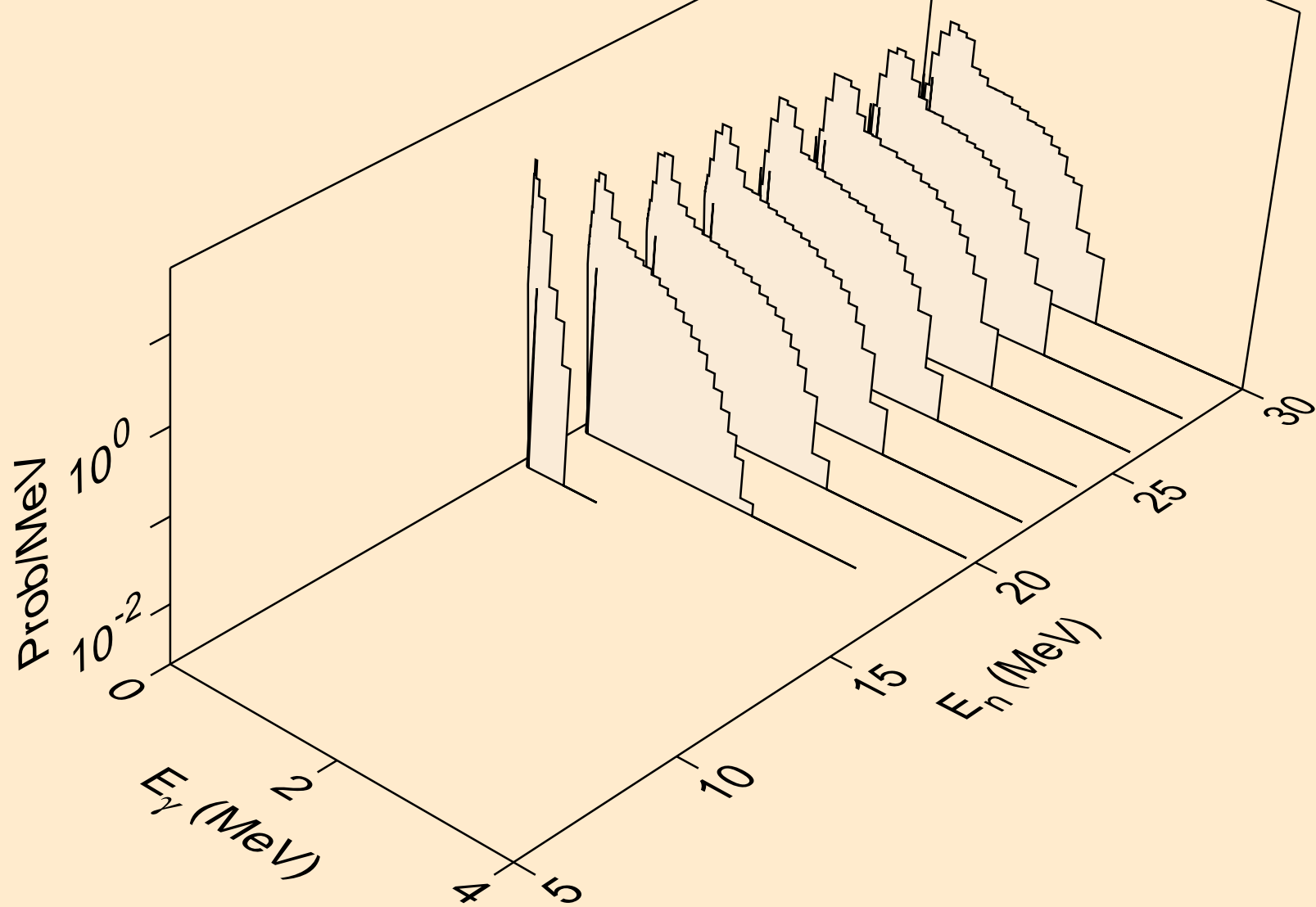

MD248 DEUTERON ACER TENDL-2021 LIBRARY; T=0.K  
Photon emission for (n,n\*)p

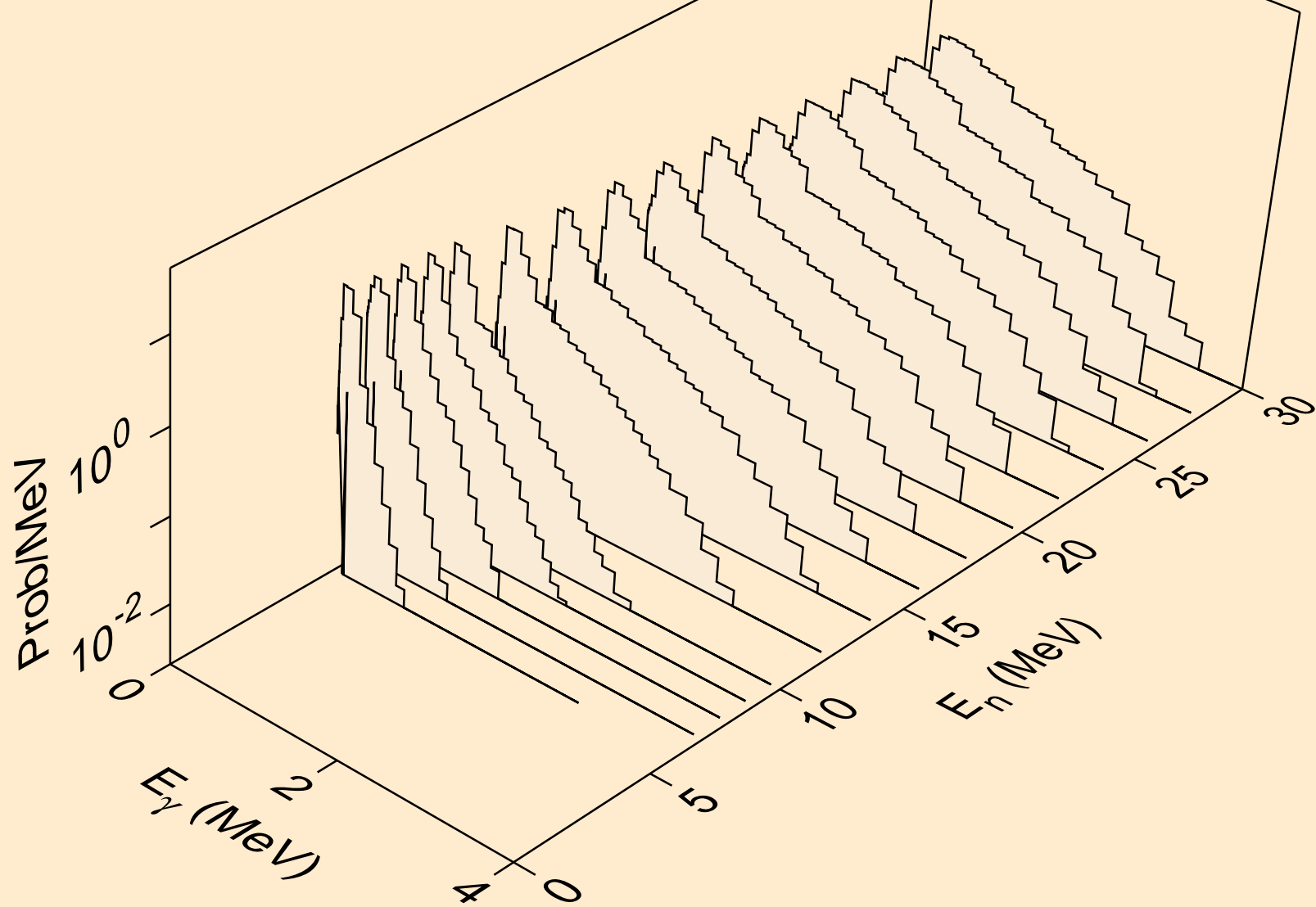

MD248 DEUTERON ACER TENDL-2021 LIBRARY; T=0.K  
Photon emission for (n,n\*)d

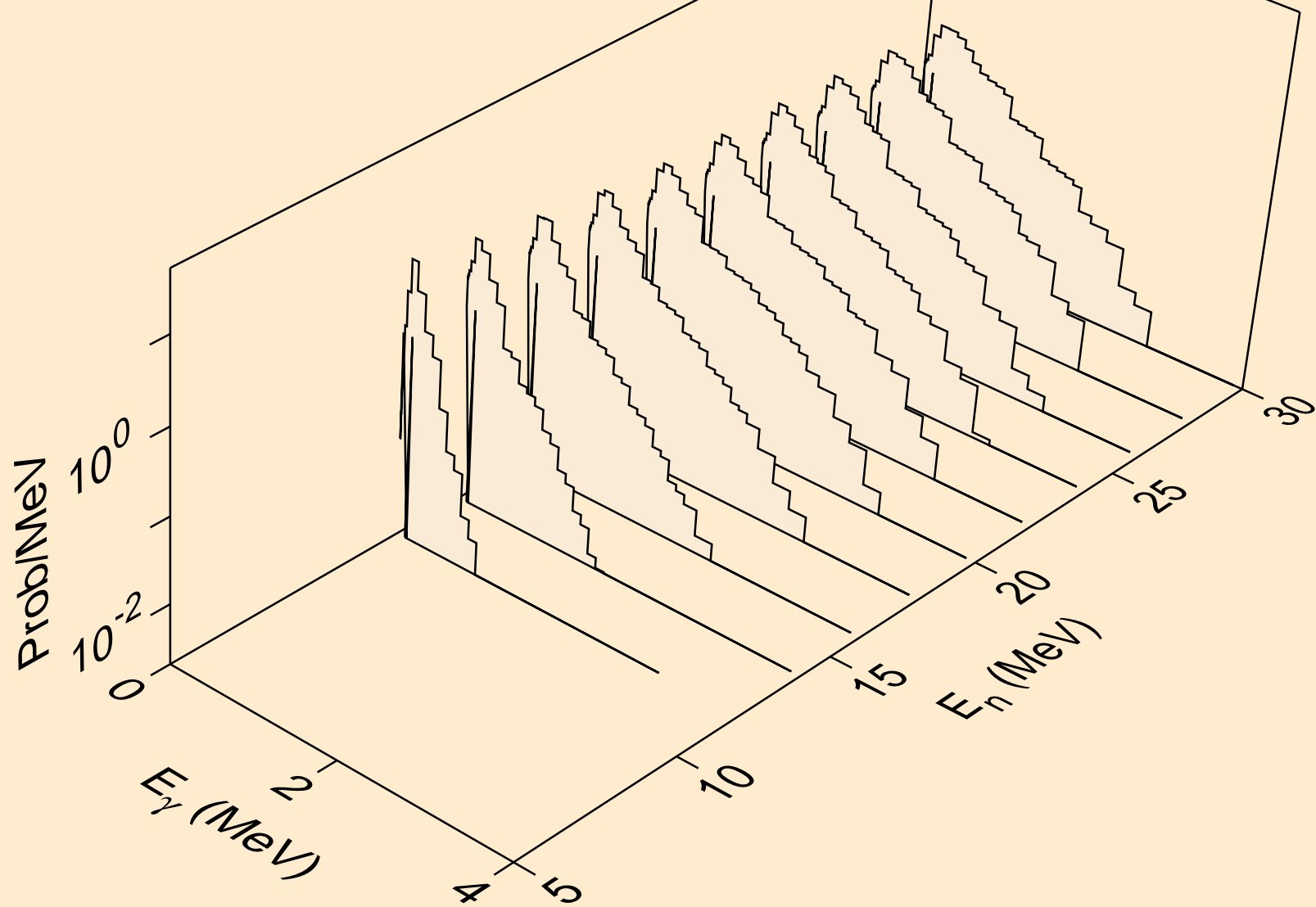

MD248 DEUTERON ACER TENDL-2021 LIBRARY; T=0.K  
Photon emission for (n,n\*)t

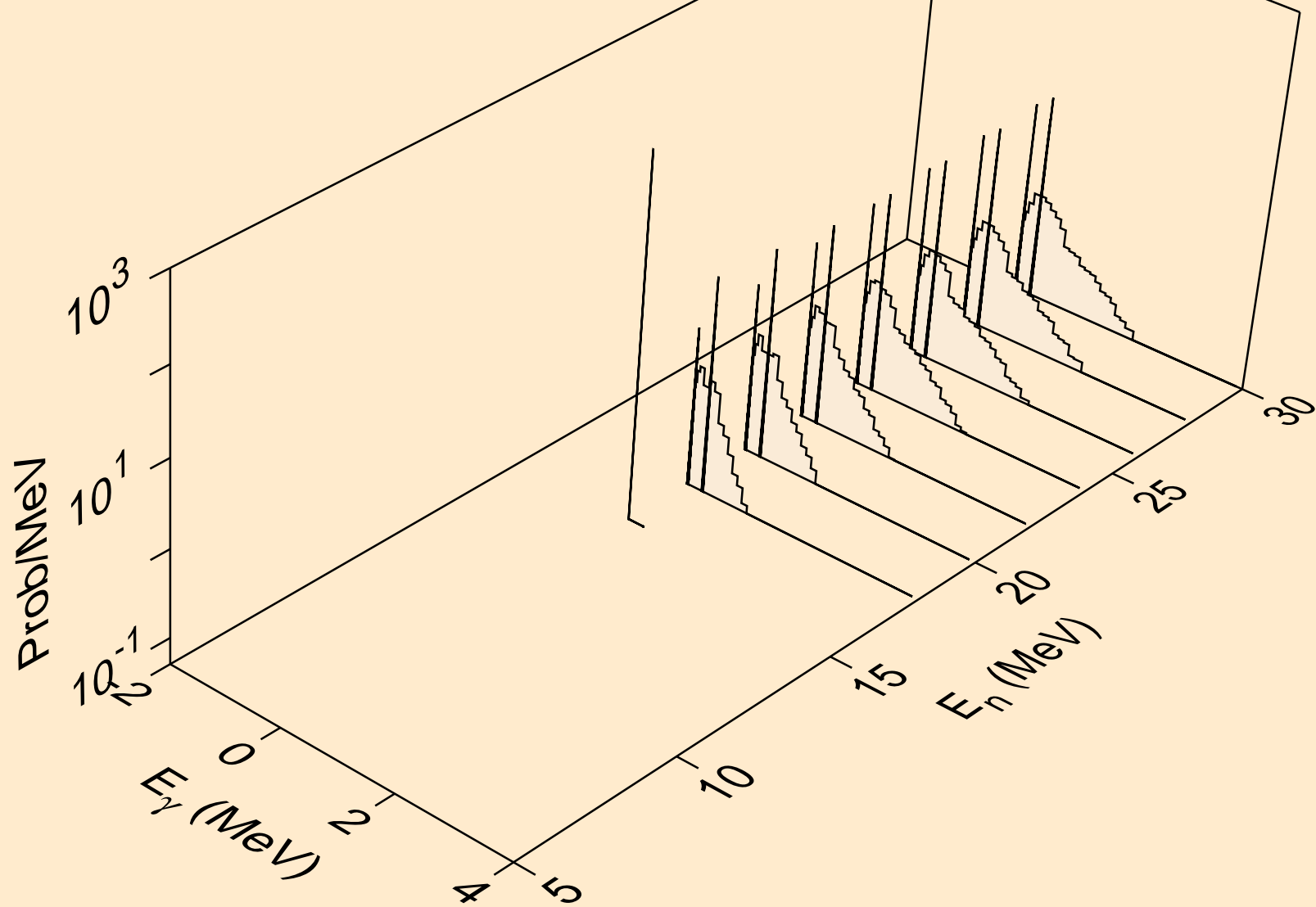

MD248 DEUTERON ACER TENDL-2021 LIBRARY; T=0.K  
Photon emission for (n,n\*)he3

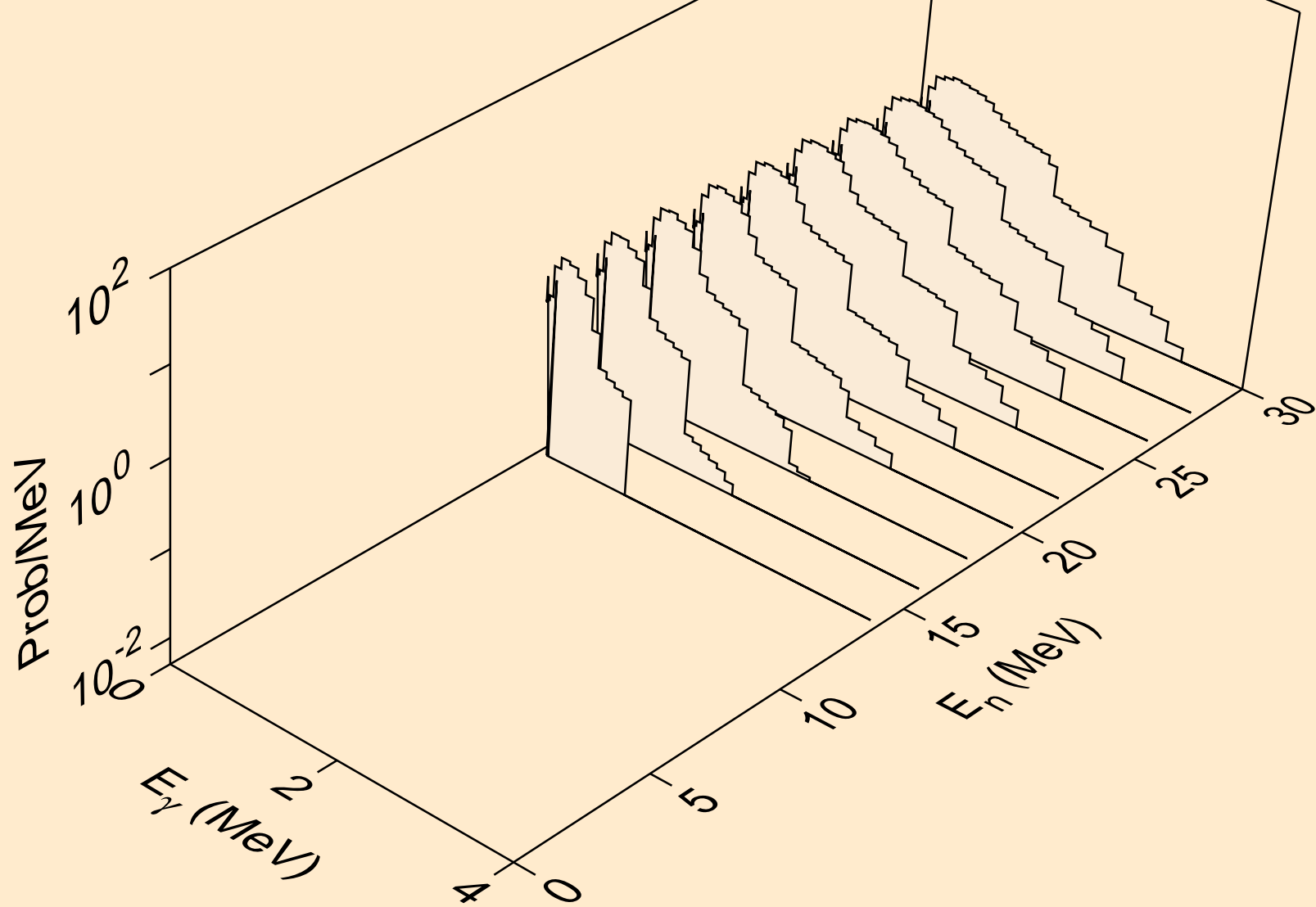

MD248 DEUTERON ACER TENDL-2021 LIBRARY; T=0.K  
Photon emission for (n,2np)

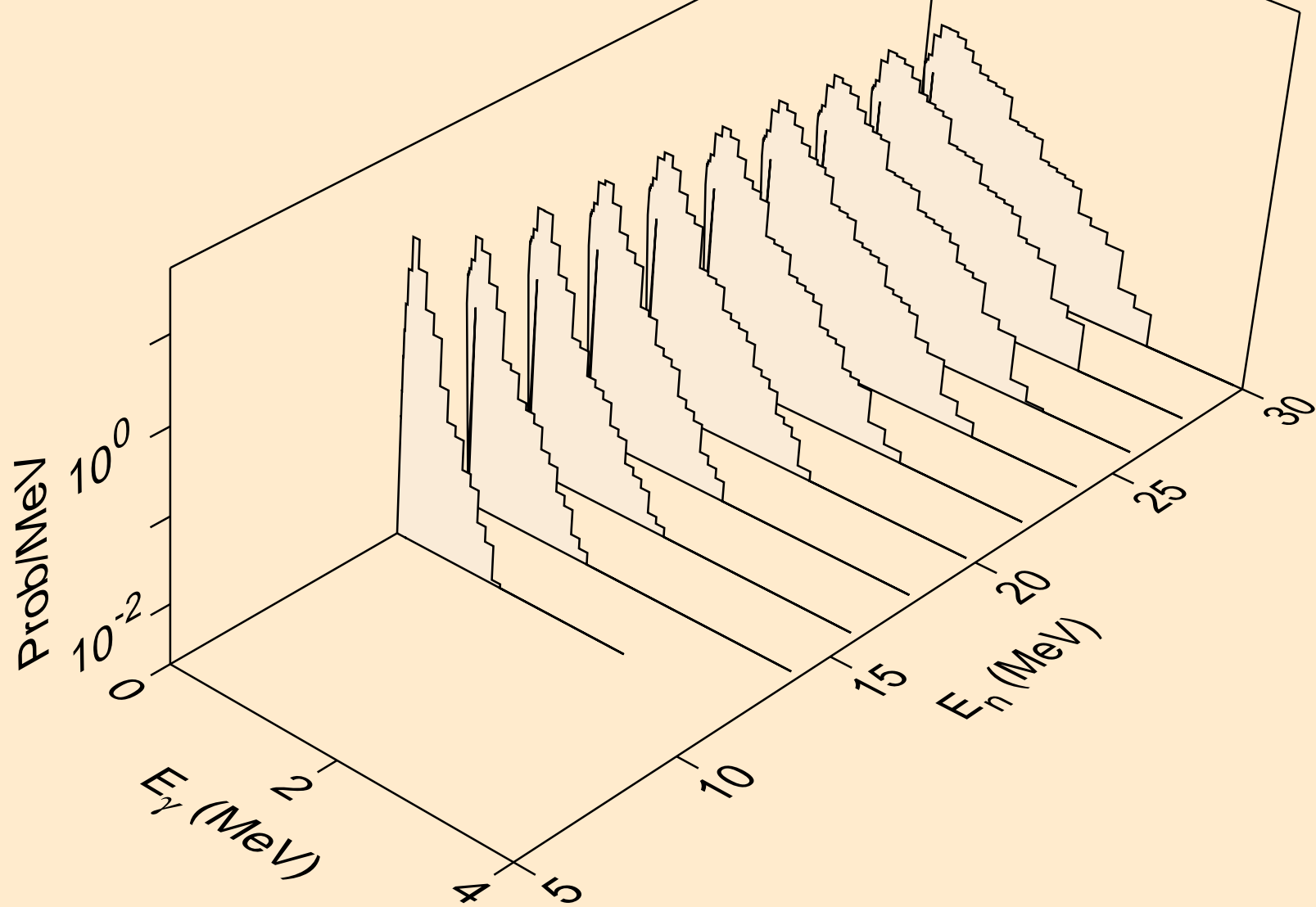



MD248 DEUTERON ACER TENDL-2021 LIBRARY; T=0.K  
Photon emission for (n,2np)

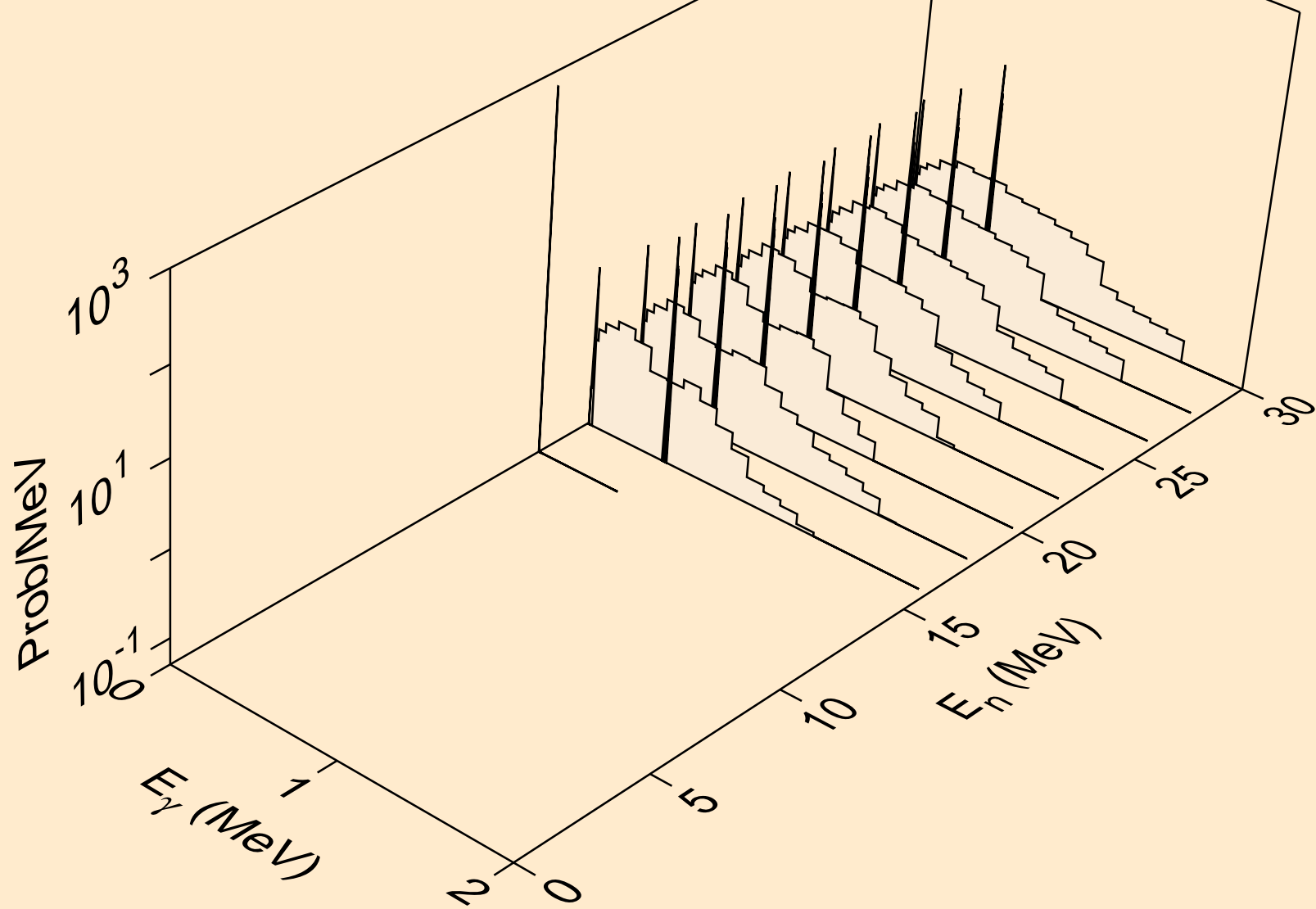

MD248 DEUTERON ACER TENDL-2021 LIBRARY; T=0.K  
Photon emission for (n,gma)

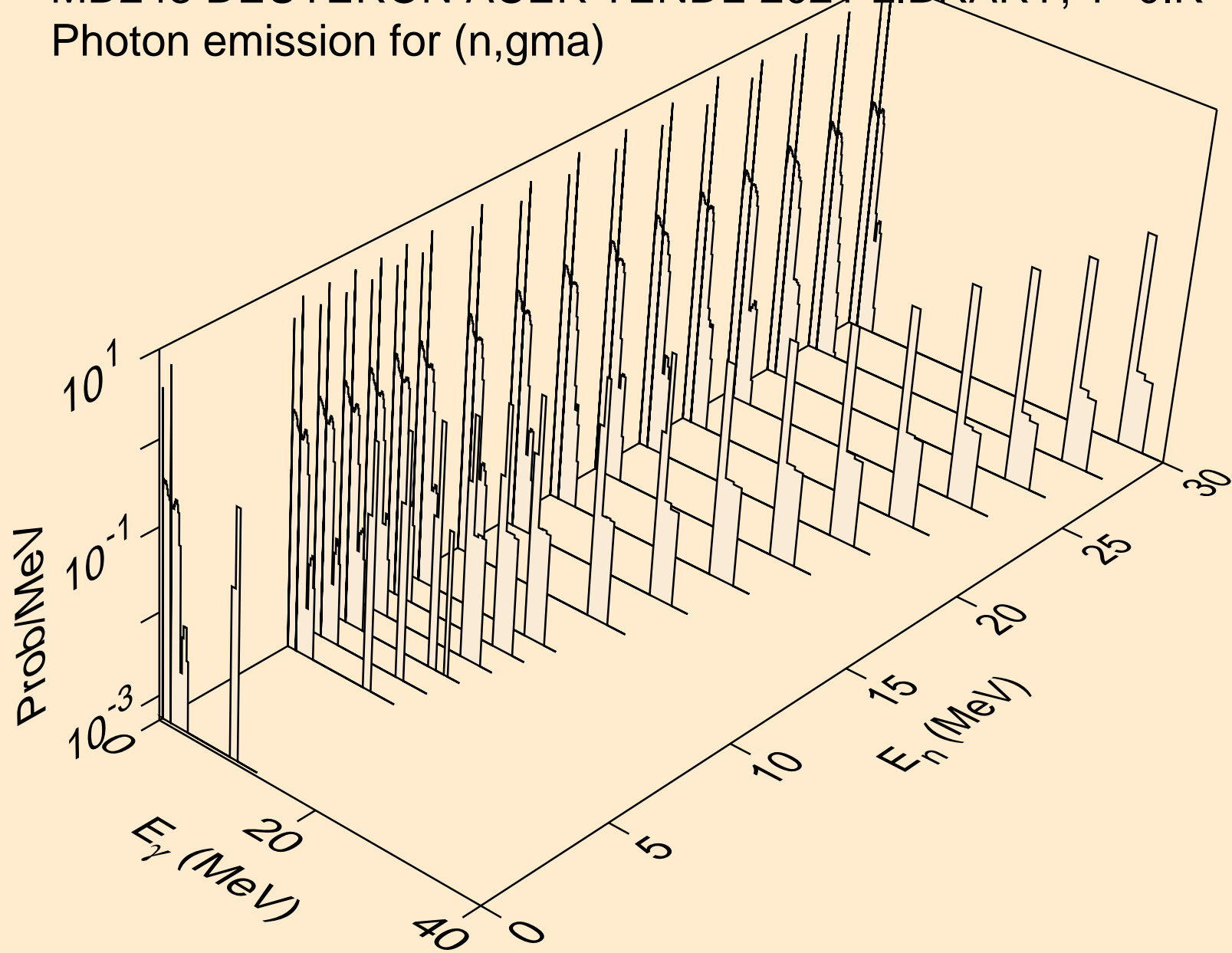

MD248 DEUTERON ACER TENDL-2021 LIBRARY; T=0.K  
Photon emission for (n,p)

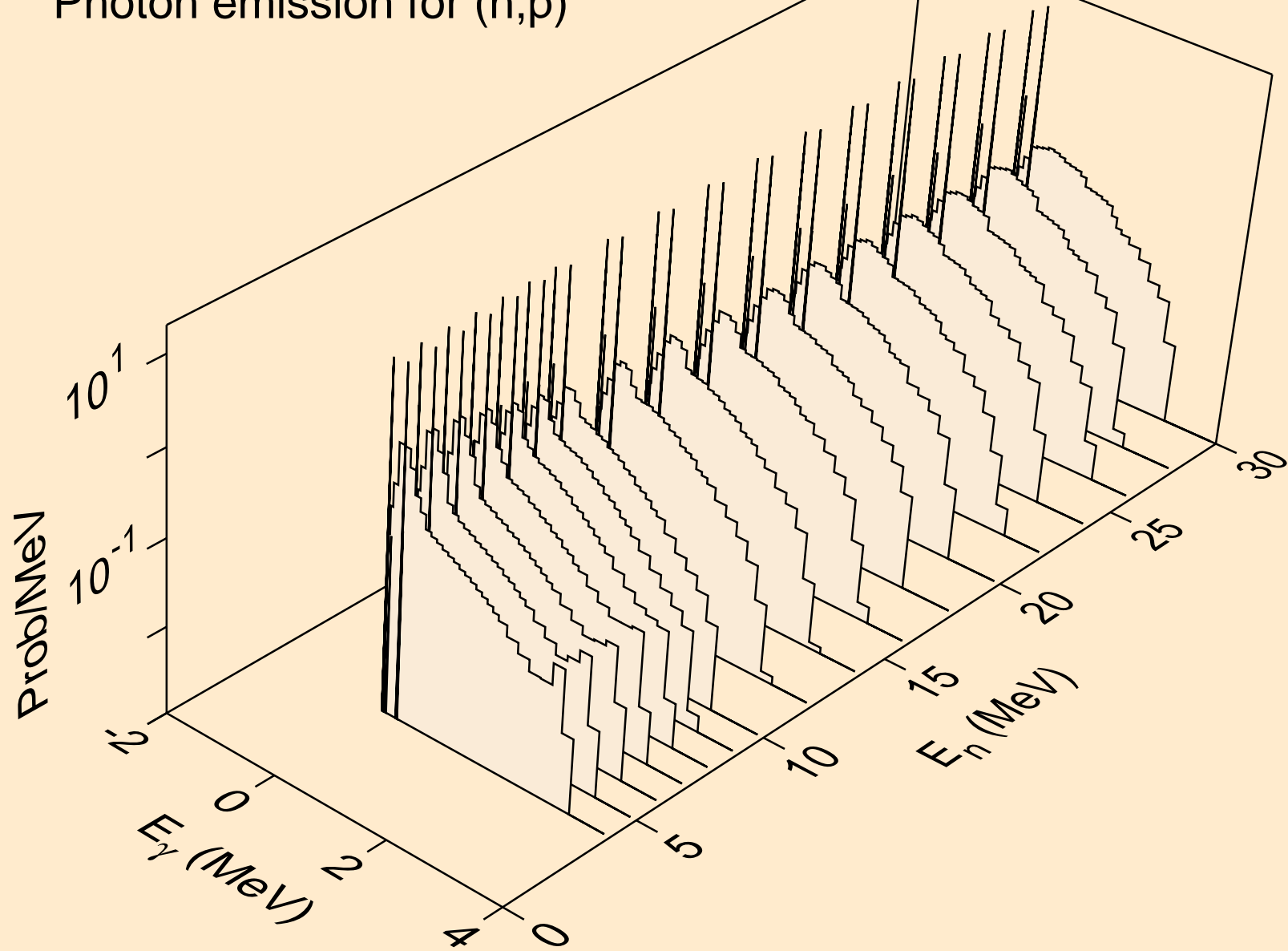

MD248 DEUTERON ACER TENDL-2021 LIBRARY; T=0.K  
Photon emission for inelastic

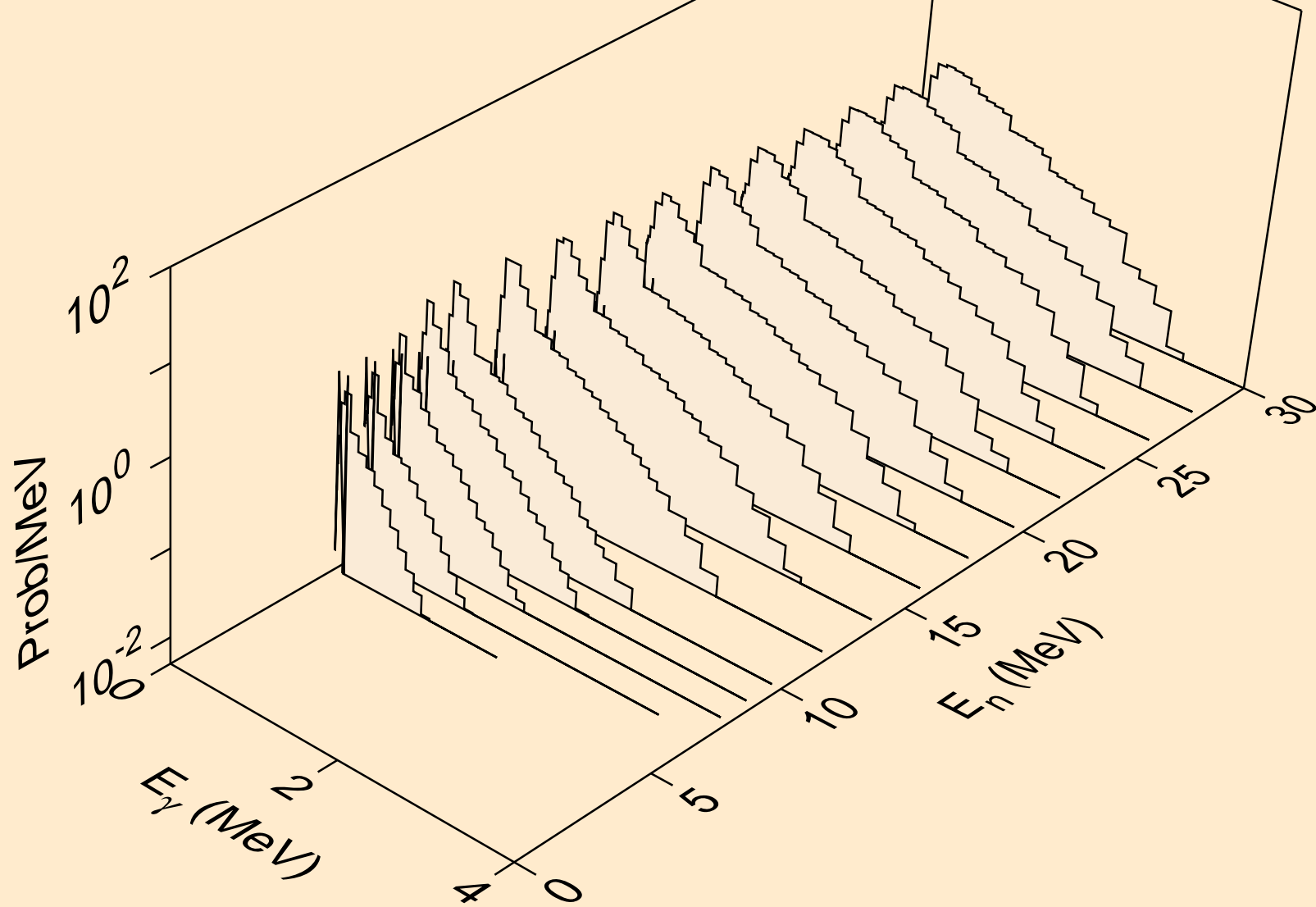

MD248 DEUTERON ACER TENDL-2021 LIBRARY; T=0.K  
Photon emission for (n,t)

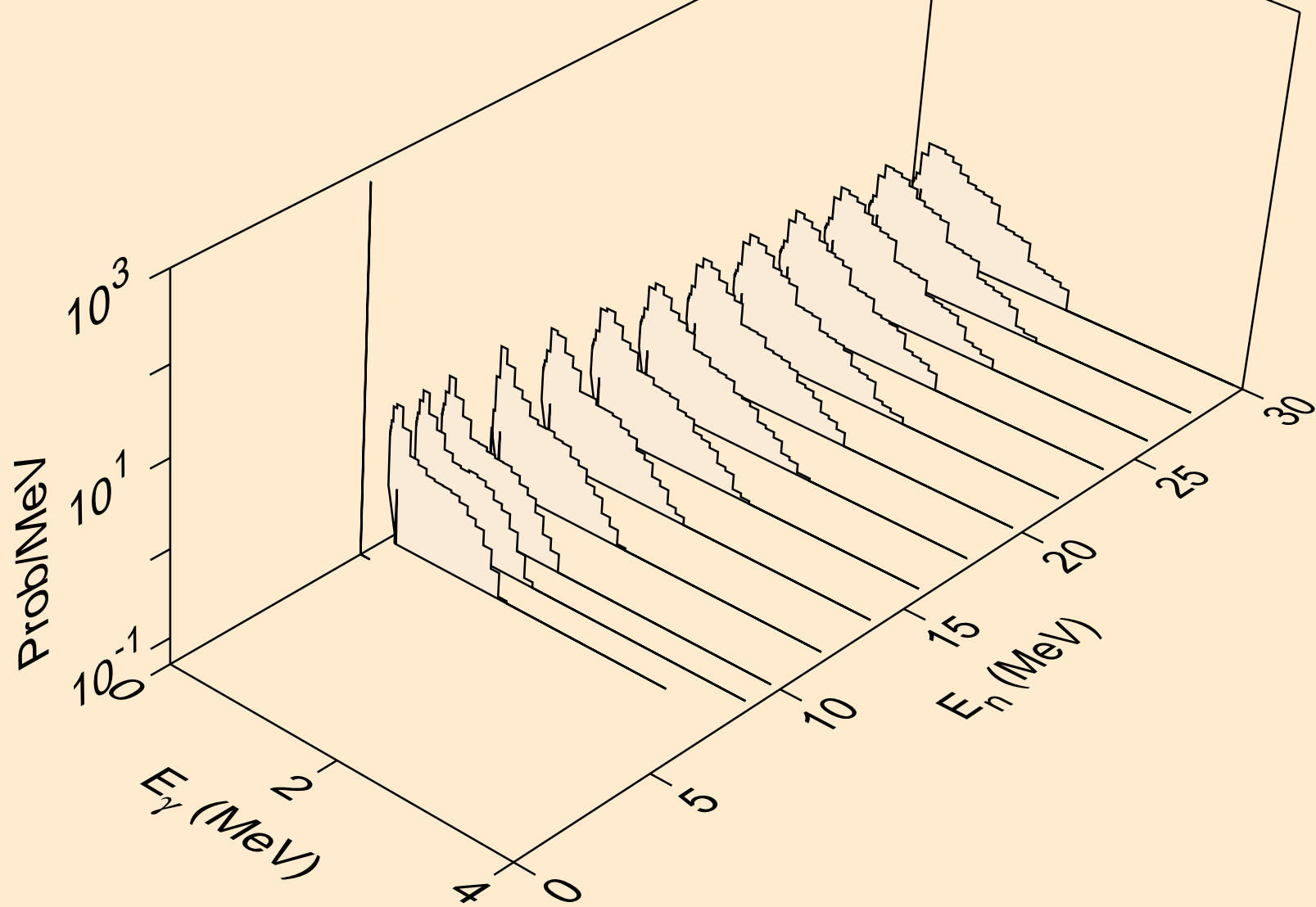

MD248 DEUTERON ACER TENDL-2021 LIBRARY; T=0.K  
Photon emission for (n,he3)

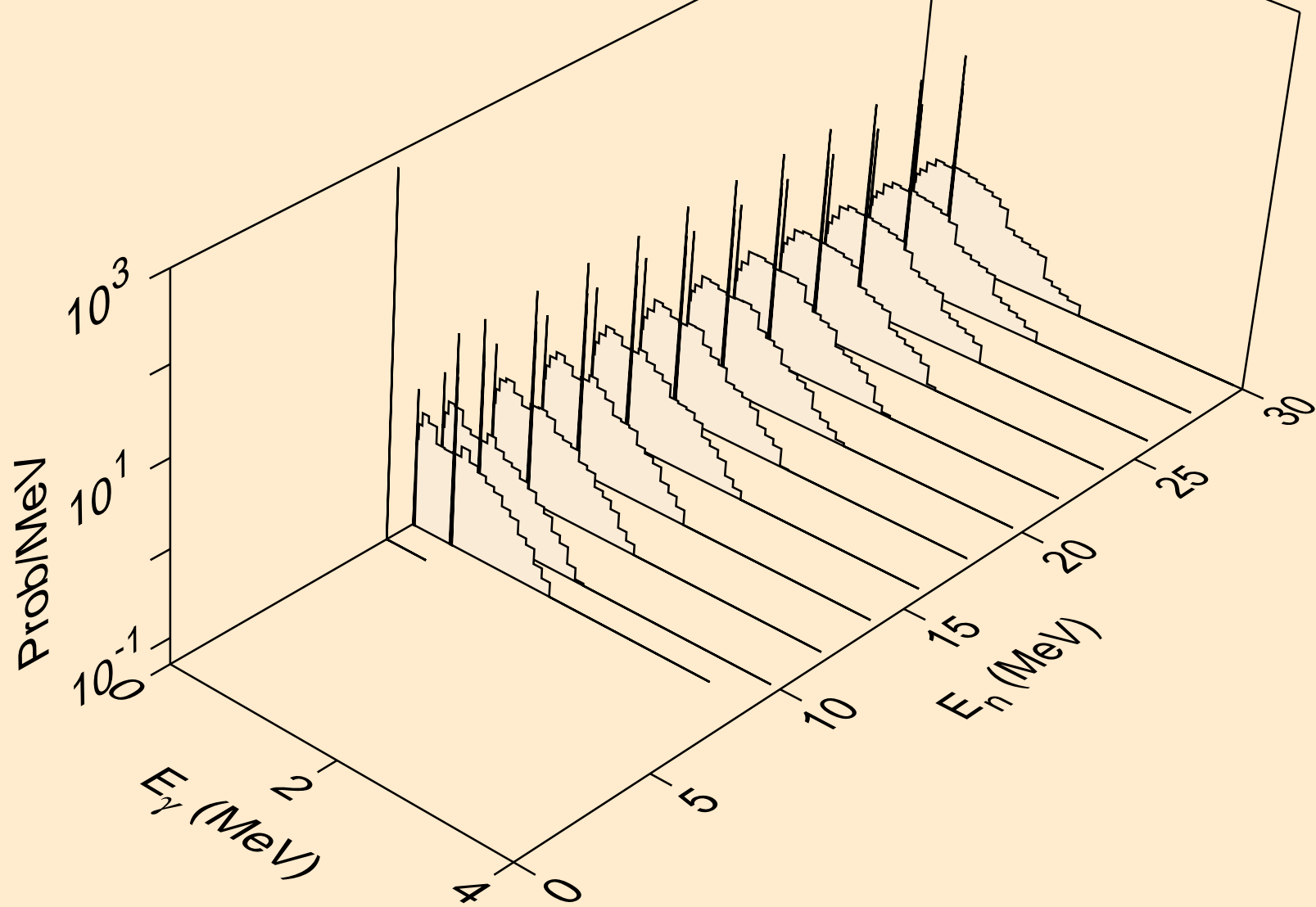

MD248 DEUTERON ACER TENDL-2021 LIBRARY; T=0.K  
Photon emission for (n,a)

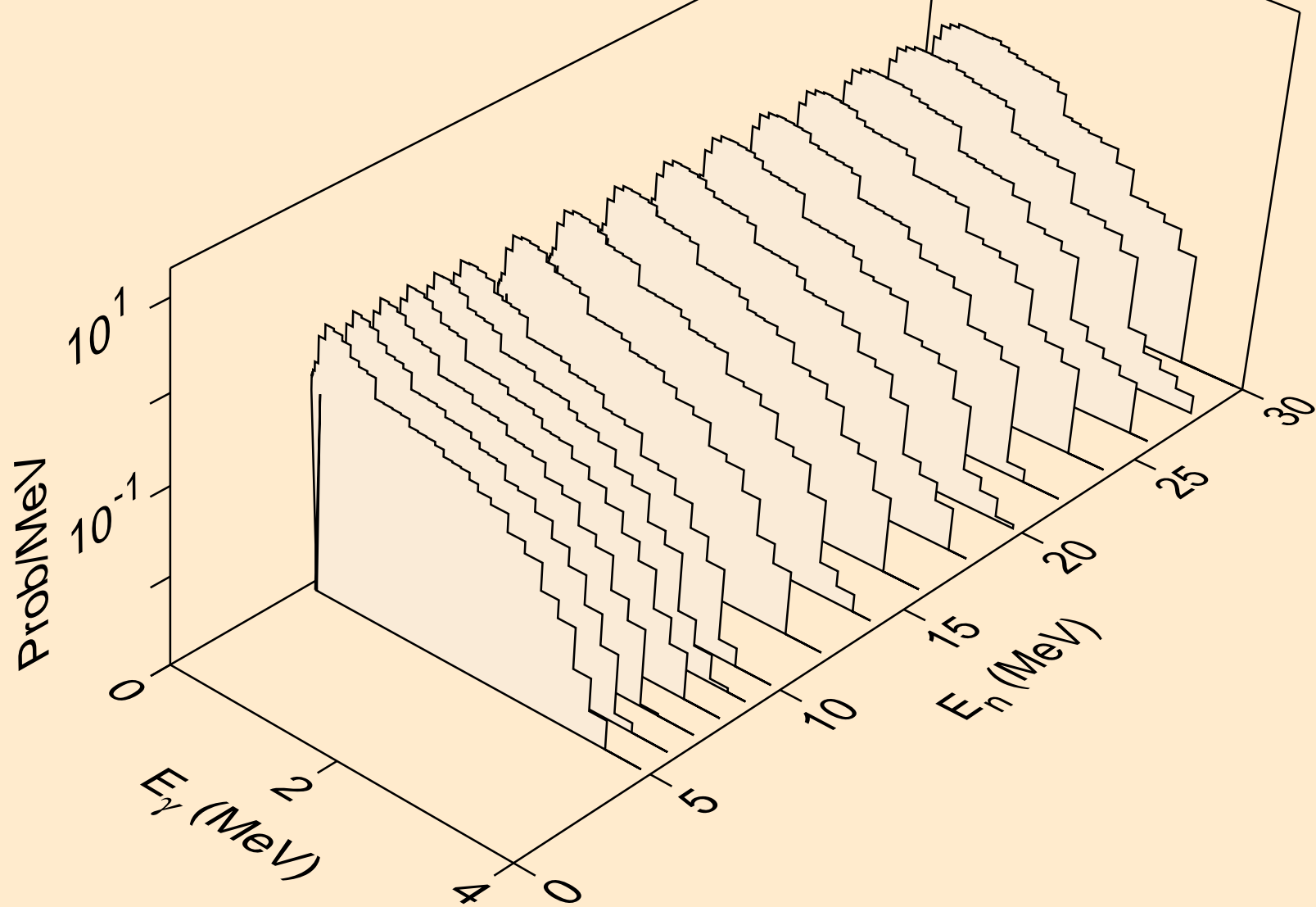

MD248 DEUTERON ACER TENDL-2021 LIBRARY; T=0.K  
Photon emission for (n,2p)

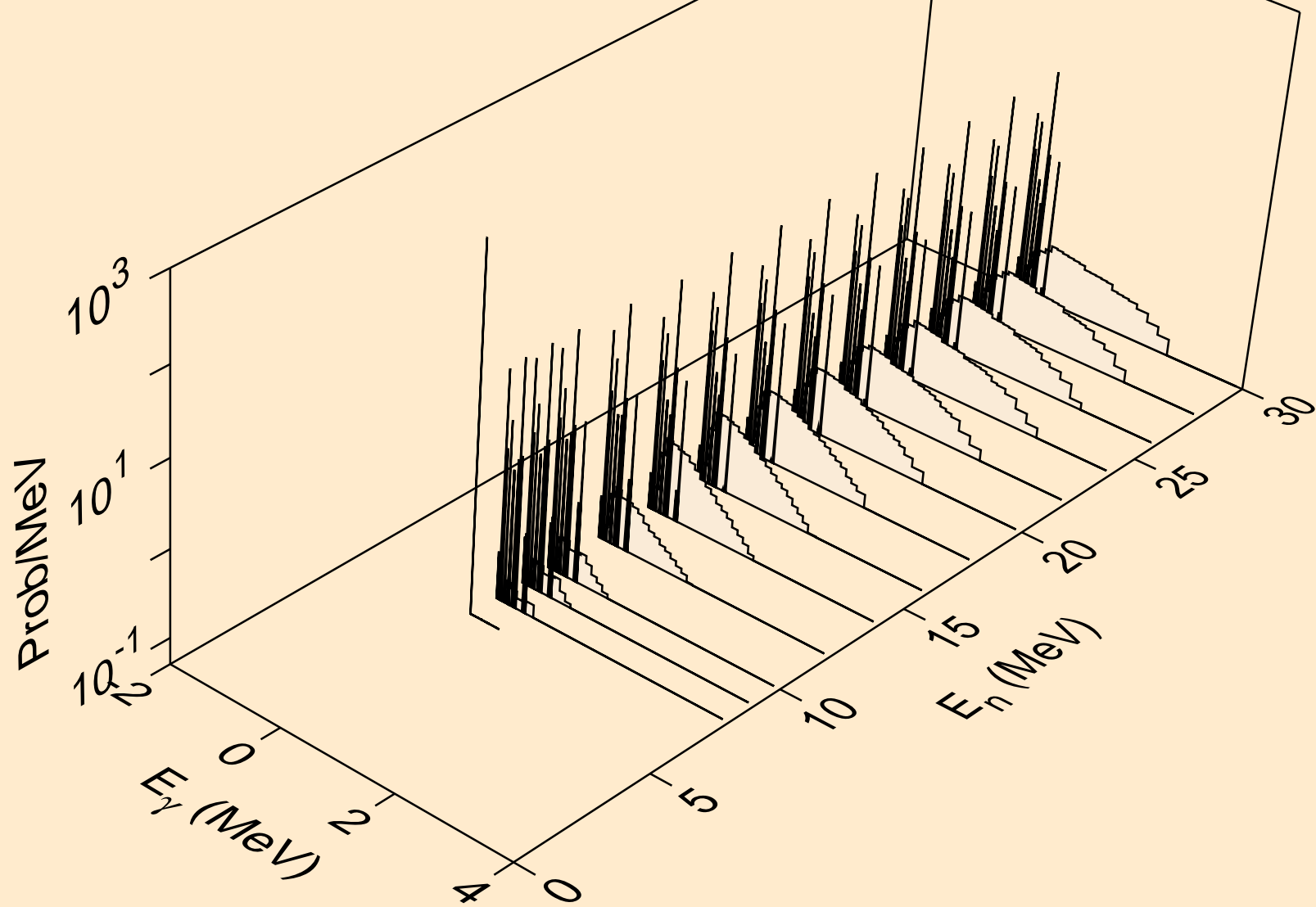



MD248 DEUTERON ACER TENDL-2021 LIBRARY; T=0.K  
Photon emission for (n,p)

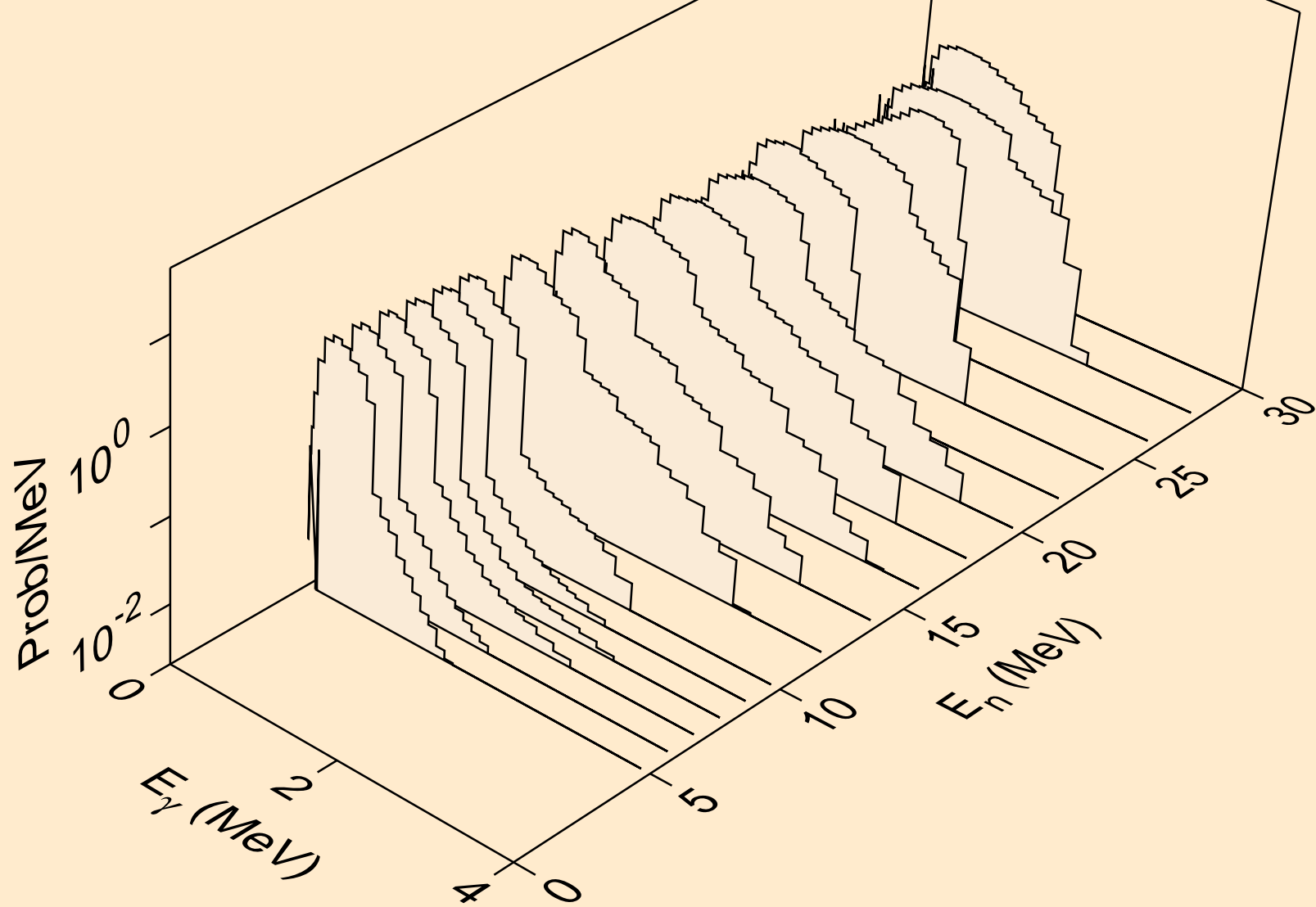

MD248 DEUTERON ACER TENDL-2021 LIBRARY; T=0.K  
Photon emission for (n,pd)

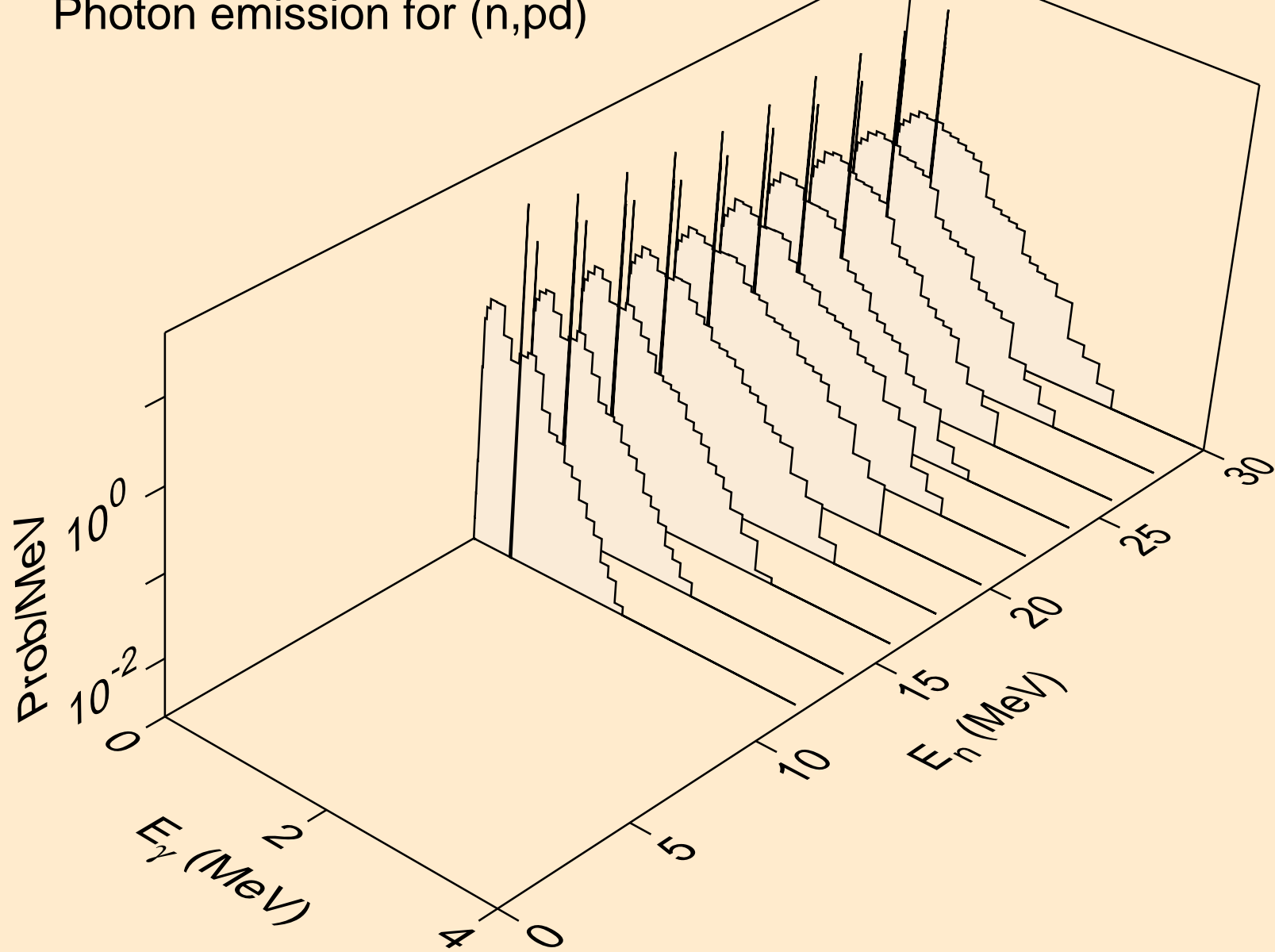

MD248 DEUTERON ACER TENDL-2021 LIBRARY; T=0.K  
Photon emission for (n,da)

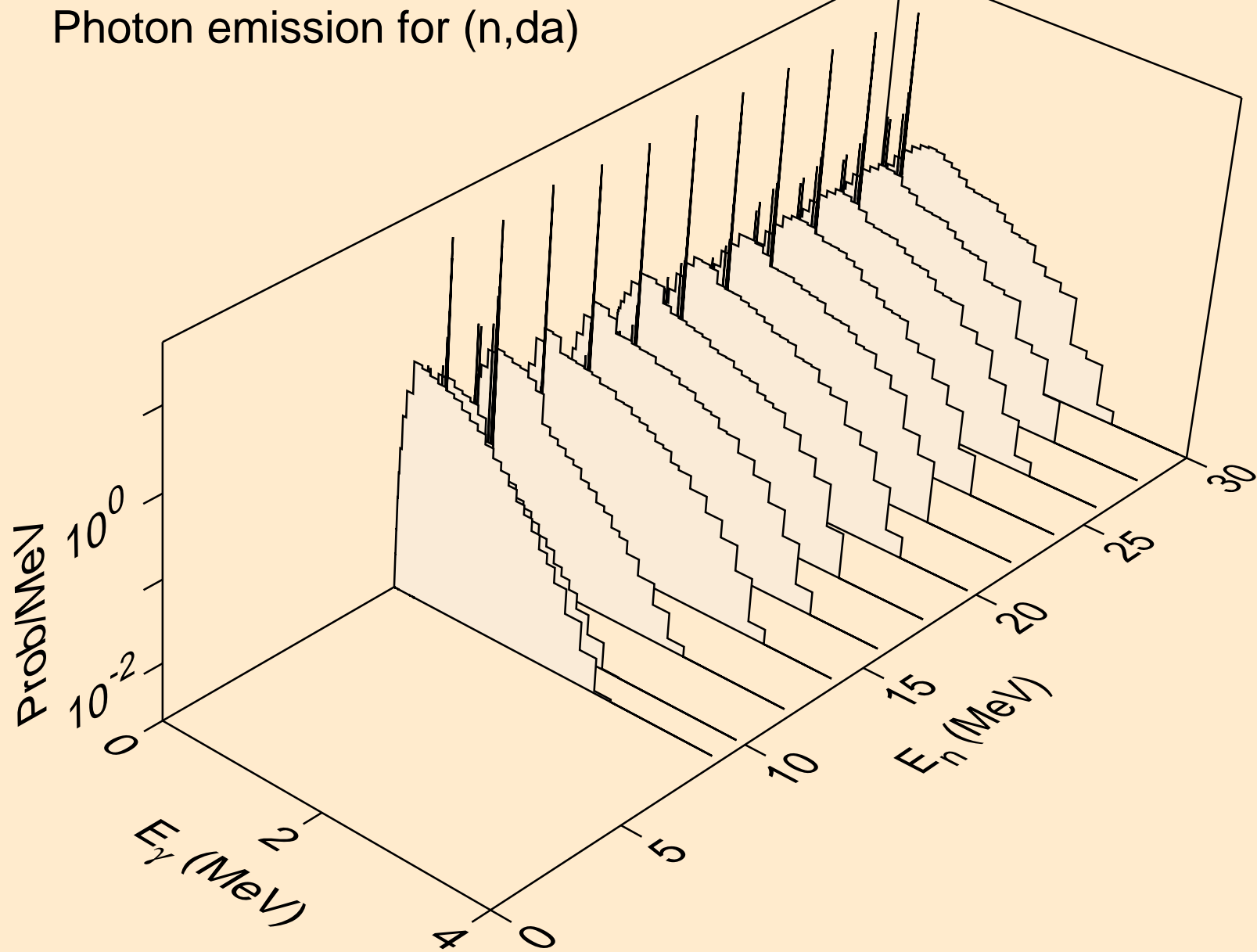

# MD248 DEUTERON ACER TENDL-2021 LIBRARY; T=0.K

## Particle heating contributions

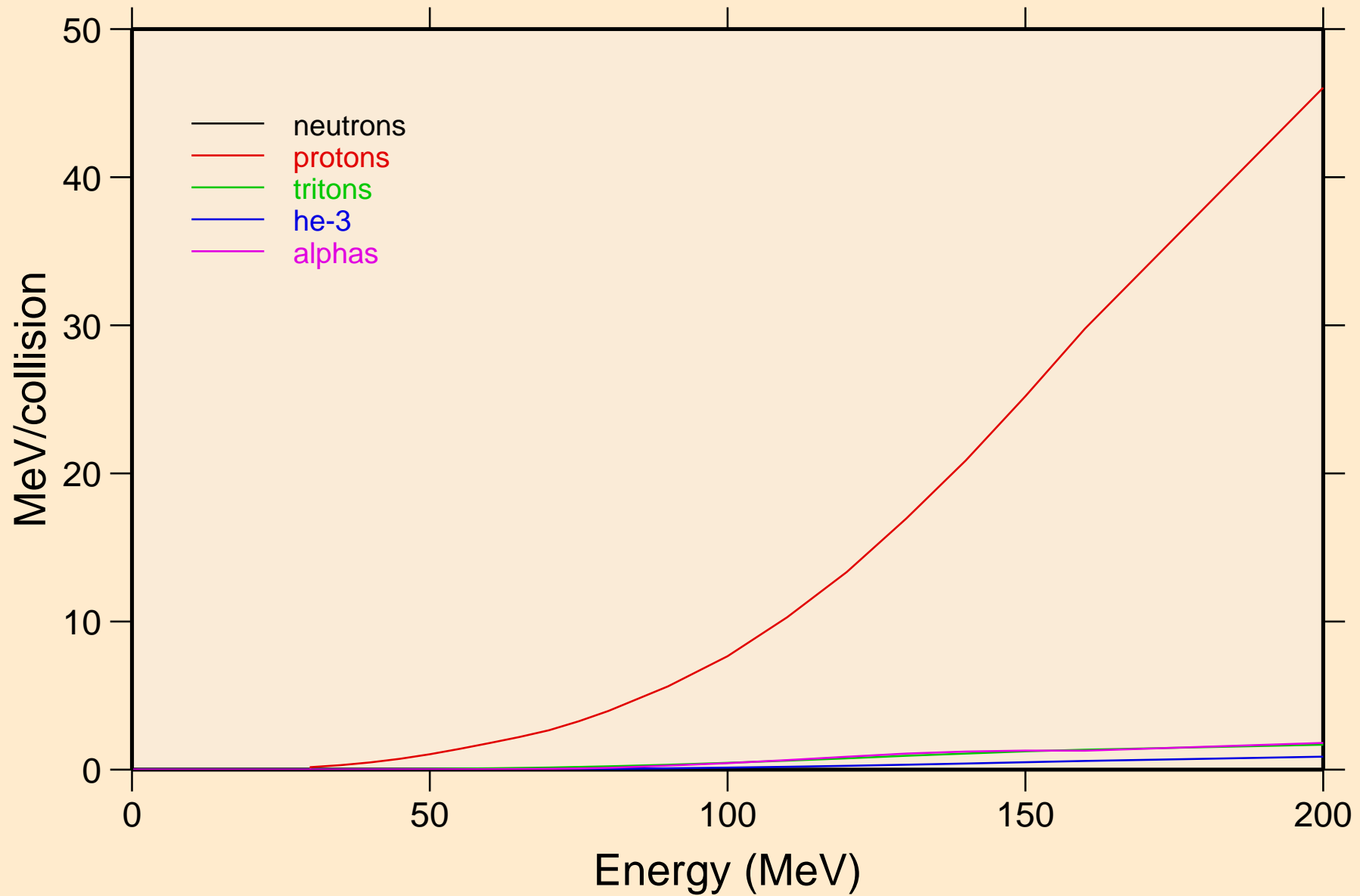

MD248 DEUTERON ACER TENDL-2021 LIBRARY; T=0.K  
Recoil Heating

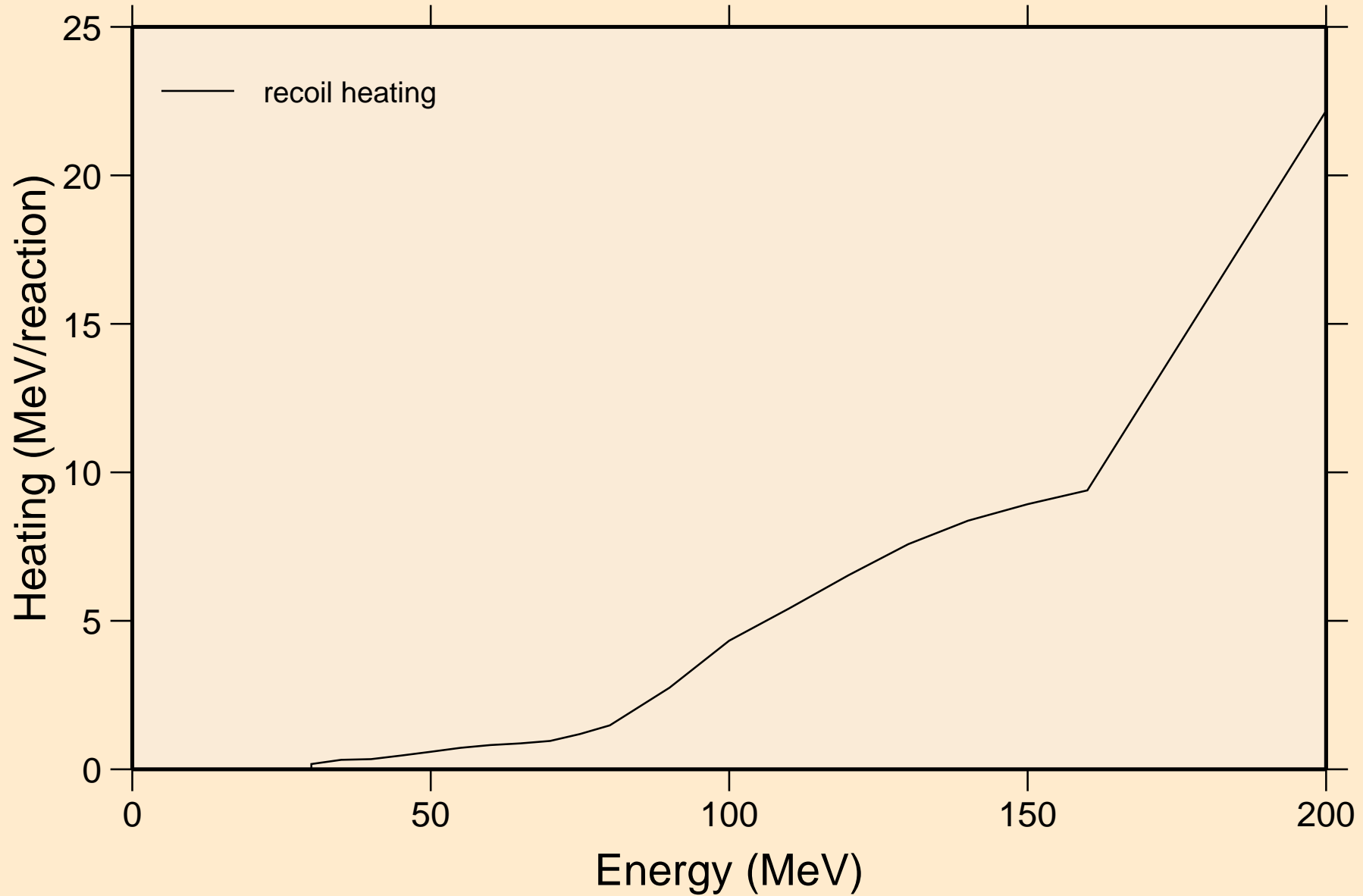

MD248 DEUTERON ACER TENDL-2021 LIBRARY; T=0.K  
Particle production cross sections

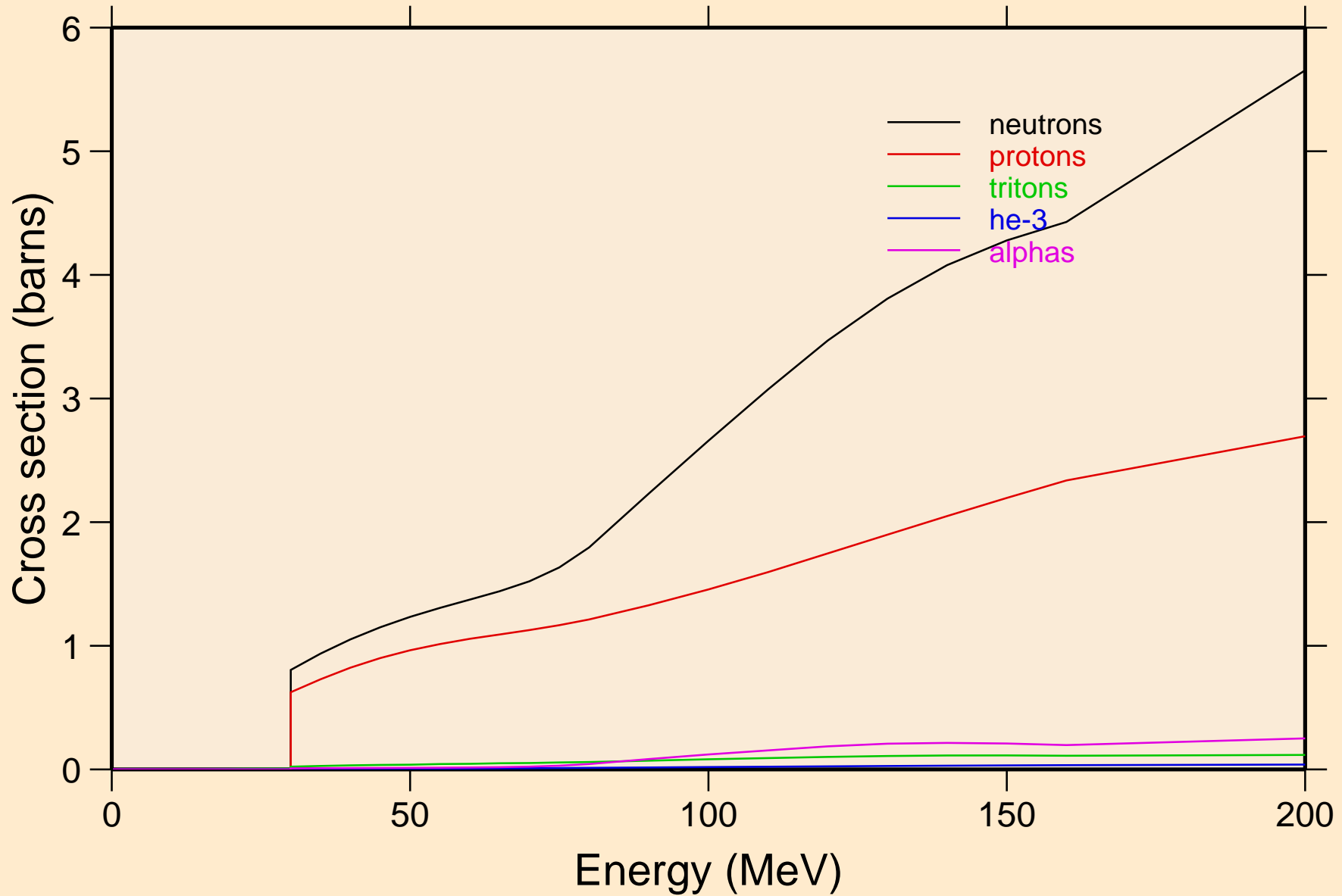

MD248 DEUTERON ACER TENDL-2021 LIBRARY; T=0.K  
neutrons from (d,n)

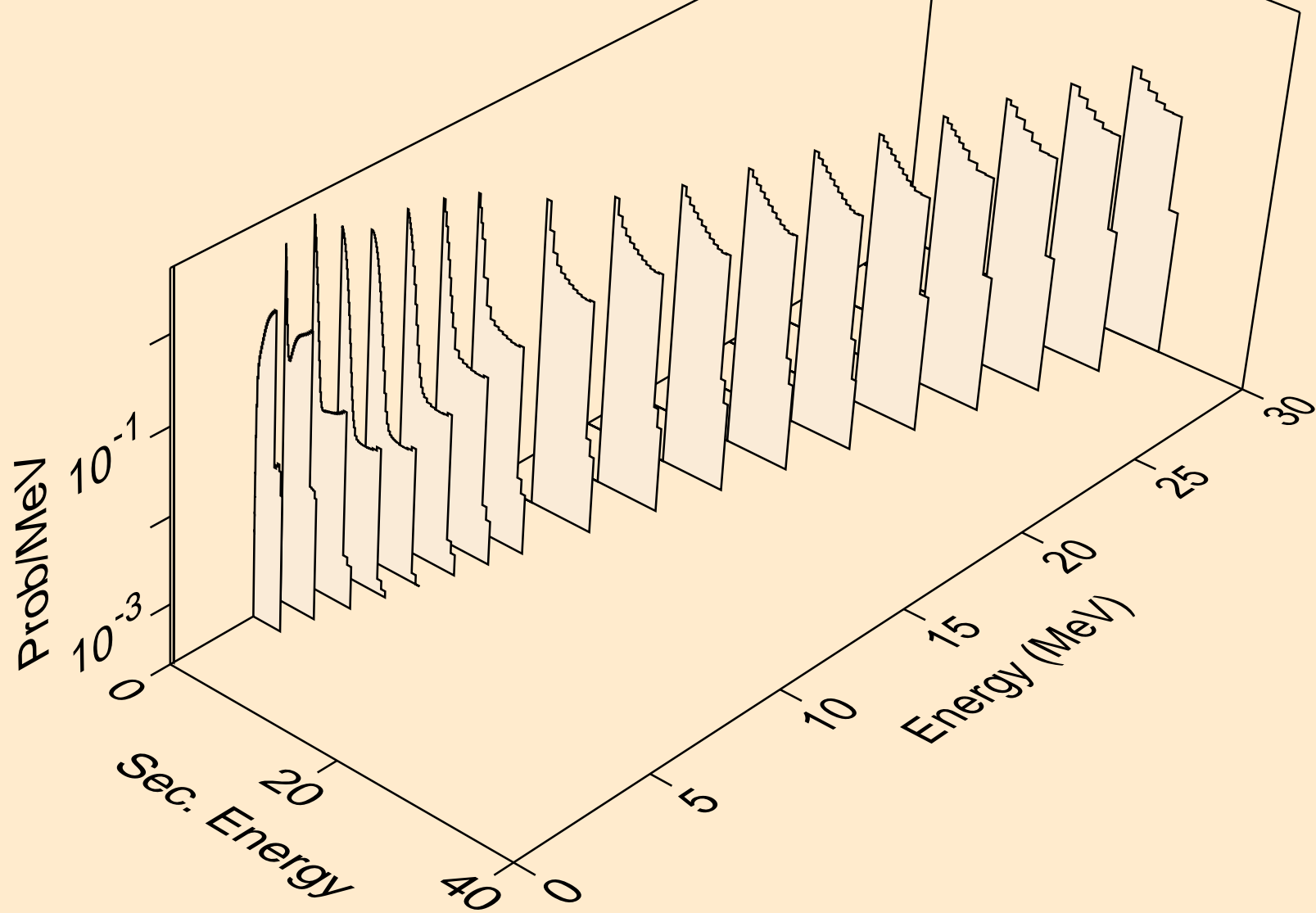

MD248 DEUTERON ACER TENDL-2021 LIBRARY; T=0.K  
neutrons from (d,x)

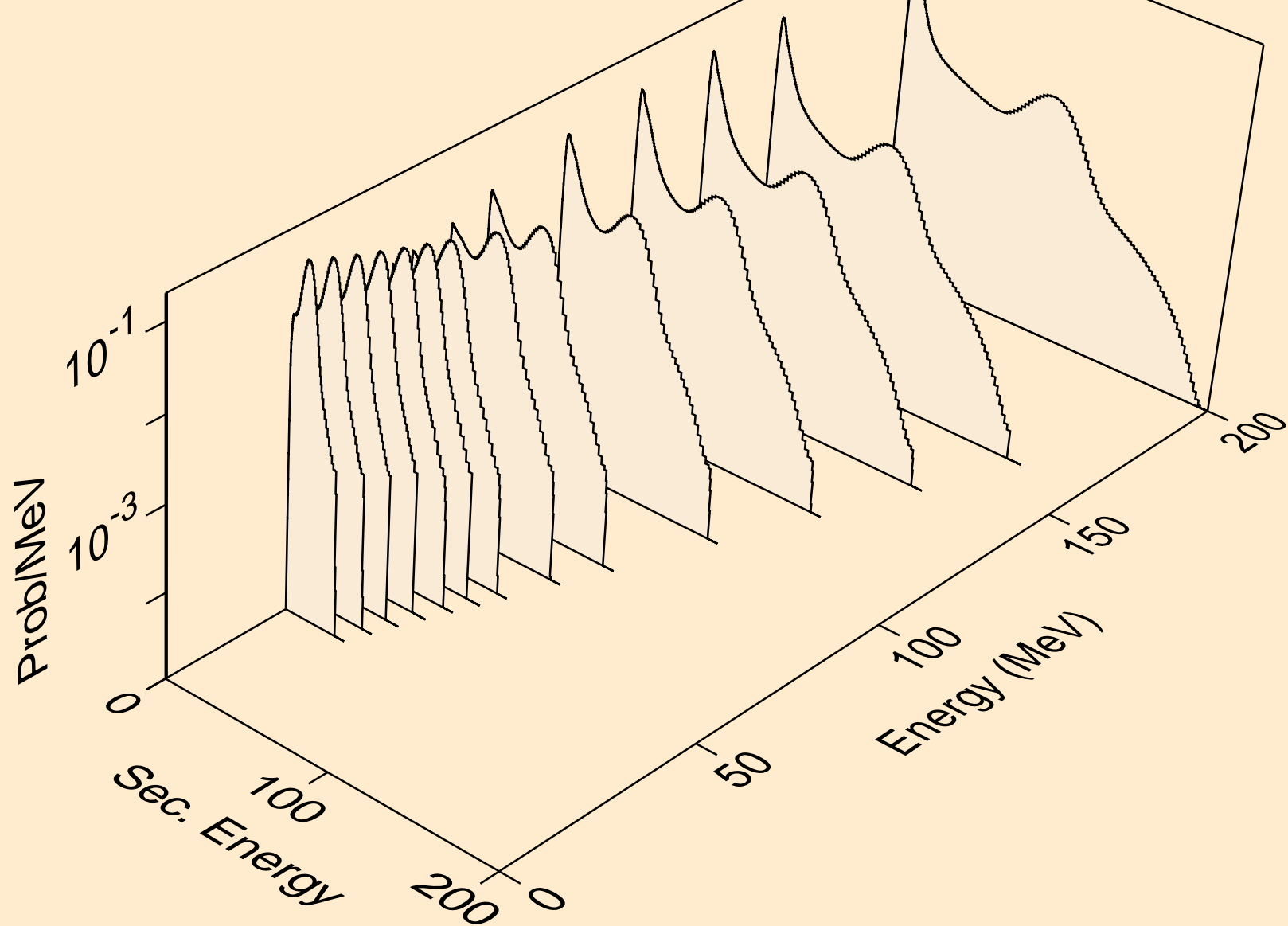



MD248 DEUTERON ACER TENDL-2021 LIBRARY; T=0.K  
neutrons from (d,2n)

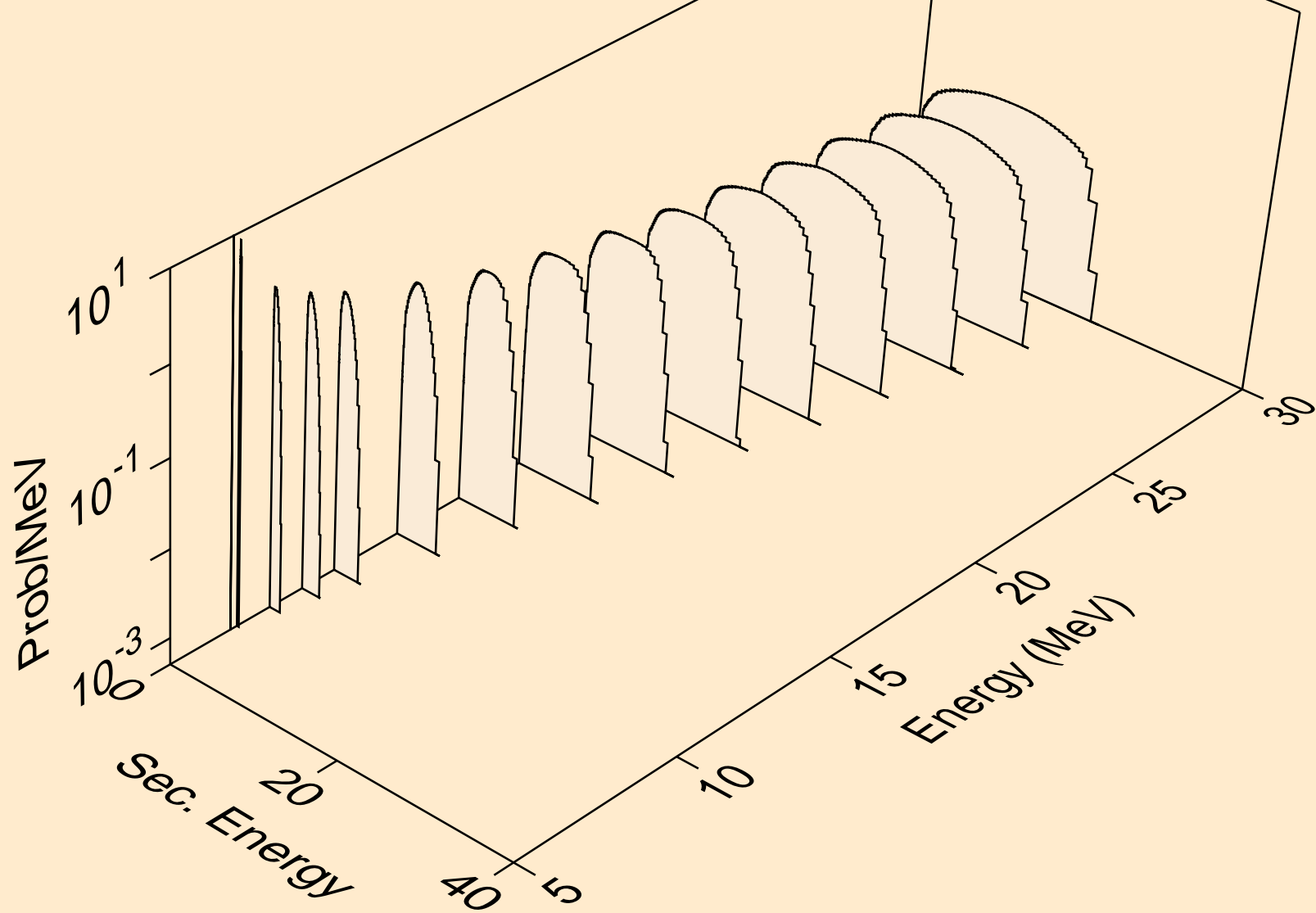

MD248 DEUTERON ACER TENDL-2021 LIBRARY; T=0.K  
neutrons from (d,3n)

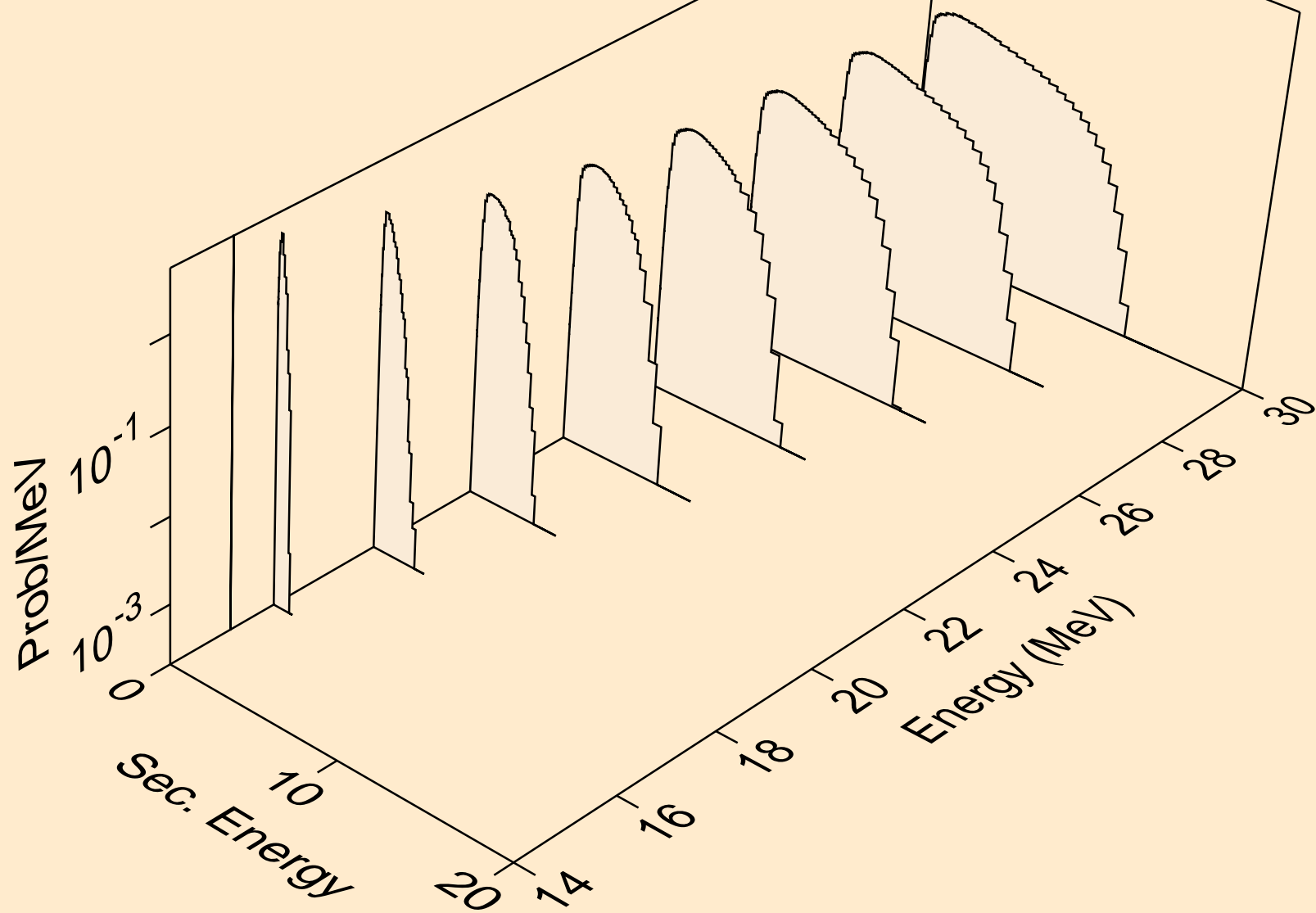

MD248 DEUTERON ACER TENDL-2021 LIBRARY; T=0.K  
neutrons from (d,n\*)a

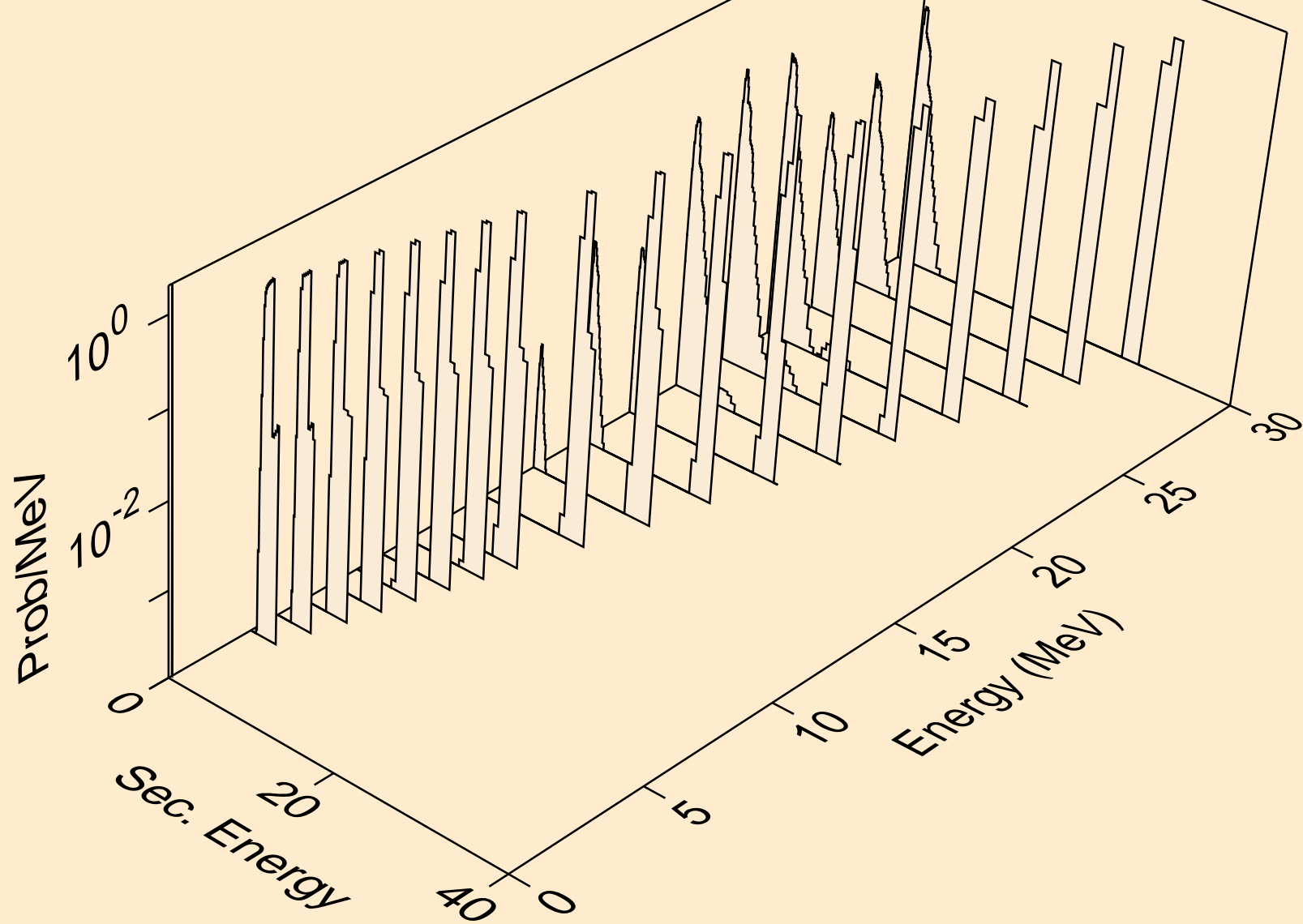

MD248 DEUTERON ACER TENDL-2021 LIBRARY; T=0.K  
neutrons from (d,2n)a

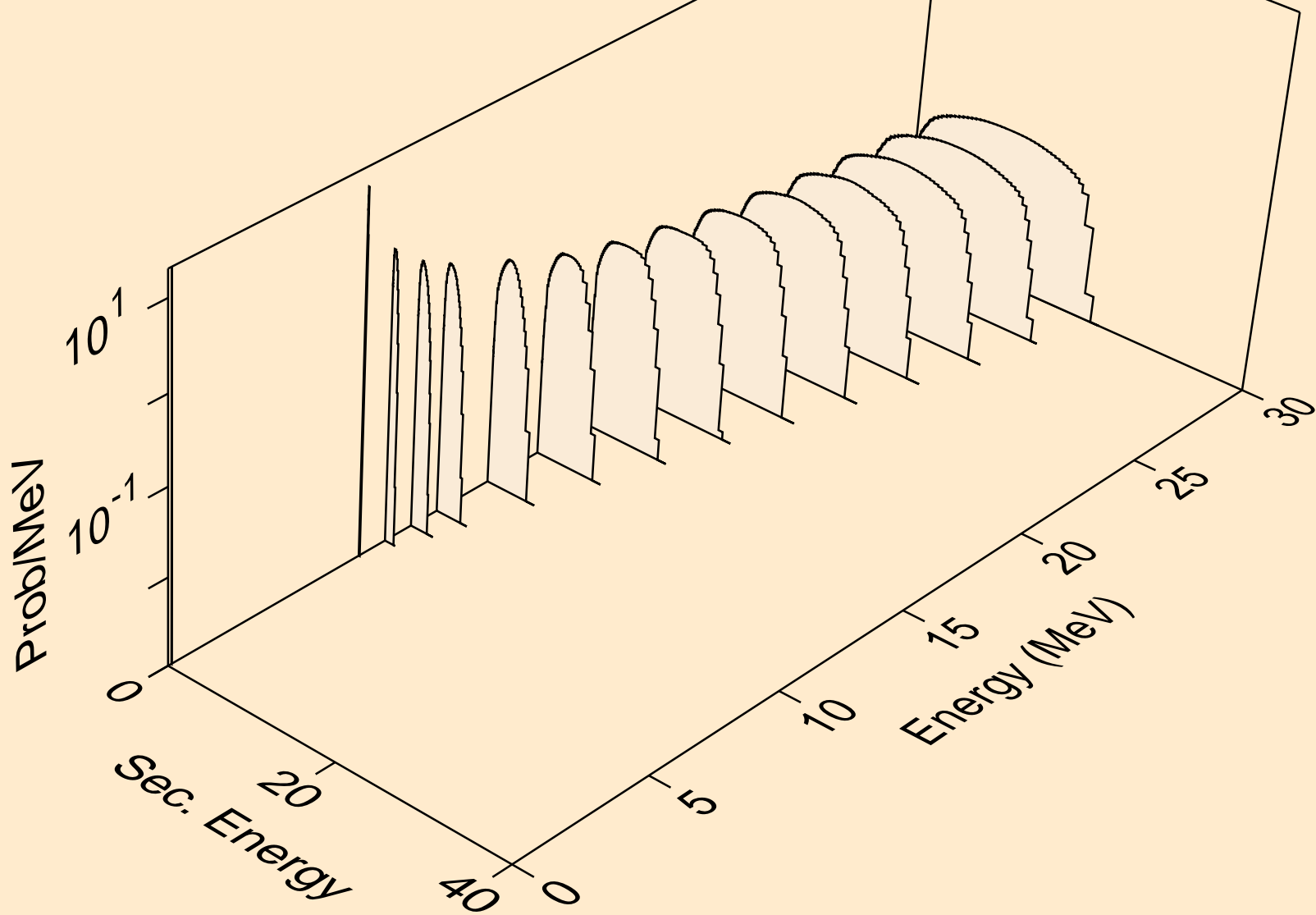

MD248 DEUTERON ACER TENDL-2021 LIBRARY; T=0.K  
neutrons from (d,3n)a

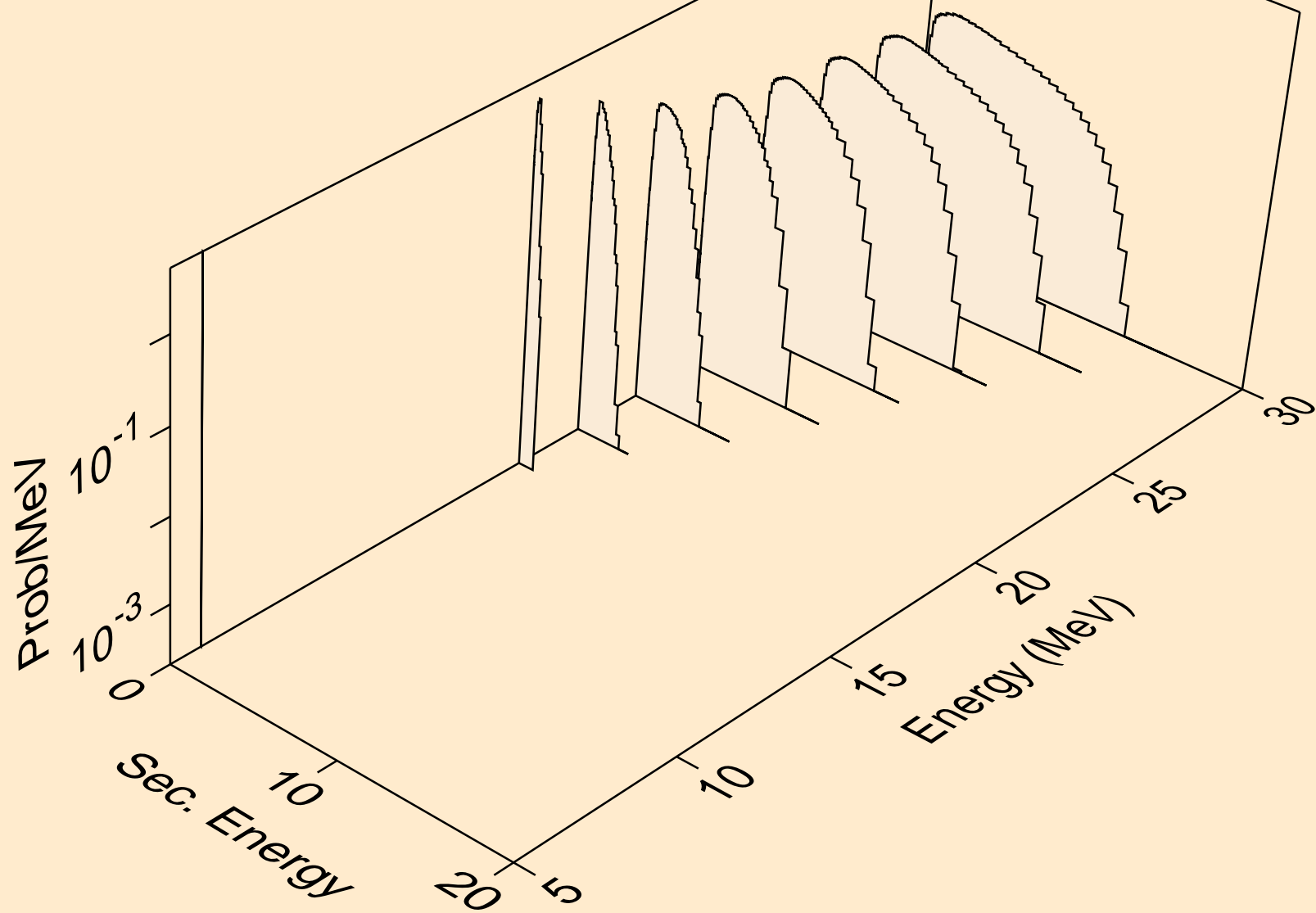

MD248 DEUTERON ACER TENDL-2021 LIBRARY; T=0.K  
neutrons from (d,n\*)p

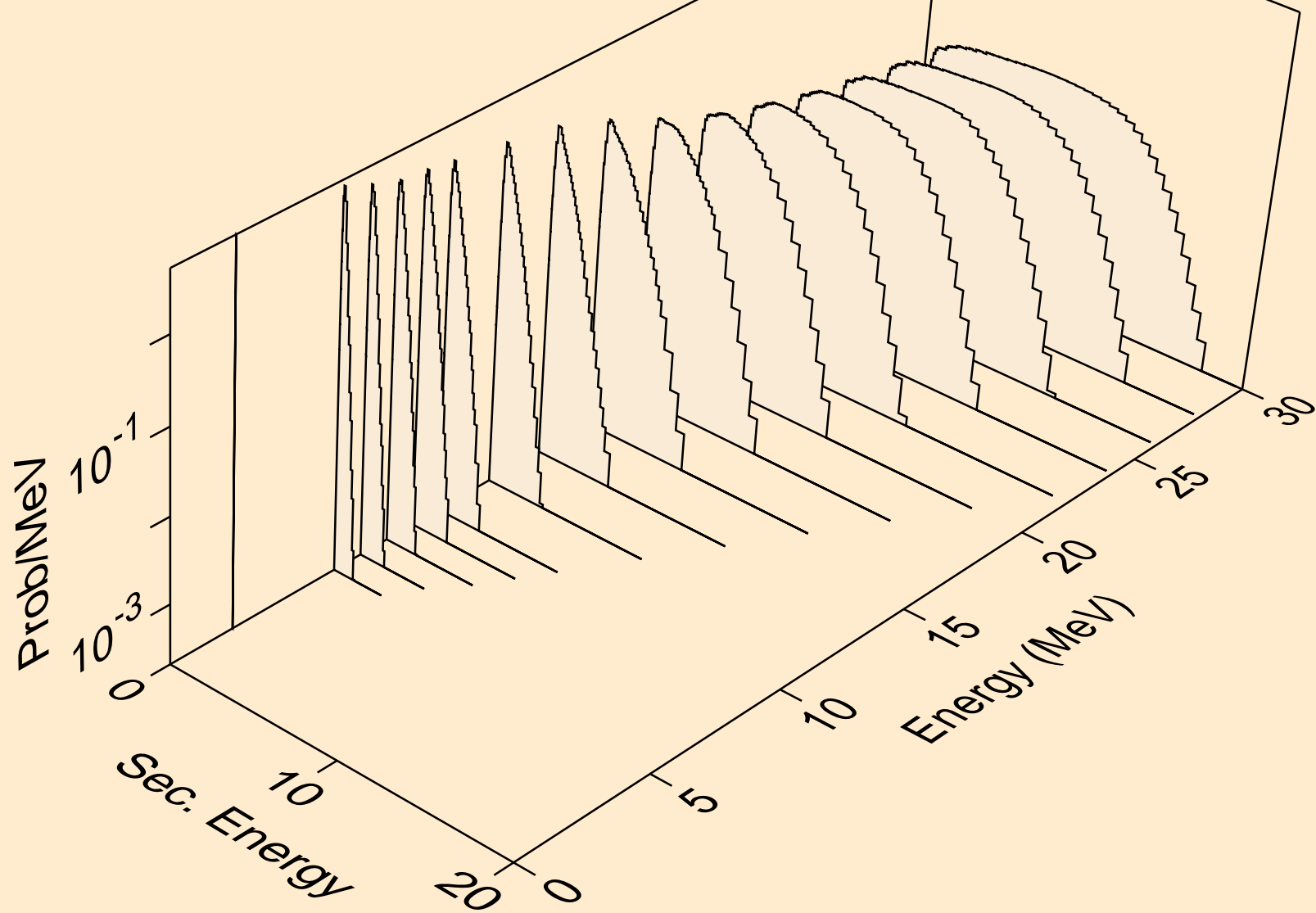

MD248 DEUTERON ACER TENDL-2021 LIBRARY; T=0.K  
neutrons from (d,n\*)d

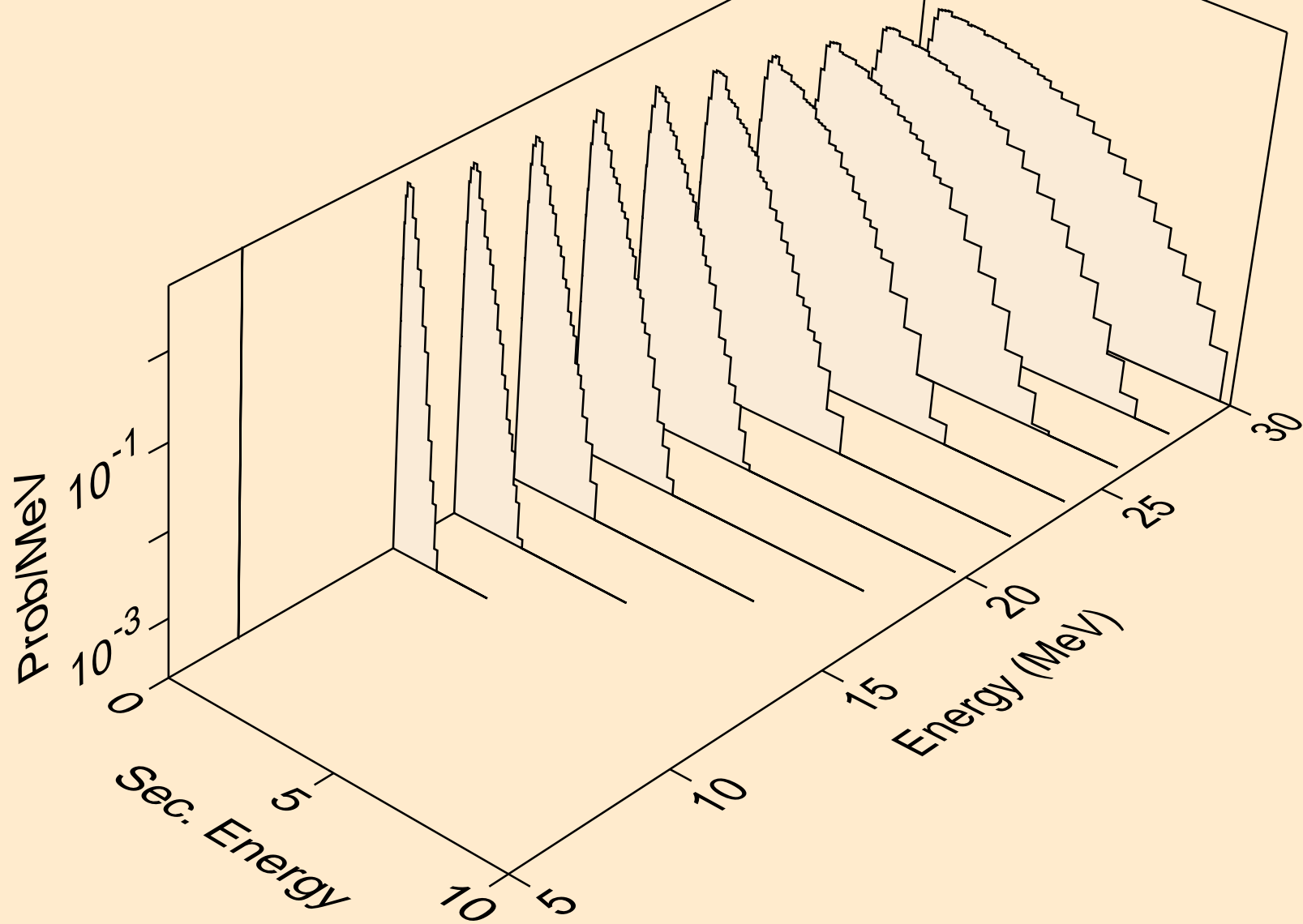

MD248 DEUTERON ACER TENDL-2021 LIBRARY; T=0.K  
neutrons from (d,n\*)t

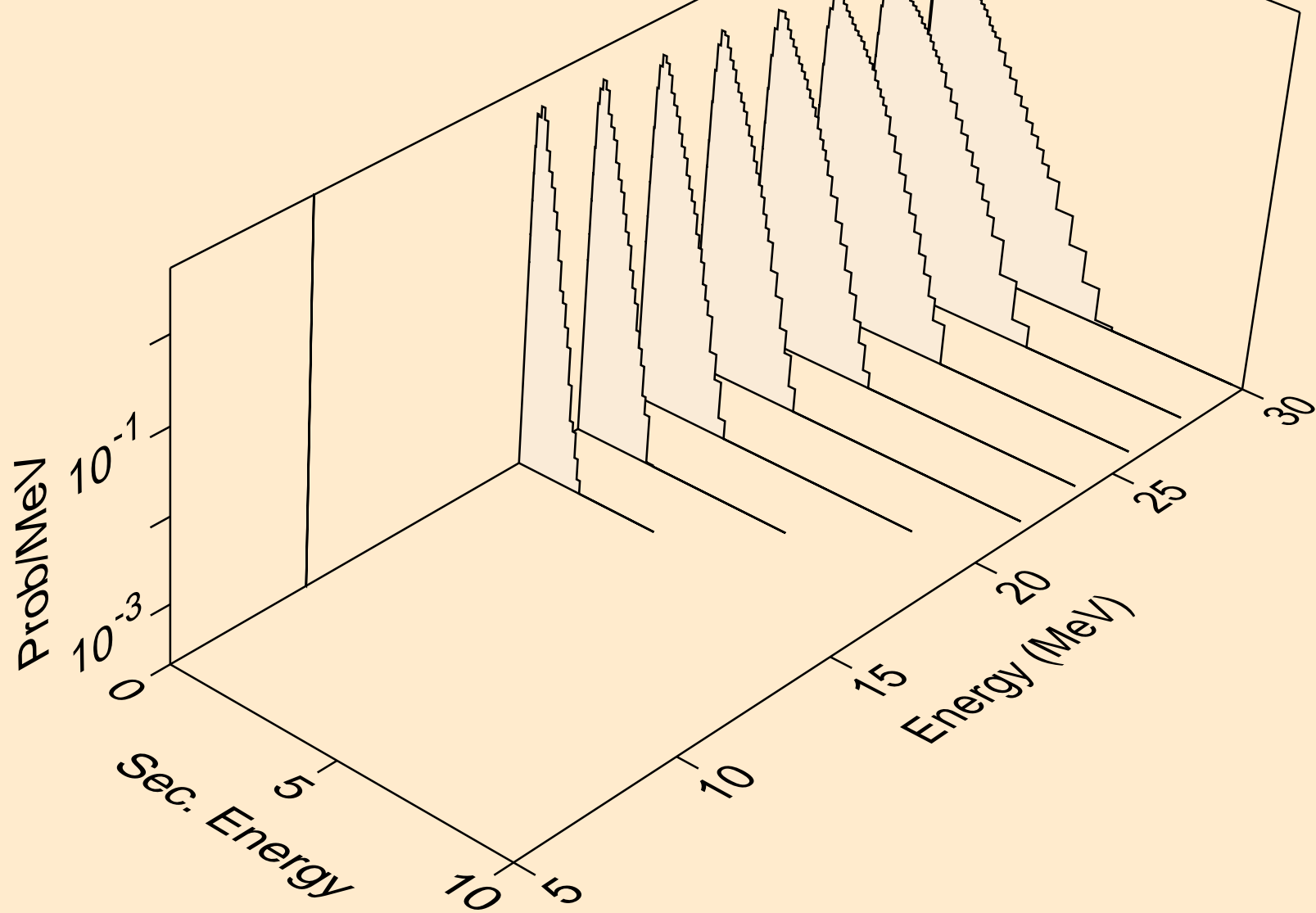



MD248 DEUTERON ACER TENDL-2021 LIBRARY; T=0.K  
neutrons from (d,n\*)he3

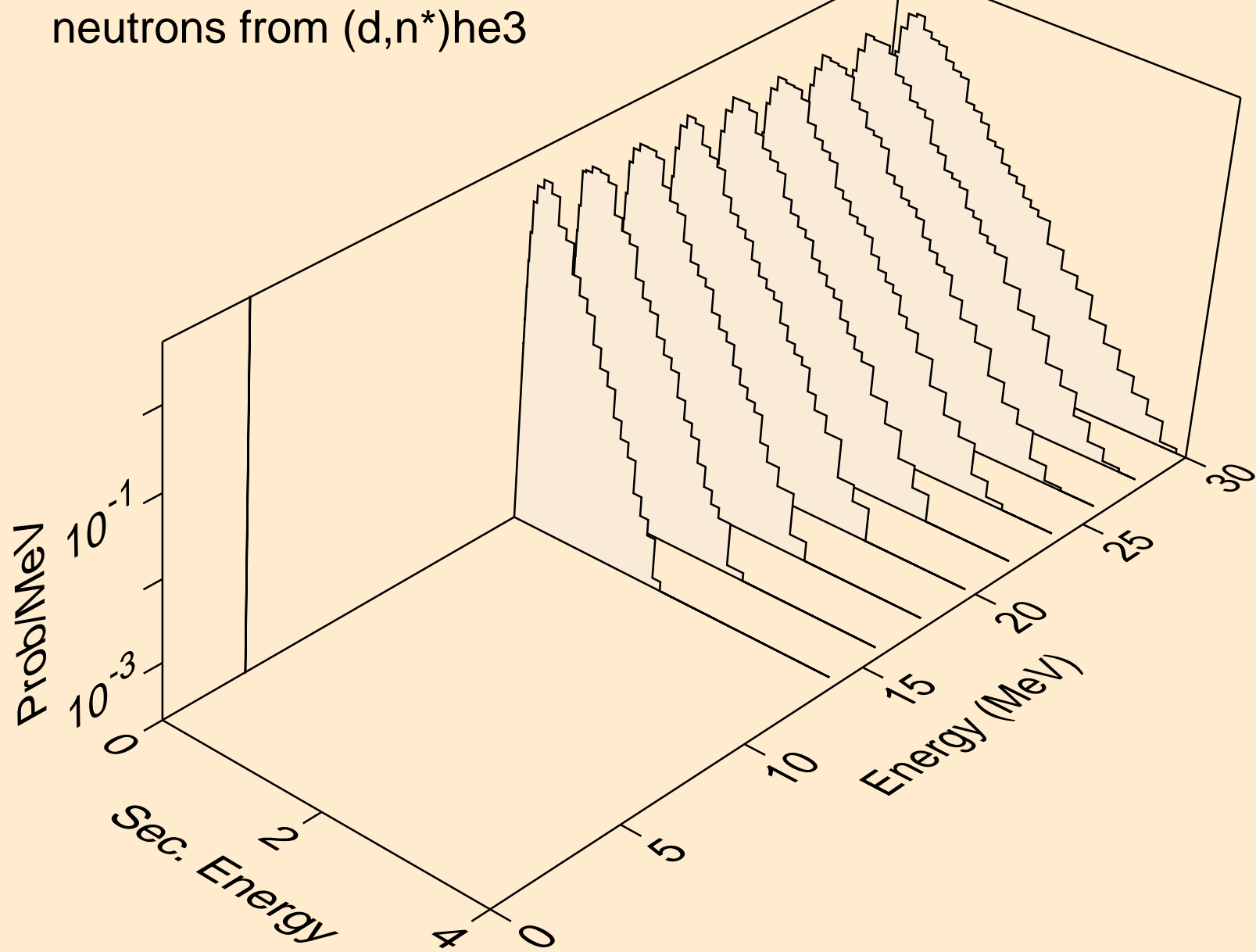

MD248 DEUTERON ACER TENDL-2021 LIBRARY; T=0.K  
neutrons from (d,2np)

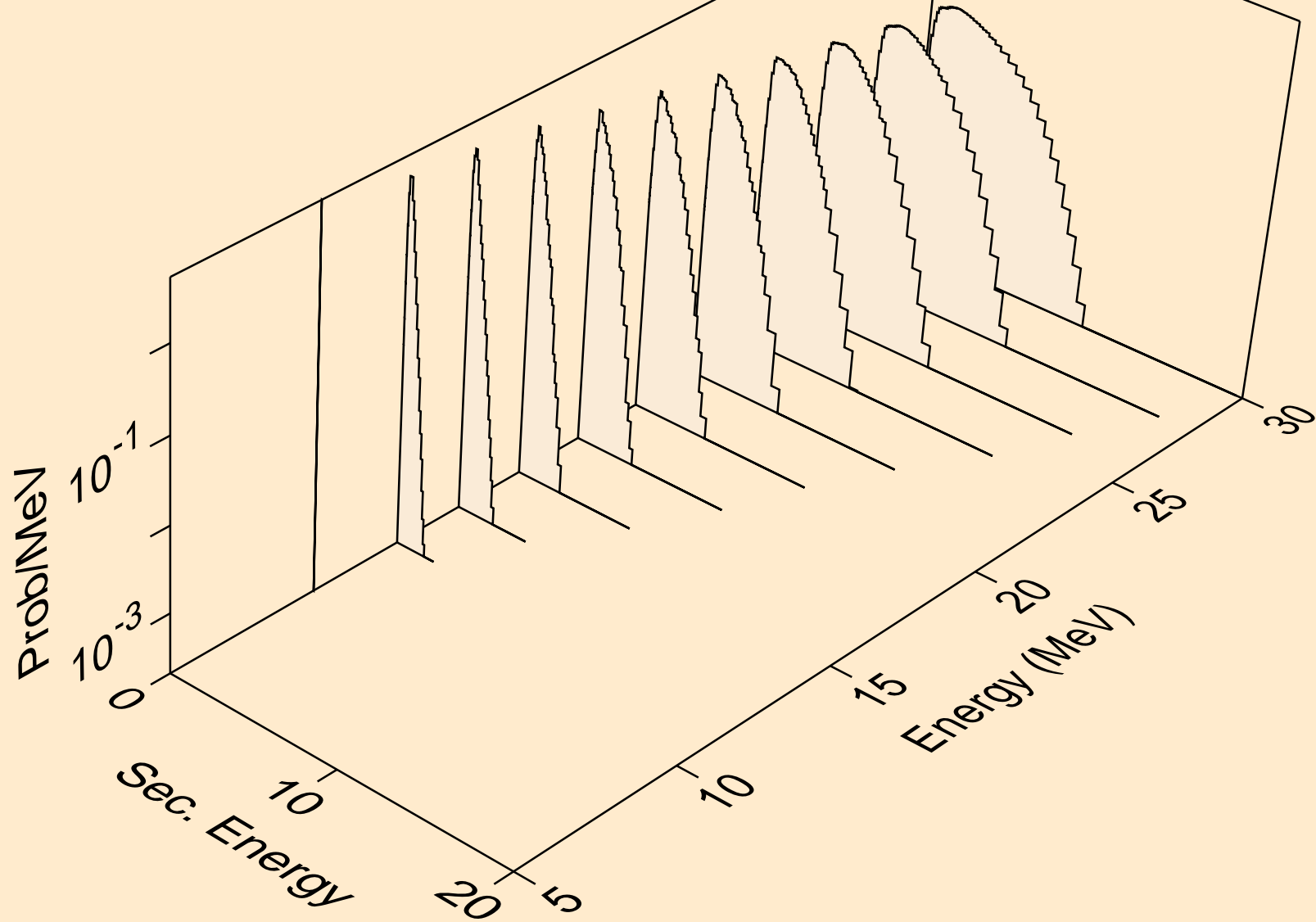

MD248 DEUTERON ACER TENDL-2021 LIBRARY; T=0.K  
neutrons from (d,2np)

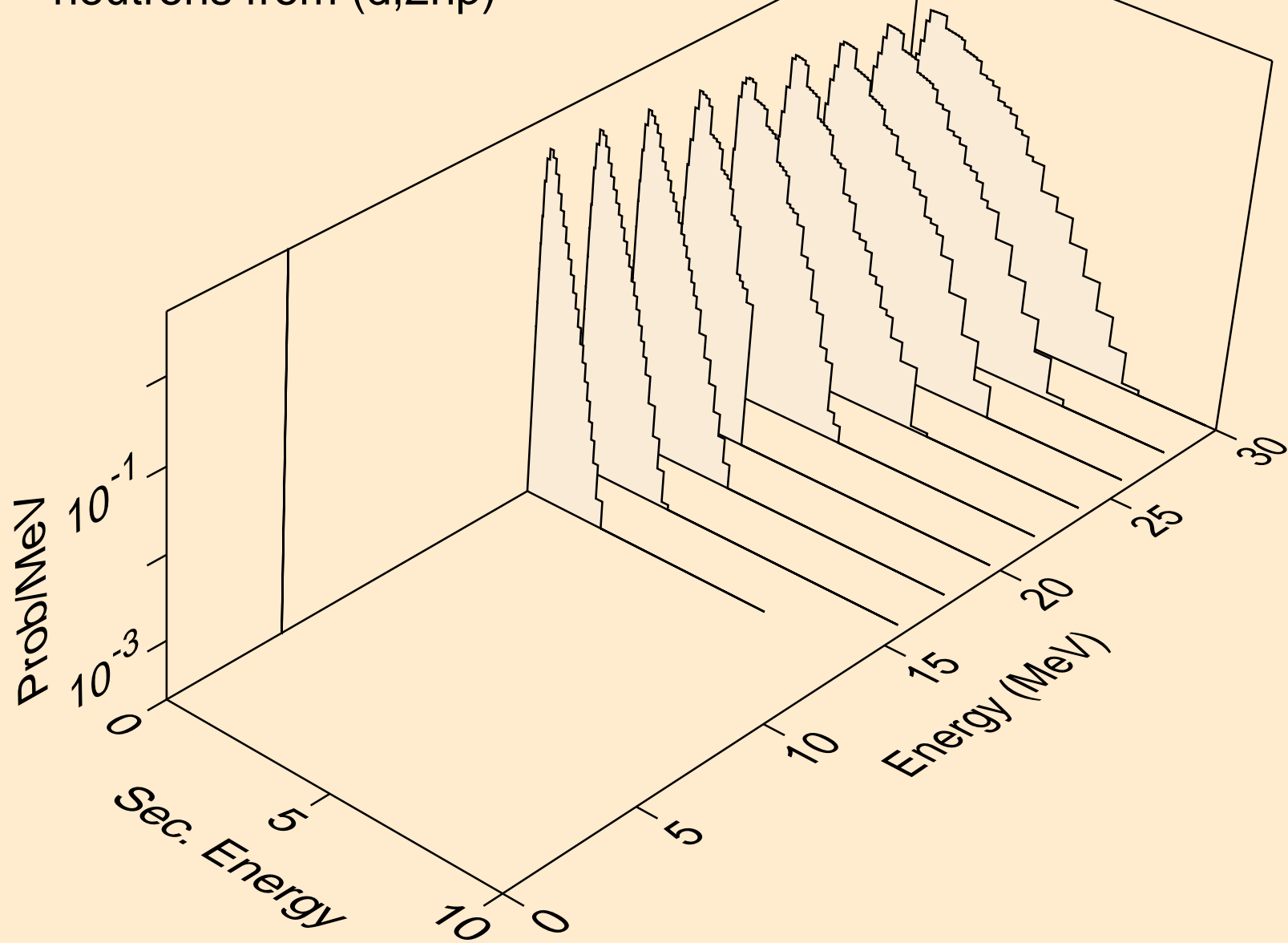

MD248 DEUTERON ACER TENDL-2021 LIBRARY; T=0.K  
protons from (d,x)

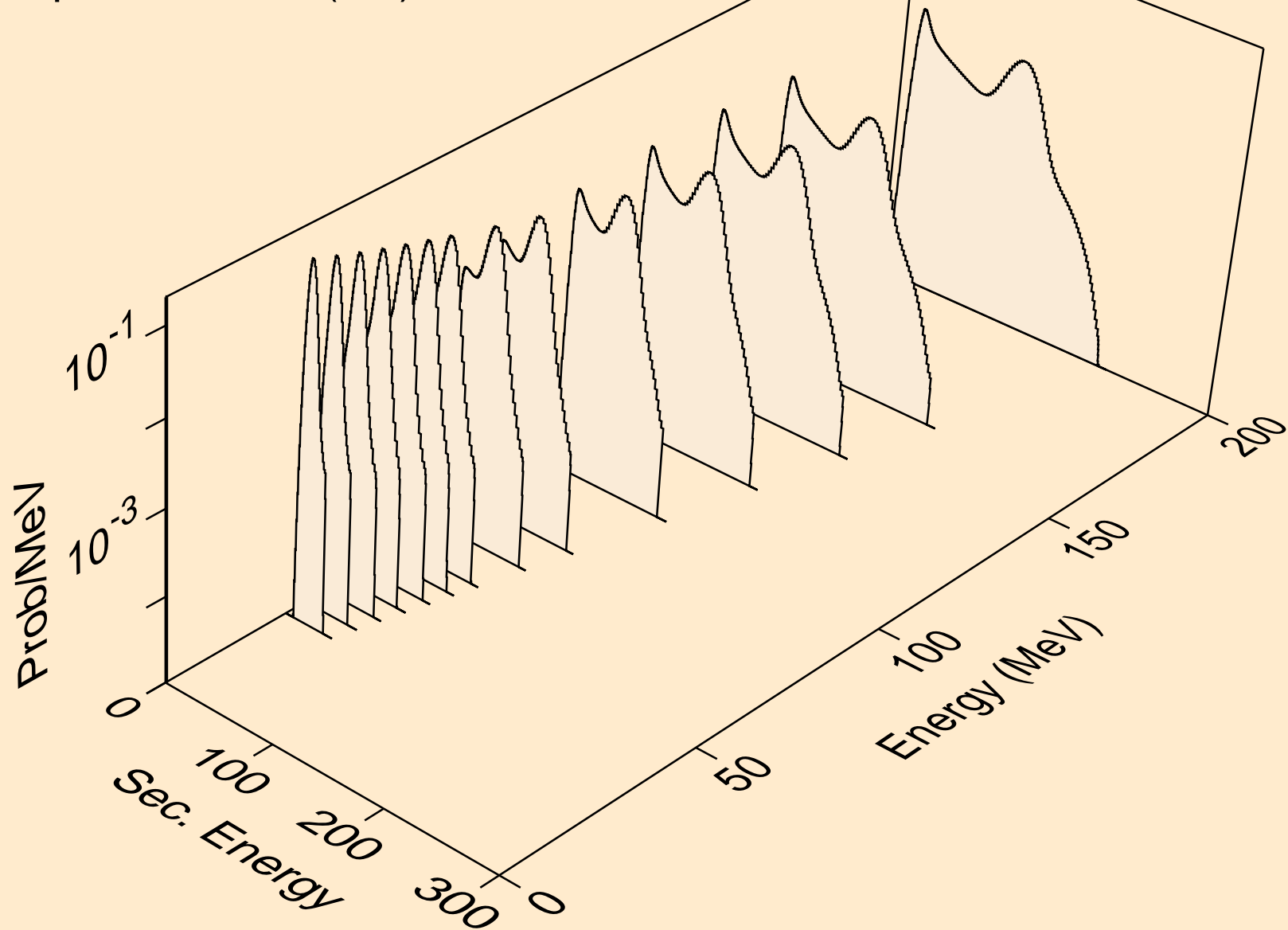

MD248 DEUTERON ACER TENDL-2021 LIBRARY; T=0.K  
protons from (d,n\*)p

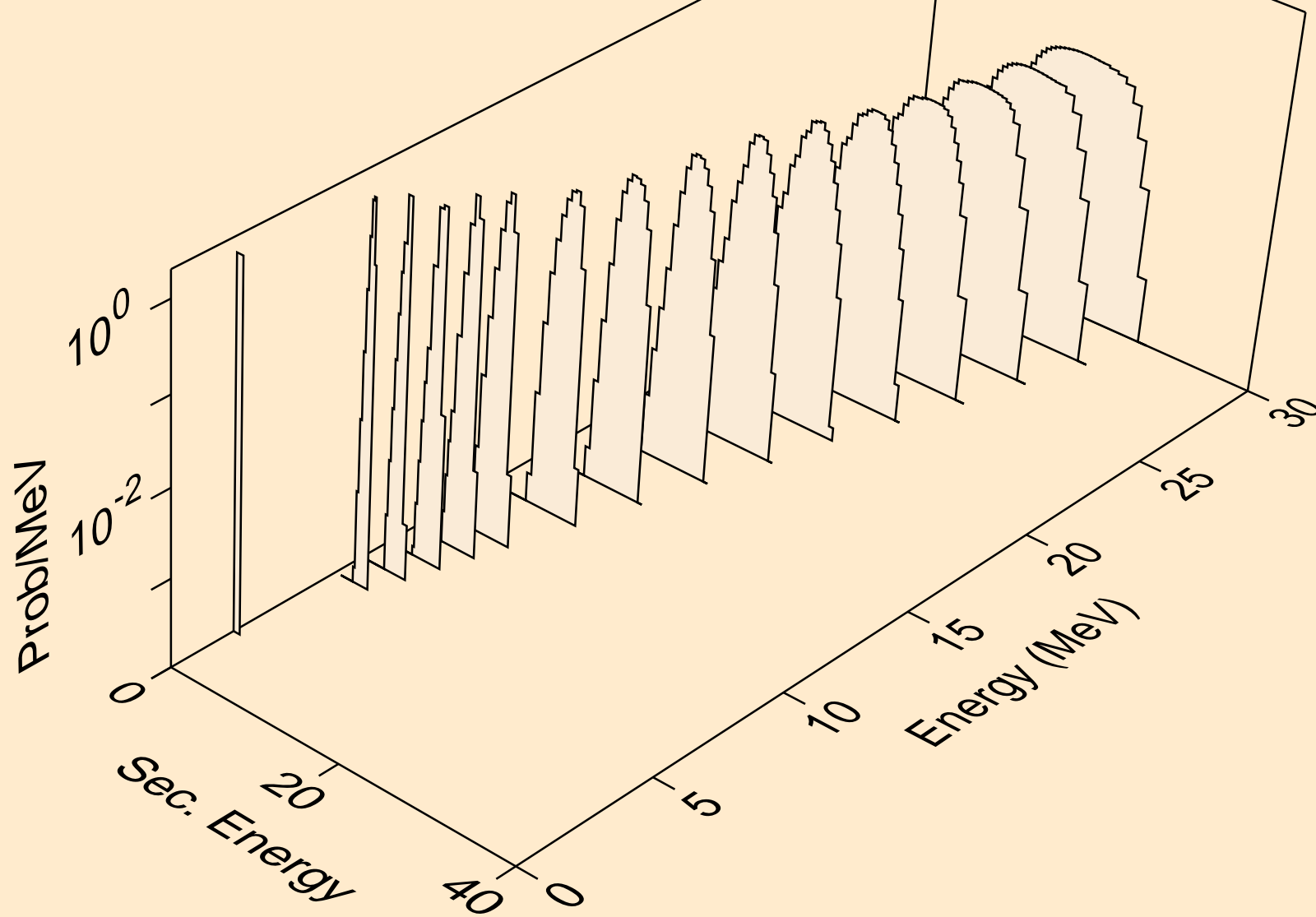

MD248 DEUTERON ACER TENDL-2021 LIBRARY; T=0.K  
protons from (d,2np)

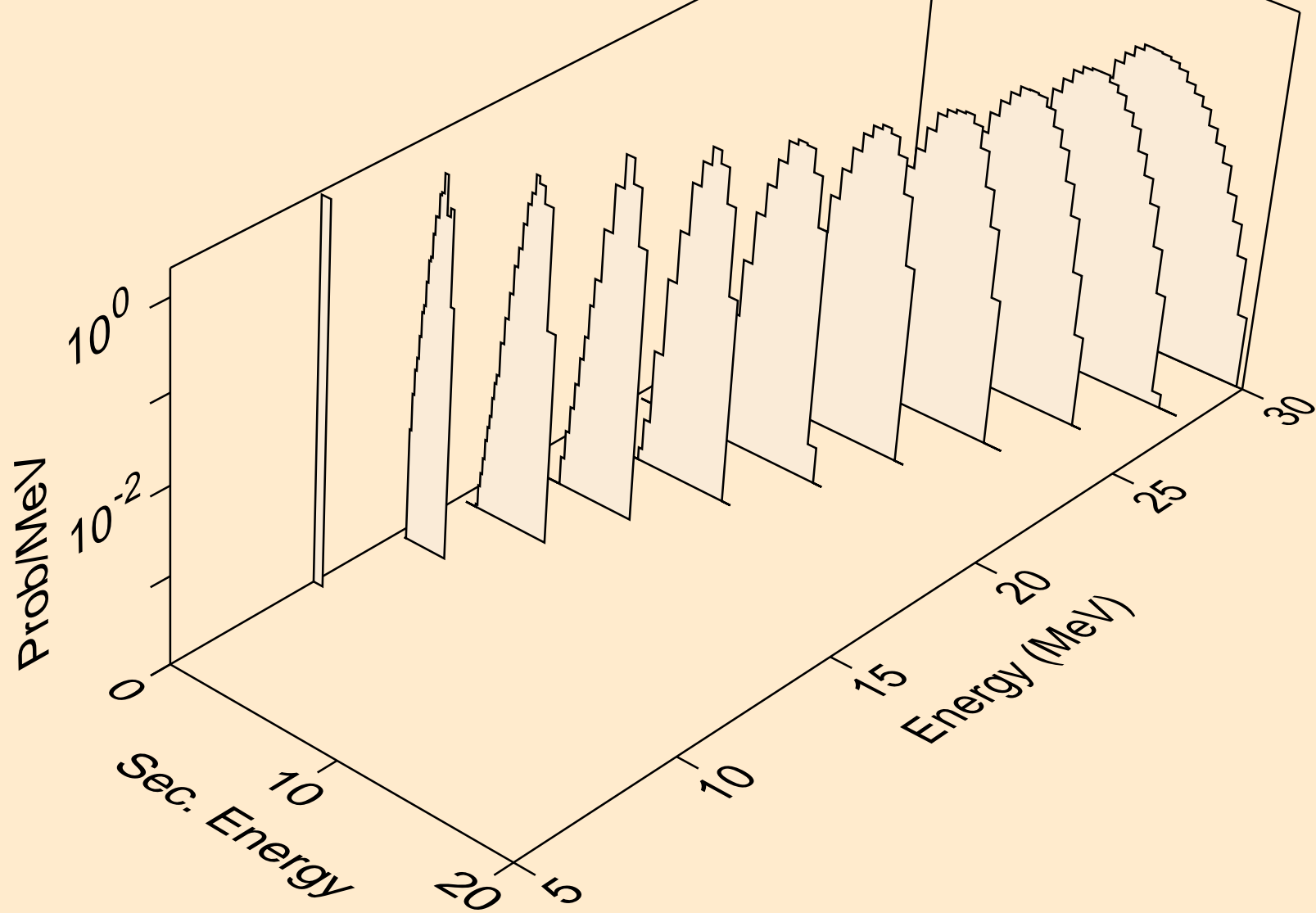

MD248 DEUTERON ACER TENDL-2021 LIBRARY; T=0.K  
protons from (d,2np)

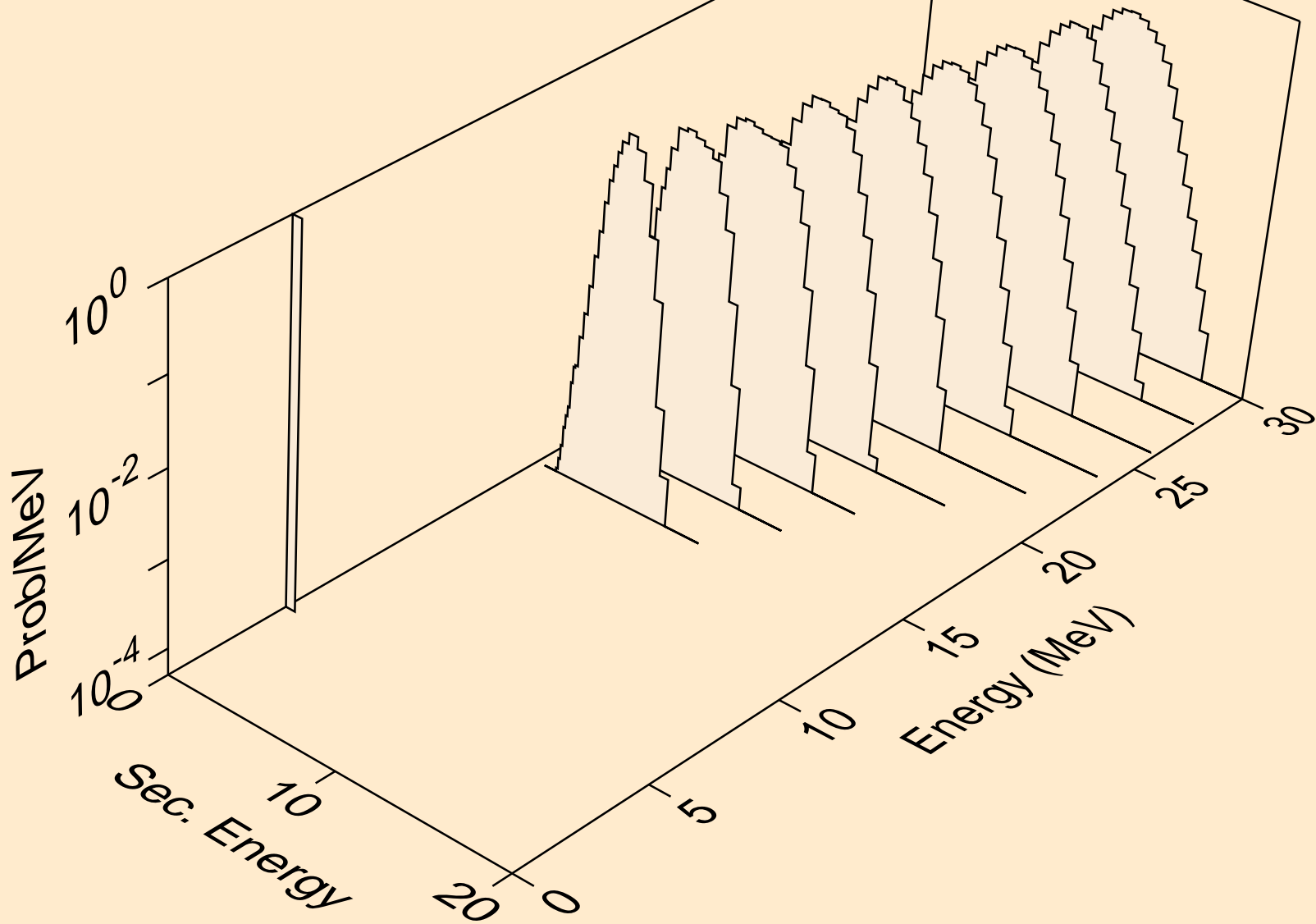

MD248 DEUTERON ACER TENDL-2021 LIBRARY; T=0.K  
protons from (d,p)

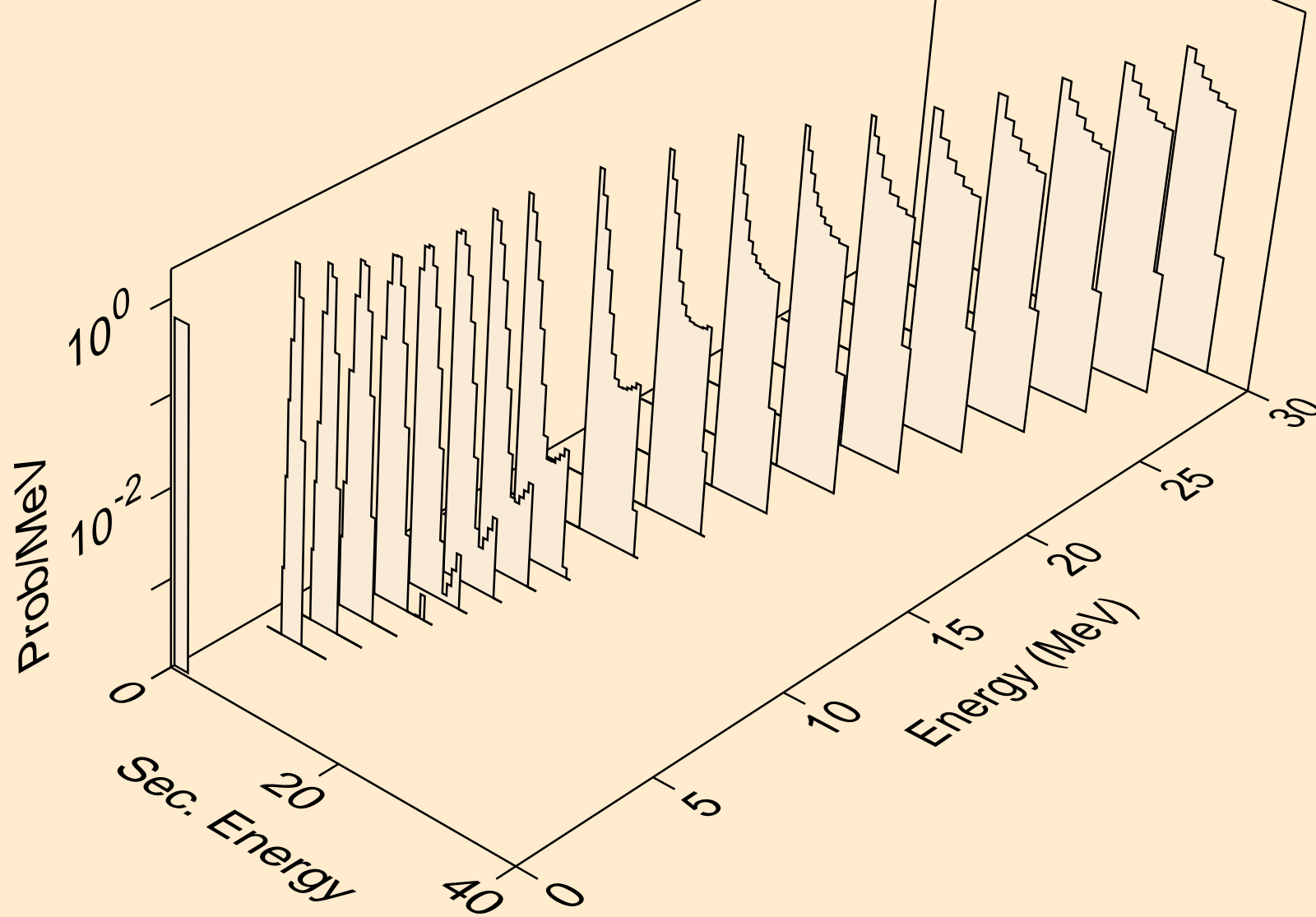



MD248 DEUTERON ACER TENDL-2021 LIBRARY; T=0.K  
protons from (d,2p)

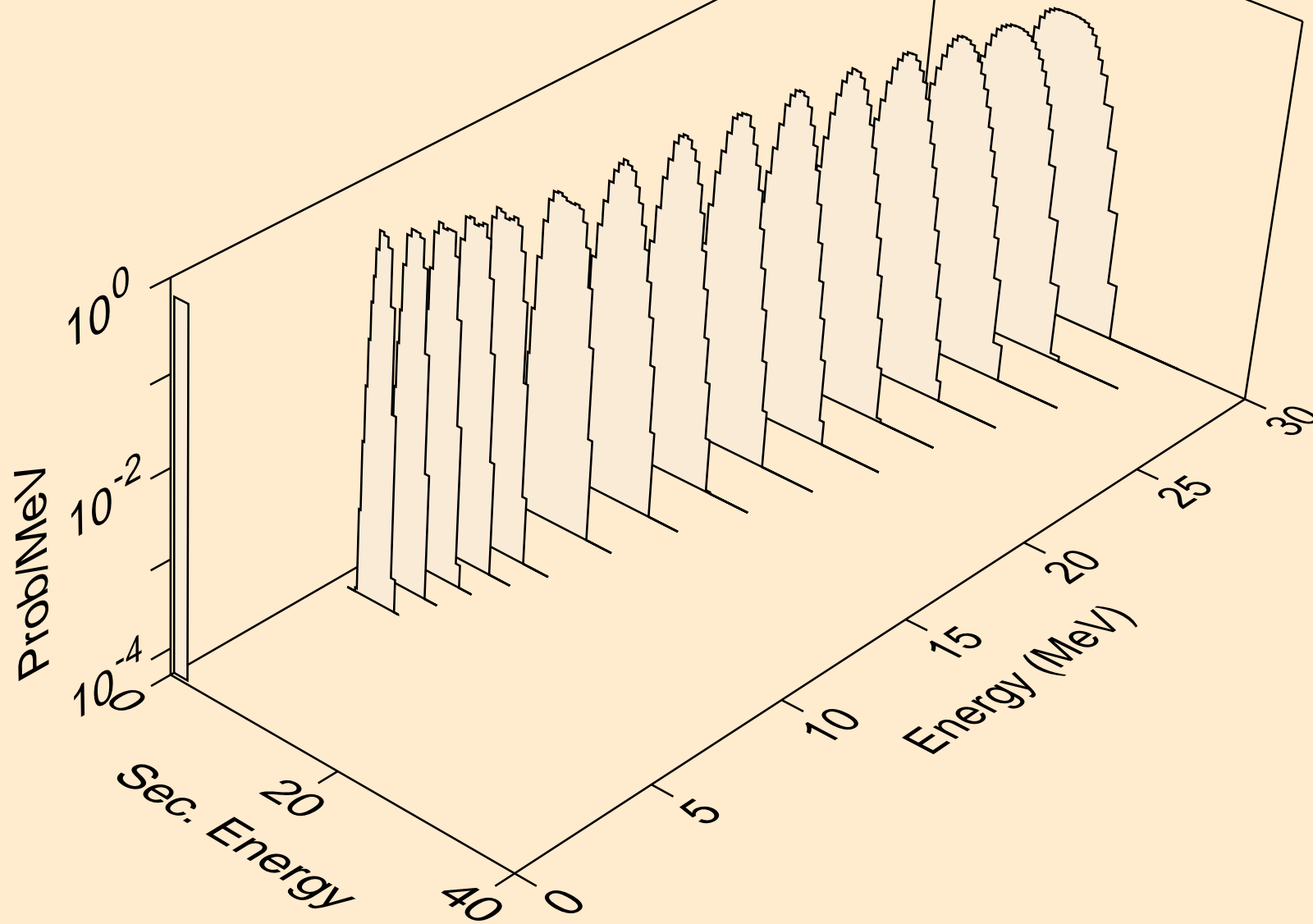

MD248 DEUTERON ACER TENDL-2021 LIBRARY; T=0.K  
protons from (d,pa)

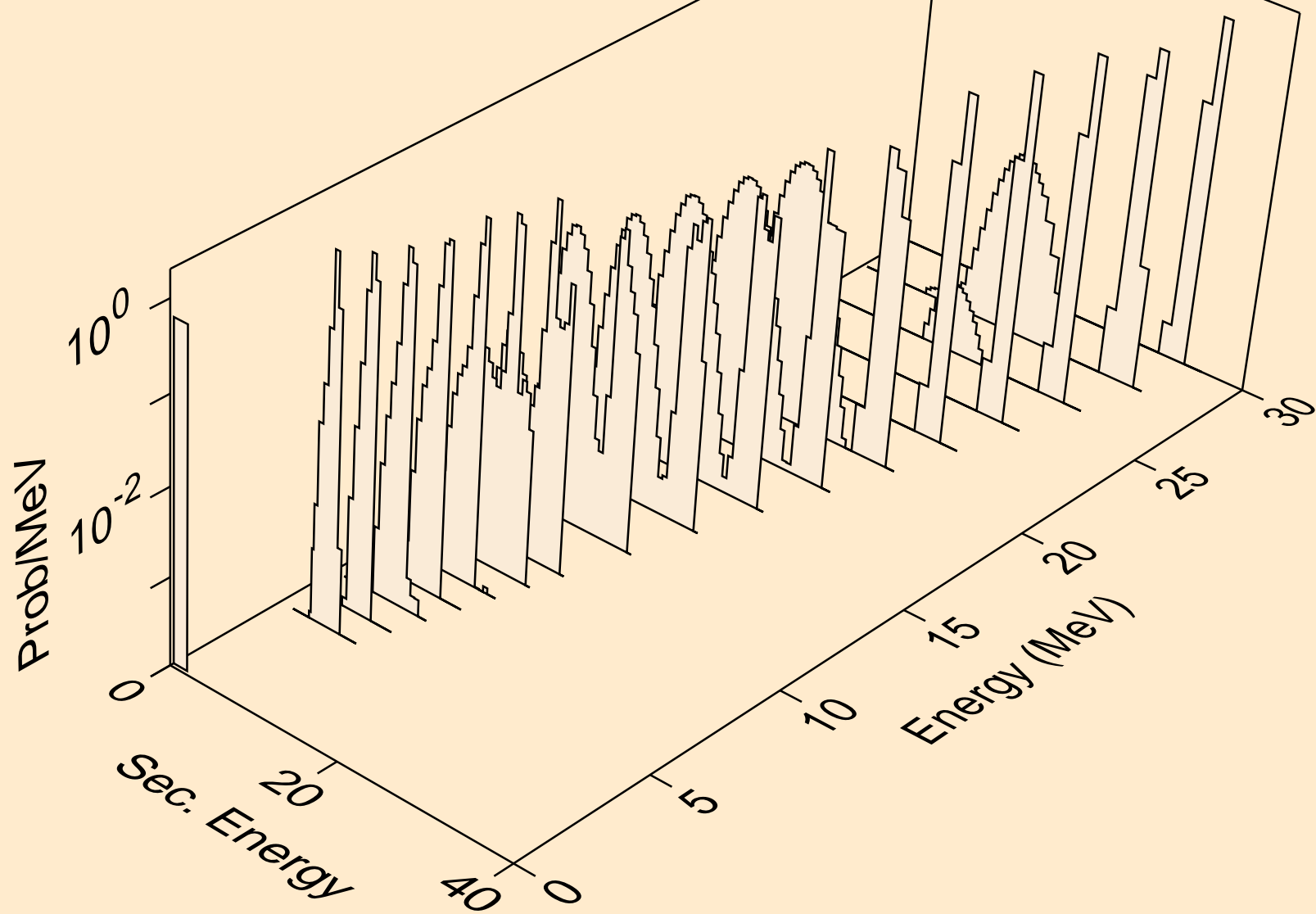

MD248 DEUTERON ACER TENDL-2021 LIBRARY; T=0.K  
protons from (d,pd)

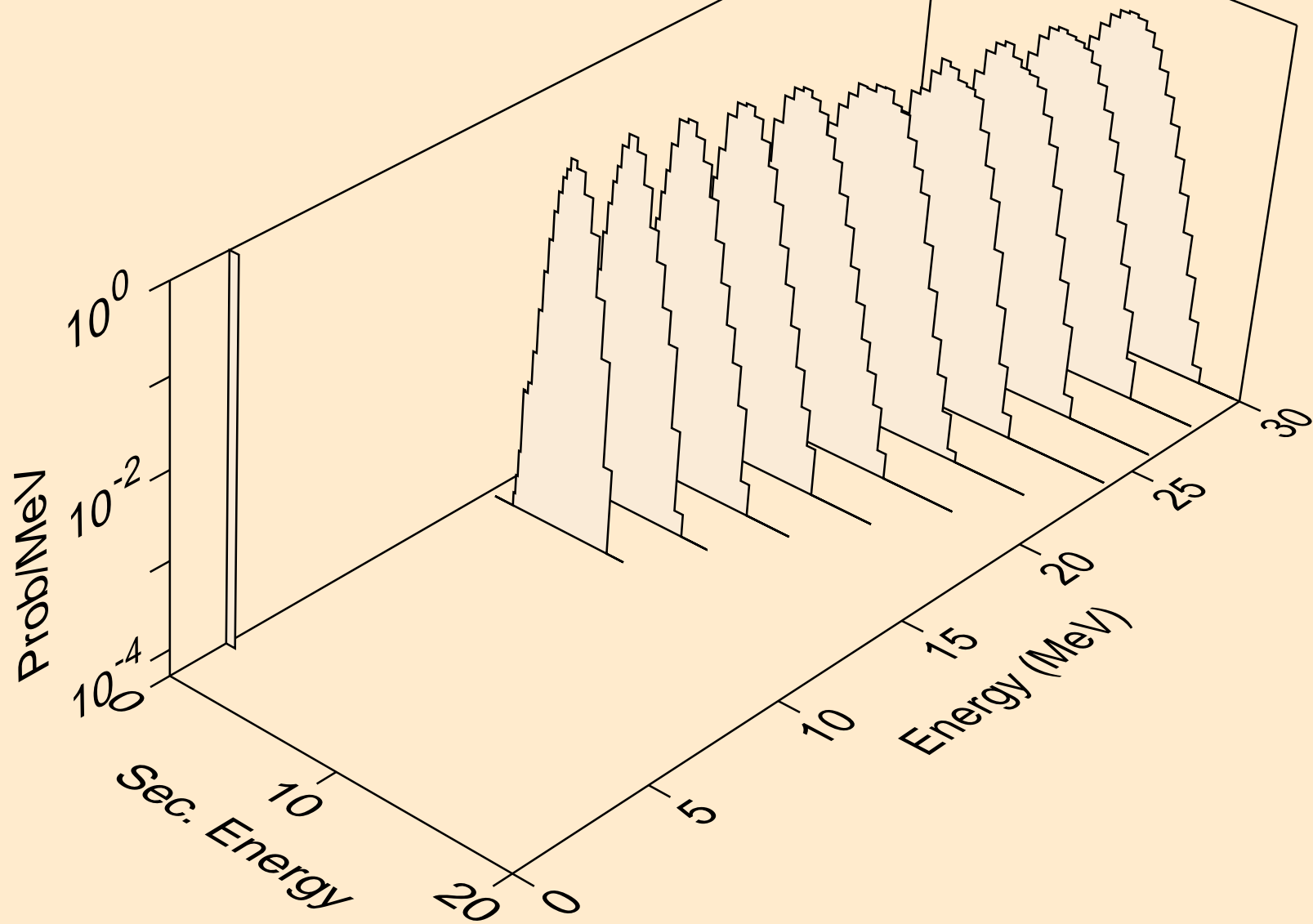

MD248 DEUTERON ACER TENDL-2021 LIBRARY; T=0.K  
tritons from (d,x)

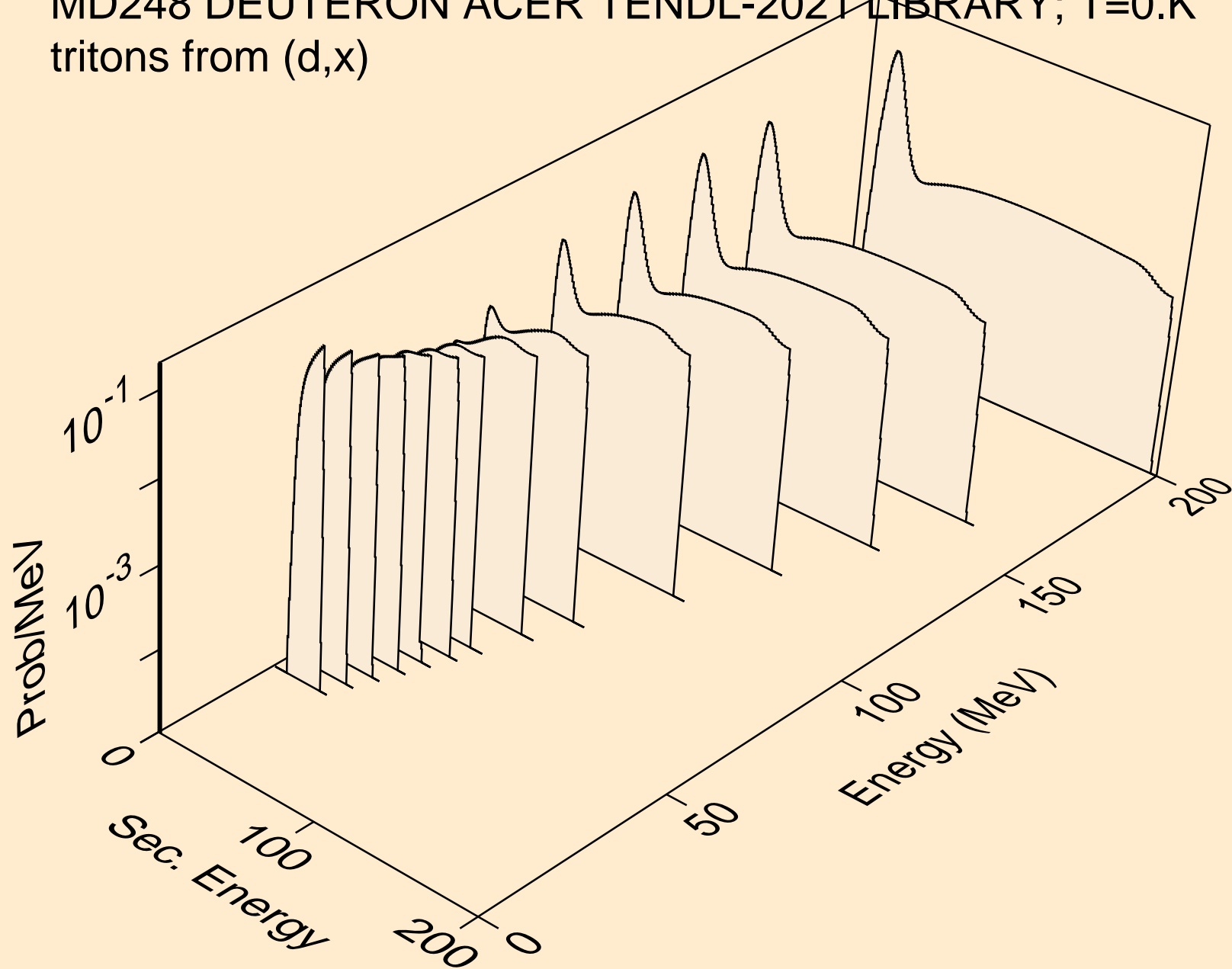

MD248 DEUTERON ACER TENDL-2021 LIBRARY; T=0.K  
tritons from (d,n\*)t

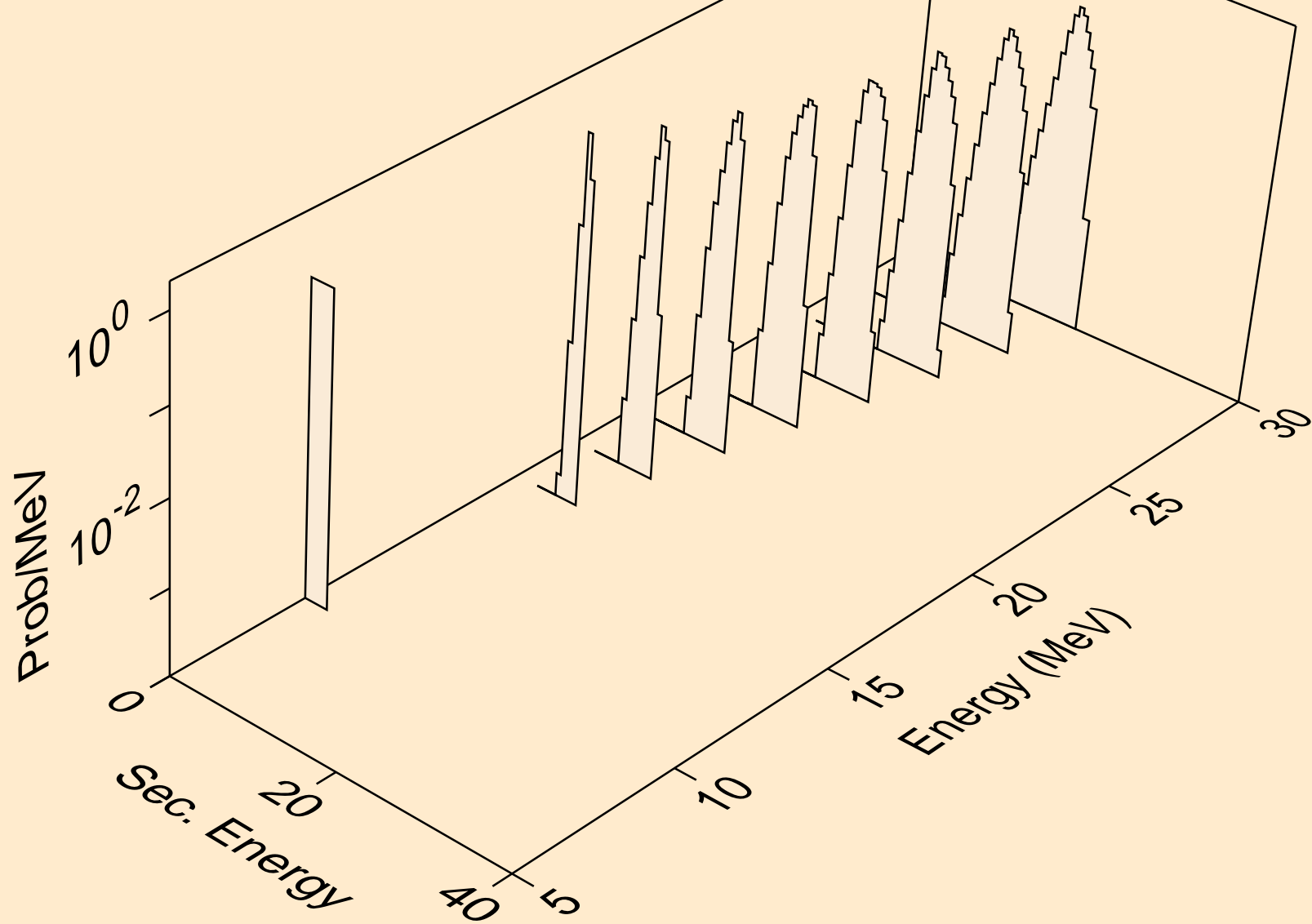

MD248 DEUTERON ACER TENDL-2021 LIBRARY; T=0.K  
tritons from (d,t)

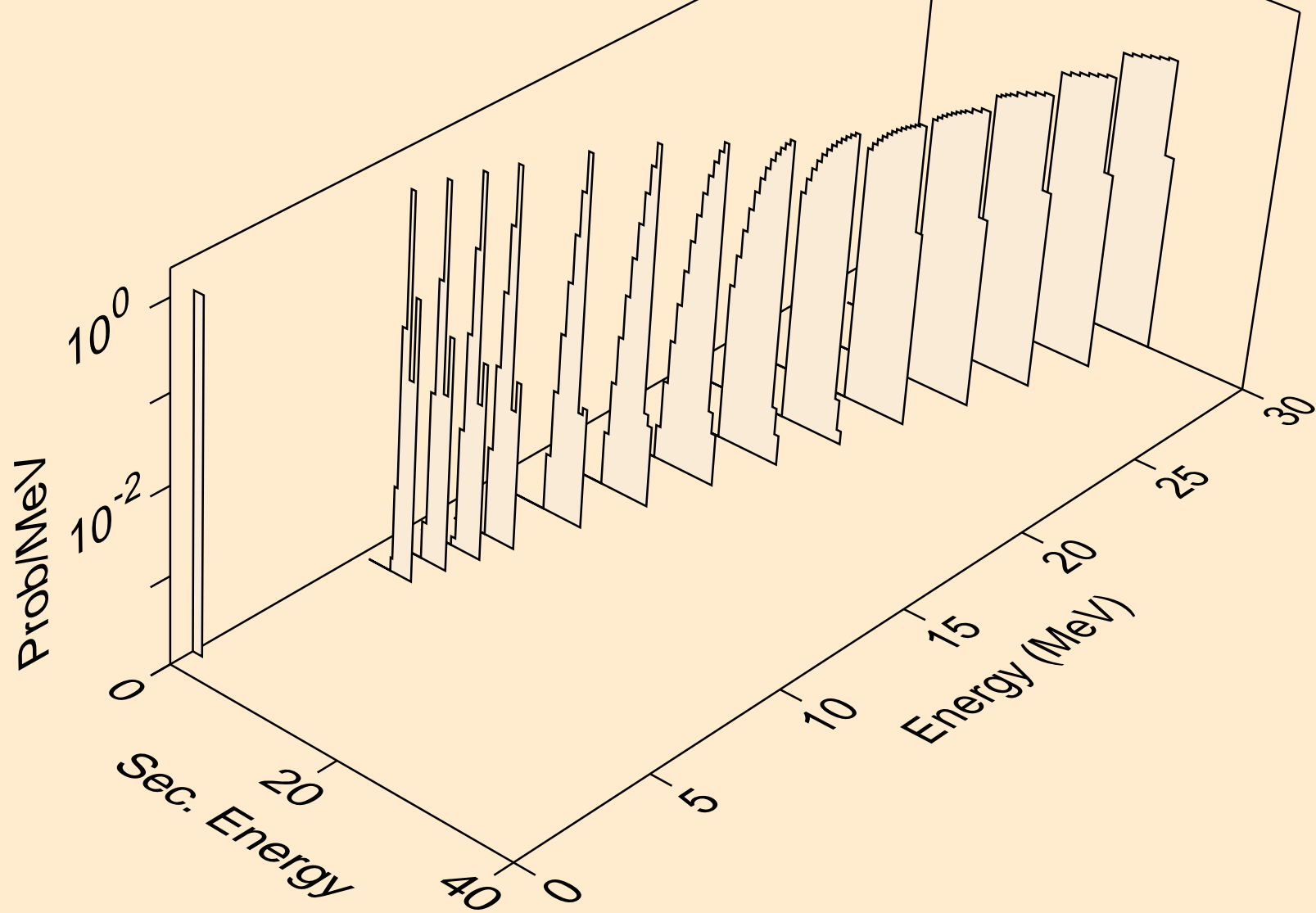

MD248 DEUTERON ACER TENDL-2021 LIBRARY; T=0.K  
he3s from (d,x)

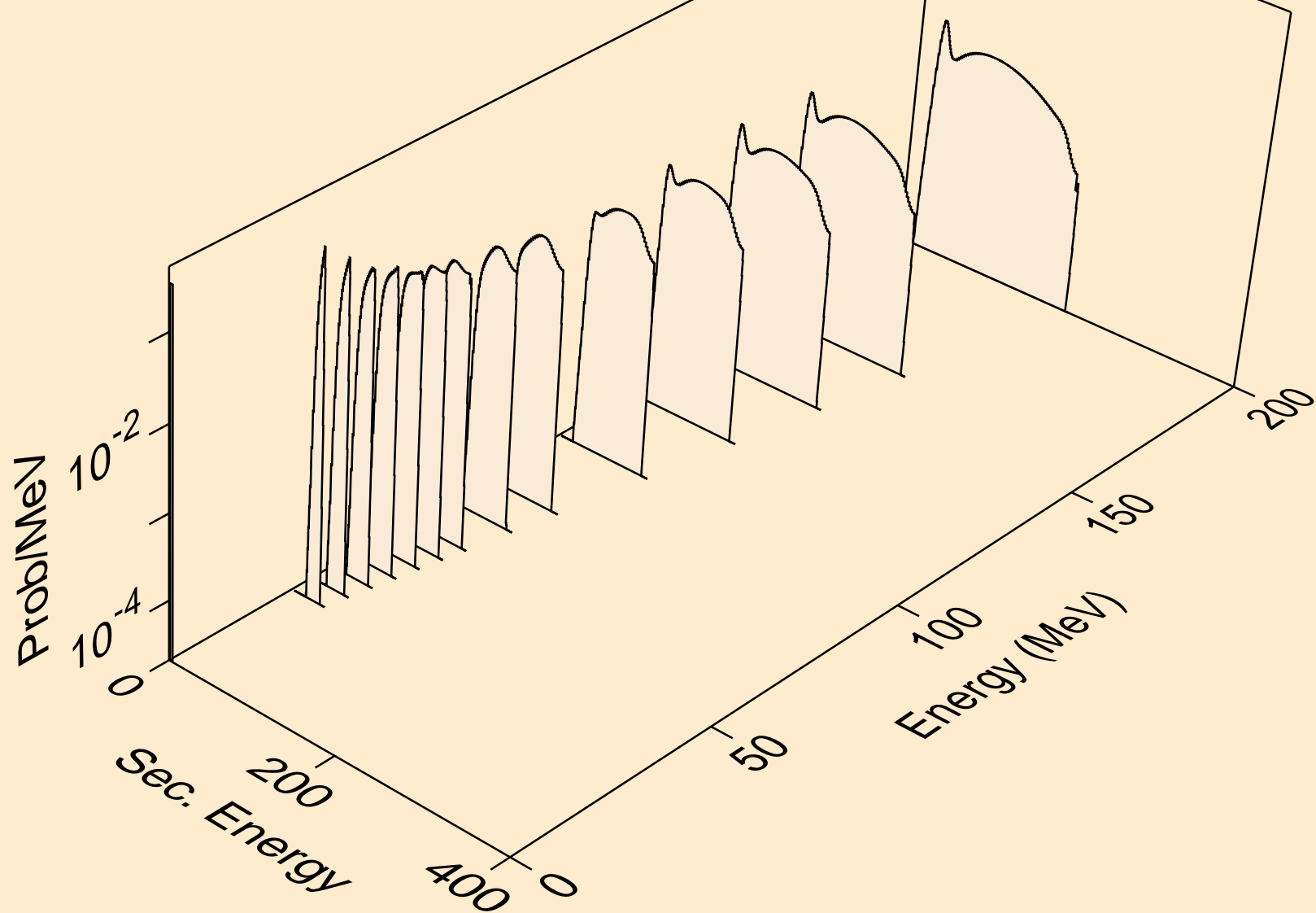

MD248 DEUTERON ACER TENDL-2021 LIBRARY; T=0.K  
he3s from (d,n\*)he3

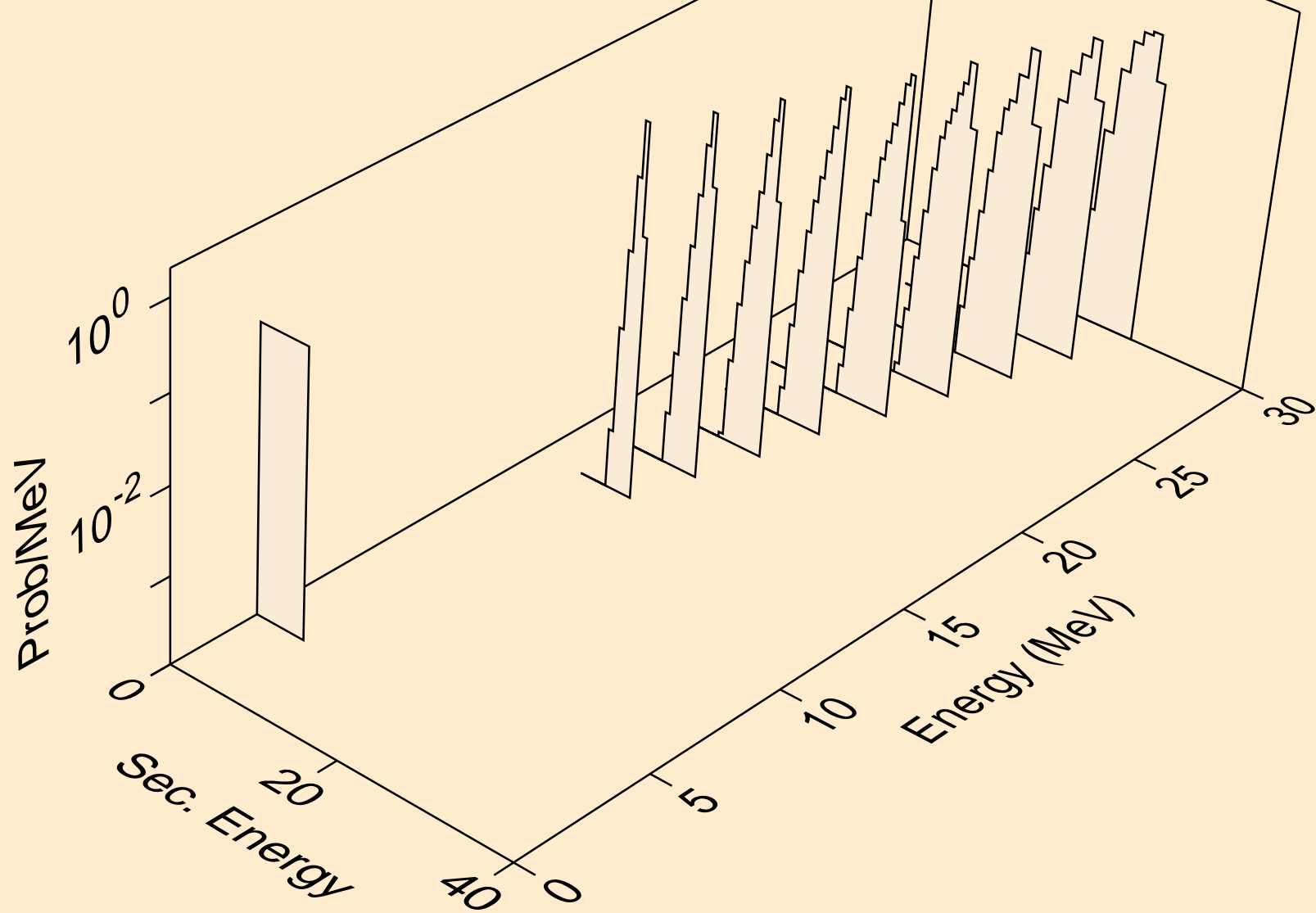



MD248 DEUTERON ACER TENDL-2021 LIBRARY; T=0.K  
he3s from (d,he3)

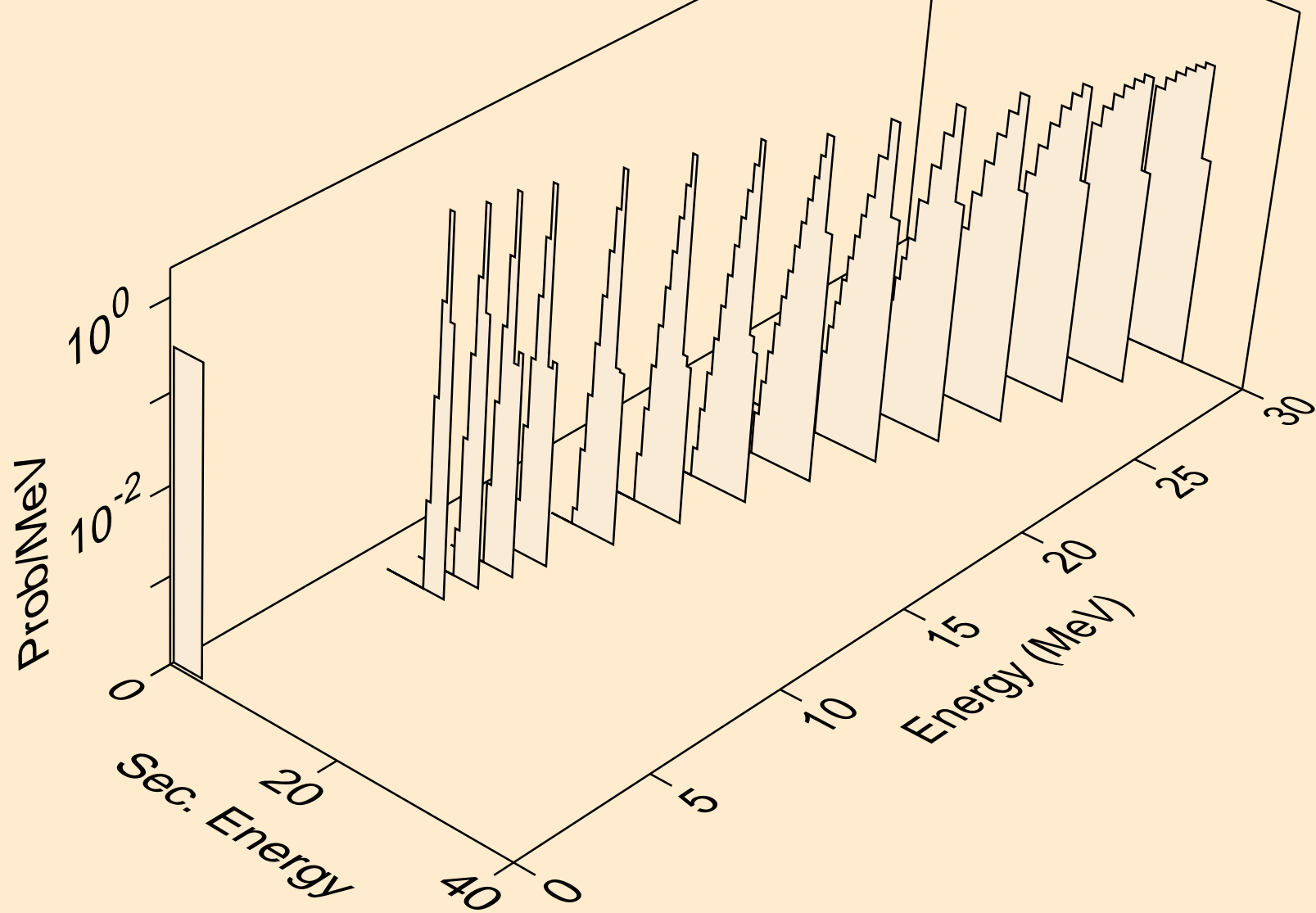

MD248 DEUTERON ACER TENDL-2021 LIBRARY; T=0.K  
alphas from (d,x)

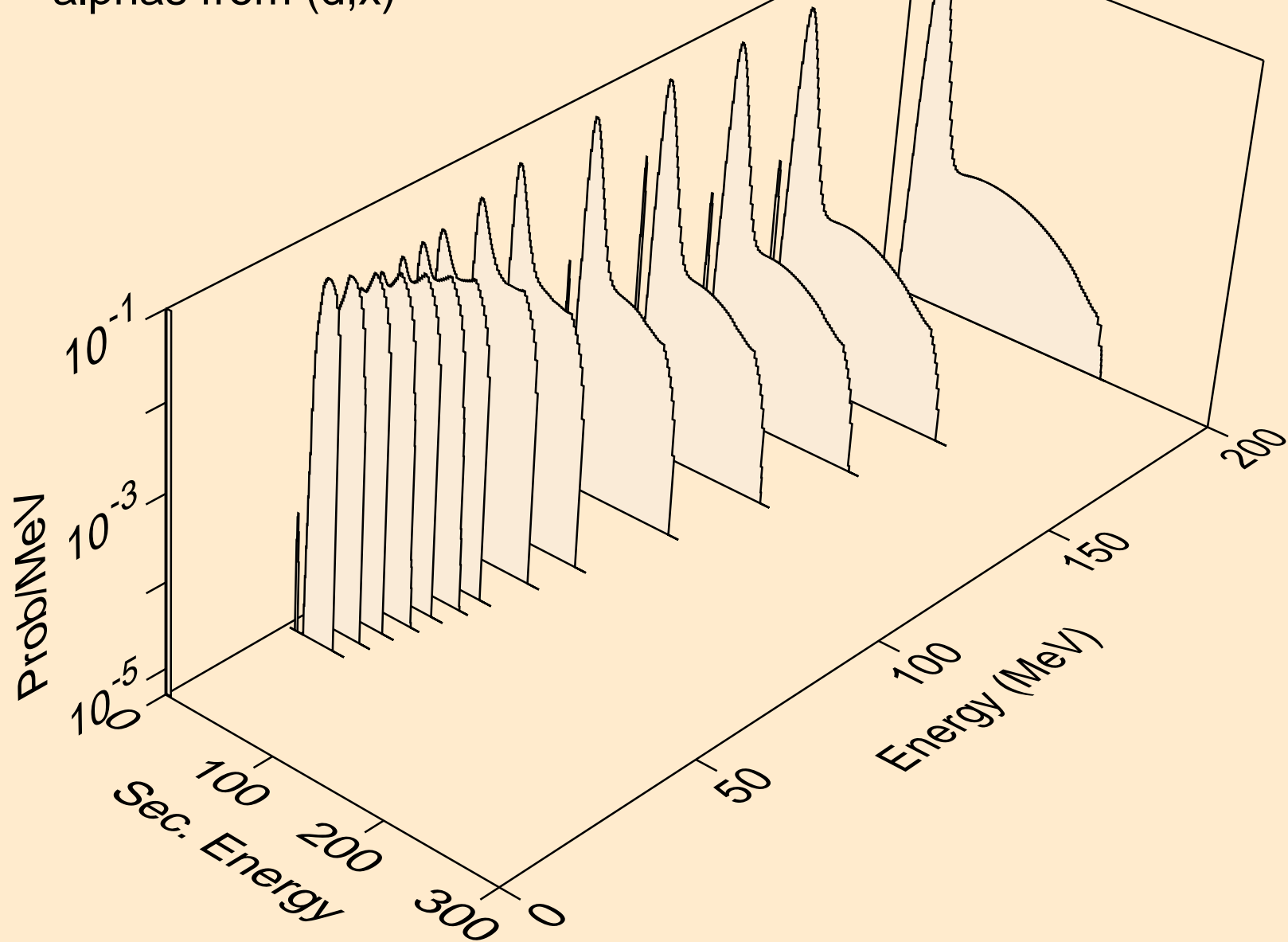

MD248 DEUTERON ACER TENDL-2021 LIBRARY; T=0.K  
alphas from (d,n\*)a

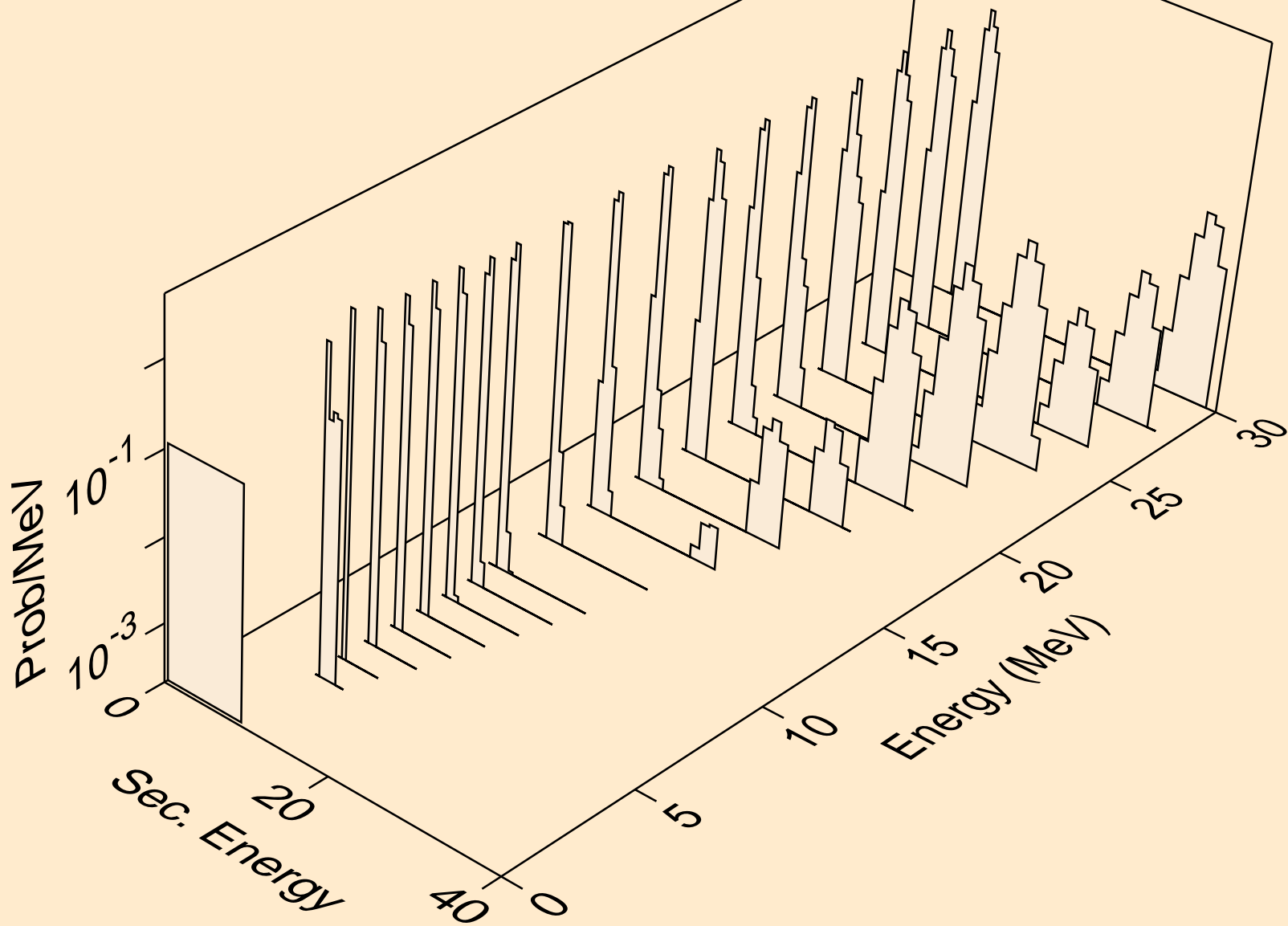

MD248 DEUTERON ACER TENDL-2021 LIBRARY; T=0.K  
alphas from (d,2n)a

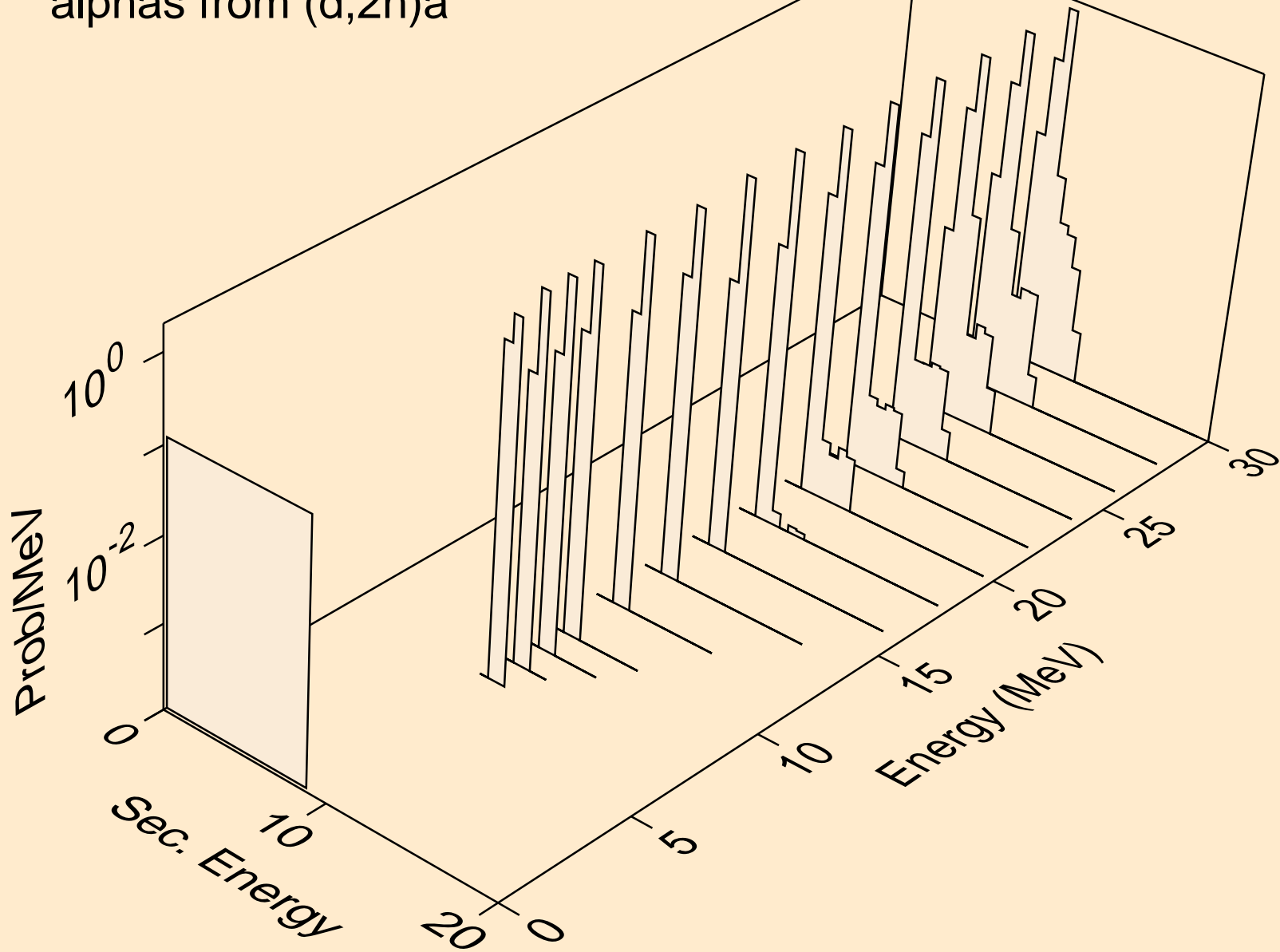

MD248 DEUTERON ACER TENDL-2021 LIBRARY; T=0.K  
alphas from (d,3n)a

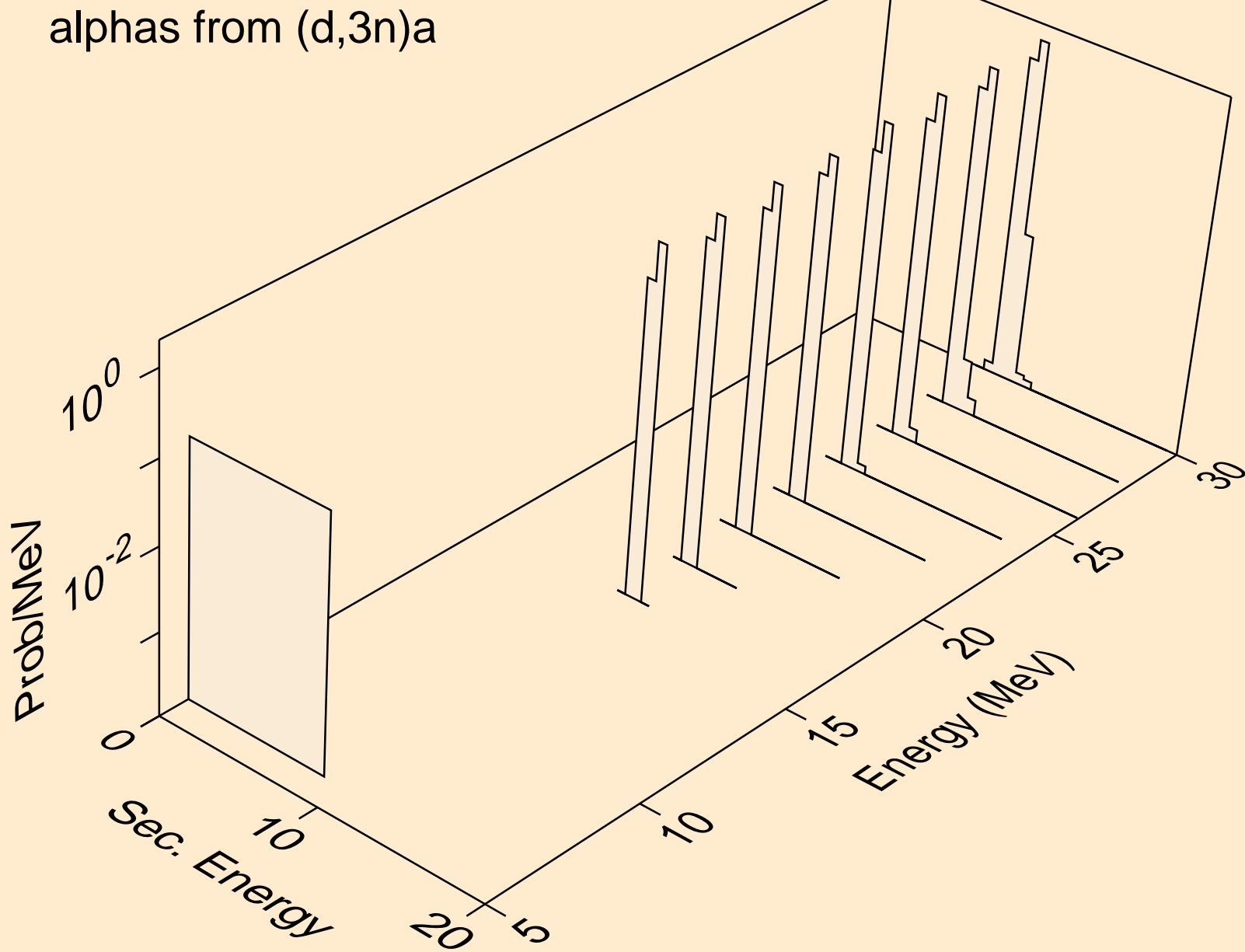

MD248 DEUTERON ACER TENDL-2021 LIBRARY; T=0.K  
alphas from (d,a)

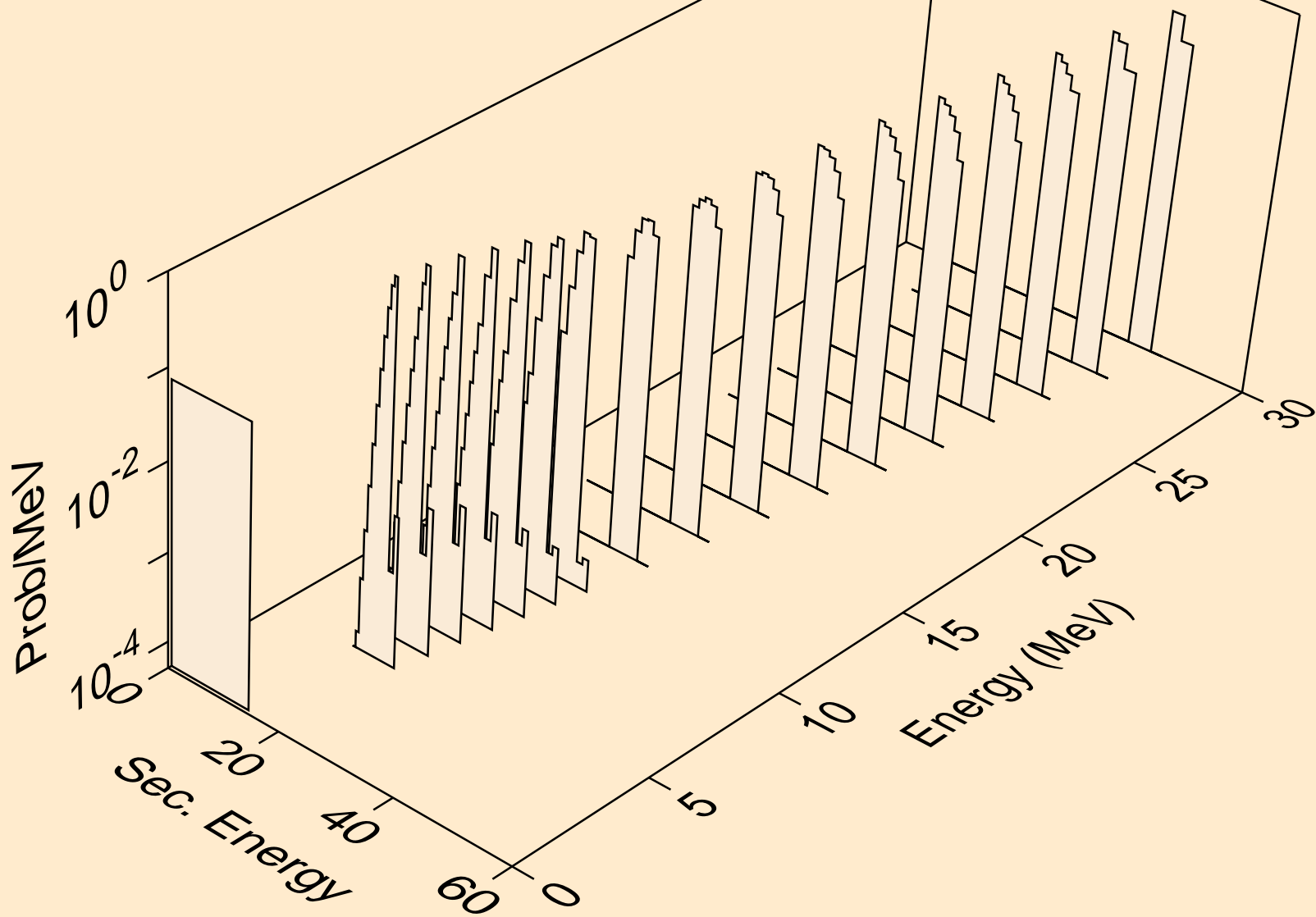

MD248 DEUTERON ACER TENDL-2021 LIBRARY; T=0.K  
alphas from (d,pa)

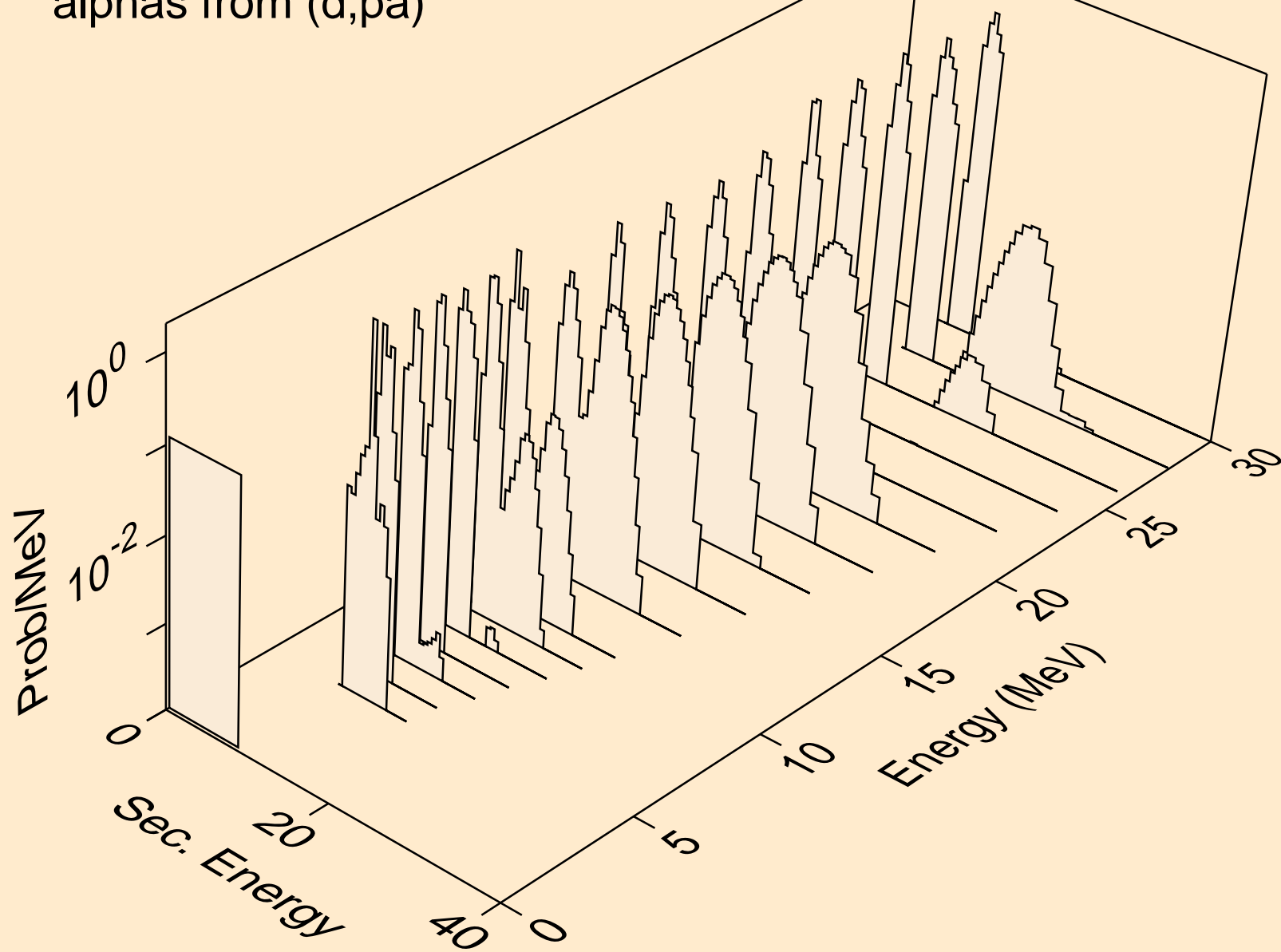

MD248 DEUTERON ACER TENDL-2021 LIBRARY; T=0.K  
alphas from (d,da)

