

MD250 DEUTERON ACER TENDL-2021 LIBRARY; T=0.K  
Principal cross sections

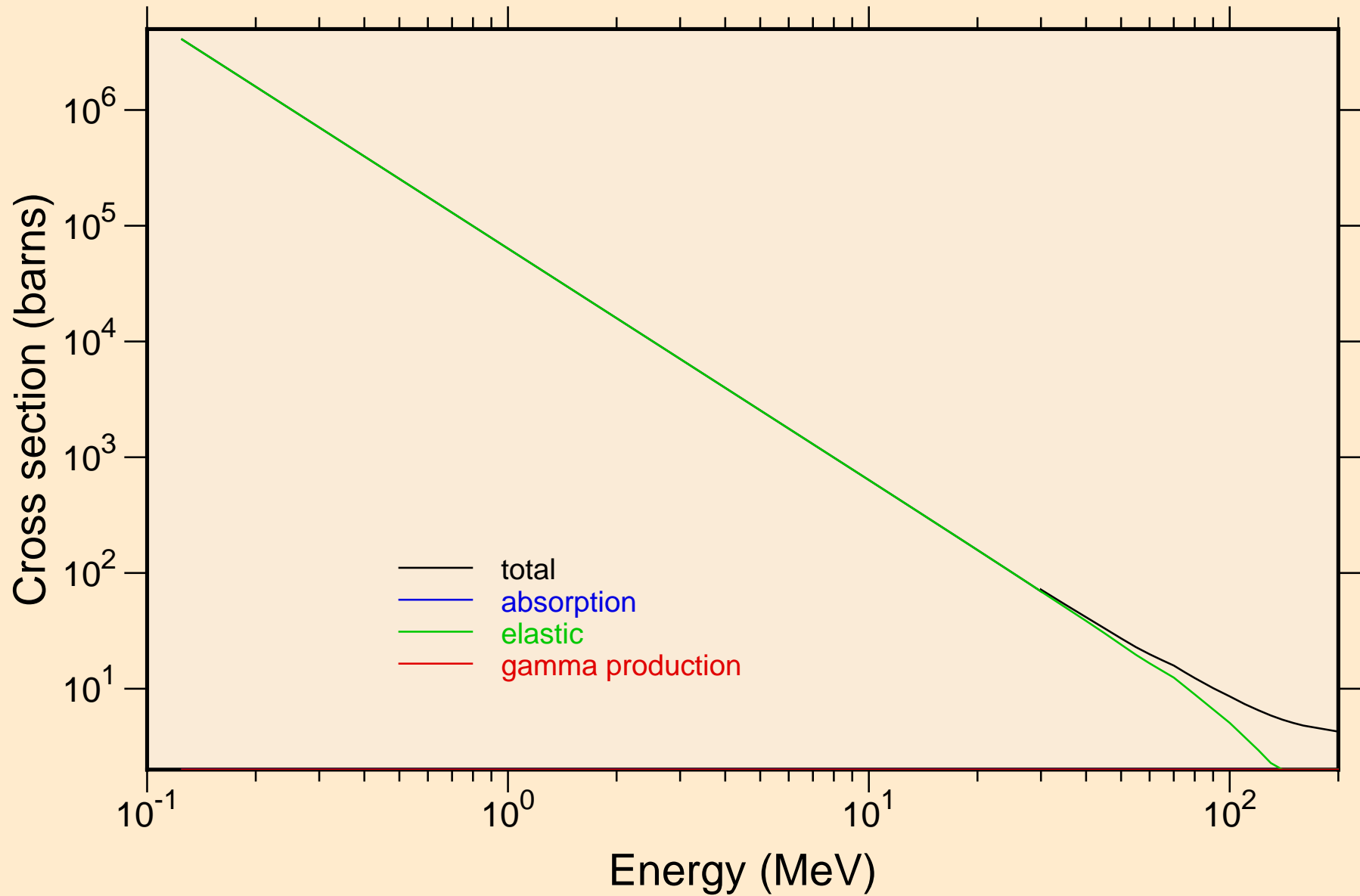

MD250 DEUTERON ACER TENDL-2021 LIBRARY; T=0.K  
Heating

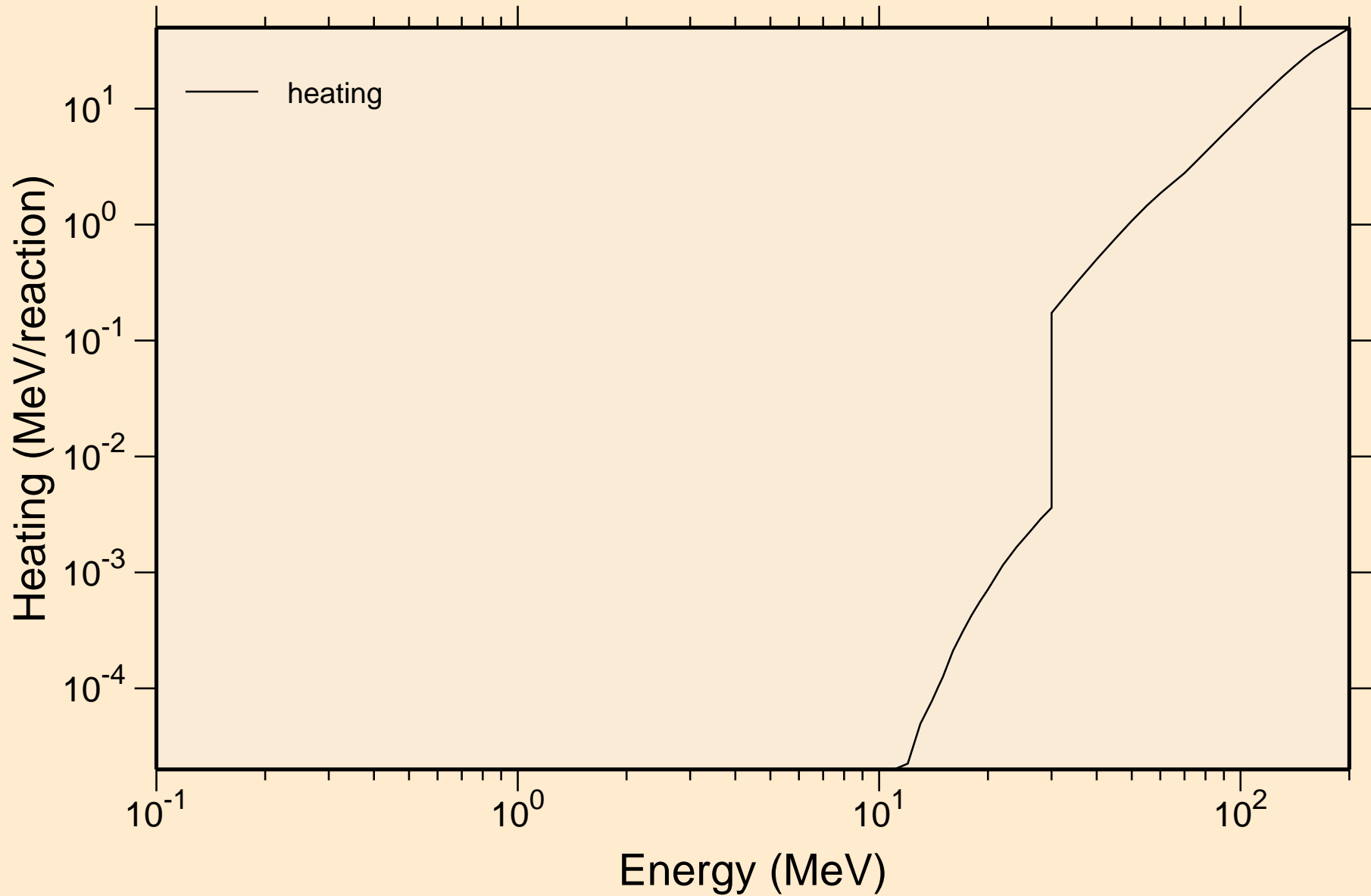

MD250 DEUTERON ACER TENDL-2021 LIBRARY; T=0.K  
Principal cross sections

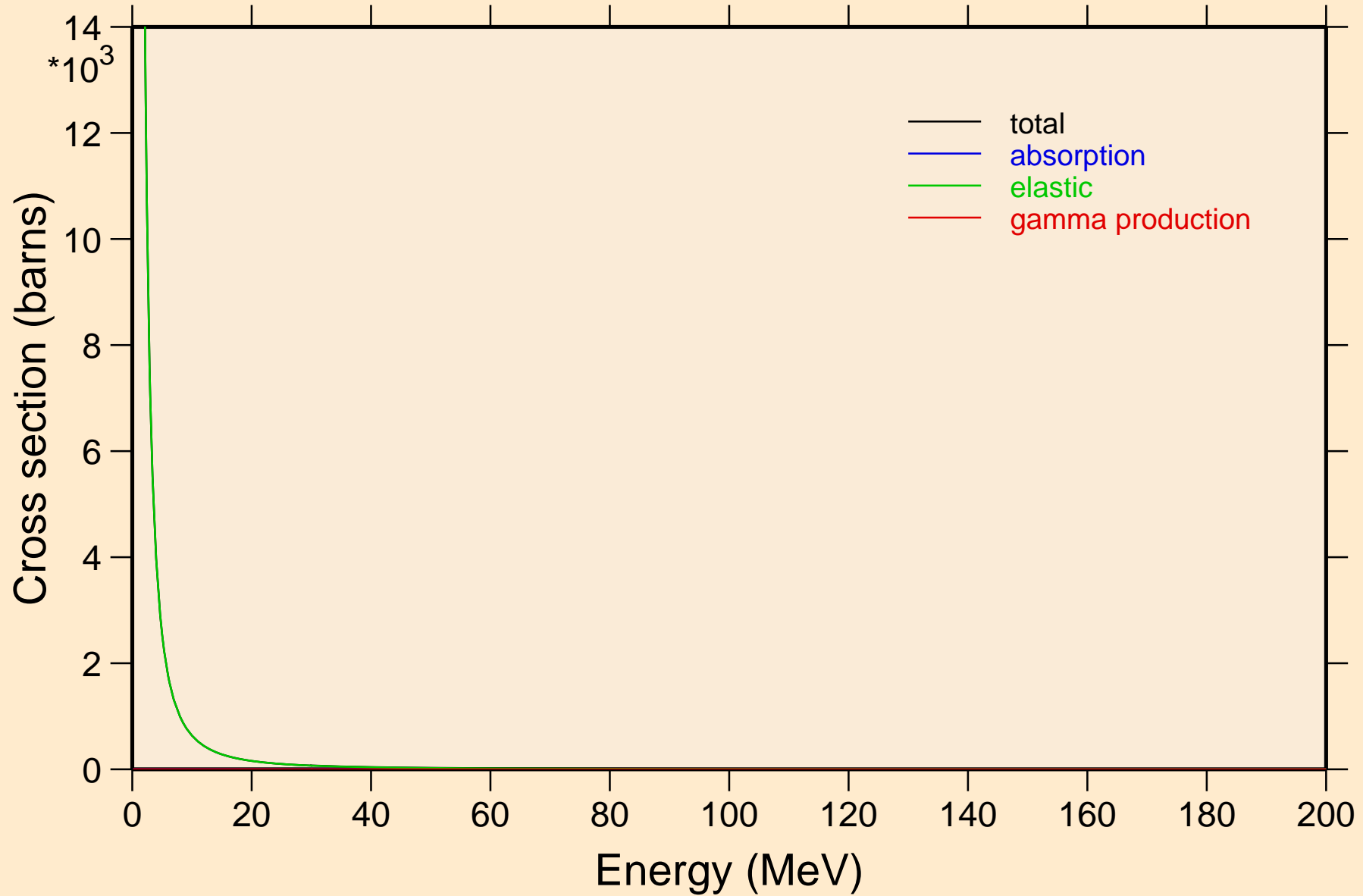

# MD250 DEUTERON ACER TENDL-2021 LIBRARY; T=0.K

## Heating

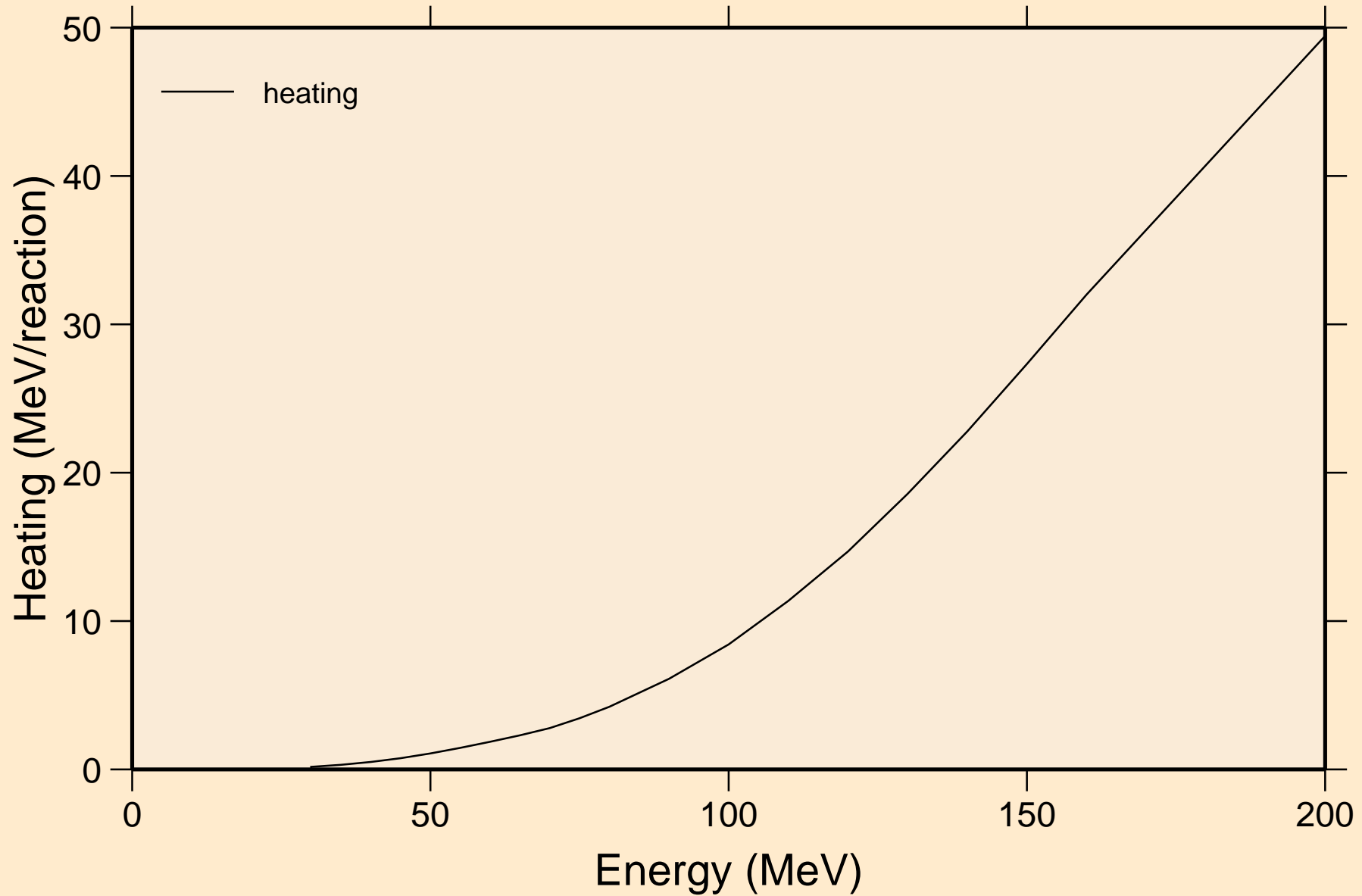

MD250 DEUTERON ACER TENDL-2021 LIBRARY; T=0.K  
Threshold reactions

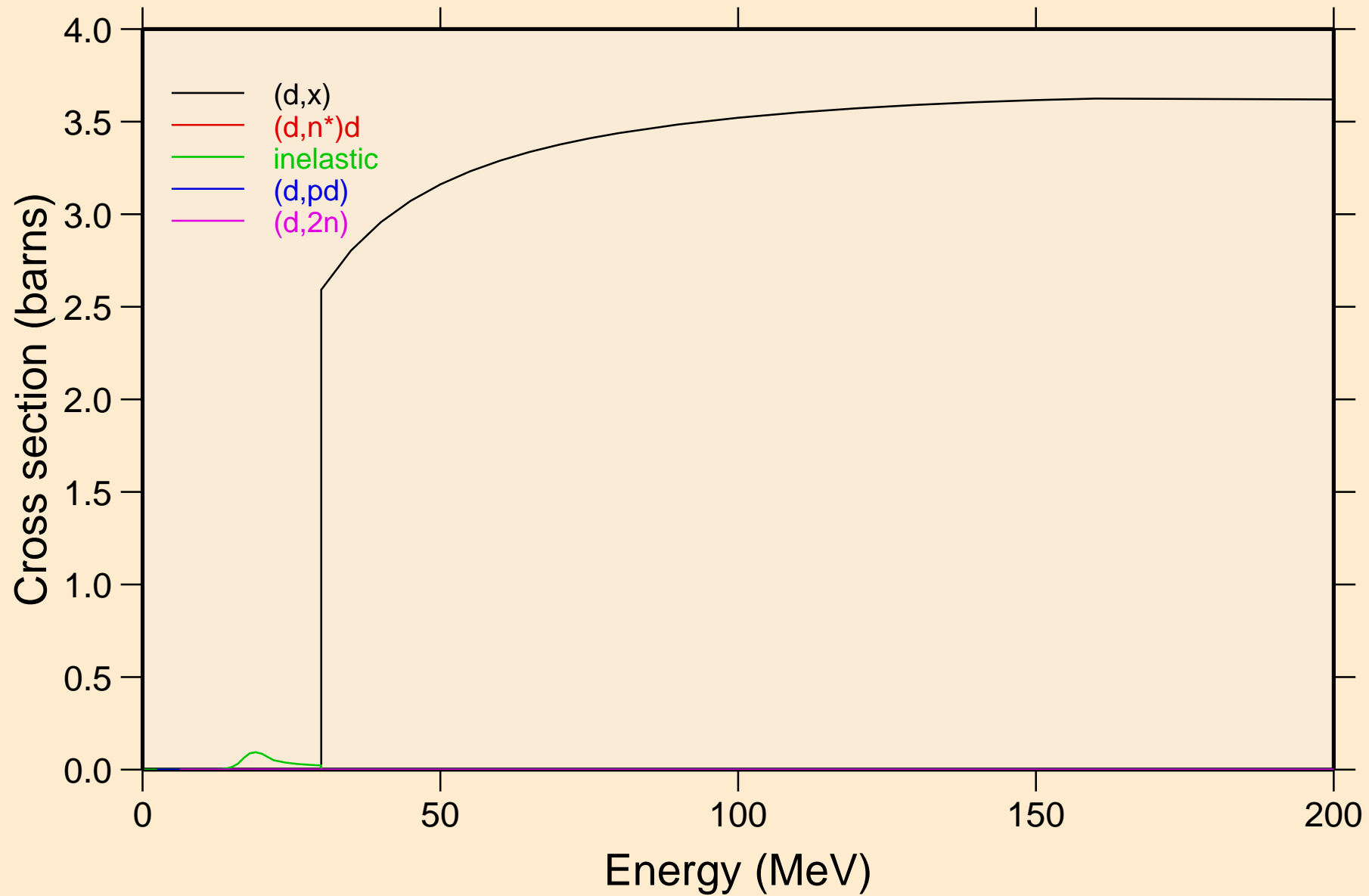

MD250 DEUTERON ACER TENDL-2021 LIBRARY; T=0.K  
Threshold reactions

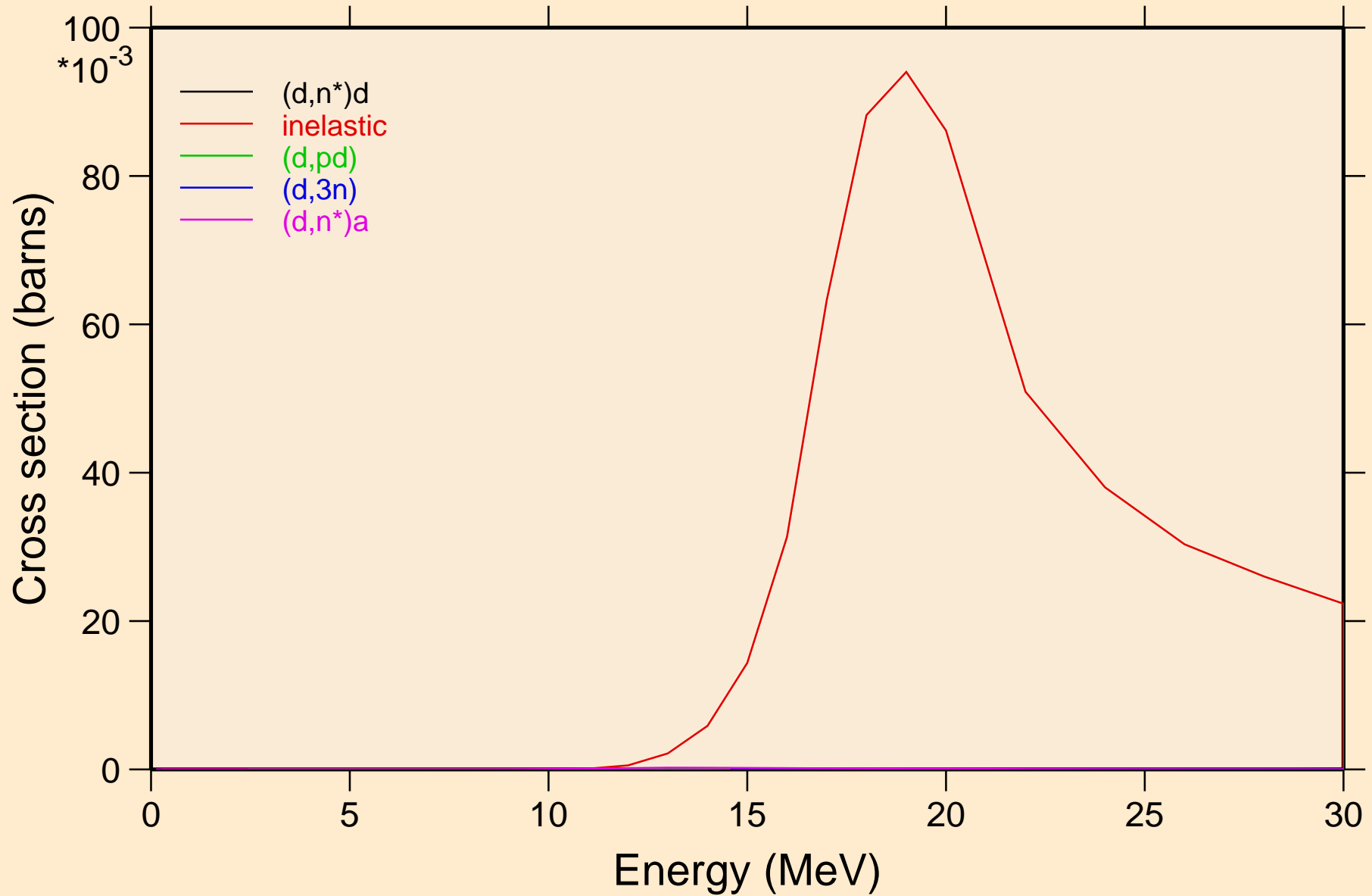

# MD250 DEUTERON ACER TENDL-2021 LIBRARY; T=0.K

## Threshold reactions

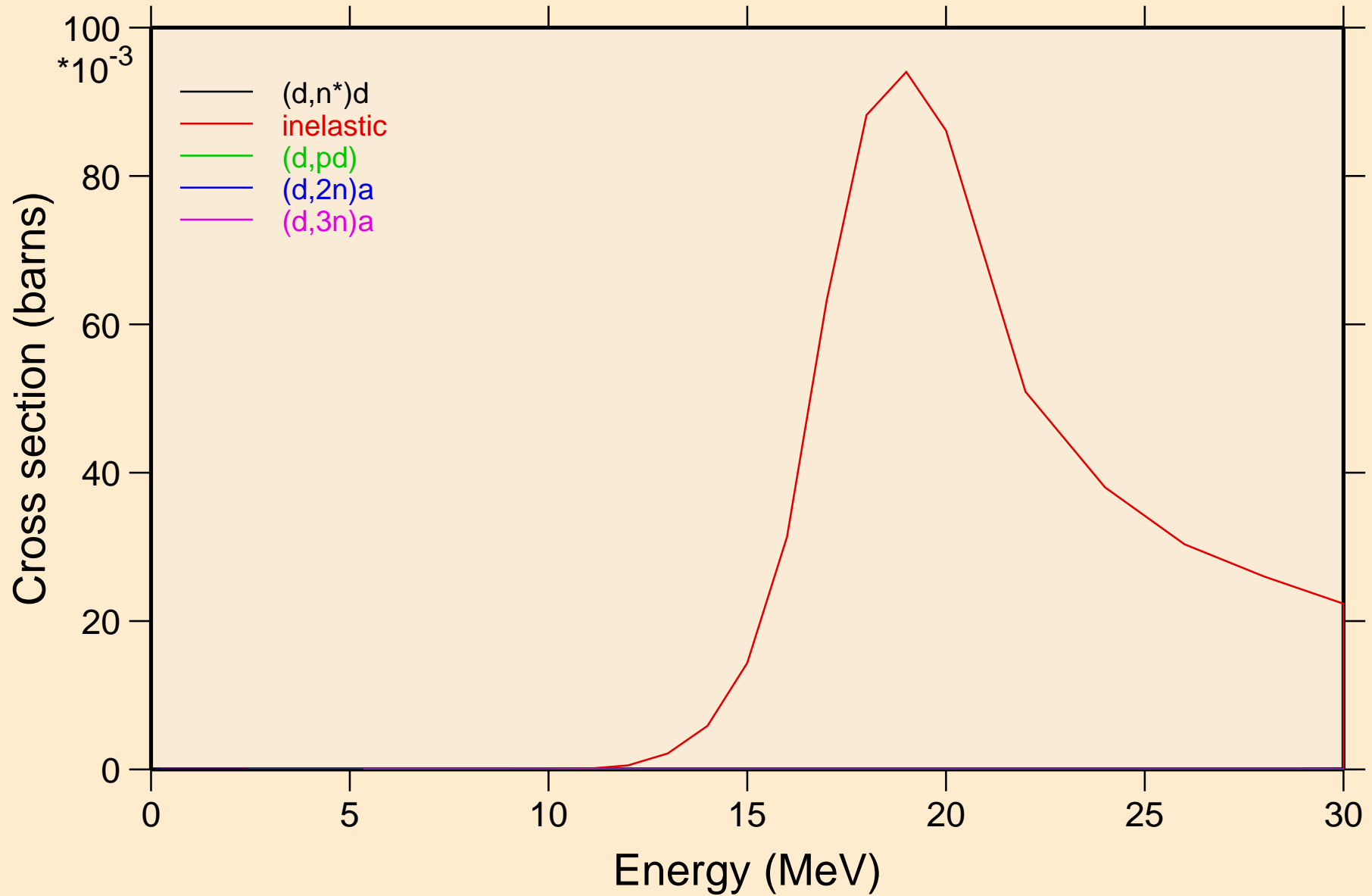

MD250 DEUTERON ACER TENDL-2021 LIBRARY; T=0.K  
Threshold reactions

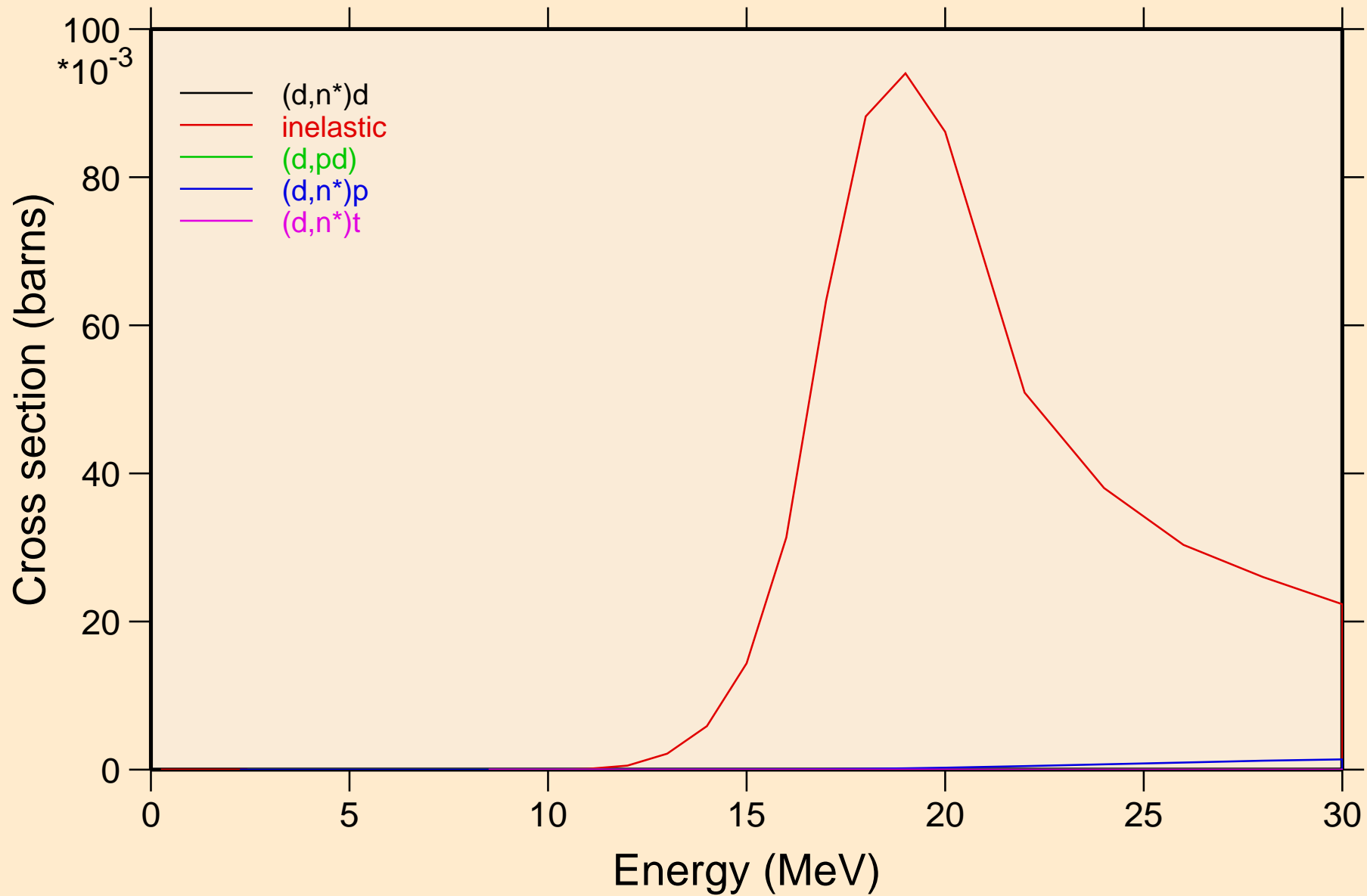



MD250 DEUTERON ACER TENDL-2021 LIBRARY; T=0.K  
Threshold reactions

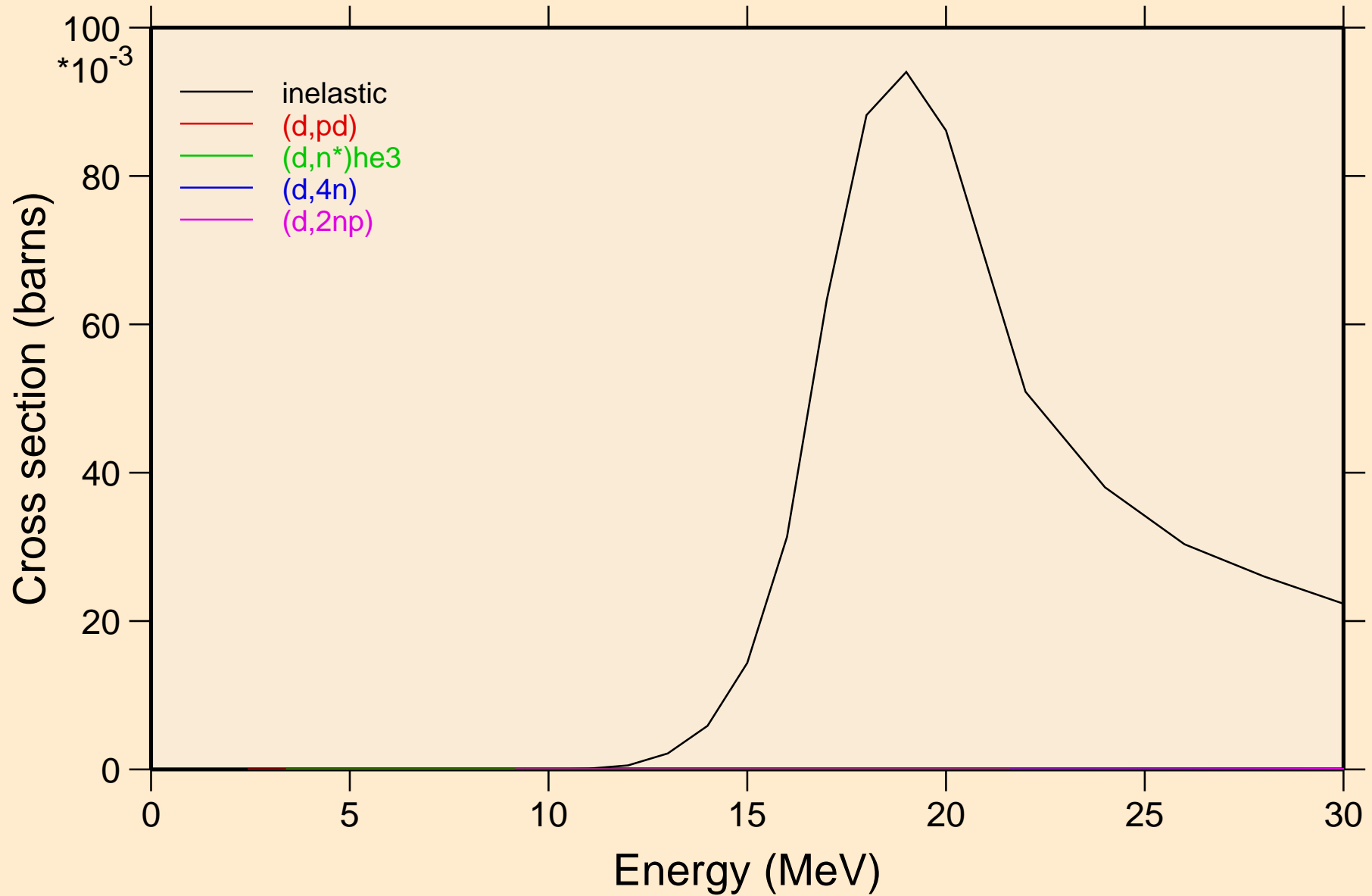

MD250 DEUTERON ACER TENDL-2021 LIBRARY; T=0.K  
Threshold reactions

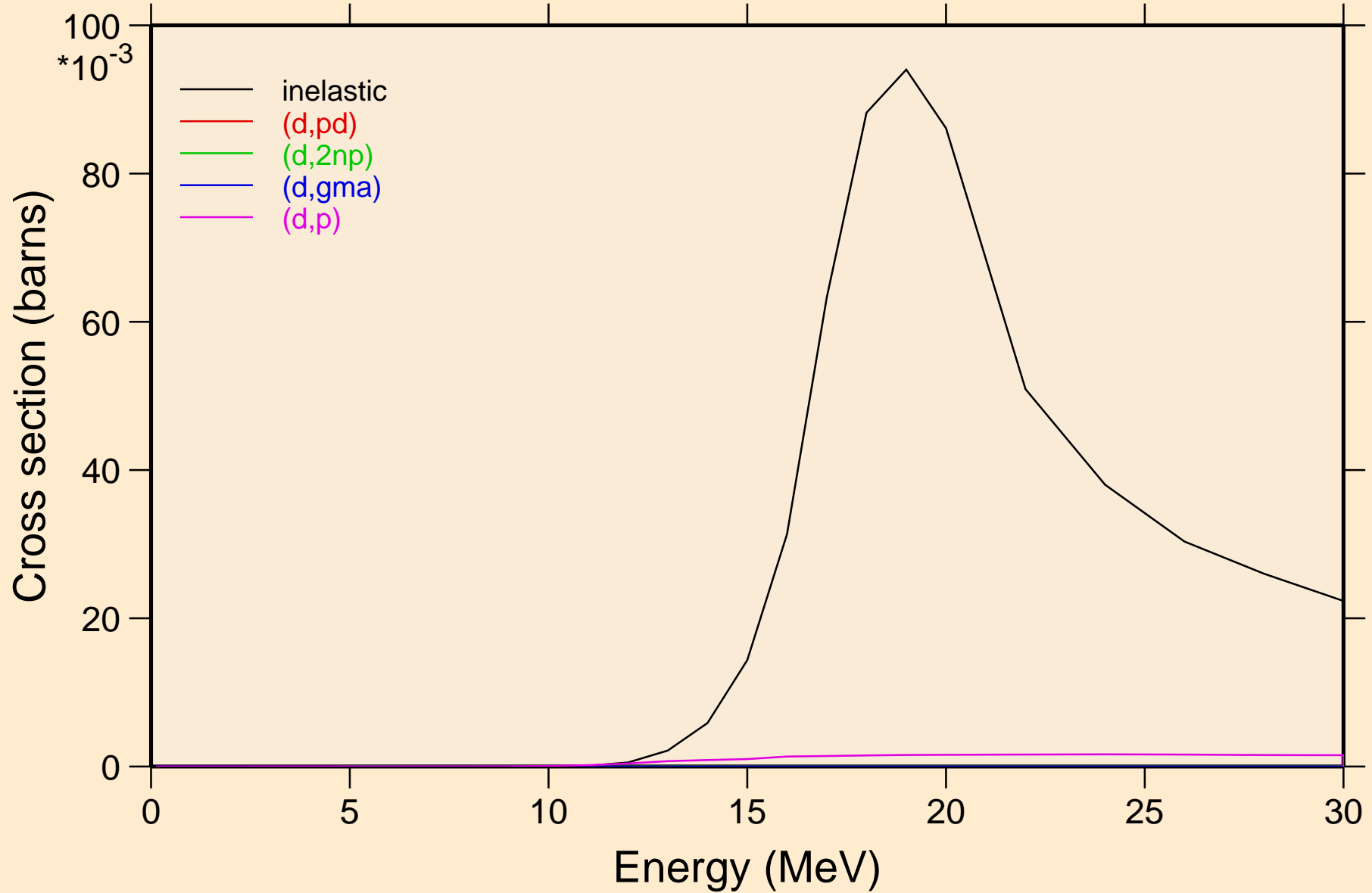

MD250 DEUTERON ACER TENDL-2021 LIBRARY; T=0.K  
Threshold reactions

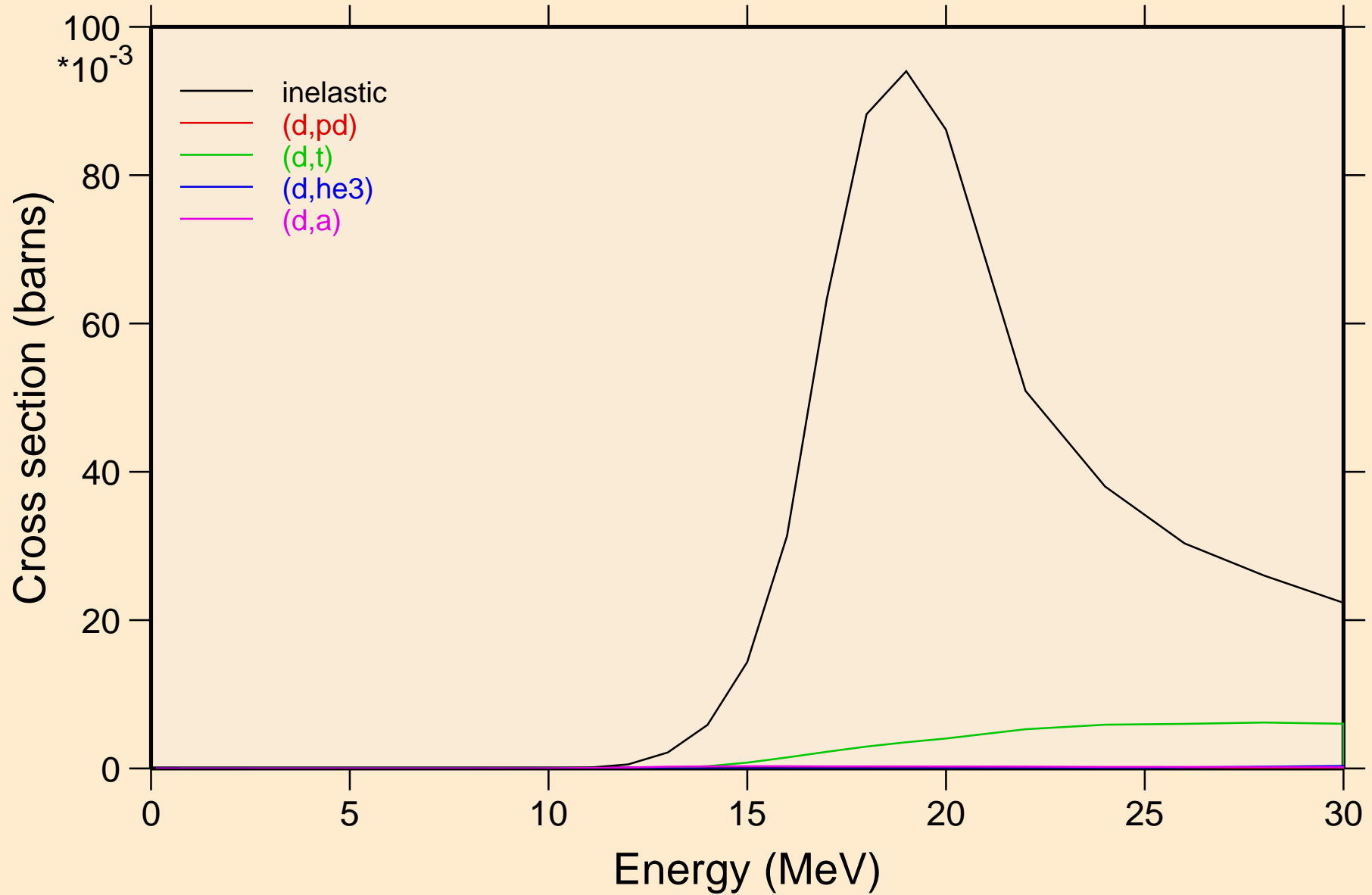

MD250 DEUTERON ACER TENDL-2021 LIBRARY; T=0.K  
Threshold reactions

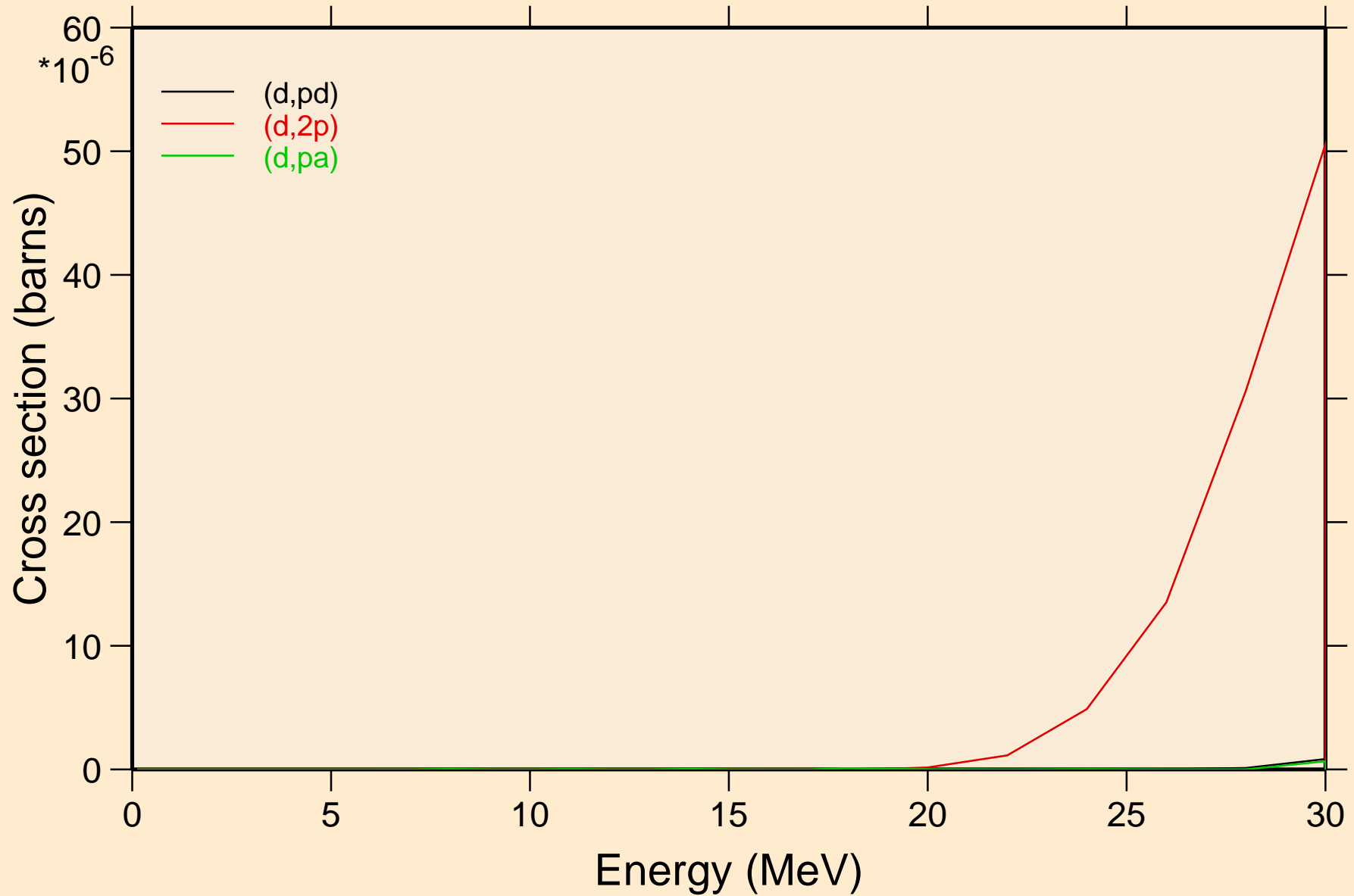

MD250 DEUTERON ACER TENDL-2021 LIBRARY; T=0.K  
Threshold reactions

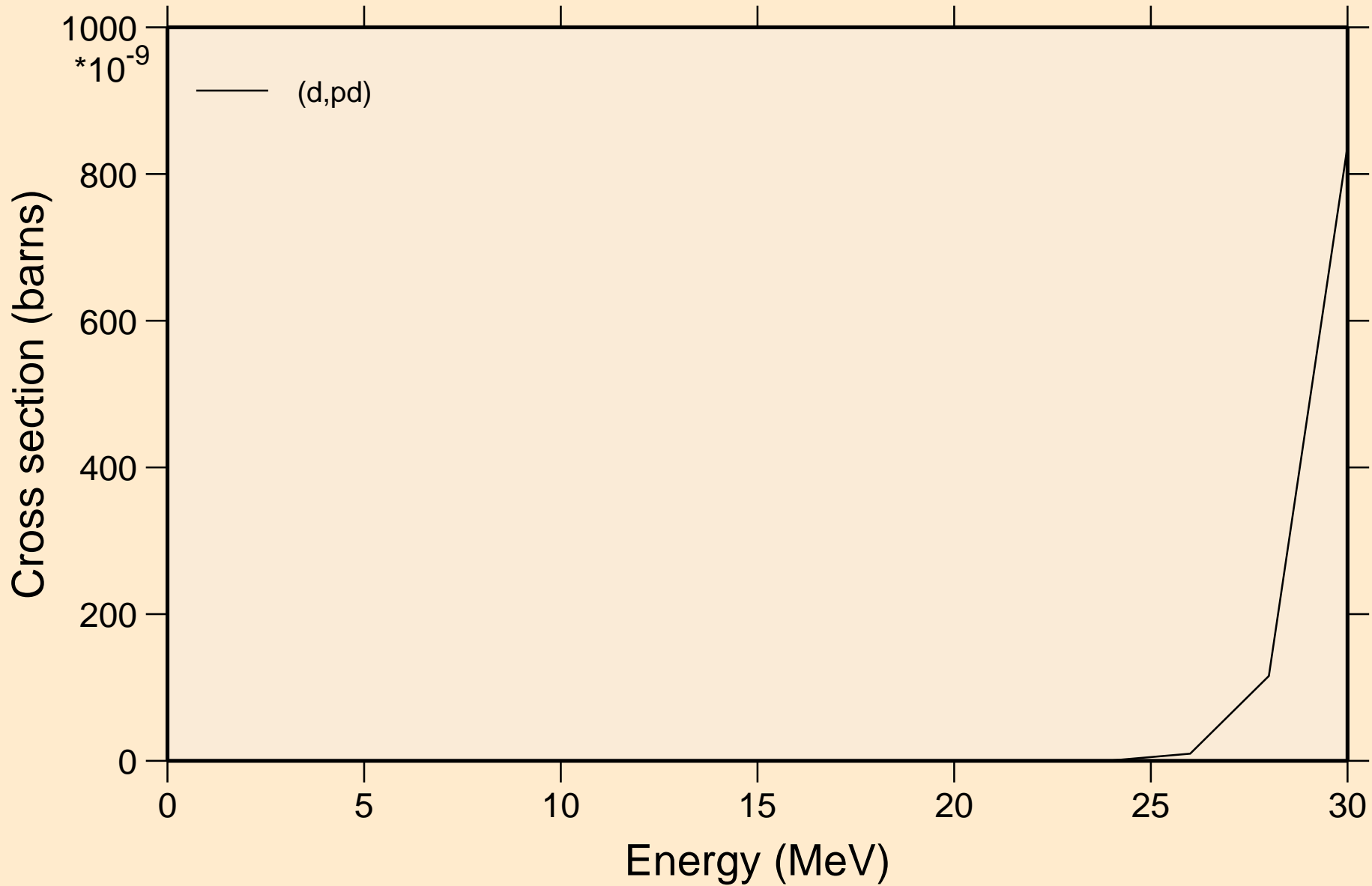

MD250 DEUTERON ACER TENDL-2021 LIBRARY; T=0.K  
angular distribution for elastic

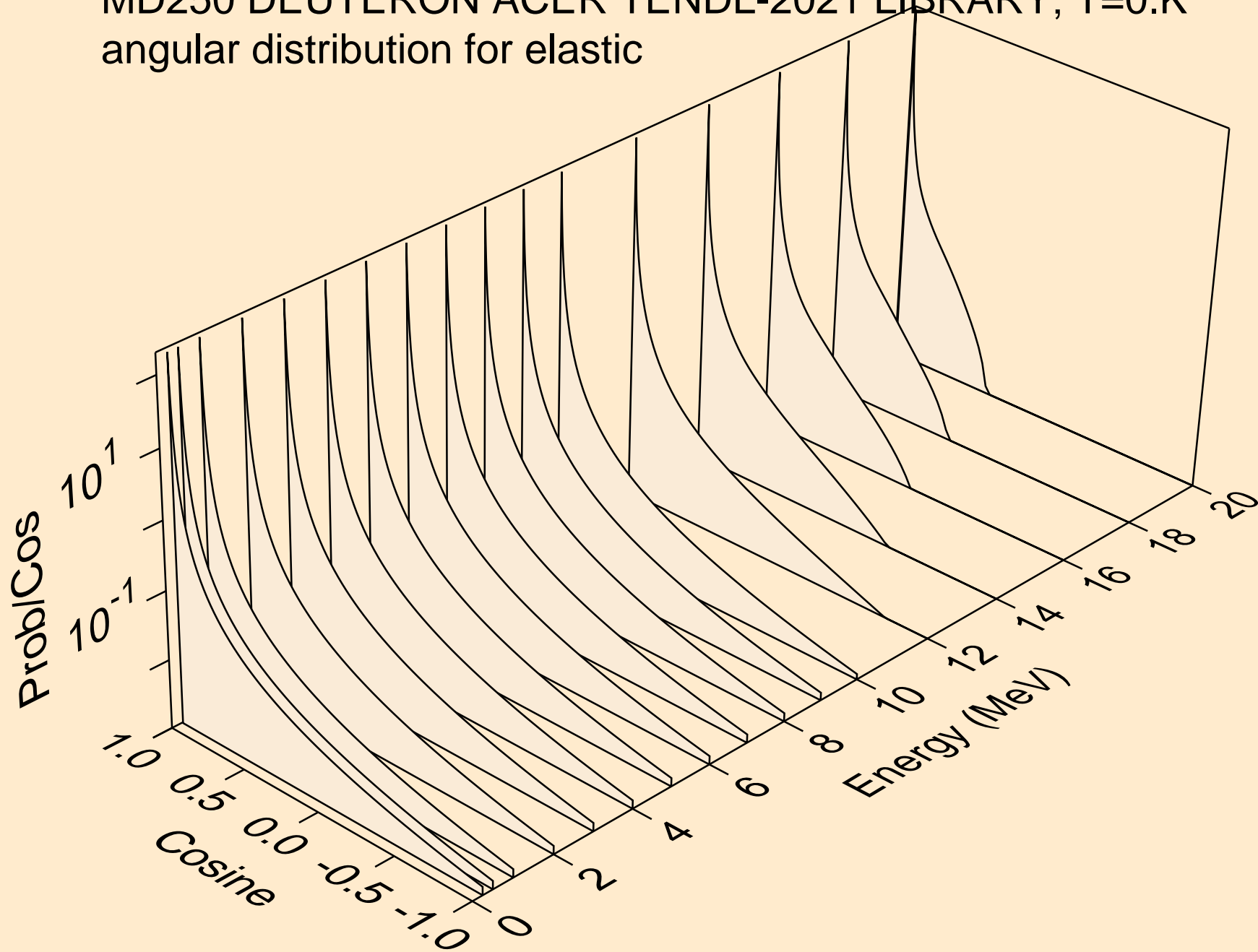

MD250 DEUTERON ACER TENDL-2021 LIBRARY; T=0.K  
angular distribution for elastic

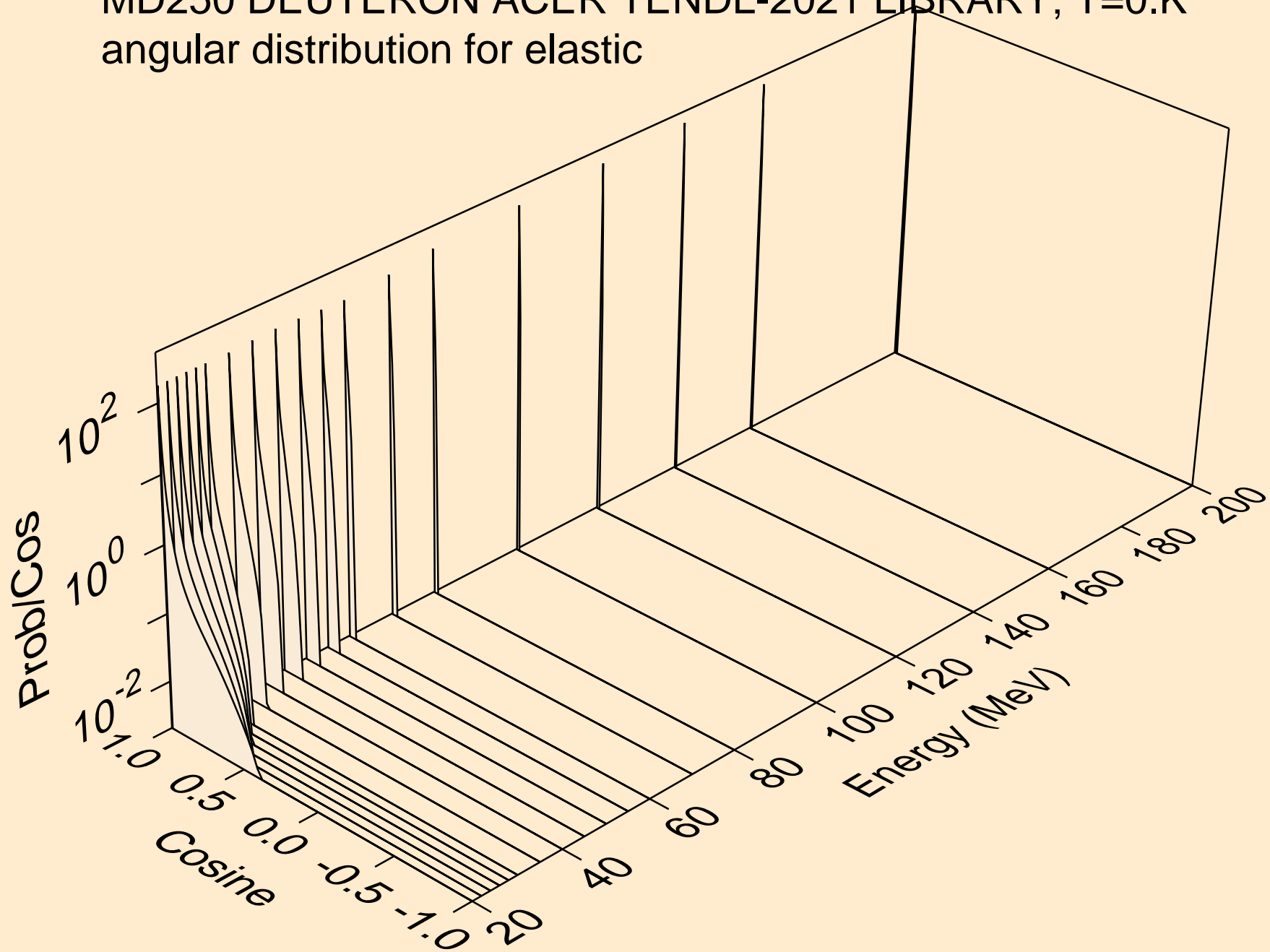

MD250 DEUTERON ACER TENDL-2021 LIBRARY; T=0.K  
Deuteron emission for (d,x)

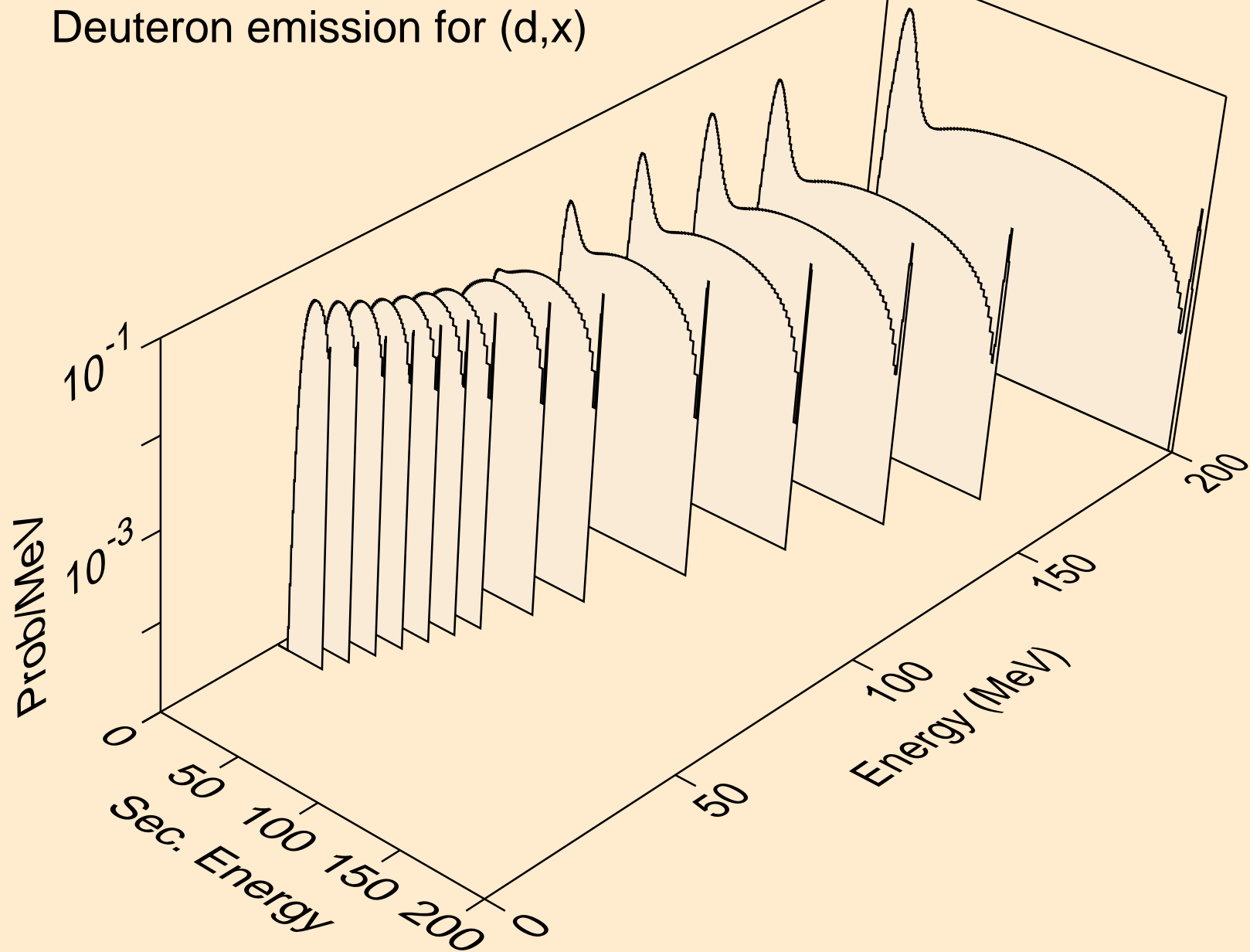



MD250 DEUTERON ACER TENDL-2021 LIBRARY; T=0.K  
Deuteron emission for (d,n\*)d

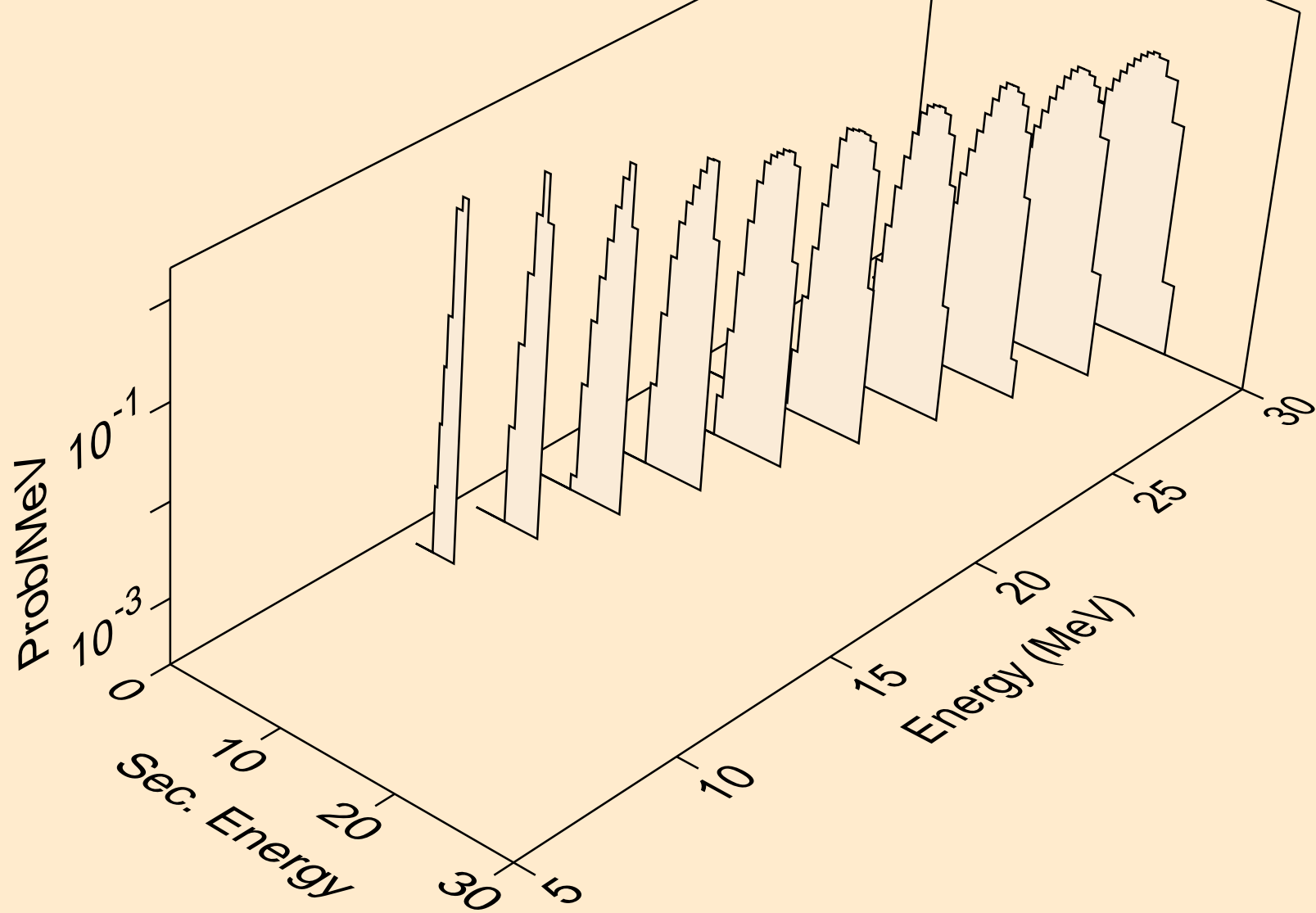

MD250 DEUTERON ACER TENDL-2021 LIBRARY; T=0.K  
Deuteron emission for inelastic

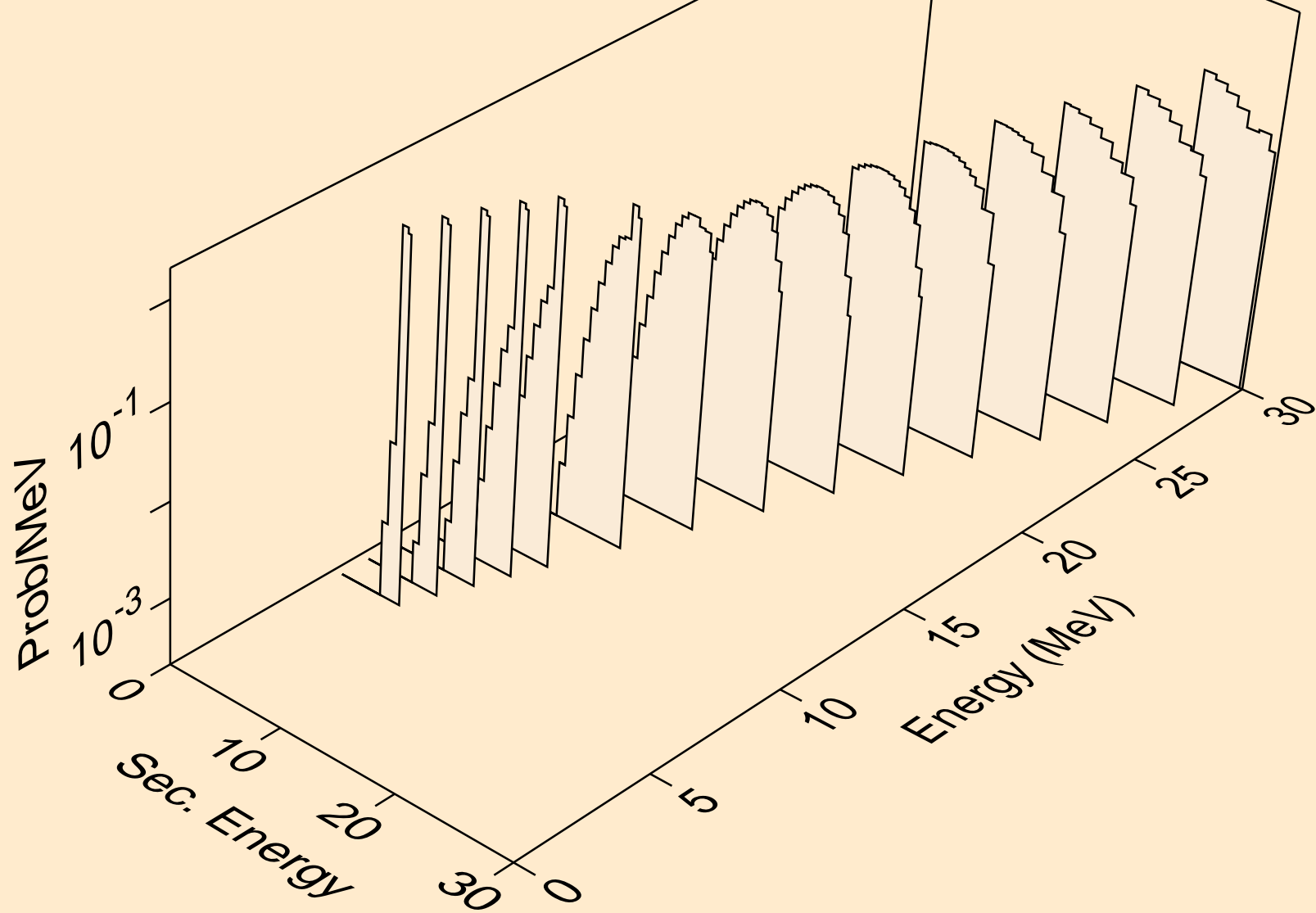

MD250 DEUTERON ACER TENDL-2021 LIBRARY; T=0.K  
Deuteron emission for (d,pd)

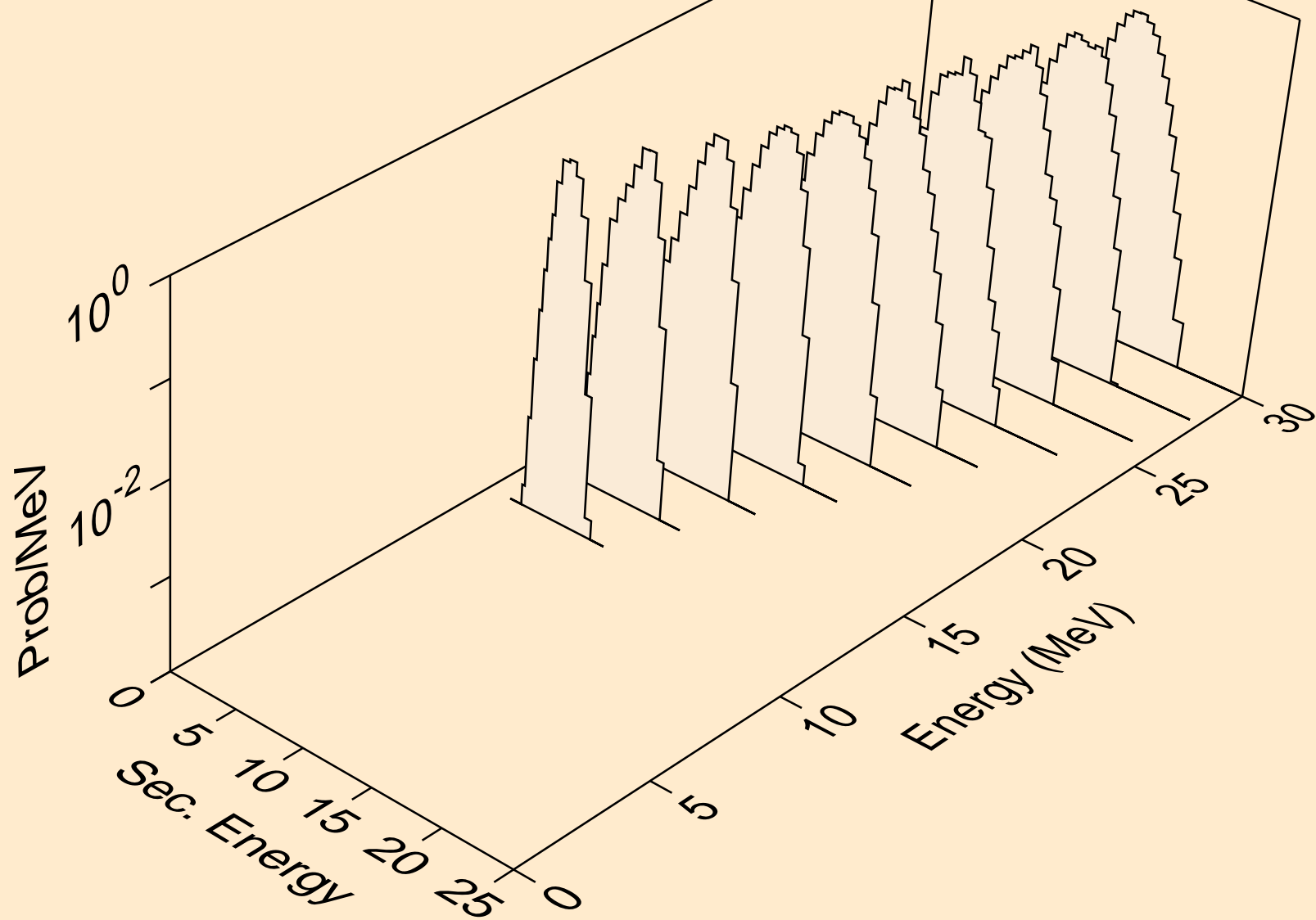

MD250 DEUTERON ACER TENDL-2021 LIBRARY; T=0.K  
Photon emission for (z,n)

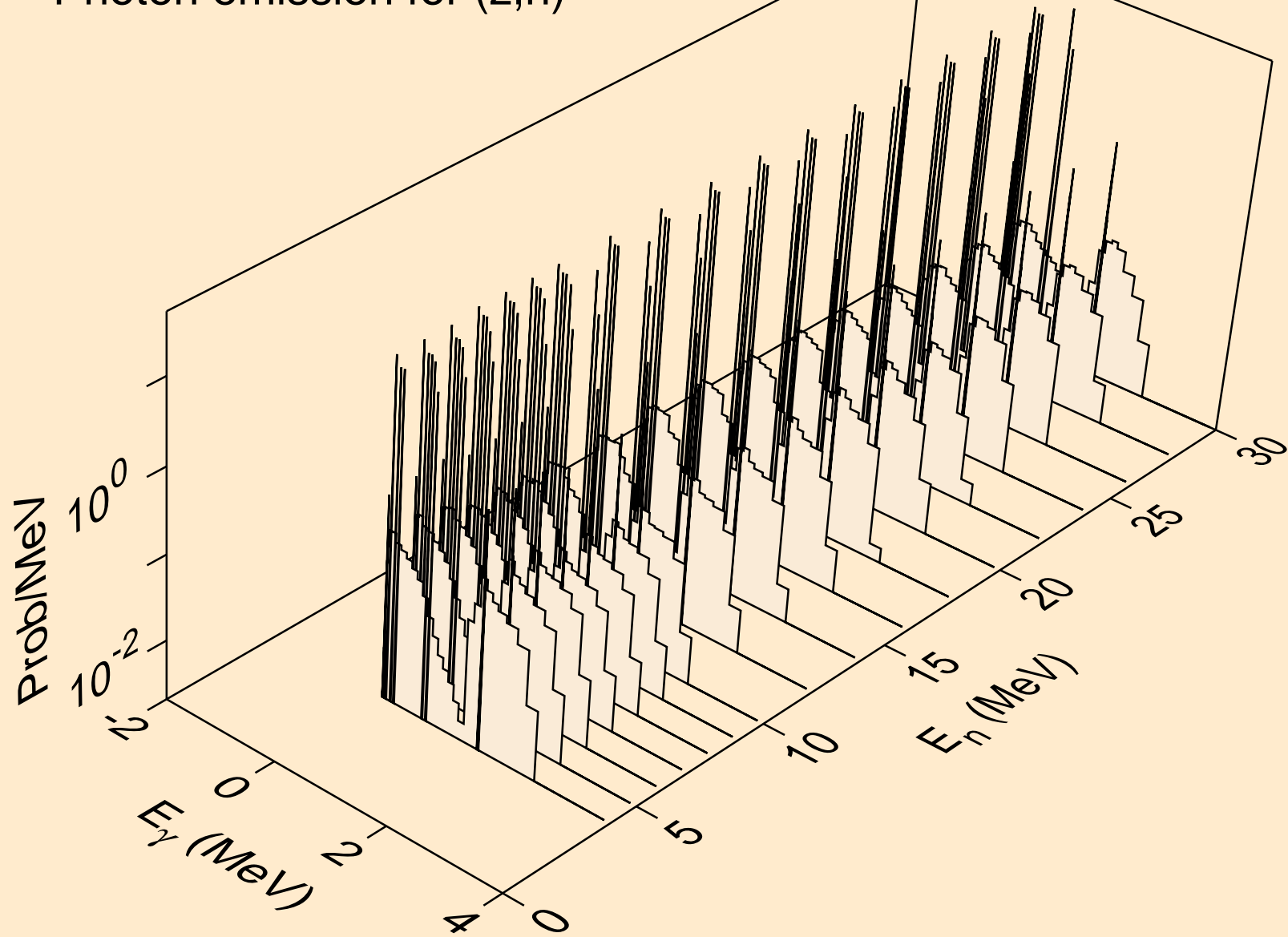

MD250 DEUTERON ACER TENDL-2021 LIBRARY; T=0.K  
Photon emission for (n,x)

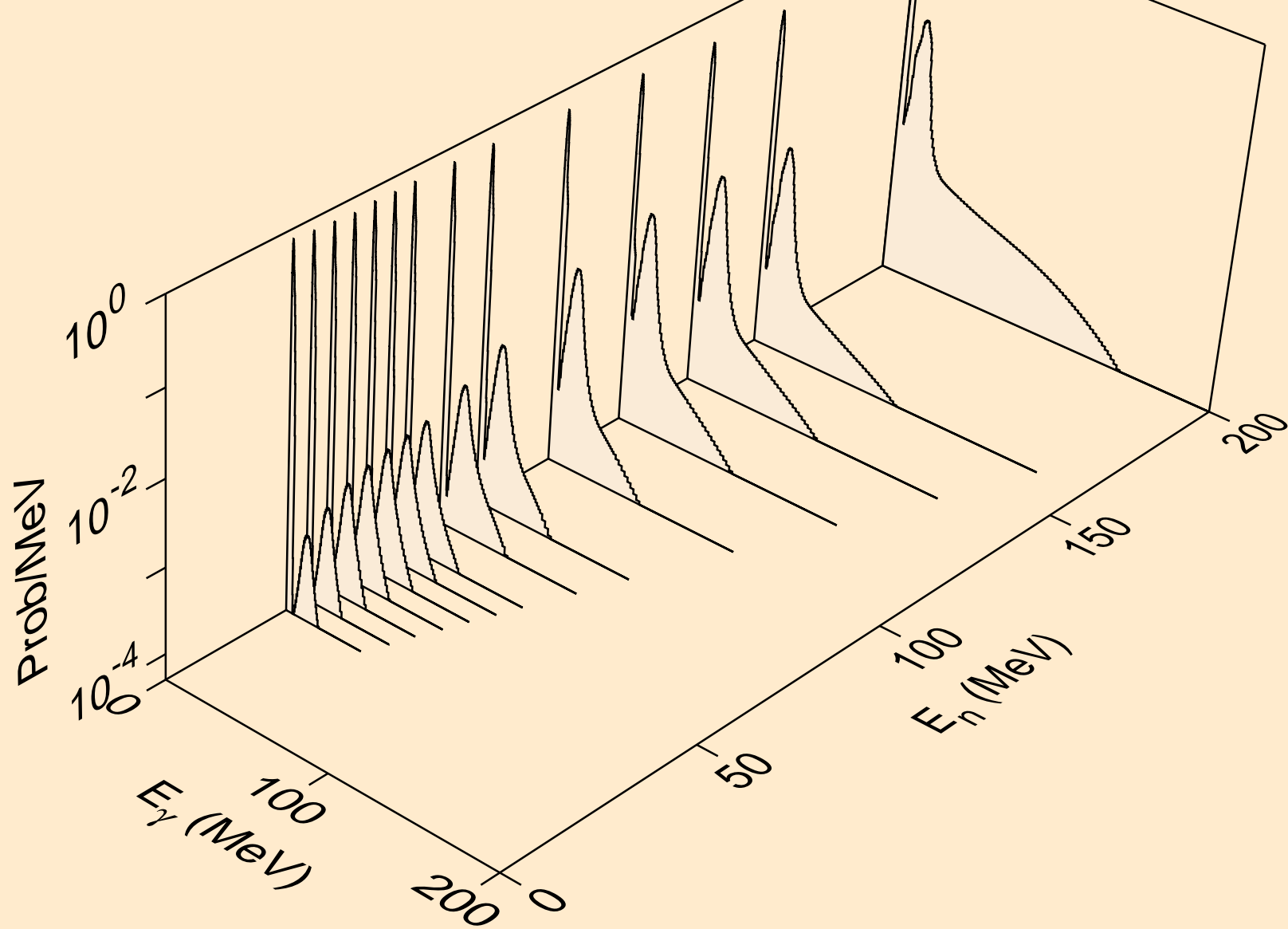

MD250 DEUTERON ACER TENDL-2021 LIBRARY; T=0.K  
Photon emission for (n,2n)

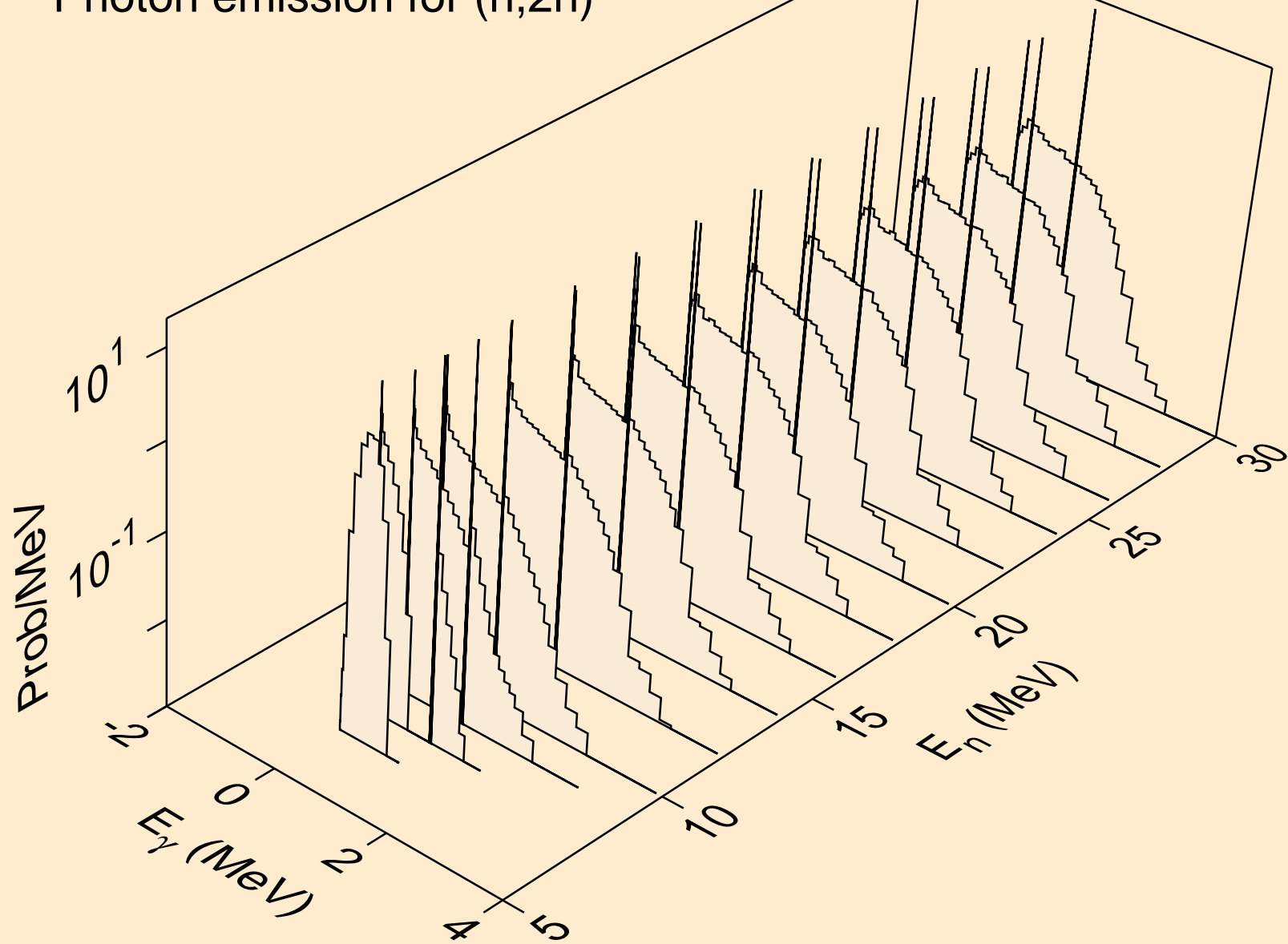

MD250 DEUTERON ACER TENDL-2021 LIBRARY; T=0.K  
Photon emission for (n,3n)

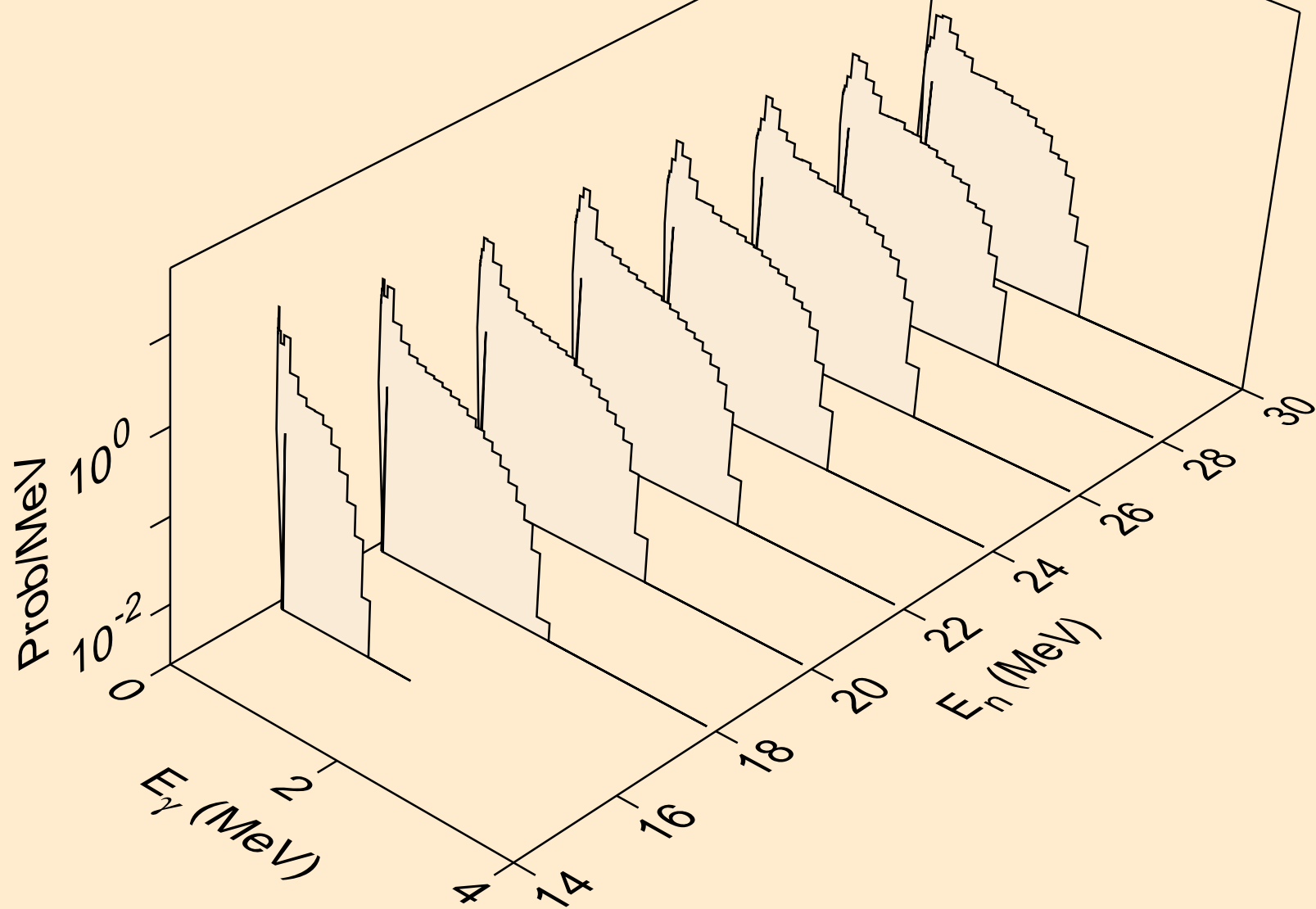

MD250 DEUTERON ACER TENDL-2021 LIBRARY; T=0.K  
Photon emission for (n,n\*)a

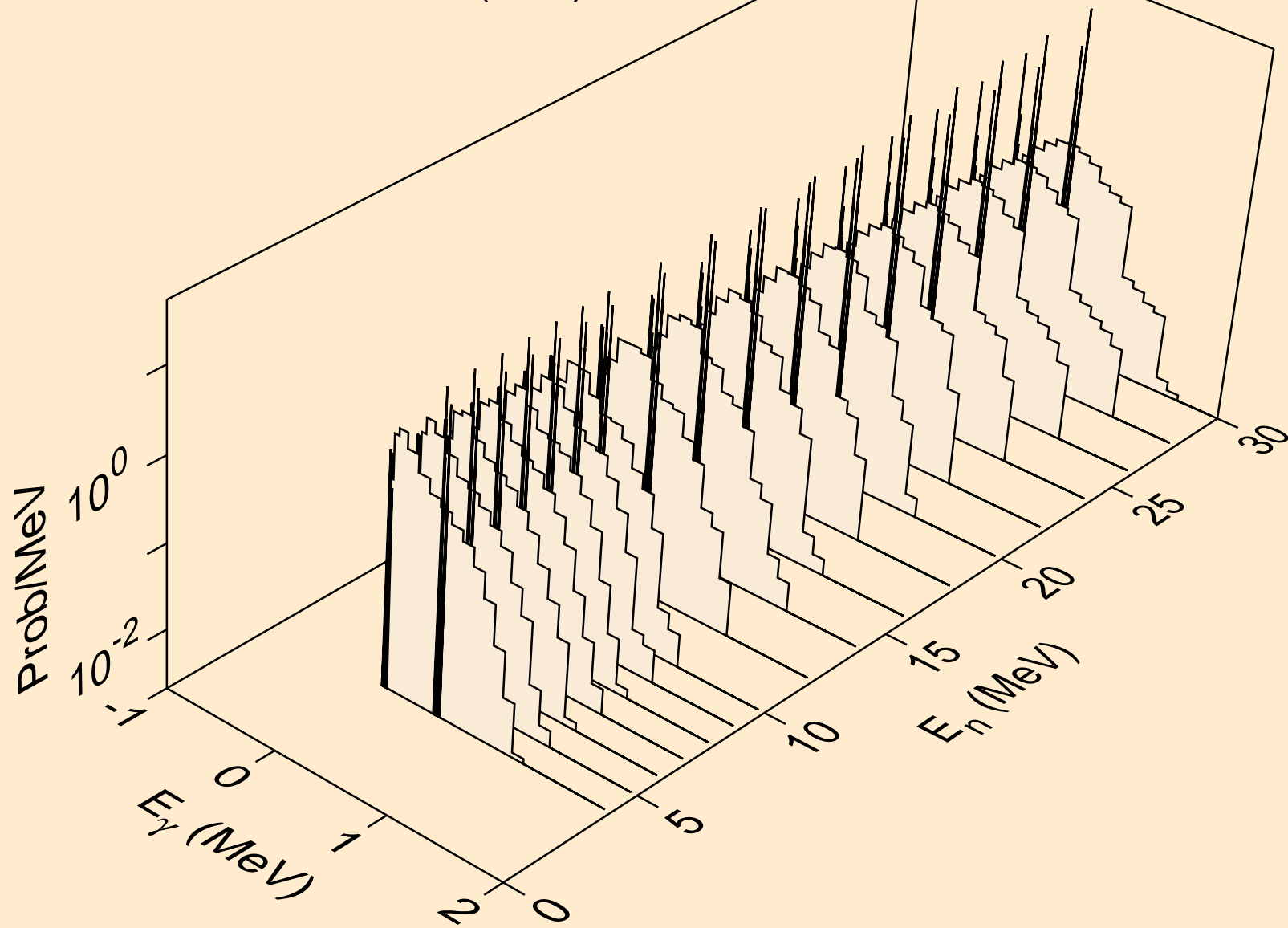



MD250 DEUTERON ACER TENDL-2021 LIBRARY; T=0.K  
Photon emission for (n,2n)a

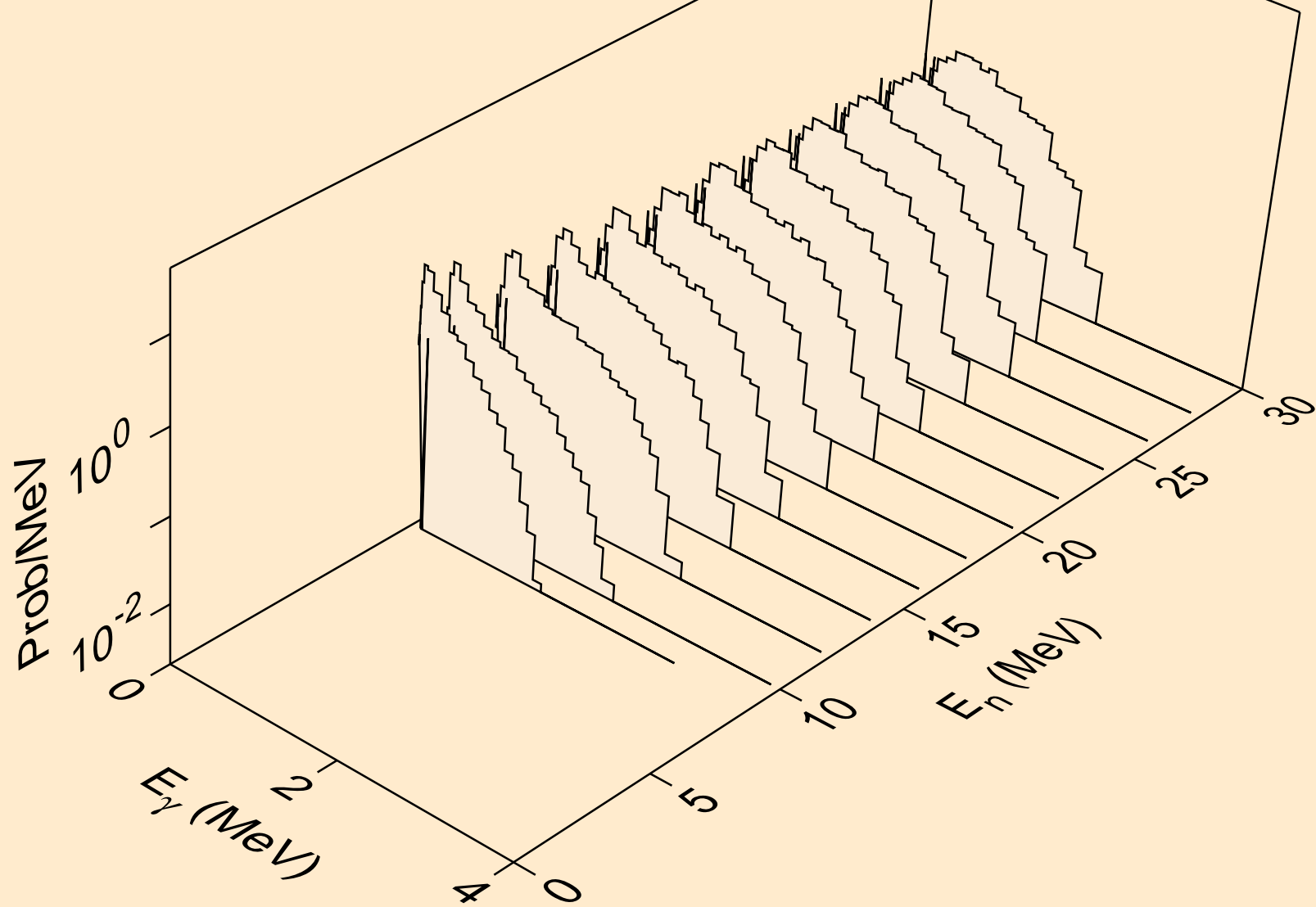

MD250 DEUTERON ACER TENDL-2021 LIBRARY; T=0.K  
Photon emission for (n,3n)a

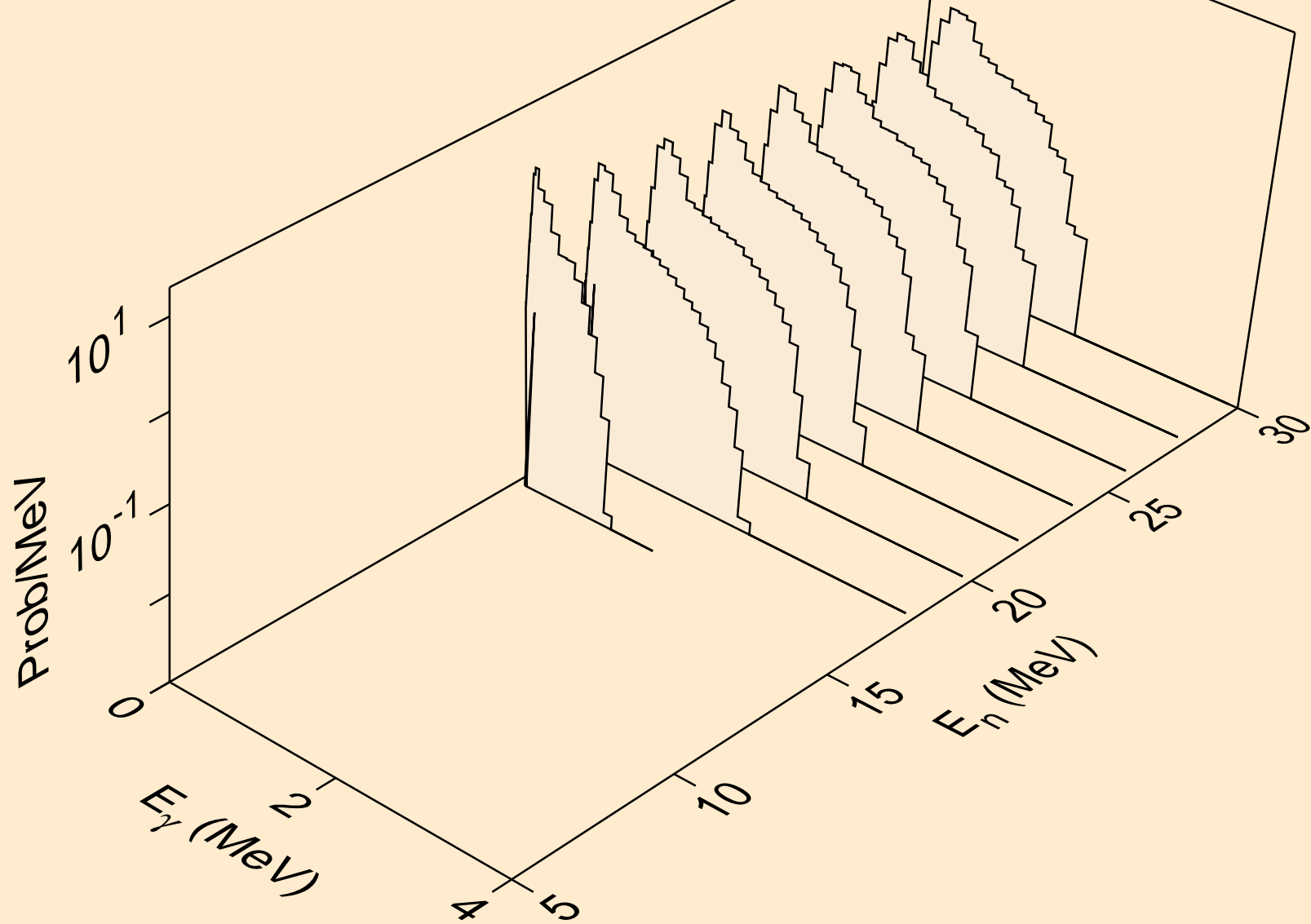

MD250 DEUTERON ACER TENDL-2021 LIBRARY; T=0.K  
Photon emission for (n,n\*)p

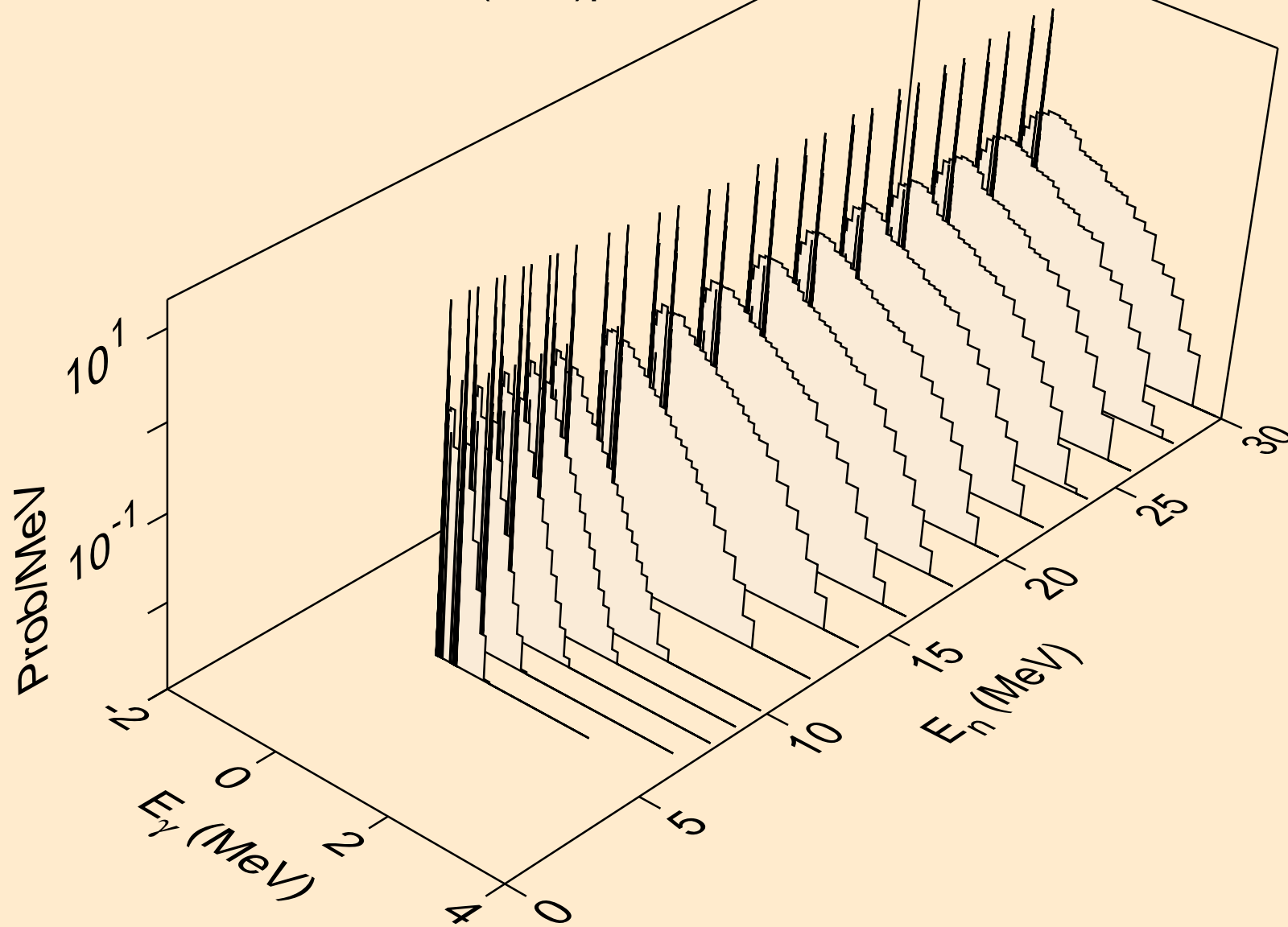

MD250 DEUTERON ACER TENDL-2021 LIBRARY; T=0.K  
Photon emission for (n,n\*)d

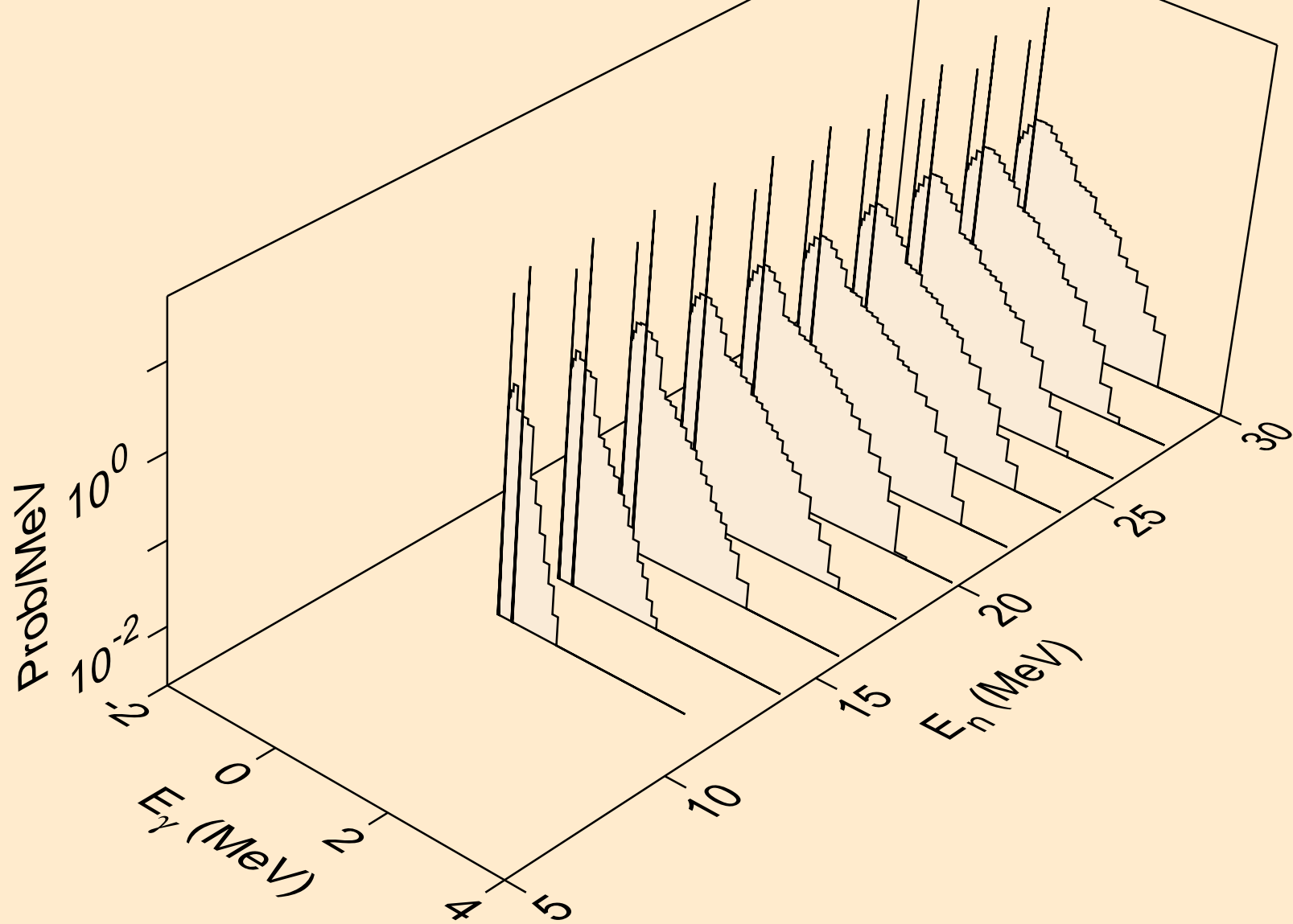

MD250 DEUTERON ACER TENDL-2021 LIBRARY; T=0.K  
Photon emission for (n,n\*)t

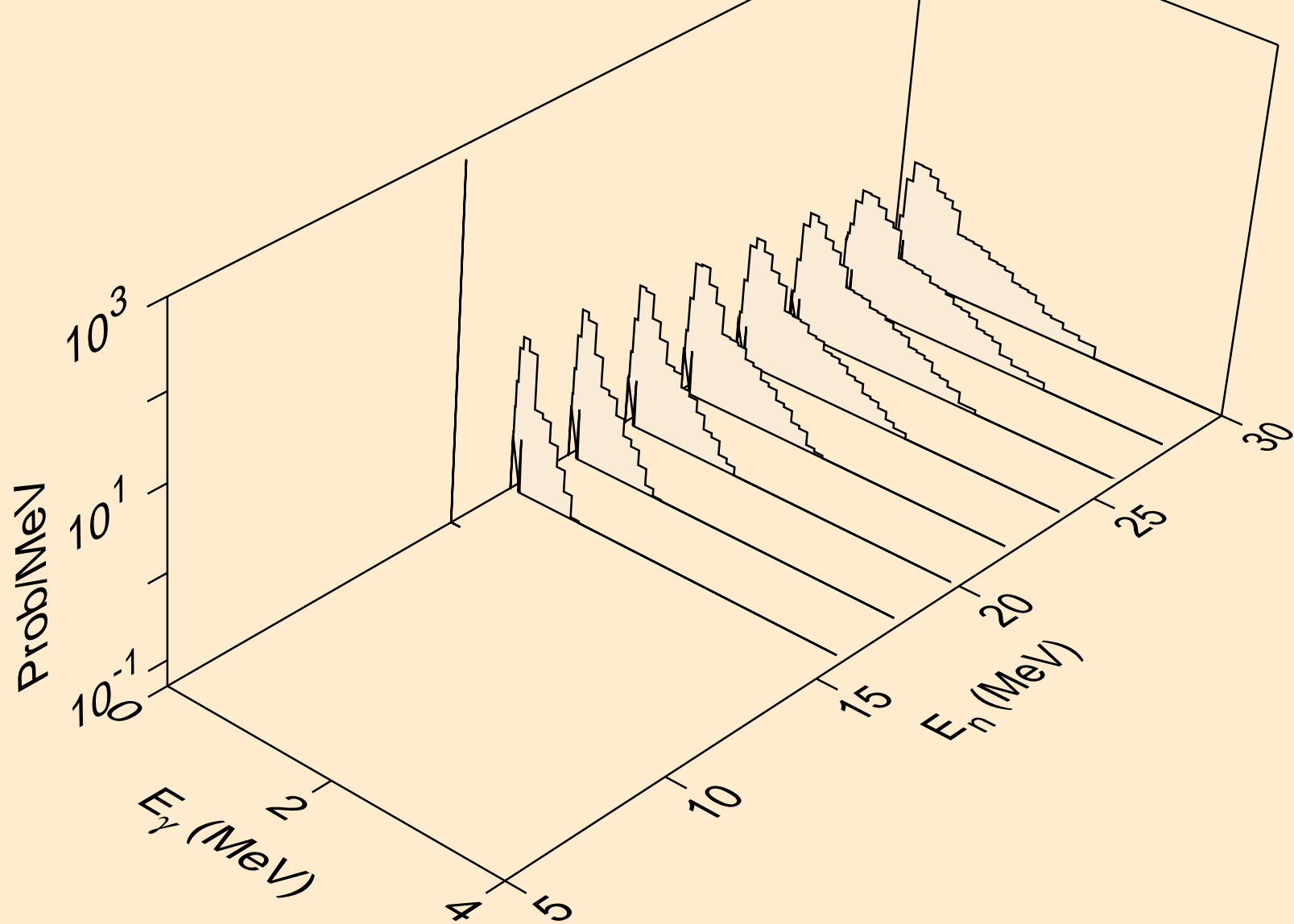

MD250 DEUTERON ACER TENDL-2021 LIBRARY; T=0.K  
Photon emission for (n,n\*)he3

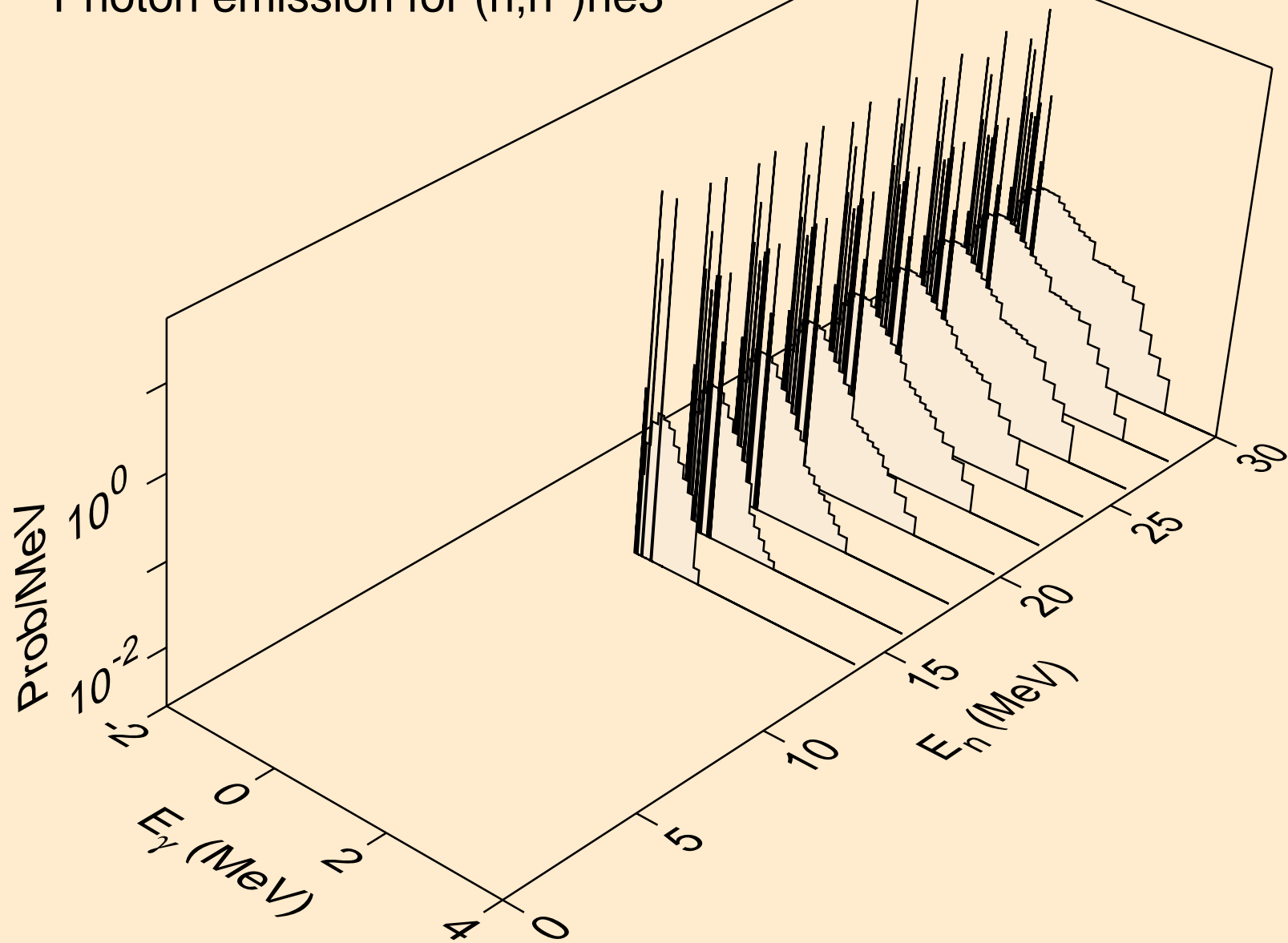

MD250 DEUTERON ACER TENDL-2021 LIBRARY; T=0.K  
Photon emission for (n,4n)

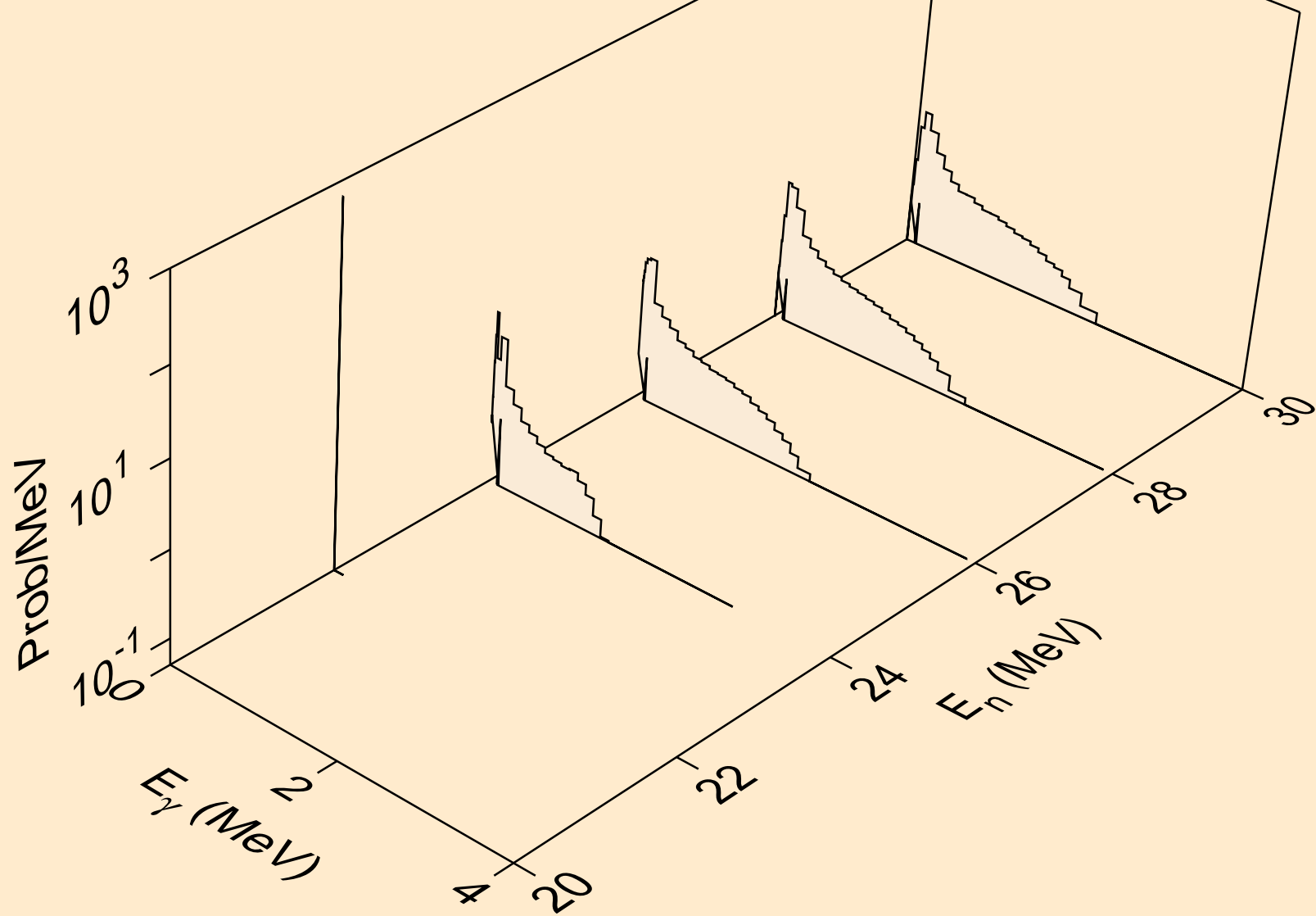

MD250 DEUTERON ACER TENDL-2021 LIBRARY; T=0.K  
Photon emission for (n,2np)

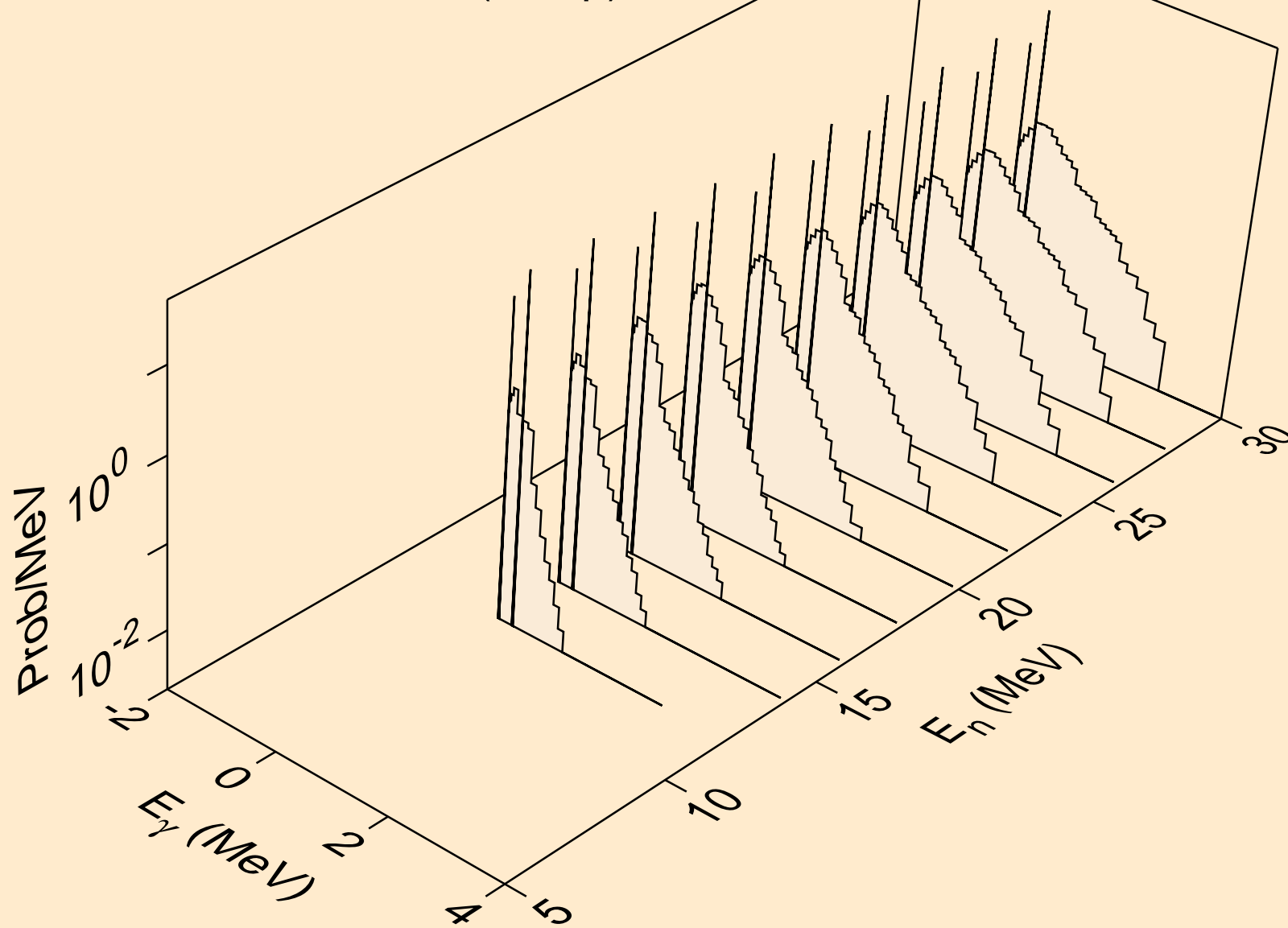



MD250 DEUTERON ACER TENDL-2021 LIBRARY; T=0.K  
Photon emission for (n,2np)

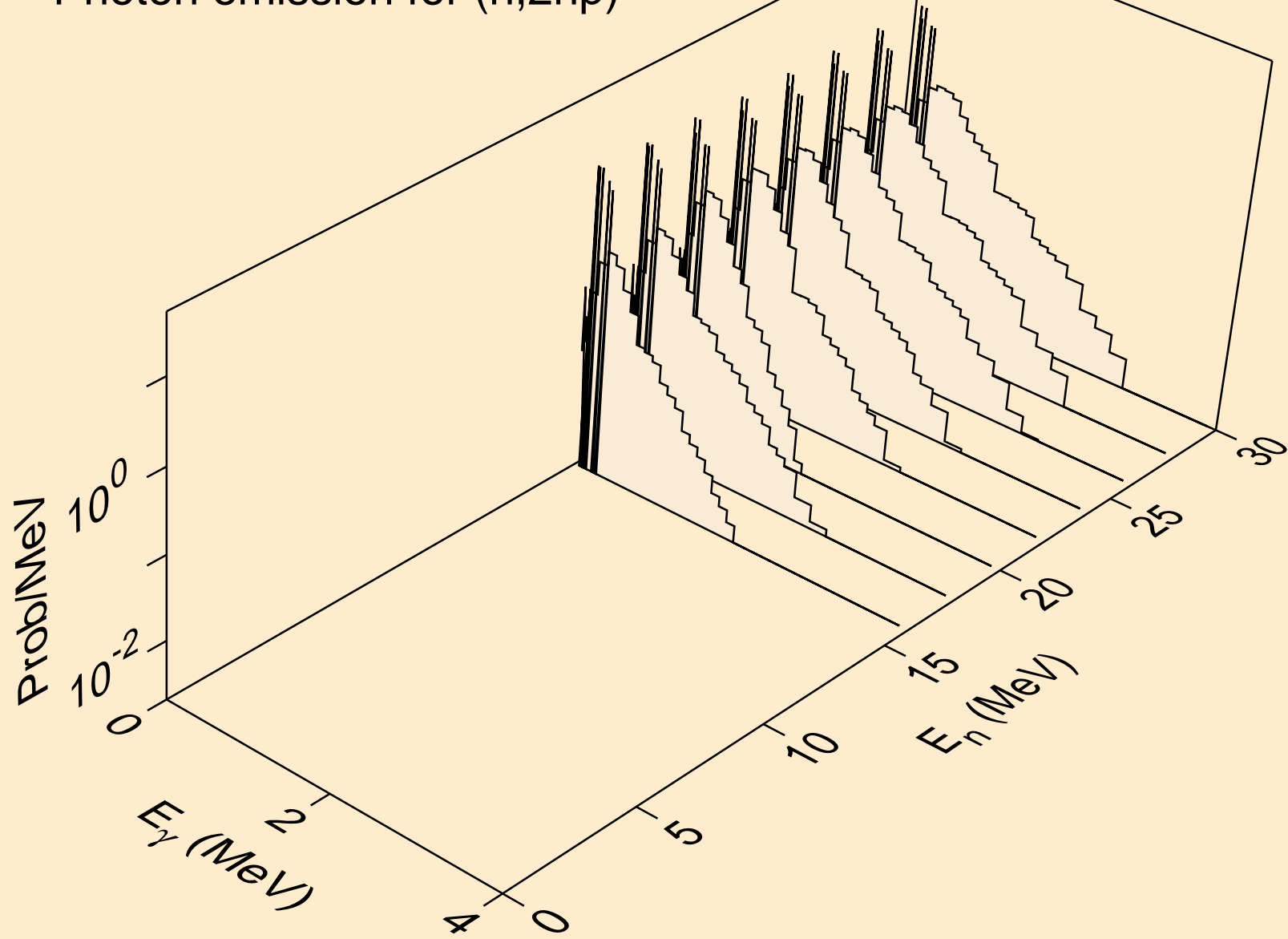

MD250 DEUTERON ACER TENDL-2021 LIBRARY; T=0.K  
Photon emission for (n,gma)

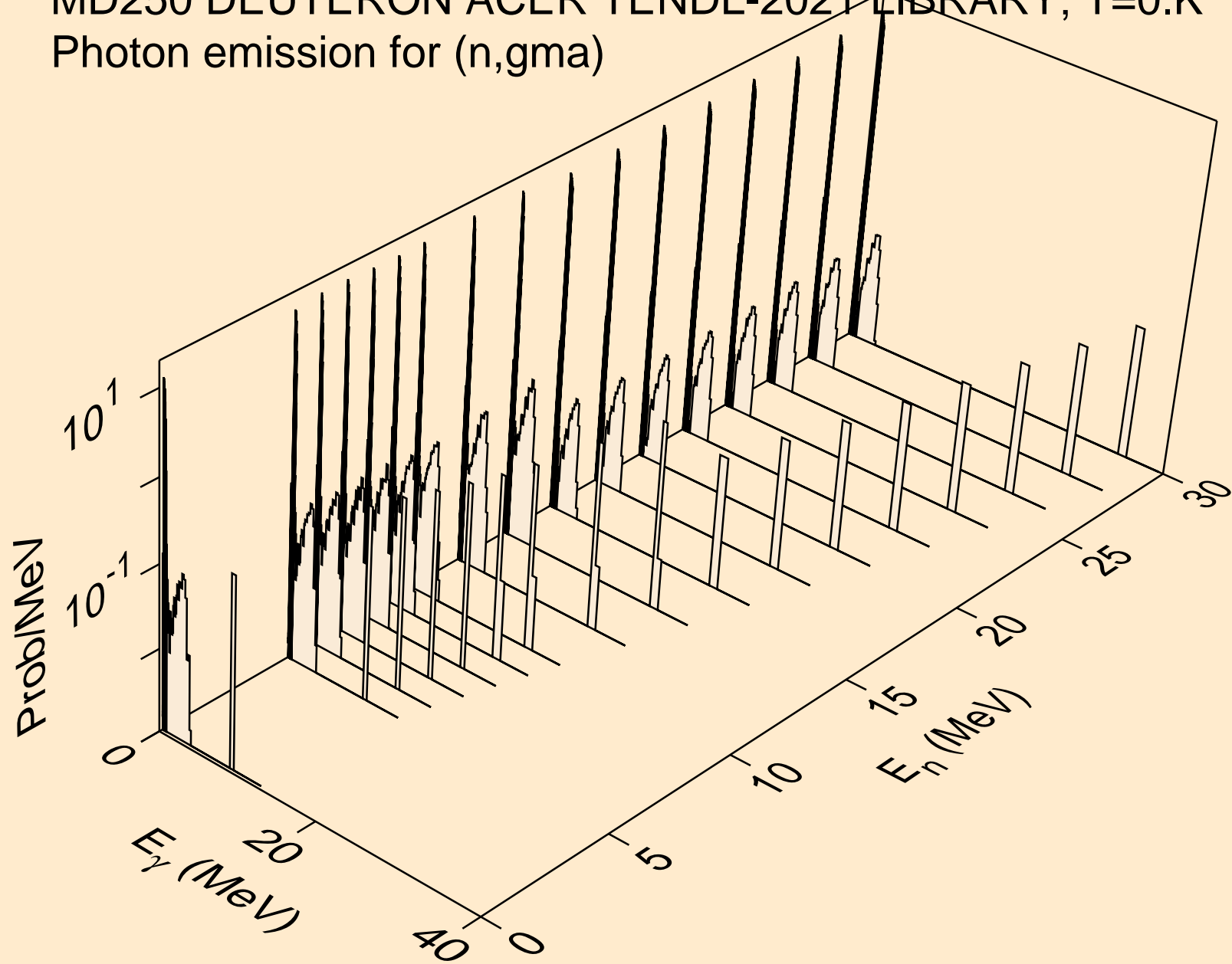

MD250 DEUTERON ACER TENDL-2021 LIBRARY; T=0.K  
Photon emission for (n,p)

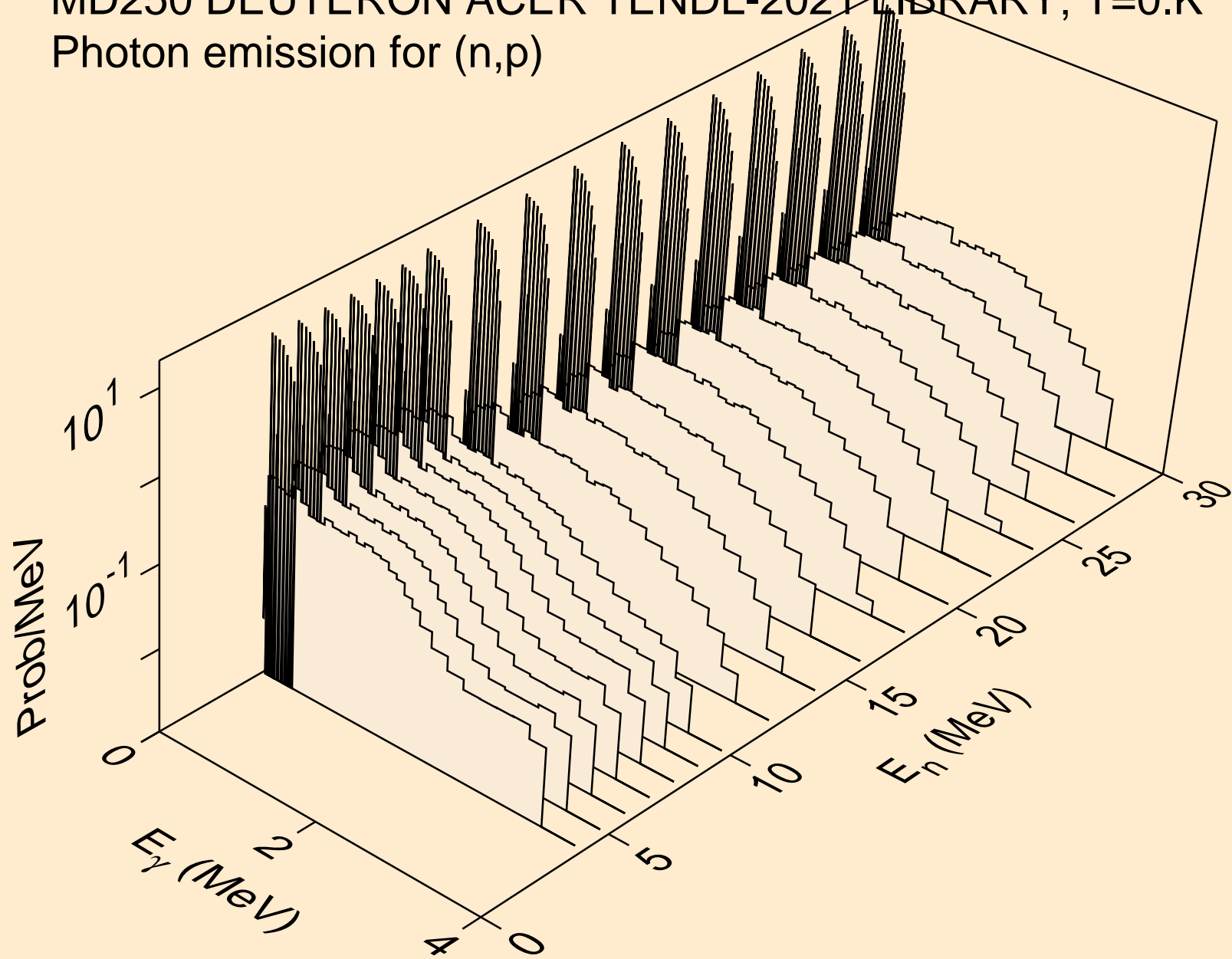

MD250 DEUTERON ACER TENDL-2021 LIBRARY; T=0.K  
Photon emission for inelastic

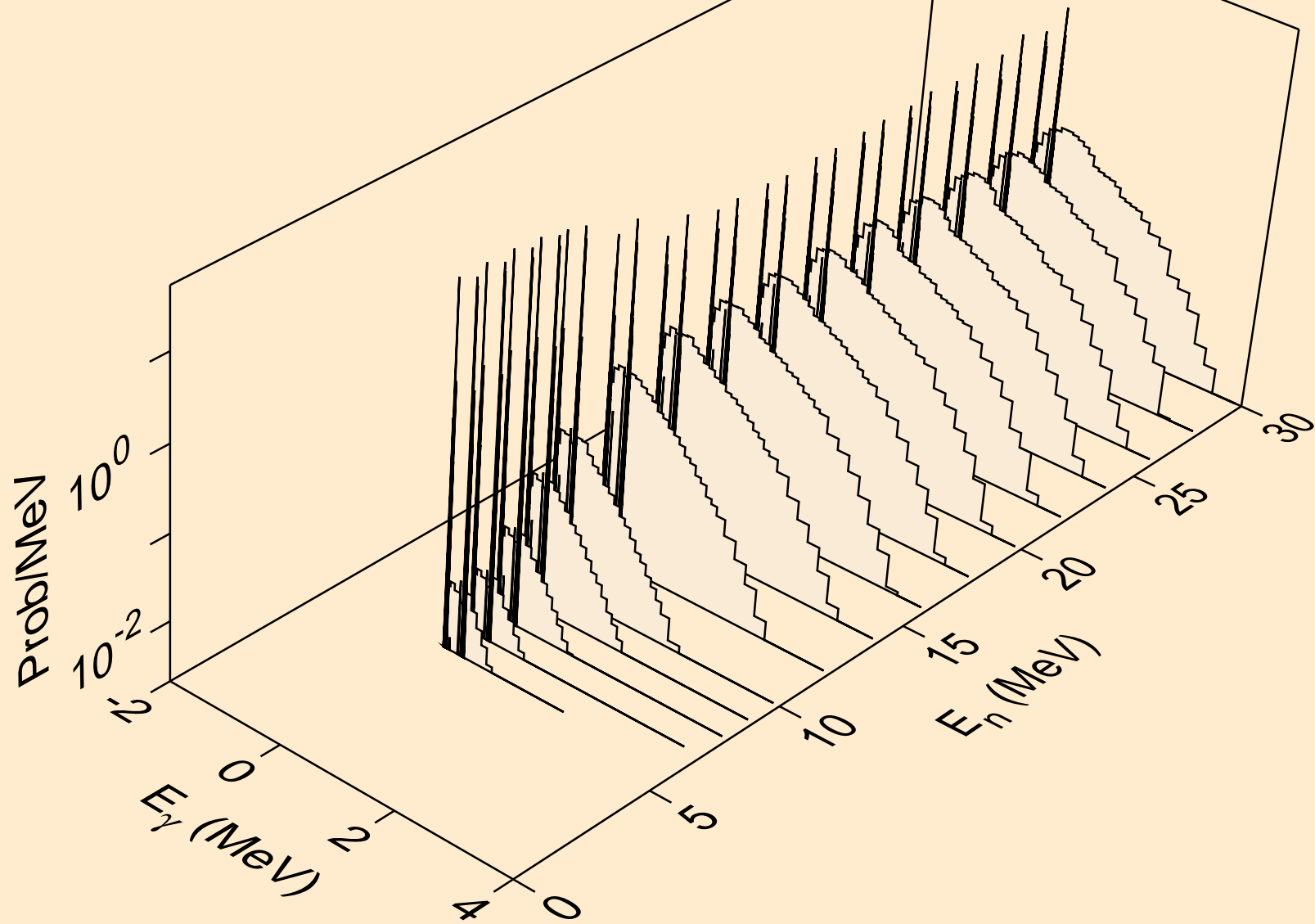

MD250 DEUTERON ACER TENDL-2021 LIBRARY; T=0.K  
Photon emission for (n,t)

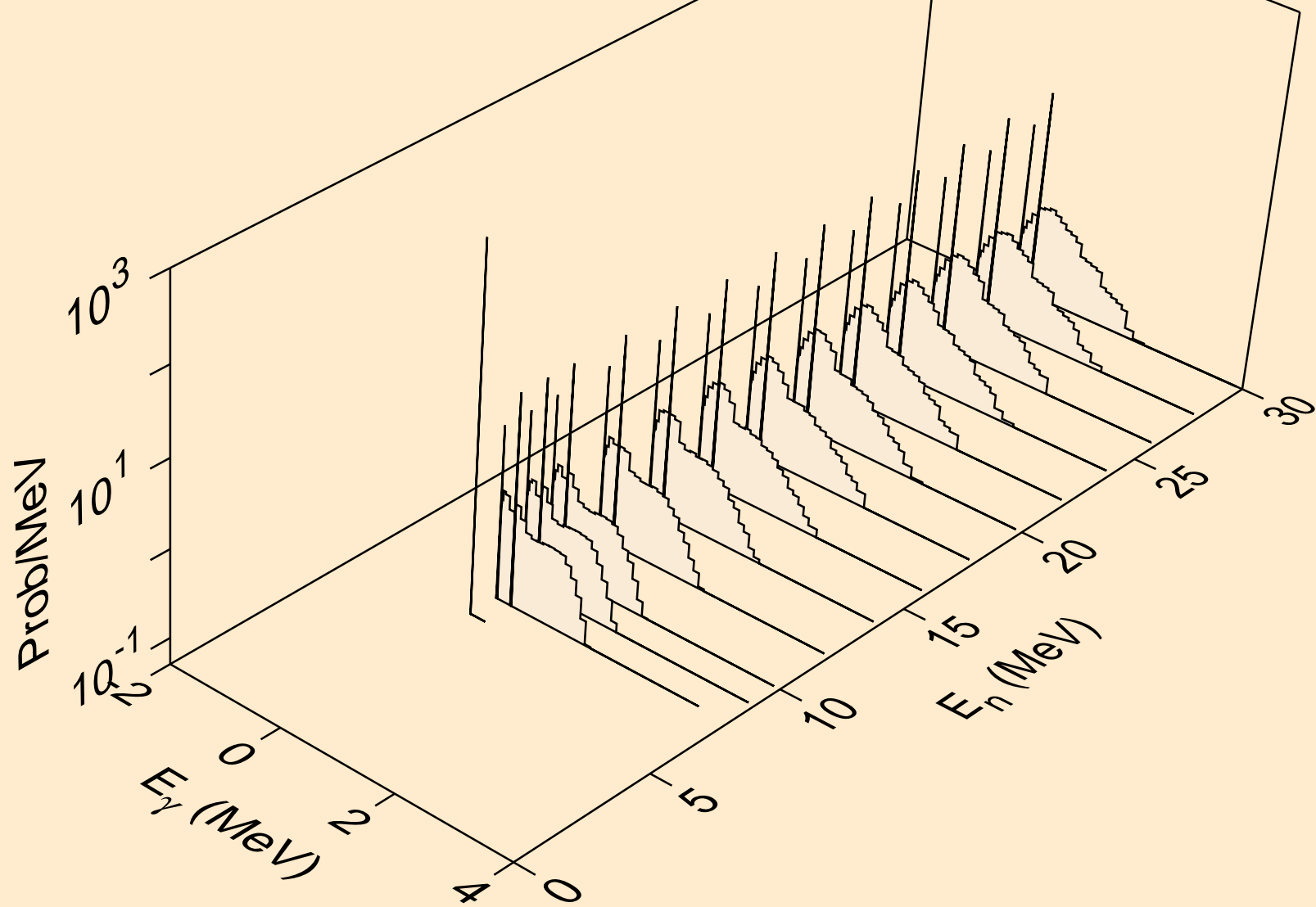

MD250 DEUTERON ACER TENDL-2021 LIBRARY; T=0.K  
Photon emission for (n,he3)

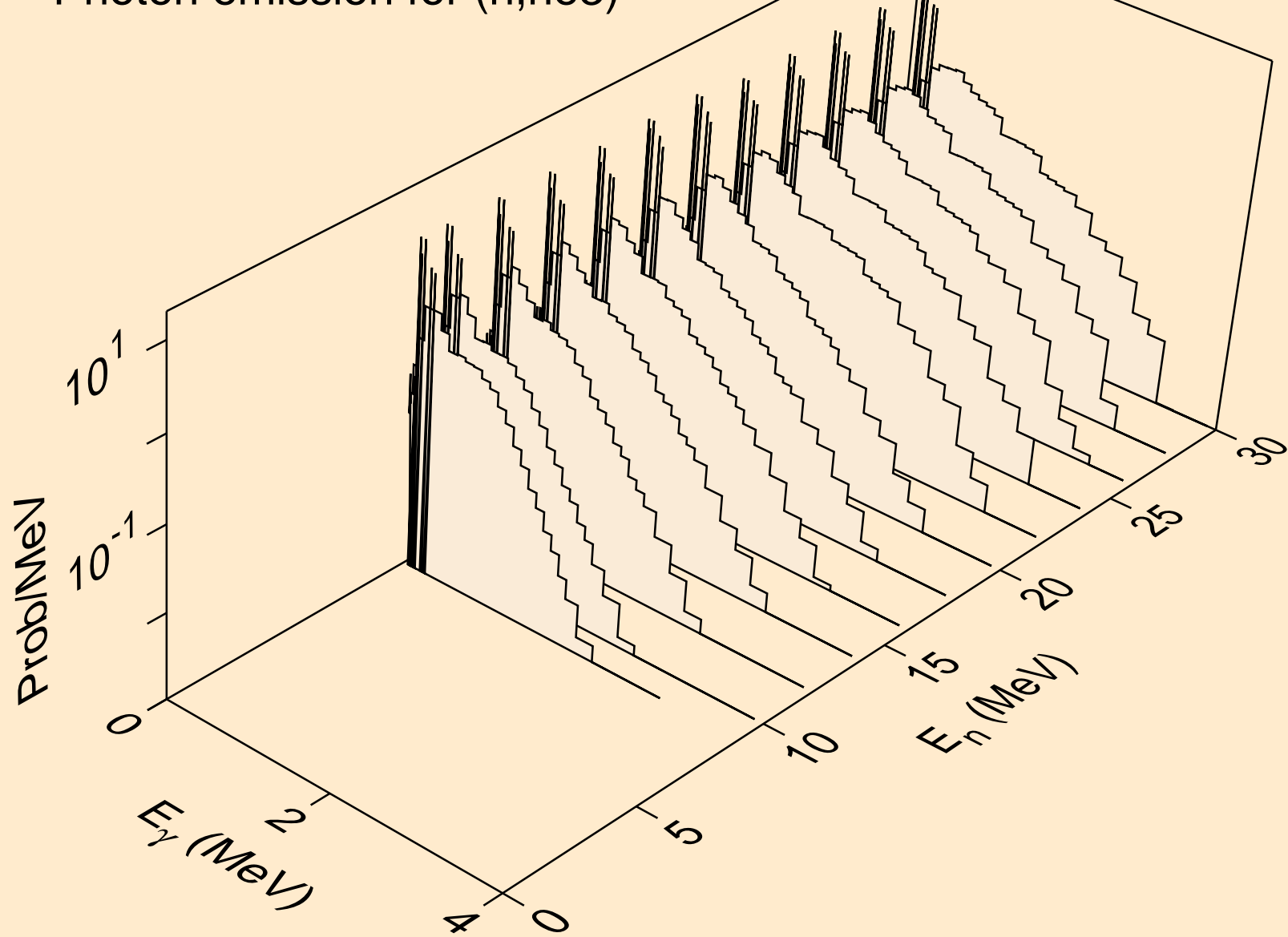

MD250 DEUTERON ACER TENDL-2021 LIBRARY; T=0.K  
Photon emission for (n,a)

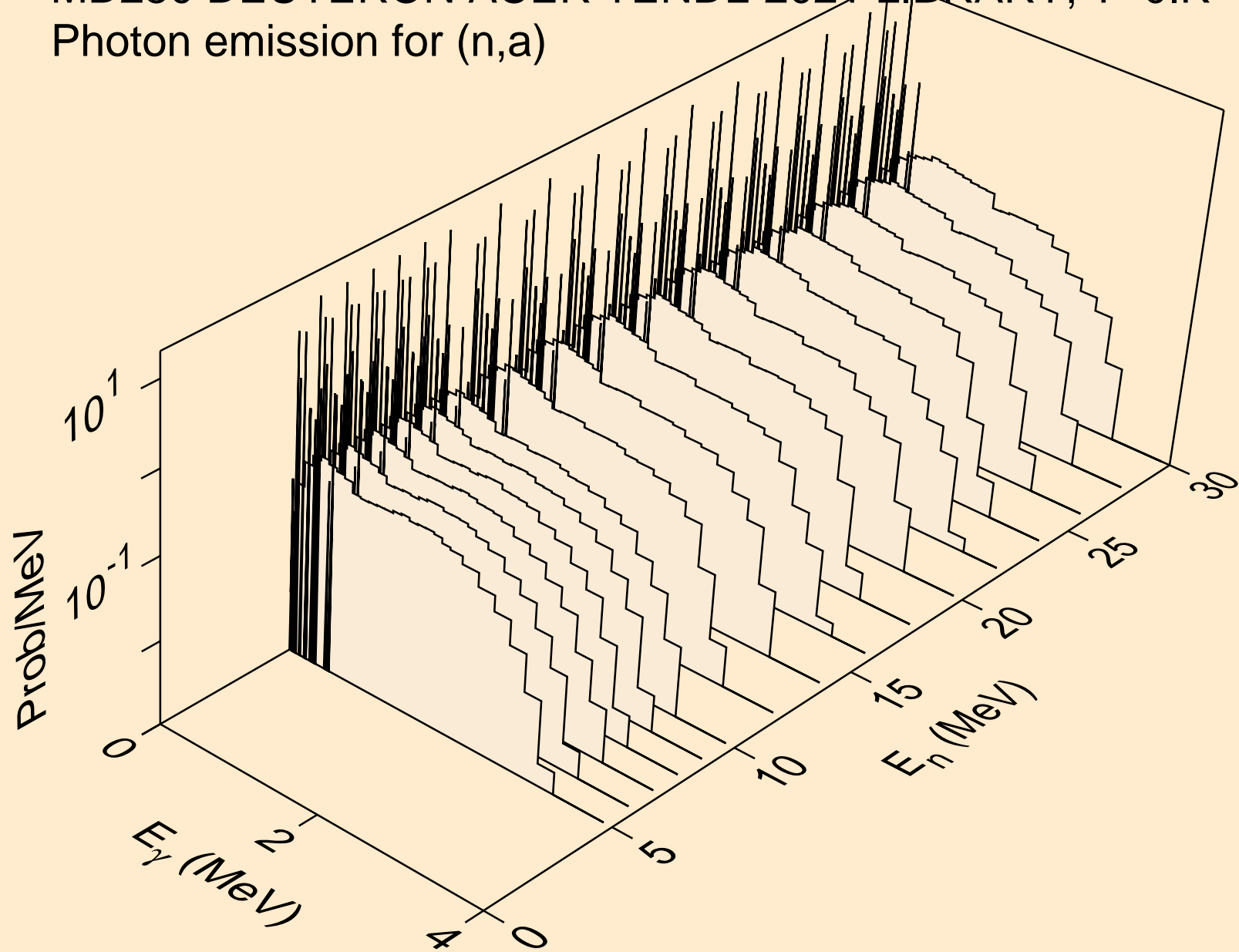

MD250 DEUTERON ACER TENDL-2021 LIBRARY; T=0.K  
Photon emission for (n,2p)

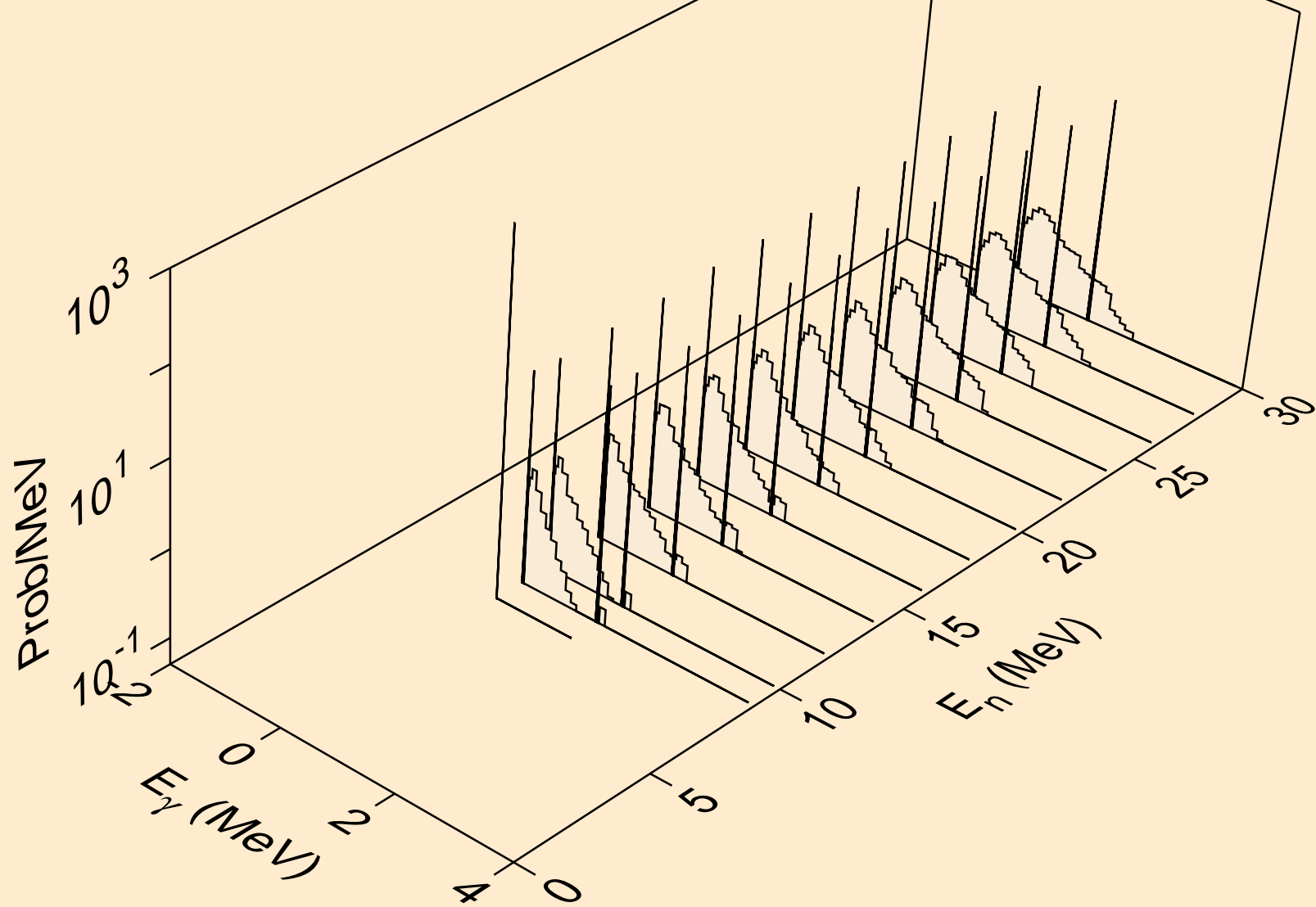



MD250 DEUTERON ACER TENDL-2021 LIBRARY; T=0.K  
Photon emission for (n,p)

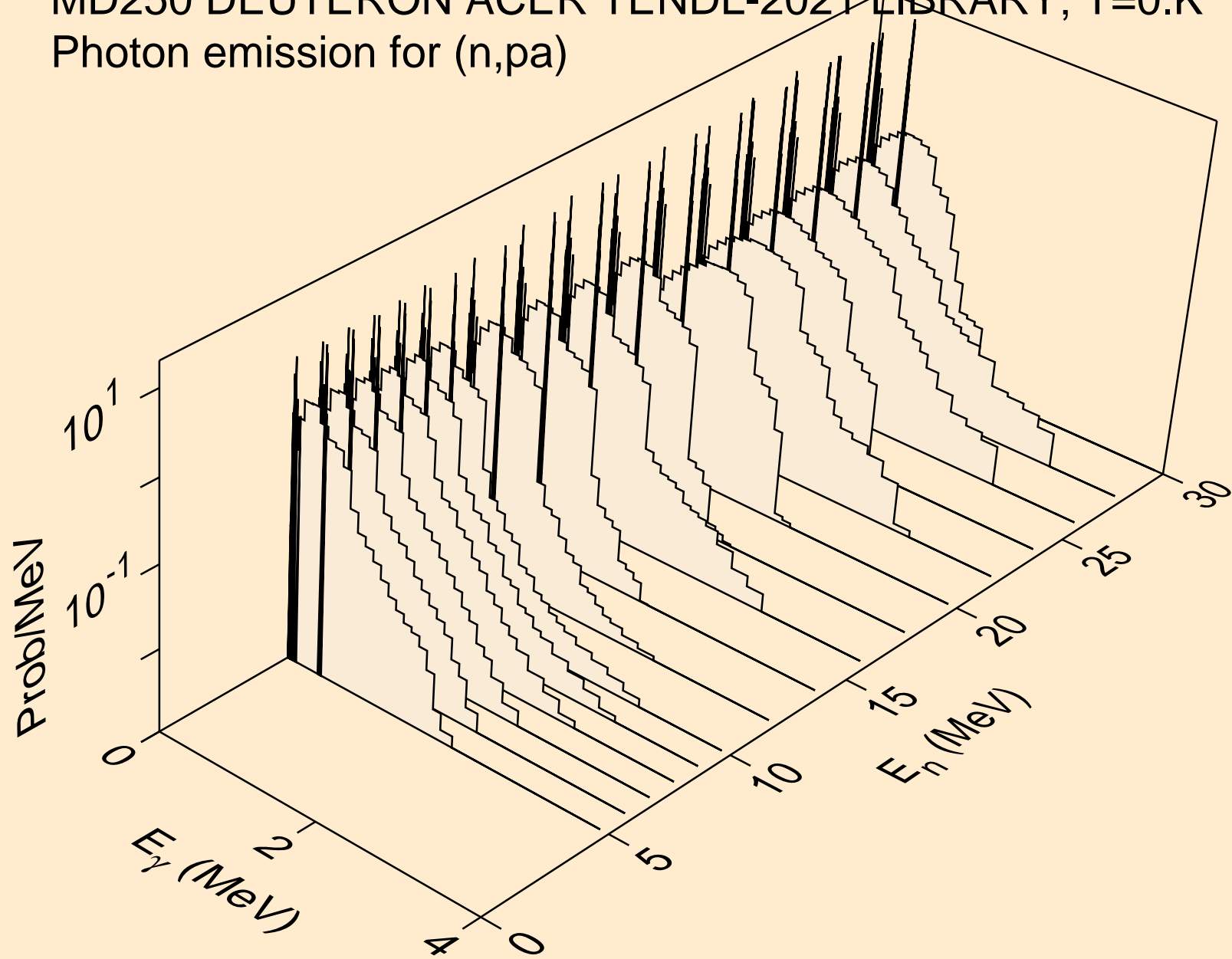

MD250 DEUTERON ACER TENDL-2021 LIBRARY; T=0.K  
Photon emission for (n,pd)

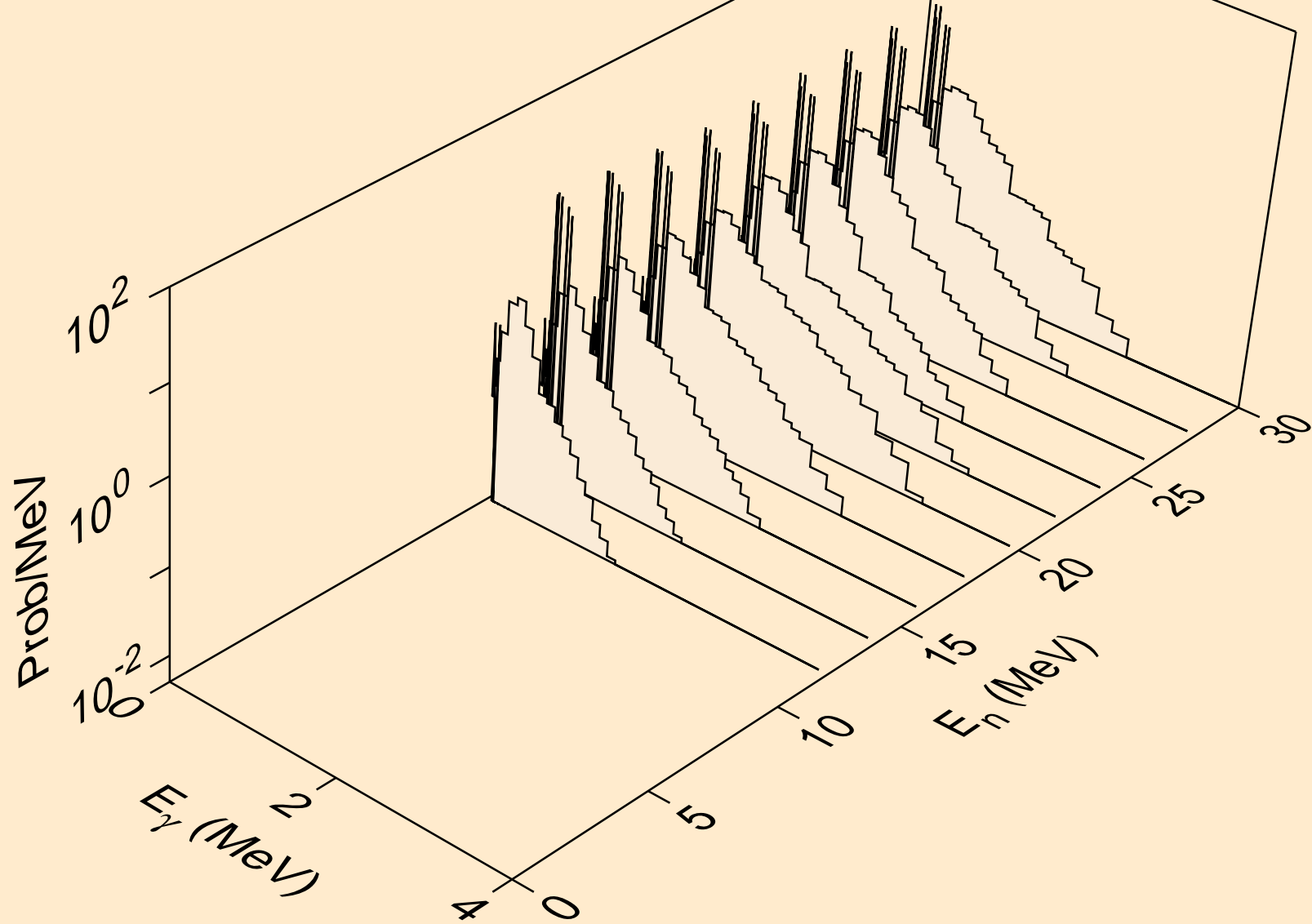

# MD250 DEUTERON ACER TENDL-2021 LIBRARY; T=0.K

## Particle heating contributions

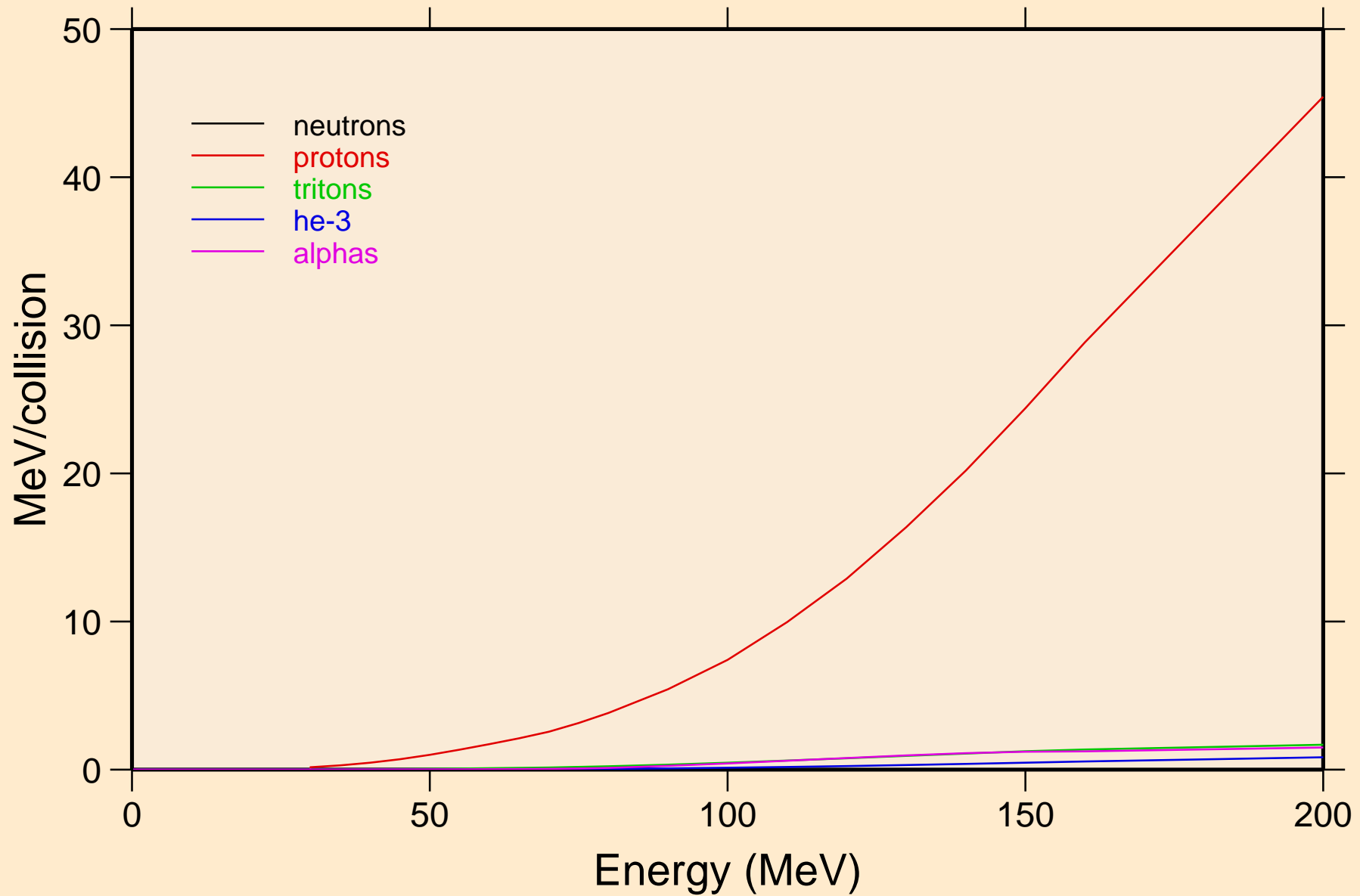

MD250 DEUTERON ACER TENDL-2021 LIBRARY; T=0.K  
Recoil Heating

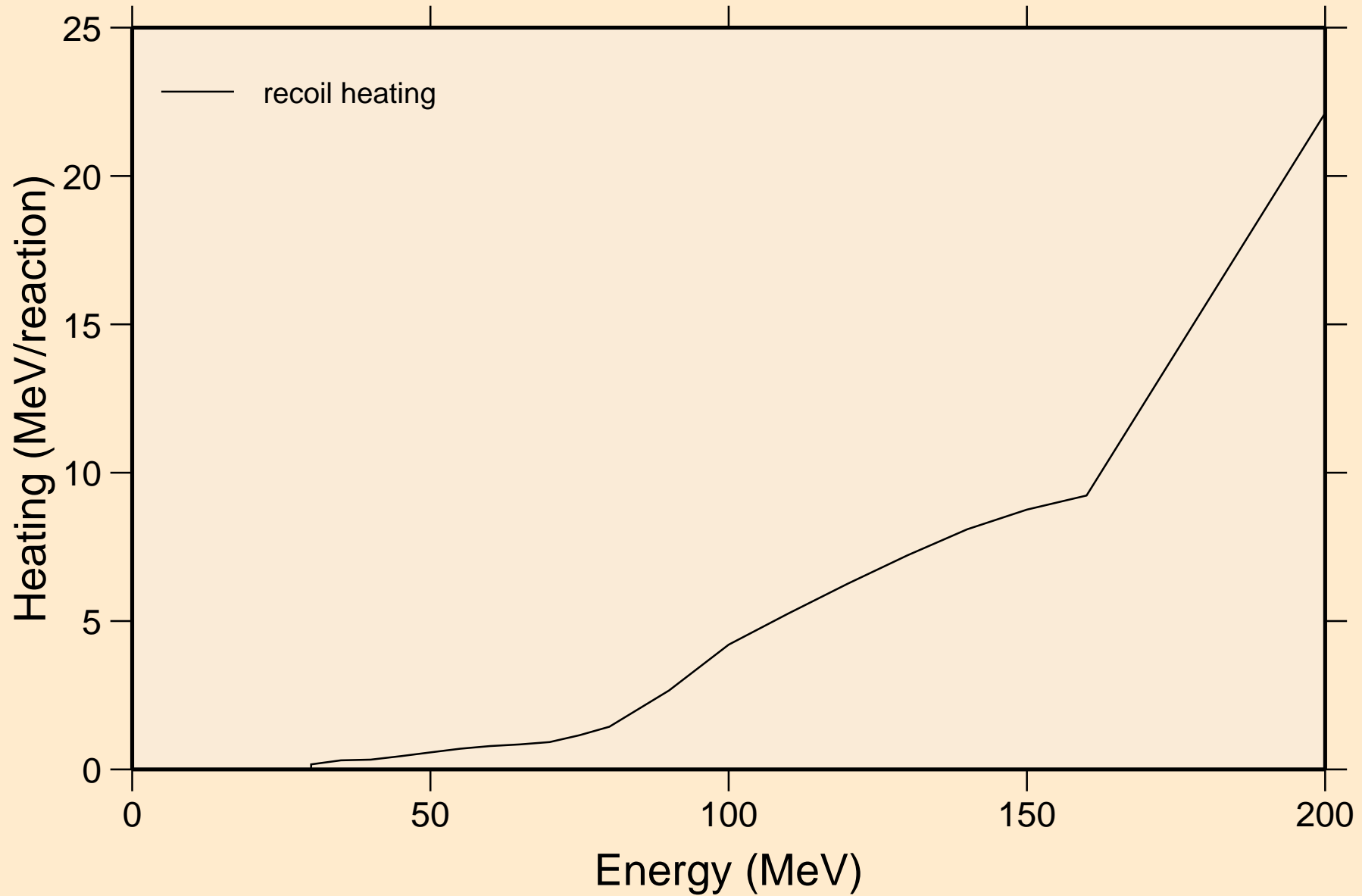

MD250 DEUTERON ACER TENDL-2021 LIBRARY; T=0.K  
Particle production cross sections

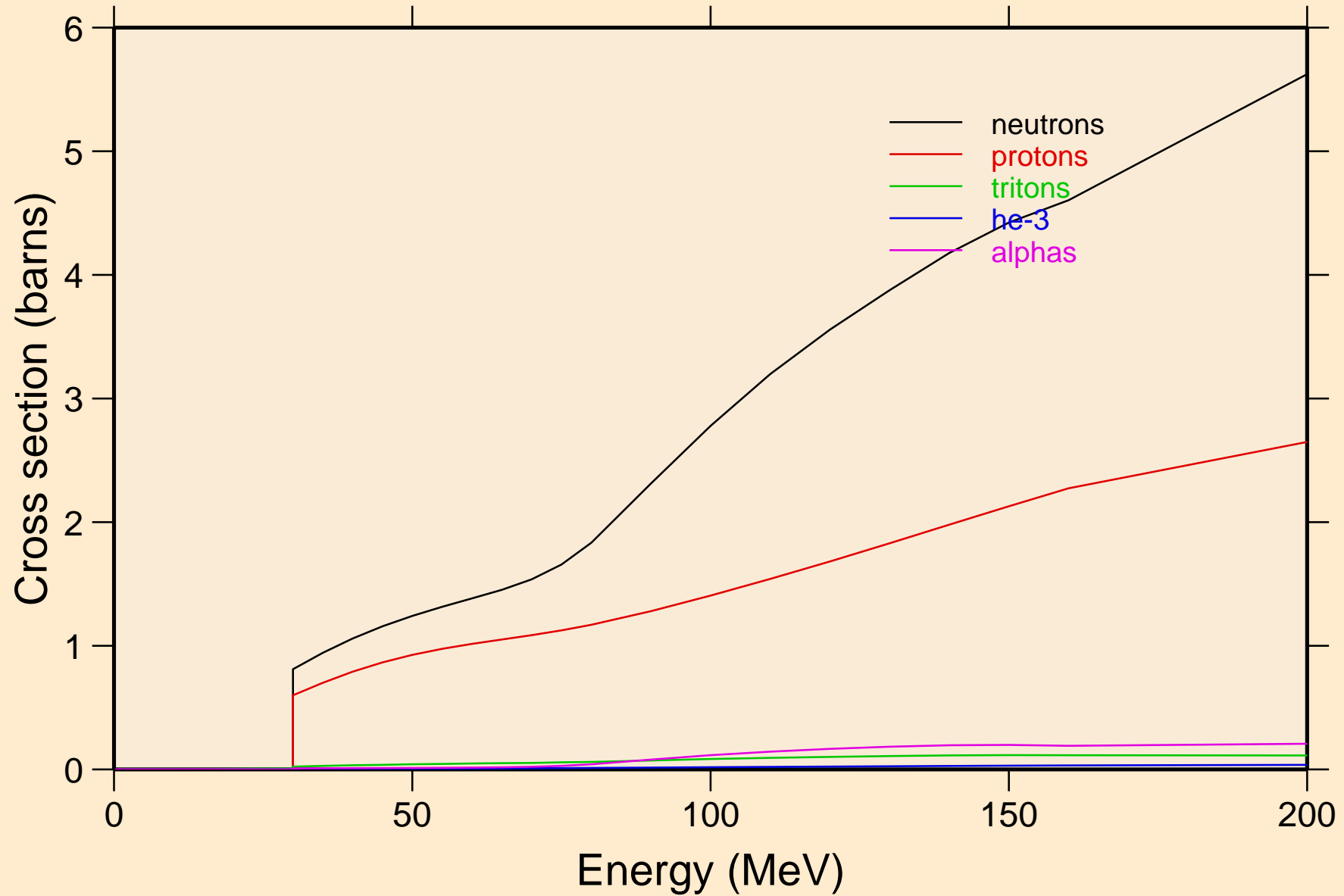

MD250 DEUTERON ACER TENDL-2021 LIBRARY; T=0.K  
neutrons from (d,n)

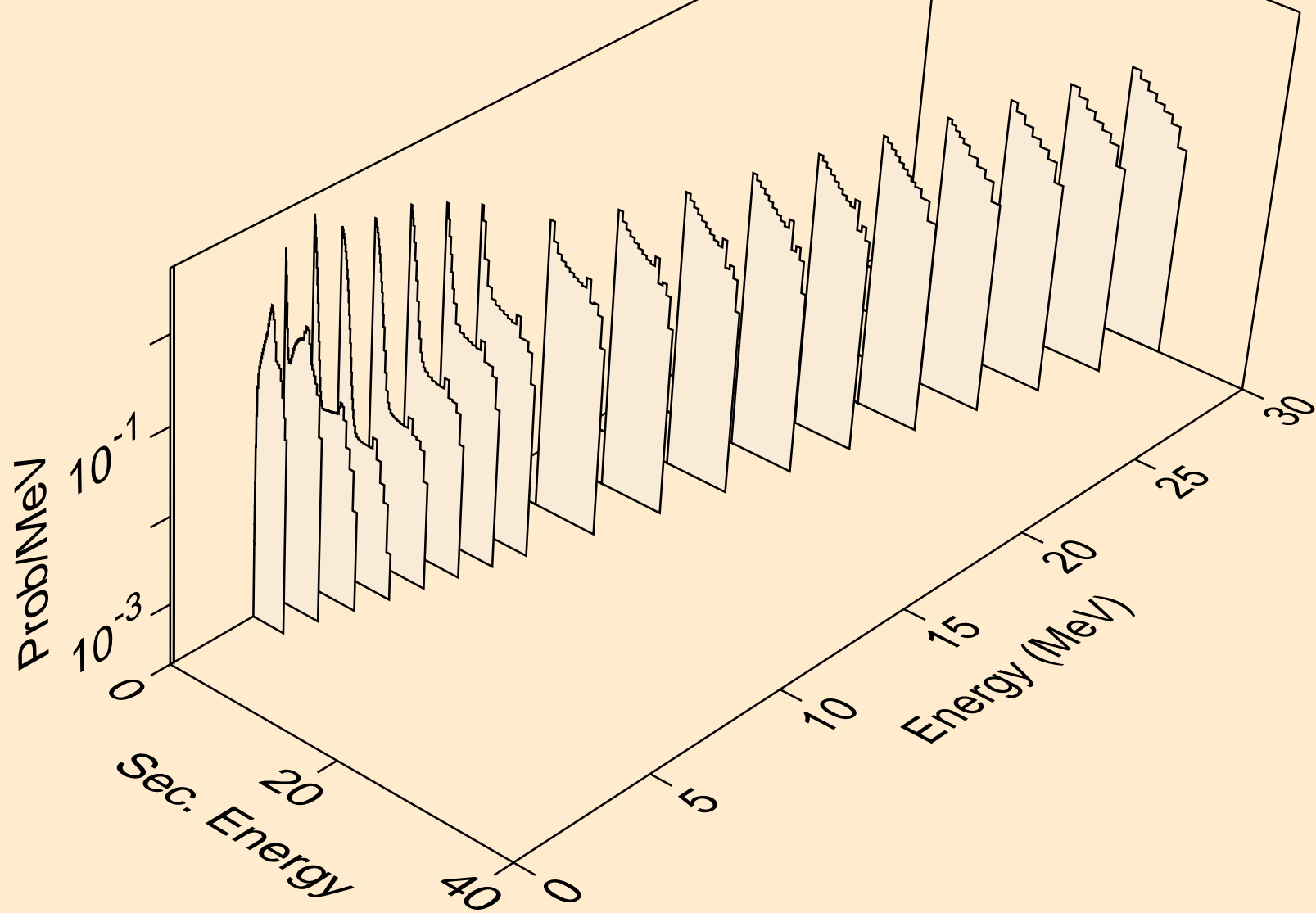

MD250 DEUTERON ACER TENDL-2021 LIBRARY; T=0.K  
neutrons from (d,x)

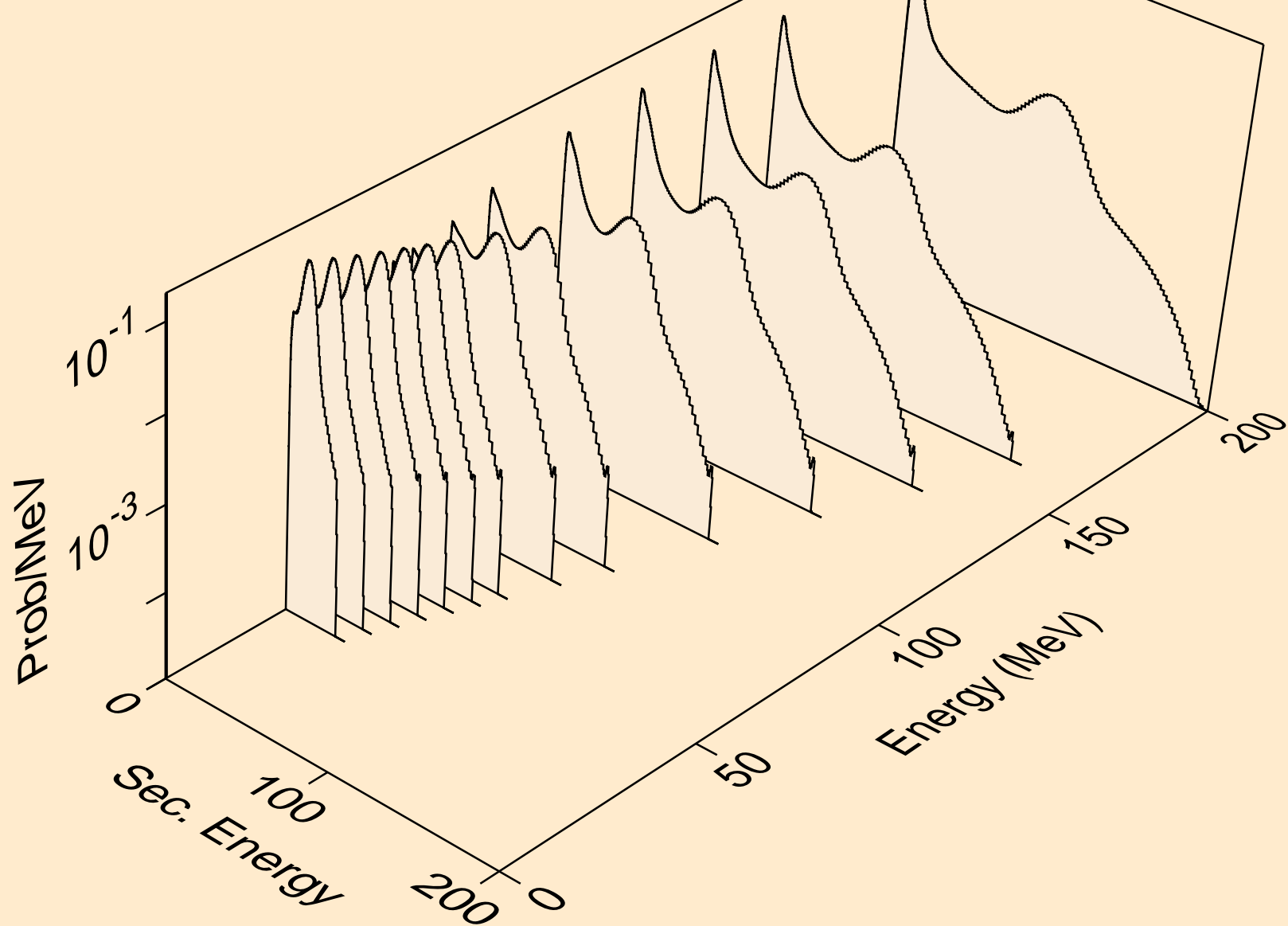

MD250 DEUTERON ACER TENDL-2021 LIBRARY; T=0.K  
neutrons from (d,2n)

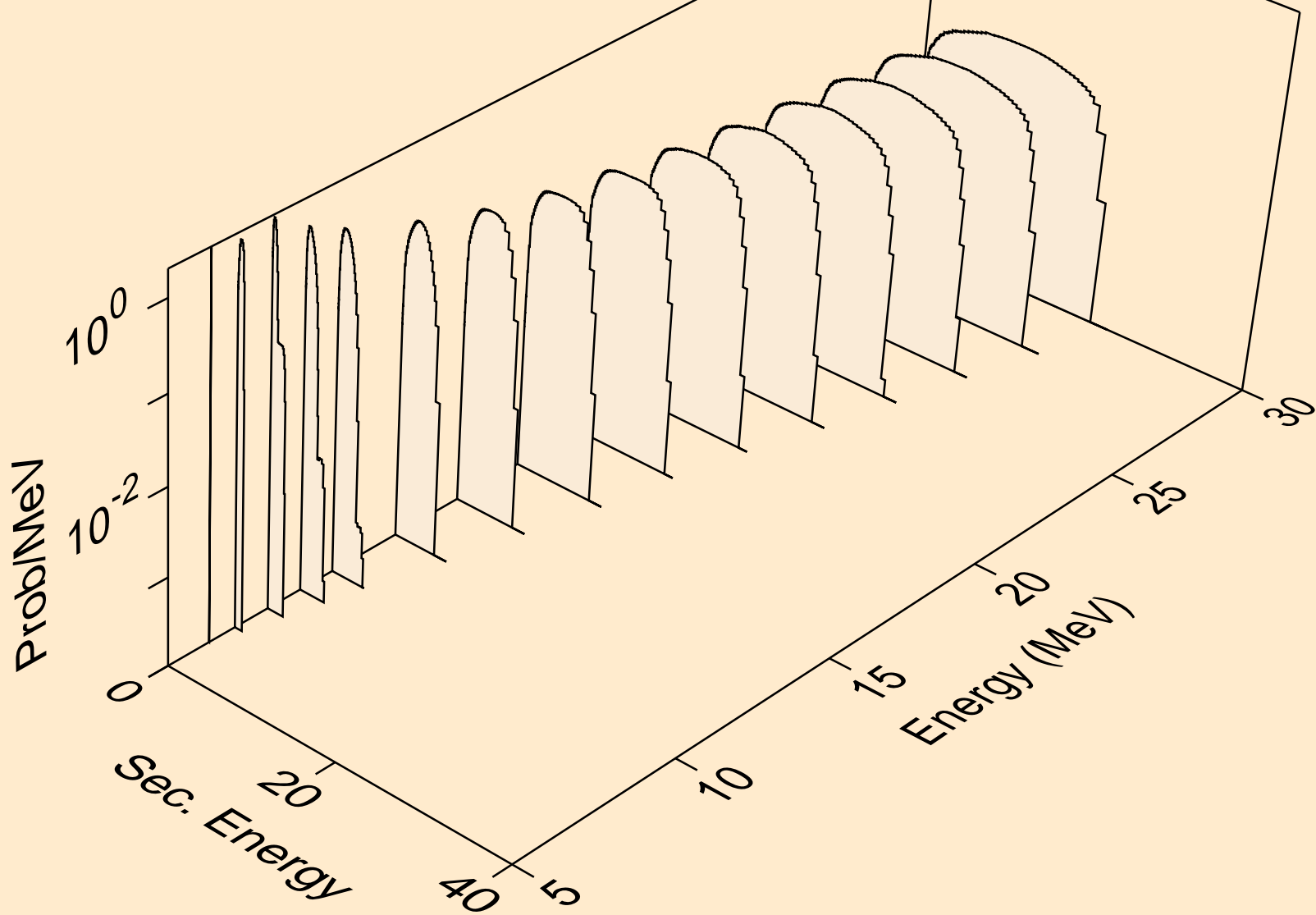



MD250 DEUTERON ACER TENDL-2021 LIBRARY; T=0.K  
neutrons from (d,3n)

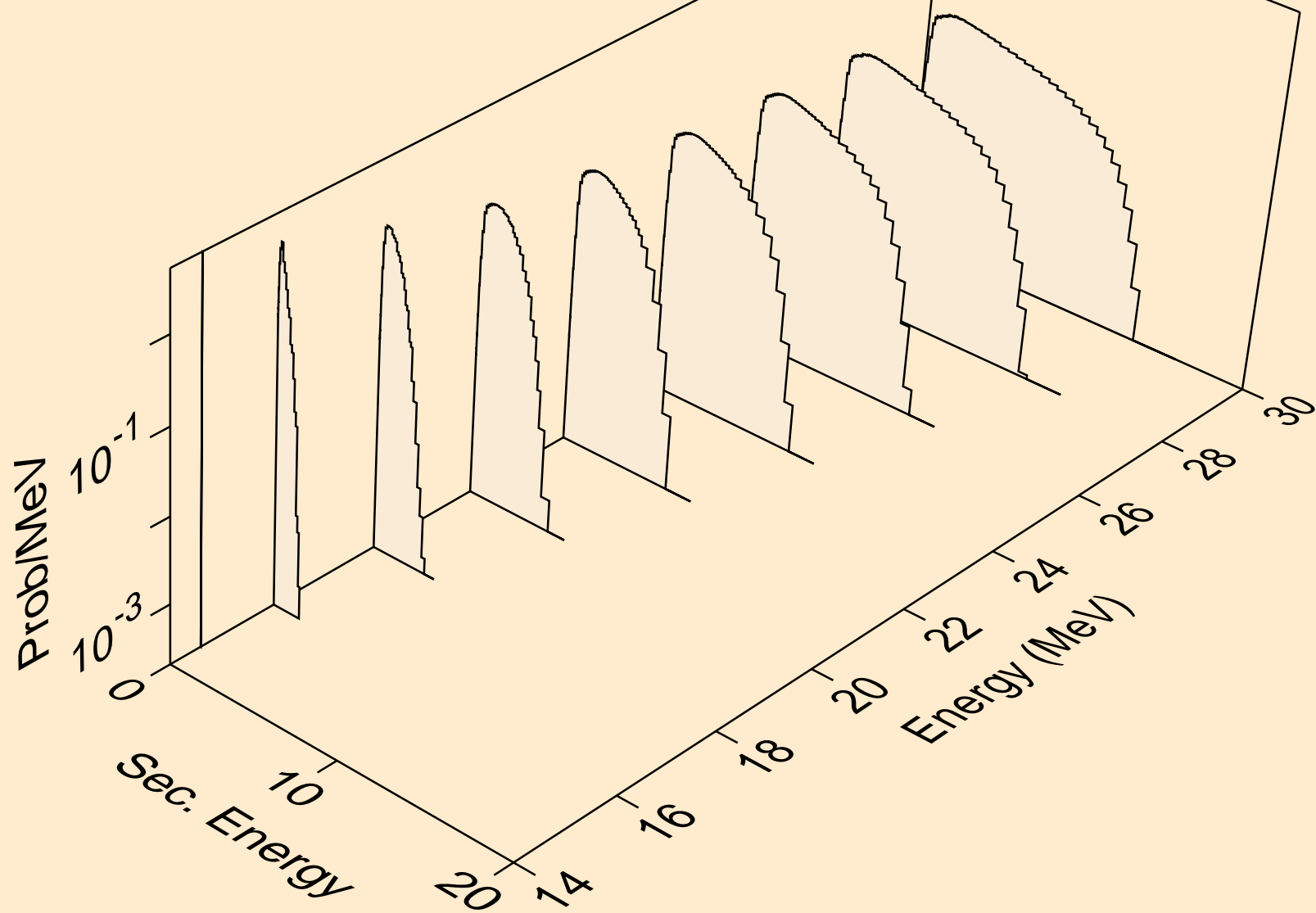

MD250 DEUTERON ACER TENDL-2021 LIBRARY; T=0.K  
neutrons from (d,n\*)a

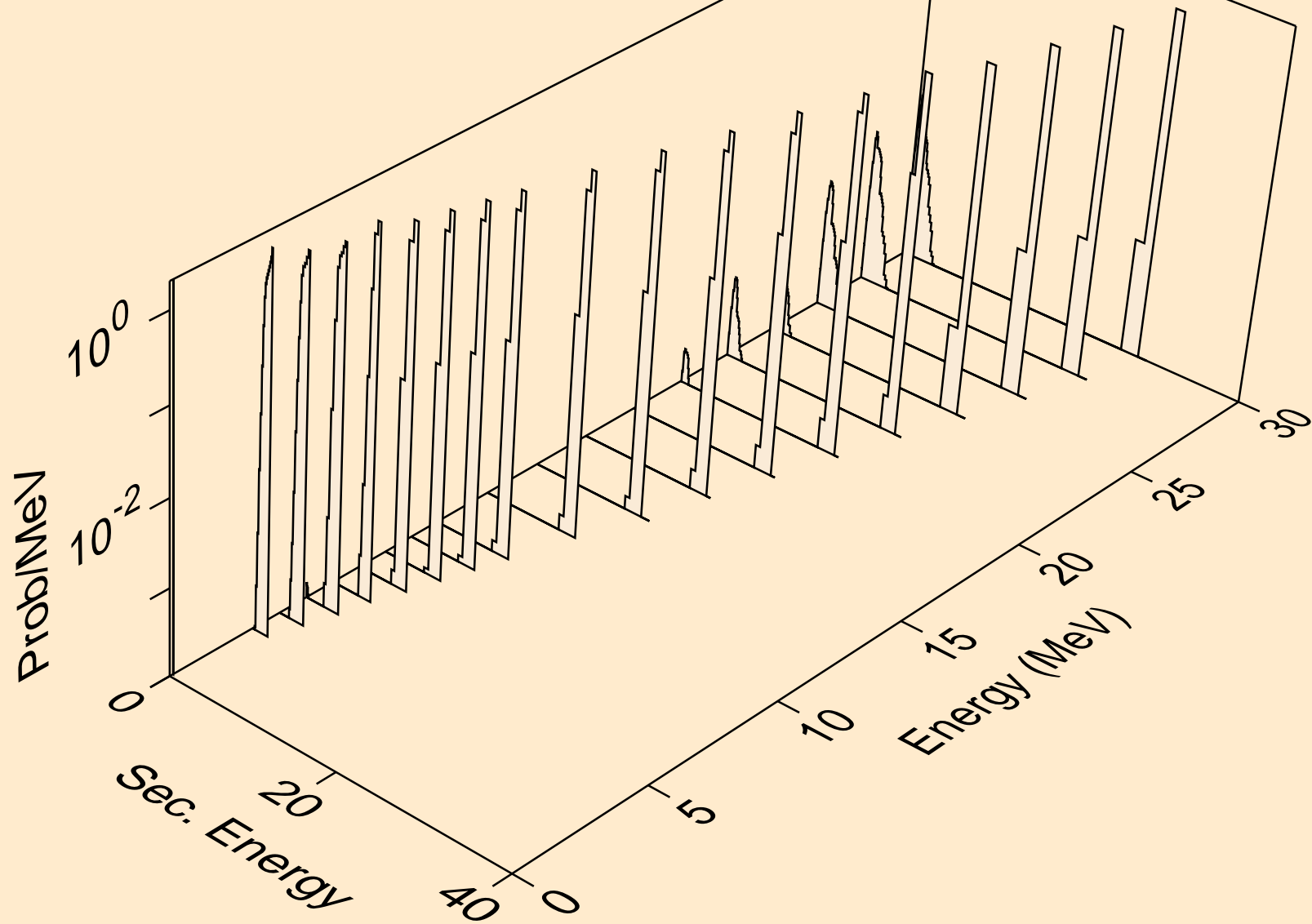

MD250 DEUTERON ACER TENDL-2021 LIBRARY; T=0.K  
neutrons from (d,2n)a

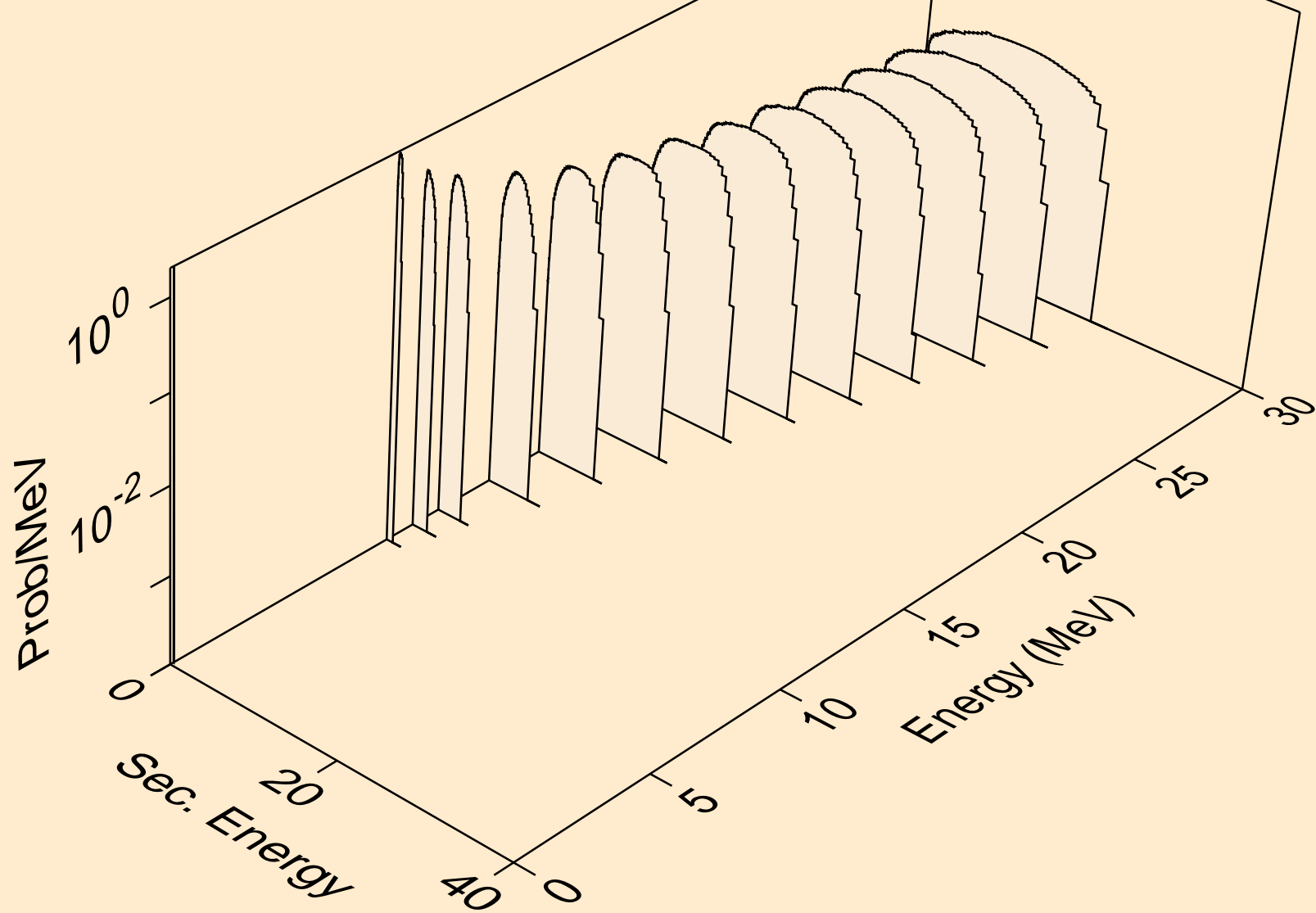

MD250 DEUTERON ACER TENDL-2021 LIBRARY; T=0.K  
neutrons from (d,3n)a

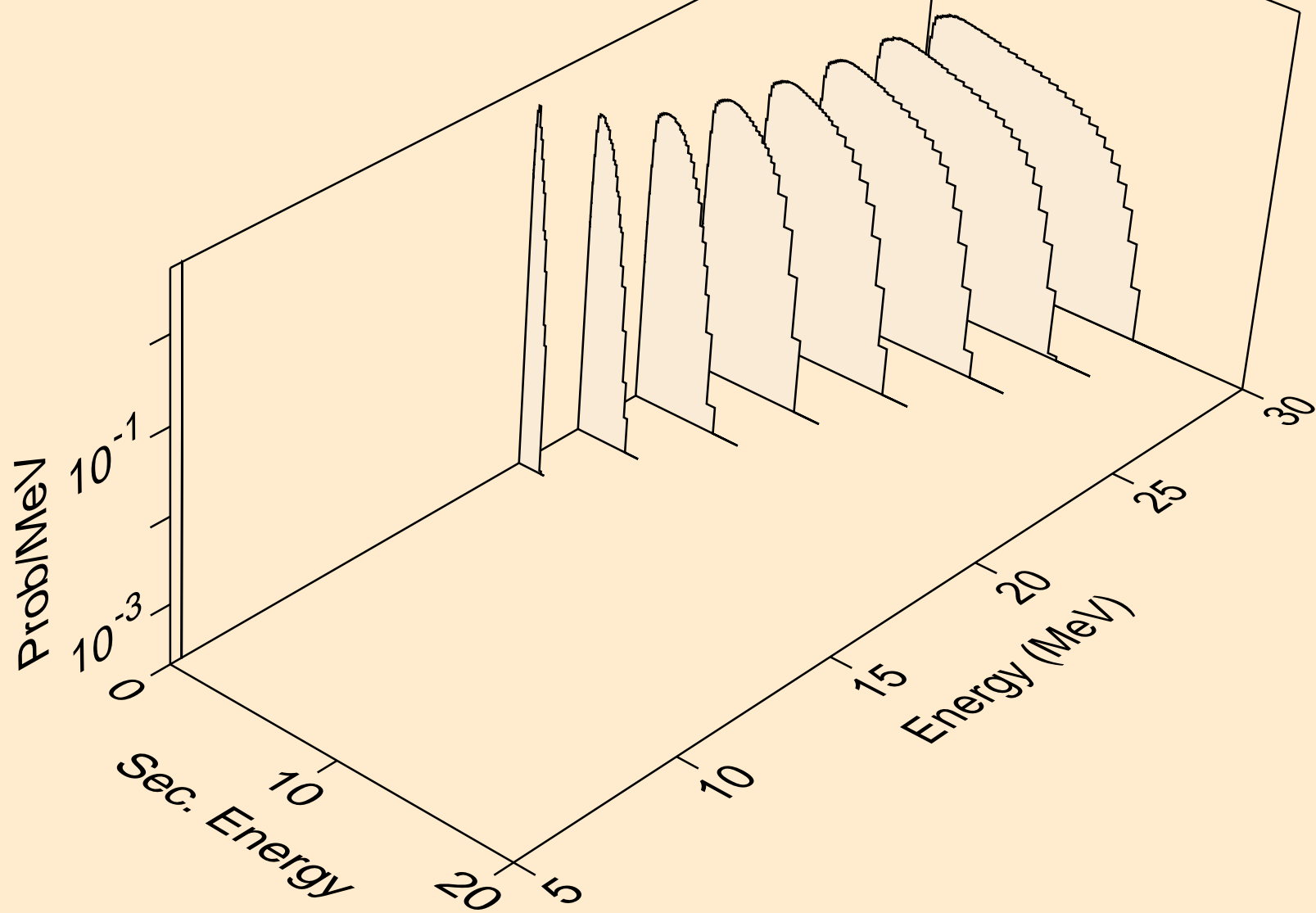

MD250 DEUTERON ACER TENDL-2021 LIBRARY; T=0.K  
neutrons from (d,n\*)p

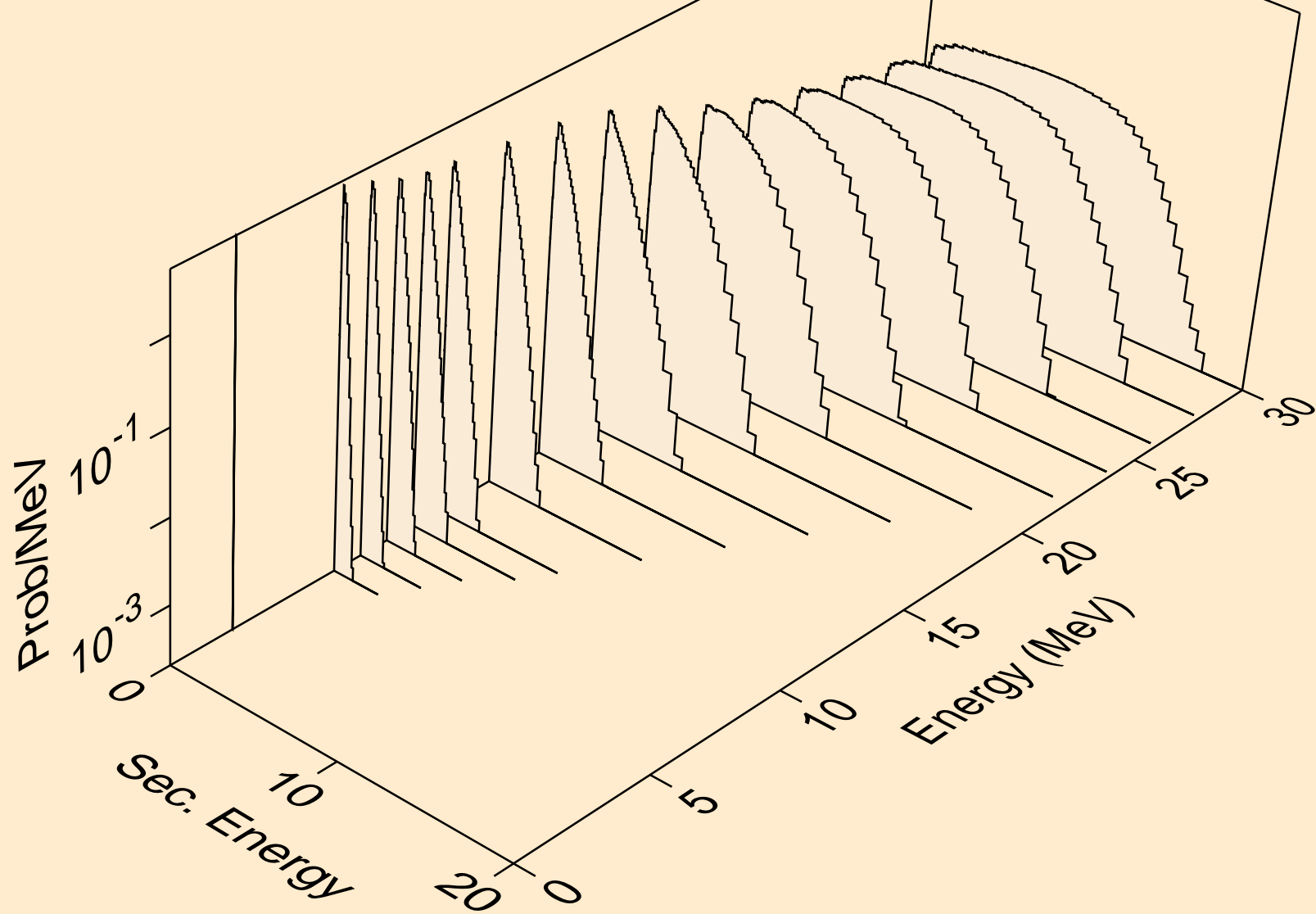

MD250 DEUTERON ACER TENDL-2021 LIBRARY; T=0.K  
neutrons from (d,n\*)d

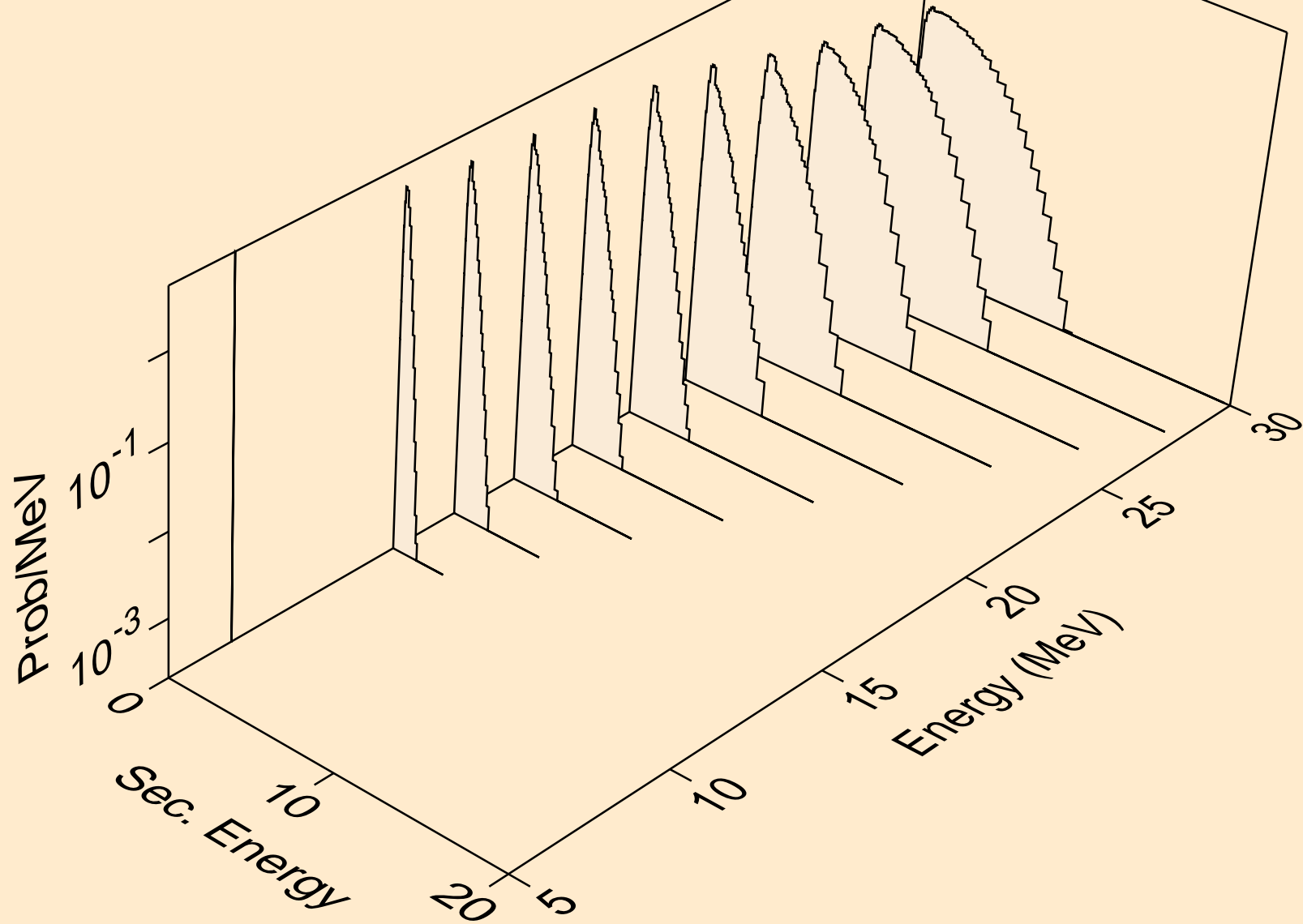

MD250 DEUTERON ACER TENDL-2021 LIBRARY; T=0.K  
neutrons from (d,n\*)t

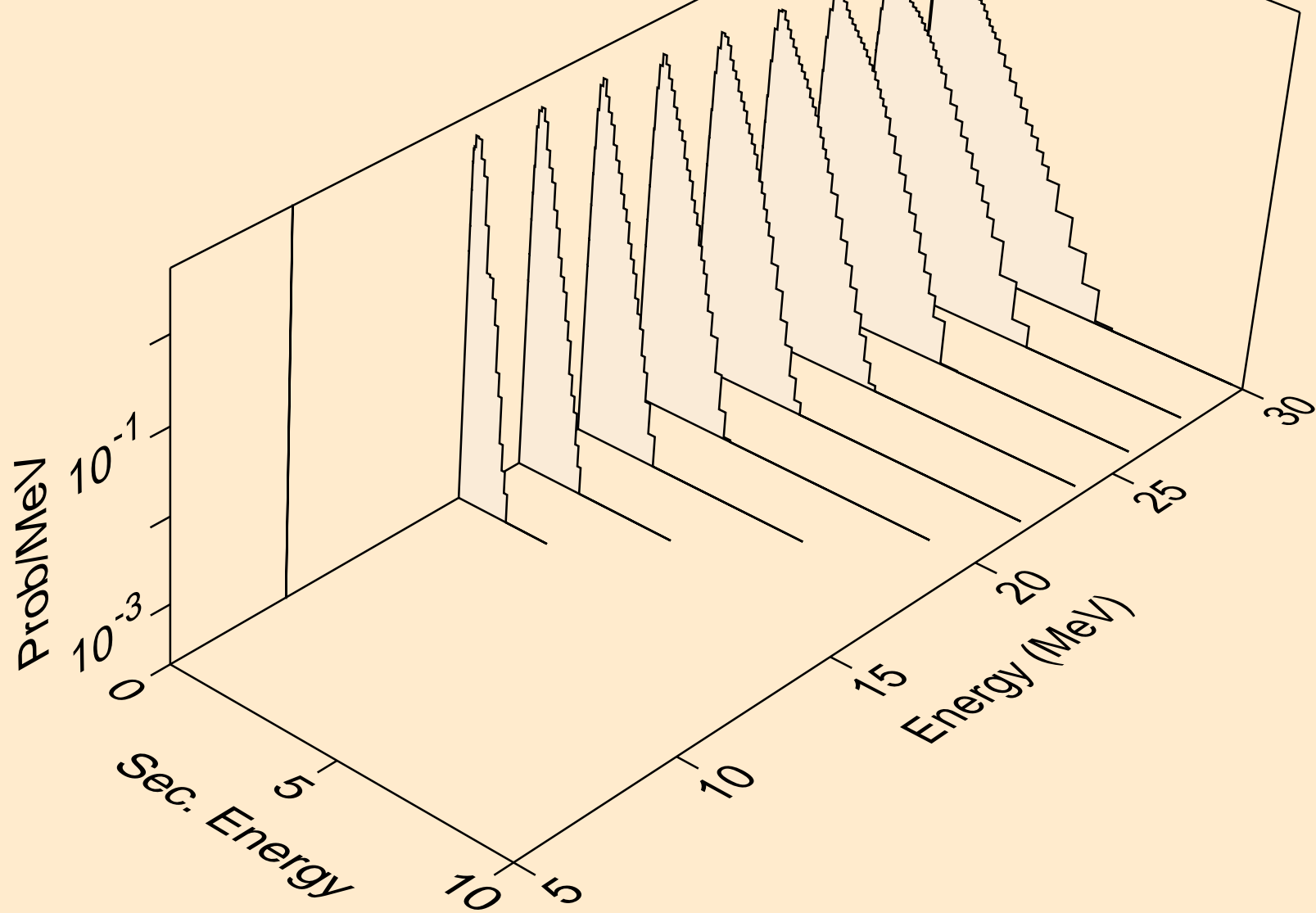

MD250 DEUTERON ACER TENDL-2021 LIBRARY; T=0.K  
neutrons from (d,n\*)he3

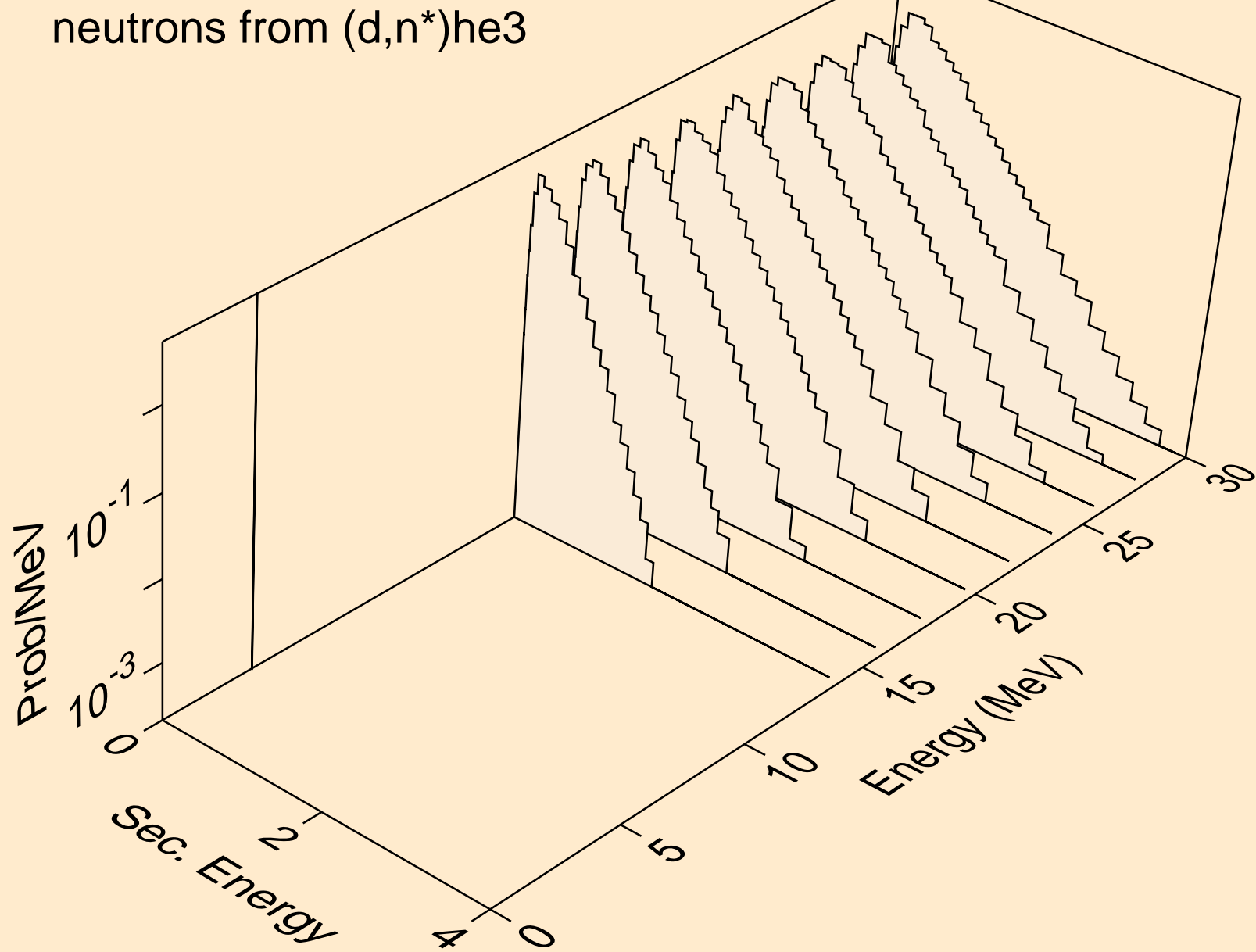



MD250 DEUTERON ACER TENDL-2021 LIBRARY; T=0.K  
neutrons from (d,4n)

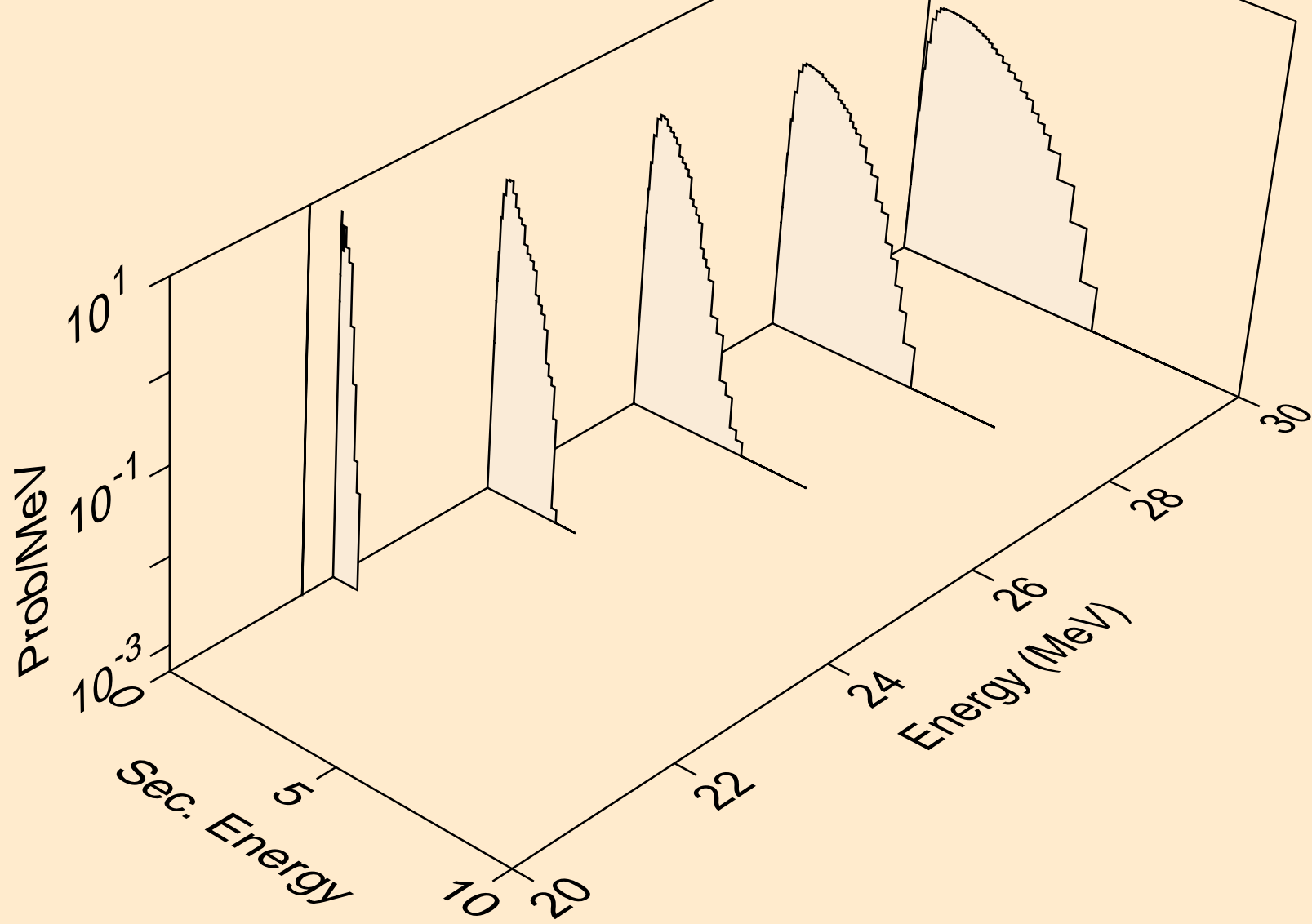

MD250 DEUTERON ACER TENDL-2021 LIBRARY; T=0.K  
neutrons from (d,2np)

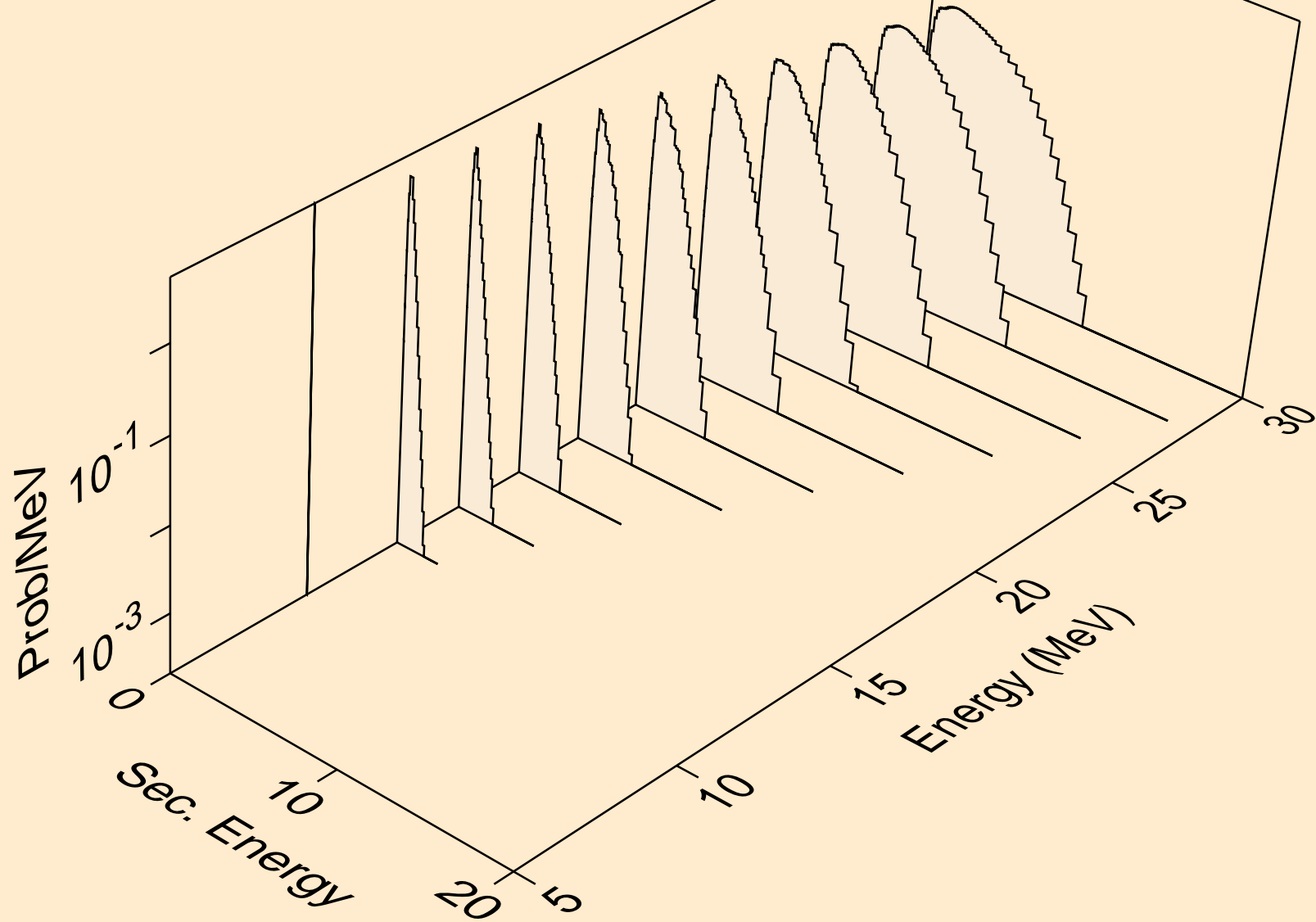

MD250 DEUTERON ACER TENDL-2021 LIBRARY; T=0.K  
neutrons from (d,2np)

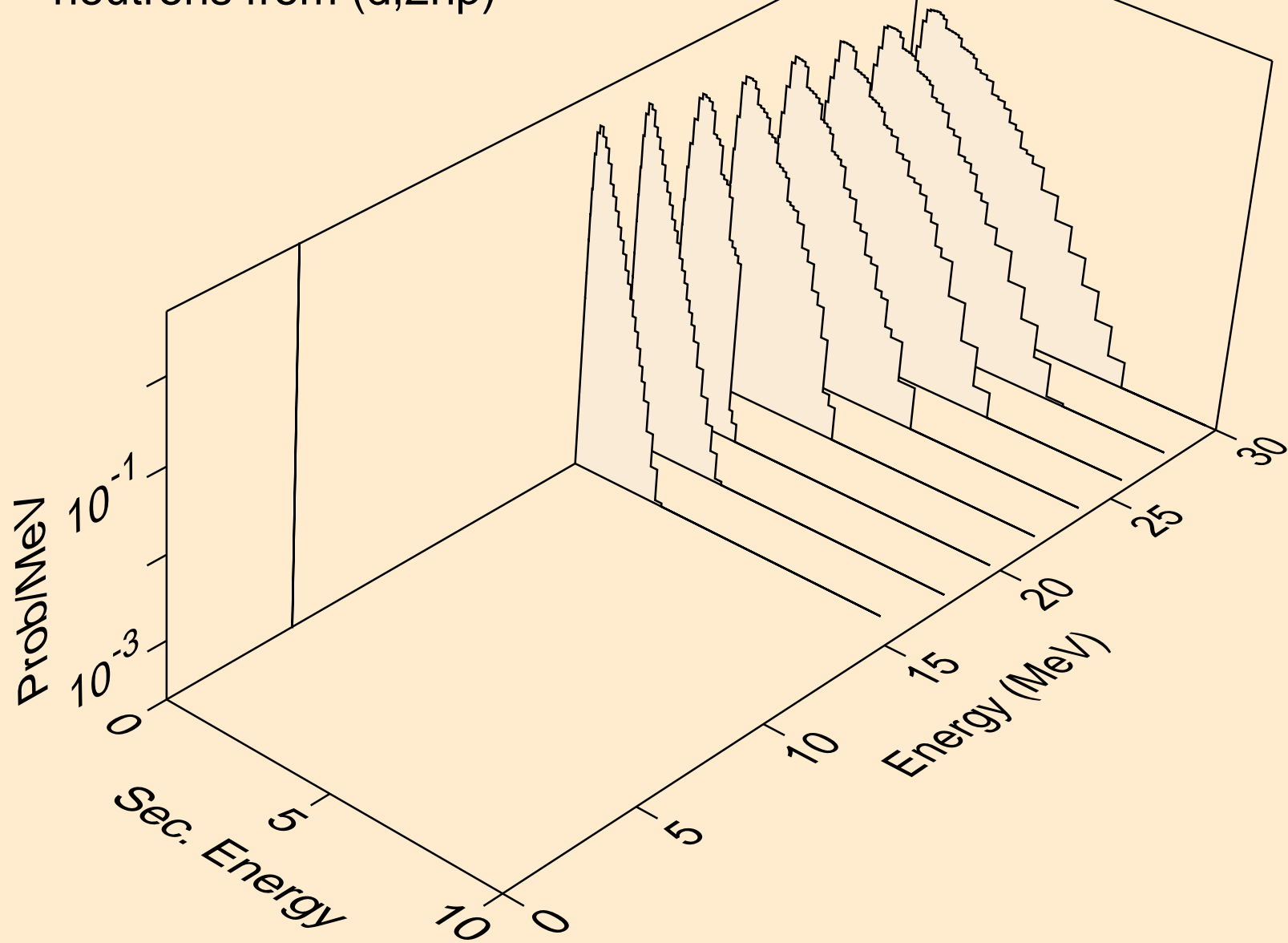

MD250 DEUTERON ACER TENDL-2021 LIBRARY; T=0.K  
protons from (d,x)

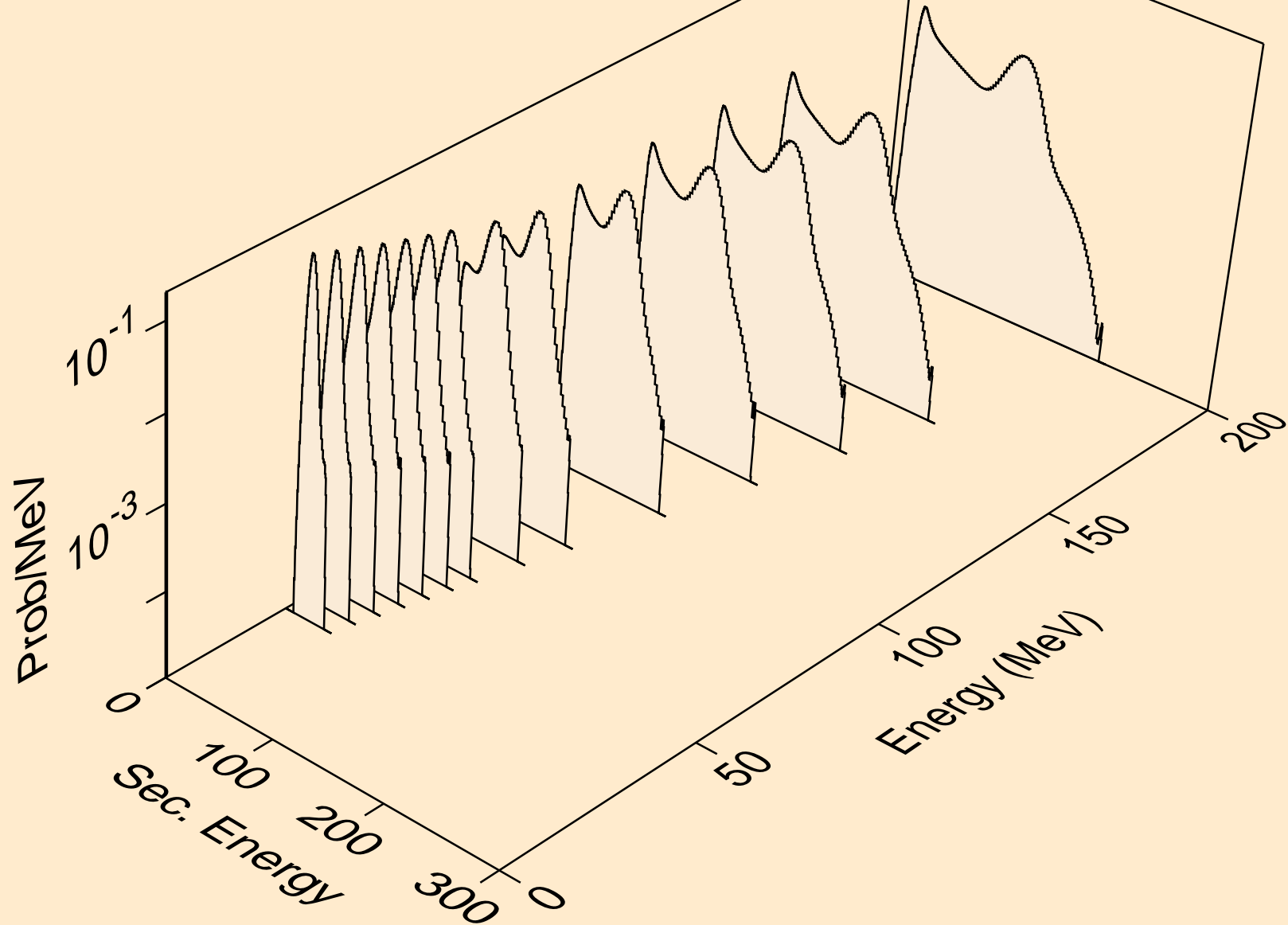

MD250 DEUTERON ACER TENDL-2021 LIBRARY; T=0.K  
protons from (d,n\*)p

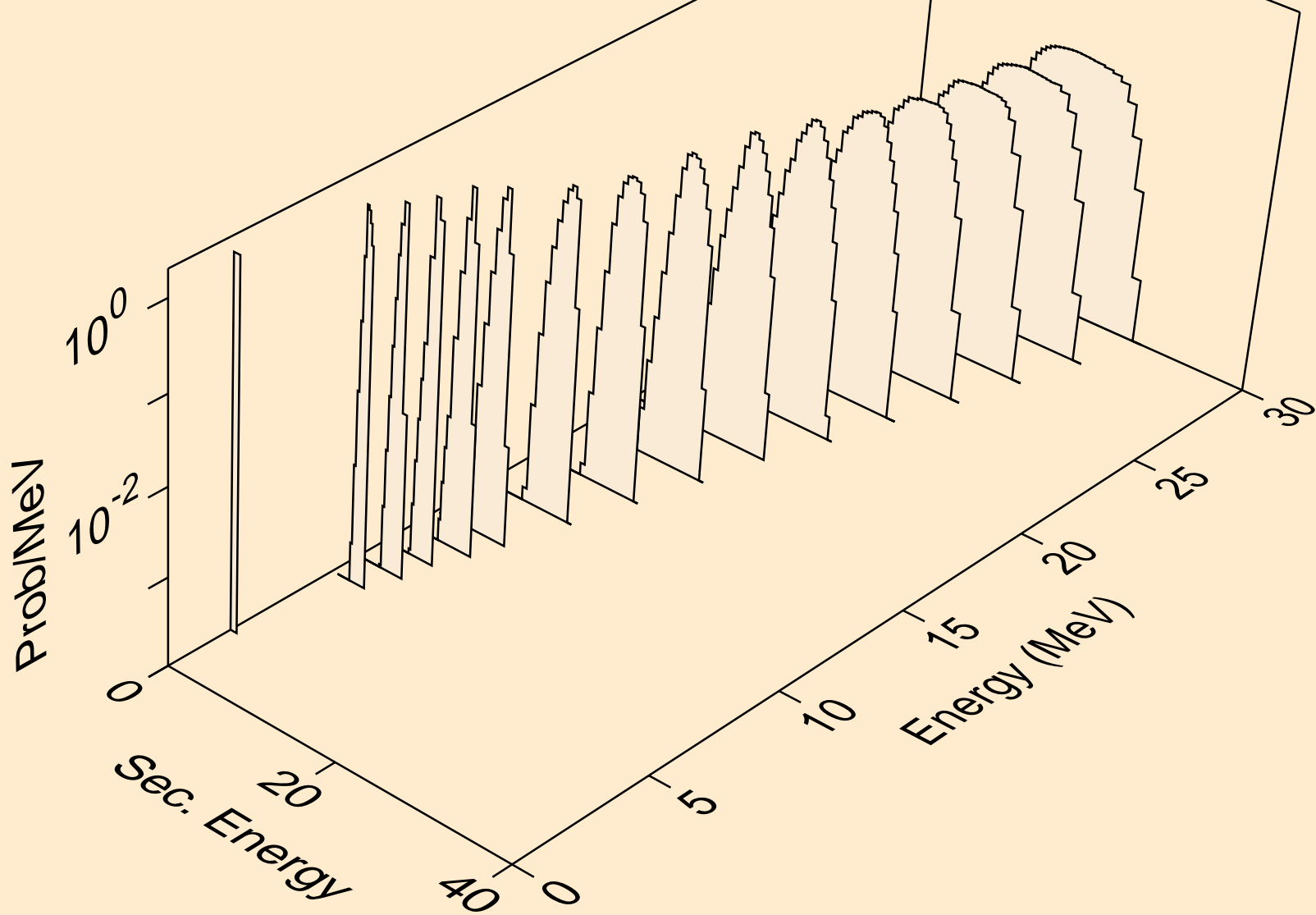

MD250 DEUTERON ACER TENDL-2021 LIBRARY; T=0.K  
protons from (d,2np)

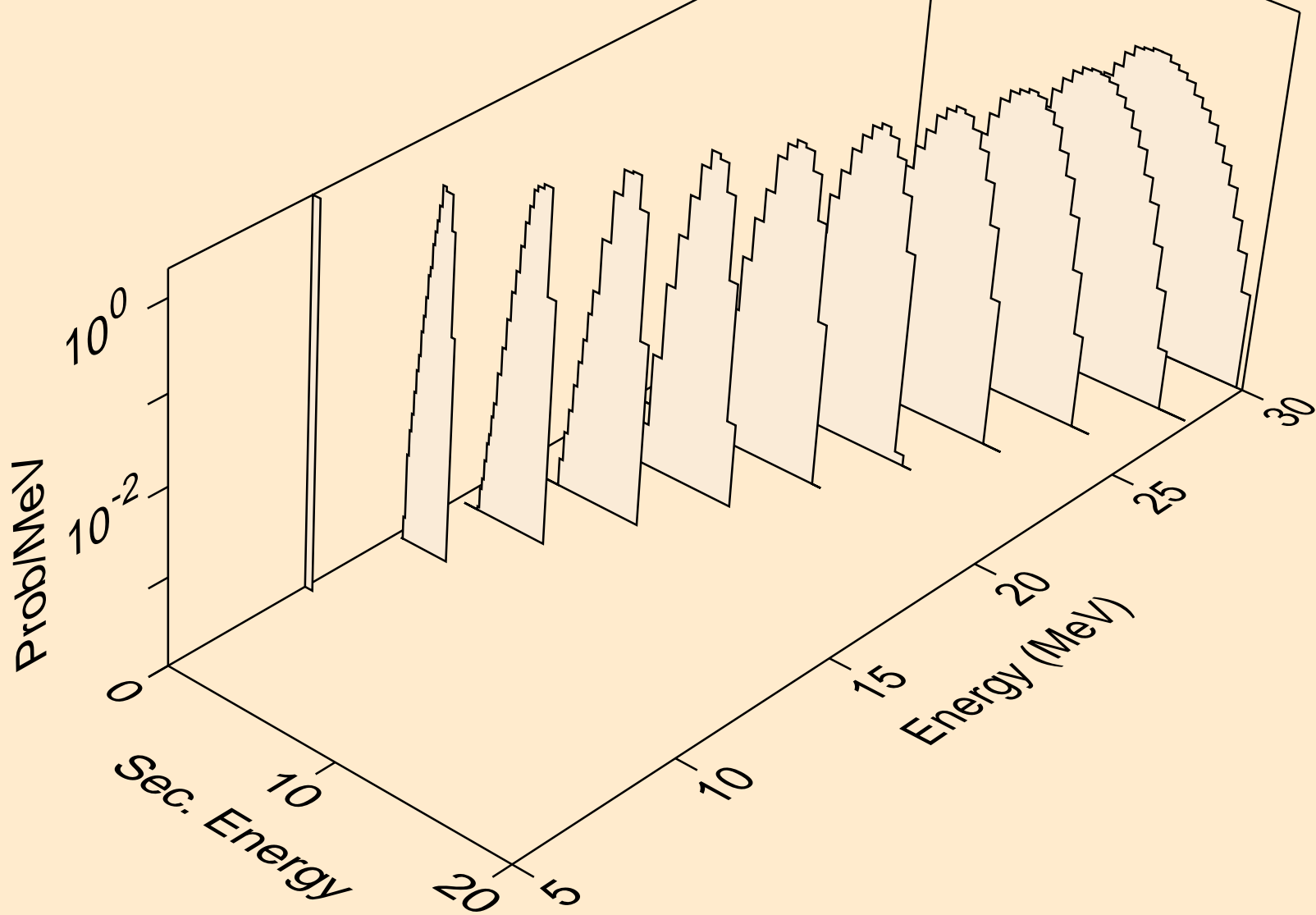

MD250 DEUTERON ACER TENDL-2021 LIBRARY; T=0.K  
protons from (d,2np)

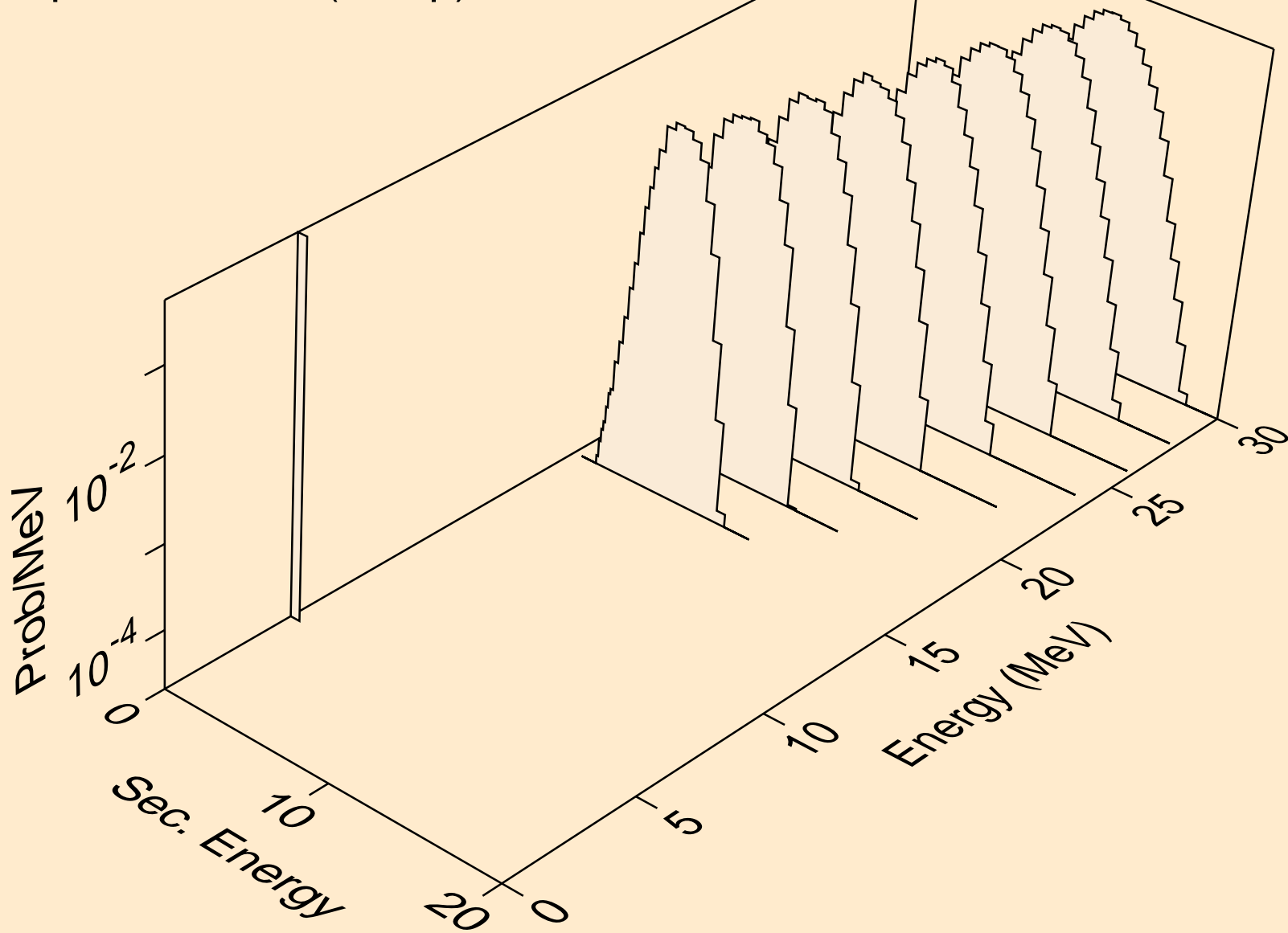

MD250 DEUTERON ACER TENDL-2021 LIBRARY; T=0.K  
protons from (d,p)

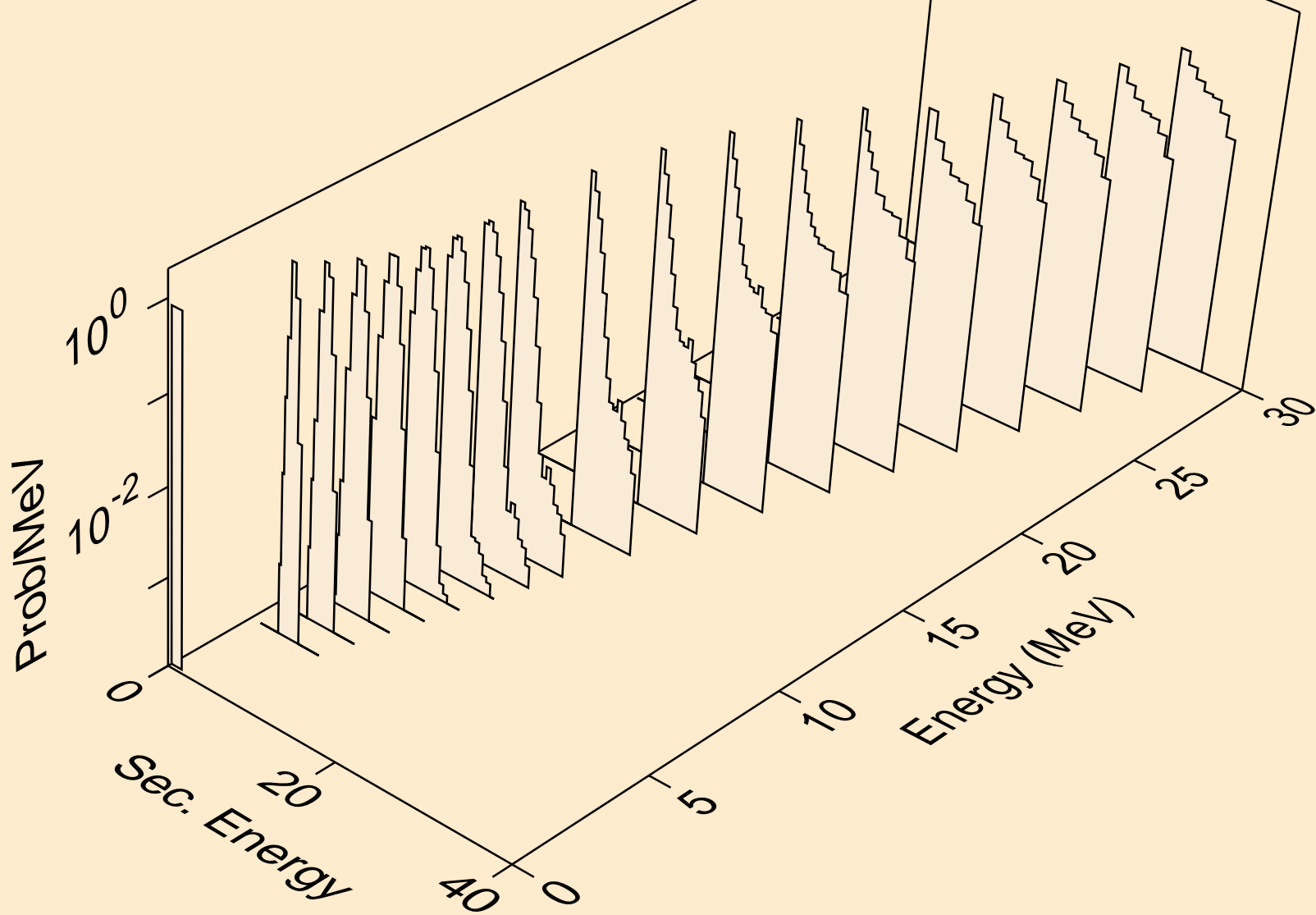



MD250 DEUTERON ACER TENDL-2021 LIBRARY; T=0.K  
protons from (d,2p)

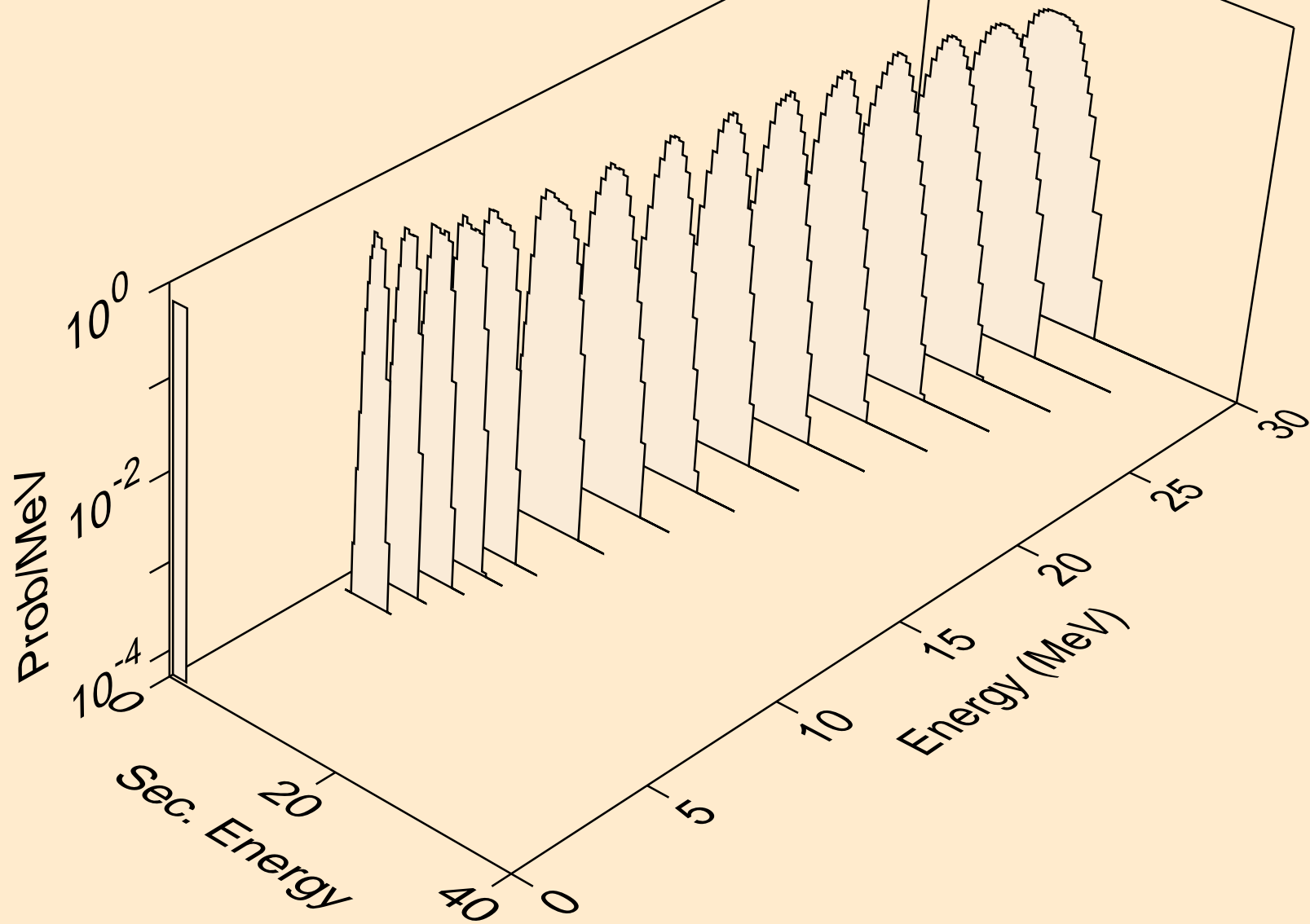

MD250 DEUTERON ACER TENDL-2021 LIBRARY; T=0.K  
protons from (d,pa)

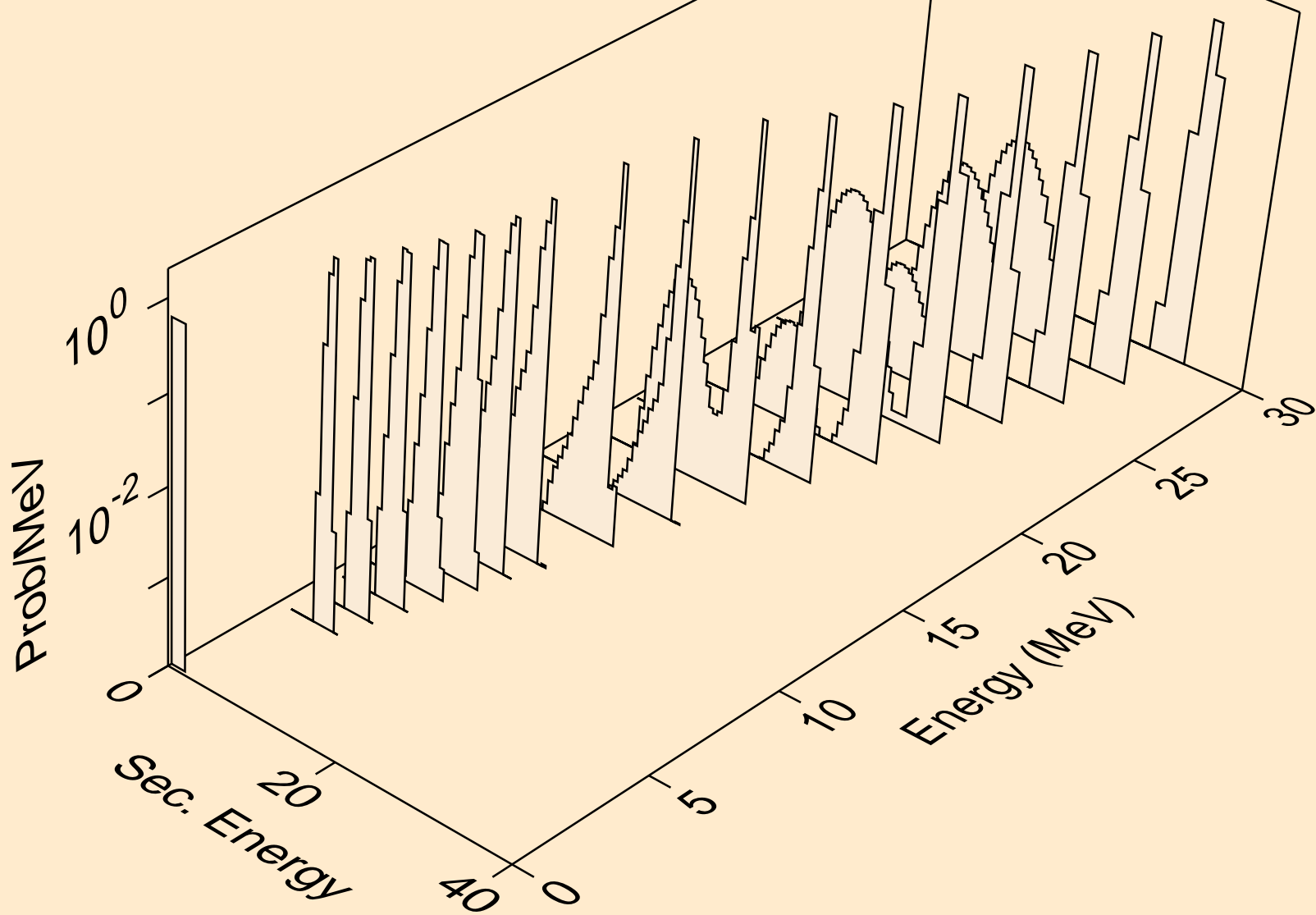

MD250 DEUTERON ACER TENDL-2021 LIBRARY; T=0.K  
protons from (d,pd)

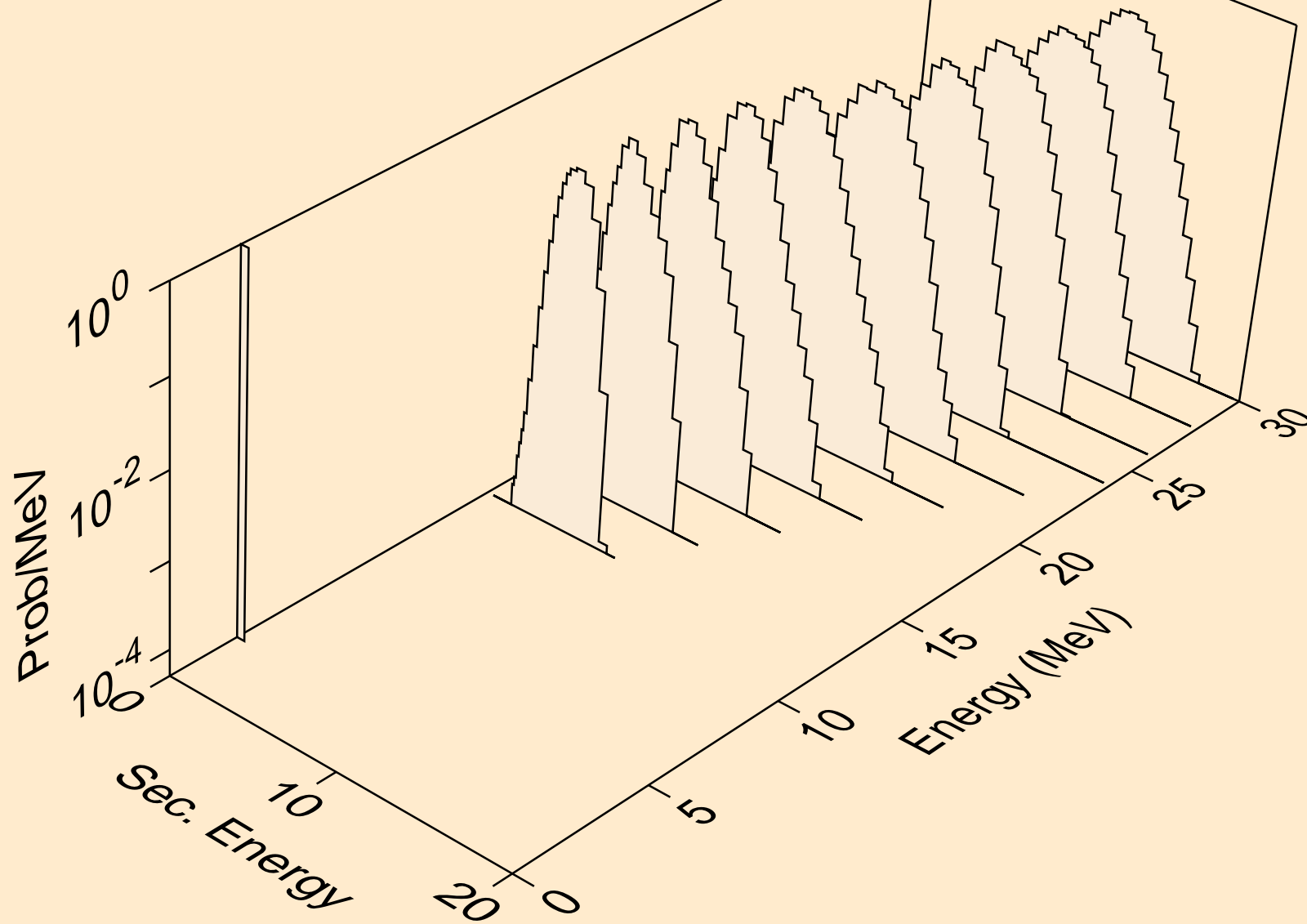

MD250 DEUTERON ACER TENDL-2021 LIBRARY; T=0.K  
tritons from (d,x)

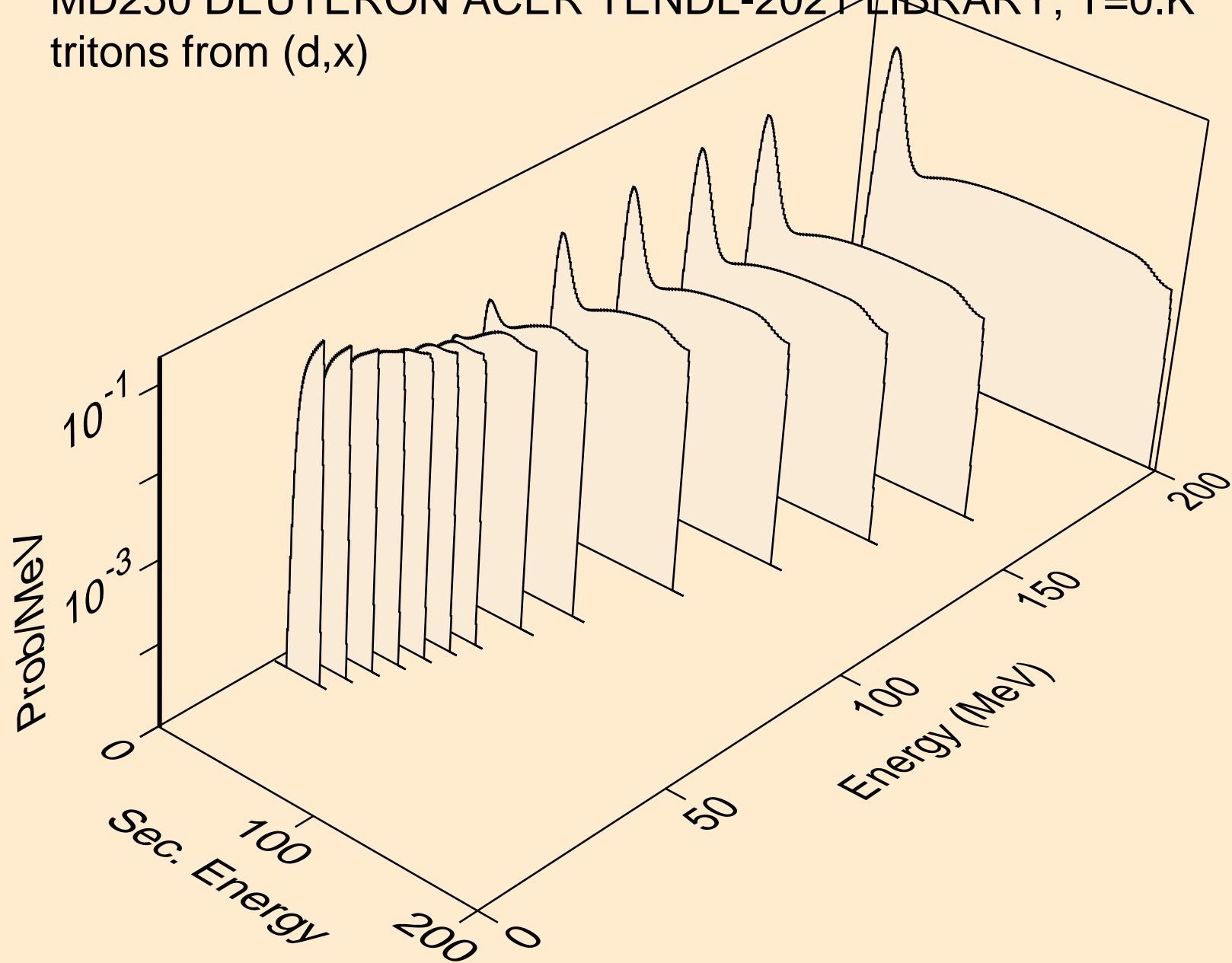

MD250 DEUTERON ACER TENDL-2021 LIBRARY; T=0.K  
tritons from (d,n\*)t

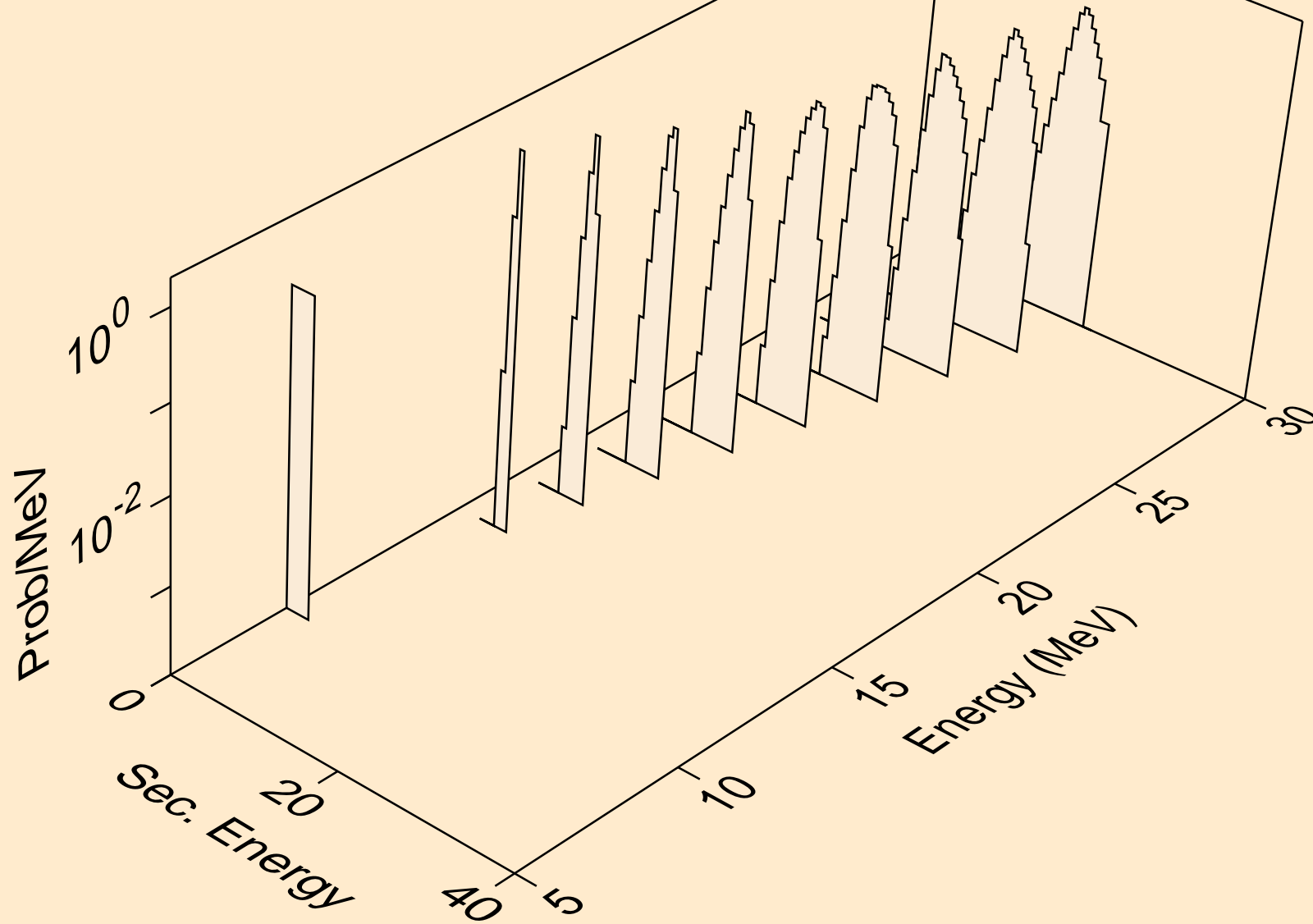

MD250 DEUTERON ACER TENDL-2021 LIBRARY; T=0.K  
tritons from (d,t)

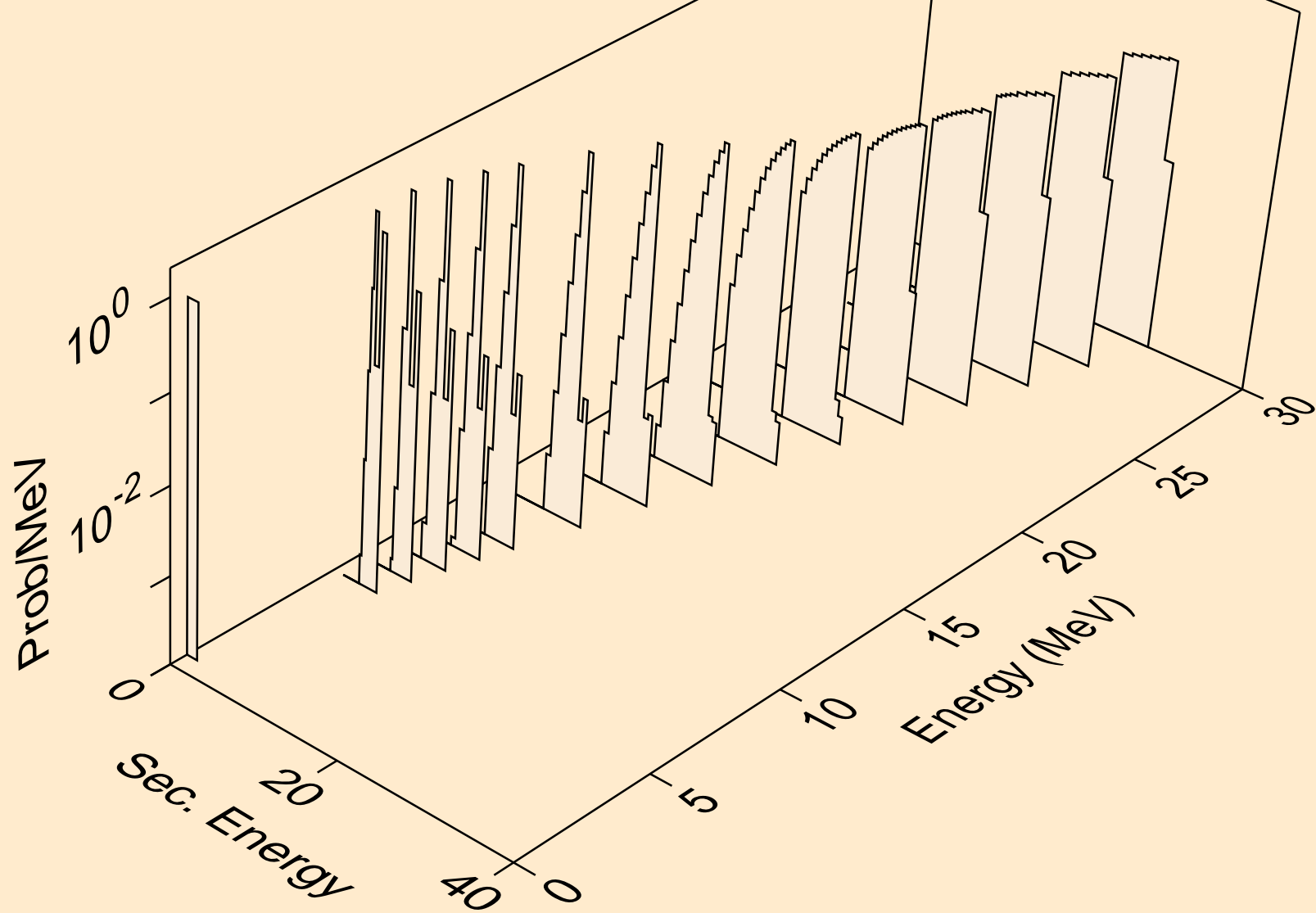

MD250 DEUTERON ACER TENDL-2021 LIBRARY; T=0.K  
he3s from (d,x)

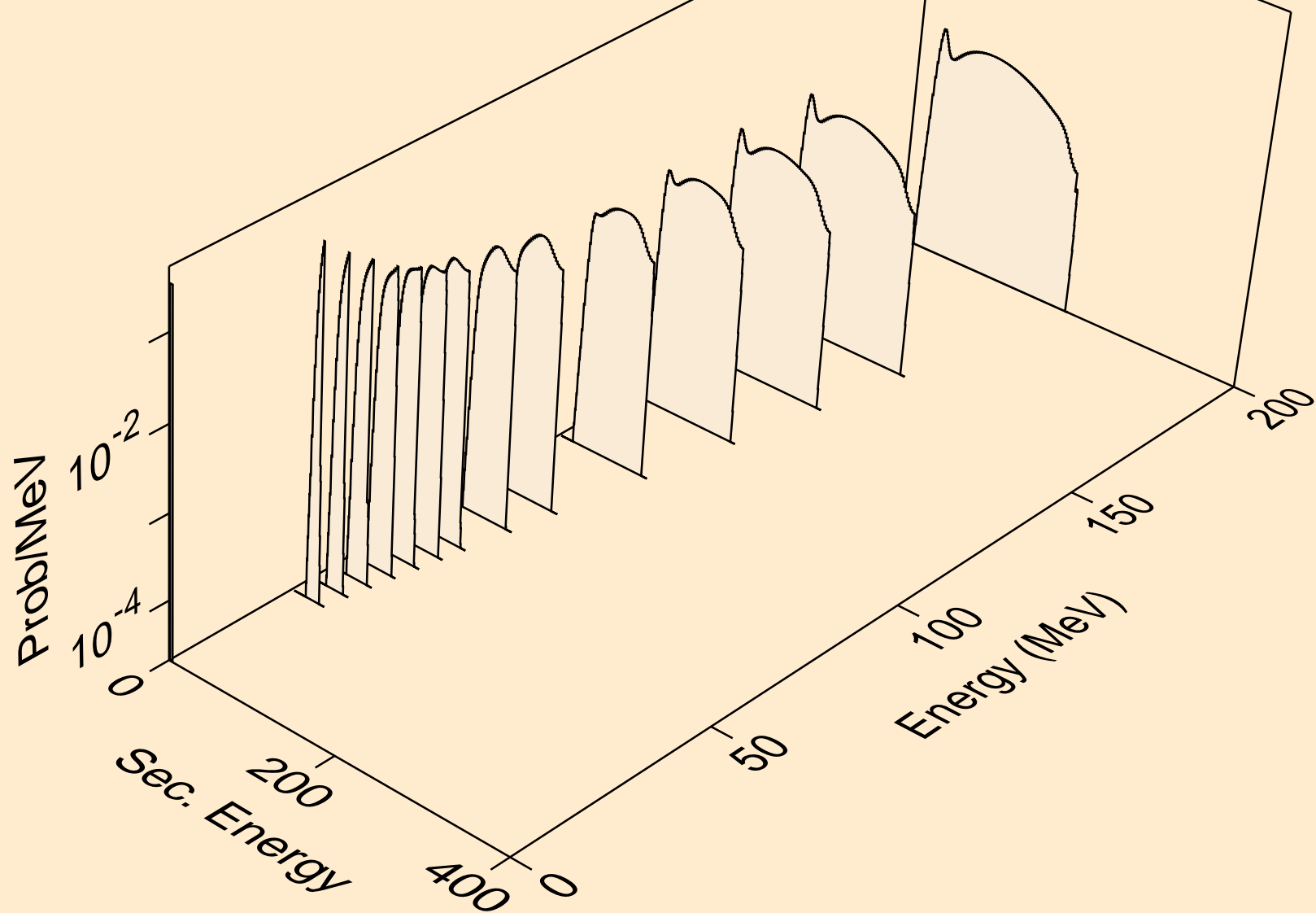

MD250 DEUTERON ACER TENDL-2021 LIBRARY; T=0.K  
he3s from (d,n\*)he3

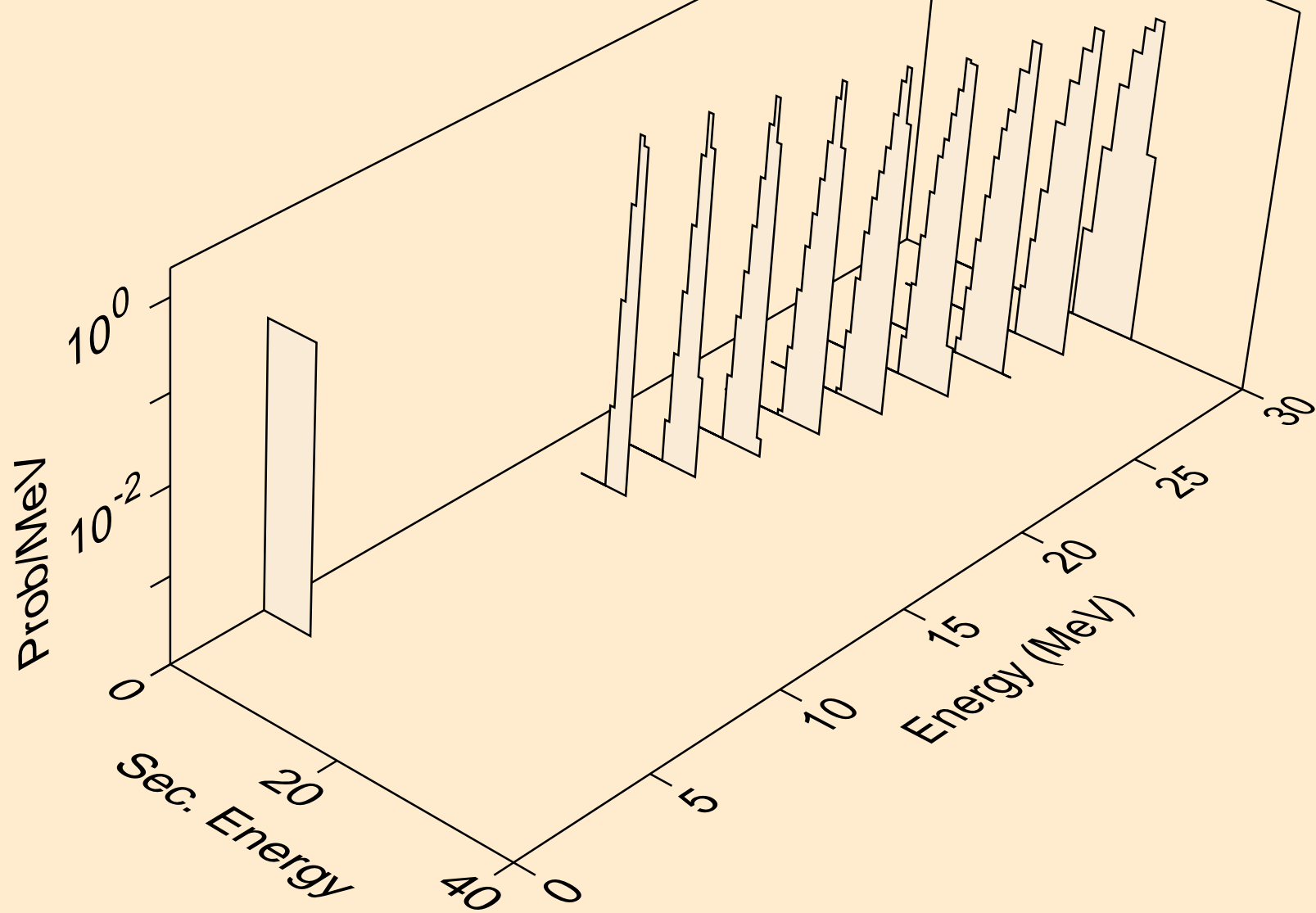



MD250 DEUTERON ACER TENDL-2021 LIBRARY; T=0.K  
he3s from (d,he3)

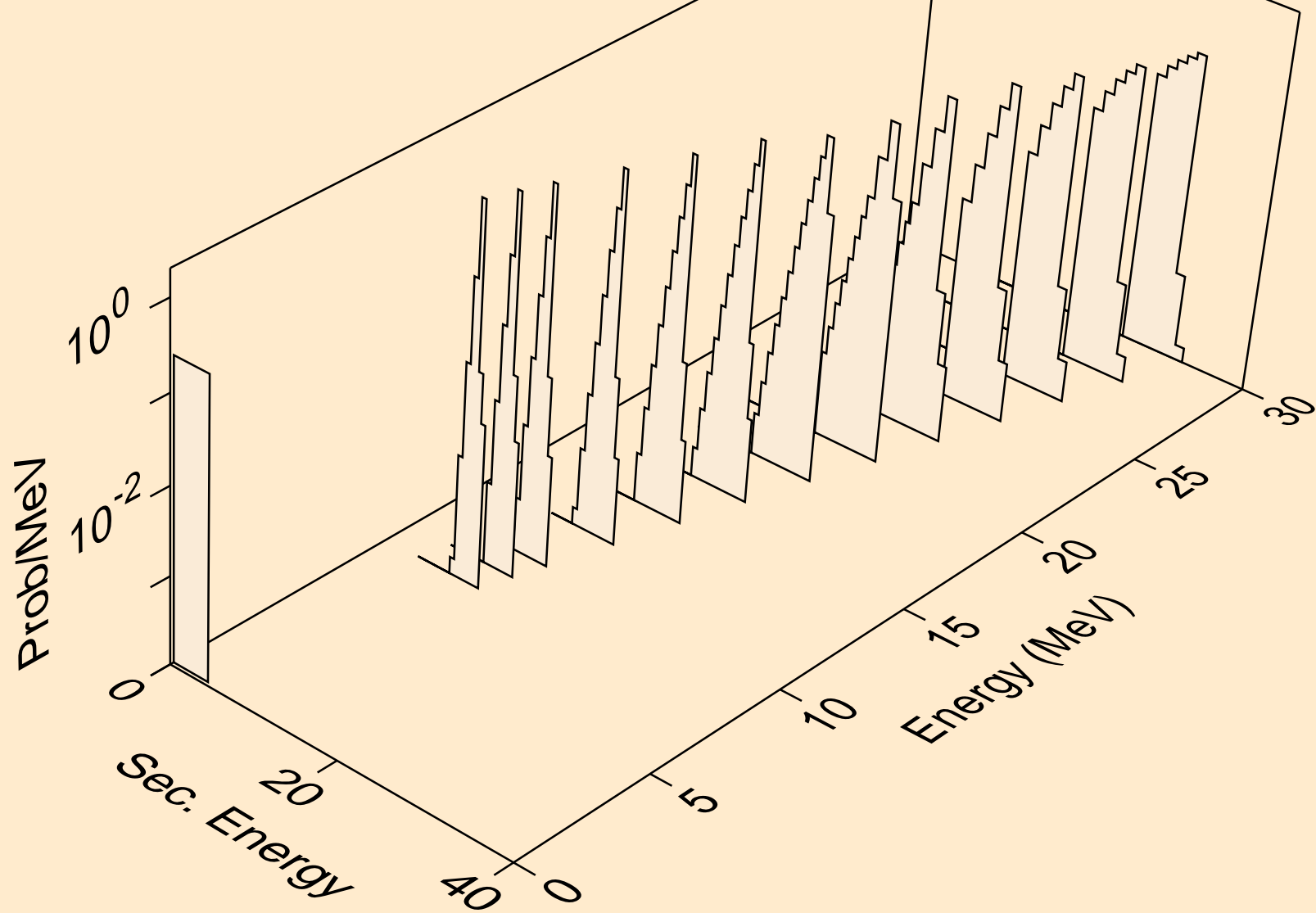

MD250 DEUTERON ACER TENDL-2021 LIBRARY; T=0.K  
alphas from (d,x)

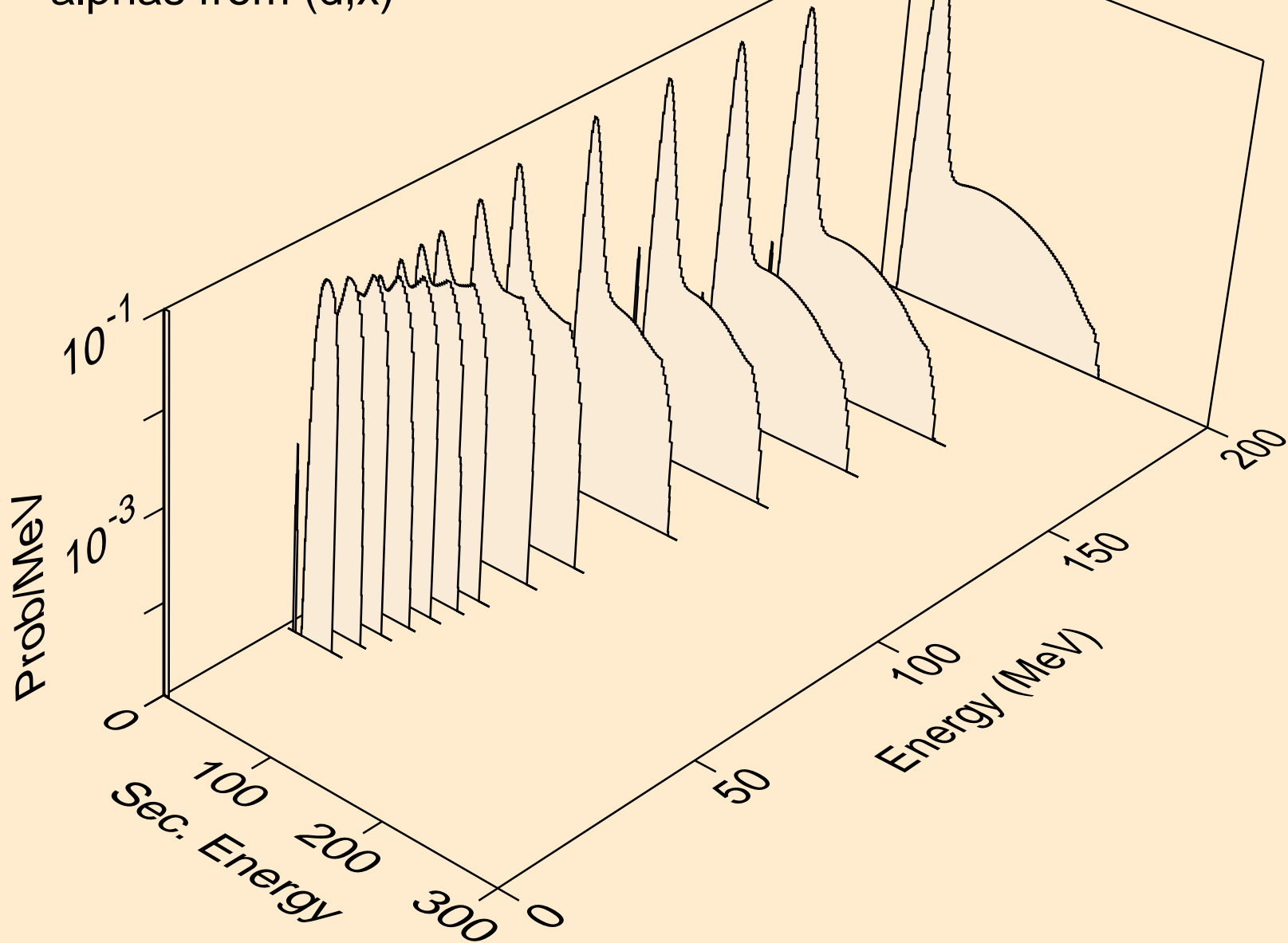

MD250 DEUTERON ACER TENDL-2021 LIBRARY; T=0.K  
alphas from (d,n\*)a

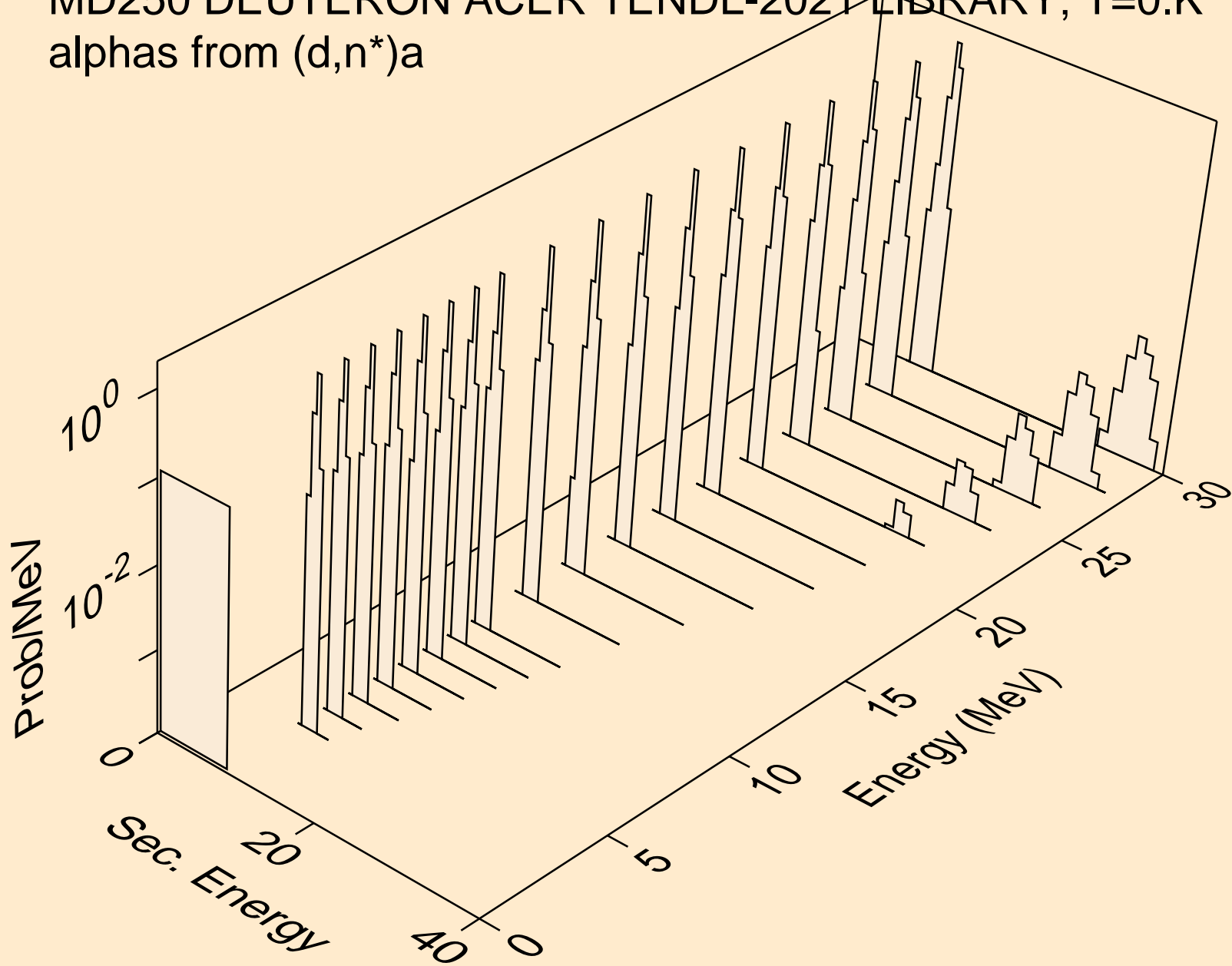

MD250 DEUTERON ACER TENDL-2021 LIBRARY; T=0.K  
alphas from (d,2n)a

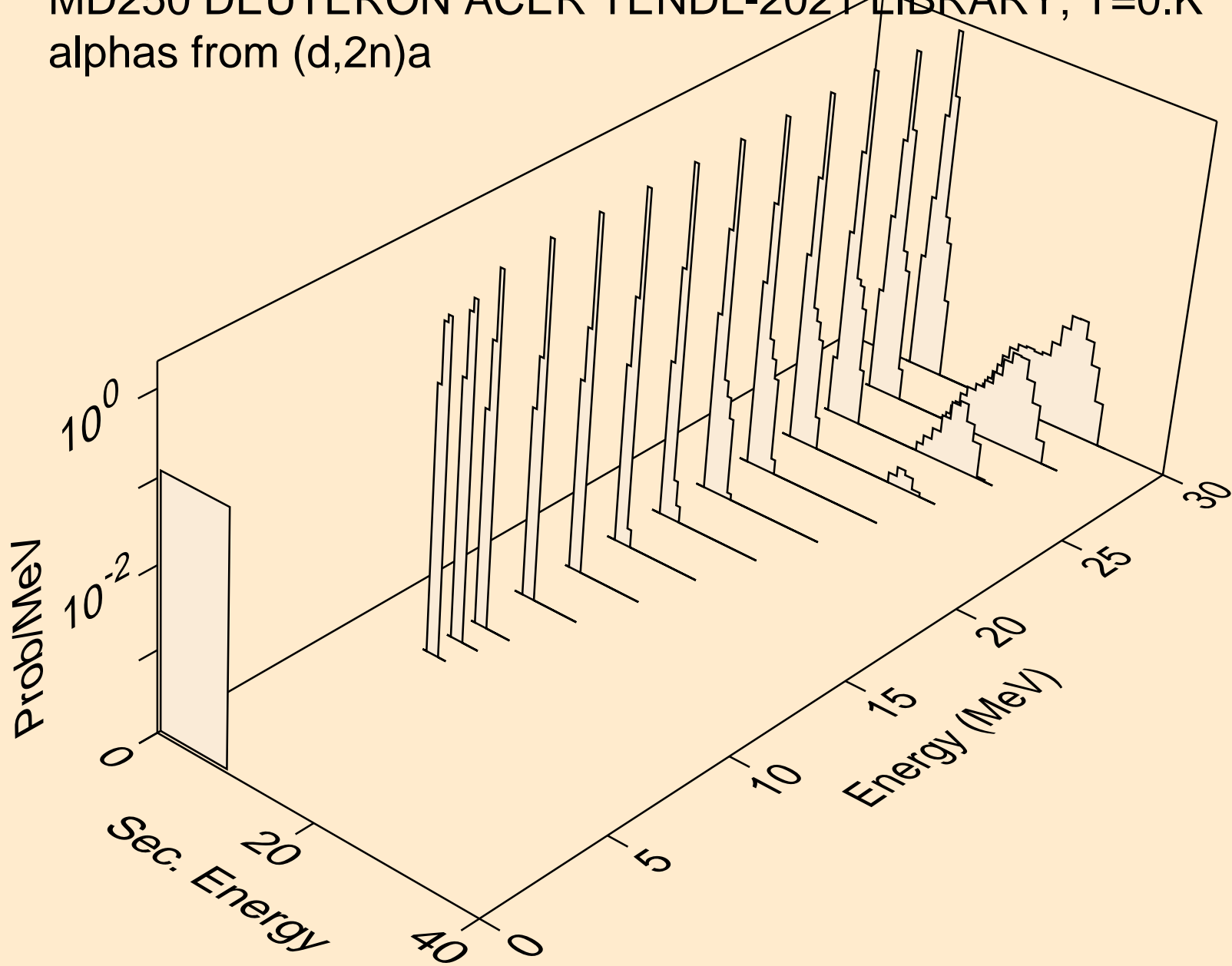

MD250 DEUTERON ACER TENDL-2021 LIBRARY; T=0.K  
alphas from (d,3n)a

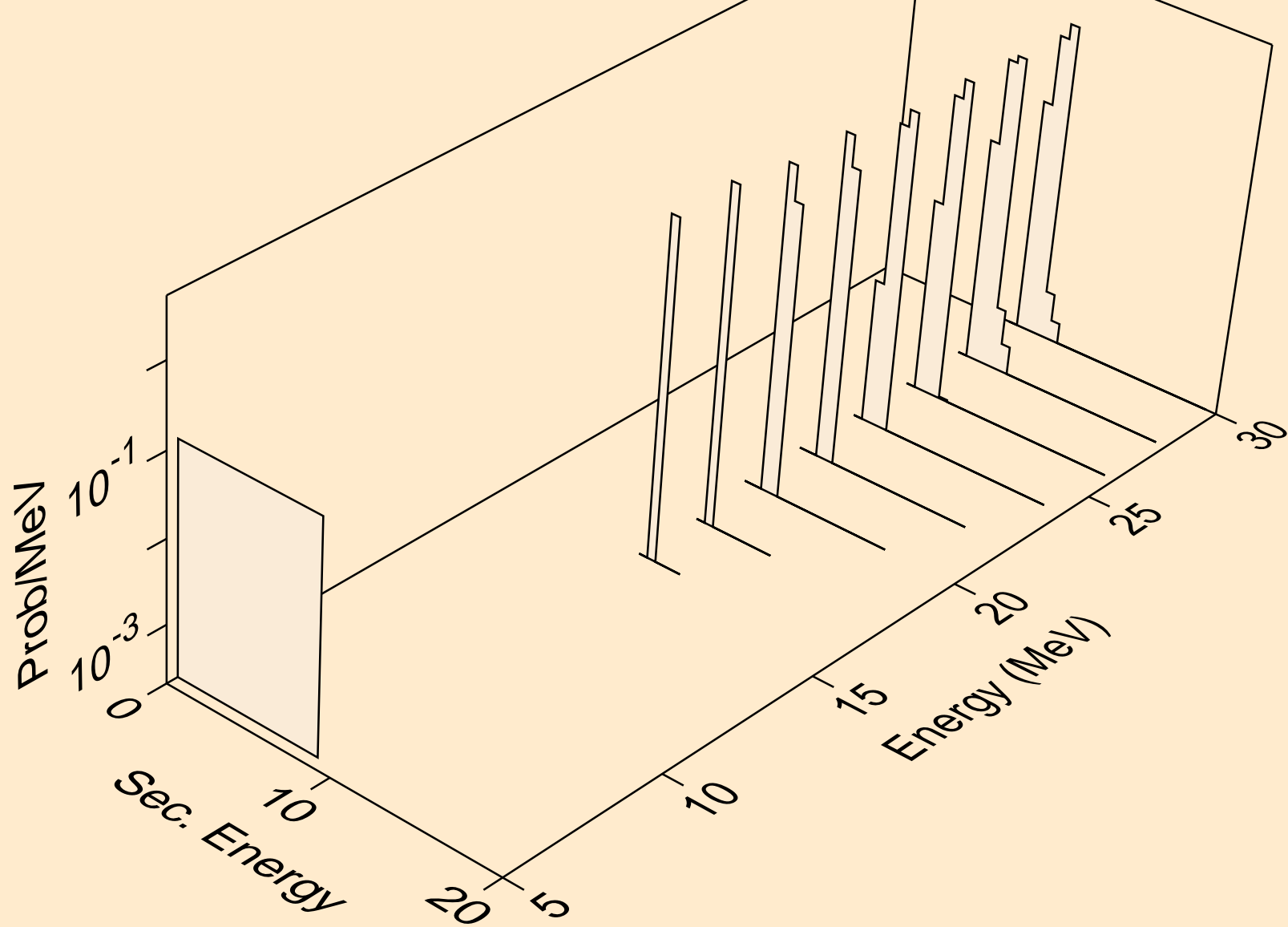

MD250 DEUTERON ACER TENDL-2021 LIBRARY; T=0.K  
alphas from (d,a)

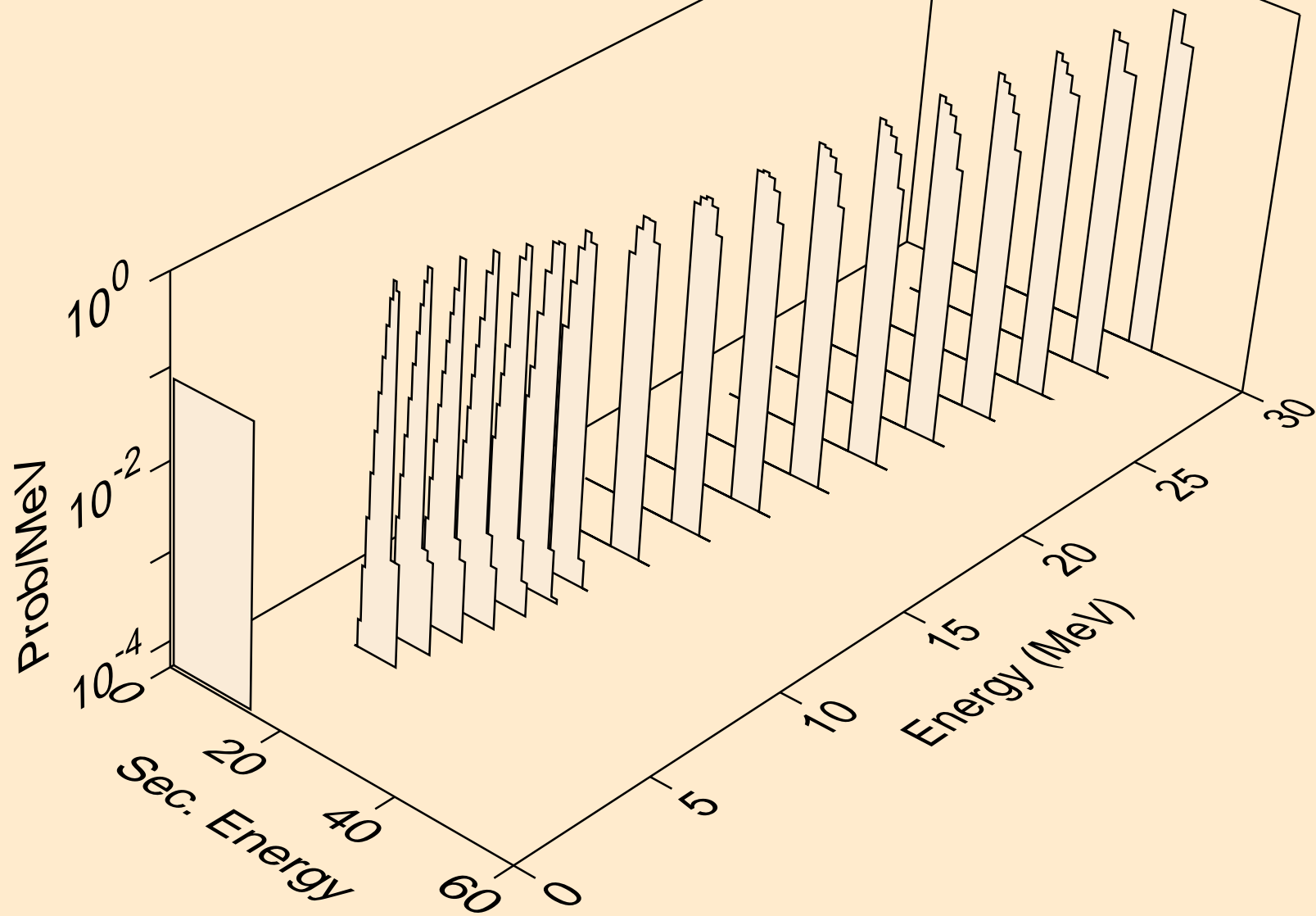

MD250 DEUTERON ACER TENDL-2021 LIBRARY; T=0.K  
alphas from (d,pa)

