

ND126 DEUTERON ACER TENDL-2021 LIBRARY; T=0.K

Principal cross sections

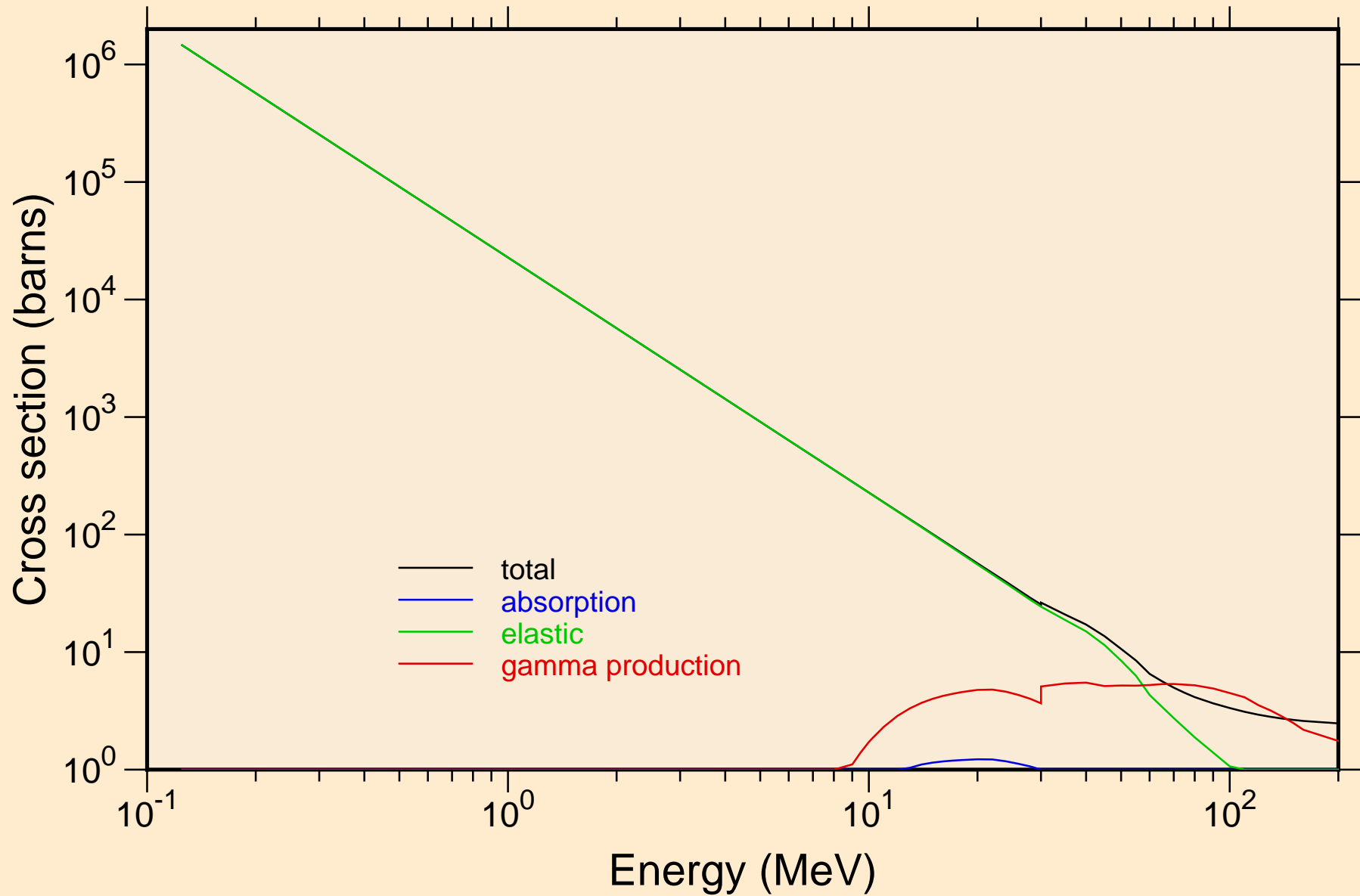

ND126 DEUTERON ACER TENDL-2021 LIBRARY; T=0.K
Heating

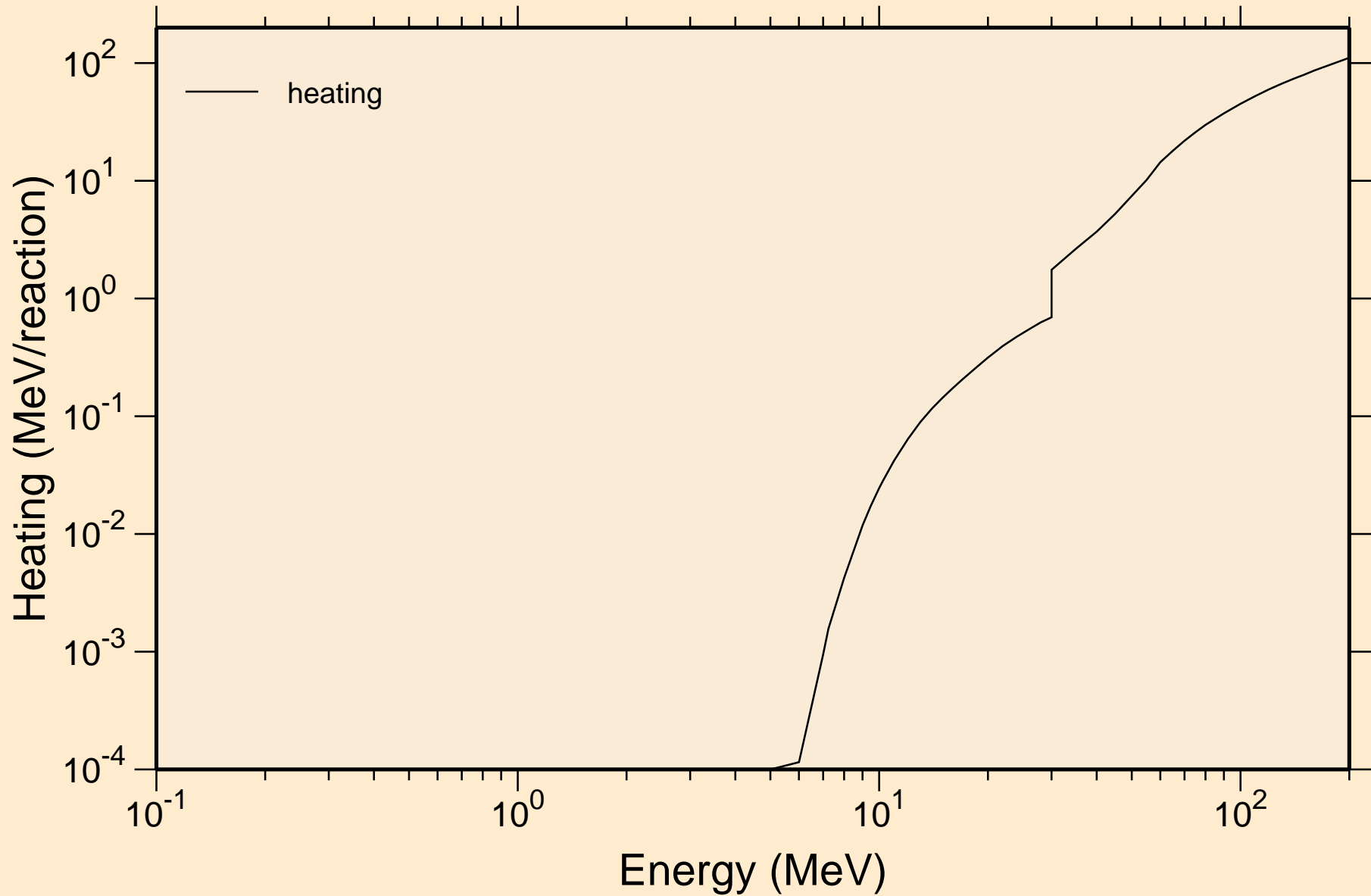

ND126 DEUTERON ACER TENDL-2021 LIBRARY; T=0.K

Principal cross sections

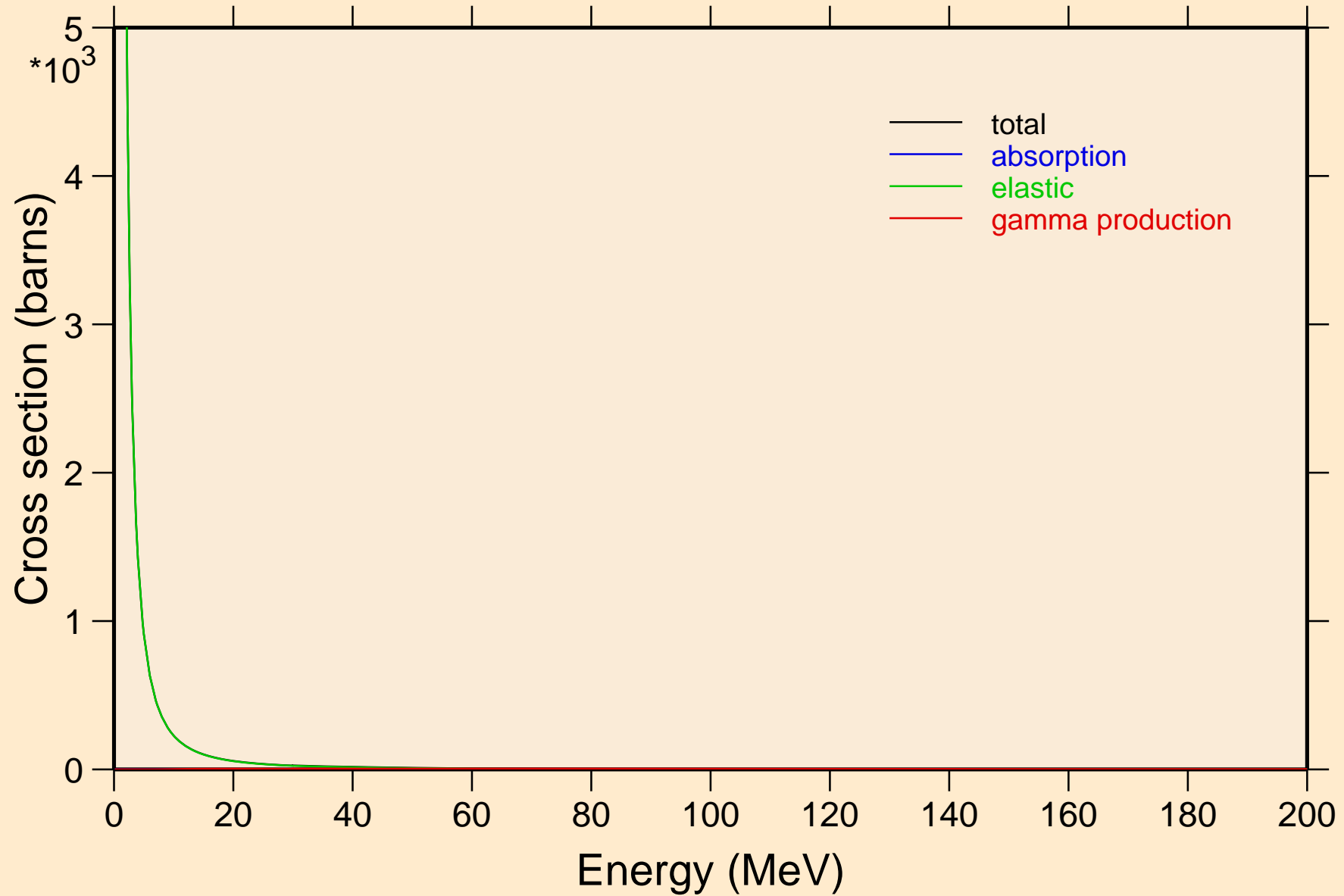

ND126 DEUTERON ACER TENDL-2021 LIBRARY; T=0.K
Heating

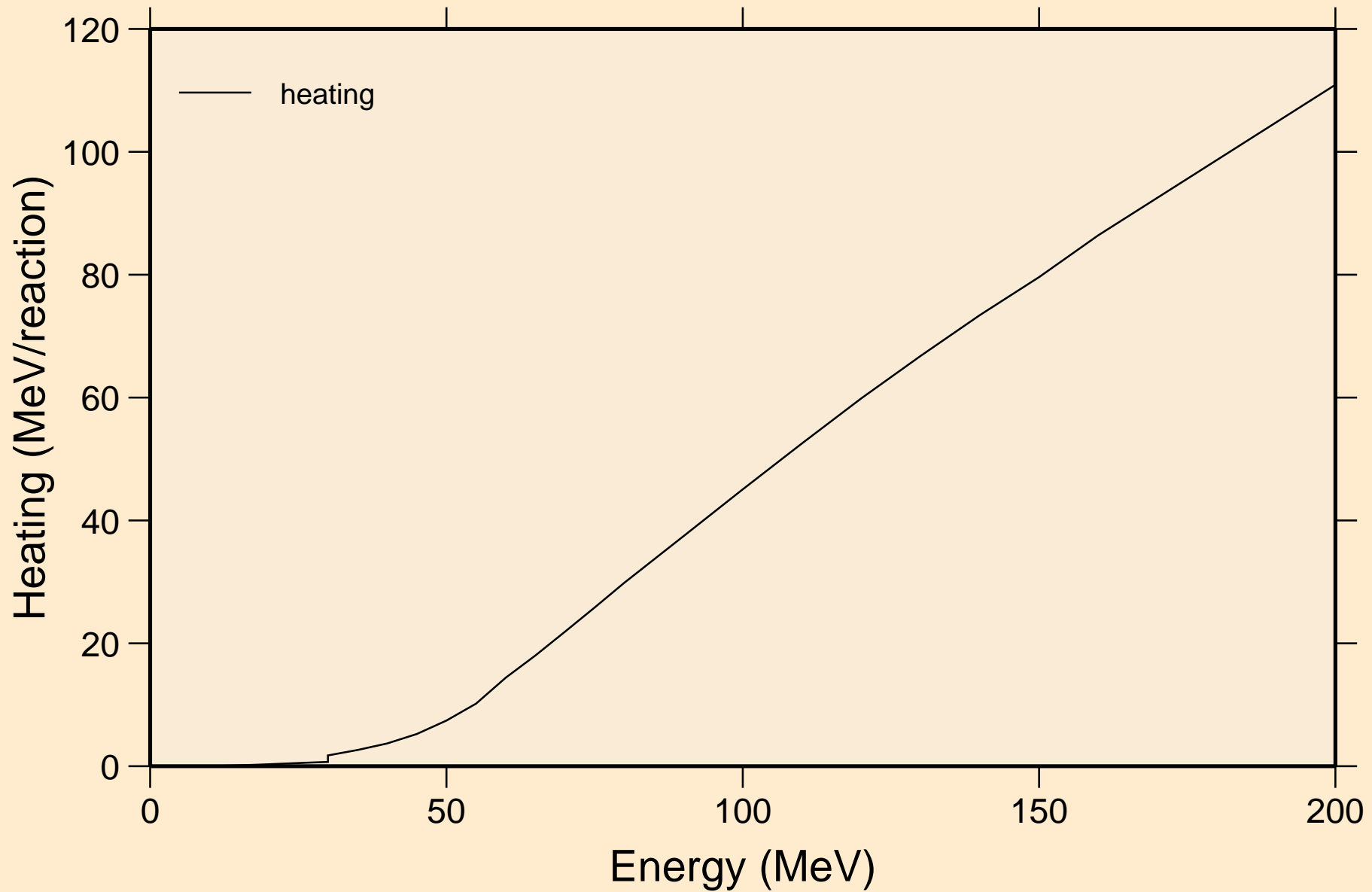

ND126 DEUTERON ACER TENDL-2021 LIBRARY; T=0.K

Threshold reactions

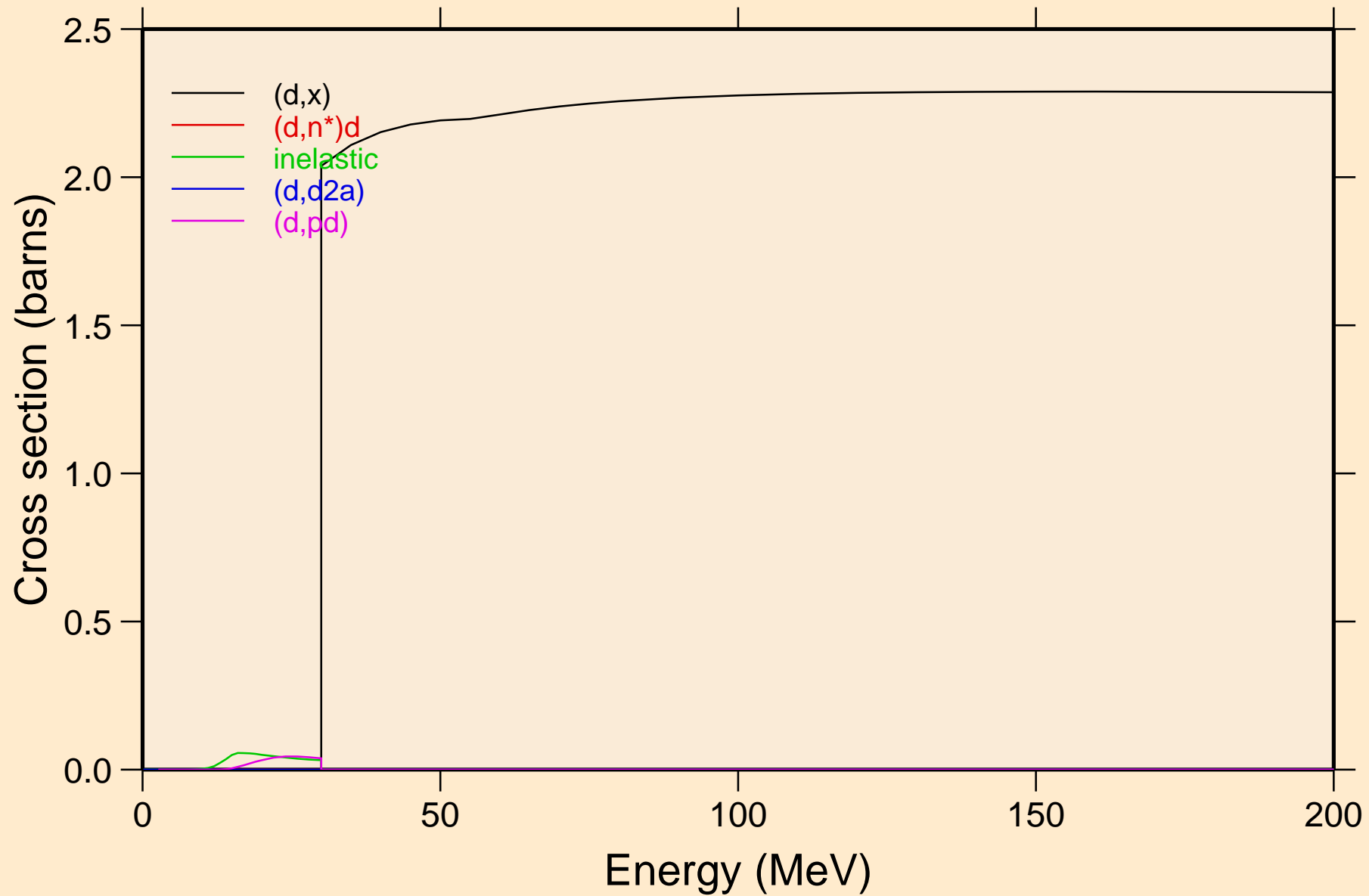

ND126 DEUTERON ACER TENDL-2021 LIBRARY; T=0.K
Threshold reactions

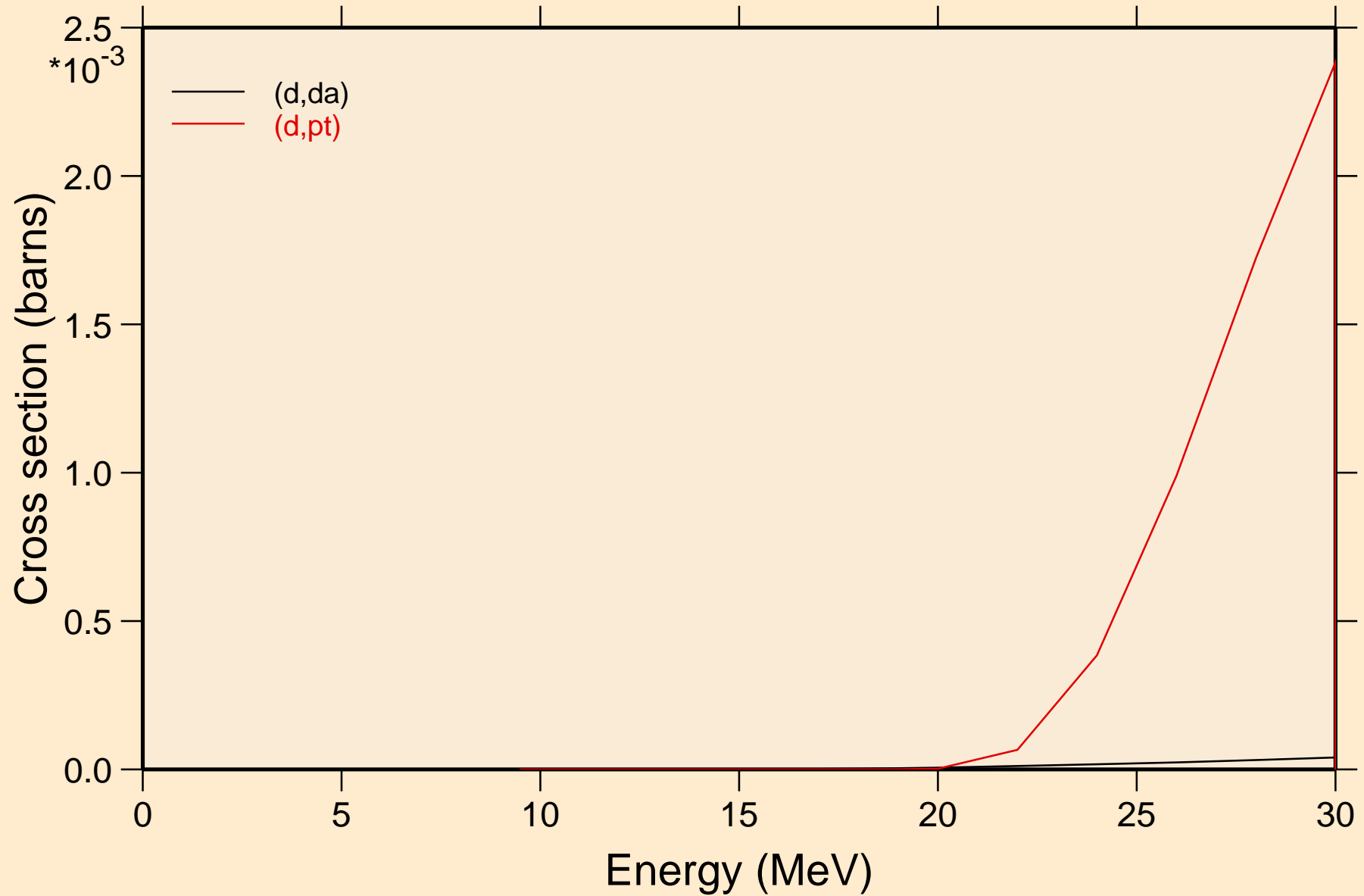

ND126 DEUTERON ACER TENDL-2021 LIBRARY; T=0.K
Threshold reactions

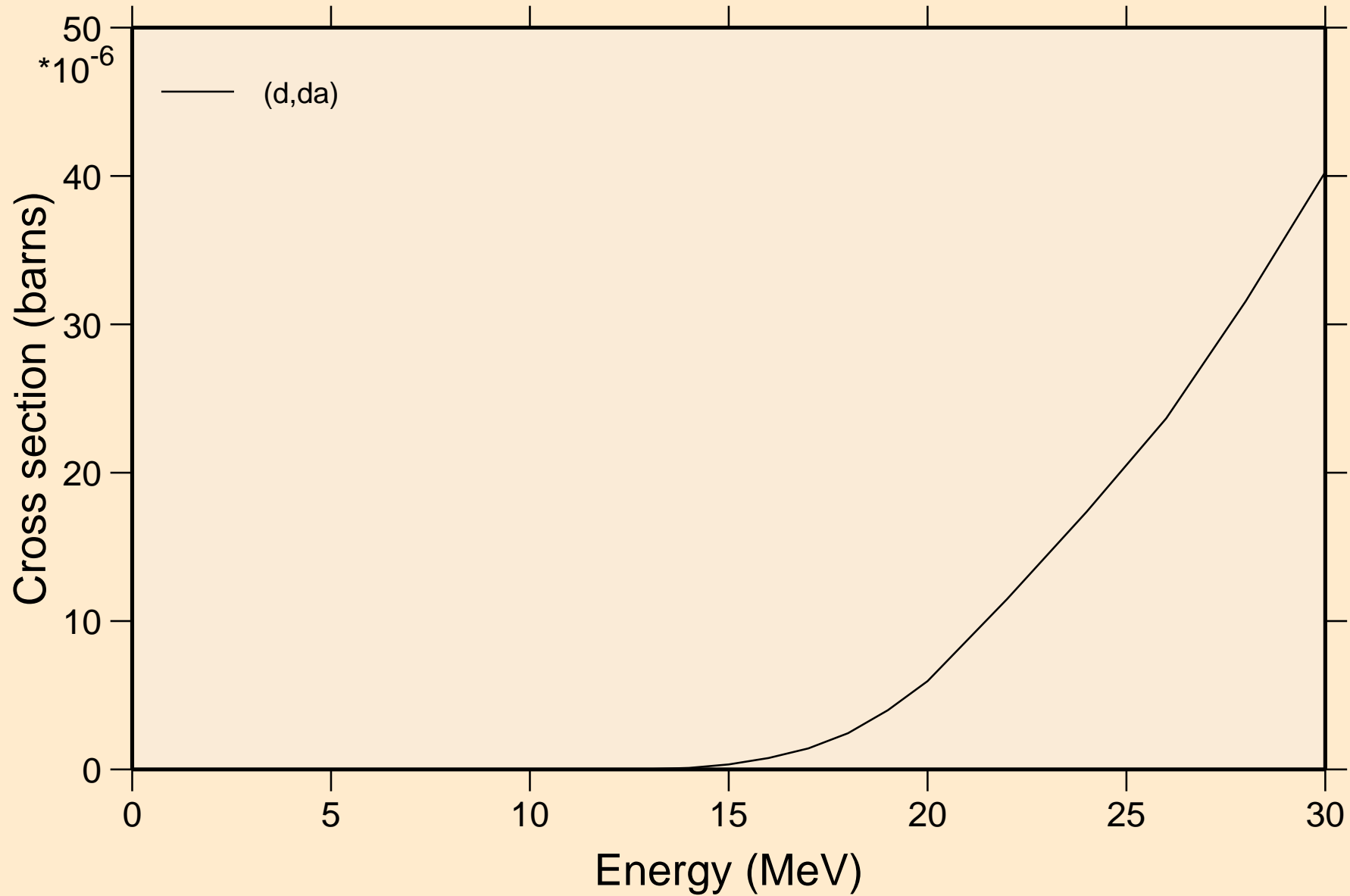

ND126 DEUTERON ACER TENDL-2021 LIBRARY; T=0.K
angular distribution for elastic

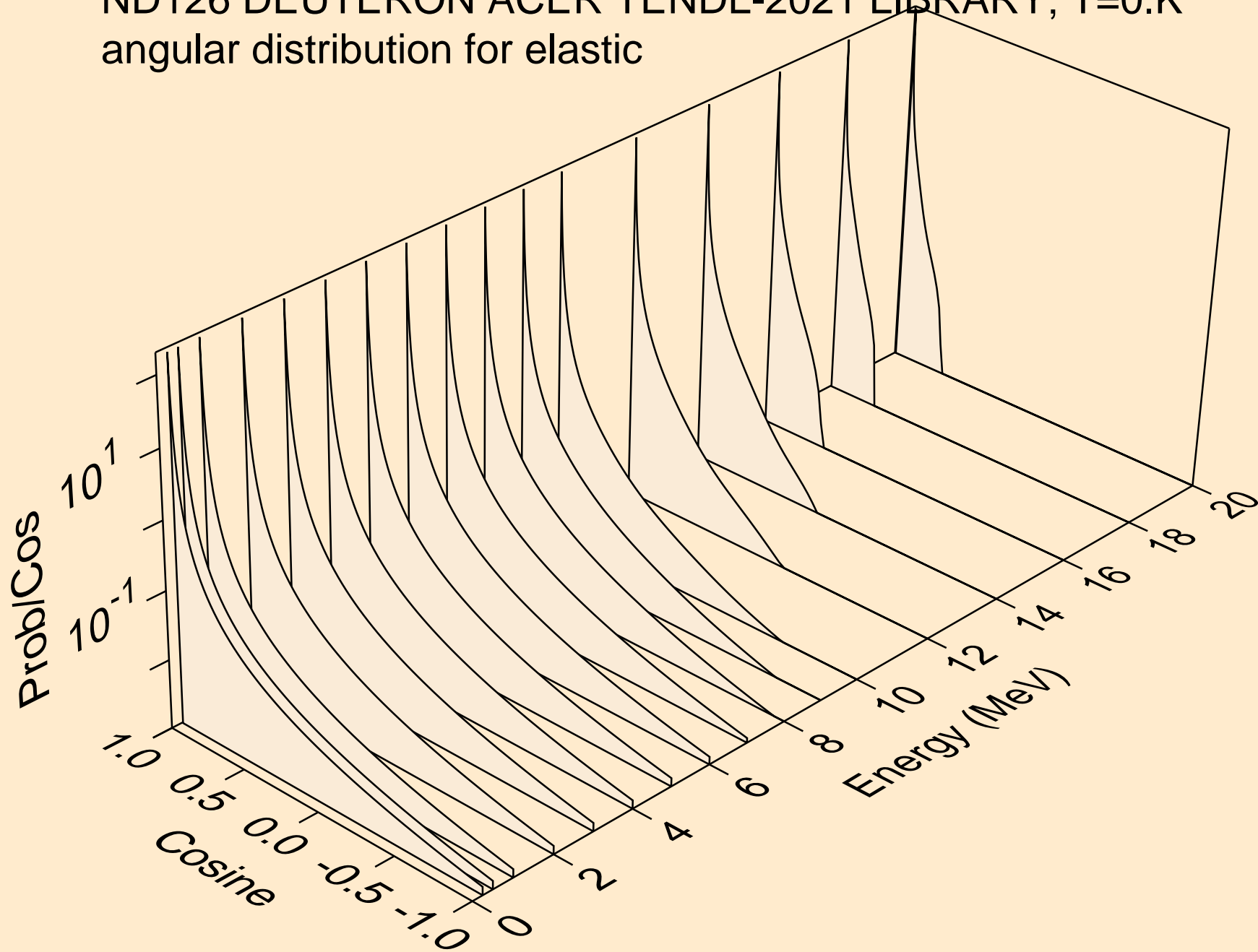

ND126 DEUTERON ACER TENDL-2021 LIBRARY; T=0.K
angular distribution for elastic

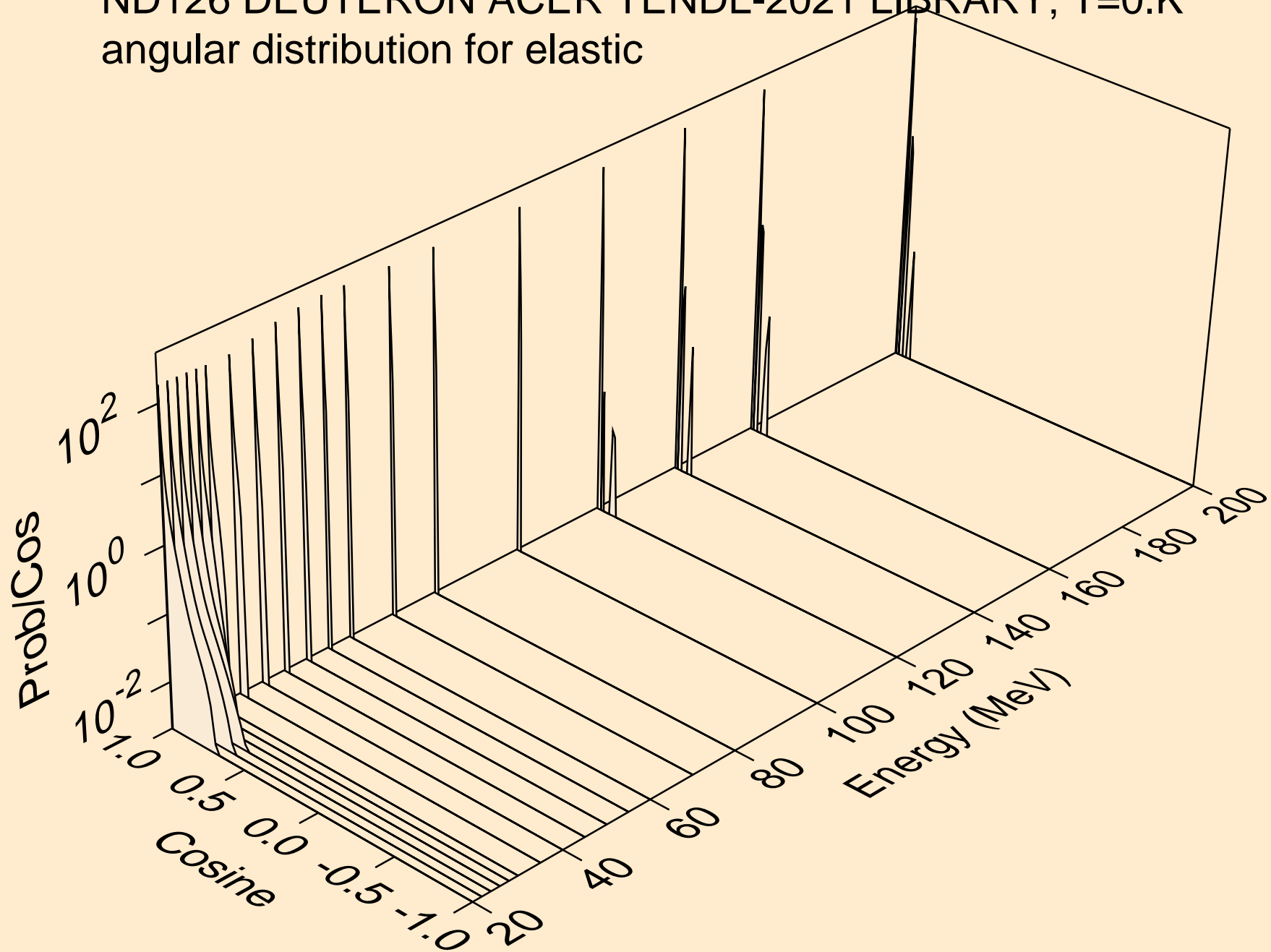

ND126 DEUTERON ACER TENDL-2021 LIBRARY; T=0.K
Deuteron emission for (d,x)

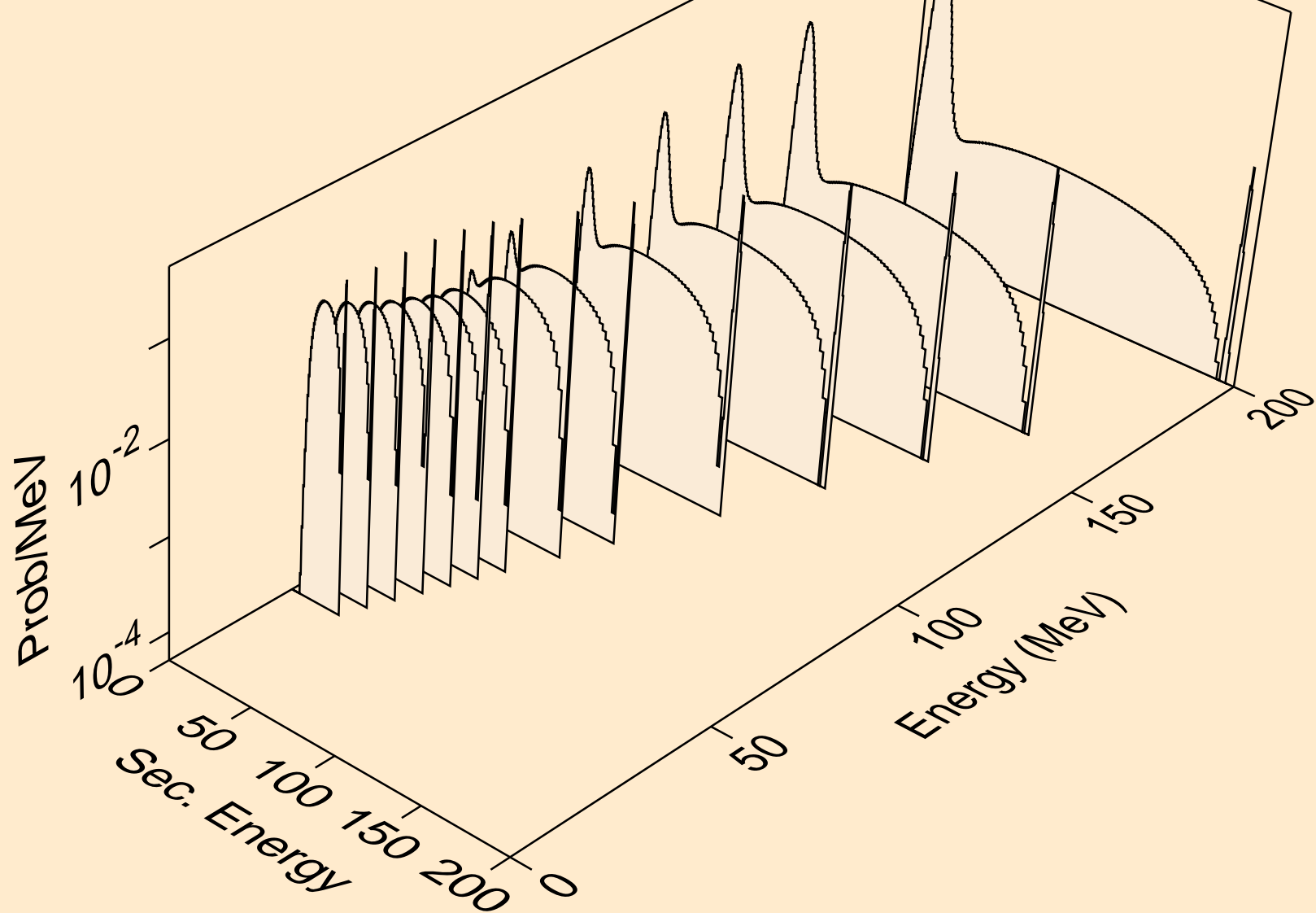

ND126 DEUTERON ACER TENDL-2021 LIBRARY; T=0.K
Deuteron emission for (d,n*)d

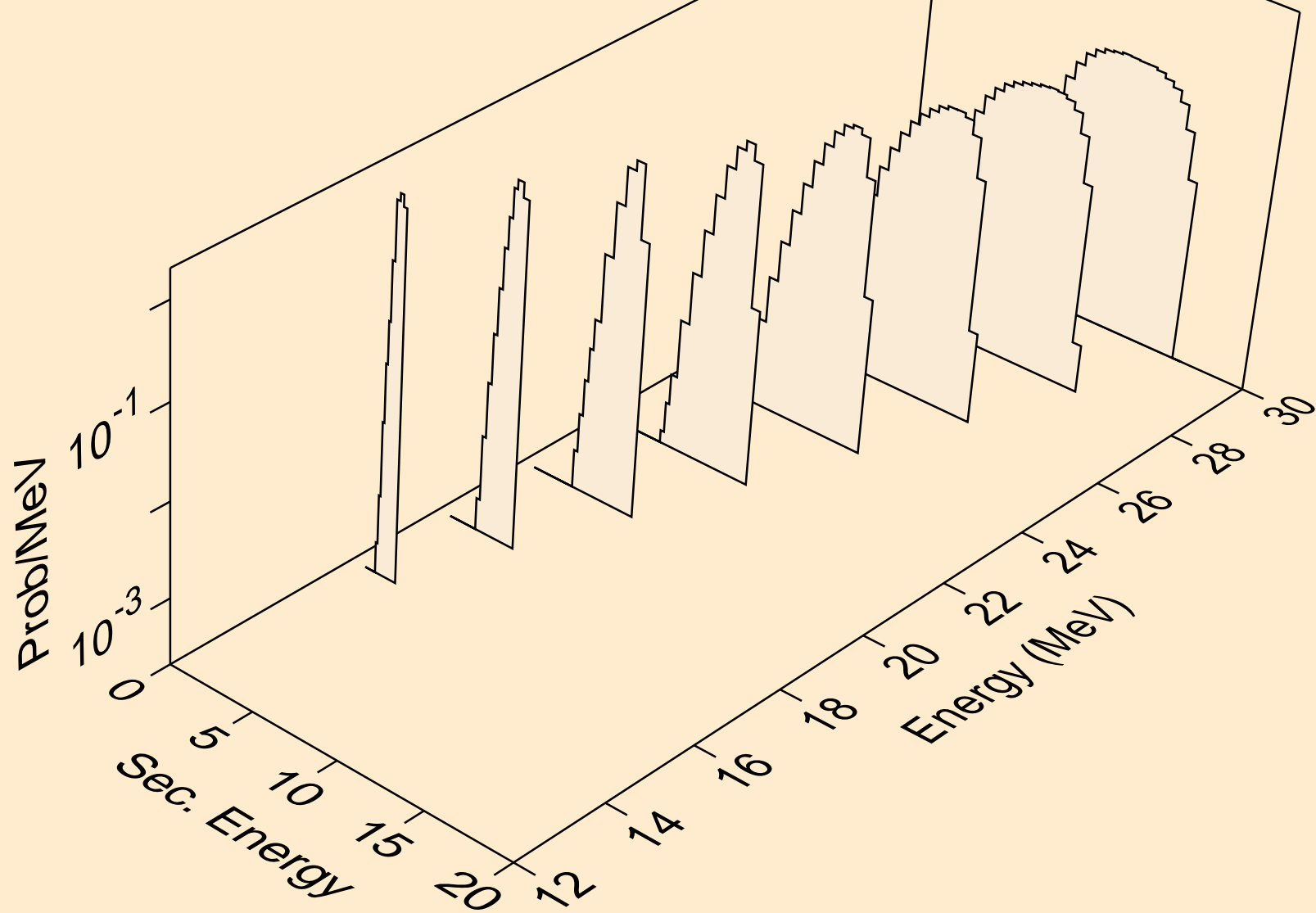

ND126 DEUTERON ACER TENDL-2021 LIBRARY; T=0.K
Deuteron emission for inelastic

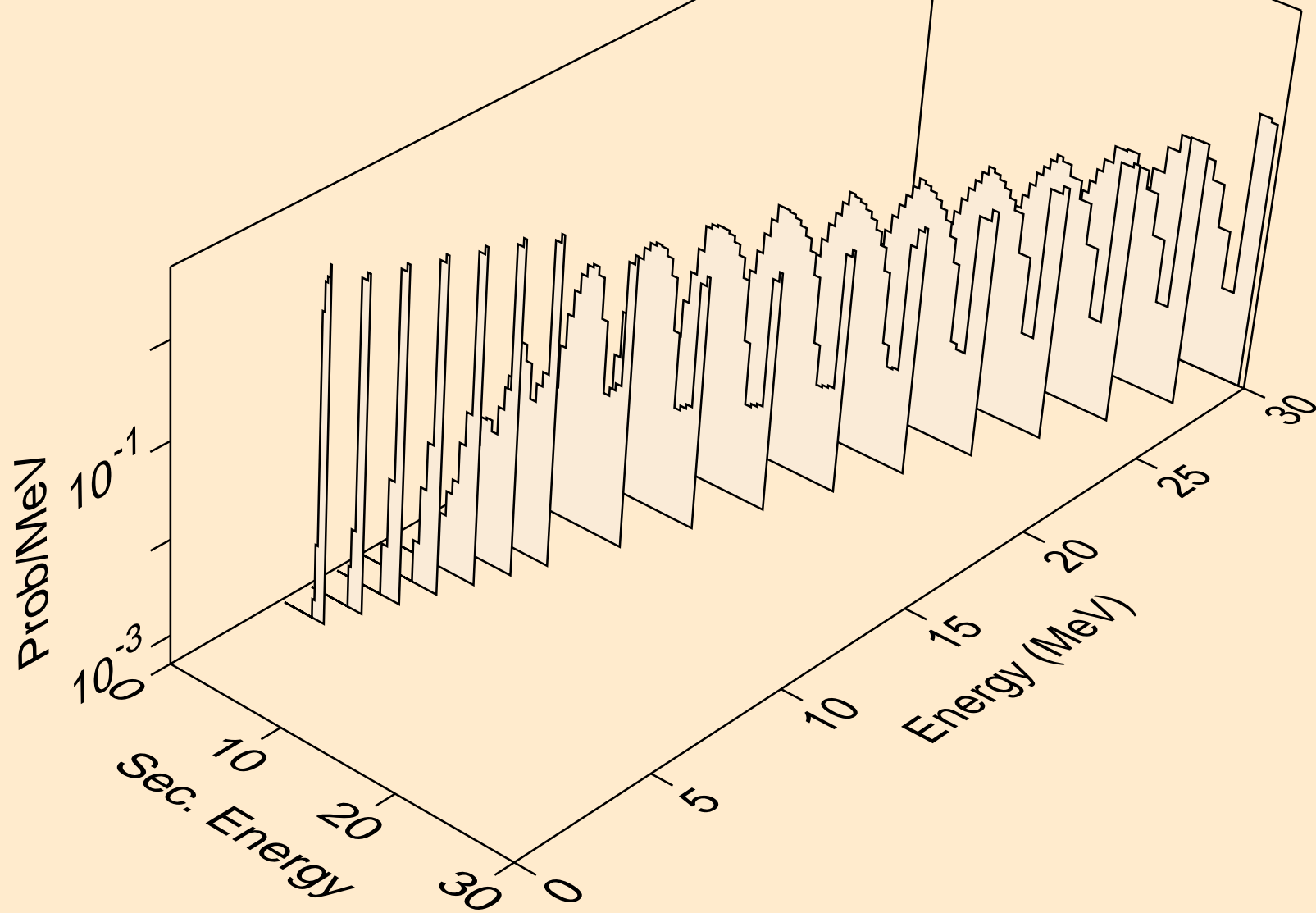

ND126 DEUTERON ACER TENDL-2021 LIBRARY; T=0.K
Deuteron emission for (d,d2a)

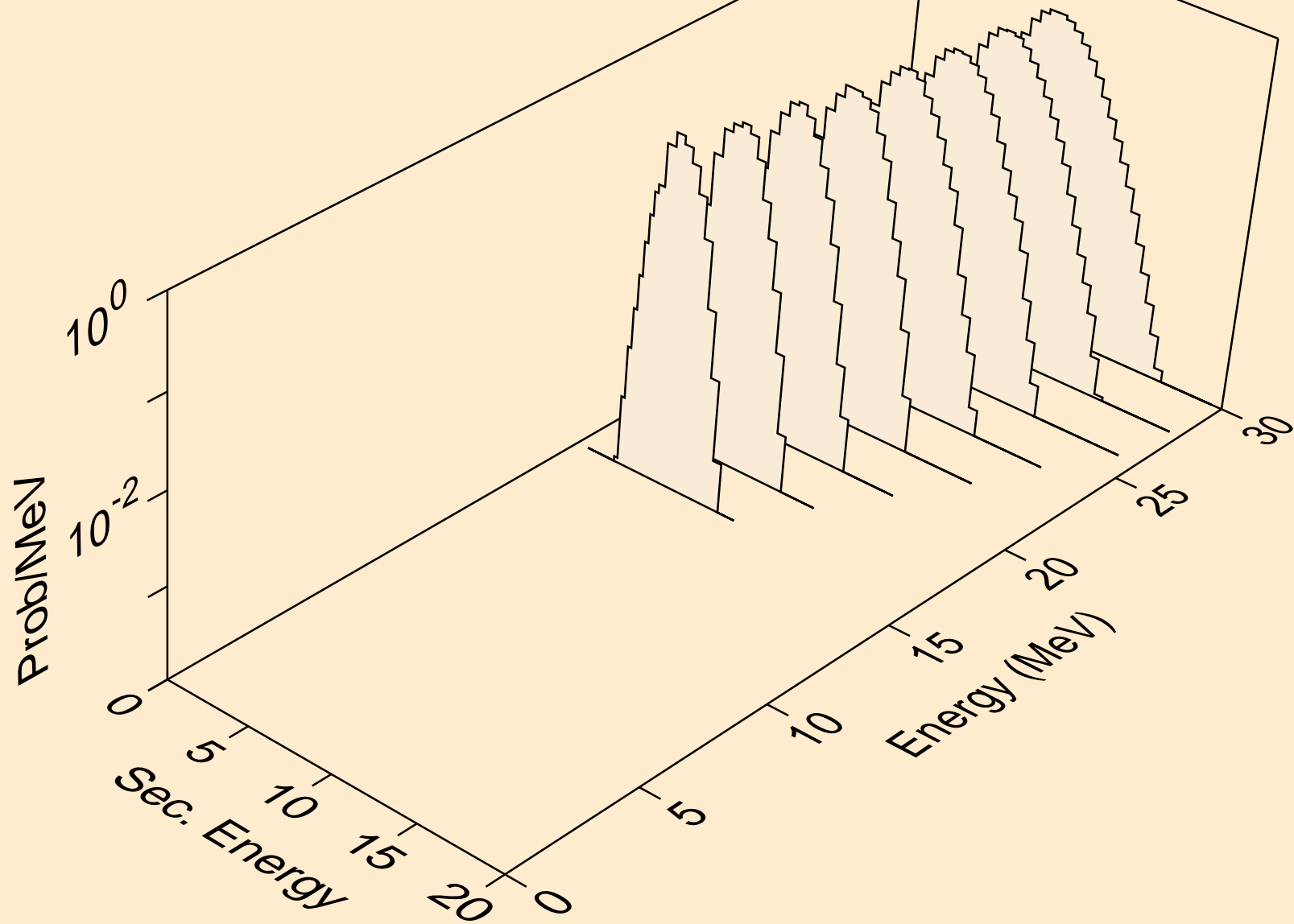

ND126 DEUTERON ACER TENDL-2021 LIBRARY; T=0.K
Deuteron emission for (d,pd)

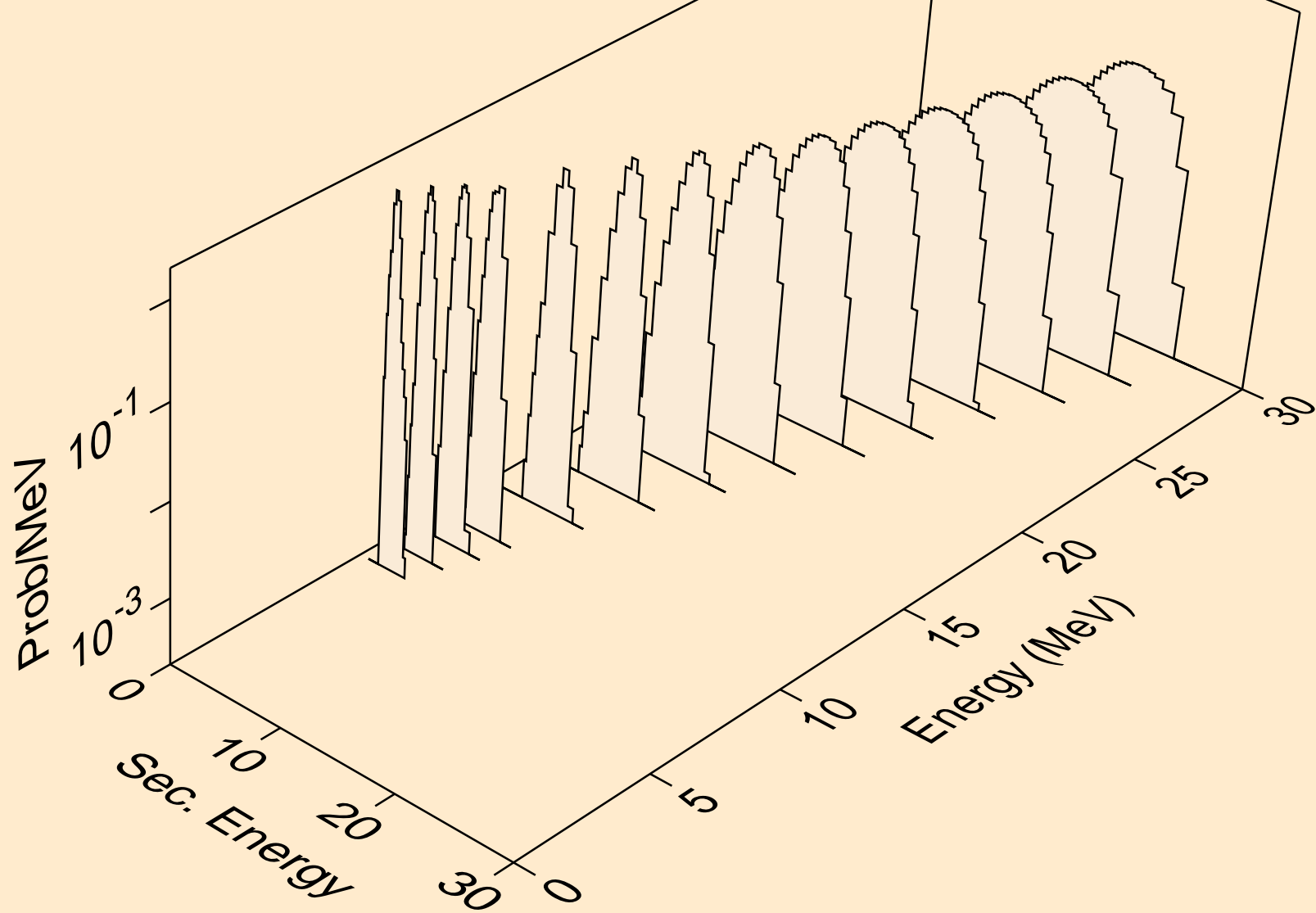

ND126 DEUTERON ACER TENDL-2021 LIBRARY; T=0.K
Deuteron emission for (d,da)

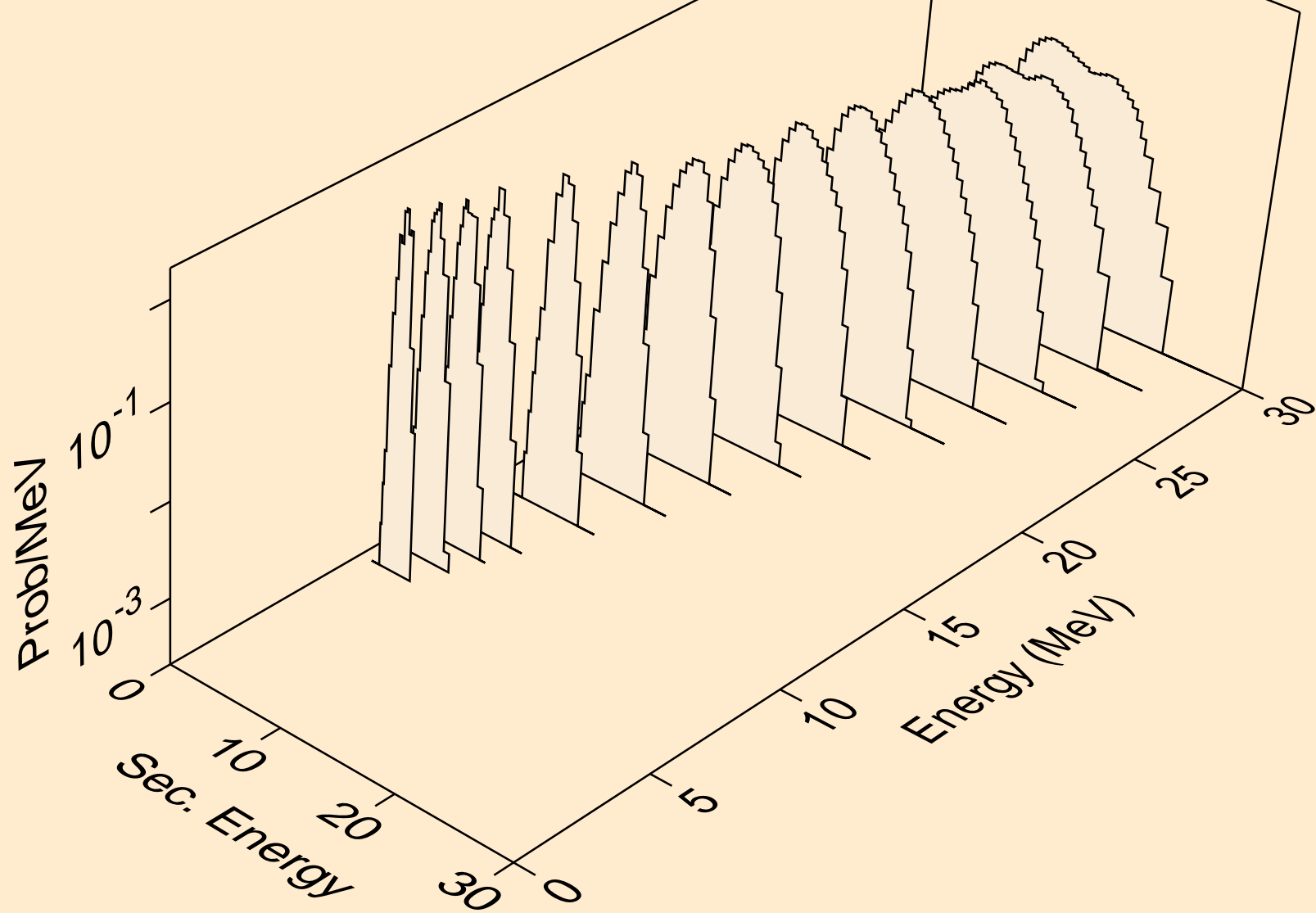

ND126 DEUTERON ACER TENDL-2021 LIBRARY; T=0.K
Photon emission for (z,n)

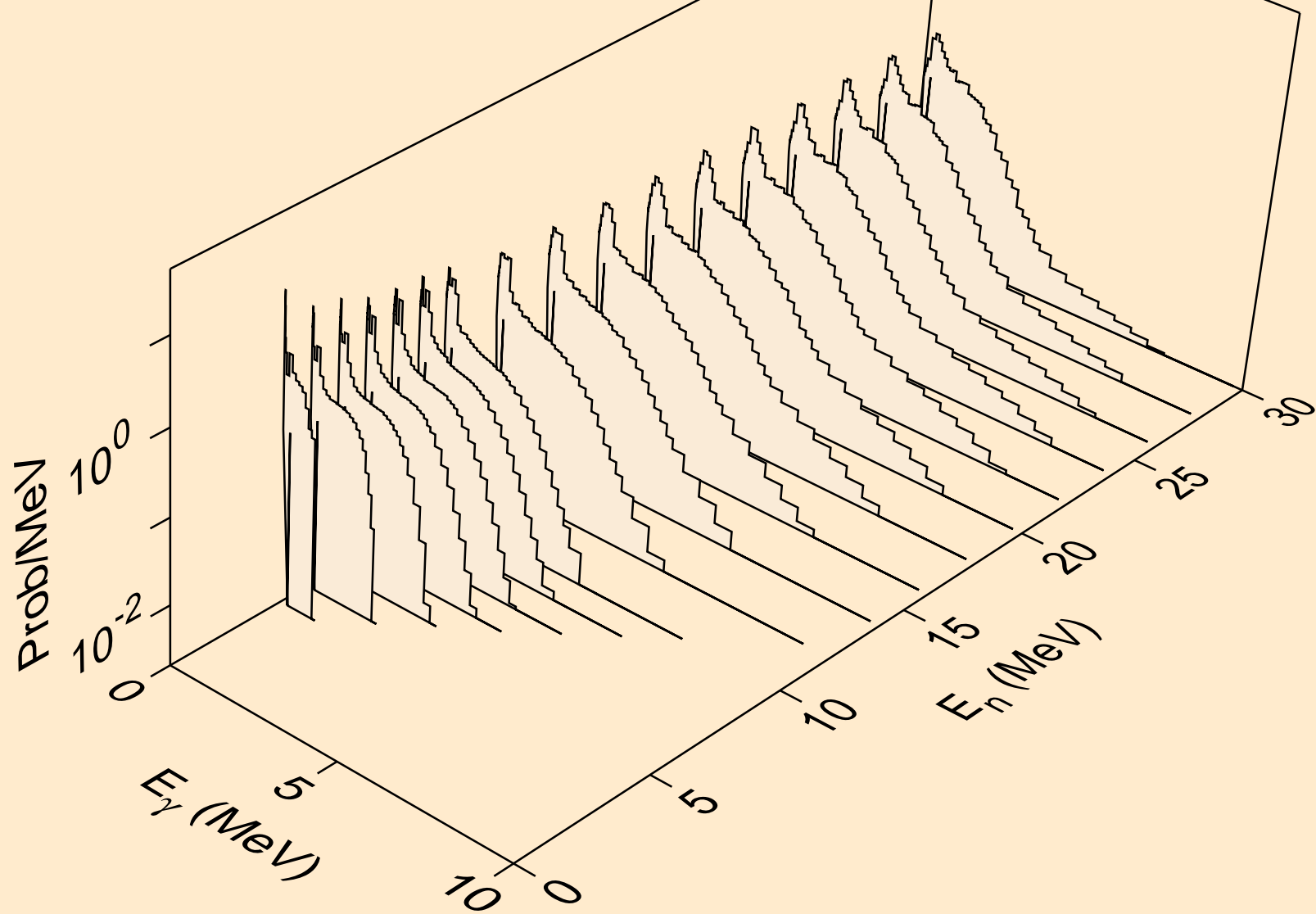

ND126 DEUTERON ACER TENDL-2021 LIBRARY; T=0.K
Photon emission for (n,x)

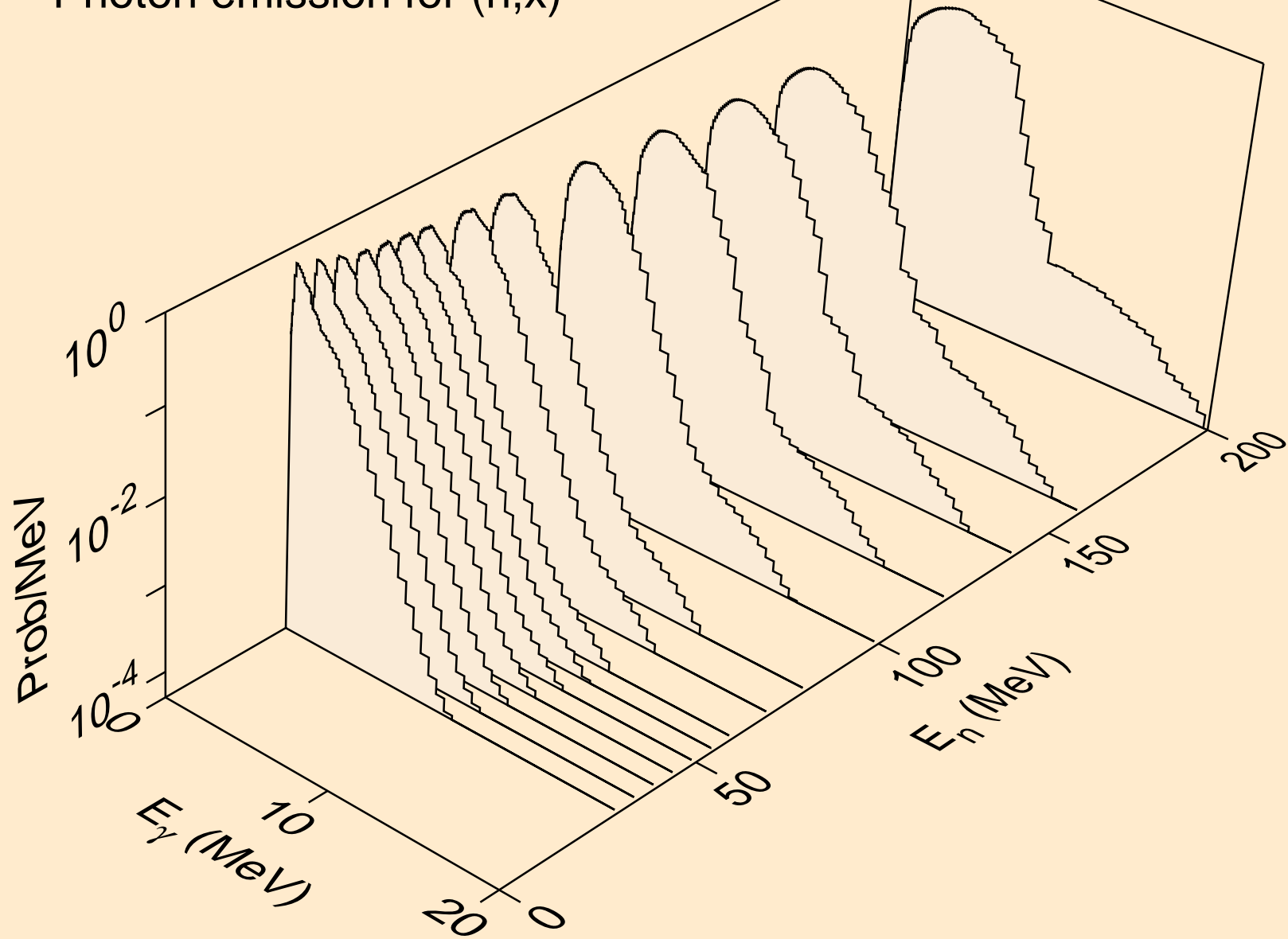

ND126 DEUTERON ACER TENDL-2021 LIBRARY; T=0.K
Photon emission for (n,2n)

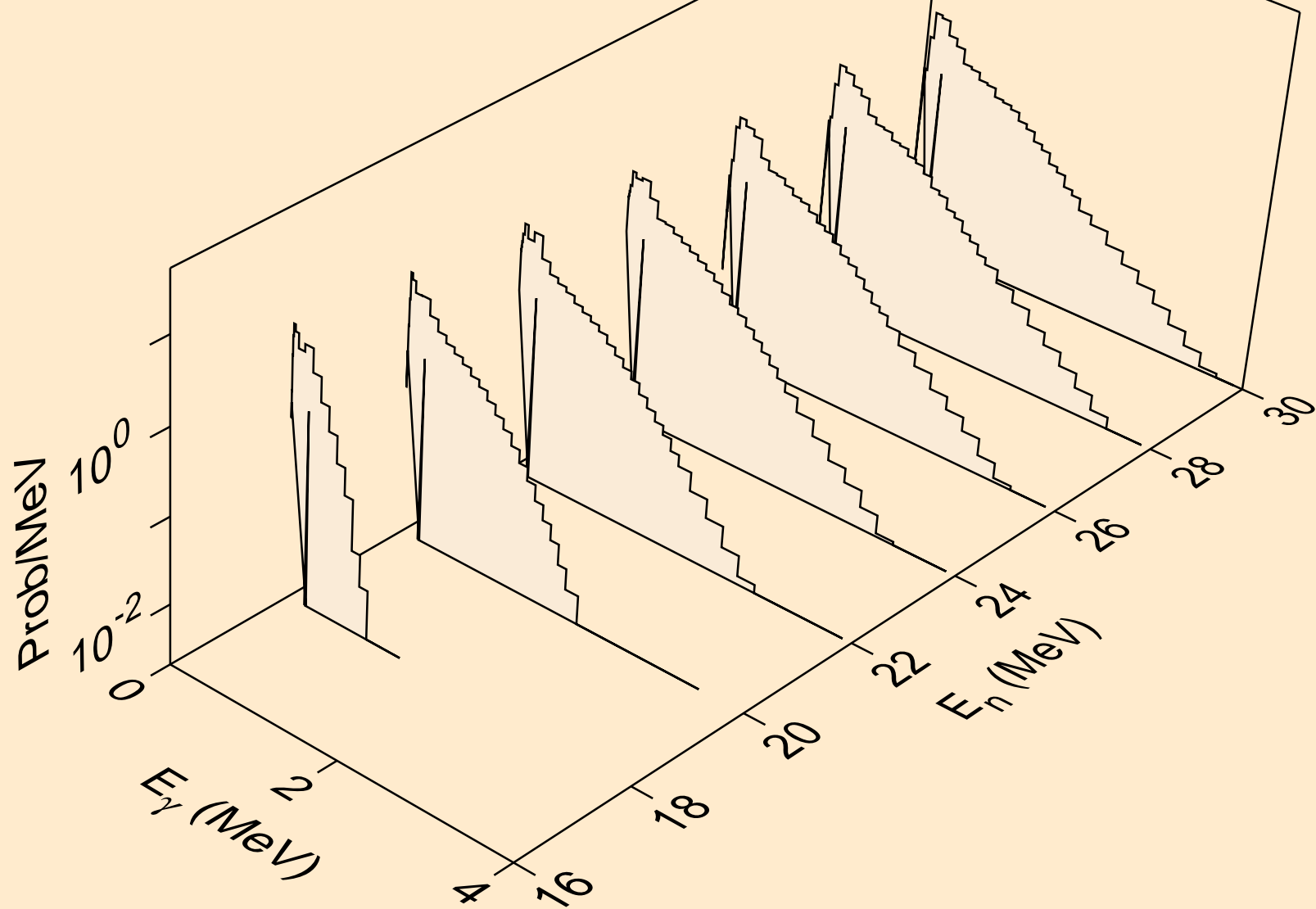

ND126 DEUTERON ACER TENDL-2021 LIBRARY; T=0.K
Photon emission for (n,n*)a

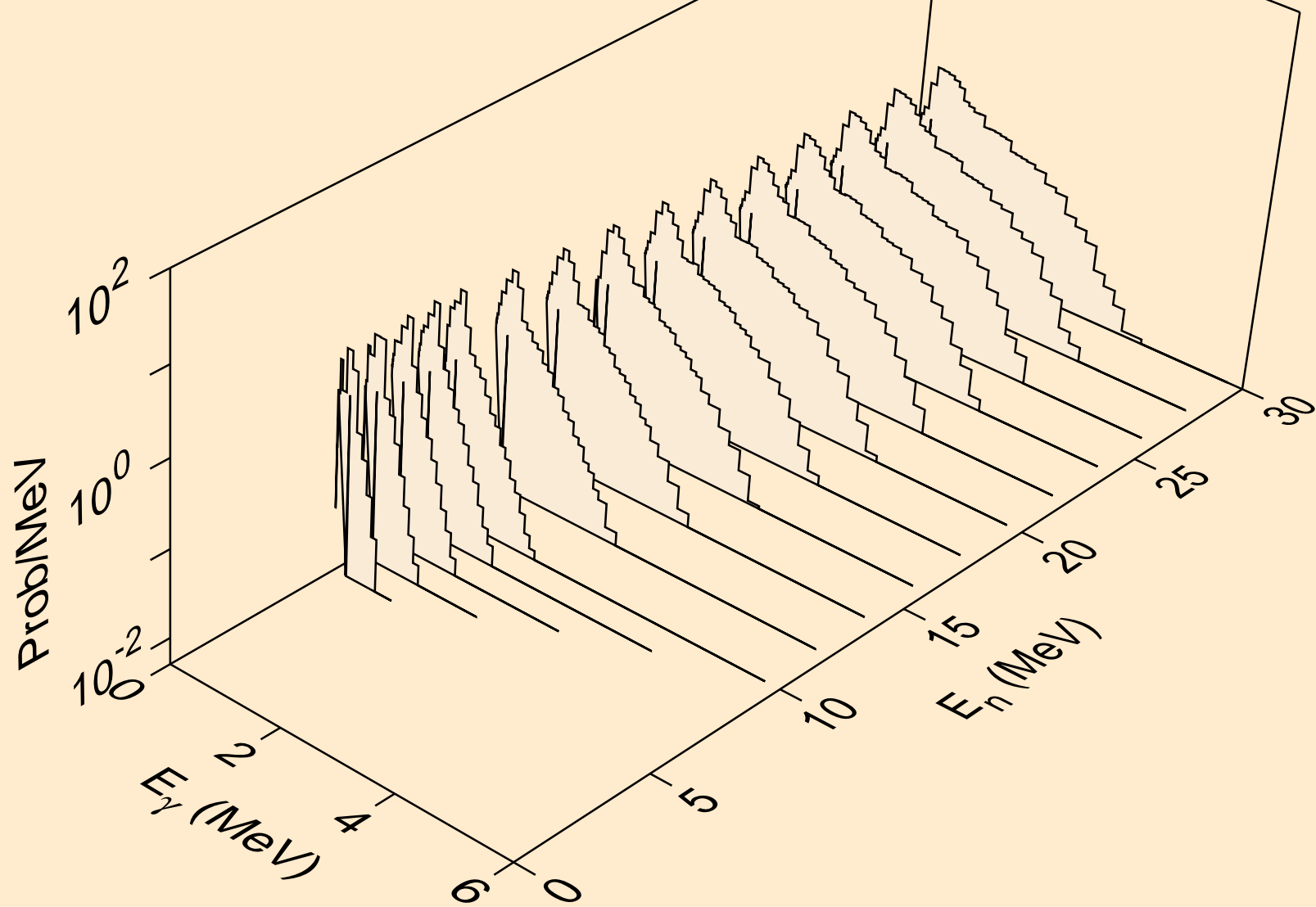

ND126 DEUTERON ACER TENDL-2021 LIBRARY; T=0.K
Photon emission for (n,2n)a

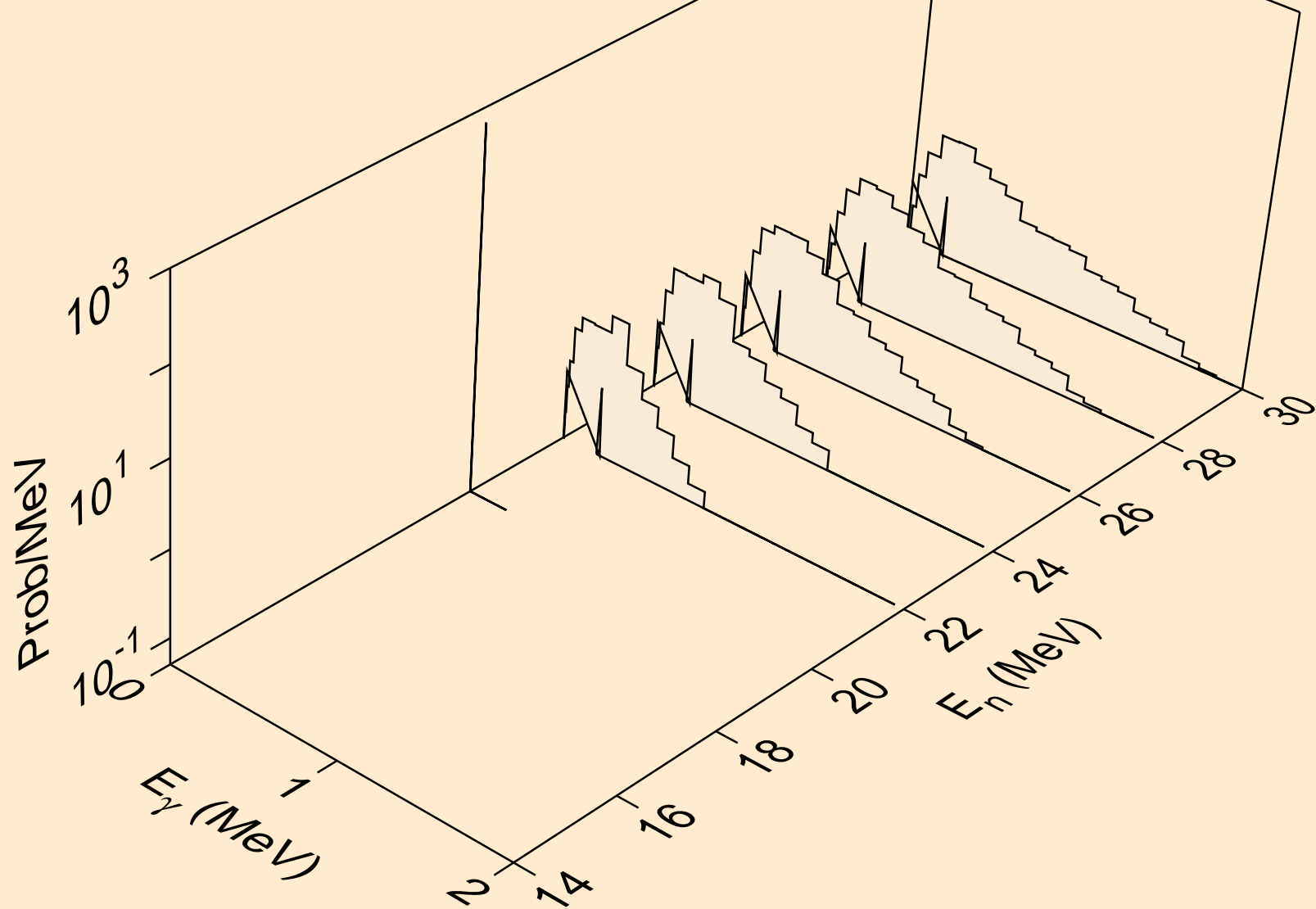

ND126 DEUTERON ACER TENDL-2021 LIBRARY; T=0.K
Photon emission for (n,n*)p

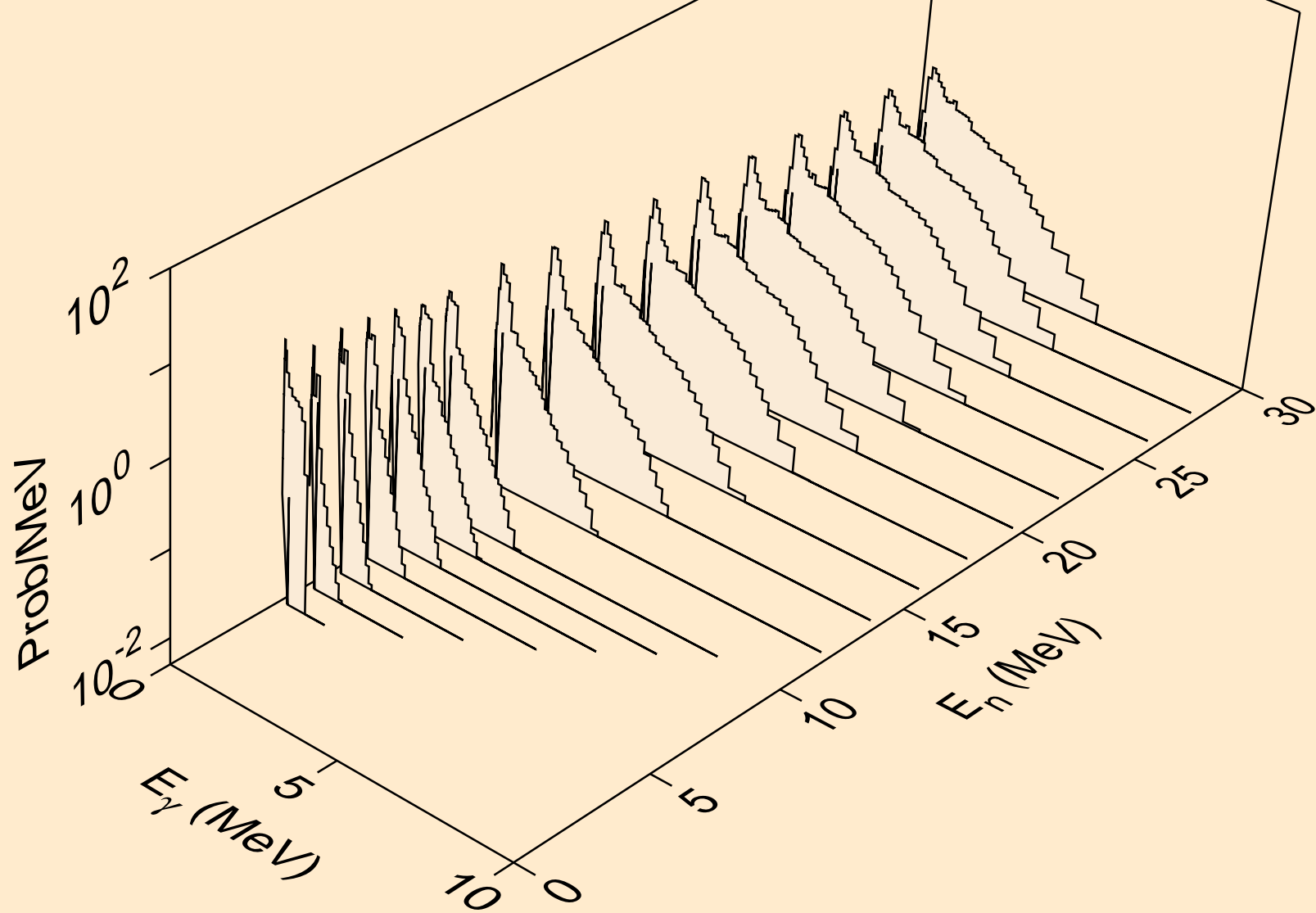

ND126 DEUTERON ACER TENDL-2021 LIBRARY; T=0.K
Photon emission for (n,n*)2a

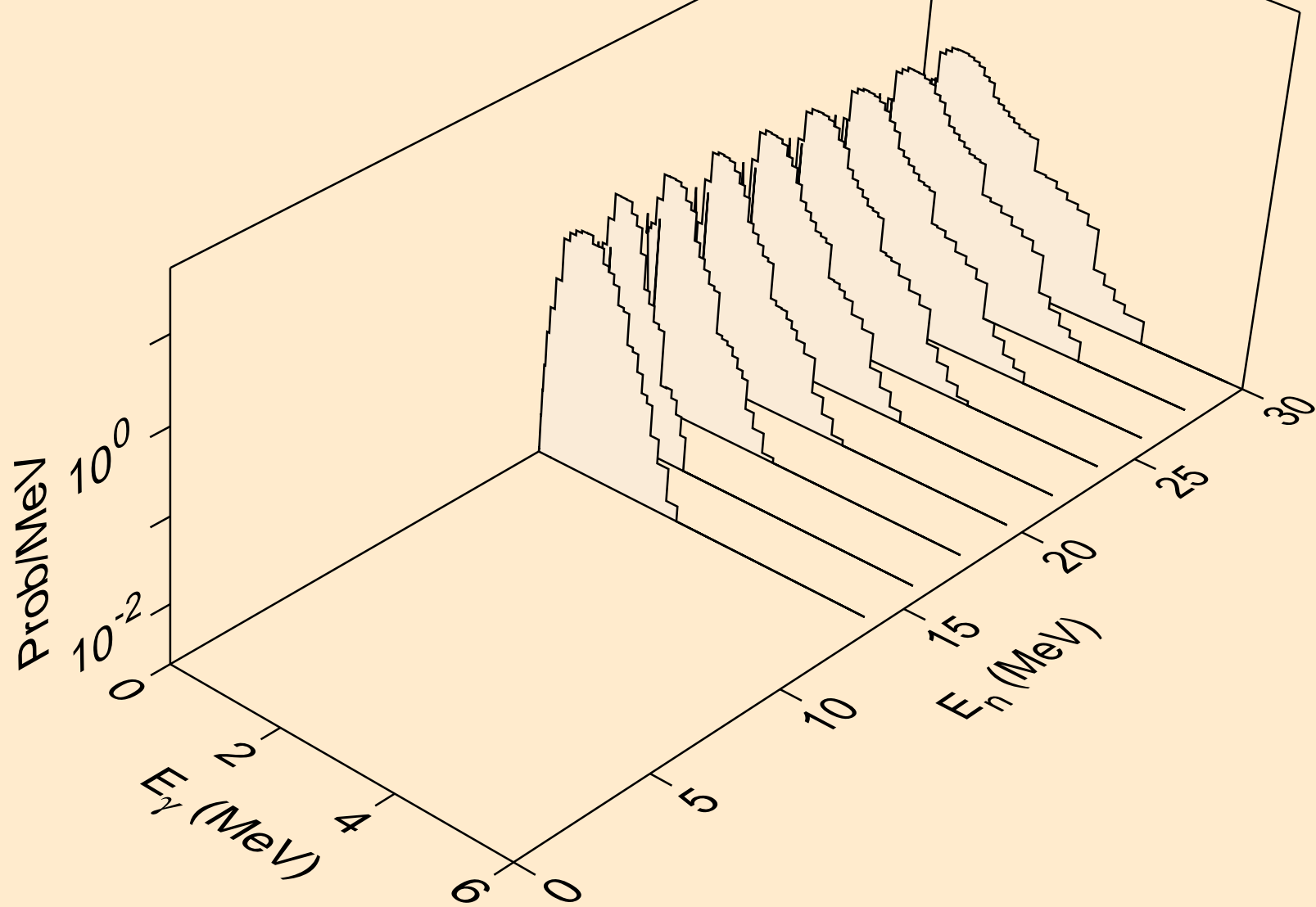

ND126 DEUTERON ACER TENDL-2021 LIBRARY; T=0.K
Photon emission for (n,n*)d

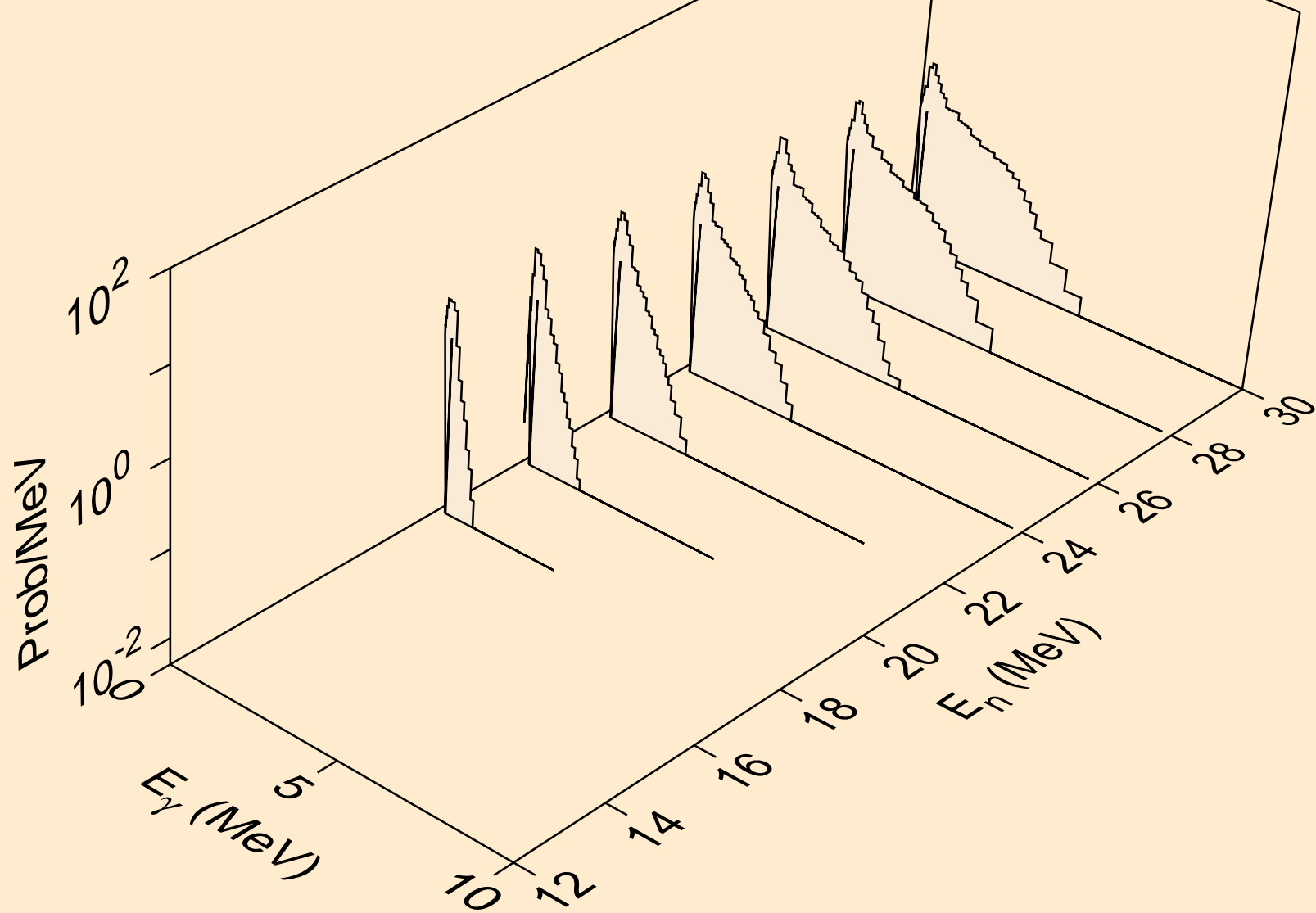

ND126 DEUTERON ACER TENDL-2021 LIBRARY; T=0.K
Photon emission for (n,n*)t

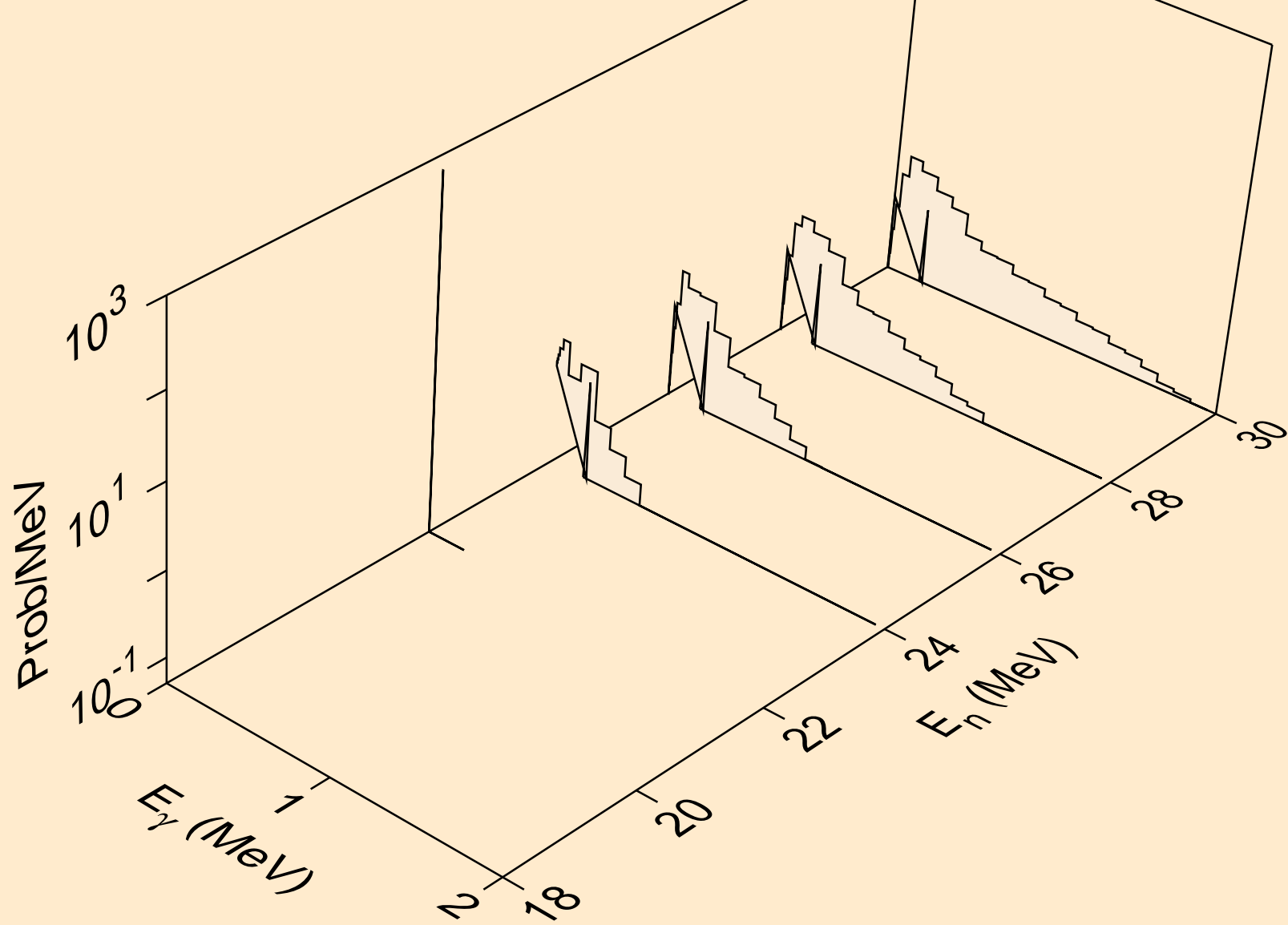

ND126 DEUTERON ACER TENDL-2021 LIBRARY; T=0.K
Photon emission for (n,n*)he3

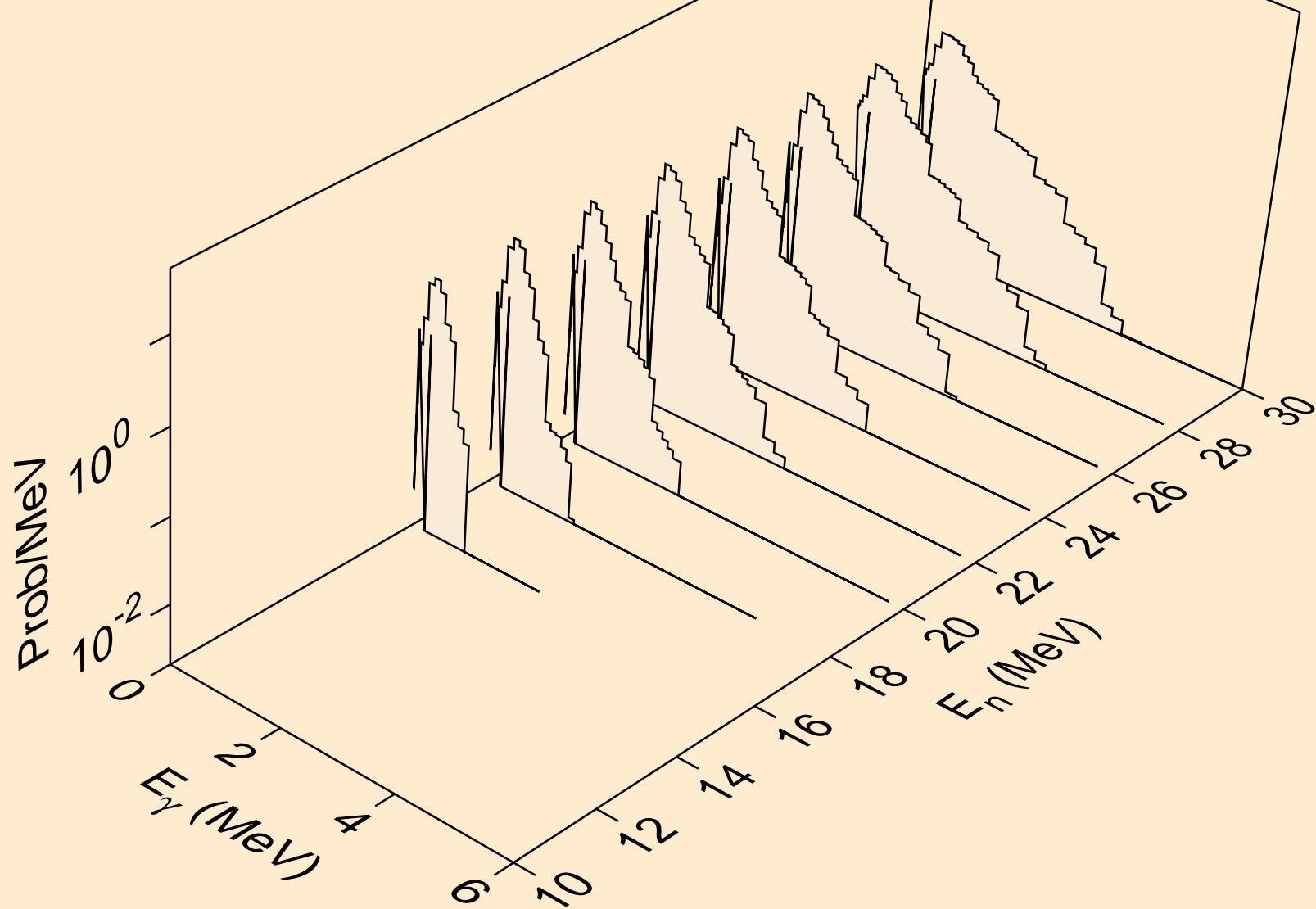

ND126 DEUTERON ACER TENDL-2021 LIBRARY; T=0.K
Photon emission for (n,2np)

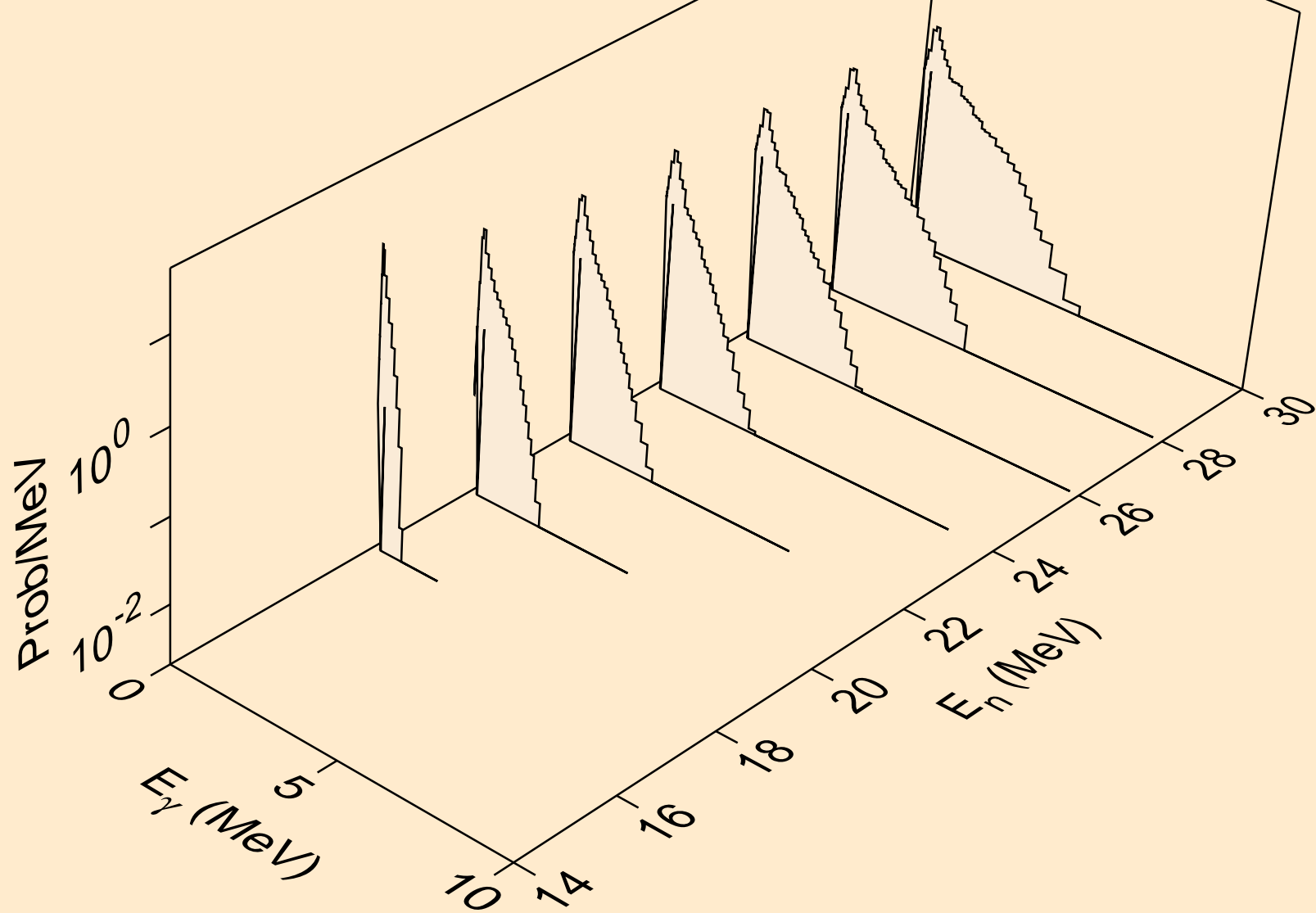

ND126 DEUTERON ACER TENDL-2021 LIBRARY; T=0.K
Photon emission for (n,2np)

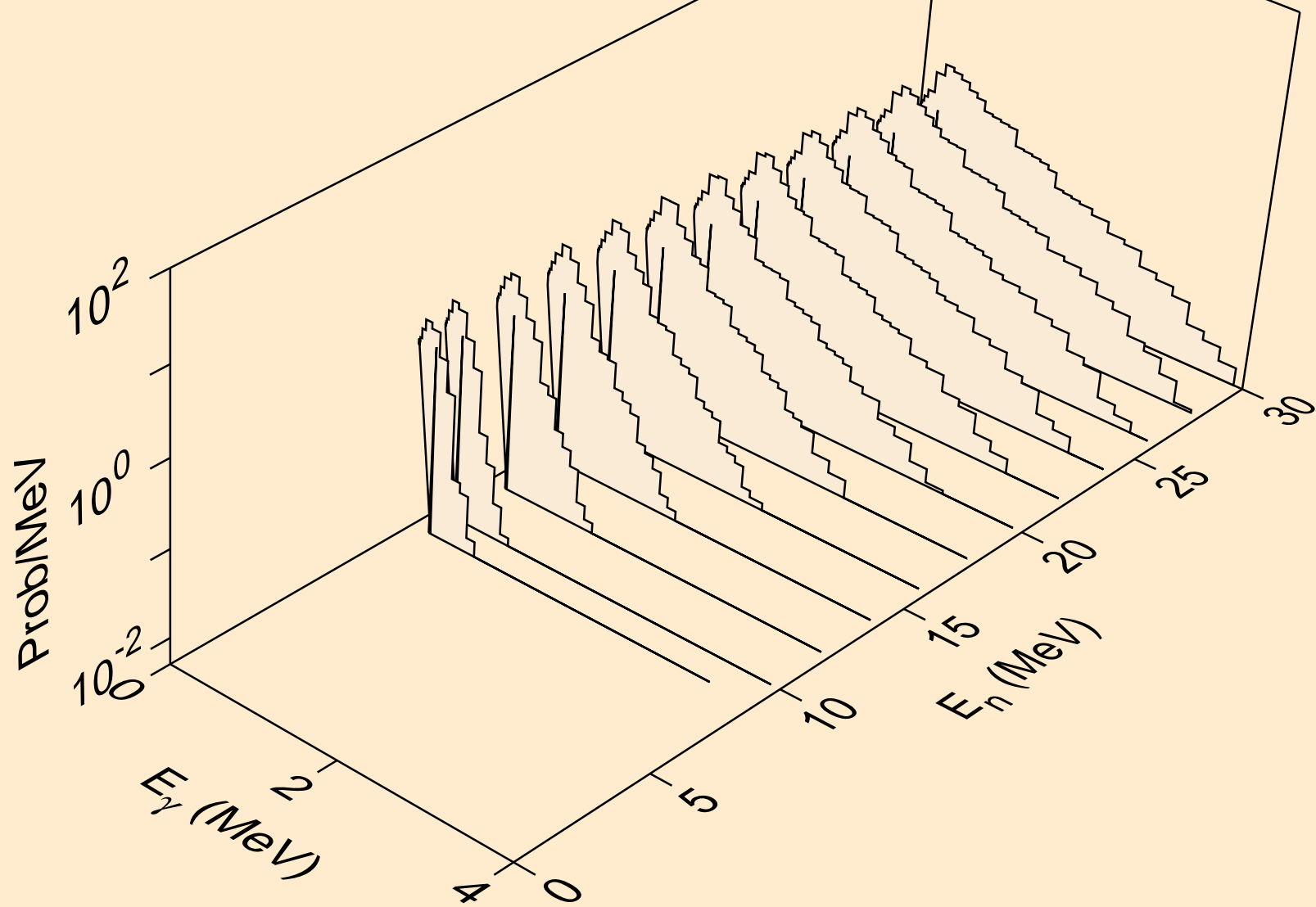

ND126 DEUTERON ACER TENDL-2021 LIBRARY; T=0.K
Photon emission for (n,npa)

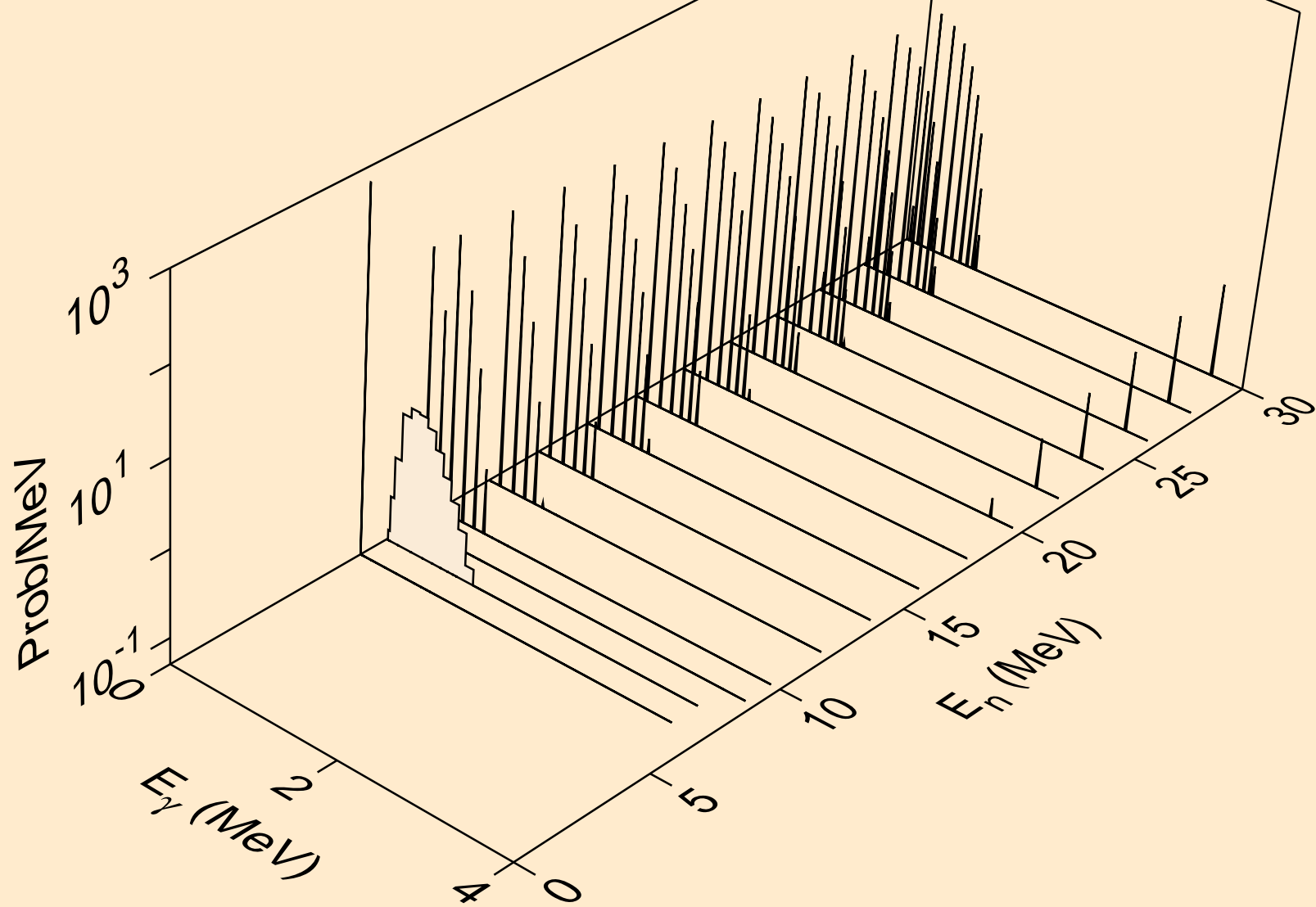

ND126 DEUTERON ACER TENDL-2021 LIBRARY; T=0.K
Photon emission for (n,gma)

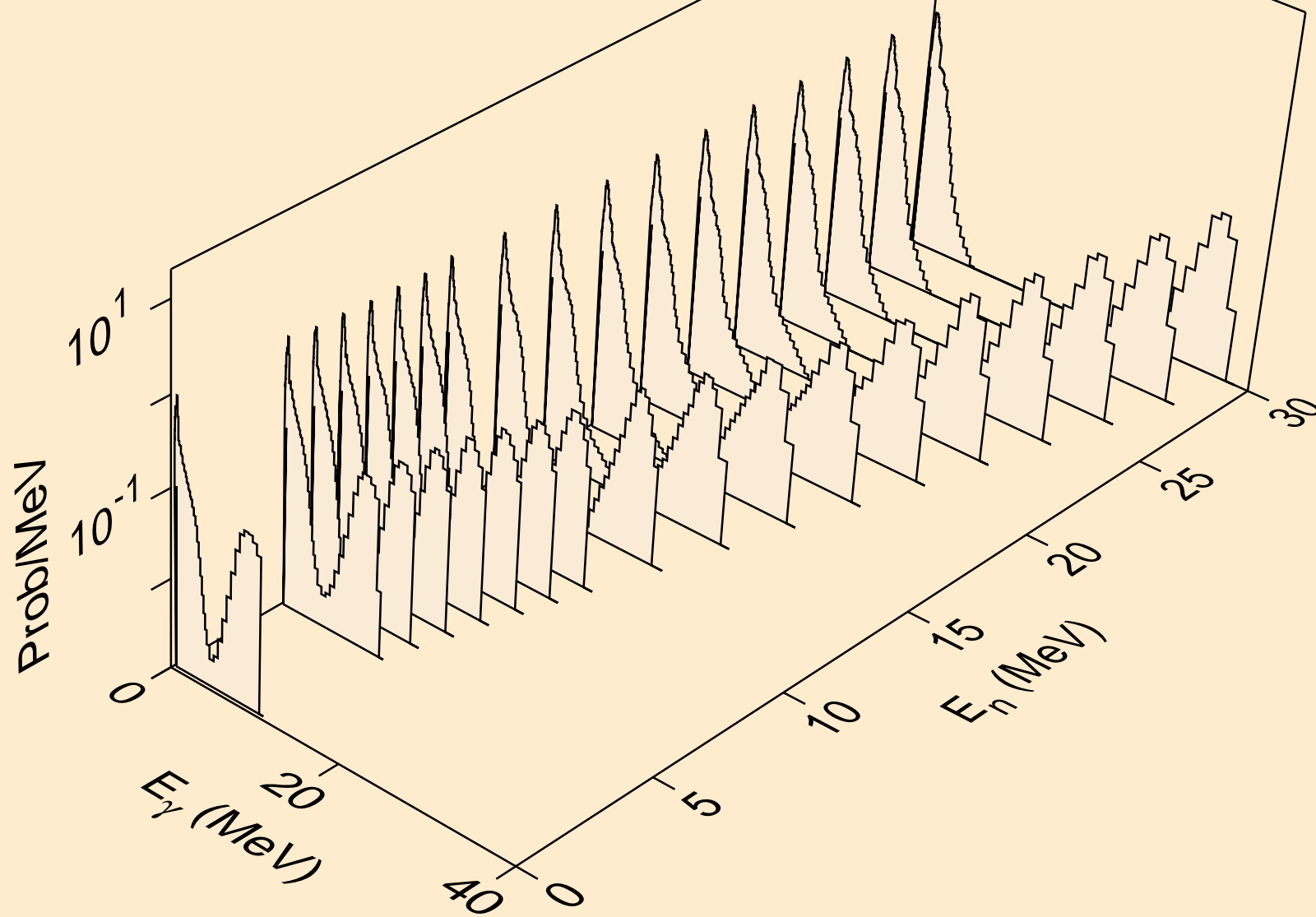

ND126 DEUTERON ACER TENDL-2021 LIBRARY; T=0.K
Photon emission for (n,p)

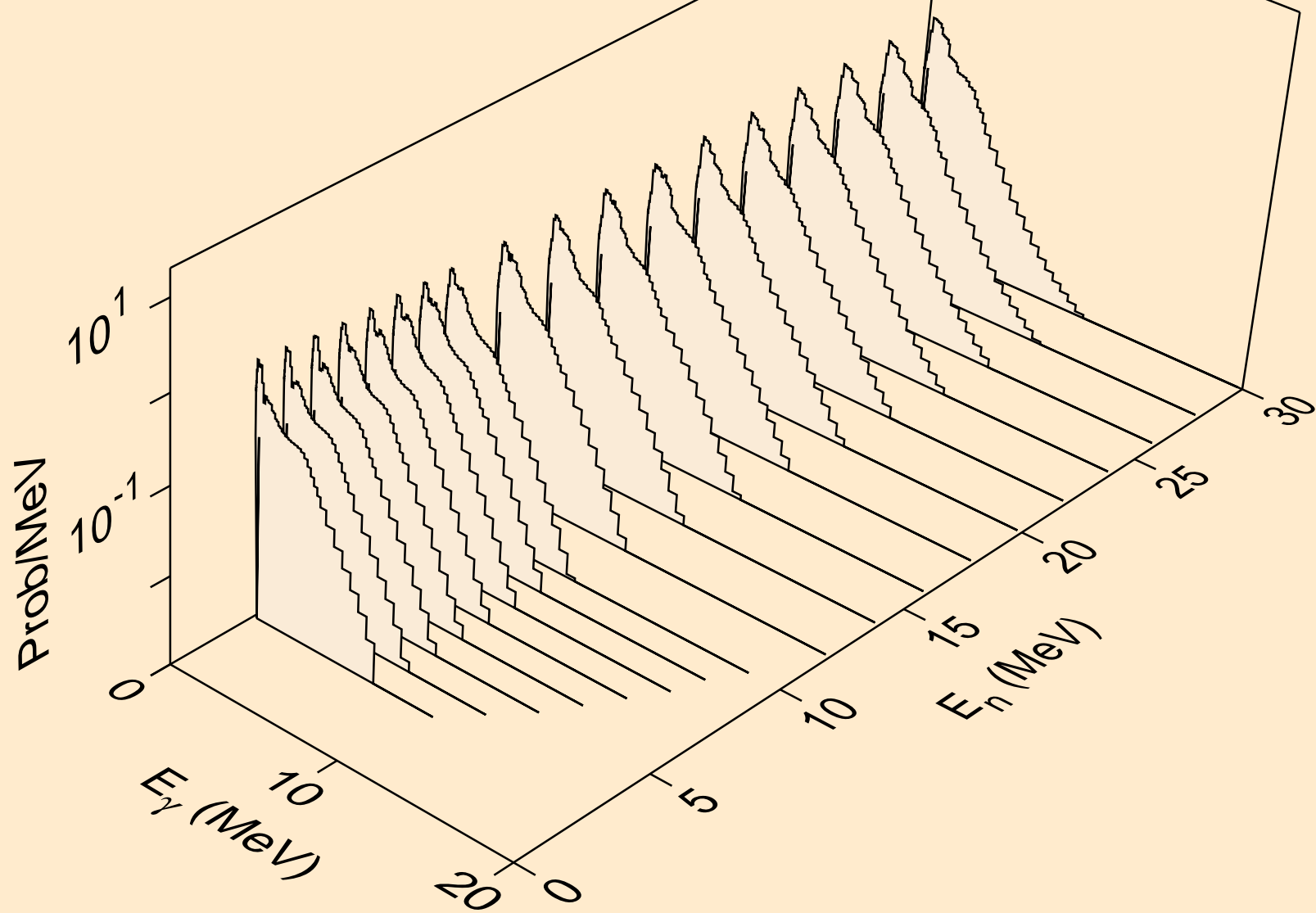

ND126 DEUTERON ACER TENDL-2021 LIBRARY; T=0.K
Photon emission for inelastic

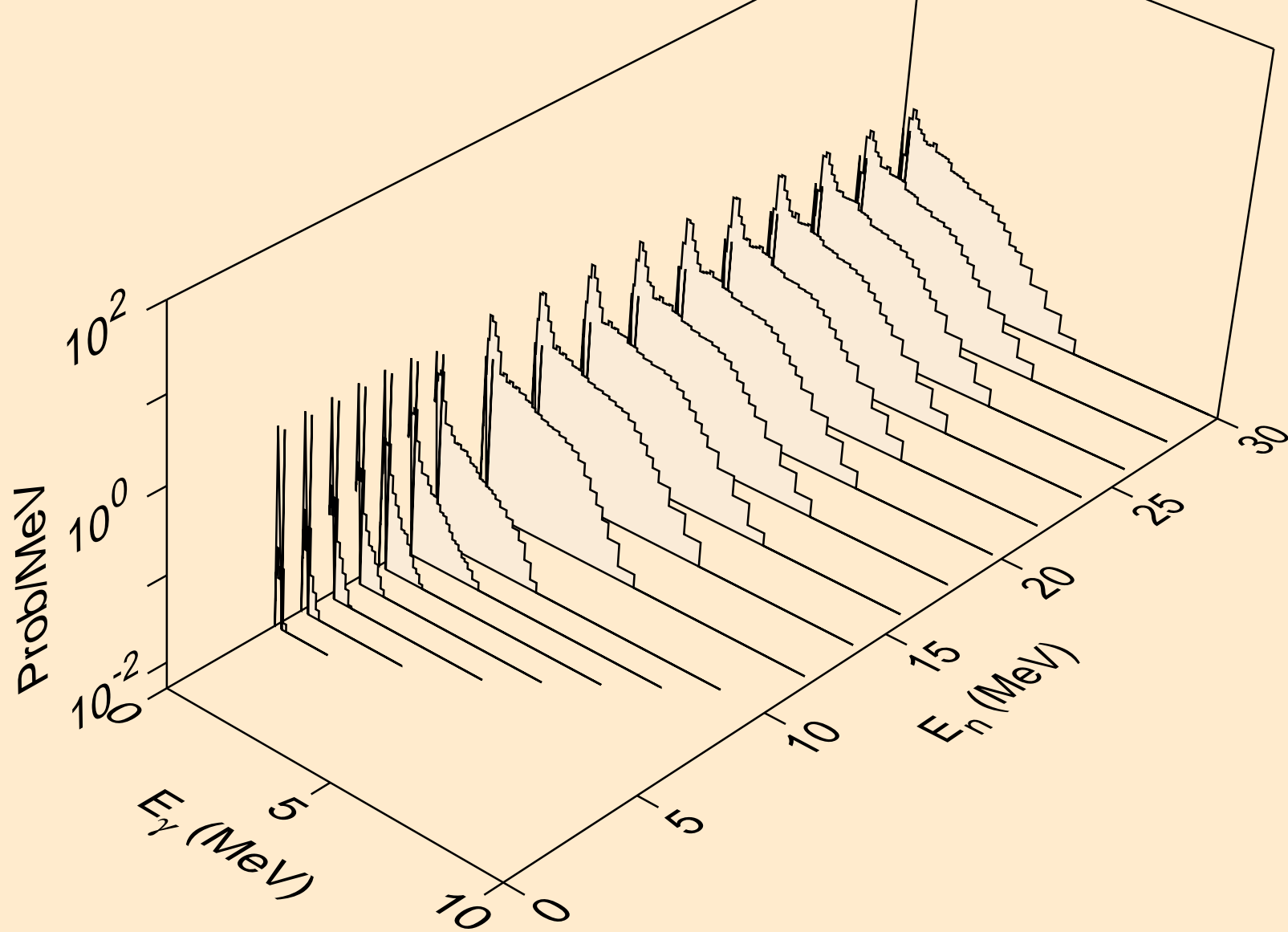

ND126 DEUTERON ACER TENDL-2021 LIBRARY; T=0.K
Photon emission for (n,t)

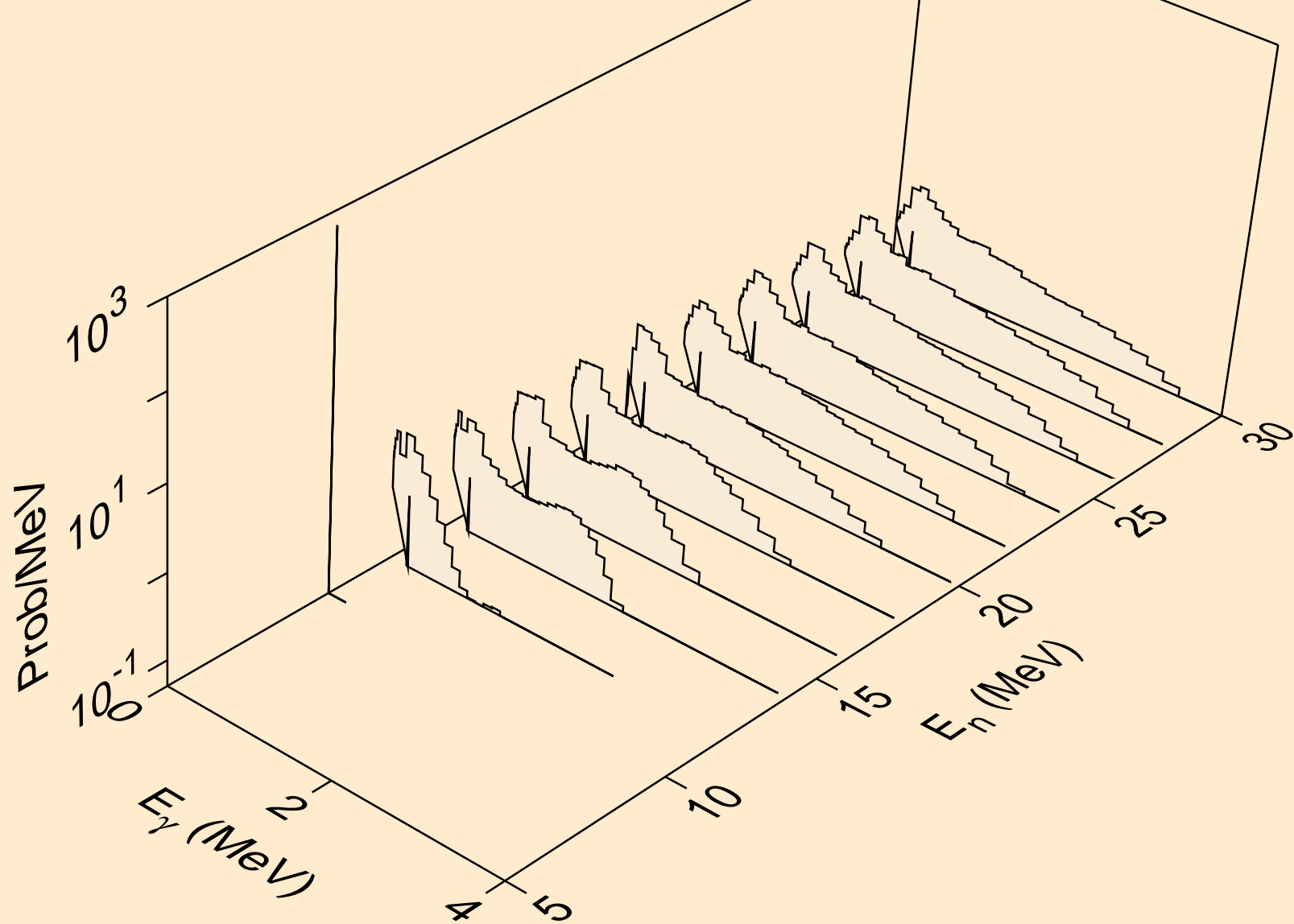

ND126 DEUTERON ACER TENDL-2021 LIBRARY; T=0.K
Photon emission for (n,he3)

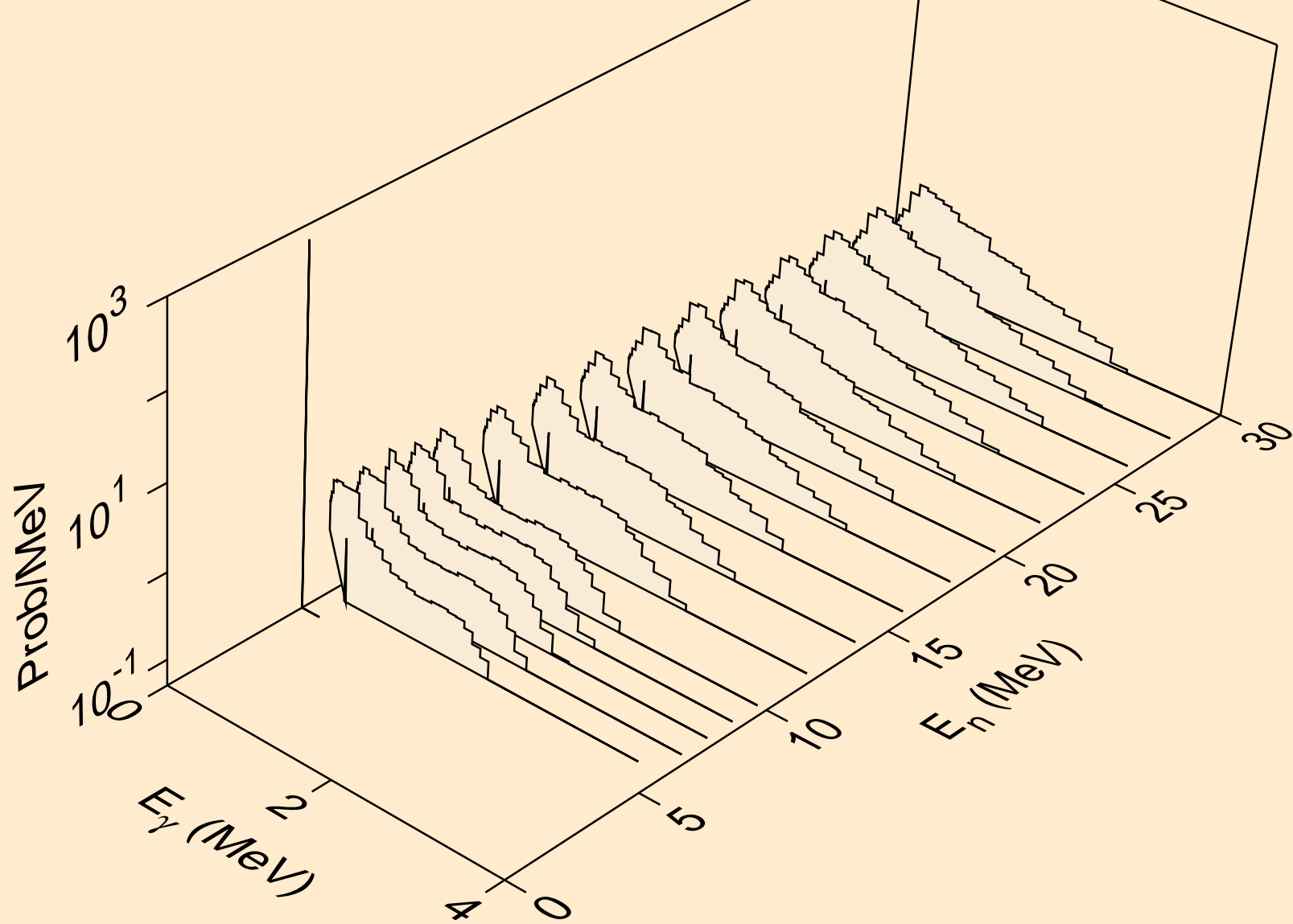

ND126 DEUTERON ACER TENDL-2021 LIBRARY; T=0.K
Photon emission for (n,a)

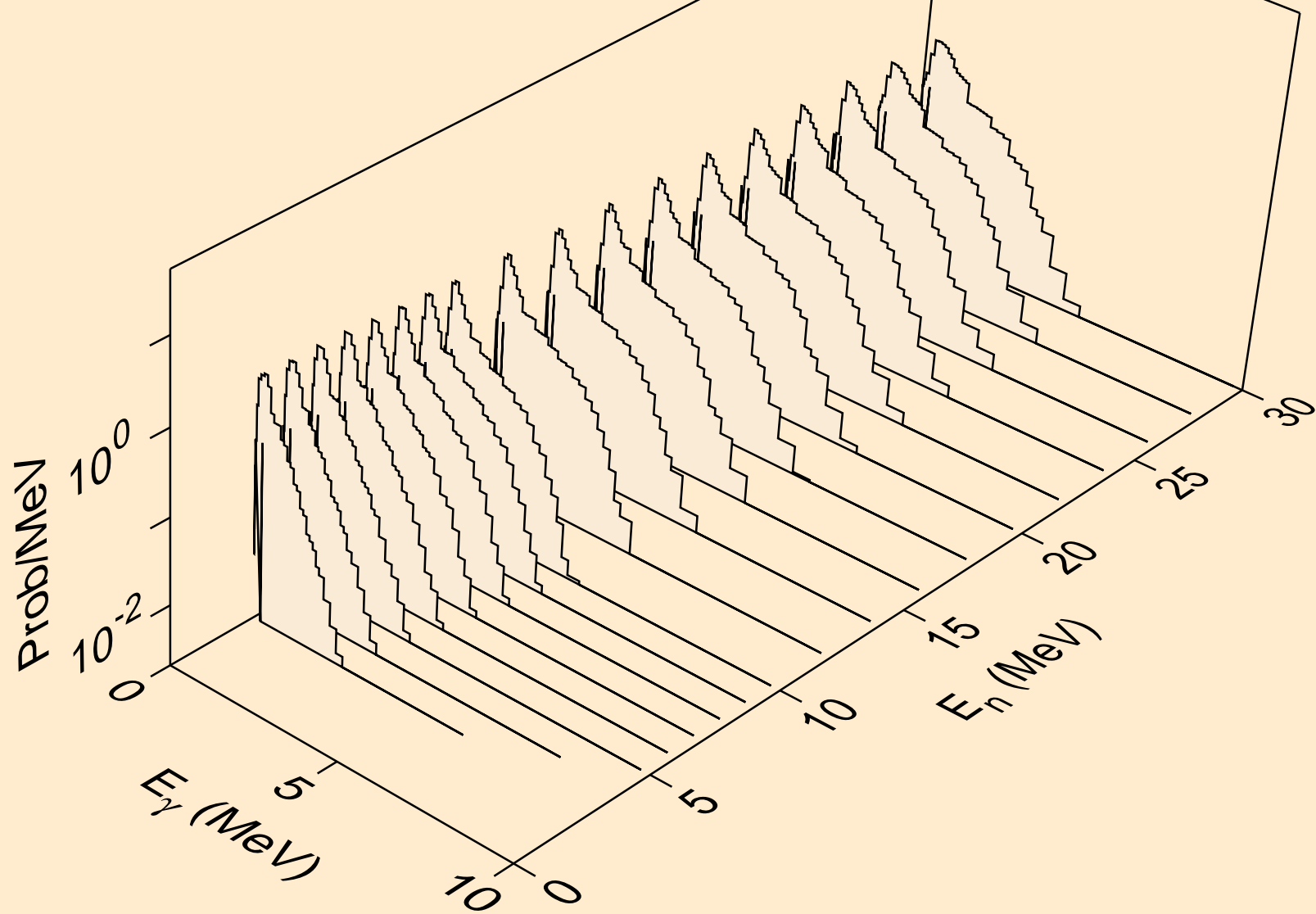

ND126 DEUTERON ACER TENDL-2021 LIBRARY; T=0.K
Photon emission for (n,2a)

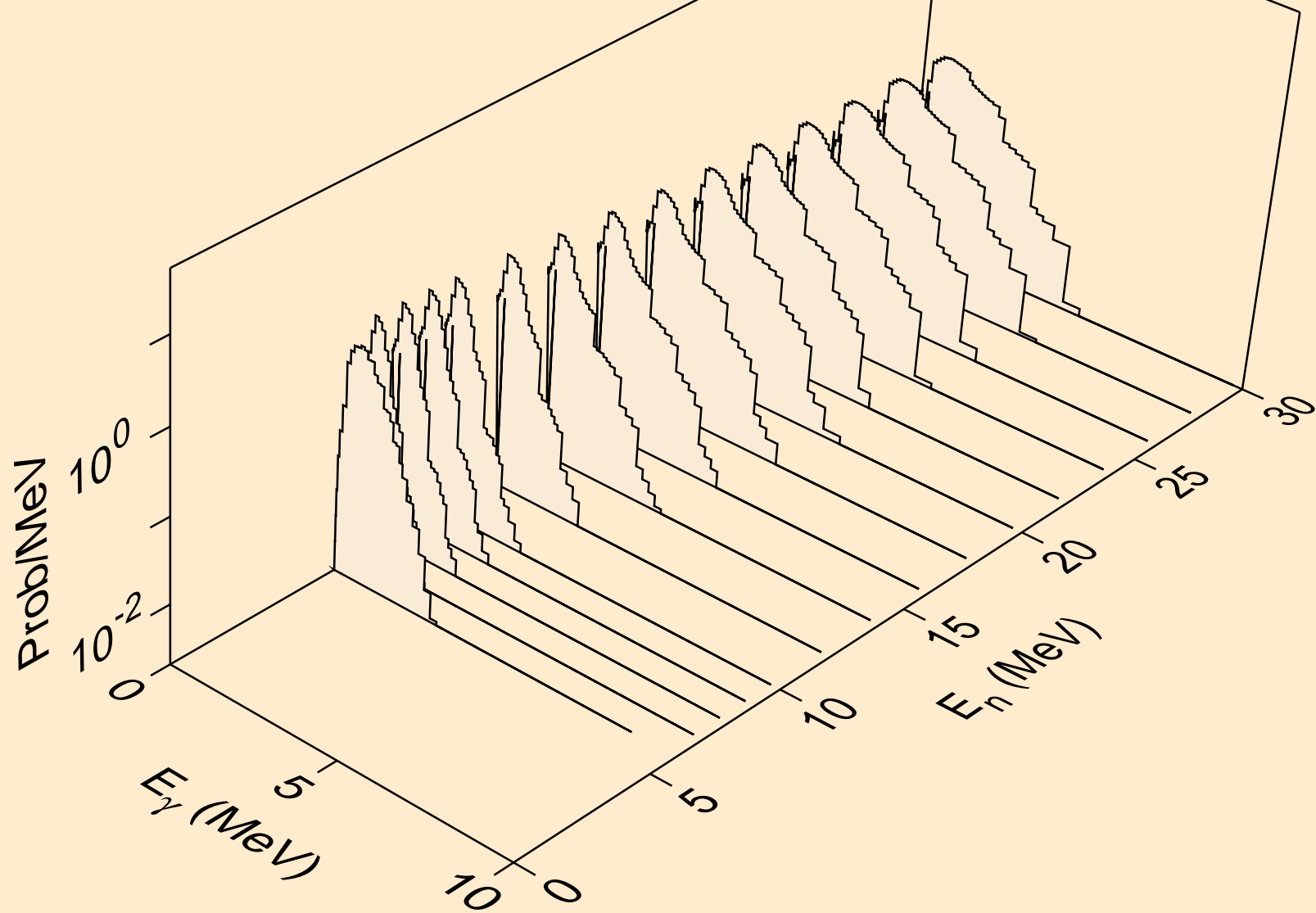

ND126 DEUTERON ACER TENDL-2021 LIBRARY; T=0.K
Photon emission for (n,2p)

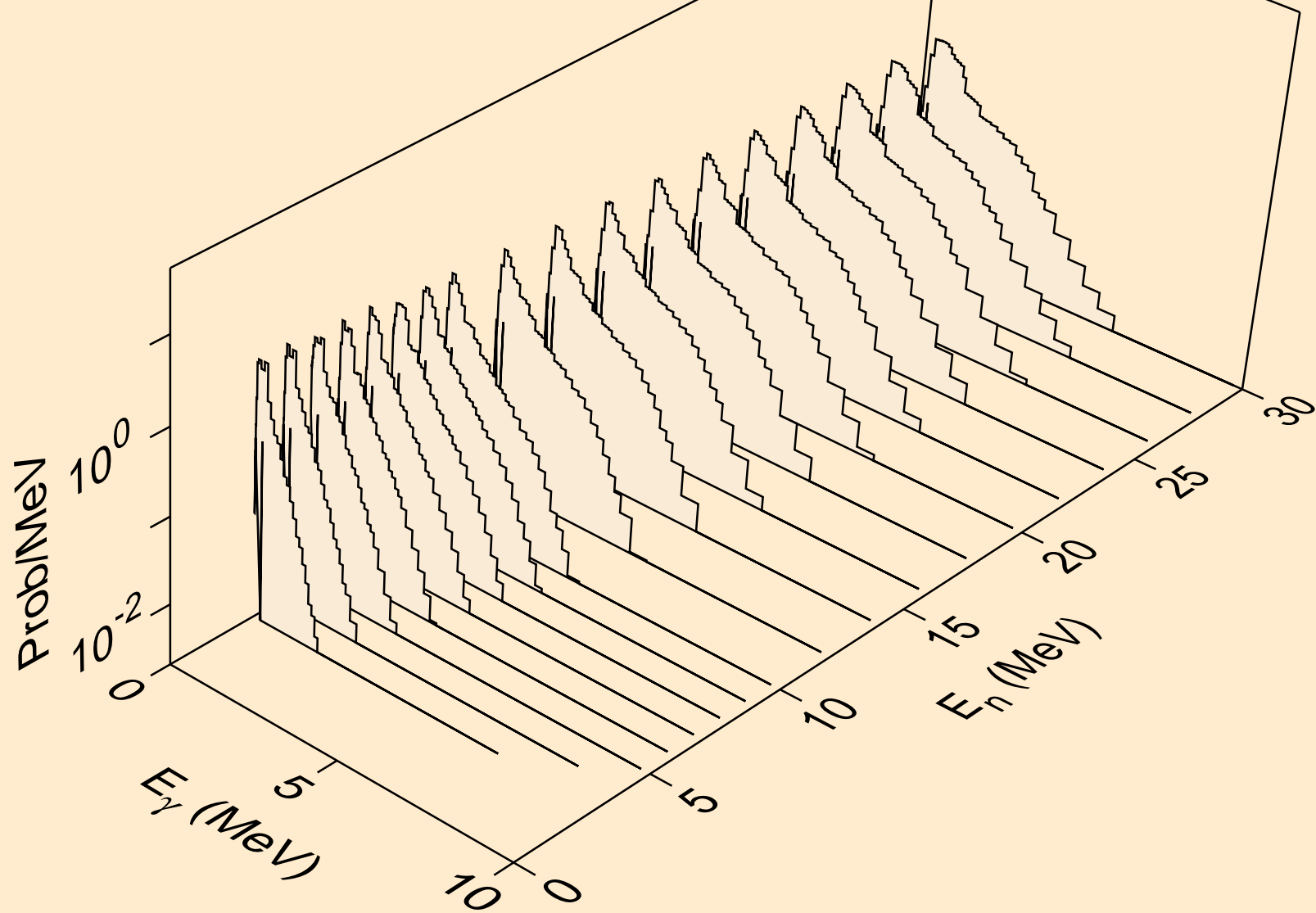

ND126 DEUTERON ACER TENDL-2021 LIBRARY; T=0.K
Photon emission for (n,p)

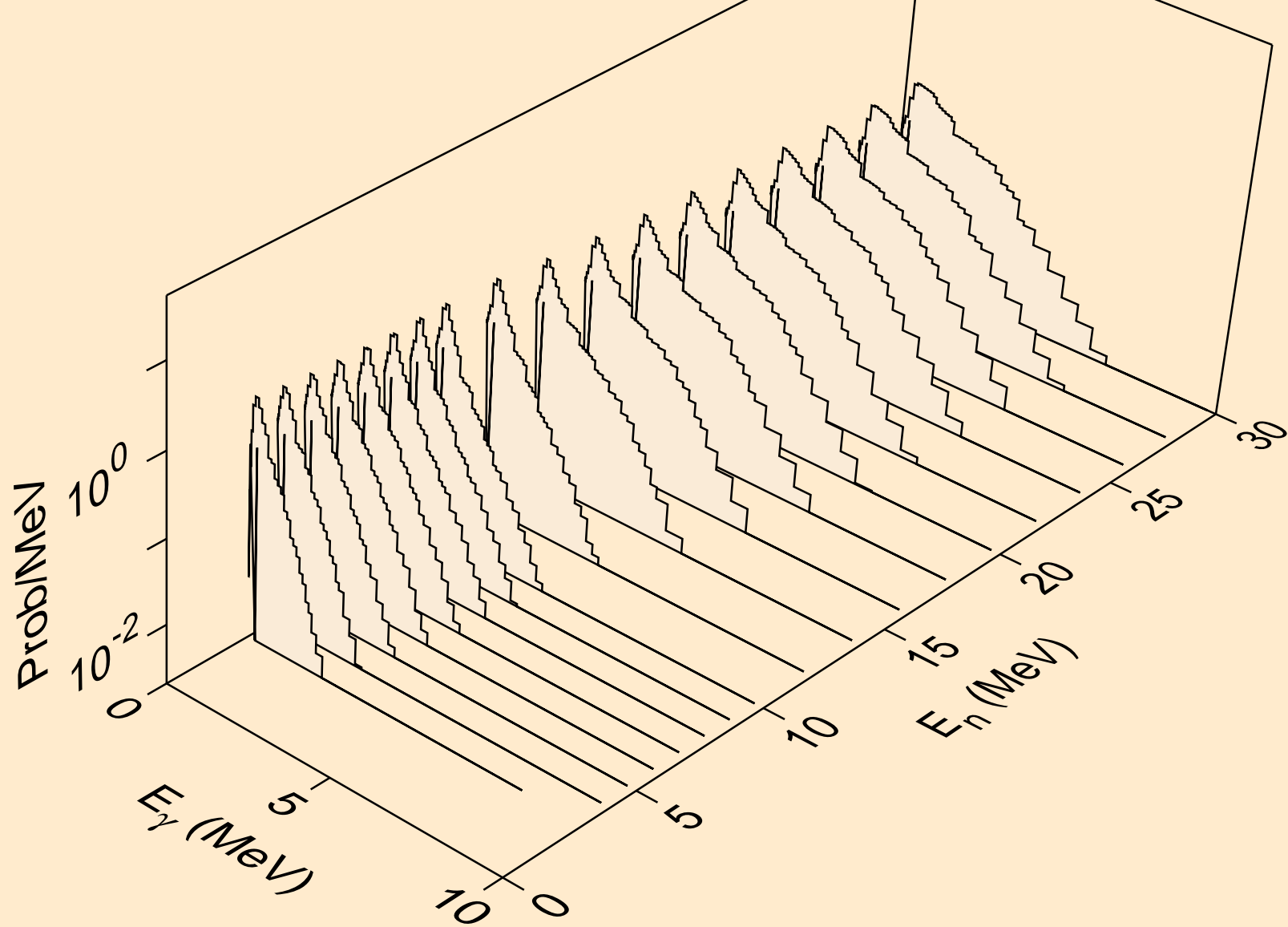

ND126 DEUTERON ACER TENDL-2021 LIBRARY; T=0.K
Photon emission for (n,d2a)

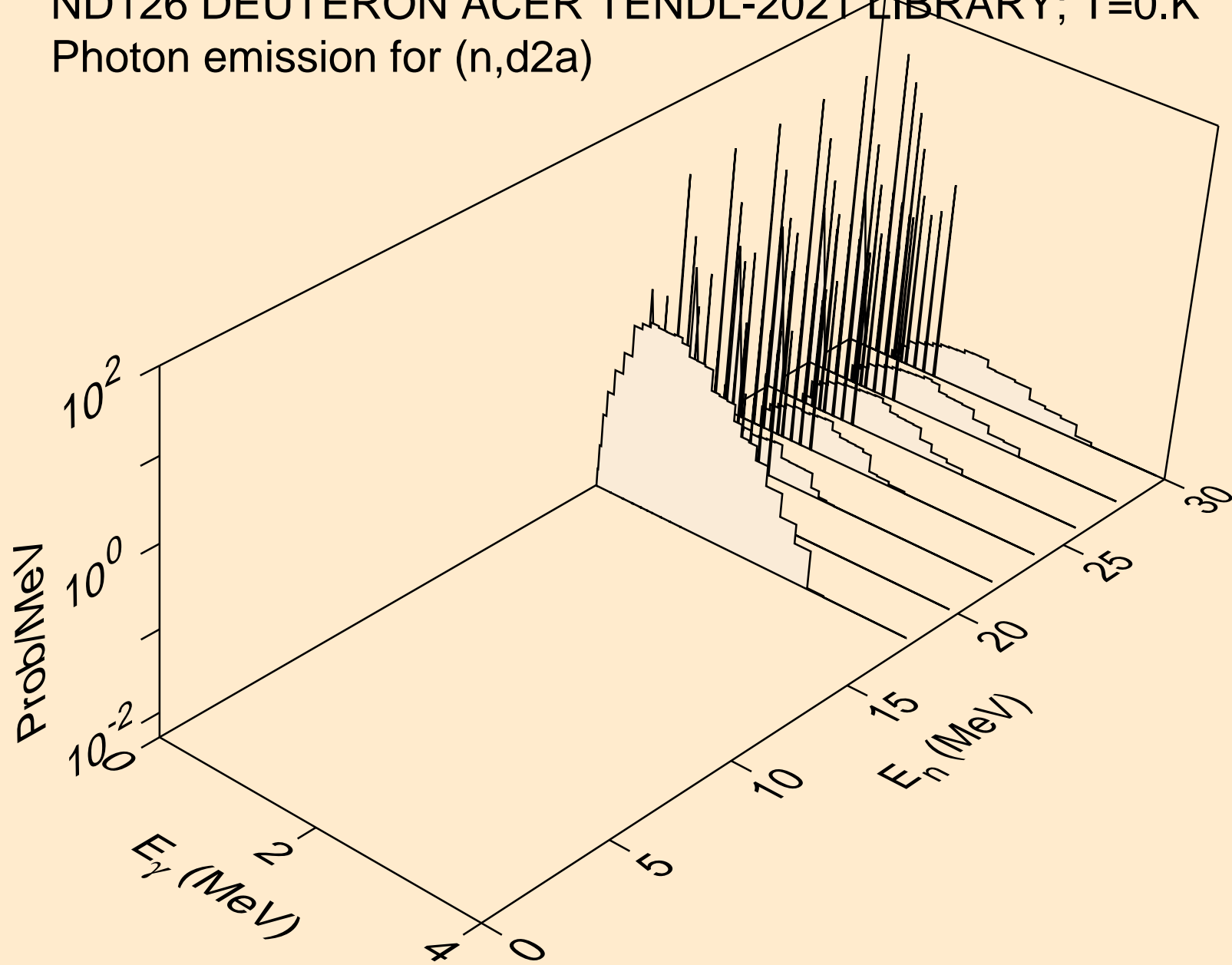

ND126 DEUTERON ACER TENDL-2021 LIBRARY; T=0.K
Photon emission for (n,pd)

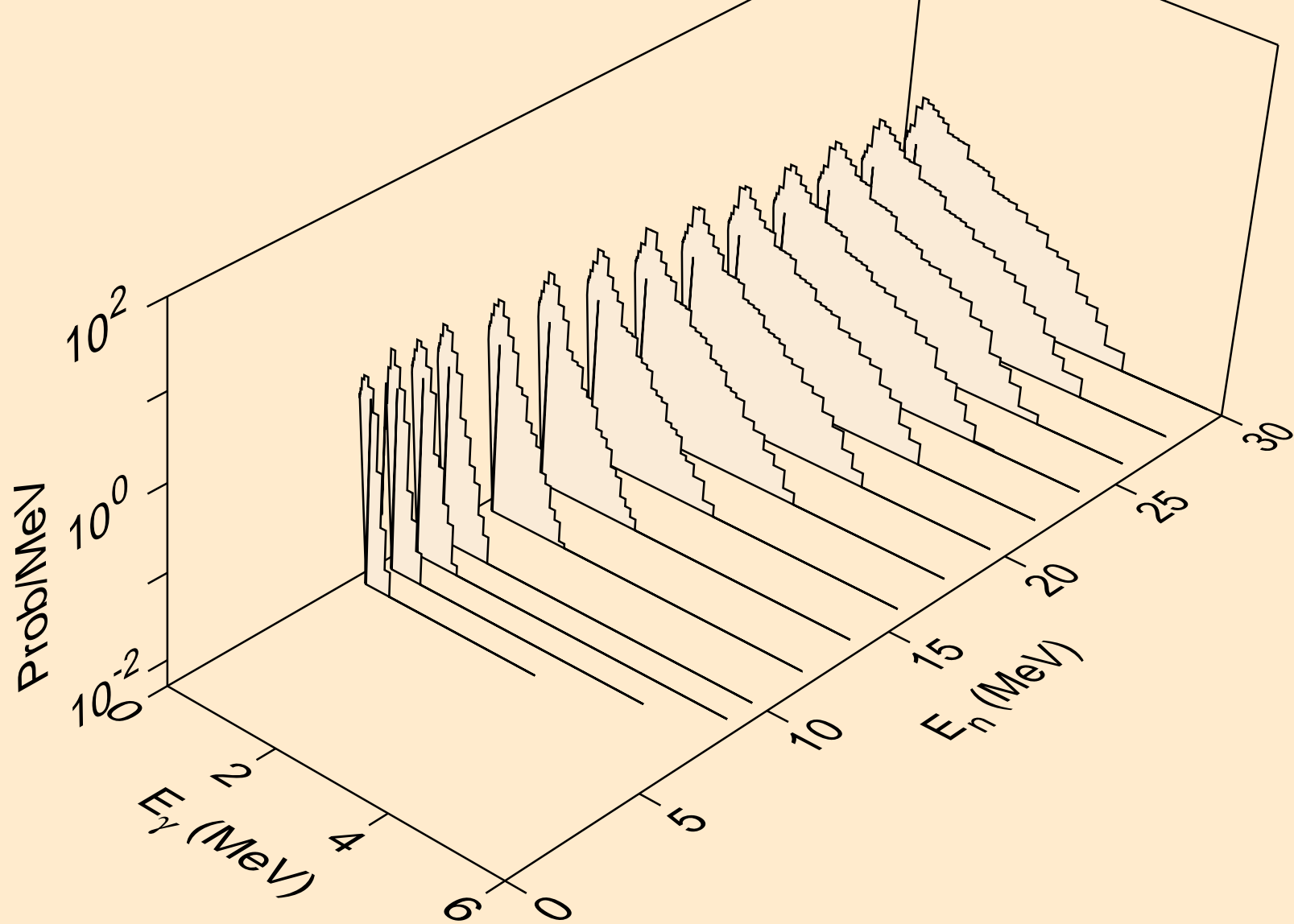

ND126 DEUTERON ACER TENDL-2021 LIBRARY; T=0.K
Photon emission for (n,pt)

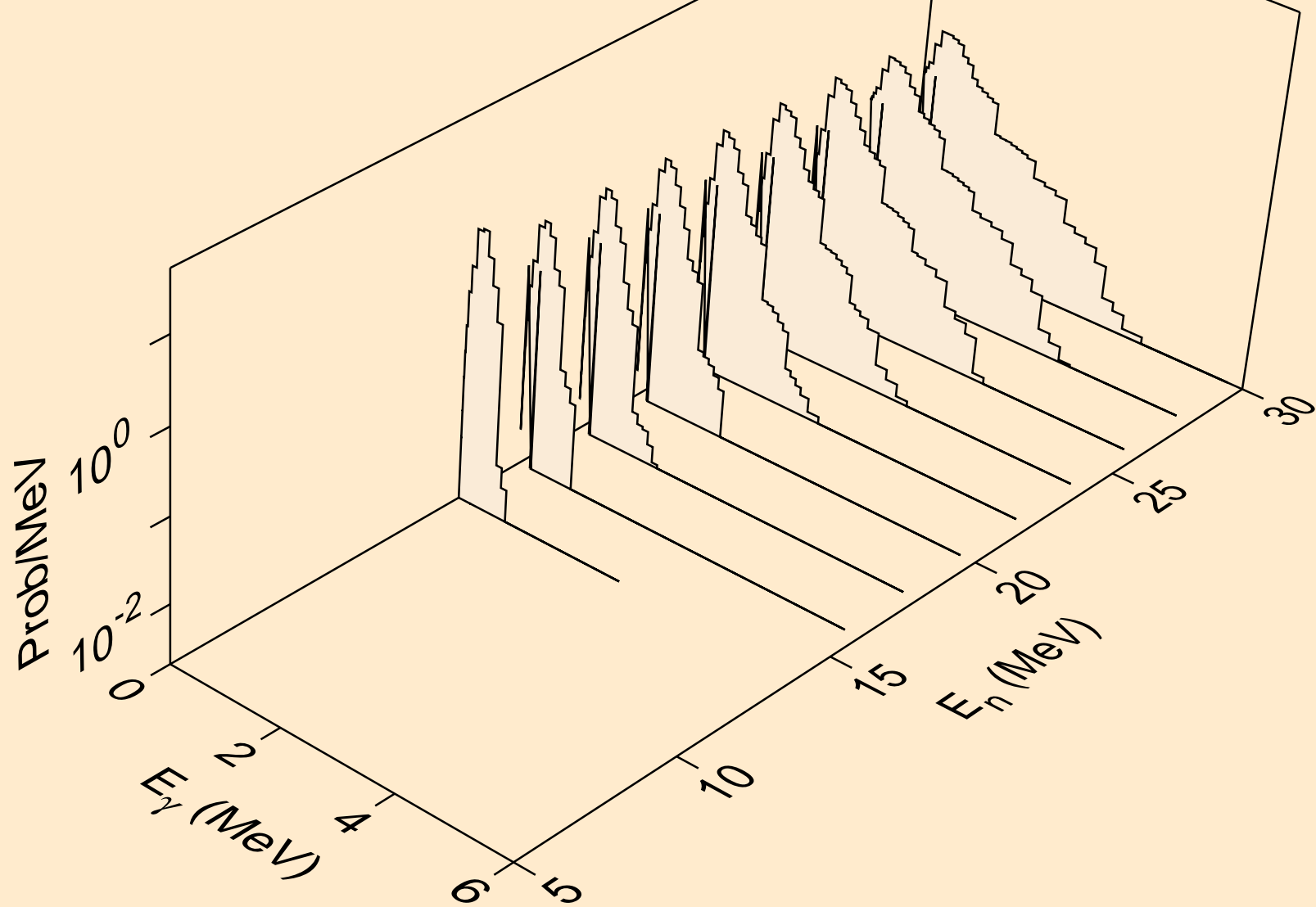

ND126 DEUTERON ACER TENDL-2021 LIBRARY; T=0.K
Photon emission for (n,da)

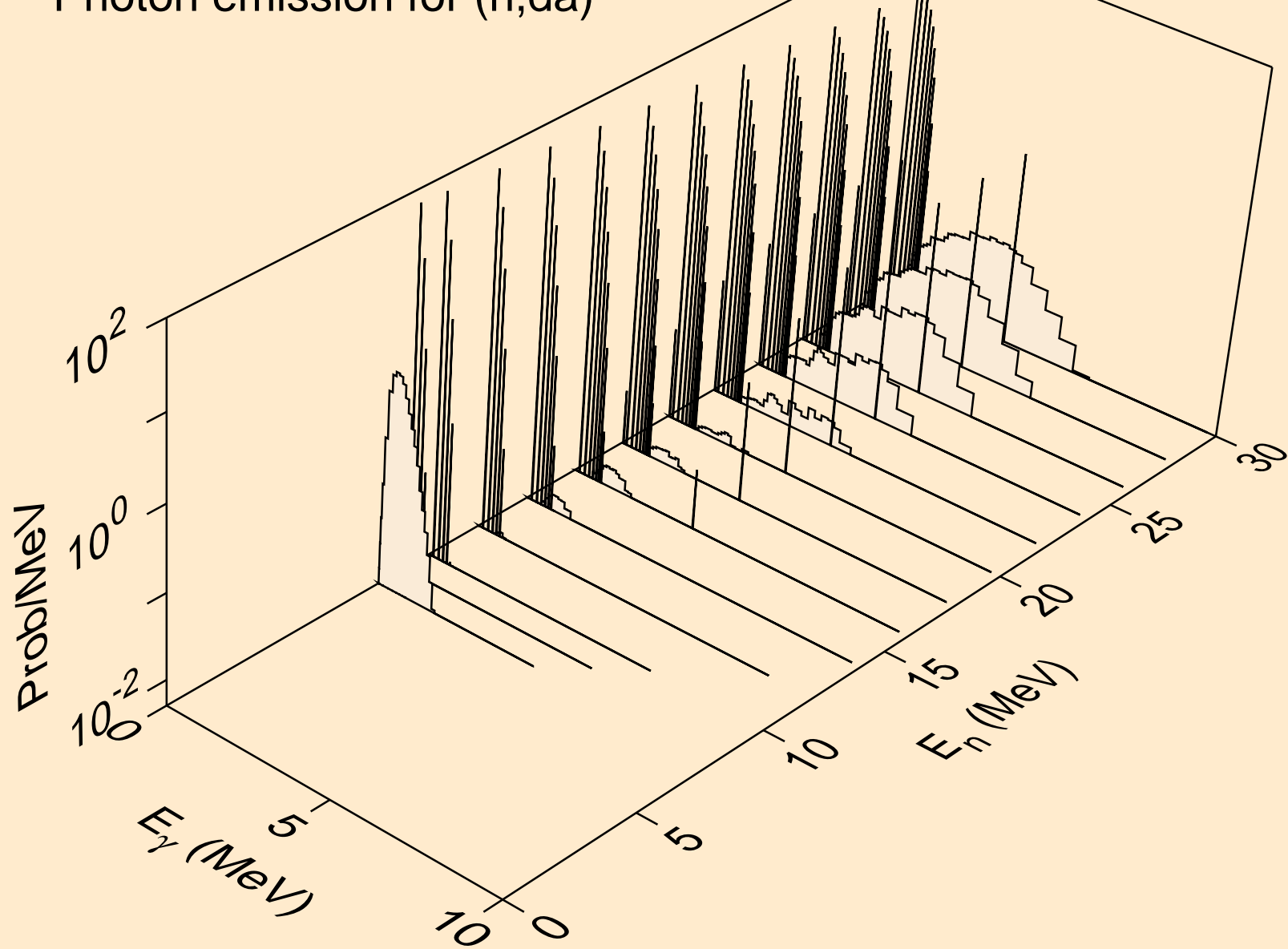

ND126 DEUTERON ACER TENDL-2021 LIBRARY; T=0.K

Particle heating contributions

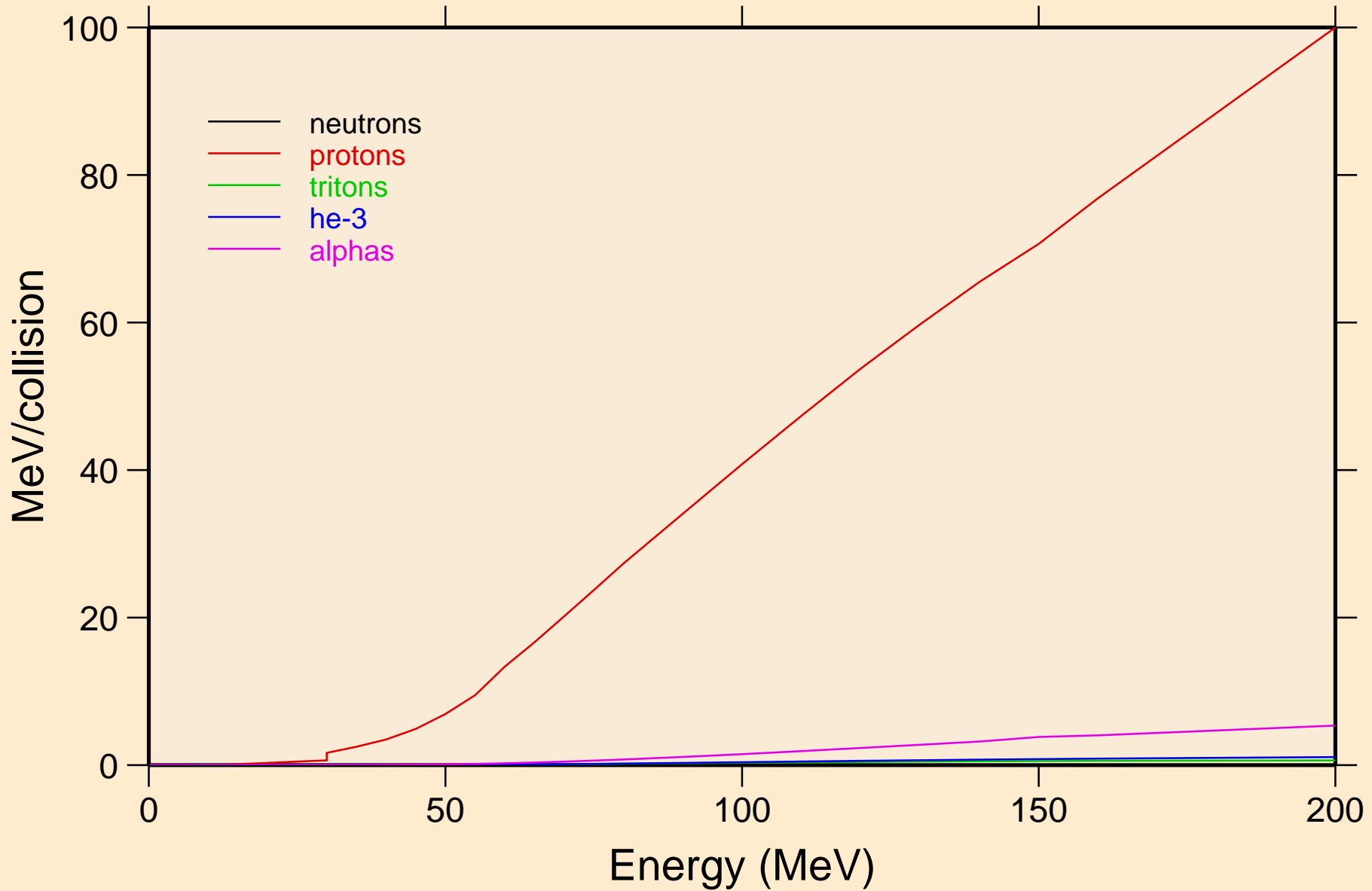

ND126 DEUTERON ACER TENDL-2021 LIBRARY; T=0.K

Recoil Heating

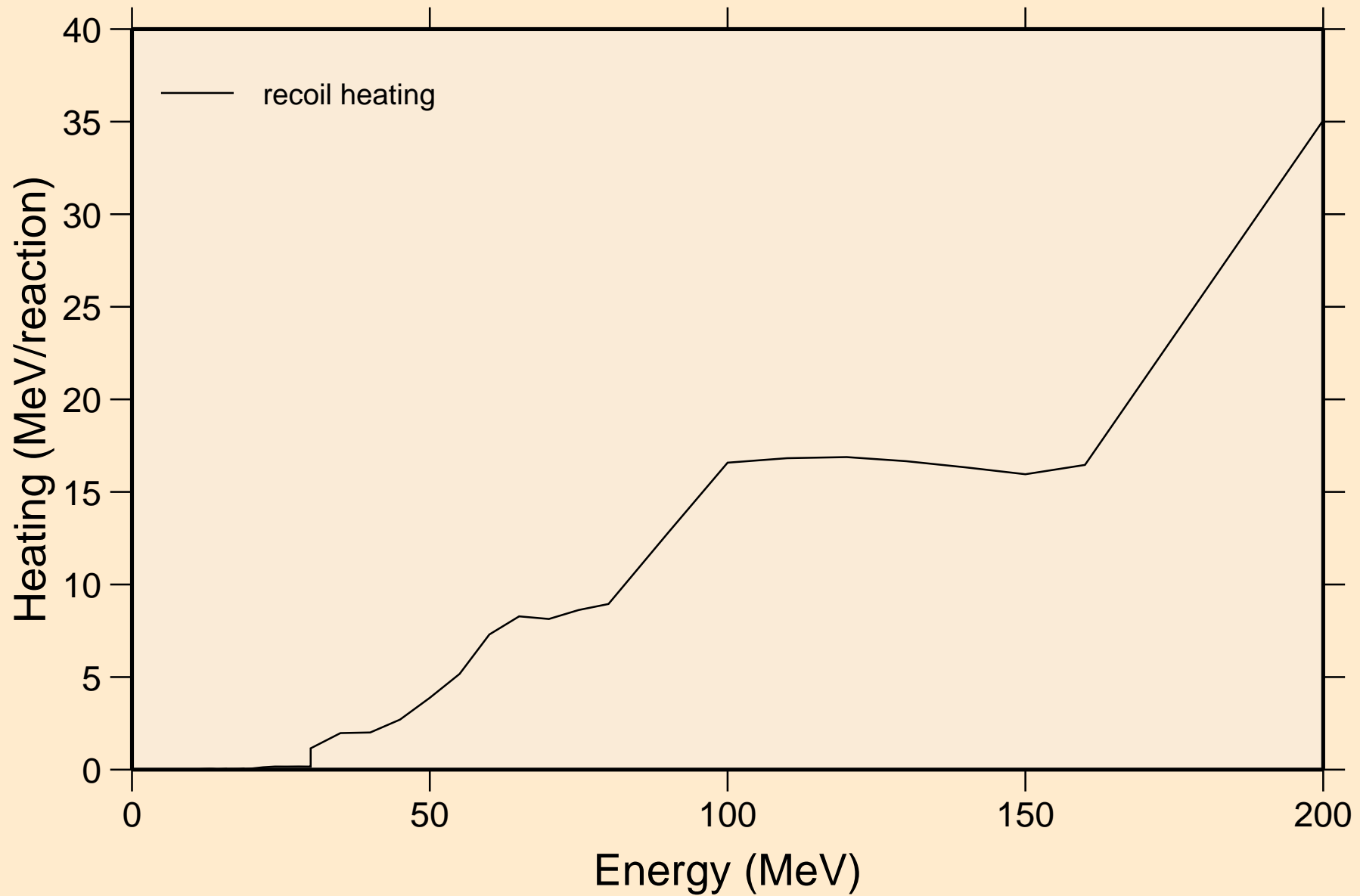

ND126 DEUTERON ACER TENDL-2021 LIBRARY; T=0.K

Particle production cross sections

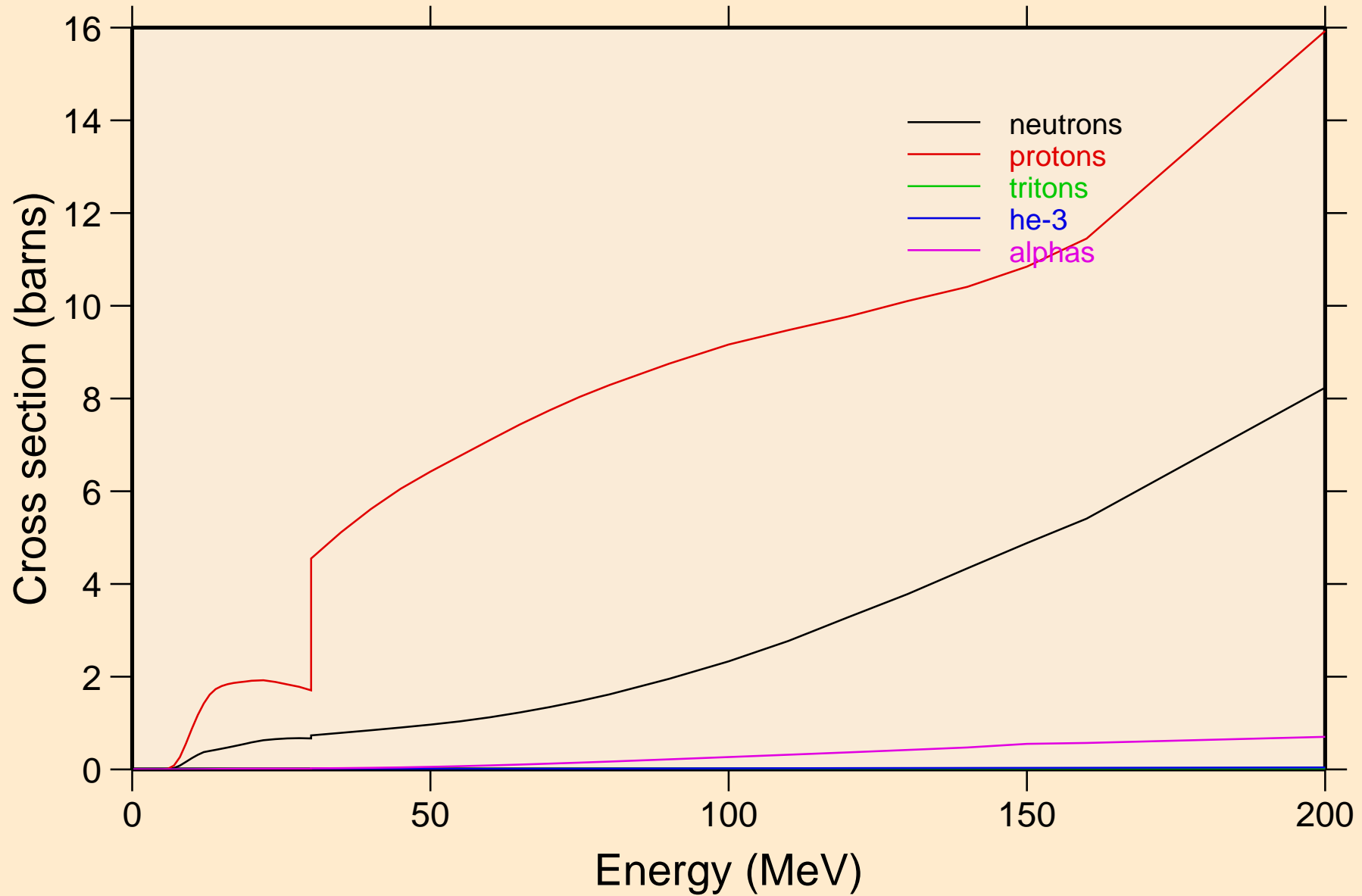

ND126 DEUTERON ACER TENDL-2021 LIBRARY; T=0.K
neutrons from (d,n)

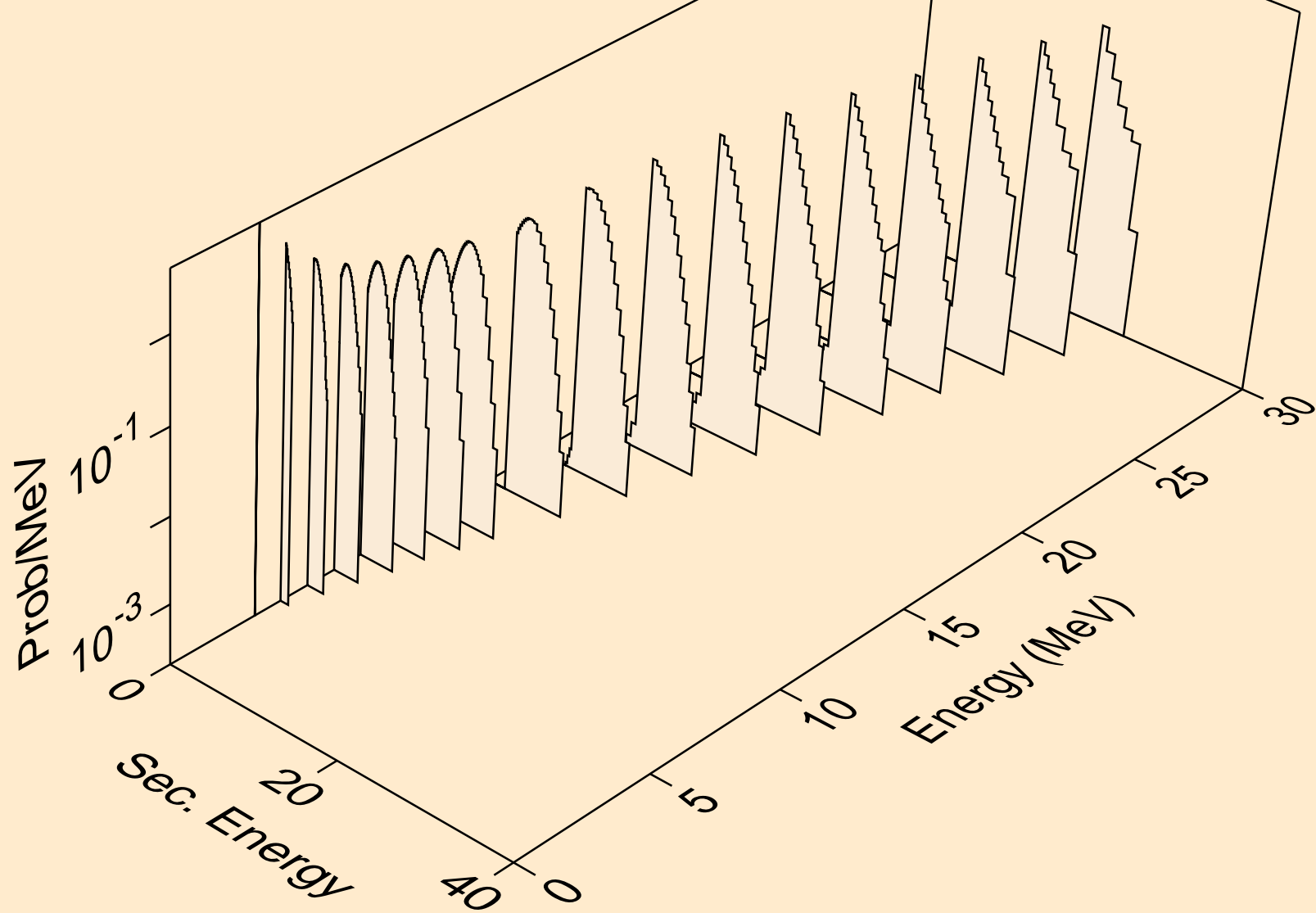

ND126 DEUTERON ACER TENDL-2021 LIBRARY; T=0.K
neutrons from (d,x)

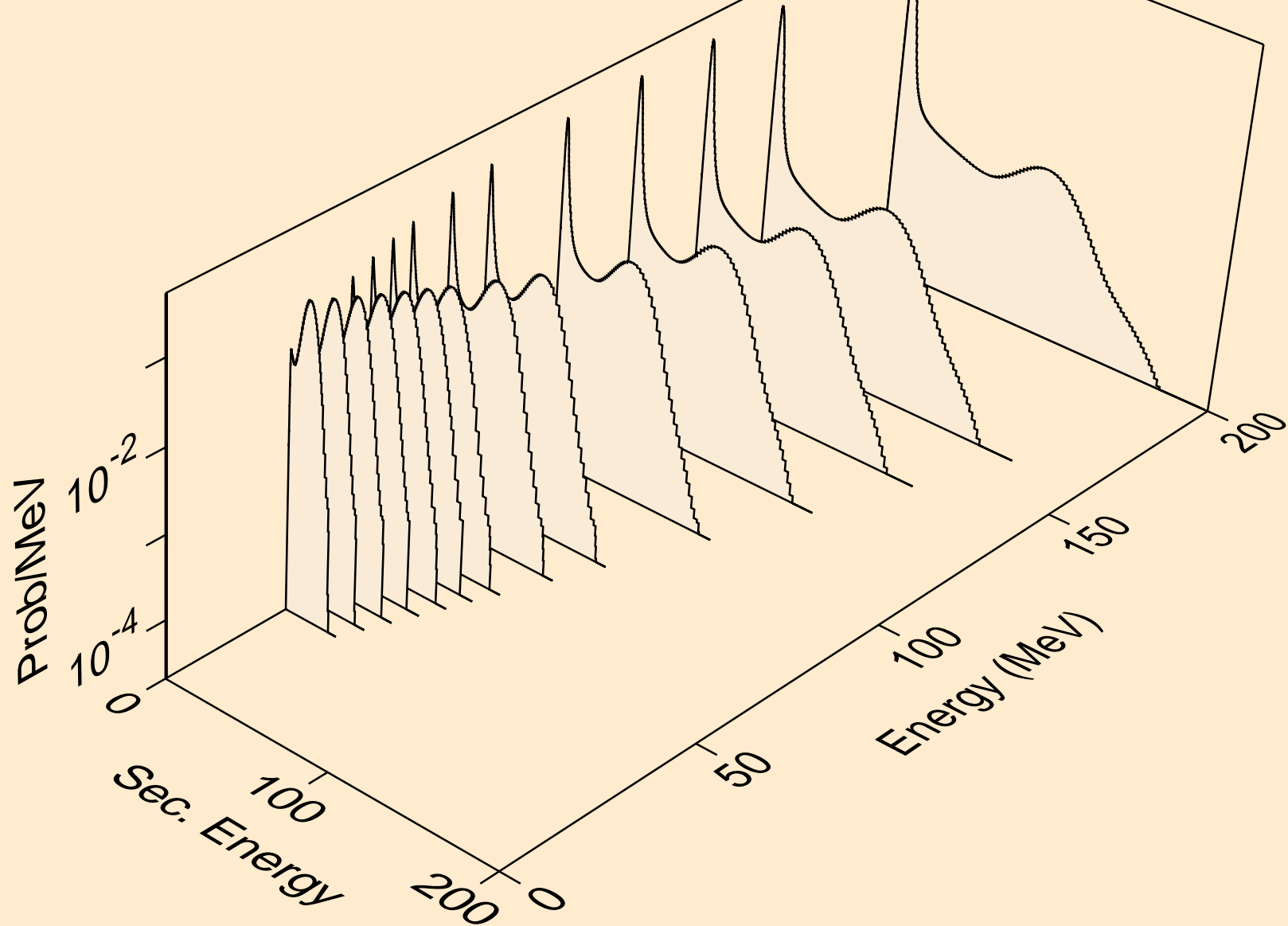

ND126 DEUTERON ACER TENDL-2021 LIBRARY; T=0.K
neutrons from (d,2n)

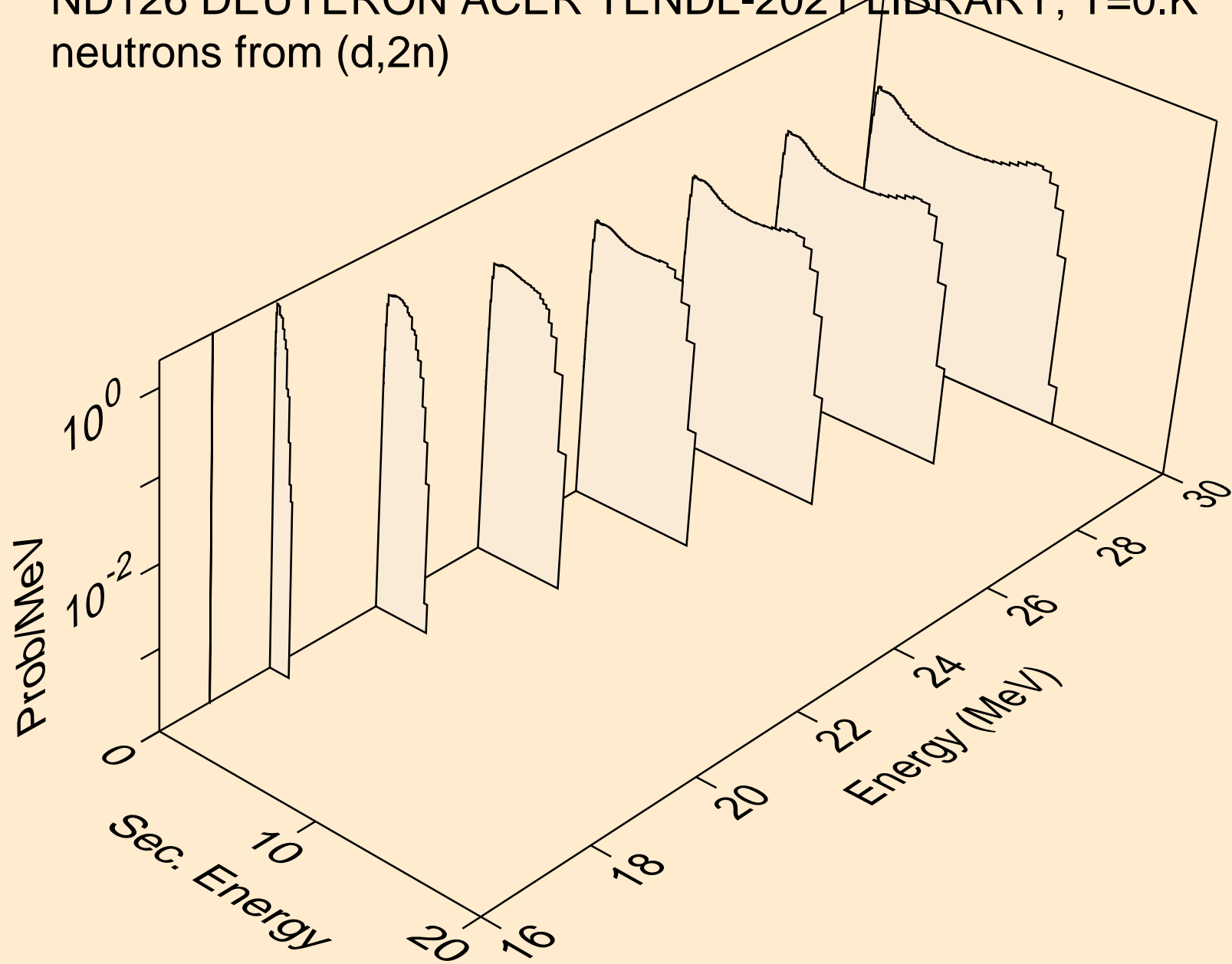

ND126 DEUTERON ACER TENDL-2021 LIBRARY; T=0.K
neutrons from (d,n*)a

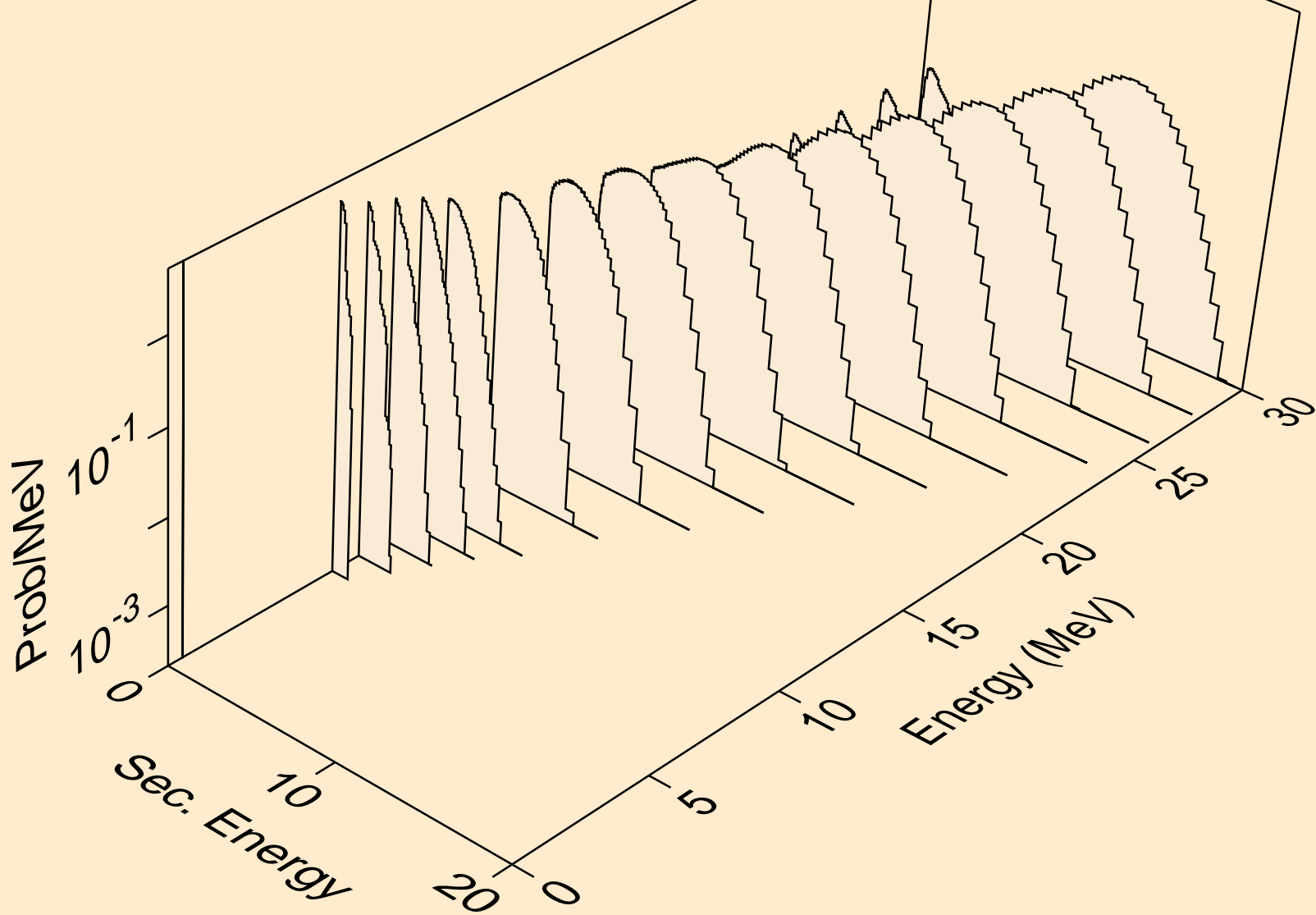

ND126 DEUTERON ACER TENDL-2021 LIBRARY; T=0.K
neutrons from (d,2n)a

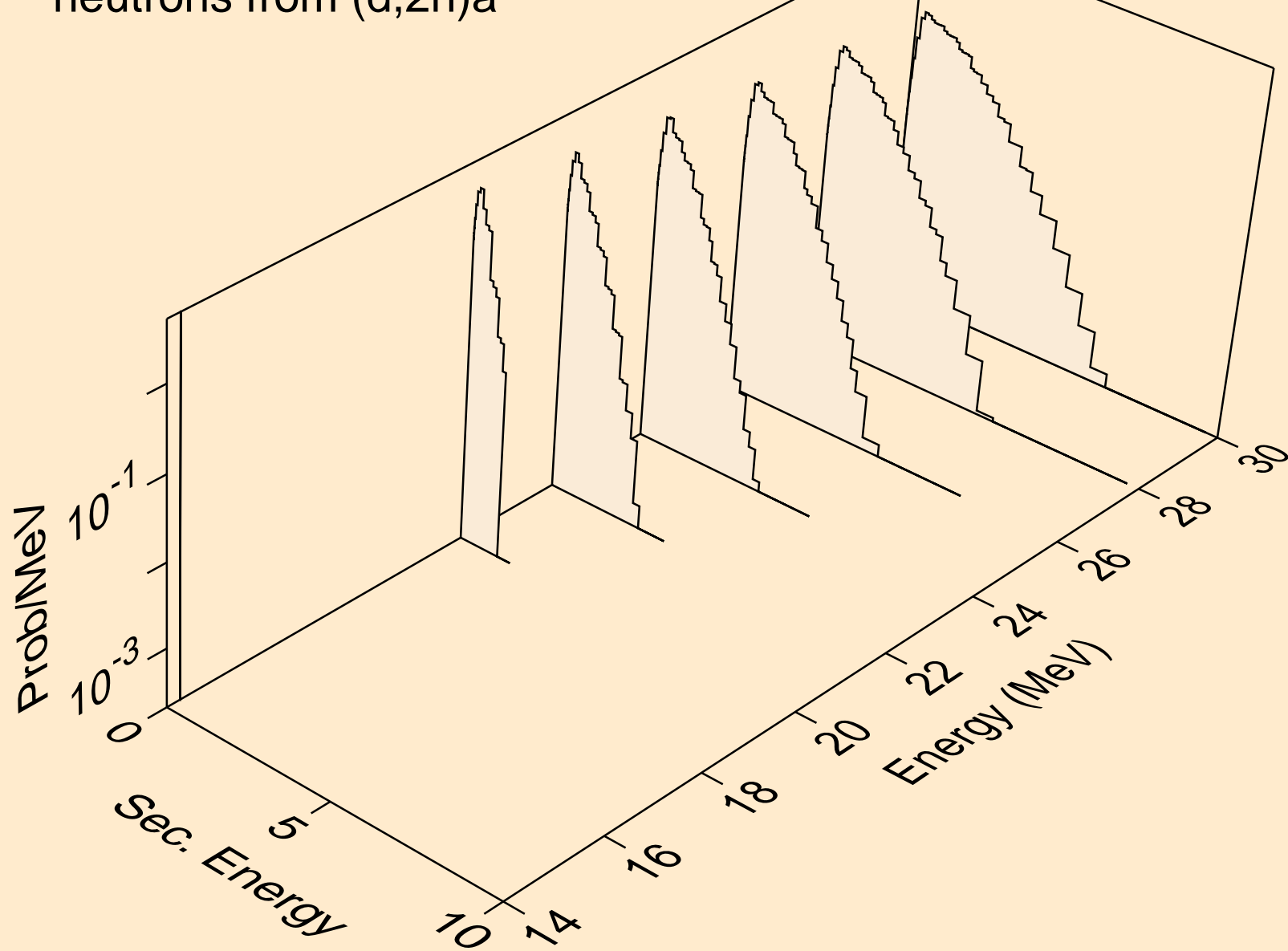

ND126 DEUTERON ACER TENDL-2021 LIBRARY; T=0.K
neutrons from (d,n*)p

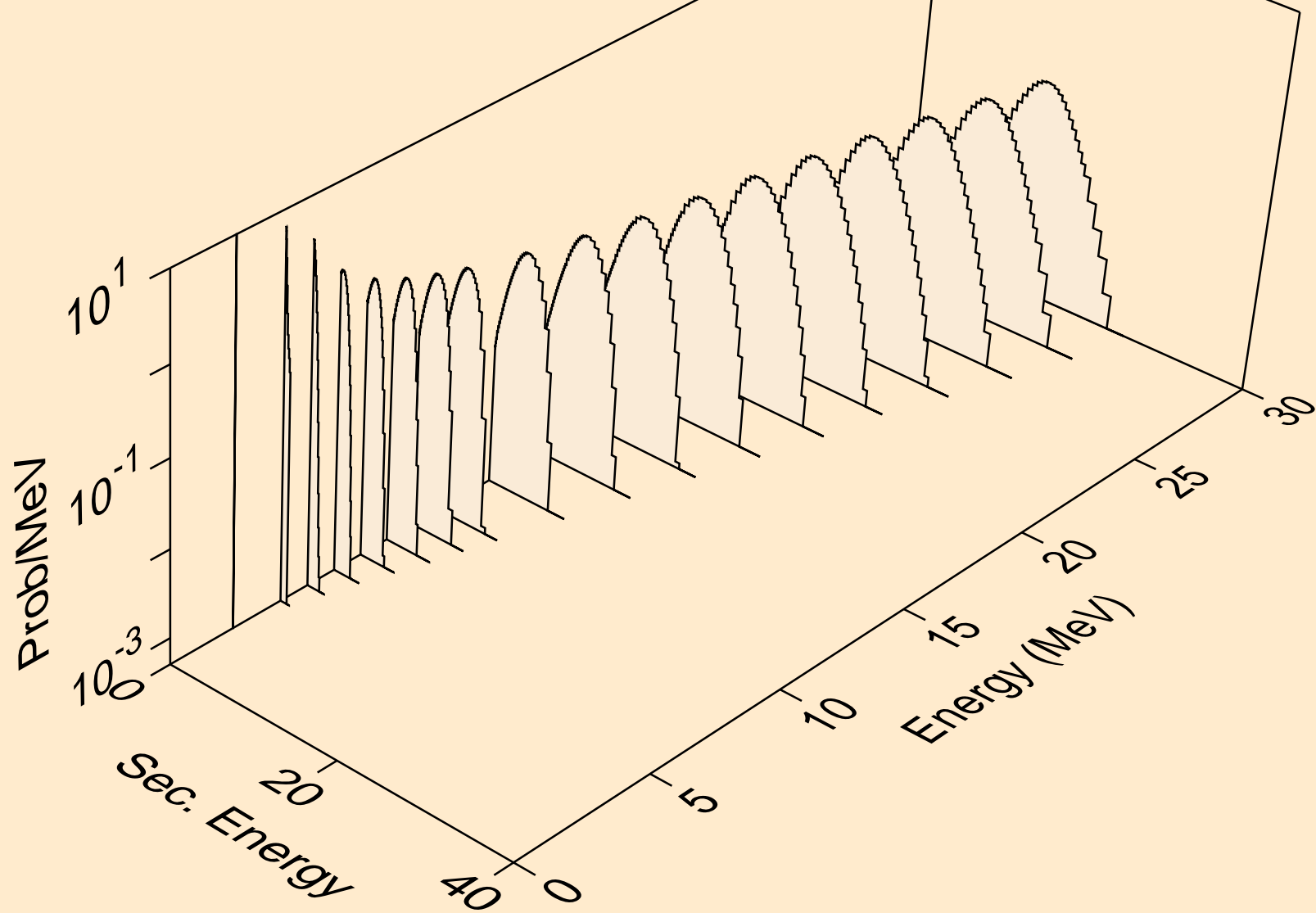

ND126 DEUTERON ACER TENDL-2021 LIBRARY; T=0.K
neutrons from (d,n*)2a

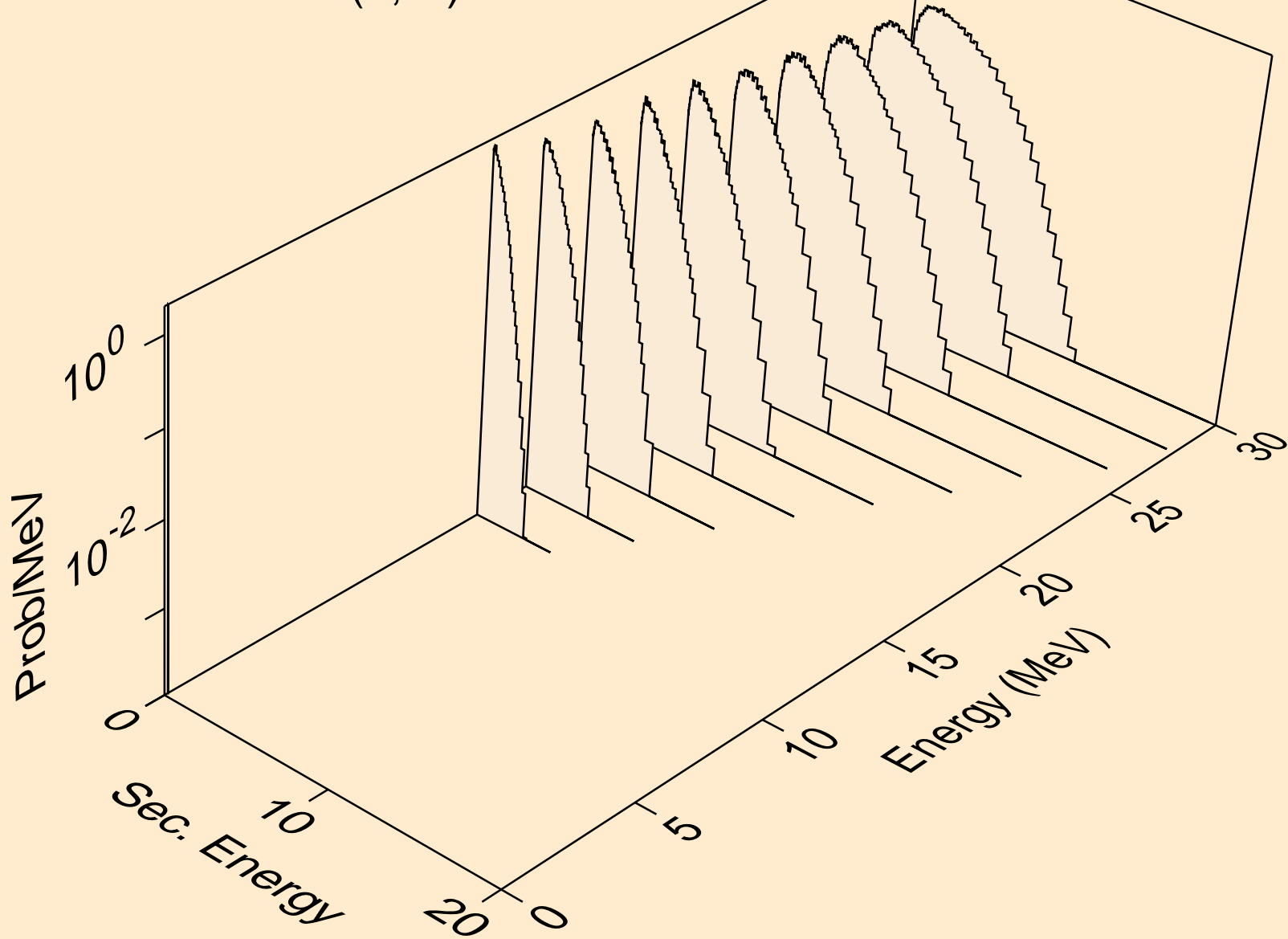

ND126 DEUTERON ACER TENDL-2021 LIBRARY; T=0.K
neutrons from (d,n*)d

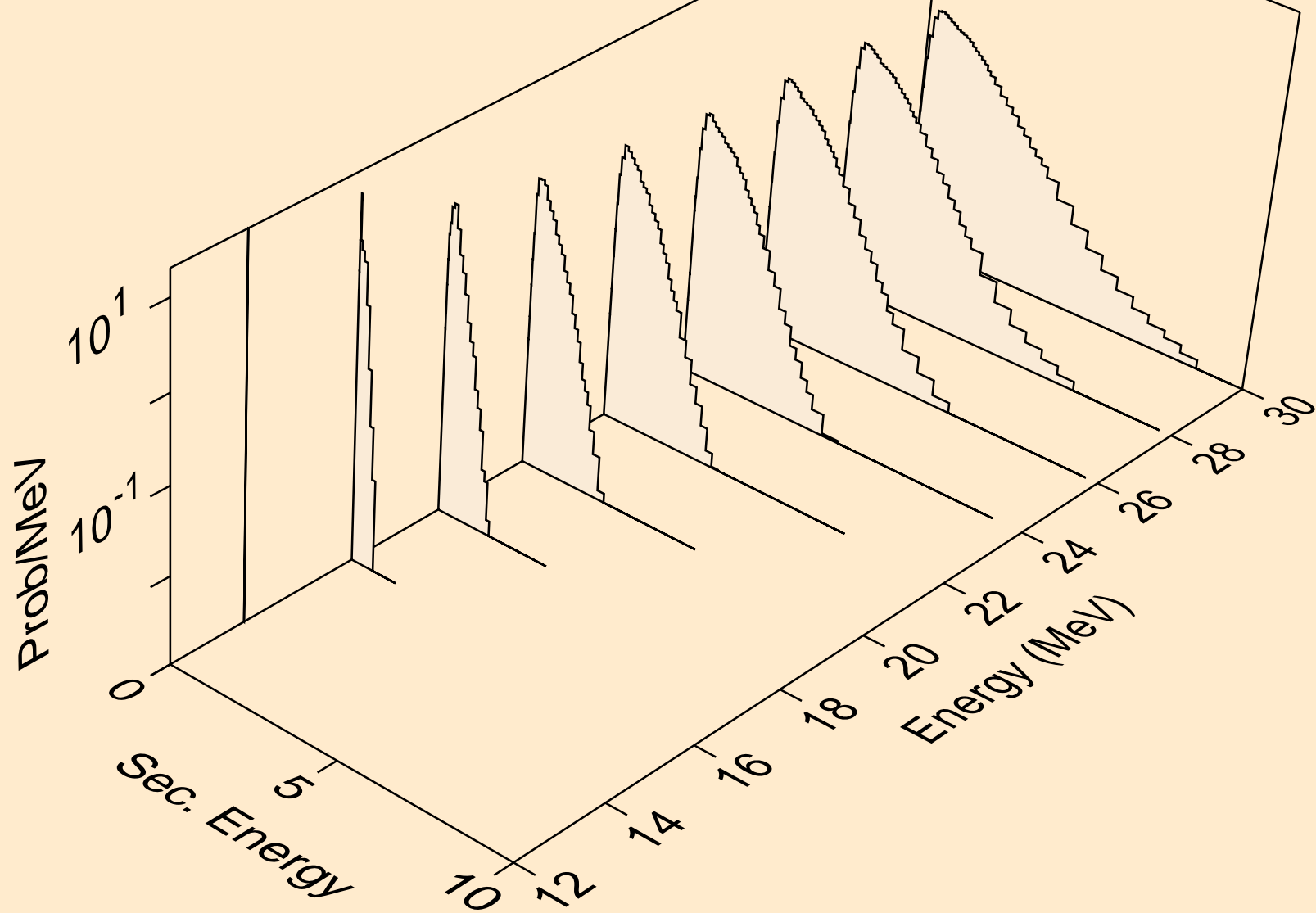

ND126 DEUTERON ACER TENDL-2021 LIBRARY; T=0.K
neutrons from (d,n*)t

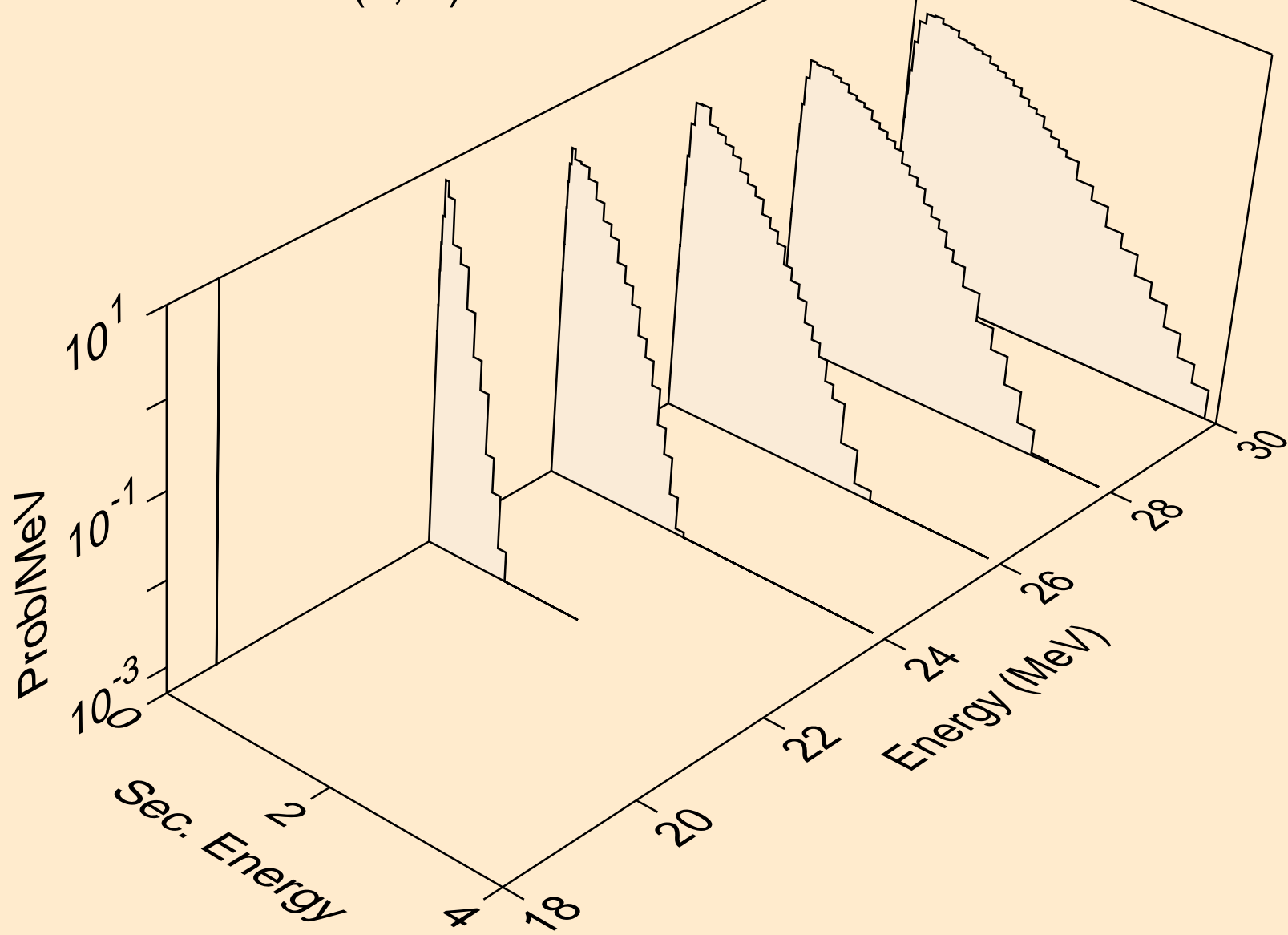

ND126 DEUTERON ACER TENDL-2021 LIBRARY; T=0.K
neutrons from (d,n*)he3

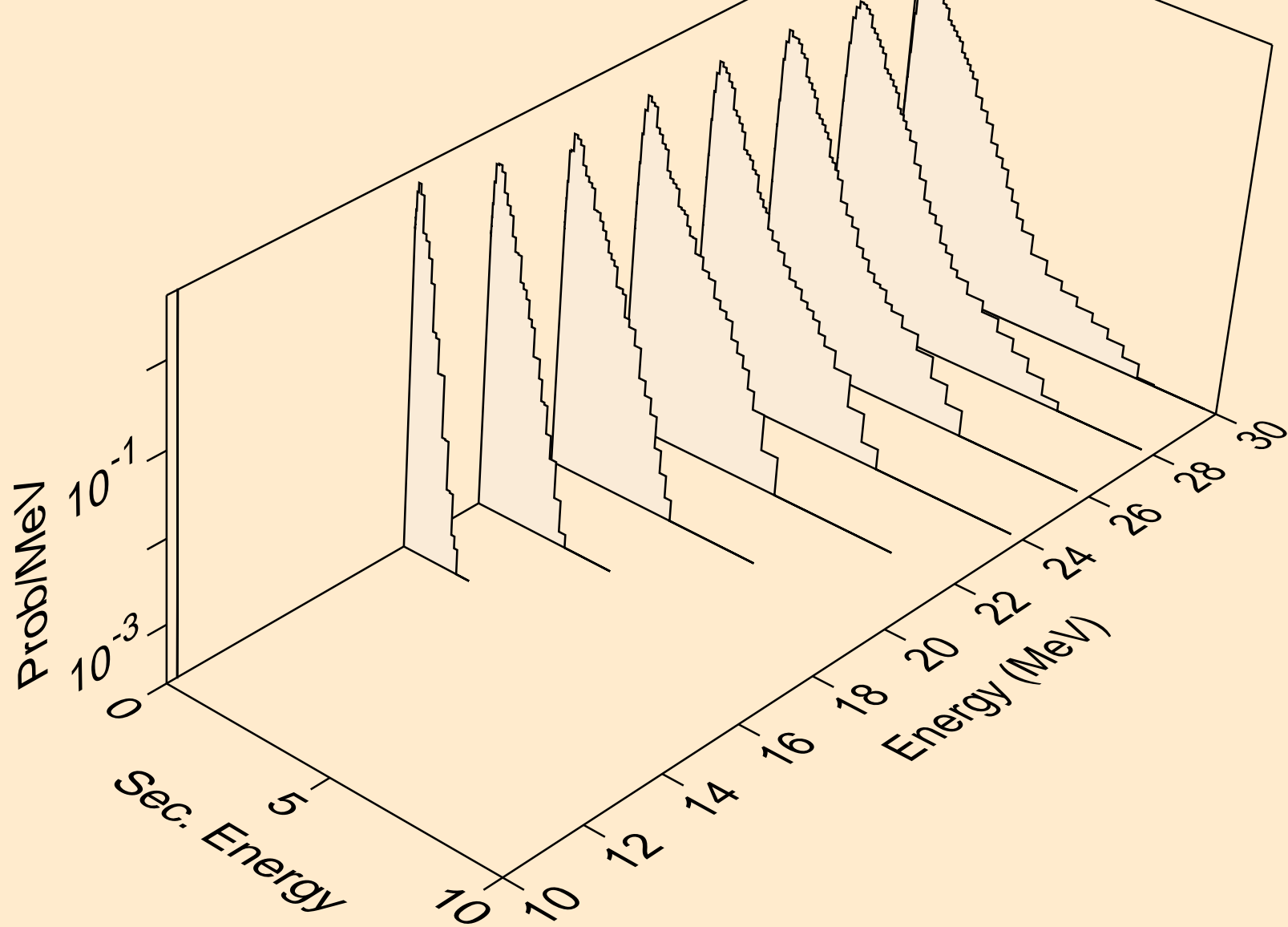

ND126 DEUTERON ACER TENDL-2021 LIBRARY; T=0.K
neutrons from (d,2np)

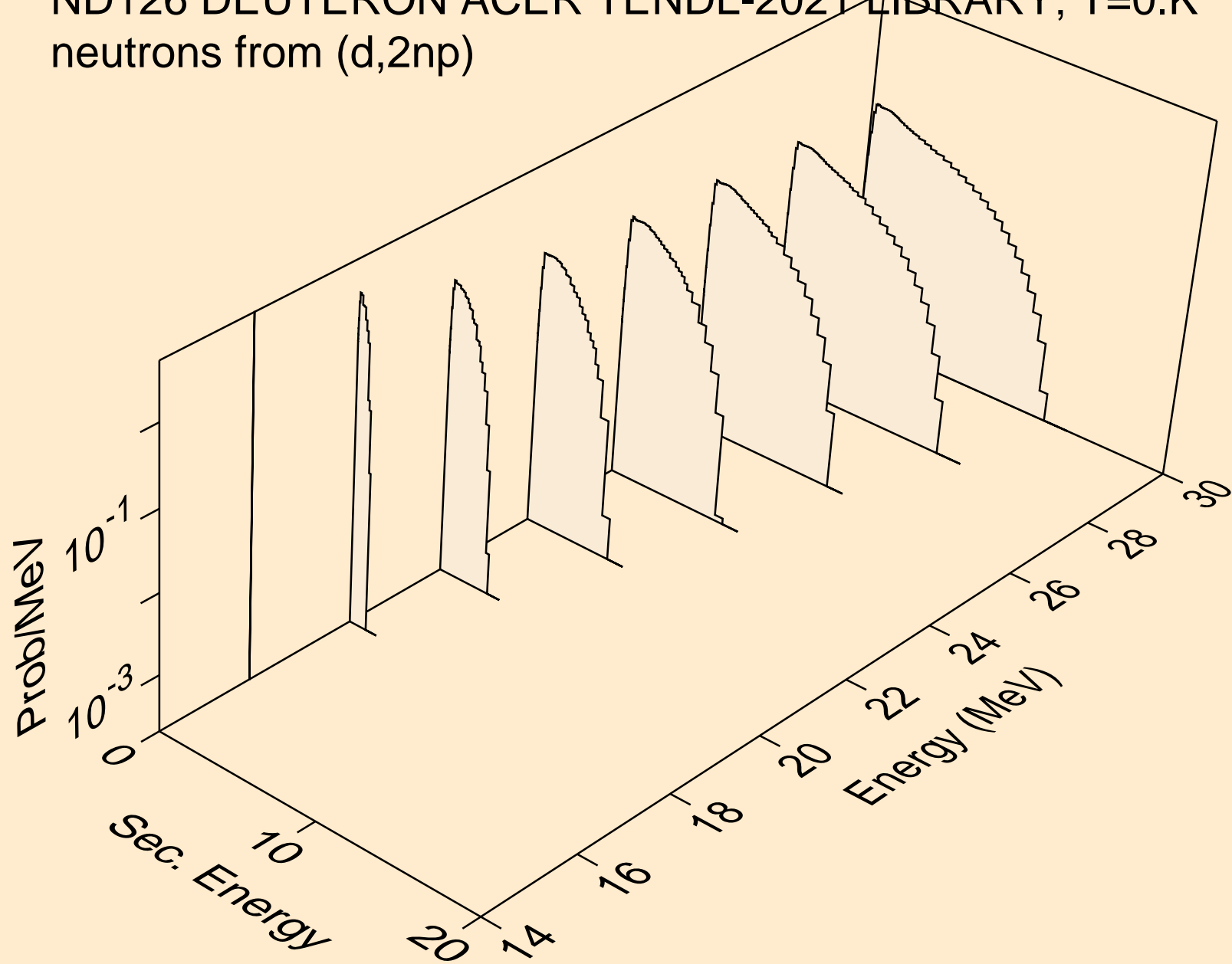

ND126 DEUTERON ACER TENDL-2021 LIBRARY; T=0.K
neutrons from (d,2np)

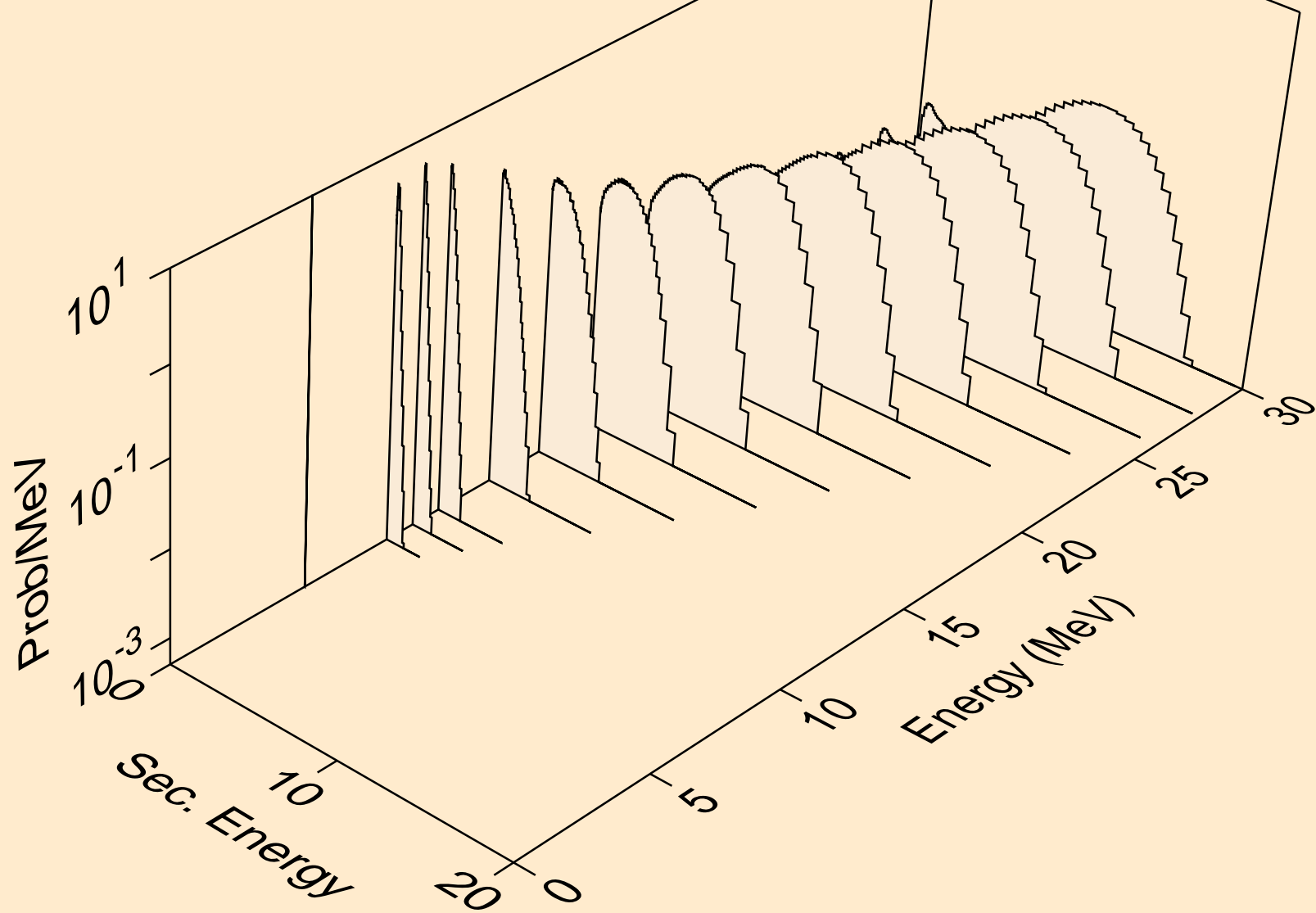

ND126 DEUTERON ACER TENDL-2021 LIBRARY; T=0.K
neutrons from (d,npa)

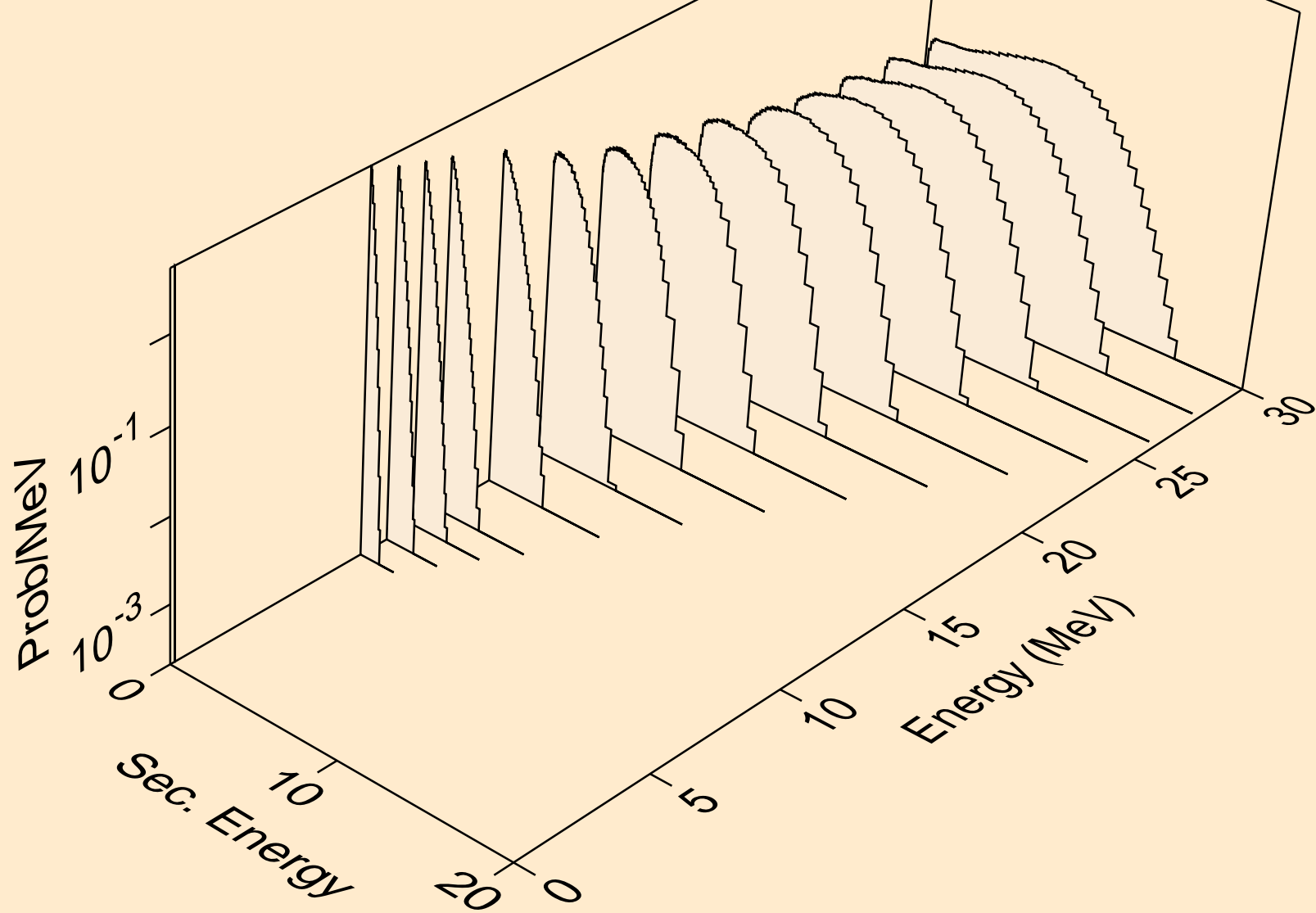

ND126 DEUTERON ACER TENDL-2021 LIBRARY; T=0.K
protons from (d,x)

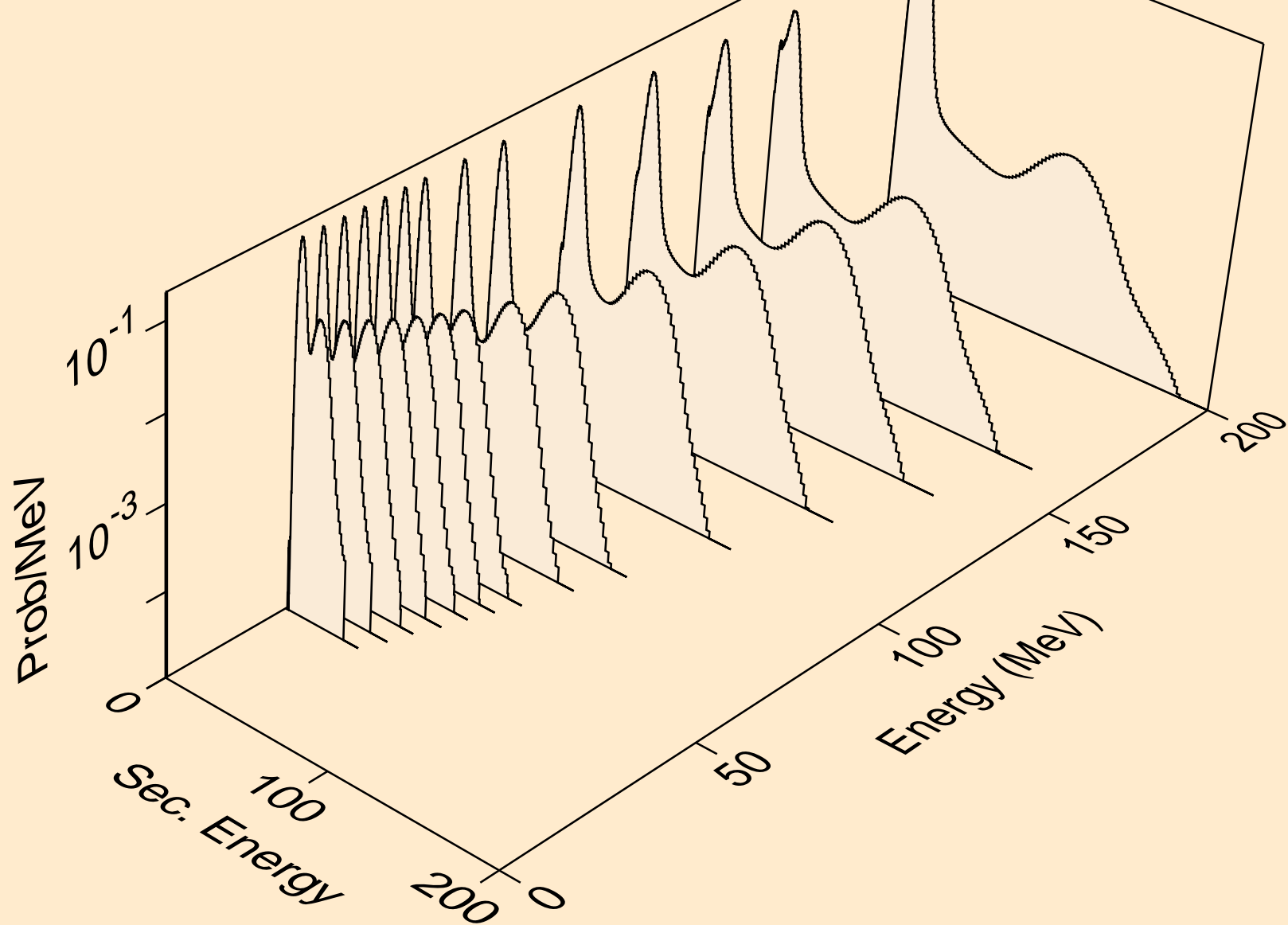

ND126 DEUTERON ACER TENDL-2021 LIBRARY; T=0.K
protons from (d,n*)p

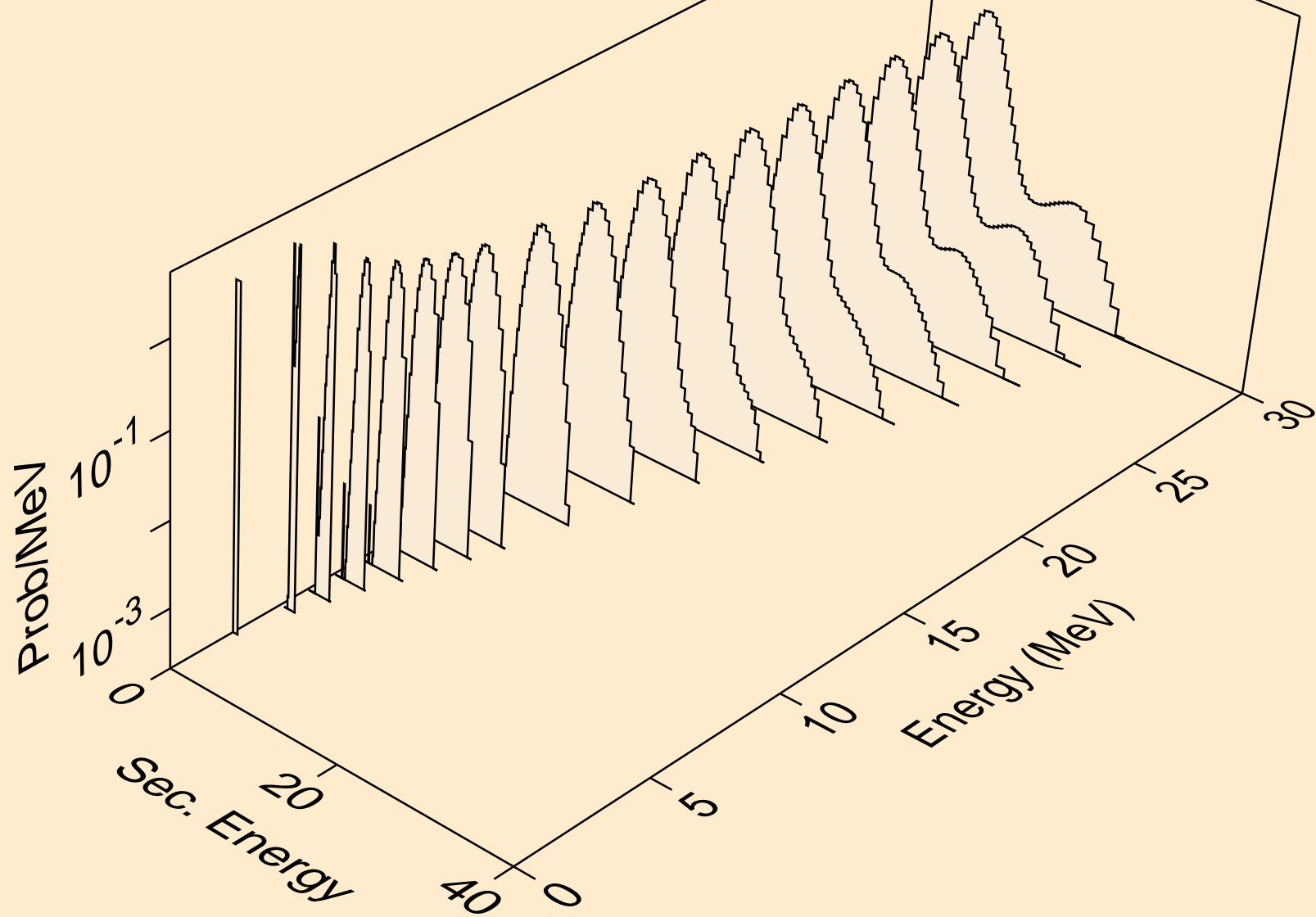

ND126 DEUTERON ACER TENDL-2021 LIBRARY; T=0.K
protons from (d,2np)

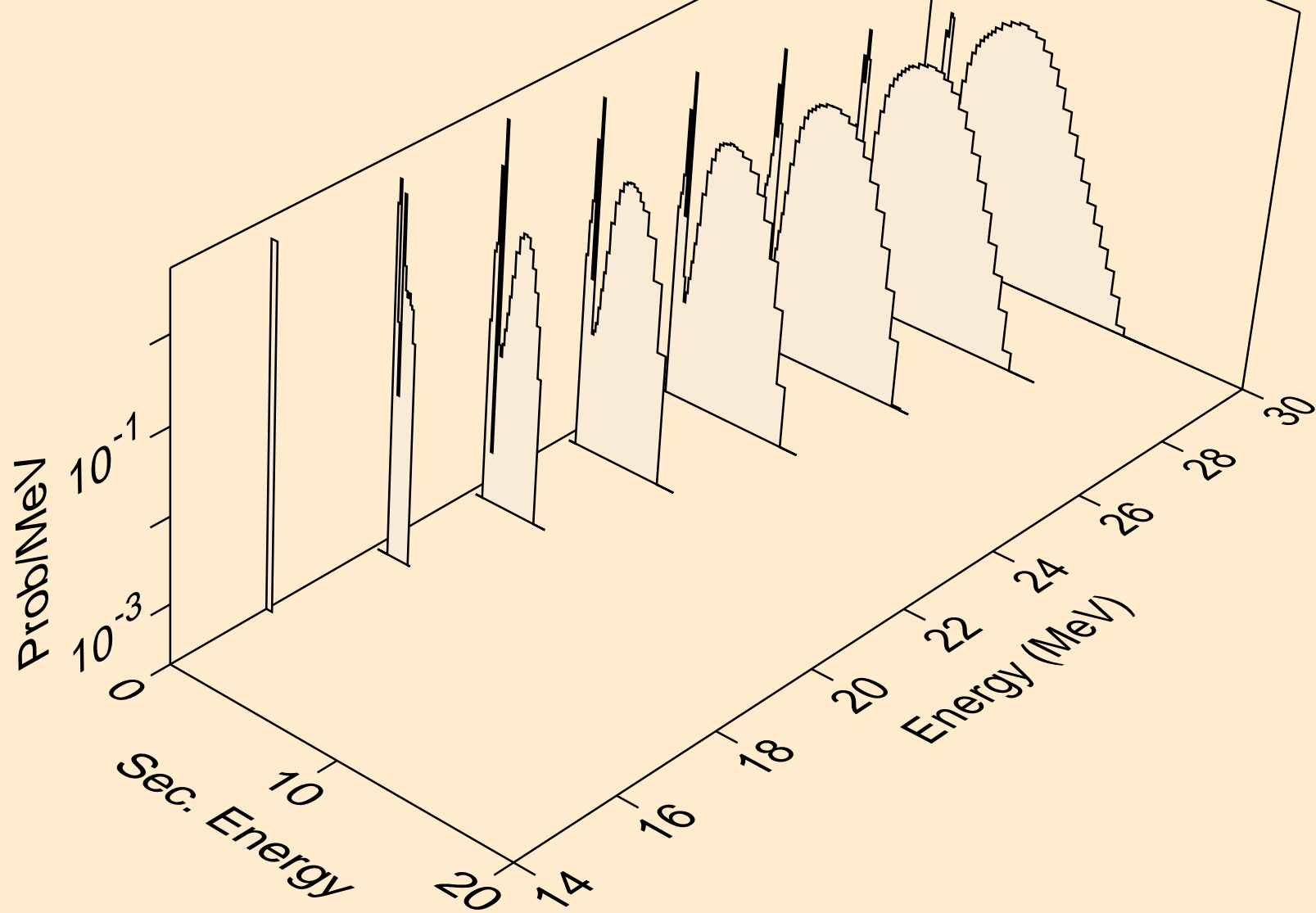

ND126 DEUTERON ACER TENDL-2021 LIBRARY; T=0.K
protons from (d,2np)

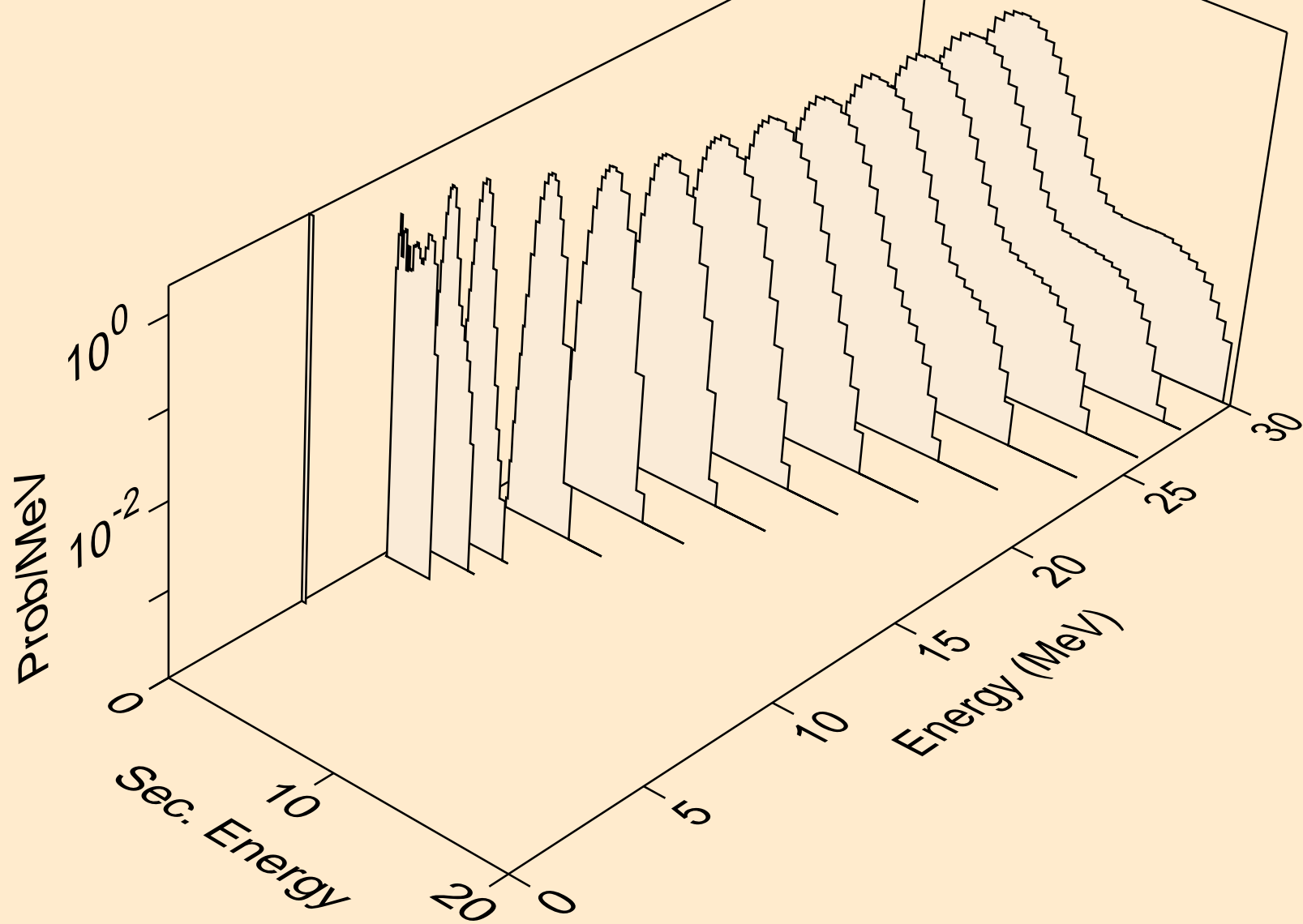

ND126 DEUTERON ACER TENDL-2021 LIBRARY; T=0.K
protons from (d,npa)

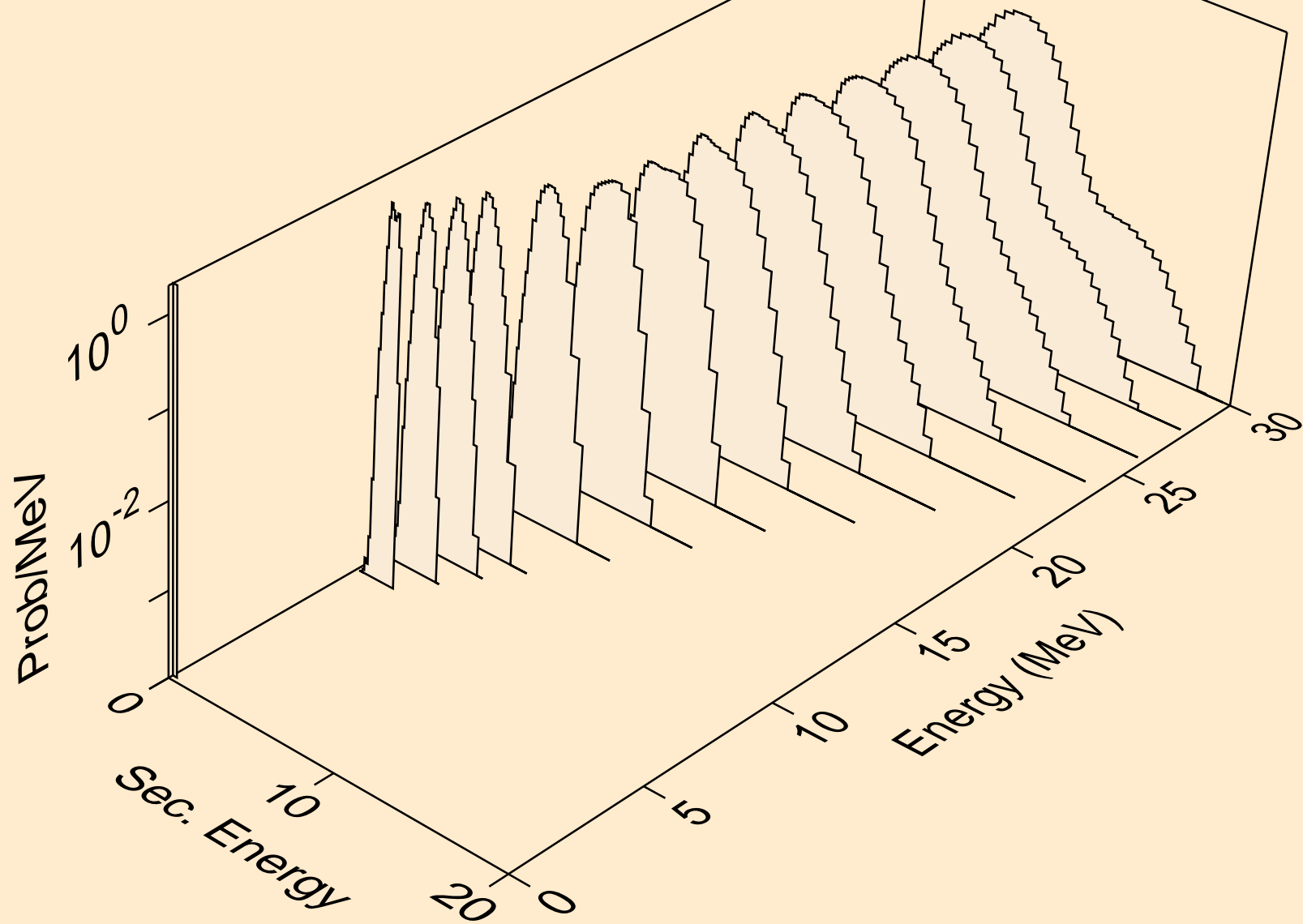

ND126 DEUTERON ACER TENDL-2021 LIBRARY; T=0.K
protons from (d,p)

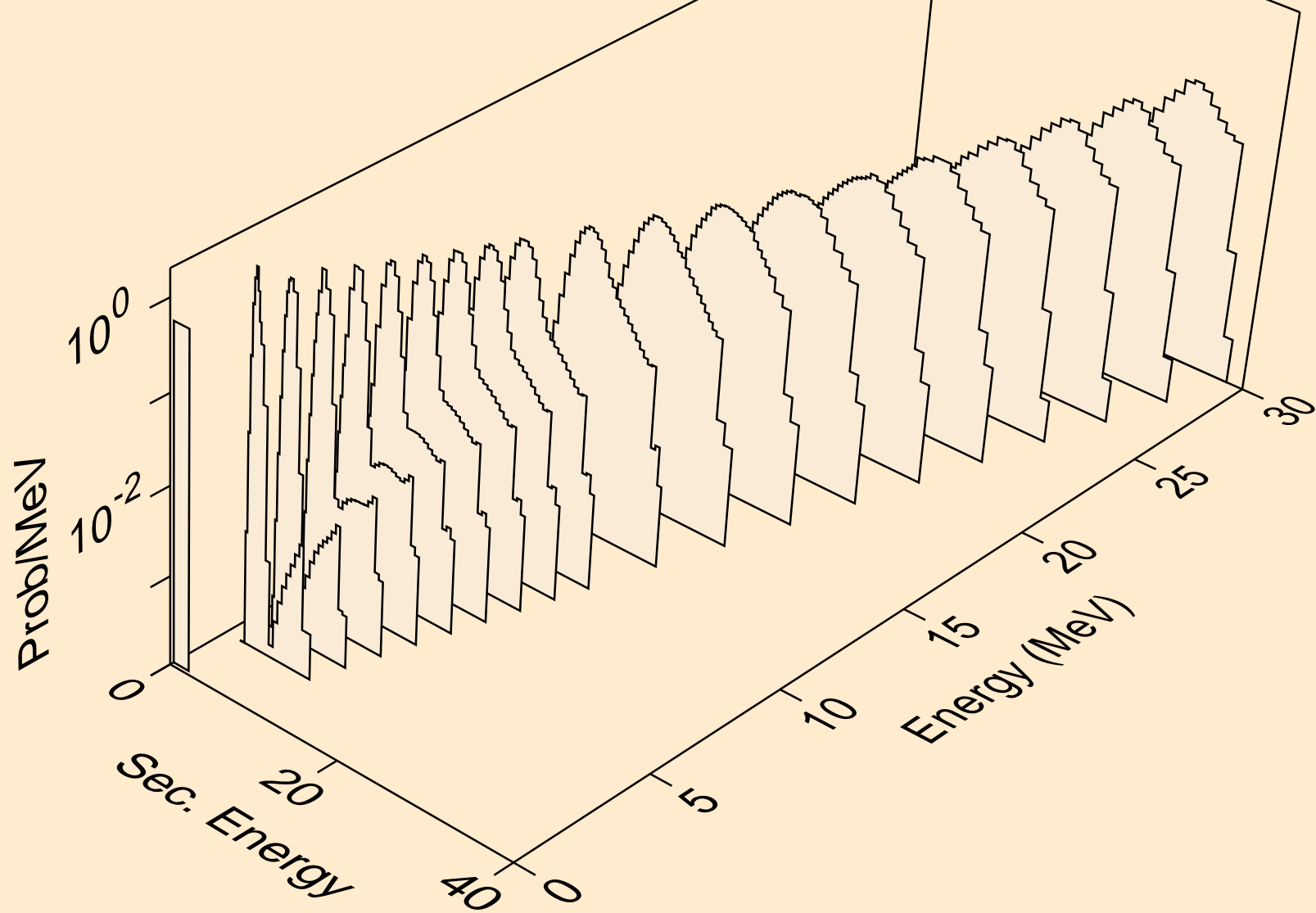

ND126 DEUTERON ACER TENDL-2021 LIBRARY; T=0.K
protons from (d,2p)

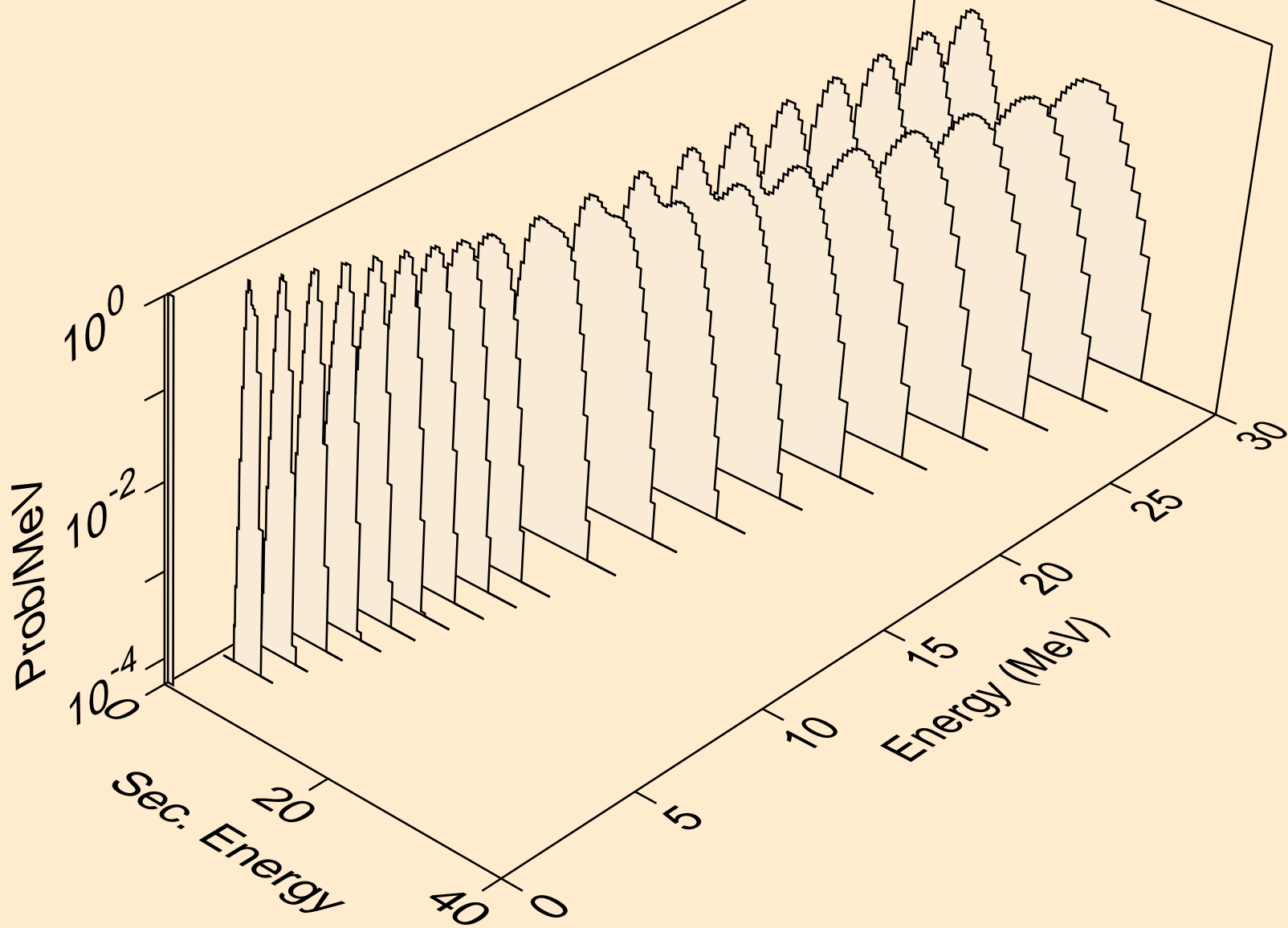

ND126 DEUTERON ACER TENDL-2021 LIBRARY; T=0.K
protons from (d,pa)

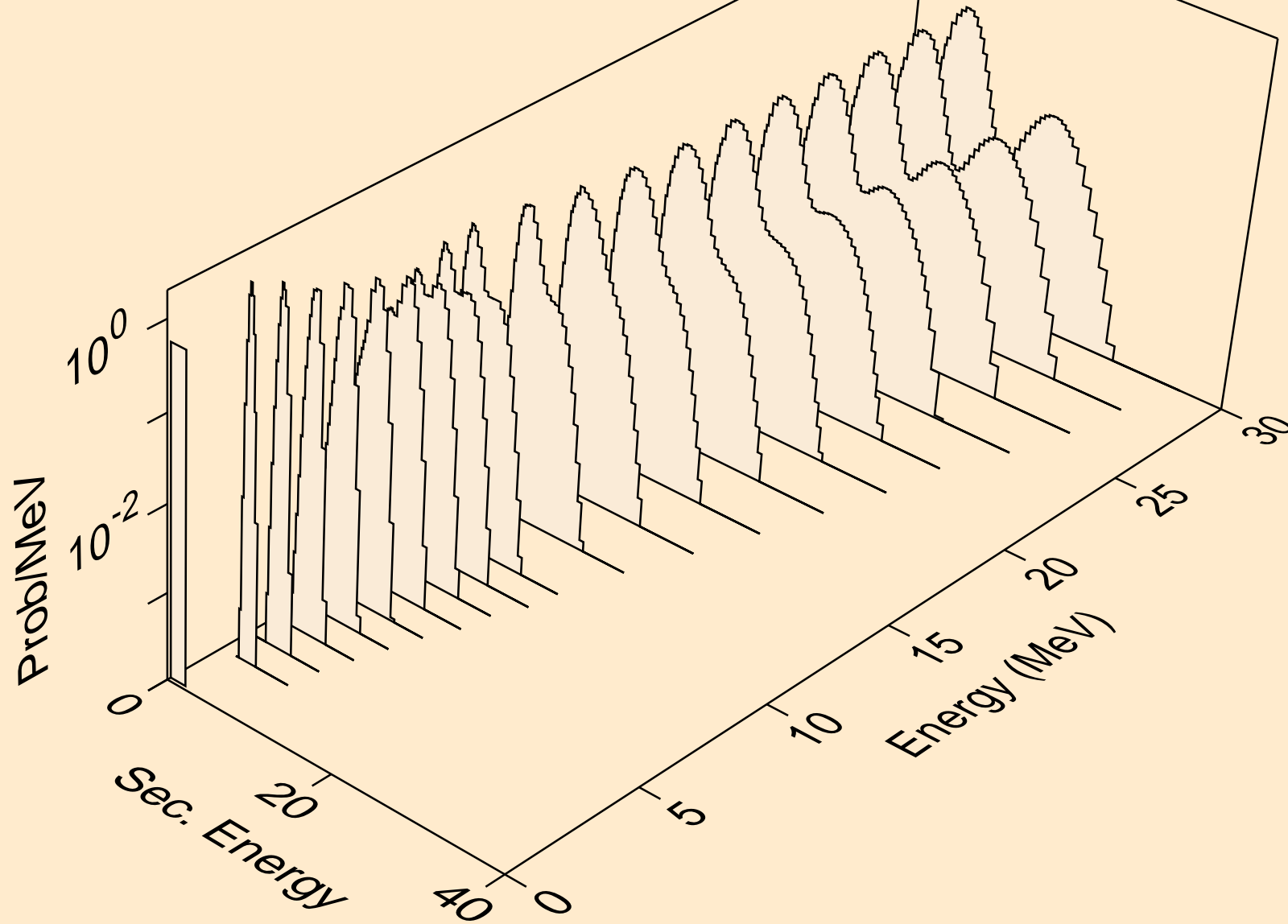

ND126 DEUTERON ACER TENDL-2021 LIBRARY; T=0.K
protons from (d,pd)

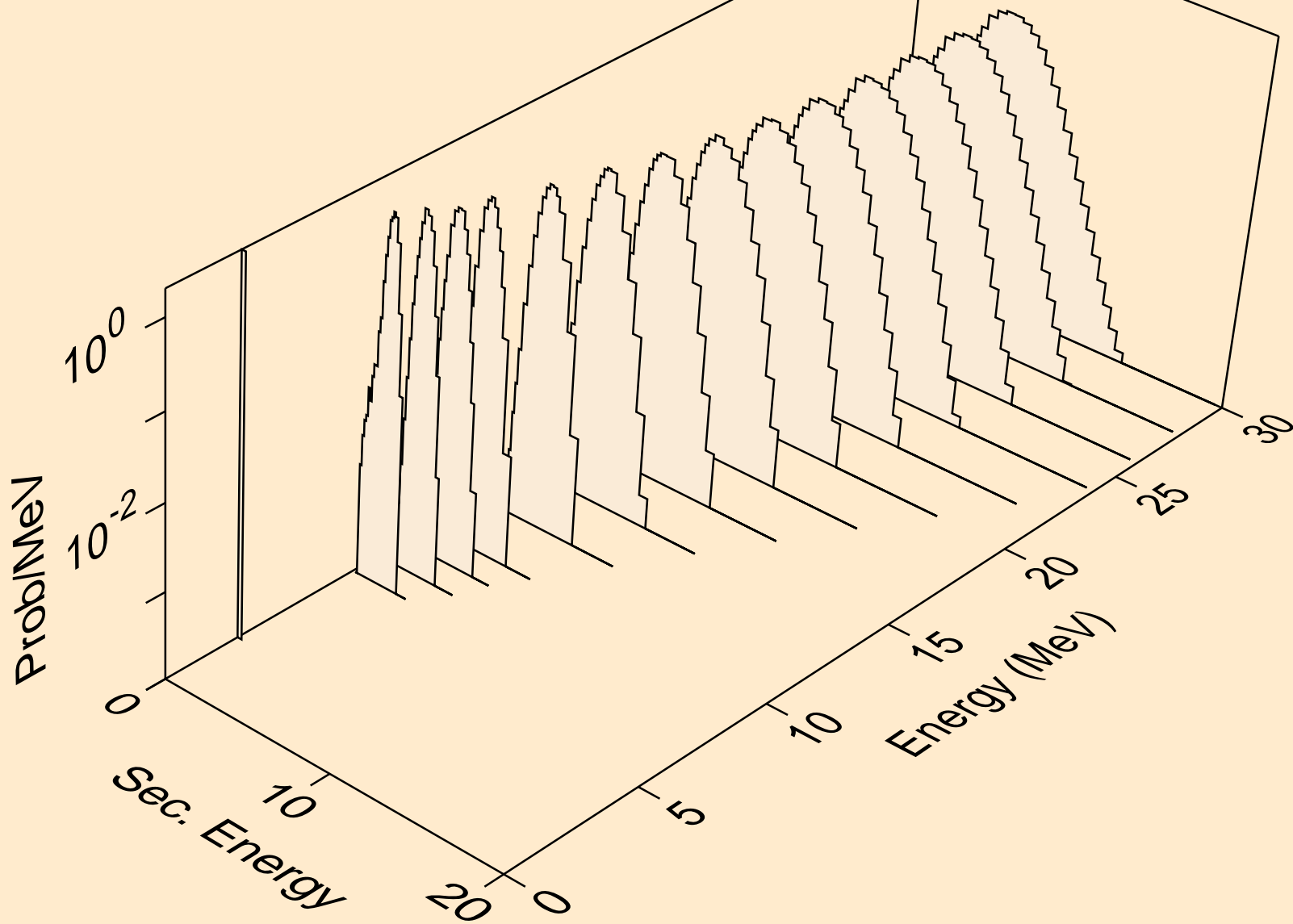

ND126 DEUTERON ACER TENDL-2021 LIBRARY; T=0.K
protons from (d,pt)

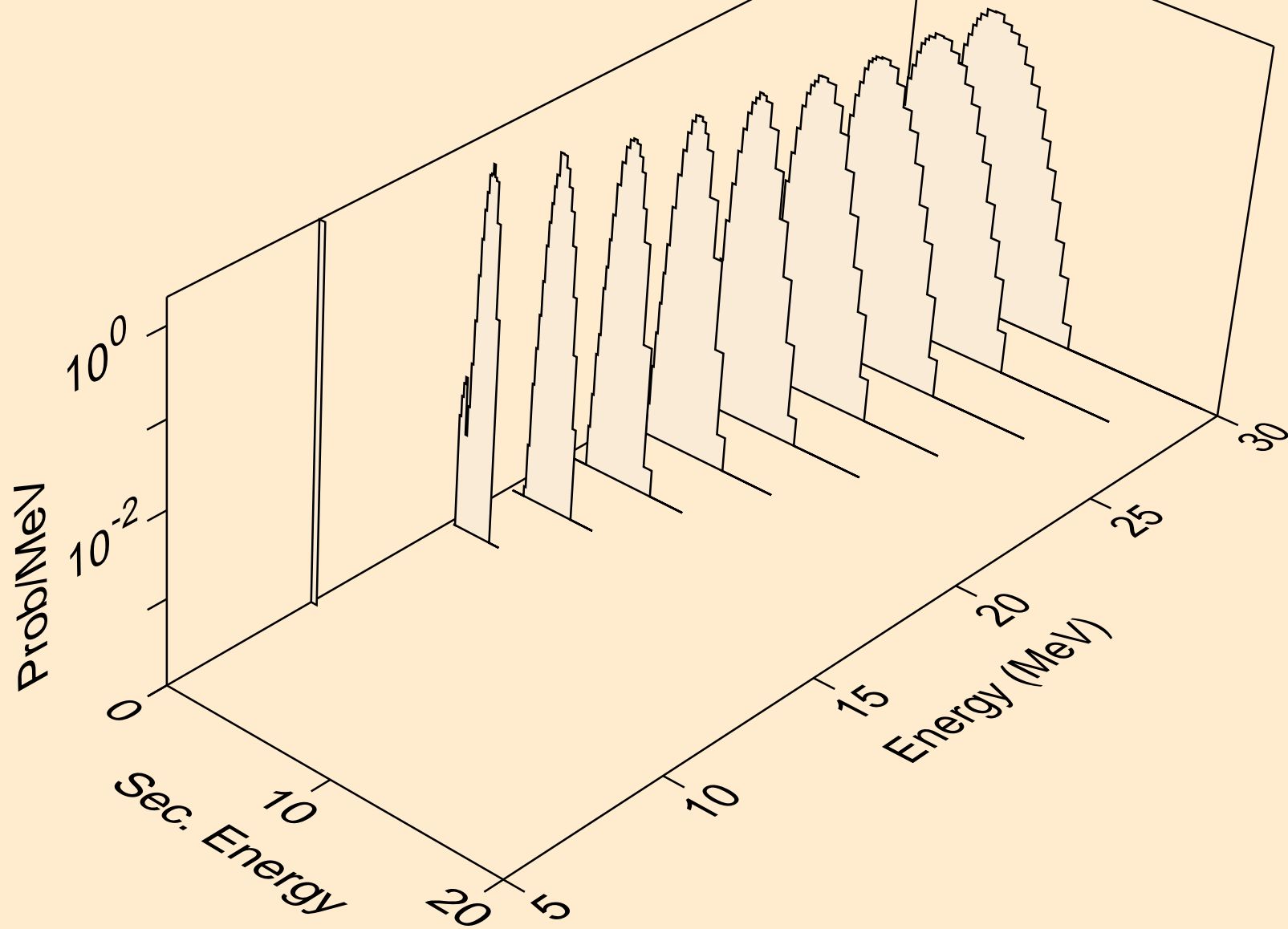

ND126 DEUTERON ACER TENDL-2021 LIBRARY; T=0.K
tritons from (d,x)

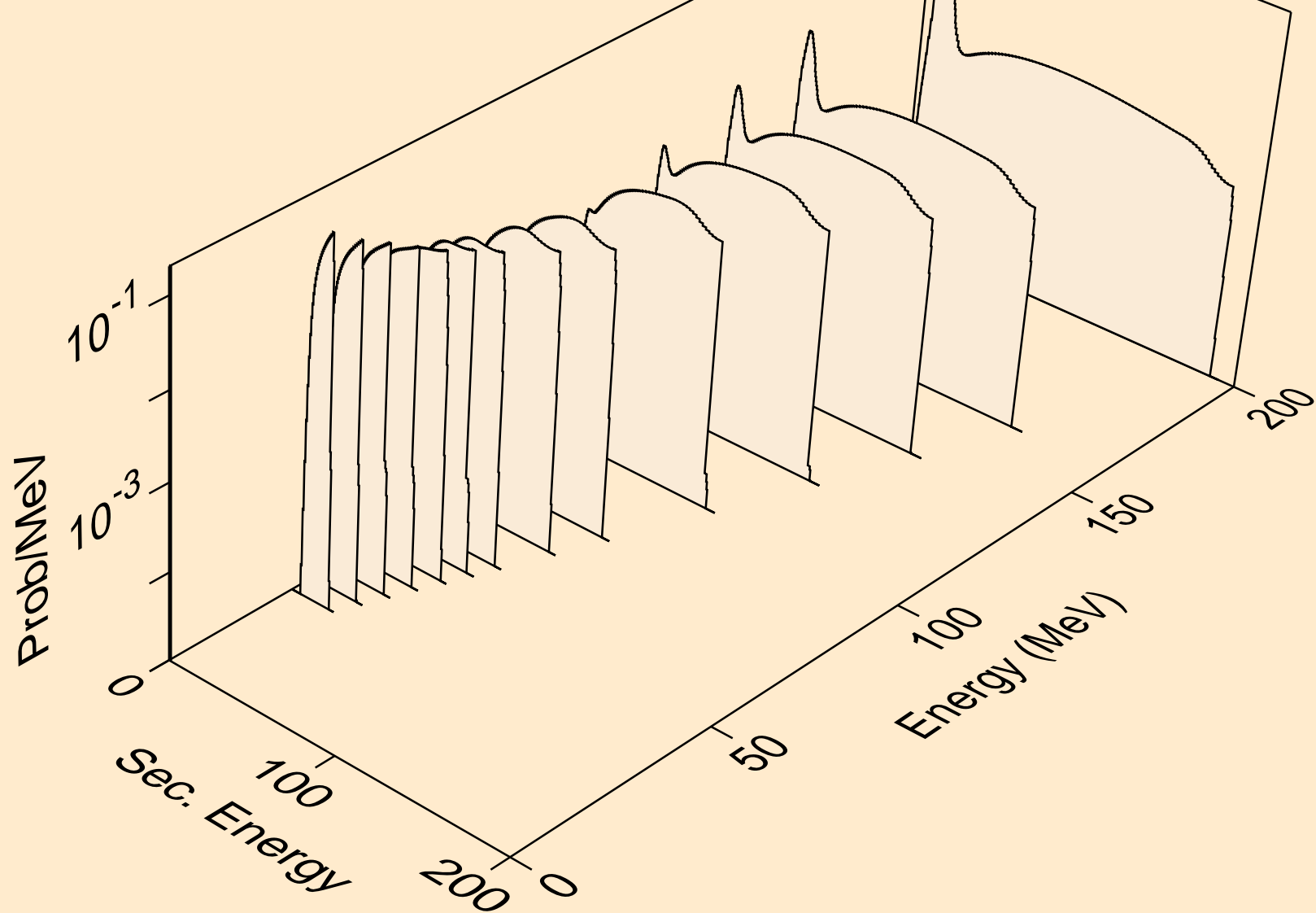

ND126 DEUTERON ACER TENDL-2021 LIBRARY; T=0.K
tritons from (d,n*)t

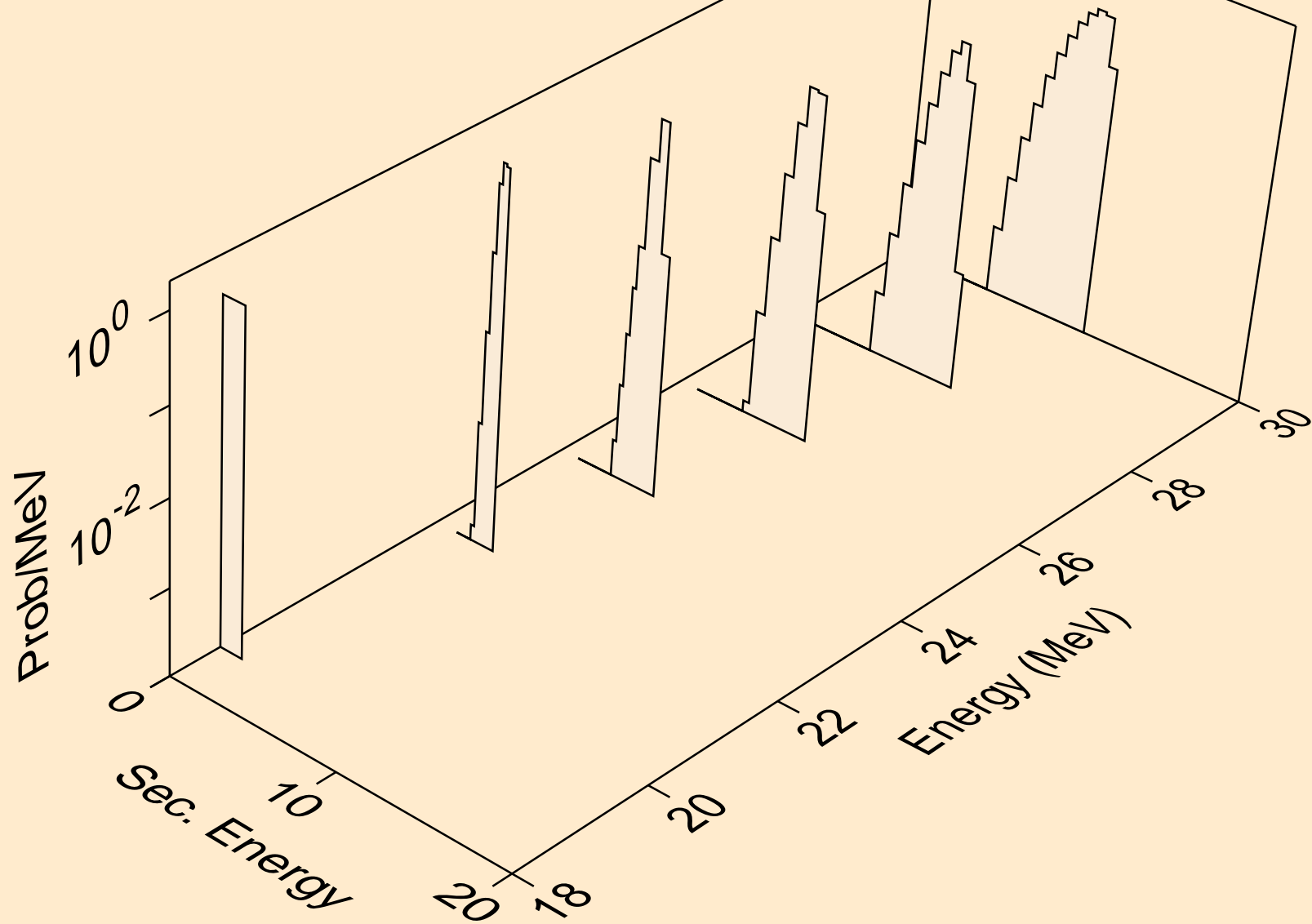

ND126 DEUTERON ACER TENDL-2021 LIBRARY; T=0.K
tritons from (d,t)

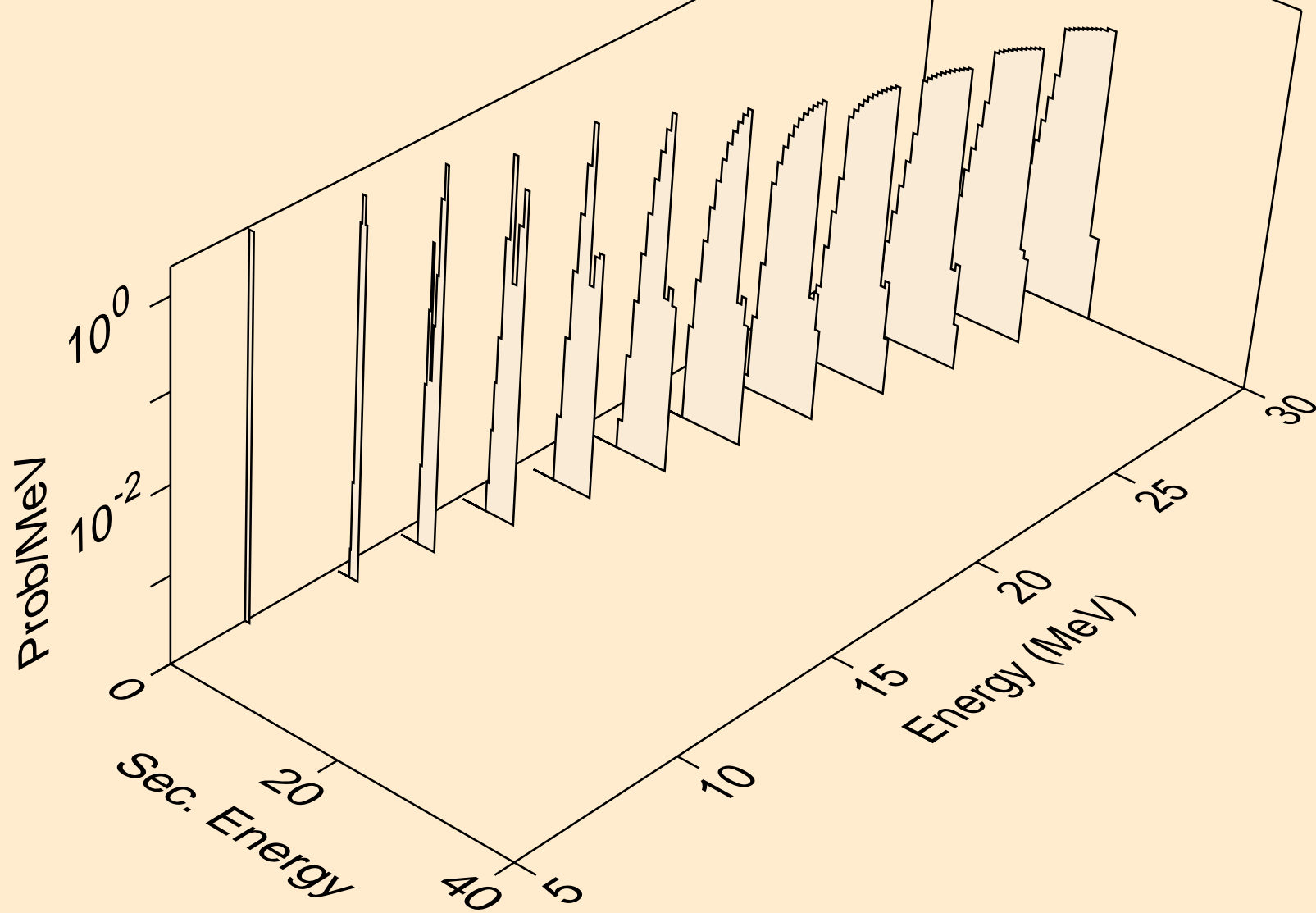

ND126 DEUTERON ACER TENDL-2021 LIBRARY; T=0.K
tritons from (d,pt)

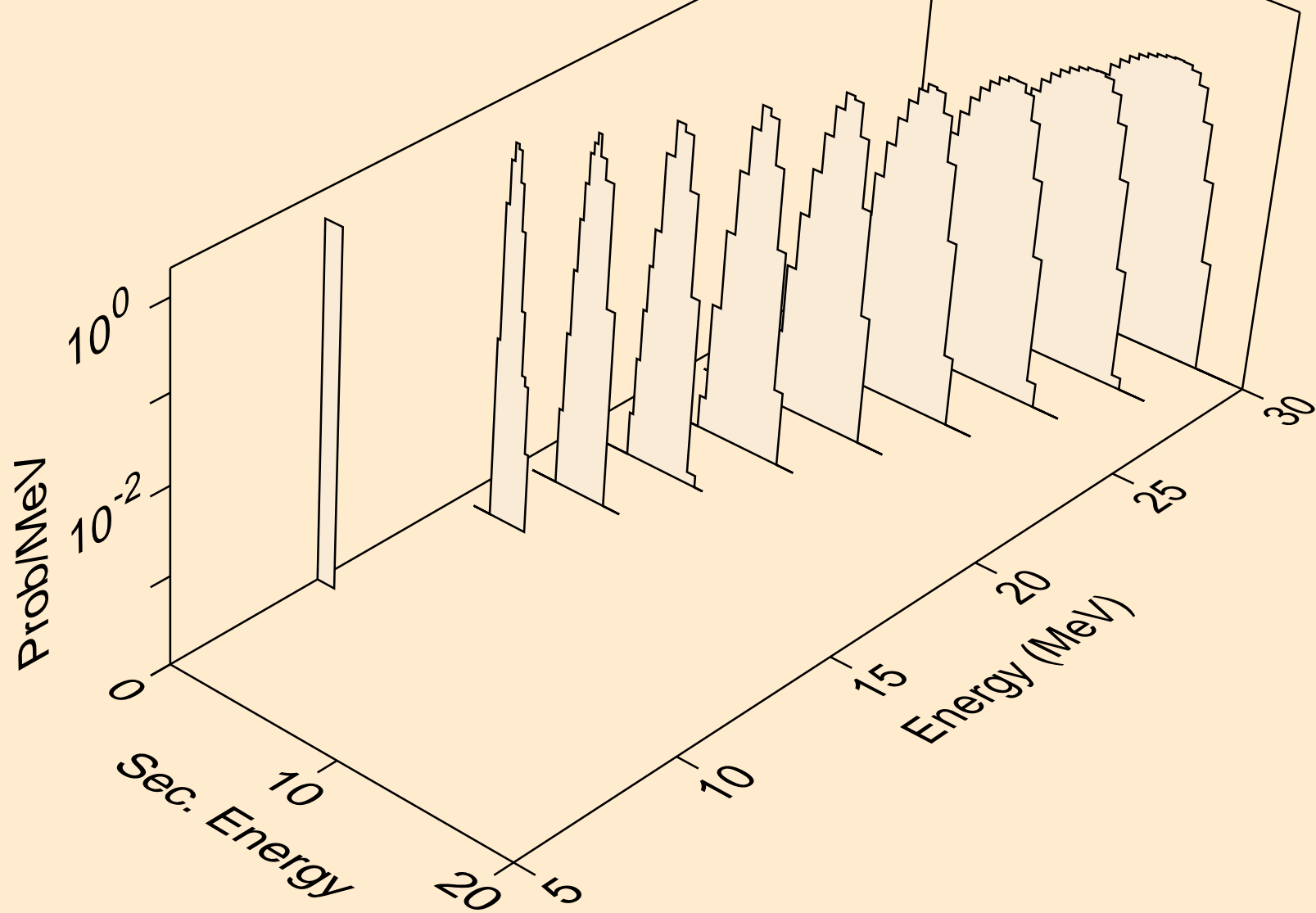

ND126 DEUTERON ACER TENDL-2021 LIBRARY; T=0.K
he3s from (d,x)

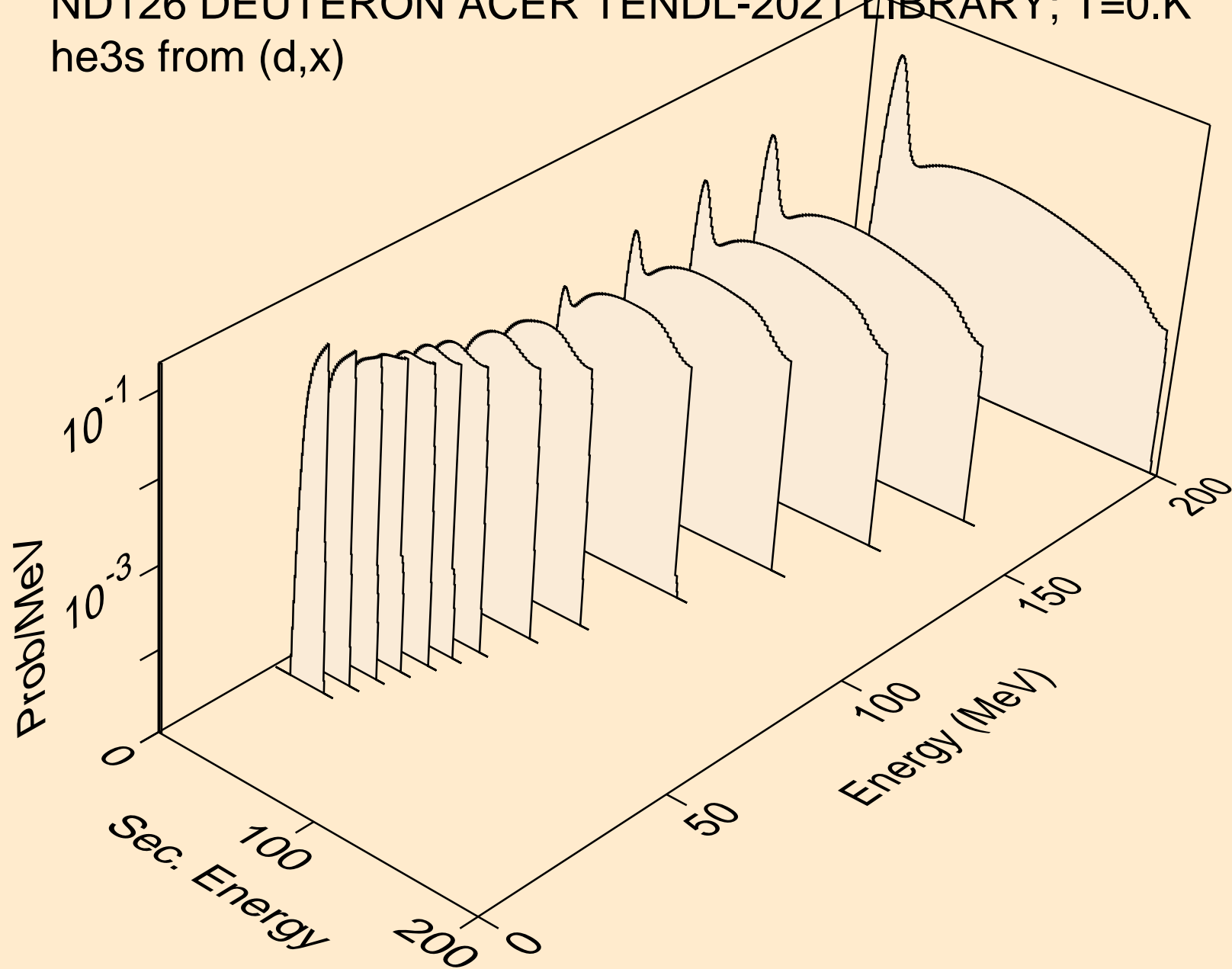

ND126 DEUTERON ACER TENDL-2021 LIBRARY; T=0.K
he3s from (d,n*)he3

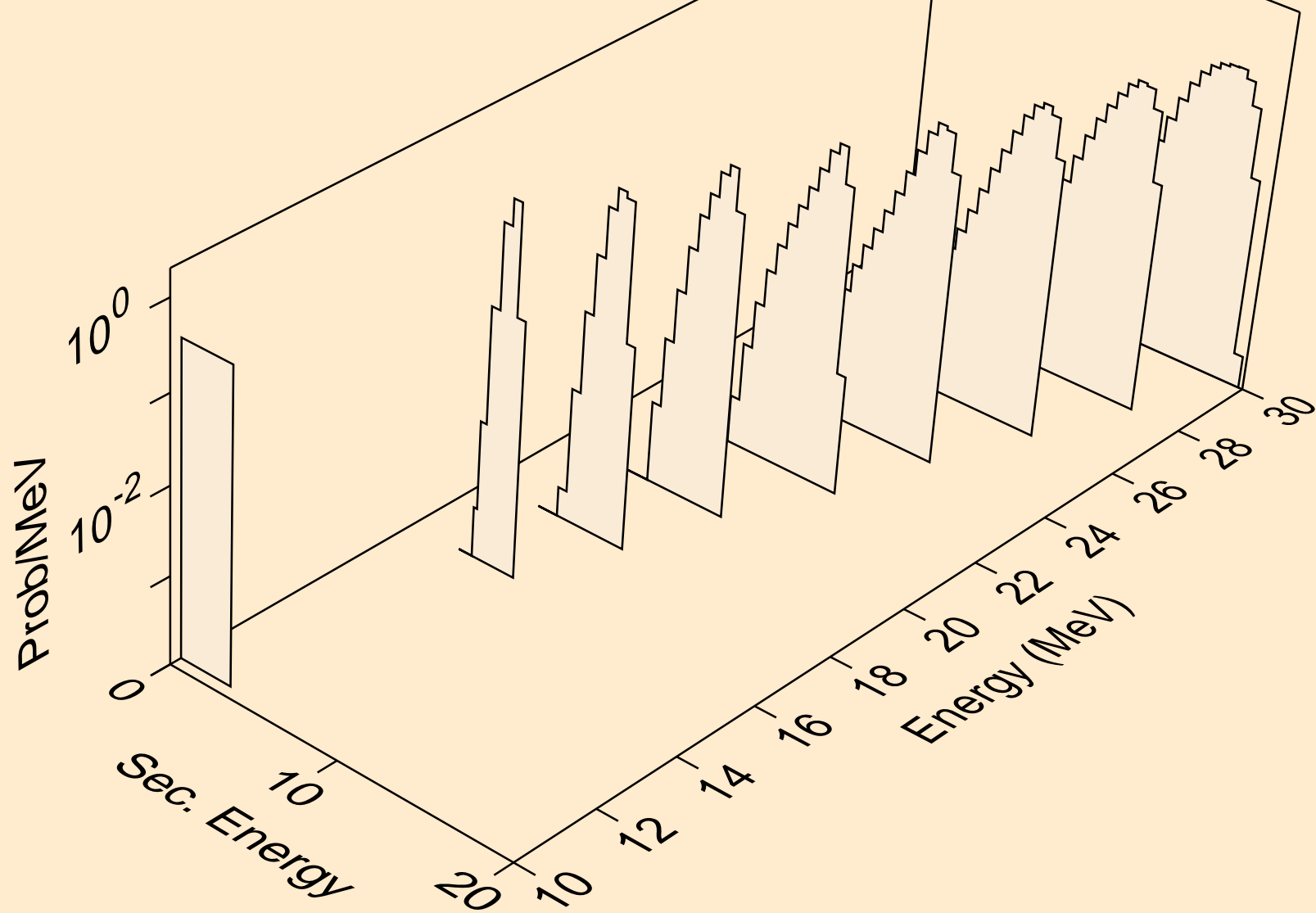

ND126 DEUTERON ACER TENDL-2021 LIBRARY; T=0.K
he3s from (d,he3)

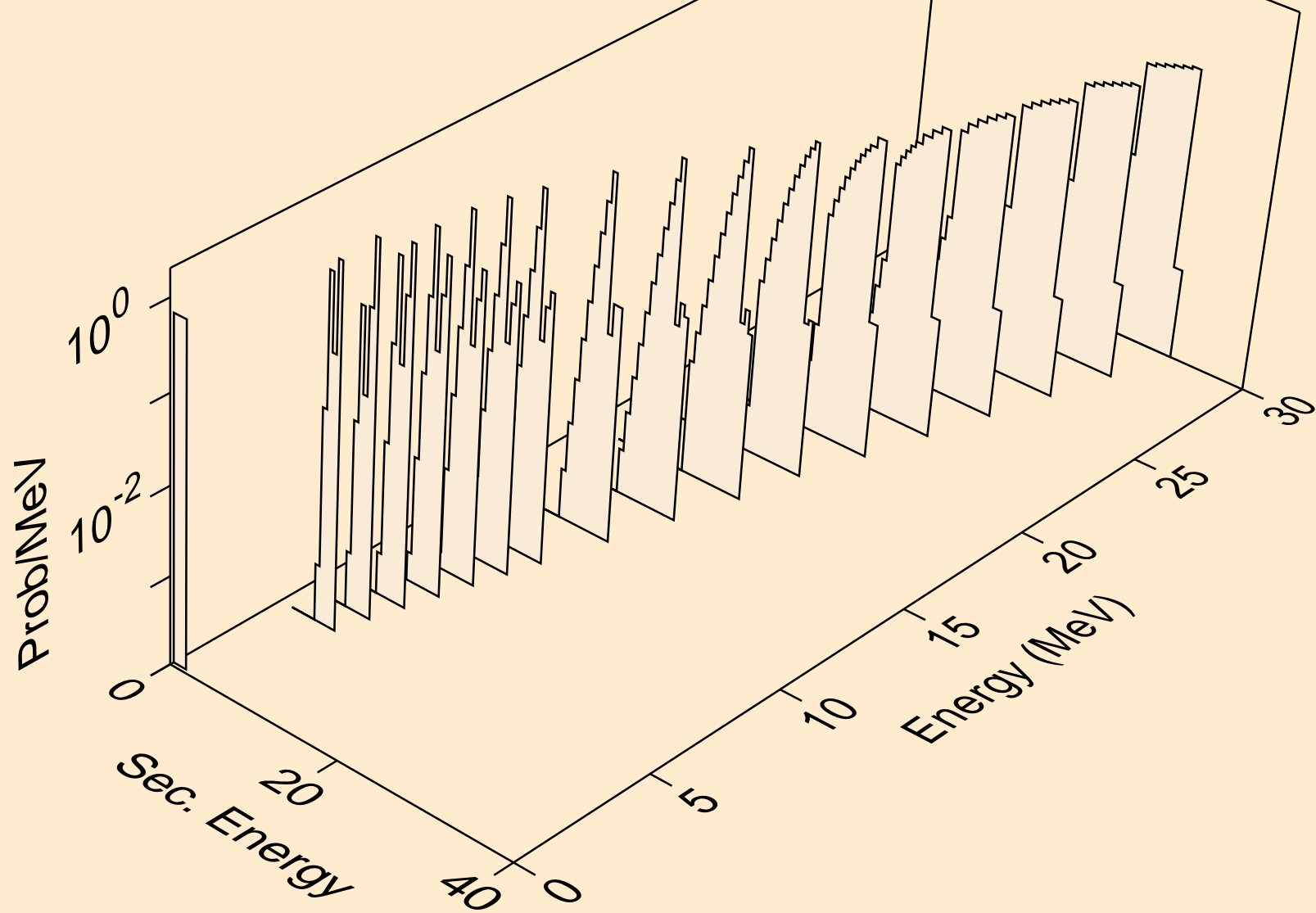

ND126 DEUTERON ACER TENDL-2021 LIBRARY; T=0.K
alphas from (d,x)

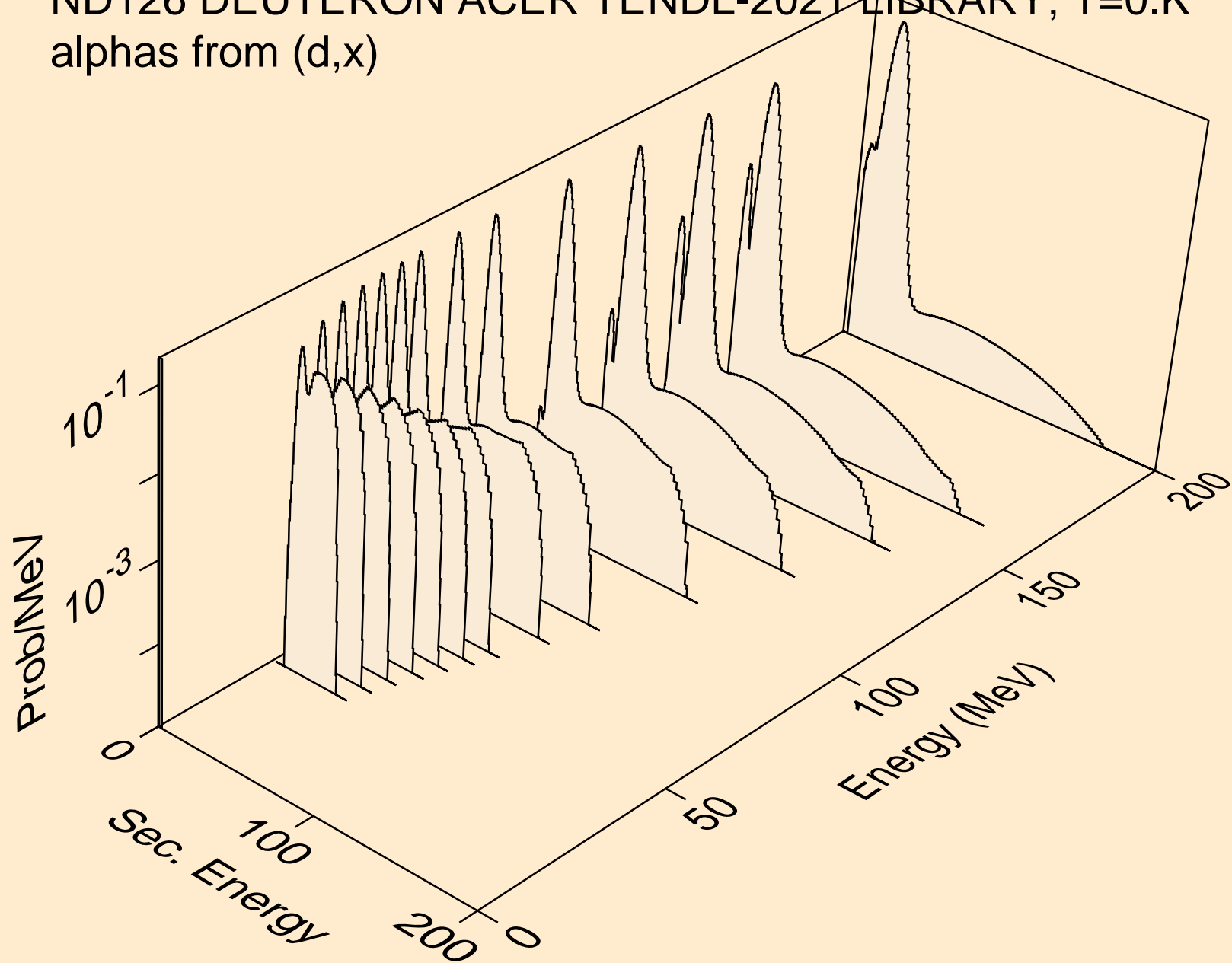

ND126 DEUTERON ACER TENDL-2021 LIBRARY; T=0.K
alphas from (d,n*)a

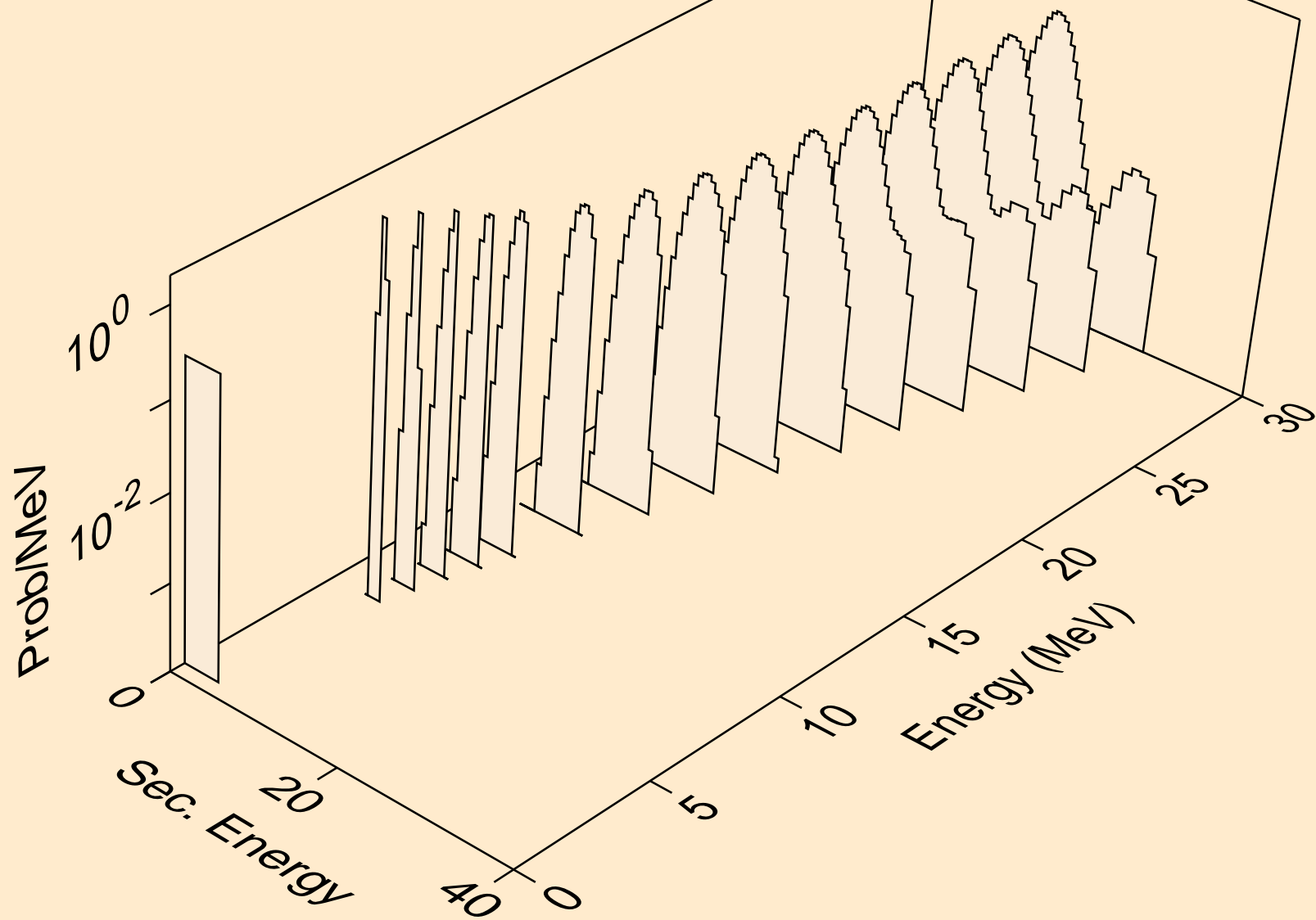

ND126 DEUTERON ACER TENDL-2021 LIBRARY; T=0.K
alphas from (d,2n)a

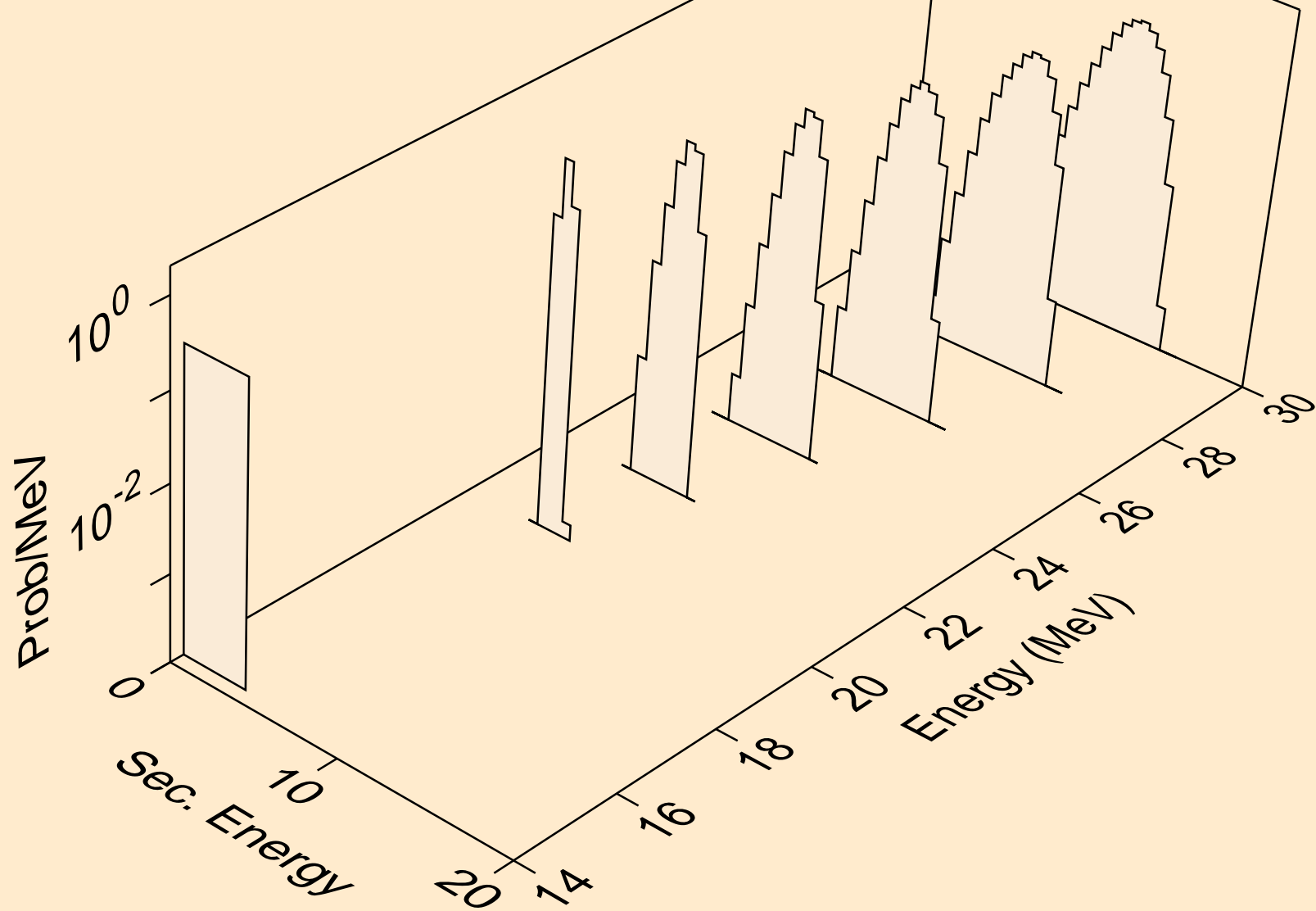

ND126 DEUTERON ACER TENDL-2021 LIBRARY; T=0.K
alphas from (d,n*)2a

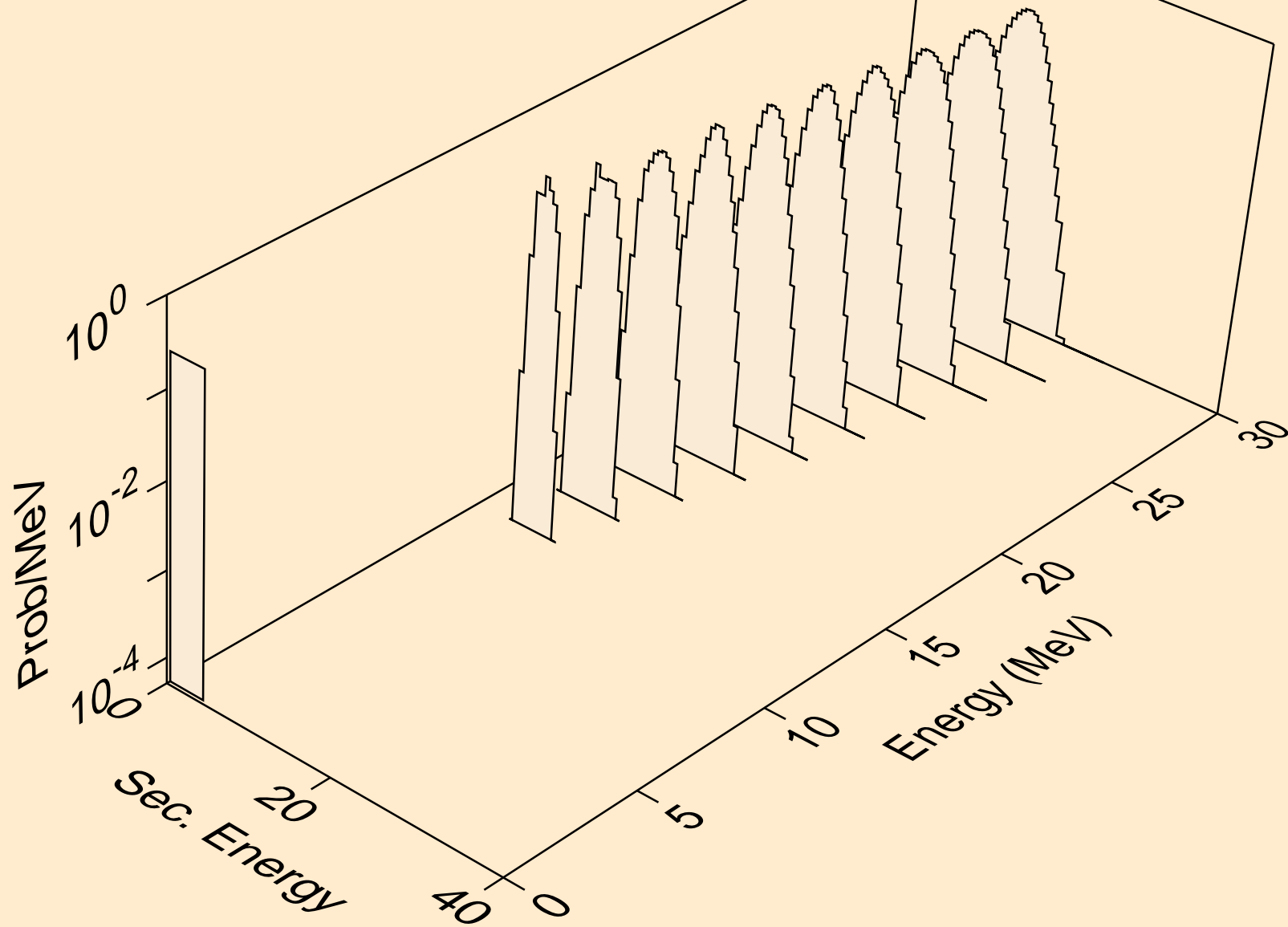

ND126 DEUTERON ACER TENDL-2021 LIBRARY; T=0.K
alphas from (d,npa)

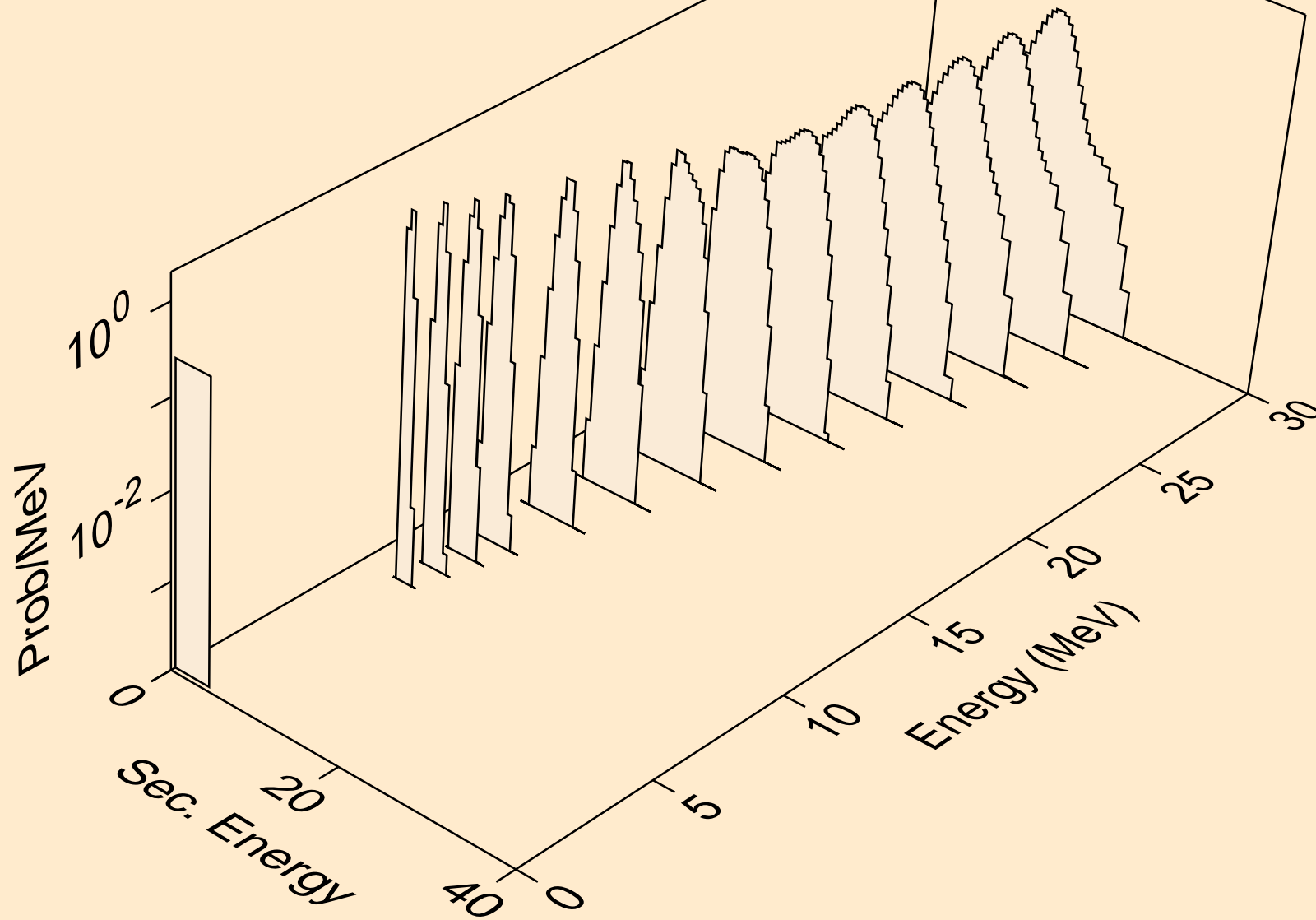

ND126 DEUTERON ACER TENDL-2021 LIBRARY; T=0.K
alphas from (d,a)

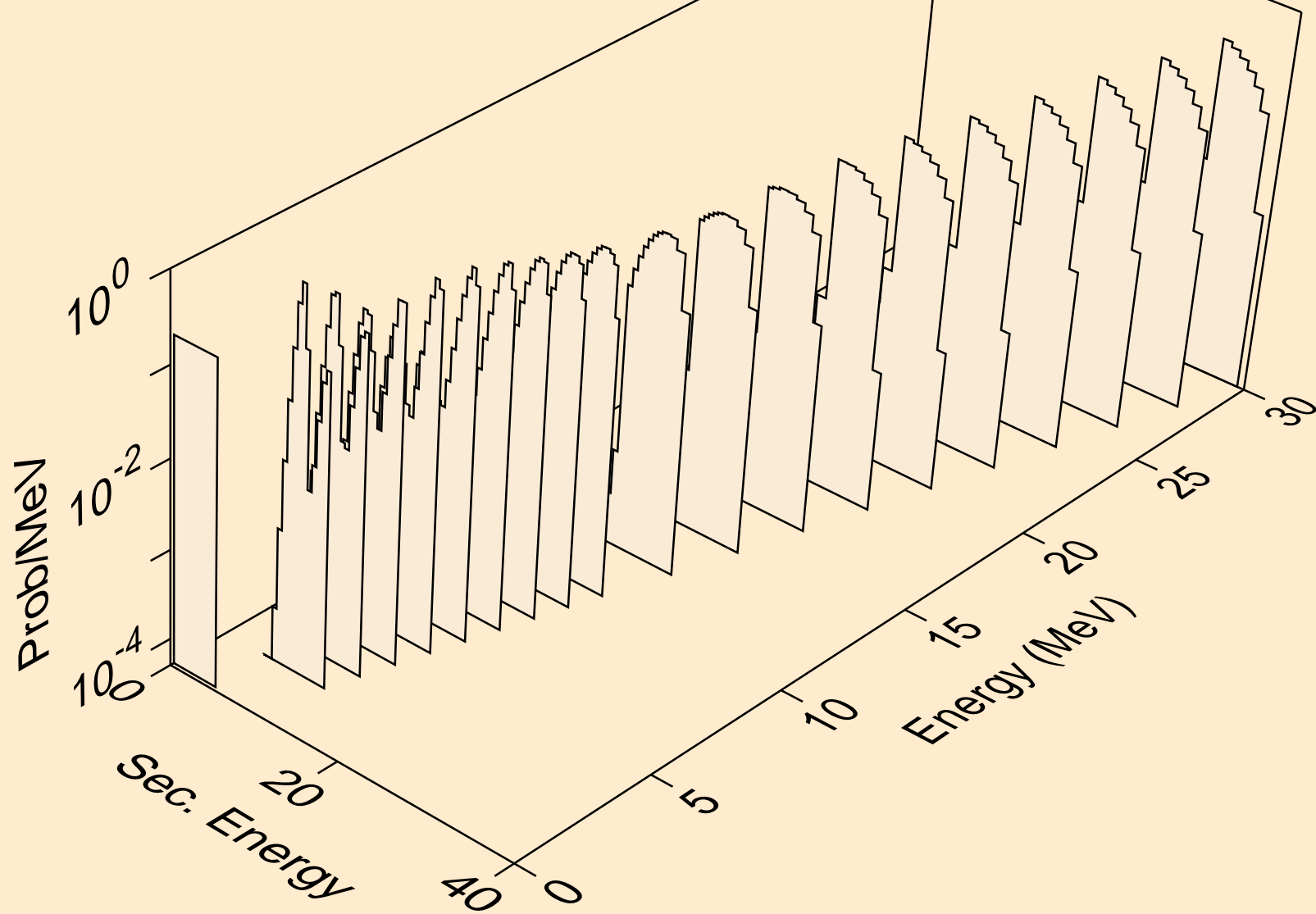

ND126 DEUTERON ACER TENDL-2021 LIBRARY; T=0.K
alphas from (d,2a)

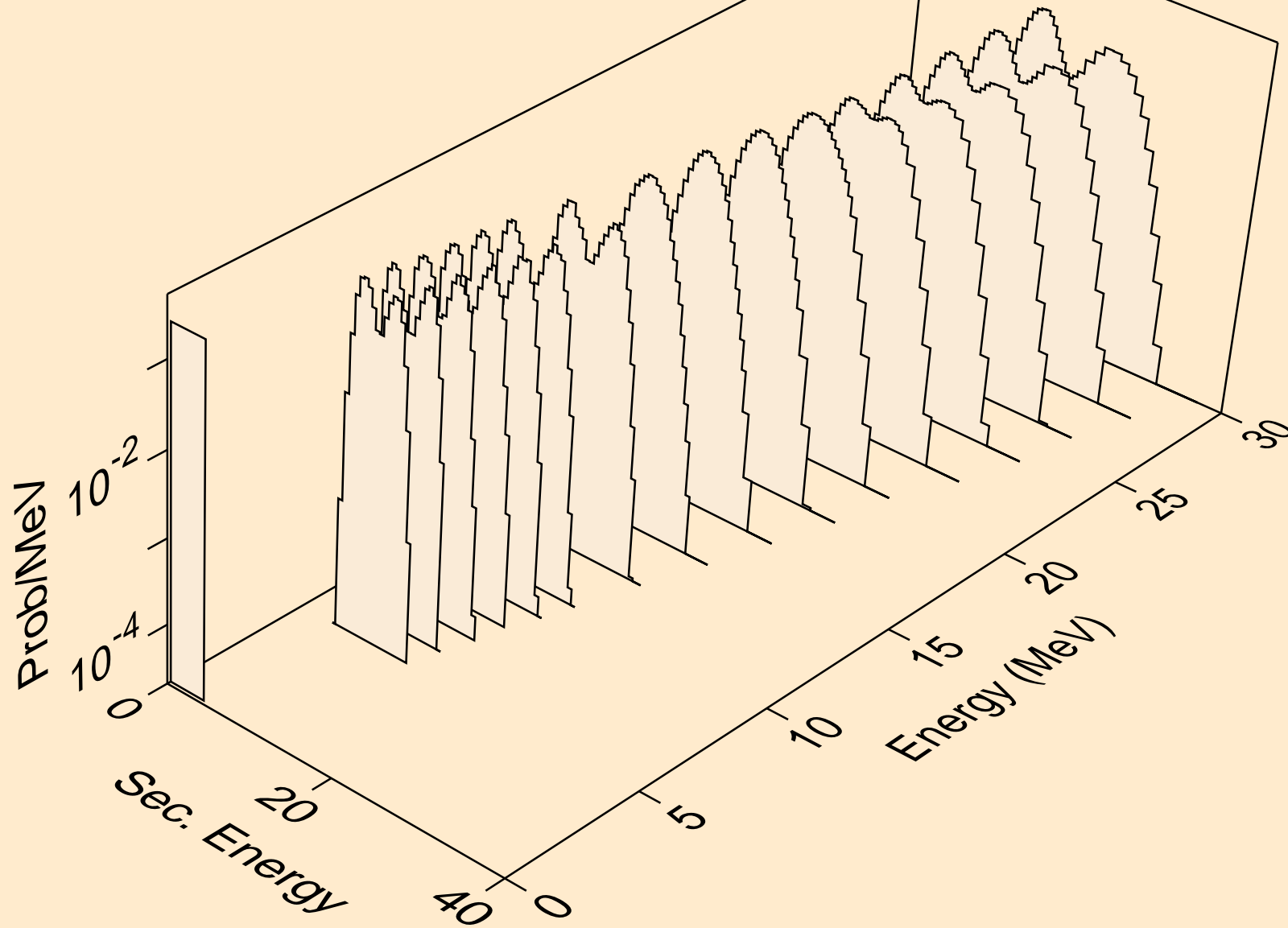

ND126 DEUTERON ACER TENDL-2021 LIBRARY; T=0.K
alphas from (d,pa)

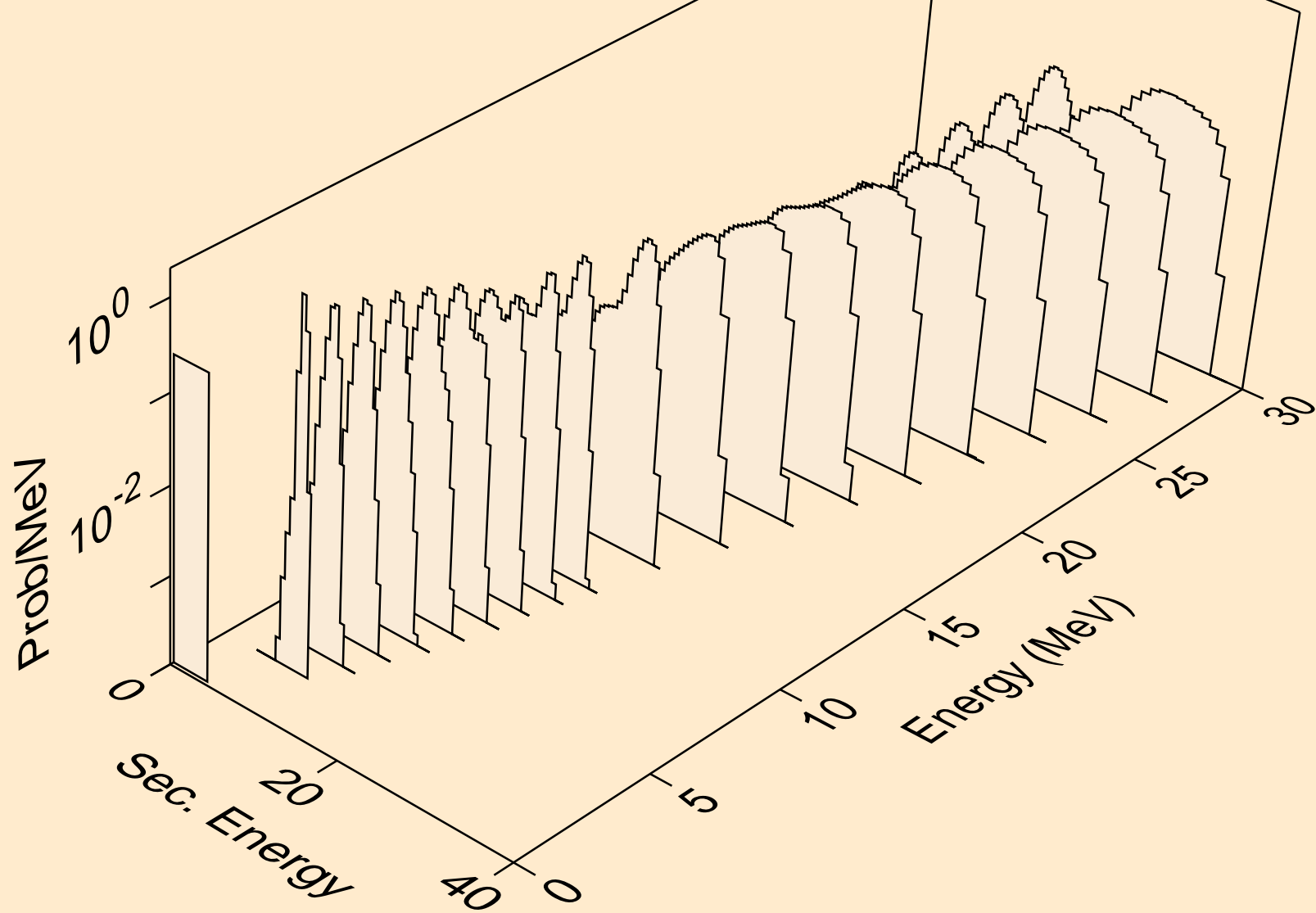

ND126 DEUTERON ACER TENDL-2021 LIBRARY; T=0.K
alphas from (d,d2a)

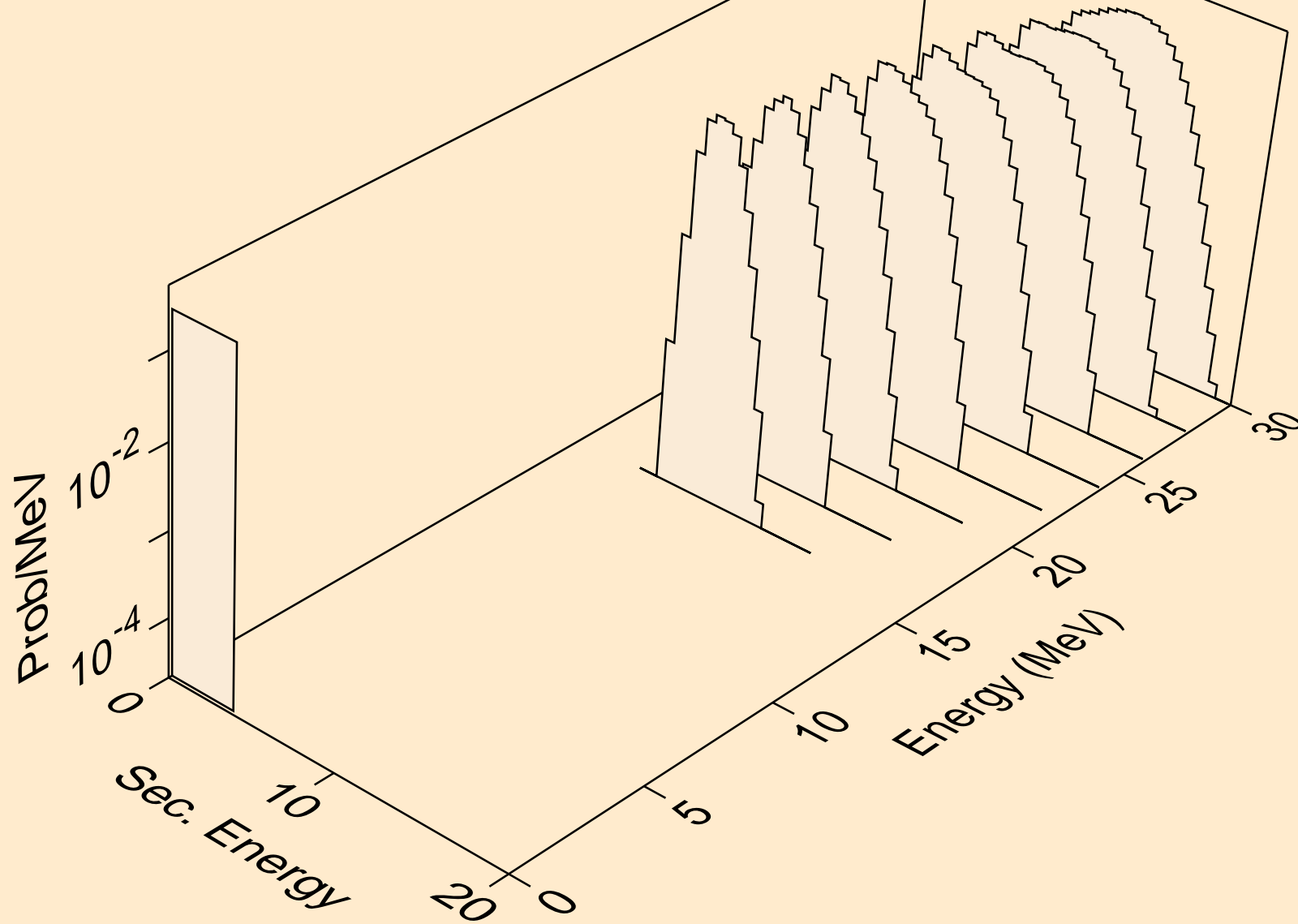

ND126 DEUTERON ACER TENDL-2021 LIBRARY; T=0.K
alphas from (d,da)

