

ND128 DEUTERON ACER TENDL-2021 LIBRARY; T=0.K

Principal cross sections

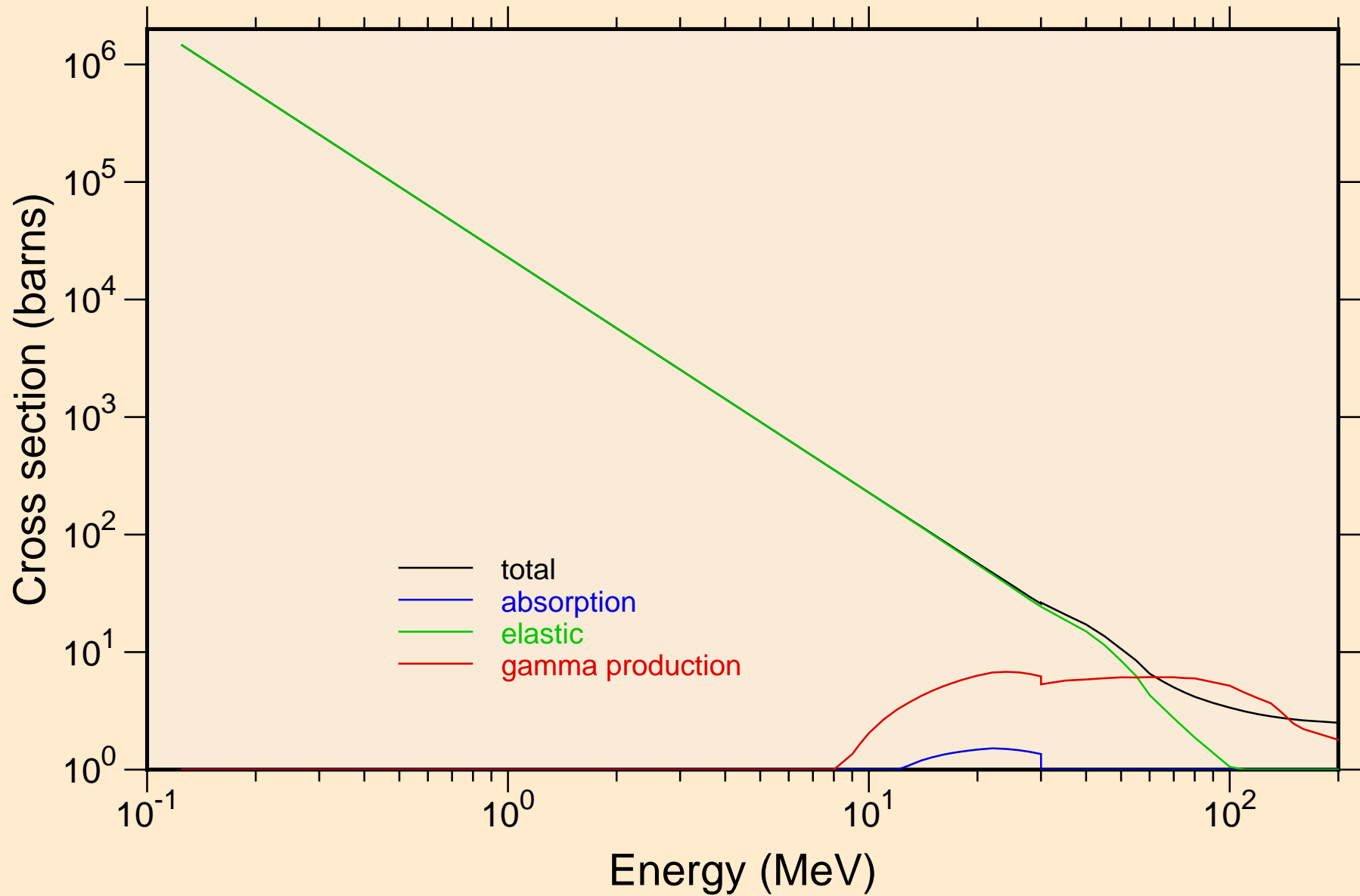

ND128 DEUTERON ACER TENDL-2021 LIBRARY; T=0.K
Heating

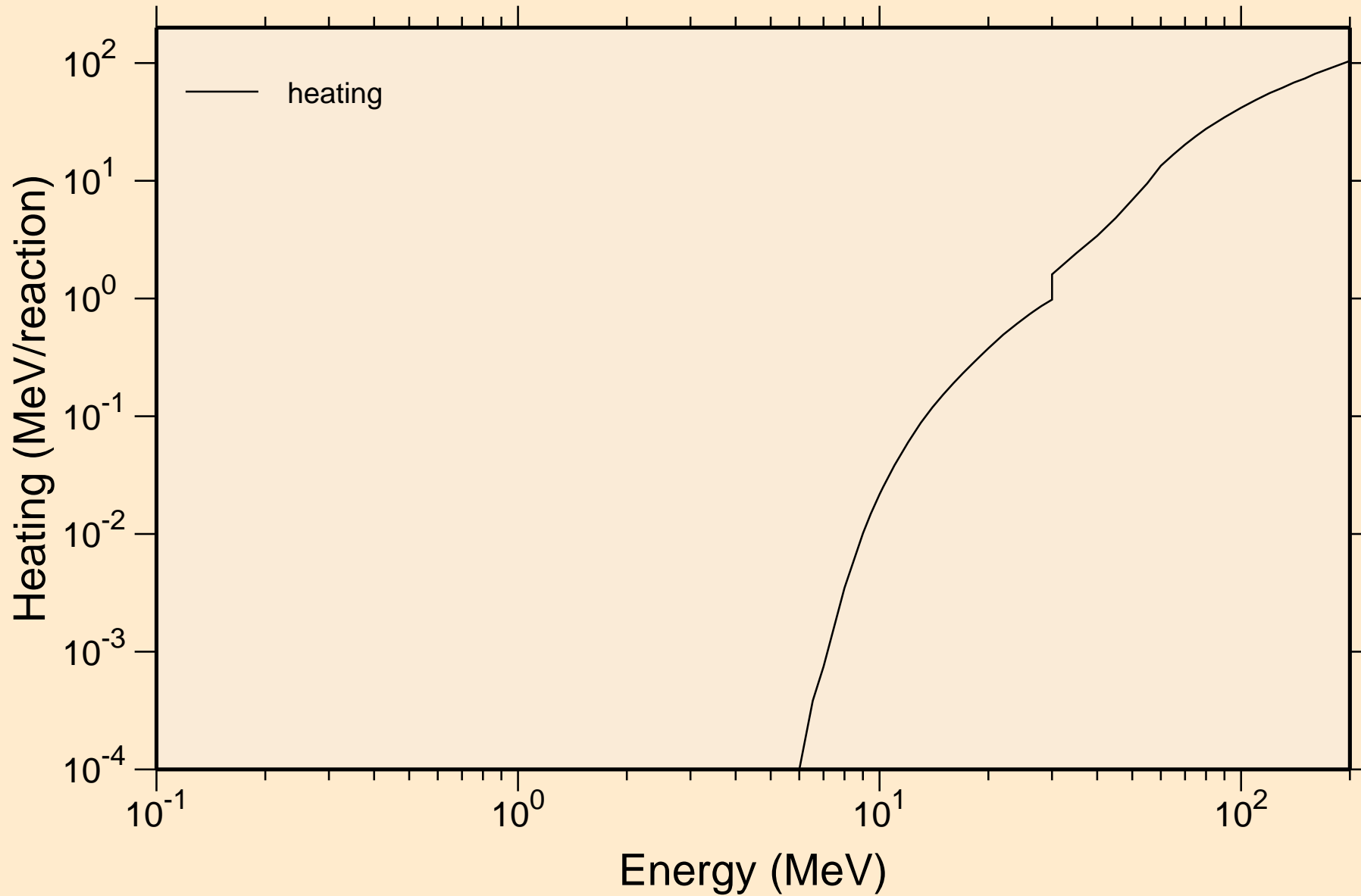

ND128 DEUTERON ACER TENDL-2021 LIBRARY; T=0.K

Principal cross sections

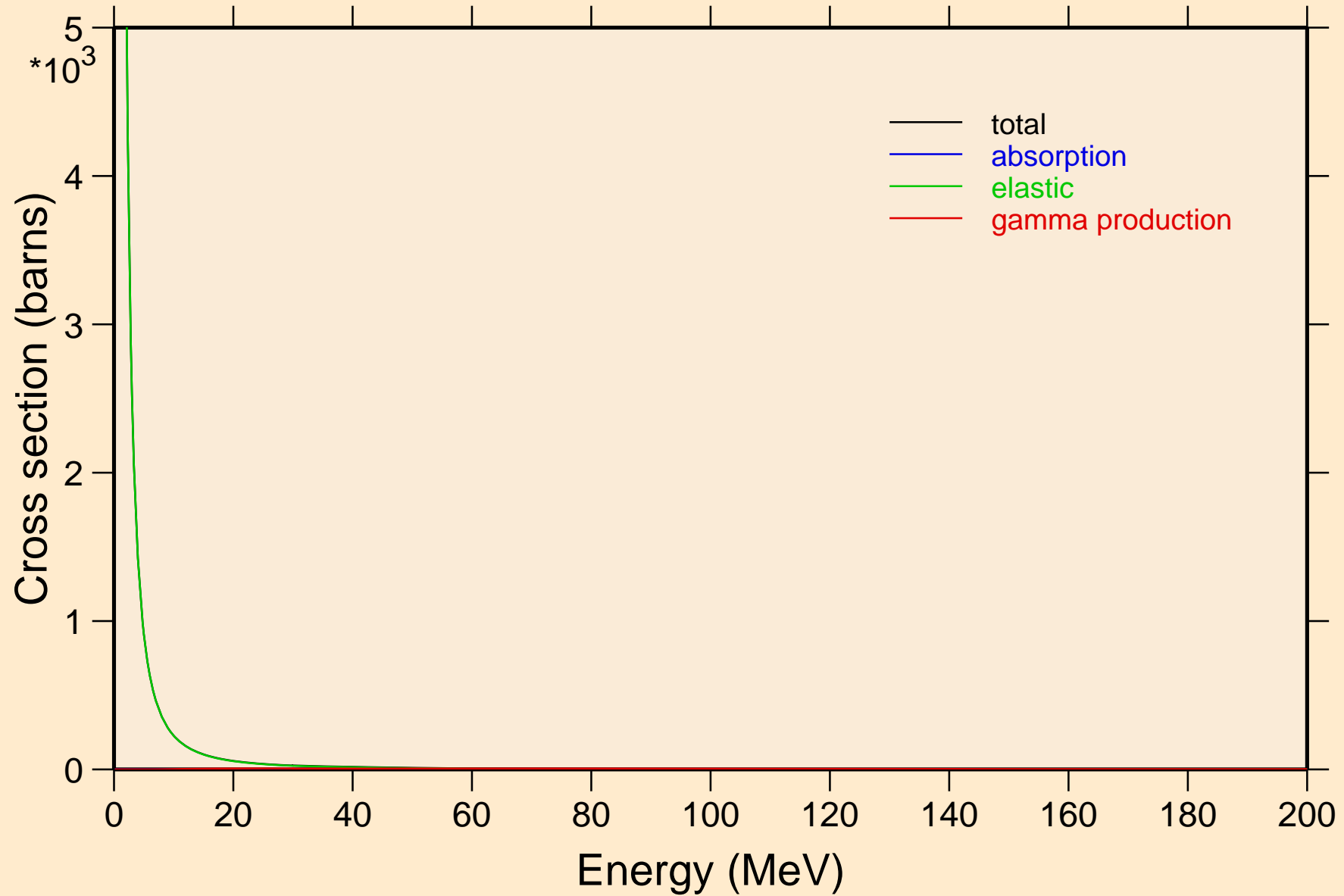

ND128 DEUTERON ACER TENDL-2021 LIBRARY; T=0.K

Heating

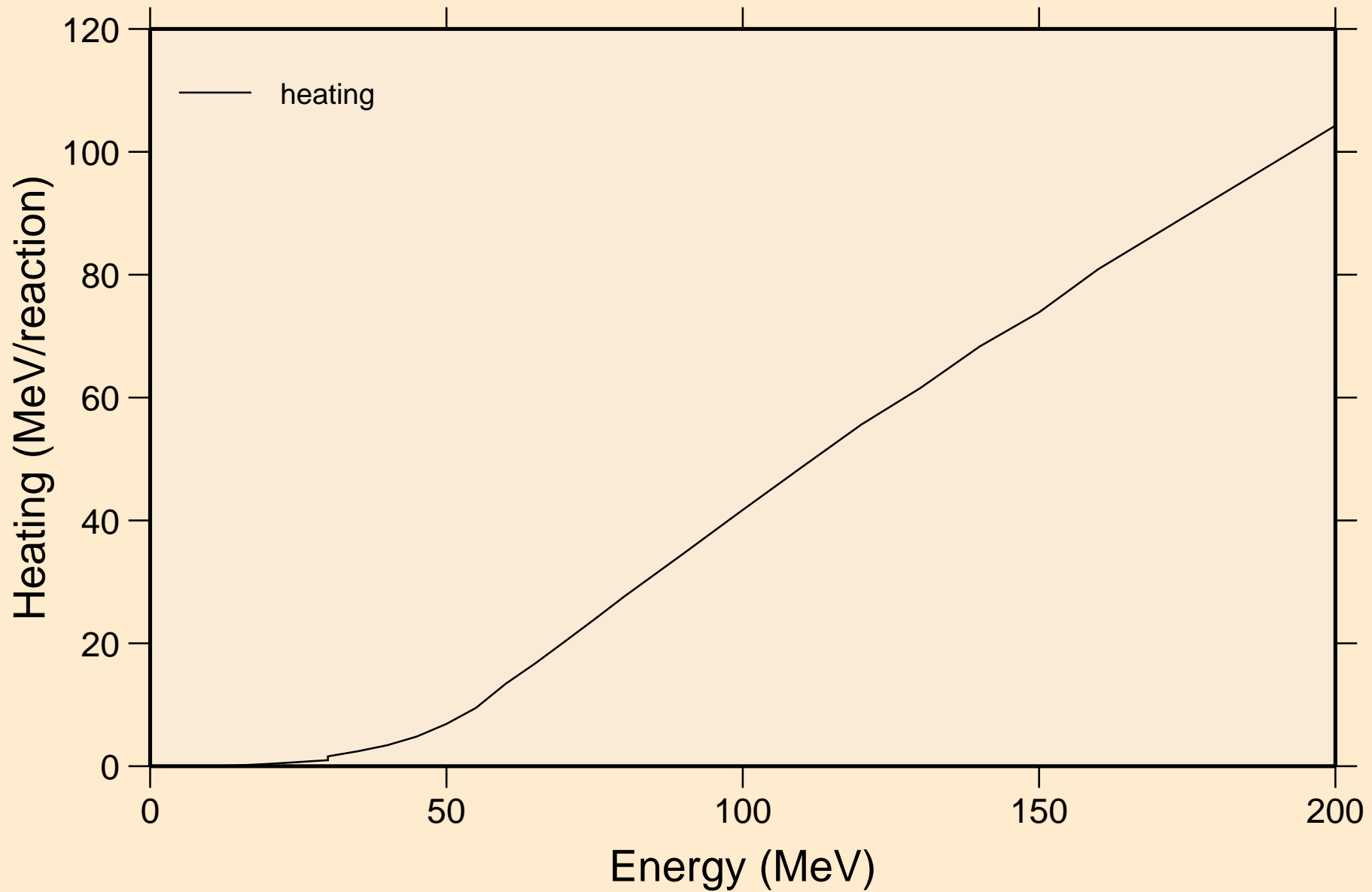

ND128 DEUTERON ACER TENDL-2021 LIBRARY; T=0.K

Threshold reactions

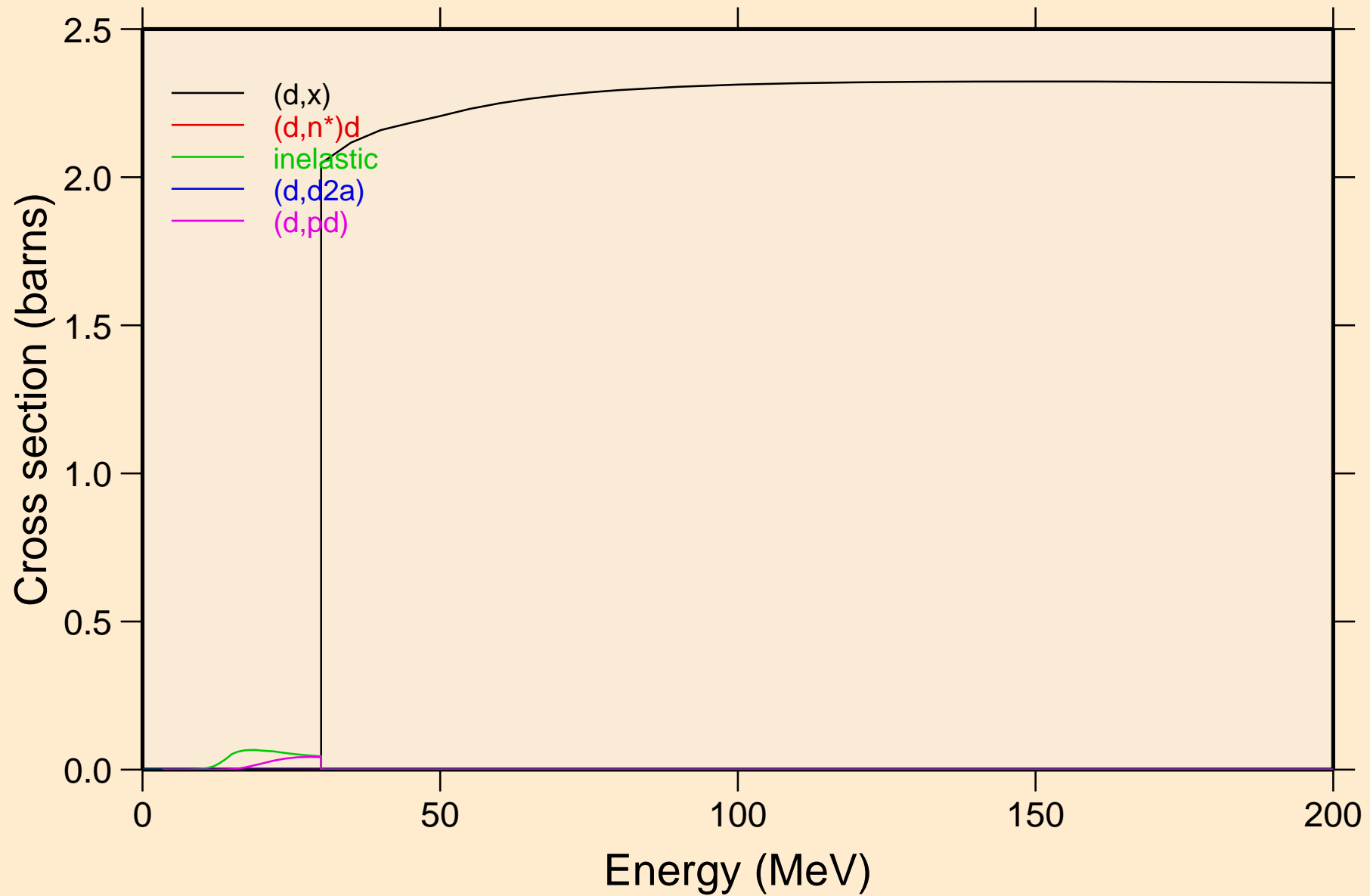

ND128 DEUTERON ACER TENDL-2021 LIBRARY; T=0.K

Threshold reactions

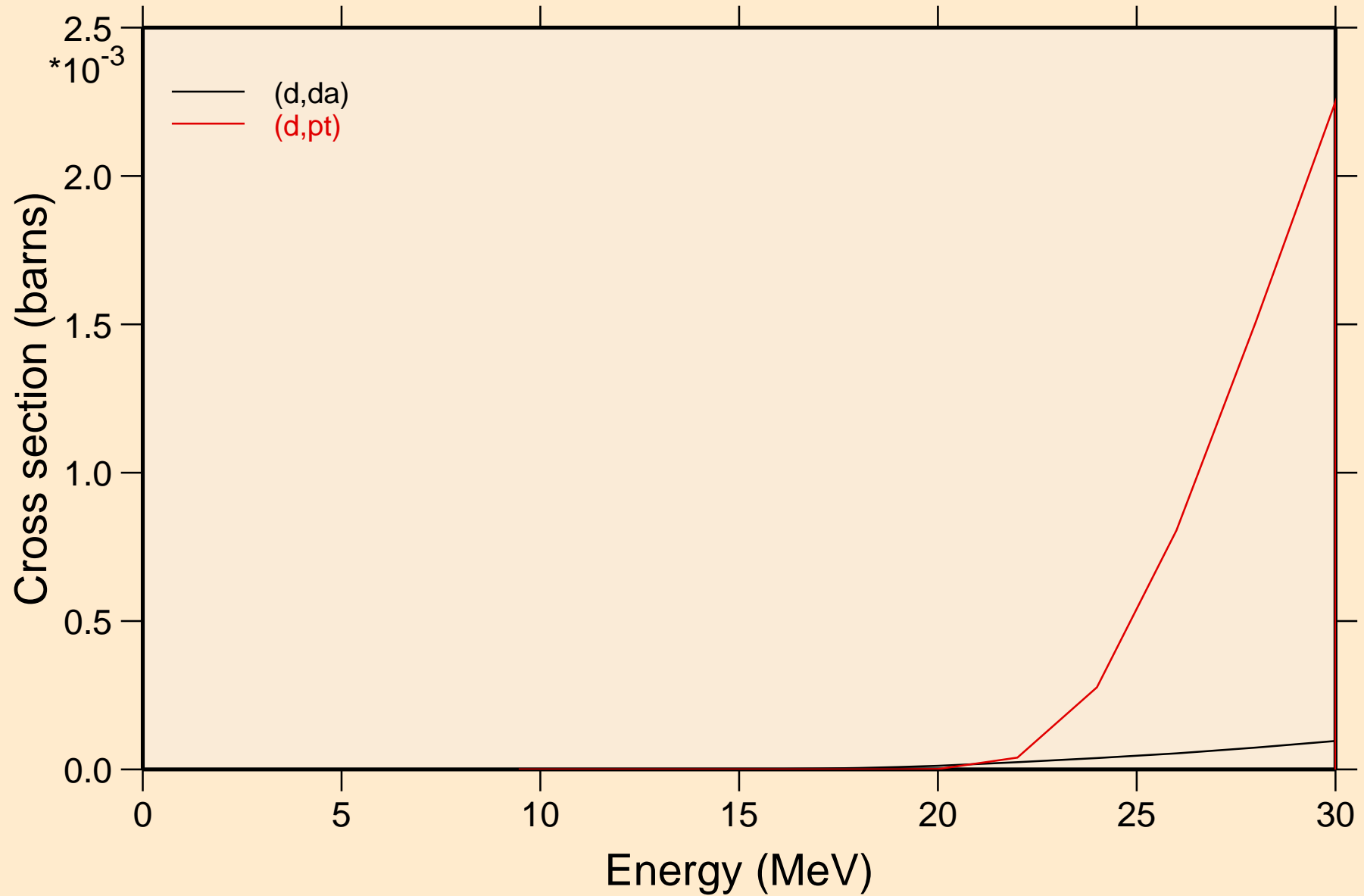

ND128 DEUTERON ACER TENDL-2021 LIBRARY; T=0.K
Threshold reactions

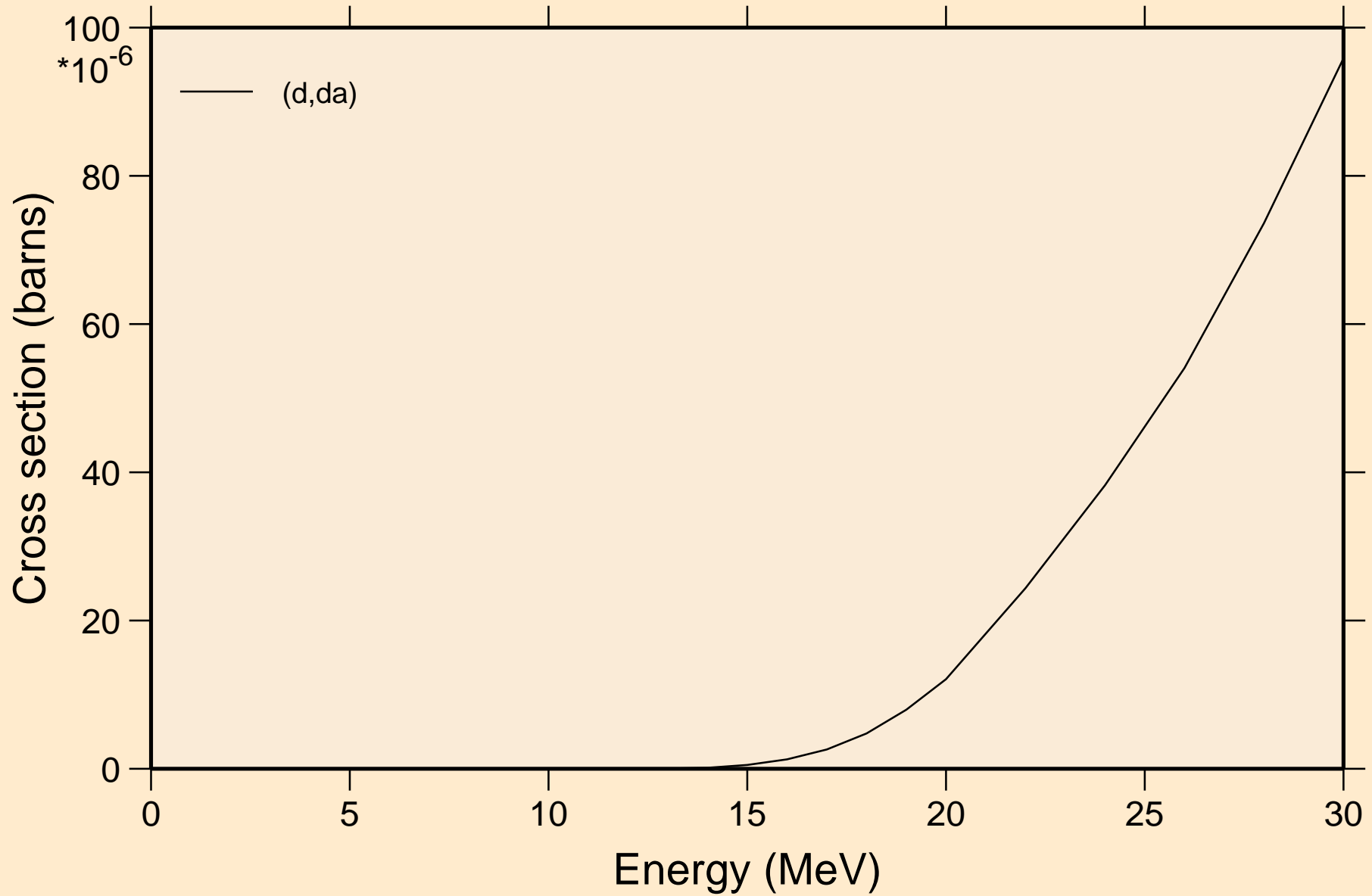

ND128 DEUTERON ACER TENDL-2021 LIBRARY; T=0.K
angular distribution for elastic

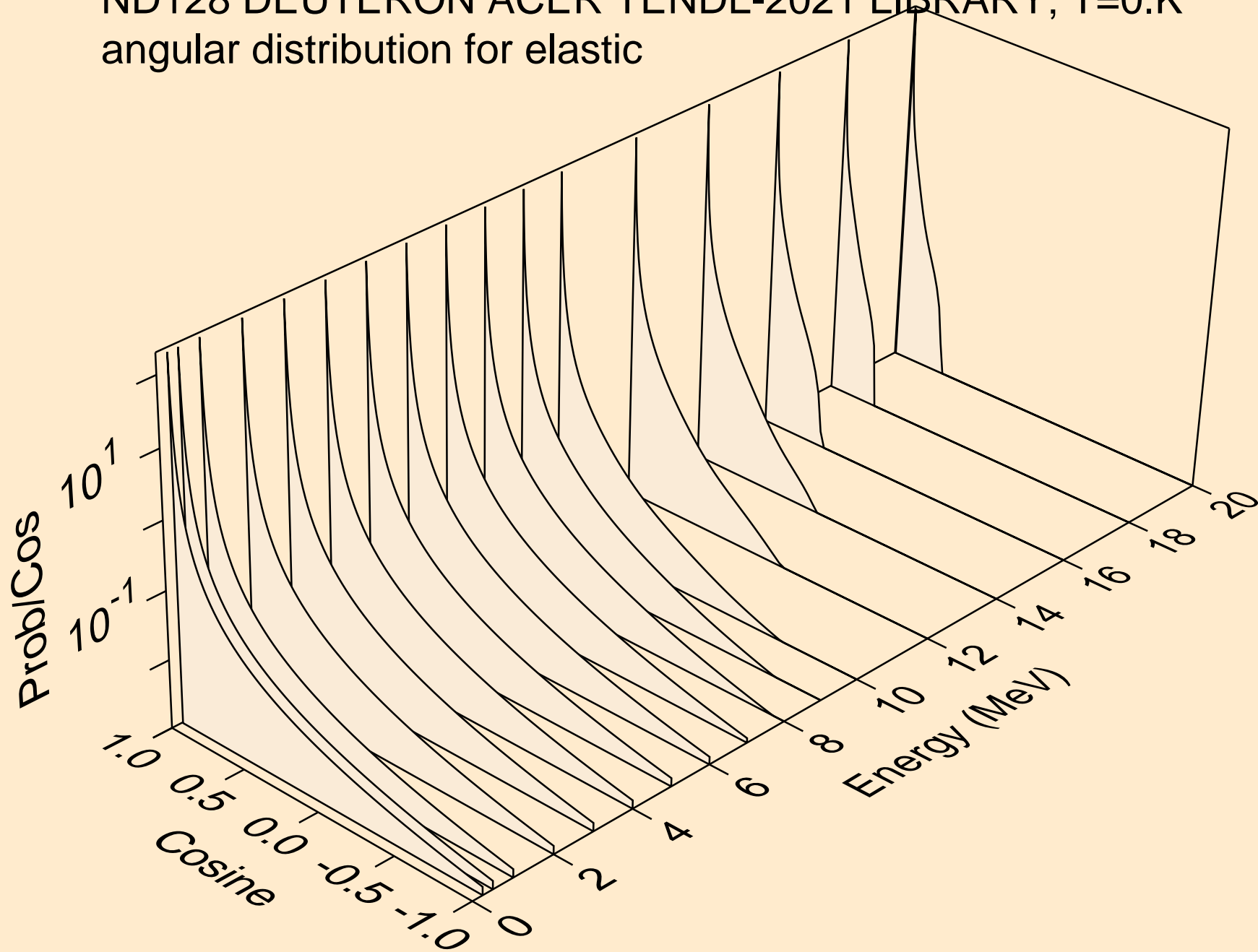

ND128 DEUTERON ACER TENDL-2021 LIBRARY; T=0.K
angular distribution for elastic

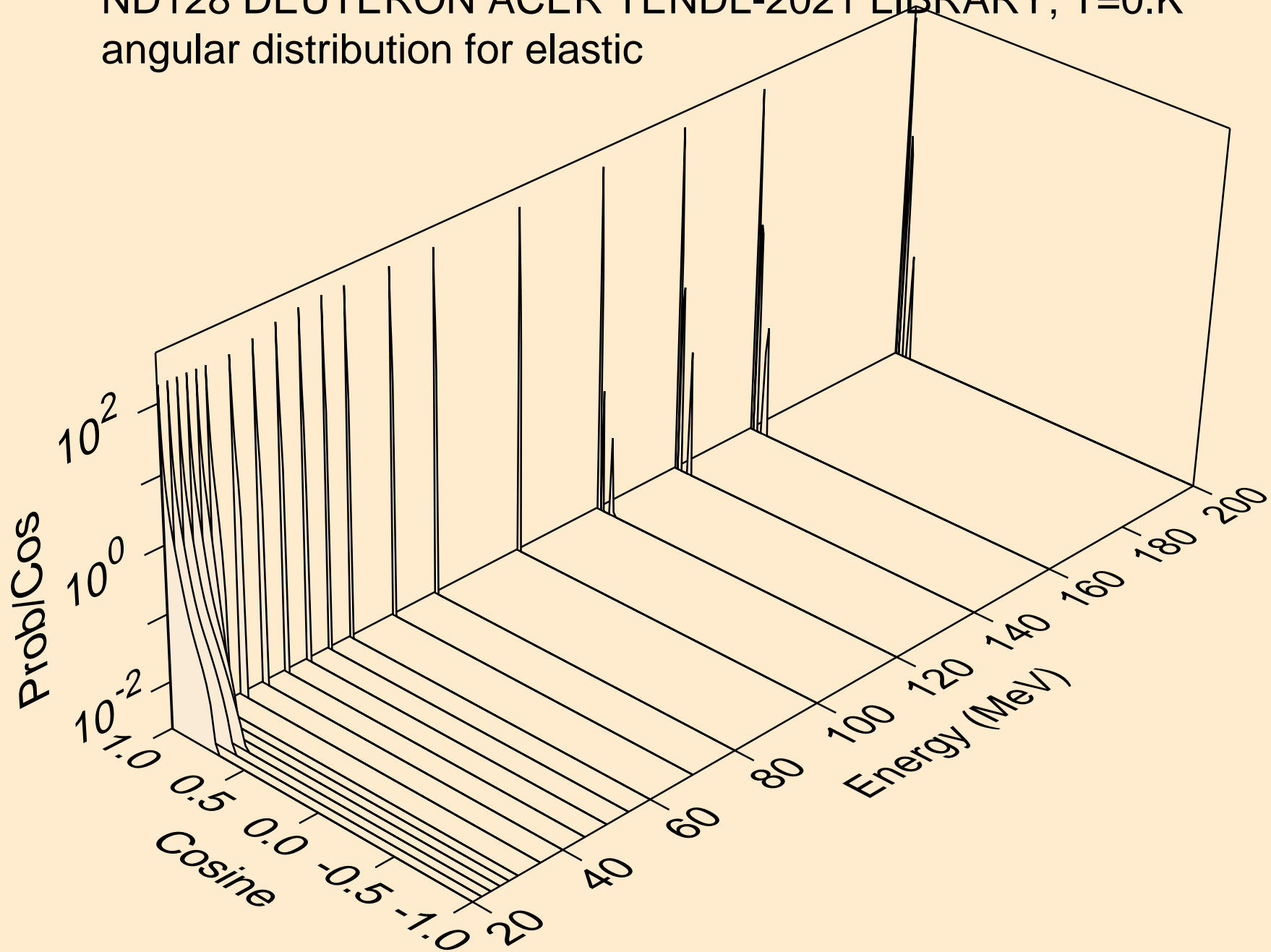

ND128 DEUTERON ACER TENDL-2021 LIBRARY; T=0.K
Deuteron emission for (d,x)

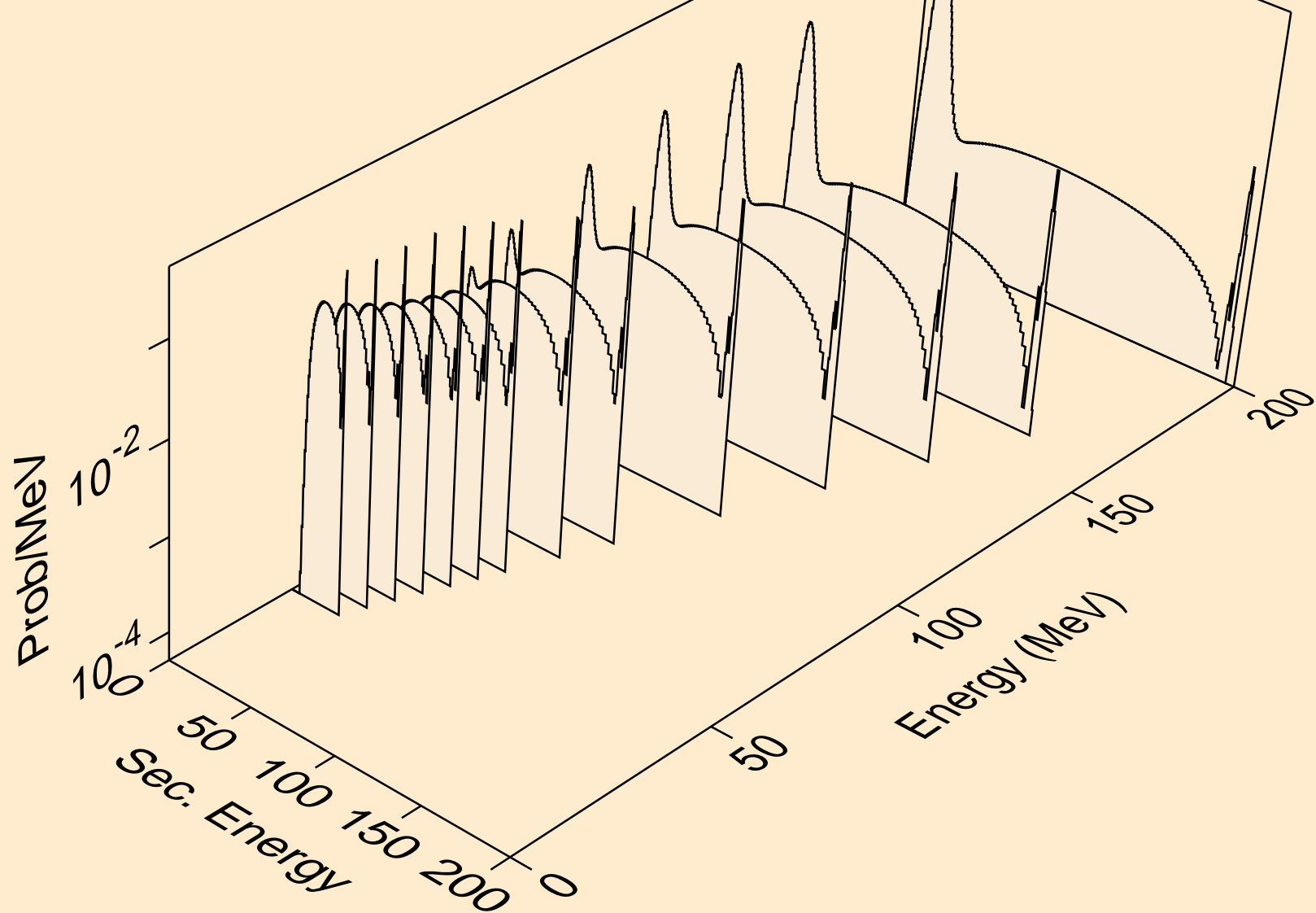

ND128 DEUTERON ACER TENDL-2021 LIBRARY; T=0.K
Deuteron emission for (d,n*)d

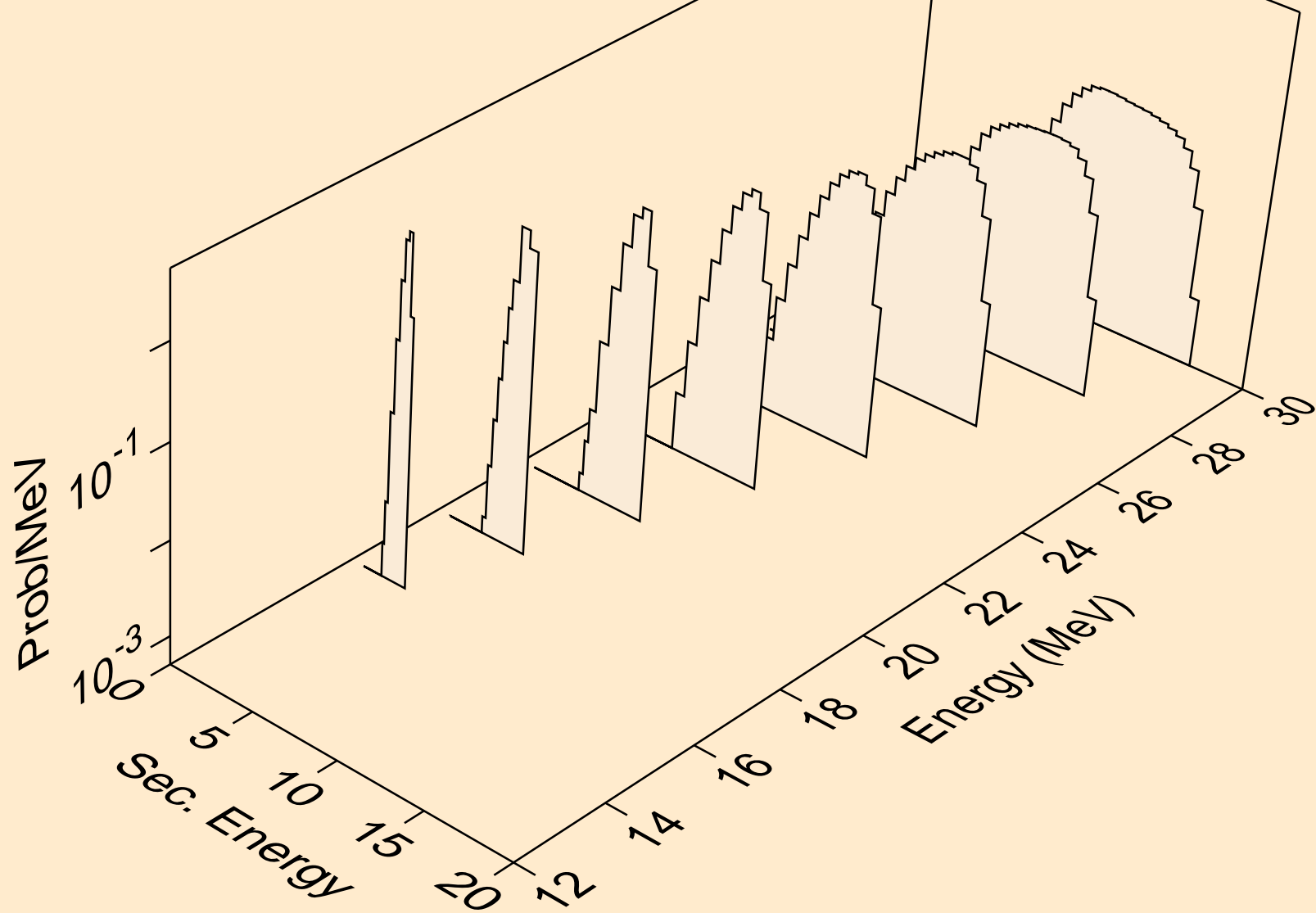

ND128 DEUTERON ACER TENDL-2021 LIBRARY; T=0.K
Deuteron emission for inelastic

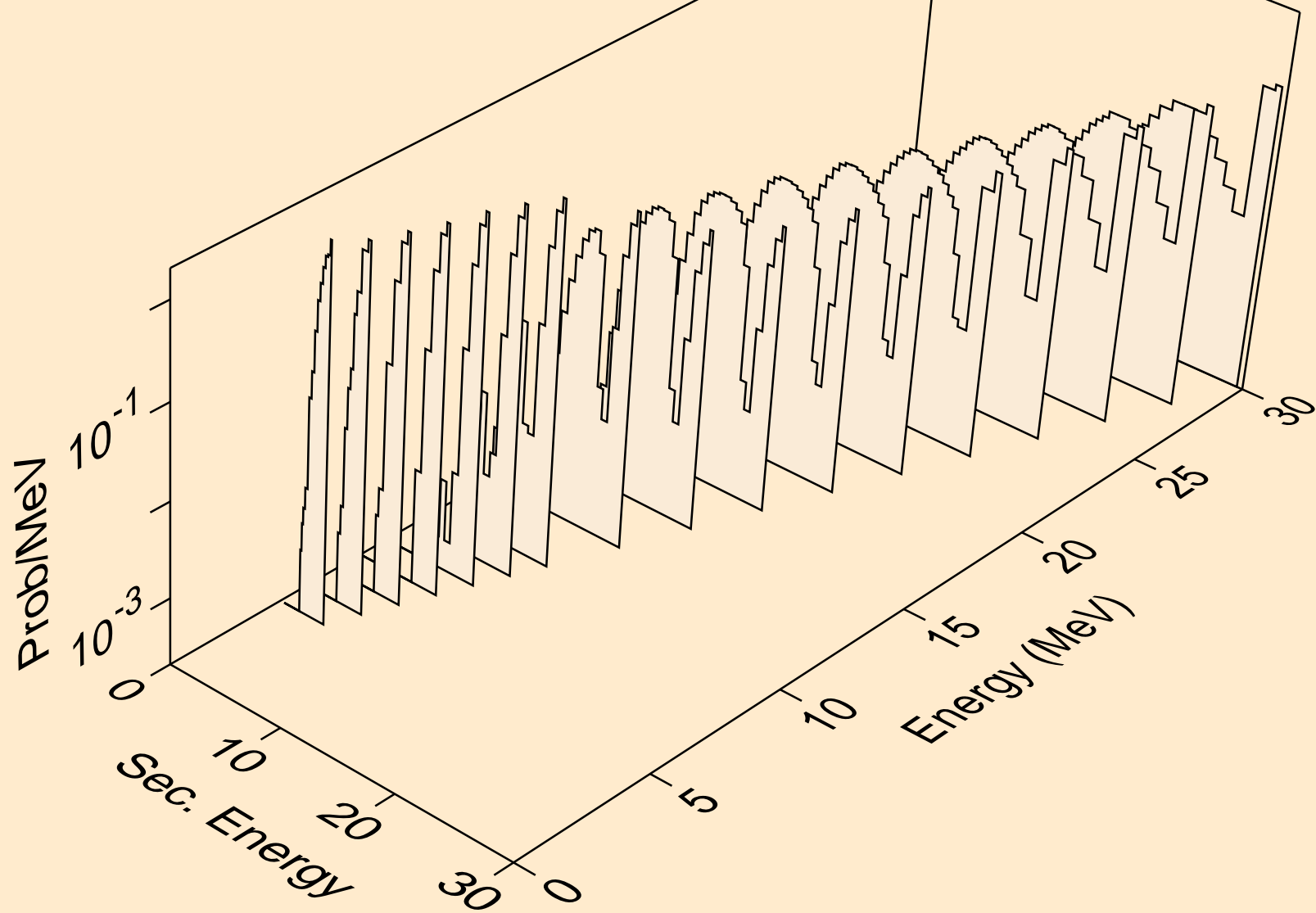

ND128 DEUTERON ACER TENDL-2021 LIBRARY; T=0.K
Deuteron emission for (d,d2a)

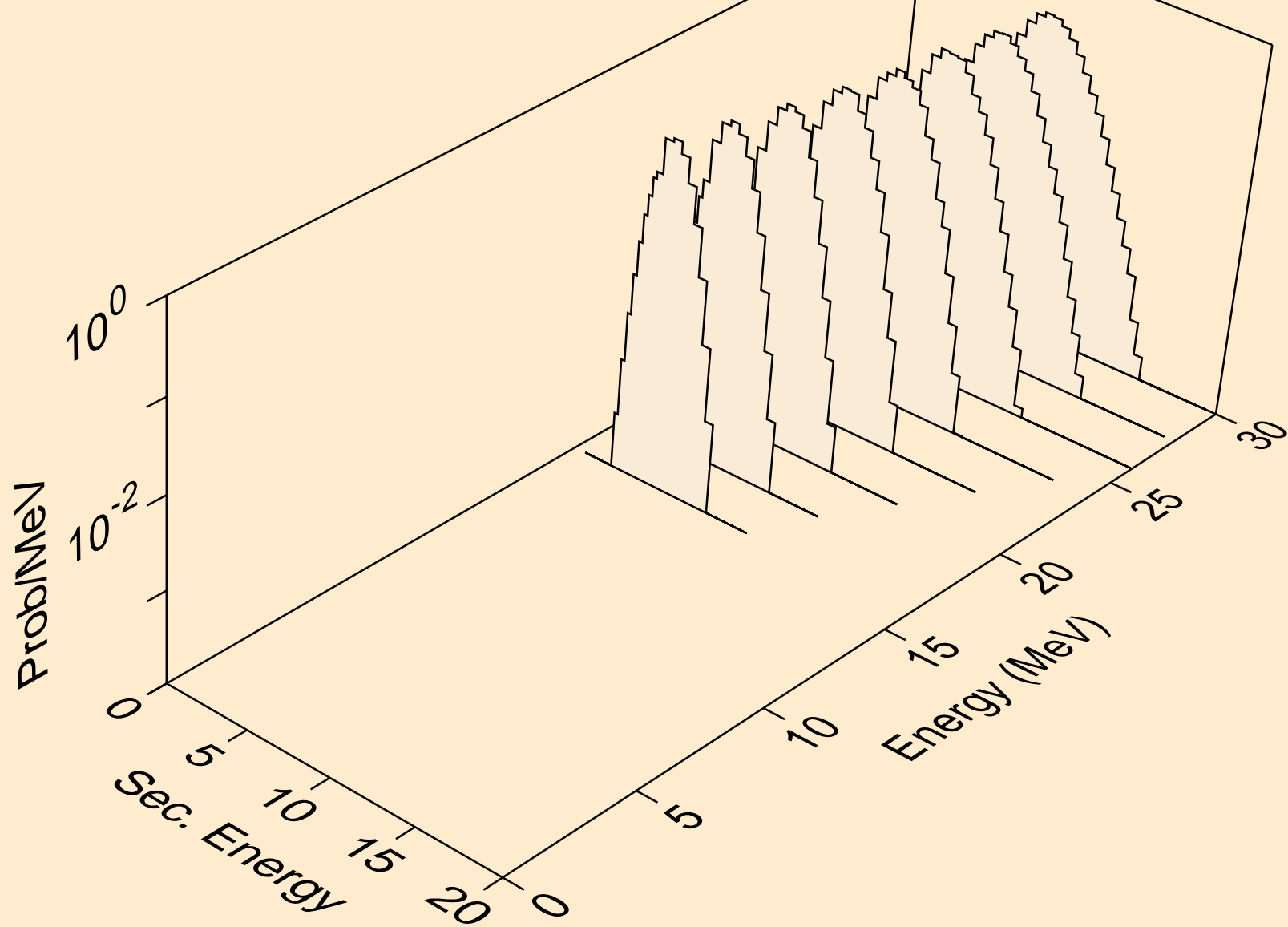

ND128 DEUTERON ACER TENDL-2021 LIBRARY; T=0.K
Deuteron emission for (d,pd)

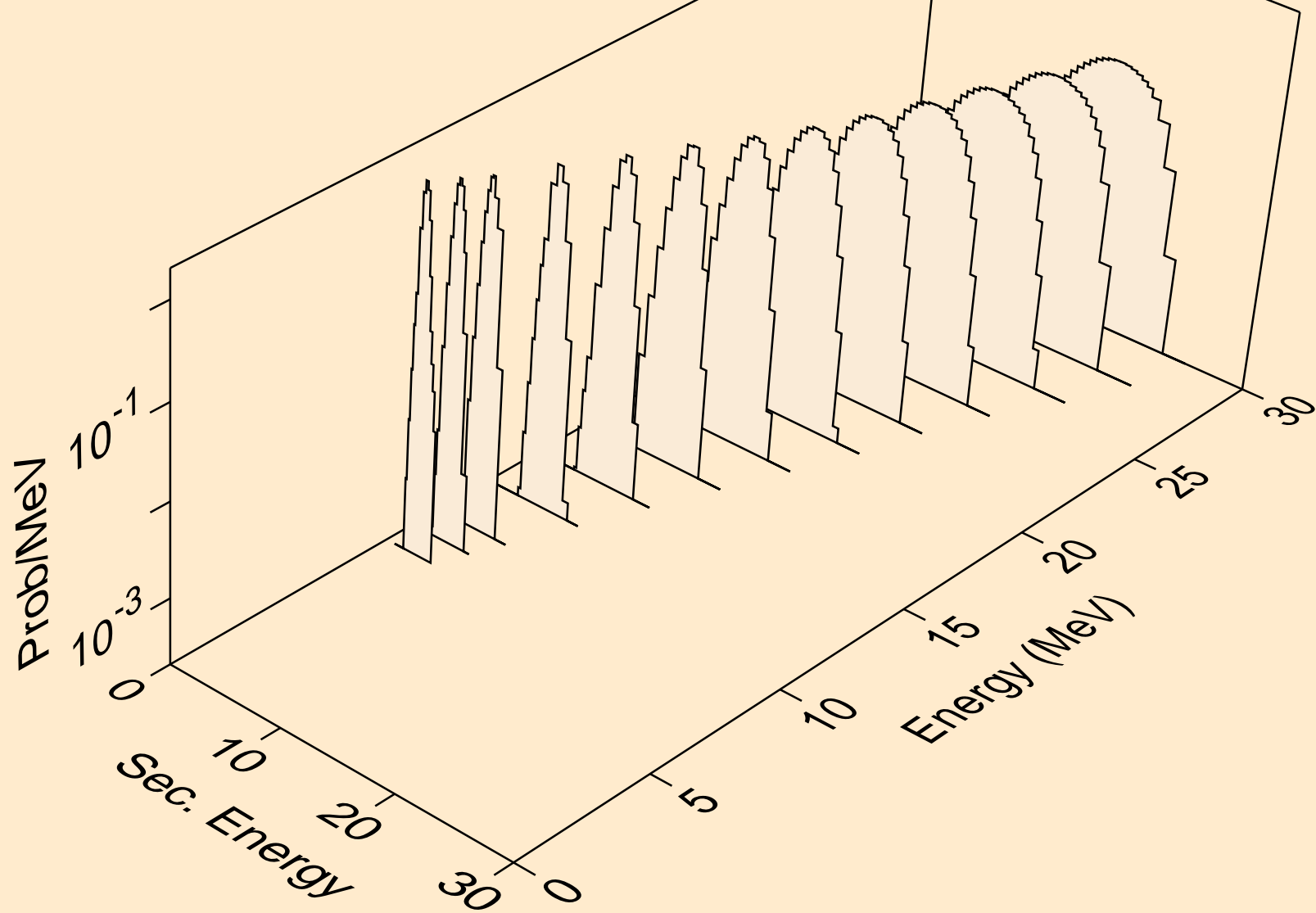

ND128 DEUTERON ACER TENDL-2021 LIBRARY; T=0.K
Deuteron emission for (d,da)

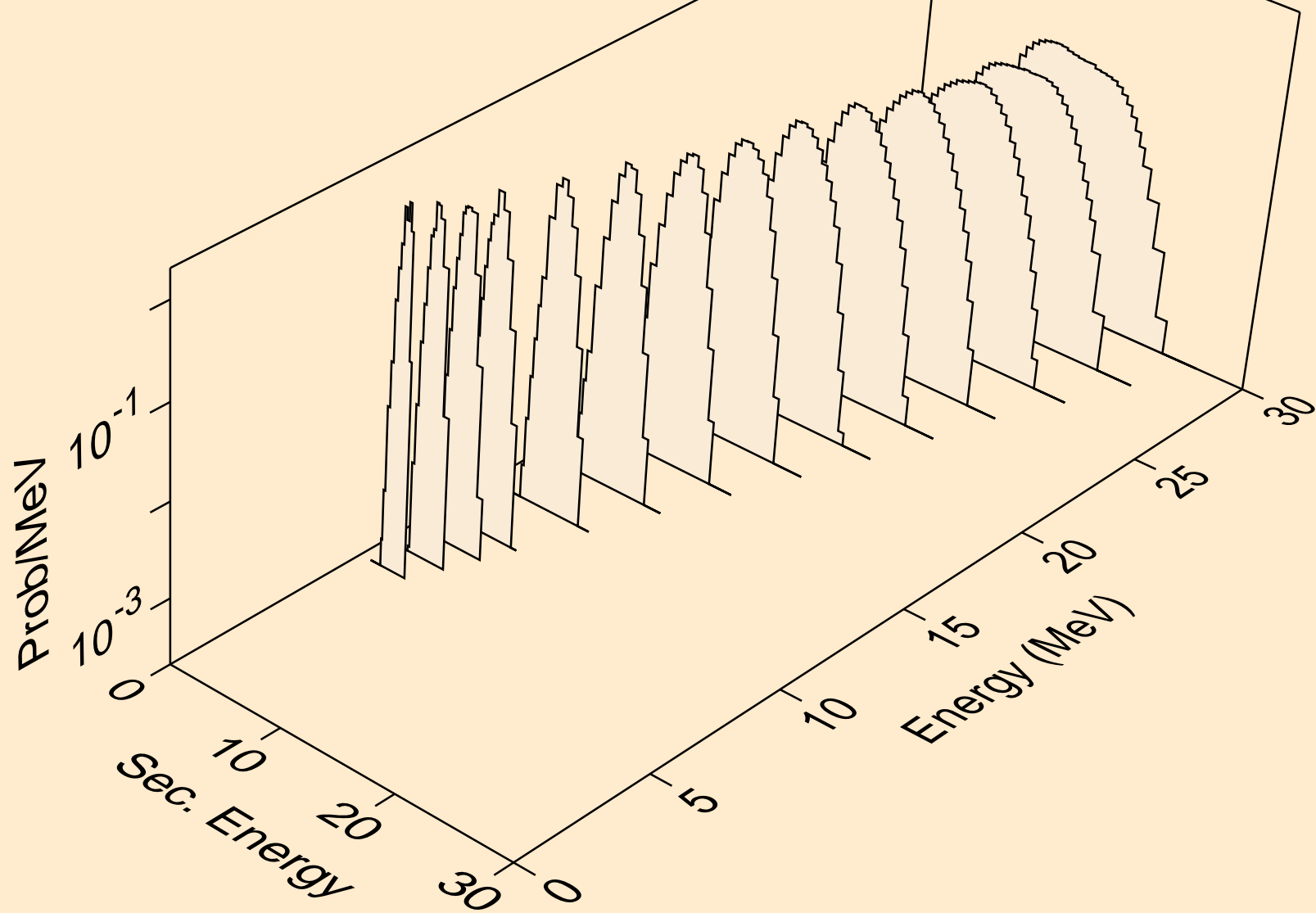

ND128 DEUTERON ACER TENDL-2021 LIBRARY; T=0.K
Photon emission for (z,n)

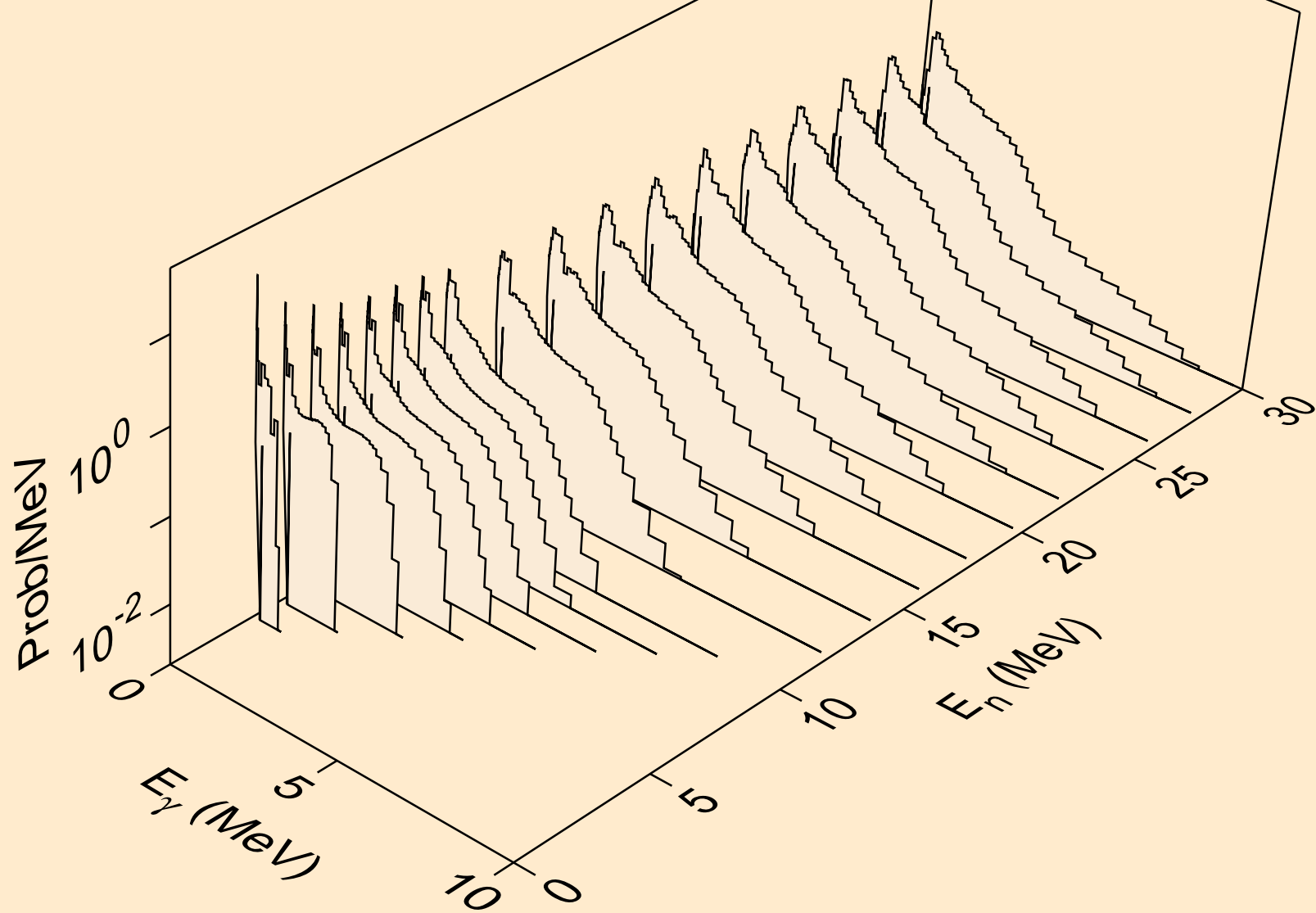

ND128 DEUTERON ACER TENDL-2021 LIBRARY; T=0.K
Photon emission for (n,x)

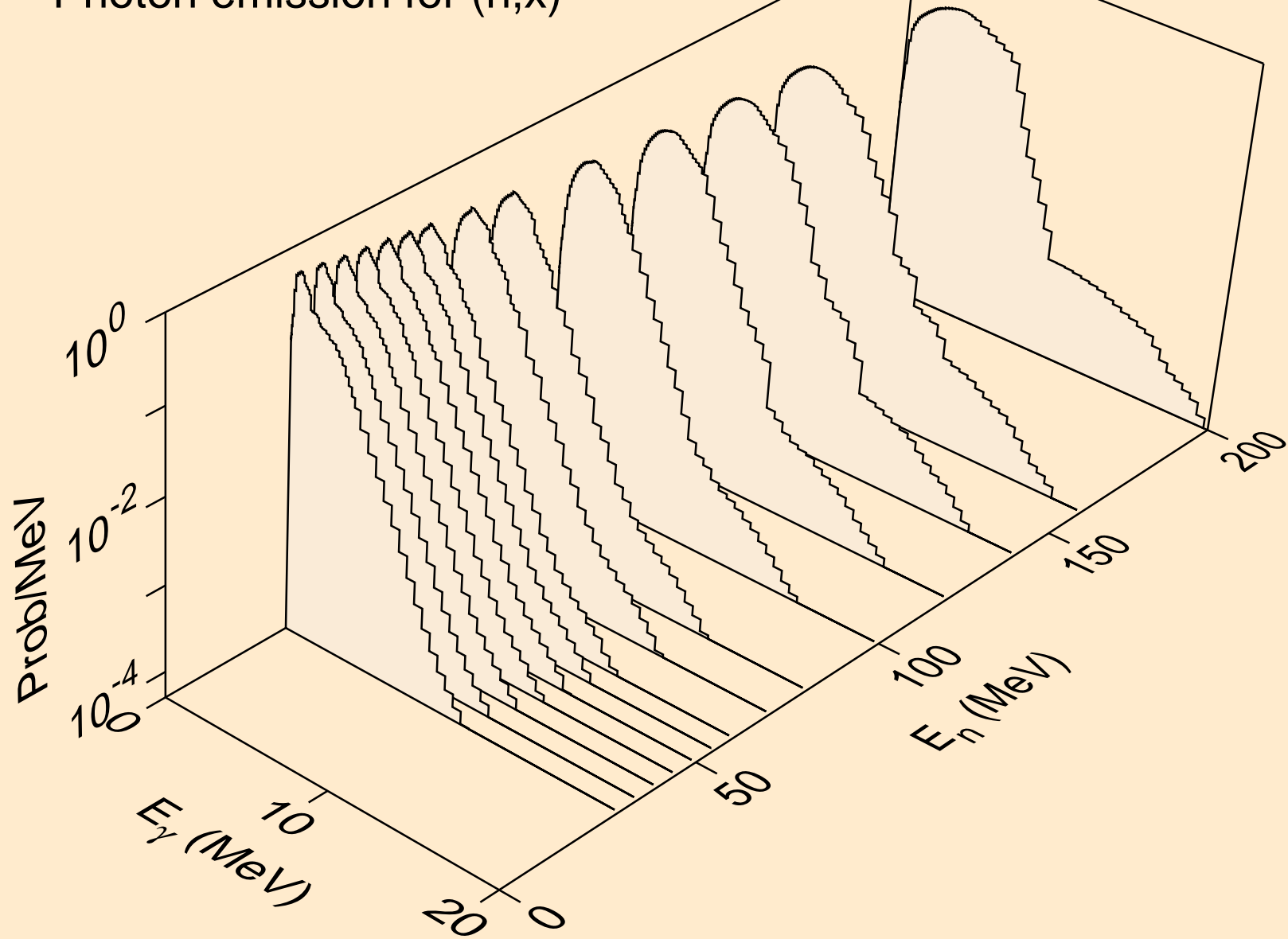

ND128 DEUTERON ACER TENDL-2021 LIBRARY; T=0.K
Photon emission for (n,2n)

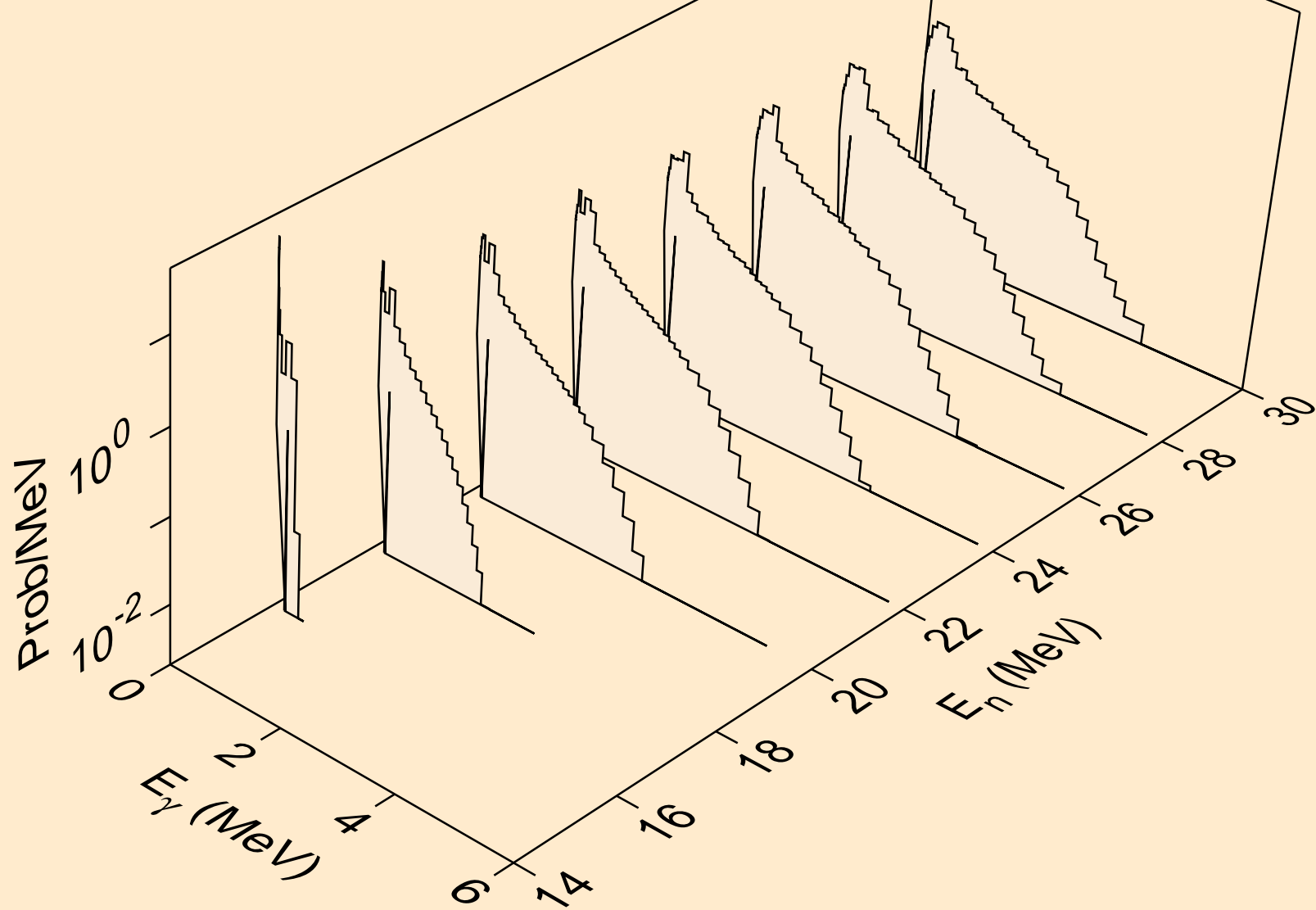

ND128 DEUTERON ACER TENDL-2021 LIBRARY; T=0.K
Photon emission for (n,3n)

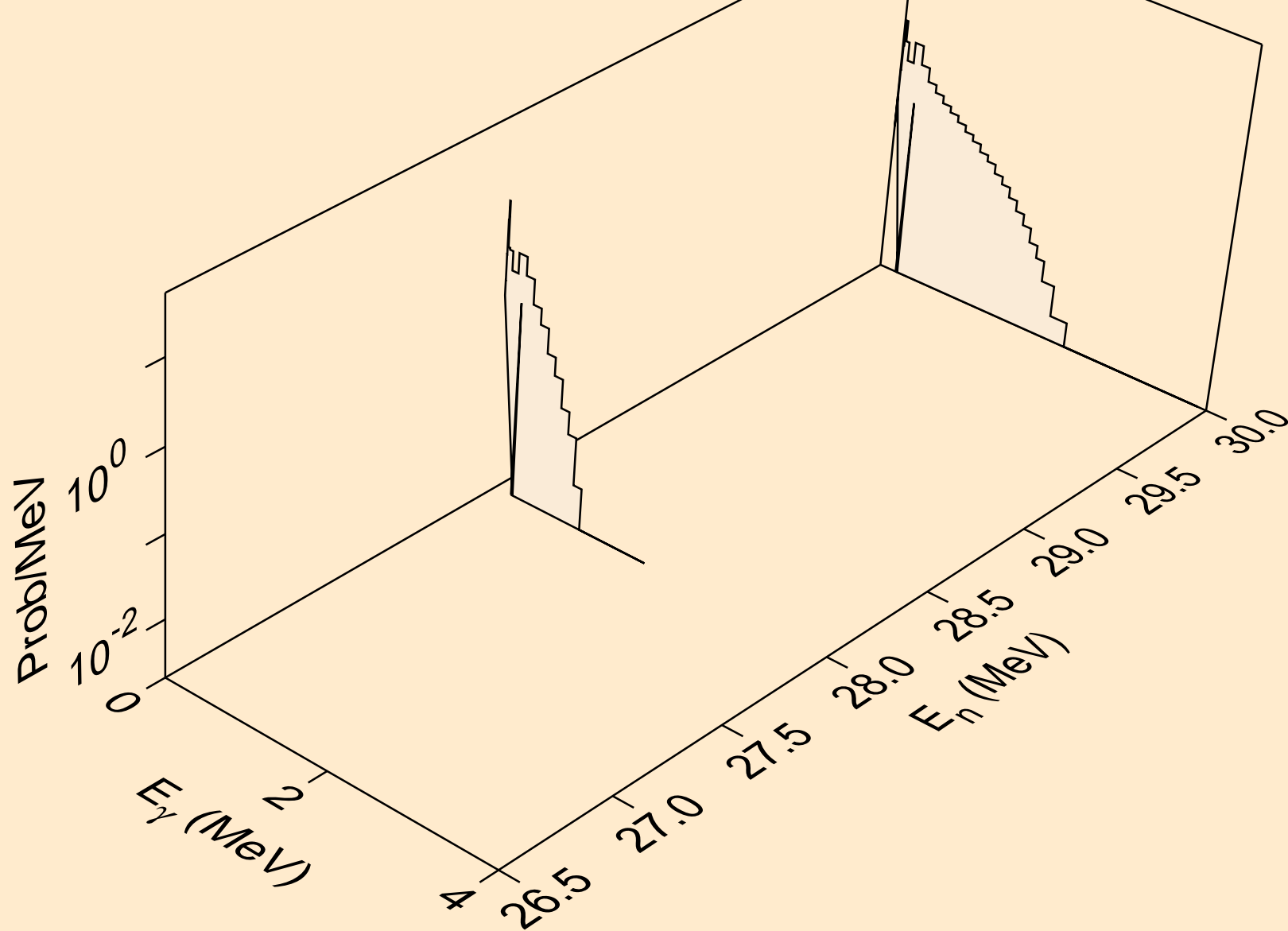

ND128 DEUTERON ACER TENDL-2021 LIBRARY; T=0.K
Photon emission for (n,n*)a

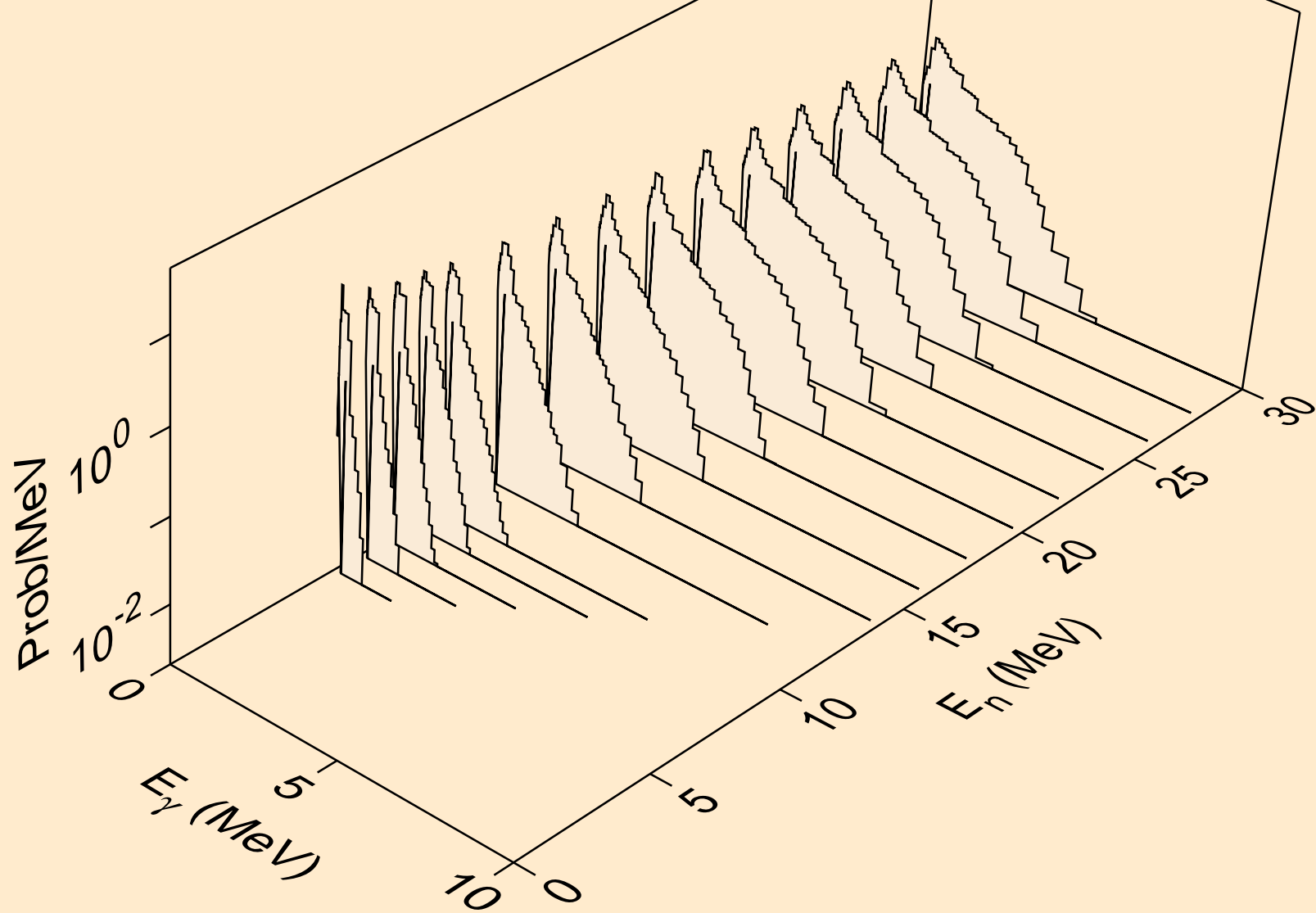

ND128 DEUTERON ACER TENDL-2021 LIBRARY; T=0.K
Photon emission for (n,2n) α

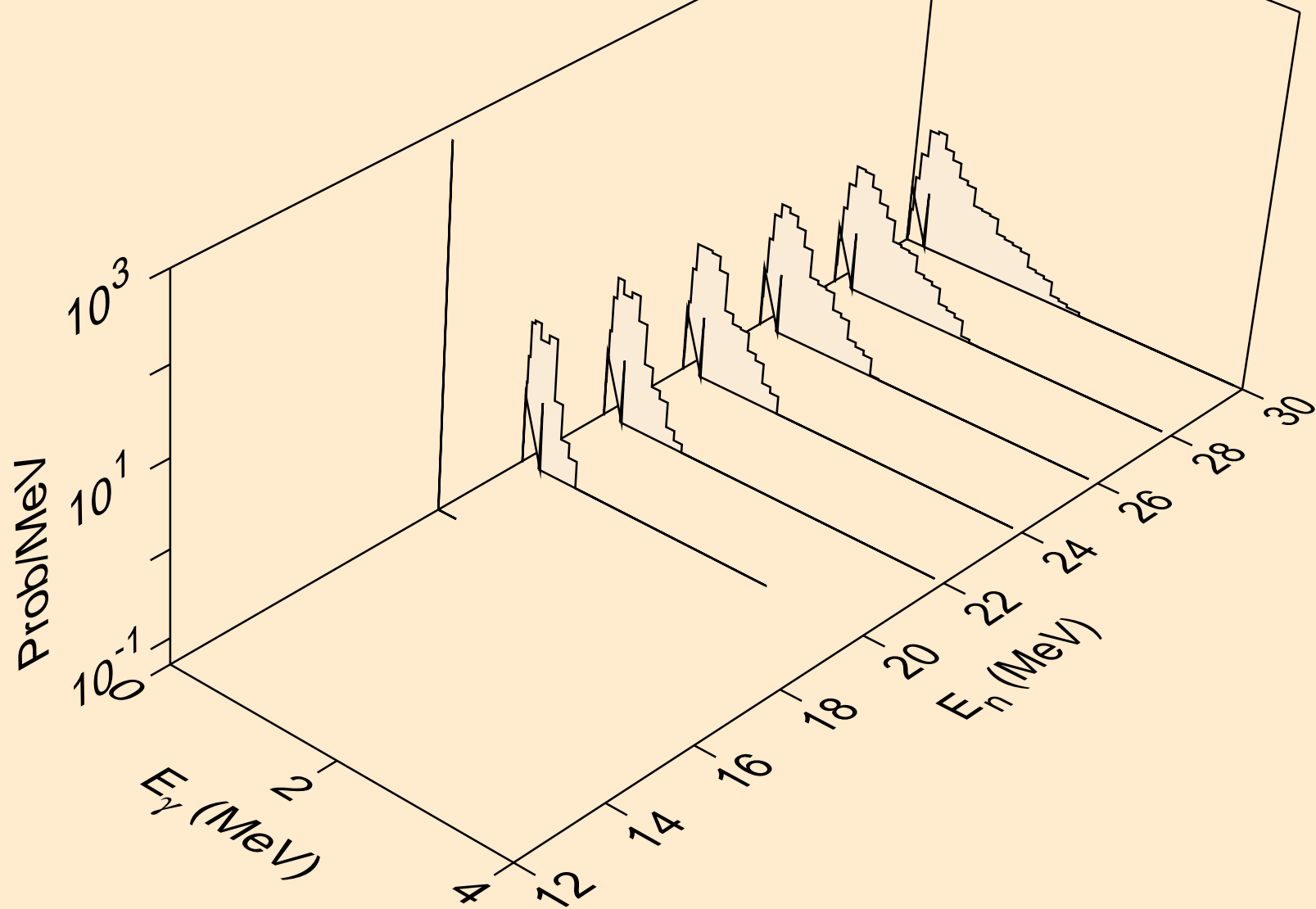

ND128 DEUTERON ACER TENDL-2021 LIBRARY; T=0.K
Photon emission for (n,n*)p

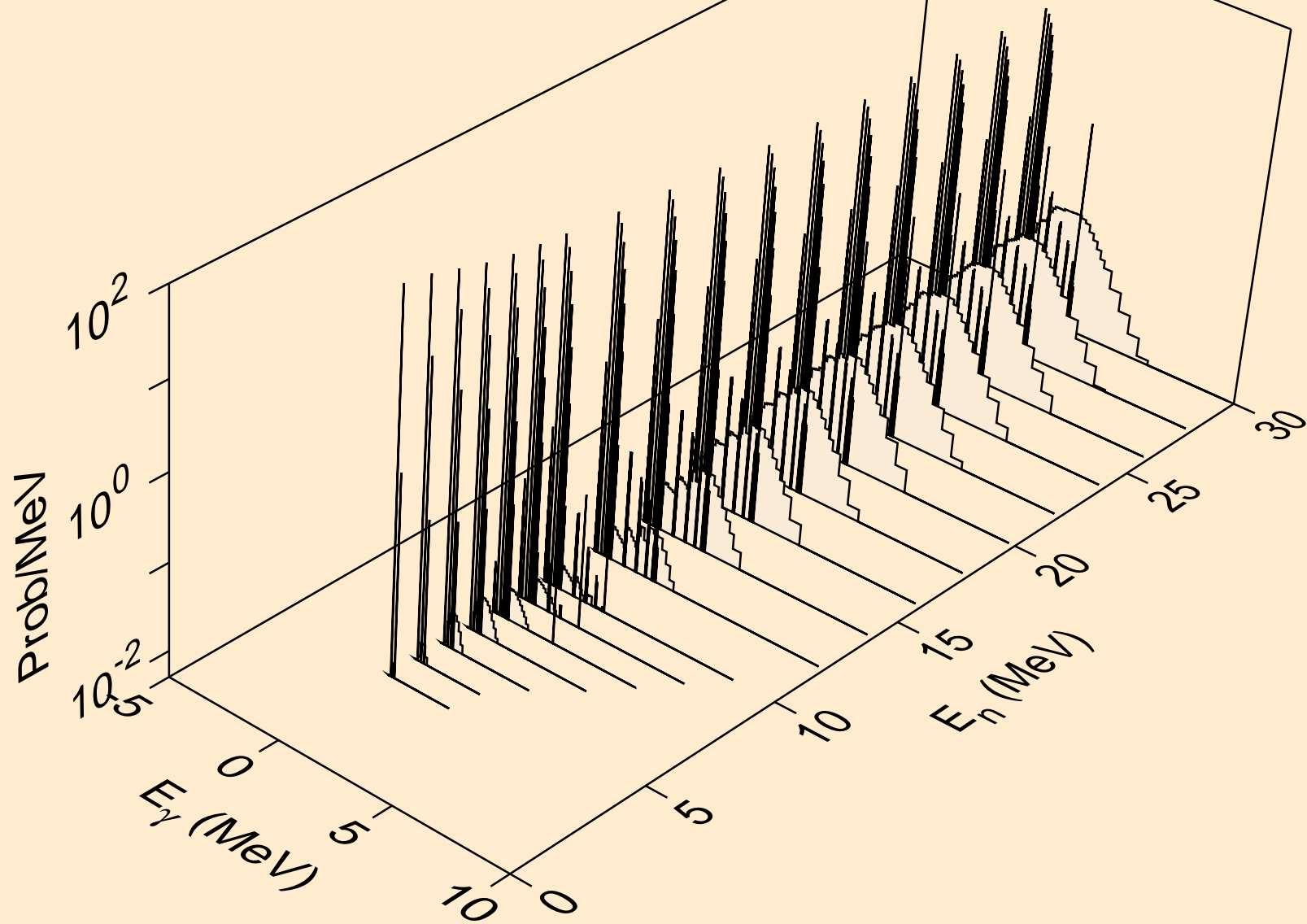

ND128 DEUTERON ACER TENDL-2021 LIBRARY; T=0.K
Photon emission for (n,n*)2a

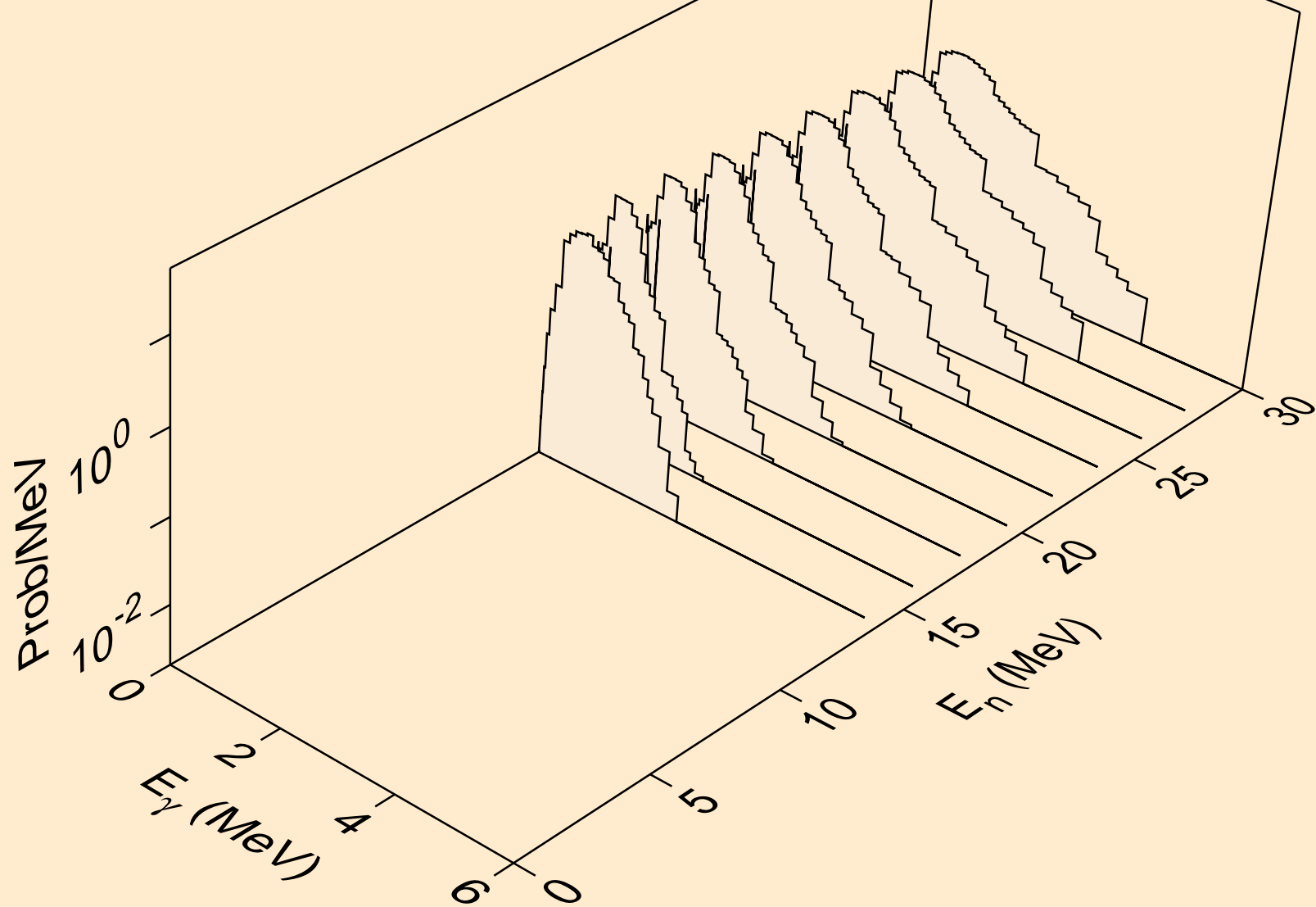

ND128 DEUTERON ACER TENDL-2021 LIBRARY; T=0.K
Photon emission for (n,n*)d

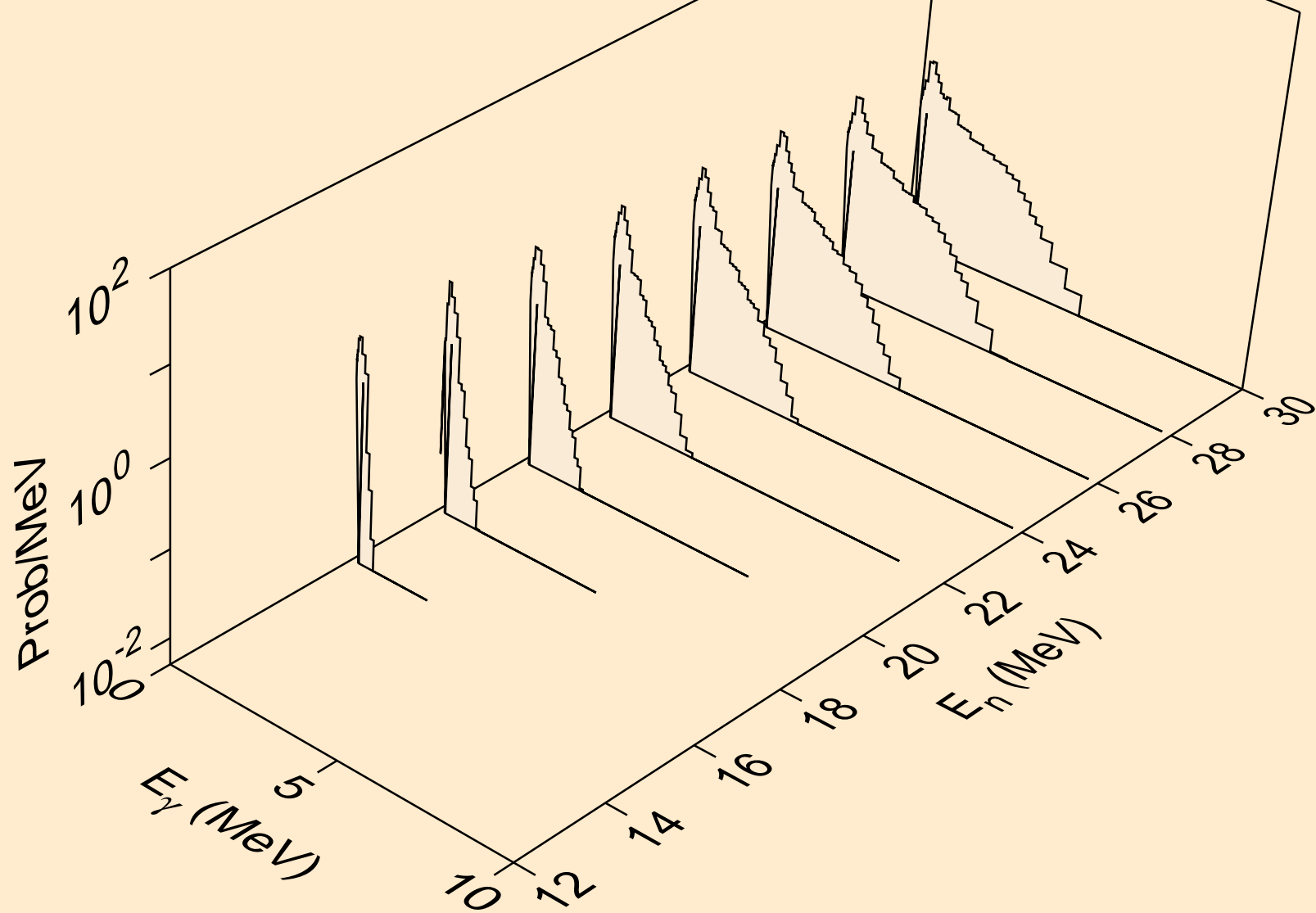

ND128 DEUTERON ACER TENDL-2021 LIBRARY; T=0.K
Photon emission for (n,n*)t

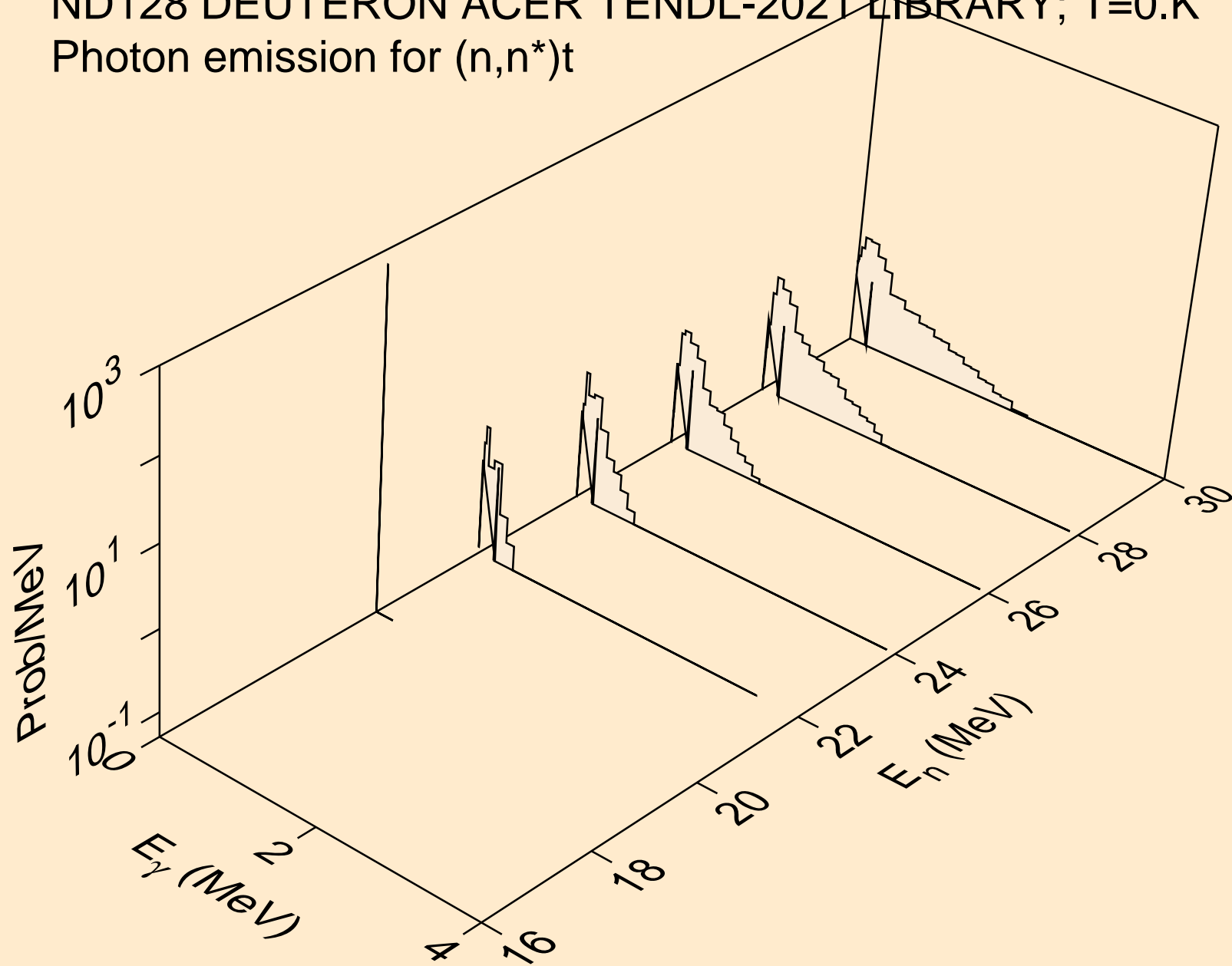

ND128 DEUTERON ACER TENDL-2021 LIBRARY; T=0.K
Photon emission for (n,n*)he3

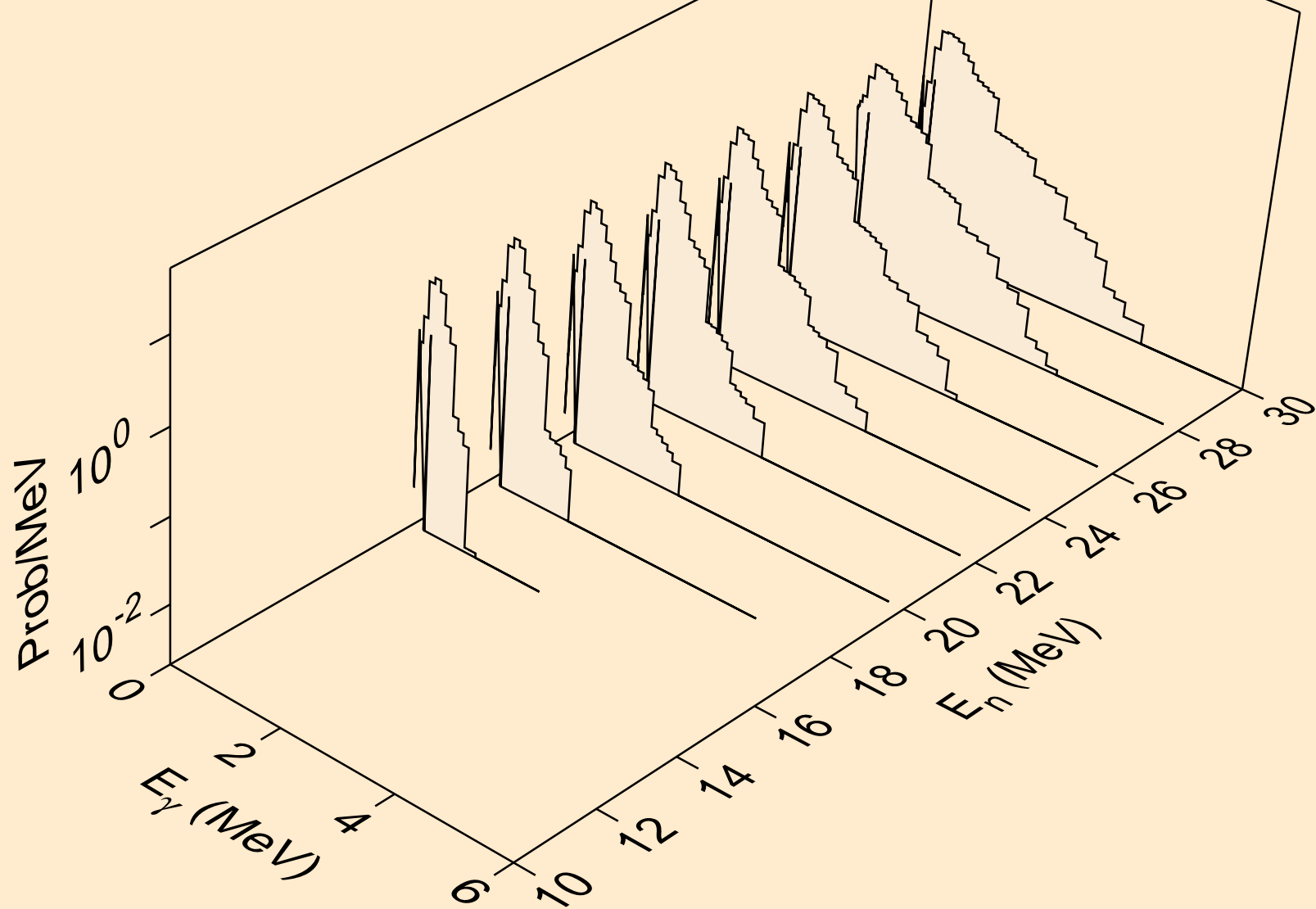

ND128 DEUTERON ACER TENDL-2021 LIBRARY; T=0.K
Photon emission for (n,2np)

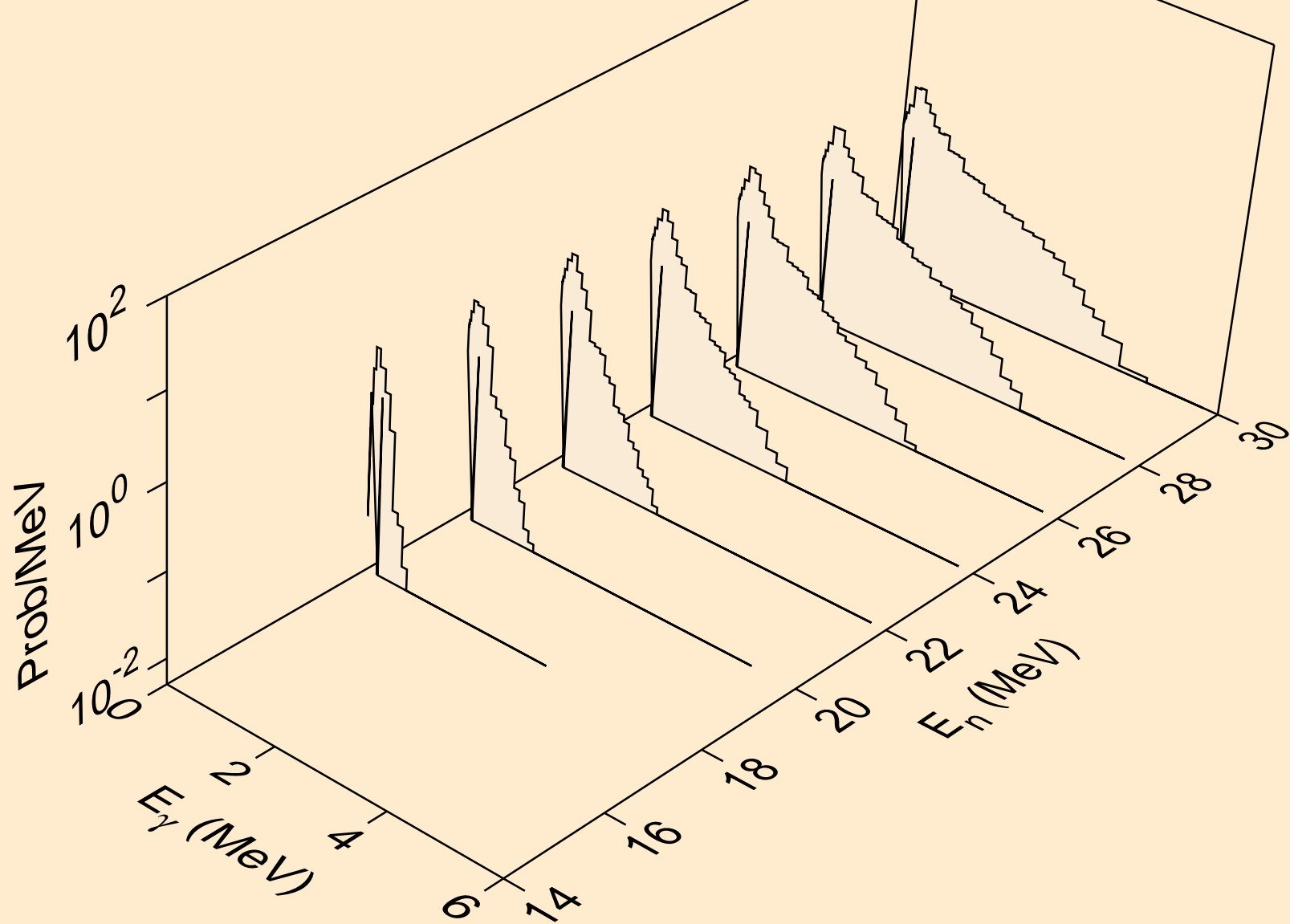

ND128 DEUTERON ACER TENDL-2021 LIBRARY; T=0.K
Photon emission for (n,3np)

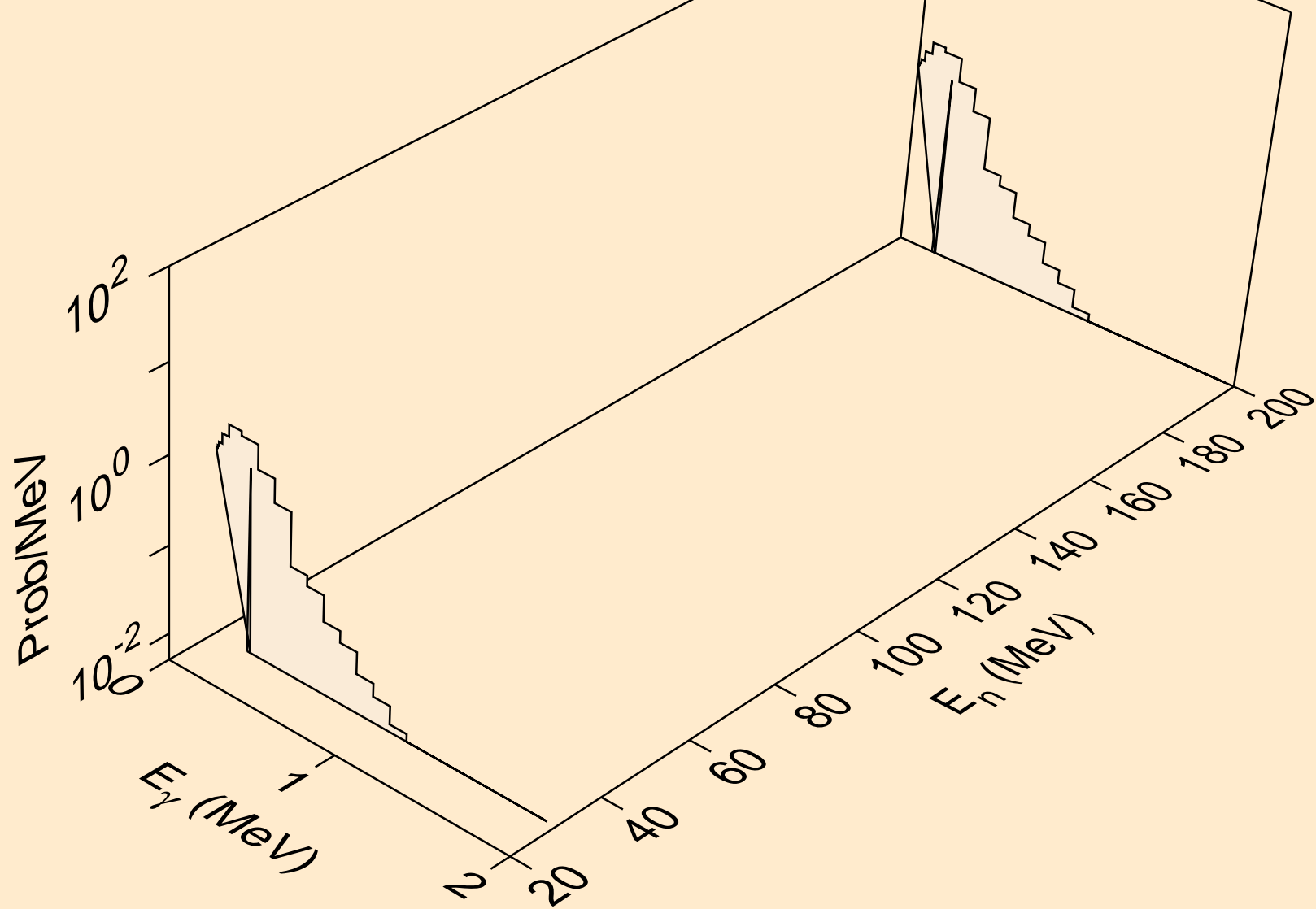

ND128 DEUTERON ACER TENDL-2021 LIBRARY; T=0.K
Photon emission for (n,2np)

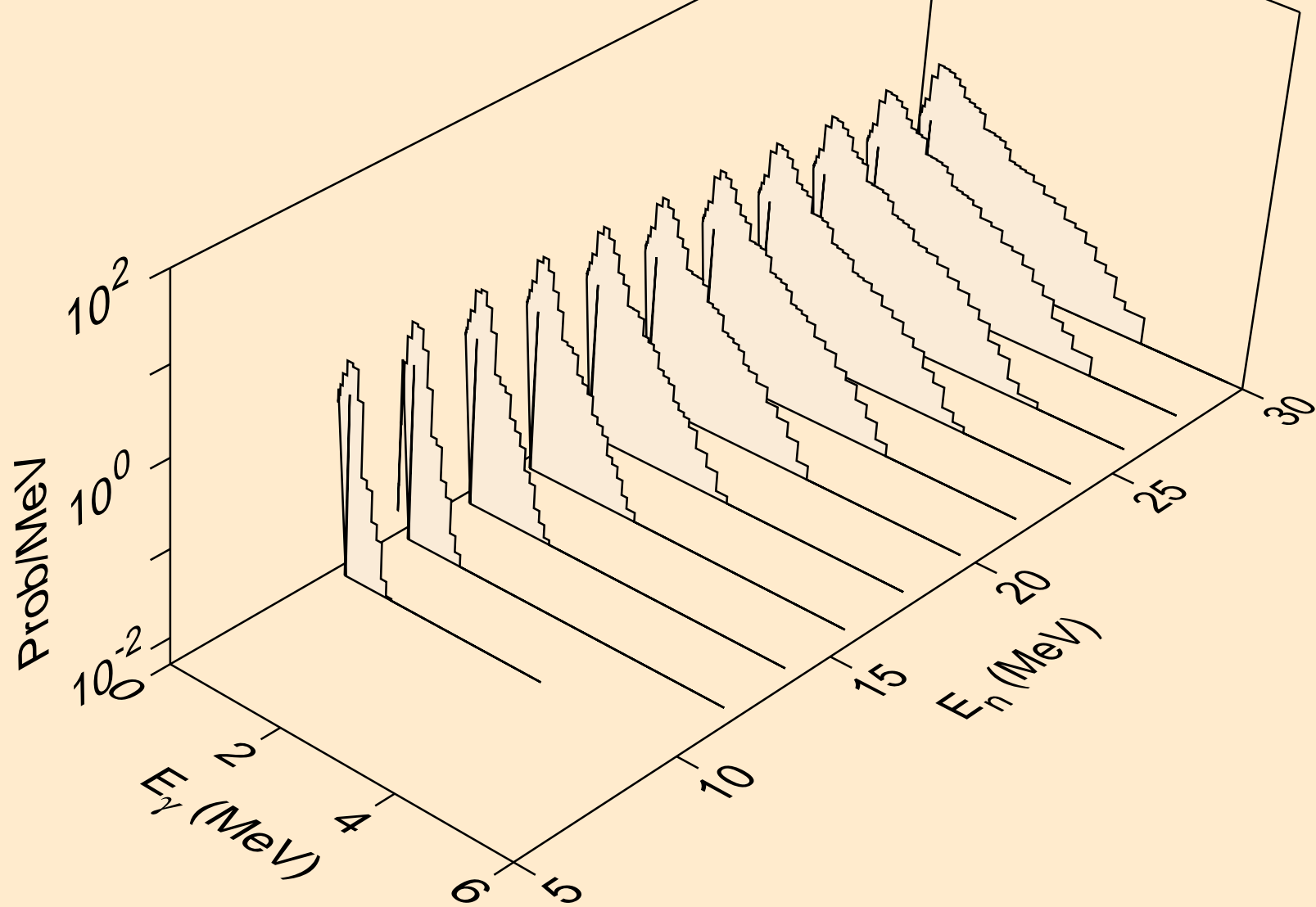

ND128 DEUTERON ACER TENDL-2021 LIBRARY; T=0.K
Photon emission for (n,npa)

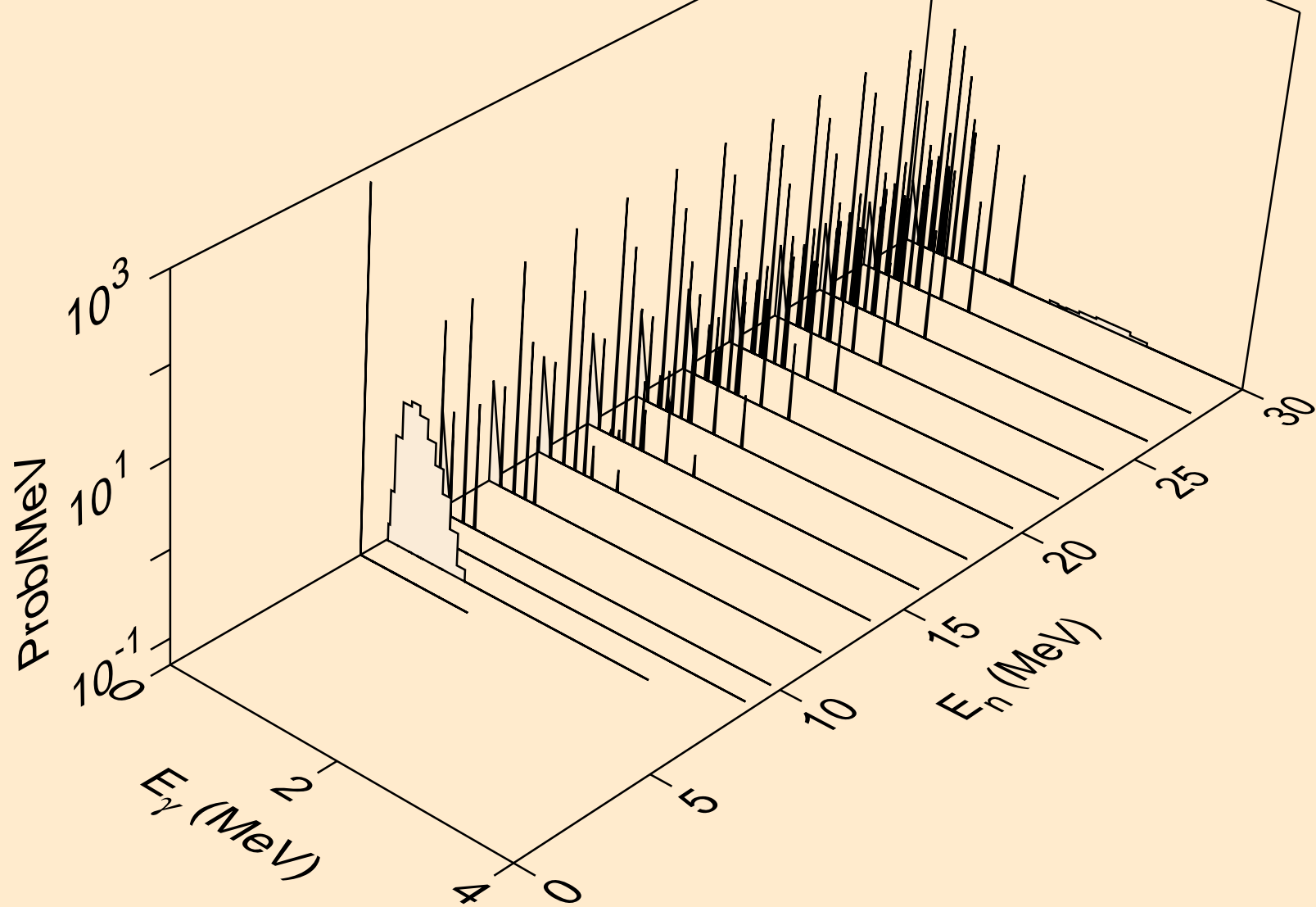

ND128 DEUTERON ACER TENDL-2021 LIBRARY; T=0.K
Photon emission for (n,gma)

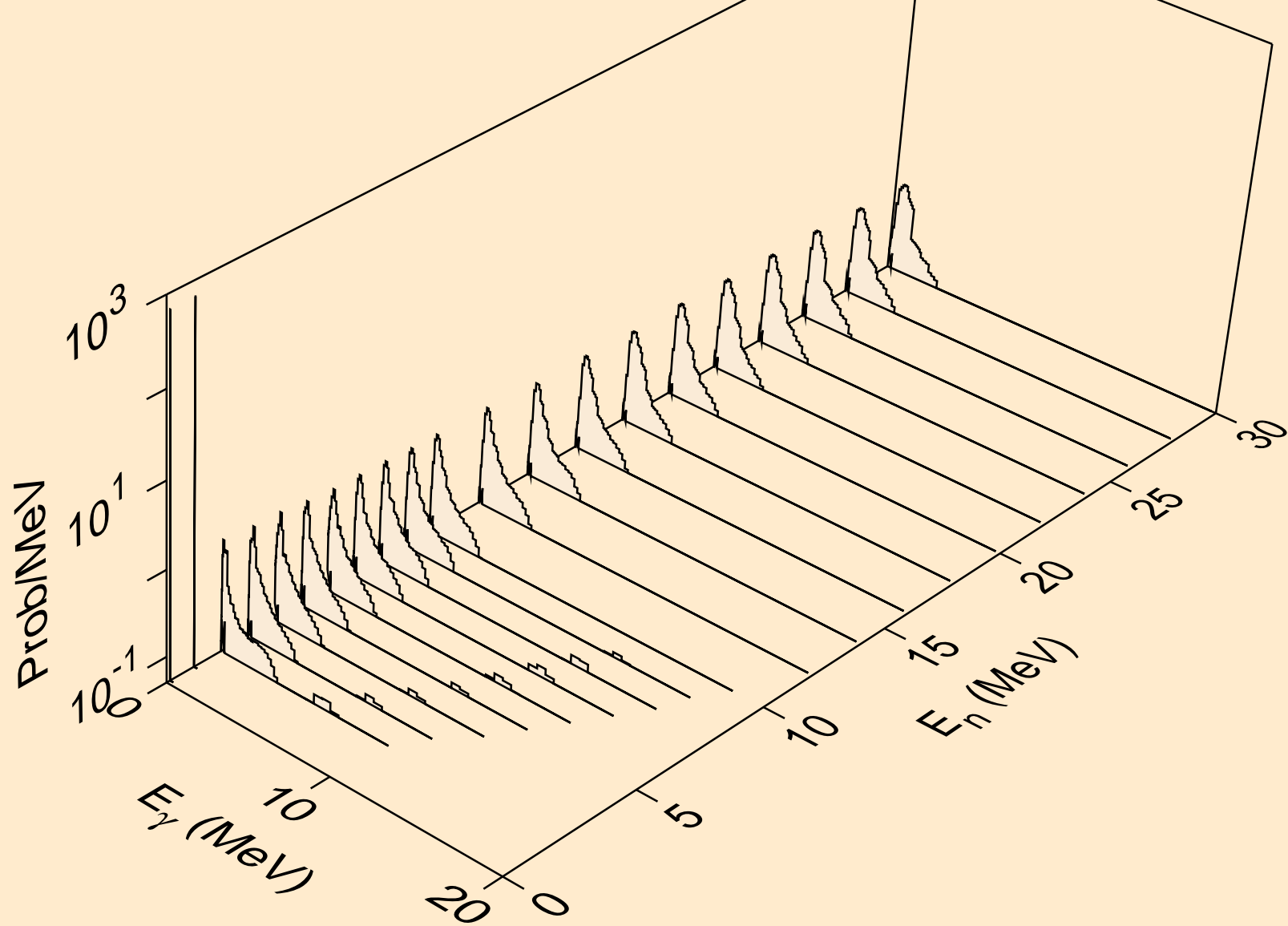

ND128 DEUTERON ACER TENDL-2021 LIBRARY; T=0.K
Photon emission for (n,p)

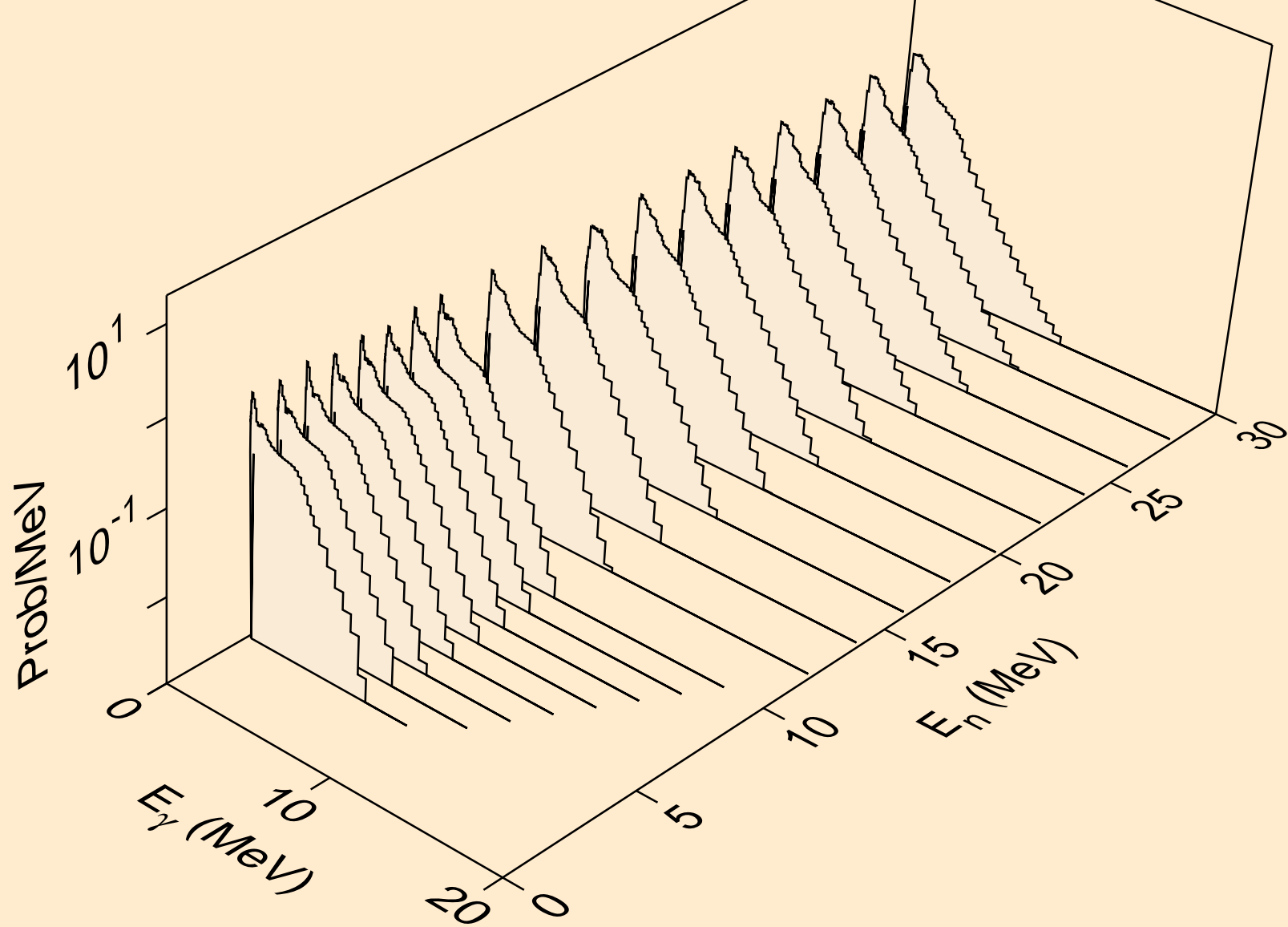

ND128 DEUTERON ACER TENDL-2021 LIBRARY; T=0.K
Photon emission for inelastic

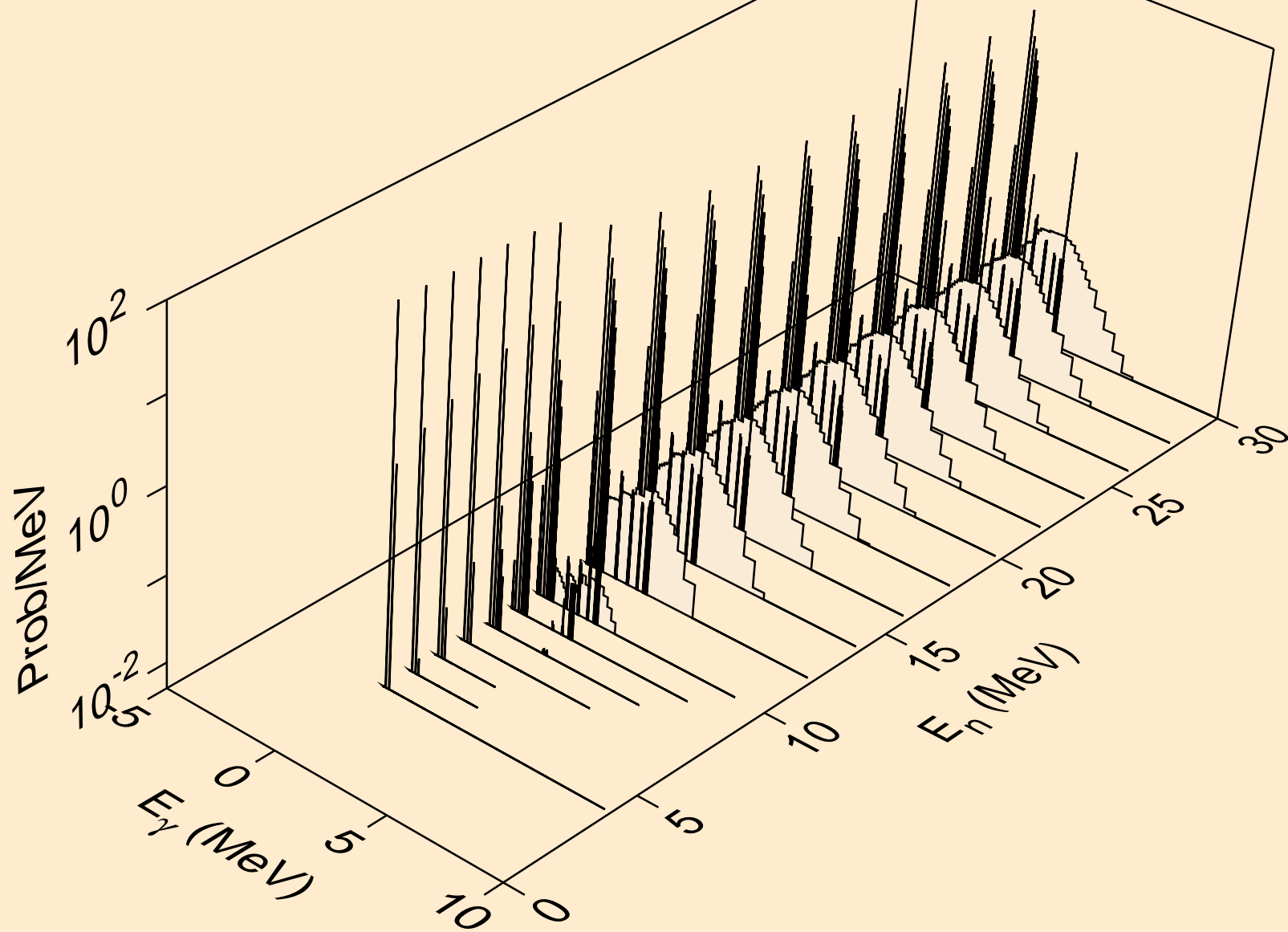

ND128 DEUTERON ACER TENDL-2021 LIBRARY; T=0.K
Photon emission for (n,t)

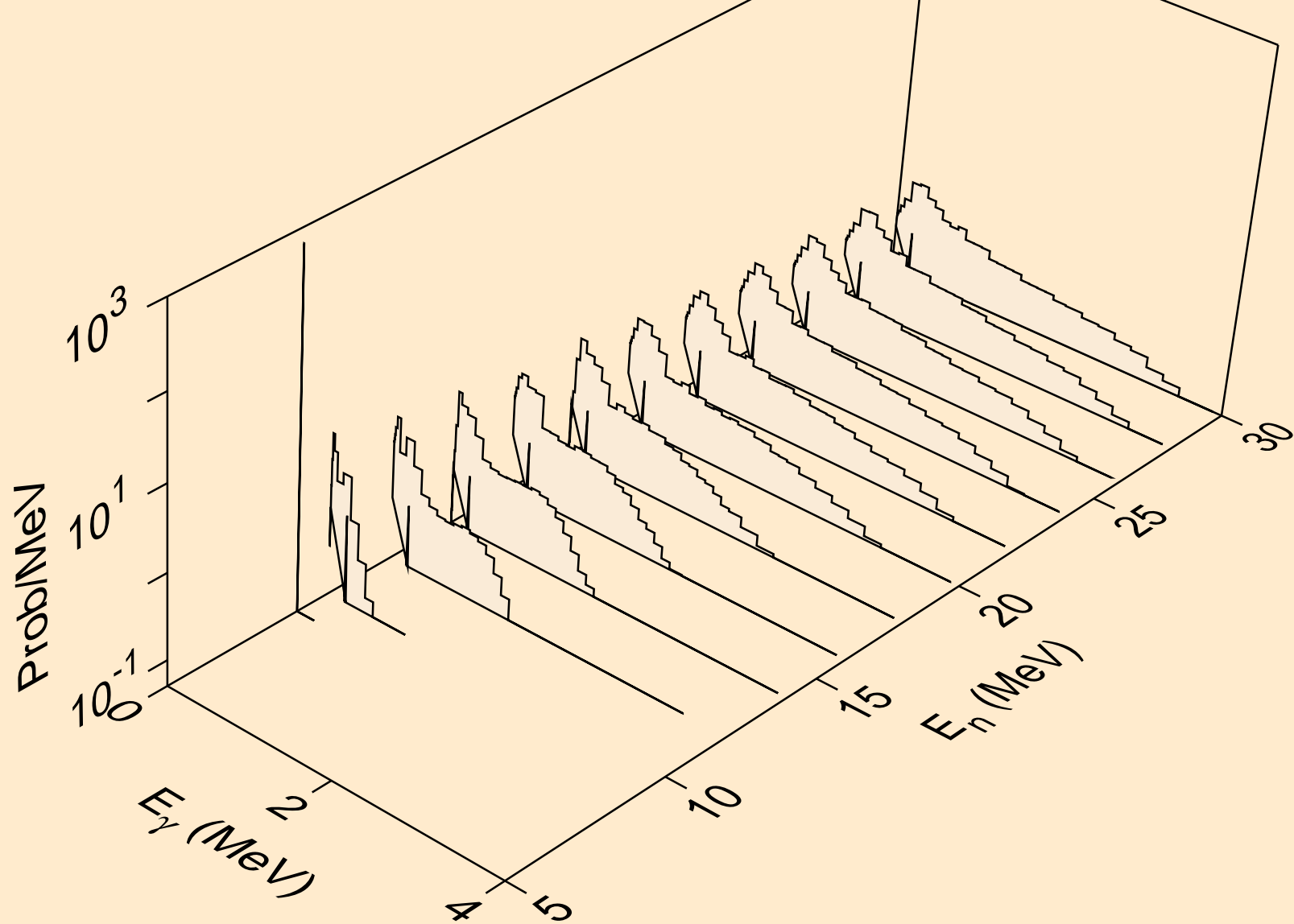

ND128 DEUTERON ACER TENDL-2021 LIBRARY; T=0.K
Photon emission for (n,he3)

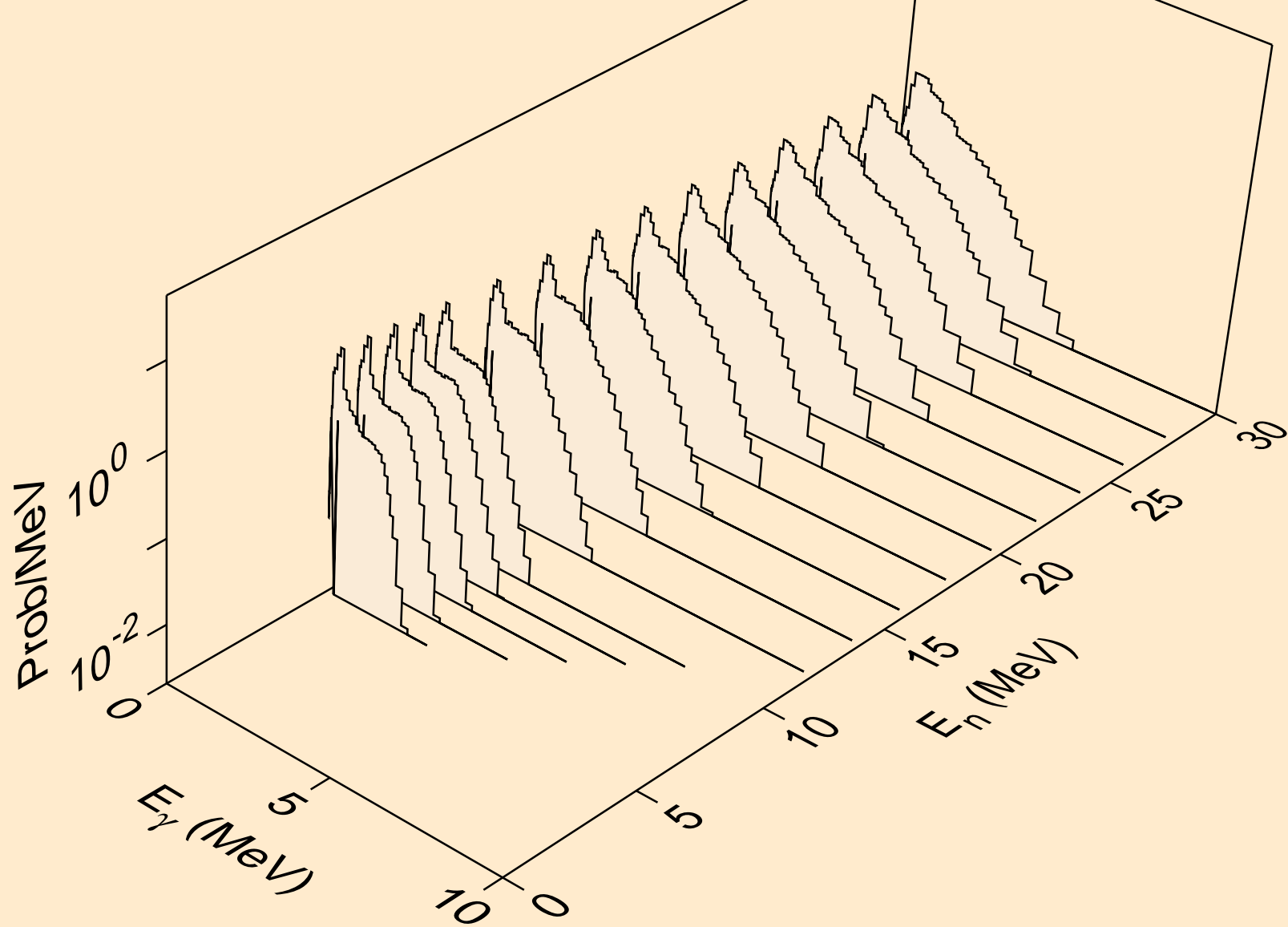

ND128 DEUTERON ACER TENDL-2021 LIBRARY; T=0.K
Photon emission for (n,a)

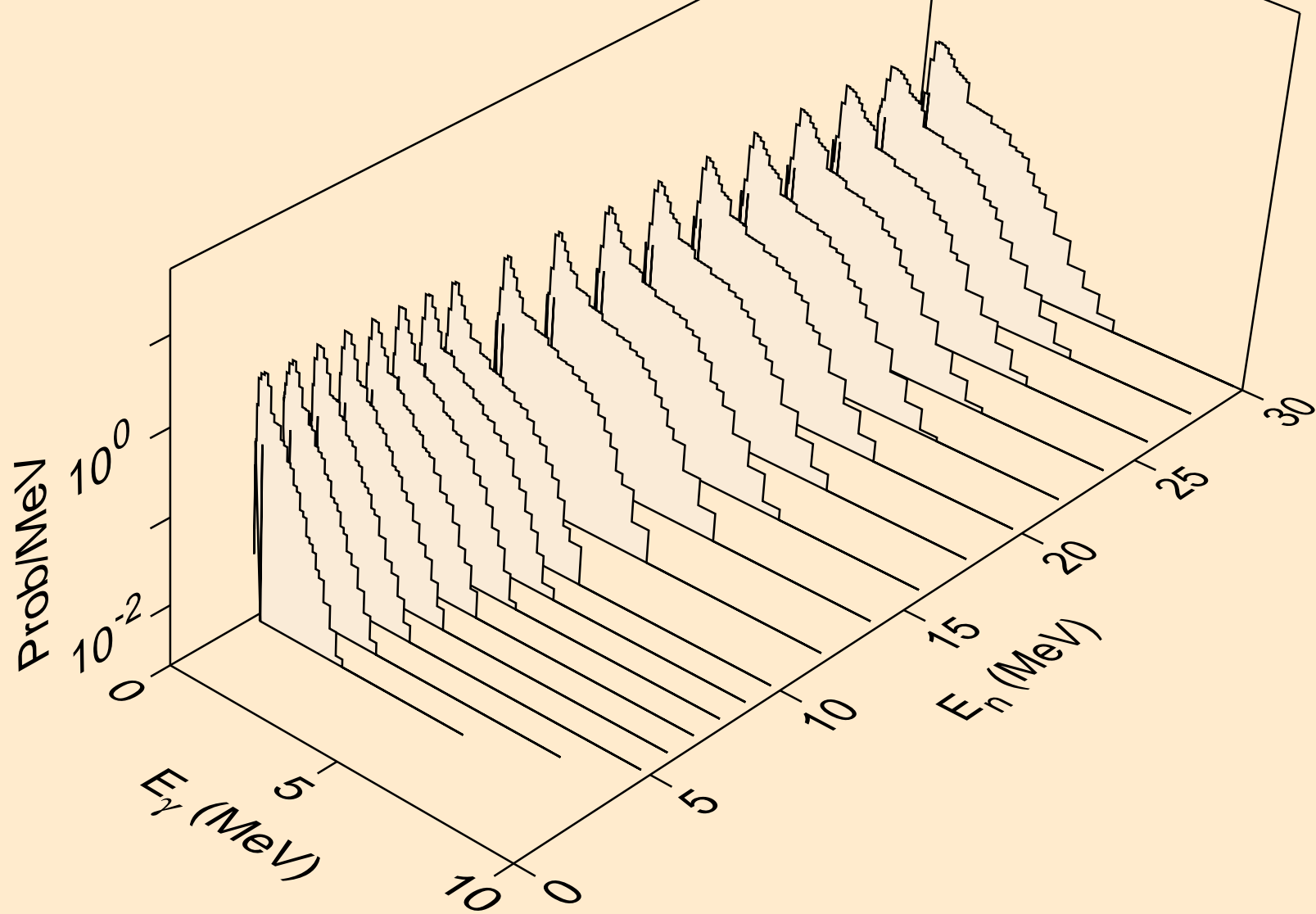

ND128 DEUTERON ACER TENDL-2021 LIBRARY; T=0.K
Photon emission for (n,2a)

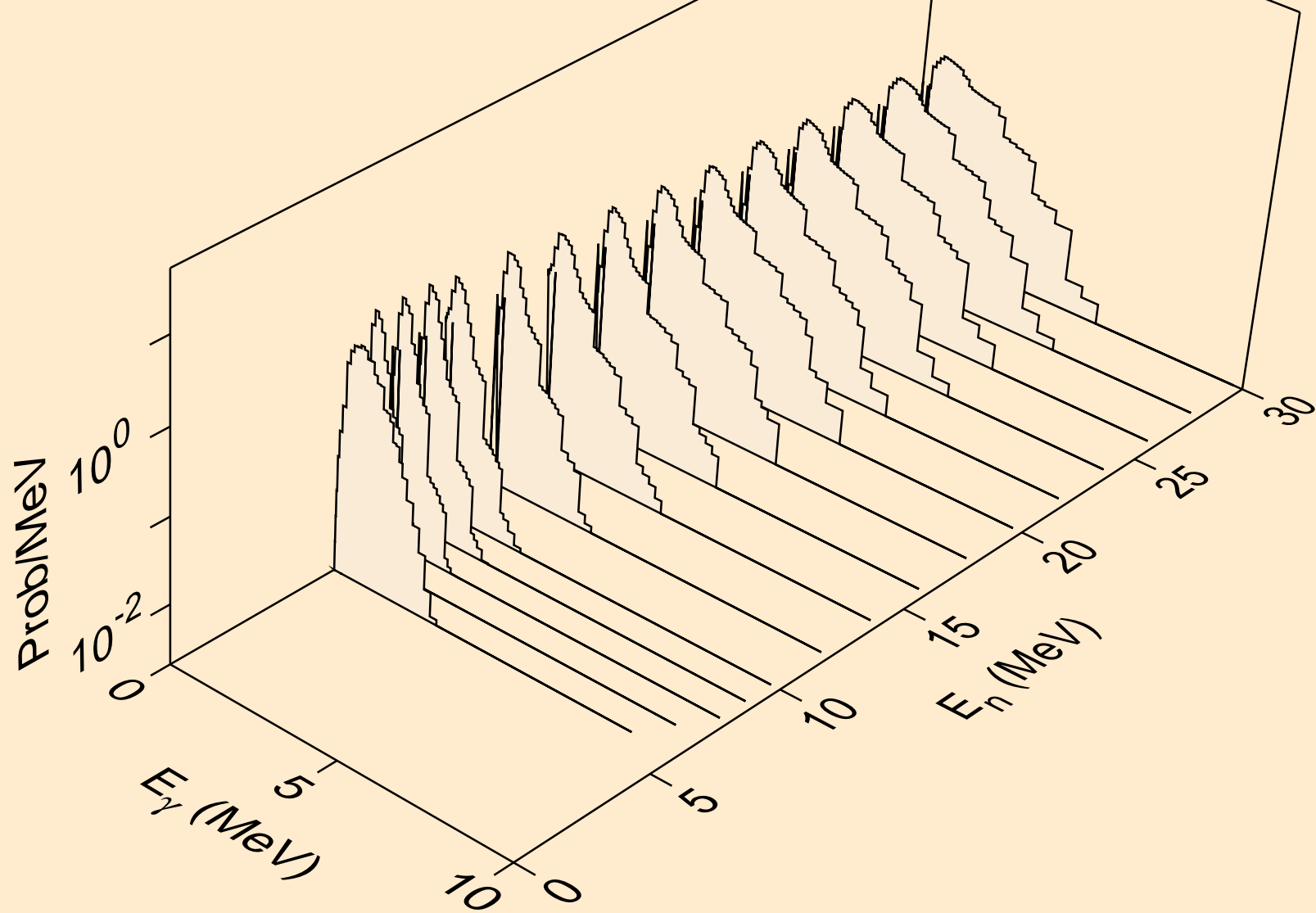

ND128 DEUTERON ACER TENDL-2021 LIBRARY; T=0.K
Photon emission for (n,2p)

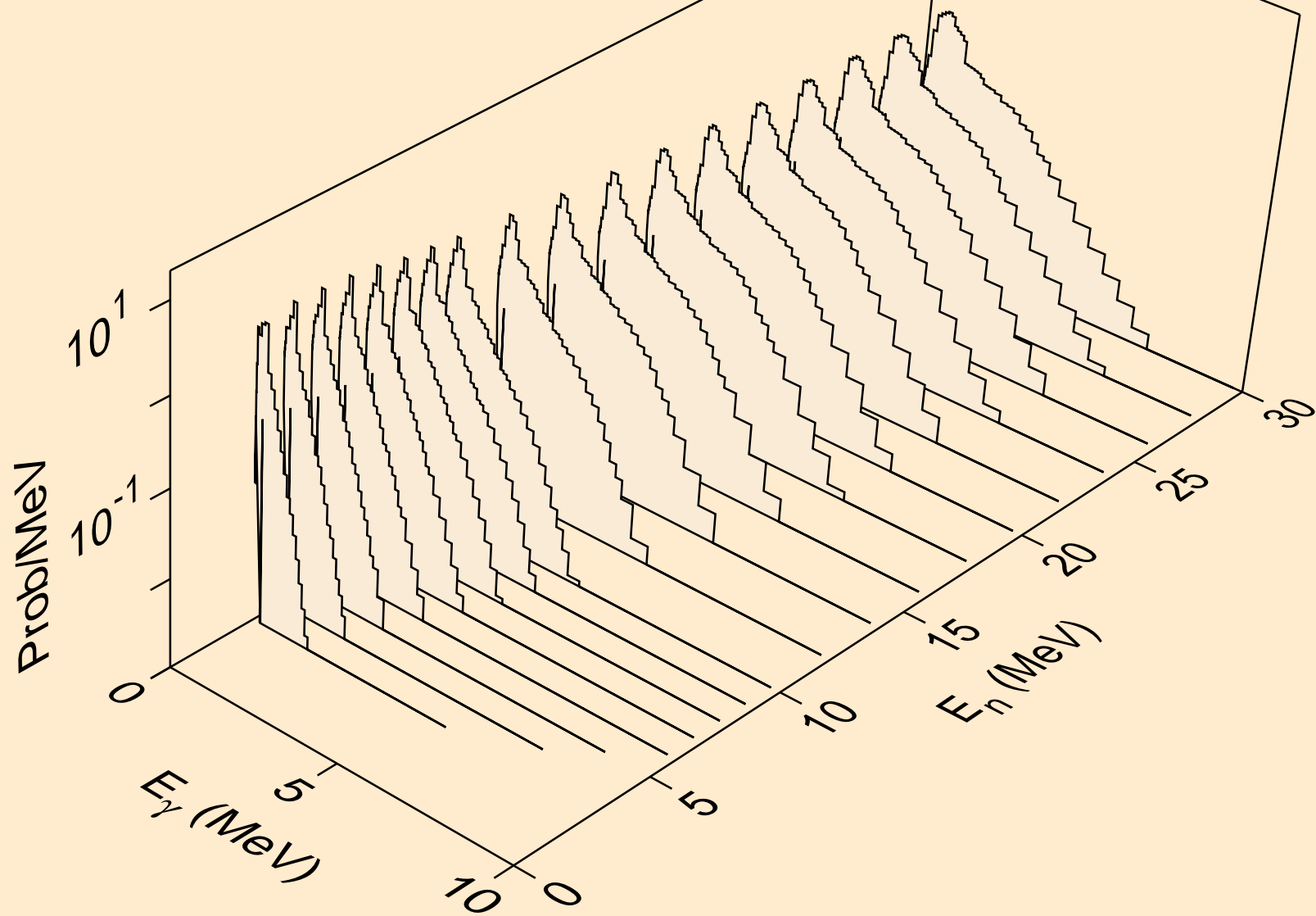

ND128 DEUTERON ACER TENDL-2021 LIBRARY; T=0.K
Photon emission for (n,p)

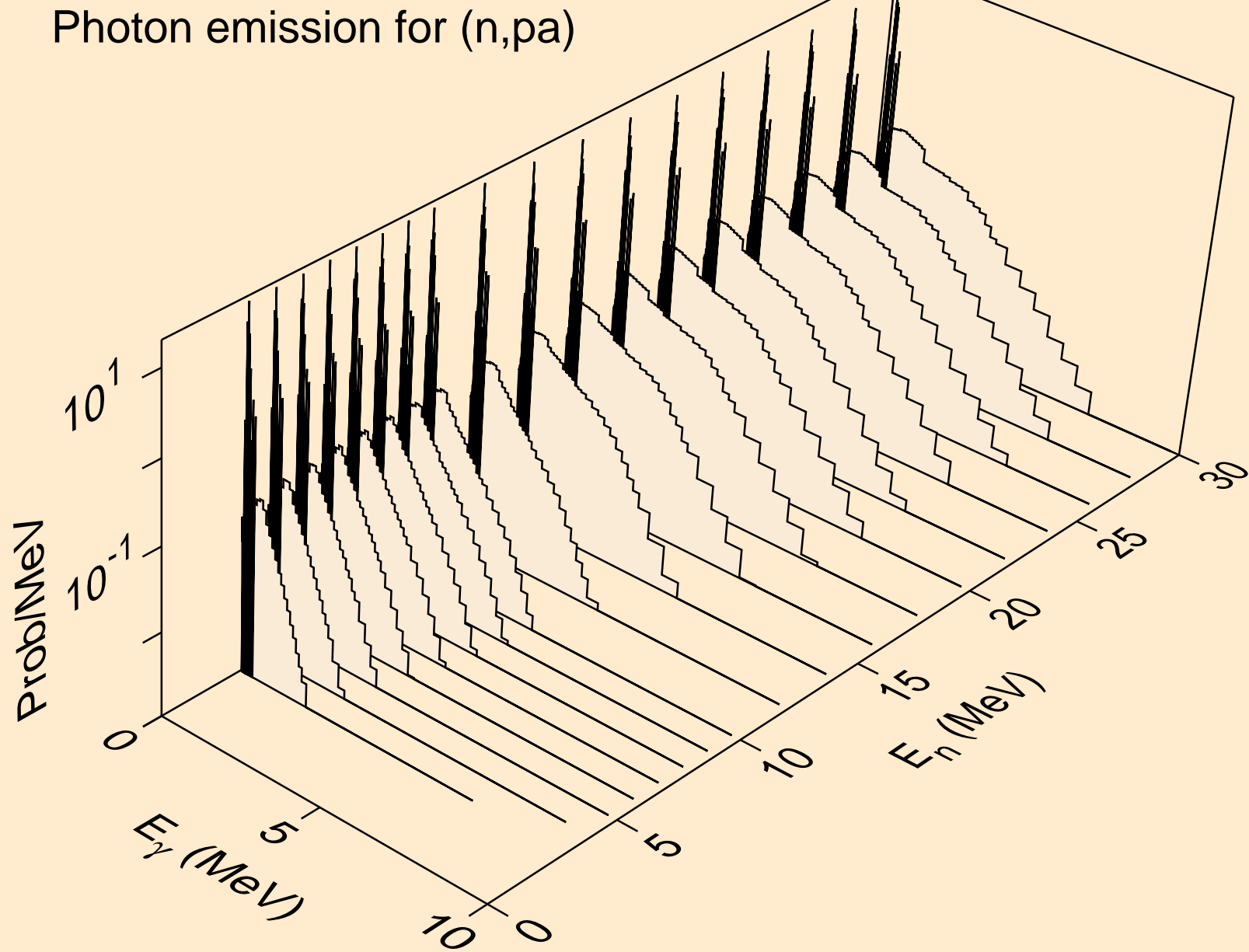

ND128 DEUTERON ACER TENDL-2021 LIBRARY; T=0.K
Photon emission for (n,d2a)

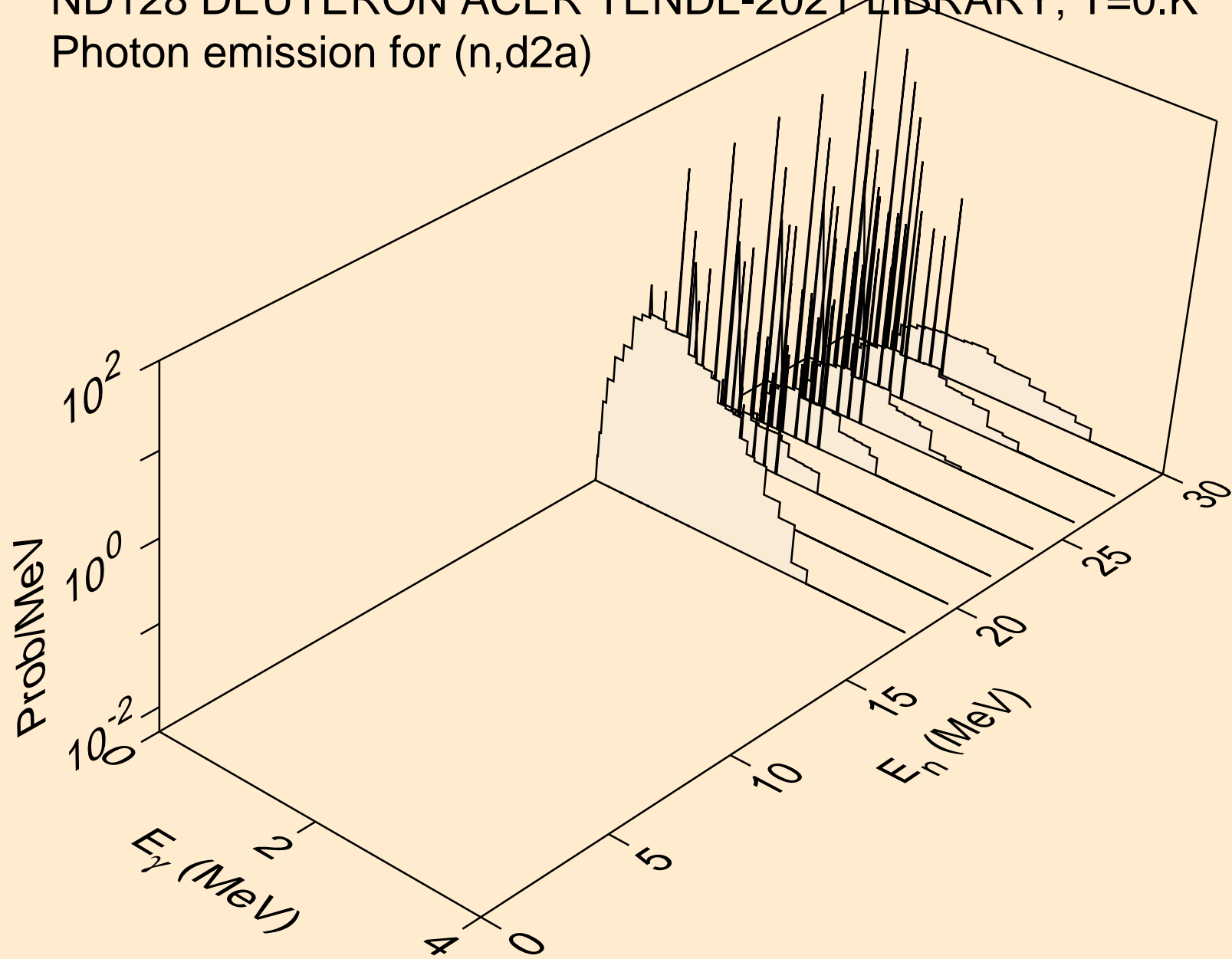

ND128 DEUTERON ACER TENDL-2021 LIBRARY; T=0.K
Photon emission for (n,pd)

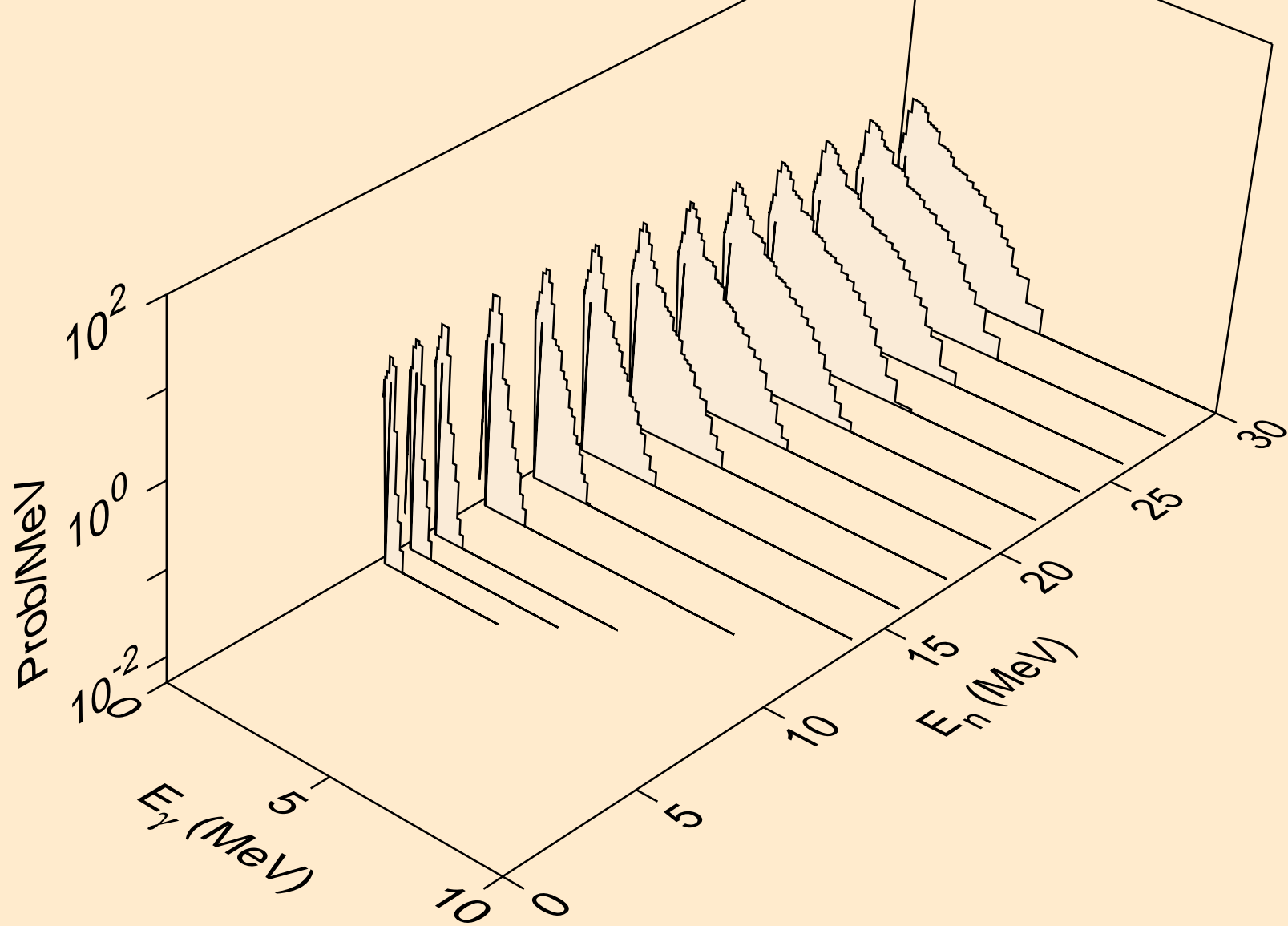

ND128 DEUTERON ACER TENDL-2021 LIBRARY; T=0.K
Photon emission for (n,pt)

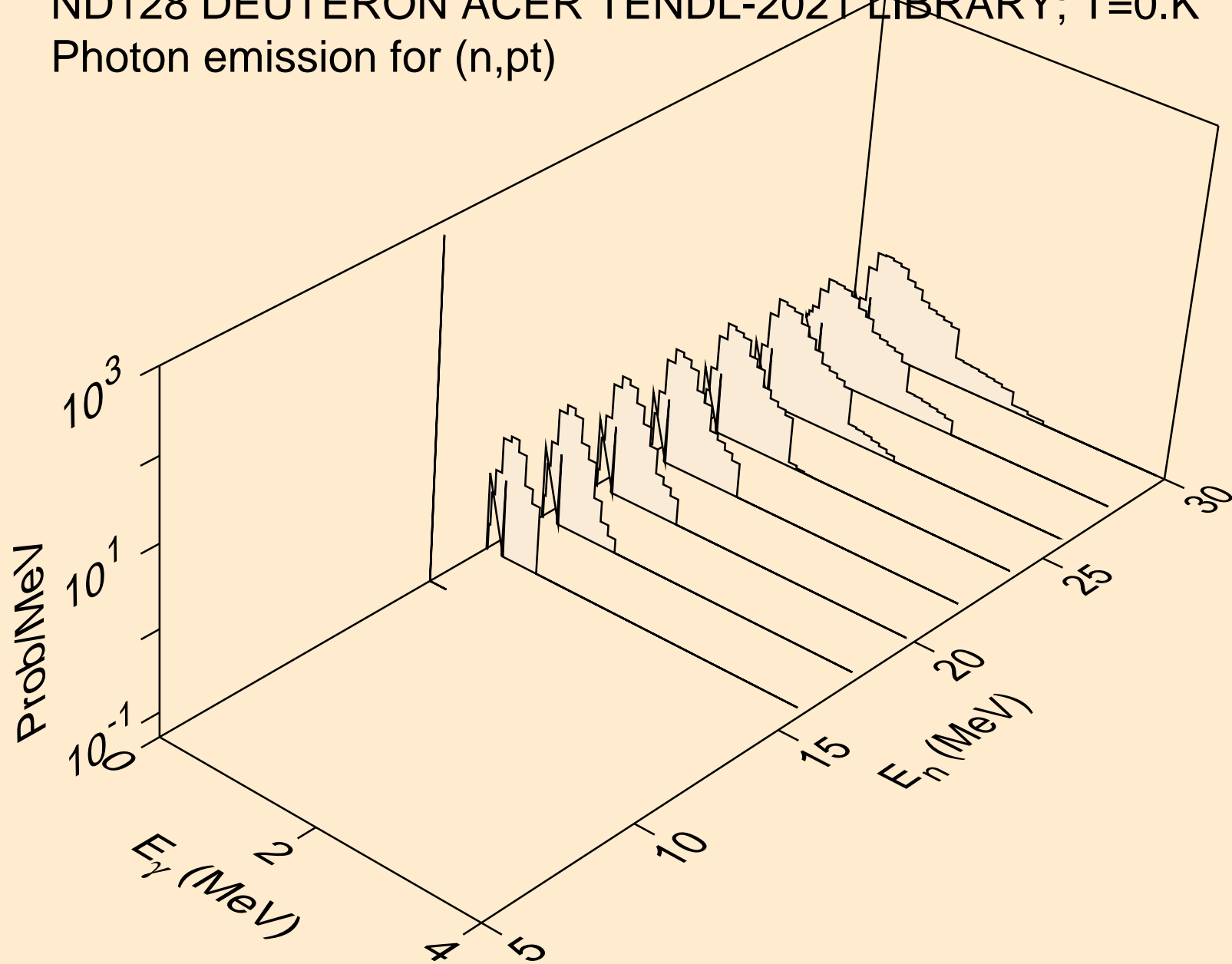

ND128 DEUTERON ACER TENDL-2021 LIBRARY; T=0.K
Photon emission for (n,da)

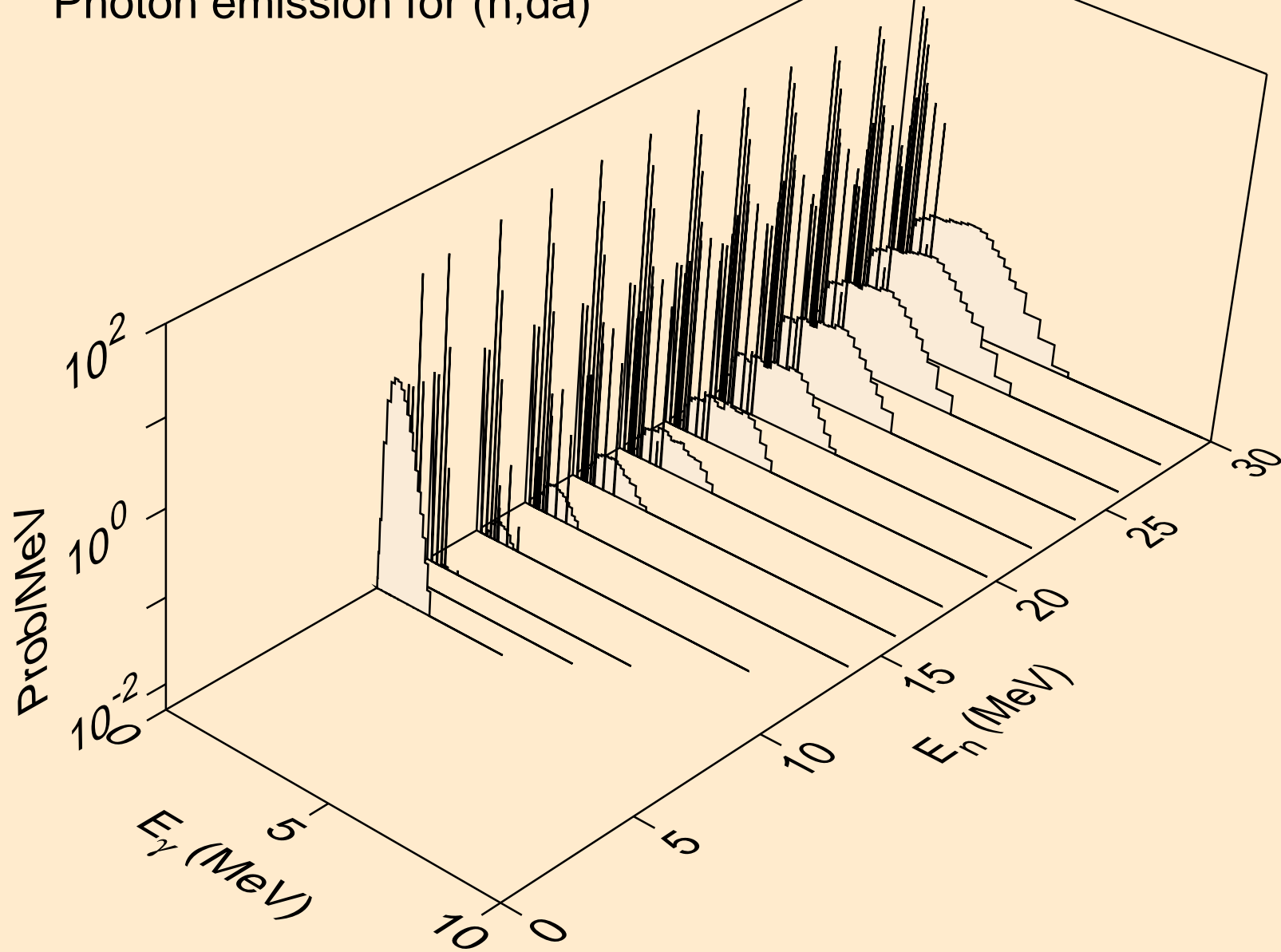

ND128 DEUTERON ACER TENDL-2021 LIBRARY; T=0.K

Particle heating contributions

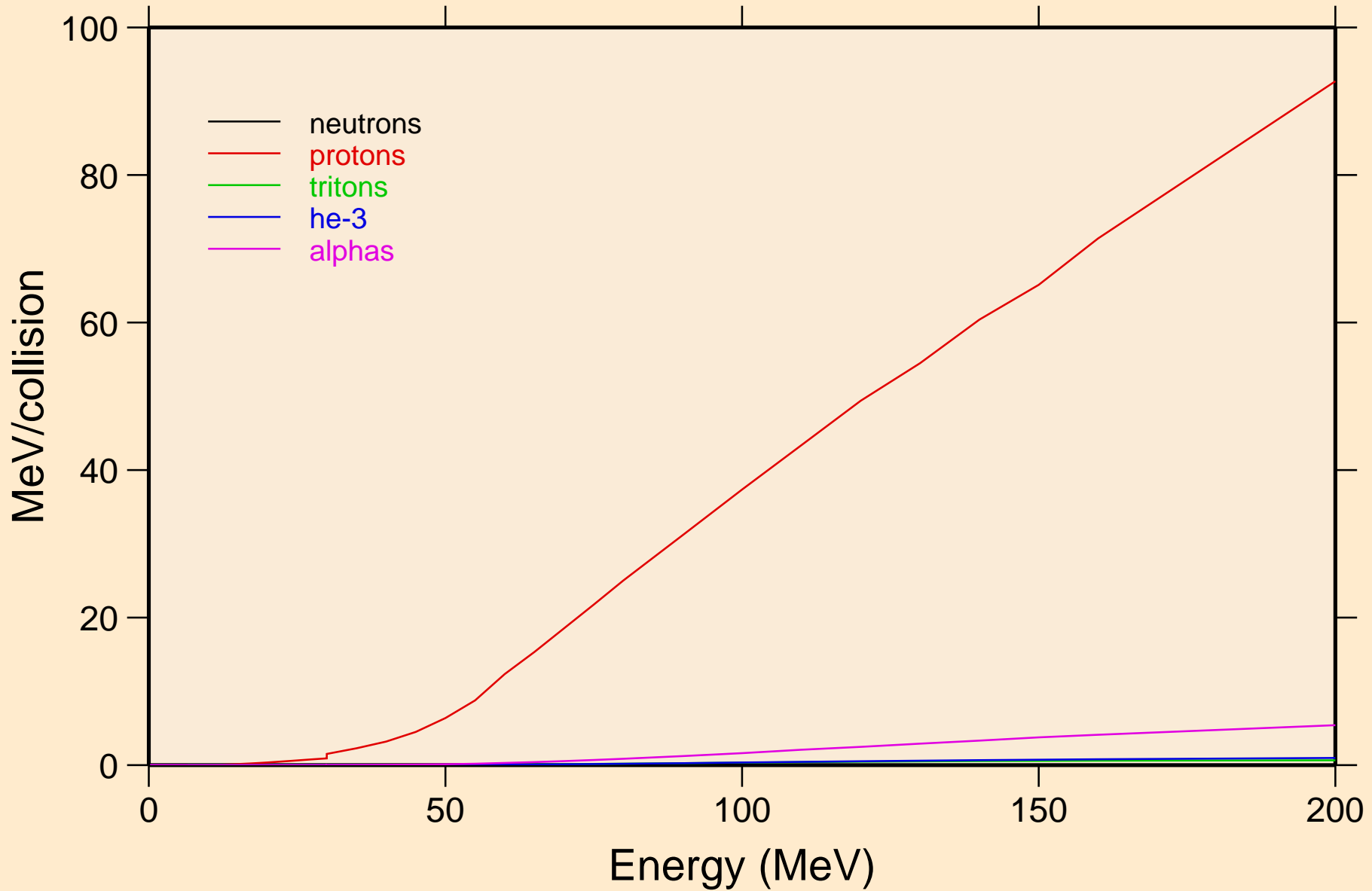

ND128 DEUTERON ACER TENDL-2021 LIBRARY; T=0.K

Recoil Heating

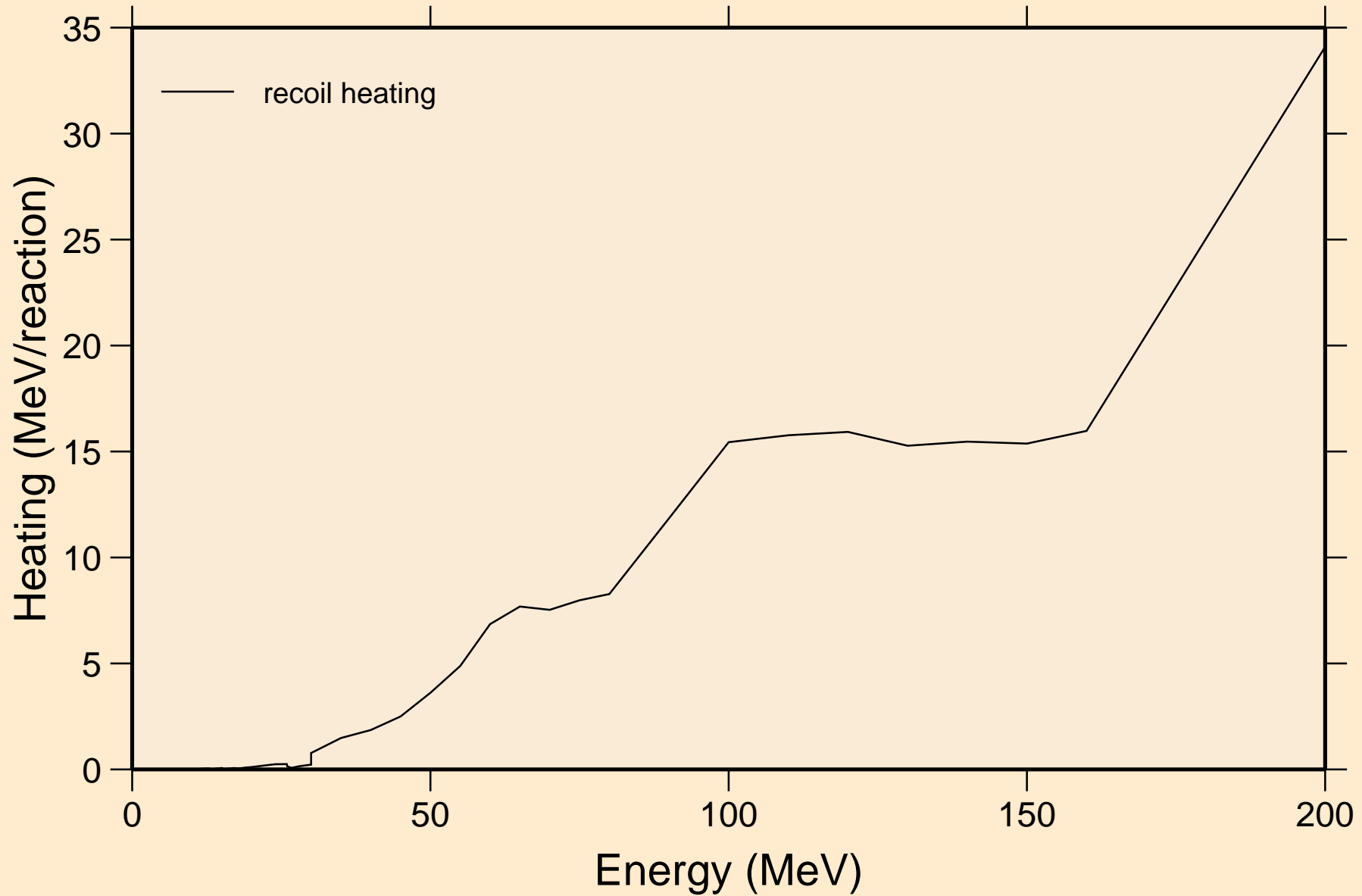

ND128 DEUTERON ACER TENDL-2021 LIBRARY; T=0.K
Particle production cross sections

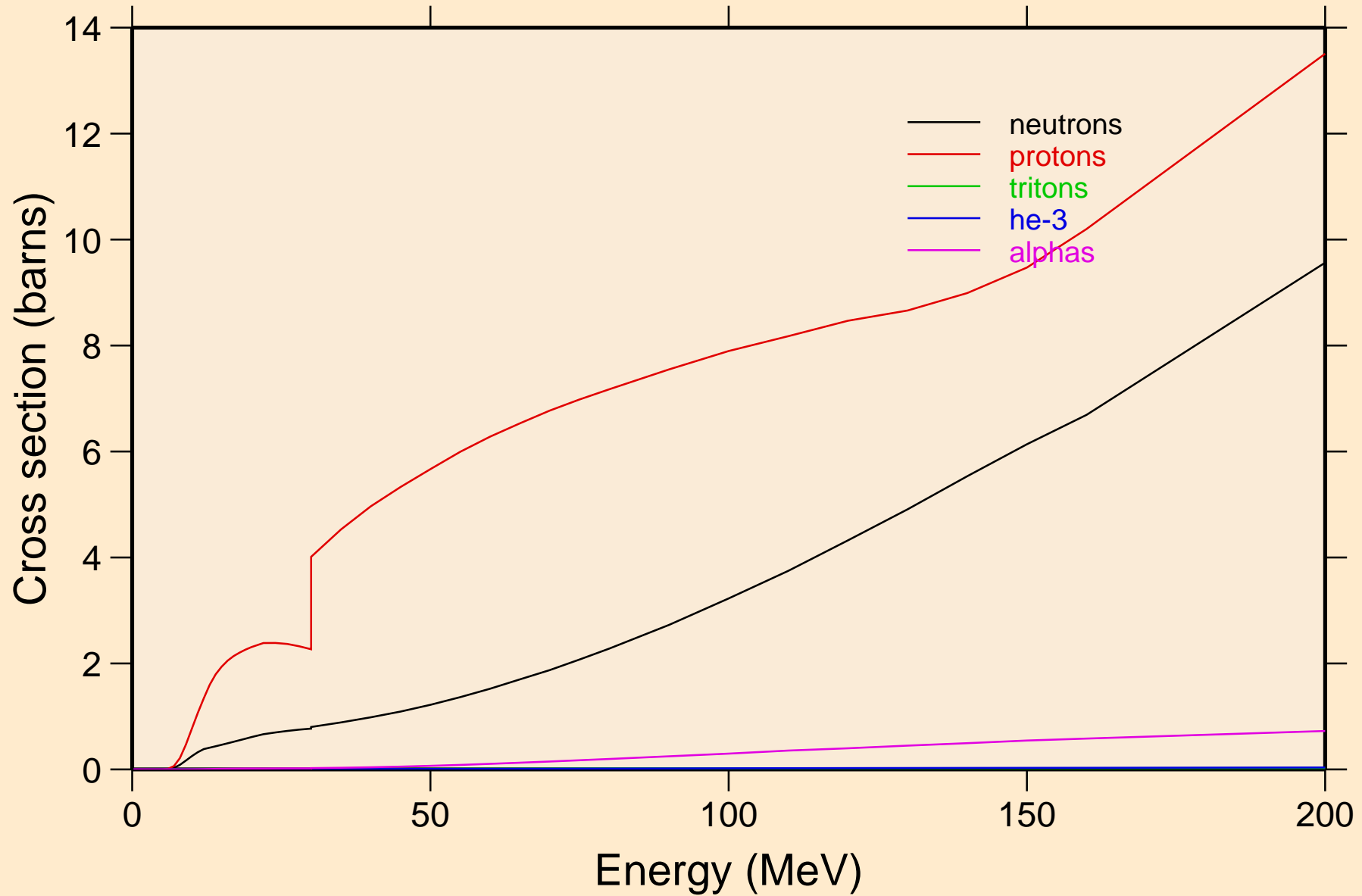

ND128 DEUTERON ACER TENDL-2021 LIBRARY; T=0.K
neutrons from (d,n)

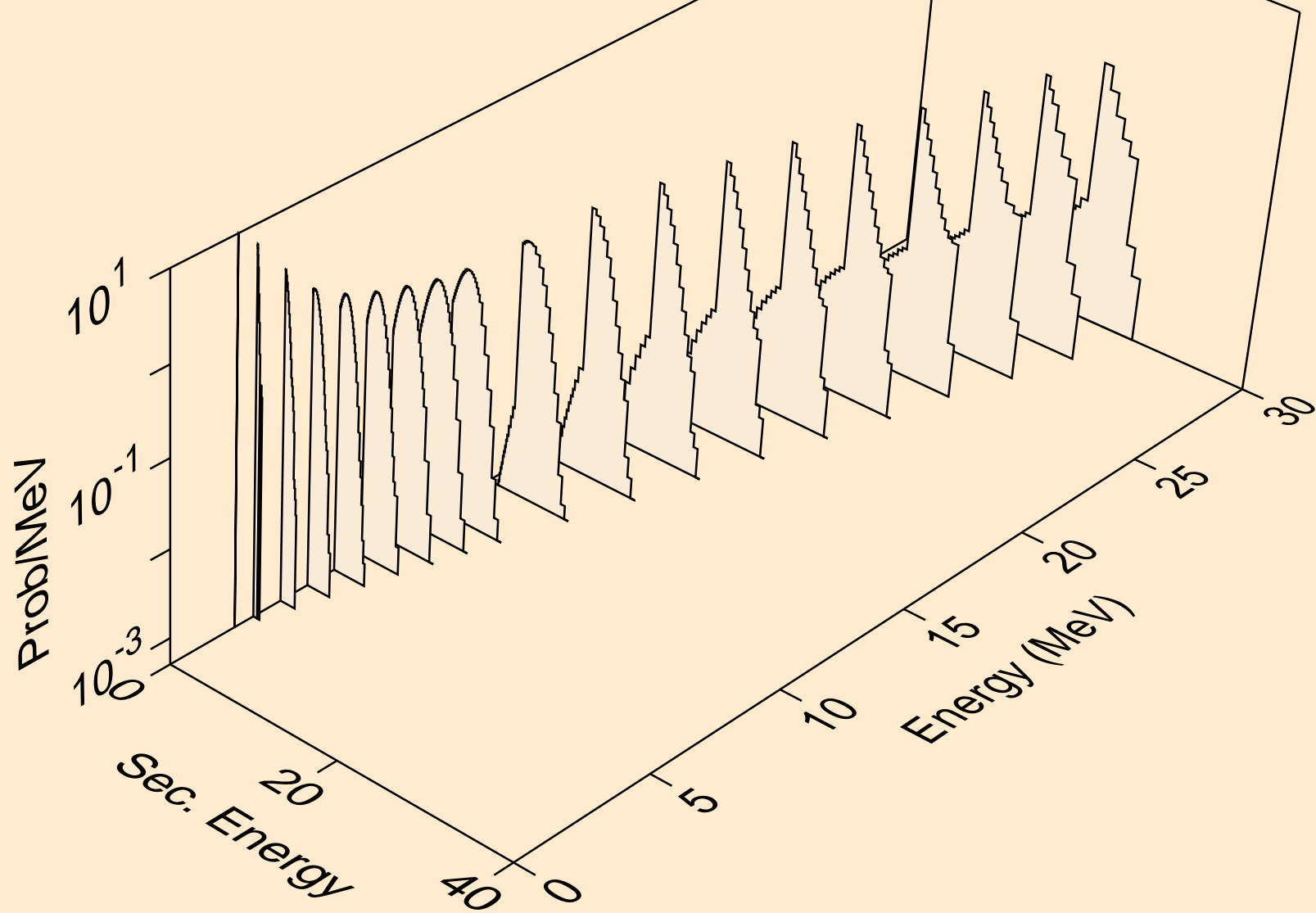

ND128 DEUTERON ACER TENDL-2021 LIBRARY; T=0.K
neutrons from (d,x)

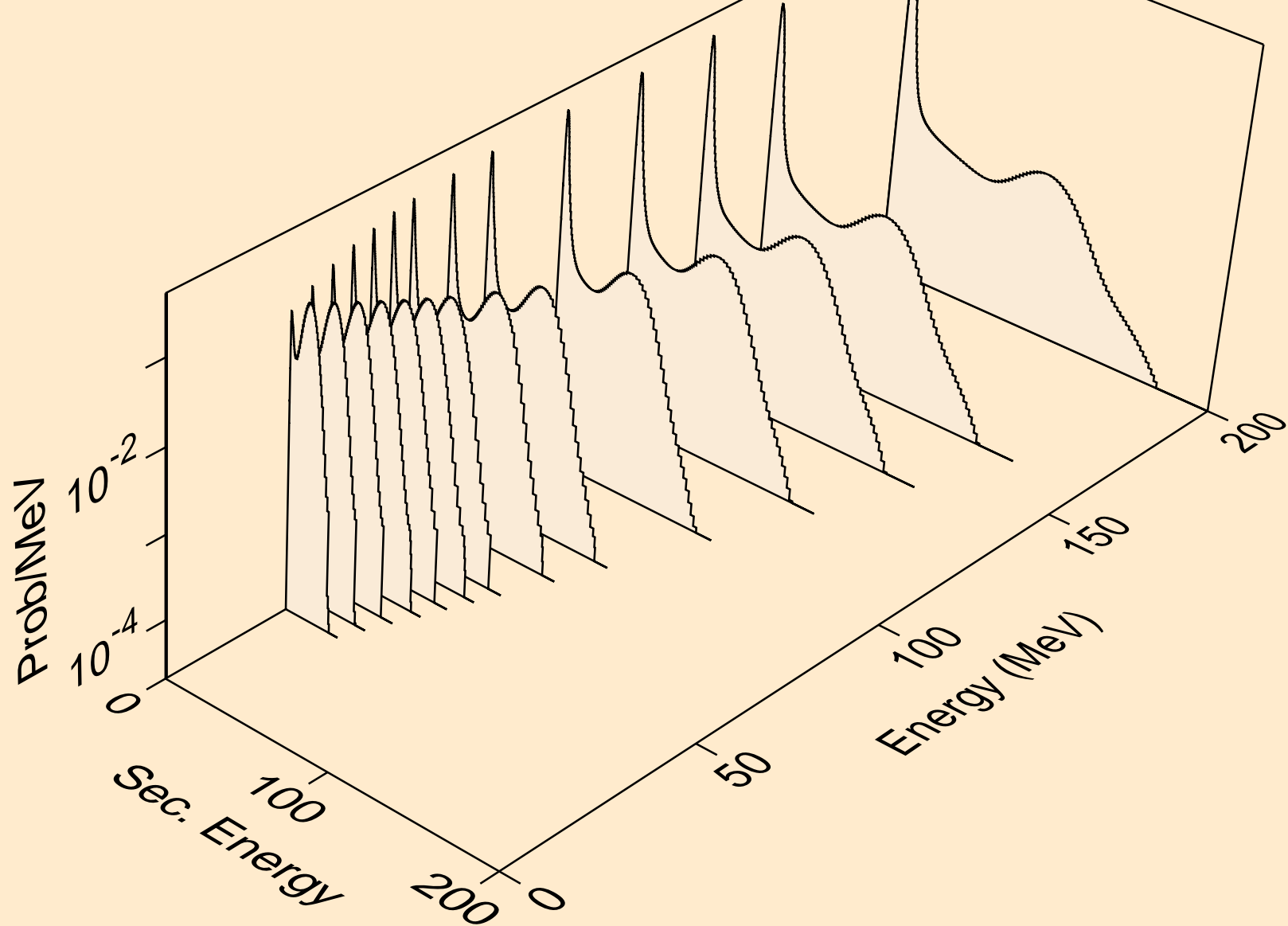

ND128 DEUTERON ACER TENDL-2021 LIBRARY; T=0.K
neutrons from (d,2n)

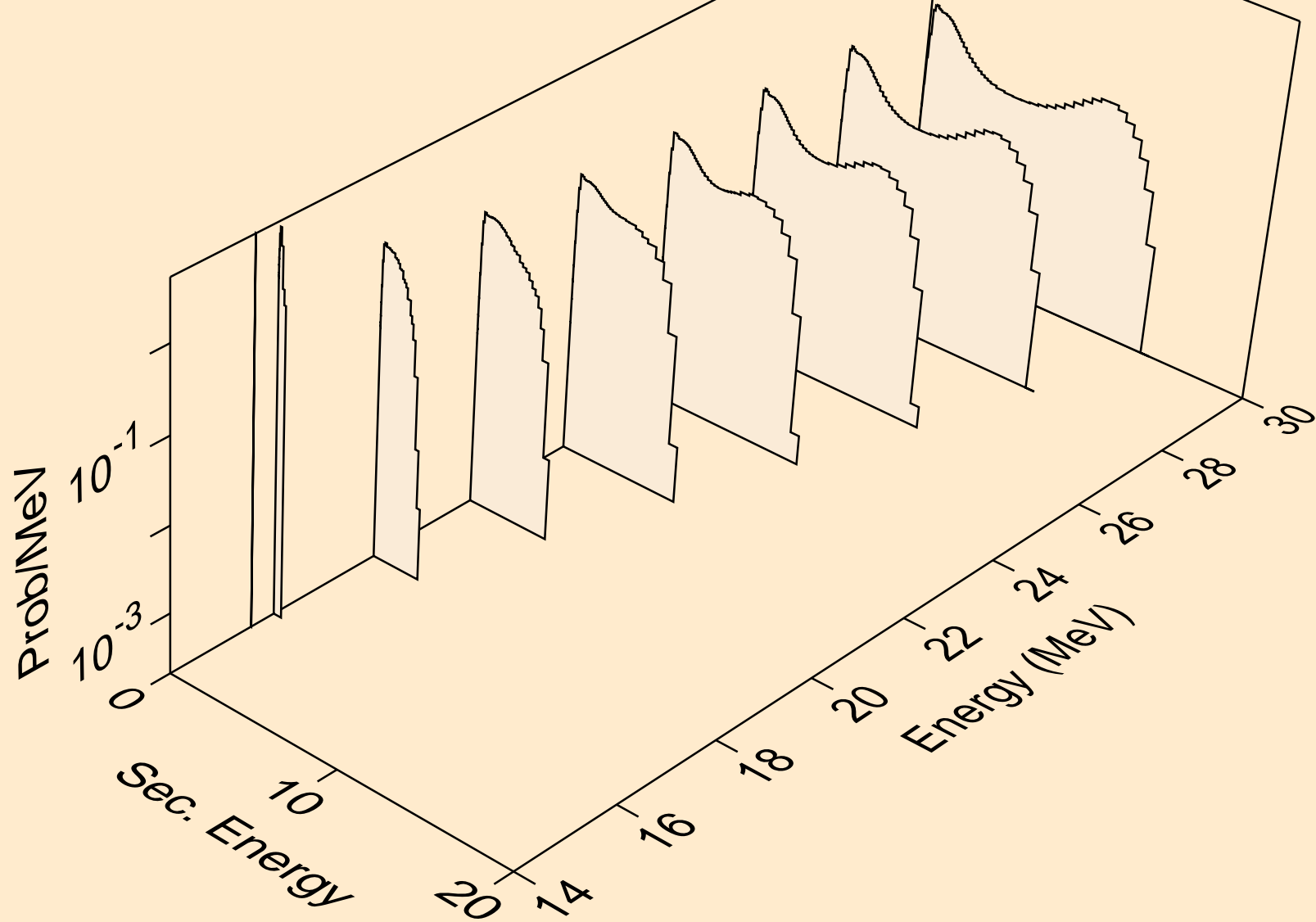

ND128 DEUTERON ACER TENDL-2021 LIBRARY; T=0.K
neutrons from (d,3n)

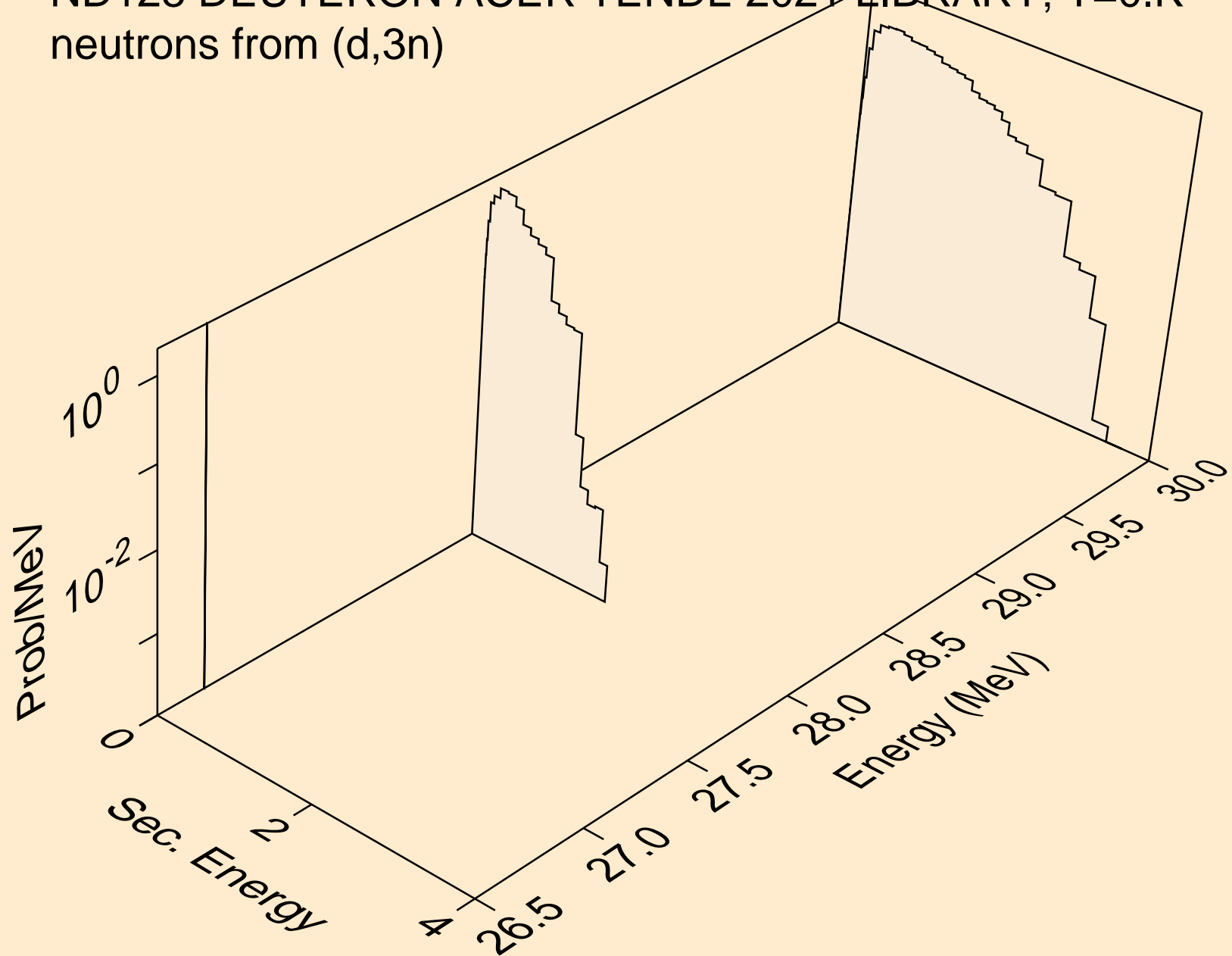

ND128 DEUTERON ACER TENDL-2021 LIBRARY; T=0.K
neutrons from (d,n*)a

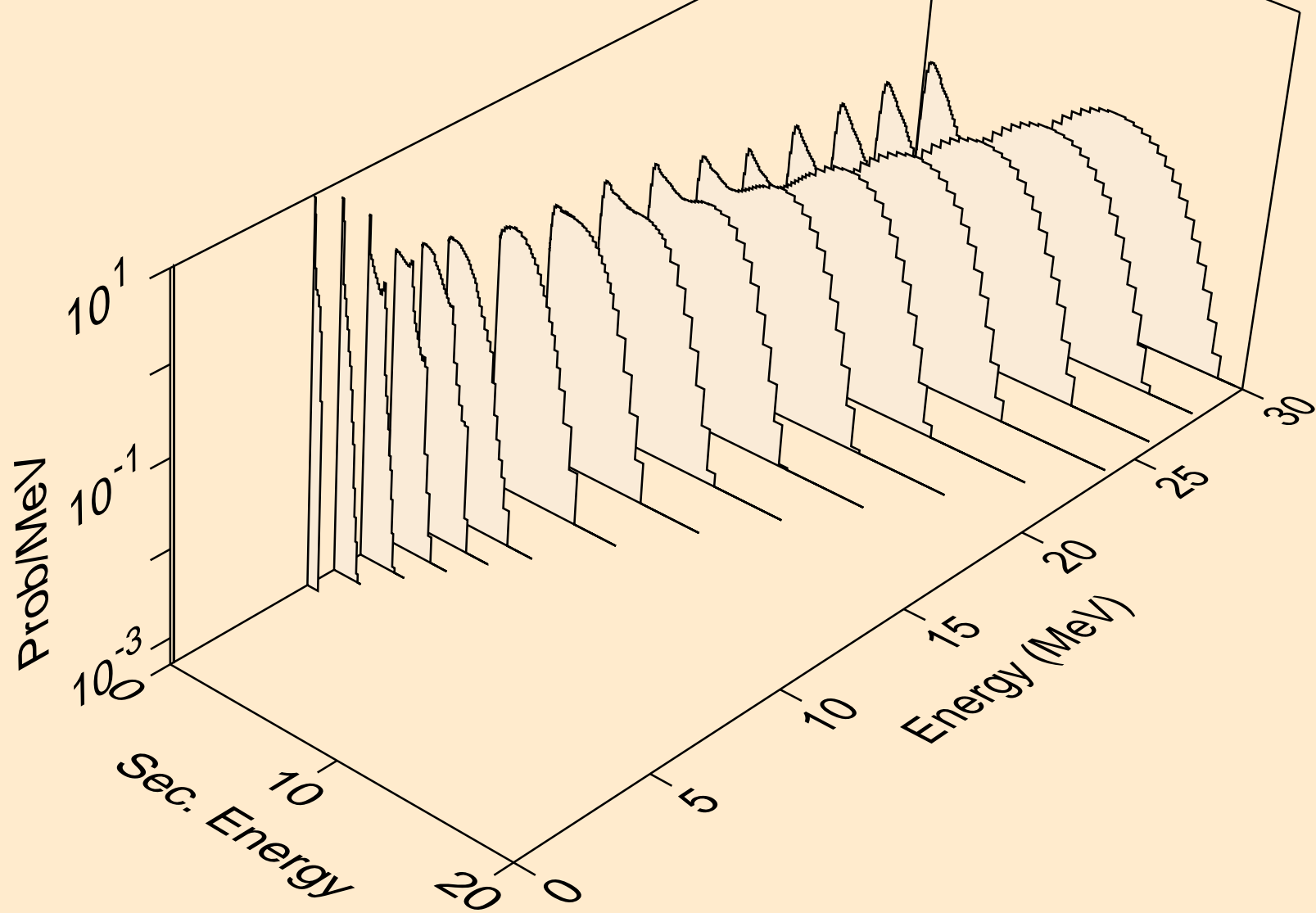

ND128 DEUTERON ACER TENDL-2021 LIBRARY; T=0.K
neutrons from (d,2n)a

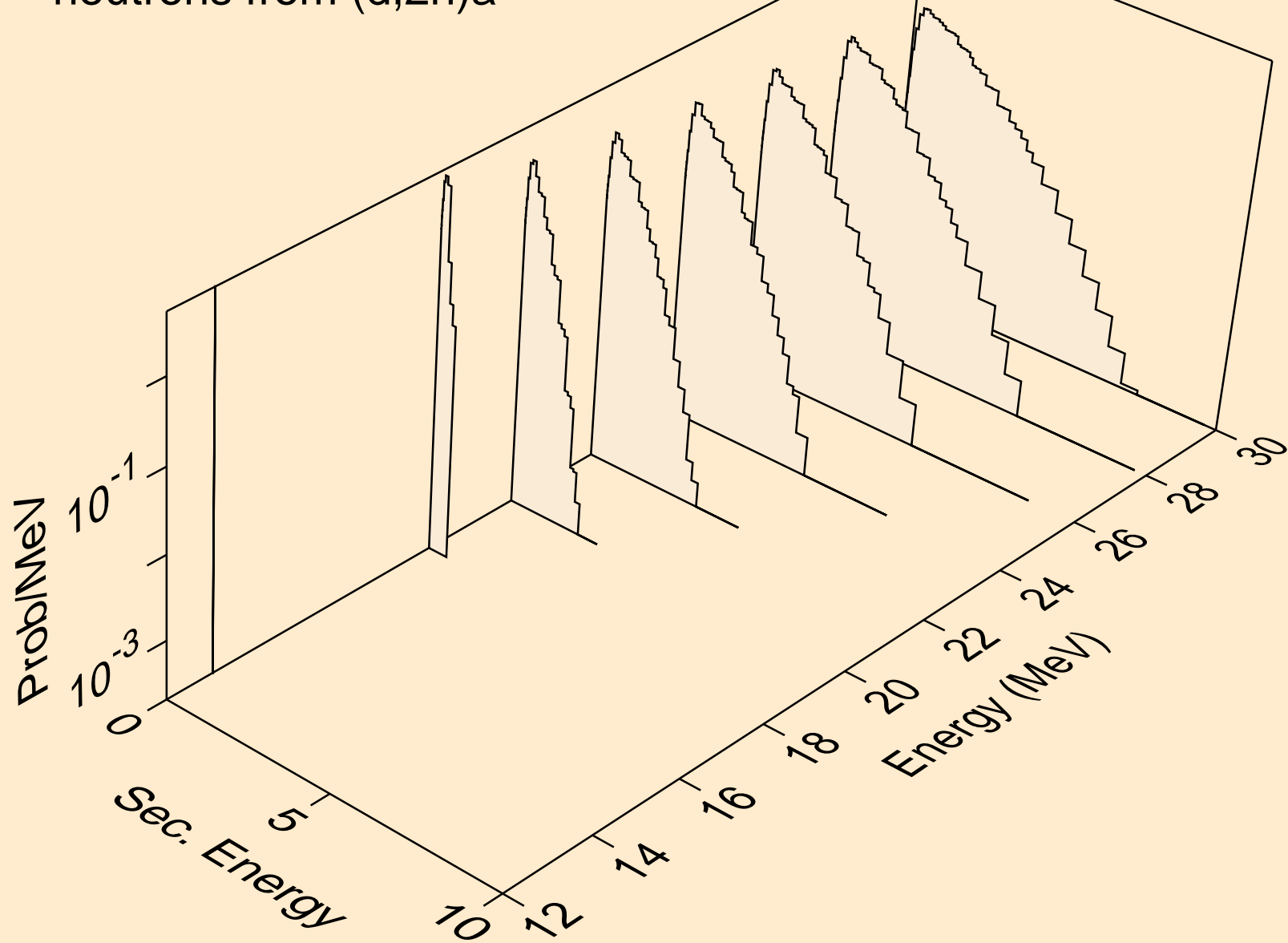

ND128 DEUTERON ACER TENDL-2021 LIBRARY; T=0.K
neutrons from (d,n*)p

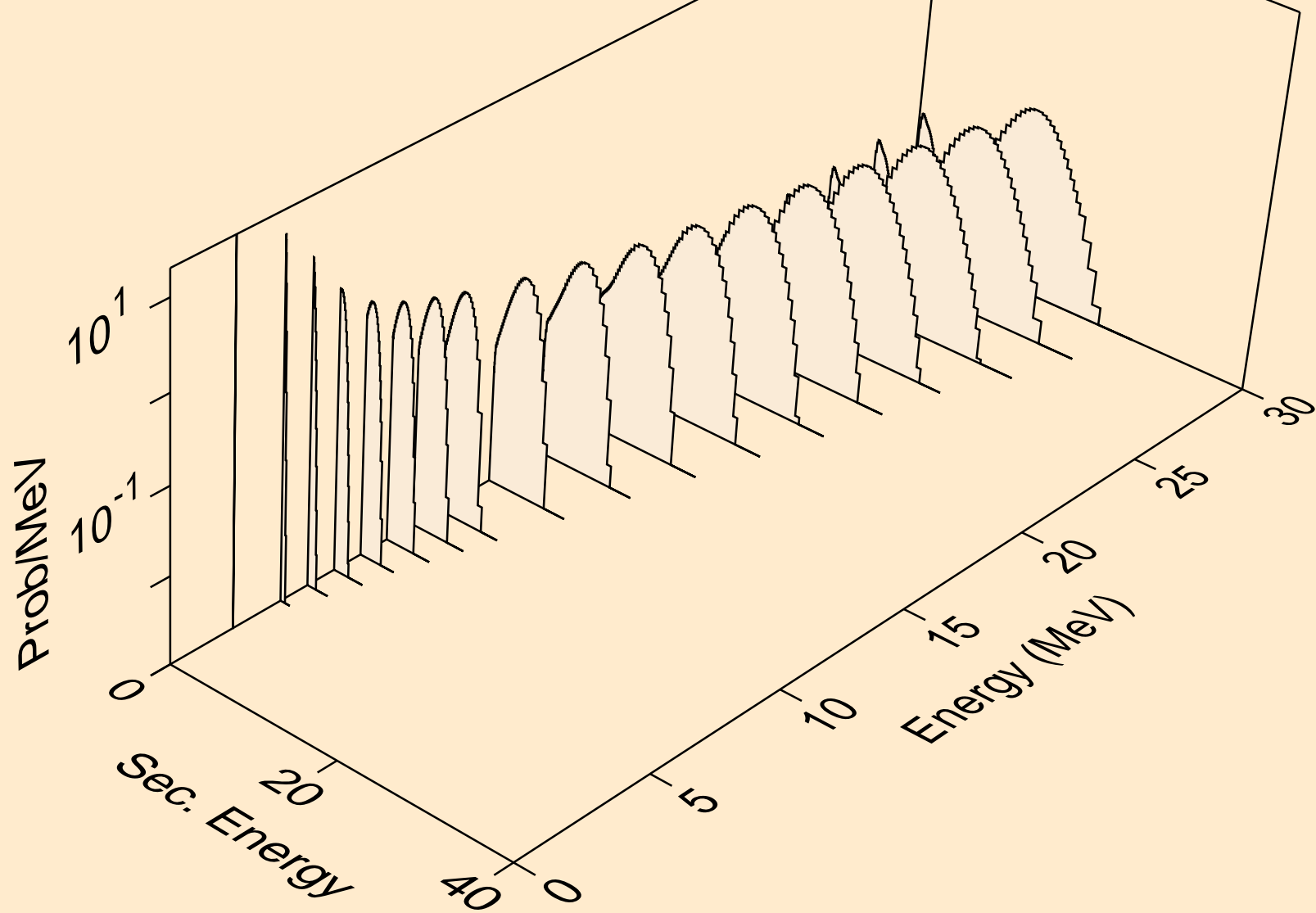

ND128 DEUTERON ACER TENDL-2021 LIBRARY; T=0.K
neutrons from (d,n*)2a

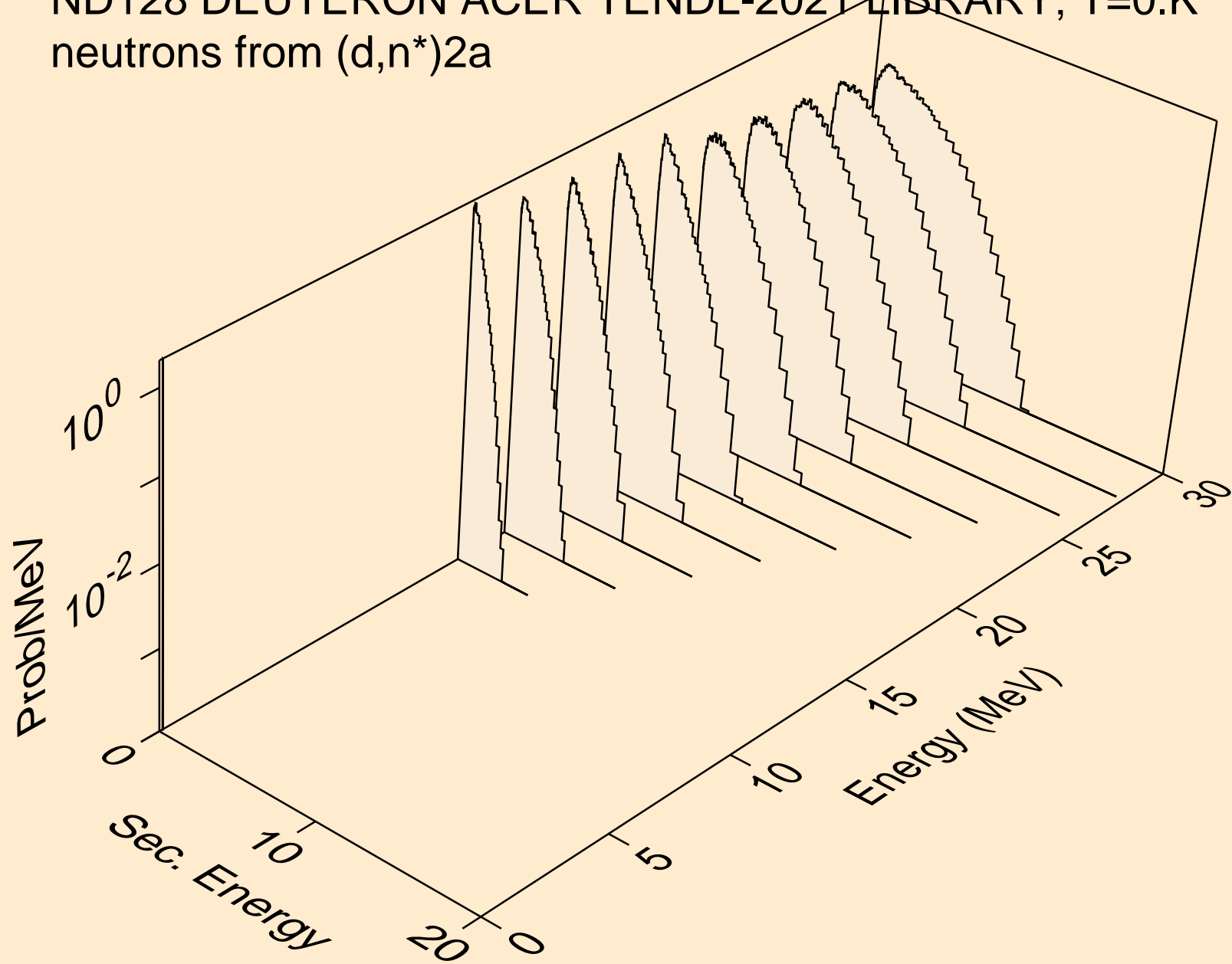

ND128 DEUTERON ACER TENDL-2021 LIBRARY; T=0.K
neutrons from (d,n*)d

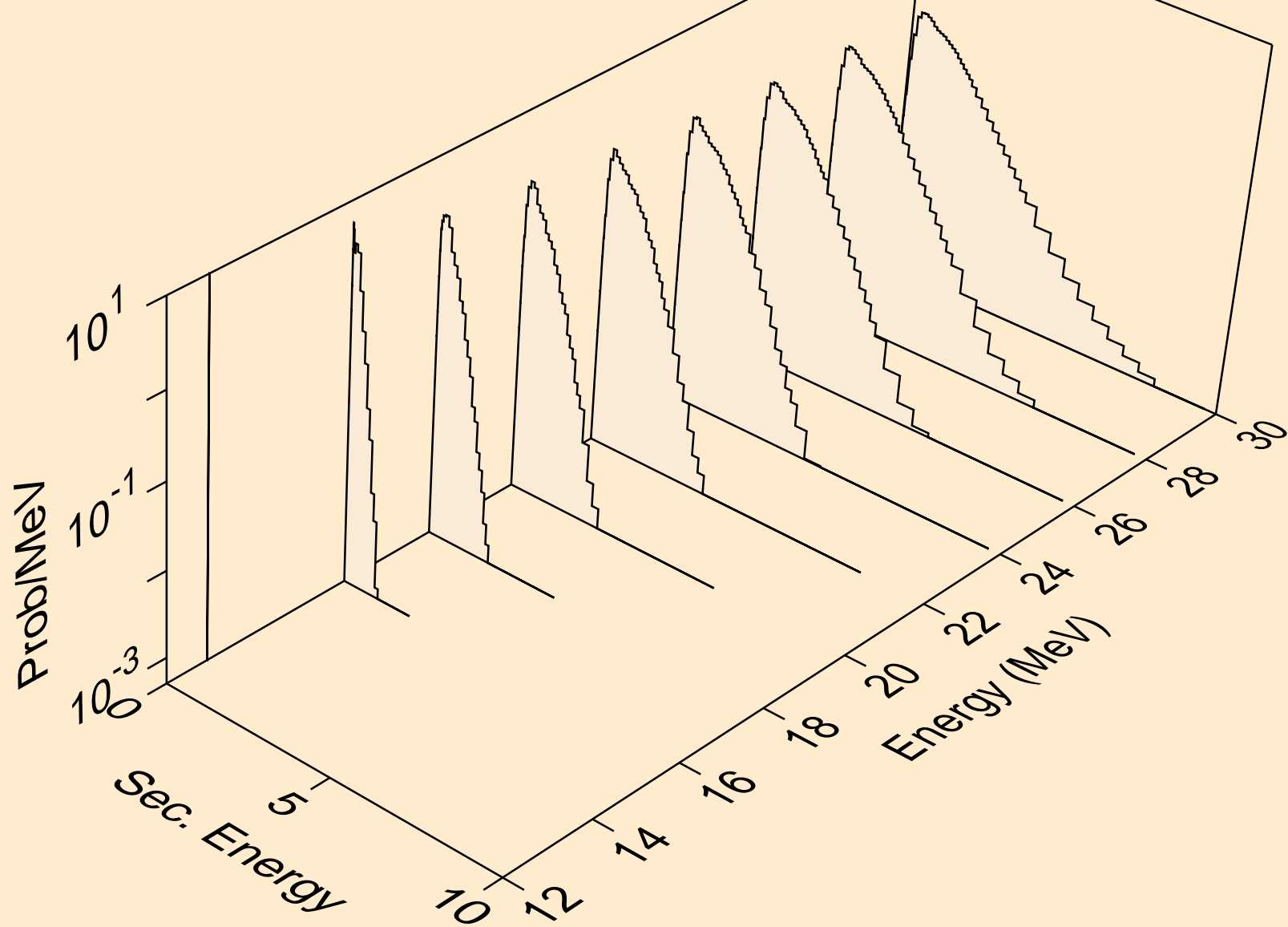

ND128 DEUTERON ACER TENDL-2021 LIBRARY; T=0.K
neutrons from (d,n*)t

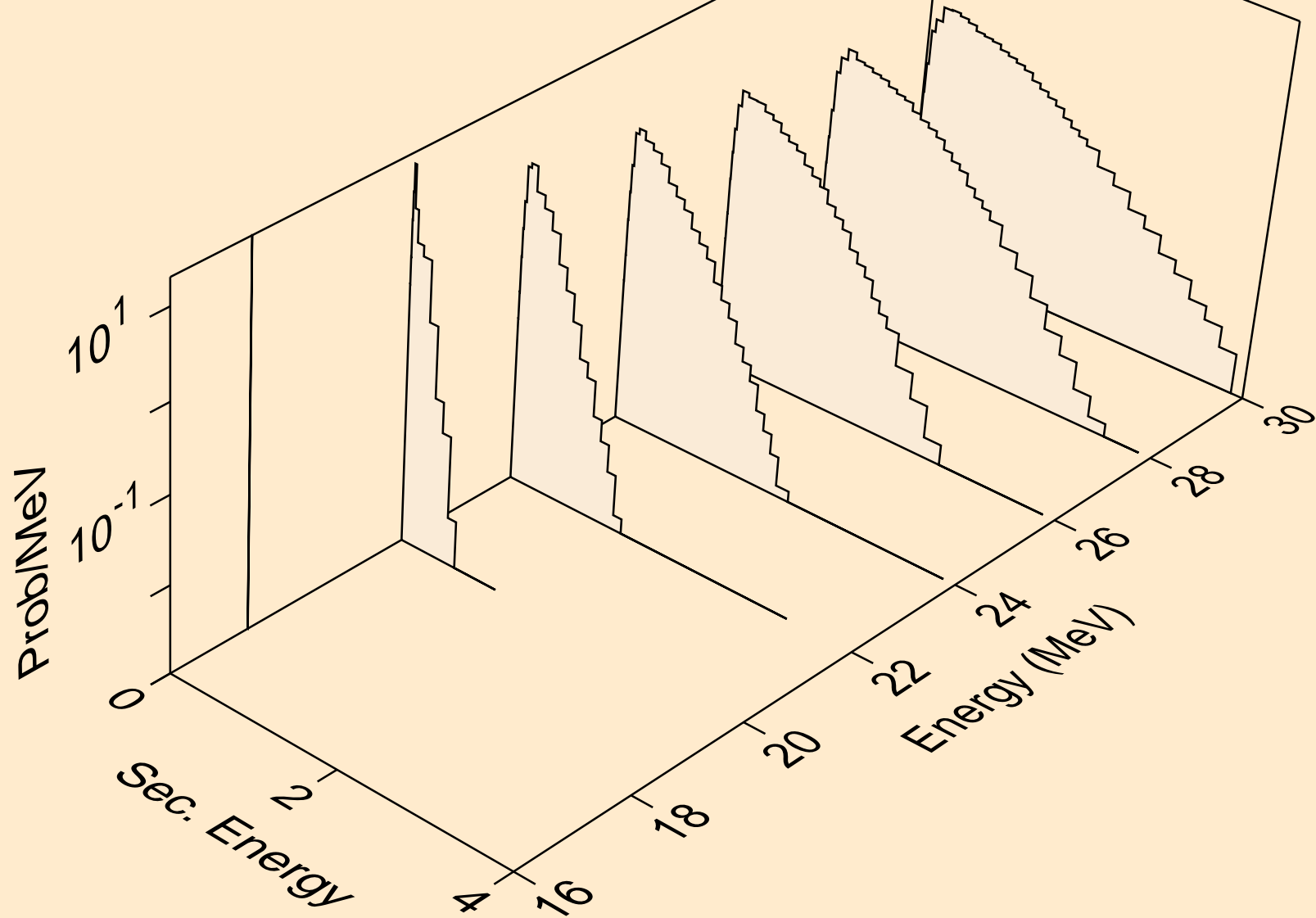

ND128 DEUTERON ACER TENDL-2021 LIBRARY; T=0.K
neutrons from (d,n*)he3

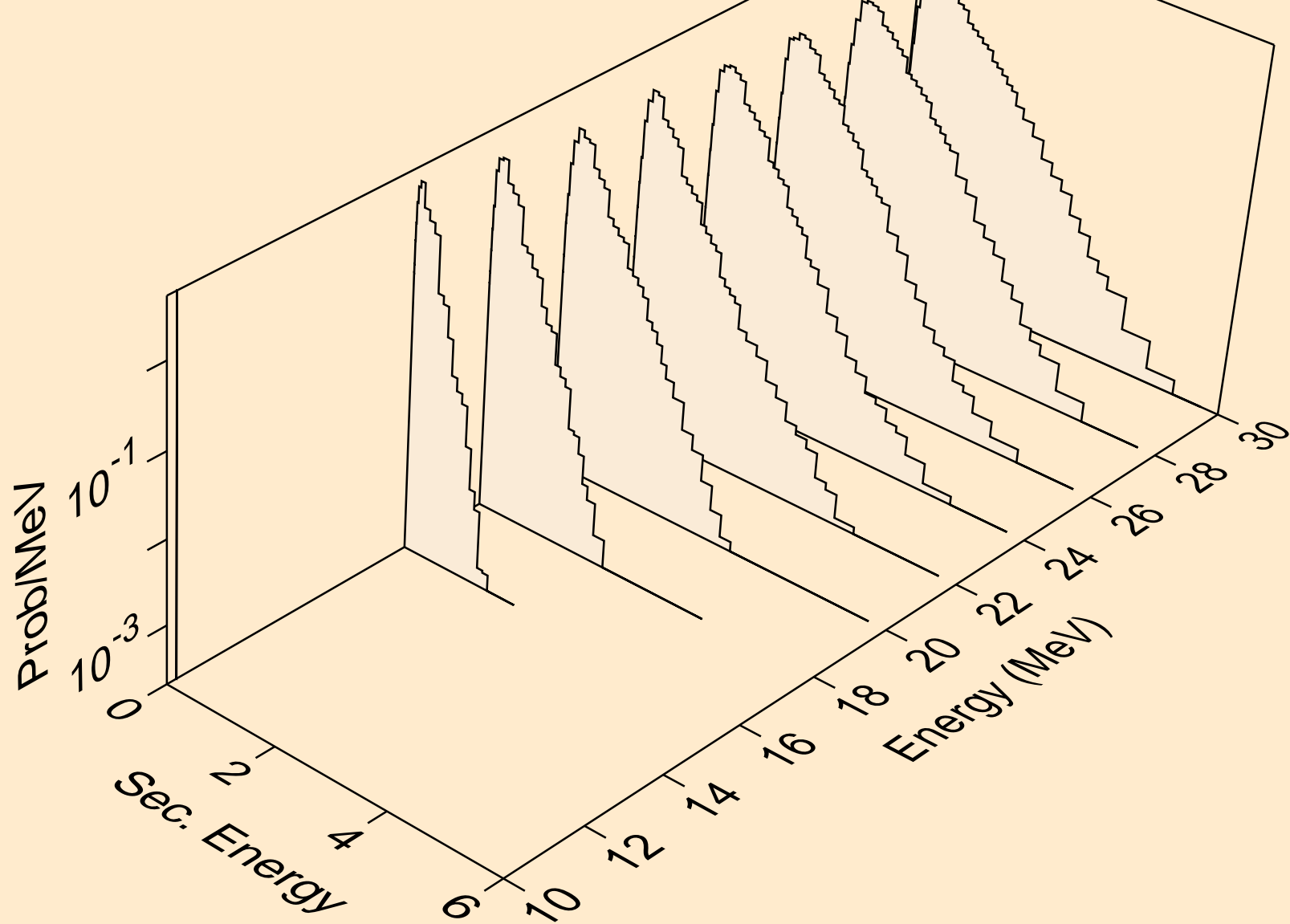

ND128 DEUTERON ACER TENDL-2021 LIBRARY; T=0.K
neutrons from (d,2np)

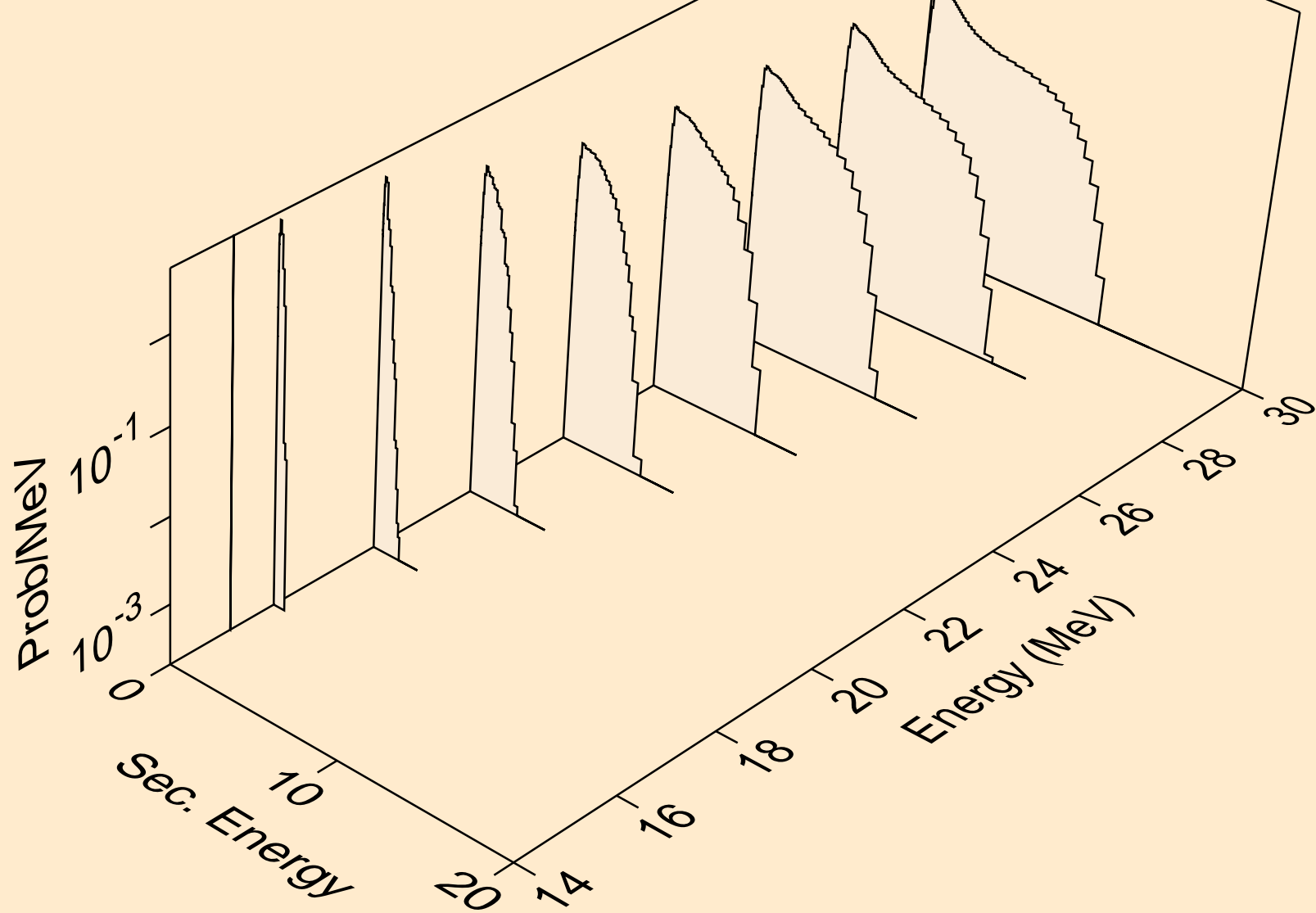

ND128 DEUTERON ACER TENDL-2021 LIBRARY; T=0.K
neutrons from (d,3np)

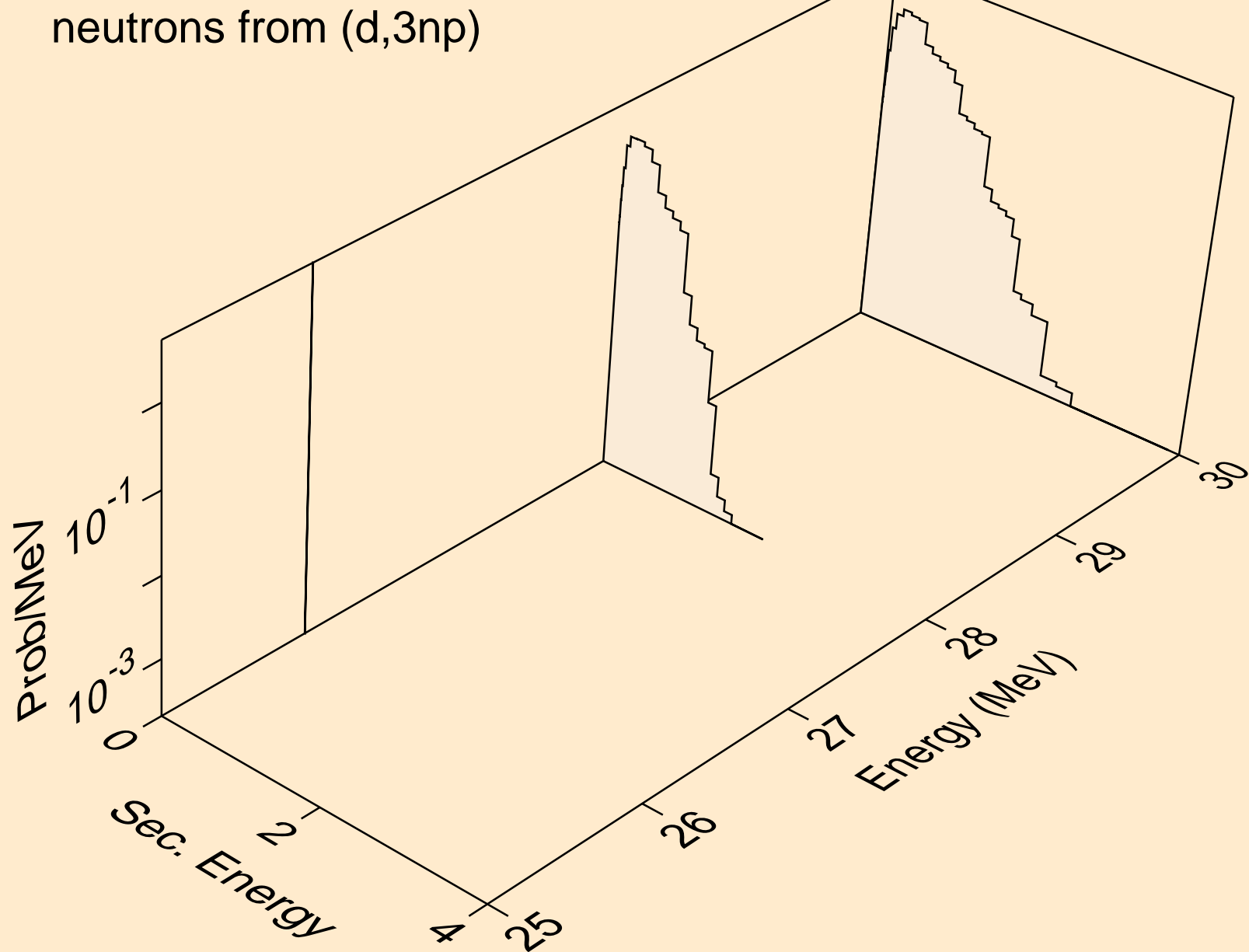

ND128 DEUTERON ACER TENDL-2021 LIBRARY; T=0.K
neutrons from (d,2np)

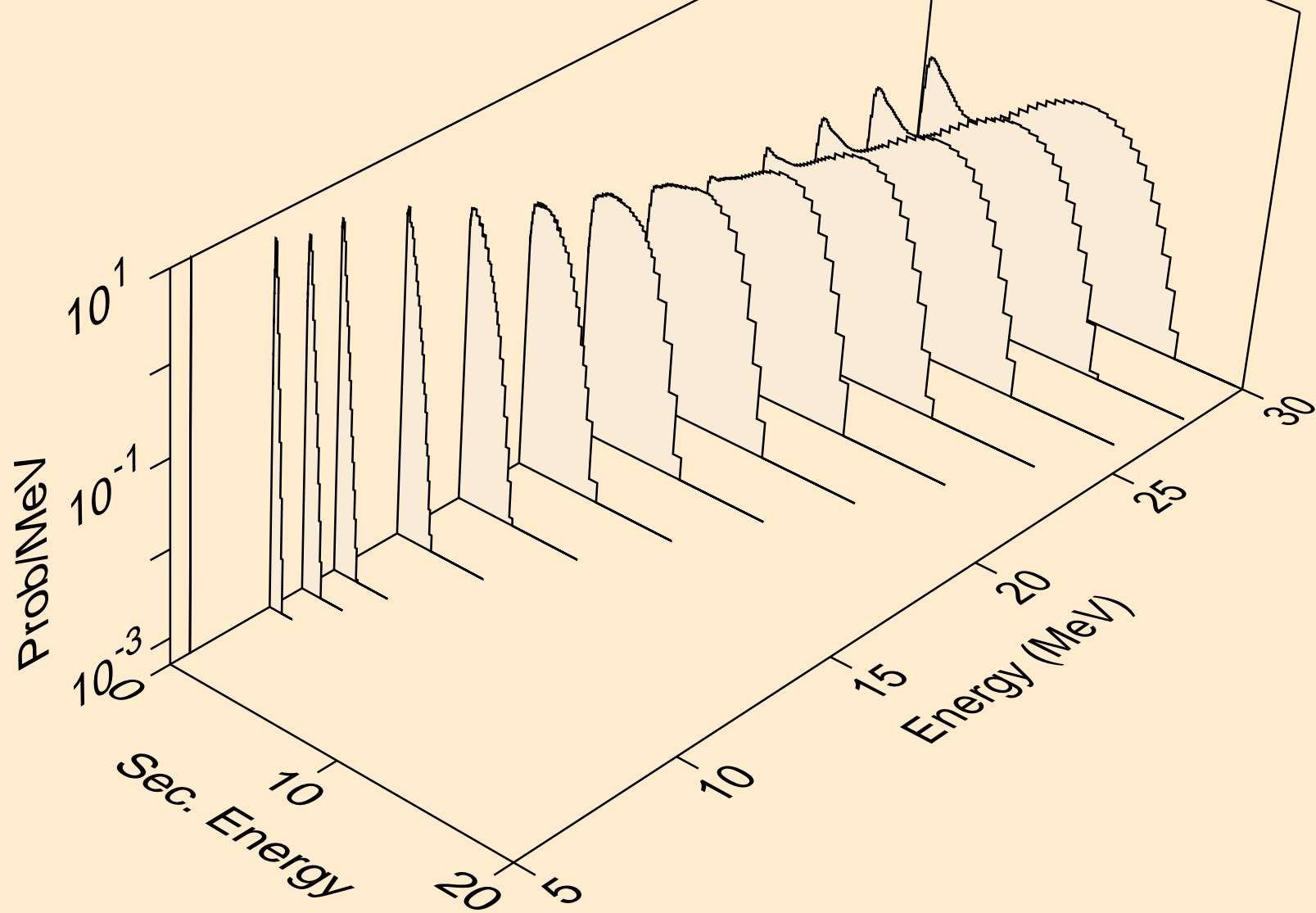

ND128 DEUTERON ACER TENDL-2021 LIBRARY; T=0.K
neutrons from (d,npa)

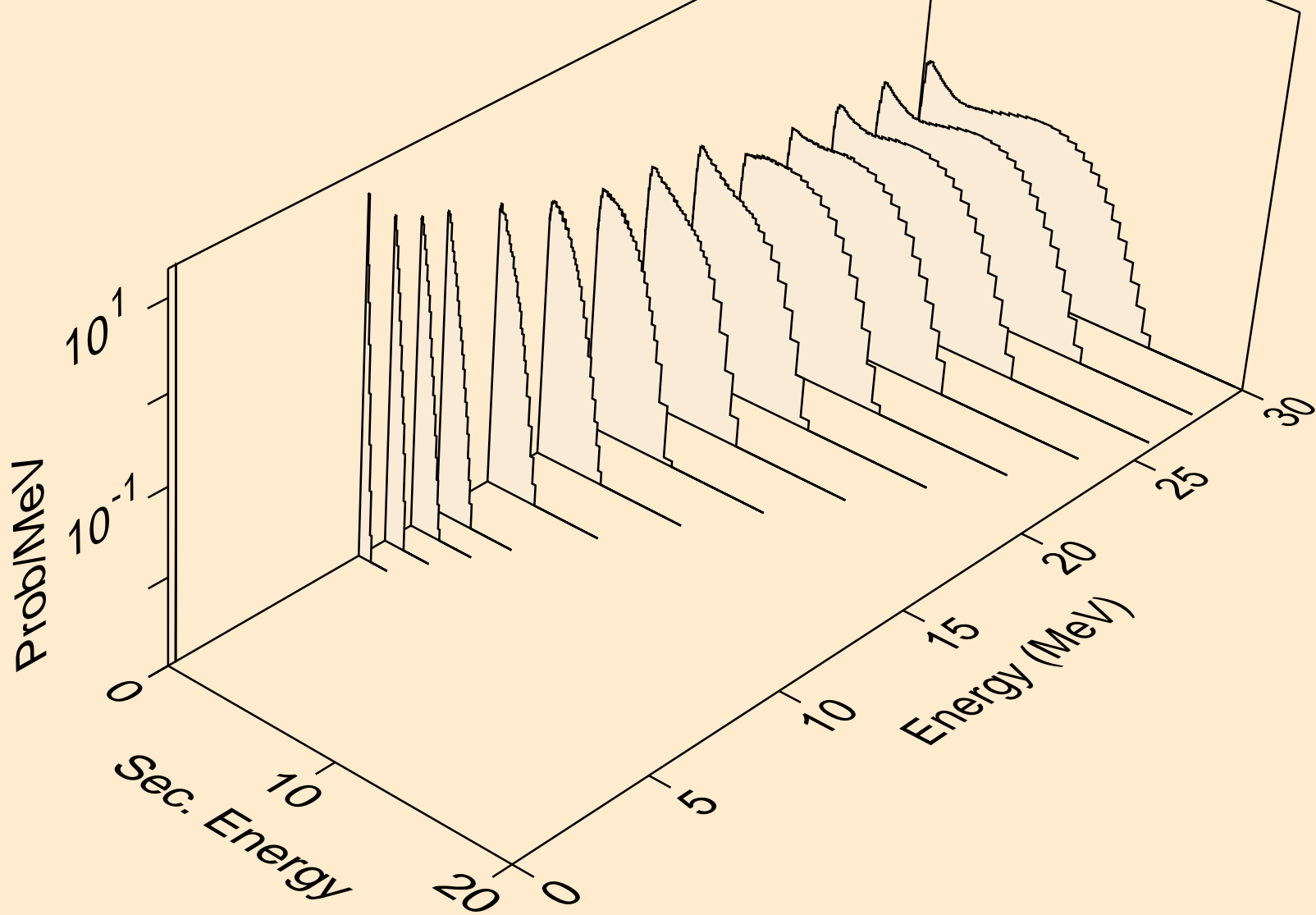

ND128 DEUTERON ACER TENDL-2021 LIBRARY; T=0.K
protons from (d,x)

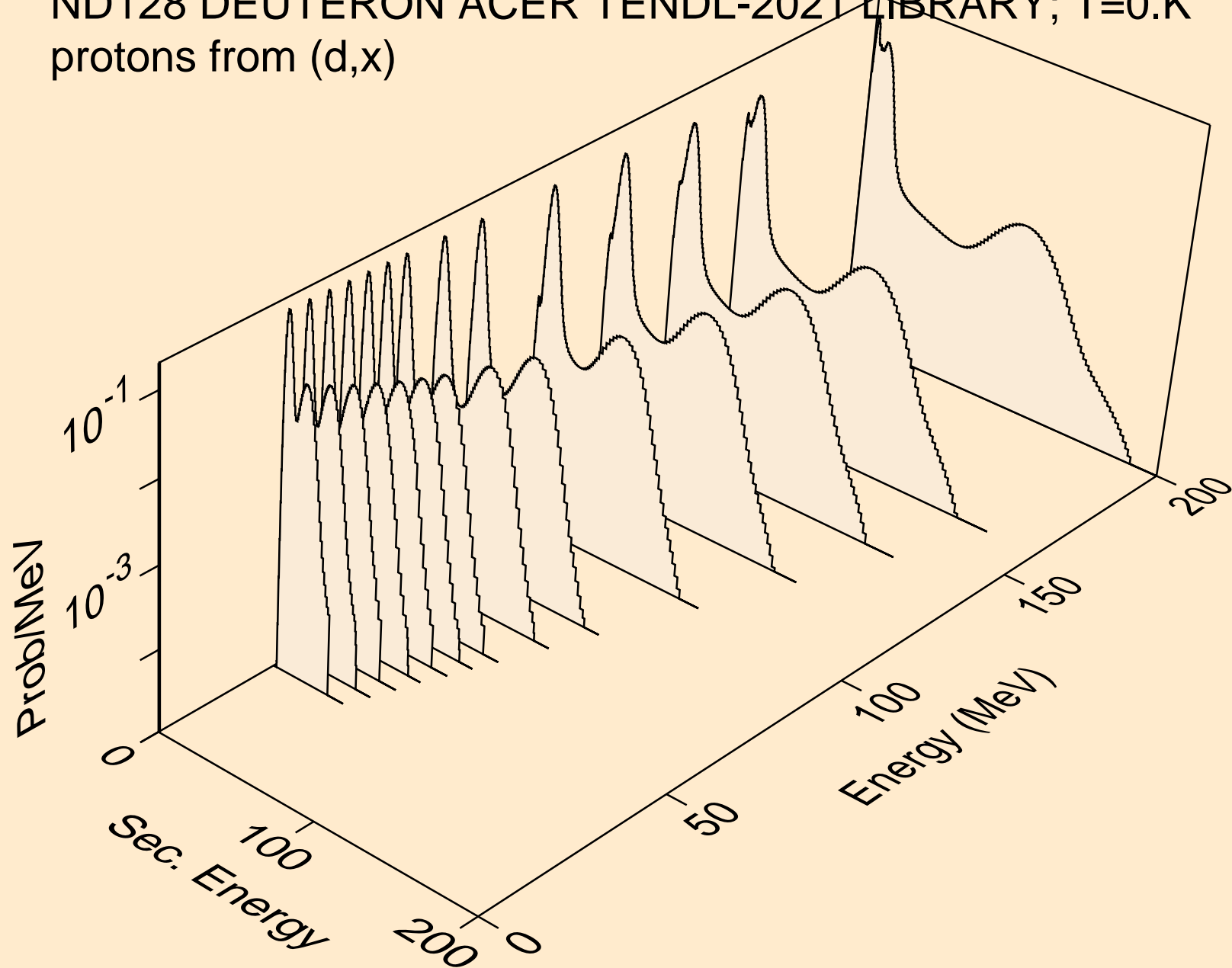

ND128 DEUTERON ACER TENDL-2021 LIBRARY; T=0.K
protons from (d,n*)p

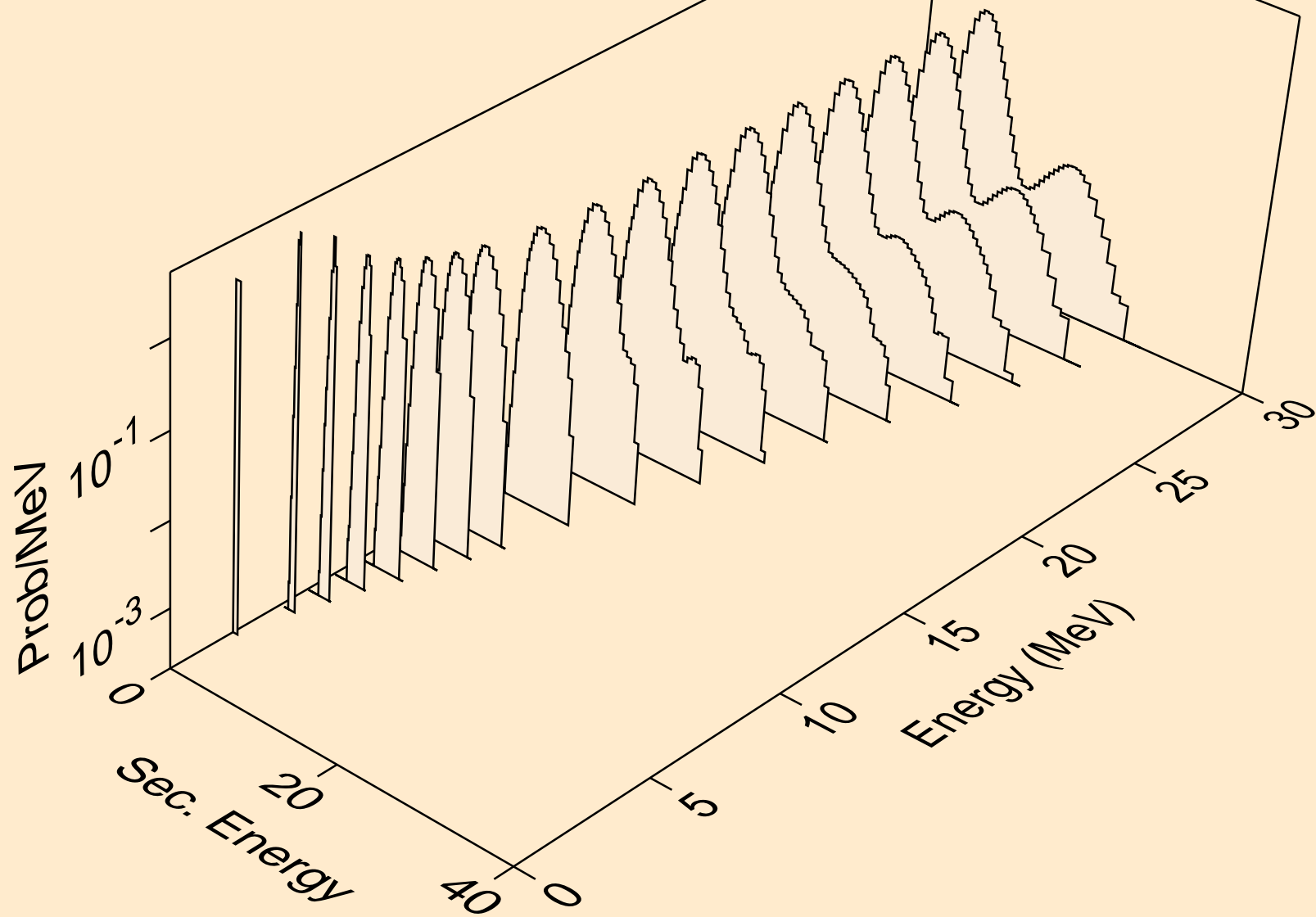

ND128 DEUTERON ACER TENDL-2021 LIBRARY; T=0.K
protons from (d,2np)

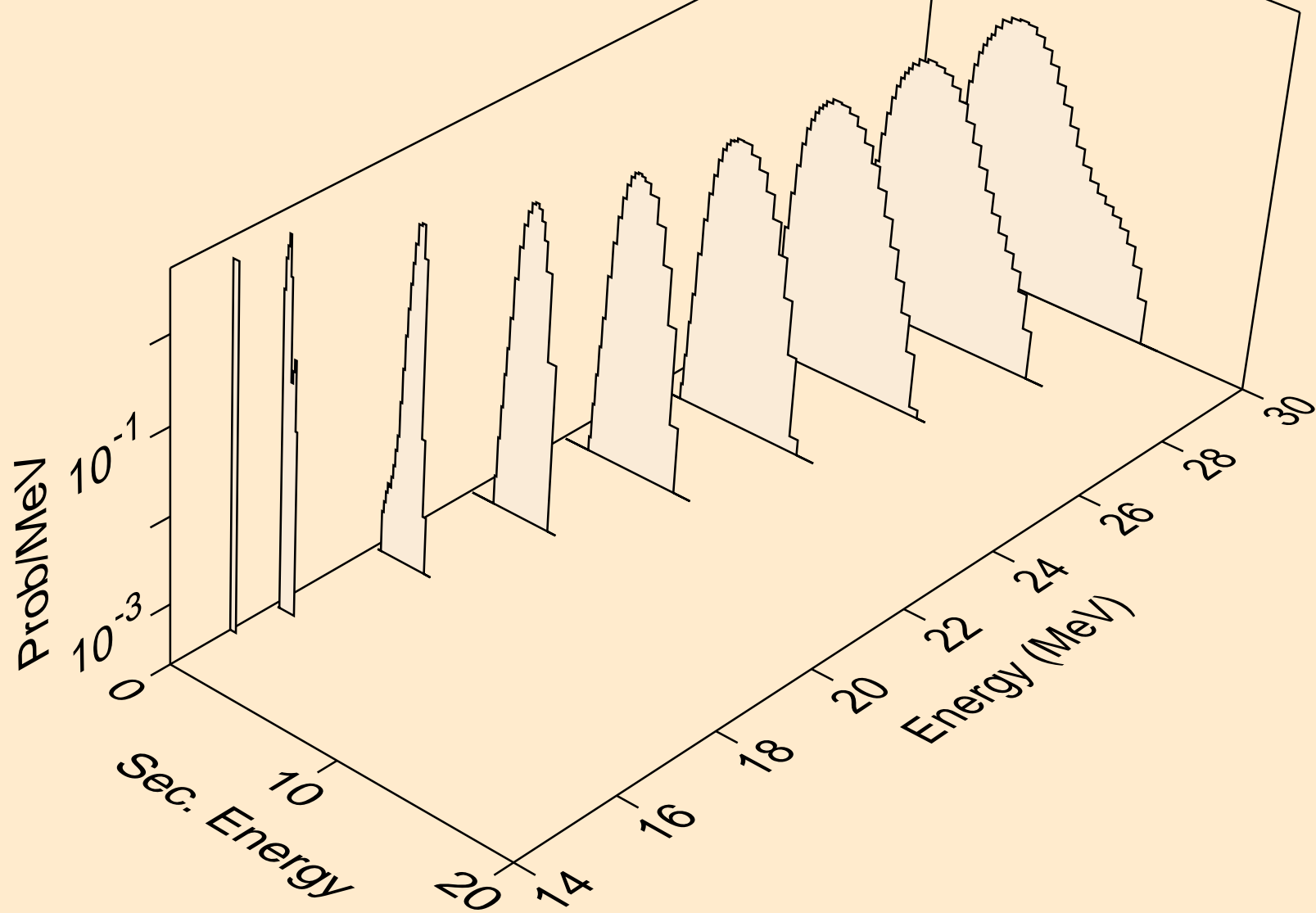

ND128 DEUTERON ACER TENDL-2021 LIBRARY; T=0.K
protons from (d,3np)

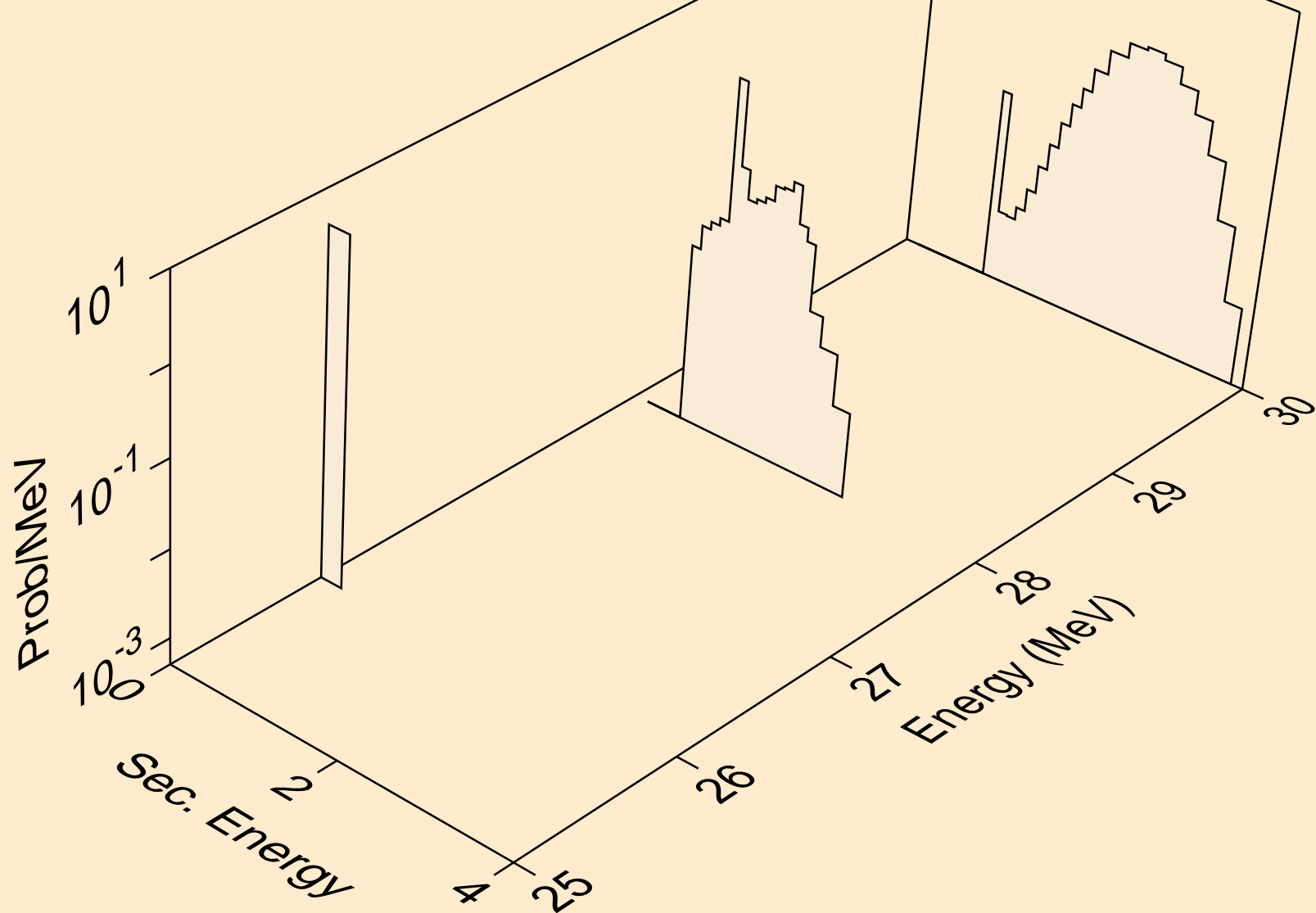

ND128 DEUTERON ACER TENDL-2021 LIBRARY; T=0.K
protons from (d,2np)

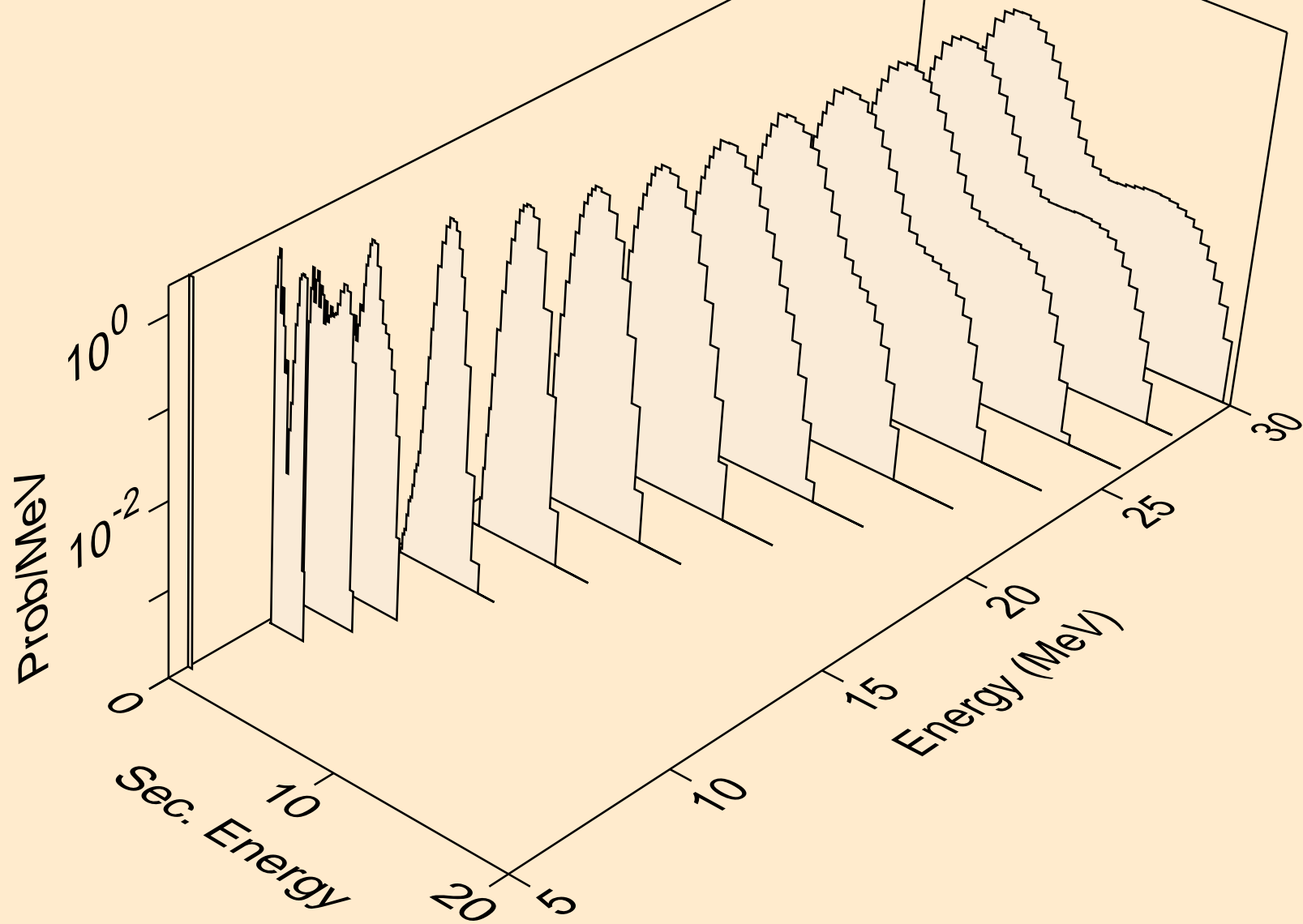

ND128 DEUTERON ACER TENDL-2021 LIBRARY; T=0.K
protons from (d,npa)

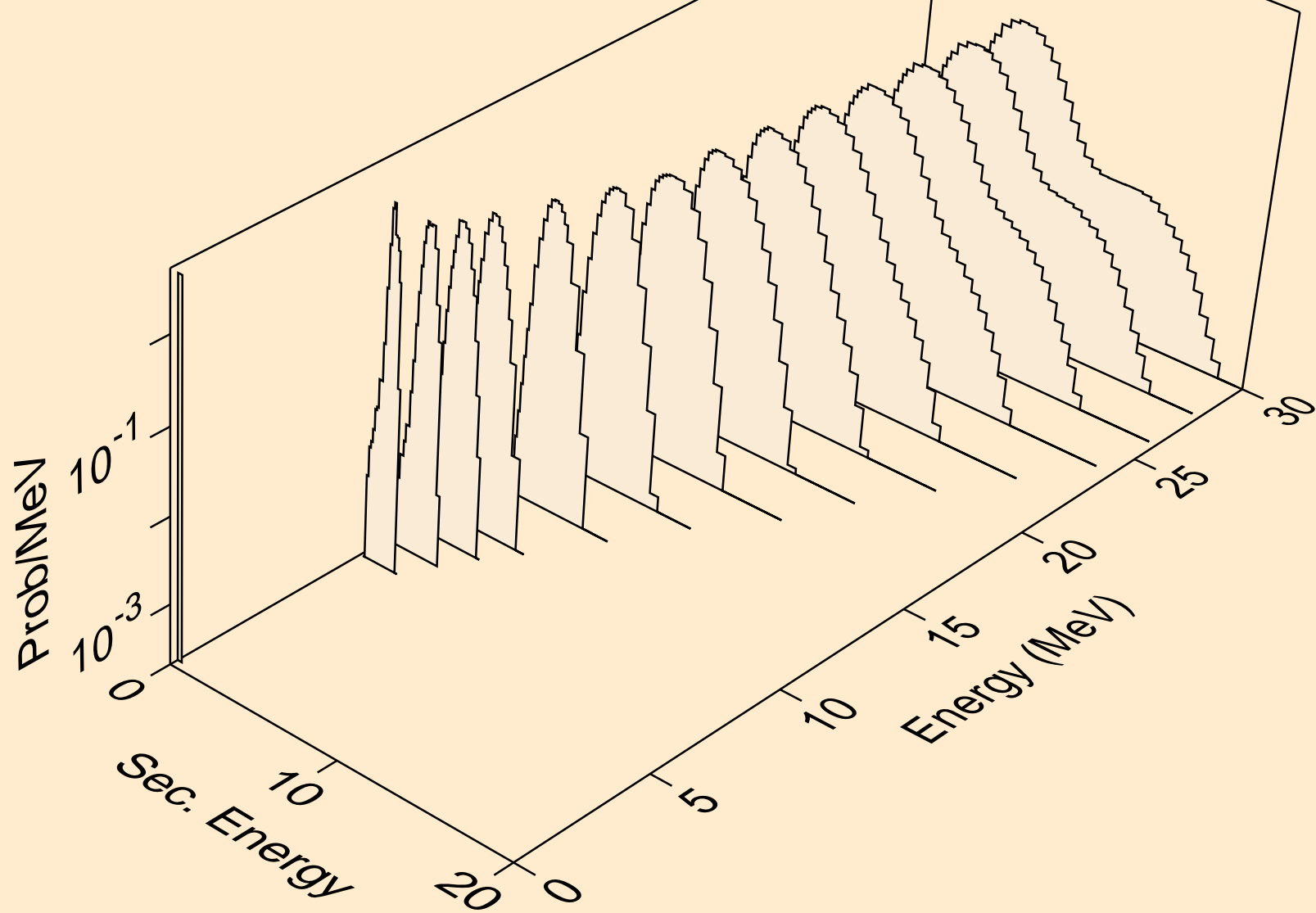

ND128 DEUTERON ACER TENDL-2021 LIBRARY; T=0.K
protons from (d,p)

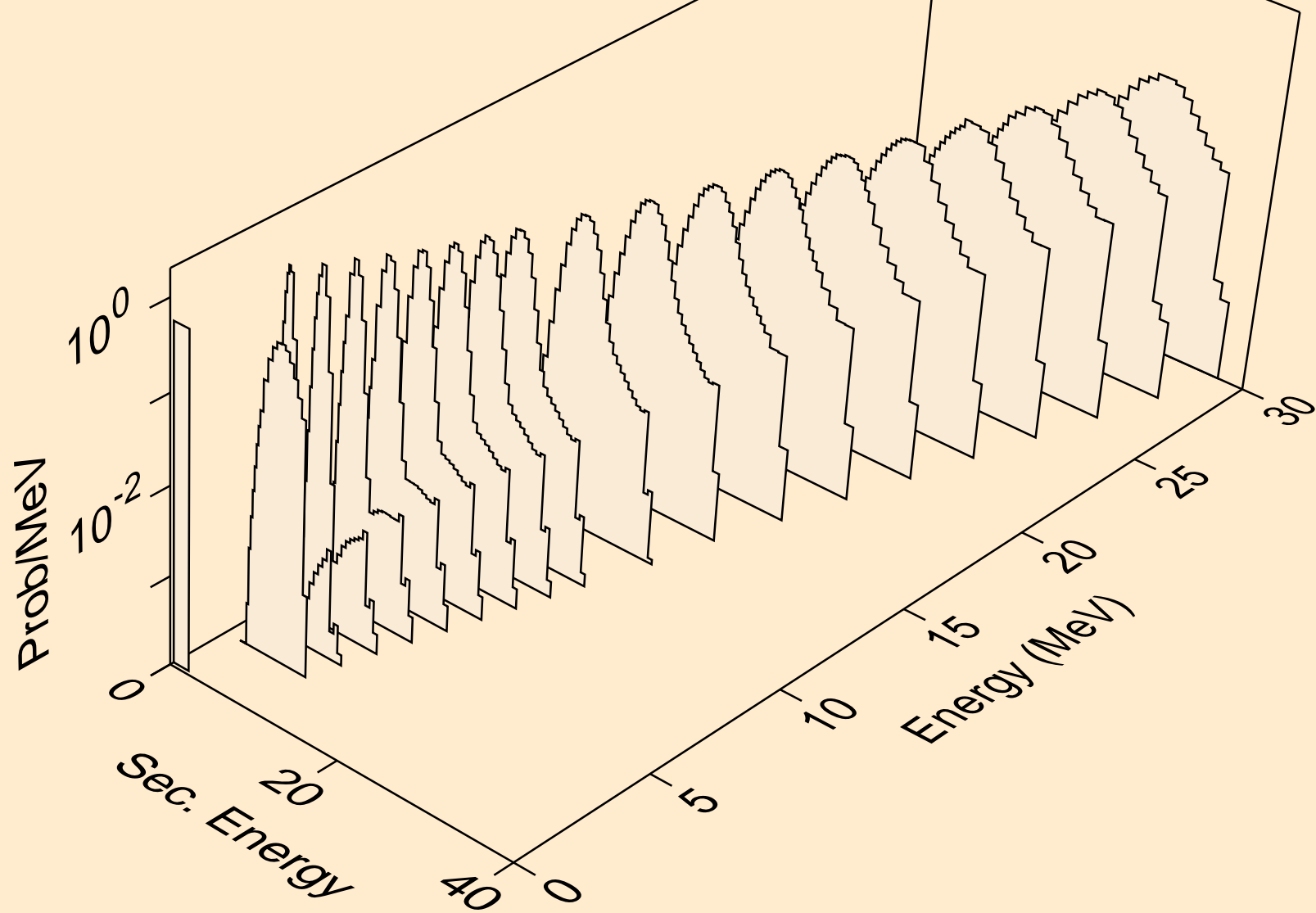

ND128 DEUTERON ACER TENDL-2021 LIBRARY; T=0.K
protons from (d,2p)

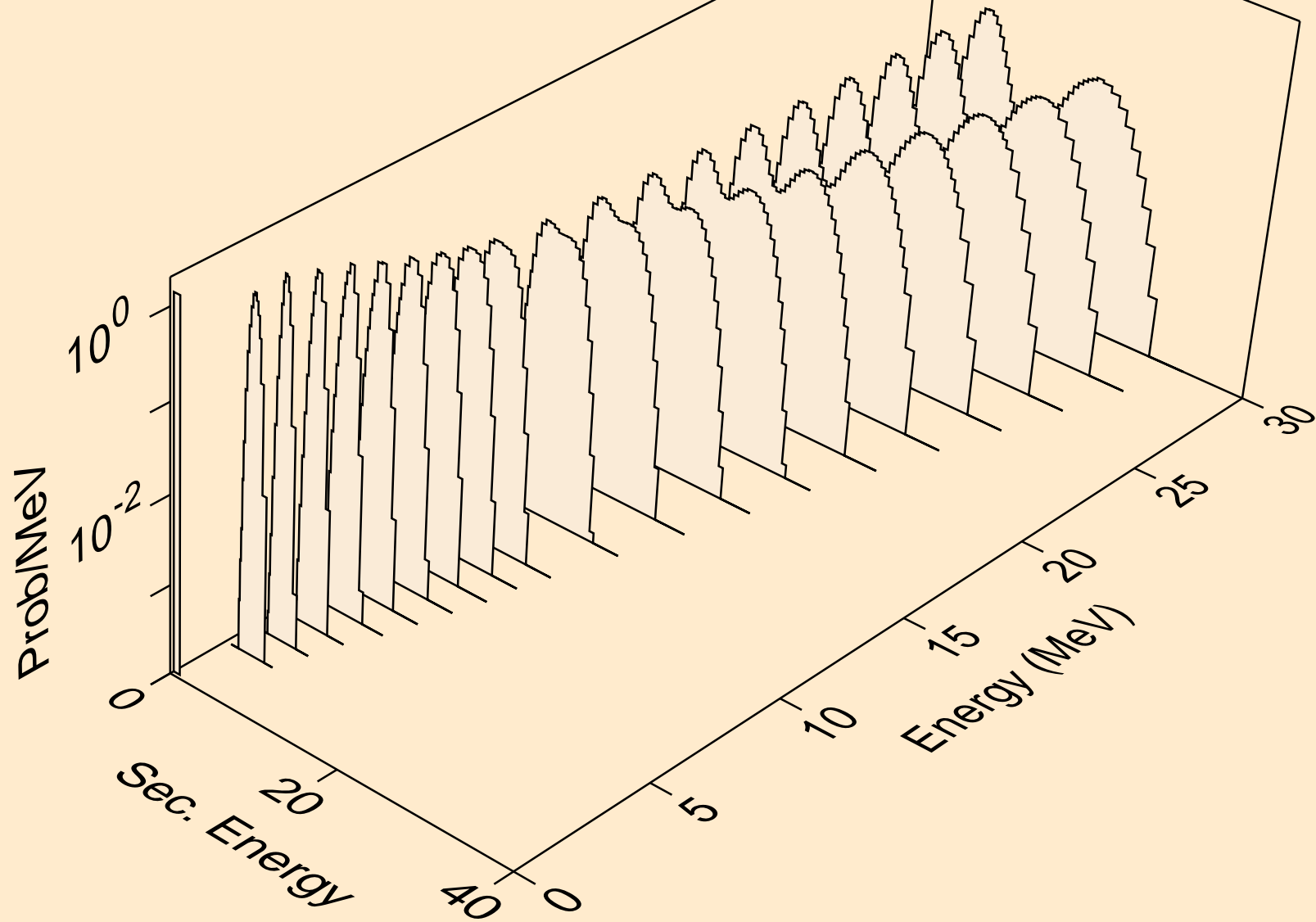

ND128 DEUTERON ACER TENDL-2021 LIBRARY; T=0.K
protons from (d,pa)

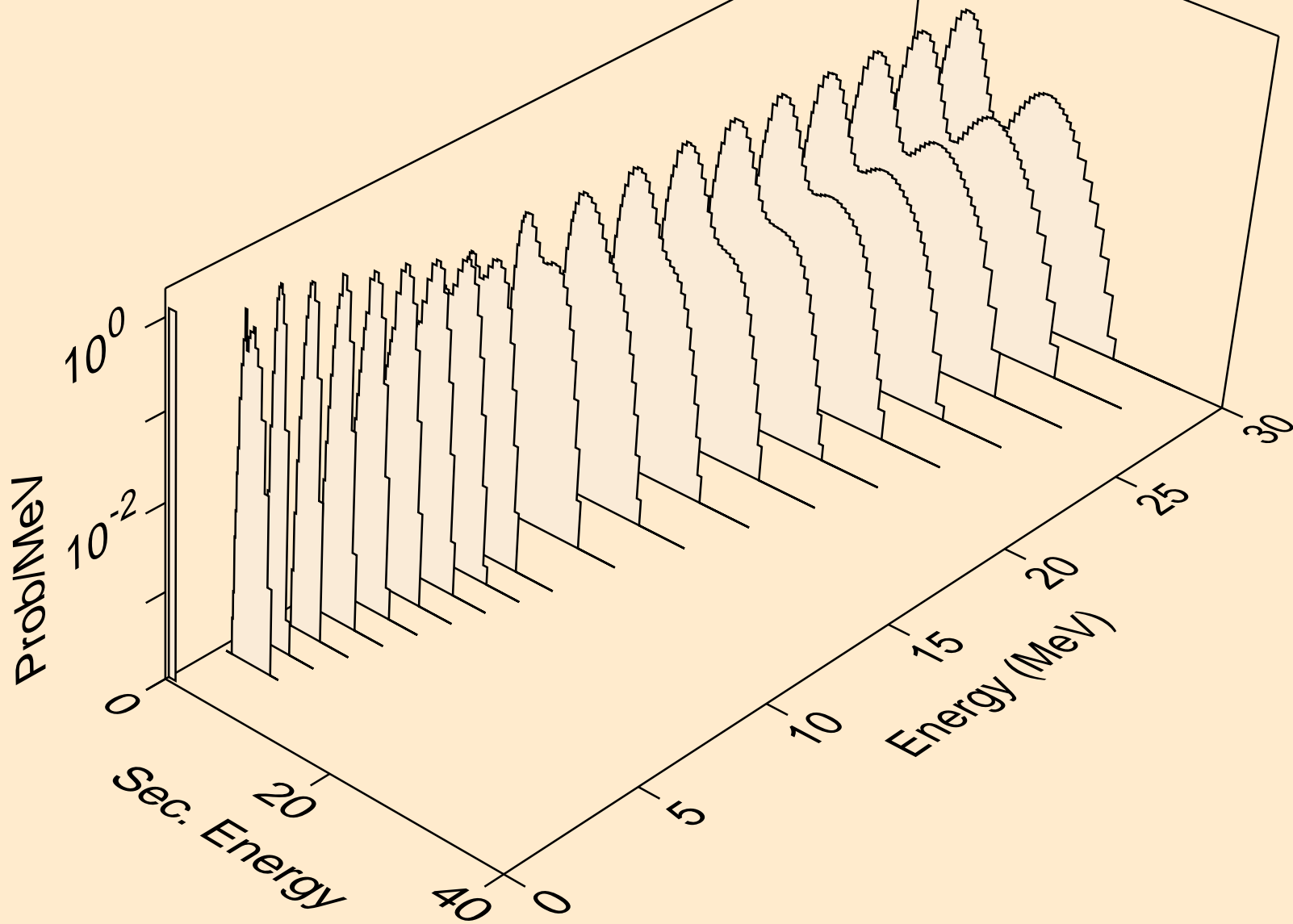

ND128 DEUTERON ACER TENDL-2021 LIBRARY; T=0.K
protons from (d,pd)

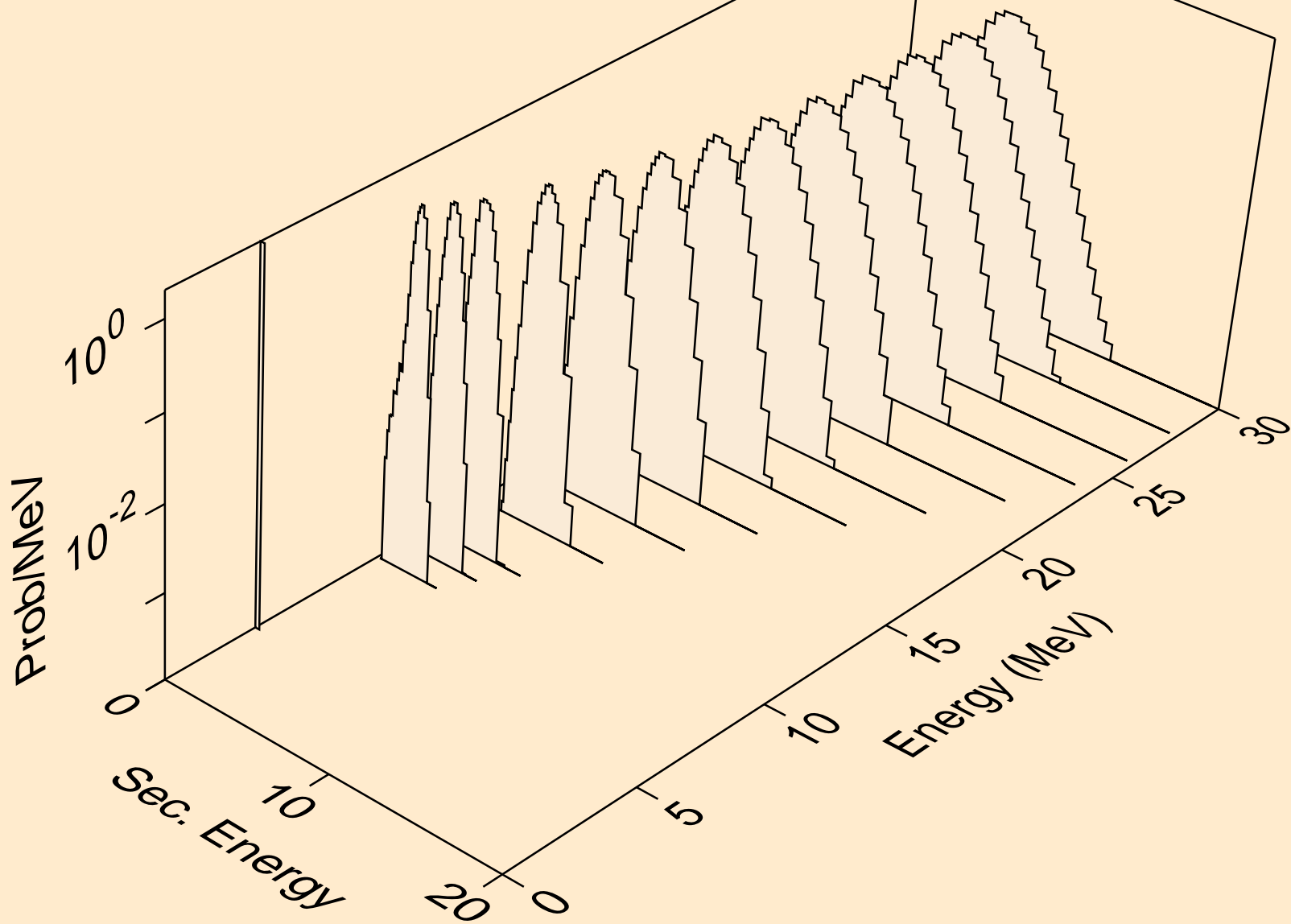

ND128 DEUTERON ACER TENDL-2021 LIBRARY; T=0.K
protons from (d,pt)

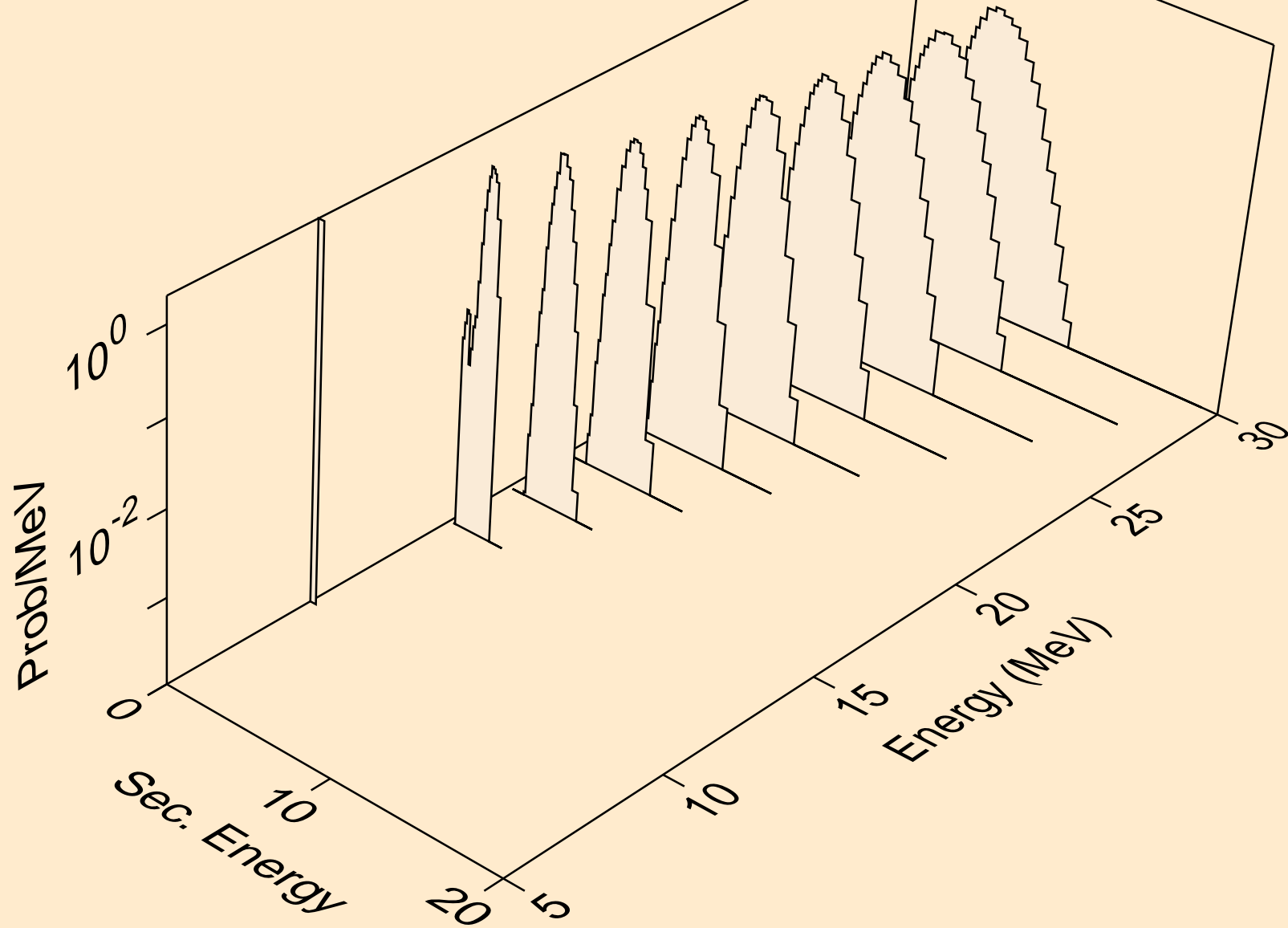

ND128 DEUTERON ACER TENDL-2021 LIBRARY; T=0.K
tritons from (d,x)

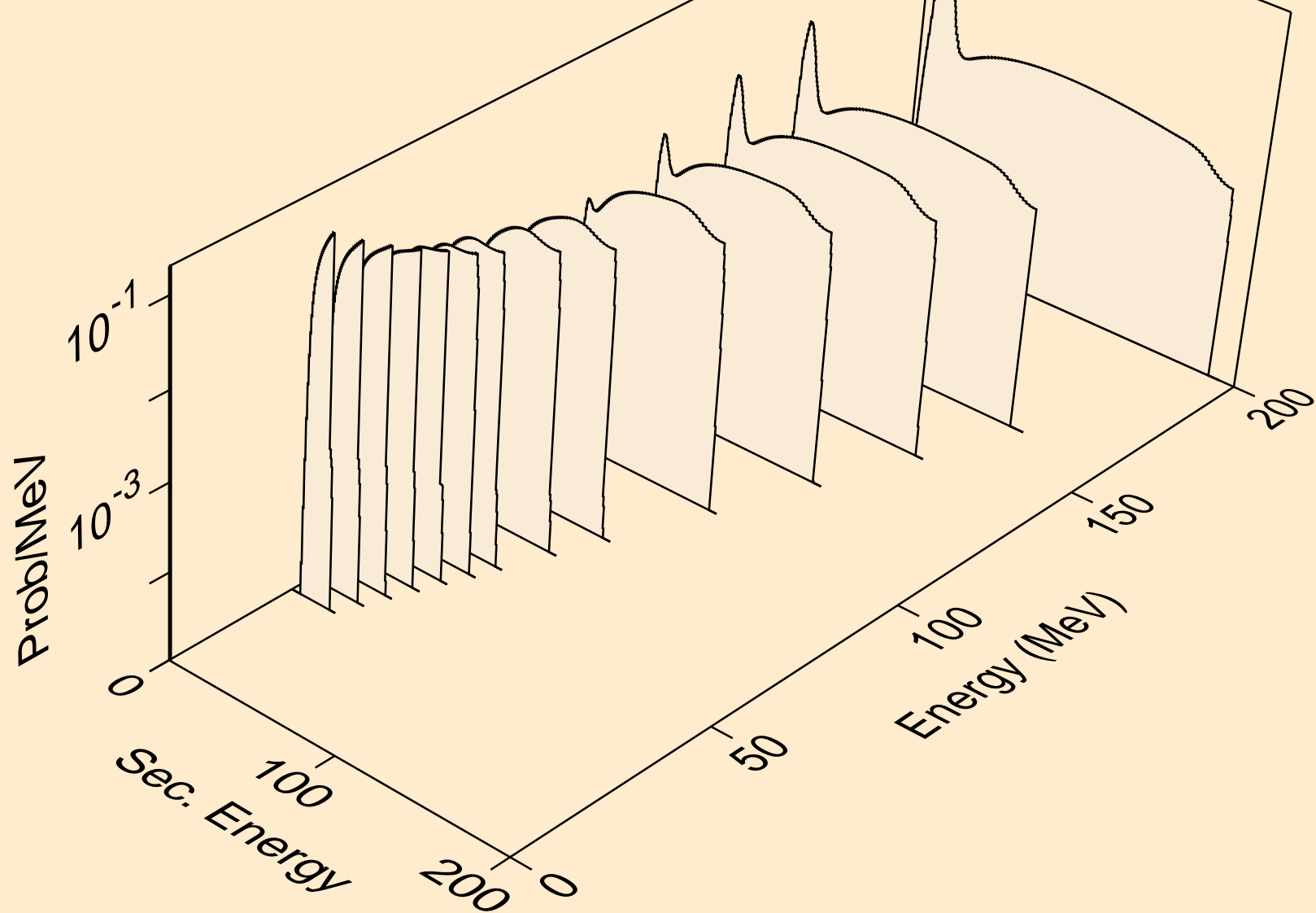

ND128 DEUTERON ACER TENDL-2021 LIBRARY; T=0.K
tritons from (d,n*)t

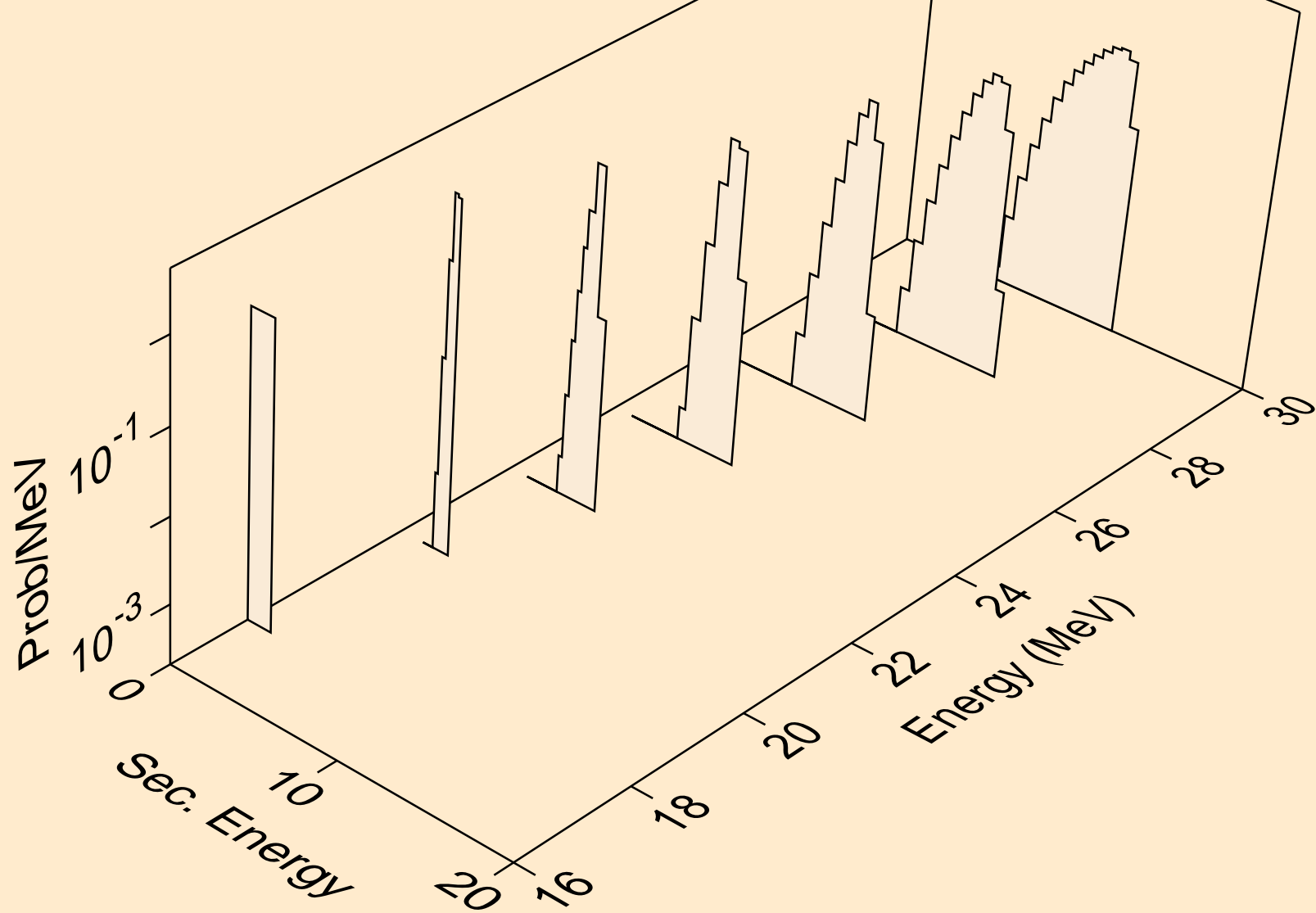

ND128 DEUTERON ACER TENDL-2021 LIBRARY; T=0.K
tritons from (d,t)

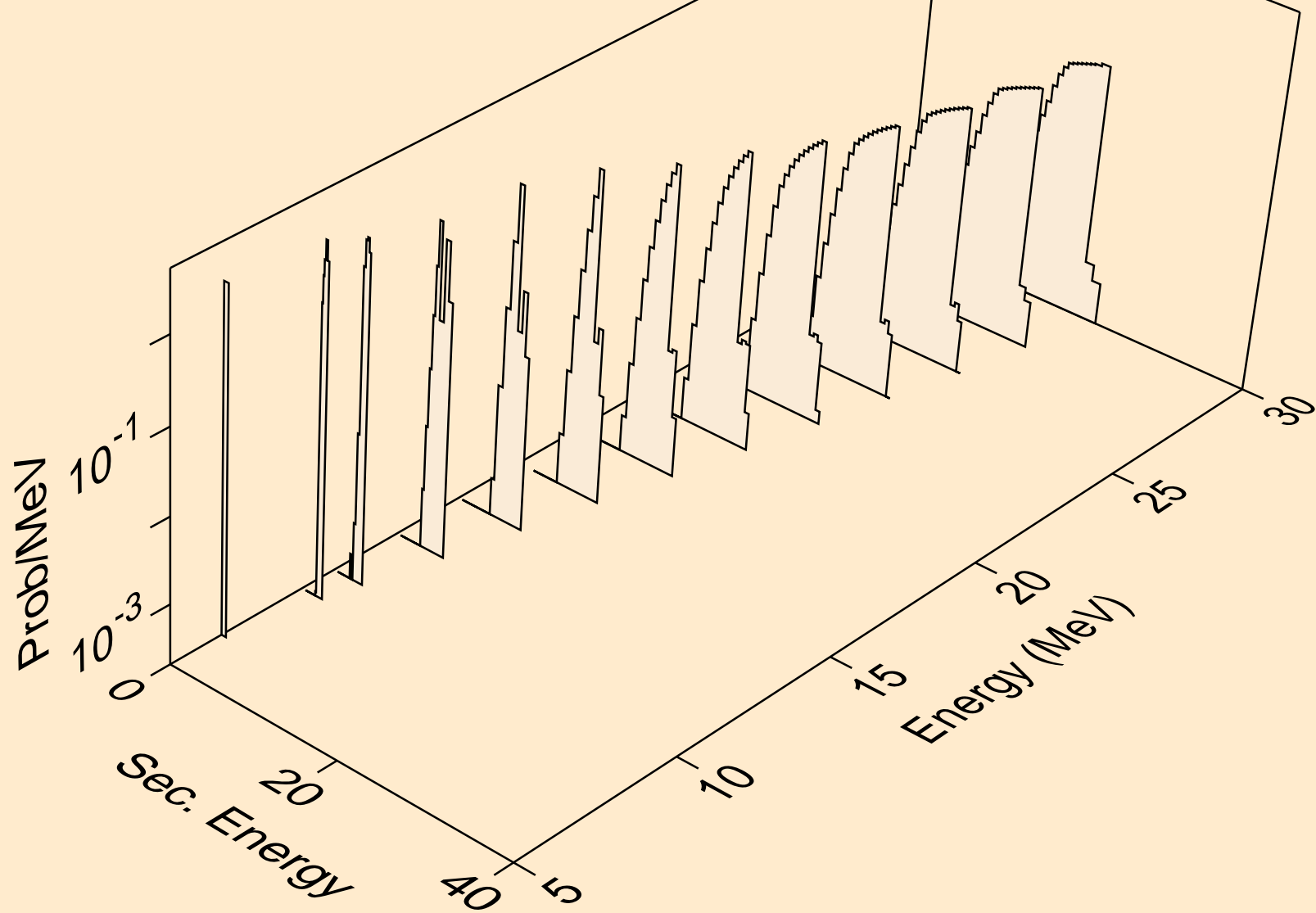

ND128 DEUTERON ACER TENDL-2021 LIBRARY; T=0.K
tritons from (d,pt)

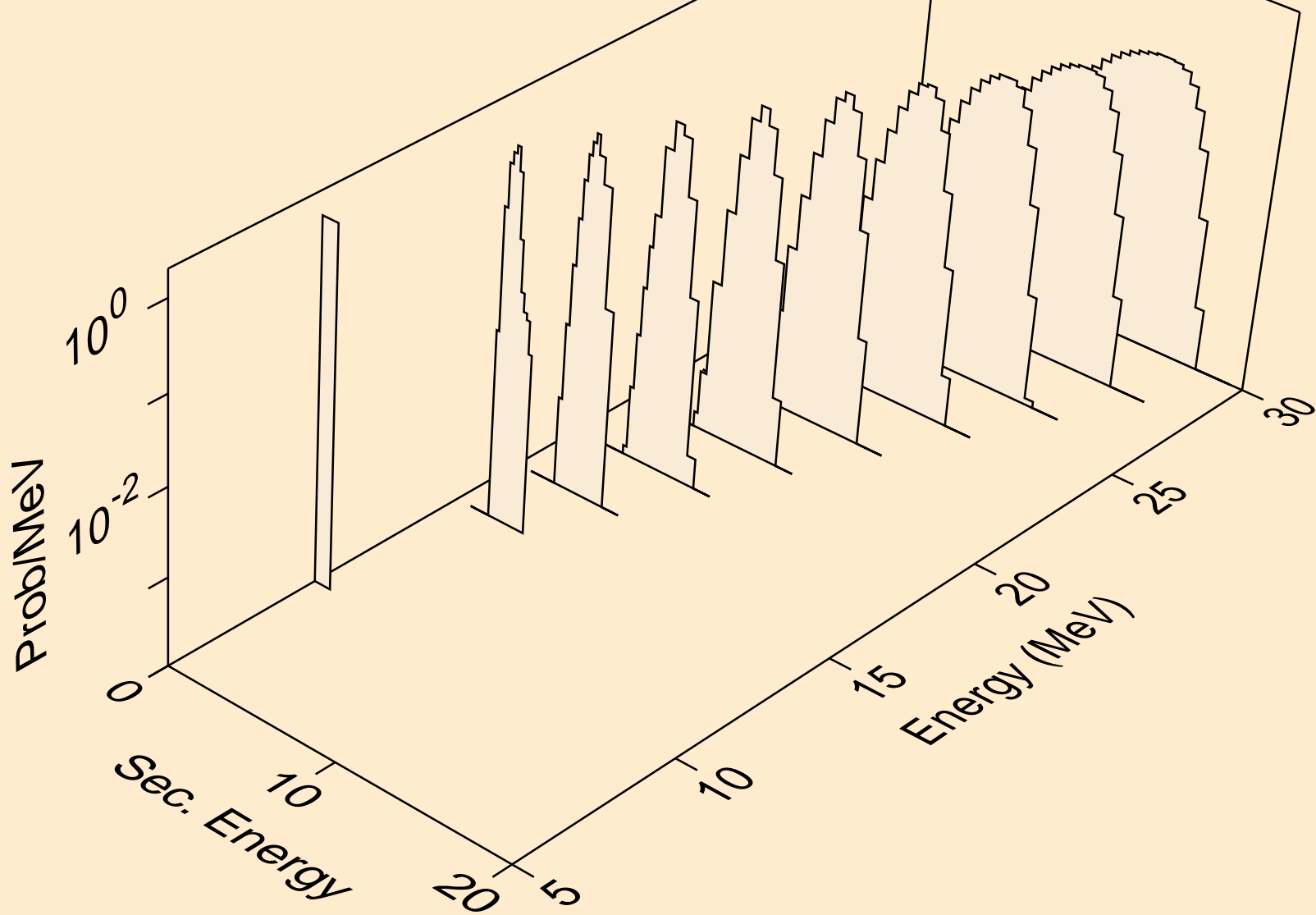

ND128 DEUTERON ACER TENDL-2021 LIBRARY; T=0.K
he3s from (d,x)

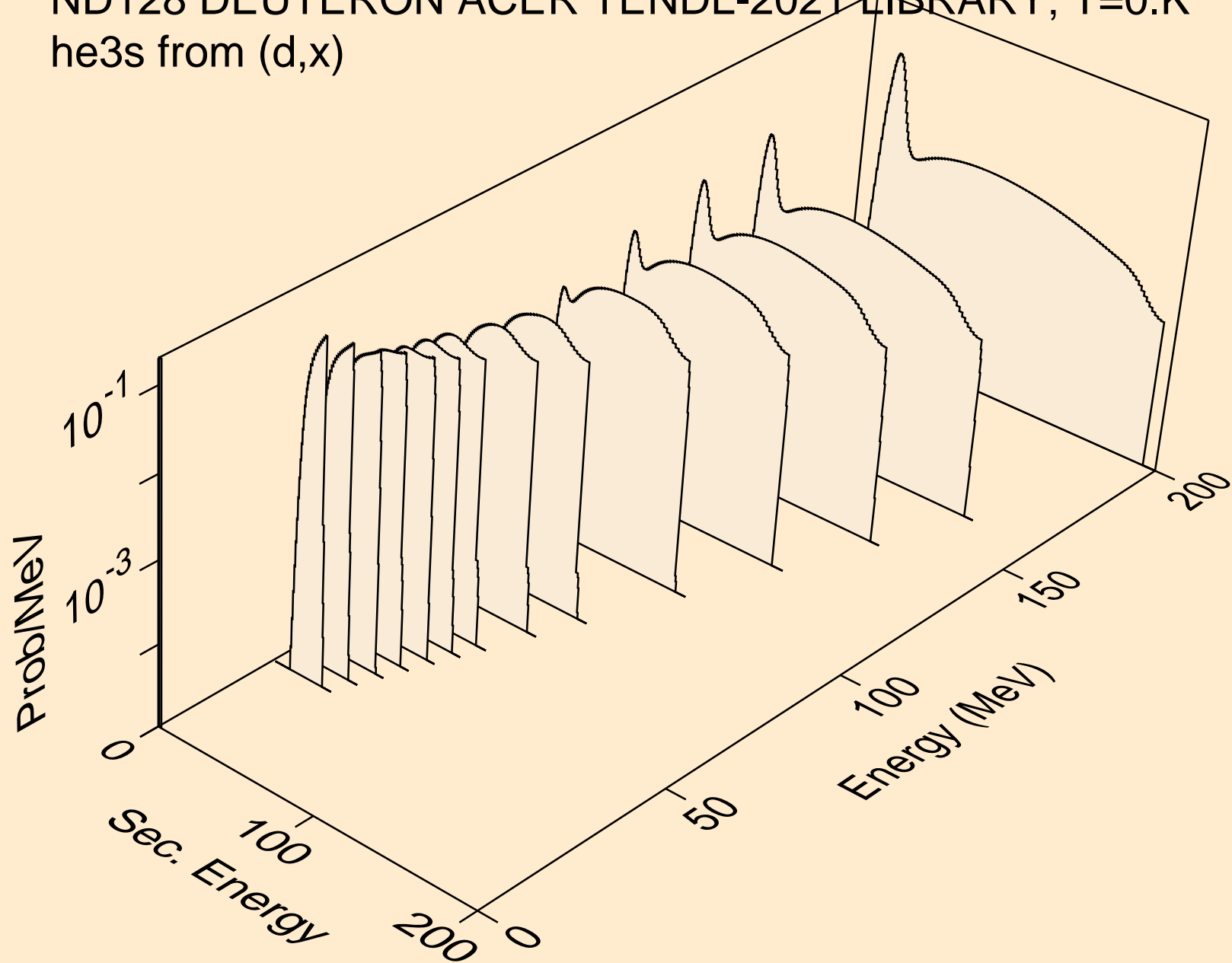

ND128 DEUTERON ACER TENDL-2021 LIBRARY; T=0.K
he3s from (d,n*)he3

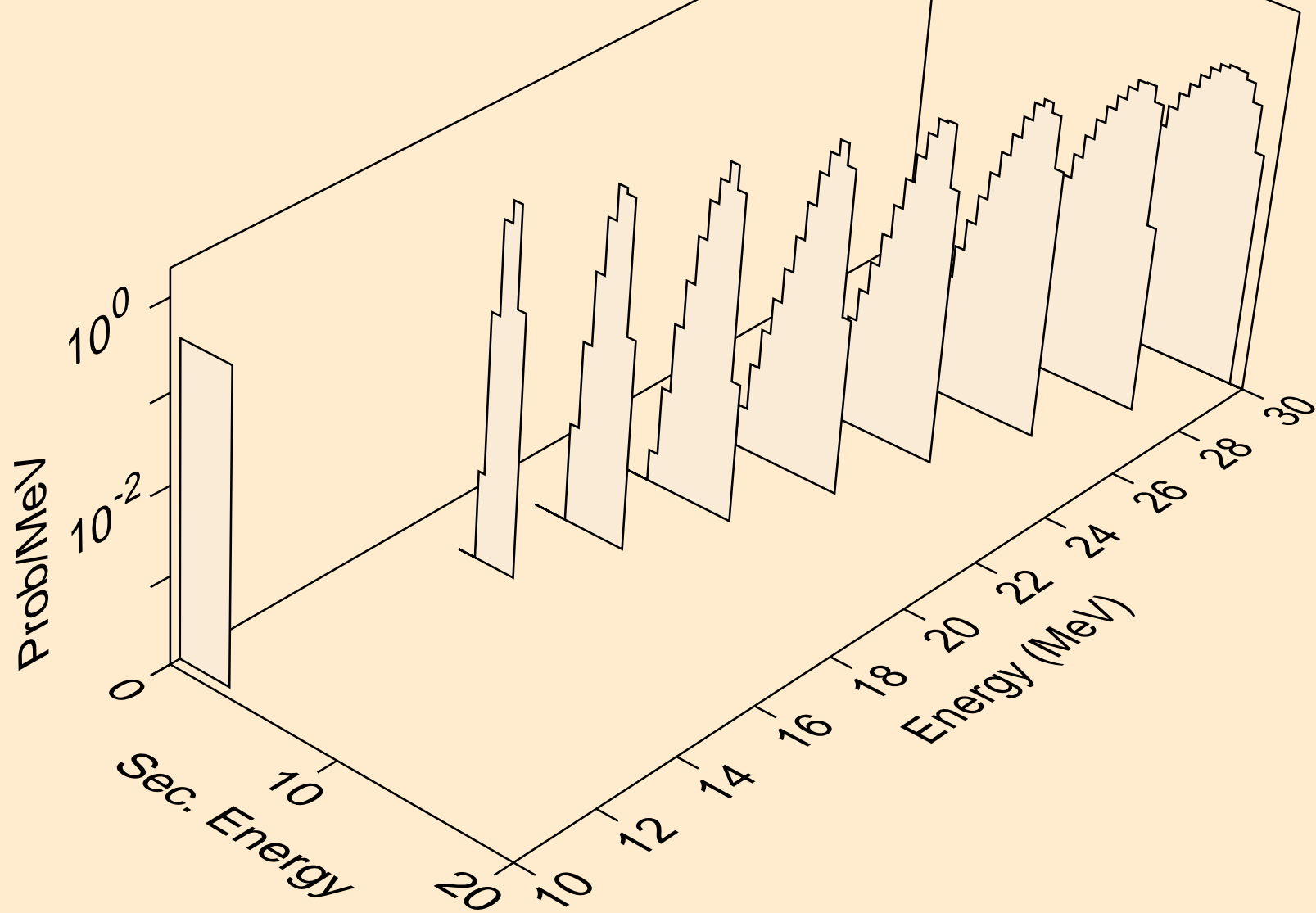

ND128 DEUTERON ACER TENDL-2021 LIBRARY; T=0.K
he3s from (d,he3)

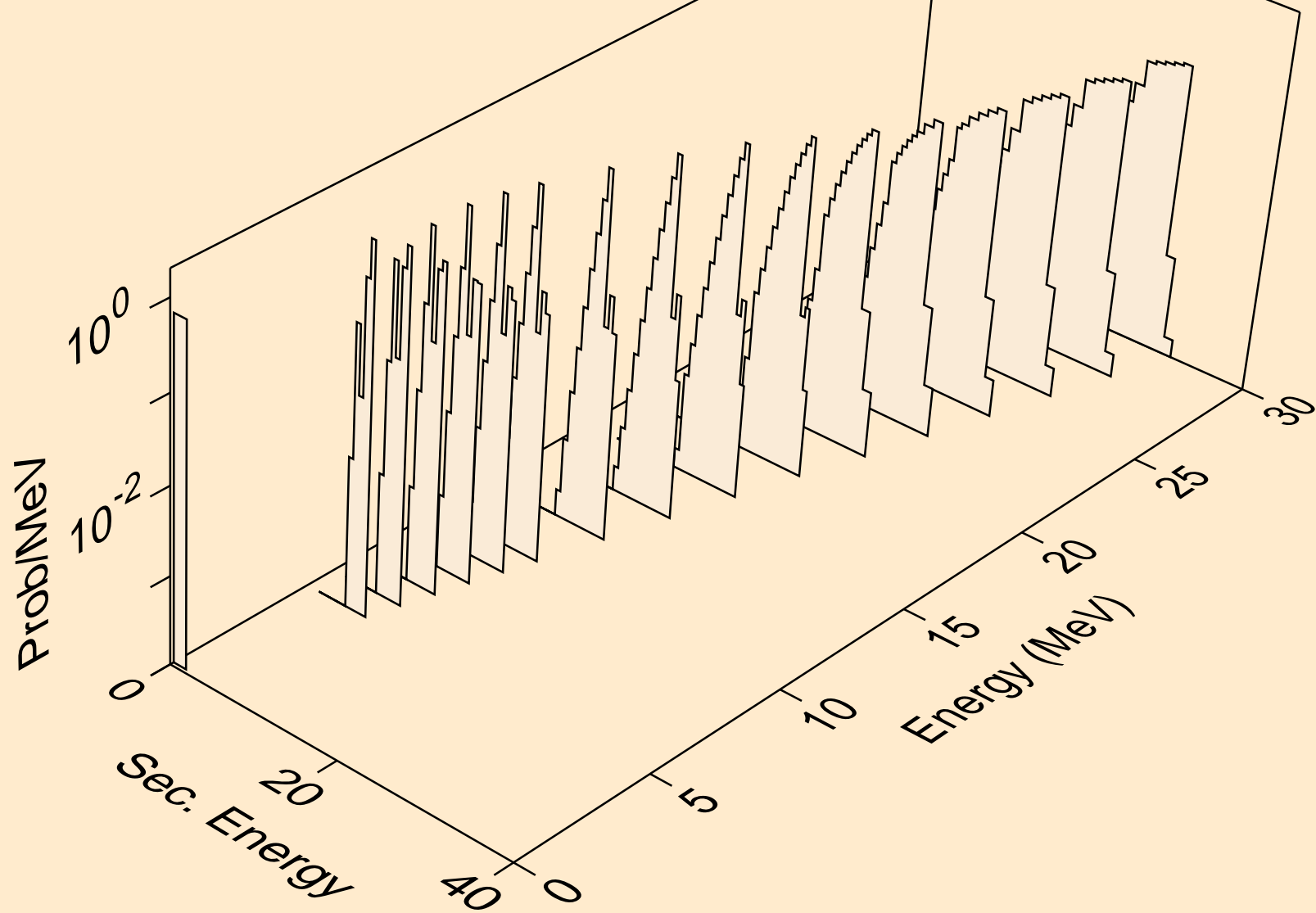

ND128 DEUTERON ACER TENDL-2021 LIBRARY; T=0.K
alphas from (d,x)

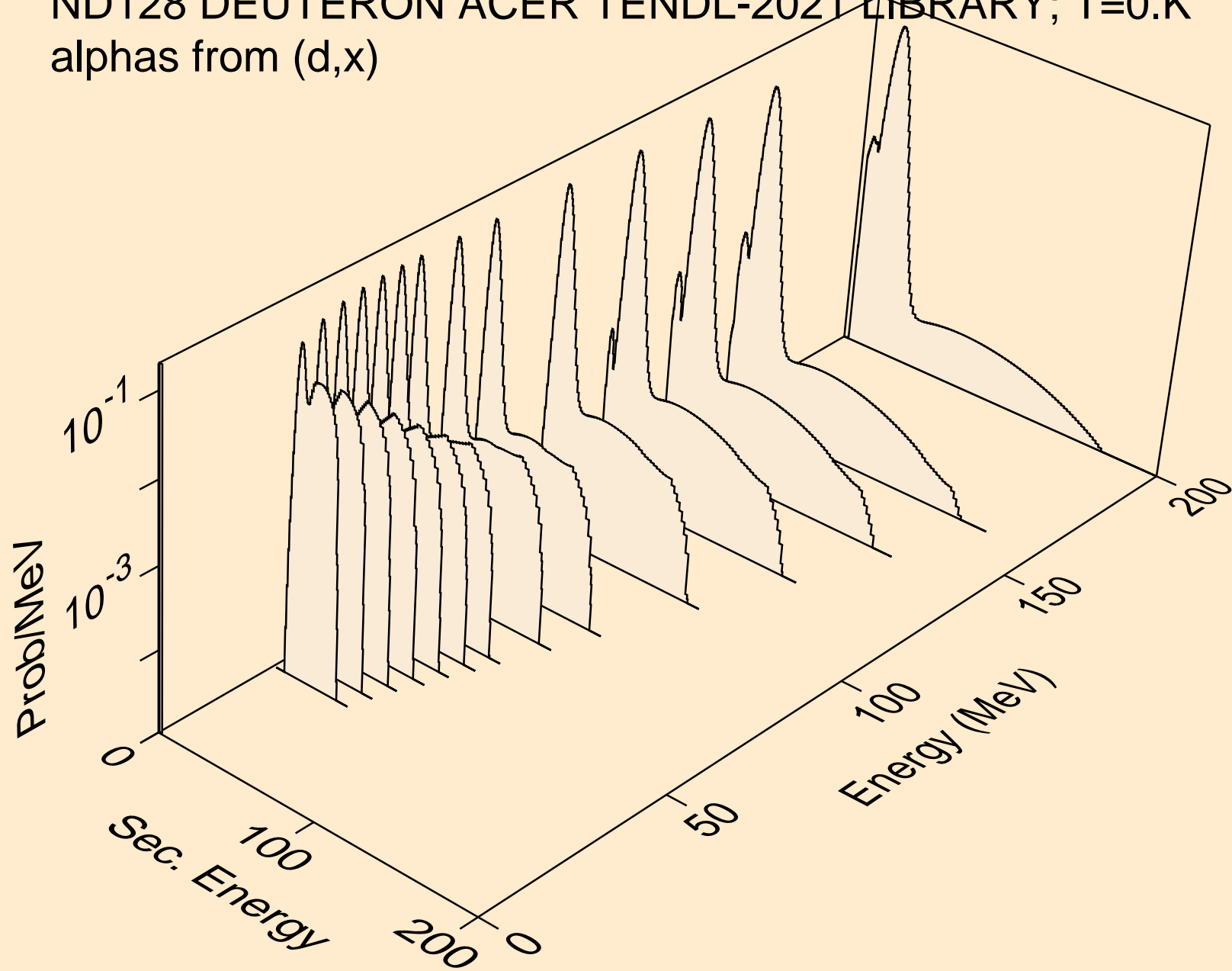

ND128 DEUTERON ACER TENDL-2021 LIBRARY; T=0.K
alphas from (d,n*)a

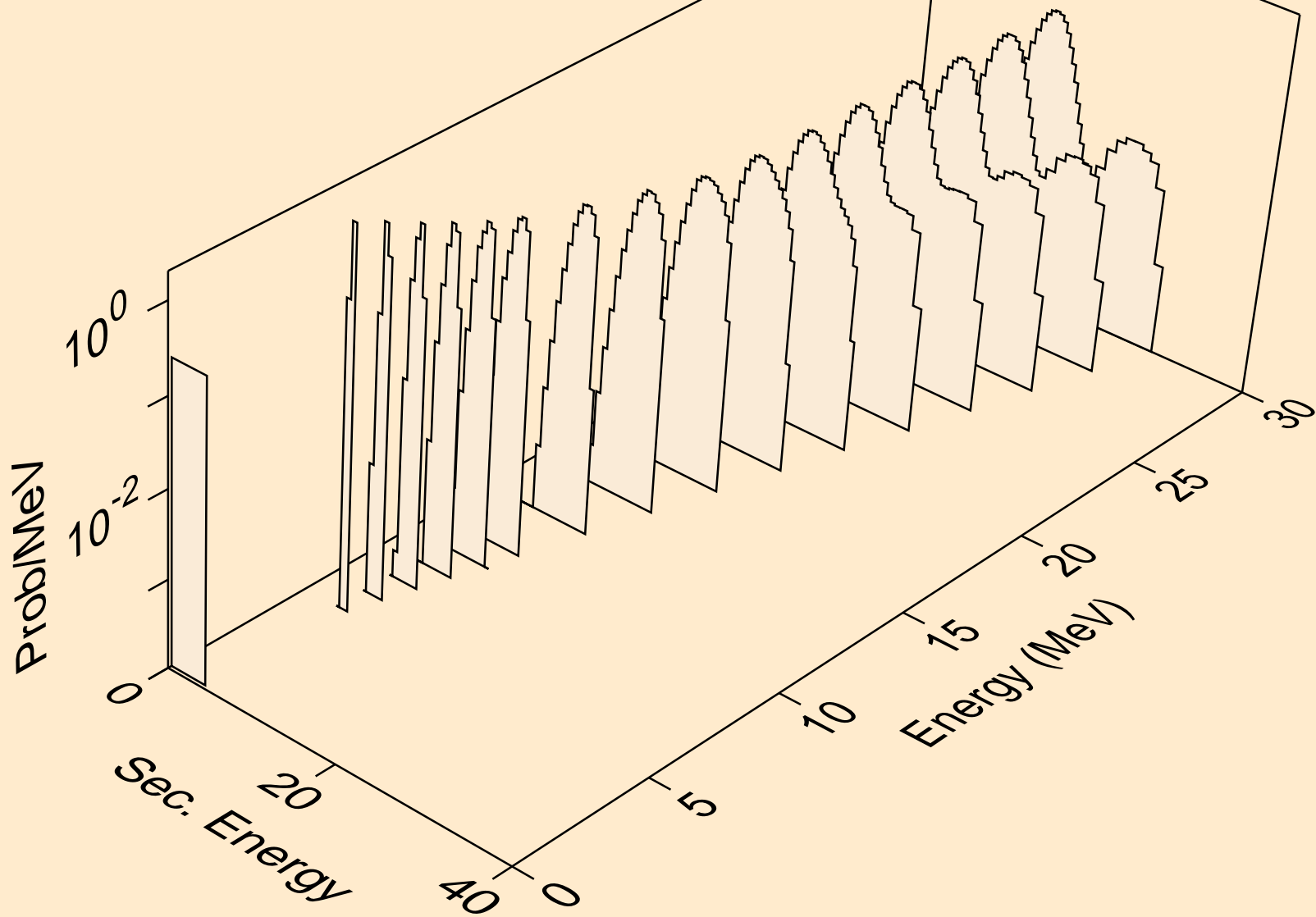

ND128 DEUTERON ACER TENDL-2021 LIBRARY; T=0.K
alphas from (d,2n)a

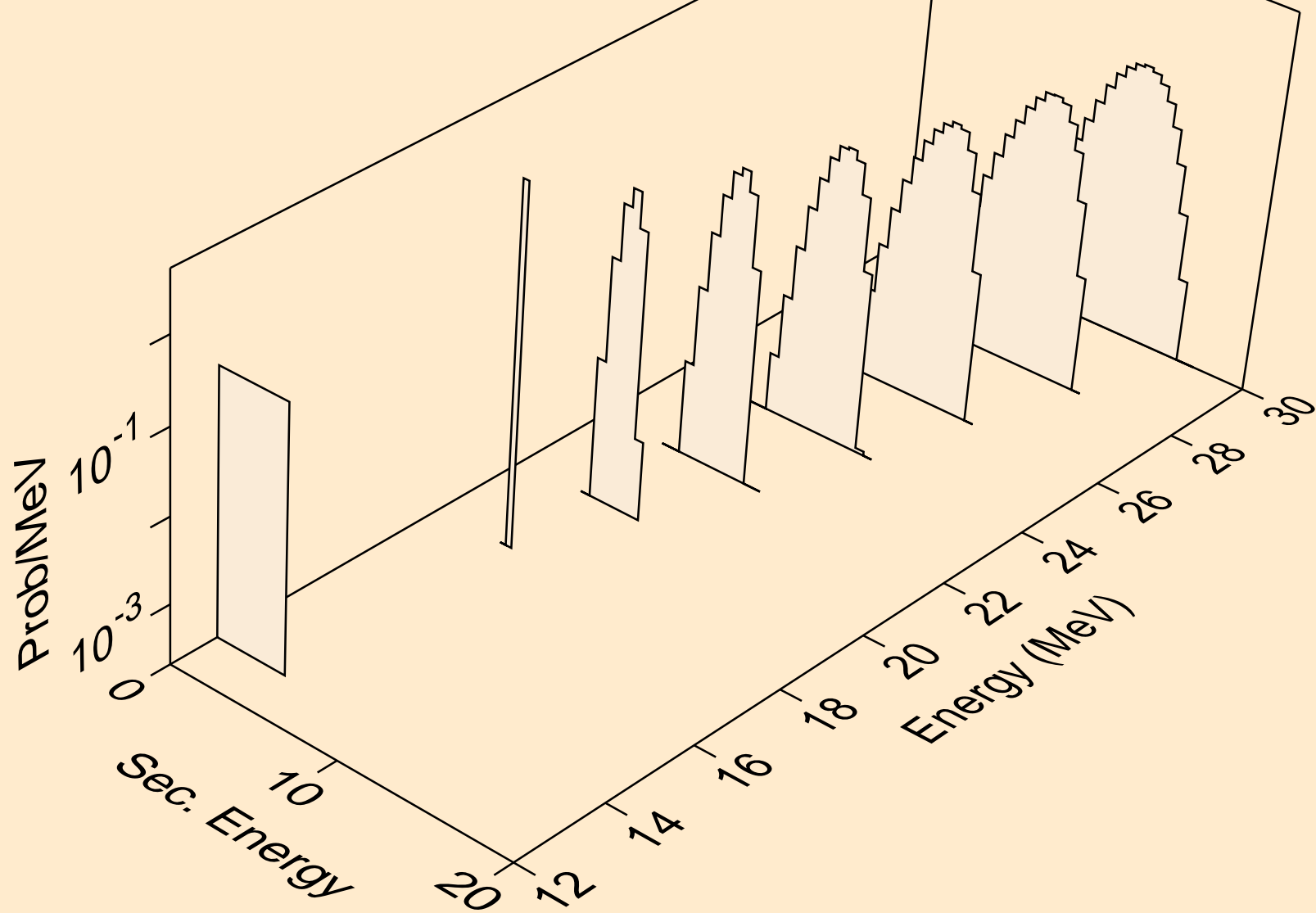

ND128 DEUTERON ACER TENDL-2021 LIBRARY; T=0.K
alphas from (d,n*)2a

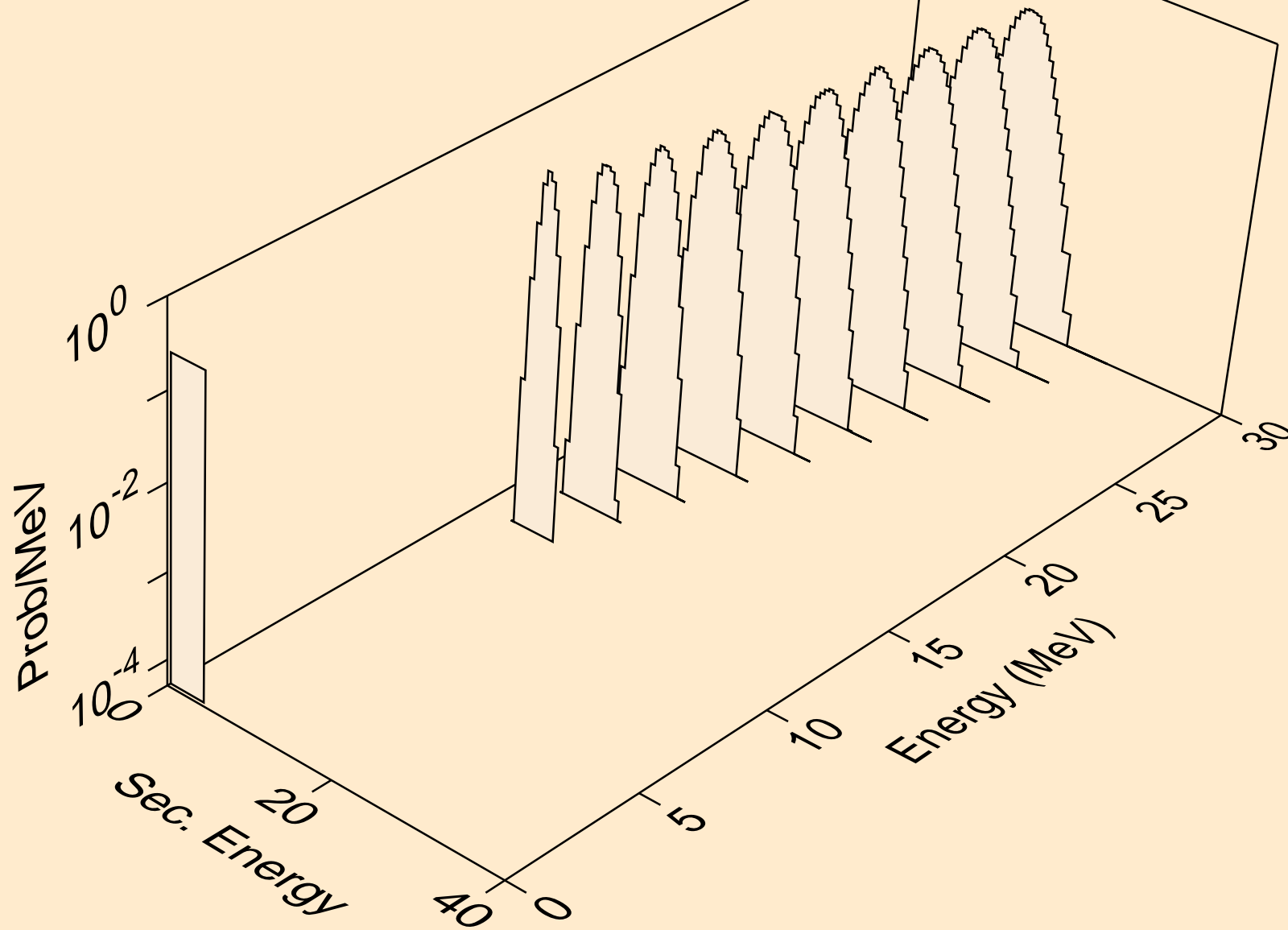

ND128 DEUTERON ACER TENDL-2021 LIBRARY; T=0.K
alphas from (d,npa)

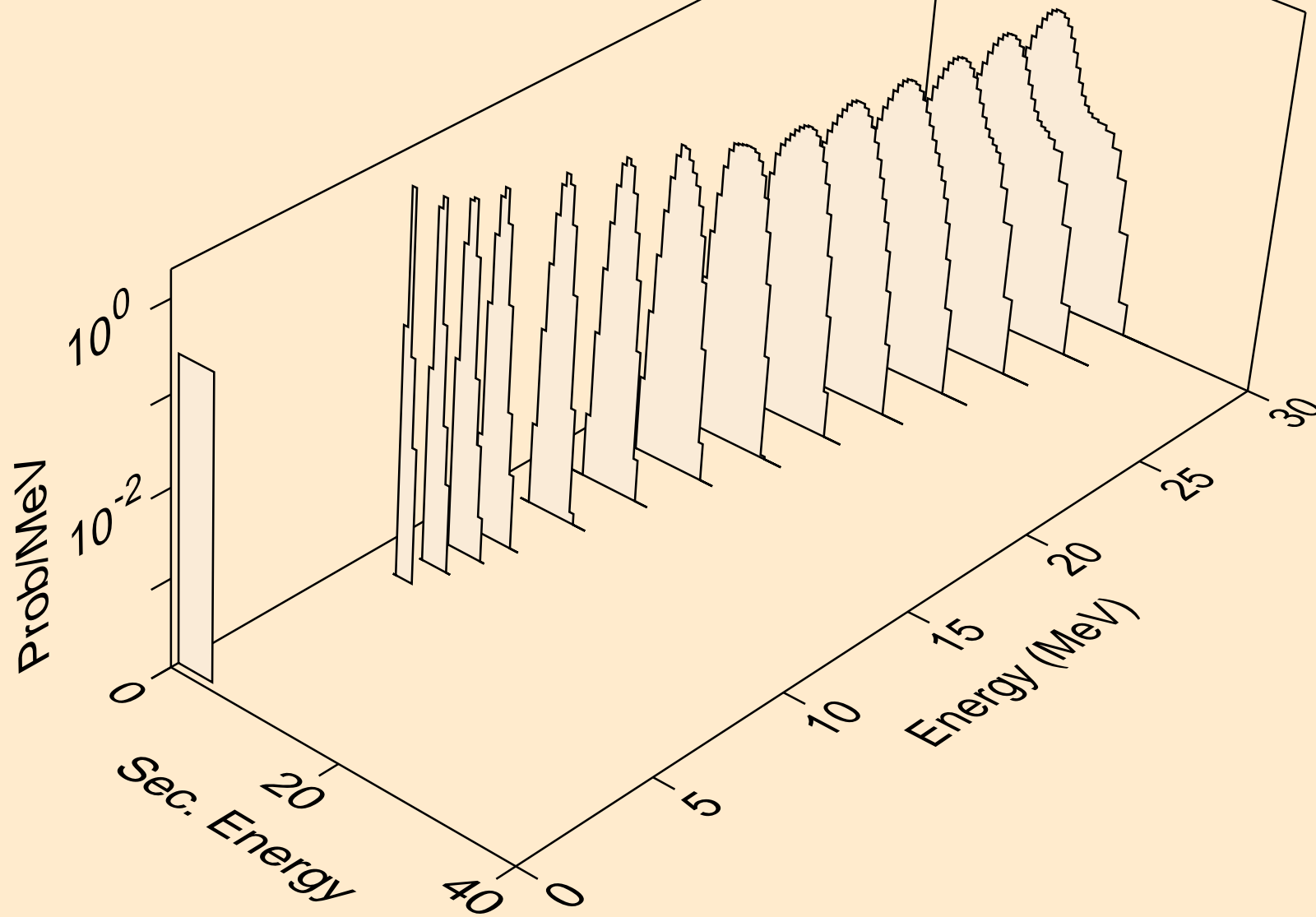

ND128 DEUTERON ACER TENDL-2021 LIBRARY; T=0.K
alphas from (d,a)

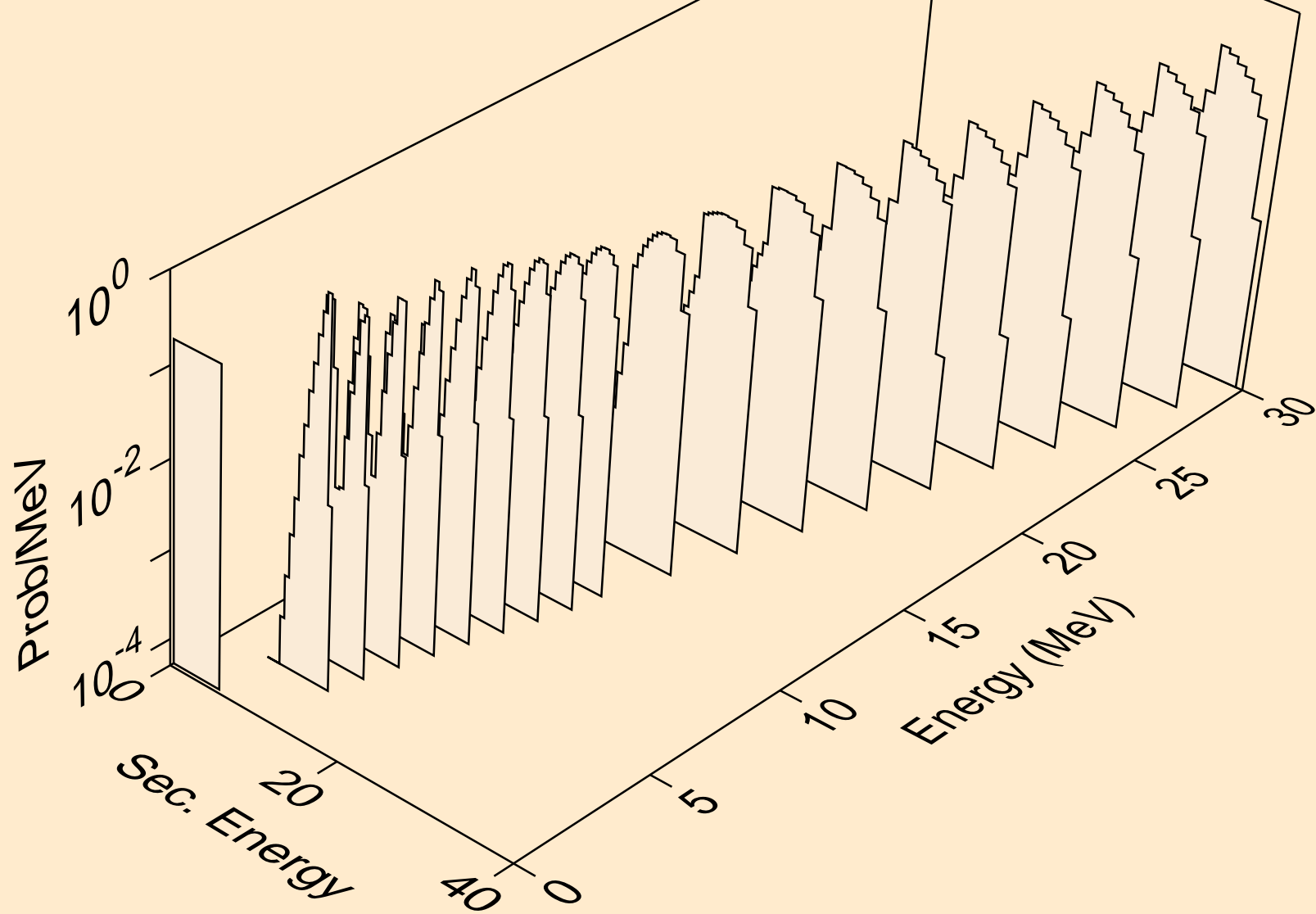

ND128 DEUTERON ACER TENDL-2021 LIBRARY; T=0.K
alphas from (d,2a)

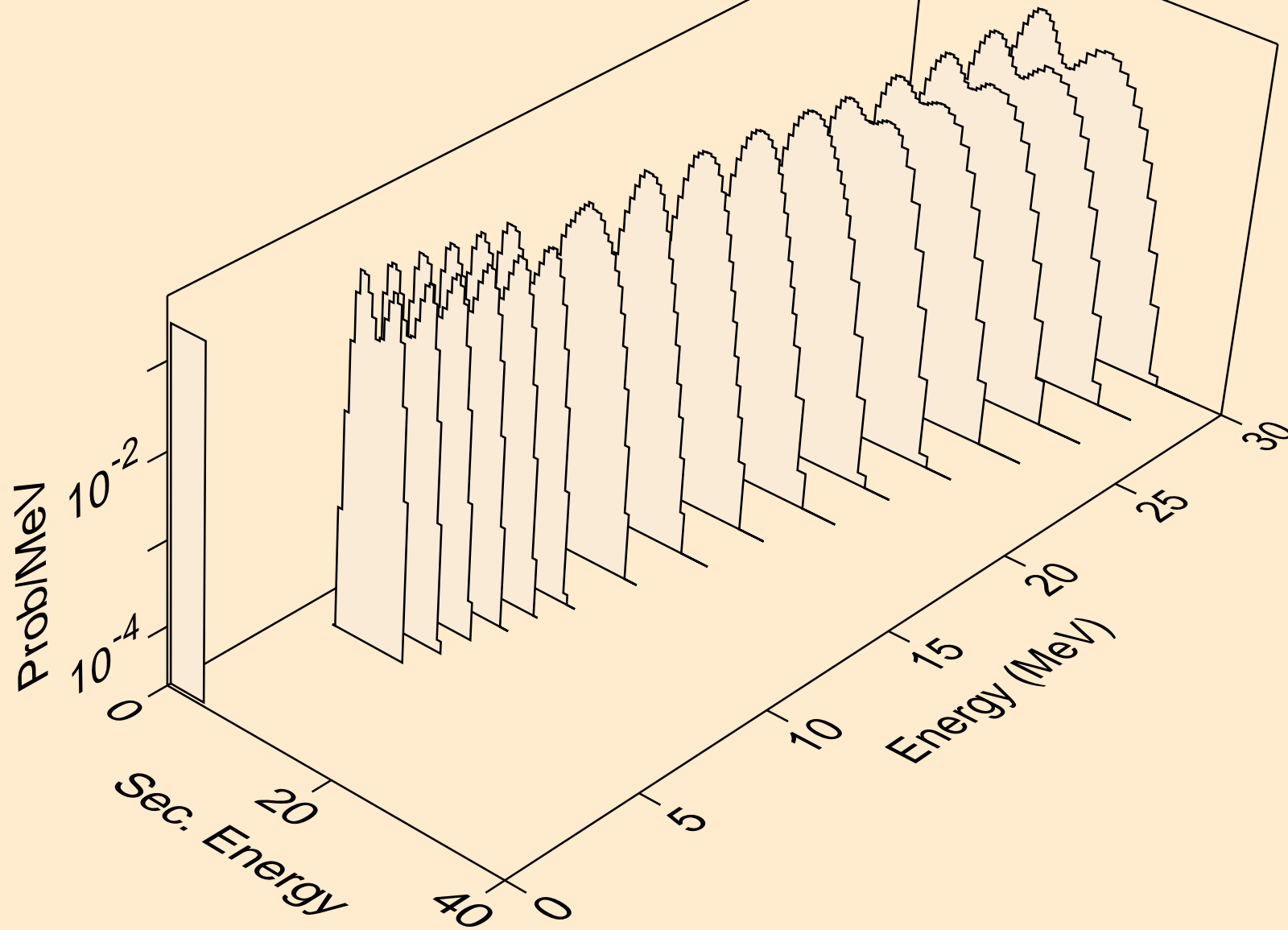

ND128 DEUTERON ACER TENDL-2021 LIBRARY; T=0.K
alphas from (d,pa)

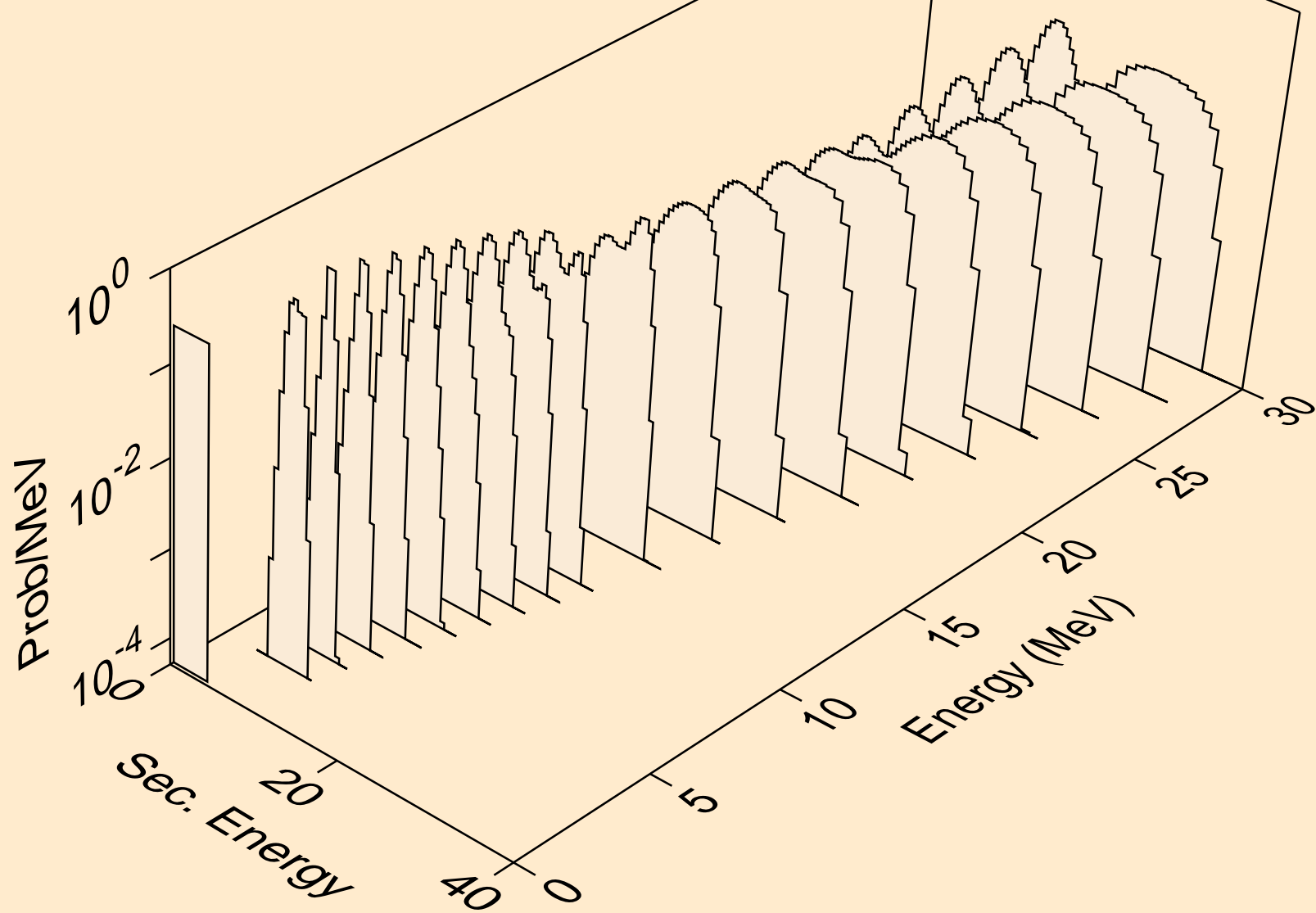

ND128 DEUTERON ACER TENDL-2021 LIBRARY; T=0.K
alphas from (d,d2a)

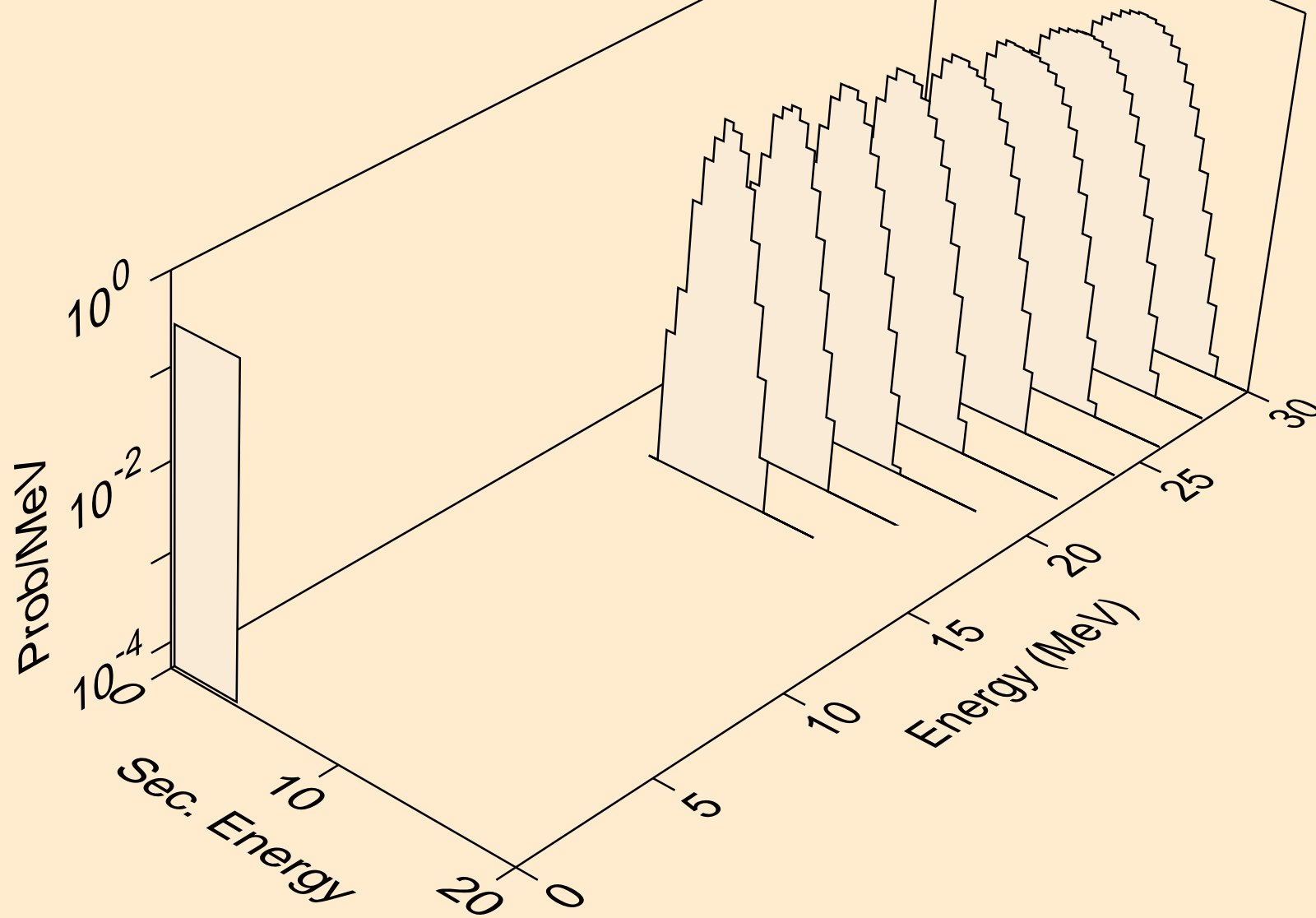

ND128 DEUTERON ACER TENDL-2021 LIBRARY; T=0.K
alphas from (d,da)

