

NP228 DEUTERON ACER TENDL-2021 LIBRARY; T=0.K

Principal cross sections

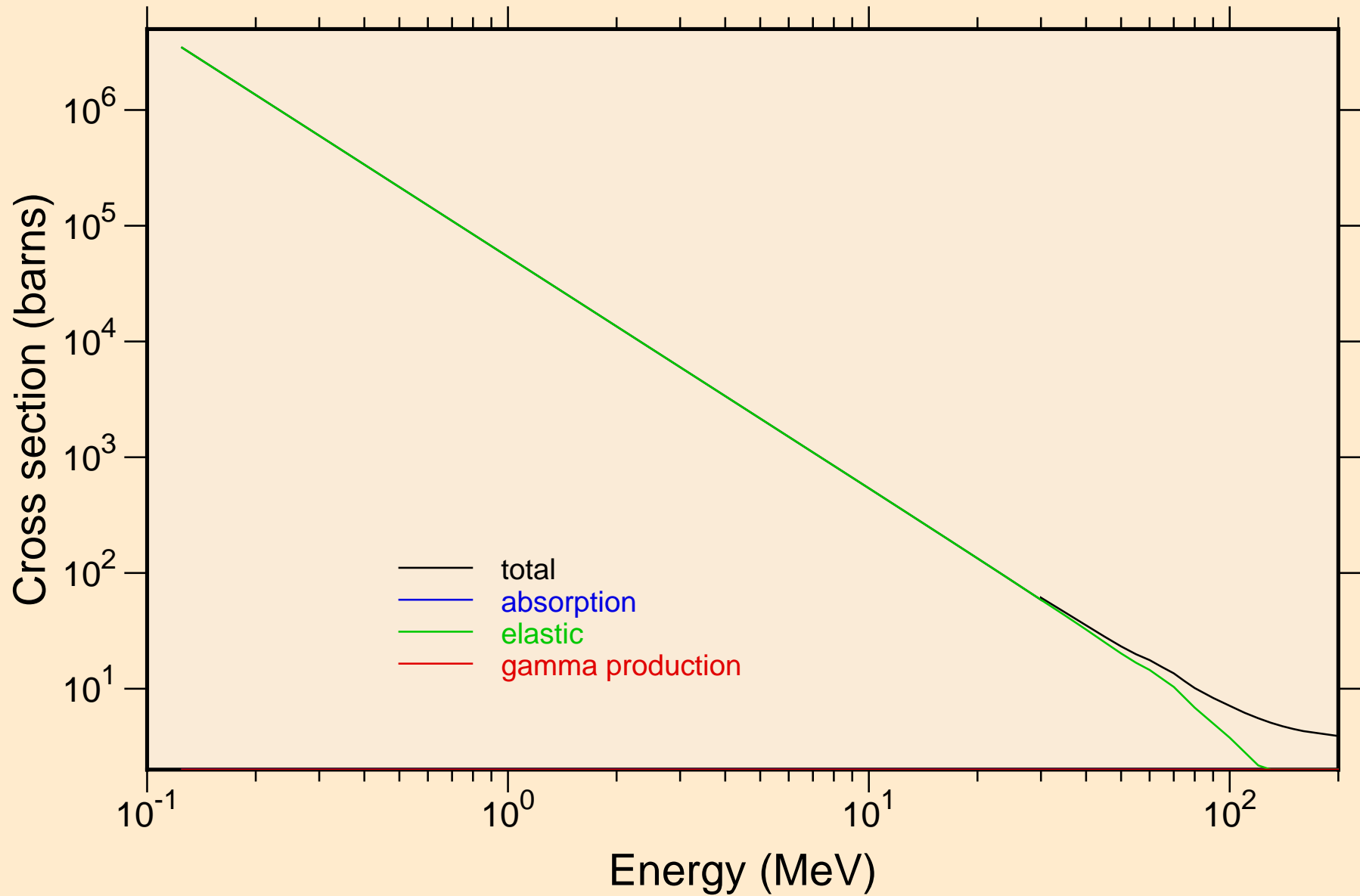

NP228 DEUTERON ACER TENDL-2021 LIBRARY; T=0.K
Heating

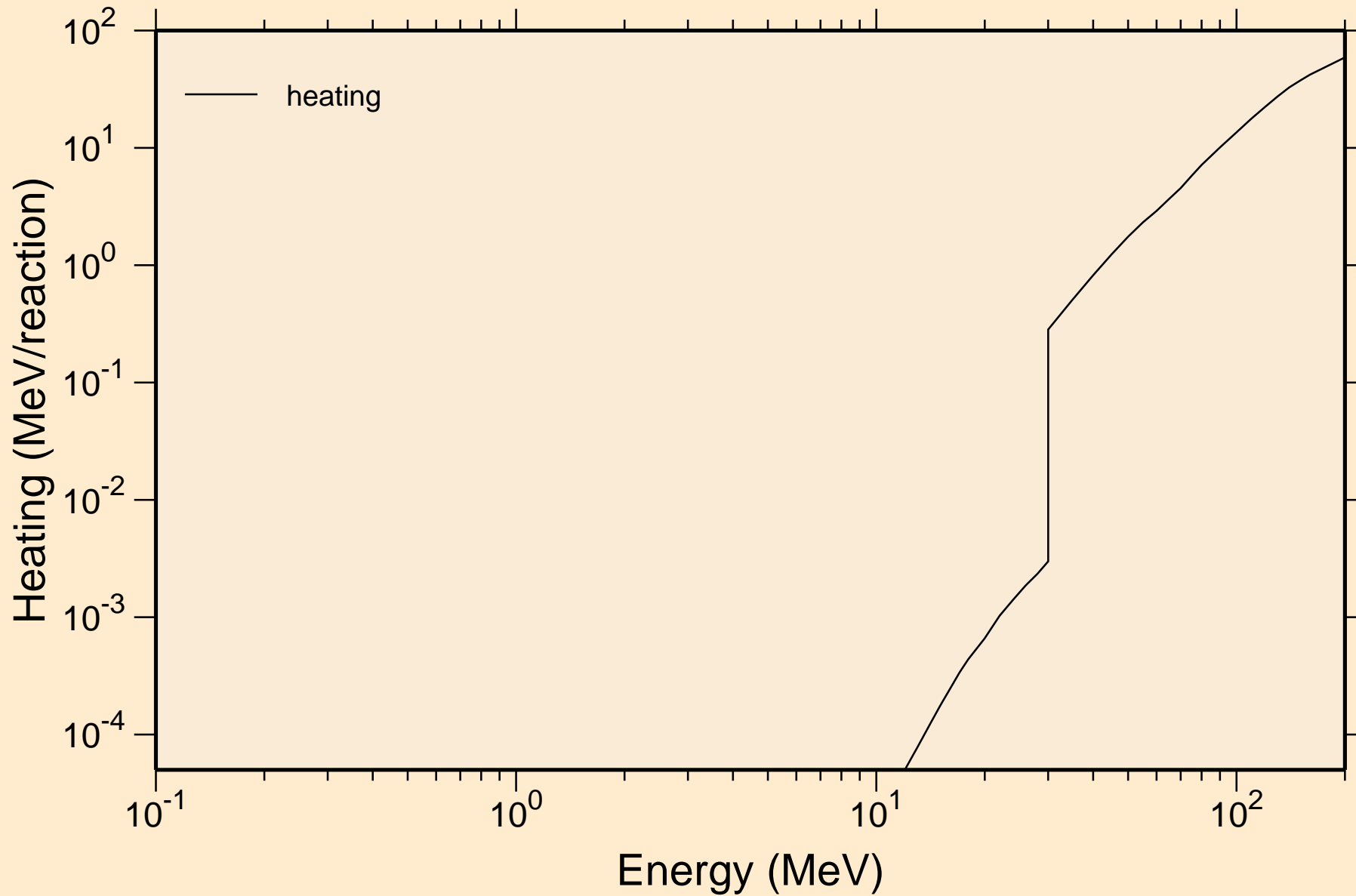

NP228 DEUTERON ACER TENDL-2021 LIBRARY; T=0.K
Principal cross sections

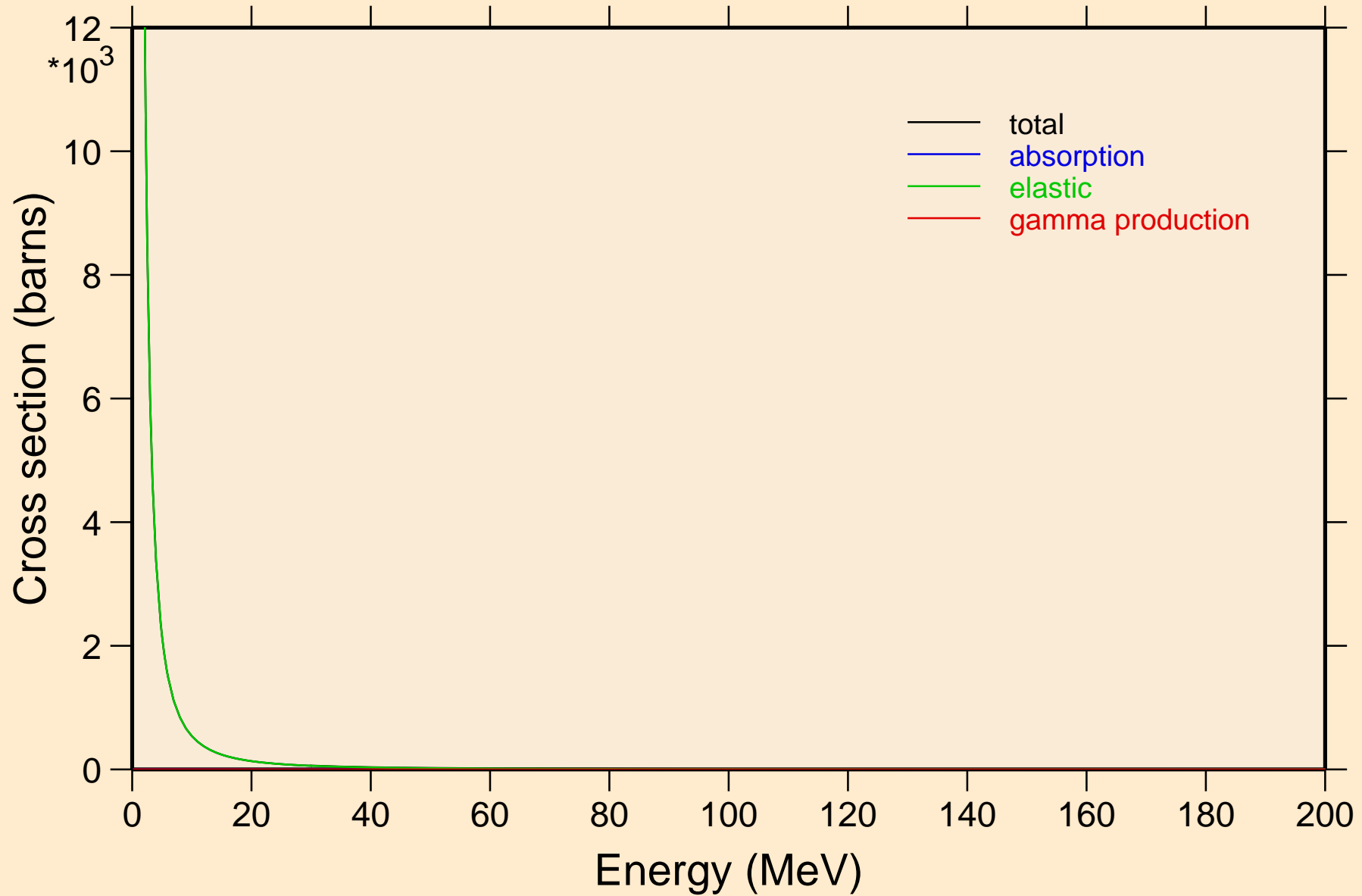

NP228 DEUTERON ACER TENDL-2021 LIBRARY; T=0.K

Heating

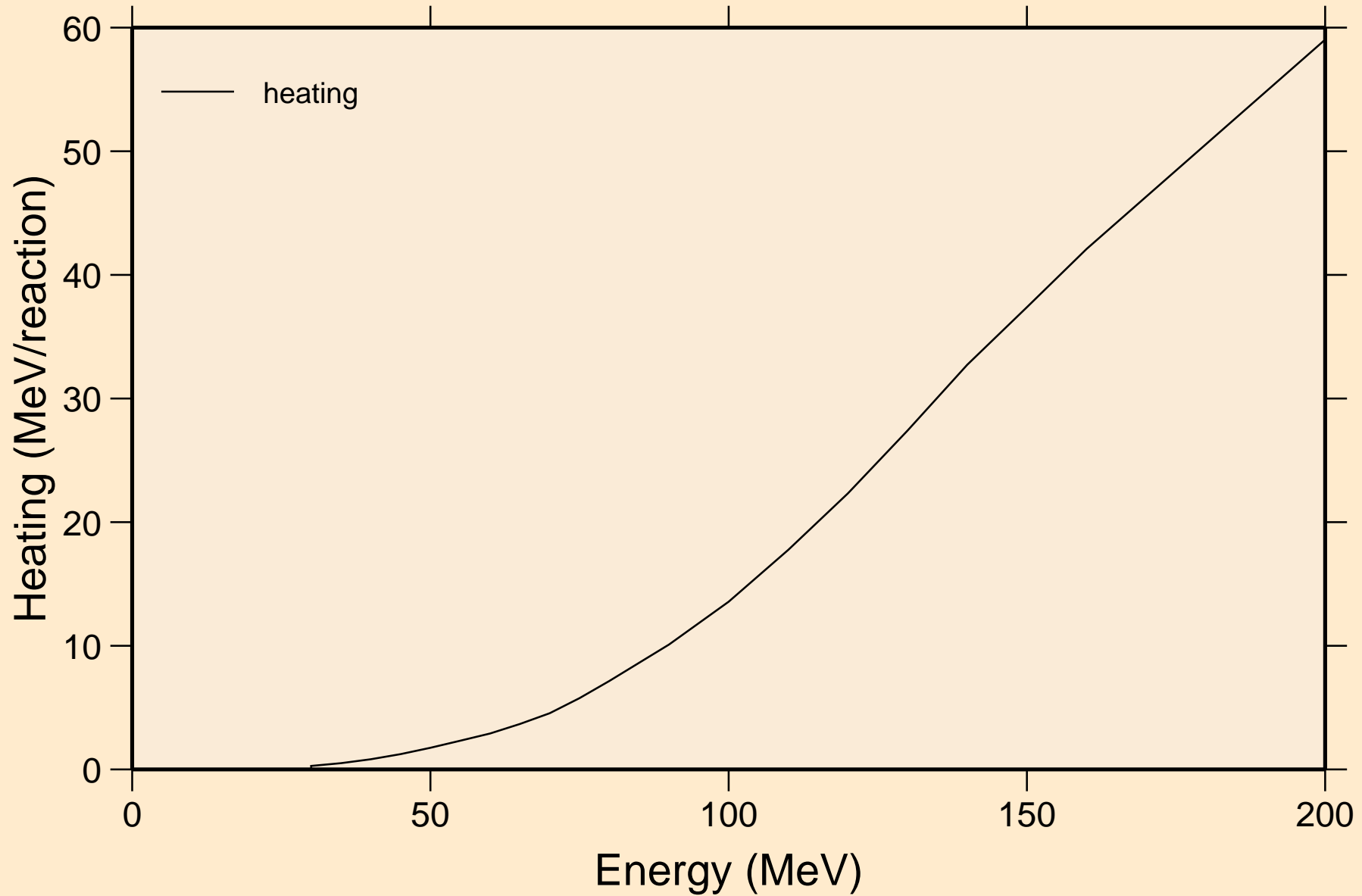

NP228 DEUTERON ACER TENDL-2021 LIBRARY; T=0.K

Threshold reactions

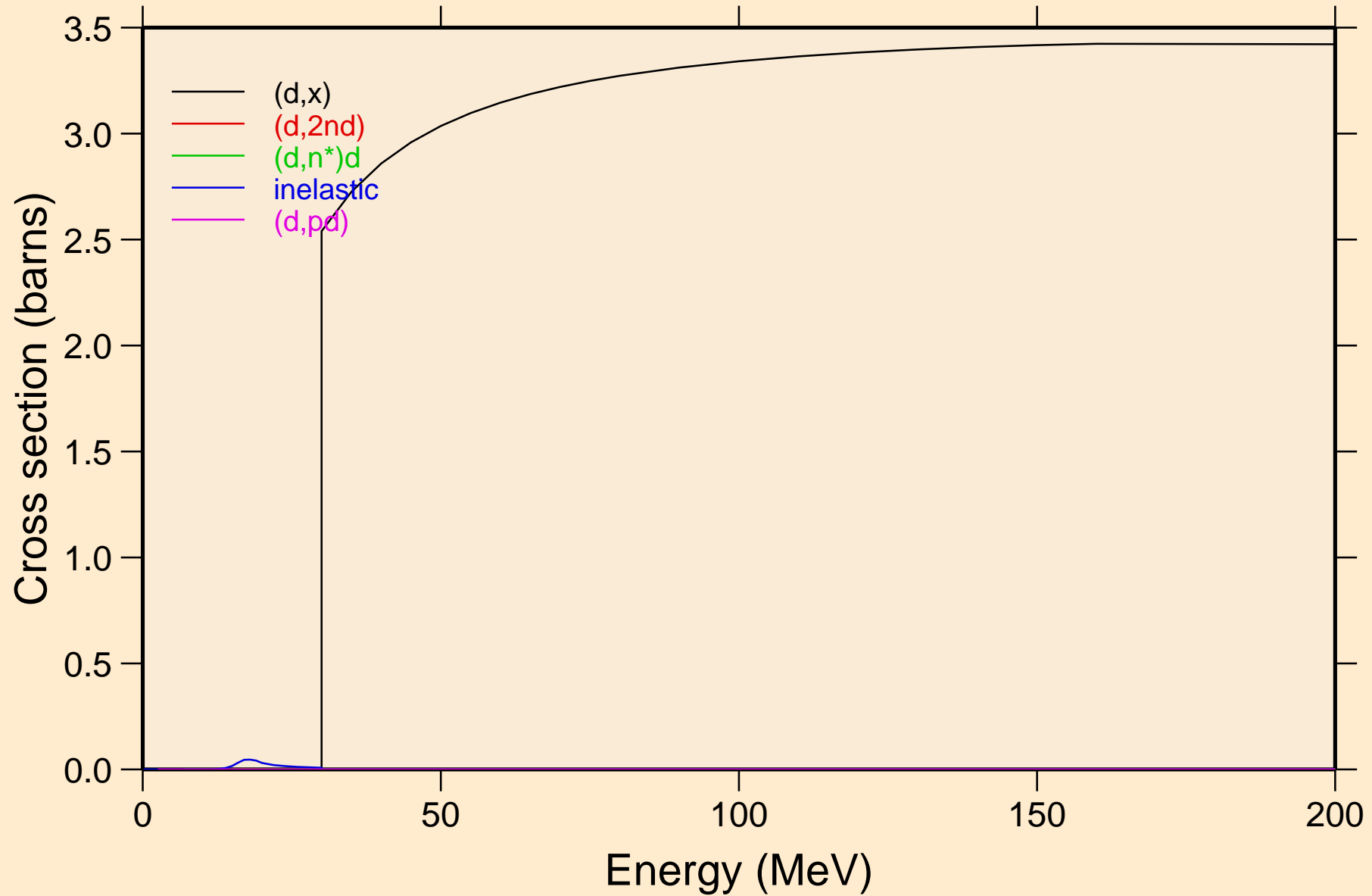

NP228 DEUTERON ACER TENDL-2021 LIBRARY; T=0.K
Threshold reactions

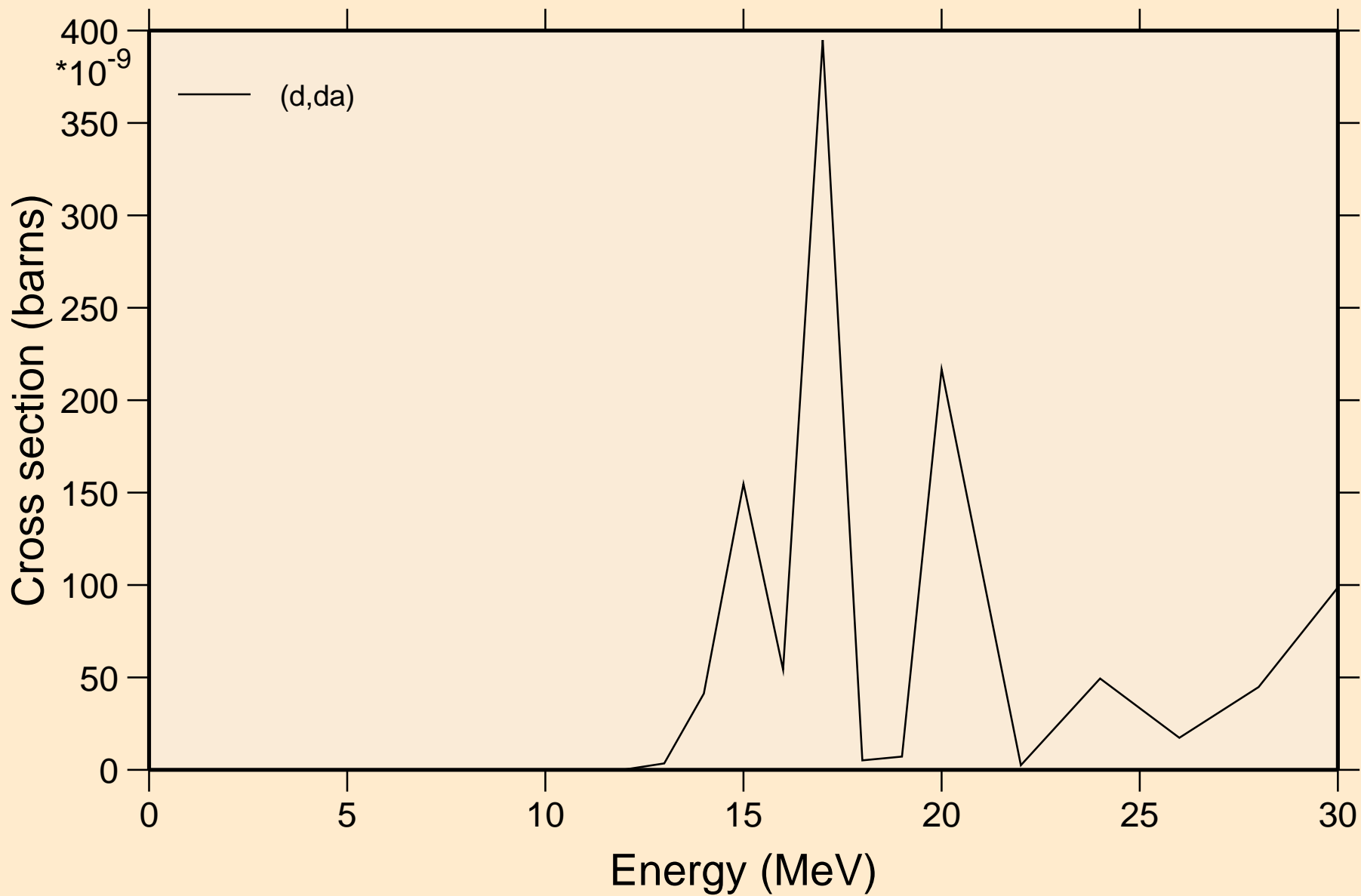

NP228 DEUTERON ACER TENDL-2021 LIBRARY; T=0.K
angular distribution for elastic

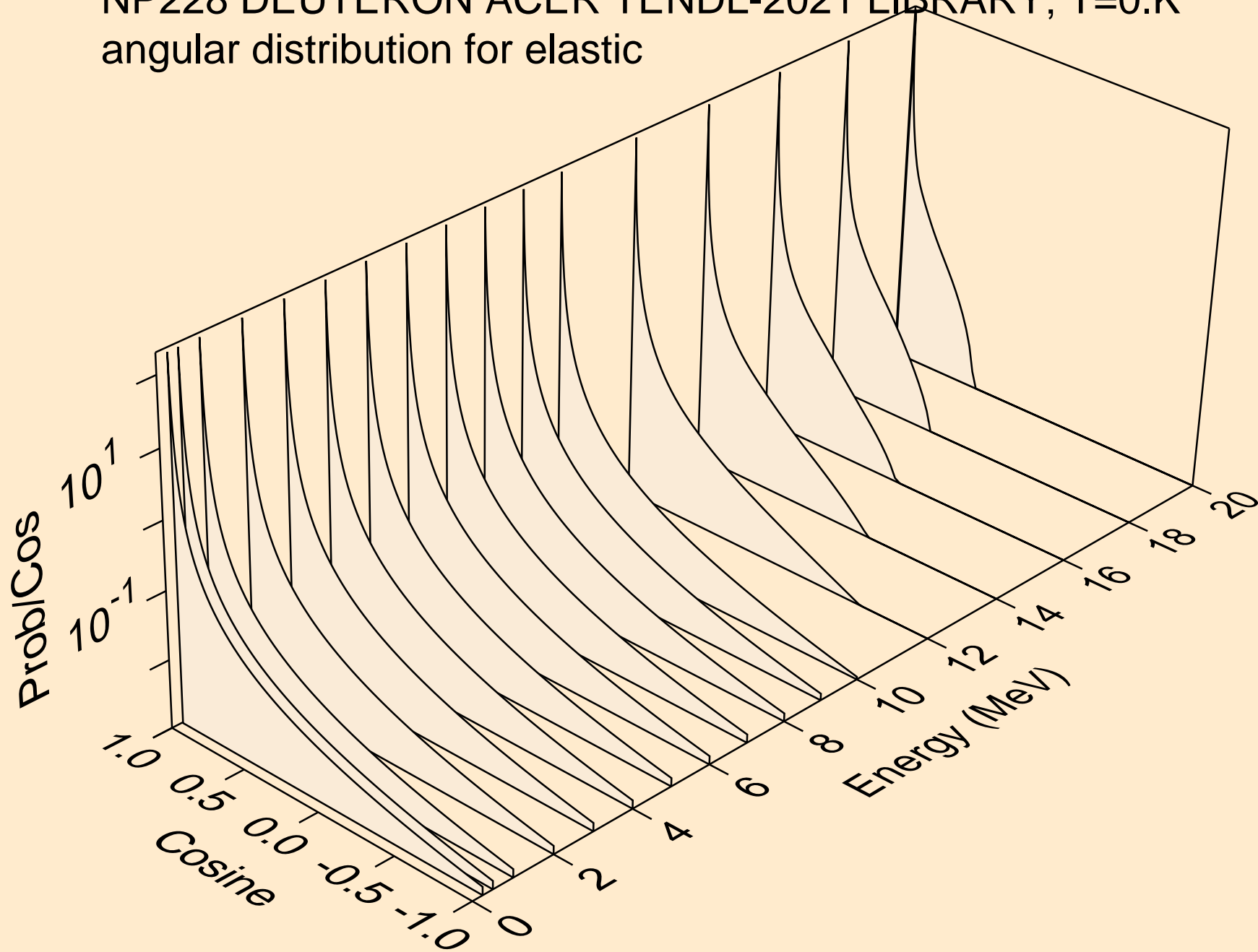

NP228 DEUTERON ACER TENDL-2021 LIBRARY; T=0.K
angular distribution for elastic

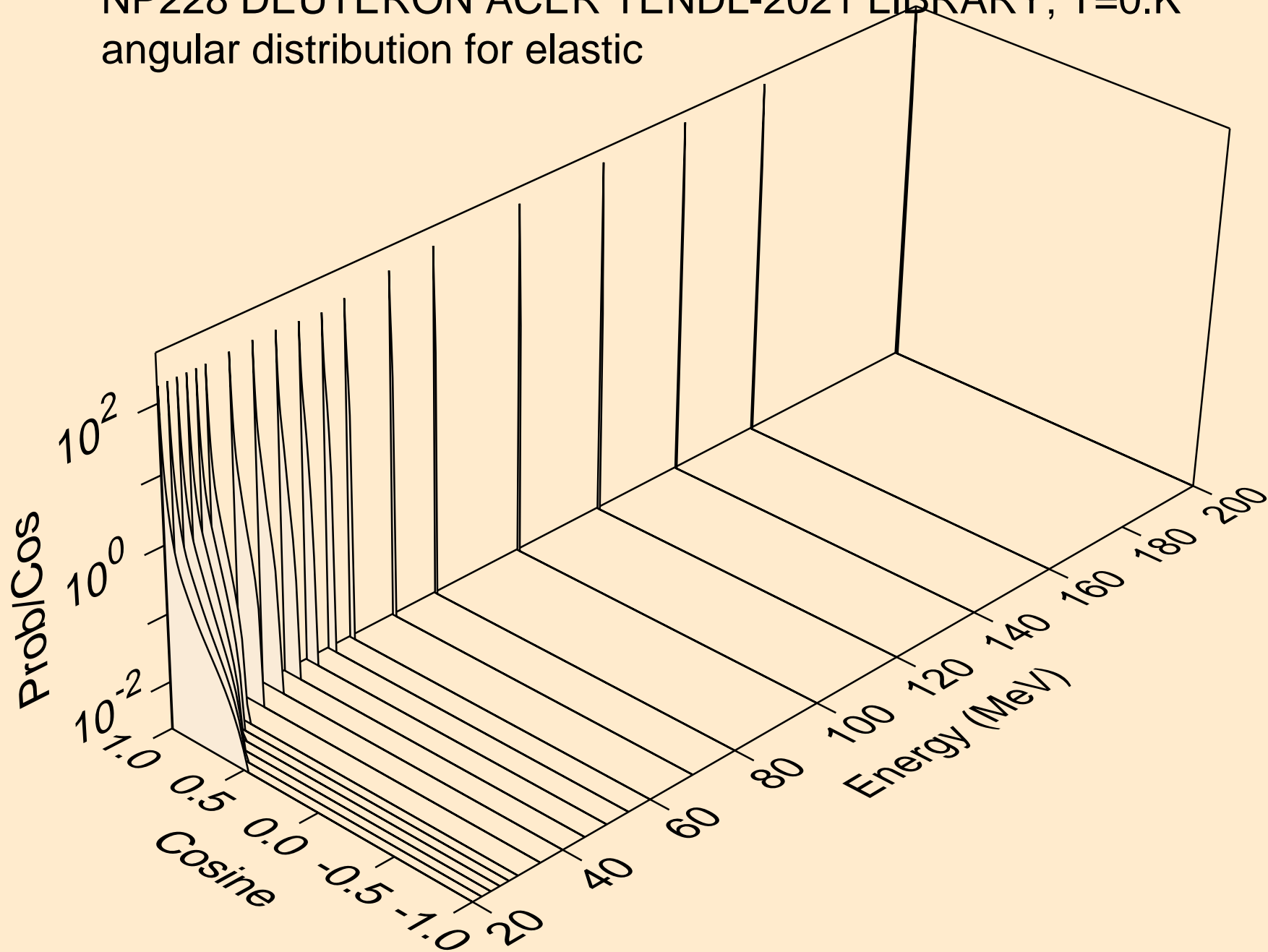

NP228 DEUTERON ACER TENDL-2021 LIBRARY; T=0.K
Deuteron emission for (d,x)

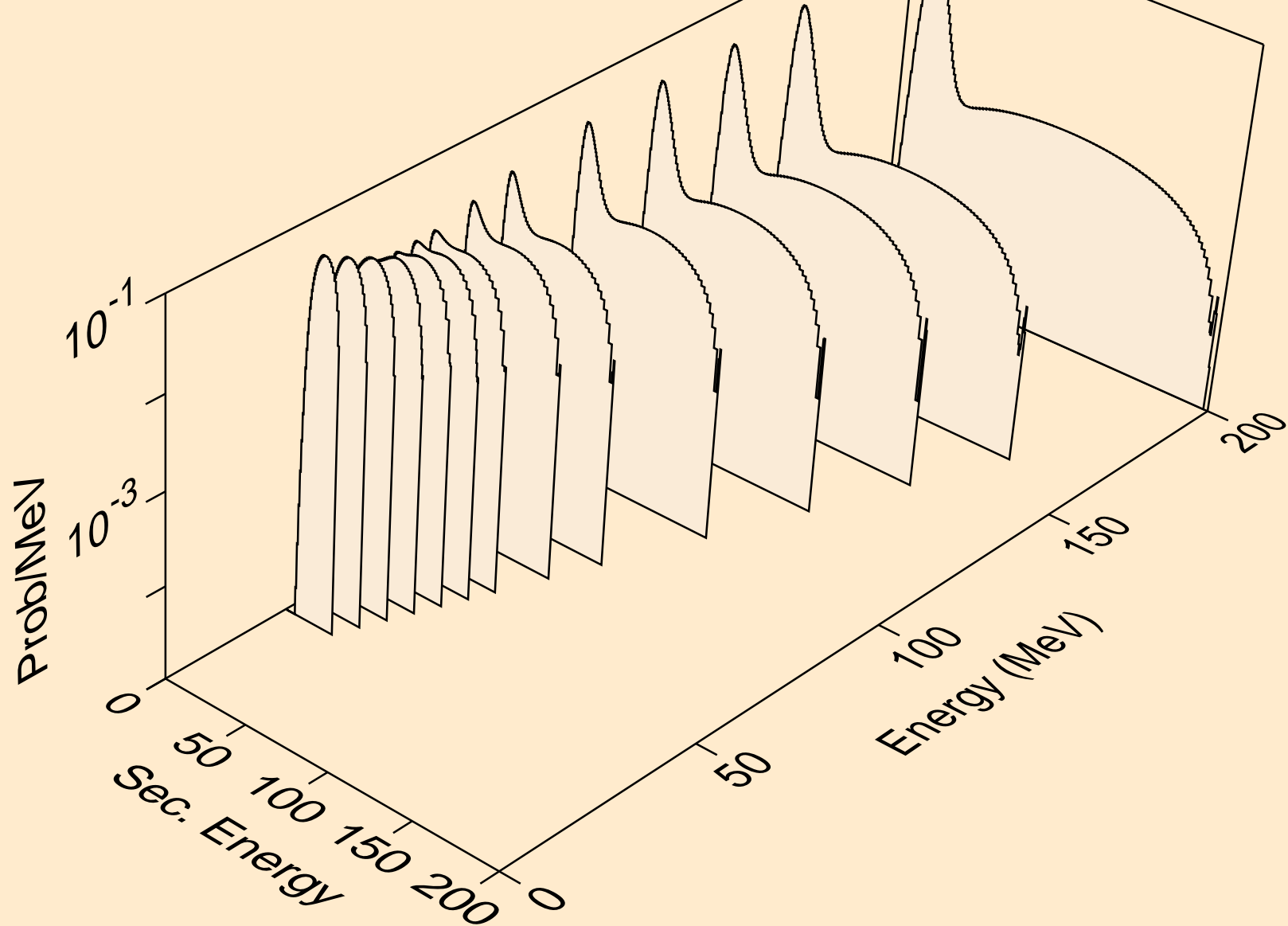

NP228 DEUTERON ACER TENDL-2021 LIBRARY; T=0.K
Deuteron emission for (d,2nd)

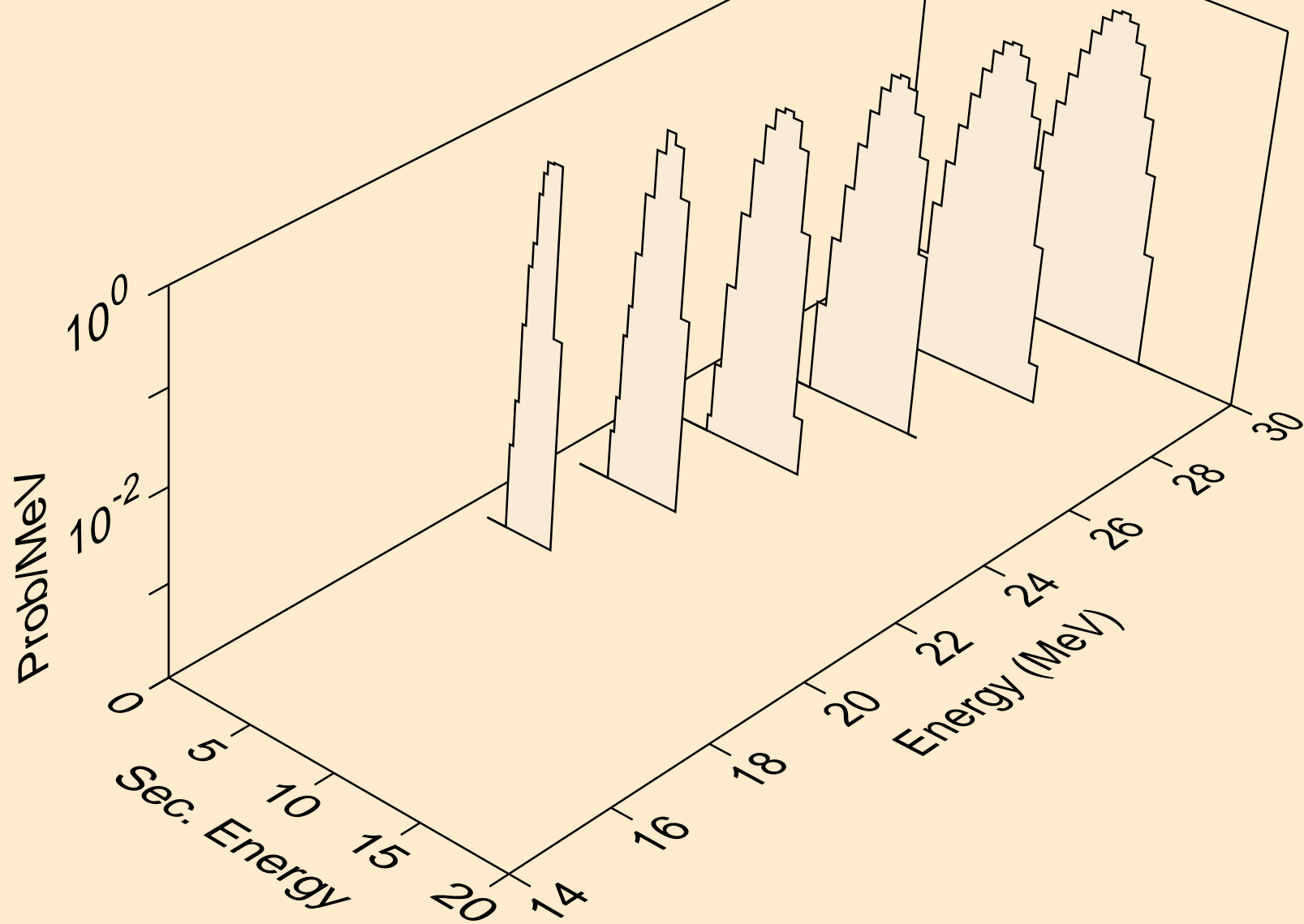

NP228 DEUTERON ACER TENDL-2021 LIBRARY; T=0.K
Deuteron emission for (d,n*)d

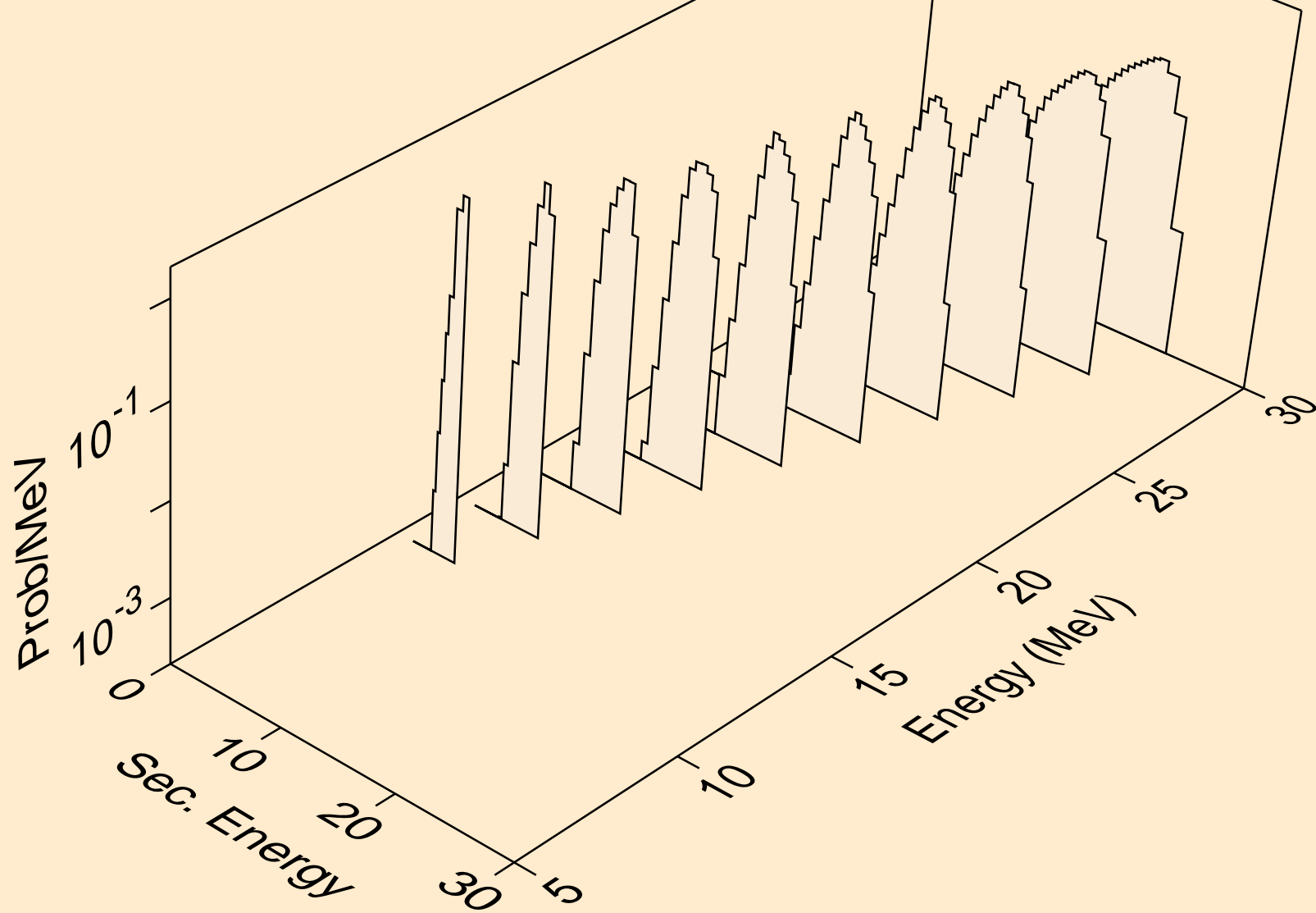

NP228 DEUTERON ACER TENDL-2021 LIBRARY; T=0.K
Deuteron emission for inelastic

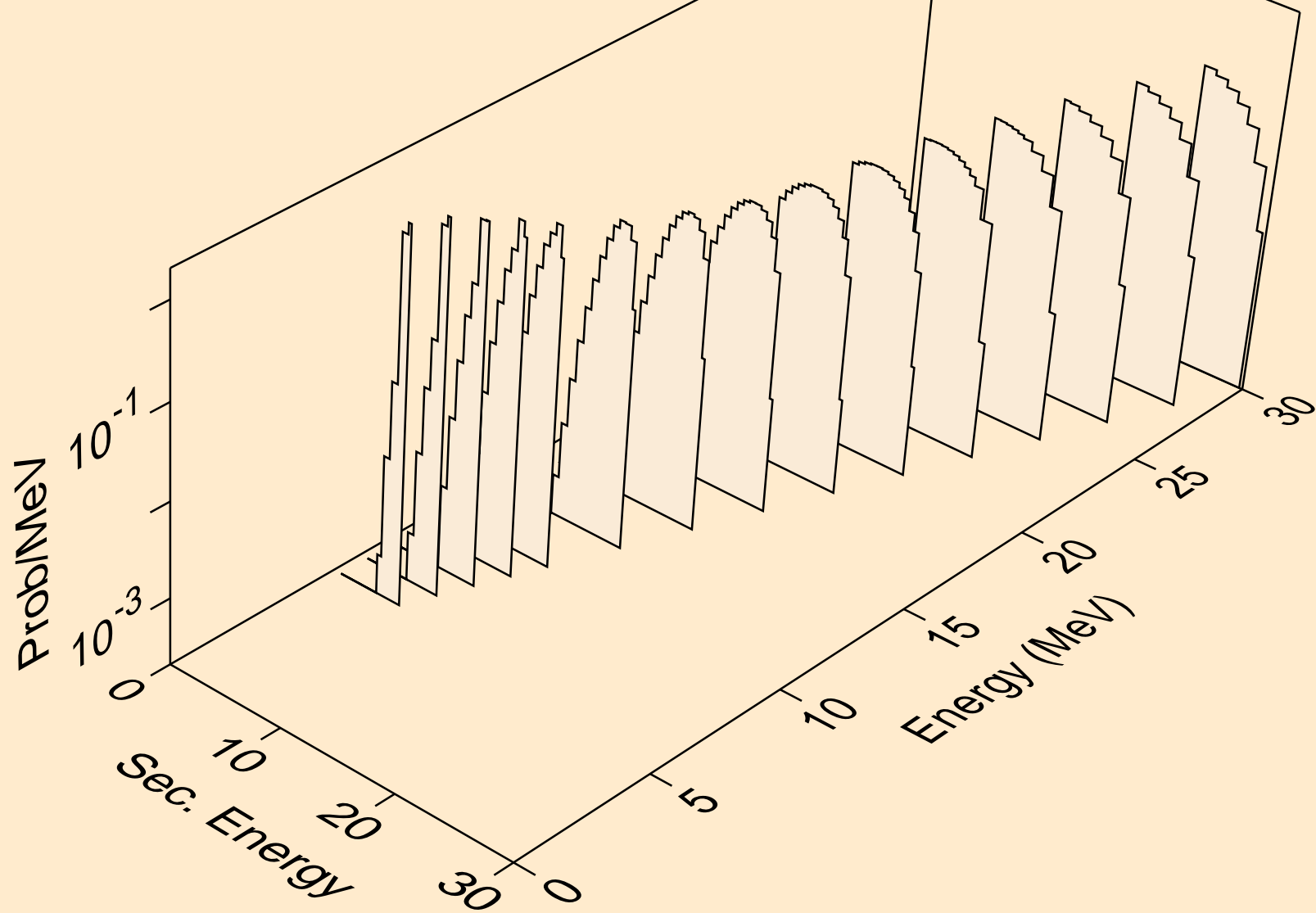

NP228 DEUTERON ACER TENDL-2021 LIBRARY; T=0.K
Deuteron emission for (d,pd)

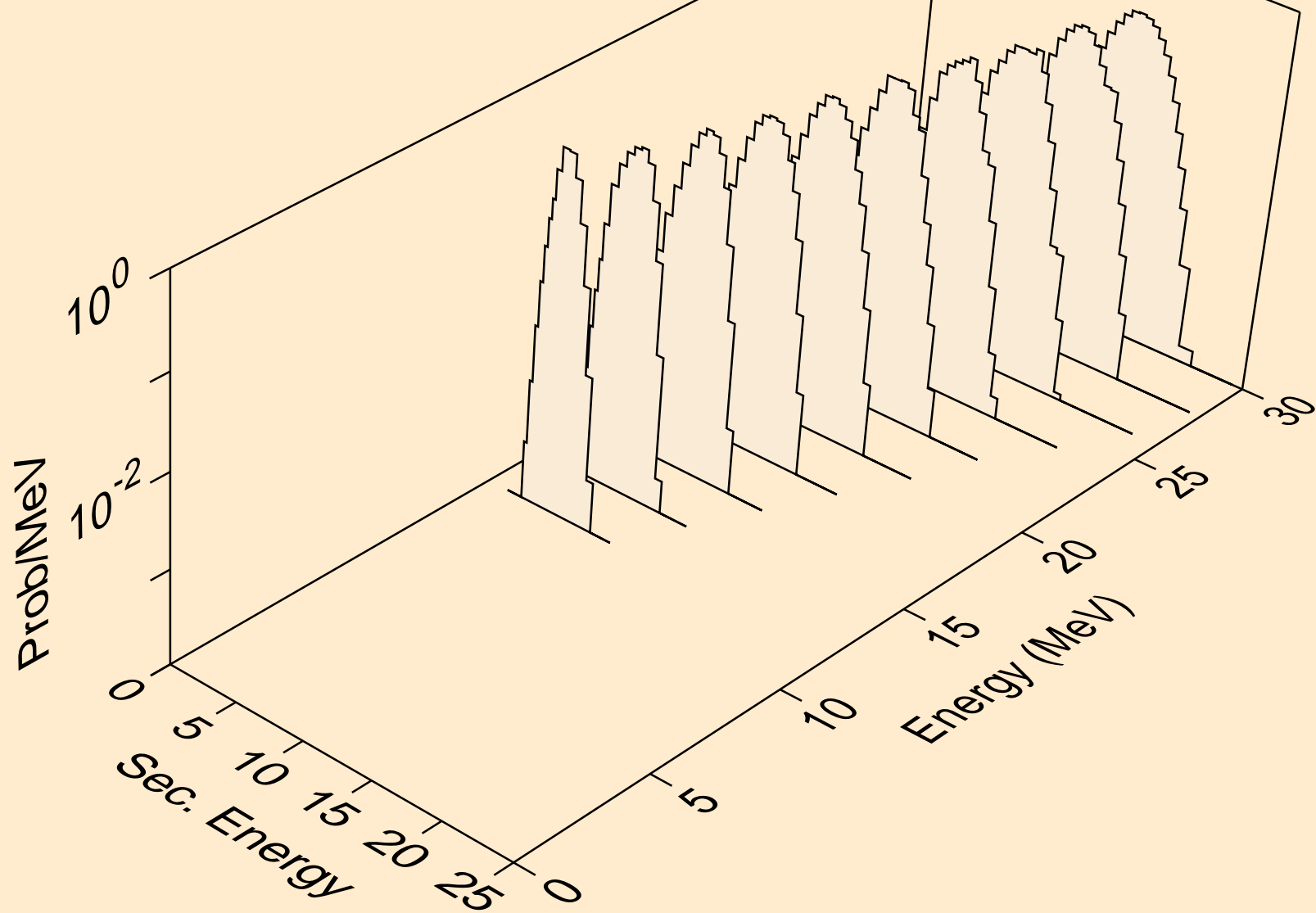

NP228 DEUTERON ACER TENDL-2021 LIBRARY; T=0.K
Deuteron emission for (d,da)

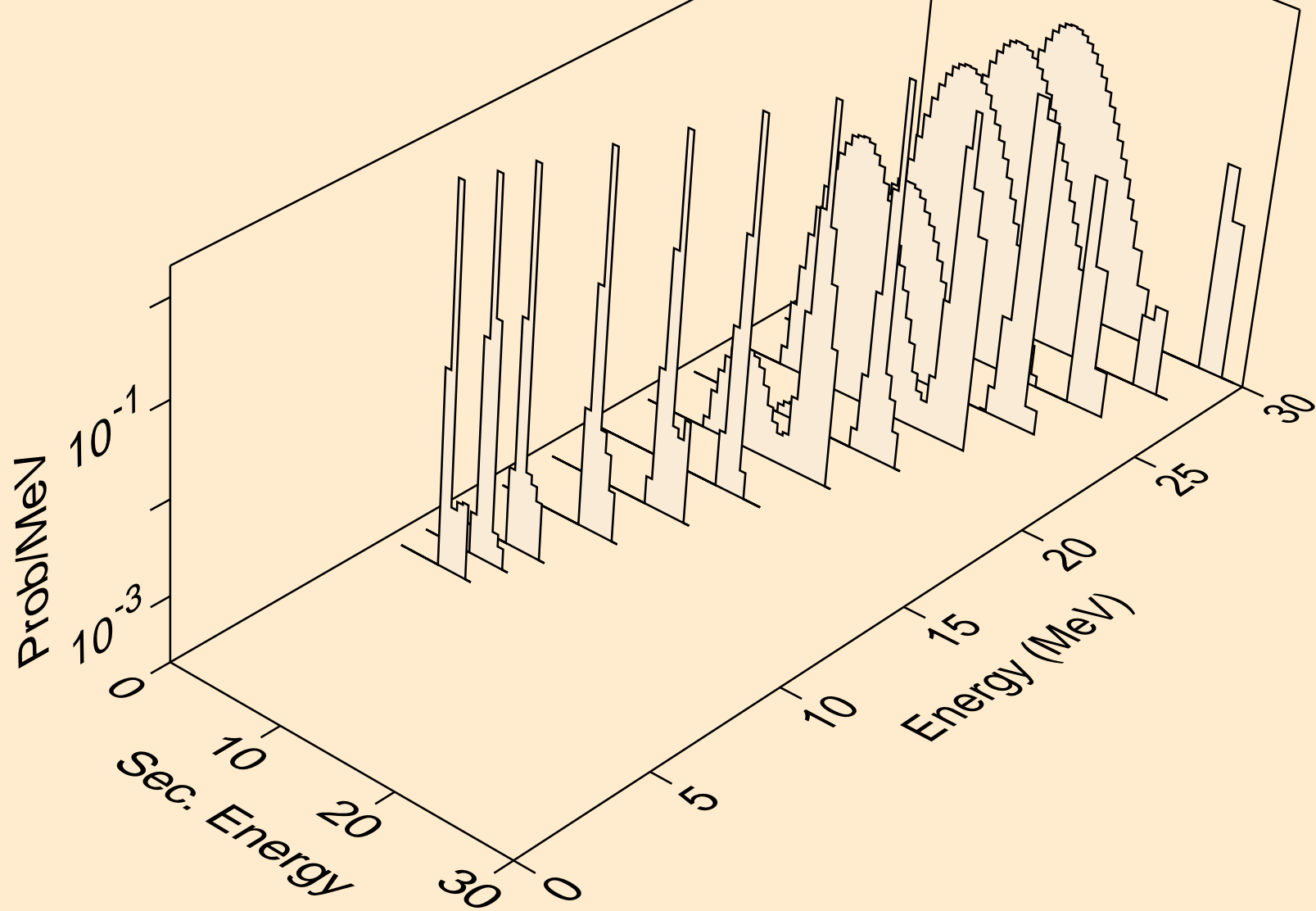

NP228 DEUTERON ACER TENDL-2021 LIBRARY; T=0.K
Photon emission for (z,n)

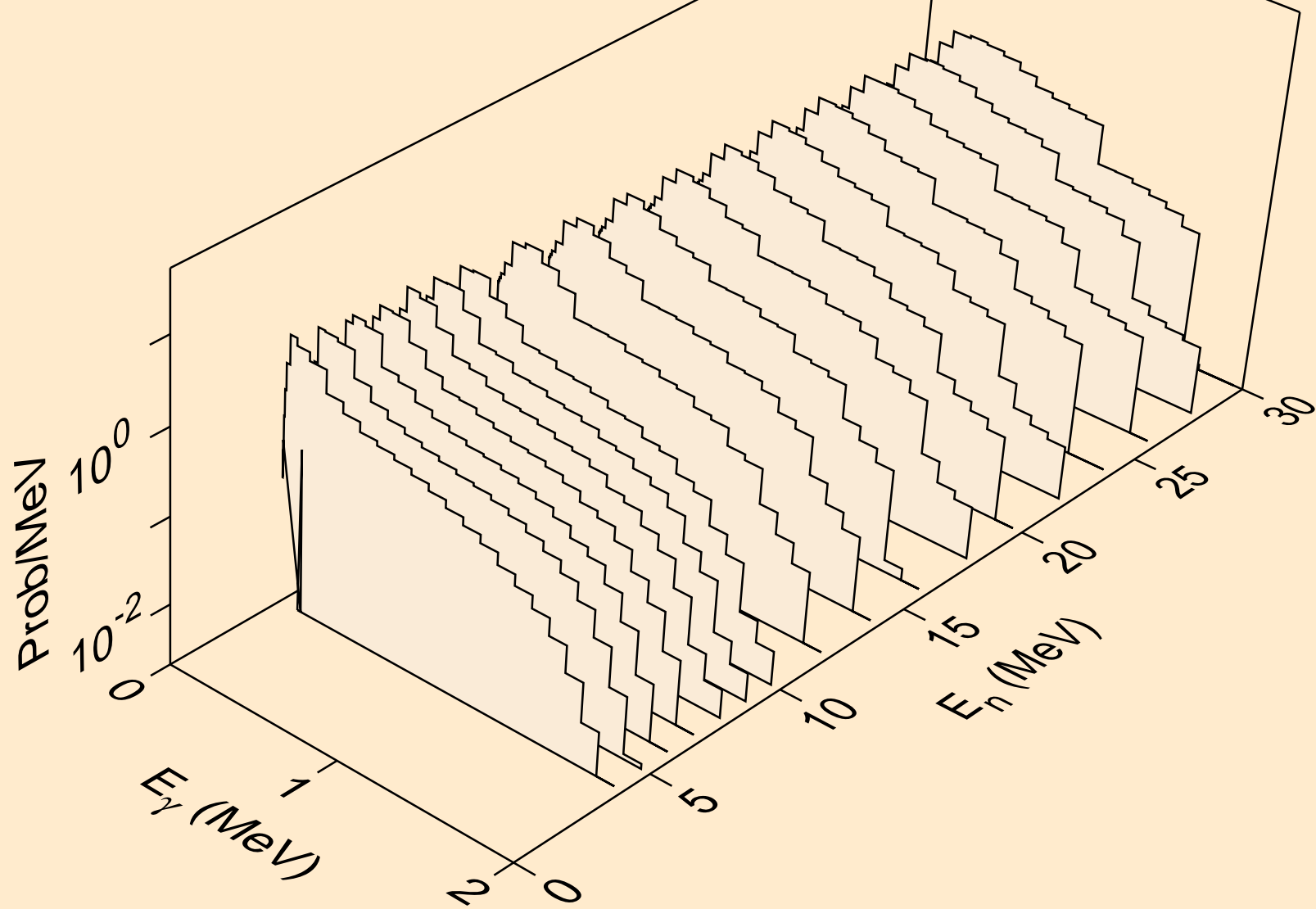

NP228 DEUTERON ACER TENDL-2021 LIBRARY; T=0.K
Photon emission for (n,x)

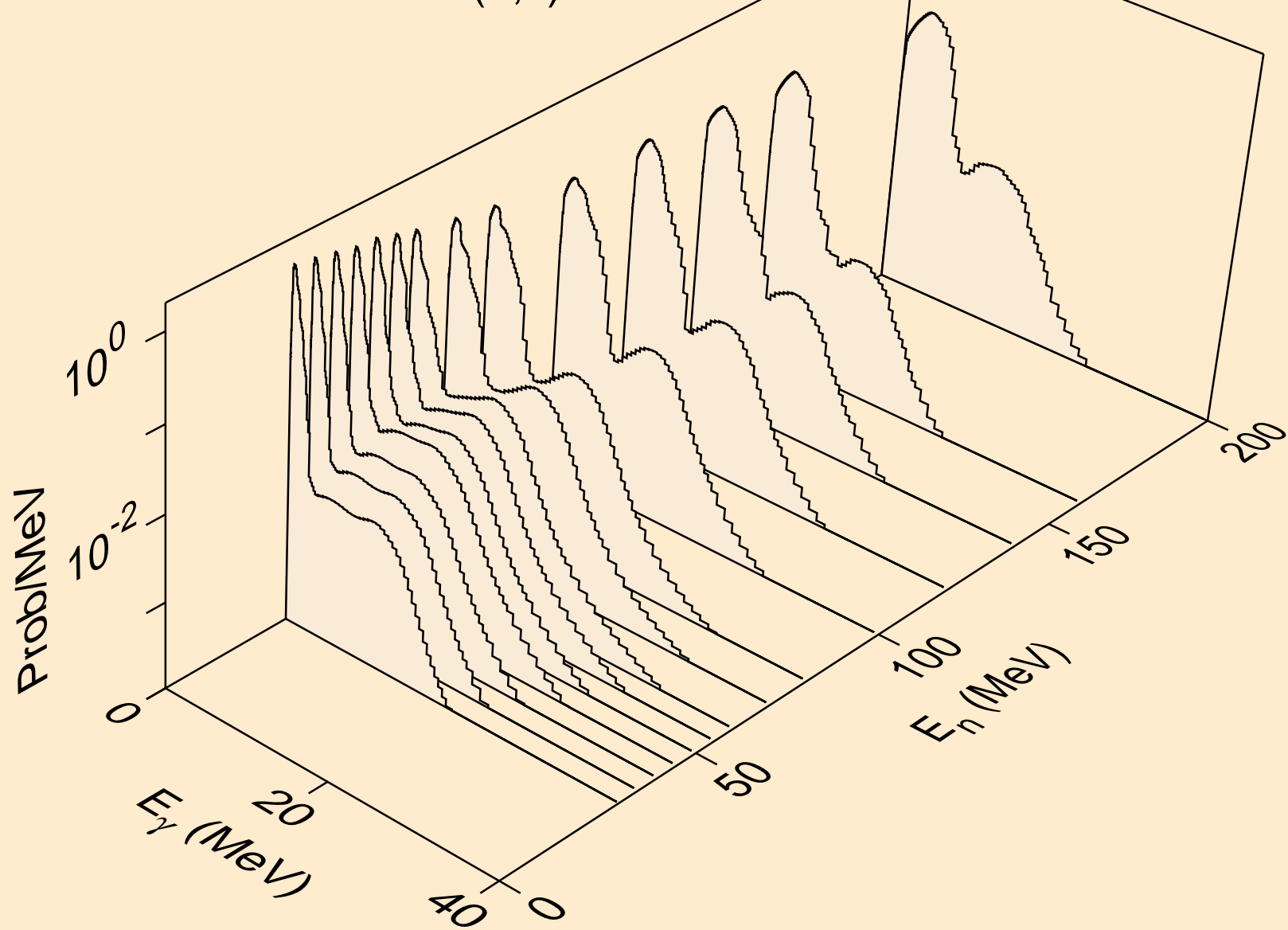

NP228 DEUTERON ACER TENDL-2021 LIBRARY; T=0.K
Photon emission for (n,2nd)

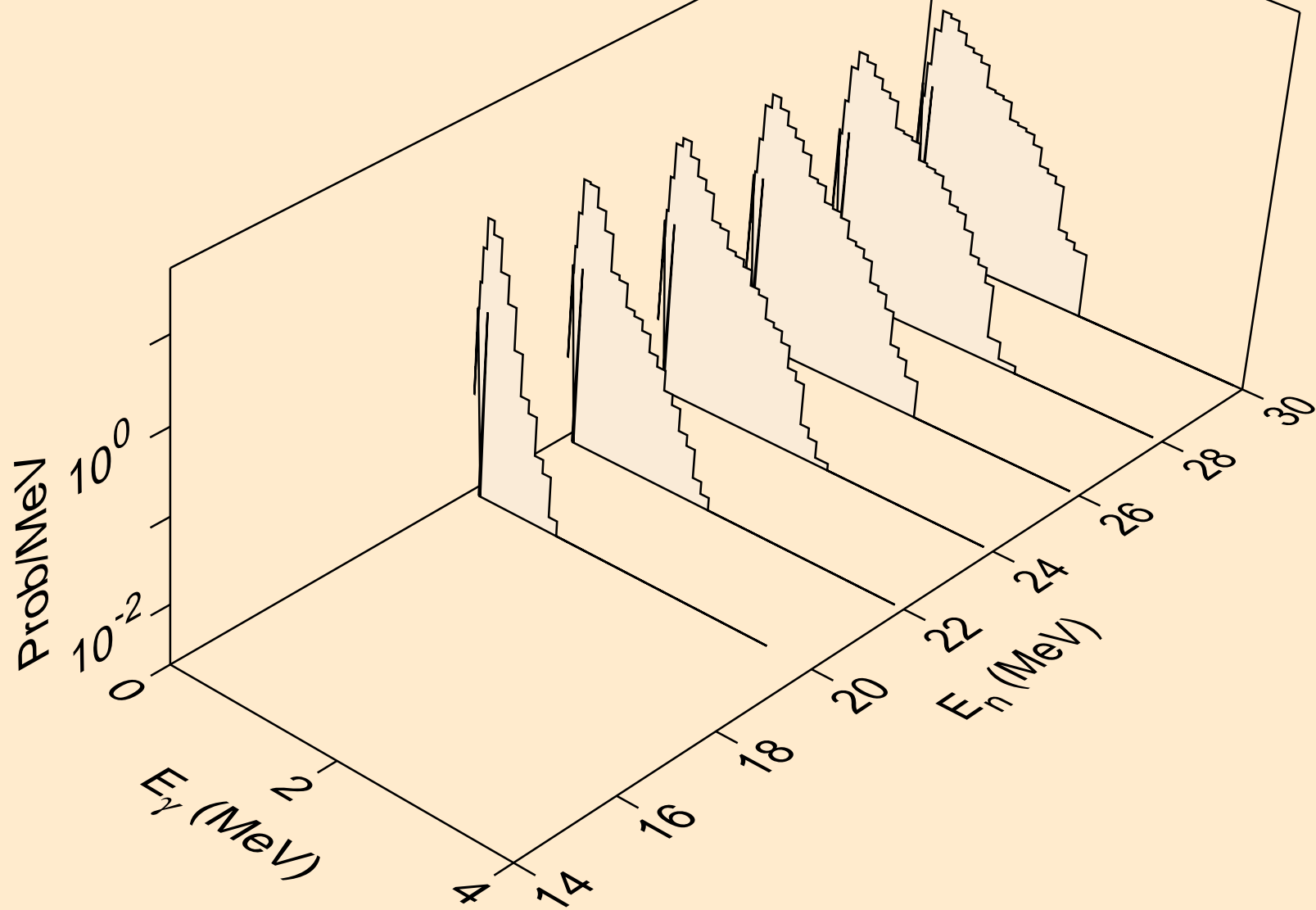

NP228 DEUTERON ACER TENDL-2021 LIBRARY; T=0.K
Photon emission for (n,2n)

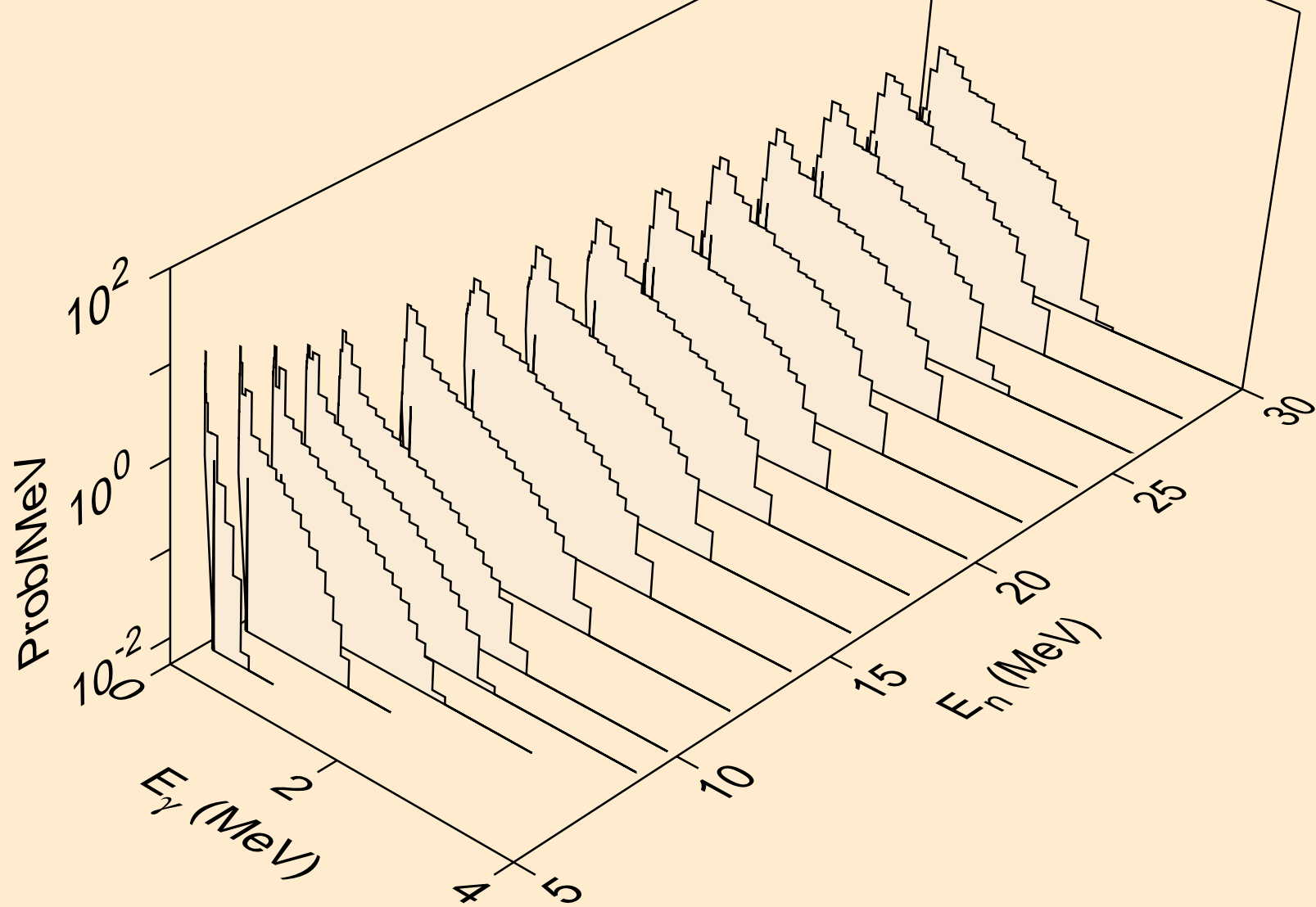

NP228 DEUTERON ACER TENDL-2021 LIBRARY; T=0.K
Photon emission for (n,3n)

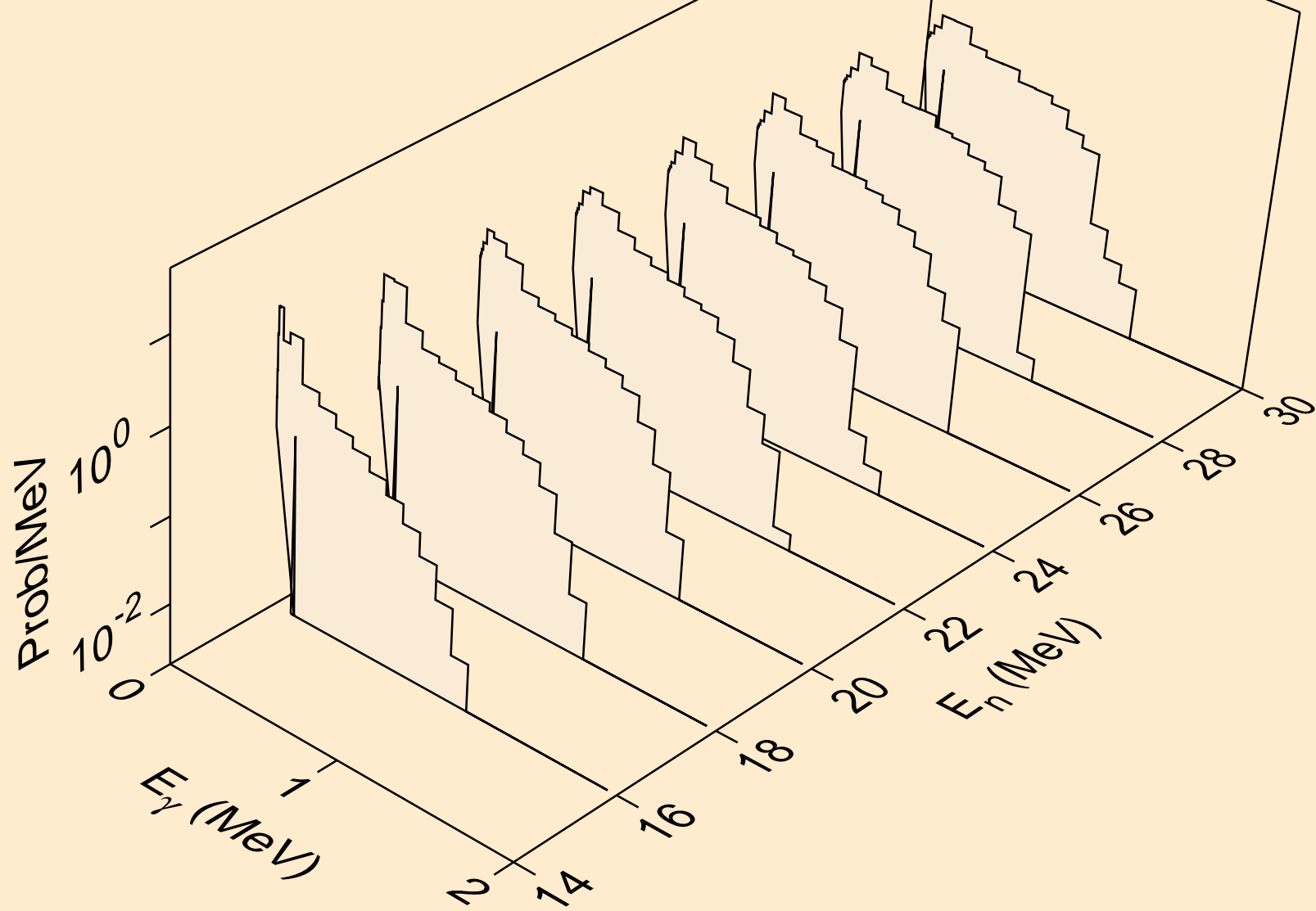

NP228 DEUTERON ACER TENDL-2021 LIBRARY; T=0.K
Photon emission for (n,n*)a

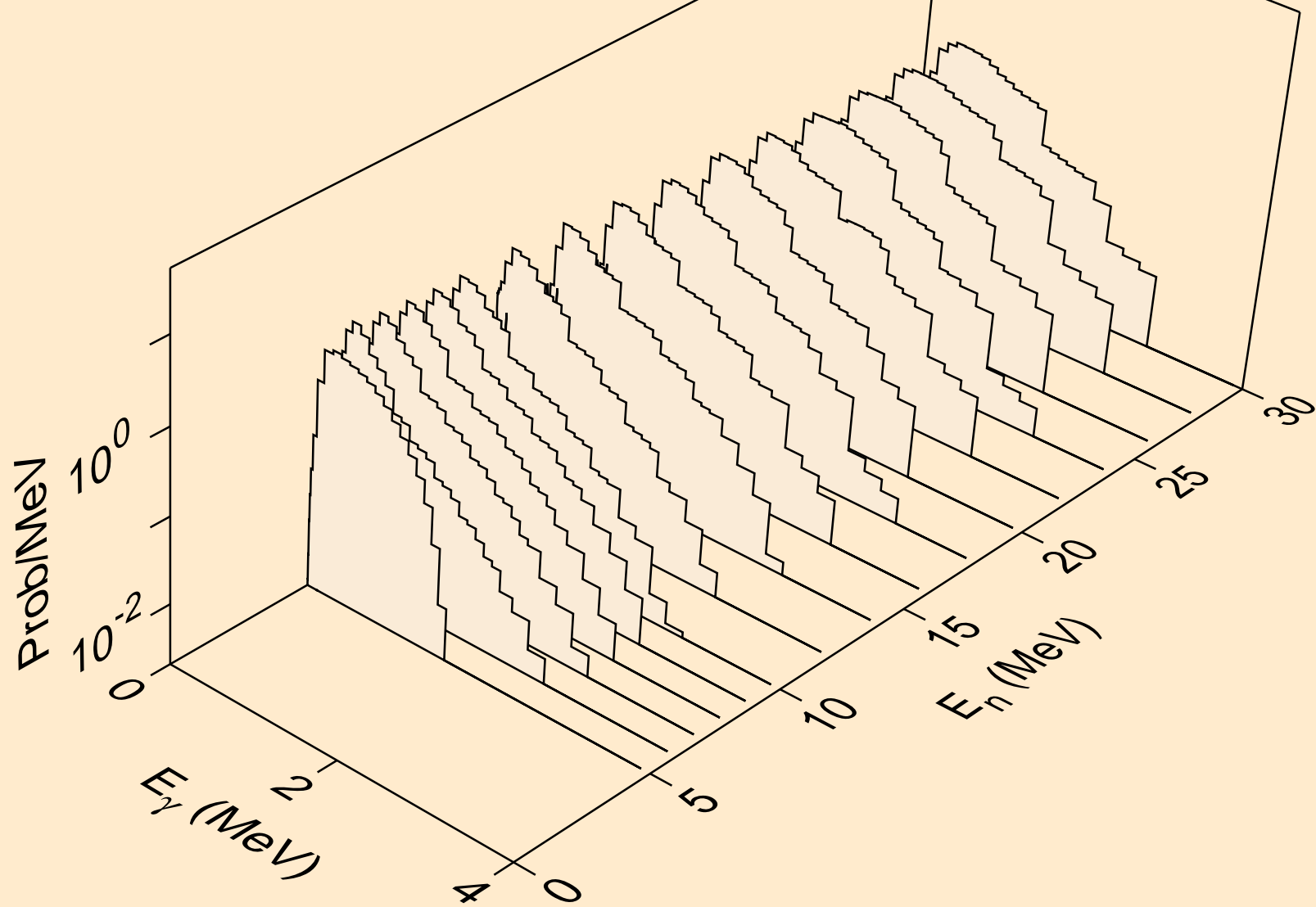

NP228 DEUTERON ACER TENDL-2021 LIBRARY; T=0.K
Photon emission for (n,n*)3a

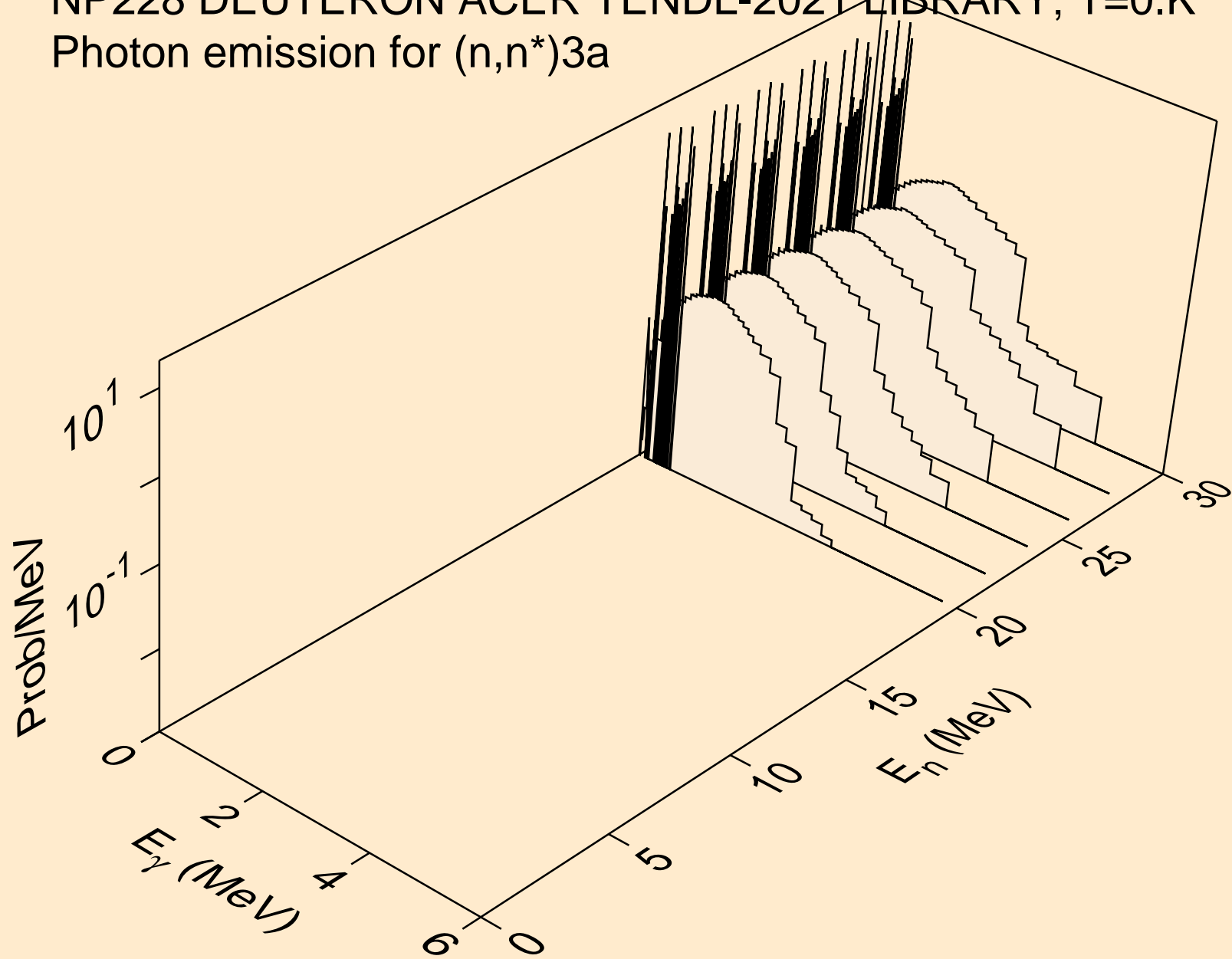

NP228 DEUTERON ACER TENDL-2021 LIBRARY; T=0.K
Photon emission for (n,2n)a

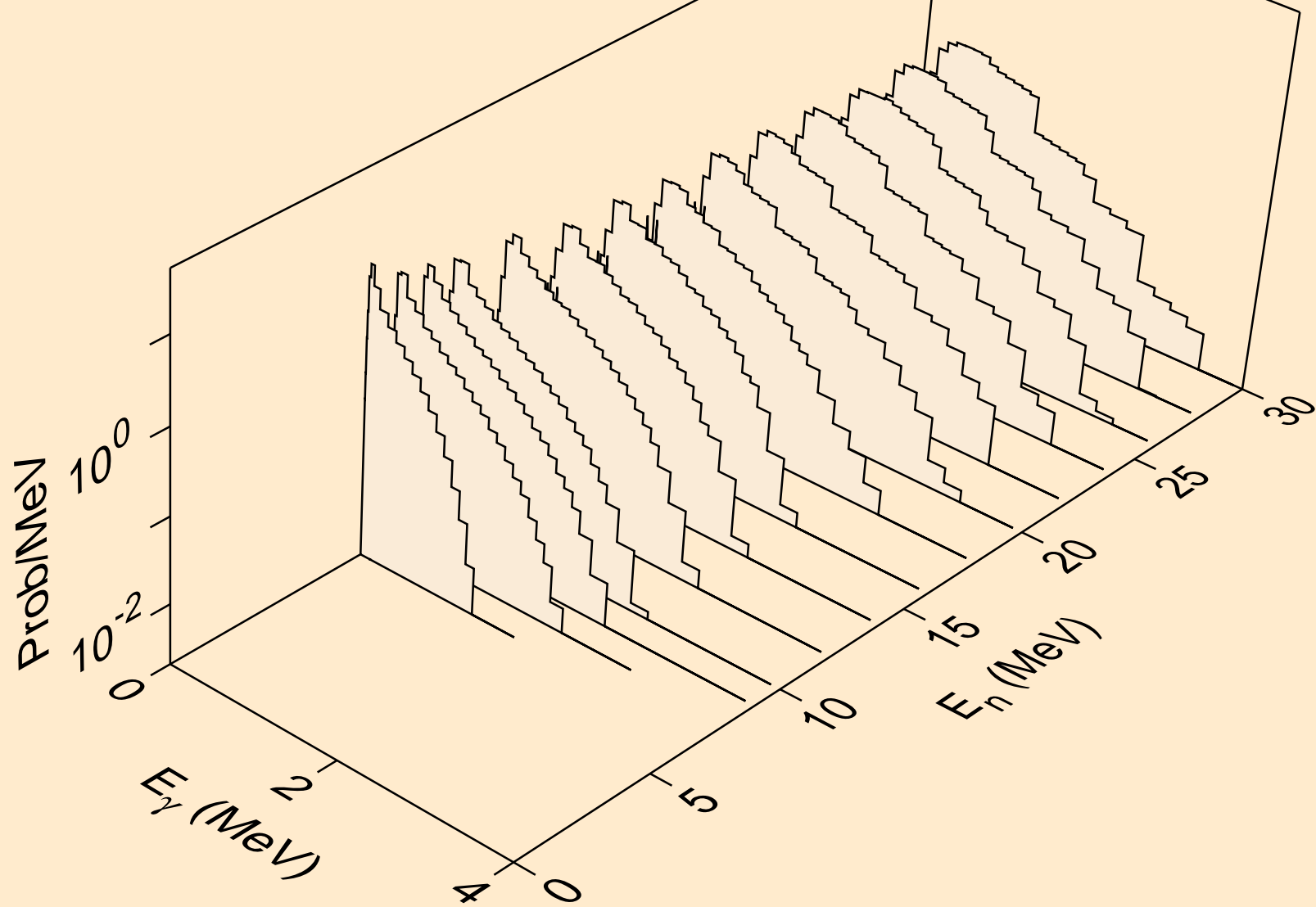

NP228 DEUTERON ACER TENDL-2021 LIBRARY; T=0.K
Photon emission for (n,3n)a

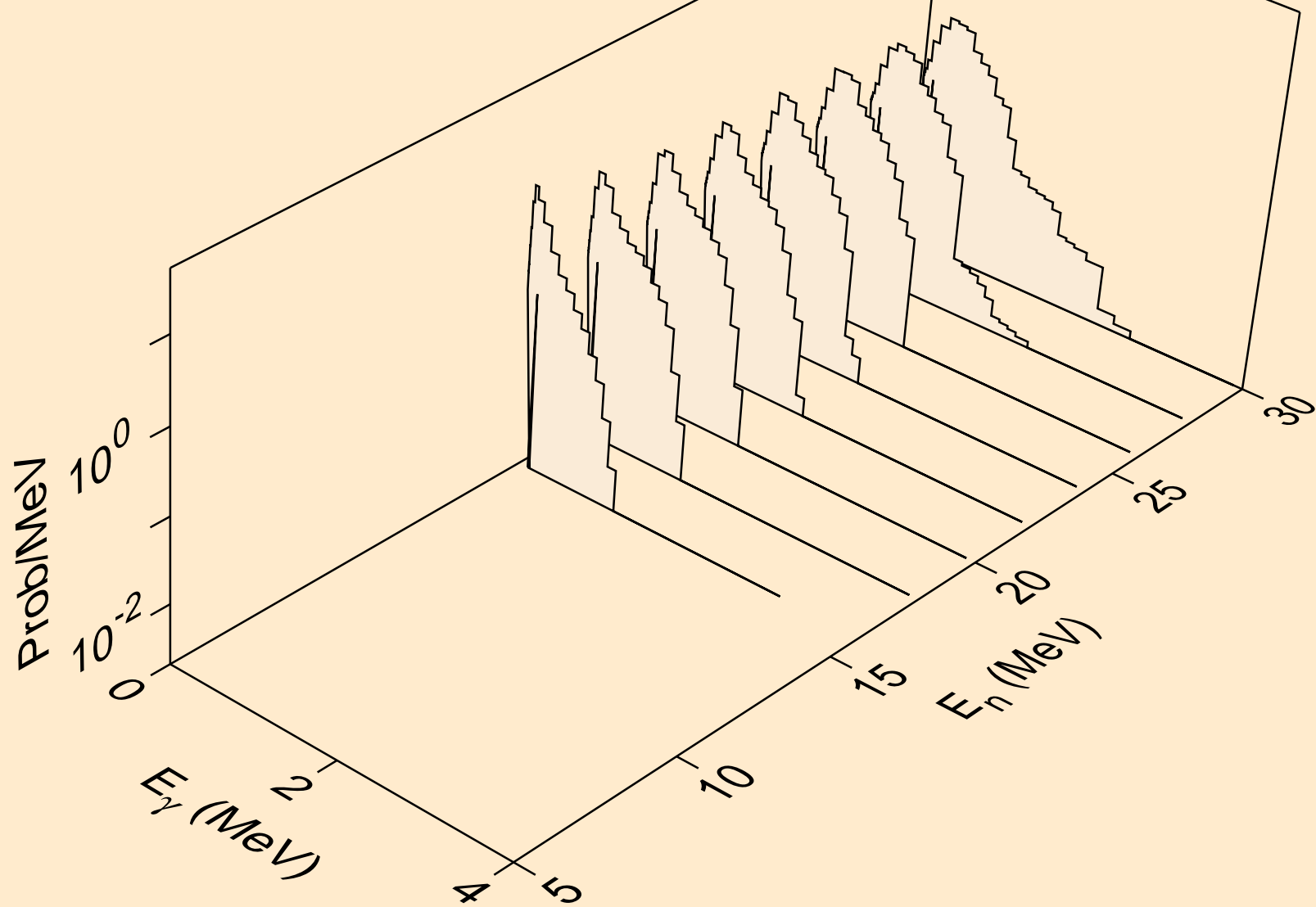

NP228 DEUTERON ACER TENDL-2021 LIBRARY; T=0.K
Photon emission for (n,n*)p

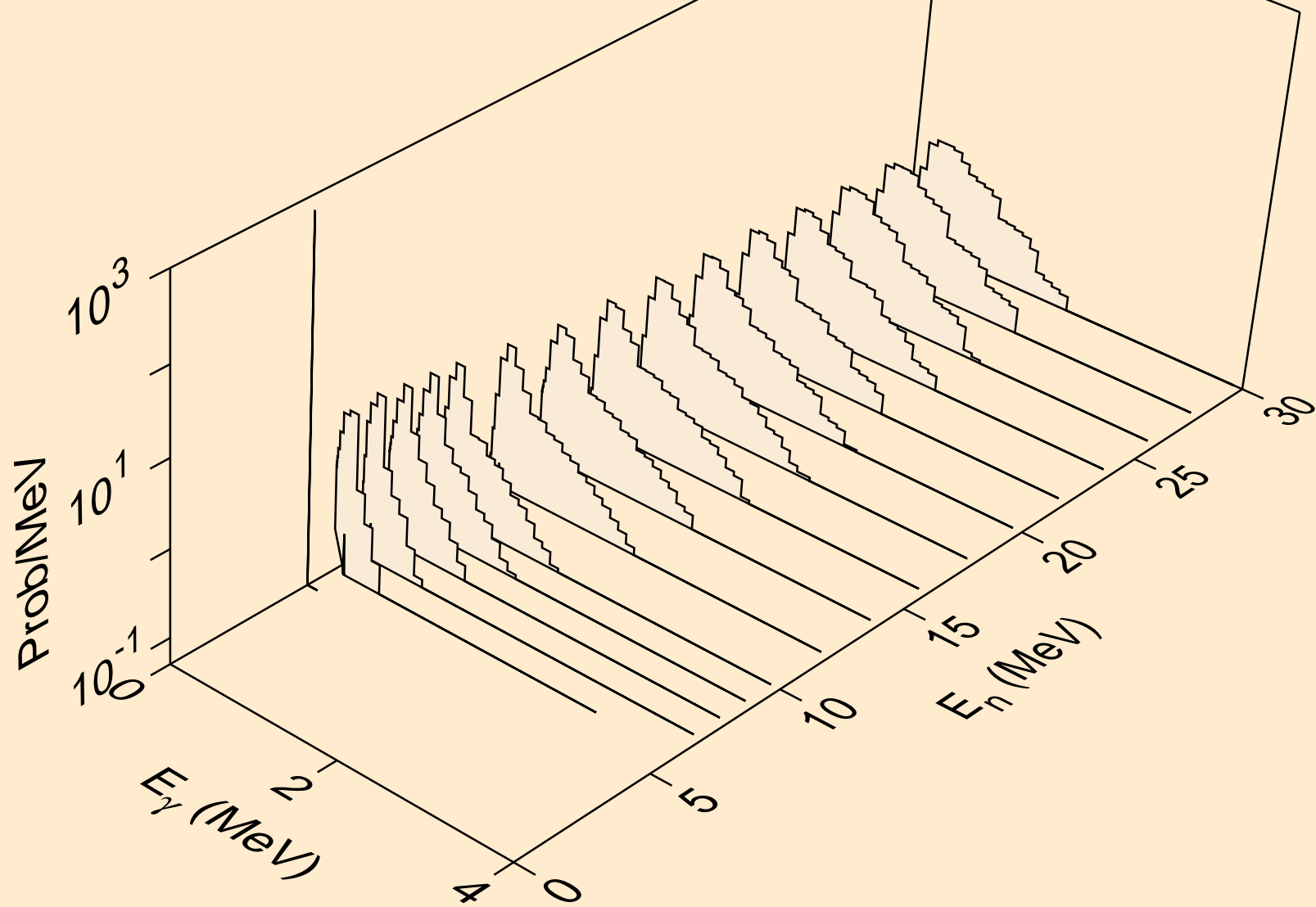

NP228 DEUTERON ACER TENDL-2021 LIBRARY; T=0.K
Photon emission for (n,n*)2a

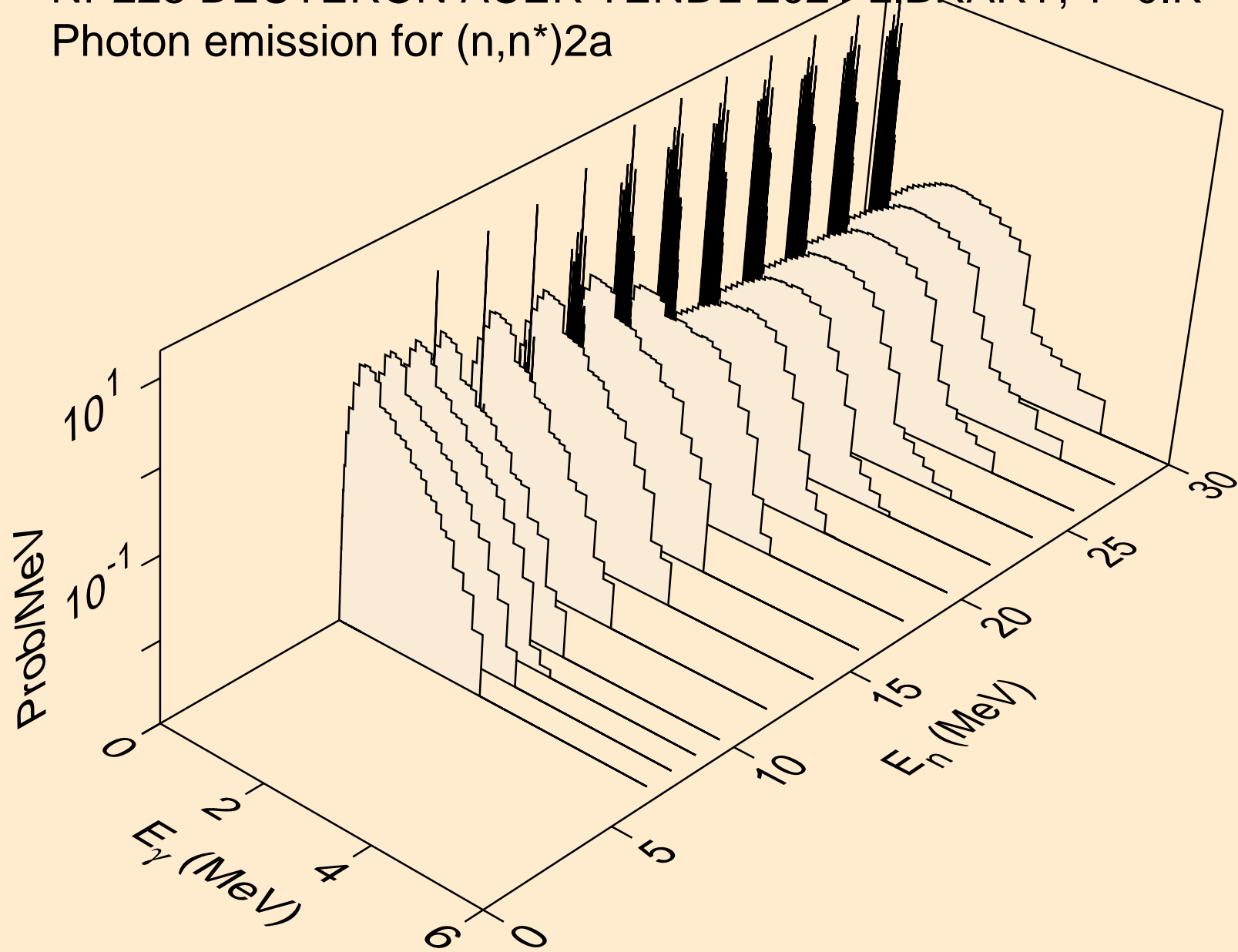

NP228 DEUTERON ACER TENDL-2021 LIBRARY; T=0.K
Photon emission for (n,2n)2a

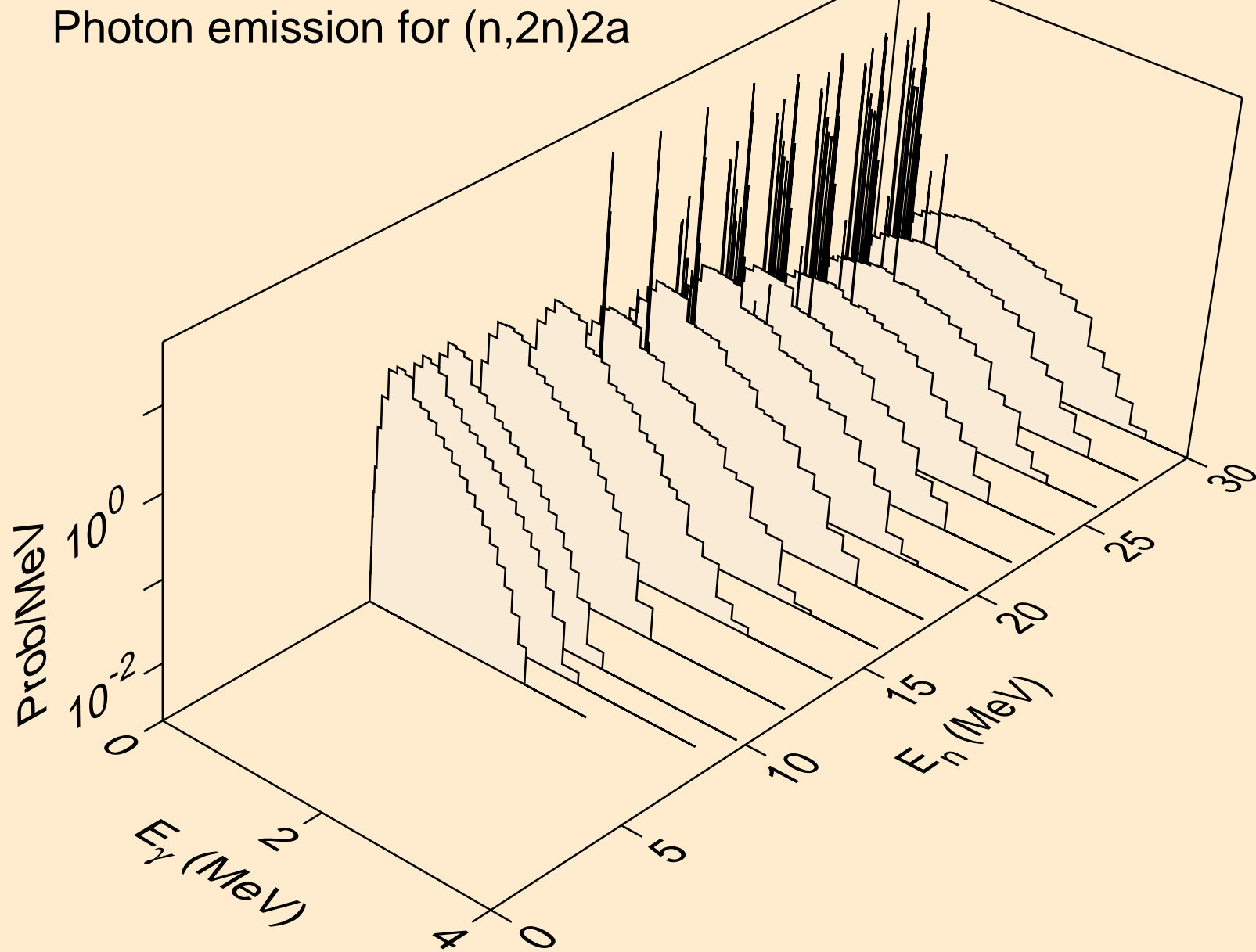

NP228 DEUTERON ACER TENDL-2021 LIBRARY; T=0.K
Photon emission for (n,n*)d

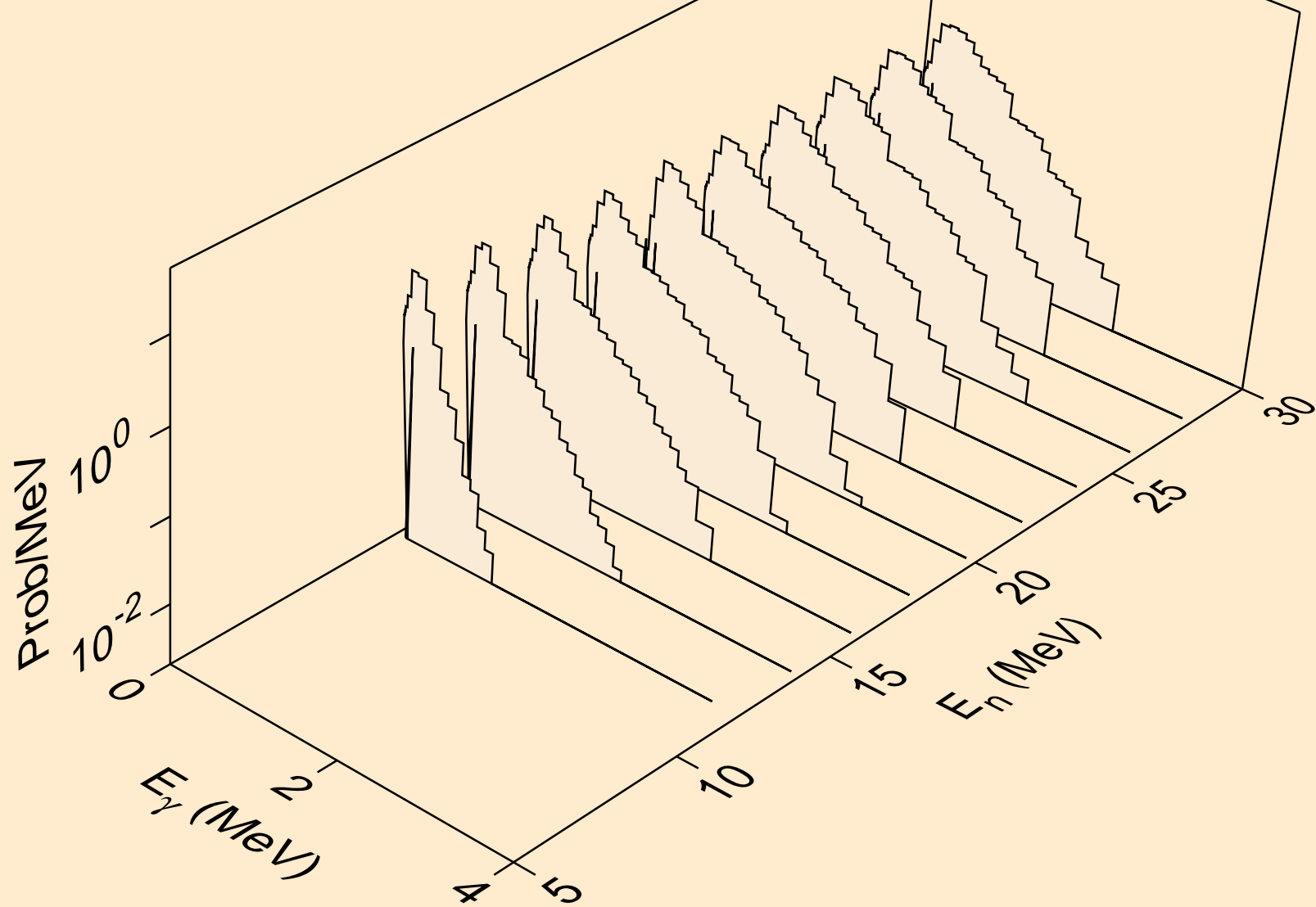

NP228 DEUTERON ACER TENDL-2021 LIBRARY; T=0.K
Photon emission for (n,n*)t

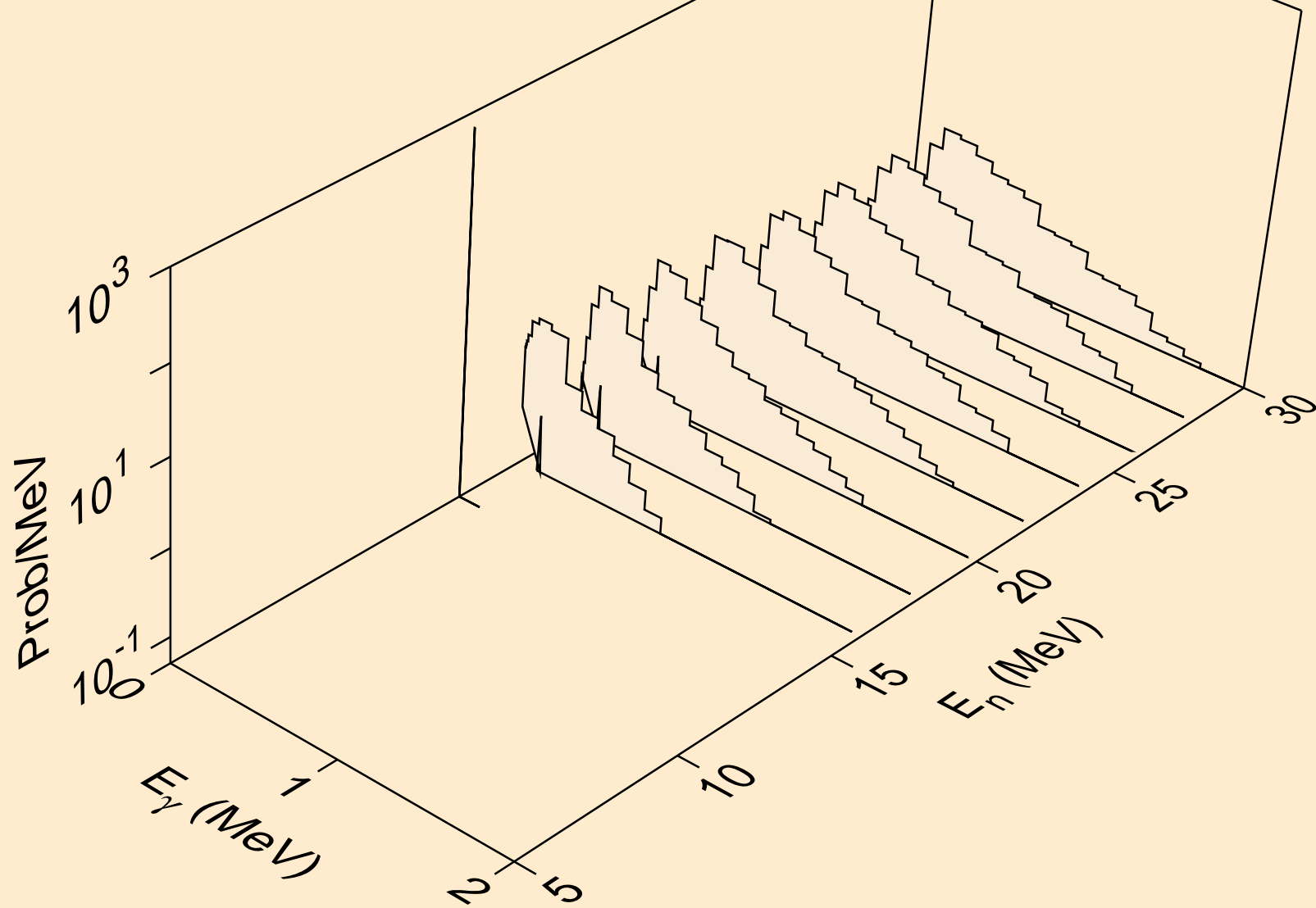

NP228 DEUTERON ACER TENDL-2021 LIBRARY; T=0.K
Photon emission for (n,n*)he3

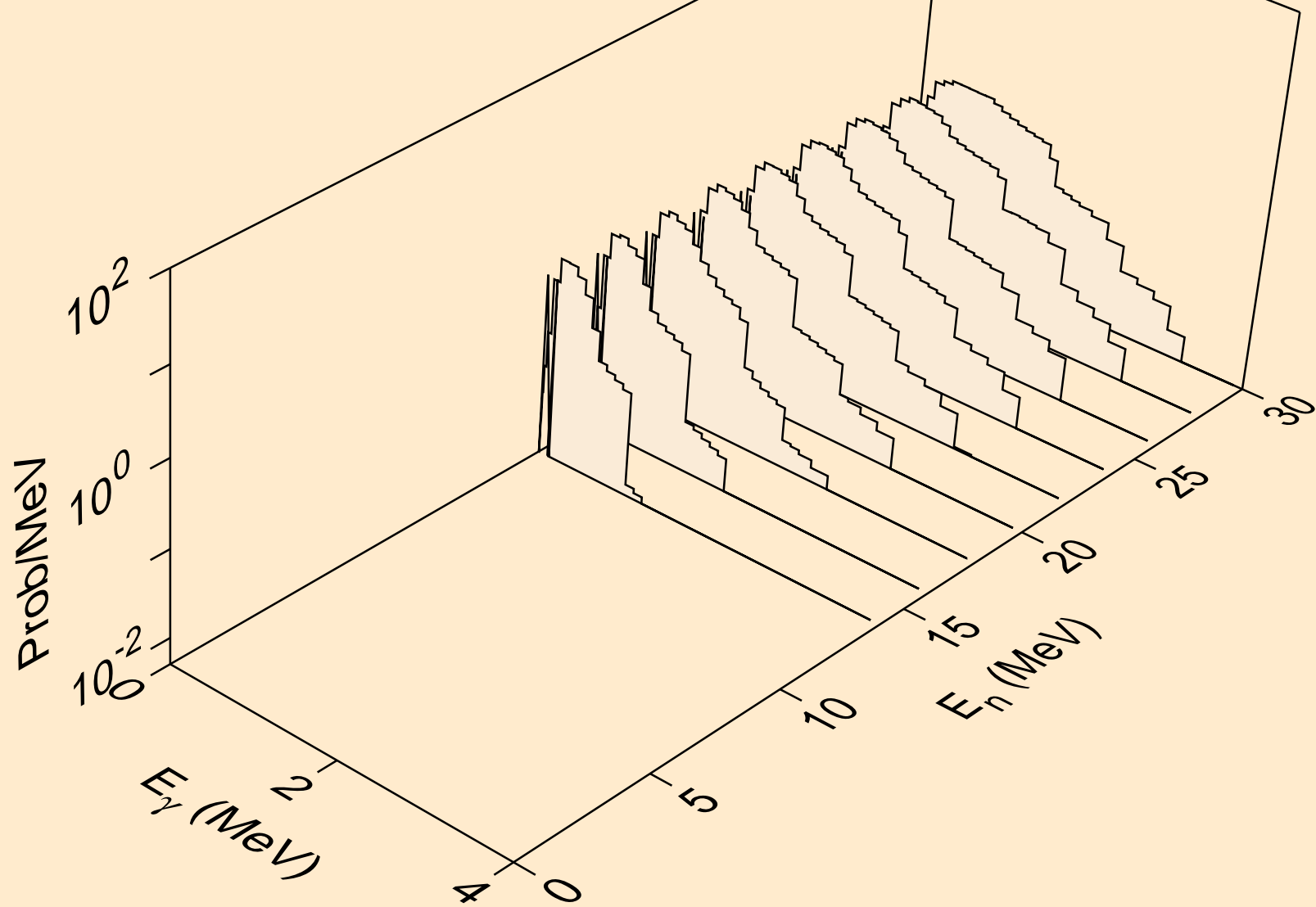

NP228 DEUTERON ACER TENDL-2021 LIBRARY; T=0.K
Photon emission for (n,4n)

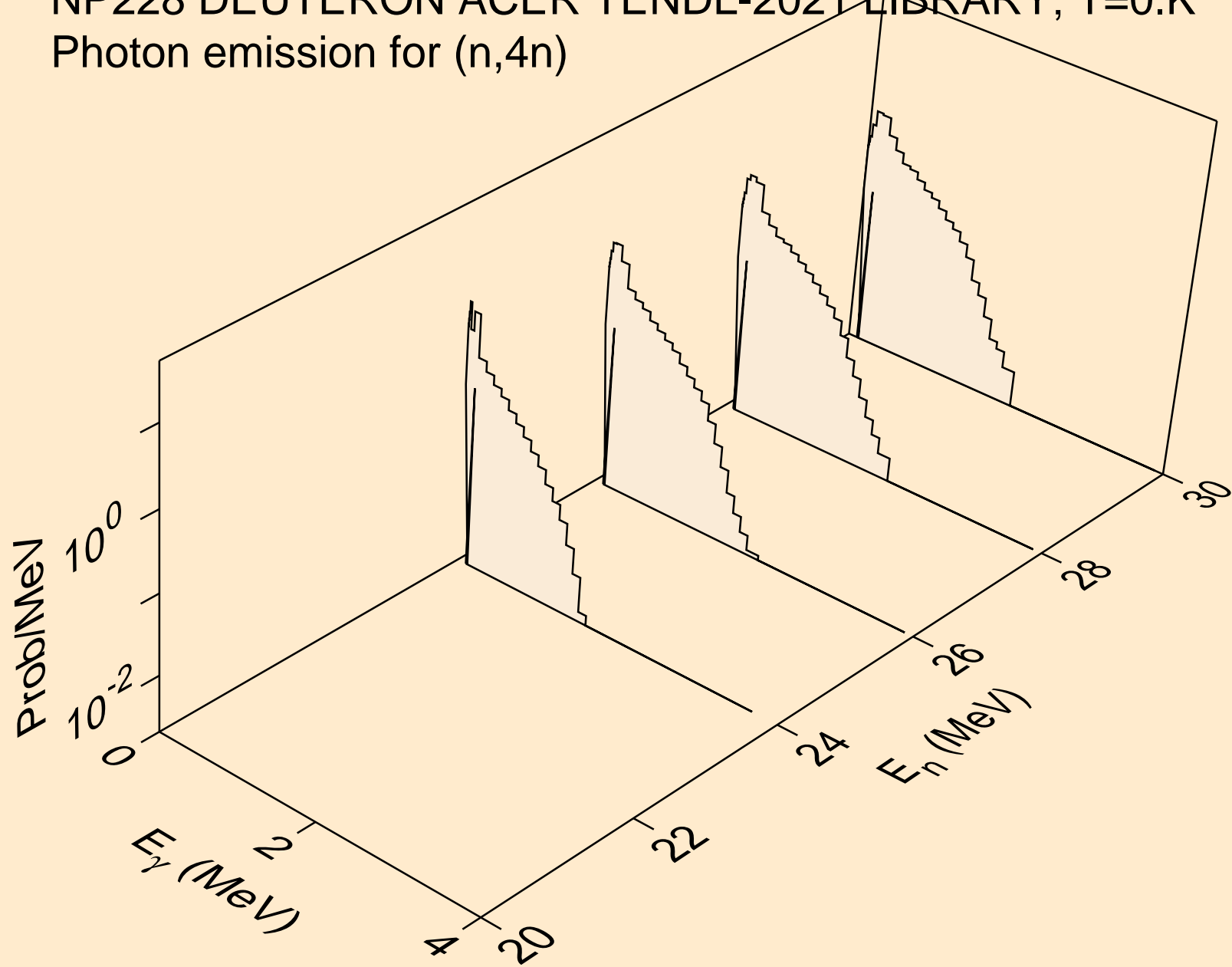

NP228 DEUTERON ACER TENDL-2021 LIBRARY; T=0.K
Photon emission for (n,2np)

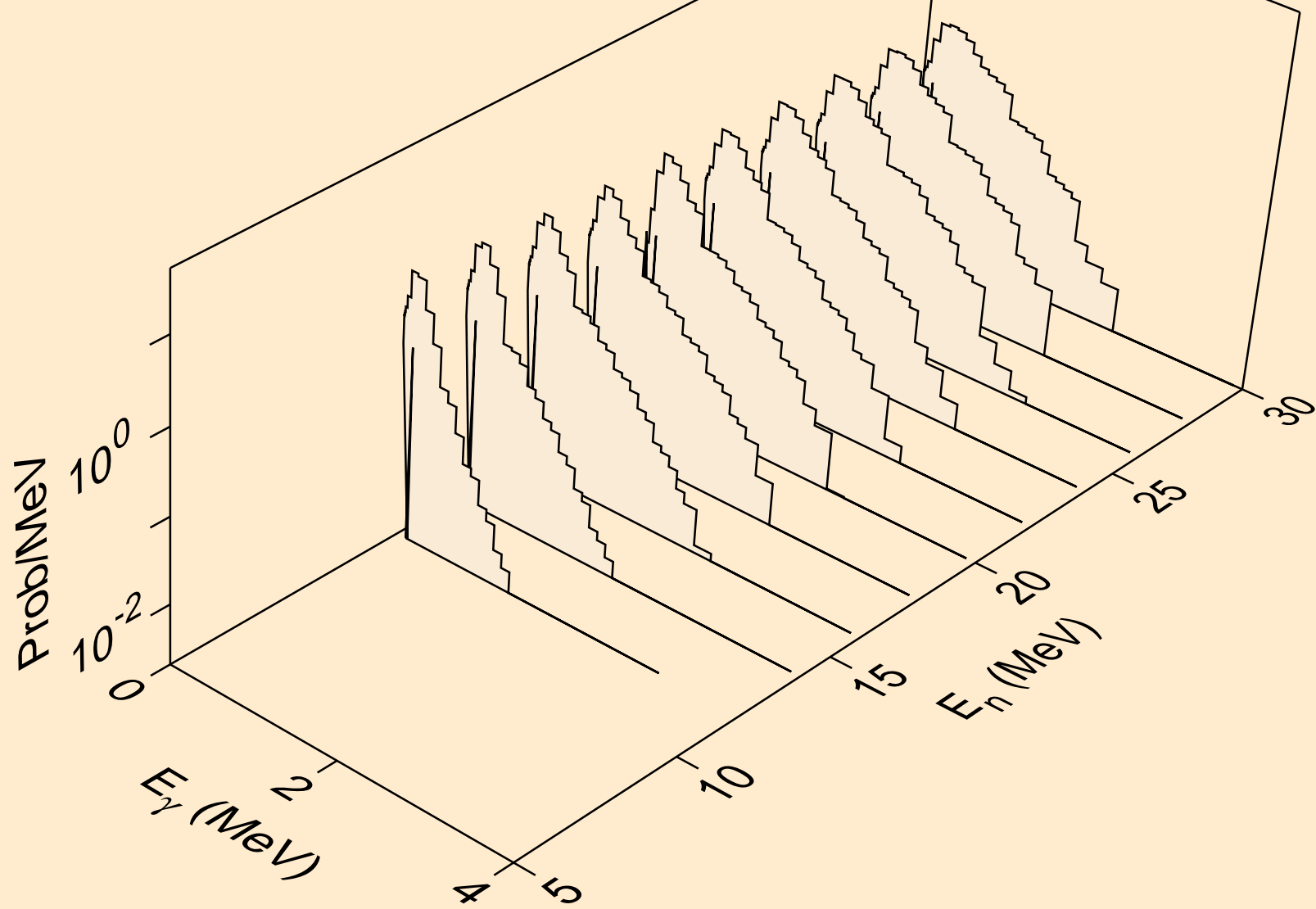

NP228 DEUTERON ACER TENDL-2021 LIBRARY; T=0.K
Photon emission for (n,3np)

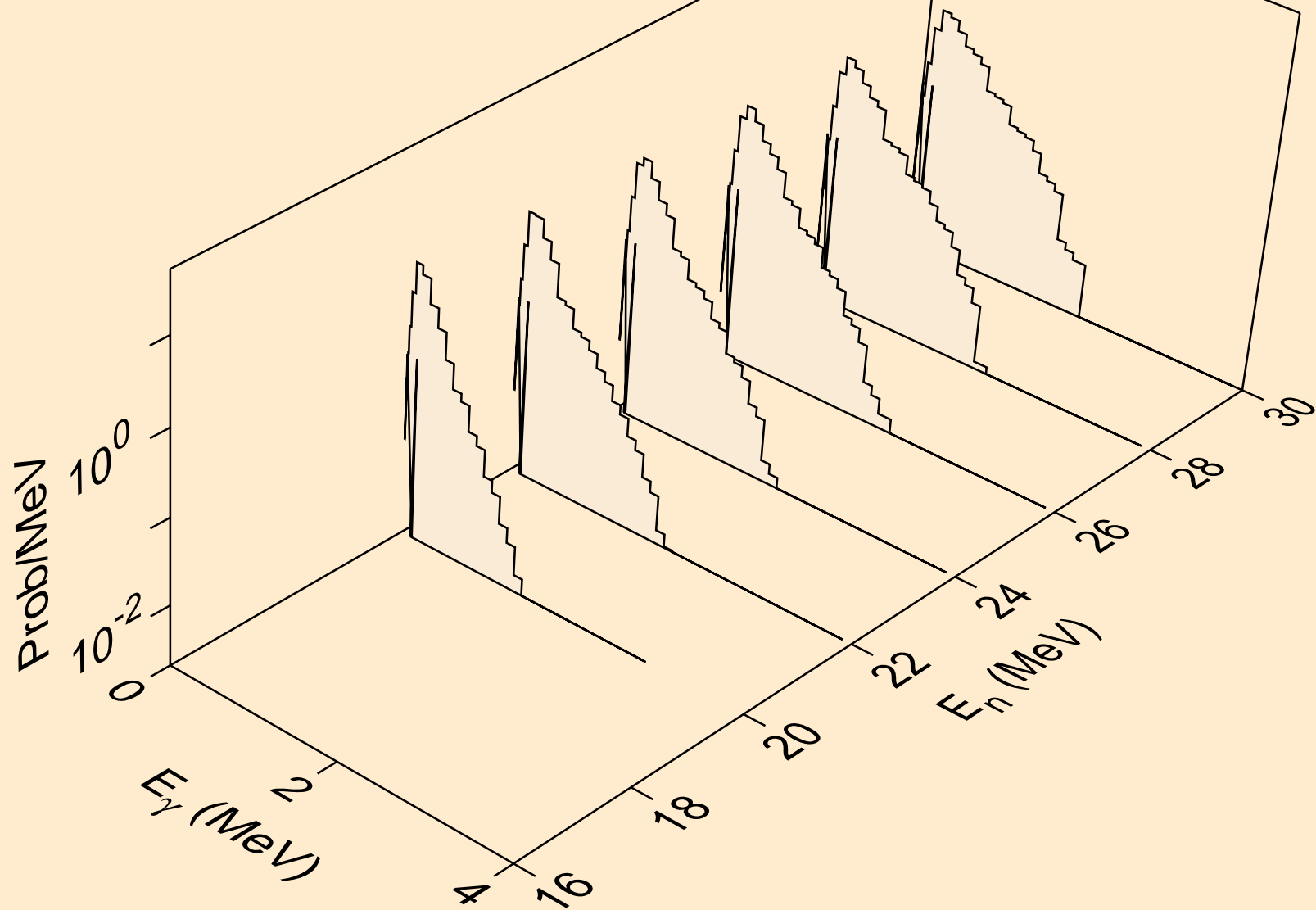

NP228 DEUTERON ACER TENDL-2021 LIBRARY; T=0.K
Photon emission for (n,2np)

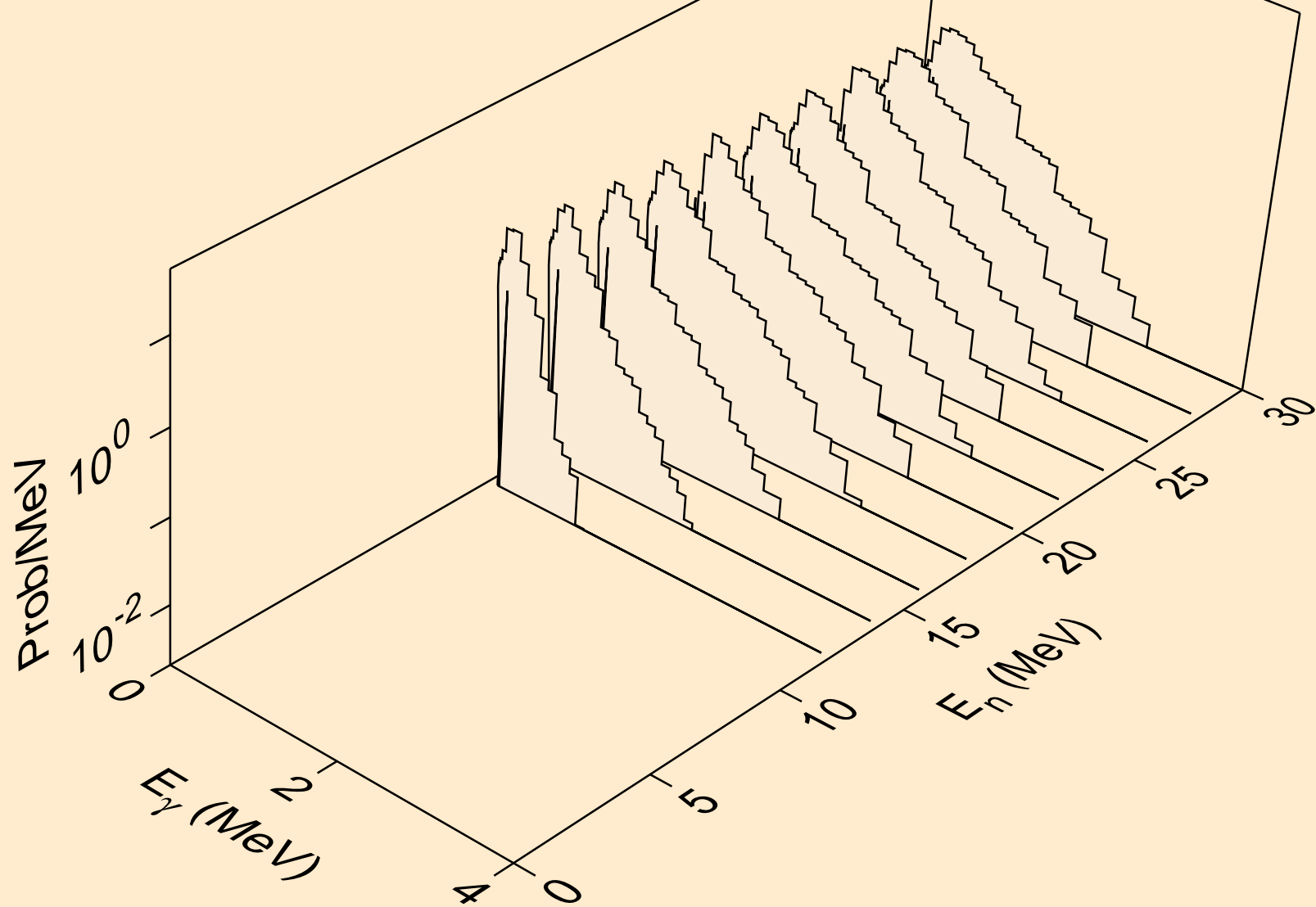

NP228 DEUTERON ACER TENDL-2021 LIBRARY; T=0.K
Photon emission for (n,npa)

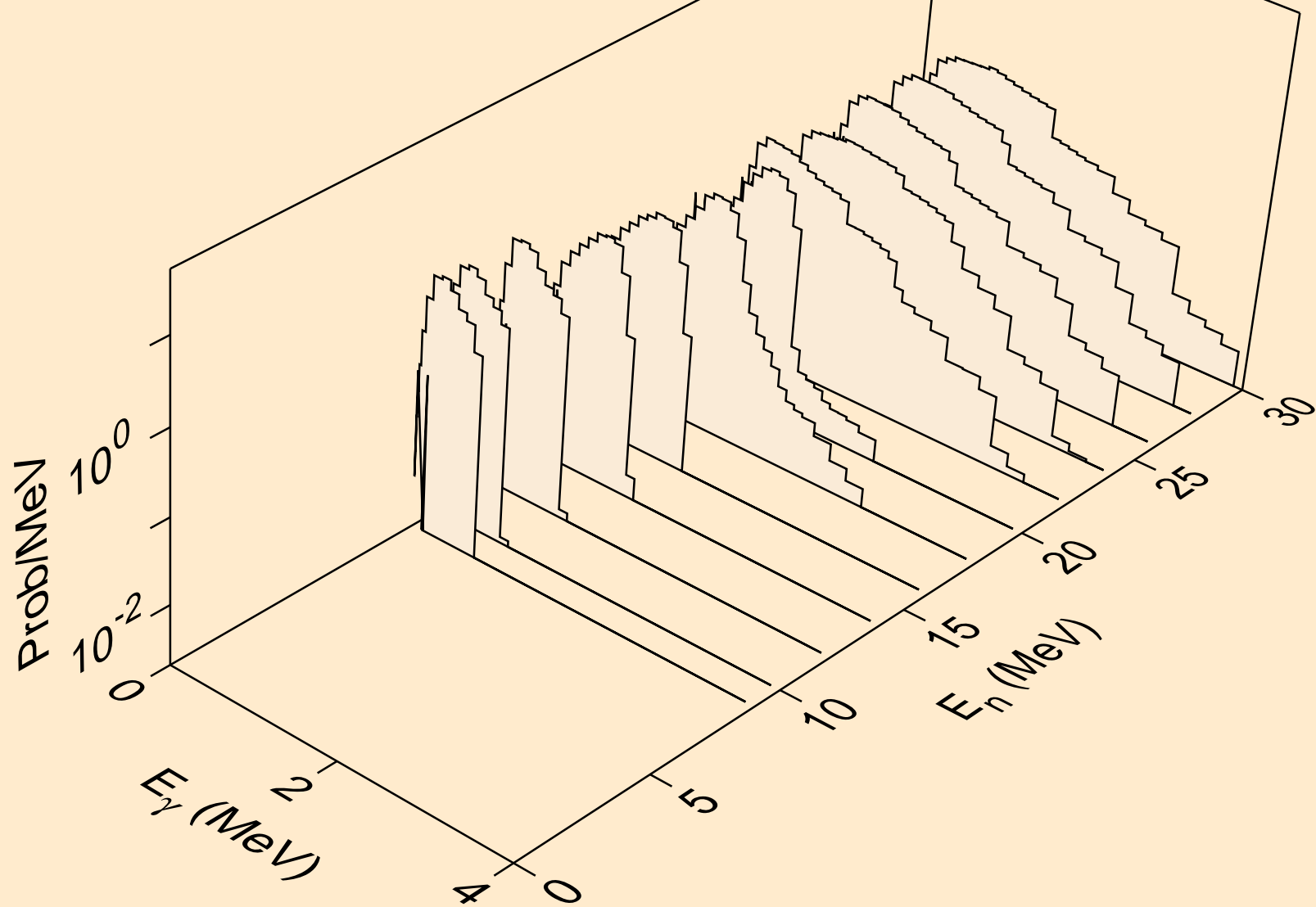

NP228 DEUTERON ACER TENDL-2021 LIBRARY; T=0.K
Photon emission for (n,p)

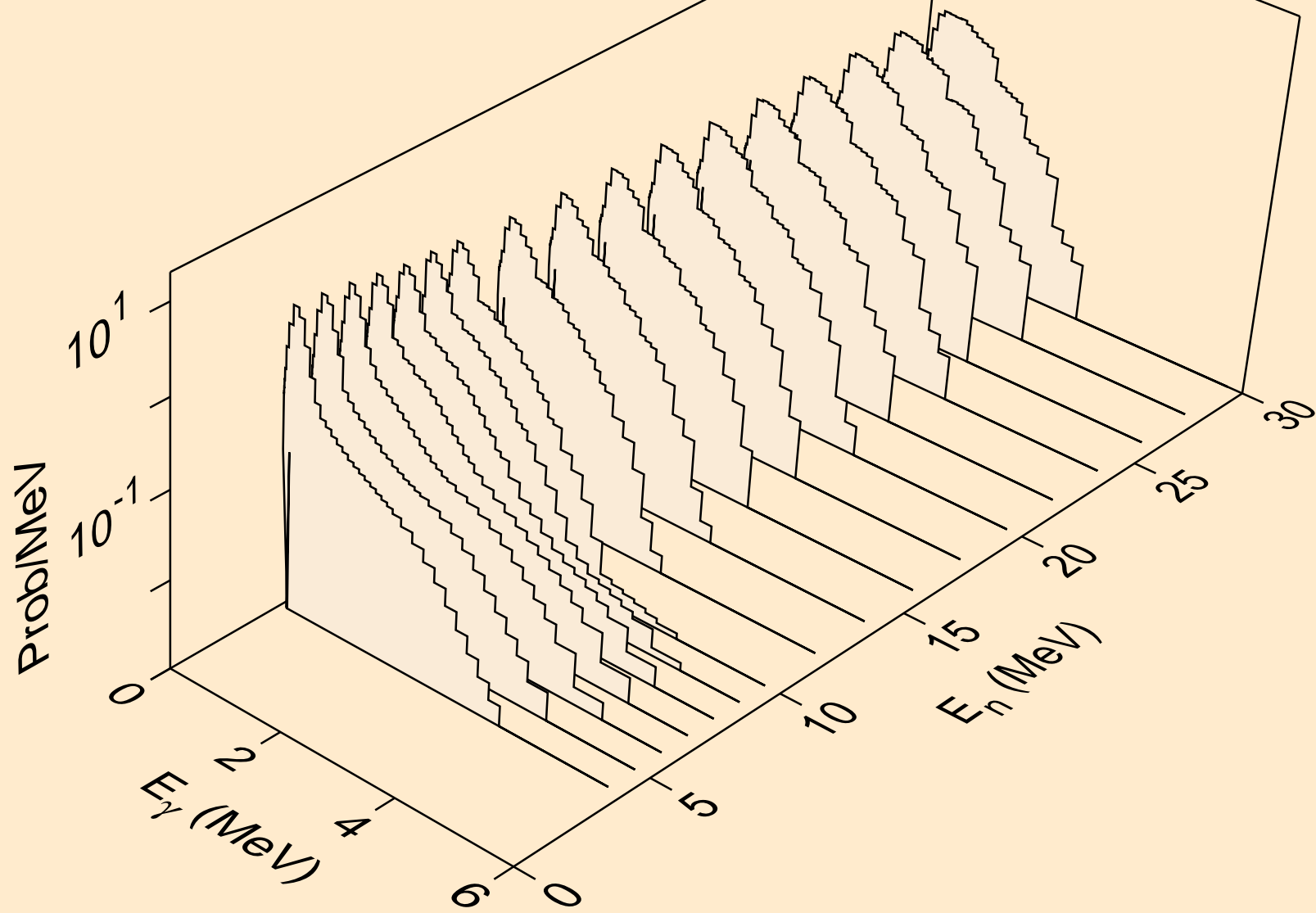

NP228 DEUTERON ACER TENDL-2021 LIBRARY; T=0.K
Photon emission for inelastic

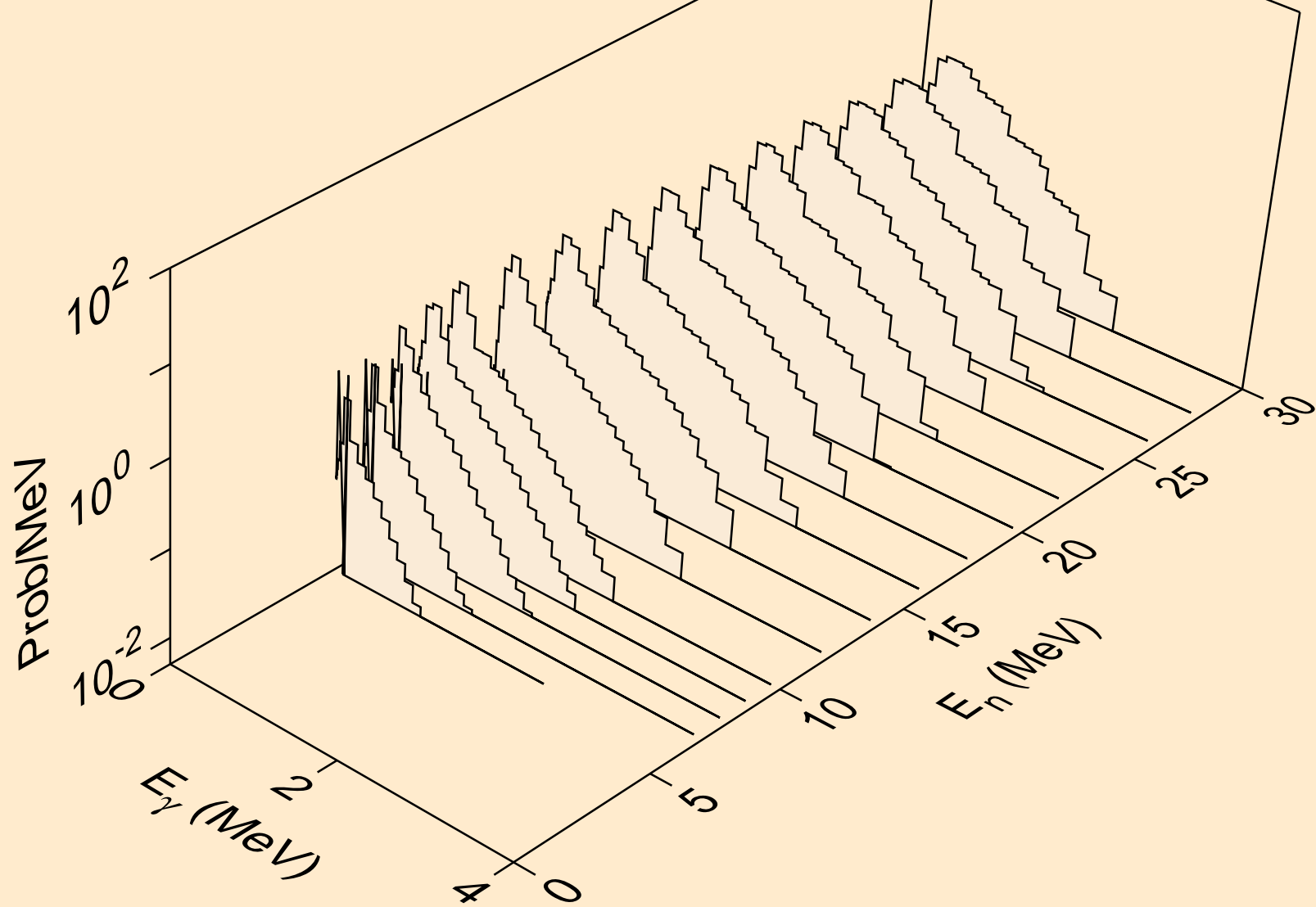

NP228 DEUTERON ACER TENDL-2021 LIBRARY; T=0.K
Photon emission for (n,t)

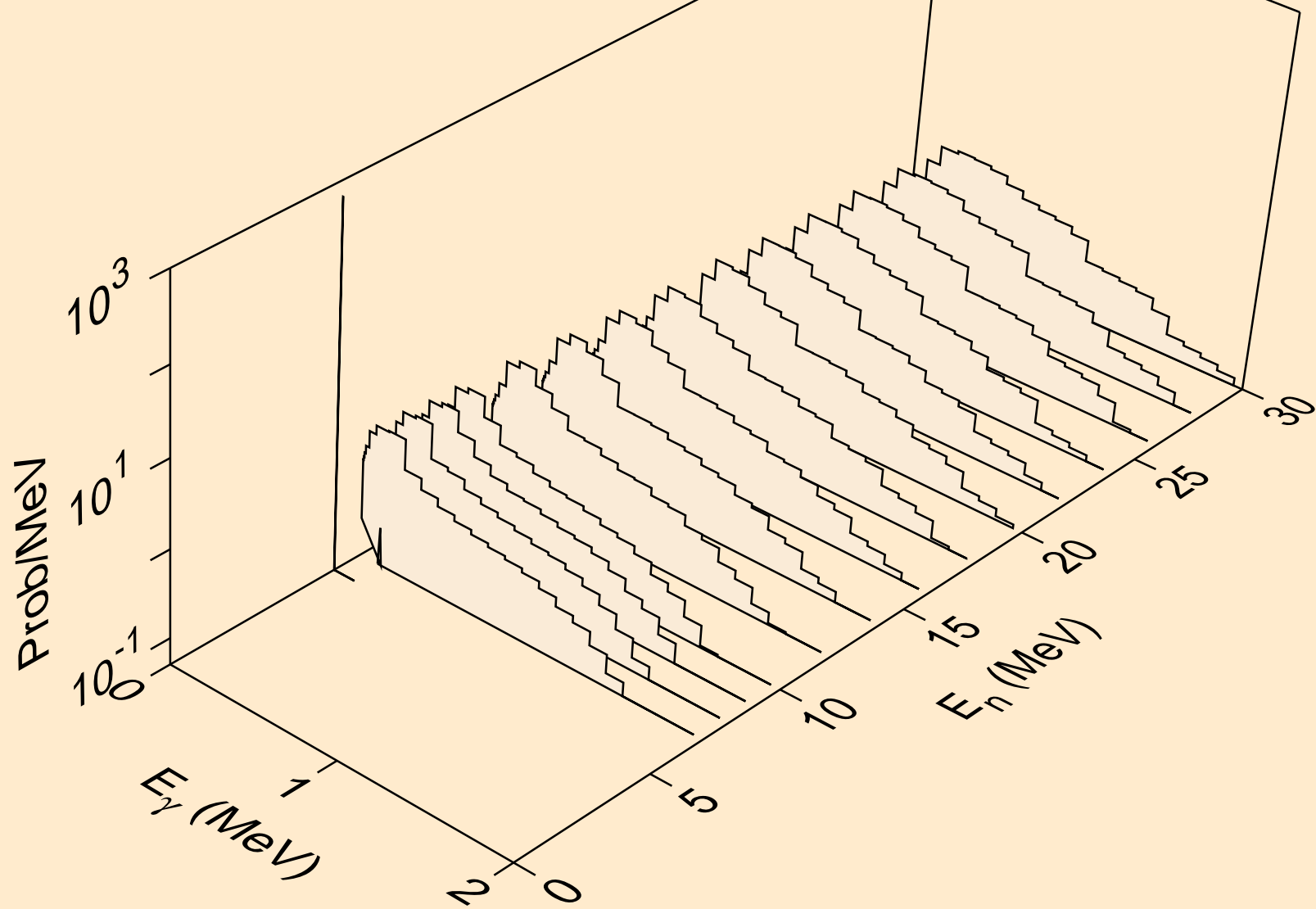

NP228 DEUTERON ACER TENDL-2021 LIBRARY; T=0.K
Photon emission for (n,he3)

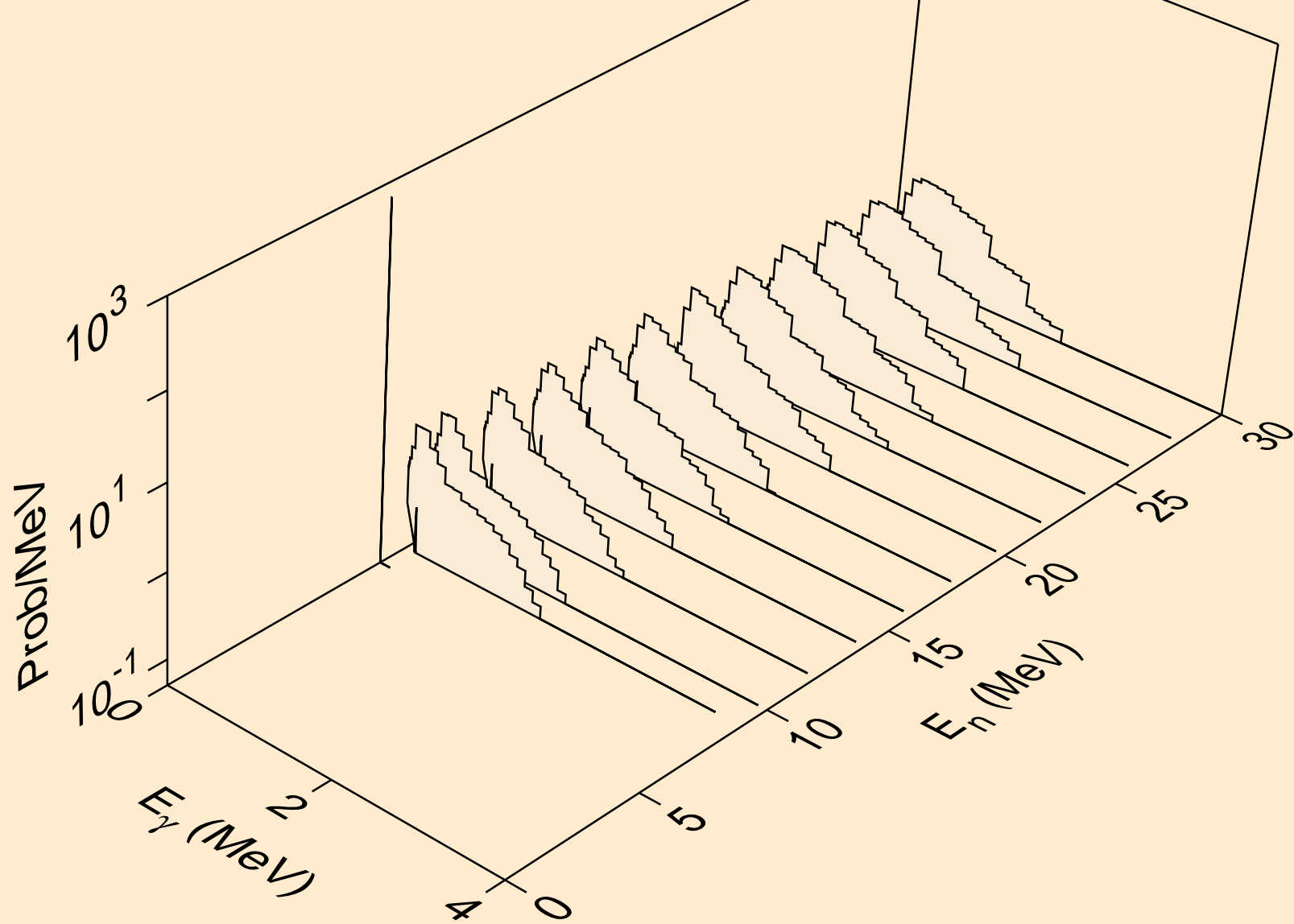

NP228 DEUTERON ACER TENDL-2021 LIBRARY; T=0.K
Photon emission for (n,a)

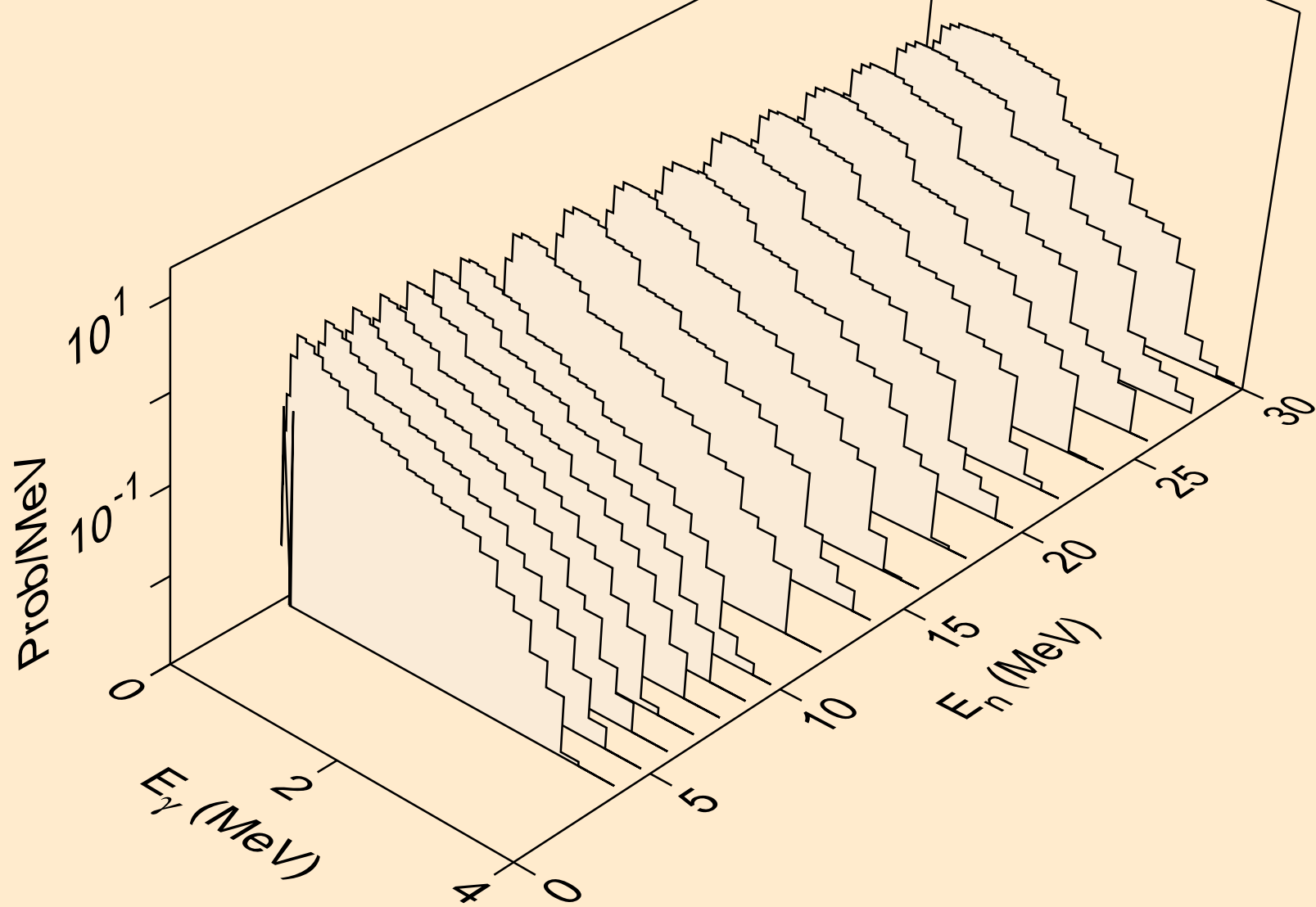

NP228 DEUTERON ACER TENDL-2021 LIBRARY; T=0.K
Photon emission for (n,2a)

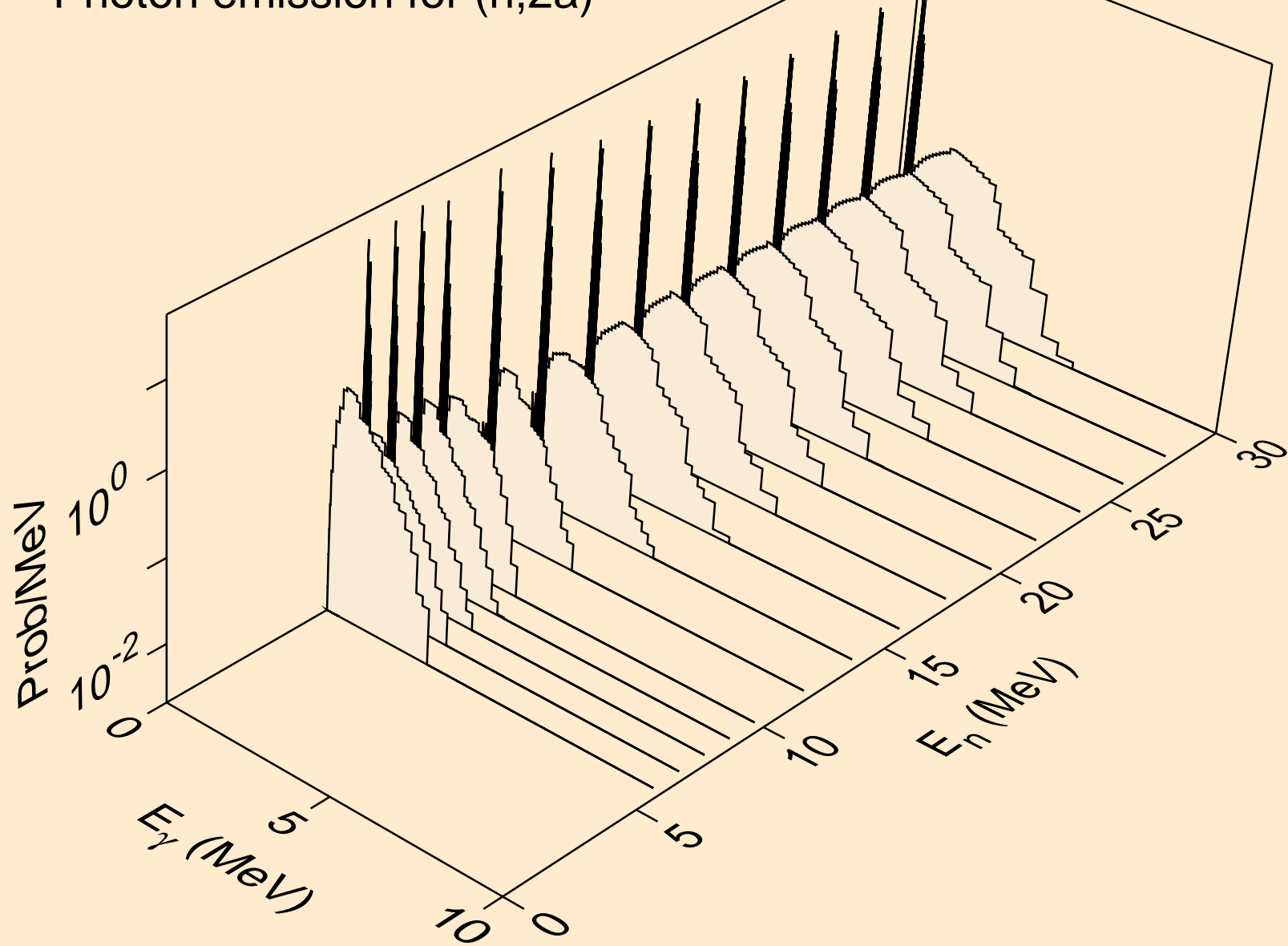

NP228 DEUTERON ACER TENDL-2021 LIBRARY; T=0.K
Photon emission for (n,3a)

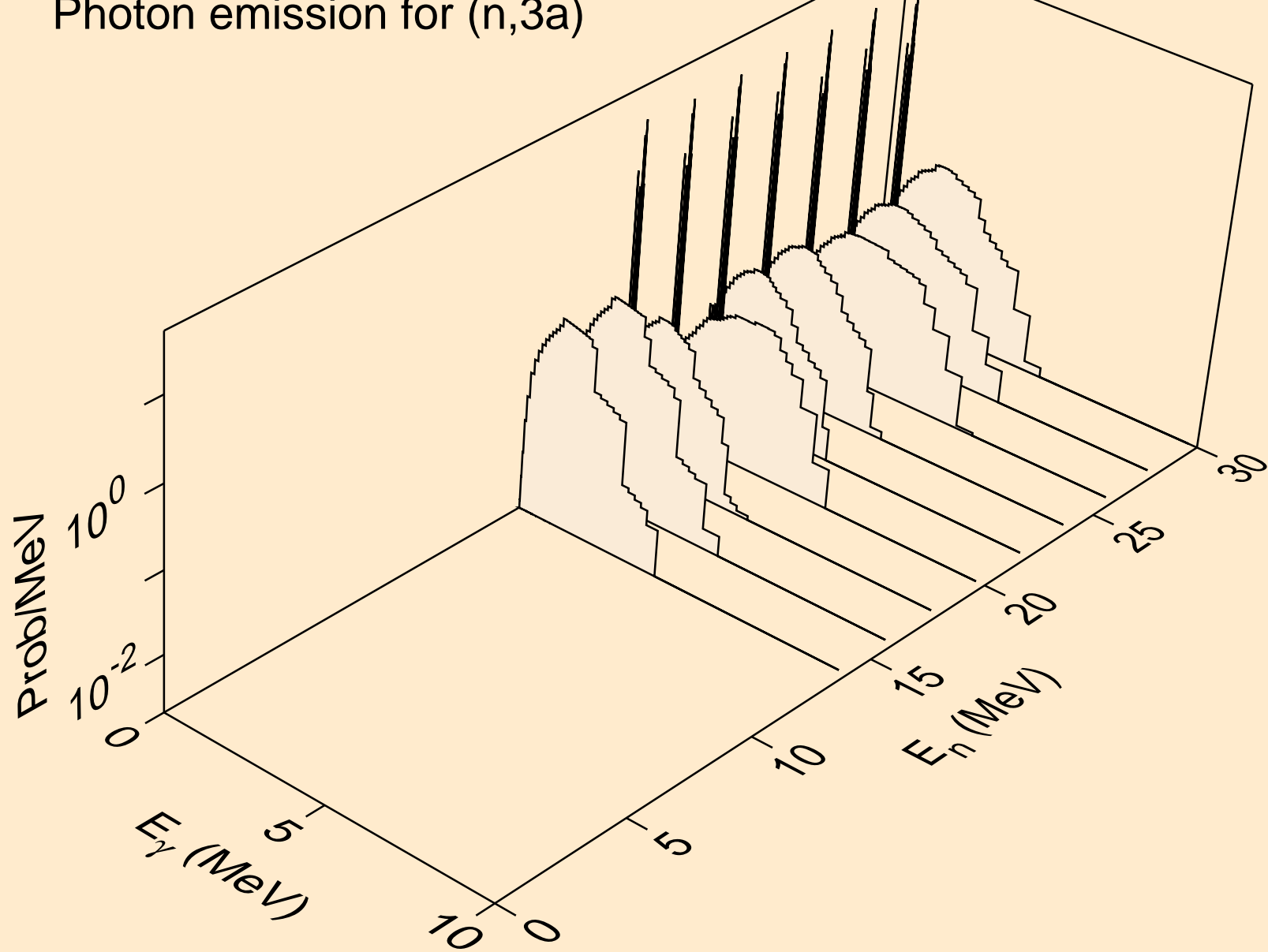

NP228 DEUTERON ACER TENDL-2021 LIBRARY; T=0.K
Photon emission for (n,2p)

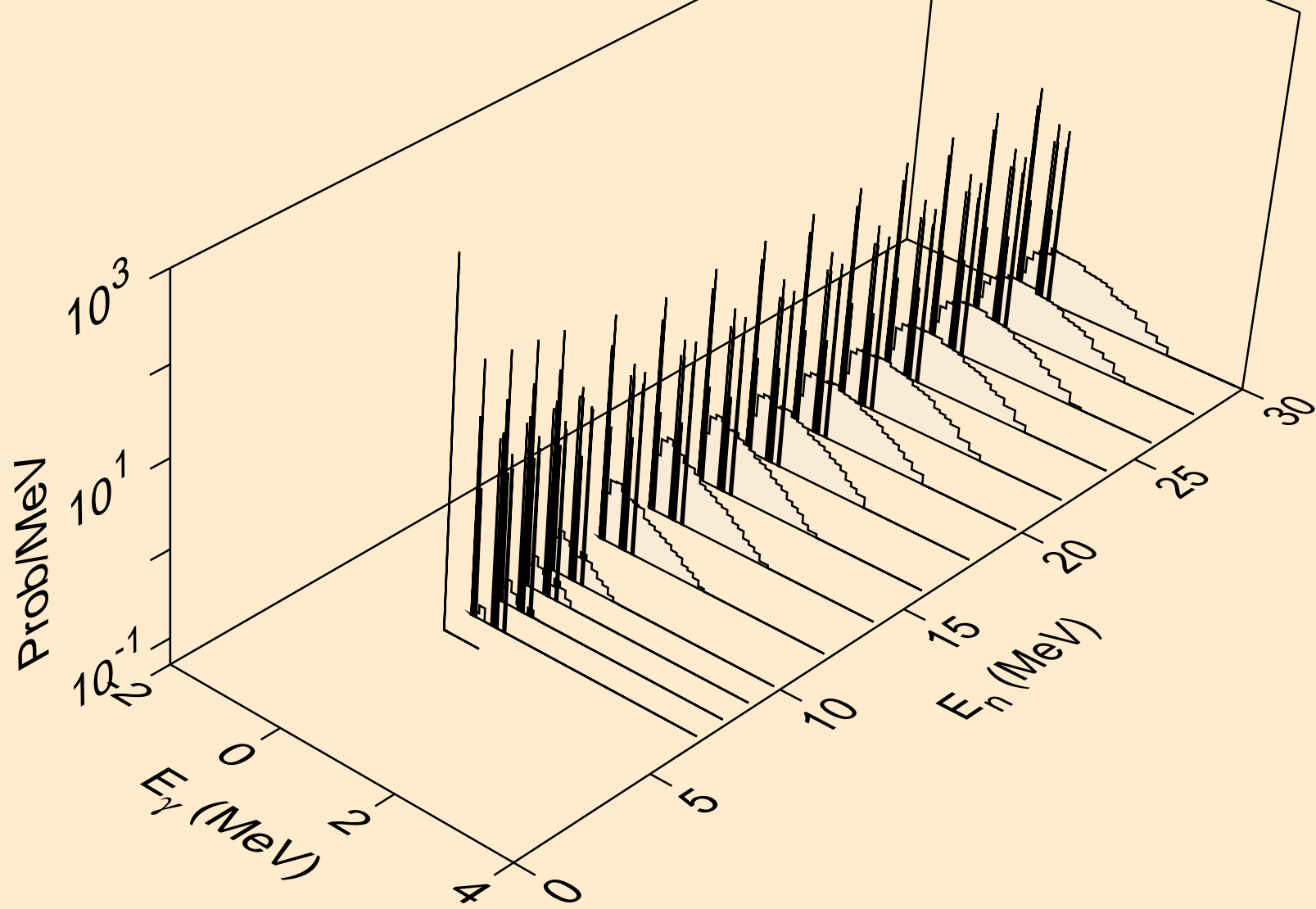

NP228 DEUTERON ACER TENDL-2021 LIBRARY; T=0.K
Photon emission for (n,p)

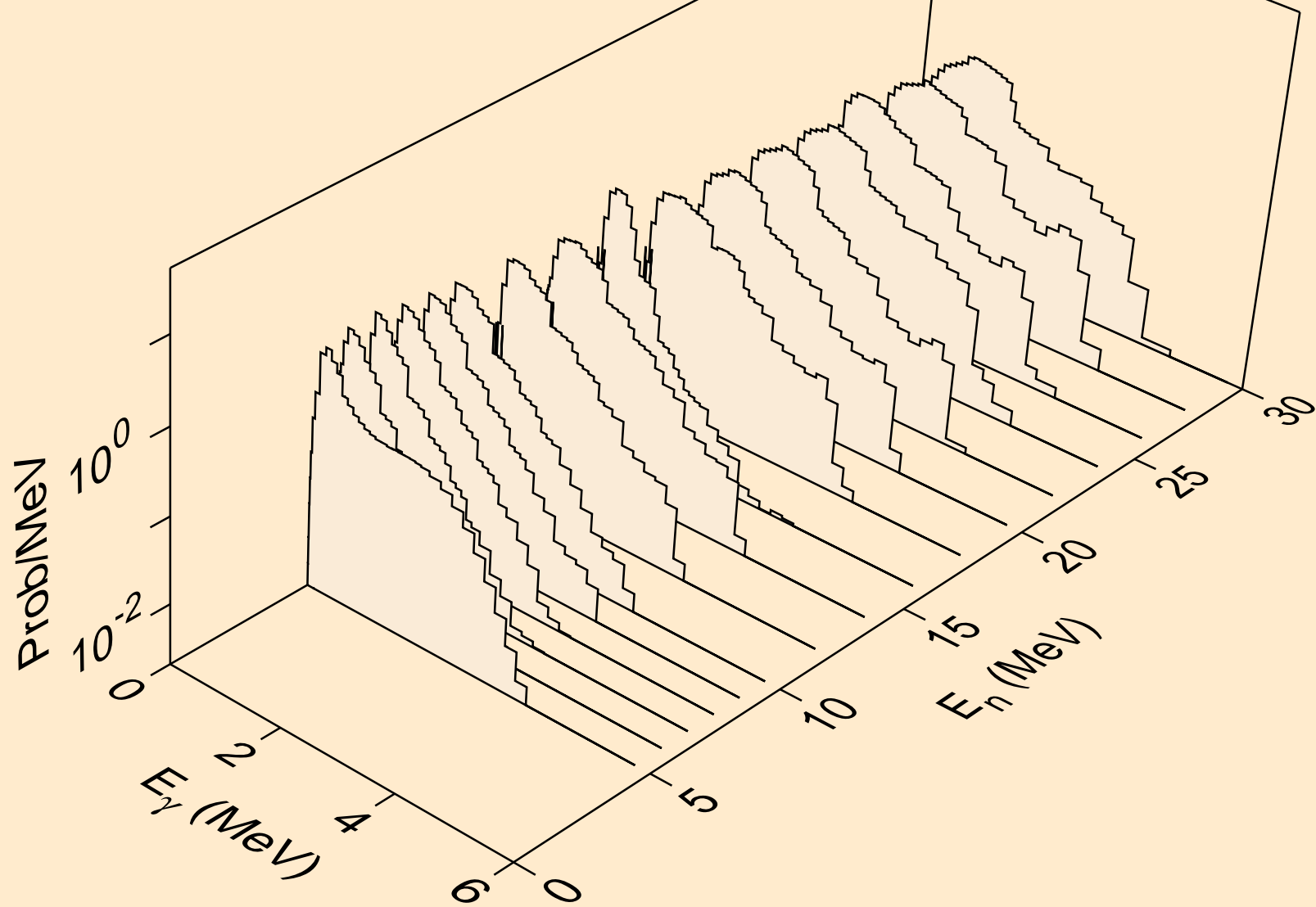

NP228 DEUTERON ACER TENDL-2021 LIBRARY; T=0.K
Photon emission for (n,pd)

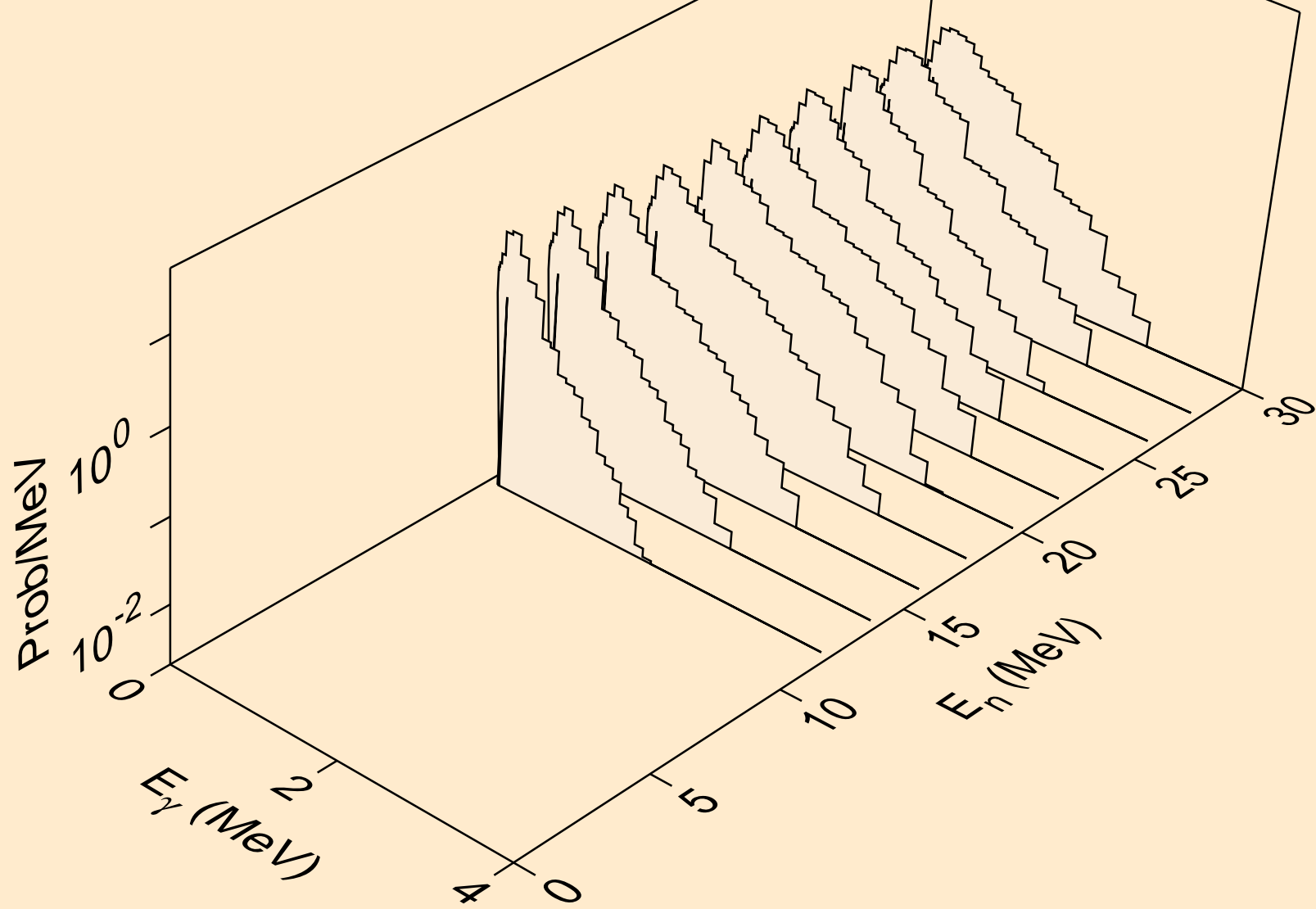

NP228 DEUTERON ACER TENDL-2021 LIBRARY; T=0.K
Photon emission for (n,da)

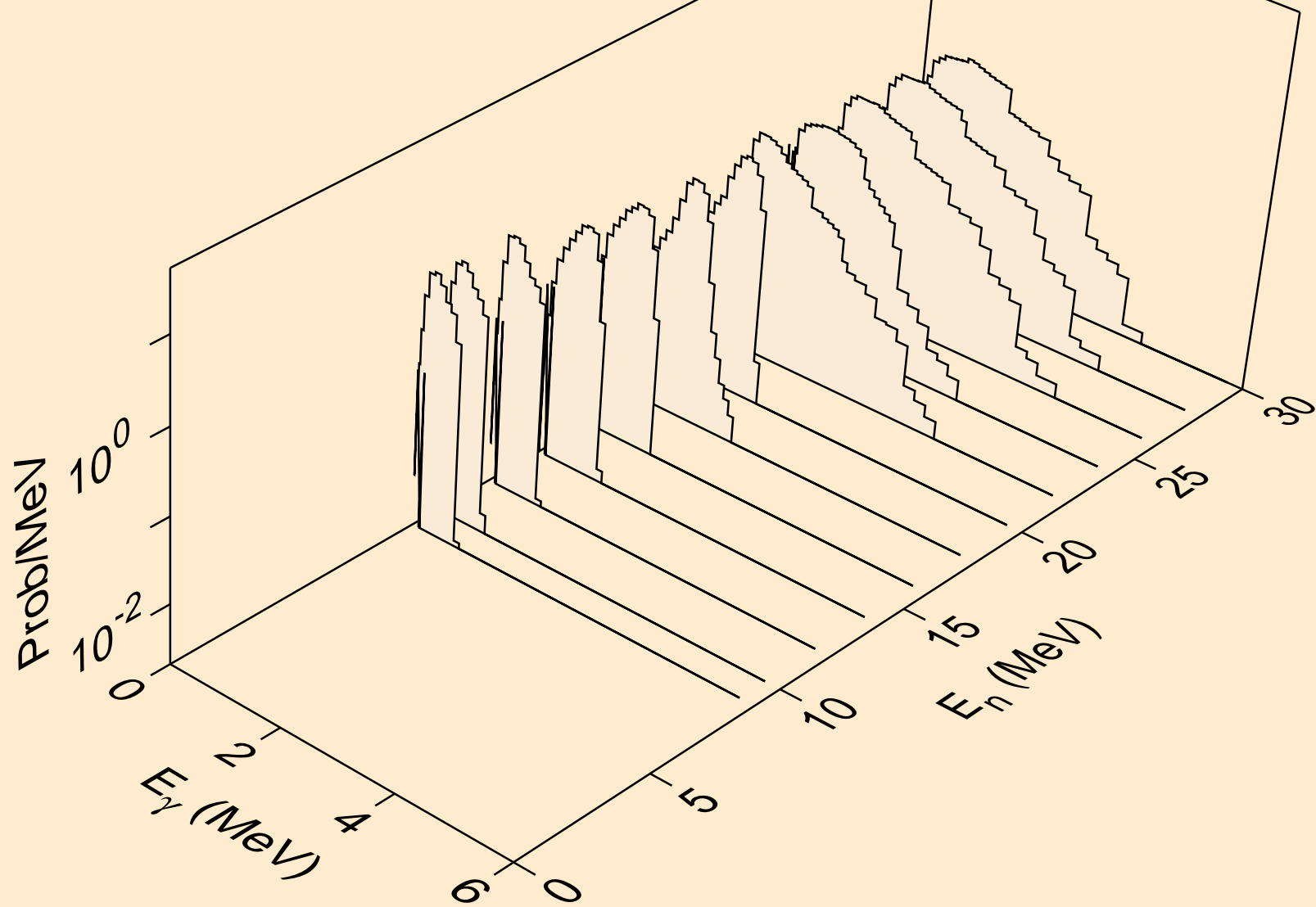

NP228 DEUTERON ACER TENDL-2021 LIBRARY; T=0.K

Particle heating contributions

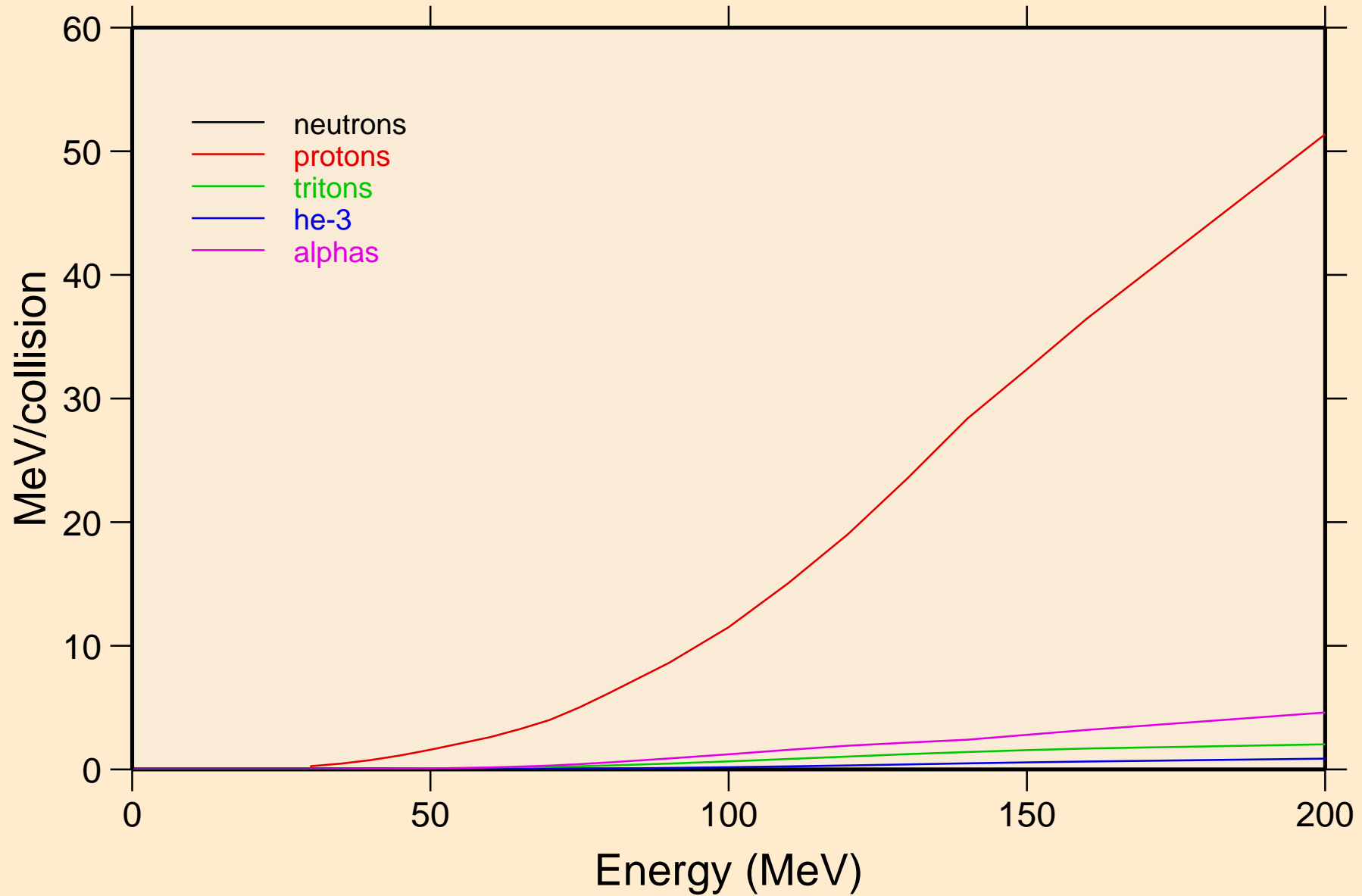

NP228 DEUTERON ACER TENDL-2021 LIBRARY; T=0.K
Recoil Heating

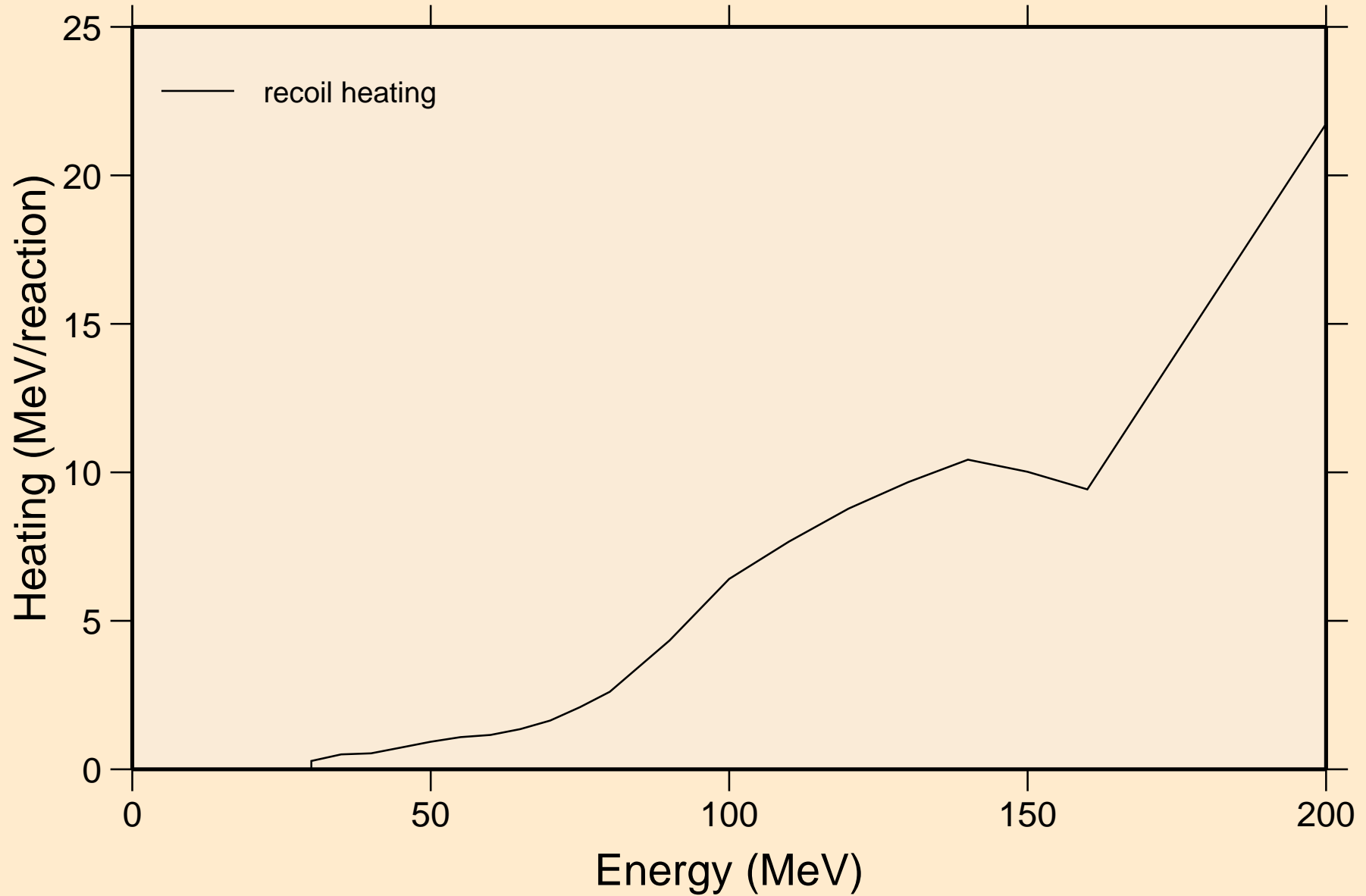

NP228 DEUTERON ACER TENDL-2021 LIBRARY; T=0.K
Particle production cross sections

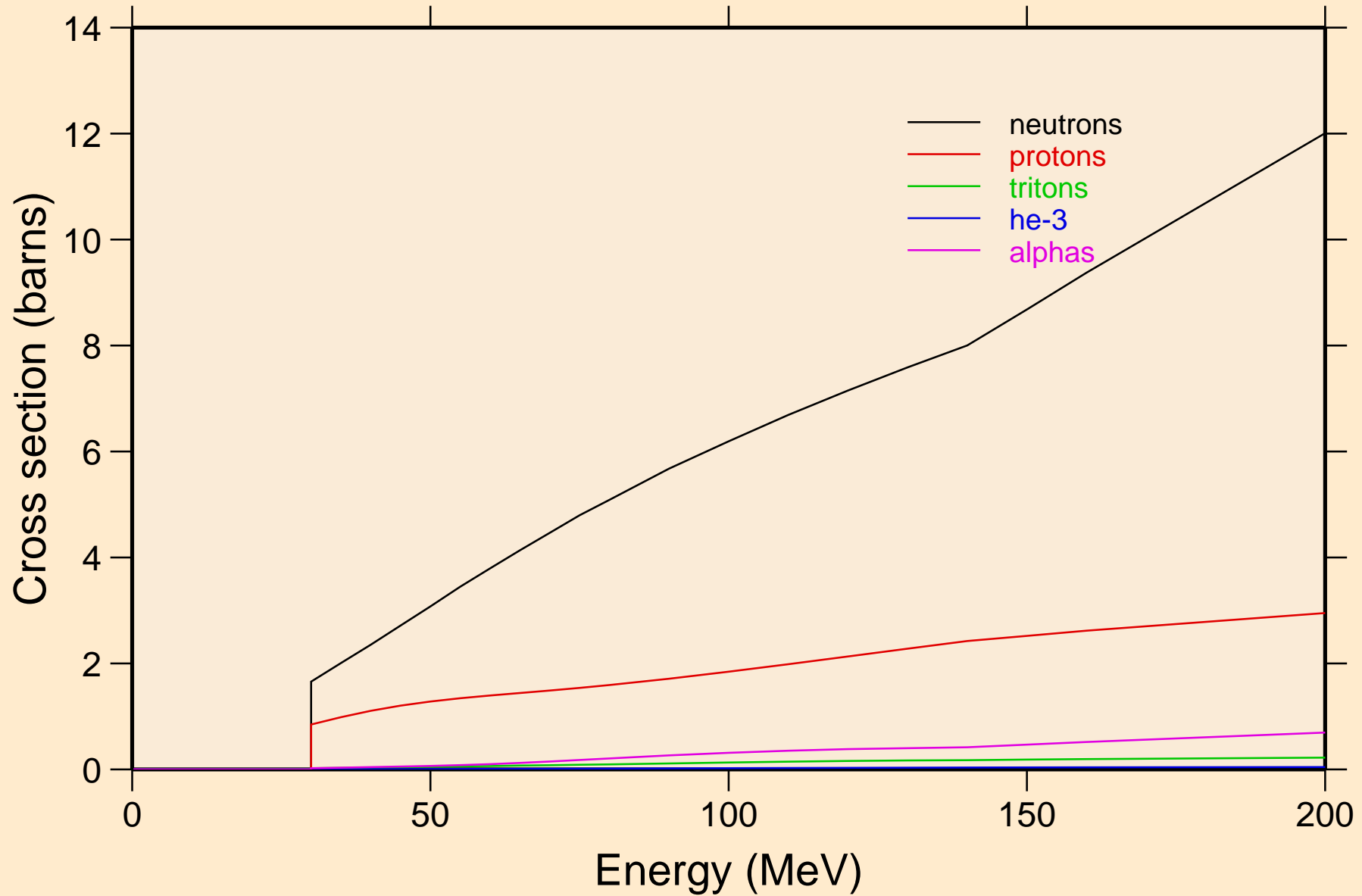

NP228 DEUTERON ACER TENDL-2021 LIBRARY; T=0.K
neutrons from (d,n)

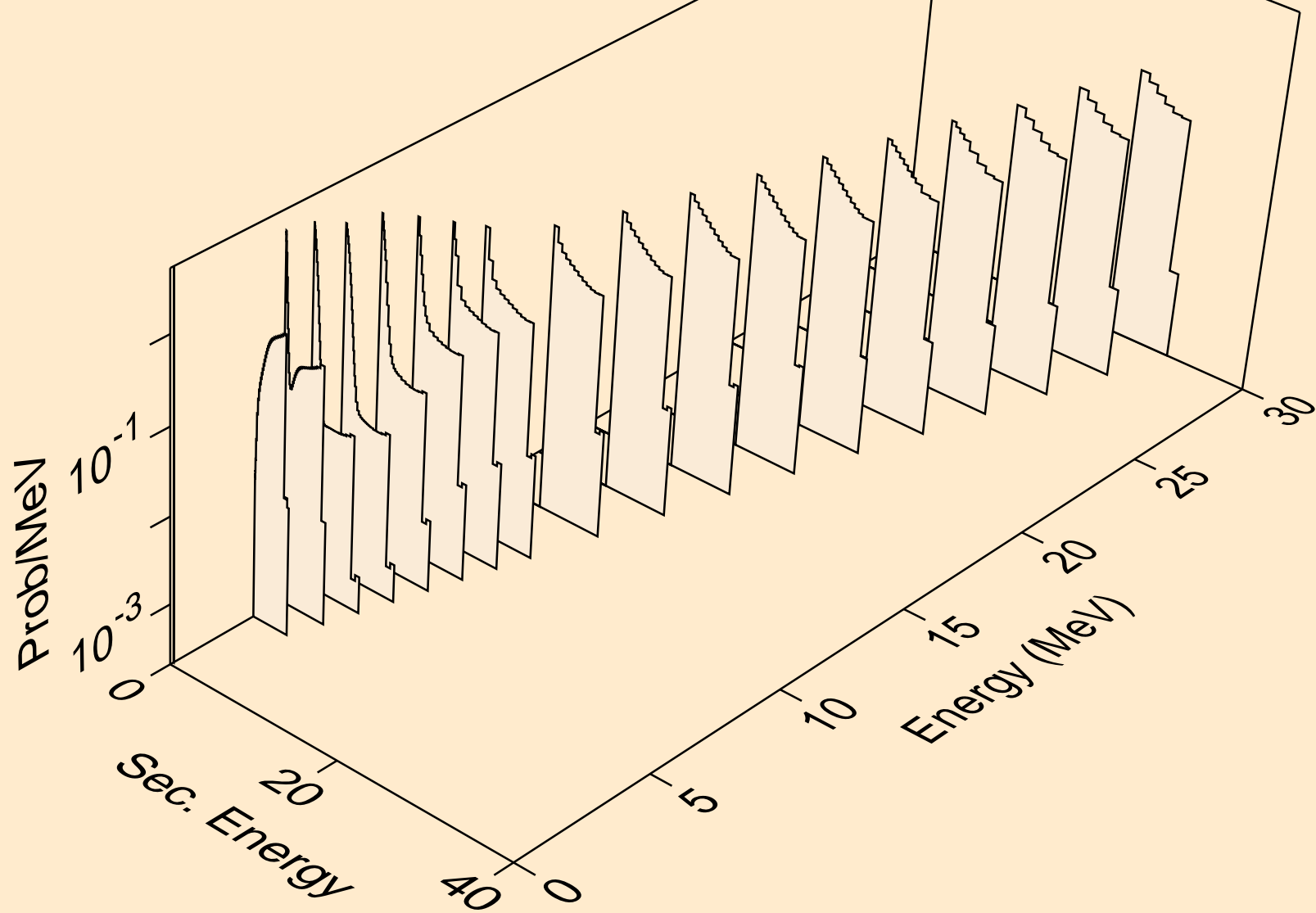

NP228 DEUTERON ACER TENDL-2021 LIBRARY; T=0.K
neutrons from (d,x)

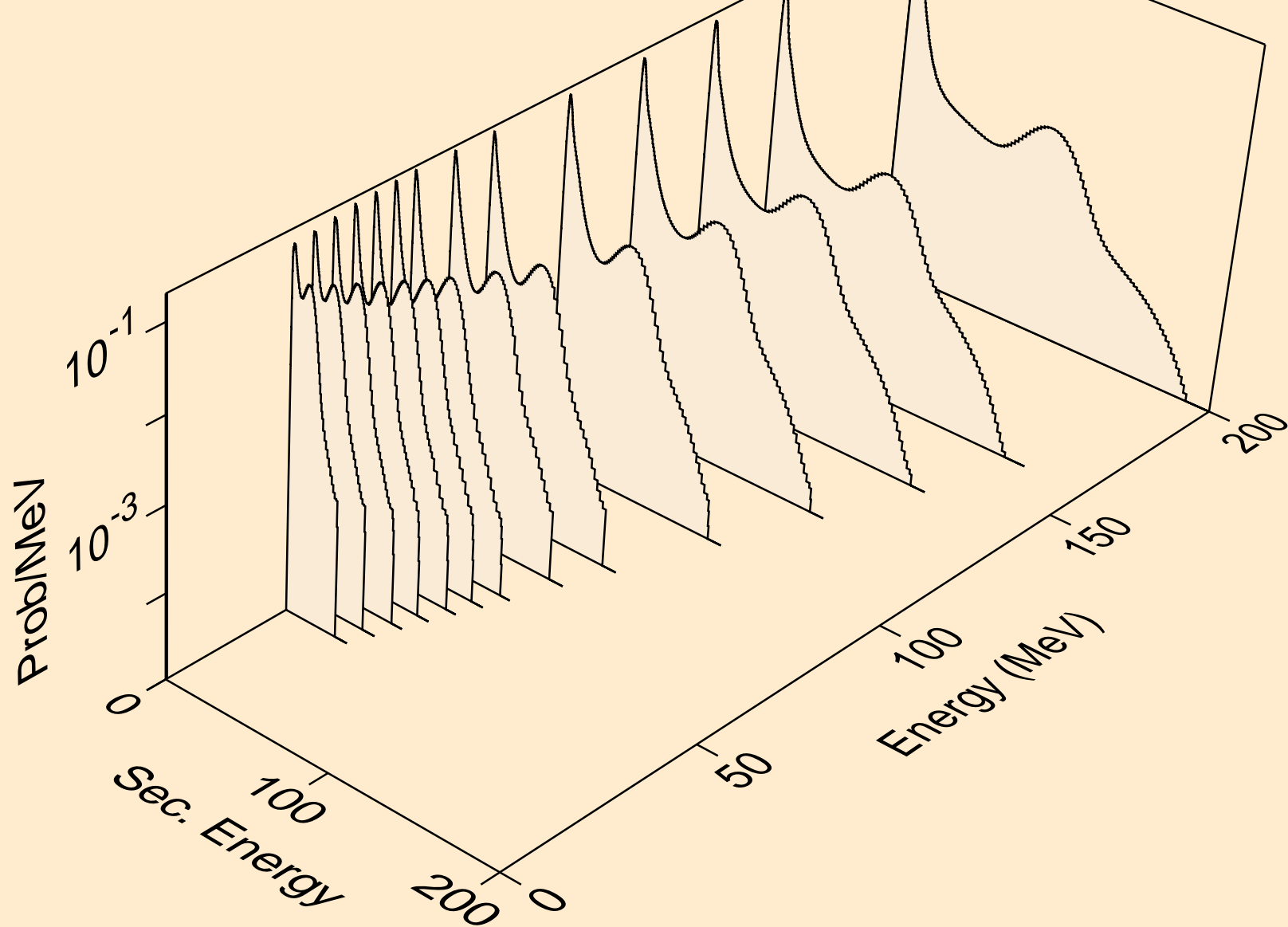

NP228 DEUTERON ACER TENDL-2021 LIBRARY; T=0.K
neutrons from (d,2nd)

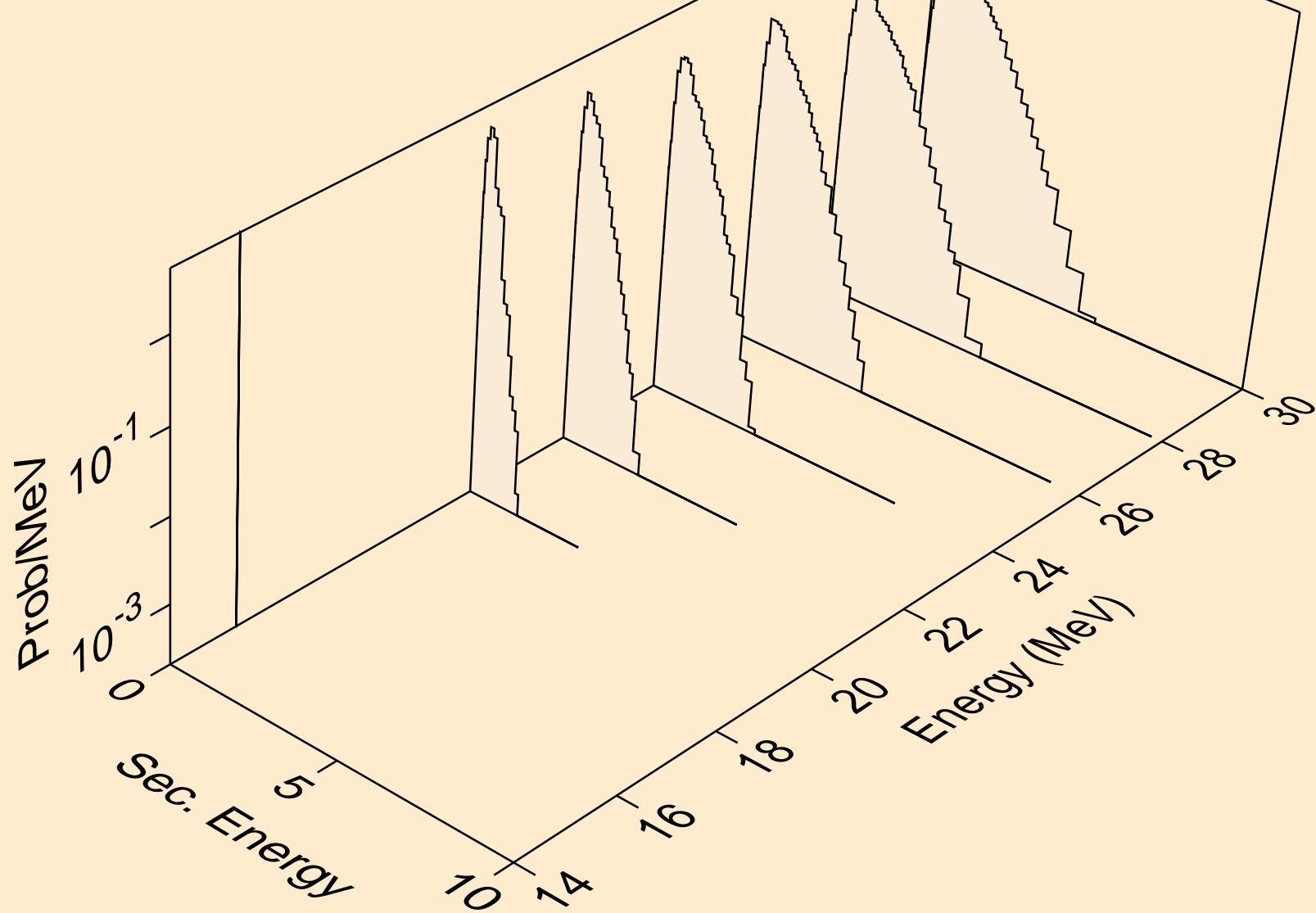

NP228 DEUTERON ACER TENDL-2021 LIBRARY; T=0.K
neutrons from (d,2n)

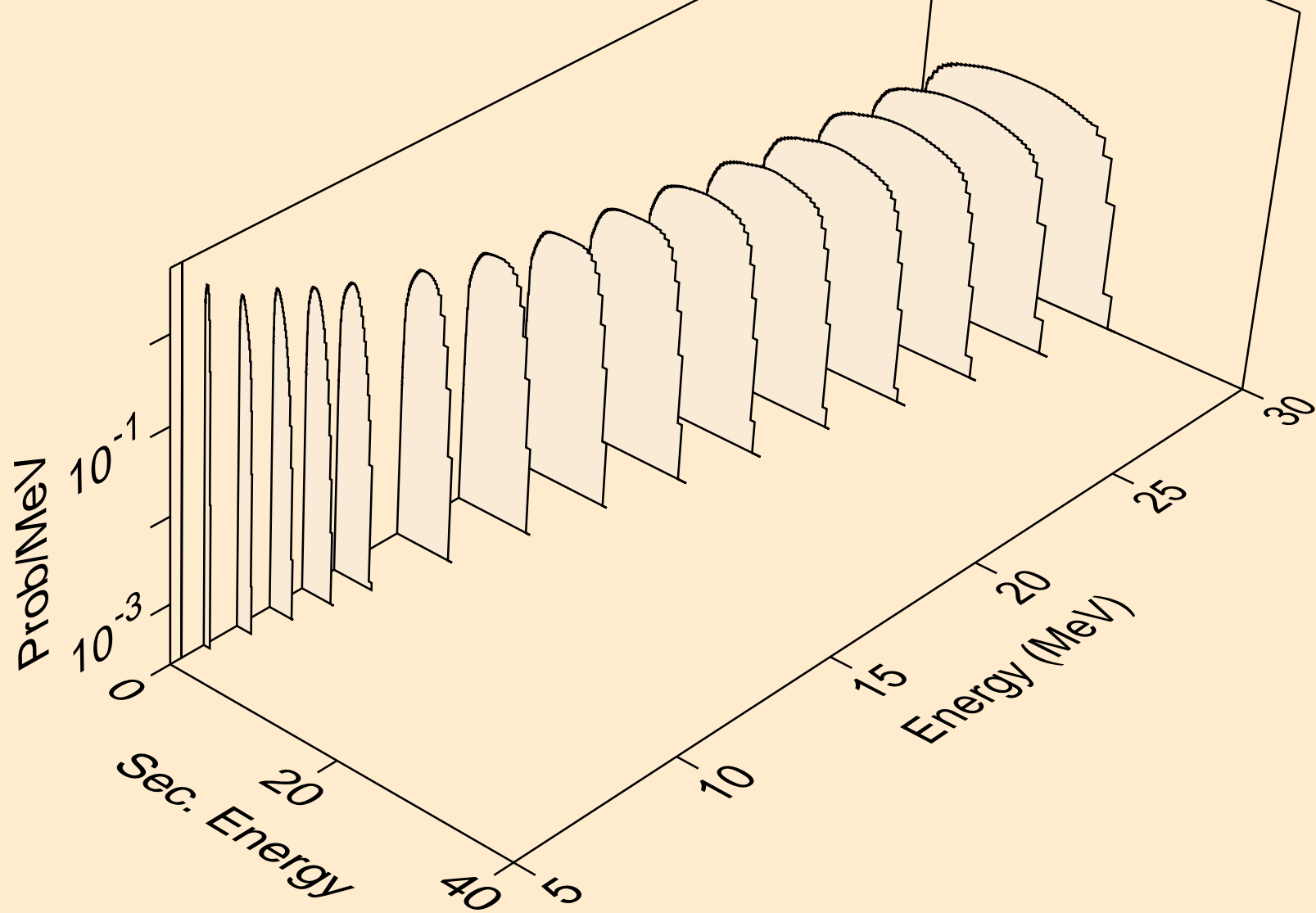

NP228 DEUTERON ACER TENDL-2021 LIBRARY; T=0.K
neutrons from (d,3n)

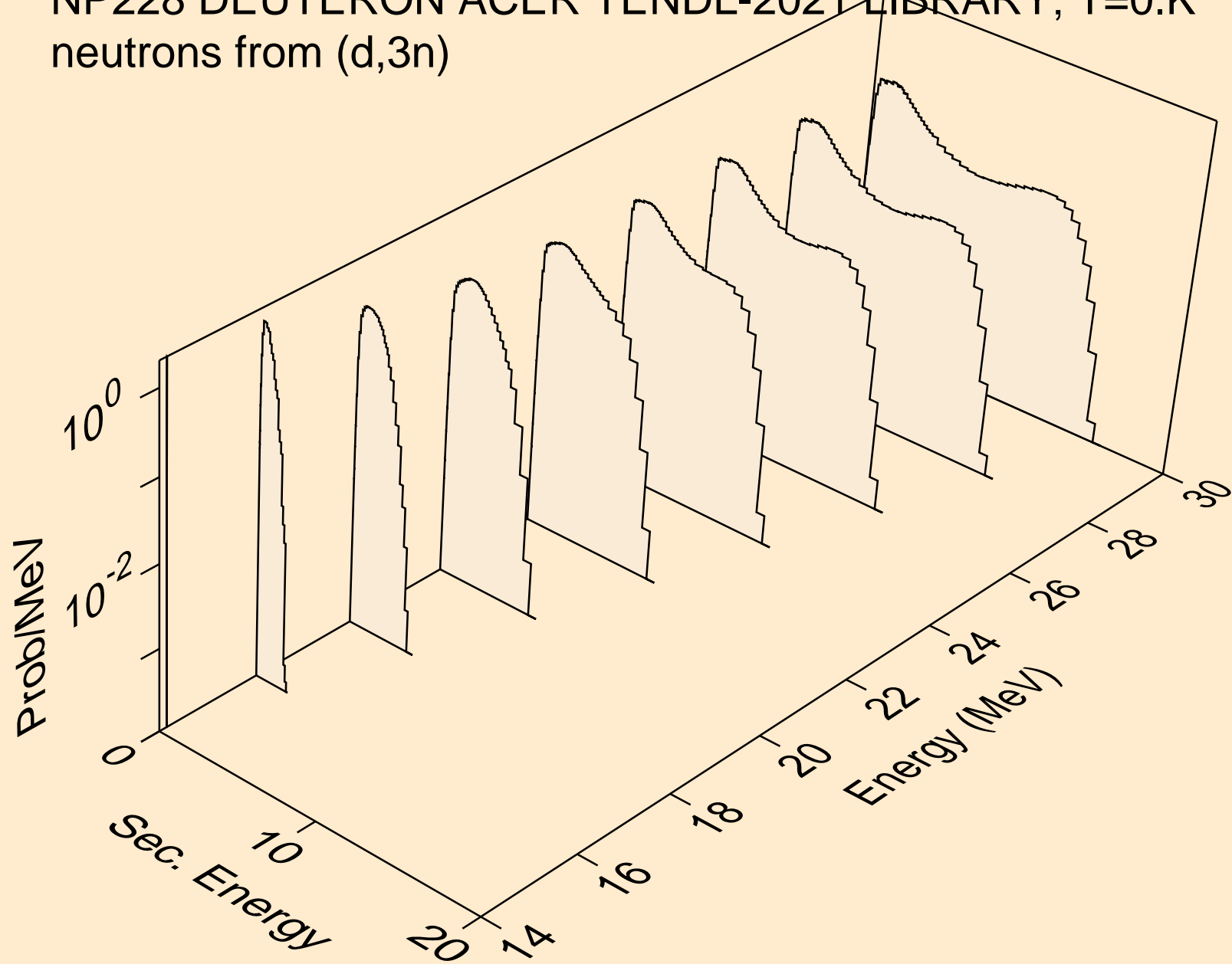

NP228 DEUTERON ACER TENDL-2021 LIBRARY; T=0.K
neutrons from (d,n*)a

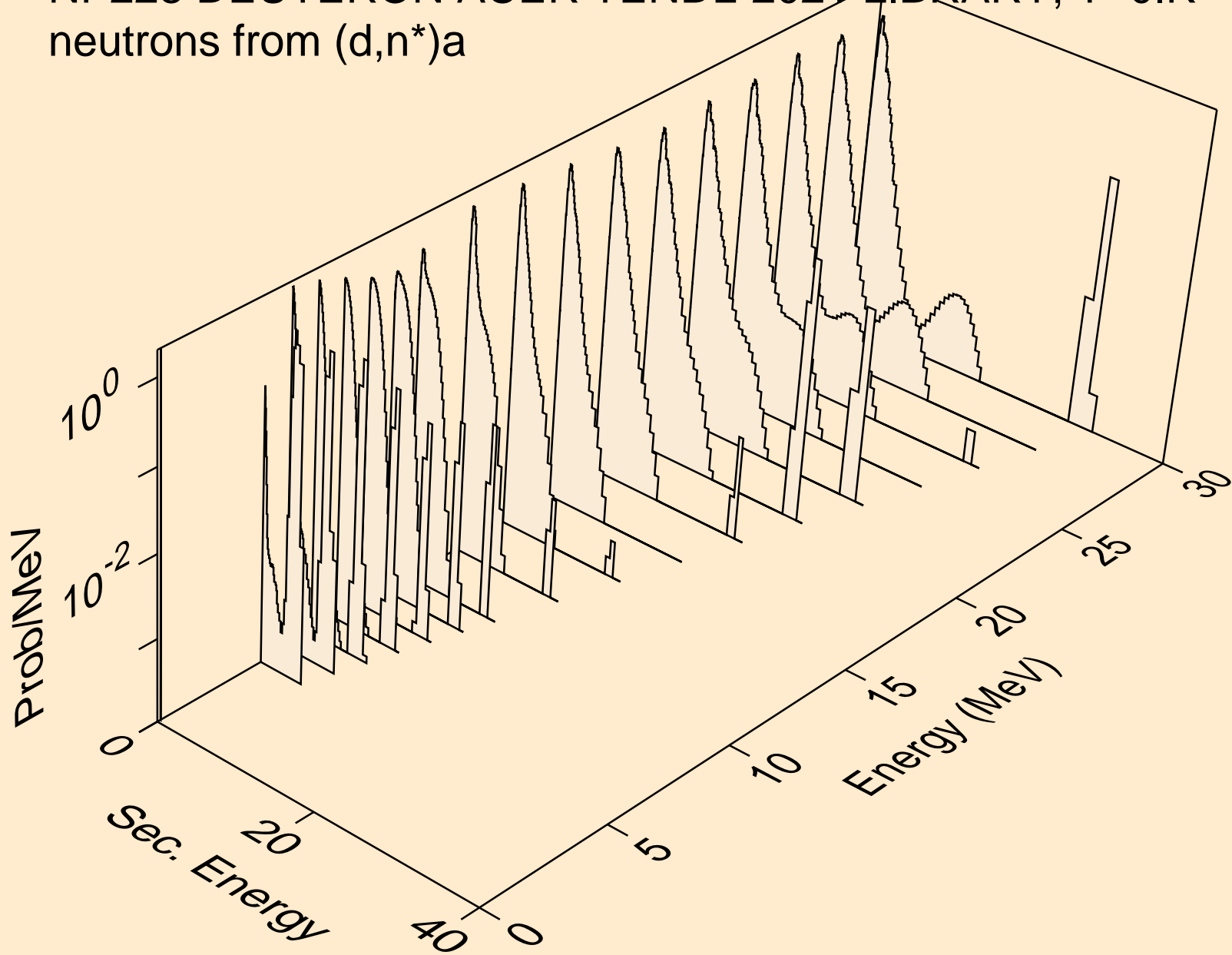

NP228 DEUTERON ACER TENDL-2021 LIBRARY; T=0.K
neutrons from (d,n*)3a

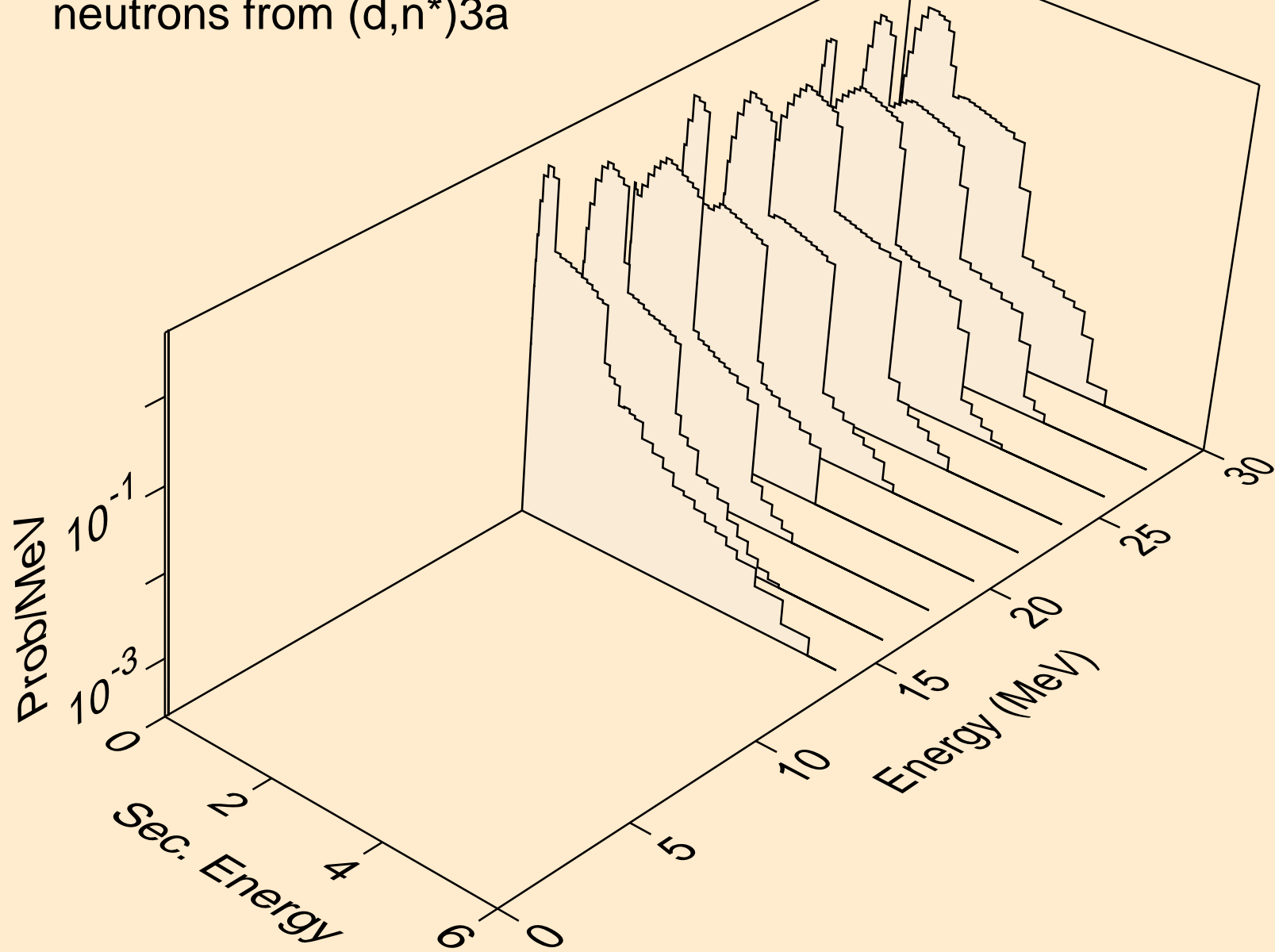

NP228 DEUTERON ACER TENDL-2021 LIBRARY; T=0.K
neutrons from (d,2n)a

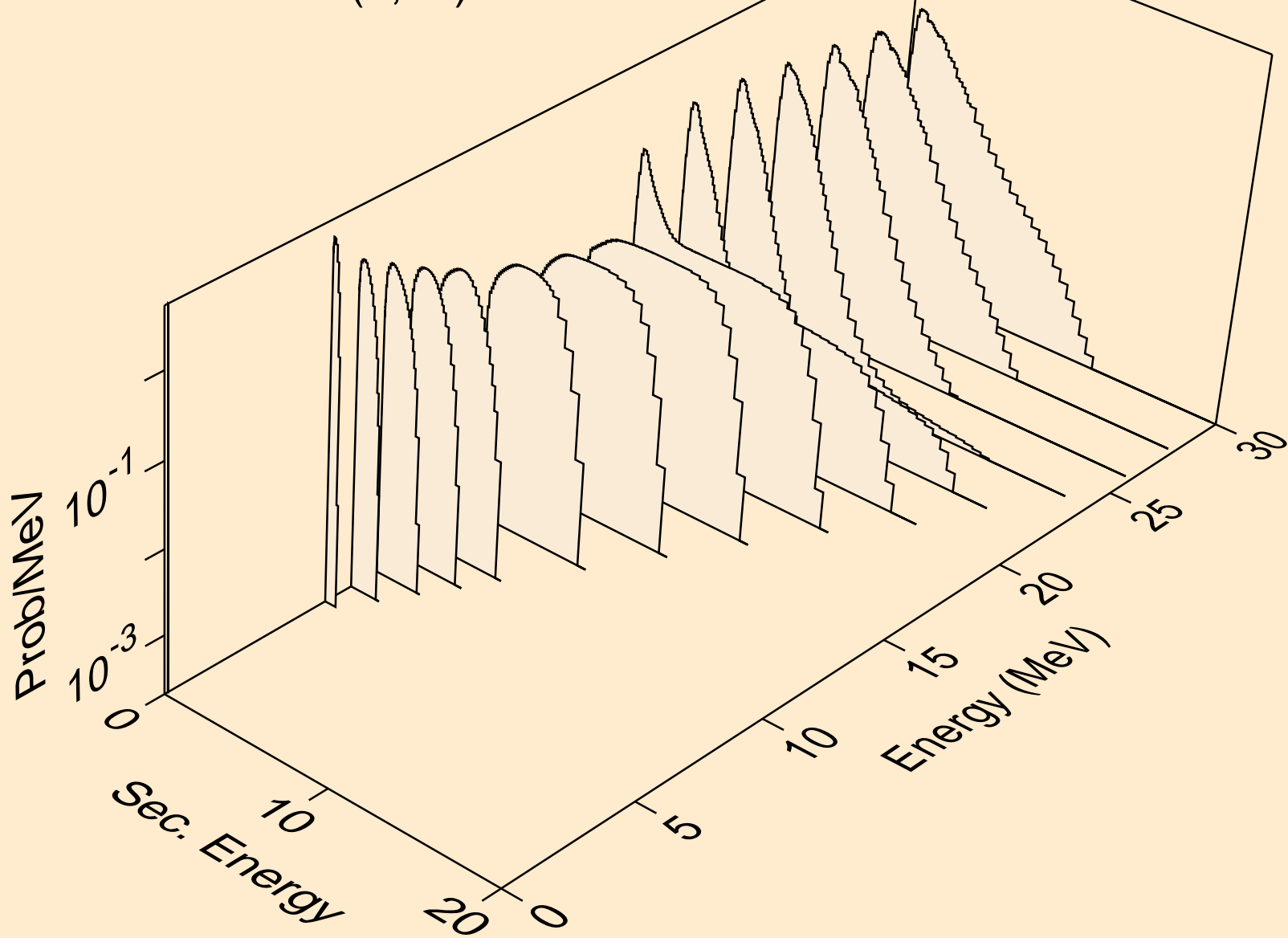

NP228 DEUTERON ACER TENDL-2021 LIBRARY; T=0.K
neutrons from (d,3n)a

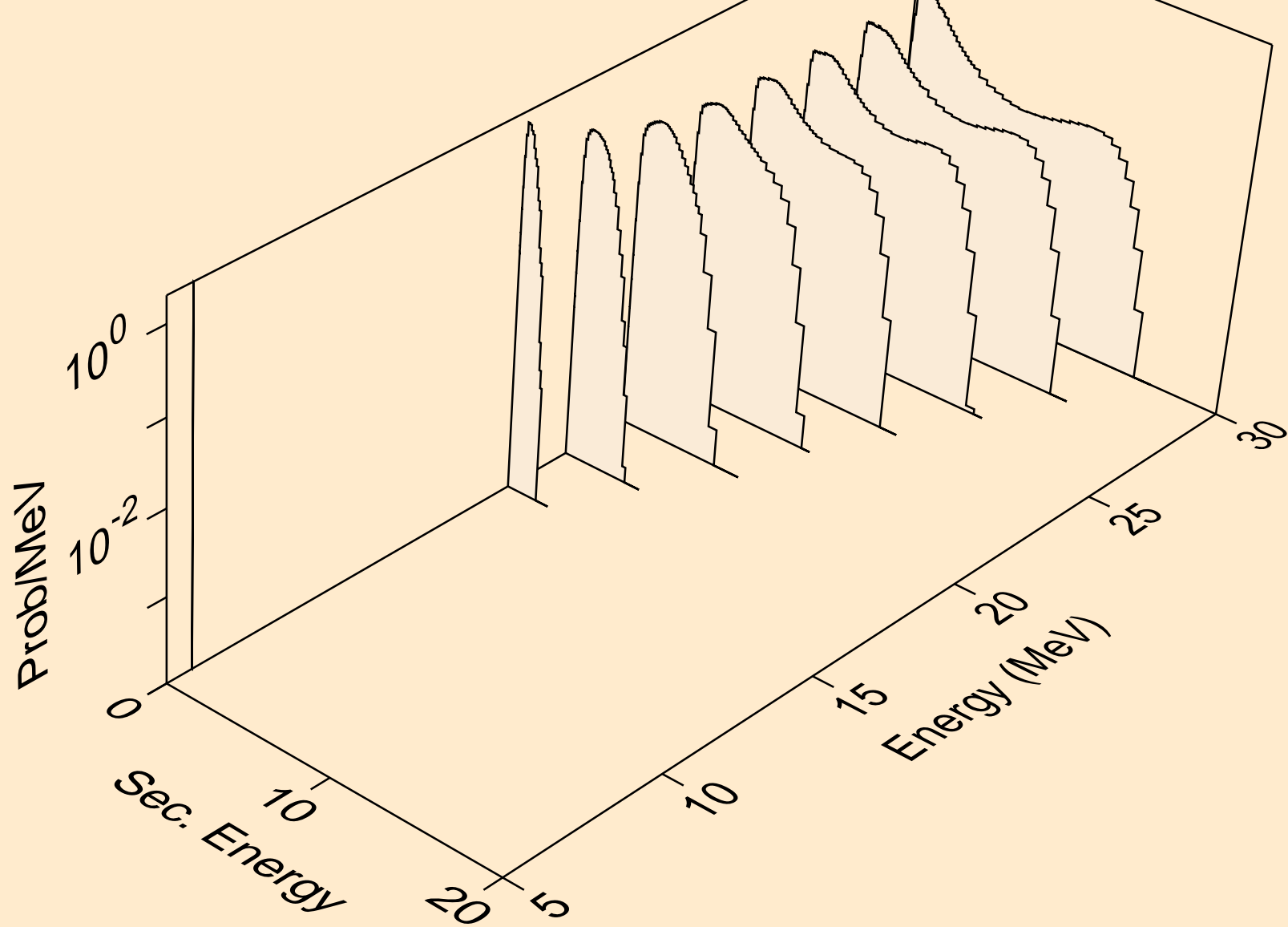

NP228 DEUTERON ACER TENDL-2021 LIBRARY; T=0.K
neutrons from (d,n*)p

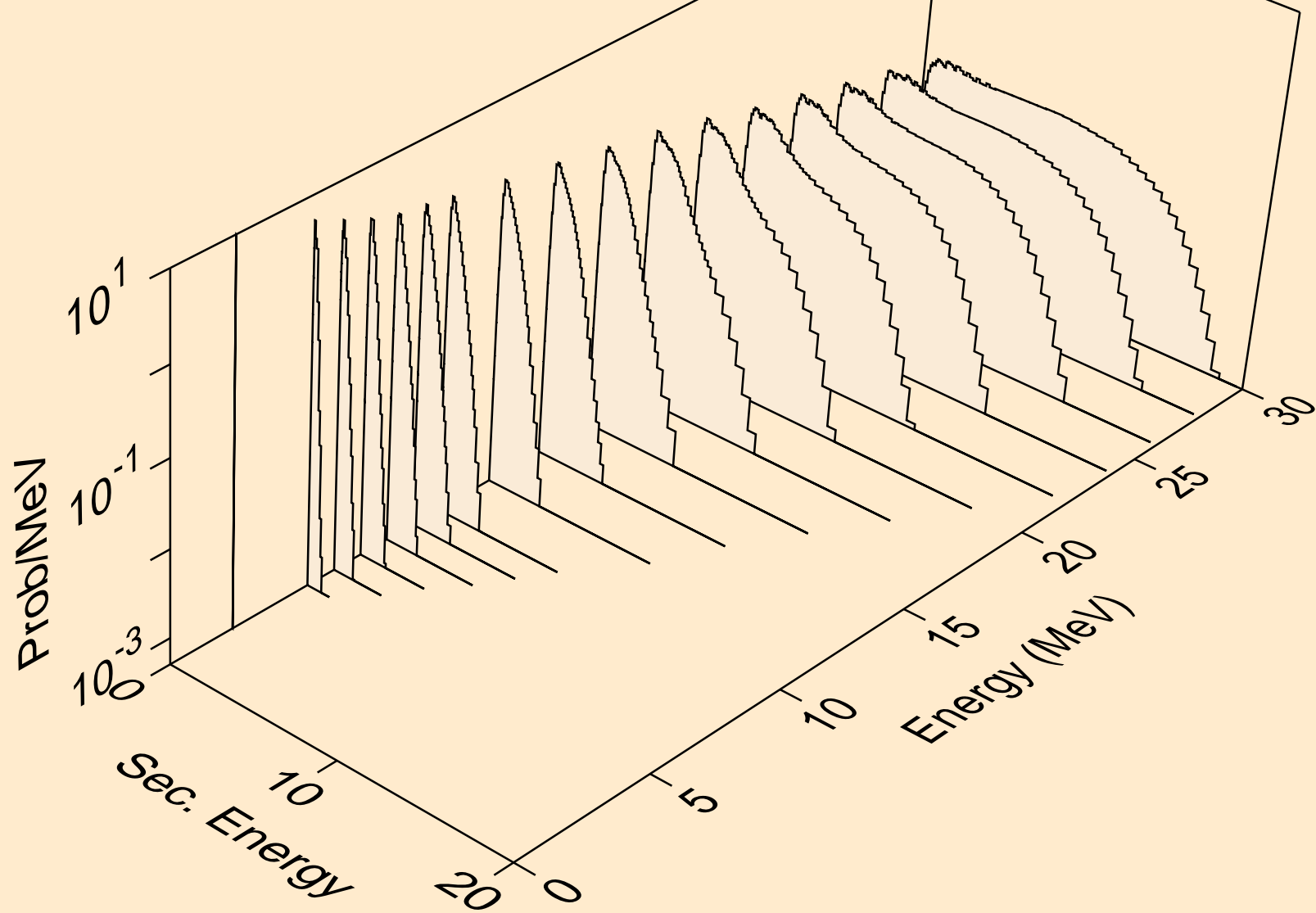

NP228 DEUTERON ACER TENDL-2021 LIBRARY; T=0.K
neutrons from (d,n*)2a

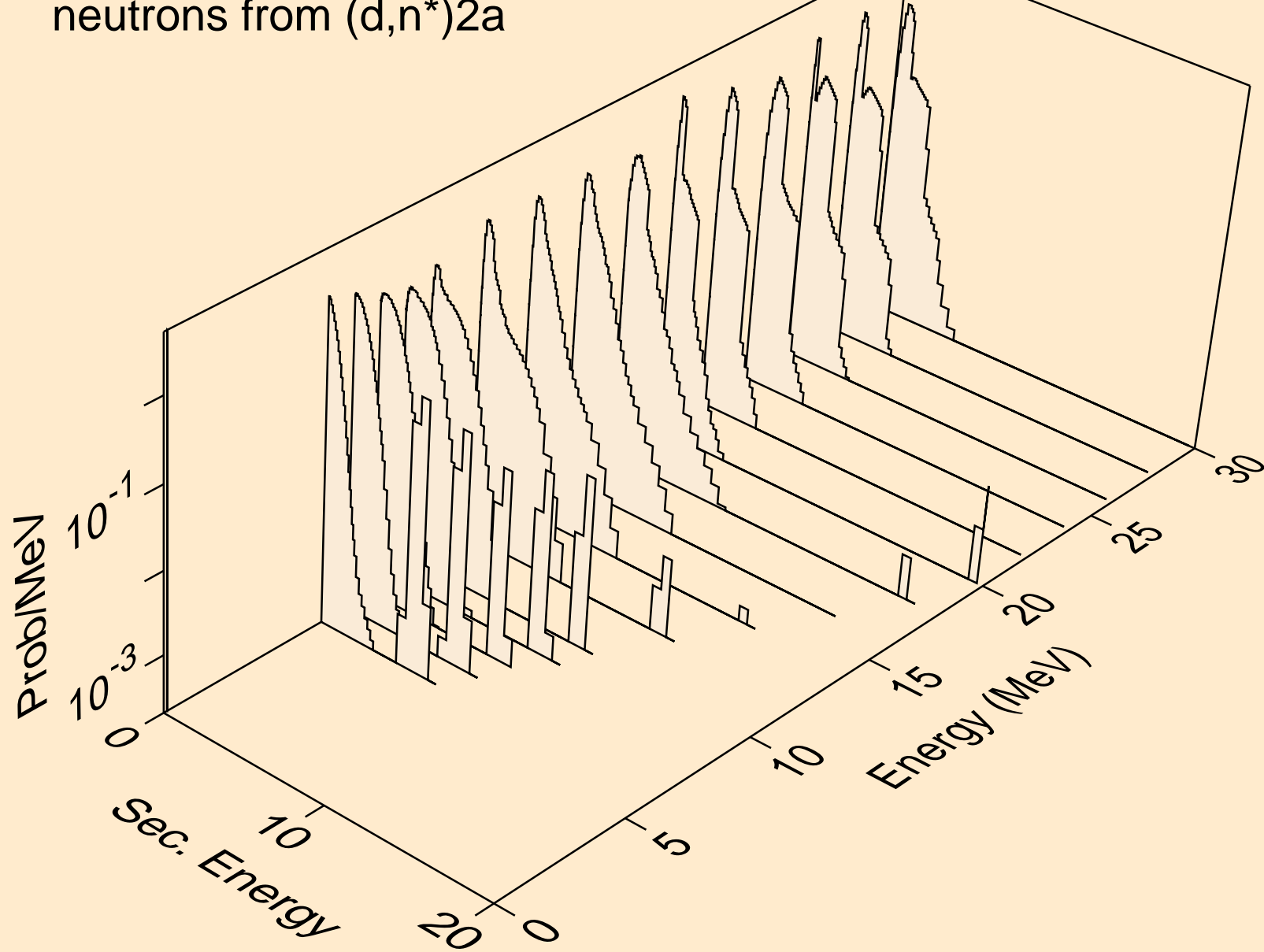

NP228 DEUTERON ACER TENDL-2021 LIBRARY; T=0.K
neutrons from (d,2n)2a

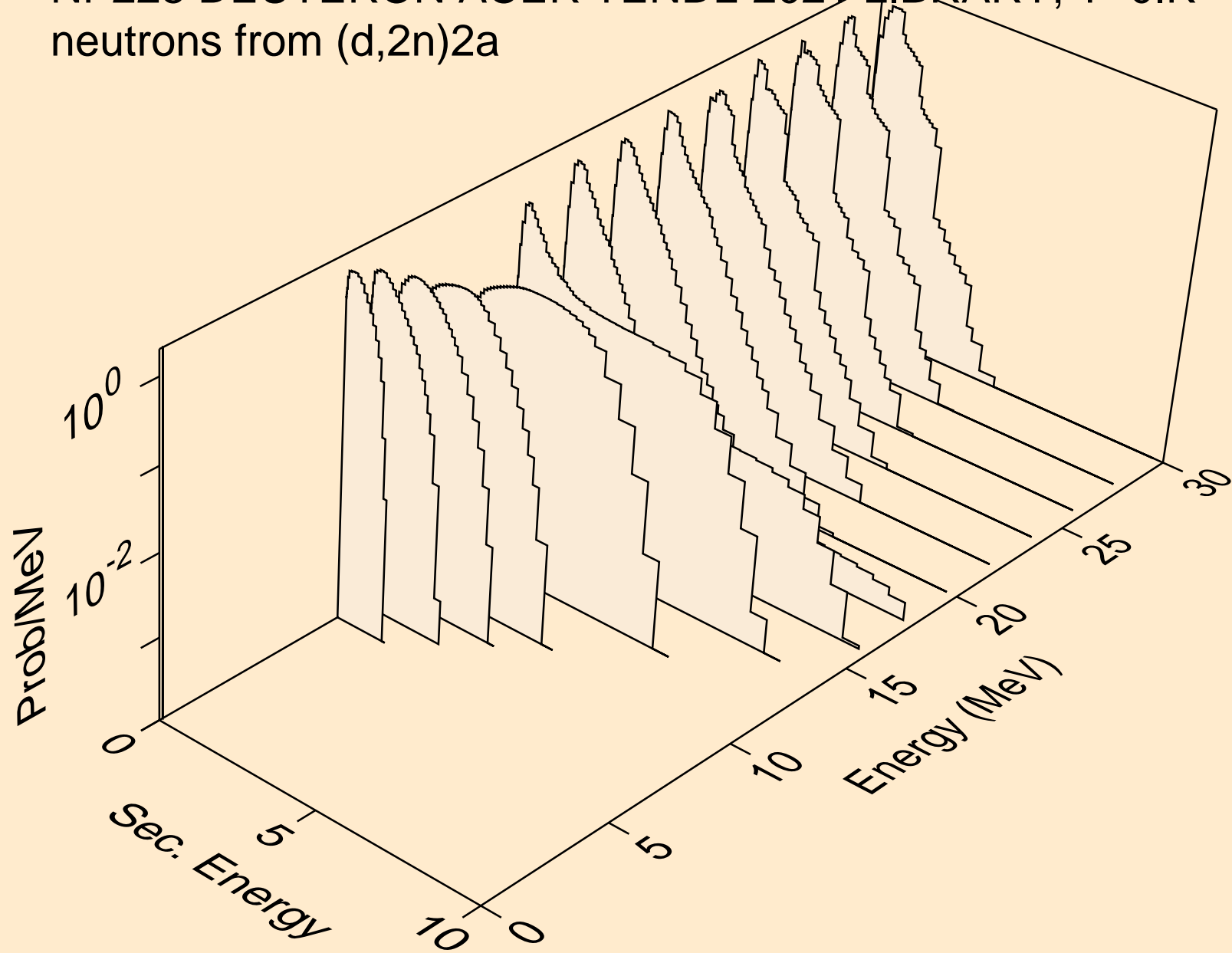

NP228 DEUTERON ACER TENDL-2021 LIBRARY; T=0.K
neutrons from (d,n*)d

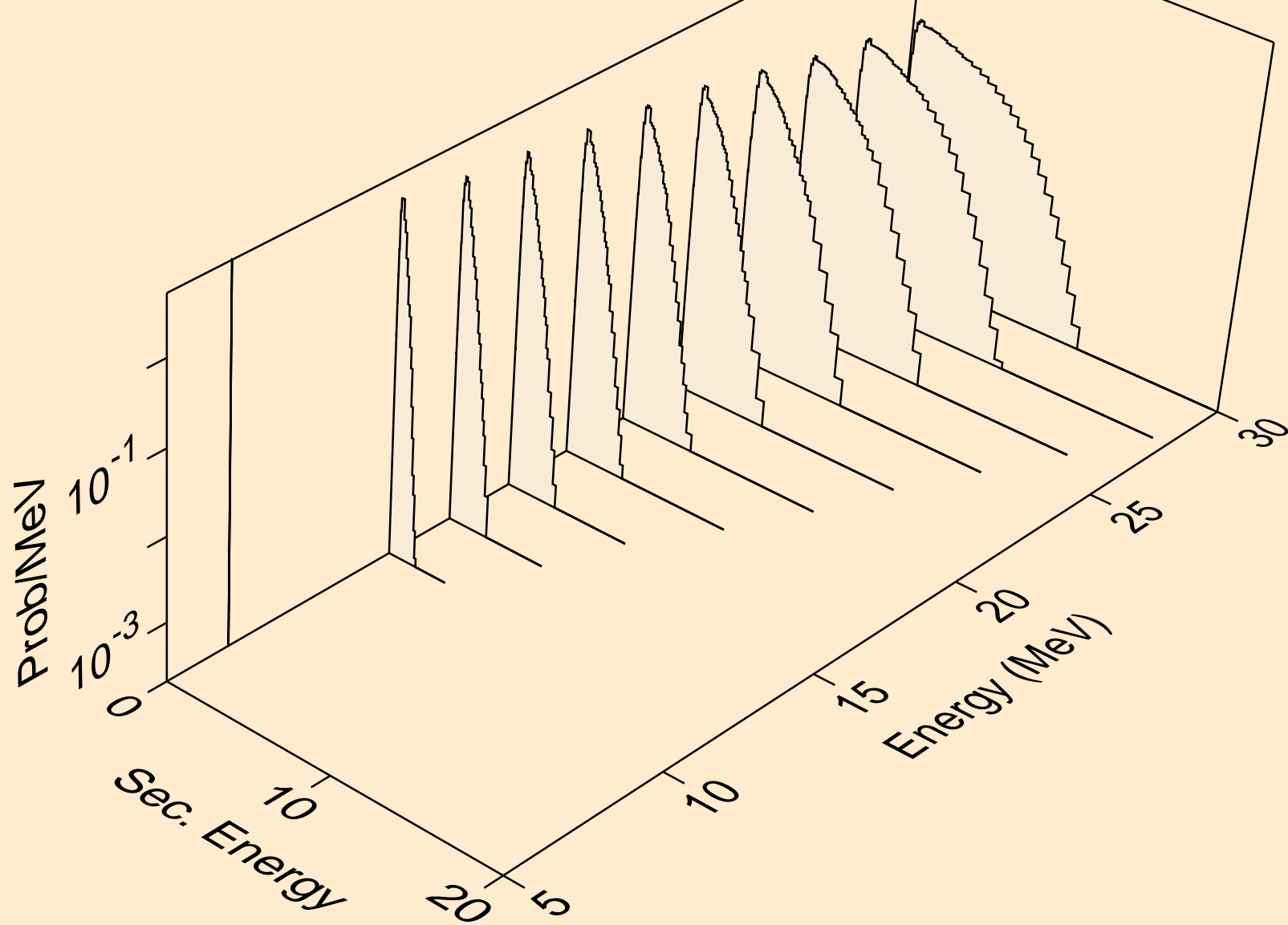

NP228 DEUTERON ACER TENDL-2021 LIBRARY; T=0.K
neutrons from (d,n*)t

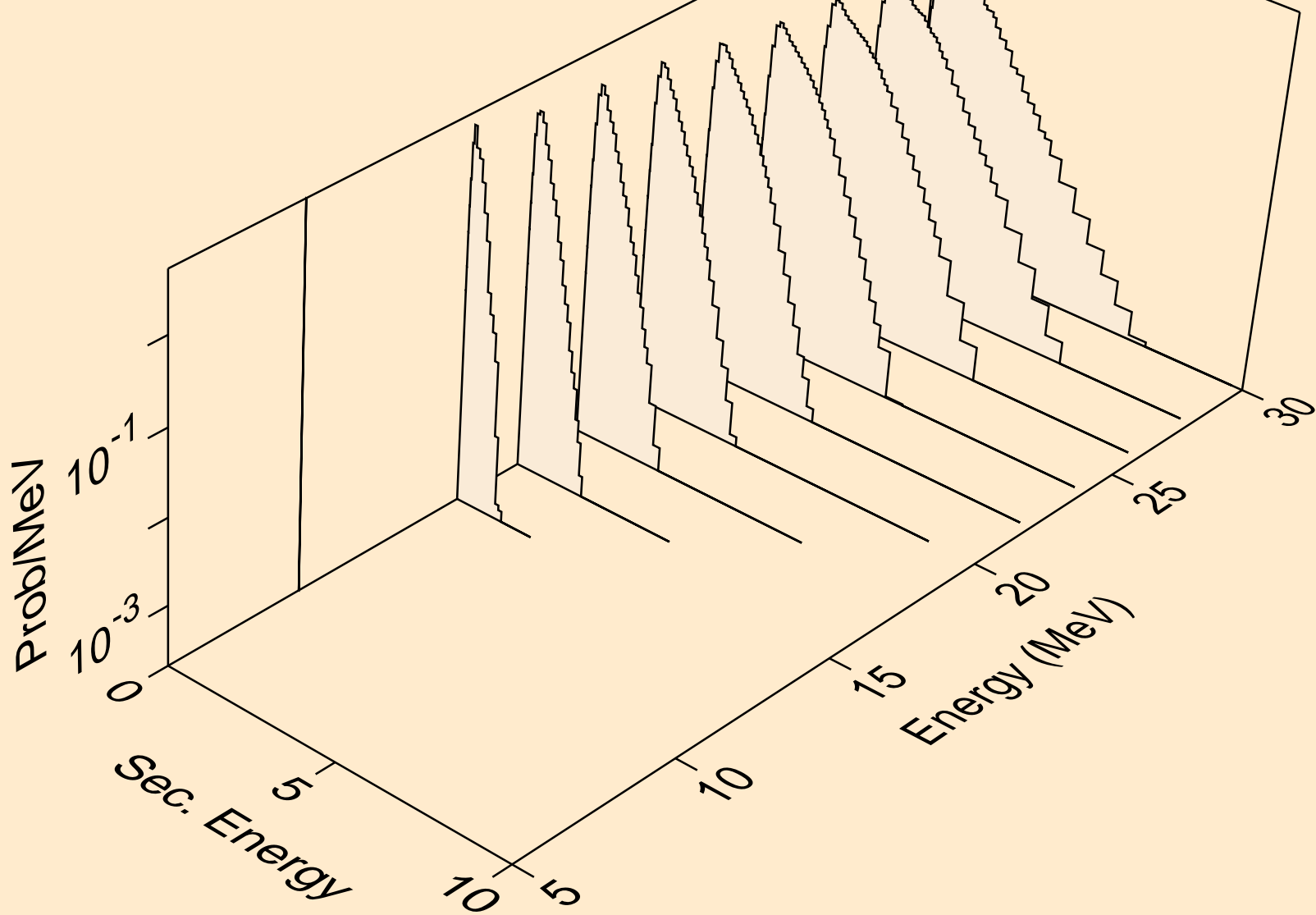

NP228 DEUTERON ACER TENDL-2021 LIBRARY; T=0.K
neutrons from (d,n*)he3

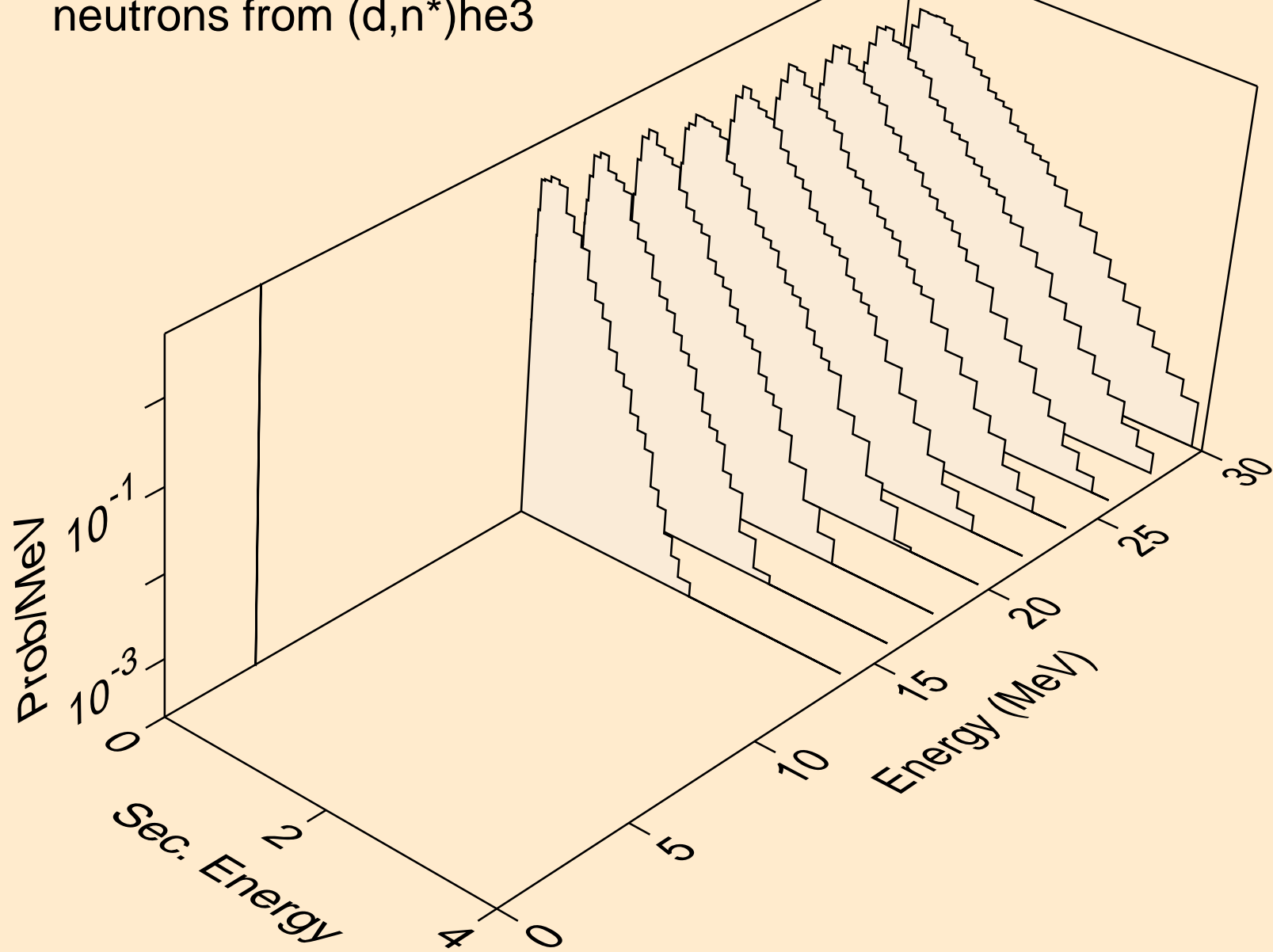

NP228 DEUTERON ACER TENDL-2021 LIBRARY; T=0.K
neutrons from (d,4n)

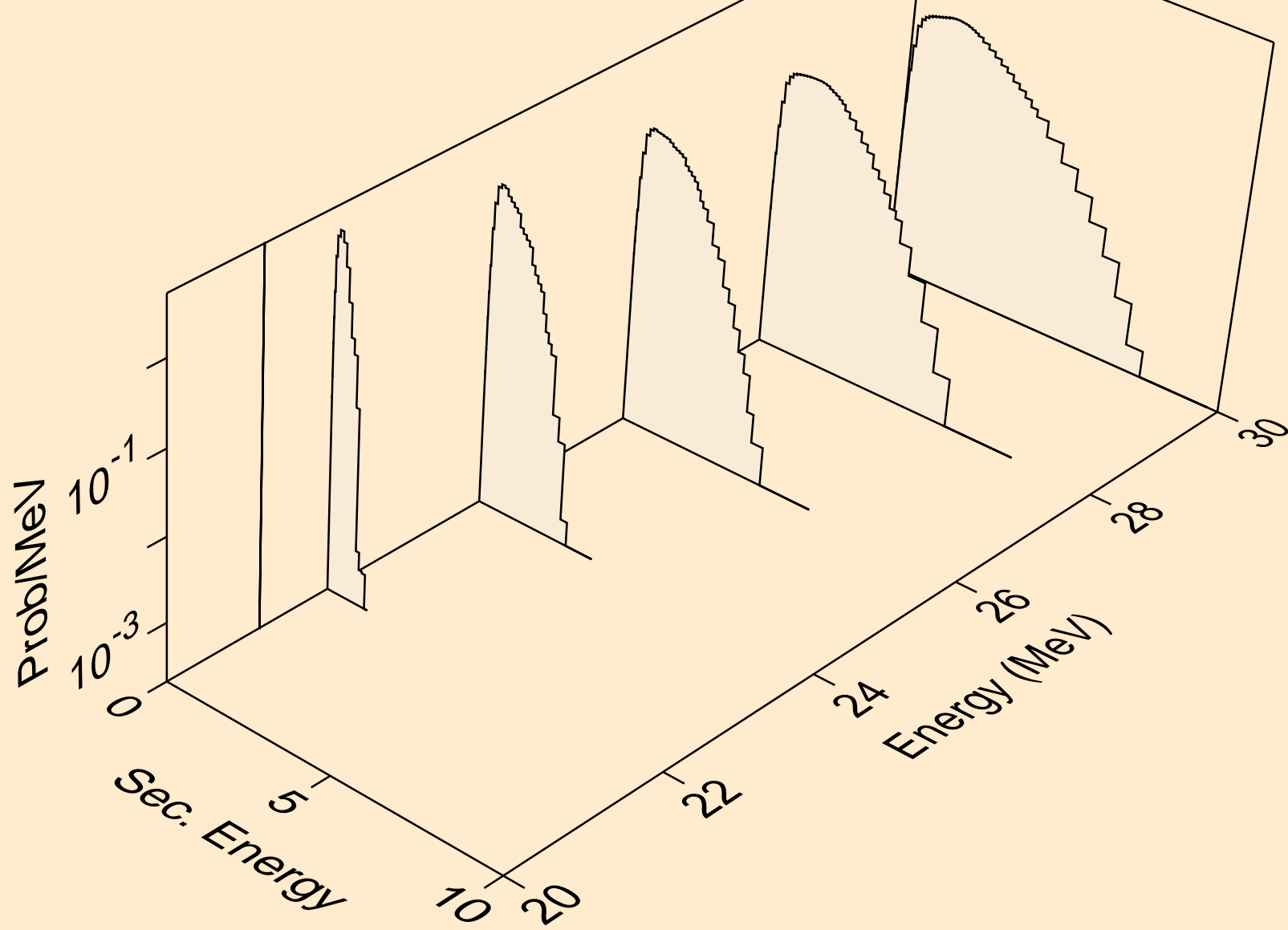

NP228 DEUTERON ACER TENDL-2021 LIBRARY; T=0.K
neutrons from (d,2np)

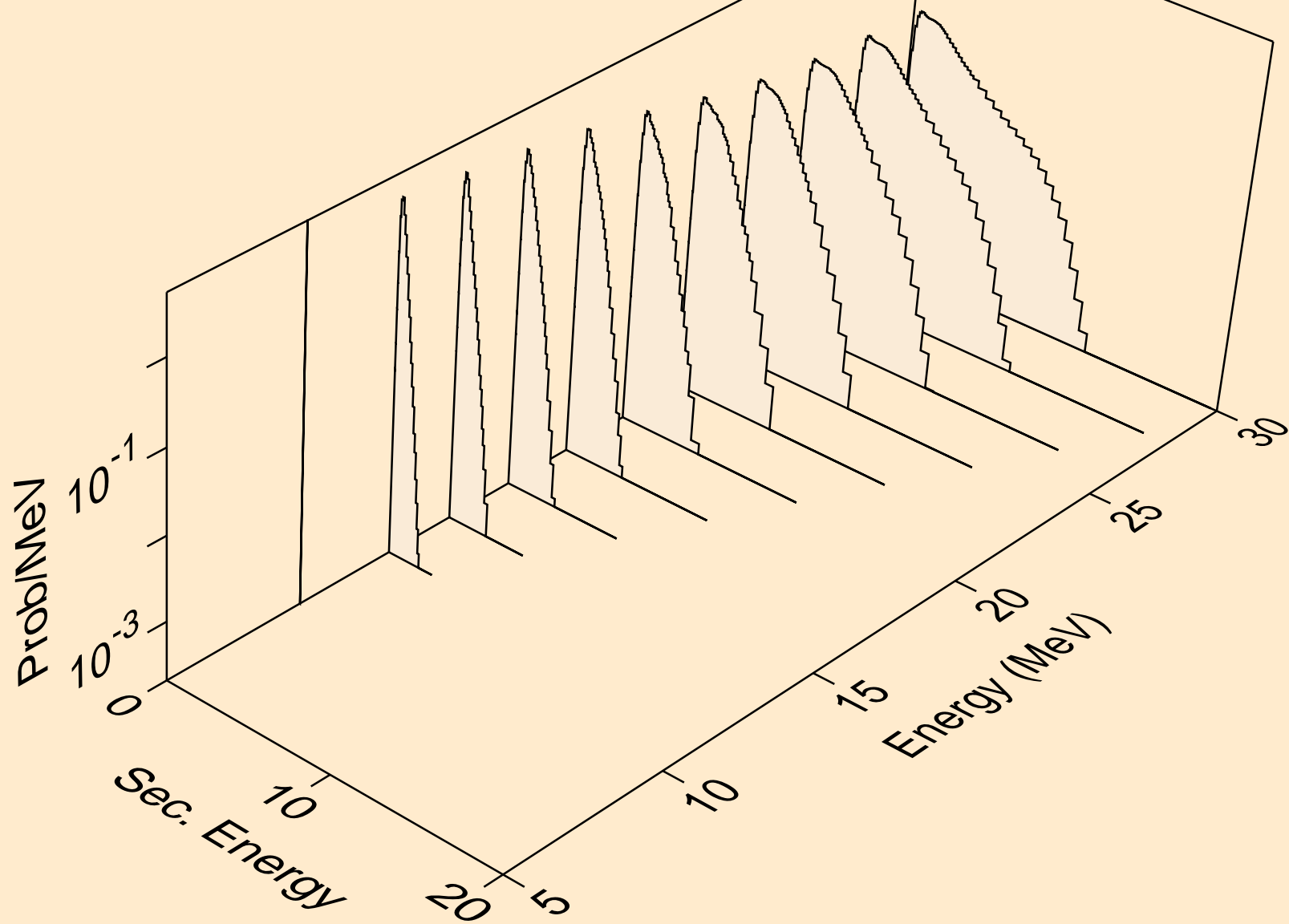

NP228 DEUTERON ACER TENDL-2021 LIBRARY; T=0.K
neutrons from (d,3np)

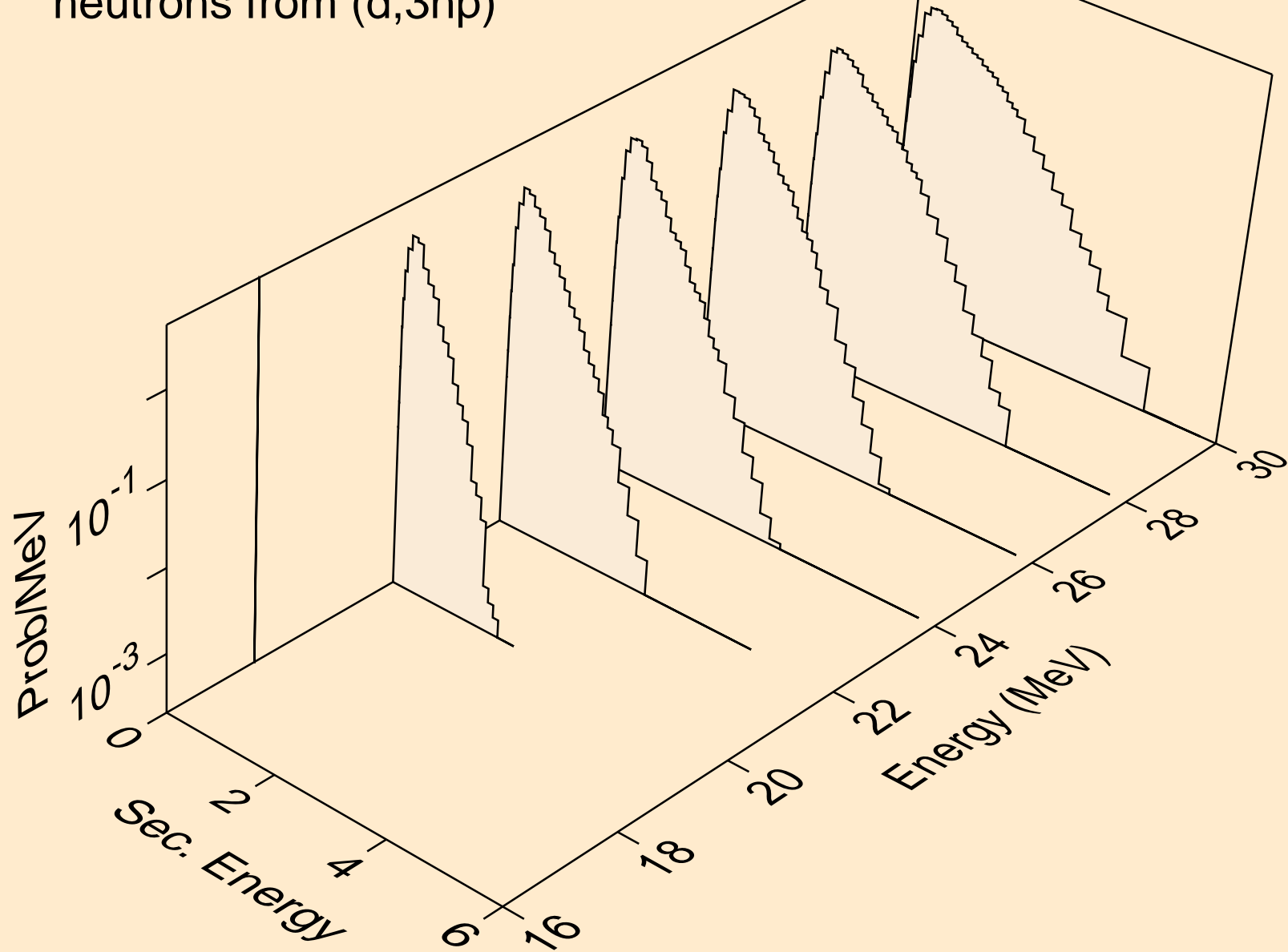

NP228 DEUTERON ACER TENDL-2021 LIBRARY; T=0.K
neutrons from (d,2np)

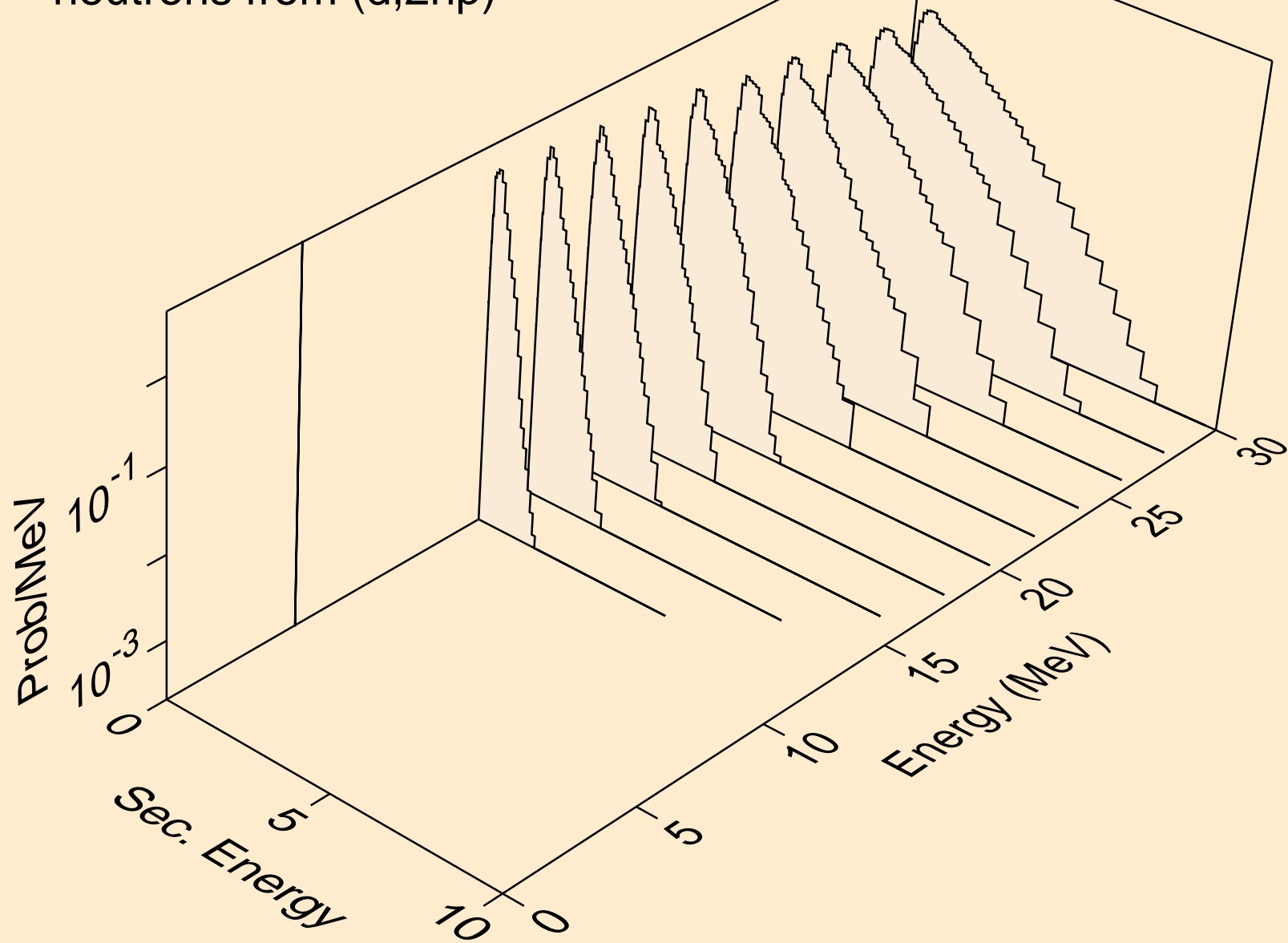

NP228 DEUTERON ACER TENDL-2021 LIBRARY; T=0.K
neutrons from (d,npa)

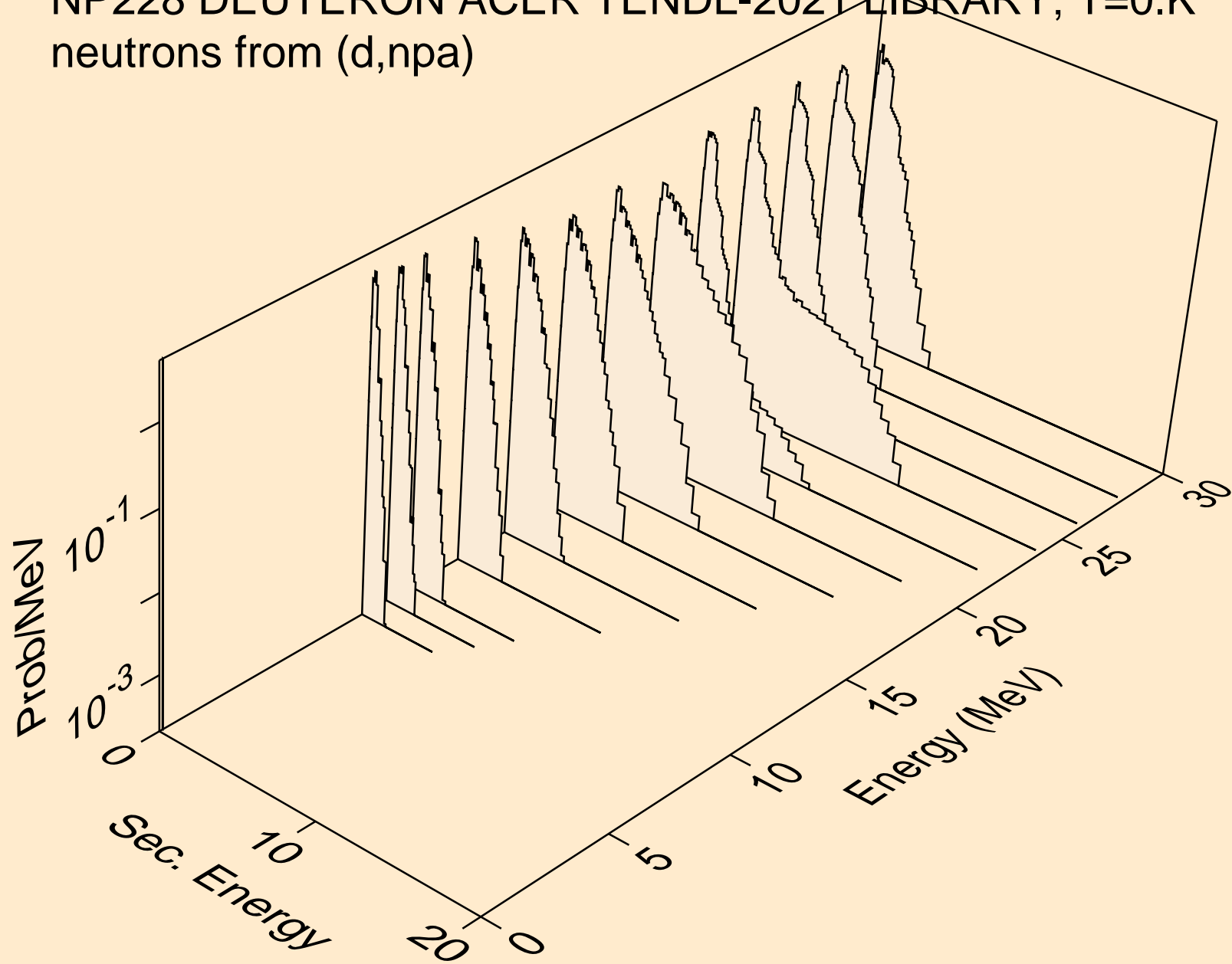

NP228 DEUTERON ACER TENDL-2021 LIBRARY; T=0.K
protons from (d,x)

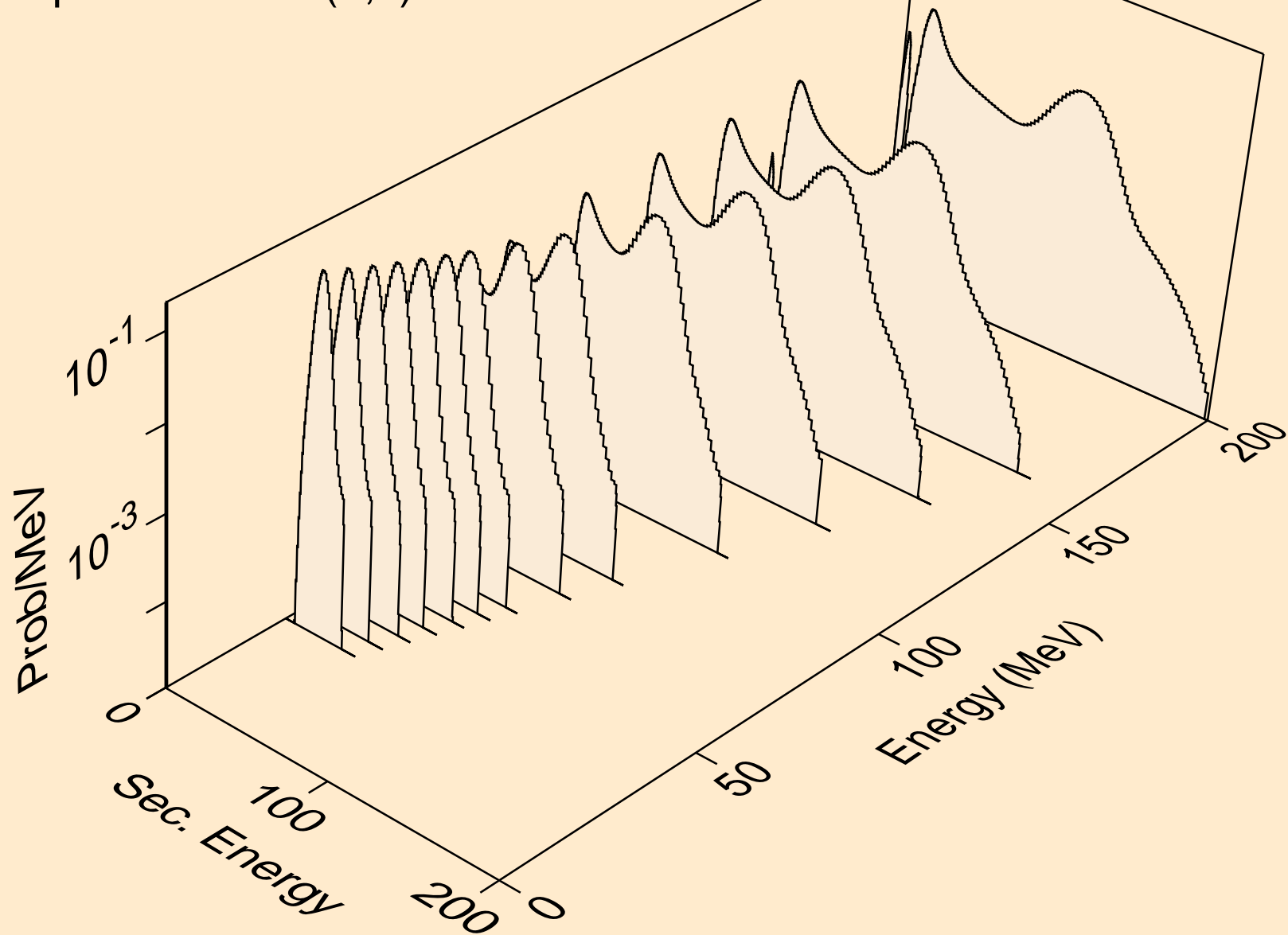

NP228 DEUTERON ACER TENDL-2021 LIBRARY; T=0.K
protons from (d,n*)p

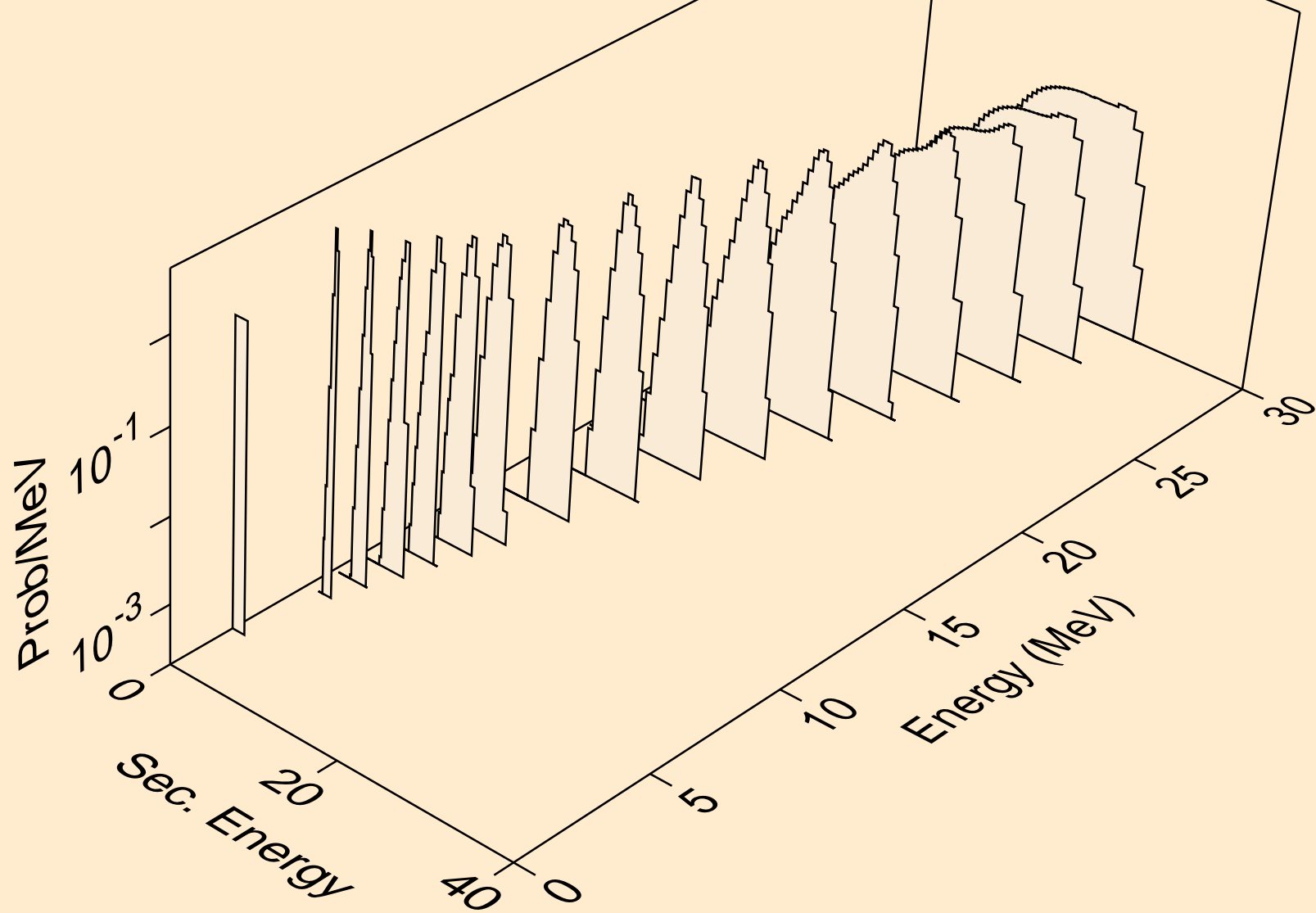

NP228 DEUTERON ACER TENDL-2021 LIBRARY; T=0.K
protons from (d,2np)

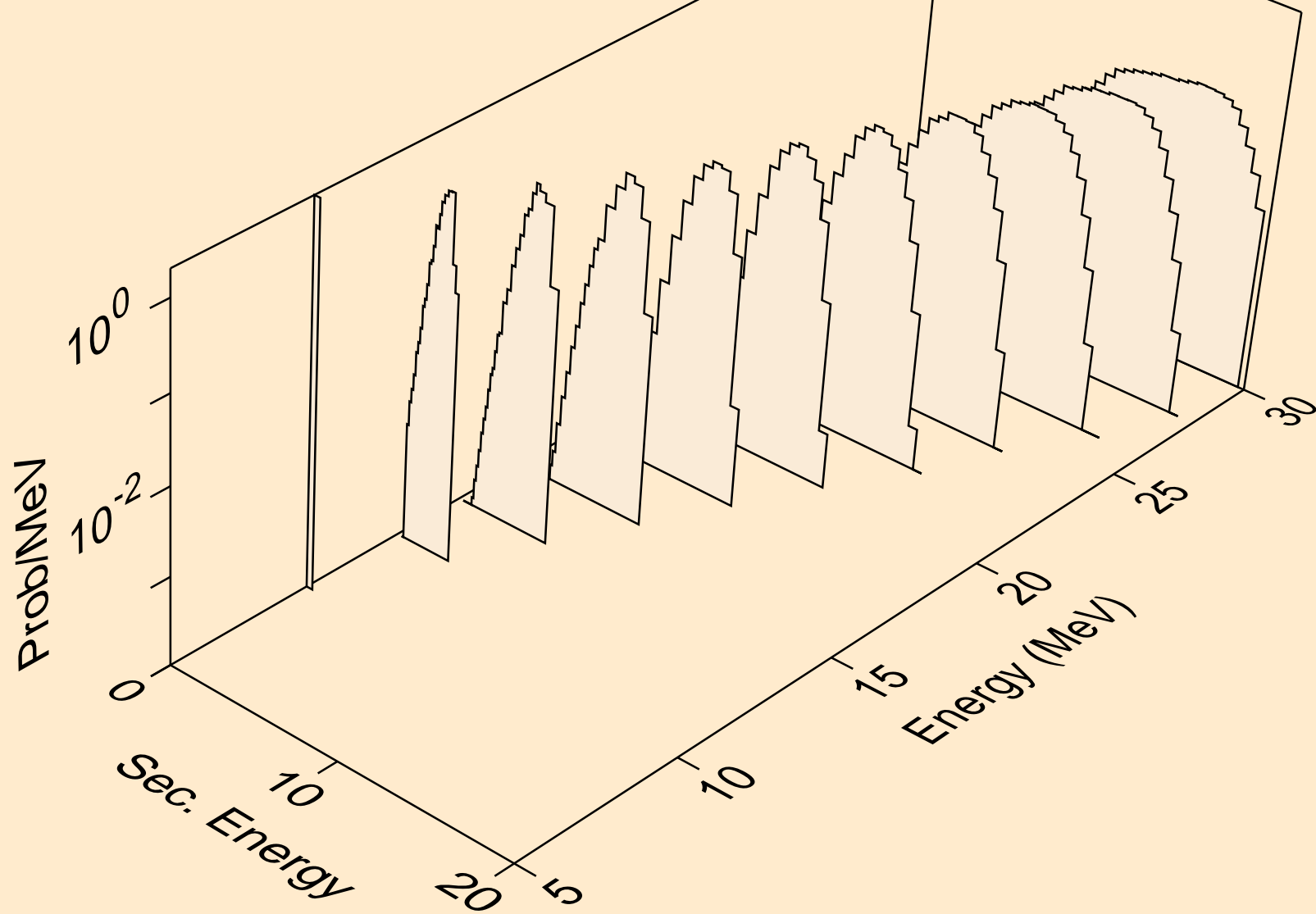

NP228 DEUTERON ACER TENDL-2021 LIBRARY; T=0.K
protons from (d,3np)

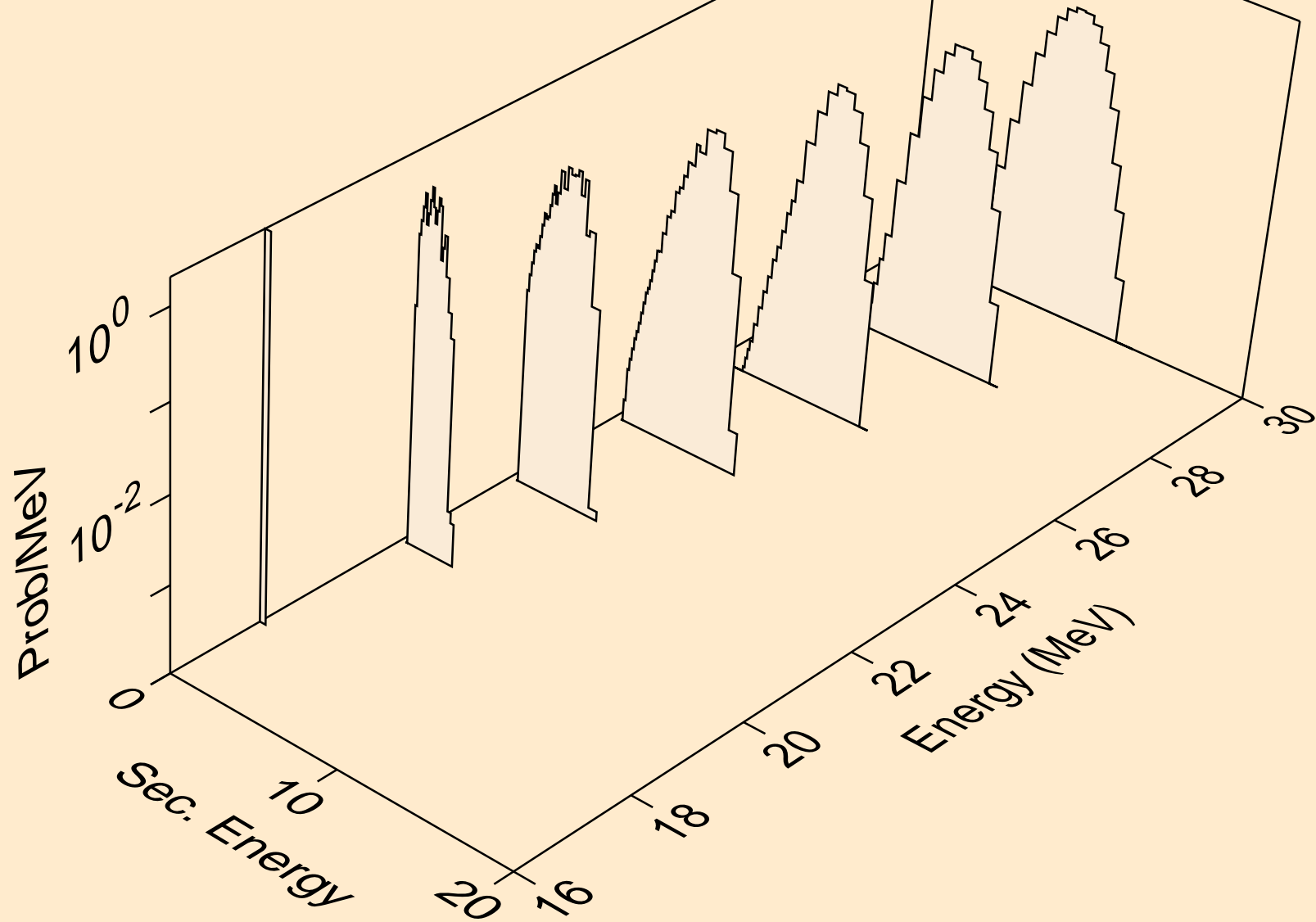

NP228 DEUTERON ACER TENDL-2021 LIBRARY; T=0.K
protons from (d,2np)

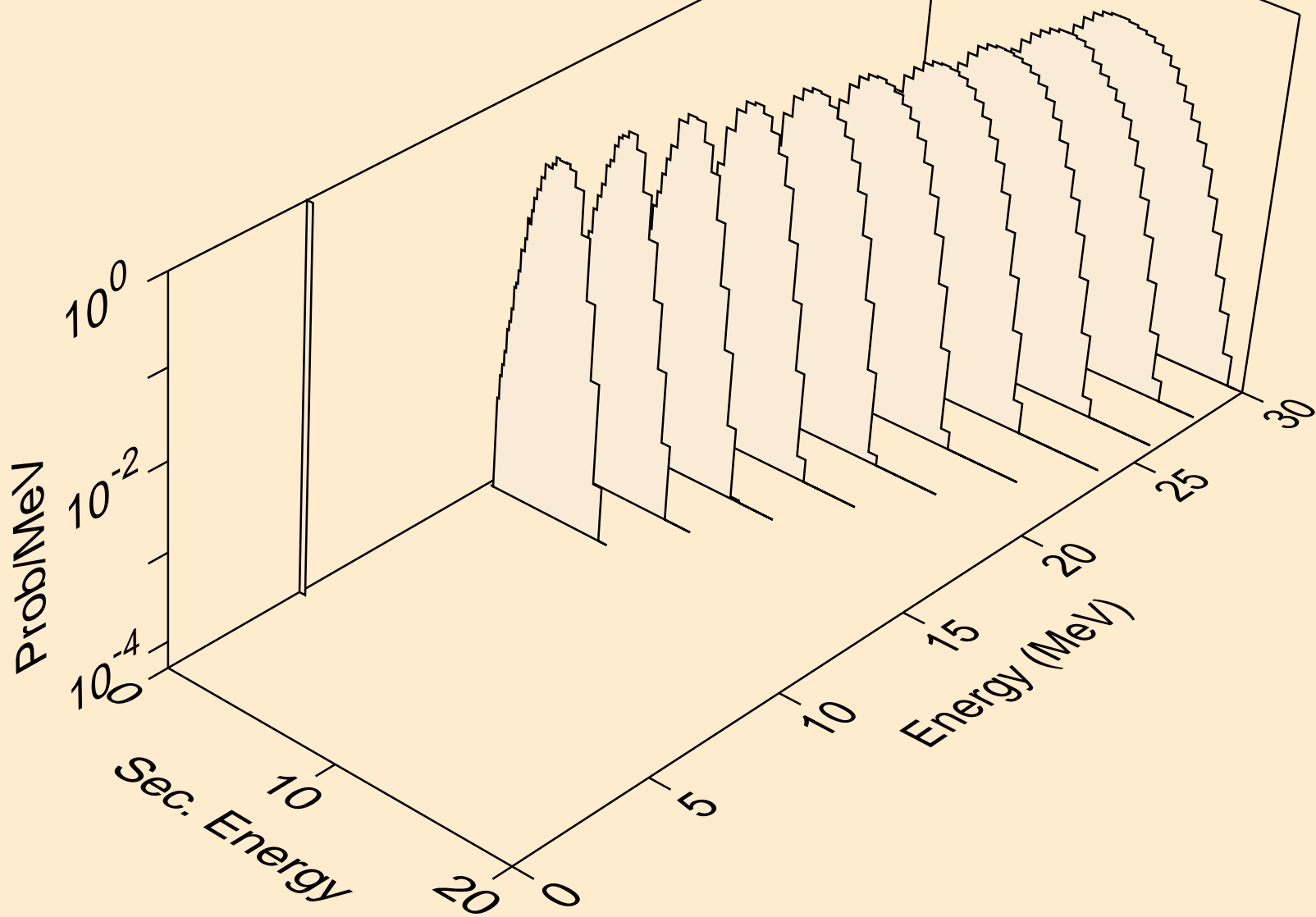

NP228 DEUTERON ACER TENDL-2021 LIBRARY; T=0.K
protons from (d,npa)

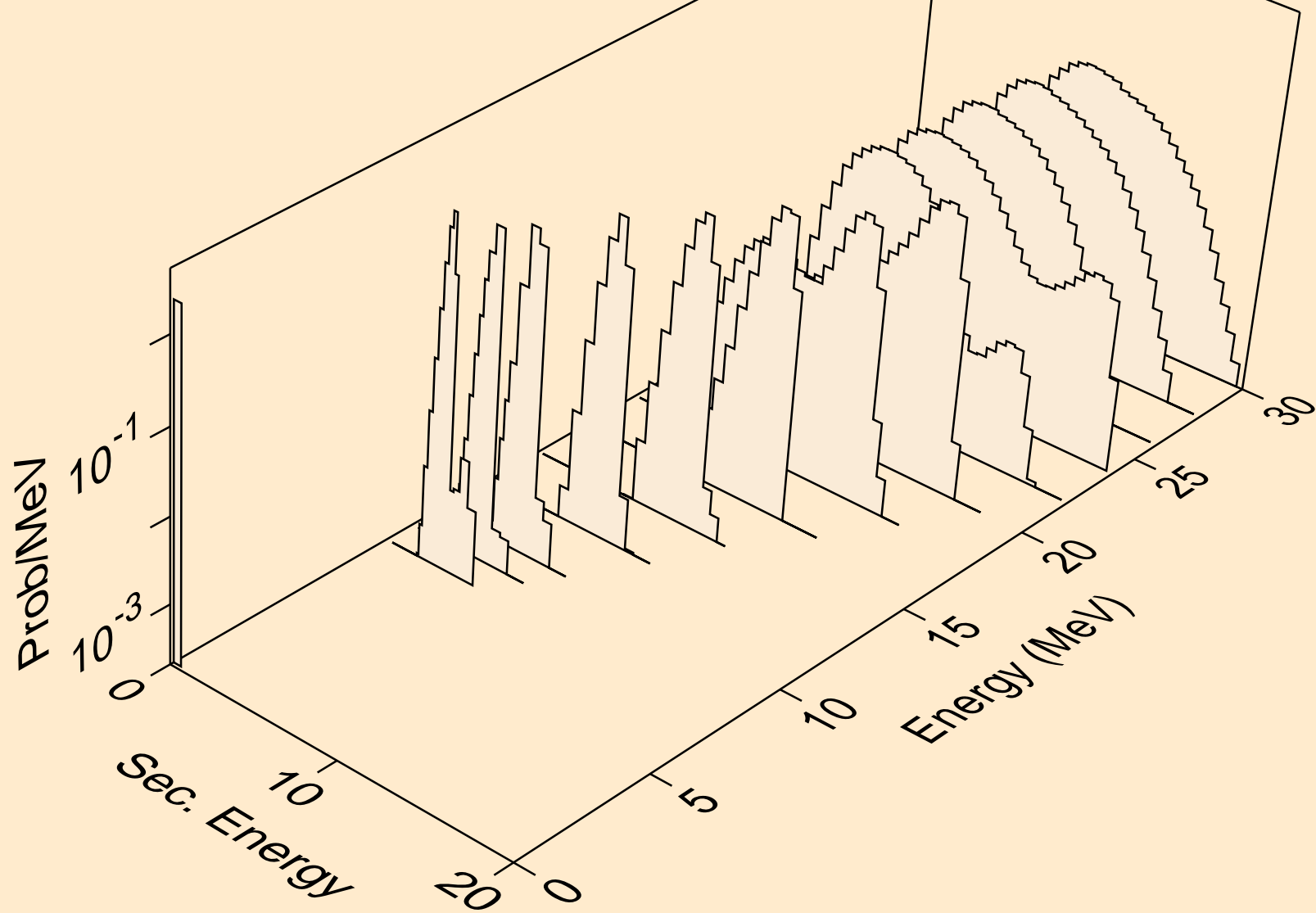

NP228 DEUTERON ACER TENDL-2021 LIBRARY; T=0.K
protons from (d,p)

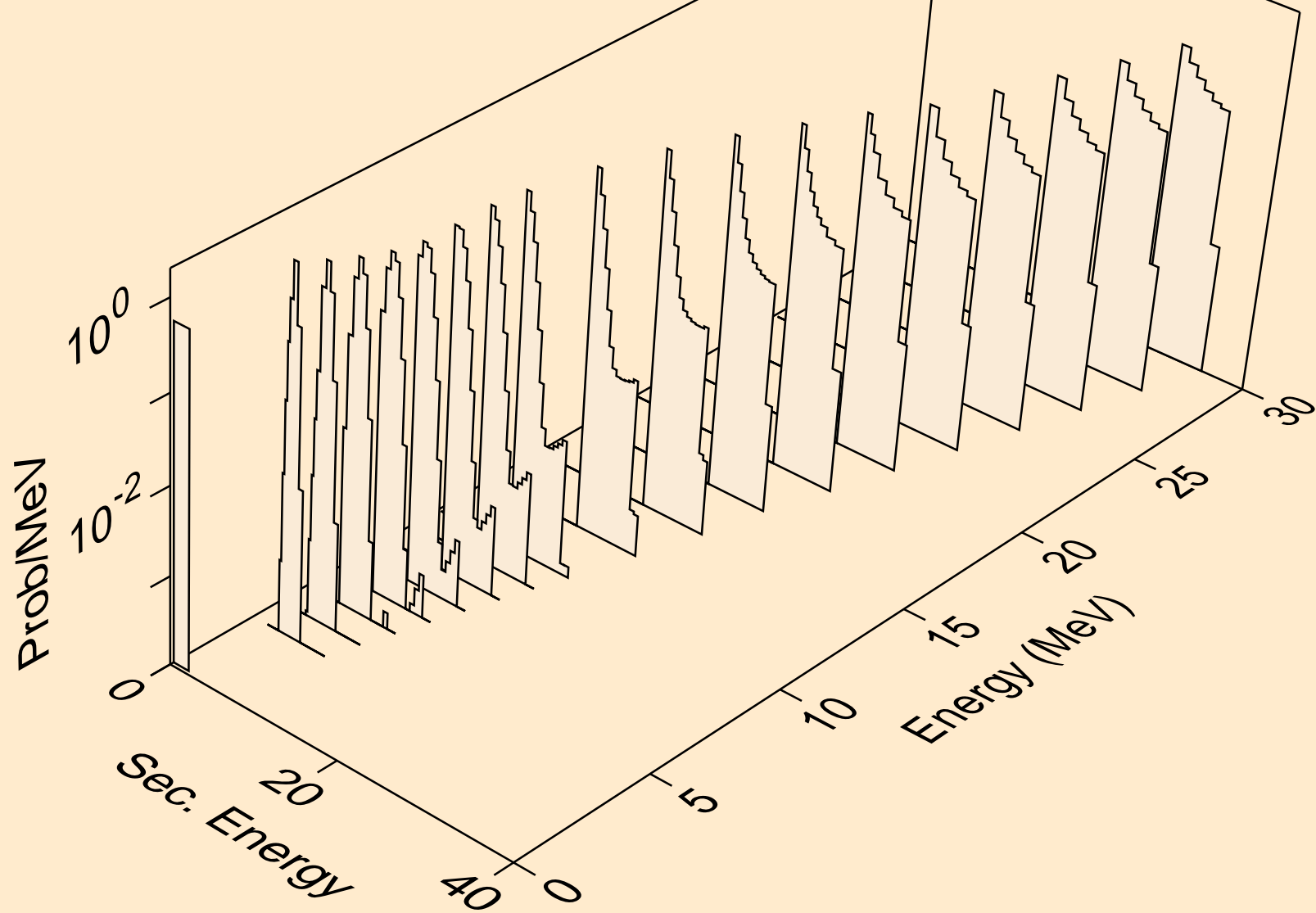

NP228 DEUTERON ACER TENDL-2021 LIBRARY; T=0.K
protons from (d,2p)

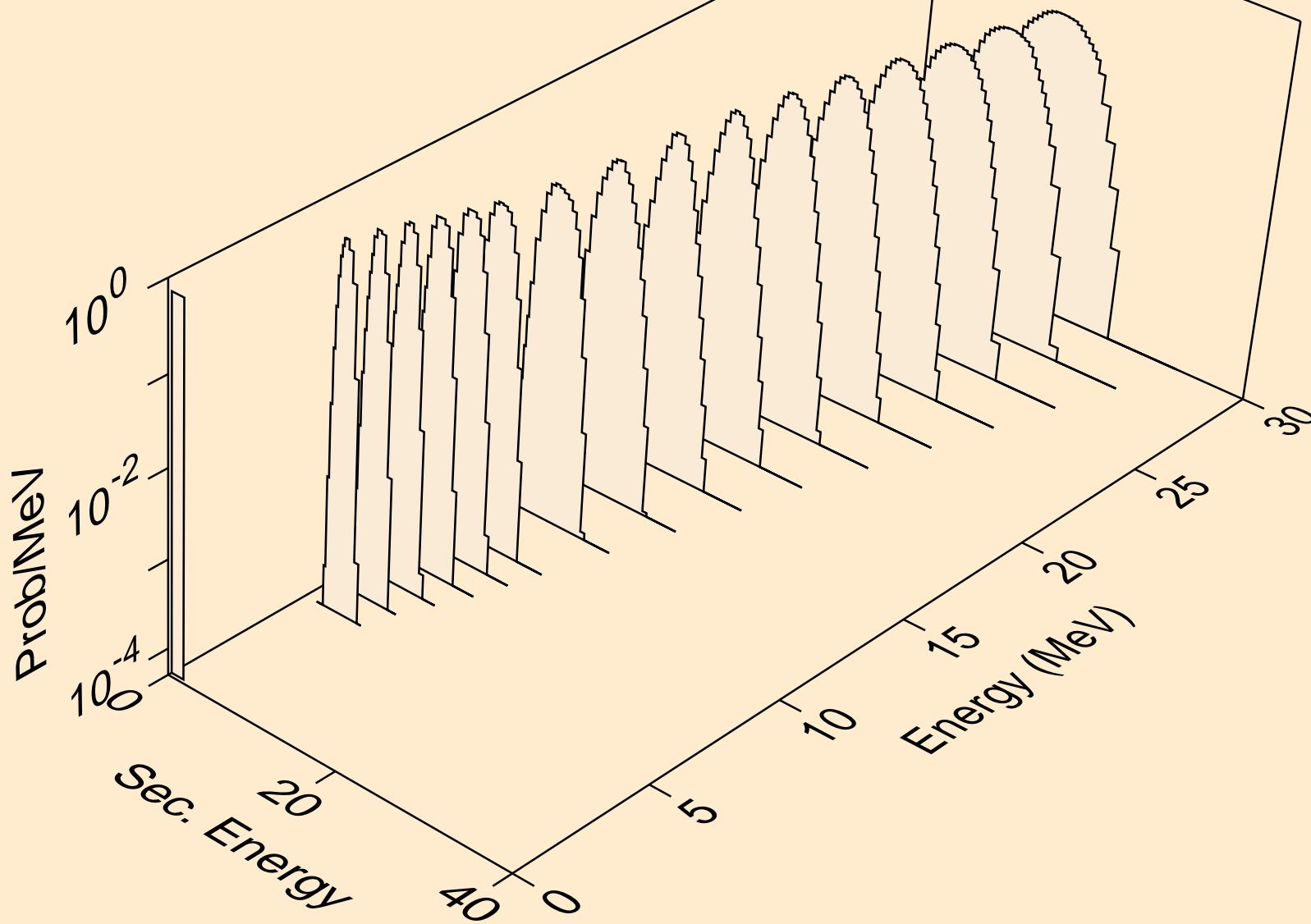

NP228 DEUTERON ACER TENDL-2021 LIBRARY; T=0.K
protons from (d,pa)

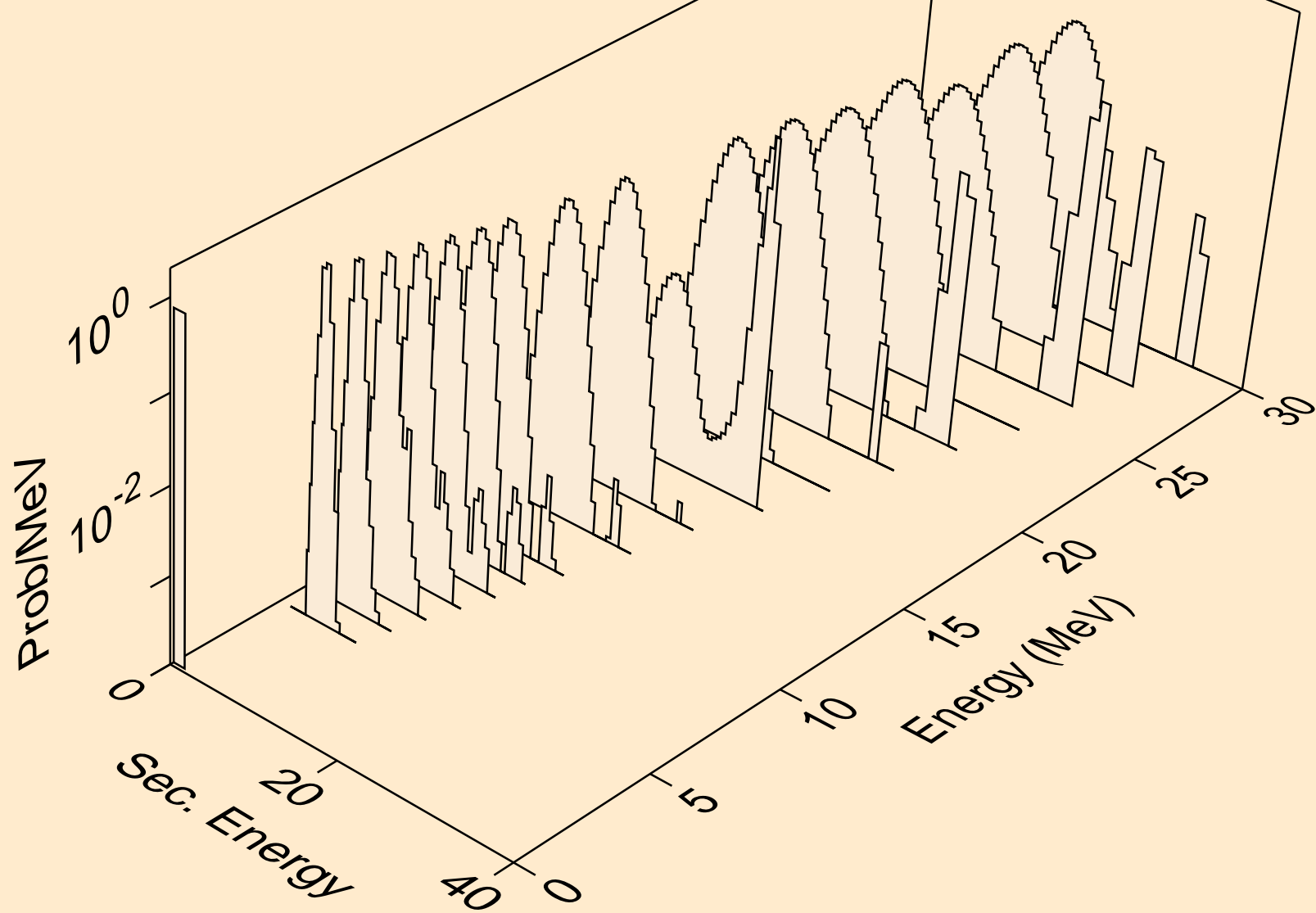

NP228 DEUTERON ACER TENDL-2021 LIBRARY; T=0.K
protons from (d,pd)

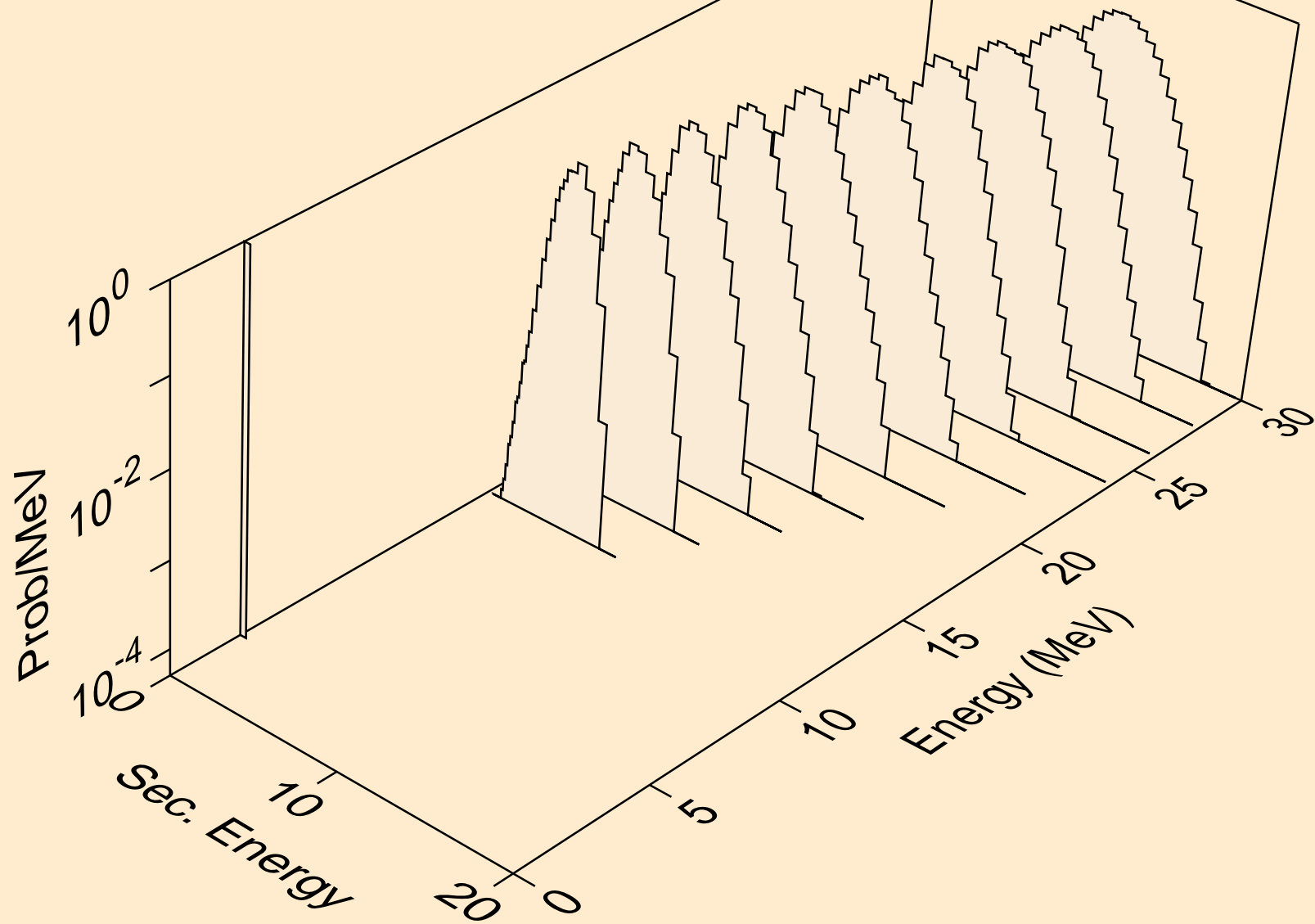

NP228 DEUTERON ACER TENDL-2021 LIBRARY; T=0.K
tritons from (d,x)

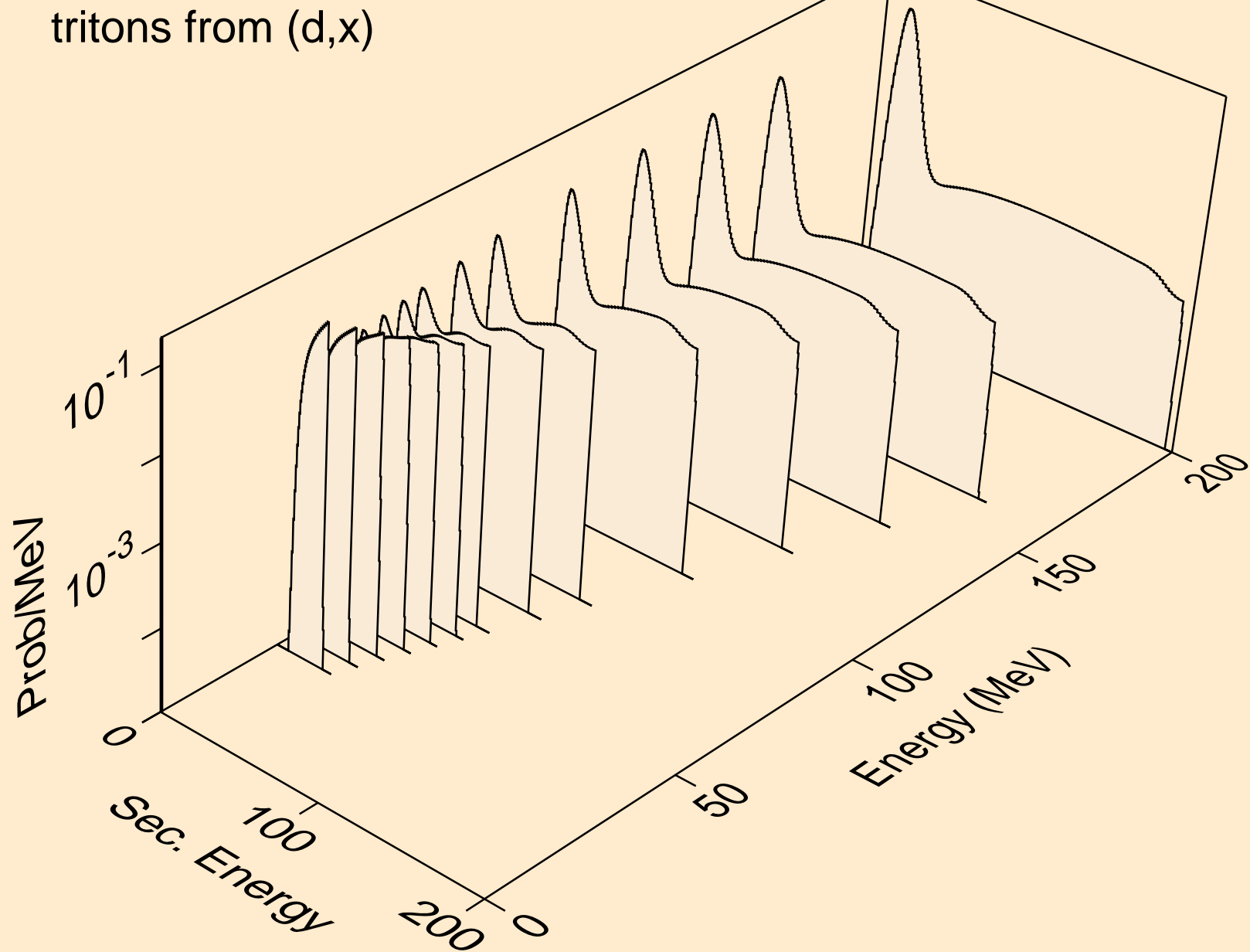

NP228 DEUTERON ACER TENDL-2021 LIBRARY; T=0.K
tritons from (d,n*)t

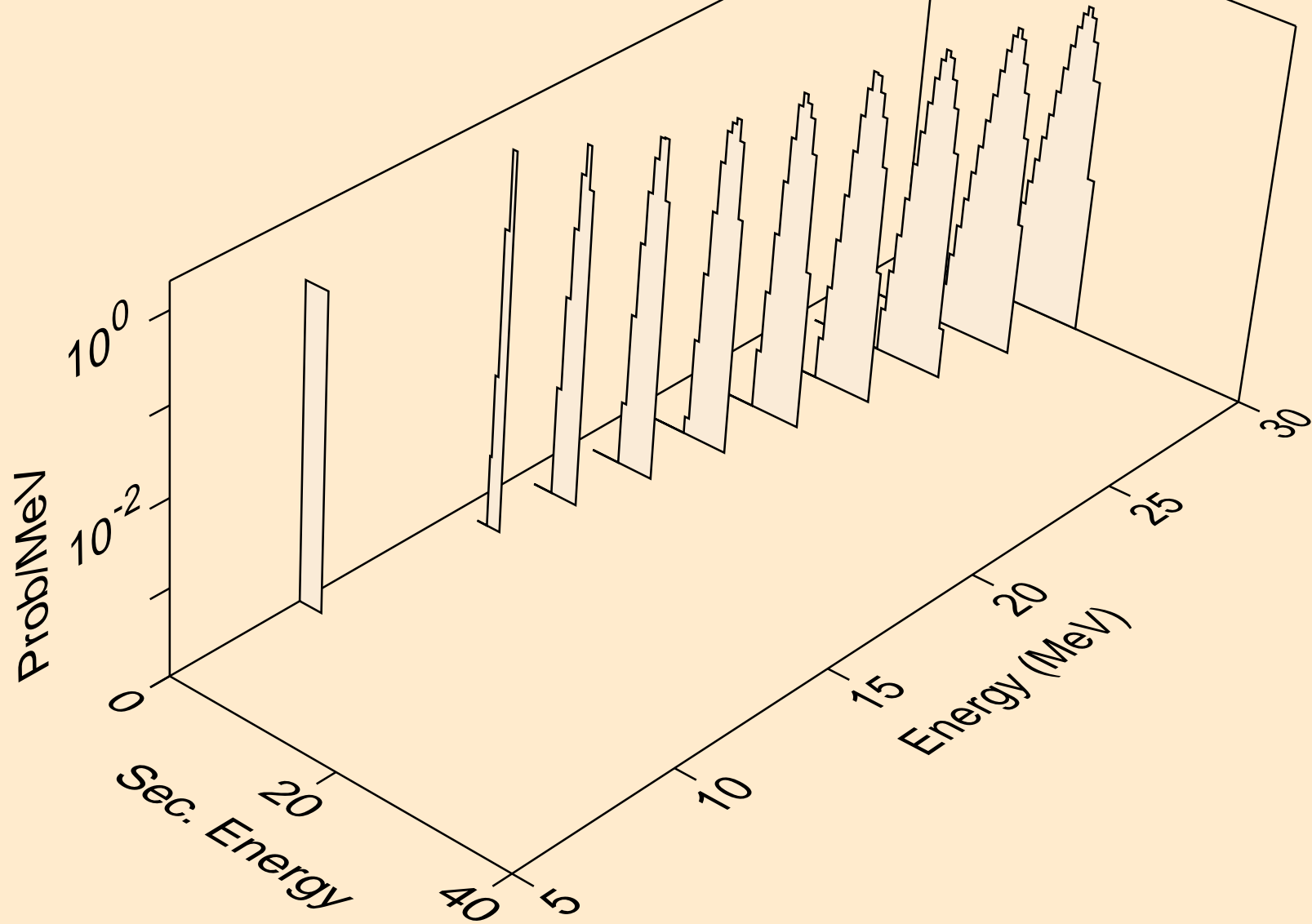

NP228 DEUTERON ACER TENDL-2021 LIBRARY; T=0.K
tritons from (d,t)

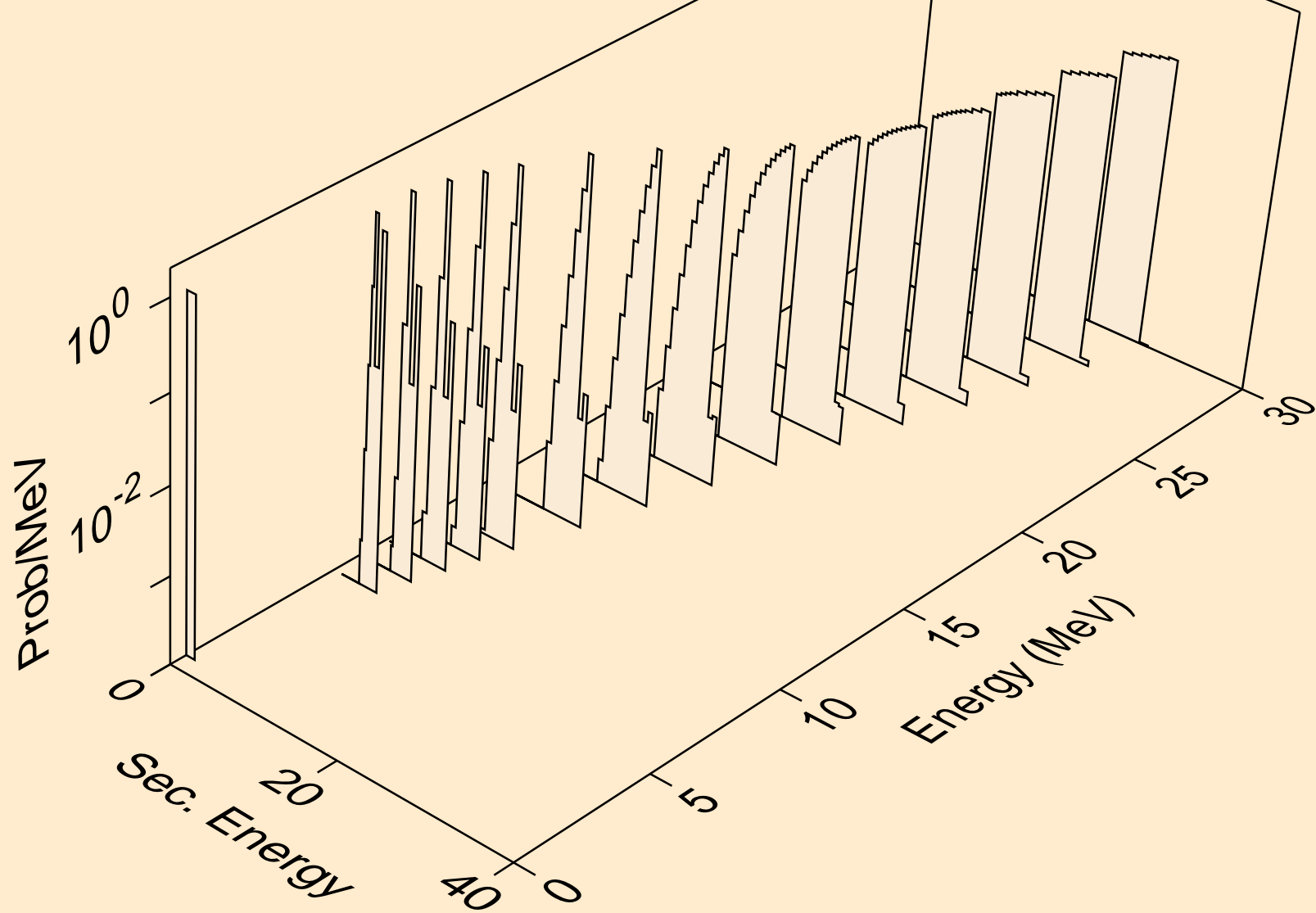

NP228 DEUTERON ACER TENDL-2021 LIBRARY; T=0.K
he3s from (d,x)

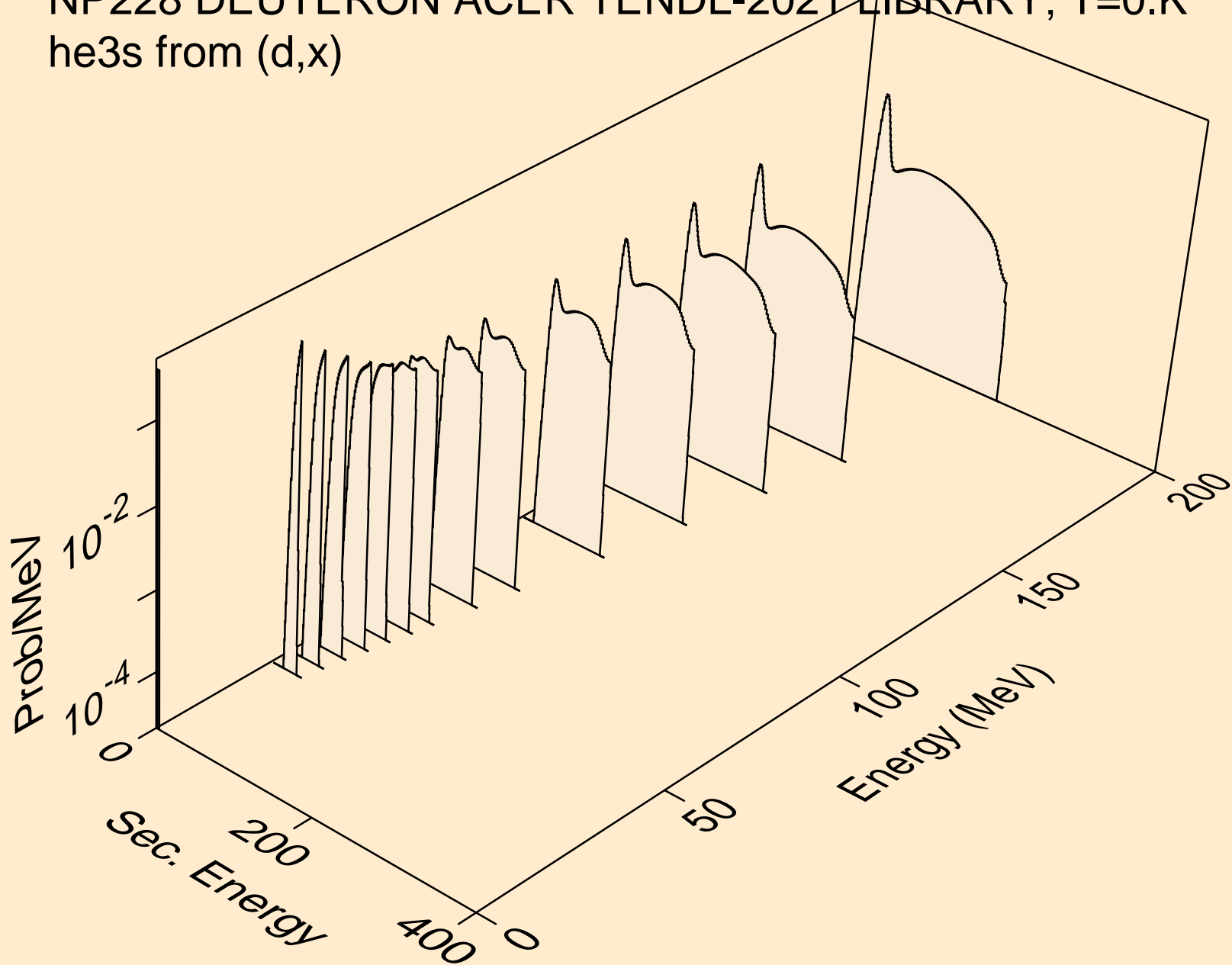

NP228 DEUTERON ACER TENDL-2021 LIBRARY; T=0.K
he3s from (d,n*)he3

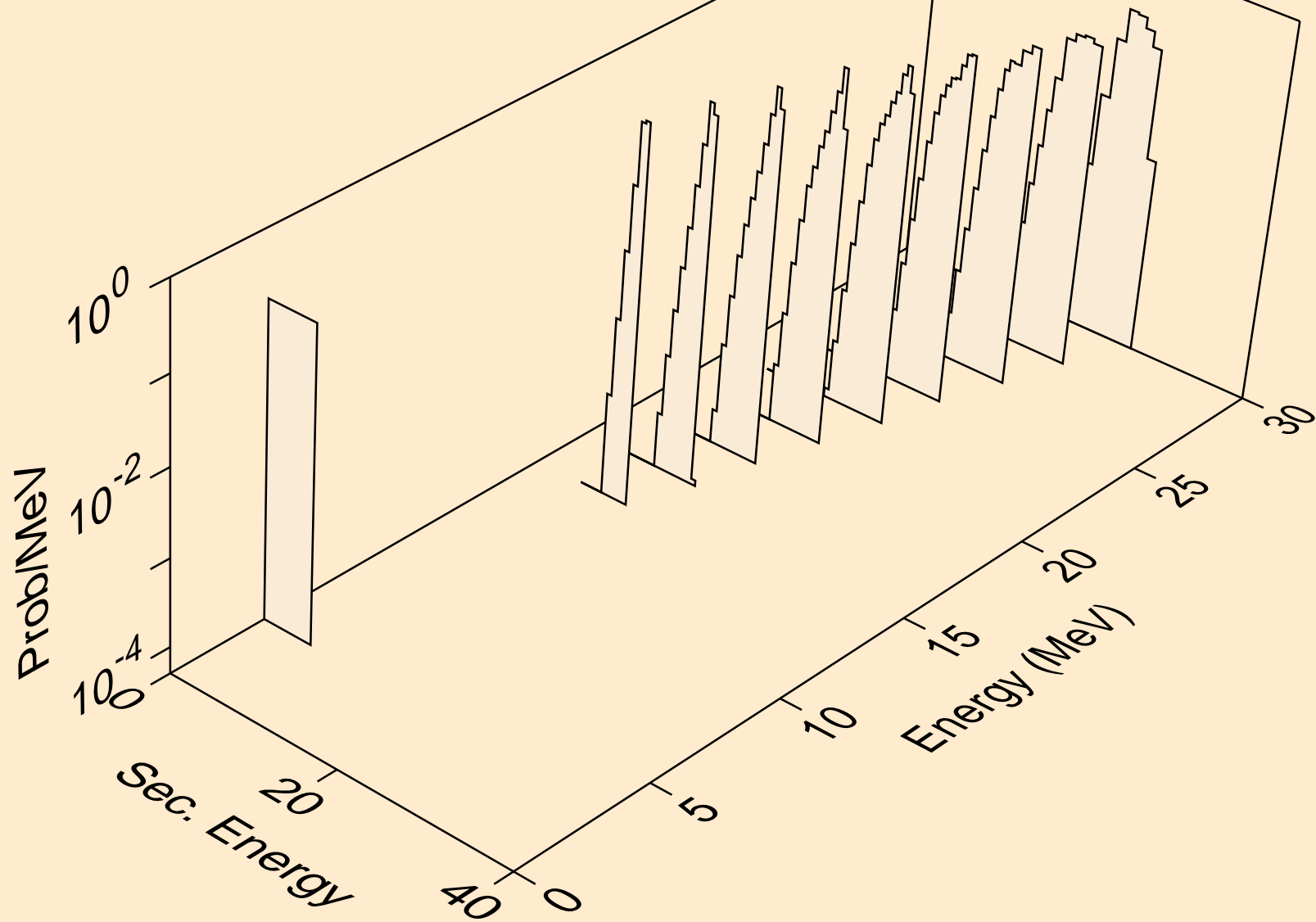

NP228 DEUTERON ACER TENDL-2021 LIBRARY; T=0.K
he3s from (d,he3)

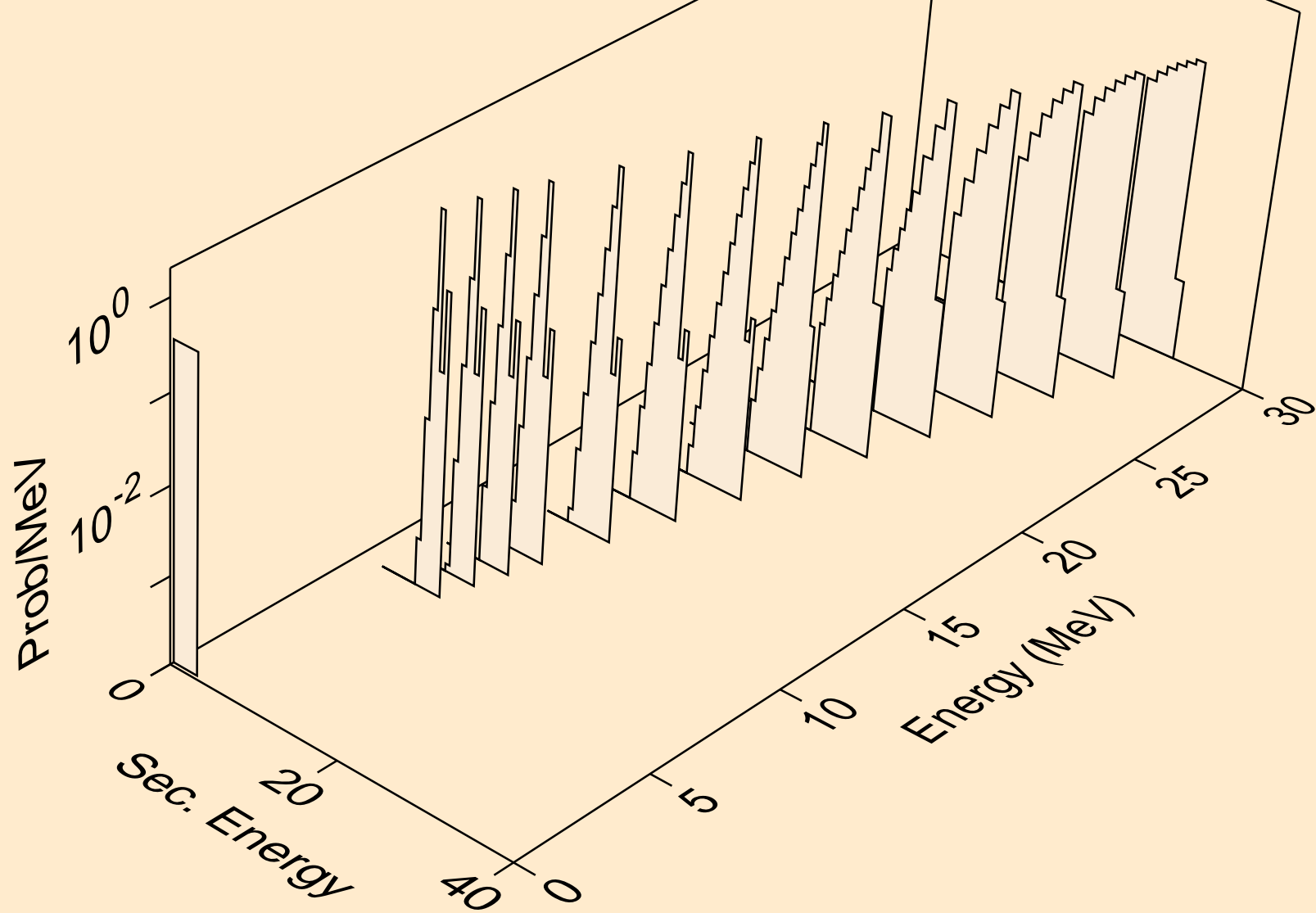

NP228 DEUTERON ACER TENDL-2021 LIBRARY; T=0.K
alphas from (d,x)

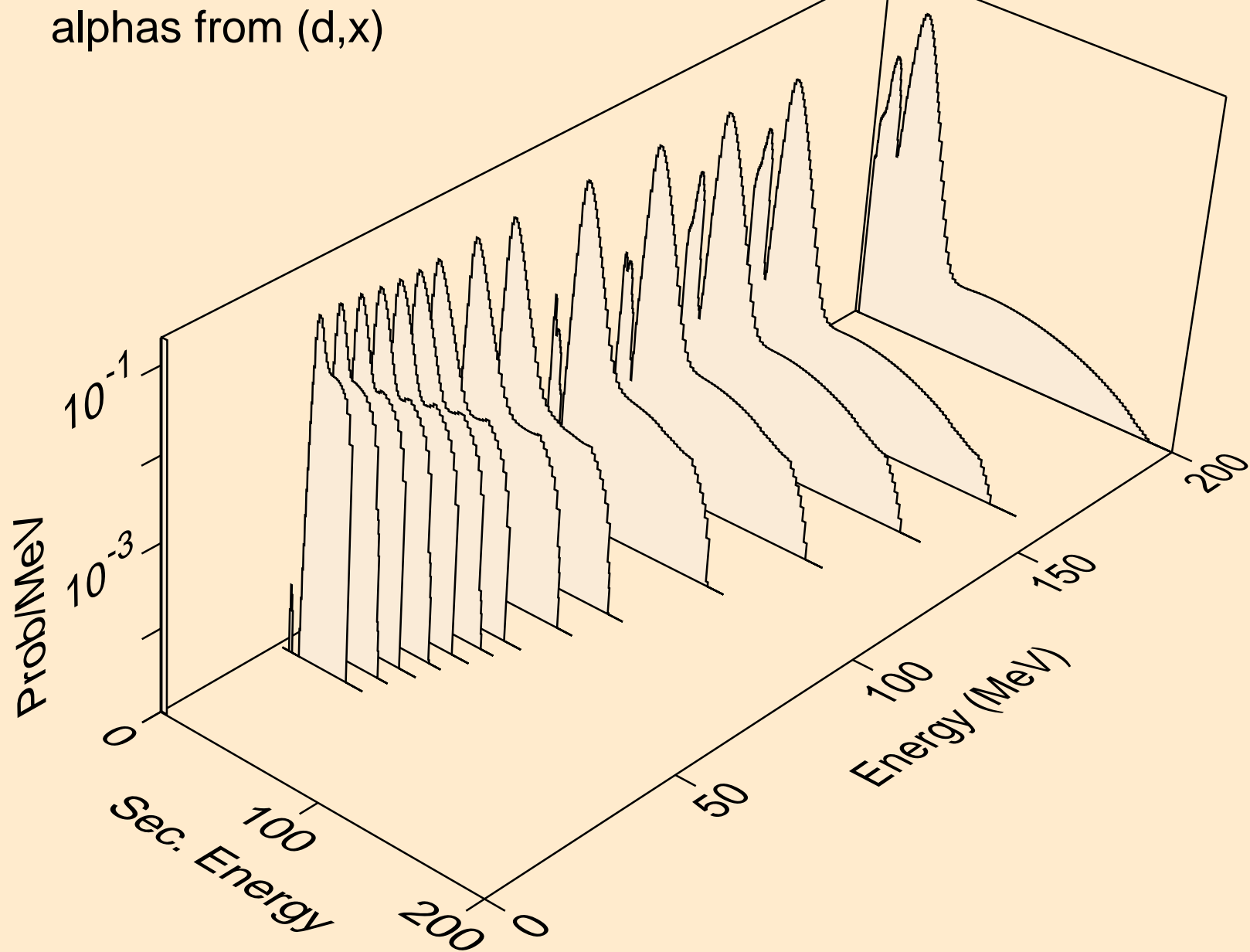

NP228 DEUTERON ACER TENDL-2021 LIBRARY; T=0.K
alphas from (d,n*)a

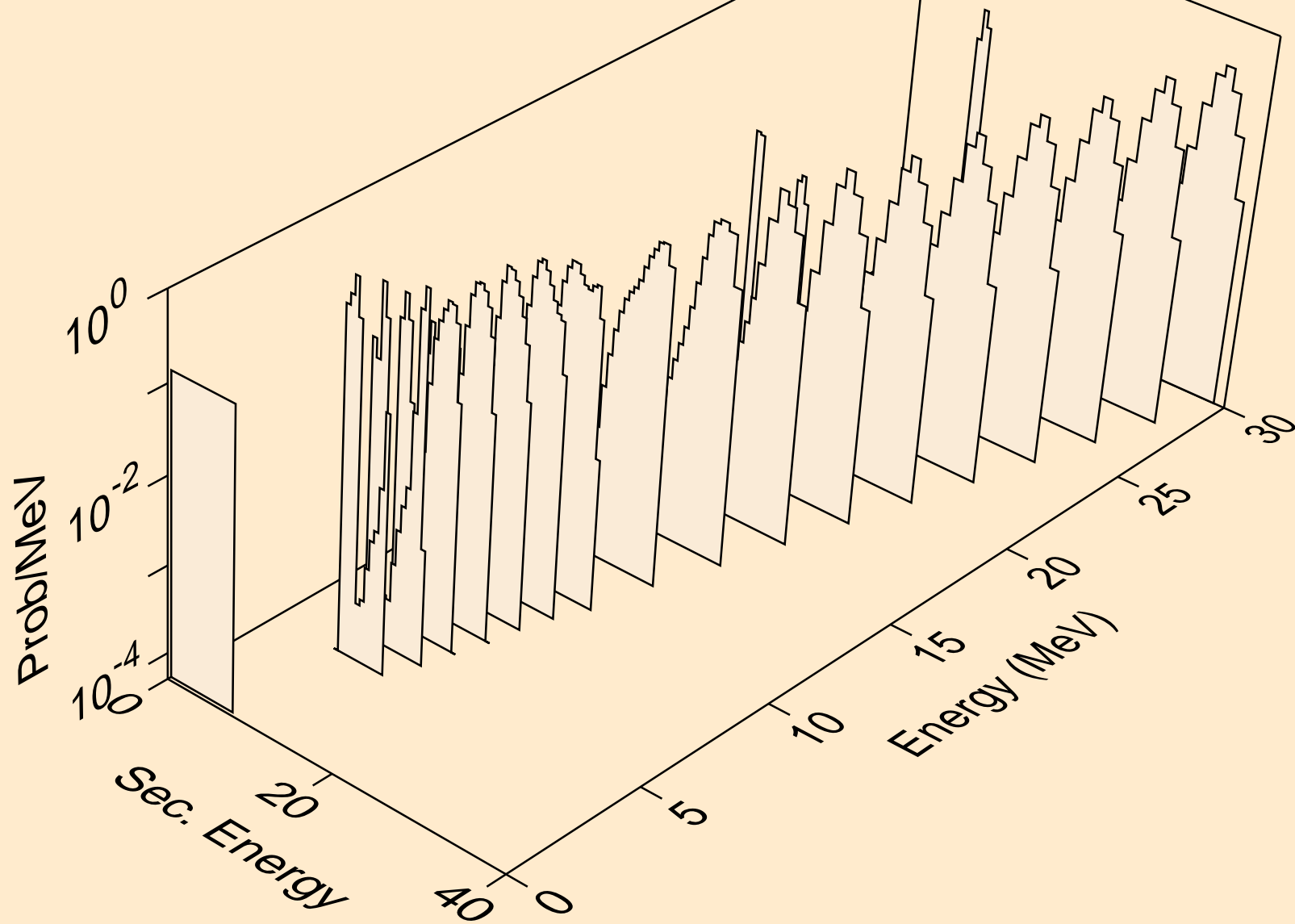

NP228 DEUTERON ACER TENDL-2021 LIBRARY; T=0.K
alphas from (d,n*)3a

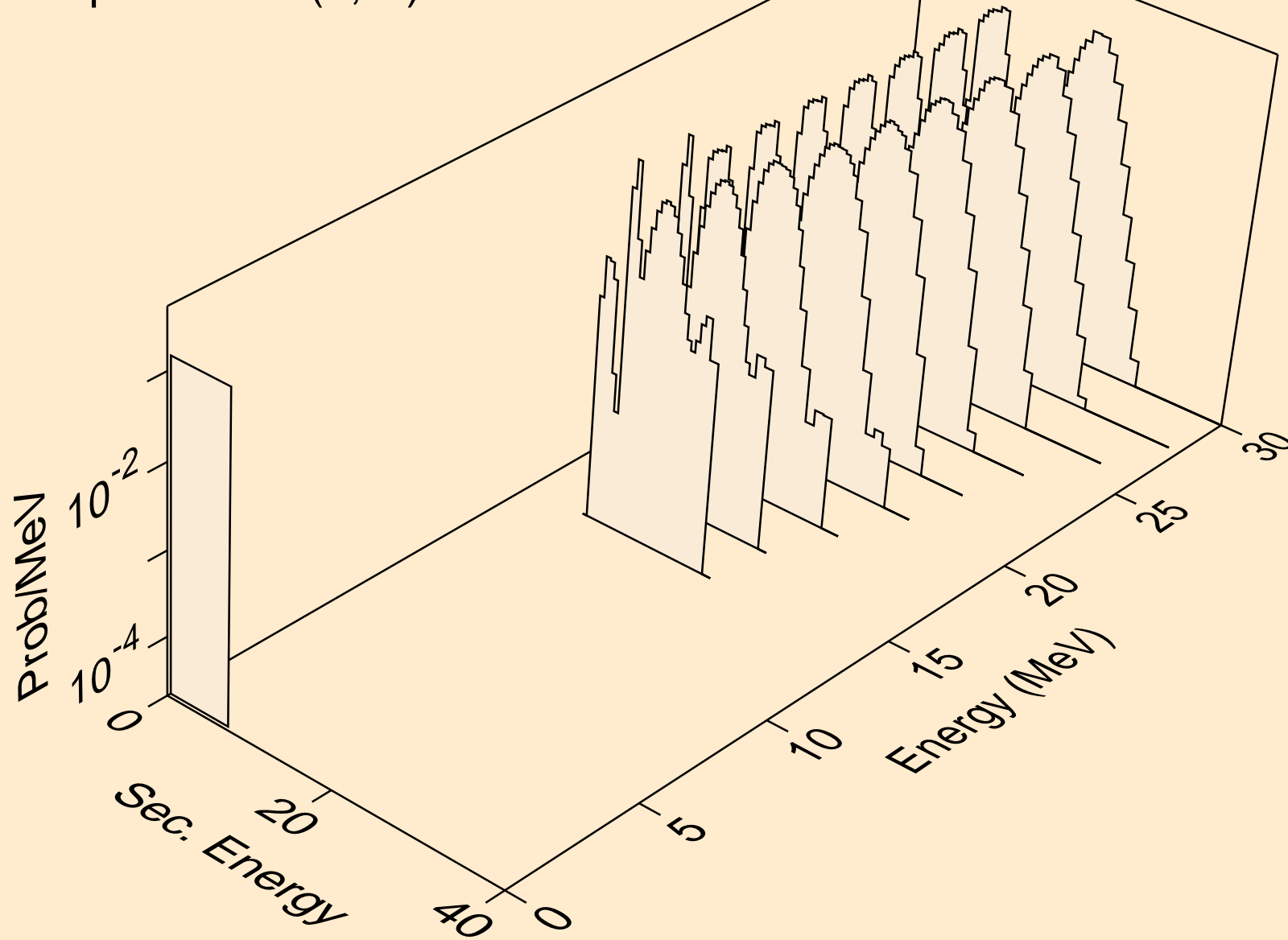

NP228 DEUTERON ACER TENDL-2021 LIBRARY; T=0.K
alphas from (d,2n)a

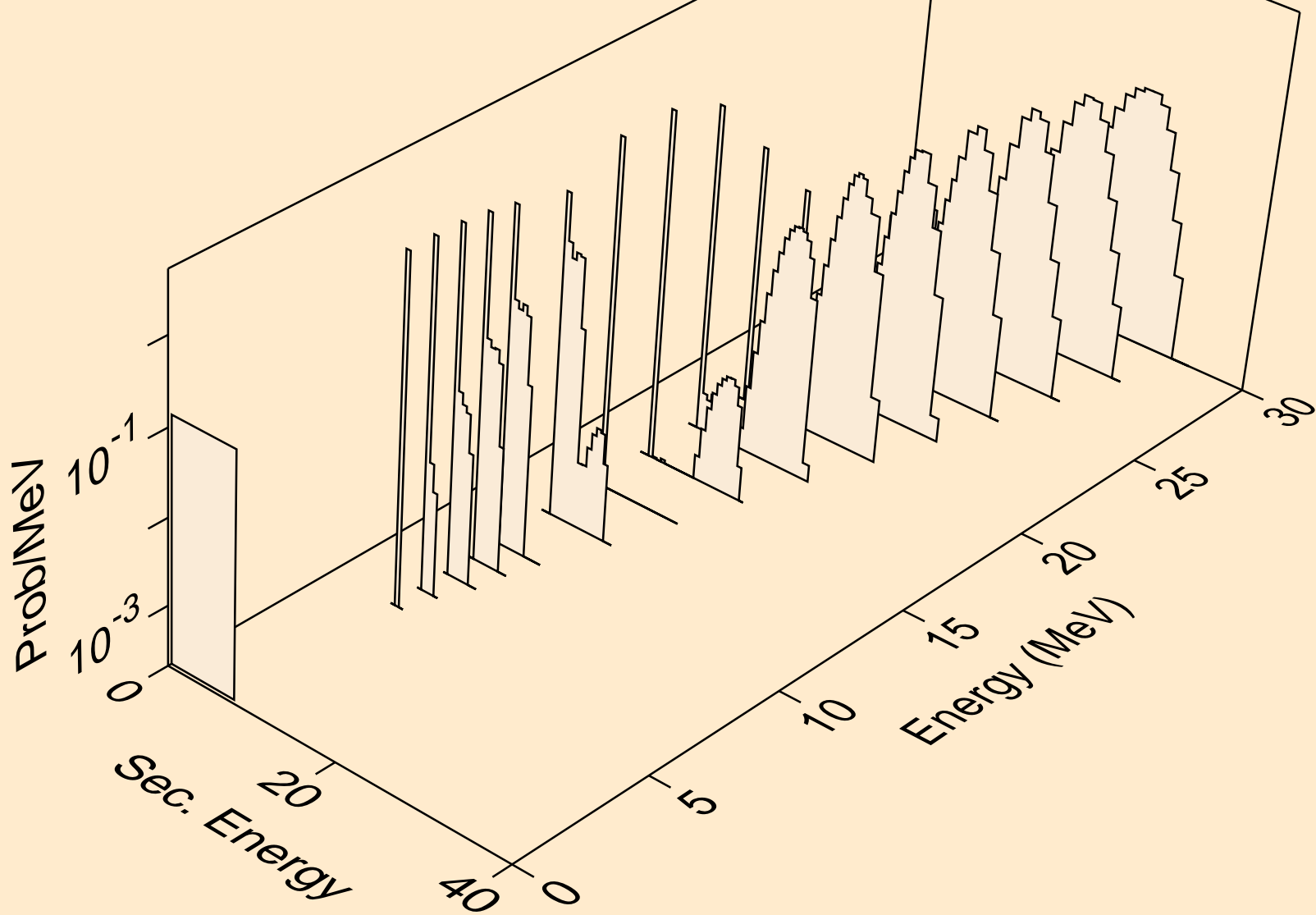

NP228 DEUTERON ACER TENDL-2021 LIBRARY; T=0.K
alphas from (d,3n)a

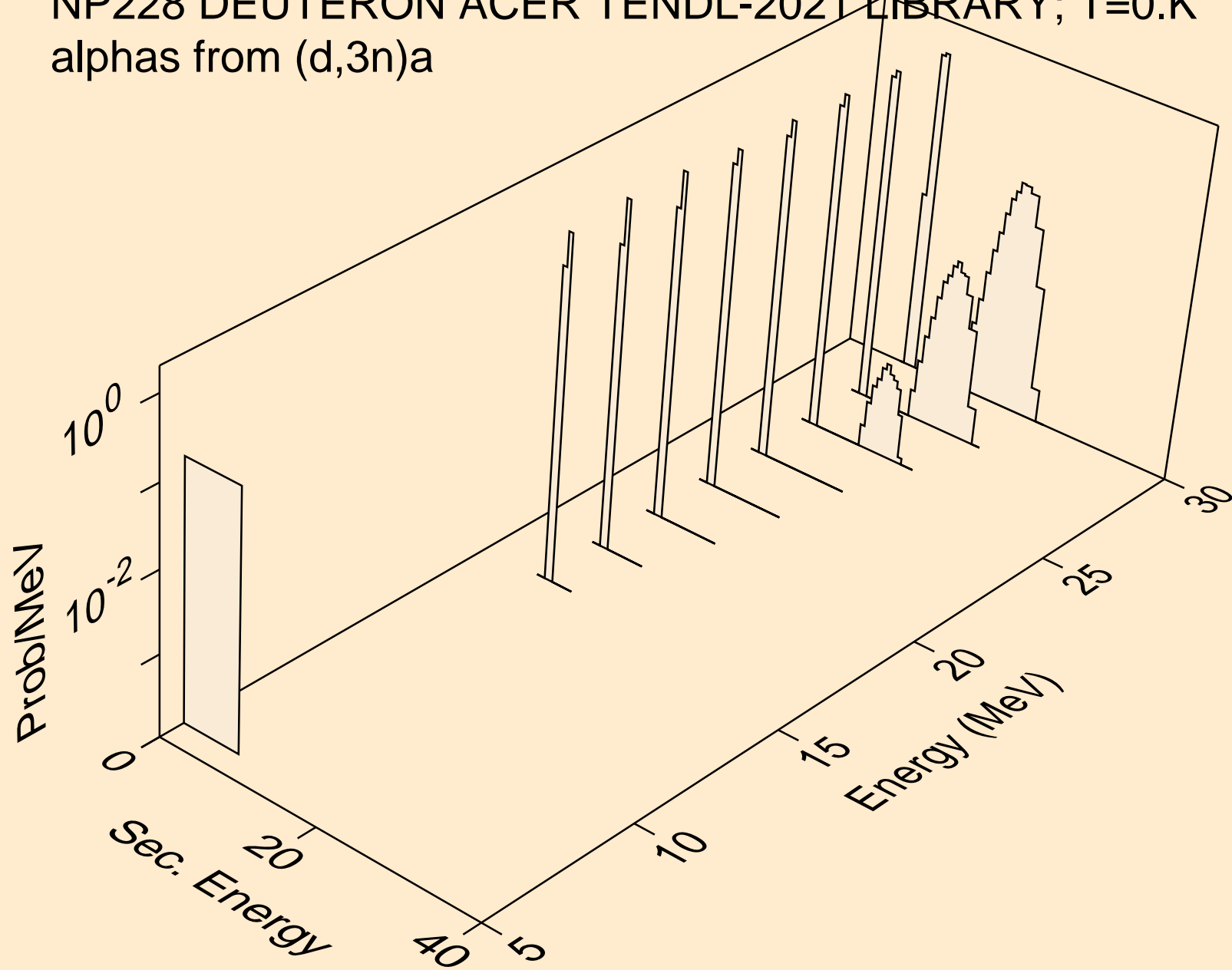

NP228 DEUTERON ACER TENDL-2021 LIBRARY; T=0.K
alphas from (d,n*)2a

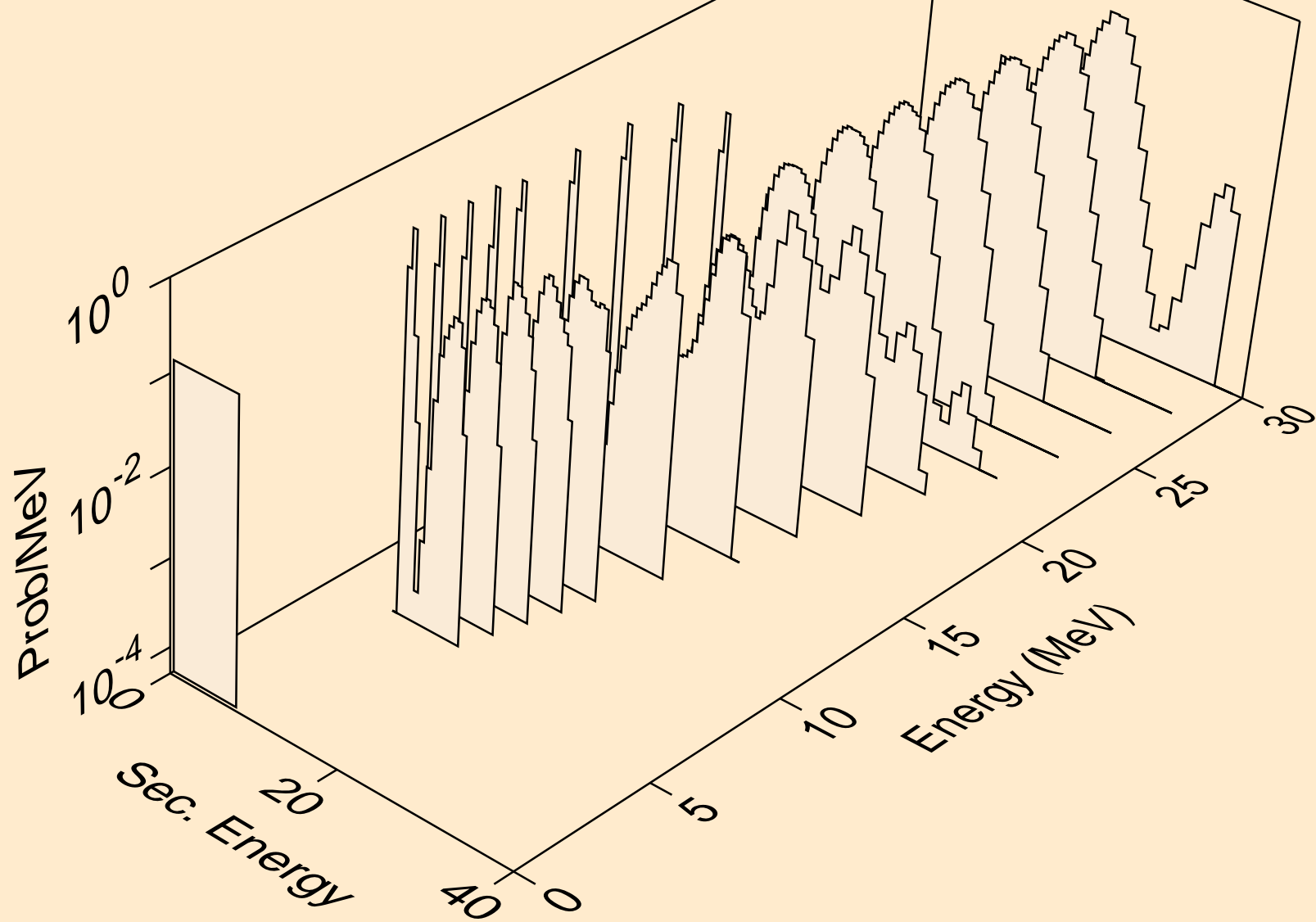

NP228 DEUTERON ACER TENDL-2021 LIBRARY; T=0.K
alphas from (d,2n)2a

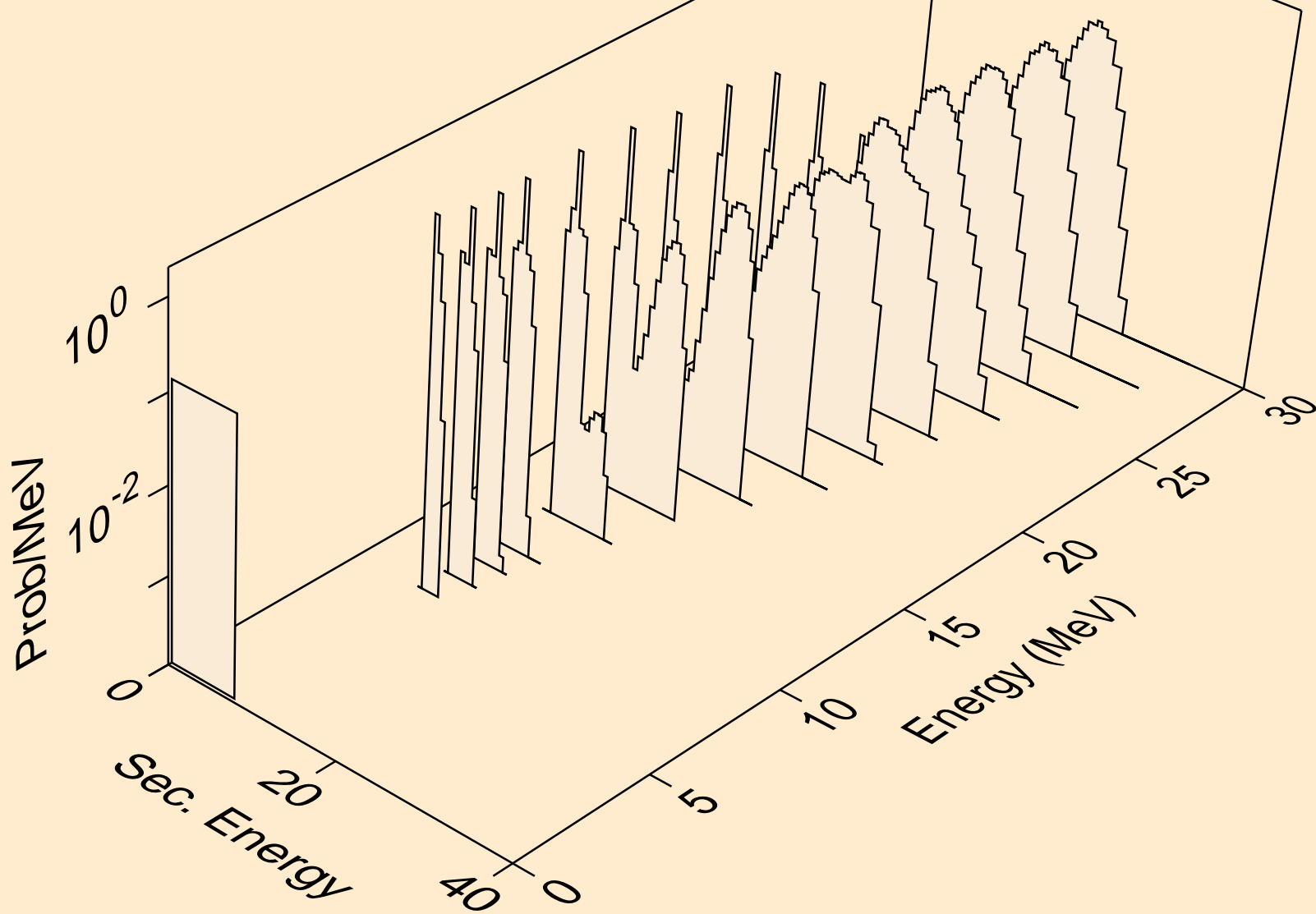

NP228 DEUTERON ACER TENDL-2021 LIBRARY; T=0.K
alphas from (d,npa)

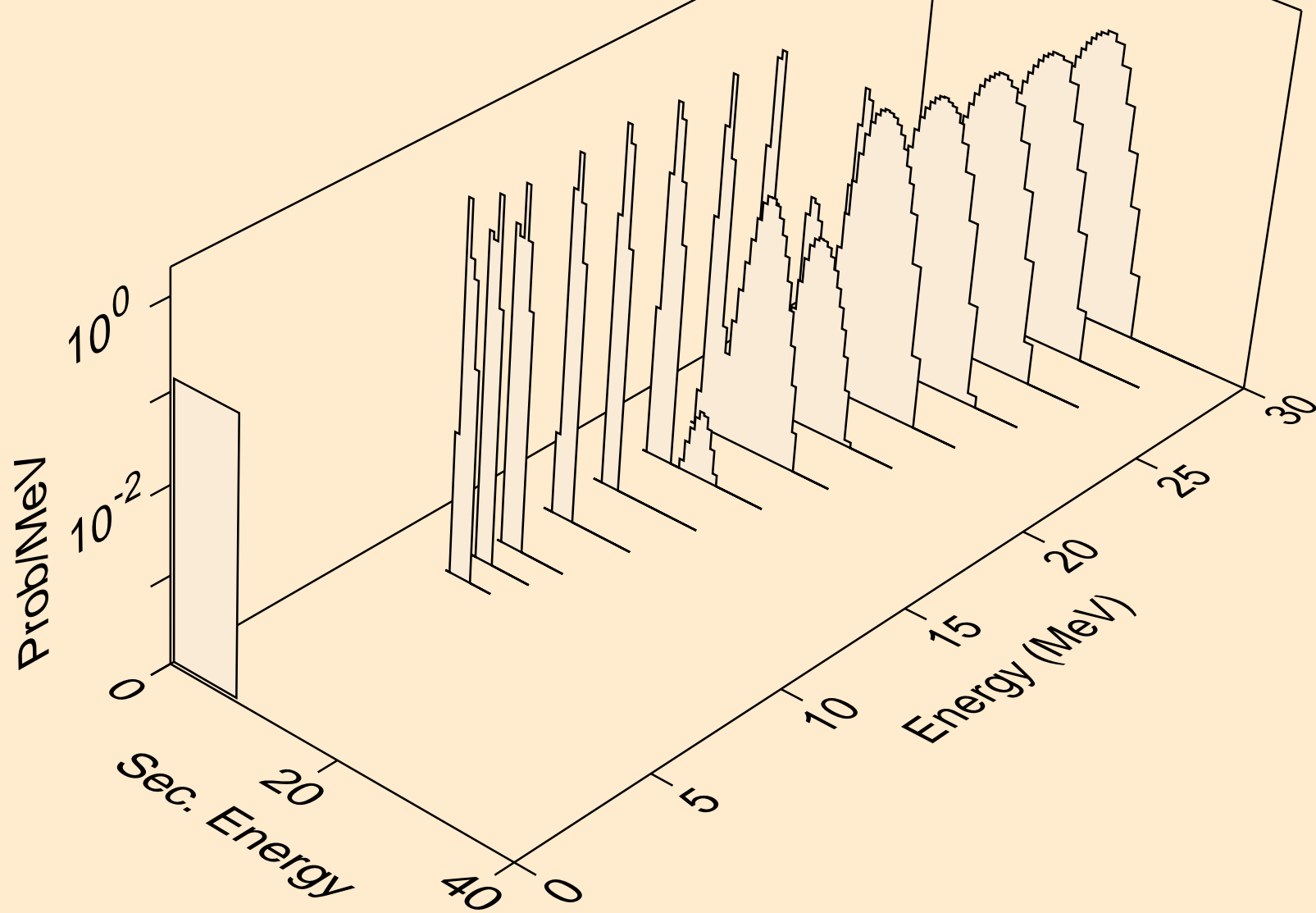

NP228 DEUTERON ACER TENDL-2021 LIBRARY; T=0.K
alphas from (d,a)

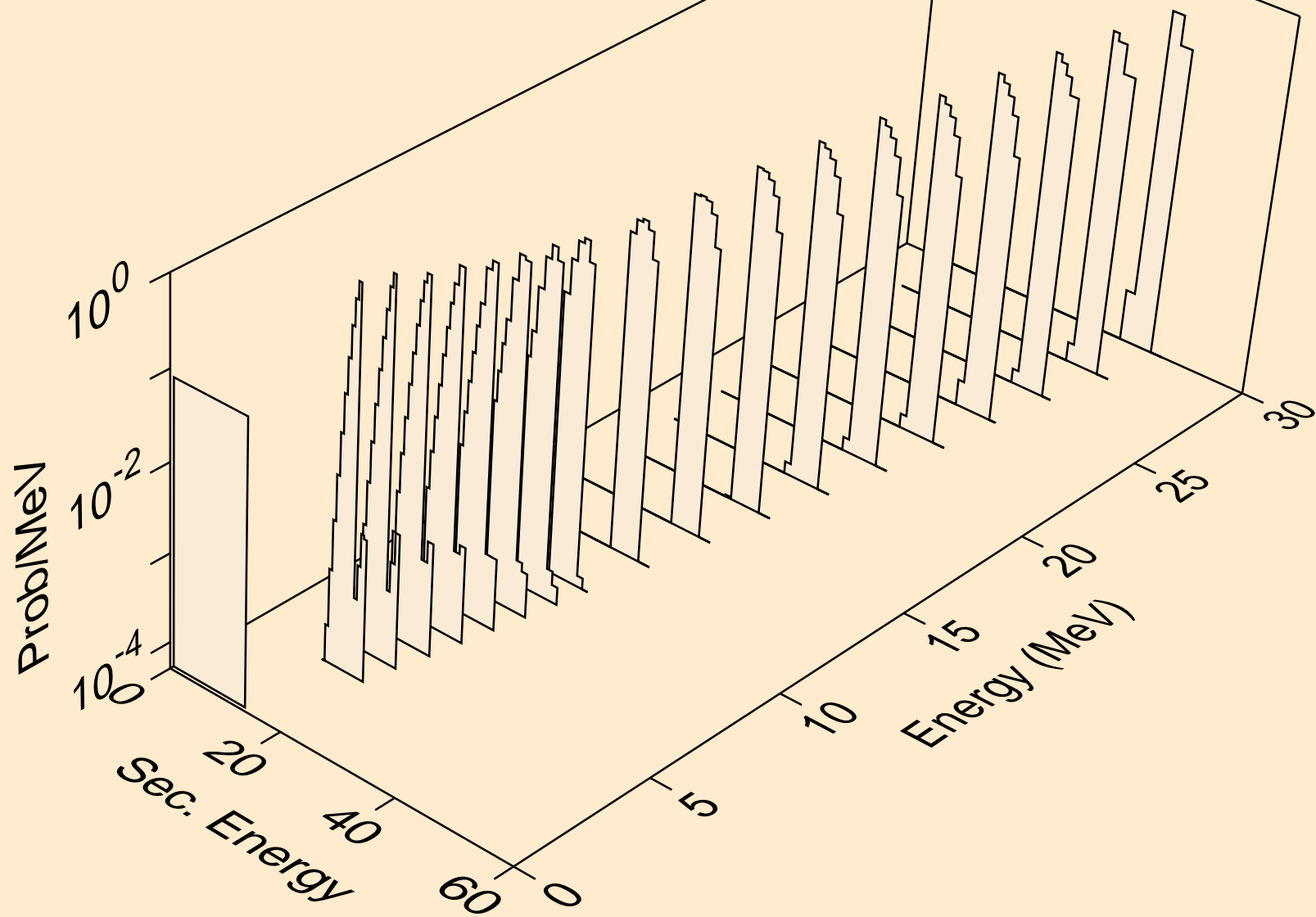

NP228 DEUTERON ACER TENDL-2021 LIBRARY; T=0.K
alphas from (d,2a)

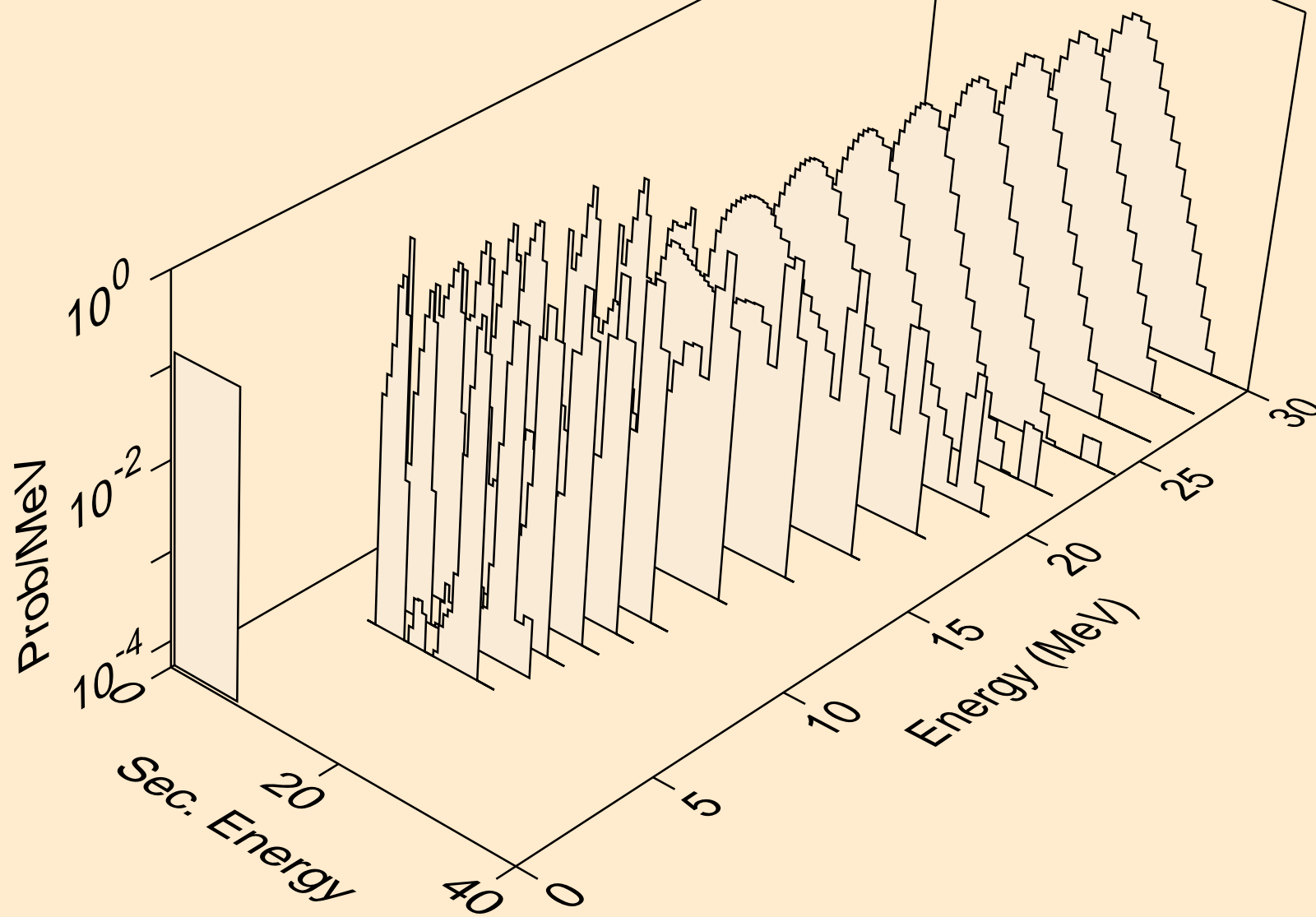

NP228 DEUTERON ACER TENDL-2021 LIBRARY; T=0.K
alphas from (d,3a)

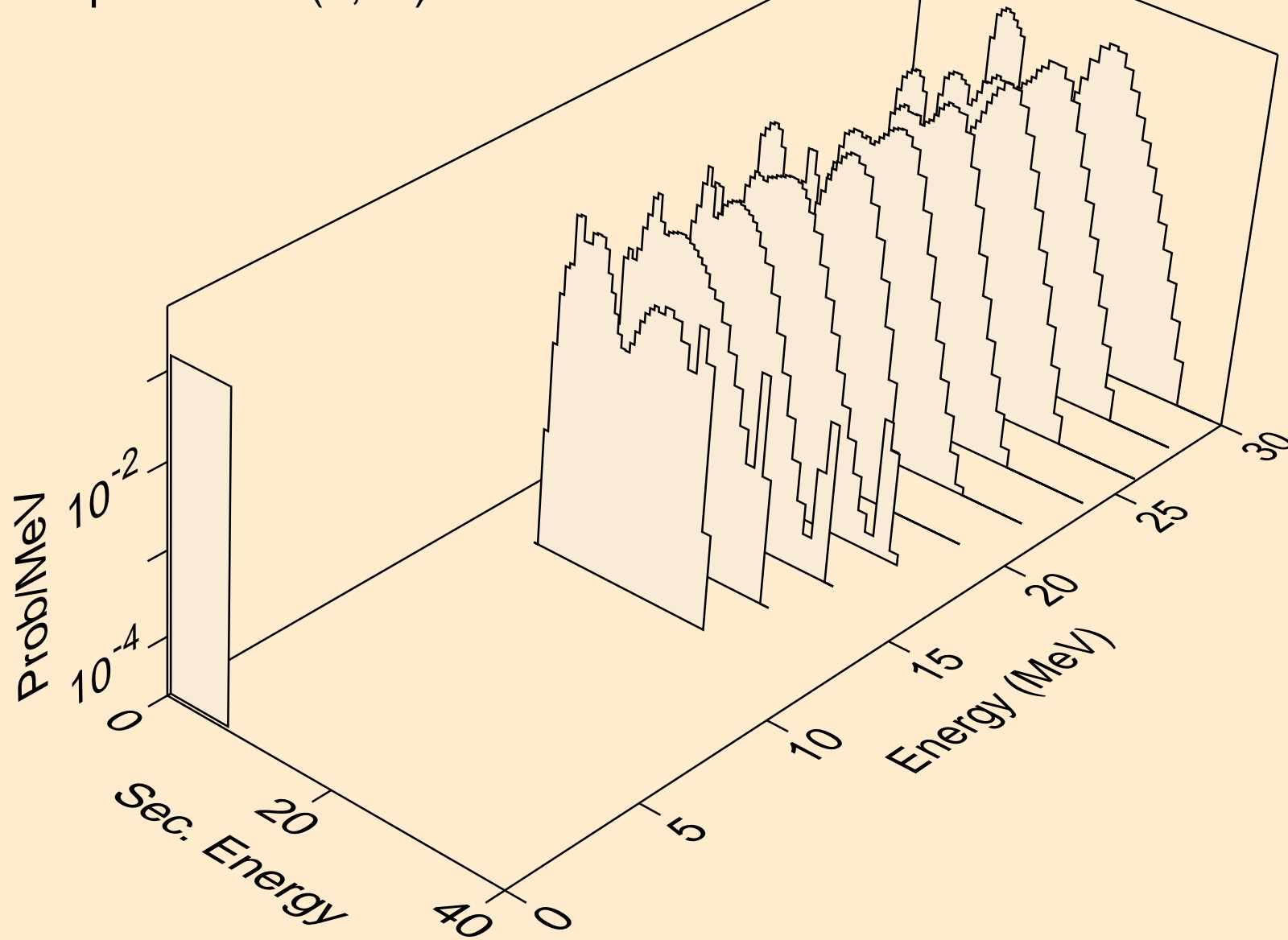

NP228 DEUTERON ACER TENDL-2021 LIBRARY; T=0.K
alphas from (d,pa)

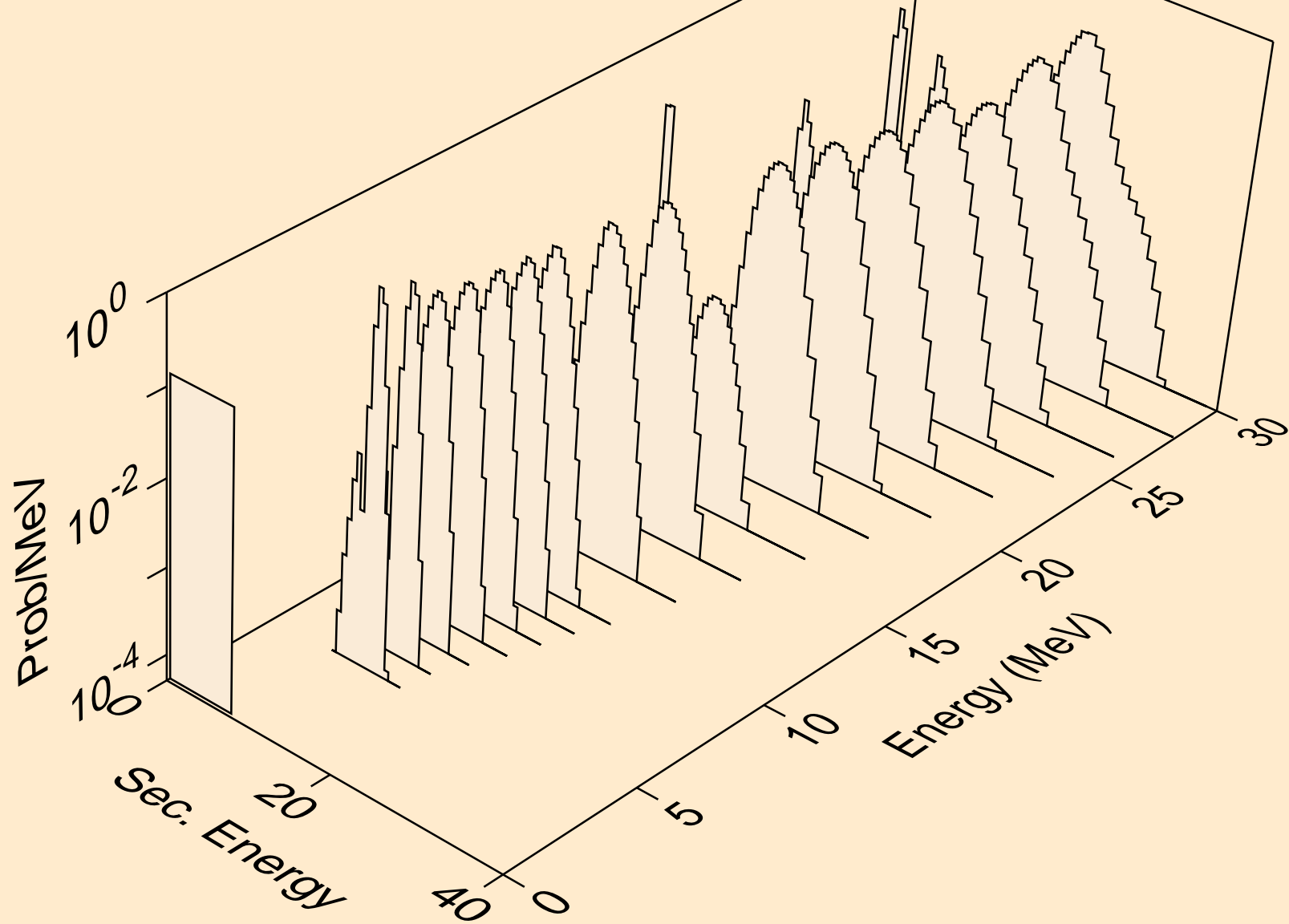

NP228 DEUTERON ACER TENDL-2021 LIBRARY; T=0.K
alphas from (d,da)

