

PM129 DEUTERON ACER TENDL-2021 LIBRARY; T=0.K

Principal cross sections

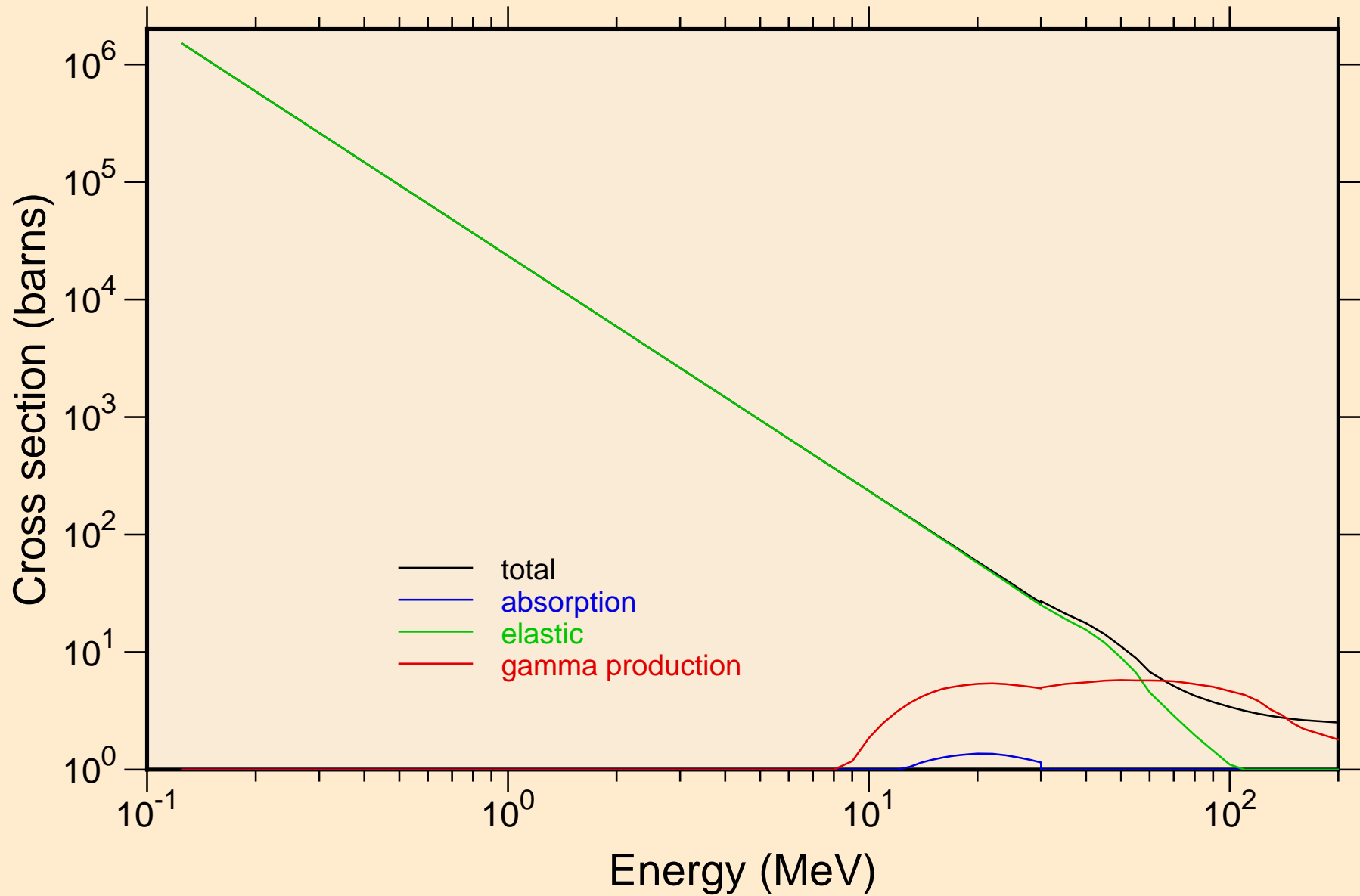

PM129 DEUTERON ACER TENDL-2021 LIBRARY; T=0.K
Heating

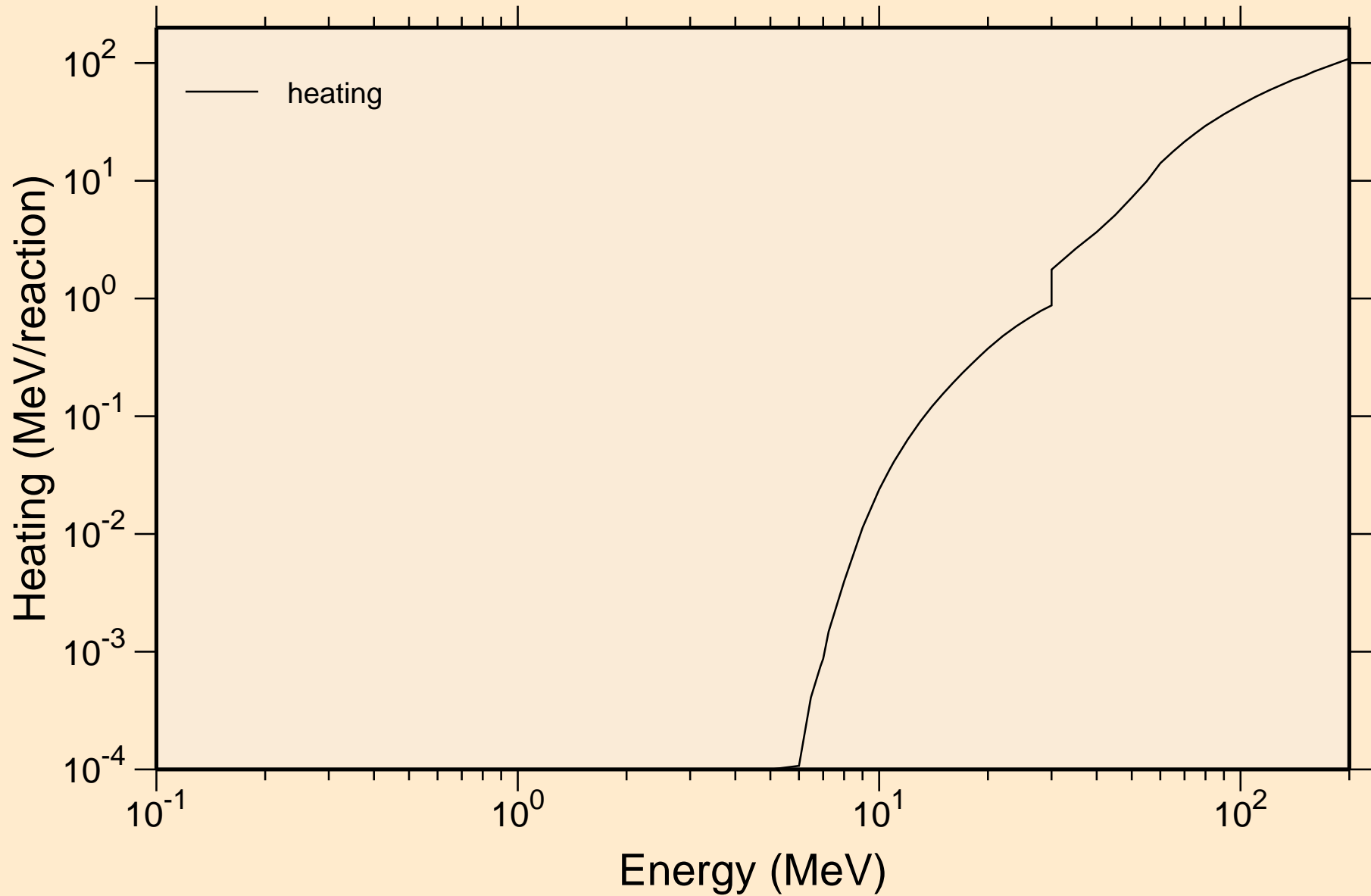

PM129 DEUTERON ACER TENDL-2021 LIBRARY; T=0.K
Principal cross sections

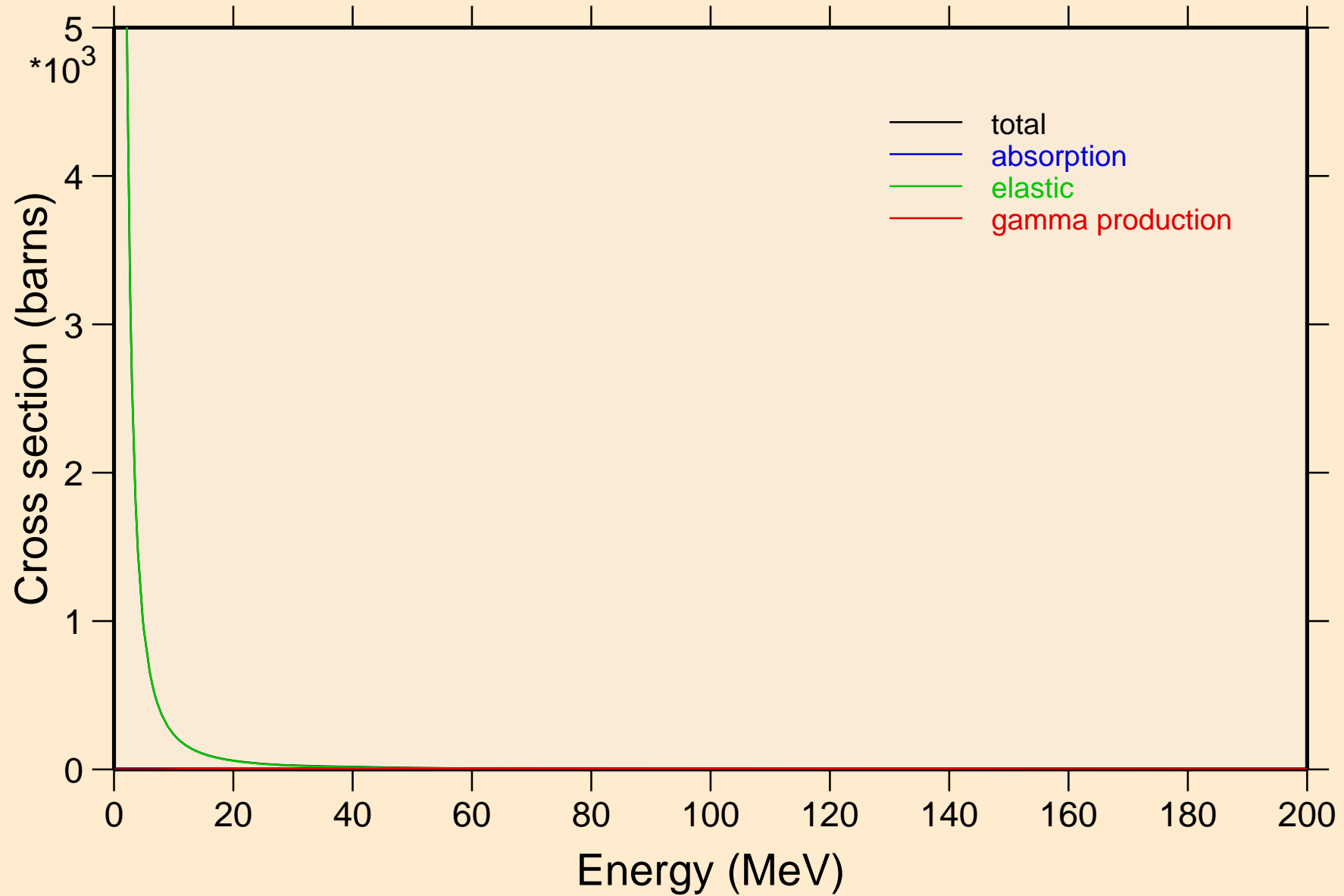

PM129 DEUTERON ACER TENDL-2021 LIBRARY; T=0.K
Heating

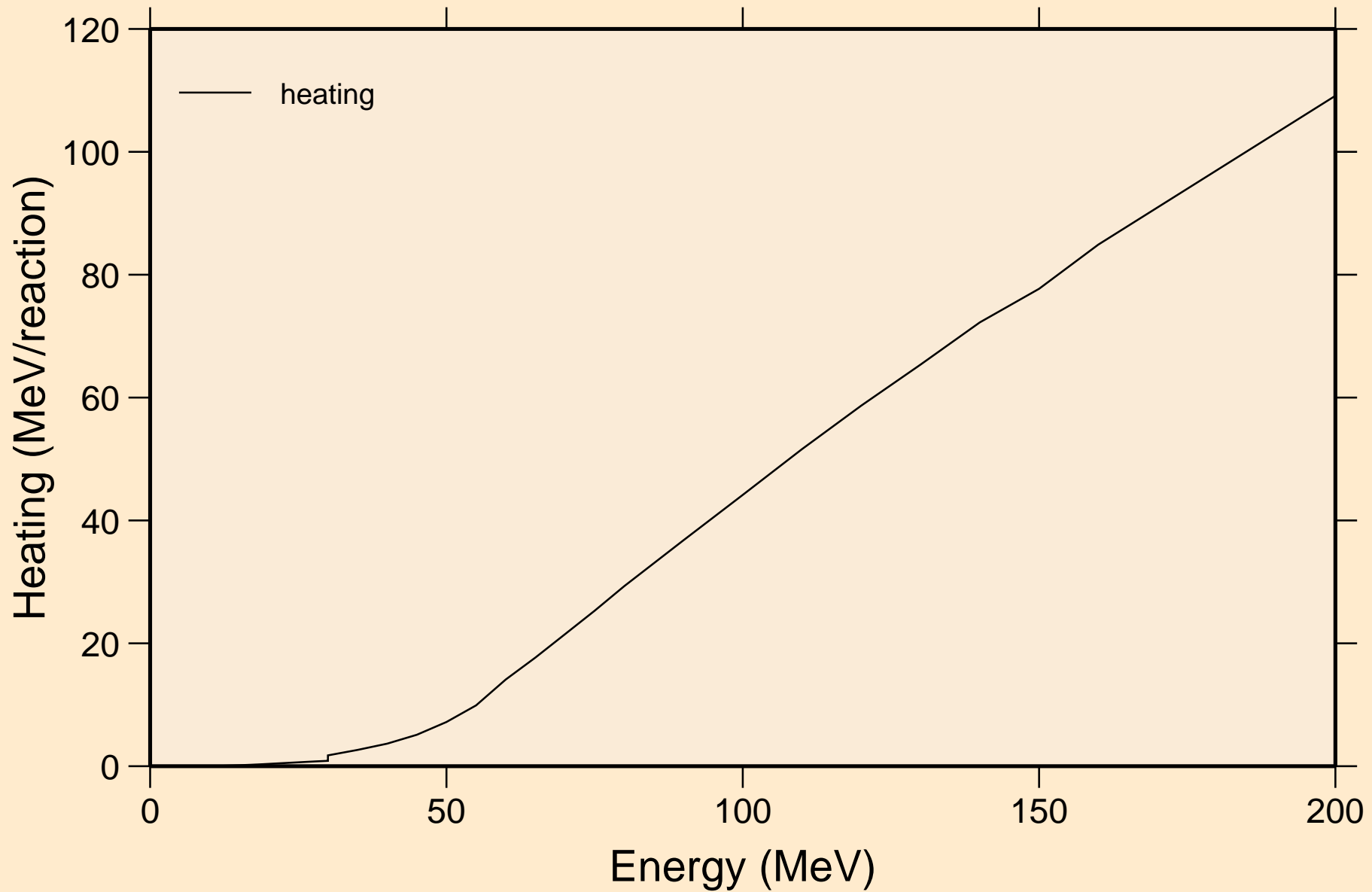

PM129 DEUTERON ACER TENDL-2021 LIBRARY; T=0.K

Threshold reactions

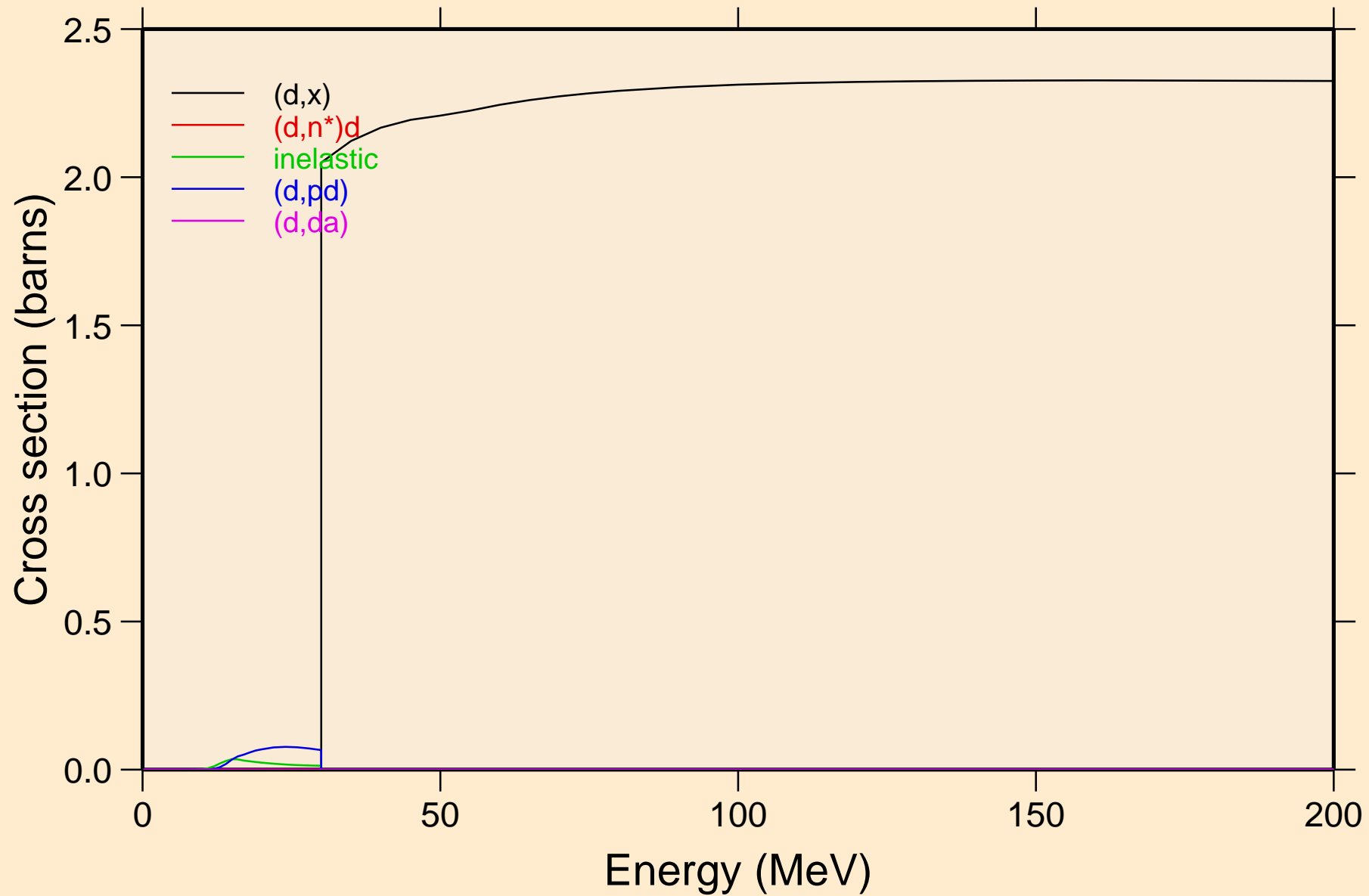

PM129 DEUTERON ACER TENDL-2021 LIBRARY; T=0.K
angular distribution for elastic

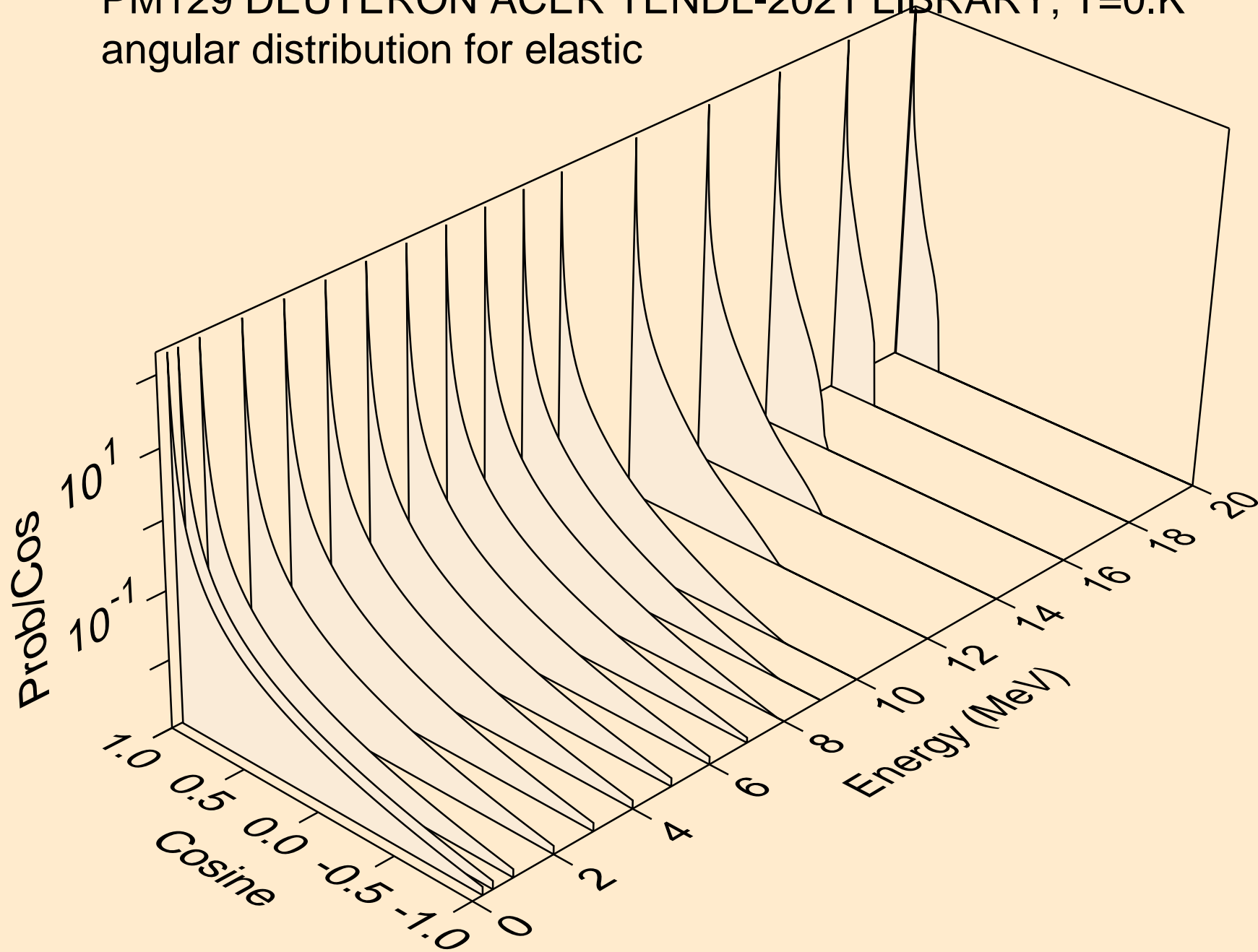

PM129 DEUTERON ACER TENDL-2021 LIBRARY; T=0.K
angular distribution for elastic

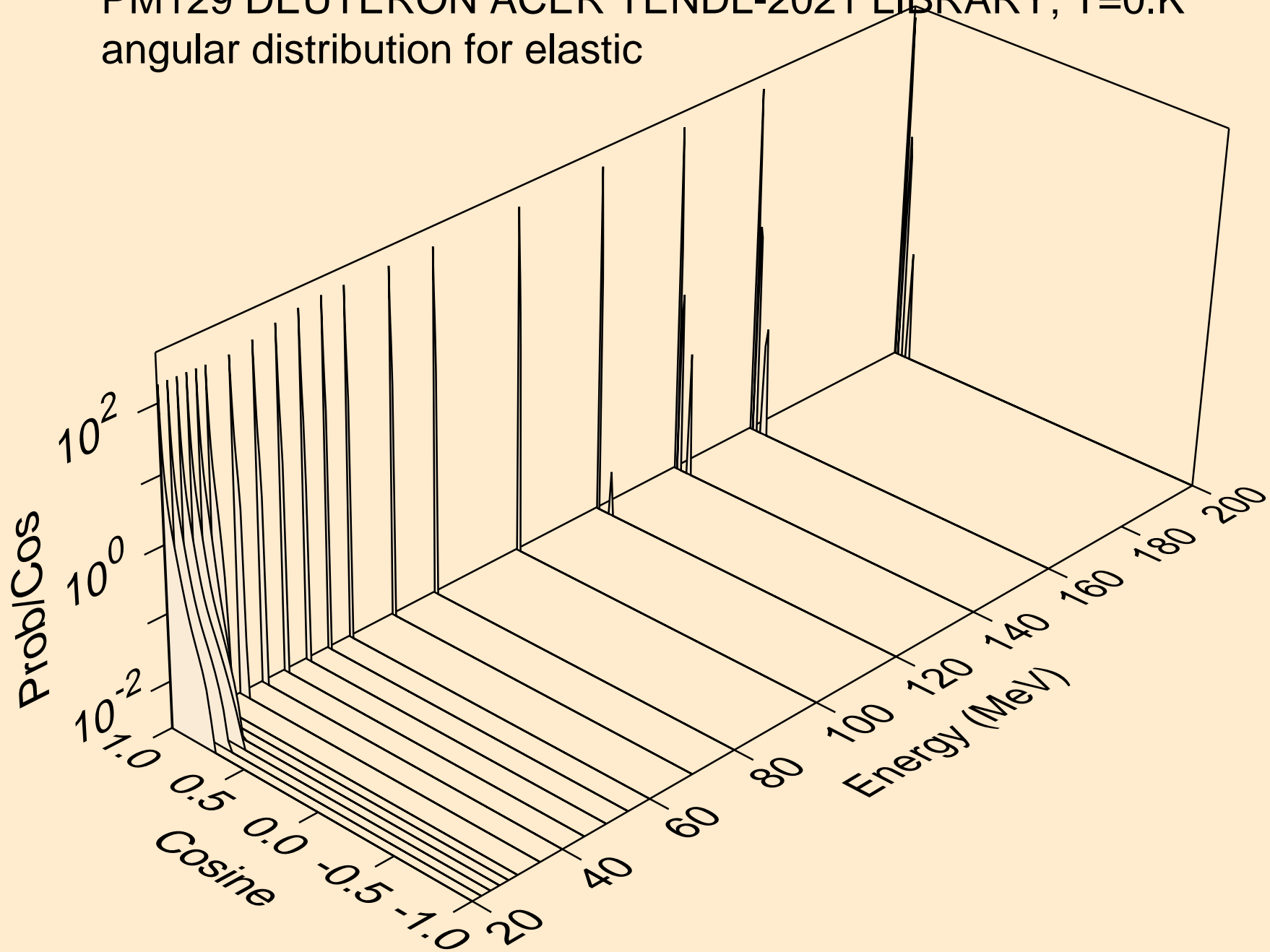

PM129 DEUTERON ACER TENDL-2021 LIBRARY; T=0.K
Deuteron emission for (d,x)

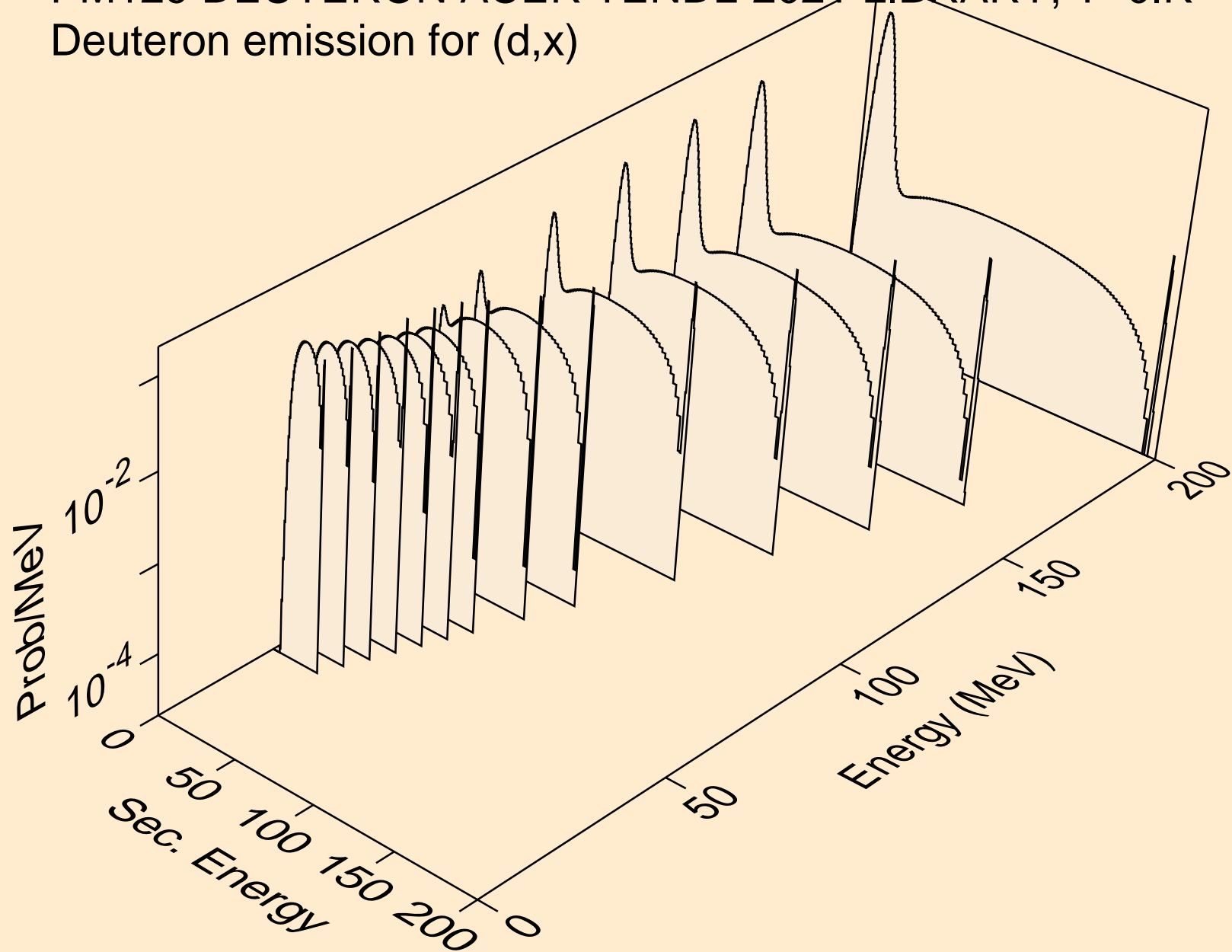

PM129 DEUTERON ACER TENDL-2021 LIBRARY; T=0.K
Deuteron emission for (d,n*)d

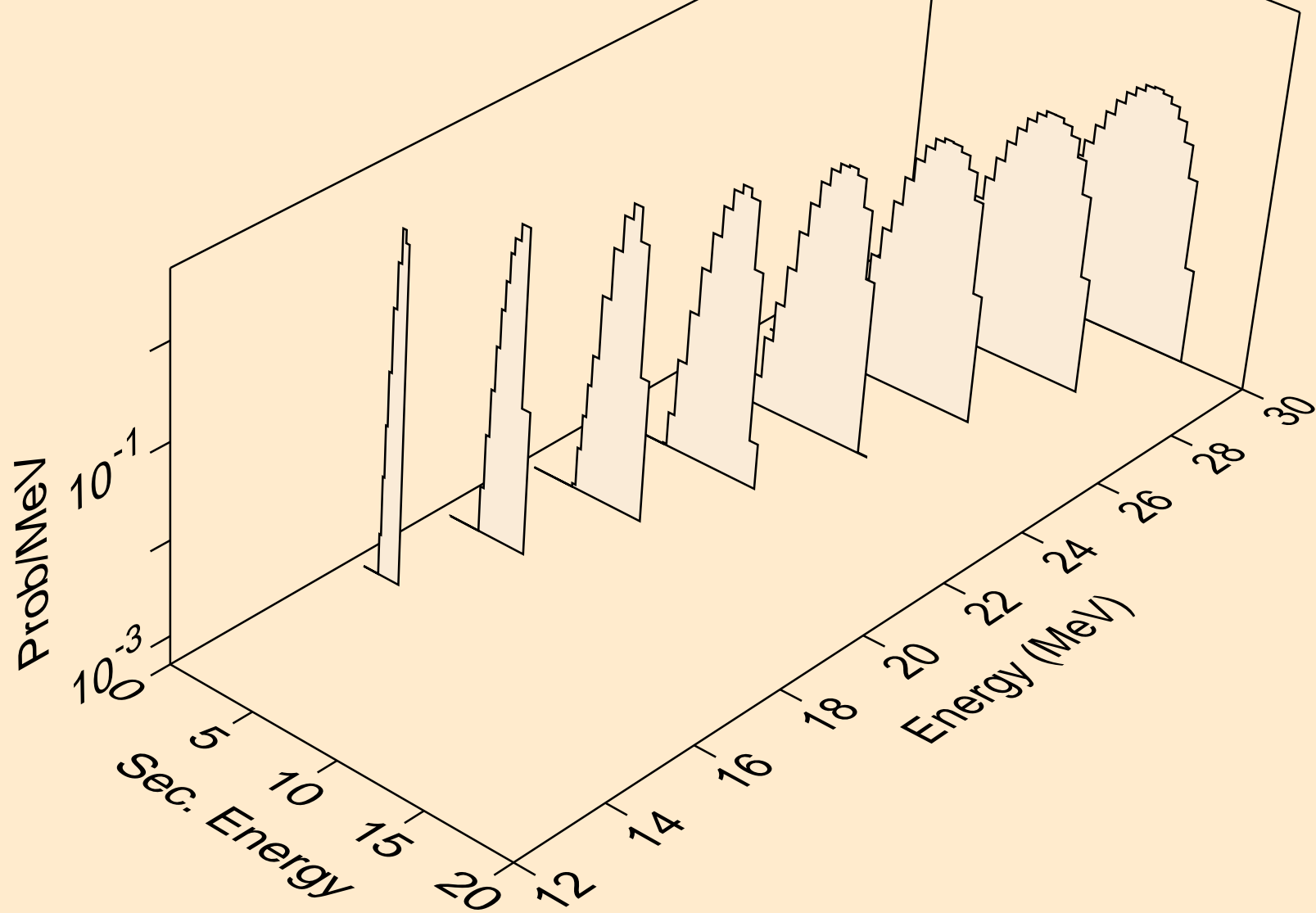

PM129 DEUTERON ACER TENDL-2021 LIBRARY; T=0.K
Deuteron emission for inelastic

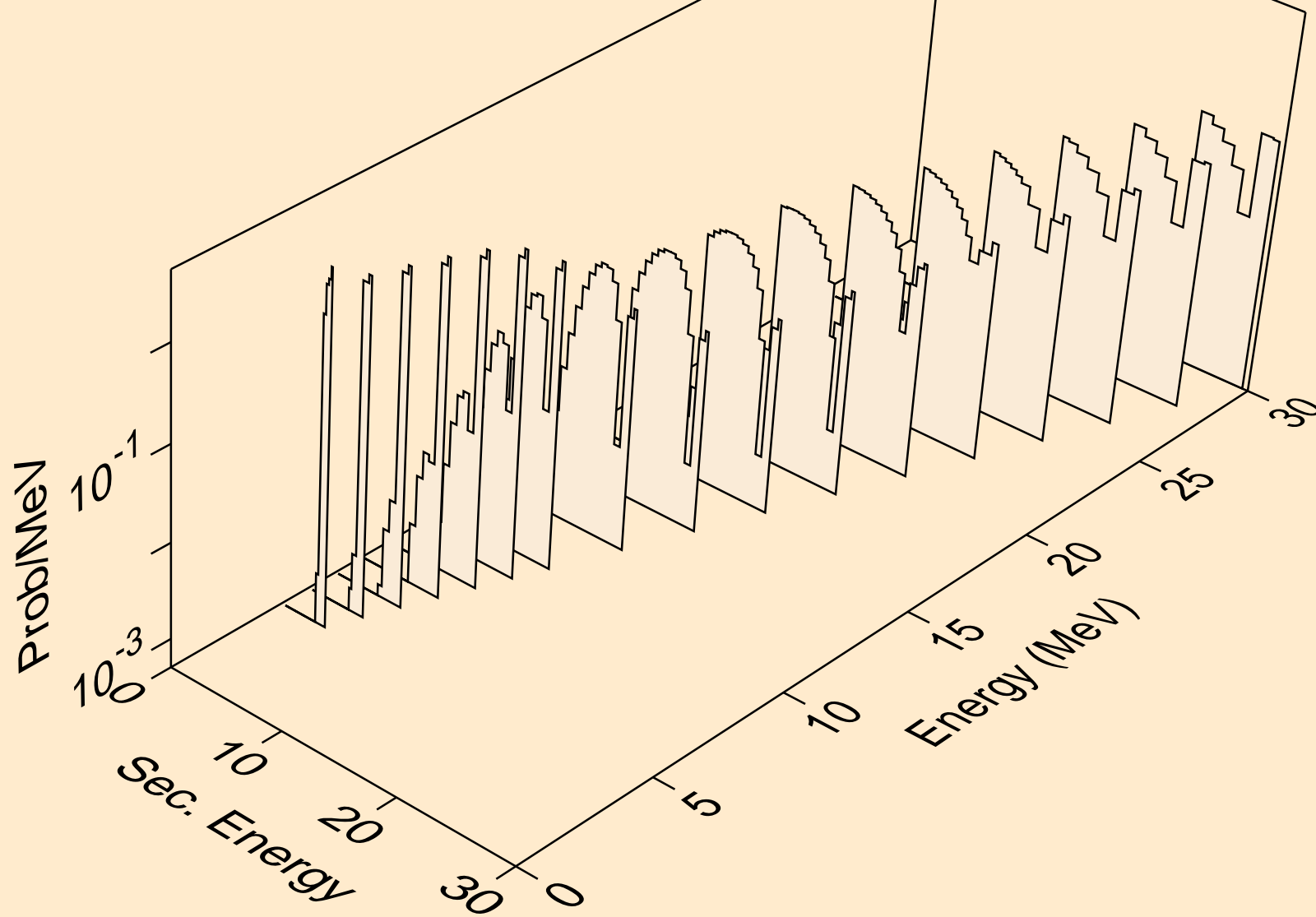

PM129 DEUTERON ACER TENDL-2021 LIBRARY; T=0.K
Deuteron emission for (d,pd)

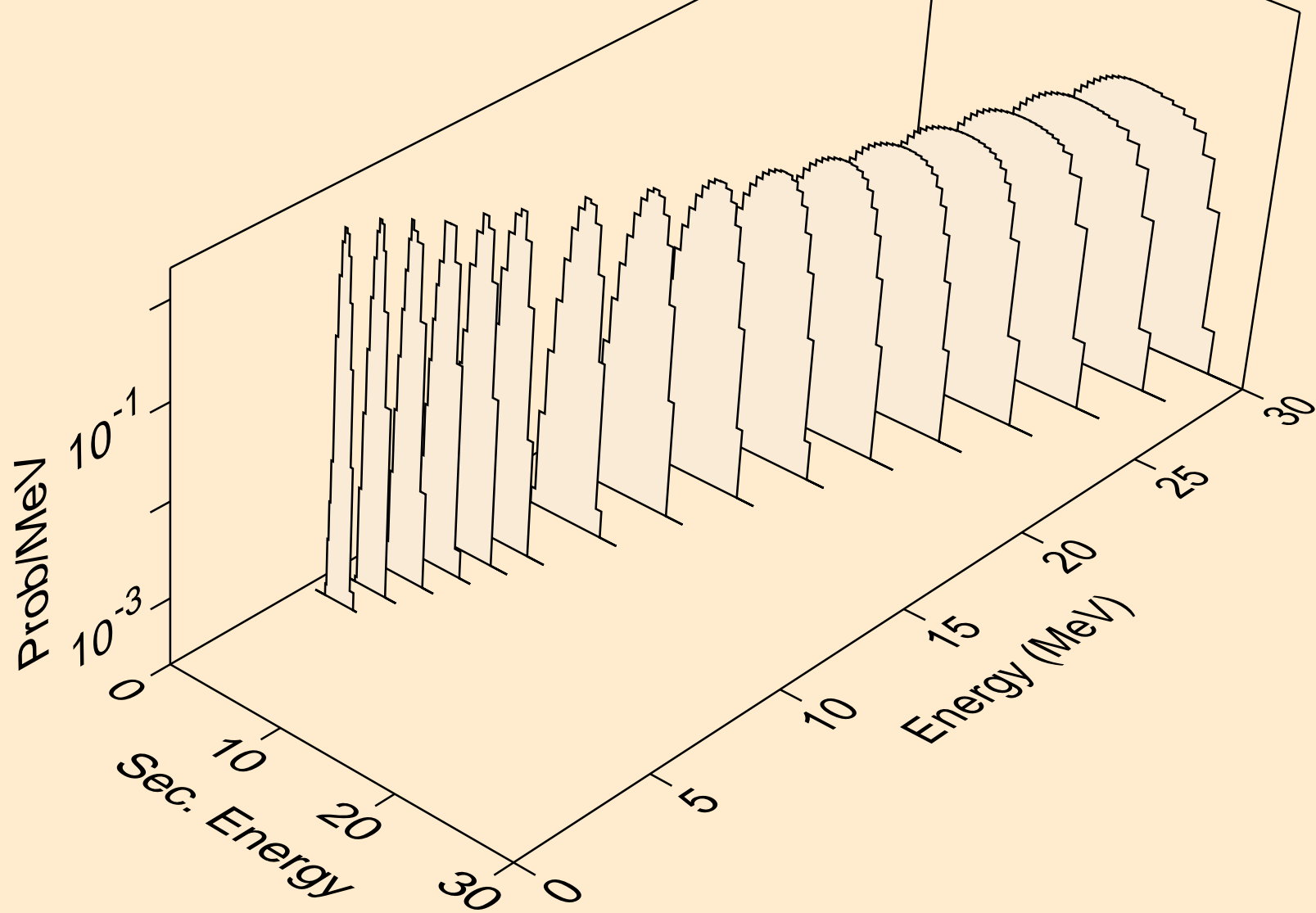

PM129 DEUTERON ACER TENDL-2021 LIBRARY; T=0.K
Deuteron emission for (d,da)

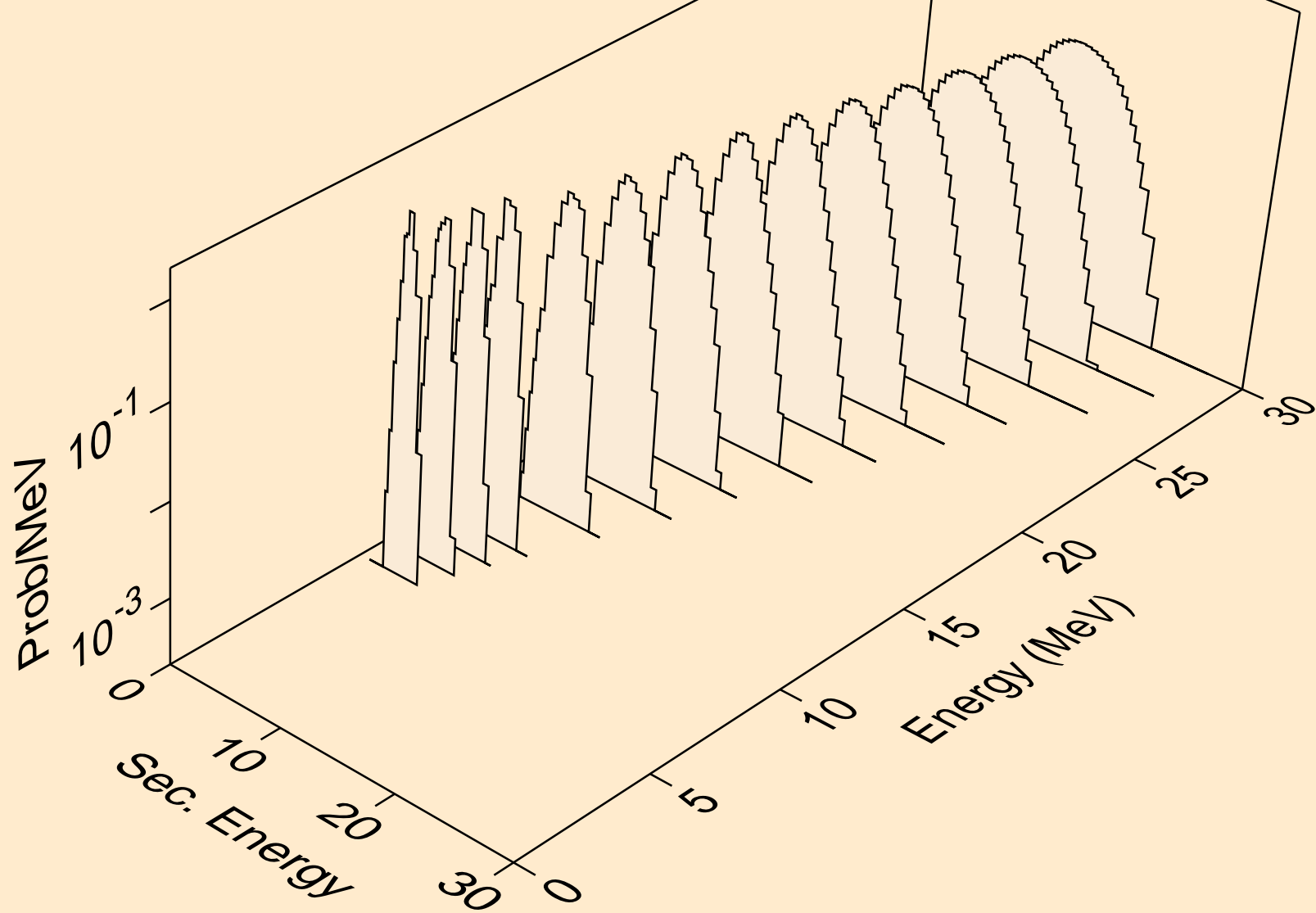

PM129 DEUTERON ACER TENDL-2021 LIBRARY; T=0.K
Photon emission for (z,n)

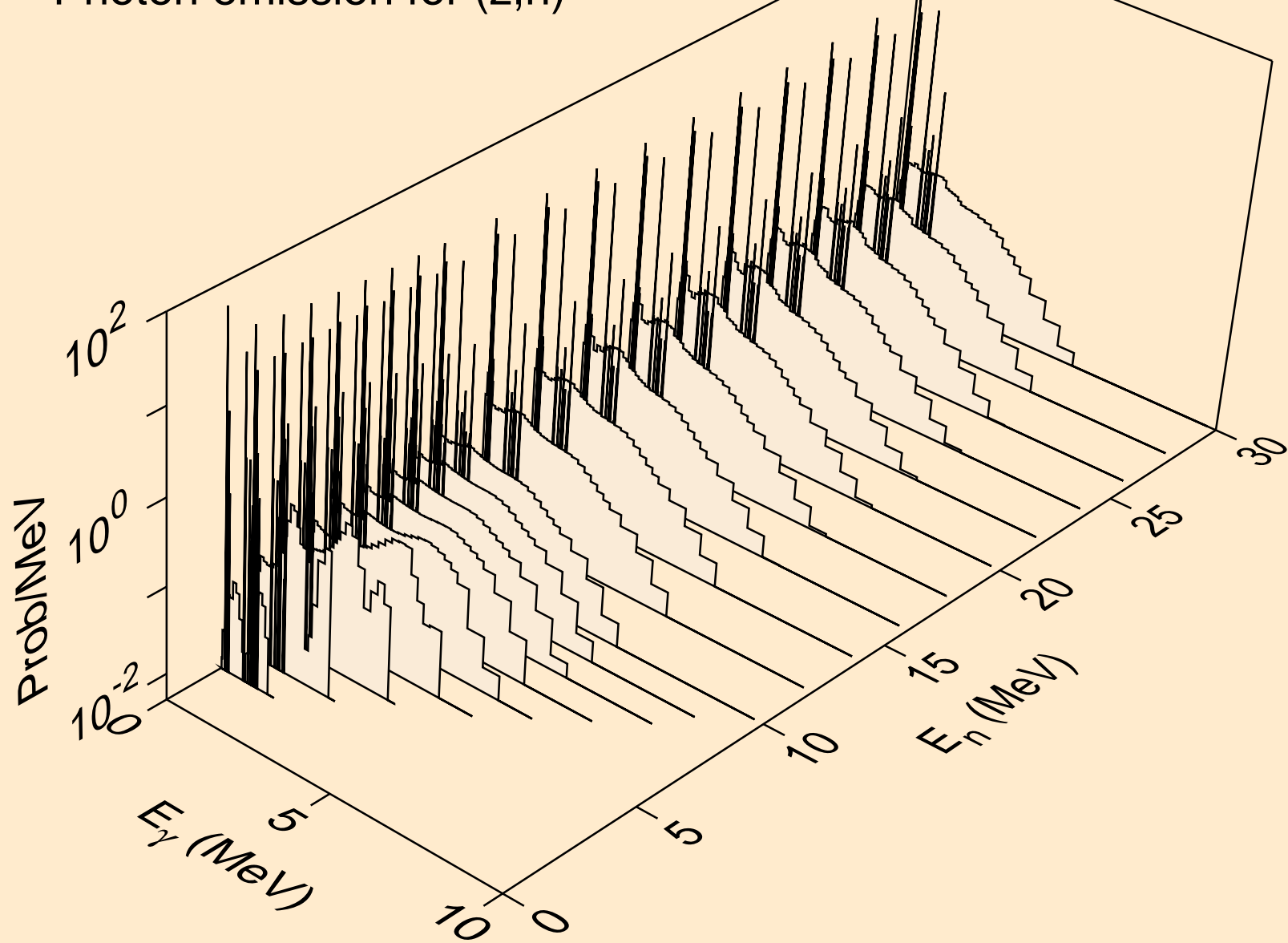

PM129 DEUTERON ACER TENDL-2021 LIBRARY; T=0.K
Photon emission for (n,x)

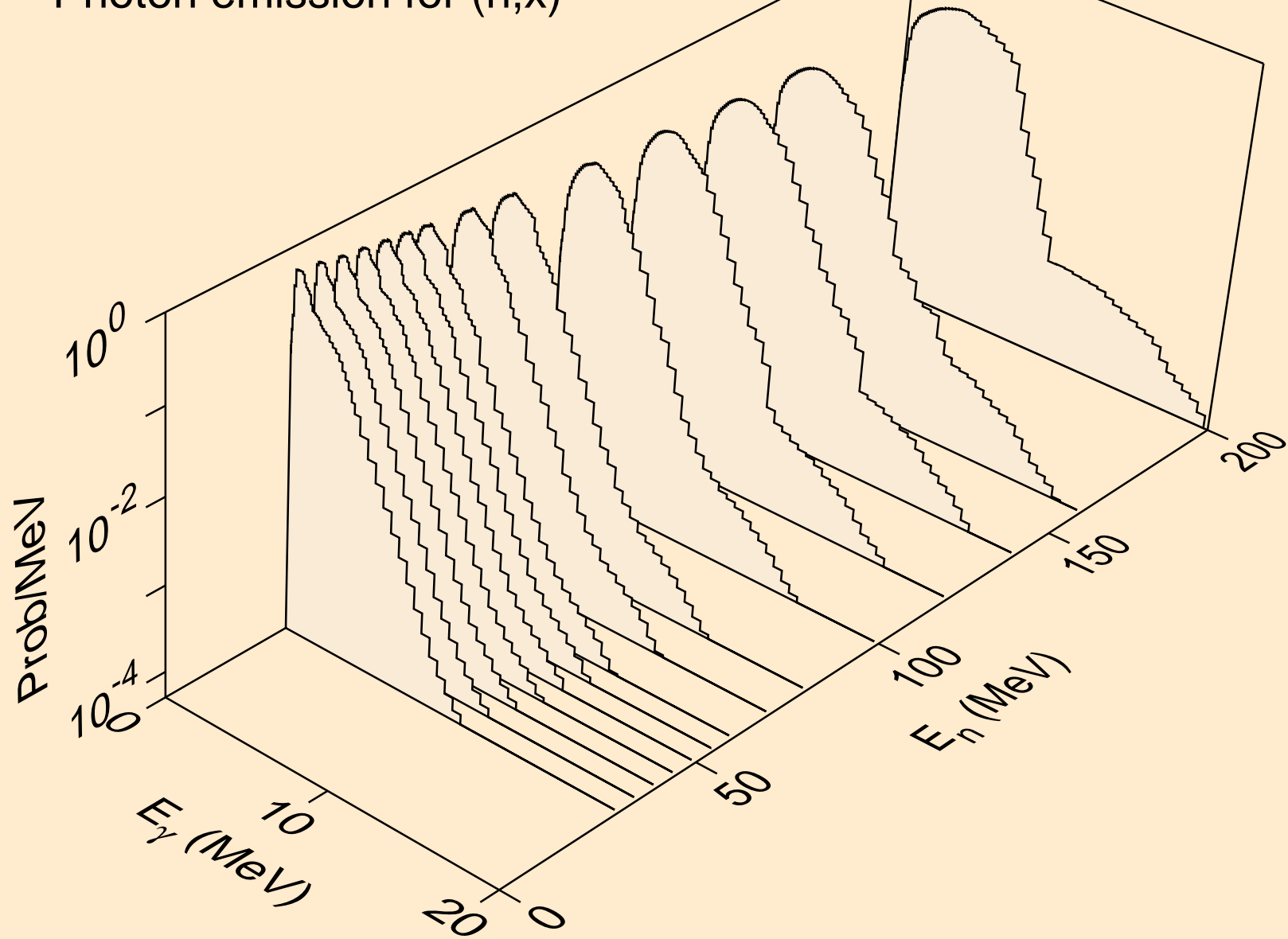

PM129 DEUTERON ACER TENDL-2021 LIBRARY; T=0.K
Photon emission for (n,2n)

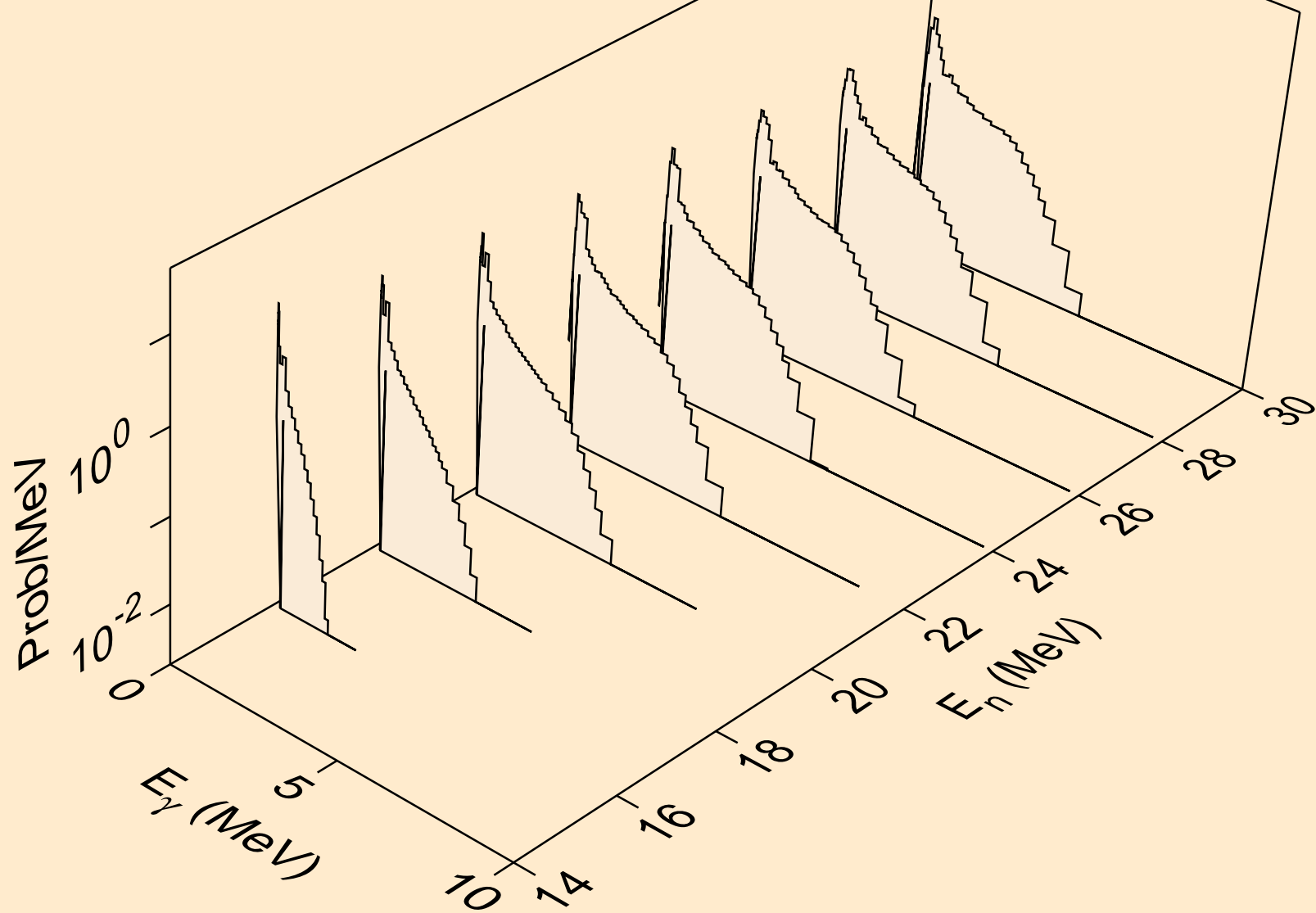

PM129 DEUTERON ACER TENDL-2021 LIBRARY; T=0.K
Photon emission for (n,3n)

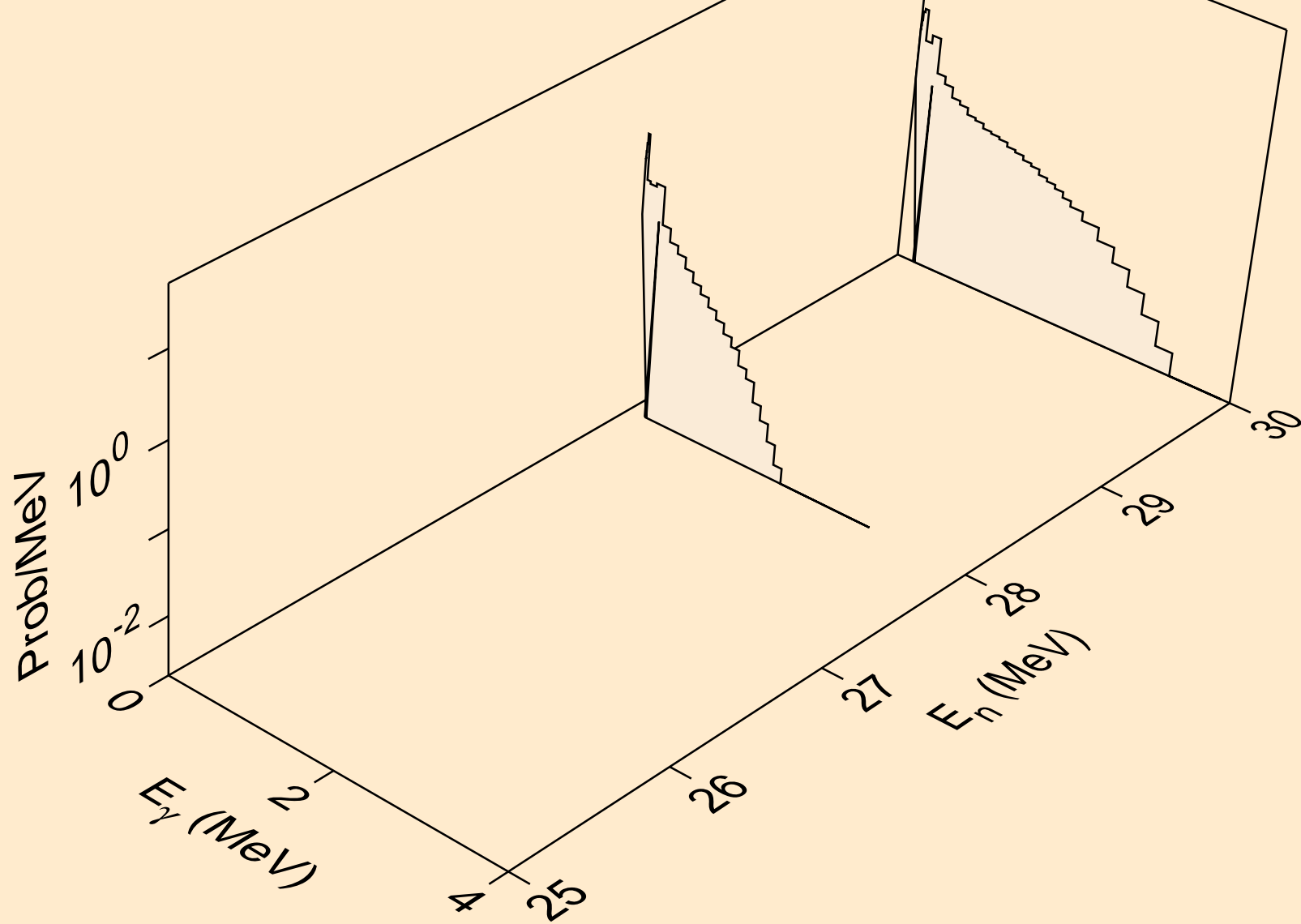

PM129 DEUTERON ACER TENDL-2021 LIBRARY; T=0.K
Photon emission for (n,n*)a

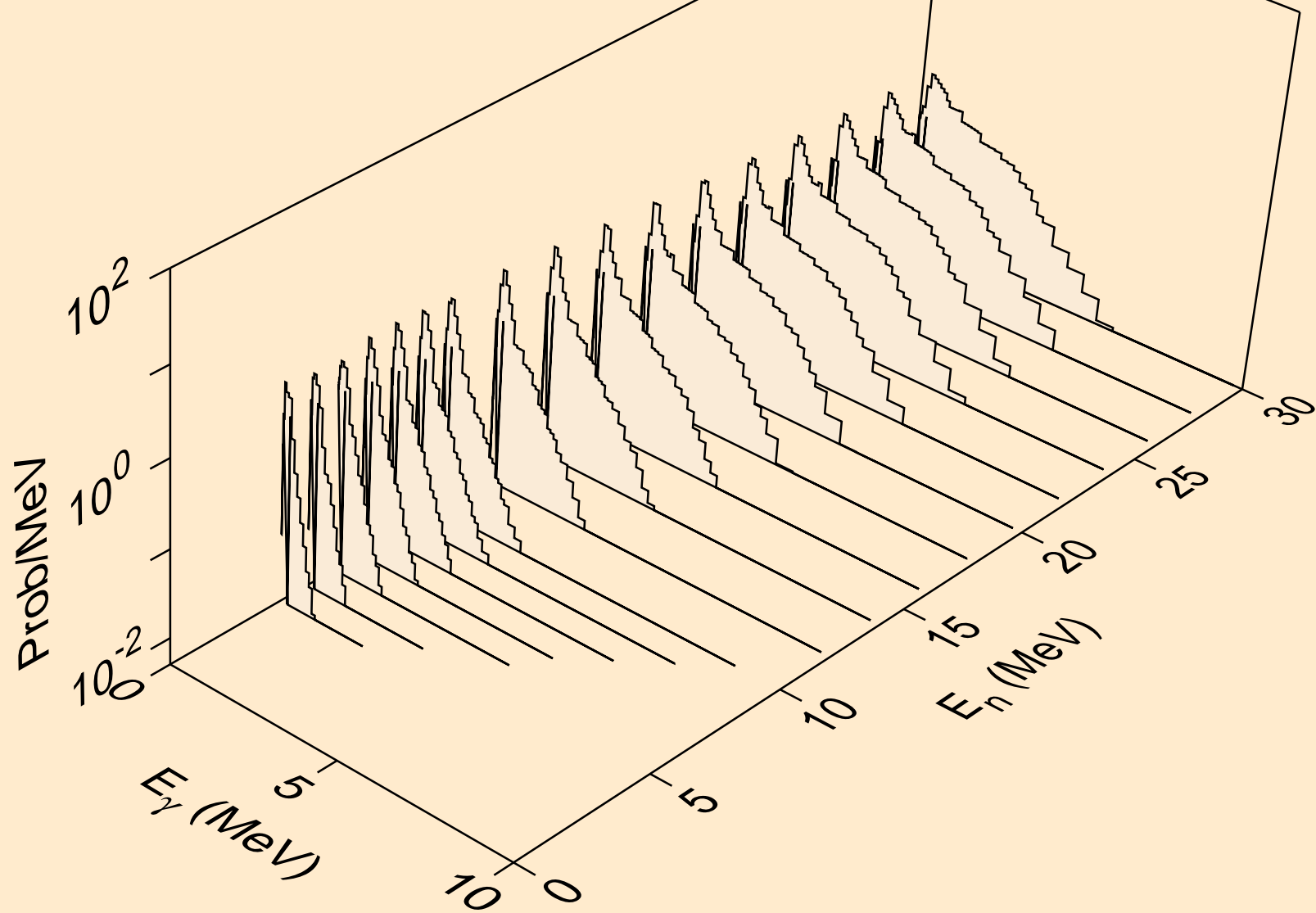

PM129 DEUTERON ACER TENDL-2021 LIBRARY; T=0.K
Photon emission for (n,2n) α

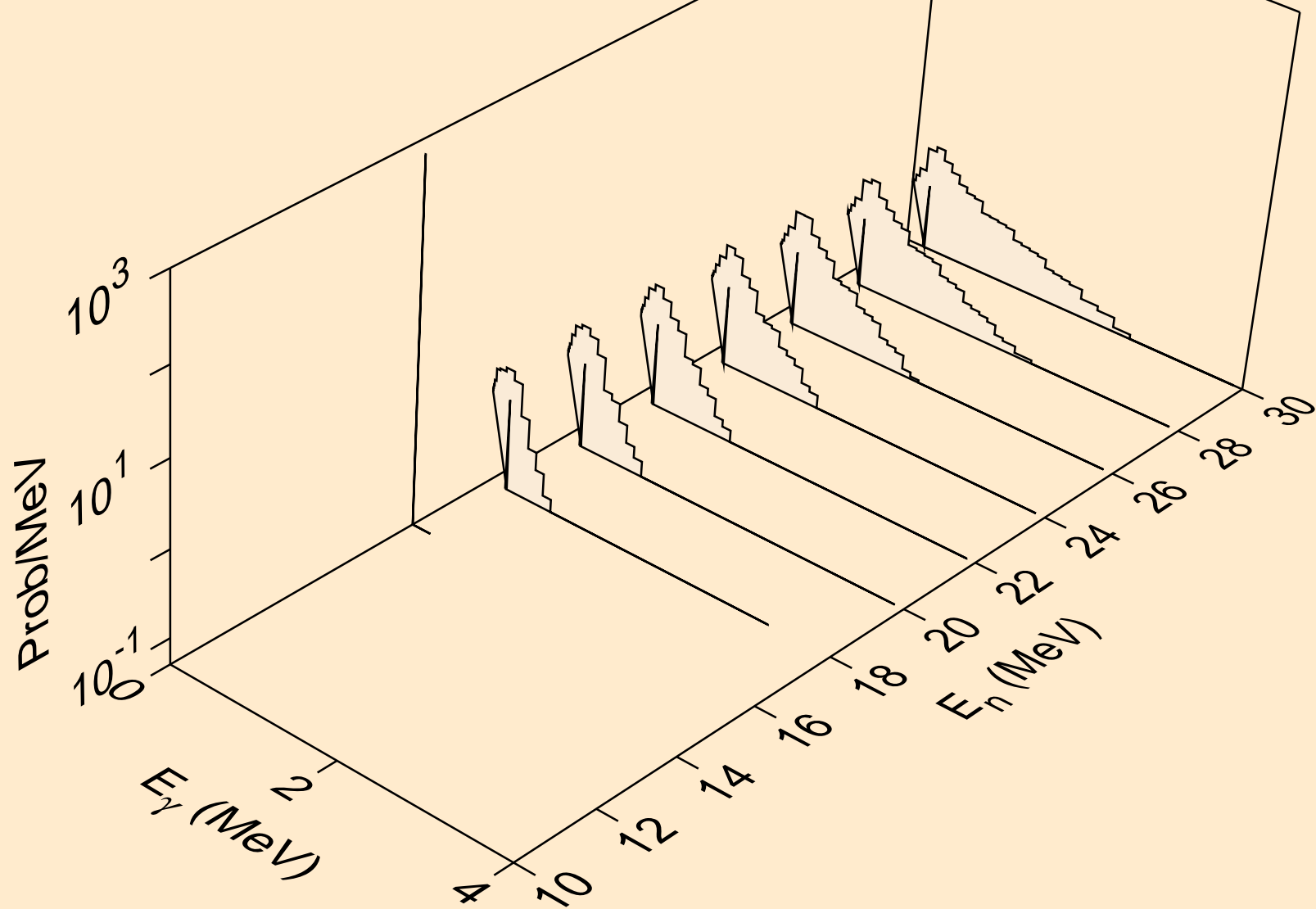

PM129 DEUTERON ACER TENDL-2021 LIBRARY; T=0.K
Photon emission for (n,n*)p

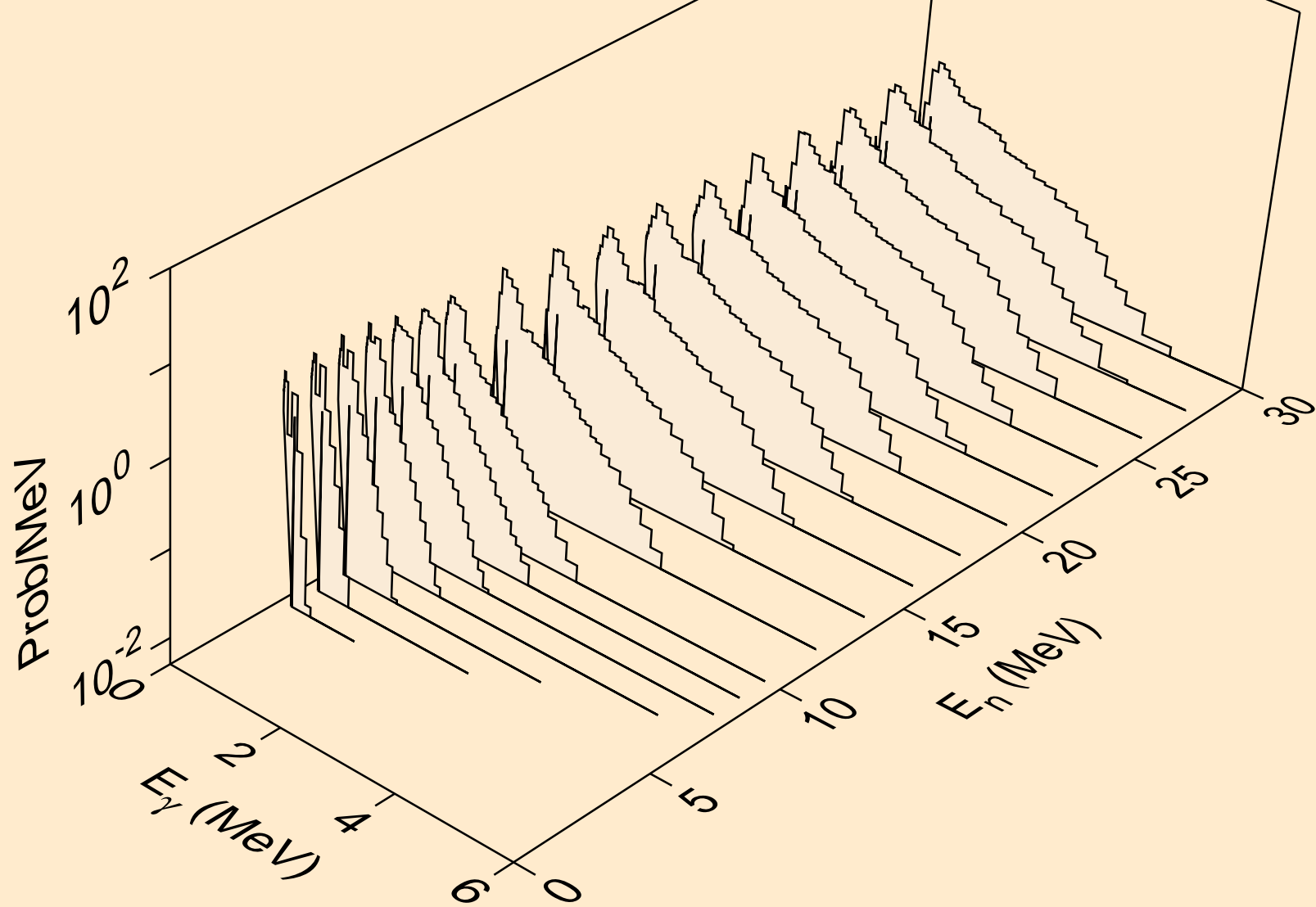

PM129 DEUTERON ACER TENDL-2021 LIBRARY; T=0.K
Photon emission for (n,n*)2a

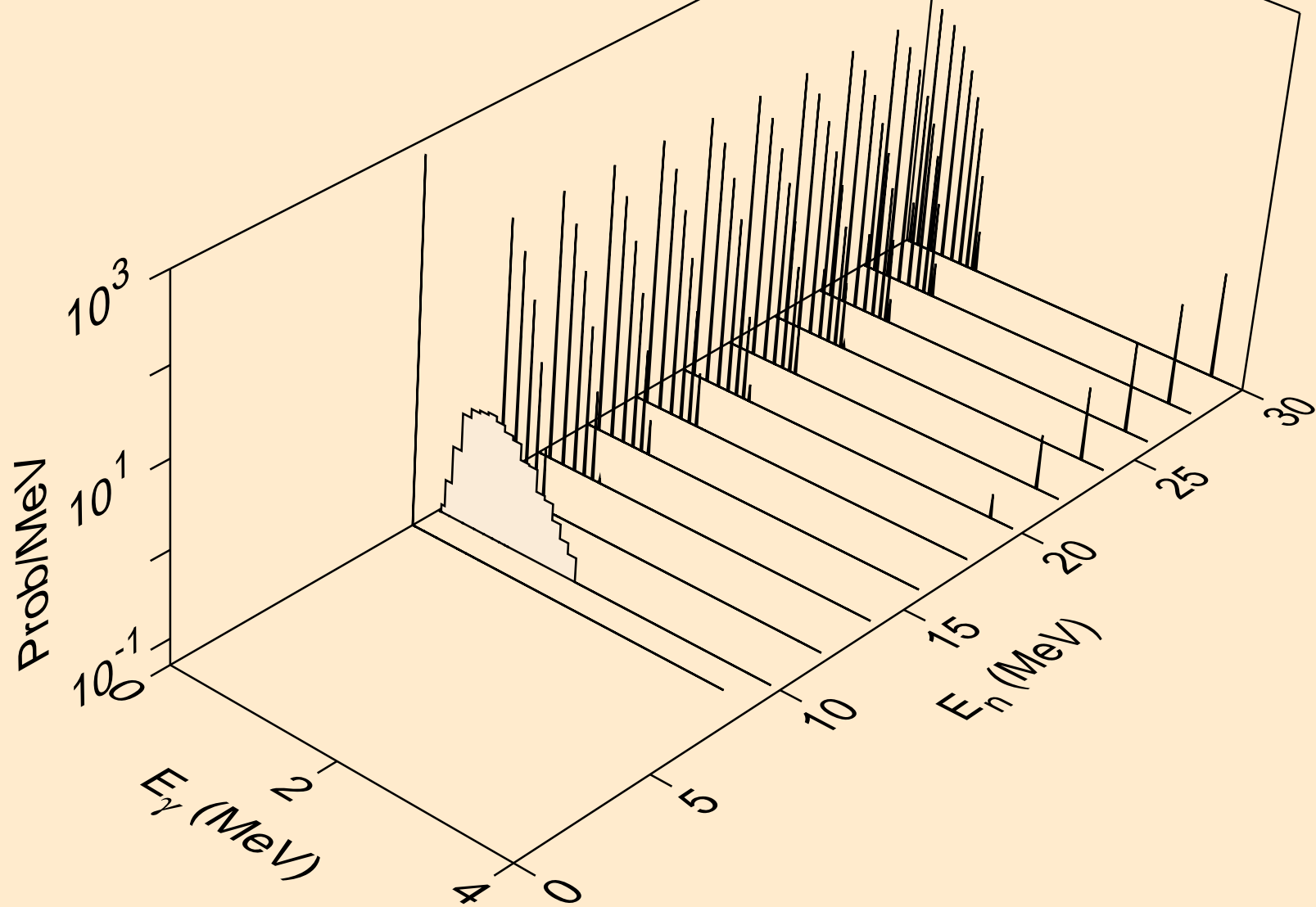

PM129 DEUTERON ACER TENDL-2021 LIBRARY; T=0.K
Photon emission for (n,n*)d

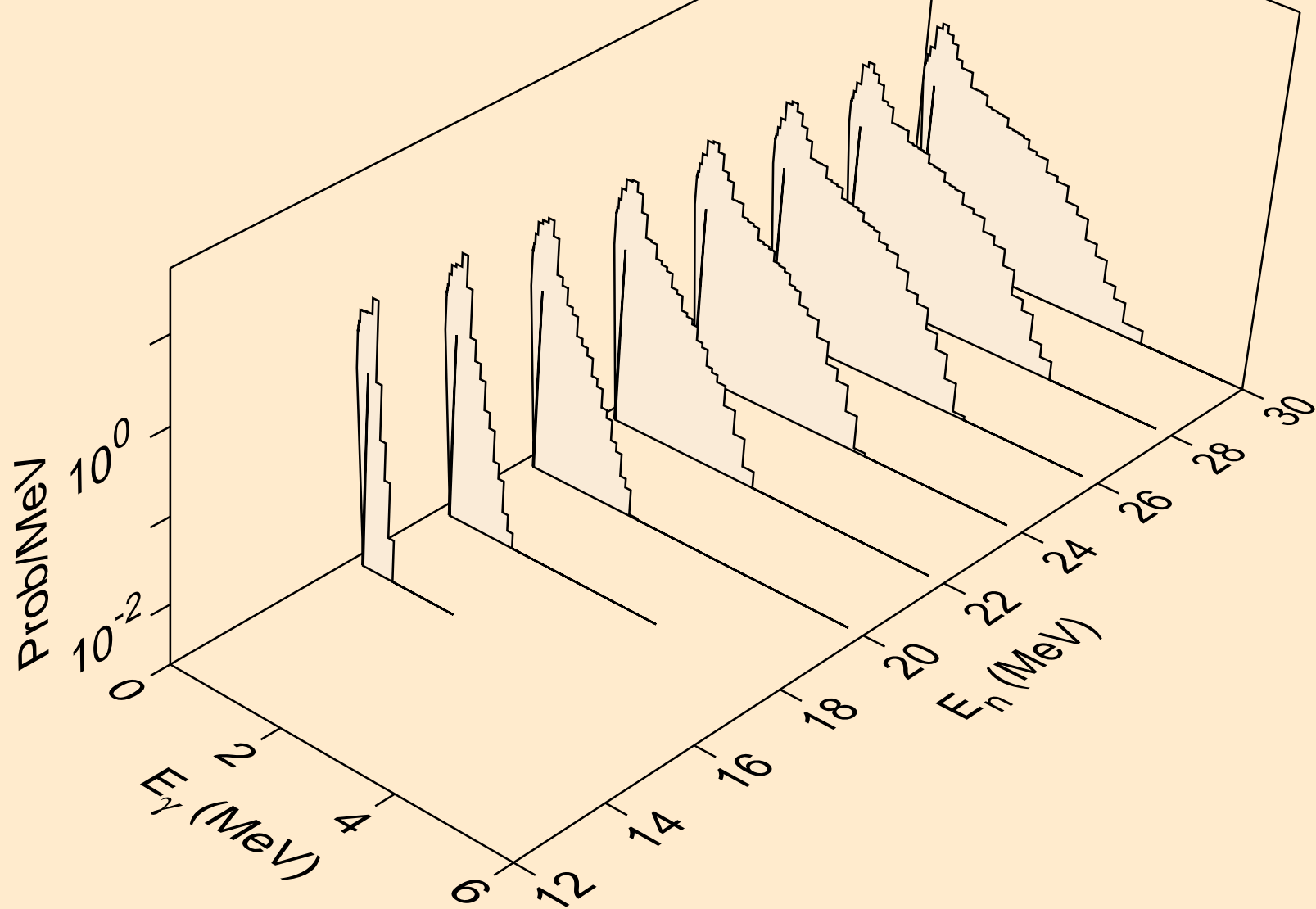

PM129 DEUTERON ACER TENDL-2021 LIBRARY; T=0.K
Photon emission for (n,n*)t

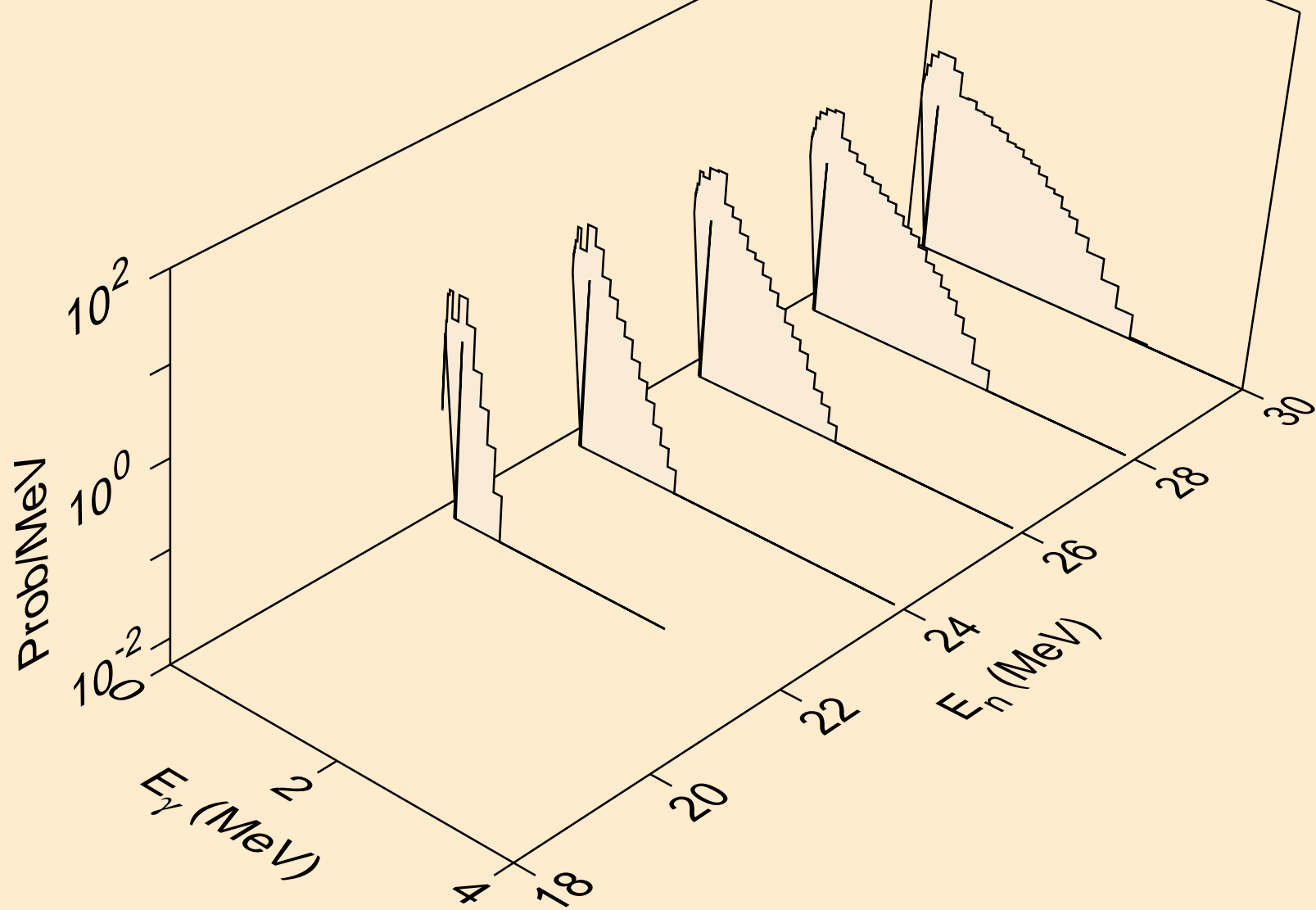

PM129 DEUTERON ACER TENDL-2021 LIBRARY; T=0.K
Photon emission for (n,n*)he3

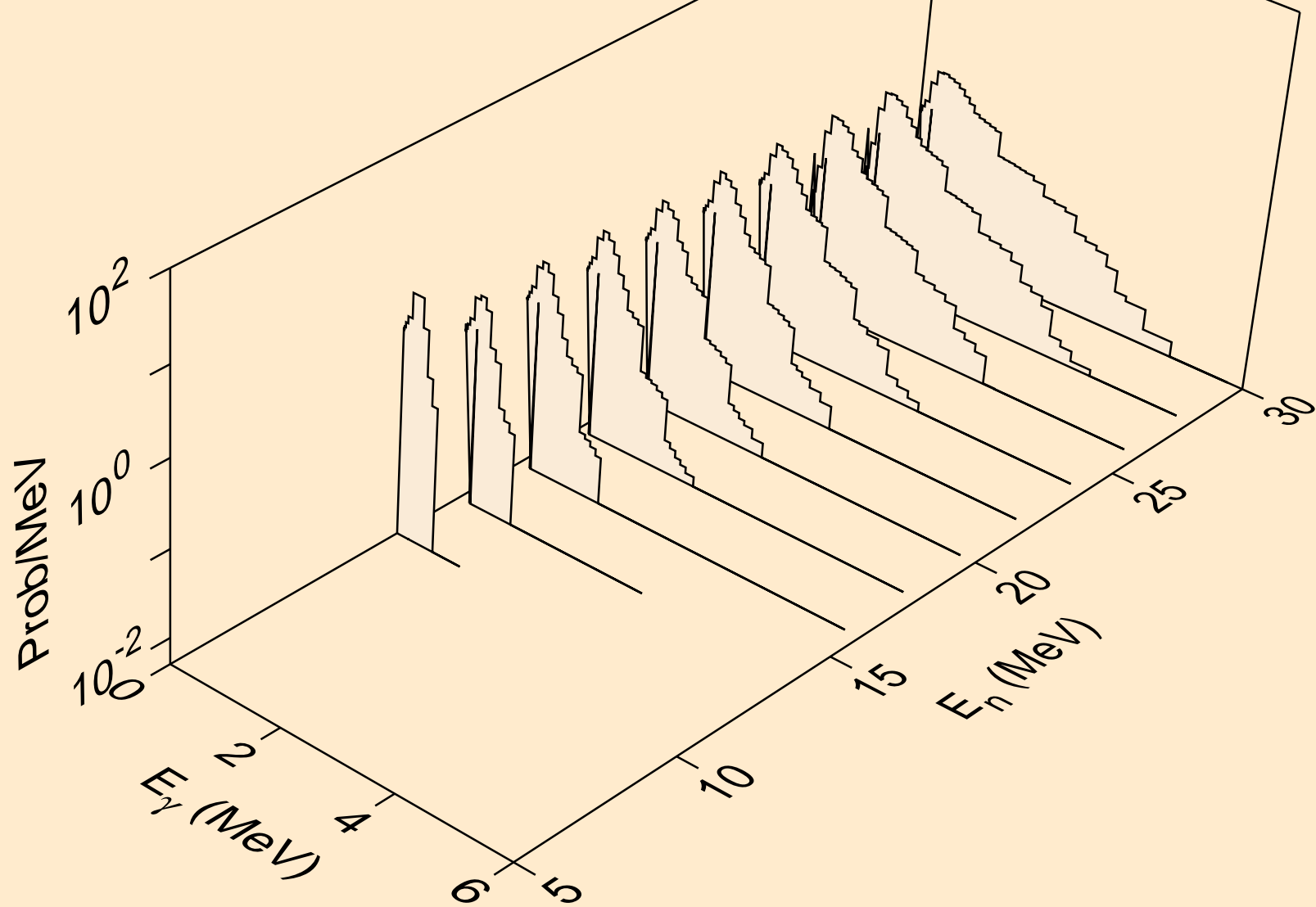

PM129 DEUTERON ACER TENDL-2021 LIBRARY; T=0.K
Photon emission for (n,2np)

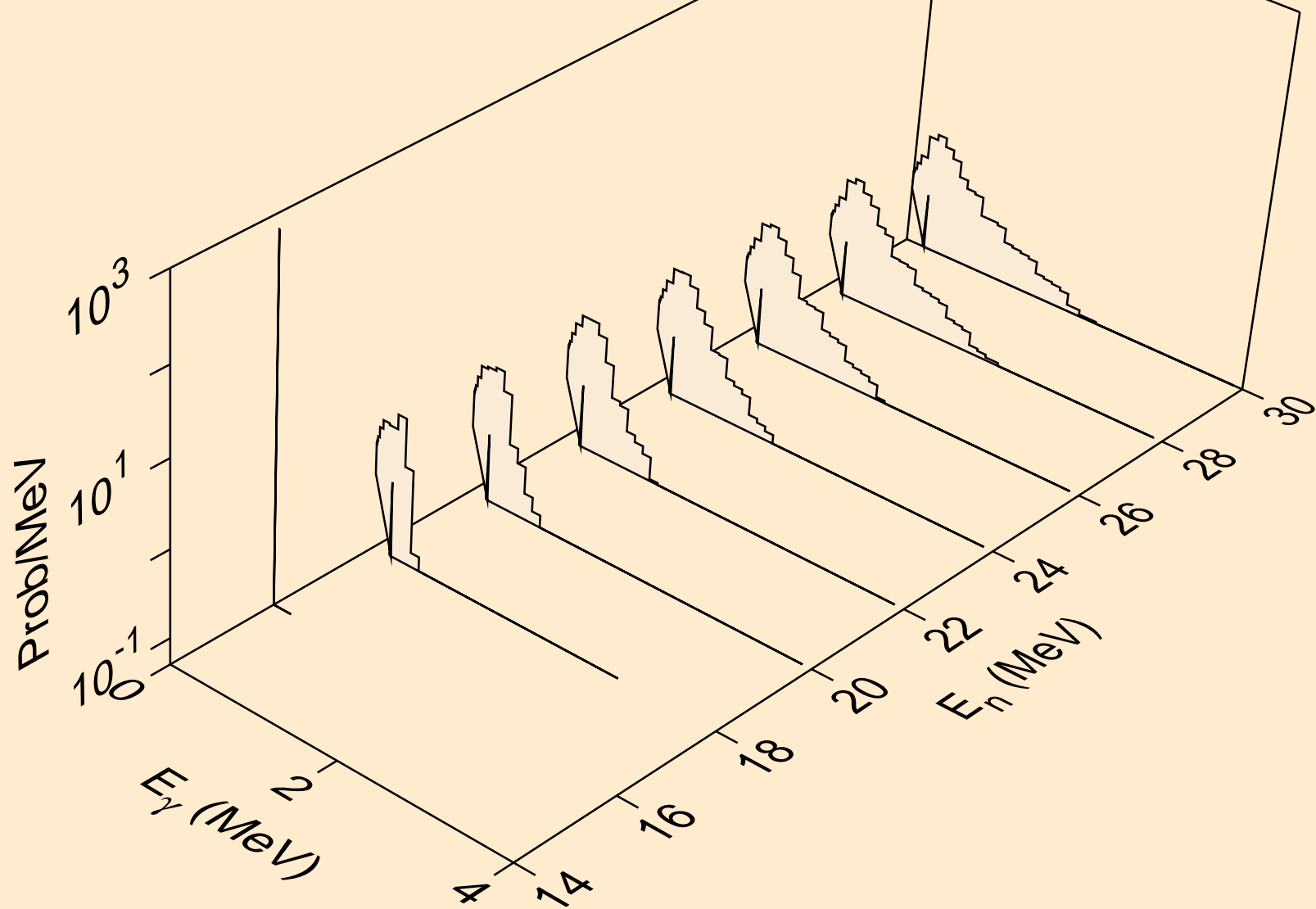

PM129 DEUTERON ACER TENDL-2021 LIBRARY; T=0.K
Photon emission for (n,2np)

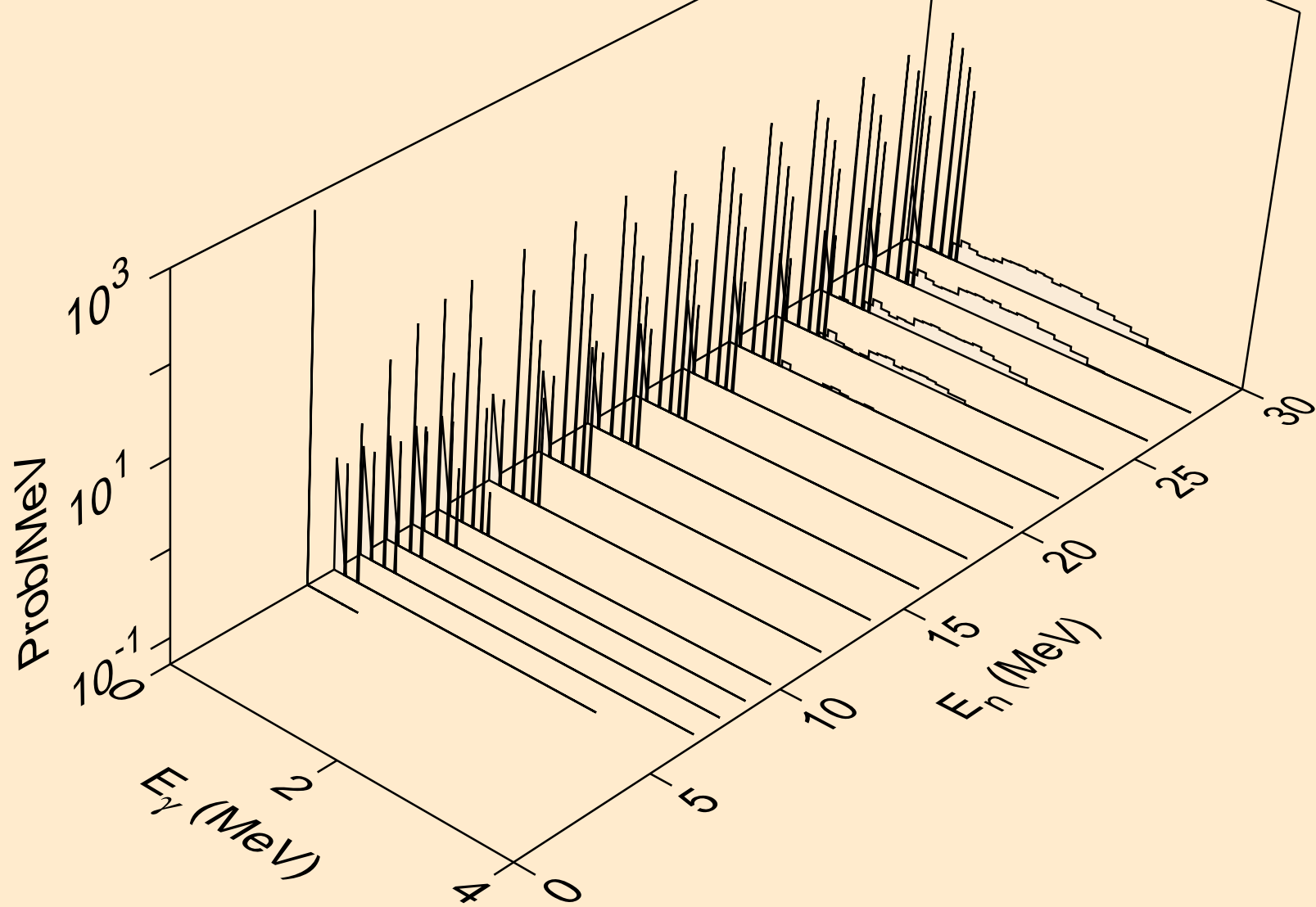

PM129 DEUTERON ACER TENDL-2021 LIBRARY; T=0.K
Photon emission for (n,npa)

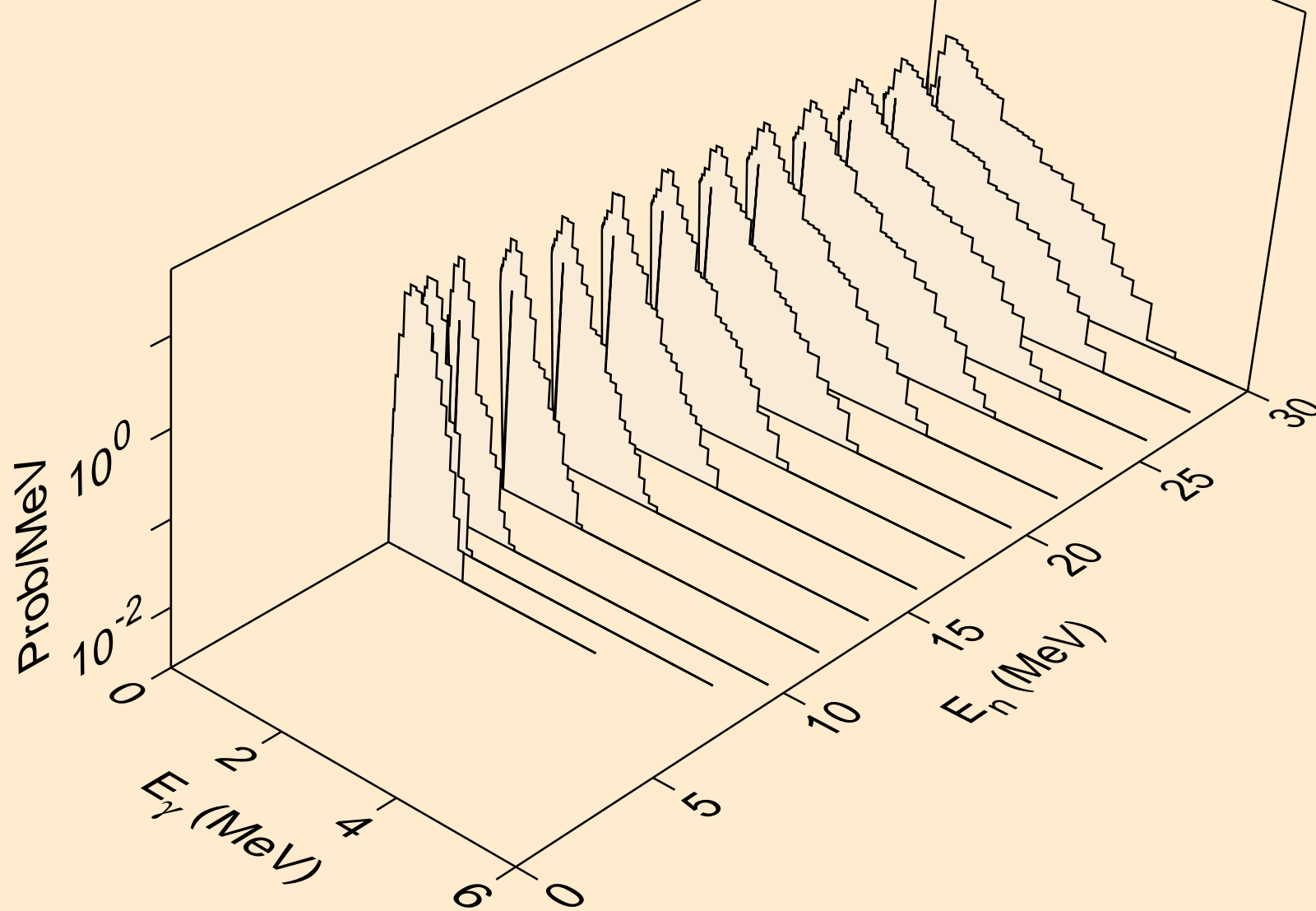

PM129 DEUTERON ACER TENDL-2021 LIBRARY; T=0.K
Photon emission for (n,gma)

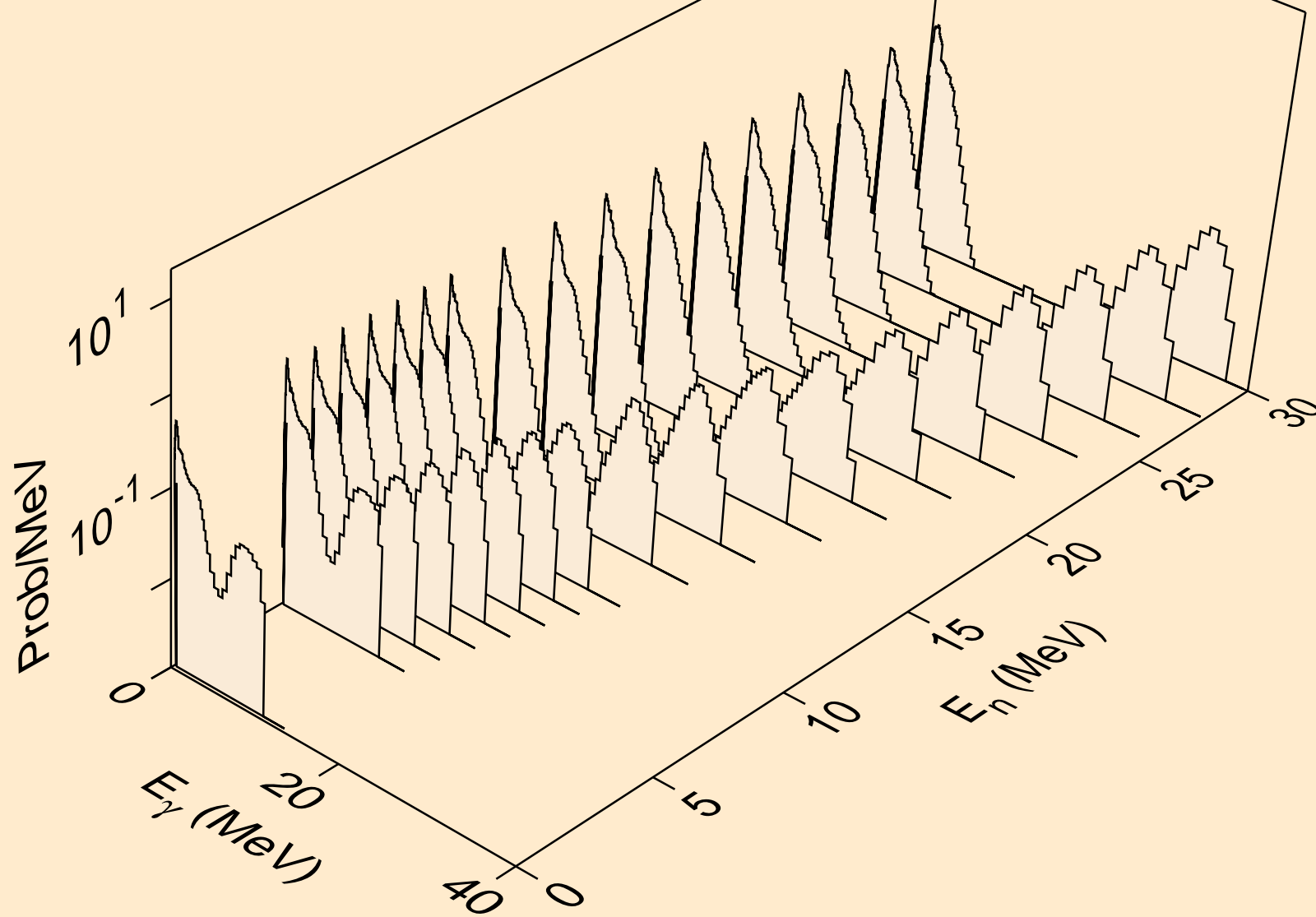

PM129 DEUTERON ACER TENDL-2021 LIBRARY; T=0.K
Photon emission for (n,p)

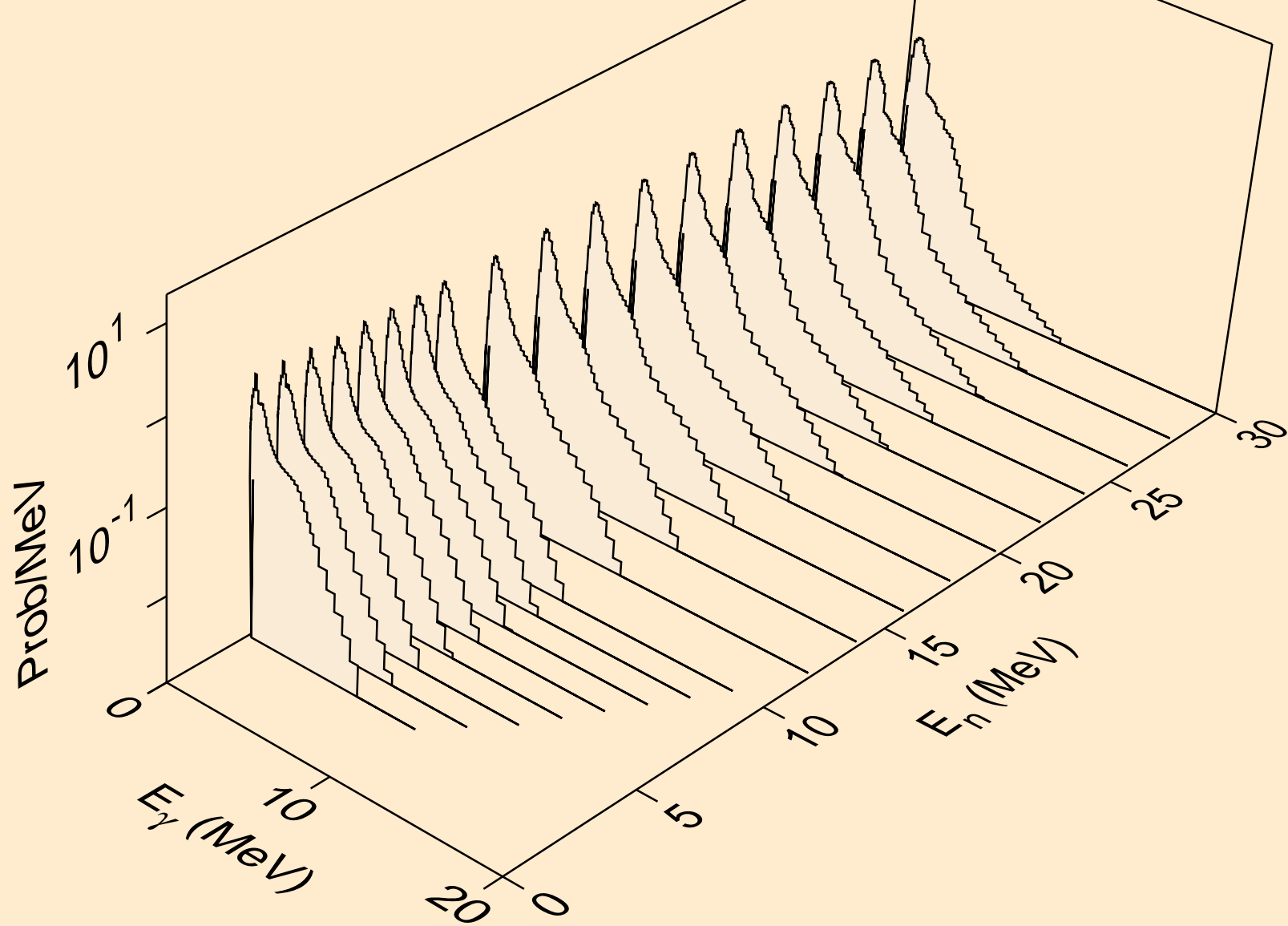

PM129 DEUTERON ACER TENDL-2021 LIBRARY; T=0.K
Photon emission for inelastic

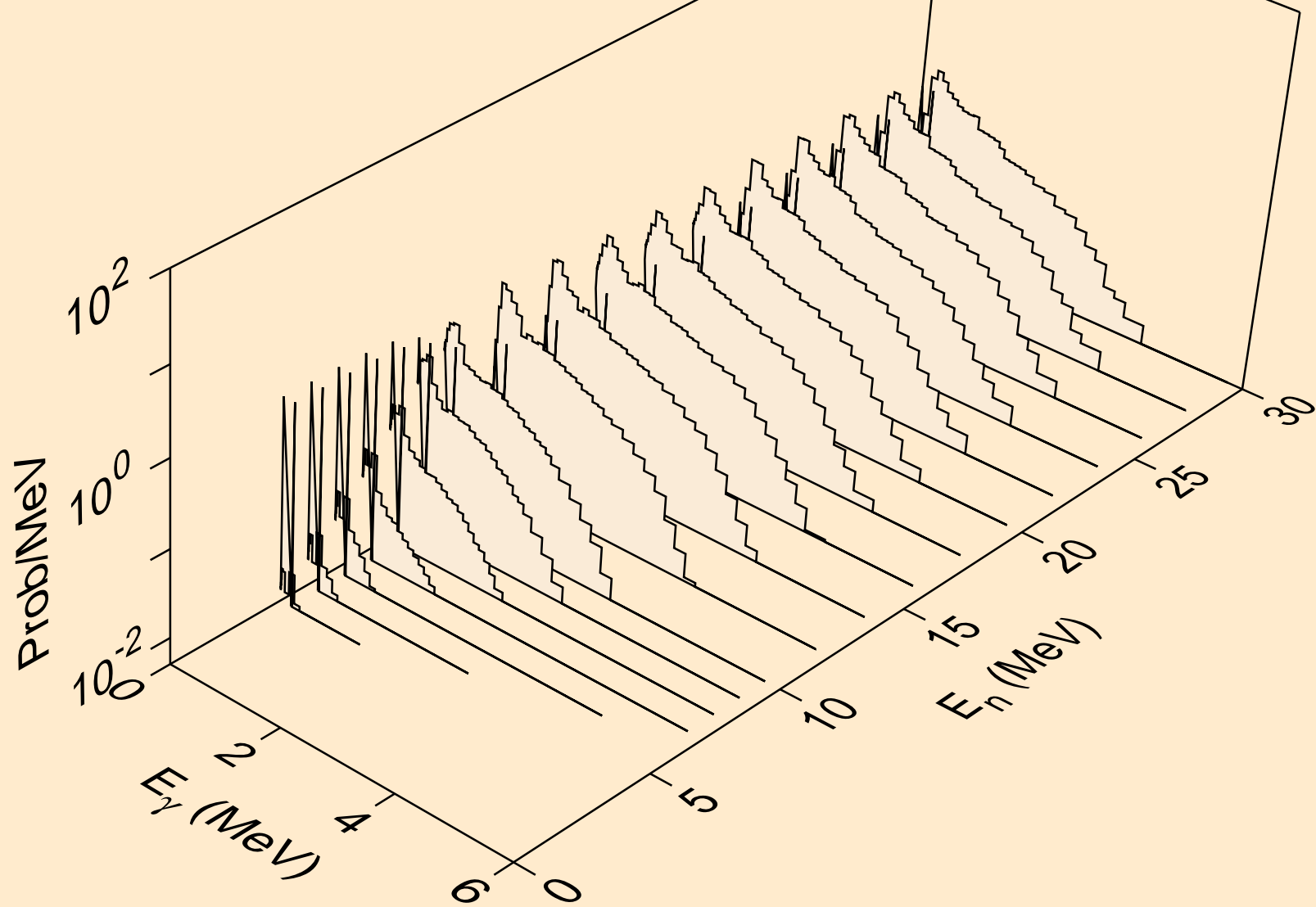

PM129 DEUTERON ACER TENDL-2021 LIBRARY; T=0.K
Photon emission for (n,t)

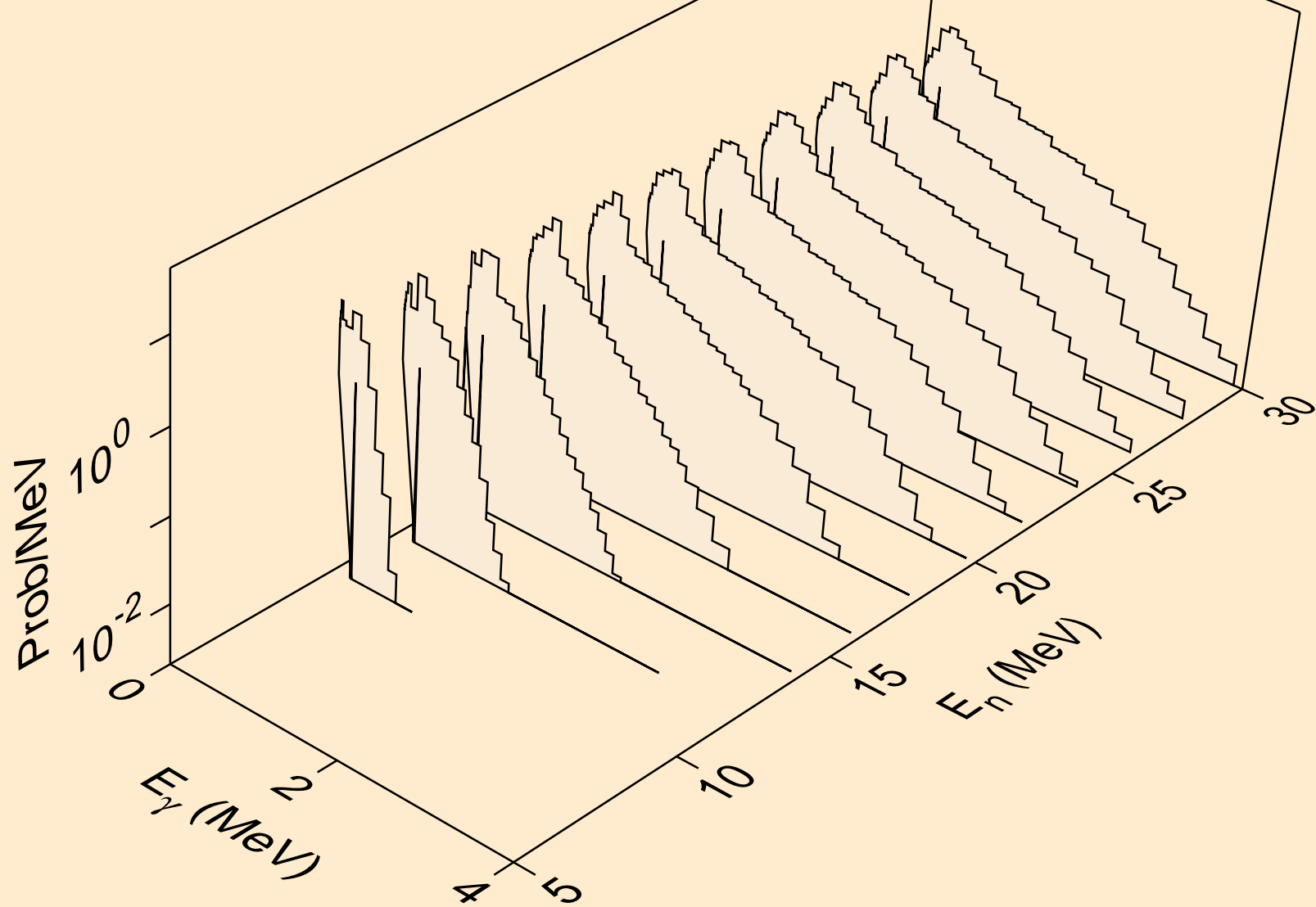

PM129 DEUTERON ACER TENDL-2021 LIBRARY; T=0.K
Photon emission for (n,he3)

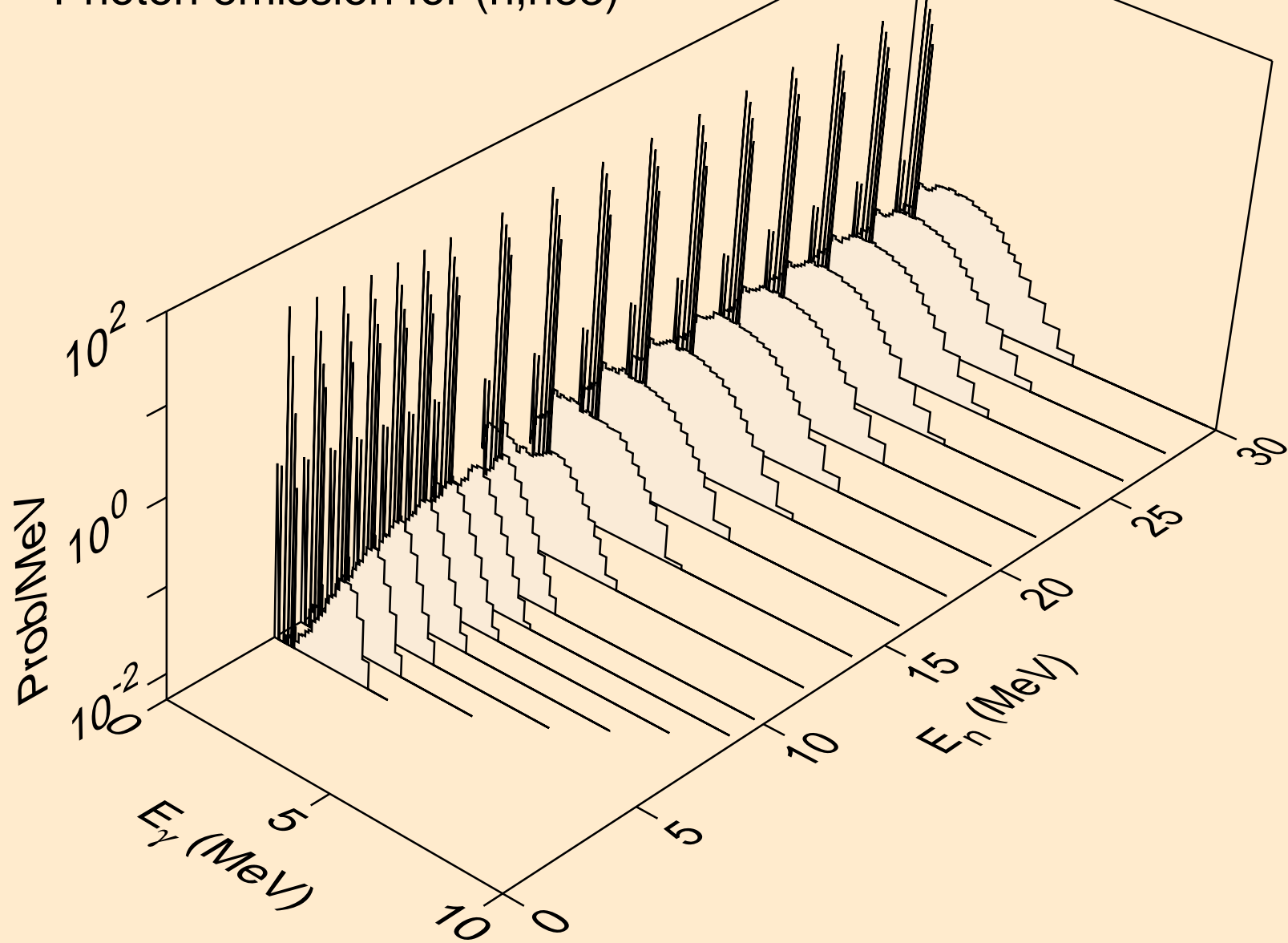

PM129 DEUTERON ACER TENDL-2021 LIBRARY; T=0.K
Photon emission for (n,a)

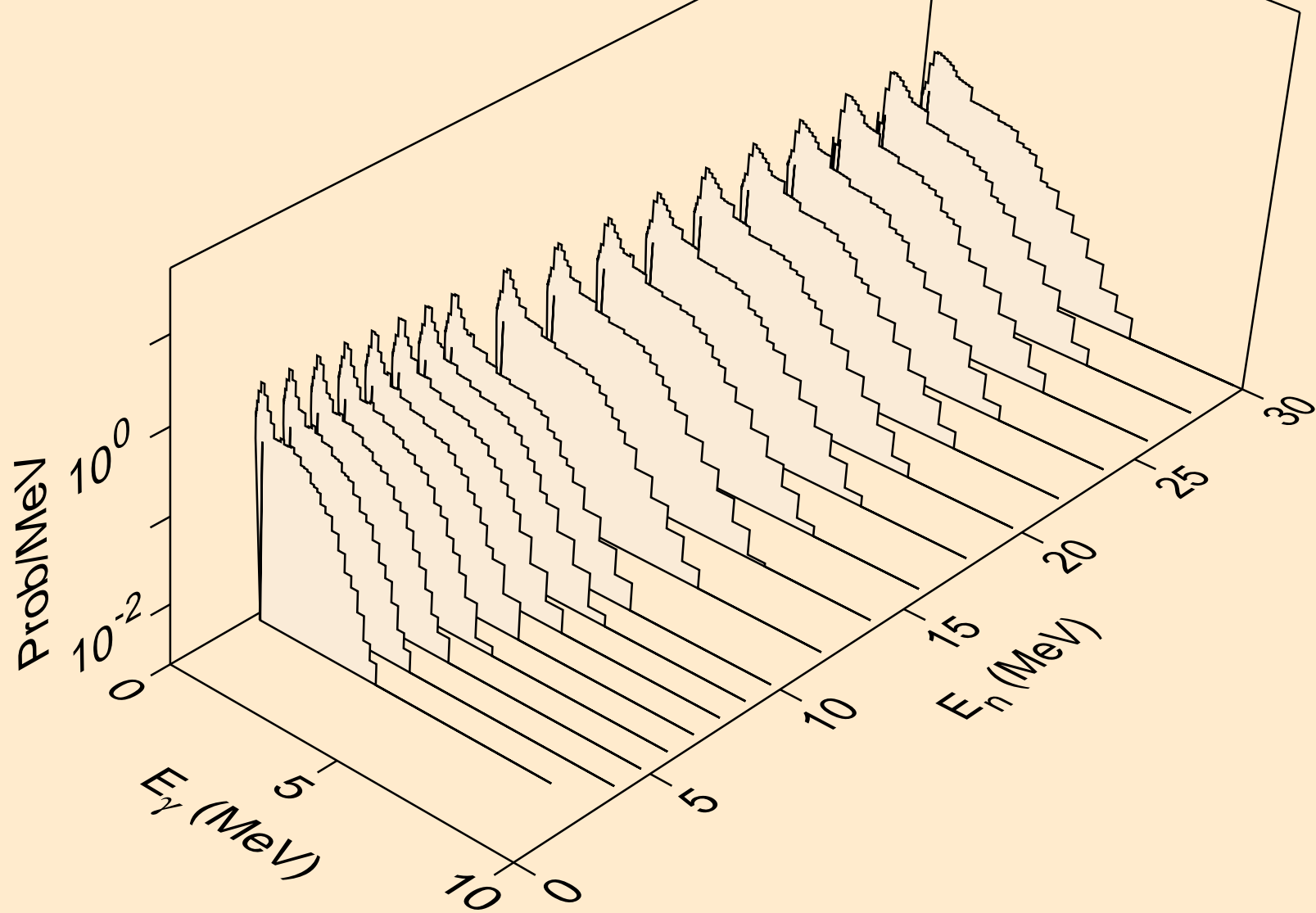

PM129 DEUTERON ACER TENDL-2021 LIBRARY; T=0.K
Photon emission for (n,2a)

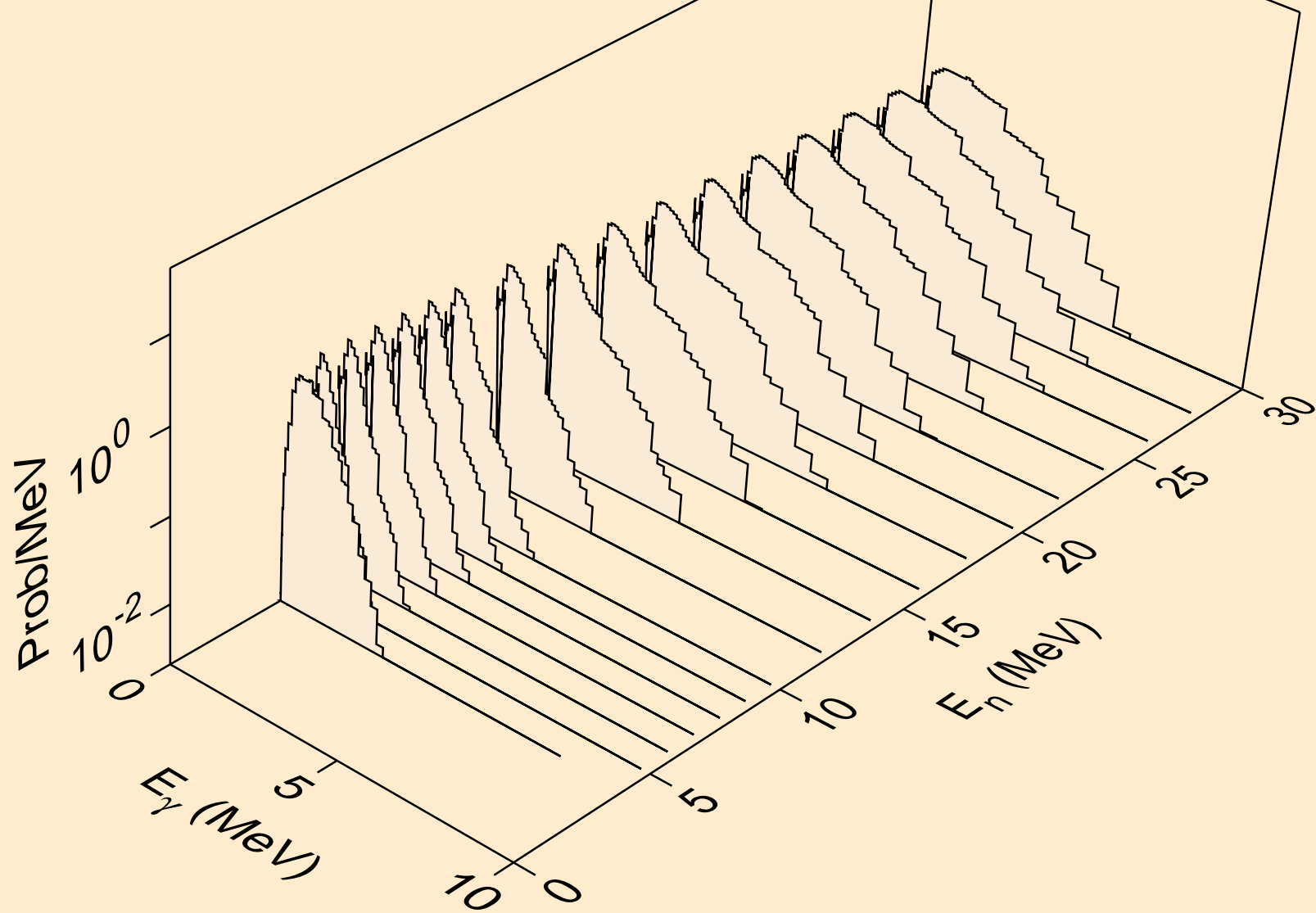

PM129 DEUTERON ACER TENDL-2021 LIBRARY; T=0.K
Photon emission for (n,3a)

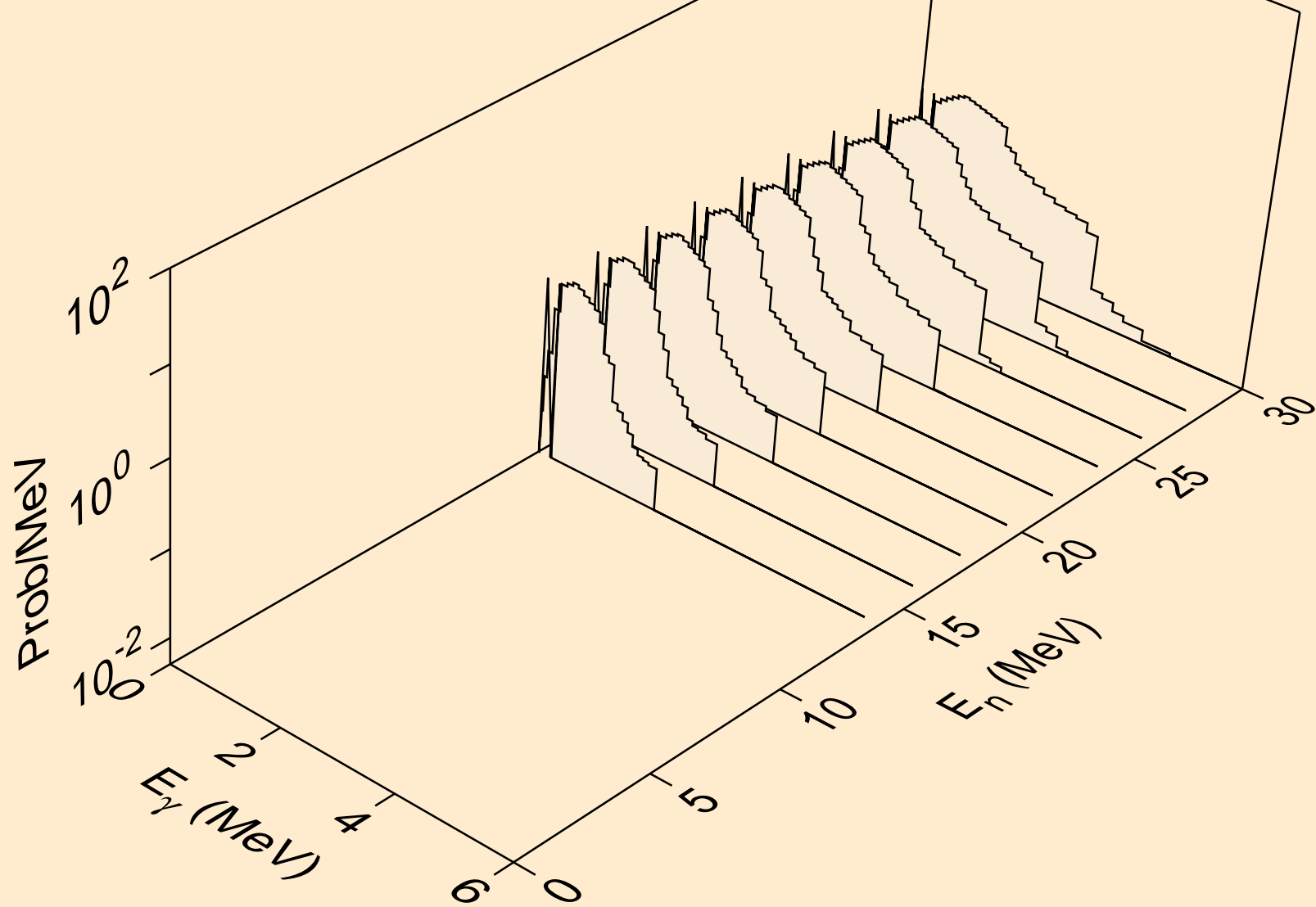

PM129 DEUTERON ACER TENDL-2021 LIBRARY; T=0.K
Photon emission for (n,2p)

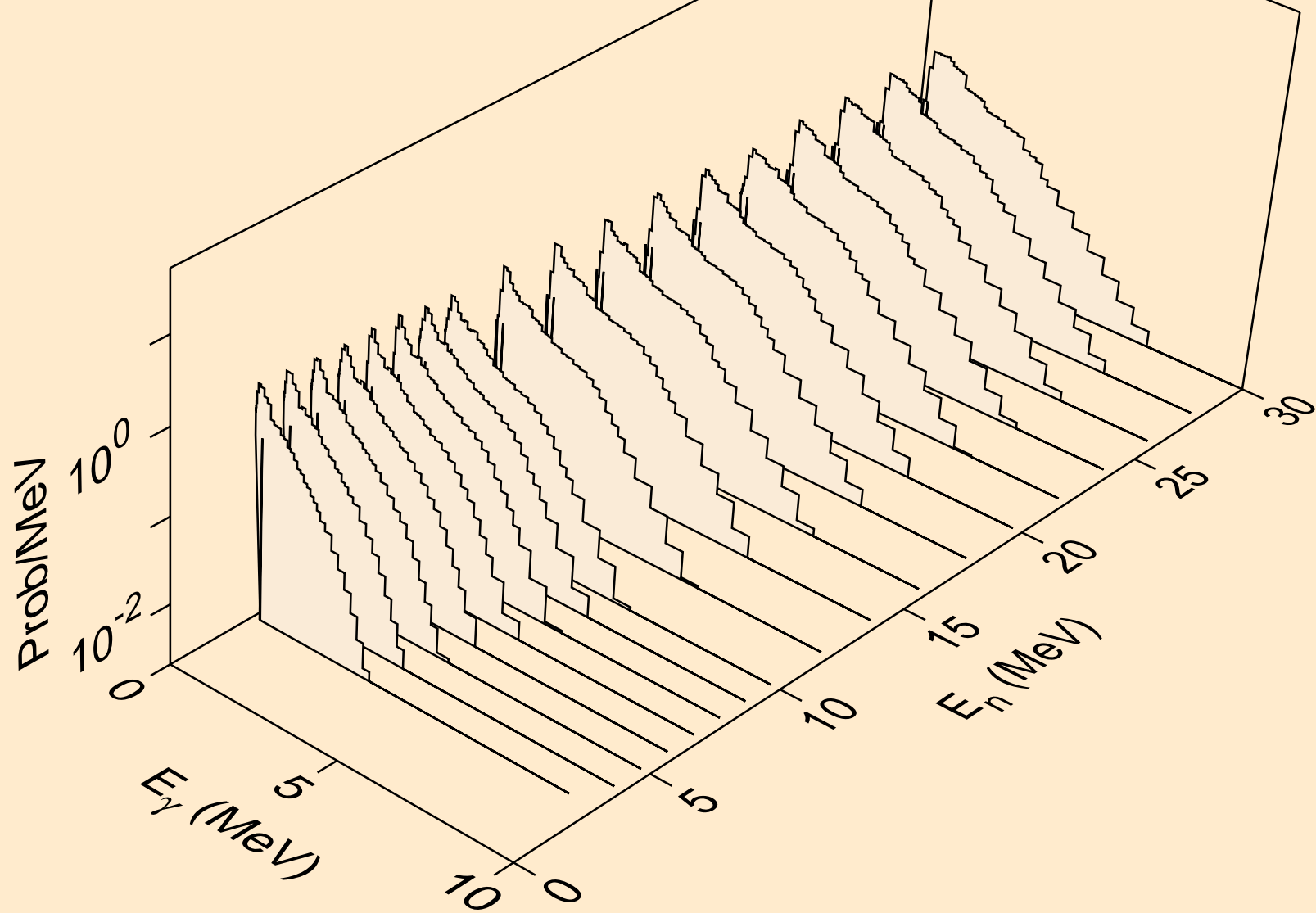

PM129 DEUTERON ACER TENDL-2021 LIBRARY; T=0.K
Photon emission for (n,p)

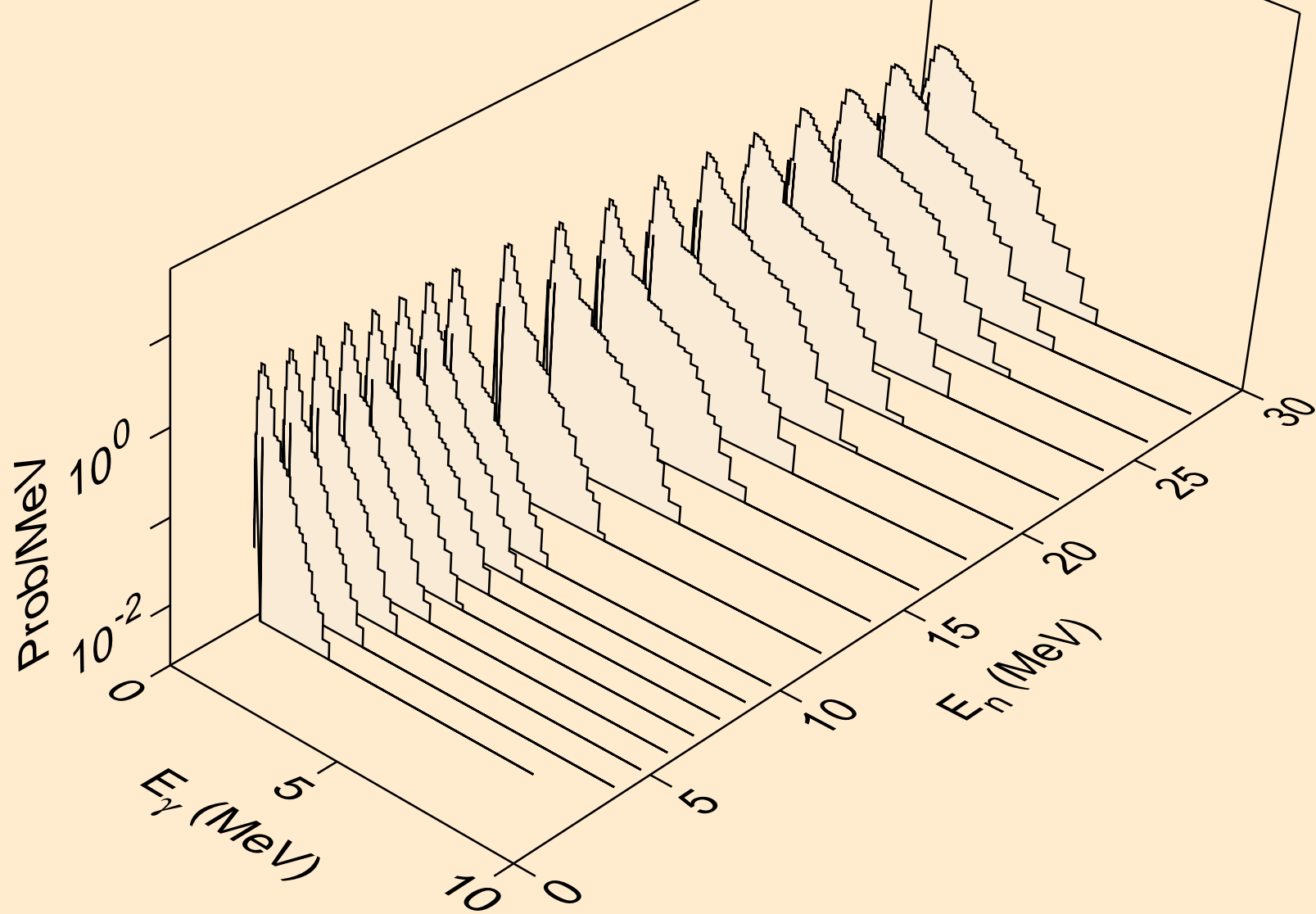

PM129 DEUTERON ACER TENDL-2021 LIBRARY; T=0.K
Photon emission for (n,pd)

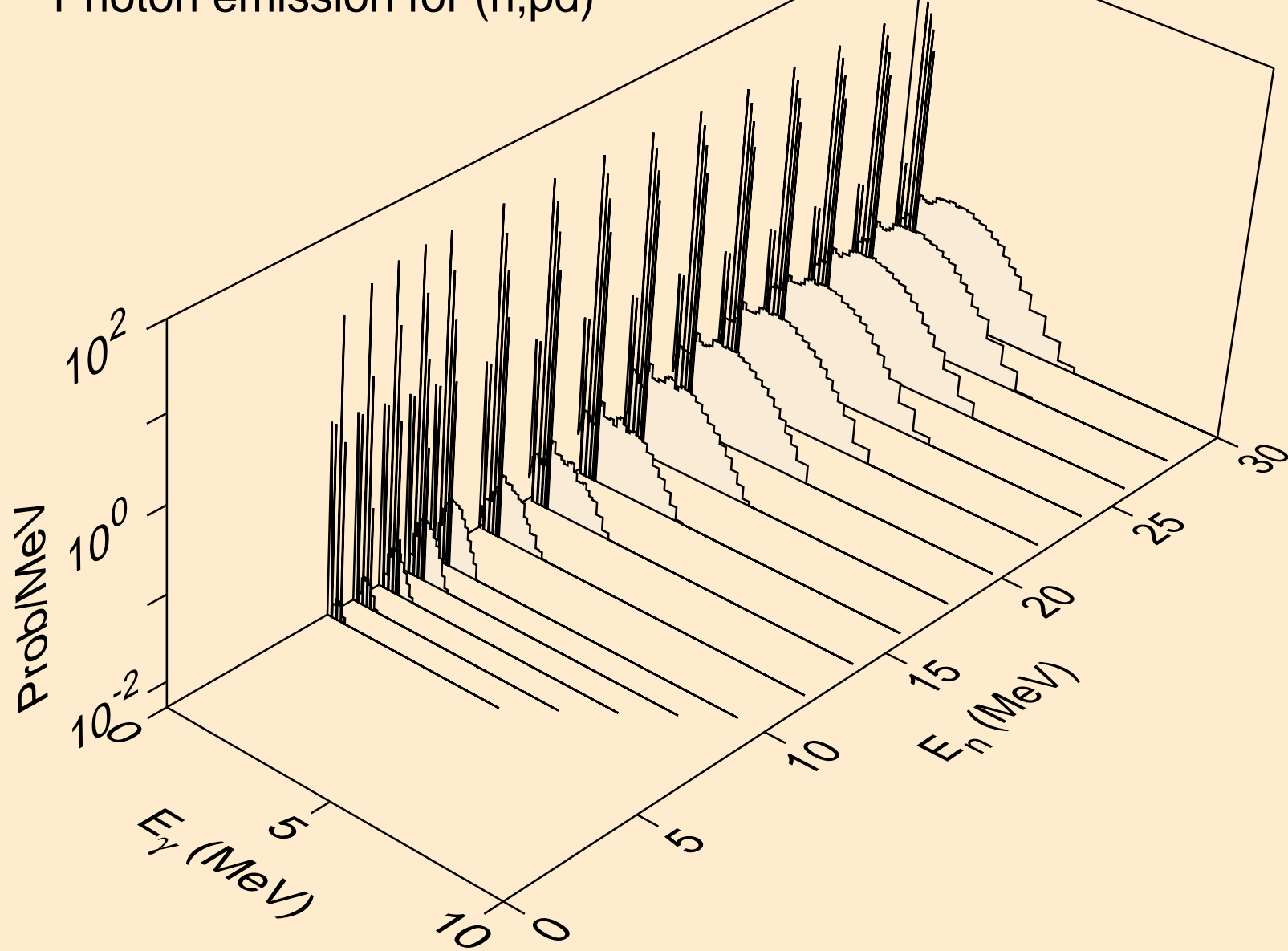

PM129 DEUTERON ACER TENDL-2021 LIBRARY; T=0.K
Photon emission for (n,pt)

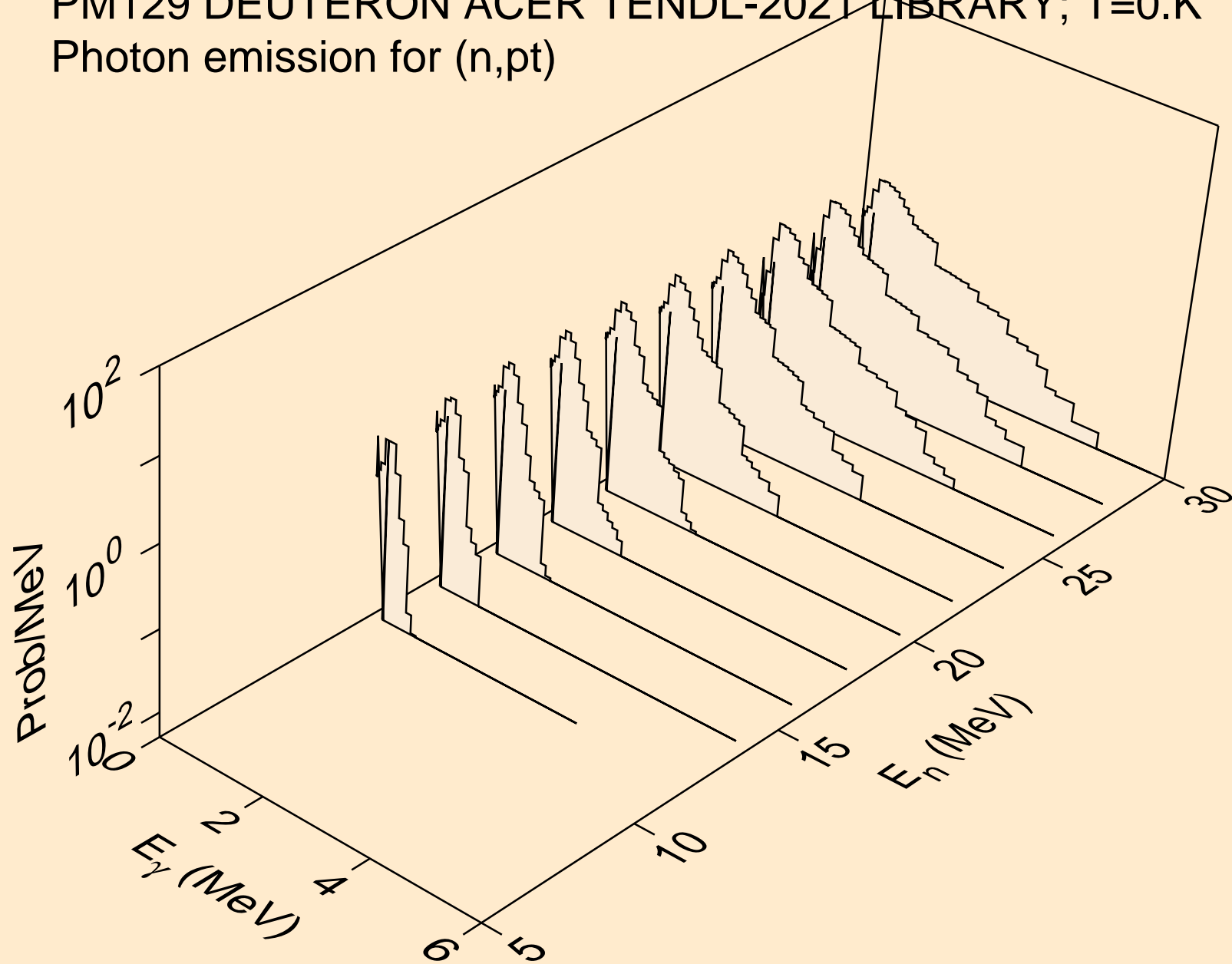

PM129 DEUTERON ACER TENDL-2021 LIBRARY; T=0.K
Photon emission for (n,da)

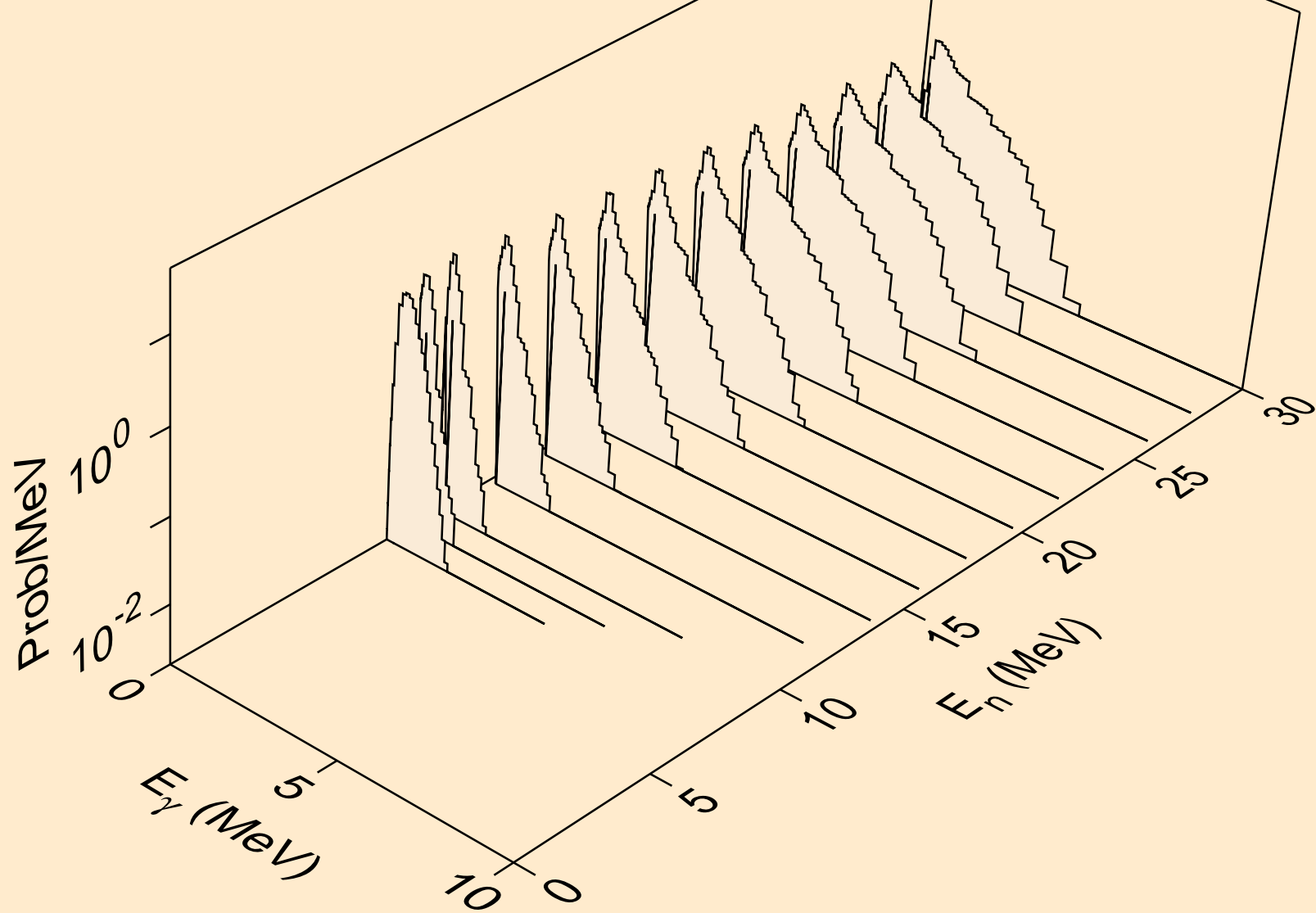

PM129 DEUTERON ACER TENDL-2021 LIBRARY; T=0.K

Particle heating contributions

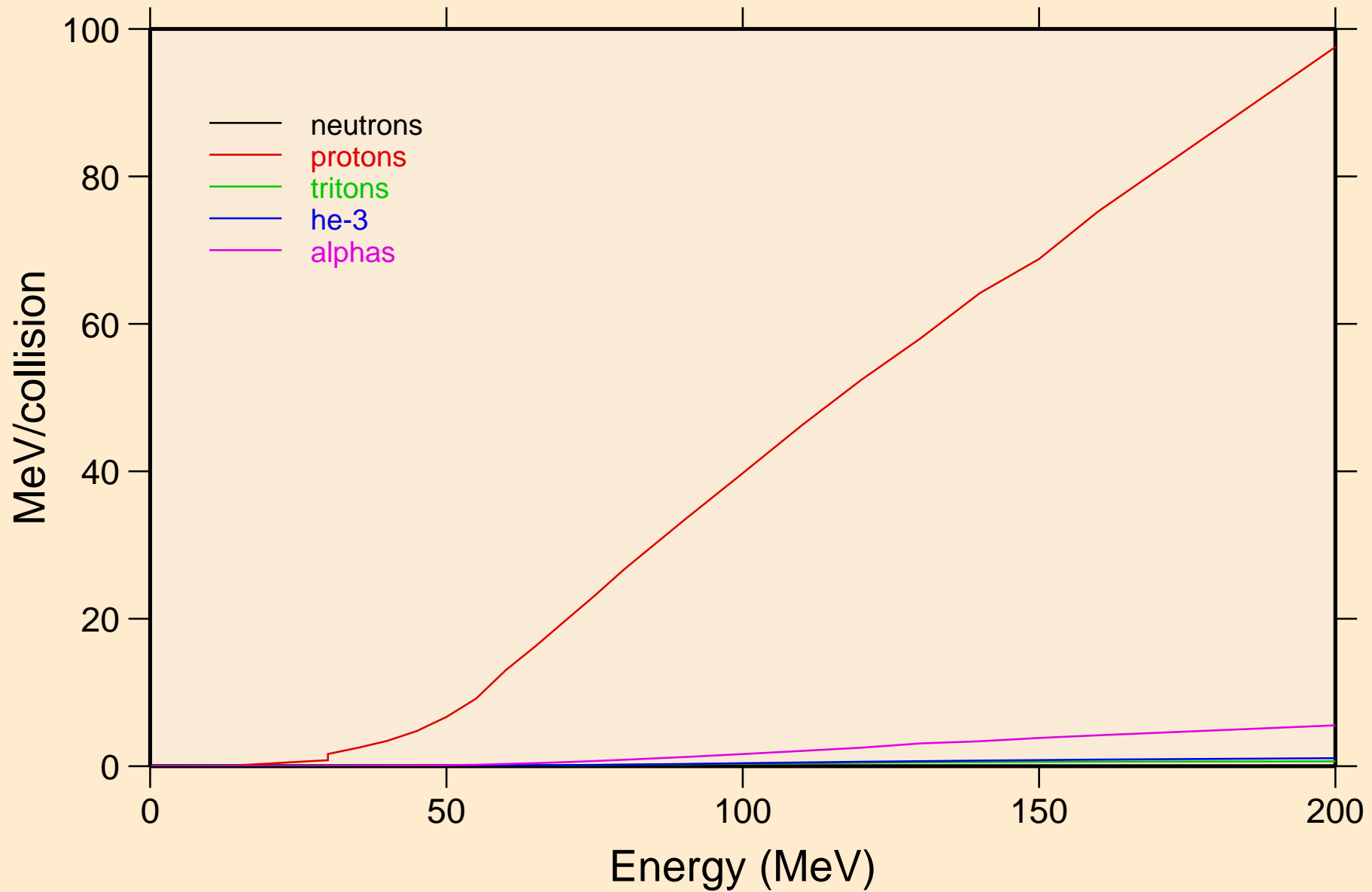

PM129 DEUTERON ACER TENDL-2021 LIBRARY; T=0.K
Recoil Heating

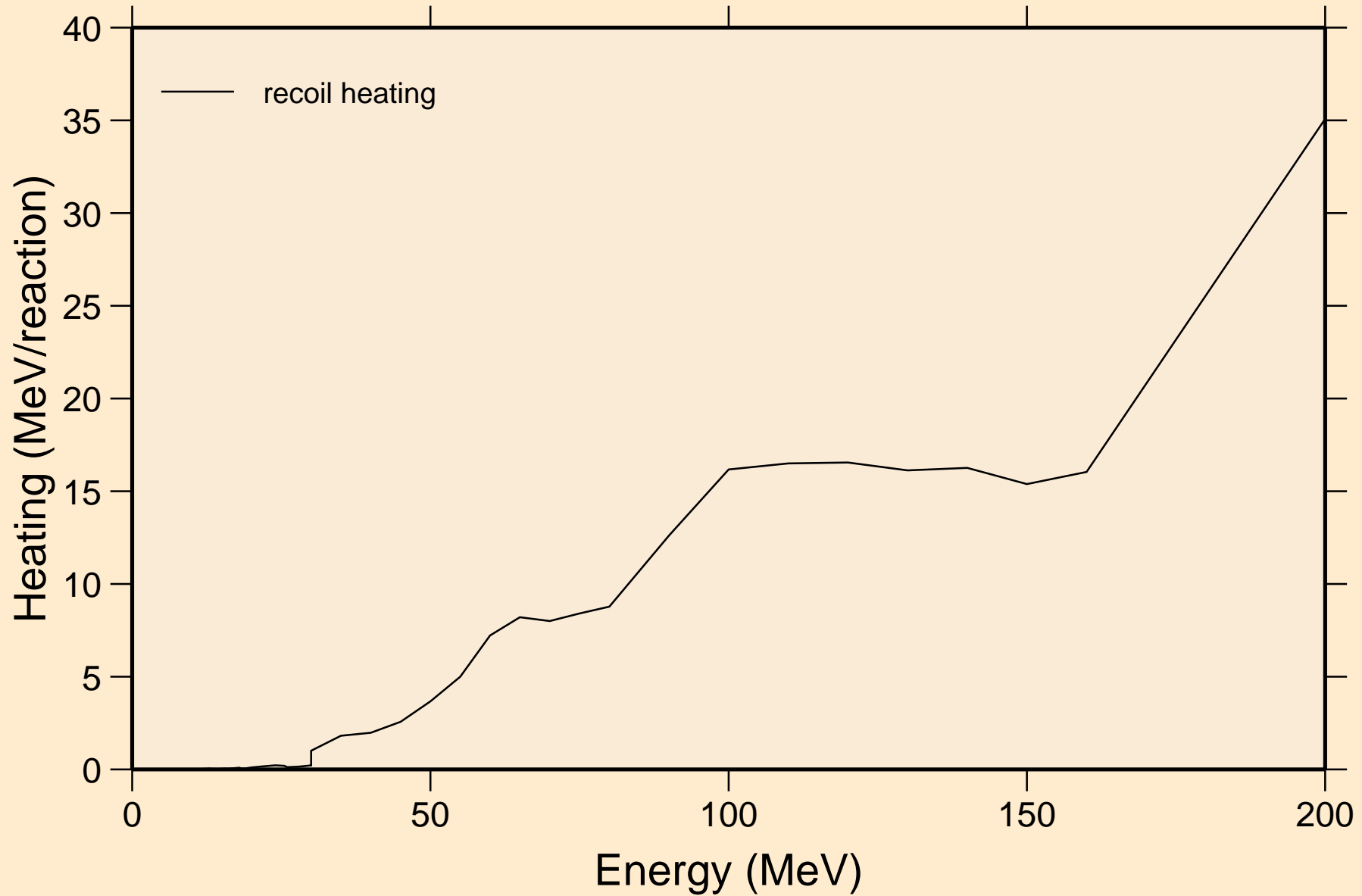

PM129 DEUTERON ACER TENDL-2021 LIBRARY; T=0.K
Particle production cross sections

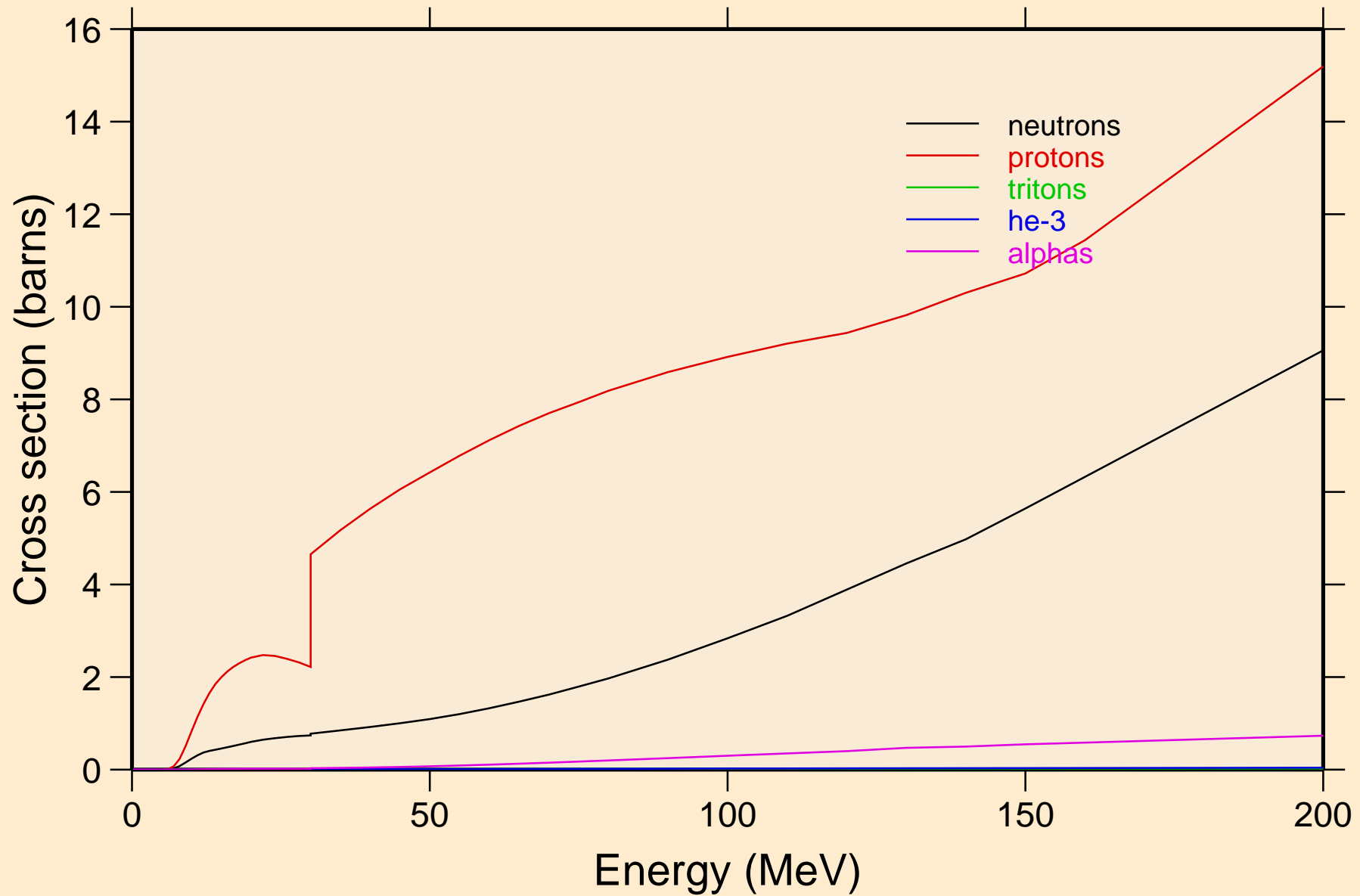

PM129 DEUTERON ACER TENDL-2021 LIBRARY; T=0.K
neutrons from (d,n)

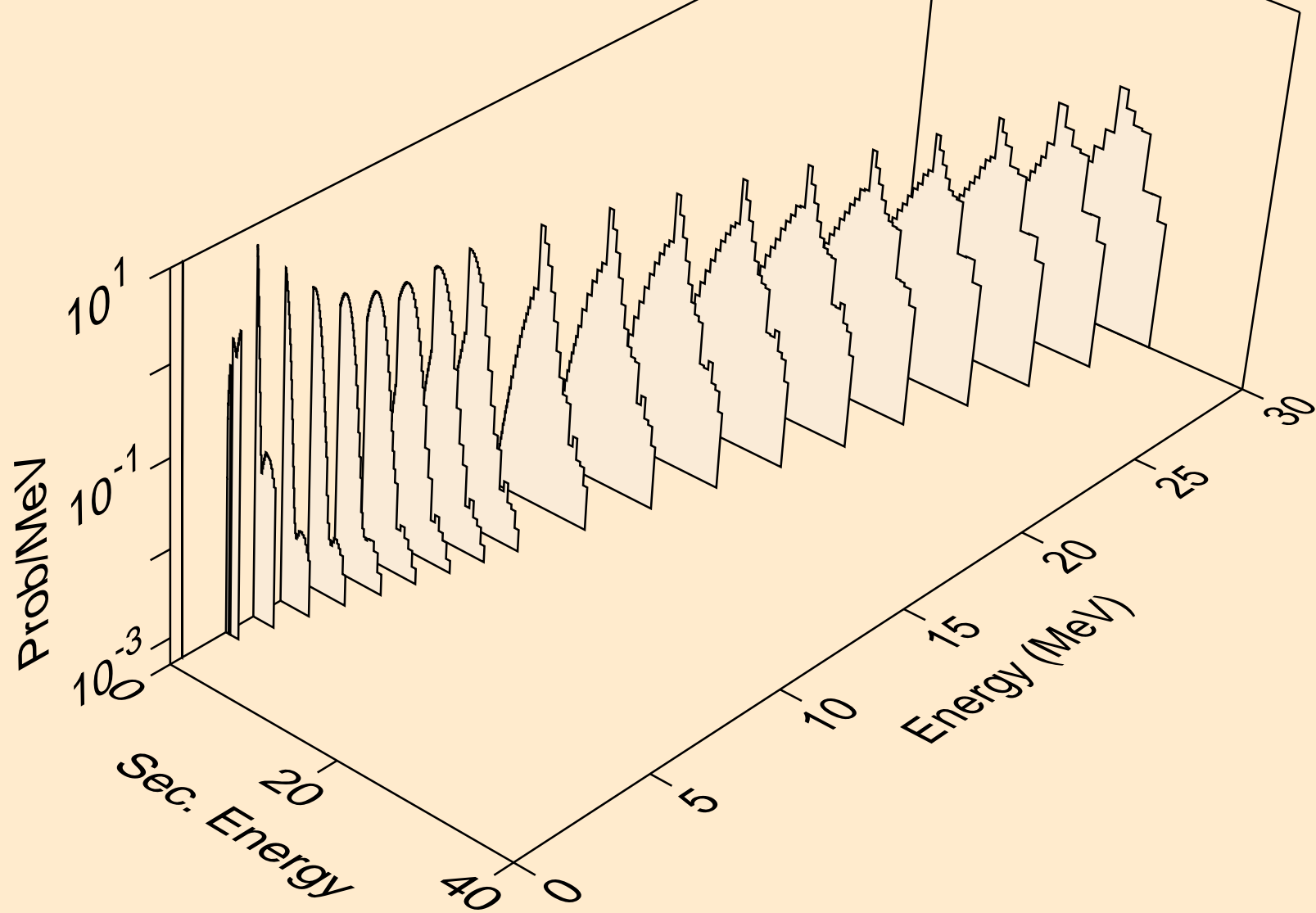

PM129 DEUTERON ACER TENDL-2021 LIBRARY; T=0.K
neutrons from (d,x)

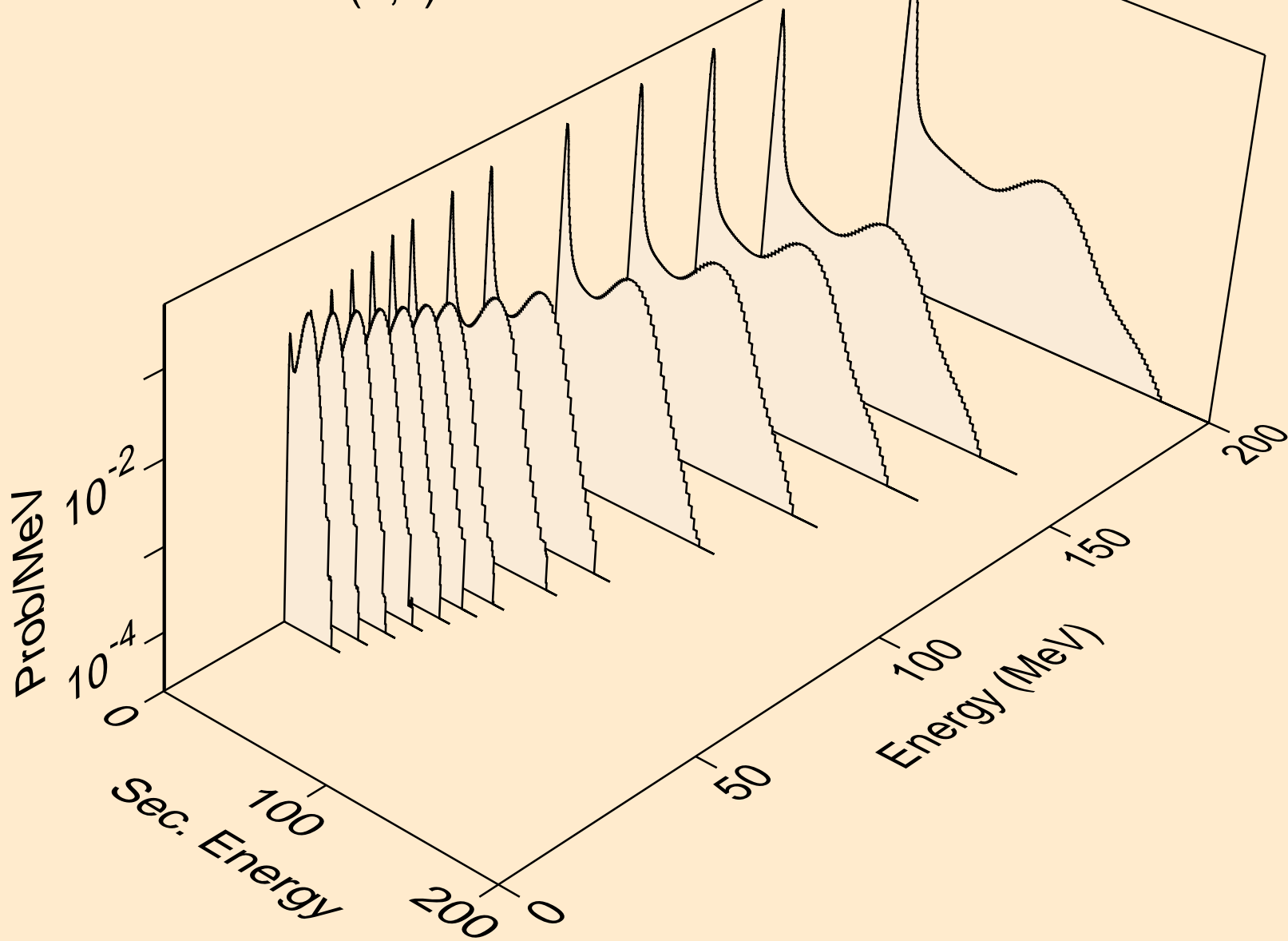

PM129 DEUTERON ACER TENDL-2021 LIBRARY; T=0.K
neutrons from (d,2n)

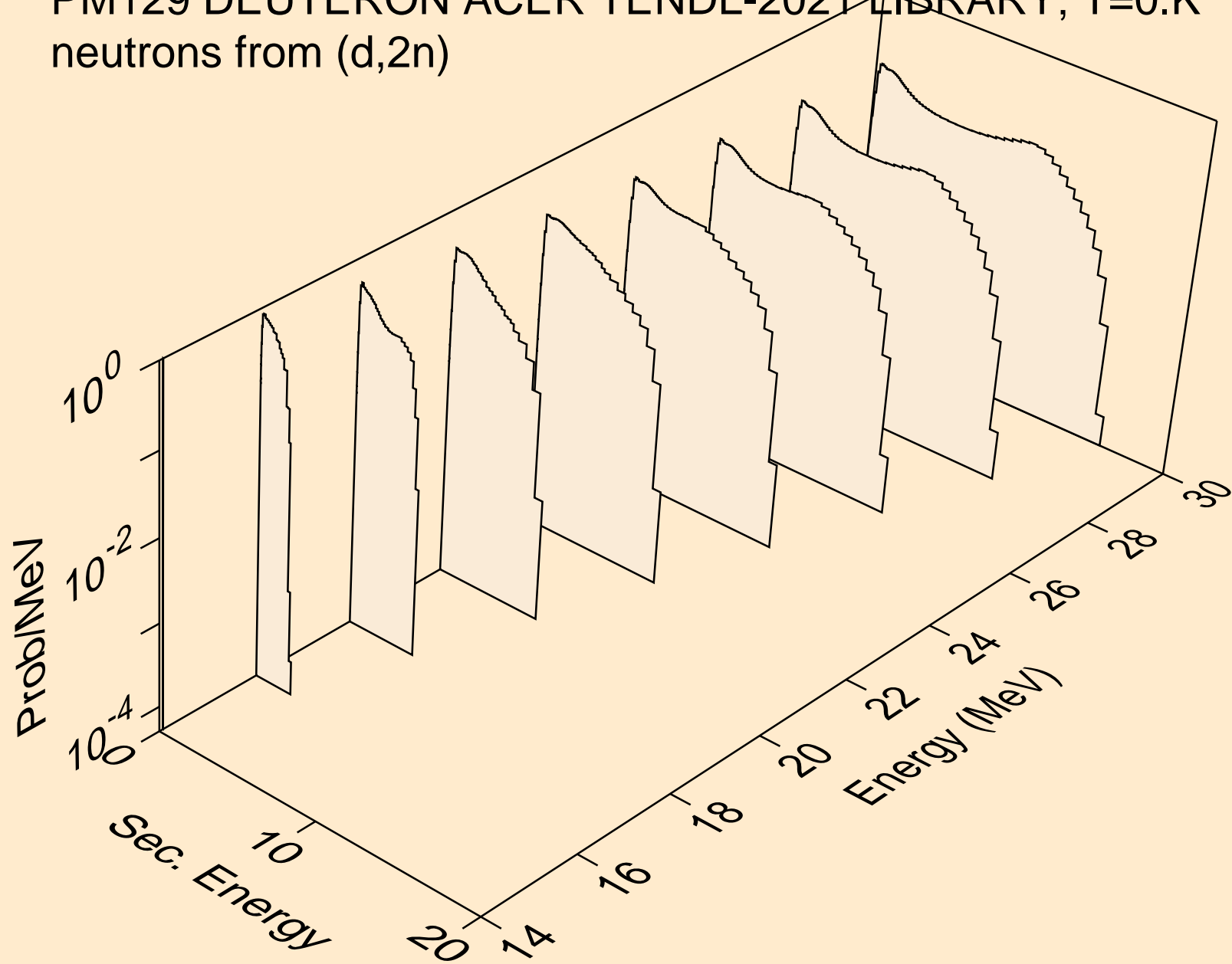

PM129 DEUTERON ACER TENDL-2021 LIBRARY; T=0.K
neutrons from (d,3n)

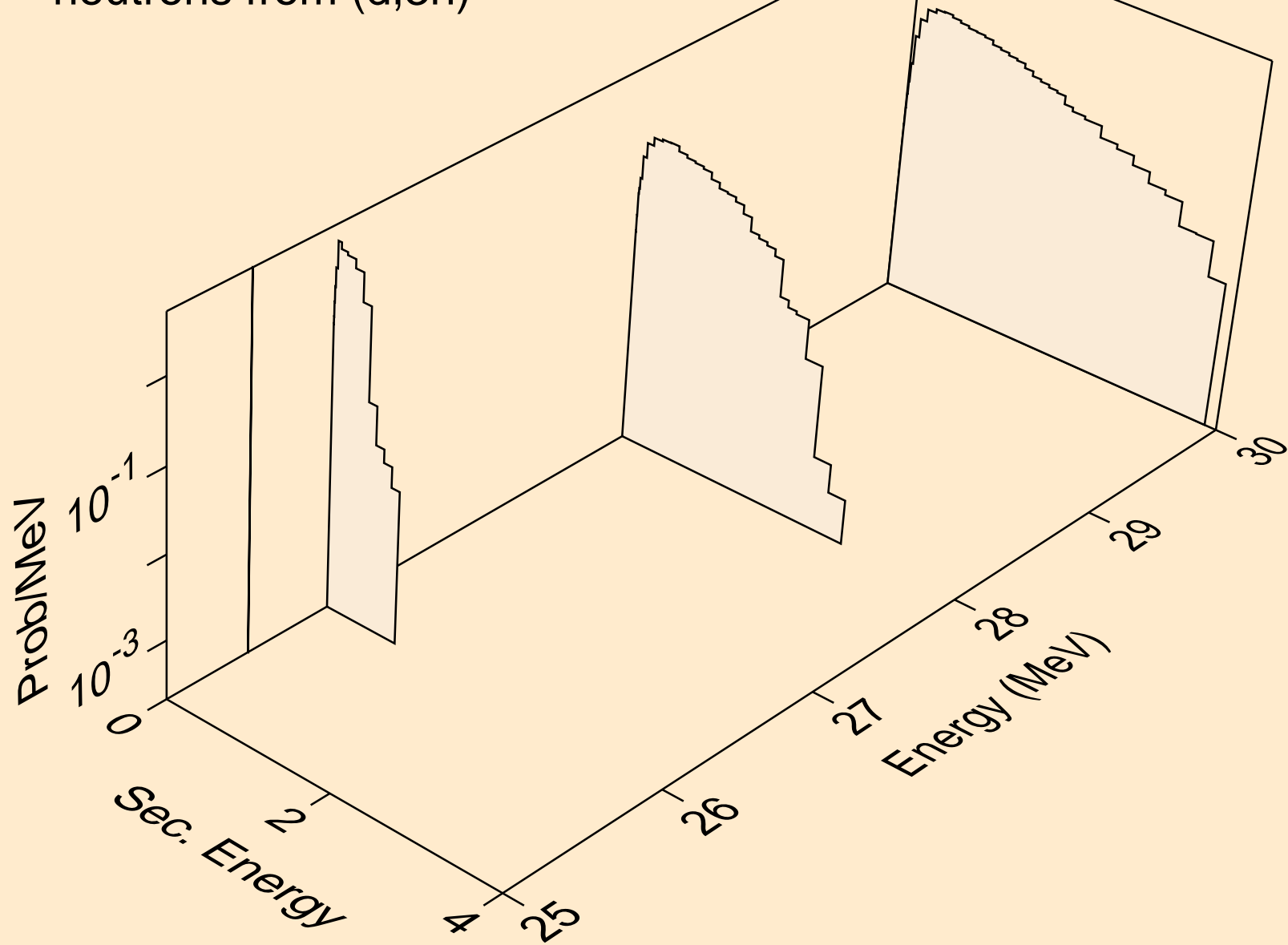

PM129 DEUTERON ACER TENDL-2021 LIBRARY; T=0.K
neutrons from (d,n*)a

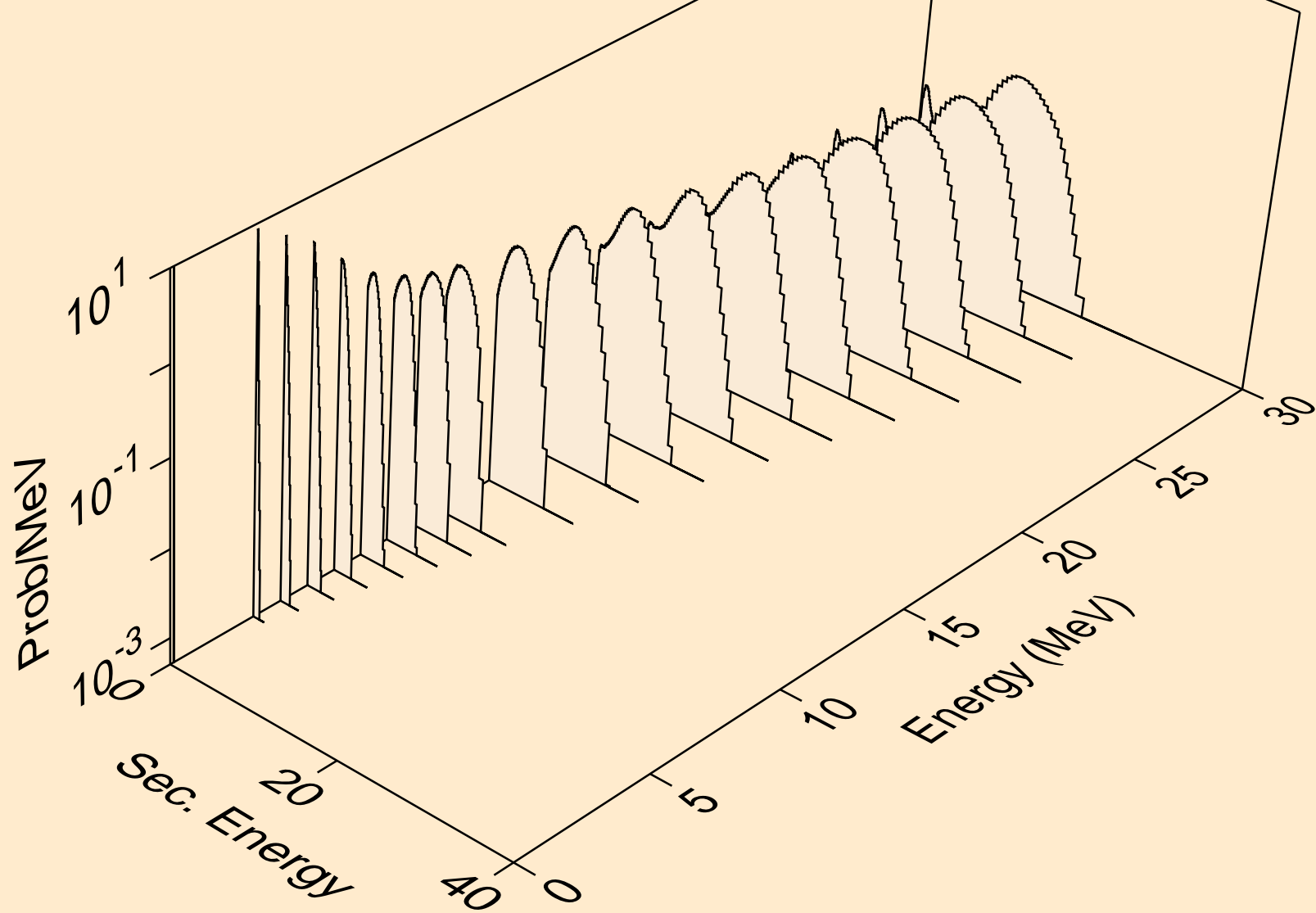

PM129 DEUTERON ACER TENDL-2021 LIBRARY; T=0.K
neutrons from (d,2n)a

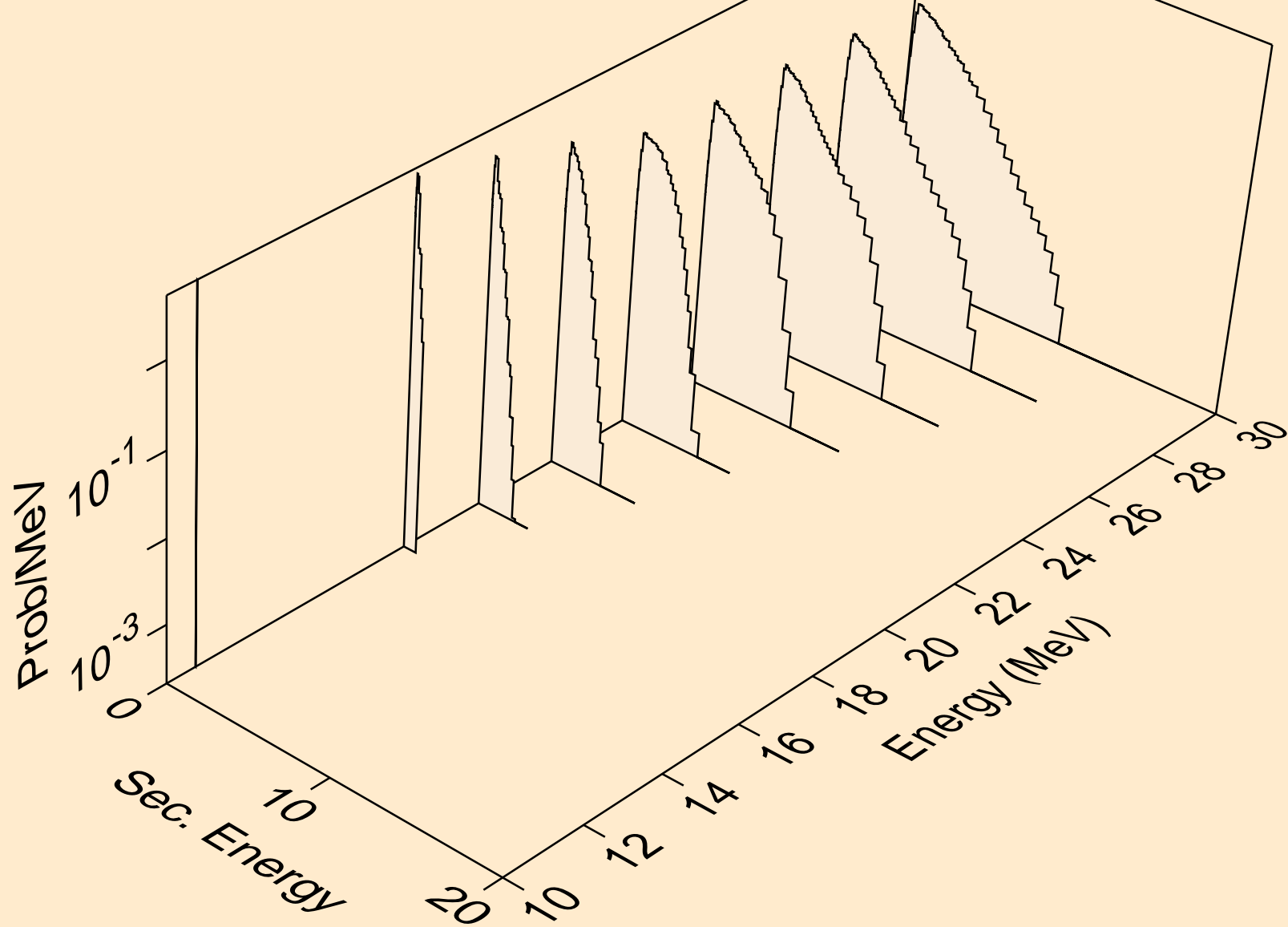

PM129 DEUTERON ACER TENDL-2021 LIBRARY; T=0.K
neutrons from (d,n*)p

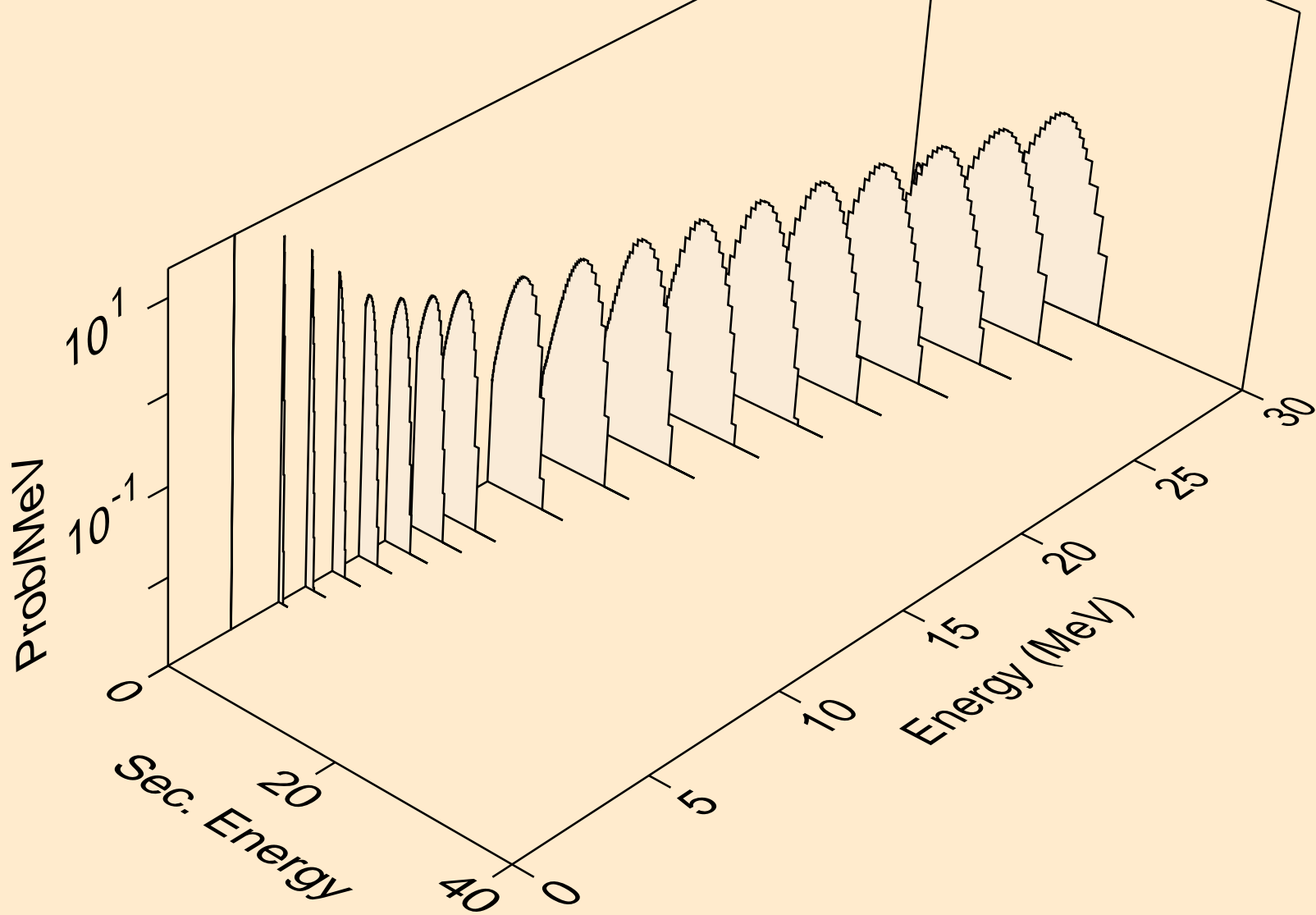

PM129 DEUTERON ACER TENDL-2021 LIBRARY; T=0.K
neutrons from (d,n*)2a

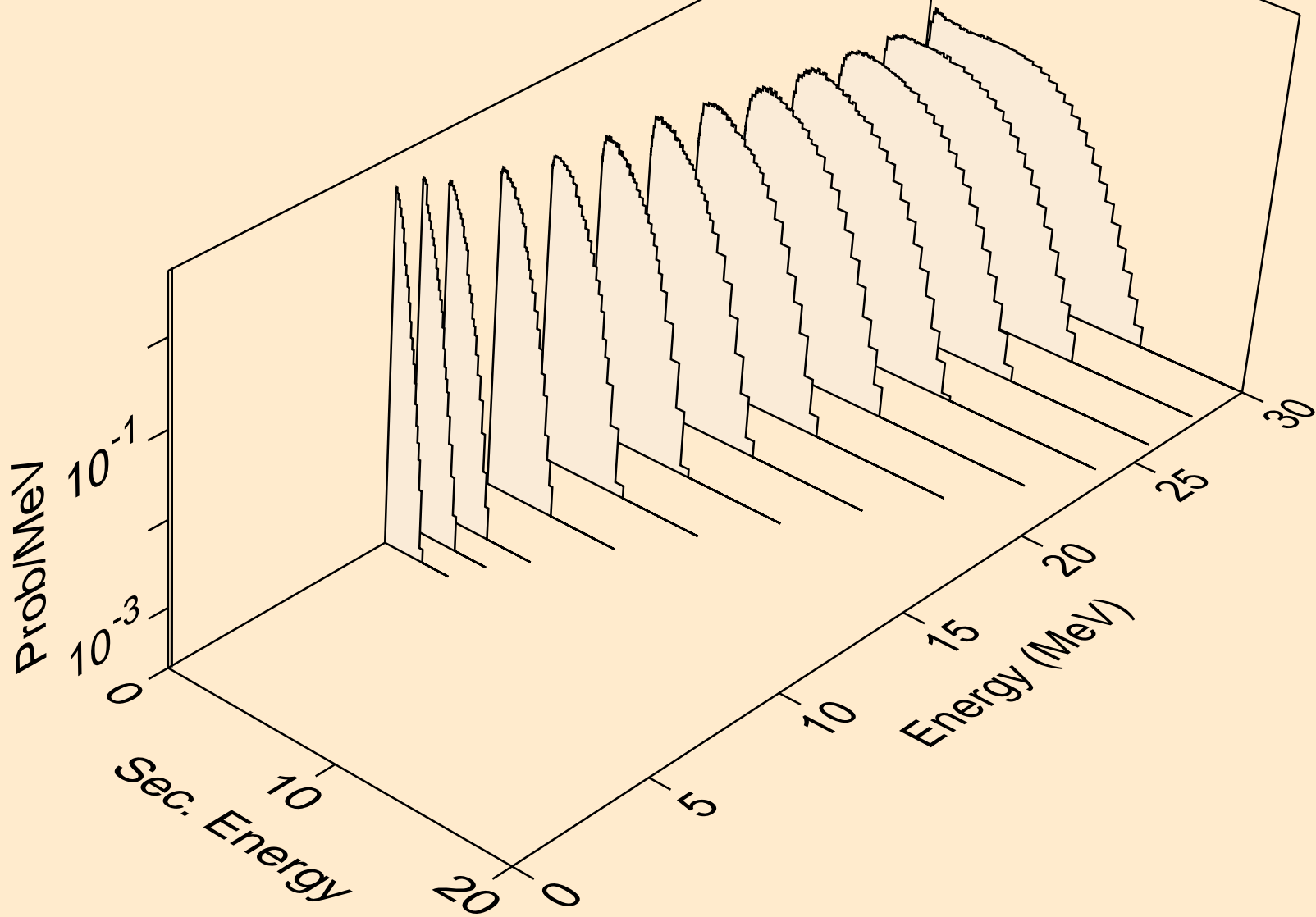

PM129 DEUTERON ACER TENDL-2021 LIBRARY; T=0.K
neutrons from (d,n*)d

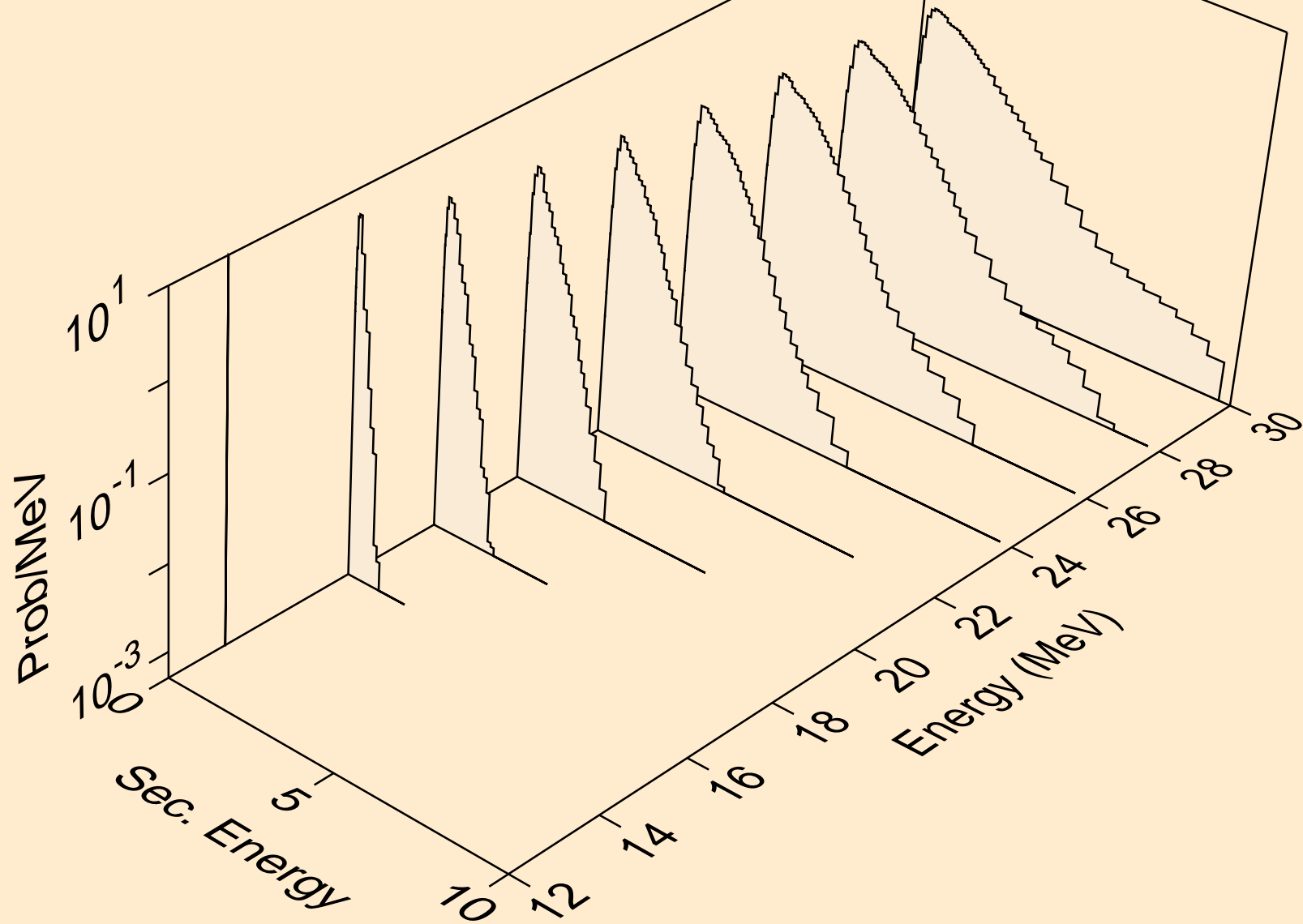

PM129 DEUTERON ACER TENDL-2021 LIBRARY; T=0.K
neutrons from (d,n*)t

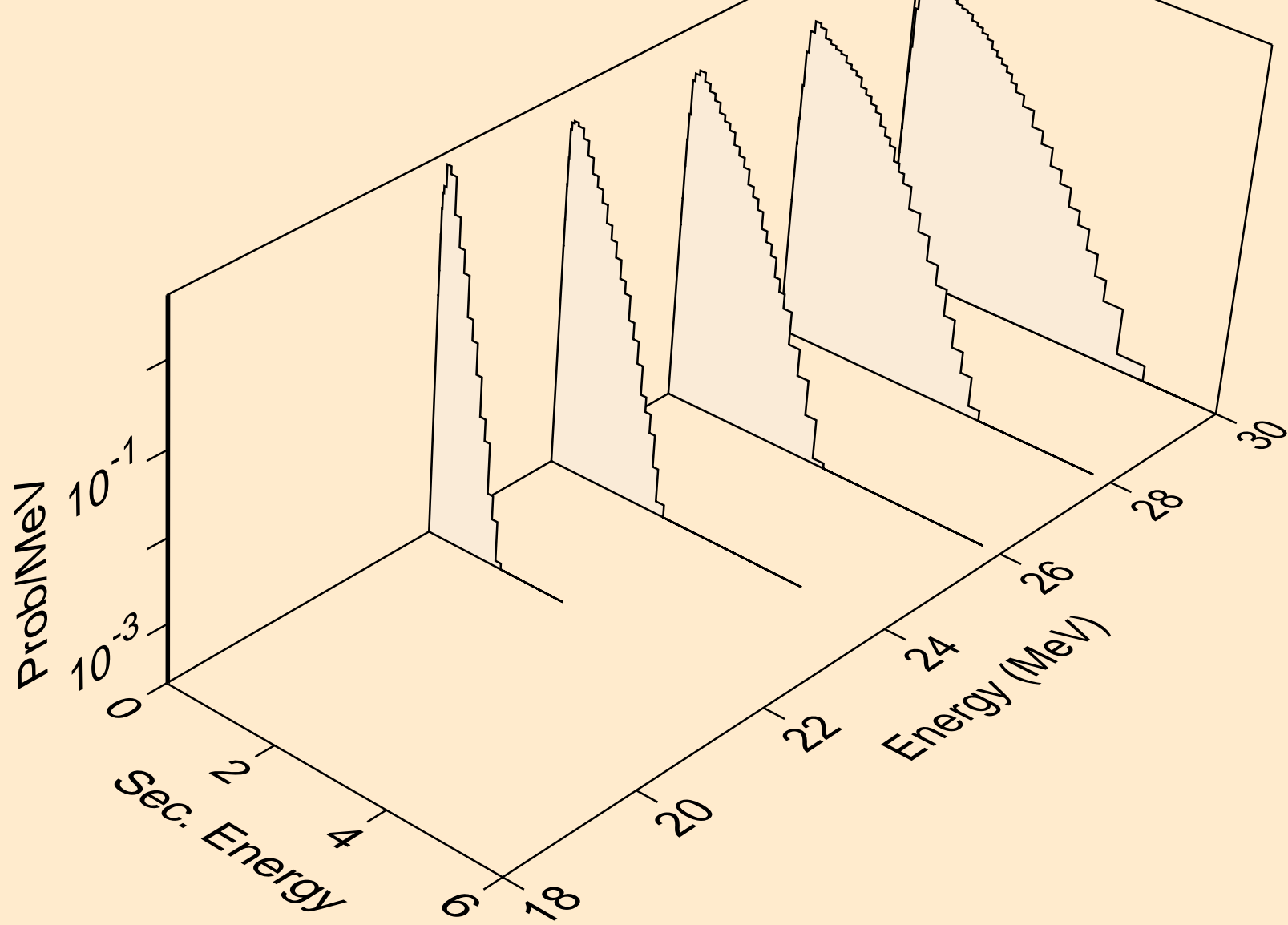

PM129 DEUTERON ACER TENDL-2021 LIBRARY; T=0.K
neutrons from (d,n*)he3

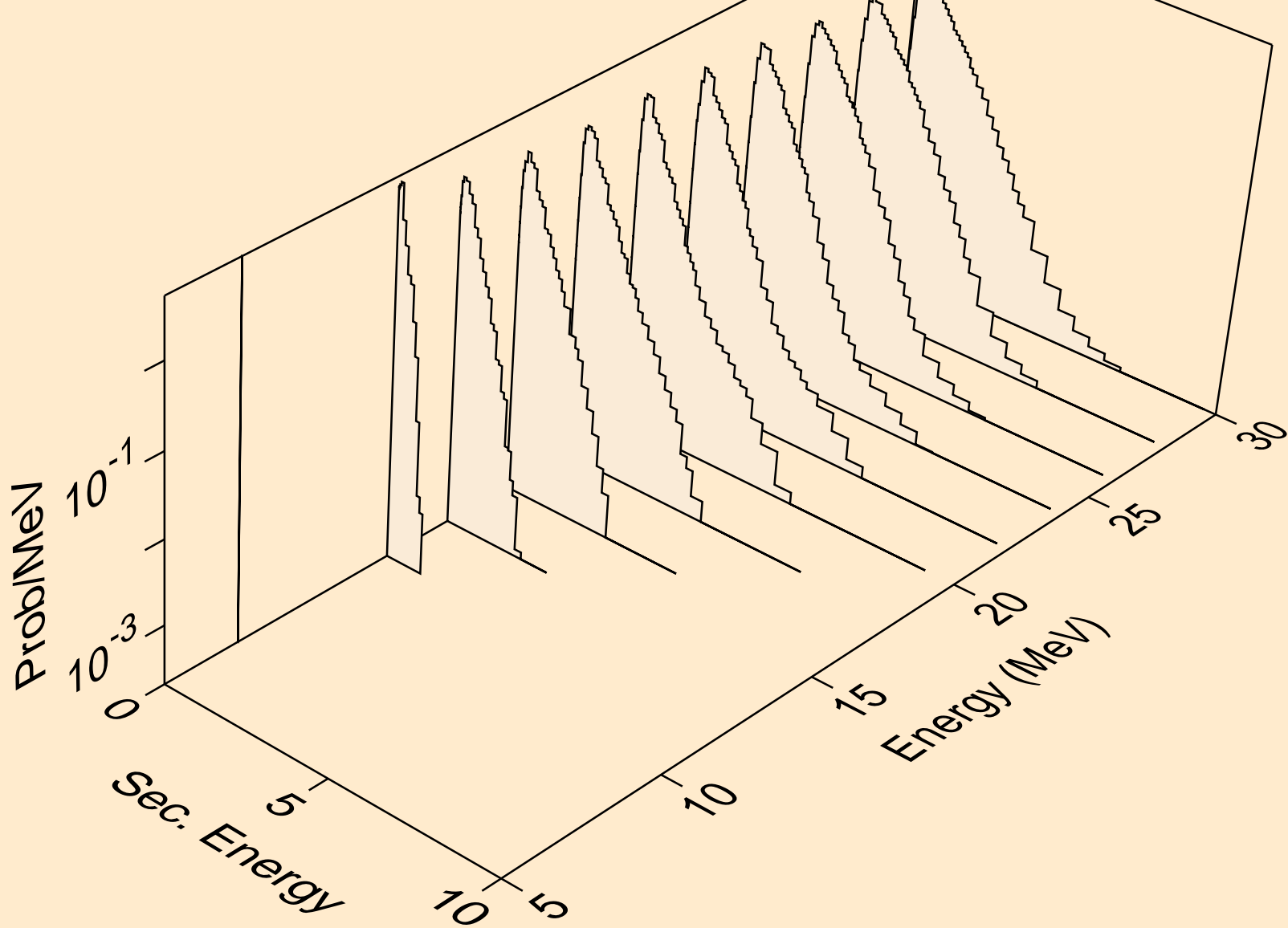

PM129 DEUTERON ACER TENDL-2021 LIBRARY; T=0.K
neutrons from (d,2np)

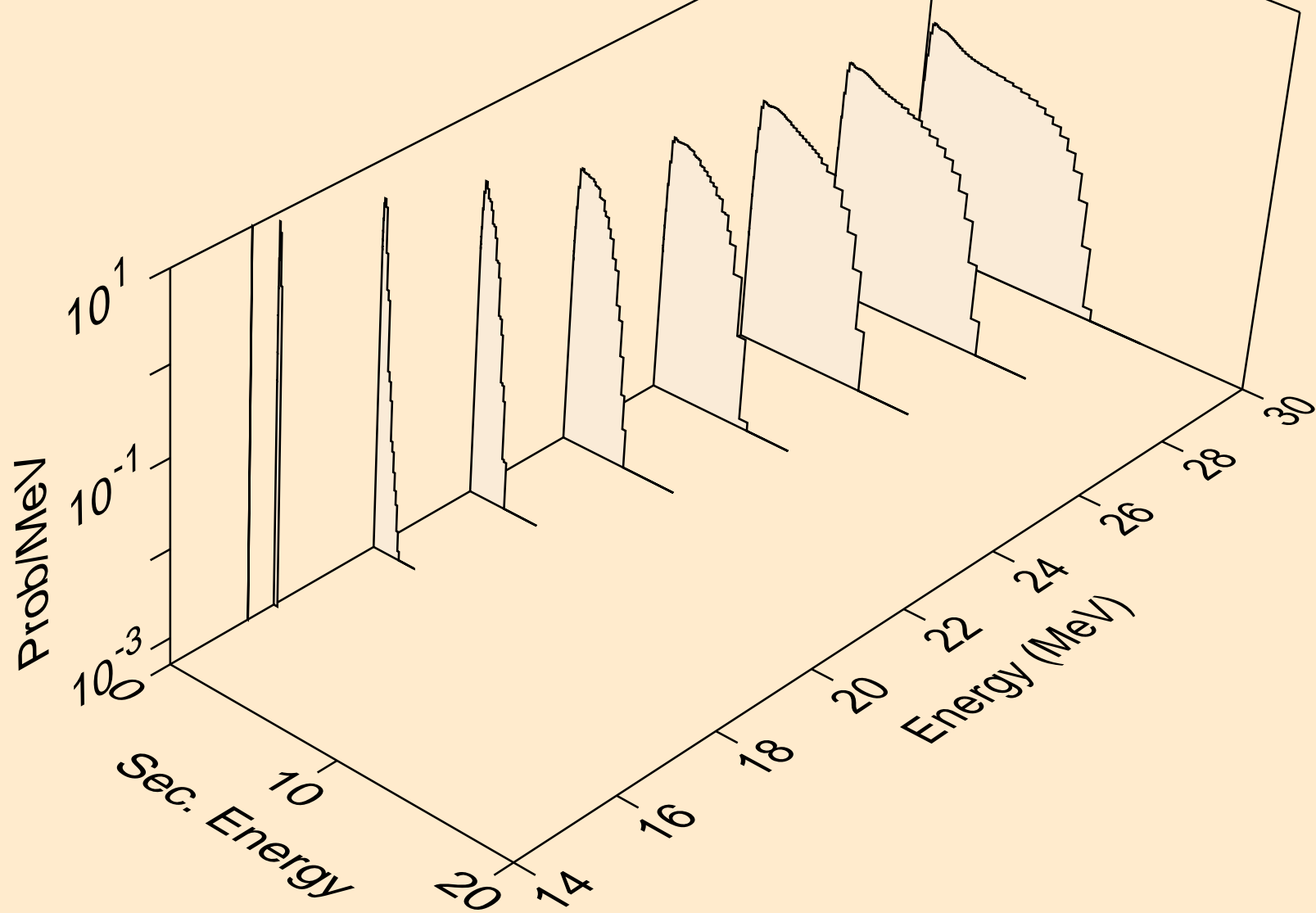

PM129 DEUTERON ACER TENDL-2021 LIBRARY; T=0.K
neutrons from (d,2np)

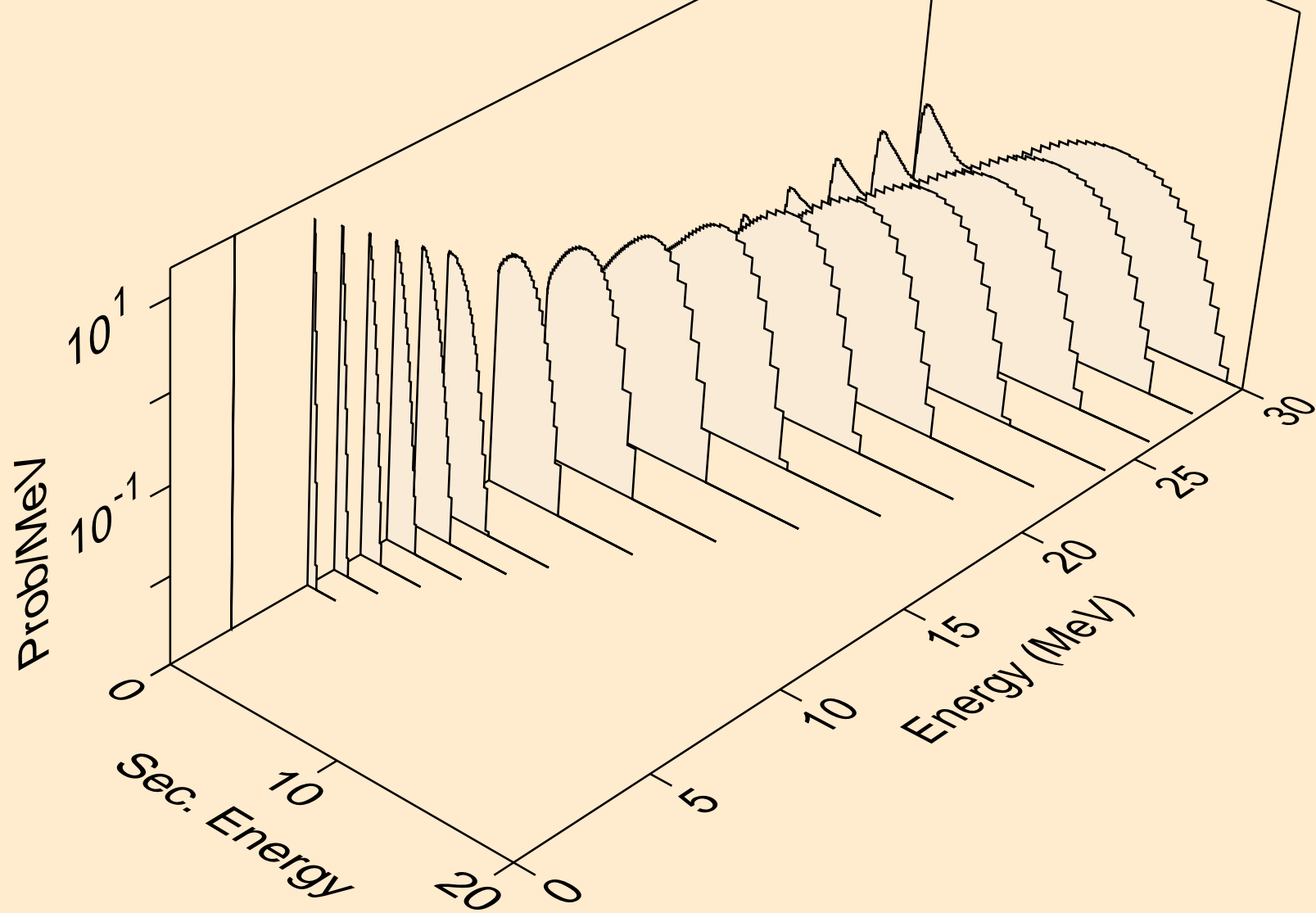

PM129 DEUTERON ACER TENDL-2021 LIBRARY; T=0.K
neutrons from (d,npa)

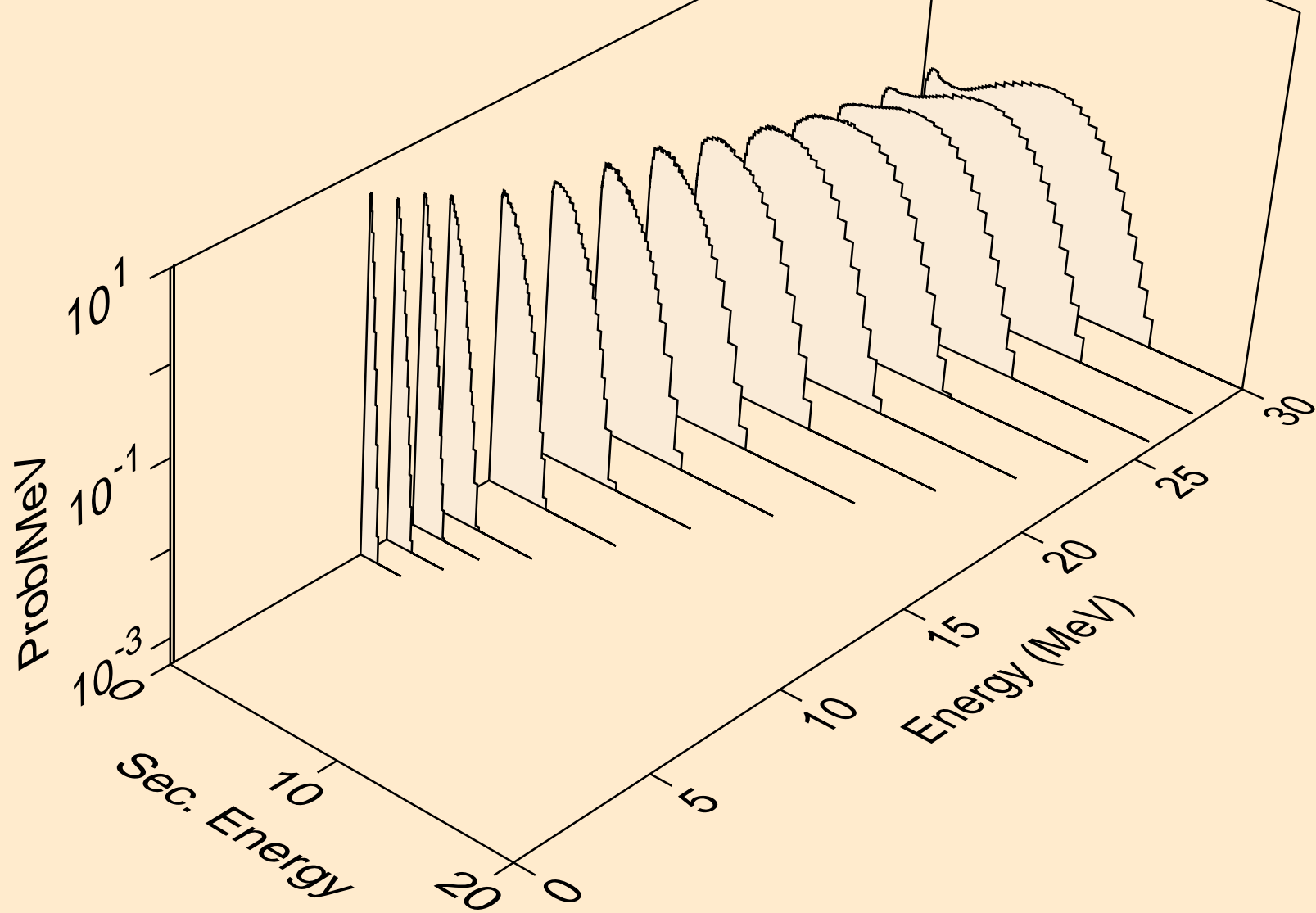

PM129 DEUTERON ACER TENDL-2021 LIBRARY; T=0.K
protons from (d,x)

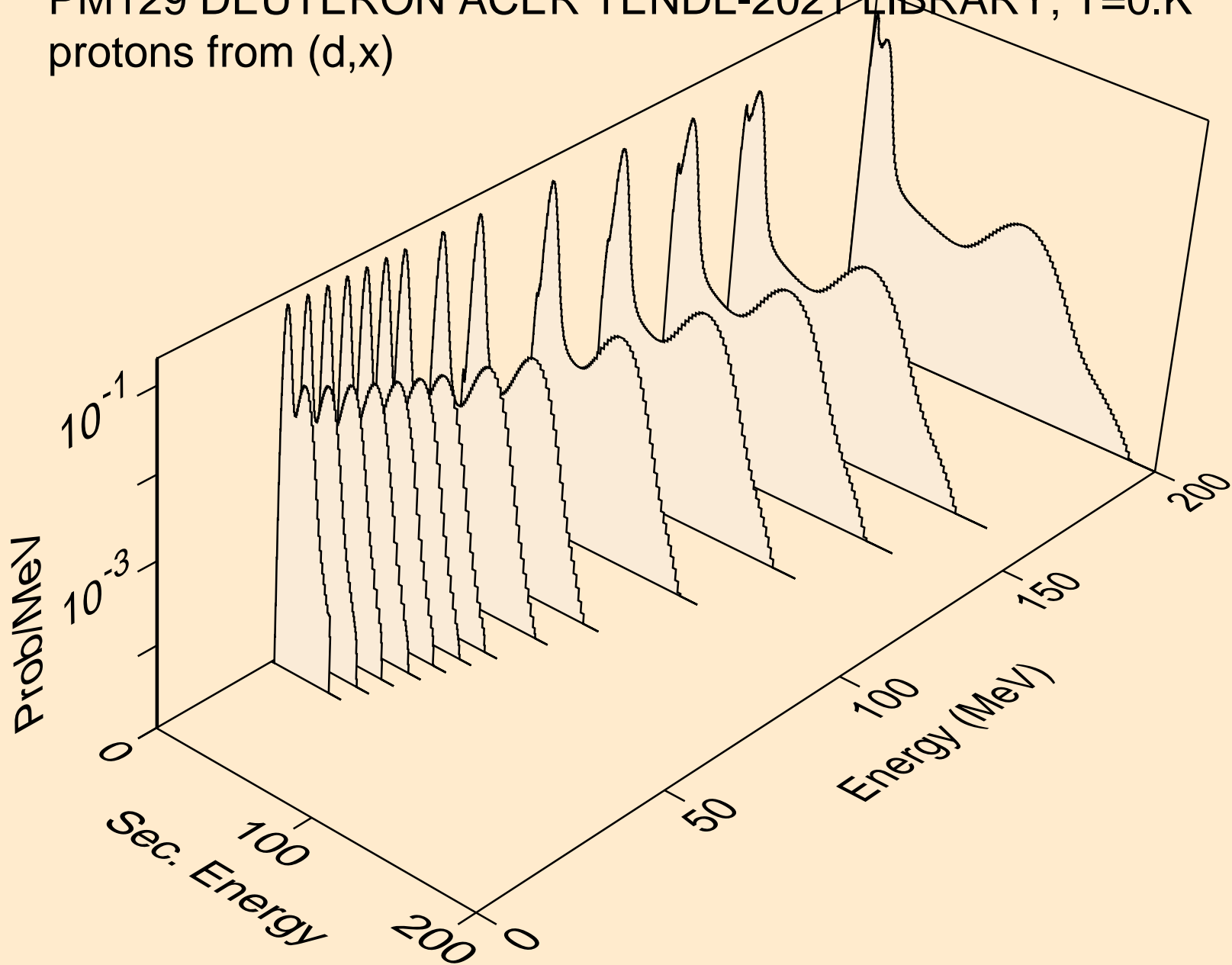

PM129 DEUTERON ACER TENDL-2021 LIBRARY; T=0.K
protons from (d,n*)p

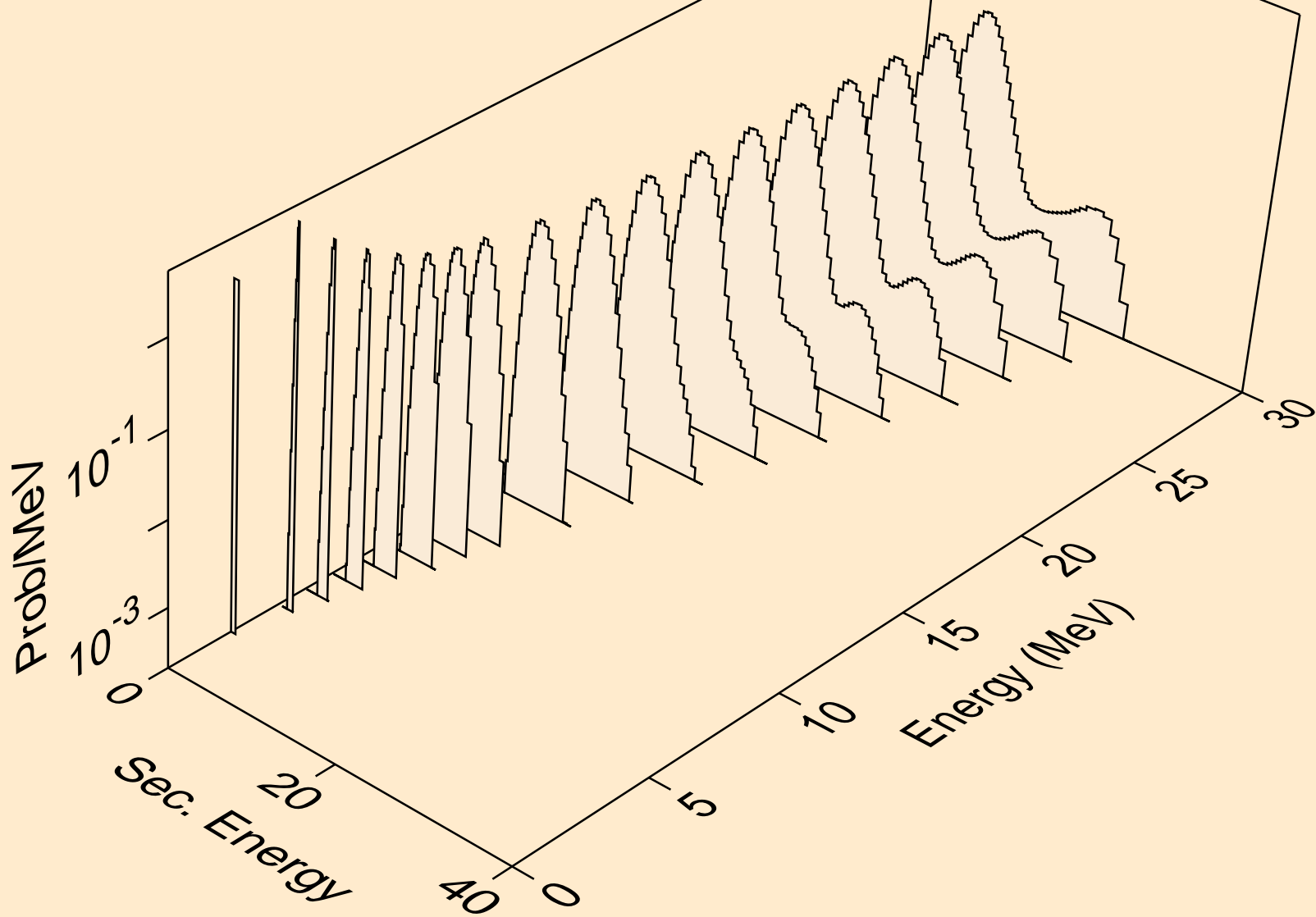

PM129 DEUTERON ACER TENDL-2021 LIBRARY; T=0.K
protons from (d,2np)

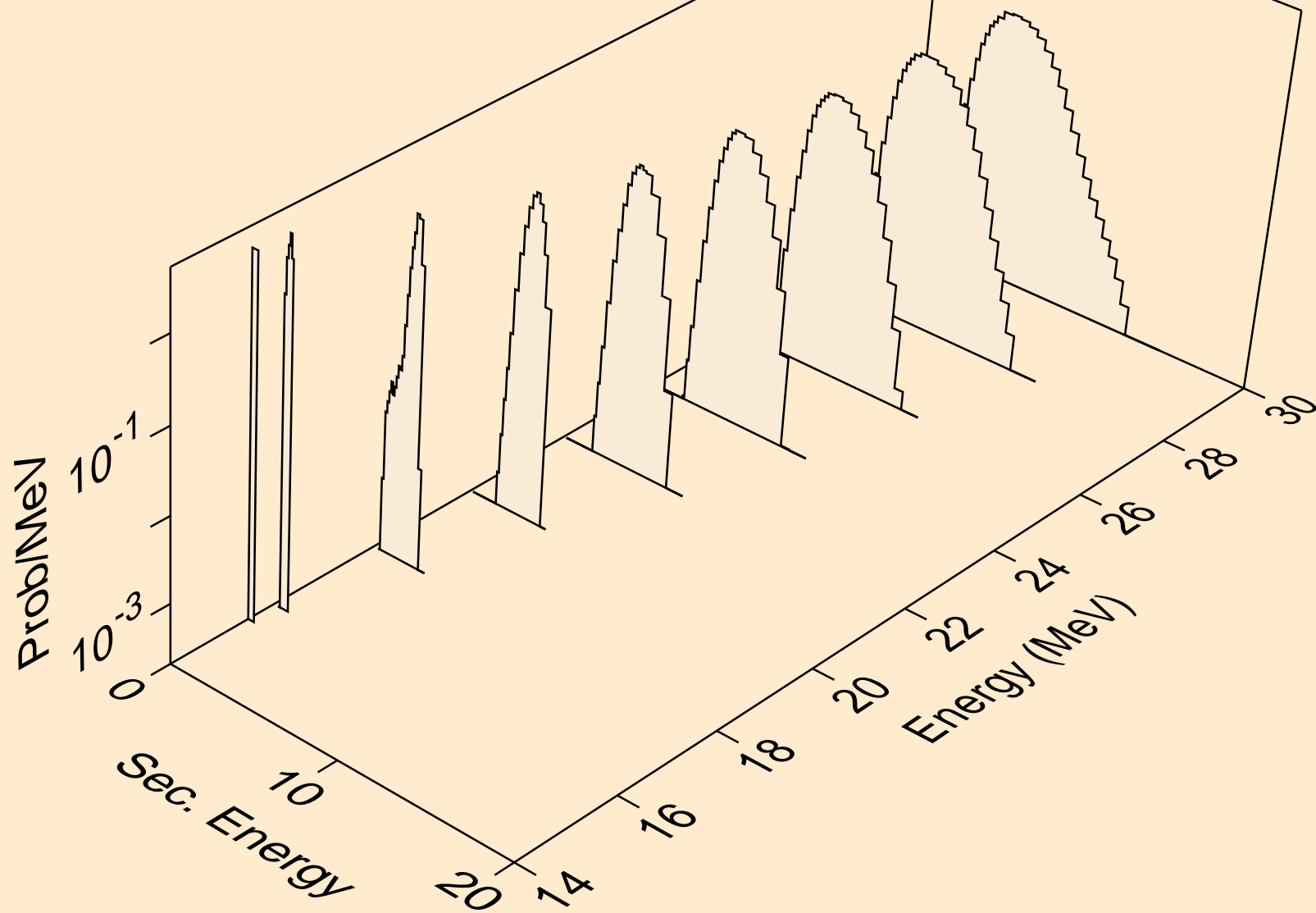

PM129 DEUTERON ACER TENDL-2021 LIBRARY; T=0.K
protons from (d,2np)

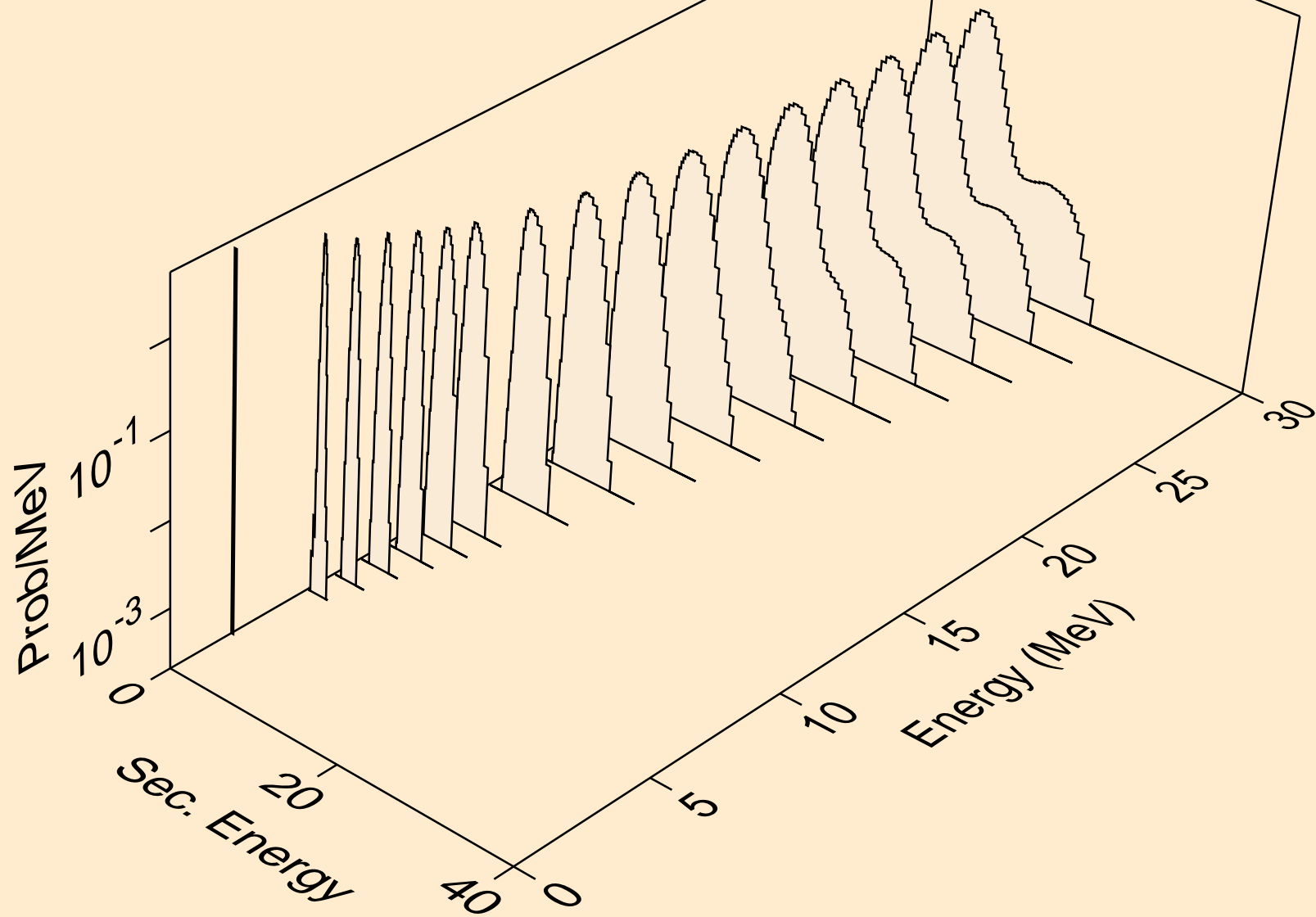

PM129 DEUTERON ACER TENDL-2021 LIBRARY; T=0.K
protons from (d,npa)

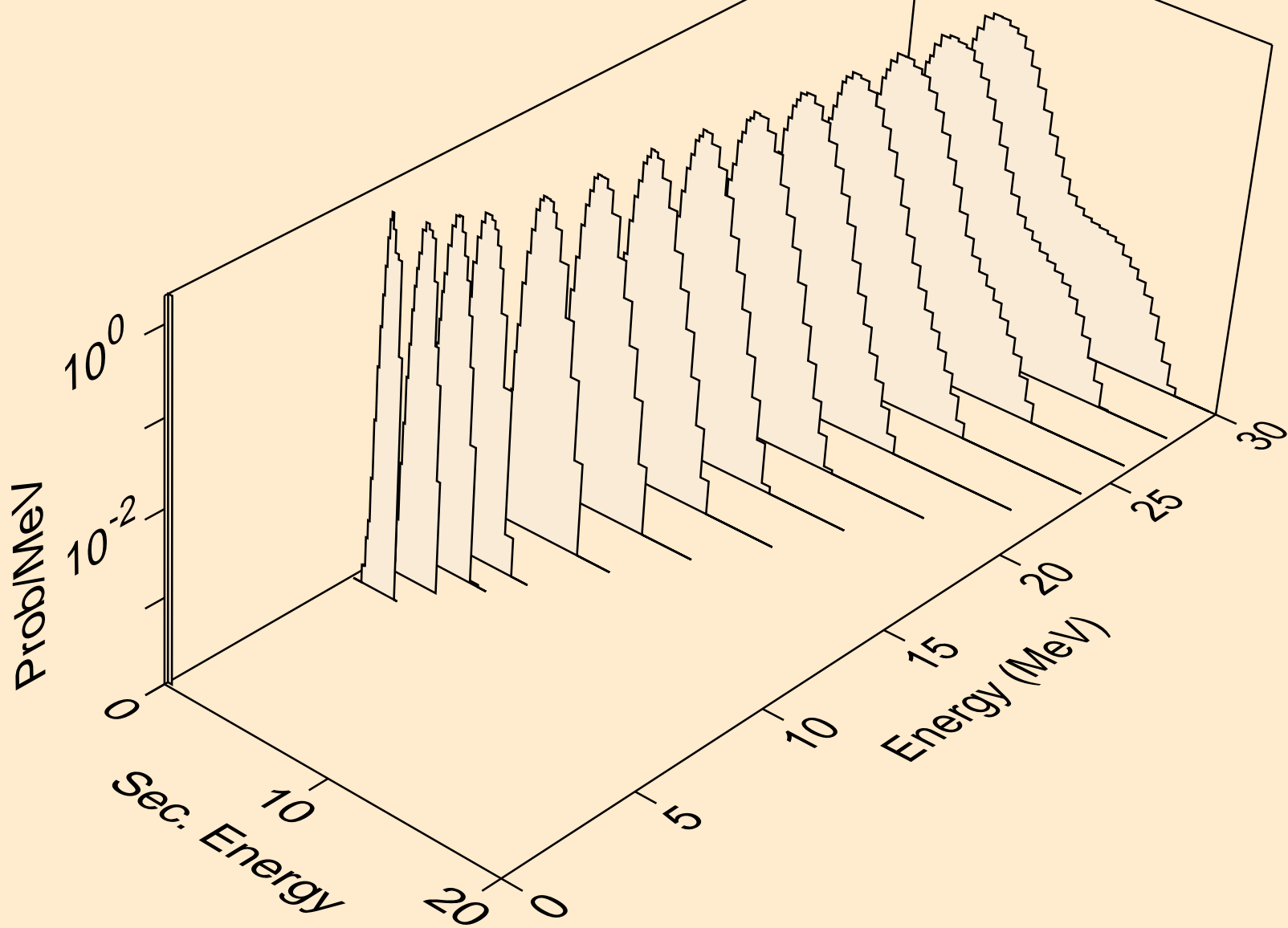

PM129 DEUTERON ACER TENDL-2021 LIBRARY; T=0.K
protons from (d,p)

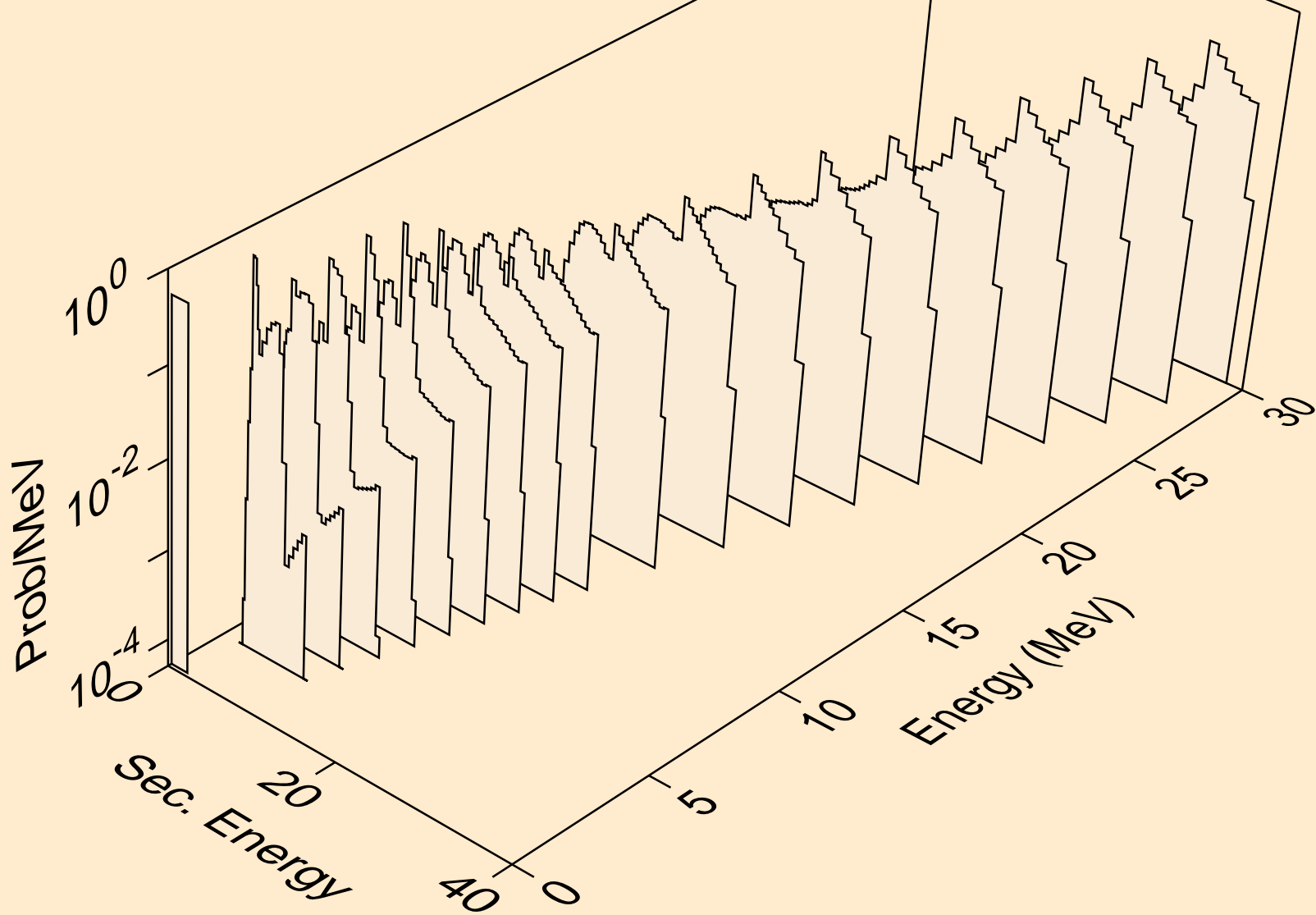

PM129 DEUTERON ACER TENDL-2021 LIBRARY; T=0.K
protons from (d,2p)

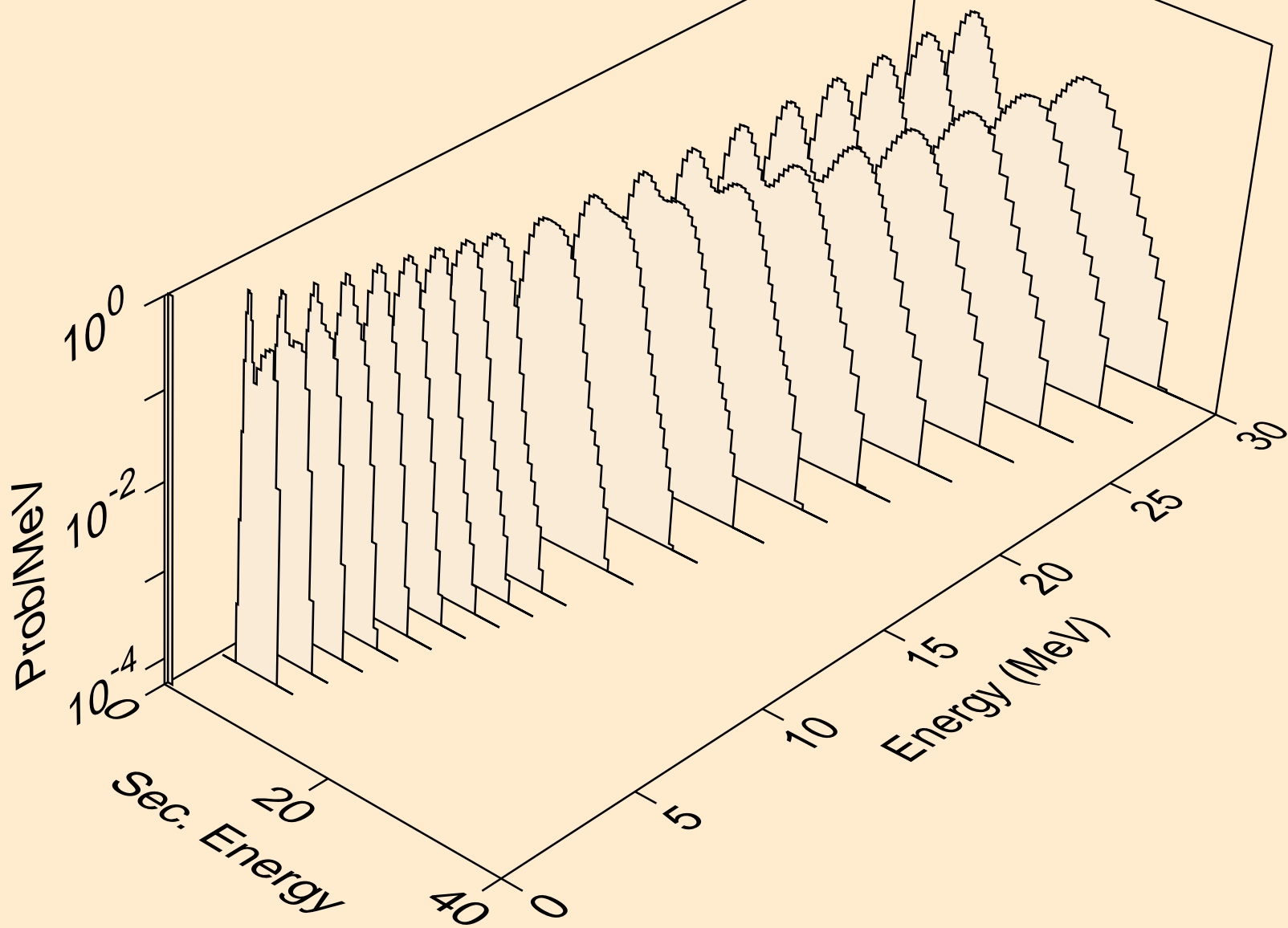

PM129 DEUTERON ACER TENDL-2021 LIBRARY; T=0.K
protons from (d,pa)

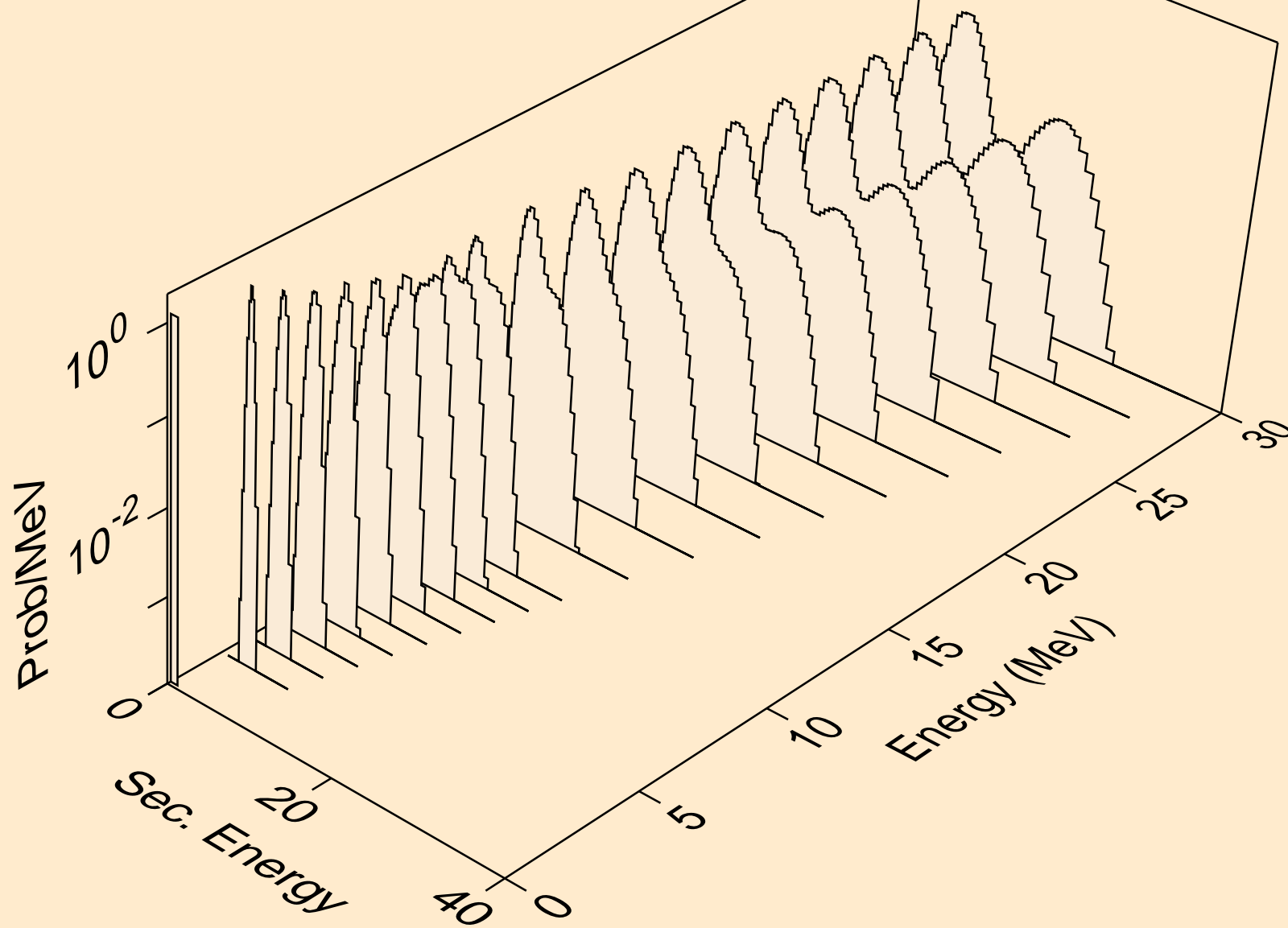

PM129 DEUTERON ACER TENDL-2021 LIBRARY; T=0.K
protons from (d,pd)

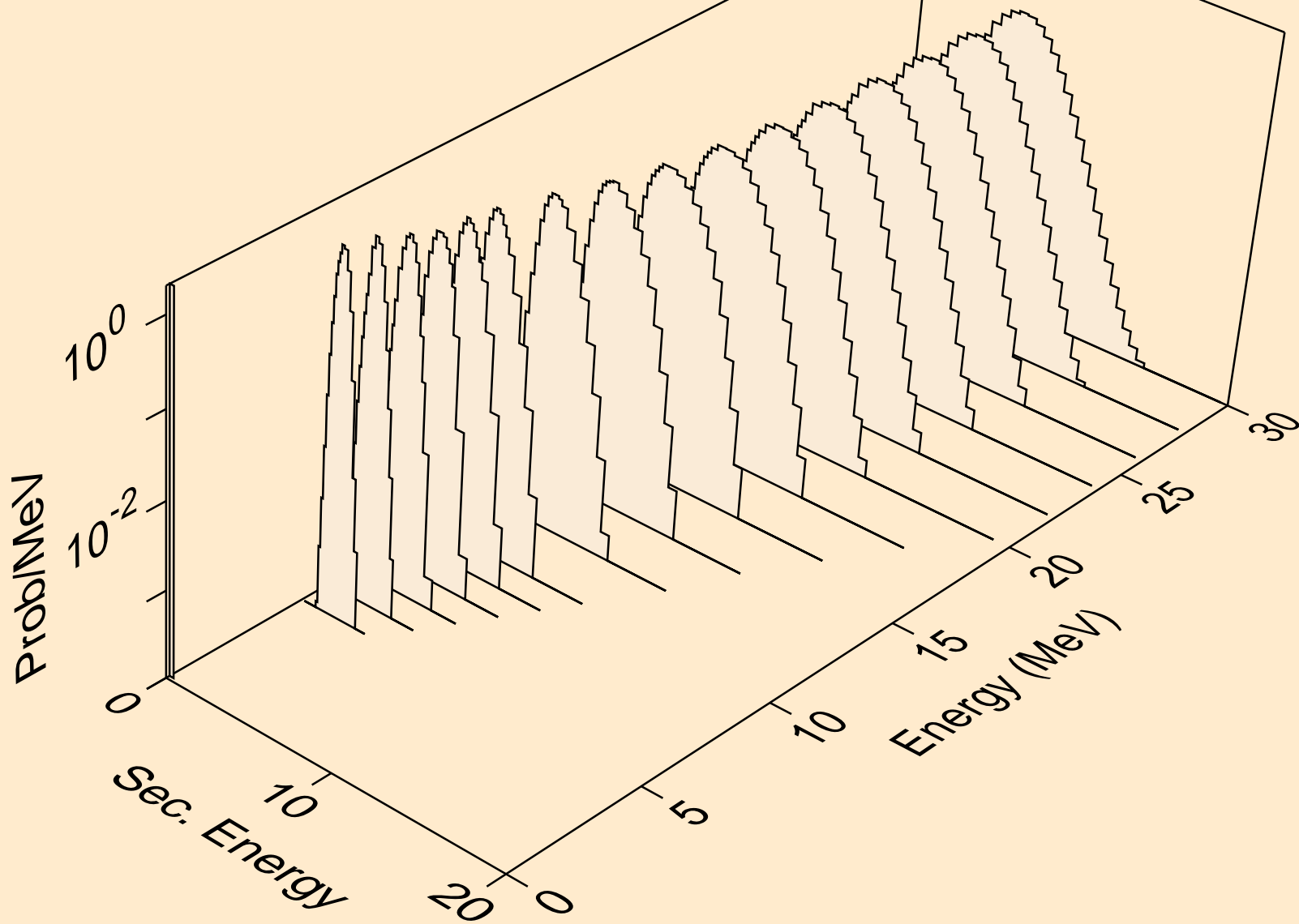

PM129 DEUTERON ACER TENDL-2021 LIBRARY; T=0.K
protons from (d,pt)

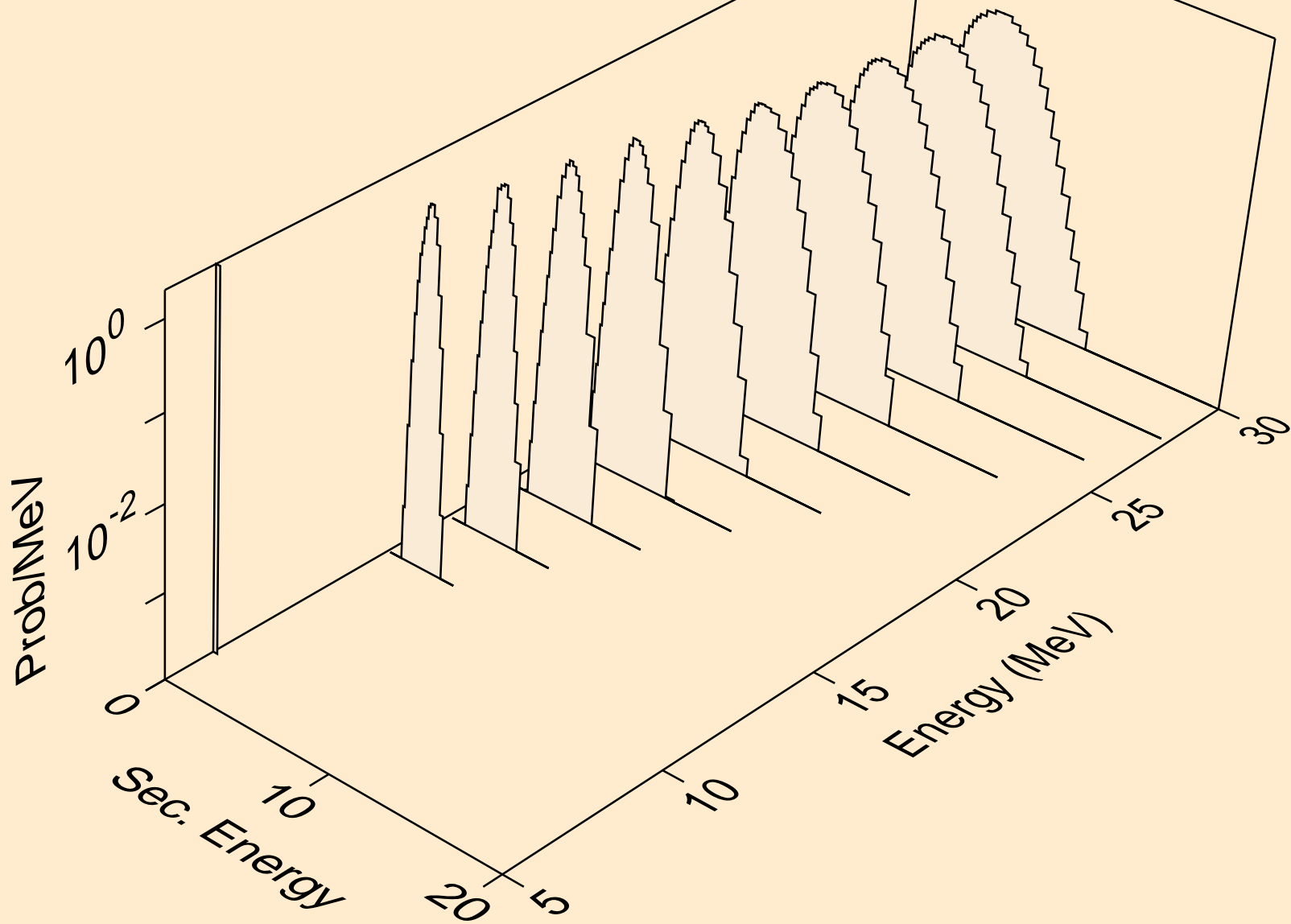

PM129 DEUTERON ACER TENDL-2021 LIBRARY; T=0.K
tritons from (d,x)

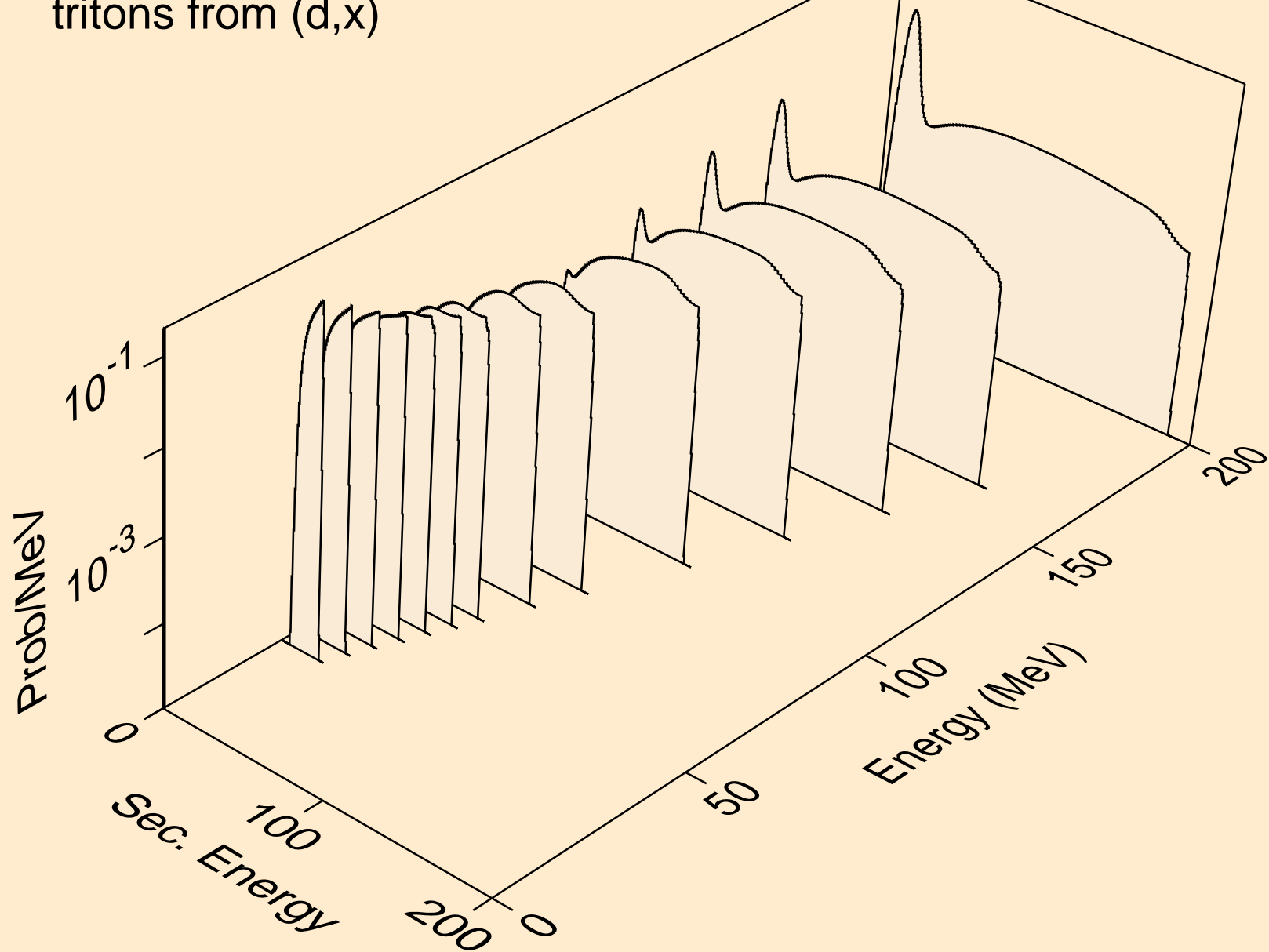

PM129 DEUTERON ACER TENDL-2021 LIBRARY; T=0.K
tritons from (d,n*)t

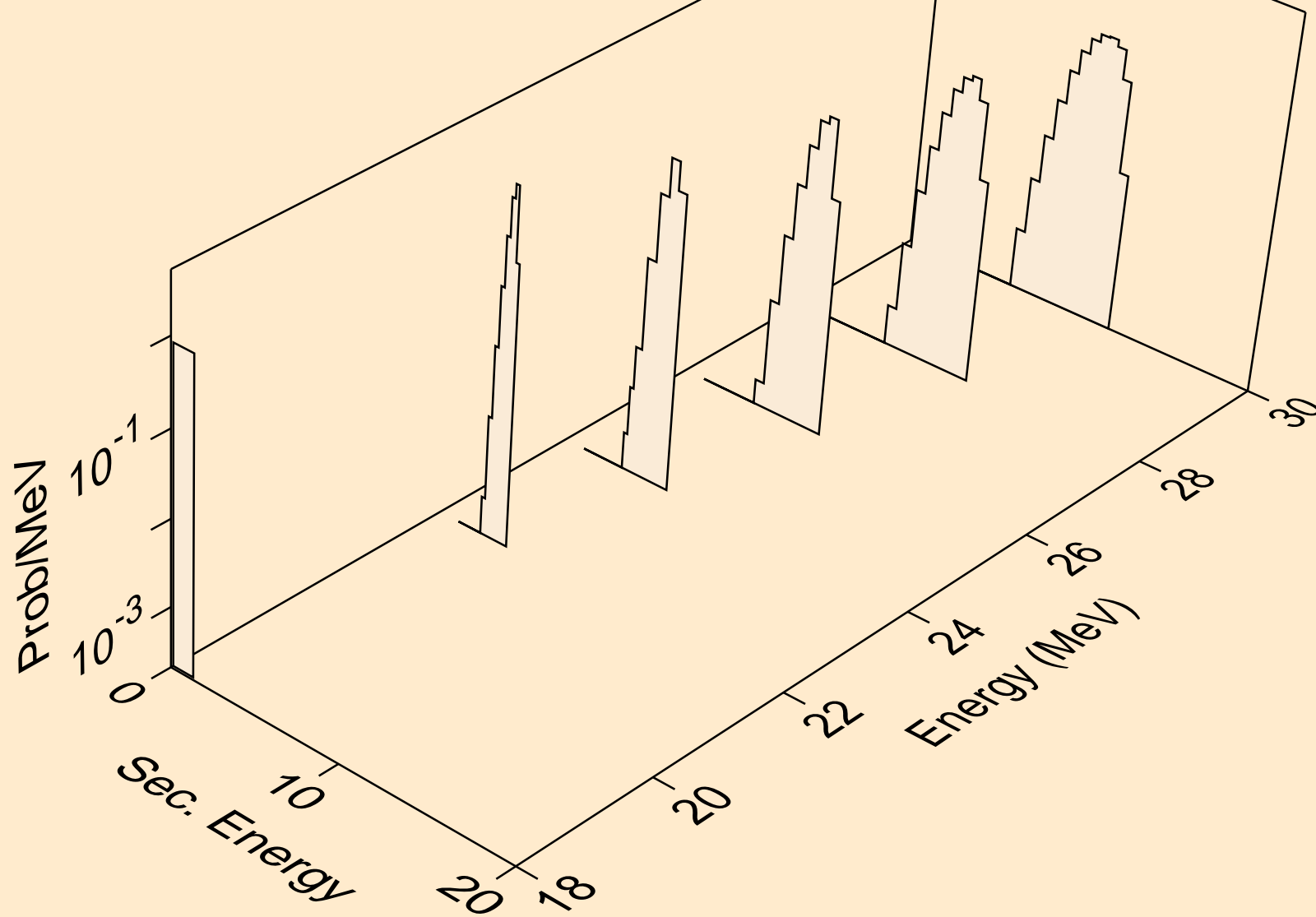

PM129 DEUTERON ACER TENDL-2021 LIBRARY; T=0.K
tritons from (d,t)

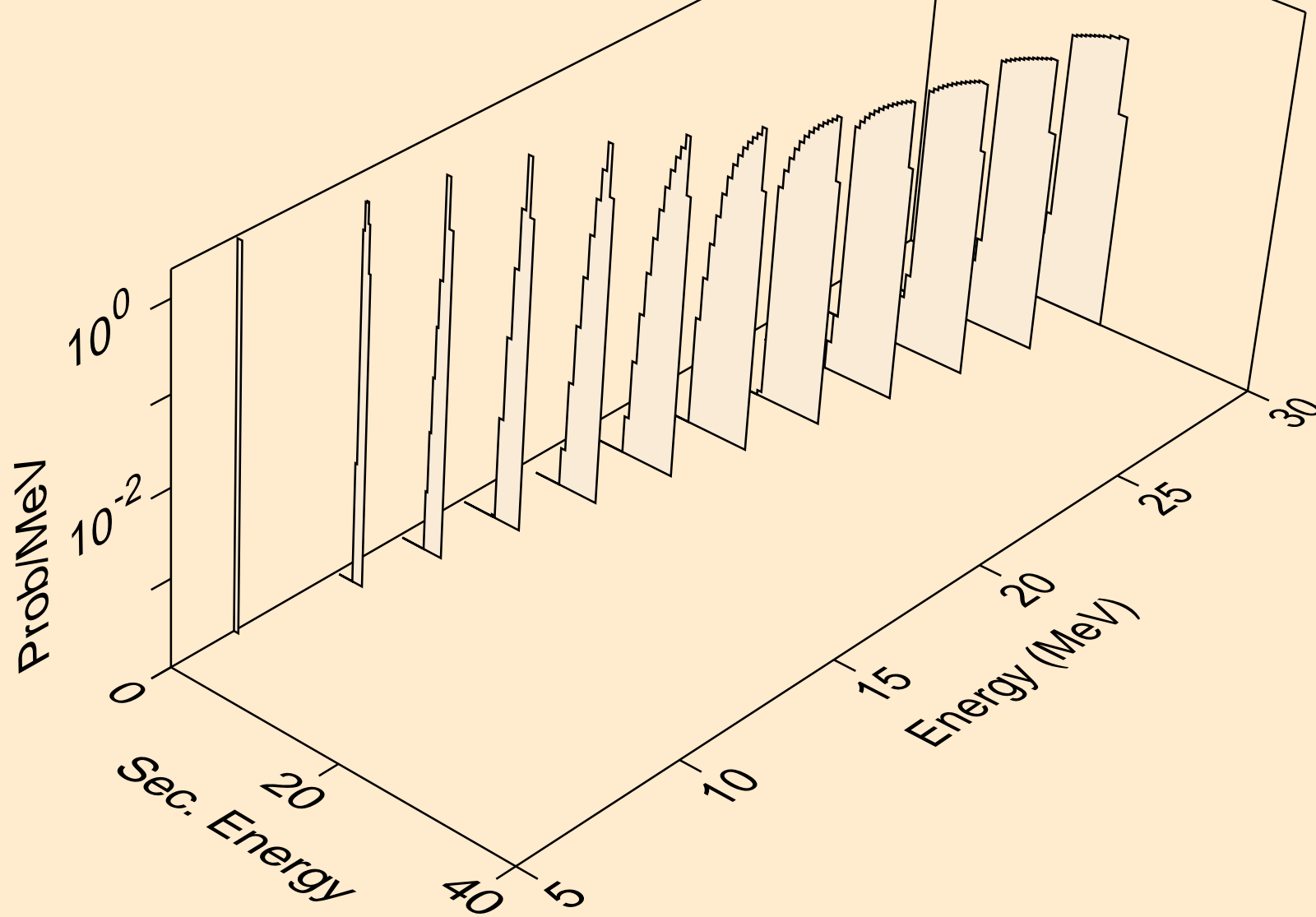

PM129 DEUTERON ACER TENDL-2021 LIBRARY; T=0.K
tritons from (d,pt)

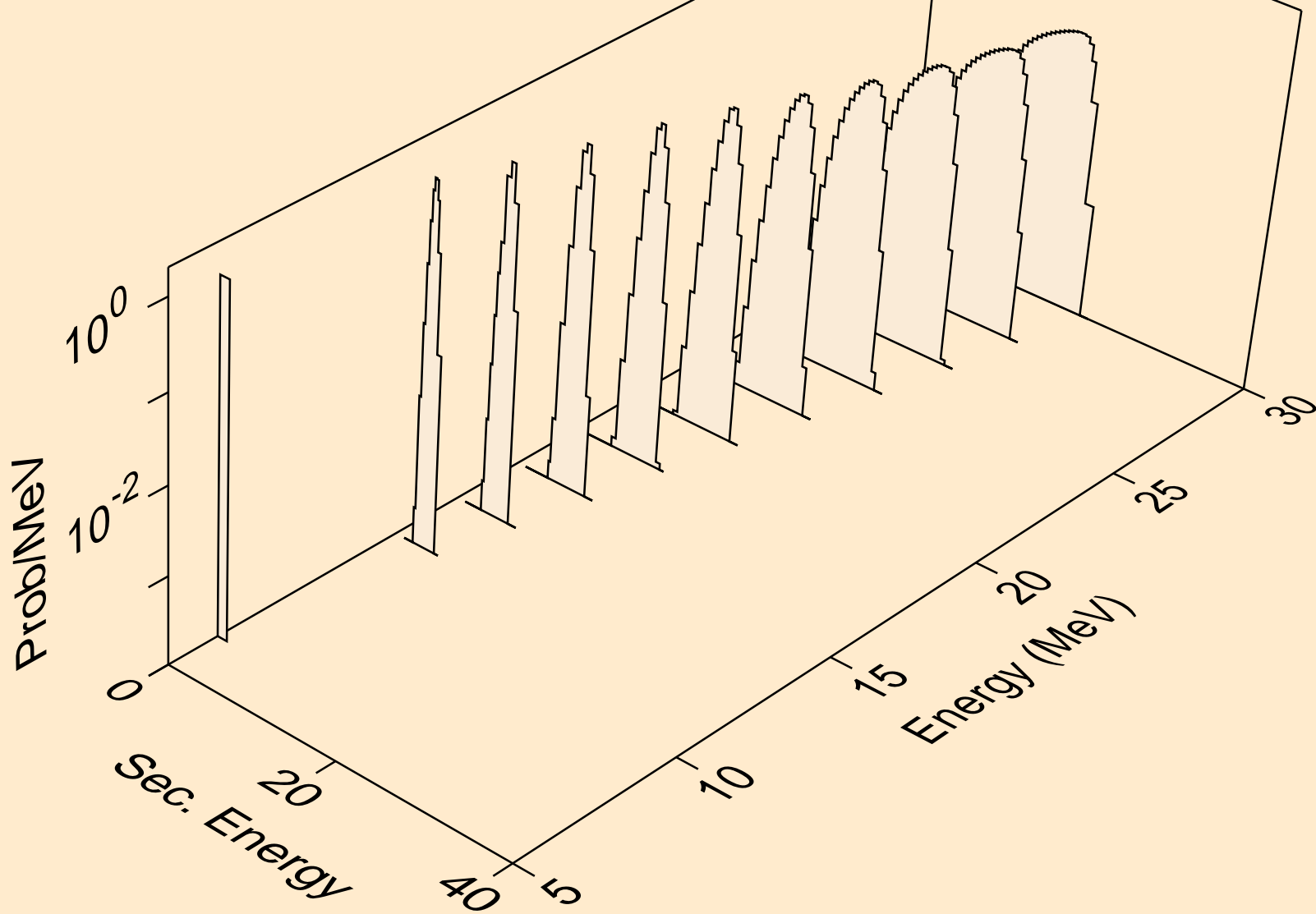

PM129 DEUTERON ACER TENDL-2021 LIBRARY; T=0.K
he3s from (d,x)

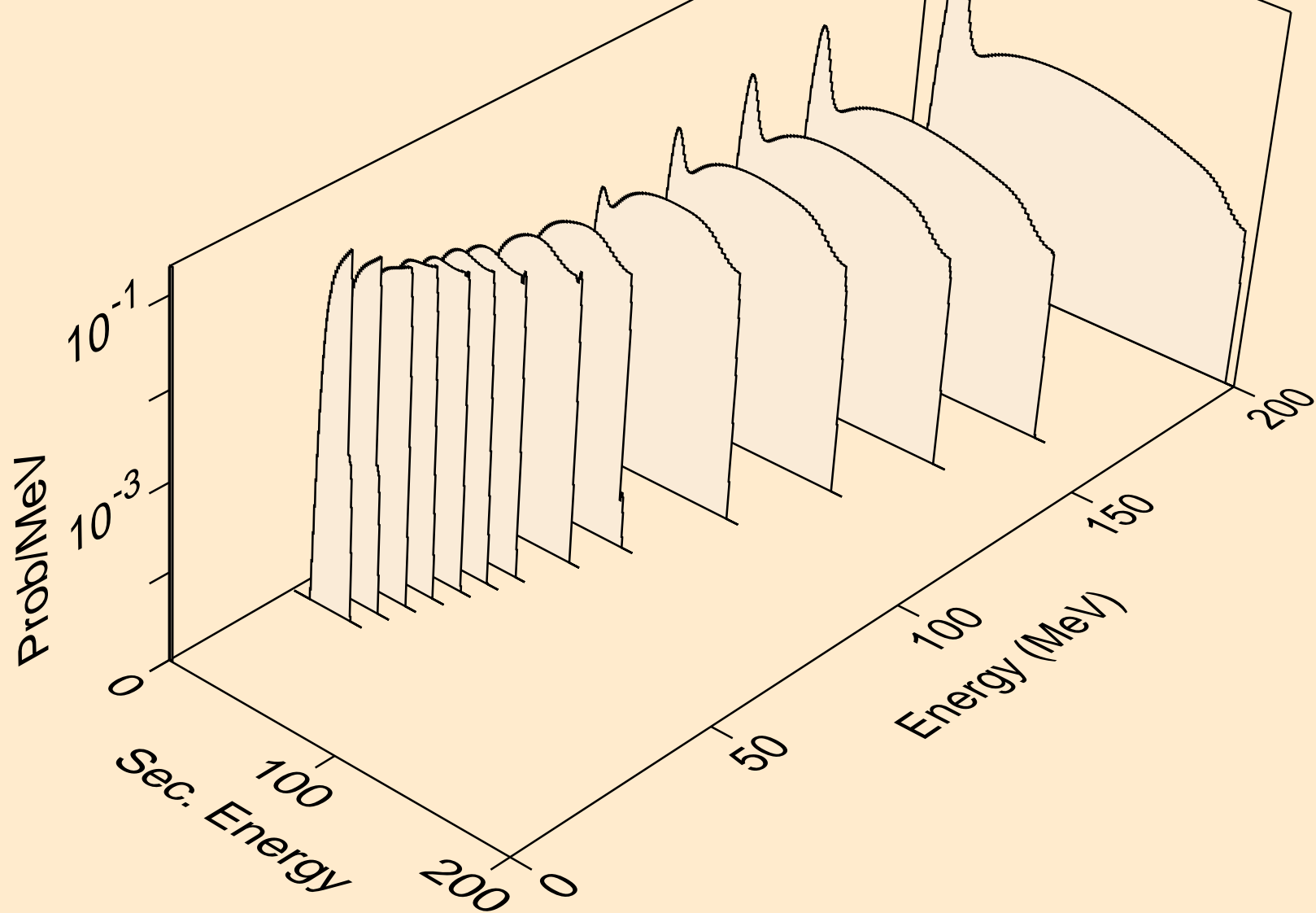

PM129 DEUTERON ACER TENDL-2021 LIBRARY; T=0.K
he3s from (d,n*)he3

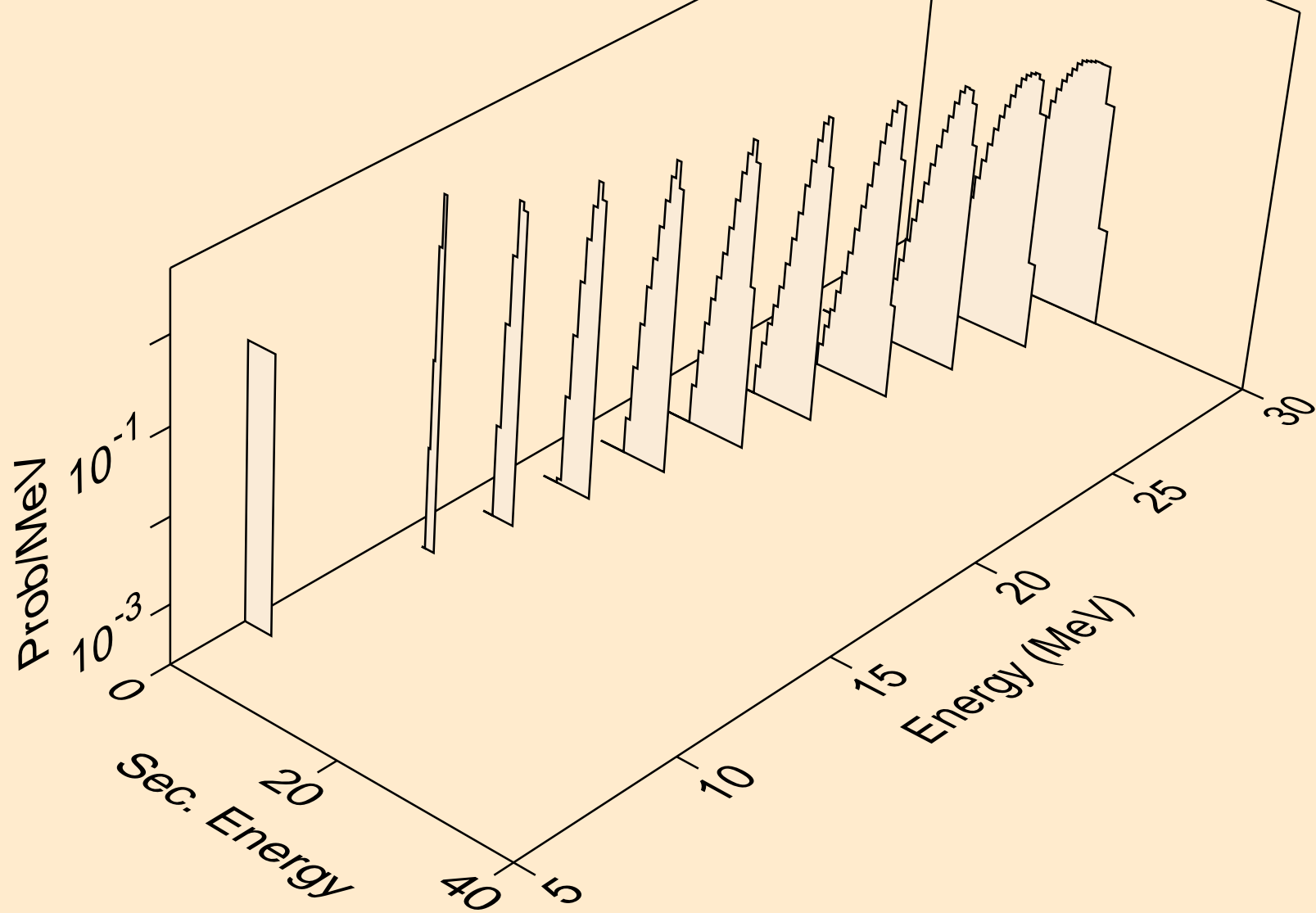

PM129 DEUTERON ACER TENDL-2021 LIBRARY; T=0.K
he3s from (d,he3)

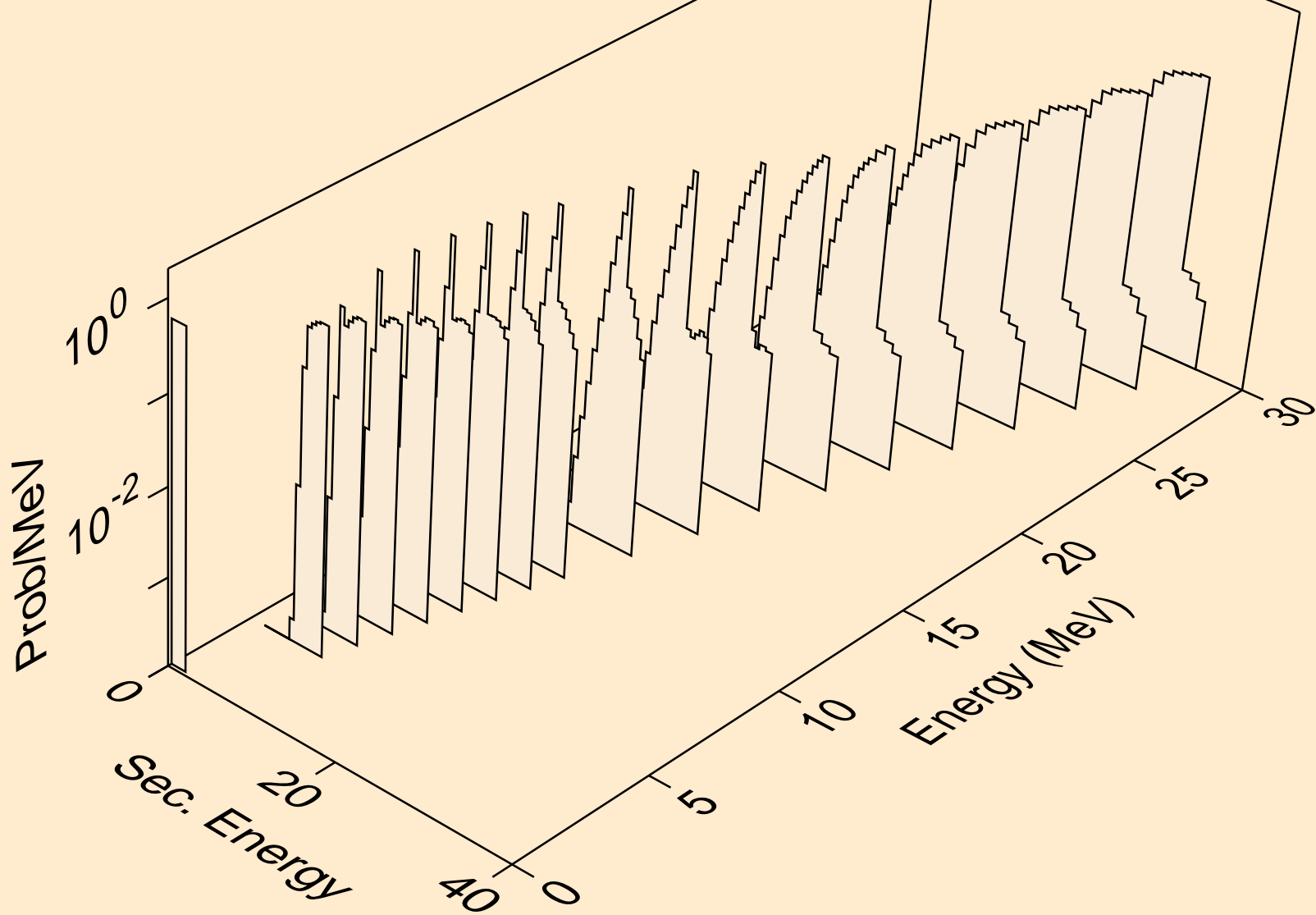

PM129 DEUTERON ACER TENDL-2021 LIBRARY; T=0.K
alphas from (d,x)

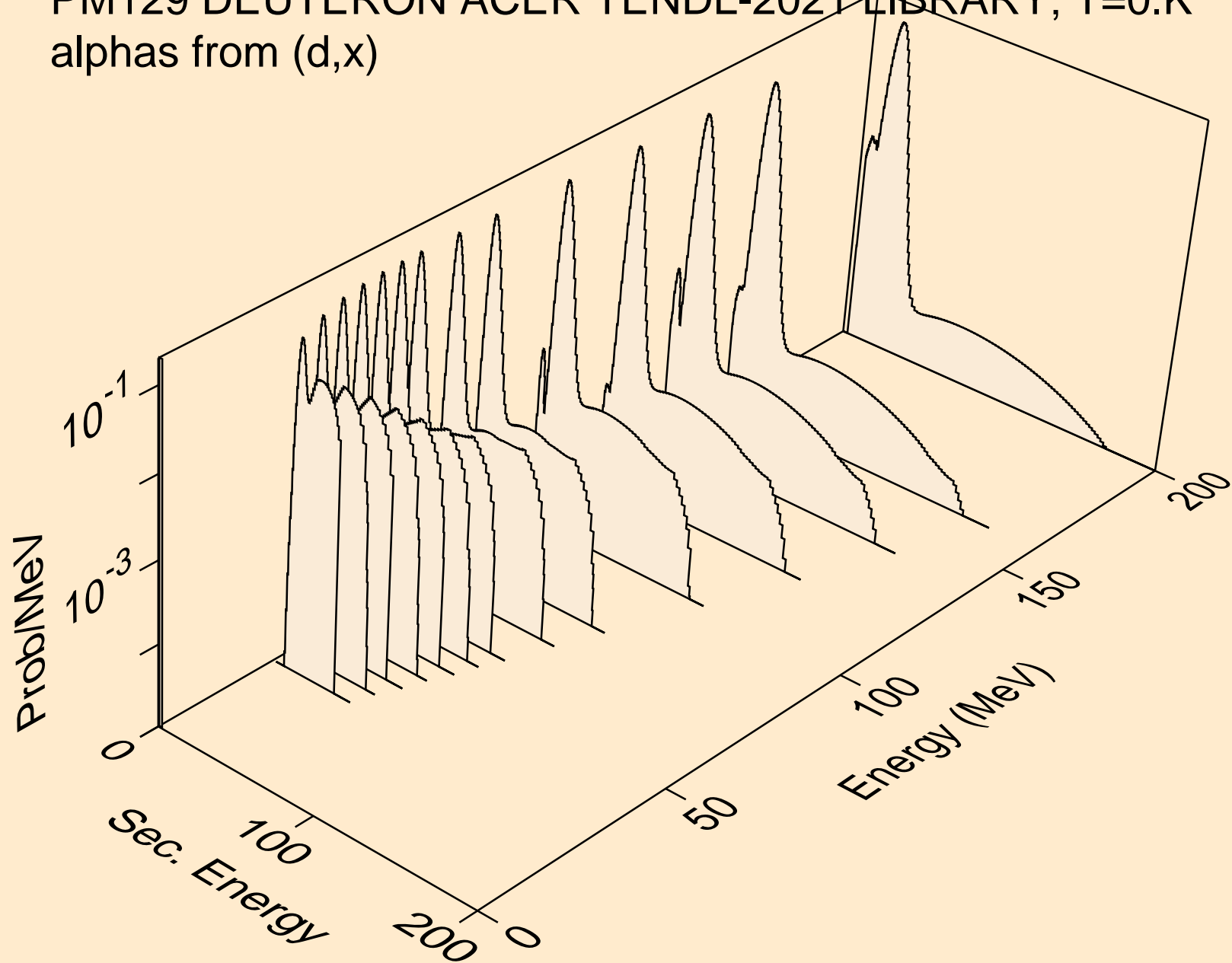

PM129 DEUTERON ACER TENDL-2021 LIBRARY; T=0.K
alphas from (d,n*)a

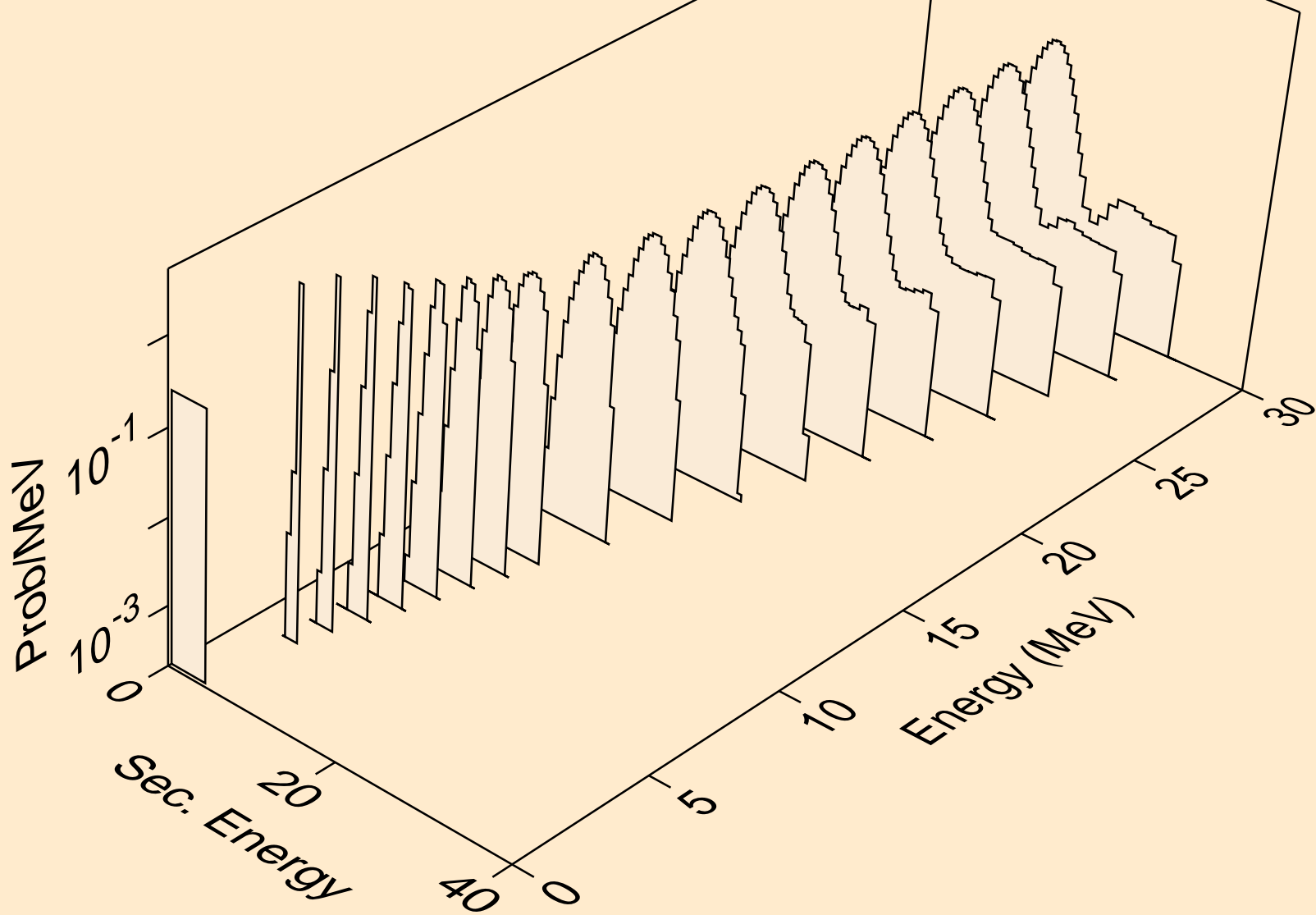

PM129 DEUTERON ACER TENDL-2021 LIBRARY; T=0.K
alphas from (d,2n)a

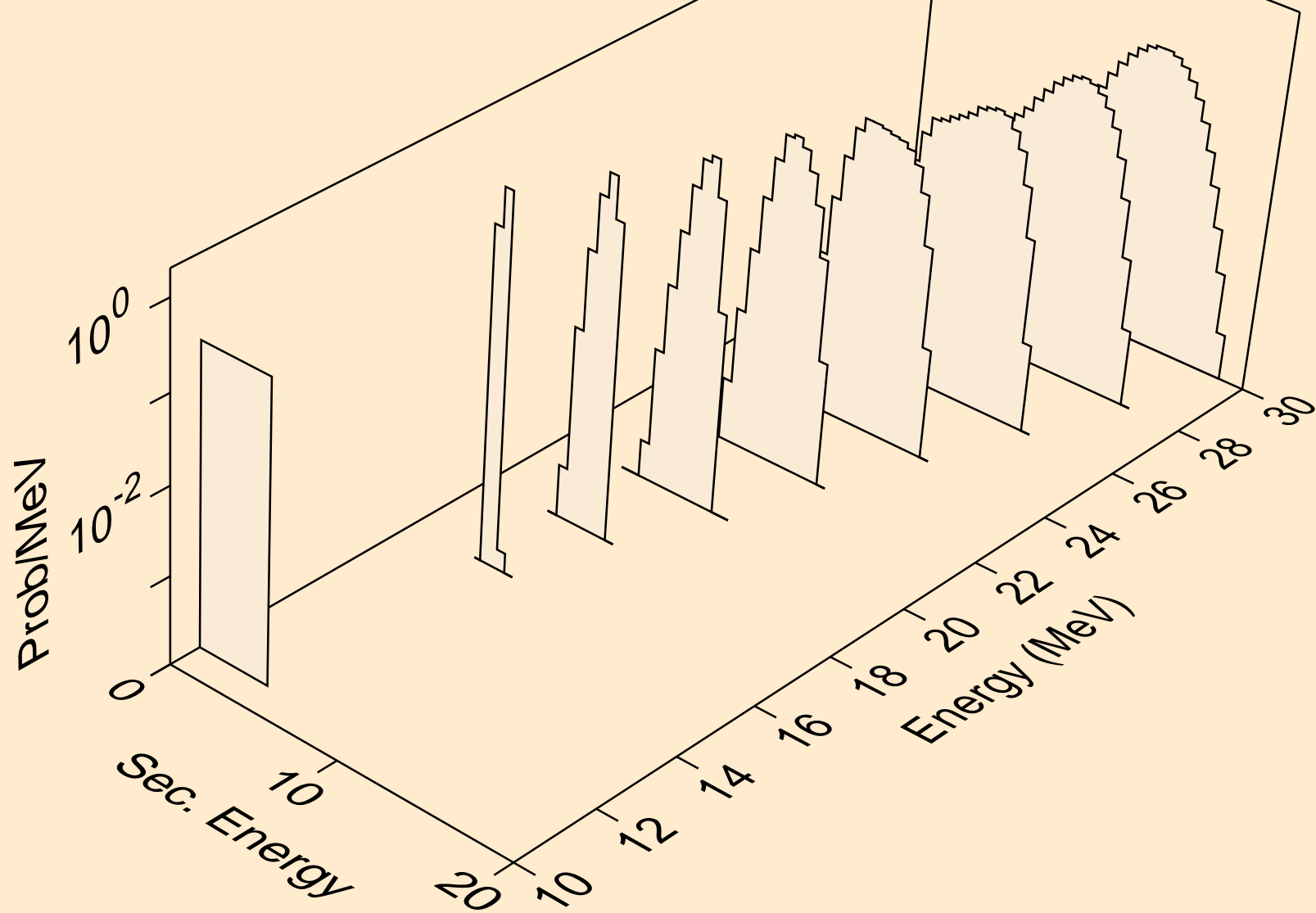

PM129 DEUTERON ACER TENDL-2021 LIBRARY; T=0.K
alphas from (d,n*)2a

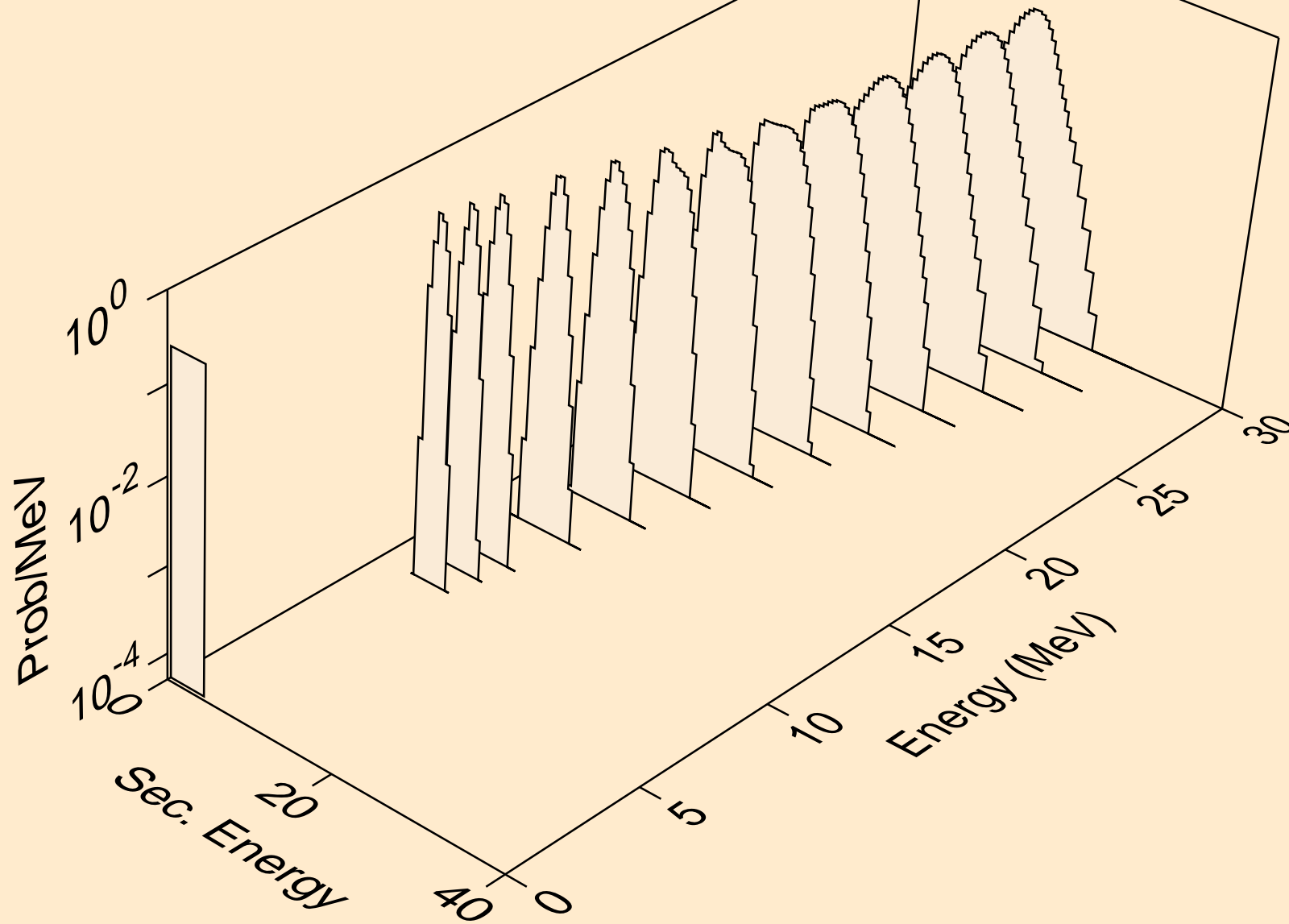

PM129 DEUTERON ACER TENDL-2021 LIBRARY; T=0.K
alphas from (d,npa)

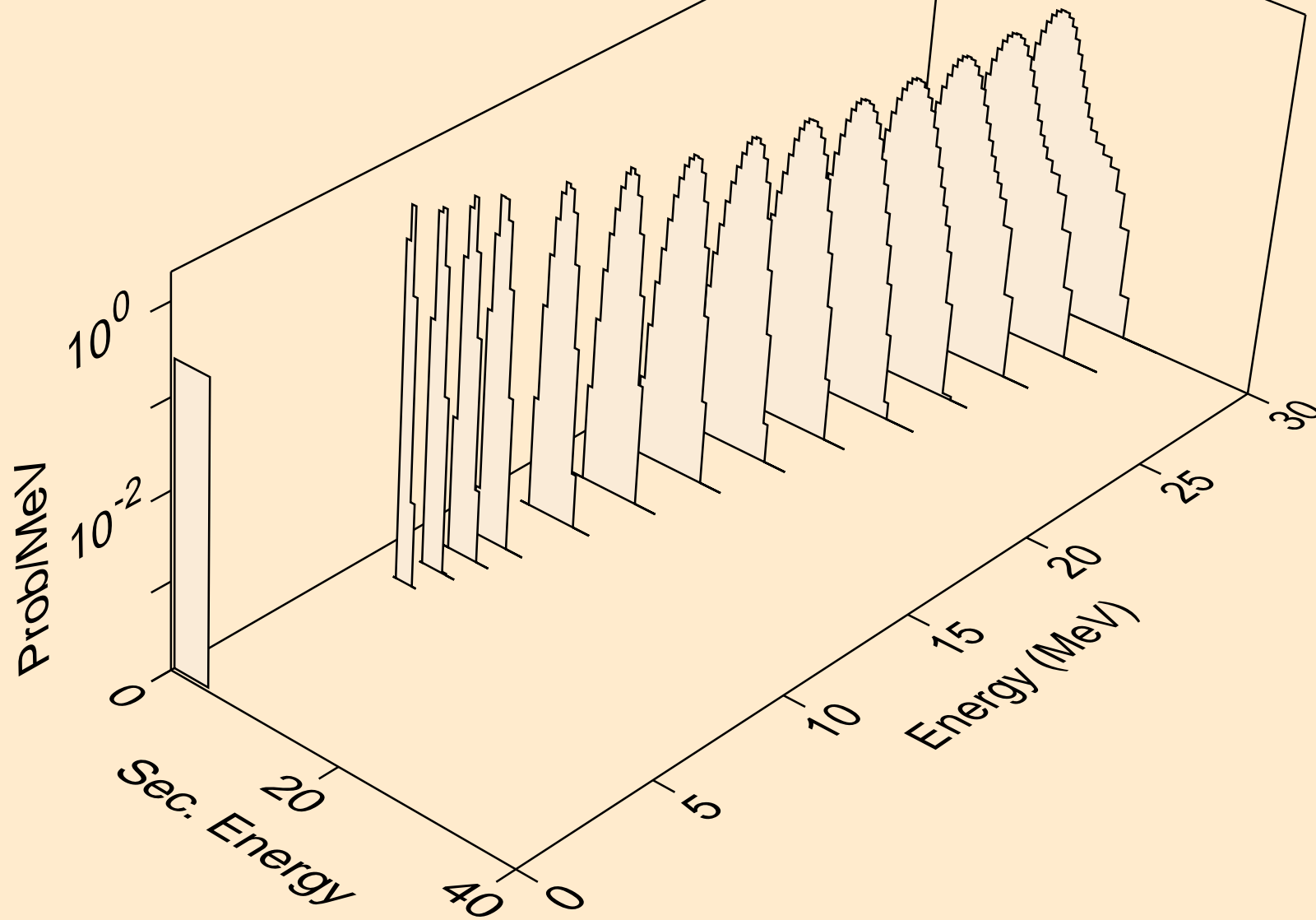

PM129 DEUTERON ACER TENDL-2021 LIBRARY; T=0.K
alphas from (d,a)

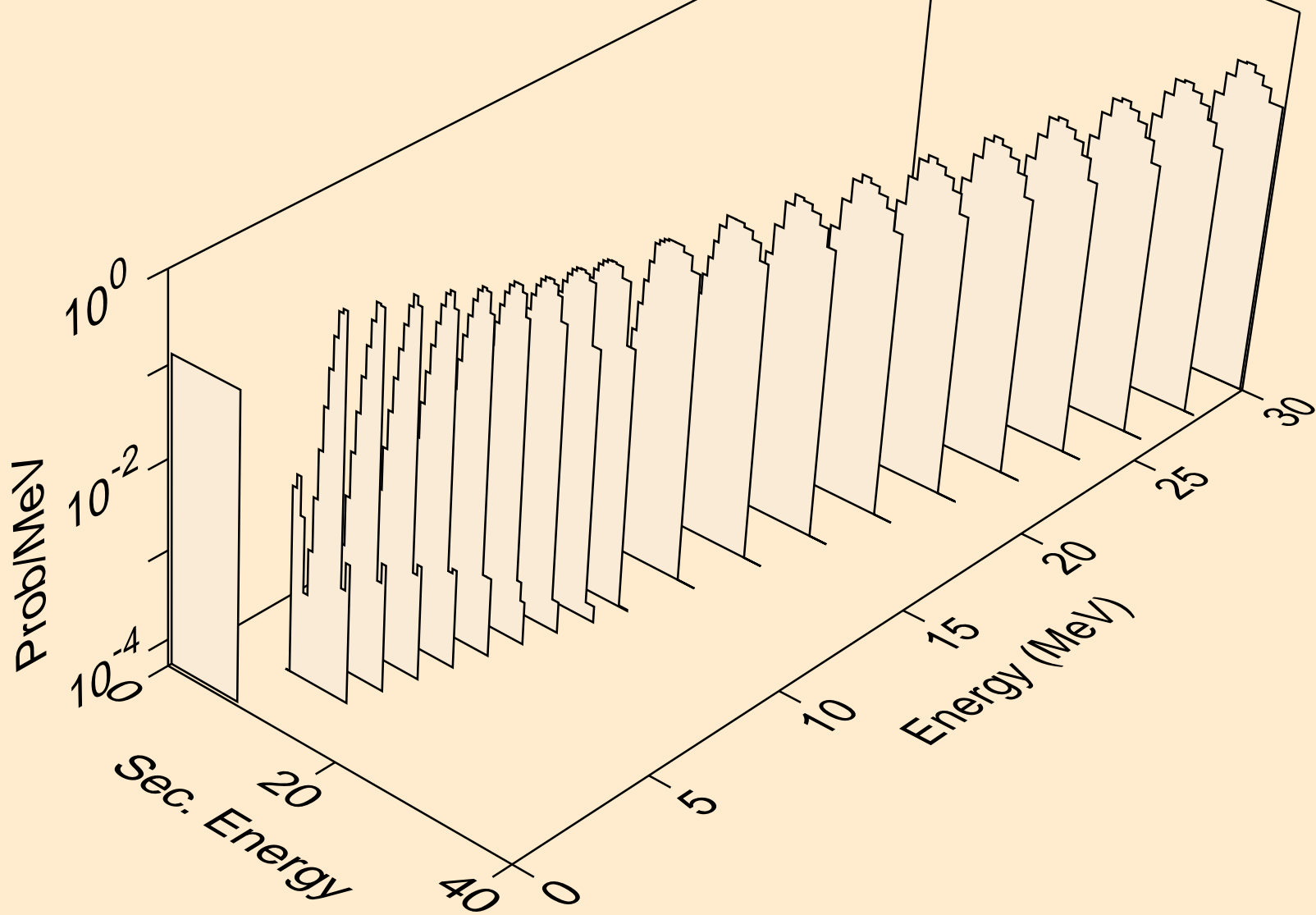

PM129 DEUTERON ACER TENDL-2021 LIBRARY; T=0.K
alphas from (d,2a)

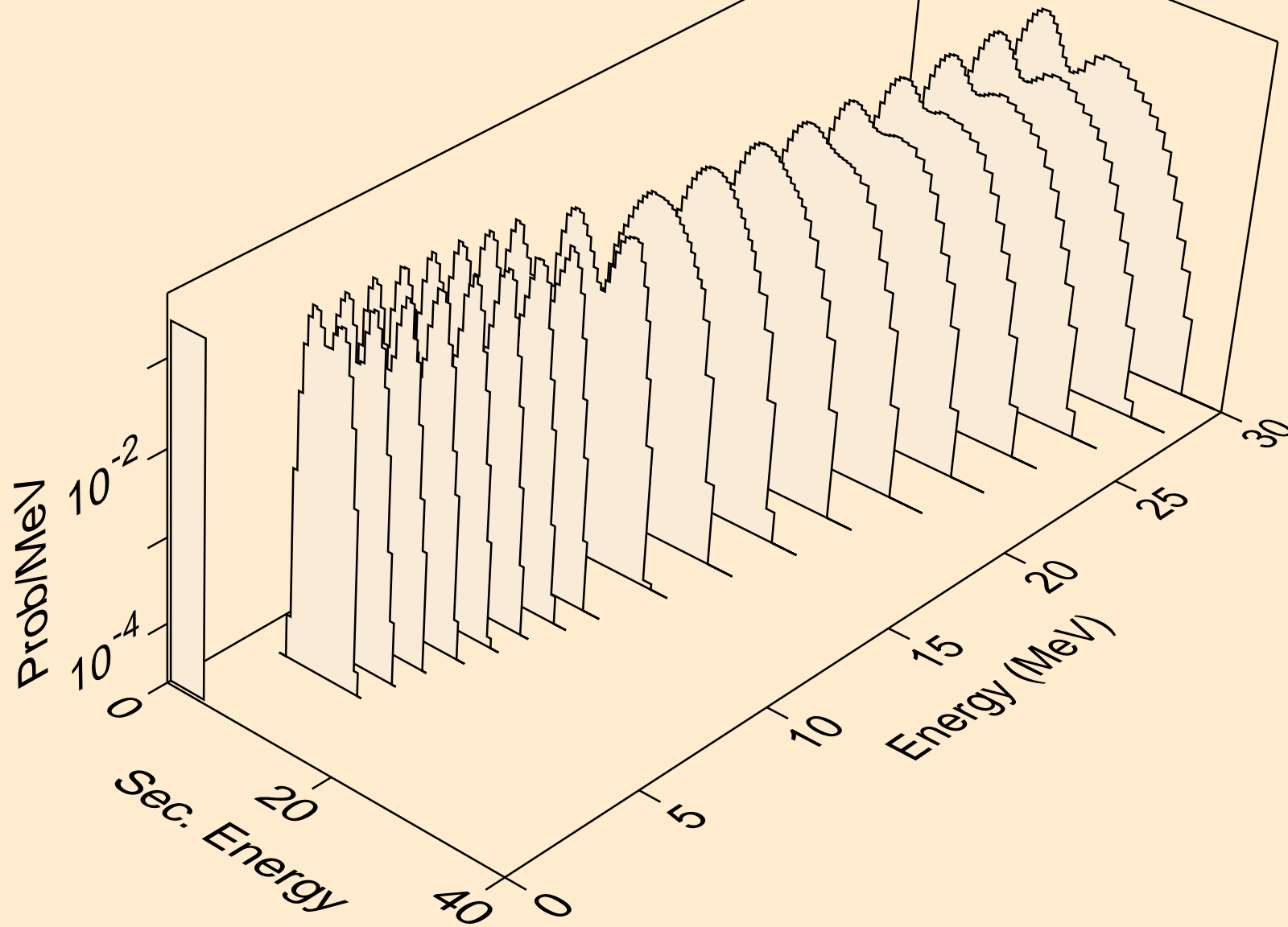

PM129 DEUTERON ACER TENDL-2021 LIBRARY; T=0.K
alphas from (d,3a)

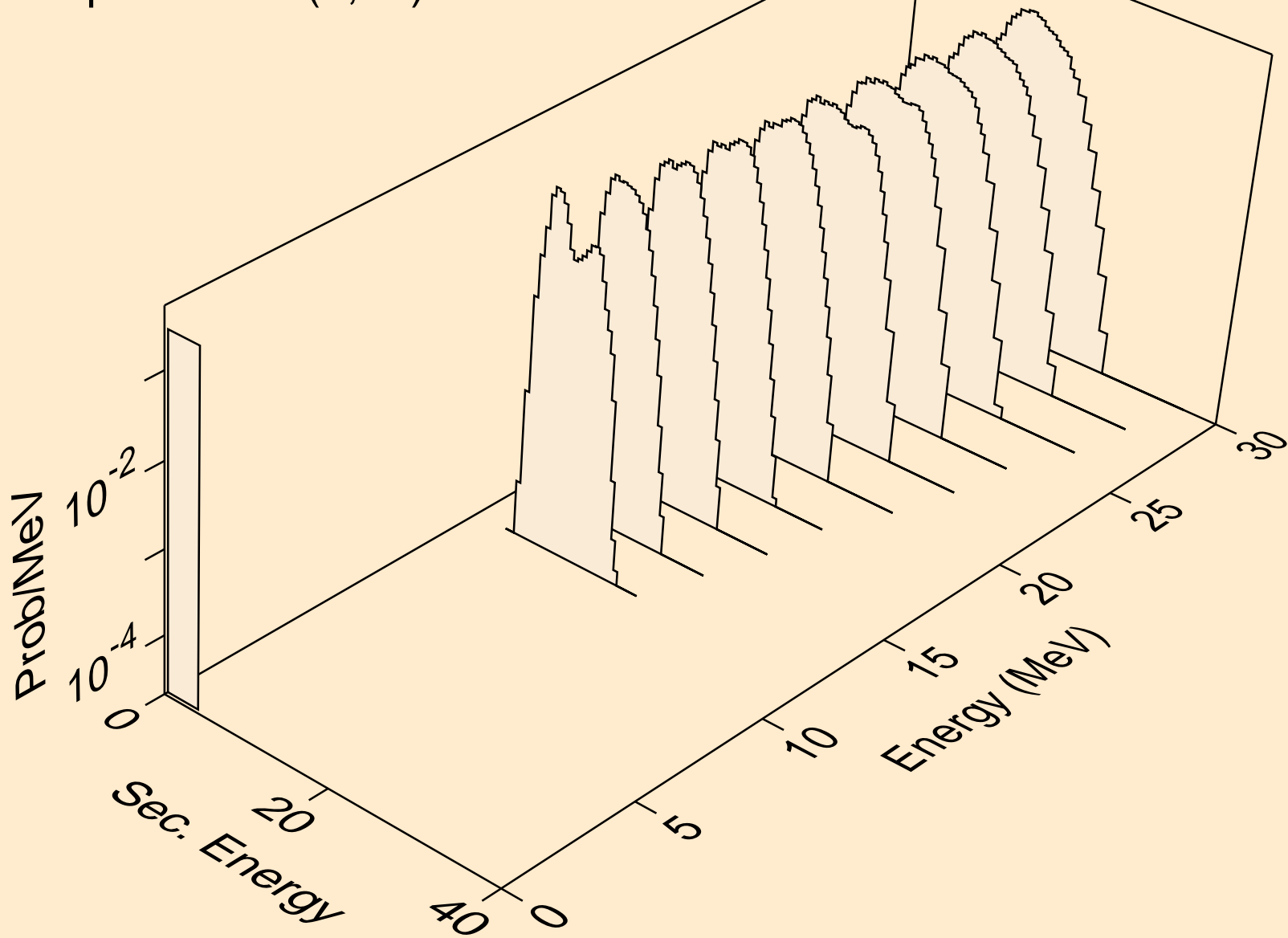

PM129 DEUTERON ACER TENDL-2021 LIBRARY; T=0.K
alphas from (d,pa)

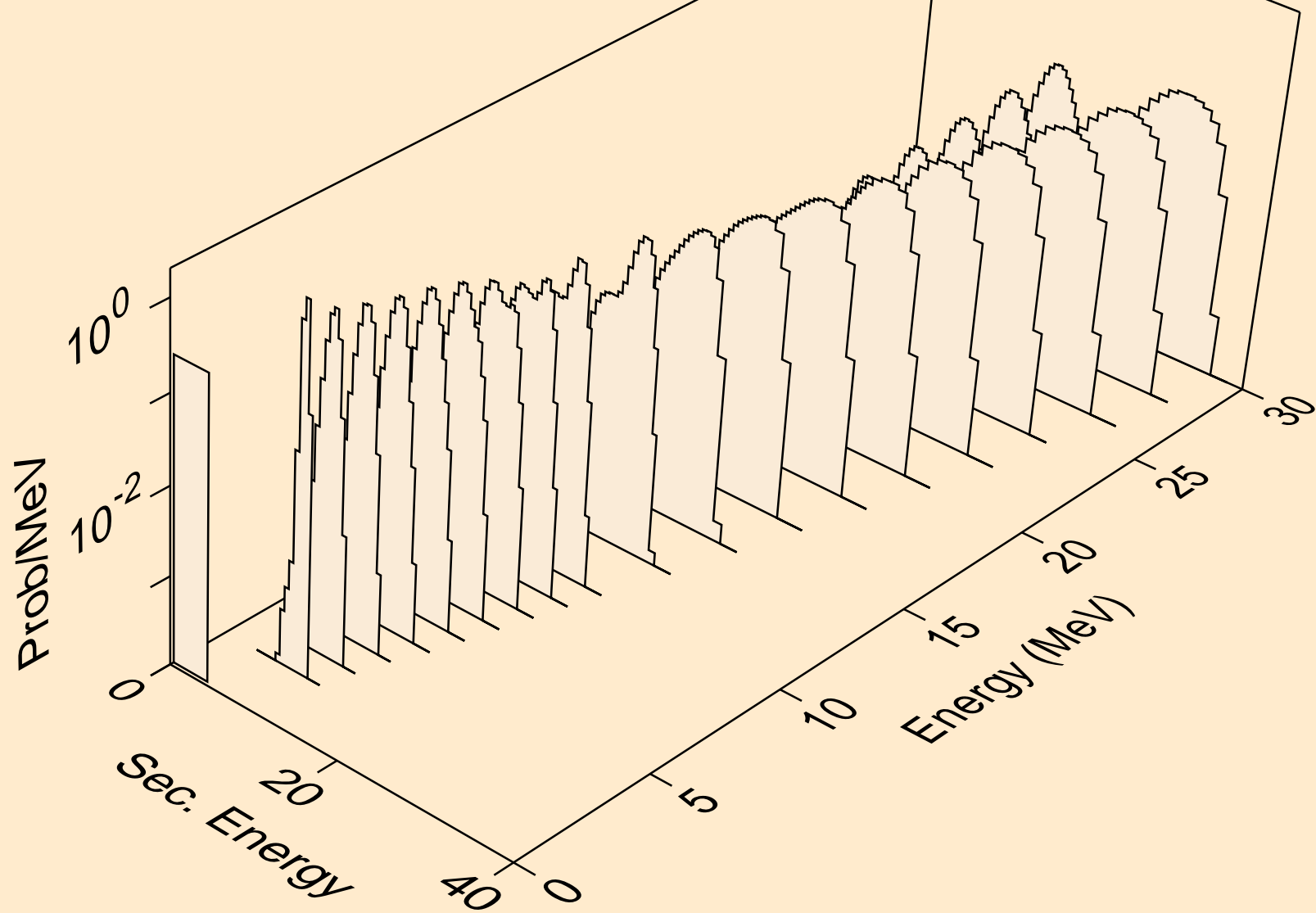

PM129 DEUTERON ACER TENDL-2021 LIBRARY; T=0.K
alphas from (d,da)

