

RF267 DEUTERON ACER TENDL-2021 LIBRARY; T=0.K  
Principal cross sections

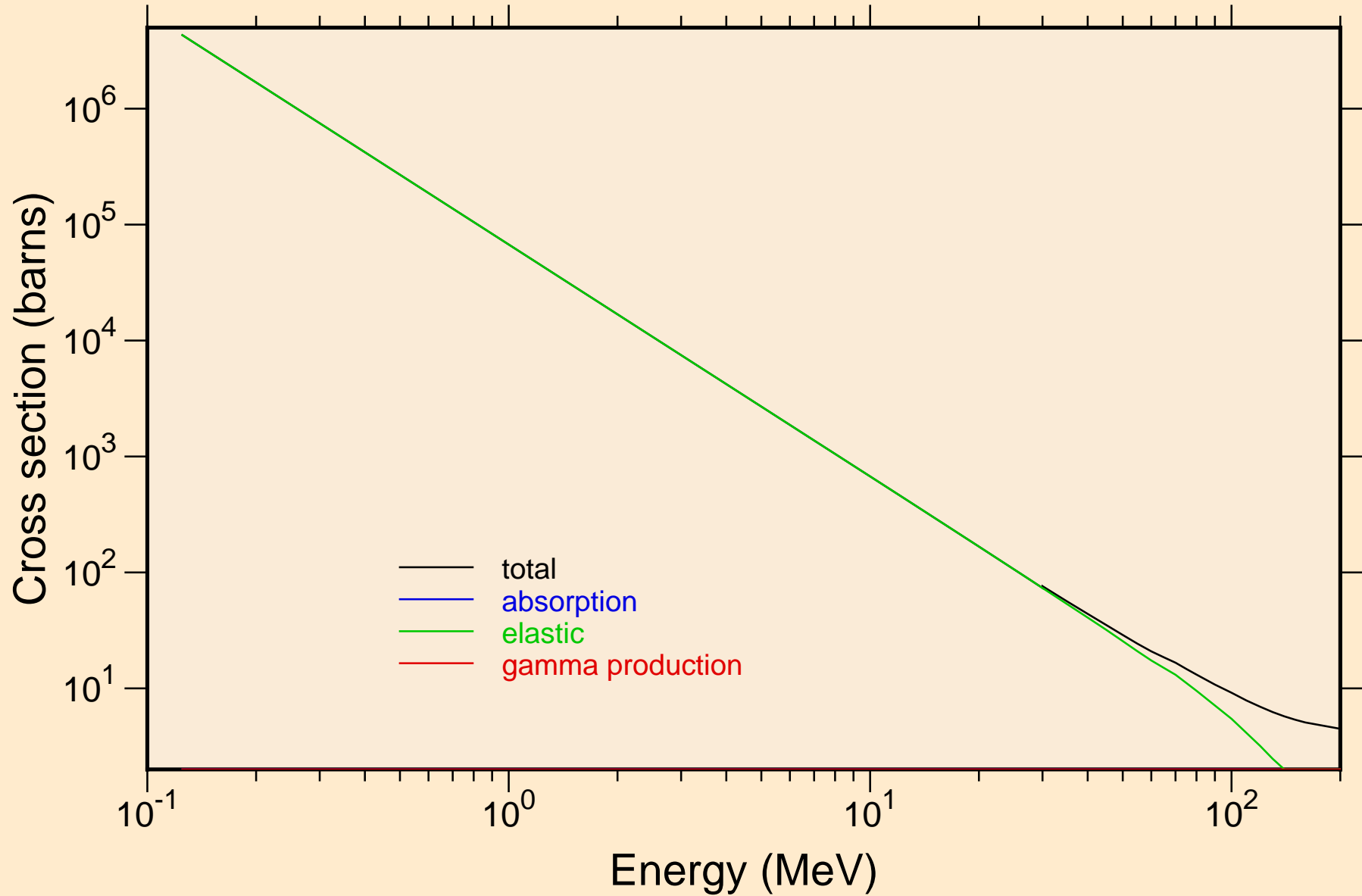

RF267 DEUTERON ACER TENDL-2021 LIBRARY; T=0.K  
Heating

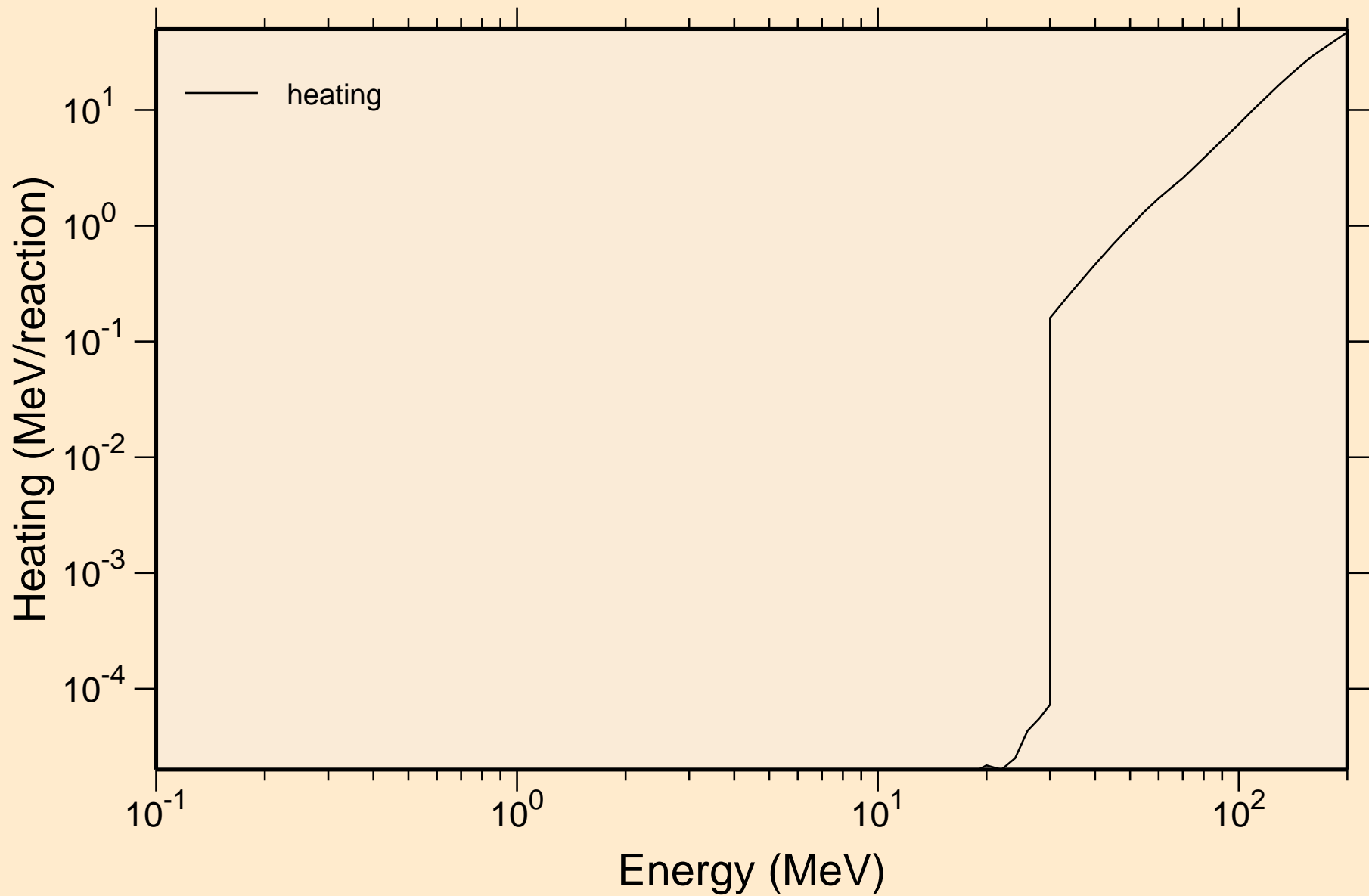

RF267 DEUTERON ACER TENDL-2021 LIBRARY; T=0.K  
Principal cross sections

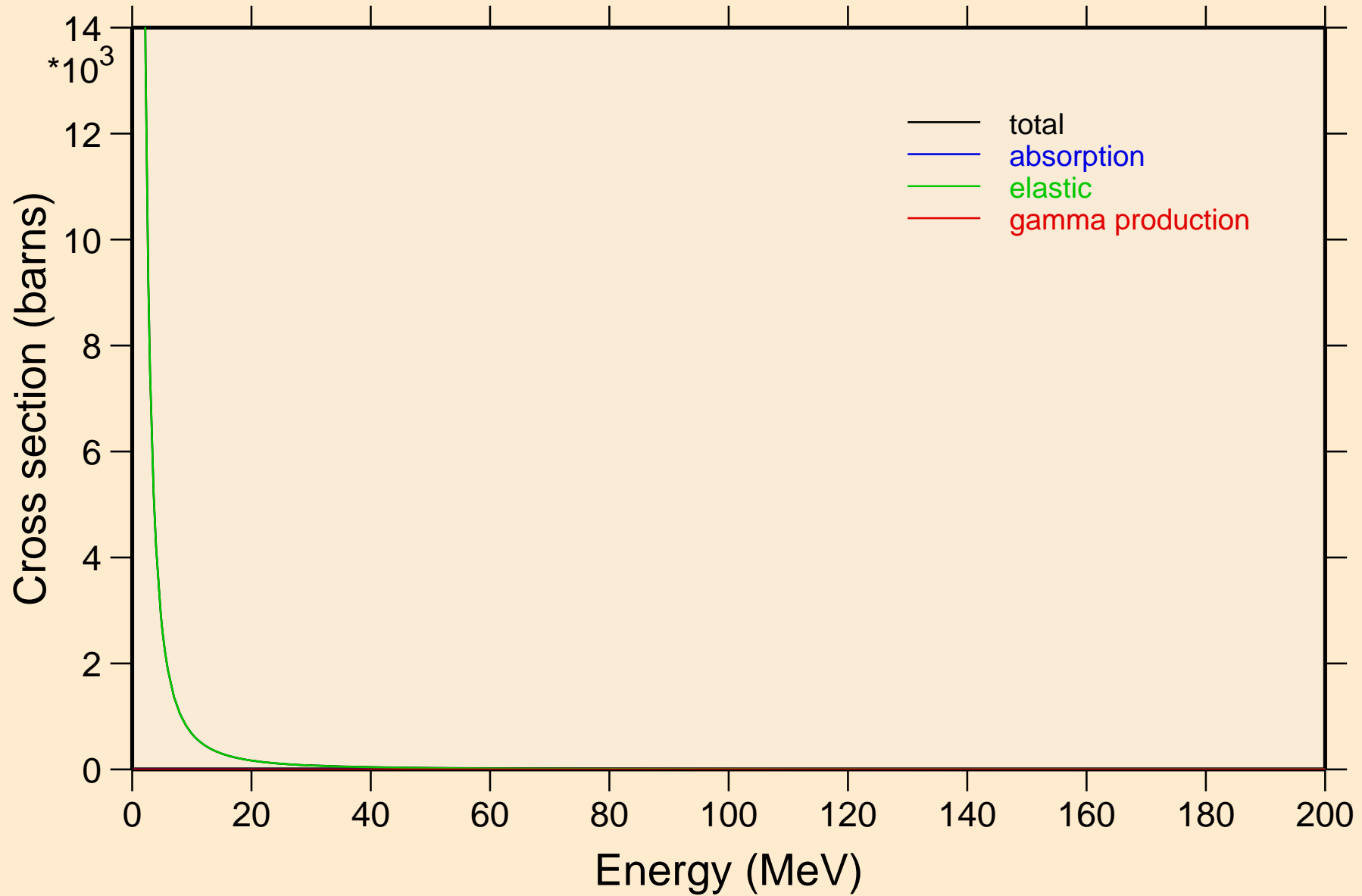

# RF267 DEUTERON ACER TENDL-2021 LIBRARY; T=0.K

## Heating

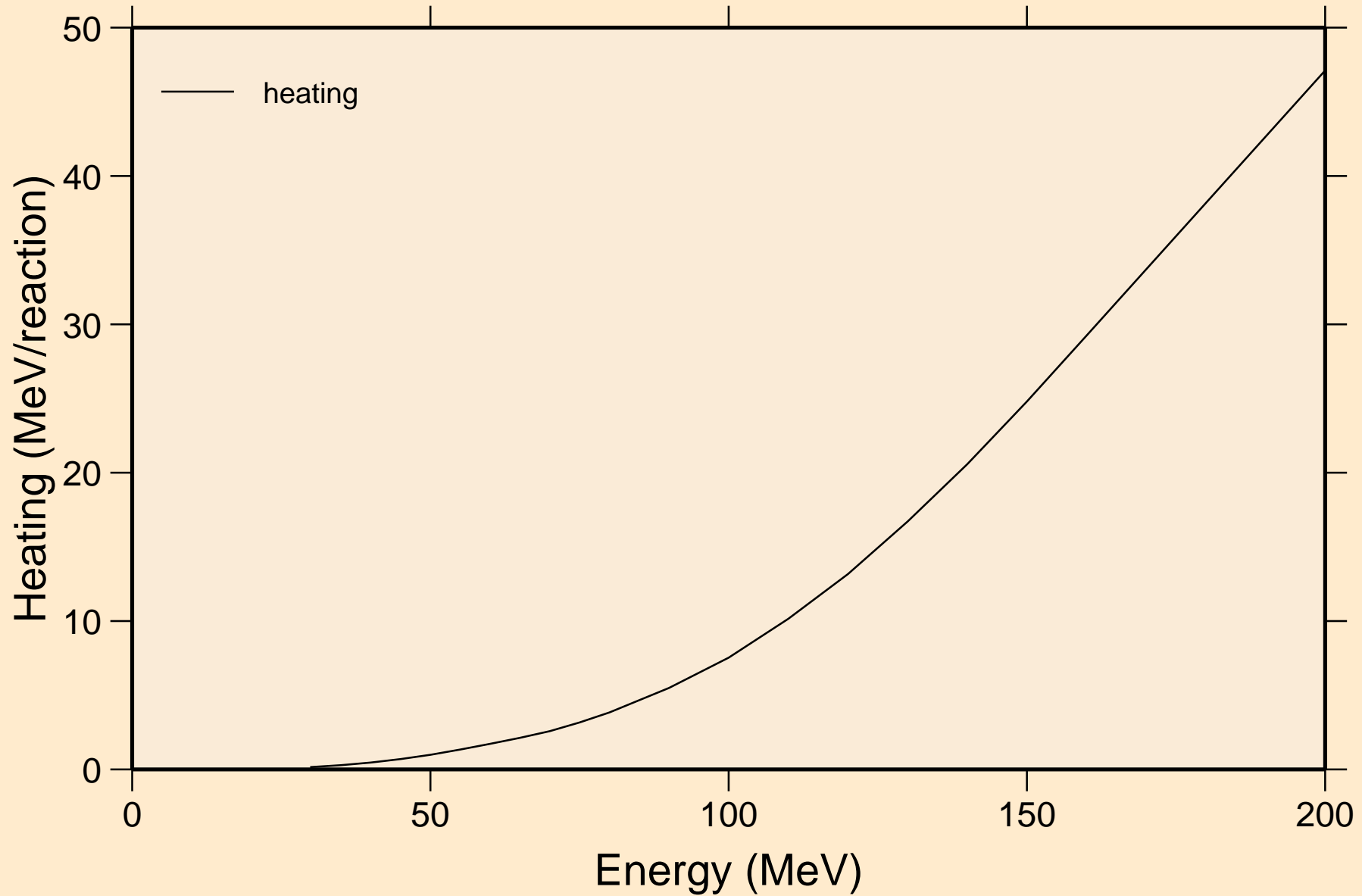

RF267 DEUTERON ACER TENDL-2021 LIBRARY; T=0.K  
Threshold reactions

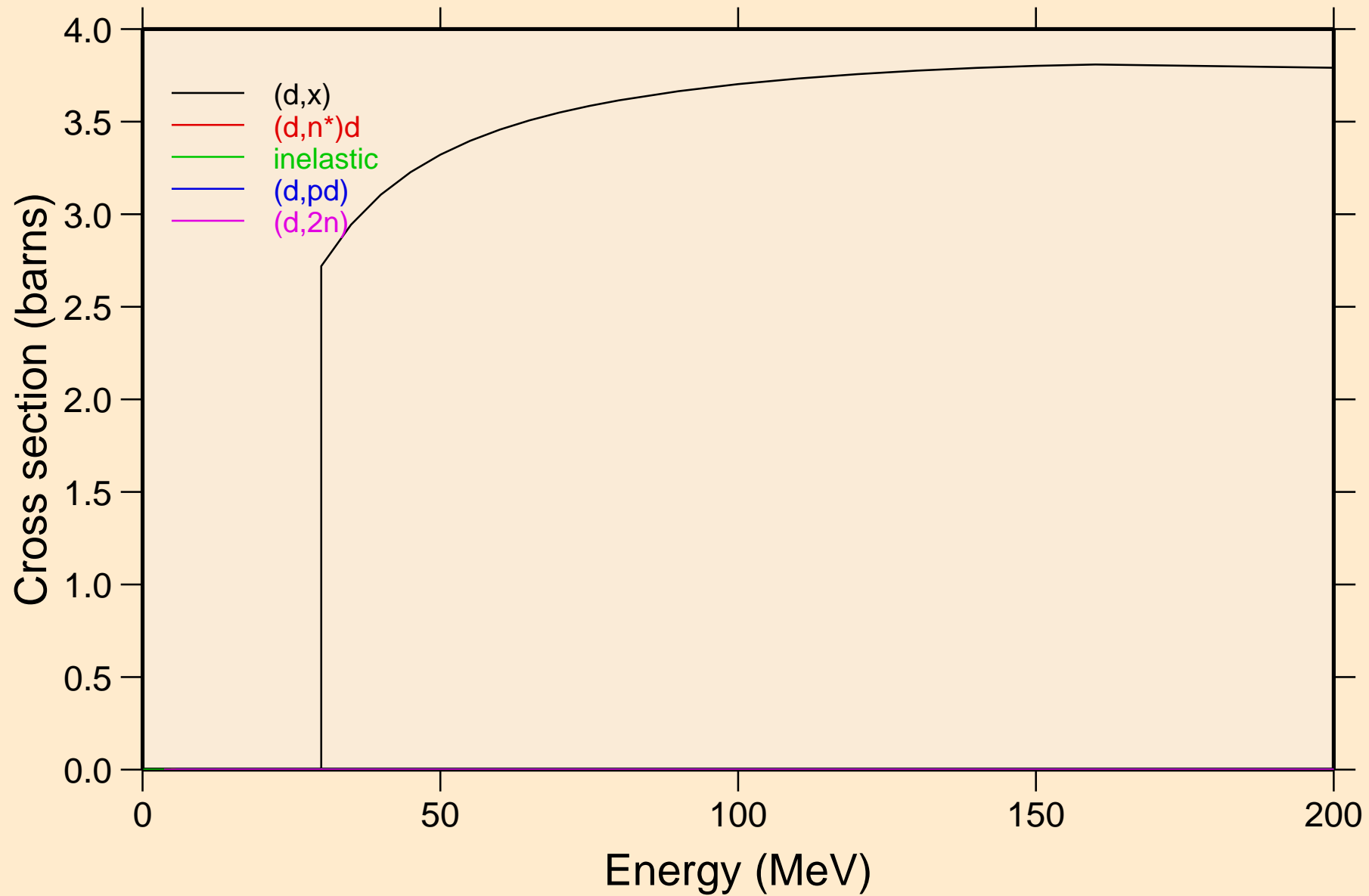

RF267 DEUTERON ACER TENDL-2021 LIBRARY; T=0.K  
Threshold reactions

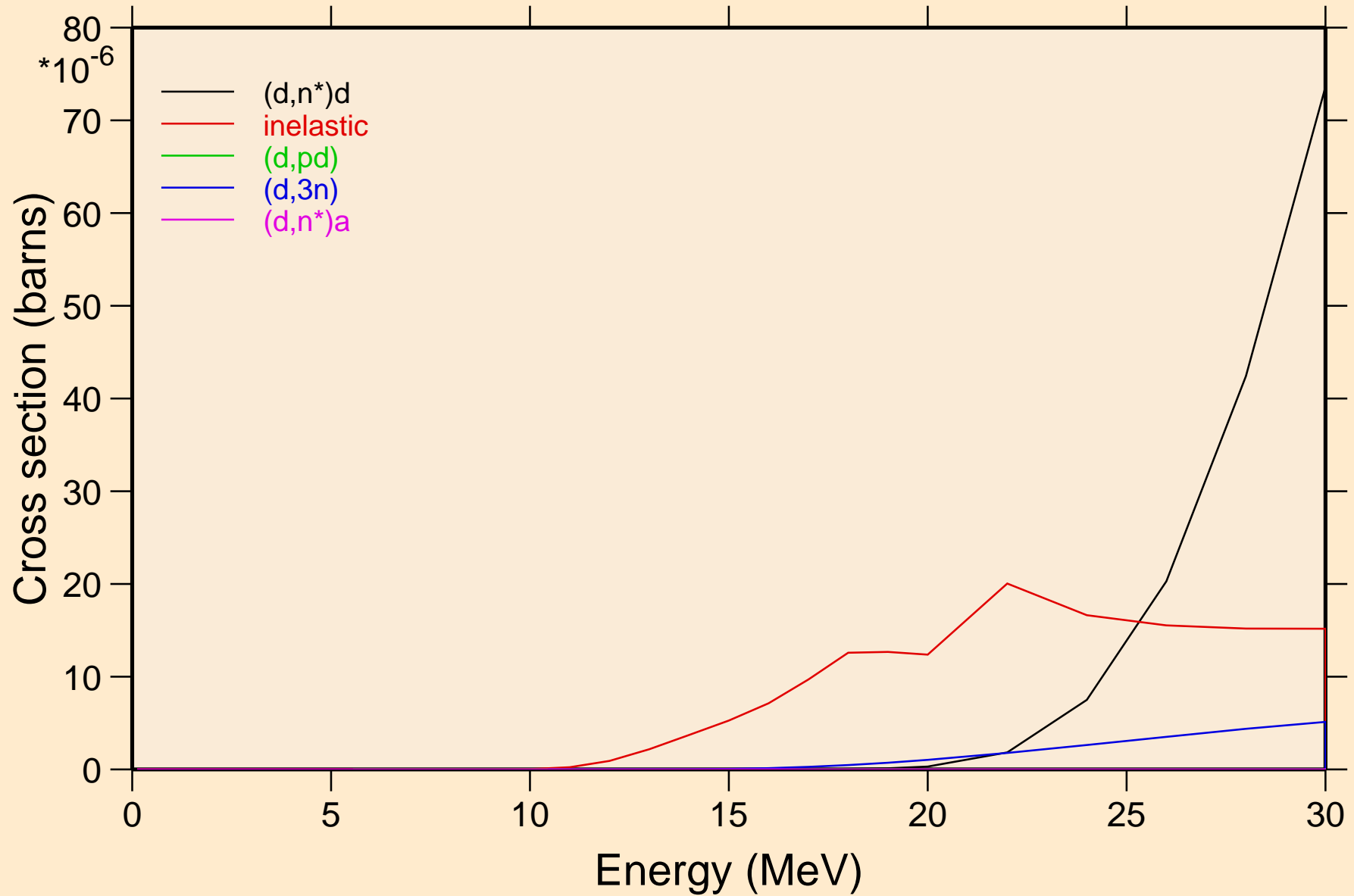

# RF267 DEUTERON ACER TENDL-2021 LIBRARY; T=0.K

## Threshold reactions

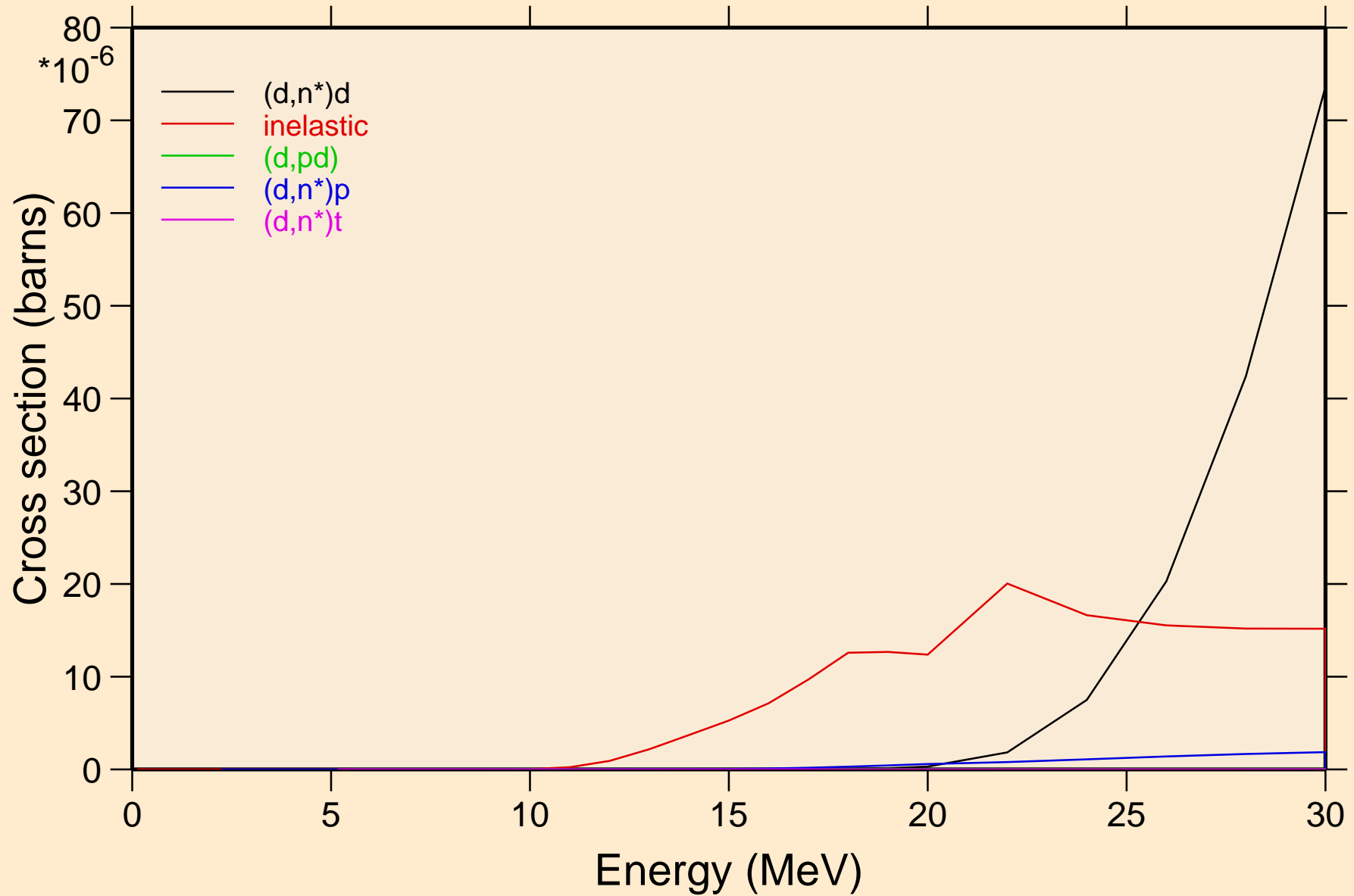

RF267 DEUTERON ACER TENDL-2021 LIBRARY; T=0.K  
Threshold reactions

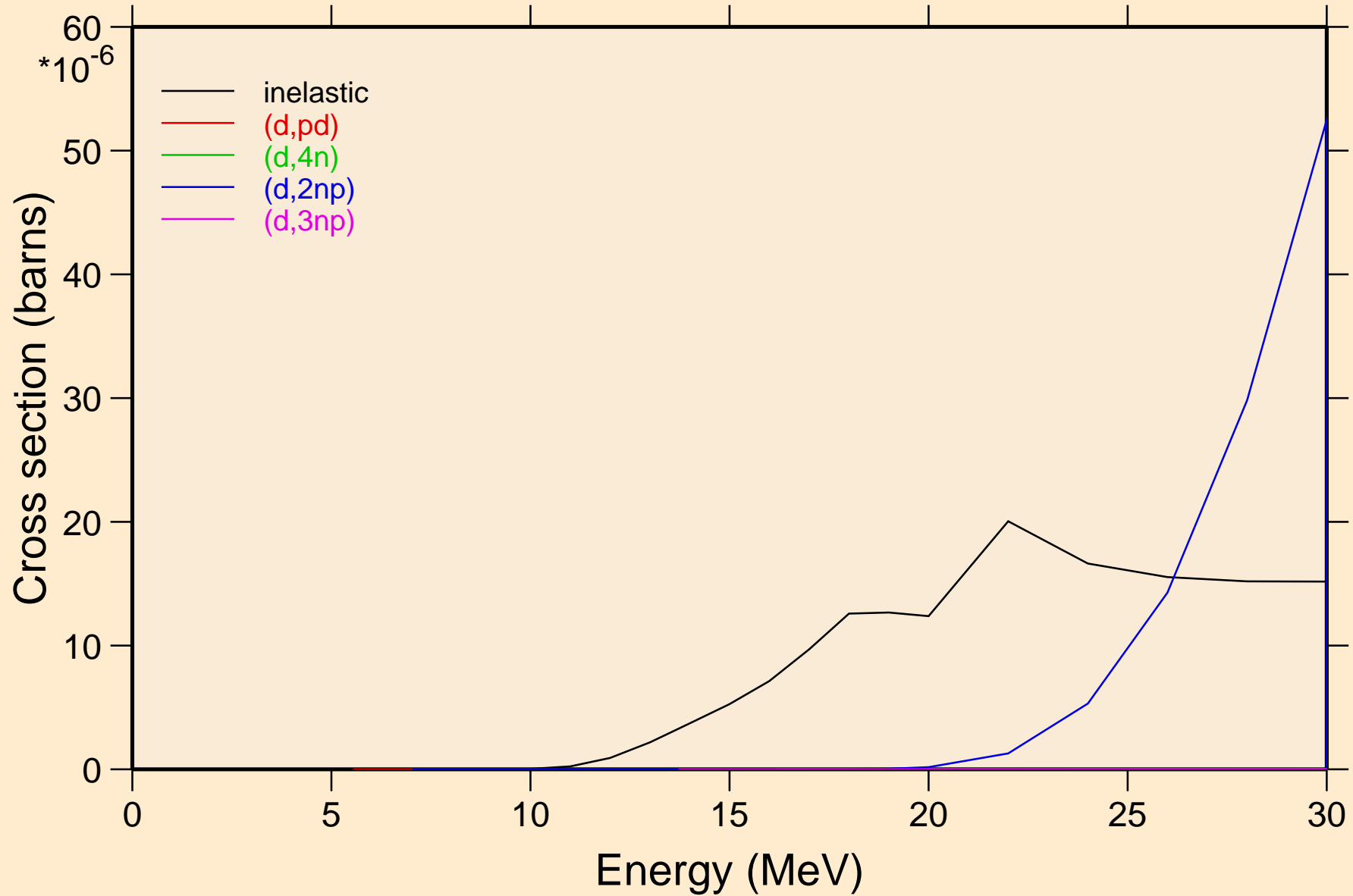



# RF267 DEUTERON ACER TENDL-2021 LIBRARY; T=0.K

## Threshold reactions

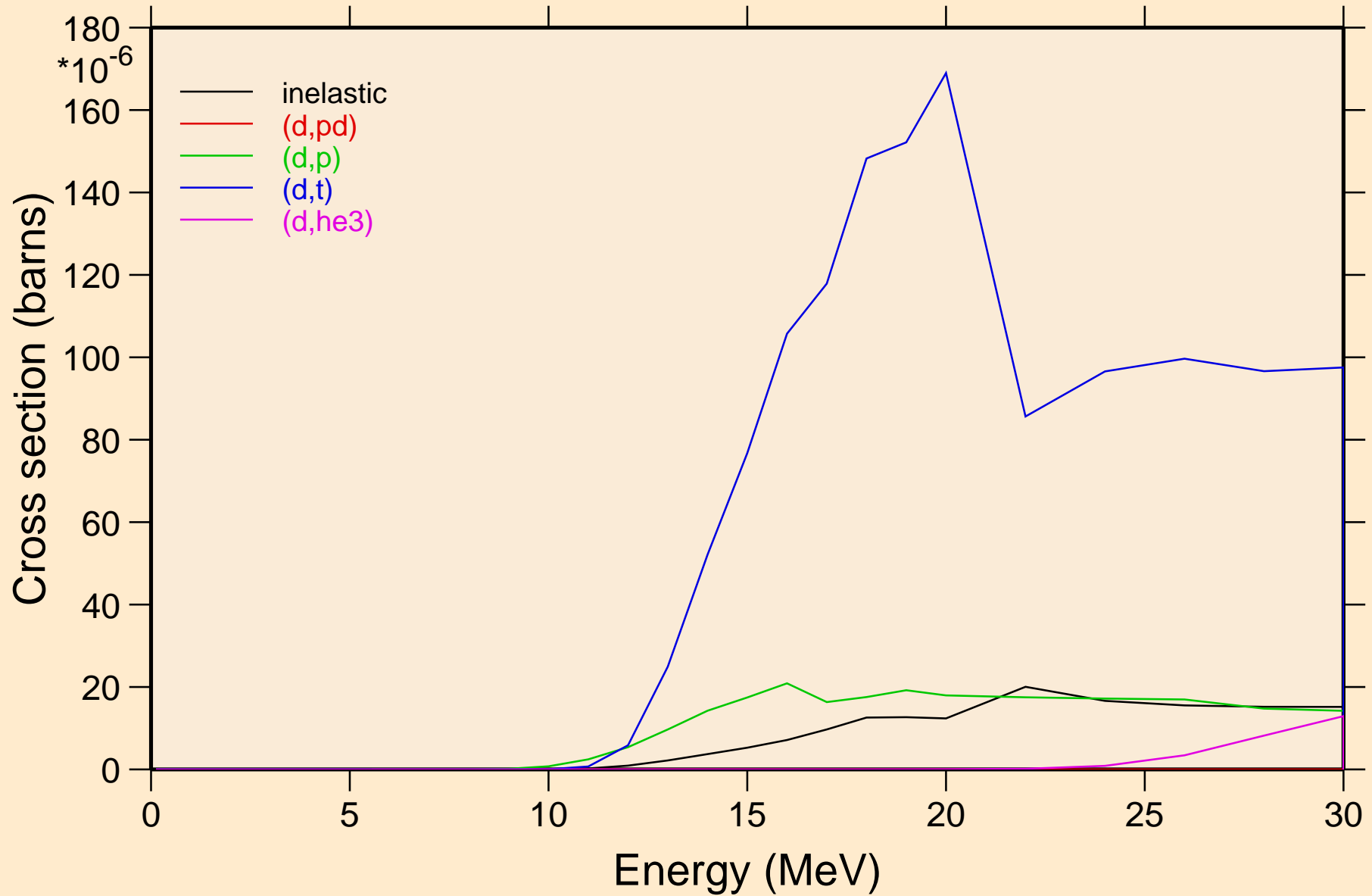

RF267 DEUTERON ACER TENDL-2021 LIBRARY; T=0.K  
Threshold reactions

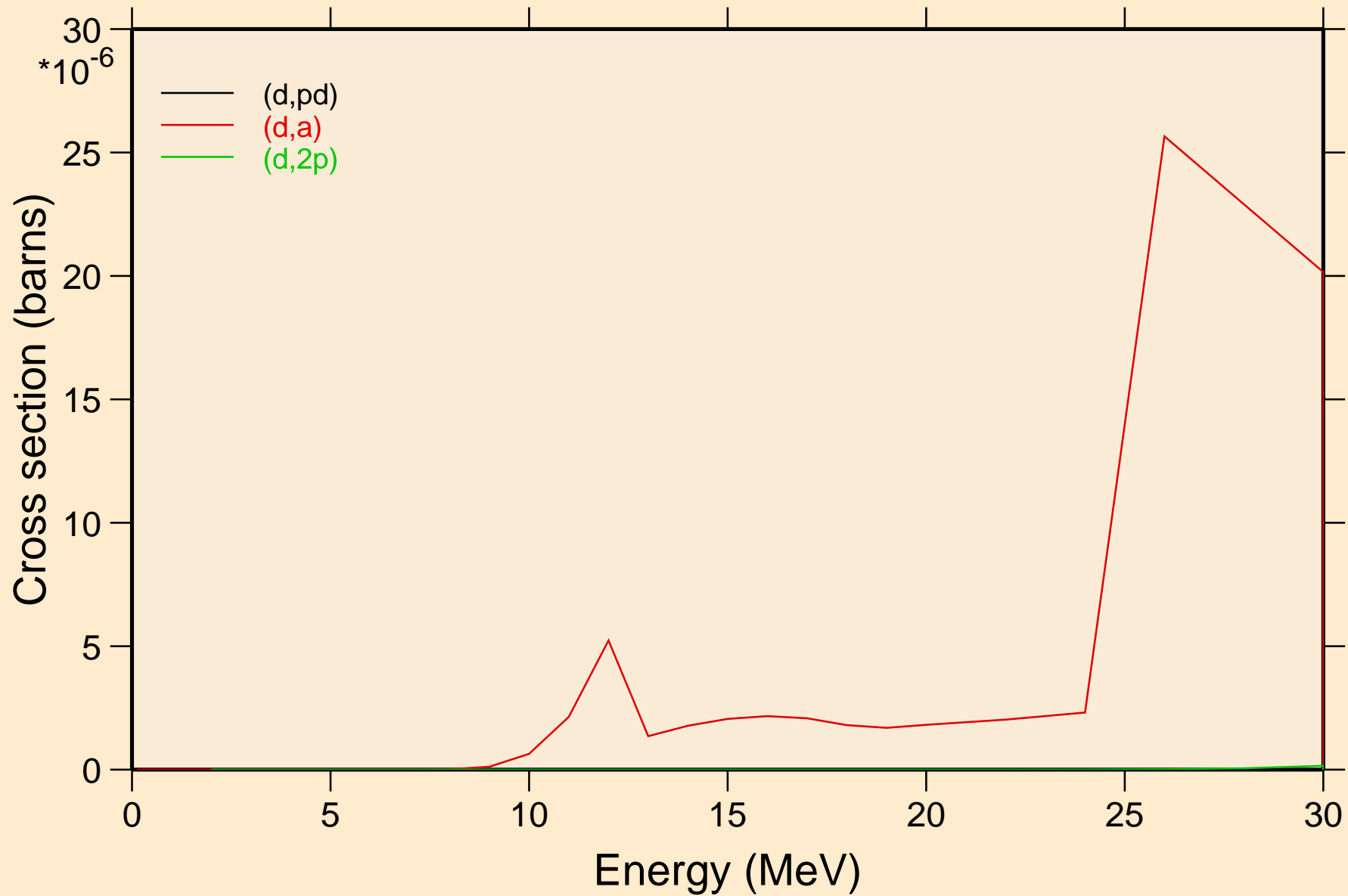

RF267 DEUTERON ACER TENDL-2021 LIBRARY; T=0.K  
Threshold reactions

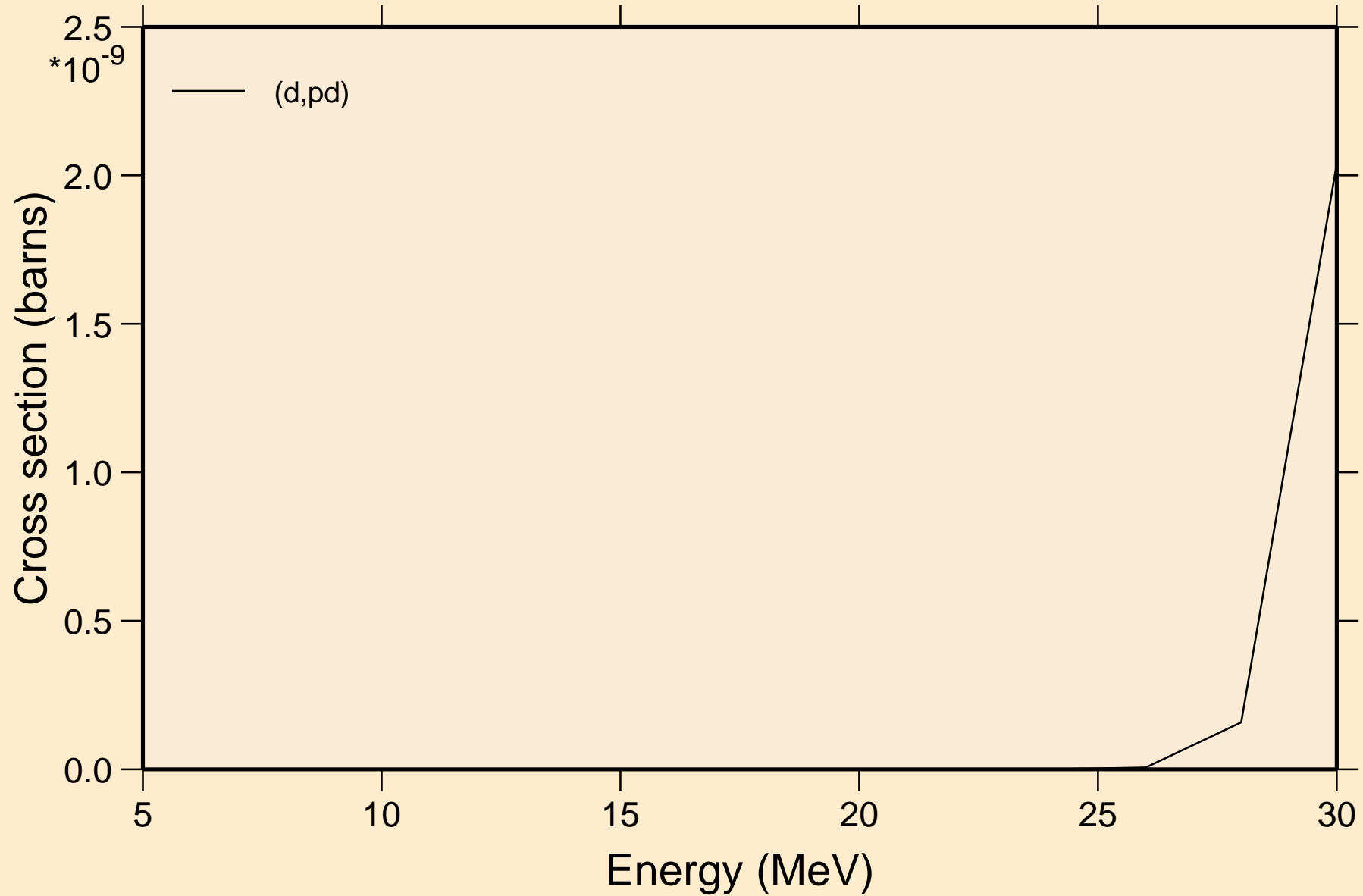

RF267 DEUTERON ACER TENDL-2021 LIBRARY; T=0.K  
angular distribution for elastic

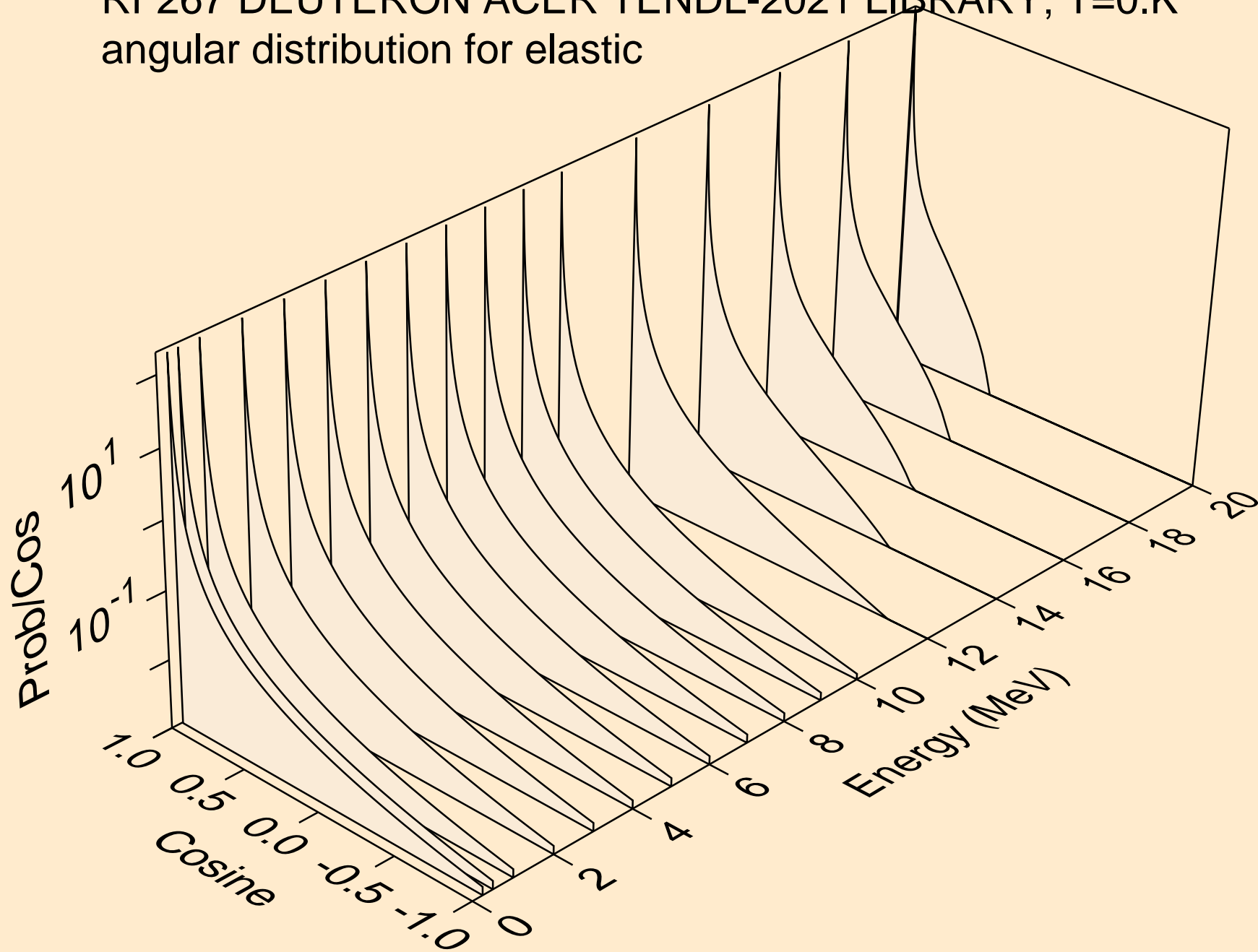

RF267 DEUTERON ACER TENDL-2021 LIBRARY; T=0.K  
angular distribution for elastic

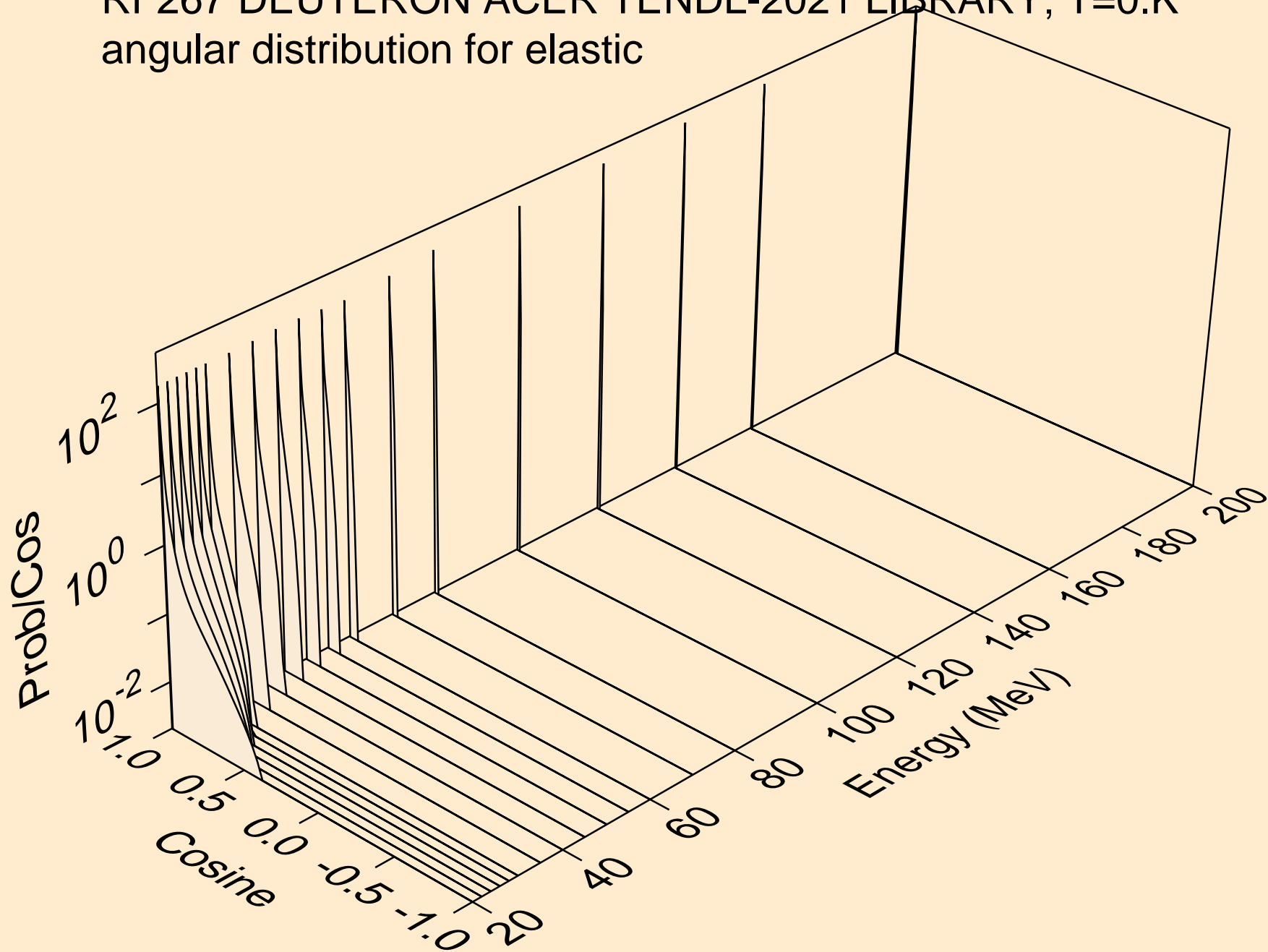

RF267 DEUTERON ACER TENDL-2021 LIBRARY; T=0.K  
Deuteron emission for (d,x)

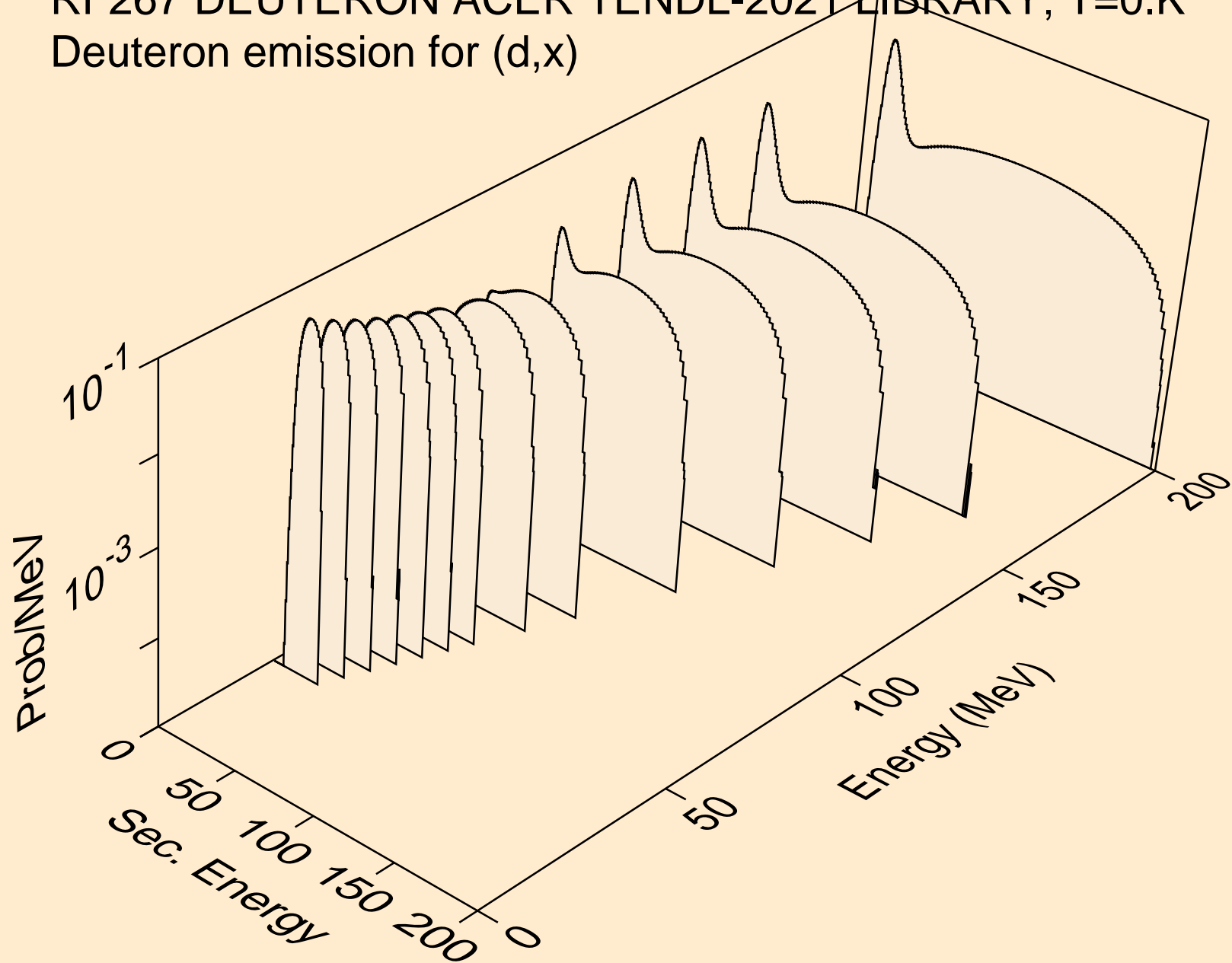

RF267 DEUTERON ACER TENDL-2021 LIBRARY; T=0.K  
Deuteron emission for (d,n\*)d

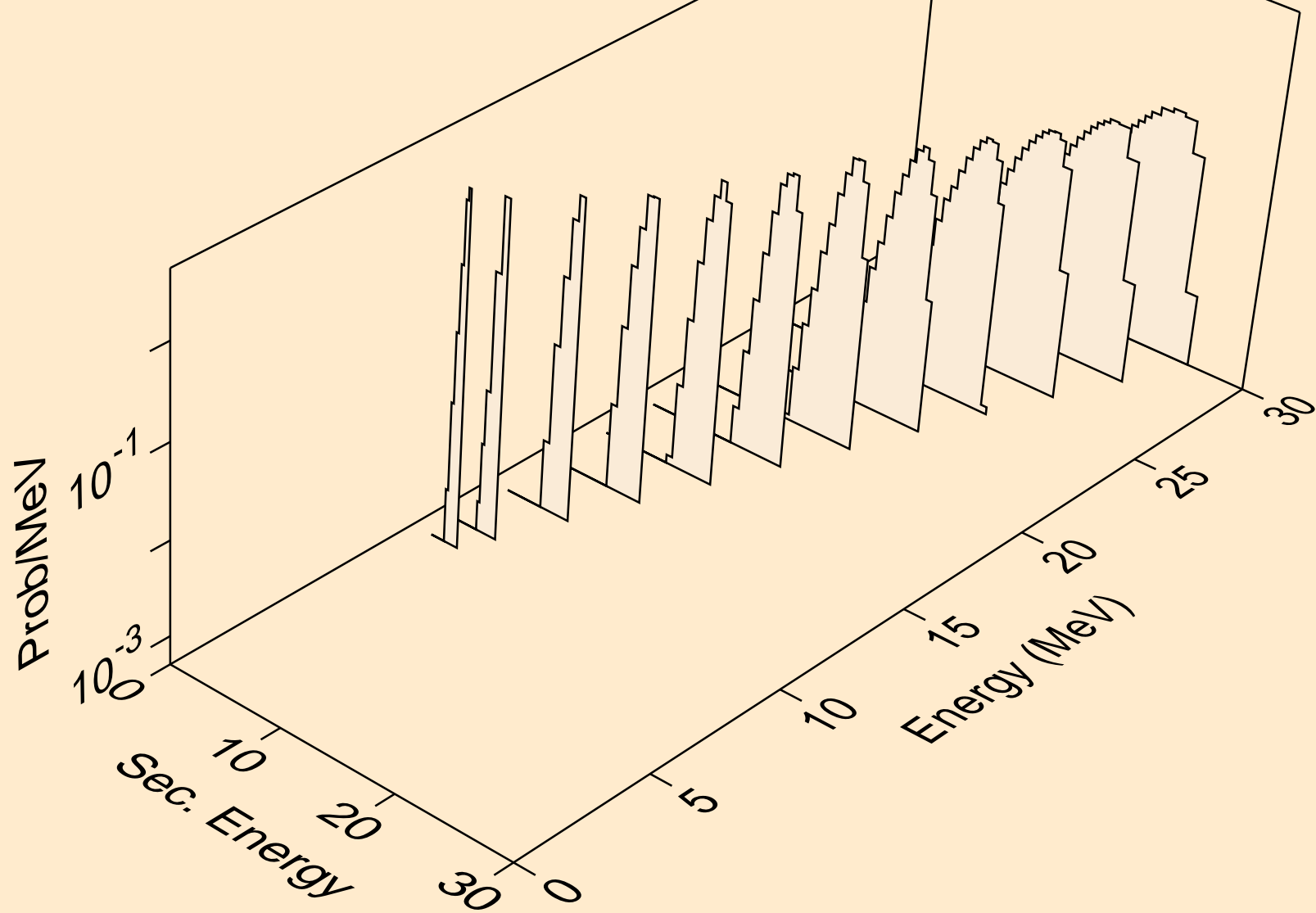

RF267 DEUTERON ACER TENDL-2021 LIBRARY; T=0.K  
Deuteron emission for inelastic

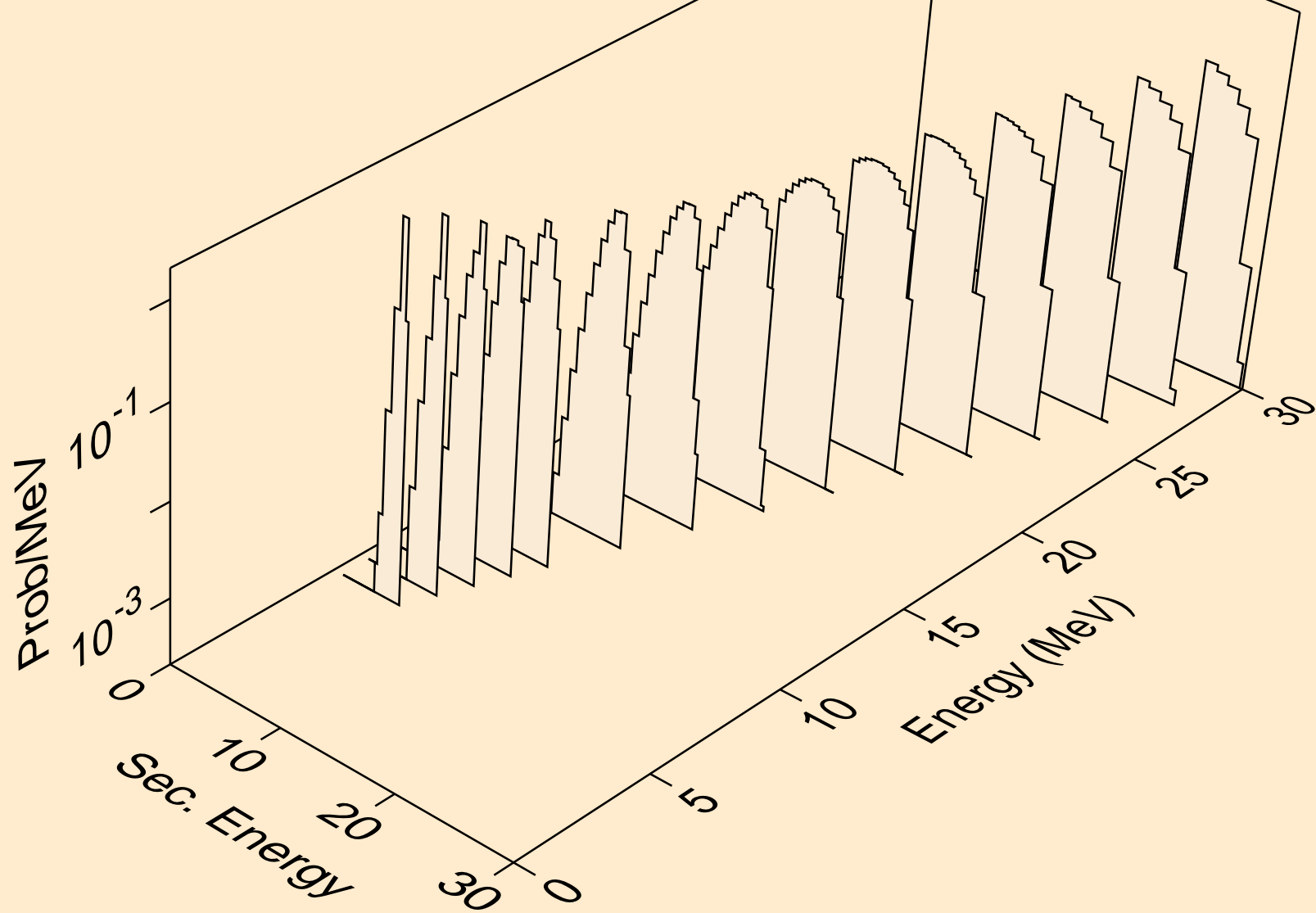



RF267 DEUTERON ACER TENDL-2021 LIBRARY; T=0.K  
Deuteron emission for (d,pd)

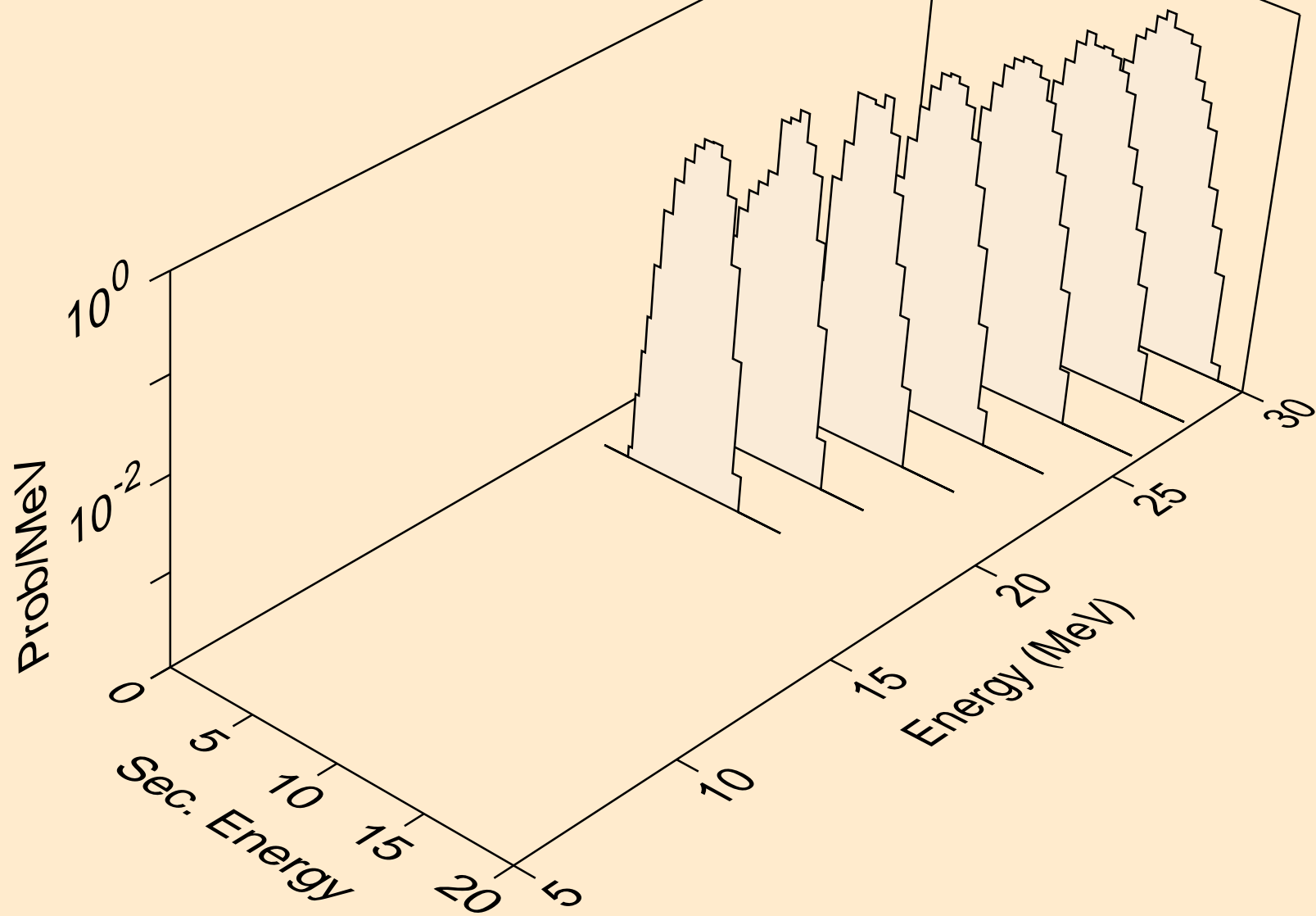

RF267 DEUTERON ACER TENDL-2021 LIBRARY; T=0.K  
Photon emission for (z,n)

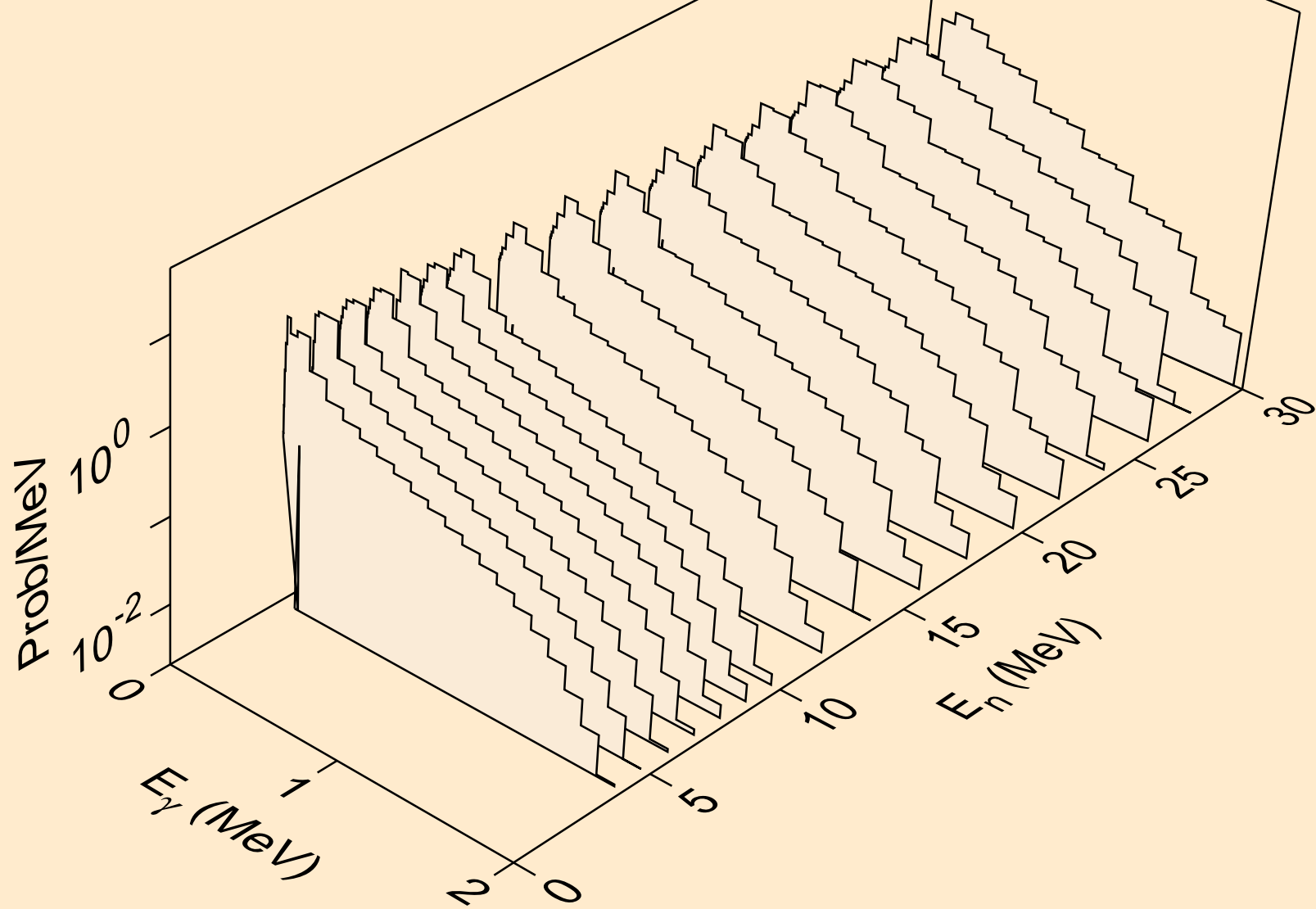

RF267 DEUTERON ACER TENDL-2021 LIBRARY; T=0.K  
Photon emission for (n,x)

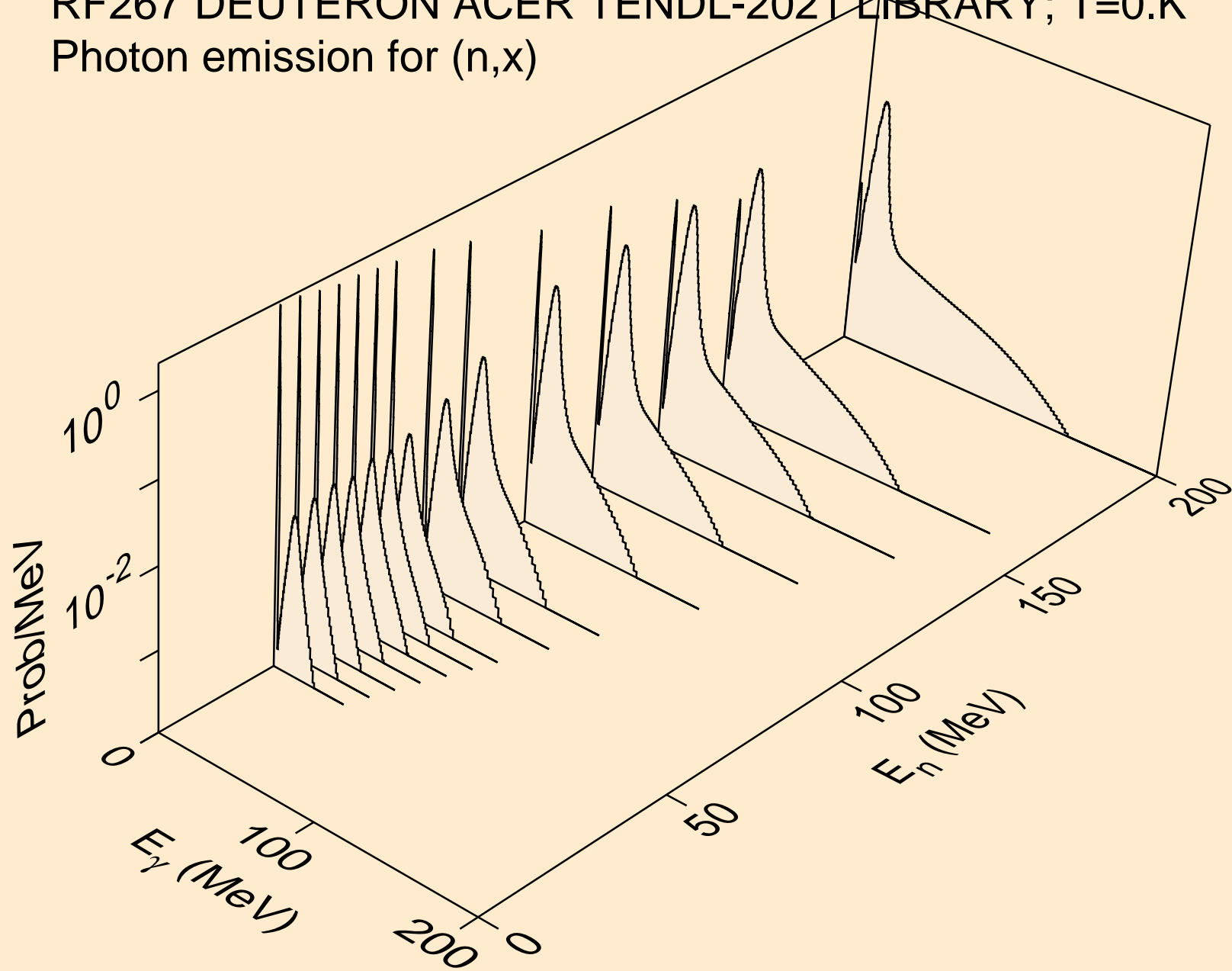

RF267 DEUTERON ACER TENDL-2021 LIBRARY; T=0.K  
Photon emission for (n,2n)

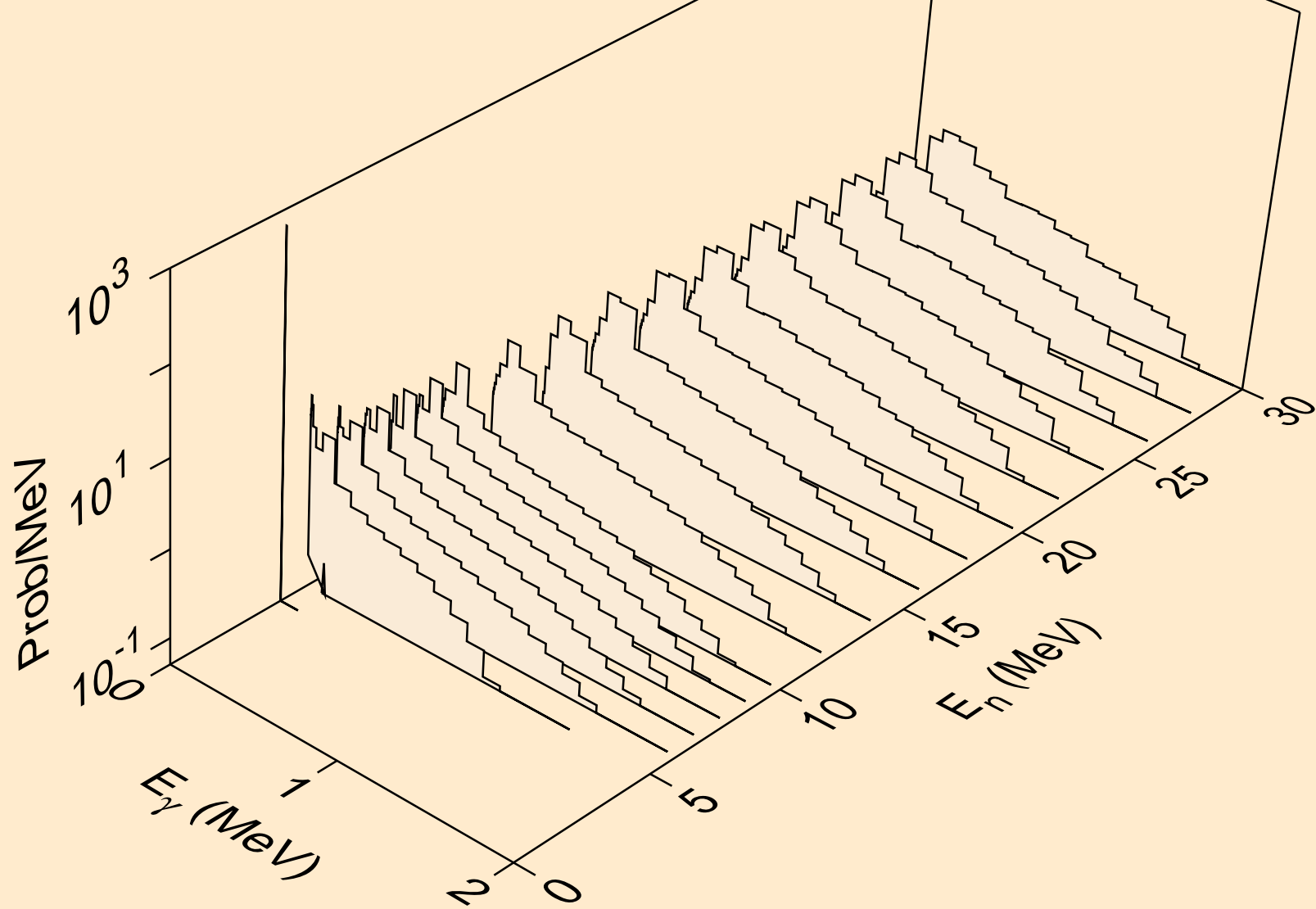

RF267 DEUTERON ACER TENDL-2021 LIBRARY; T=0.K  
Photon emission for (n,3n)

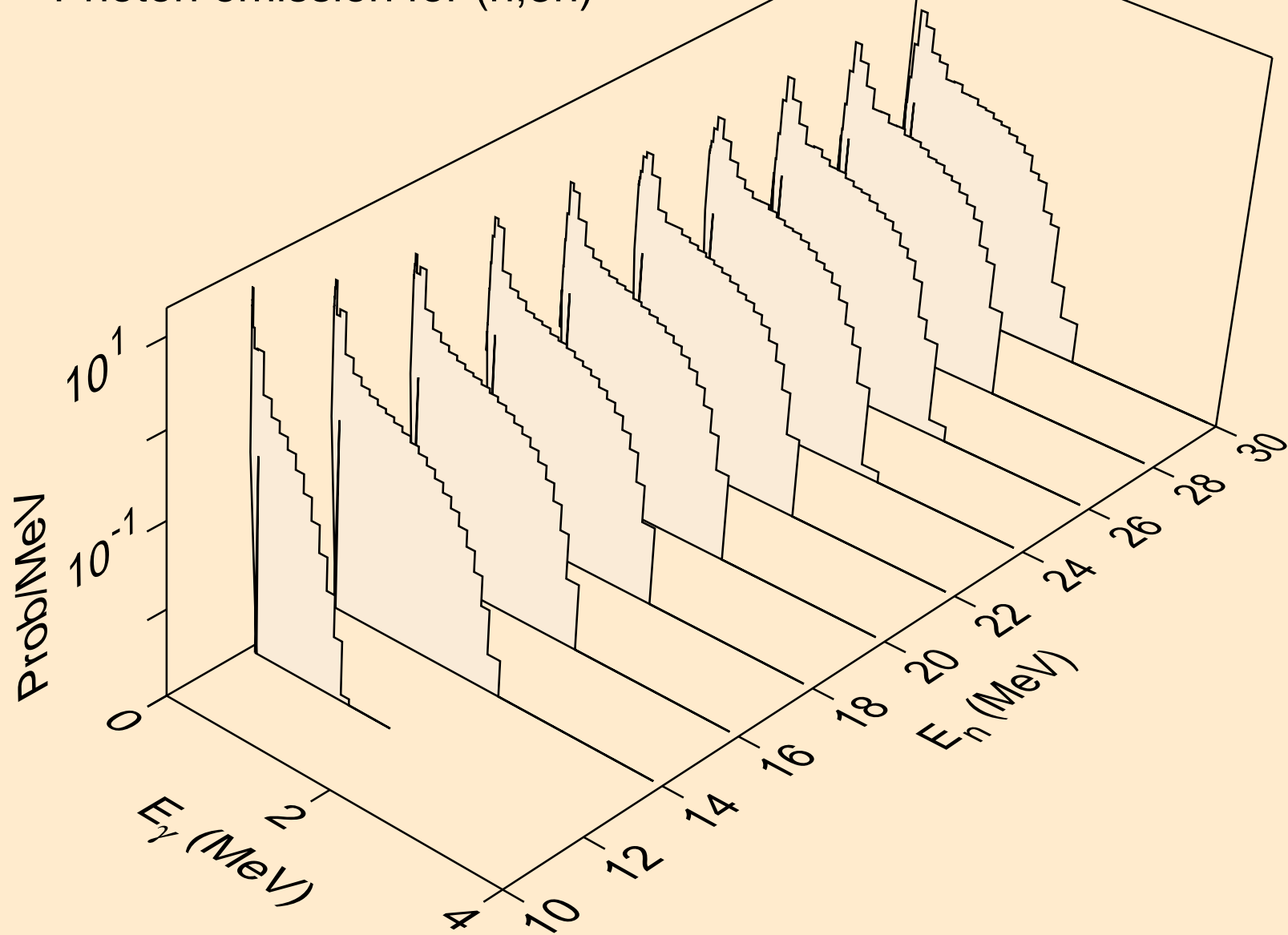

RF267 DEUTERON ACER TENDL-2021 LIBRARY; T=0.K  
Photon emission for (n,n\*)a

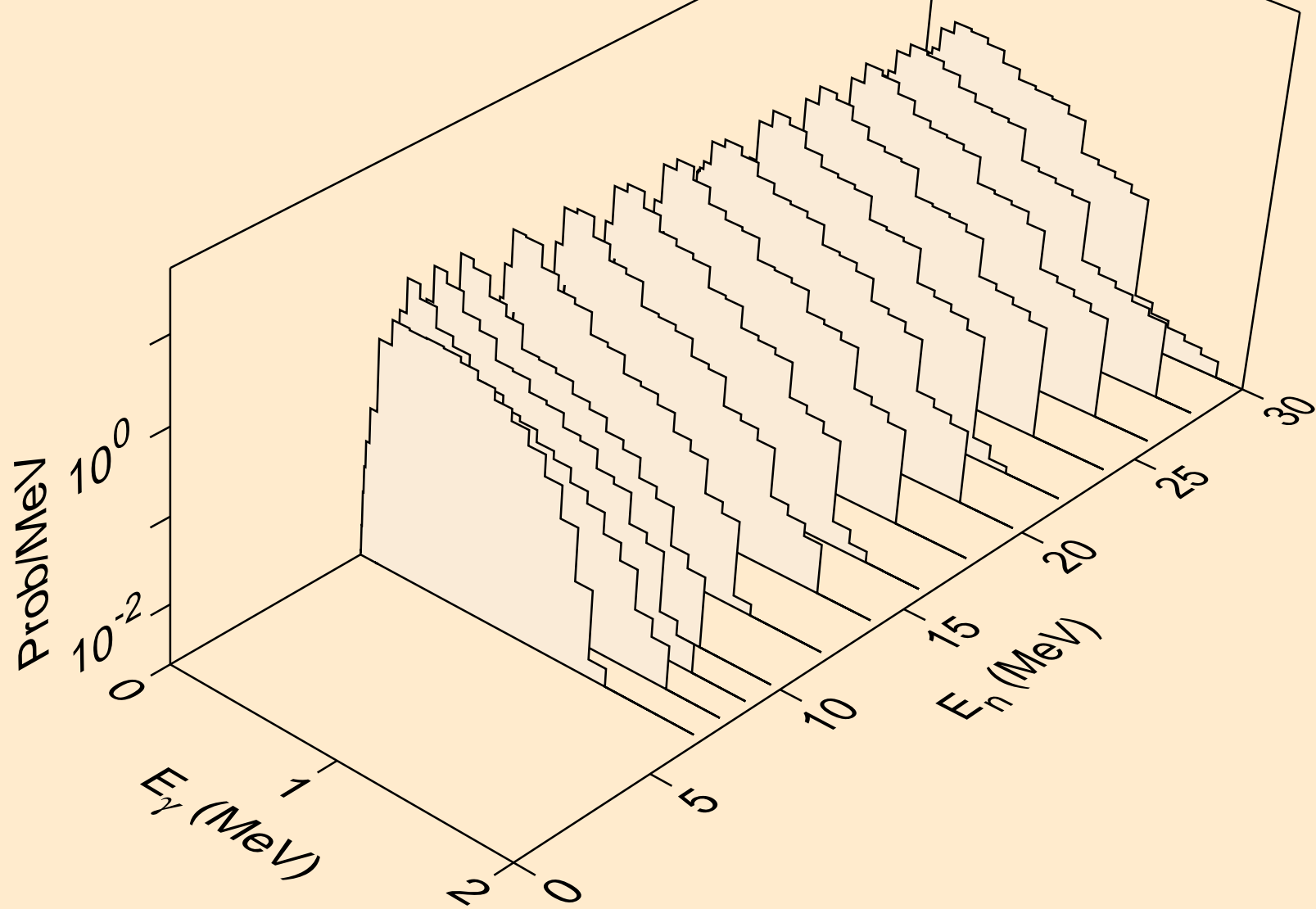

RF267 DEUTERON ACER TENDL-2021 LIBRARY; T=0.K  
Photon emission for (n,n\*)p

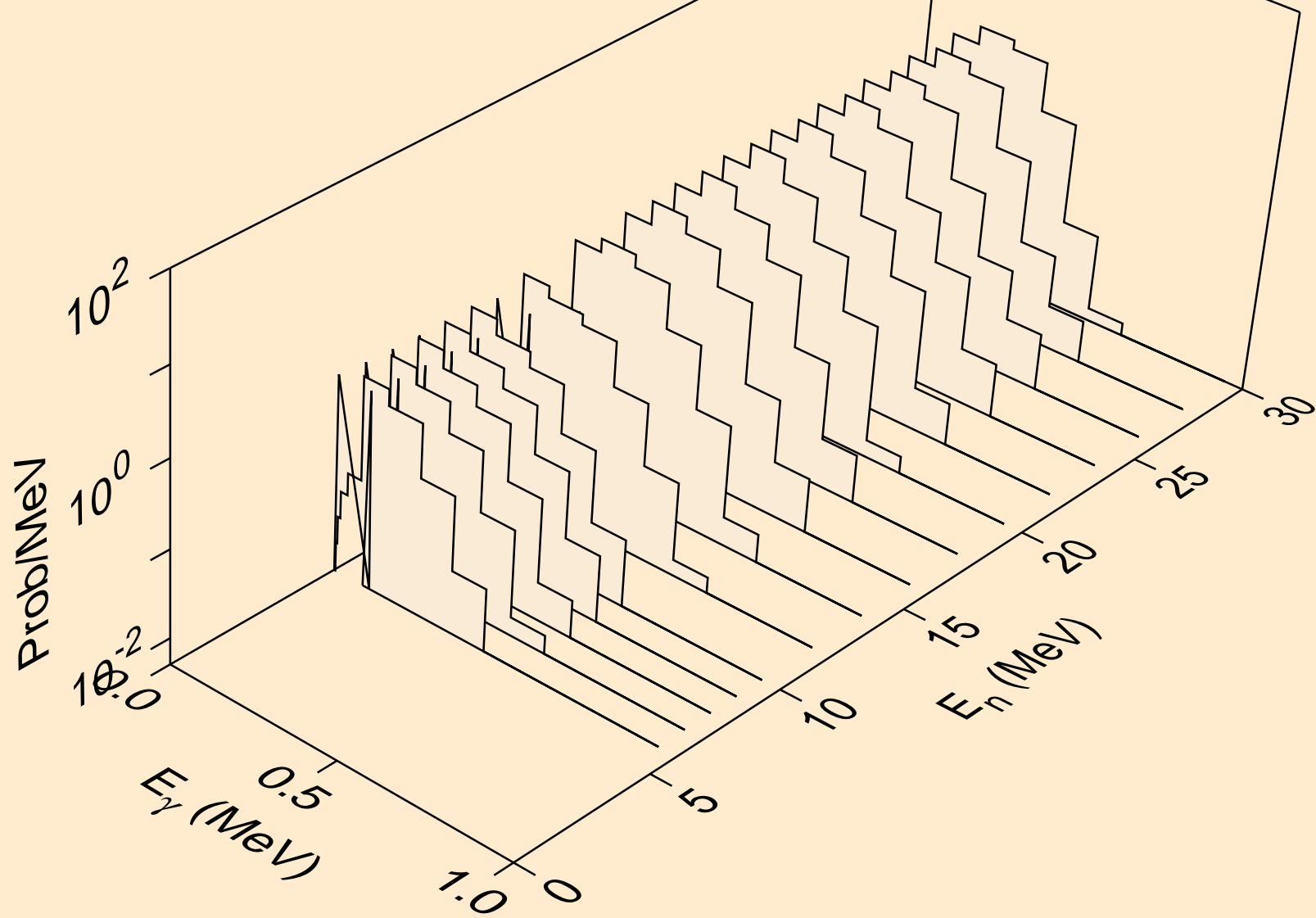

RF267 DEUTERON ACER TENDL-2021 LIBRARY; T=0.K  
Photon emission for (n,n\*)d

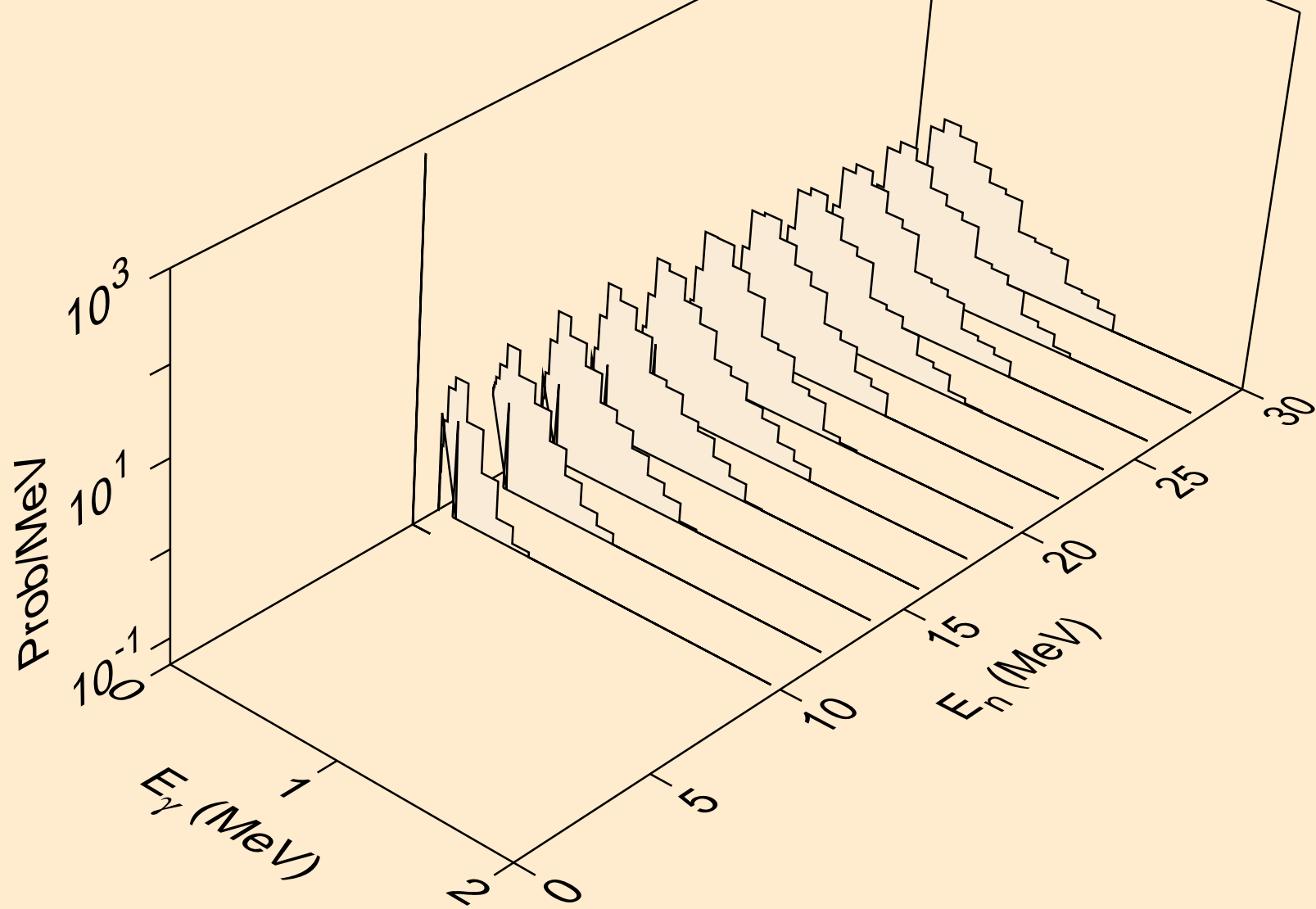



RF267 DEUTERON ACER TENDL-2021 LIBRARY; T=0.K  
Photon emission for (n,n\*)t

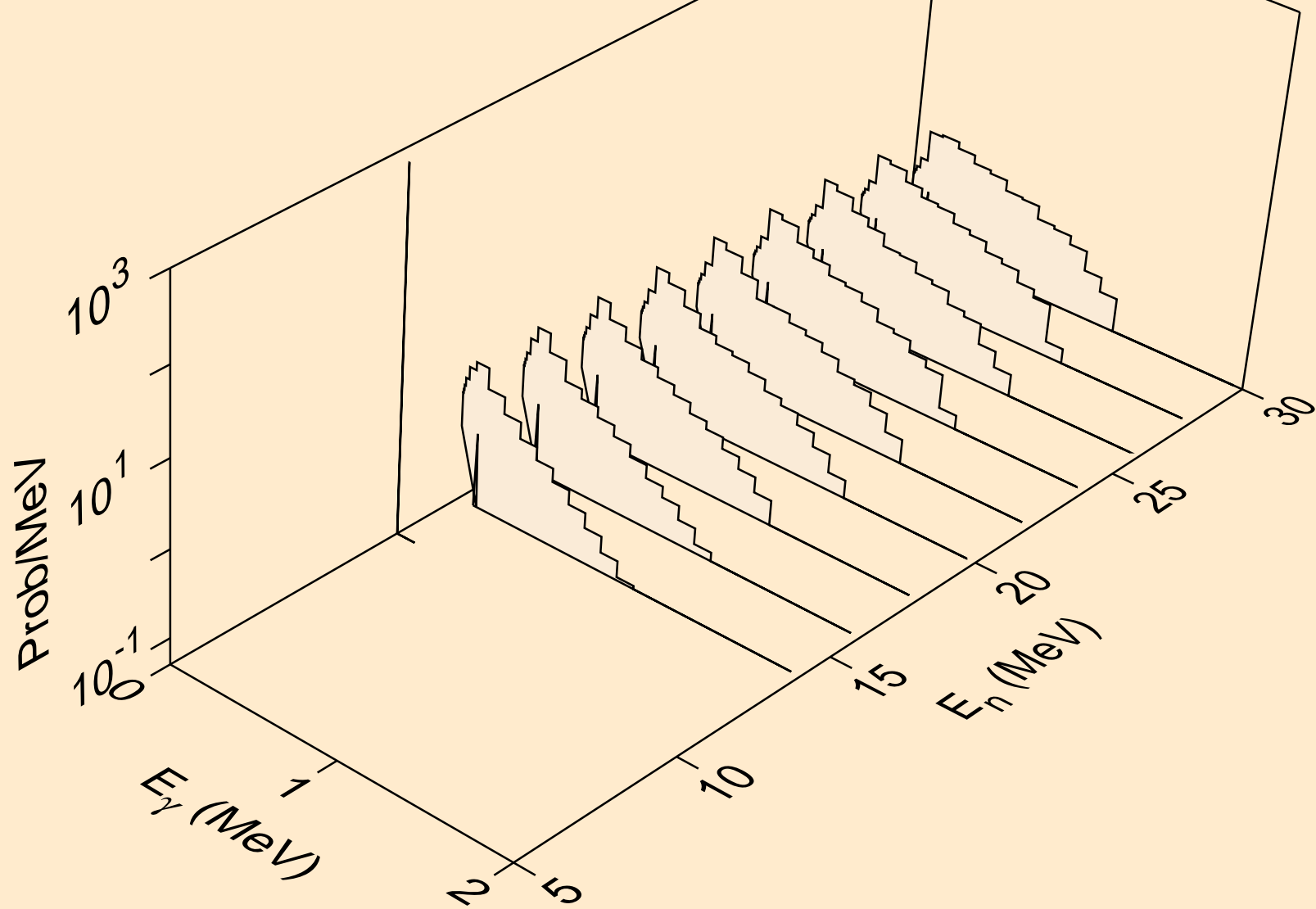

RF267 DEUTERON ACER TENDL-2021 LIBRARY; T=0.K  
Photon emission for (n,4n)

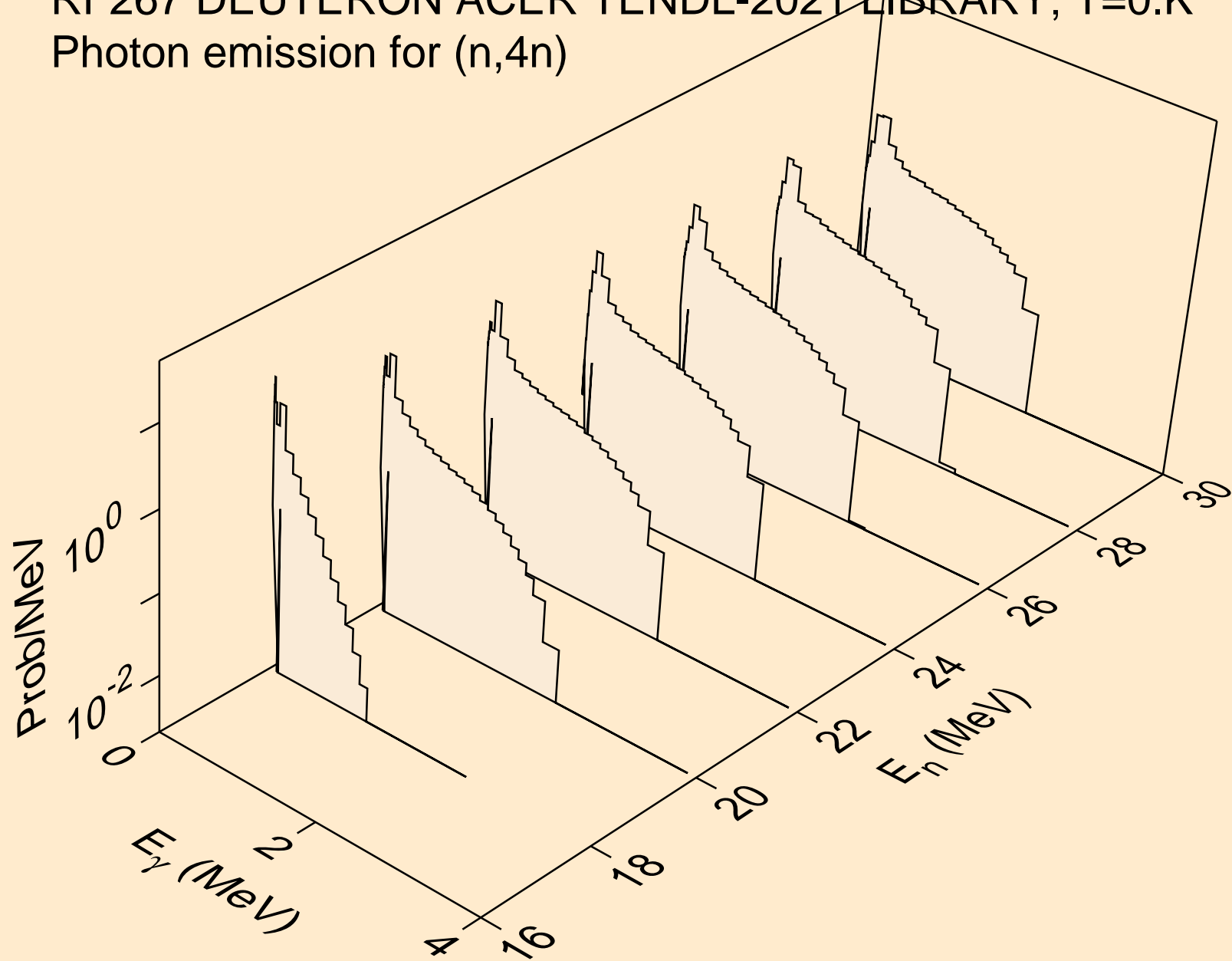

RF267 DEUTERON ACER TENDL-2021 LIBRARY; T=0.K  
Photon emission for (n,2np)

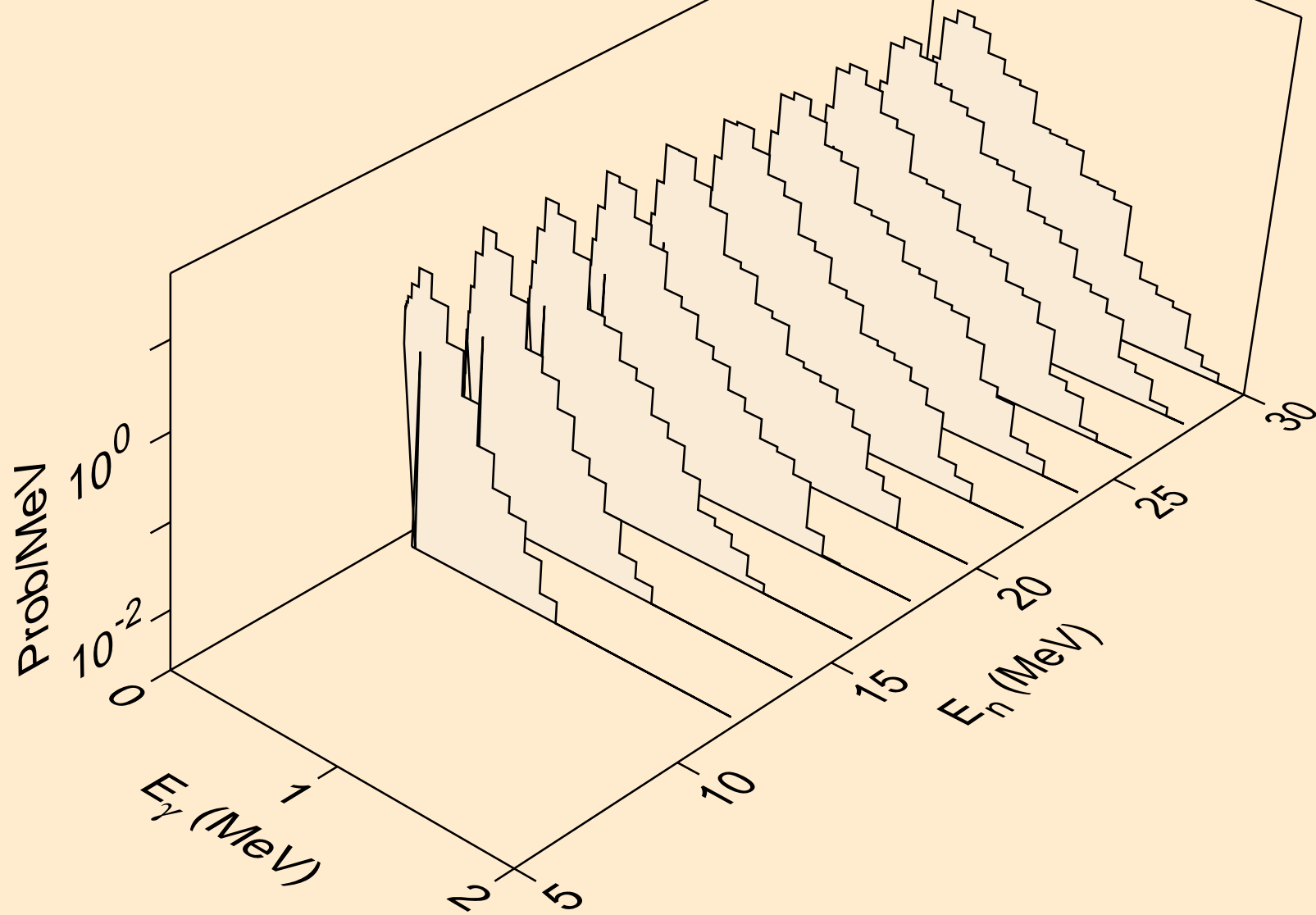

RF267 DEUTERON ACER TENDL-2021 LIBRARY; T=0.K  
Photon emission for (n,3np)

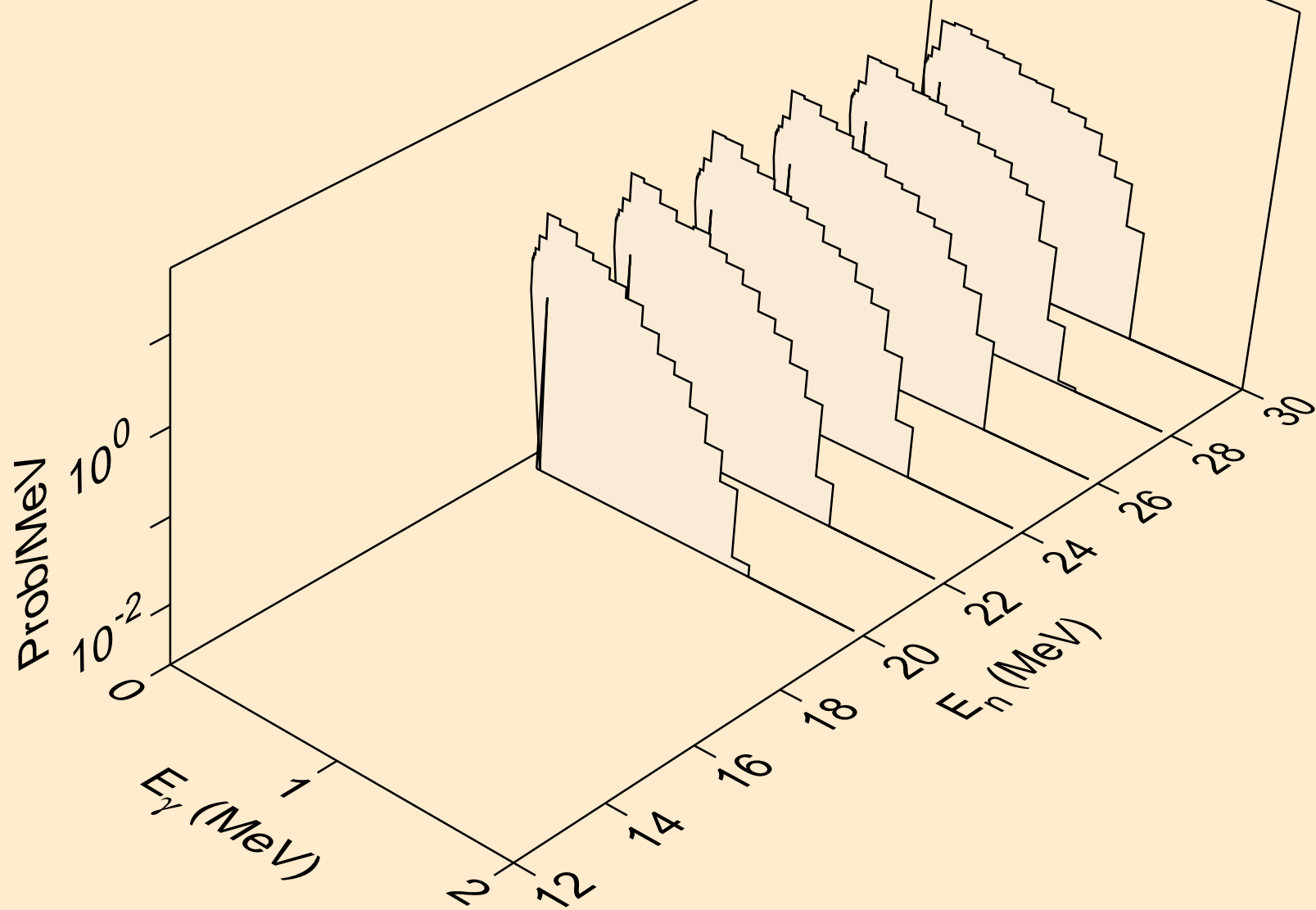

RF267 DEUTERON ACER TENDL-2021 LIBRARY; T=0.K  
Photon emission for (n,p)

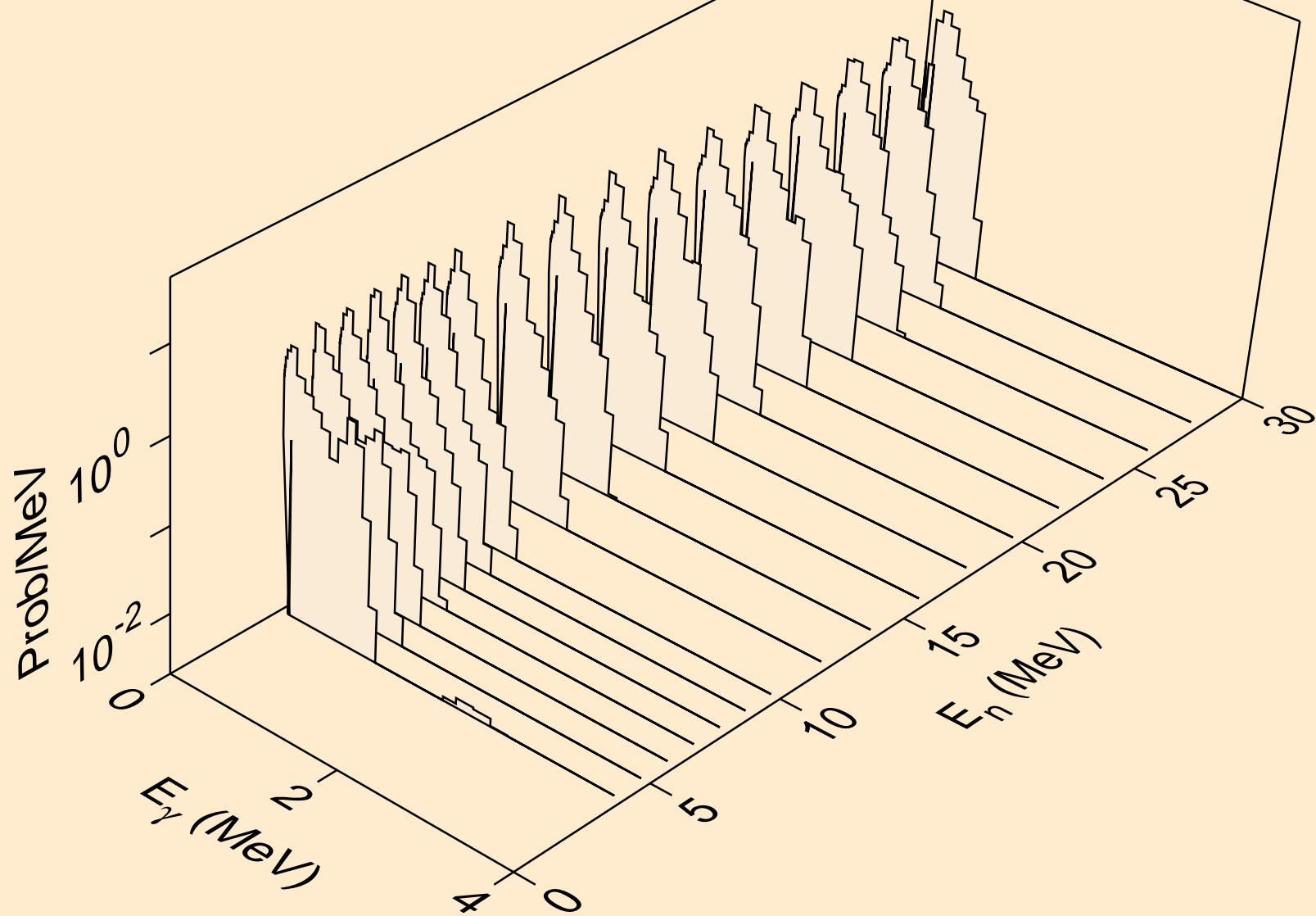

RF267 DEUTERON ACER TENDL-2021 LIBRARY; T=0.K  
Photon emission for inelastic

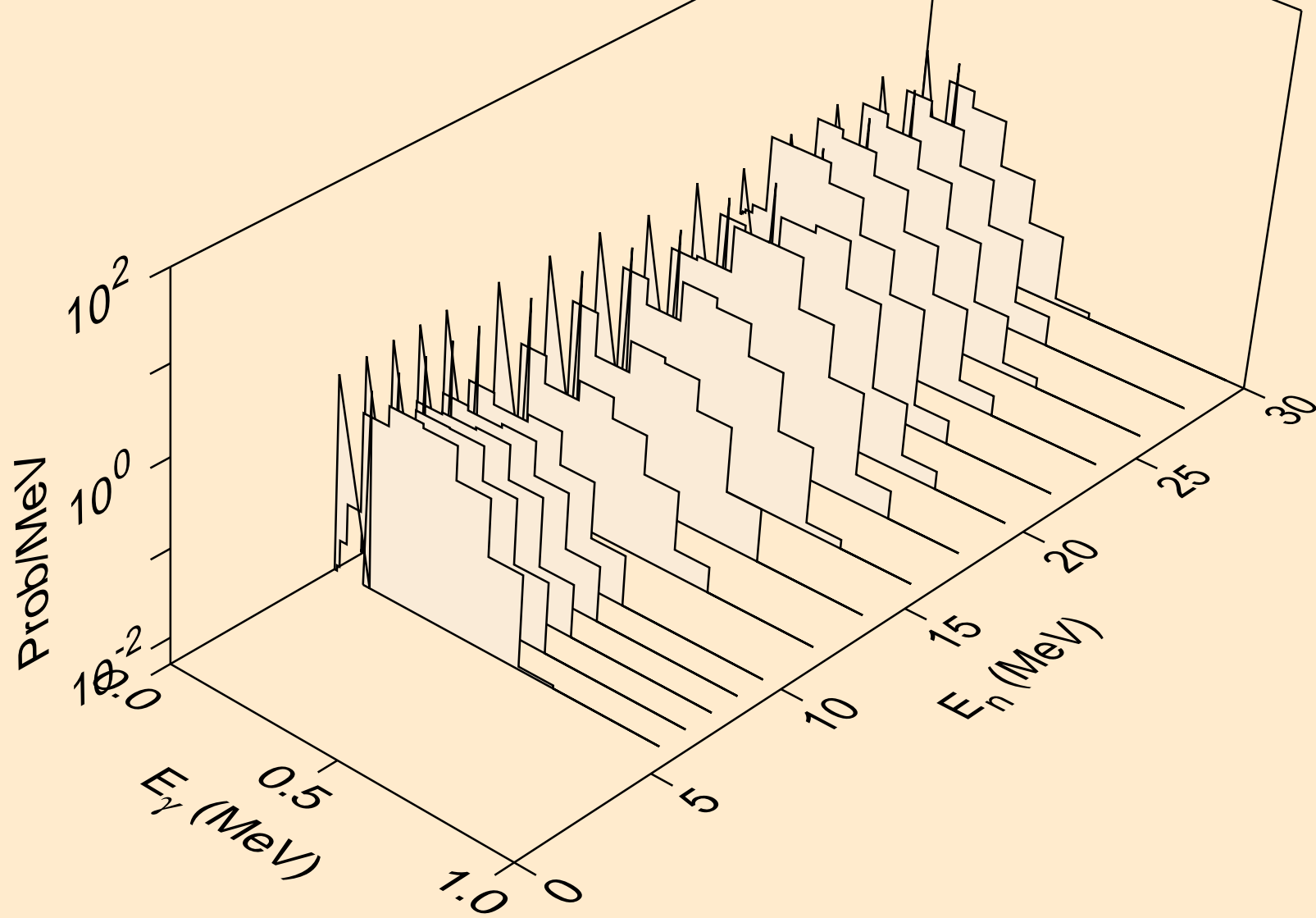

RF267 DEUTERON ACER TENDL-2021 LIBRARY; T=0.K  
Photon emission for (n,t)

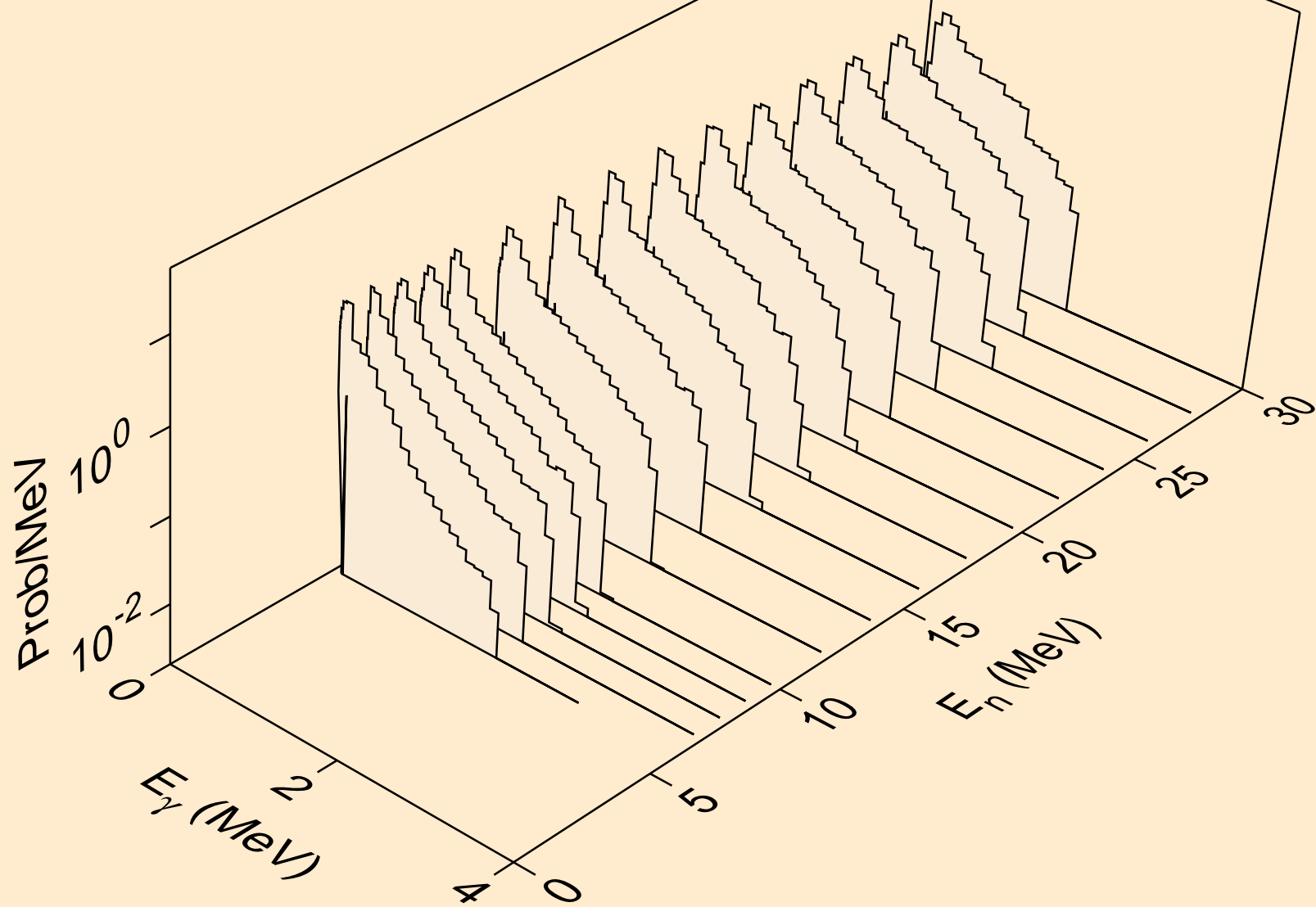

RF267 DEUTERON ACER TENDL-2021 LIBRARY; T=0.K  
Photon emission for (n,he3)

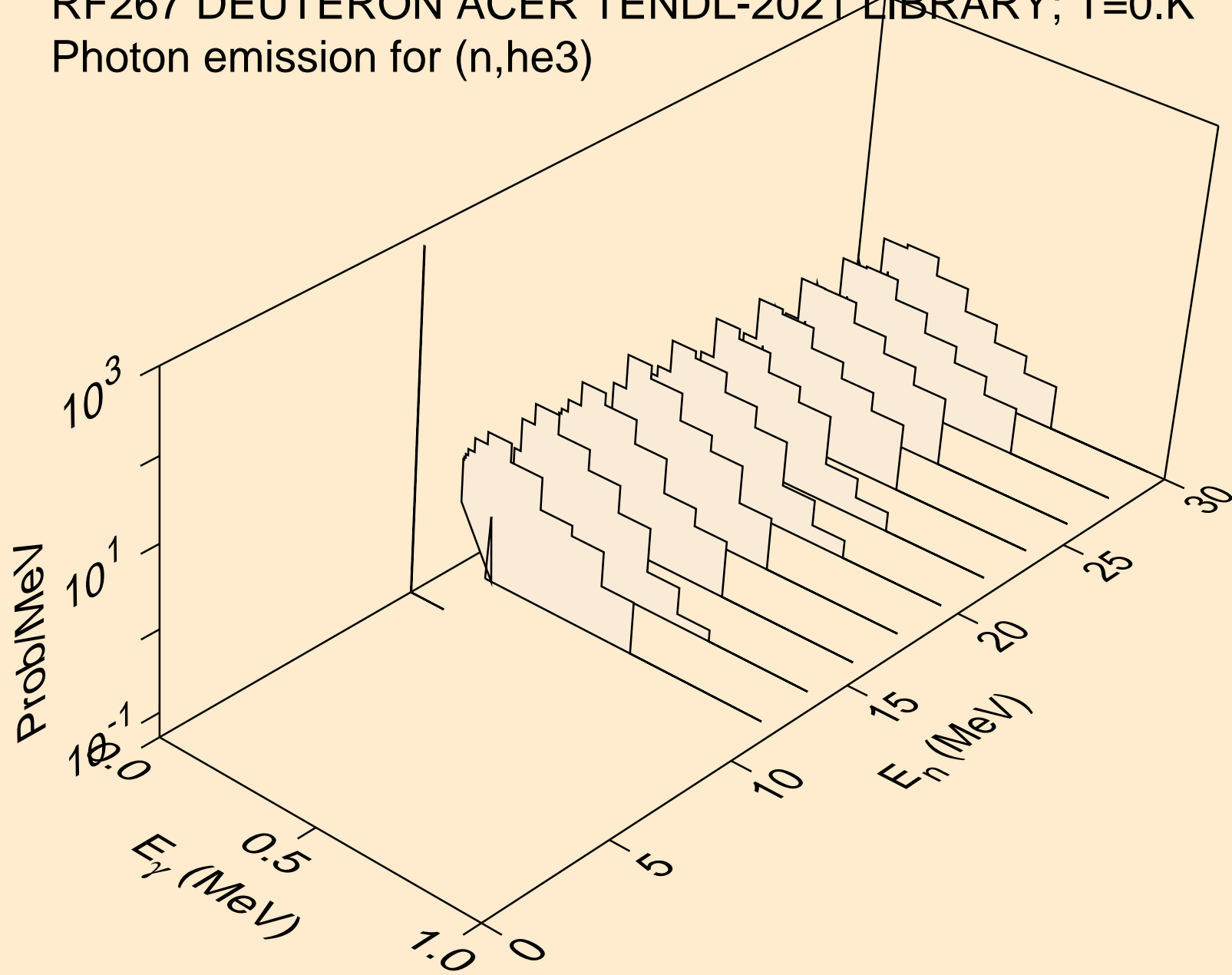



RF267 DEUTERON ACER TENDL-2021 LIBRARY; T=0.K  
Photon emission for (n,a)

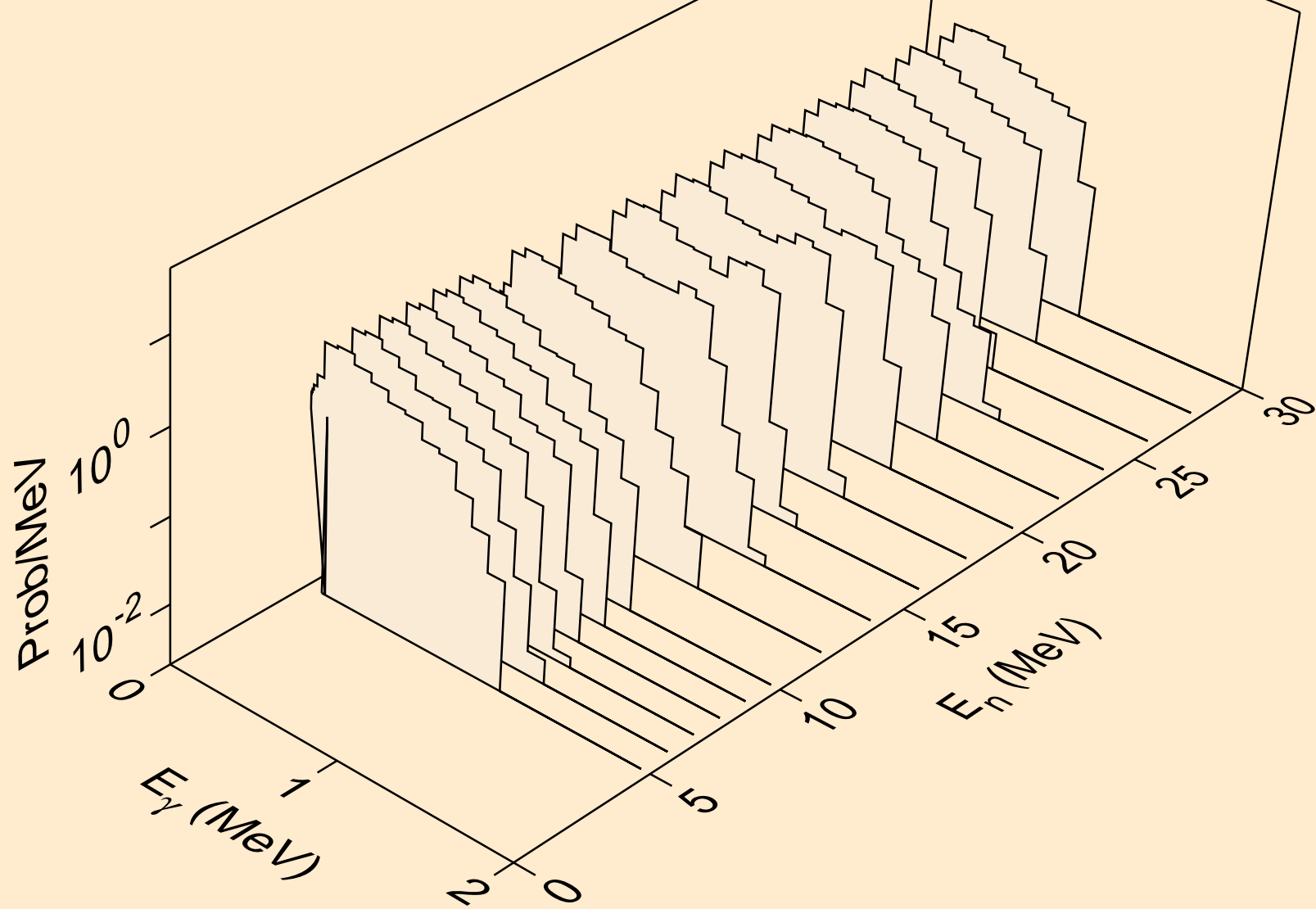

RF267 DEUTERON ACER TENDL-2021 LIBRARY; T=0.K  
Photon emission for (n,2p)

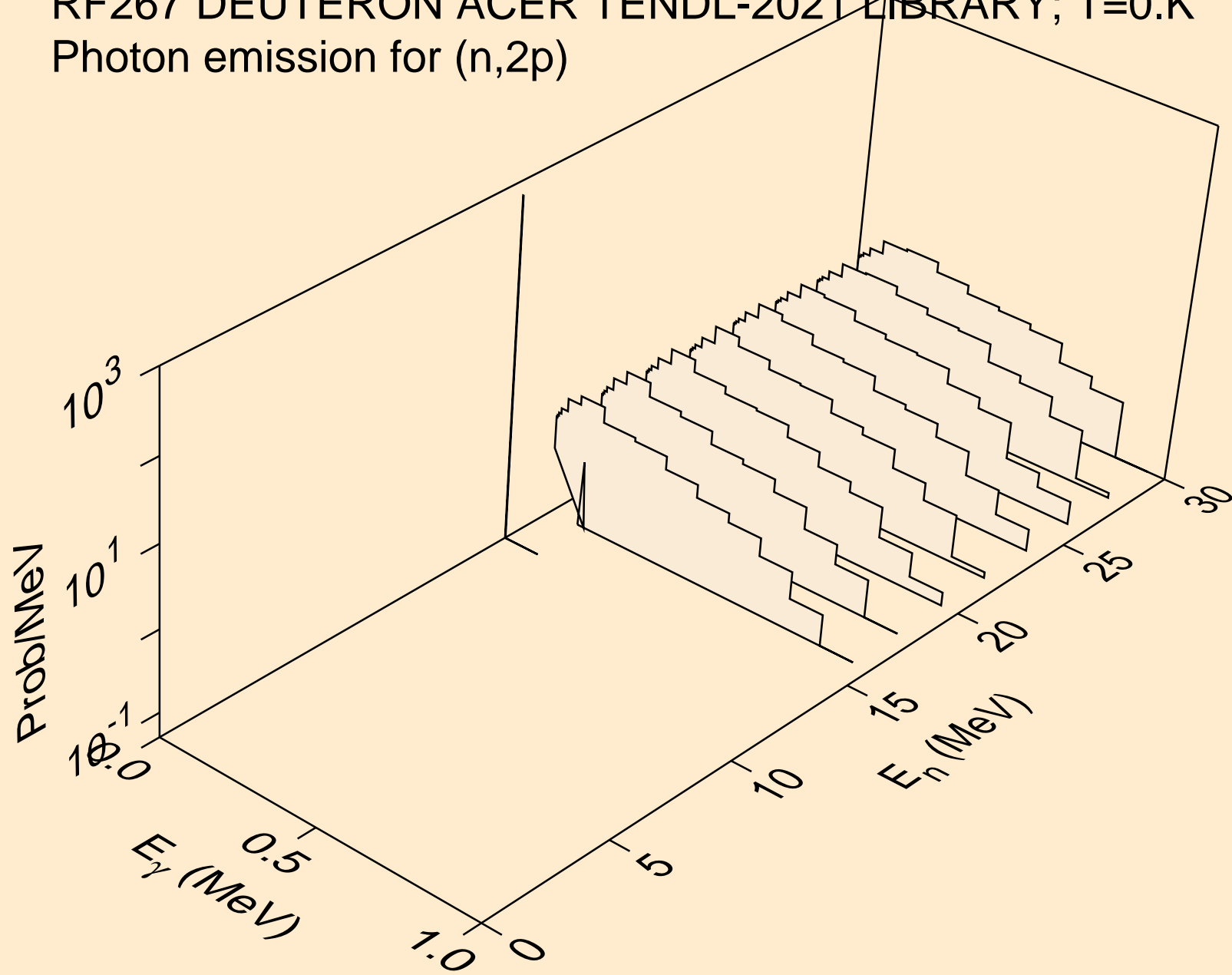

RF267 DEUTERON ACER TENDL-2021 LIBRARY; T=0.K  
Photon emission for (n,pd)

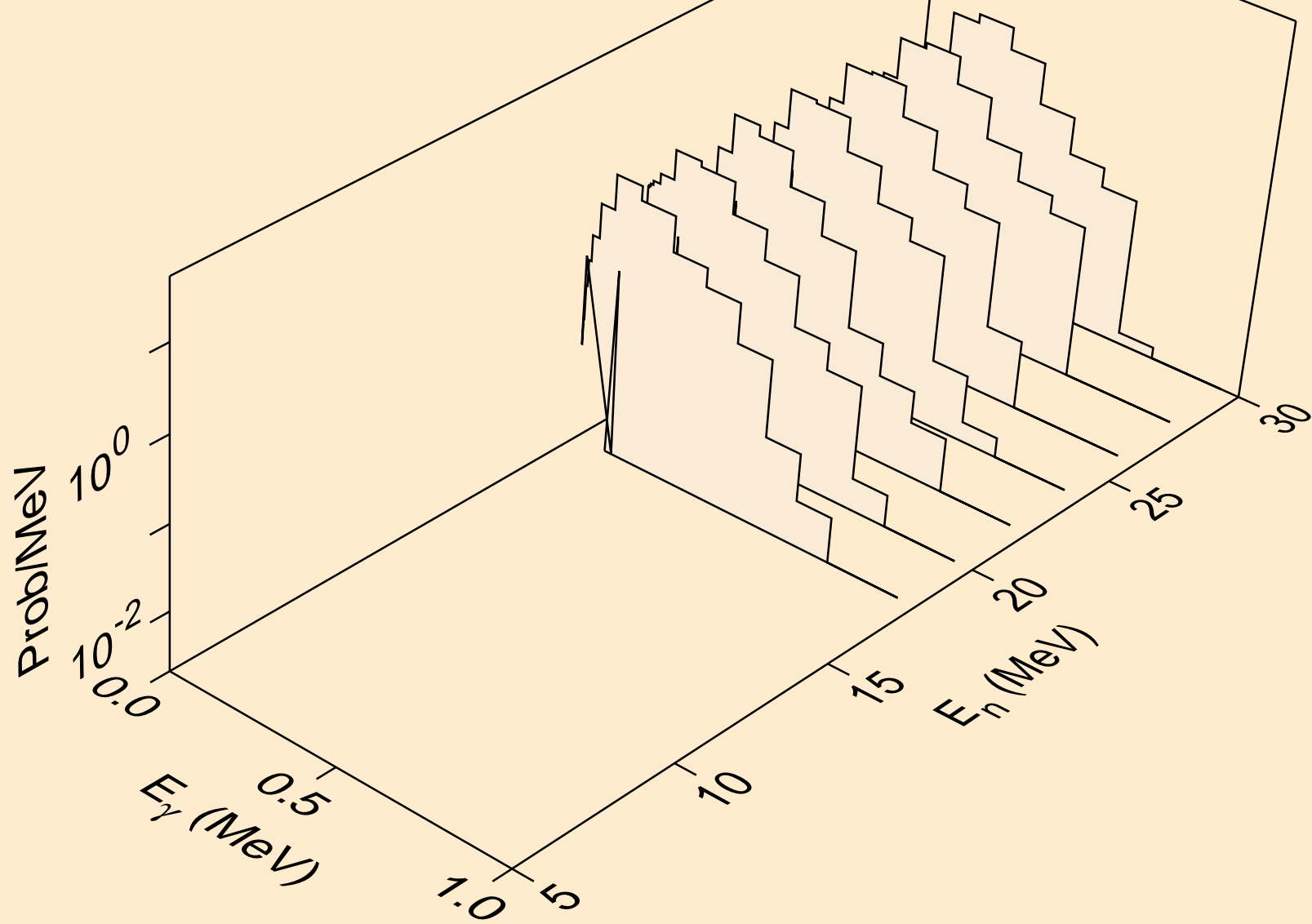

RF267 DEUTERON ACER TENDL-2021 LIBRARY; T=0.K  
Particle heating contributions

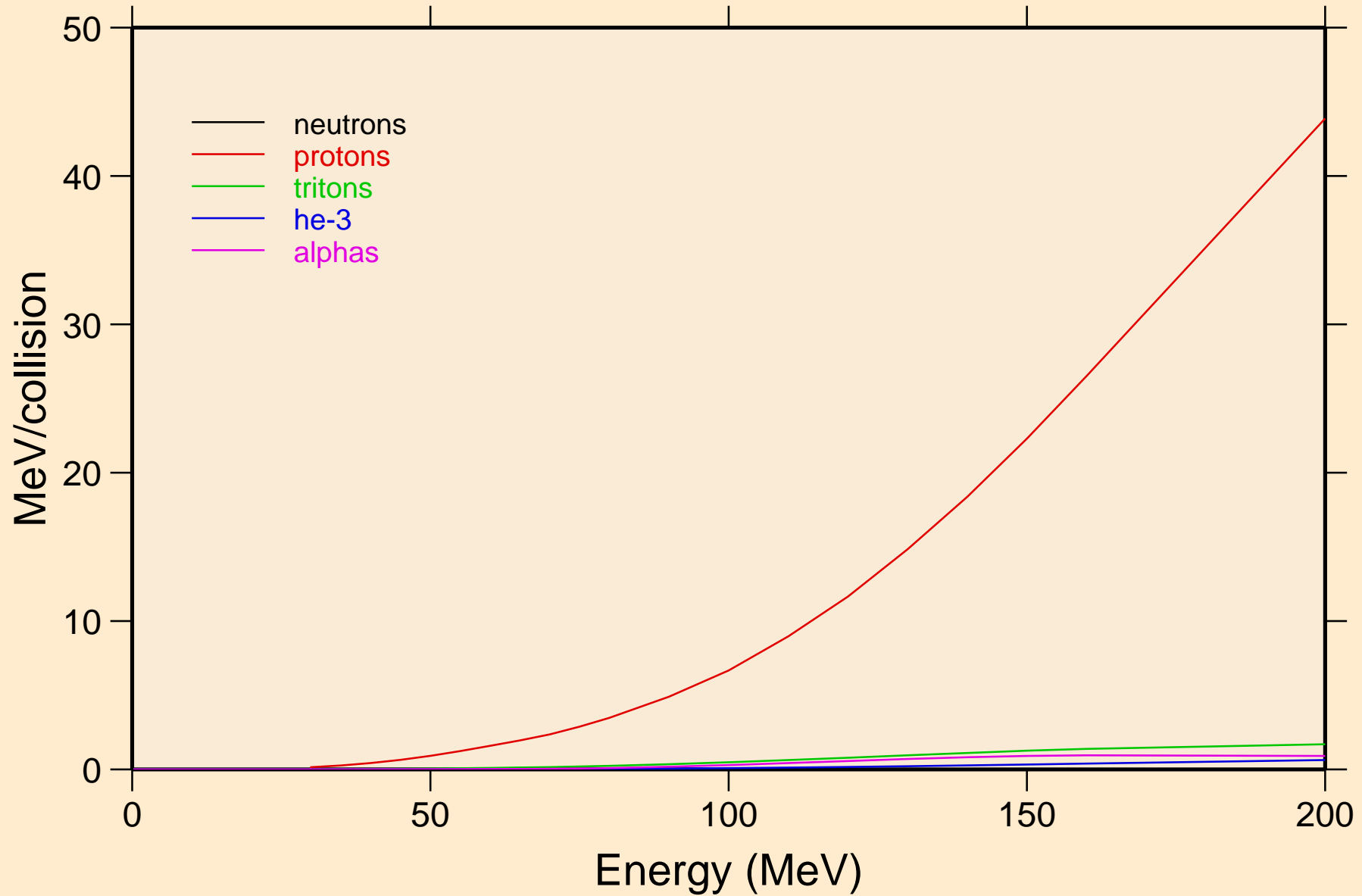

RF267 DEUTERON ACER TENDL-2021 LIBRARY; T=0.K  
Recoil Heating

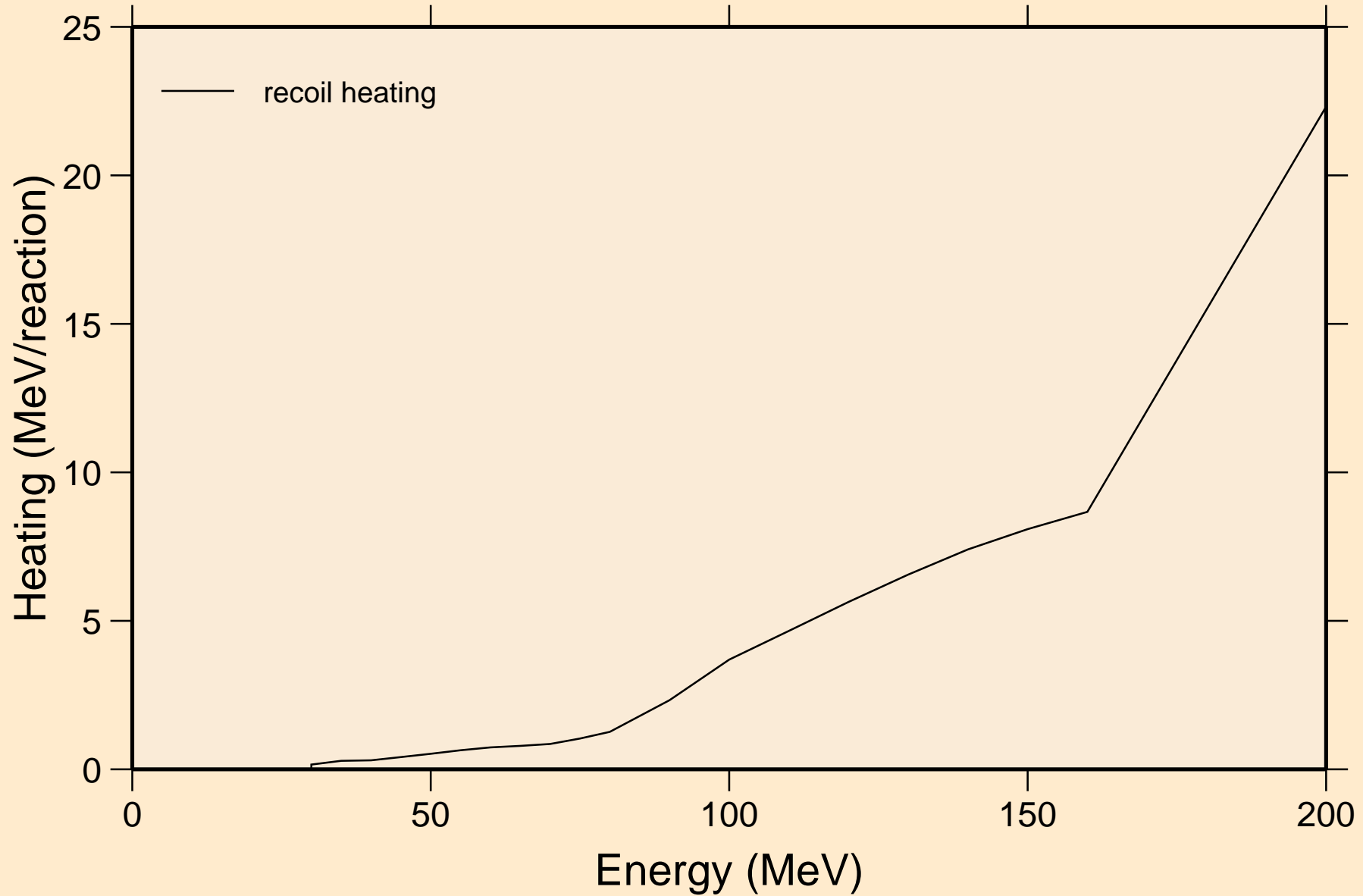

RF267 DEUTERON ACER TENDL-2021 LIBRARY; T=0.K  
Particle production cross sections

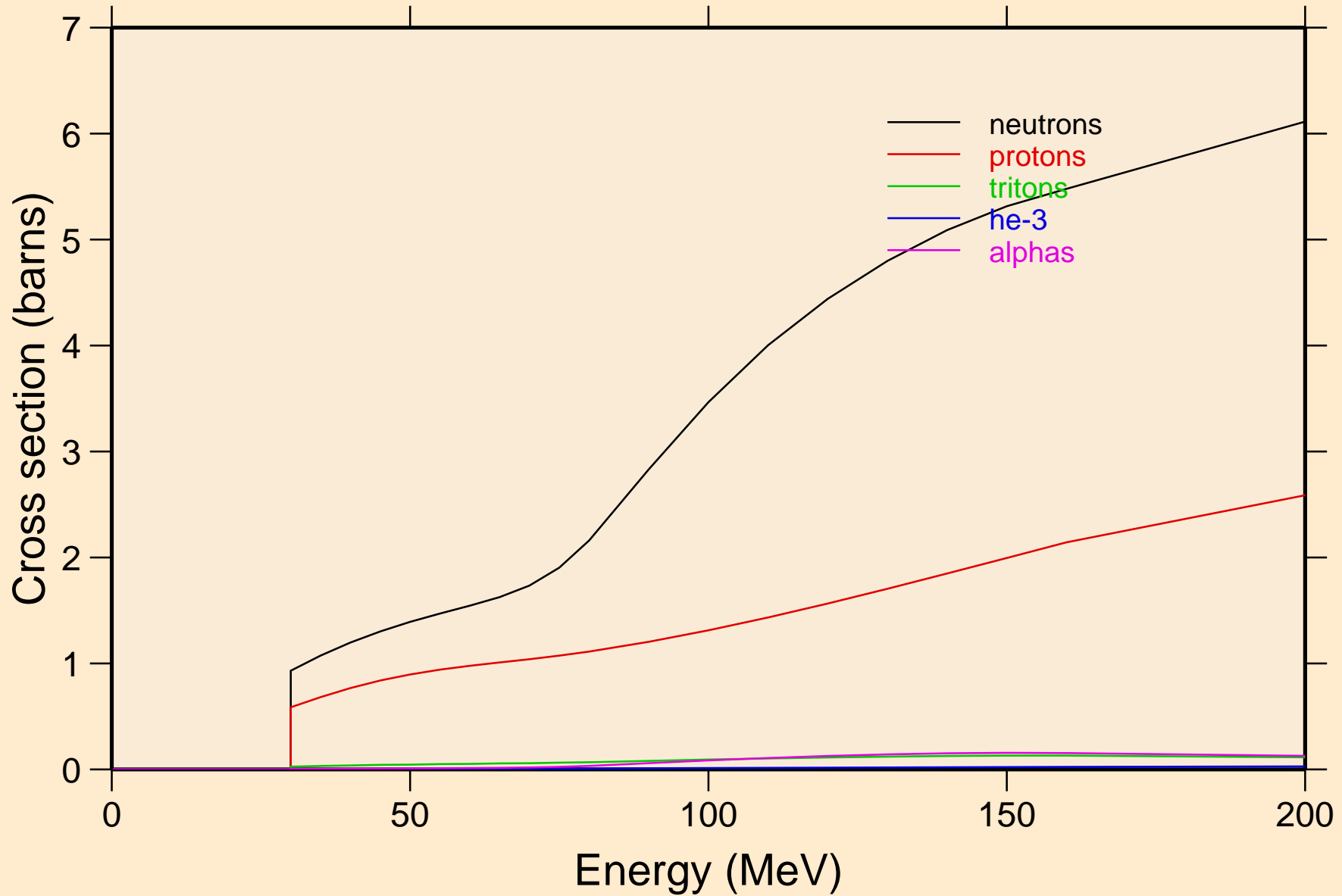

RF267 DEUTERON ACER TENDL-2021 LIBRARY; T=0.K  
neutrons from (d,n)

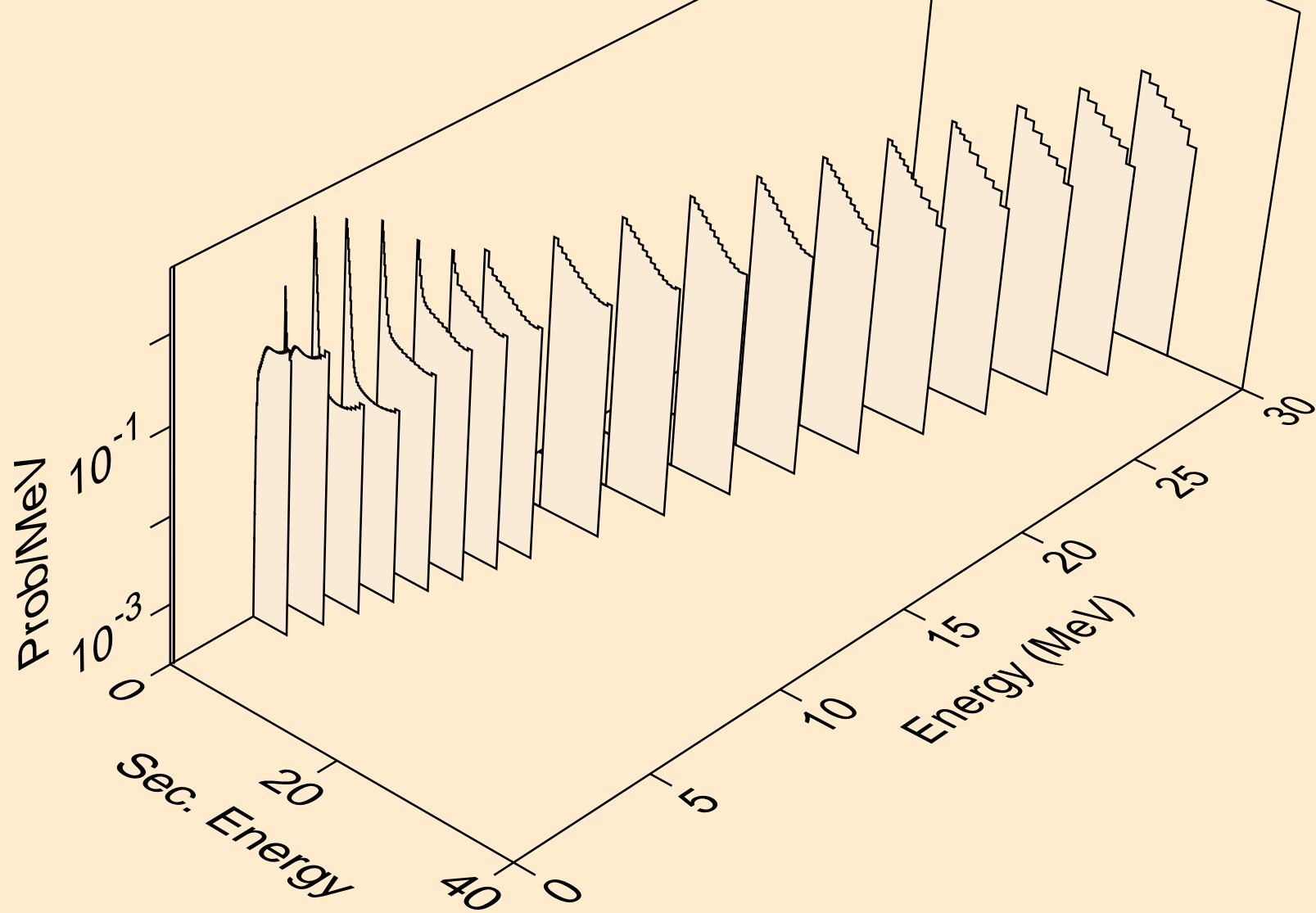

RF267 DEUTERON ACER TENDL-2021 LIBRARY; T=0.K  
neutrons from (d,x)

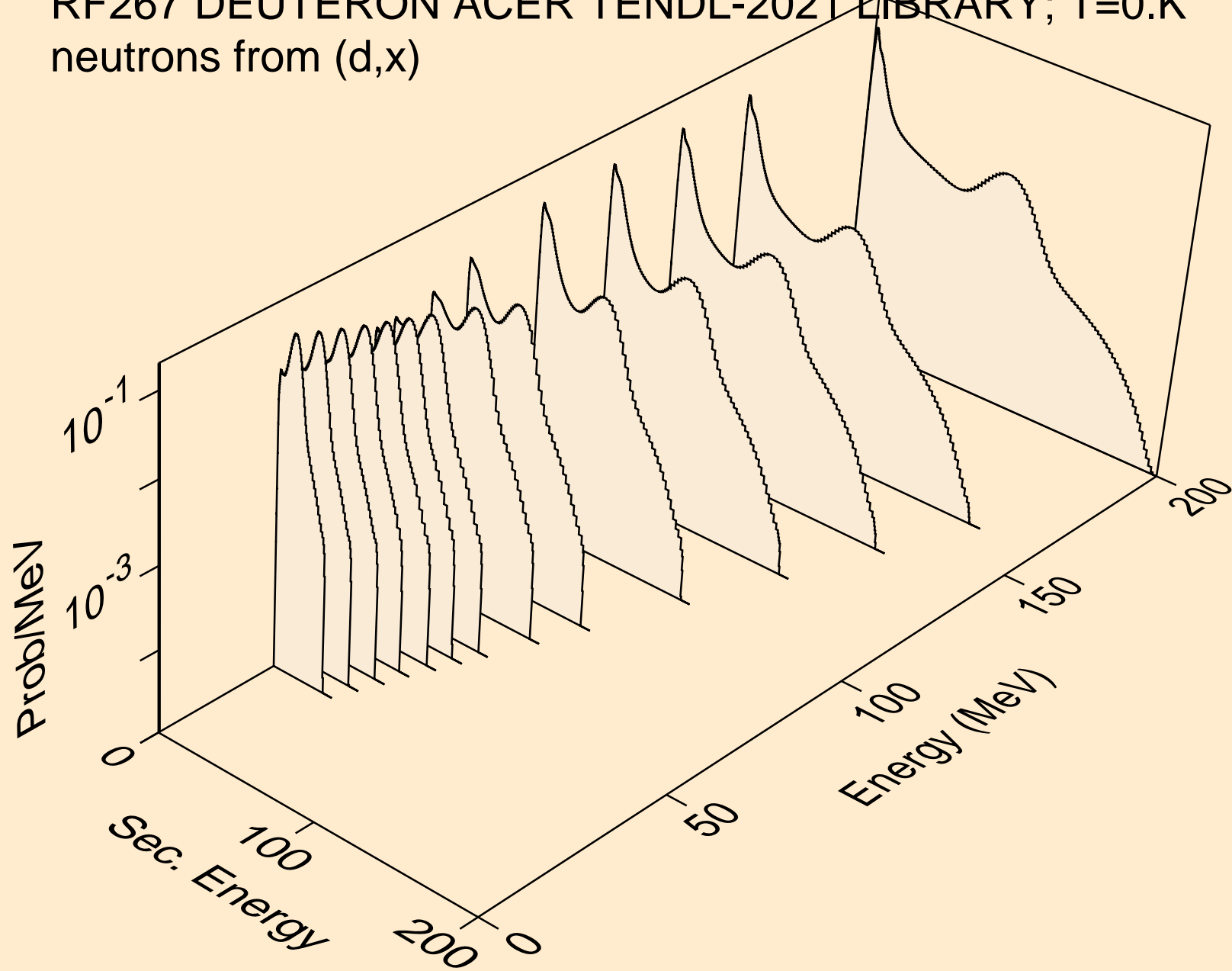



RF267 DEUTERON ACER TENDL-2021 LIBRARY; T=0.K  
neutrons from (d,2n)

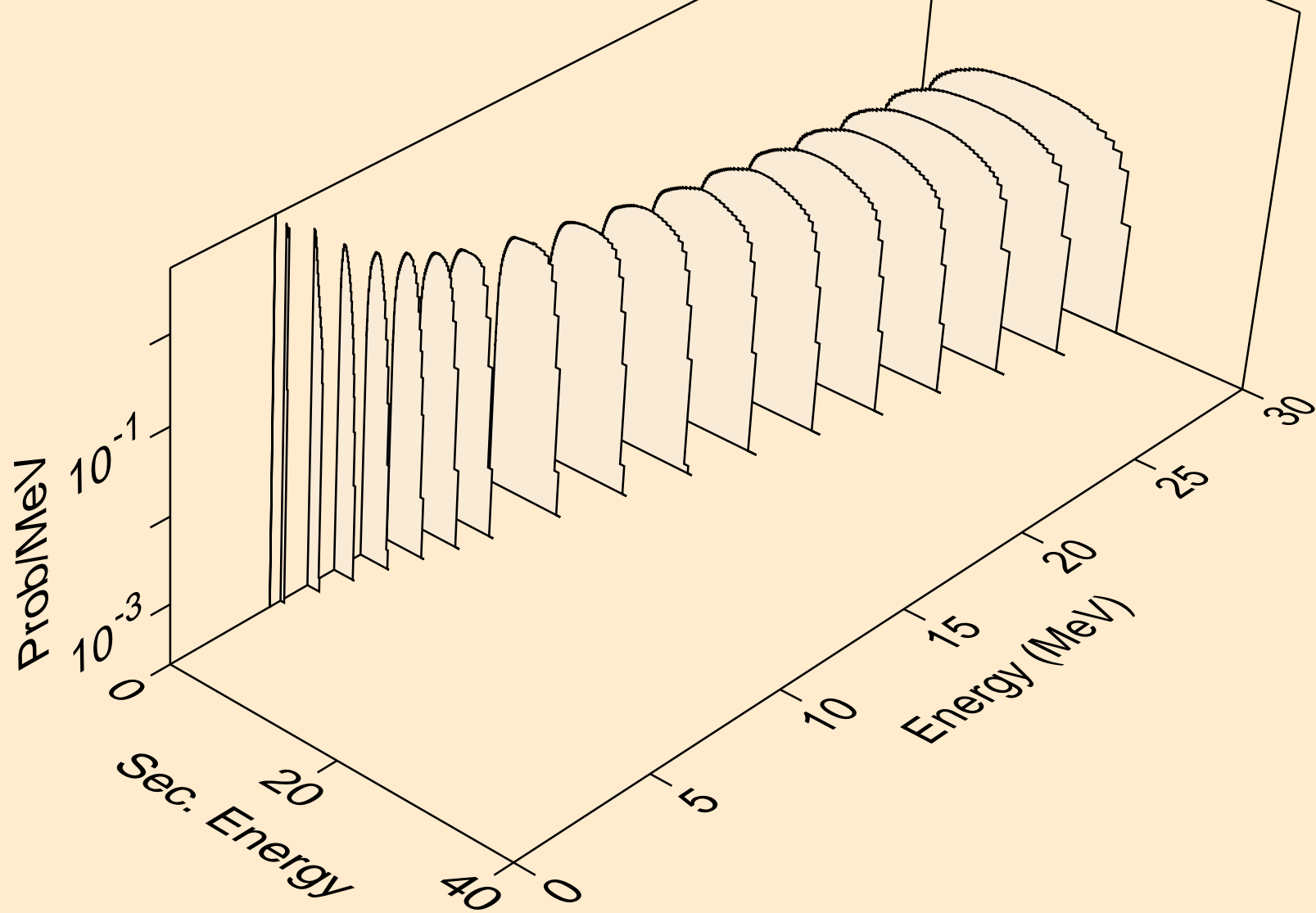

RF267 DEUTERON ACER TENDL-2021 LIBRARY; T=0.K  
neutrons from (d,3n)

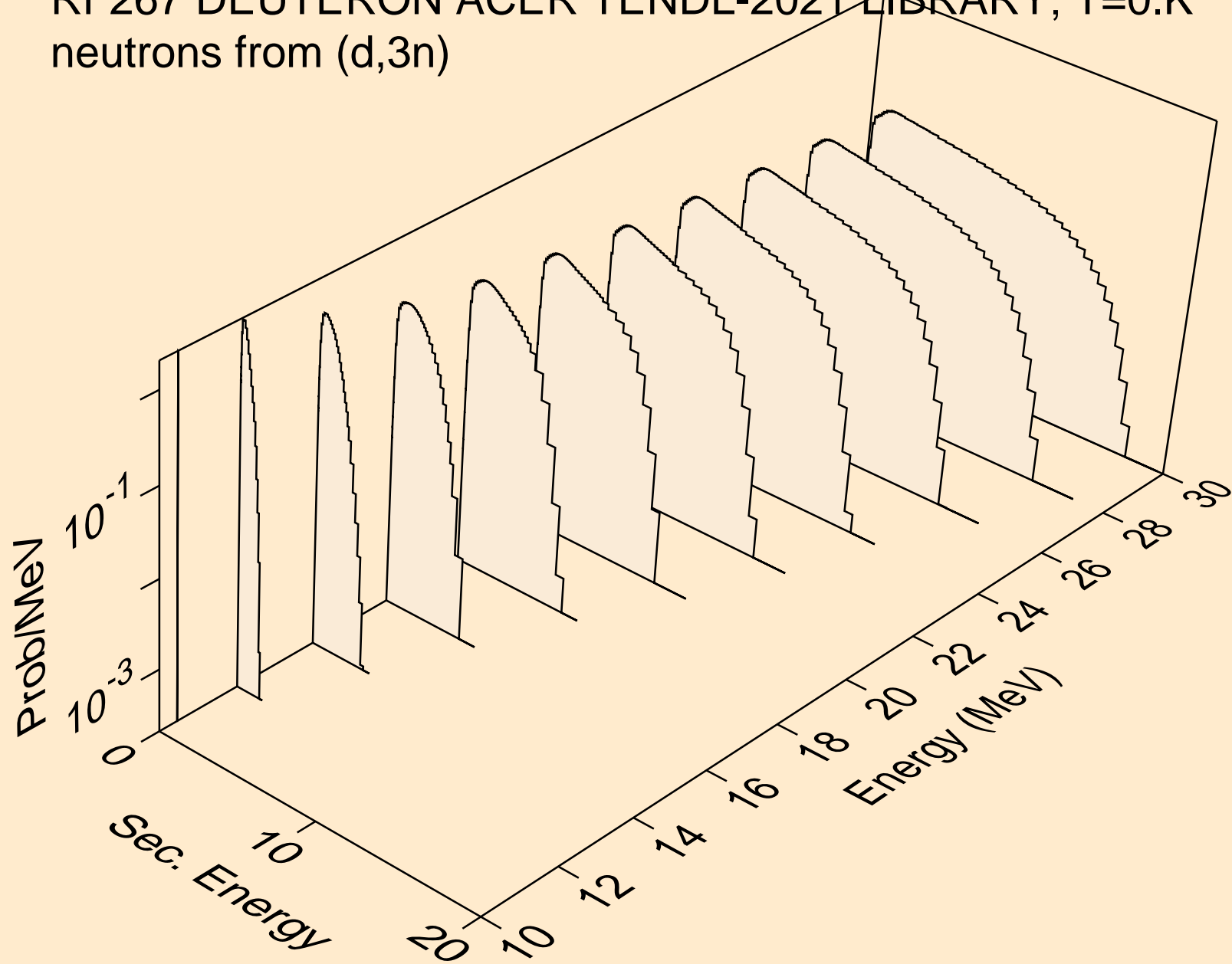

RF267 DEUTERON ACER TENDL-2021 LIBRARY; T=0.K  
neutrons from (d,n\*)a

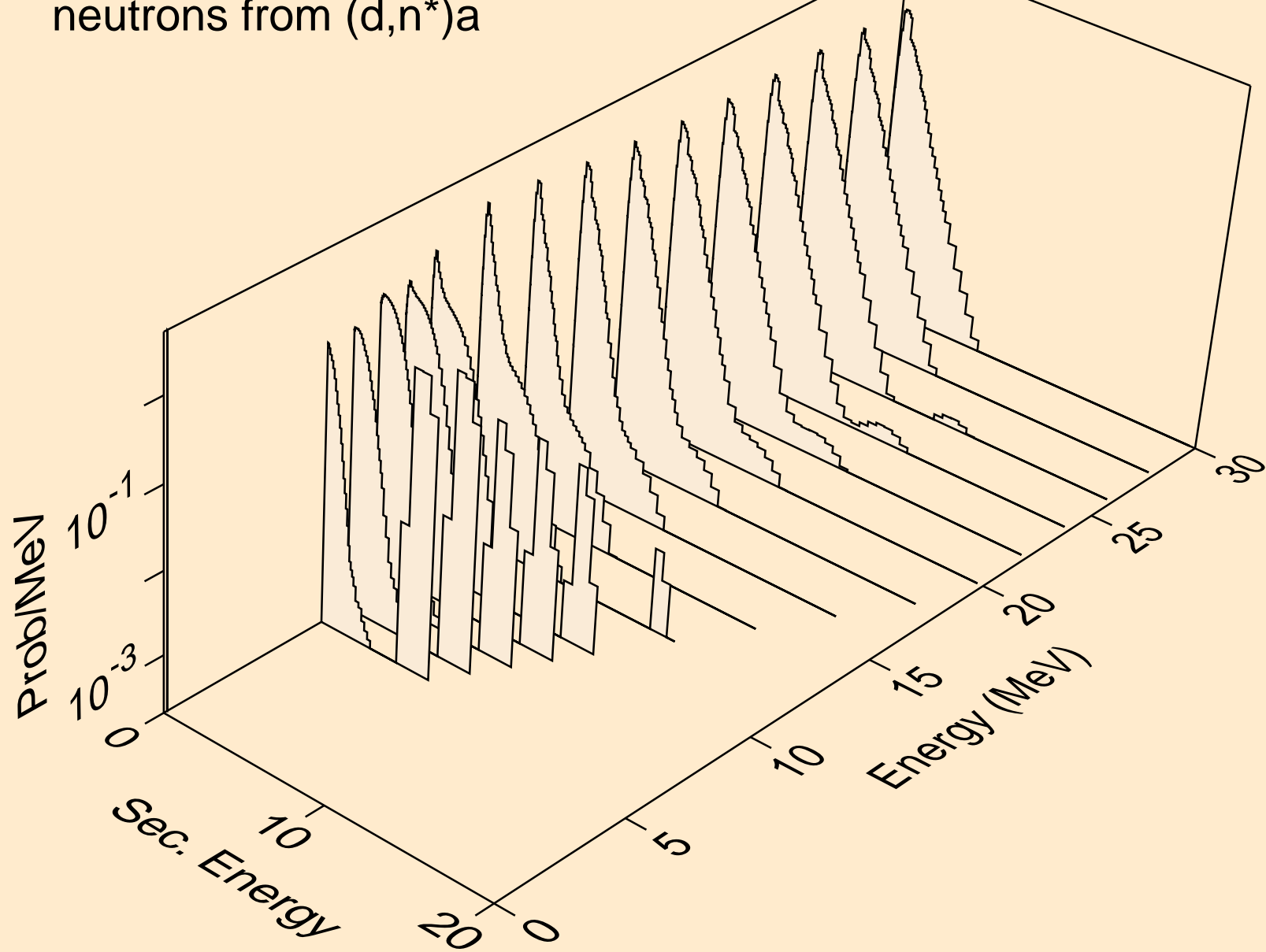

RF267 DEUTERON ACER TENDL-2021 LIBRARY; T=0.K  
neutrons from (d,n\*)p

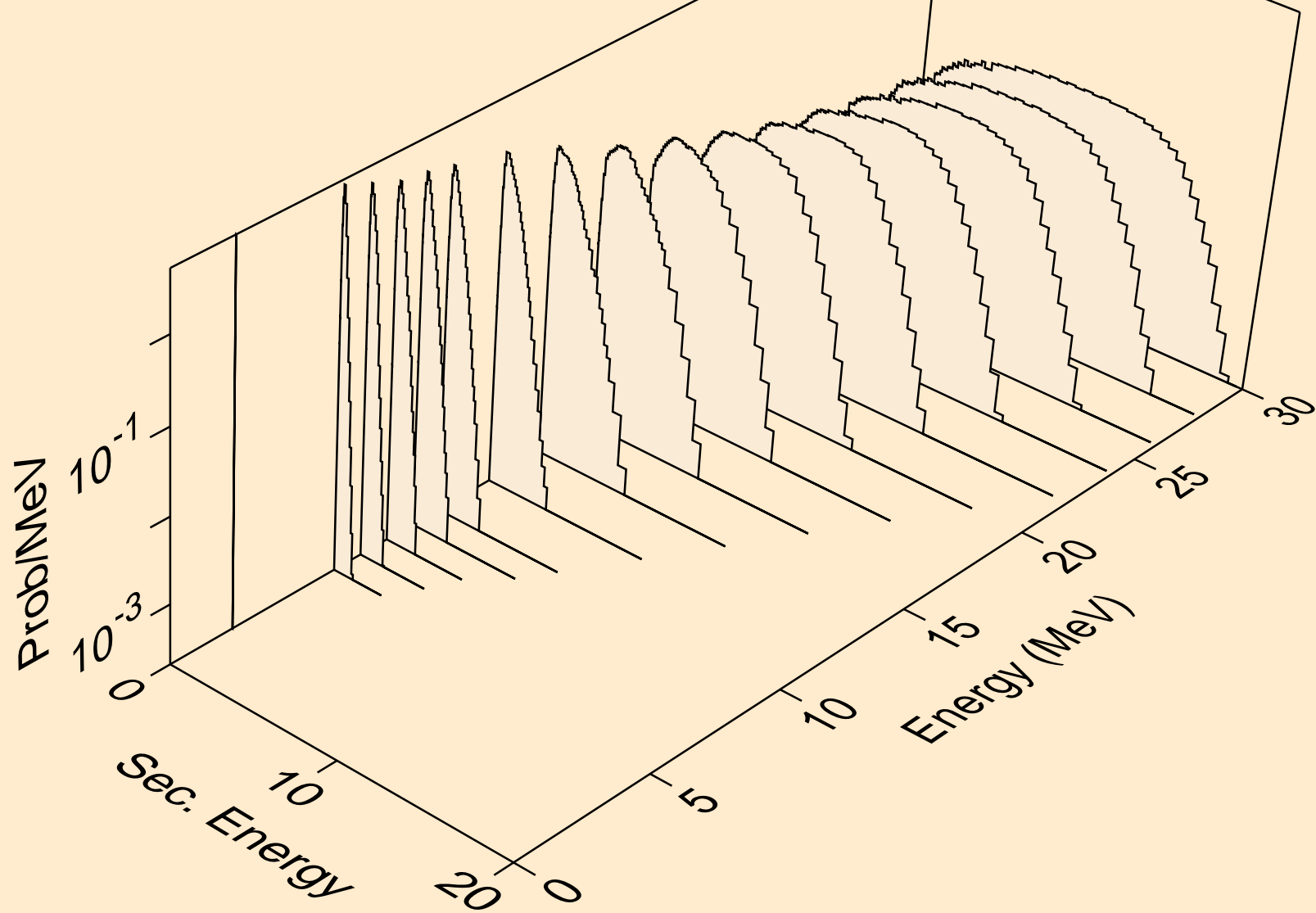

RF267 DEUTERON ACER TENDL-2021 LIBRARY; T=0.K  
neutrons from (d,n\*)d

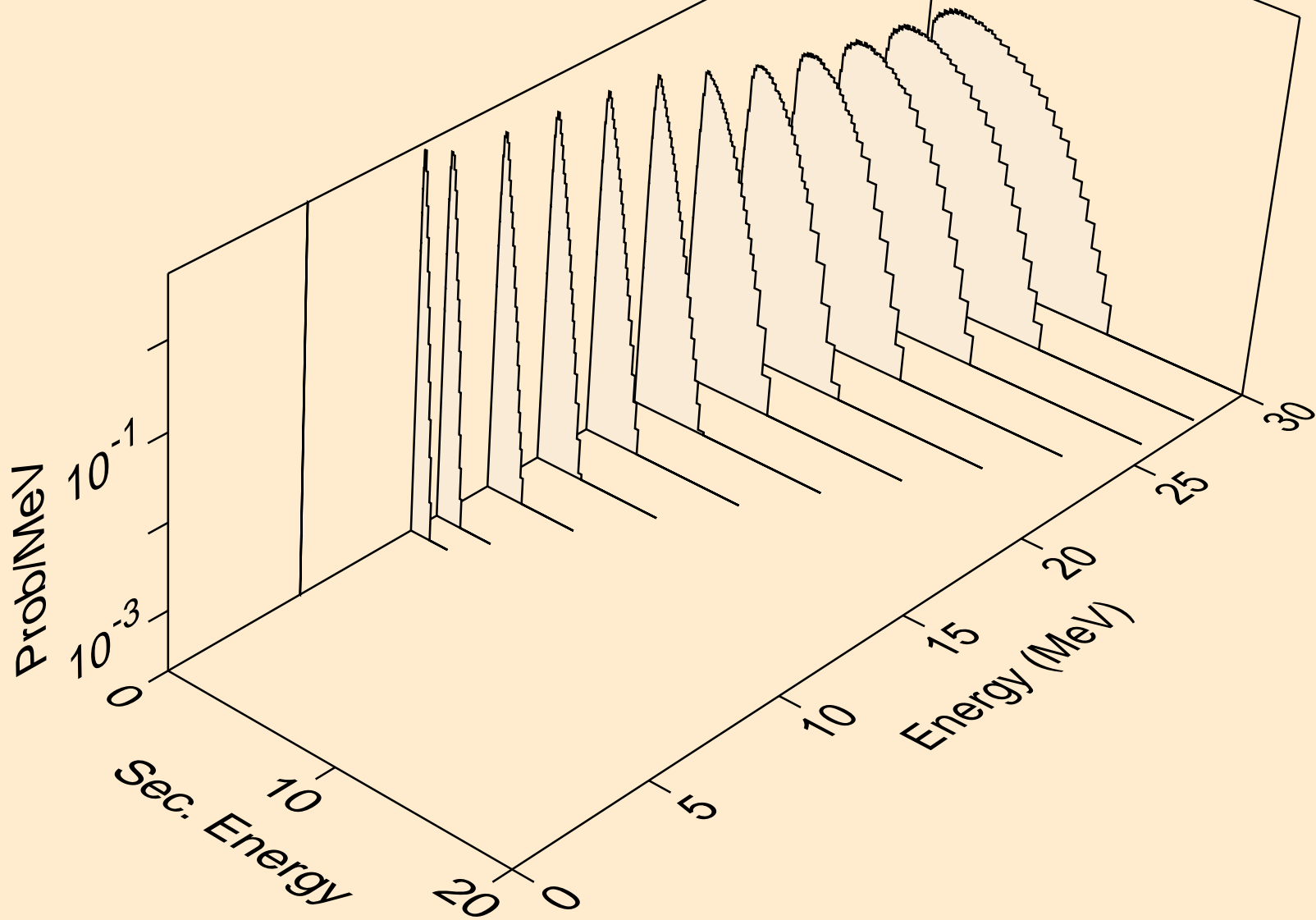

RF267 DEUTERON ACER TENDL-2021 LIBRARY; T=0.K  
neutrons from (d,n\*)t

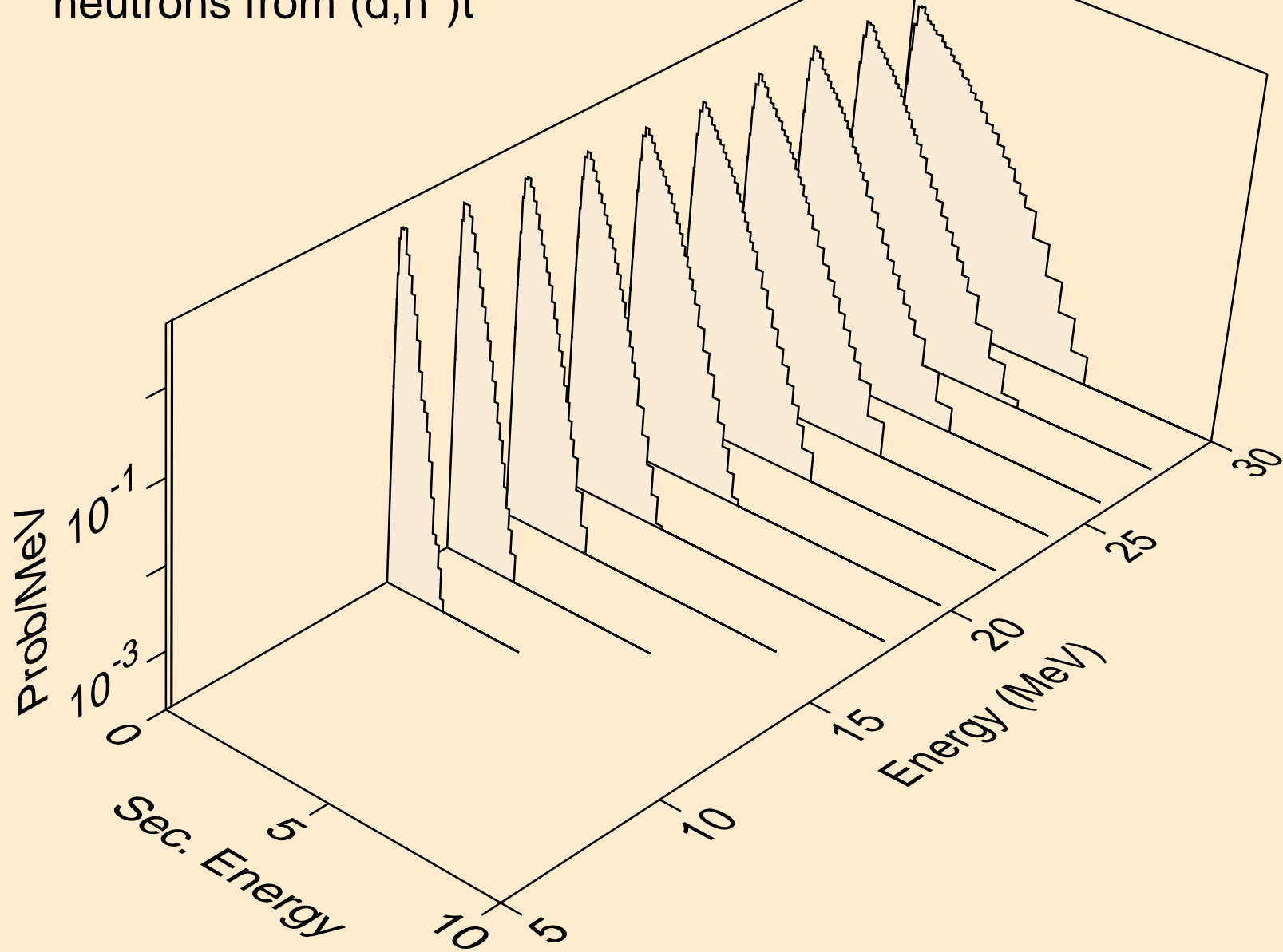

RF267 DEUTERON ACER TENDL-2021 LIBRARY; T=0.K  
neutrons from (d,4n)

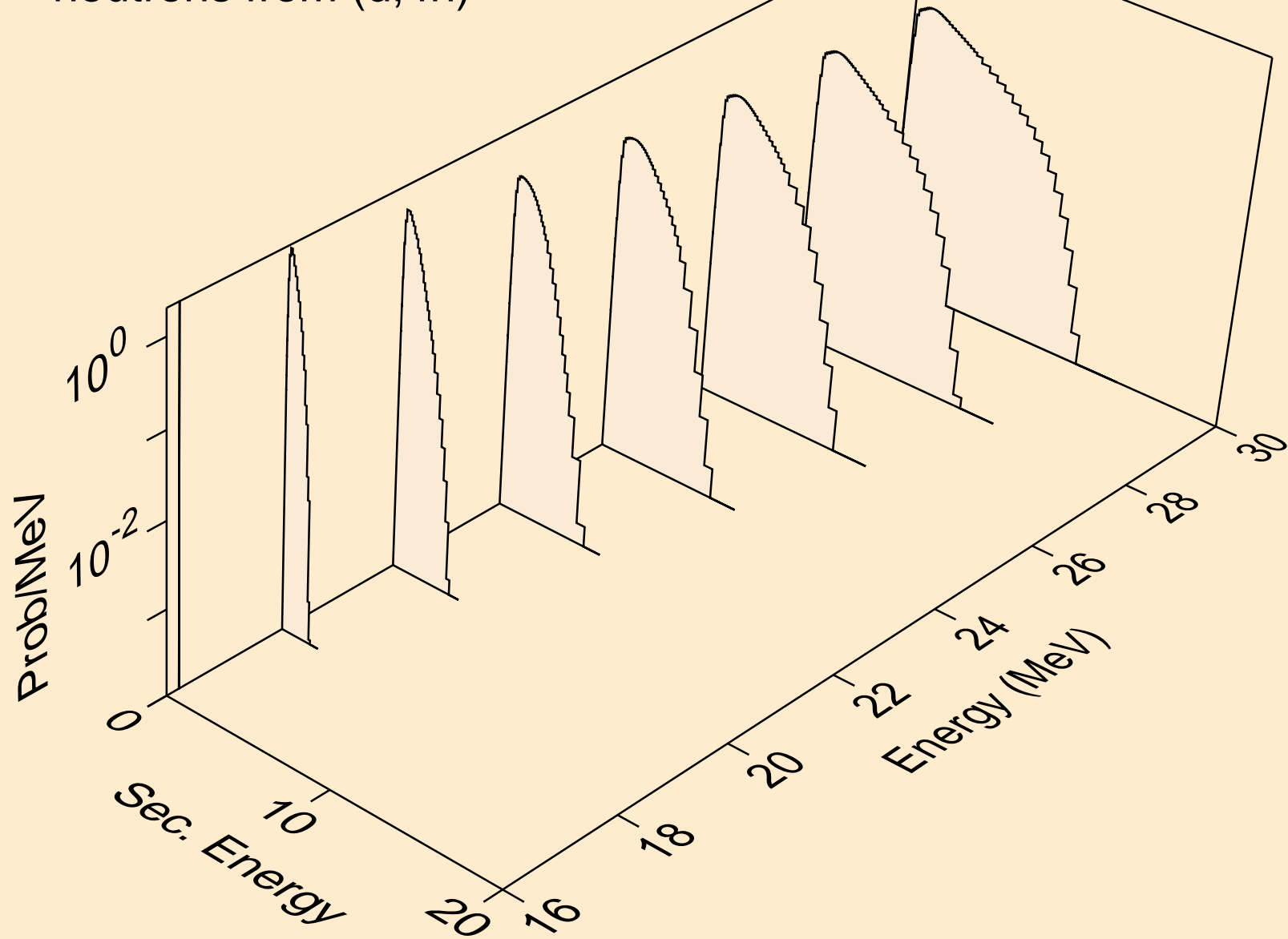

RF267 DEUTERON ACER TENDL-2021 LIBRARY; T=0.K  
neutrons from (d,2np)

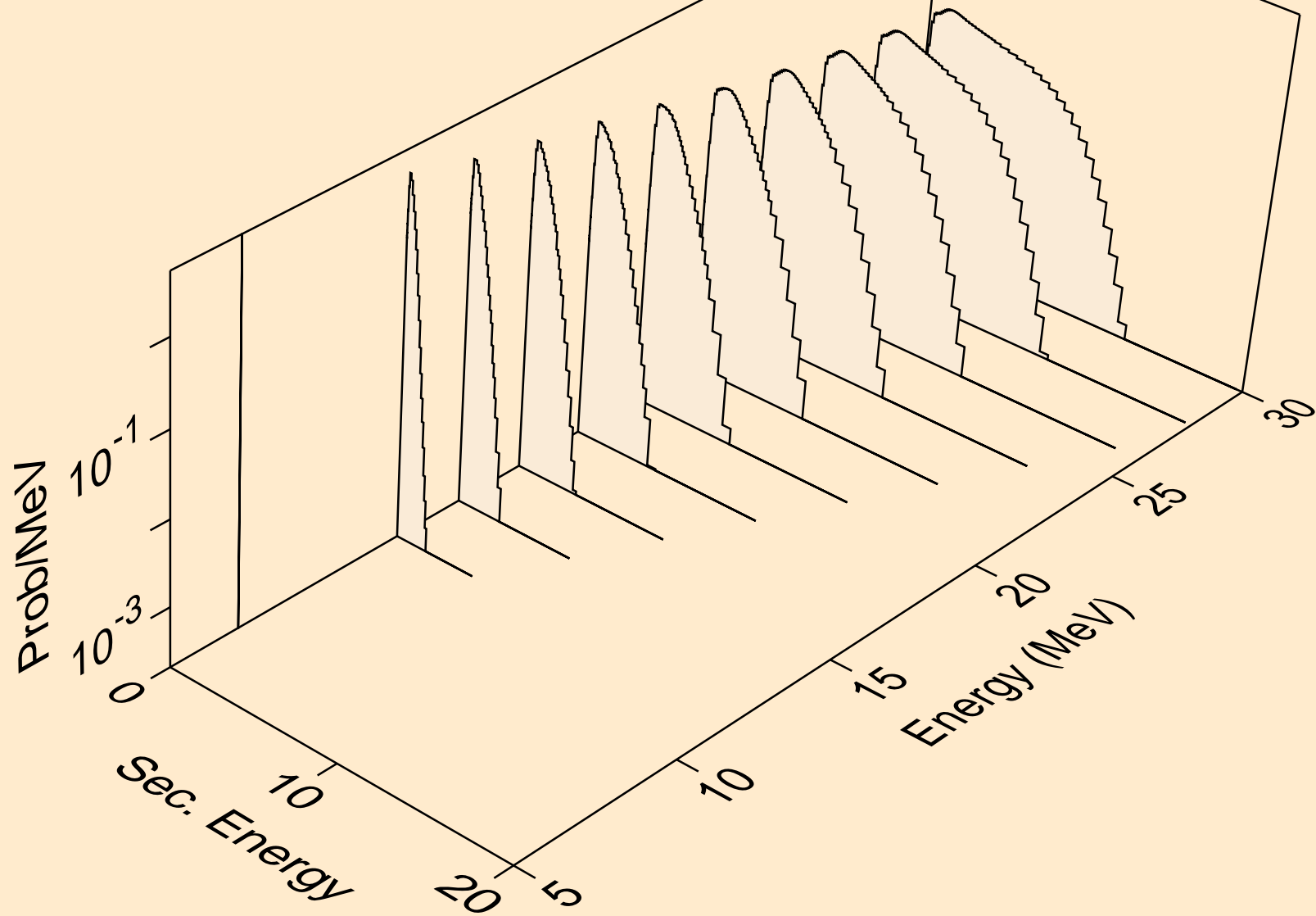



RF267 DEUTERON ACER TENDL-2021 LIBRARY; T=0.K  
neutrons from (d,3np)

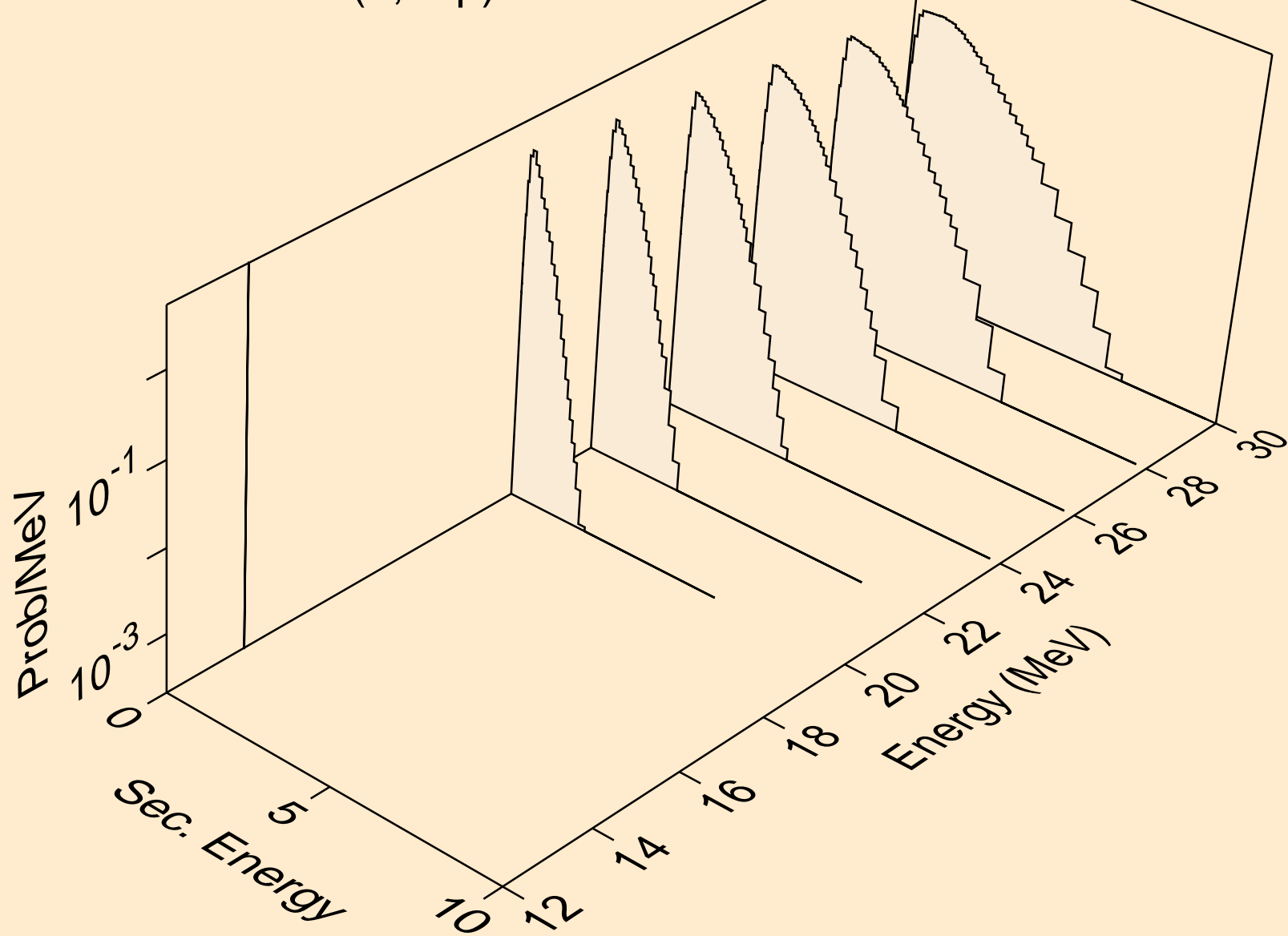

RF267 DEUTERON ACER TENDL-2021 LIBRARY; T=0.K  
protons from (d,x)

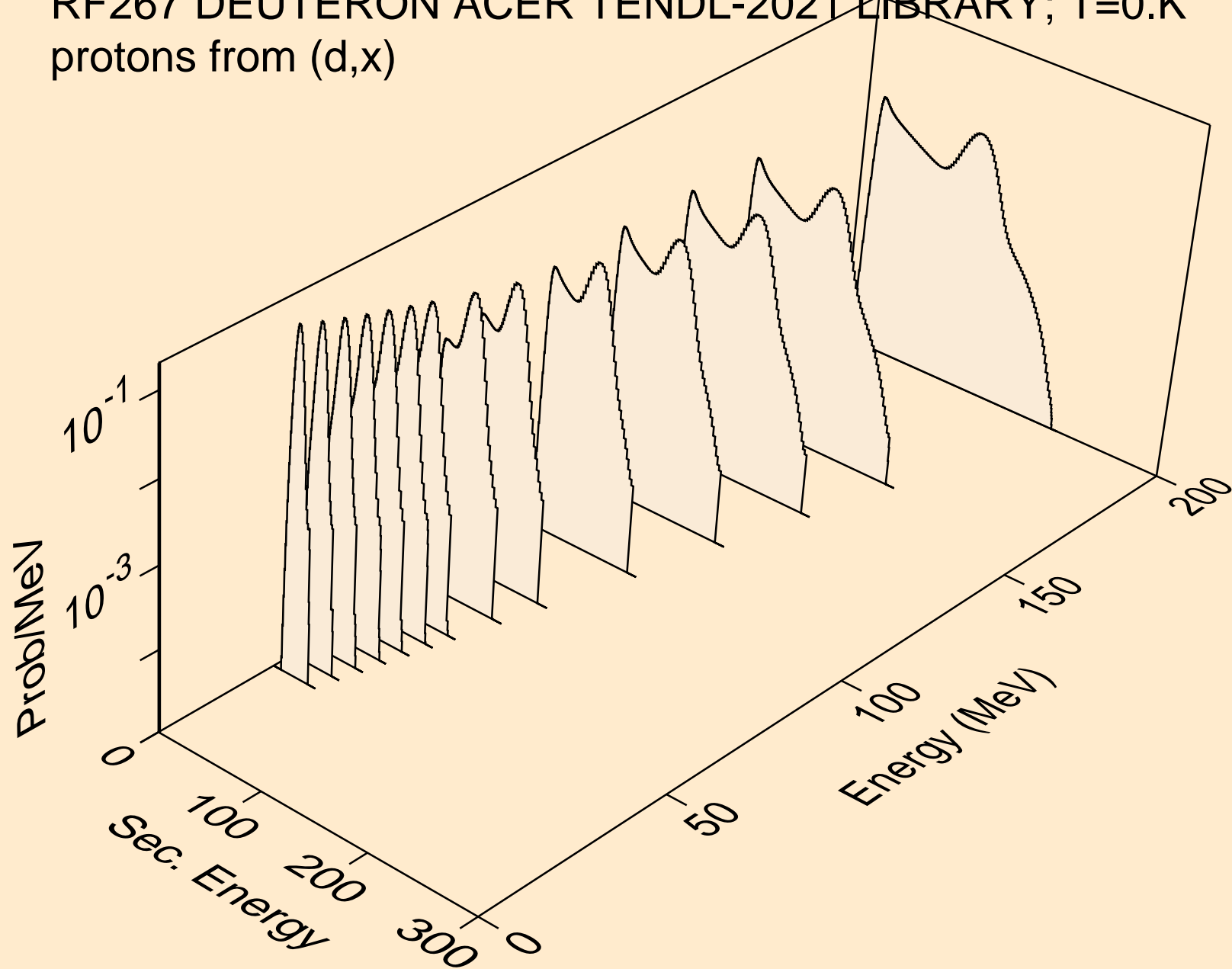

RF267 DEUTERON ACER TENDL-2021 LIBRARY; T=0.K  
protons from (d,n\*)p

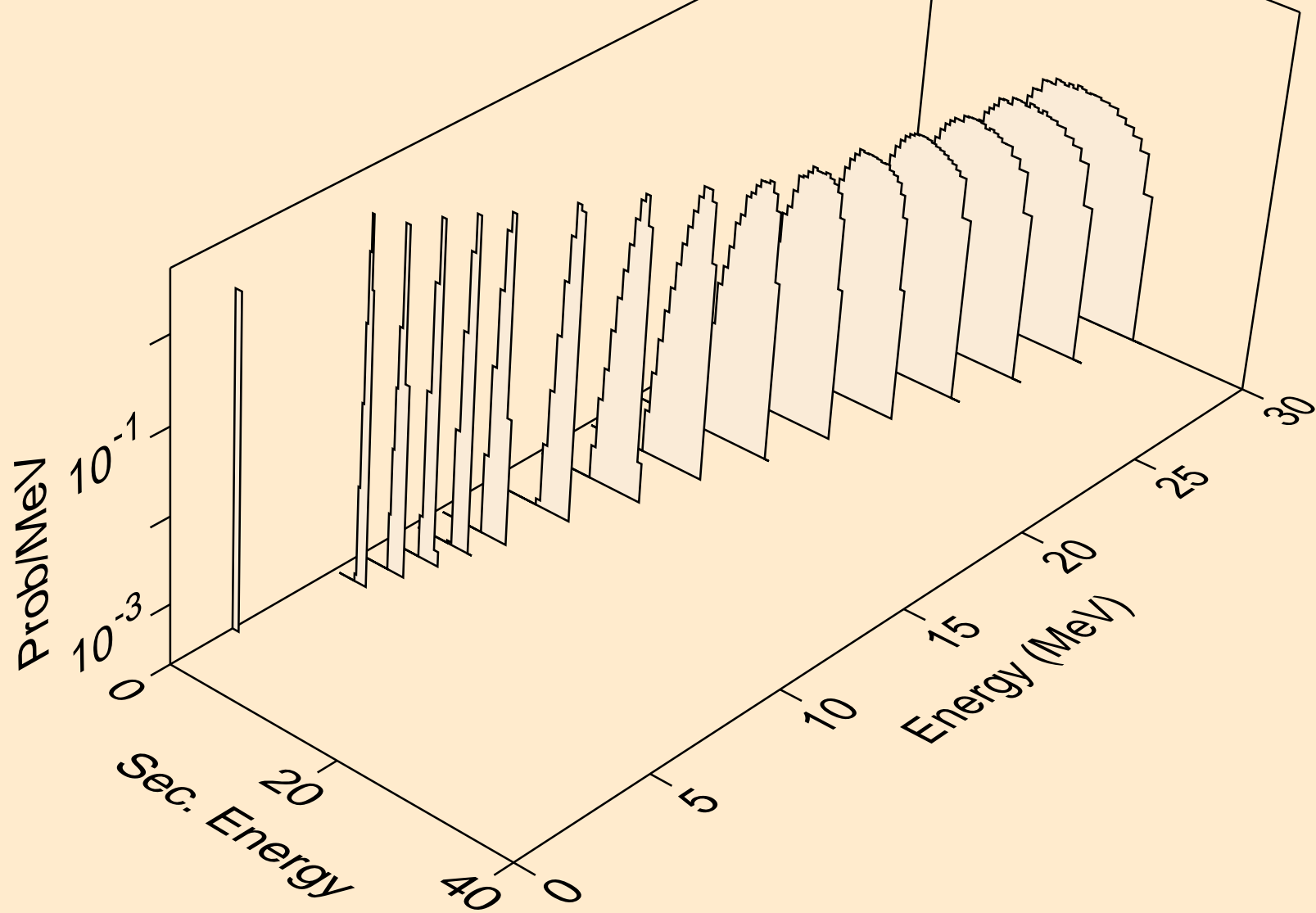

RF267 DEUTERON ACER TENDL-2021 LIBRARY; T=0.K  
protons from (d,2np)

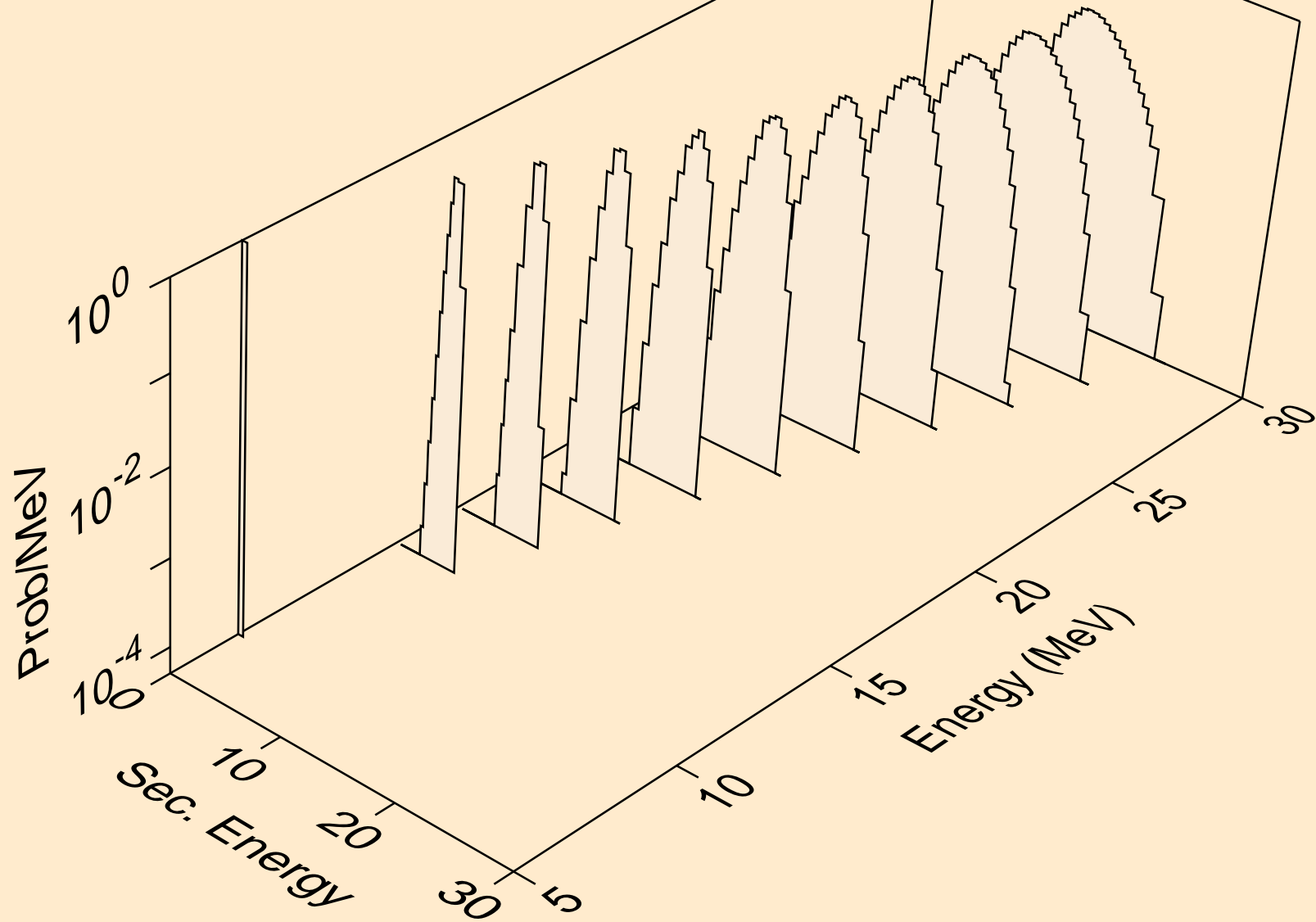

RF267 DEUTERON ACER TENDL-2021 LIBRARY; T=0.K  
protons from (d,3np)

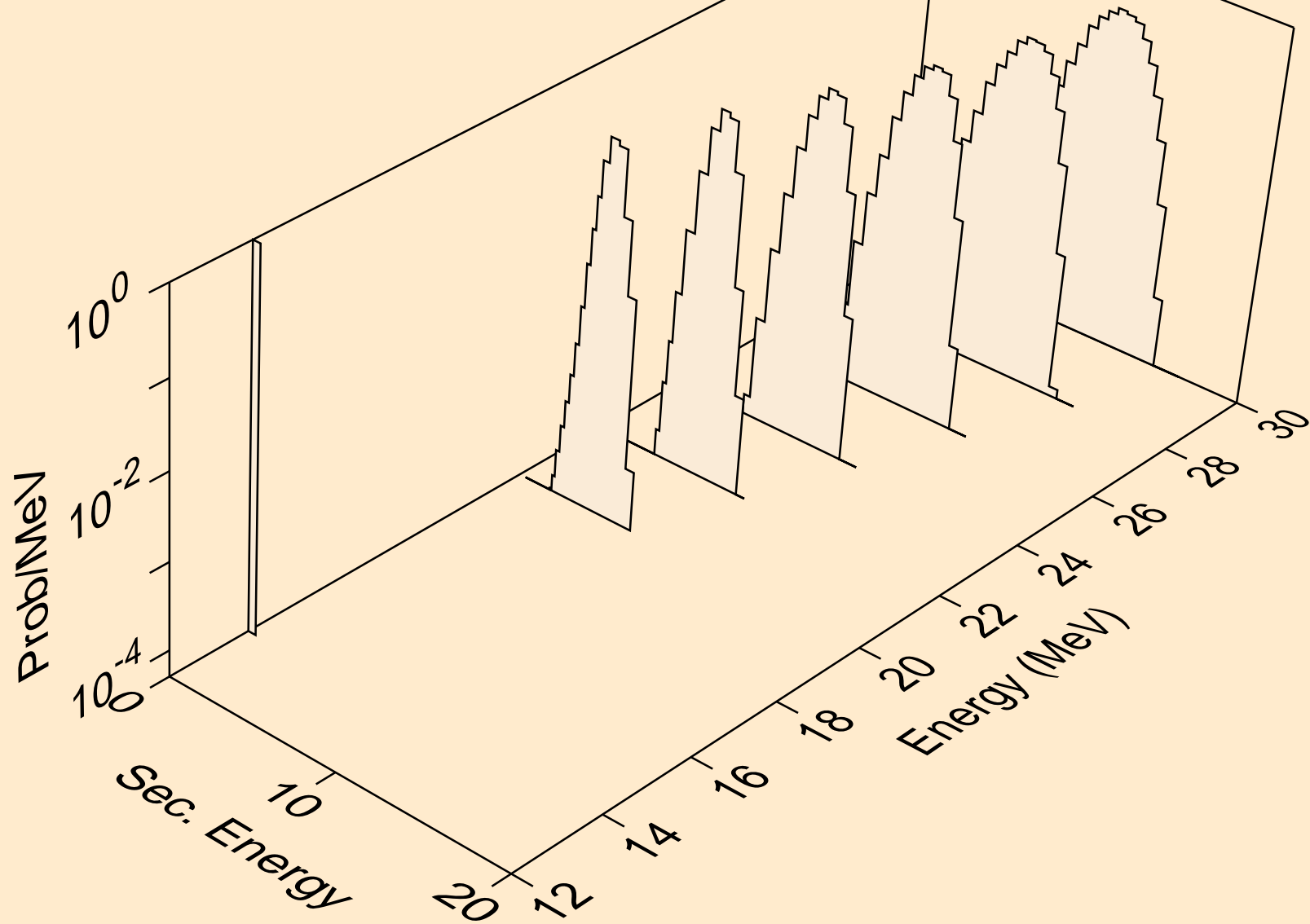

RF267 DEUTERON ACER TENDL-2021 LIBRARY; T=0.K  
protons from (d,p)

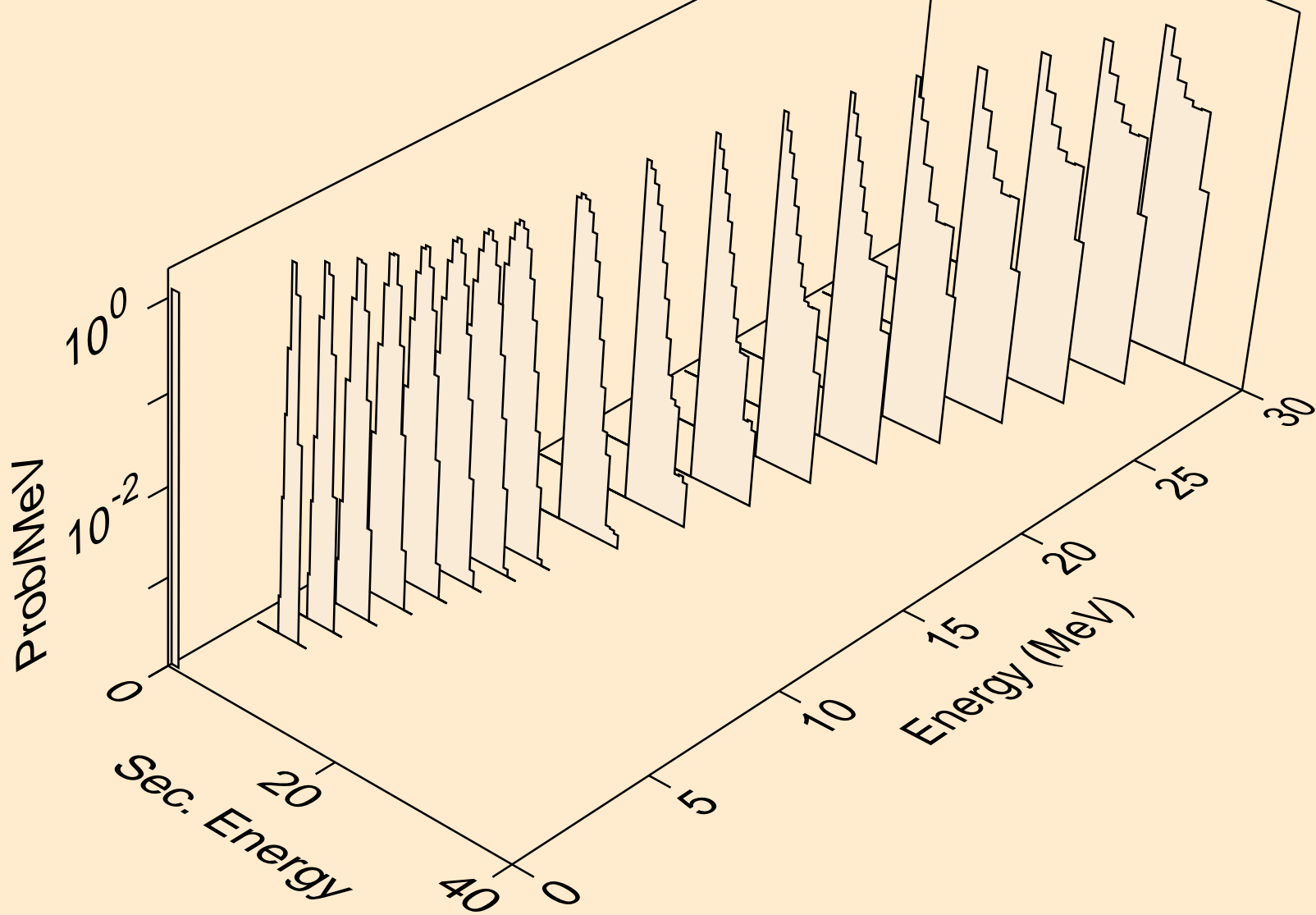

RF267 DEUTERON ACER TENDL-2021 LIBRARY; T=0.K  
protons from (d,2p)

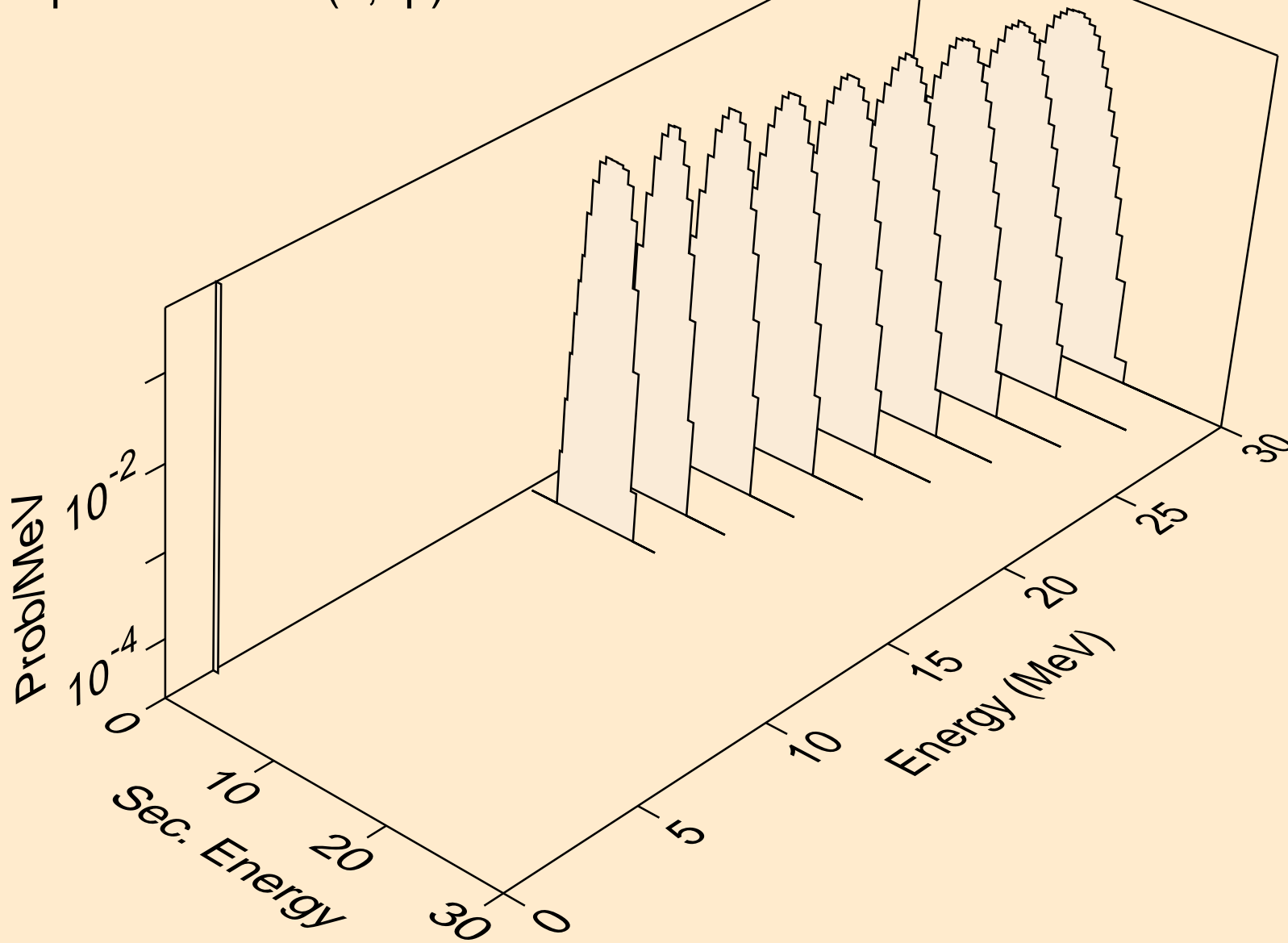

RF267 DEUTERON ACER TENDL-2021 LIBRARY; T=0.K  
protons from (d,pd)

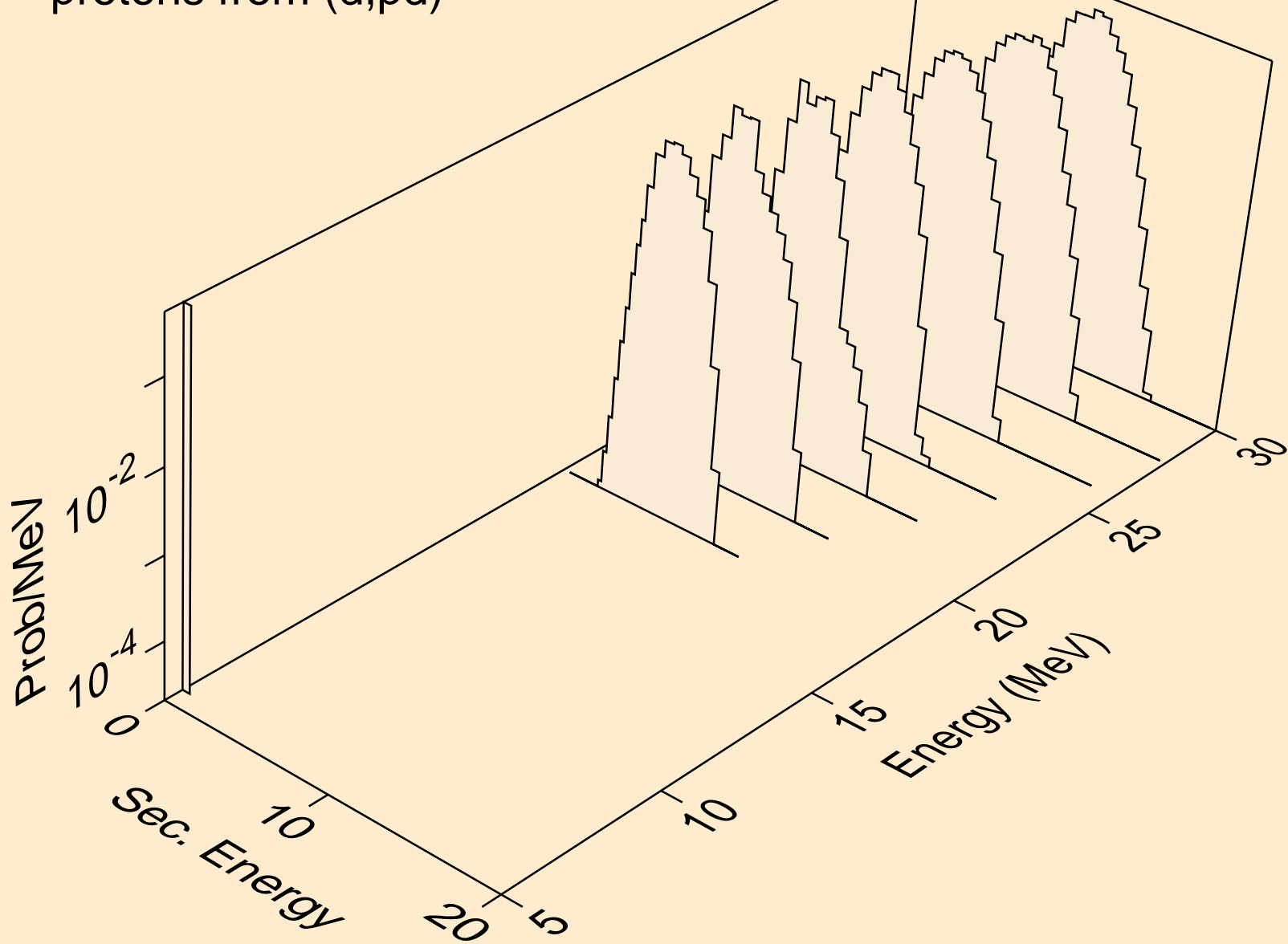



RF267 DEUTERON ACER TENDL-2021 LIBRARY; T=0.K  
tritons from (d,x)

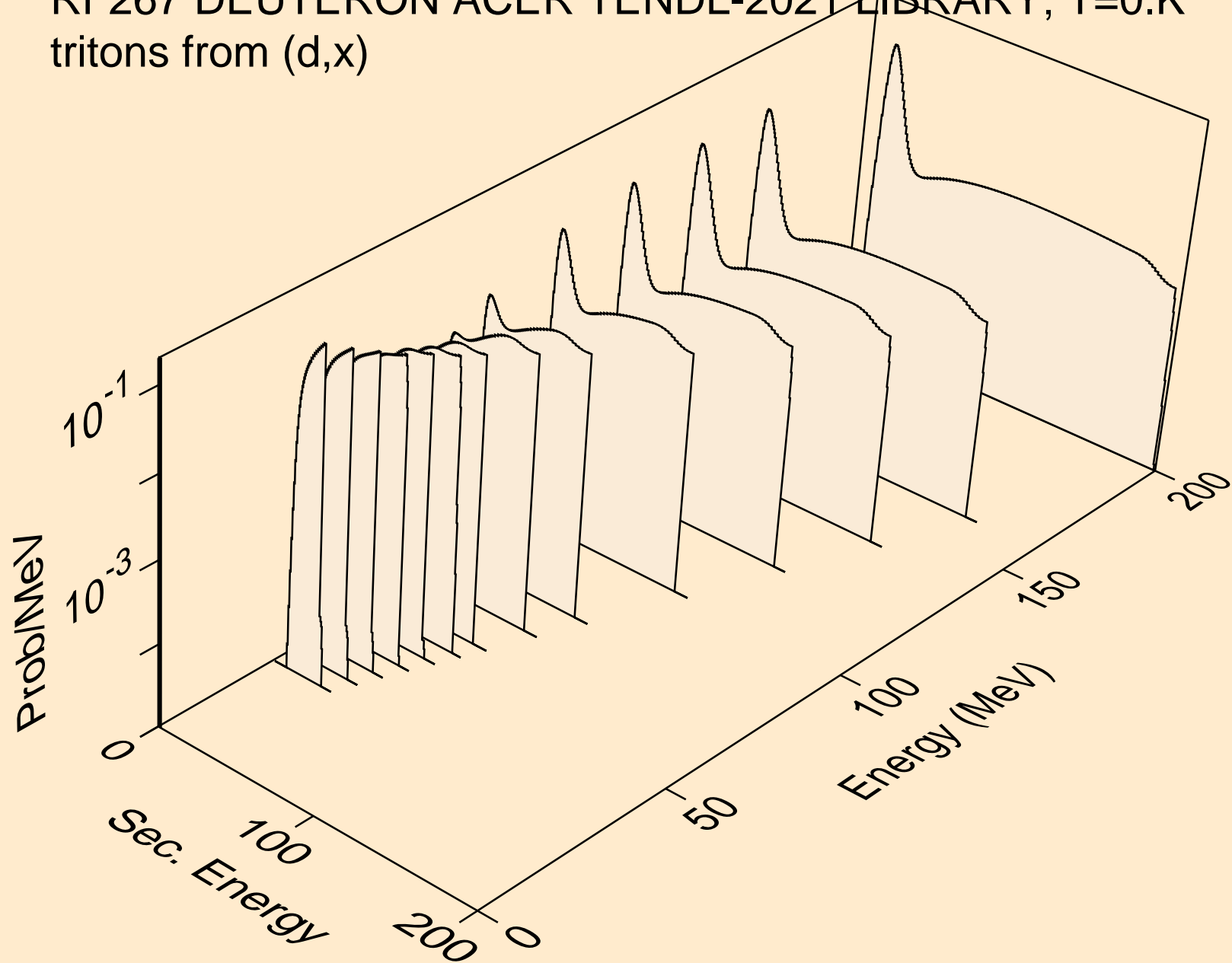

RF267 DEUTERON ACER TENDL-2021 LIBRARY; T=0.K  
tritons from (d,n\*)t

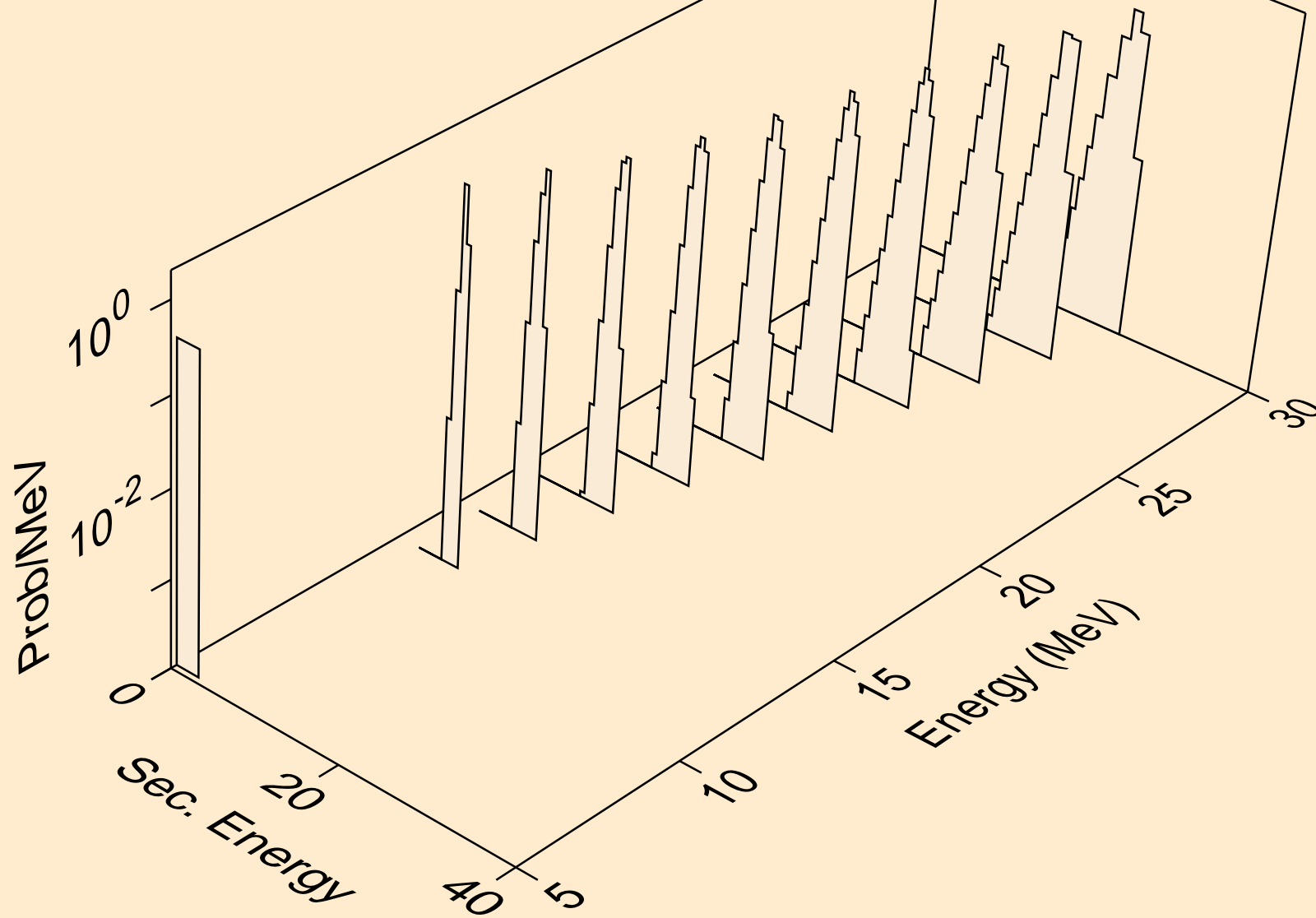

RF267 DEUTERON ACER TENDL-2021 LIBRARY; T=0.K  
tritons from (d,t)

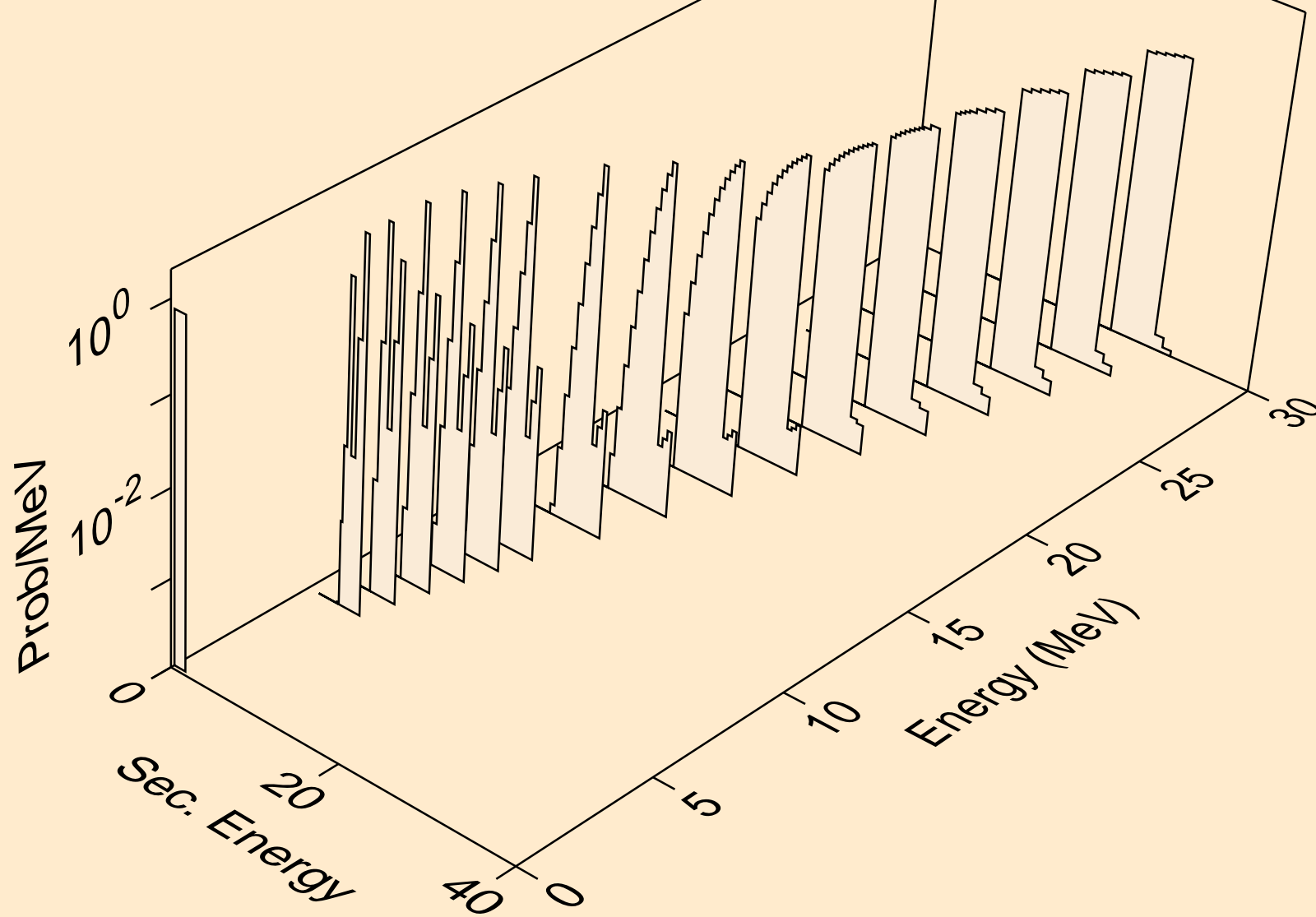

RF267 DEUTERON ACER TENDL-2021 LIBRARY; T=0.K  
he3s from (d,x)

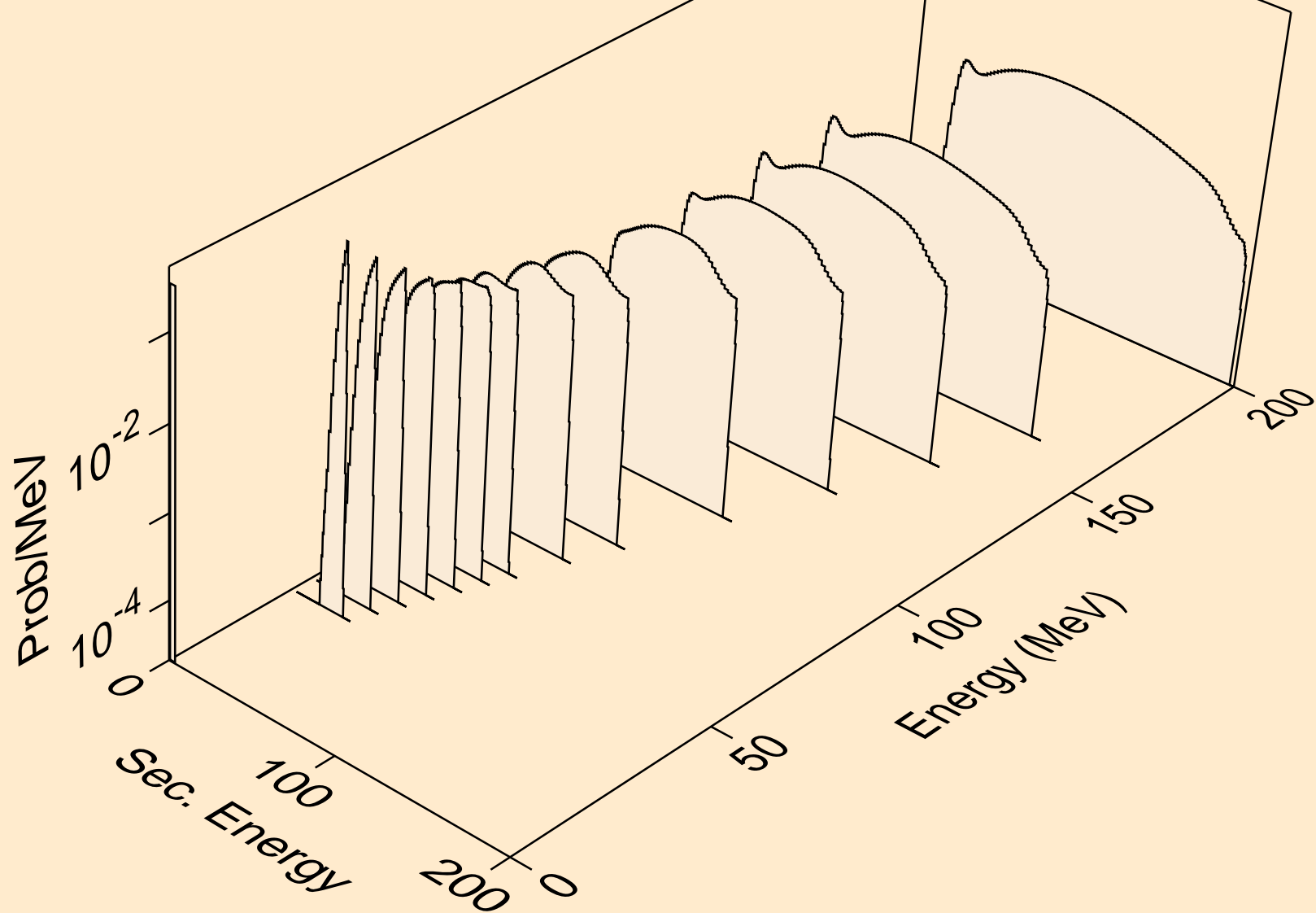

RF267 DEUTERON ACER TENDL-2021 LIBRARY; T=0.K  
he3s from (d,he3)

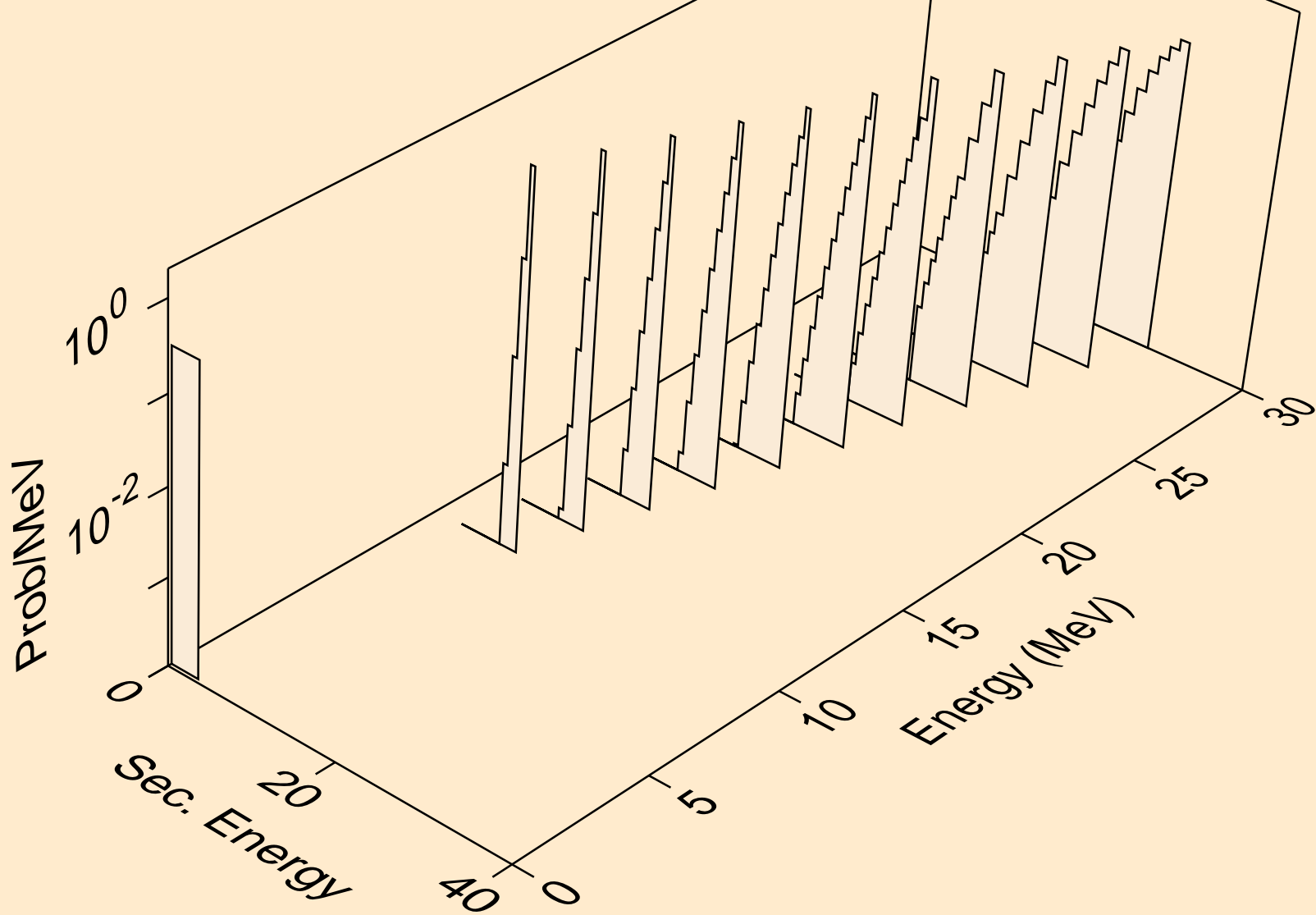

RF267 DEUTERON ACER TENDL-2021 LIBRARY; T=0.K  
alphas from (d,x)

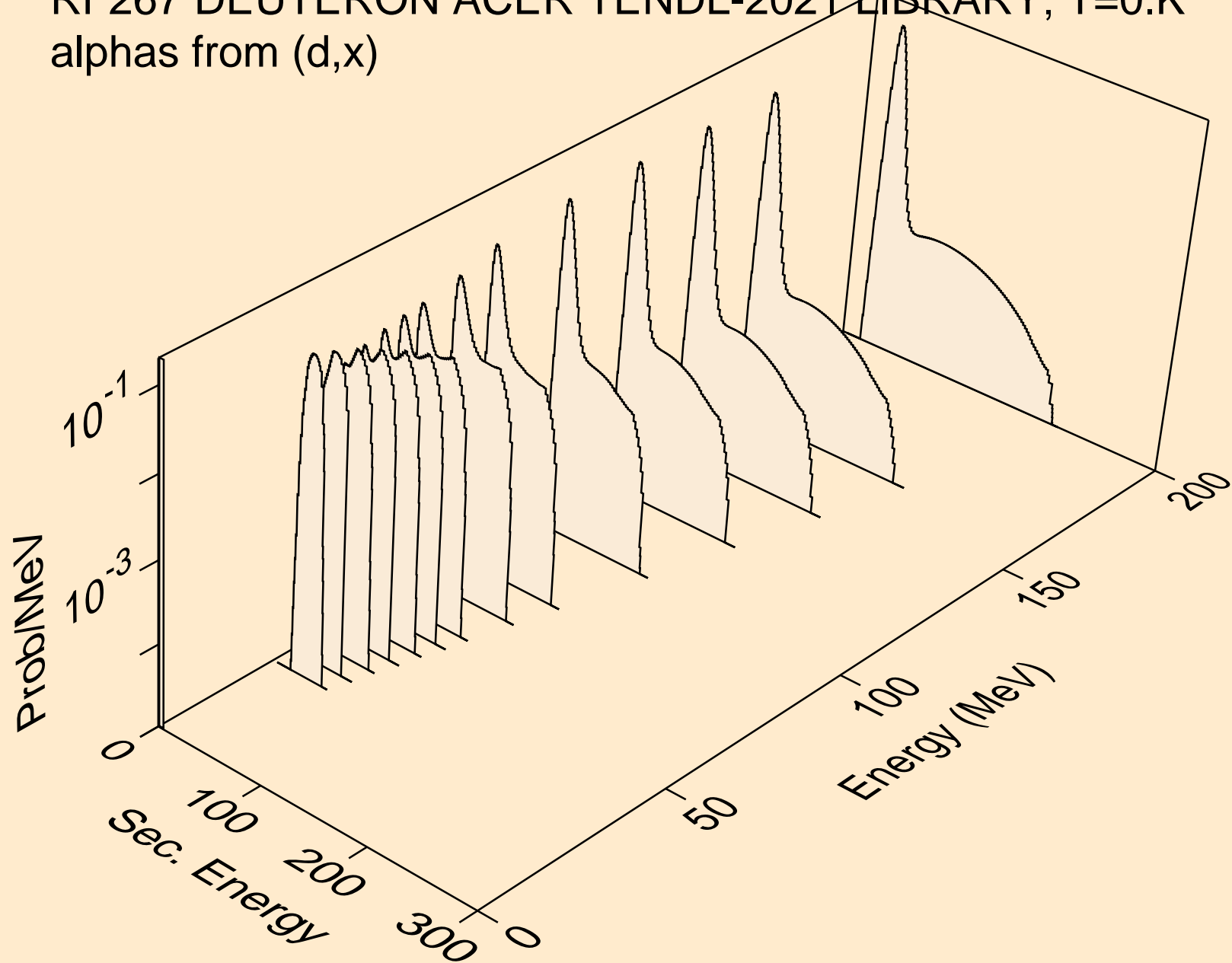

RF267 DEUTERON ACER TENDL-2021 LIBRARY; T=0.K  
alphas from (d,n\*)a

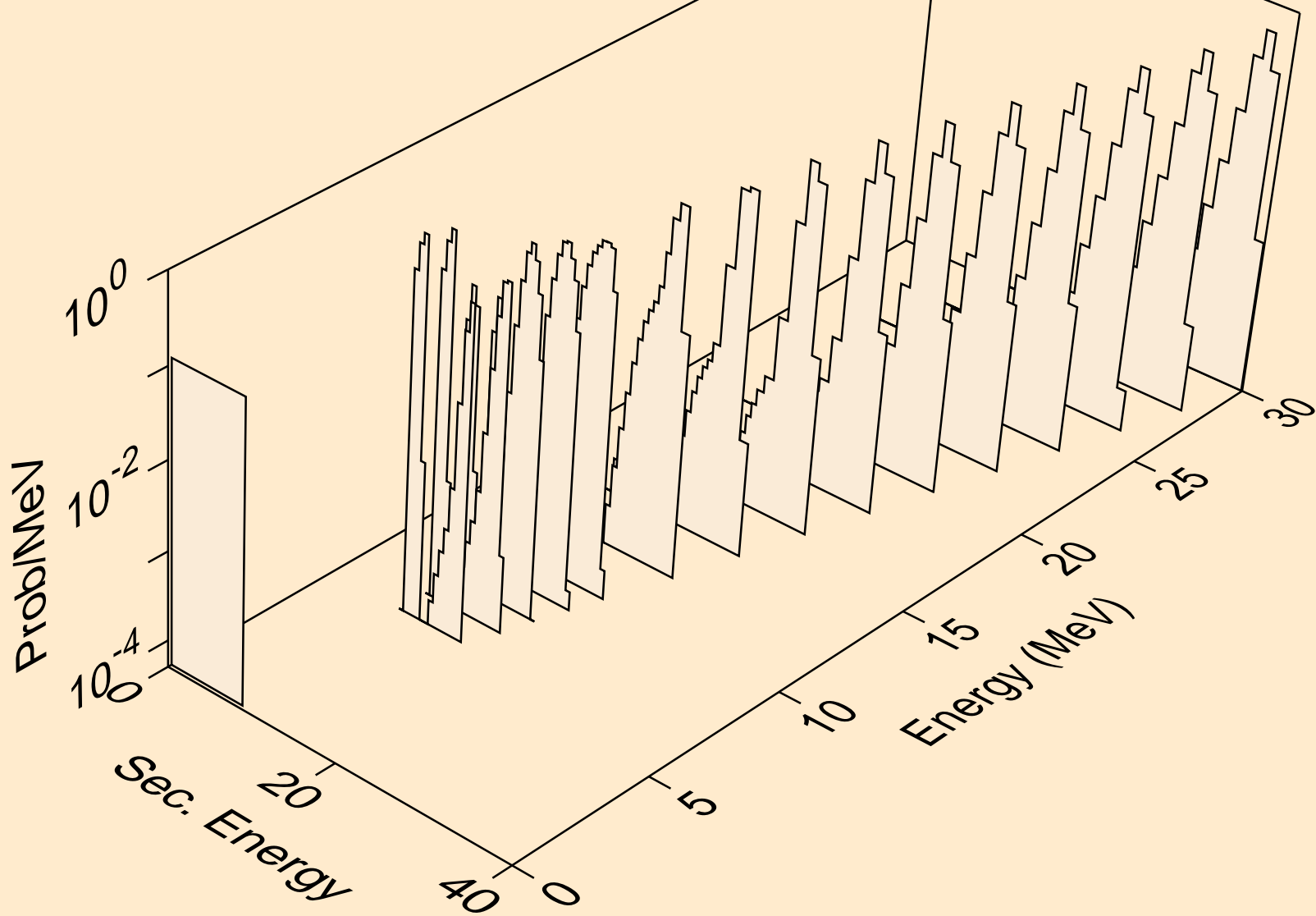

RF267 DEUTERON ACER TENDL-2021 LIBRARY; T=0.K  
alphas from (d,a)

