

RU089 DEUTERON ACER TENDL-2021 LIBRARY; T=0.K
Principal cross sections

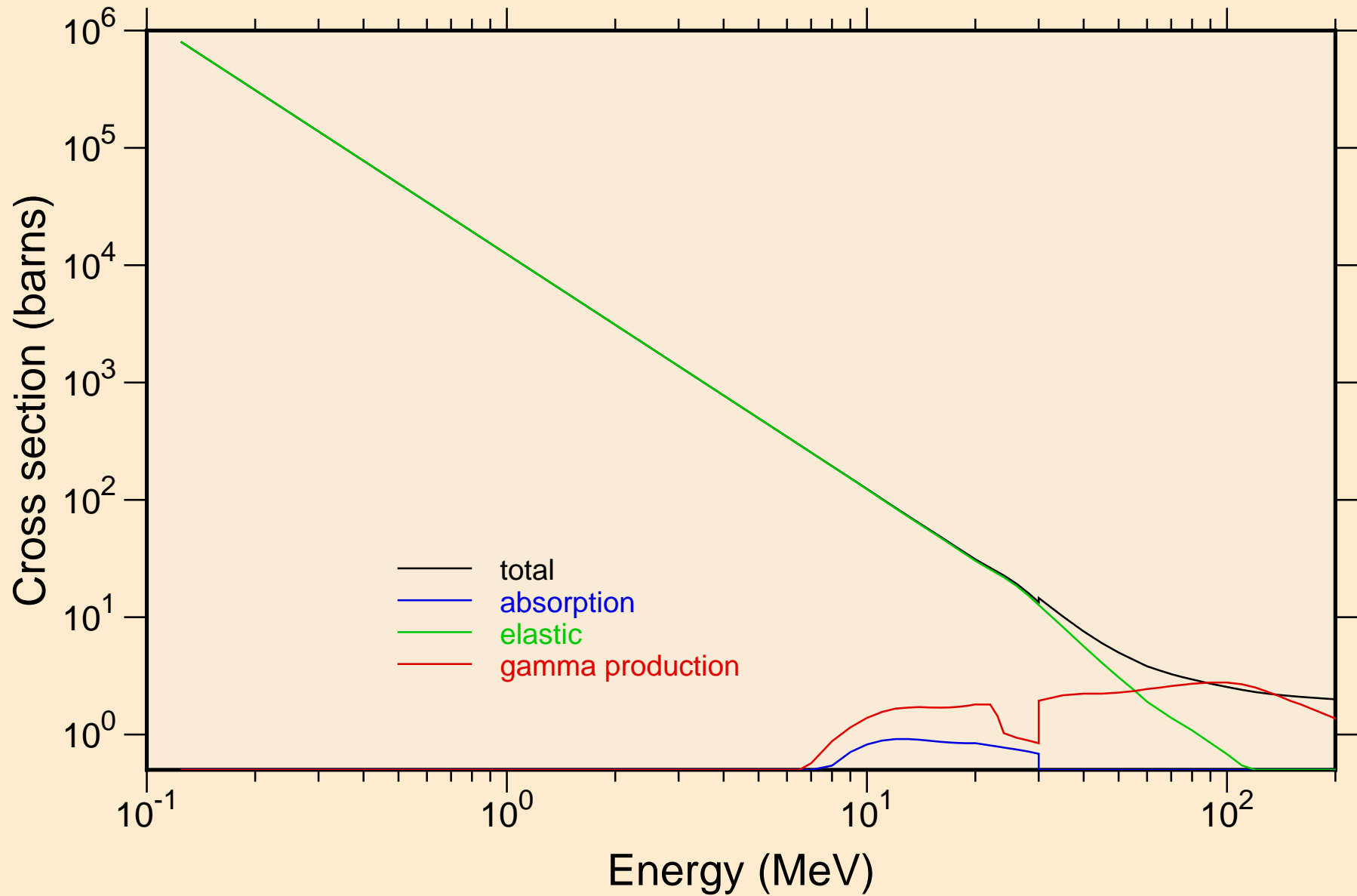

RU089 DEUTERON ACER TENDL-2021 LIBRARY; T=0.K
Heating

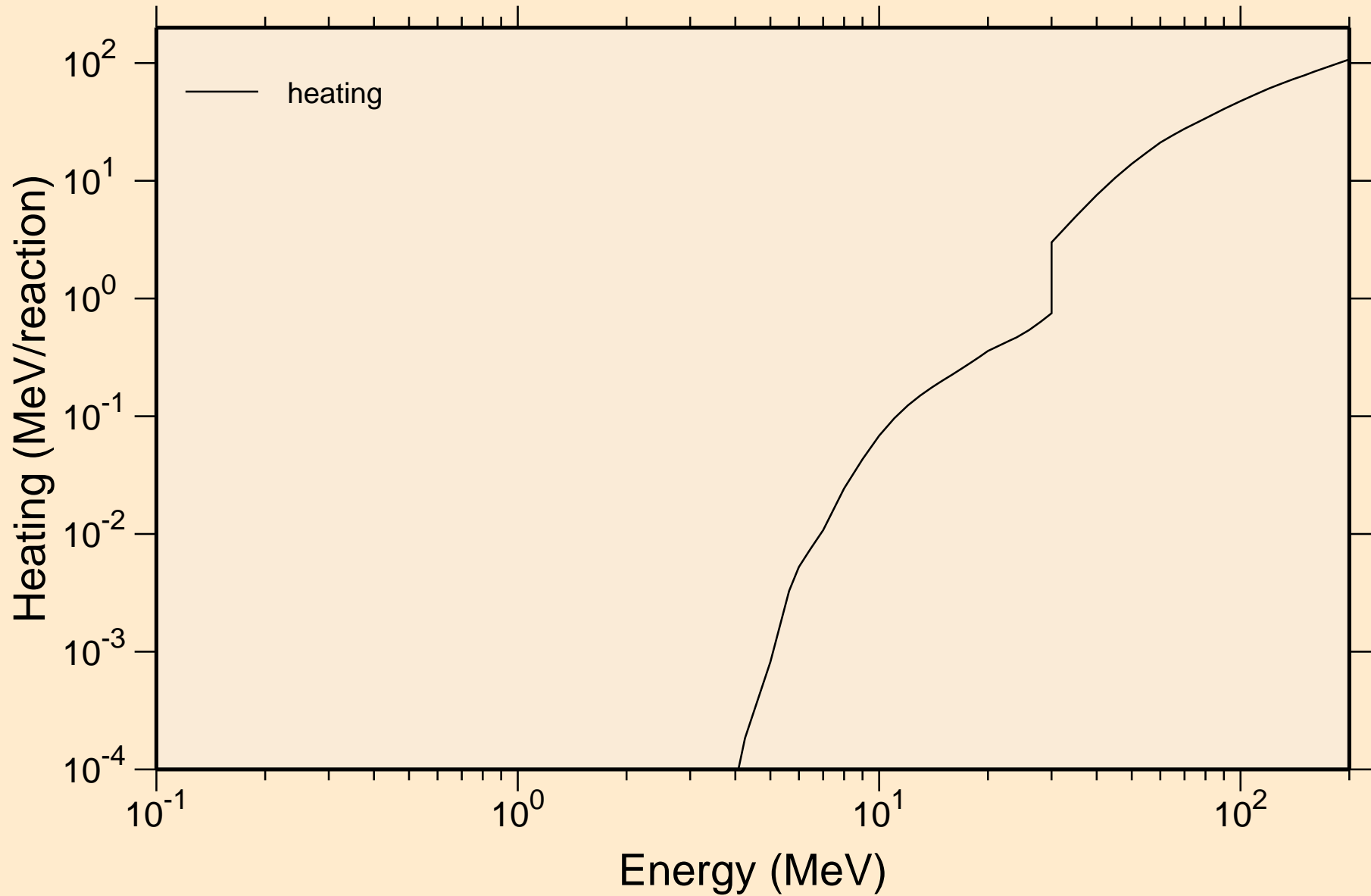

RU089 DEUTERON ACER TENDL-2021 LIBRARY; T=0.K
Principal cross sections

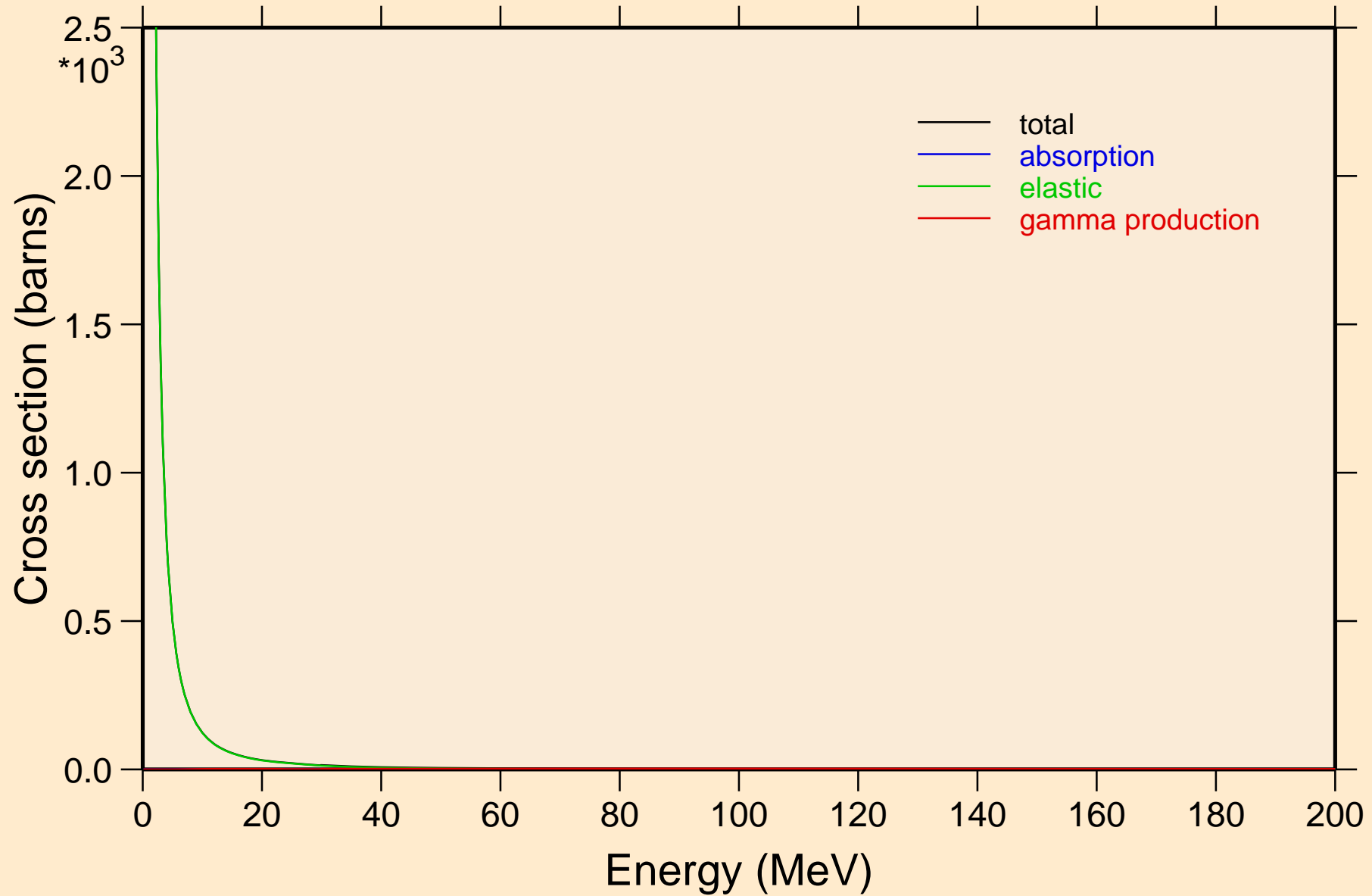

RU089 DEUTERON ACER TENDL-2021 LIBRARY; T=0.K
Heating

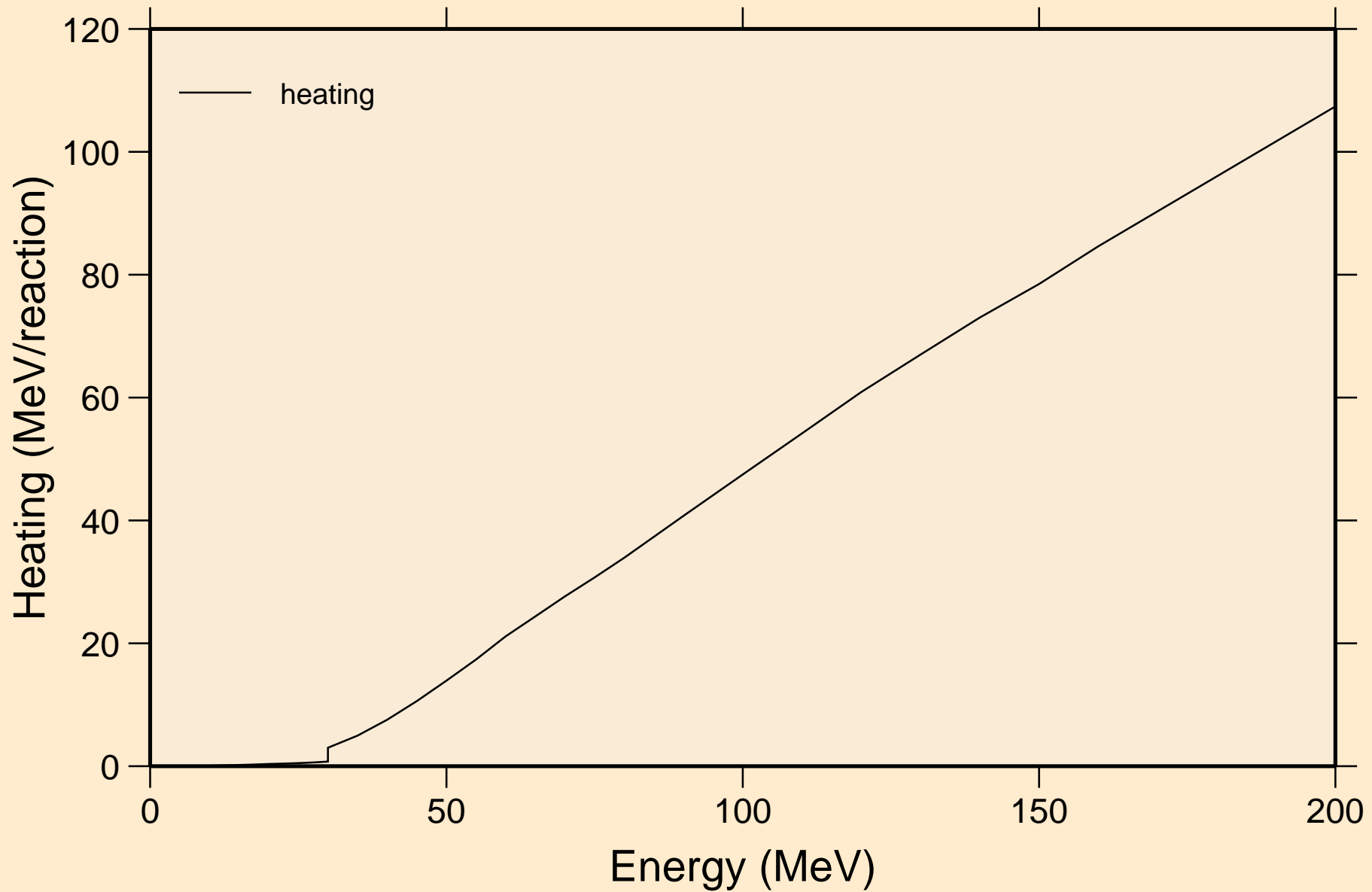

RU089 DEUTERON ACER TENDL-2021 LIBRARY; T=0.K
Threshold reactions

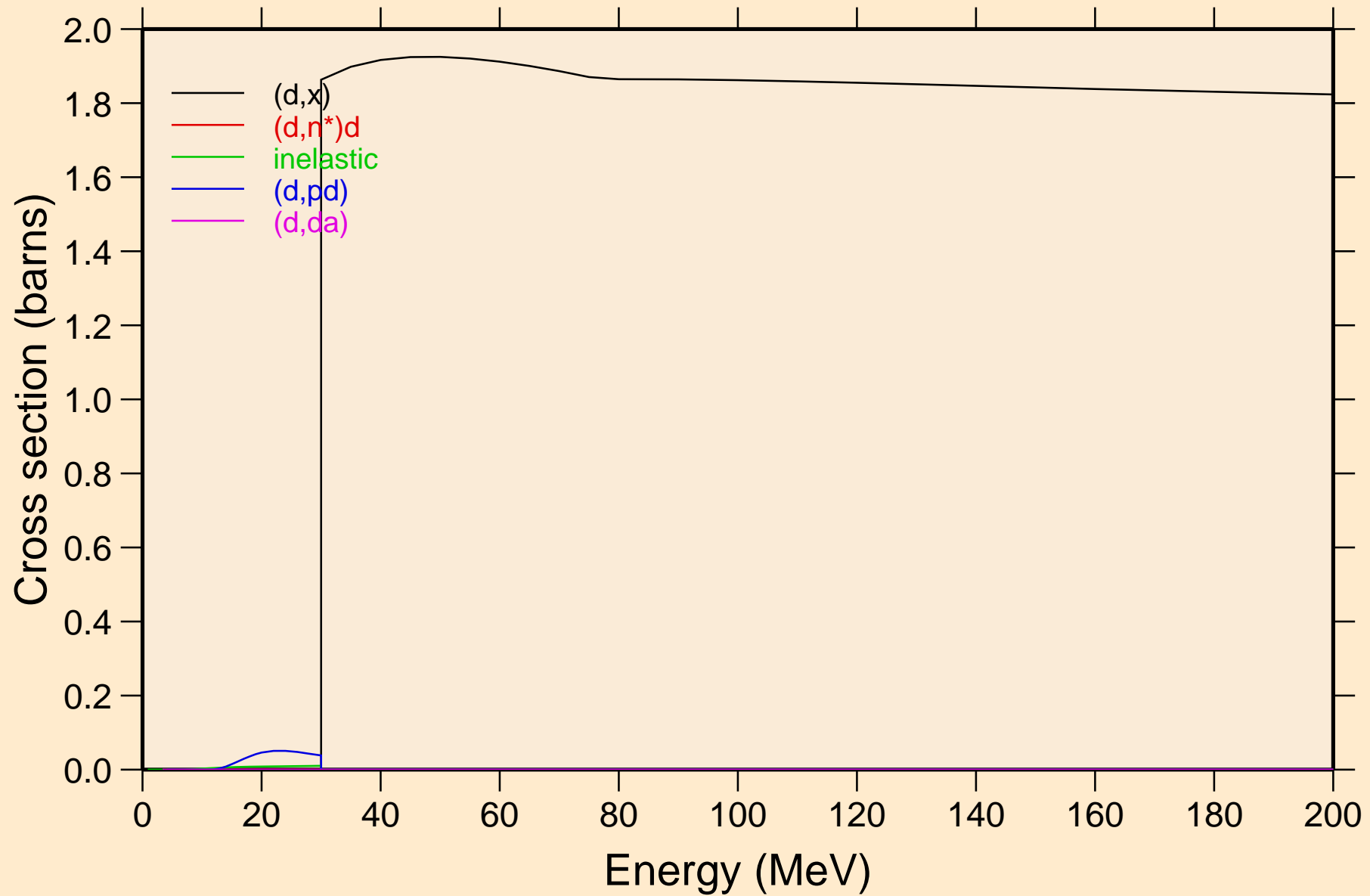

RU089 DEUTERON ACER TENDL-2021 LIBRARY; T=0.K
angular distribution for elastic

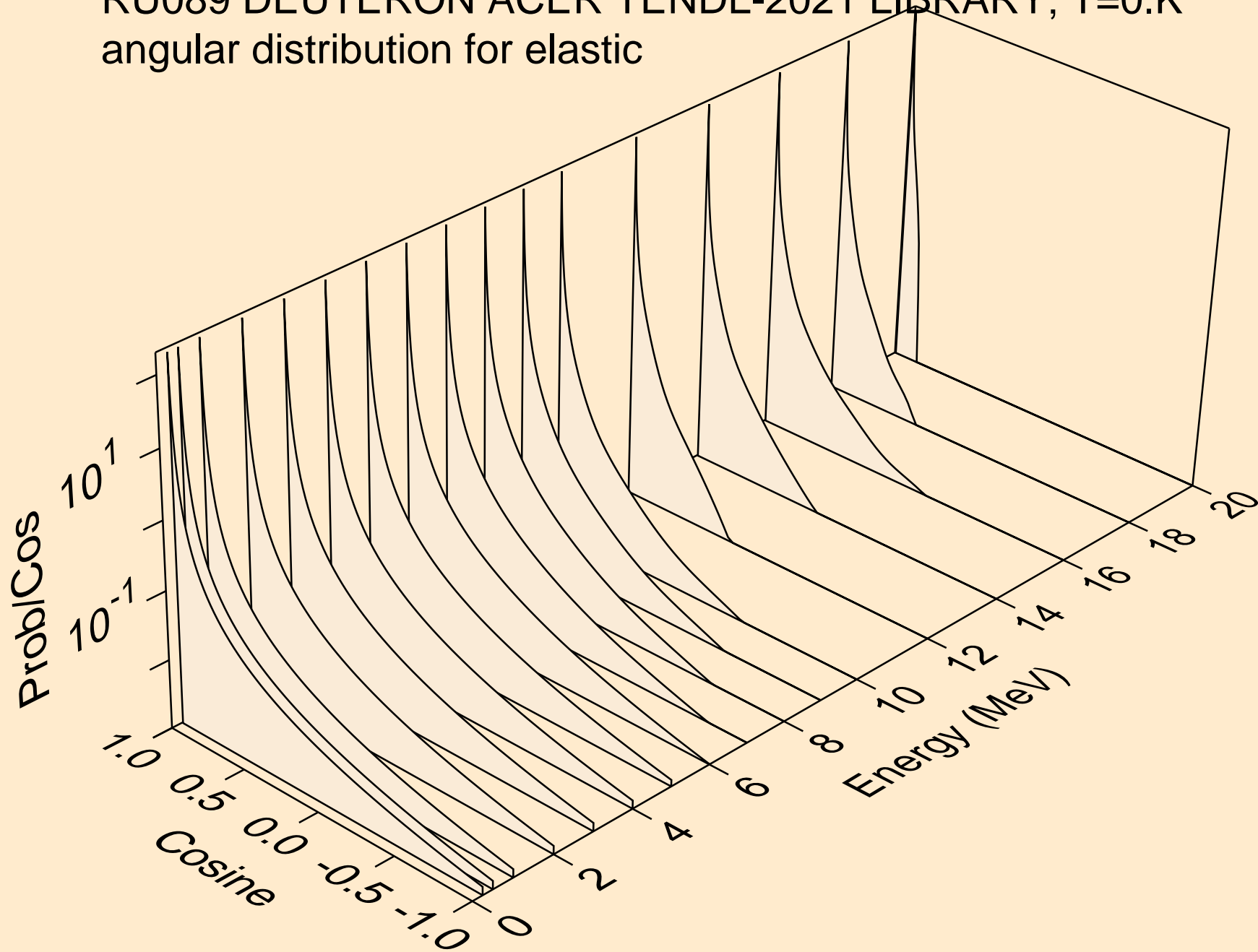

RU089 DEUTERON ACER TENDL-2021 LIBRARY; T=0.K
angular distribution for elastic

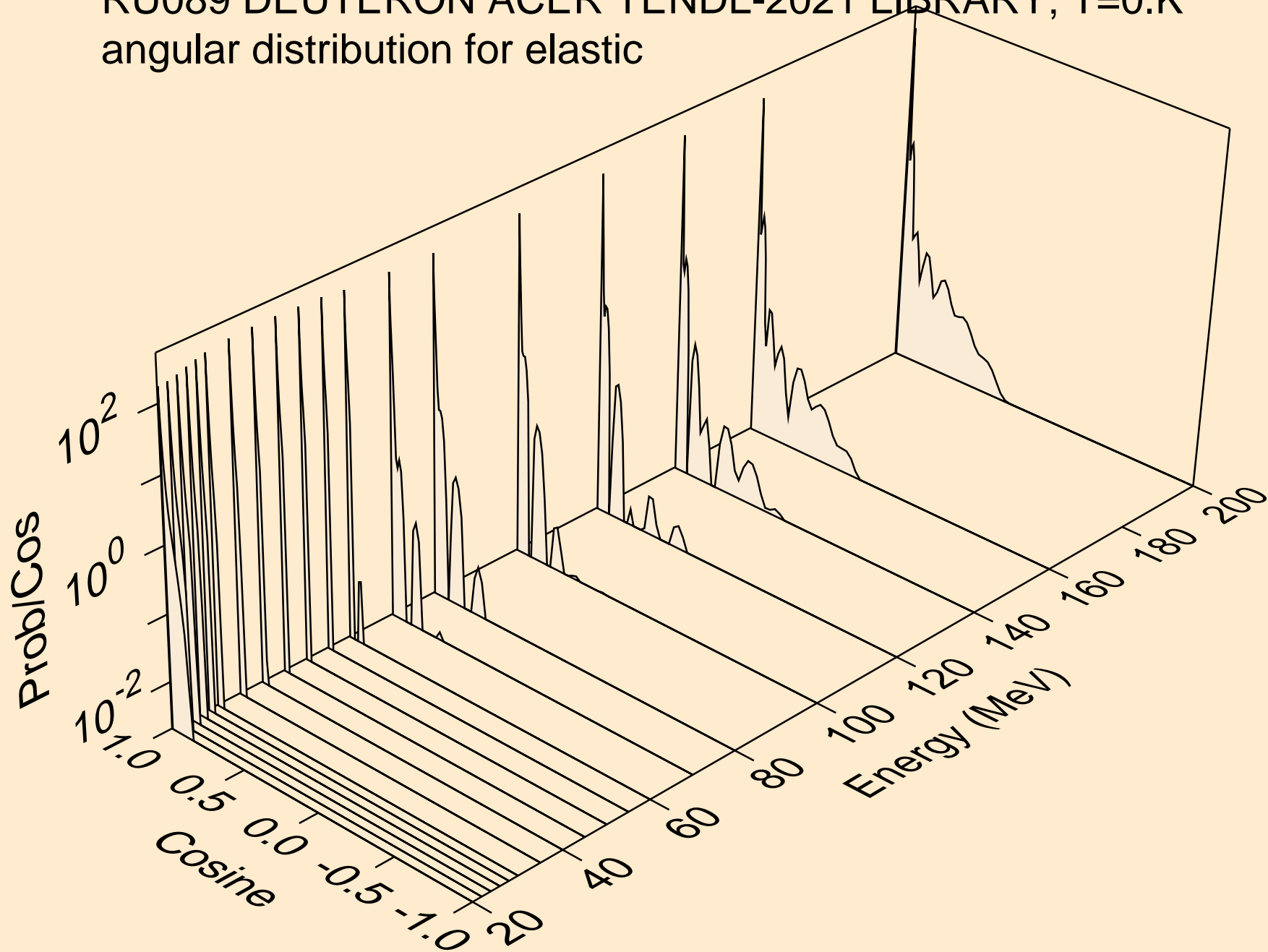

RU089 DEUTERON ACER TENDL-2021 LIBRARY; T=0.K
Deuteron emission for (d,x)

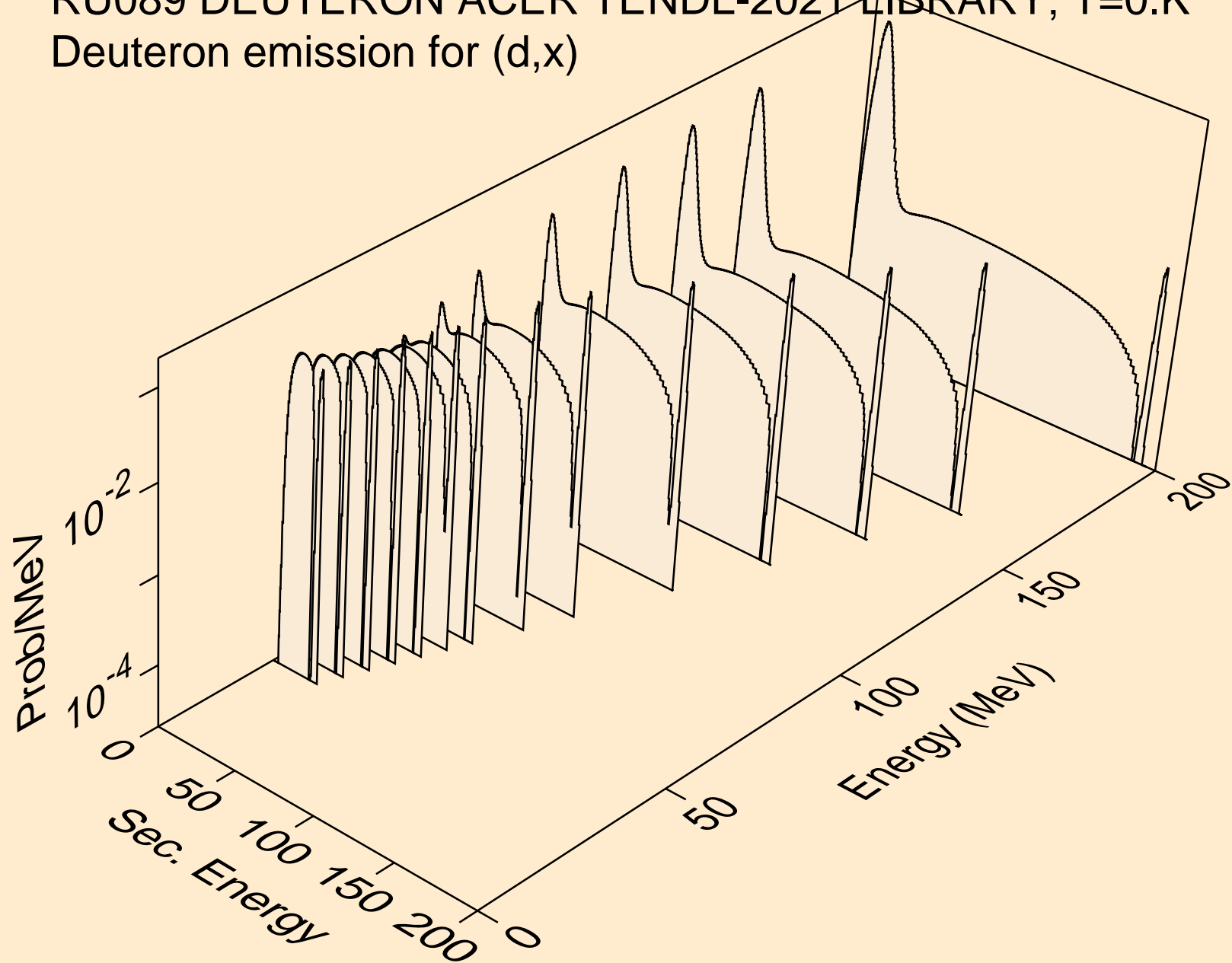

RU089 DEUTERON ACER TENDL-2021 LIBRARY; T=0.K
Deuteron emission for (d,n*)d

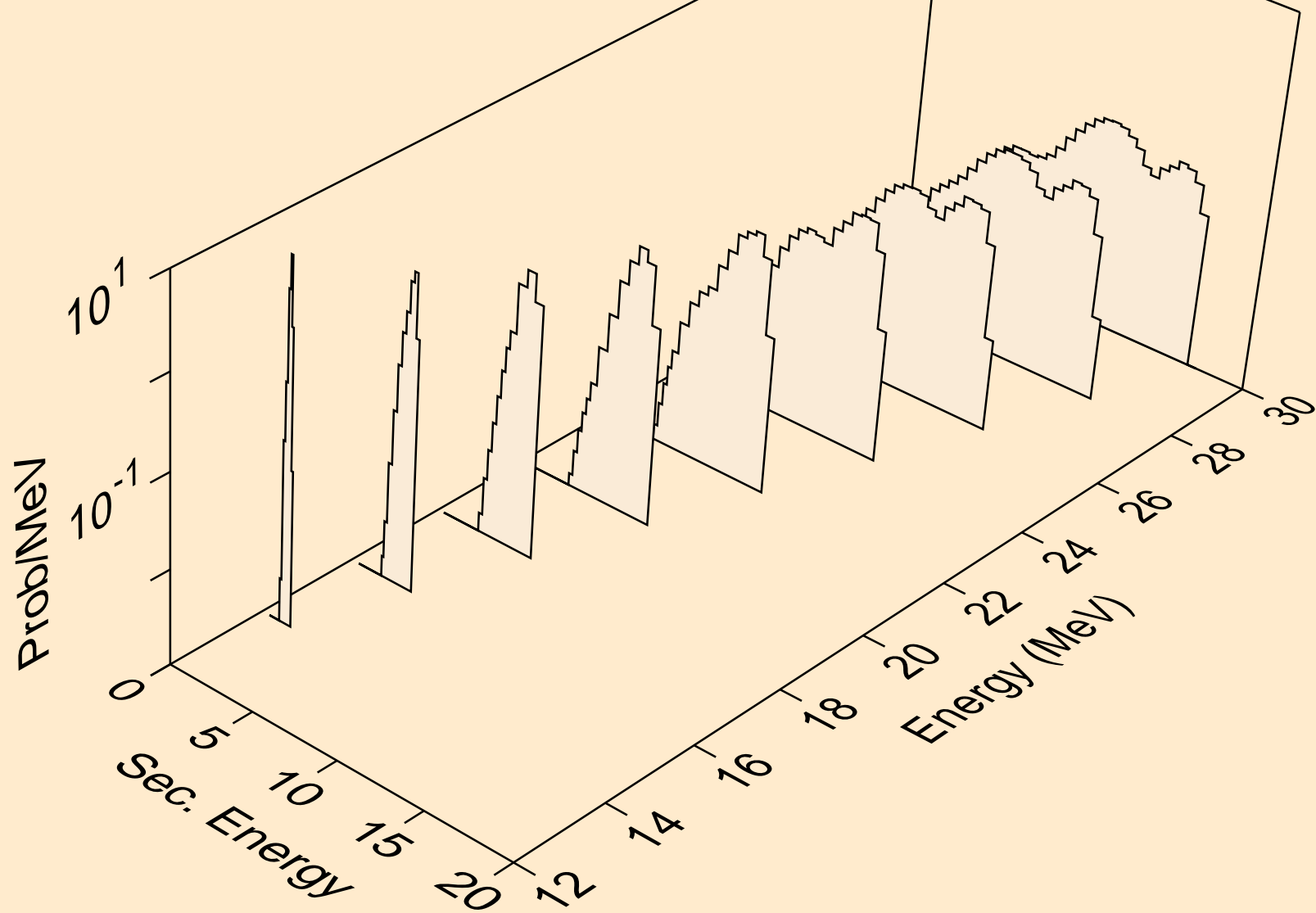

RU089 DEUTERON ACER TENDL-2021 LIBRARY; T=0.K
Deuteron emission for inelastic

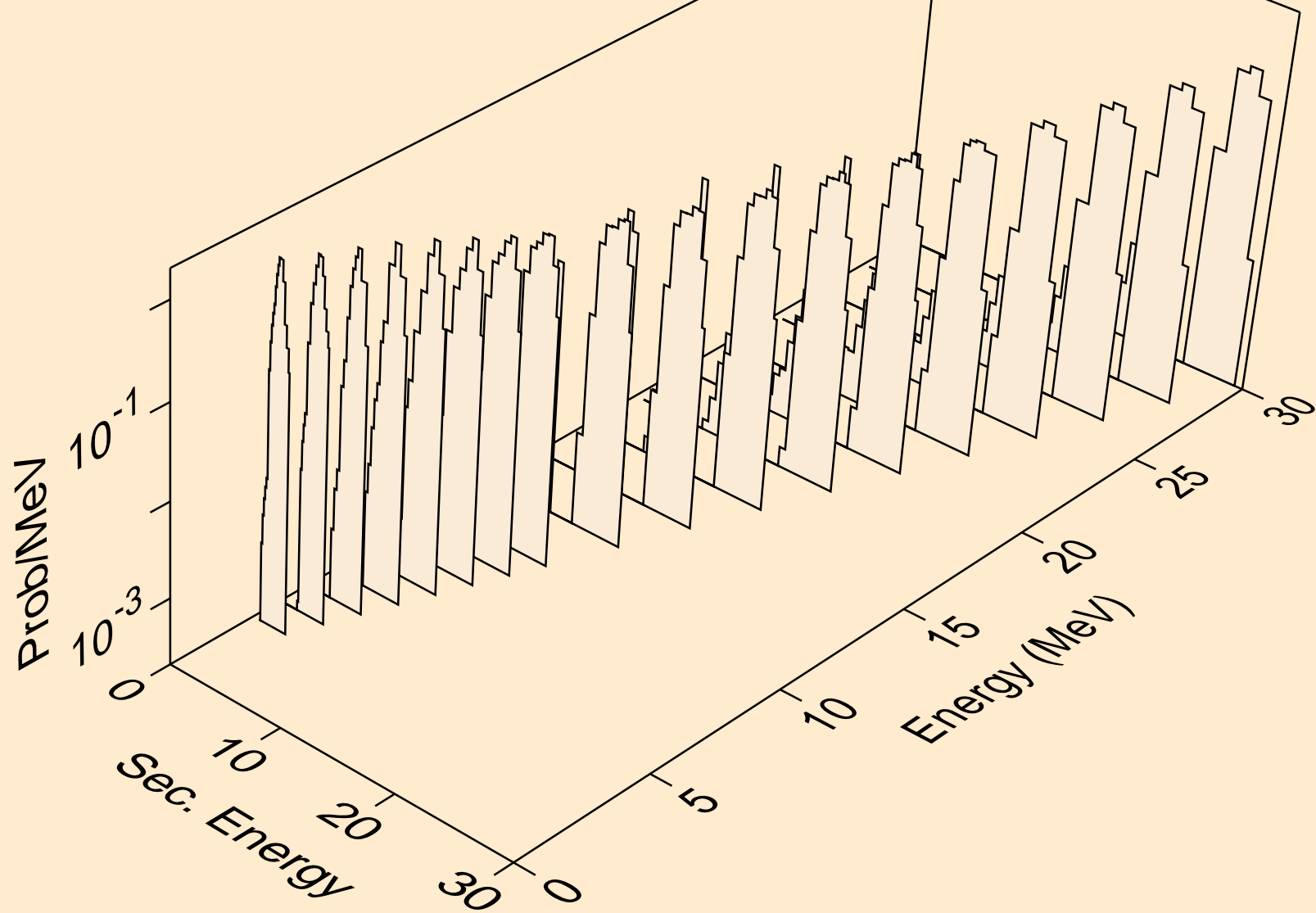

RU089 DEUTERON ACER TENDL-2021 LIBRARY; T=0.K
Deuteron emission for (d,pd)

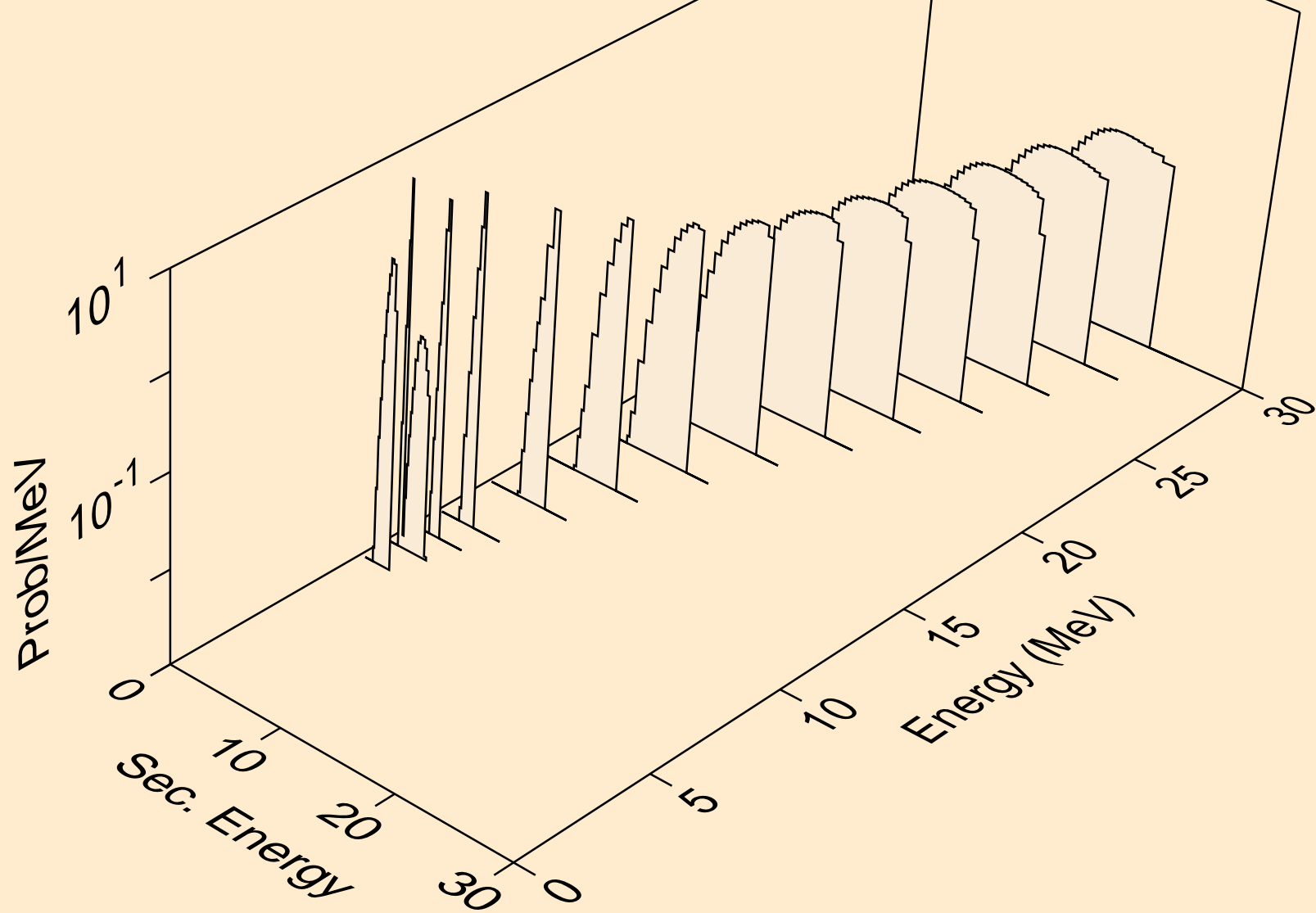

RU089 DEUTERON ACER TENDL-2021 LIBRARY; T=0.K
Deuteron emission for (d,da)

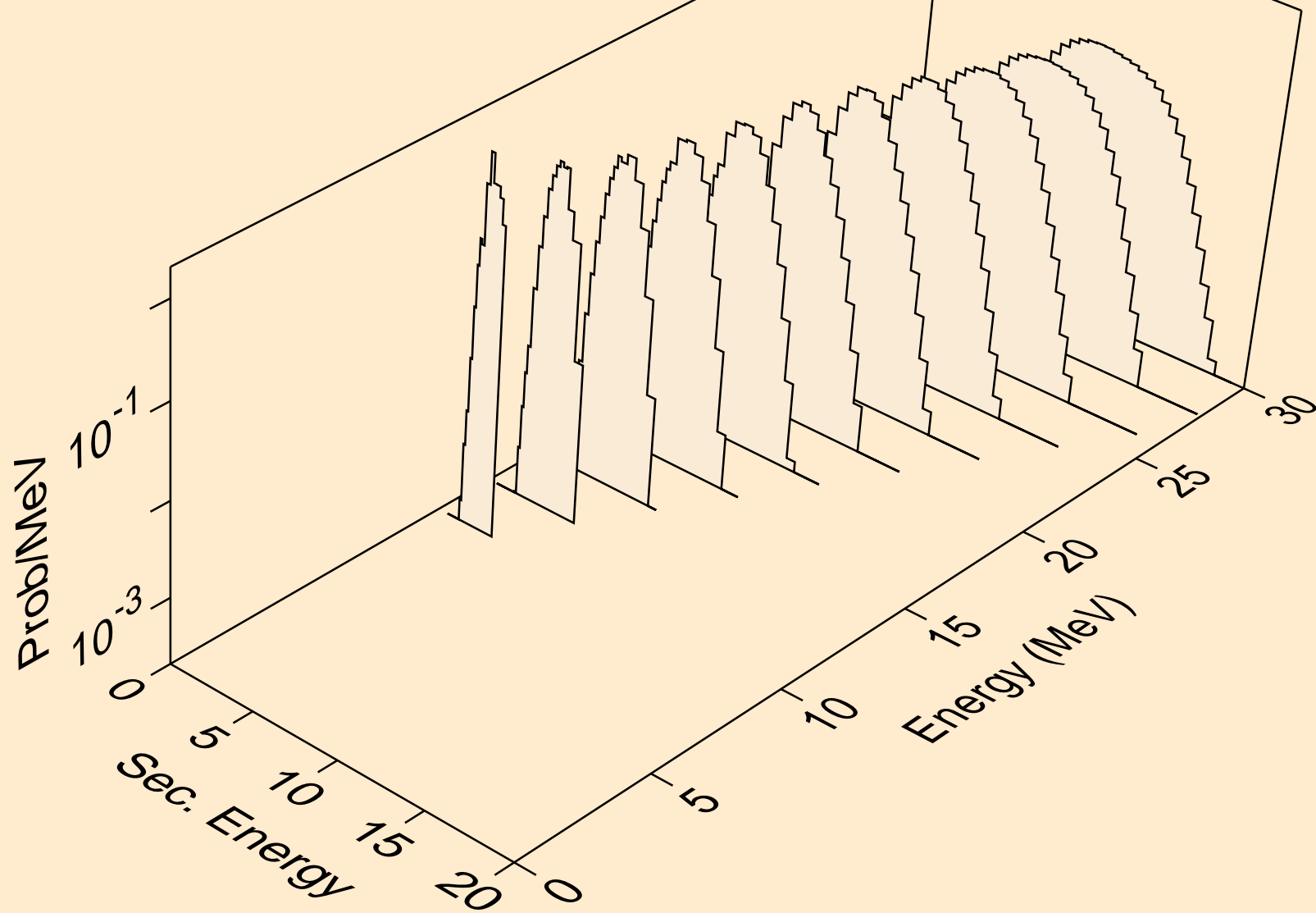

RU089 DEUTERON ACER TENDL-2021 LIBRARY; T=0.K
Photon emission for (z,n)

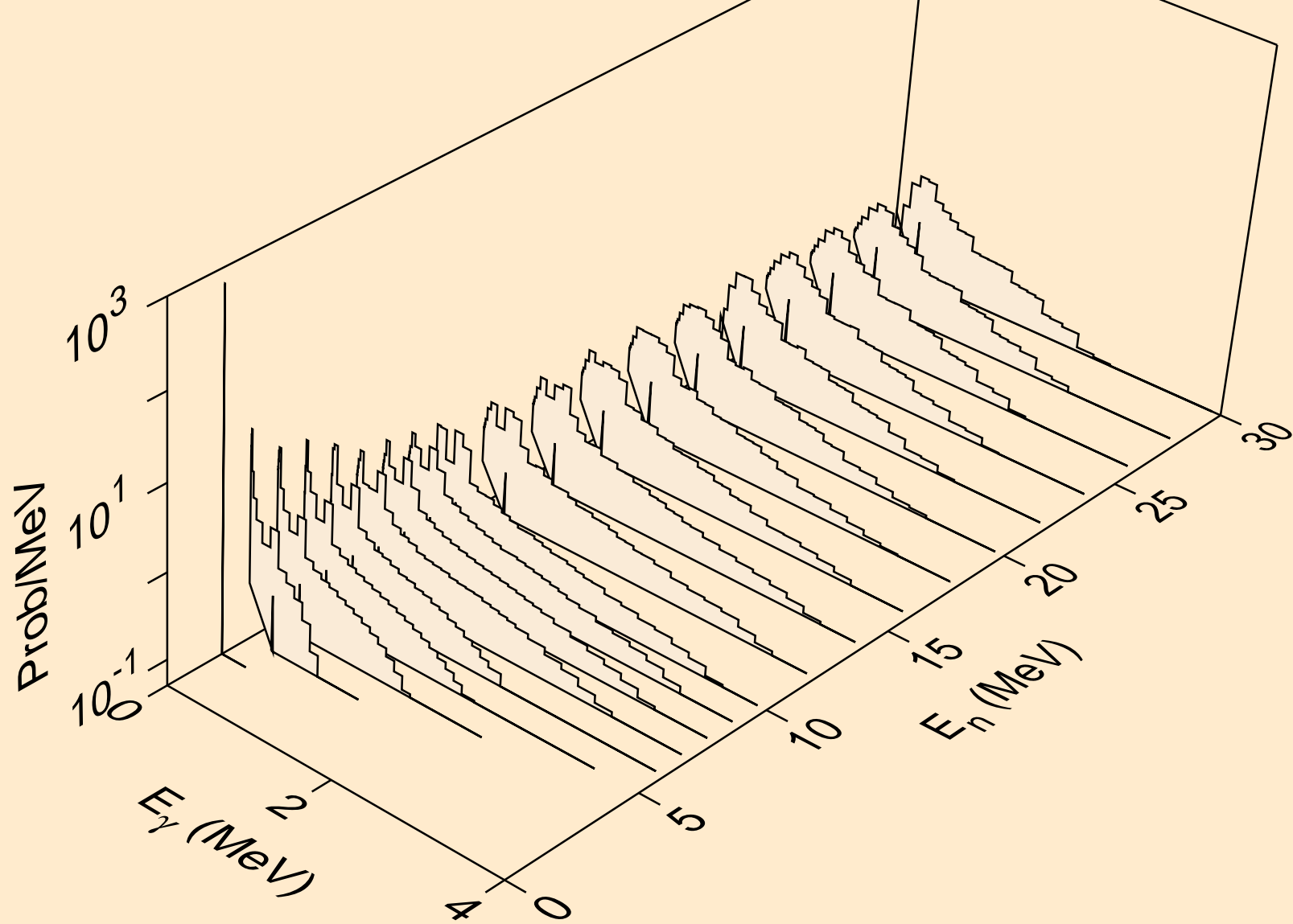

RU089 DEUTERON ACER TENDL-2021 LIBRARY; T=0.K
Photon emission for (n,x)

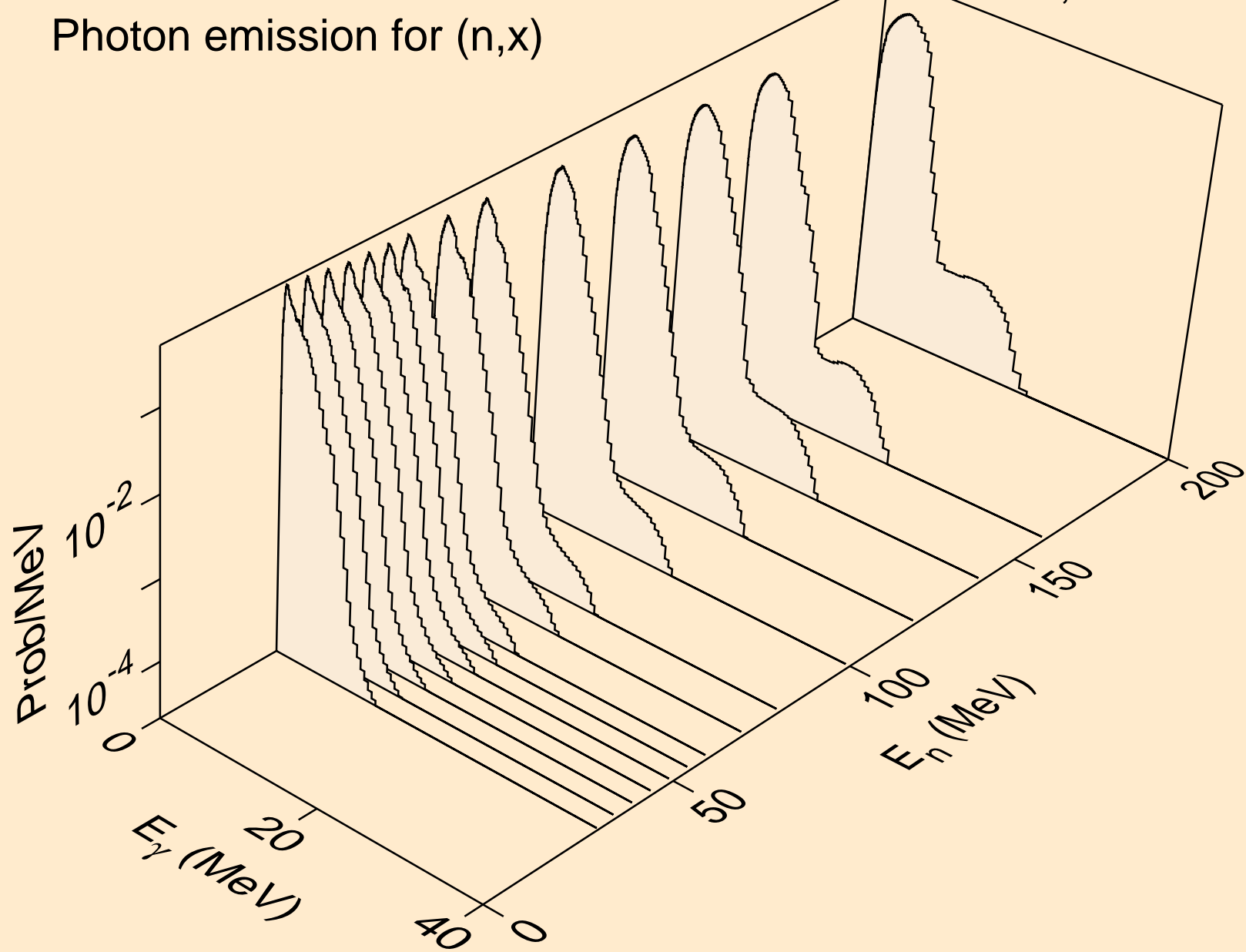

RU089 DEUTERON ACER TENDL-2021 LIBRARY; T=0.K
Photon emission for (n,2n)

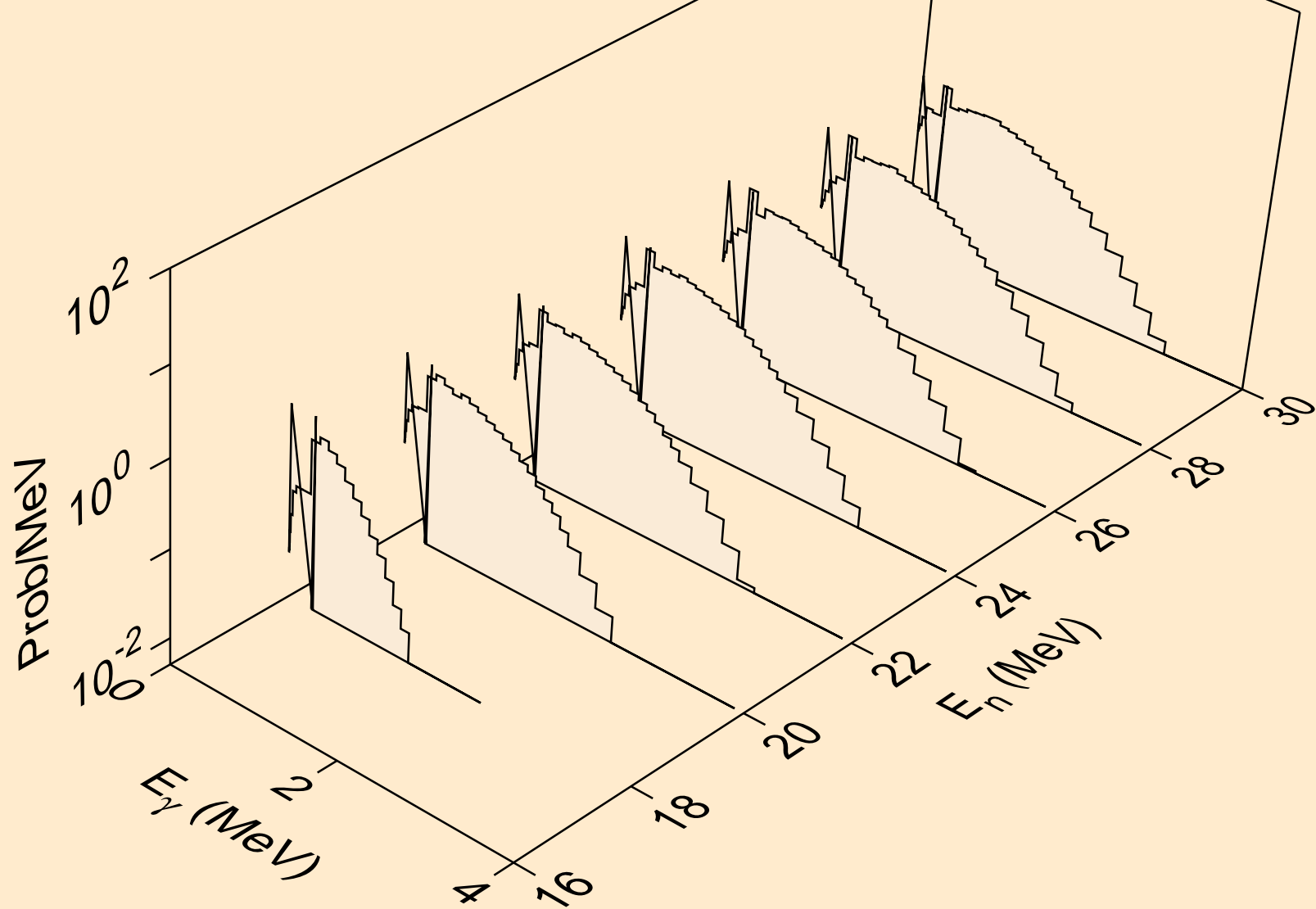

RU089 DEUTERON ACER TENDL-2021 LIBRARY; T=0.K
Photon emission for (n,n*)a

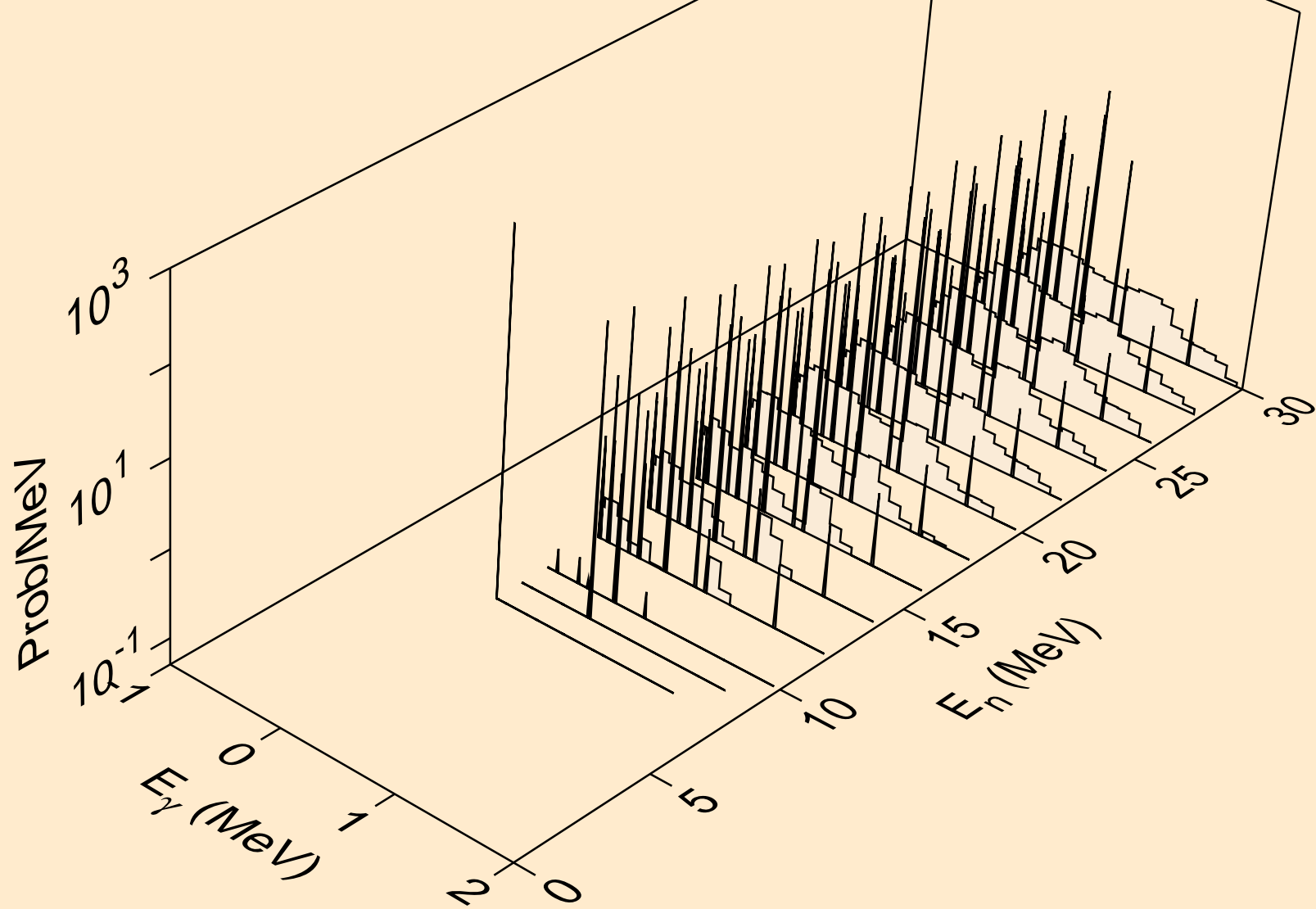

RU089 DEUTERON ACER TENDL-2021 LIBRARY; T=0.K
Photon emission for (n,n*)p

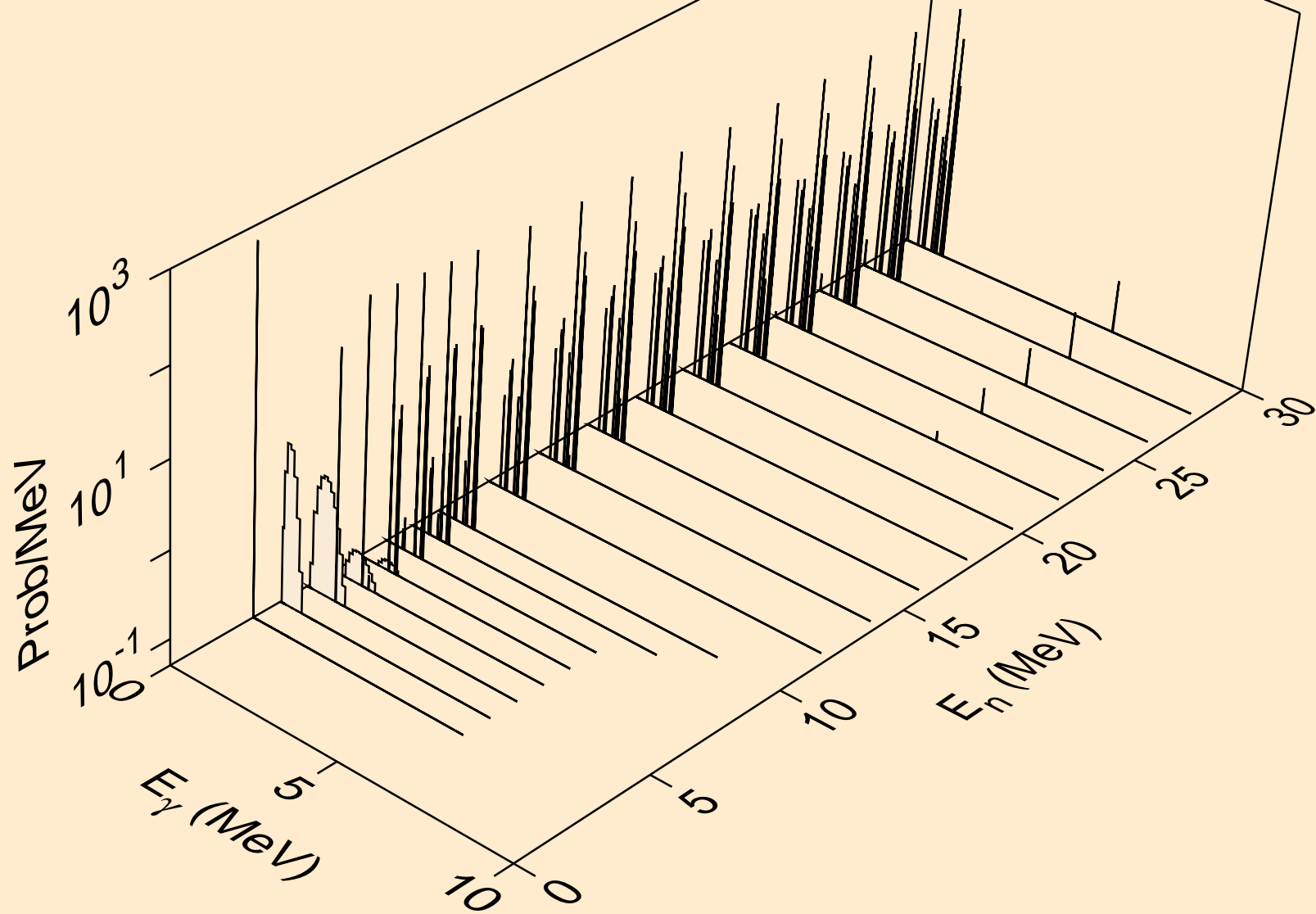

RU089 DEUTERON ACER TENDL-2021 LIBRARY; T=0.K
Photon emission for (n,n*)2a

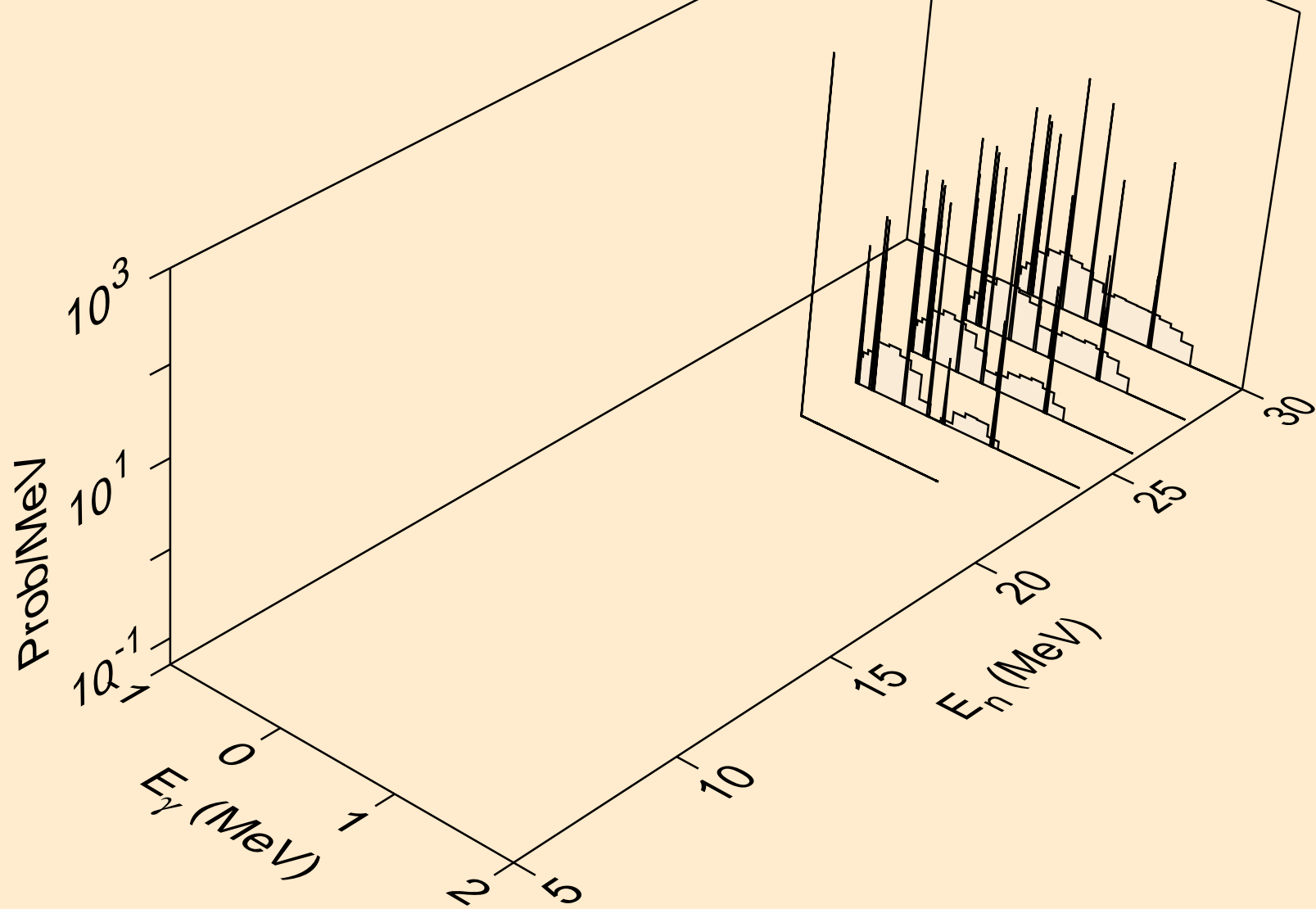

RU089 DEUTERON ACER TENDL-2021 LIBRARY; T=0.K
Photon emission for (n,n*)d

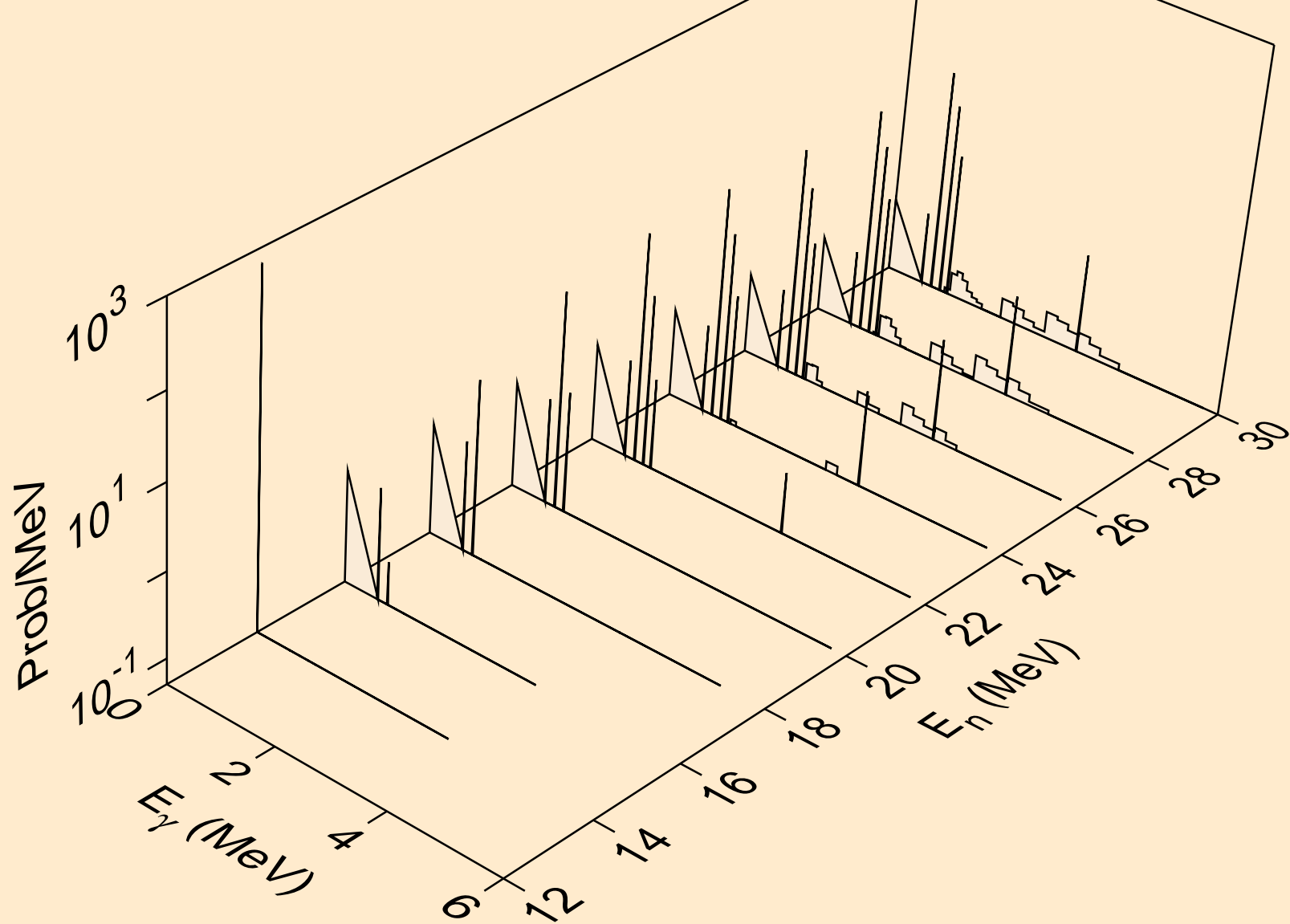

RU089 DEUTERON ACER TENDL-2021 LIBRARY; T=0.K
Photon emission for (n,n*)t

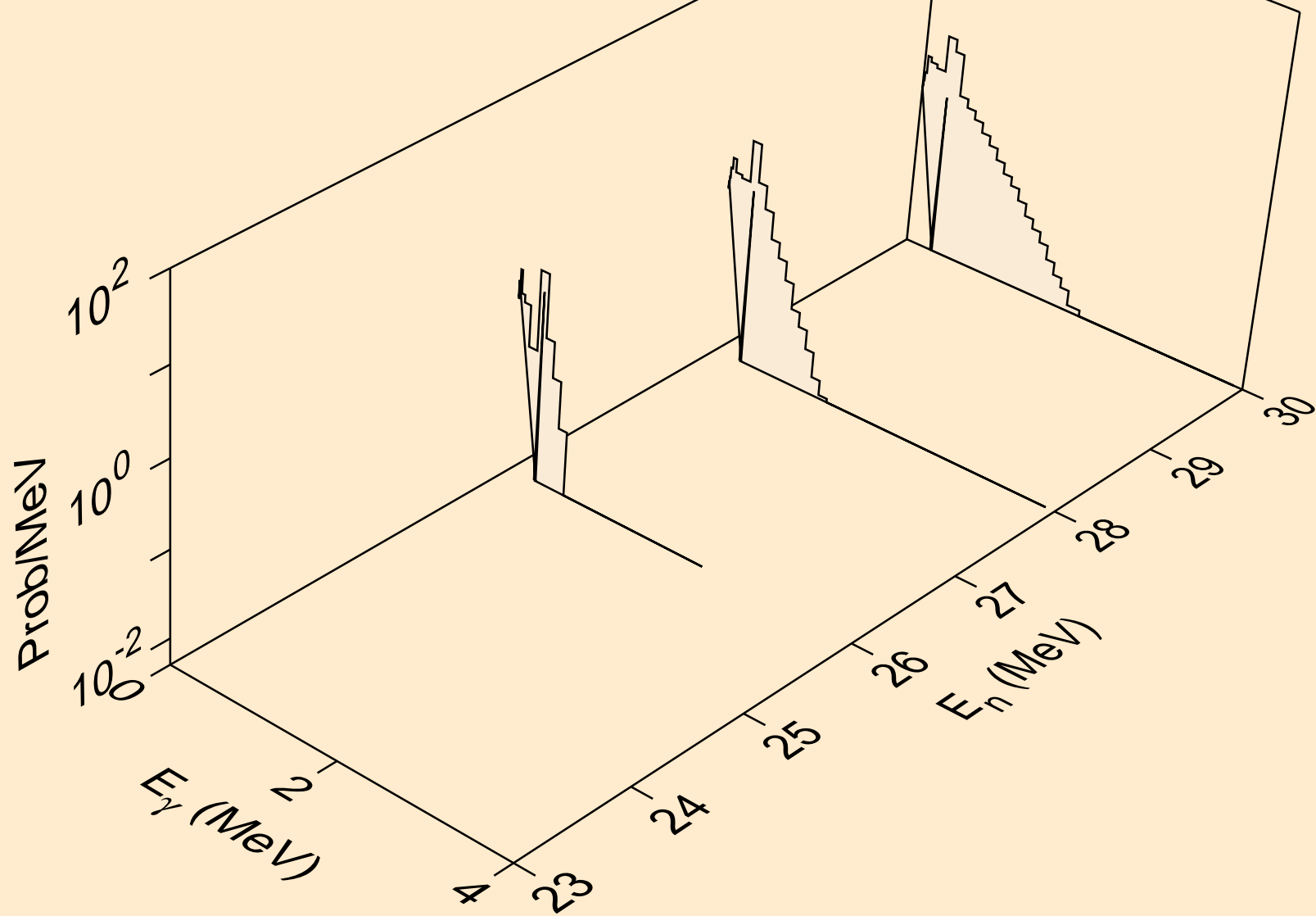

RU089 DEUTERON ACER TENDL-2021 LIBRARY; T=0.K
Photon emission for (n,n*)he3

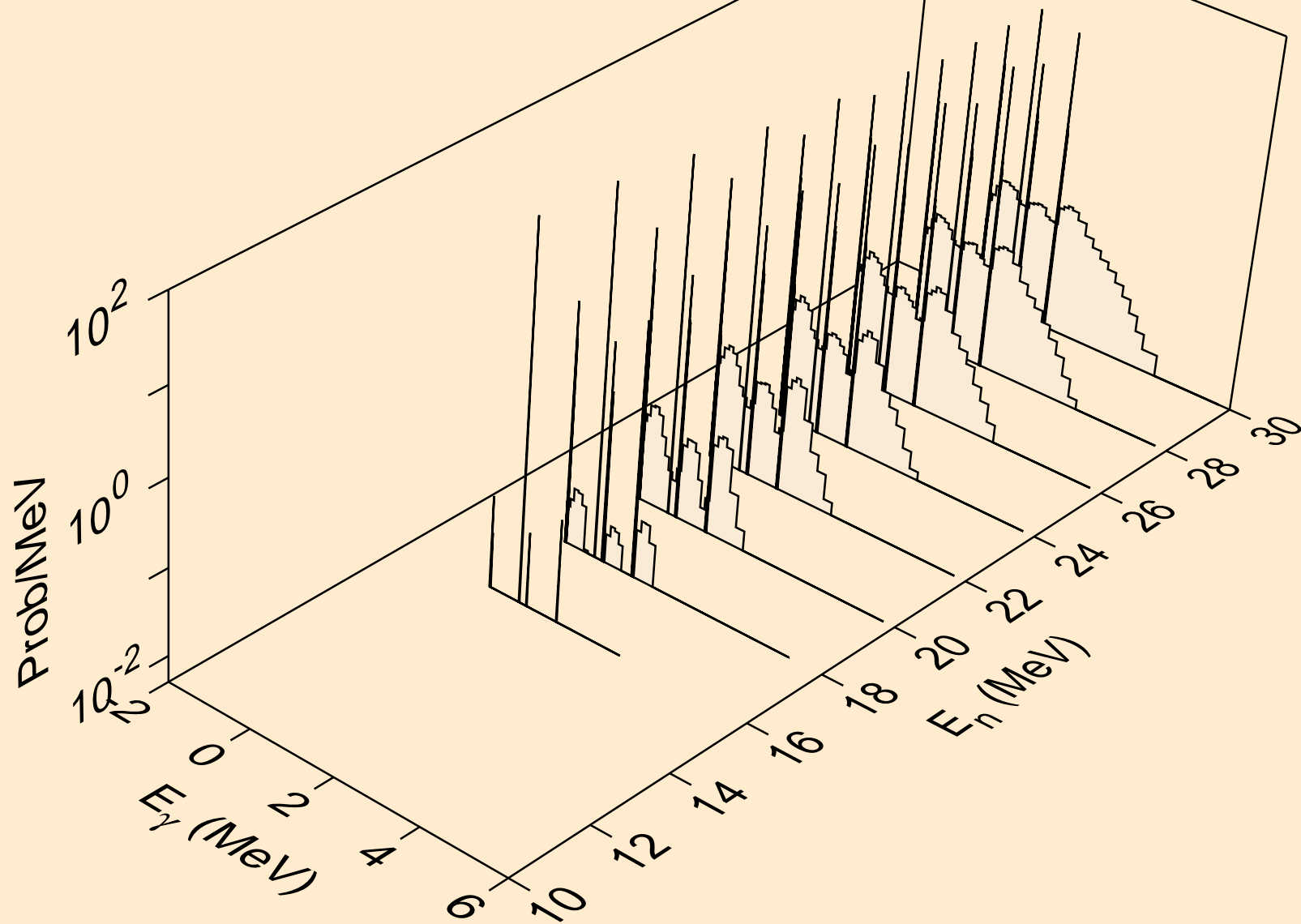

RU089 DEUTERON ACER TENDL-2021 LIBRARY; T=0.K
Photon emission for (n,2np)

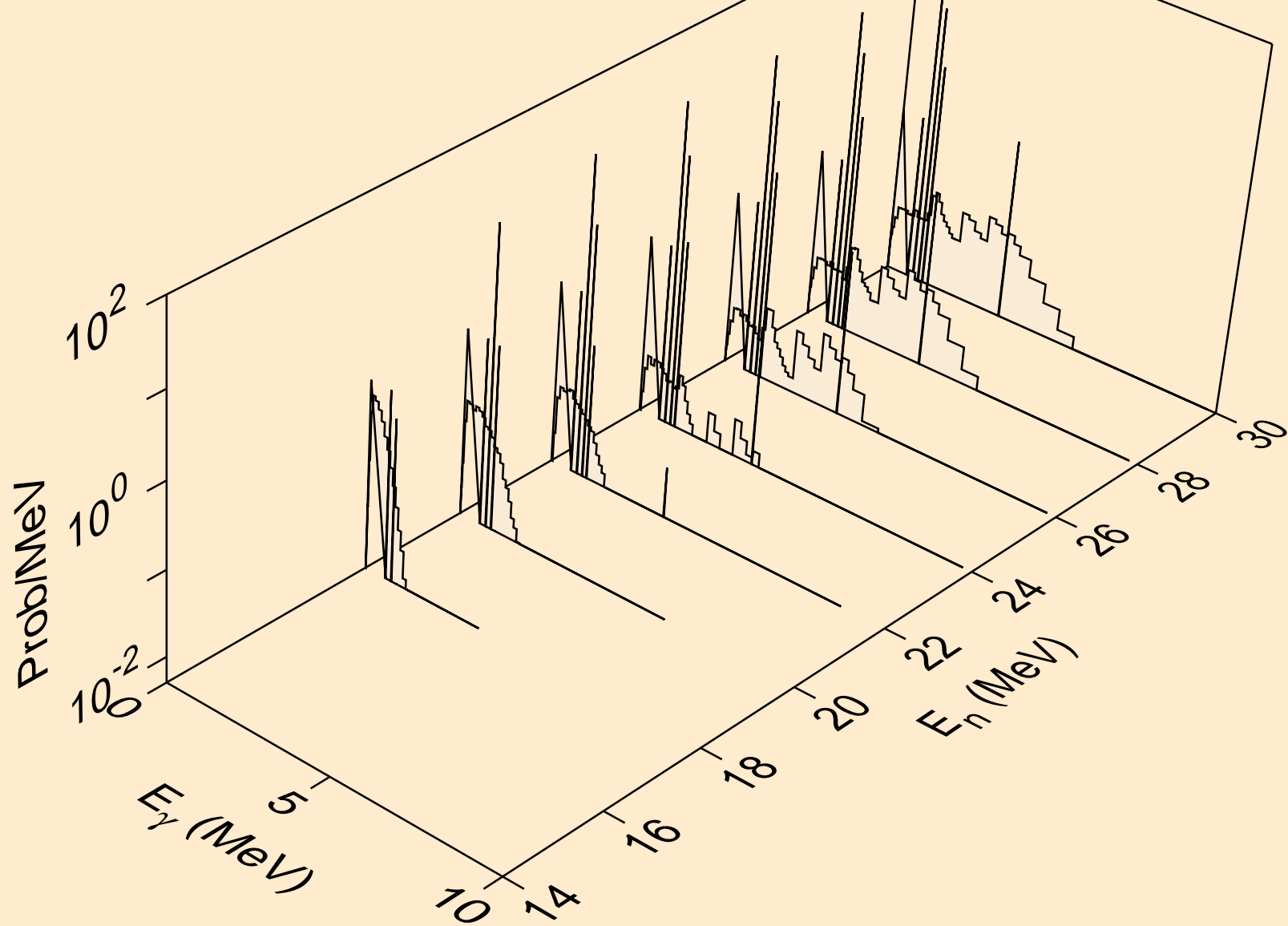

RU089 DEUTERON ACER TENDL-2021 LIBRARY; T=0.K
Photon emission for (n,2np)

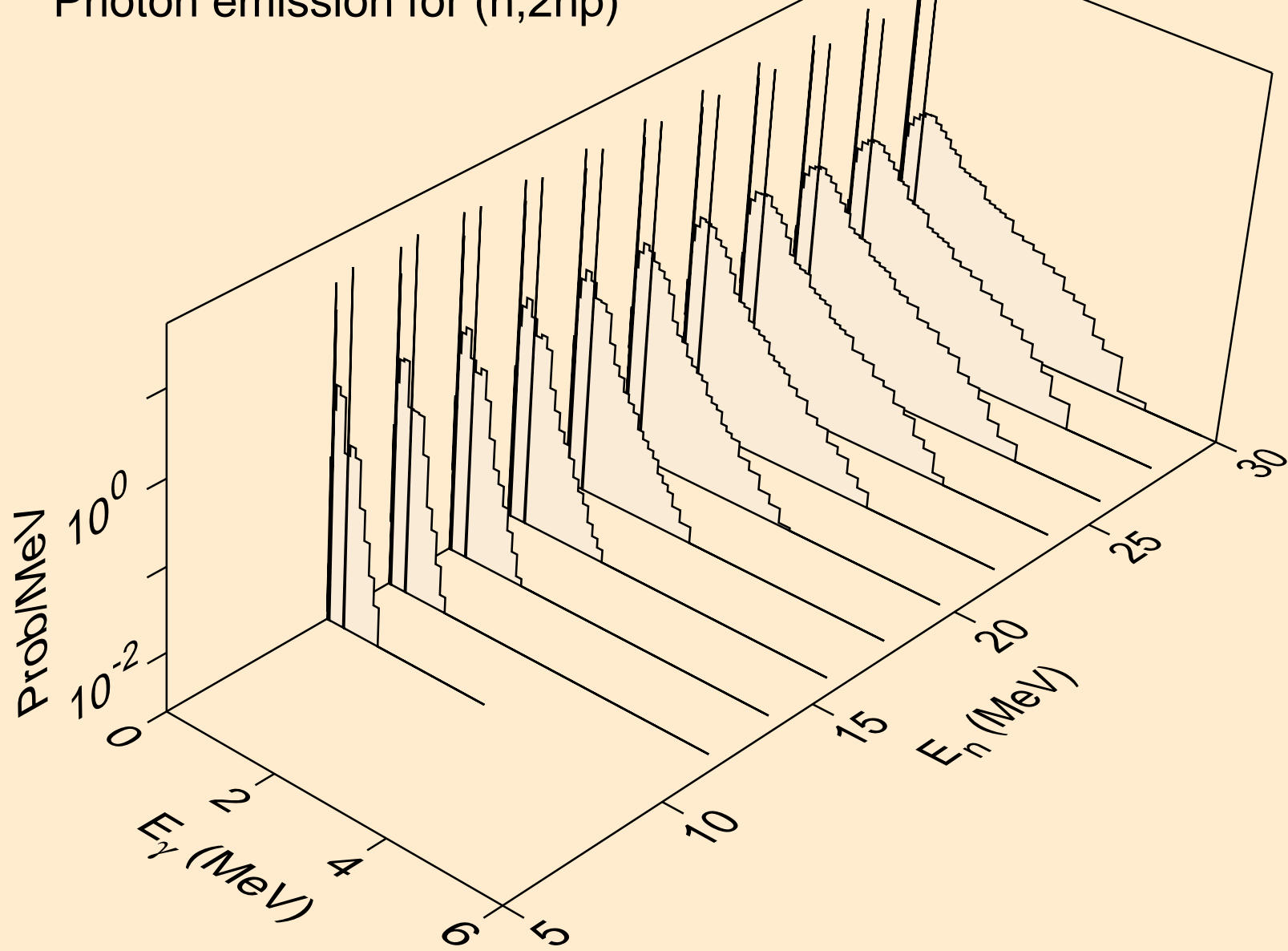

RU089 DEUTERON ACER TENDL-2021 LIBRARY; T=0.K
Photon emission for (n,npa)

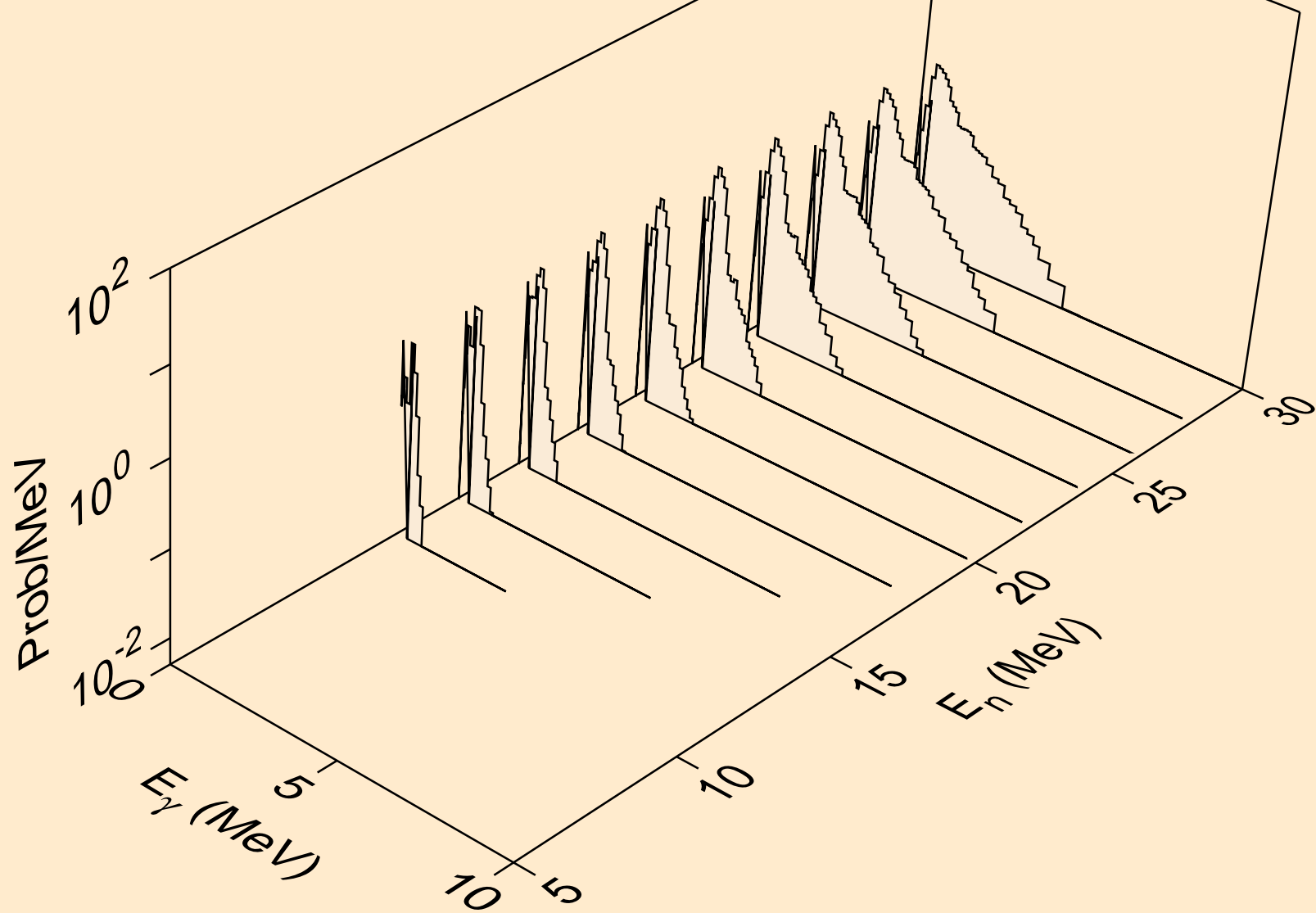

RU089 DEUTERON ACER TENDL-2021 LIBRARY; T=0.K
Photon emission for (n,gma)

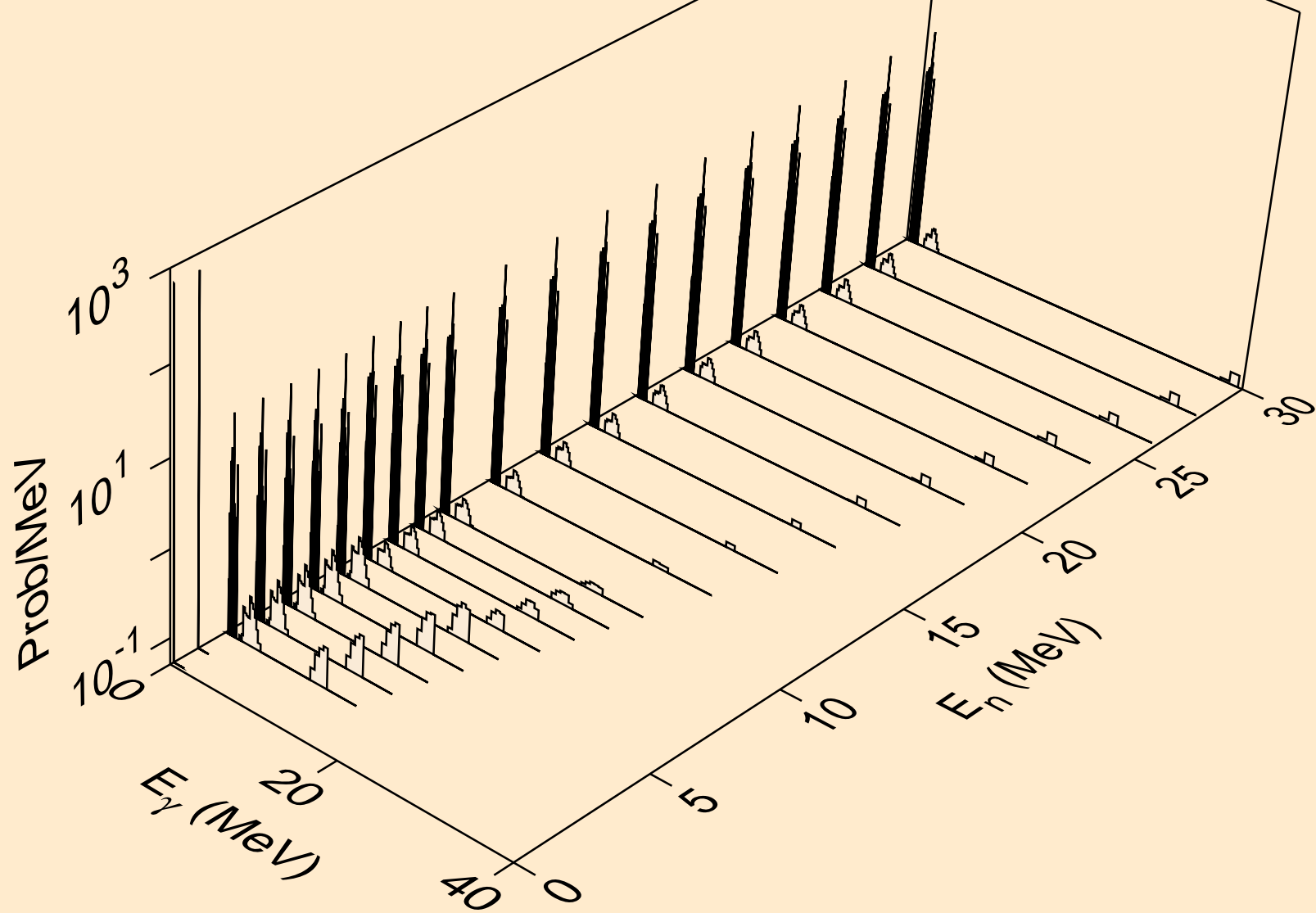

RU089 DEUTERON ACER TENDL-2021 LIBRARY; T=0.K
Photon emission for (n,p)

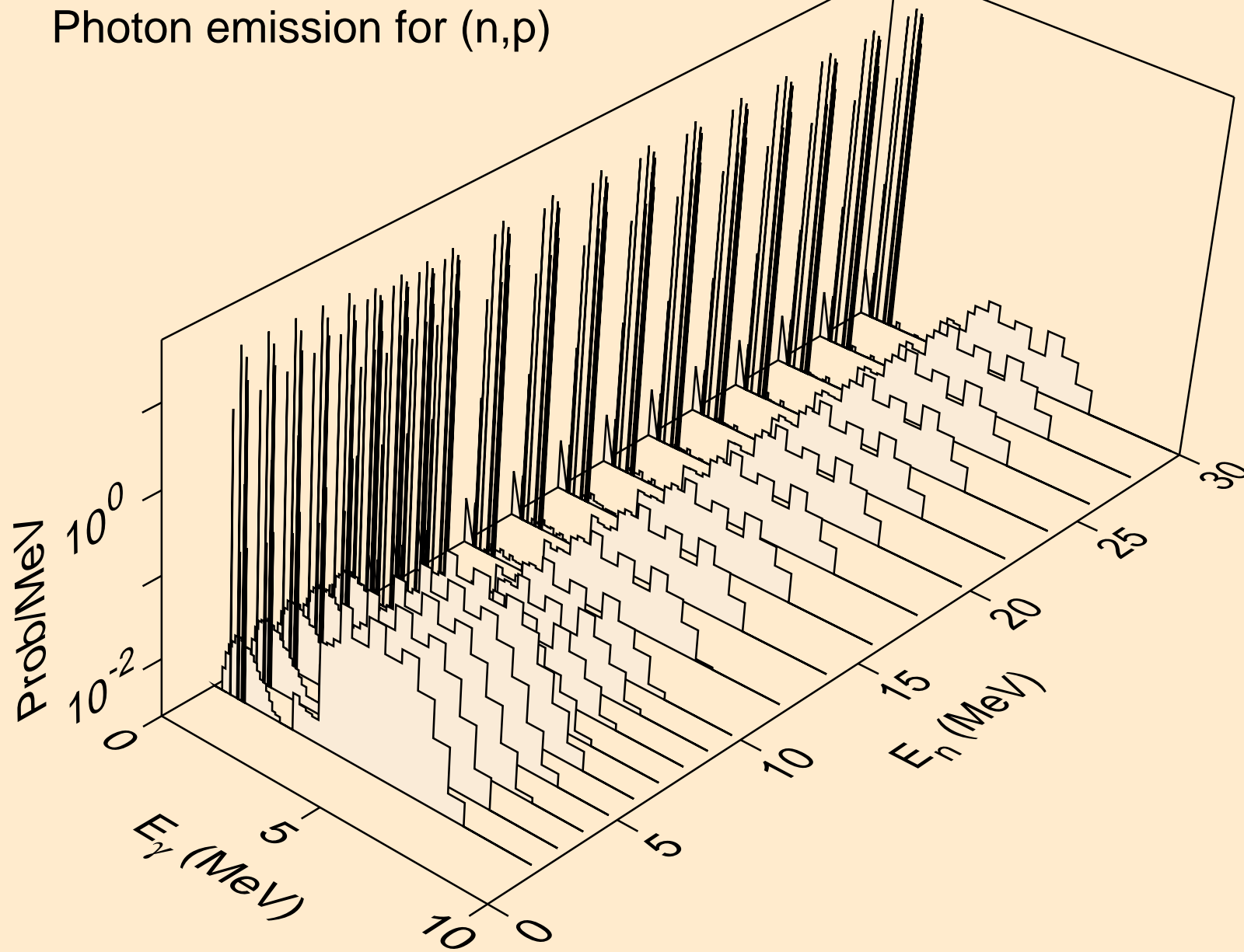

RU089 DEUTERON ACER TENDL-2021 LIBRARY; T=0.K
Photon emission for inelastic

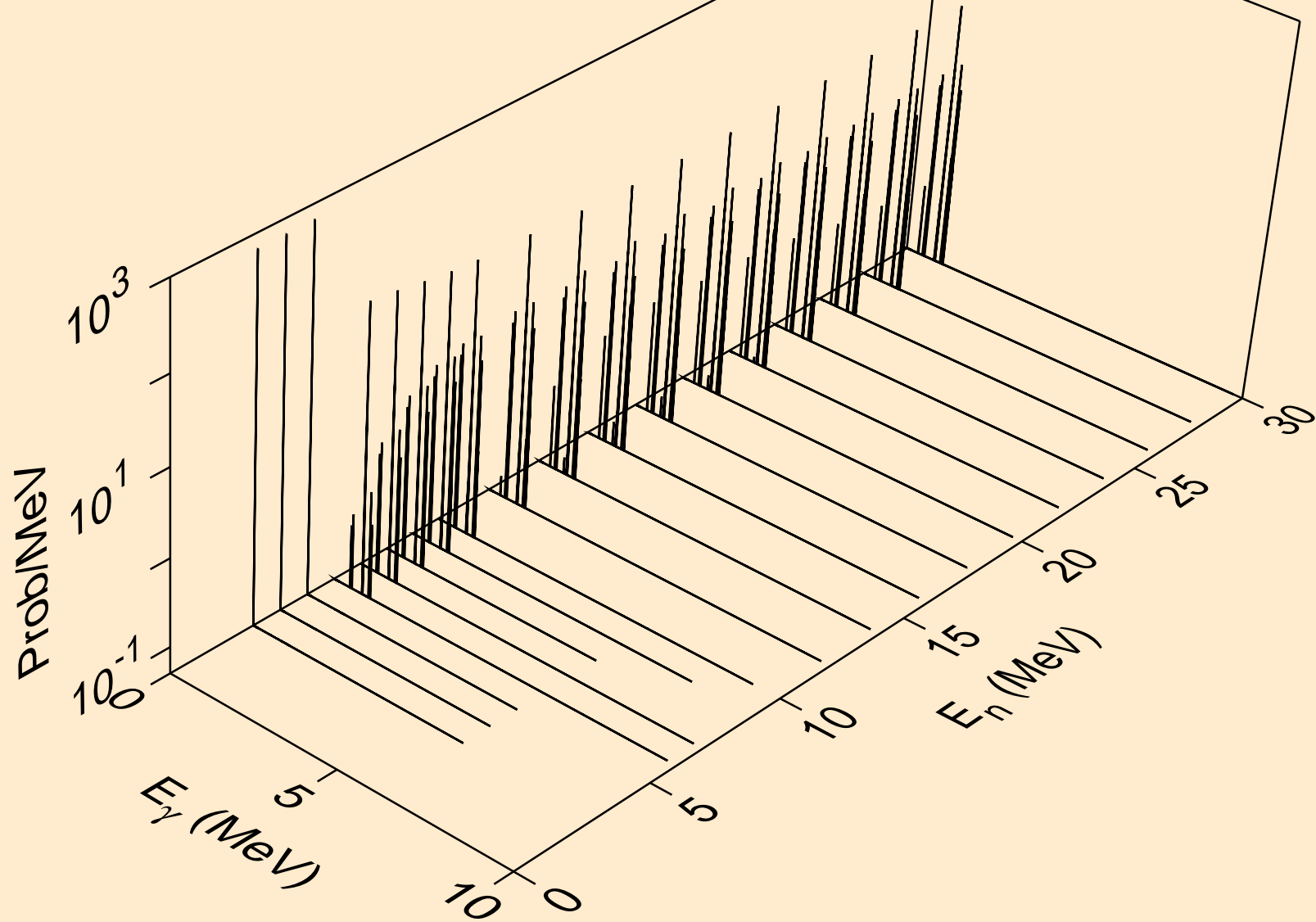

RU089 DEUTERON ACER TENDL-2021 LIBRARY; T=0.K
Photon emission for (n,t)

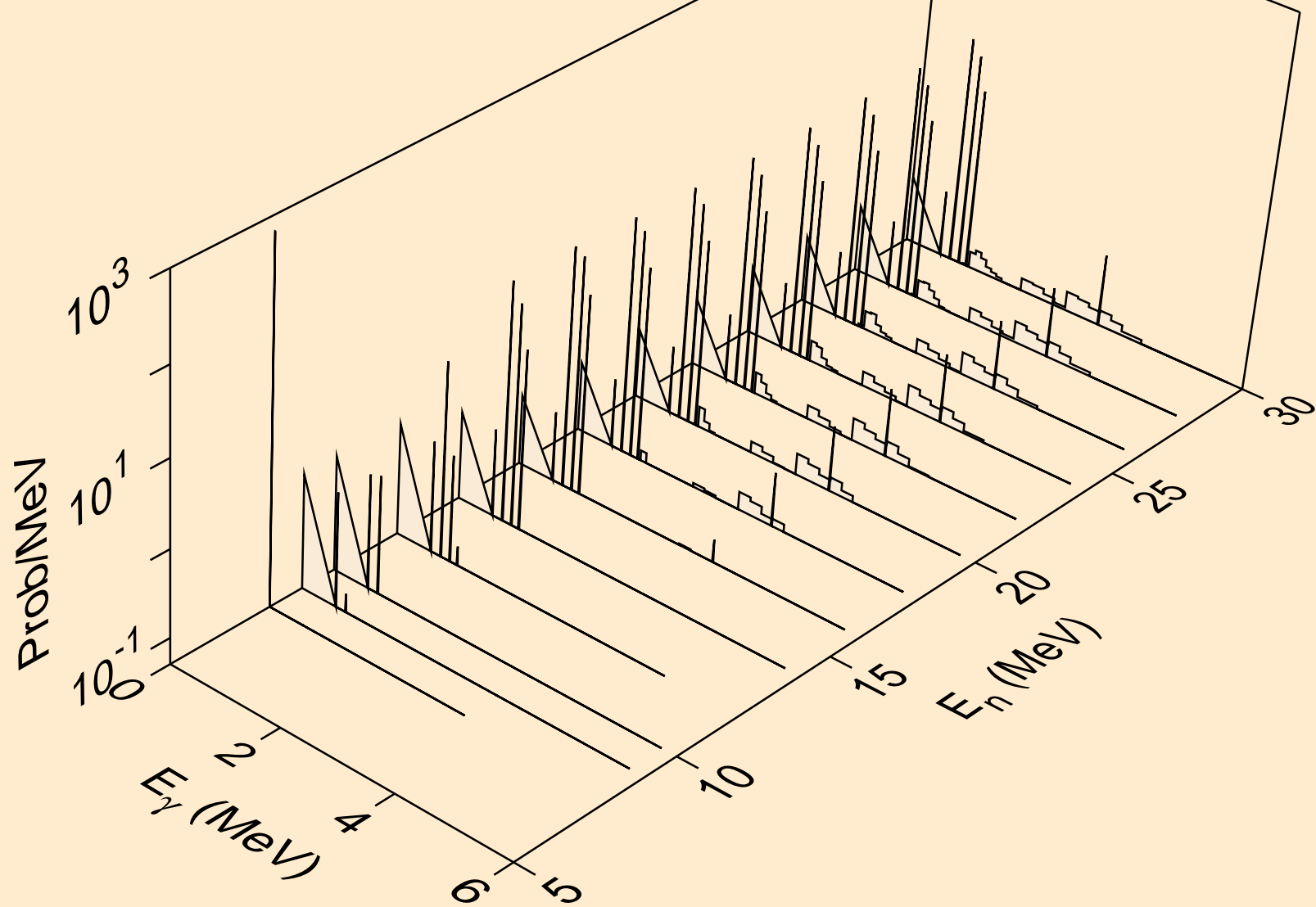

RU089 DEUTERON ACER TENDL-2021 LIBRARY; T=0.K
Photon emission for (n,he3)

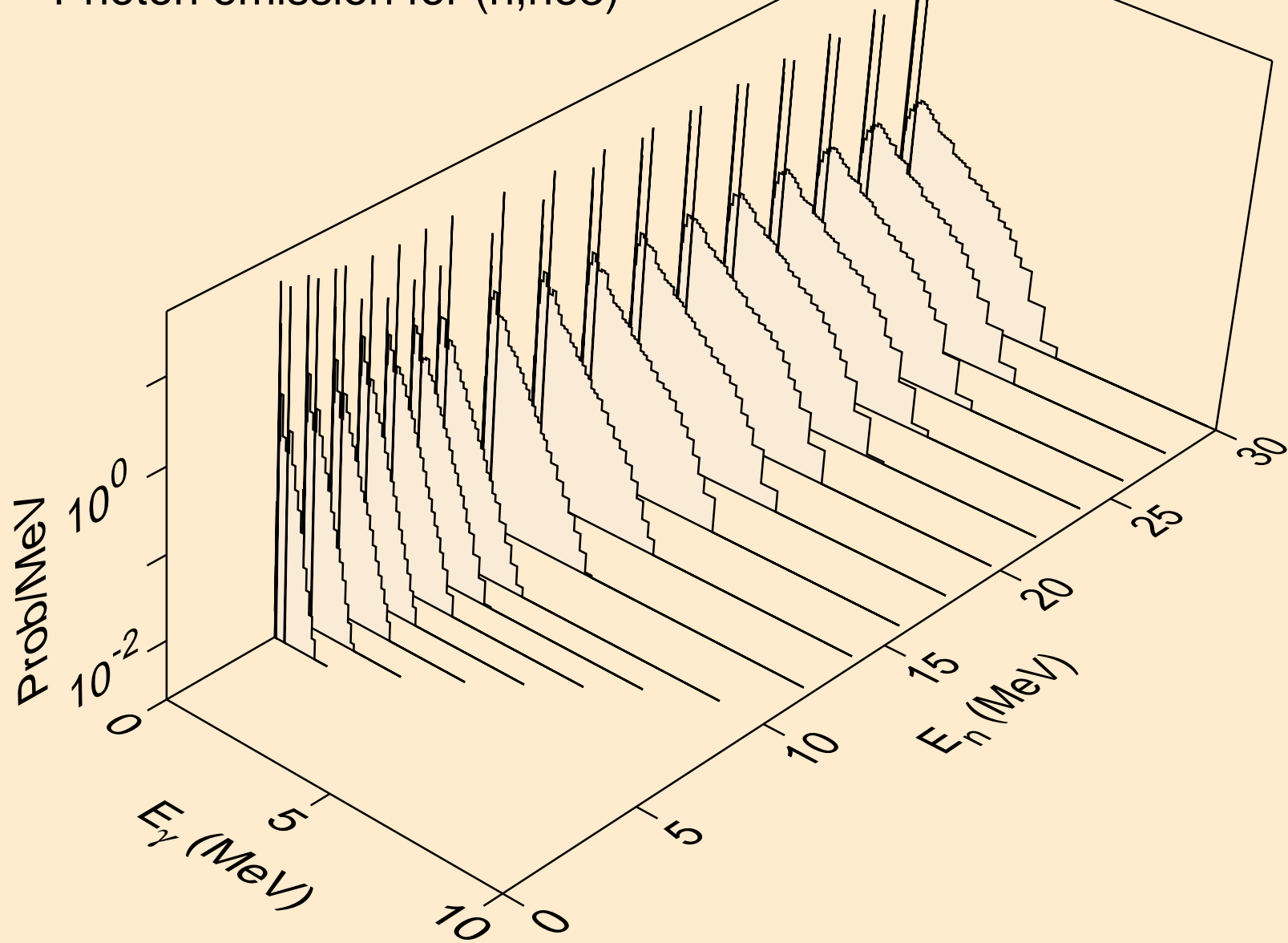

RU089 DEUTERON ACER TENDL-2021 LIBRARY; T=0.K
Photon emission for (n,a)

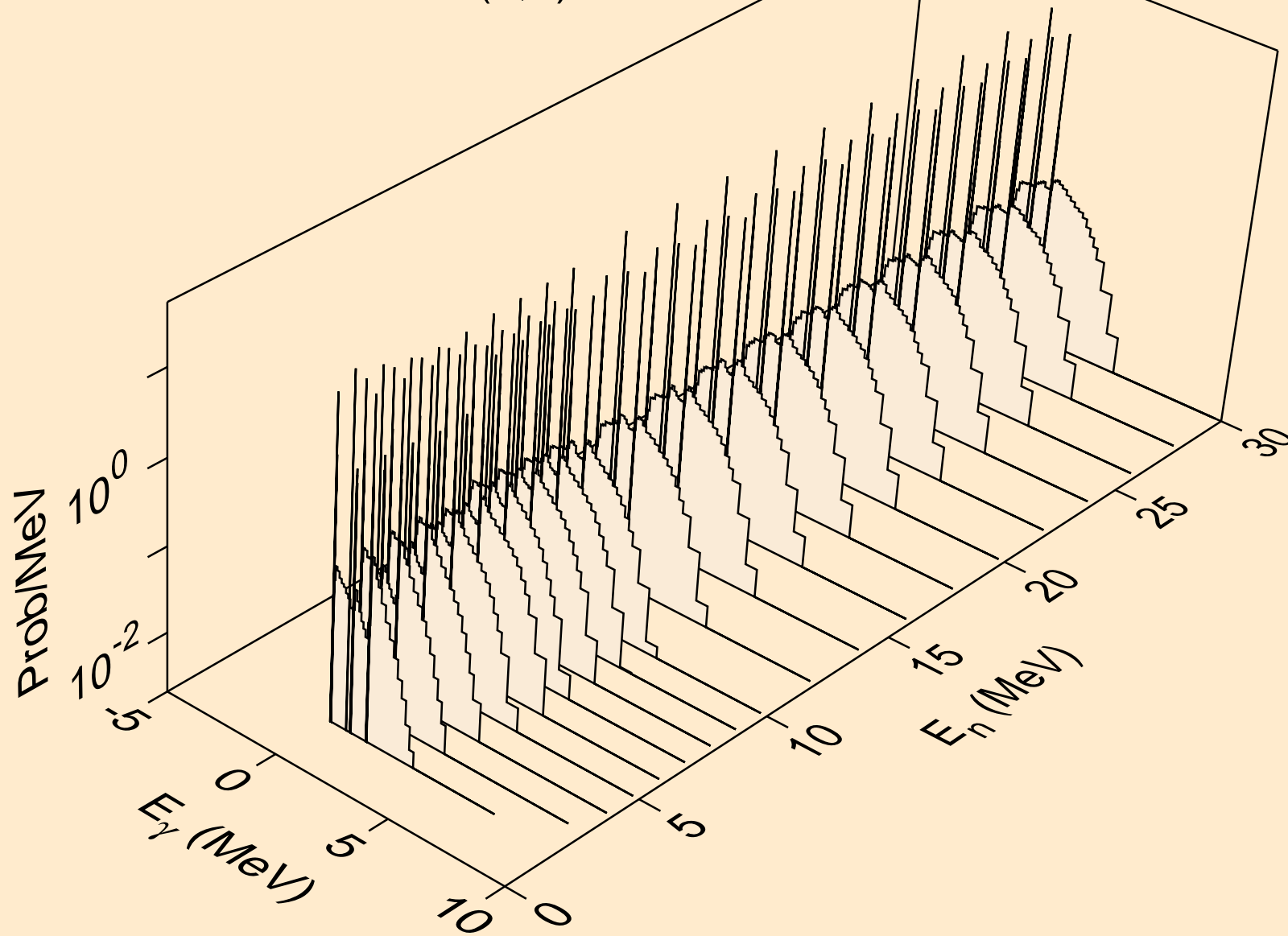

RU089 DEUTERON ACER TENDL-2021 LIBRARY; T=0.K
Photon emission for (n,2a)

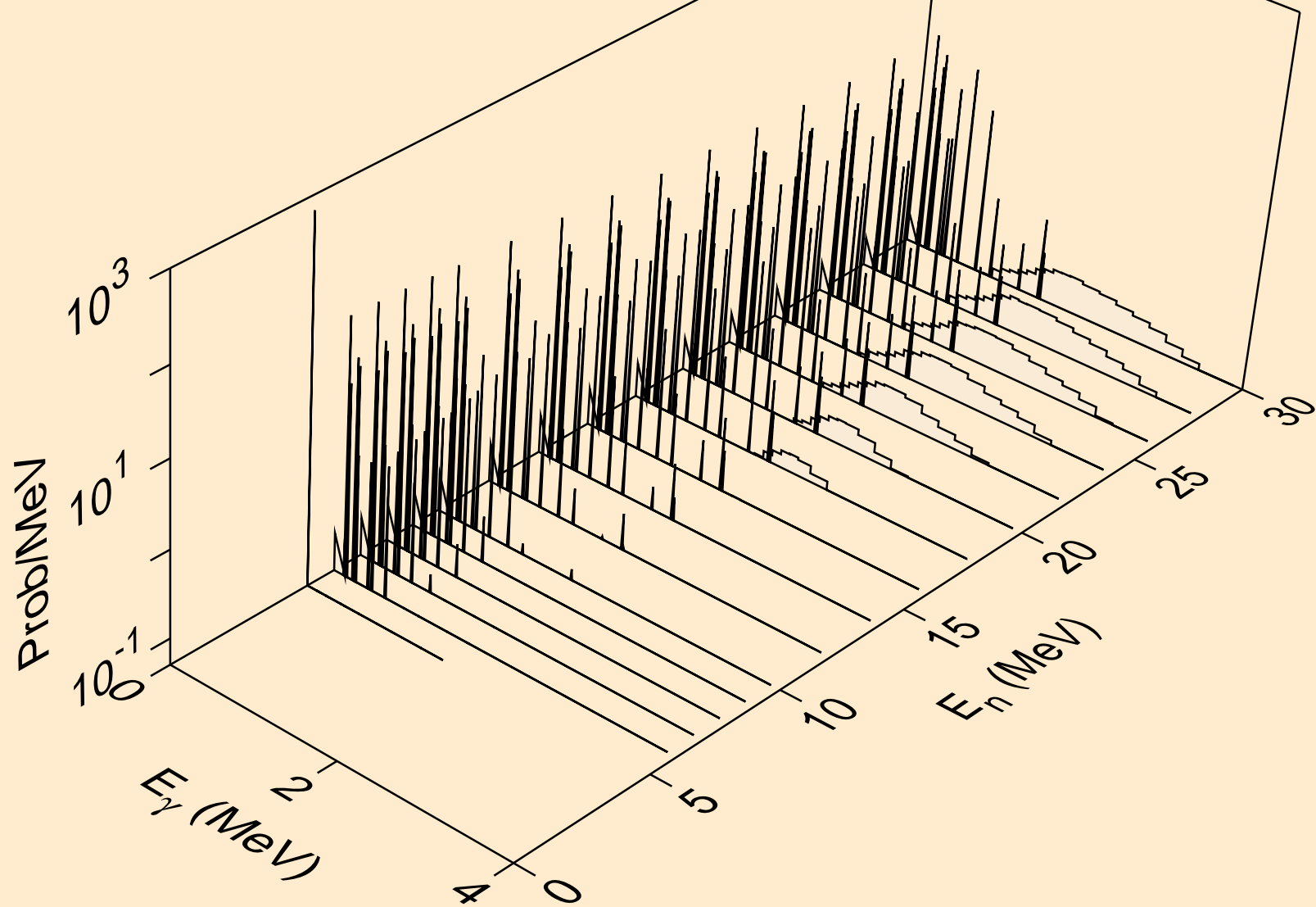

RU089 DEUTERON ACER TENDL-2021 LIBRARY; T=0.K
Photon emission for (n,2p)

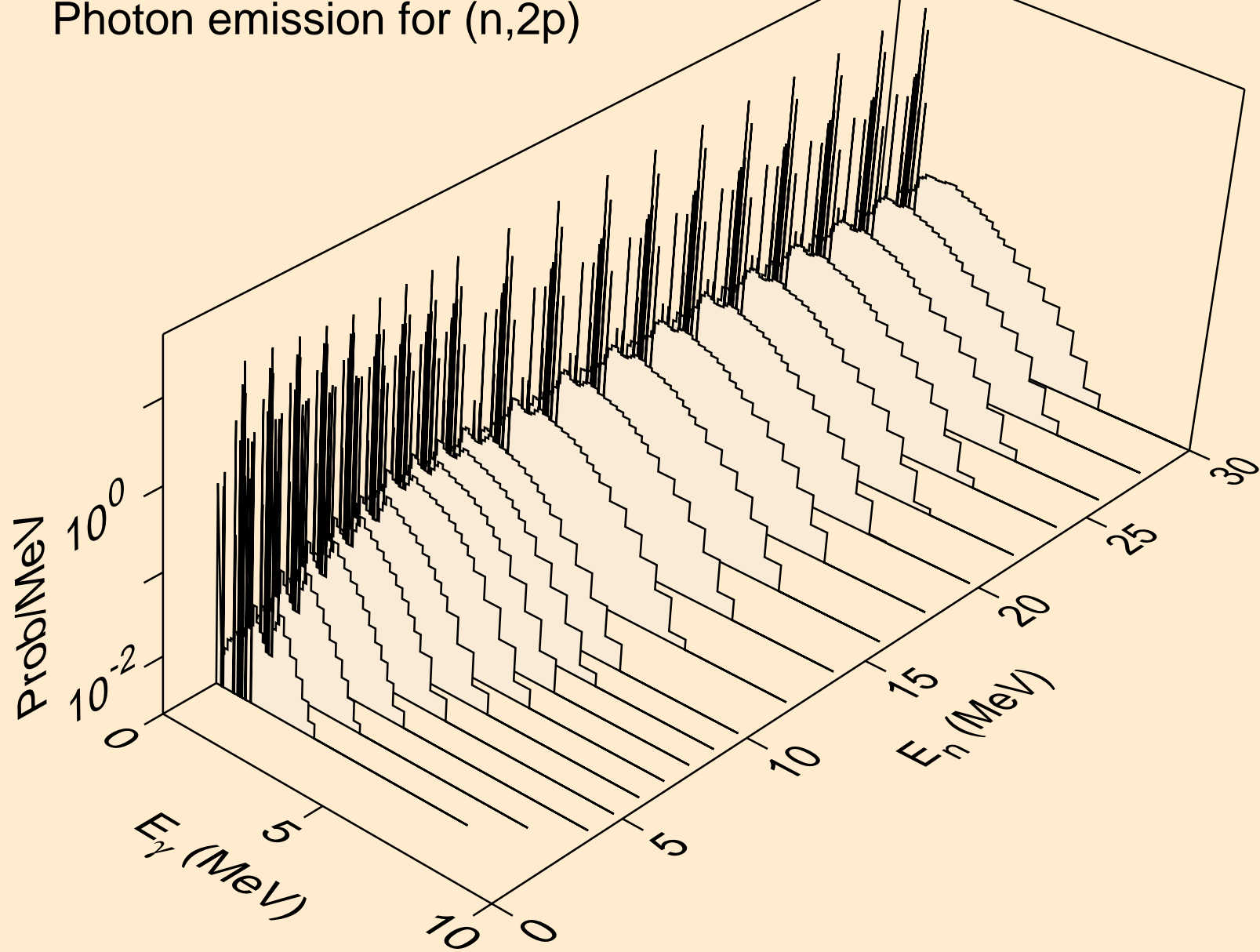

RU089 DEUTERON ACER TENDL-2021 LIBRARY; T=0.K
Photon emission for (n,p)

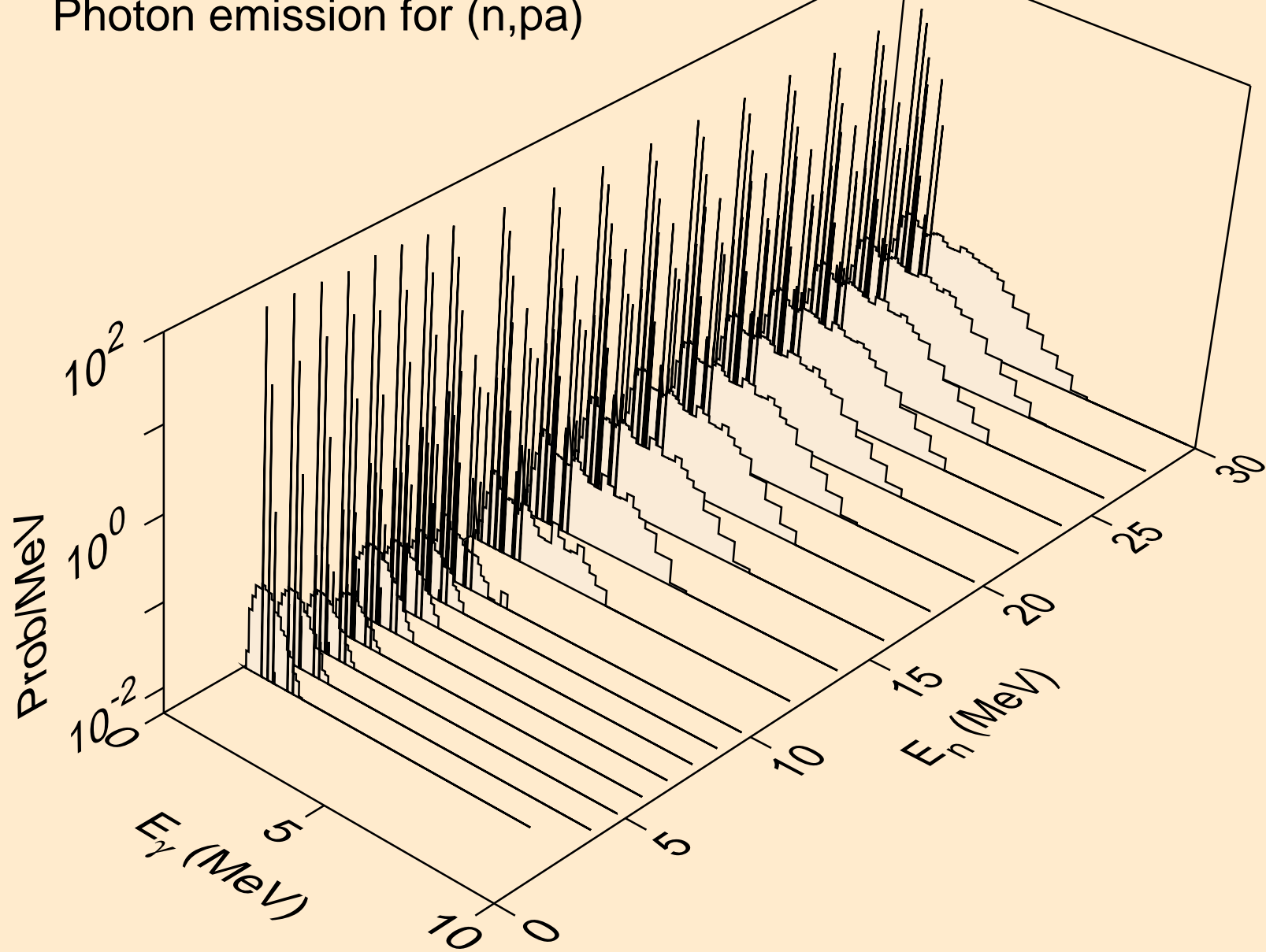

RU089 DEUTERON ACER TENDL-2021 LIBRARY; T=0.K
Photon emission for (n,pd)

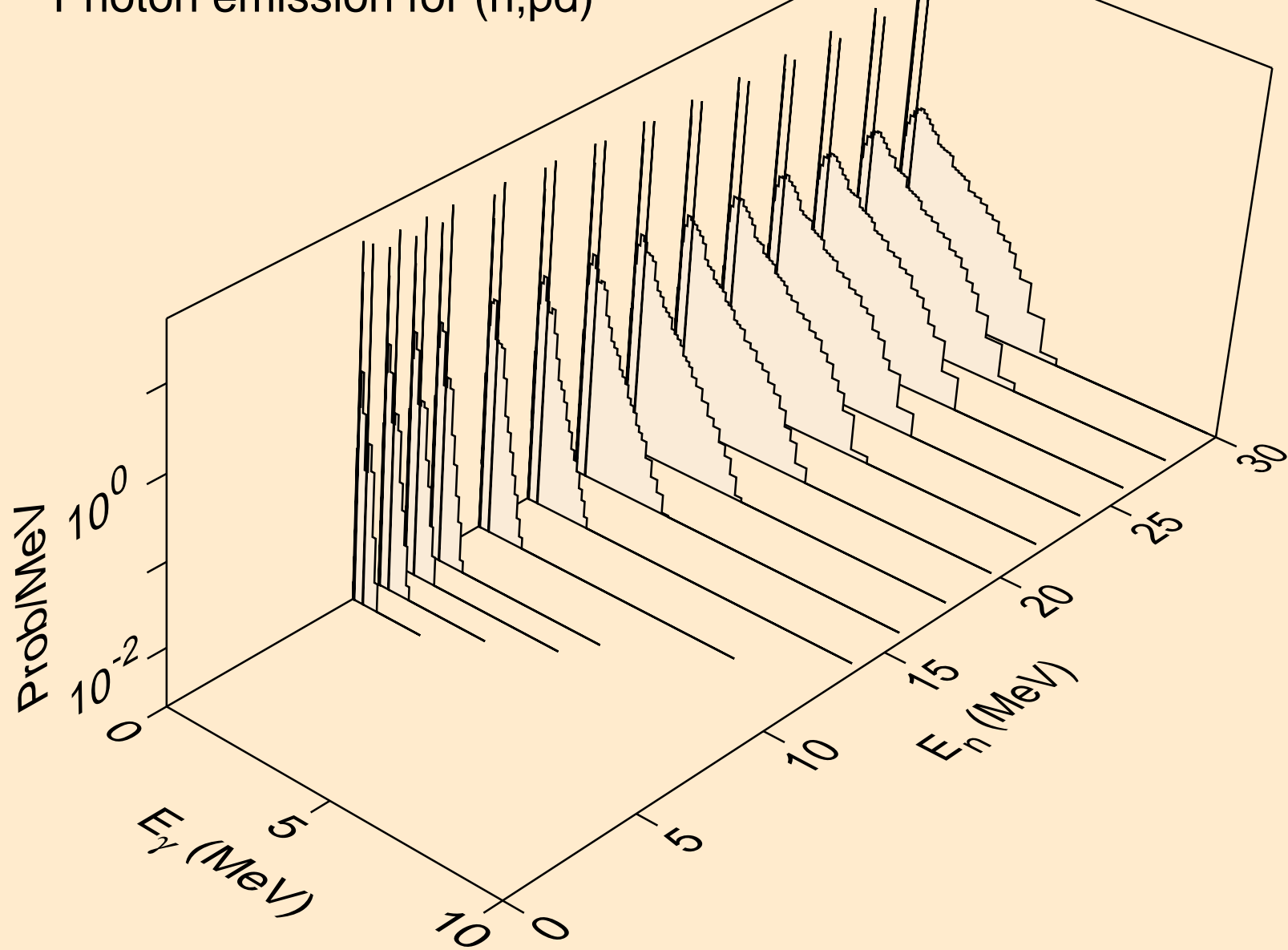

RU089 DEUTERON ACER TENDL-2021 LIBRARY; T=0.K
Photon emission for (n,pt)

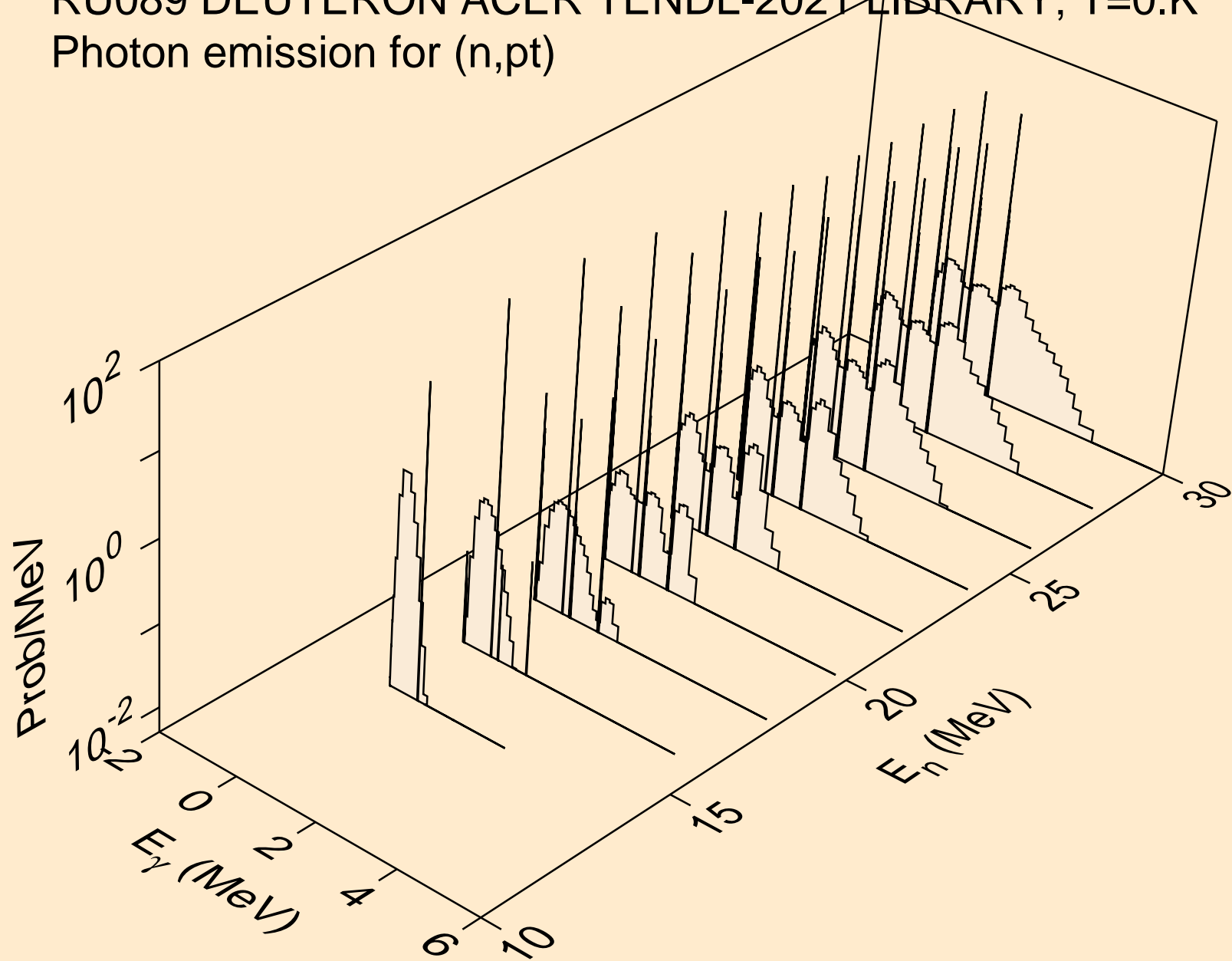

RU089 DEUTERON ACER TENDL-2021 LIBRARY; T=0.K
Photon emission for (n,da)

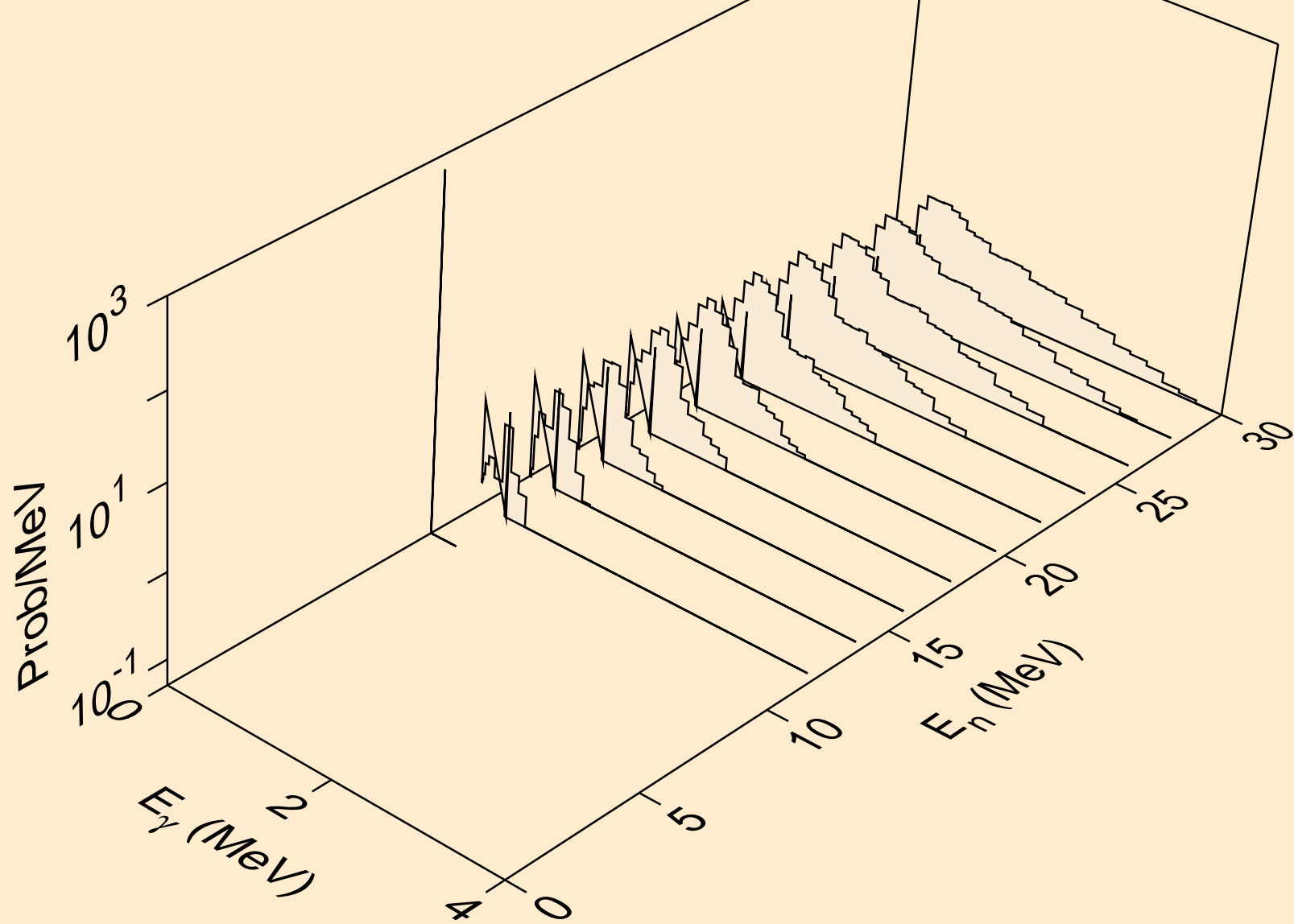

RU089 DEUTERON ACER TENDL-2021 LIBRARY; T=0.K
Particle heating contributions

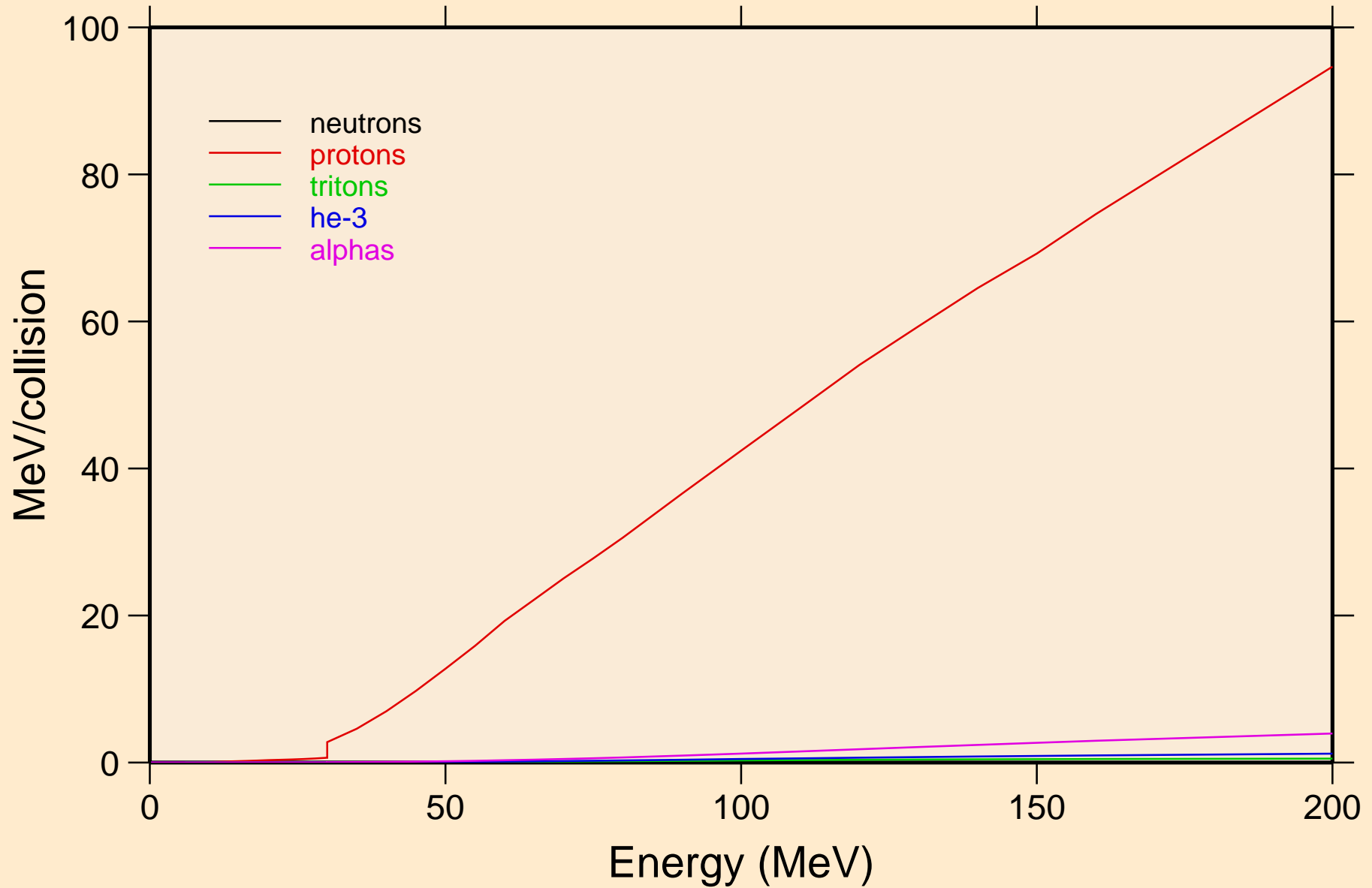

RU089 DEUTERON ACER TENDL-2021 LIBRARY; T=0.K
Recoil Heating

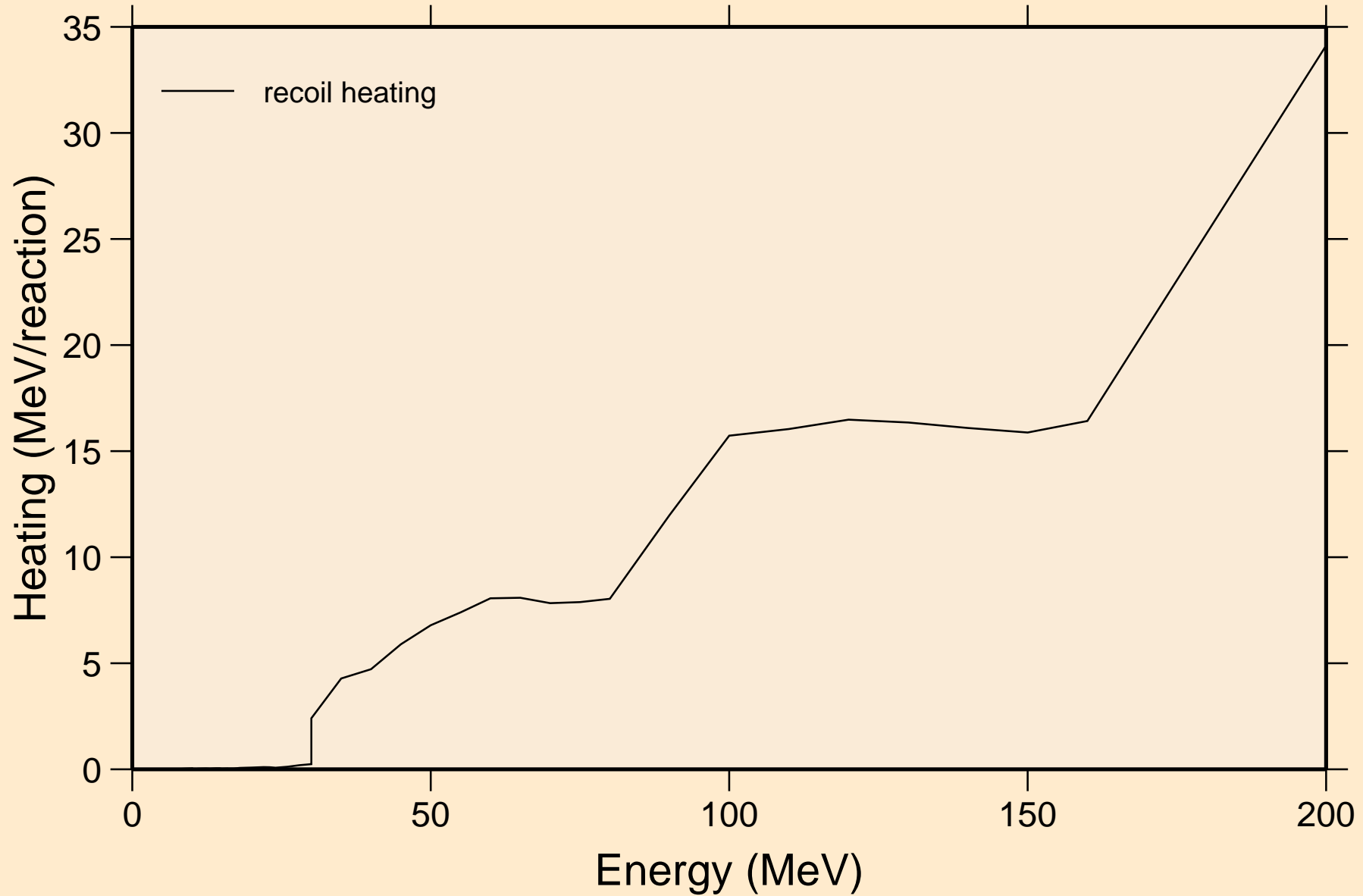

RU089 DEUTERON ACER TENDL-2021 LIBRARY; T=0.K
Particle production cross sections

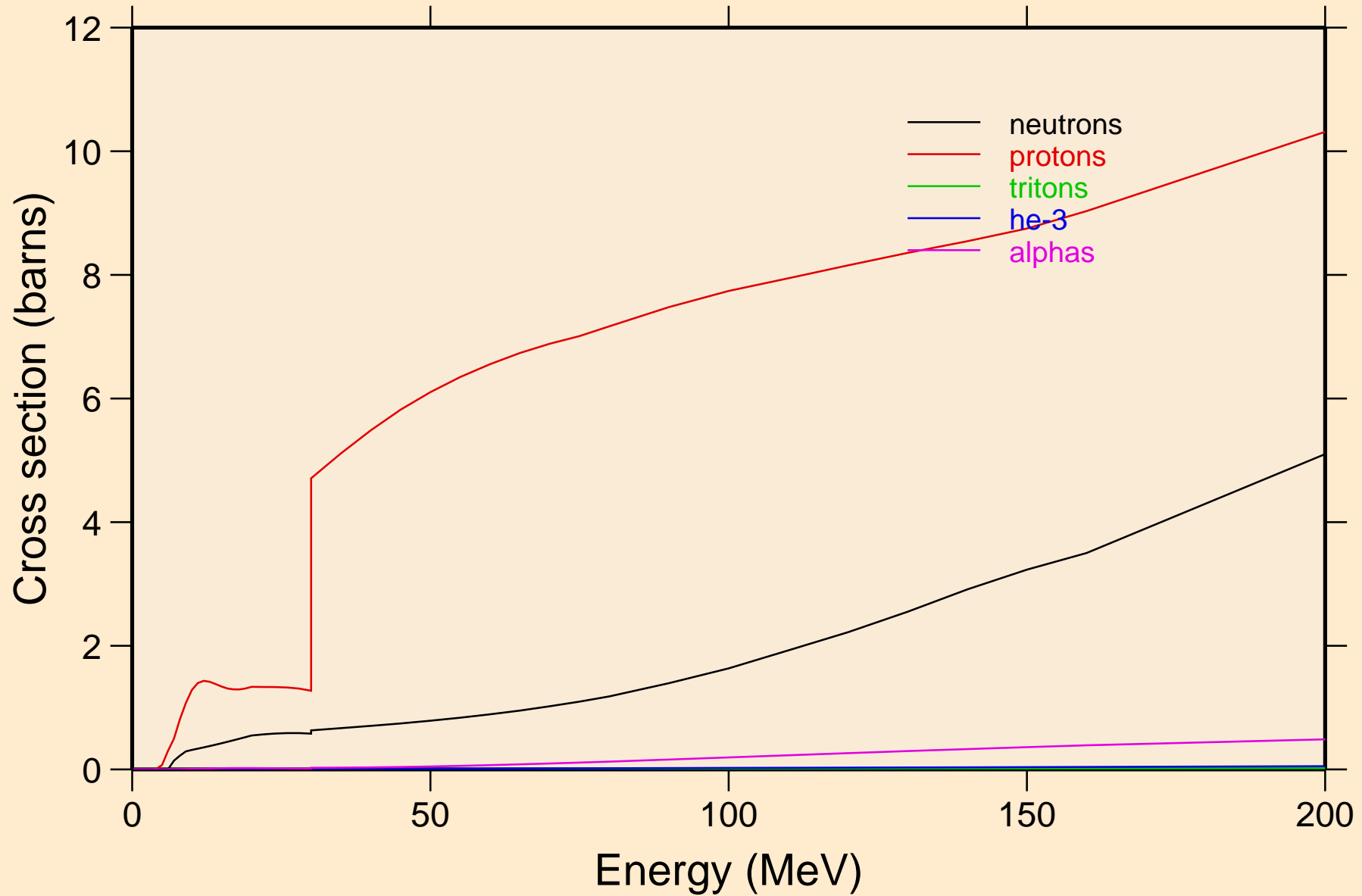

RU089 DEUTERON ACER TENDL-2021 LIBRARY; T=0.K
neutrons from (d,n)

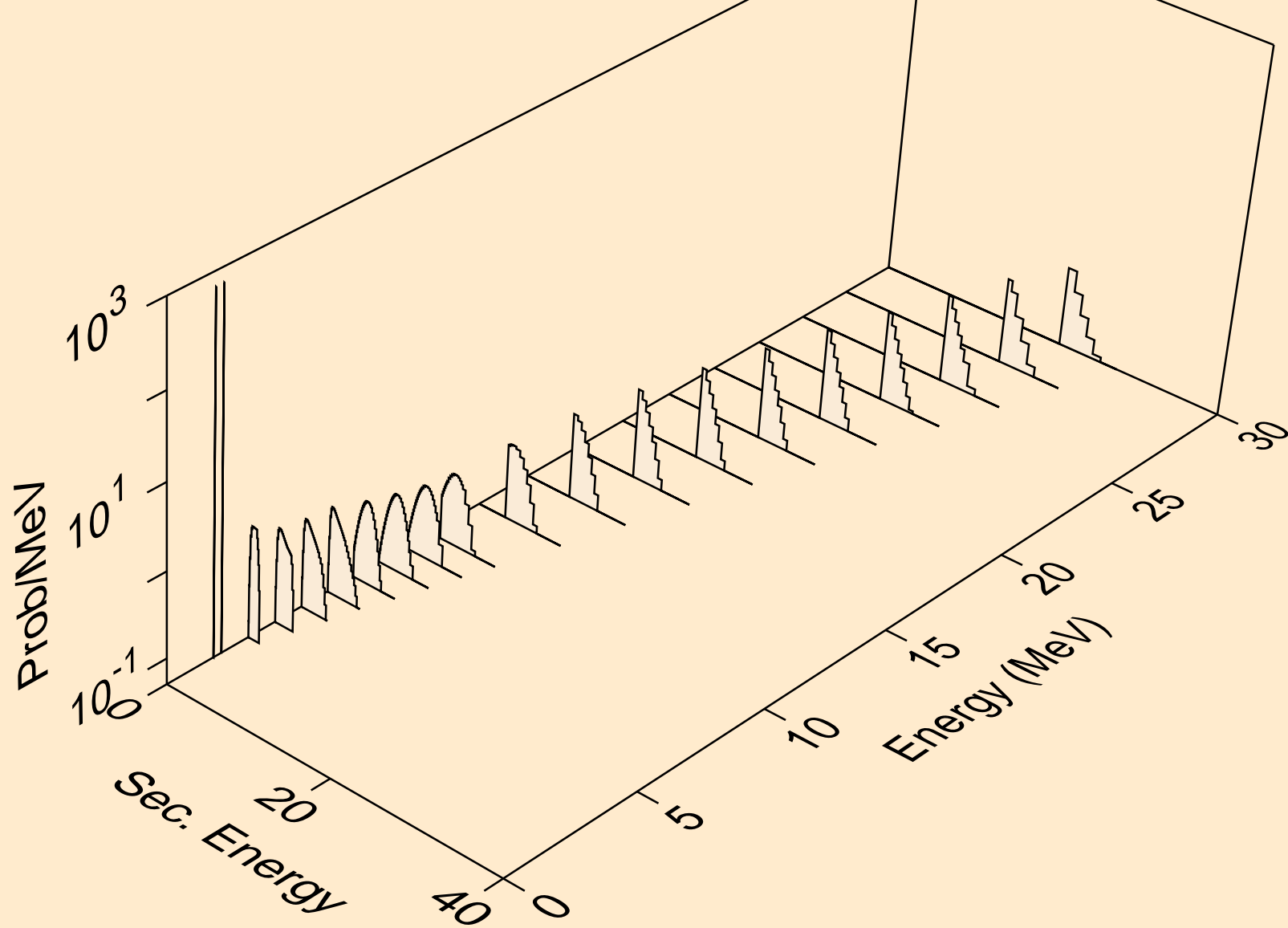

RU089 DEUTERON ACER TENDL-2021 LIBRARY; T=0.K
neutrons from (d,x)

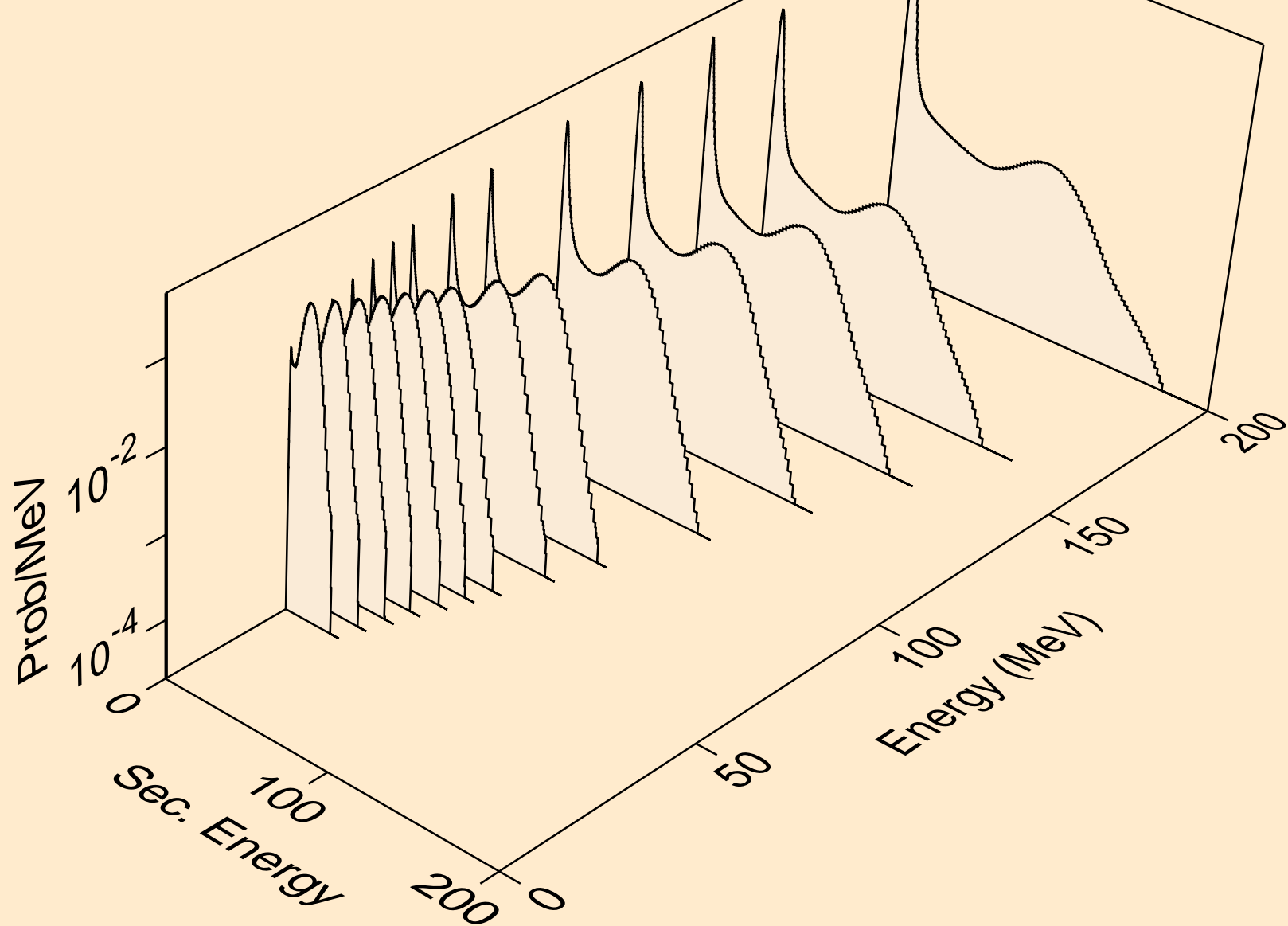

RU089 DEUTERON ACER TENDL-2021 LIBRARY; T=0.K
neutrons from (d,2n)

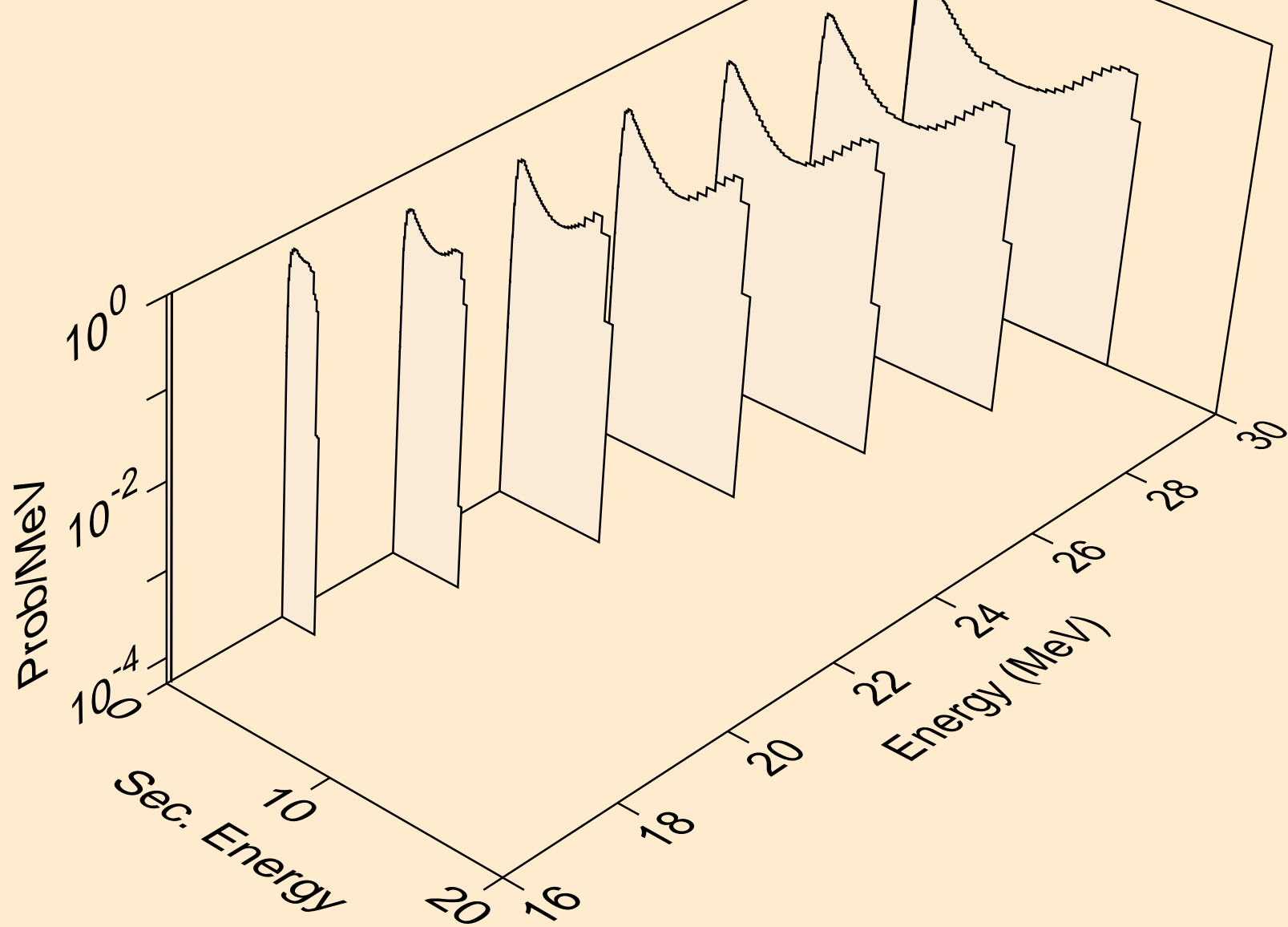

RU089 DEUTERON ACER TENDL-2021 LIBRARY; T=0.K
neutrons from (d,n*)a

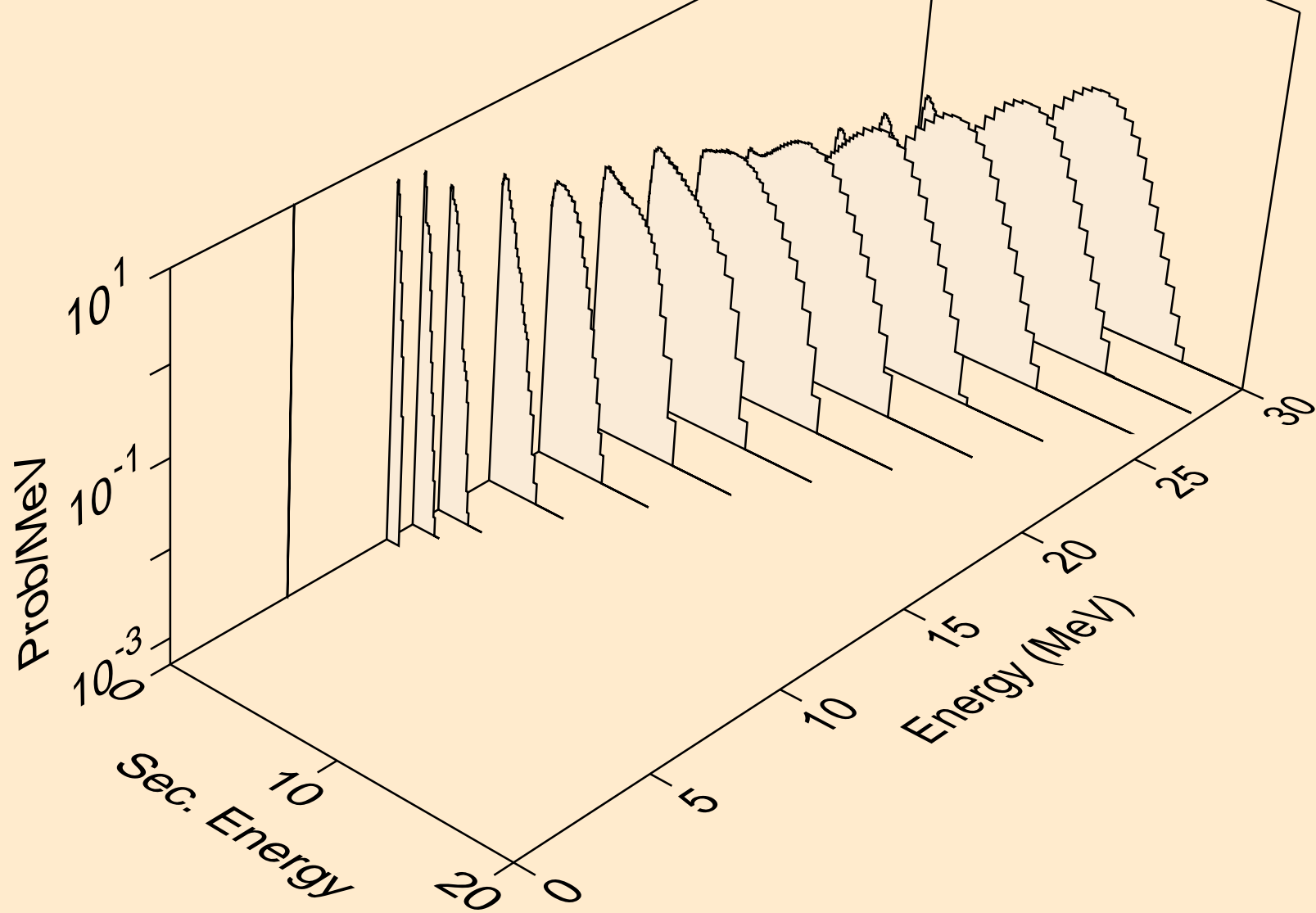

RU089 DEUTERON ACER TENDL-2021 LIBRARY; T=0.K
neutrons from (d,n*)p

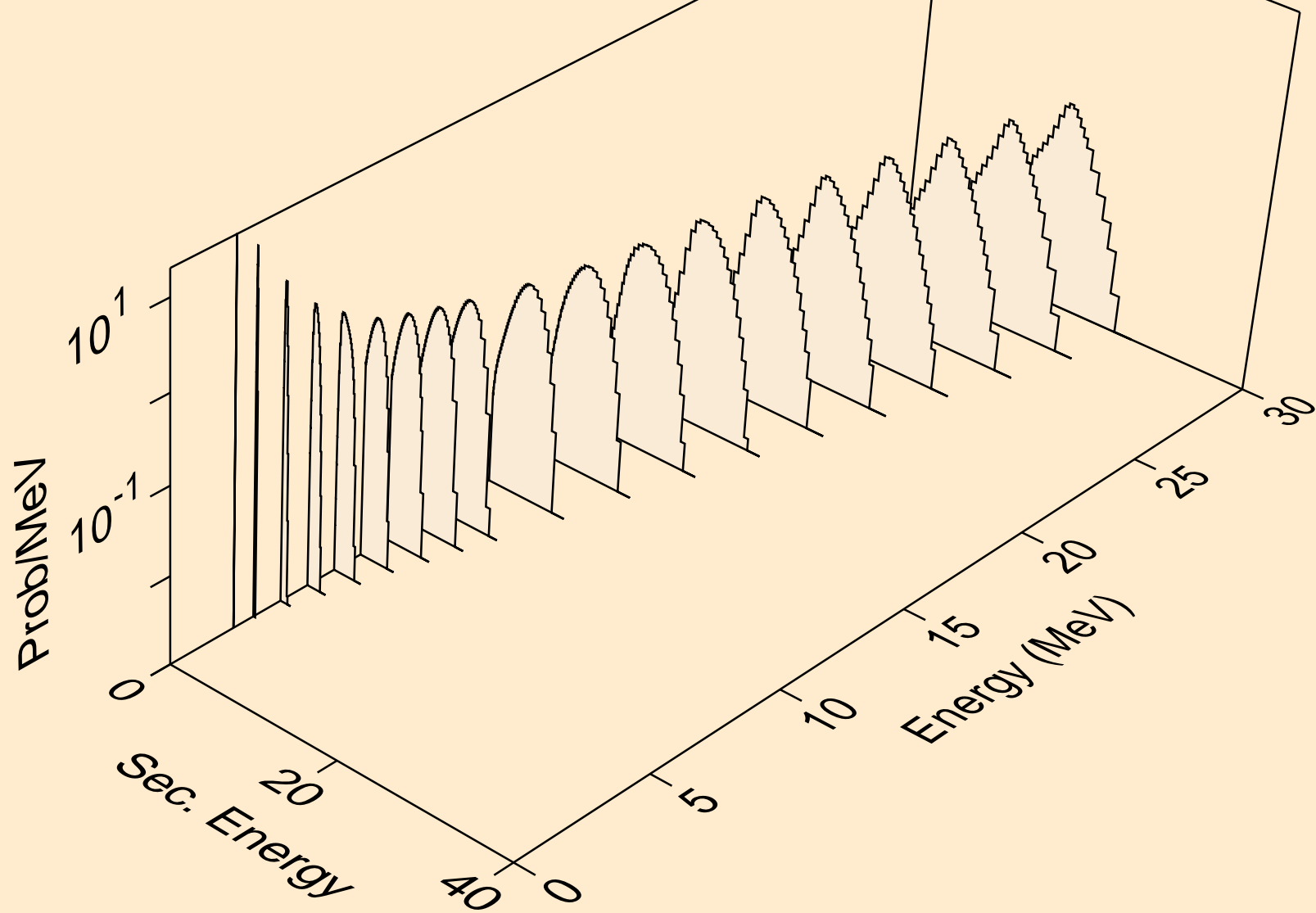

RU089 DEUTERON ACER TENDL-2021 LIBRARY; T=0.K
neutrons from (d,n*)2a

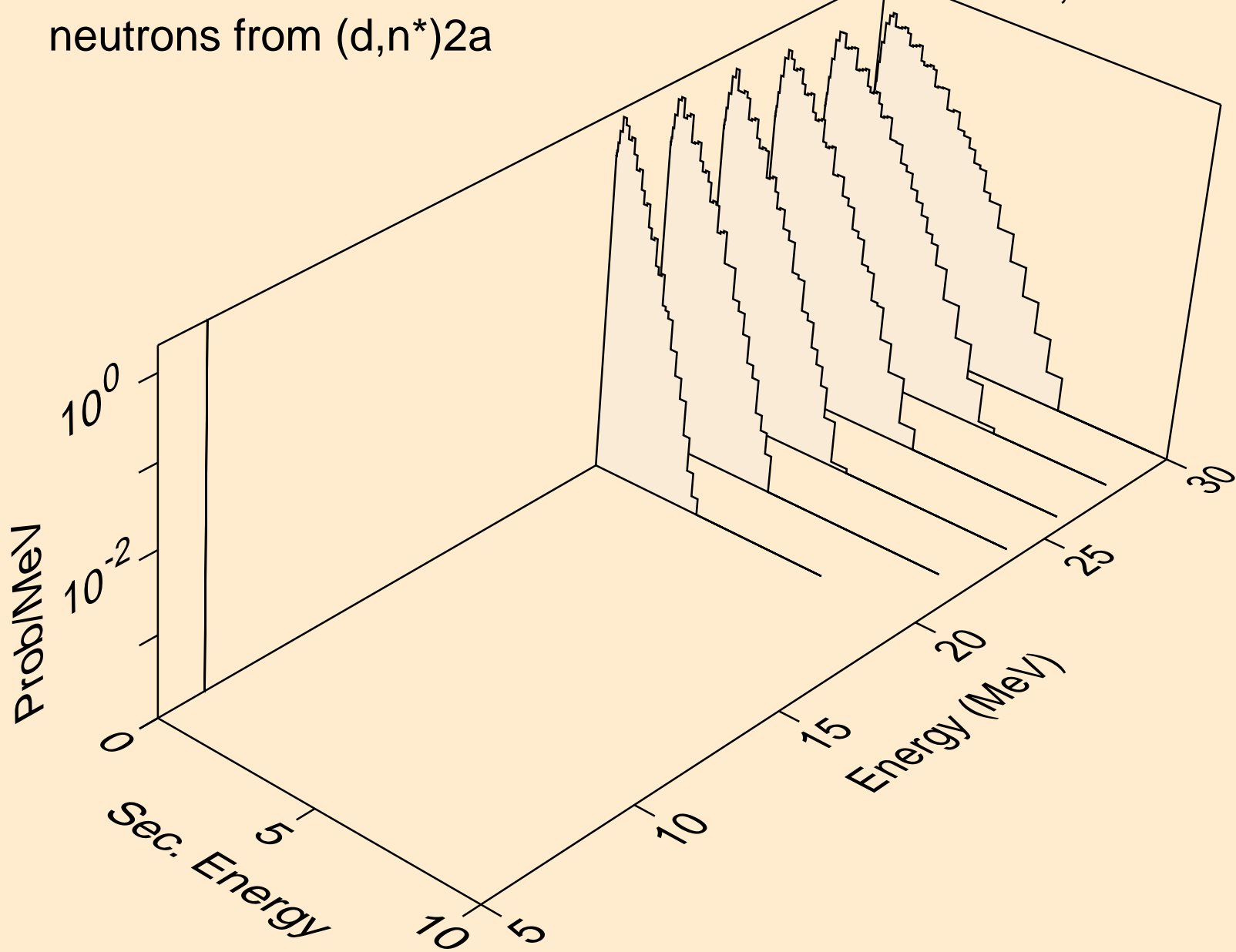

RU089 DEUTERON ACER TENDL-2021 LIBRARY; T=0.K
neutrons from (d,n*)d

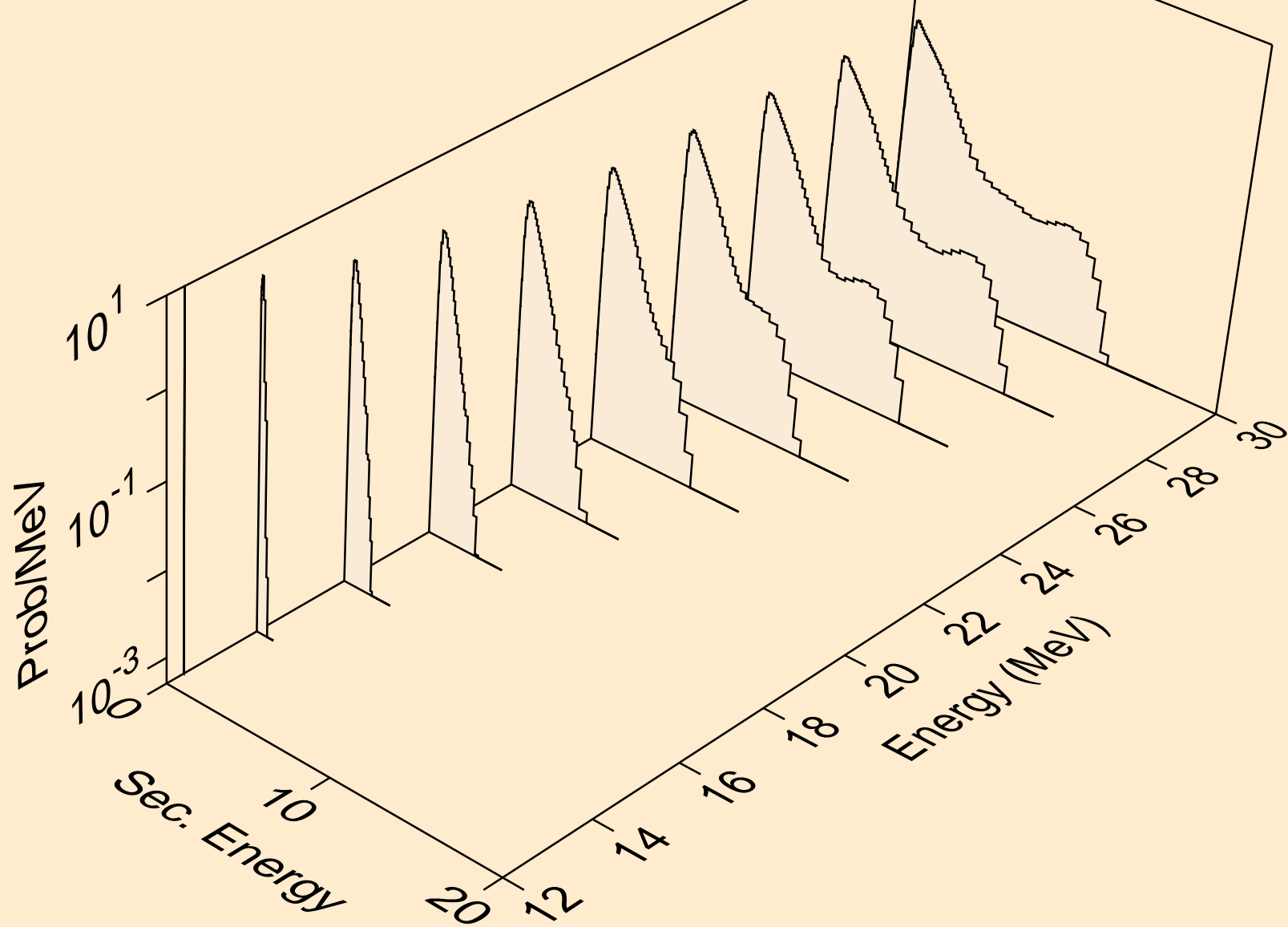

RU089 DEUTERON ACER TENDL-2021 LIBRARY; T=0.K
neutrons from (d,n*)t

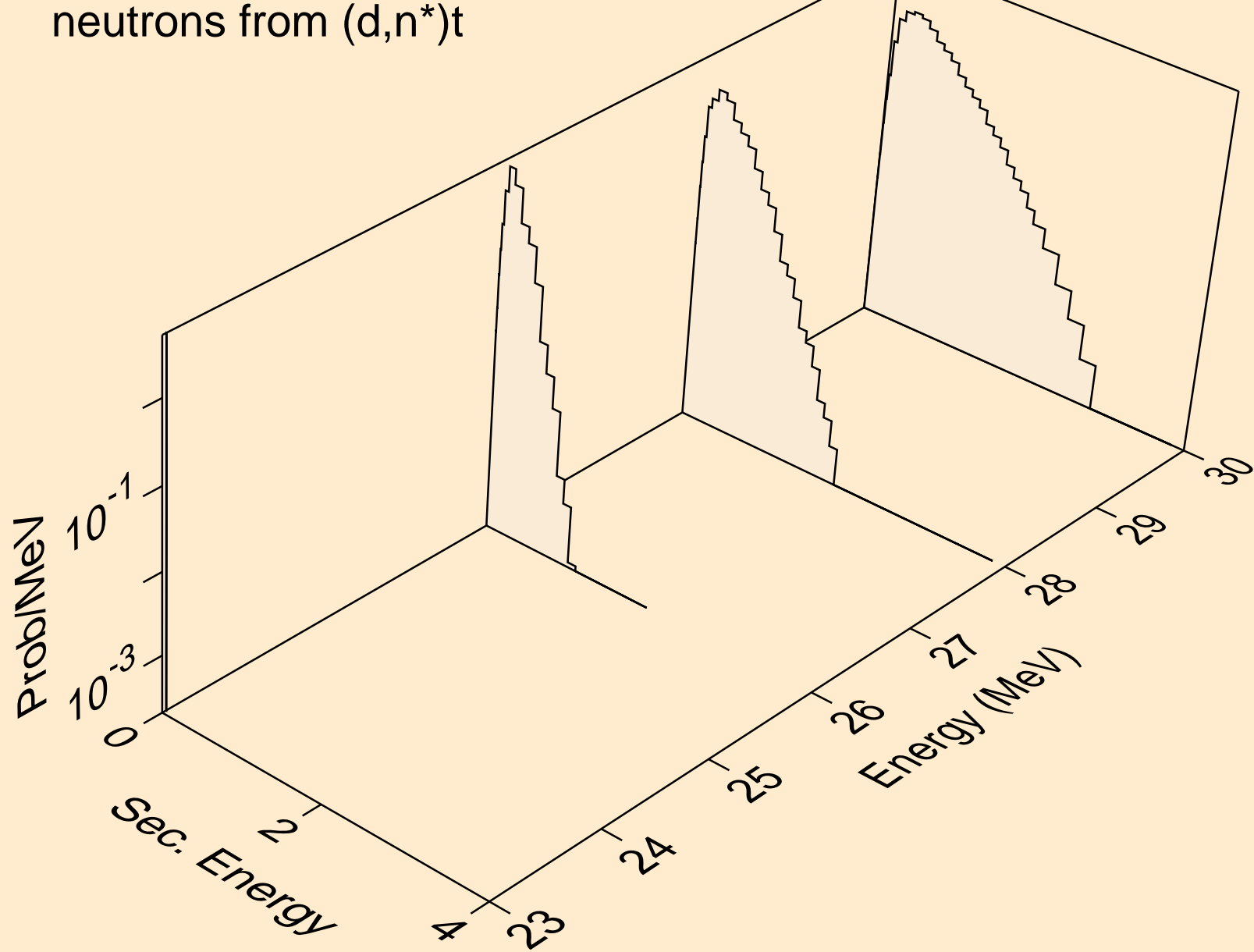

RU089 DEUTERON ACER TENDL-2021 LIBRARY; T=0.K
neutrons from (d,n*)he3

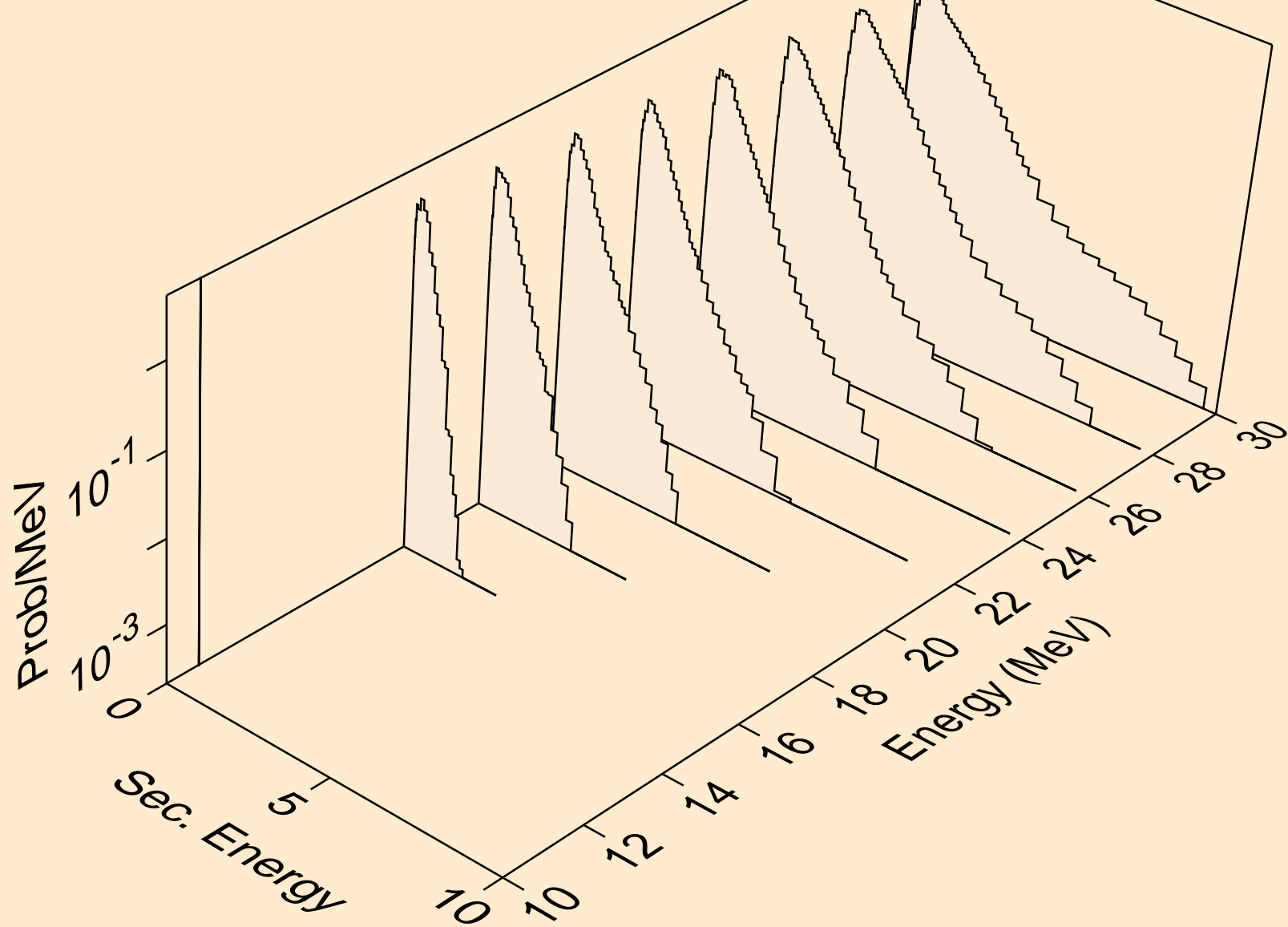

RU089 DEUTERON ACER TENDL-2021 LIBRARY; T=0.K
neutrons from (d,2np)

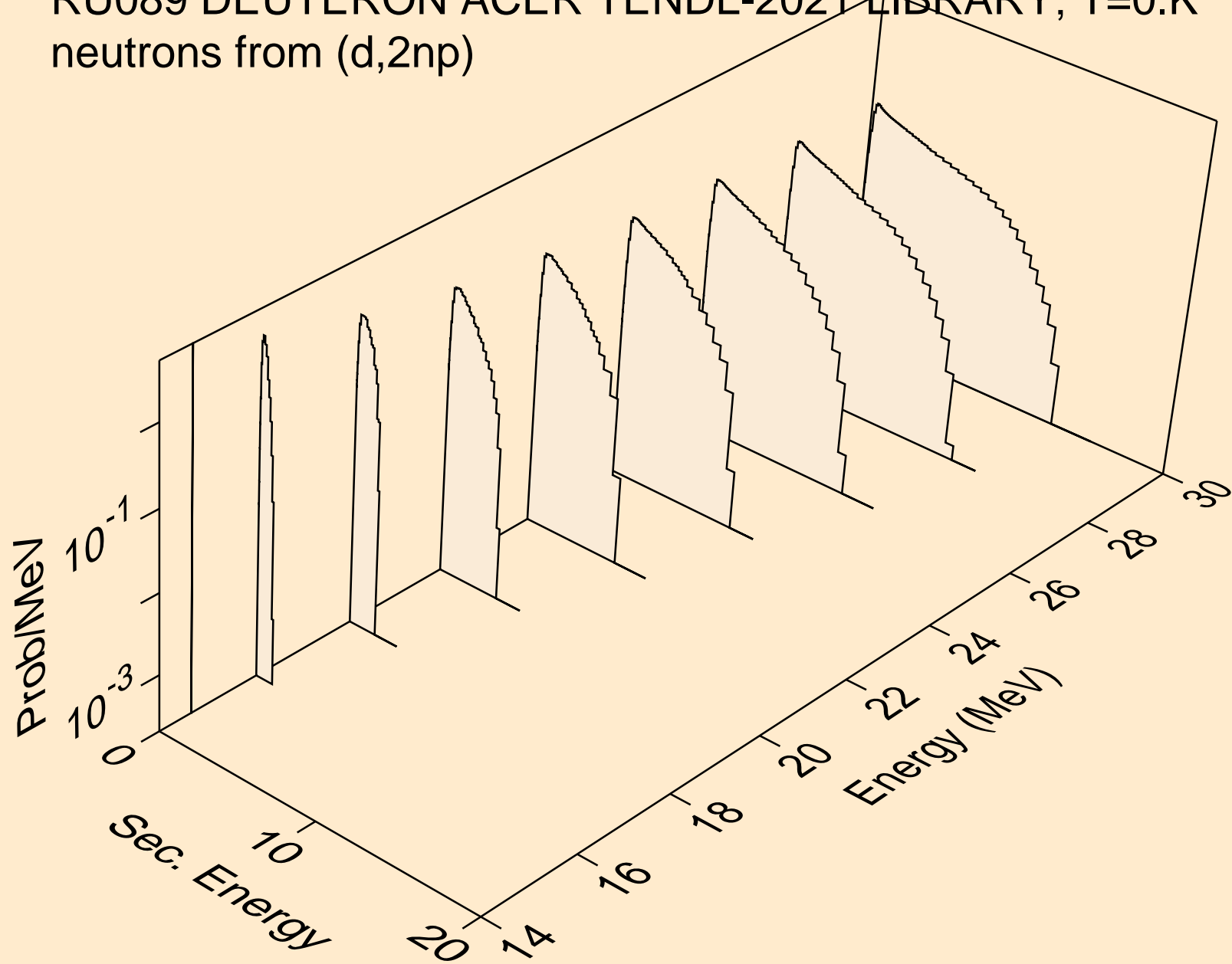

RU089 DEUTERON ACER TENDL-2021 LIBRARY; T=0.K
neutrons from (d,2np)

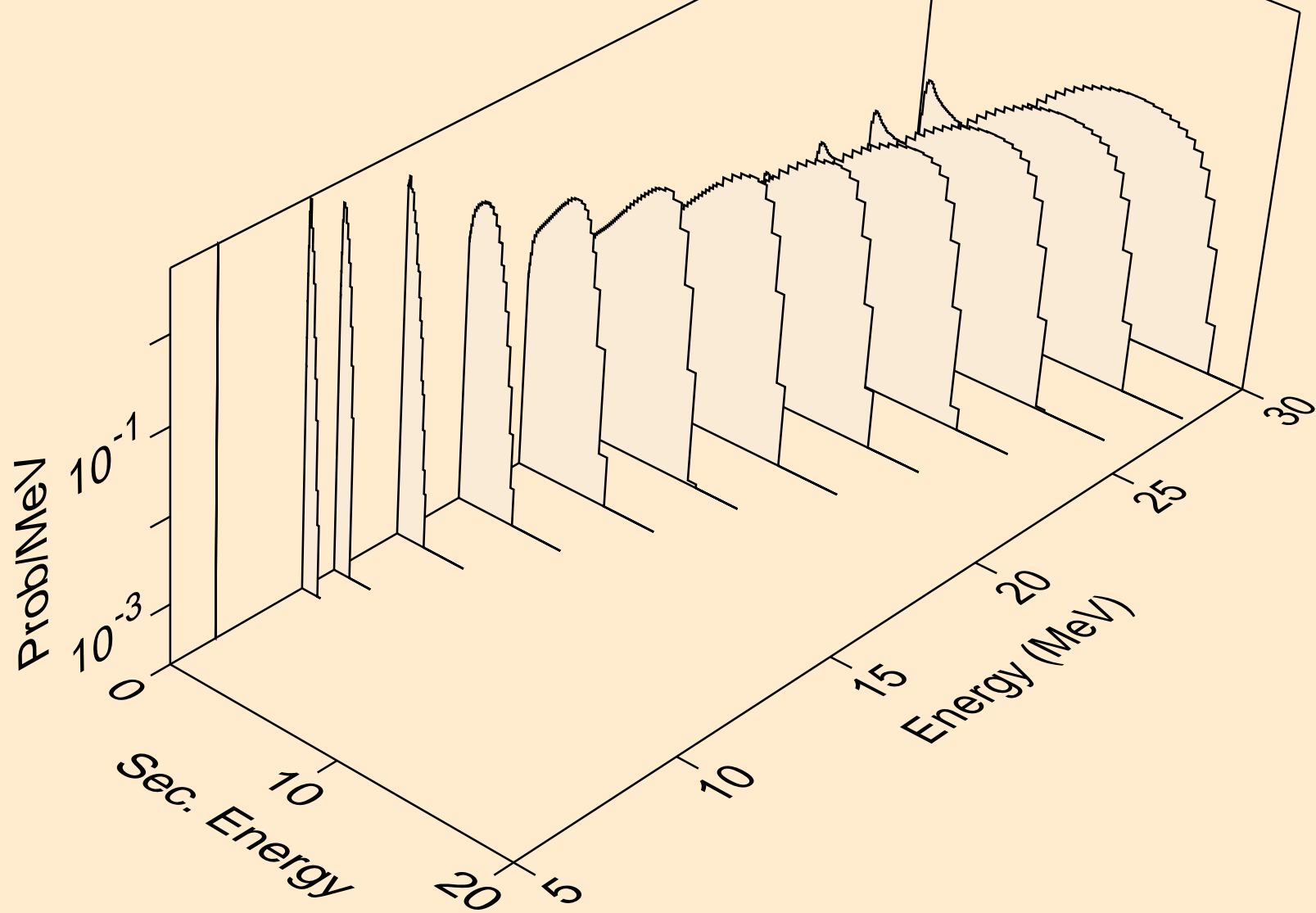

RU089 DEUTERON ACER TENDL-2021 LIBRARY; T=0.K
neutrons from (d,npa)

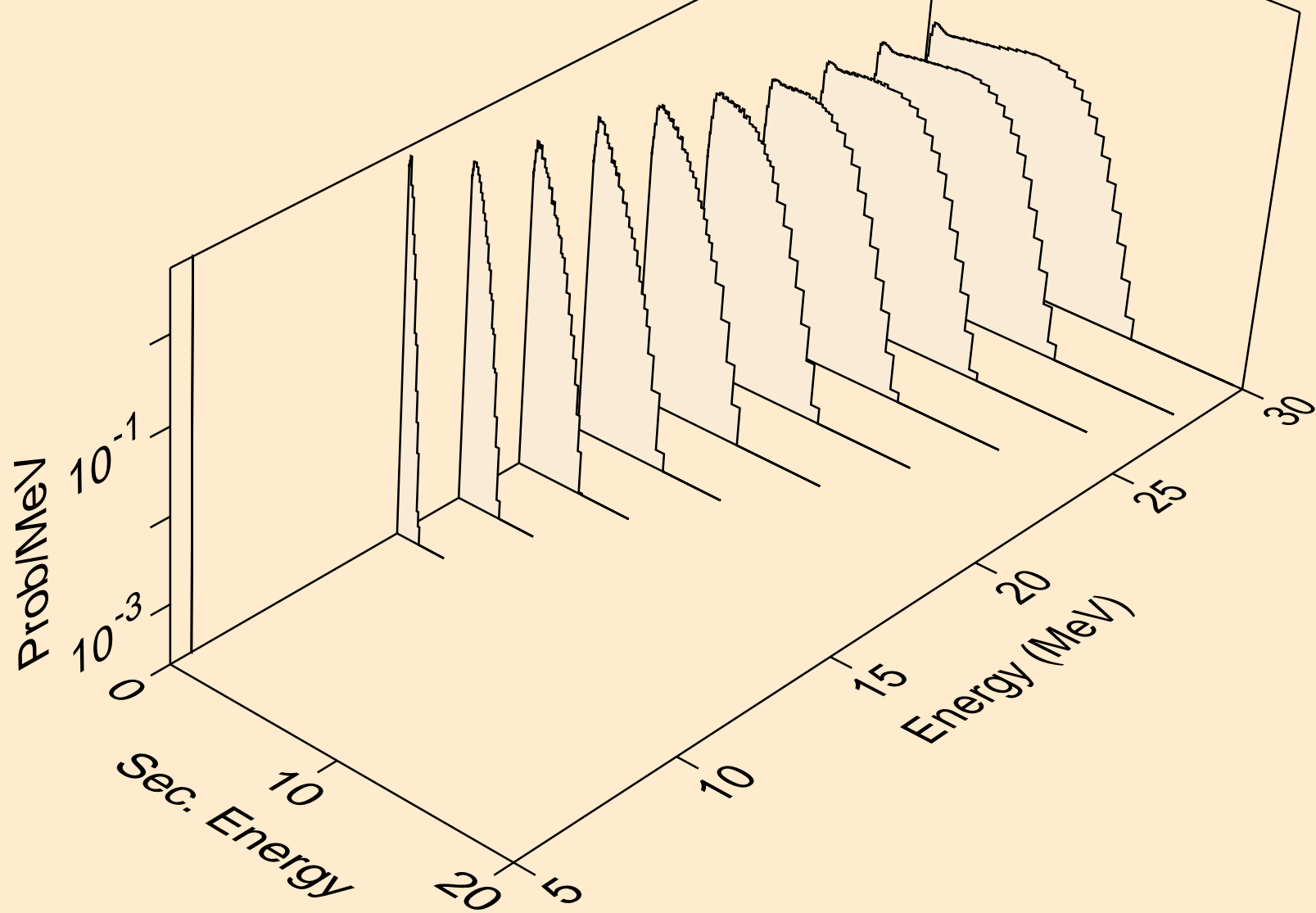

RU089 DEUTERON ACER TENDL-2021 LIBRARY; T=0.K
protons from (d,x)

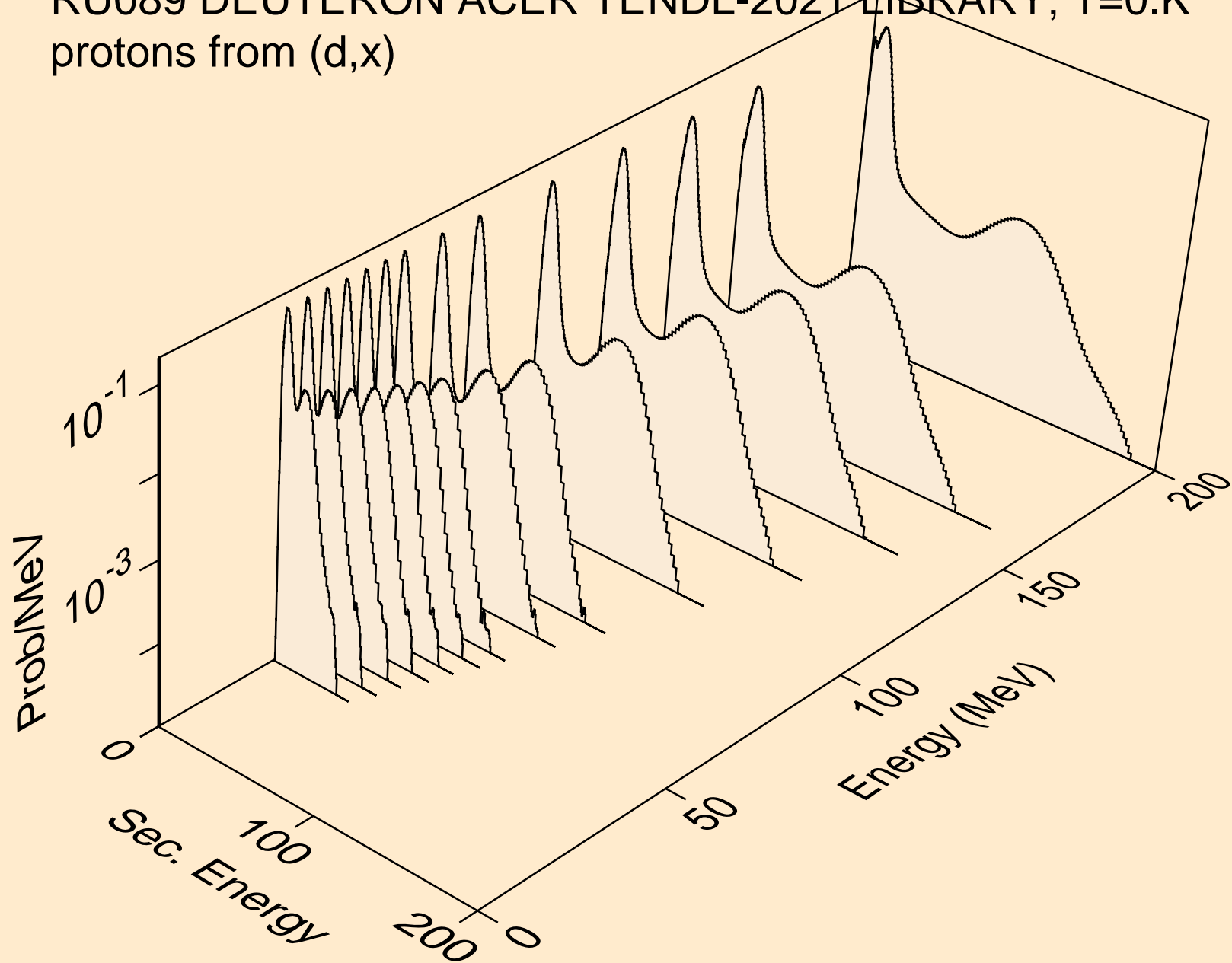

RU089 DEUTERON ACER TENDL-2021 LIBRARY; T=0.K
protons from (d,n*)p

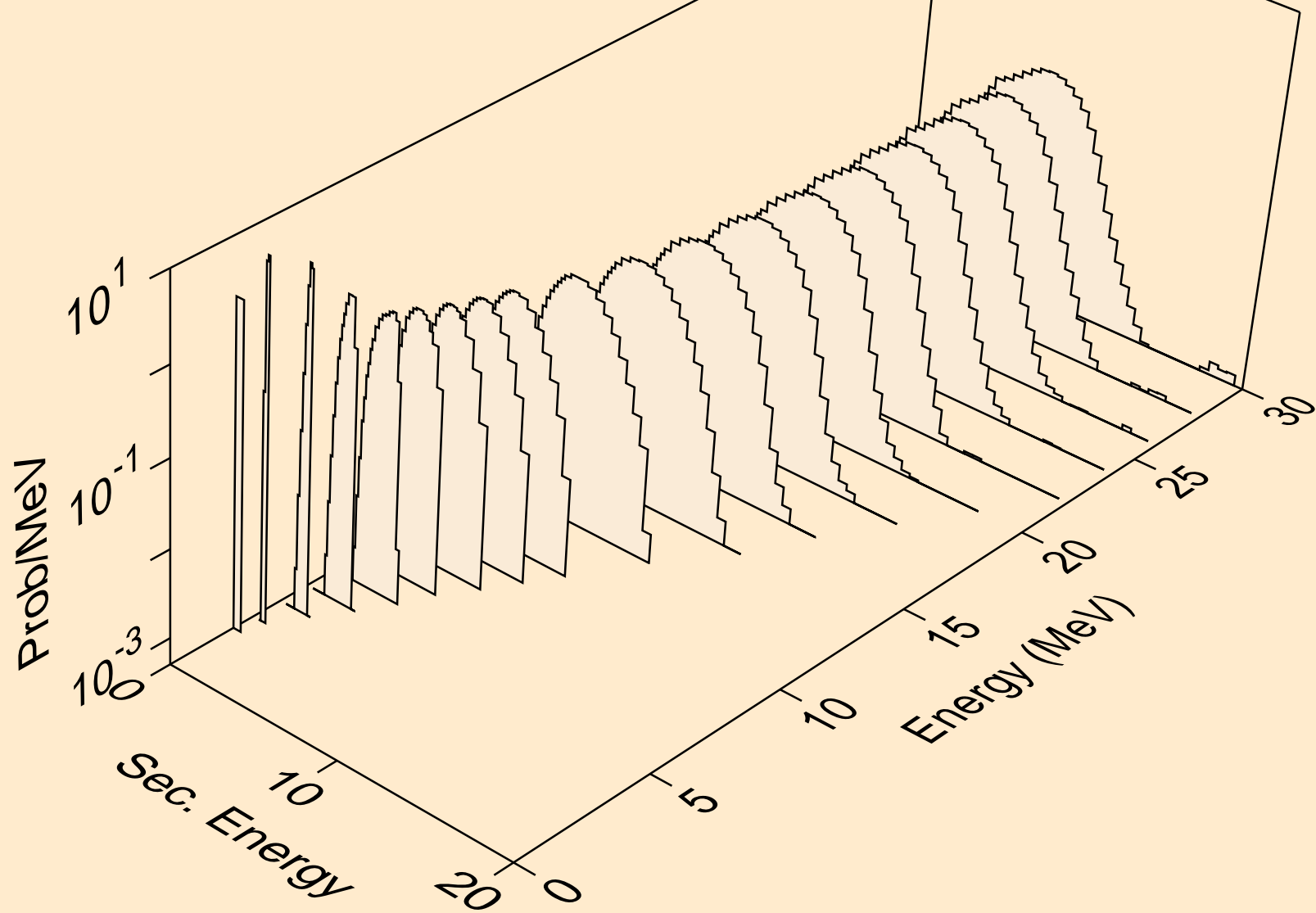

RU089 DEUTERON ACER TENDL-2021 LIBRARY; T=0.K
protons from (d,2np)

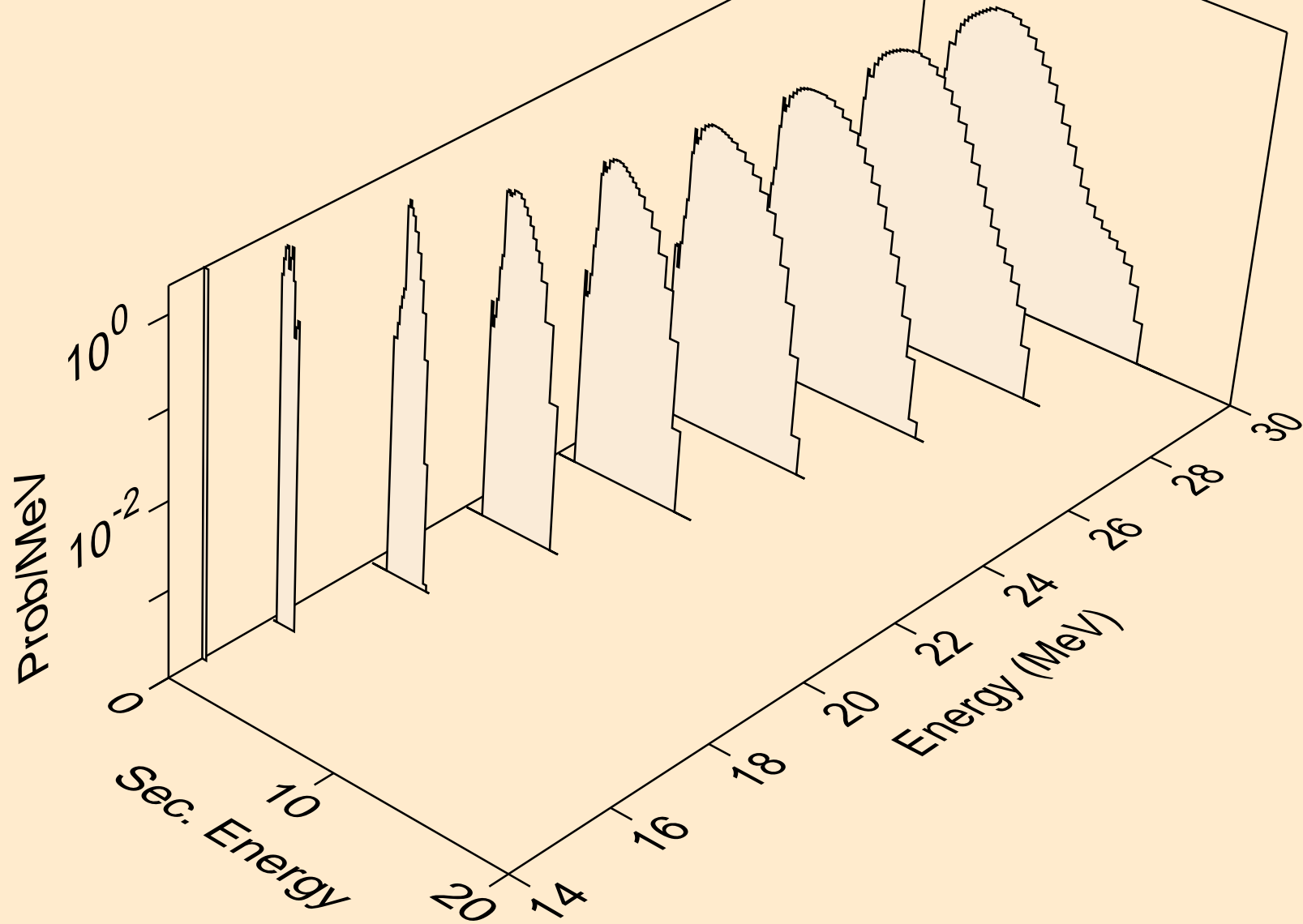

RU089 DEUTERON ACER TENDL-2021 LIBRARY; T=0.K
protons from (d,2np)

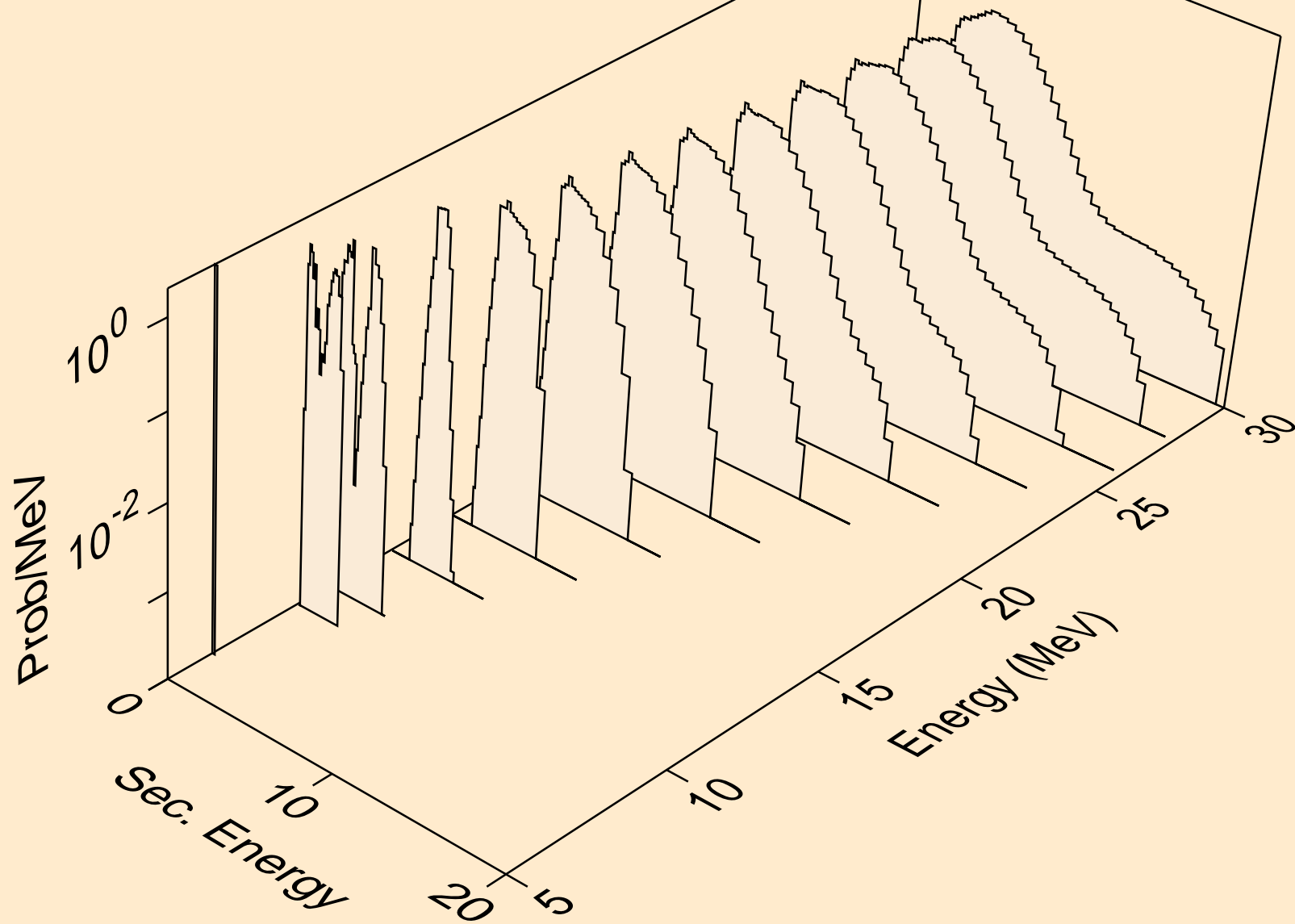

RU089 DEUTERON ACER TENDL-2021 LIBRARY; T=0.K
protons from (d,npa)

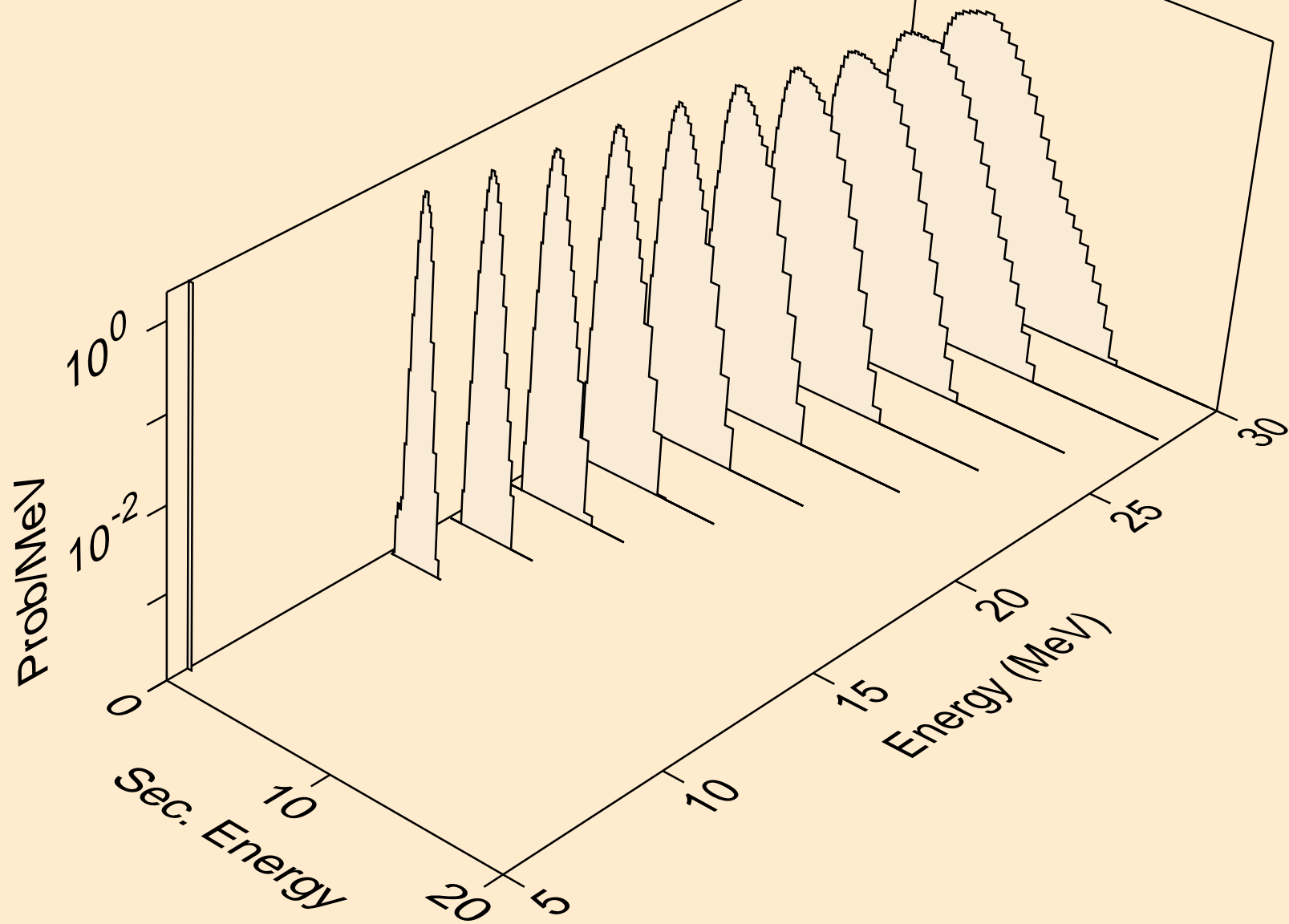

RU089 DEUTERON ACER TENDL-2021 LIBRARY; T=0.K
protons from (d,p)

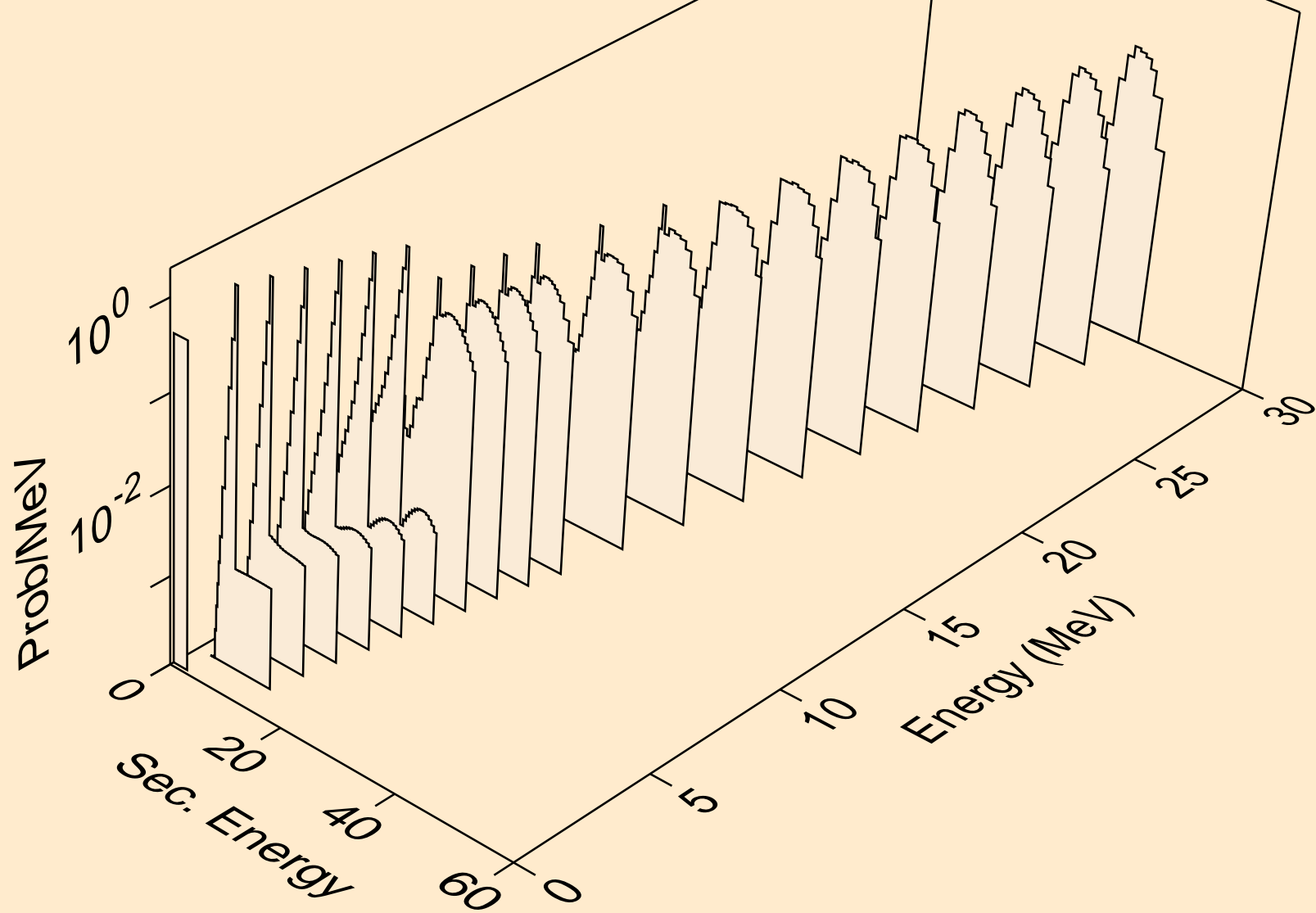

RU089 DEUTERON ACER TENDL-2021 LIBRARY; T=0.K
protons from (d,2p)

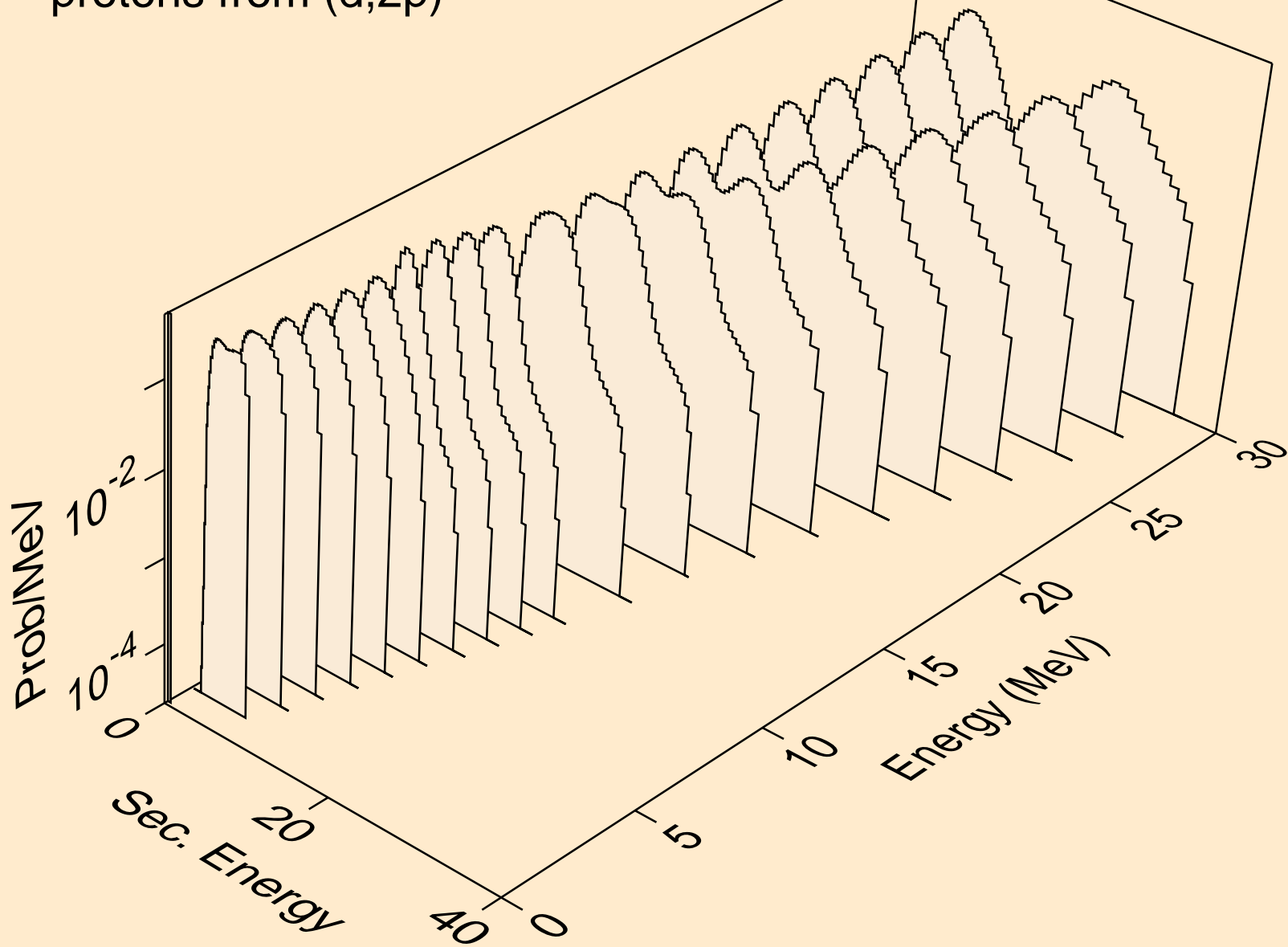

RU089 DEUTERON ACER TENDL-2021 LIBRARY; T=0.K
protons from (d,pa)

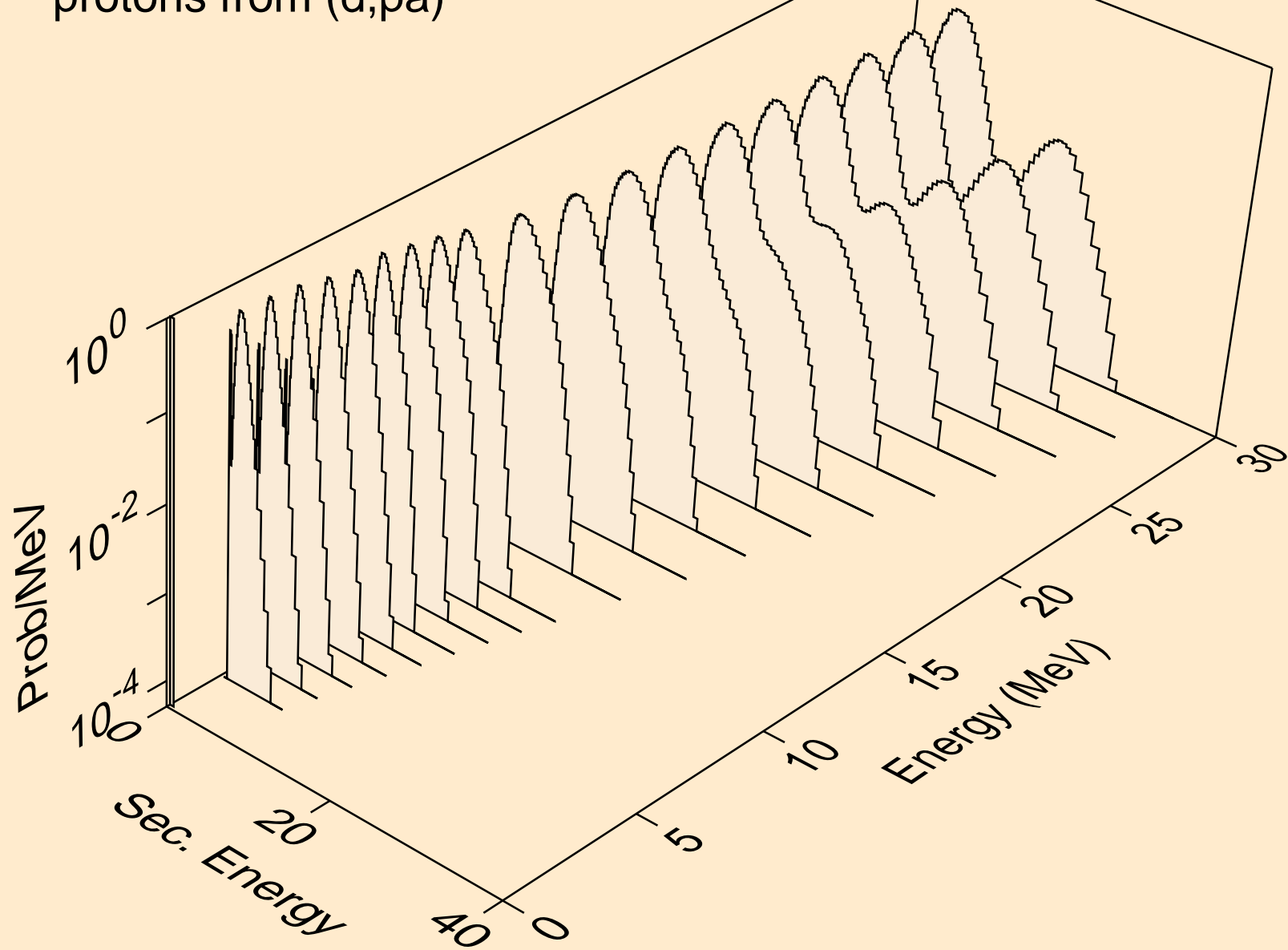

RU089 DEUTERON ACER TENDL-2021 LIBRARY; T=0.K
protons from (d,pd)

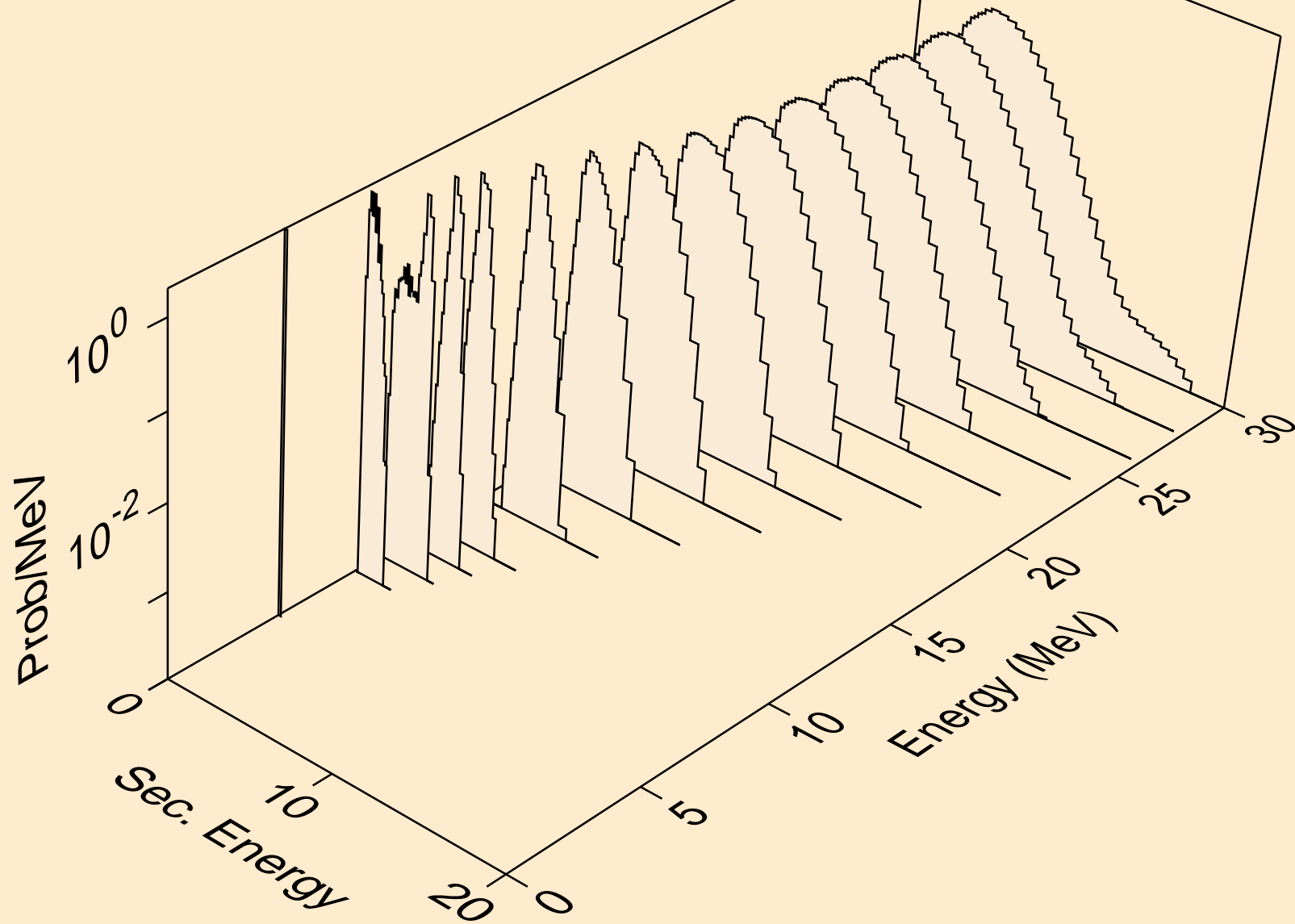

RU089 DEUTERON ACER TENDL-2021 LIBRARY; T=0.K
protons from (d,pt)

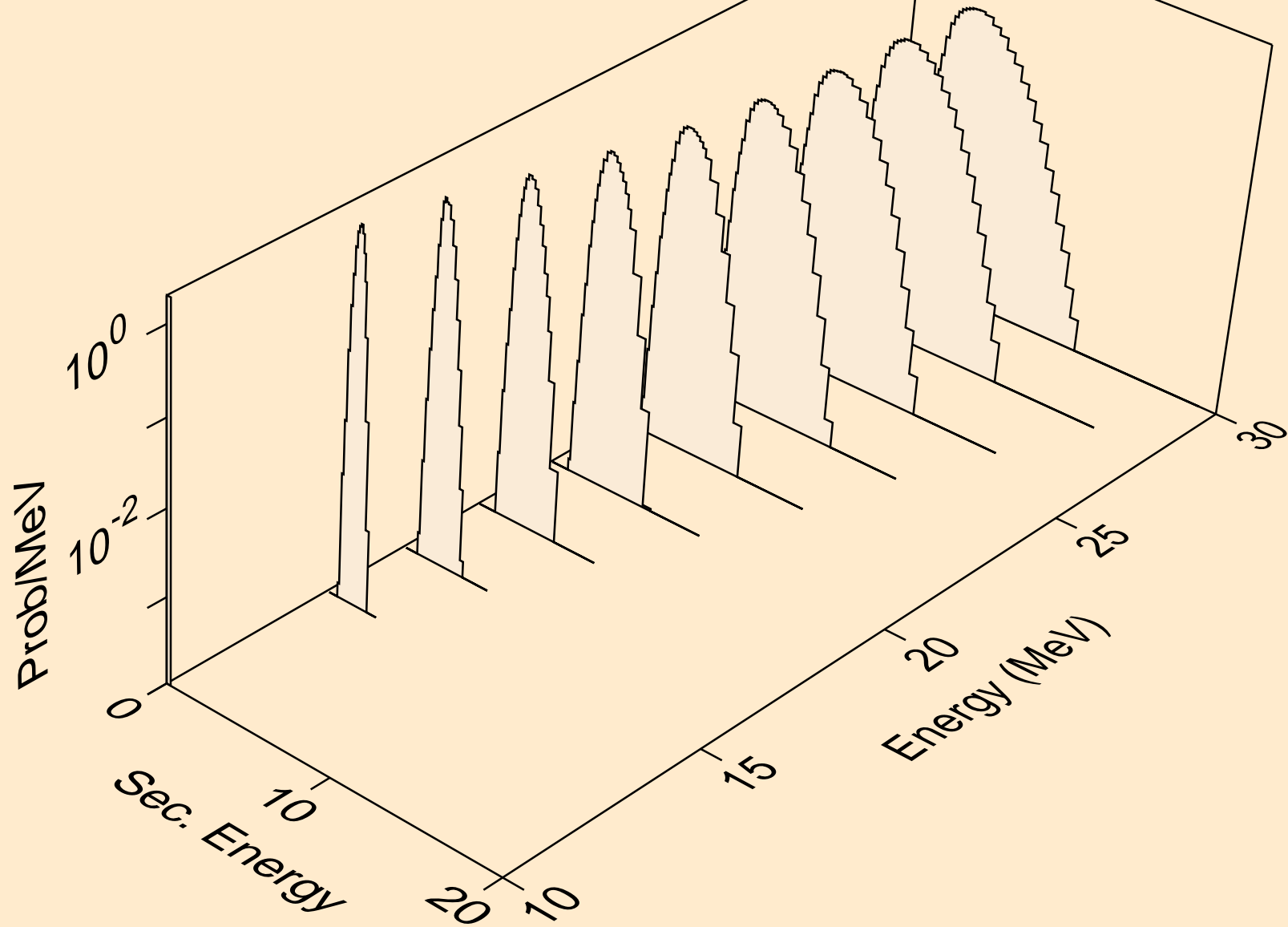

RU089 DEUTERON ACER TENDL-2021 LIBRARY; T=0.K
tritons from (d,x)

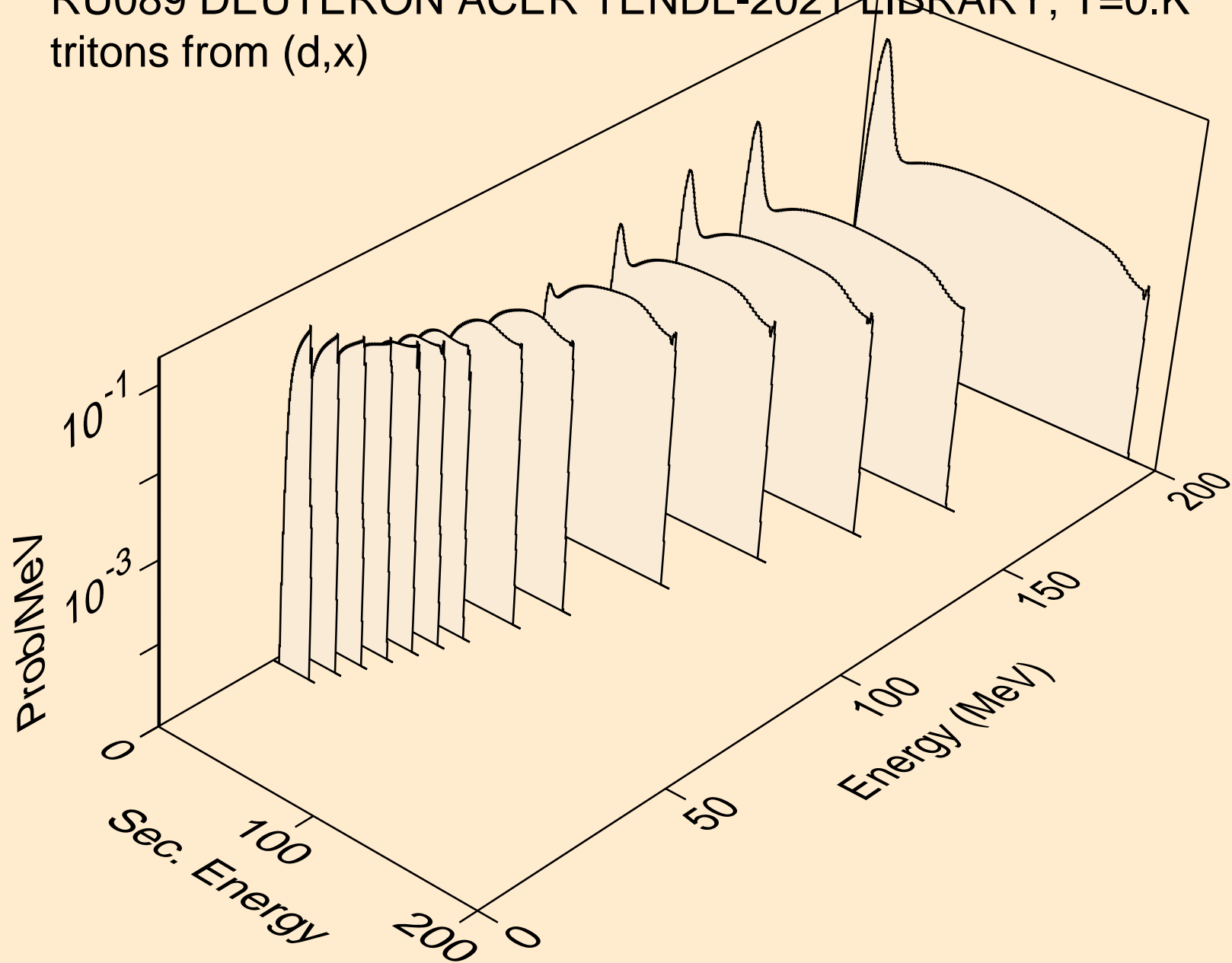

RU089 DEUTERON ACER TENDL-2021 LIBRARY; T=0.K
tritons from (d,n*)t

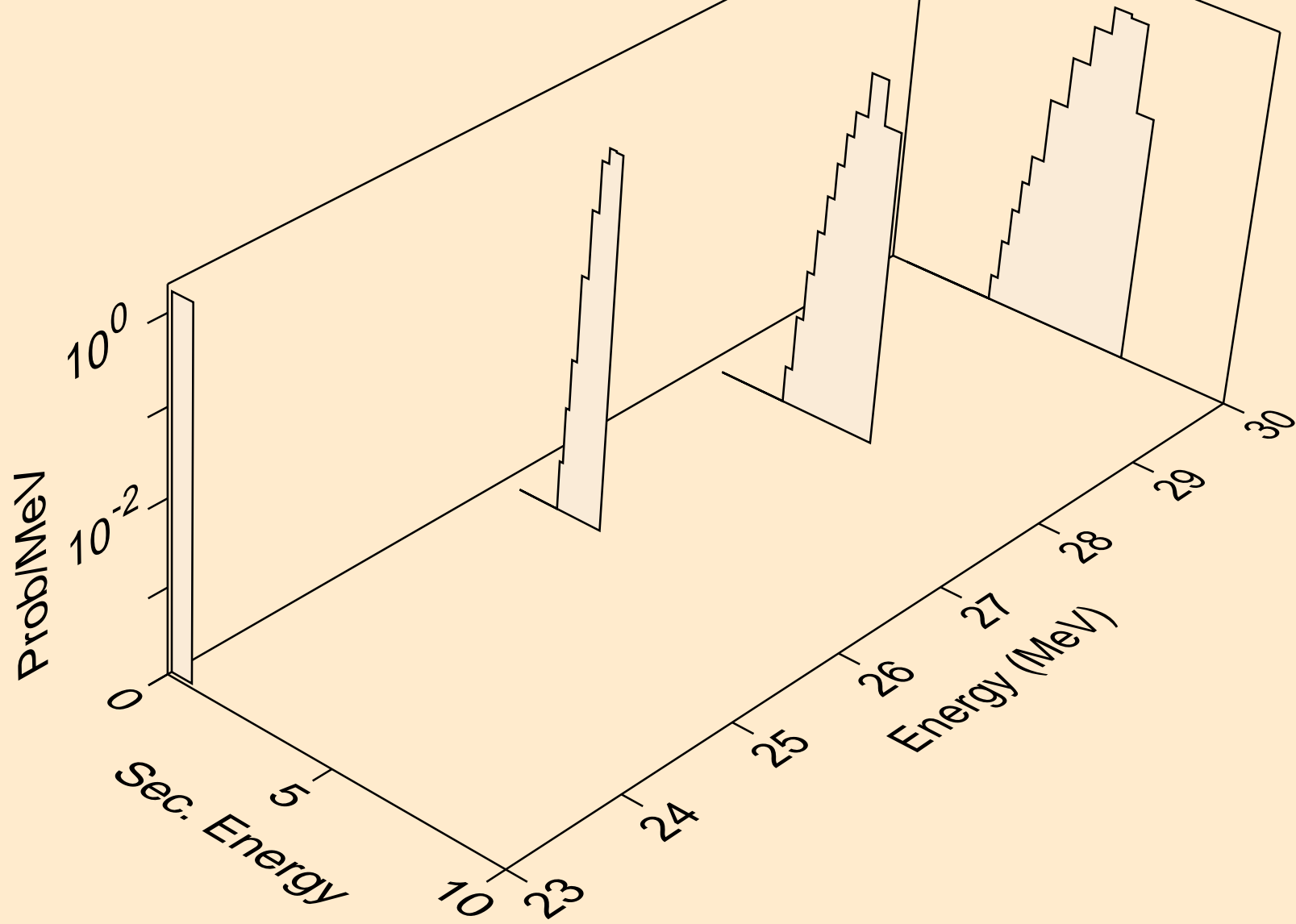

RU089 DEUTERON ACER TENDL-2021 LIBRARY; T=0.K
tritons from (d,t)

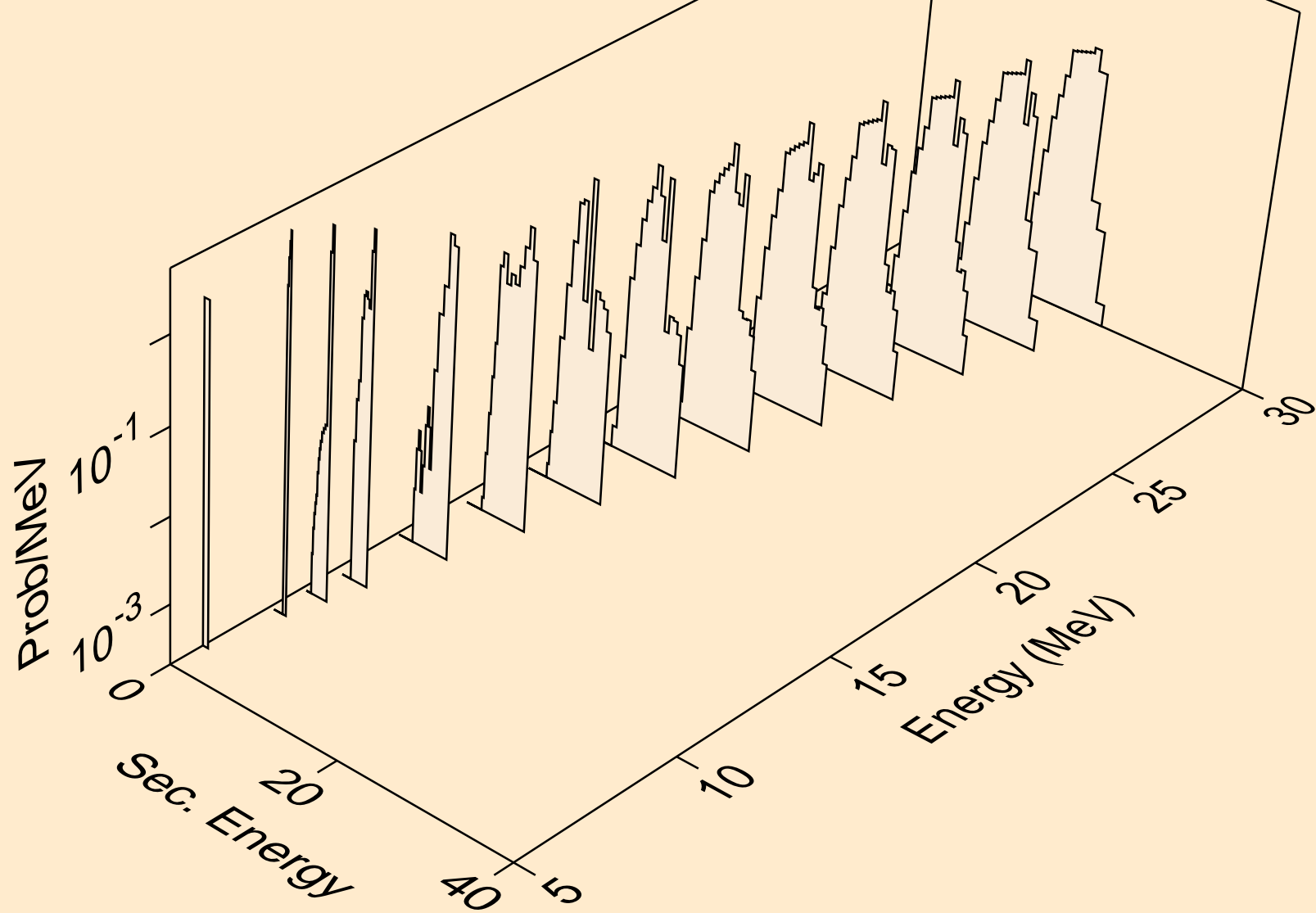

RU089 DEUTERON ACER TENDL-2021 LIBRARY; T=0.K
tritons from (d,pt)

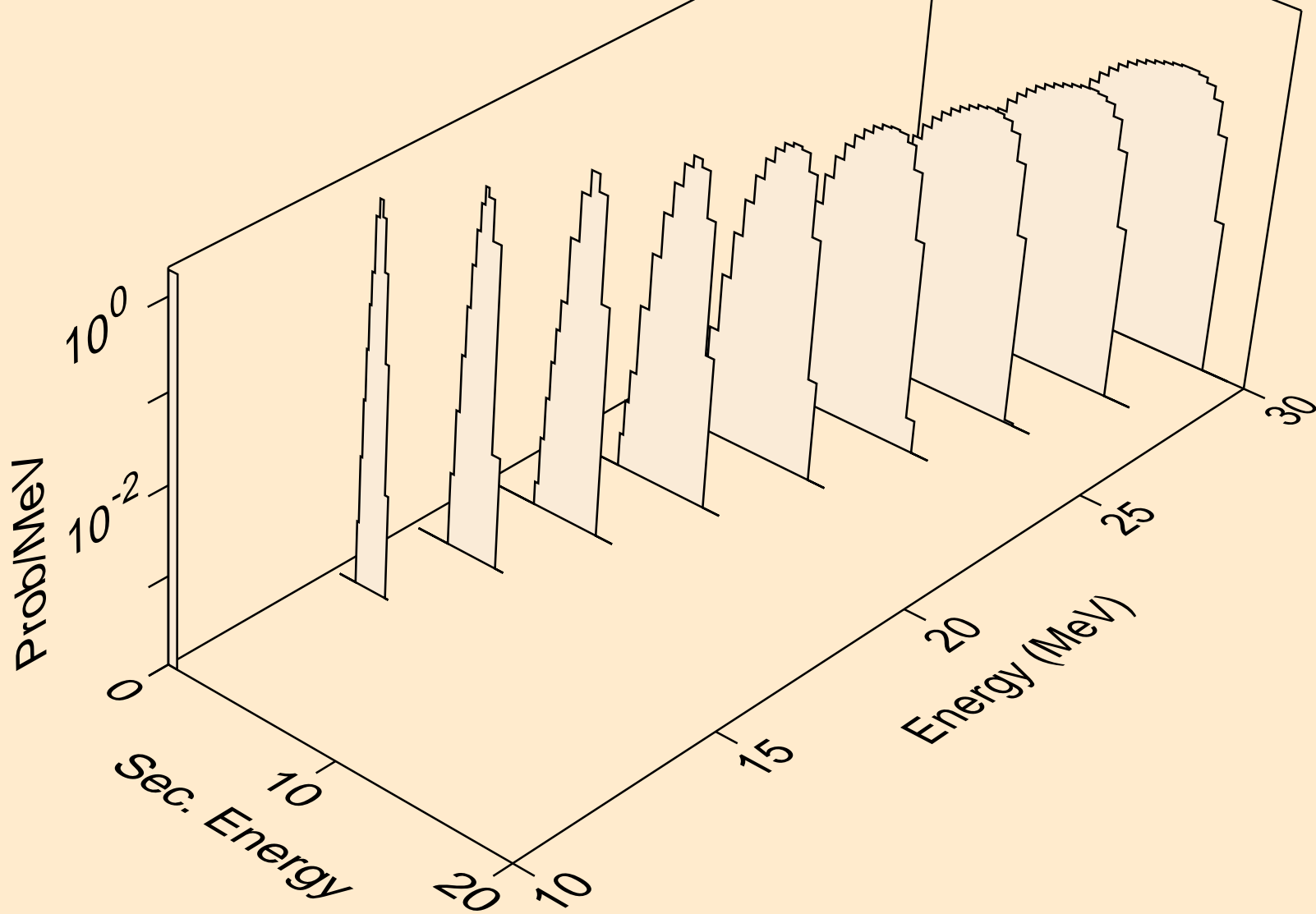

RU089 DEUTERON ACER TENDL-2021 LIBRARY; T=0.K
he3s from (d,x)

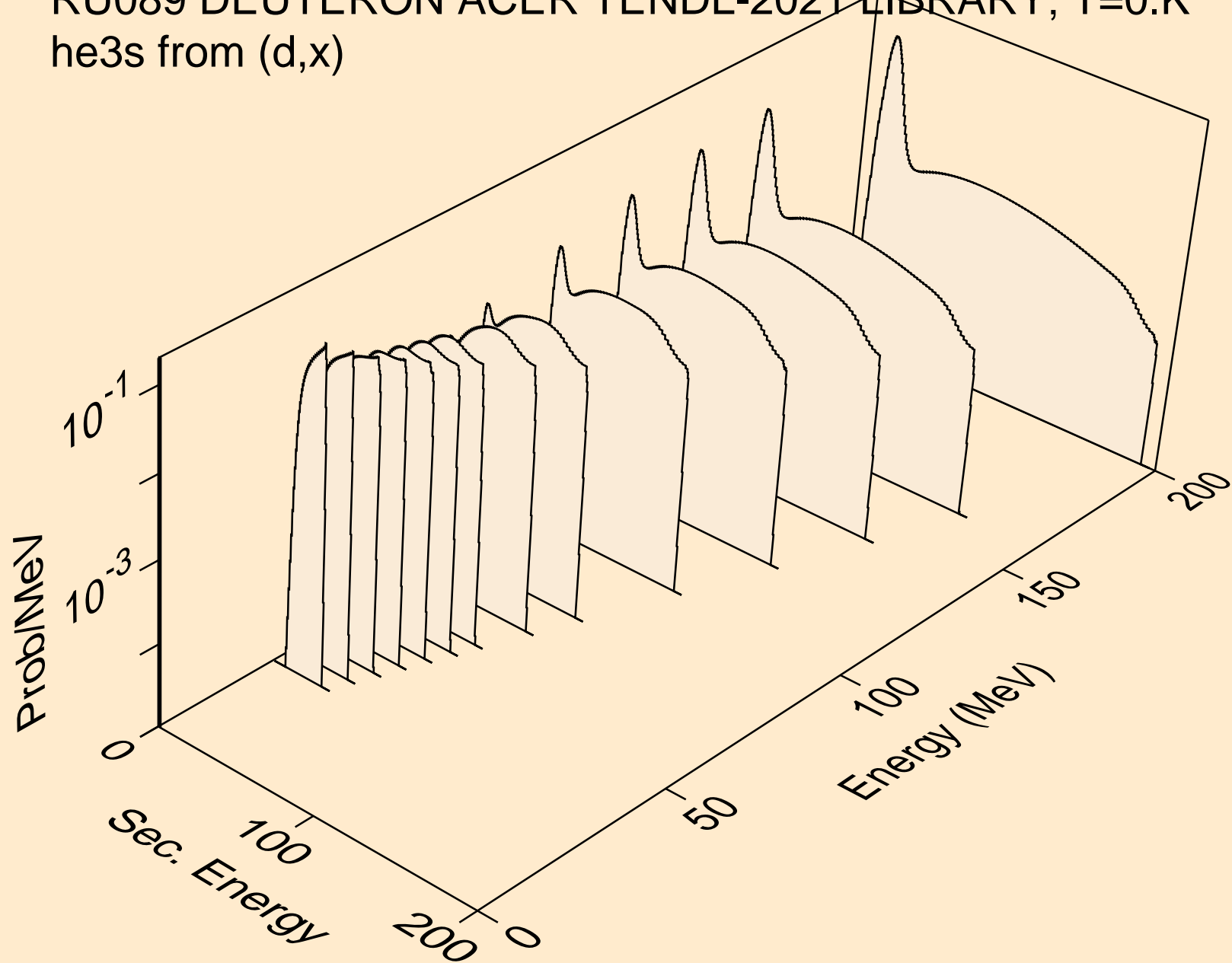

RU089 DEUTERON ACER TENDL-2021 LIBRARY; T=0.K
he3s from (d,n*)he3

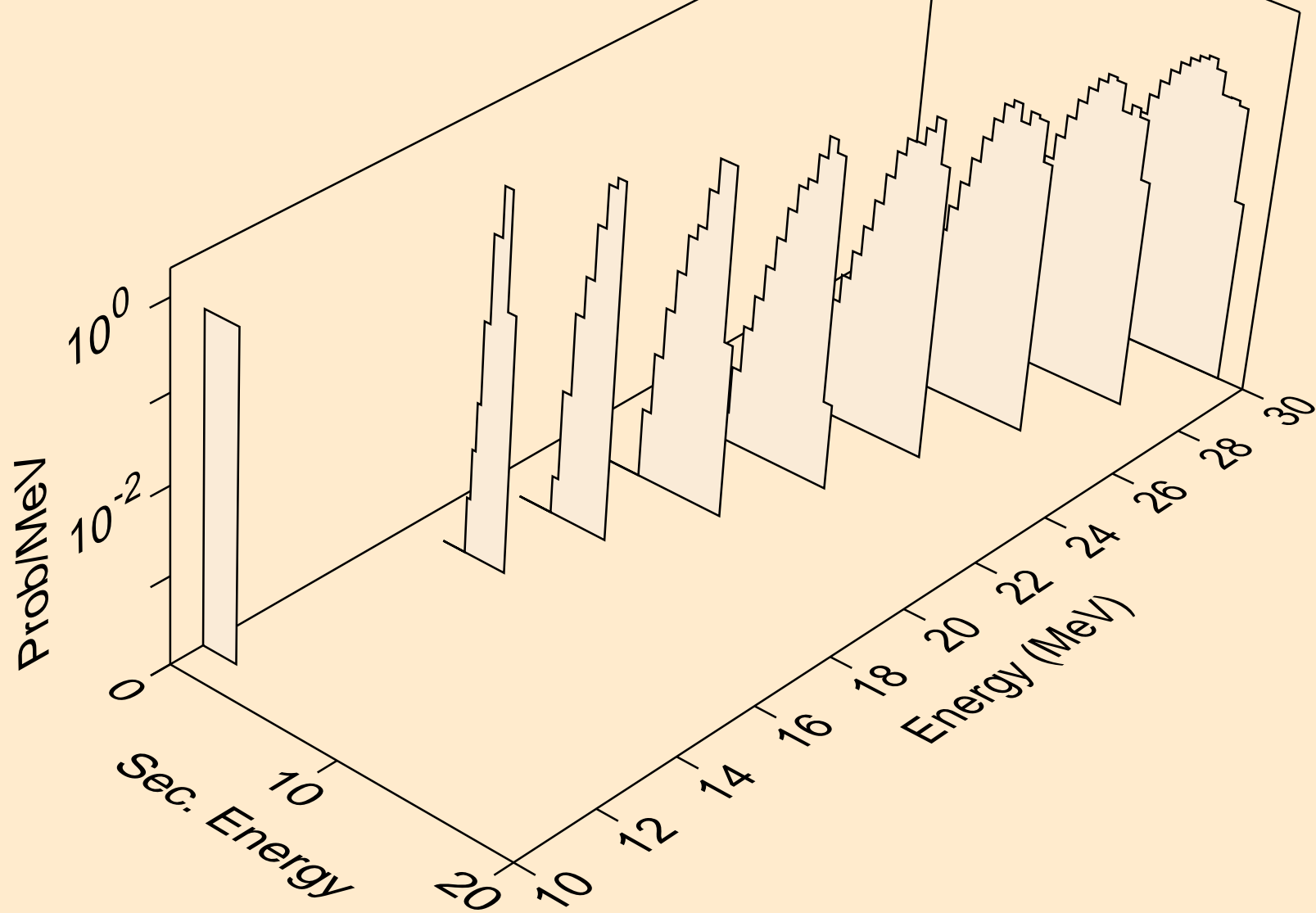

RU089 DEUTERON ACER TENDL-2021 LIBRARY; T=0.K
he3s from (d,he3)

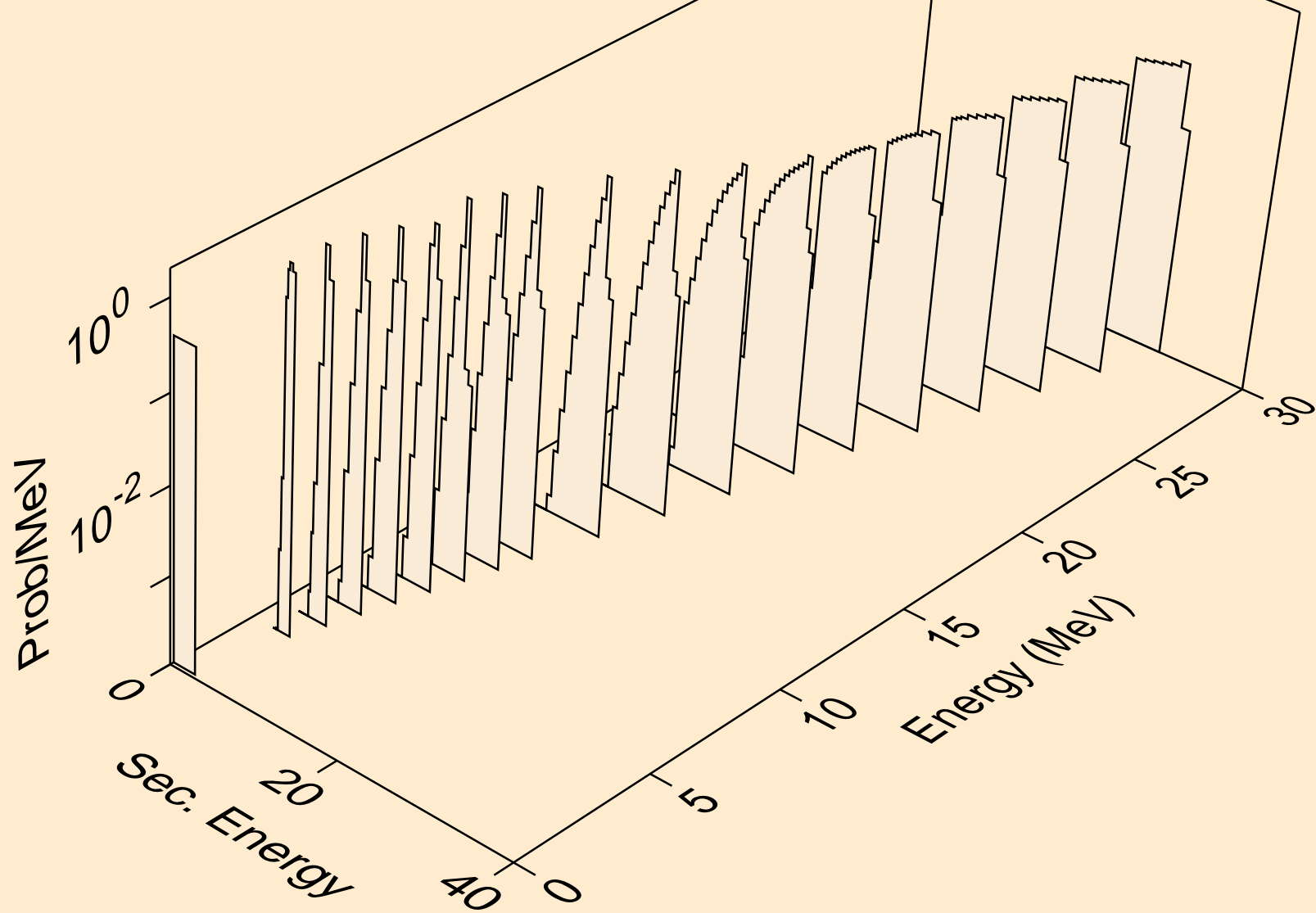

RU089 DEUTERON ACER TENDL-2021 LIBRARY; T=0.K
alphas from (d,x)

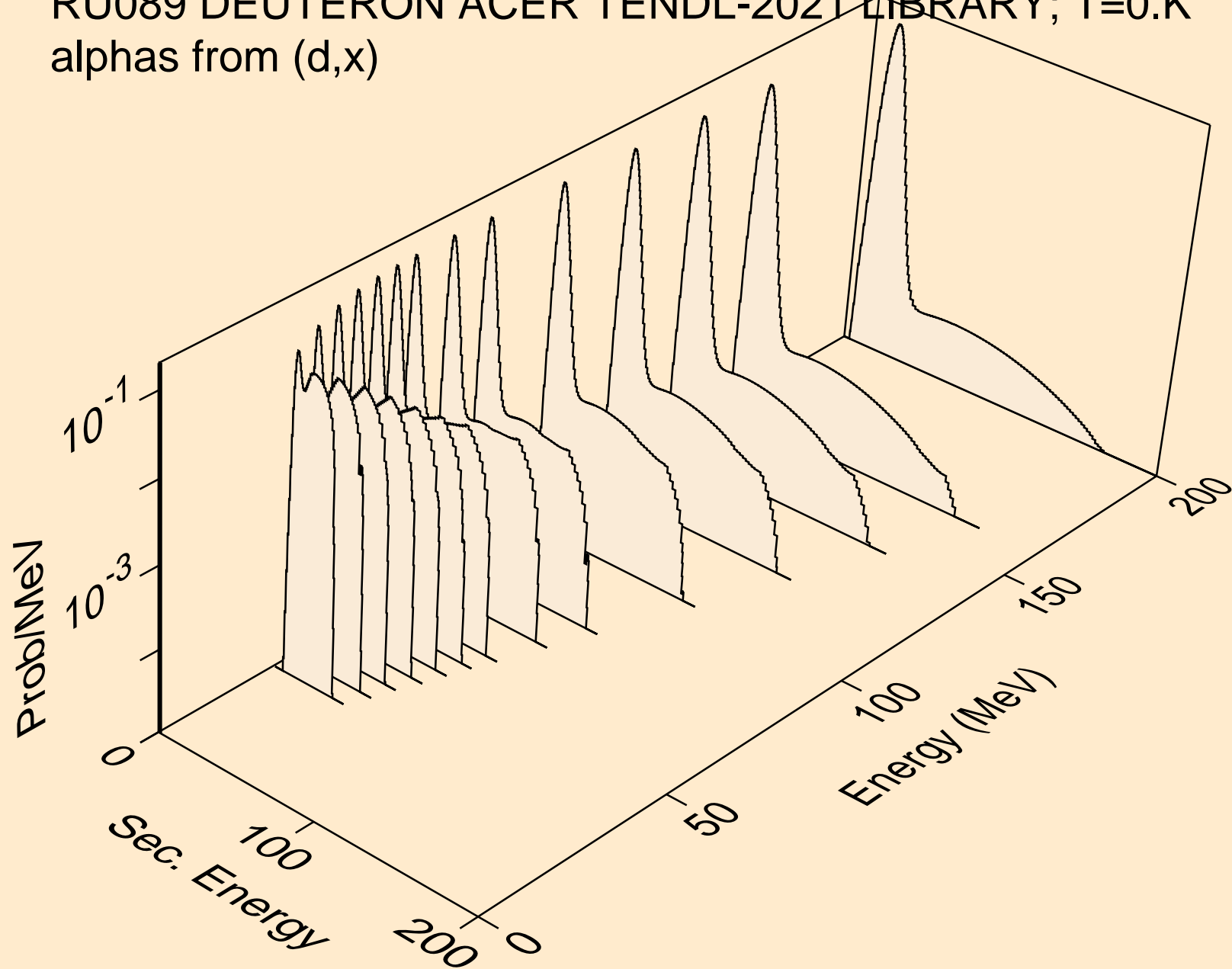

RU089 DEUTERON ACER TENDL-2021 LIBRARY; T=0.K
alphas from (d,n*)a

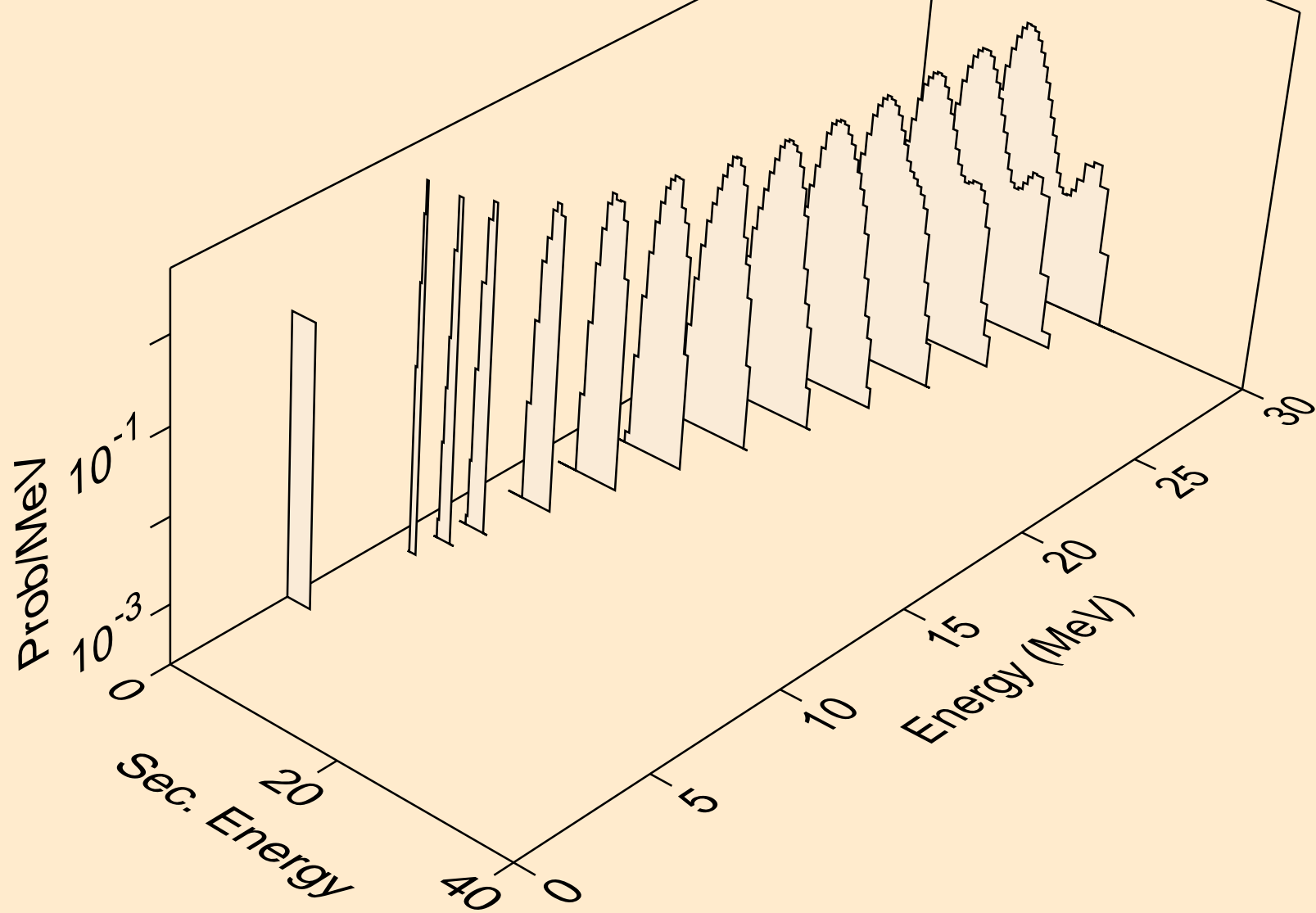

RU089 DEUTERON ACER TENDL-2021 LIBRARY; T=0.K
alphas from (d,n*)2a

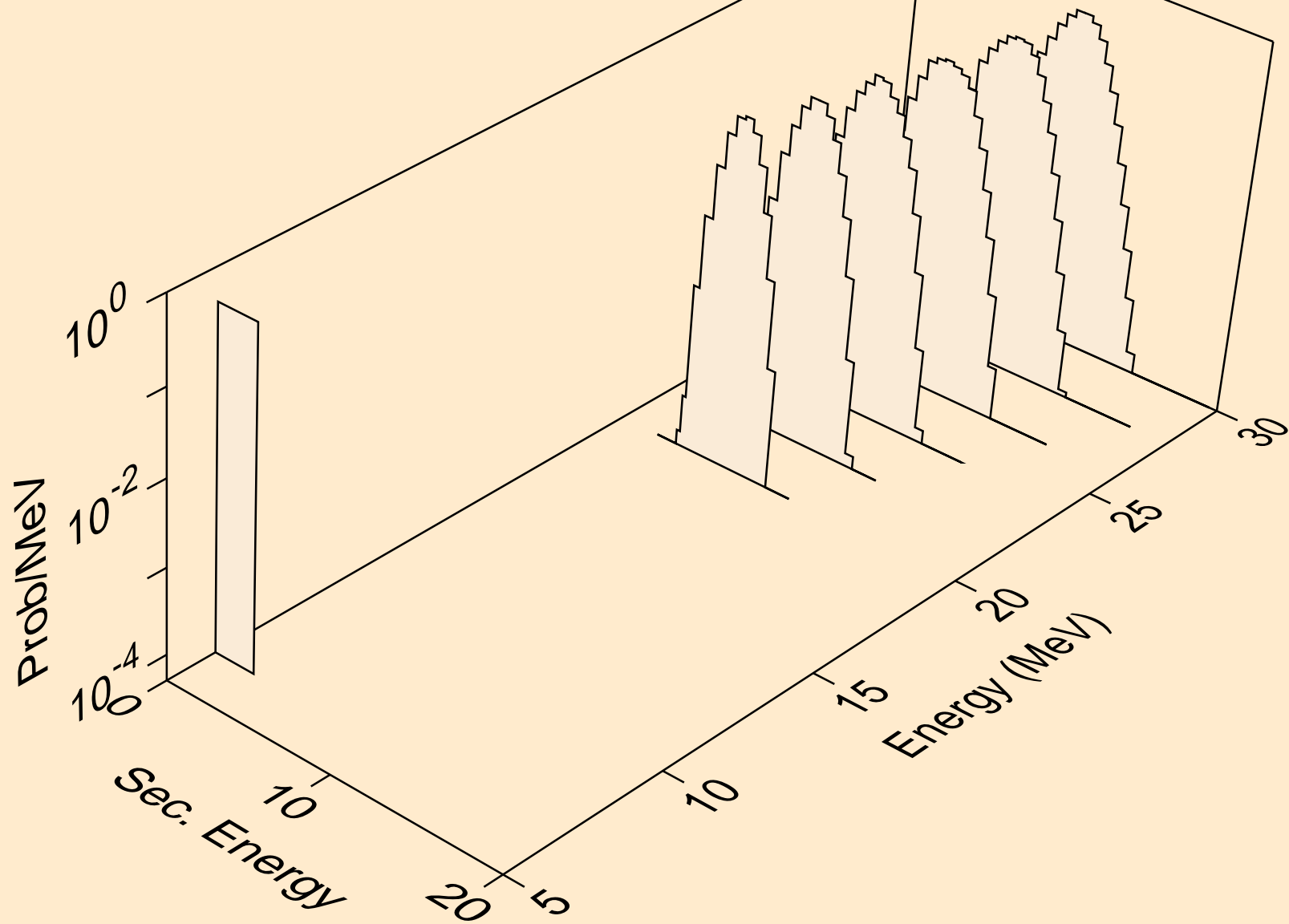

RU089 DEUTERON ACER TENDL-2021 LIBRARY; T=0.K
alphas from (d,npa)

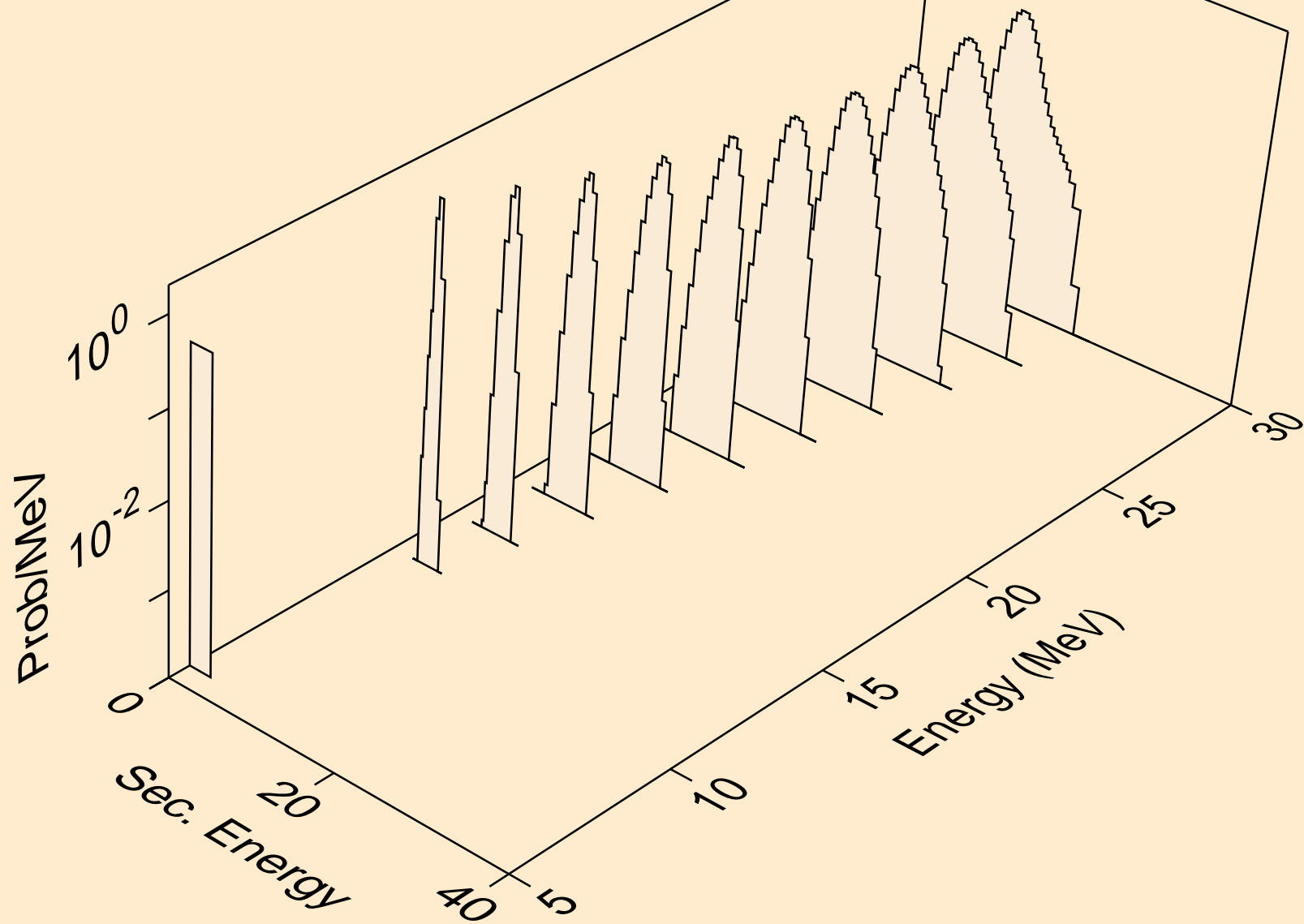

RU089 DEUTERON ACER TENDL-2021 LIBRARY; T=0.K
alphas from (d,a)

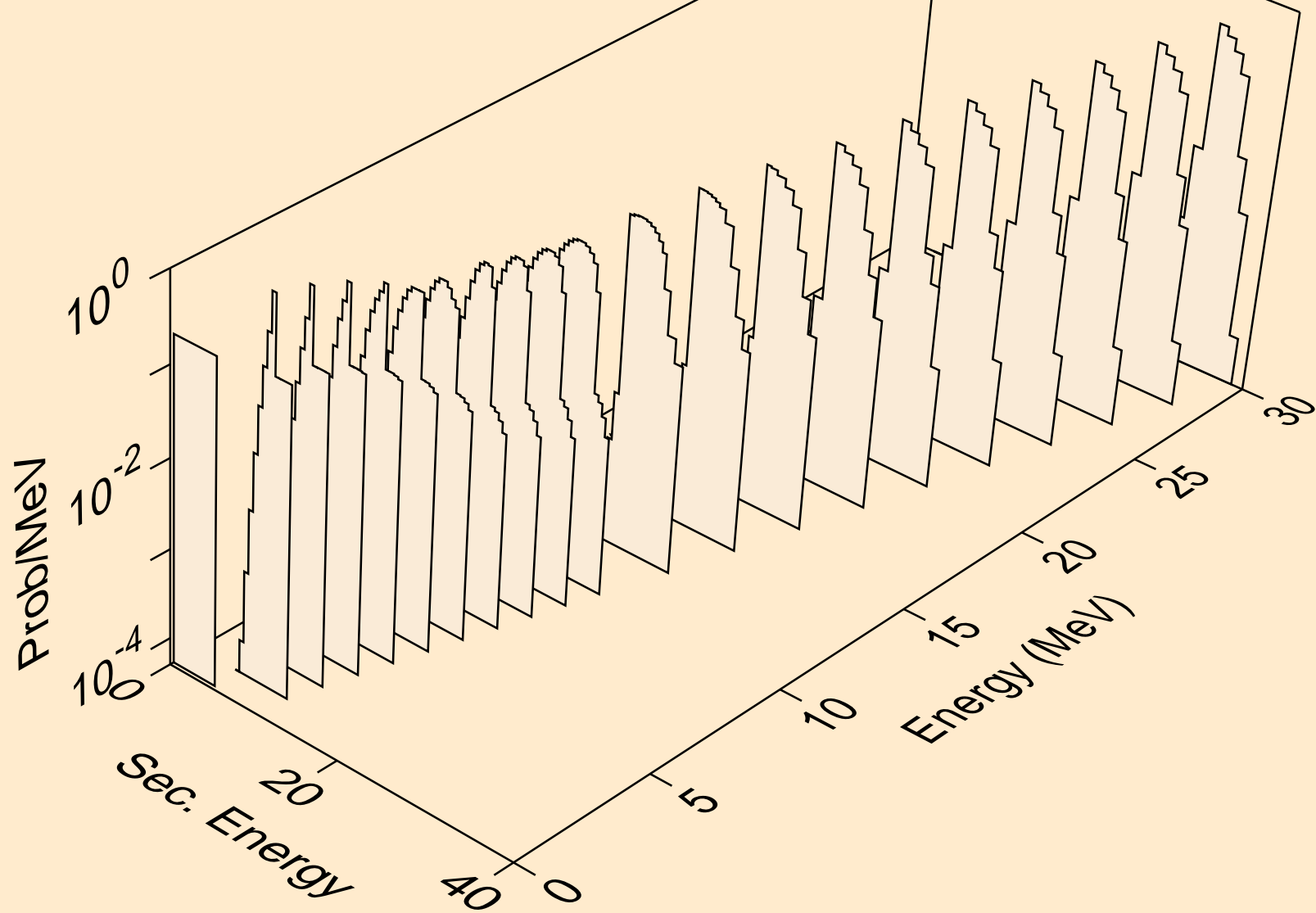

RU089 DEUTERON ACER TENDL-2021 LIBRARY; T=0.K
alphas from (d,2a)

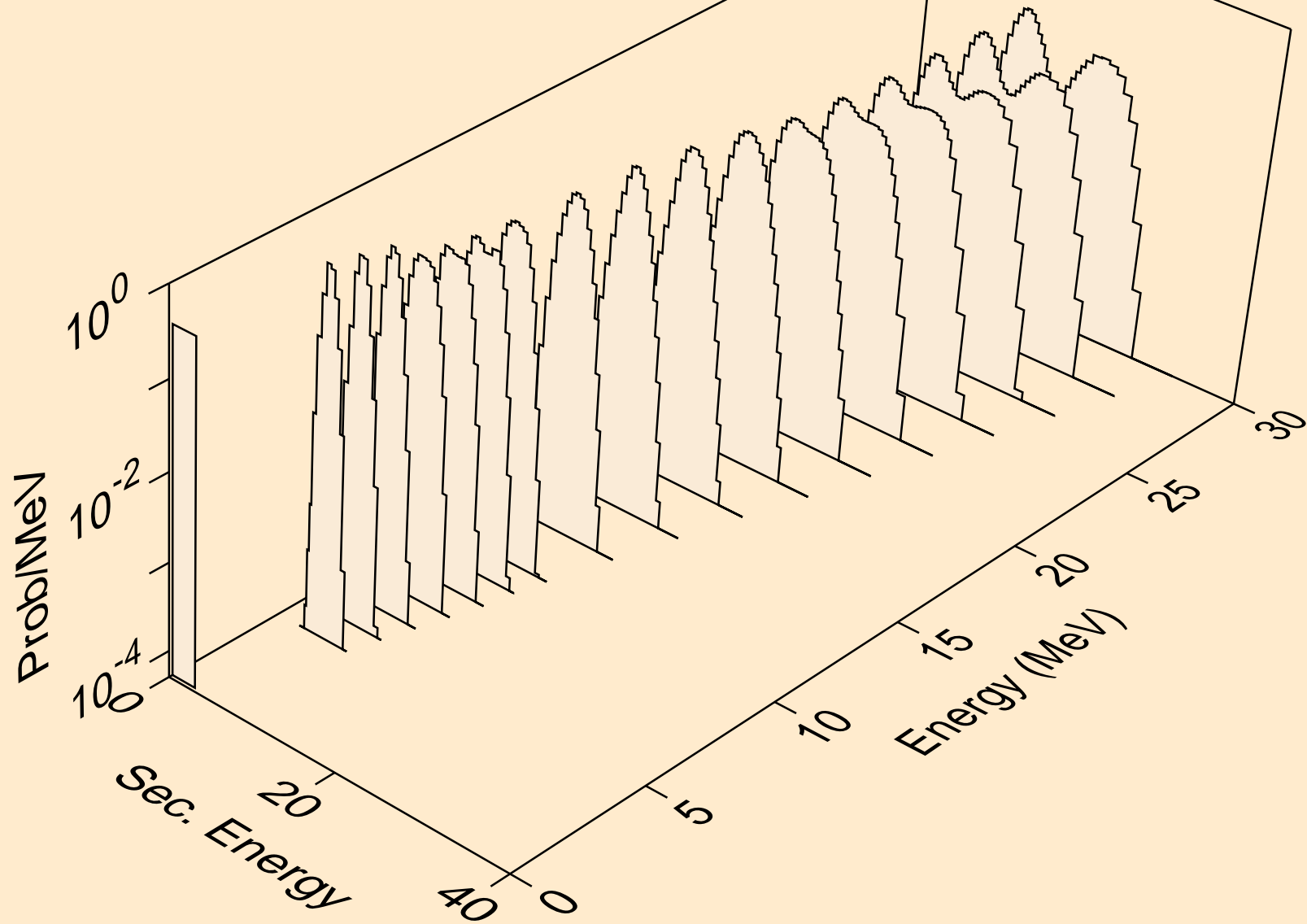

RU089 DEUTERON ACER TENDL-2021 LIBRARY; T=0.K
alphas from (d,pa)

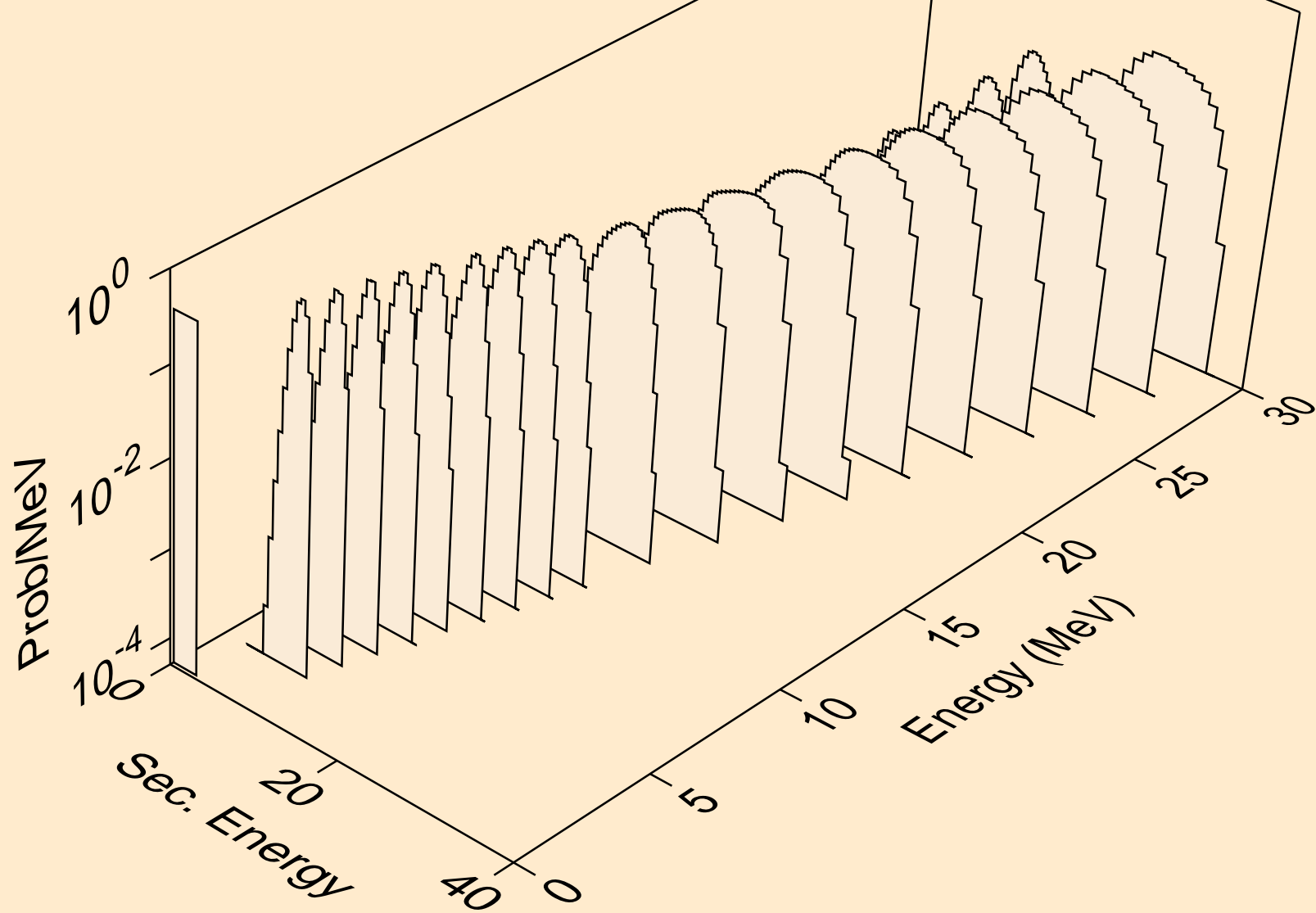

RU089 DEUTERON ACER TENDL-2021 LIBRARY; T=0.K
alphas from (d,da)

