

# SM130 DEUTERON ACER TENDL-2021 LIBRARY; T=0.K

## Principal cross sections

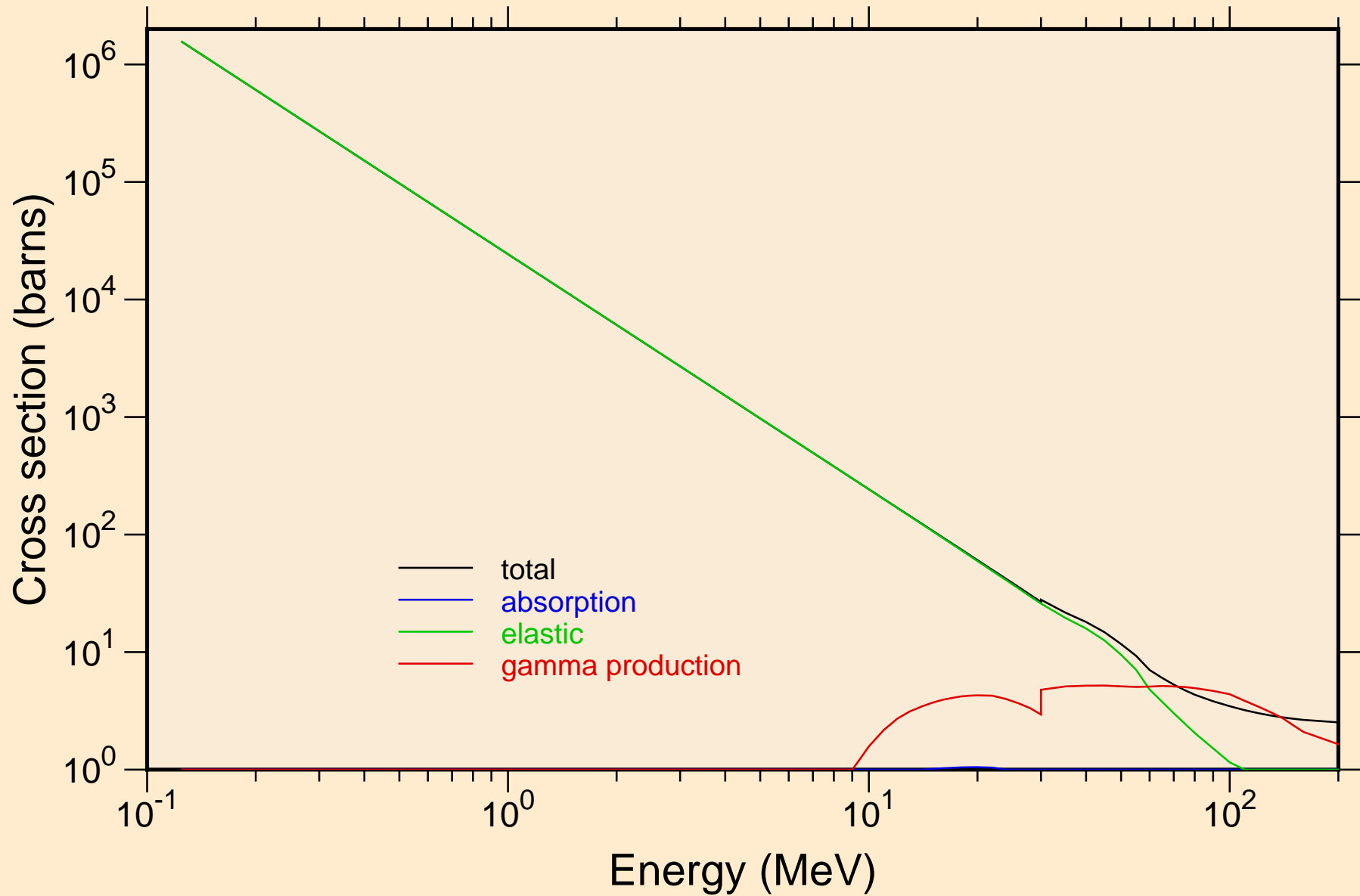

SM130 DEUTERON ACER TENDL-2021 LIBRARY; T=0.K  
Heating

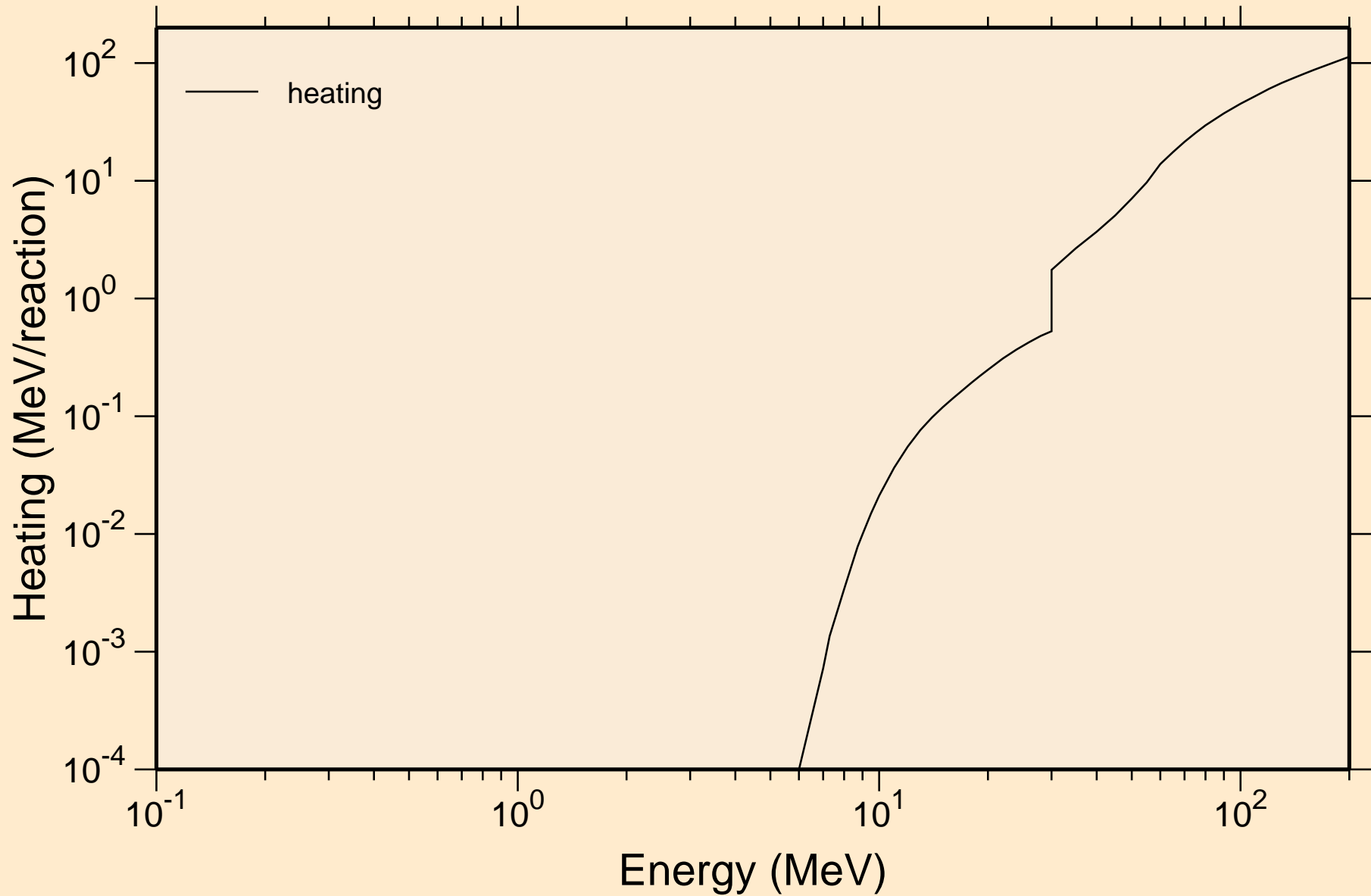

# SM130 DEUTERON ACER TENDL-2021 LIBRARY; T=0.K

## Principal cross sections

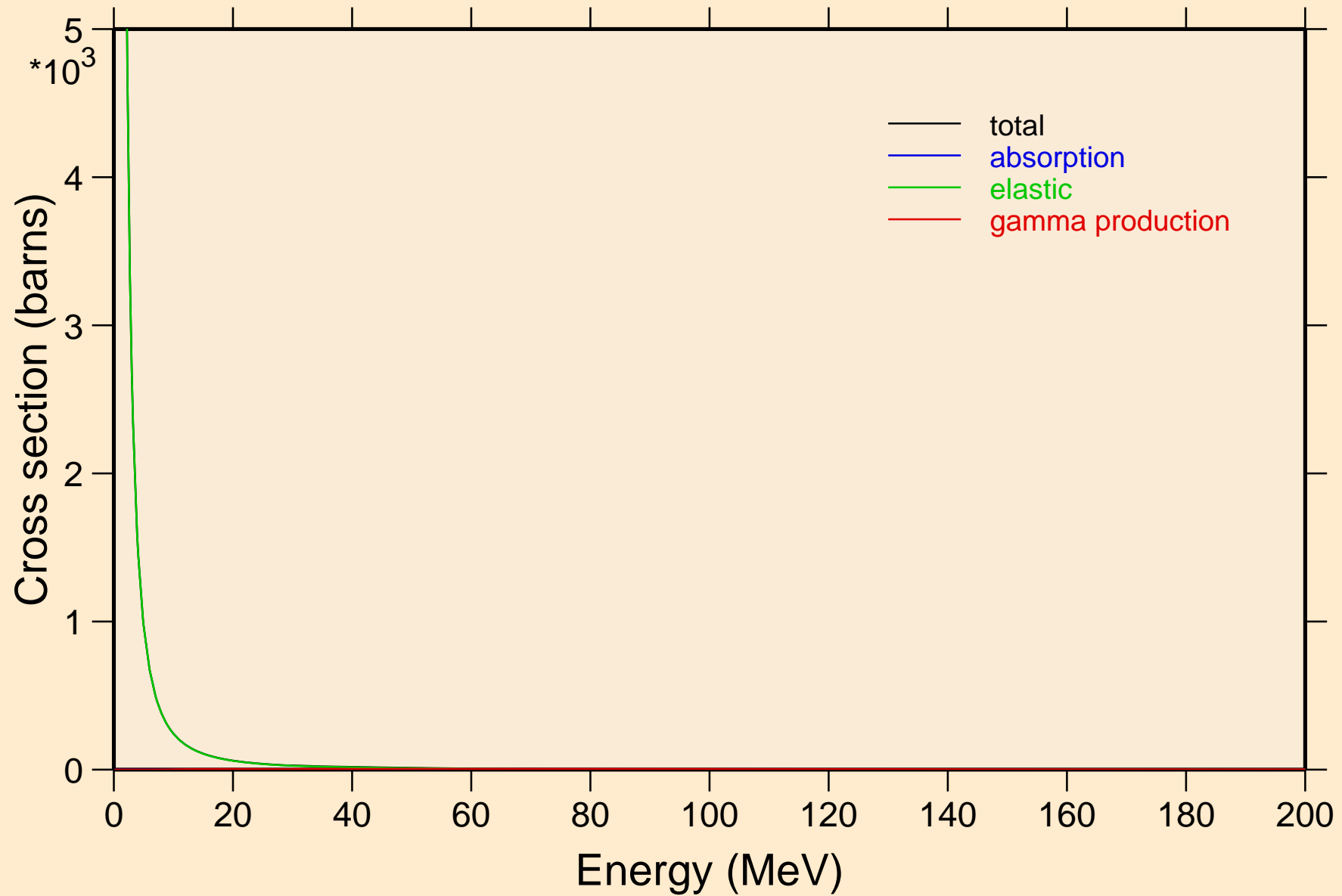

# SM130 DEUTERON ACER TENDL-2021 LIBRARY; T=0.K

## Heating

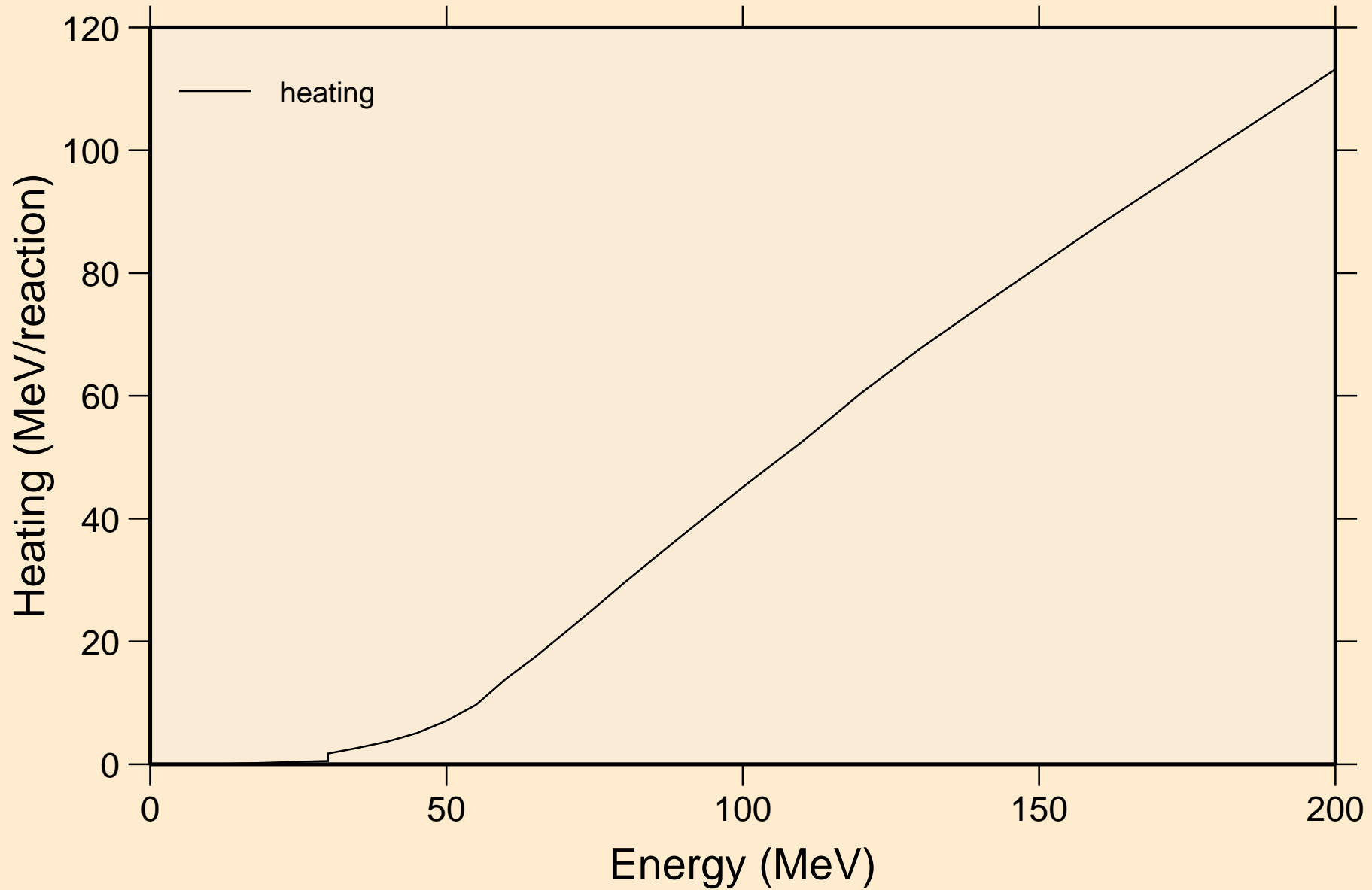

# SM130 DEUTERON ACER TENDL-2021 LIBRARY; T=0.K

## Threshold reactions

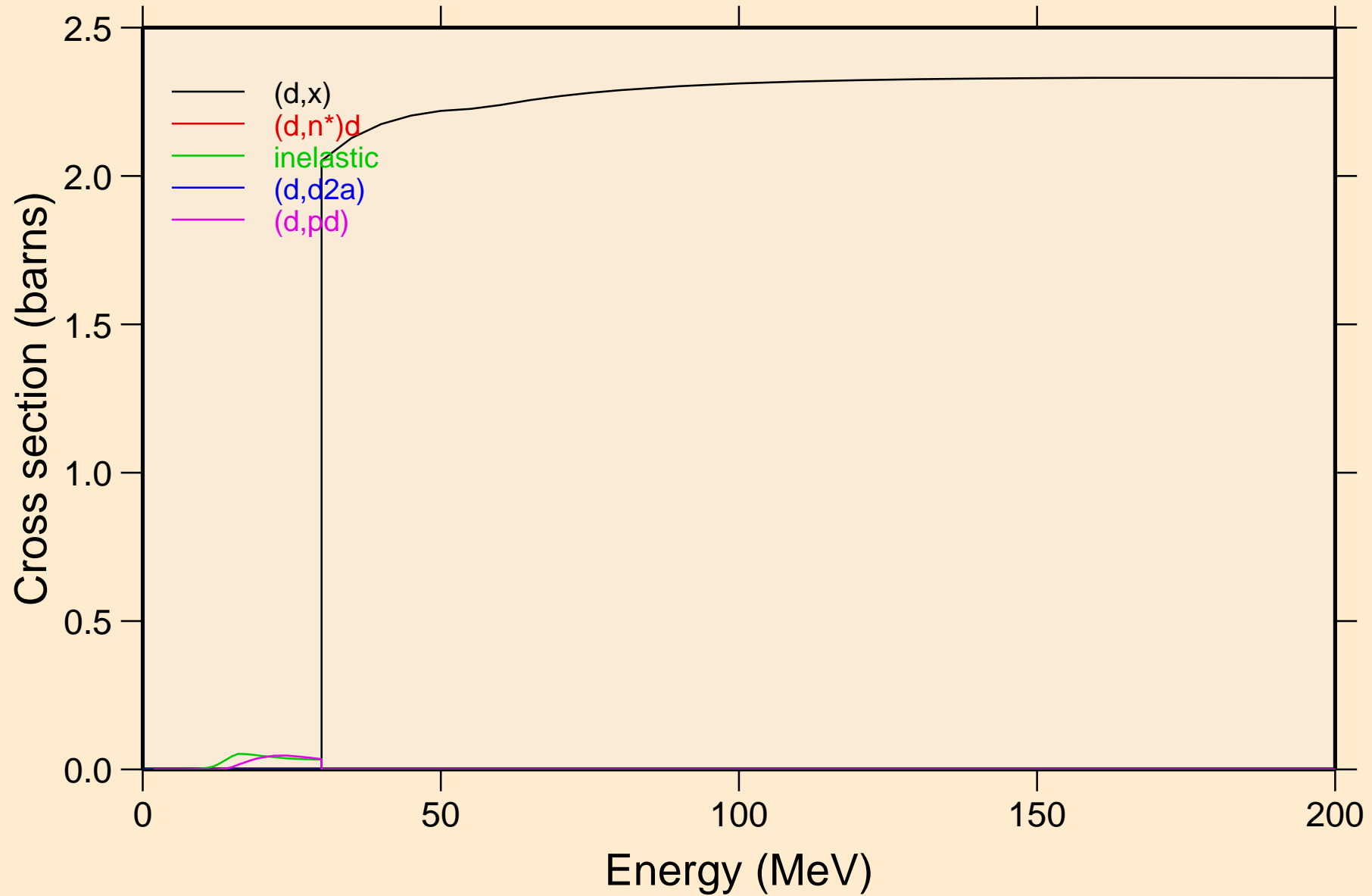

SM130 DEUTERON ACER TENDL-2021 LIBRARY; T=0.K  
Threshold reactions

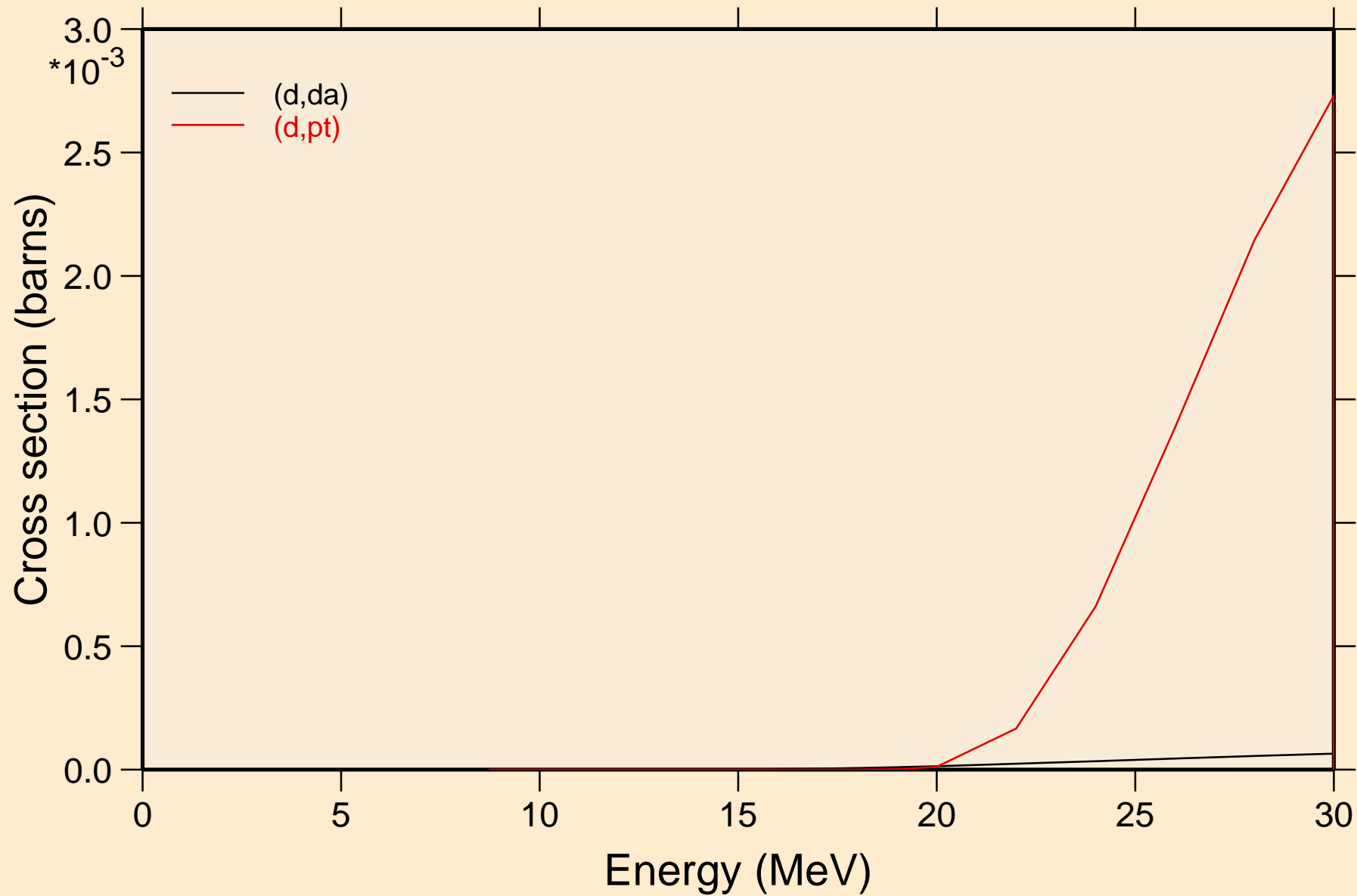

SM130 DEUTERON ACER TENDL-2021 LIBRARY; T=0.K  
Threshold reactions

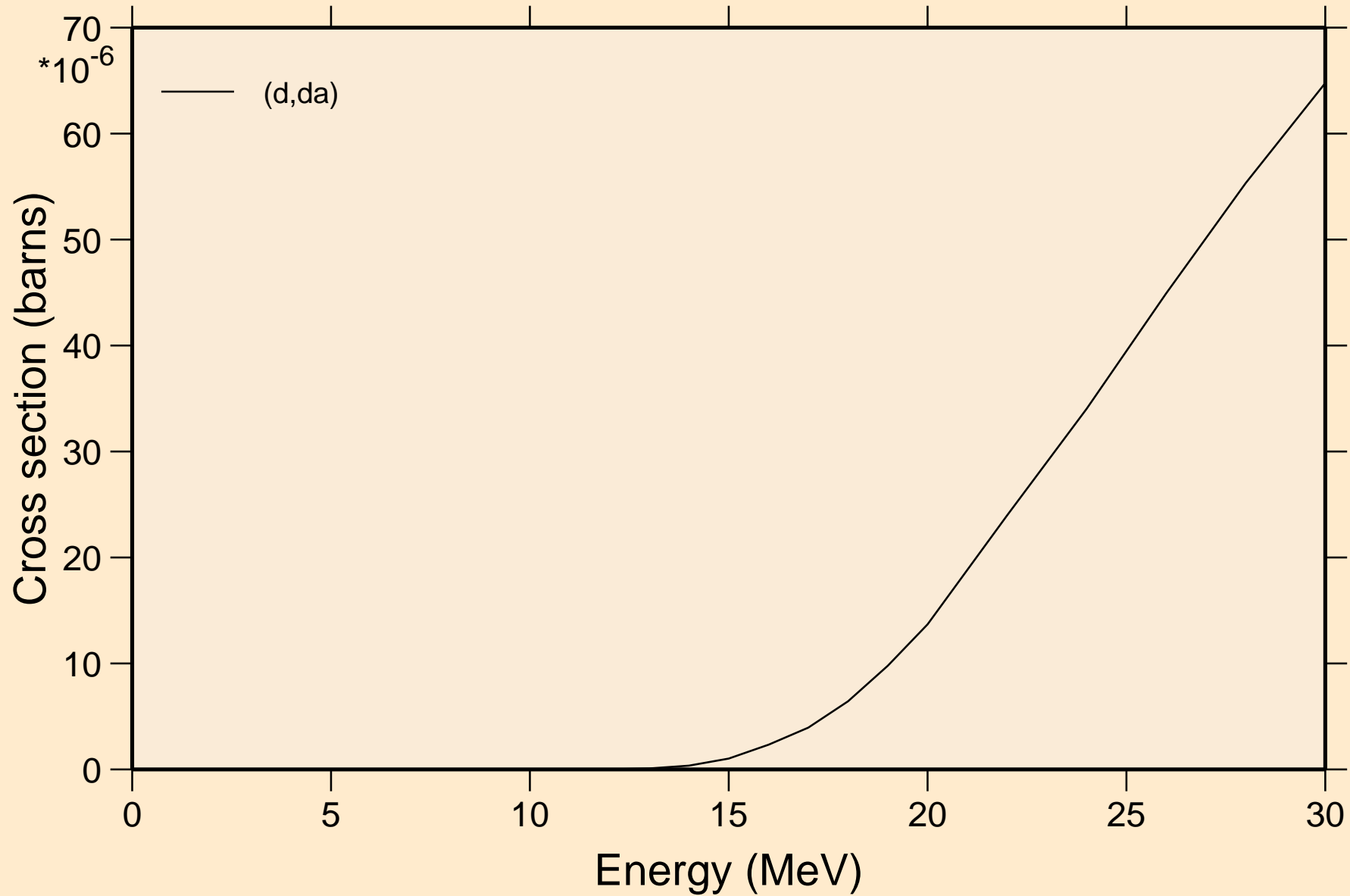

SM130 DEUTERON ACER TENDL-2021 LIBRARY; T=0.K  
angular distribution for elastic

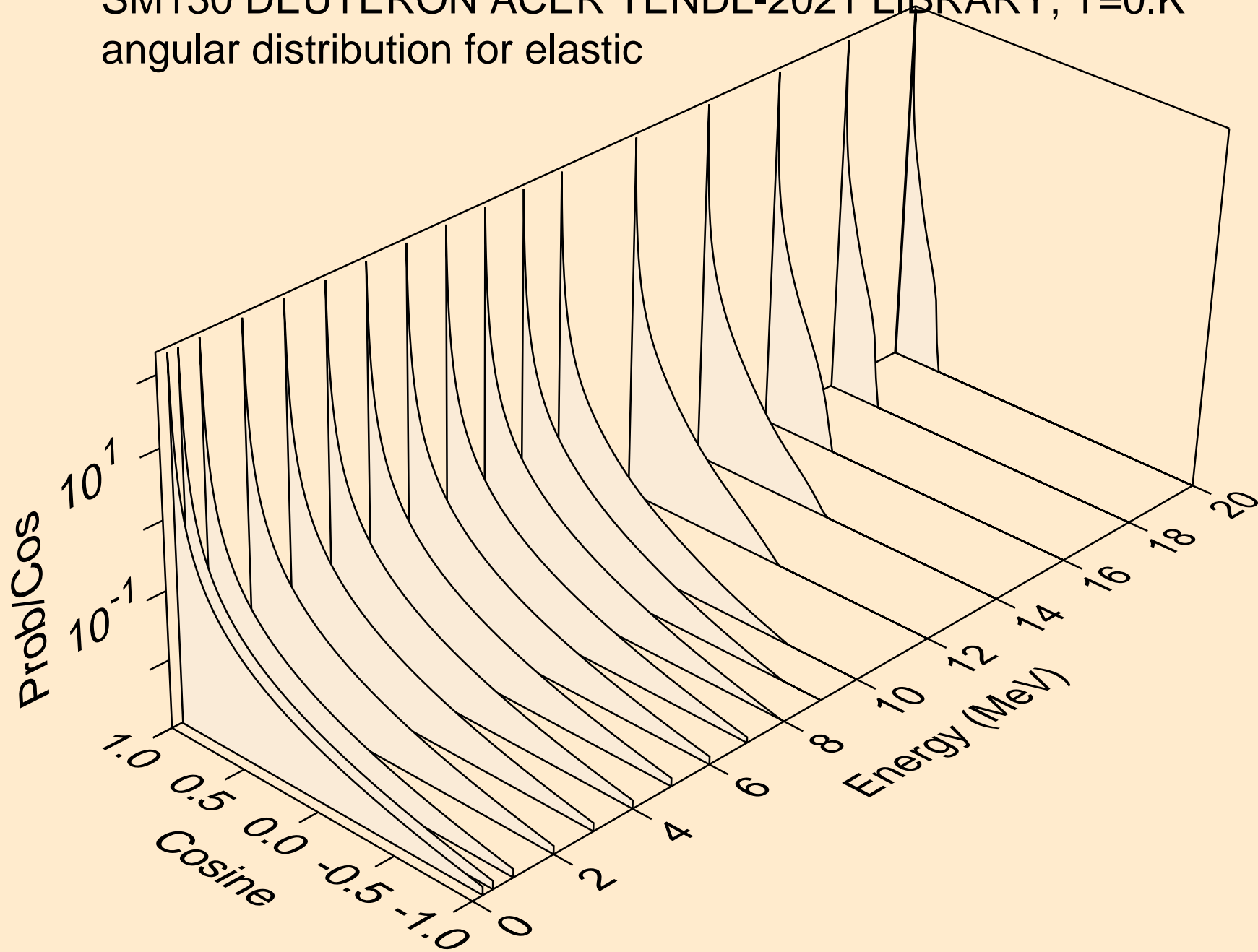



SM130 DEUTERON ACER TENDL-2021 LIBRARY; T=0.K  
angular distribution for elastic

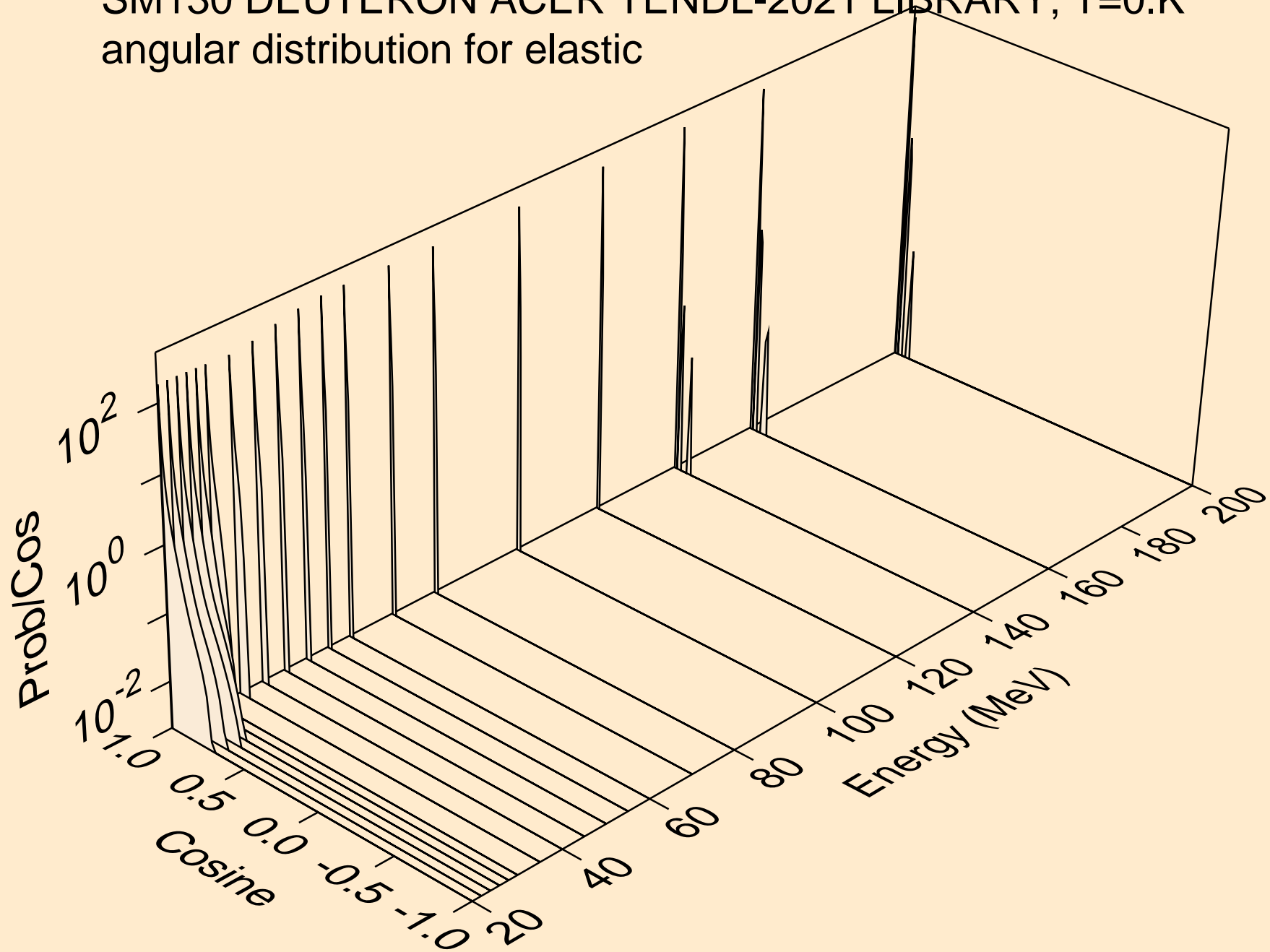

SM130 DEUTERON ACER TENDL-2021 LIBRARY; T=0.K  
Deuteron emission for (d,x)

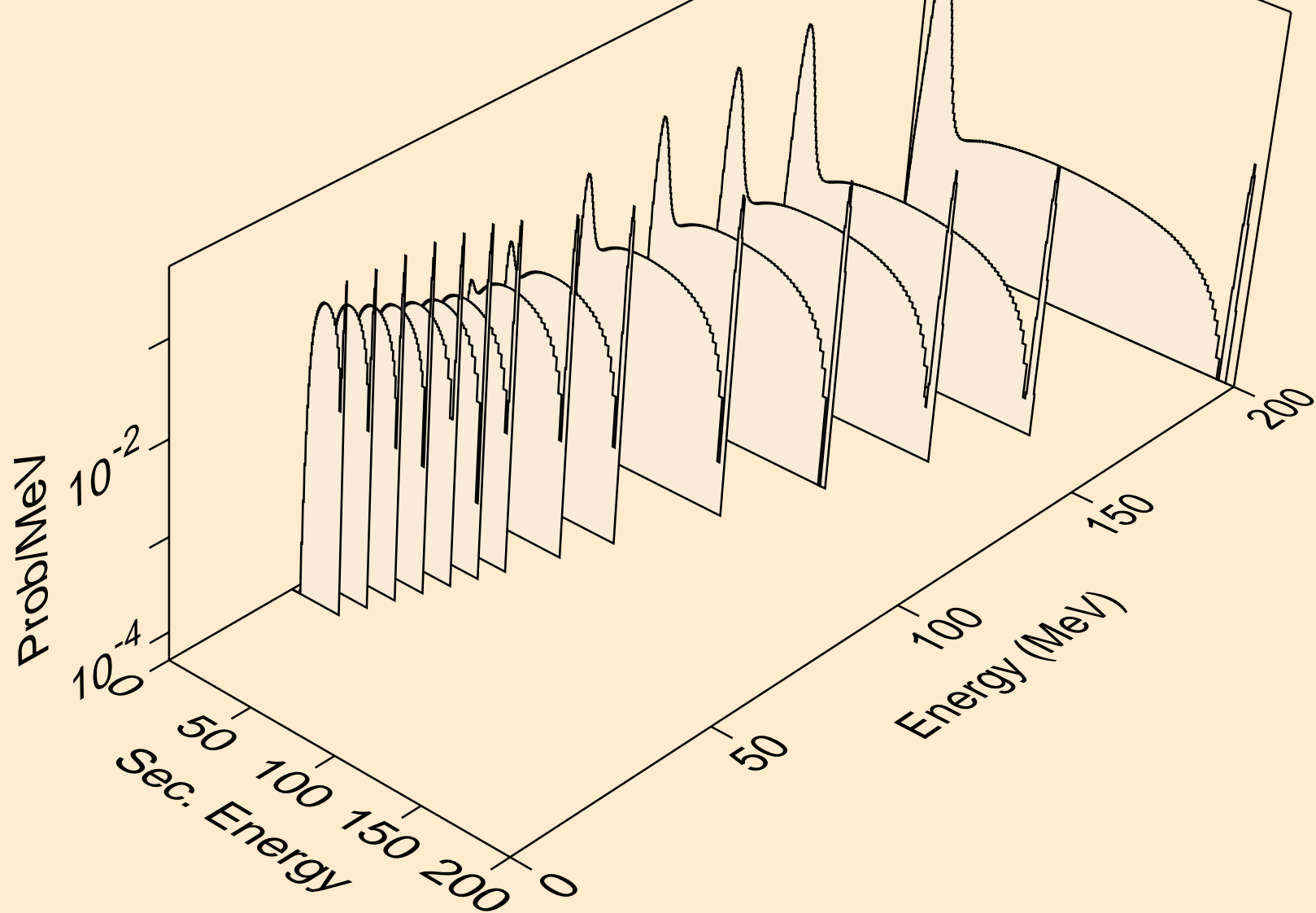

SM130 DEUTERON ACER TENDL-2021 LIBRARY; T=0.K  
Deuteron emission for (d,n\*)d

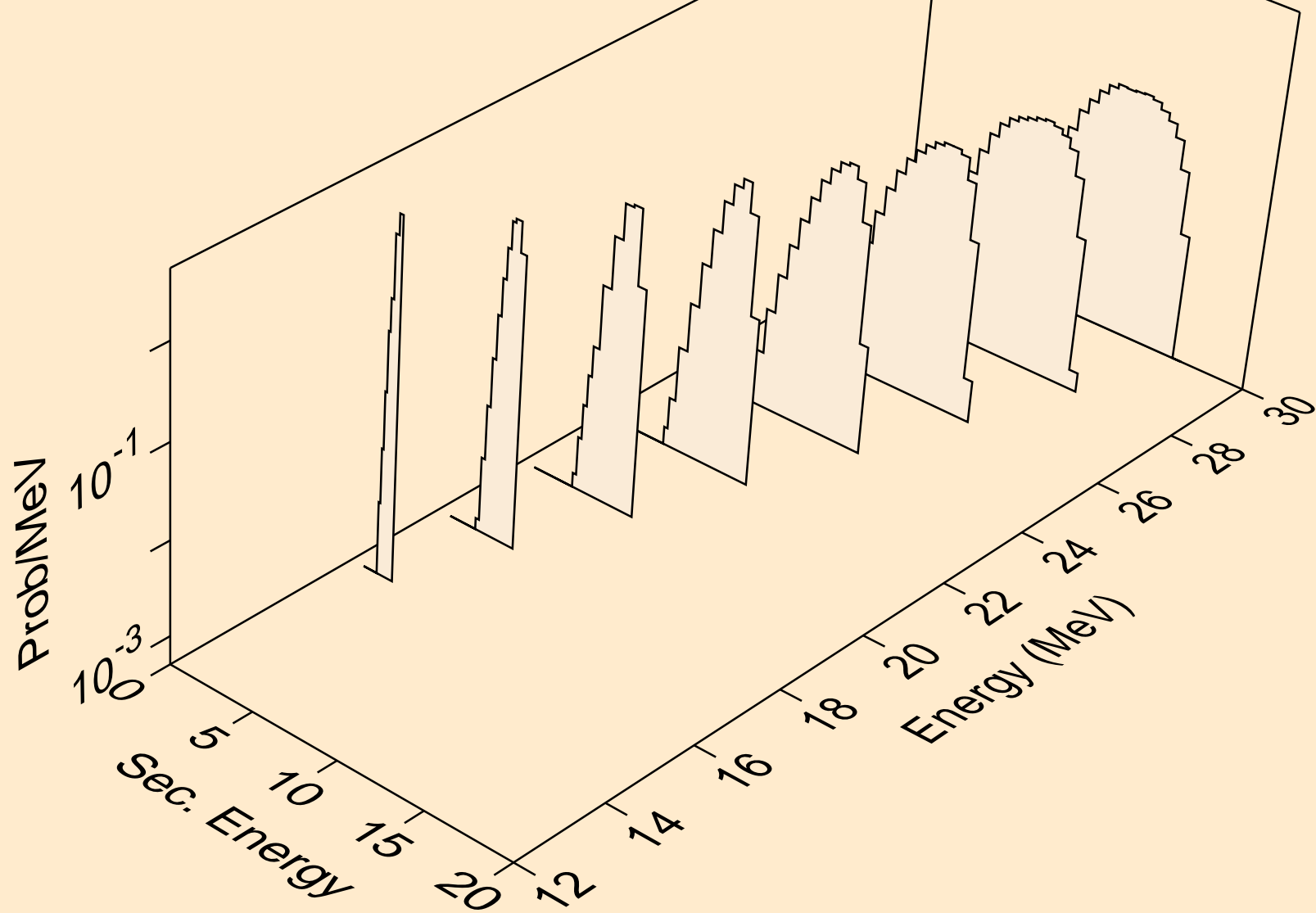

SM130 DEUTERON ACER TENDL-2021 LIBRARY; T=0.K  
Deuteron emission for inelastic

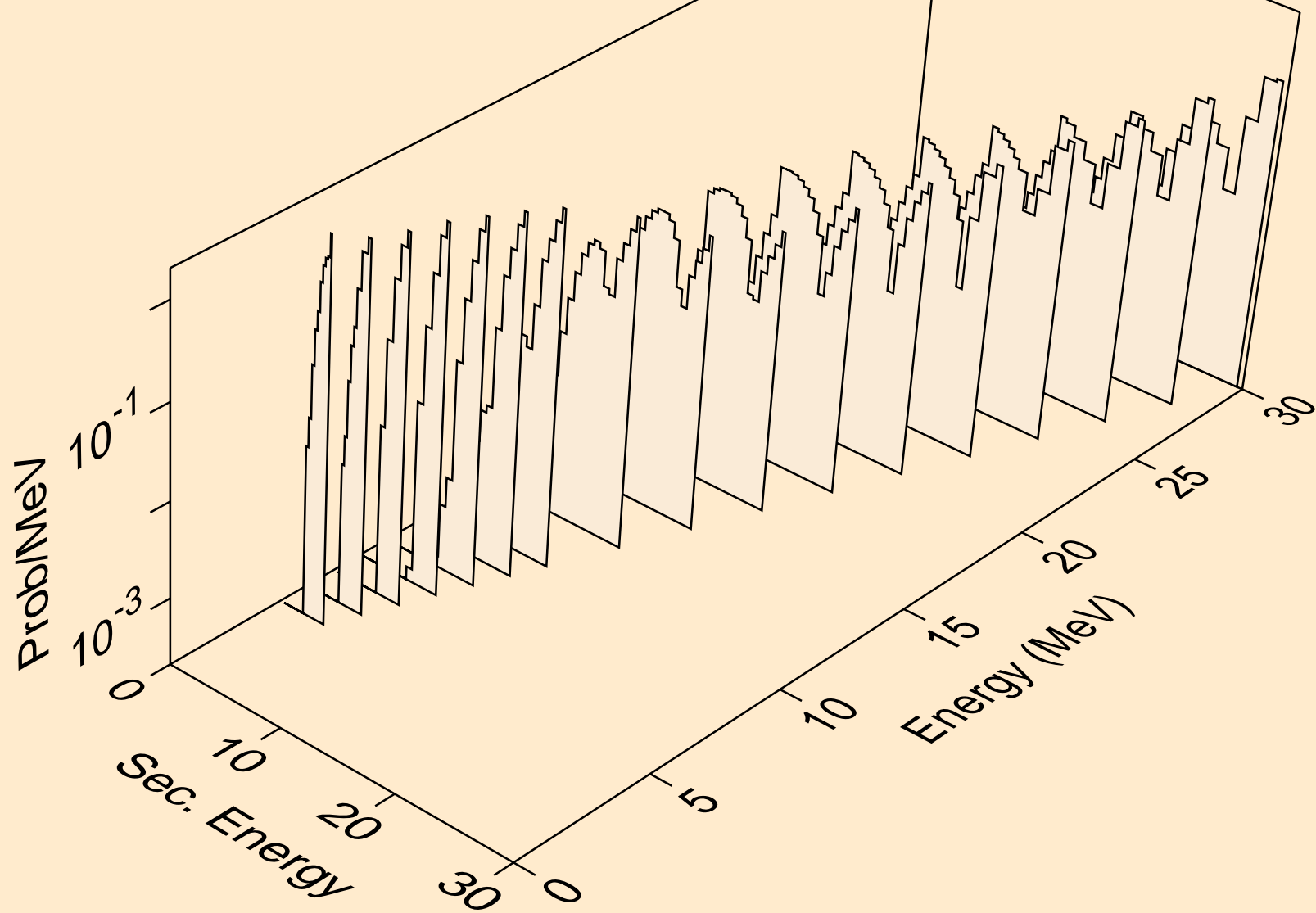

SM130 DEUTERON ACER TENDL-2021 LIBRARY; T=0.K  
Deuteron emission for (d,d2a)

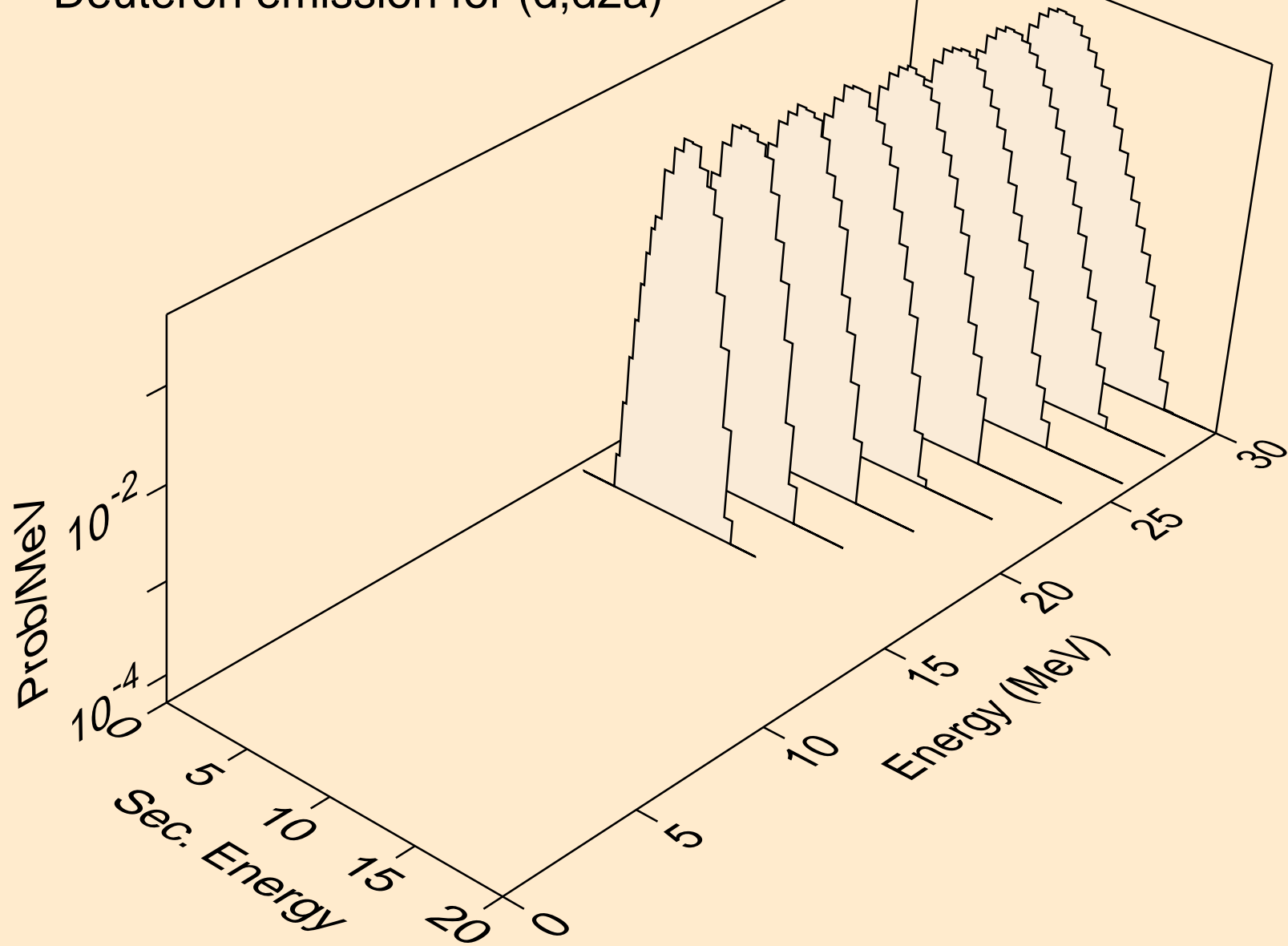

SM130 DEUTERON ACER TENDL-2021 LIBRARY; T=0.K  
Deuteron emission for (d,pd)

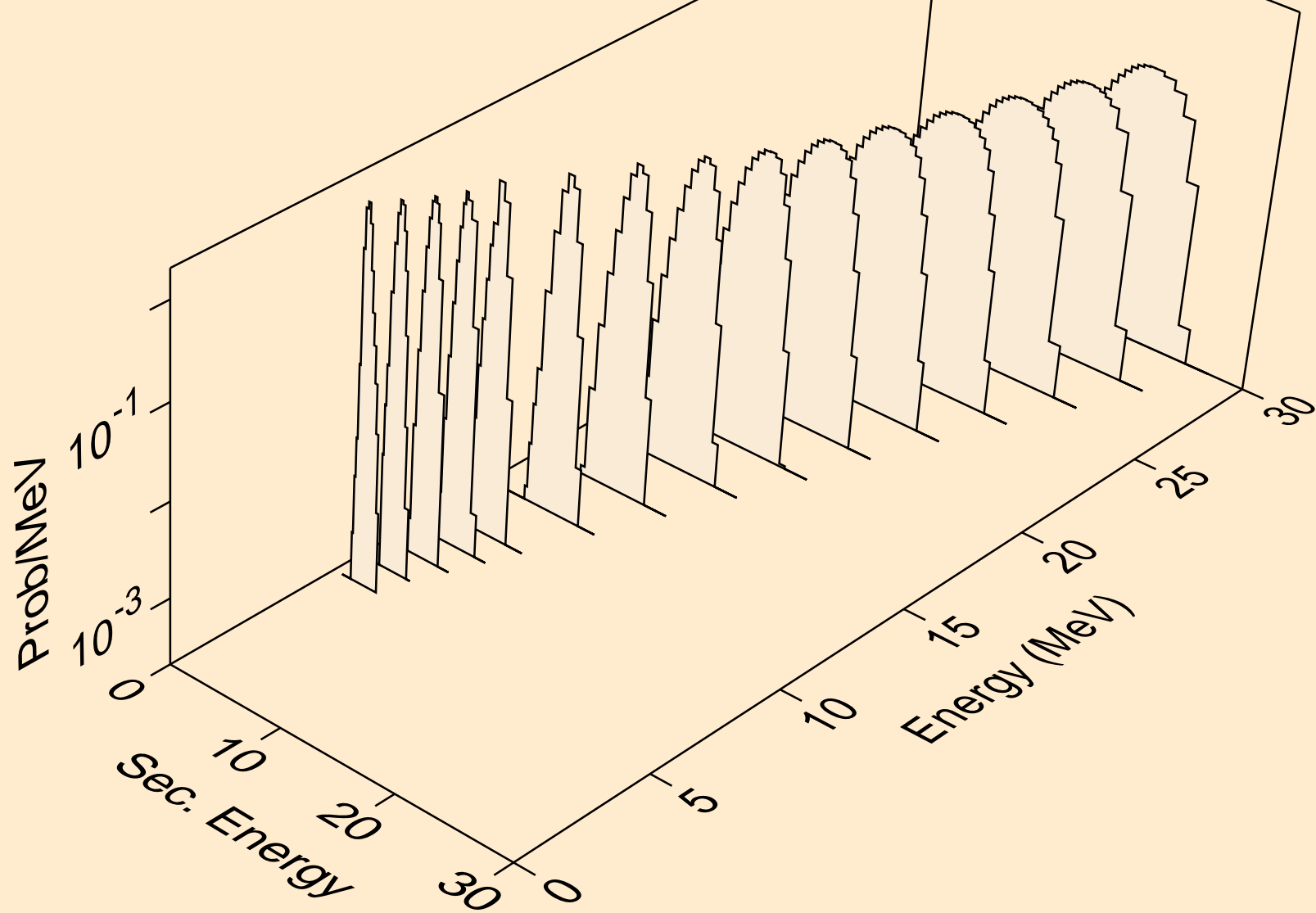

SM130 DEUTERON ACER TENDL-2021 LIBRARY; T=0.K  
Deuteron emission for (d,da)

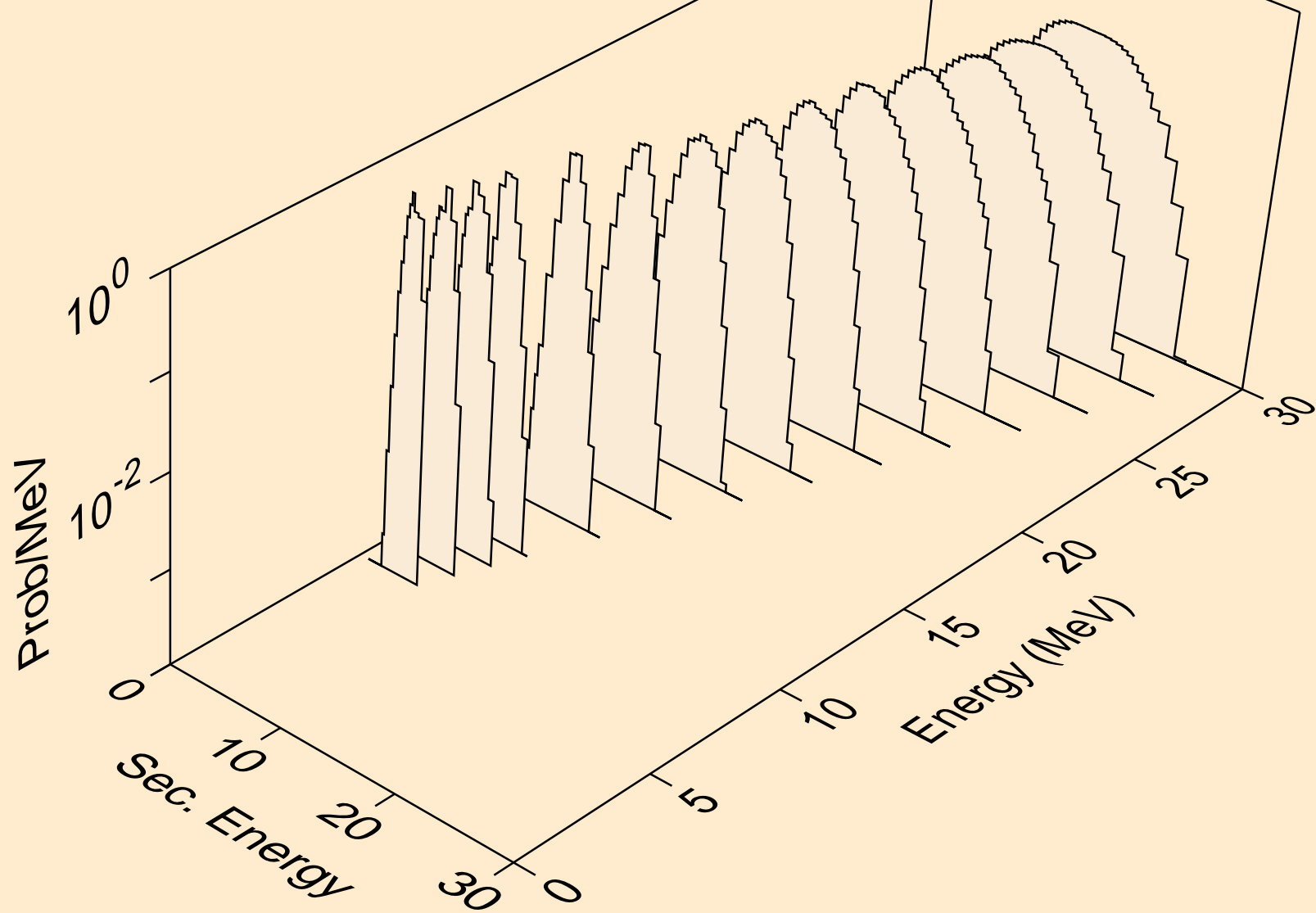

SM130 DEUTERON ACER TENDL-2021 LIBRARY; T=0.K  
Photon emission for (z,n)

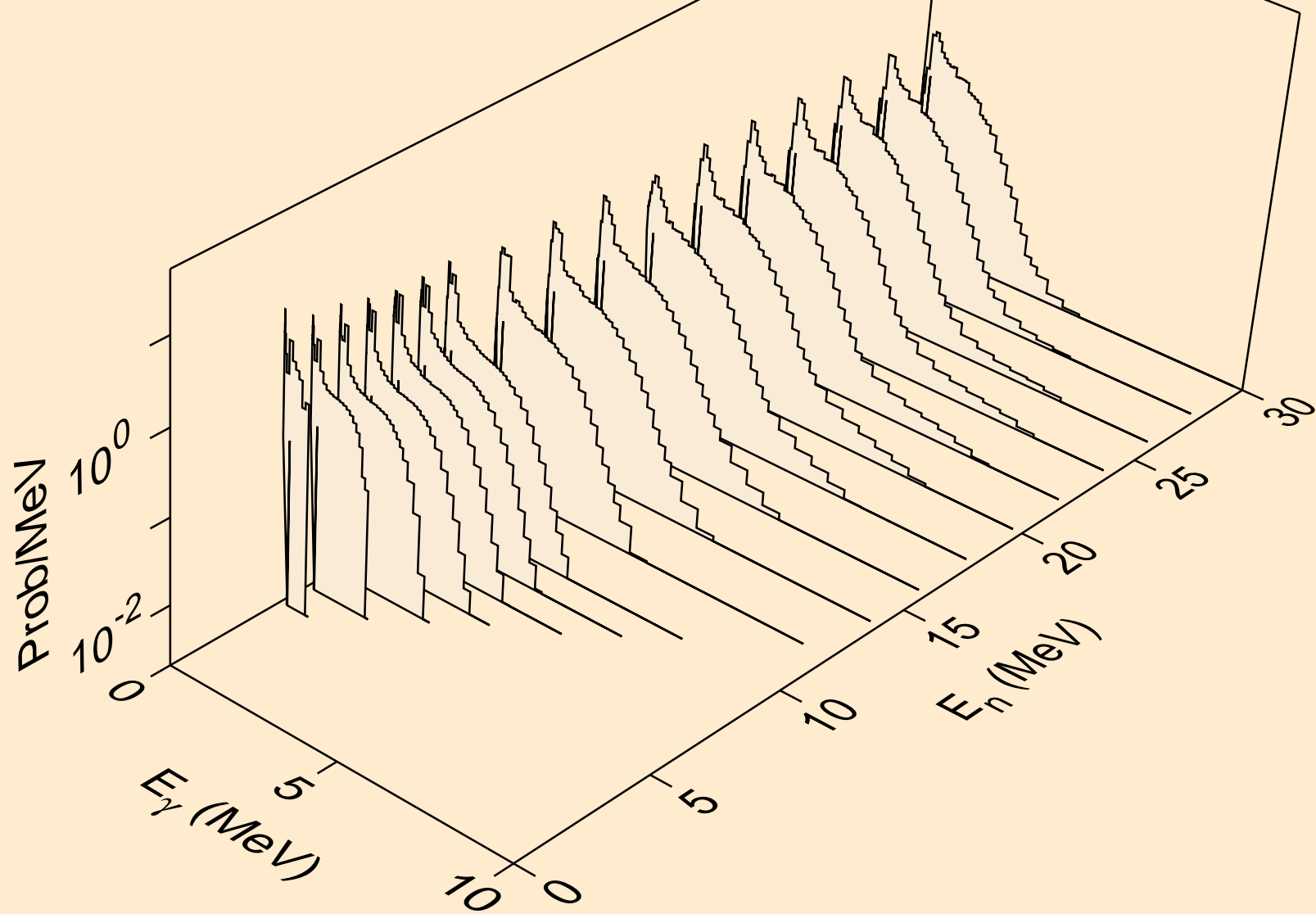



SM130 DEUTERON ACER TENDL-2021 LIBRARY; T=0.K  
Photon emission for (n,x)

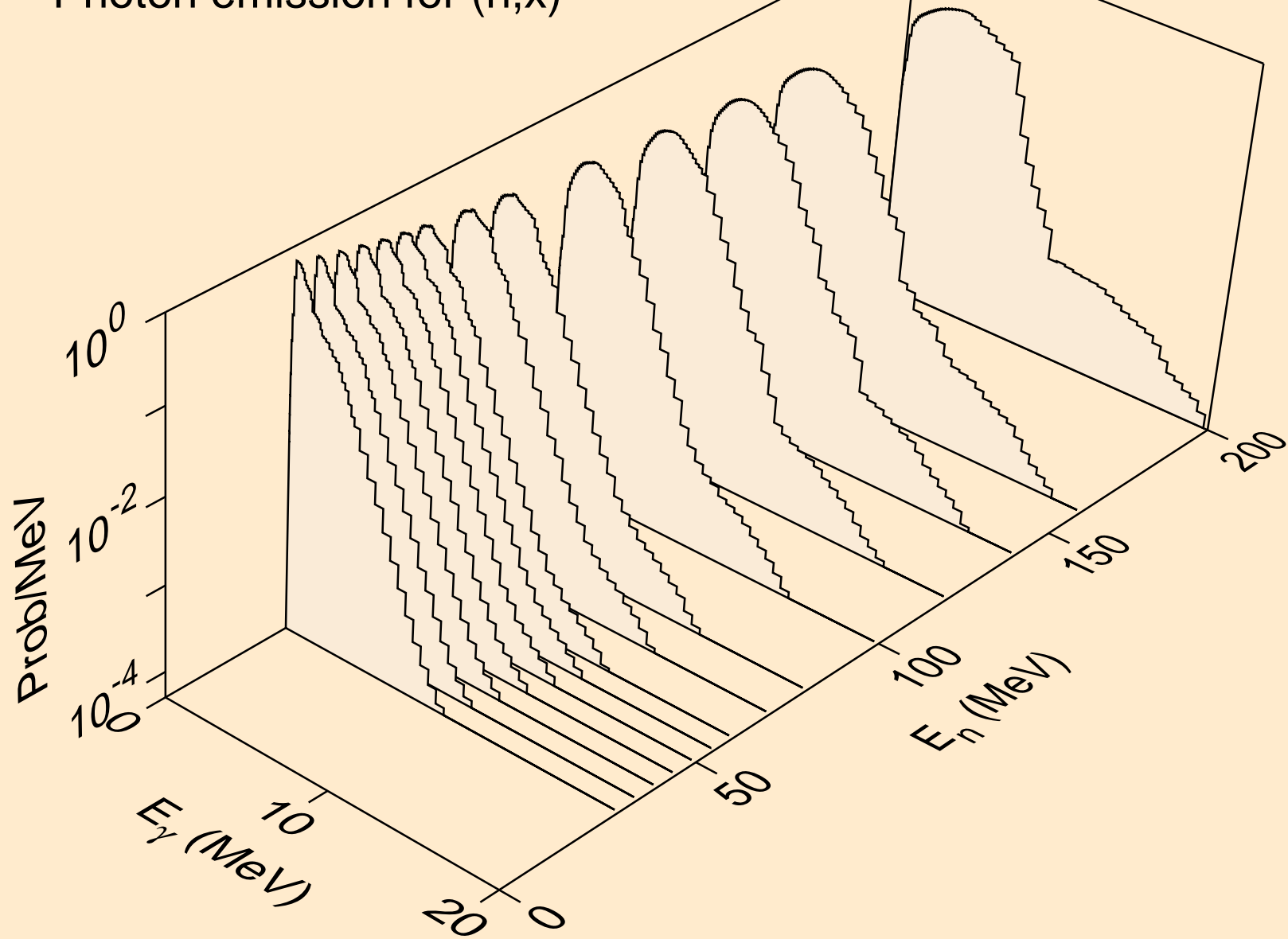

SM130 DEUTERON ACER TENDL-2021 LIBRARY; T=0.K  
Photon emission for (n,2n)

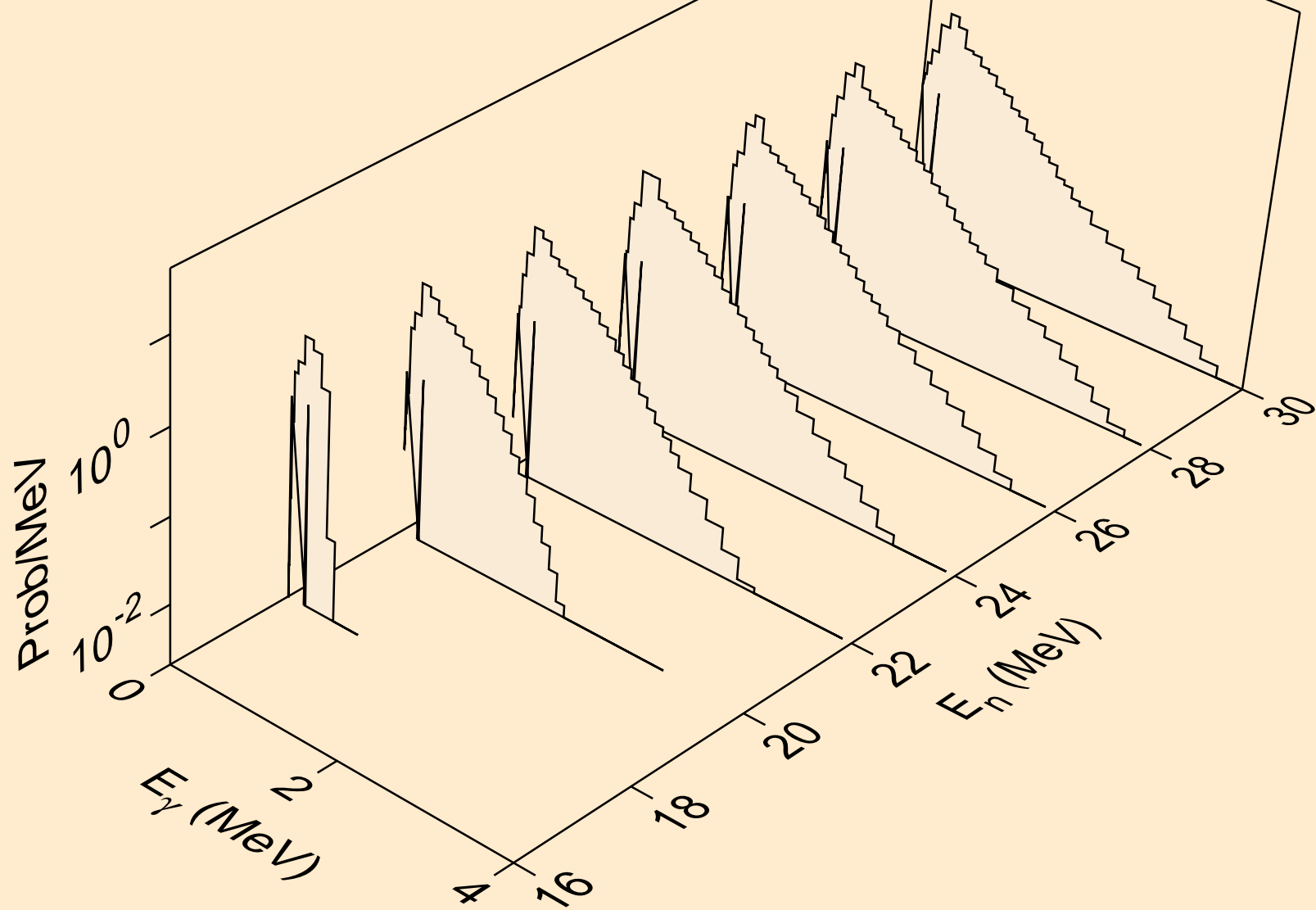

SM130 DEUTERON ACER TENDL-2021 LIBRARY; T=0.K  
Photon emission for (n,n\*)a

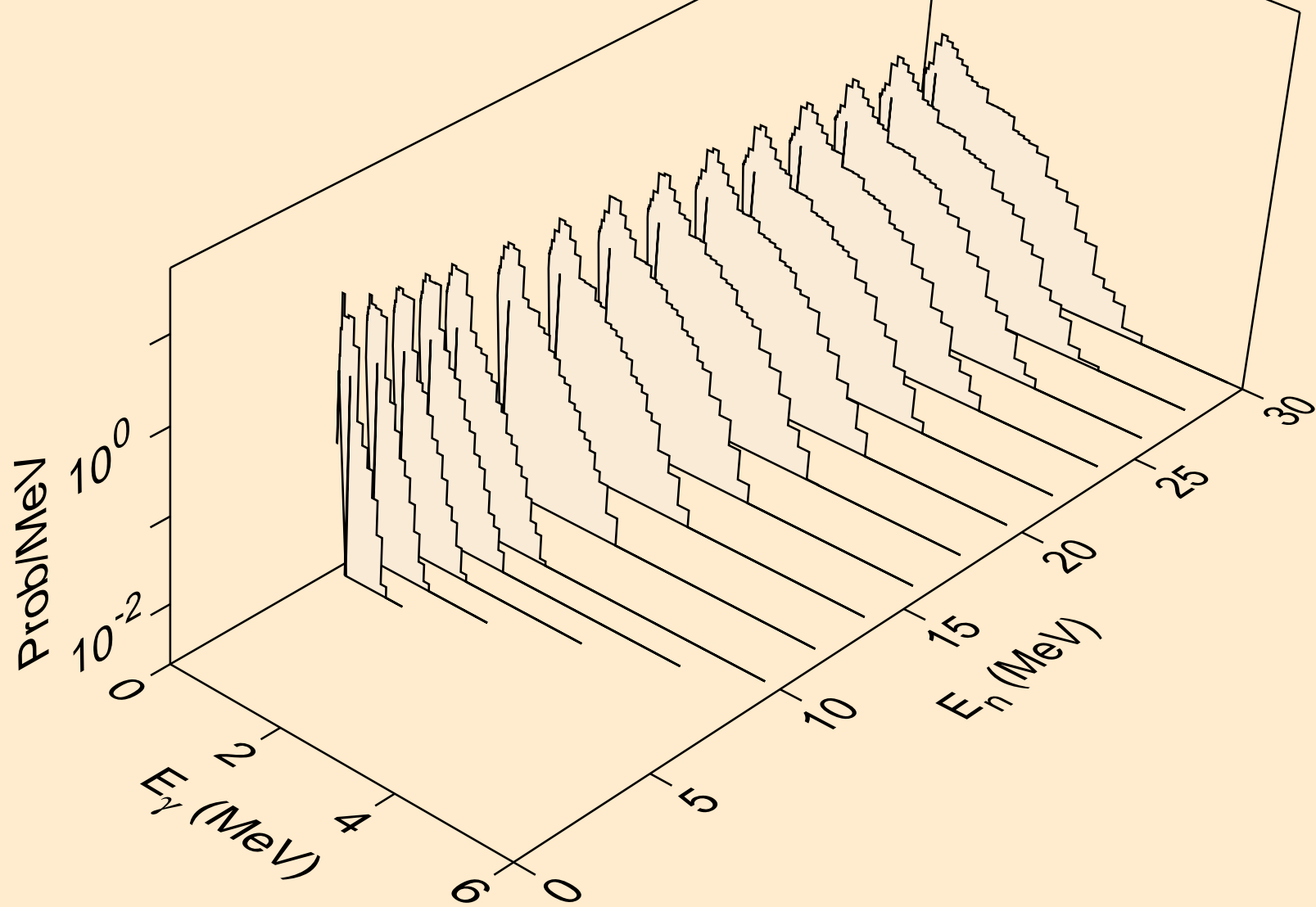

SM130 DEUTERON ACER TENDL-2021 LIBRARY; T=0.K  
Photon emission for (n,2n)a

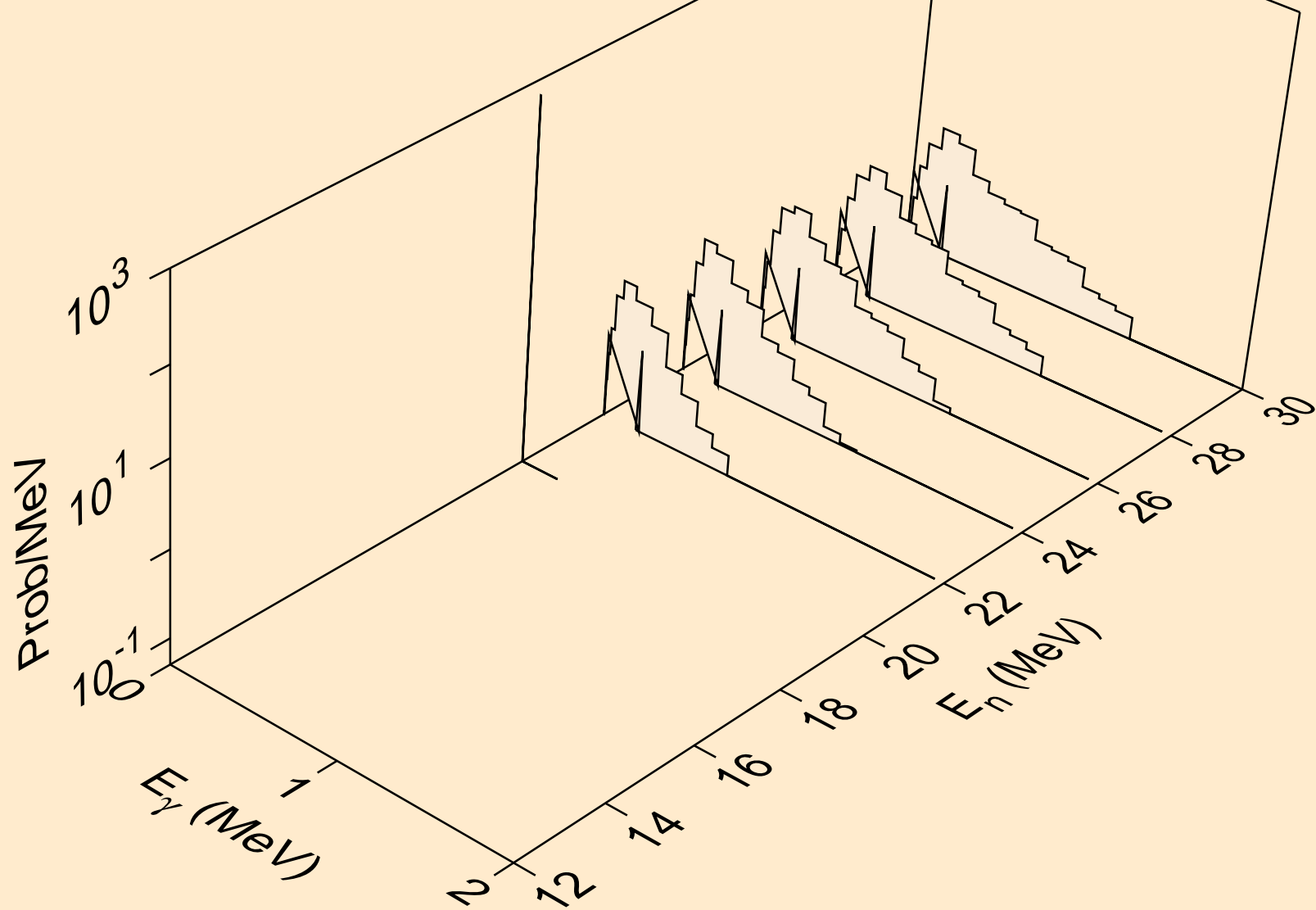

SM130 DEUTERON ACER TENDL-2021 LIBRARY; T=0.K  
Photon emission for (n,n\*)p

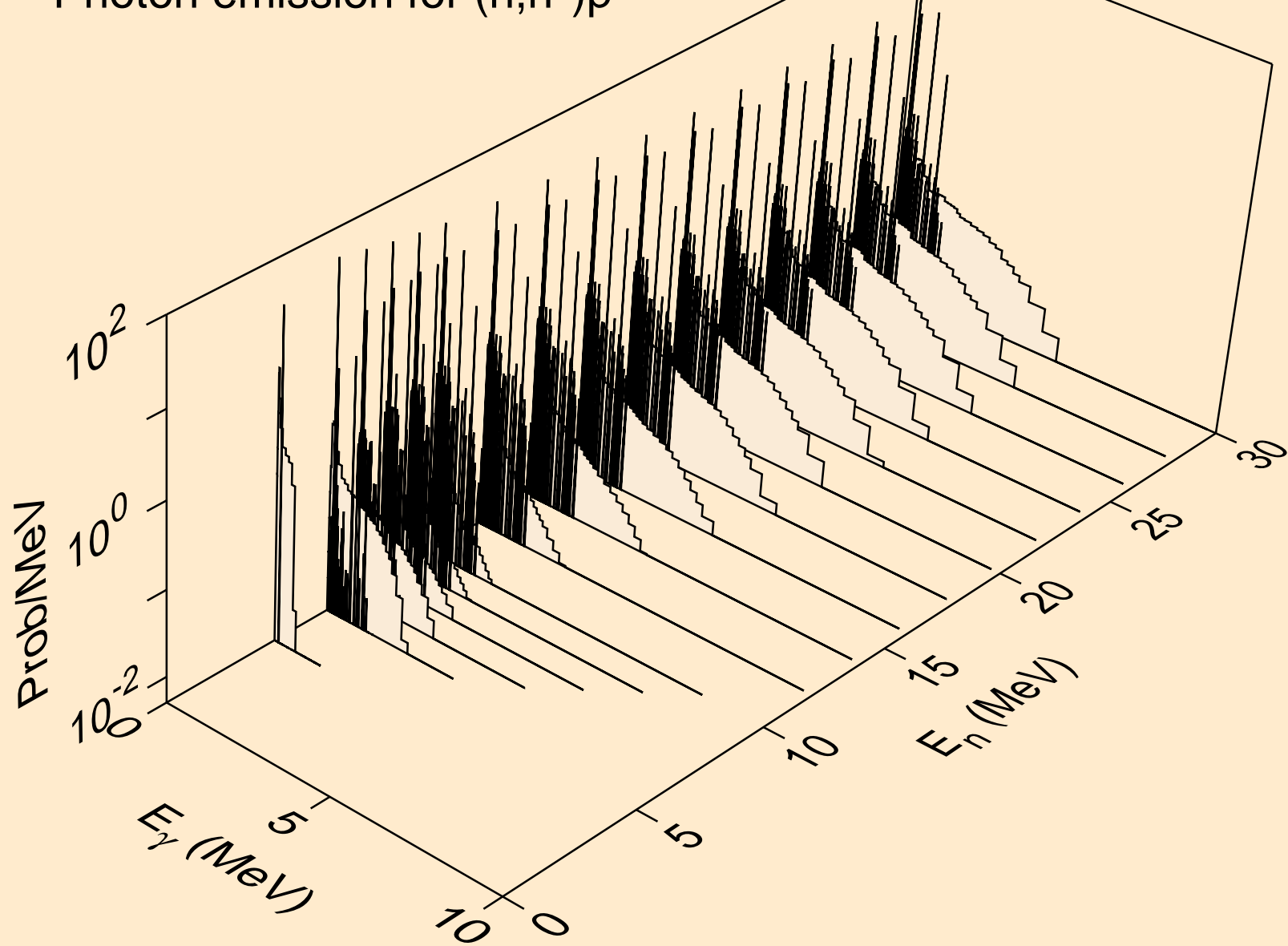

SM130 DEUTERON ACER TENDL-2021 LIBRARY; T=0.K  
Photon emission for (n,n\*)2a

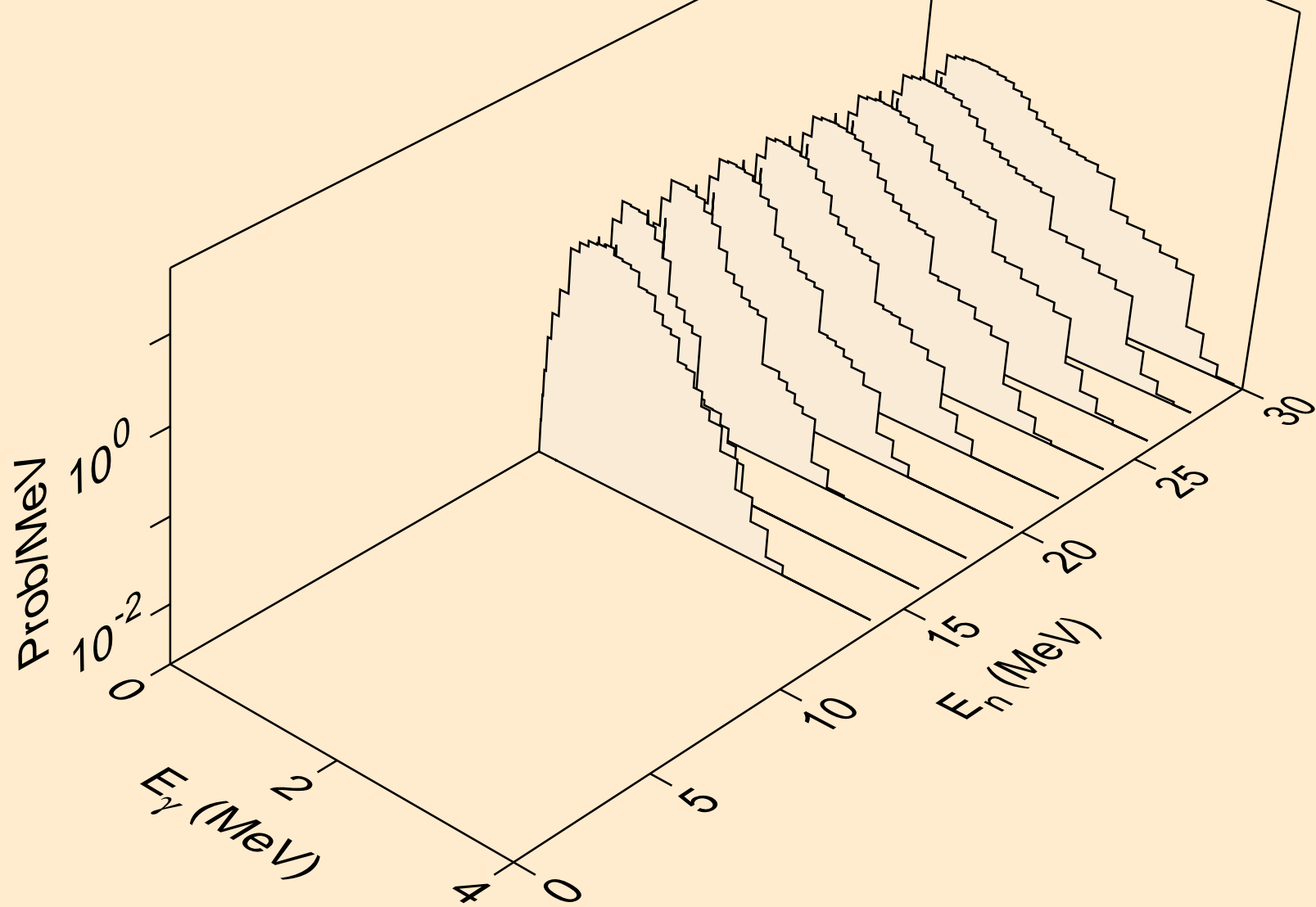

SM130 DEUTERON ACER TENDL-2021 LIBRARY; T=0.K  
Photon emission for (n,n\*)d

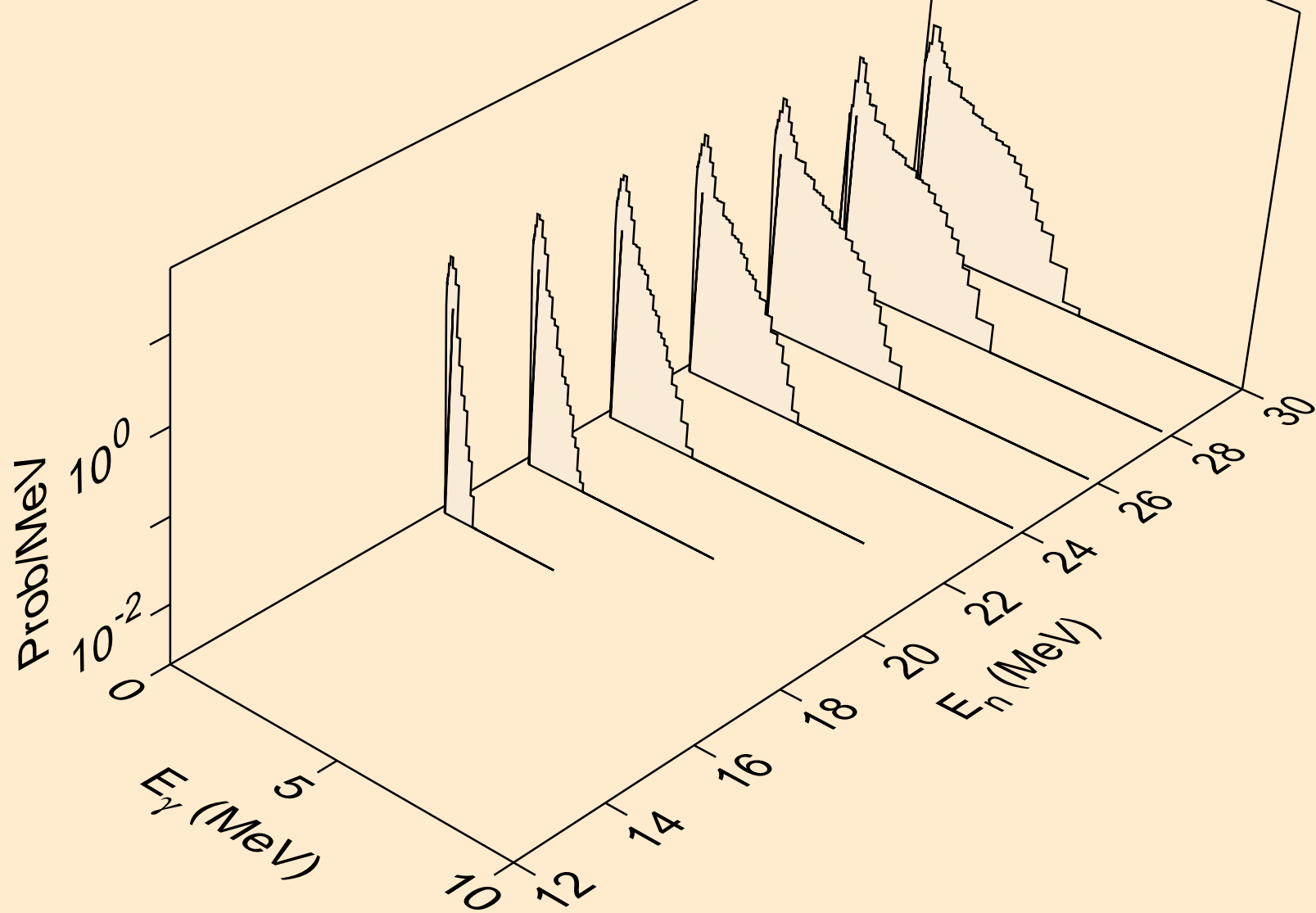

SM130 DEUTERON ACER TENDL-2021 LIBRARY; T=0.K  
Photon emission for (n,n\*)t

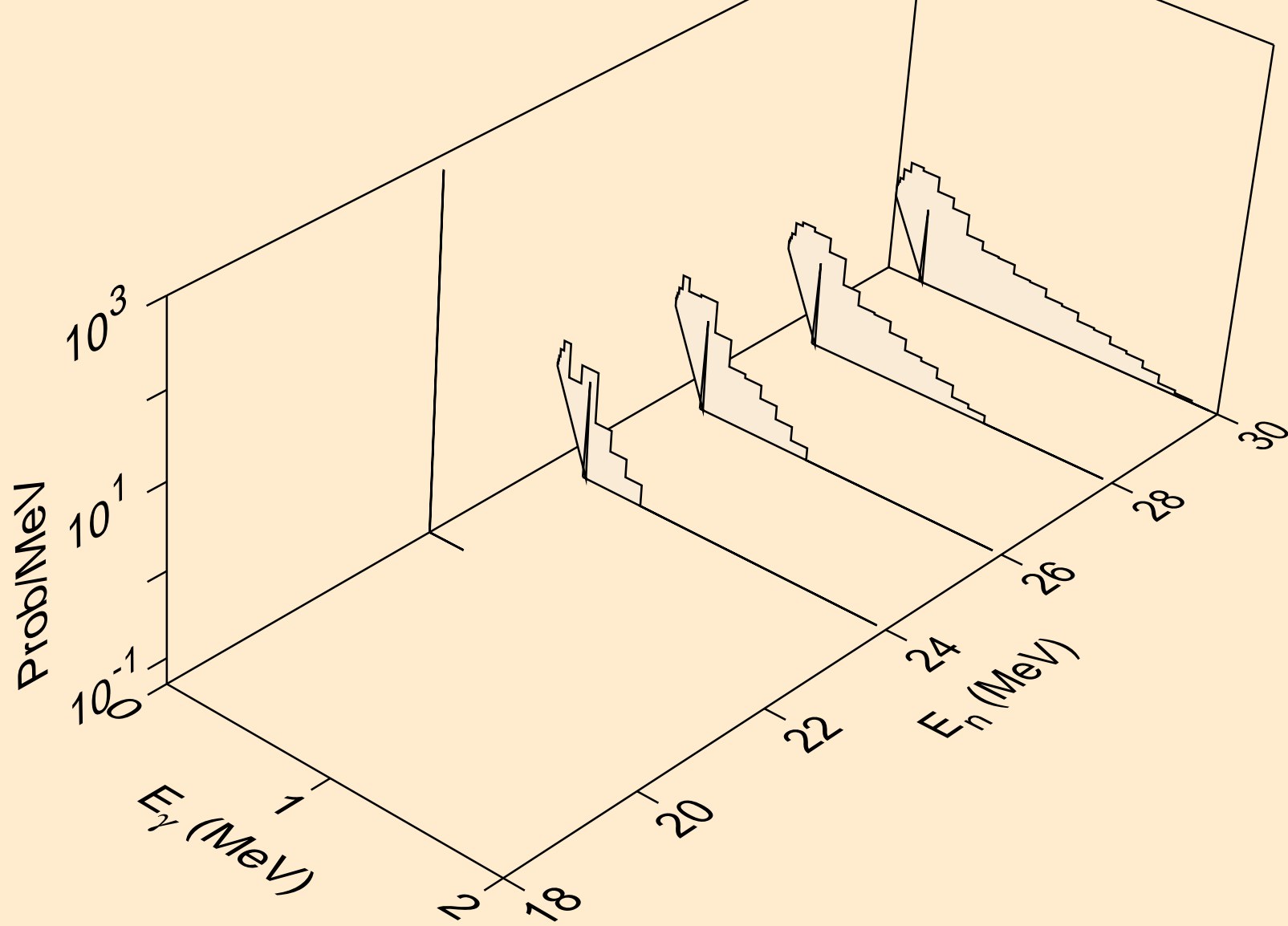



SM130 DEUTERON ACER TENDL-2021 LIBRARY; T=0.K  
Photon emission for (n,n\*)he3

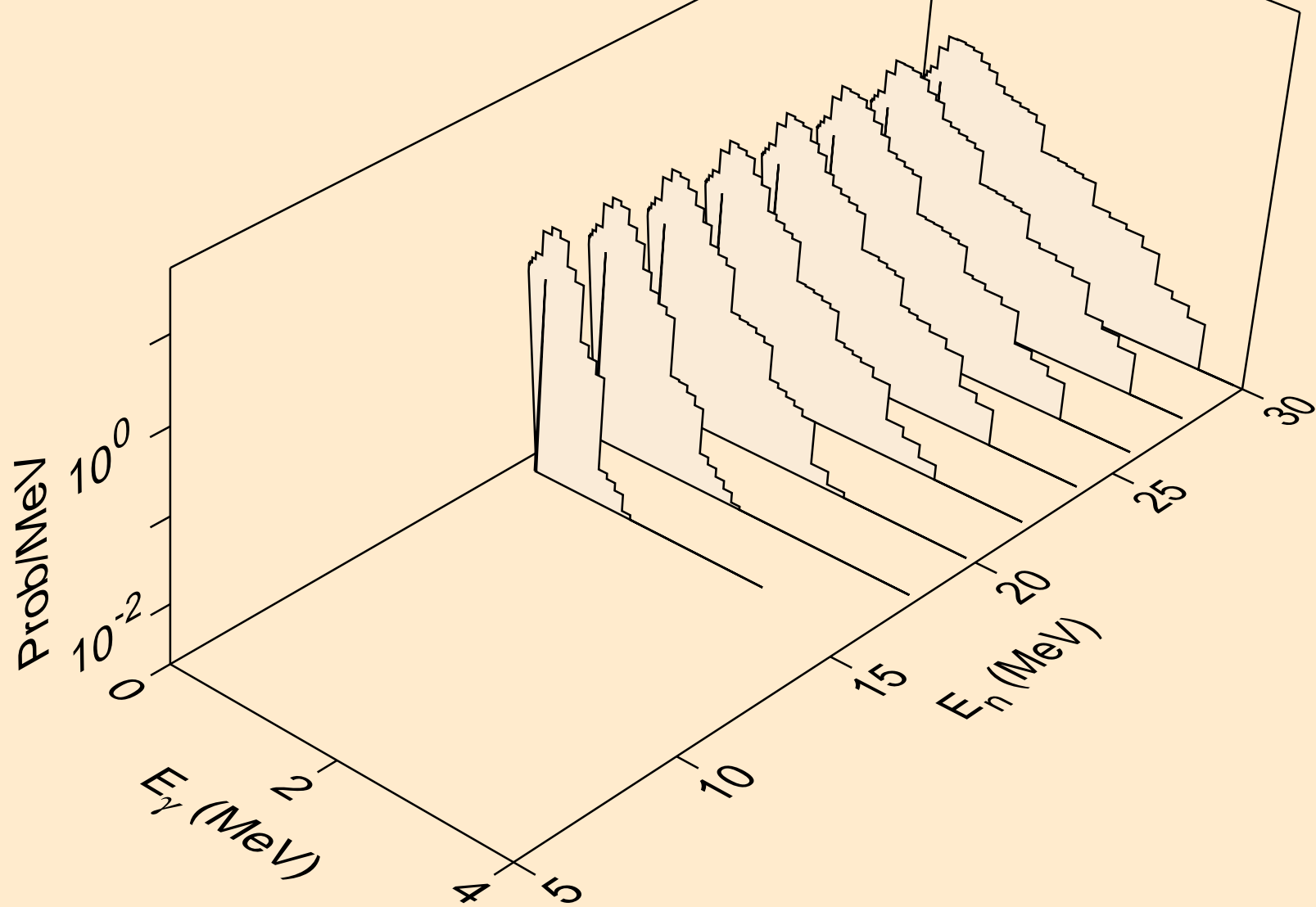

SM130 DEUTERON ACER TENDL-2021 LIBRARY; T=0.K  
Photon emission for (n,2np)

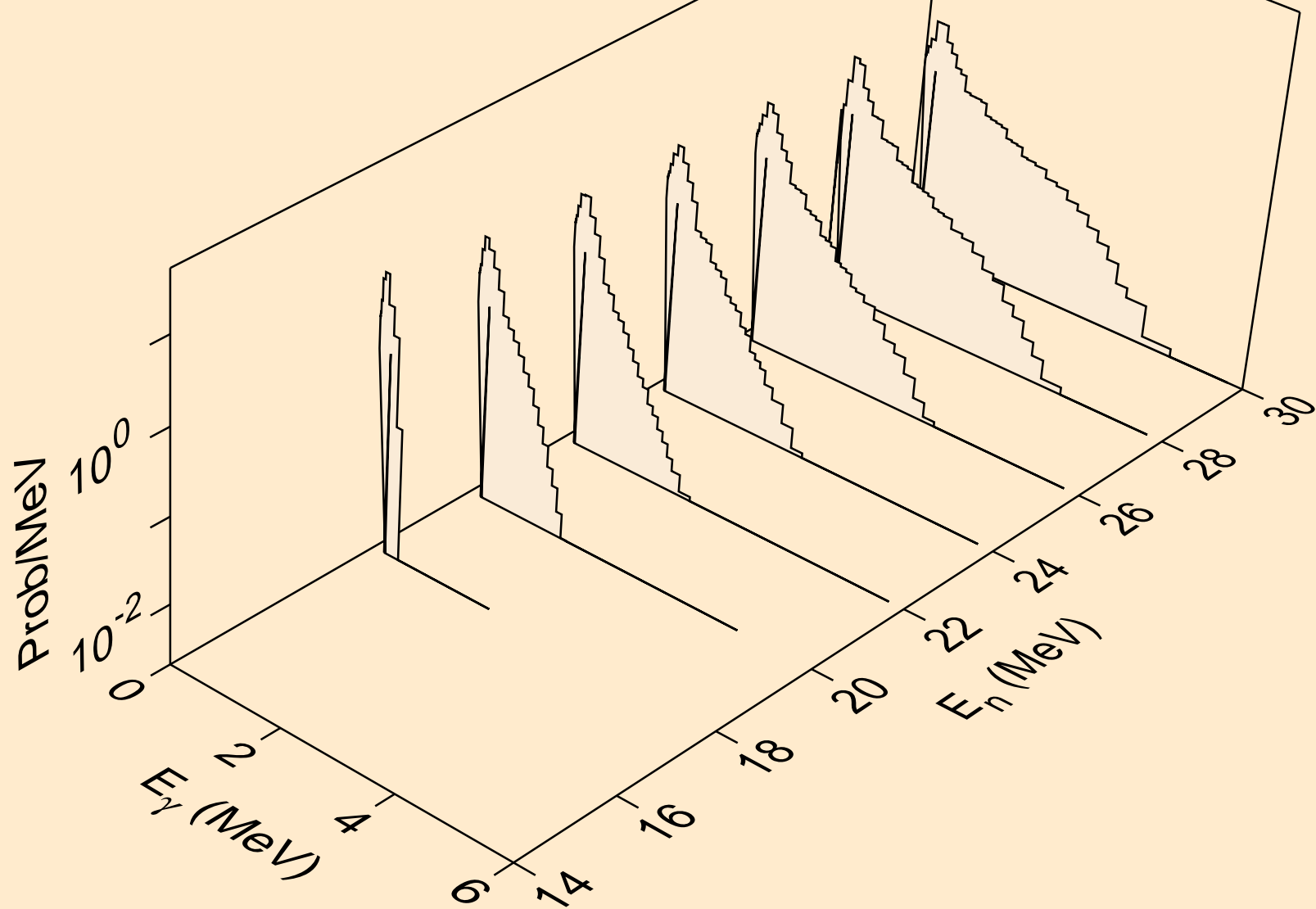

SM130 DEUTERON ACER TENDL-2021 LIBRARY; T=0.K  
Photon emission for (n,2np)

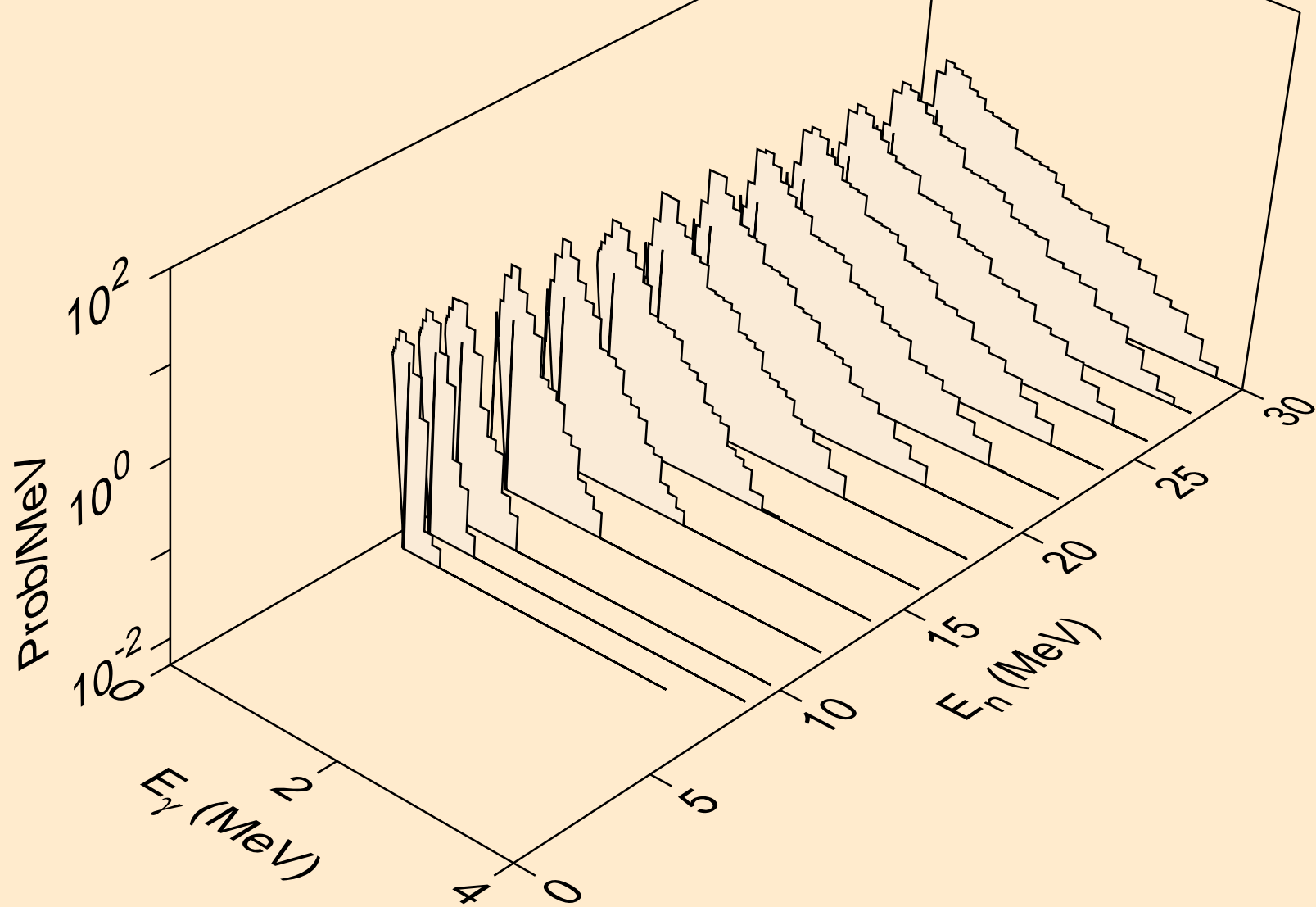

SM130 DEUTERON ACER TENDL-2021 LIBRARY; T=0.K  
Photon emission for (n,npa)

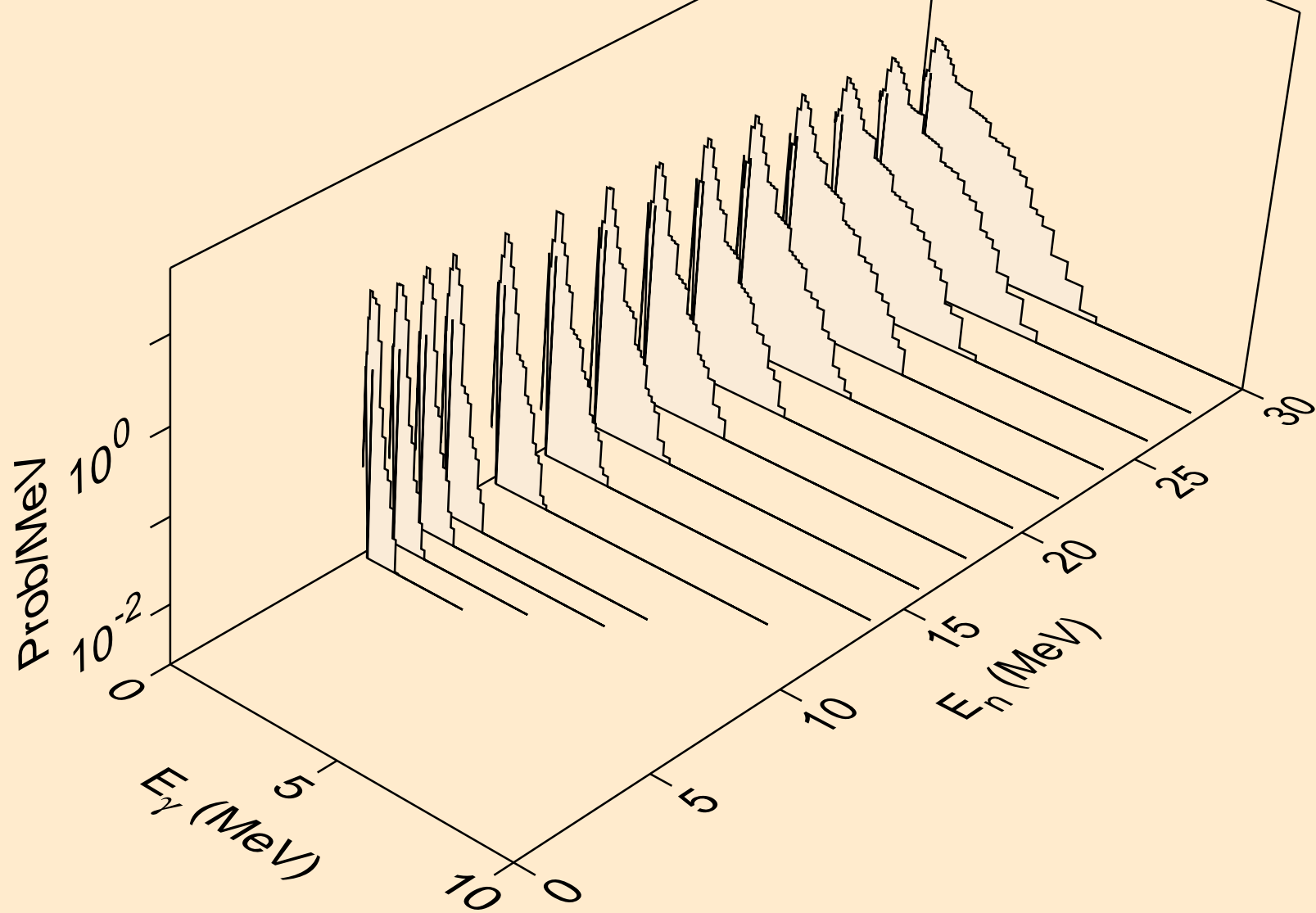

SM130 DEUTERON ACER TENDL-2021 LIBRARY; T=0.K  
Photon emission for (n,gma)

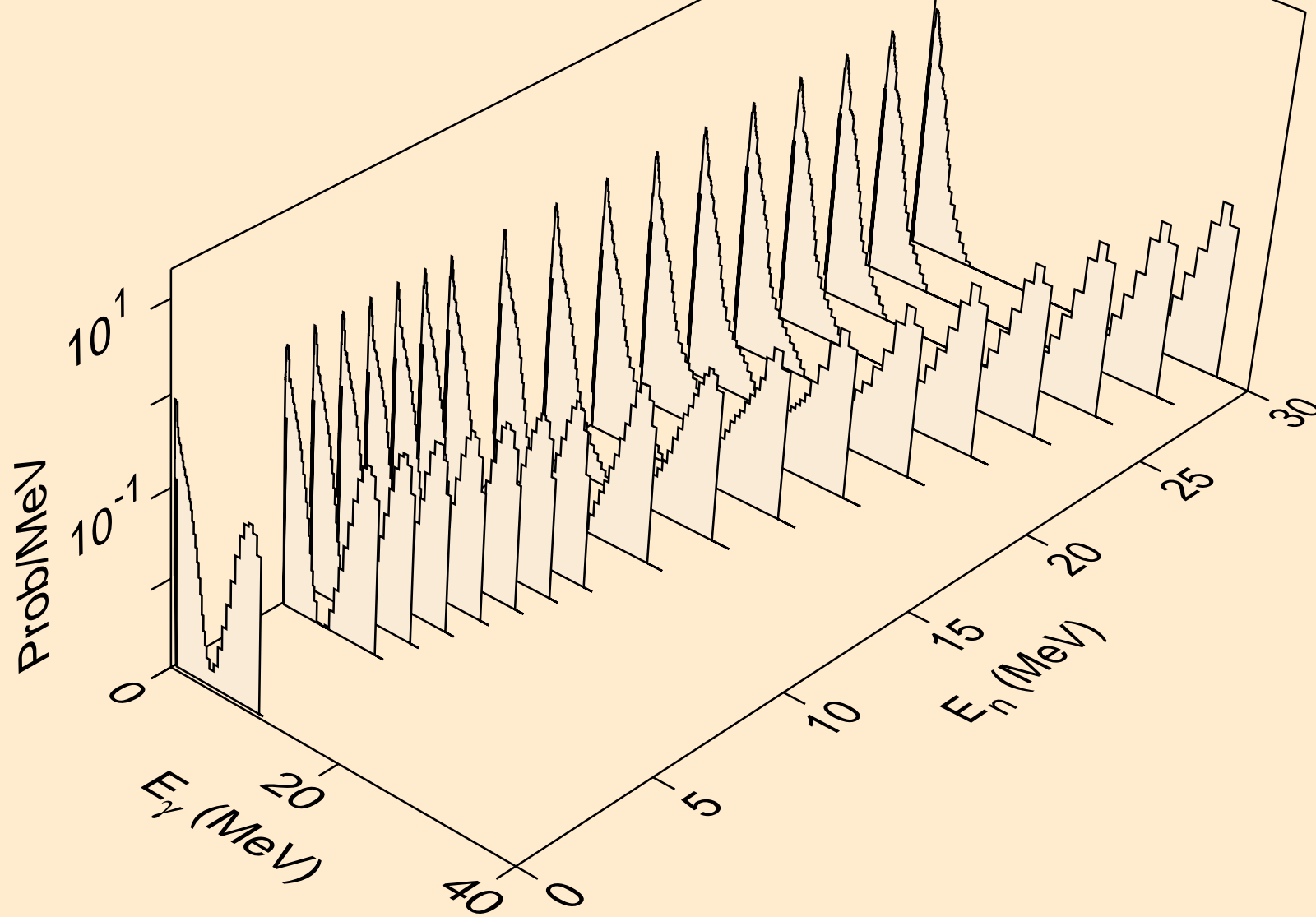

SM130 DEUTERON ACER TENDL-2021 LIBRARY; T=0.K  
Photon emission for (n,p)

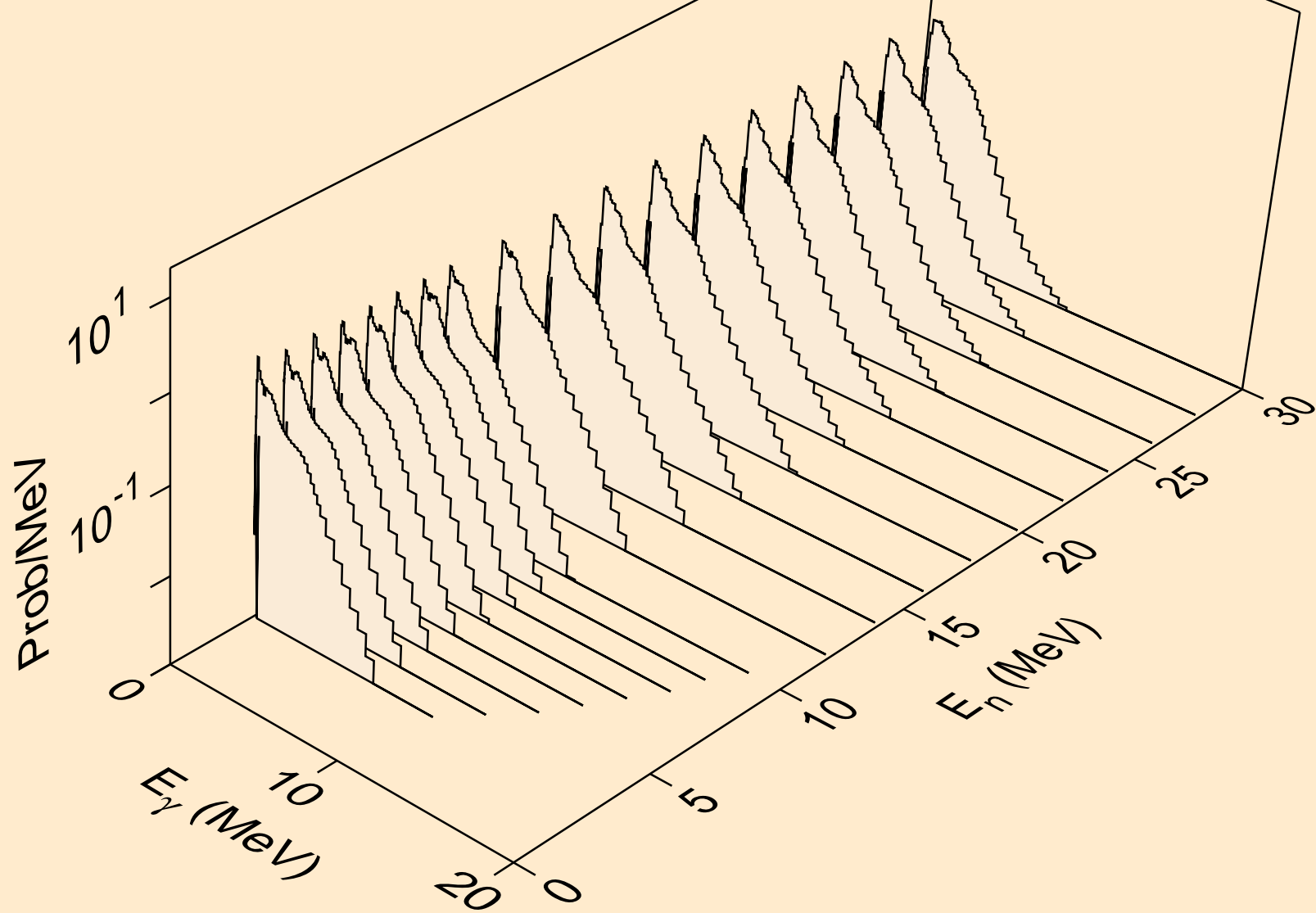

SM130 DEUTERON ACER TENDL-2021 LIBRARY; T=0.K  
Photon emission for inelastic

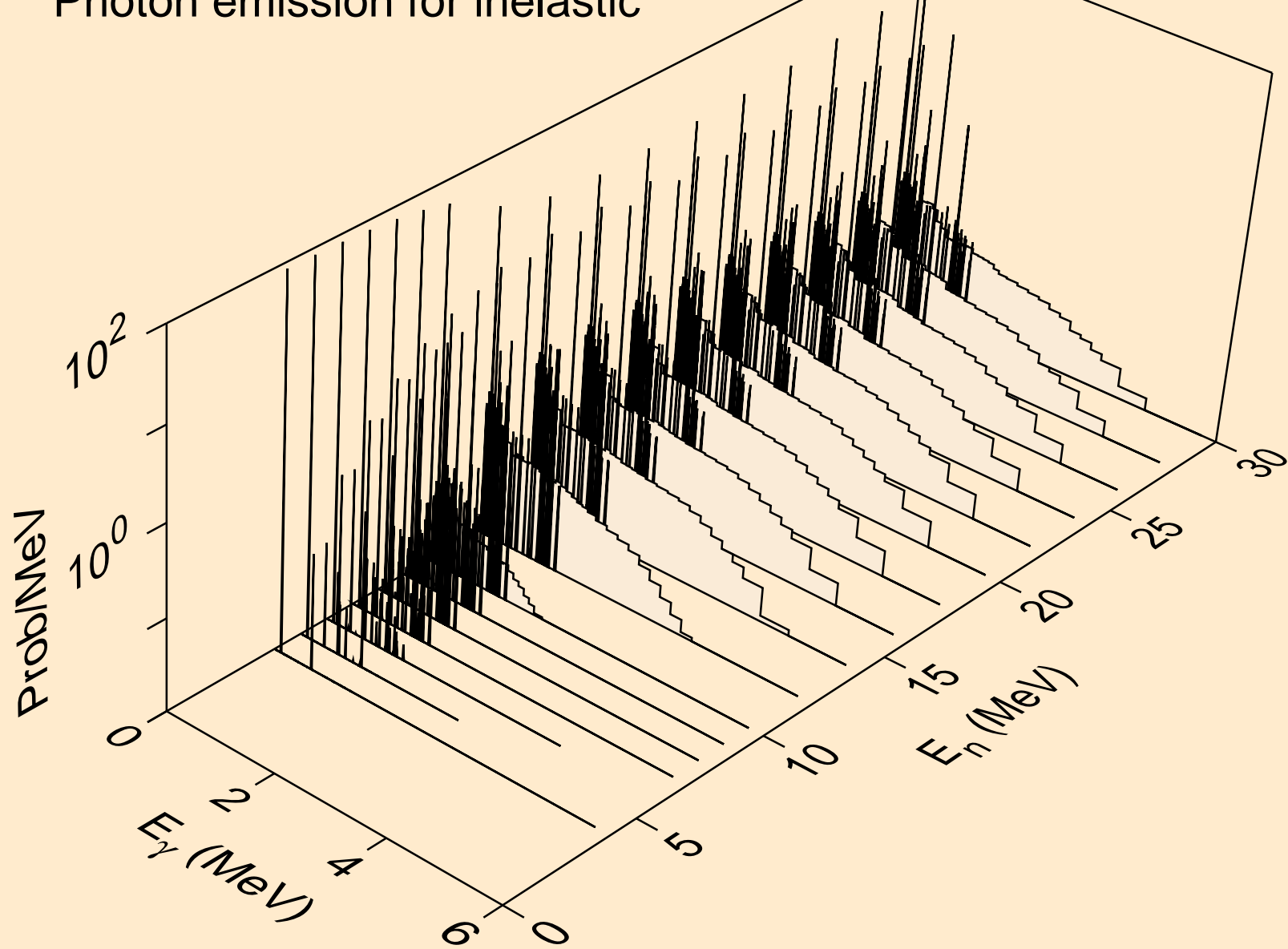

SM130 DEUTERON ACER TENDL-2021 LIBRARY; T=0.K  
Photon emission for (n,t)

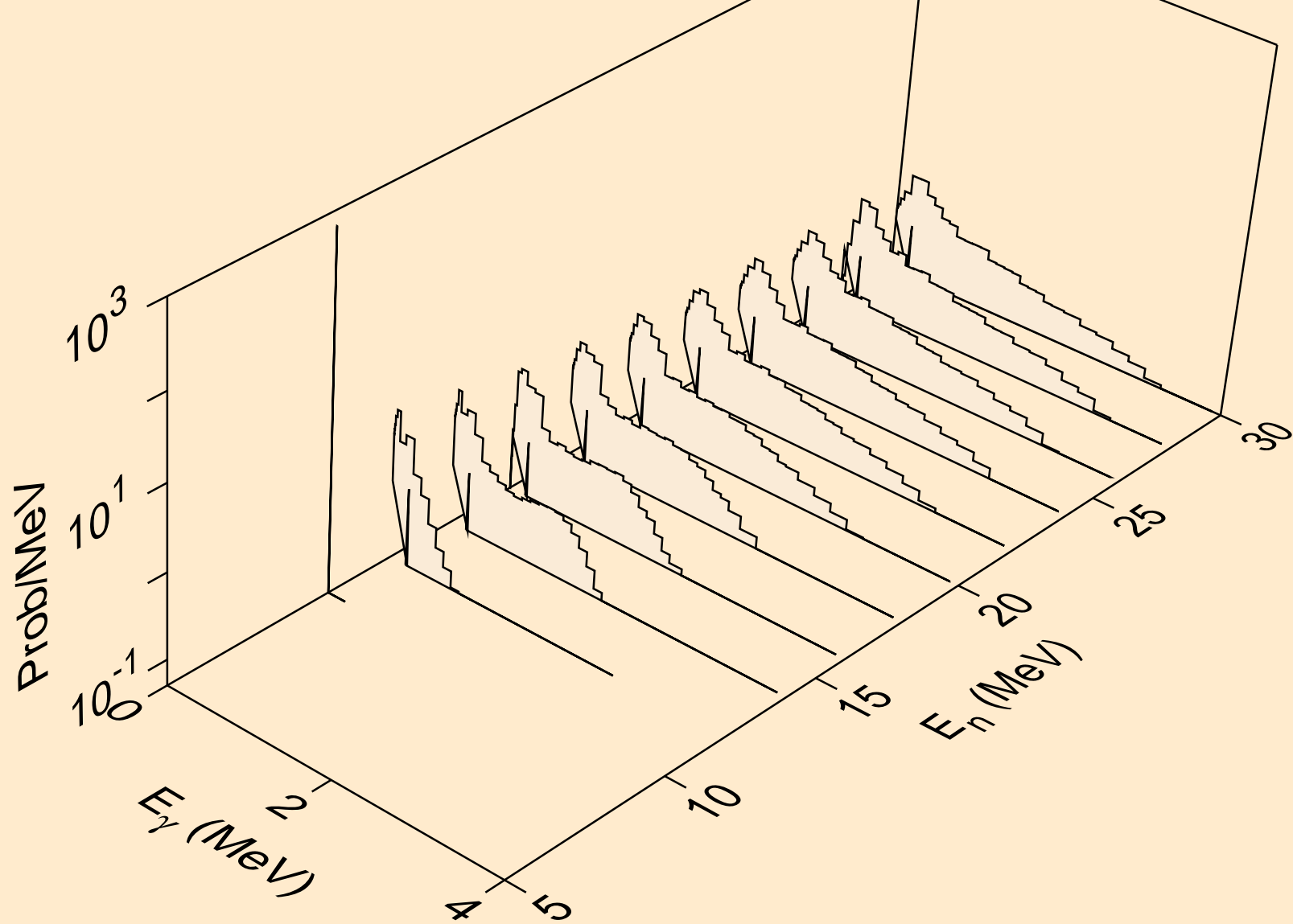



SM130 DEUTERON ACER TENDL-2021 LIBRARY; T=0.K  
Photon emission for (n,he3)

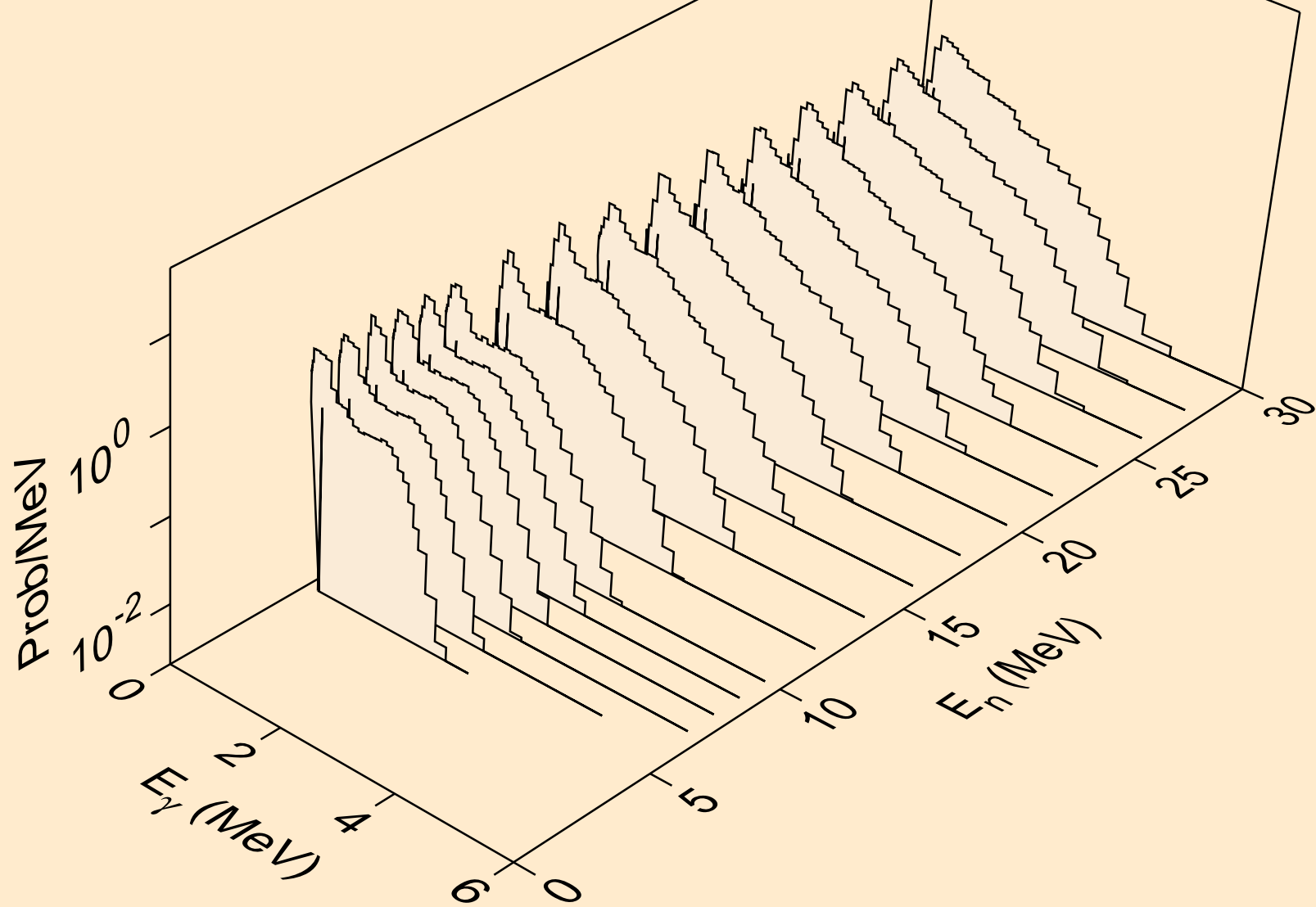

SM130 DEUTERON ACER TENDL-2021 LIBRARY; T=0.K  
Photon emission for (n,a)

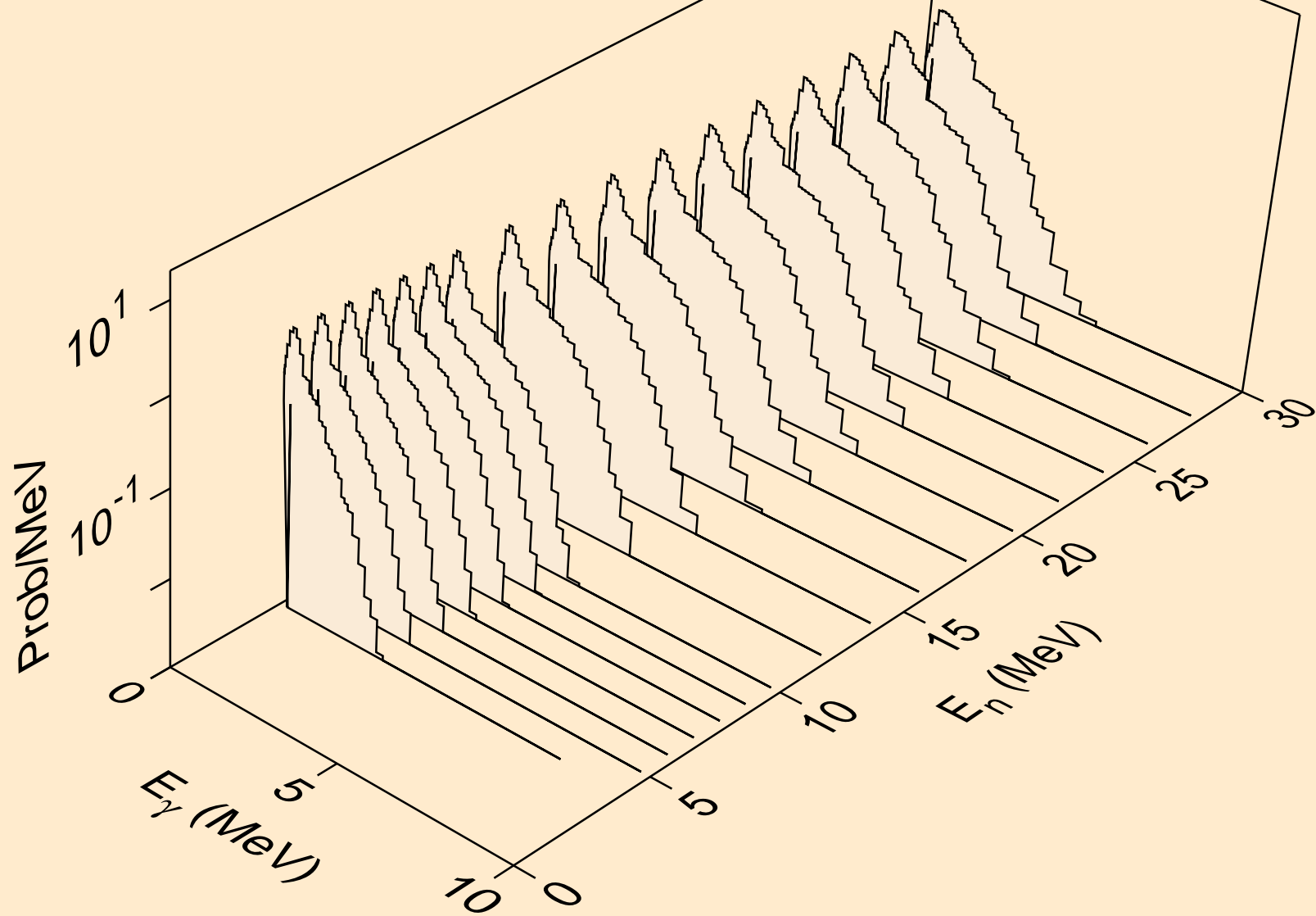

SM130 DEUTERON ACER TENDL-2021 LIBRARY; T=0.K  
Photon emission for (n,2a)

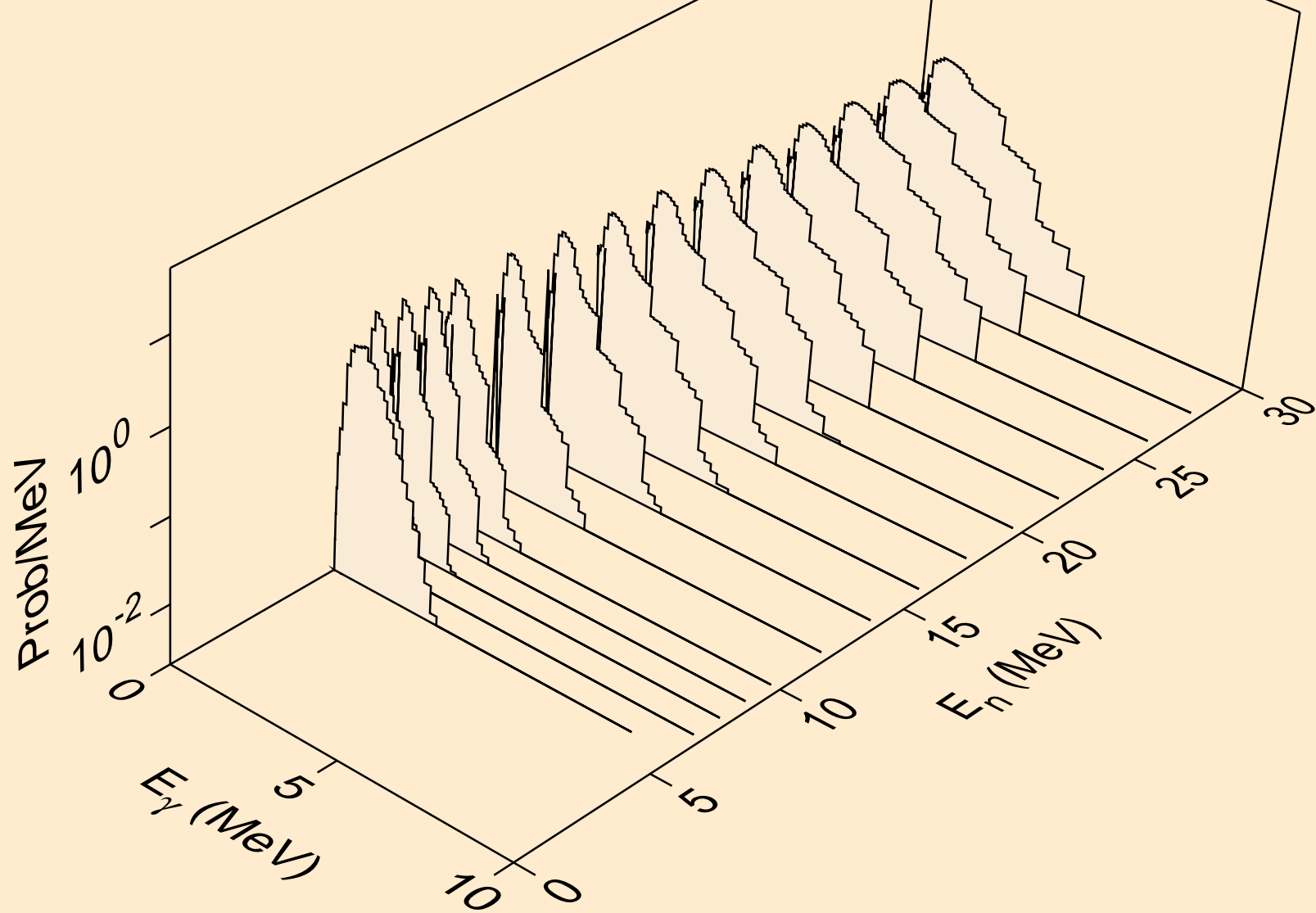

SM130 DEUTERON ACER TENDL-2021 LIBRARY; T=0.K  
Photon emission for (n,2p)

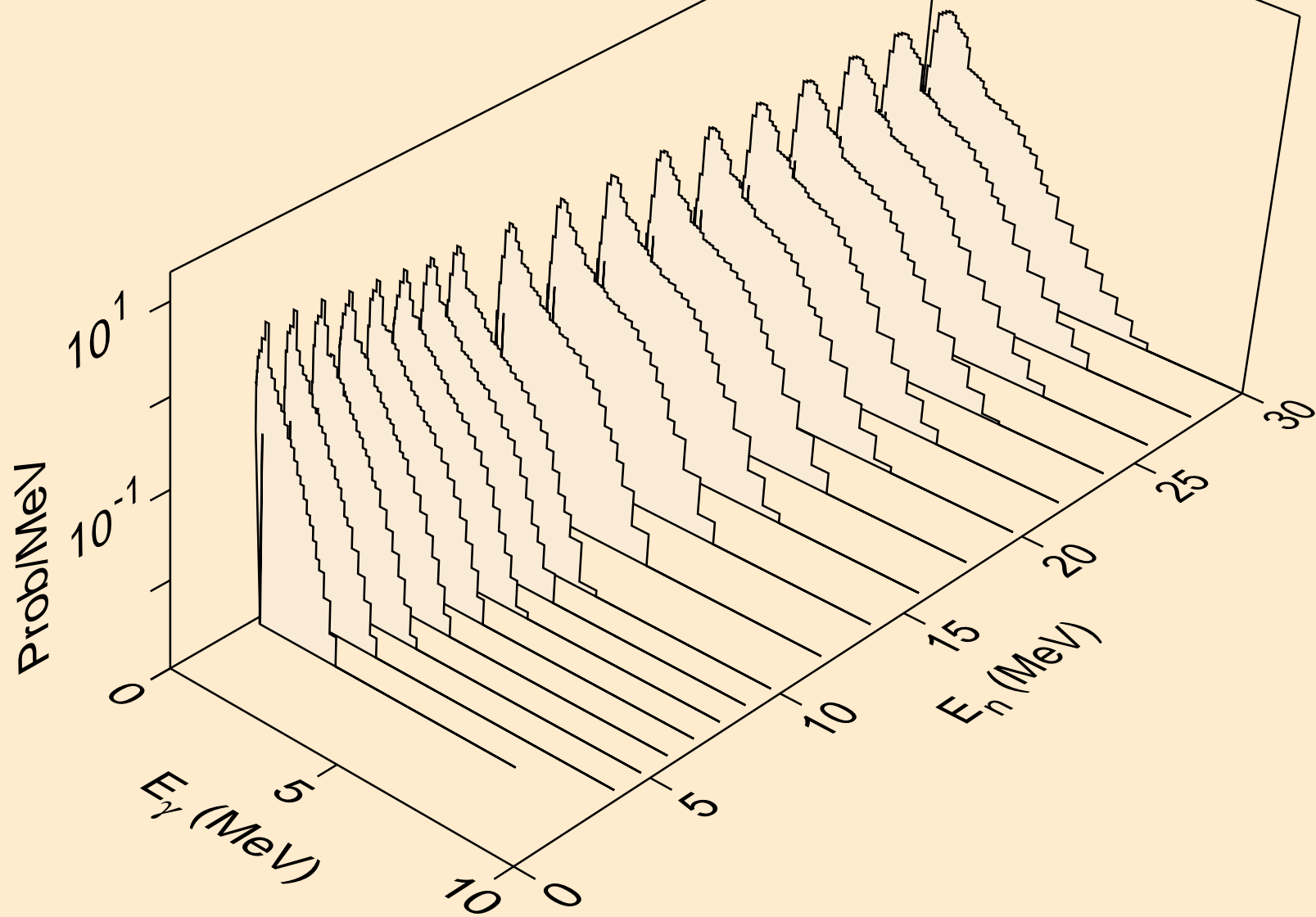

SM130 DEUTERON ACER TENDL-2021 LIBRARY; T=0.K  
Photon emission for (n,p)

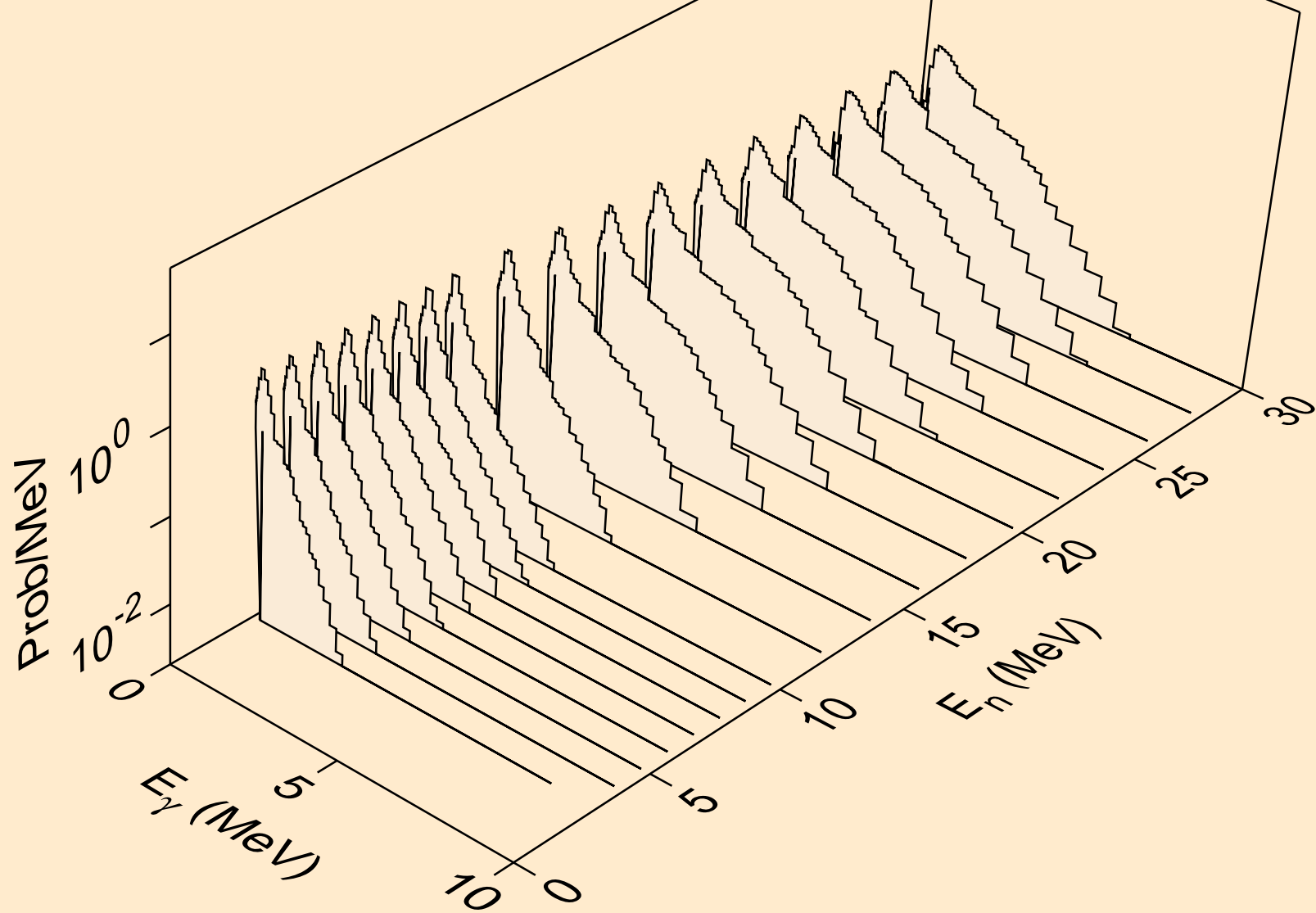

SM130 DEUTERON ACER TENDL-2021 LIBRARY; T=0.K  
Photon emission for (n,d2a)

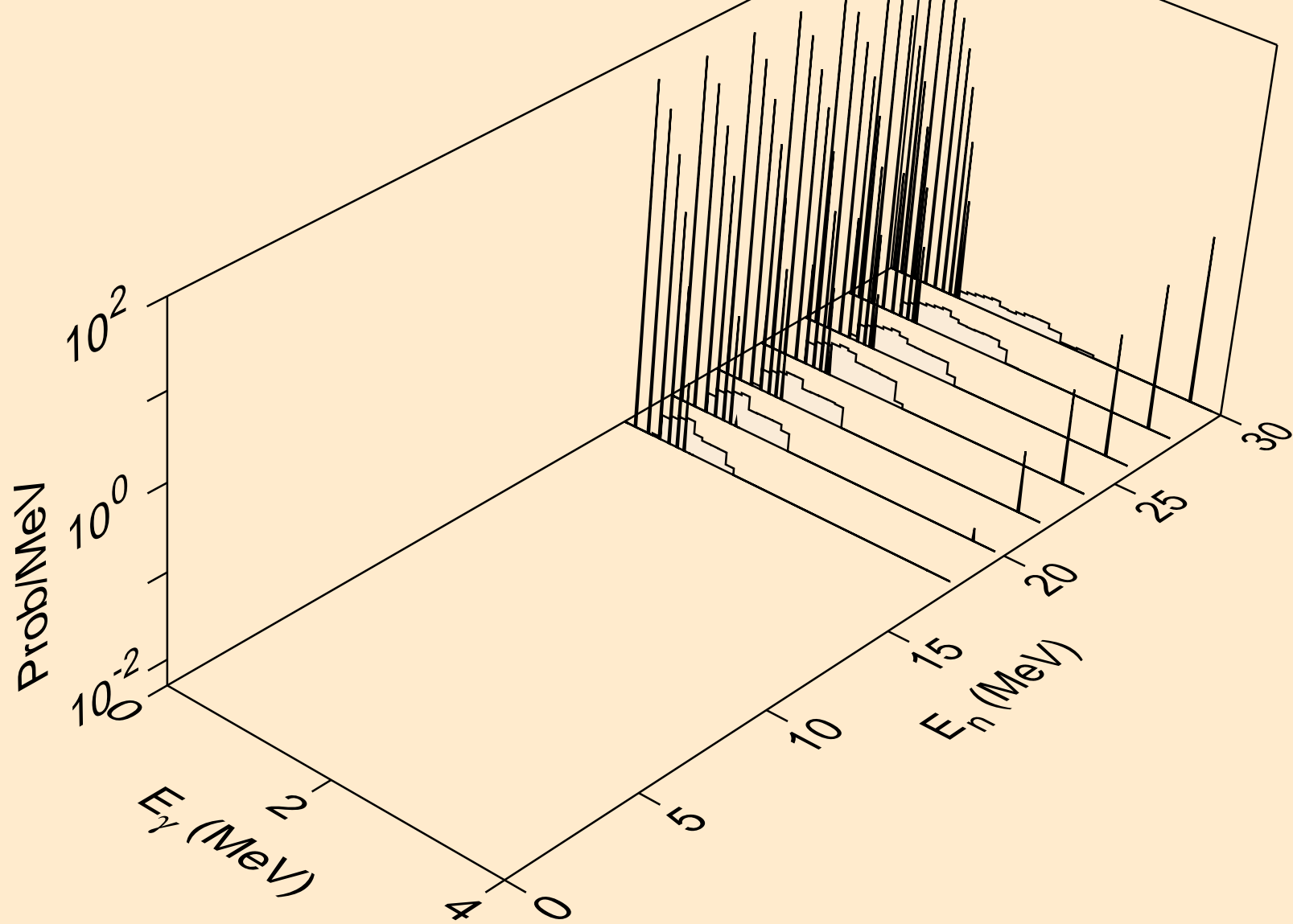

SM130 DEUTERON ACER TENDL-2021 LIBRARY; T=0.K  
Photon emission for (n,pd)

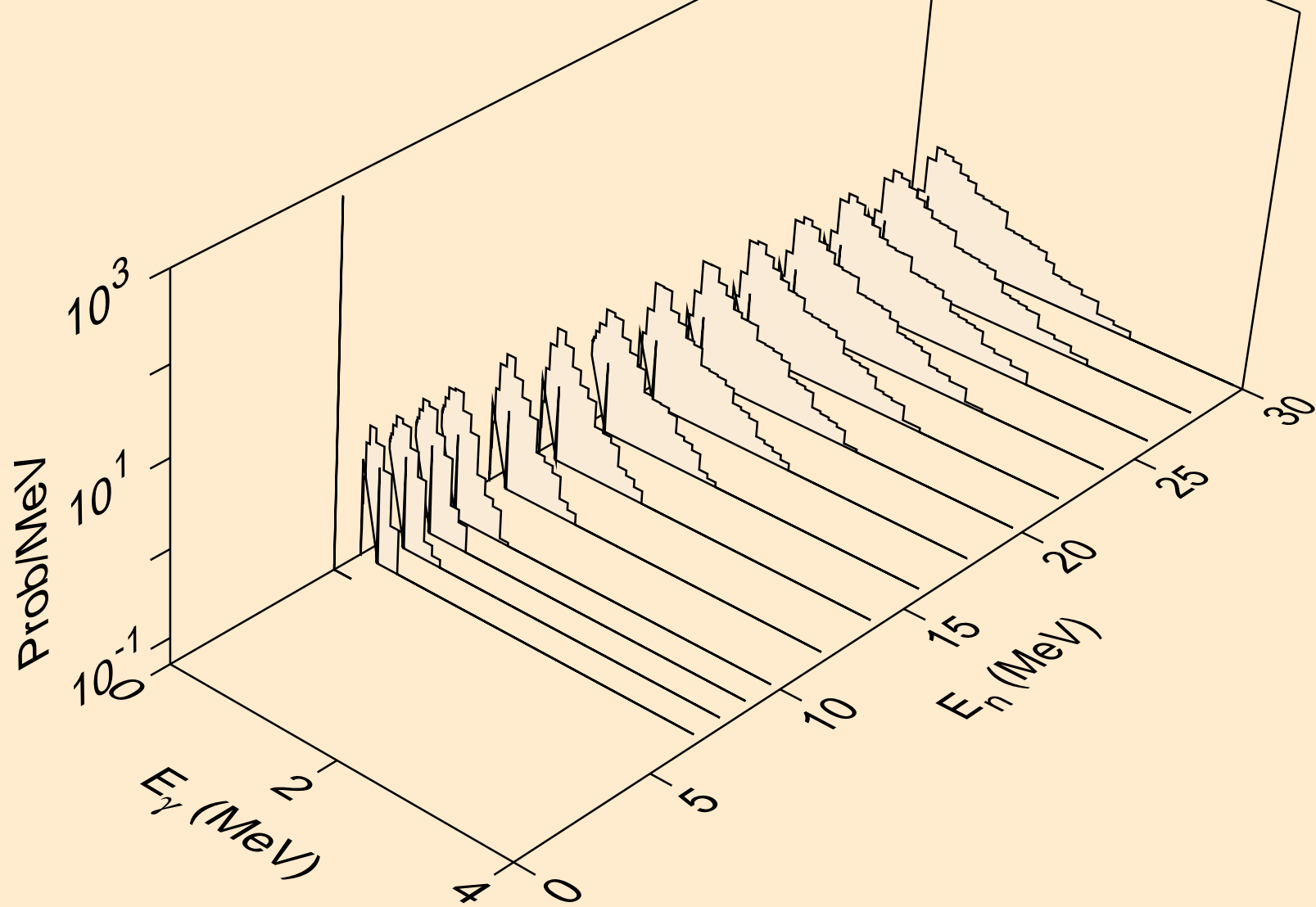

SM130 DEUTERON ACER TENDL-2021 LIBRARY; T=0.K  
Photon emission for (n,pt)

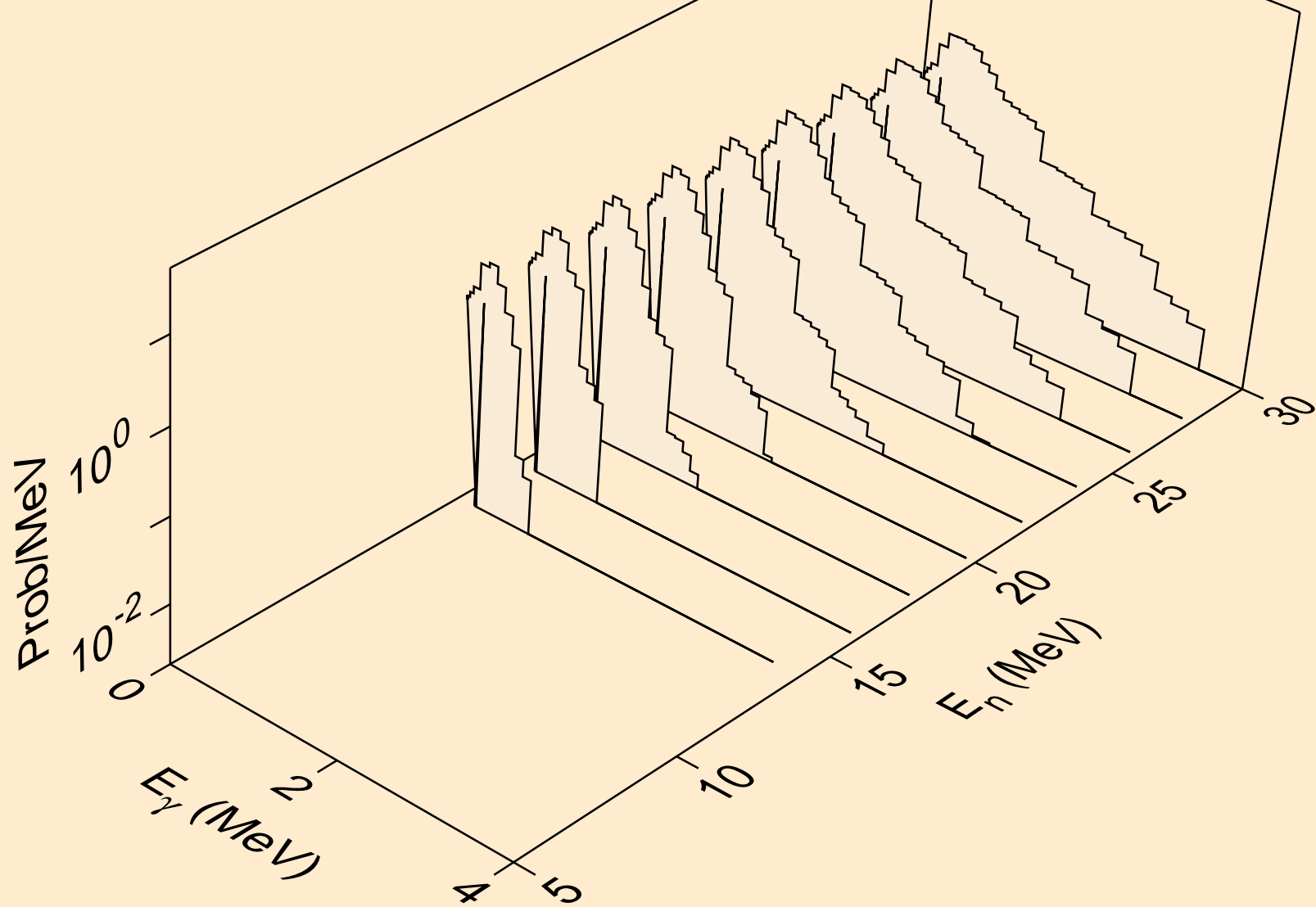



SM130 DEUTERON ACER TENDL-2021 LIBRARY; T=0.K  
Photon emission for (n,da)

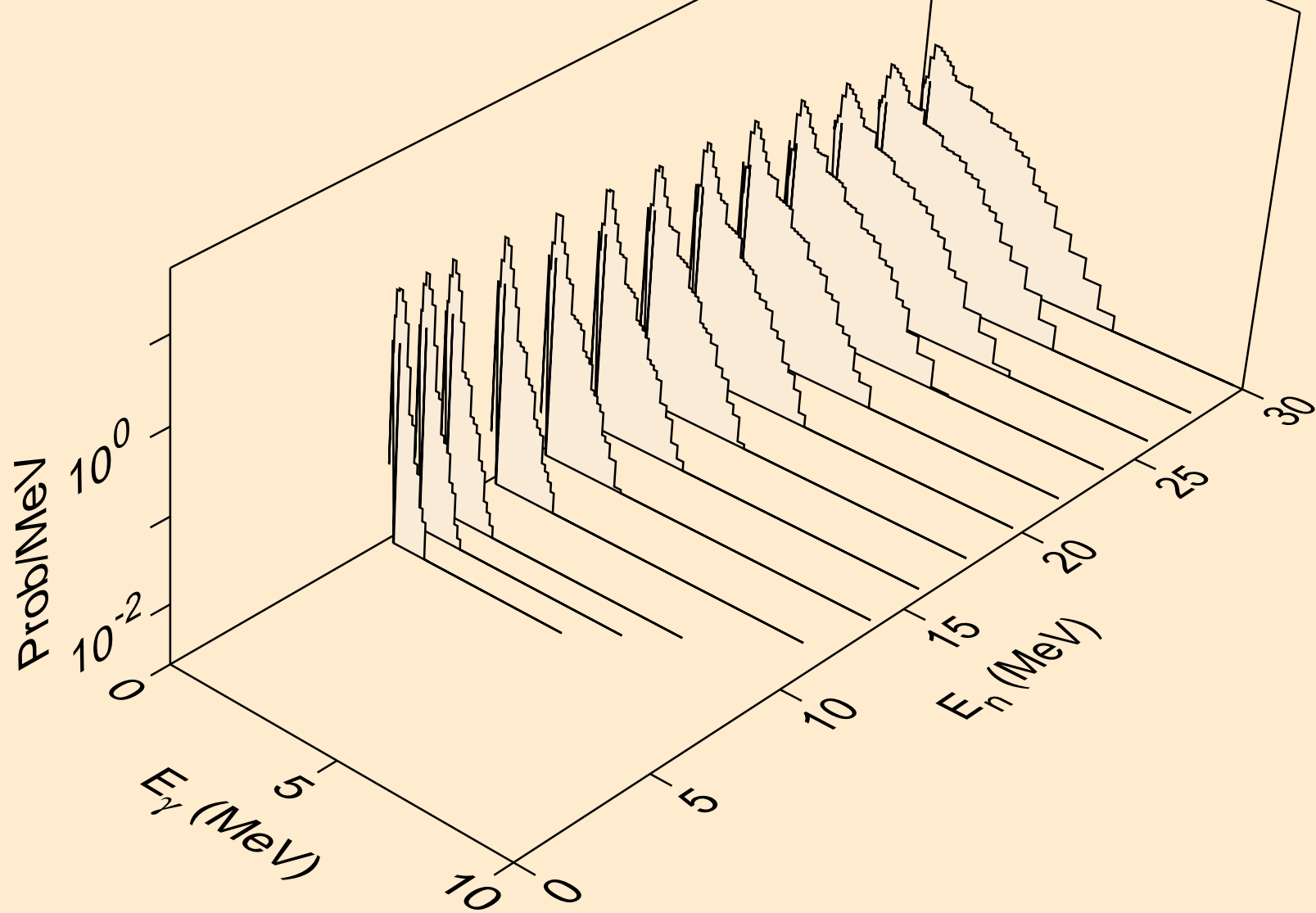

# SM130 DEUTERON ACER TENDL-2021 LIBRARY; T=0.K

## Particle heating contributions

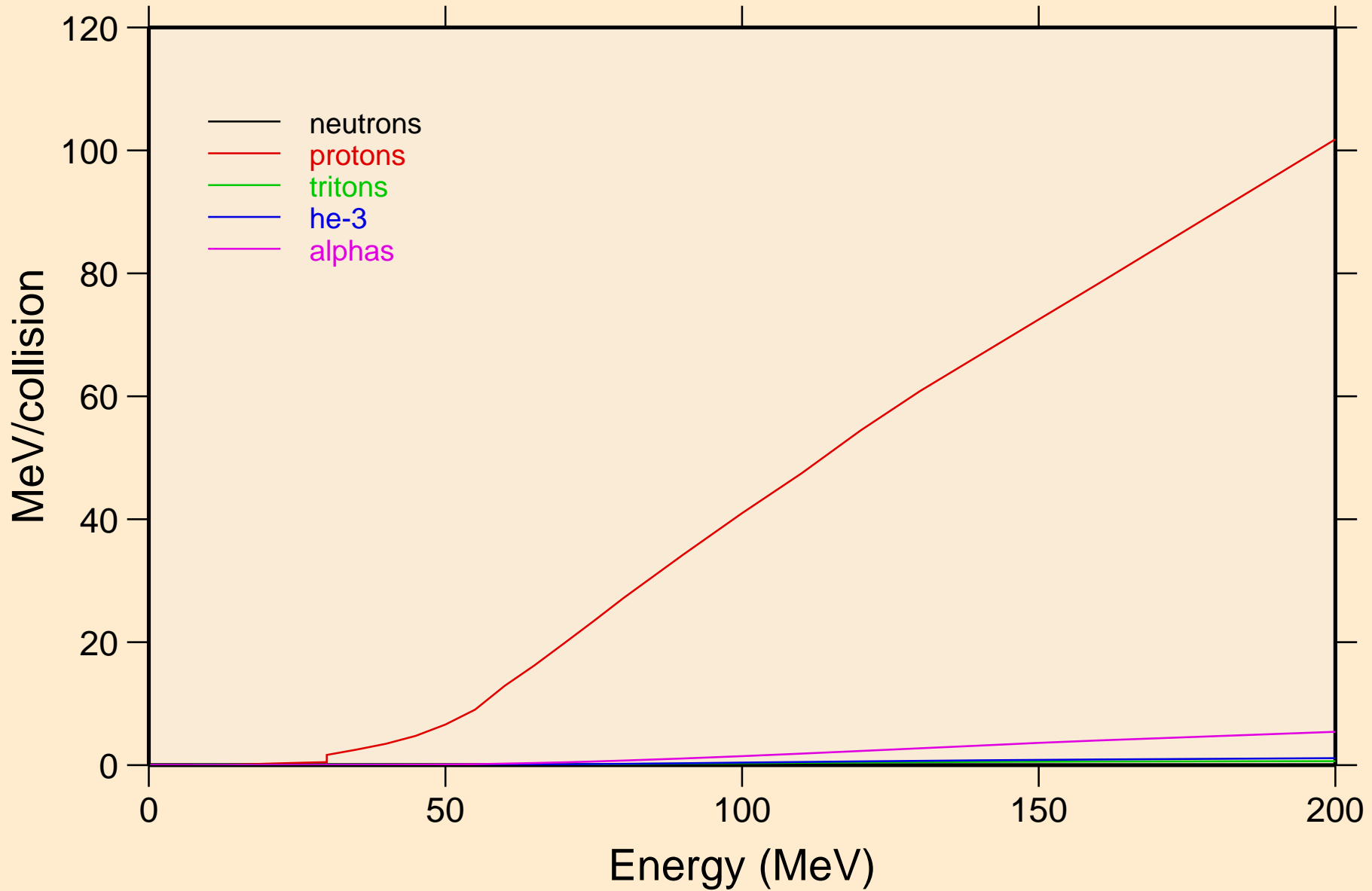

SM130 DEUTERON ACER TENDL-2021 LIBRARY; T=0.K  
Recoil Heating

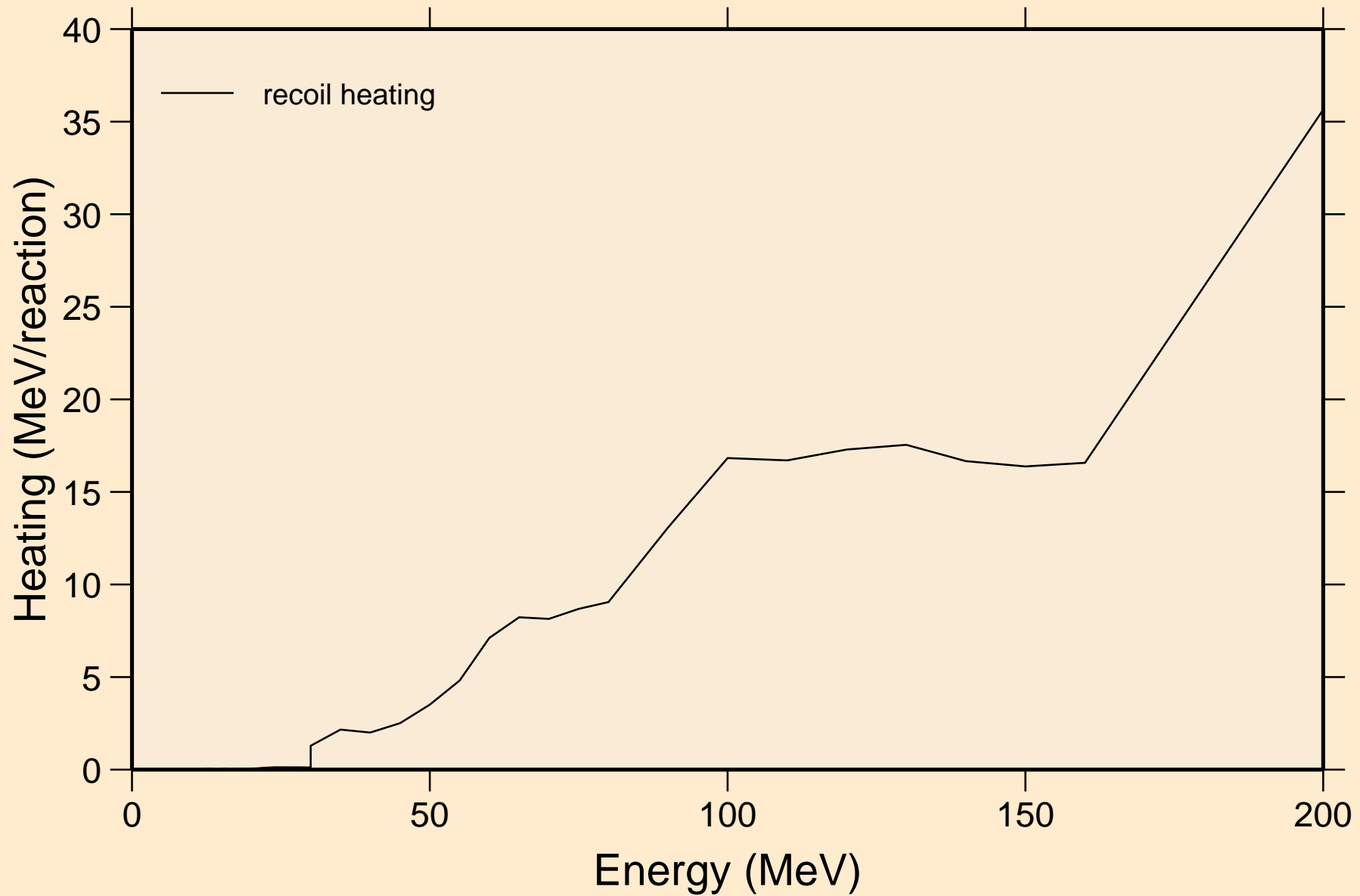

# SM130 DEUTERON ACER TENDL-2021 LIBRARY; T=0.K

## Particle production cross sections

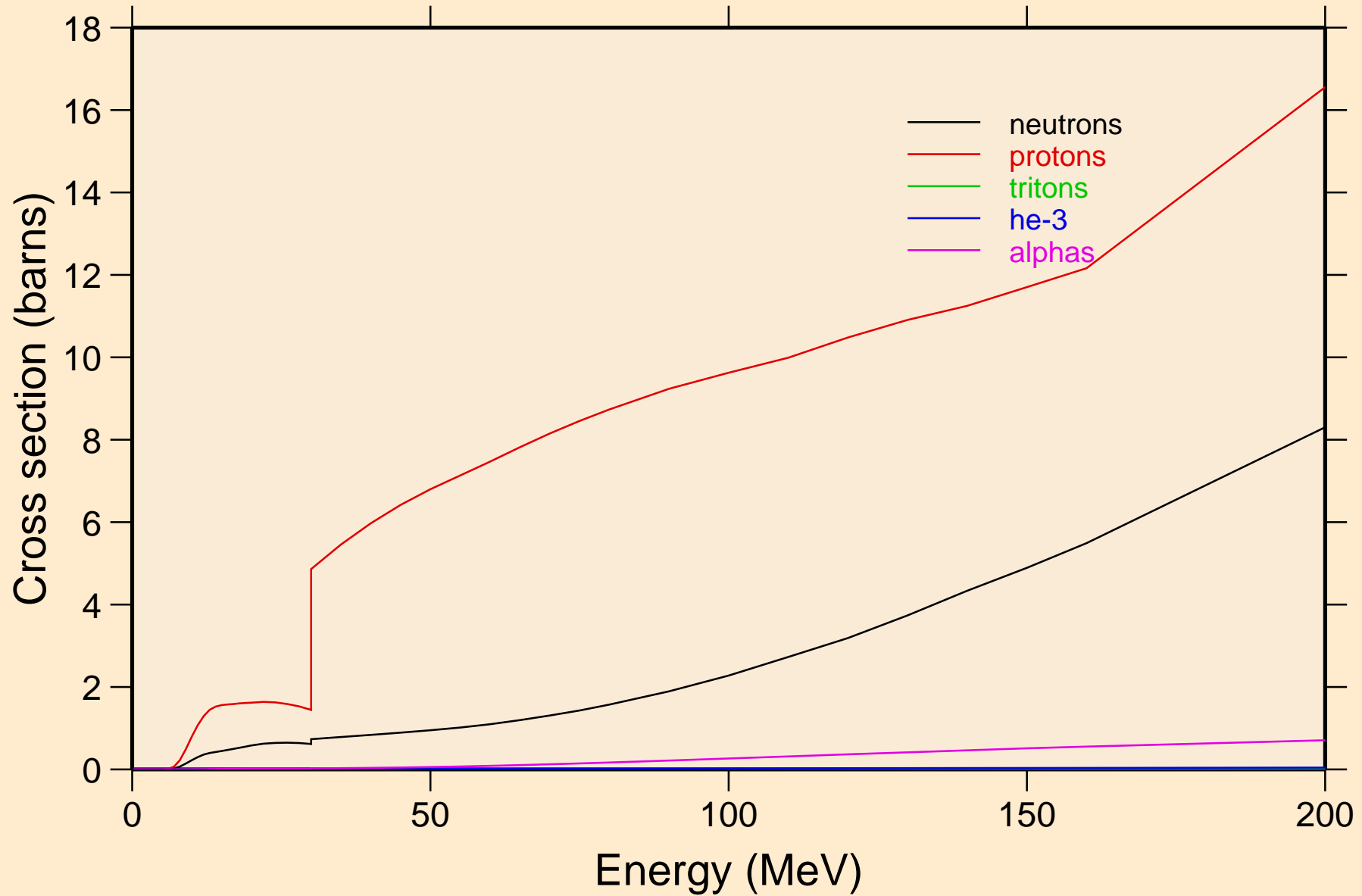

SM130 DEUTERON ACER TENDL-2021 LIBRARY; T=0.K  
neutrons from (d,n)

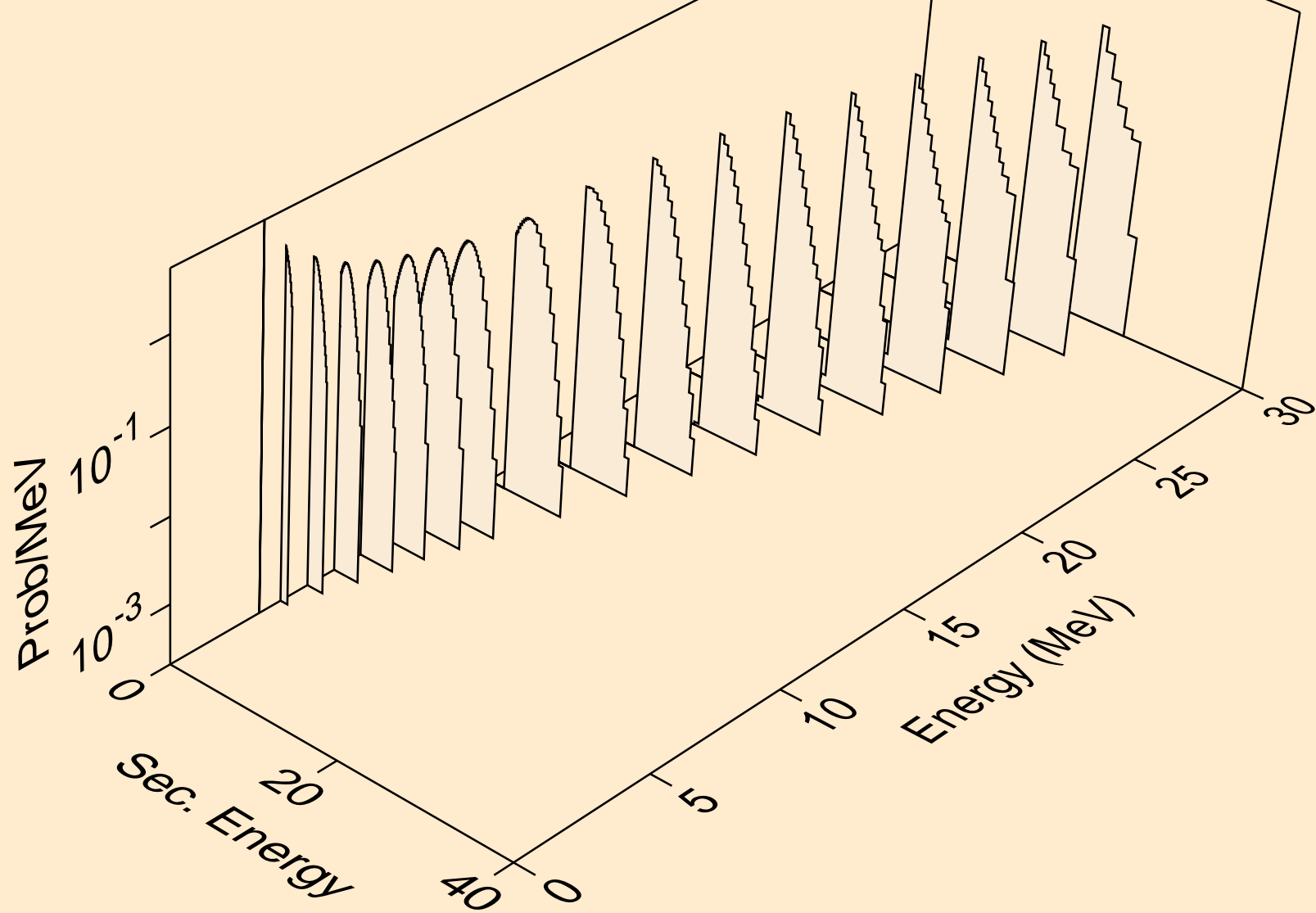

SM130 DEUTERON ACER TENDL-2021 LIBRARY; T=0.K  
neutrons from (d,x)

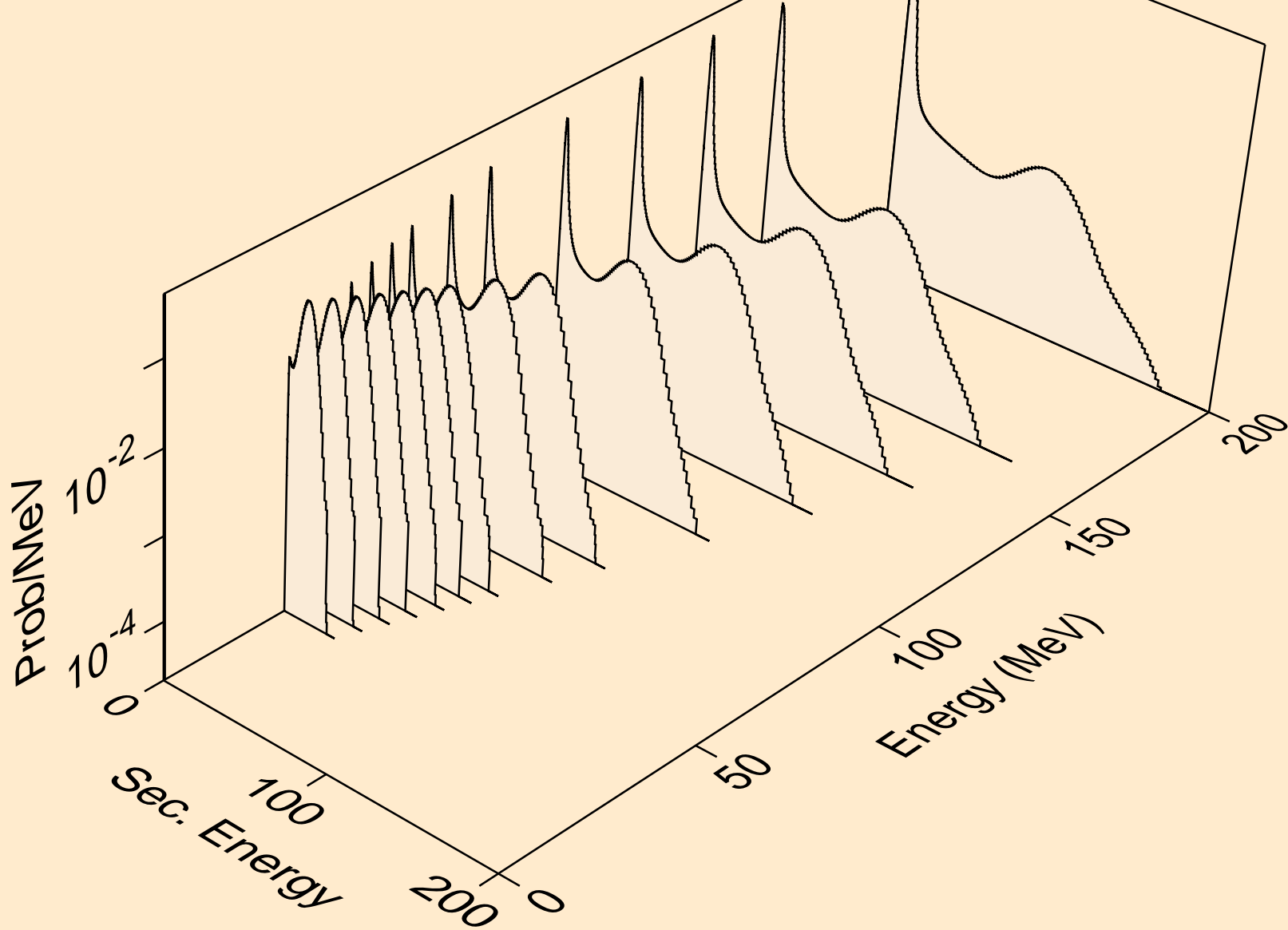

SM130 DEUTERON ACER TENDL-2021 LIBRARY; T=0.K  
neutrons from (d,2n)

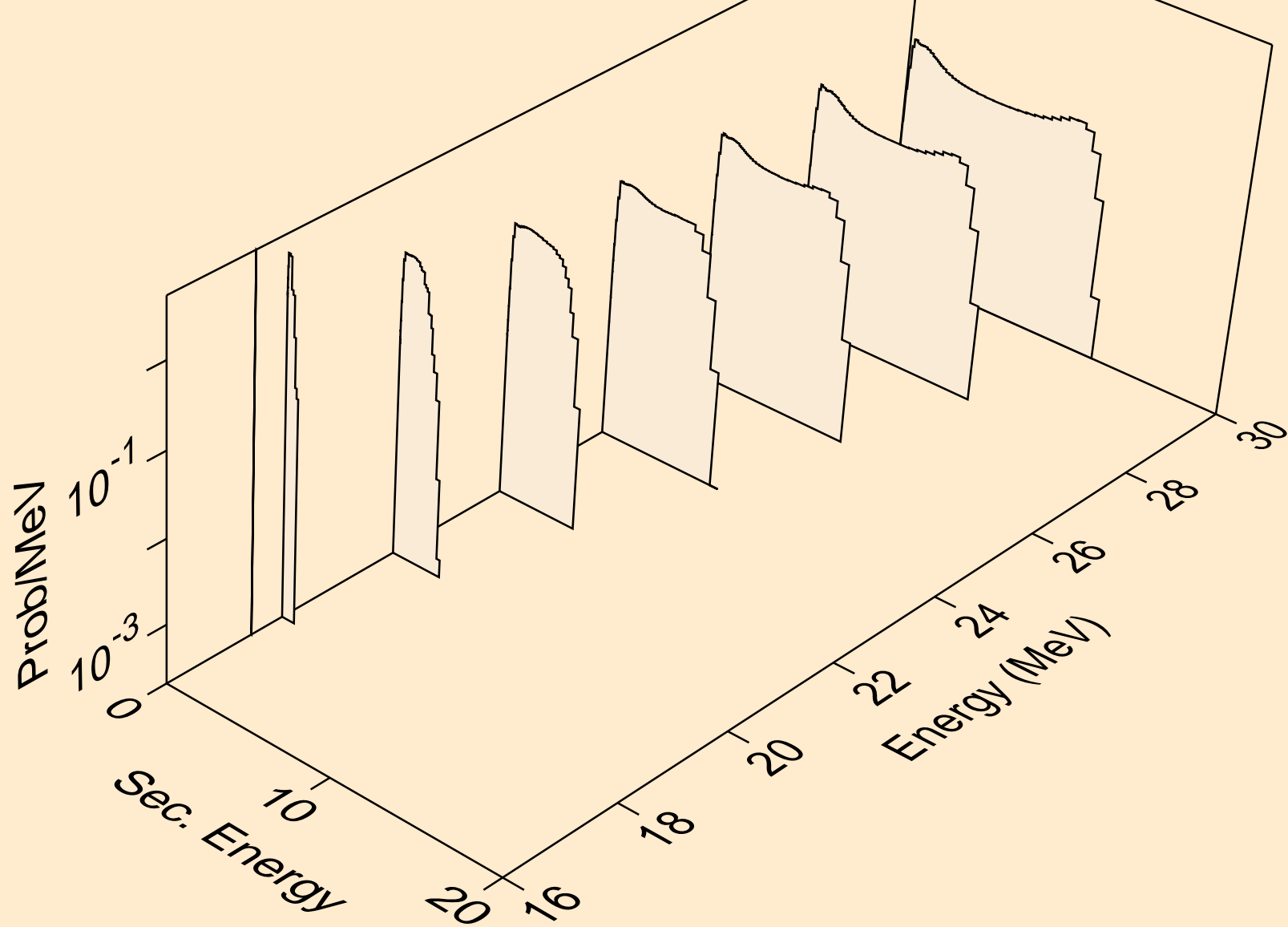

SM130 DEUTERON ACER TENDL-2021 LIBRARY; T=0.K  
neutrons from (d,n\*)a

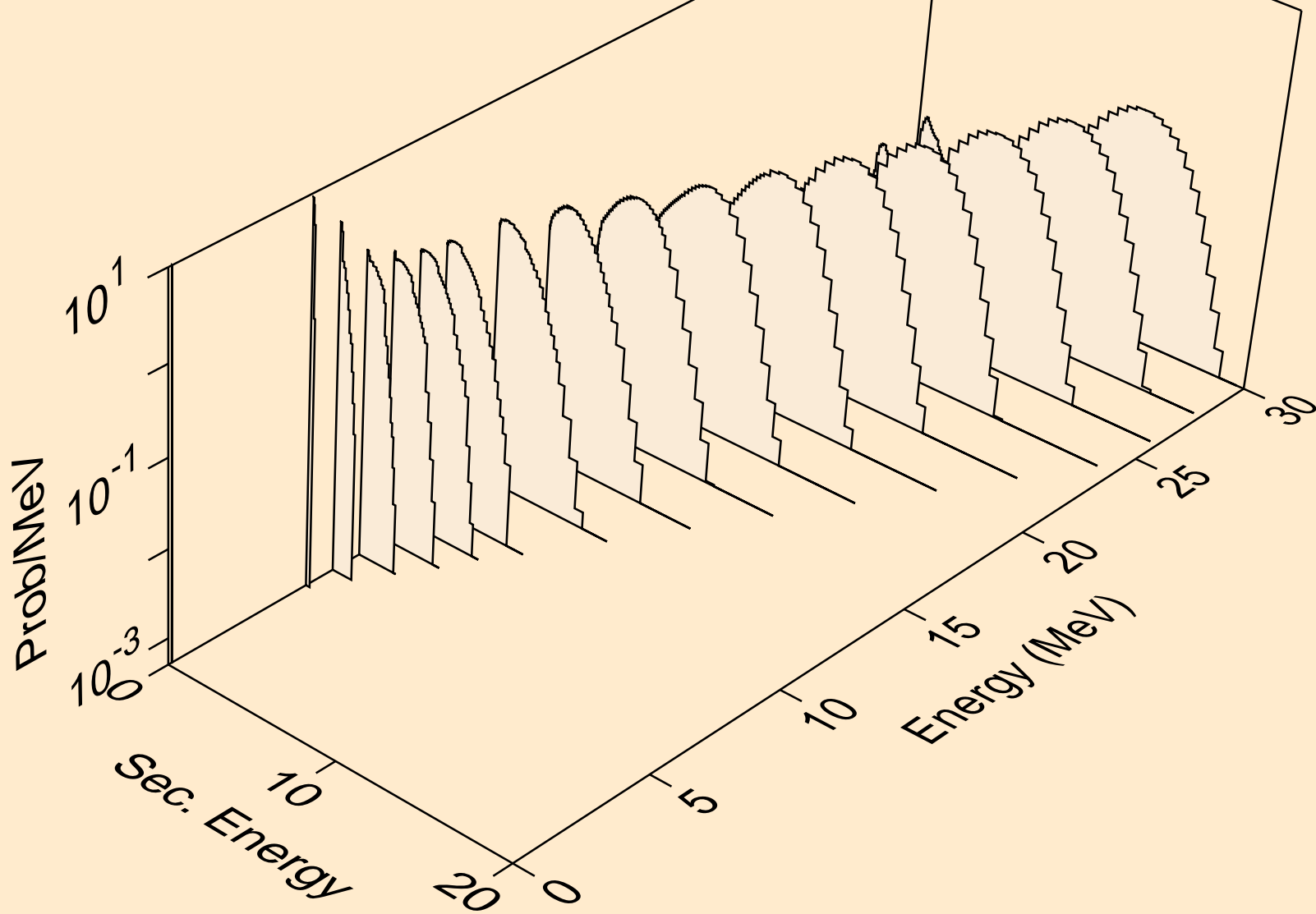



SM130 DEUTERON ACER TENDL-2021 LIBRARY; T=0.K  
neutrons from (d,2n)a

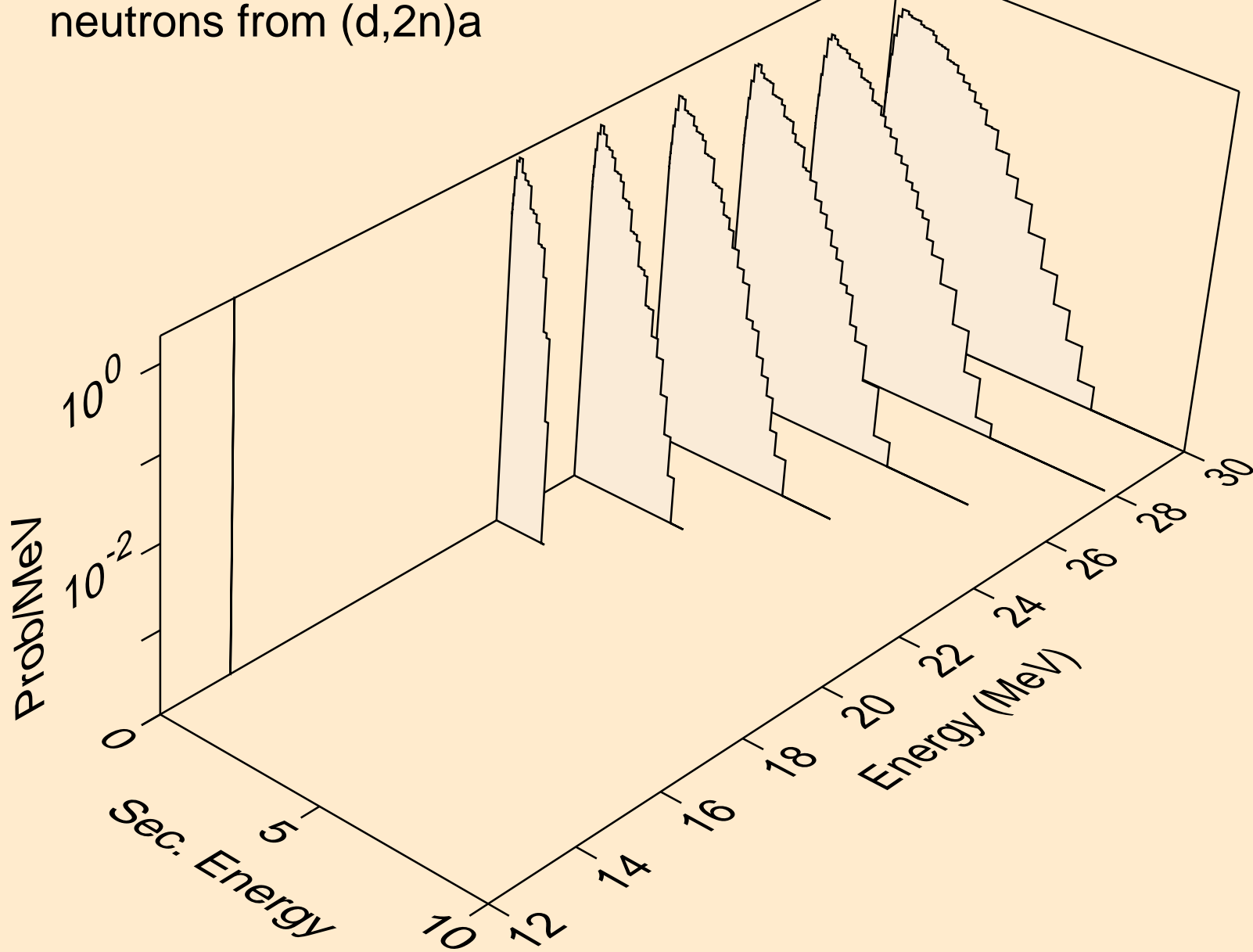

SM130 DEUTERON ACER TENDL-2021 LIBRARY; T=0.K  
neutrons from (d,n\*)p

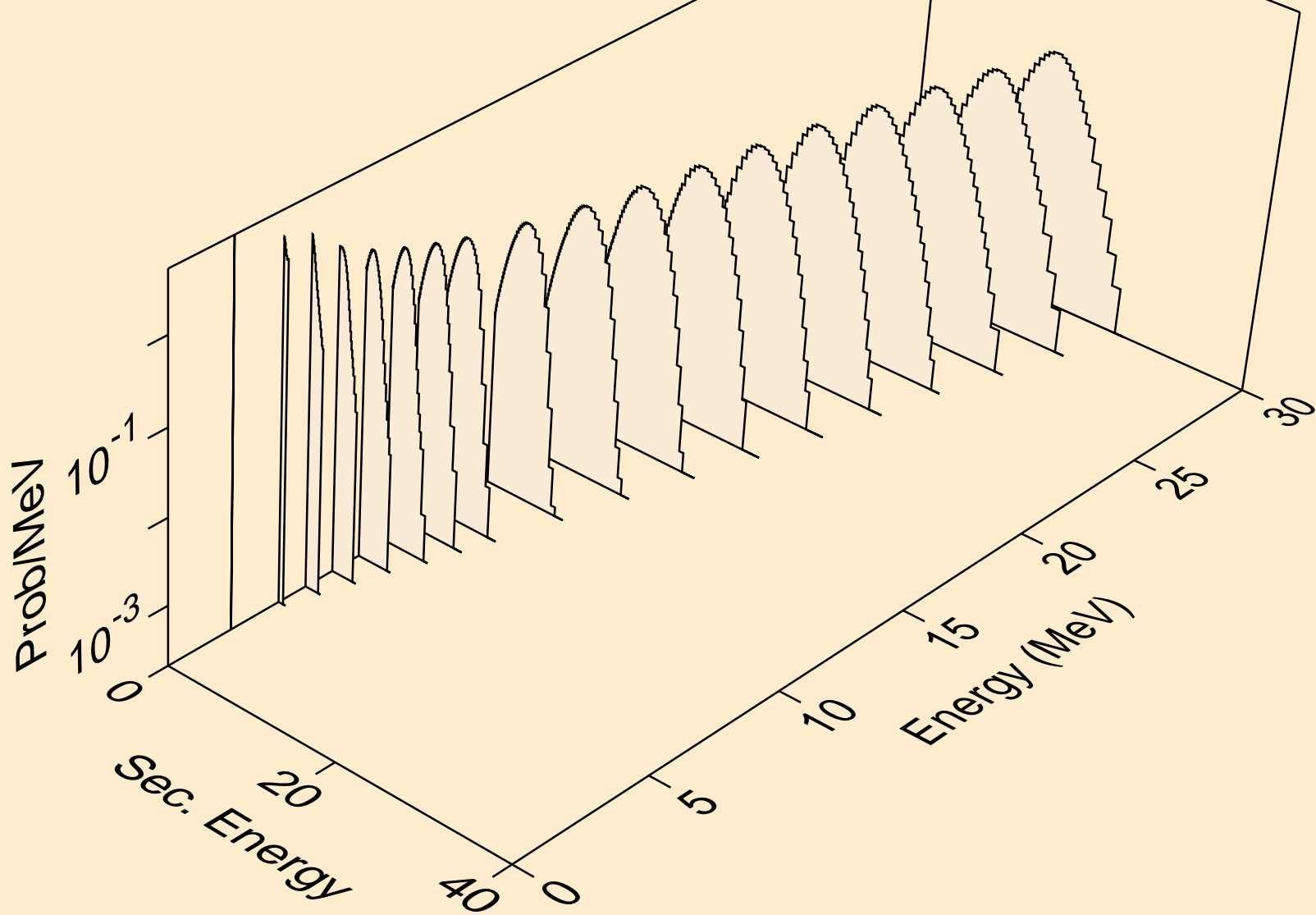

SM130 DEUTERON ACER TENDL-2021 LIBRARY; T=0.K  
neutrons from (d,n\*)2a

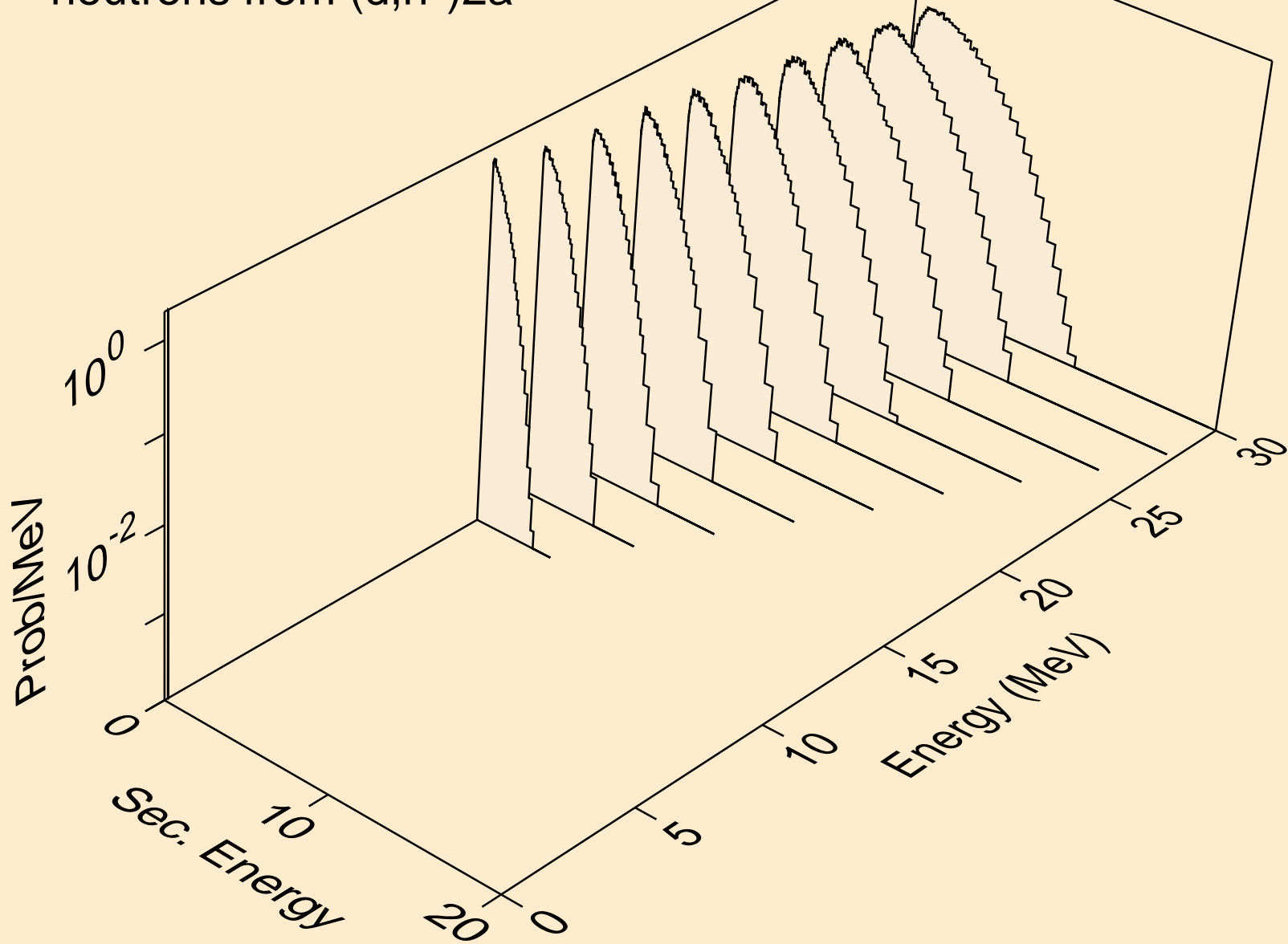

SM130 DEUTERON ACER TENDL-2021 LIBRARY; T=0.K  
neutrons from (d,n\*)d

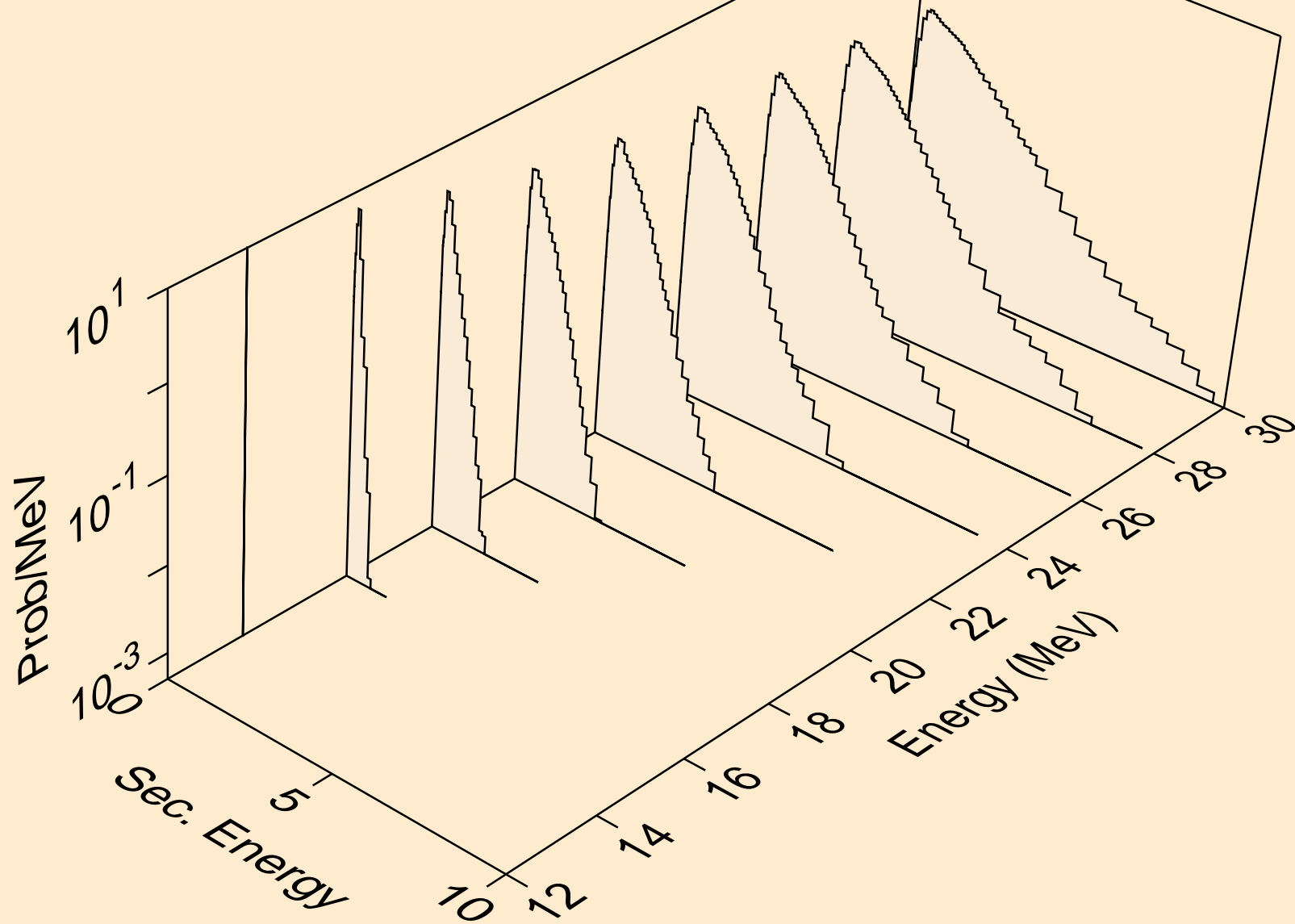

SM130 DEUTERON ACER TENDL-2021 LIBRARY; T=0.K  
neutrons from (d,n\*)t

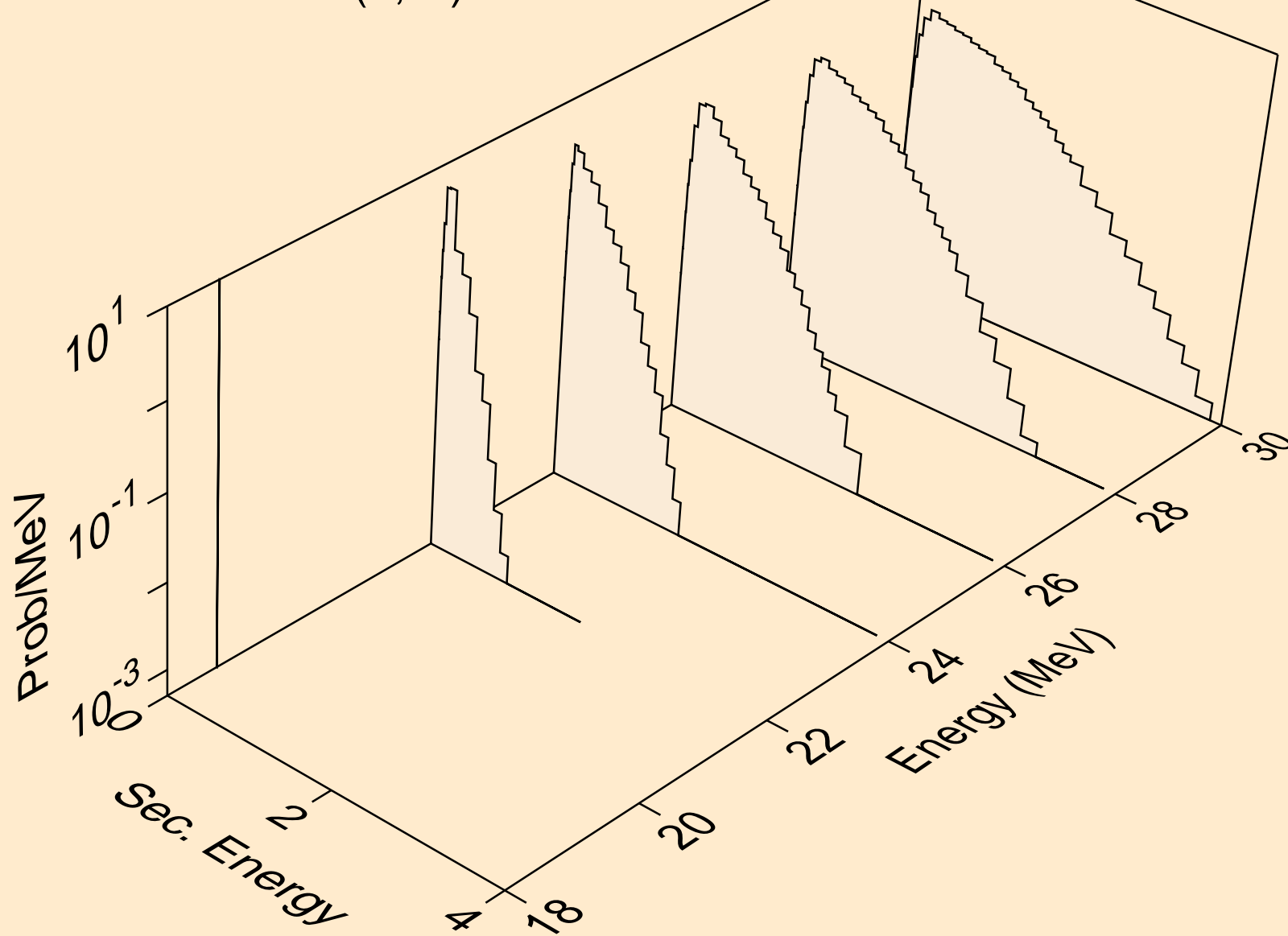

SM130 DEUTERON ACER TENDL-2021 LIBRARY; T=0.K  
neutrons from (d,n\*)he3

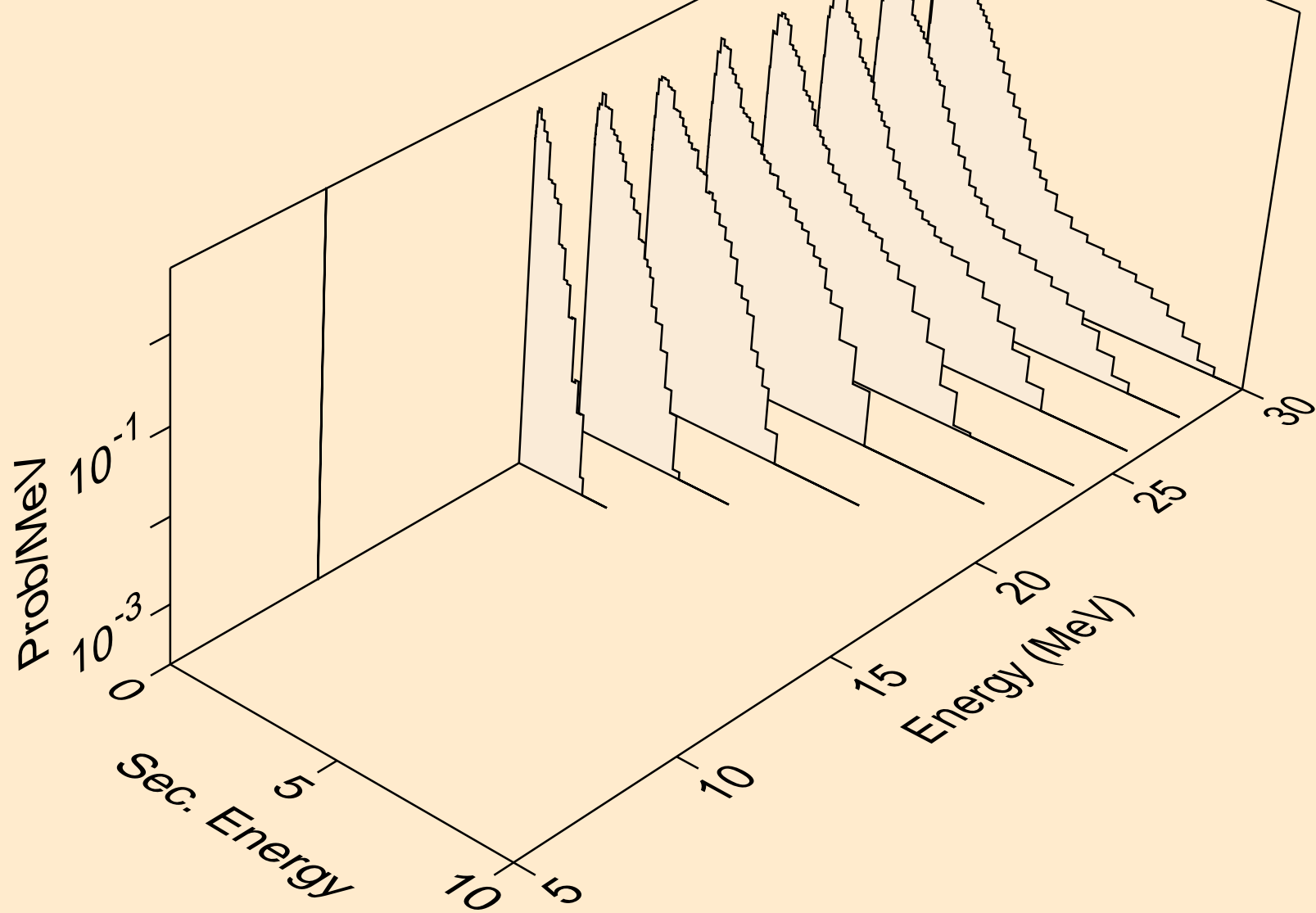

SM130 DEUTERON ACER TENDL-2021 LIBRARY; T=0.K  
neutrons from (d,2np)

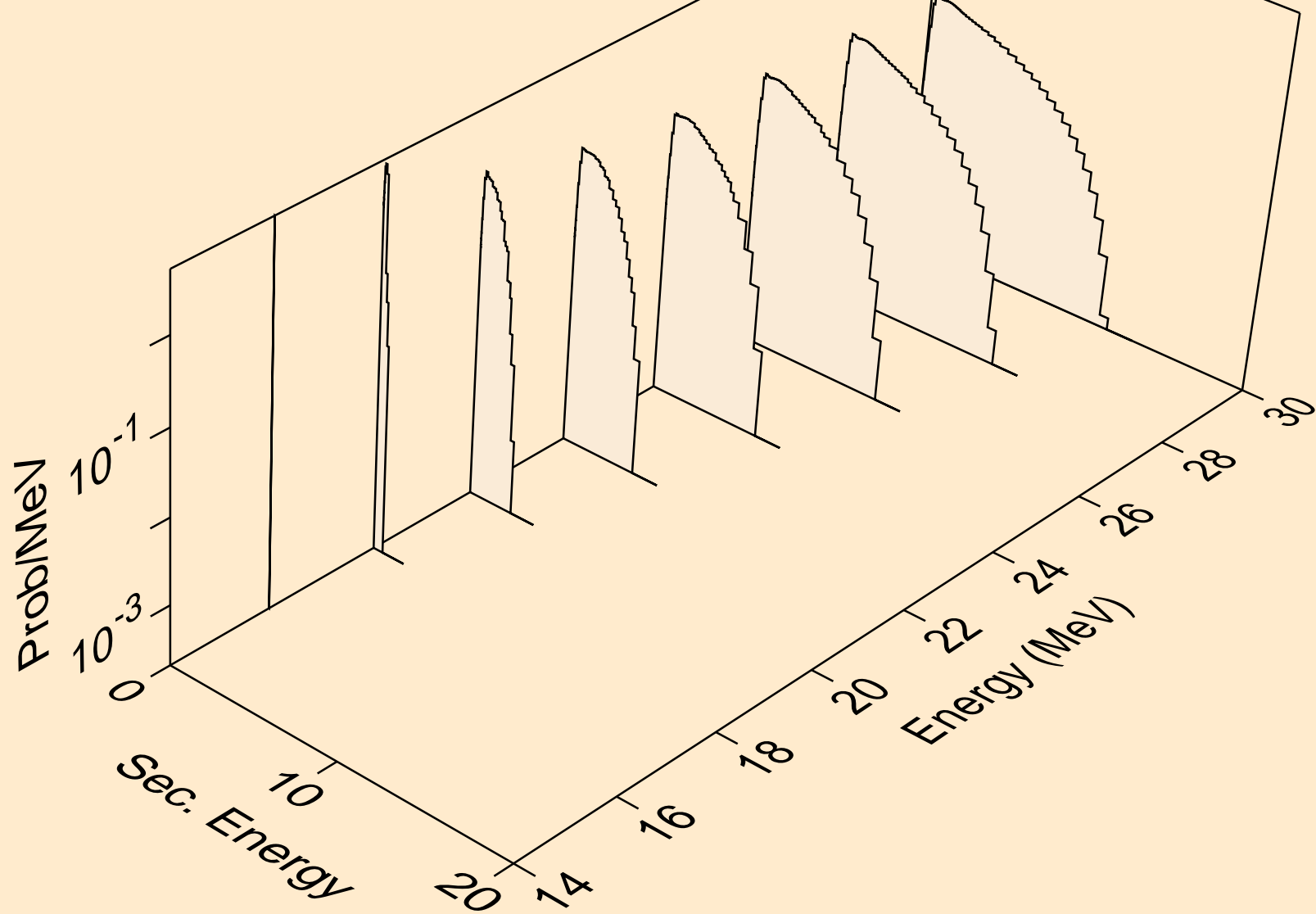

SM130 DEUTERON ACER TENDL-2021 LIBRARY; T=0.K  
neutrons from (d,2np)

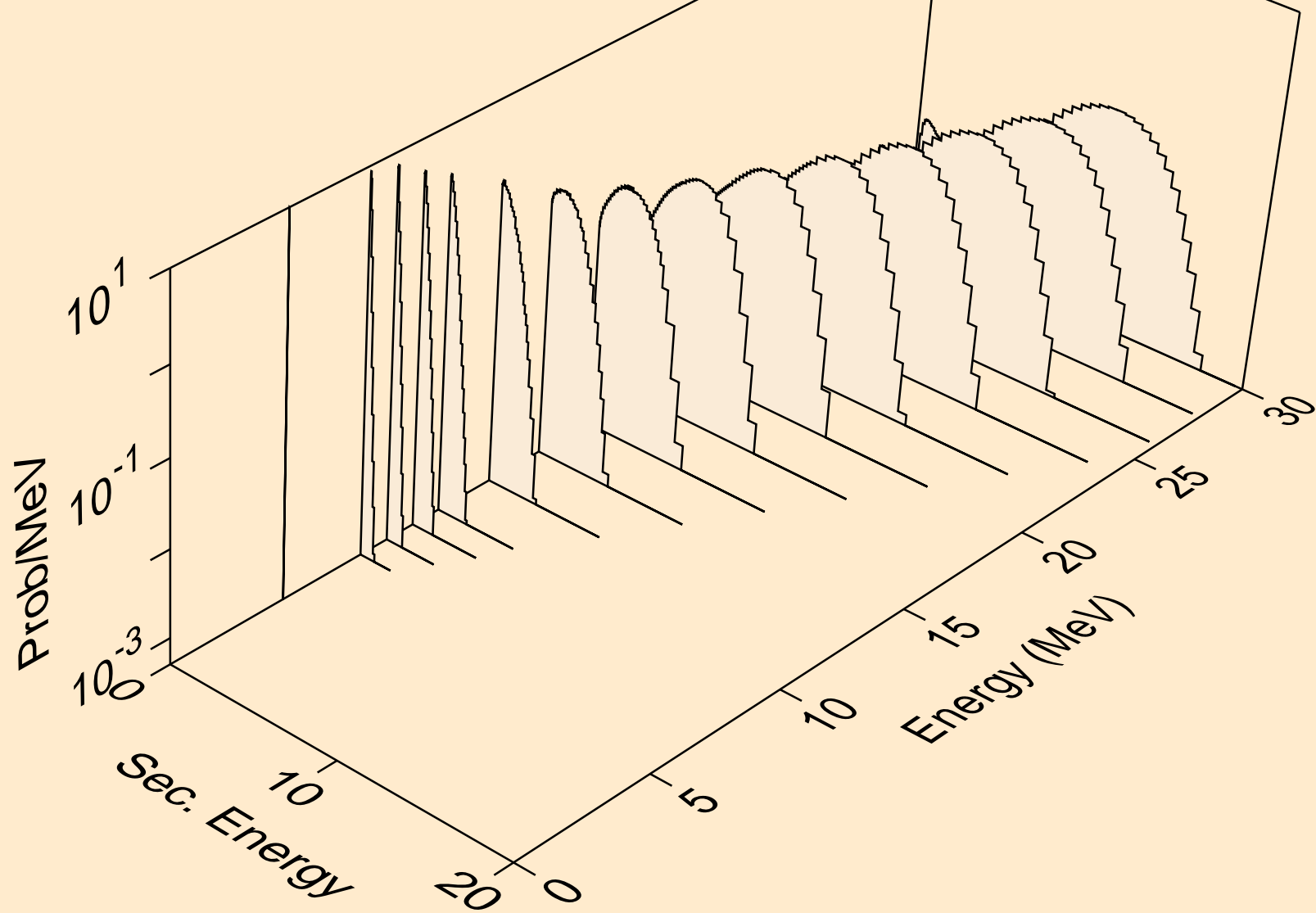



SM130 DEUTERON ACER TENDL-2021 LIBRARY; T=0.K  
neutrons from (d,npa)

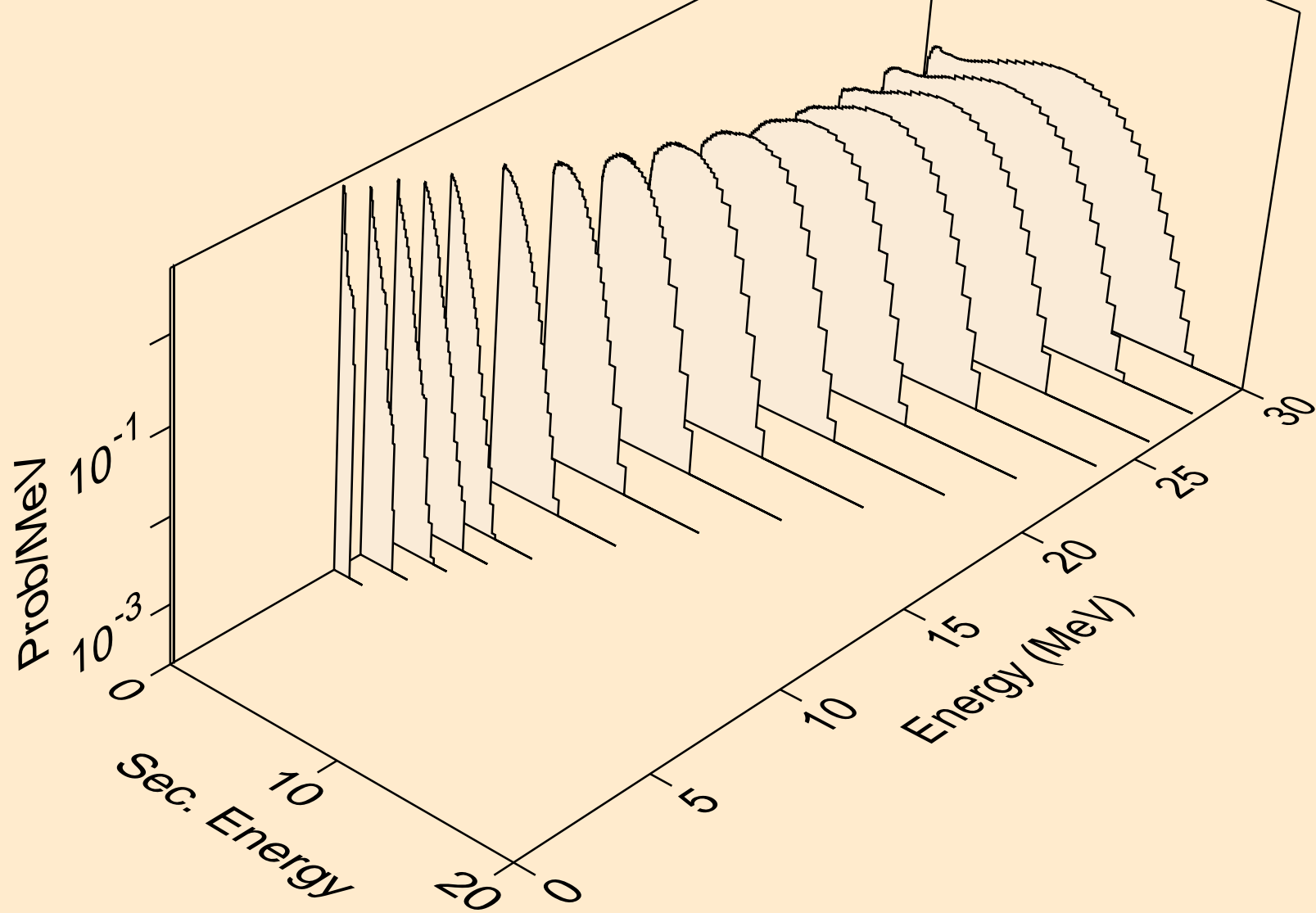

SM130 DEUTERON ACER TENDL-2021 LIBRARY; T=0.K  
protons from (d,x)

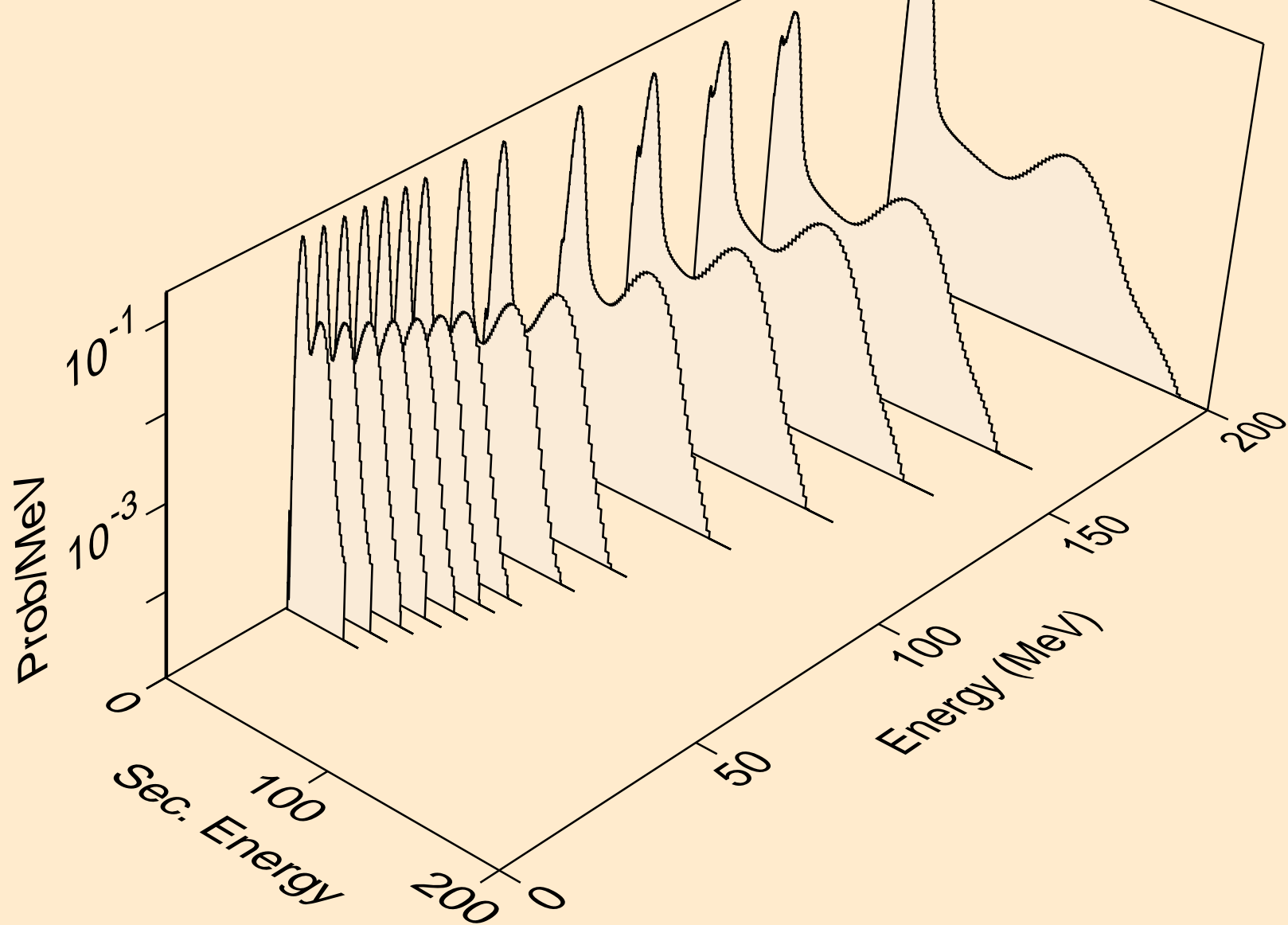

SM130 DEUTERON ACER TENDL-2021 LIBRARY; T=0.K  
protons from (d,n\*)p

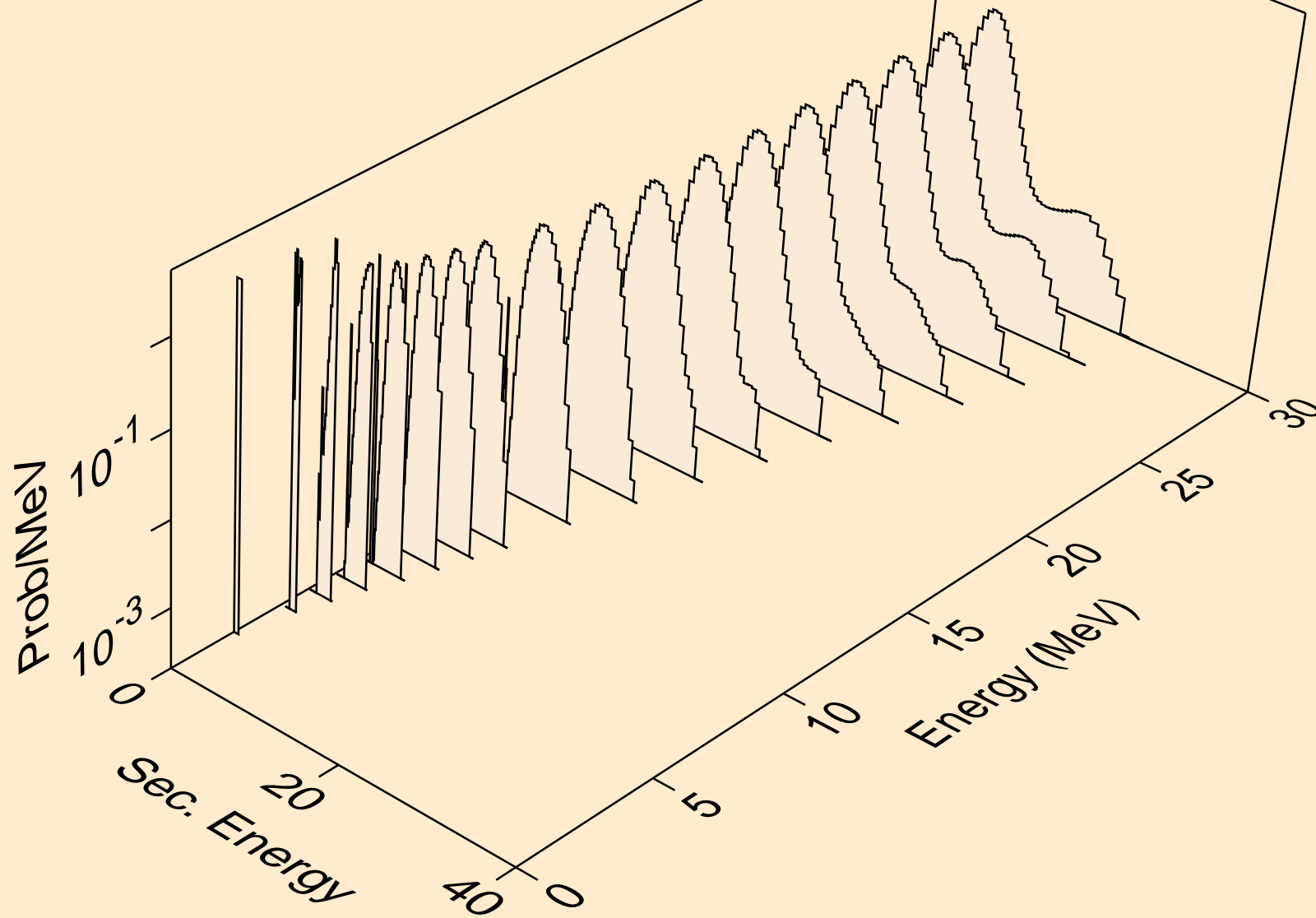

SM130 DEUTERON ACER TENDL-2021 LIBRARY; T=0.K  
protons from (d,2np)

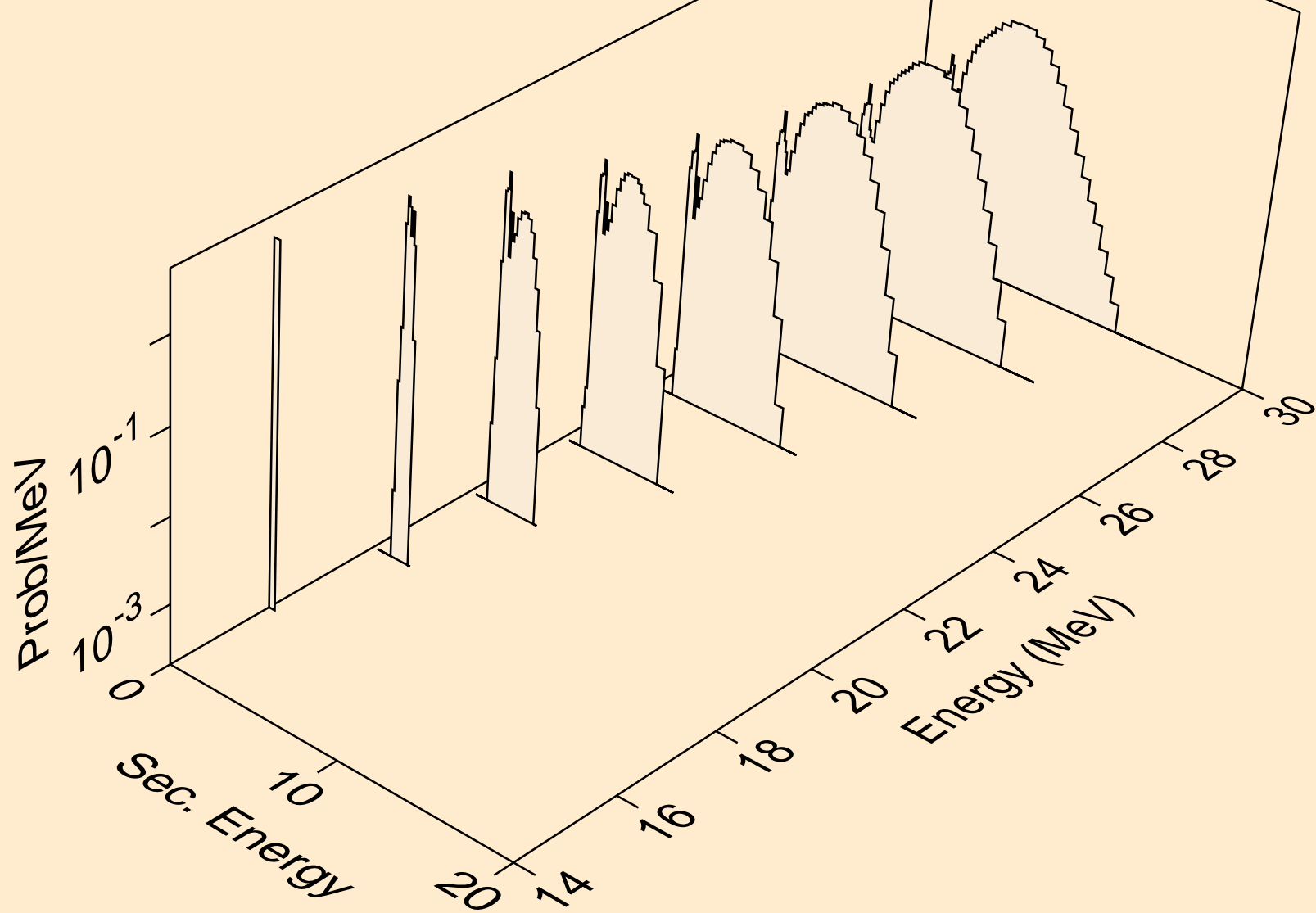

SM130 DEUTERON ACER TENDL-2021 LIBRARY; T=0.K  
protons from (d,2np)

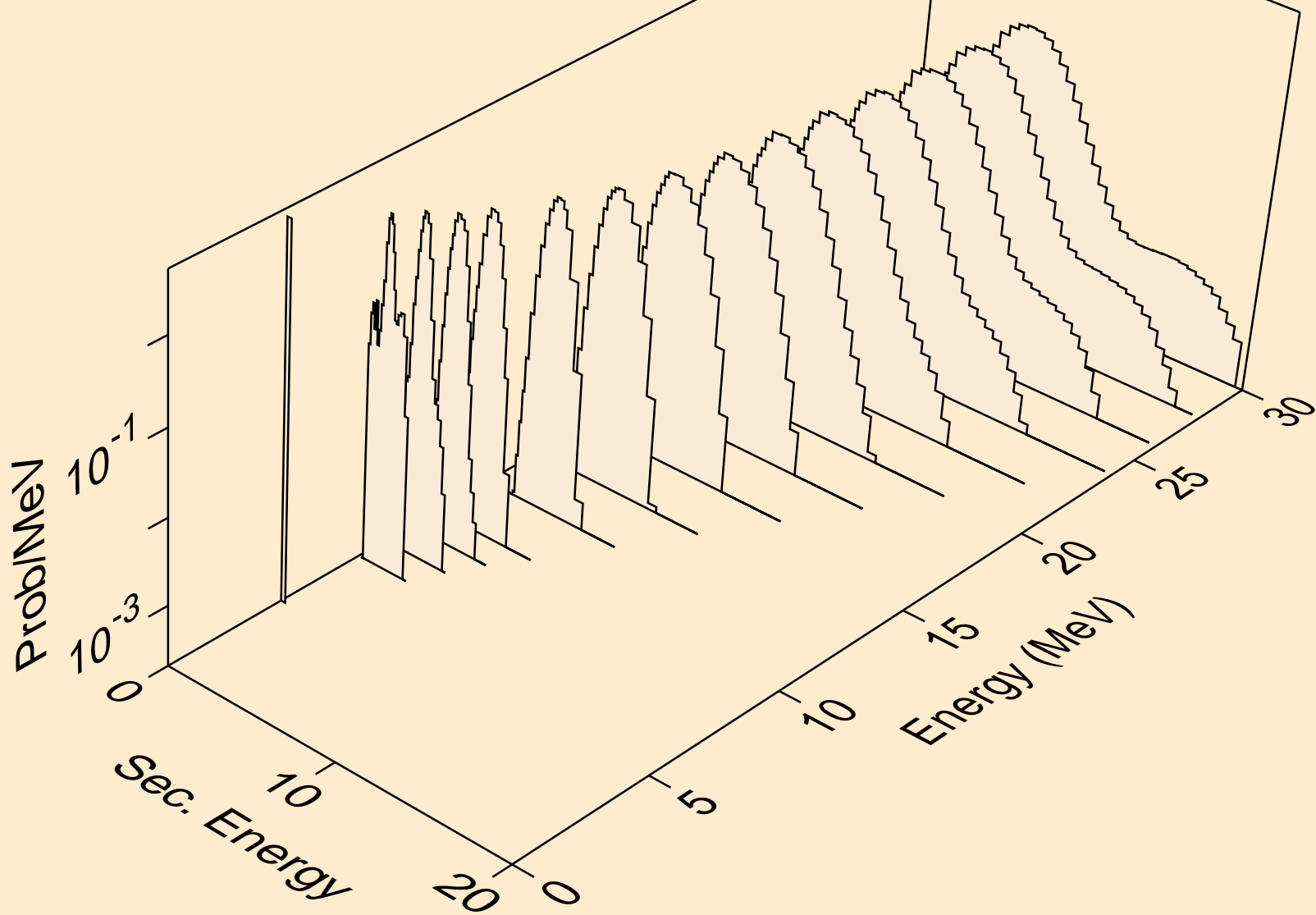

SM130 DEUTERON ACER TENDL-2021 LIBRARY; T=0.K  
protons from (d,npa)

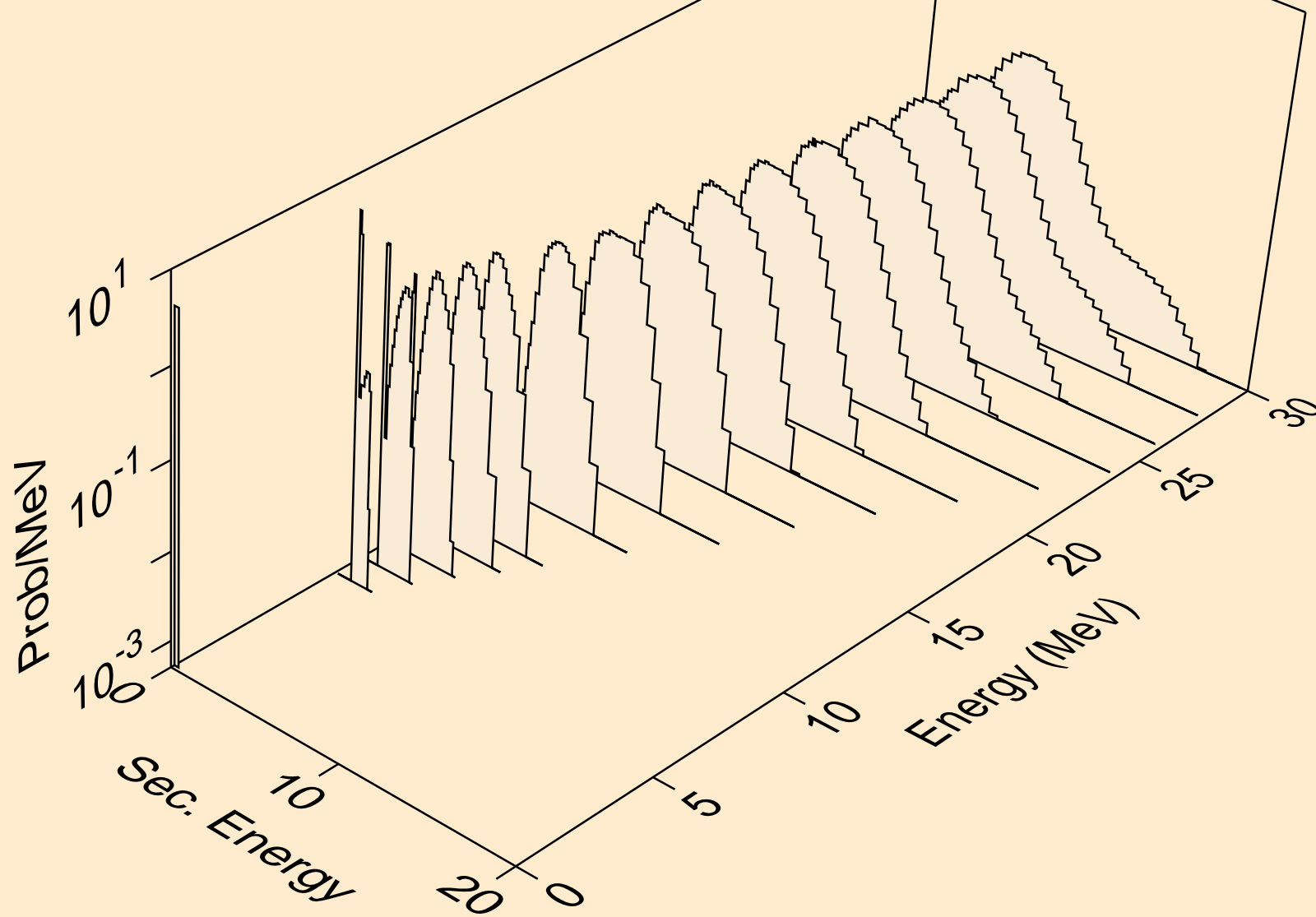

SM130 DEUTERON ACER TENDL-2021 LIBRARY; T=0.K  
protons from (d,p)

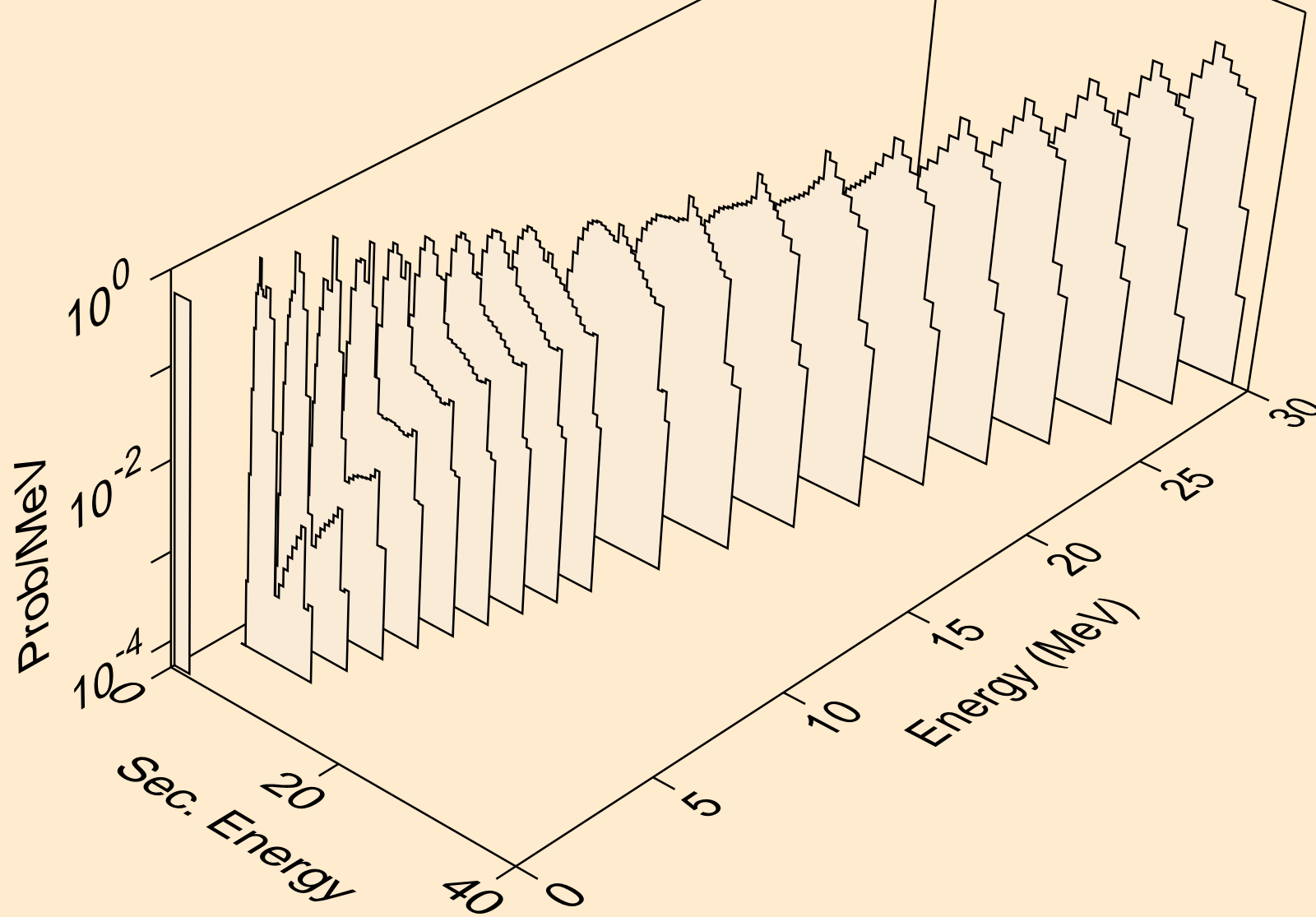

SM130 DEUTERON ACER TENDL-2021 LIBRARY; T=0.K  
protons from (d,2p)

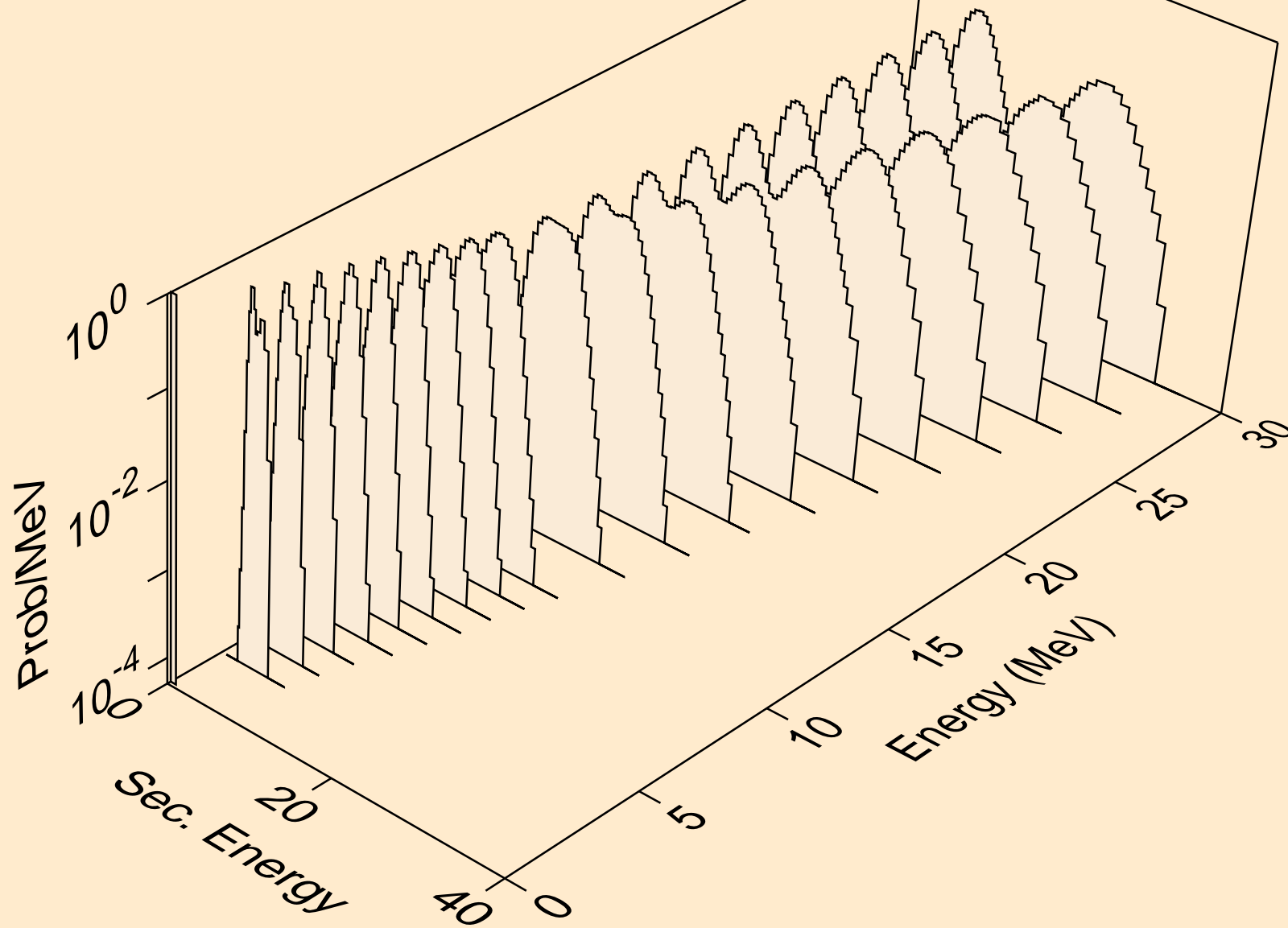



SM130 DEUTERON ACER TENDL-2021 LIBRARY; T=0.K  
protons from (d,pa)

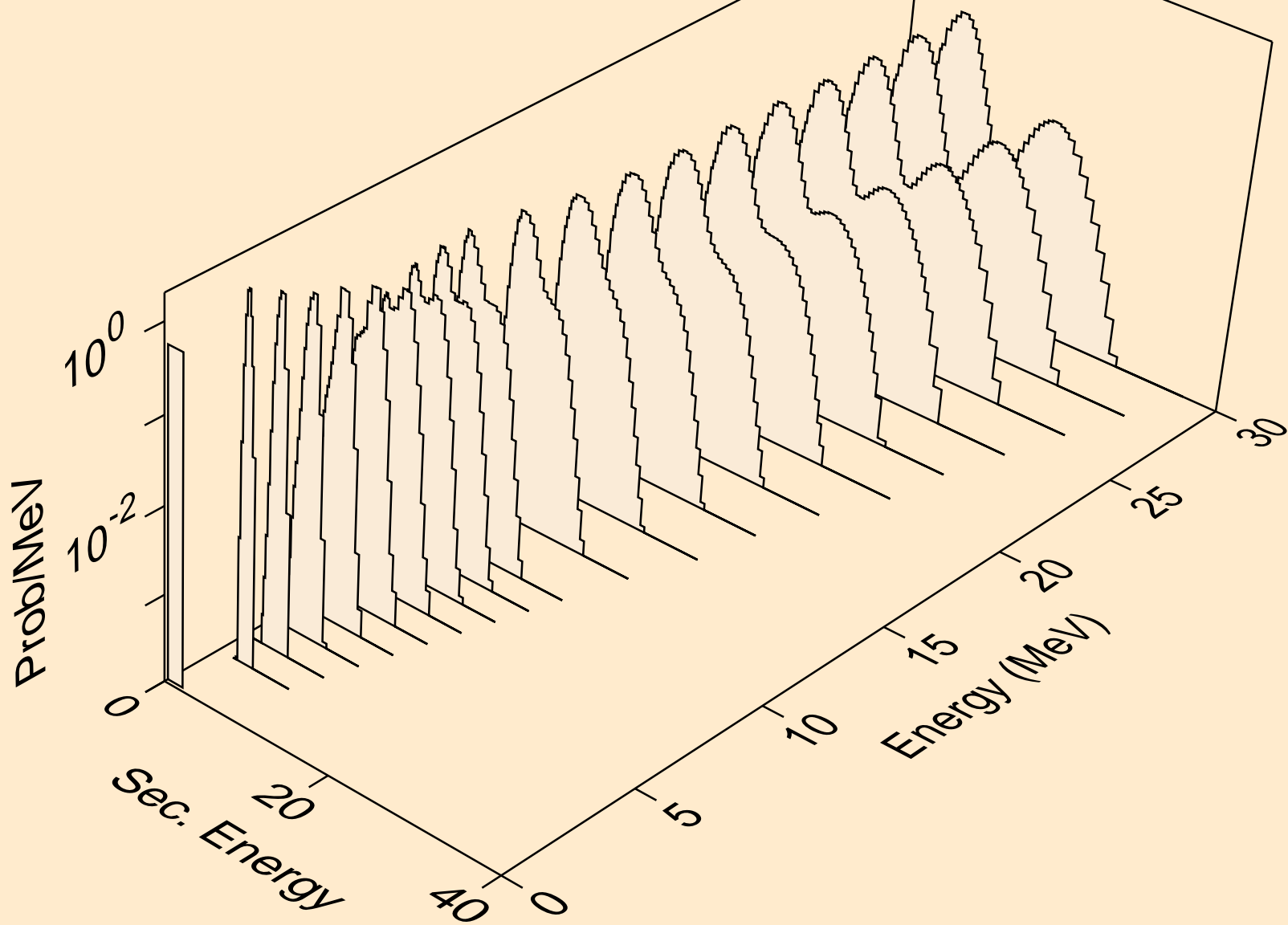

SM130 DEUTERON ACER TENDL-2021 LIBRARY; T=0.K  
protons from (d,pd)

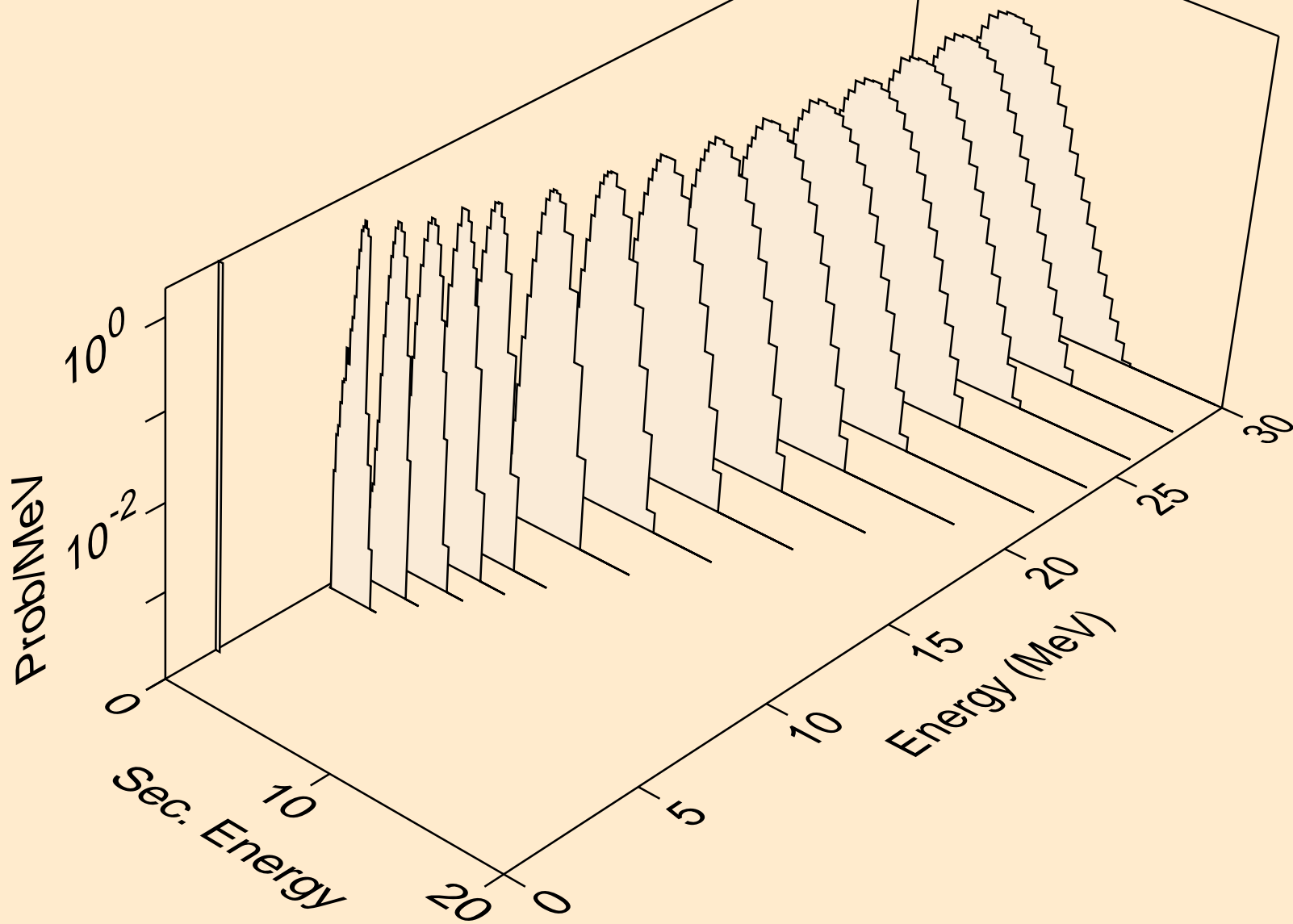

SM130 DEUTERON ACER TENDL-2021 LIBRARY; T=0.K  
protons from (d,pt)

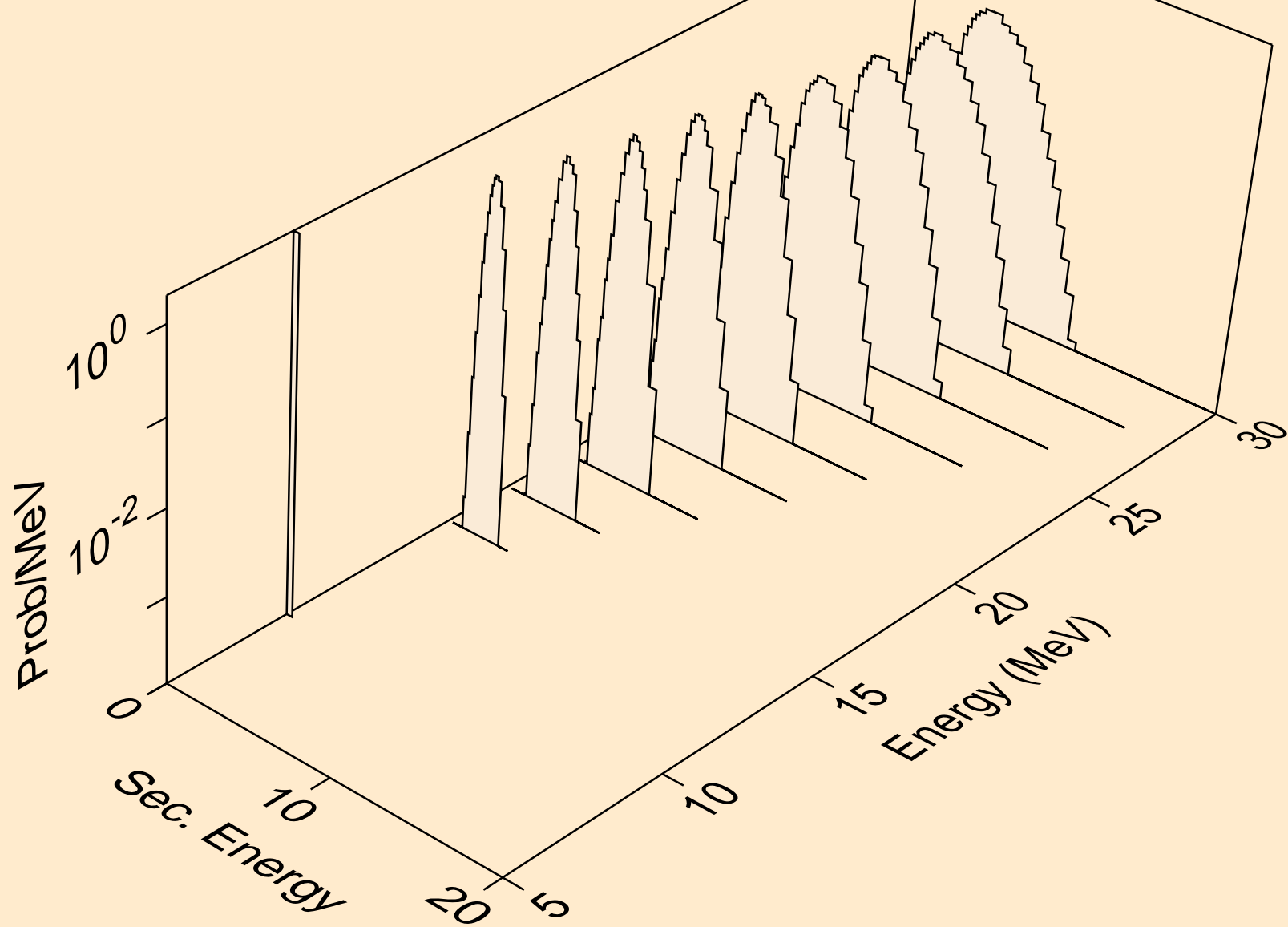

SM130 DEUTERON ACER TENDL-2021 LIBRARY; T=0.K  
tritons from (d,x)

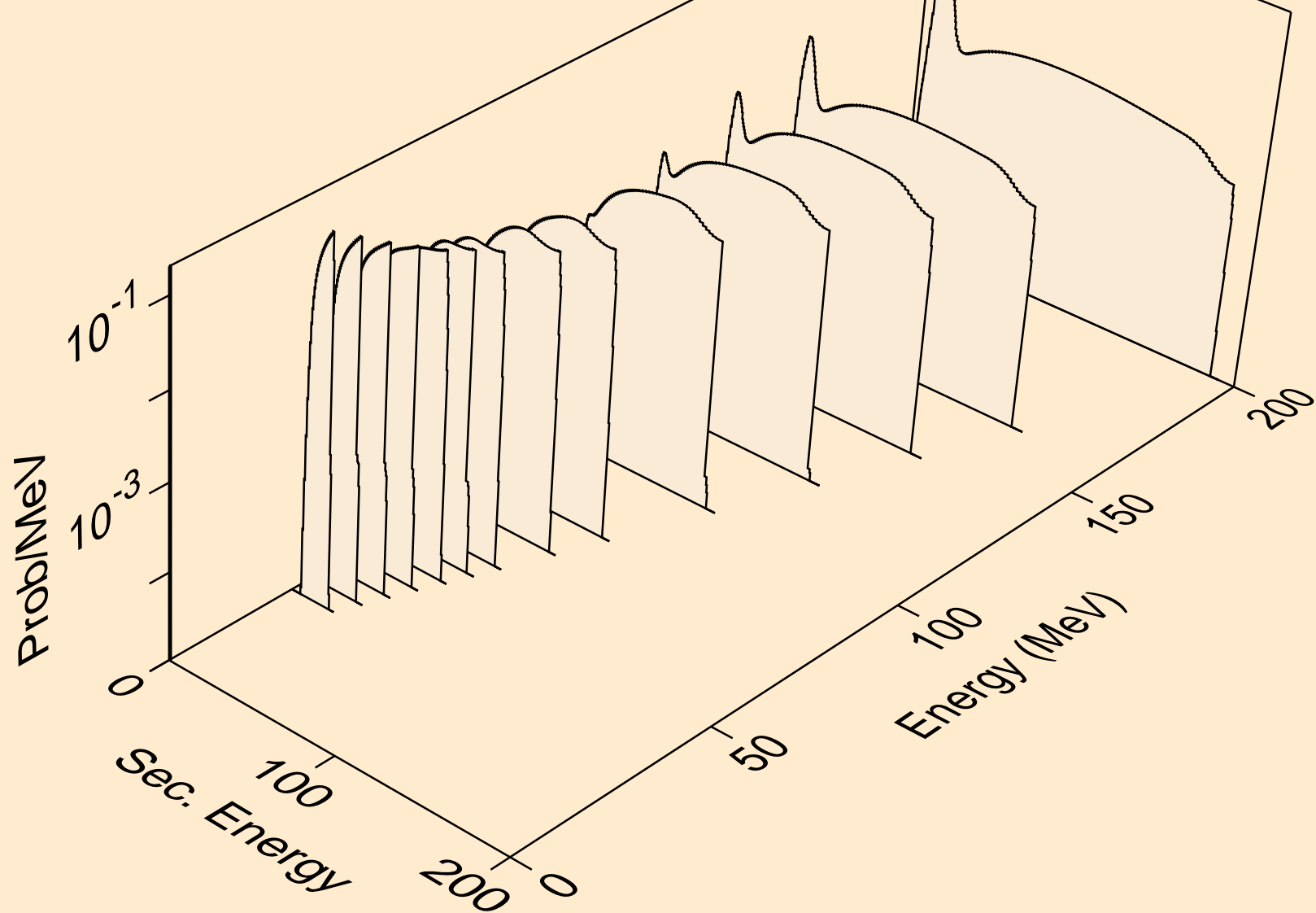

SM130 DEUTERON ACER TENDL-2021 LIBRARY; T=0.K  
tritons from (d,n\*)t

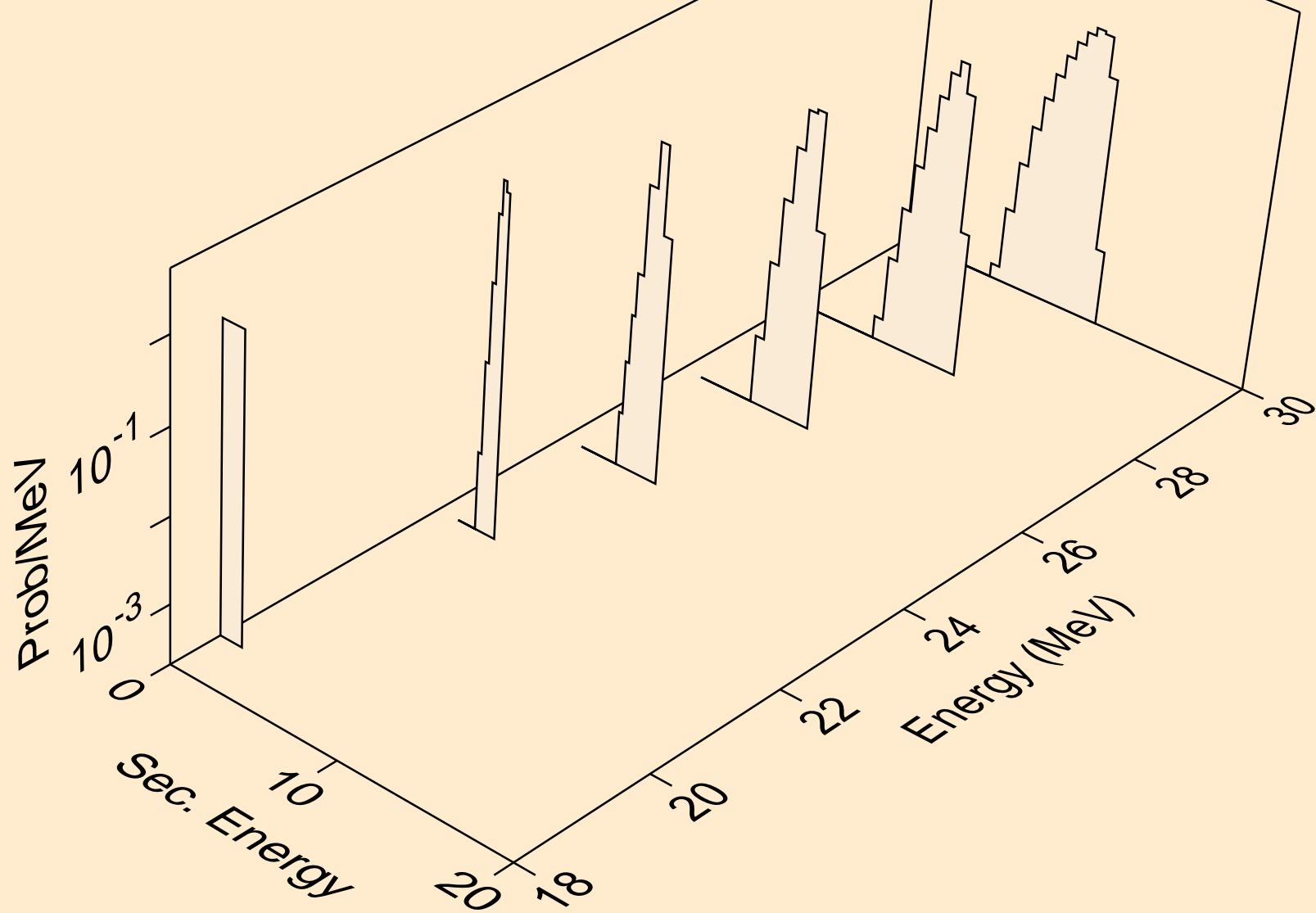

SM130 DEUTERON ACER TENDL-2021 LIBRARY; T=0.K  
tritons from (d,t)

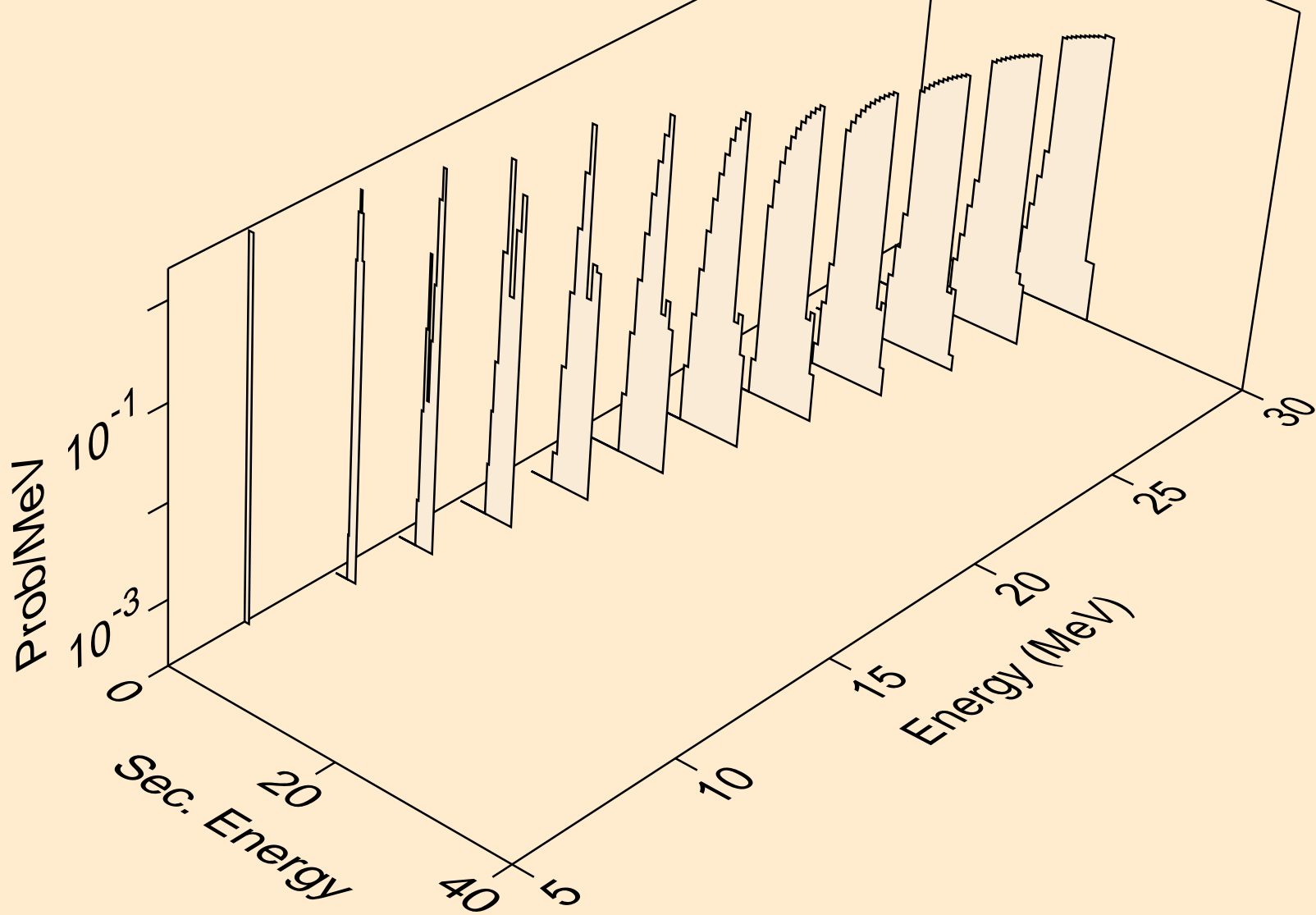

SM130 DEUTERON ACER TENDL-2021 LIBRARY; T=0.K  
tritons from (d,pt)

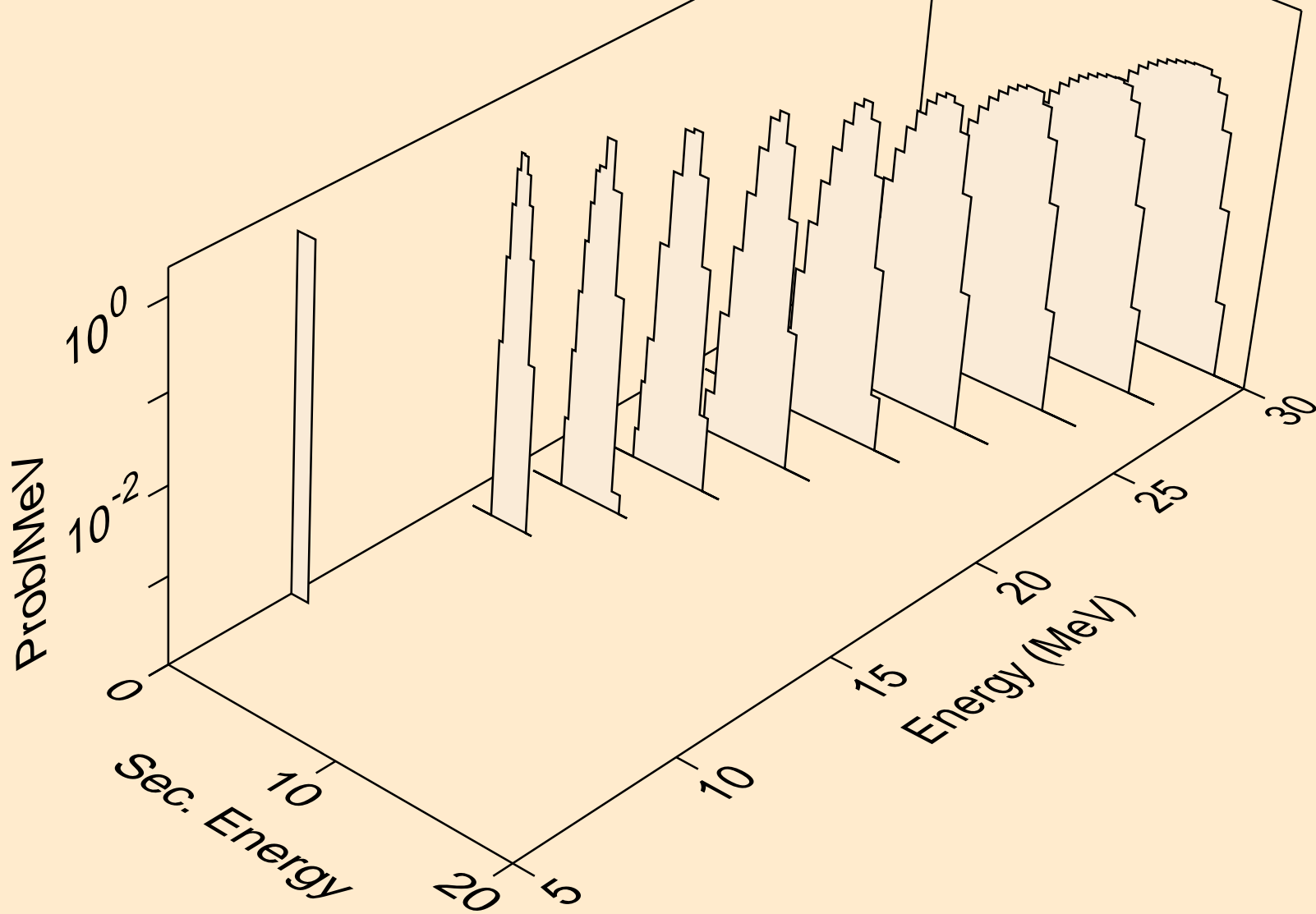

SM130 DEUTERON ACER TENDL-2021 LIBRARY; T=0.K  
he3s from (d,x)

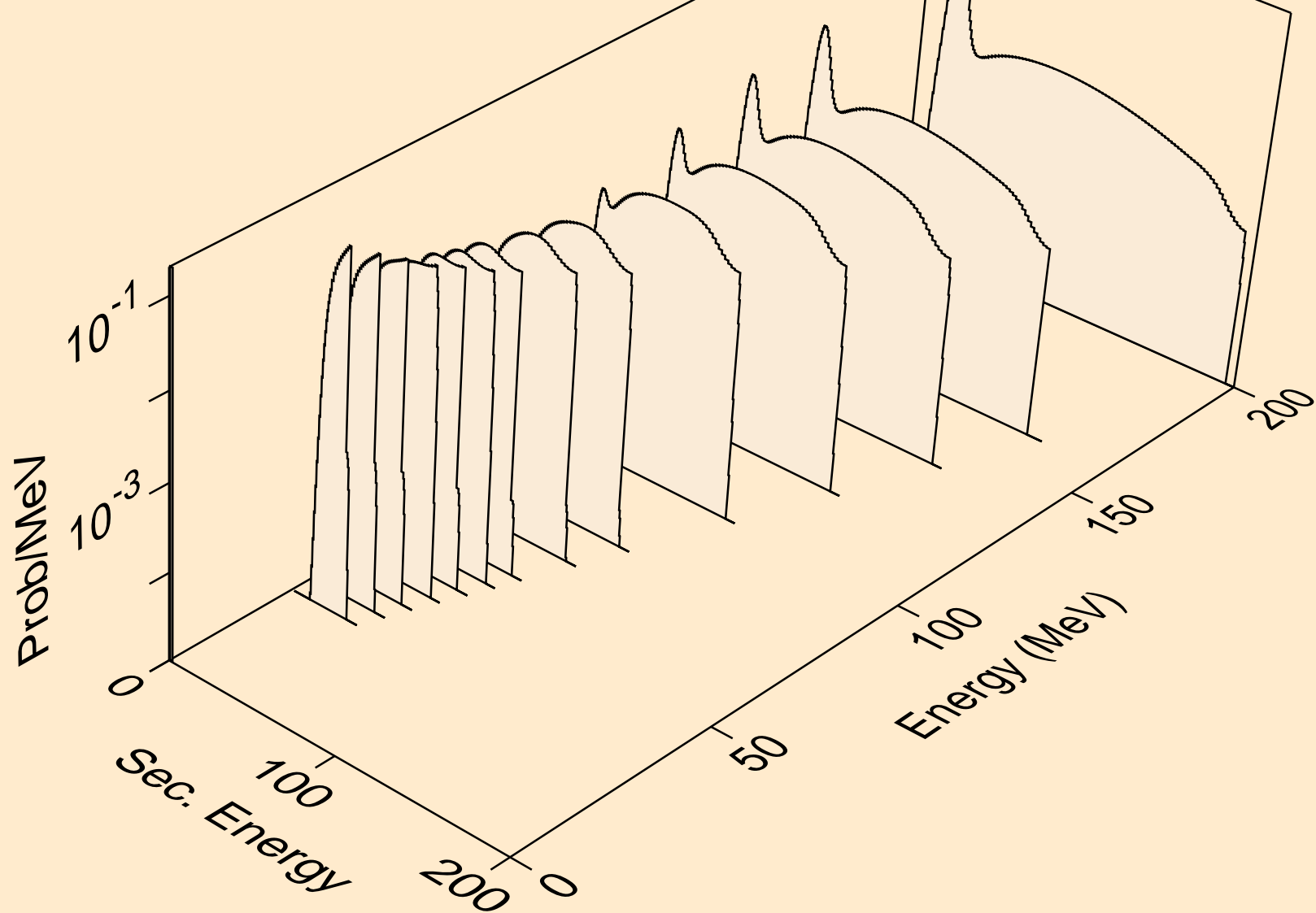



SM130 DEUTERON ACER TENDL-2021 LIBRARY; T=0.K  
he3s from (d,n\*)he3

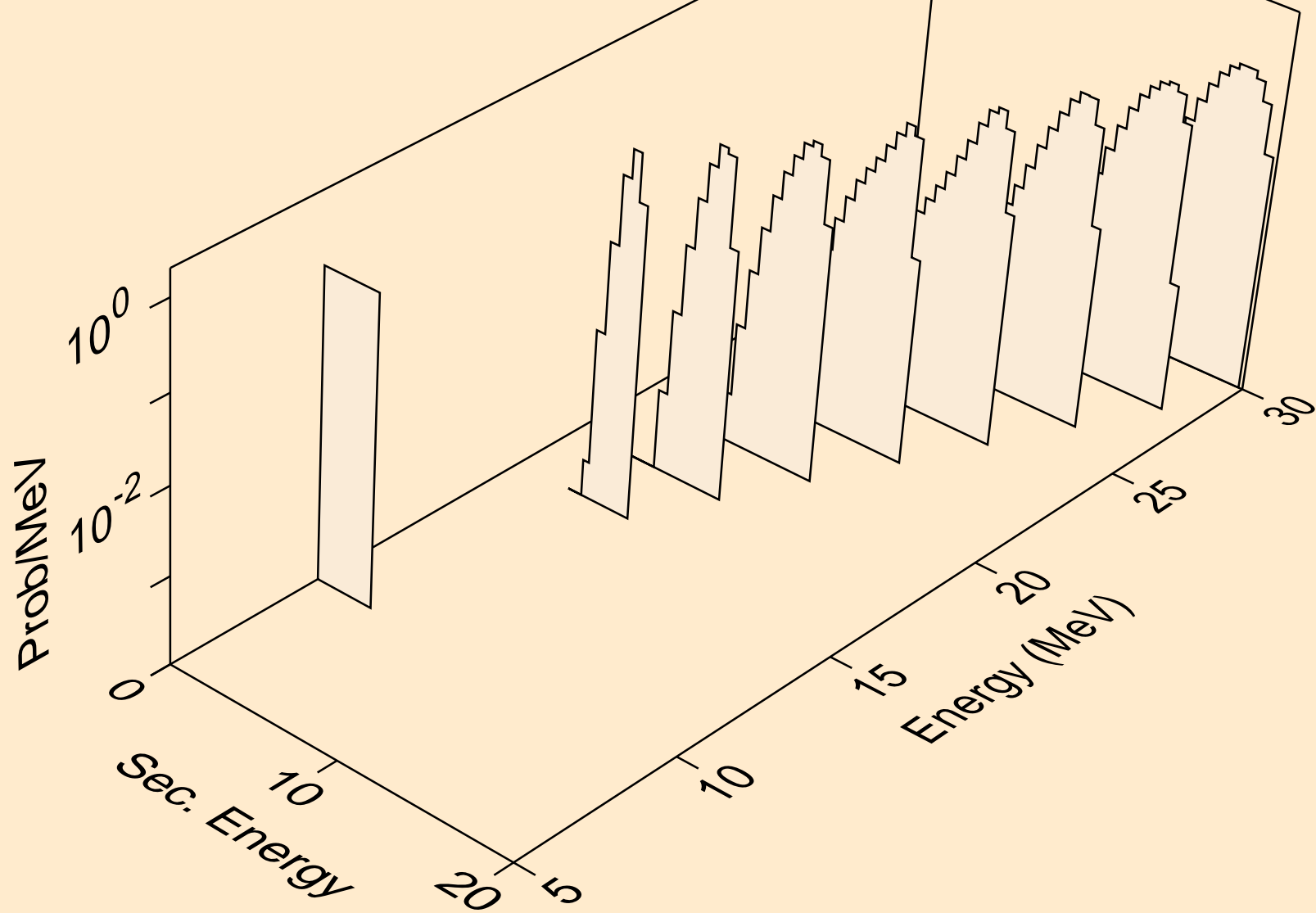

SM130 DEUTERON ACER TENDL-2021 LIBRARY; T=0.K  
he3s from (d,he3)

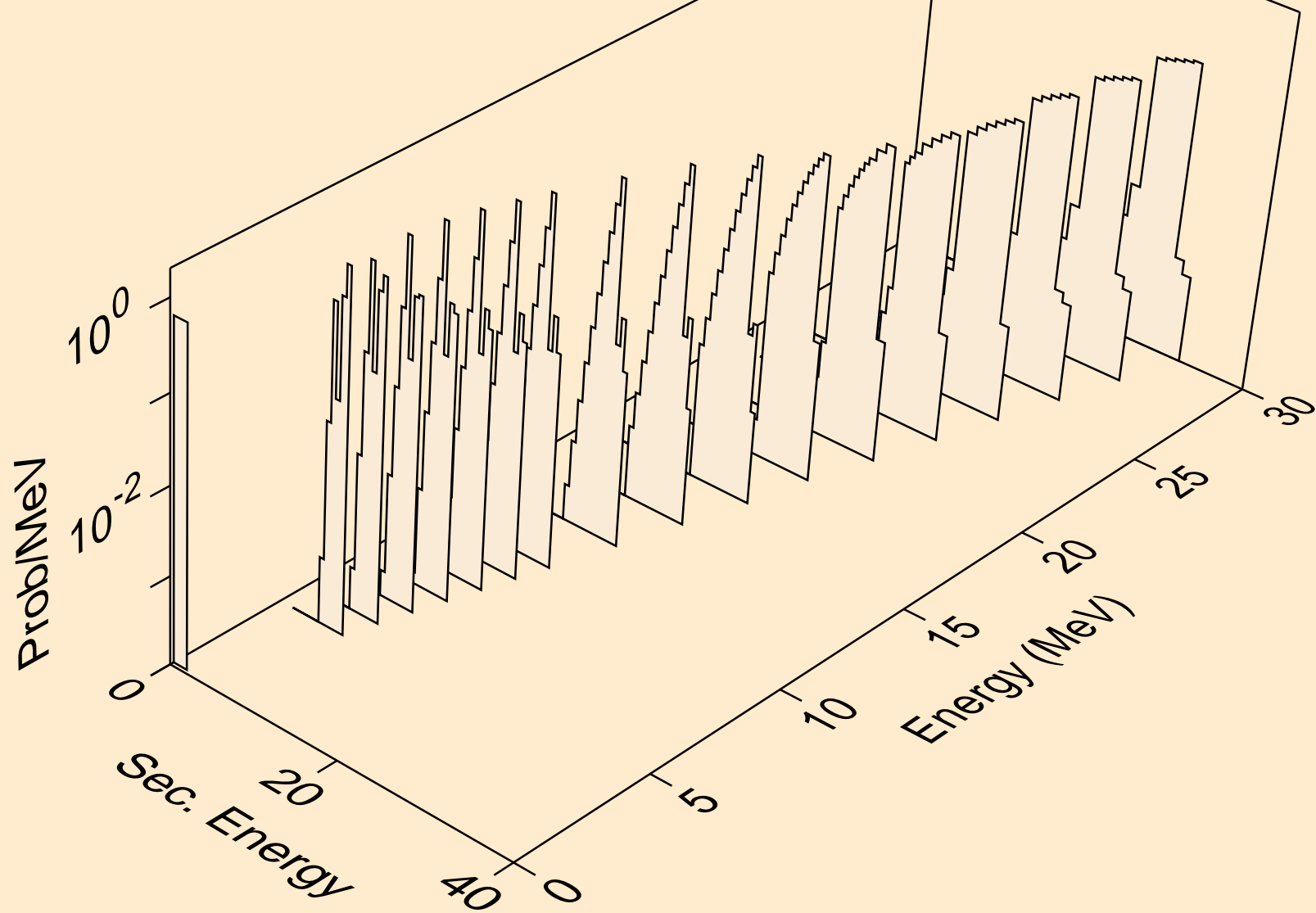

SM130 DEUTERON ACER TENDL-2021 LIBRARY; T=0.K  
alphas from (d,x)

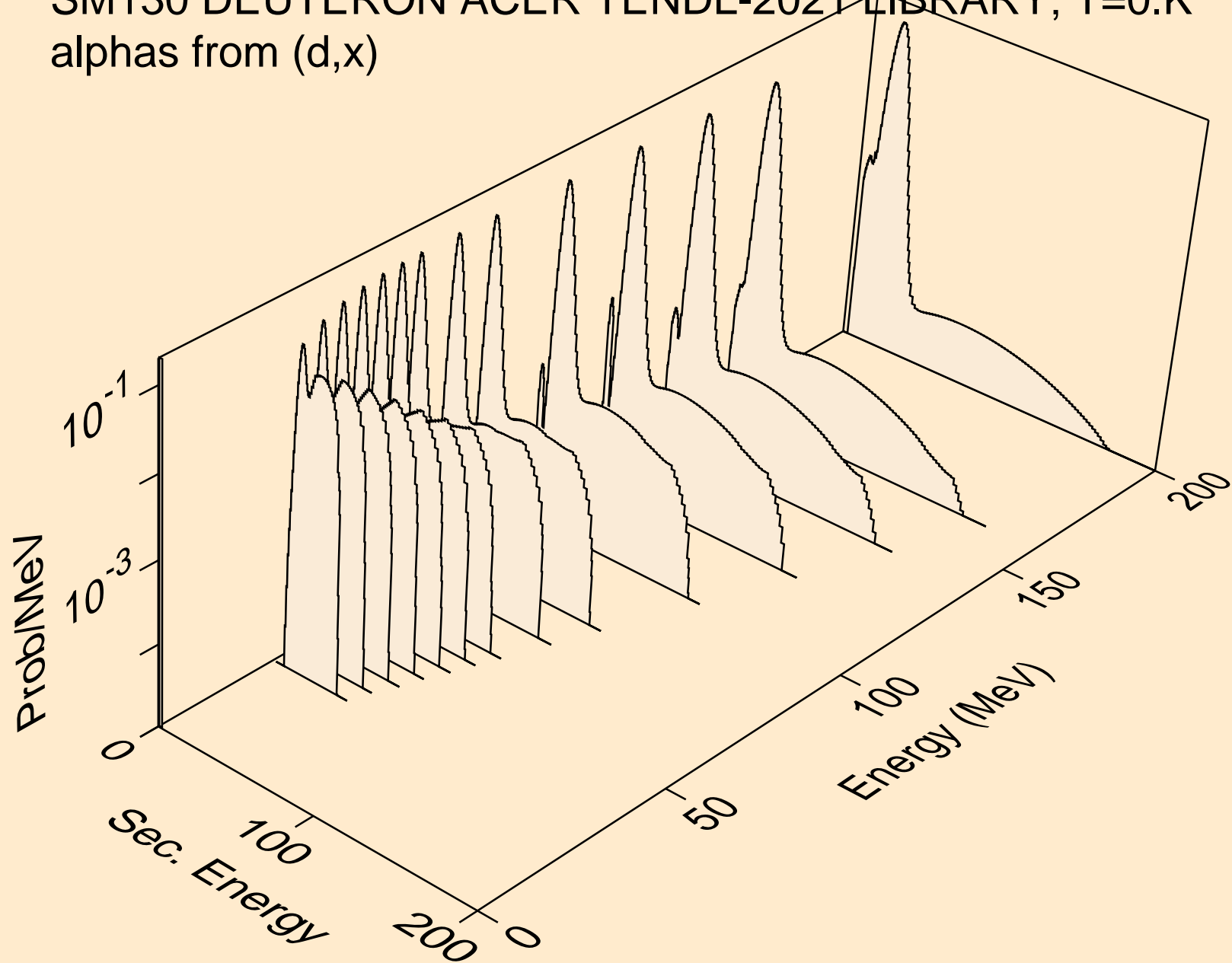

SM130 DEUTERON ACER TENDL-2021 LIBRARY; T=0.K  
alphas from (d,n\*)a

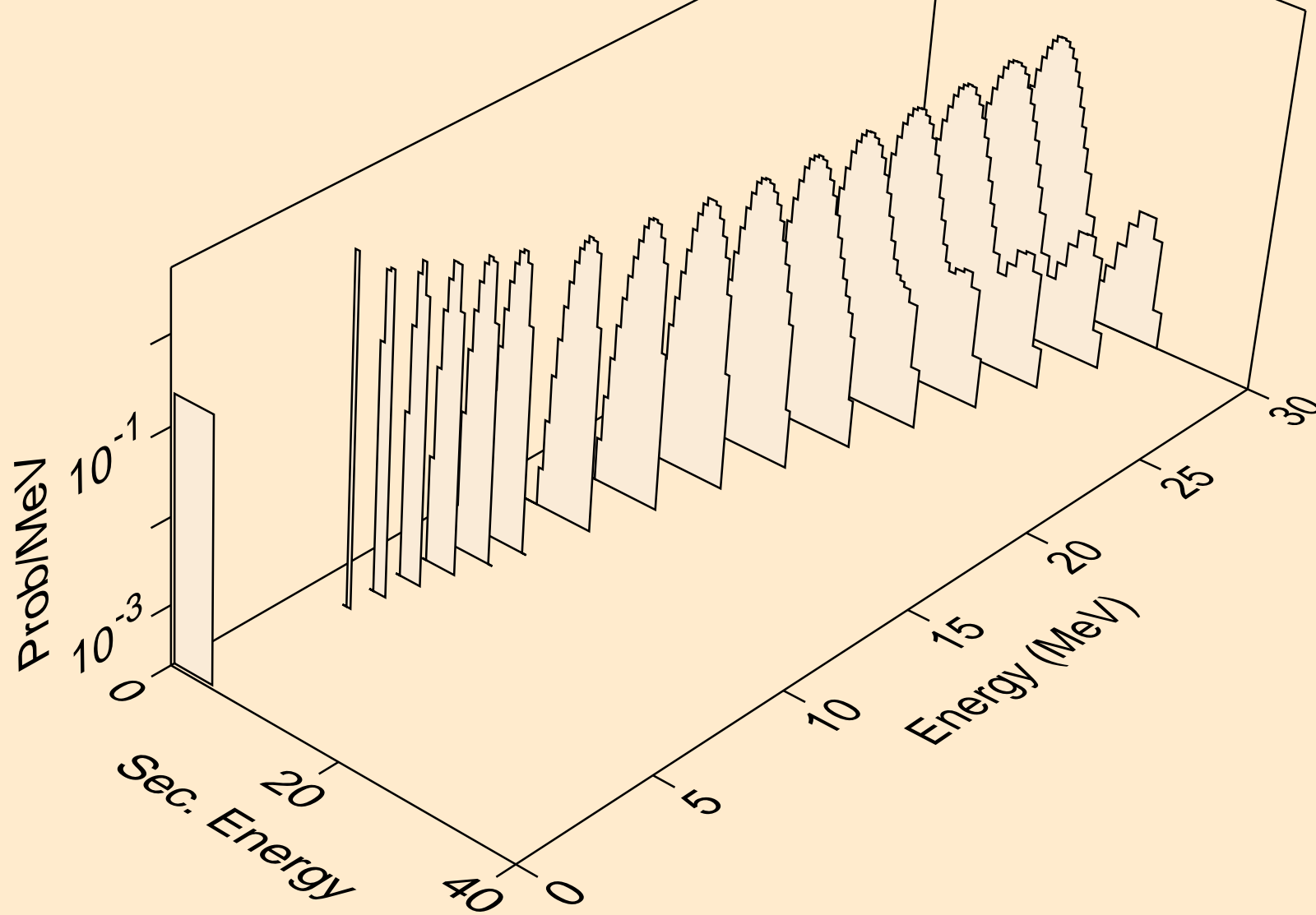

SM130 DEUTERON ACER TENDL-2021 LIBRARY; T=0.K  
alphas from (d,2n)a

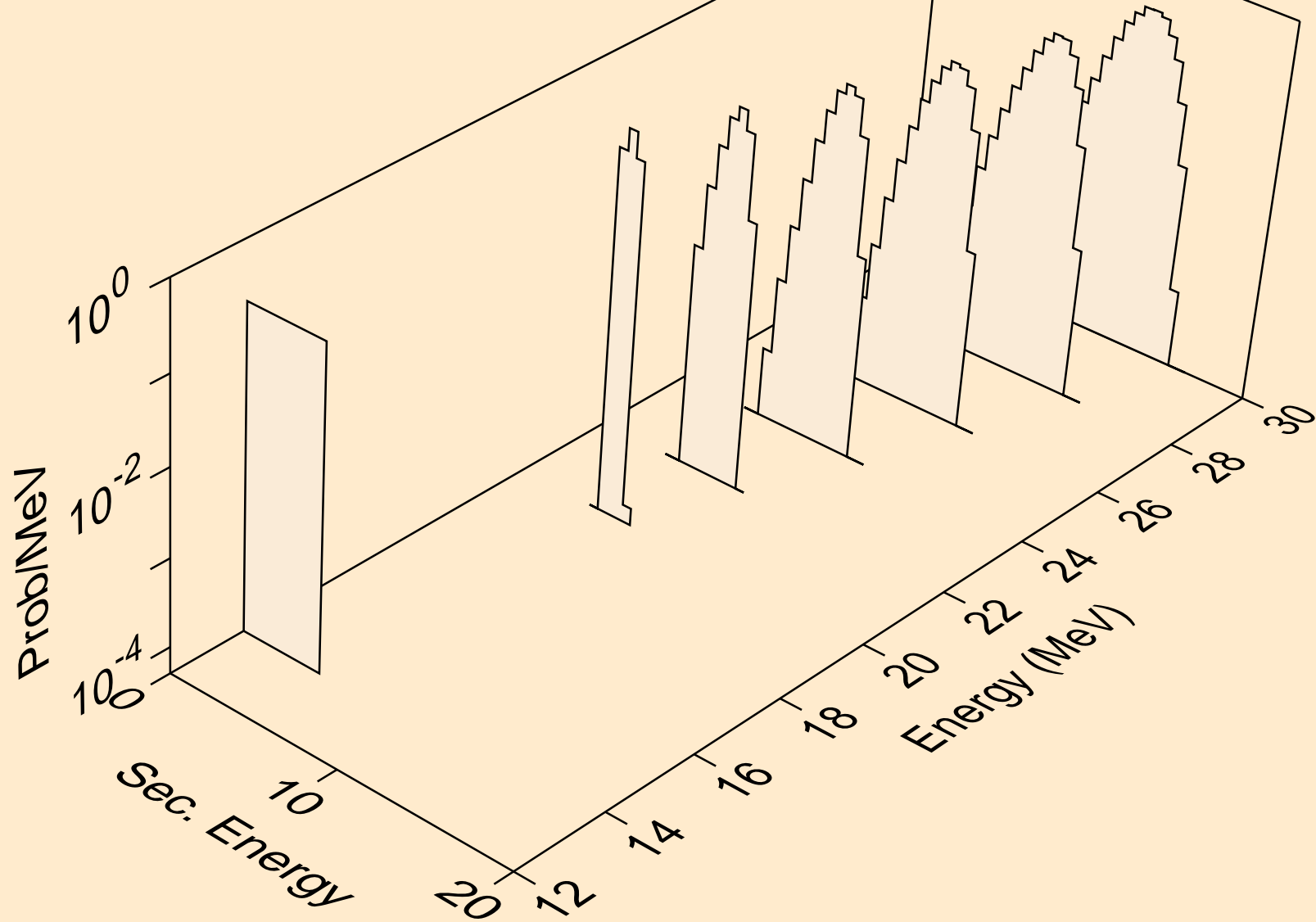

SM130 DEUTERON ACER TENDL-2021 LIBRARY; T=0.K  
alphas from (d,n\*)2a

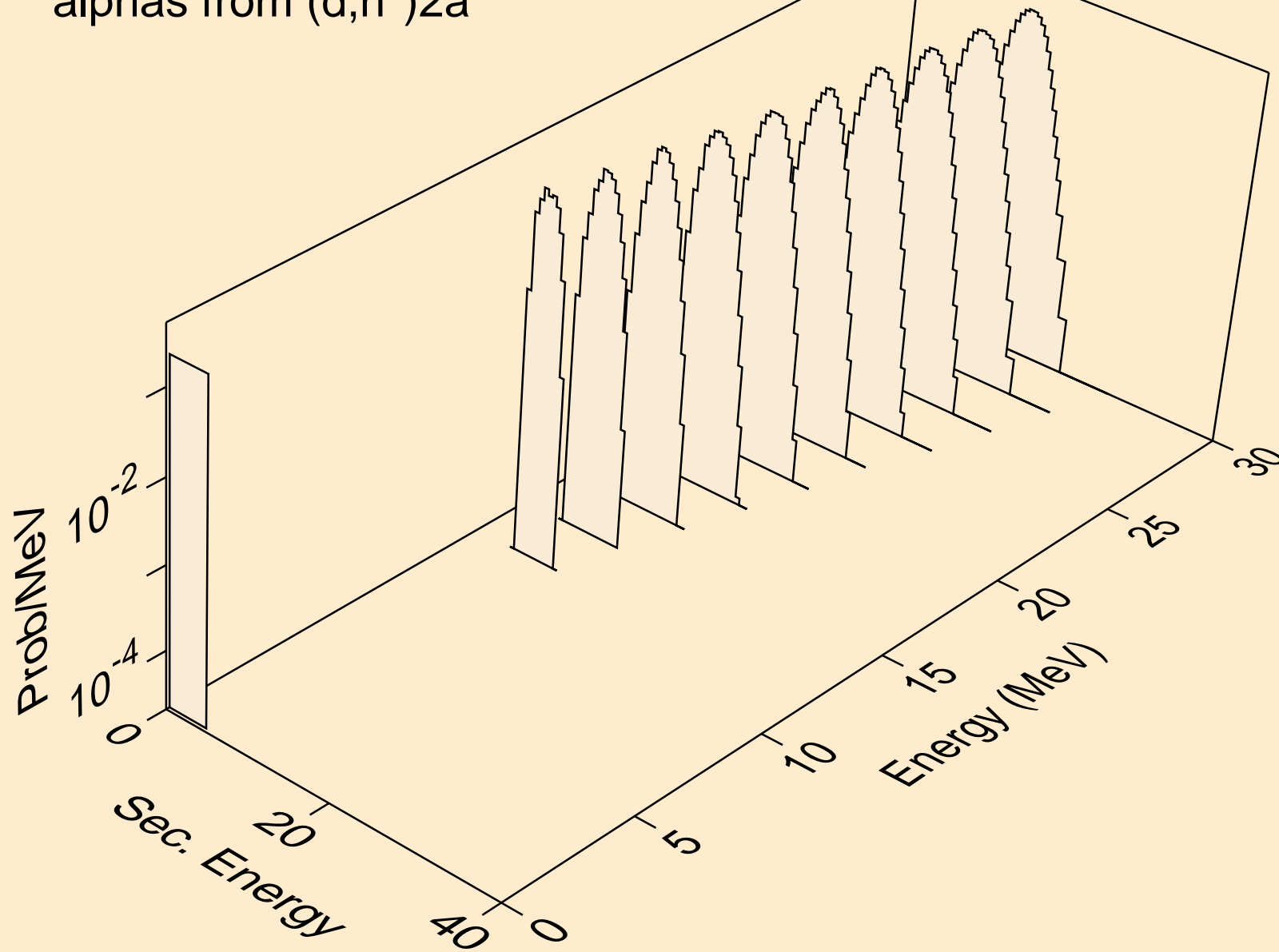

SM130 DEUTERON ACER TENDL-2021 LIBRARY; T=0.K  
alphas from (d,npa)

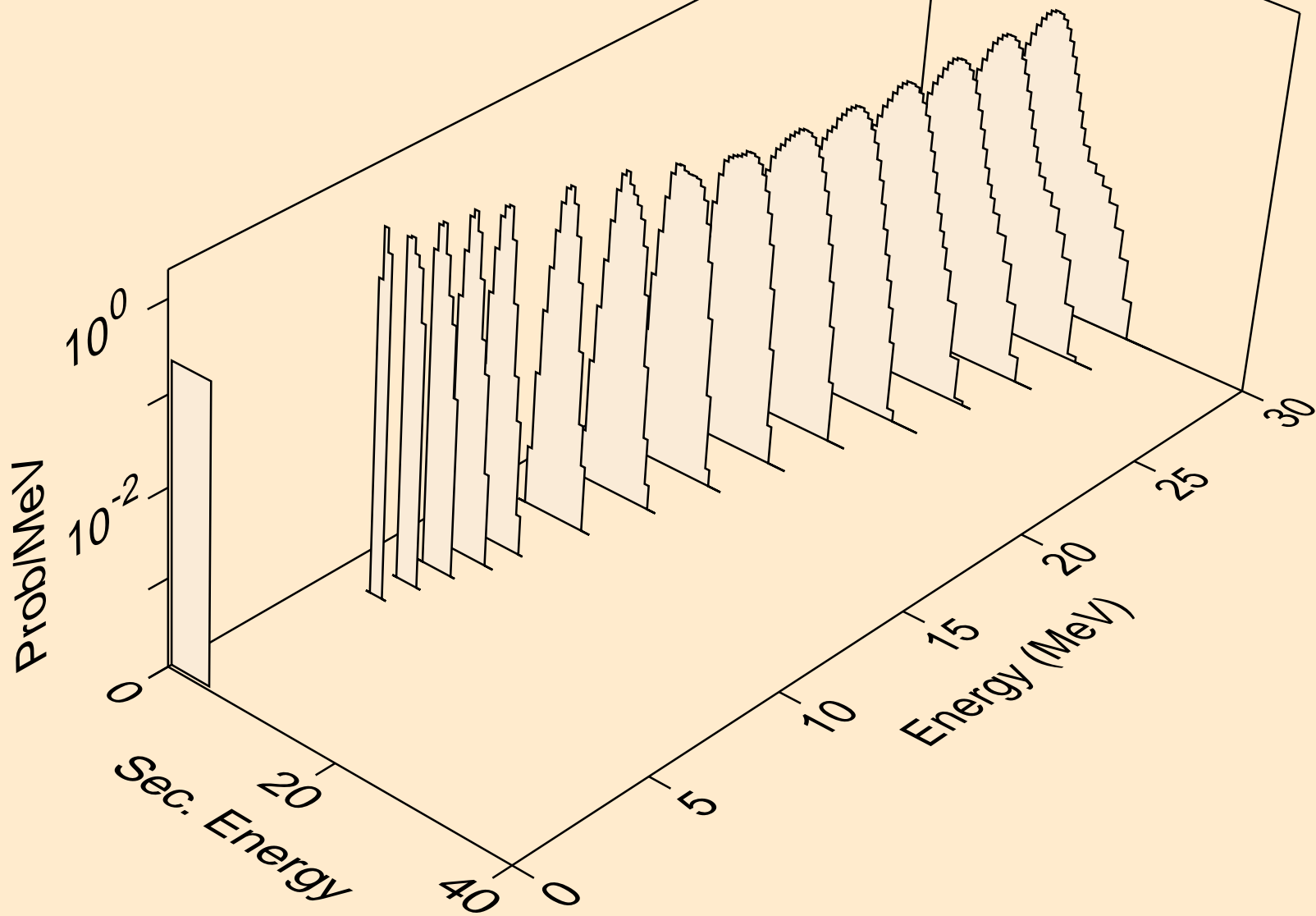

SM130 DEUTERON ACER TENDL-2021 LIBRARY; T=0.K  
alphas from (d,a)

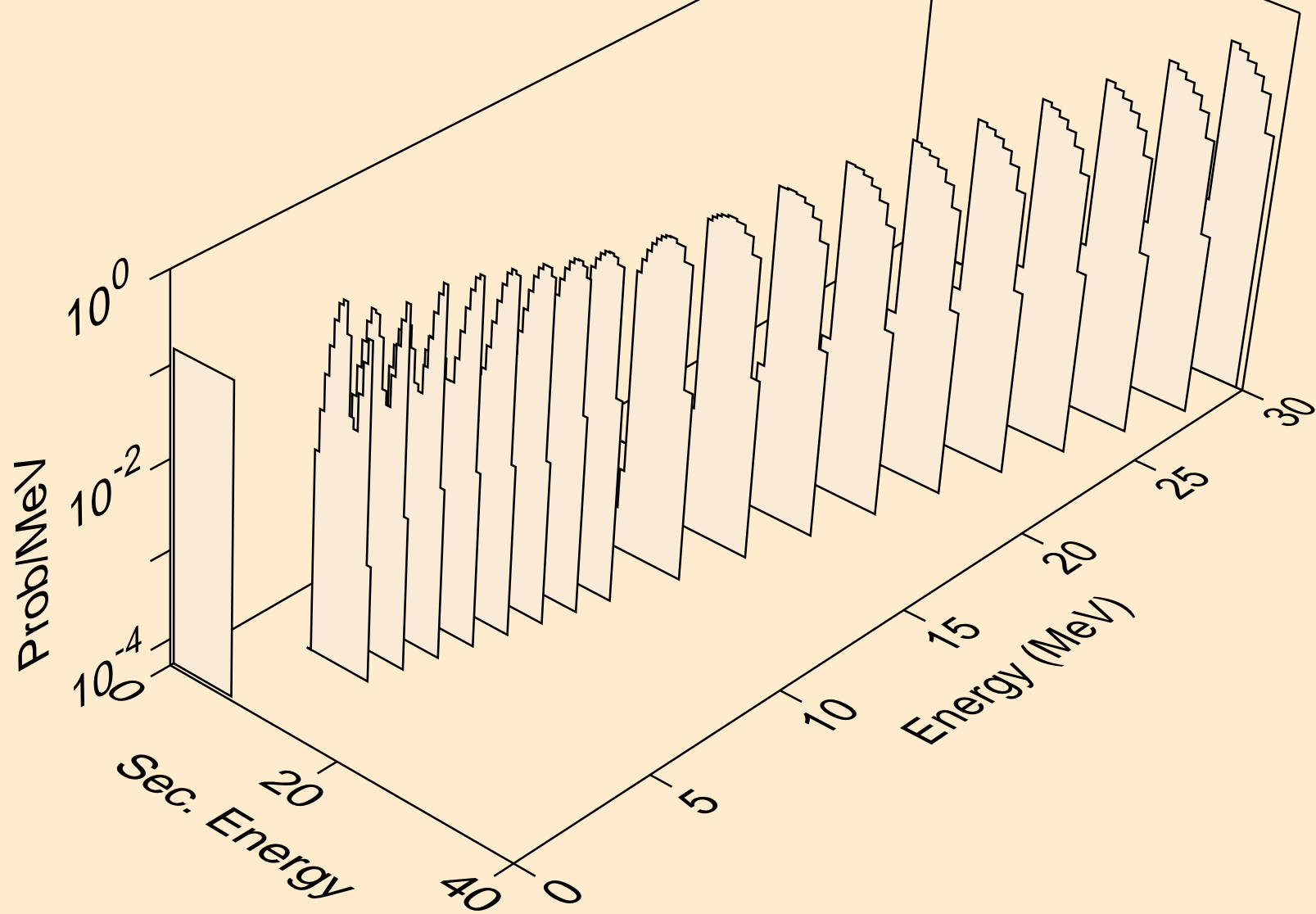



SM130 DEUTERON ACER TENDL-2021 LIBRARY; T=0.K  
alphas from (d,2a)

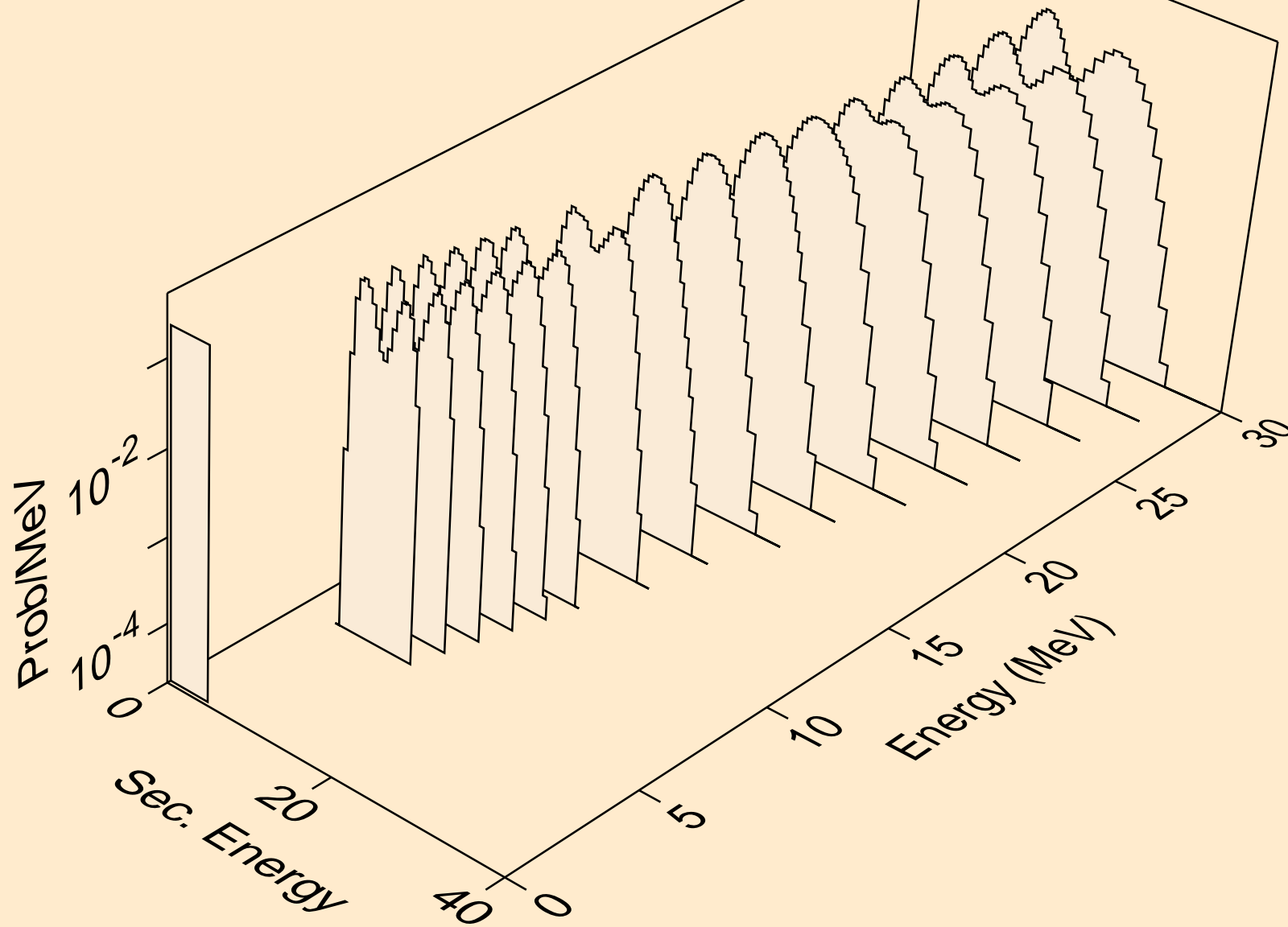

SM130 DEUTERON ACER TENDL-2021 LIBRARY; T=0.K  
alphas from (d,pa)

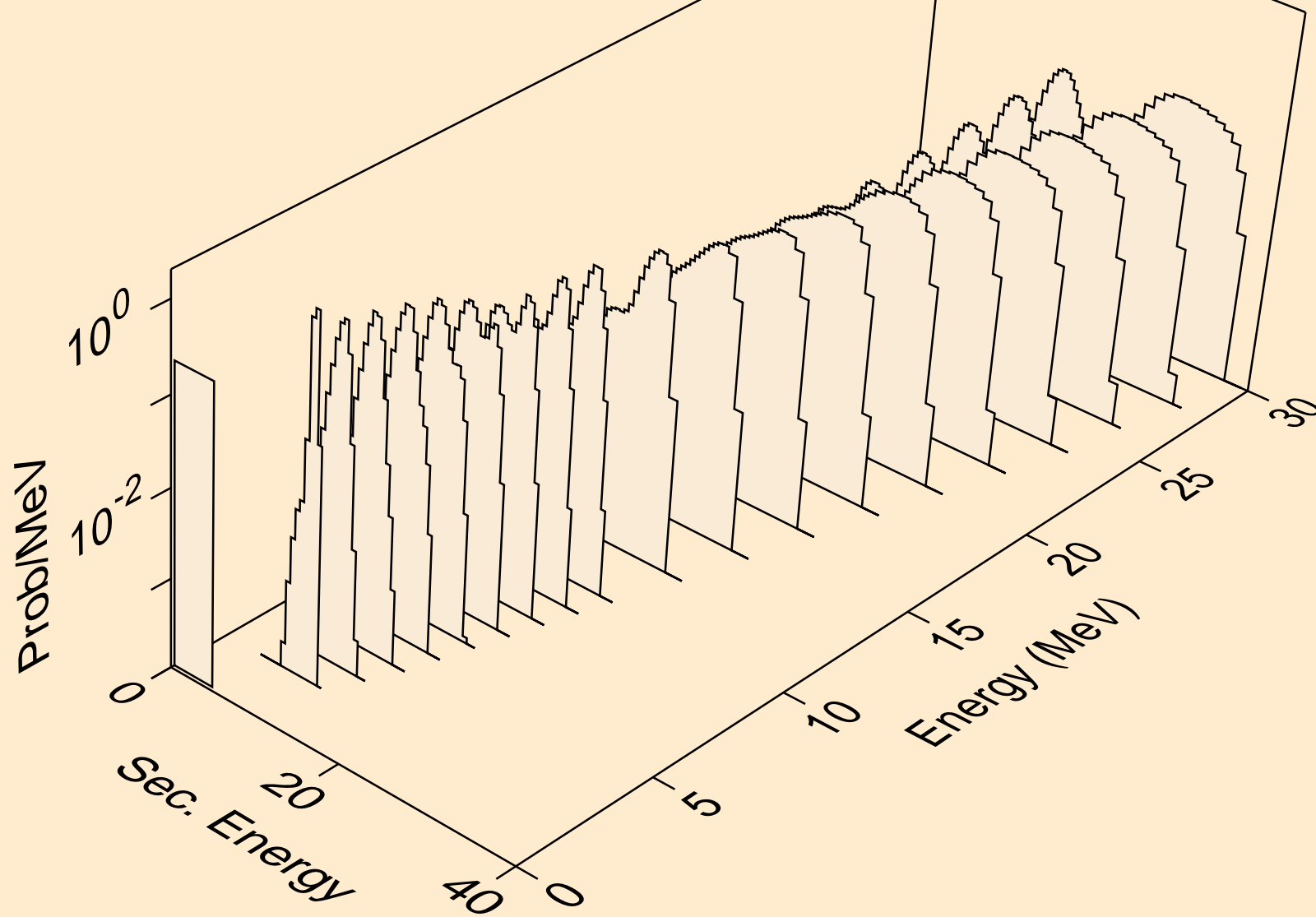

SM130 DEUTERON ACER TENDL-2021 LIBRARY; T=0.K  
alphas from (d,d2a)

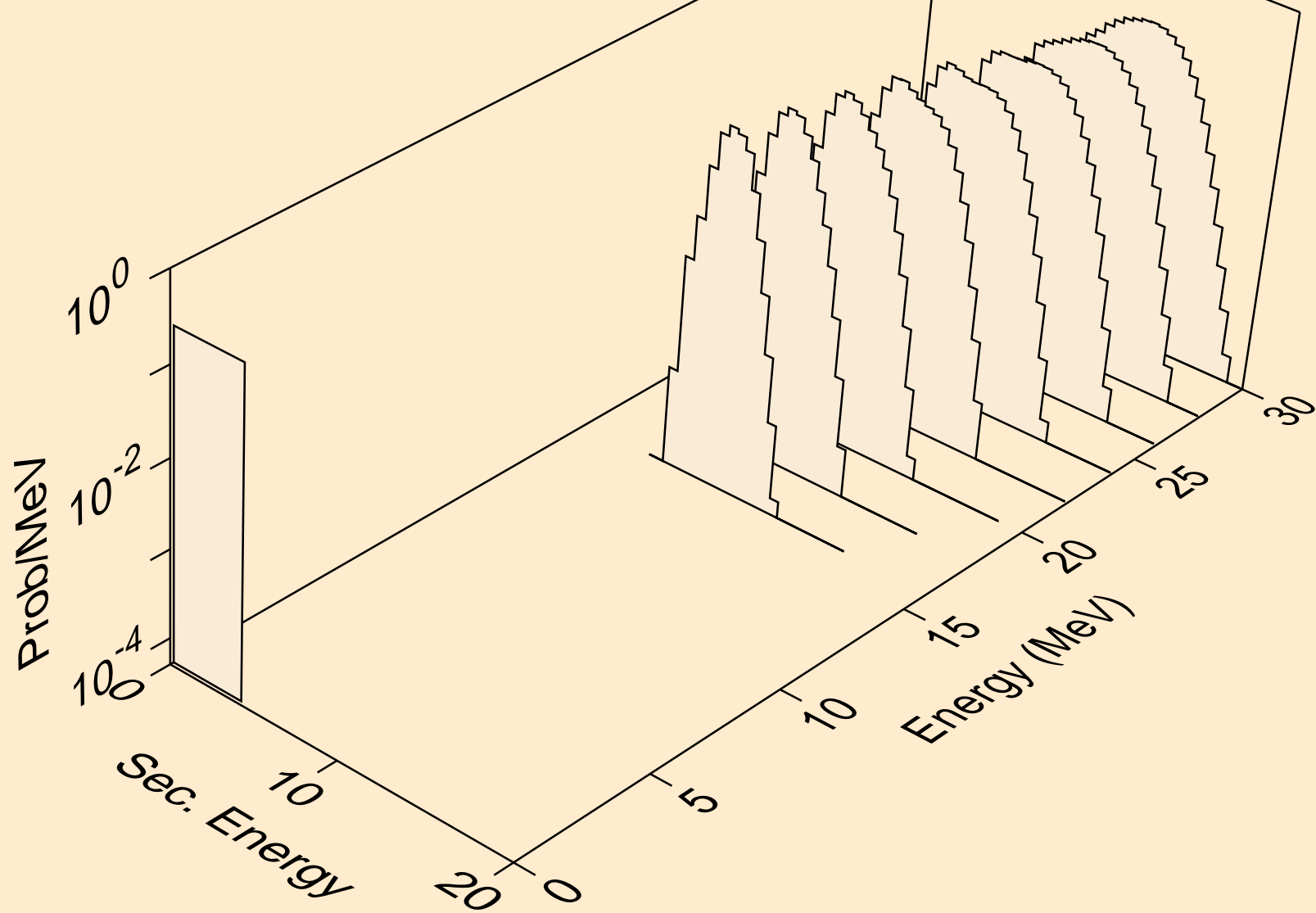

SM130 DEUTERON ACER TENDL-2021 LIBRARY; T=0.K  
alphas from (d,da)

