

# SM158 DEUTERON ACER TENDL-2021 LIBRARY; T=0.K

## Principal cross sections

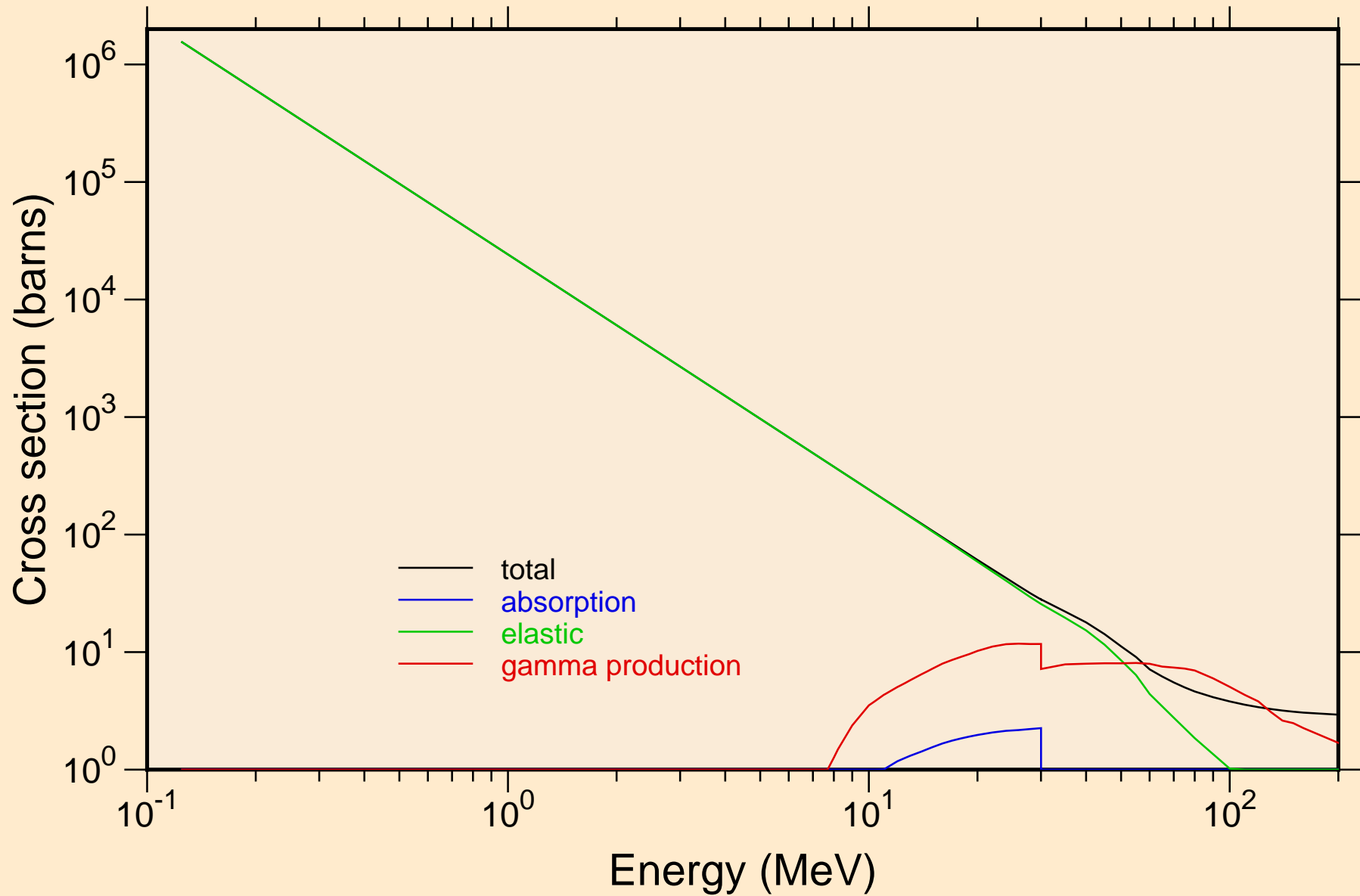

# SM158 DEUTERON ACER TENDL-2021 LIBRARY; T=0.K

## Heating

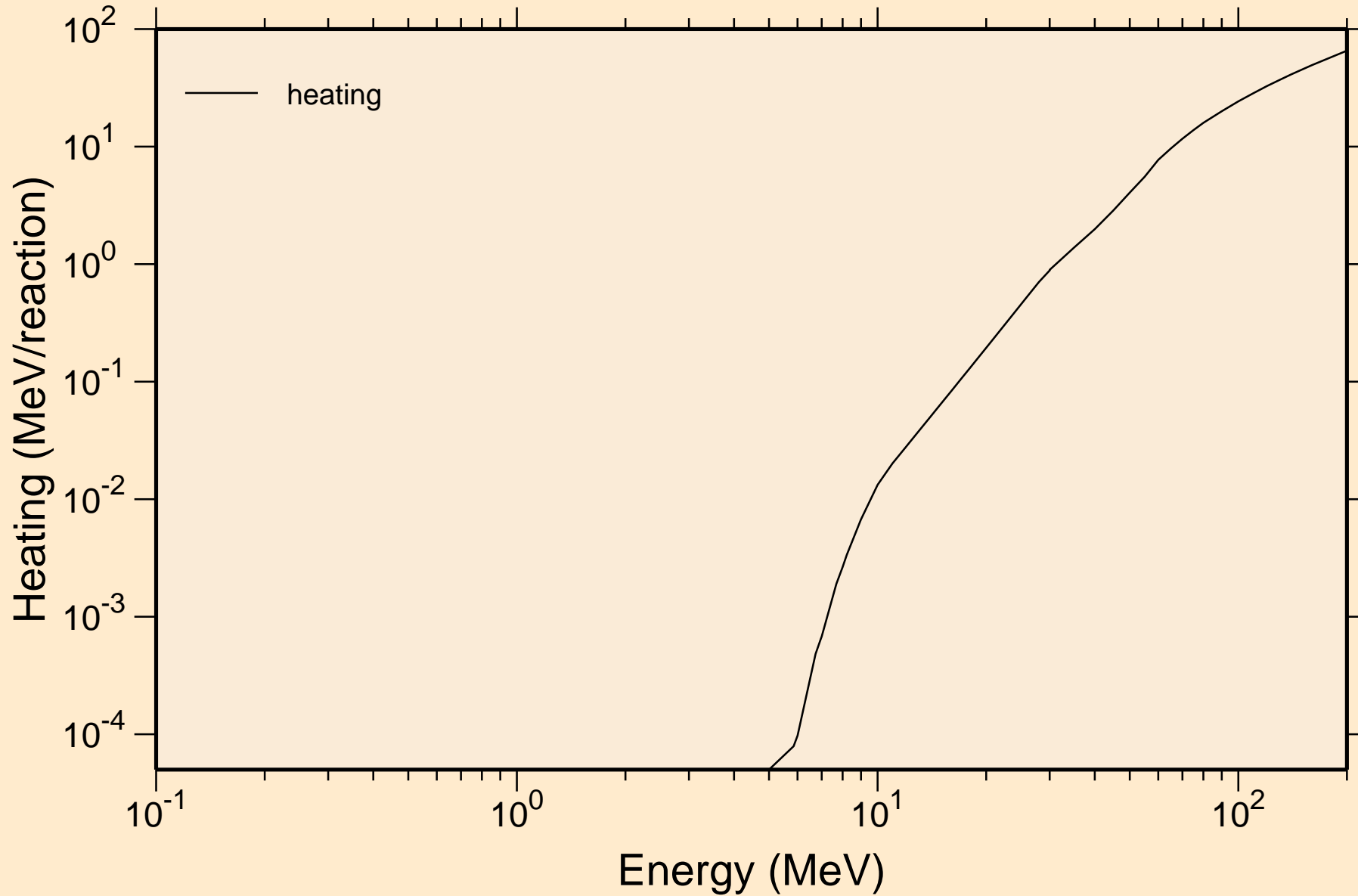

# SM158 DEUTERON ACER TENDL-2021 LIBRARY; T=0.K

## Principal cross sections

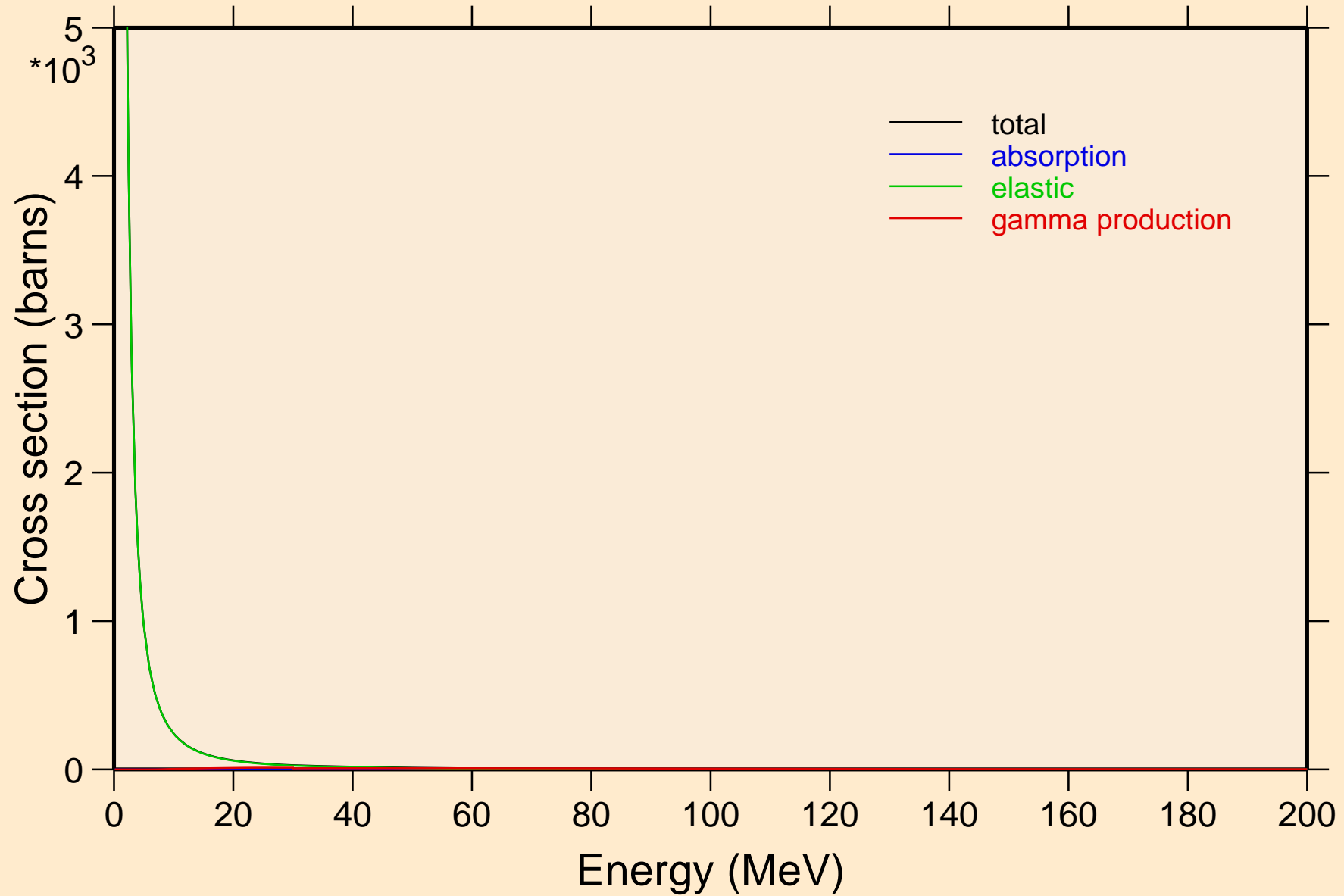

# SM158 DEUTERON ACER TENDL-2021 LIBRARY; T=0.K

## Heating

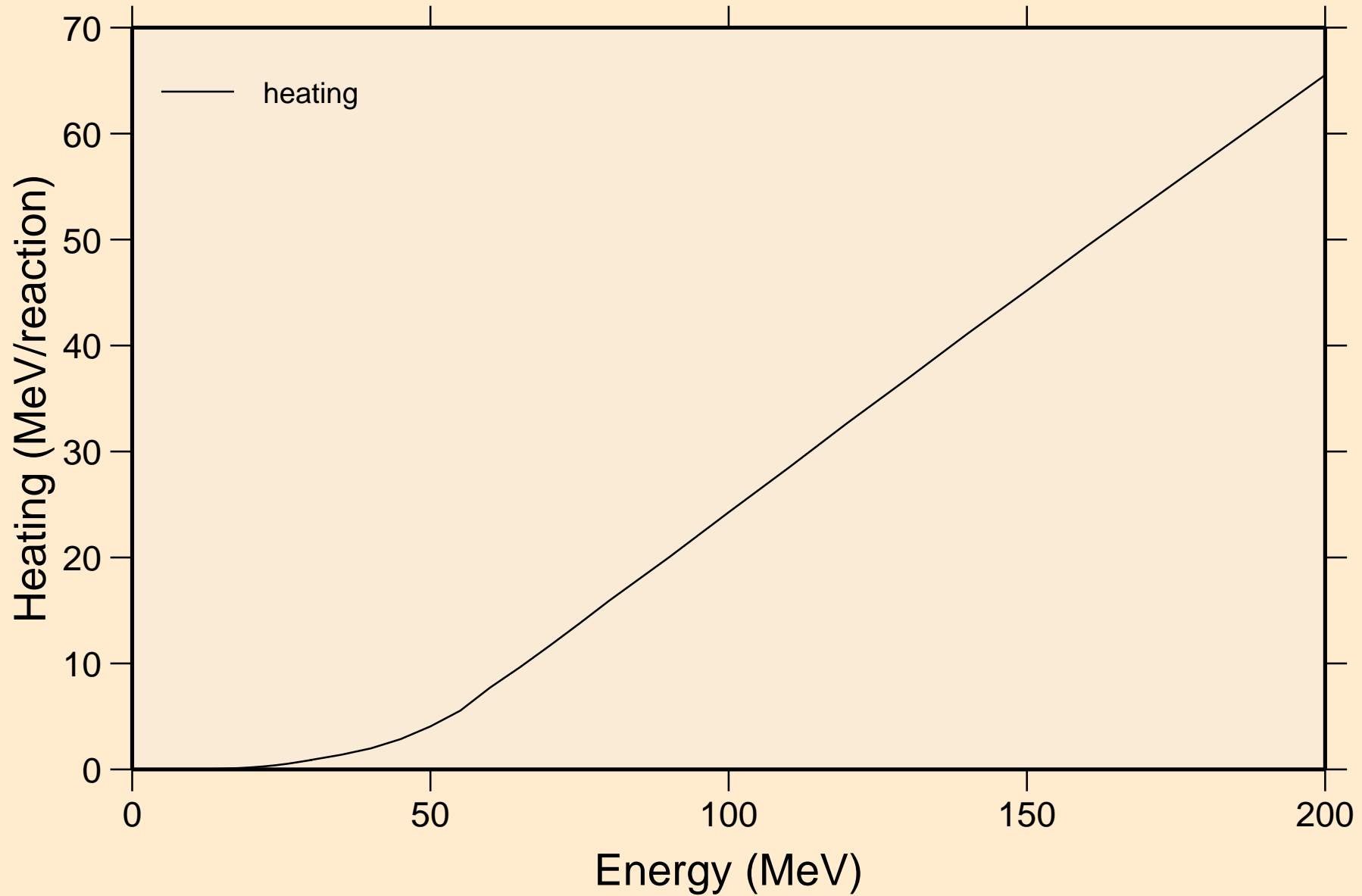

# SM158 DEUTERON ACER TENDL-2021 LIBRARY; T=0.K

## Threshold reactions

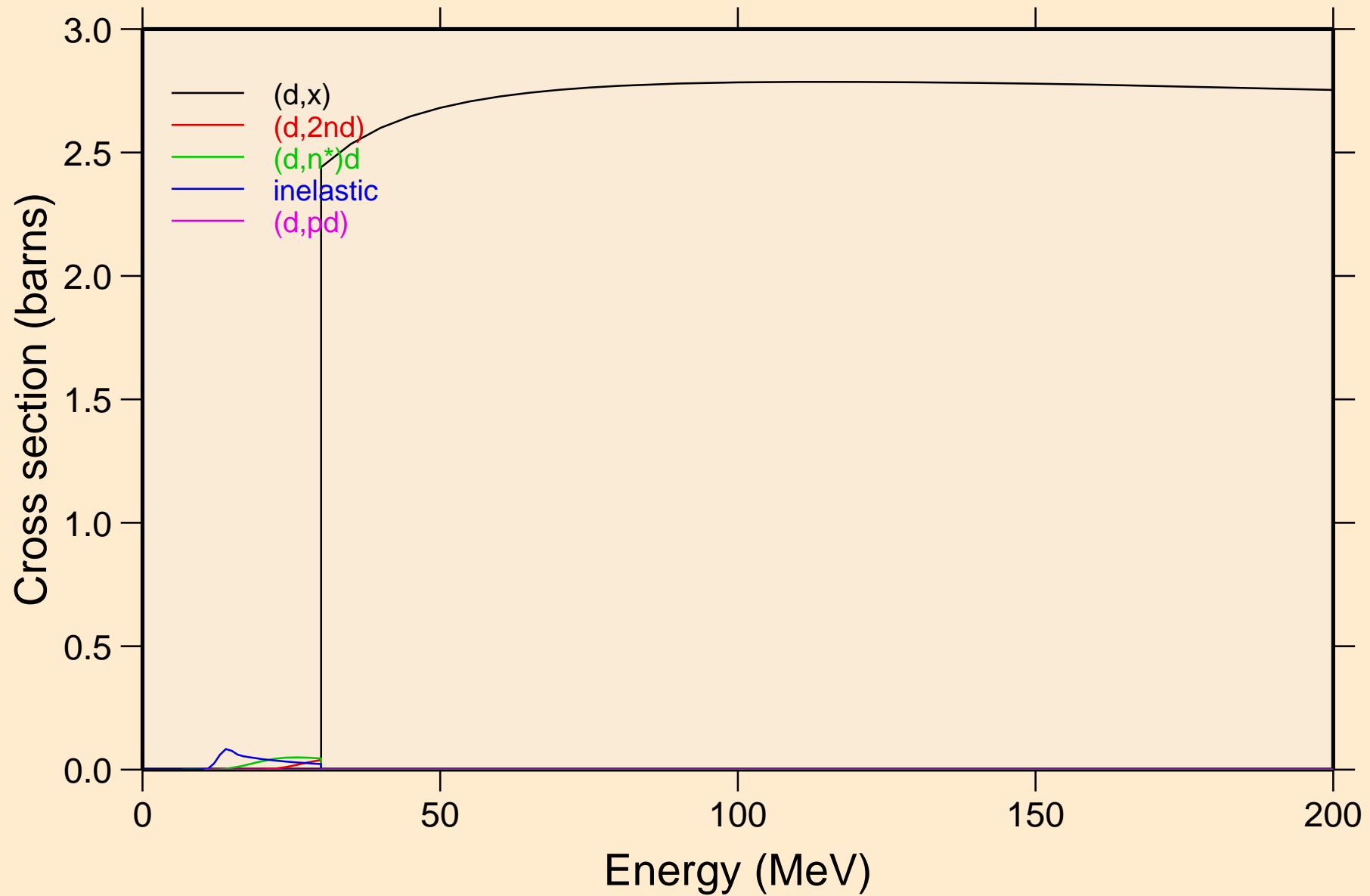

SM158 DEUTERON ACER TENDL-2021 LIBRARY; T=0.K  
angular distribution for elastic

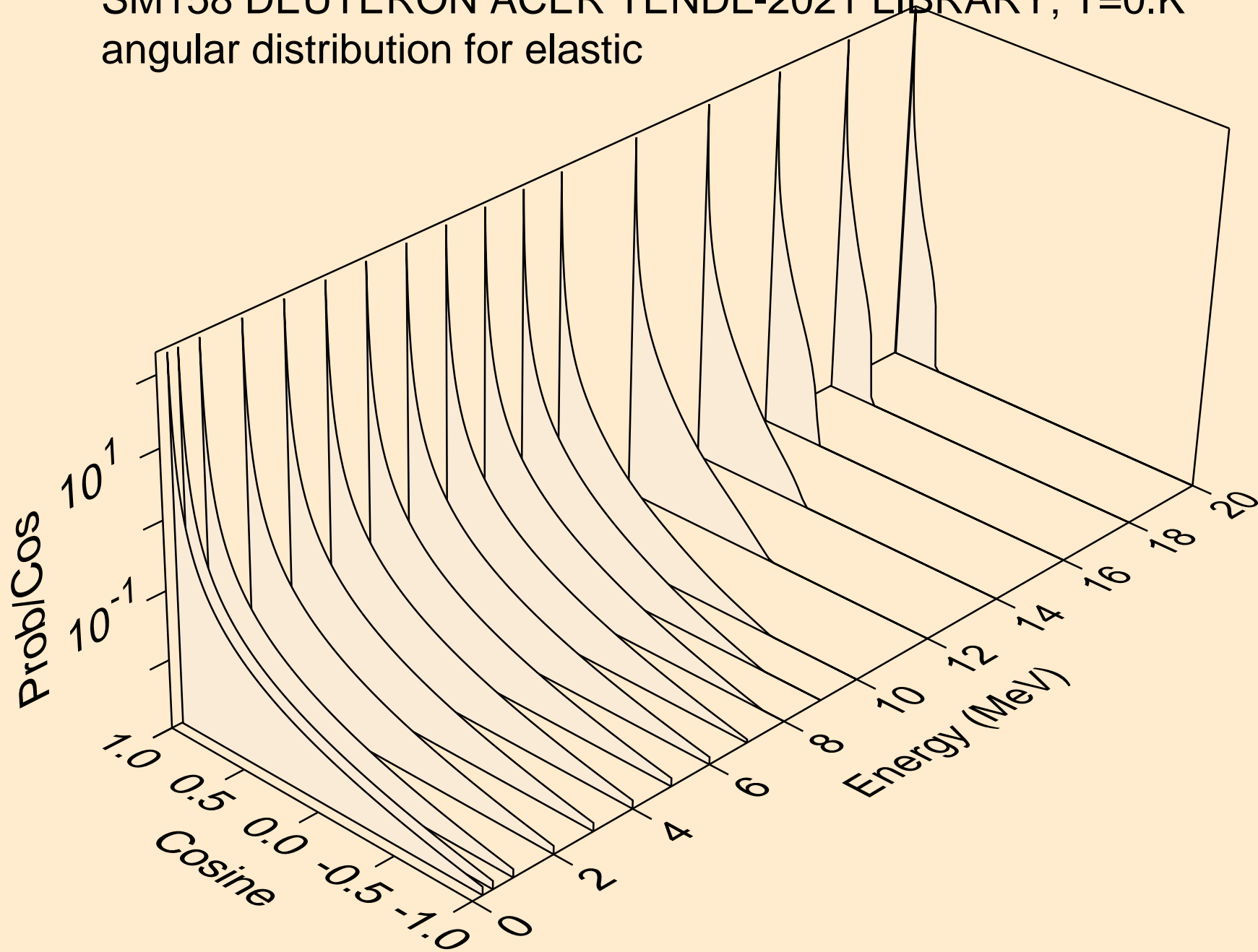

SM158 DEUTERON ACER TENDL-2021 LIBRARY; T=0.K  
angular distribution for elastic

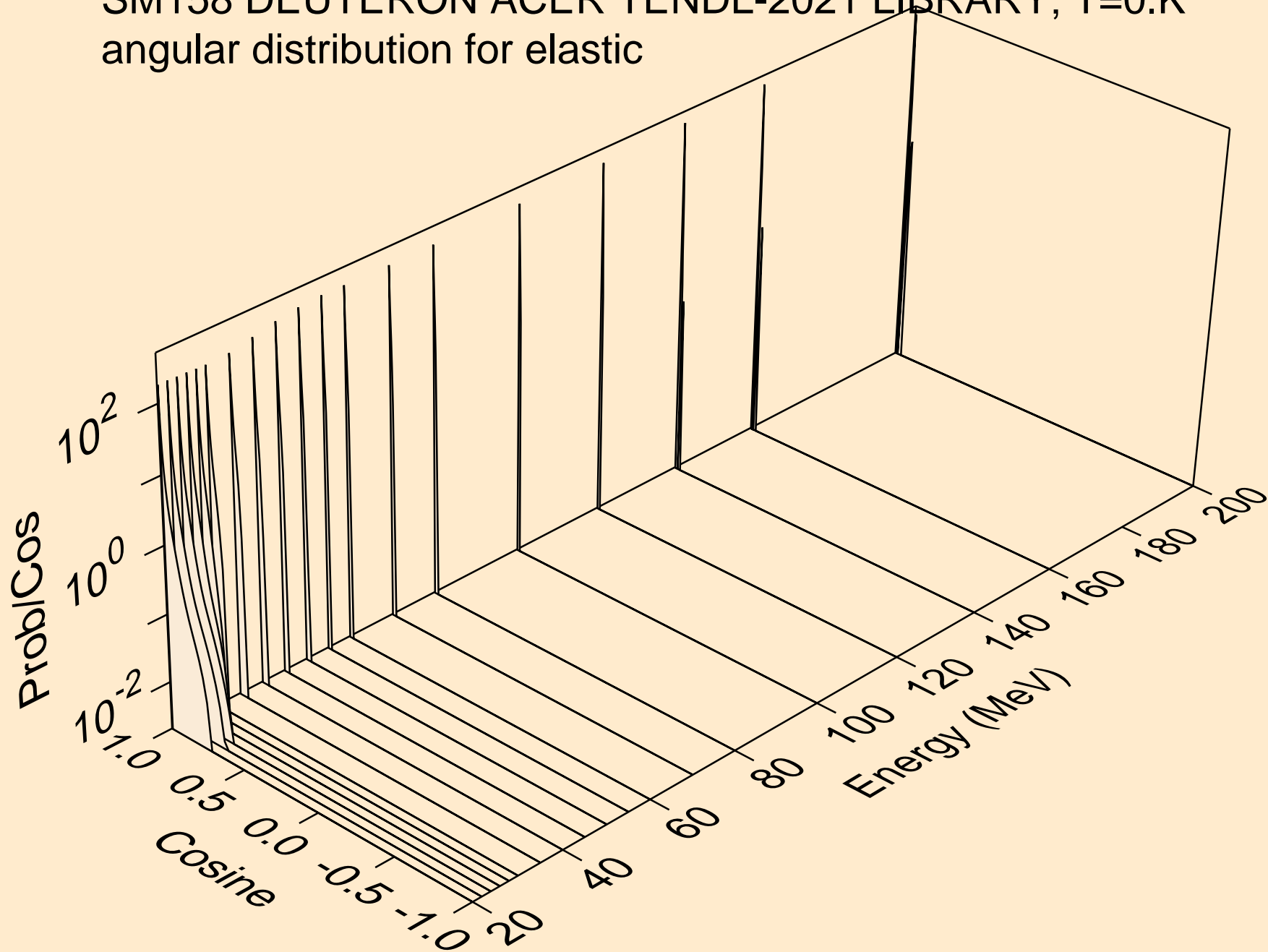

SM158 DEUTERON ACER TENDL-2021 LIBRARY; T=0.K  
Deuteron emission for (d,x)

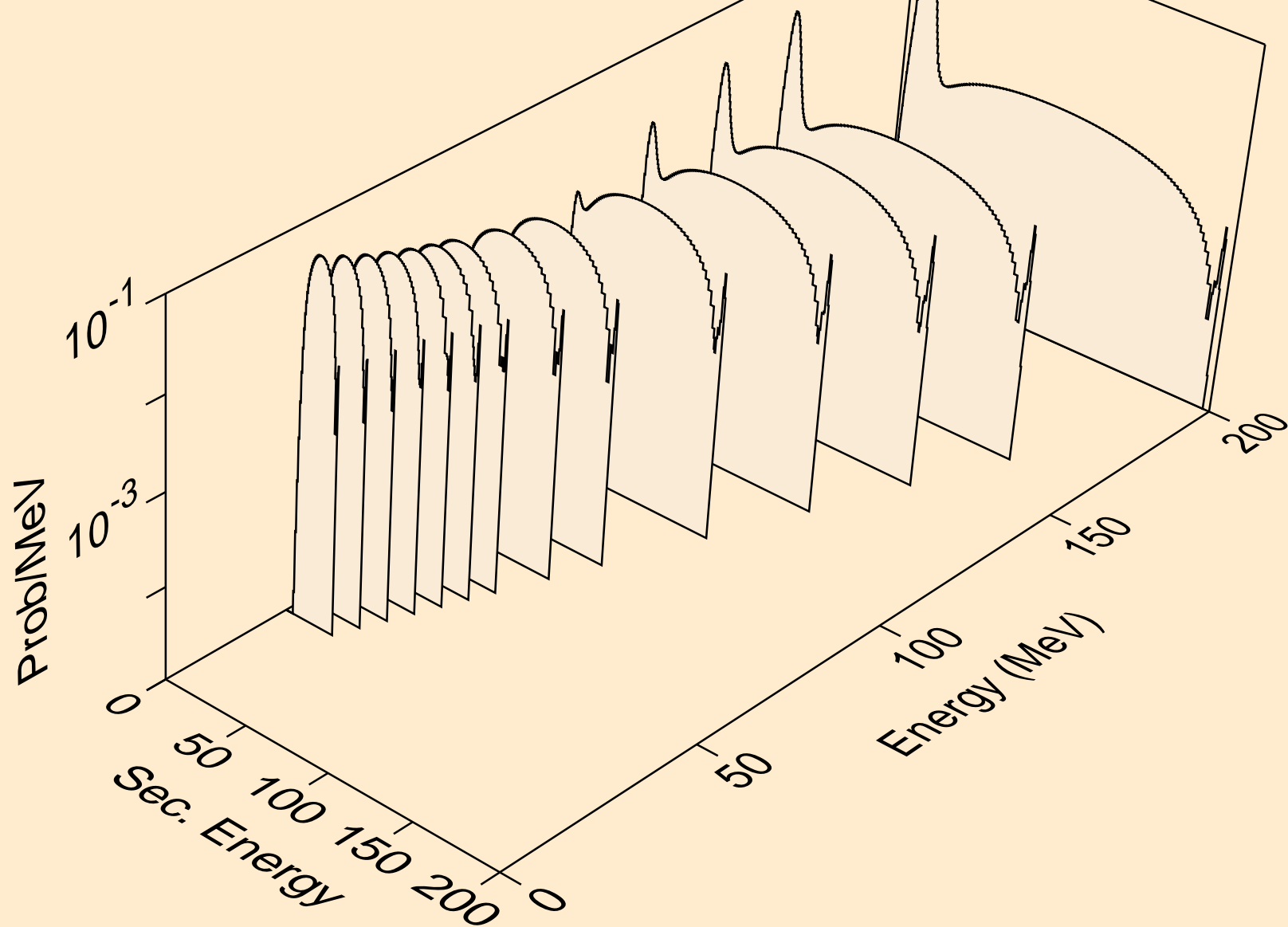



SM158 DEUTERON ACER TENDL-2021 LIBRARY; T=0.K  
Deuteron emission for (d,2nd)

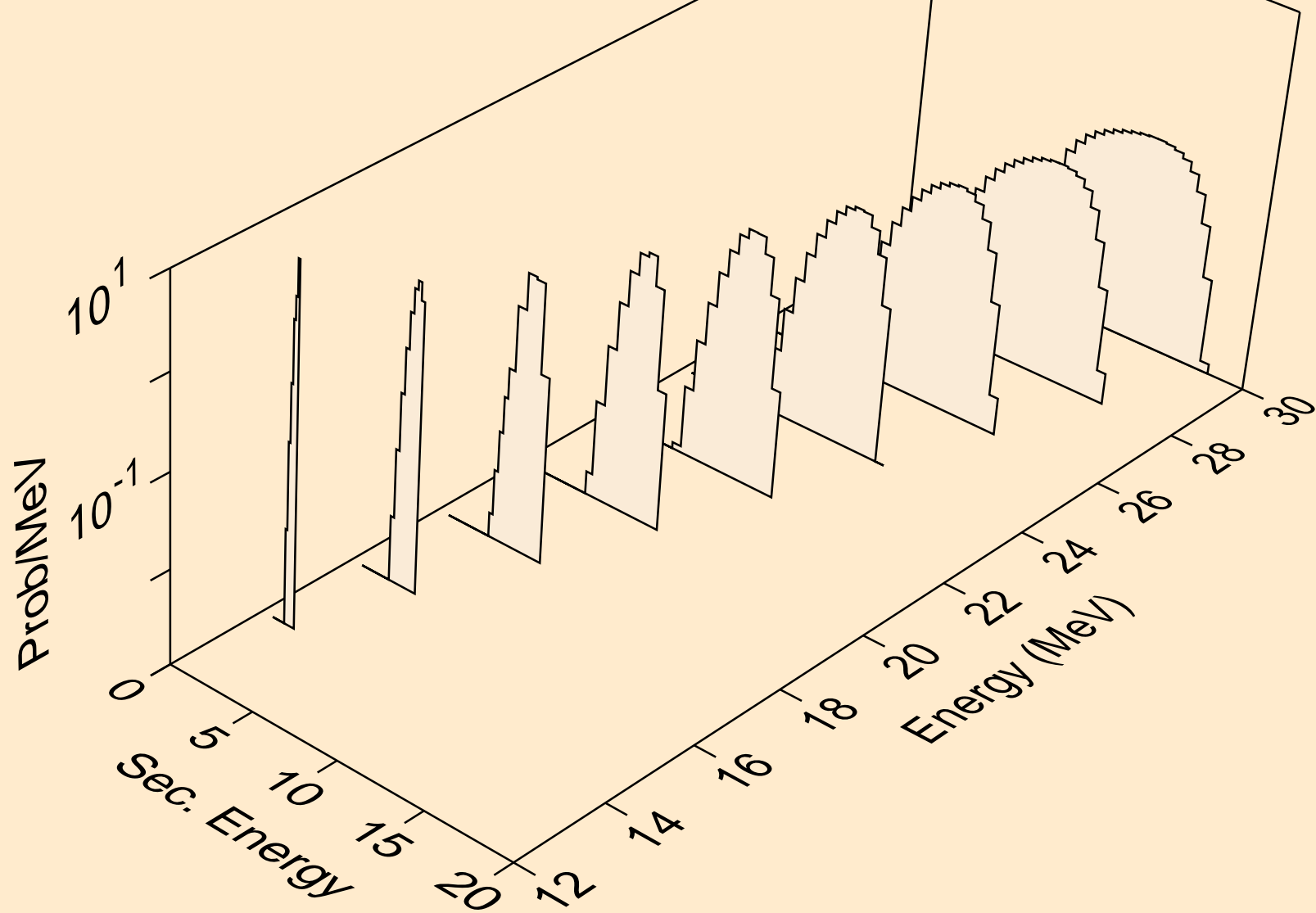

SM158 DEUTERON ACER TENDL-2021 LIBRARY; T=0.K  
Deuteron emission for (d,n\*)d

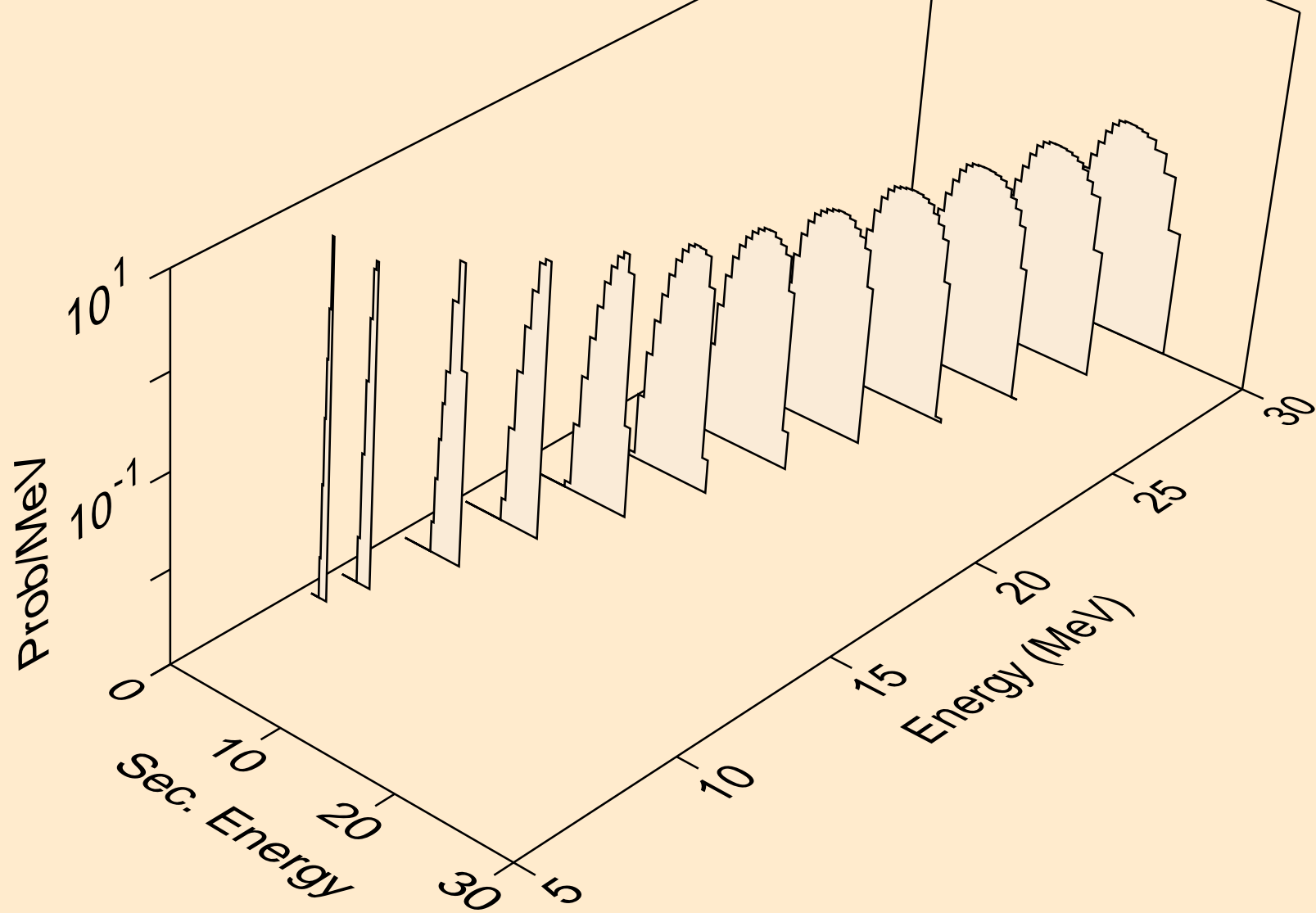

SM158 DEUTERON ACER TENDL-2021 LIBRARY; T=0.K  
Deuteron emission for inelastic

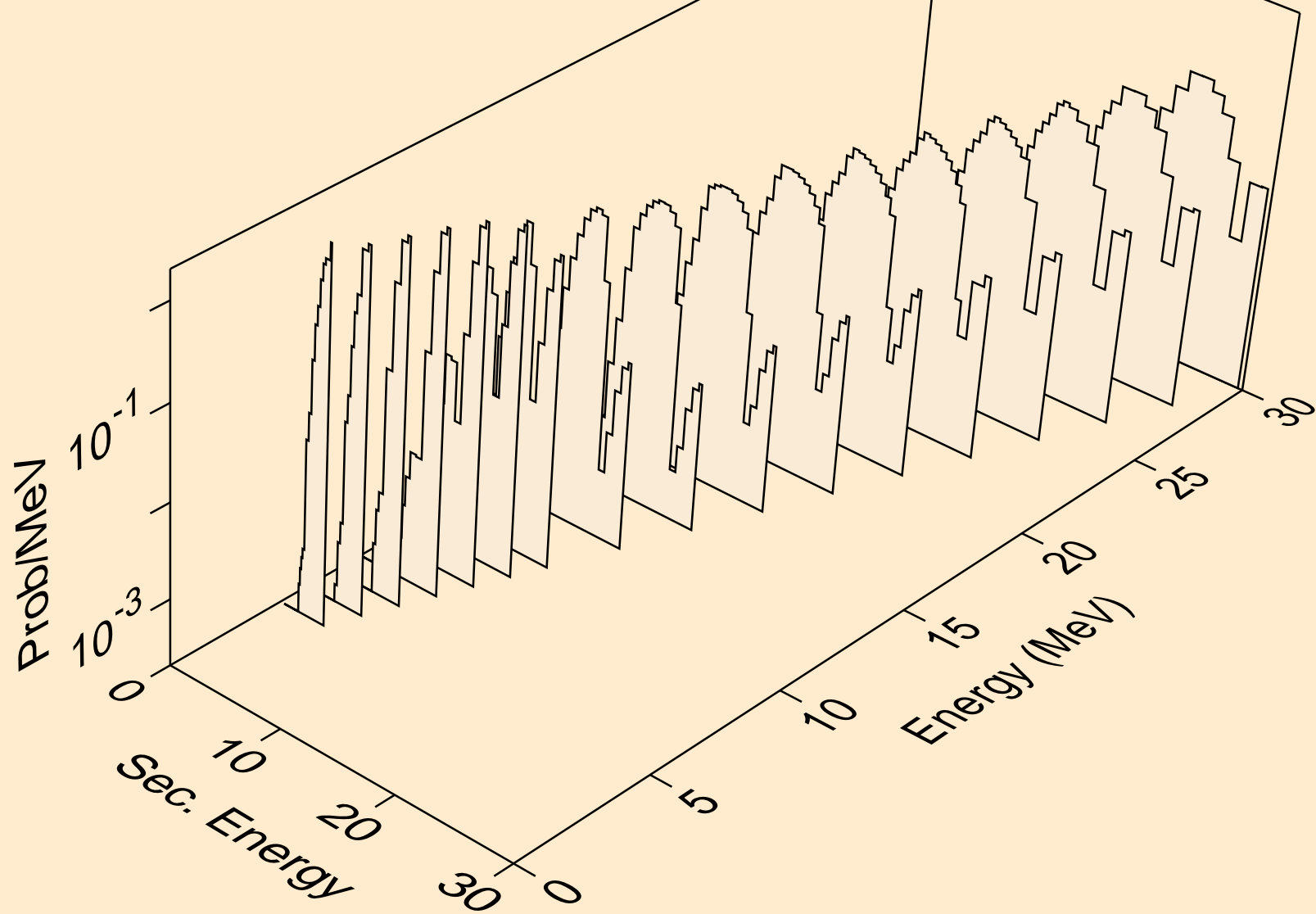

SM158 DEUTERON ACER TENDL-2021 LIBRARY; T=0.K  
Deuteron emission for (d,pd)

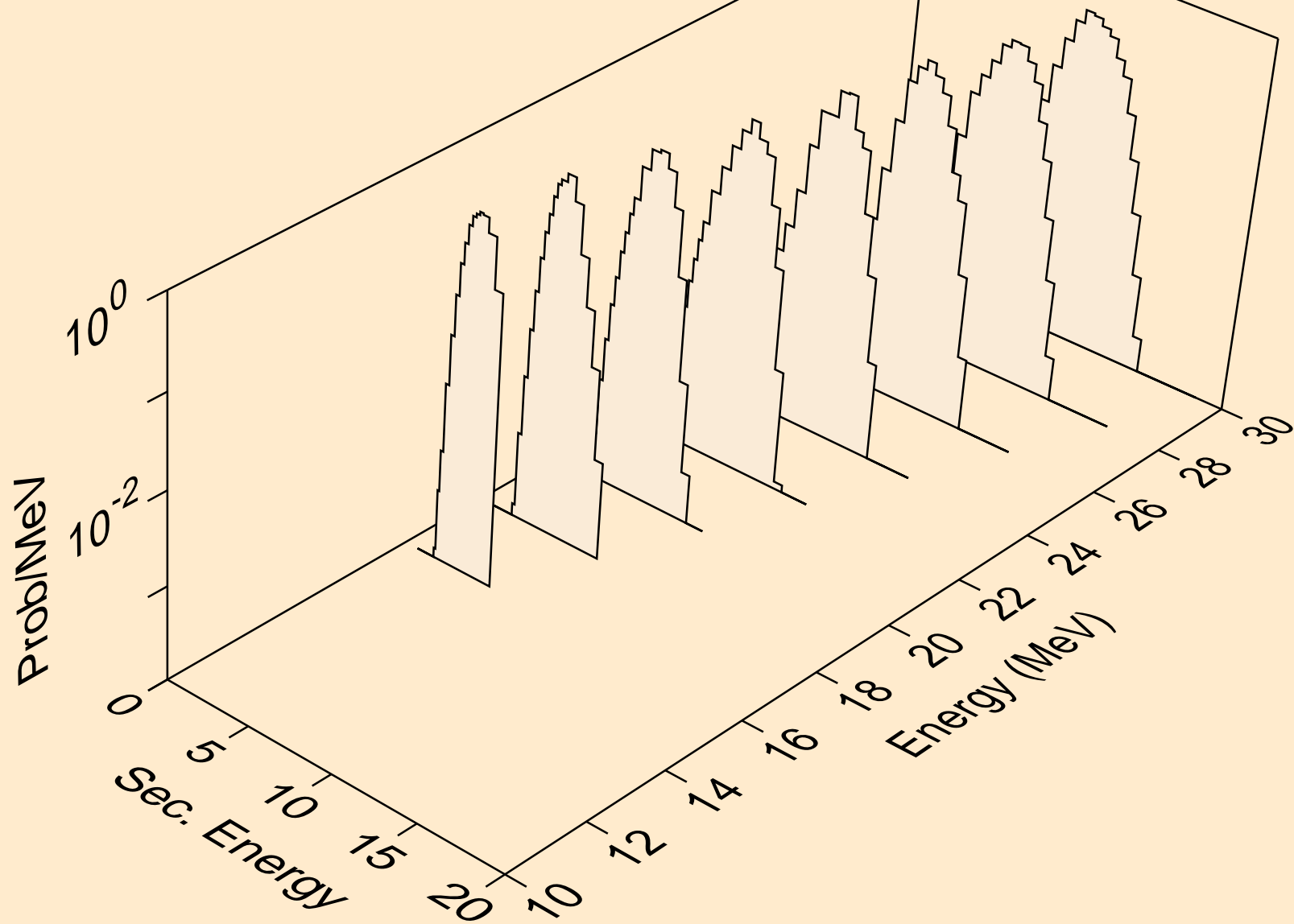

SM158 DEUTERON ACER TENDL-2021 LIBRARY; T=0.K  
Photon emission for (z,n)

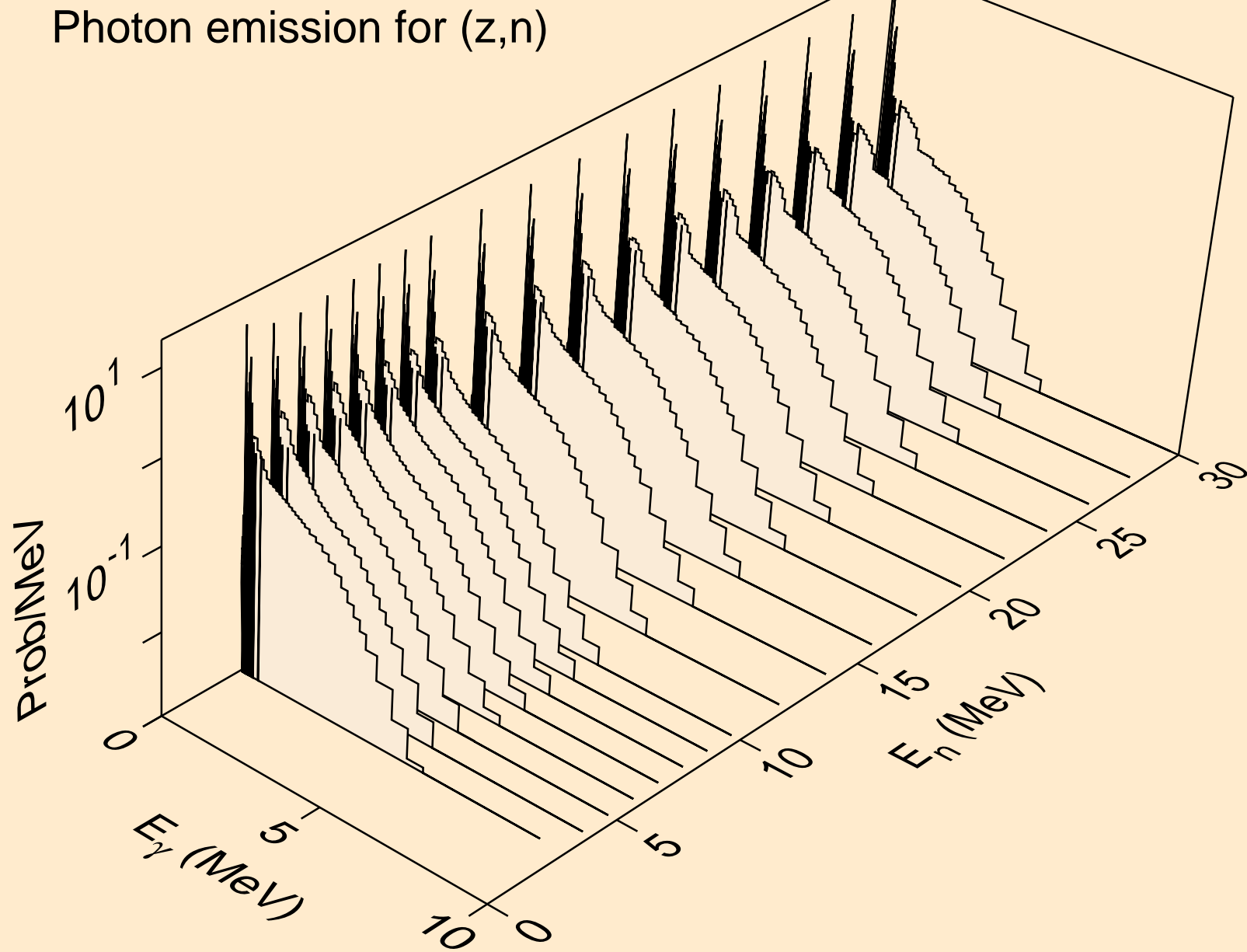

SM158 DEUTERON ACER TENDL-2021 LIBRARY; T=0.K  
Photon emission for (n,x)

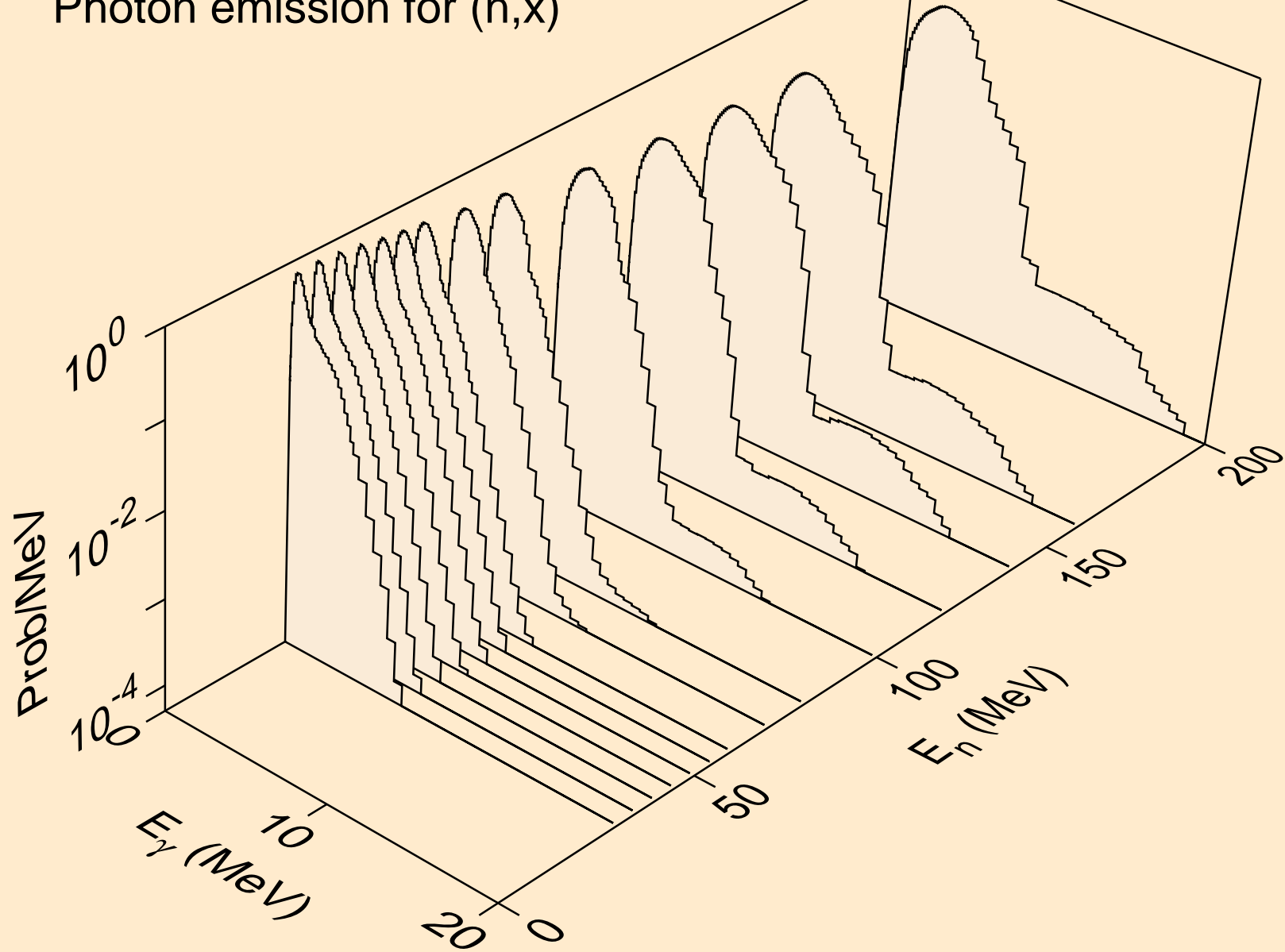

SM158 DEUTERON ACER TENDL-2021 LIBRARY; T=0.K  
Photon emission for (n,2nd)

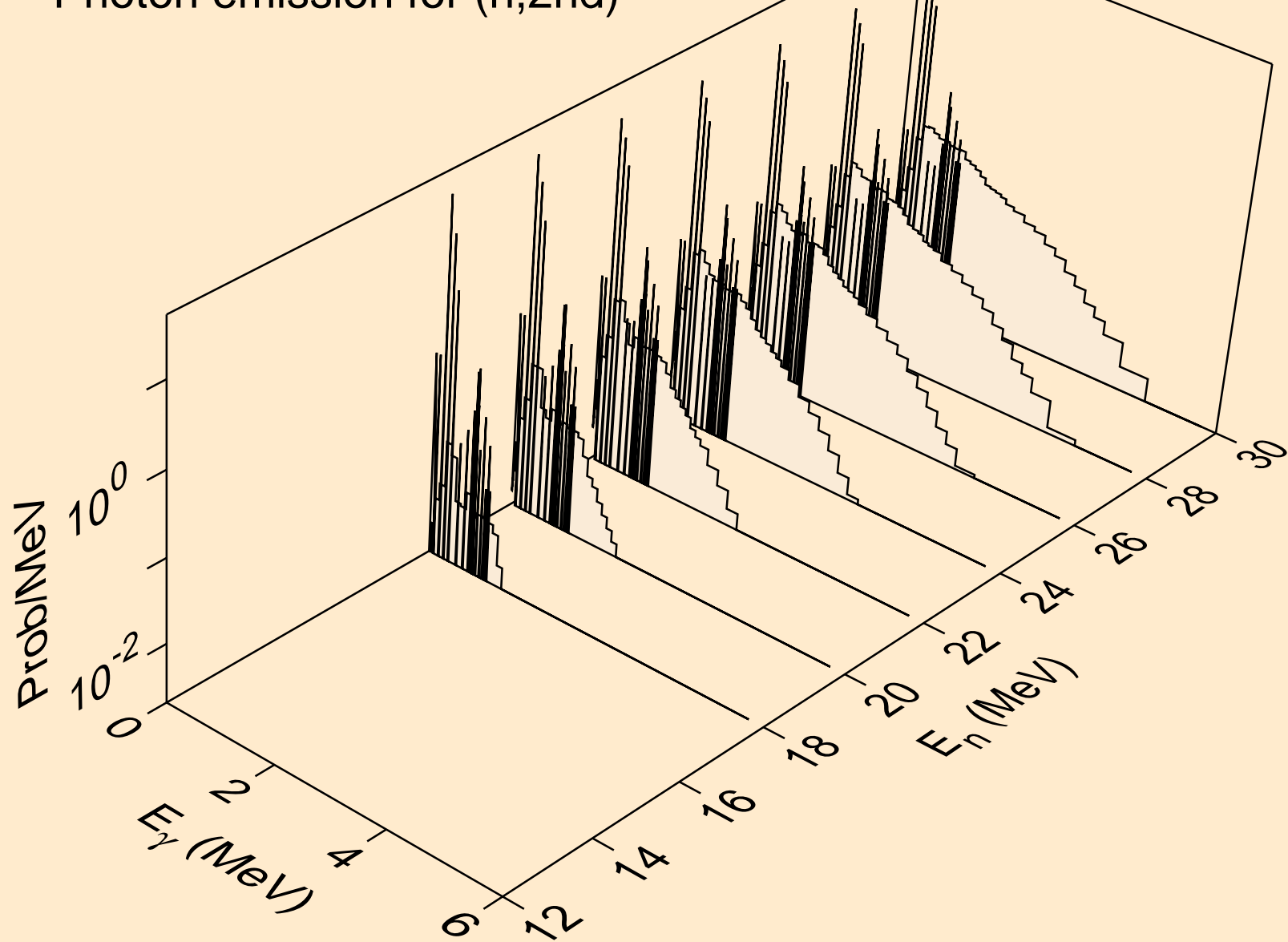

SM158 DEUTERON ACER TENDL-2021 LIBRARY; T=0.K  
Photon emission for (n,2n)

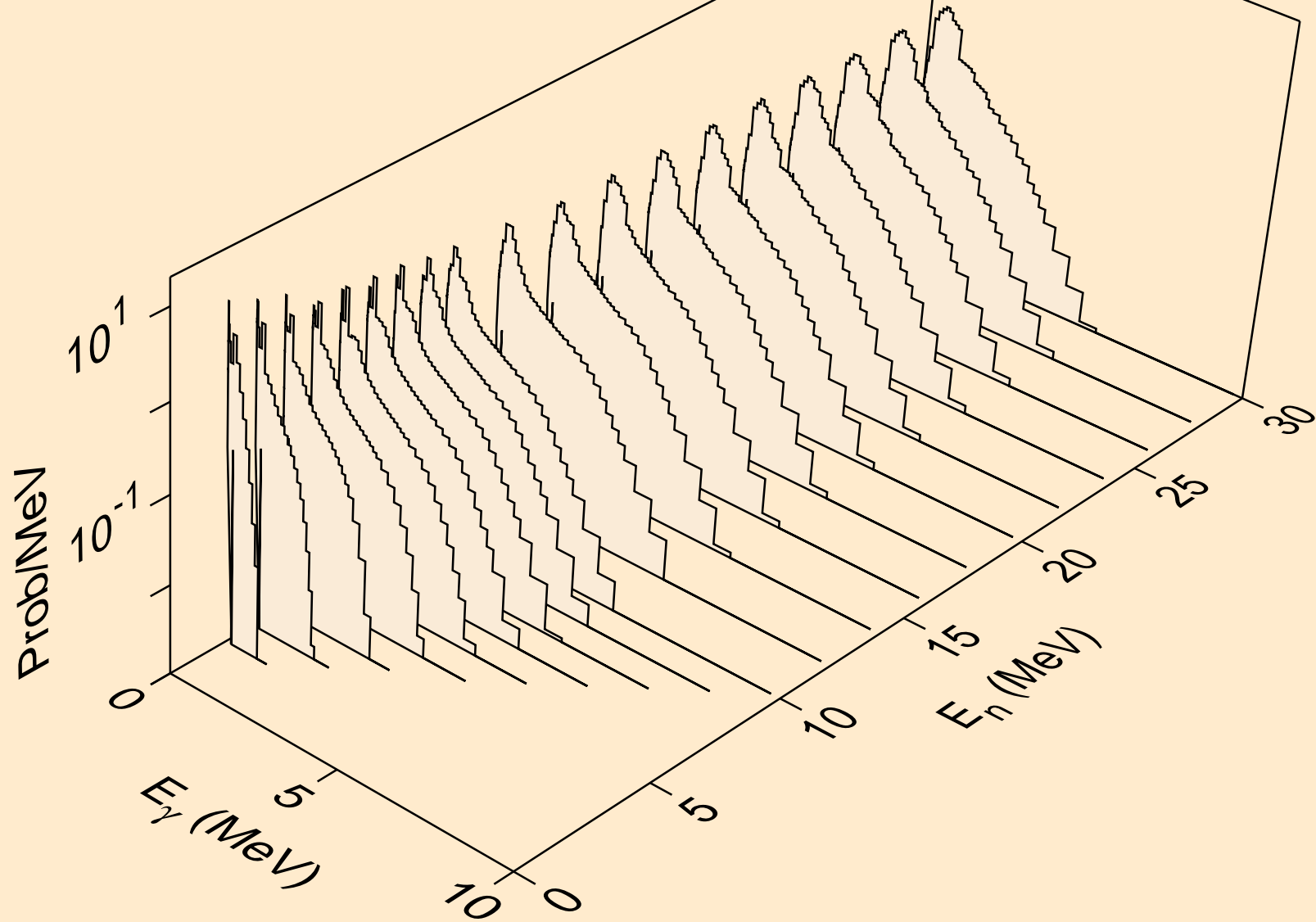



SM158 DEUTERON ACER TENDL-2021 LIBRARY; T=0.K  
Photon emission for (n,3n)

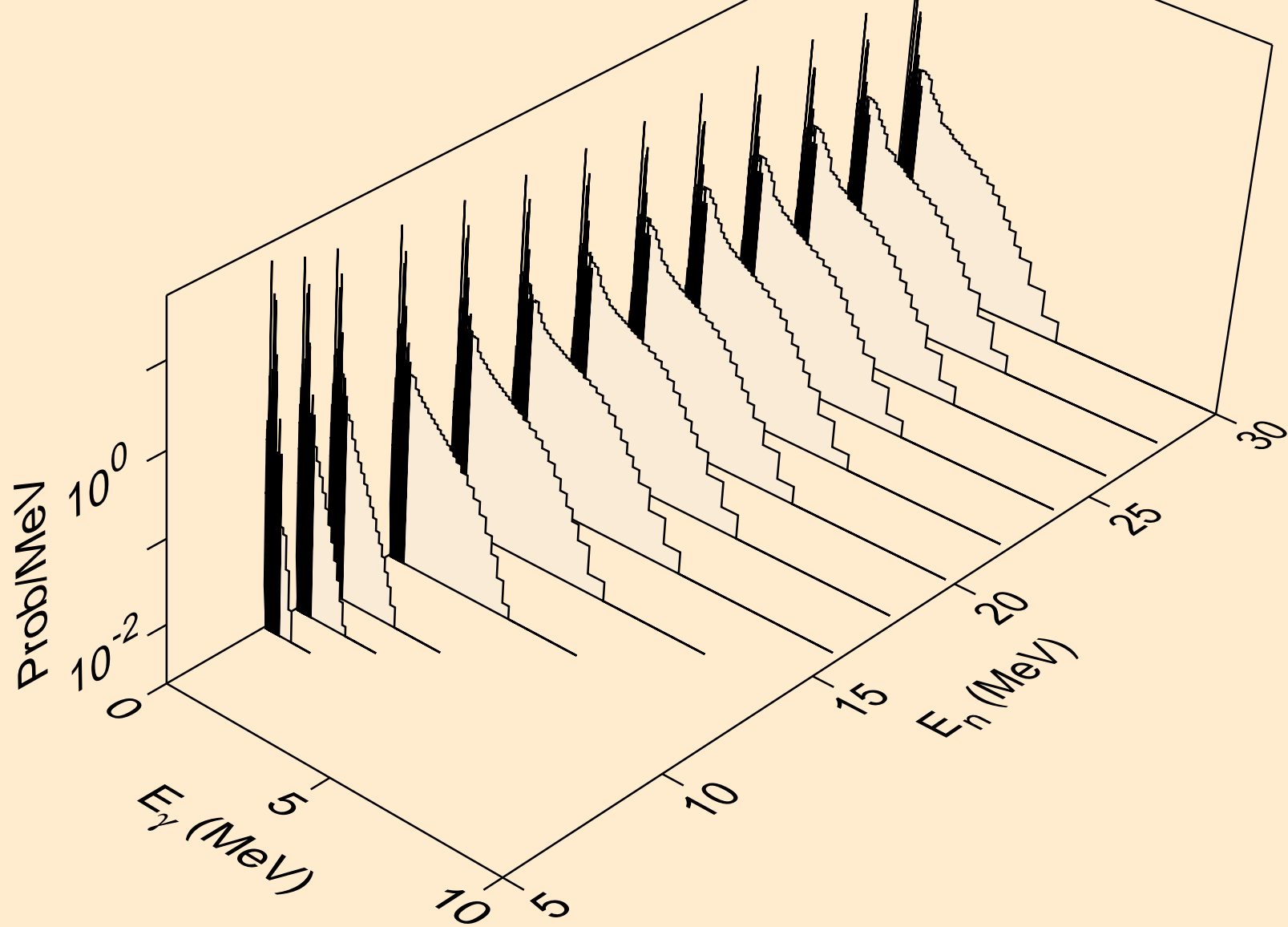

SM158 DEUTERON ACER TENDL-2021 LIBRARY; T=0.K  
Photon emission for (n,n\*)a

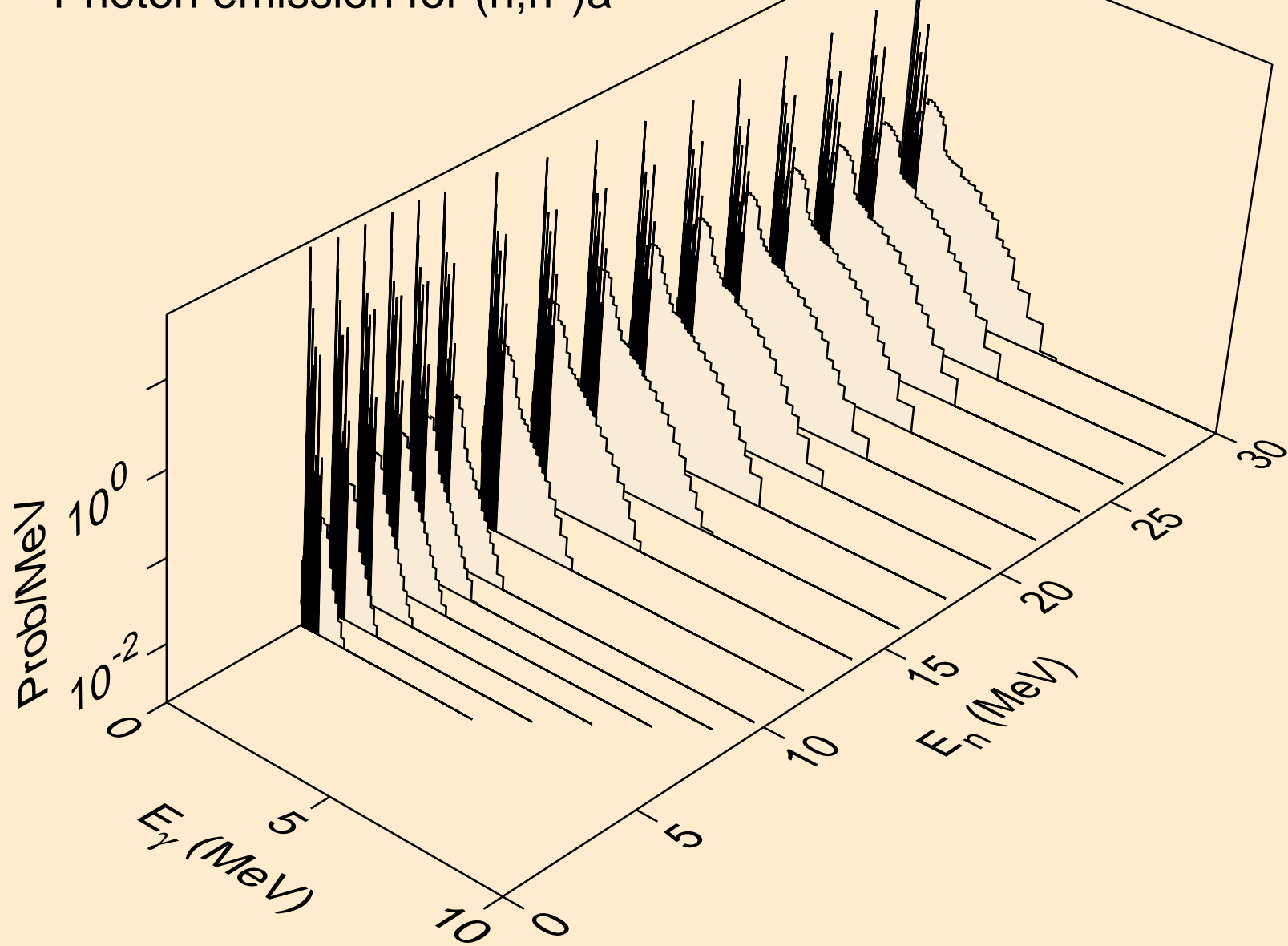

SM158 DEUTERON ACER TENDL-2021 LIBRARY; T=0.K  
Photon emission for (n,2n)a

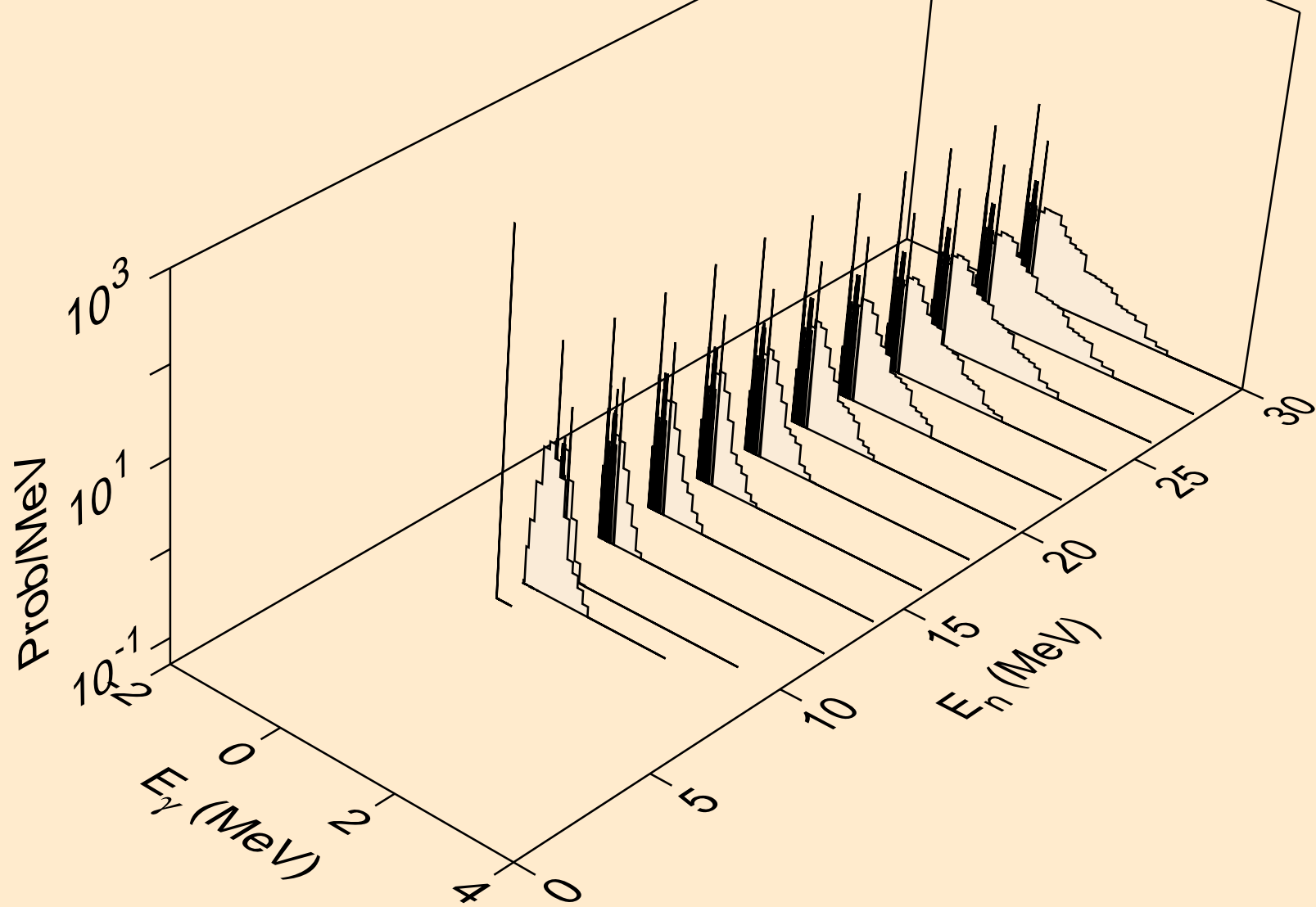

SM158 DEUTERON ACER TENDL-2021 LIBRARY; T=0.K  
Photon emission for (n,3n)a

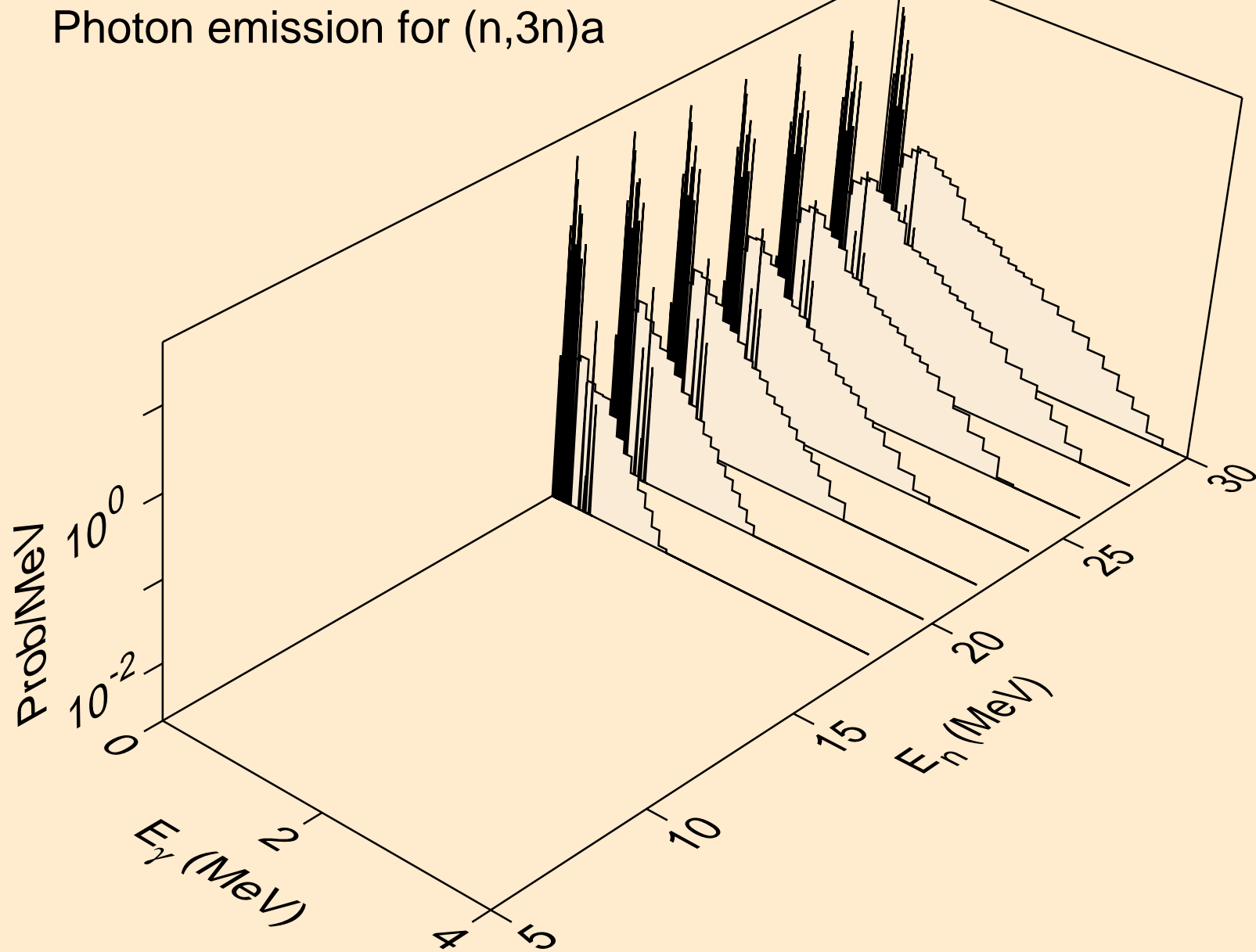

SM158 DEUTERON ACER TENDL-2021 LIBRARY; T=0.K  
Photon emission for (n,n\*)p

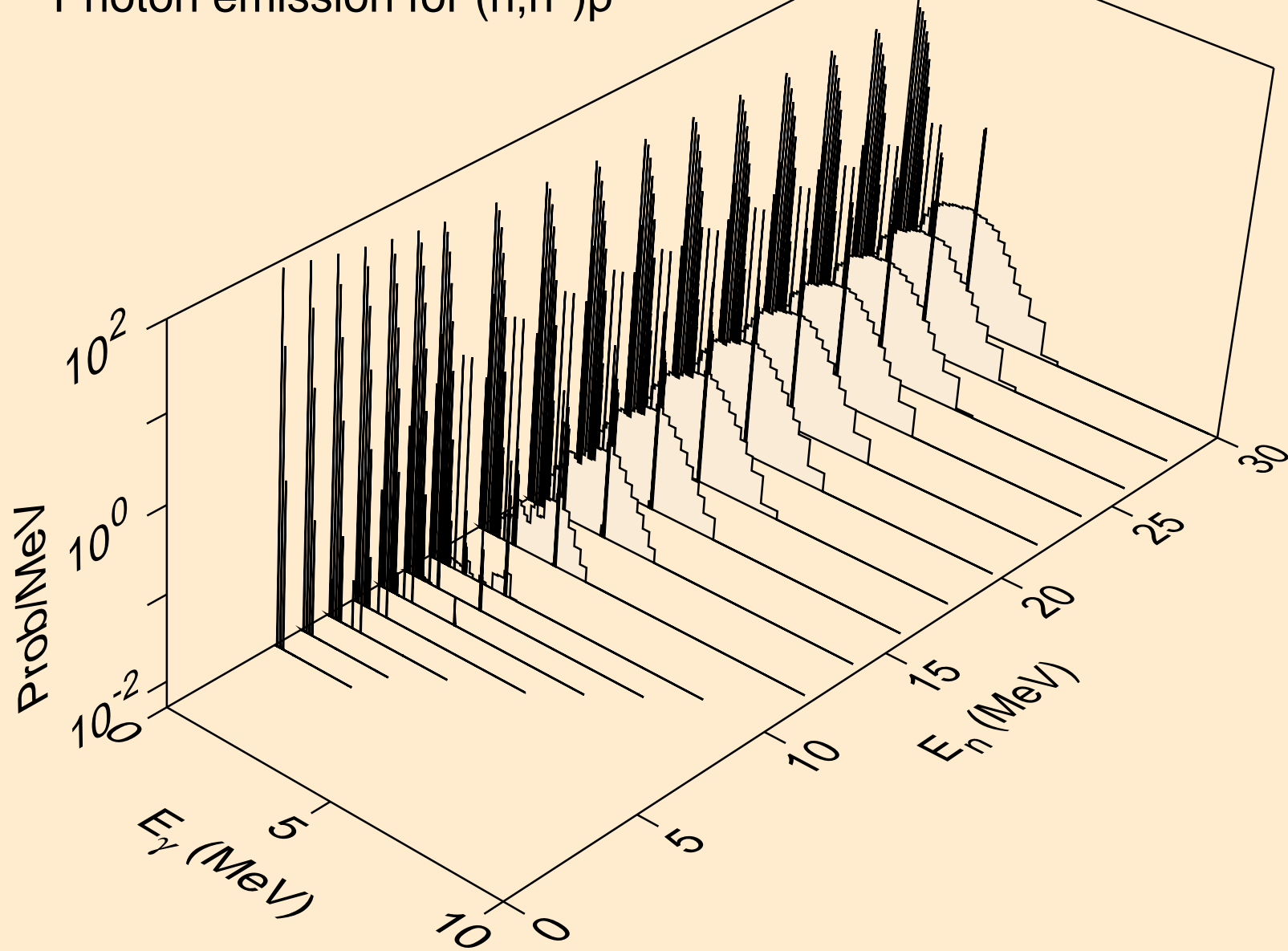

SM158 DEUTERON ACER TENDL-2021 LIBRARY; T=0.K  
Photon emission for (n,n\*)d

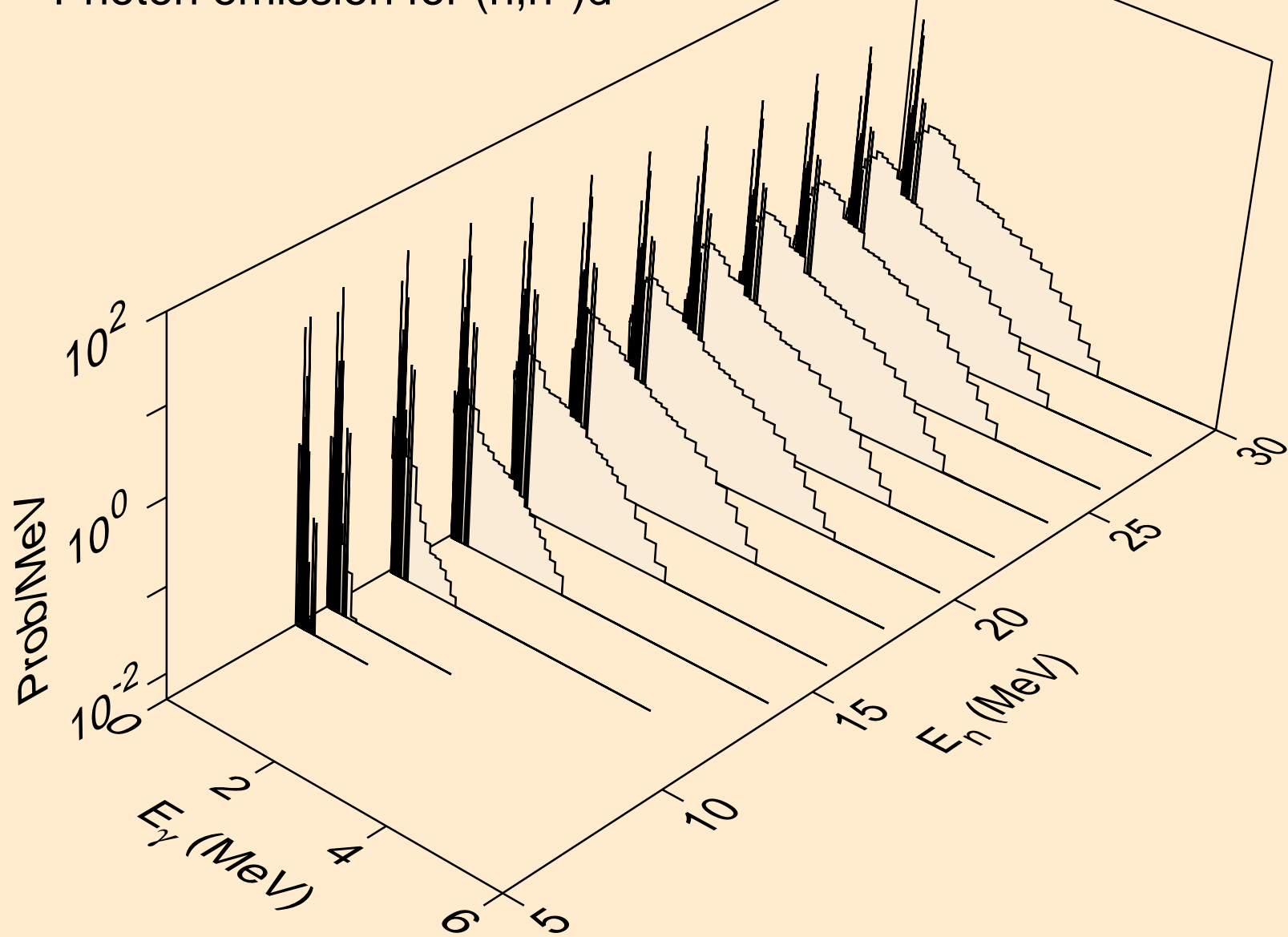

SM158 DEUTERON ACER TENDL-2021 LIBRARY; T=0.K  
Photon emission for (n,n\*)t

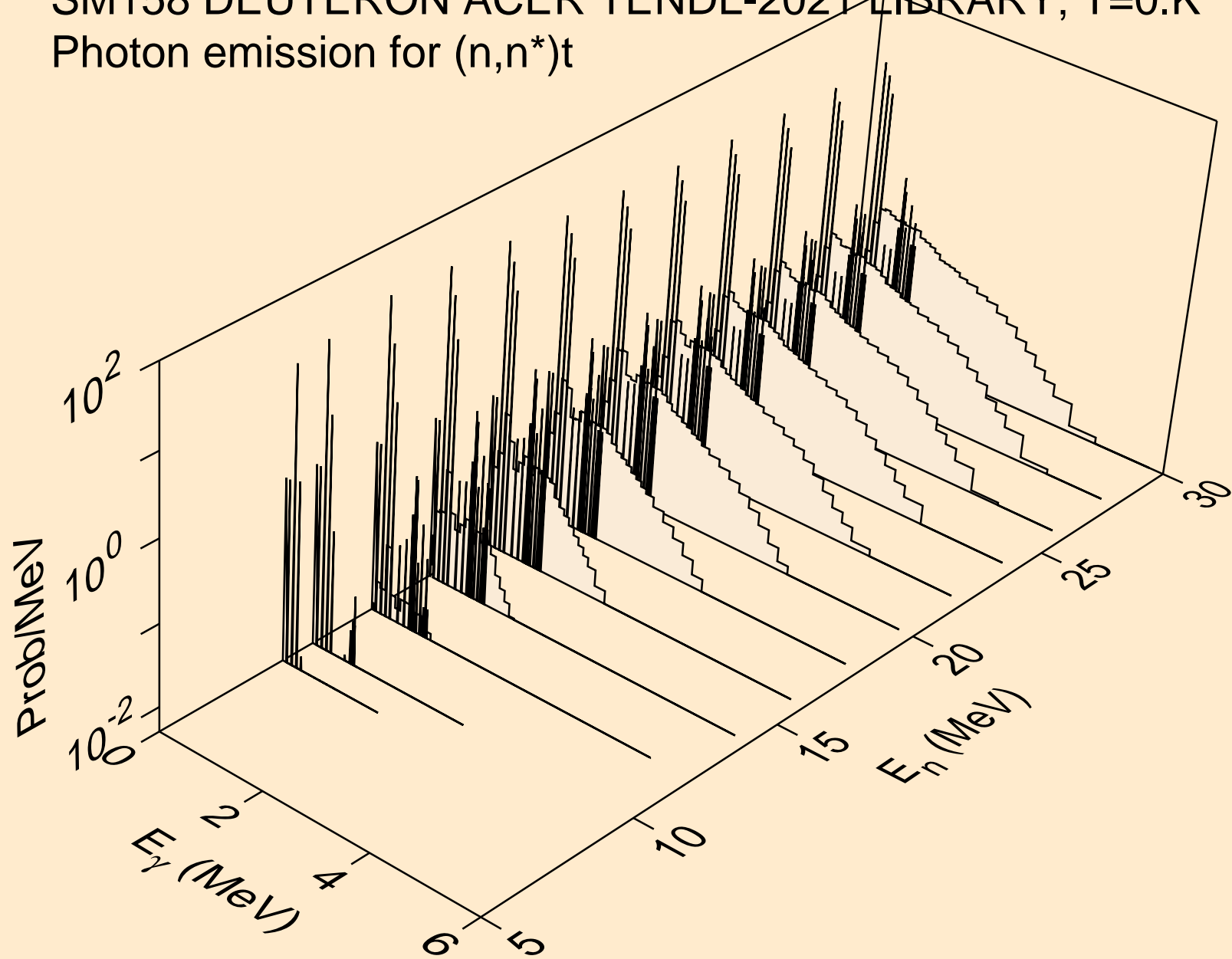

SM158 DEUTERON ACER TENDL-2021 LIBRARY; T=0.K  
Photon emission for (n,n\*)he3

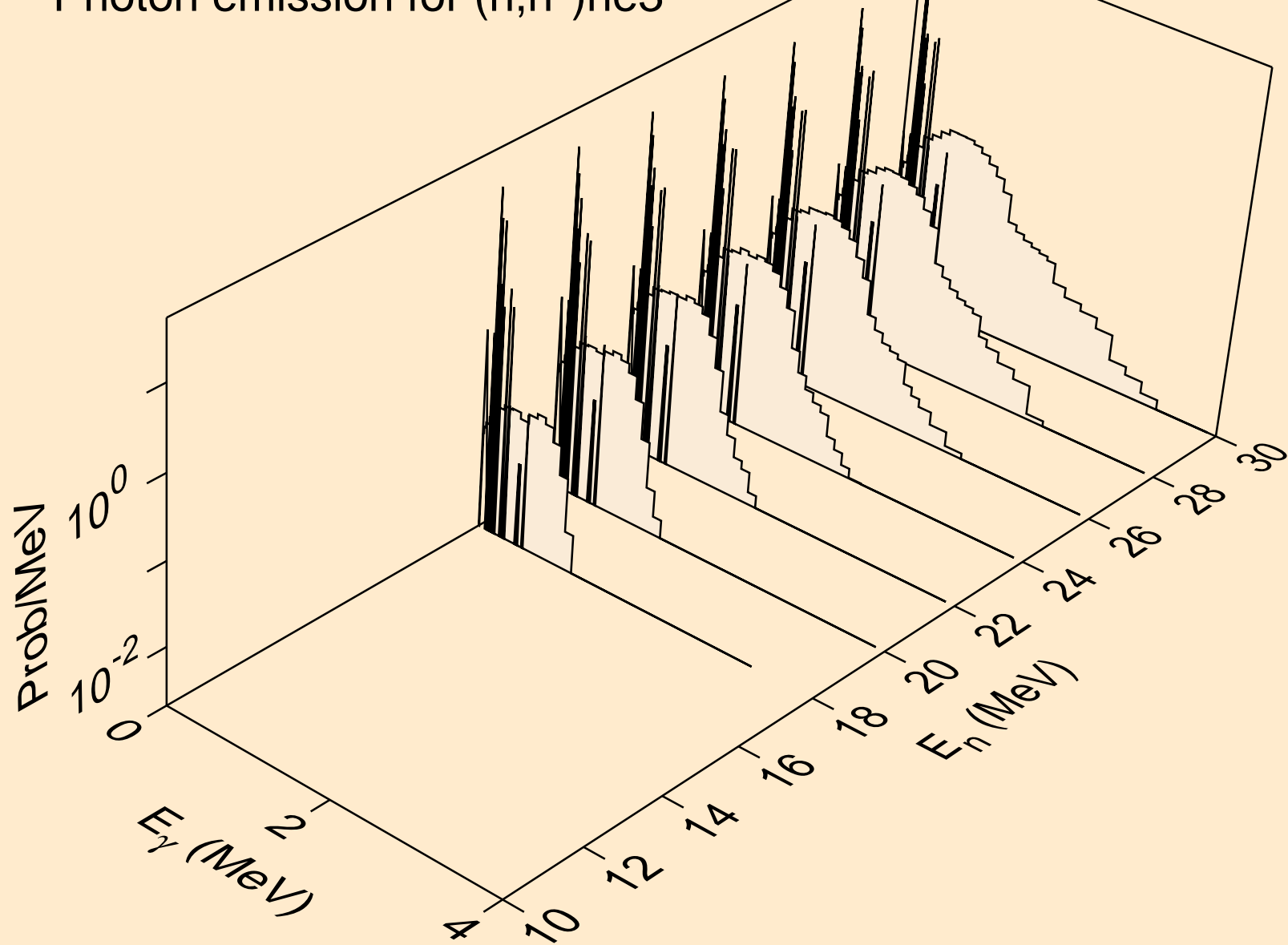



SM158 DEUTERON ACER TENDL-2021 LIBRARY; T=0.K  
Photon emission for (n,4n)

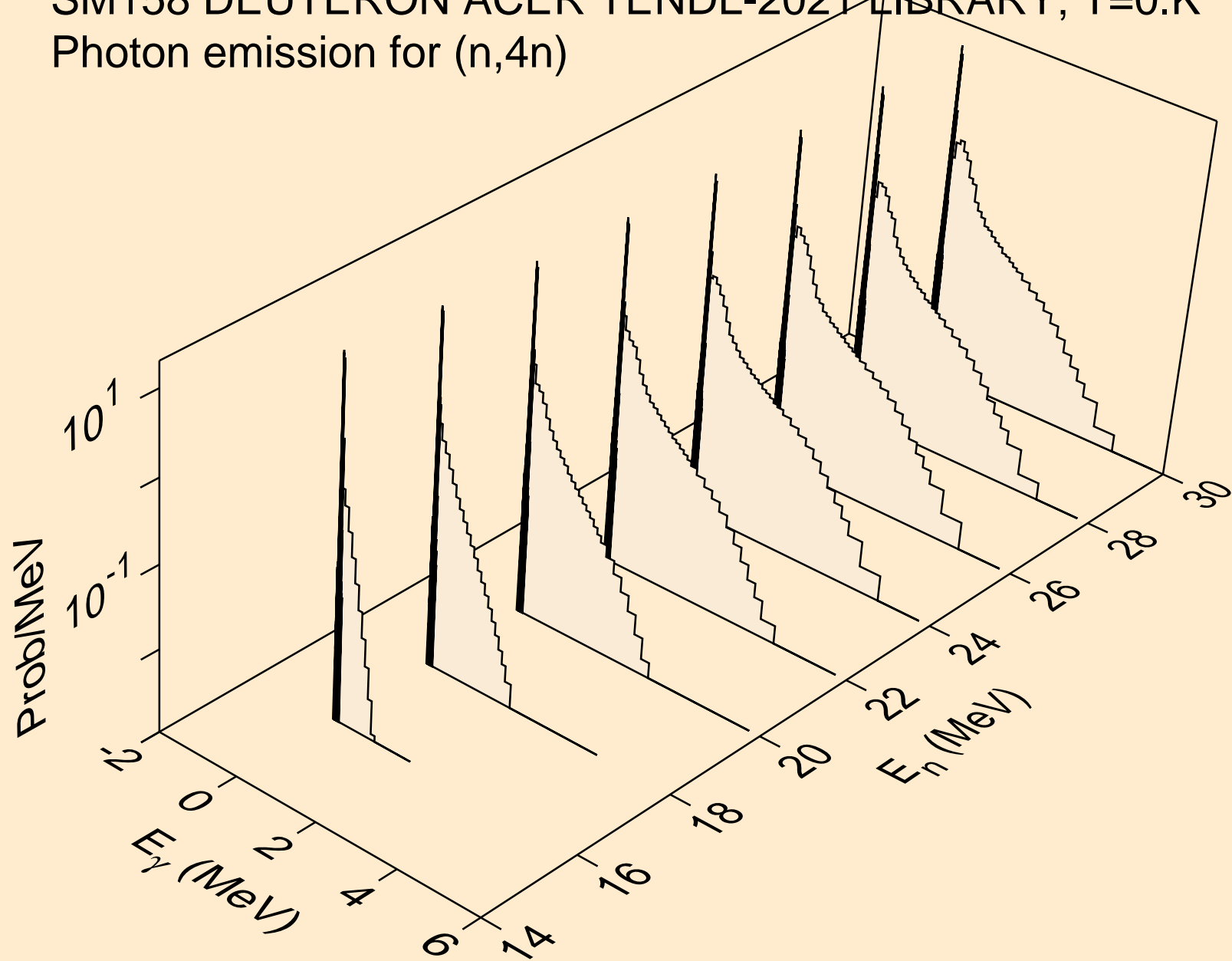

SM158 DEUTERON ACER TENDL-2021 LIBRARY; T=0.K  
Photon emission for (n,2np)

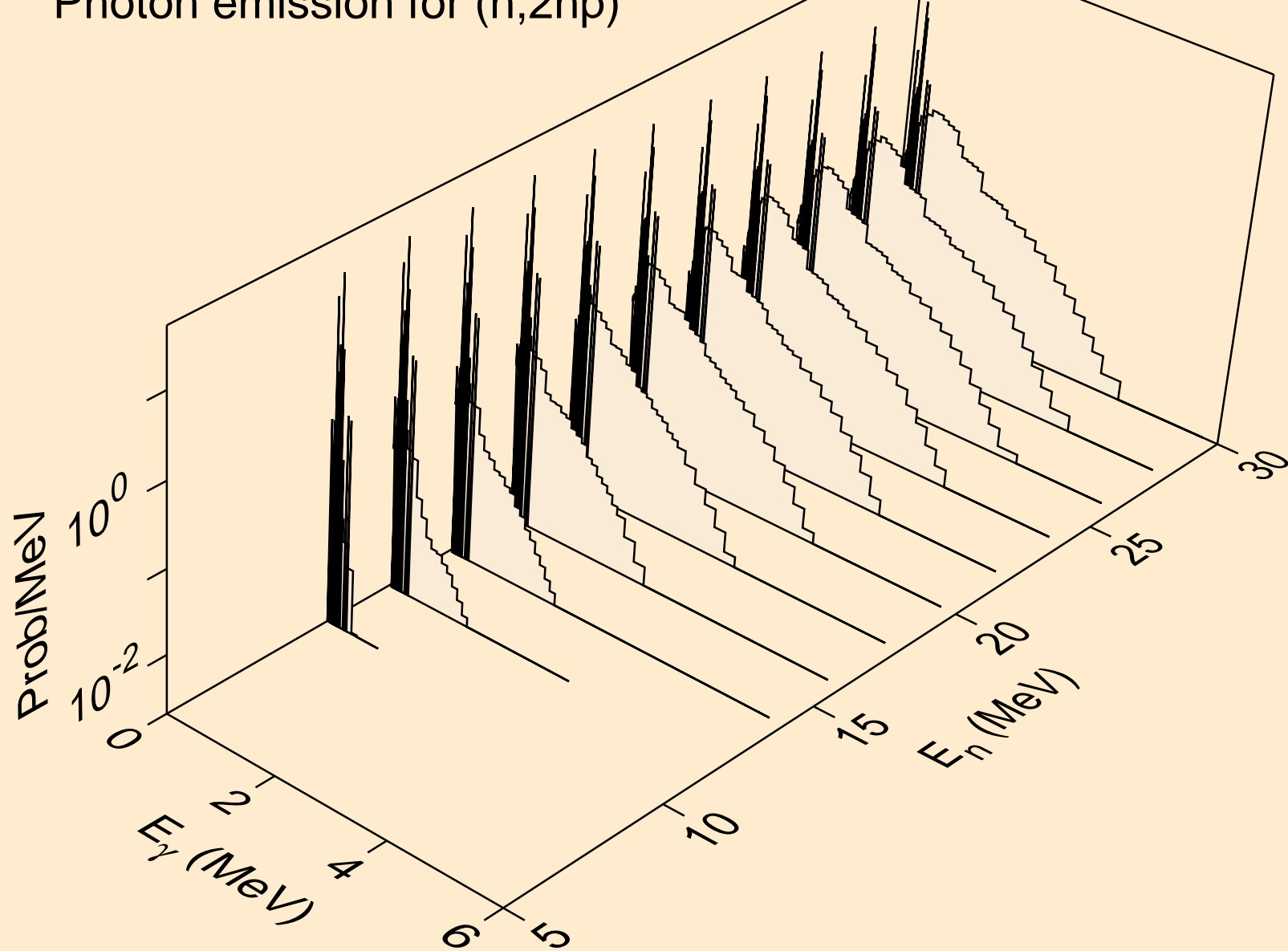

SM158 DEUTERON ACER TENDL-2021 LIBRARY; T=0.K  
Photon emission for (n,3np)

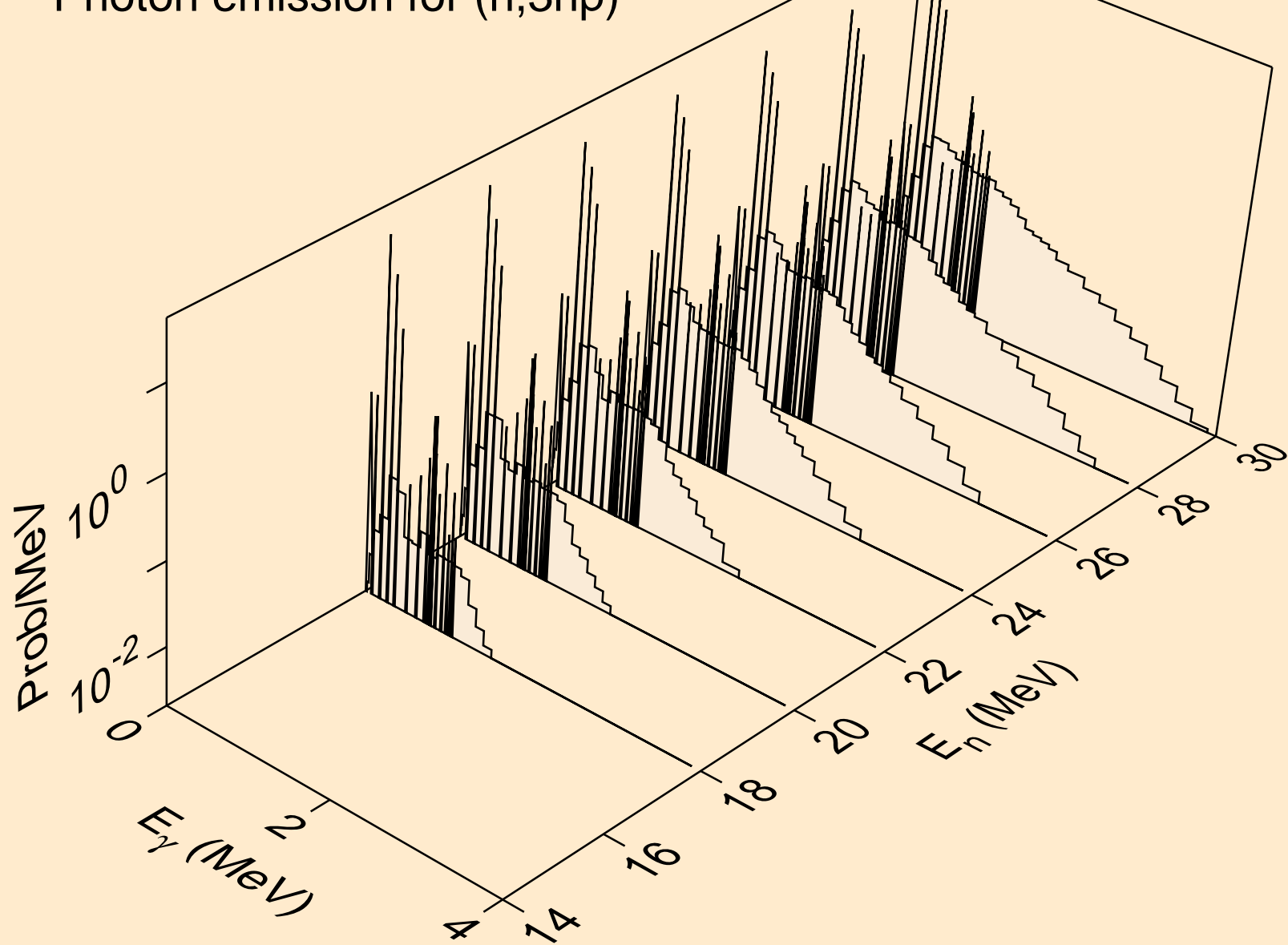

SM158 DEUTERON ACER TENDL-2021 LIBRARY; T=0.K  
Photon emission for (n,2np)

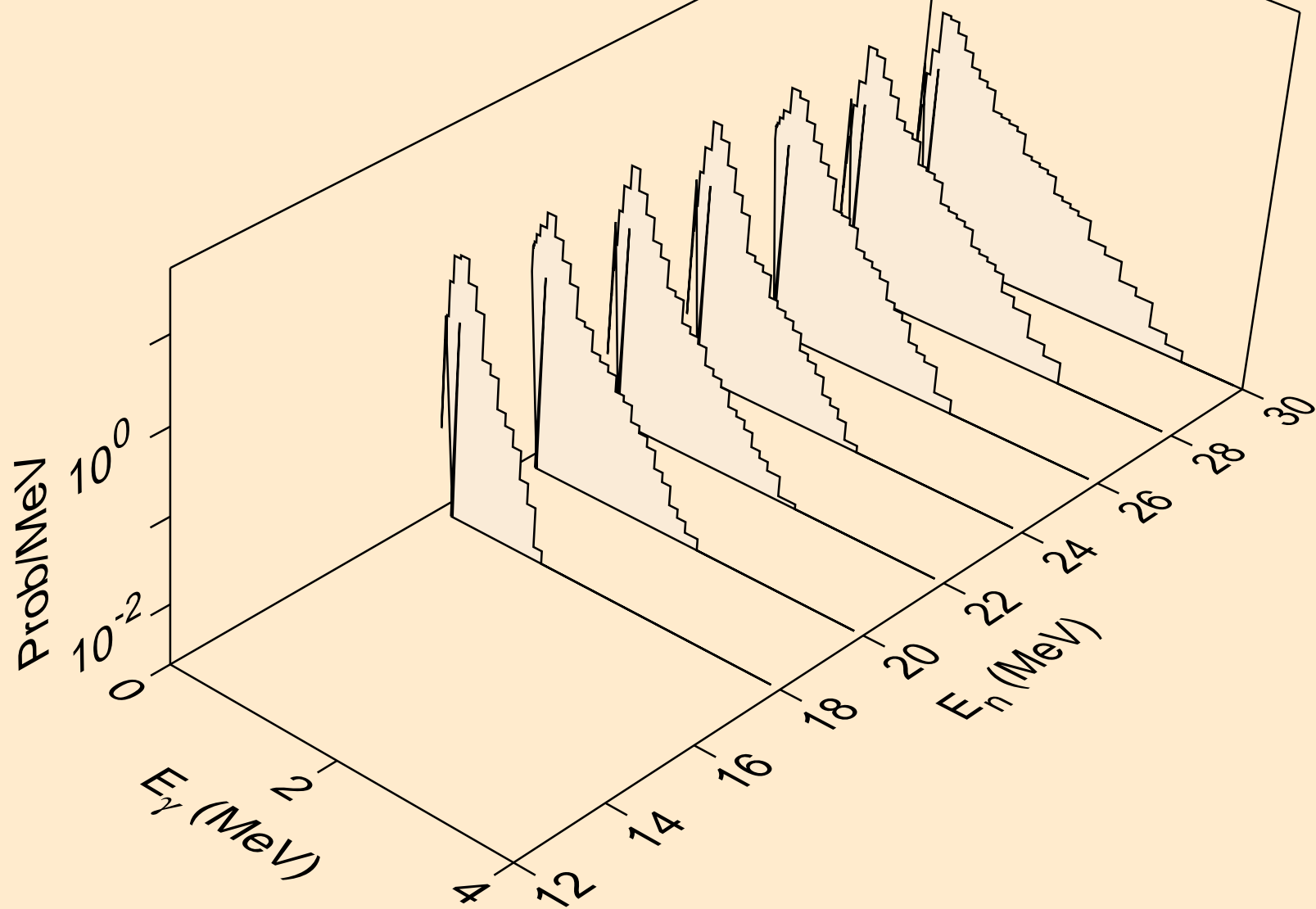

SM158 DEUTERON ACER TENDL-2021 LIBRARY; T=0.K  
Photon emission for (n,npa)

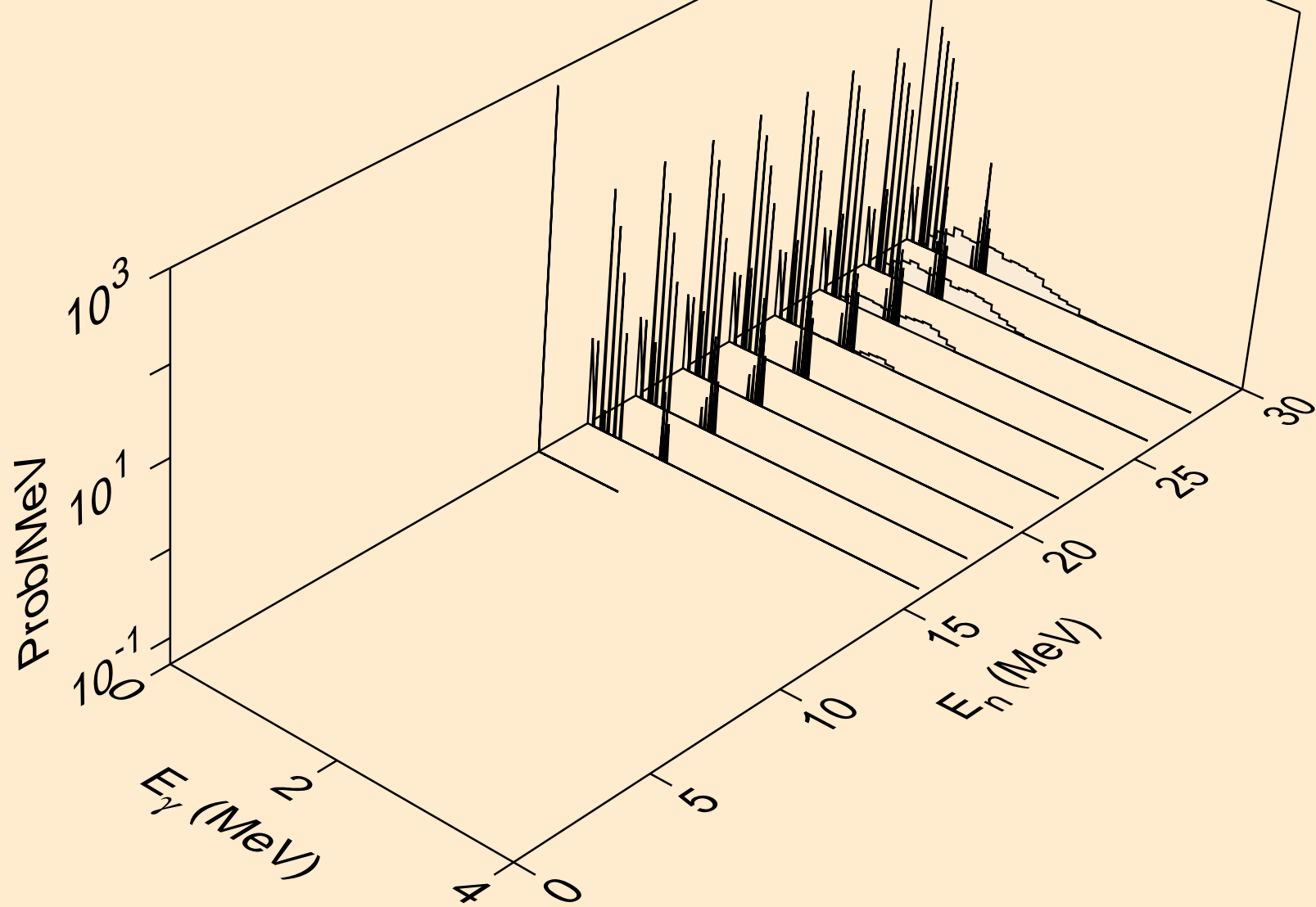

SM158 DEUTERON ACER TENDL-2021 LIBRARY; T=0.K  
Photon emission for (n,gma)

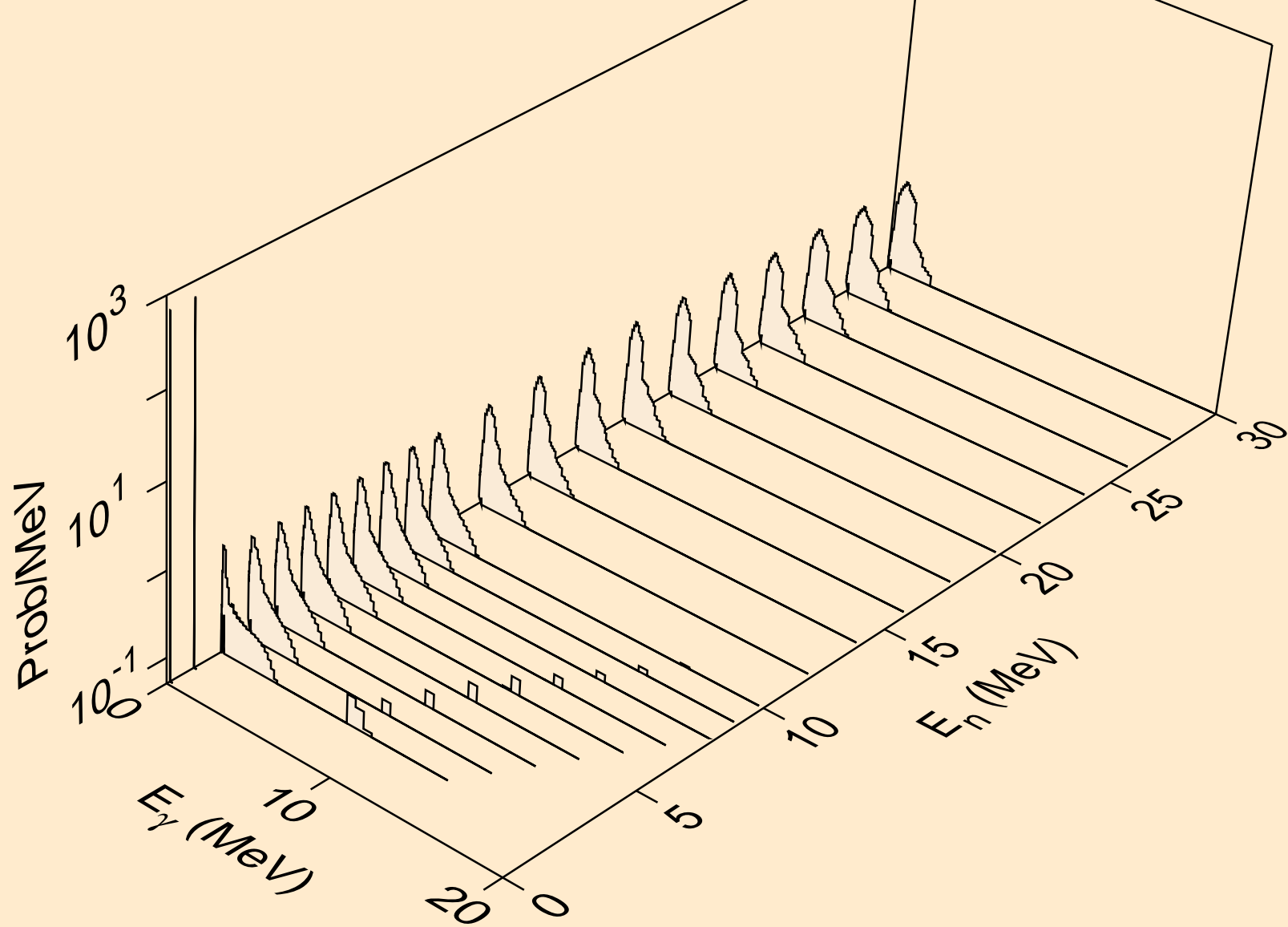

SM158 DEUTERON ACER TENDL-2021 LIBRARY; T=0.K  
Photon emission for (n,p)

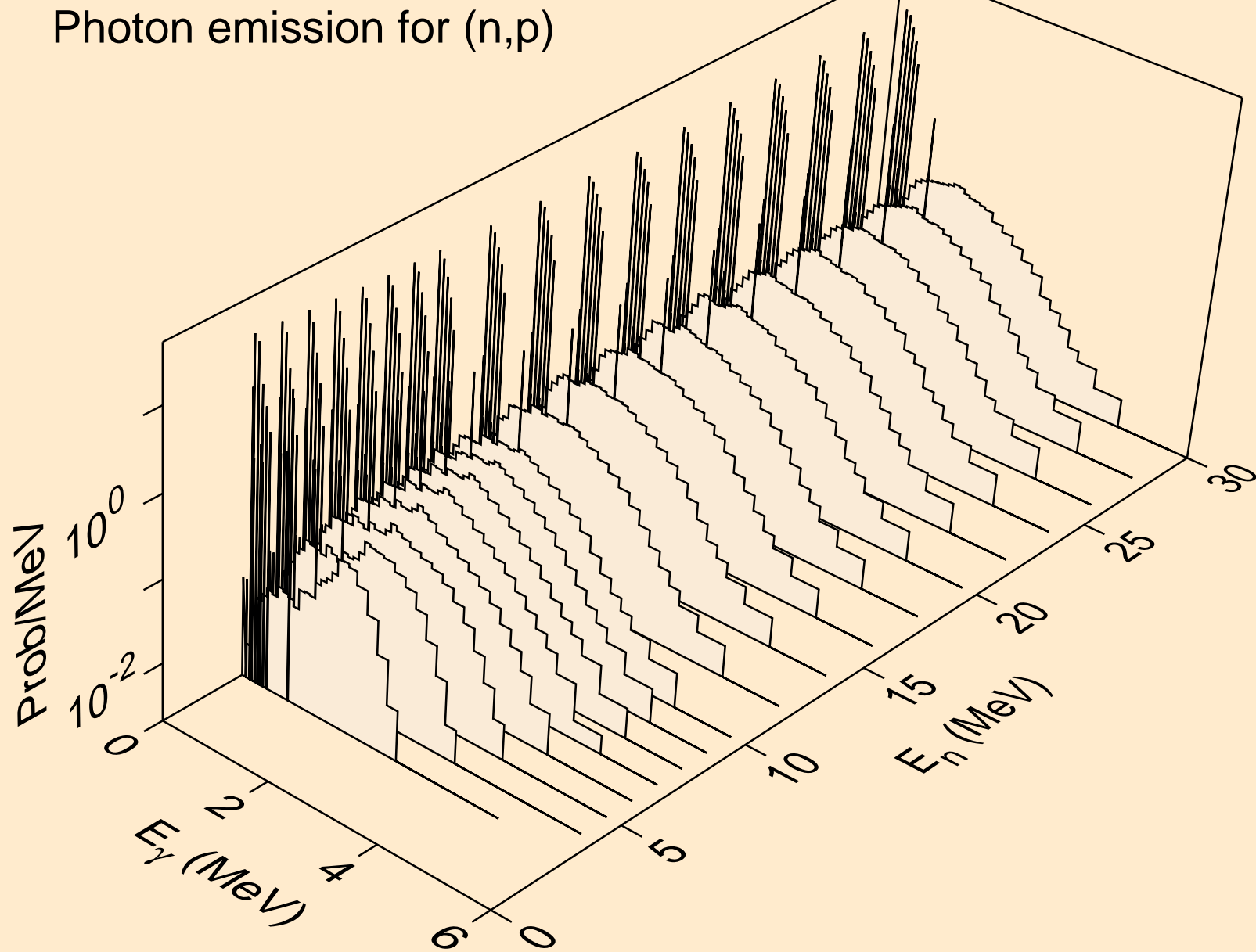

SM158 DEUTERON ACER TENDL-2021 LIBRARY; T=0.K  
Photon emission for inelastic

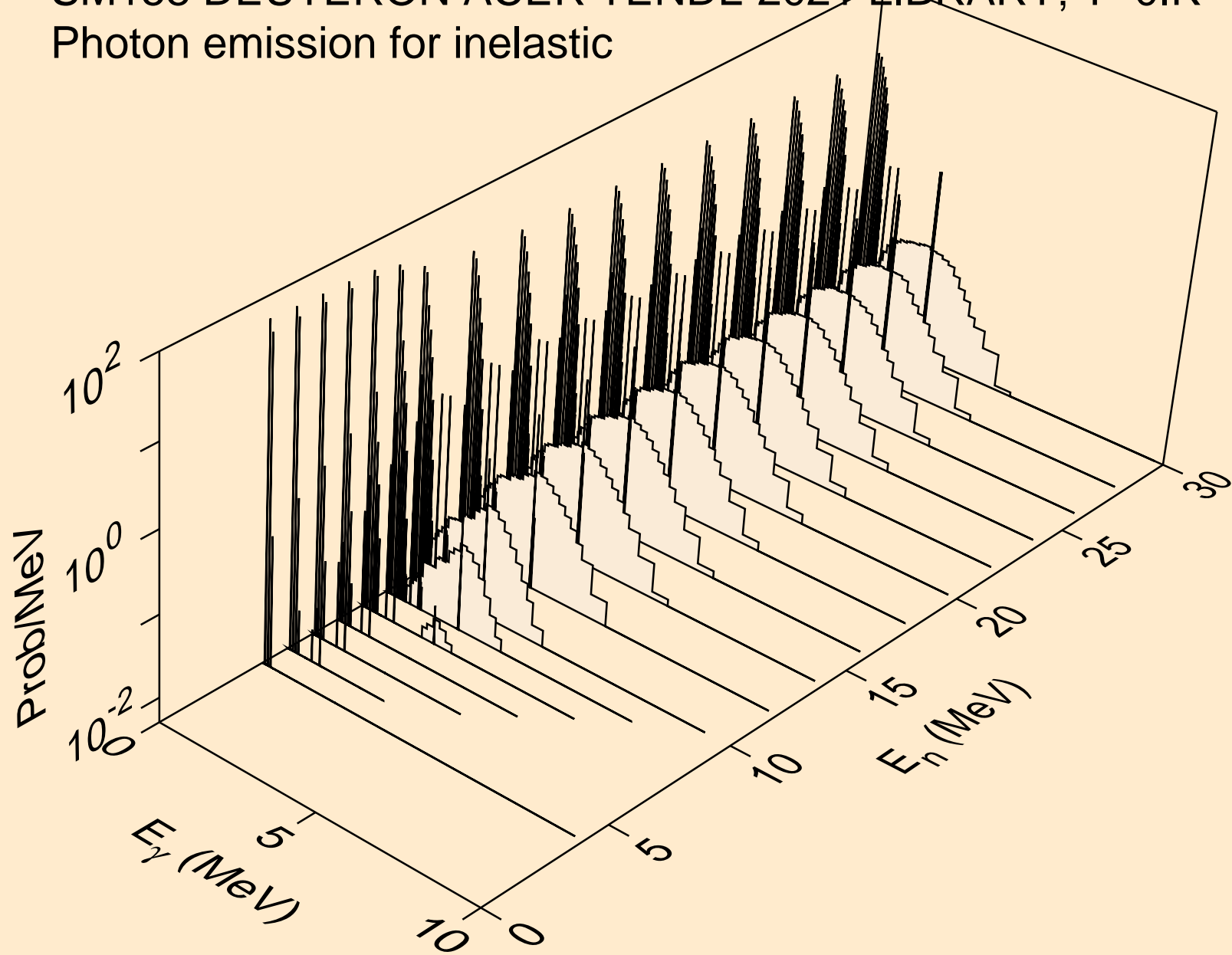



SM158 DEUTERON ACER TENDL-2021 LIBRARY; T=0.K  
Photon emission for (n,t)

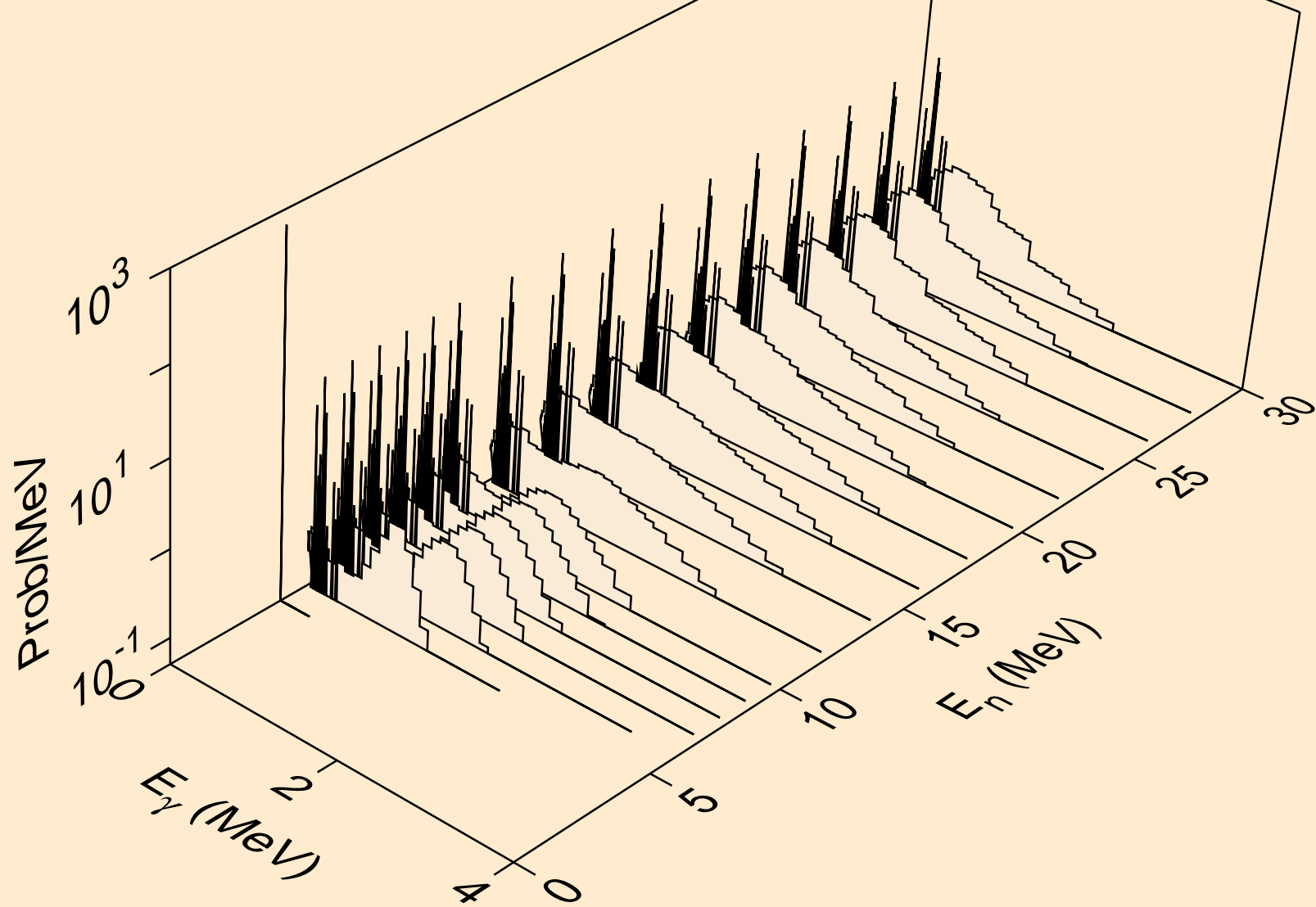

SM158 DEUTERON ACER TENDL-2021 LIBRARY; T=0.K  
Photon emission for (n,he3)

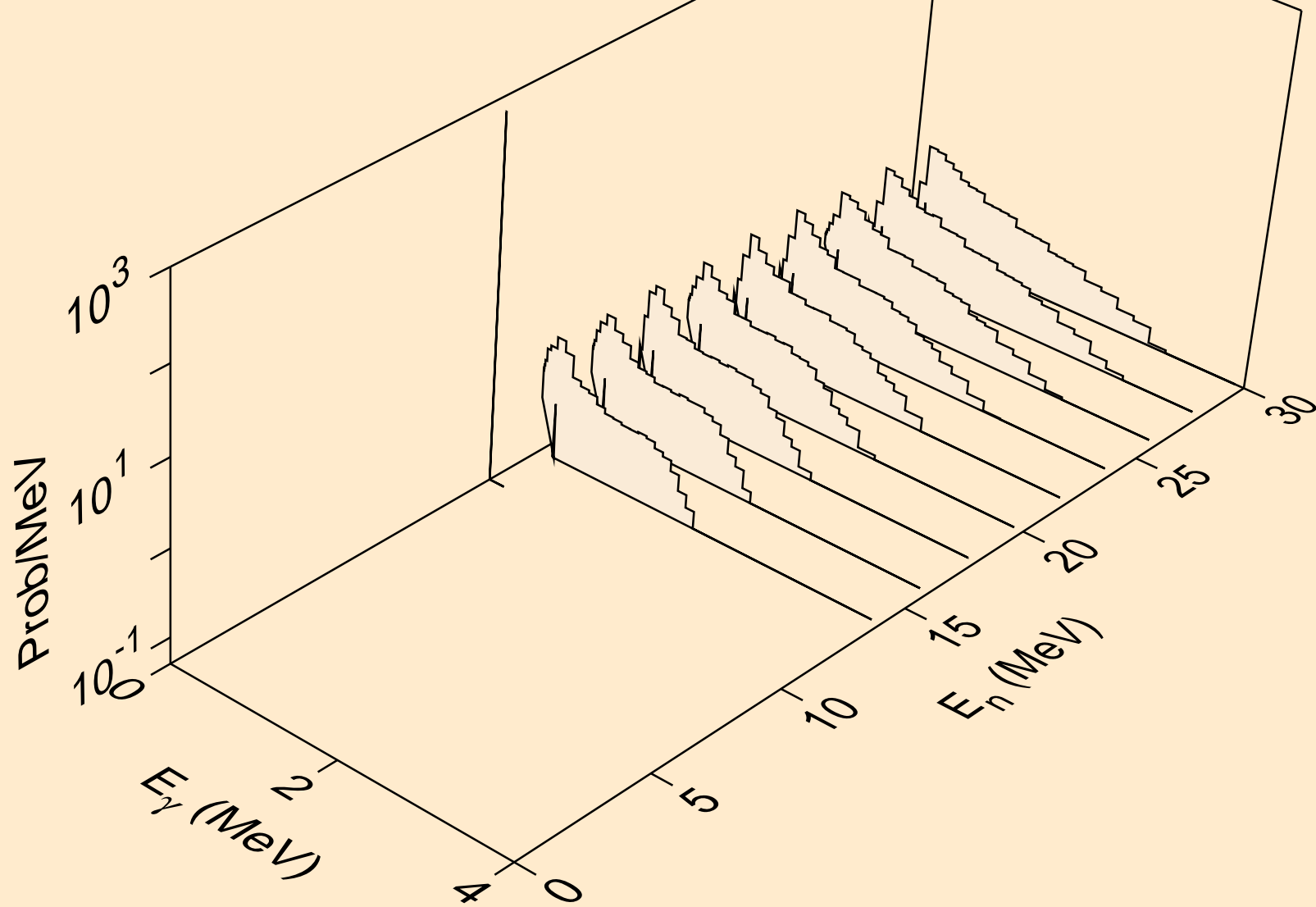

SM158 DEUTERON ACER TENDL-2021 LIBRARY; T=0.K  
Photon emission for (n,a)

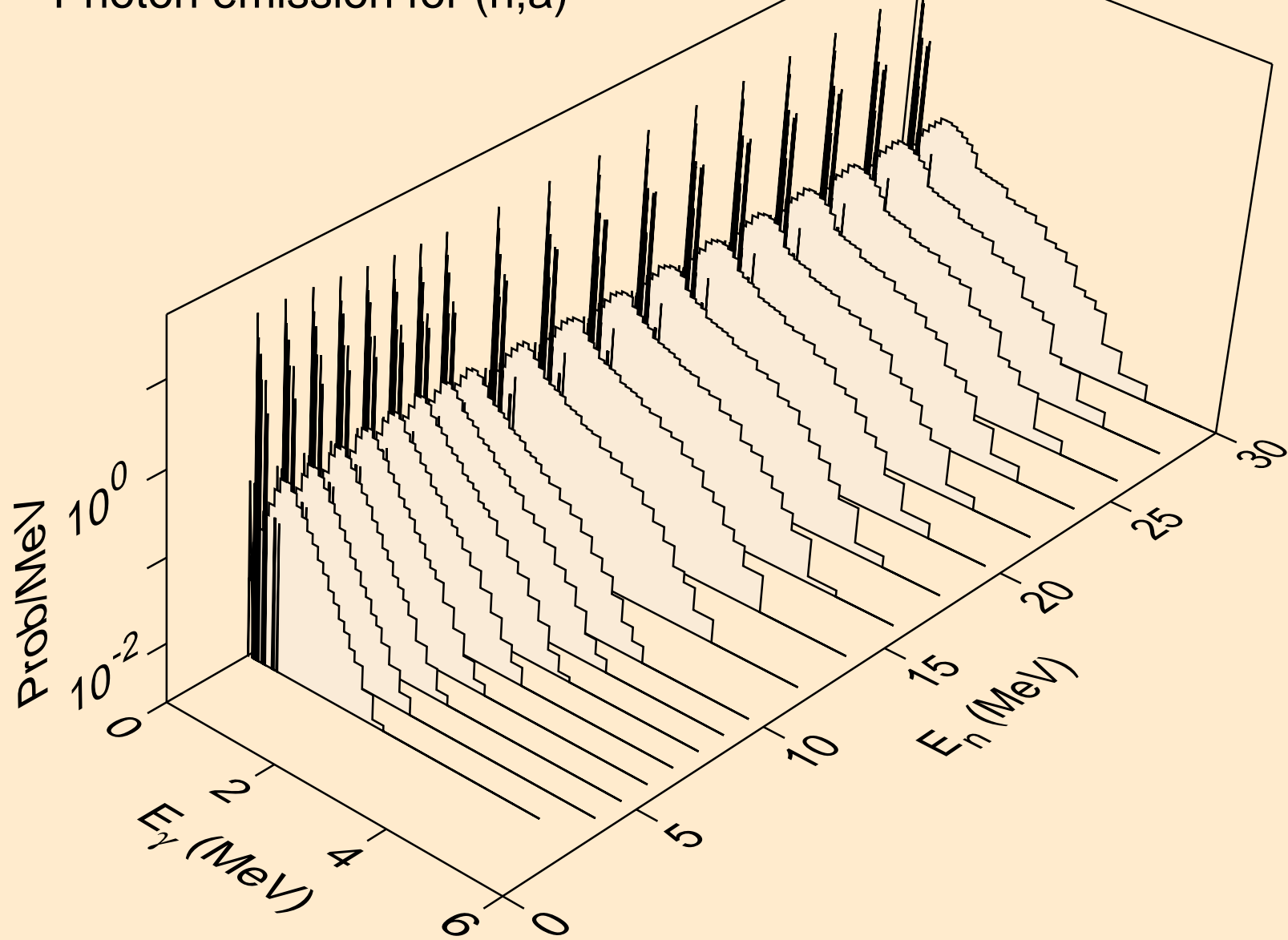

SM158 DEUTERON ACER TENDL-2021 LIBRARY; T=0.K  
Photon emission for (n,2p)

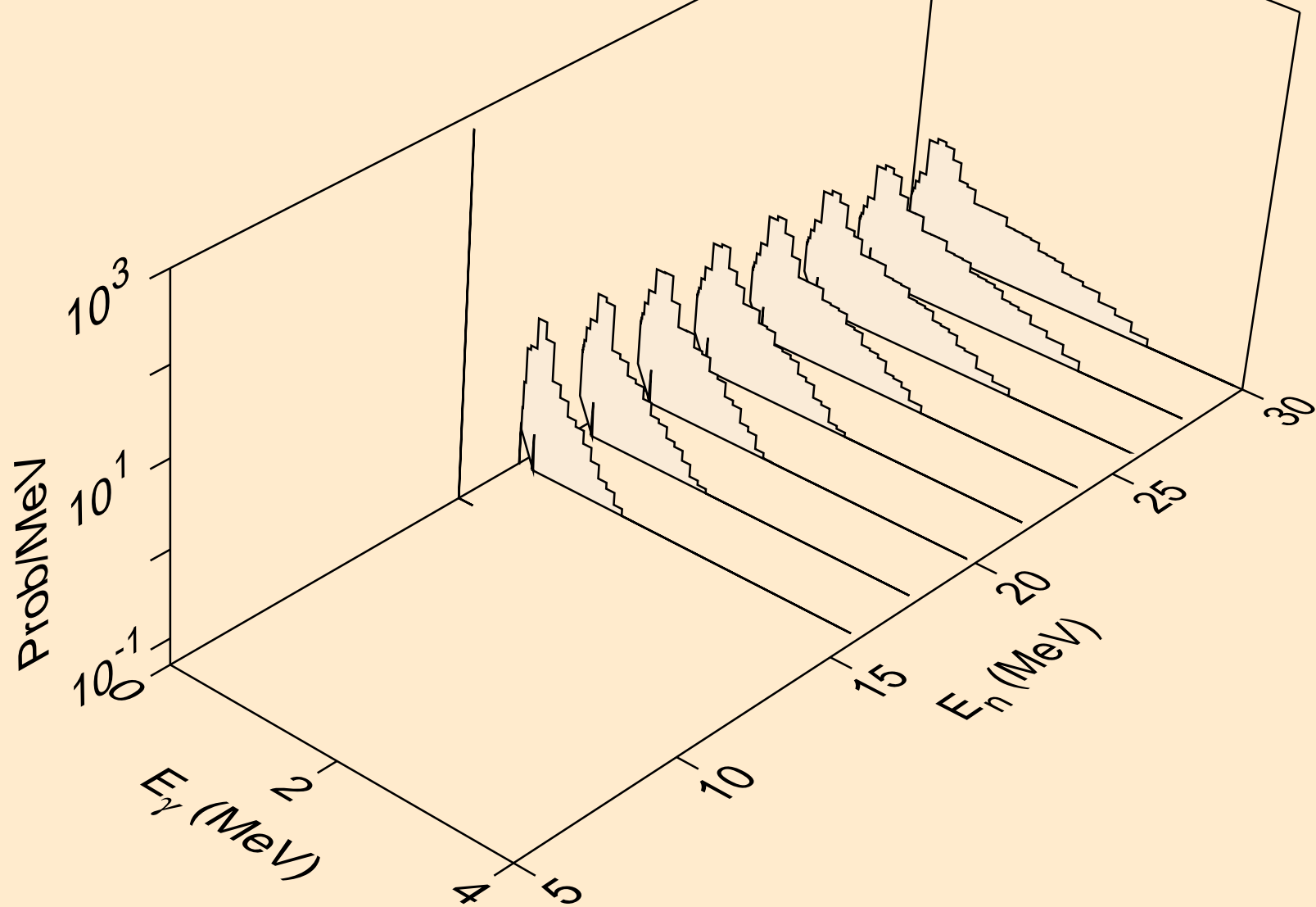

SM158 DEUTERON ACER TENDL-2021 LIBRARY; T=0.K  
Photon emission for (n,p)

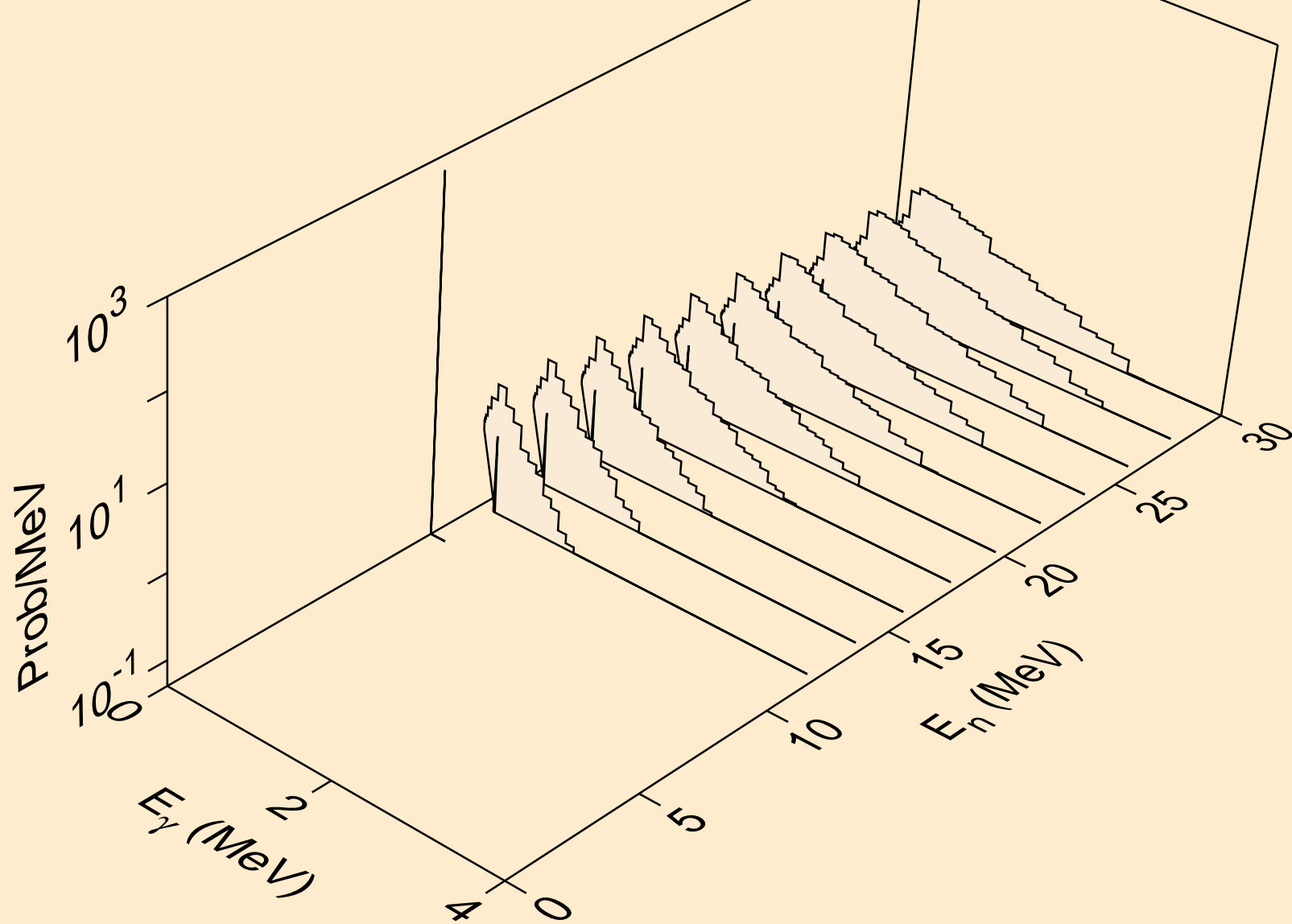

SM158 DEUTERON ACER TENDL-2021 LIBRARY; T=0.K  
Photon emission for (n,pd)

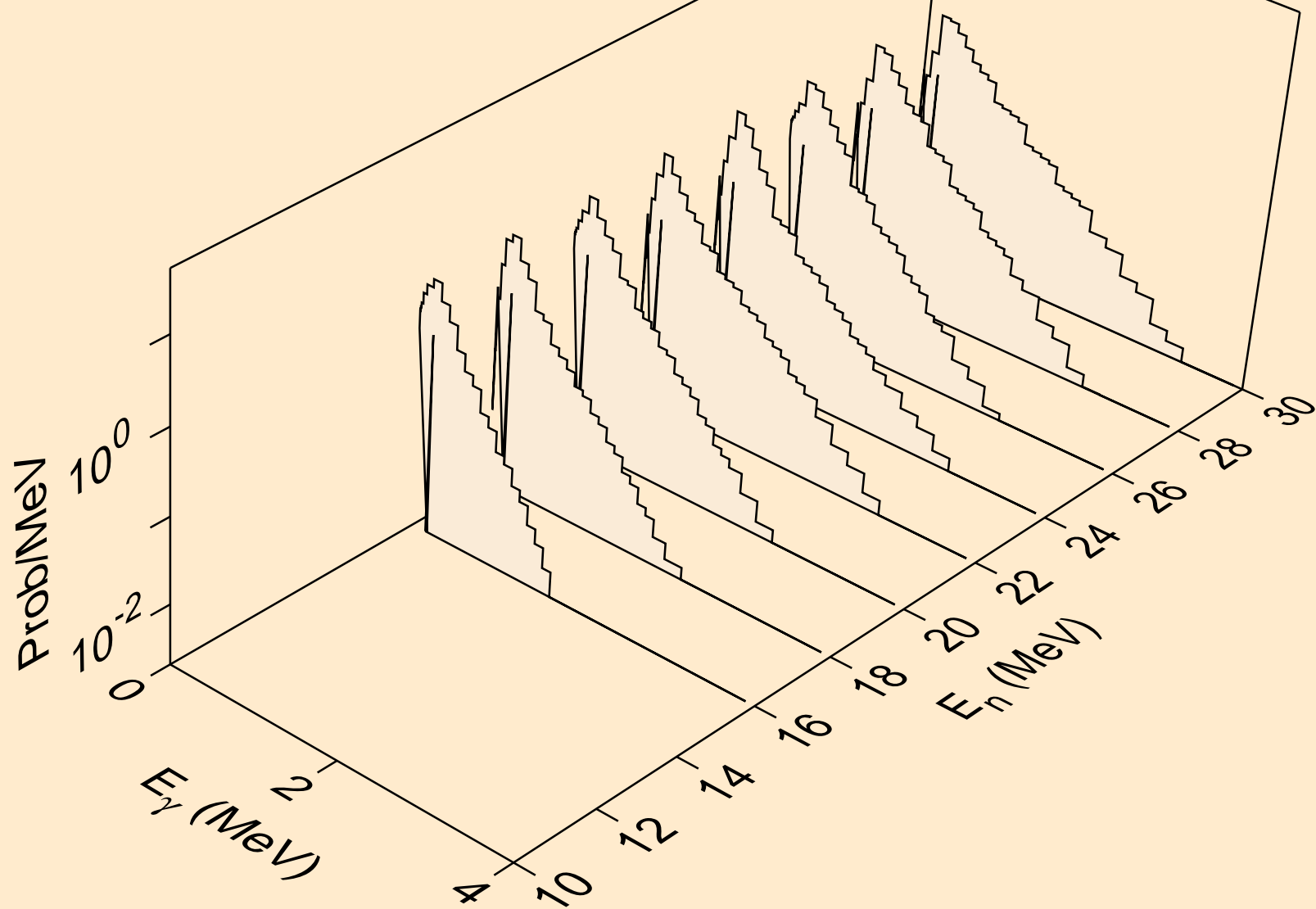

# SM158 DEUTERON ACER TENDL-2021 LIBRARY; T=0.K

## Particle heating contributions

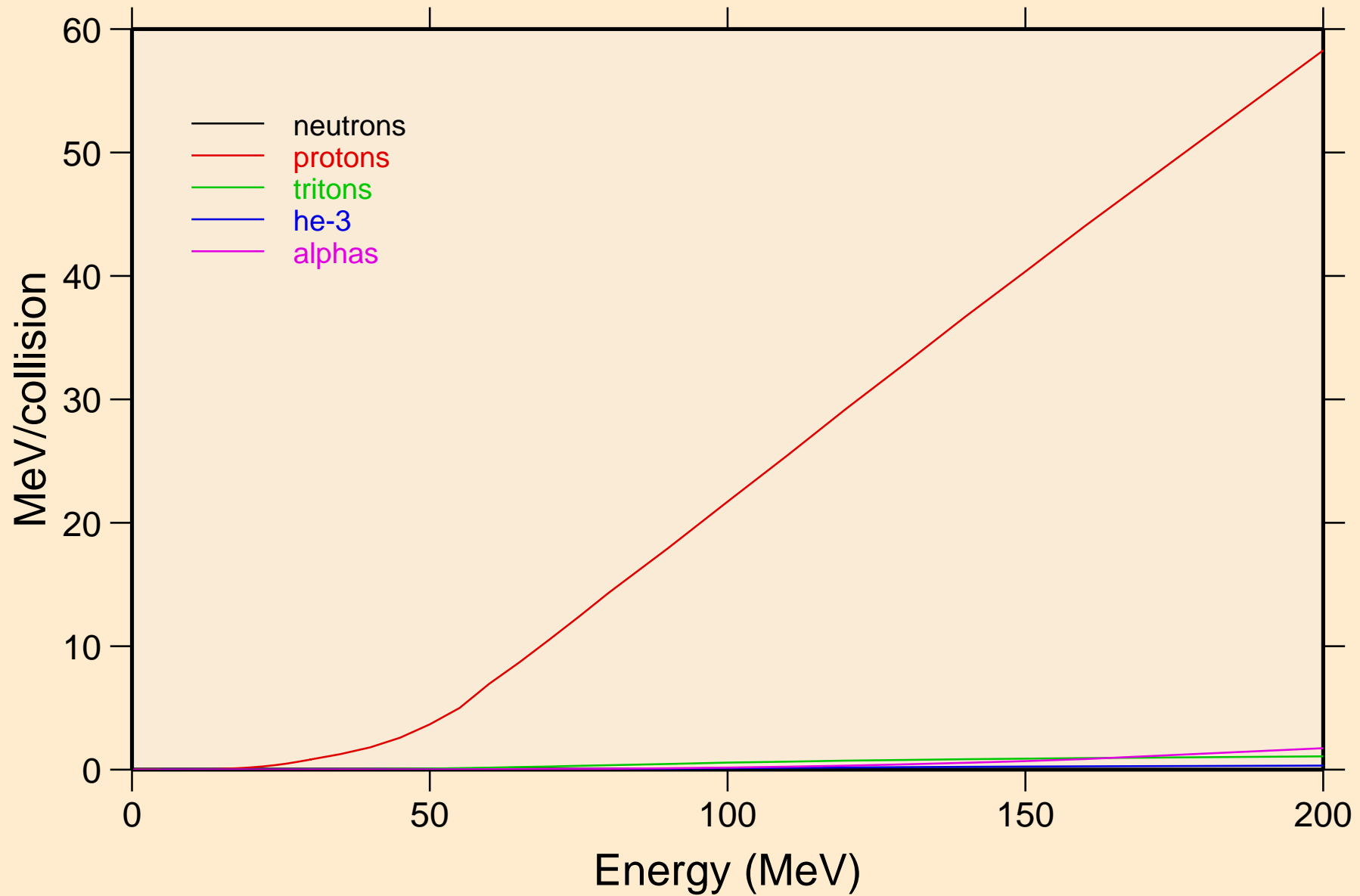

SM158 DEUTERON ACER TENDL-2021 LIBRARY; T=0.K  
Recoil Heating

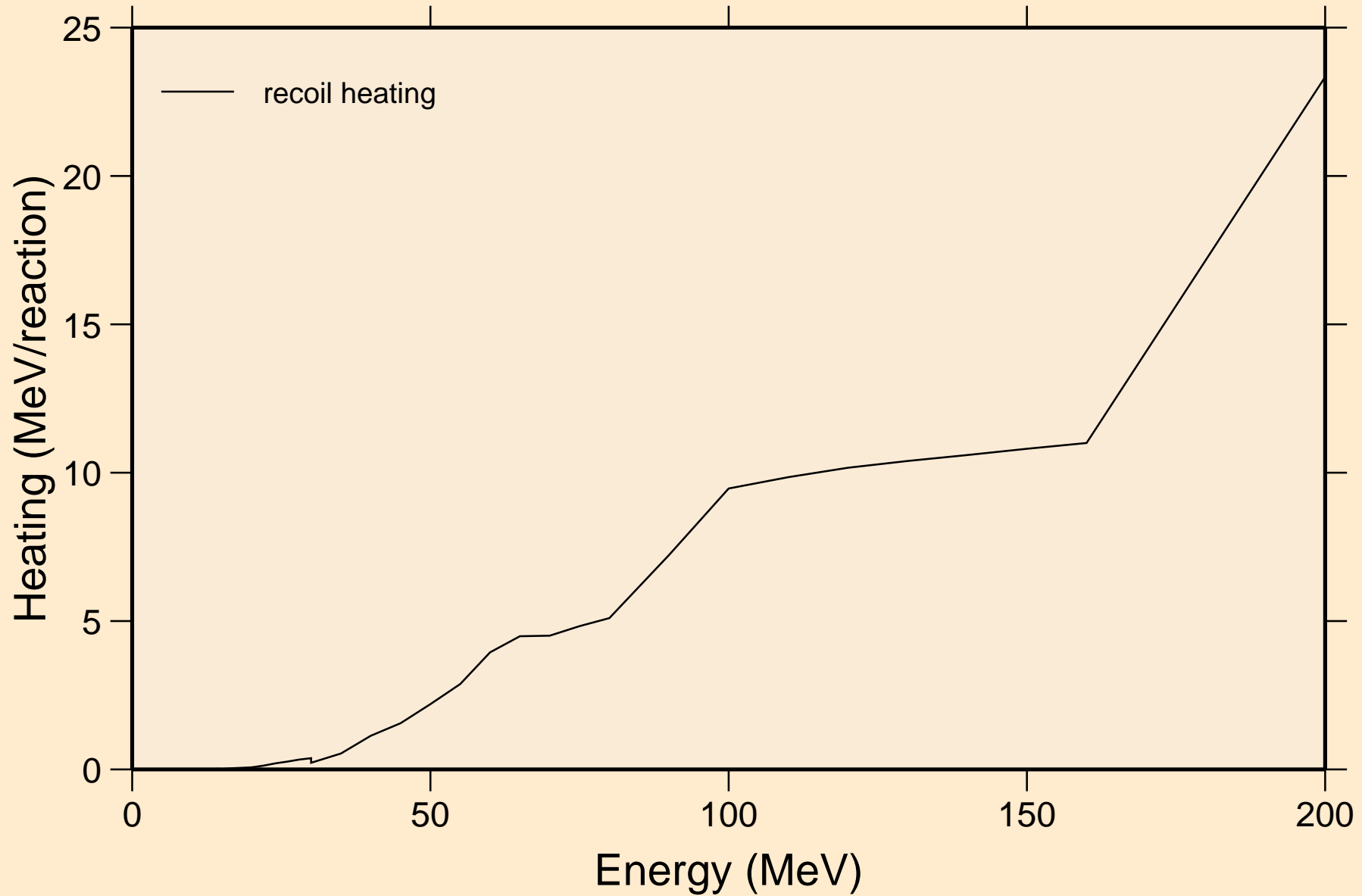



SM158 DEUTERON ACER TENDL-2021 LIBRARY; T=0.K  
Particle production cross sections

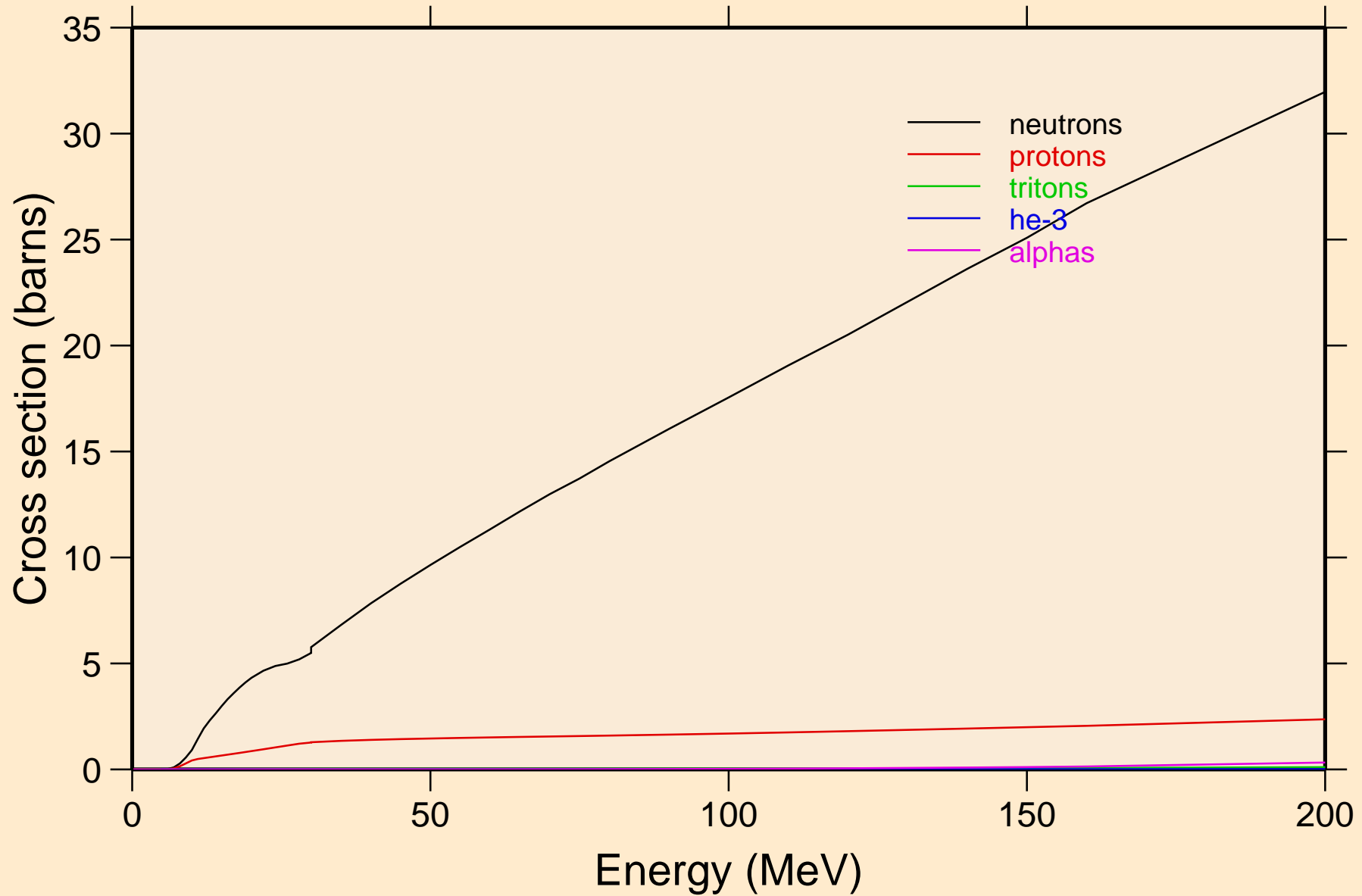

SM158 DEUTERON ACER TENDL-2021 LIBRARY; T=0.K  
neutrons from (d,n)

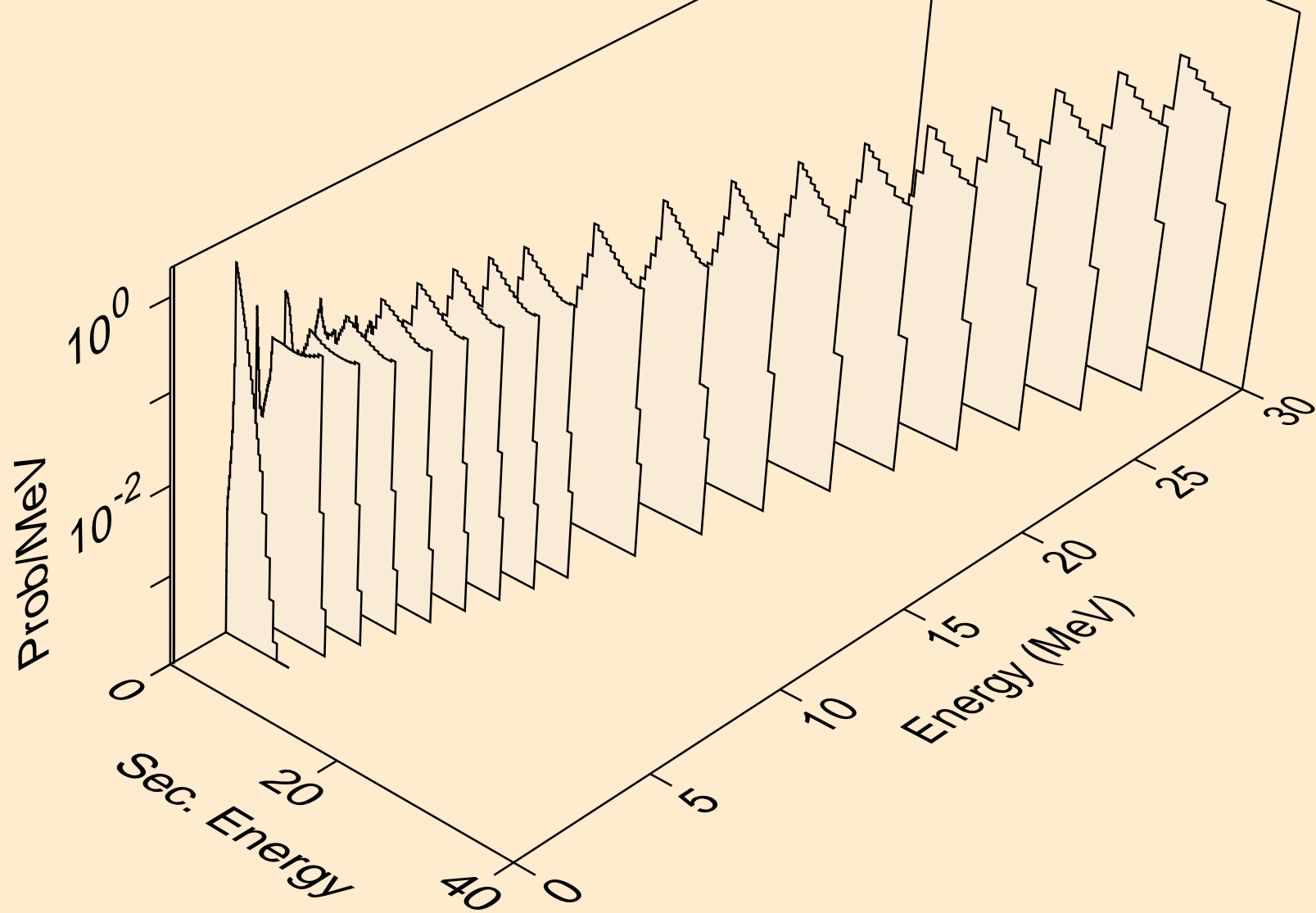

SM158 DEUTERON ACER TENDL-2021 LIBRARY; T=0.K  
neutrons from (d,x)

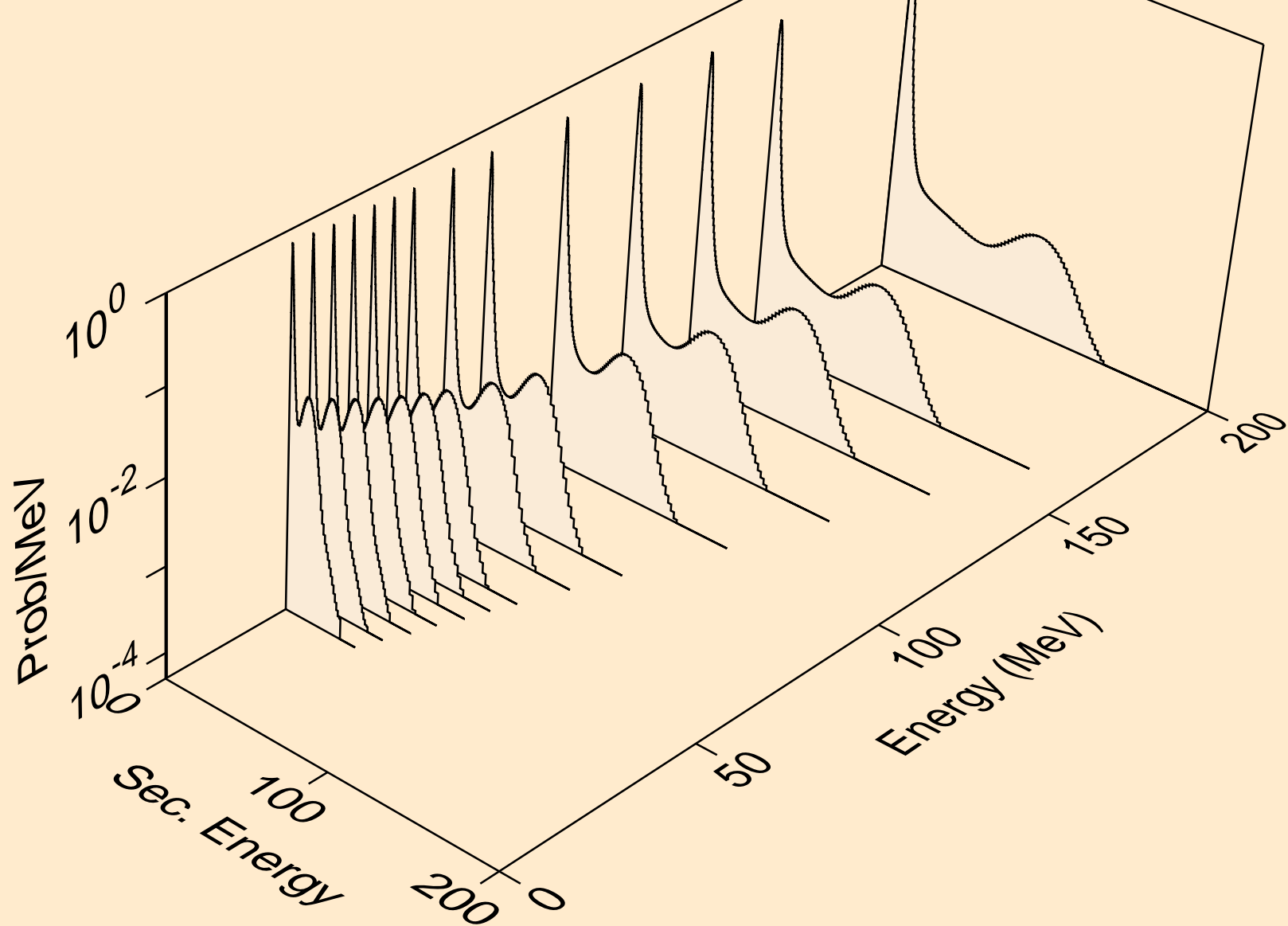

SM158 DEUTERON ACER TENDL-2021 LIBRARY; T=0.K  
neutrons from (d,2nd)

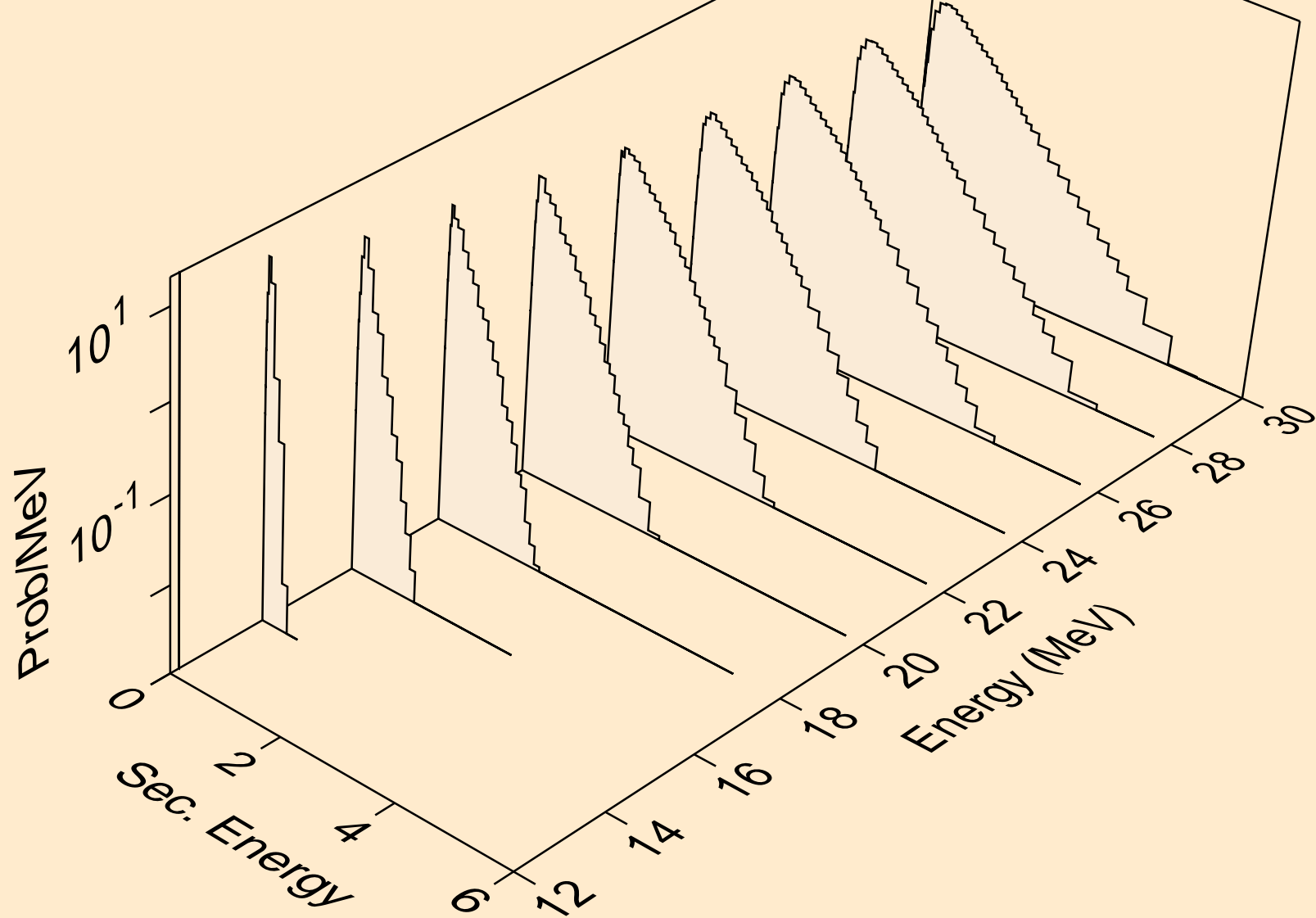

SM158 DEUTERON ACER TENDL-2021 LIBRARY; T=0.K  
neutrons from (d,2n)

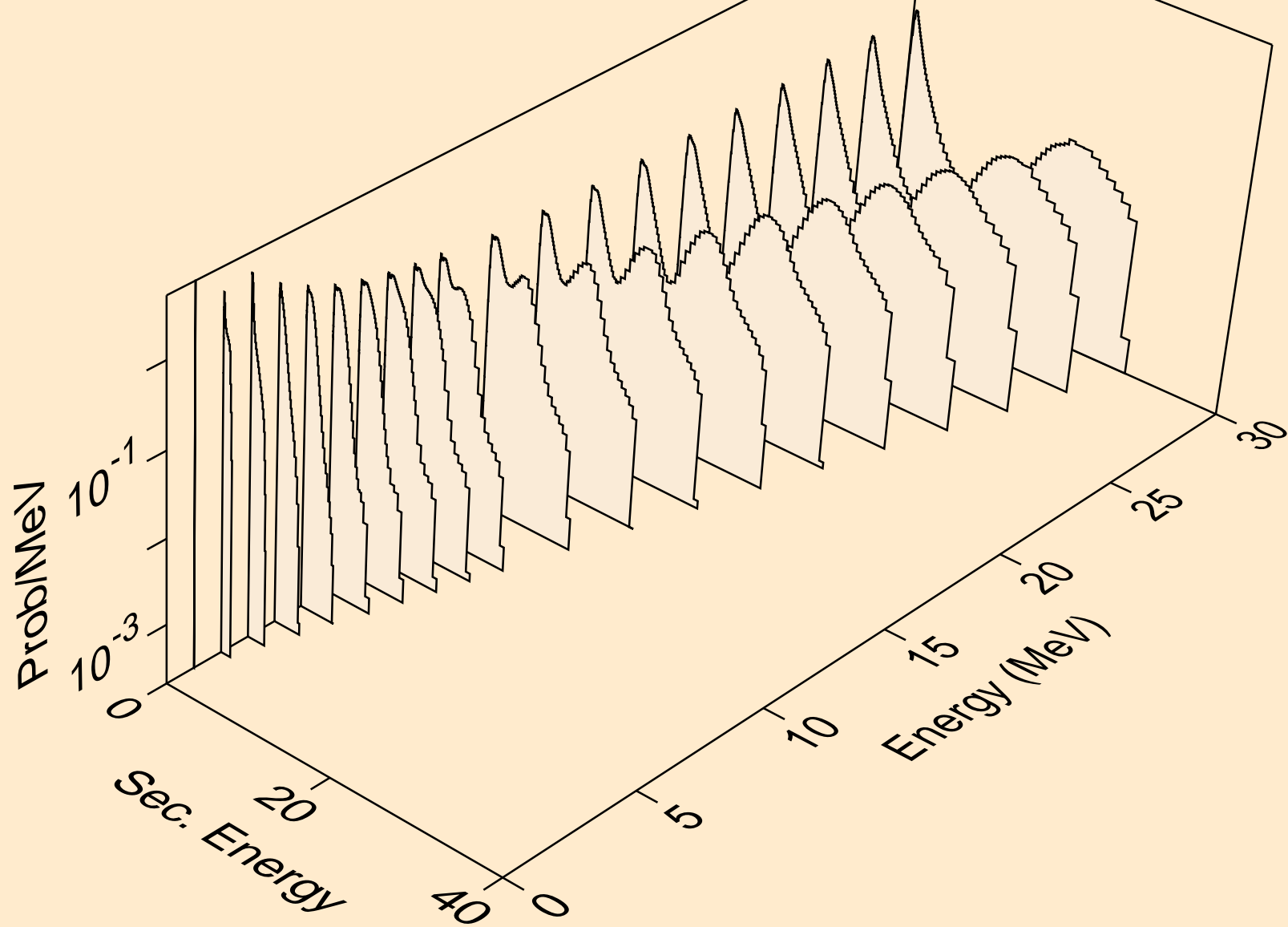

SM158 DEUTERON ACER TENDL-2021 LIBRARY; T=0.K  
neutrons from (d,3n)

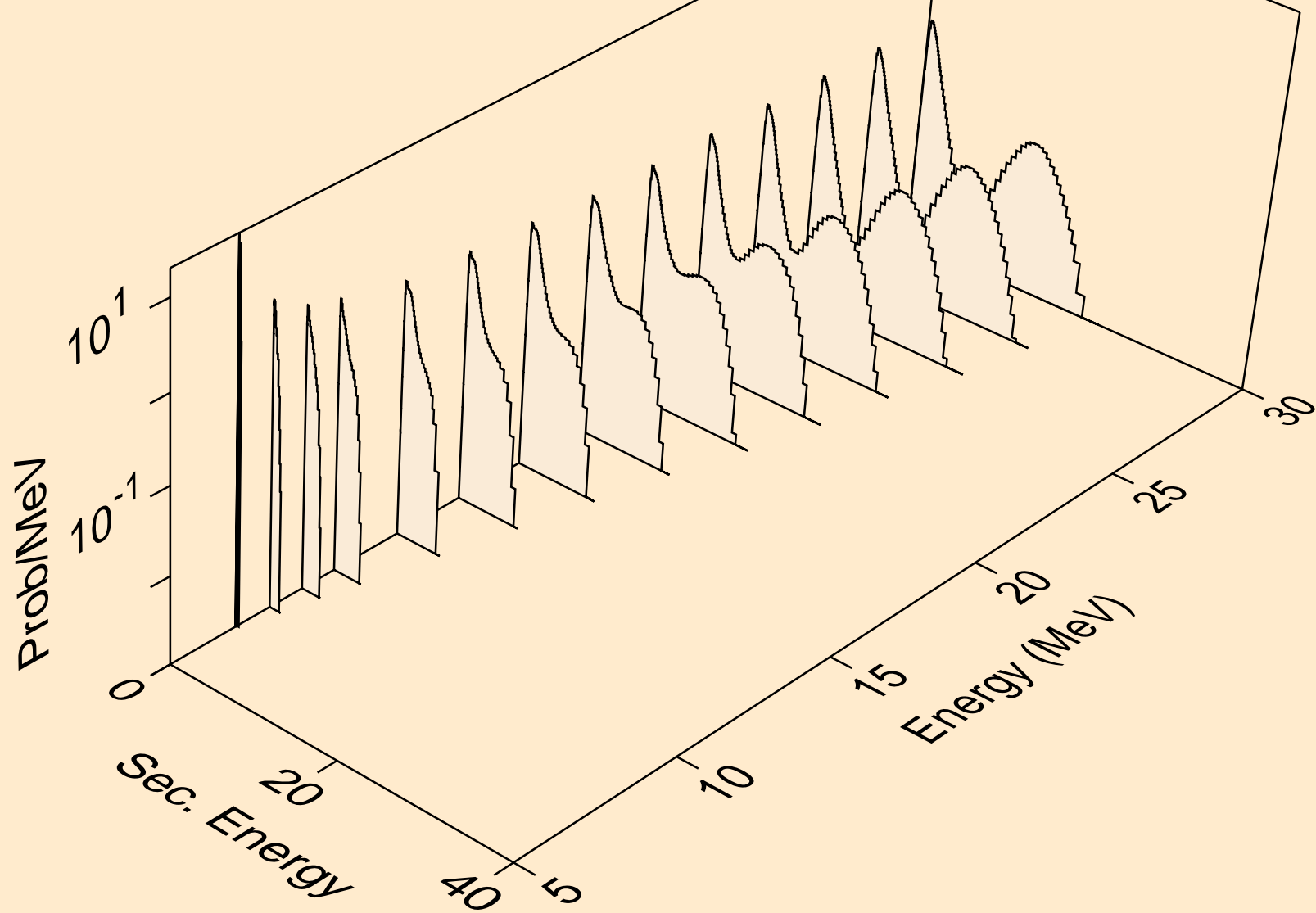

SM158 DEUTERON ACER TENDL-2021 LIBRARY; T=0.K  
neutrons from (d,n\*)a

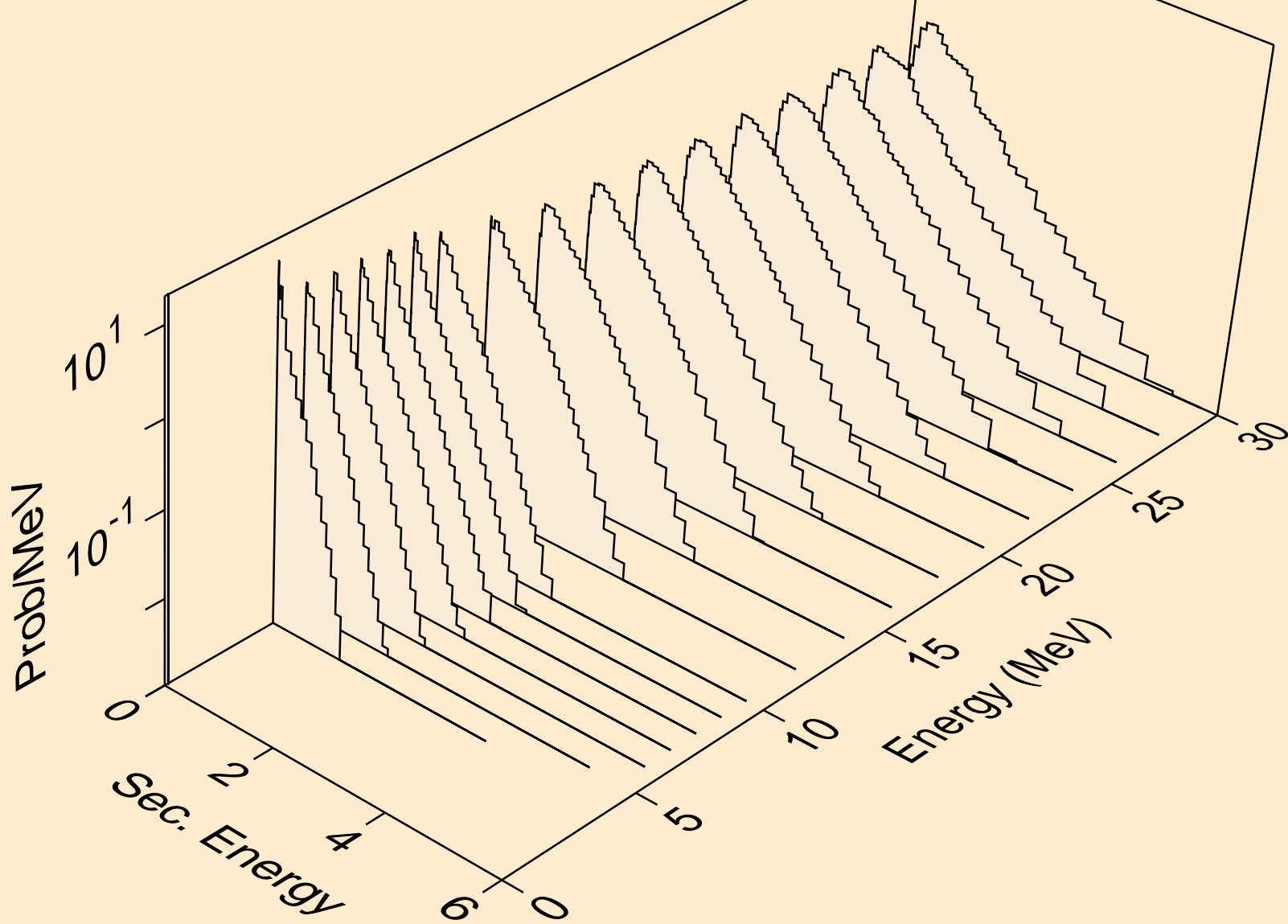

SM158 DEUTERON ACER TENDL-2021 LIBRARY; T=0.K  
neutrons from (d,2n)a

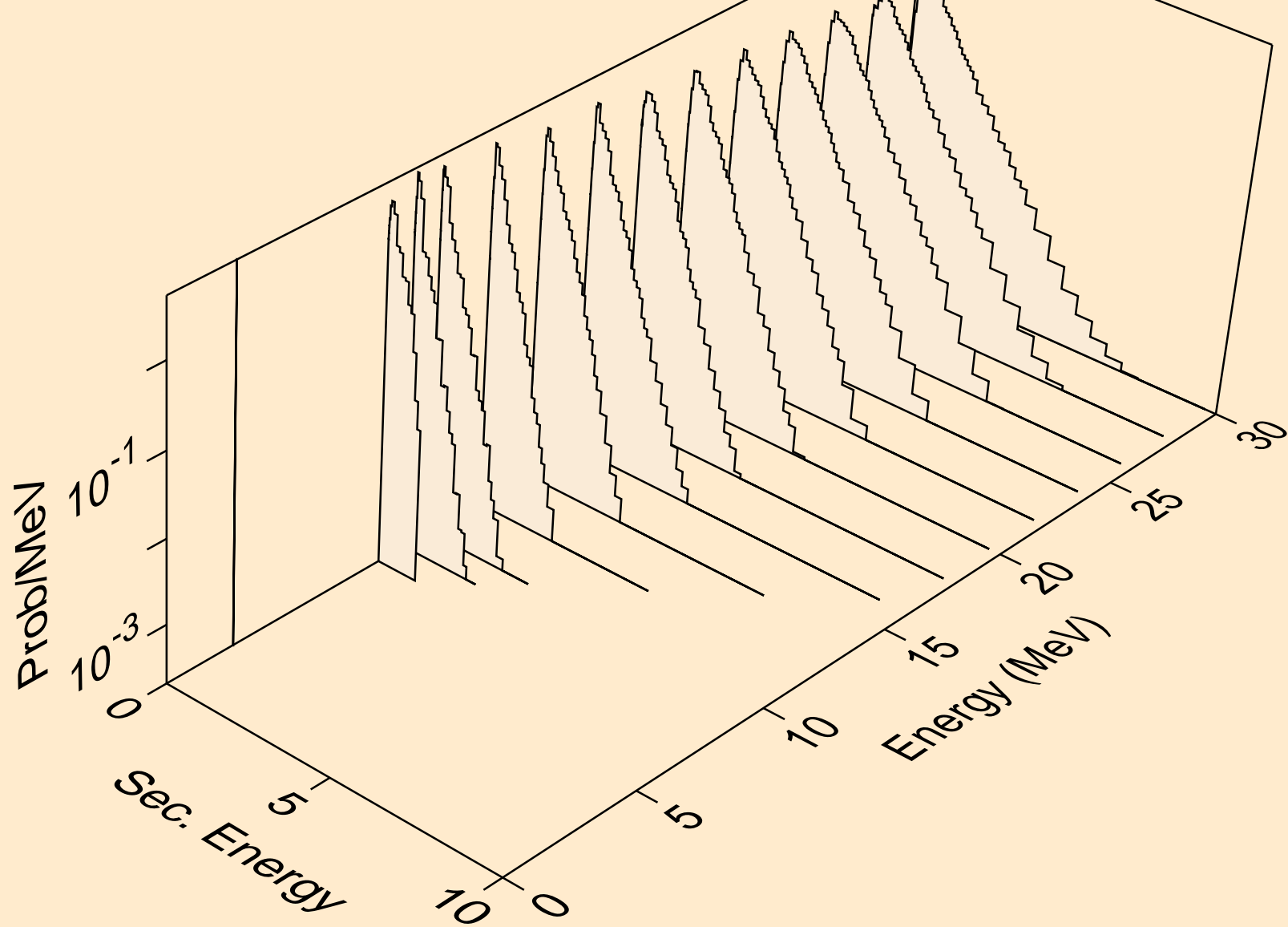



SM158 DEUTERON ACER TENDL-2021 LIBRARY; T=0.K  
neutrons from (d,3n)a

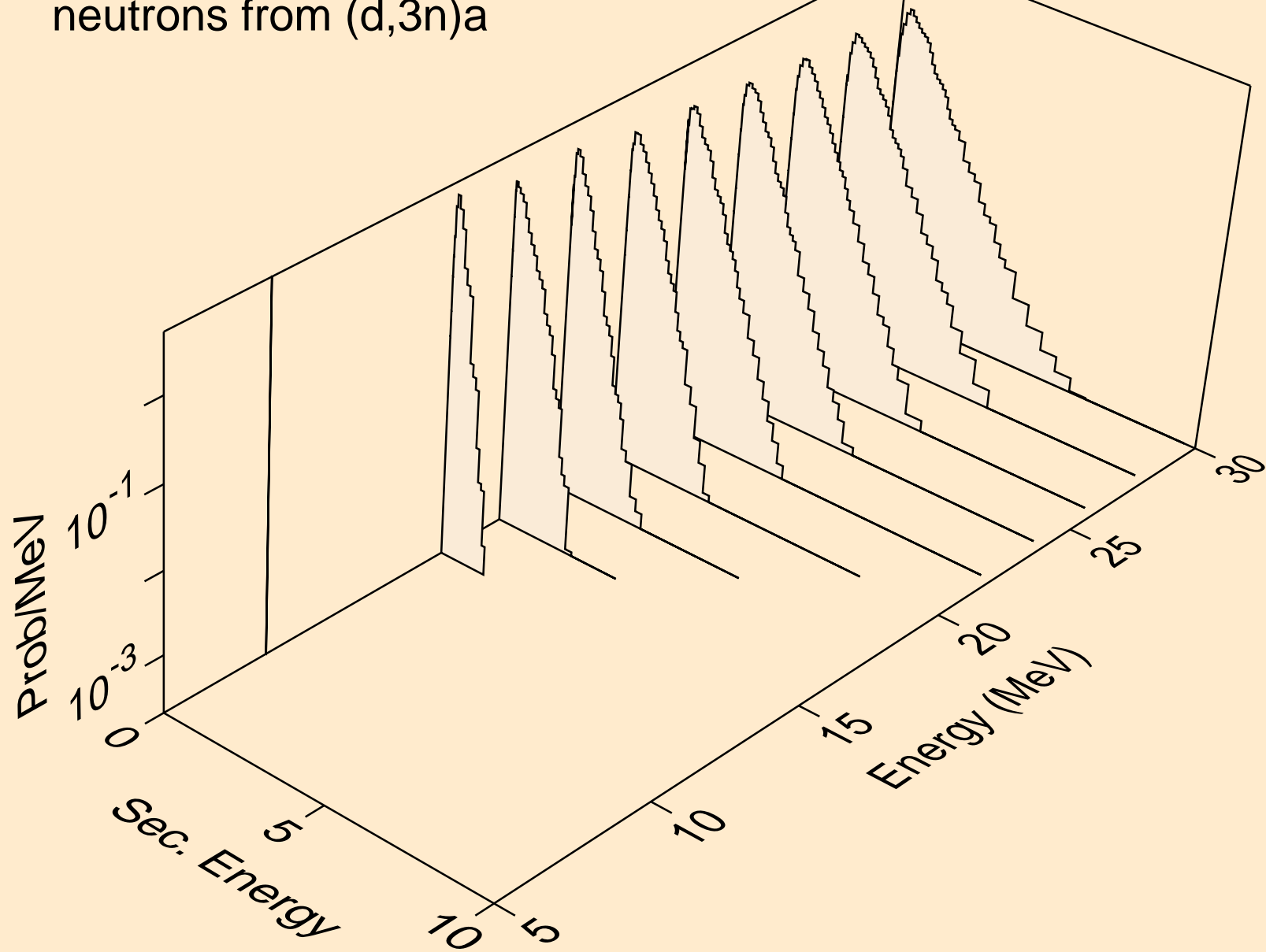

SM158 DEUTERON ACER TENDL-2021 LIBRARY; T=0.K  
neutrons from (d,n\*)p

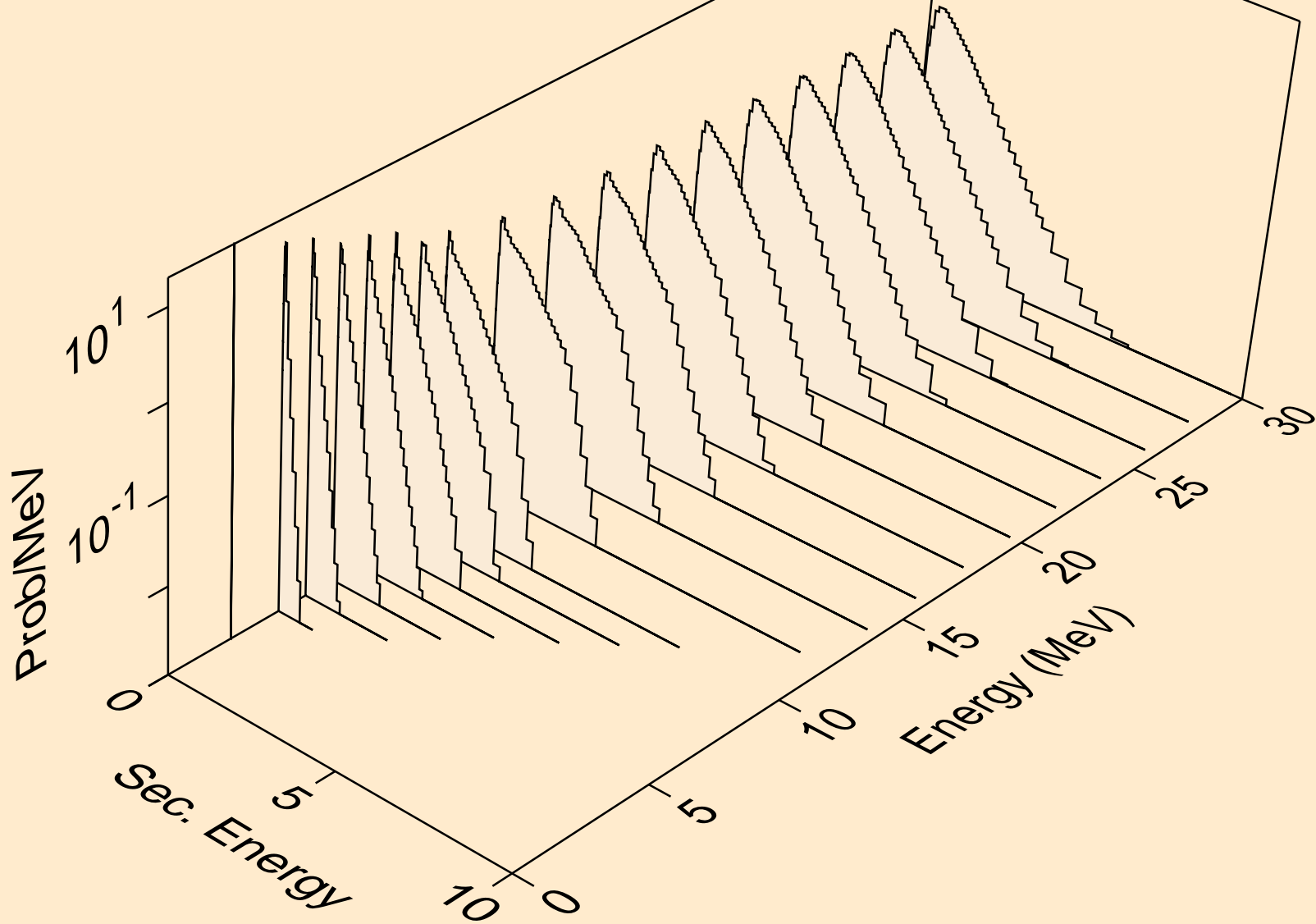

SM158 DEUTERON ACER TENDL-2021 LIBRARY; T=0.K  
neutrons from (d,n\*)d

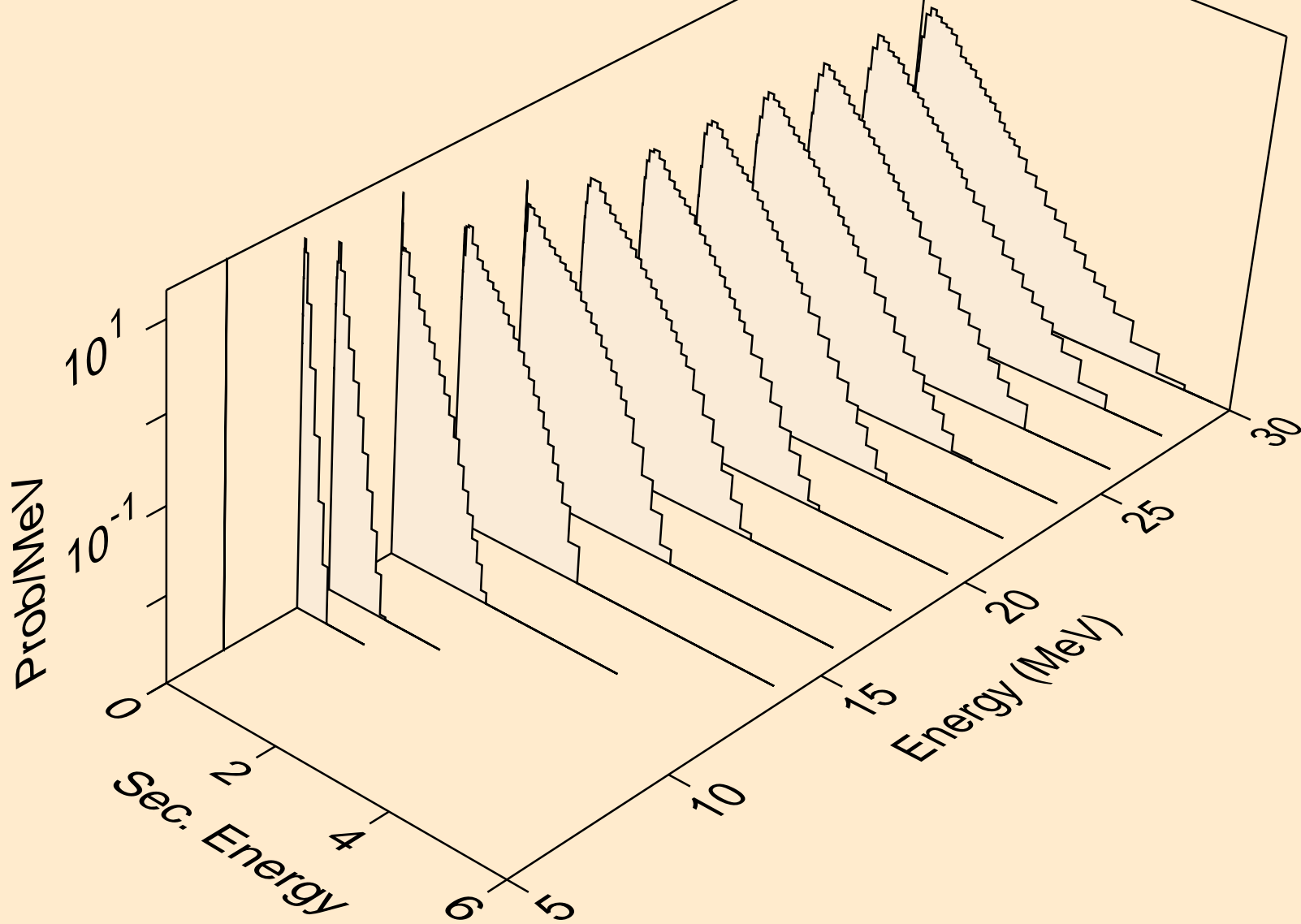

SM158 DEUTERON ACER TENDL-2021 LIBRARY; T=0.K  
neutrons from (d,n\*)t

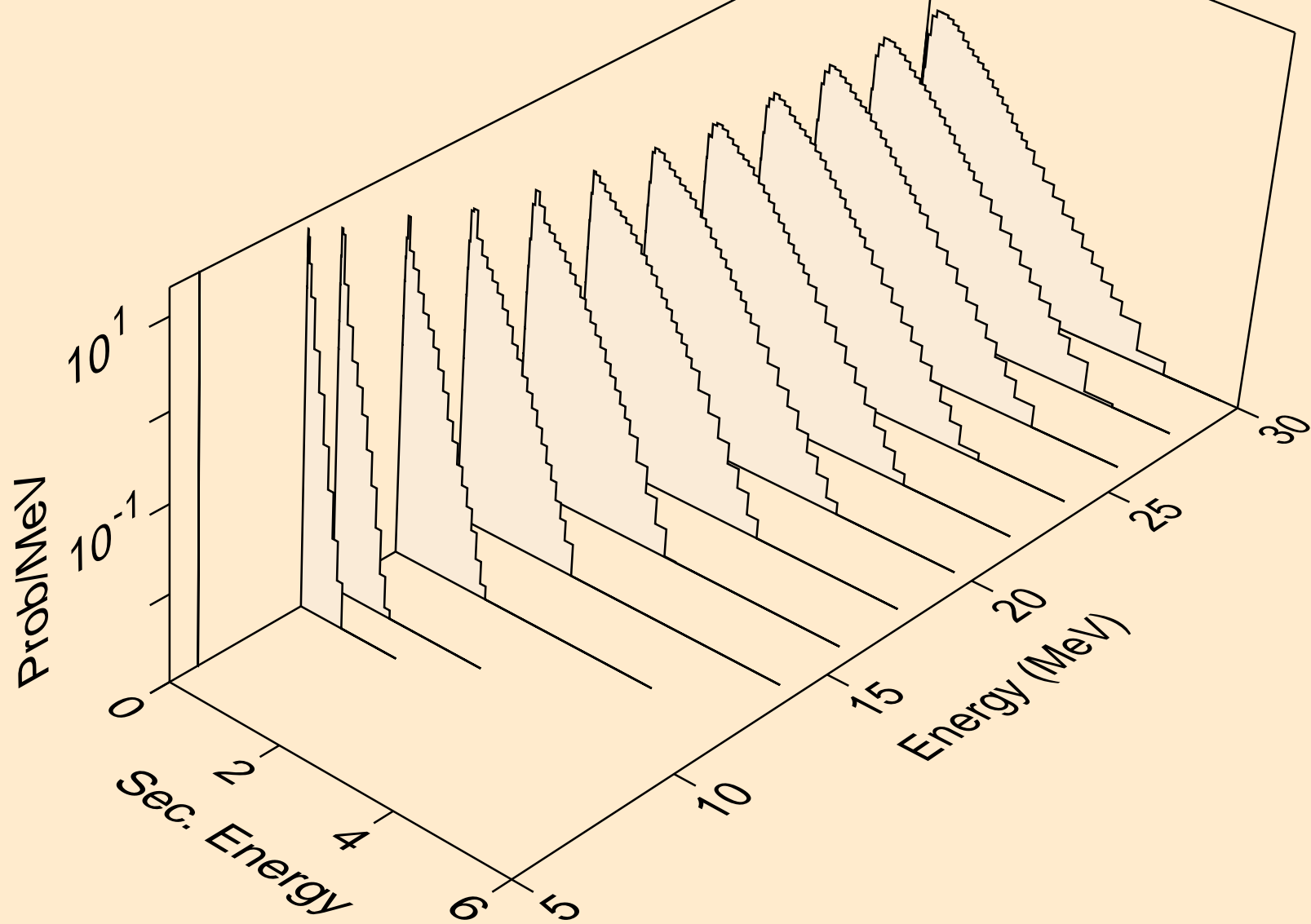

SM158 DEUTERON ACER TENDL-2021 LIBRARY; T=0.K  
neutrons from (d,n\*)he3

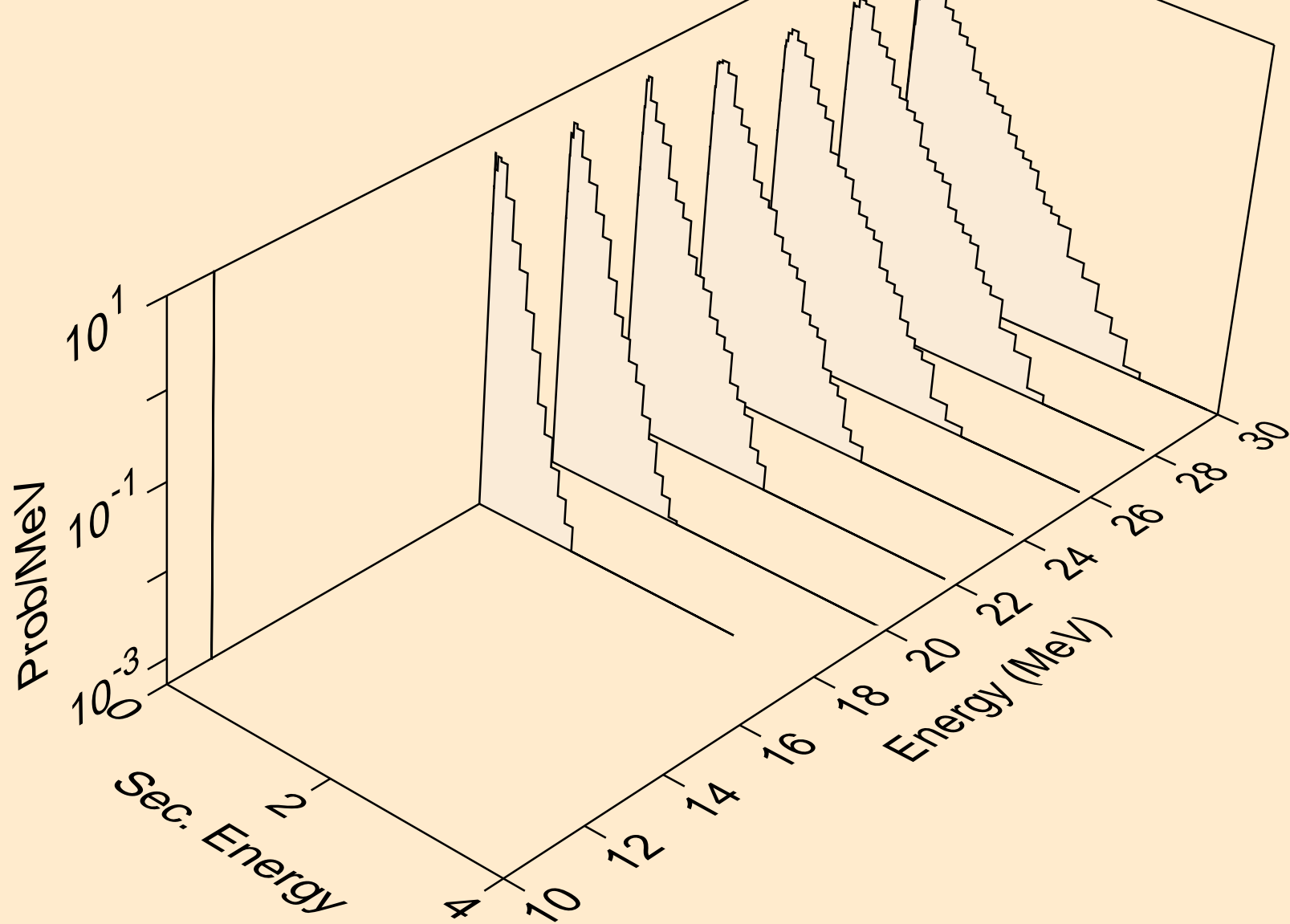

SM158 DEUTERON ACER TENDL-2021 LIBRARY; T=0.K  
neutrons from (d,4n)

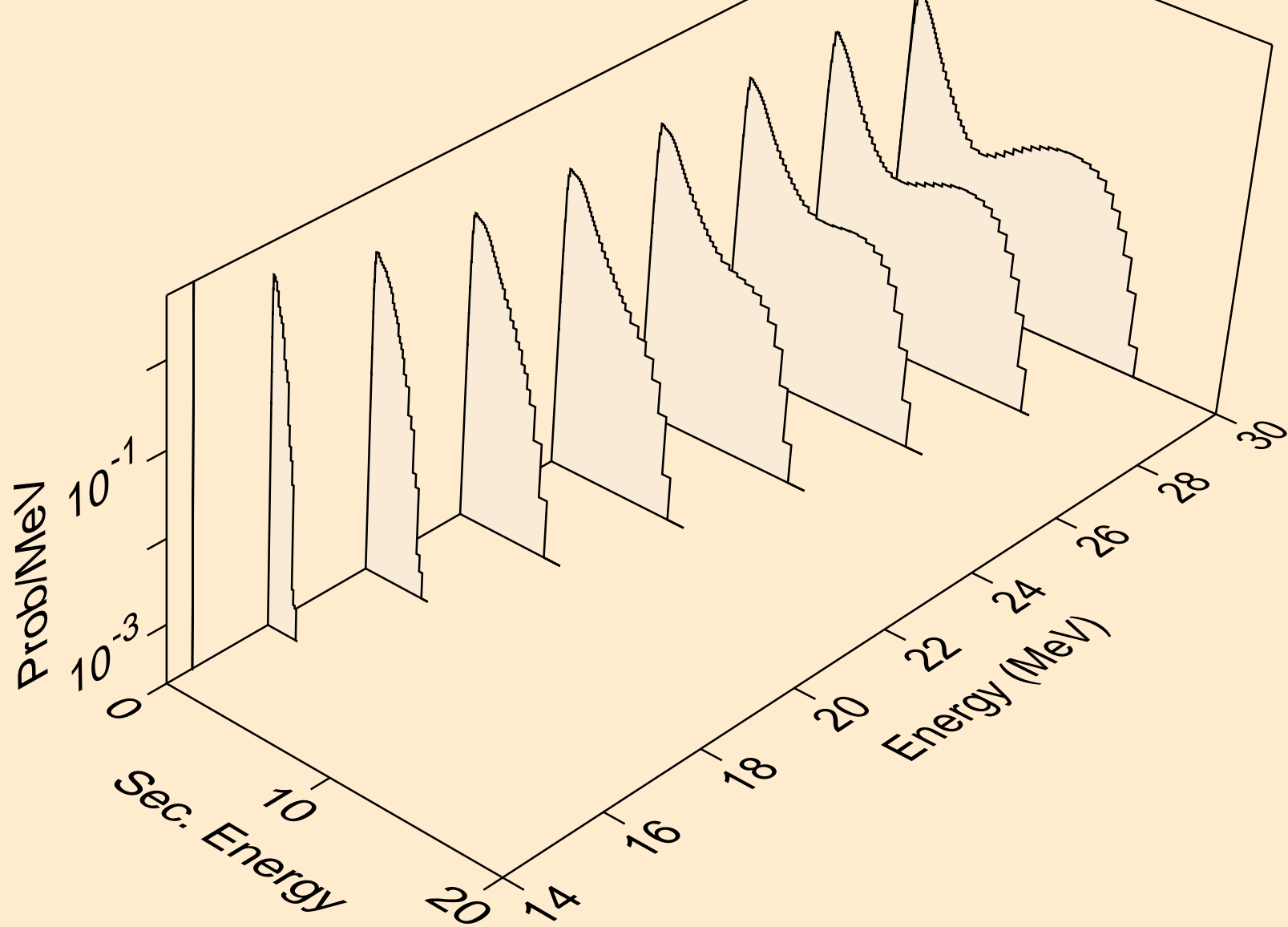

SM158 DEUTERON ACER TENDL-2021 LIBRARY; T=0.K  
neutrons from (d,2np)

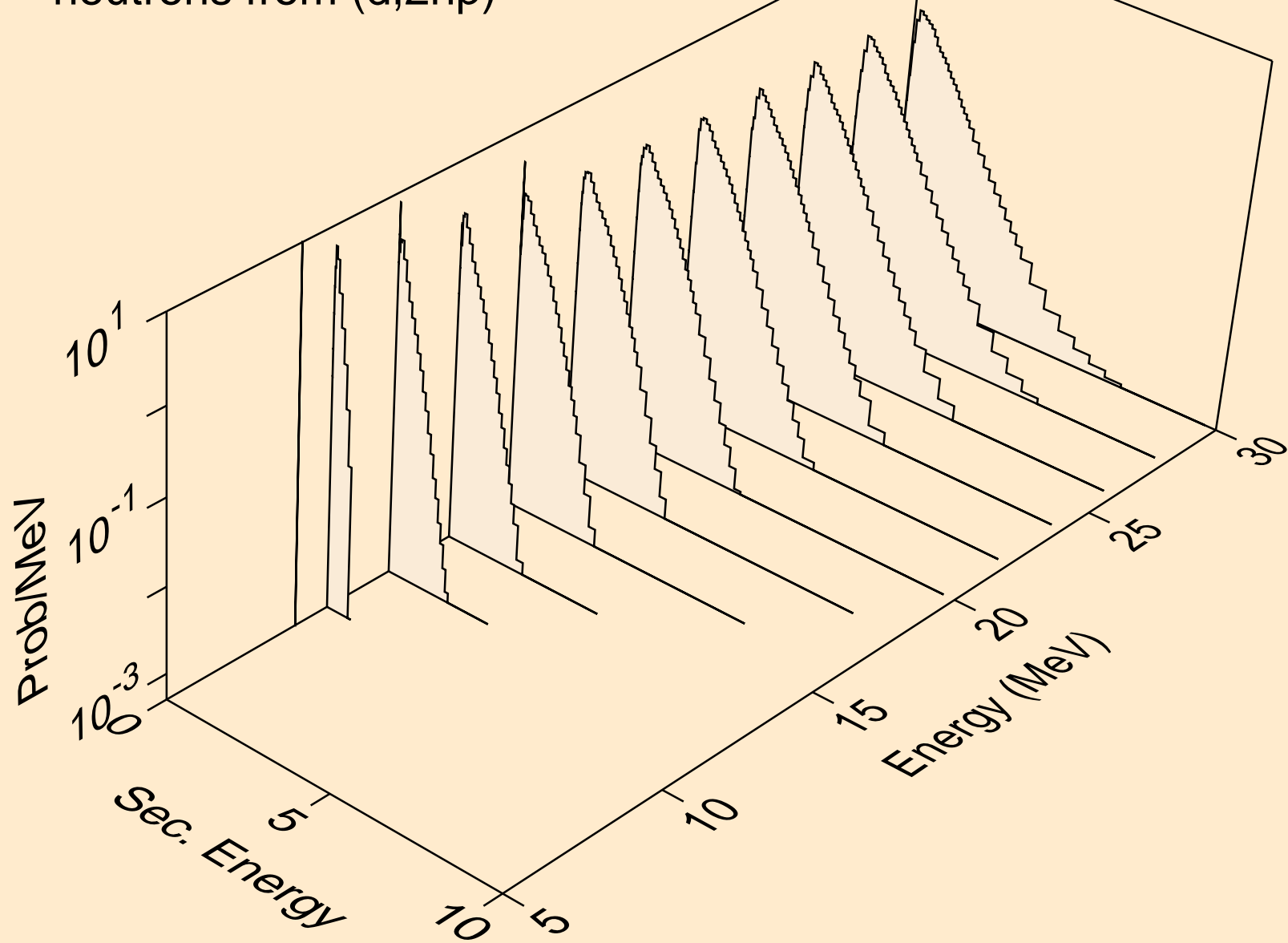

SM158 DEUTERON ACER TENDL-2021 LIBRARY; T=0.K  
neutrons from (d,3np)

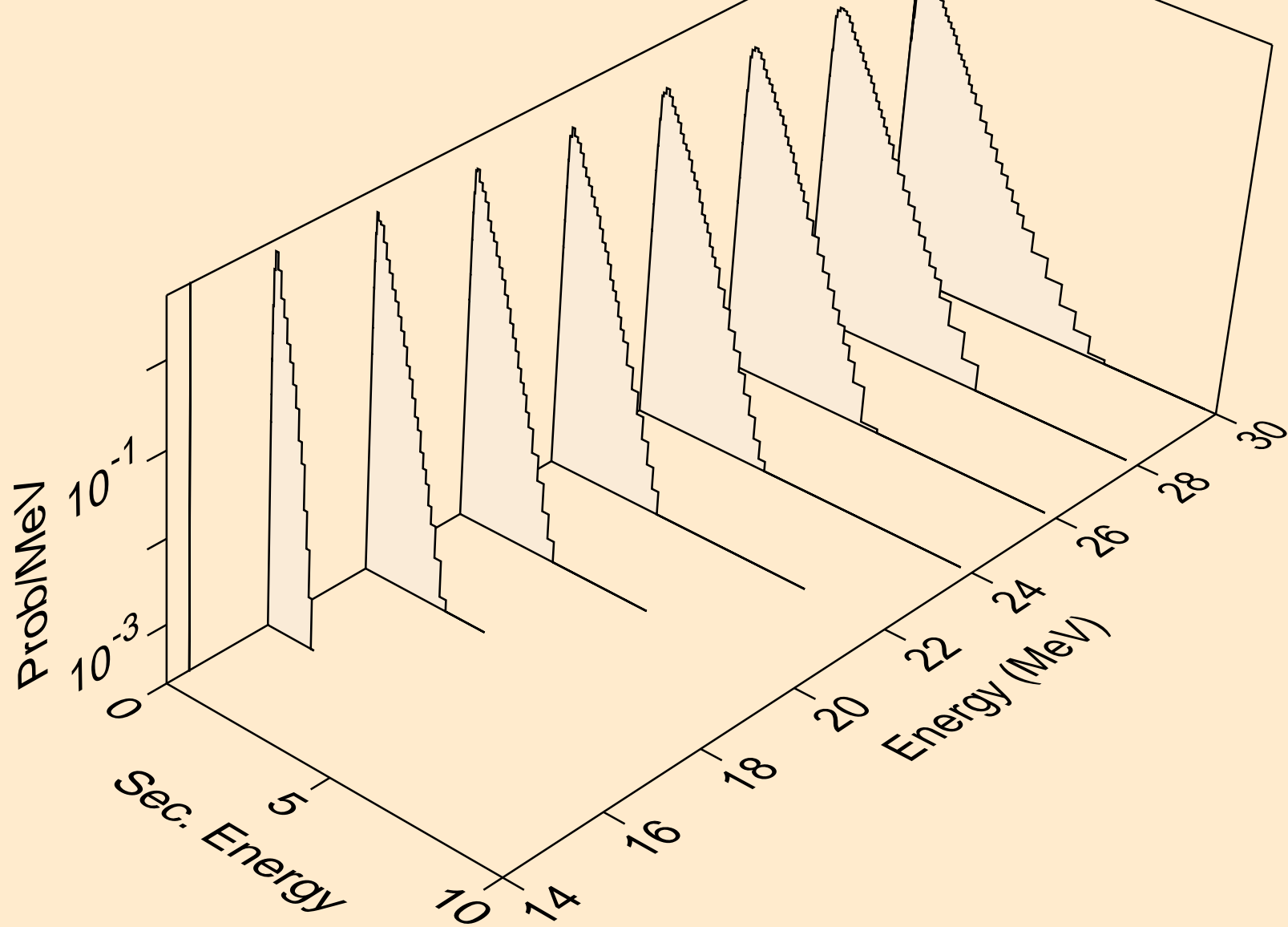



SM158 DEUTERON ACER TENDL-2021 LIBRARY; T=0.K  
neutrons from (d,2np)

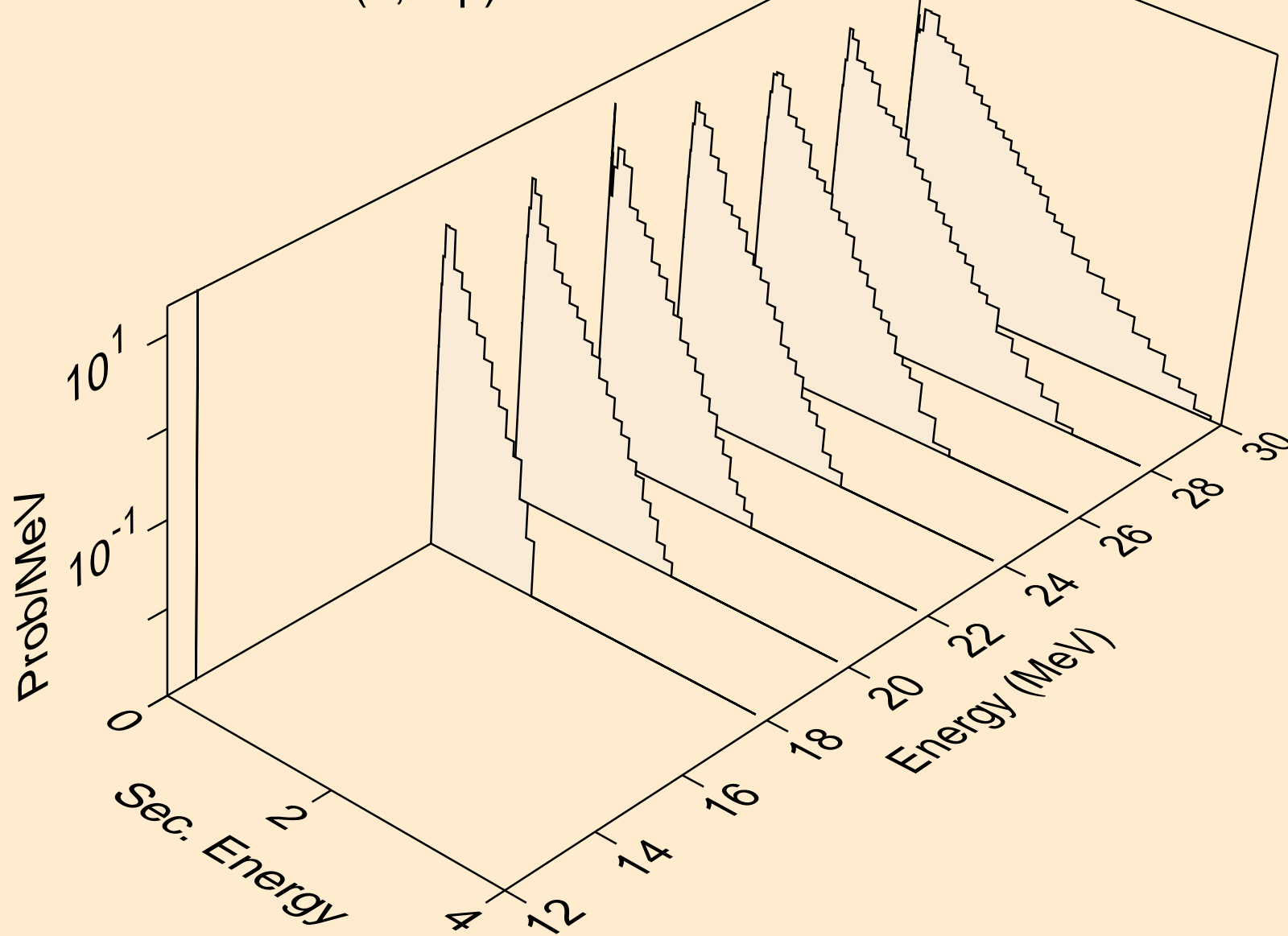

SM158 DEUTERON ACER TENDL-2021 LIBRARY; T=0.K  
neutrons from (d,npa)

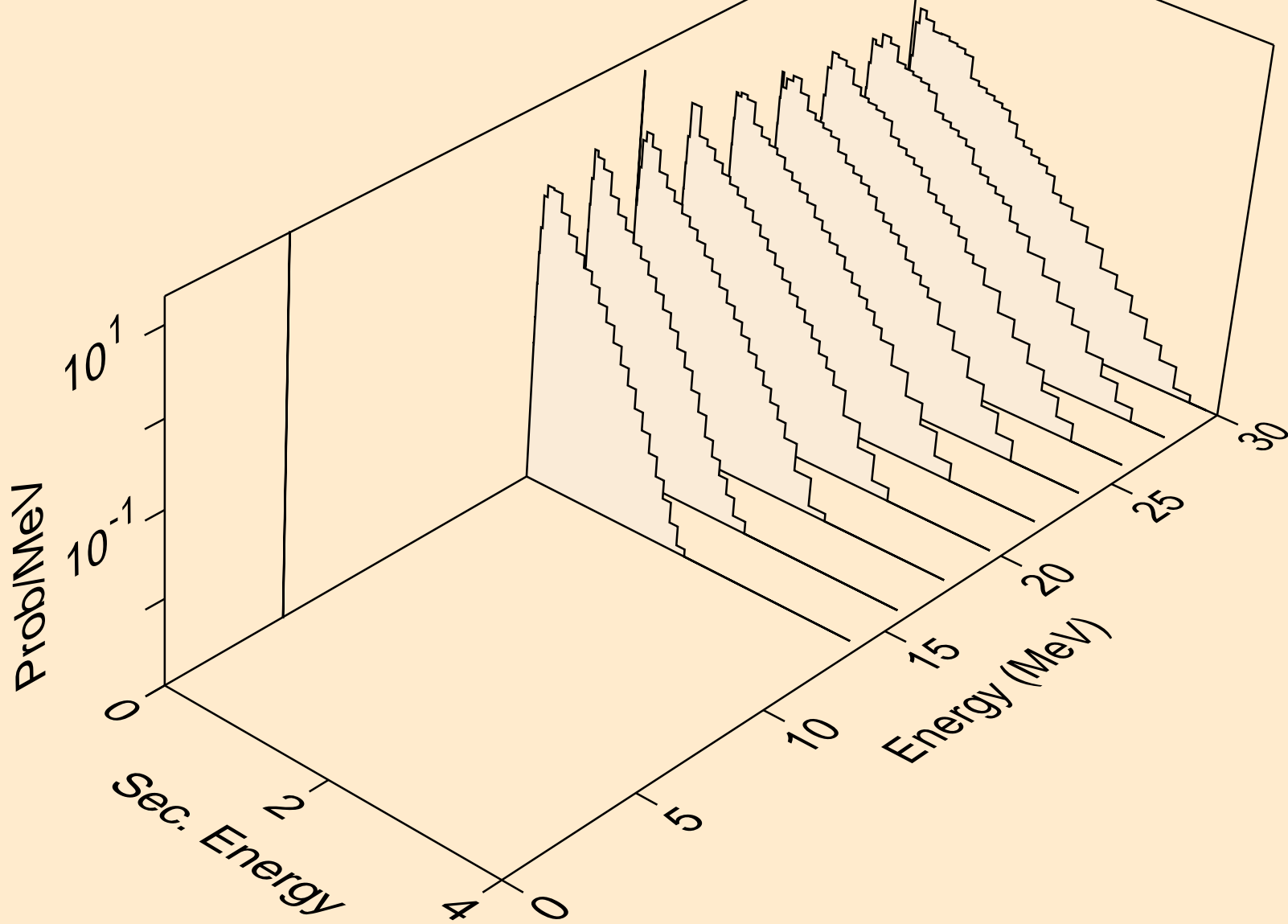

SM158 DEUTERON ACER TENDL-2021 LIBRARY; T=0.K  
protons from (d,x)

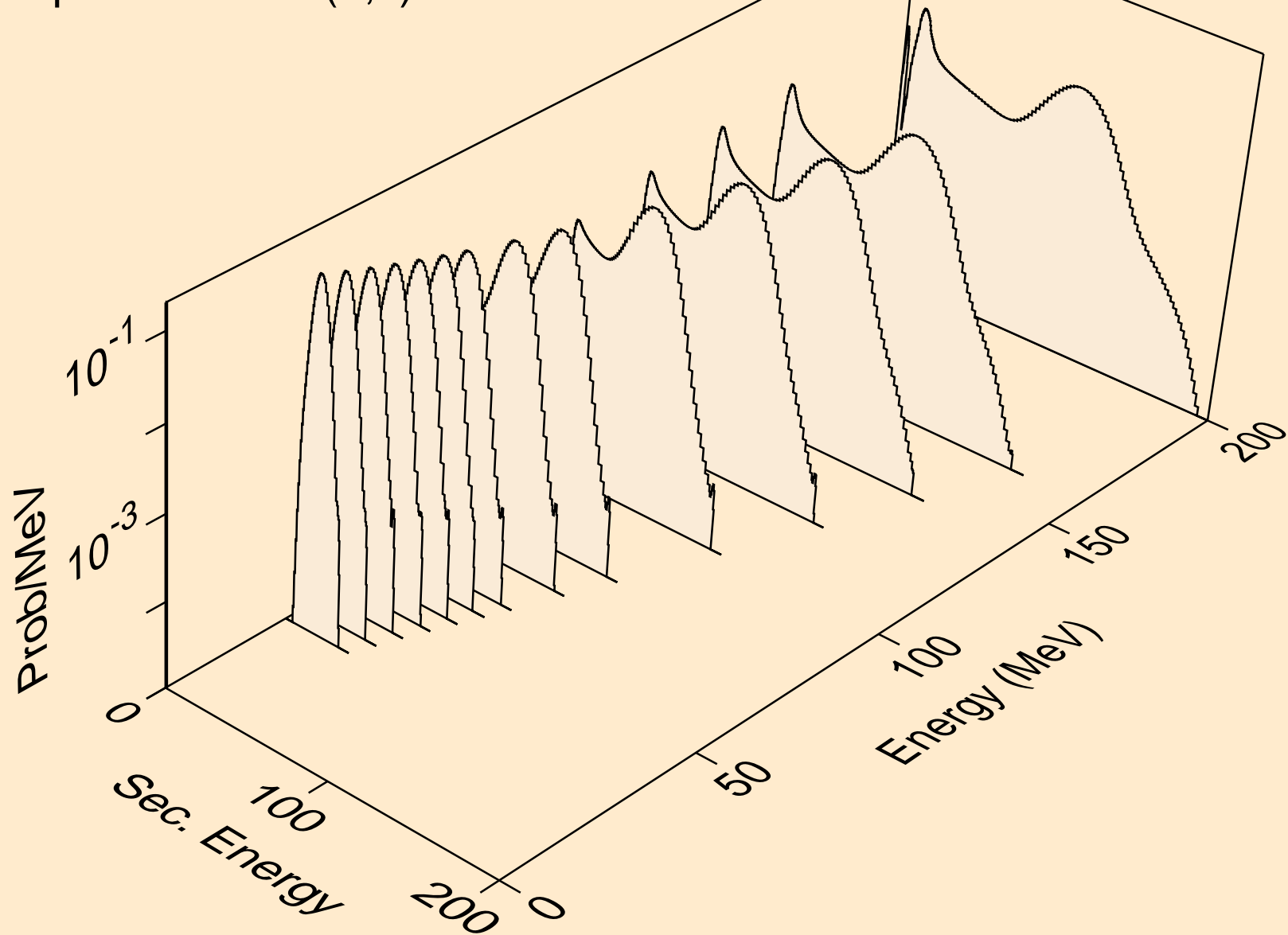

SM158 DEUTERON ACER TENDL-2021 LIBRARY; T=0.K  
protons from (d,n\*)p

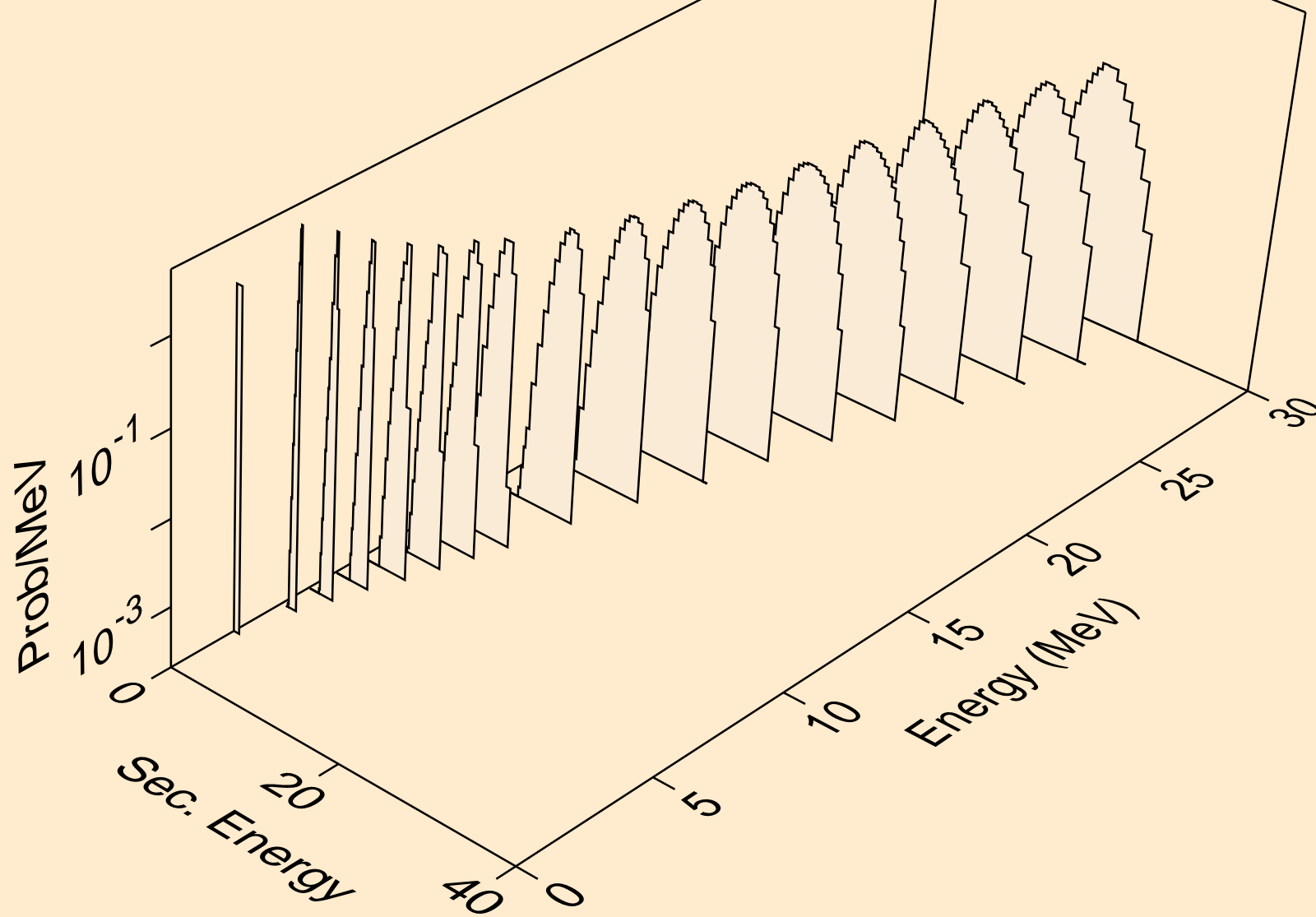

SM158 DEUTERON ACER TENDL-2021 LIBRARY; T=0.K  
protons from (d,2np)

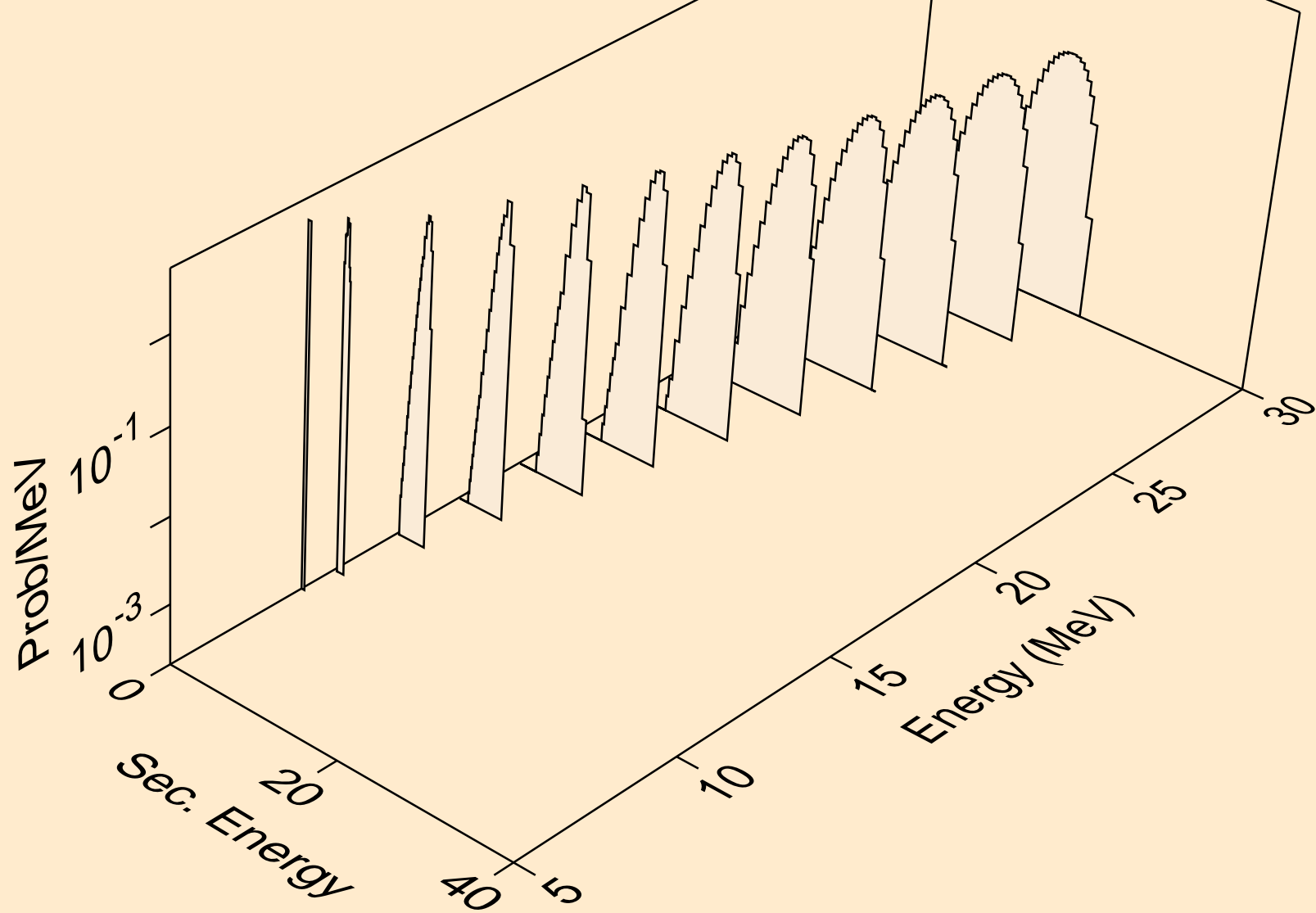

SM158 DEUTERON ACER TENDL-2021 LIBRARY; T=0.K  
protons from (d,3np)

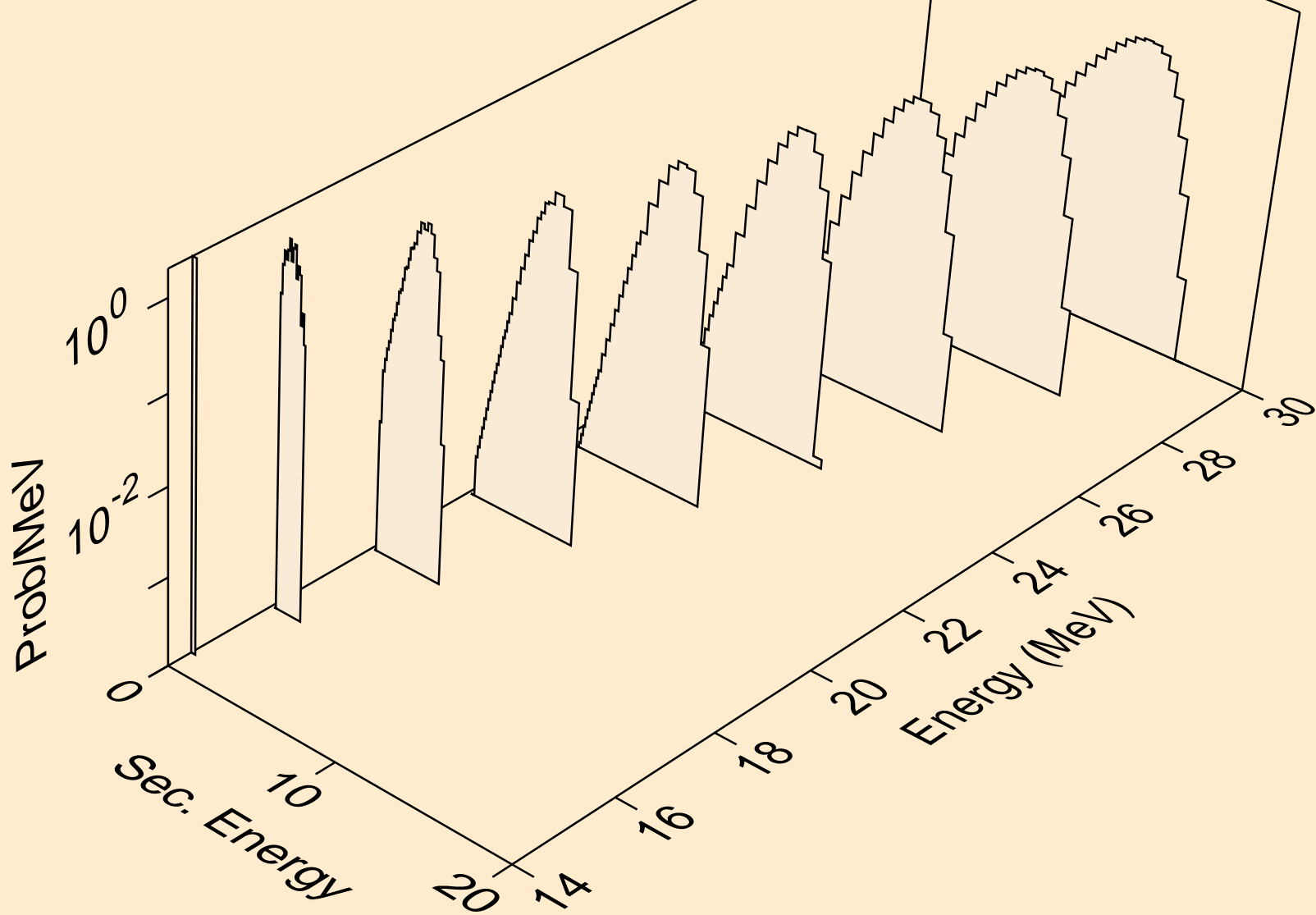

SM158 DEUTERON ACER TENDL-2021 LIBRARY; T=0.K  
protons from (d,2np)

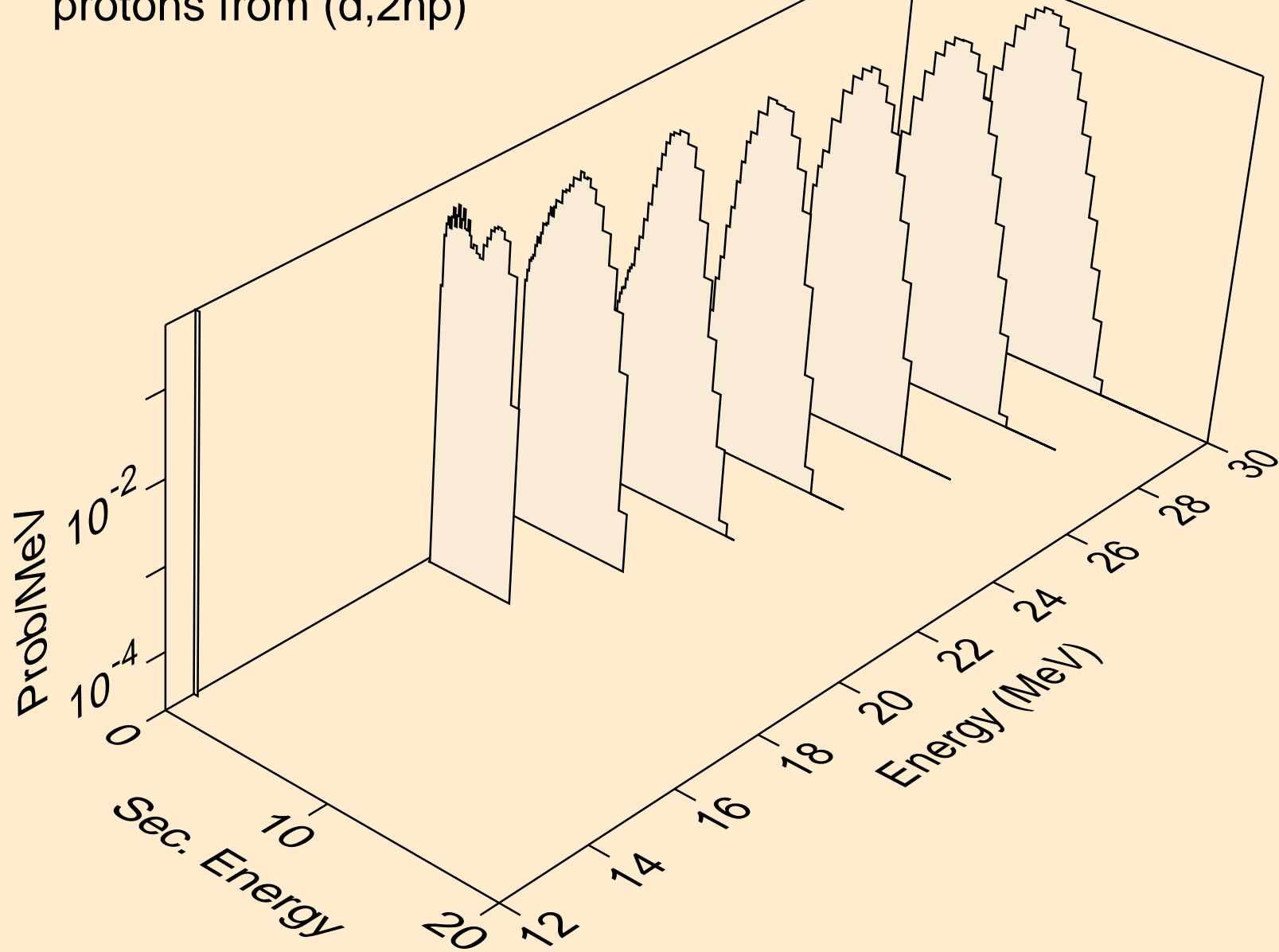

SM158 DEUTERON ACER TENDL-2021 LIBRARY; T=0.K  
protons from (d,npa)

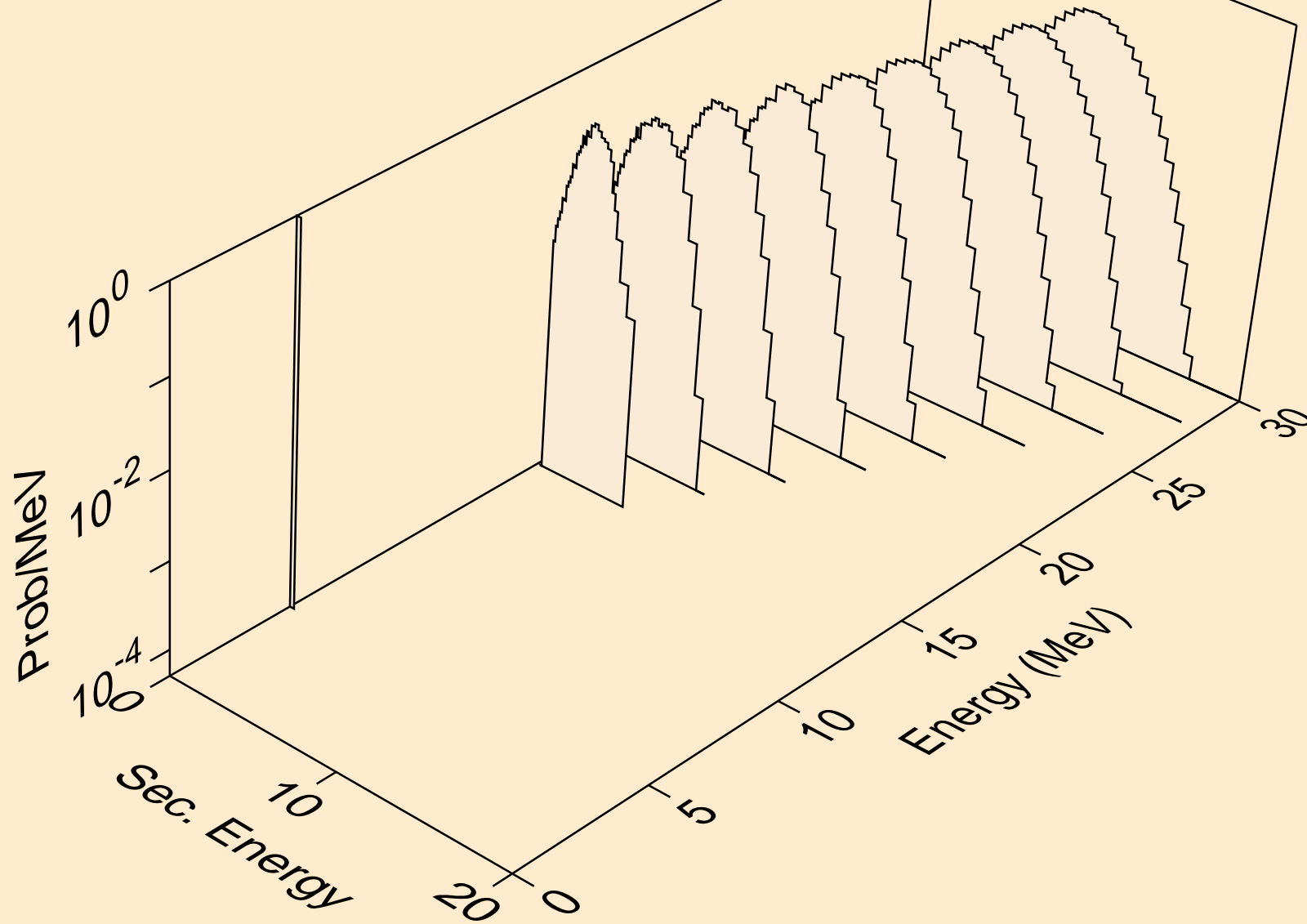



SM158 DEUTERON ACER TENDL-2021 LIBRARY; T=0.K  
protons from (d,p)

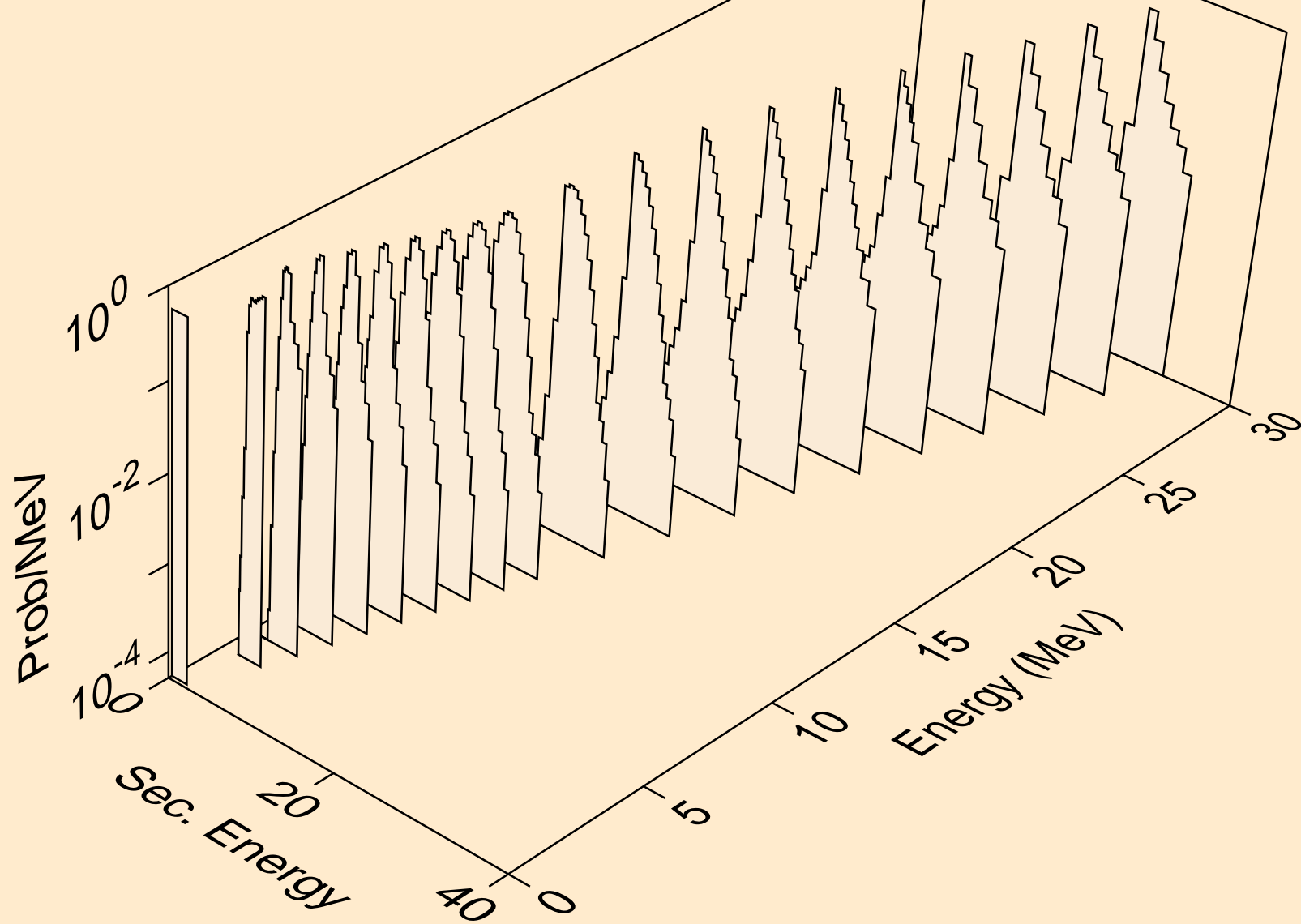

SM158 DEUTERON ACER TENDL-2021 LIBRARY; T=0.K  
protons from (d,2p)

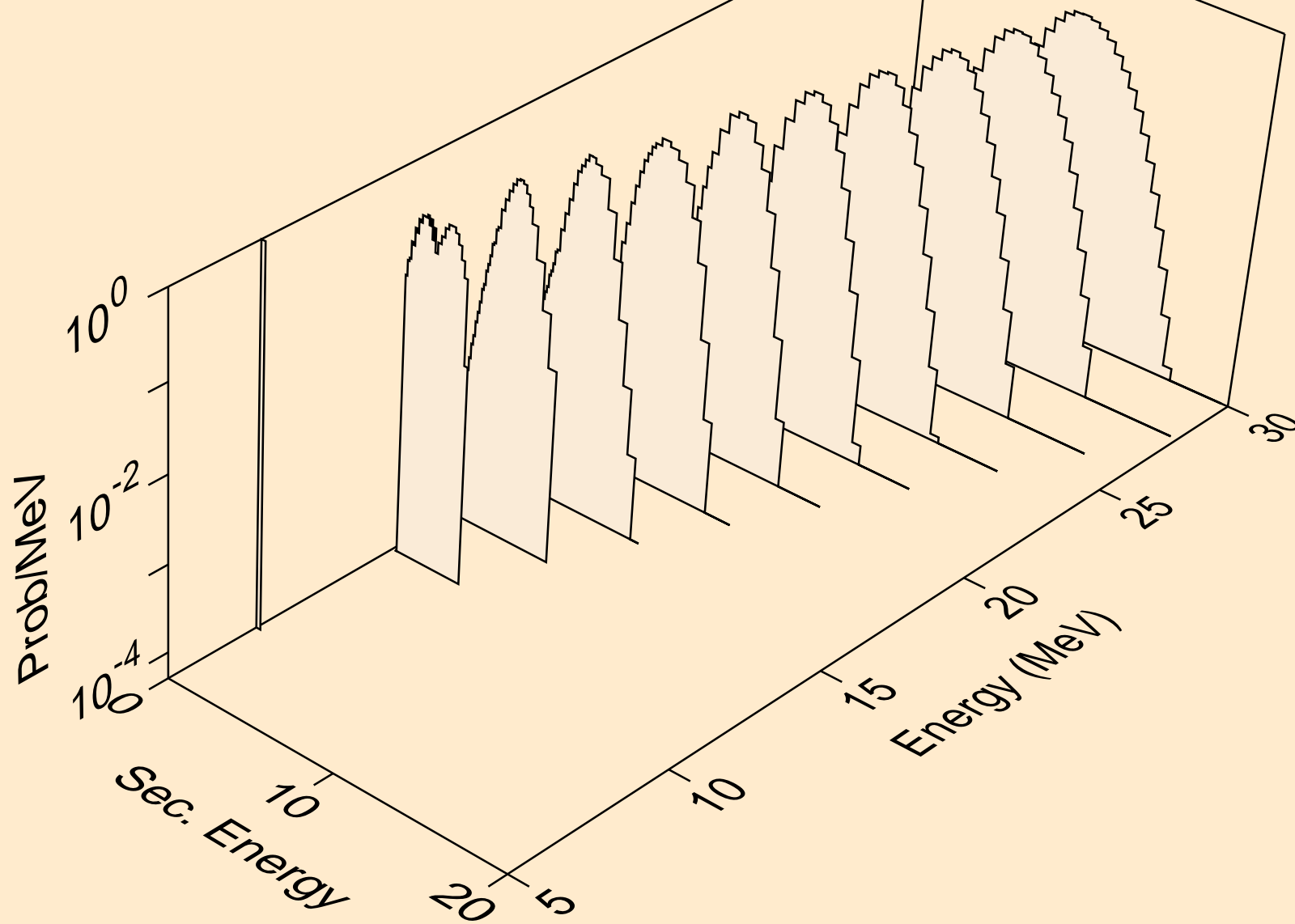

SM158 DEUTERON ACER TENDL-2021 LIBRARY; T=0.K  
protons from (d,pa)

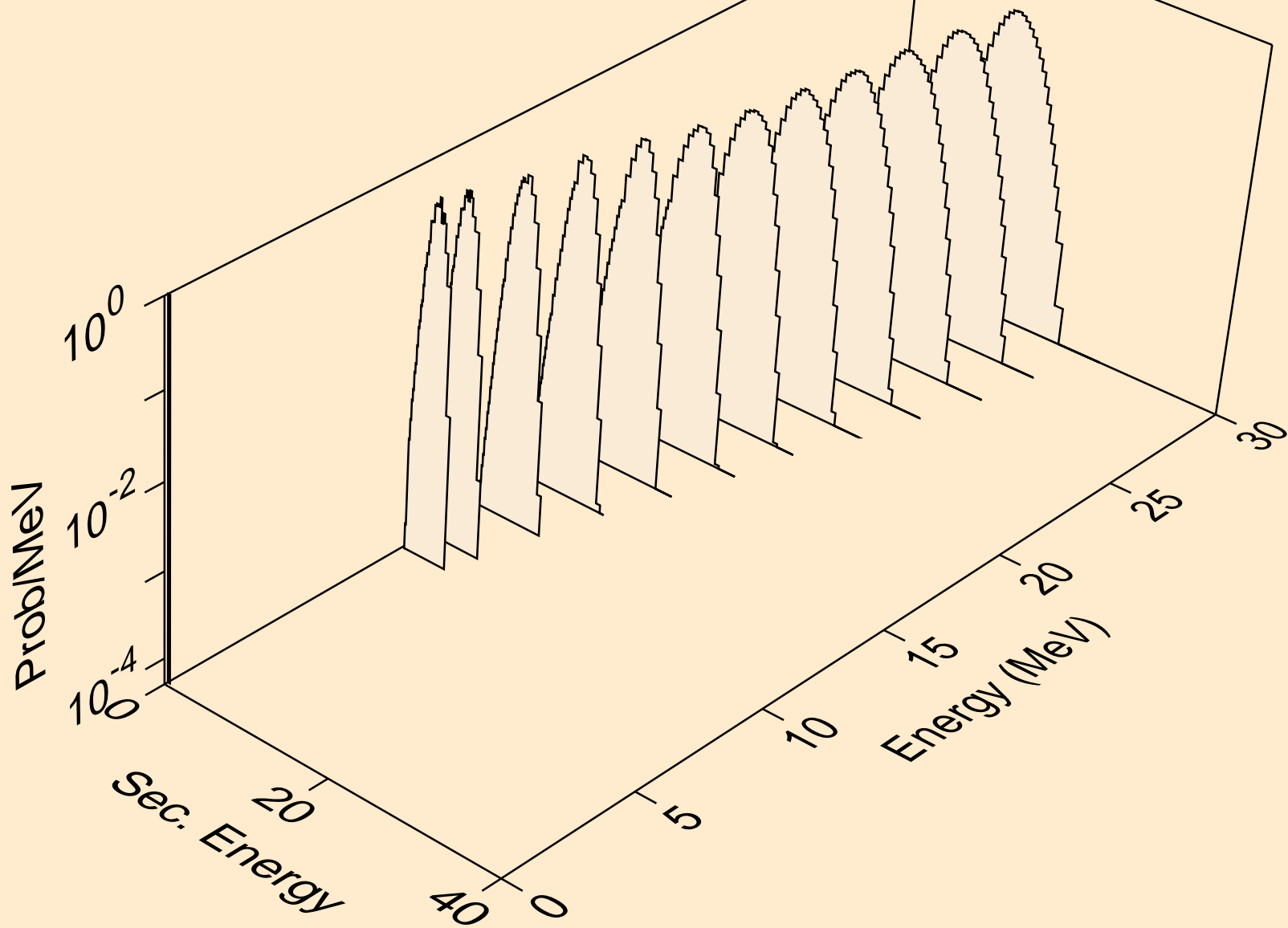

SM158 DEUTERON ACER TENDL-2021 LIBRARY; T=0.K  
protons from (d,pd)

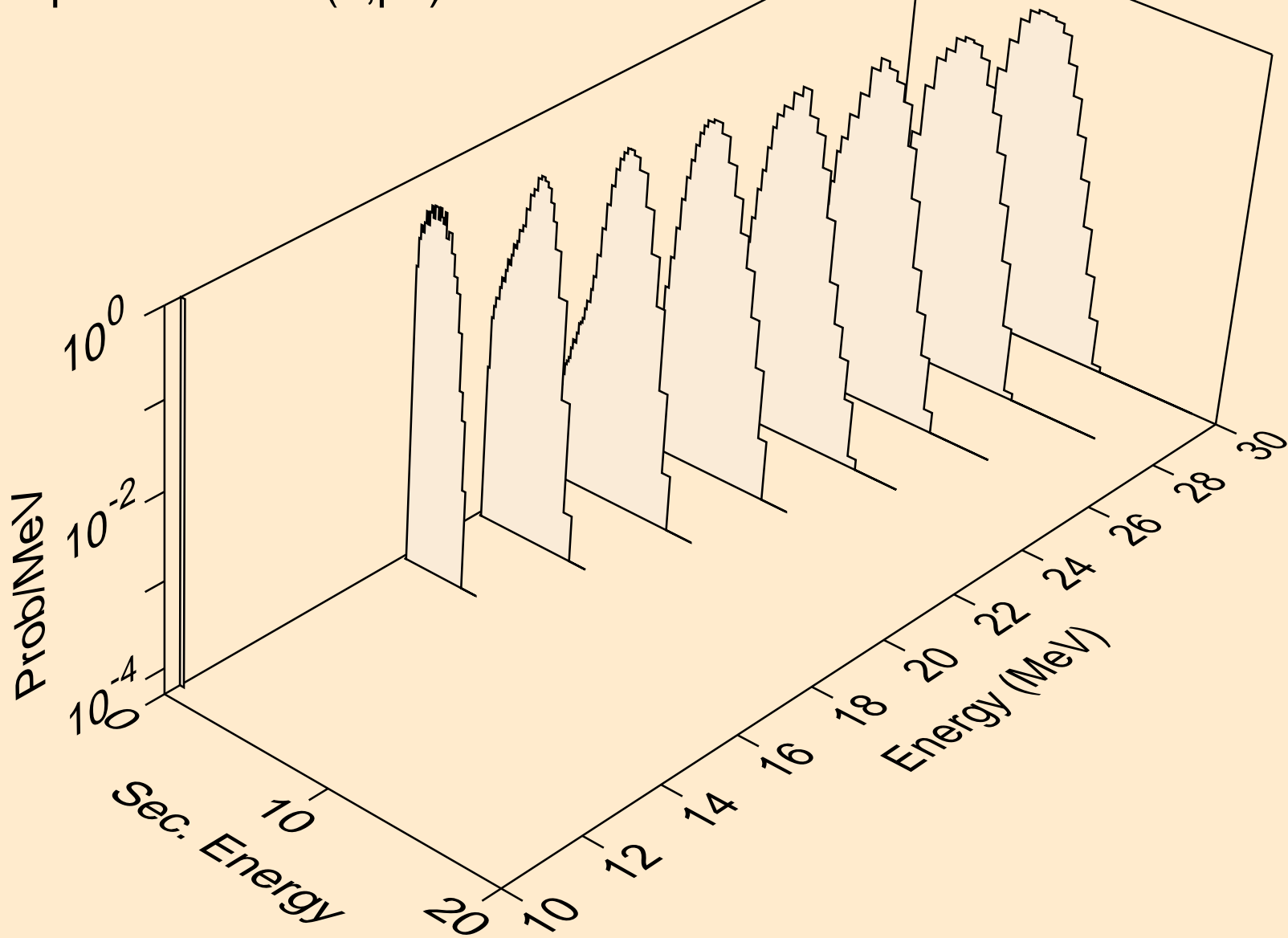

SM158 DEUTERON ACER TENDL-2021 LIBRARY; T=0.K  
tritons from (d,x)

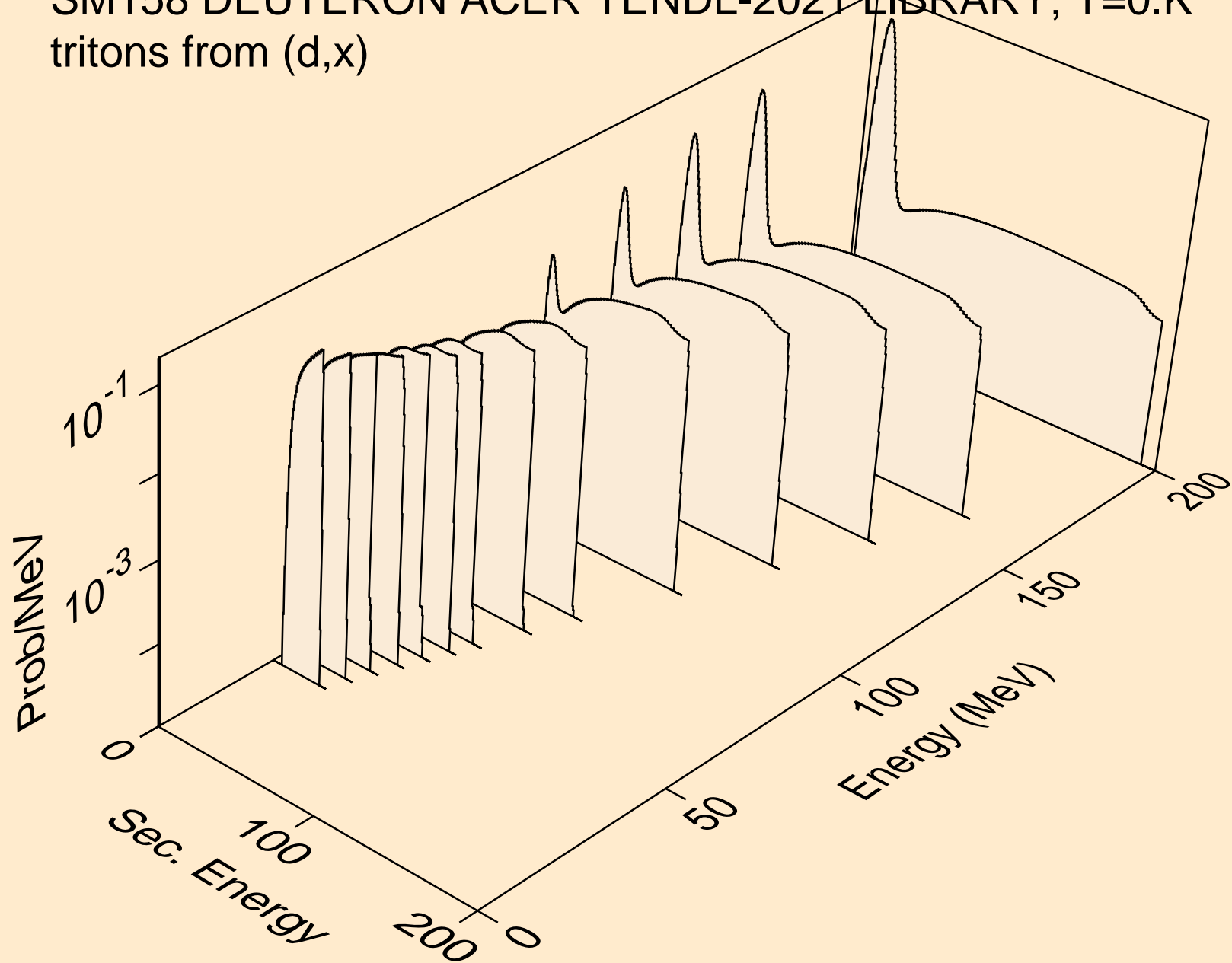

SM158 DEUTERON ACER TENDL-2021 LIBRARY; T=0.K  
tritons from (d,n\*)t

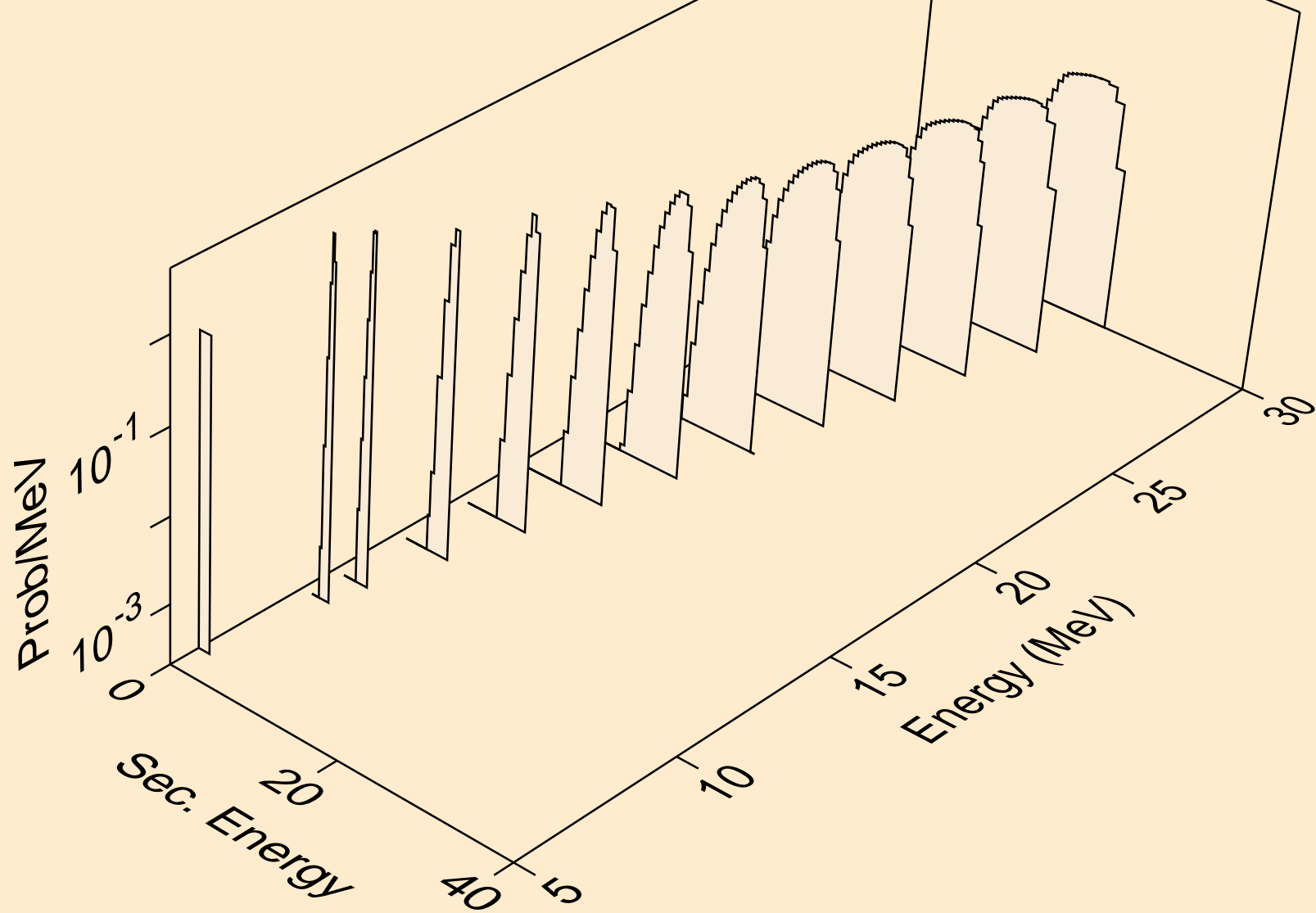

SM158 DEUTERON ACER TENDL-2021 LIBRARY; T=0.K  
tritons from (d,t)

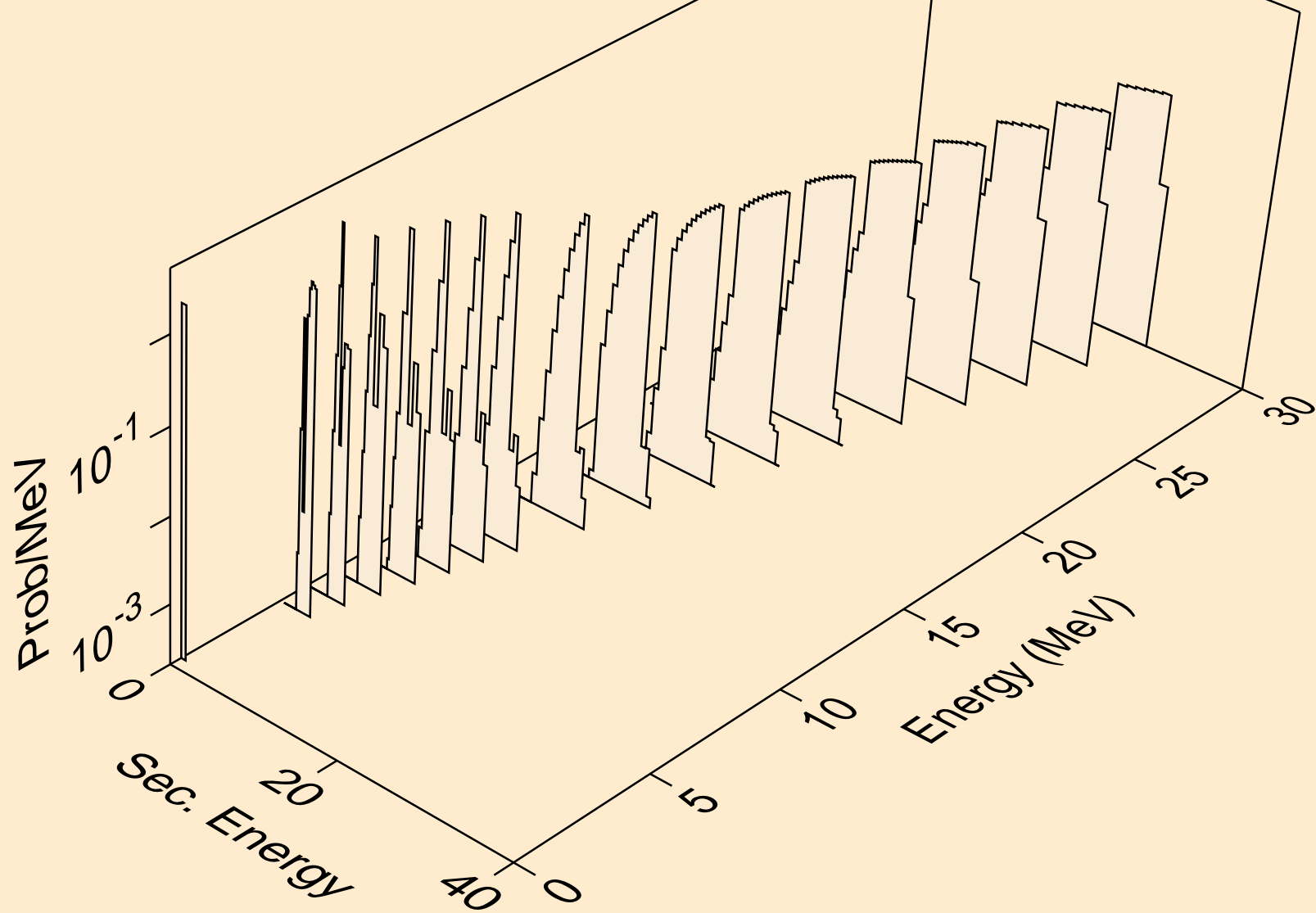

SM158 DEUTERON ACER TENDL-2021 LIBRARY; T=0.K  
he3s from (d,x)

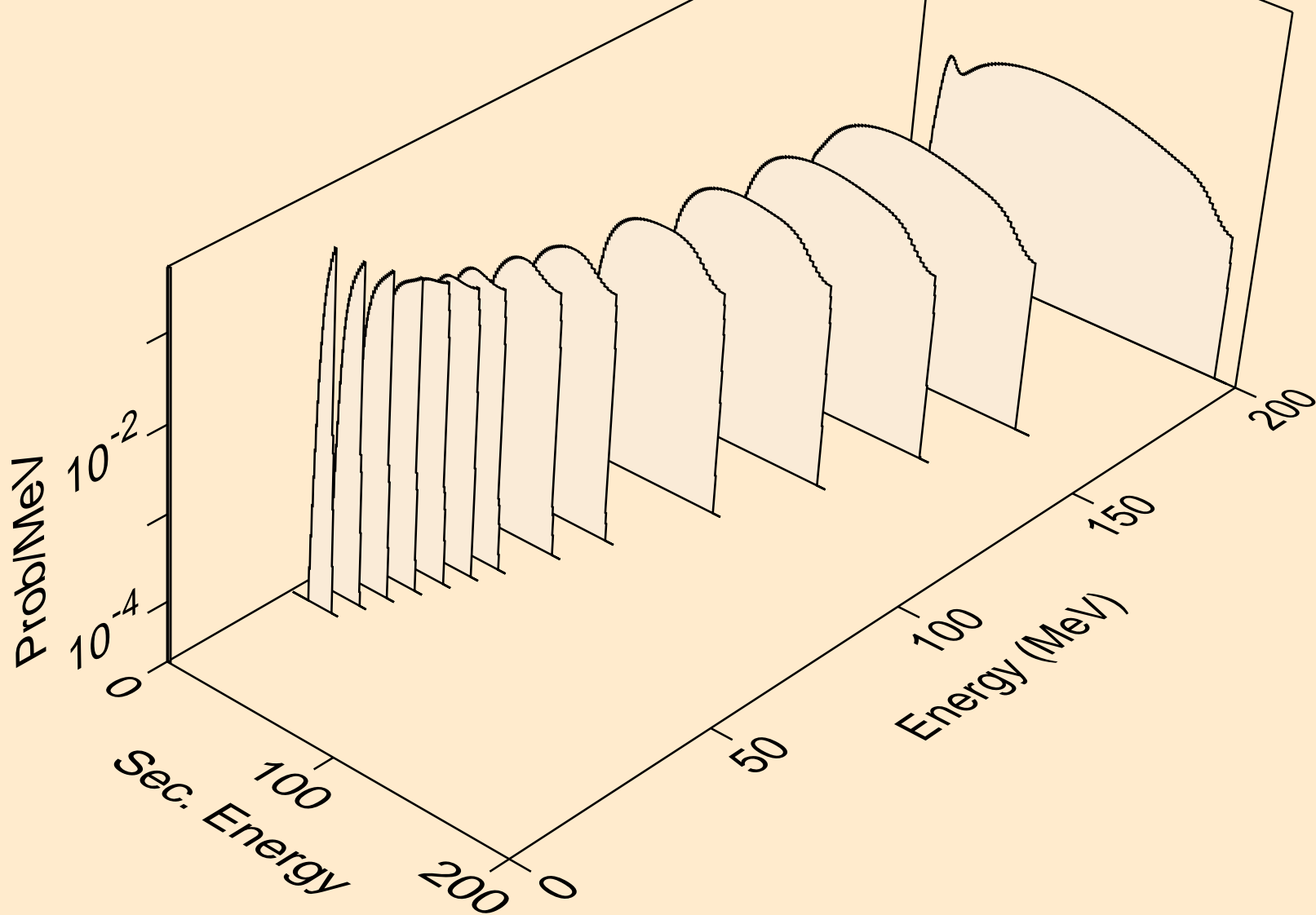



SM158 DEUTERON ACER TENDL-2021 LIBRARY; T=0.K  
he3s from (d,n\*)he3

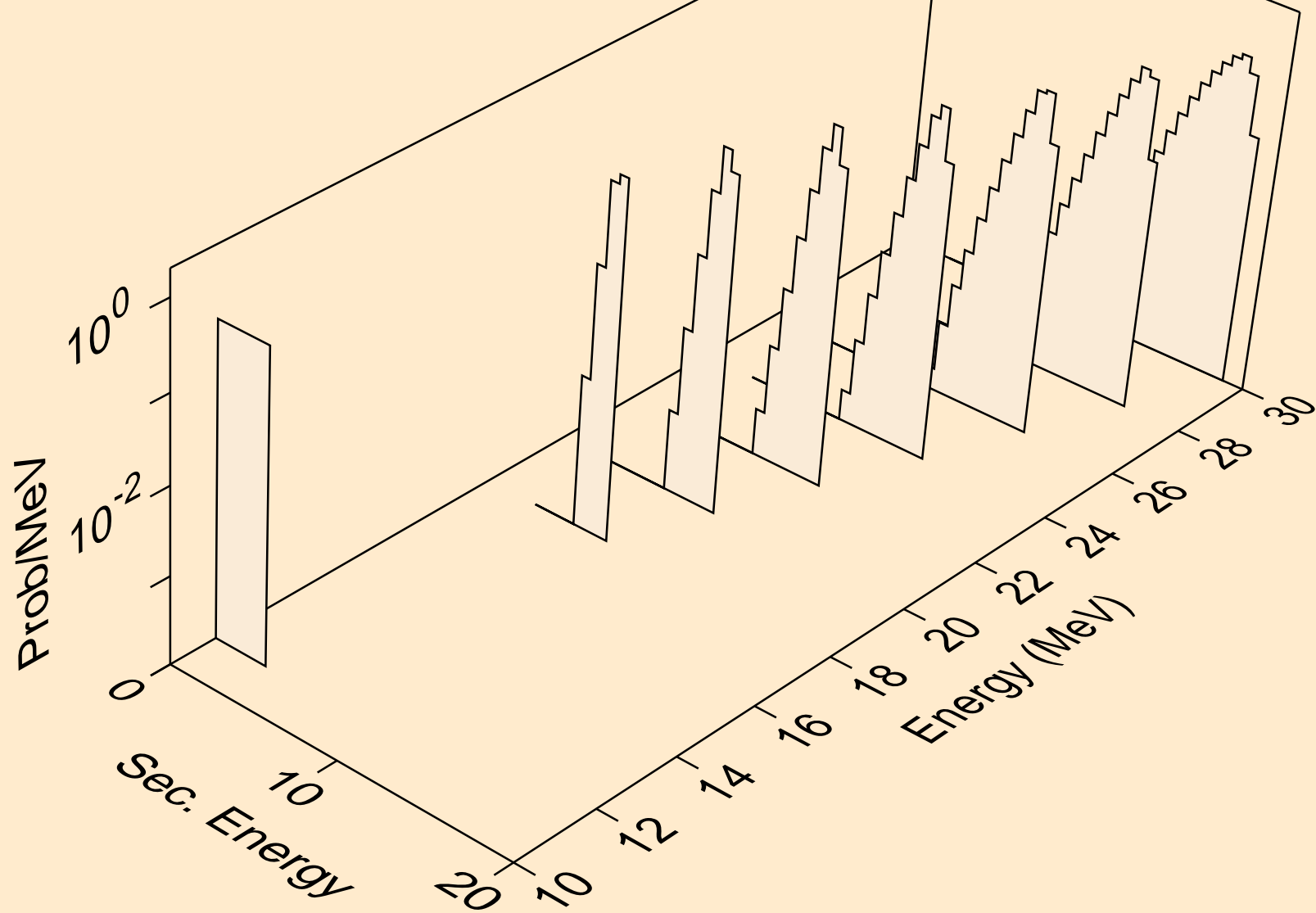

SM158 DEUTERON ACER TENDL-2021 LIBRARY; T=0.K  
he3s from (d,he3)

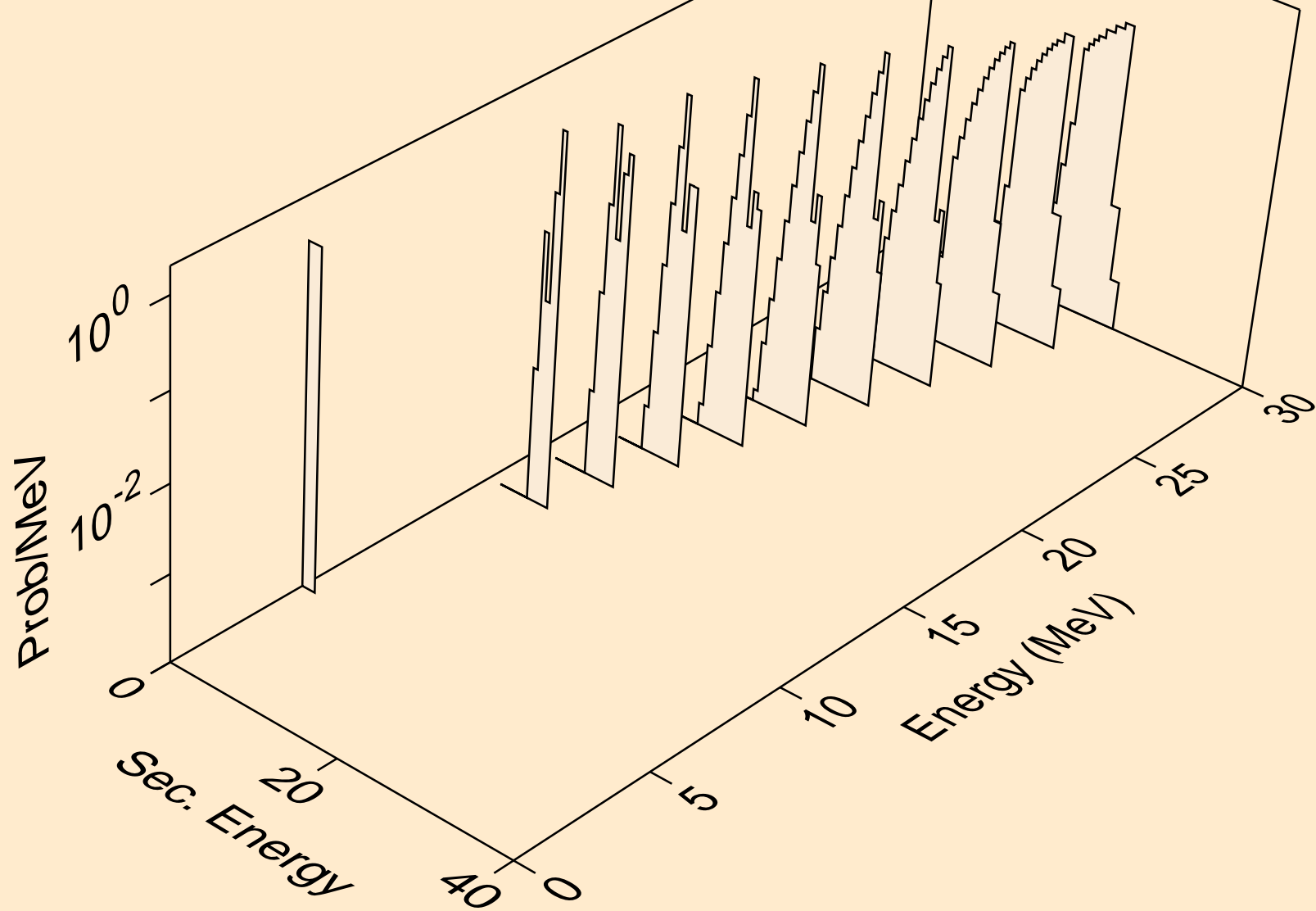

SM158 DEUTERON ACER TENDL-2021 LIBRARY; T=0.K  
alphas from (d,x)

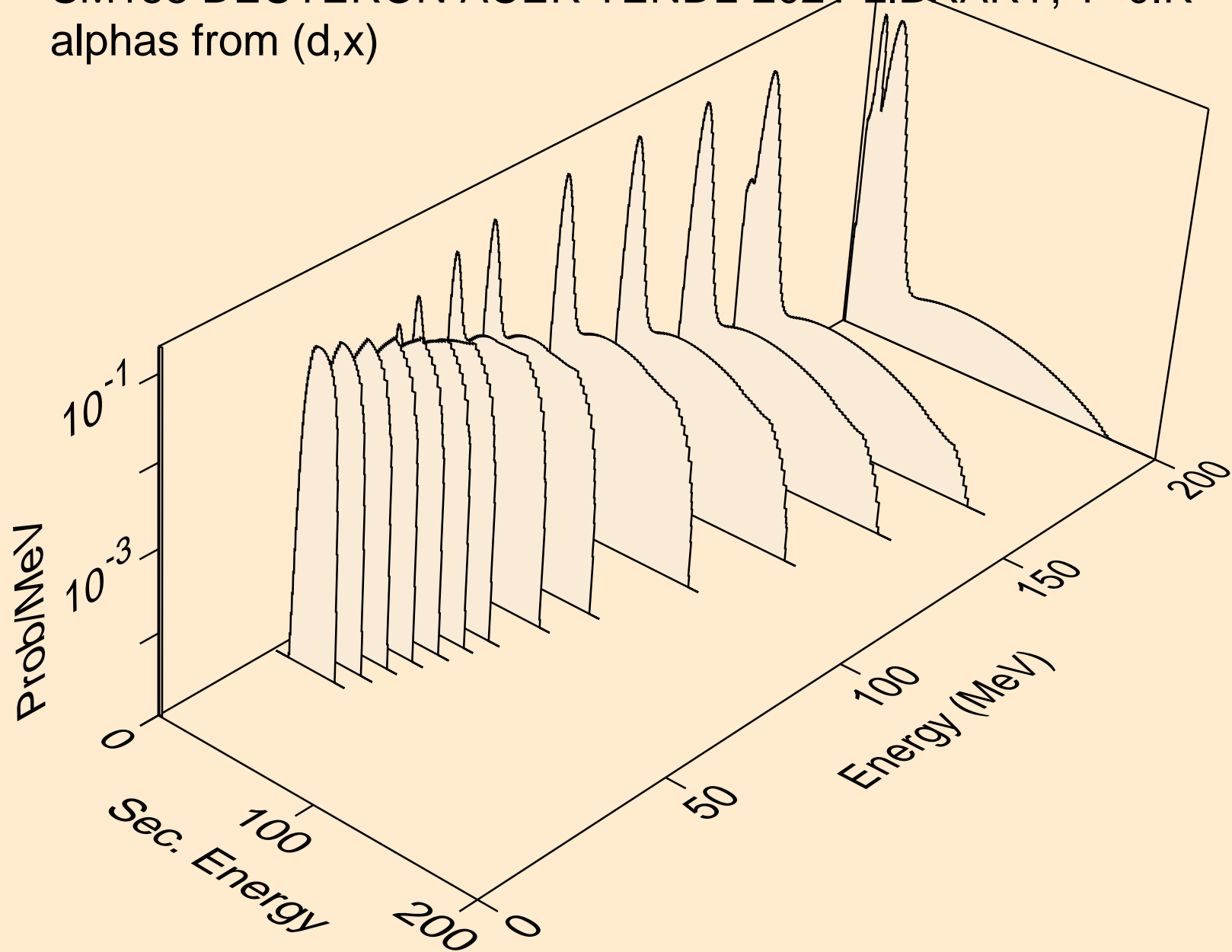

SM158 DEUTERON ACER TENDL-2021 LIBRARY; T=0.K  
alphas from (d,n\*)a

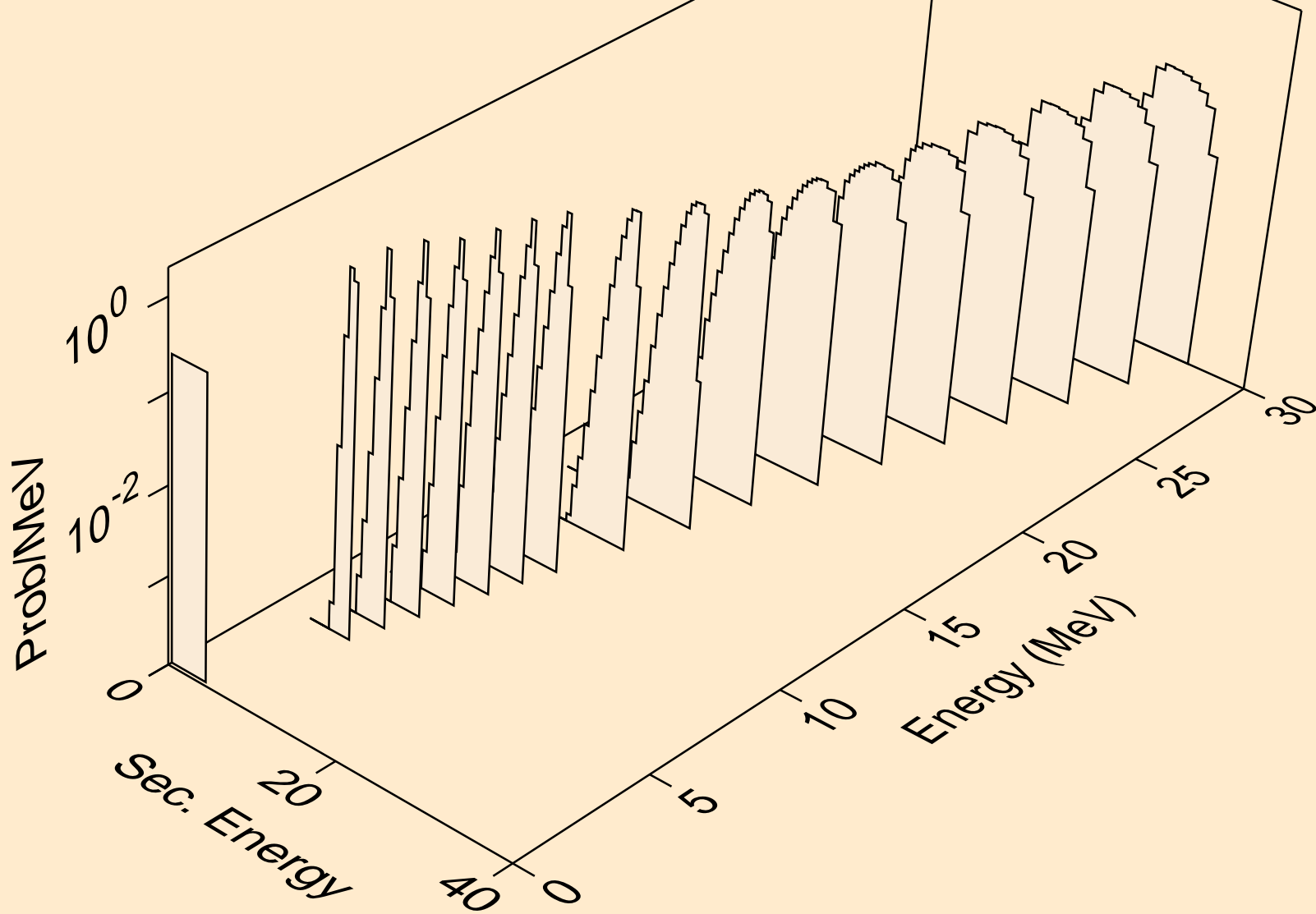

SM158 DEUTERON ACER TENDL-2021 LIBRARY; T=0.K  
alphas from (d,2n)a

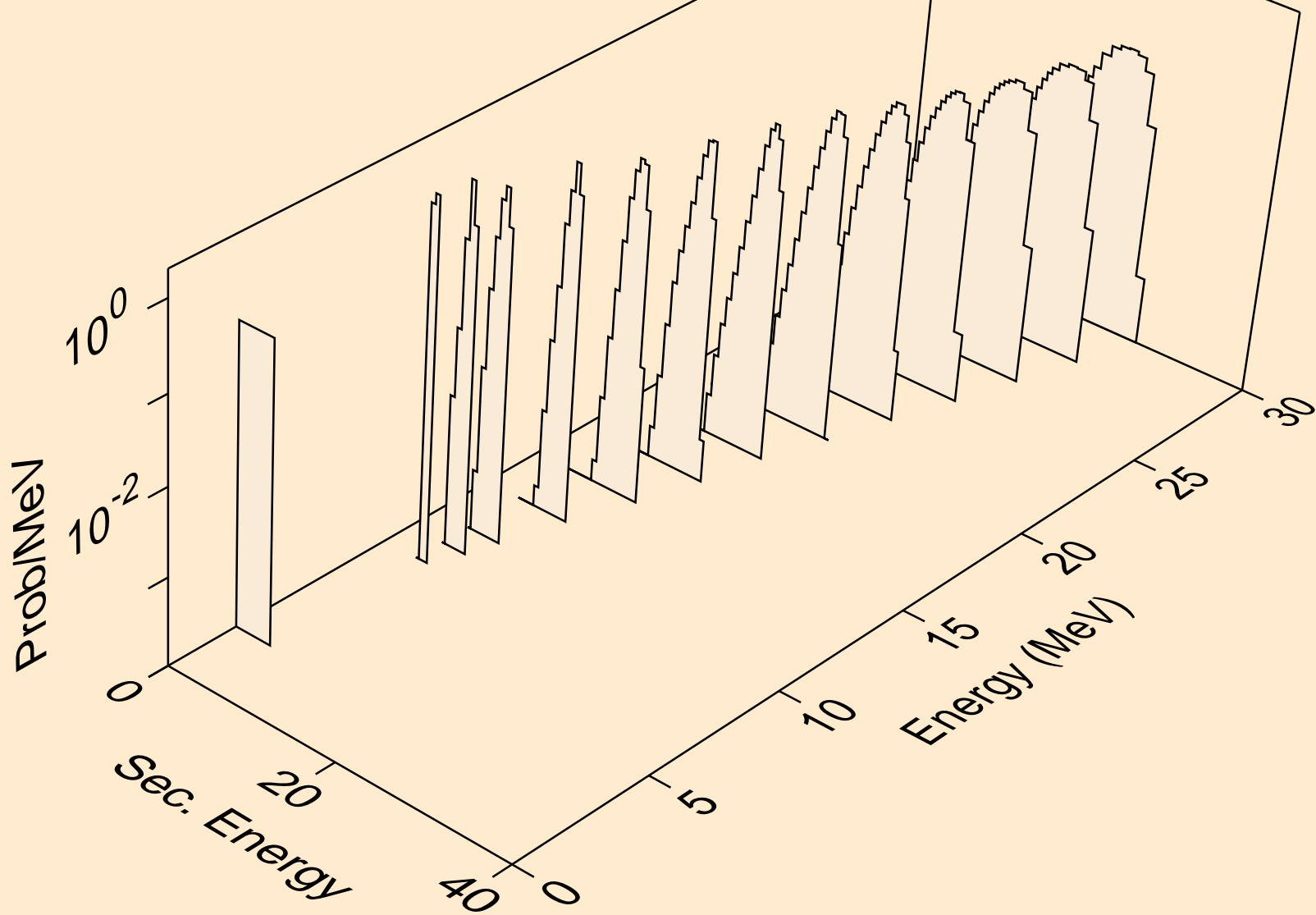

SM158 DEUTERON ACER TENDL-2021 LIBRARY; T=0.K  
alphas from (d,3n)a

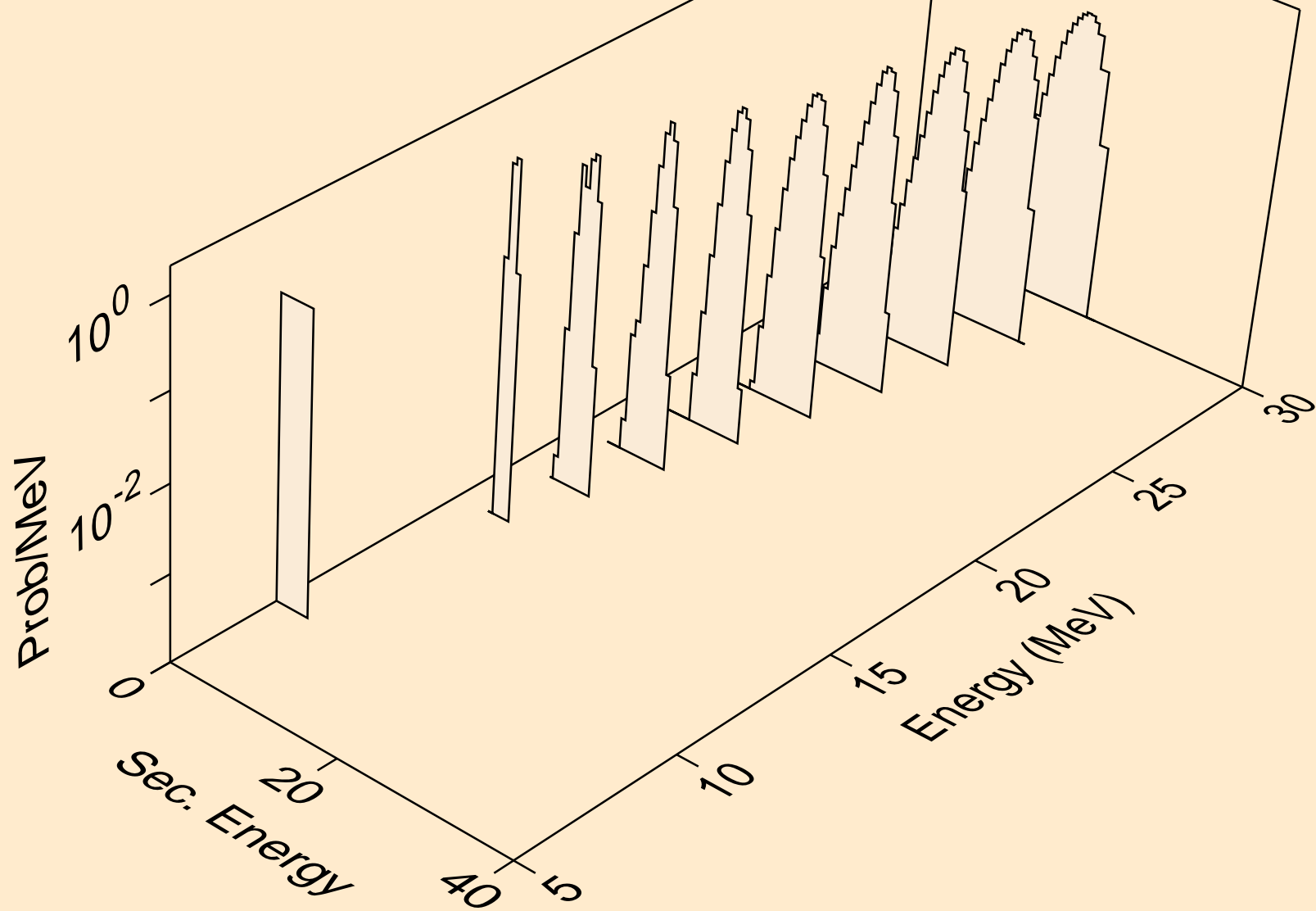

SM158 DEUTERON ACER TENDL-2021 LIBRARY; T=0.K  
alphas from (d,npa)

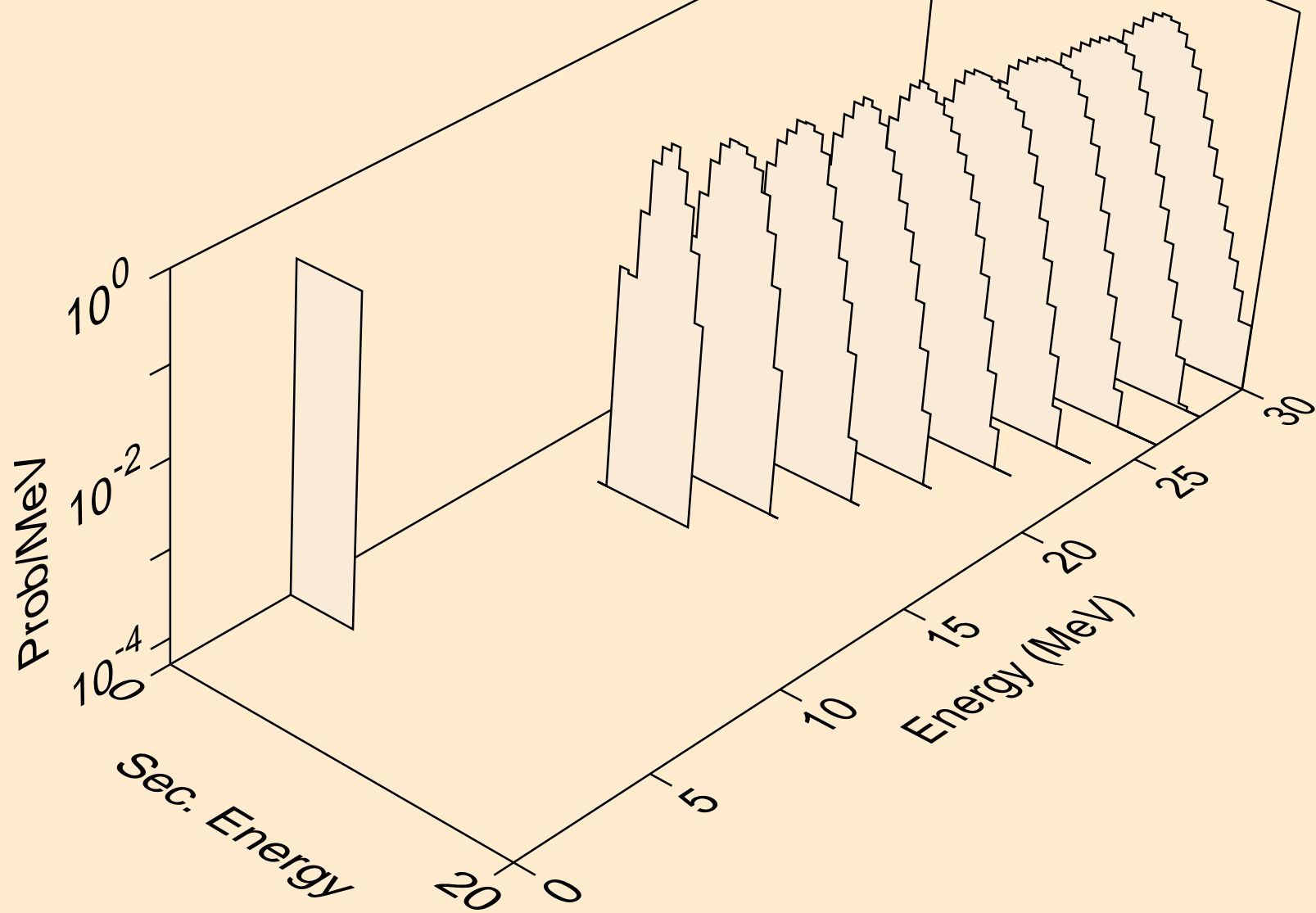

SM158 DEUTERON ACER TENDL-2021 LIBRARY; T=0.K  
alphas from (d,a)

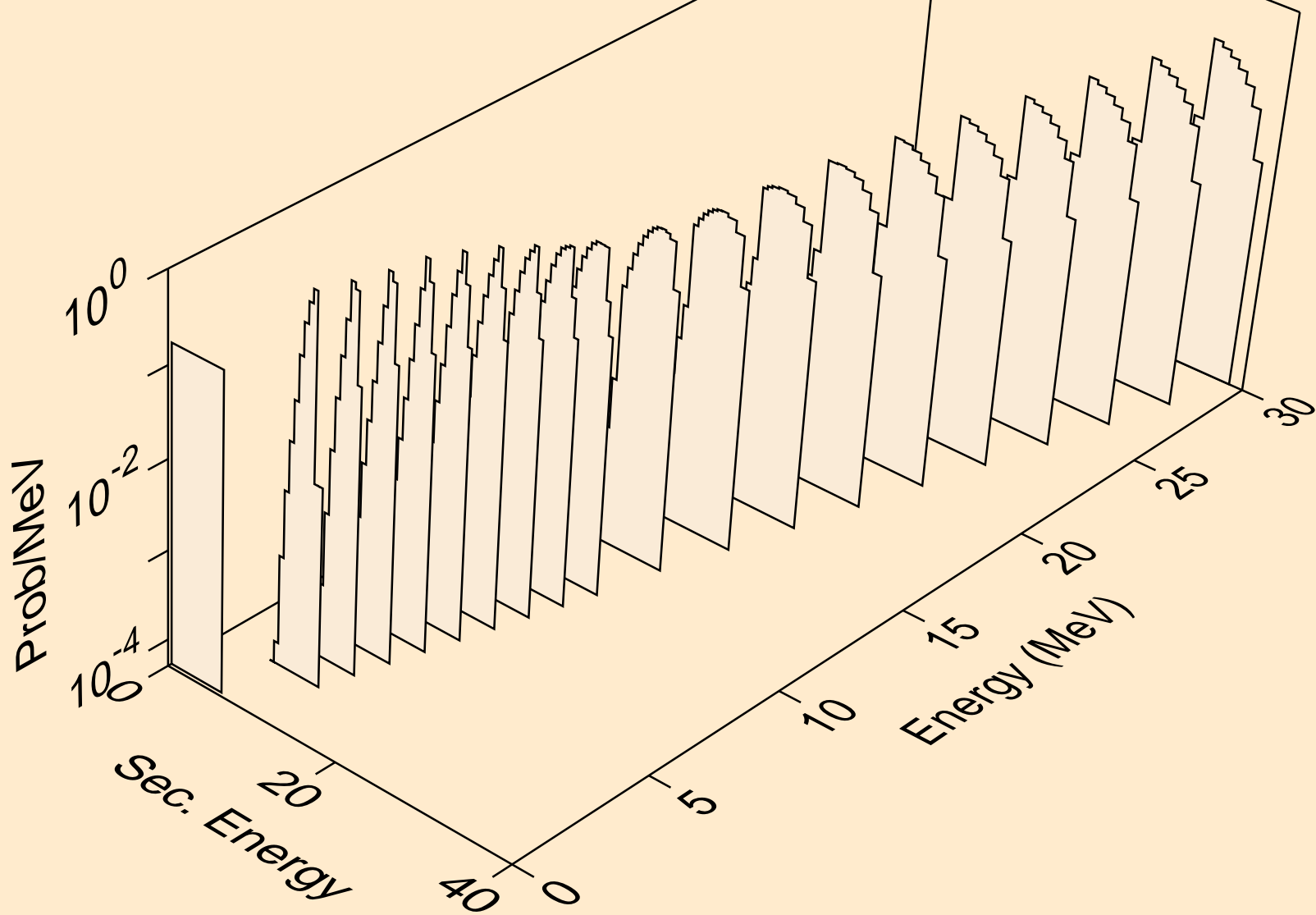



SM158 DEUTERON ACER TENDL-2021 LIBRARY; T=0.K  
alphas from (d,pa)

