

# TL213 DEUTERON ACER TENDL-2021 LIBRARY; T=0.K

## Principal cross sections

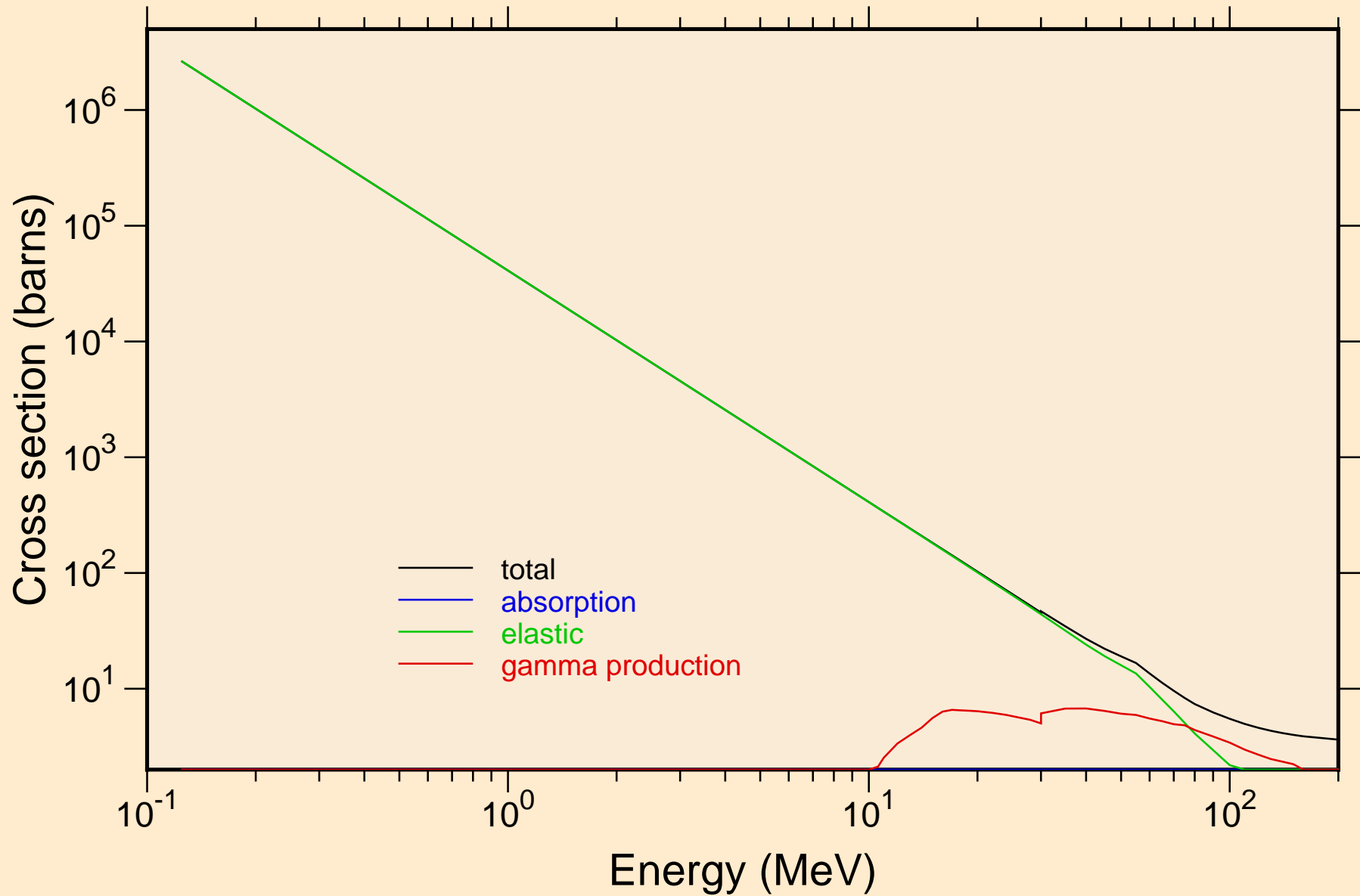

# TL213 DEUTERON ACER TENDL-2021 LIBRARY; T=0.K

## Heating

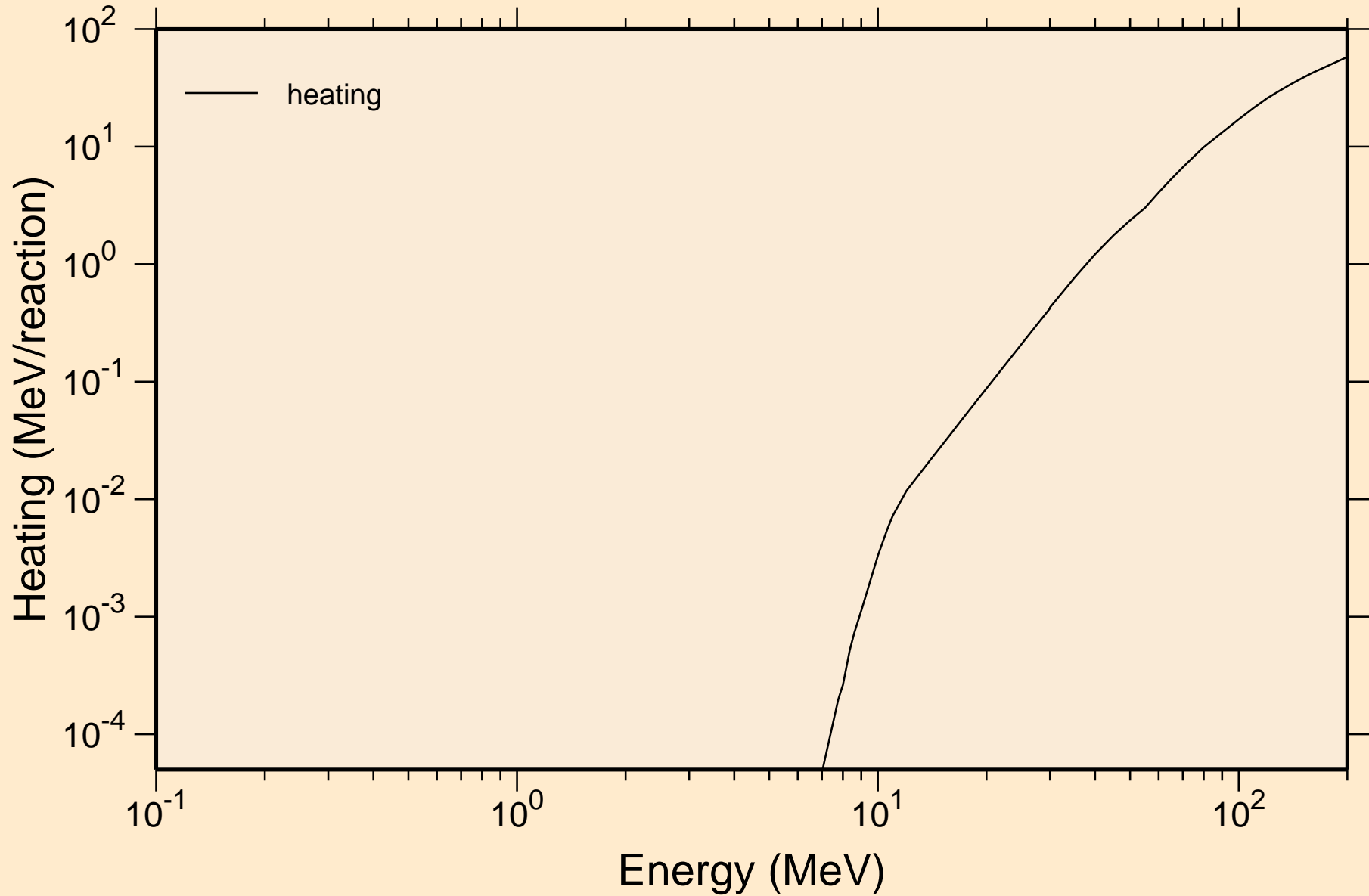

TL213 DEUTERON ACER TENDL-2021 LIBRARY; T=0.K  
Principal cross sections

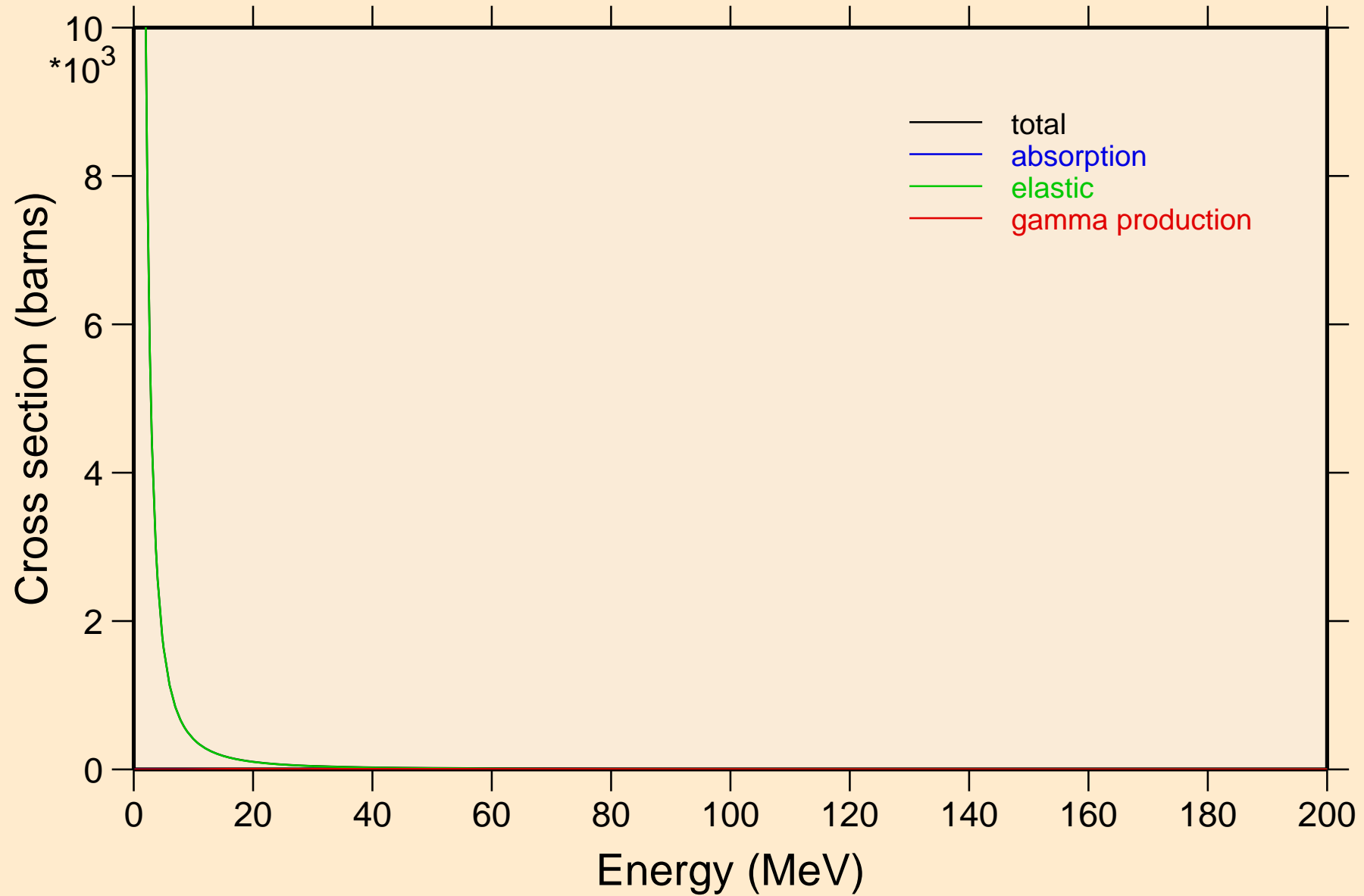

TL213 DEUTERON ACER TENDL-2021 LIBRARY; T=0.K

Heating

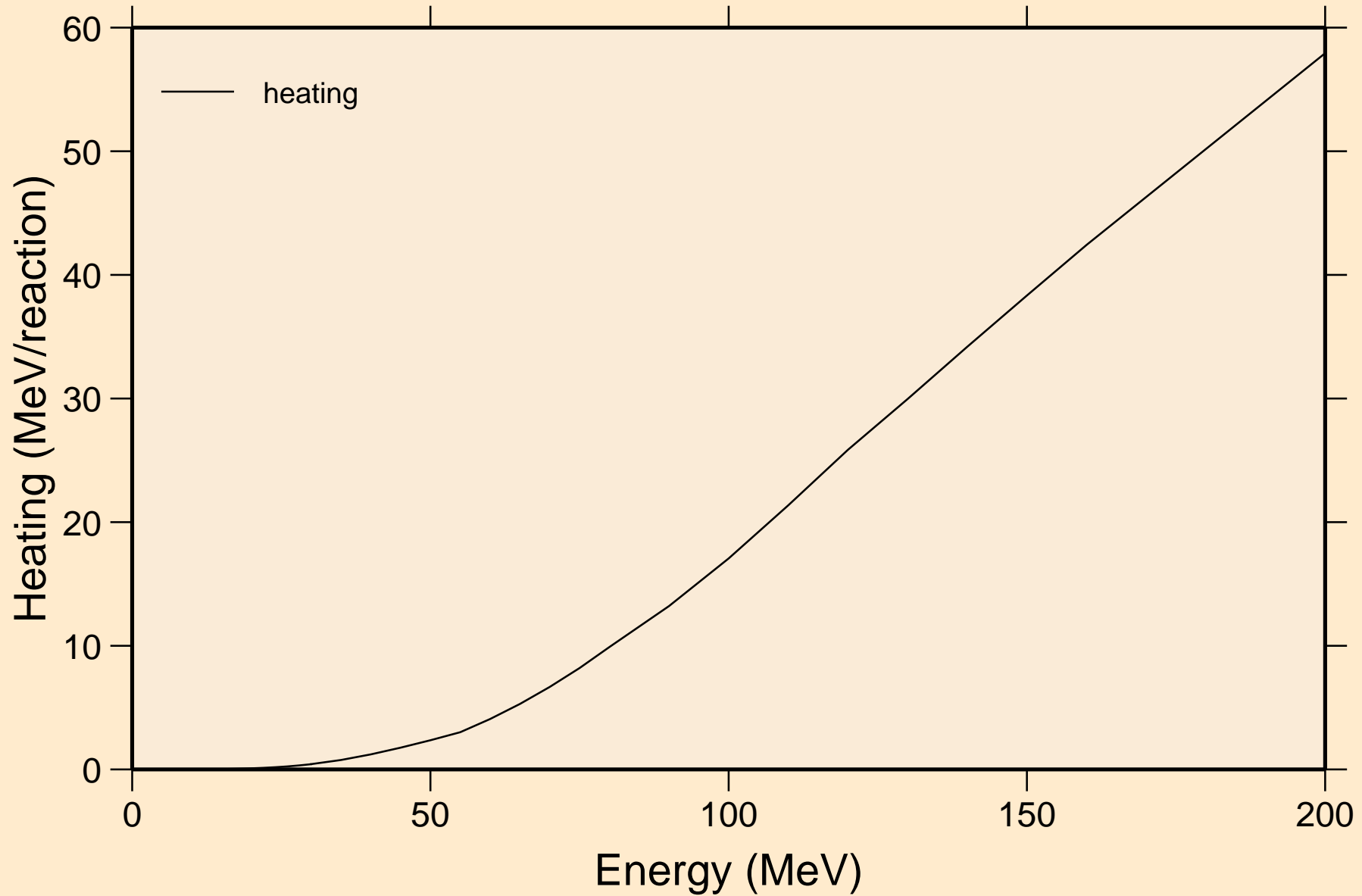

TL213 DEUTERON ACER TENDL-2021 LIBRARY; T=0.K  
Threshold reactions

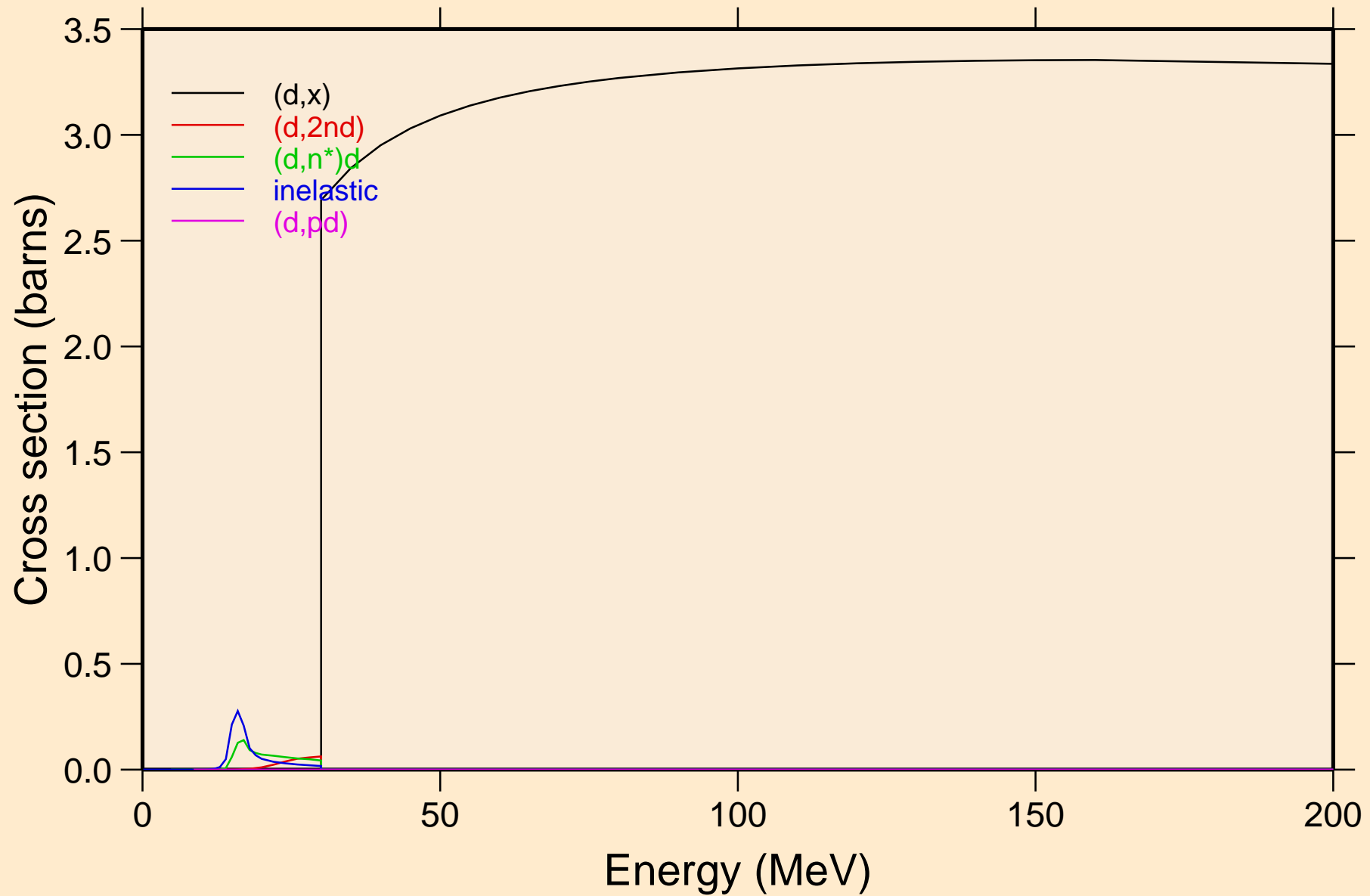

TL213 DEUTERON ACER TENDL-2021 LIBRARY; T=0.K  
angular distribution for elastic

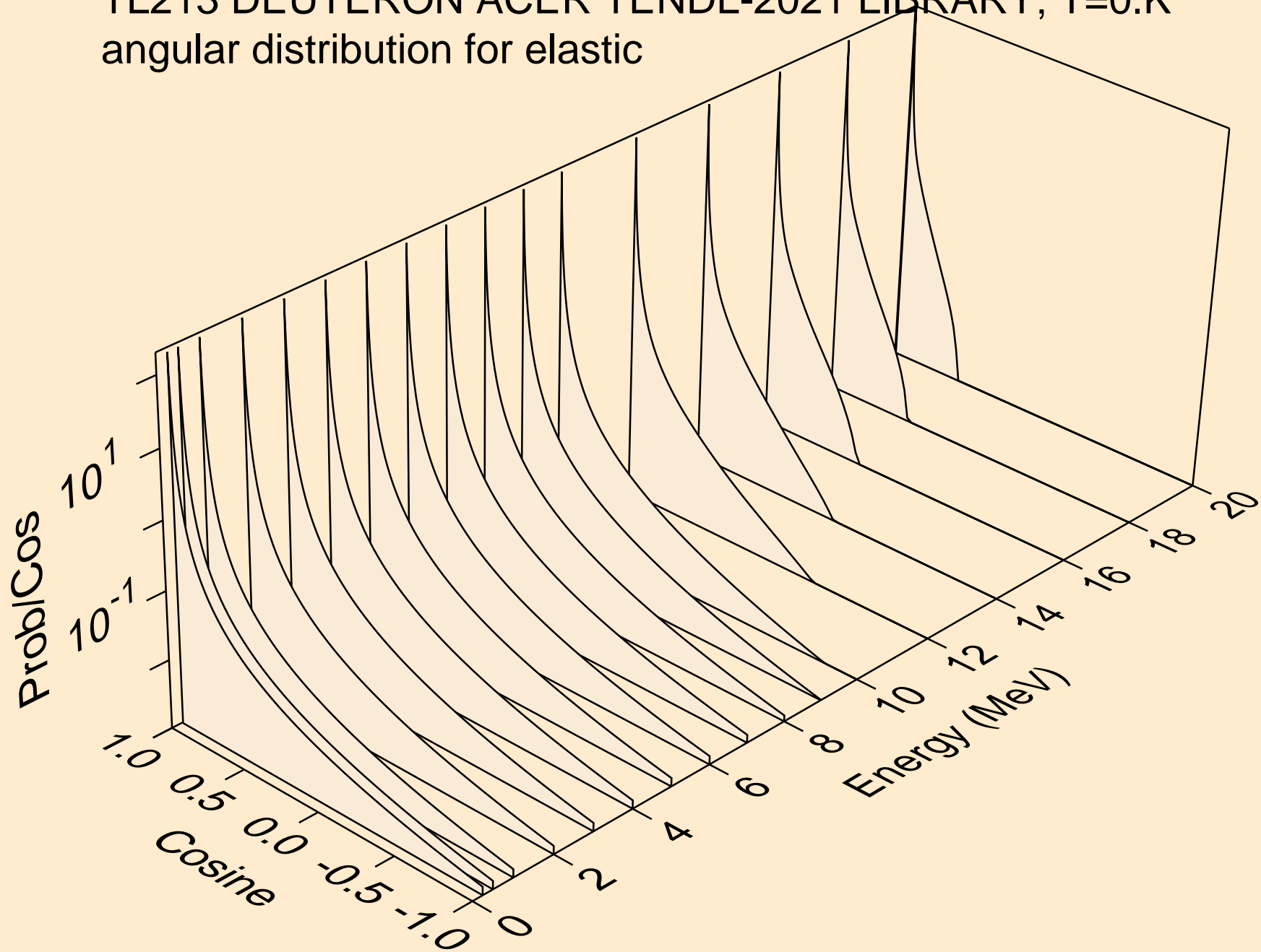

TL213 DEUTERON ACER TENDL-2021 LIBRARY; T=0.K  
angular distribution for elastic

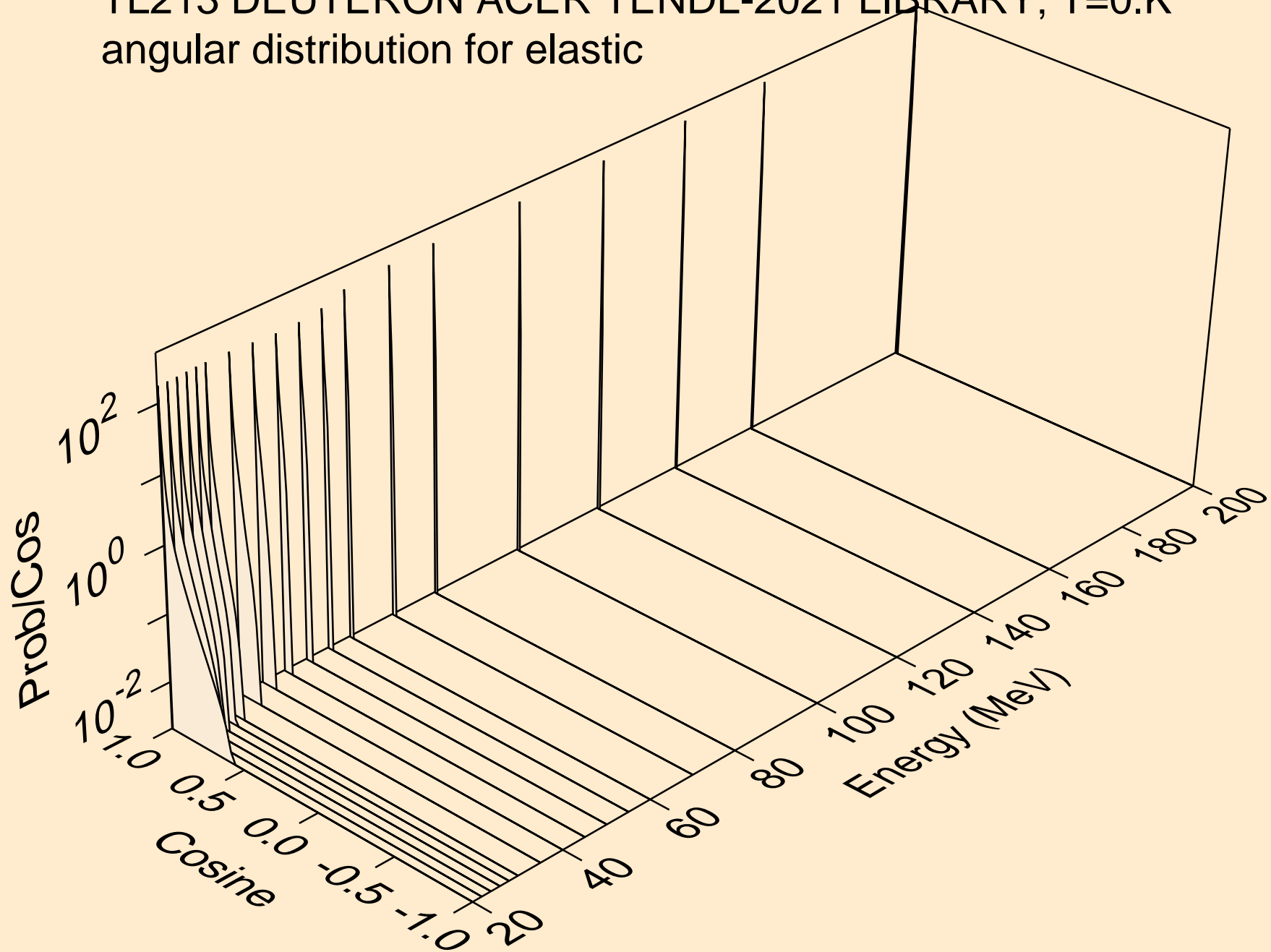

TL213 DEUTERON ACER TENDL-2021 LIBRARY; T=0.K  
Deuteron emission for (d,x)

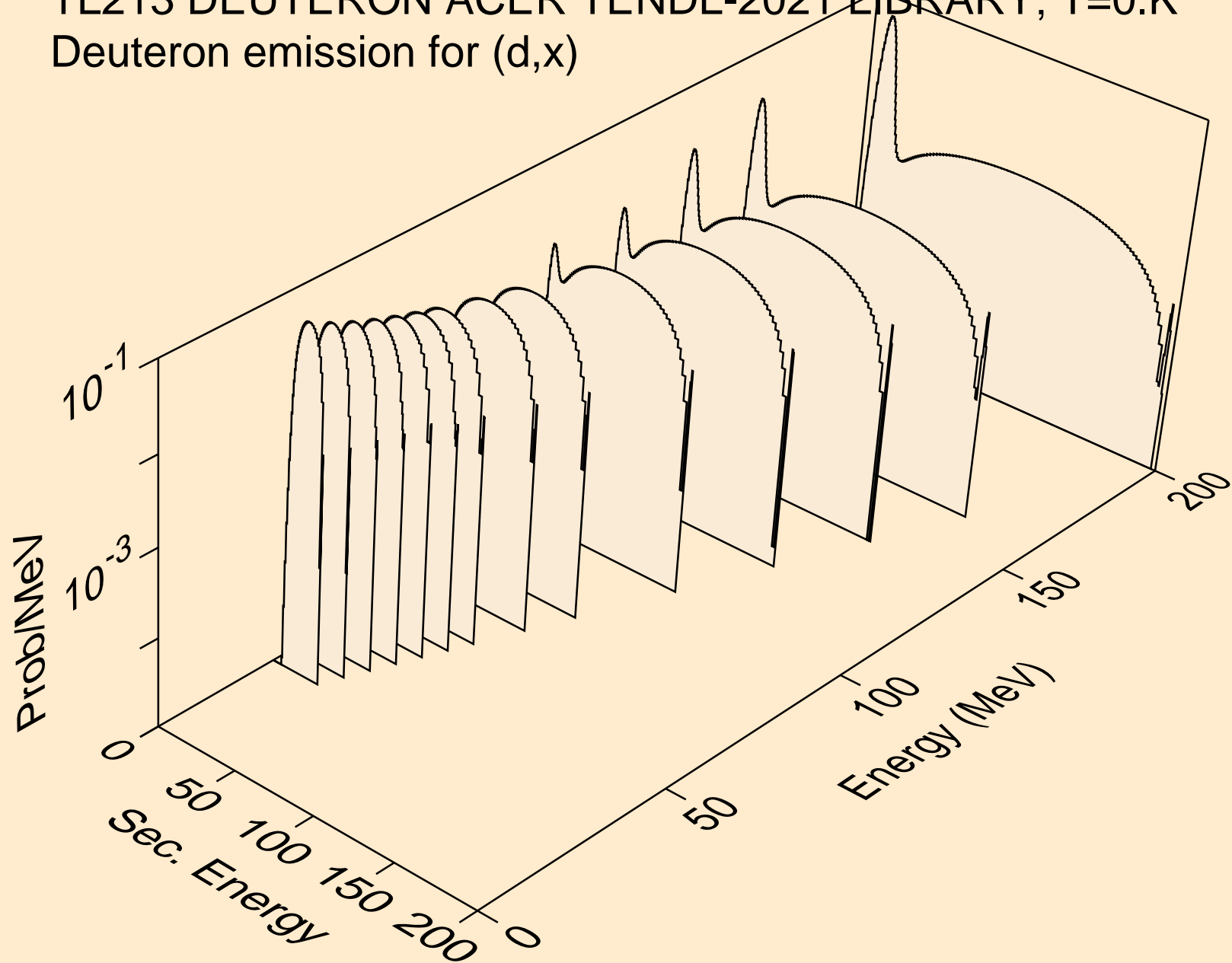



TL213 DEUTERON ACER TENDL-2021 LIBRARY; T=0.K  
Deuteron emission for (d,2nd)

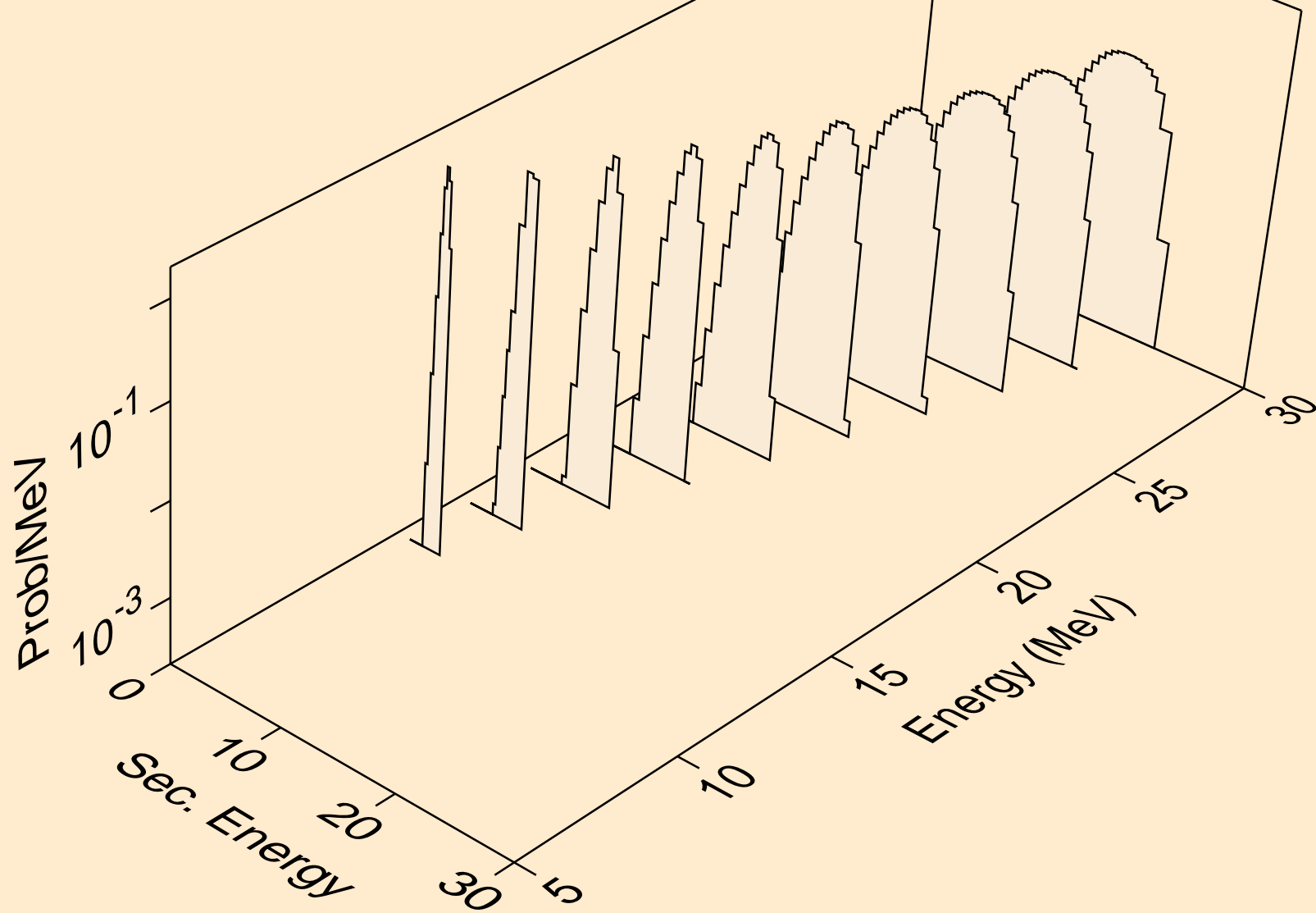

TL213 DEUTERON ACER TENDL-2021 LIBRARY; T=0.K  
Deuteron emission for (d,n\*)d

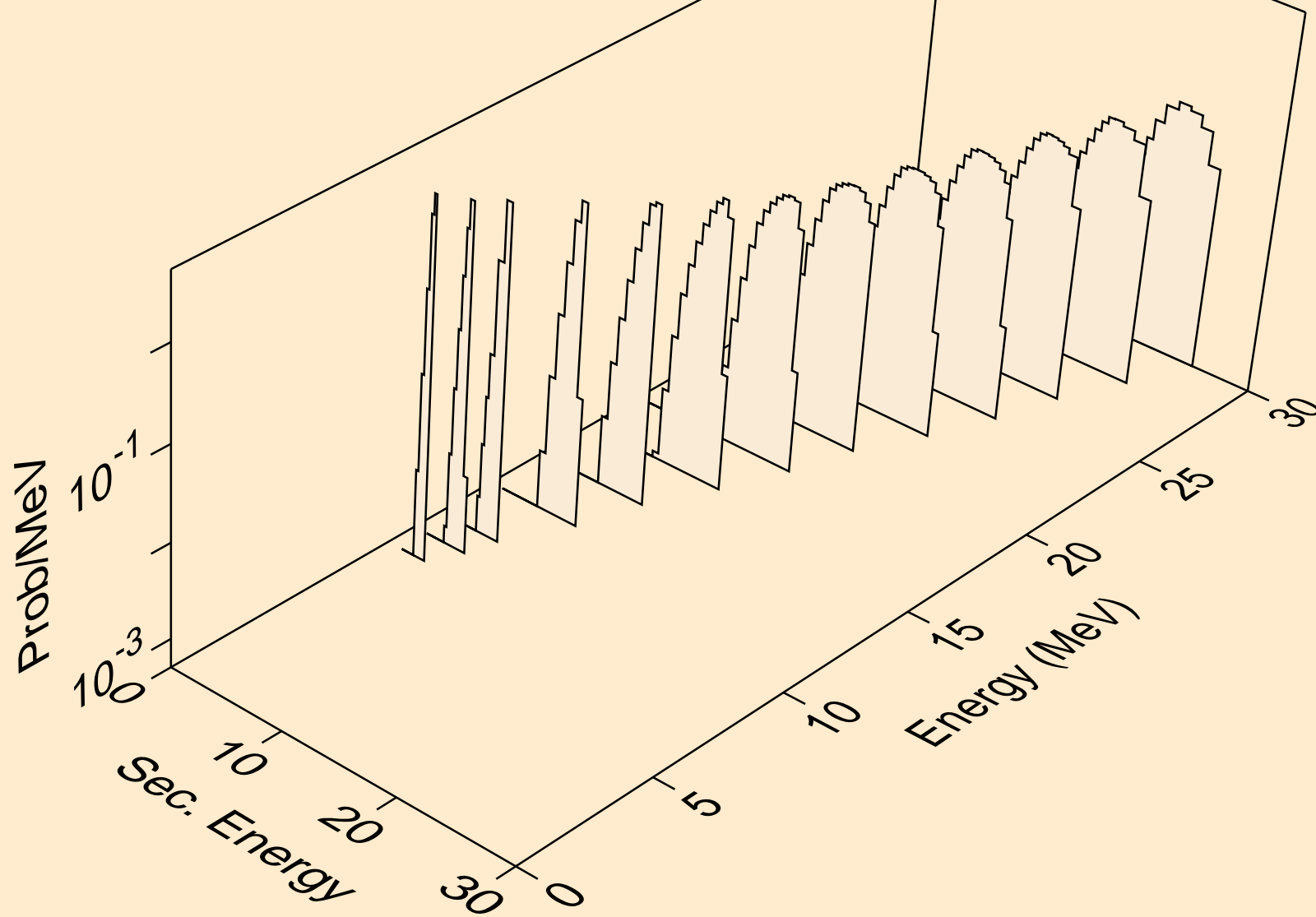

TL213 DEUTERON ACER TENDL-2021 LIBRARY; T=0.K  
Deuteron emission for inelastic

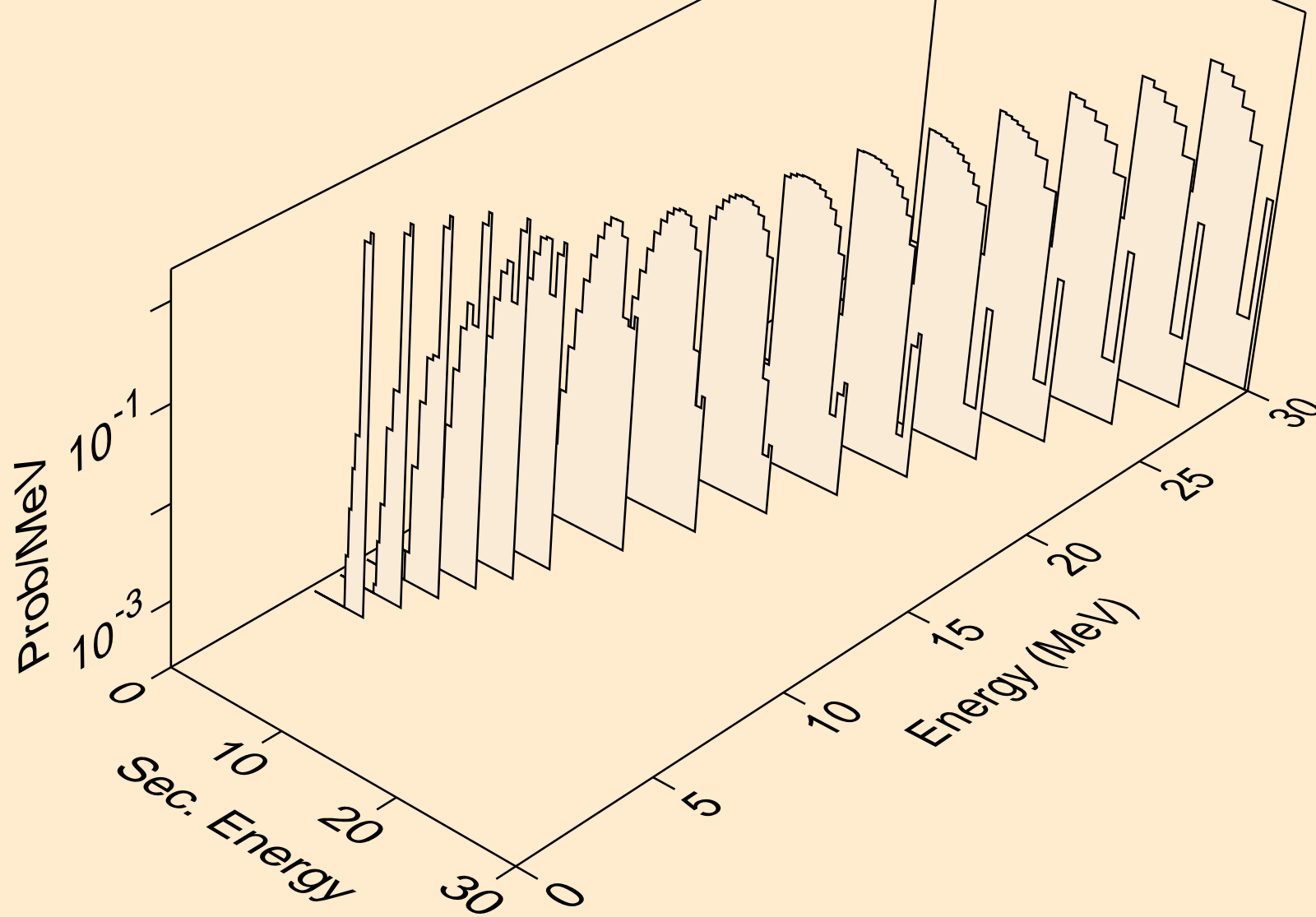

TL213 DEUTERON ACER TENDL-2021 LIBRARY; T=0.K  
Deuteron emission for (d,pd)

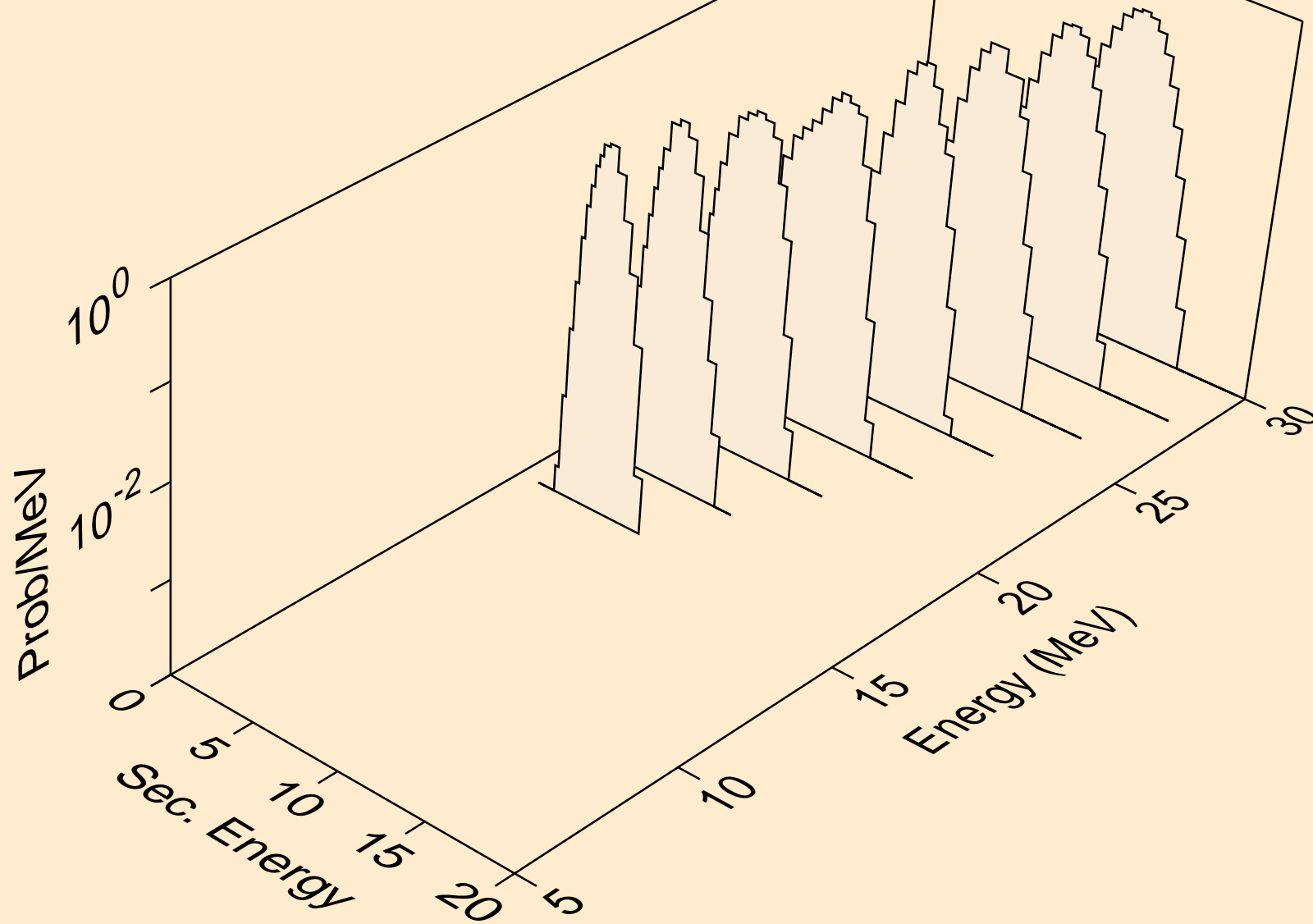

TL213 DEUTERON ACER TENDL-2021 LIBRARY; T=0.K  
Photon emission for (z,n)

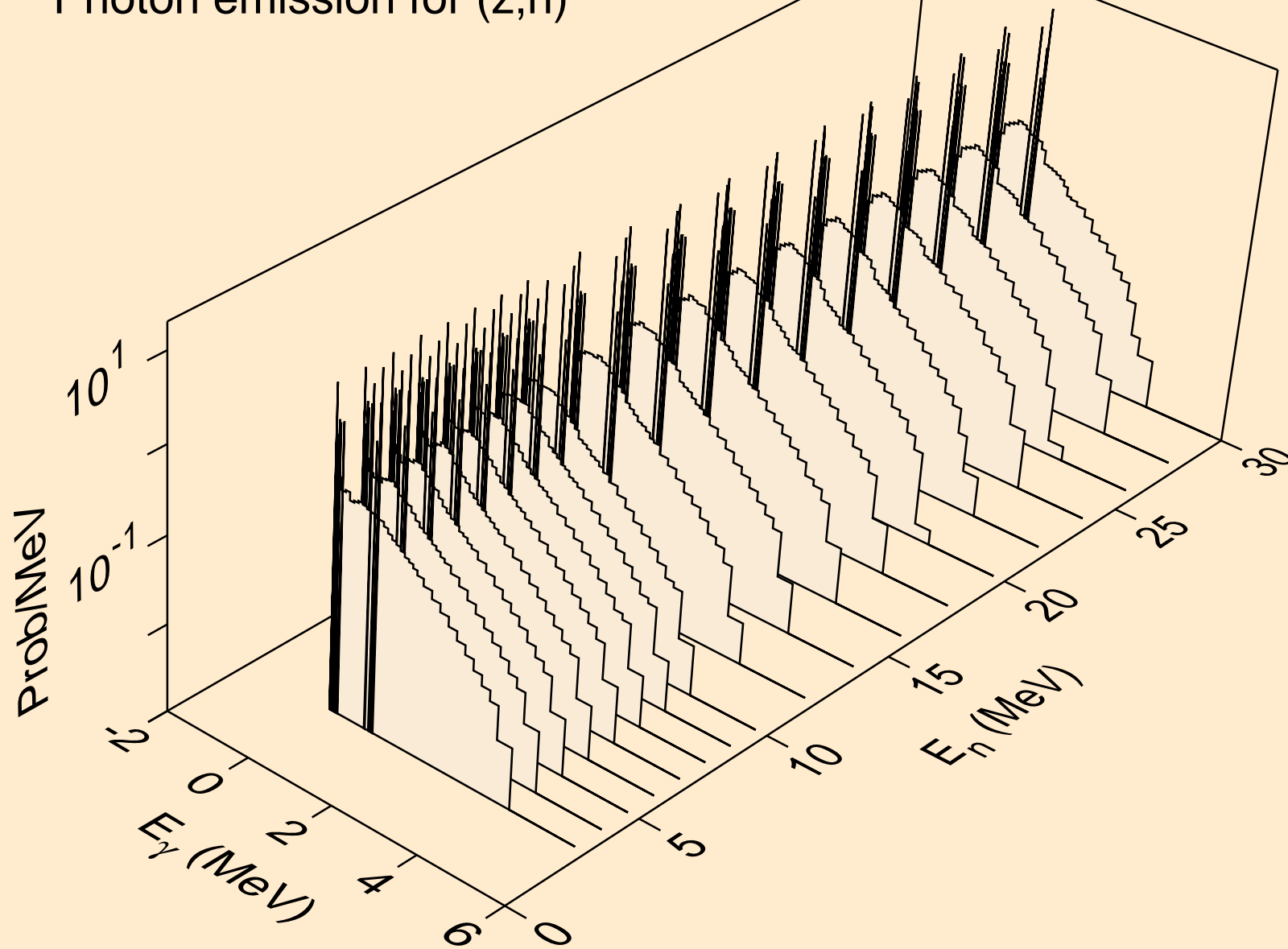

TL213 DEUTERON ACER TENDL-2021 LIBRARY; T=0.K  
Photon emission for (n,x)

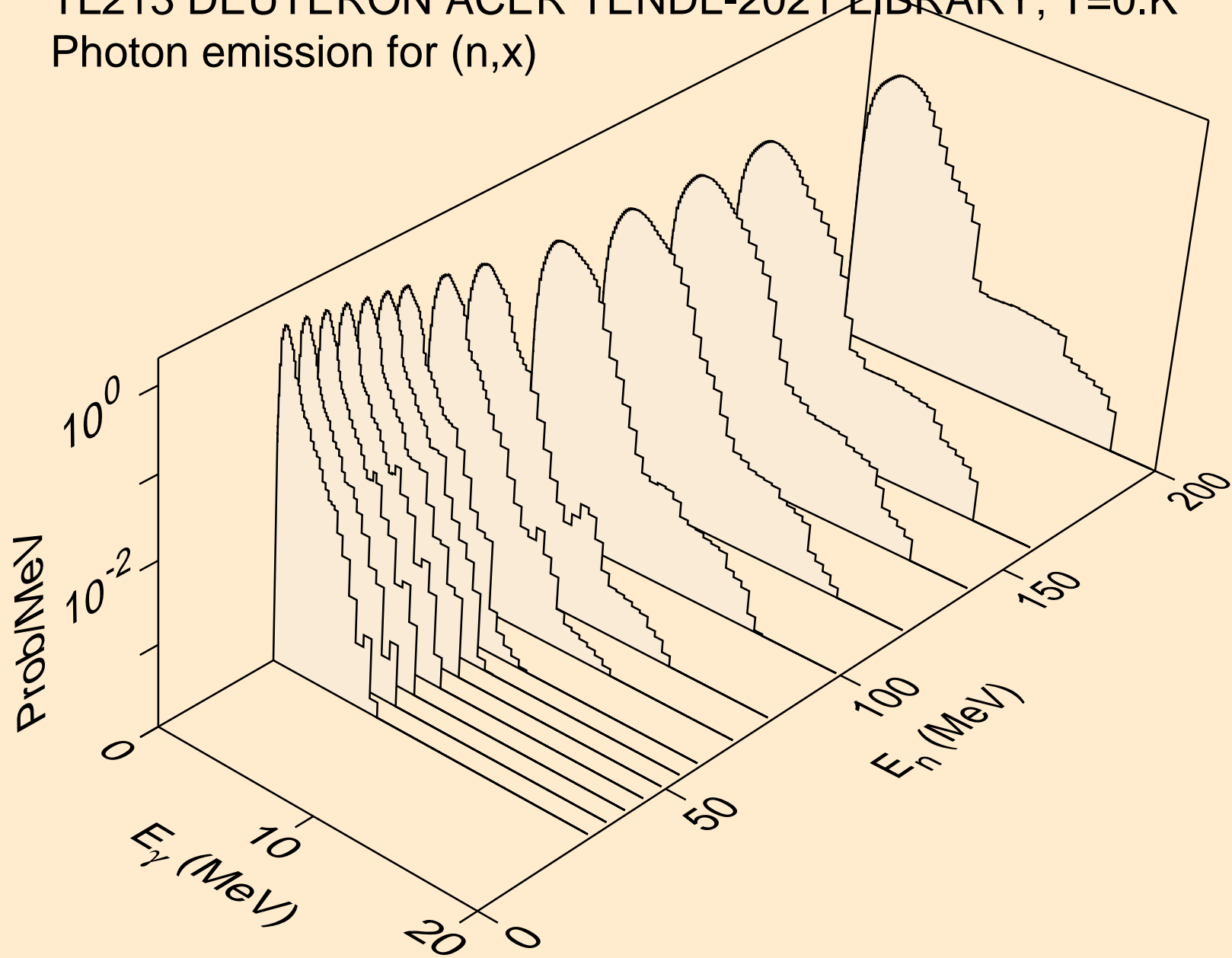

TL213 DEUTERON ACER TENDL-2021 LIBRARY; T=0.K  
Photon emission for (n,2nd)

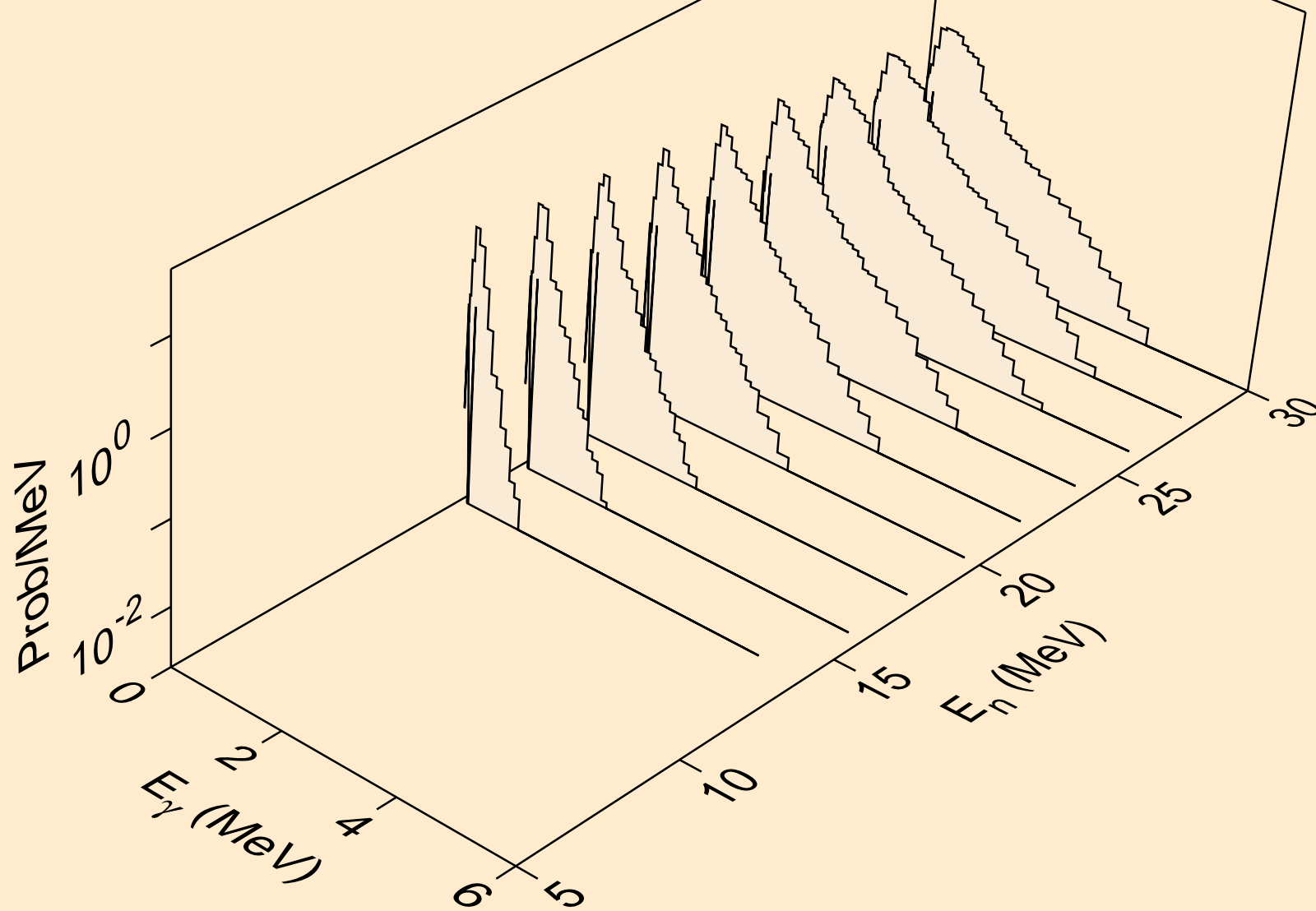

TL213 DEUTERON ACER TENDL-2021 LIBRARY; T=0.K  
Photon emission for (n,2n)

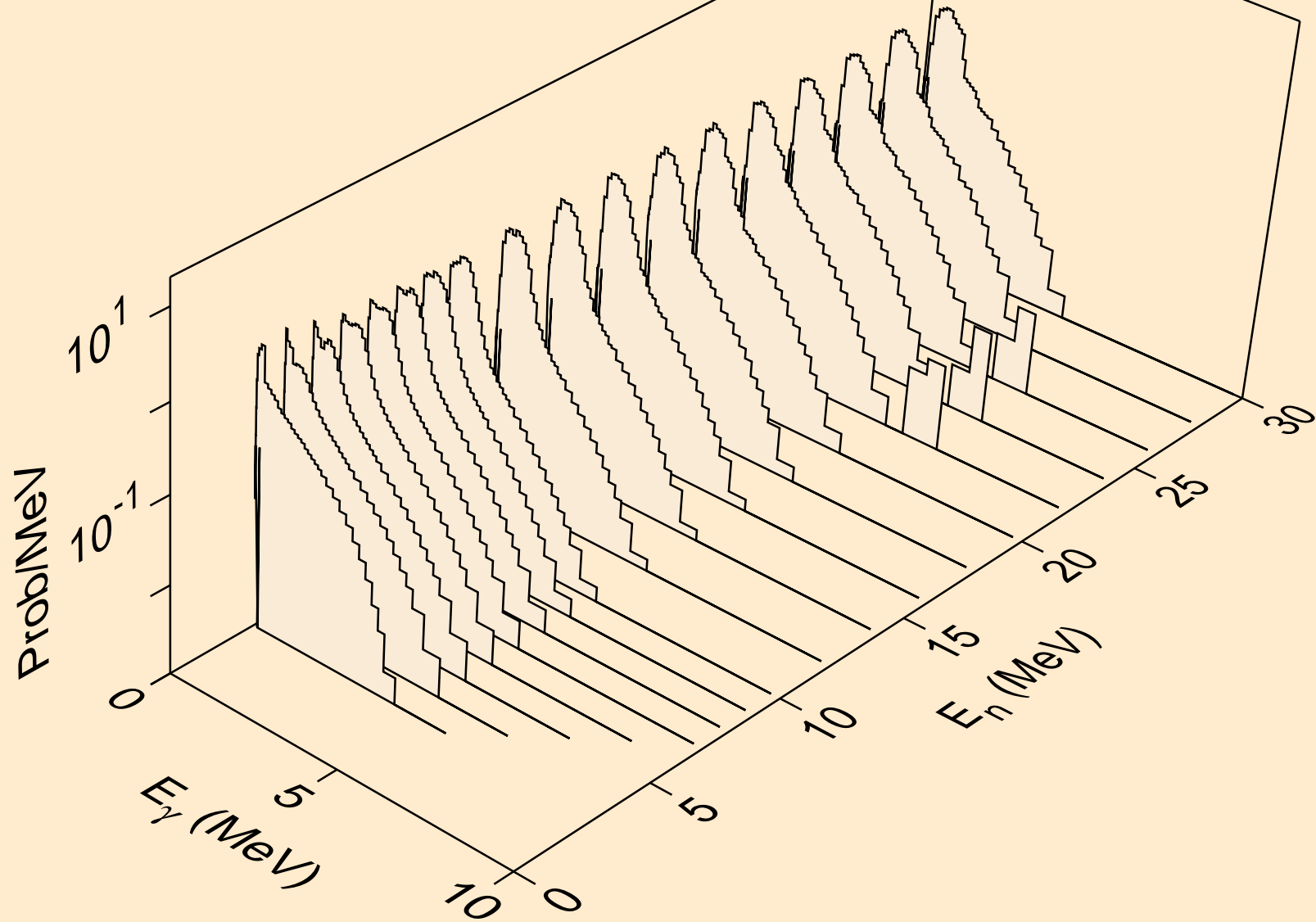



TL213 DEUTERON ACER TENDL-2021 LIBRARY; T=0.K  
Photon emission for (n,3n)

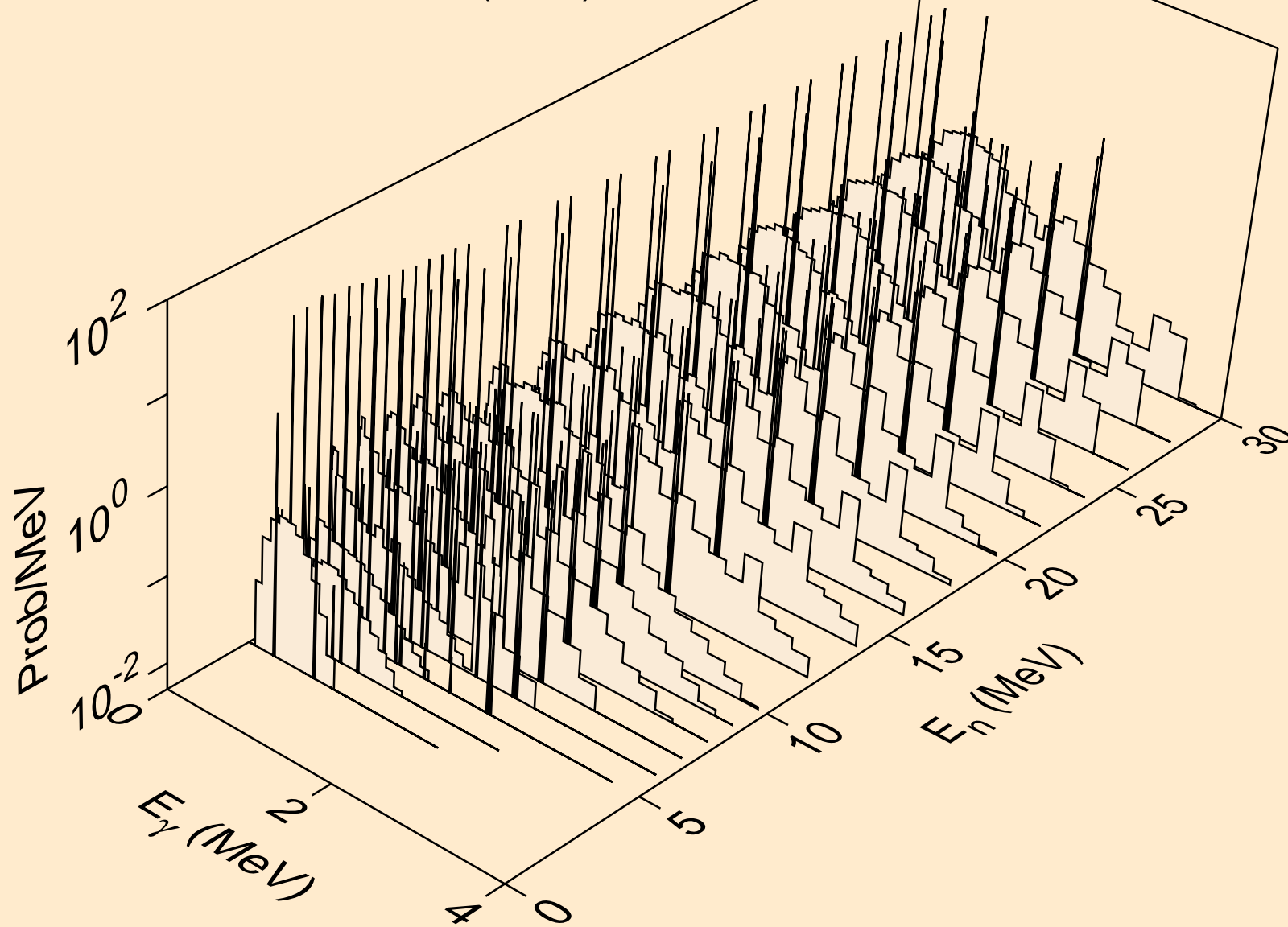

TL213 DEUTERON ACER TENDL-2021 LIBRARY; T=0.K  
Photon emission for (n,n\*)a

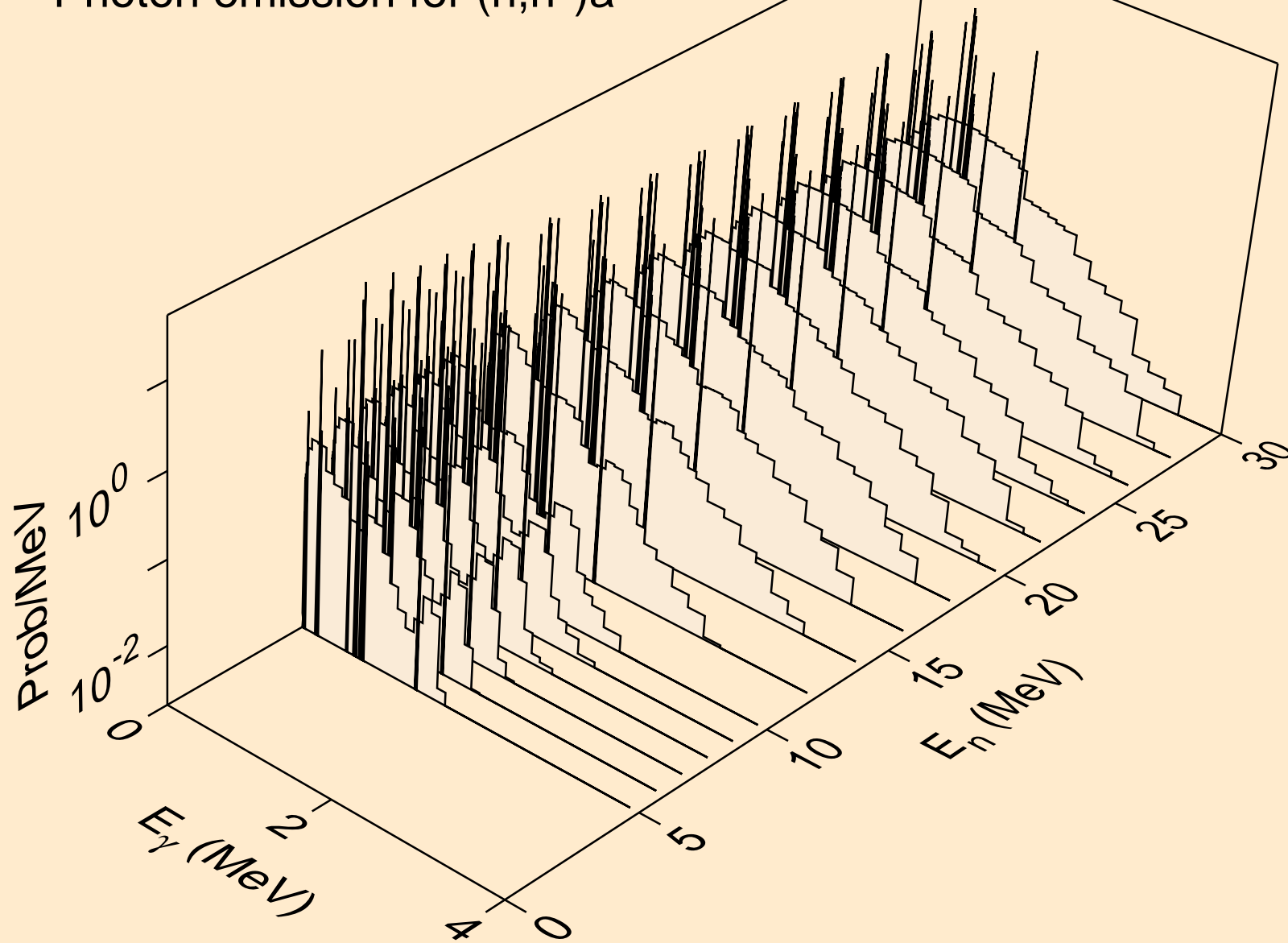

TL213 DEUTERON ACER TENDL-2021 LIBRARY; T=0.K  
Photon emission for (n,2n)a

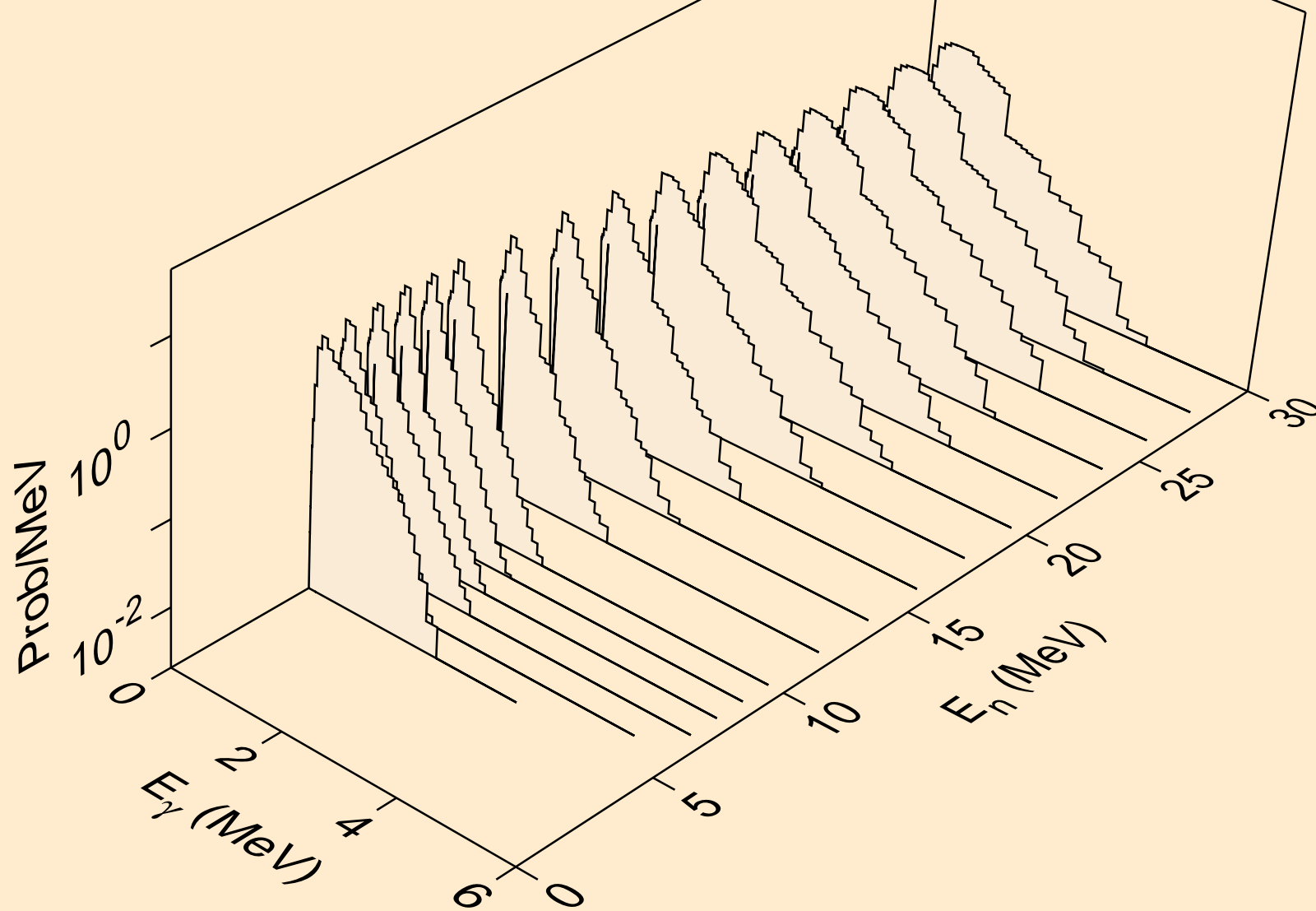

TL213 DEUTERON ACER TENDL-2021 LIBRARY; T=0.K  
Photon emission for (n,3n)a

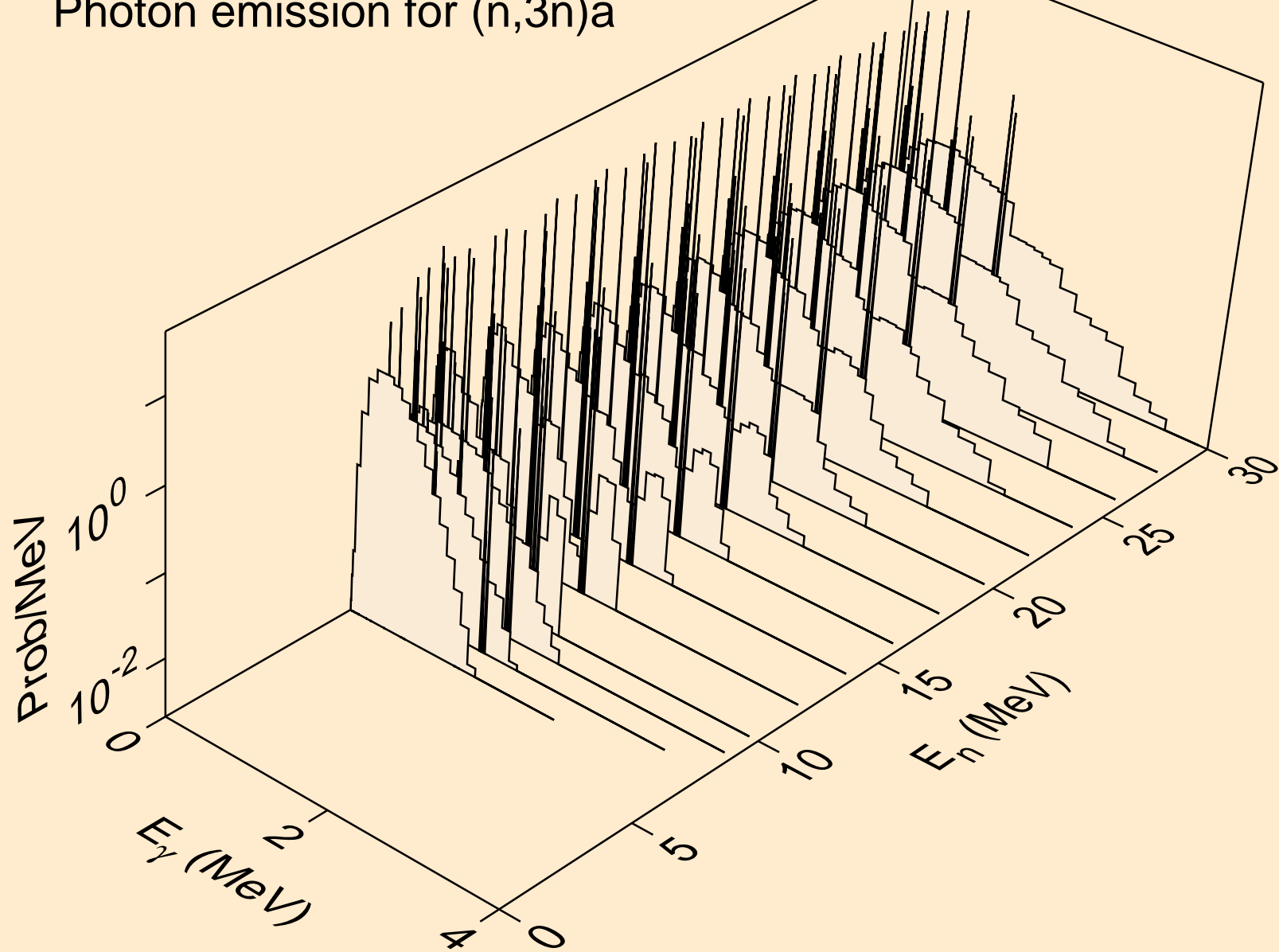

TL213 DEUTERON ACER TENDL-2021 LIBRARY; T=0.K  
Photon emission for (n,n\*)p

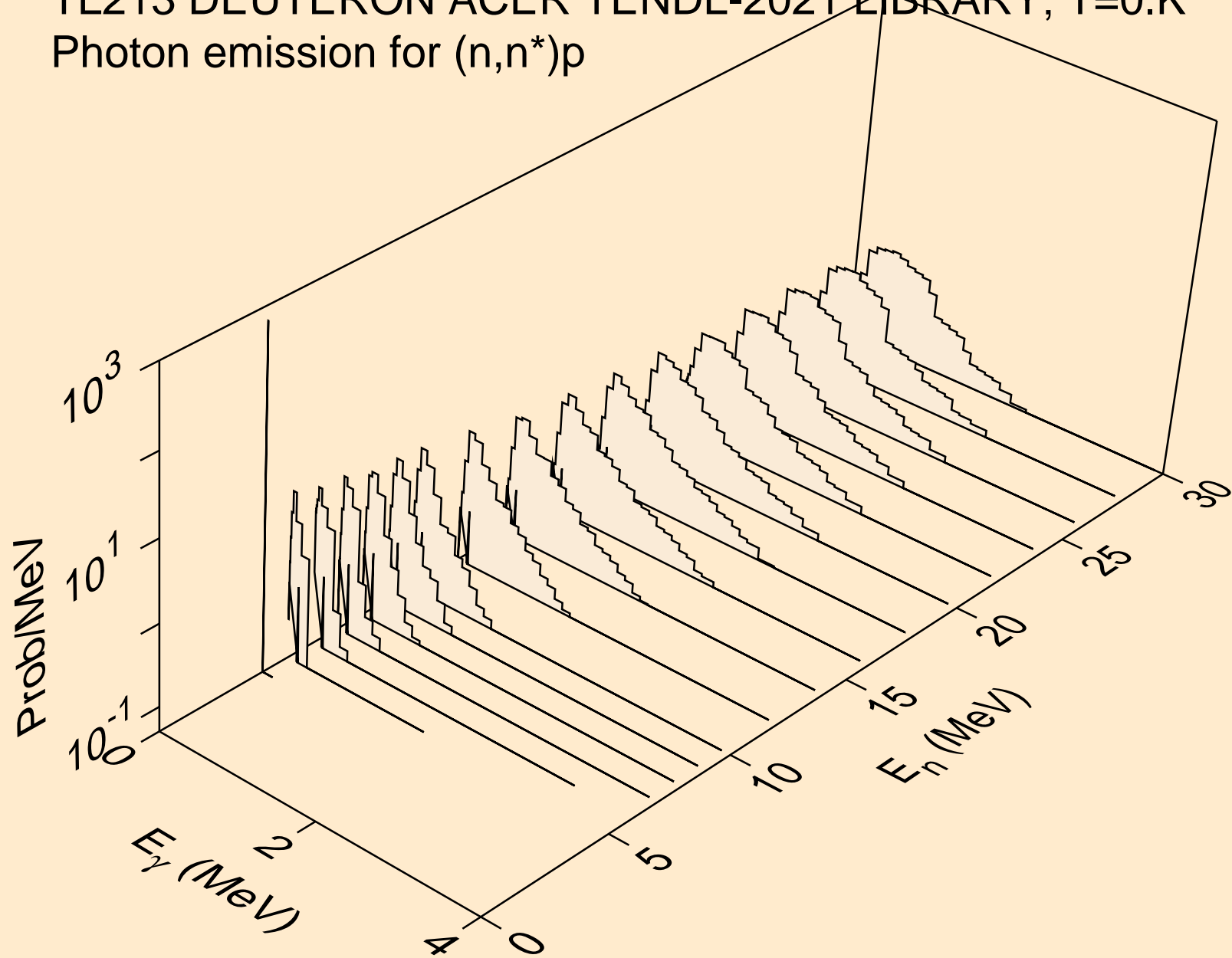

TL213 DEUTERON ACER TENDL-2021 LIBRARY; T=0.K  
Photon emission for (n,n\*)d

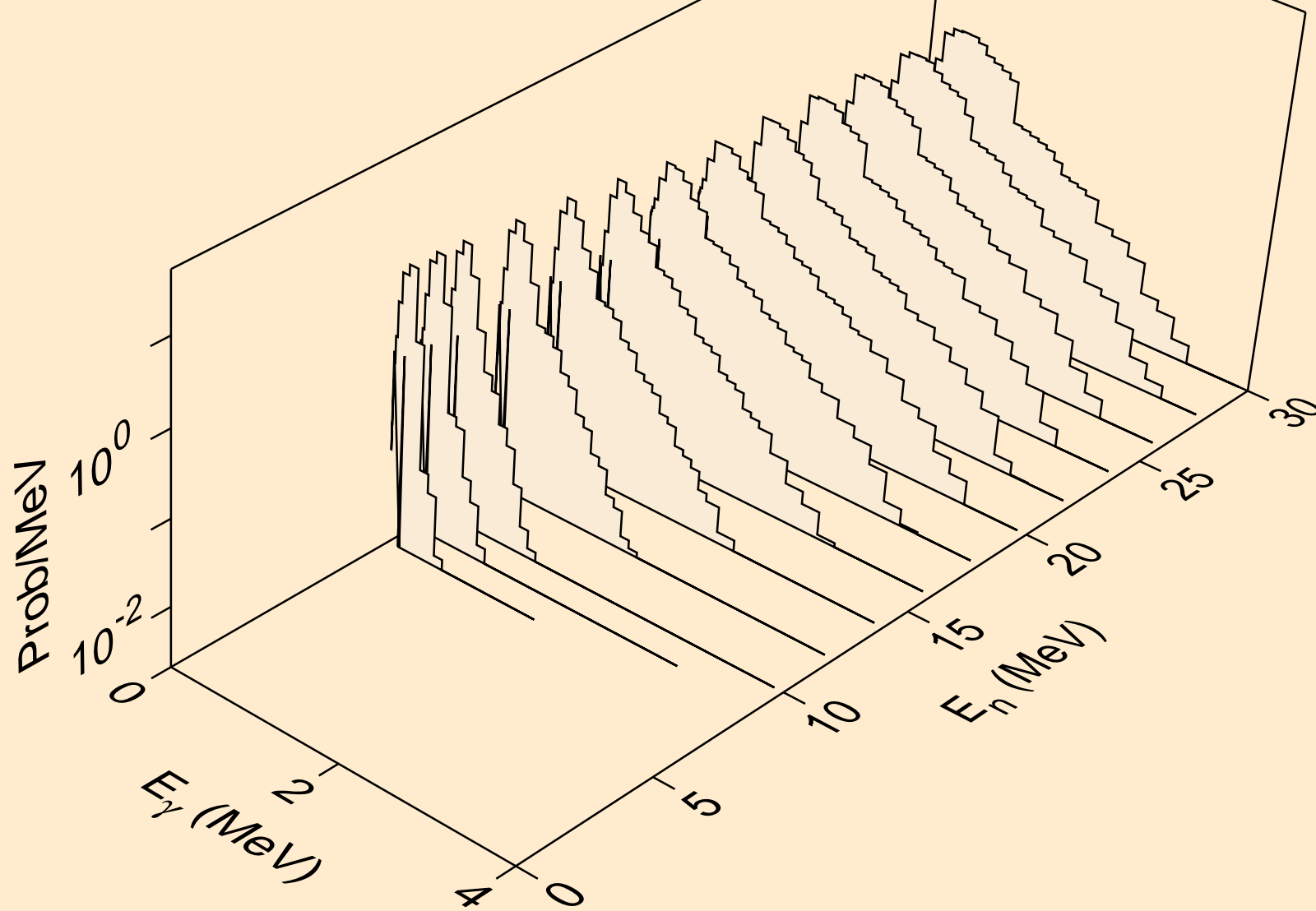

TL213 DEUTERON ACER TENDL-2021 LIBRARY; T=0.K  
Photon emission for (n,n\*)t

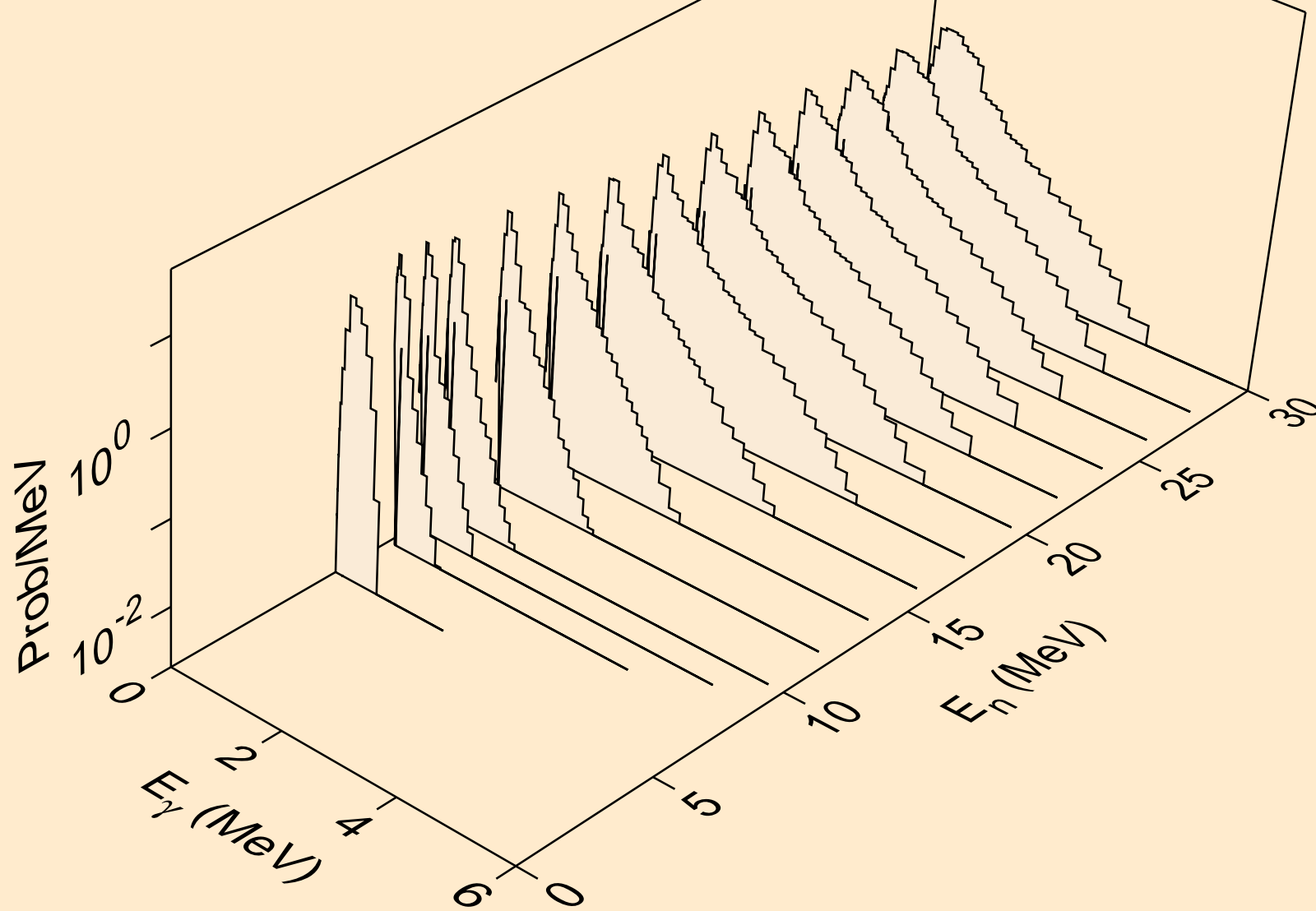

TL213 DEUTERON ACER TENDL-2021 LIBRARY; T=0.K  
Photon emission for (n,n\*)he3

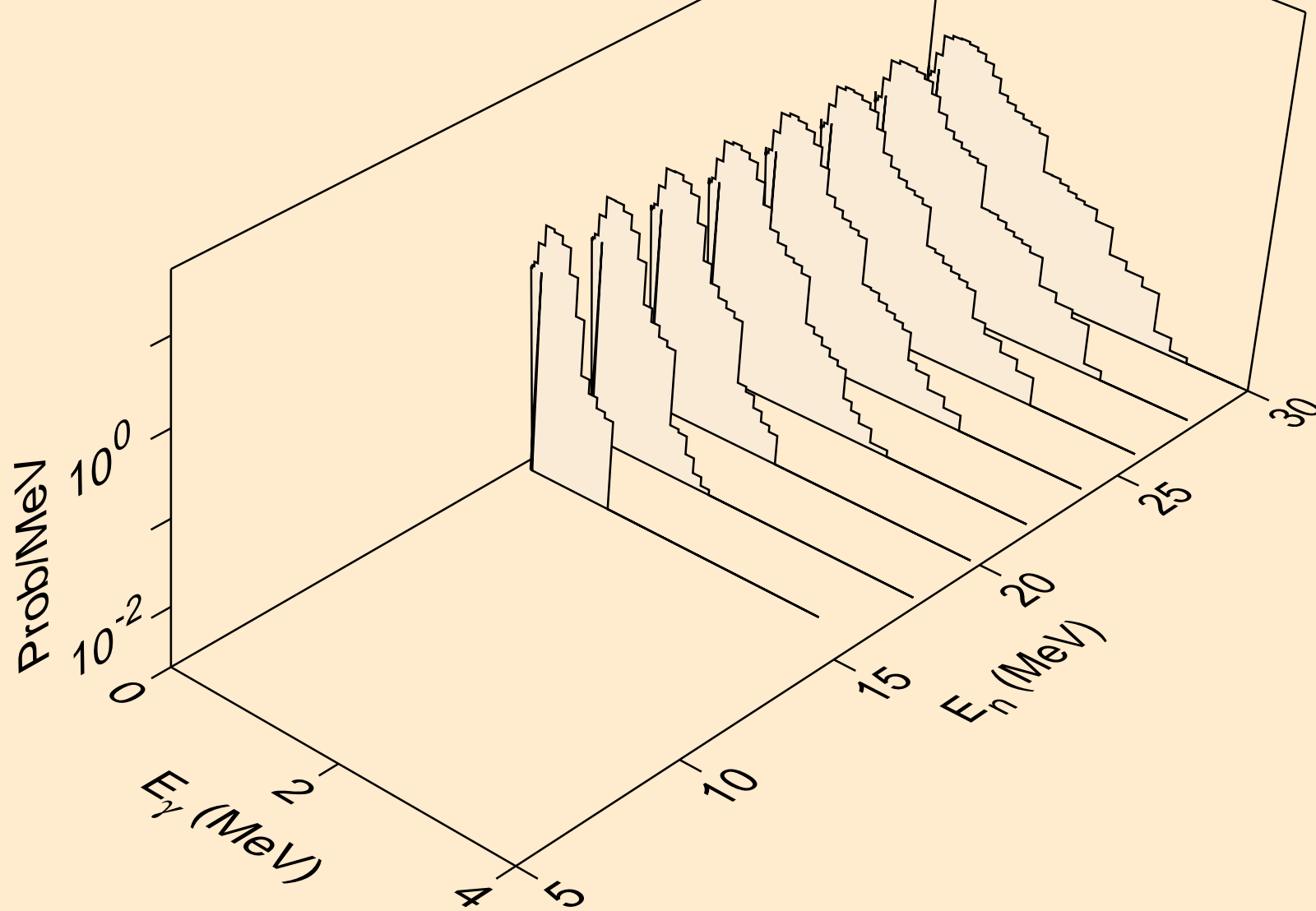



TL213 DEUTERON ACER TENDL-2021 LIBRARY; T=0.K  
Photon emission for (n,4n)

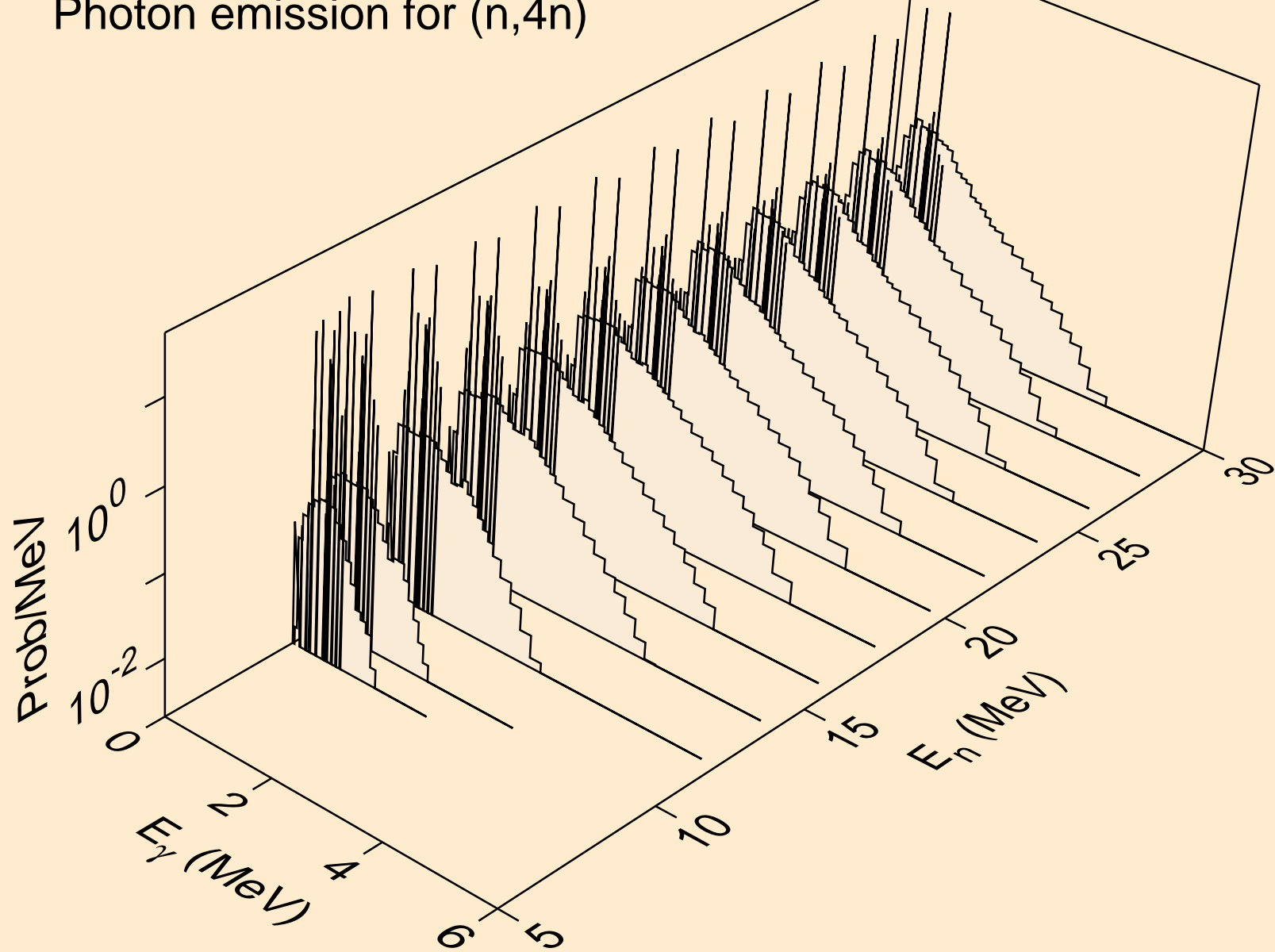

TL213 DEUTERON ACER TENDL-2021 LIBRARY; T=0.K  
Photon emission for (n,2np)

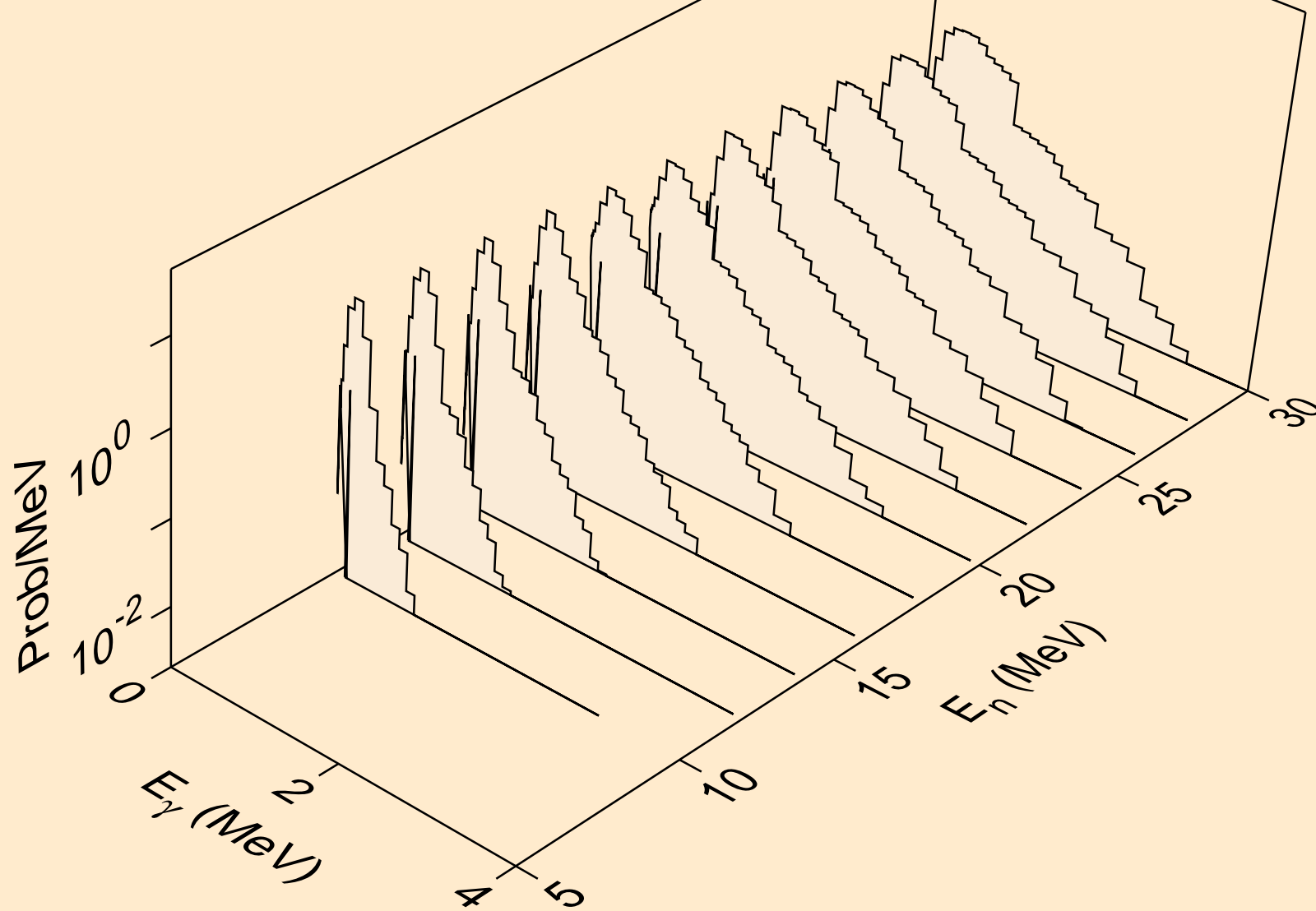

TL213 DEUTERON ACER TENDL-2021 LIBRARY; T=0.K  
Photon emission for (n,3np)

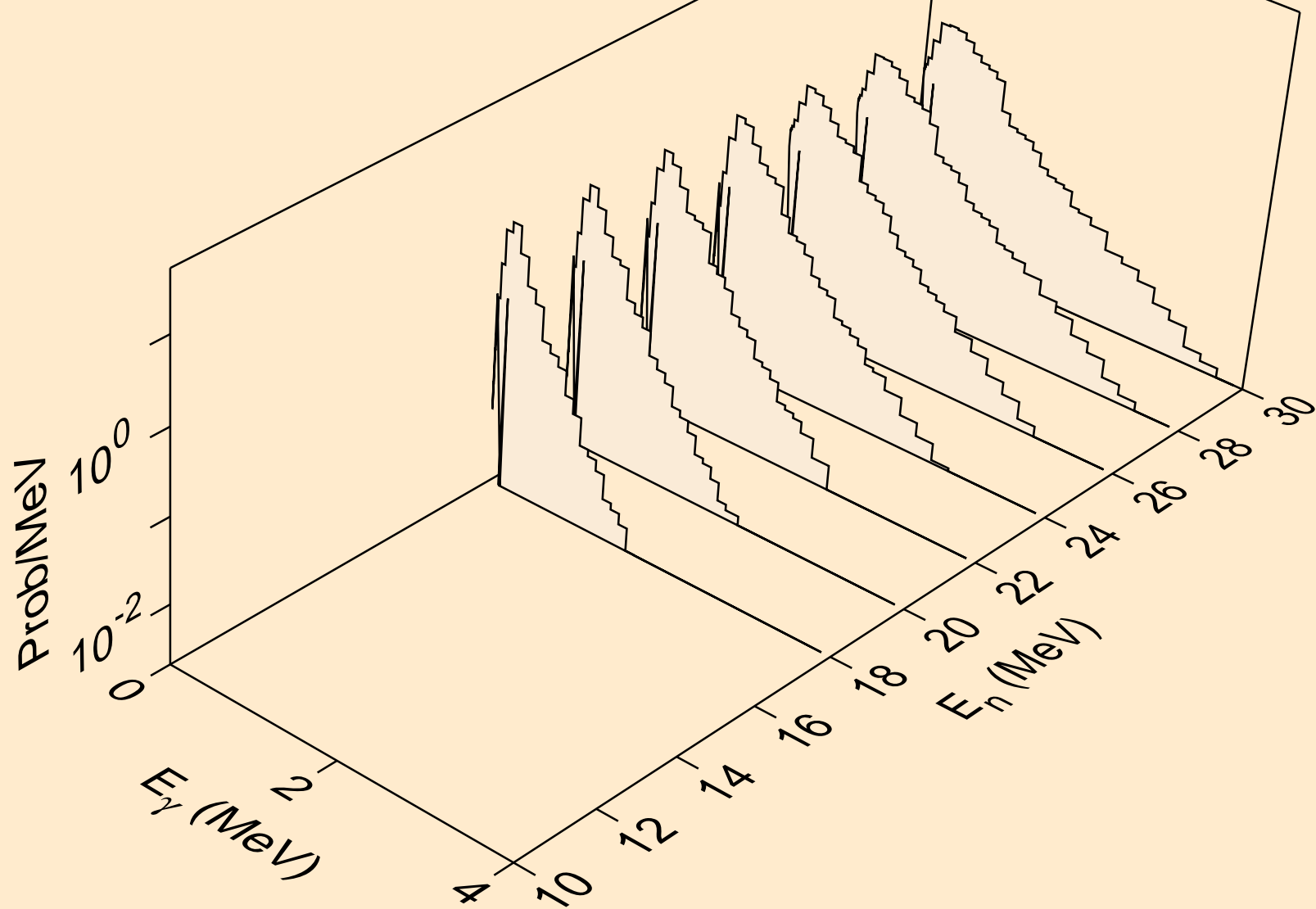

TL213 DEUTERON ACER TENDL-2021 LIBRARY; T=0.K  
Photon emission for (n,2np)

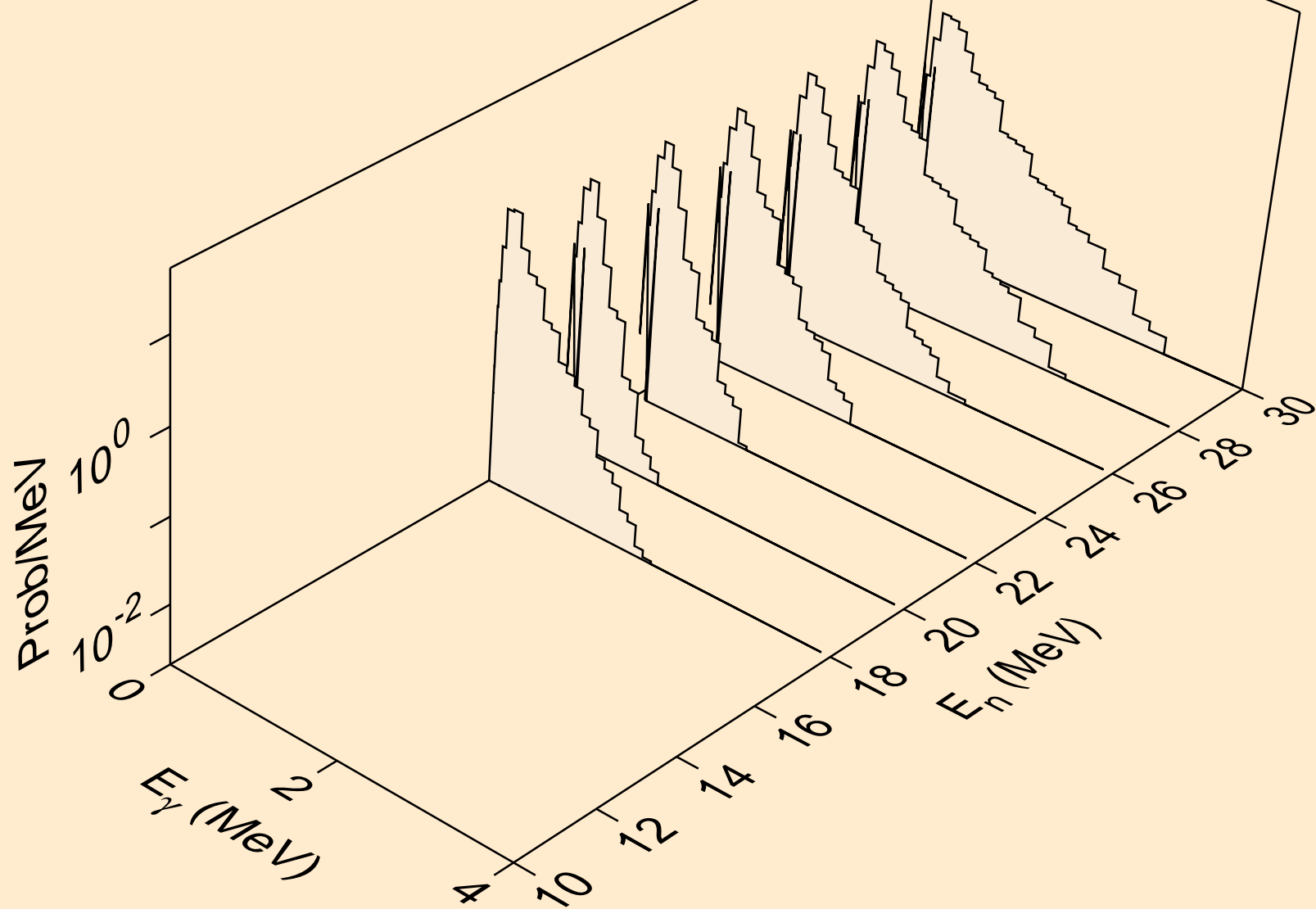

TL213 DEUTERON ACER TENDL-2021 LIBRARY; T=0.K  
Photon emission for (n,gma)

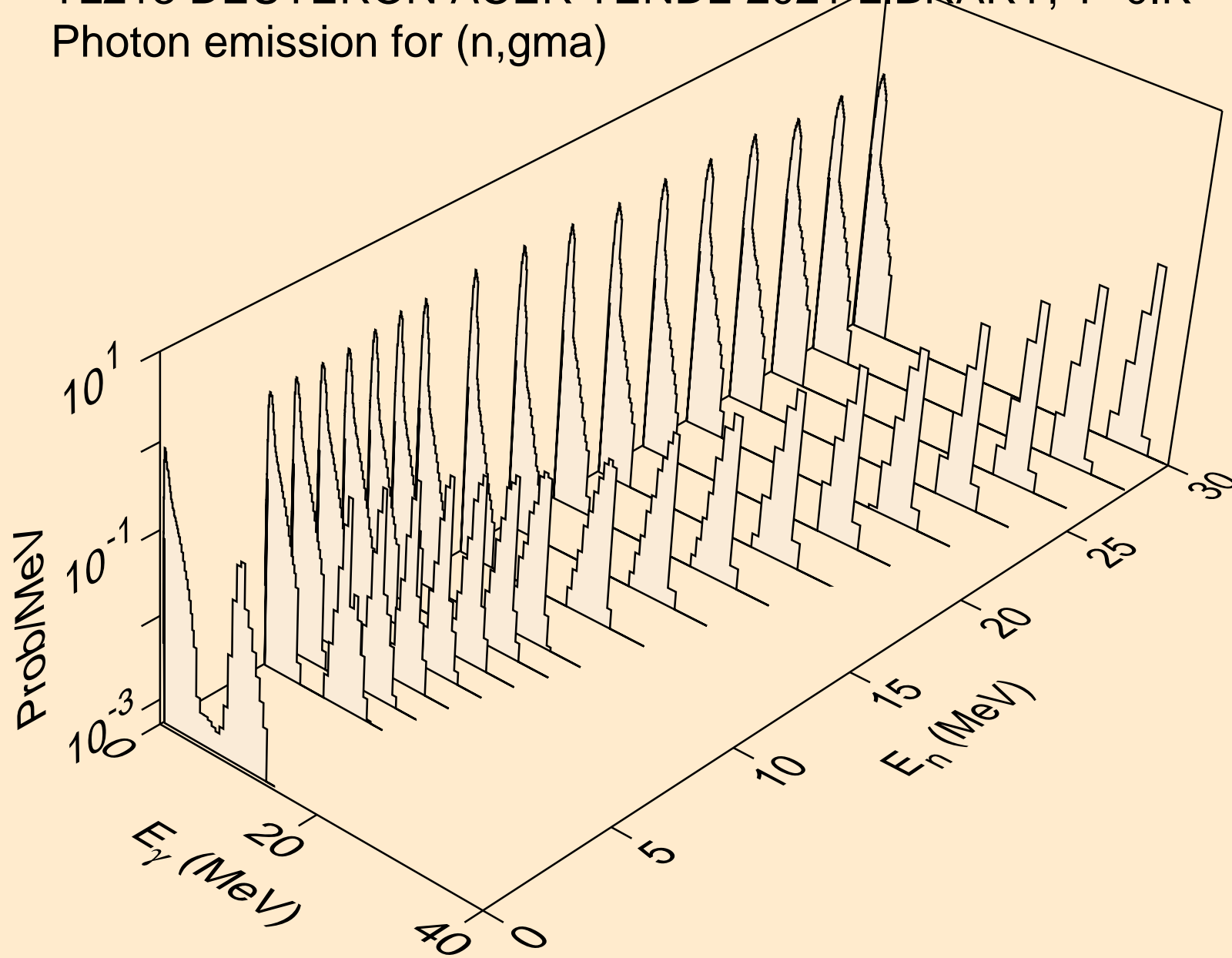

TL213 DEUTERON ACER TENDL-2021 LIBRARY; T=0.K  
Photon emission for (n,p)

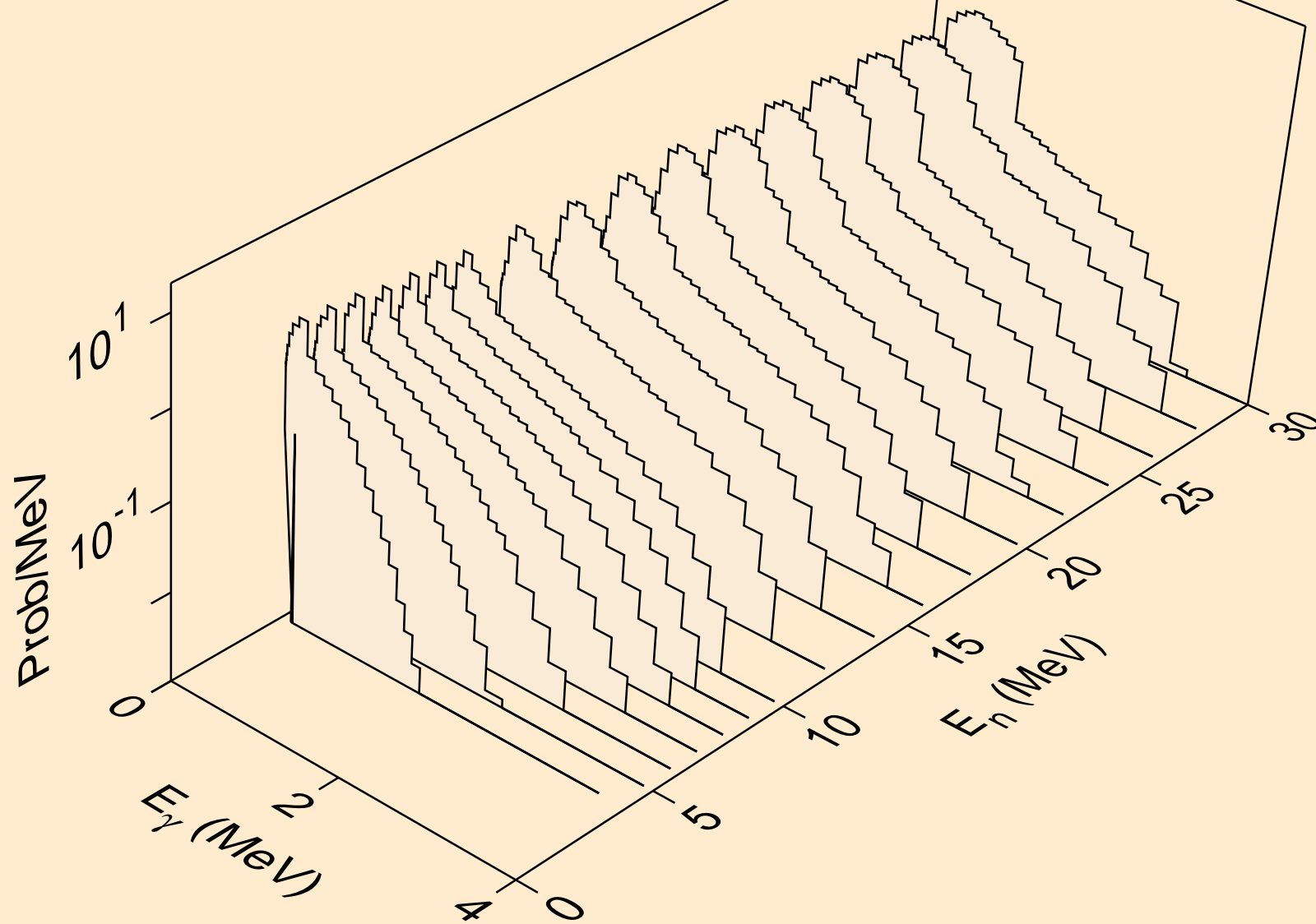

TL213 DEUTERON ACER TENDL-2021 LIBRARY; T=0.K  
Photon emission for inelastic

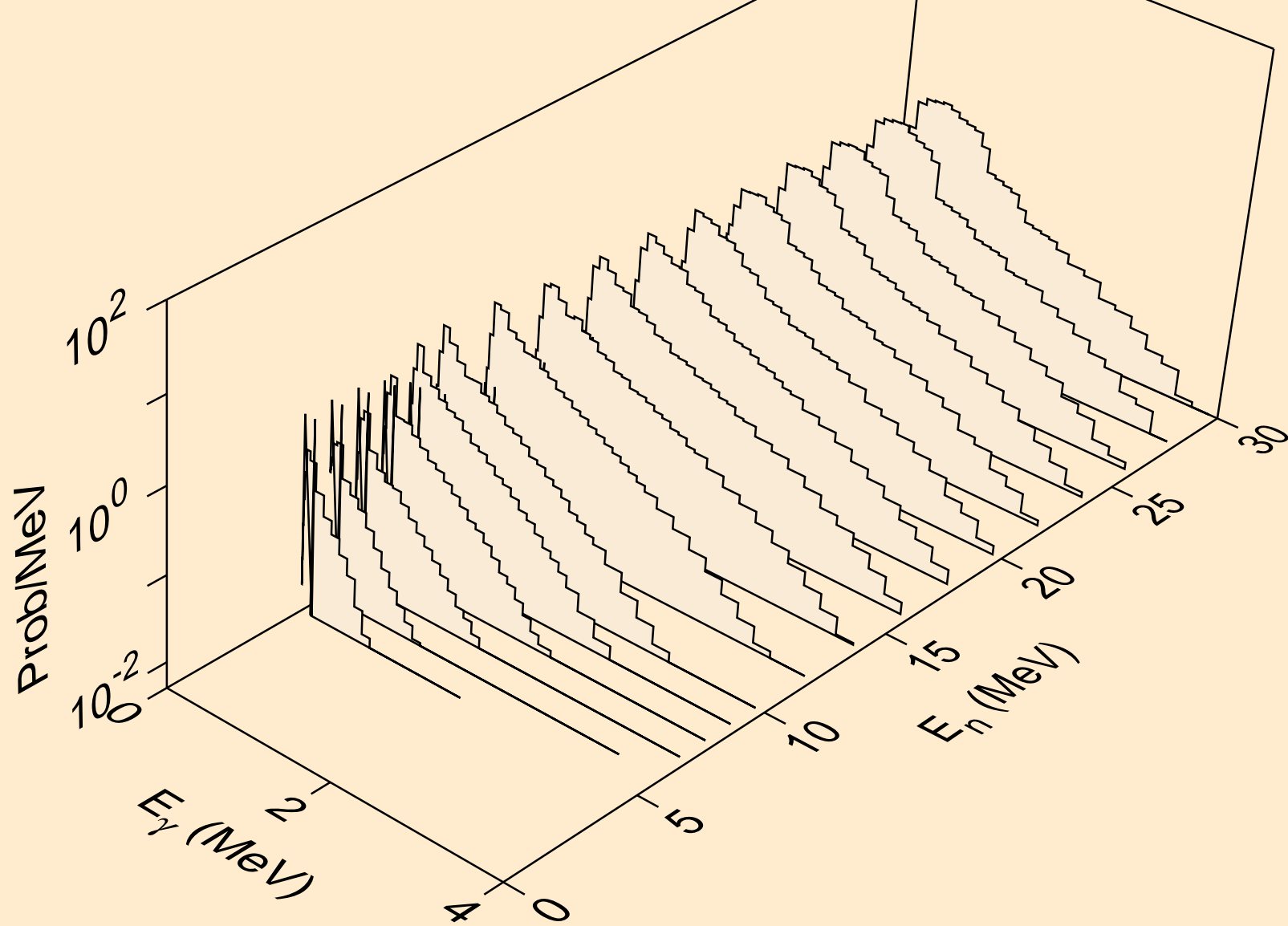

TL213 DEUTERON ACER TENDL-2021 LIBRARY; T=0.K  
Photon emission for (n,t)

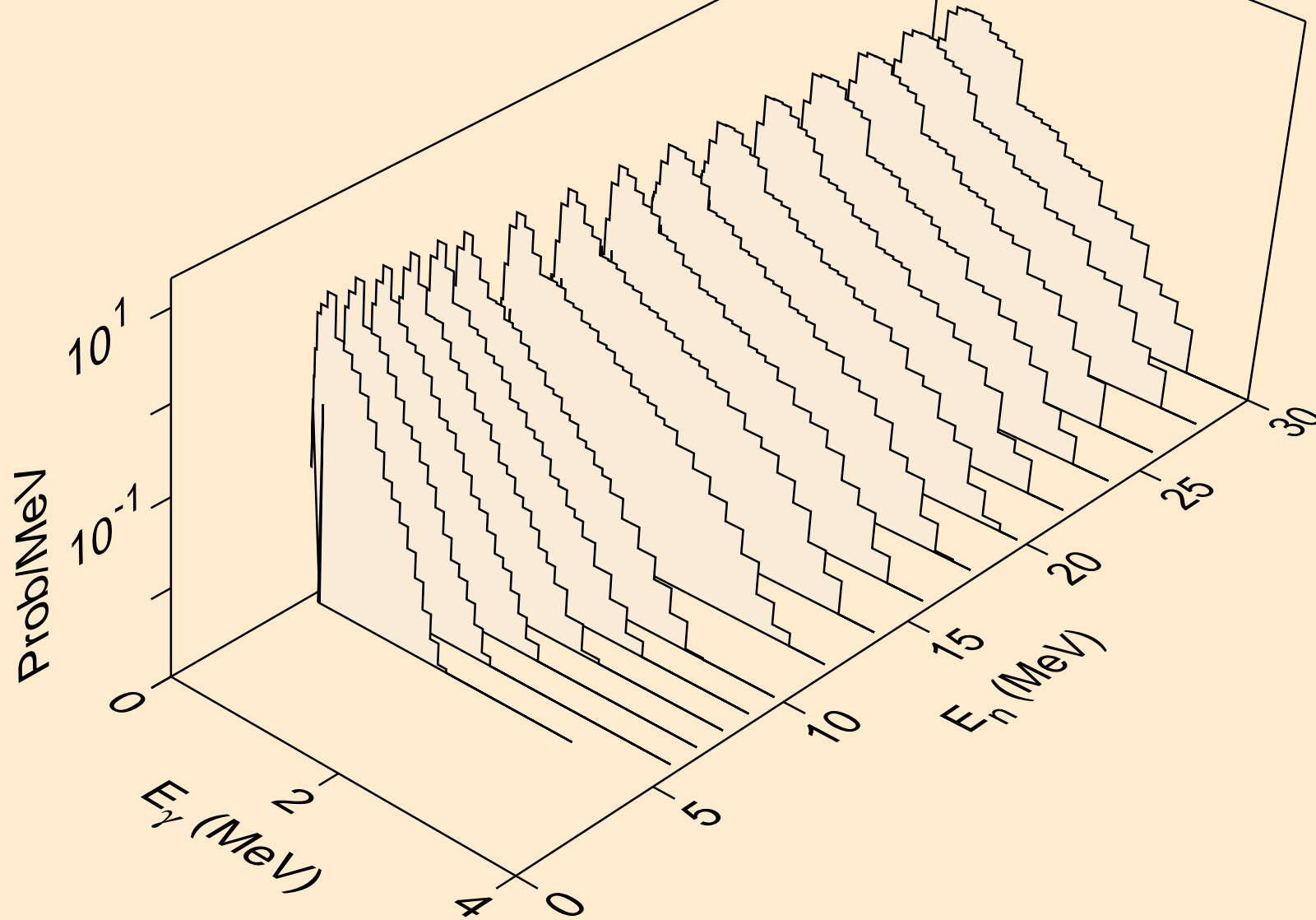



TL213 DEUTERON ACER TENDL-2021 LIBRARY; T=0.K  
Photon emission for (n,he3)

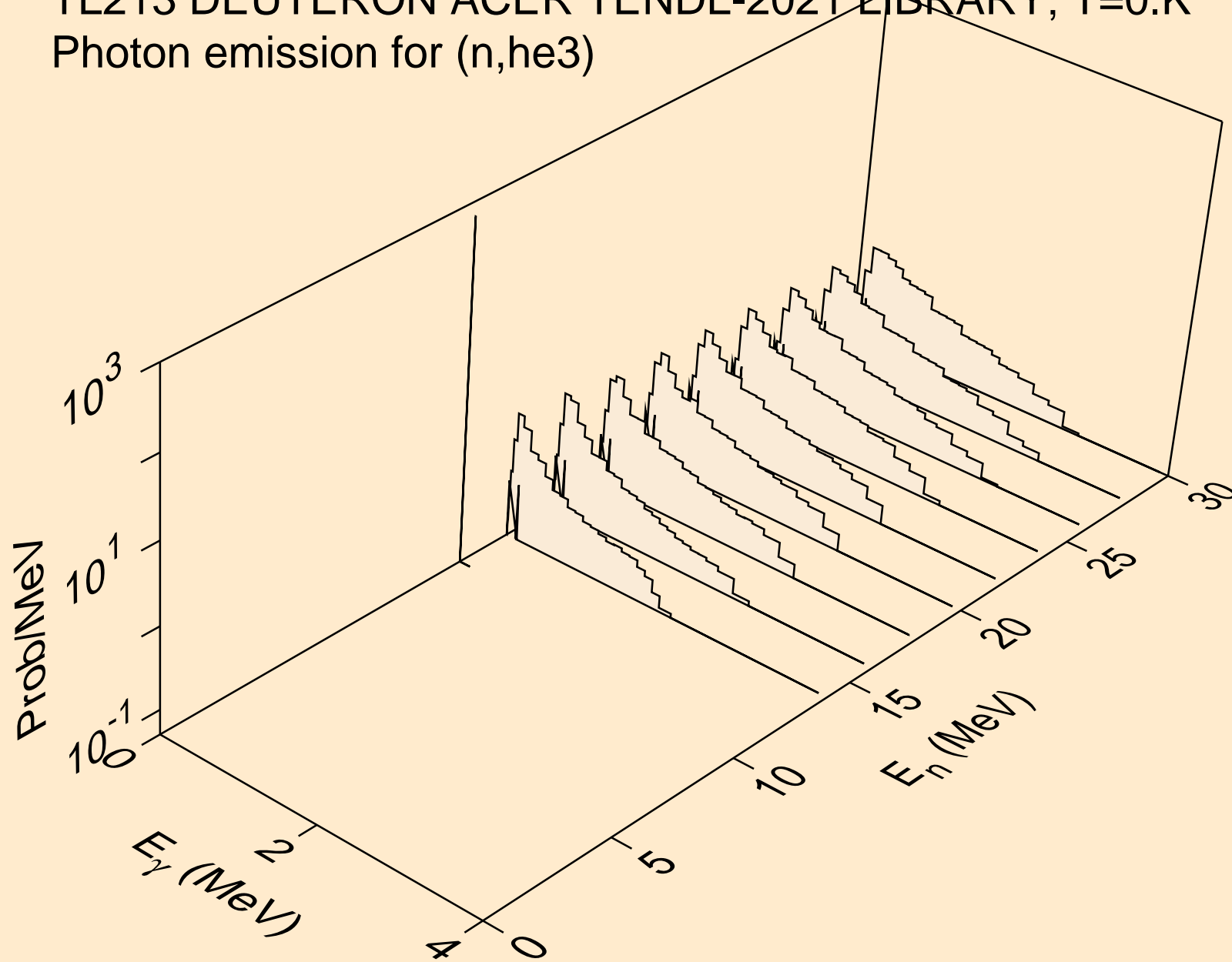

TL213 DEUTERON ACER TENDL-2021 LIBRARY; T=0.K  
Photon emission for (n,a)

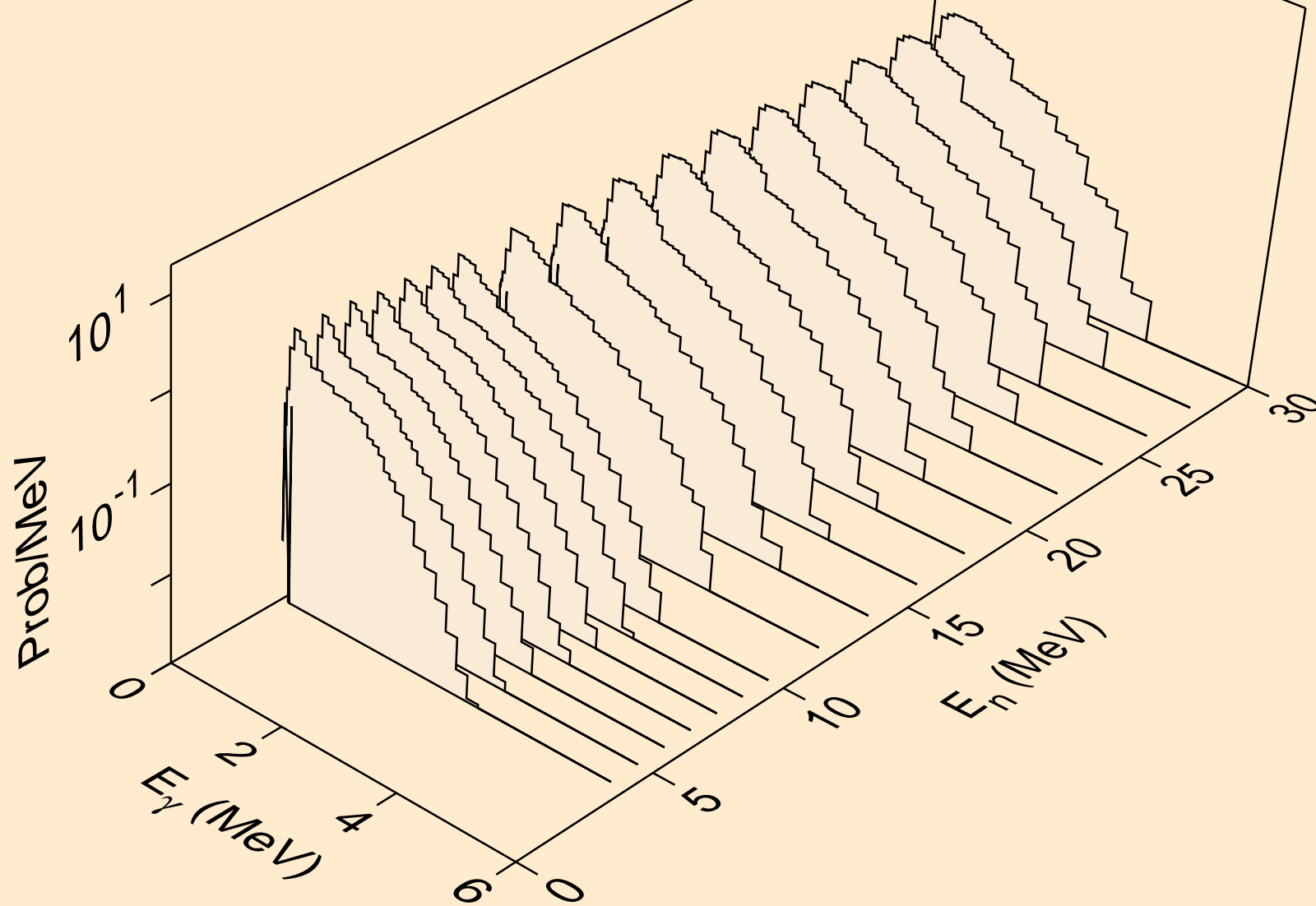

TL213 DEUTERON ACER TENDL-2021 LIBRARY; T=0.K  
Photon emission for (n,2p)

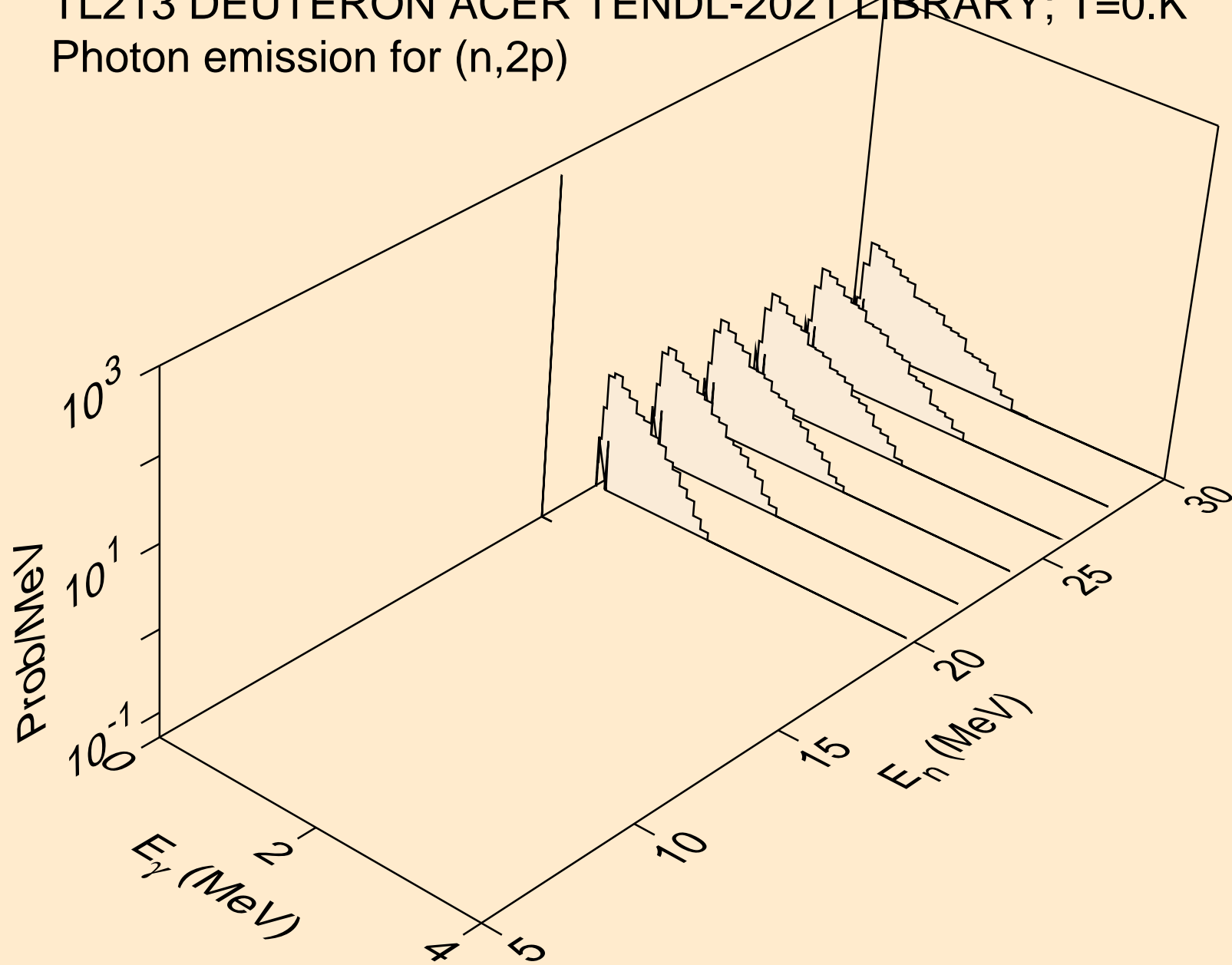

TL213 DEUTERON ACER TENDL-2021 LIBRARY; T=0.K  
Photon emission for (n,pd)

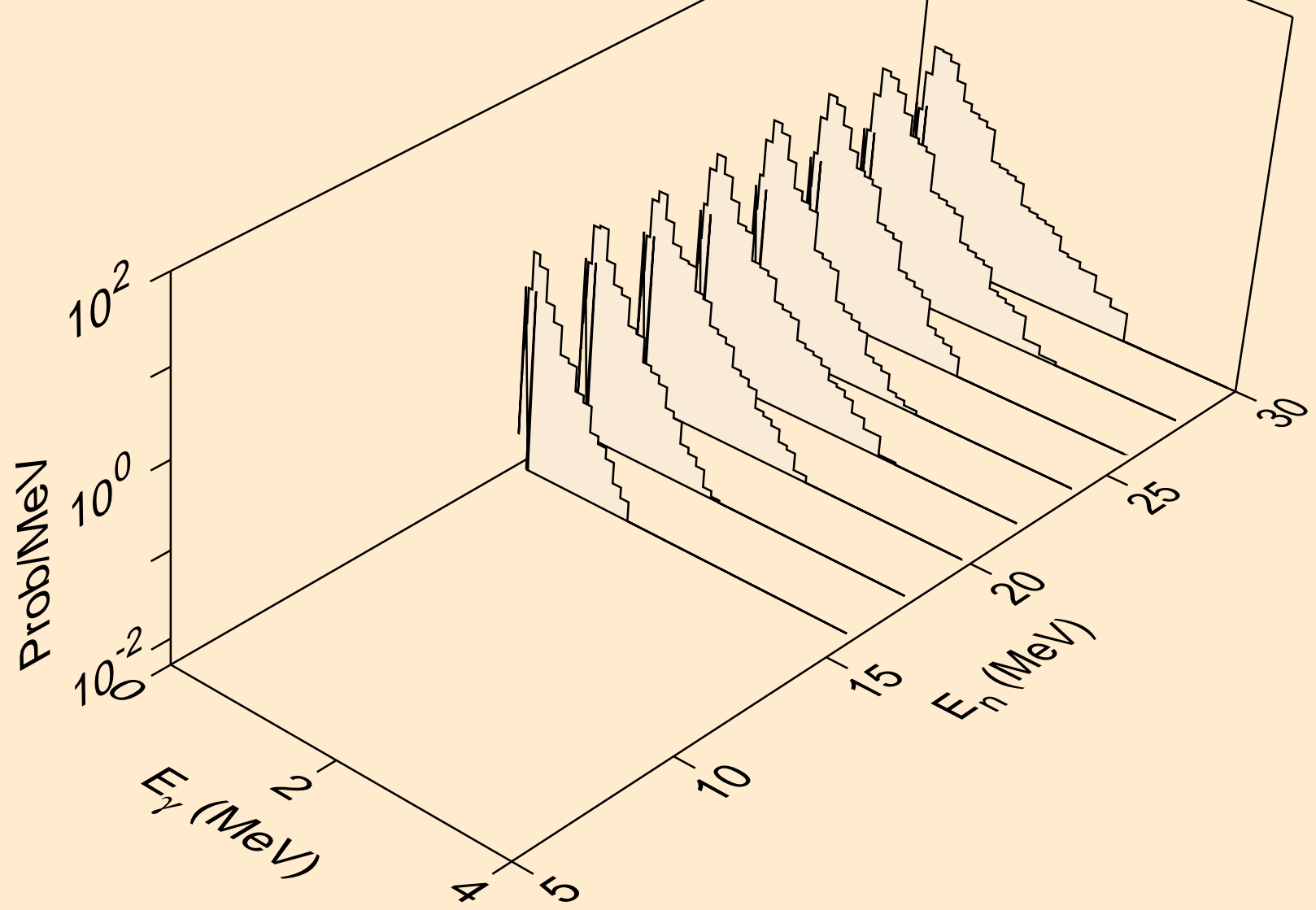

# TL213 DEUTERON ACER TENDL-2021 LIBRARY; T=0.K

## Particle heating contributions

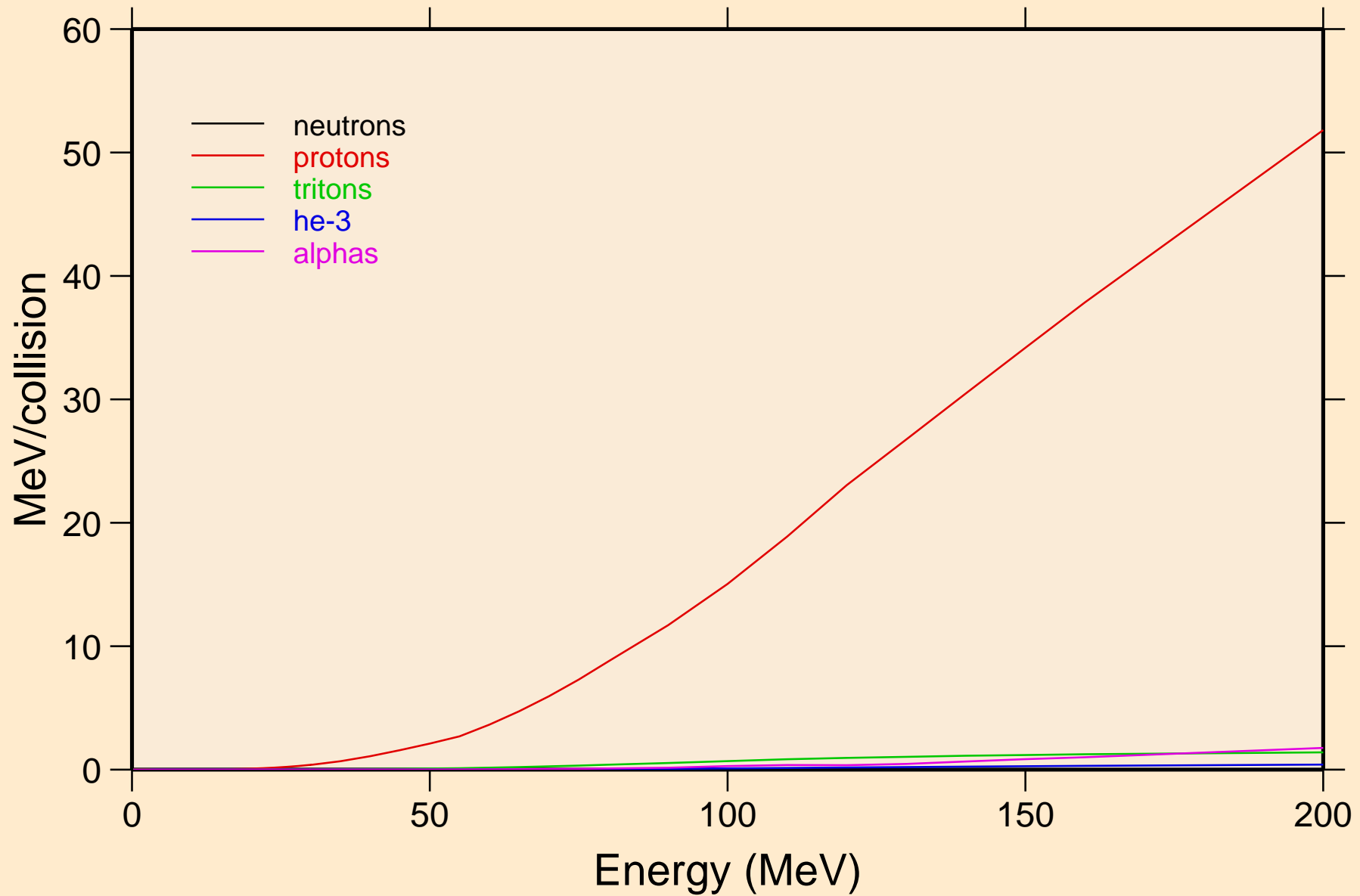

TL213 DEUTERON ACER TENDL-2021 LIBRARY; T=0.K  
Recoil Heating

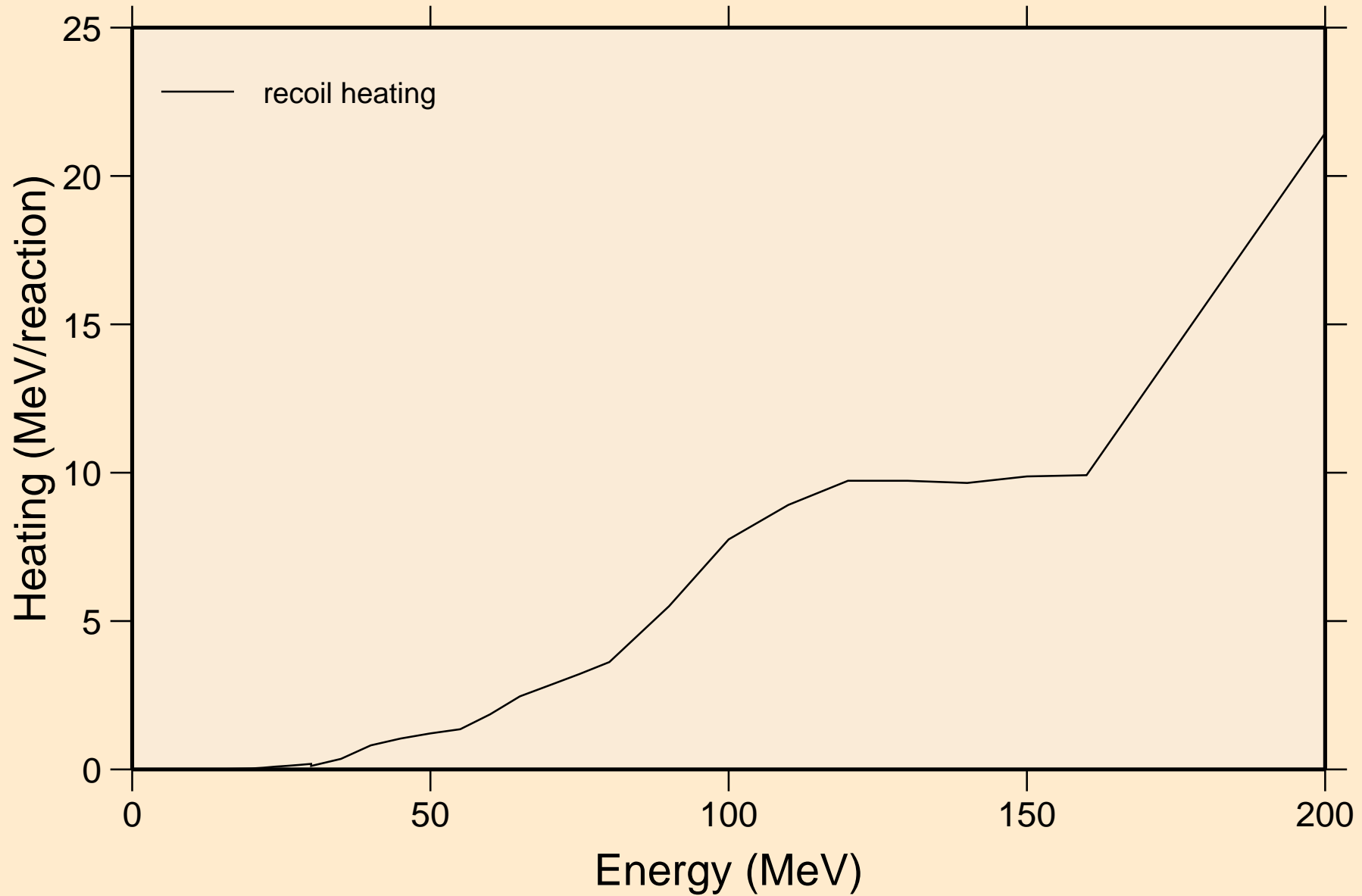

TL213 DEUTERON ACER TENDL-2021 LIBRARY; T=0.K  
Particle production cross sections

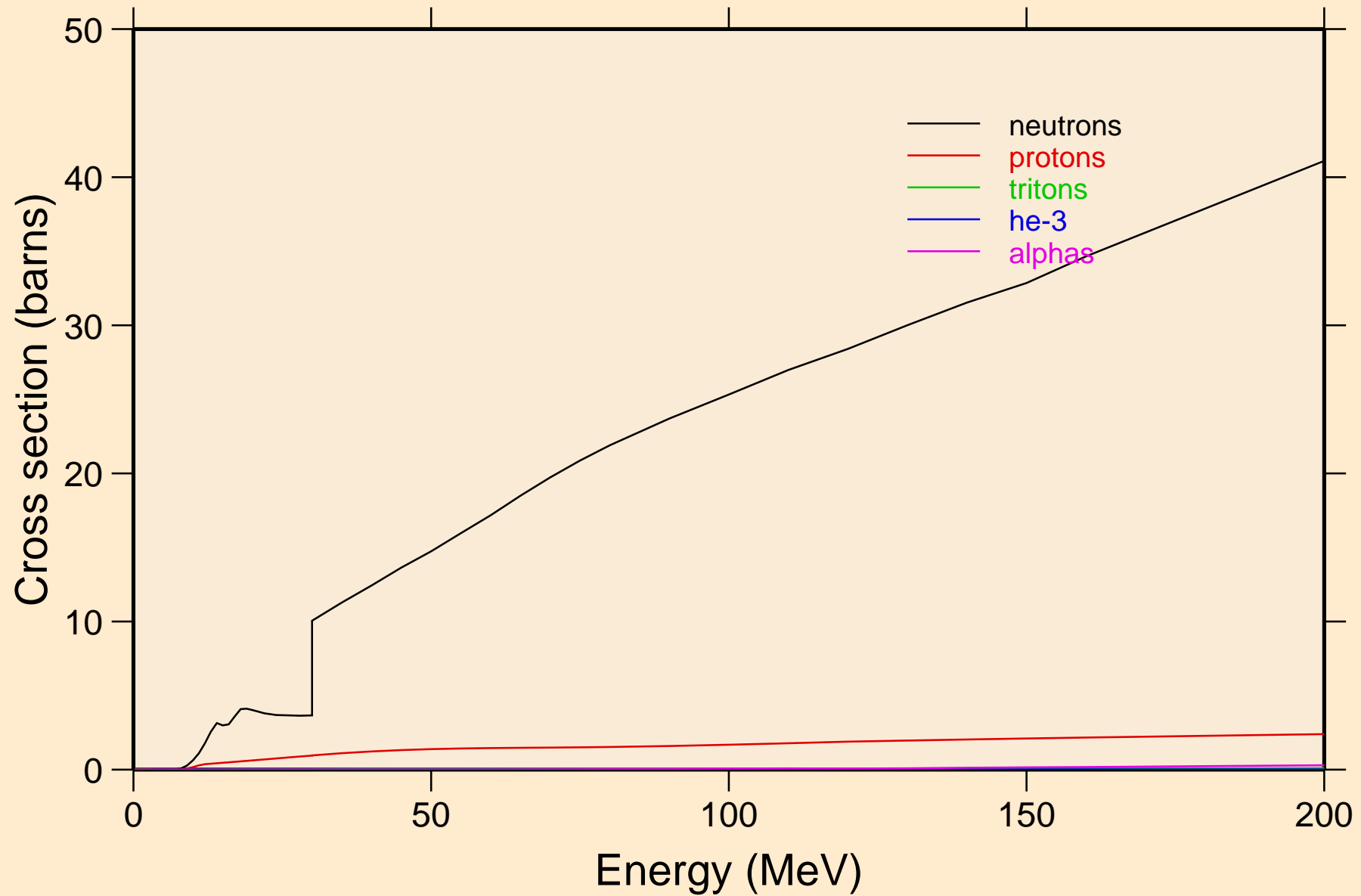

TL213 DEUTERON ACER TENDL-2021 LIBRARY; T=0.K  
neutrons from (d,n)

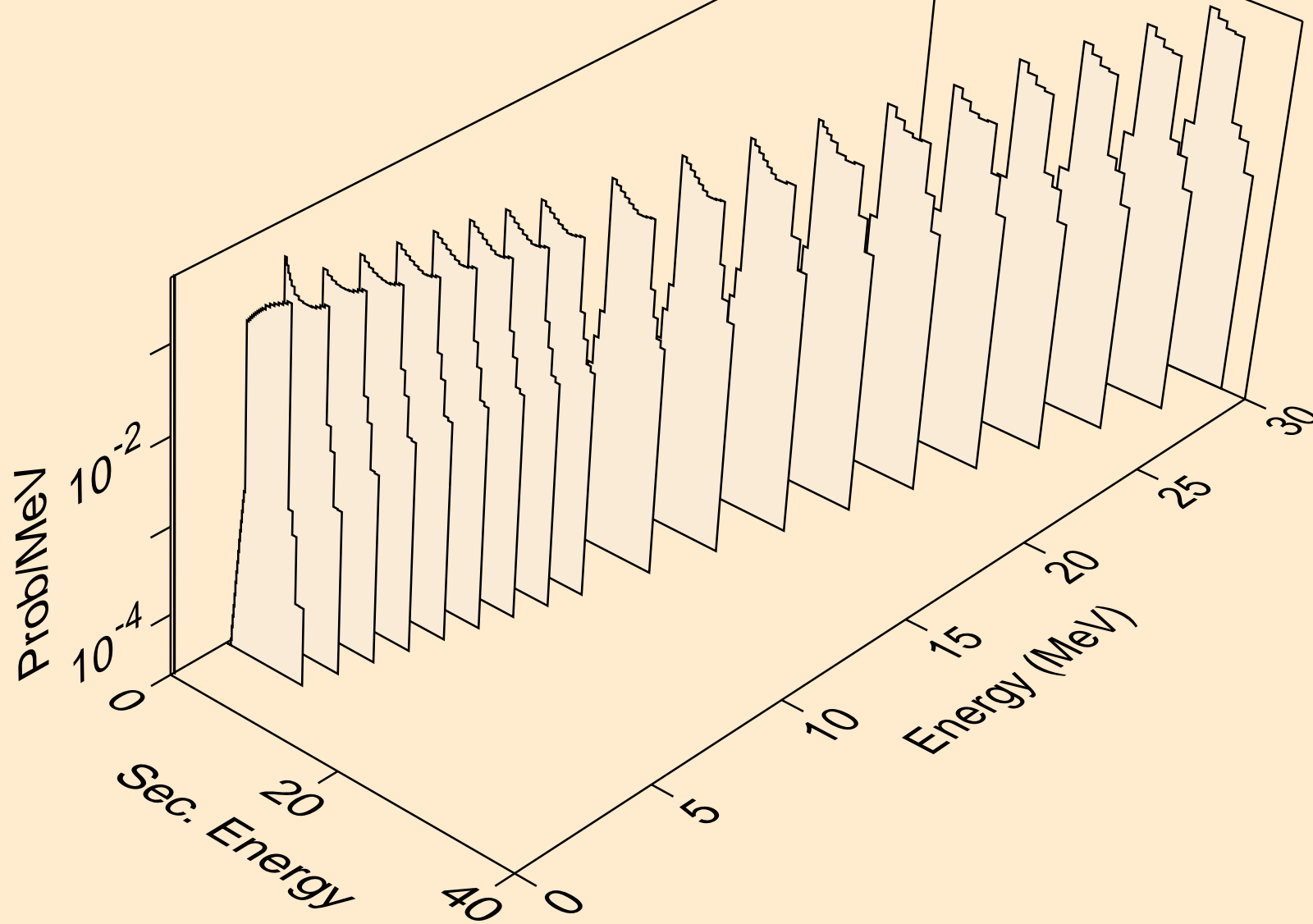



TL213 DEUTERON ACER TENDL-2021 LIBRARY; T=0.K  
neutrons from (d,x)

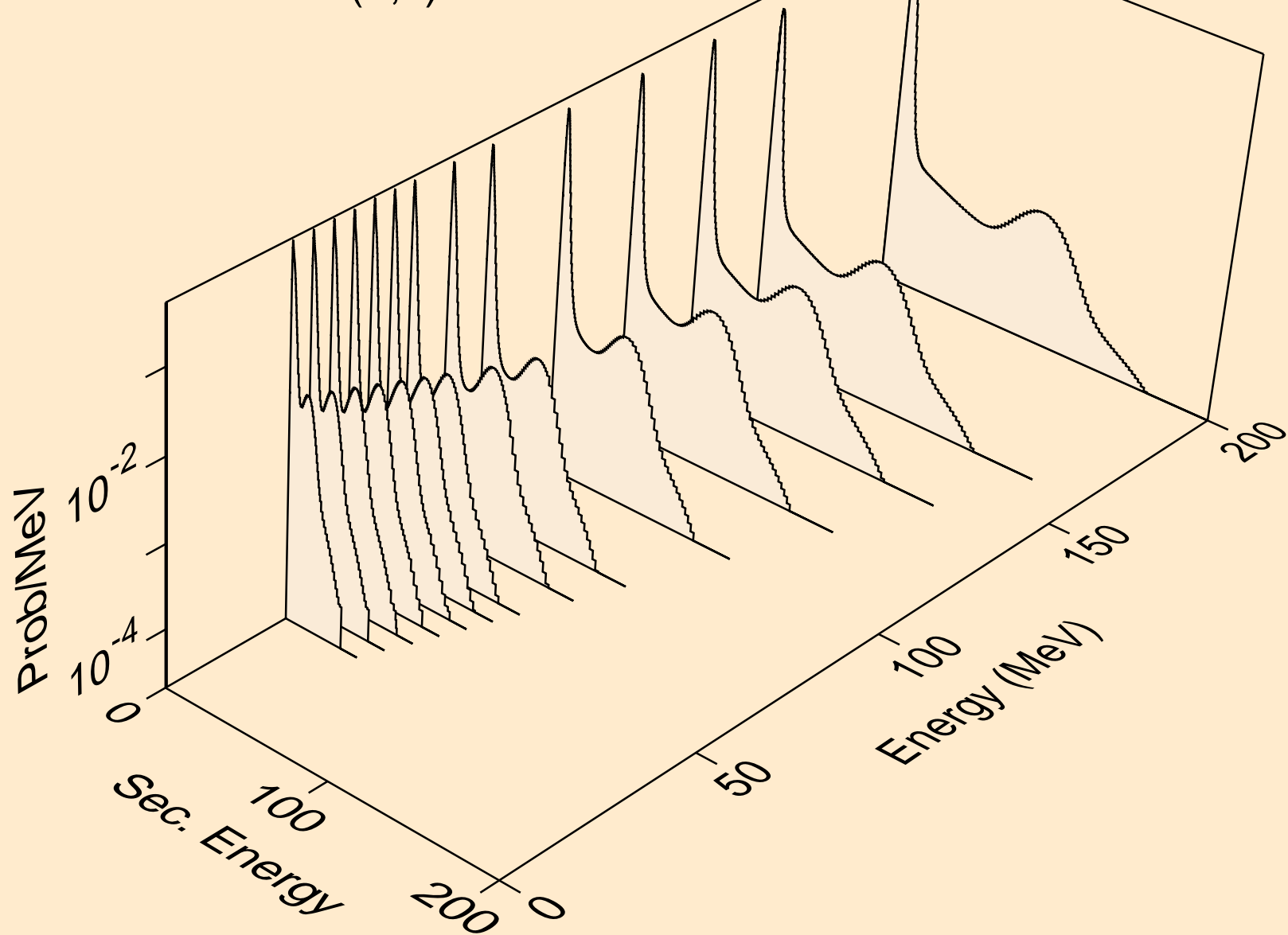

TL213 DEUTERON ACER TENDL-2021 LIBRARY; T=0.K  
neutrons from (d,2nd)

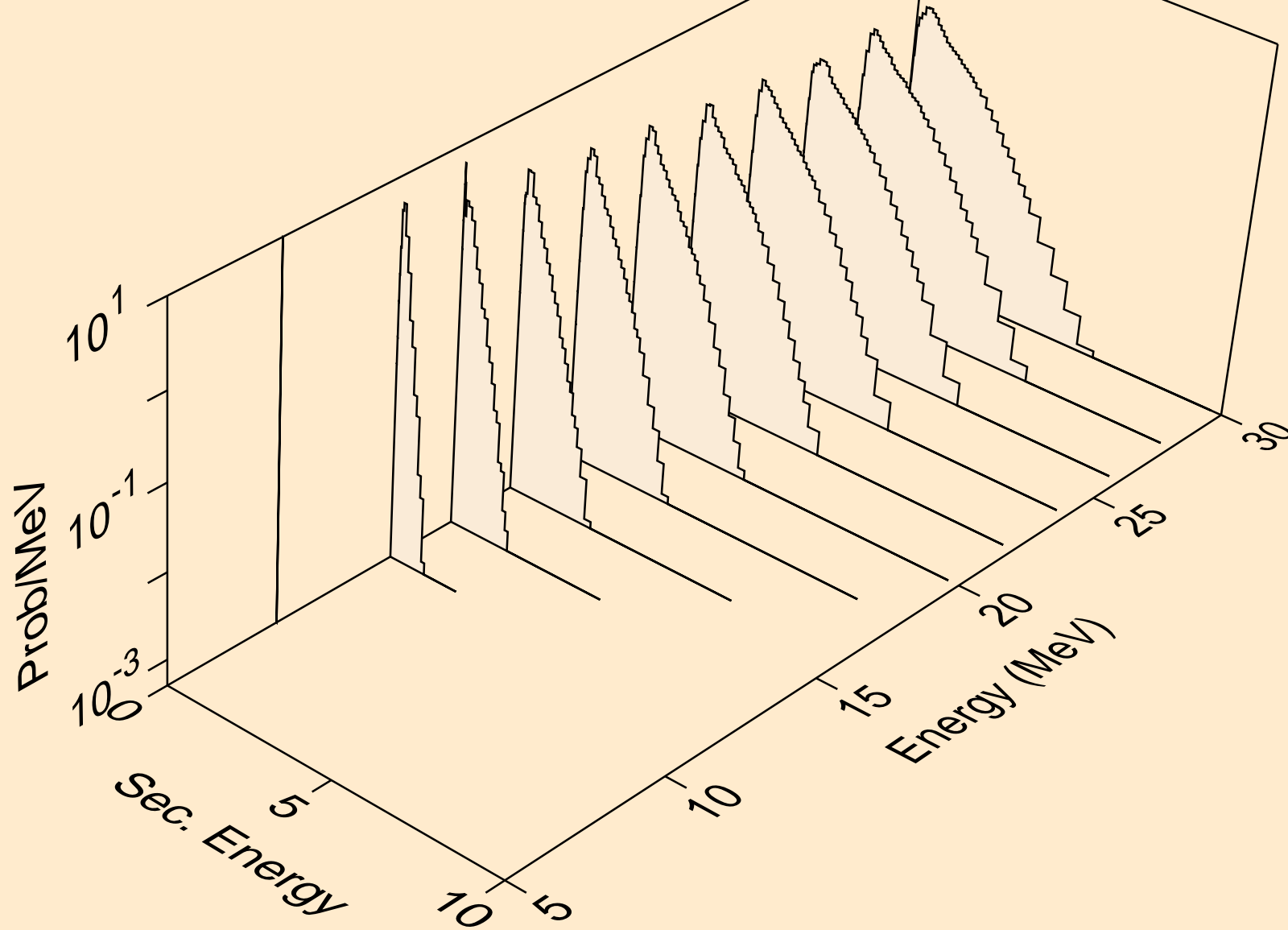

TL213 DEUTERON ACER TENDL-2021 LIBRARY; T=0.K  
neutrons from (d,2n)

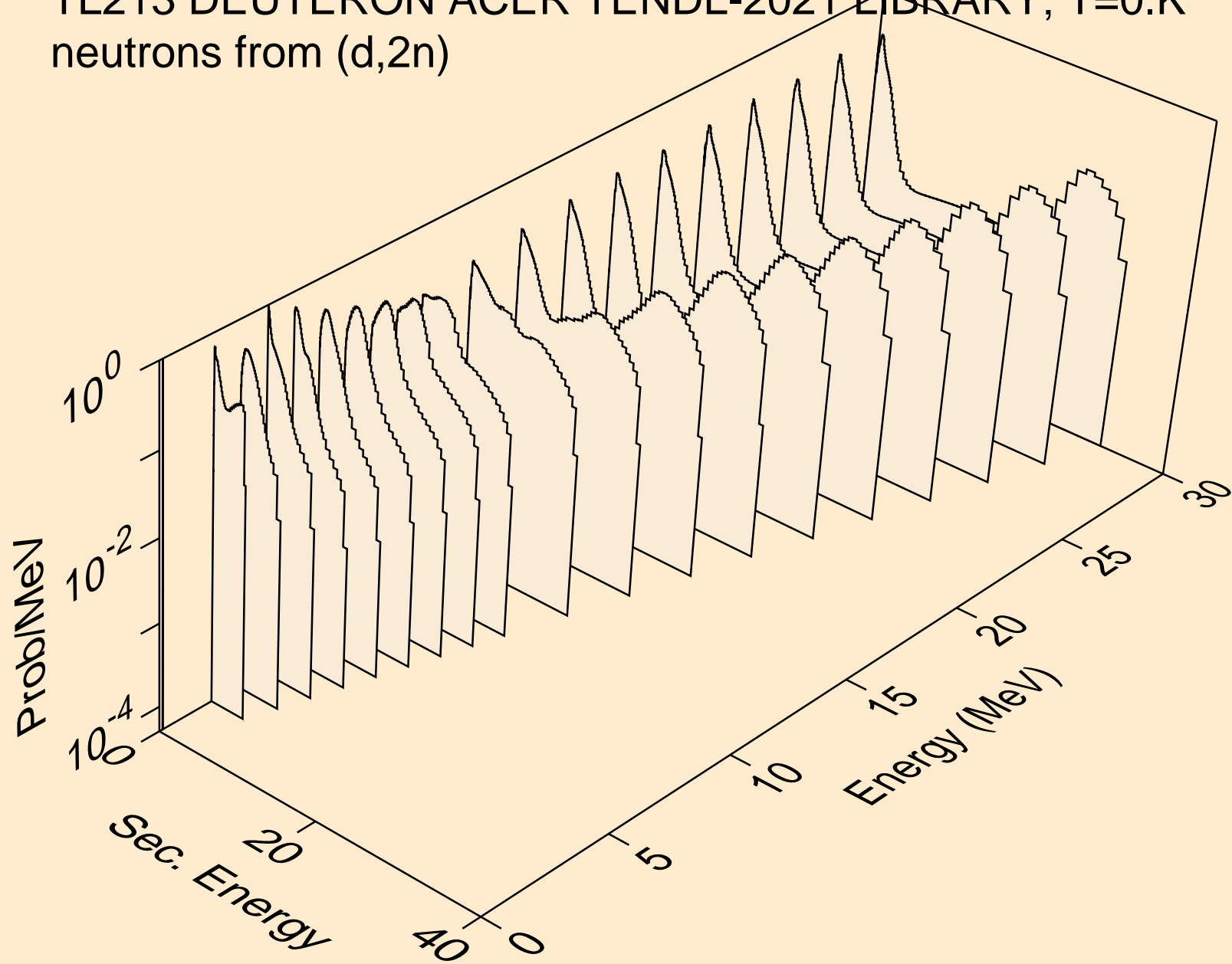

TL213 DEUTERON ACER TENDL-2021 LIBRARY; T=0.K  
neutrons from (d,3n)

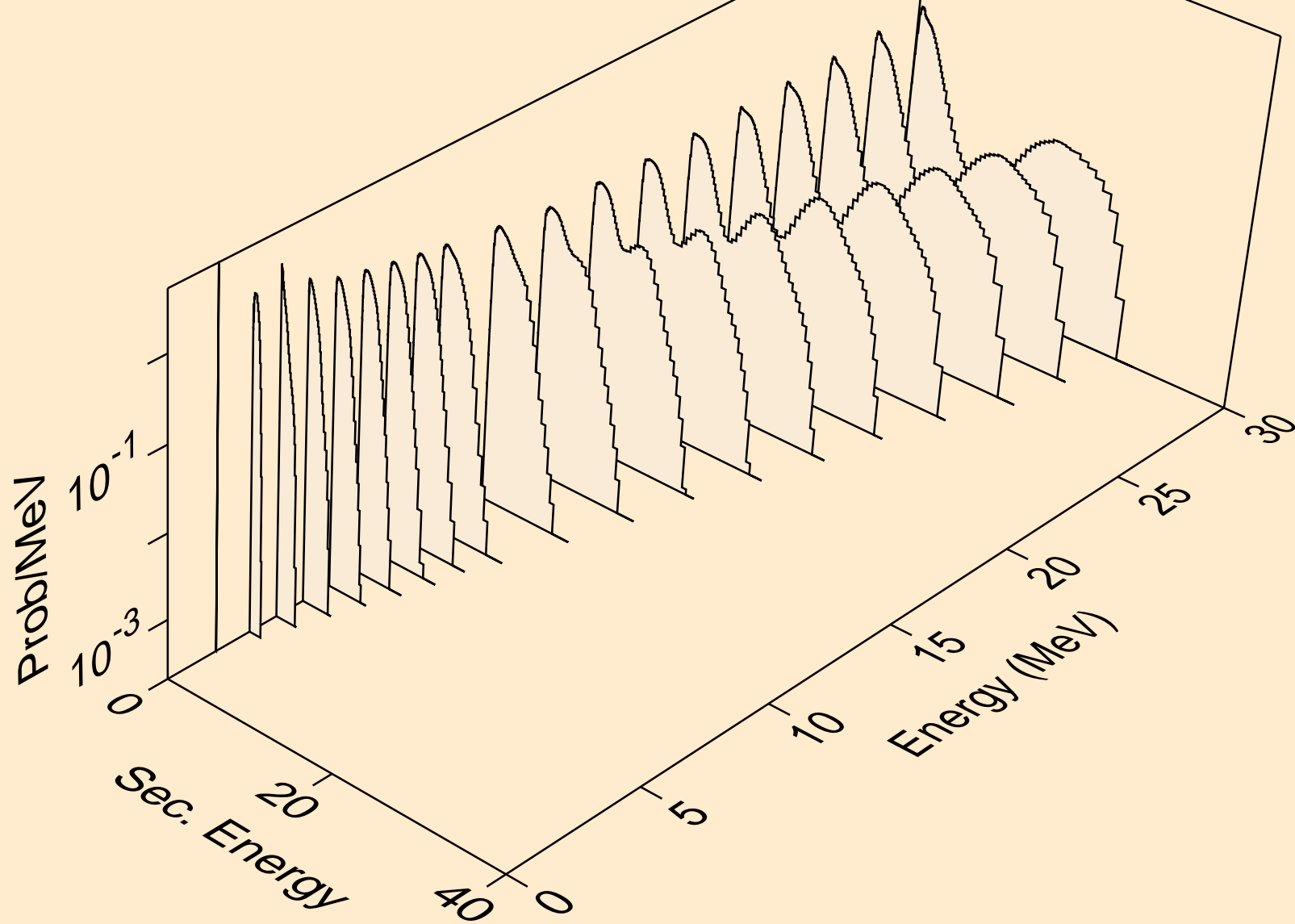

TL213 DEUTERON ACER TENDL-2021 LIBRARY; T=0.K  
neutrons from (d,n\*)a

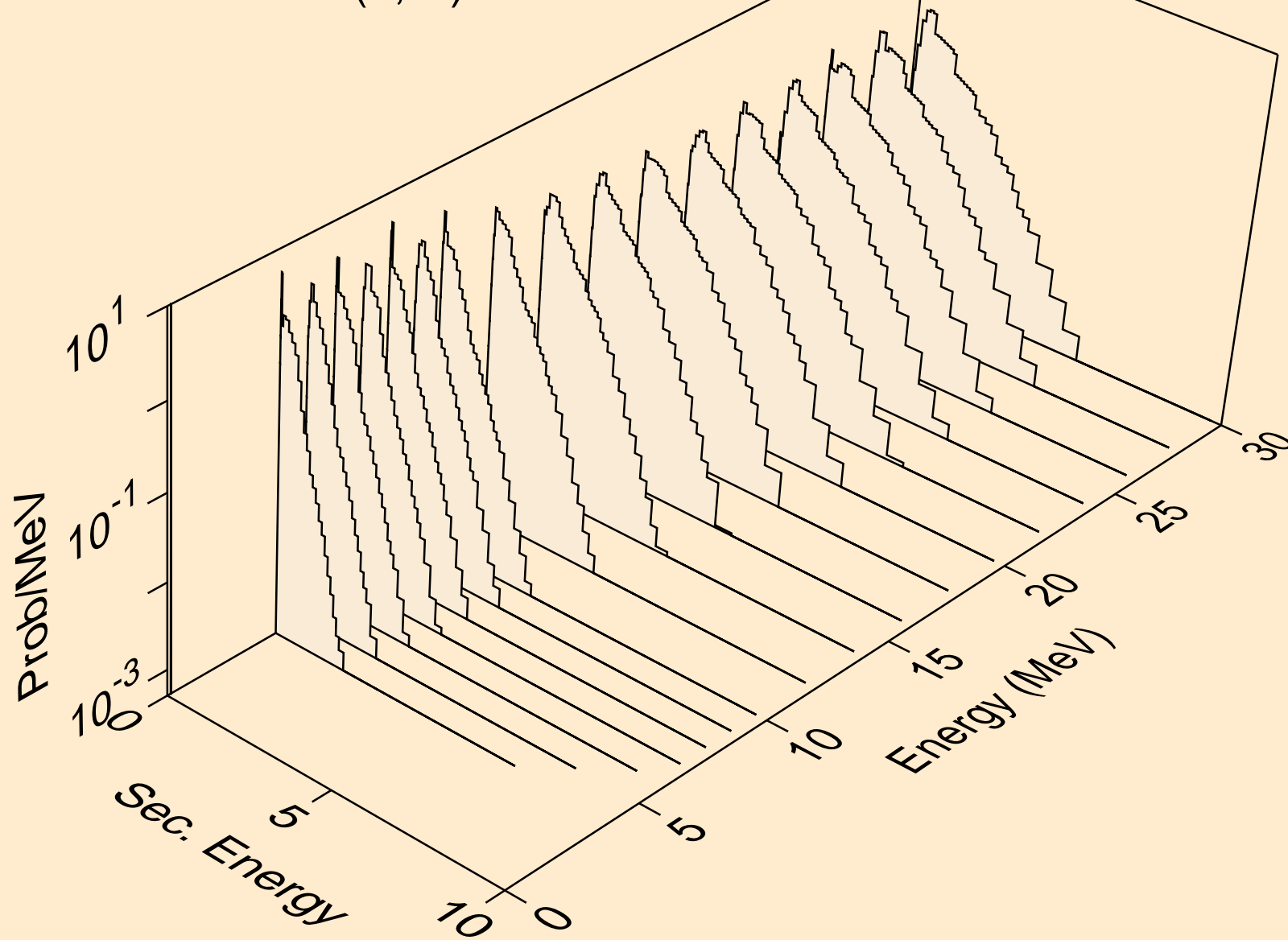

TL213 DEUTERON ACER TENDL-2021 LIBRARY; T=0.K  
neutrons from (d,2n)a

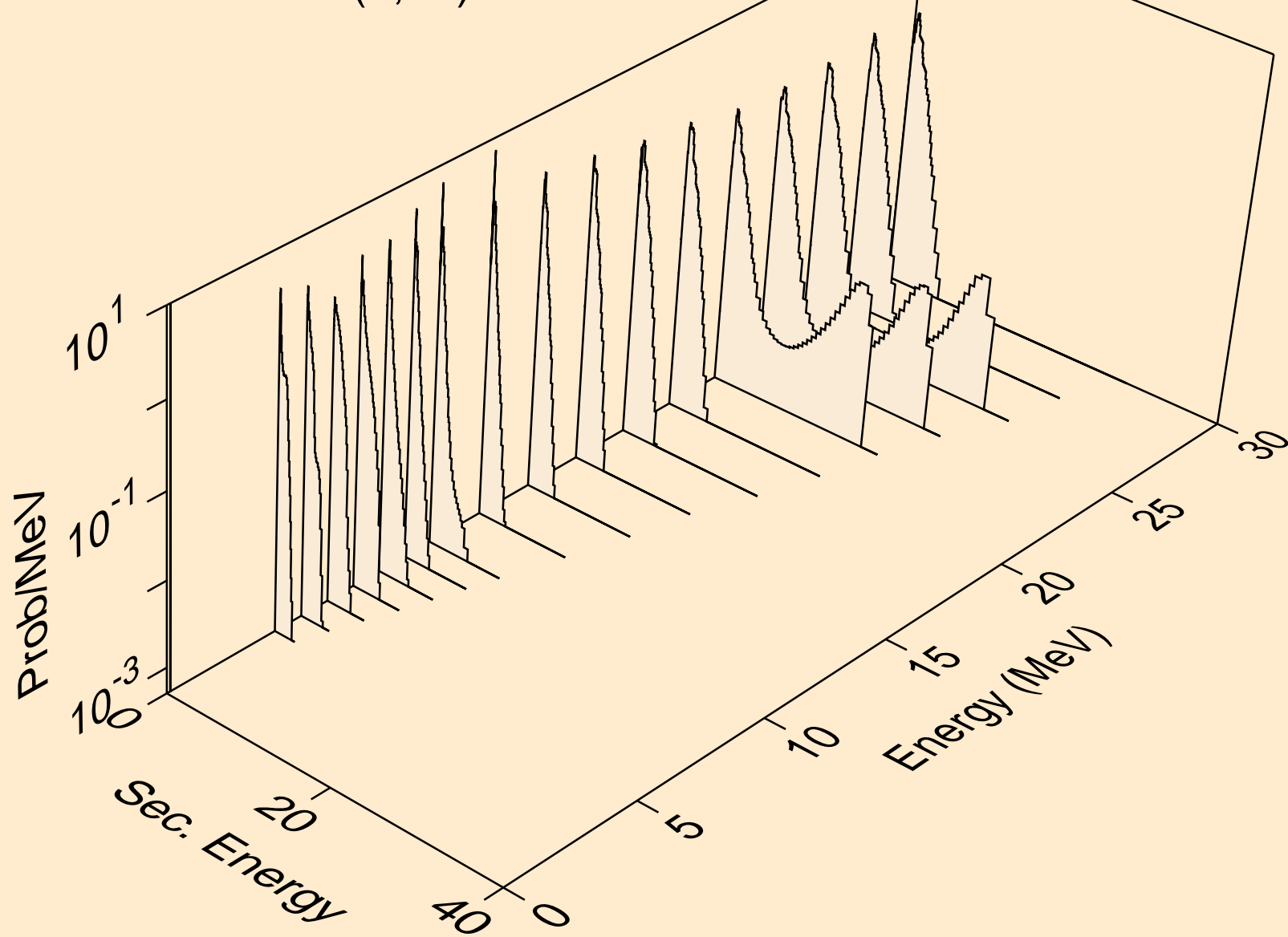

TL213 DEUTERON ACER TENDL-2021 LIBRARY; T=0.K  
neutrons from (d,3n)a

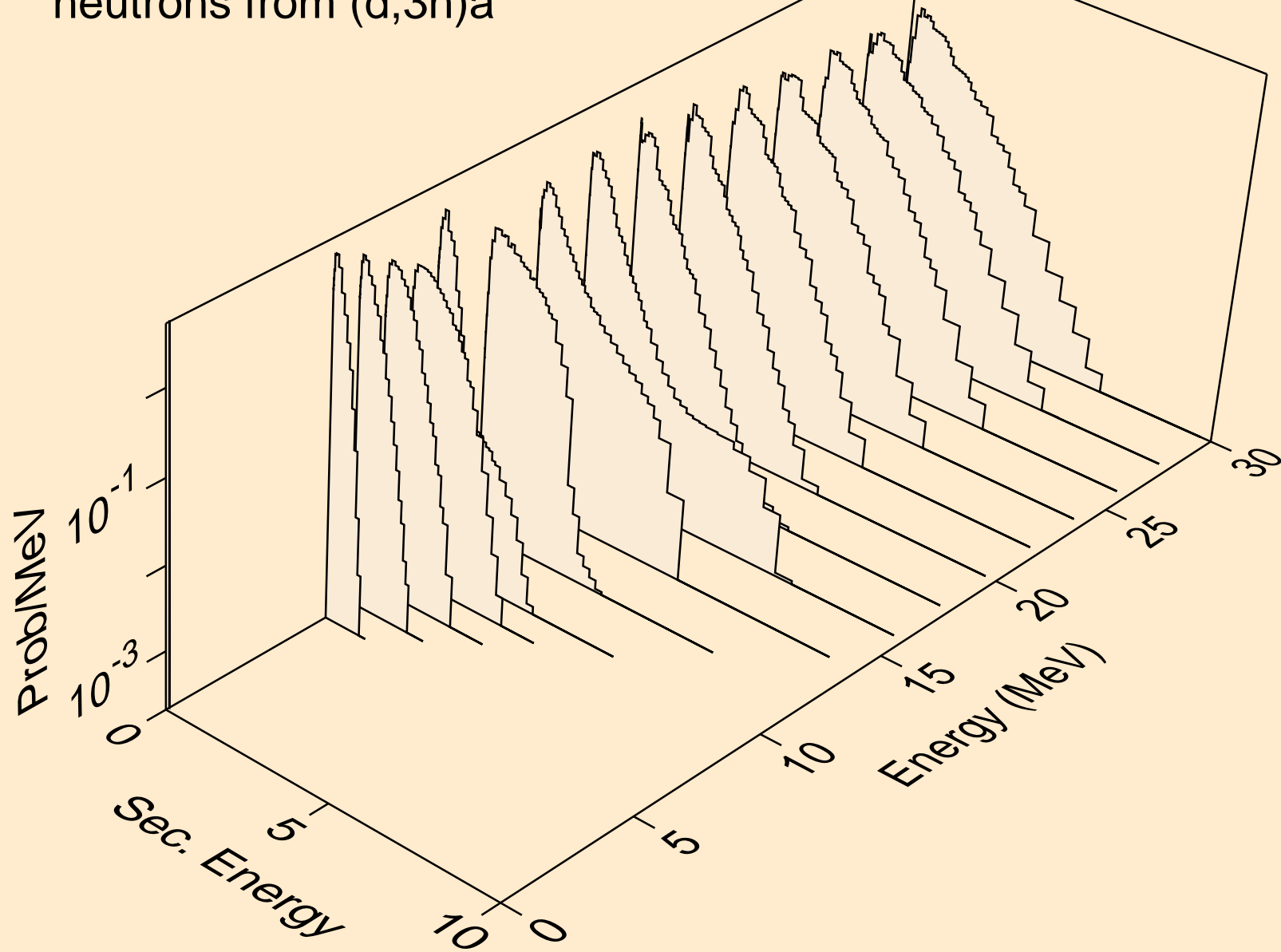

TL213 DEUTERON ACER TENDL-2021 LIBRARY; T=0.K  
neutrons from (d,n\*)p

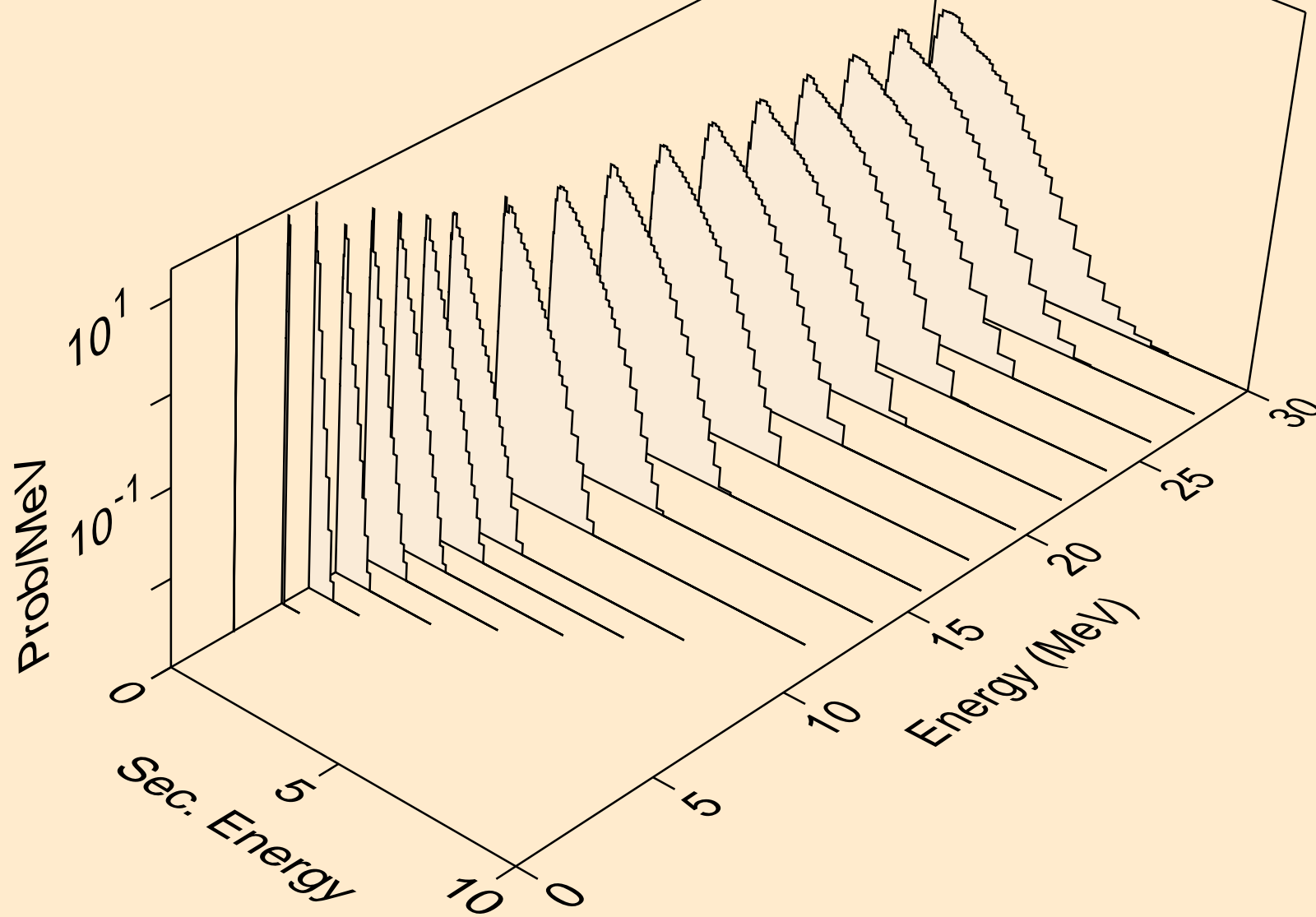



TL213 DEUTERON ACER TENDL-2021 LIBRARY; T=0.K  
neutrons from (d,n\*)d

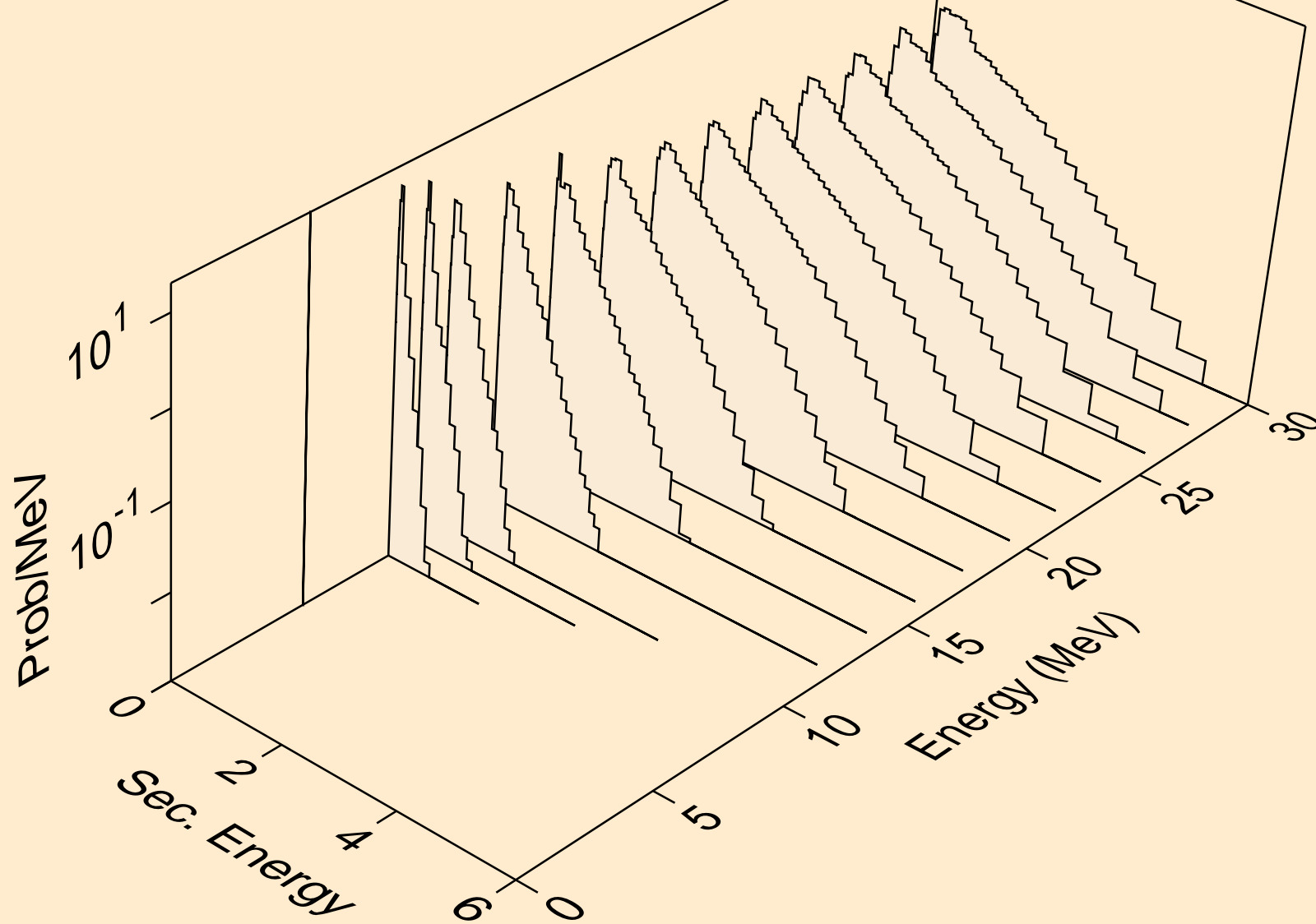

TL213 DEUTERON ACER TENDL-2021 LIBRARY; T=0.K  
neutrons from (d,n\*)t

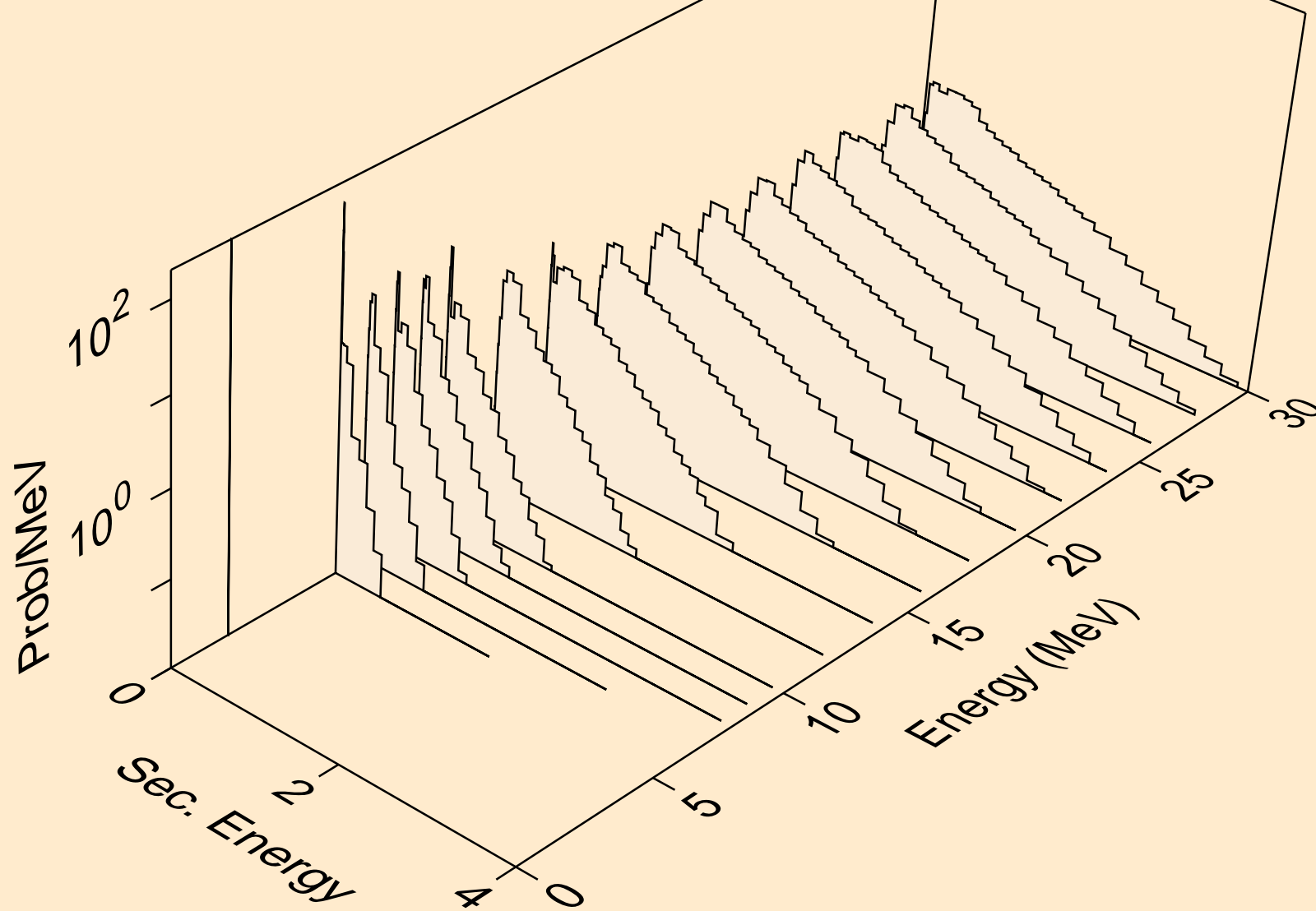

TL213 DEUTERON ACER TENDL-2021 LIBRARY; T=0.K  
neutrons from (d,n\*)he3

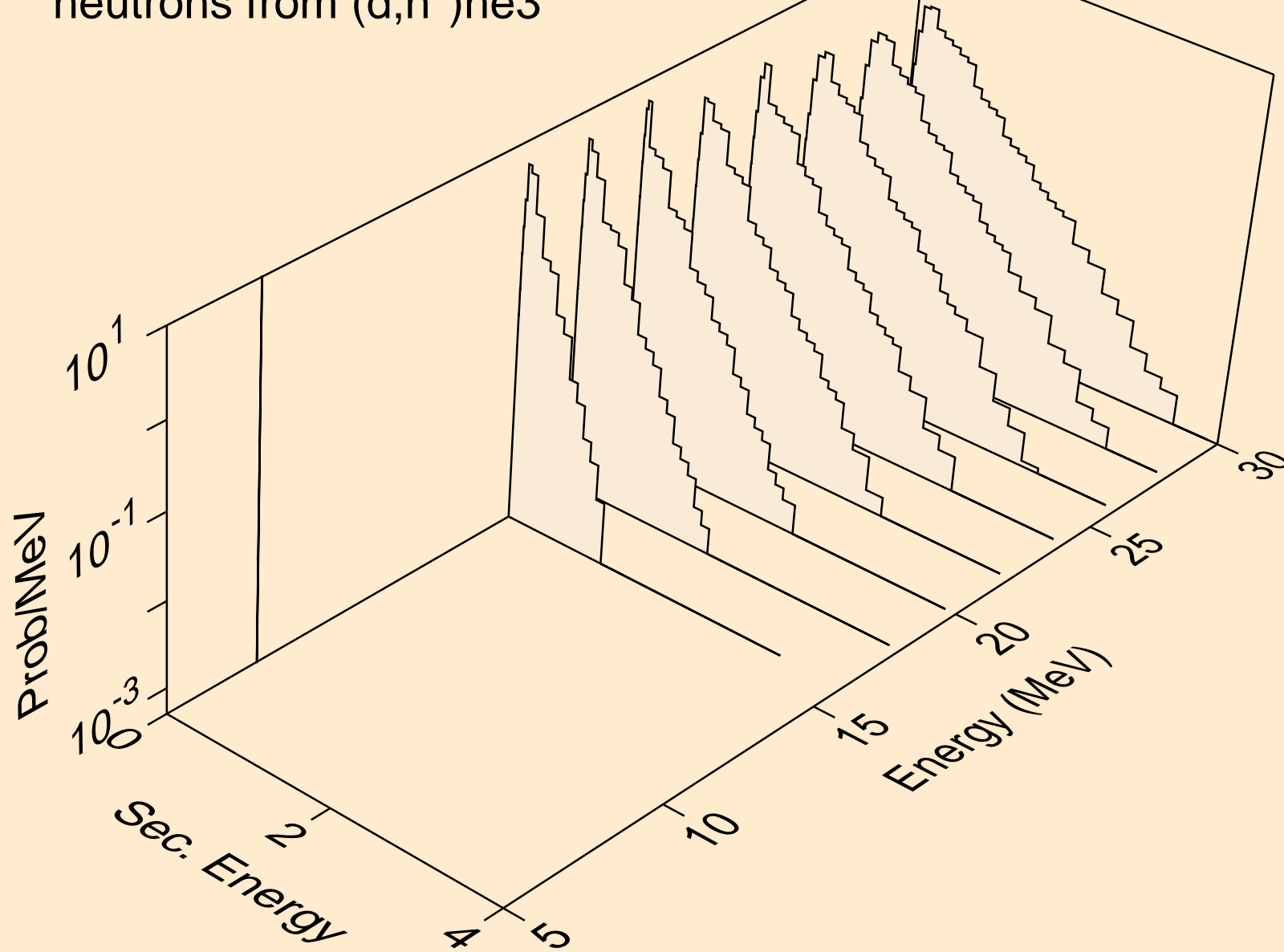

TL213 DEUTERON ACER TENDL-2021 LIBRARY; T=0.K  
neutrons from (d,4n)

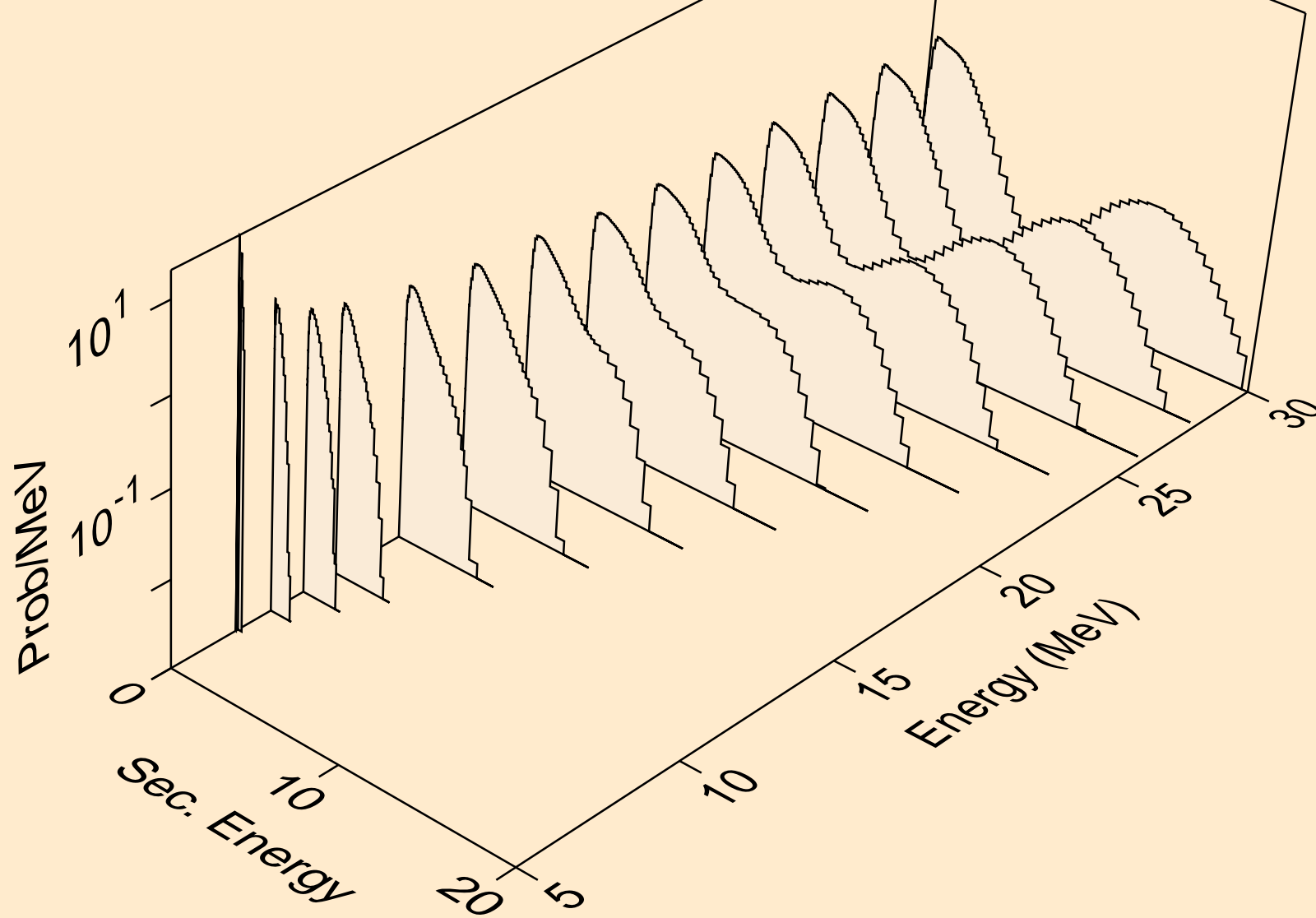

TL213 DEUTERON ACER TENDL-2021 LIBRARY; T=0.K  
neutrons from (d,2np)

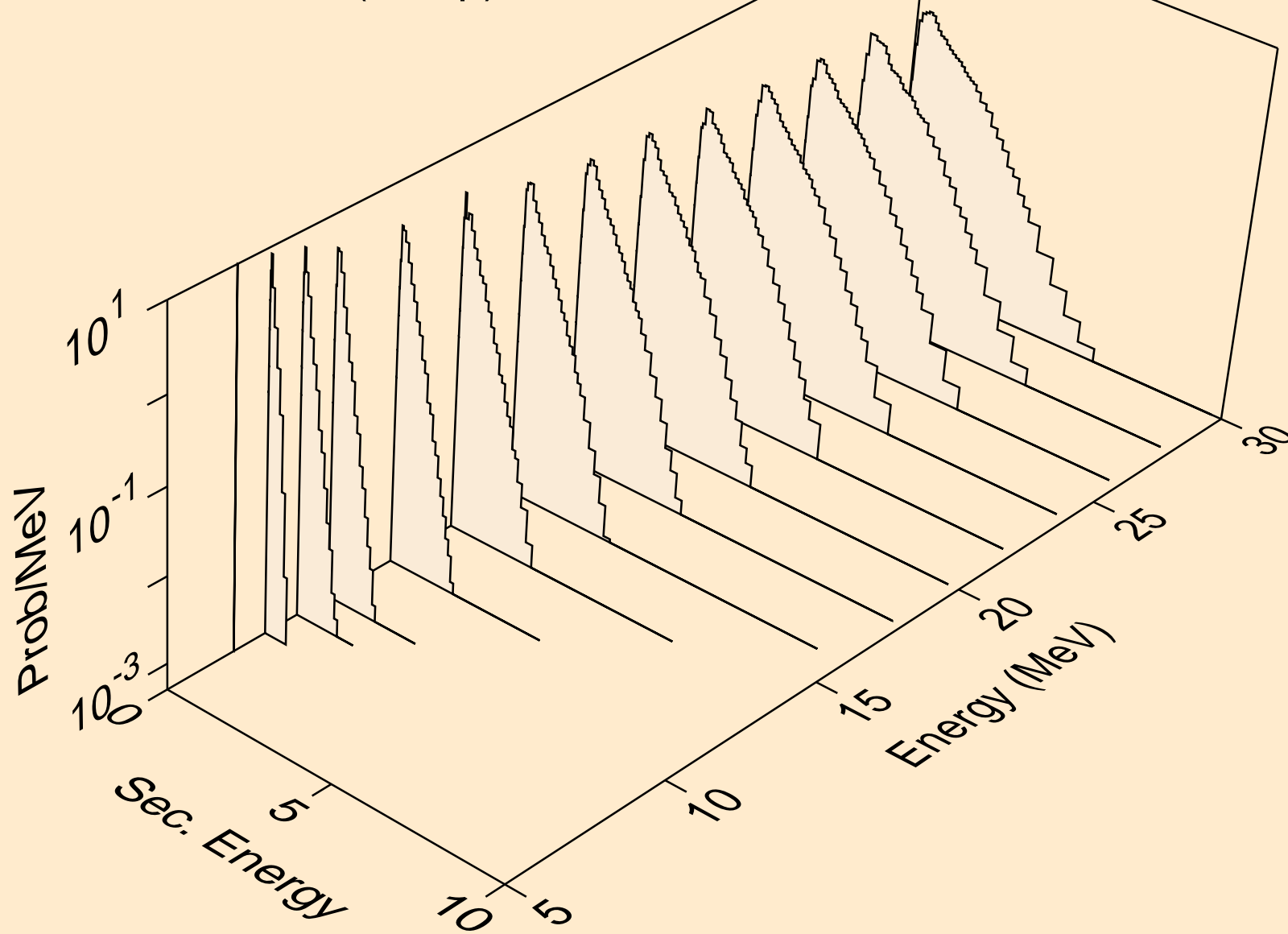

TL213 DEUTERON ACER TENDL-2021 LIBRARY; T=0.K  
neutrons from (d,3np)

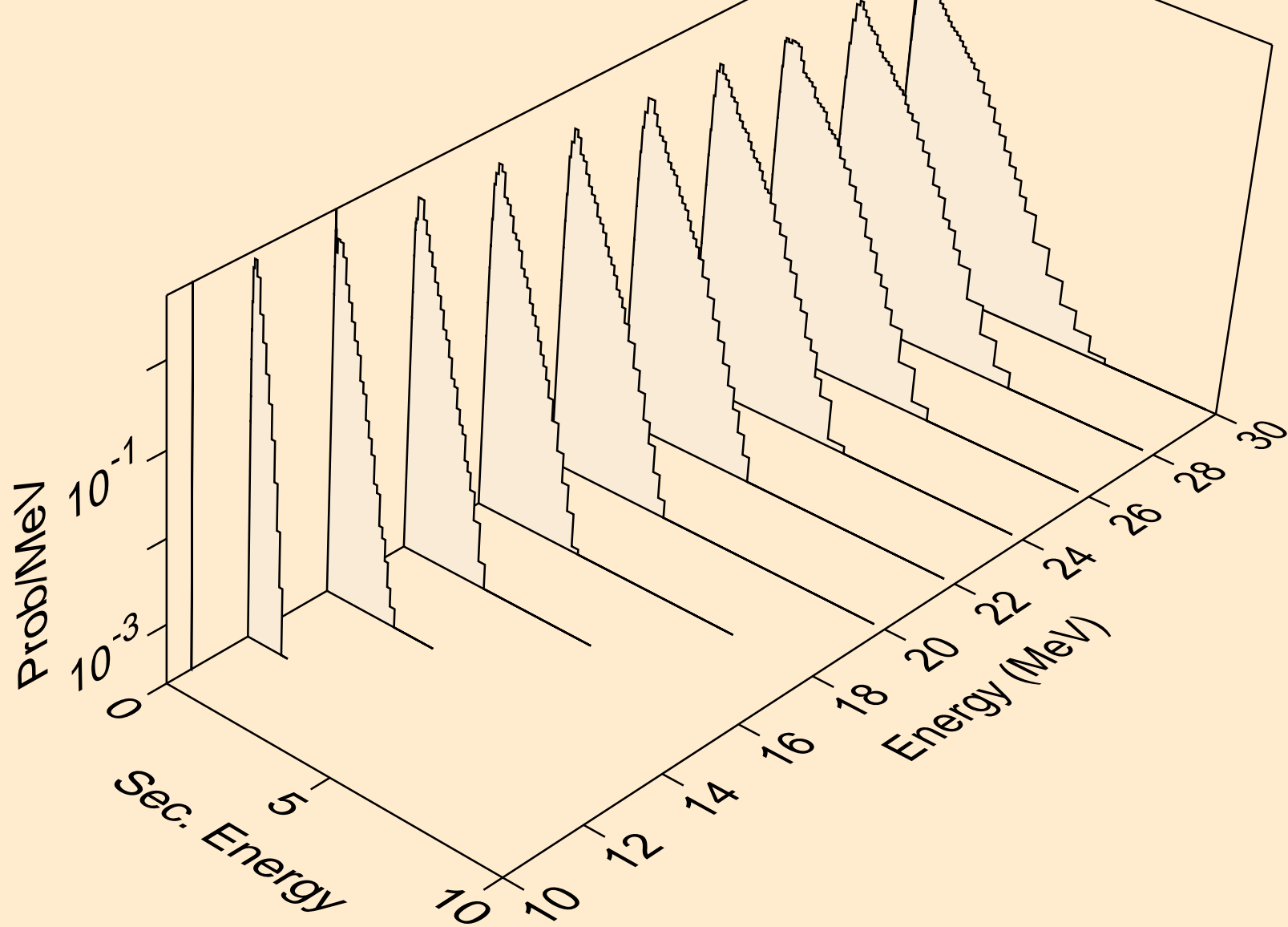

TL213 DEUTERON ACER TENDL-2021 LIBRARY; T=0.K  
neutrons from (d,2np)

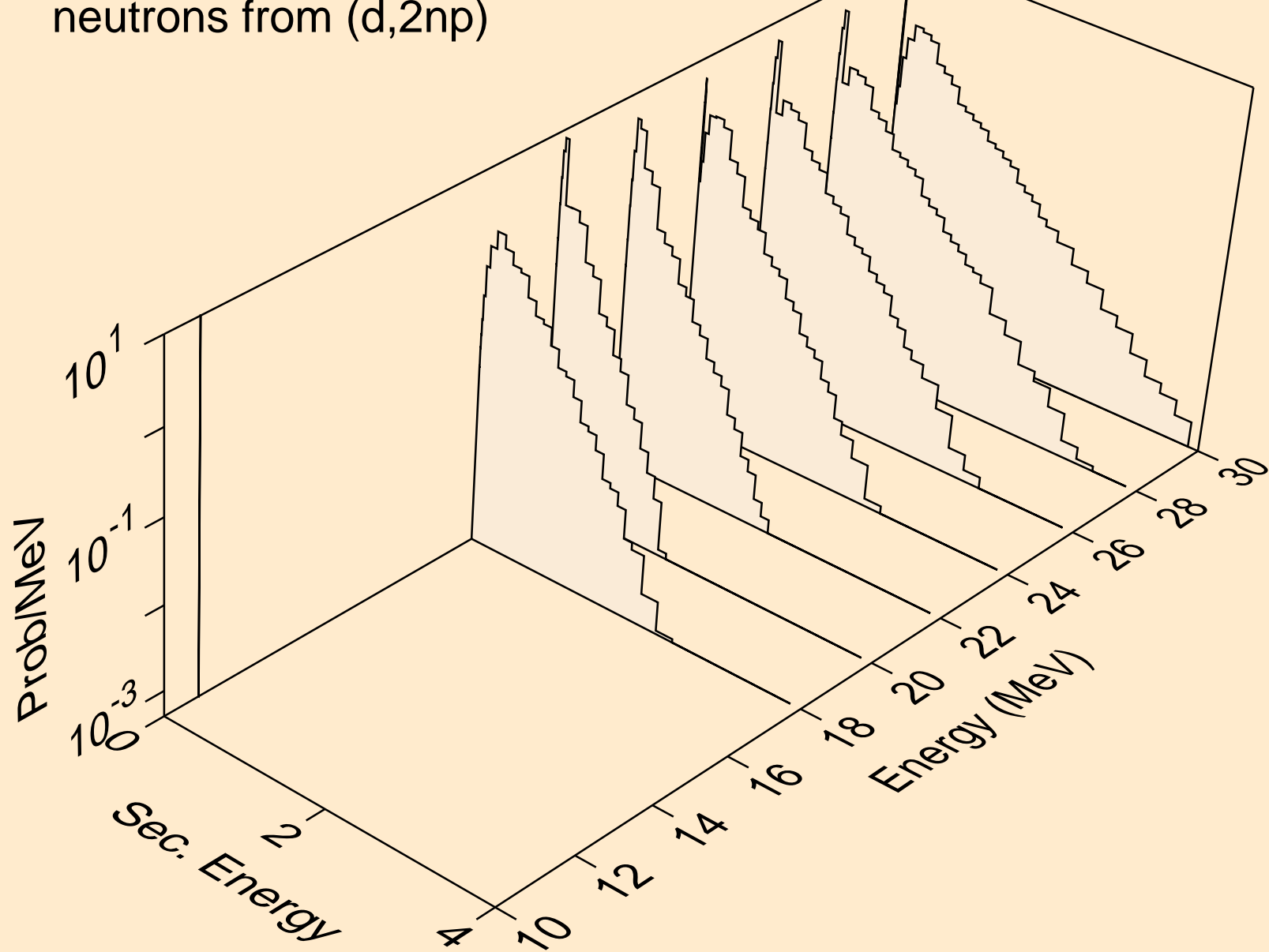

TL213 DEUTERON ACER TENDL-2021 LIBRARY; T=0.K  
protons from (d,x)

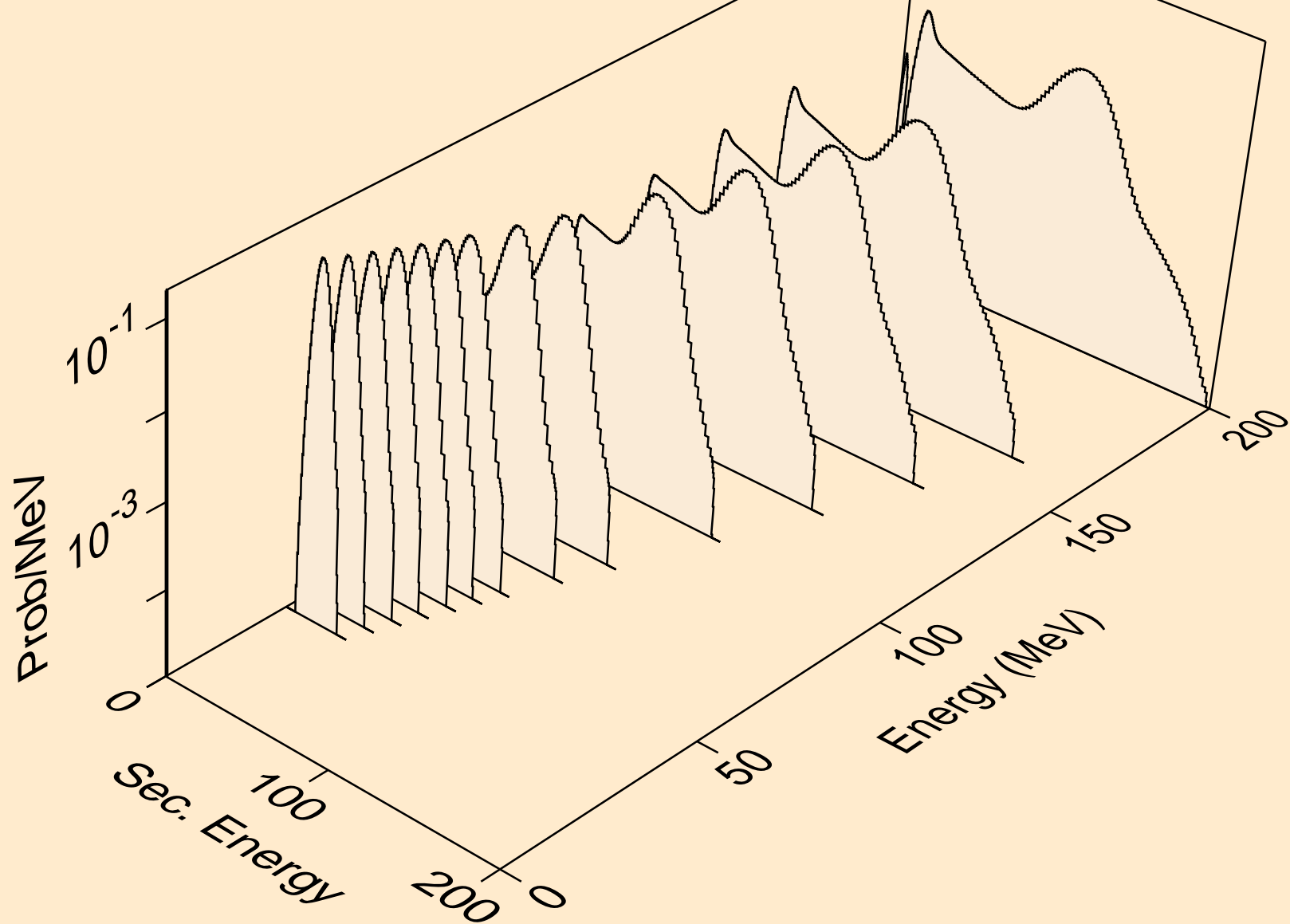



TL213 DEUTERON ACER TENDL-2021 LIBRARY; T=0.K  
protons from (d,n\*)p

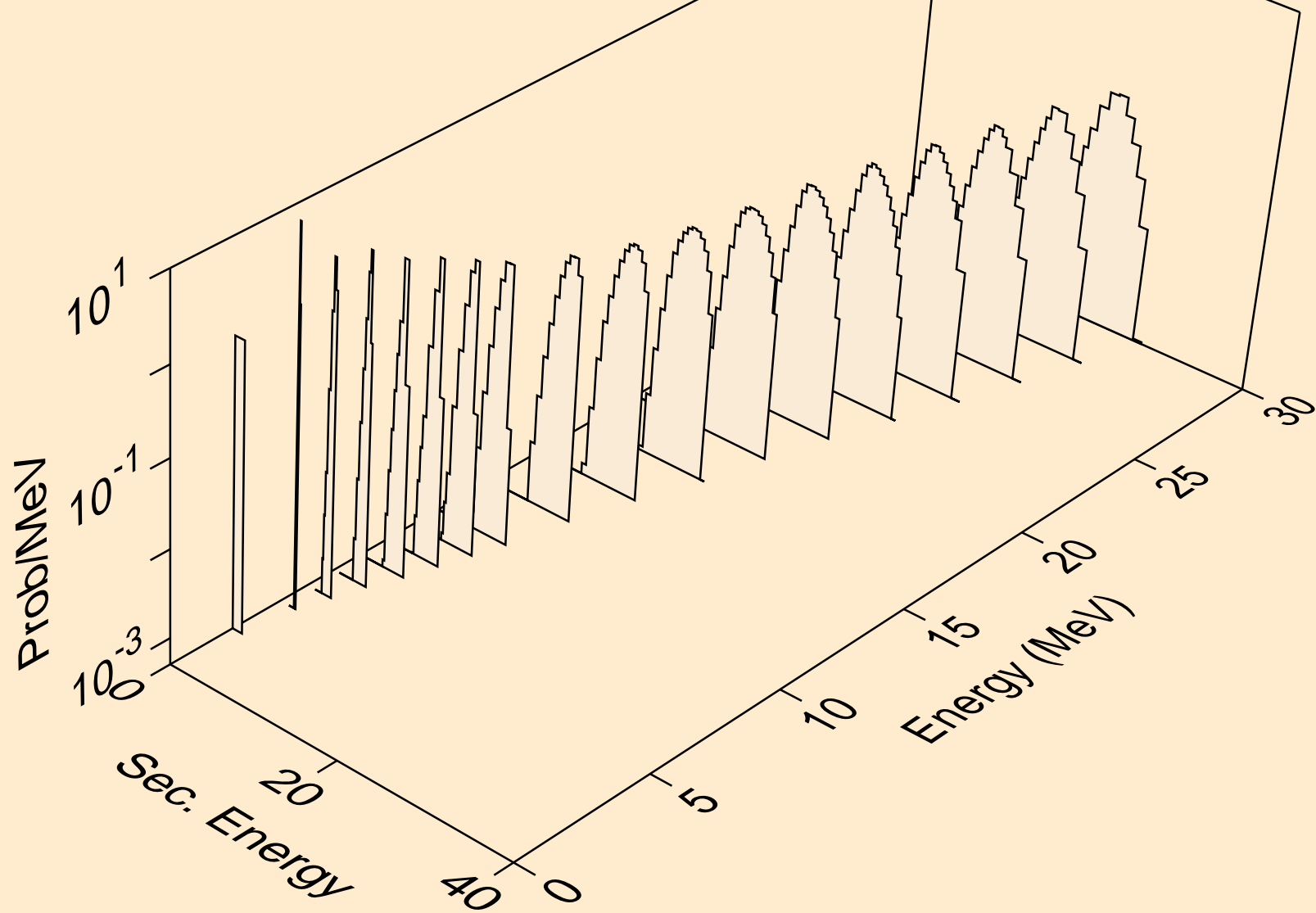

TL213 DEUTERON ACER TENDL-2021 LIBRARY; T=0.K  
protons from (d,2np)

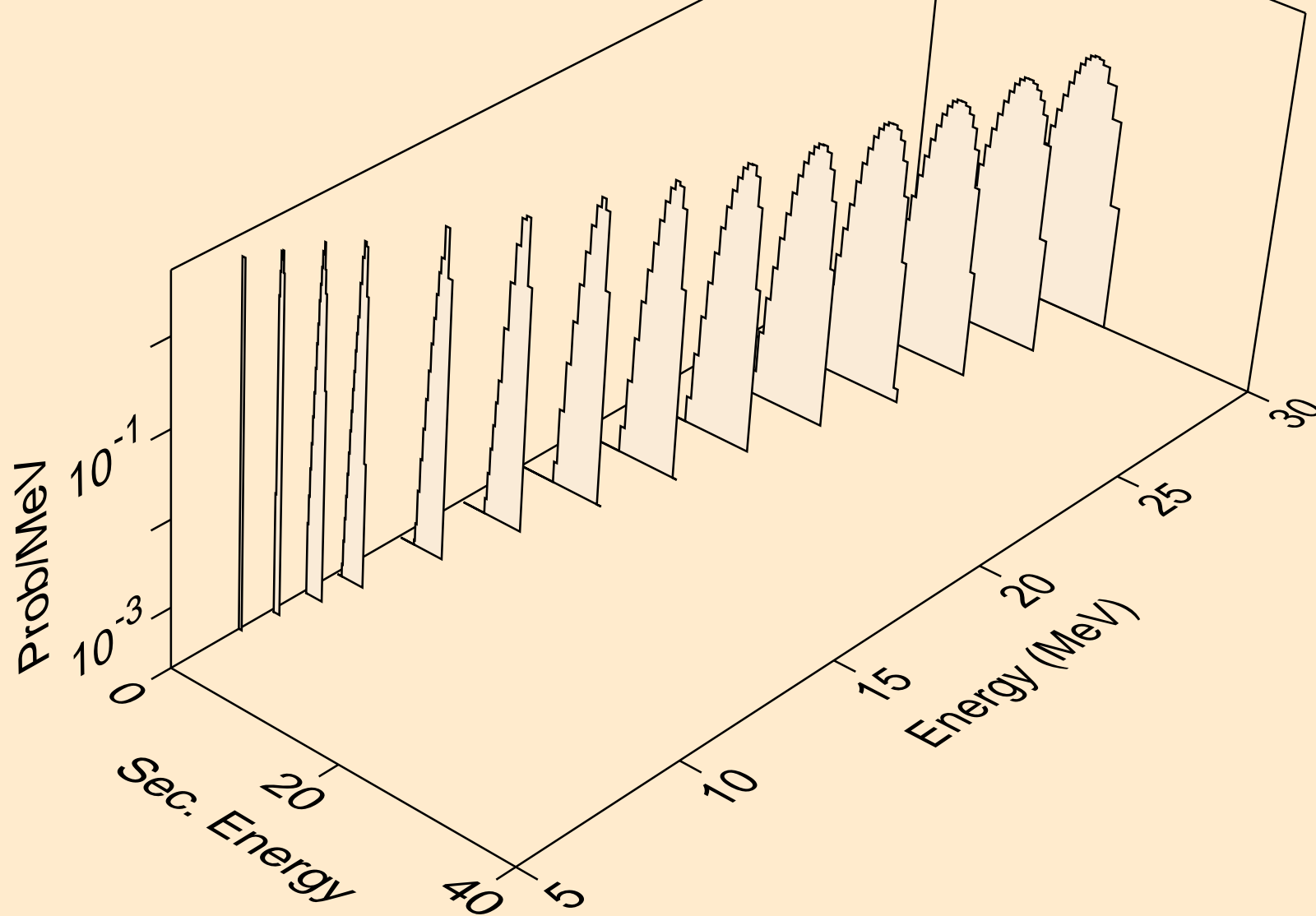

TL213 DEUTERON ACER TENDL-2021 LIBRARY; T=0.K  
protons from (d,3np)

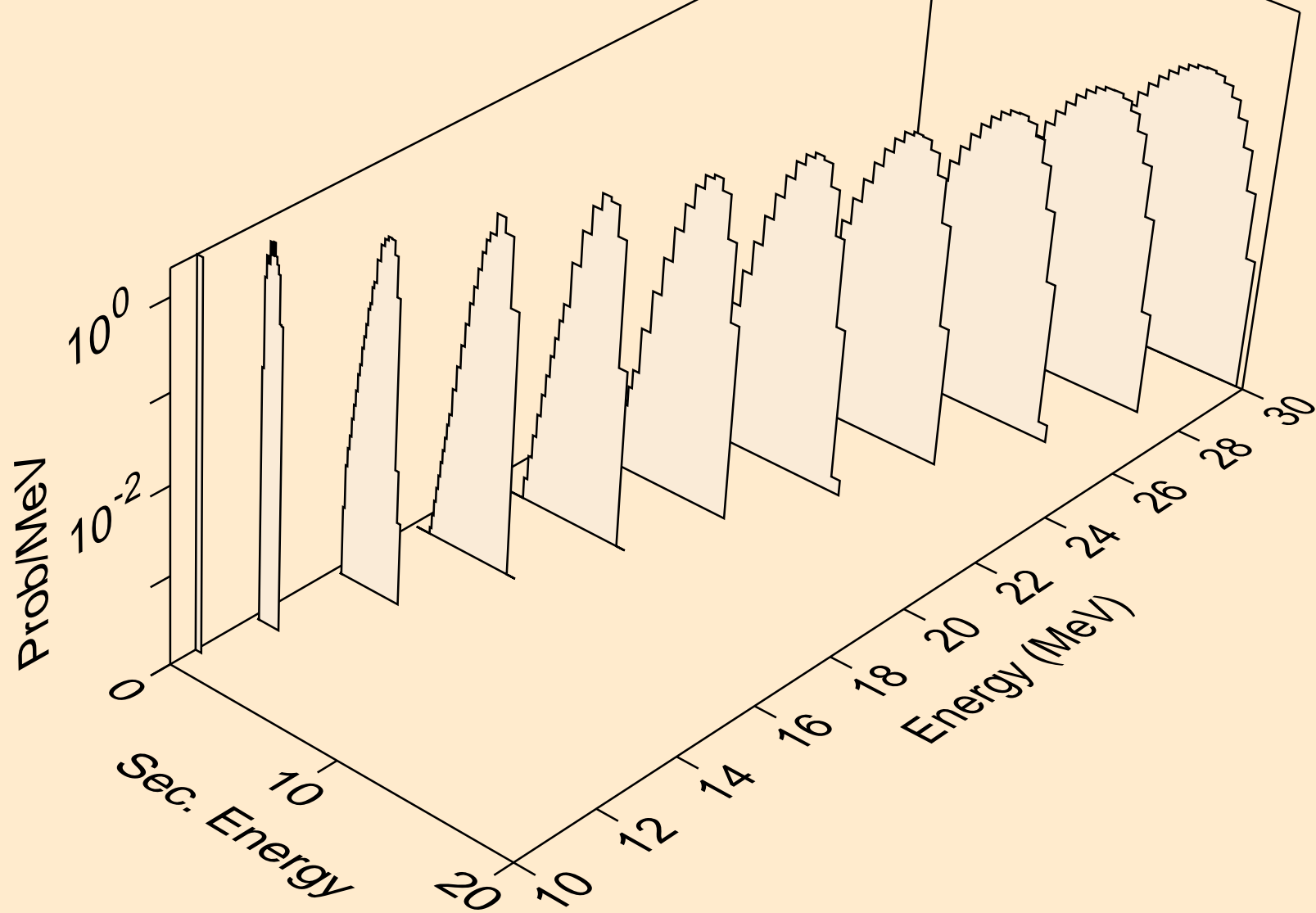

TL213 DEUTERON ACER TENDL-2021 LIBRARY; T=0.K  
protons from (d,2np)

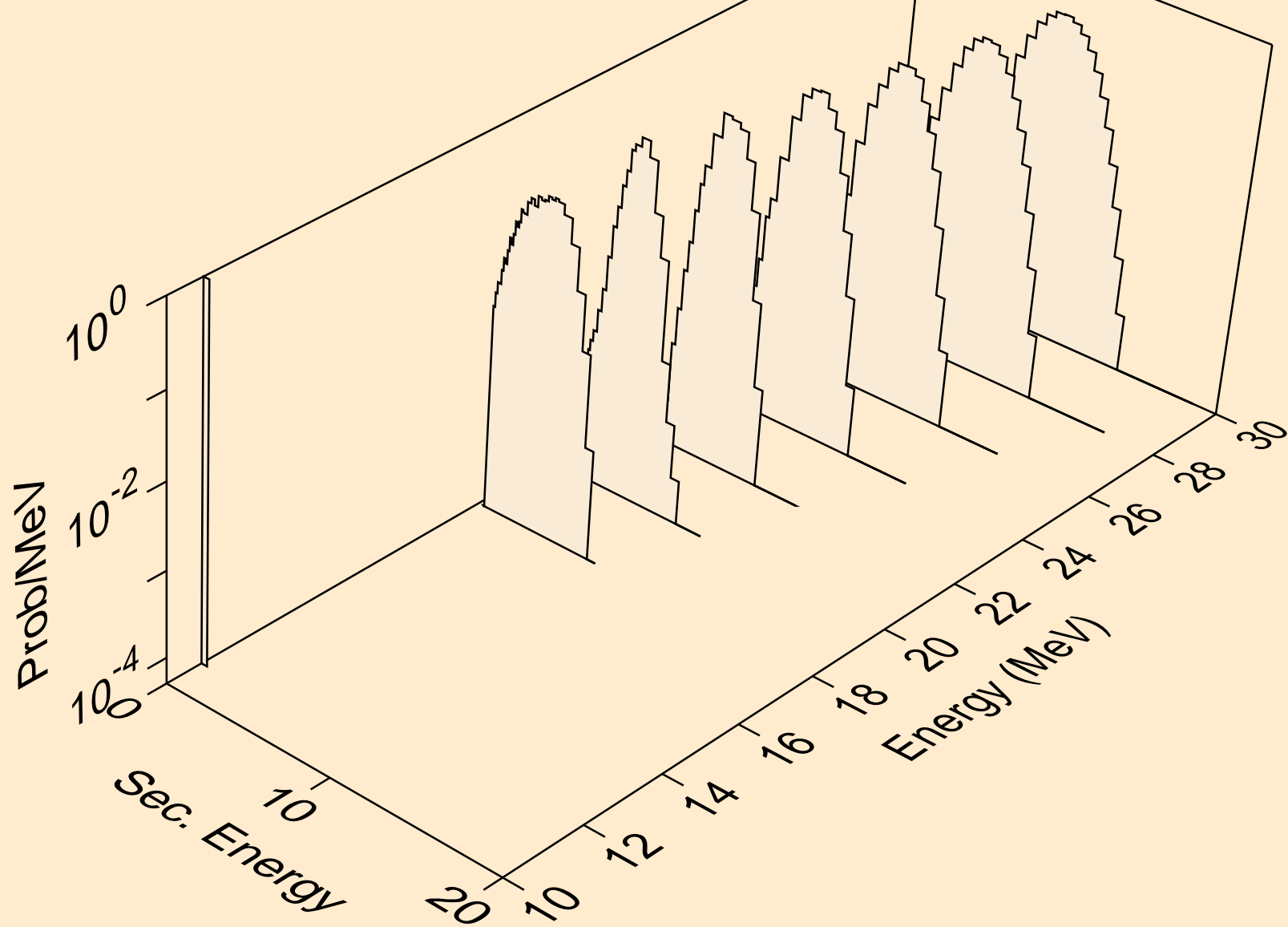

TL213 DEUTERON ACER TENDL-2021 LIBRARY; T=0.K  
protons from (d,p)

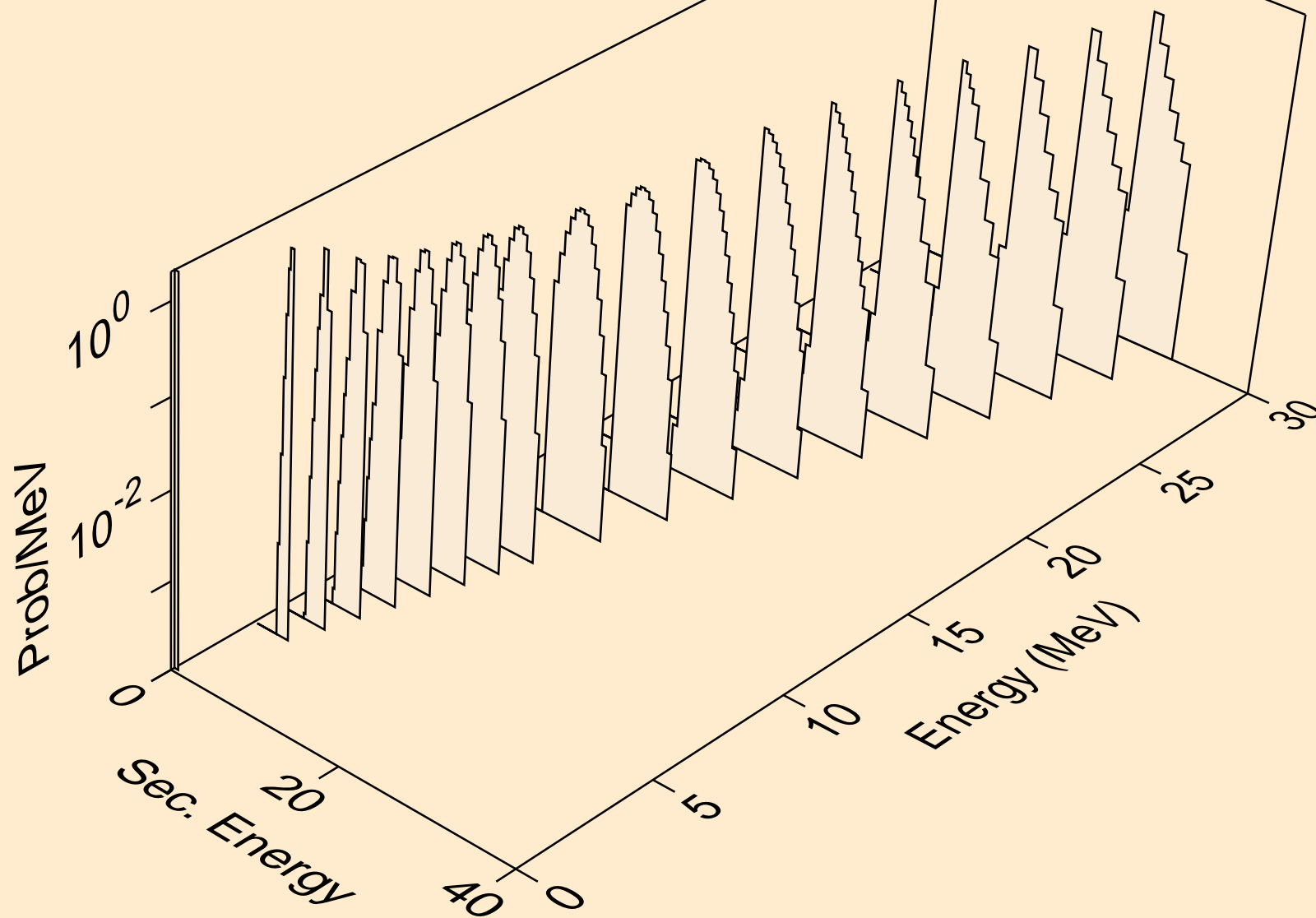

TL213 DEUTERON ACER TENDL-2021 LIBRARY; T=0.K  
protons from (d,2p)

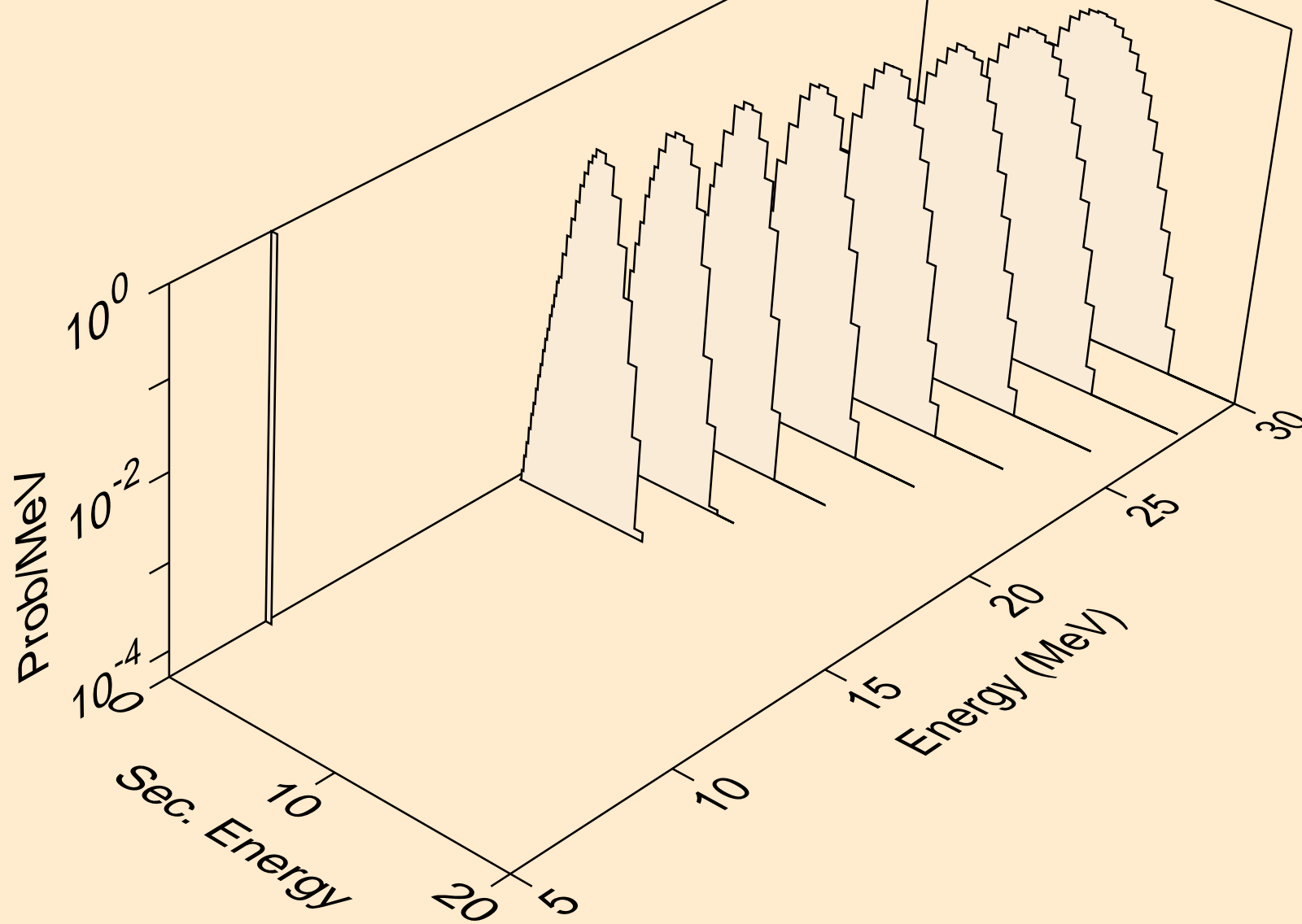

TL213 DEUTERON ACER TENDL-2021 LIBRARY; T=0.K  
protons from (d,pd)

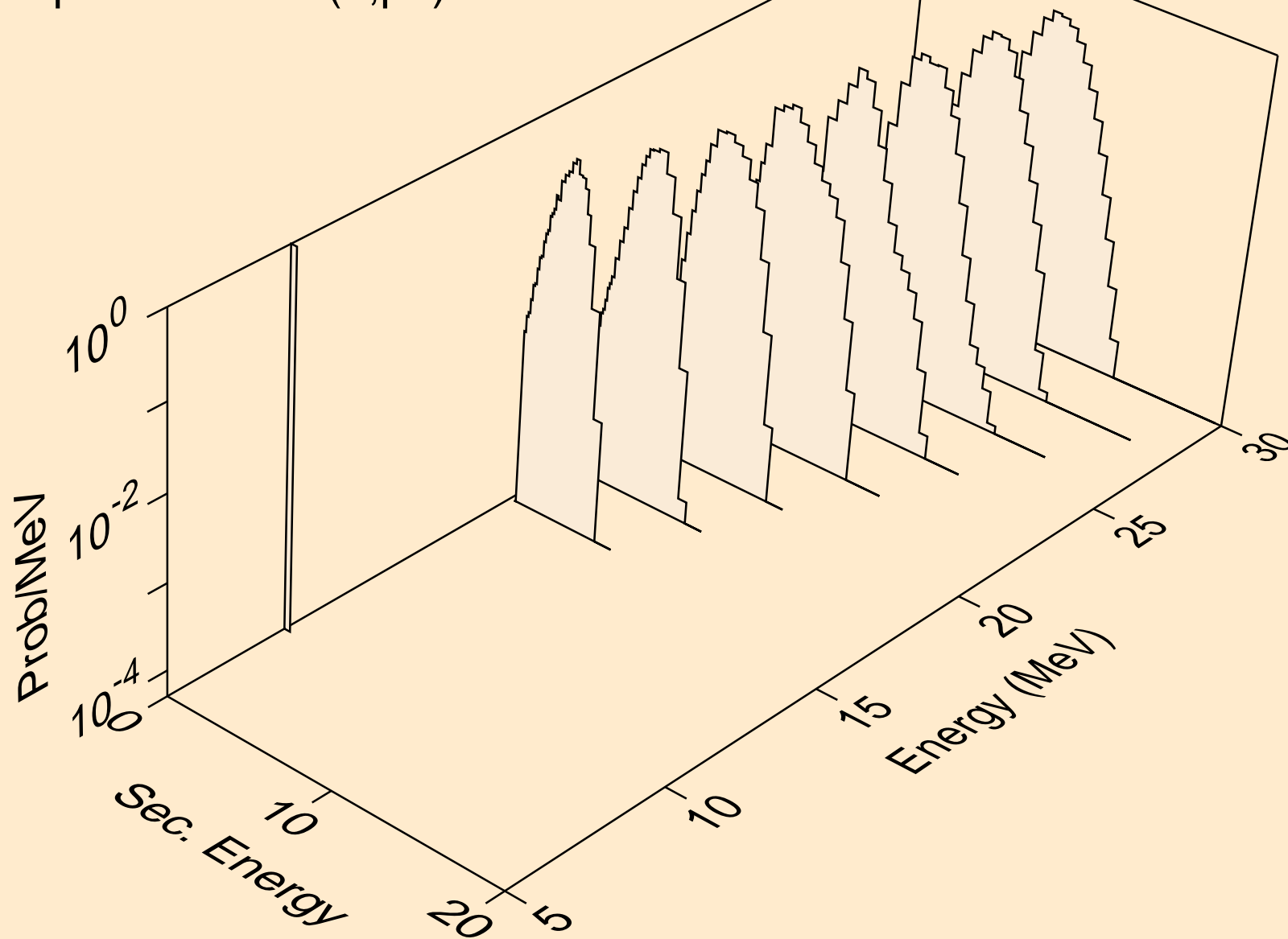

TL213 DEUTERON ACER TENDL-2021 LIBRARY; T=0.K  
tritons from (d,x)

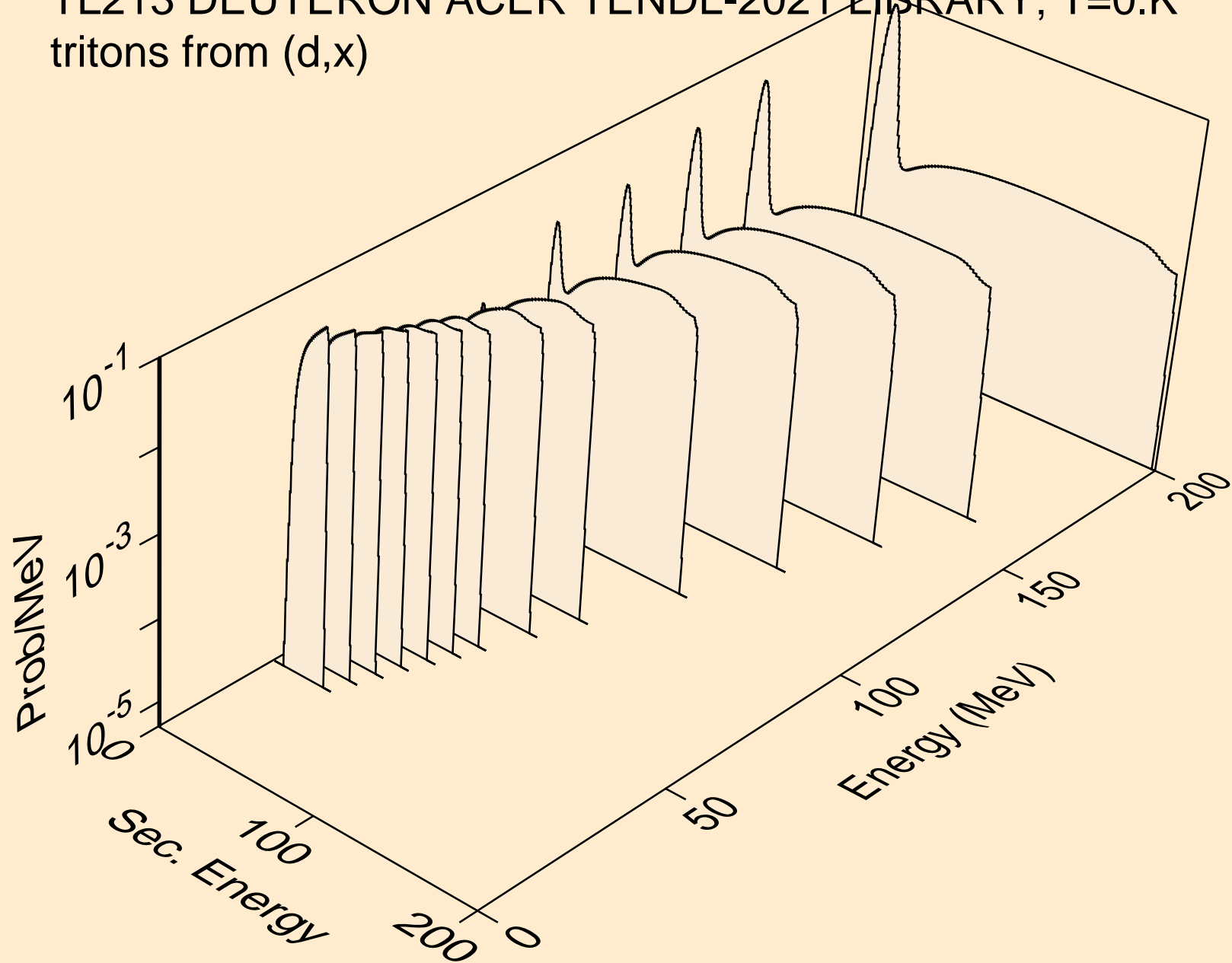



TL213 DEUTERON ACER TENDL-2021 LIBRARY; T=0.K  
tritons from (d,n\*)t

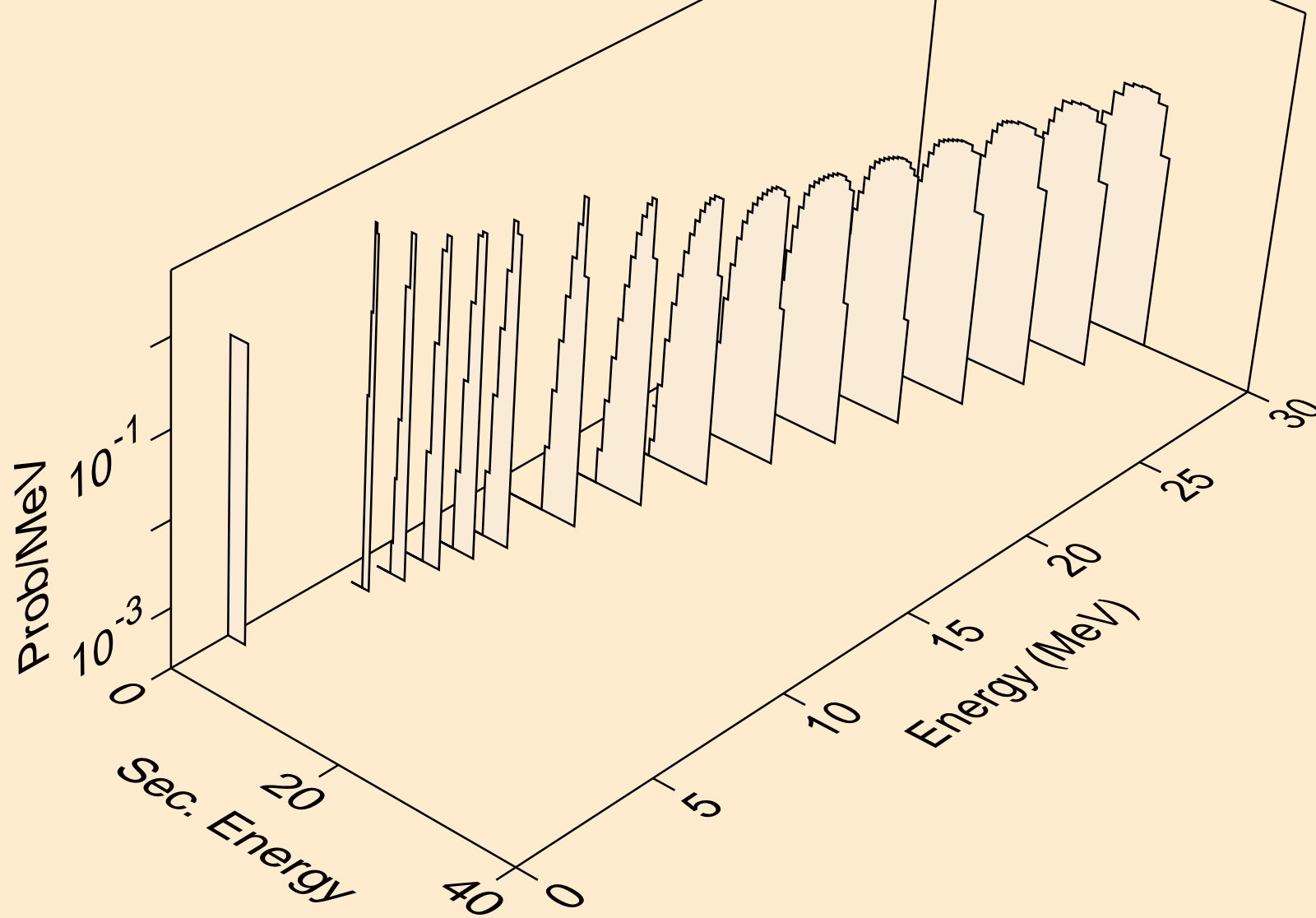

TL213 DEUTERON ACER TENDL-2021 LIBRARY; T=0.K  
tritons from (d,t)

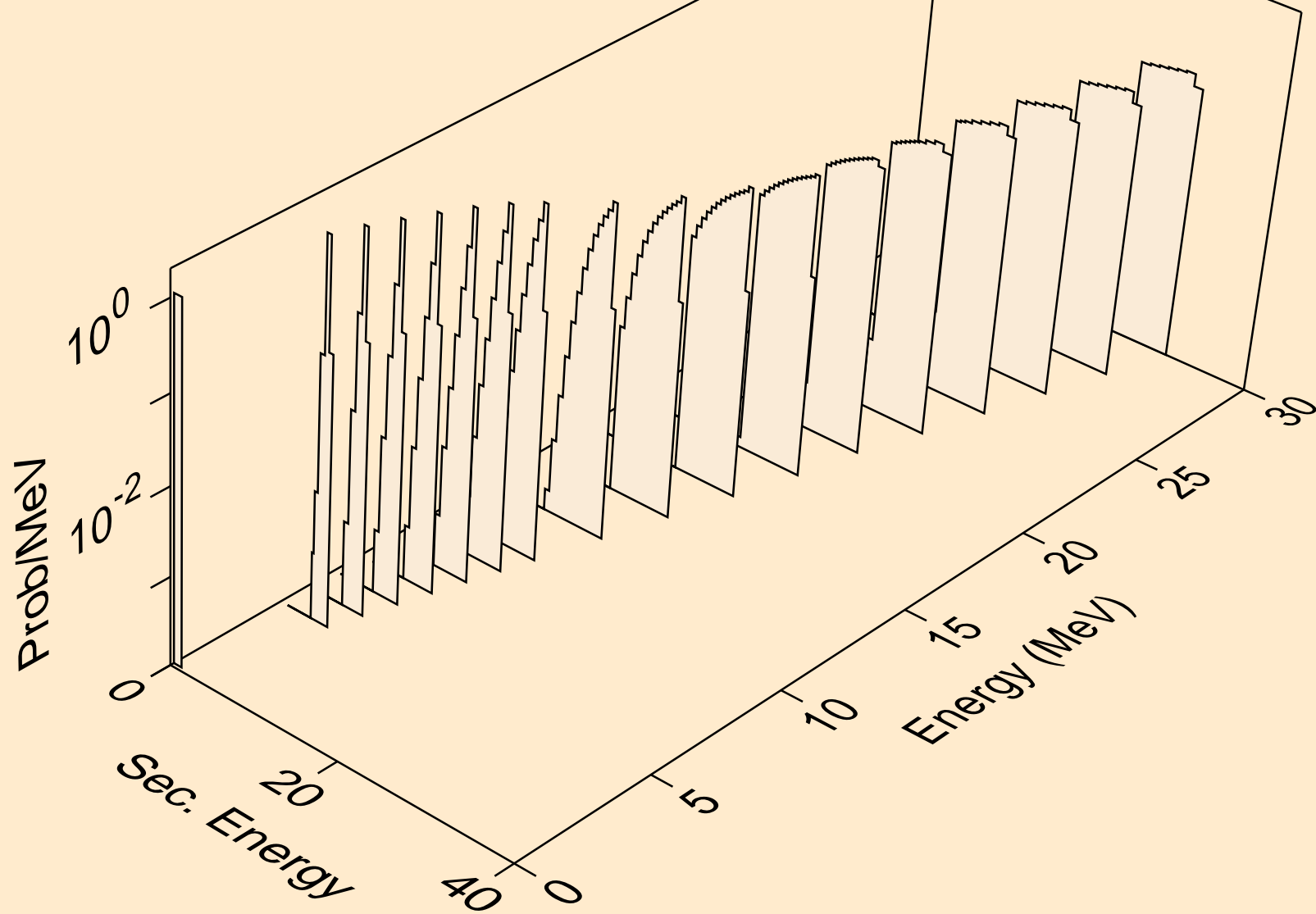

TL213 DEUTERON ACER TENDL-2021 LIBRARY; T=0.K  
he3s from (d,x)

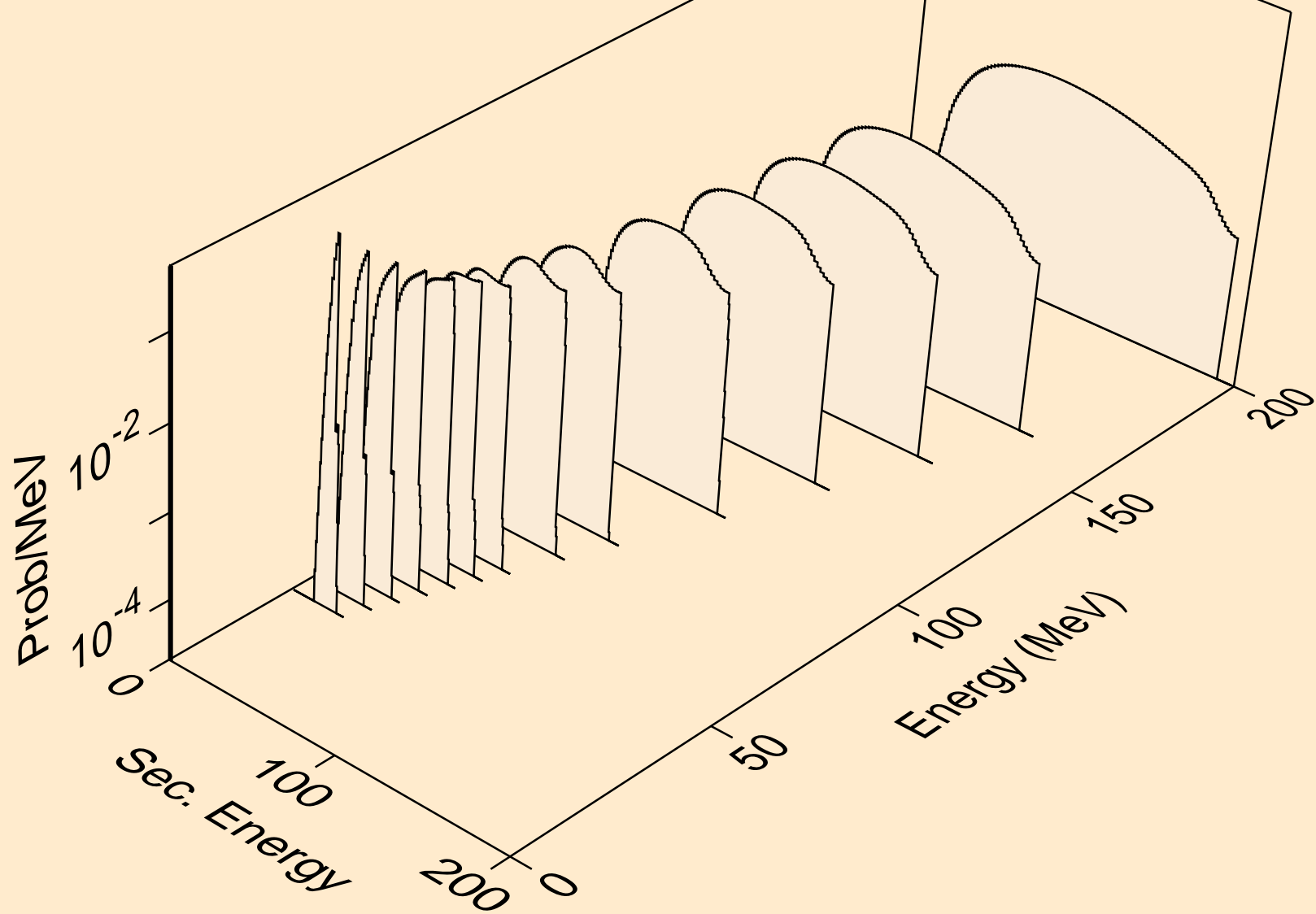

TL213 DEUTERON ACER TENDL-2021 LIBRARY; T=0.K  
he3s from (d,n\*)he3

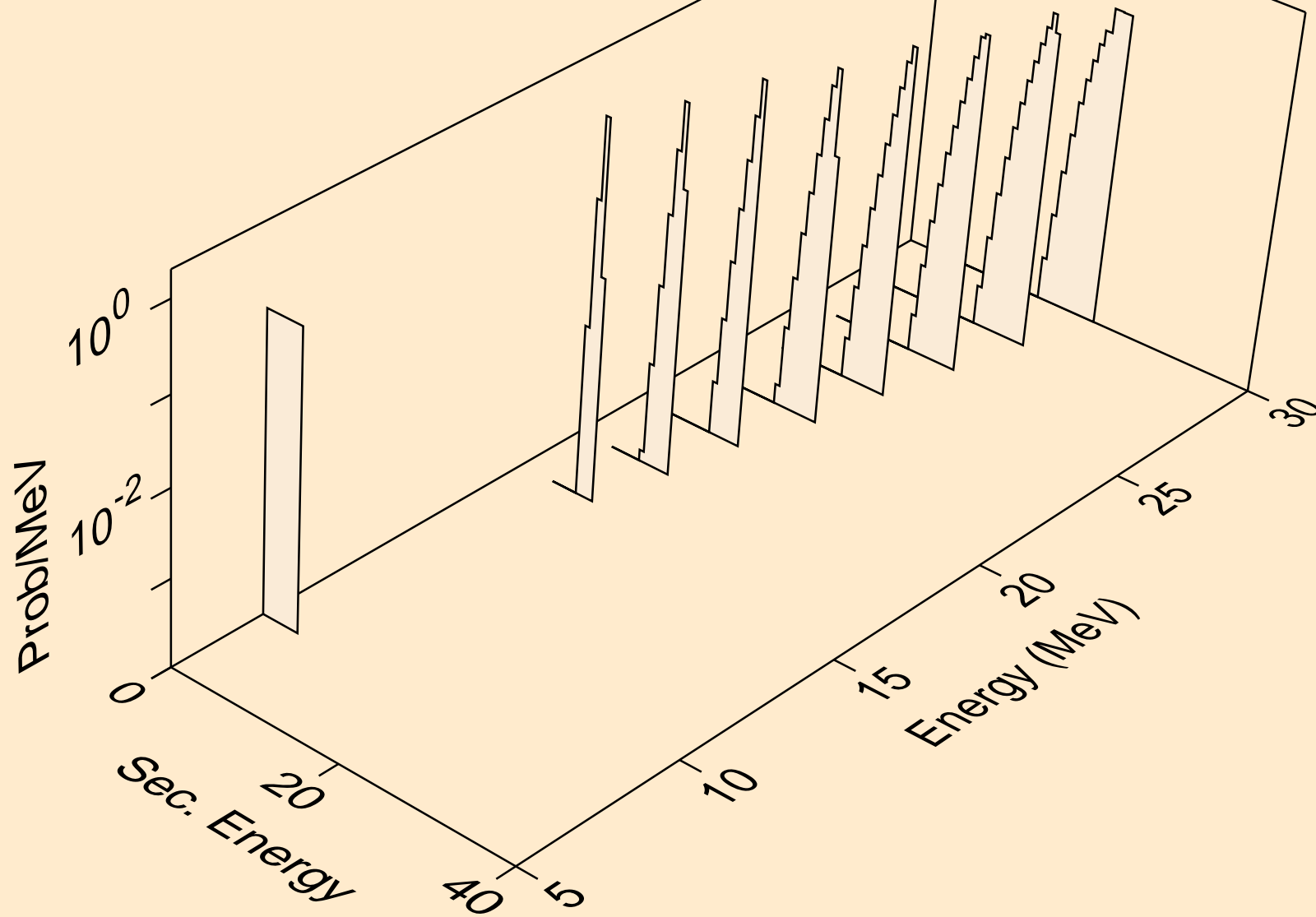

TL213 DEUTERON ACER TENDL-2021 LIBRARY; T=0.K  
he3s from (d,he3)

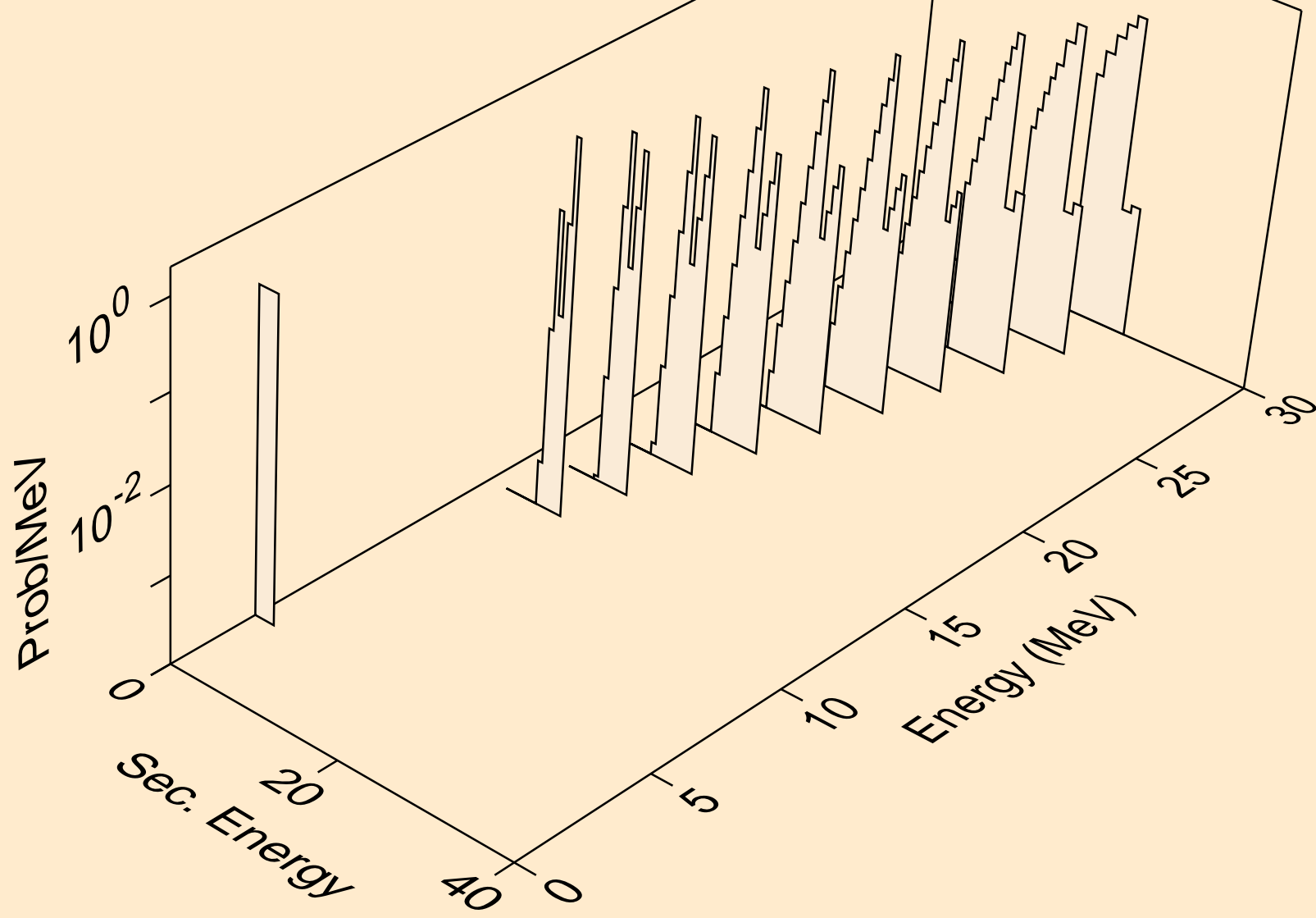

TL213 DEUTERON ACER TENDL-2021 LIBRARY; T=0.K  
alphas from (d,x)

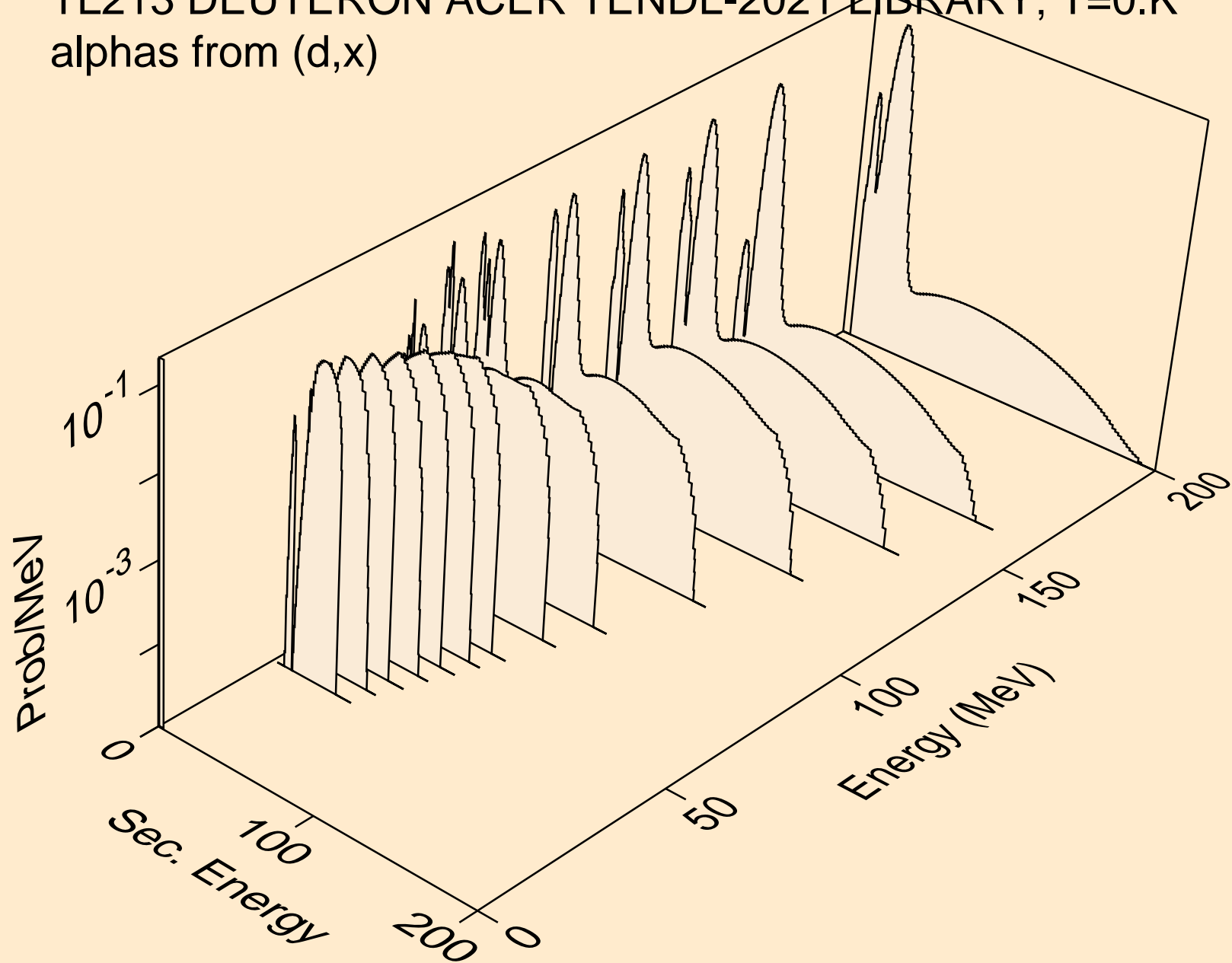

TL213 DEUTERON ACER TENDL-2021 LIBRARY; T=0.K  
alphas from (d,n\*)a

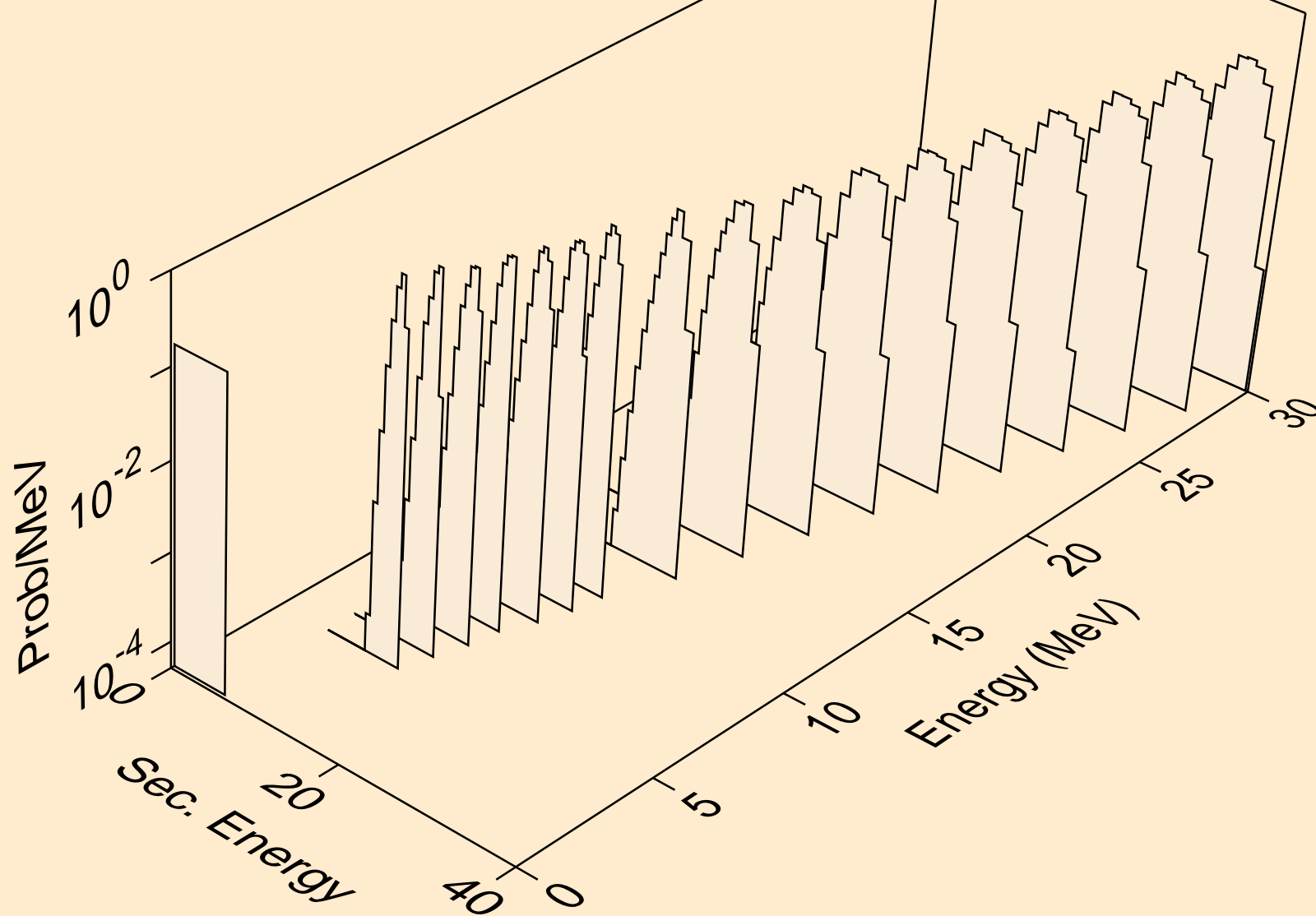

TL213 DEUTERON ACER TENDL-2021 LIBRARY; T=0.K  
alphas from (d,2n)a

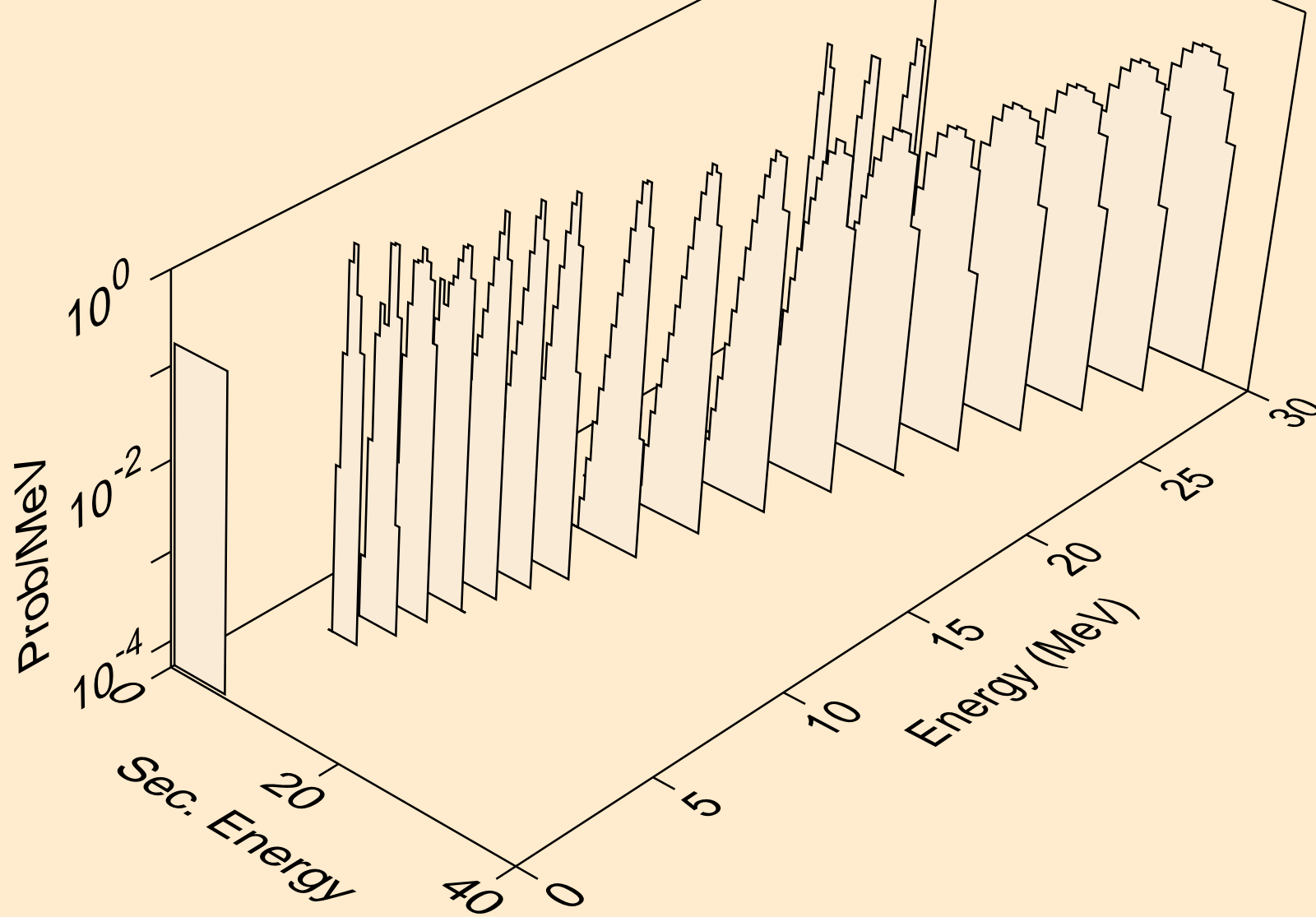



TL213 DEUTERON ACER TENDL-2021 LIBRARY; T=0.K  
alphas from (d,3n)a

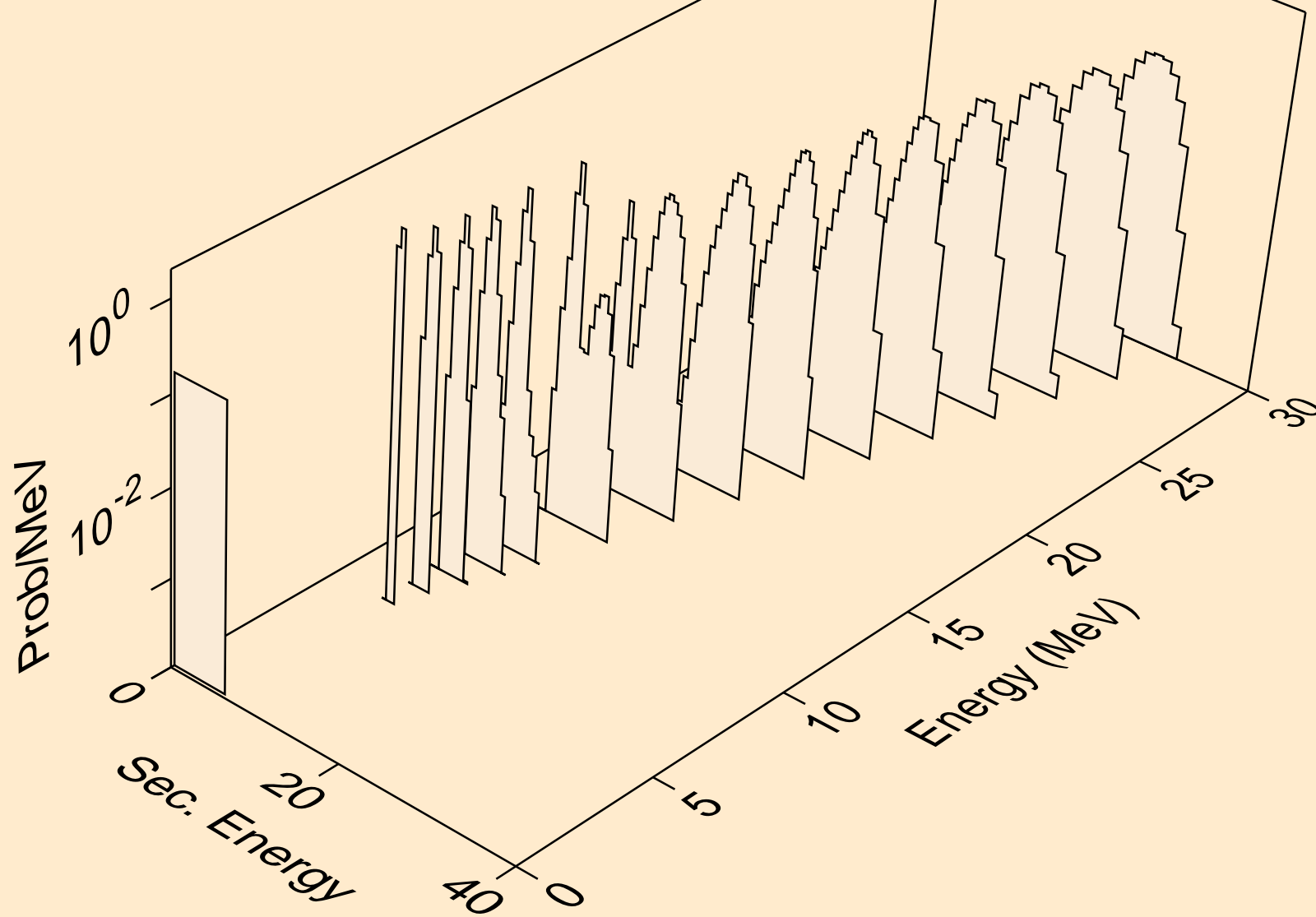

TL213 DEUTERON ACER TENDL-2021 LIBRARY; T=0.K  
alphas from (d,a)

