

# TM150 DEUTERON ACER TENDL-2021 LIBRARY; T=0.K

## Principal cross sections

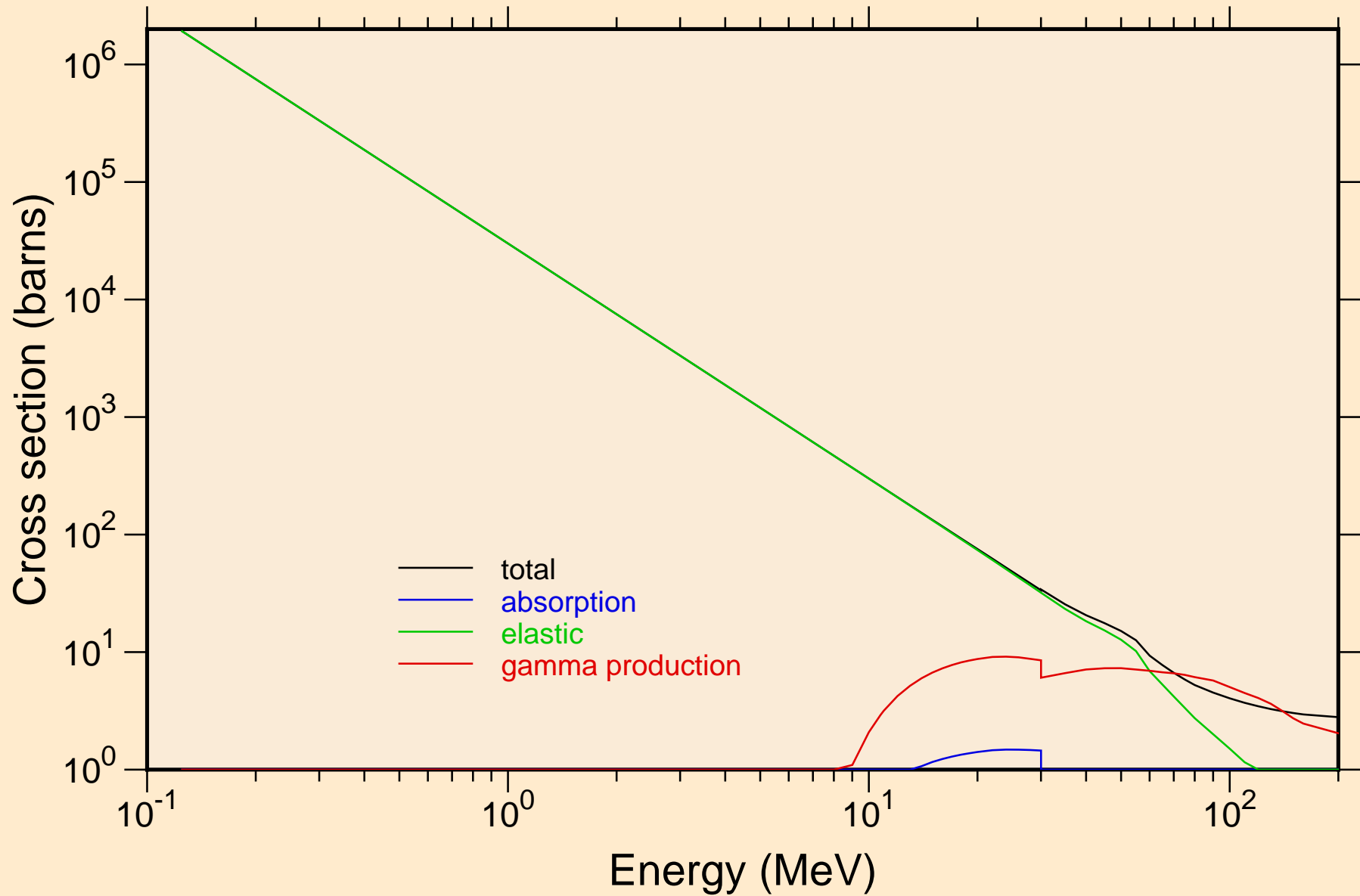

TM150 DEUTERON ACER TENDL-2021 LIBRARY; T=0.K  
Heating

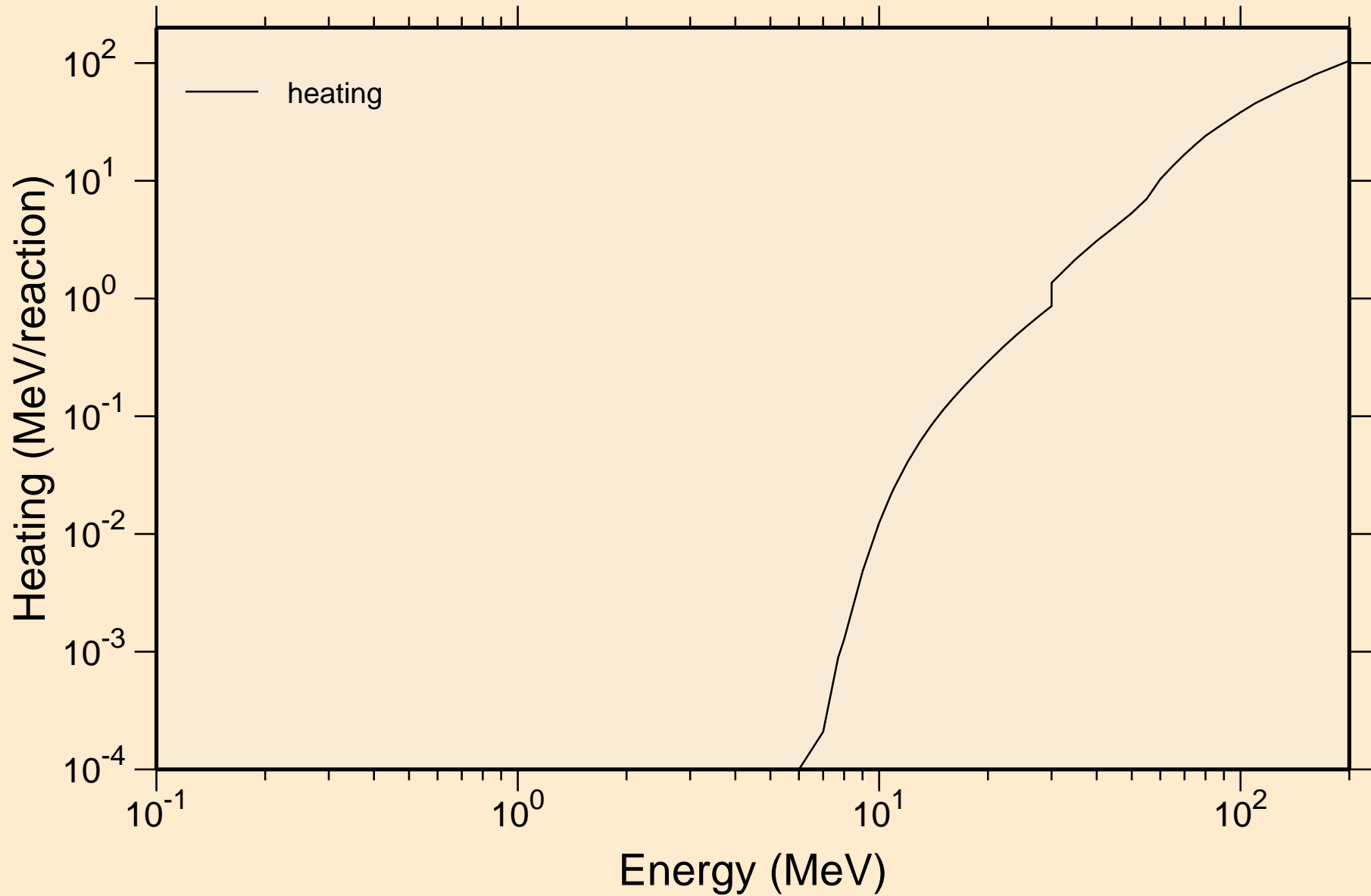

# TM150 DEUTERON ACER TENDL-2021 LIBRARY; T=0.K

## Principal cross sections

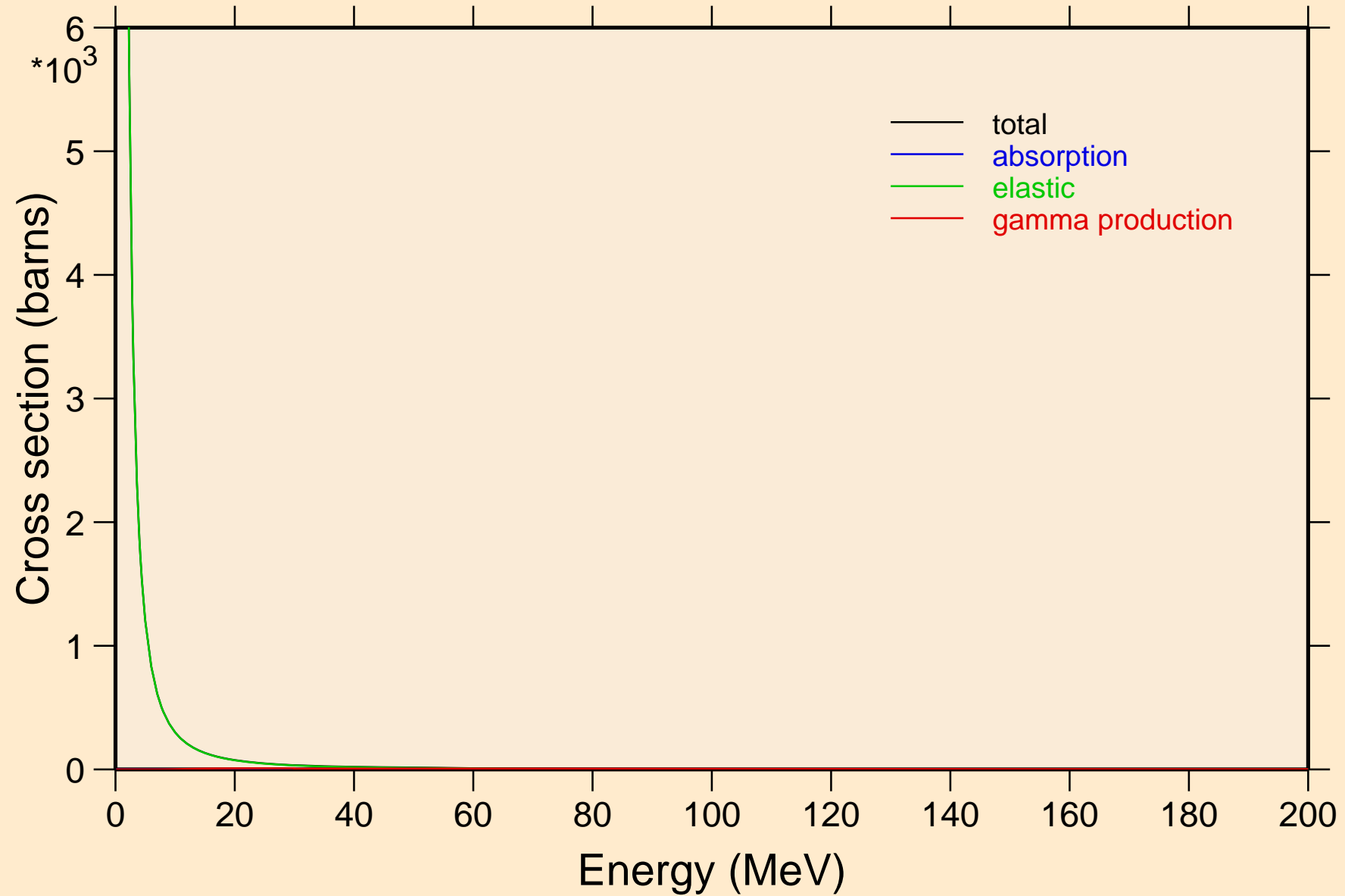

TM150 DEUTERON ACER TENDL-2021 LIBRARY; T=0.K  
Heating

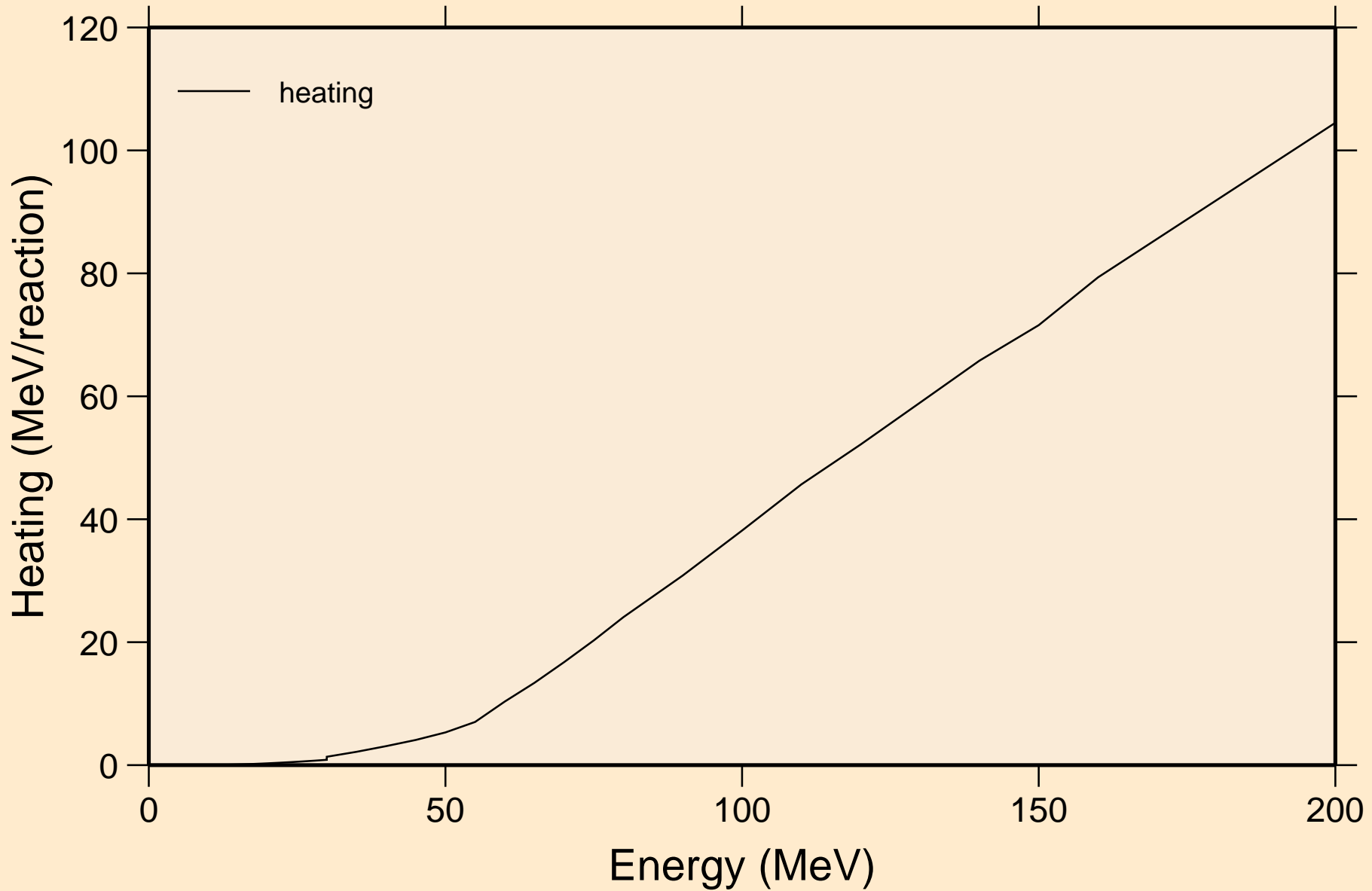

# TM150 DEUTERON ACER TENDL-2021 LIBRARY; T=0.K

## Threshold reactions

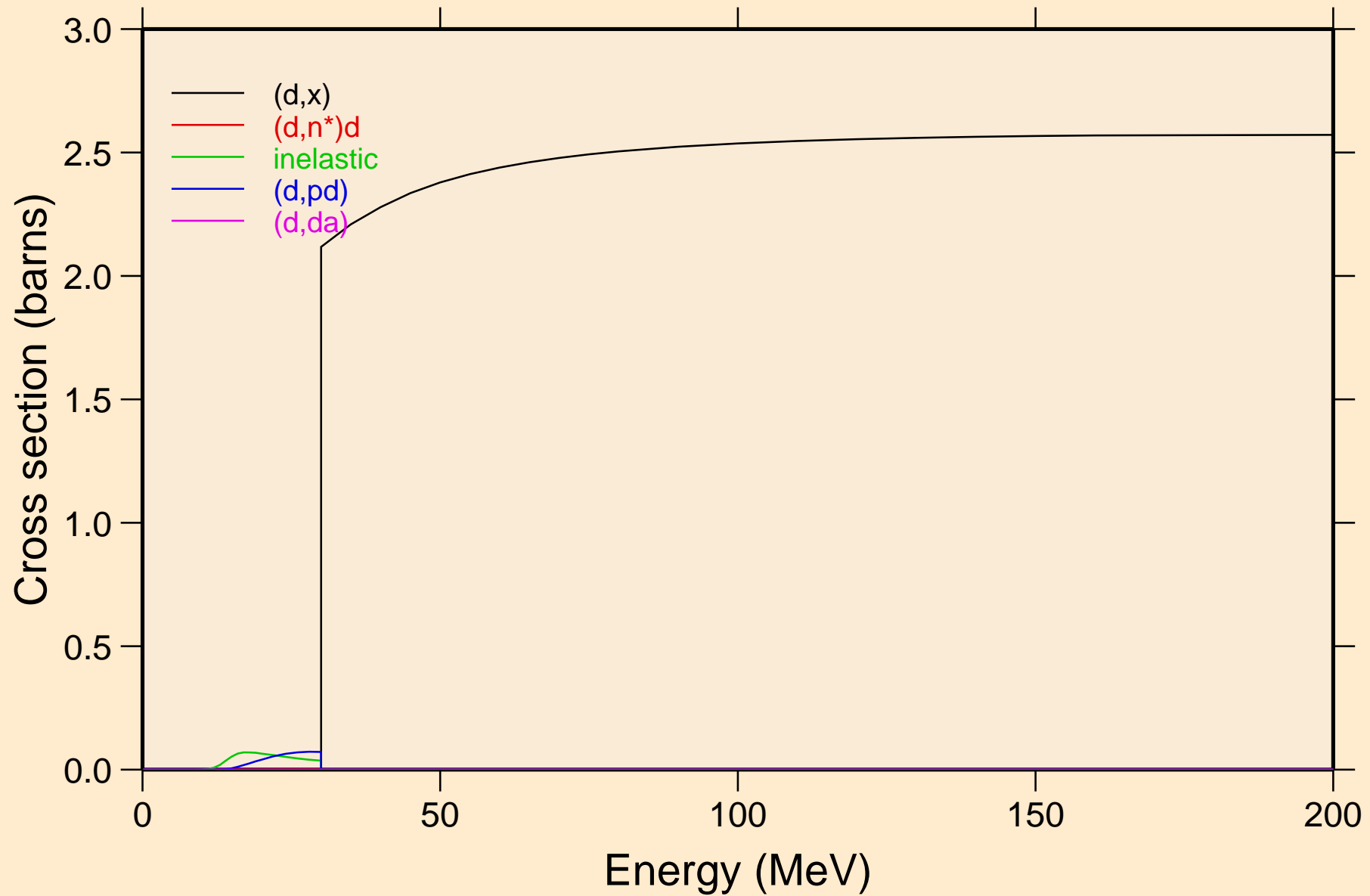

TM150 DEUTERON ACER TENDL-2021 LIBRARY; T=0.K  
angular distribution for elastic

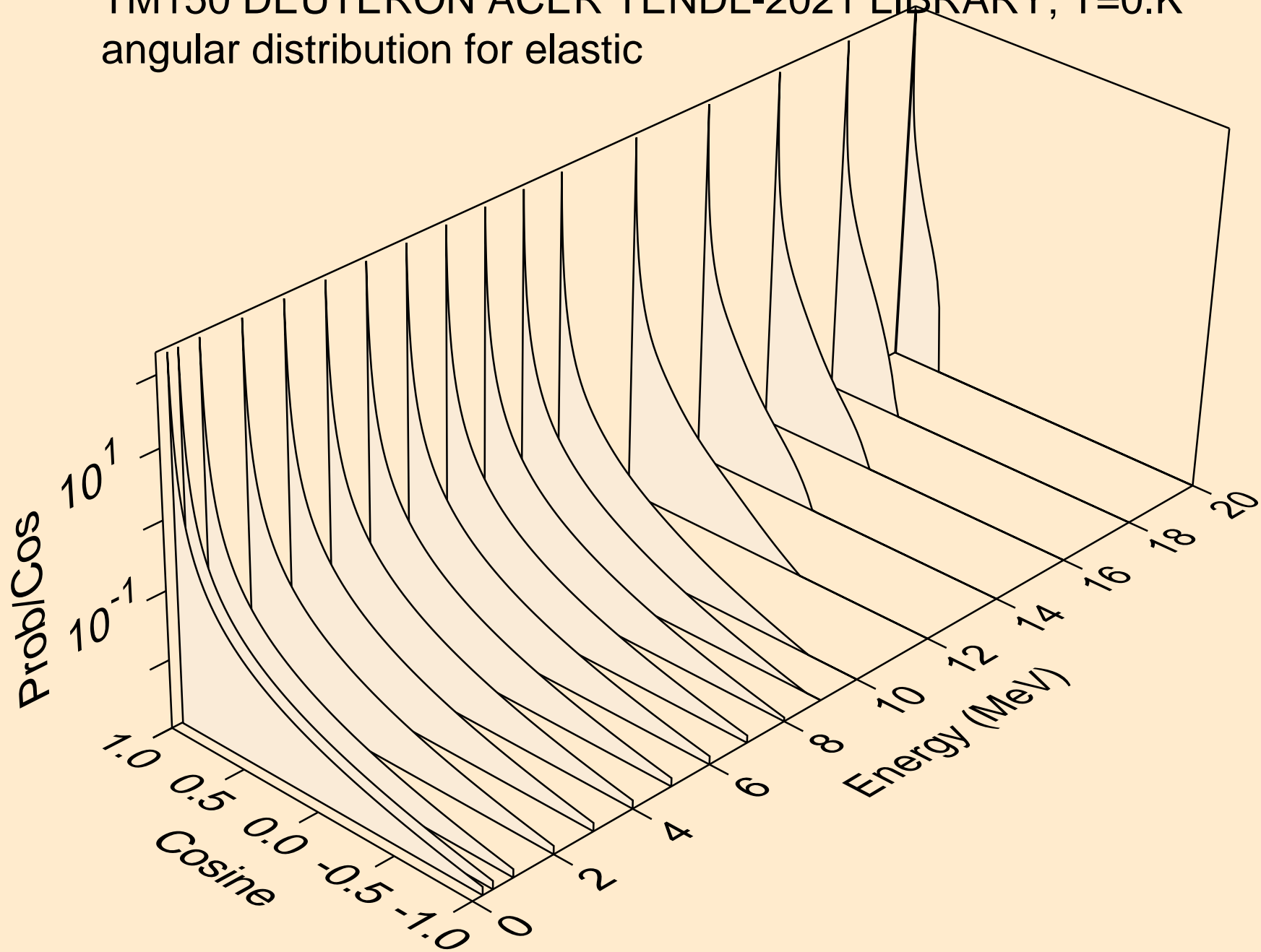

TM150 DEUTERON ACER TENDL-2021 LIBRARY; T=0.K  
angular distribution for elastic

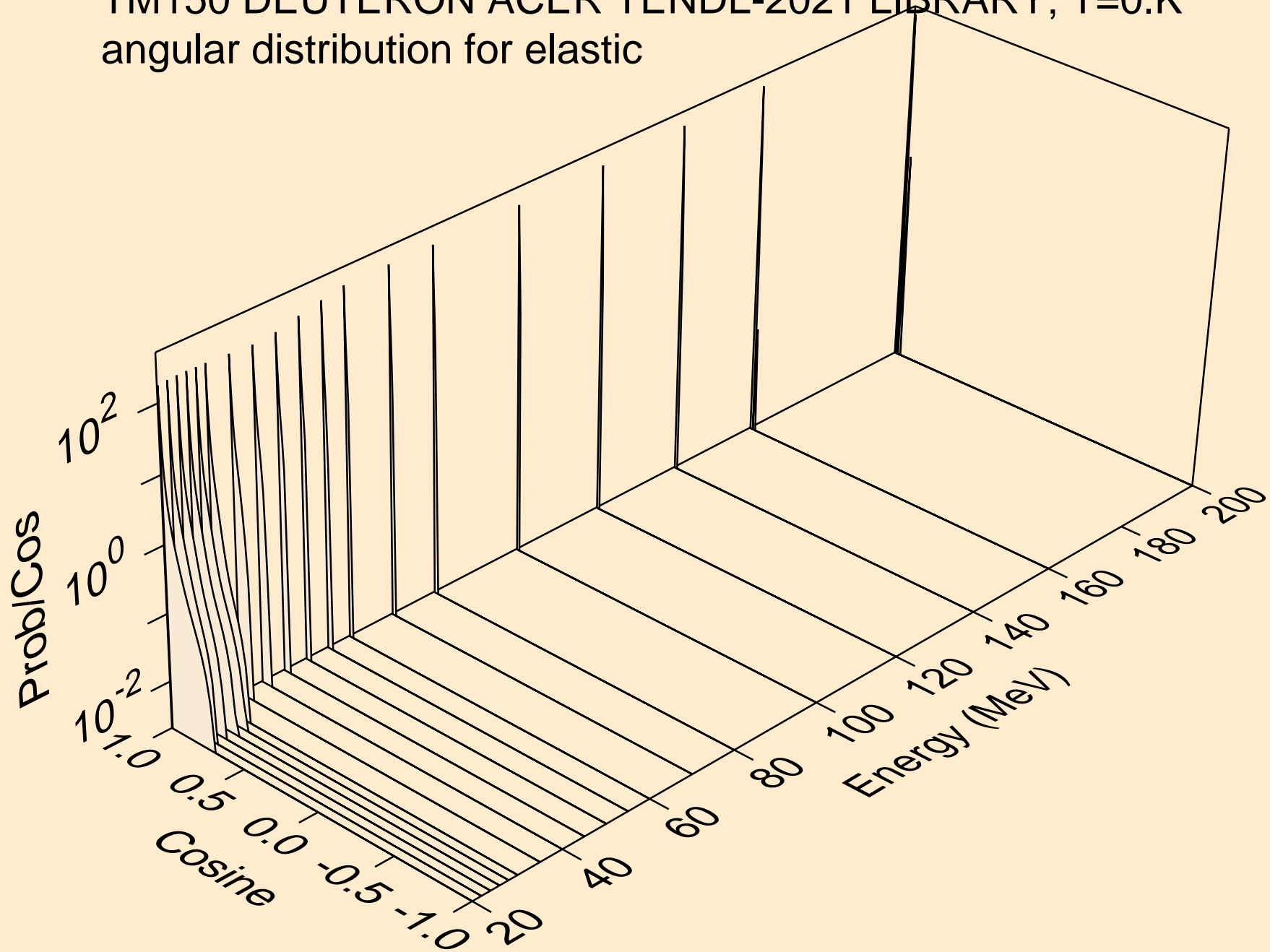

TM150 DEUTERON ACER TENDL-2021 LIBRARY; T=0.K  
Deuteron emission for (d,x)

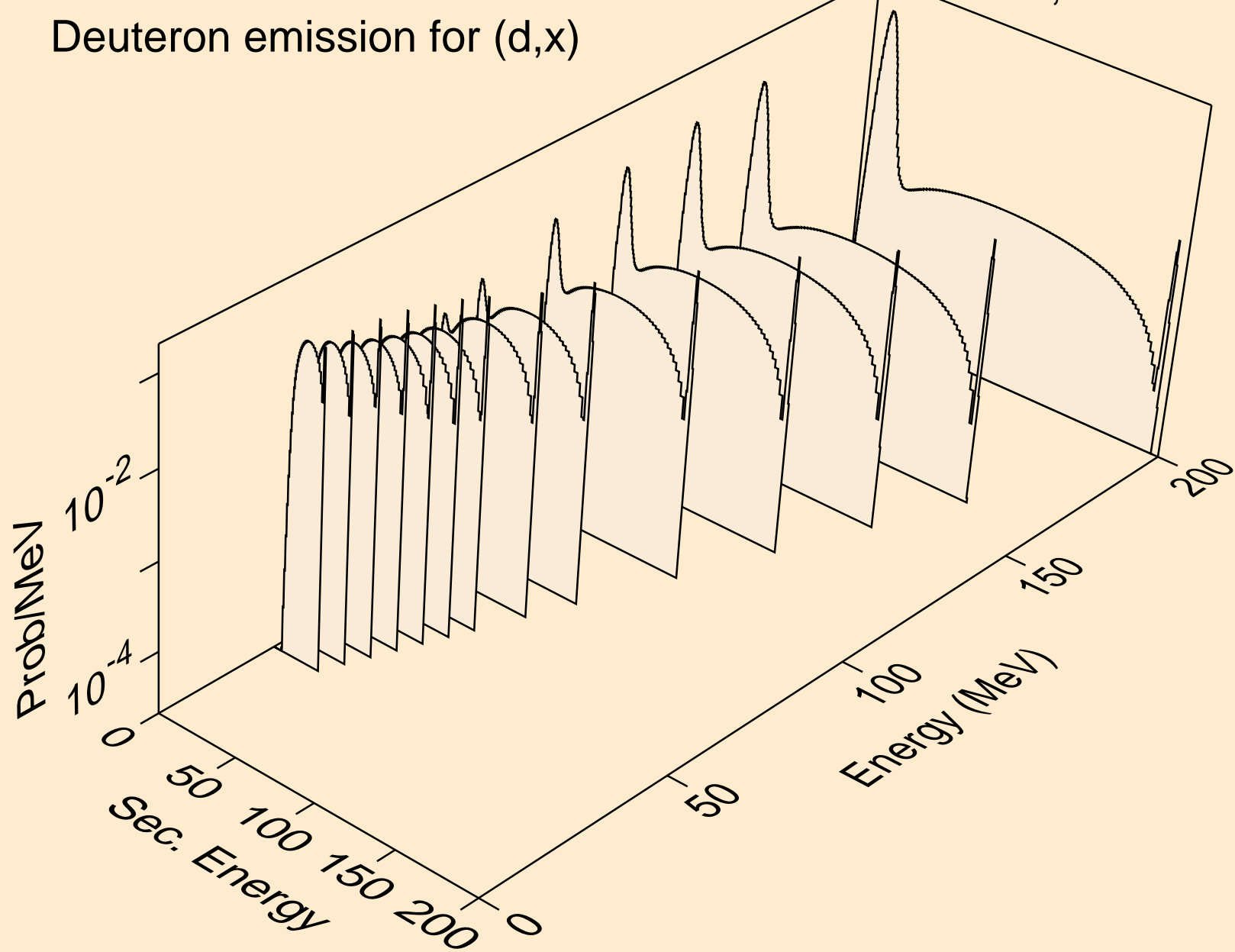



TM150 DEUTERON ACER TENDL-2021 LIBRARY; T=0.K  
Deuteron emission for (d,n\*)d

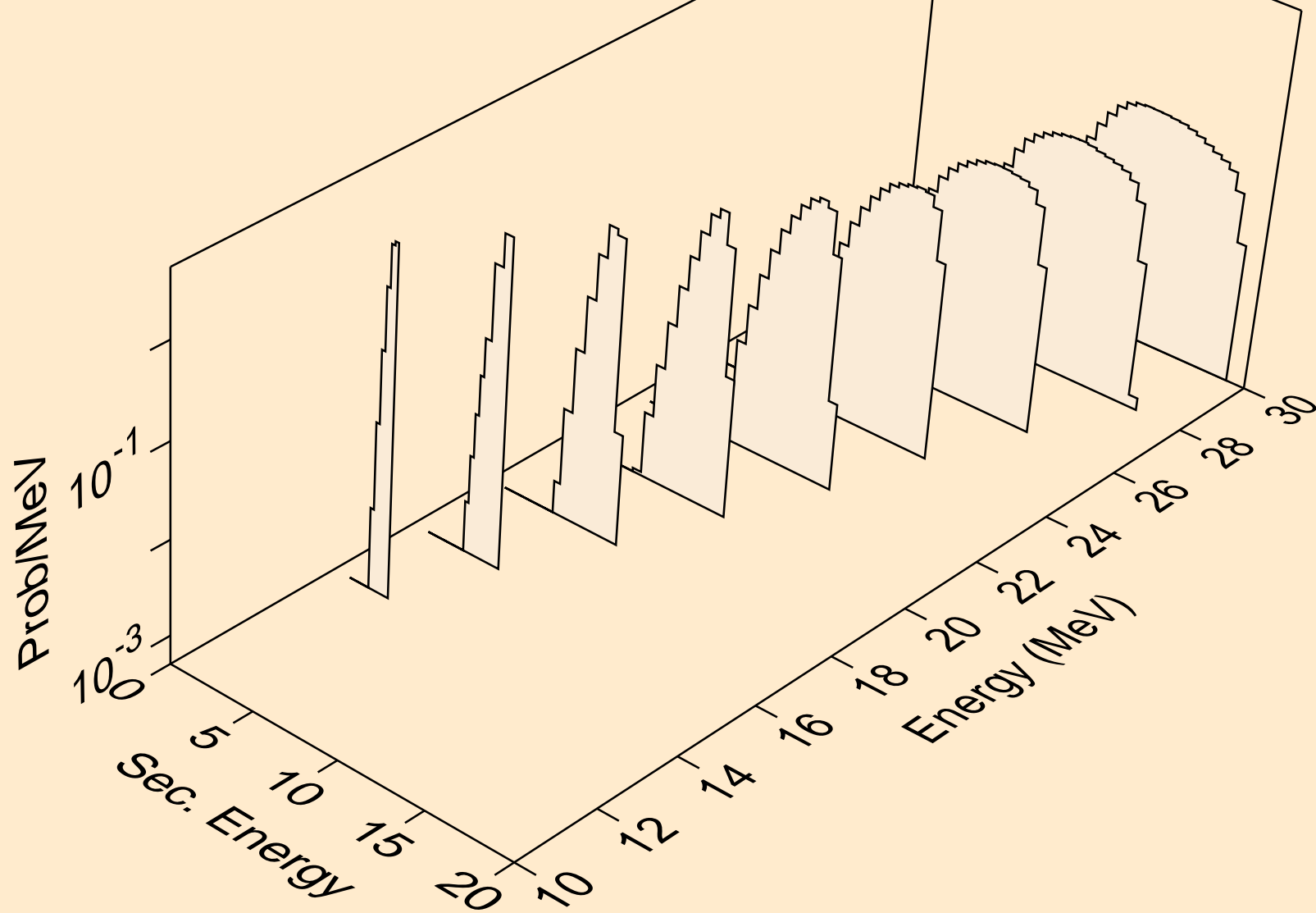

TM150 DEUTERON ACER TENDL-2021 LIBRARY; T=0.K  
Deuteron emission for inelastic

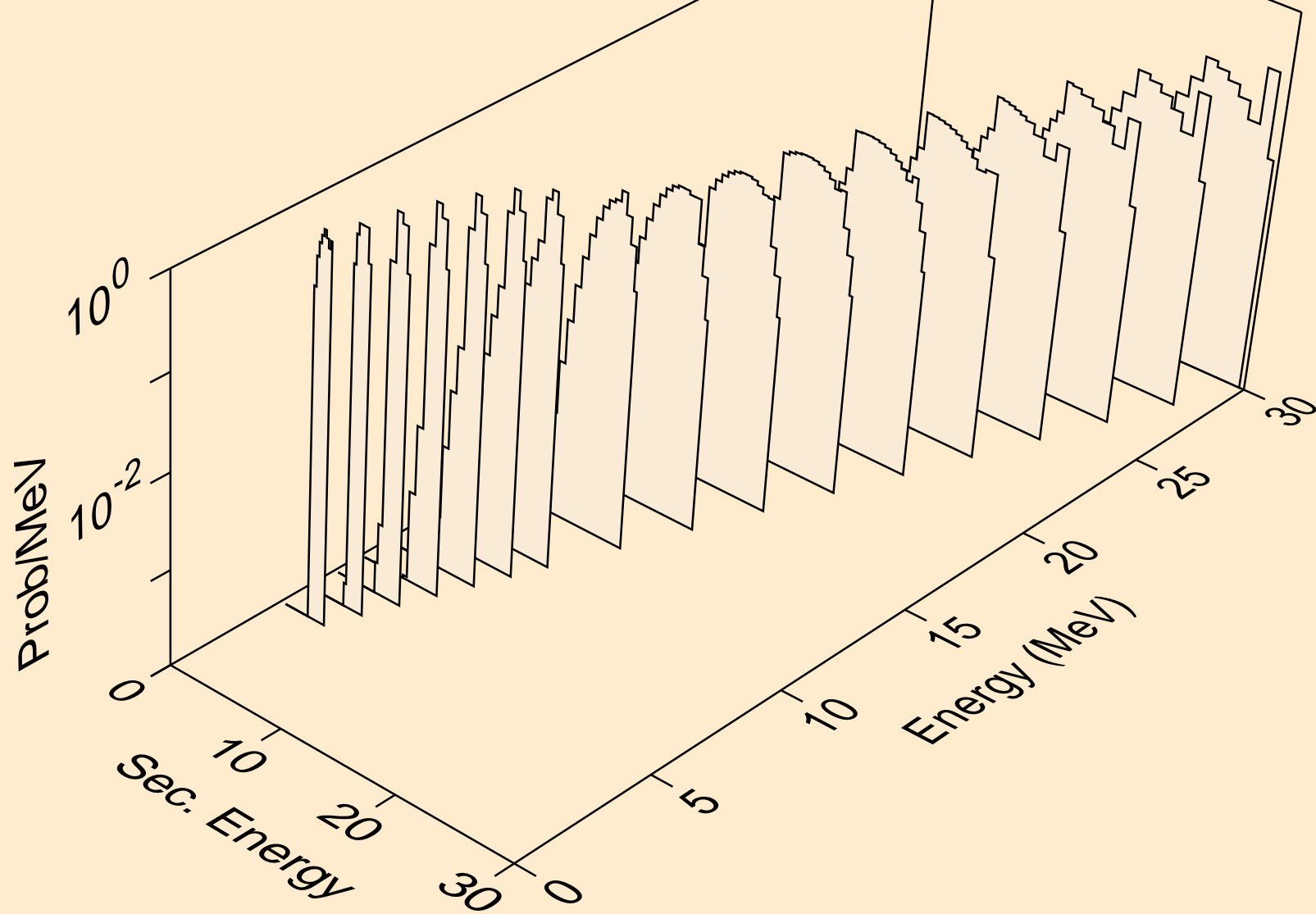

TM150 DEUTERON ACER TENDL-2021 LIBRARY; T=0.K  
Deuteron emission for (d,pd)

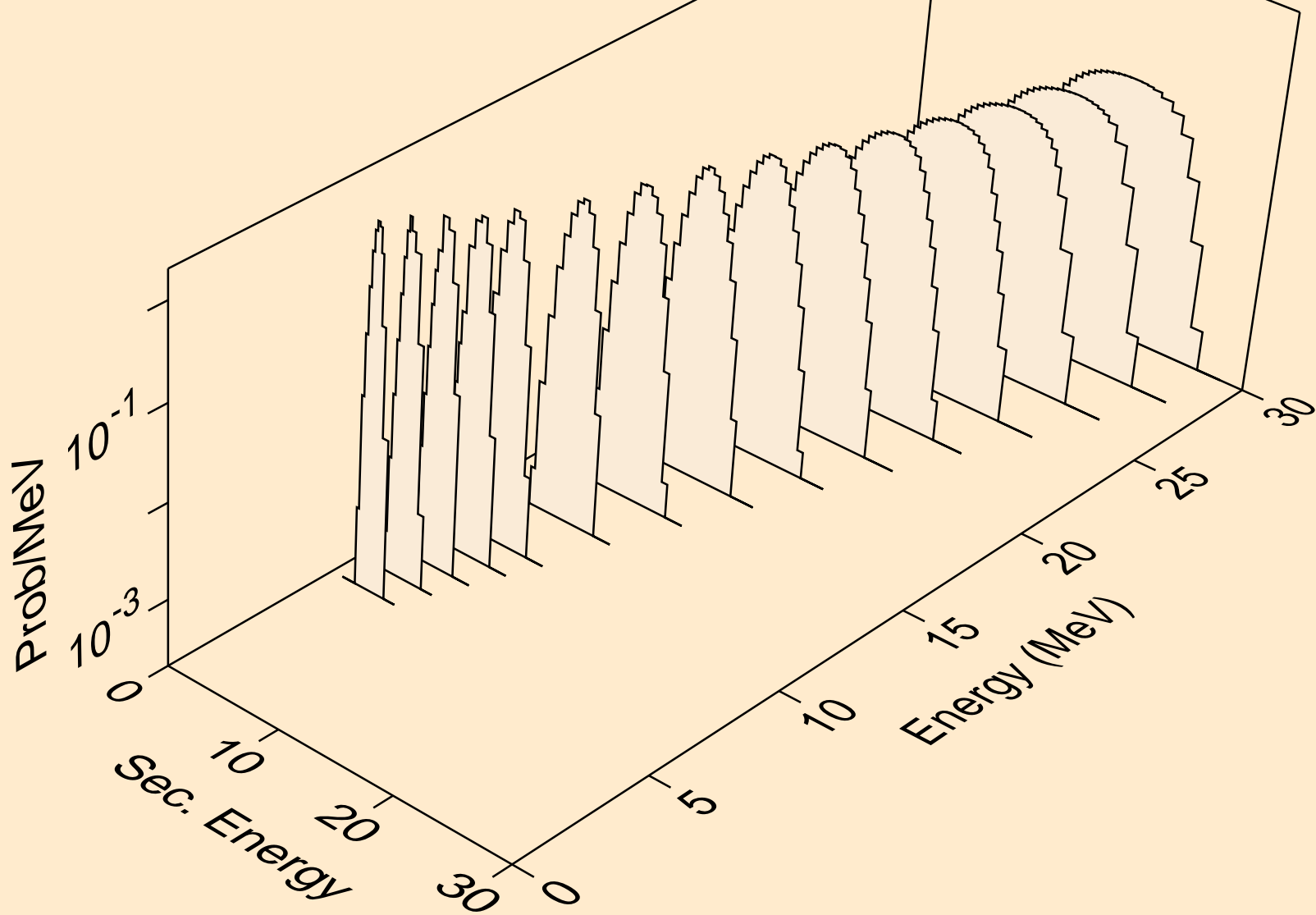

TM150 DEUTERON ACER TENDL-2021 LIBRARY; T=0.K  
Deuteron emission for (d,da)

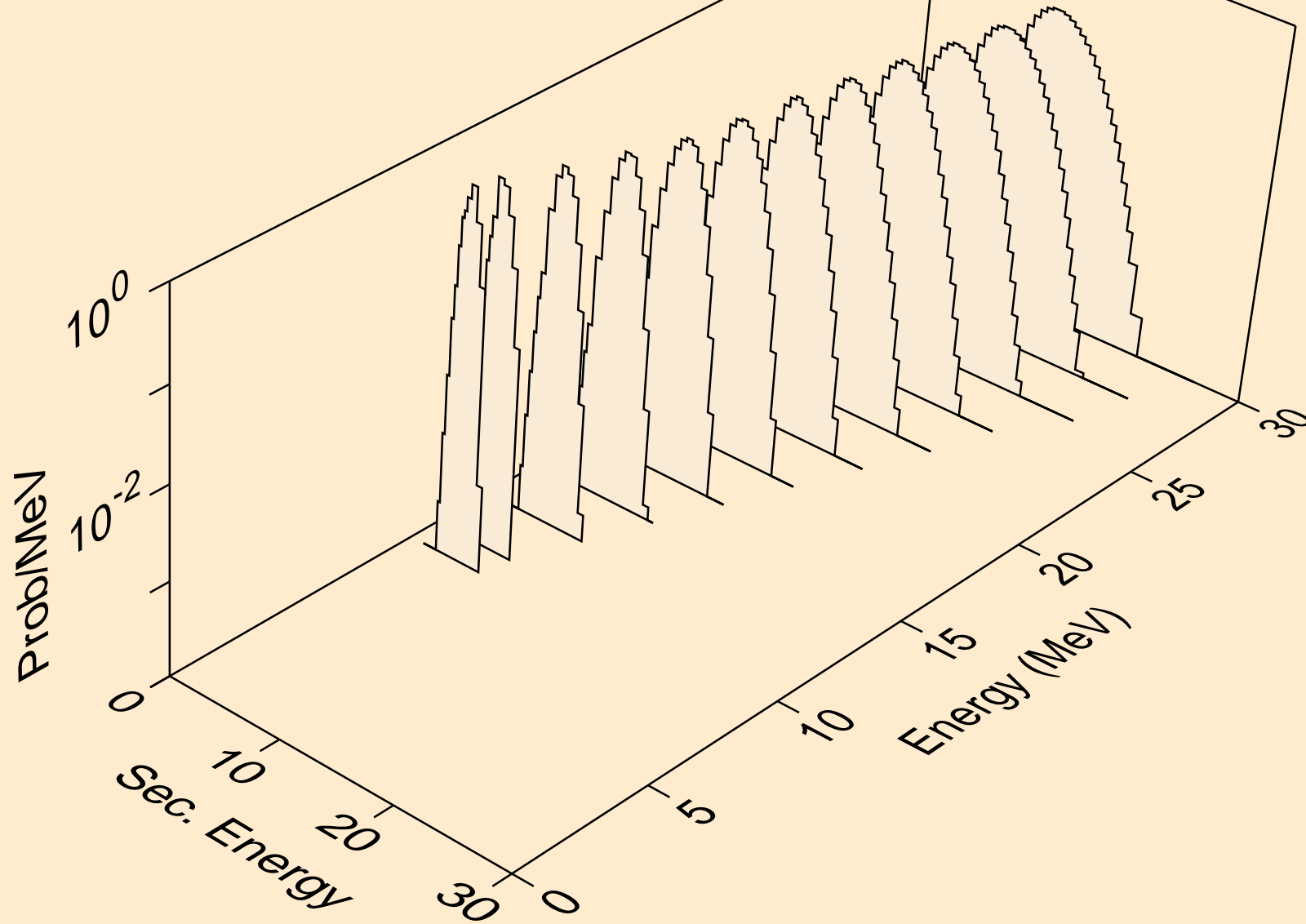

TM150 DEUTERON ACER TENDL-2021 LIBRARY; T=0.K  
Photon emission for (z,n)

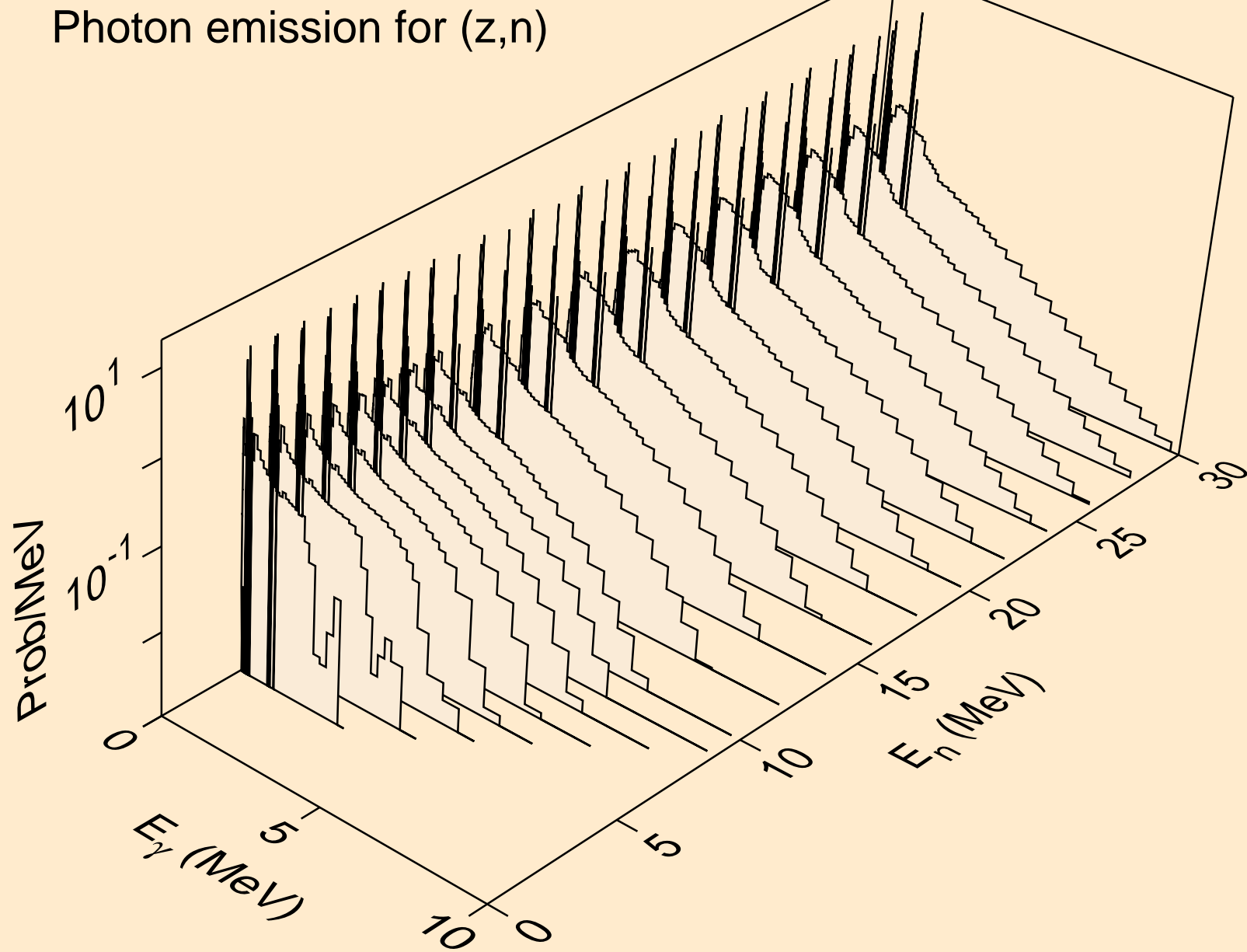

TM150 DEUTERON ACER TENDL-2021 LIBRARY; T=0.K  
Photon emission for (n,x)

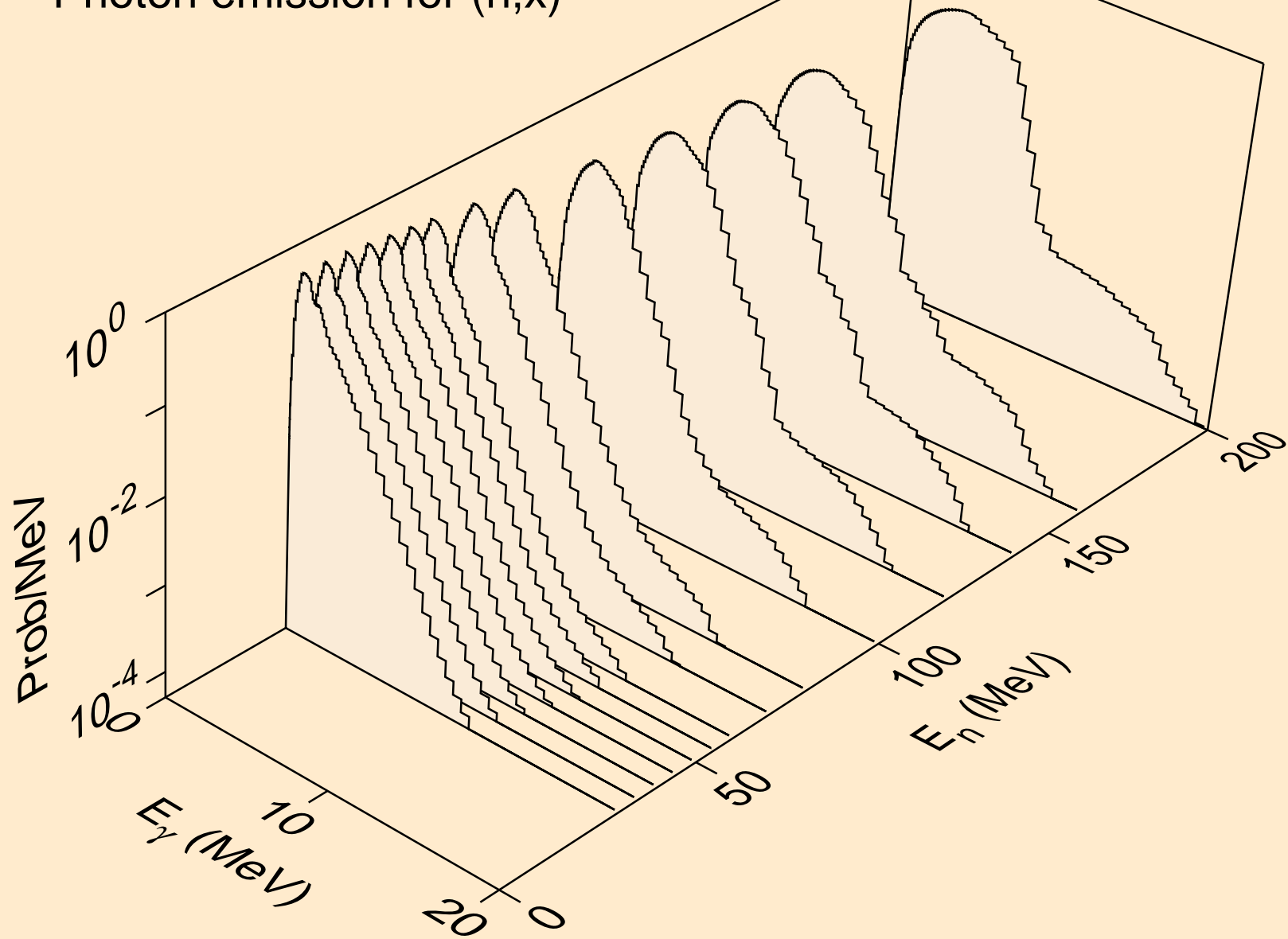

TM150 DEUTERON ACER TENDL-2021 LIBRARY; T=0.K  
Photon emission for (n,2n)

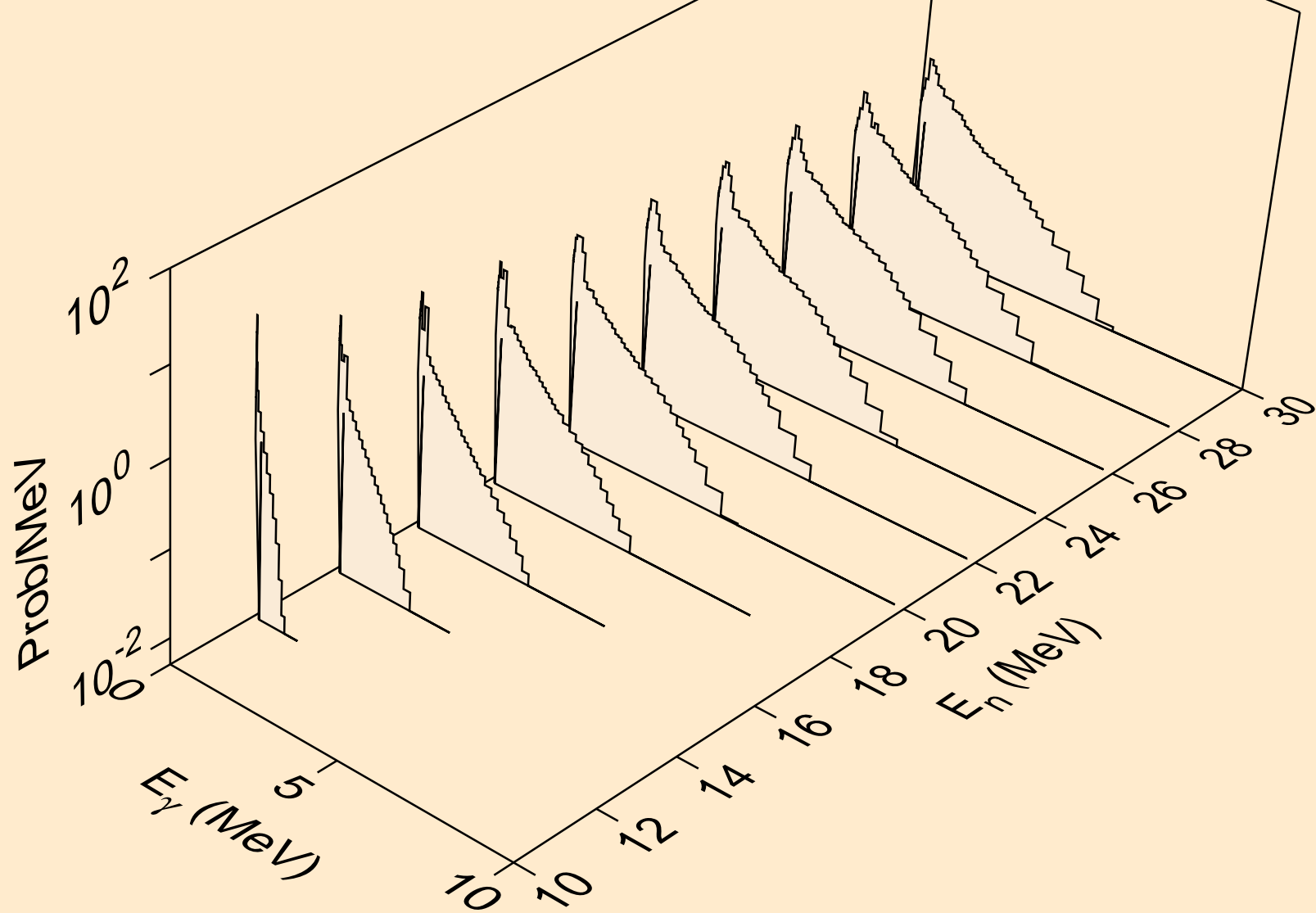

TM150 DEUTERON ACER TENDL-2021 LIBRARY; T=0.K  
Photon emission for (n,3n)

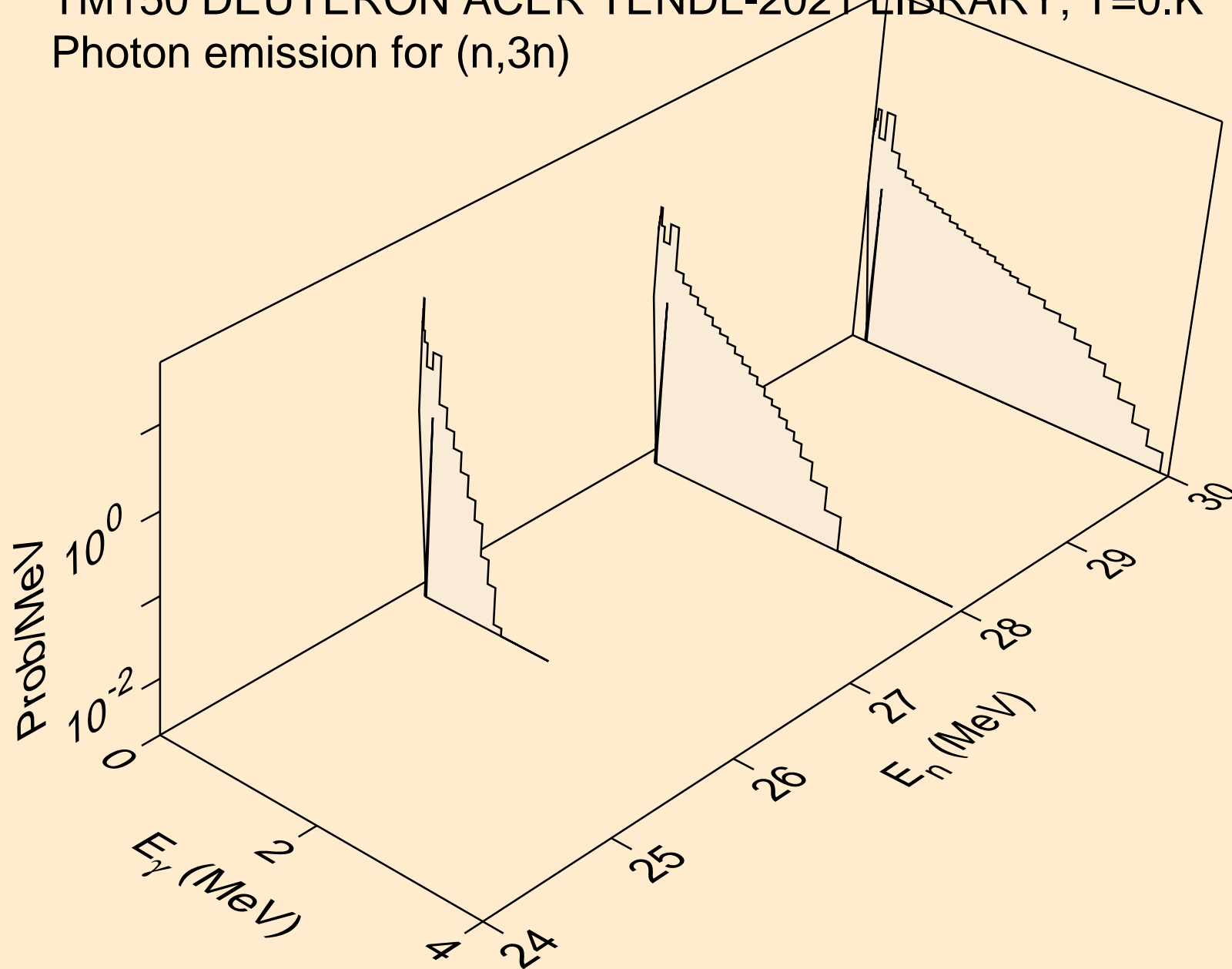



TM150 DEUTERON ACER TENDL-2021 LIBRARY; T=0.K  
Photon emission for (n,n\*)a

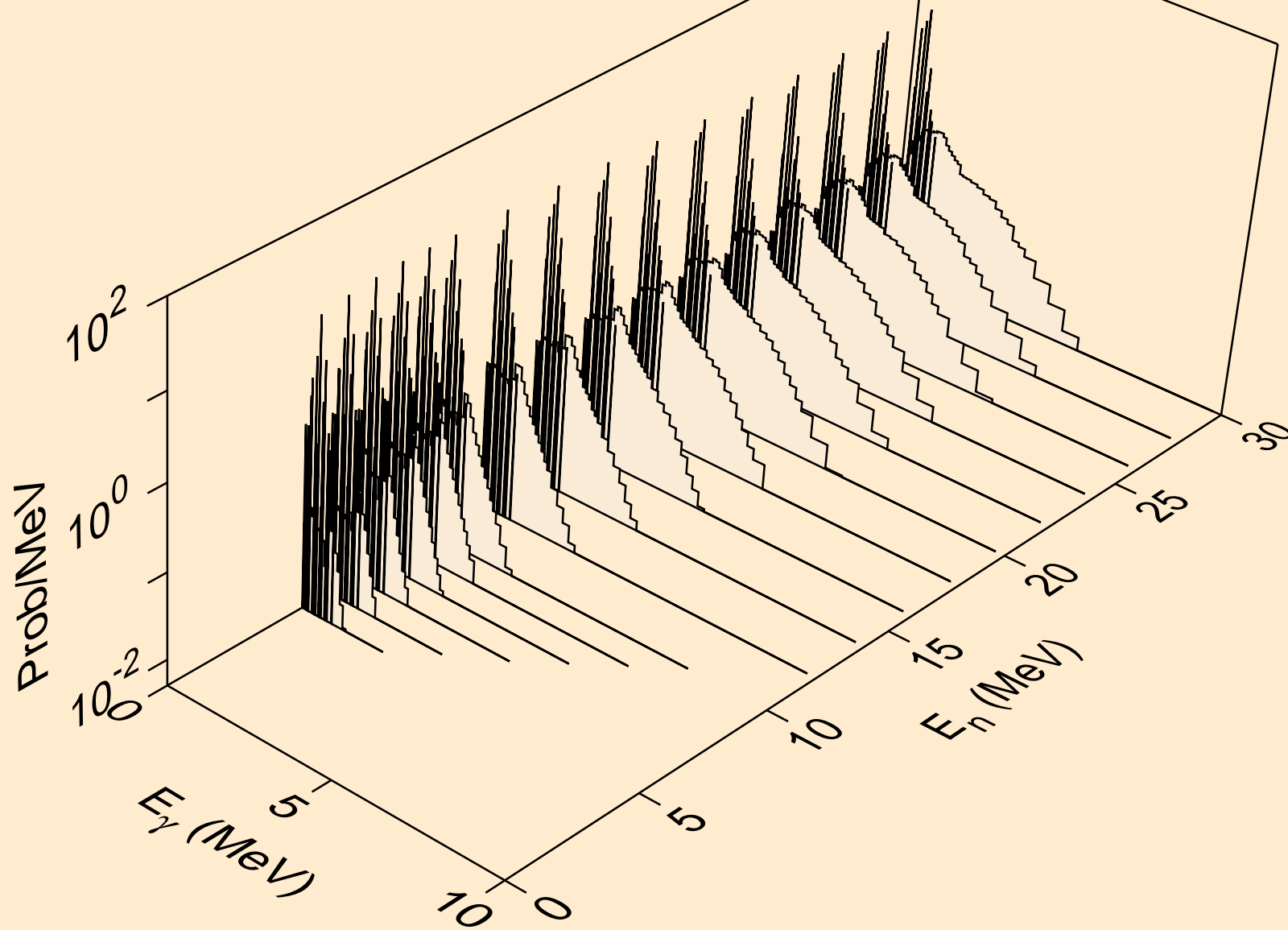

TM150 DEUTERON ACER TENDL-2021 LIBRARY; T=0.K  
Photon emission for (n,2n) $\alpha$

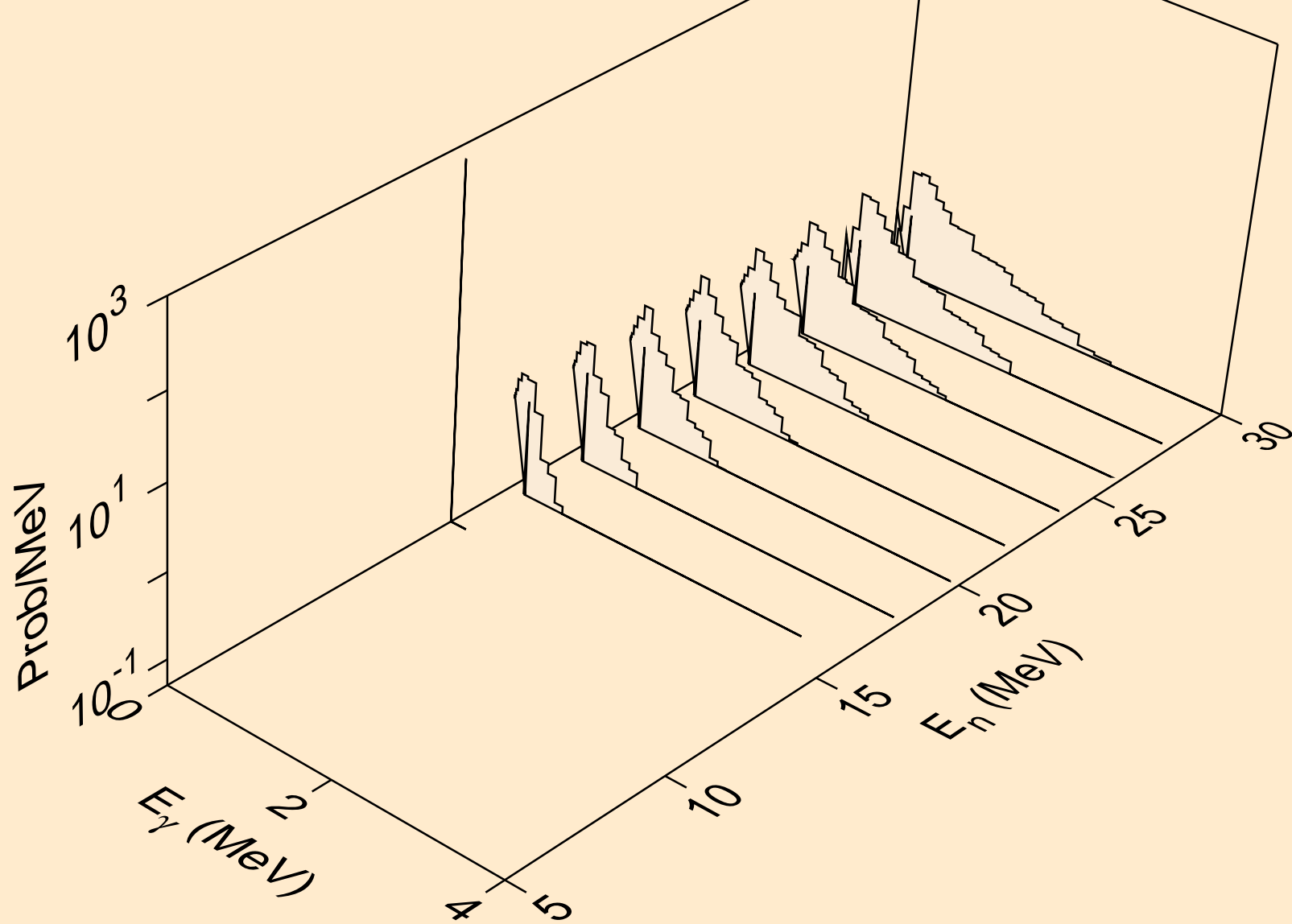

TM150 DEUTERON ACER TENDL-2021 LIBRARY; T=0.K  
Photon emission for (n,n\*)p

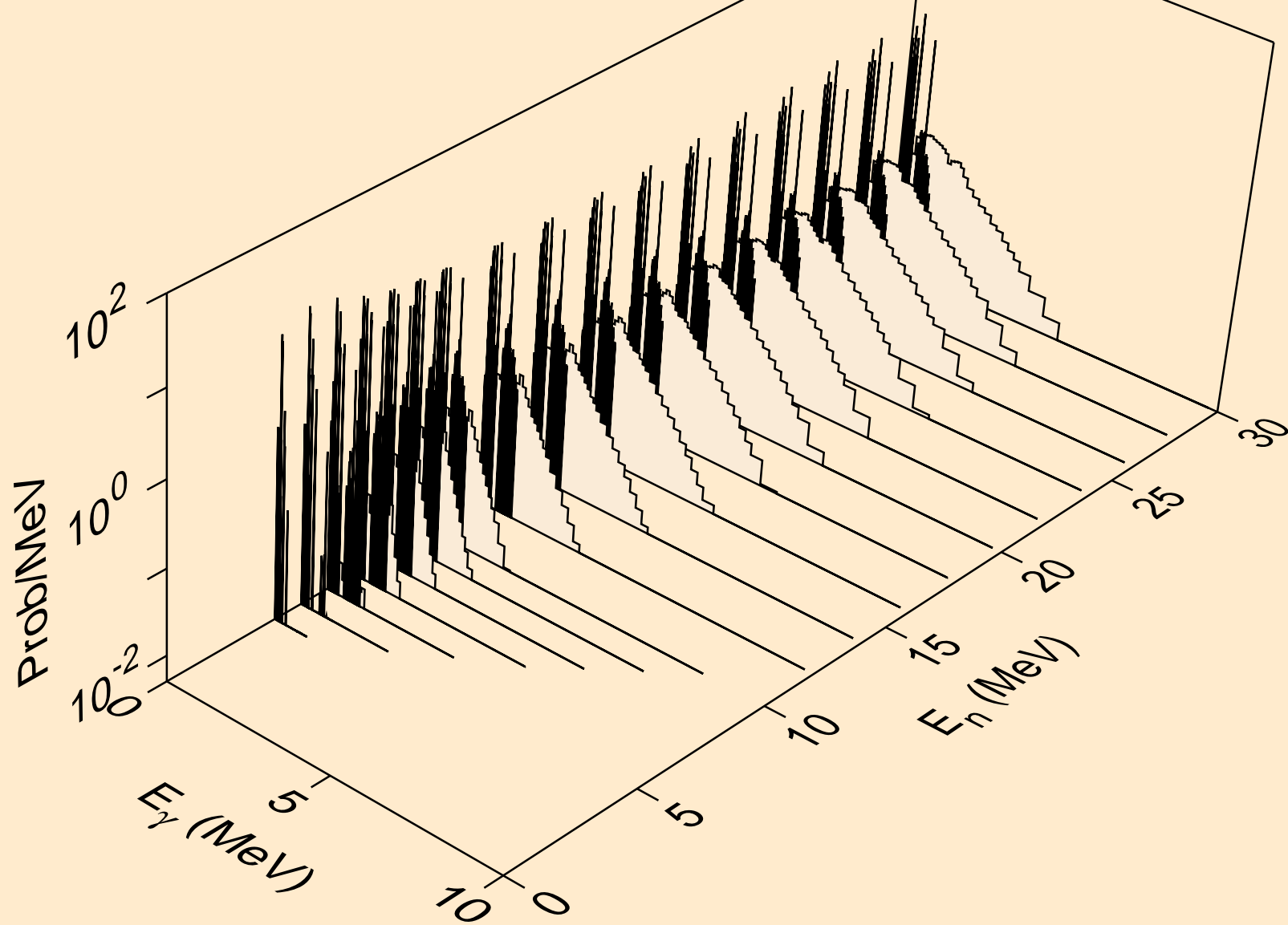

TM150 DEUTERON ACER TENDL-2021 LIBRARY; T=0.K  
Photon emission for (n,n\*)2a

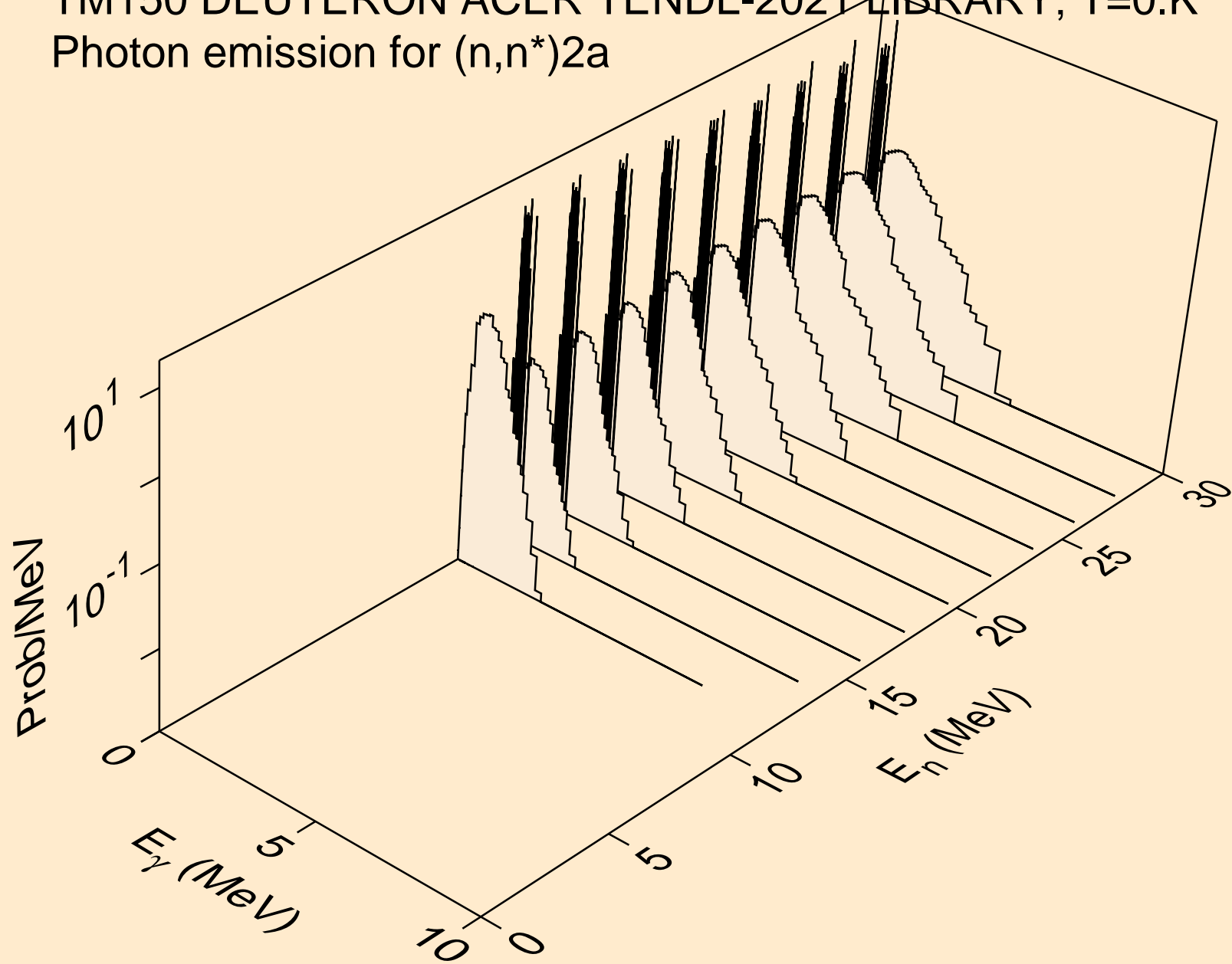

TM150 DEUTERON ACER TENDL-2021 LIBRARY; T=0.K  
Photon emission for (n,n\*)d

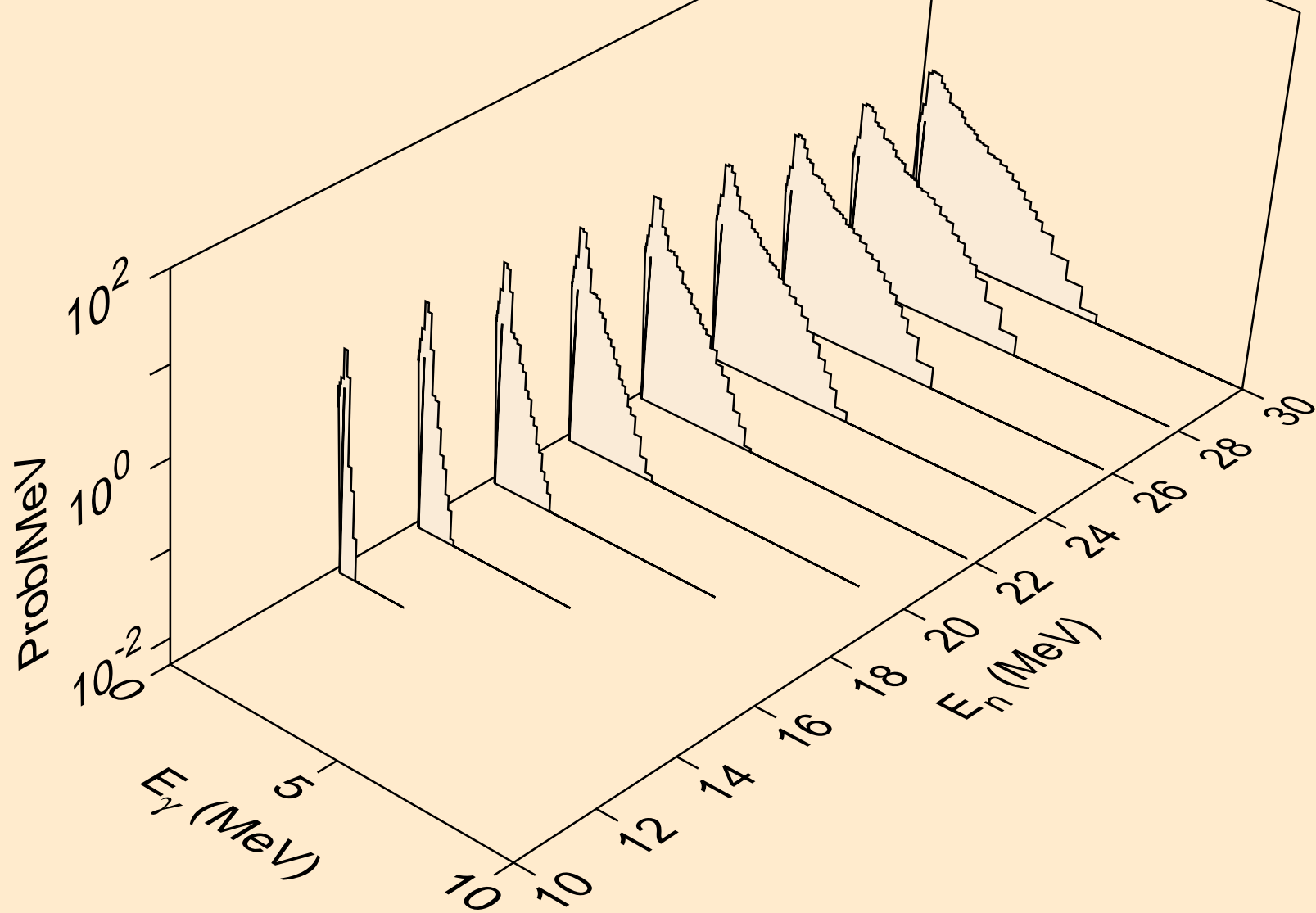

TM150 DEUTERON ACER TENDL-2021 LIBRARY; T=0.K  
Photon emission for (n,n\*)t

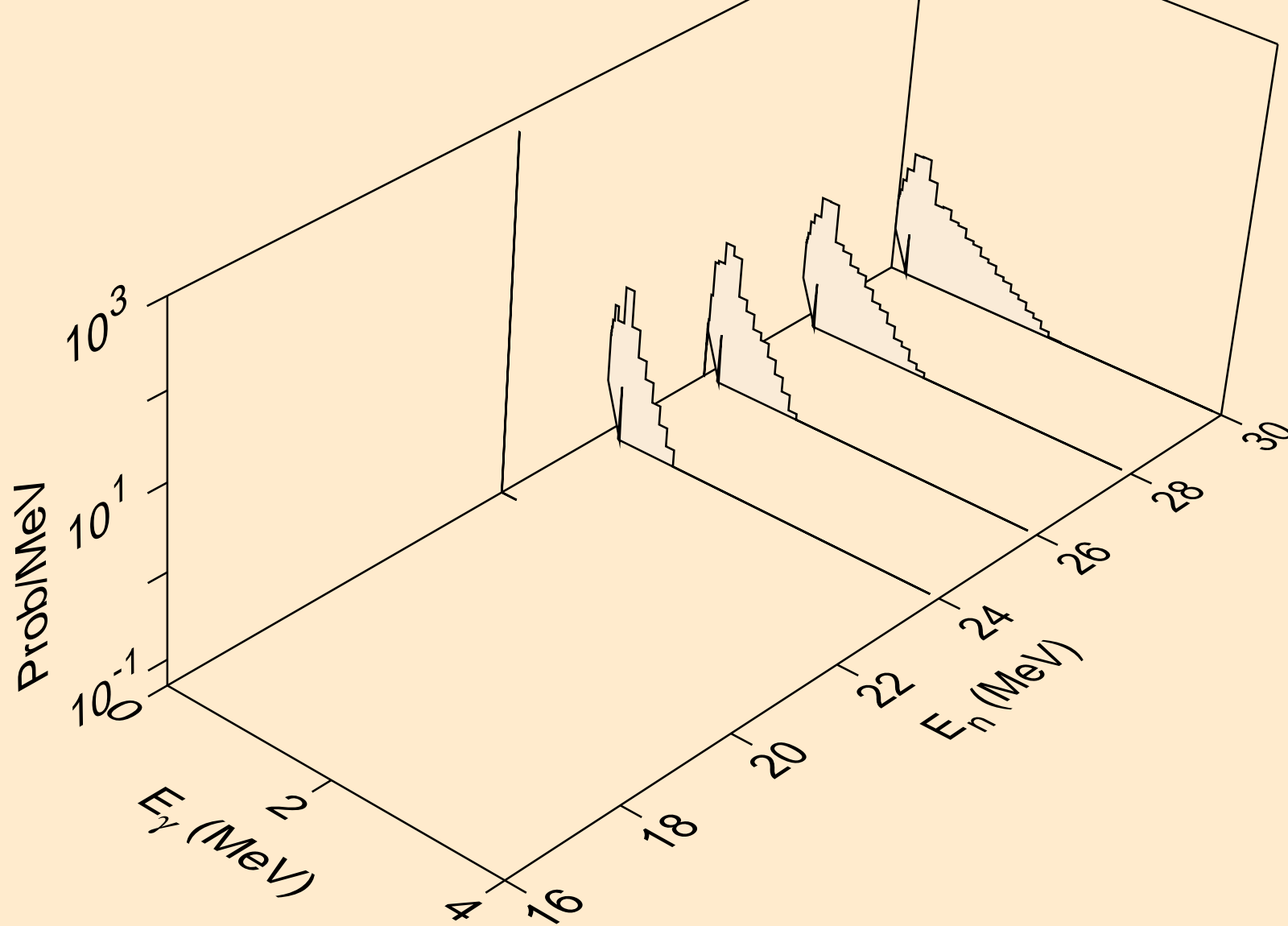

TM150 DEUTERON ACER TENDL-2021 LIBRARY; T=0.K  
Photon emission for (n,n\*)he3

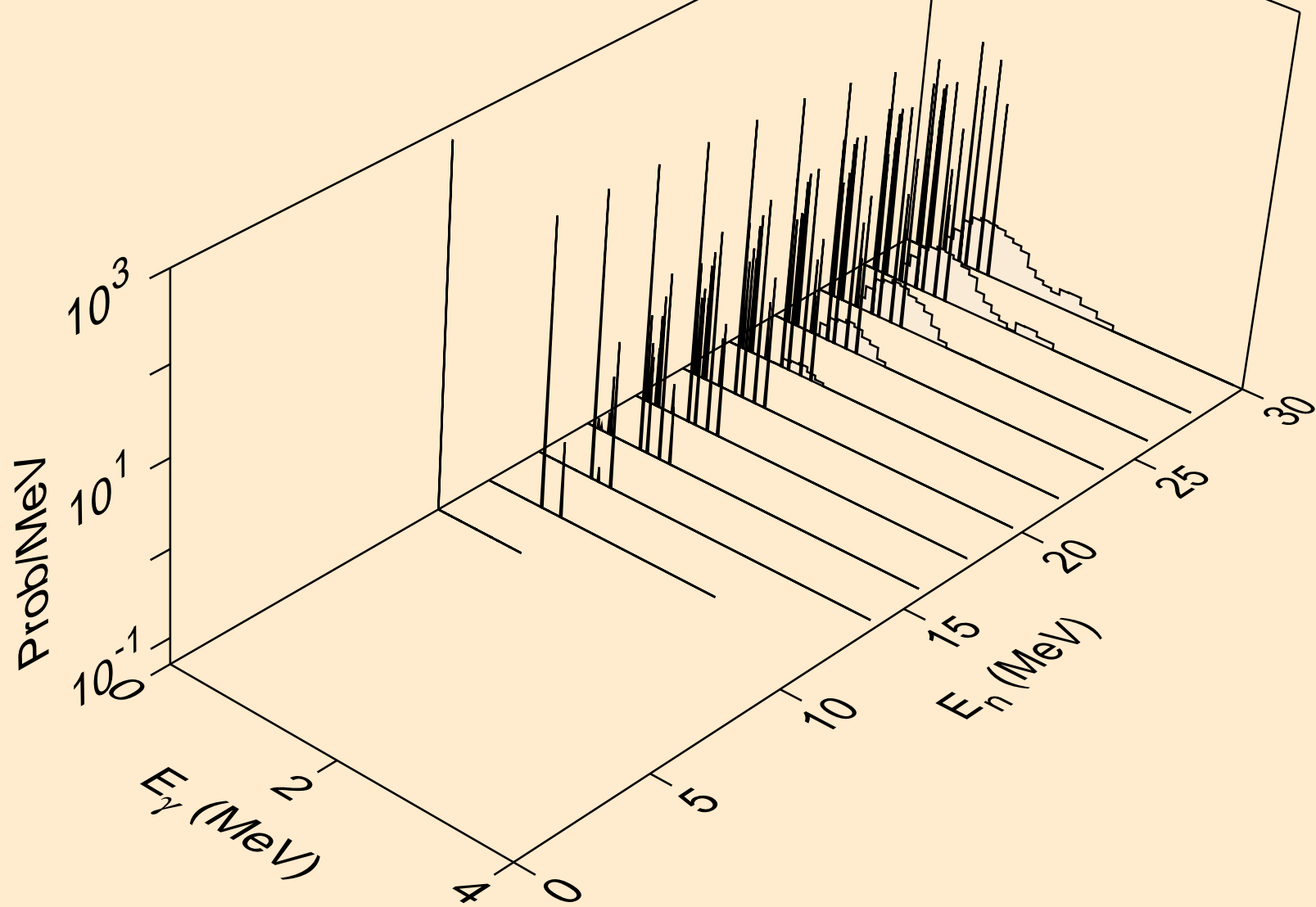

TM150 DEUTERON ACER TENDL-2021 LIBRARY; T=0.K  
Photon emission for (n,2np)

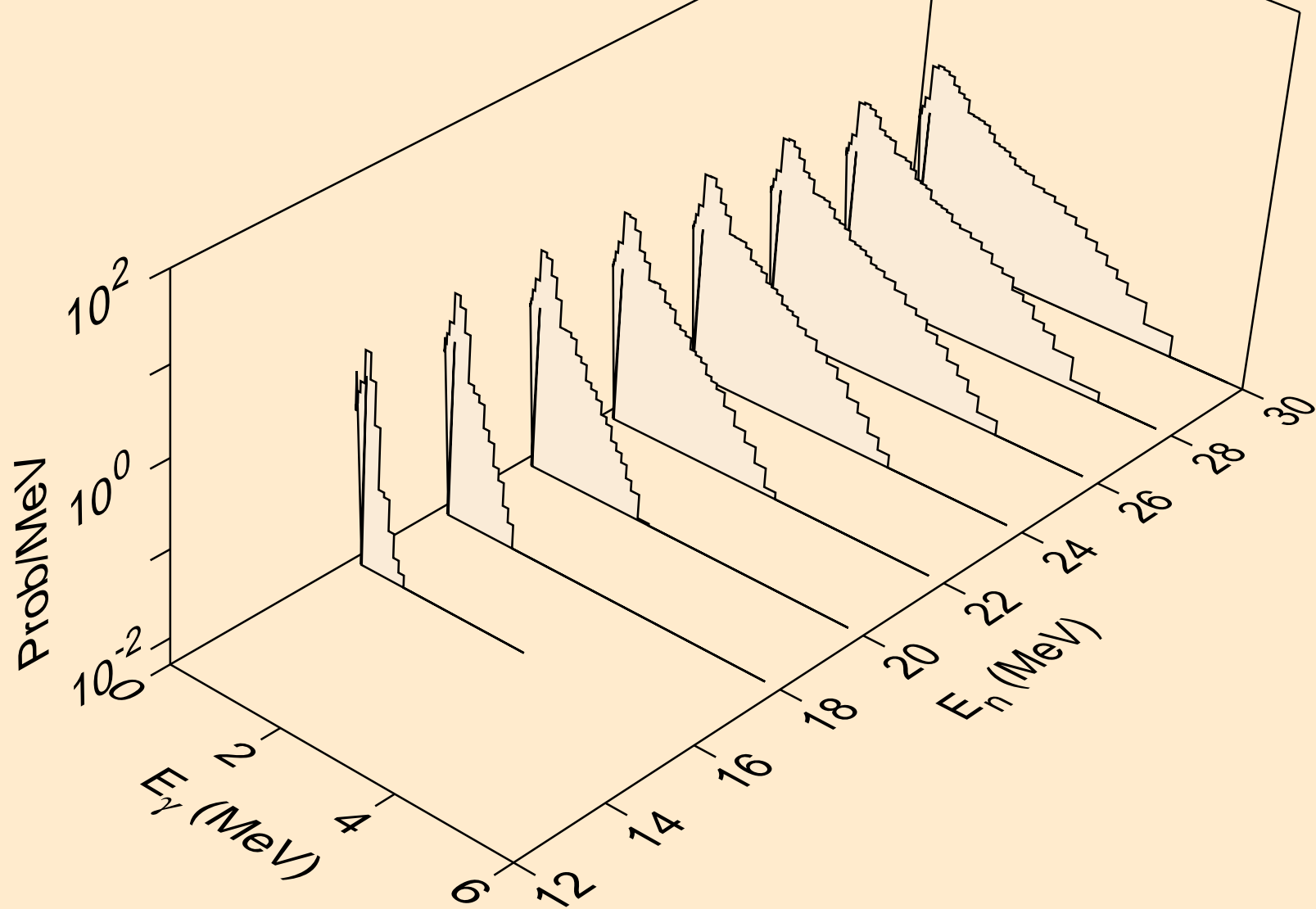



TM150 DEUTERON ACER TENDL-2021 LIBRARY; T=0.K  
Photon emission for (n,2np)

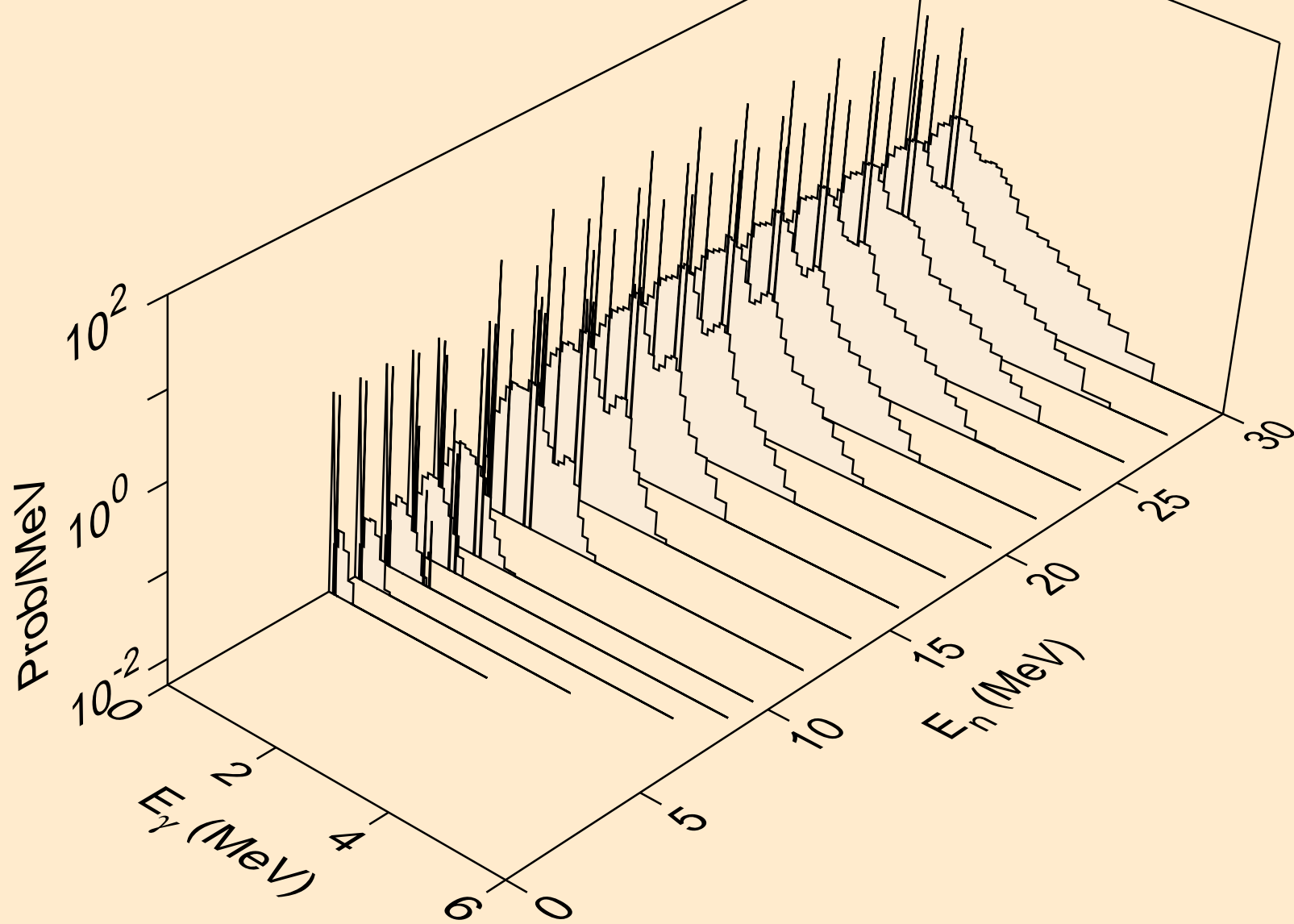

TM150 DEUTERON ACER TENDL-2021 LIBRARY; T=0.K  
Photon emission for (n,npa)

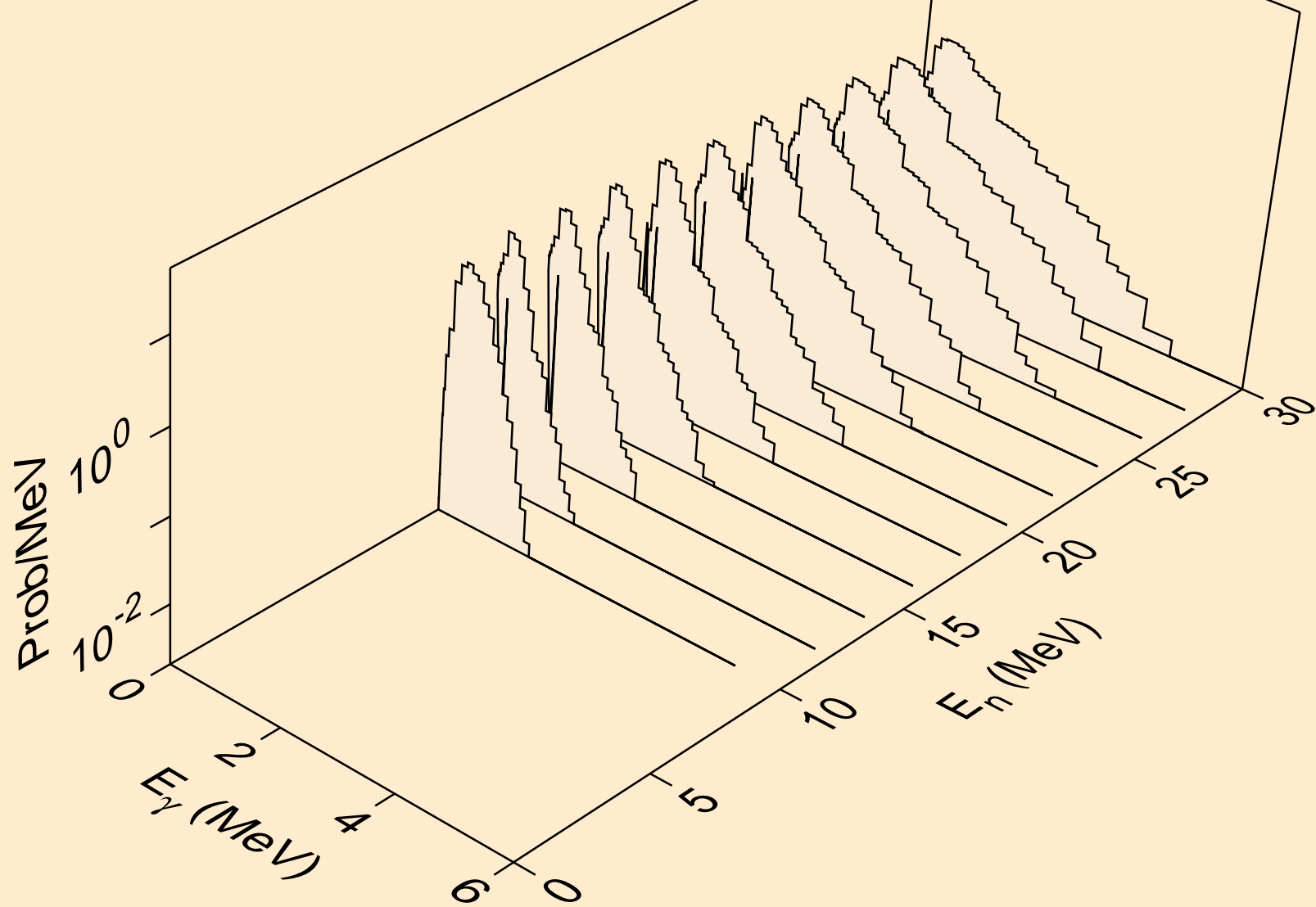

TM150 DEUTERON ACER TENDL-2021 LIBRARY; T=0.K  
Photon emission for (n,gma)

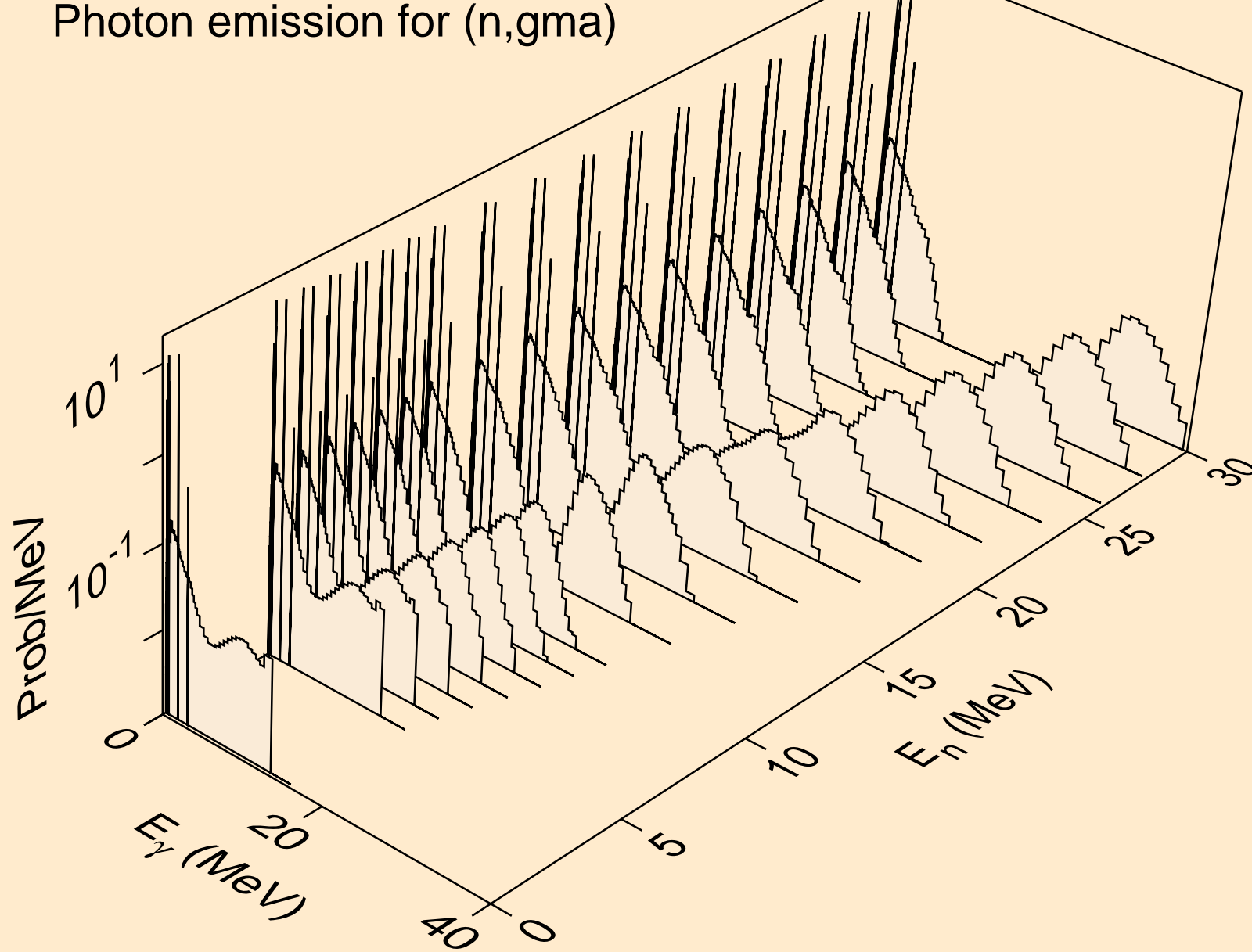

TM150 DEUTERON ACER TENDL-2021 LIBRARY; T=0.K  
Photon emission for (n,p)

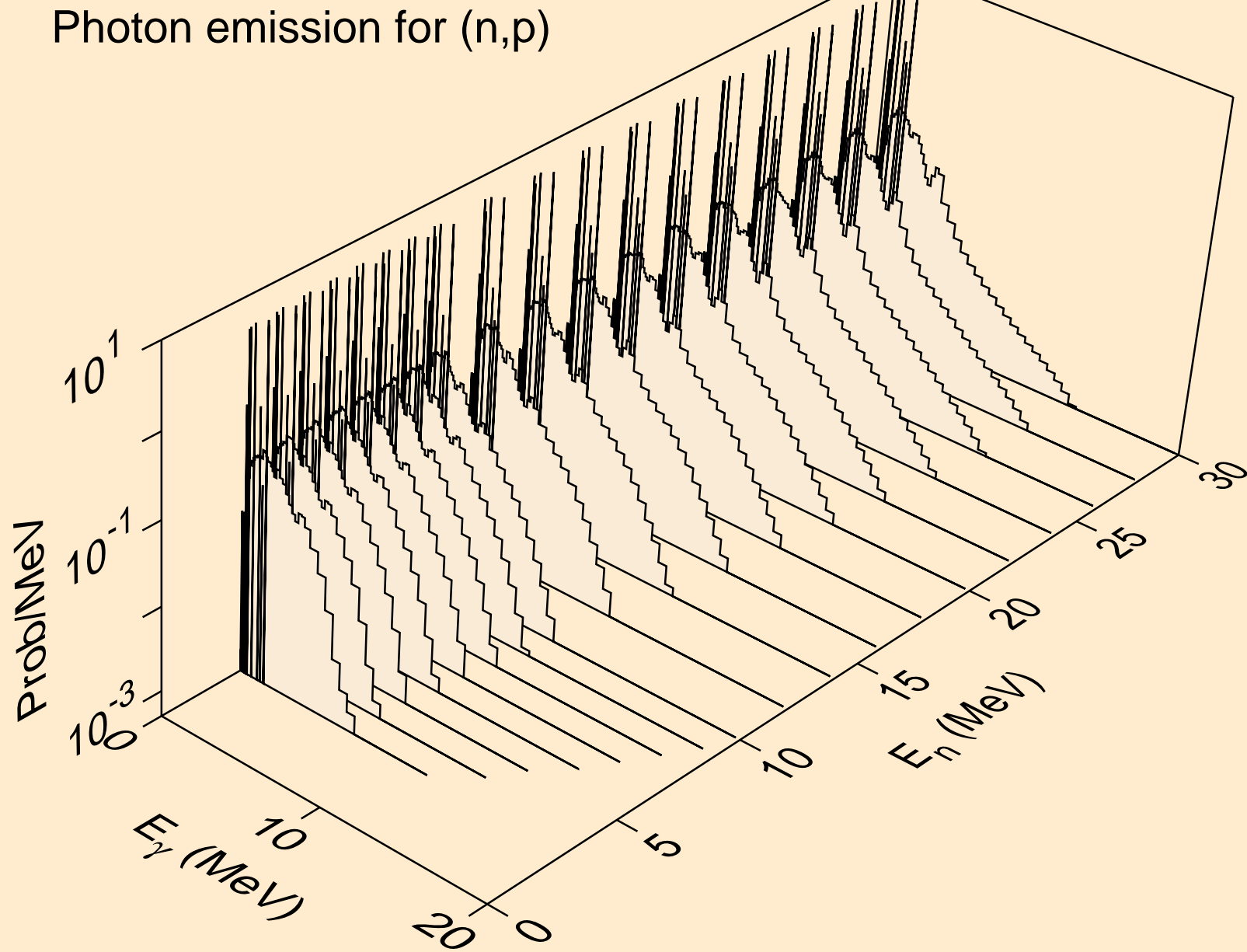

TM150 DEUTERON ACER TENDL-2021 LIBRARY; T=0.K  
Photon emission for inelastic

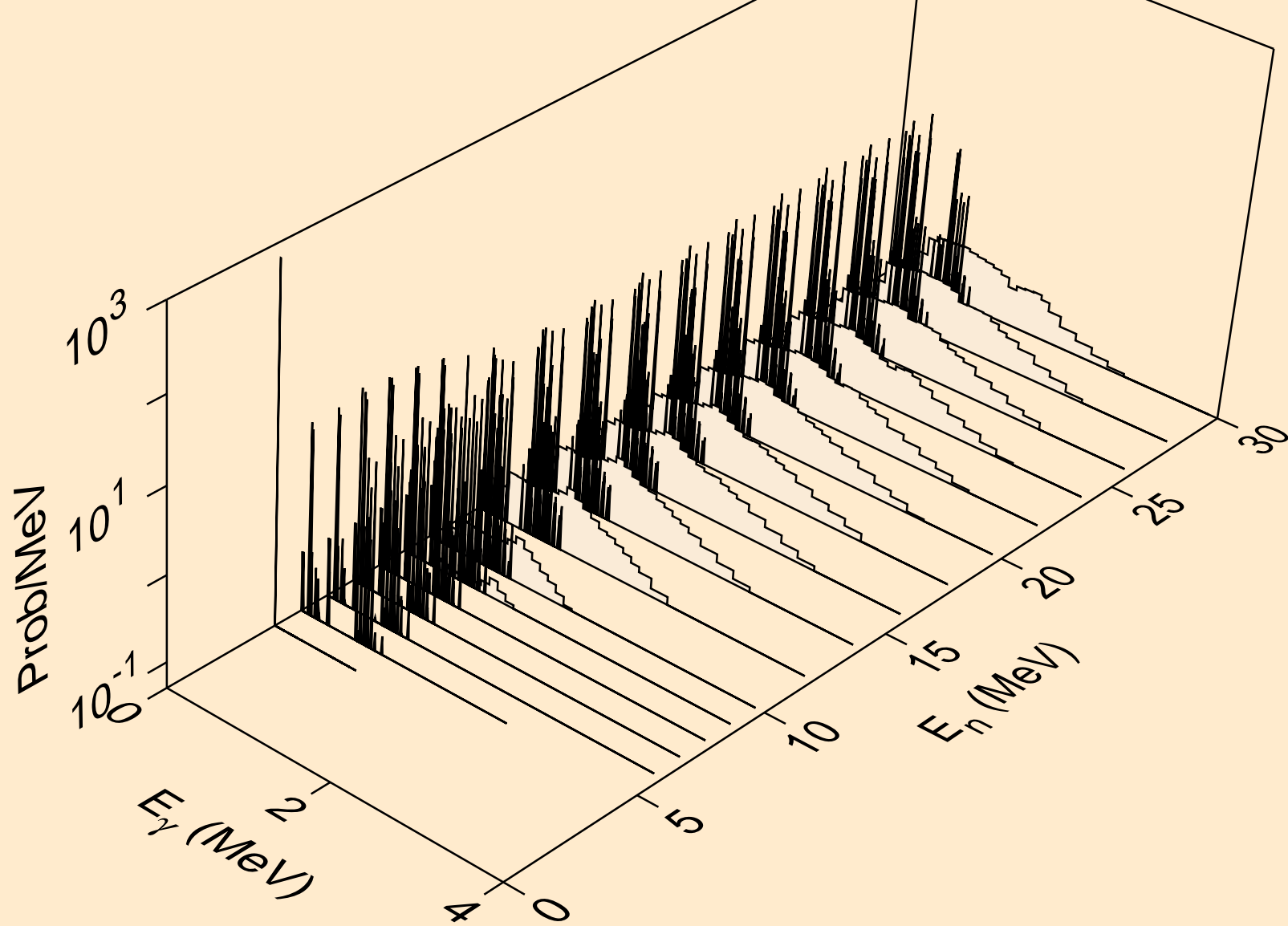

TM150 DEUTERON ACER TENDL-2021 LIBRARY; T=0.K  
Photon emission for (n,t)

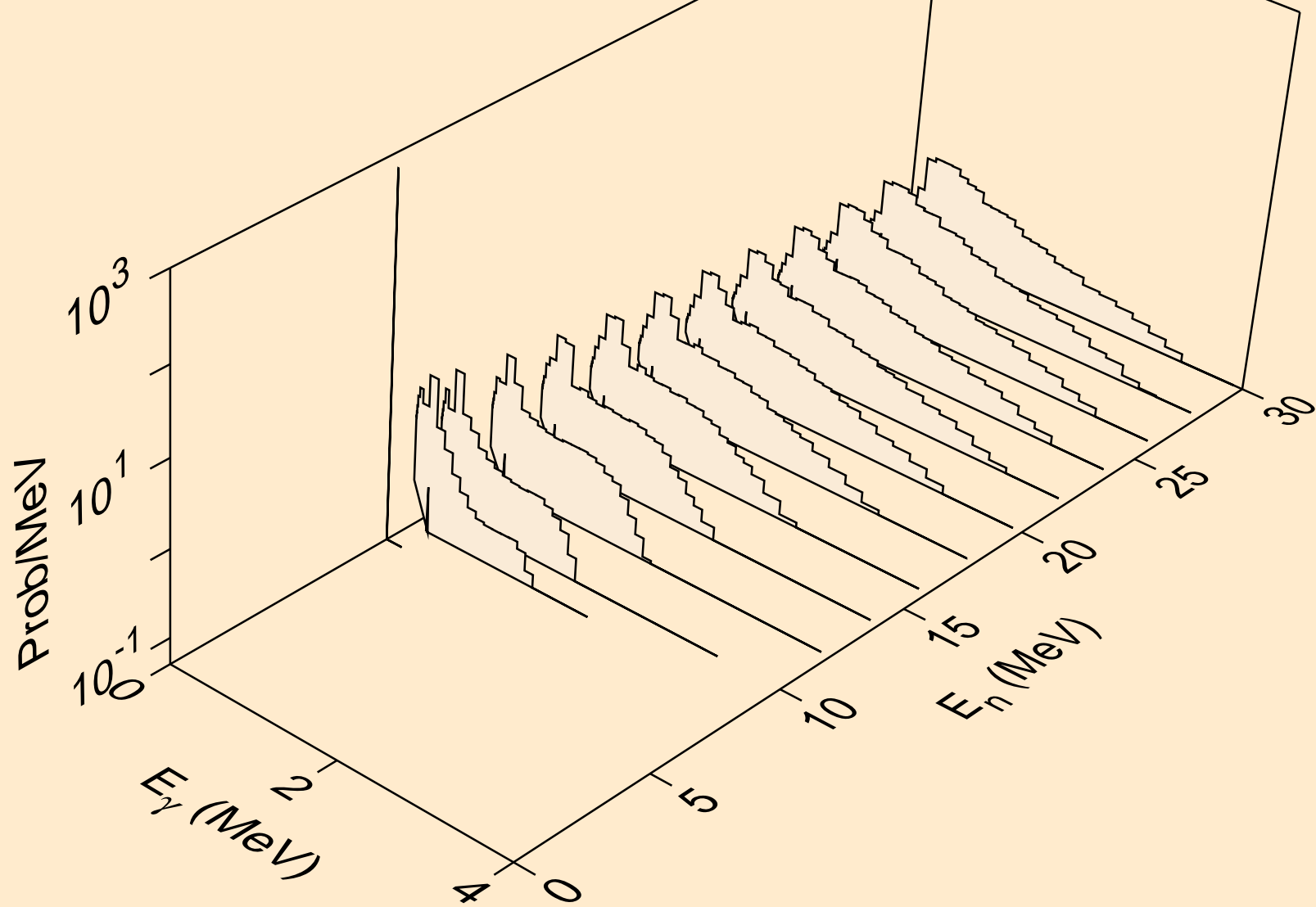

TM150 DEUTERON ACER TENDL-2021 LIBRARY; T=0.K  
Photon emission for (n,he3)

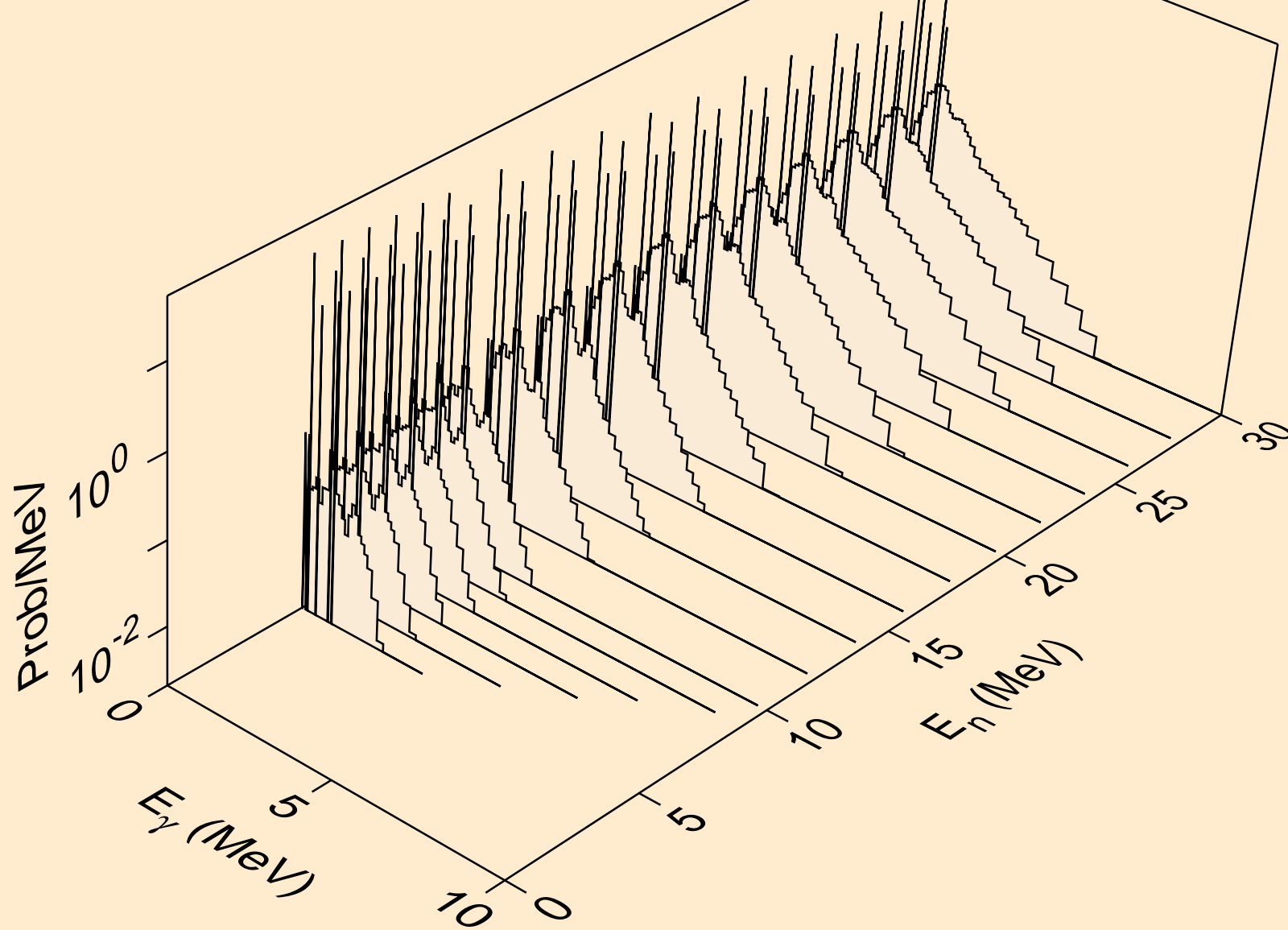

TM150 DEUTERON ACER TENDL-2021 LIBRARY; T=0.K  
Photon emission for (n,a)

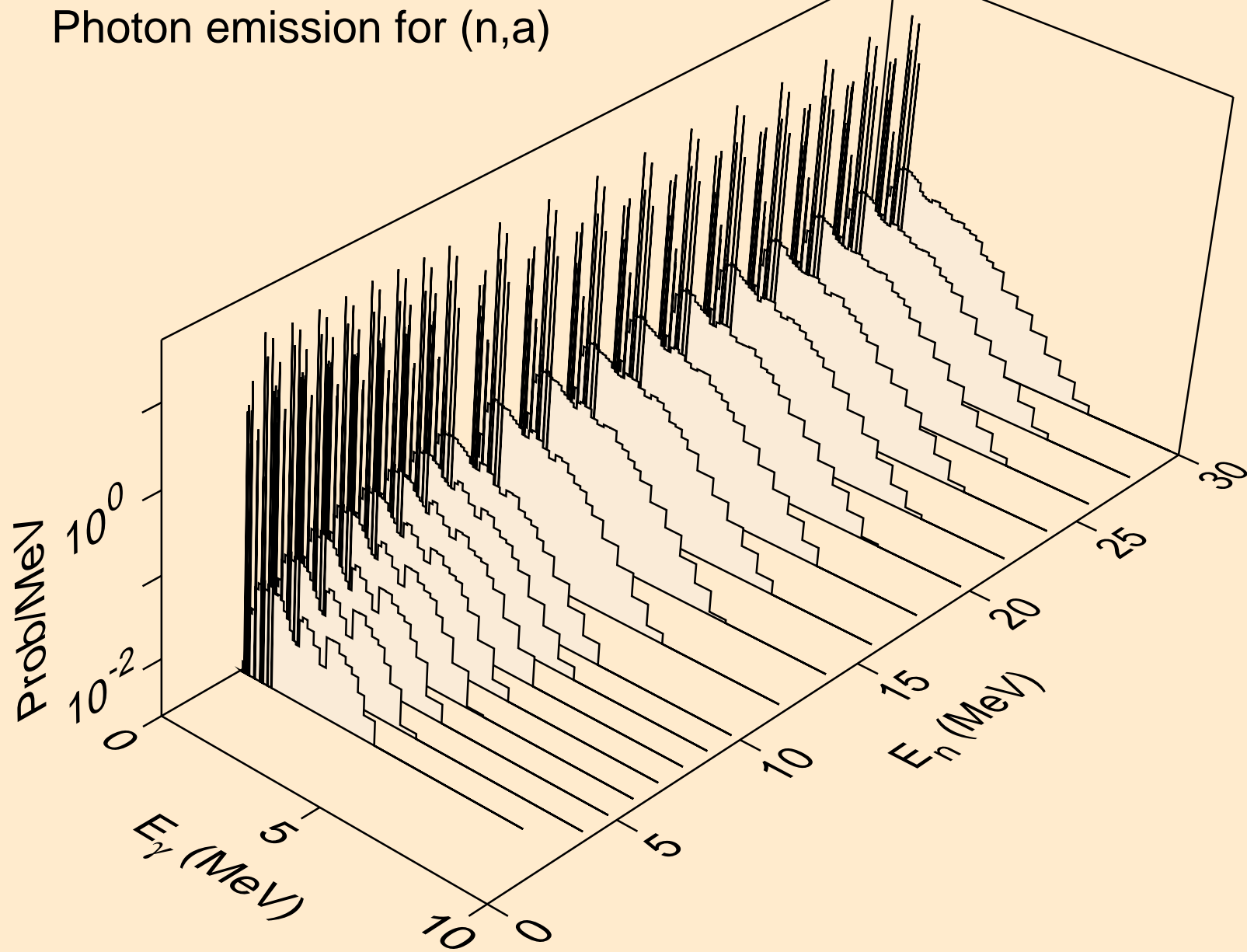



TM150 DEUTERON ACER TENDL-2021 LIBRARY; T=0.K  
Photon emission for (n,2a)

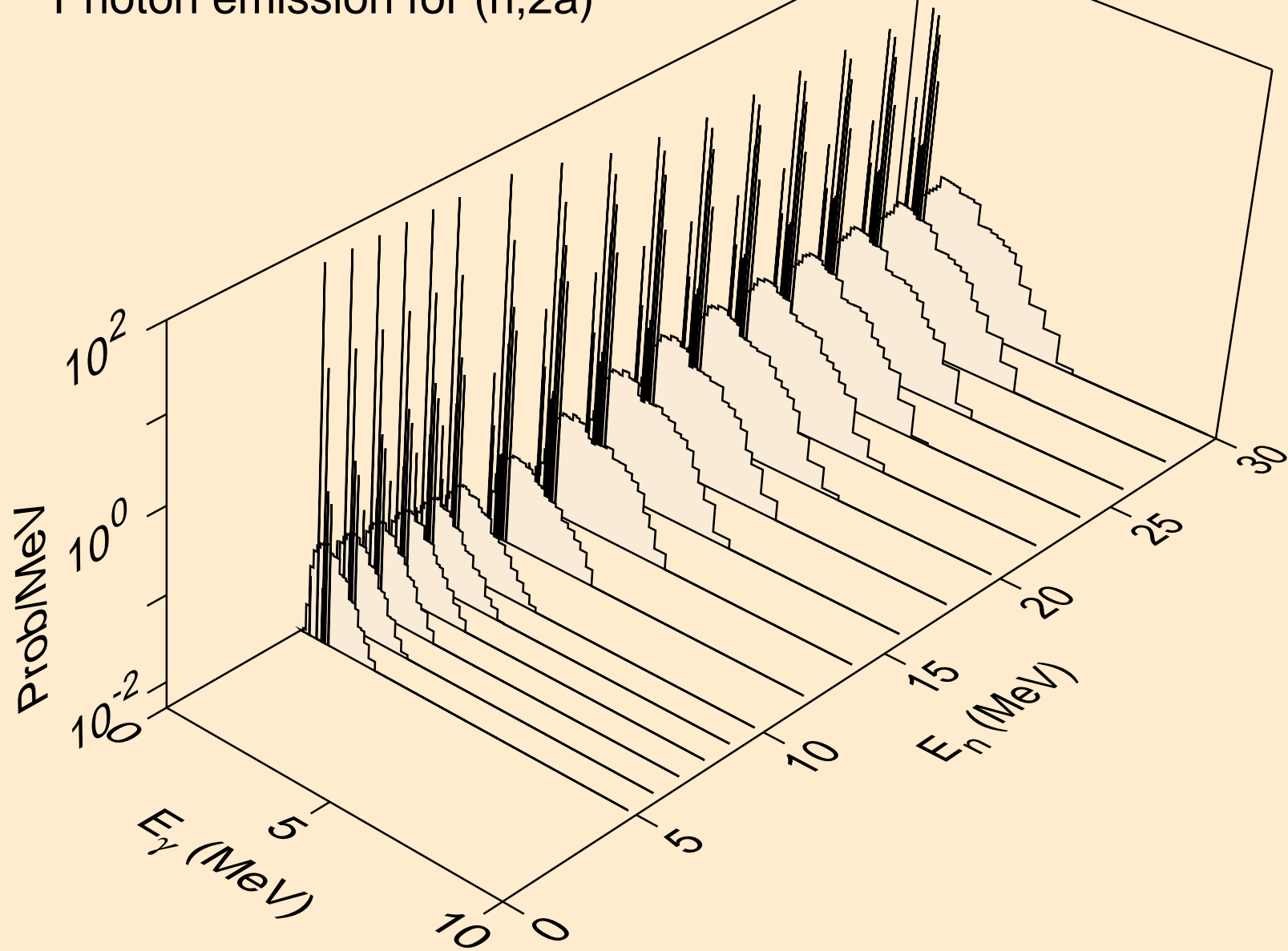

TM150 DEUTERON ACER TENDL-2021 LIBRARY; T=0.K  
Photon emission for (n,3a)

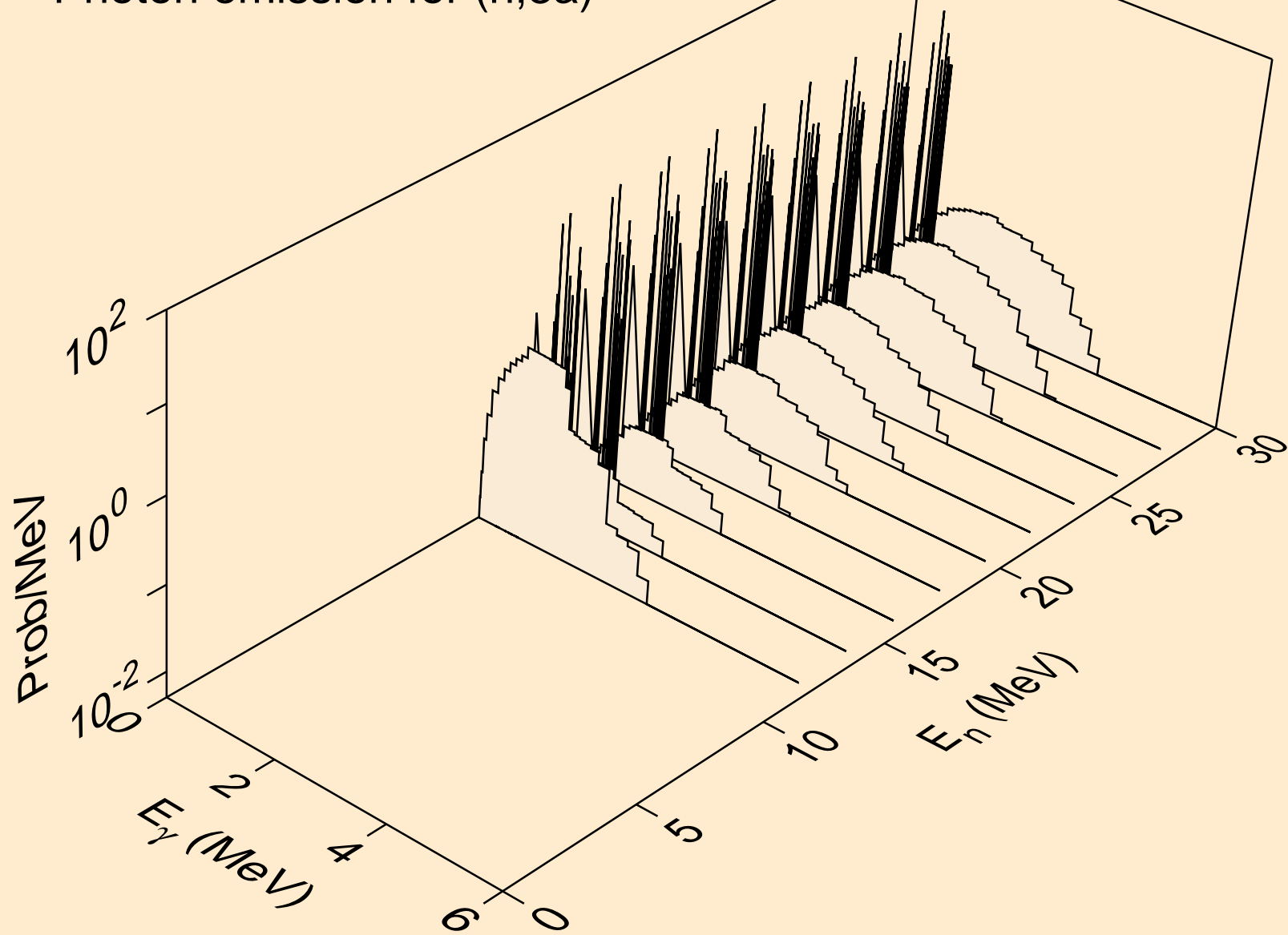

TM150 DEUTERON ACER TENDL-2021 LIBRARY; T=0.K  
Photon emission for (n,2p)

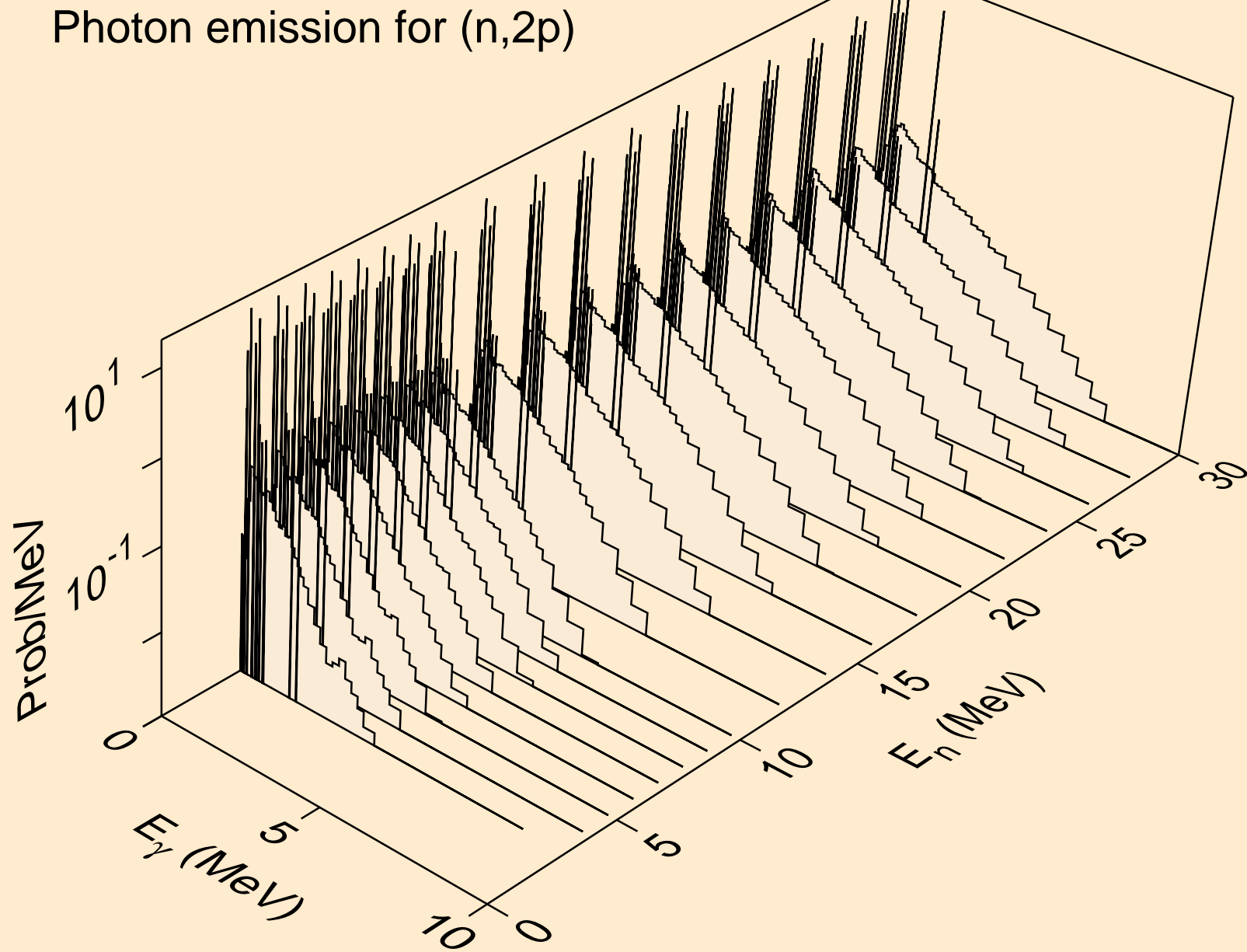

TM150 DEUTERON ACER TENDL-2021 LIBRARY; T=0.K  
Photon emission for (n,p)

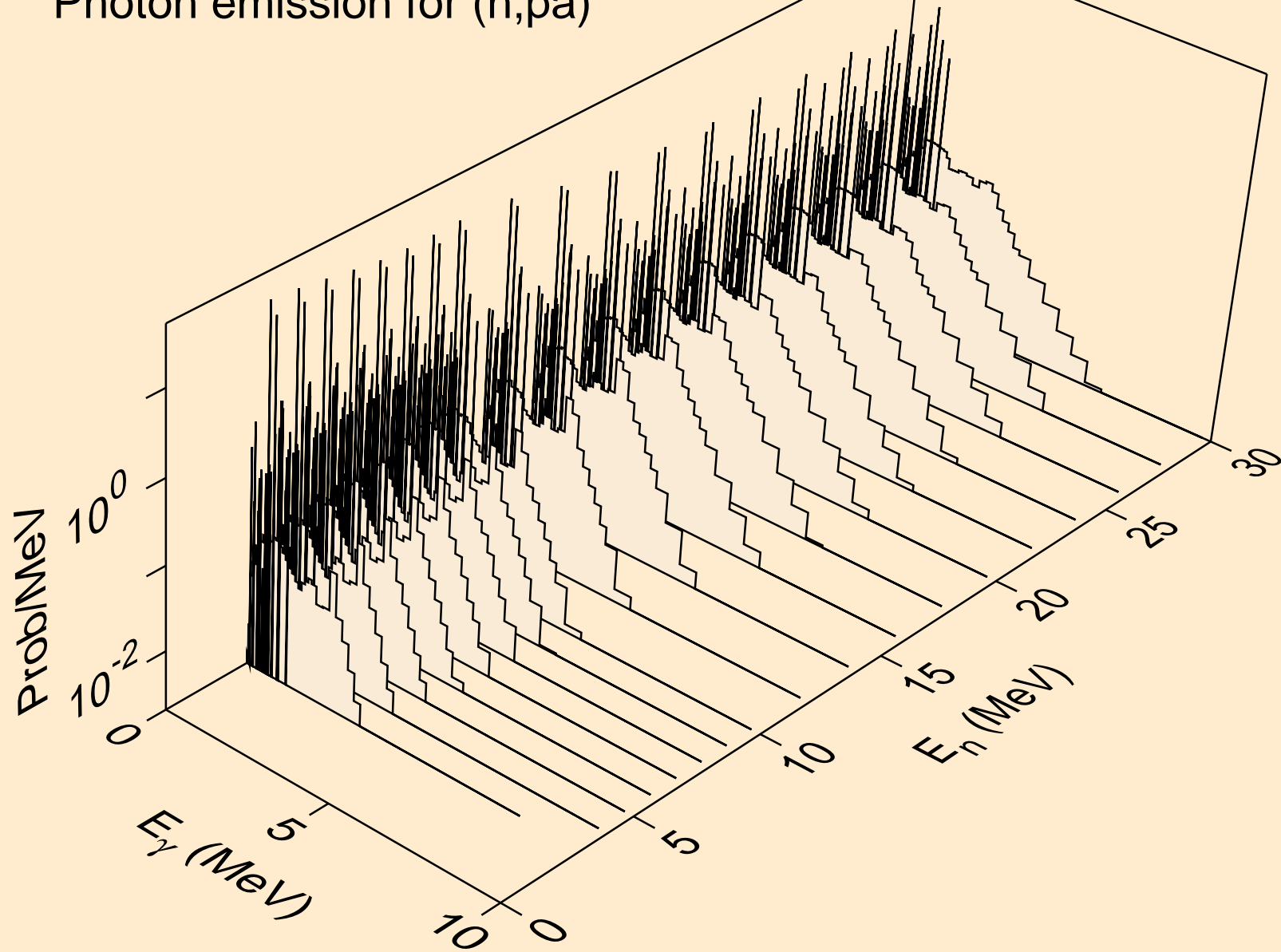

TM150 DEUTERON ACER TENDL-2021 LIBRARY; T=0.K  
Photon emission for (n,pd)

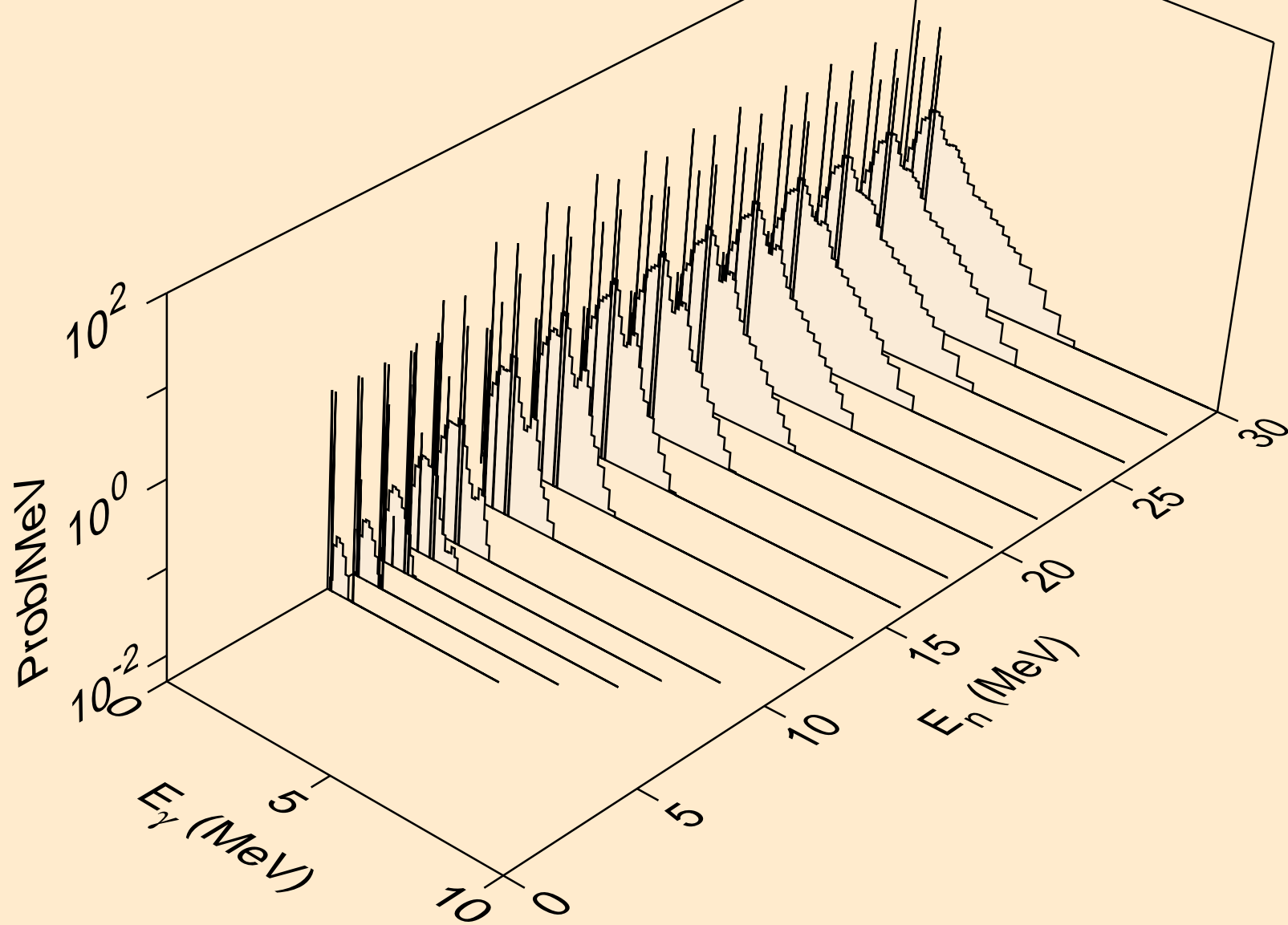

TM150 DEUTERON ACER TENDL-2021 LIBRARY; T=0.K  
Photon emission for (n,pt)

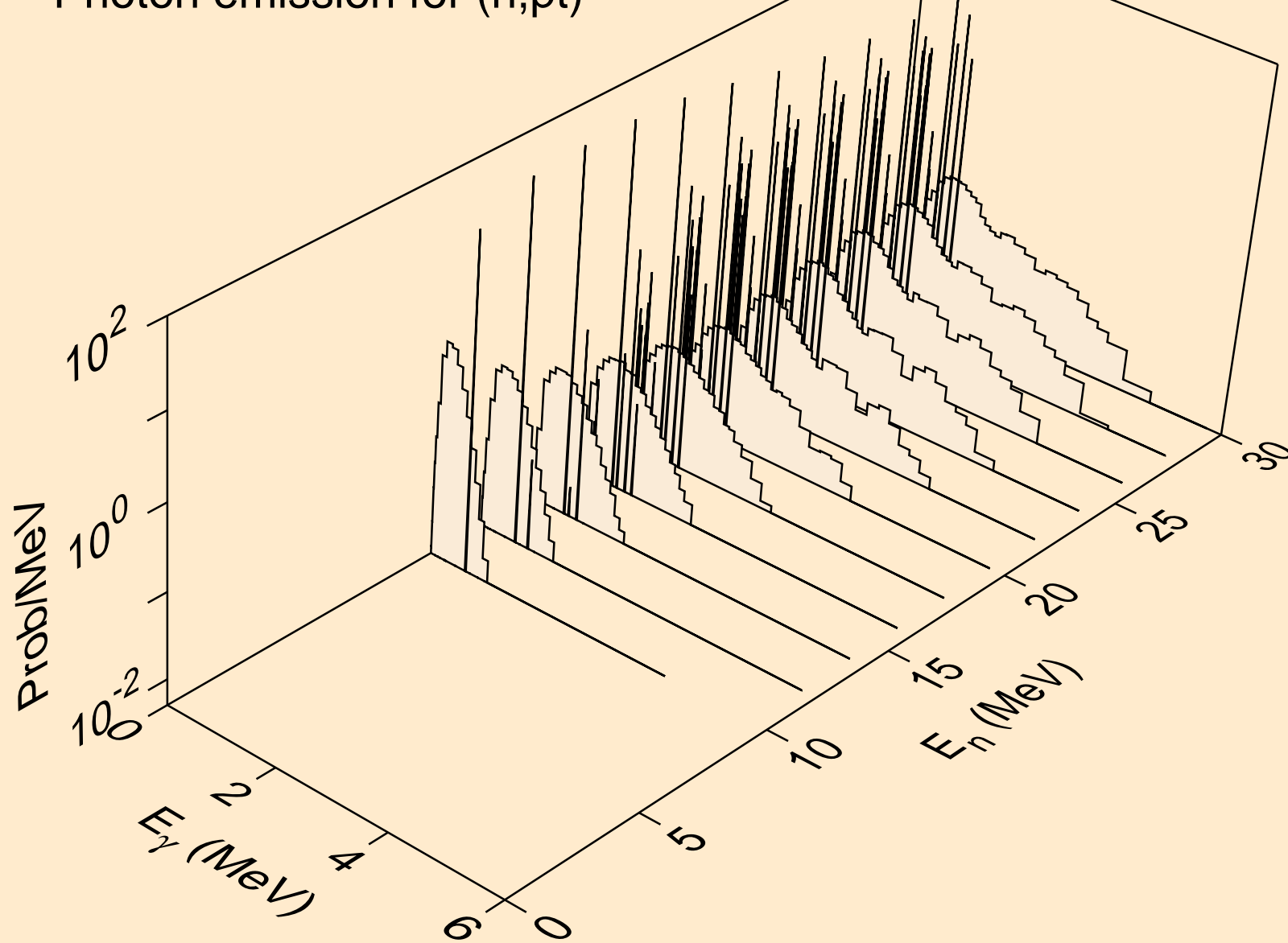

TM150 DEUTERON ACER TENDL-2021 LIBRARY; T=0.K  
Photon emission for (n,da)

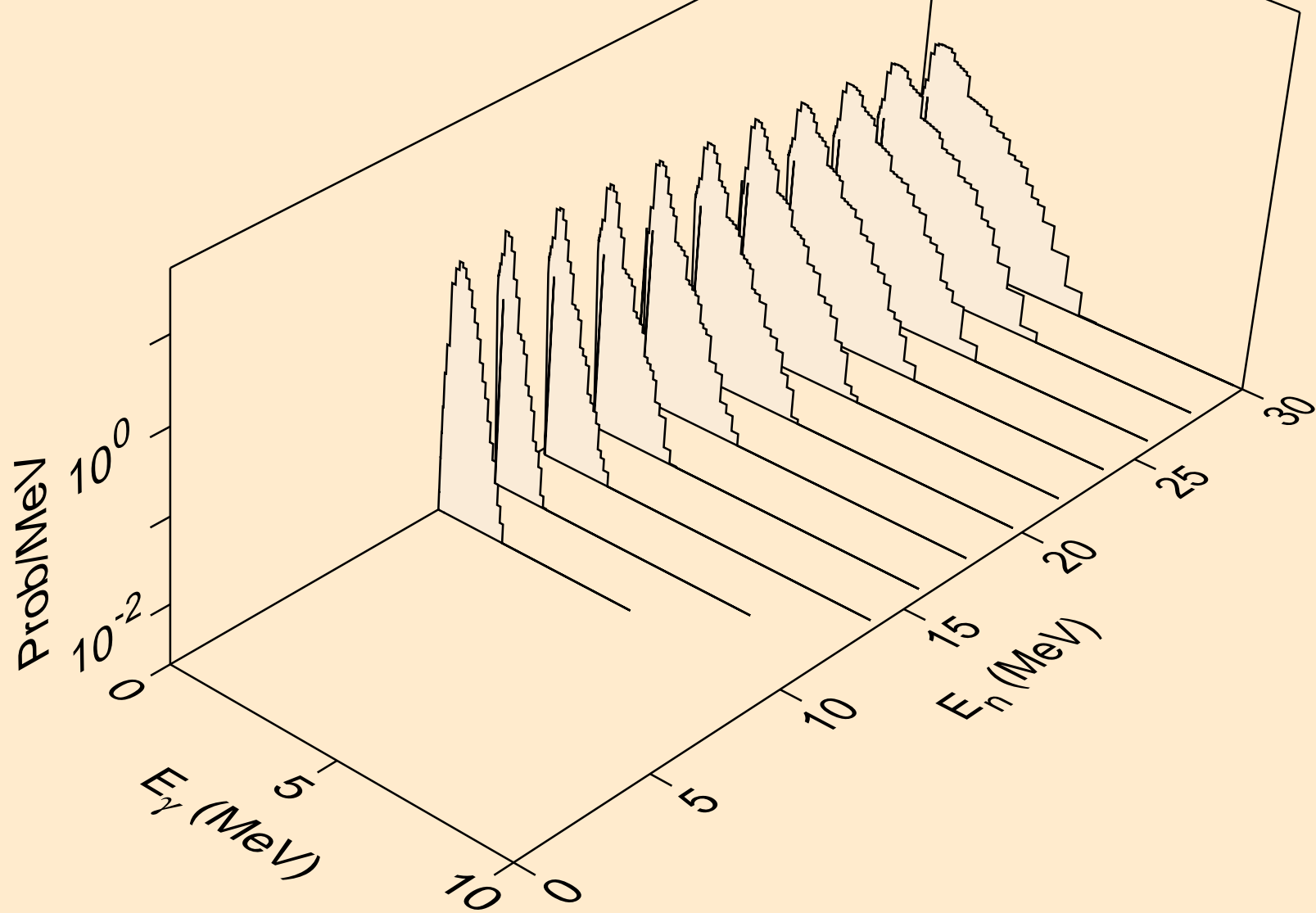

# TM150 DEUTERON ACER TENDL-2021 LIBRARY; T=0.K

## Particle heating contributions

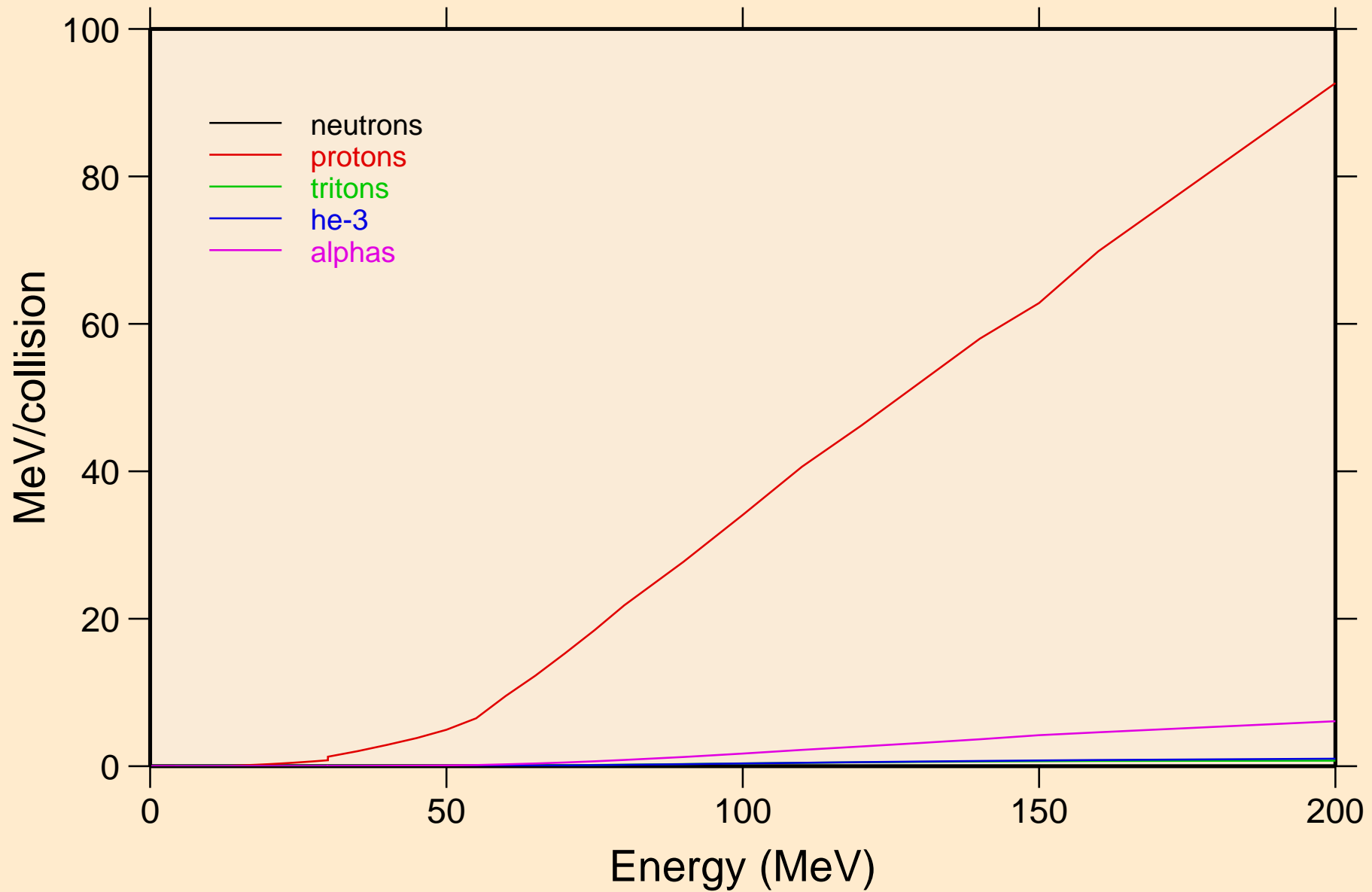



TM150 DEUTERON ACER TENDL-2021 LIBRARY; T=0.K  
Recoil Heating

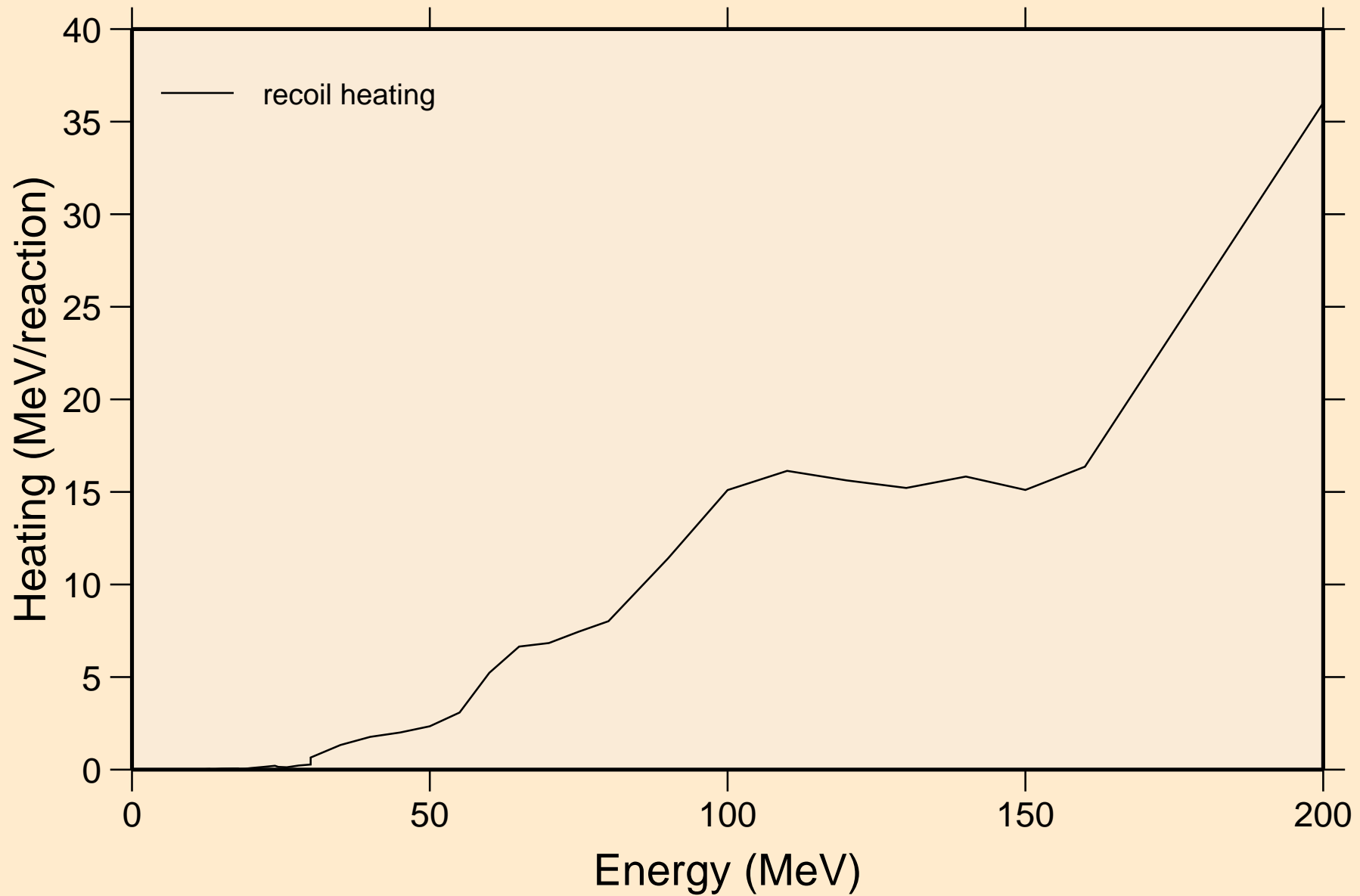

TM150 DEUTERON ACER TENDL-2021 LIBRARY; T=0.K  
Particle production cross sections

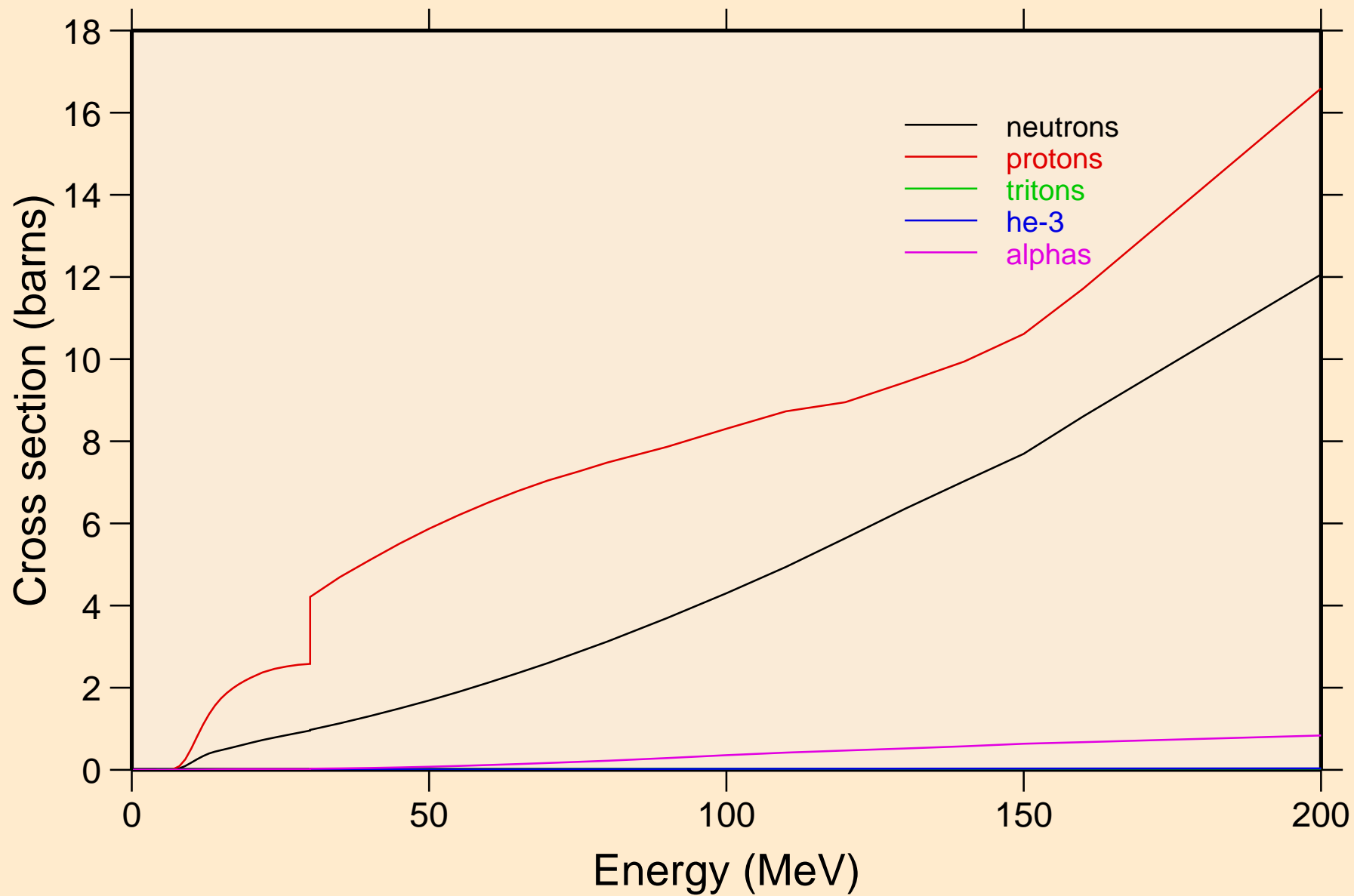

TM150 DEUTERON ACER TENDL-2021 LIBRARY; T=0.K  
neutrons from (d,n)

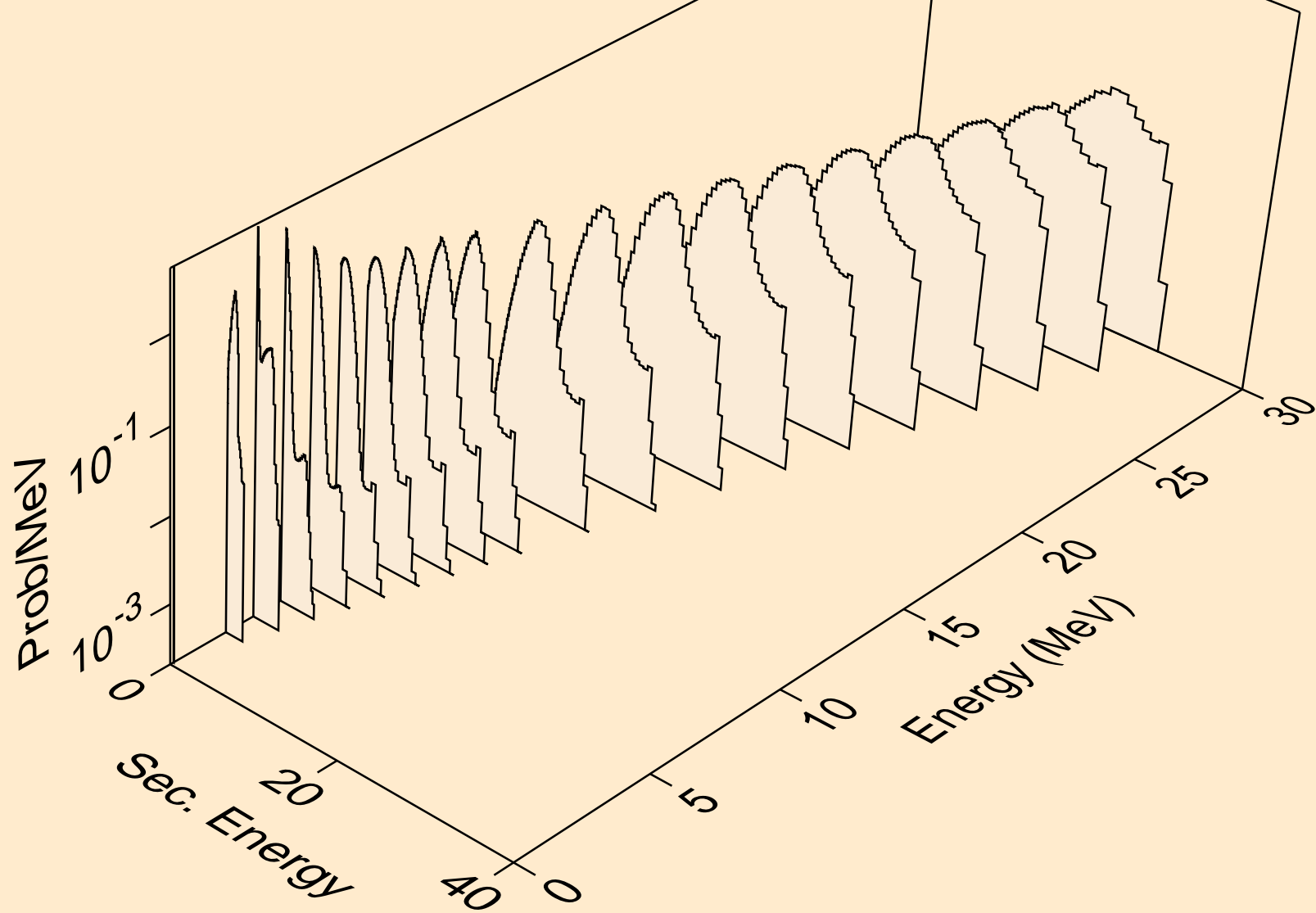

TM150 DEUTERON ACER TENDL-2021 LIBRARY; T=0.K  
neutrons from (d,x)

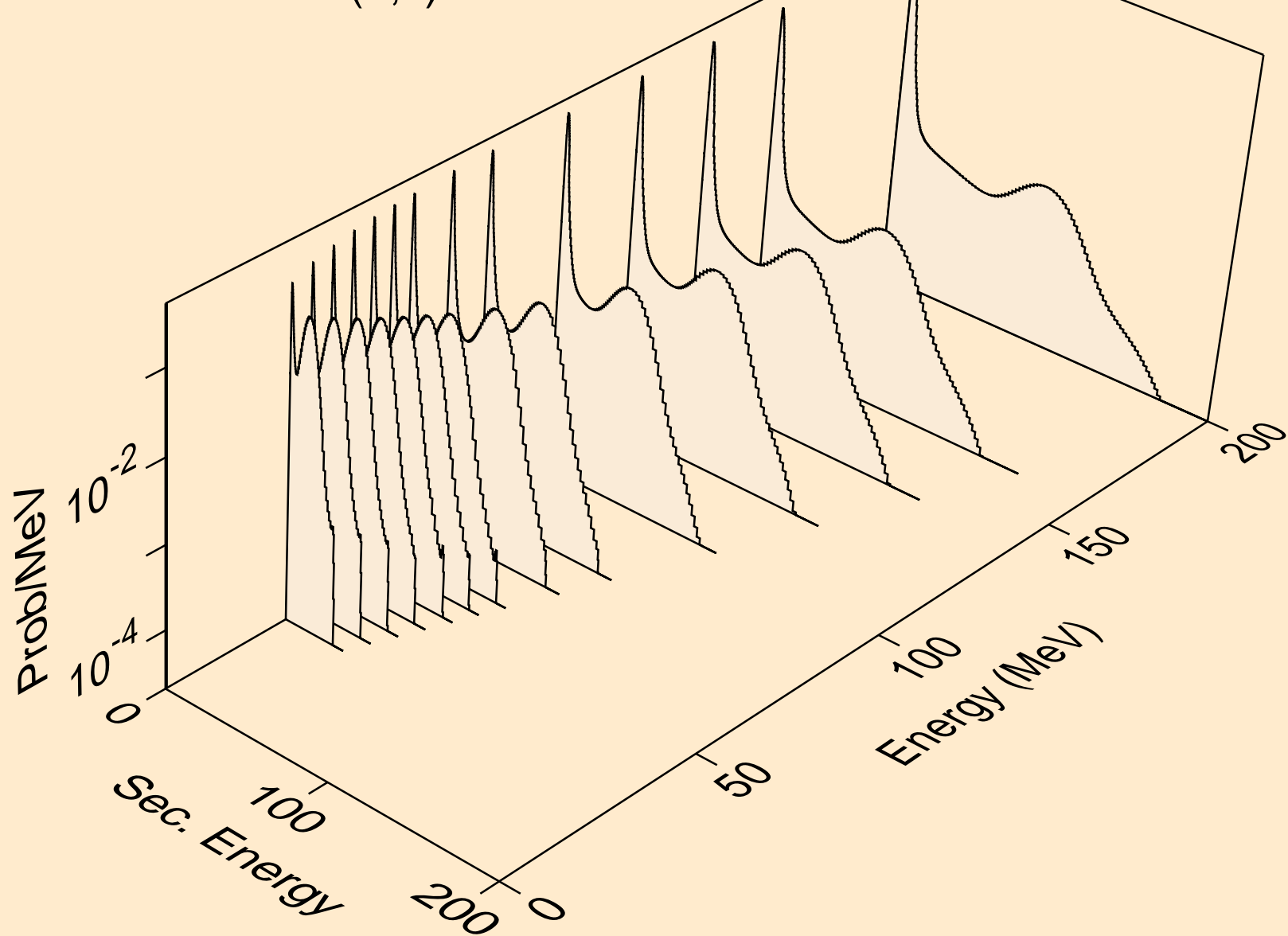

TM150 DEUTERON ACER TENDL-2021 LIBRARY; T=0.K  
neutrons from (d,2n)

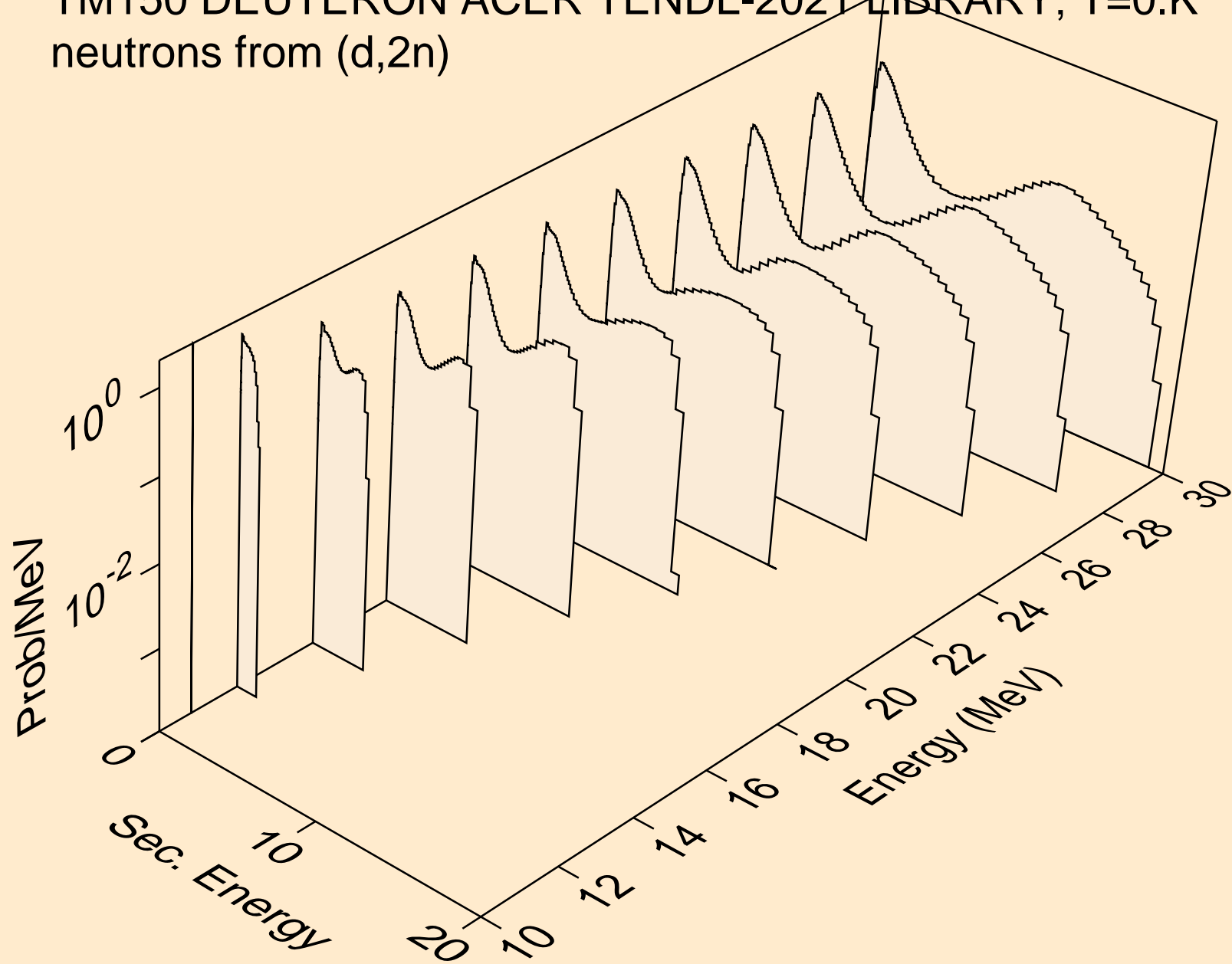

TM150 DEUTERON ACER TENDL-2021 LIBRARY; T=0.K  
neutrons from (d,3n)

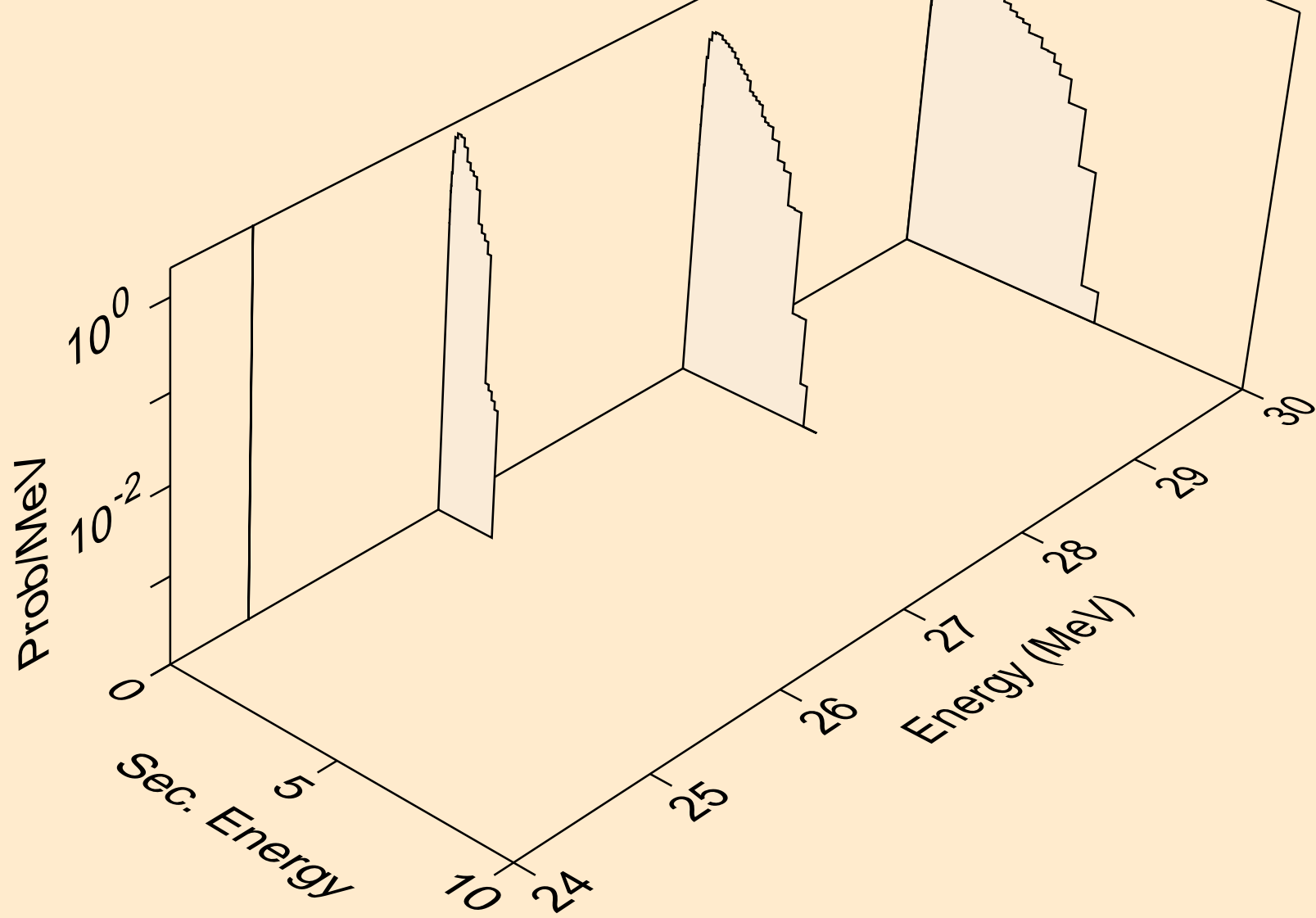

TM150 DEUTERON ACER TENDL-2021 LIBRARY; T=0.K  
neutrons from (d,n\*)a

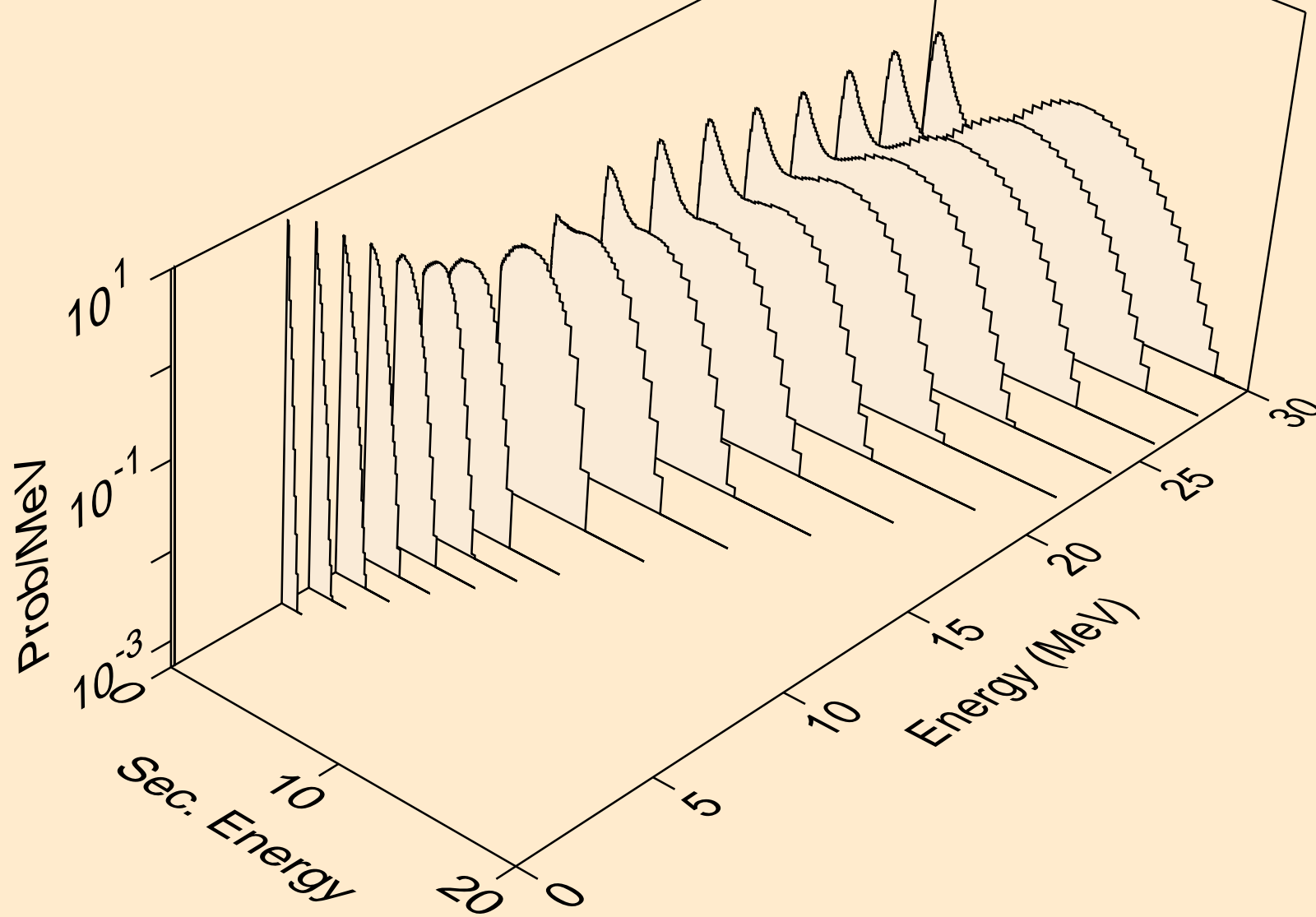

TM150 DEUTERON ACER TENDL-2021 LIBRARY; T=0.K  
neutrons from (d,2n)a

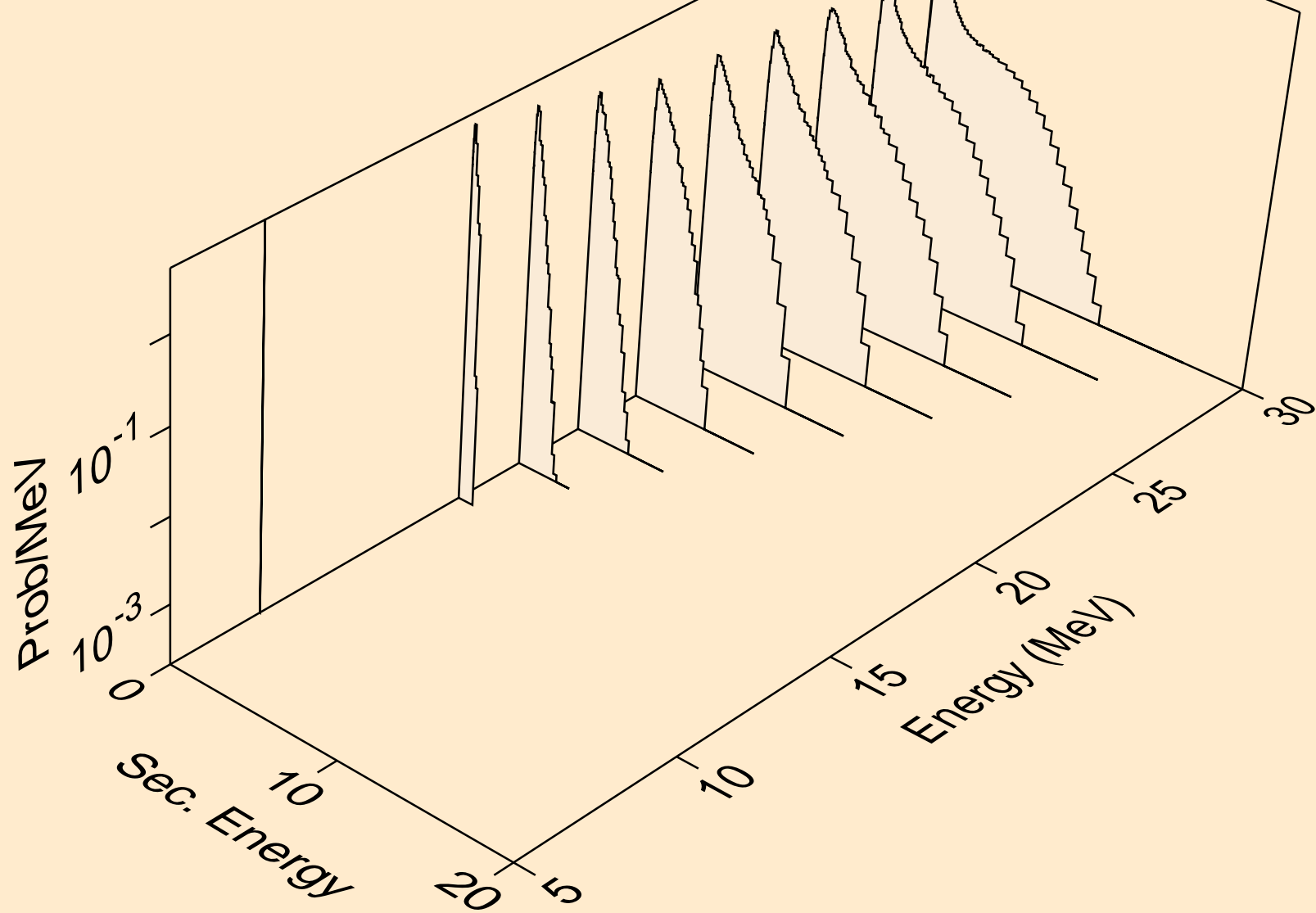



TM150 DEUTERON ACER TENDL-2021 LIBRARY; T=0.K  
neutrons from (d,n\*)p

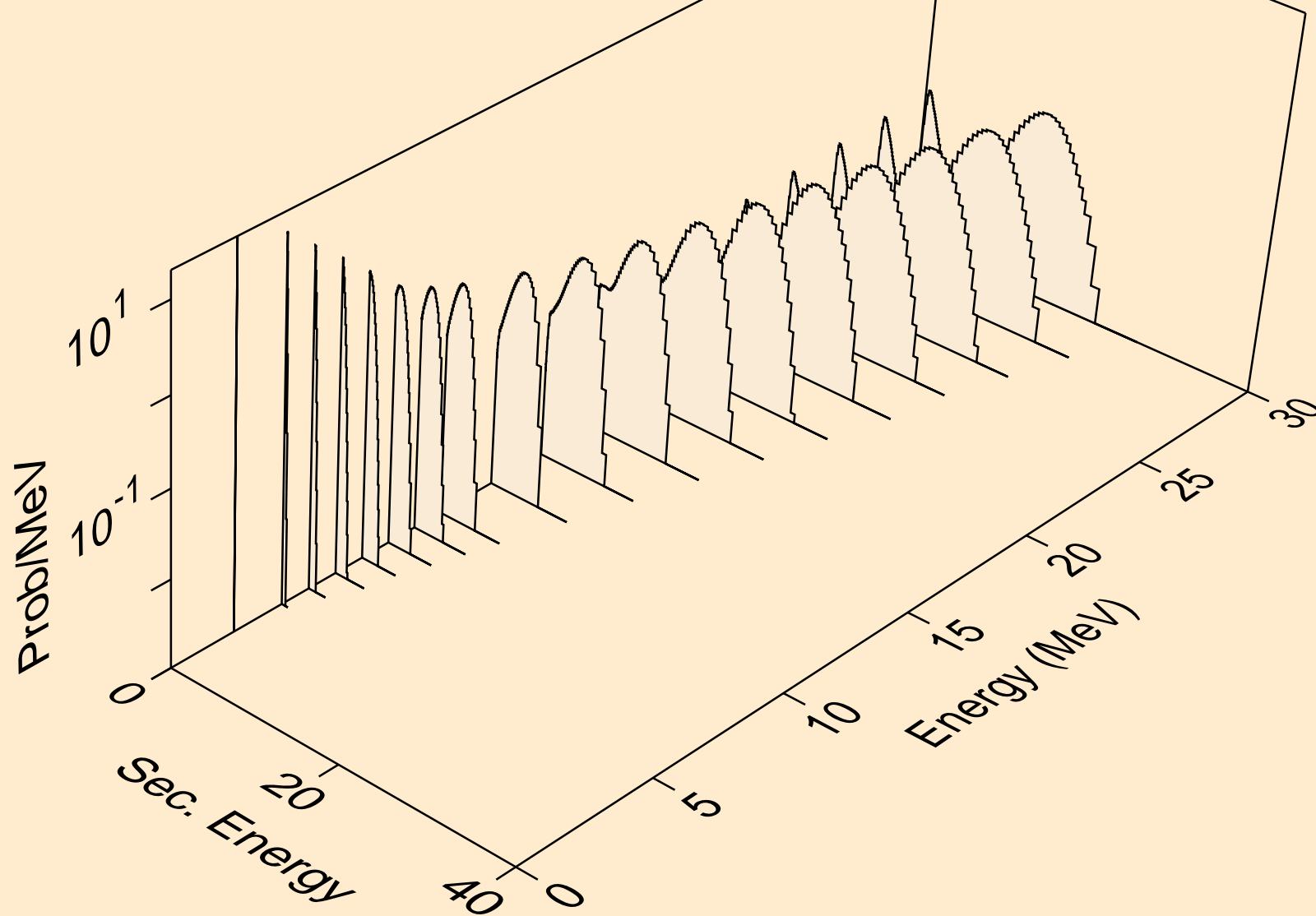

TM150 DEUTERON ACER TENDL-2021 LIBRARY; T=0.K  
neutrons from (d,n\*)2a

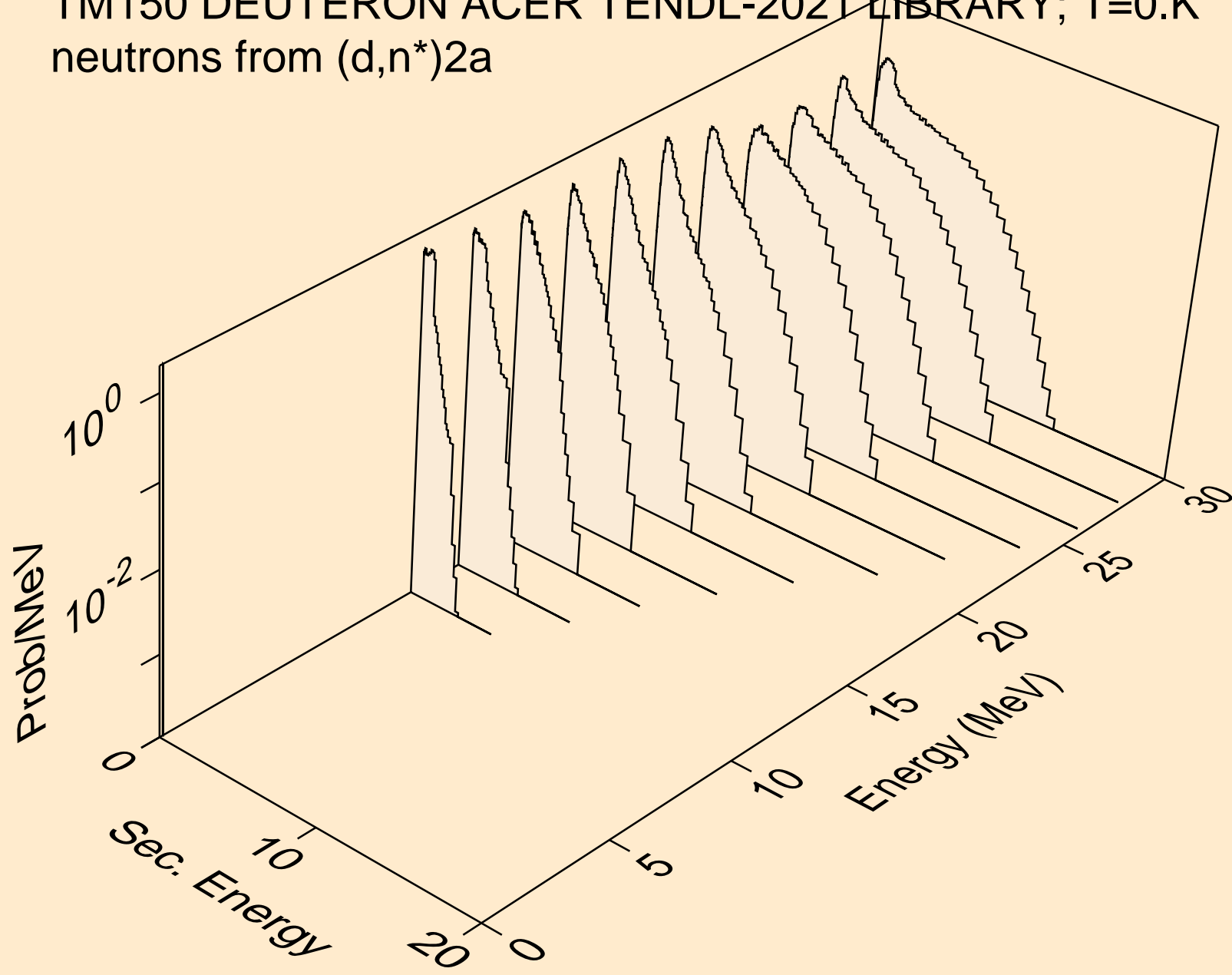

TM150 DEUTERON ACER TENDL-2021 LIBRARY; T=0.K  
neutrons from (d,n\*)d

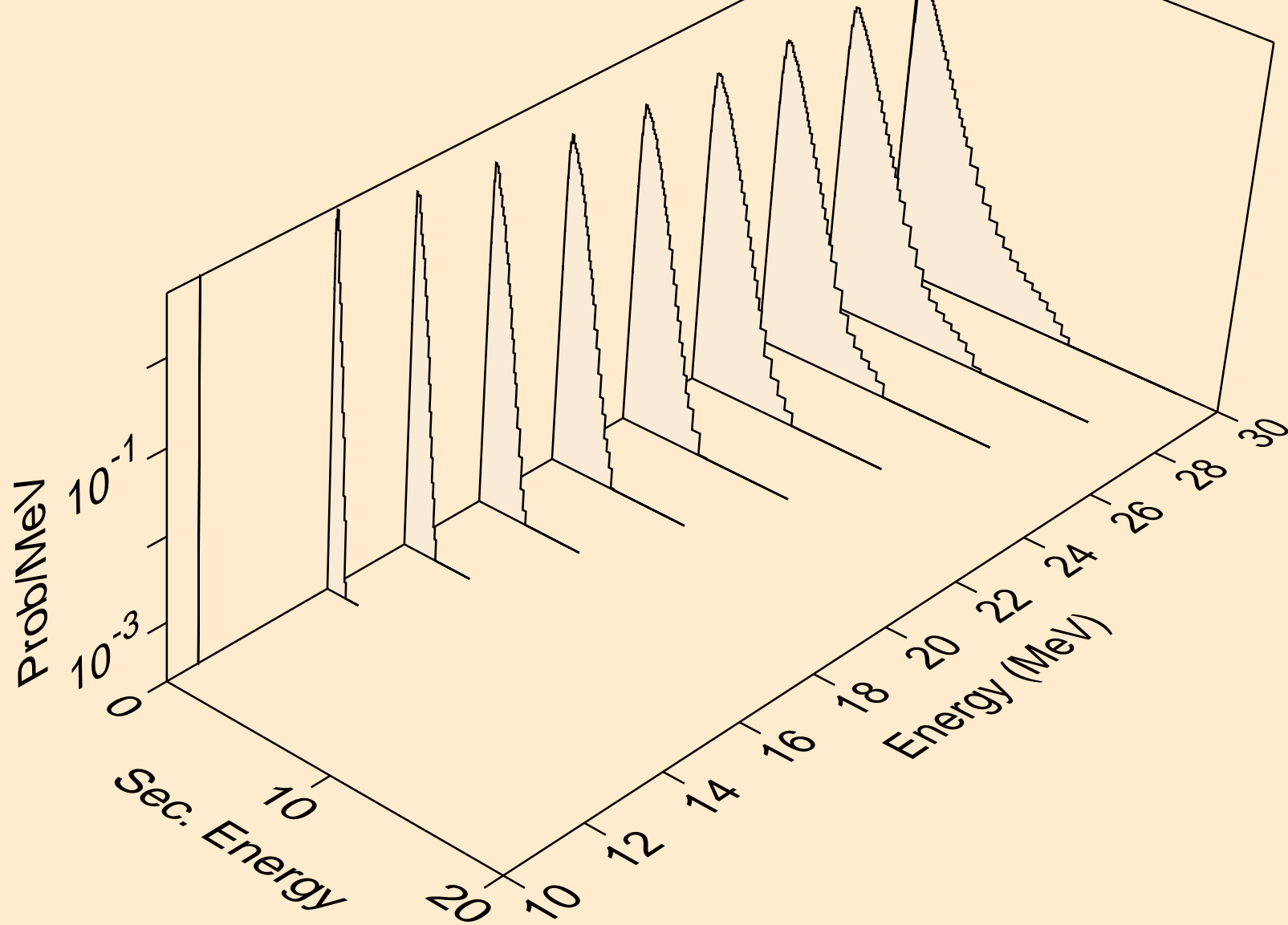

TM150 DEUTERON ACER TENDL-2021 LIBRARY; T=0.K  
neutrons from (d,n\*)t

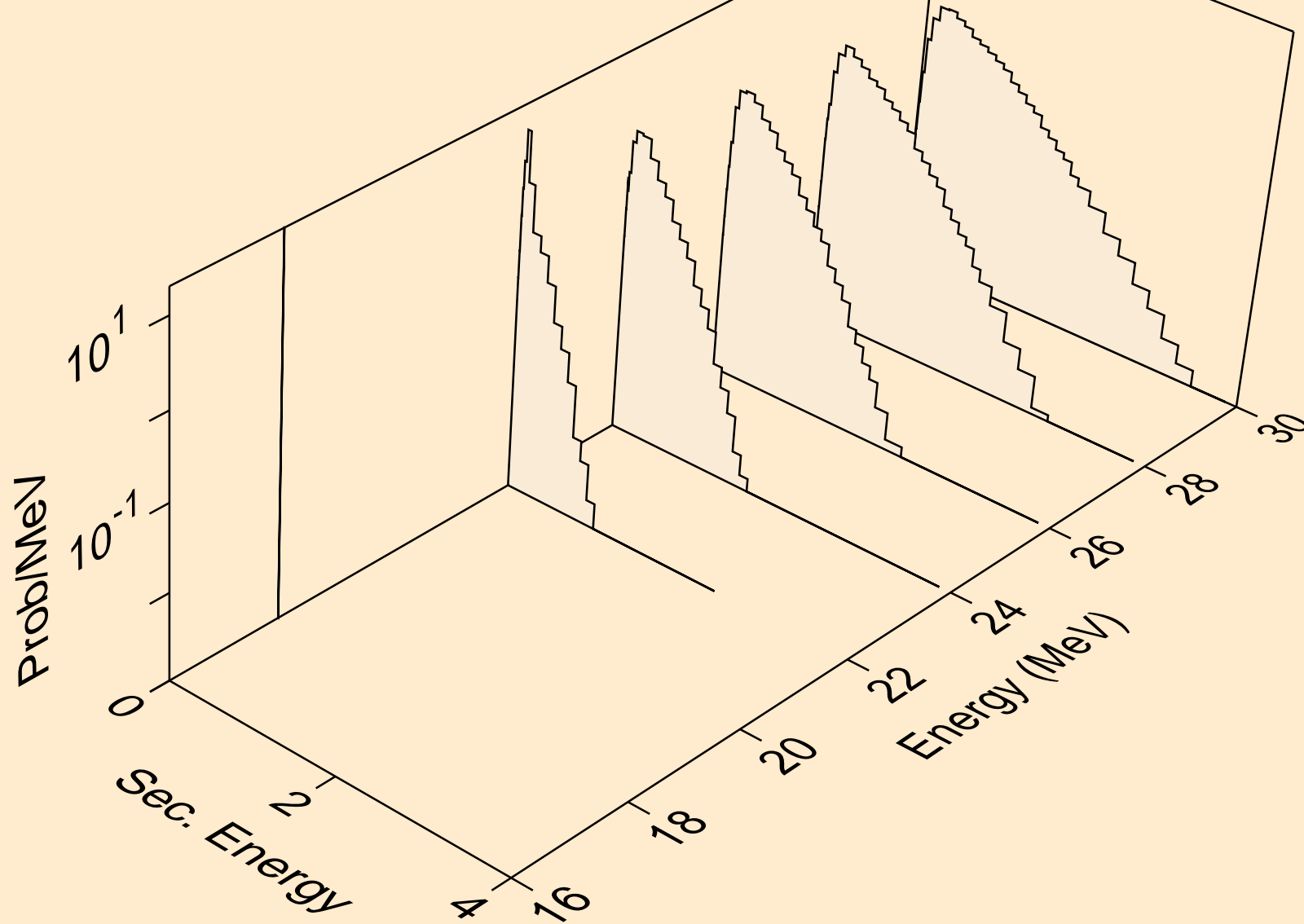

TM150 DEUTERON ACER TENDL-2021 LIBRARY; T=0.K  
neutrons from (d,n\*)he3

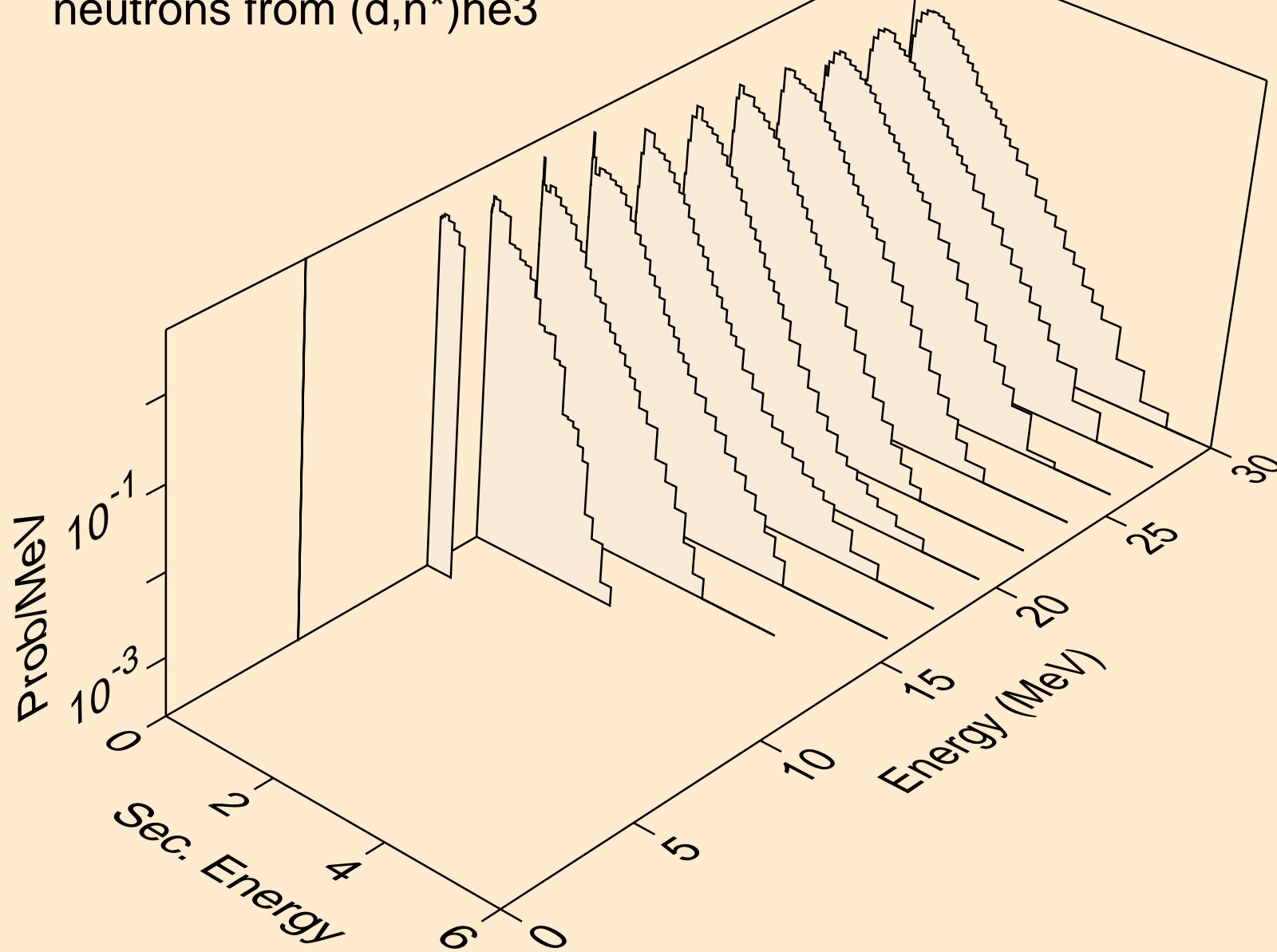

TM150 DEUTERON ACER TENDL-2021 LIBRARY; T=0.K  
neutrons from (d,2np)

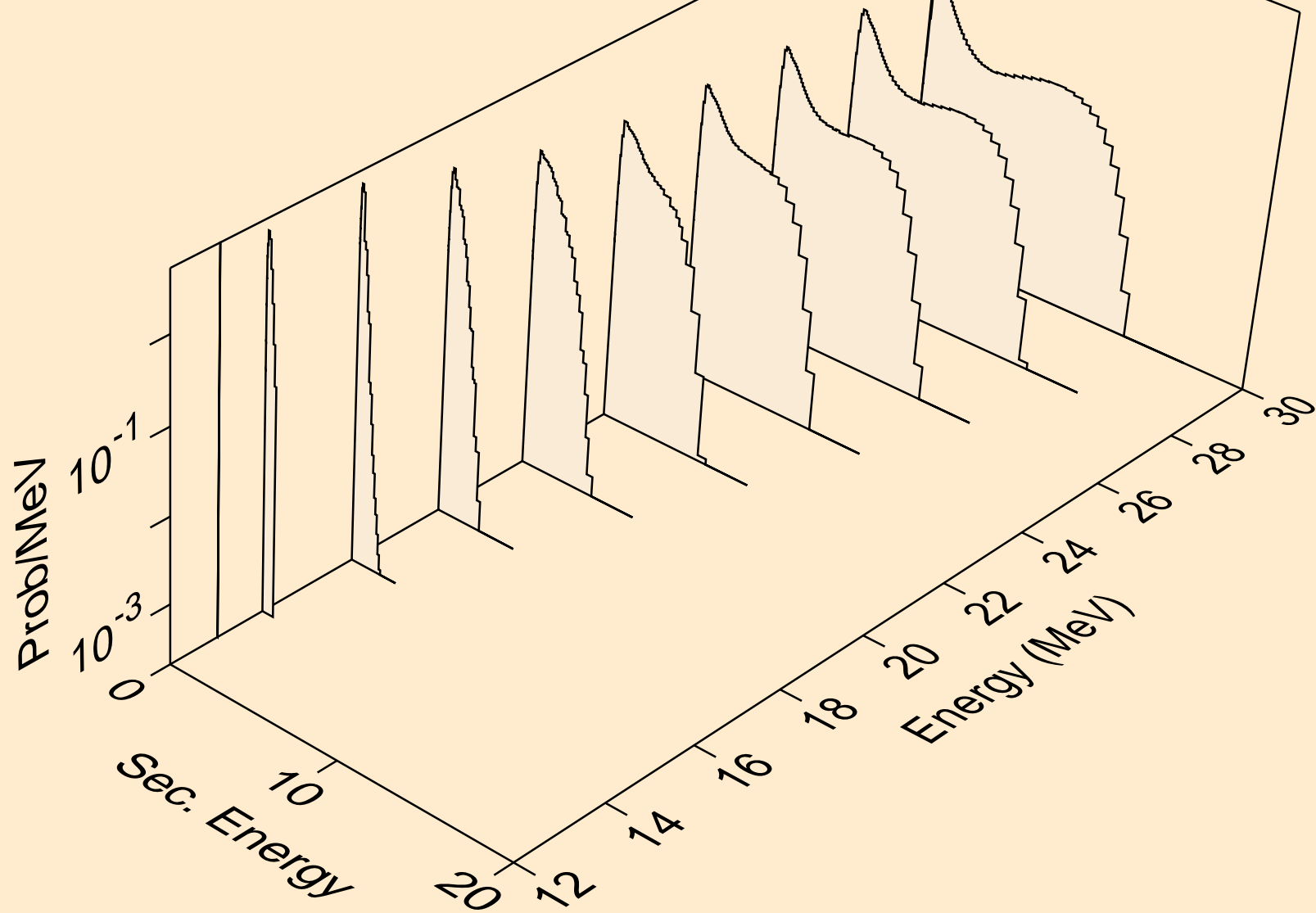

TM150 DEUTERON ACER TENDL-2021 LIBRARY; T=0.K  
neutrons from (d,2np)

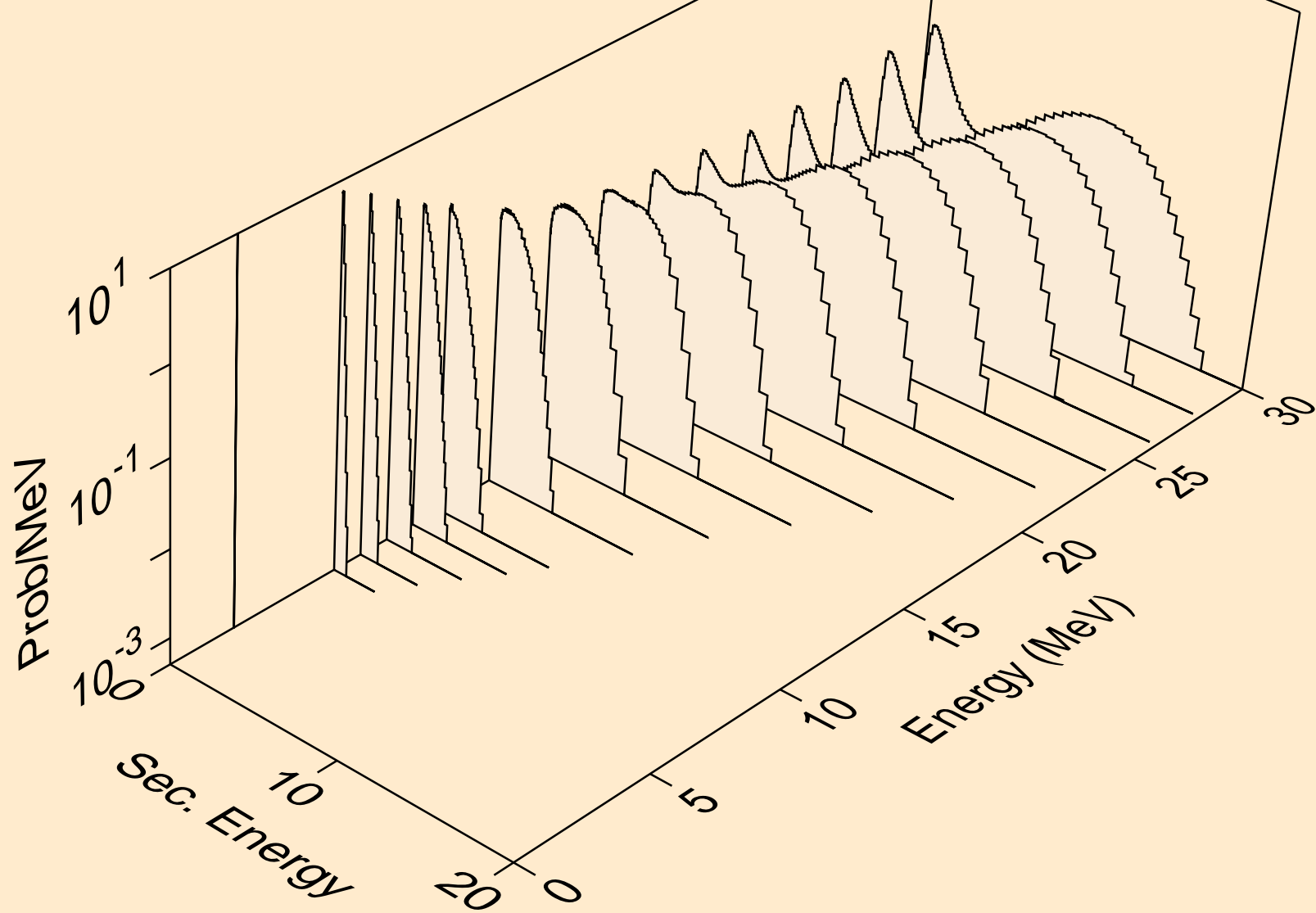

TM150 DEUTERON ACER TENDL-2021 LIBRARY; T=0.K  
neutrons from (d,npa)

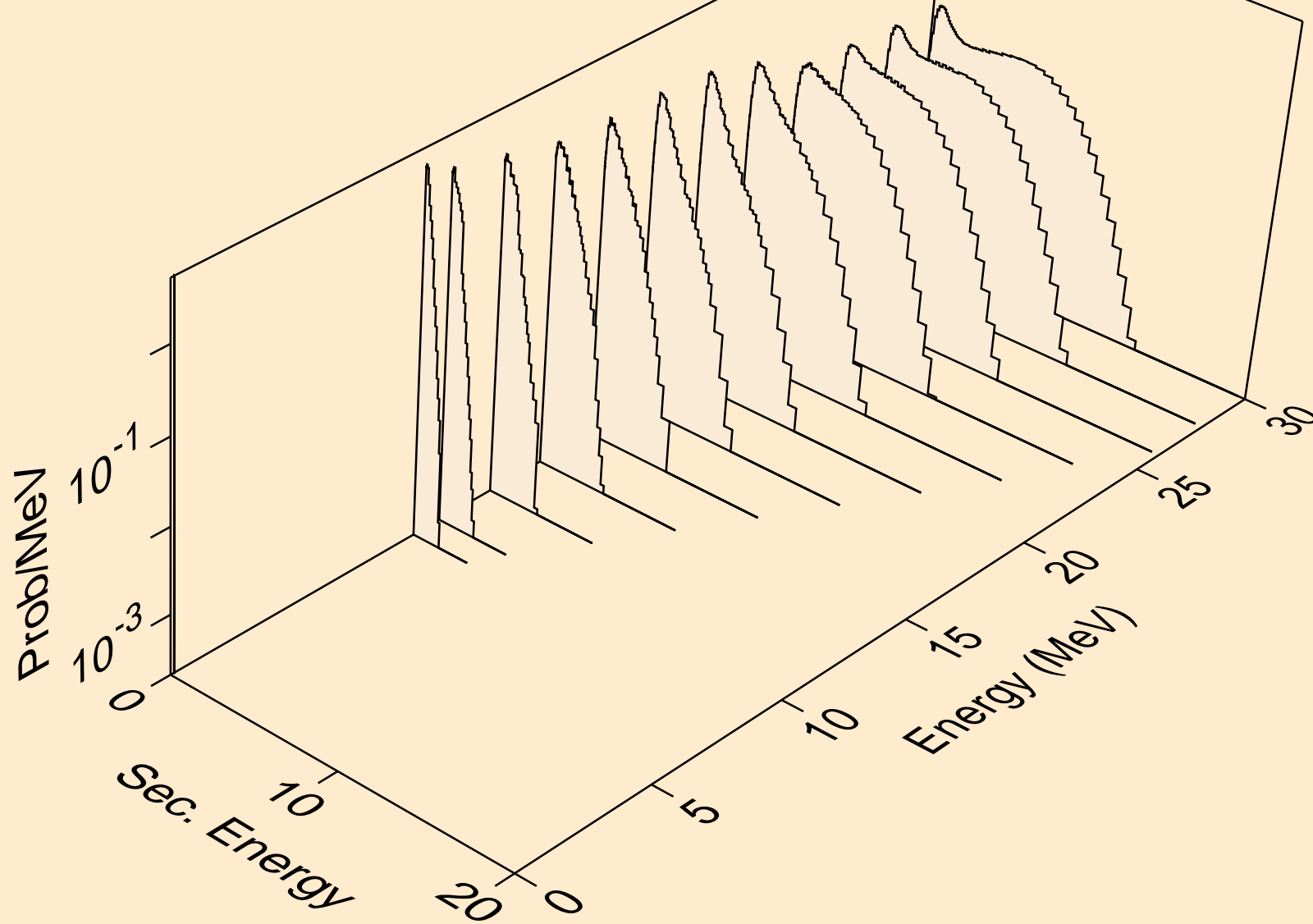



TM150 DEUTERON ACER TENDL-2021 LIBRARY; T=0.K  
protons from (d,x)

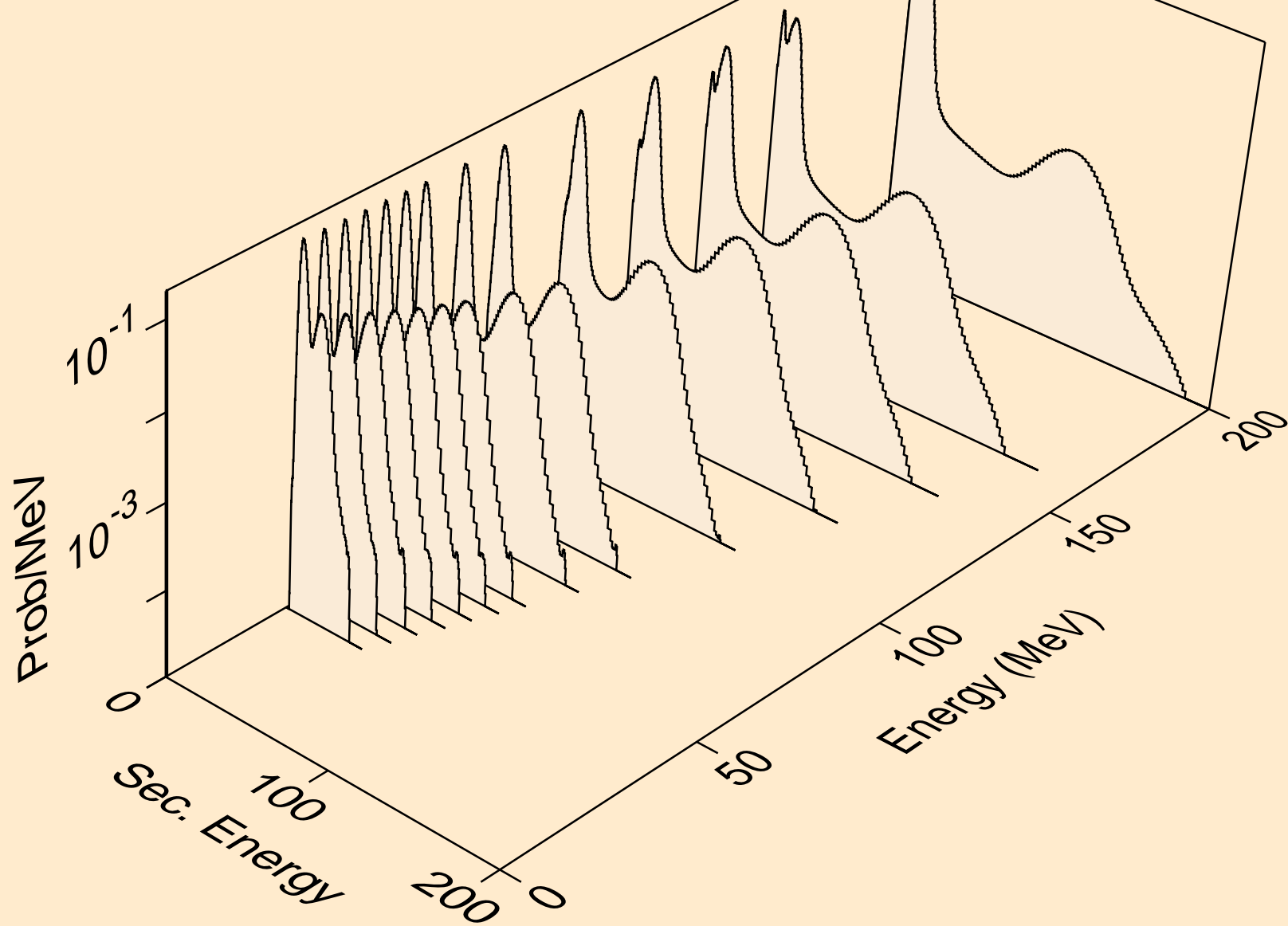

TM150 DEUTERON ACER TENDL-2021 LIBRARY; T=0.K  
protons from (d,n\*)p

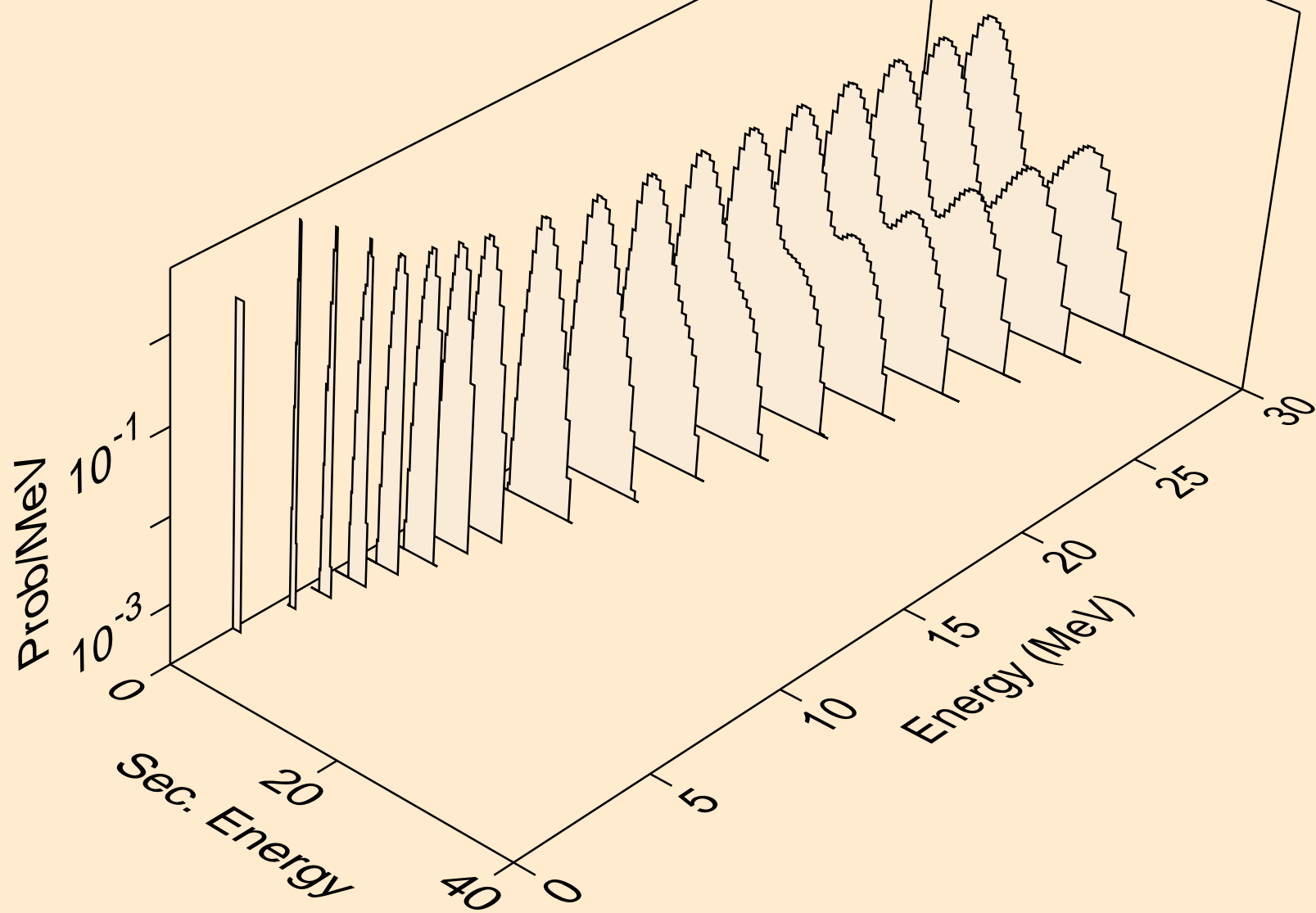

TM150 DEUTERON ACER TENDL-2021 LIBRARY; T=0.K  
protons from (d,2np)

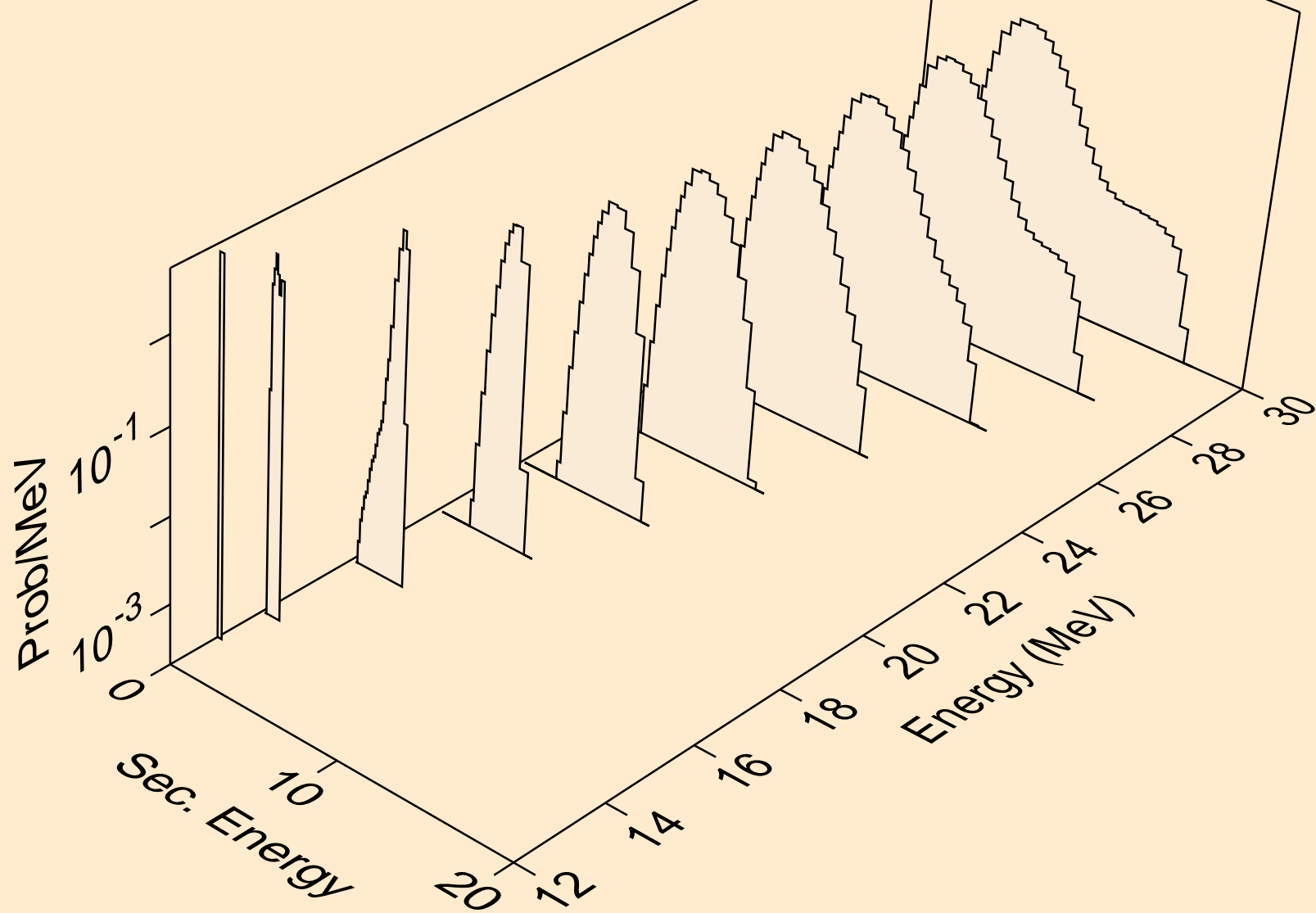

TM150 DEUTERON ACER TENDL-2021 LIBRARY; T=0.K  
protons from (d,2np)

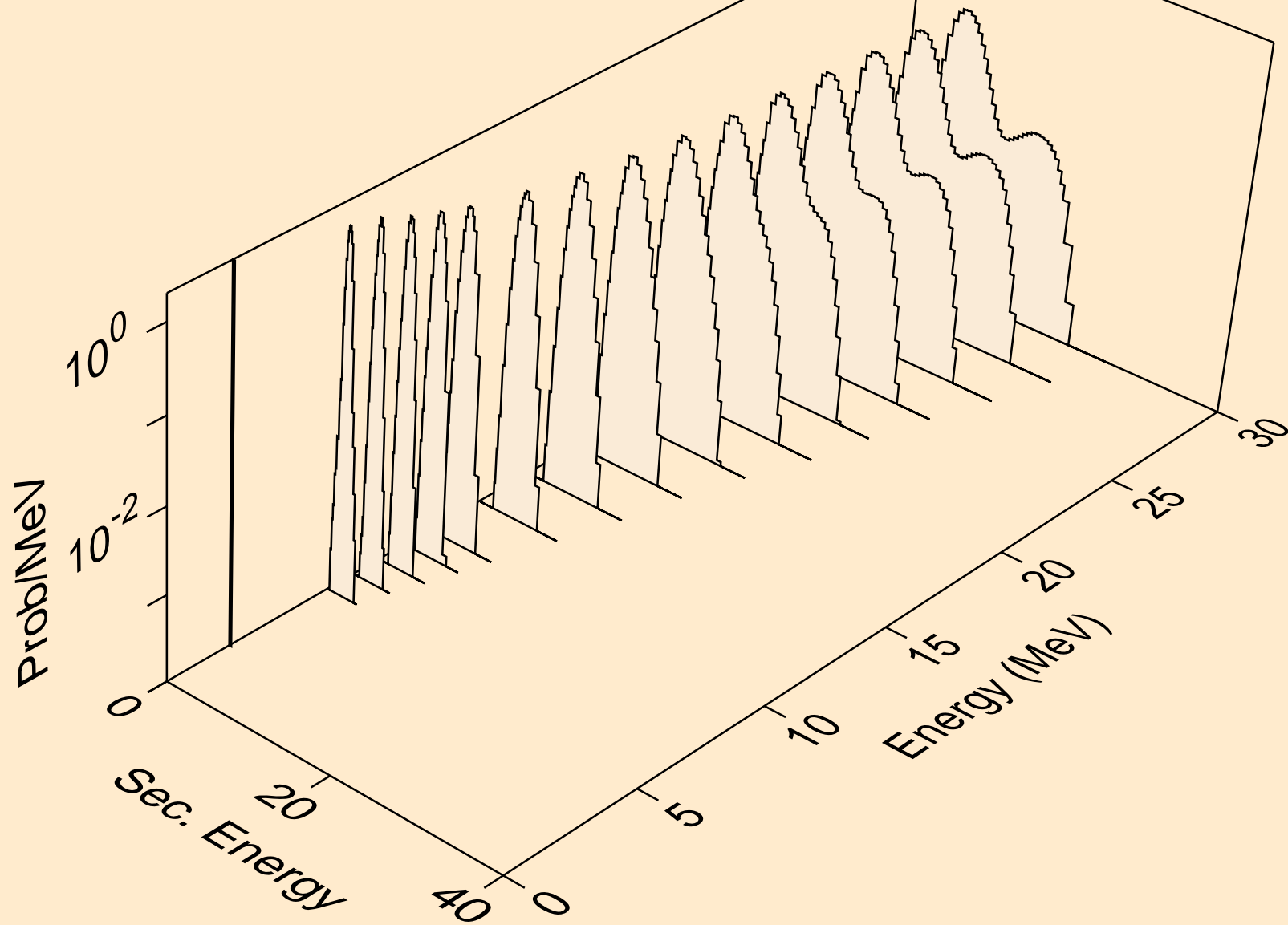

TM150 DEUTERON ACER TENDL-2021 LIBRARY; T=0.K  
protons from (d,npa)

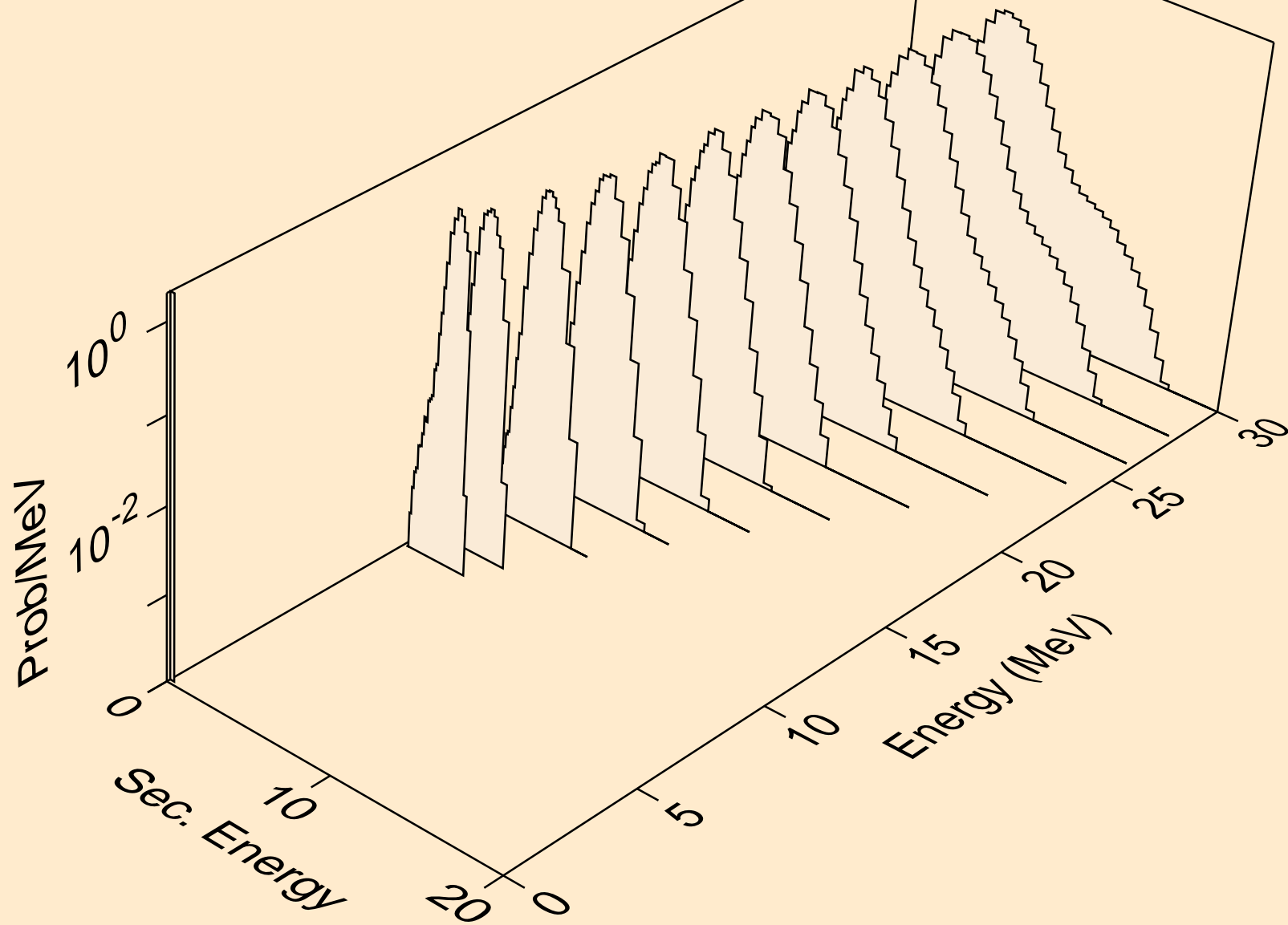

TM150 DEUTERON ACER TENDL-2021 LIBRARY; T=0.K  
protons from (d,p)

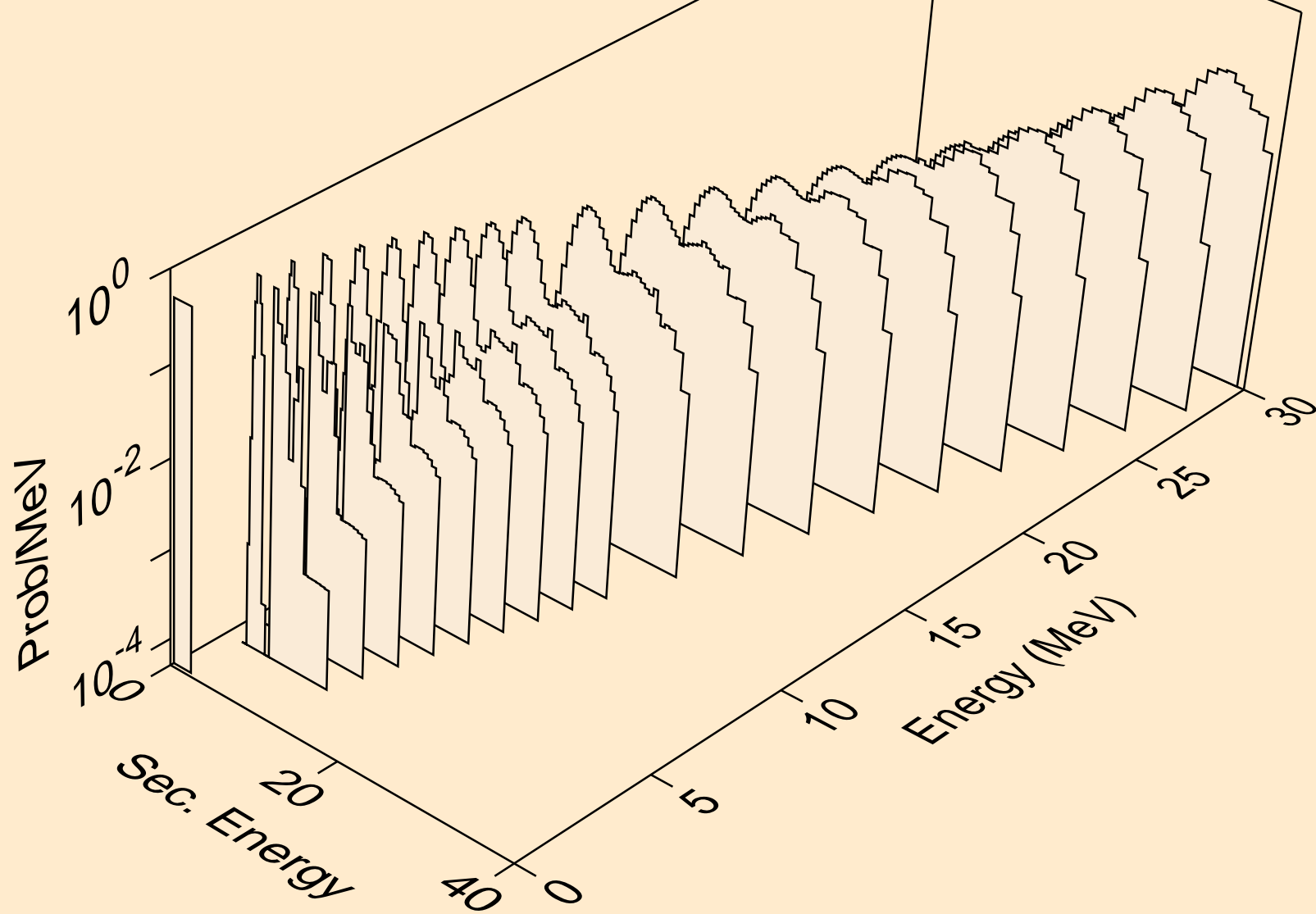

TM150 DEUTERON ACER TENDL-2021 LIBRARY; T=0.K  
protons from (d,2p)

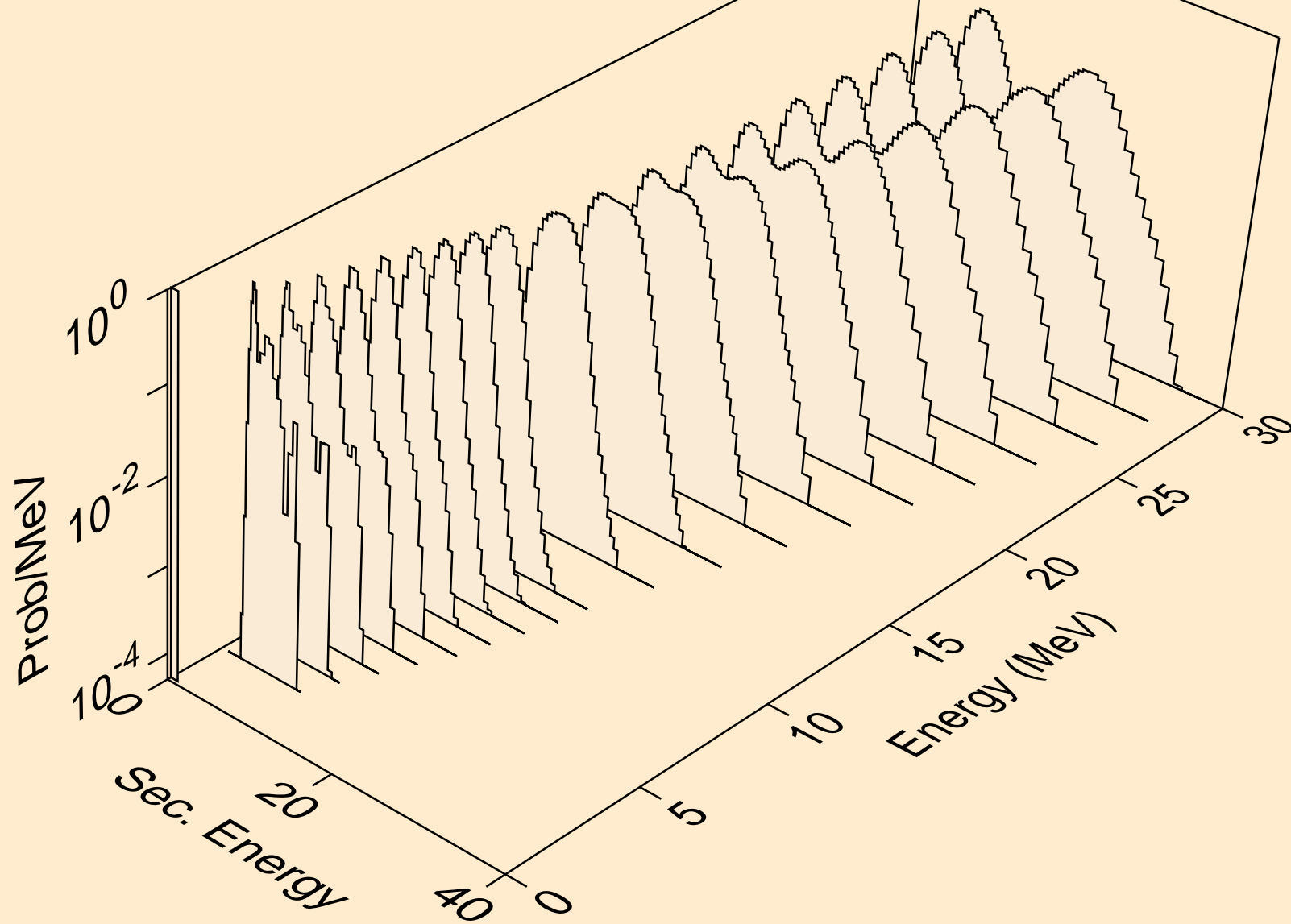

TM150 DEUTERON ACER TENDL-2021 LIBRARY; T=0.K  
protons from (d,pa)

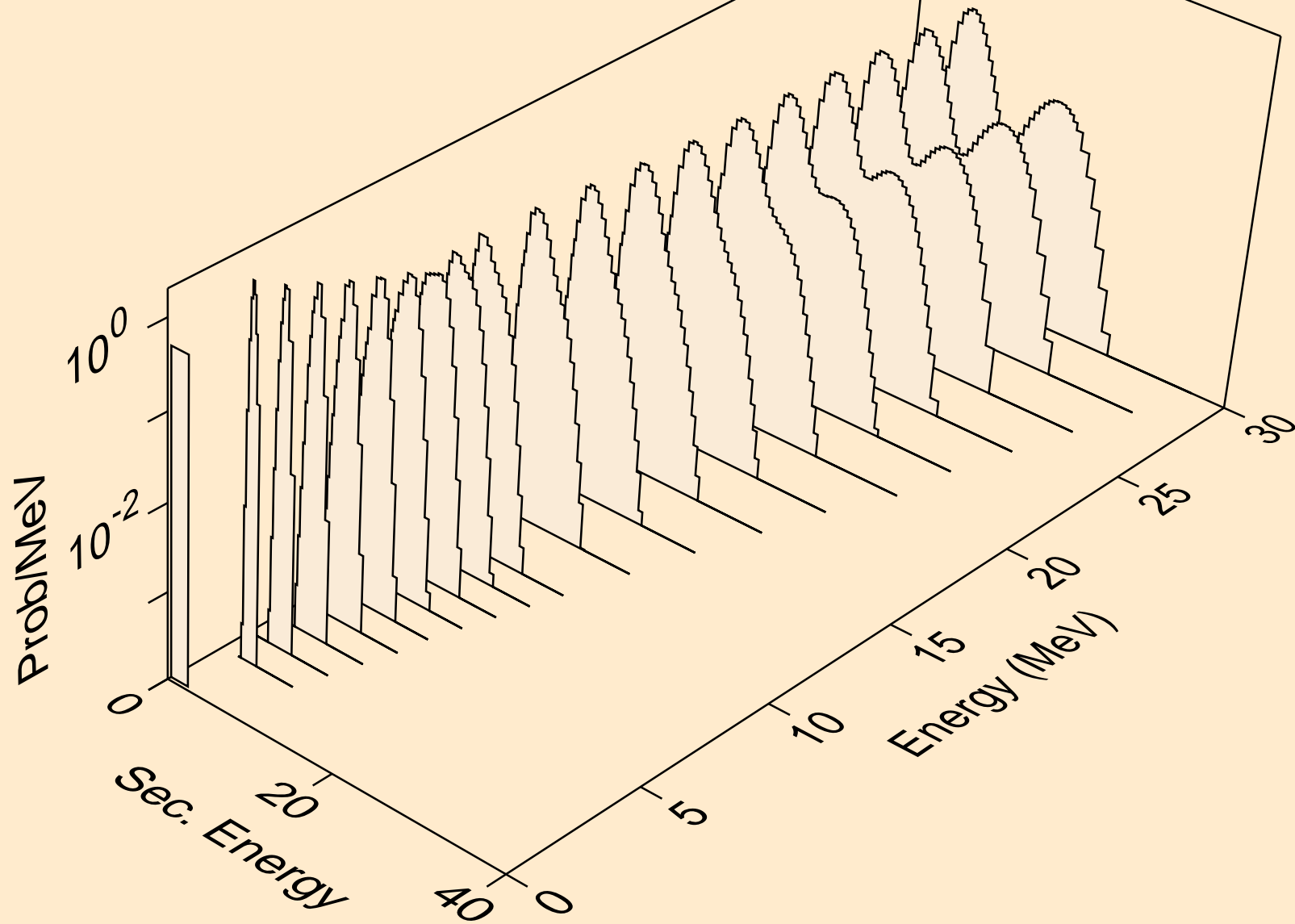



TM150 DEUTERON ACER TENDL-2021 LIBRARY; T=0.K  
protons from (d,pd)

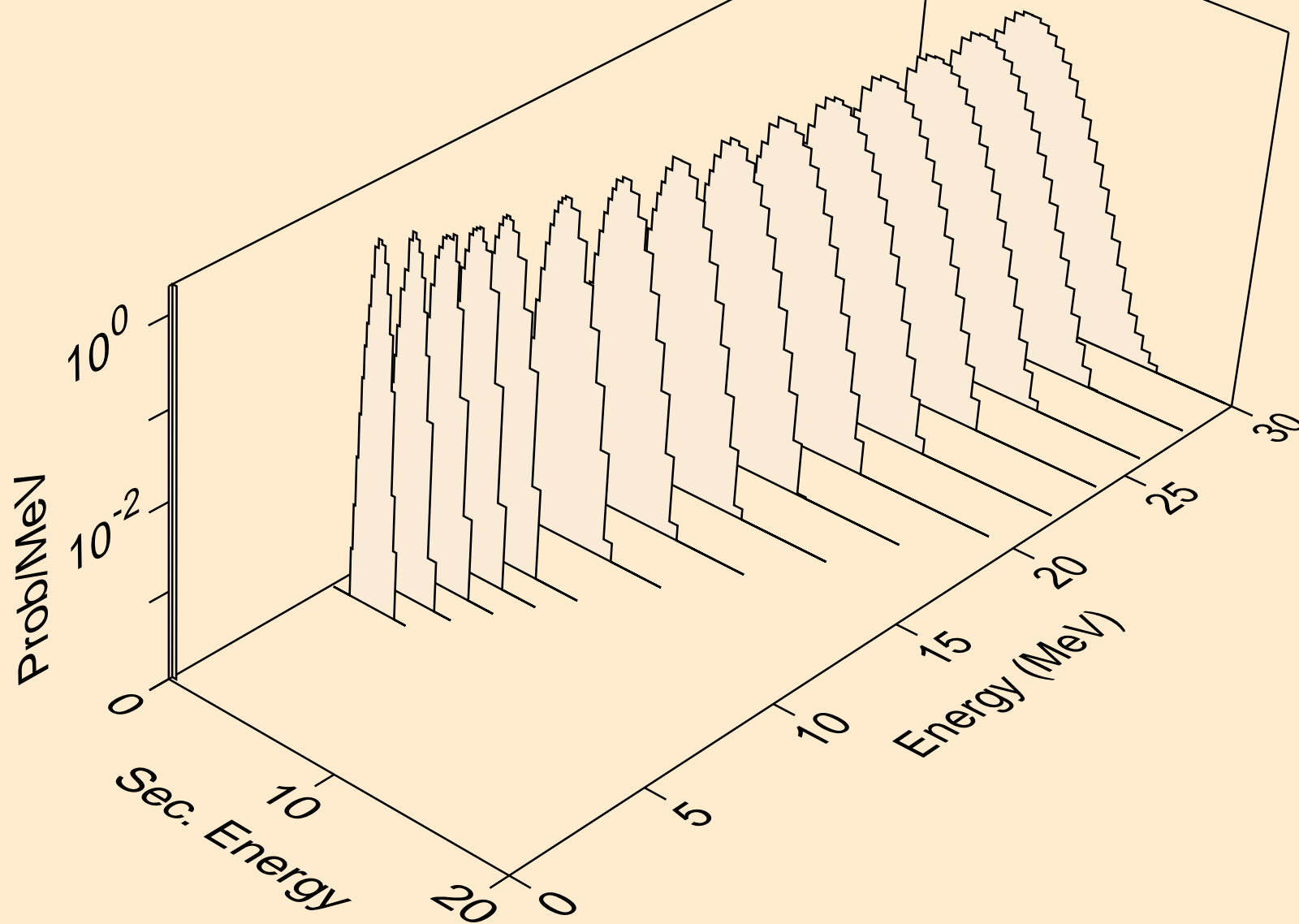

TM150 DEUTERON ACER TENDL-2021 LIBRARY; T=0.K  
protons from (d,pt)

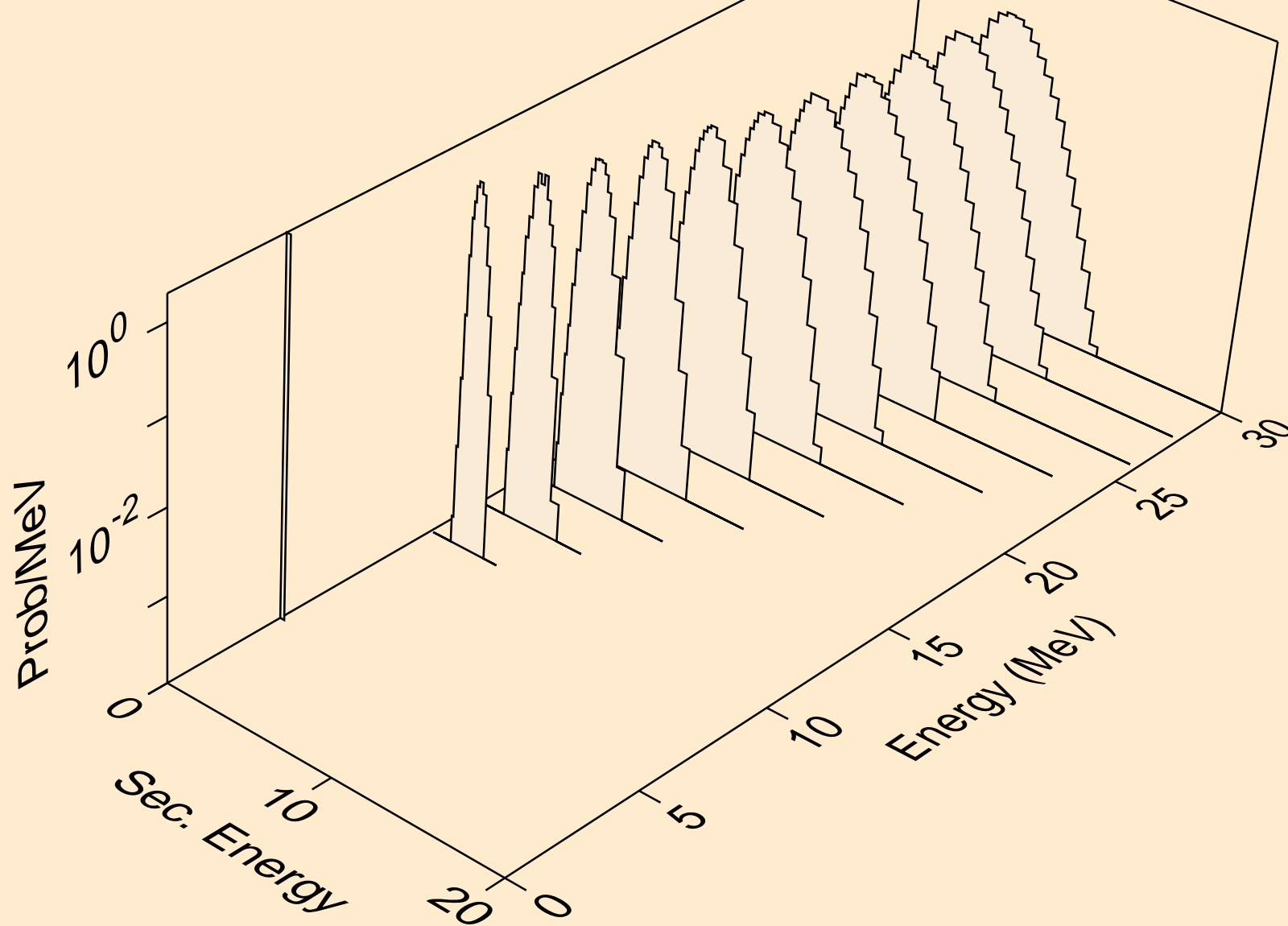

TM150 DEUTERON ACER TENDL-2021 LIBRARY; T=0.K  
tritons from (d,x)

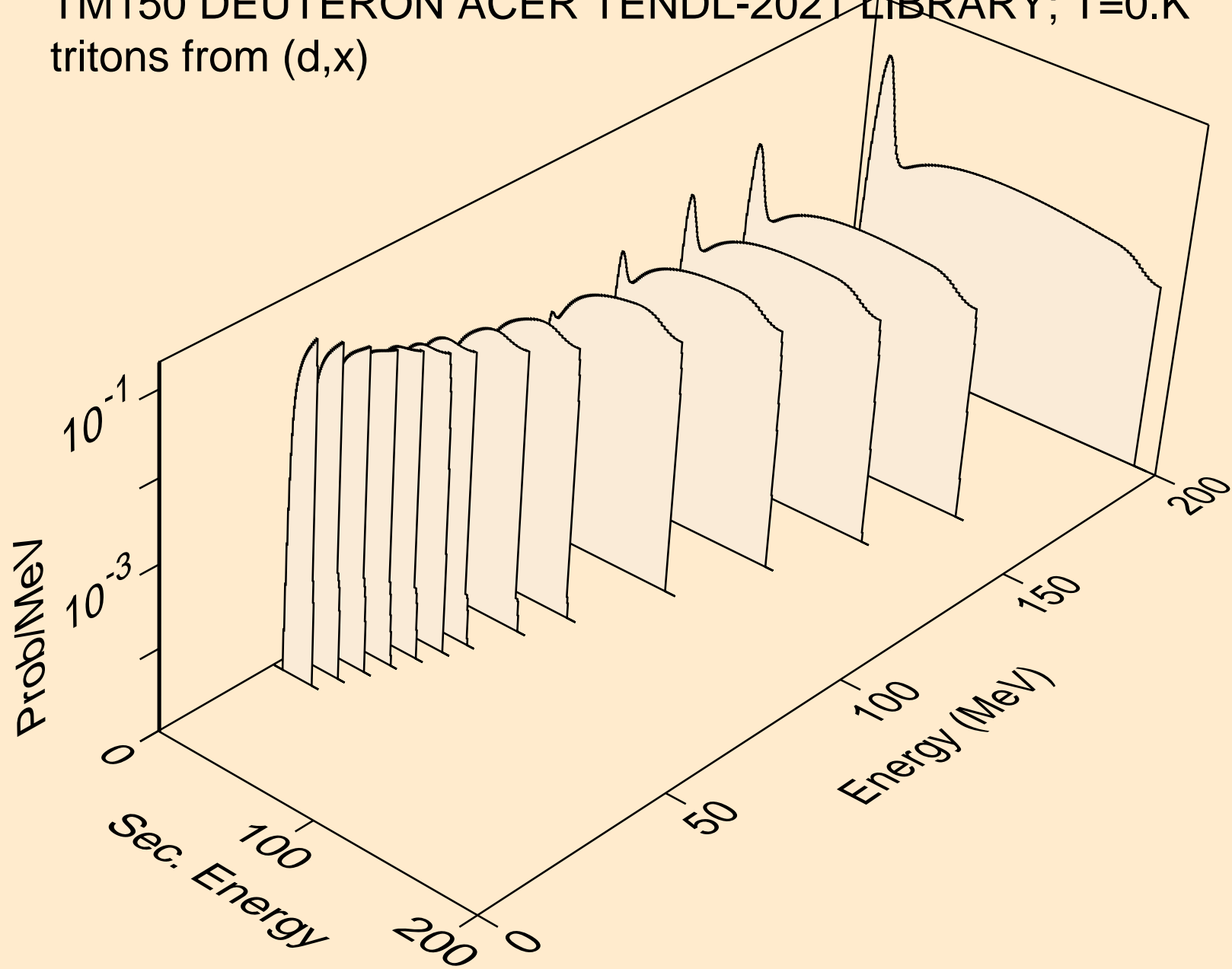

TM150 DEUTERON ACER TENDL-2021 LIBRARY; T=0.K  
tritons from (d,n\*)t

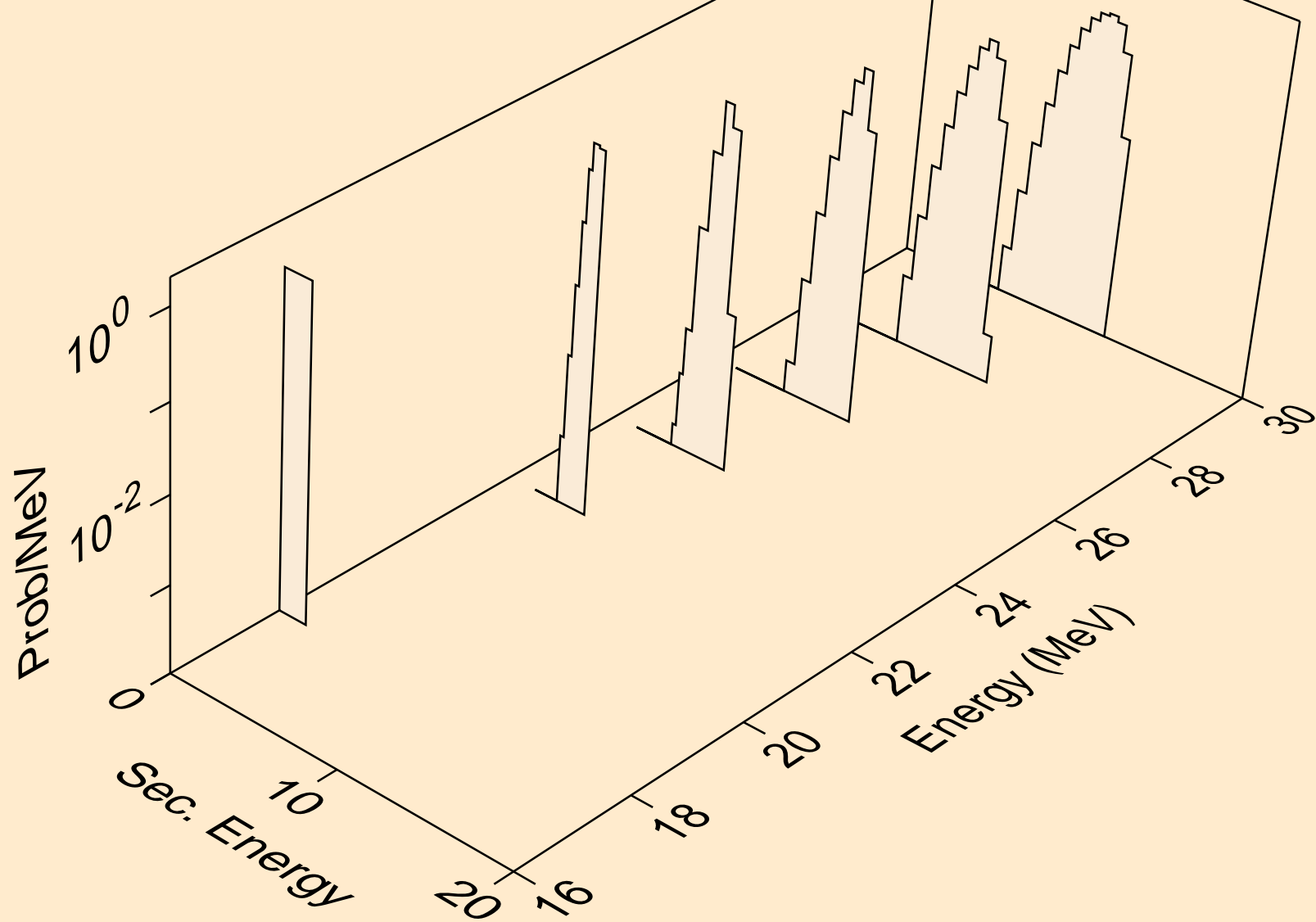

TM150 DEUTERON ACER TENDL-2021 LIBRARY; T=0.K  
tritons from (d,t)

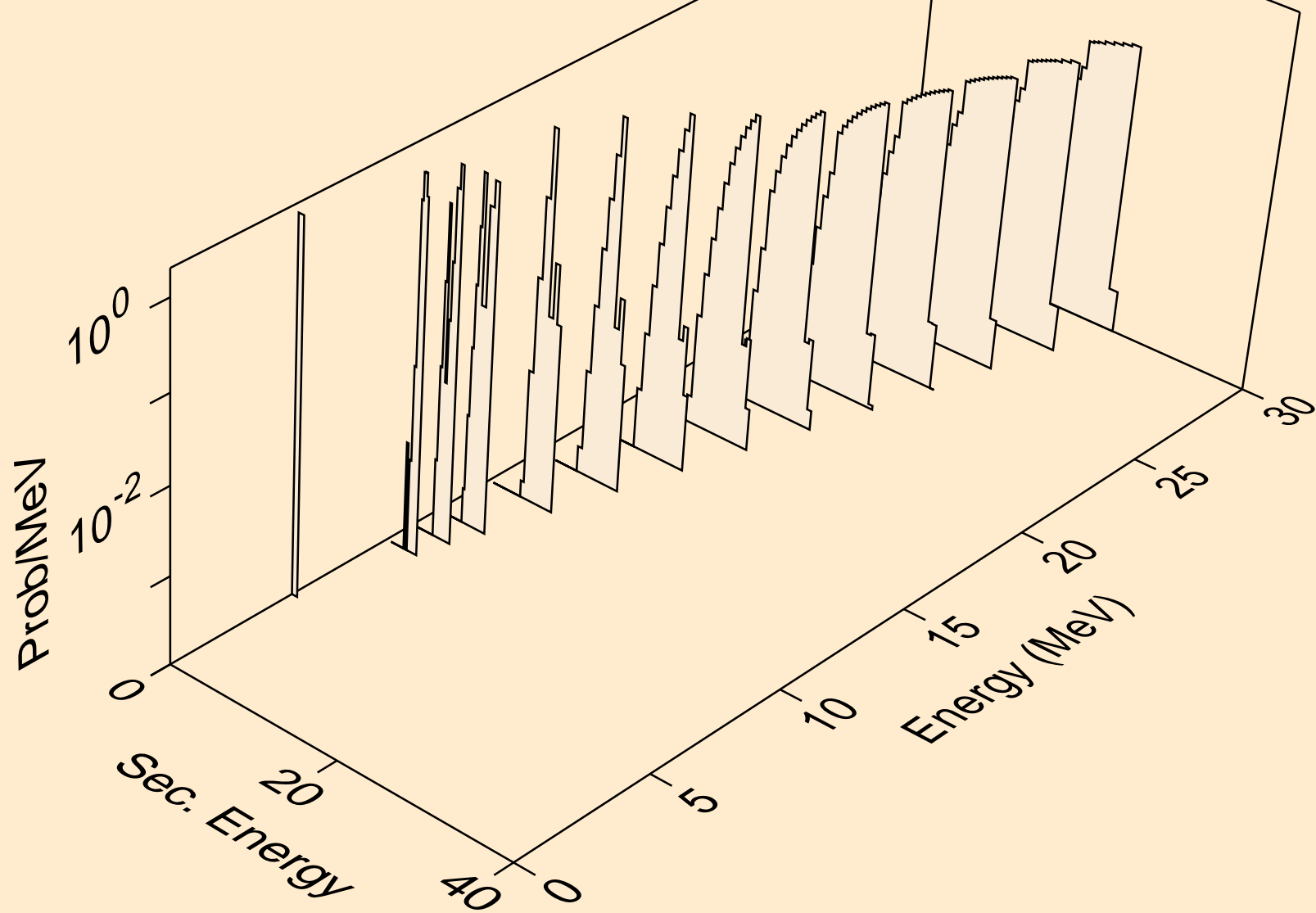

TM150 DEUTERON ACER TENDL-2021 LIBRARY; T=0.K  
tritons from (d,pt)

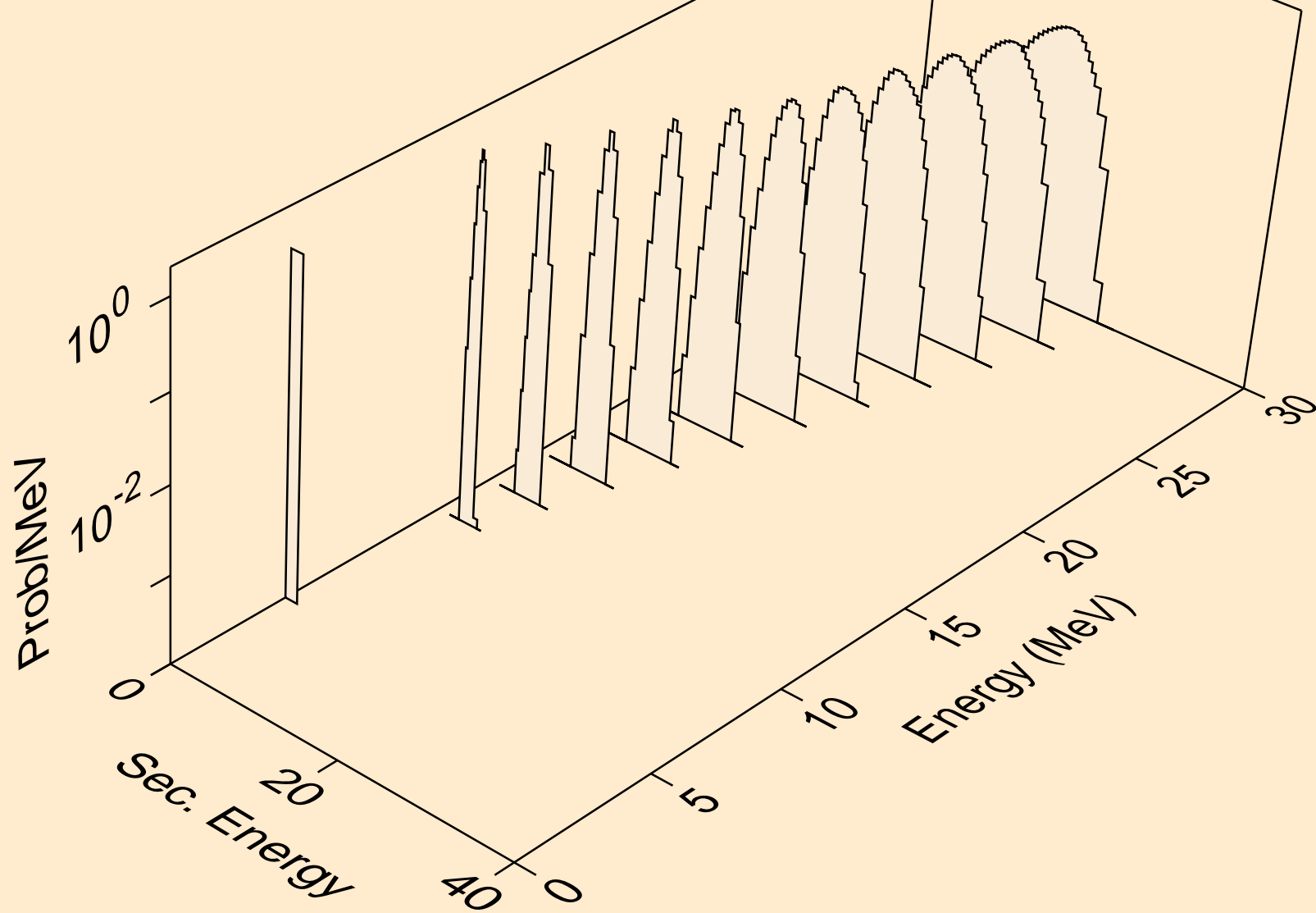

TM150 DEUTERON ACER TENDL-2021 LIBRARY; T=0.K  
he3s from (d,x)

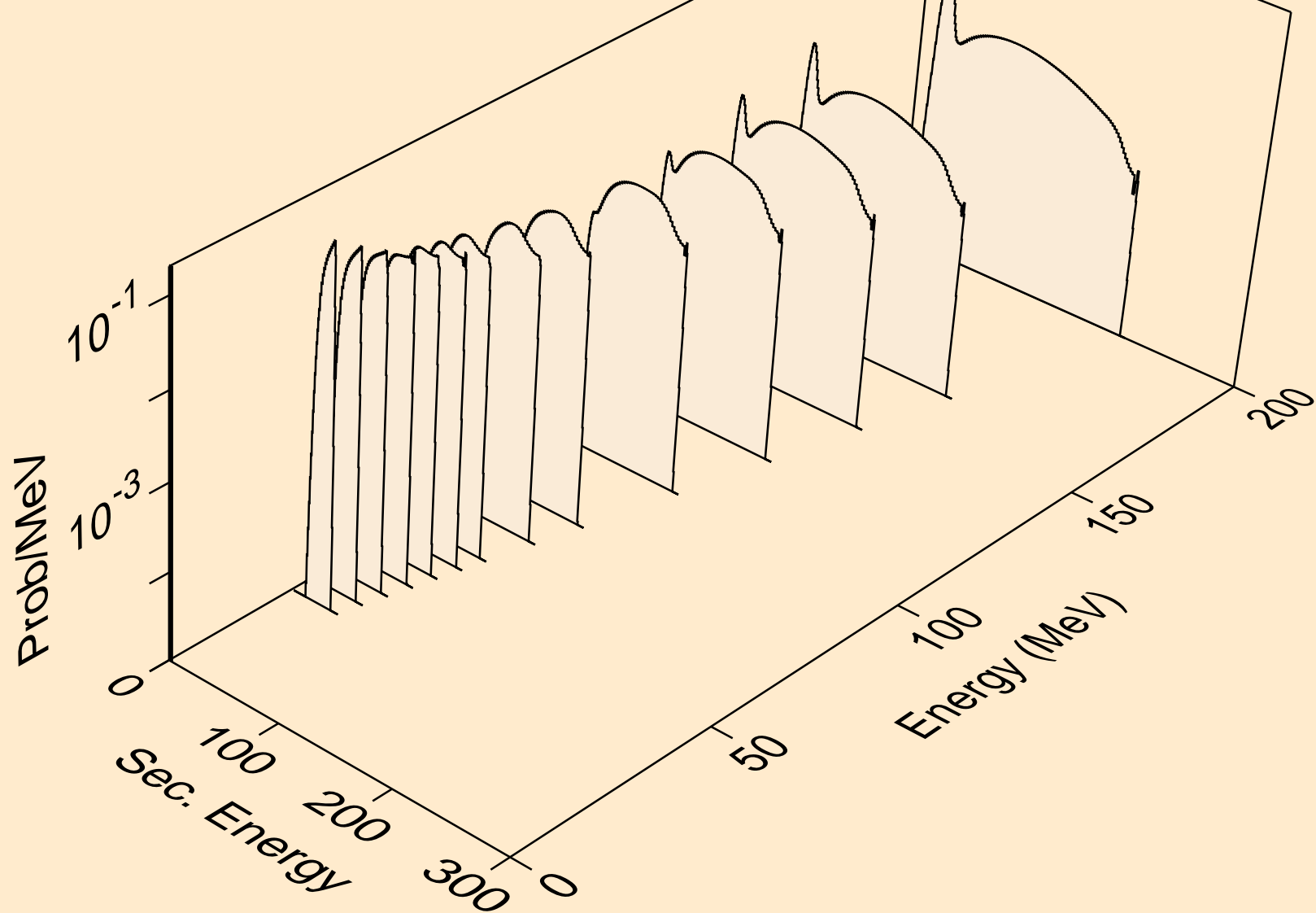

TM150 DEUTERON ACER TENDL-2021 LIBRARY; T=0.K  
he3s from (d,n\*)he3

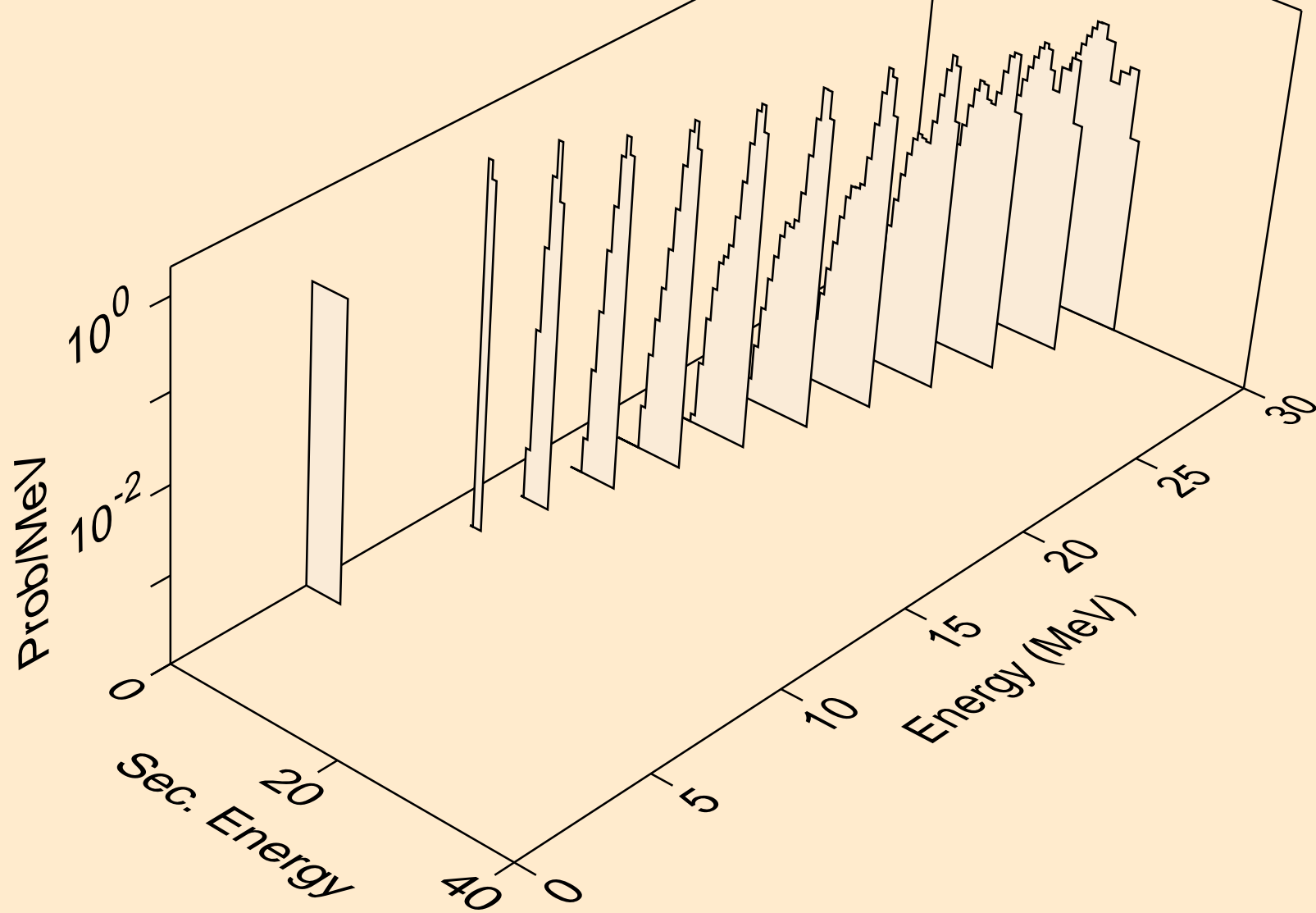



TM150 DEUTERON ACER TENDL-2021 LIBRARY; T=0.K  
he3s from (d,he3)

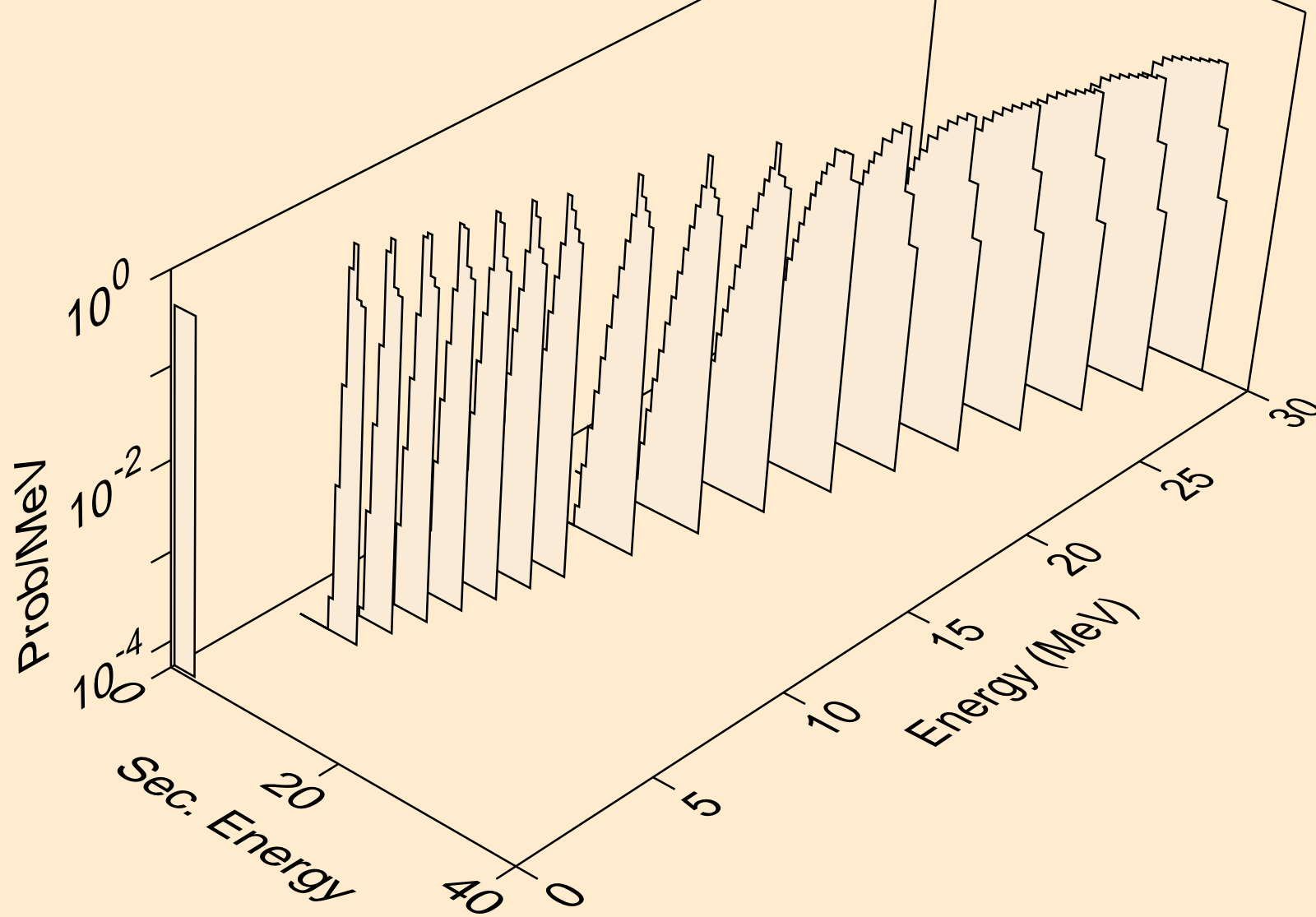

TM150 DEUTERON ACER TENDL-2021 LIBRARY; T=0.K  
alphas from (d,x)

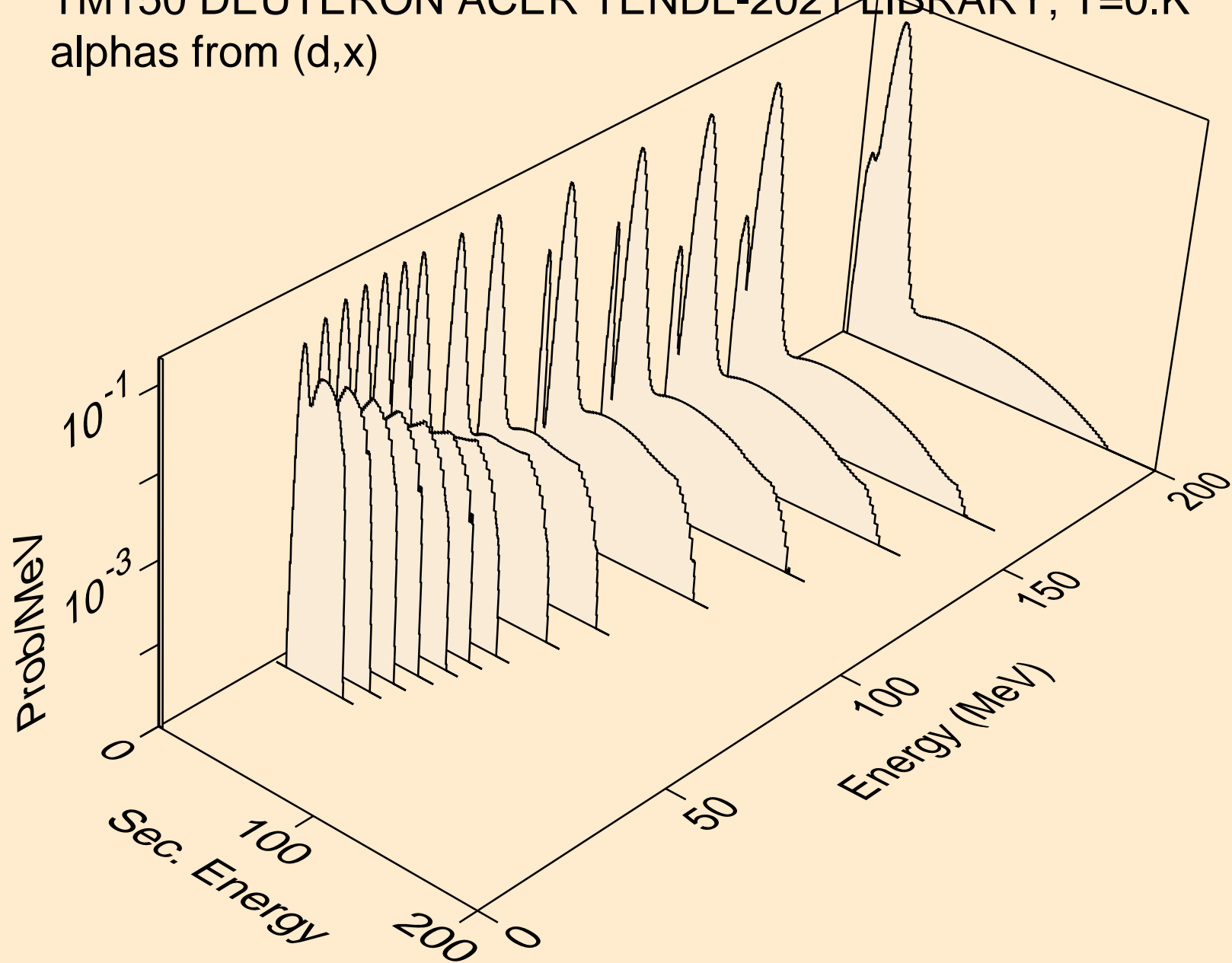

TM150 DEUTERON ACER TENDL-2021 LIBRARY; T=0.K  
alphas from (d,n\*)a

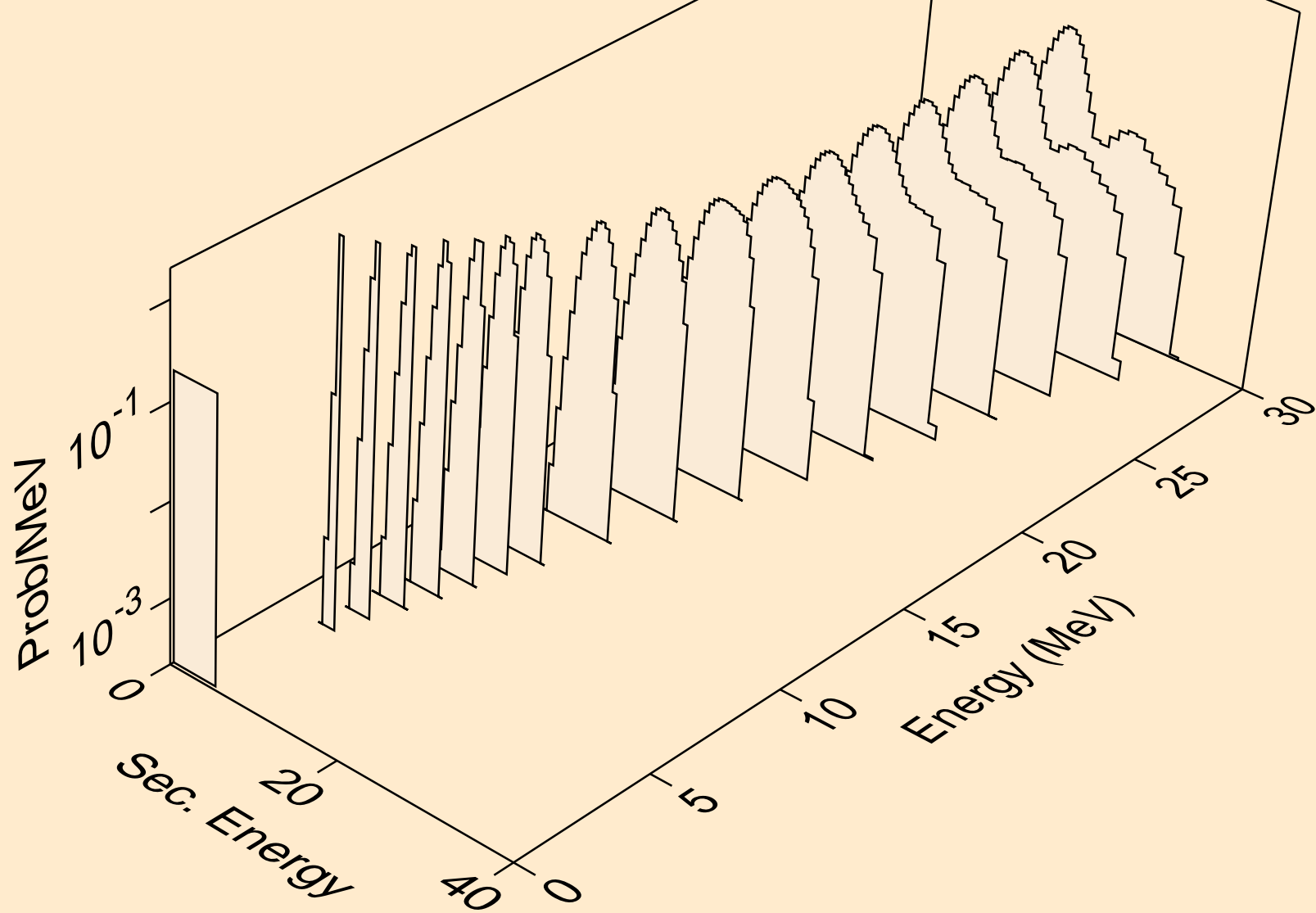

TM150 DEUTERON ACER TENDL-2021 LIBRARY; T=0.K  
alphas from (d,2n)a

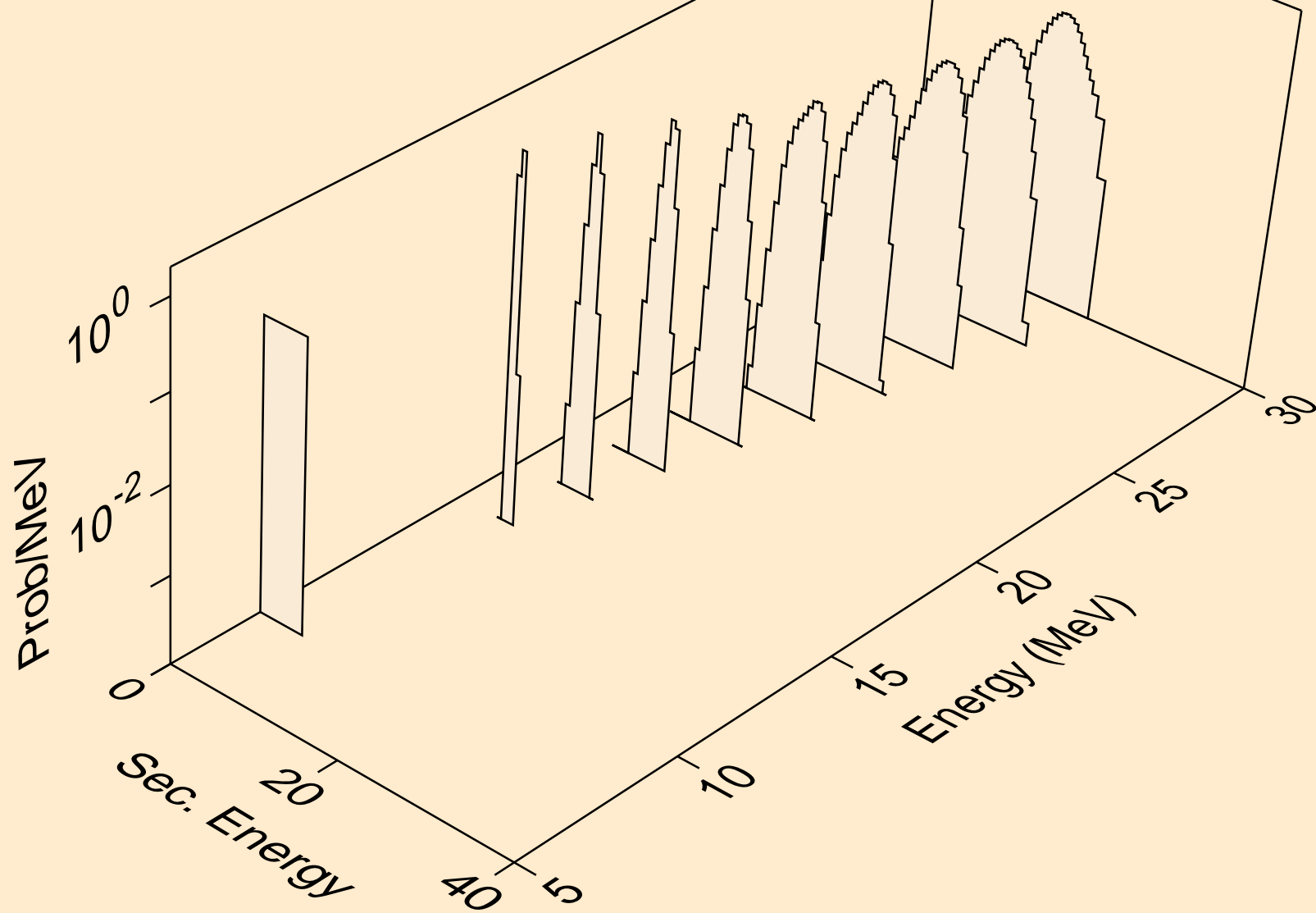

TM150 DEUTERON ACER TENDL-2021 LIBRARY; T=0.K  
alphas from (d,n\*)2a

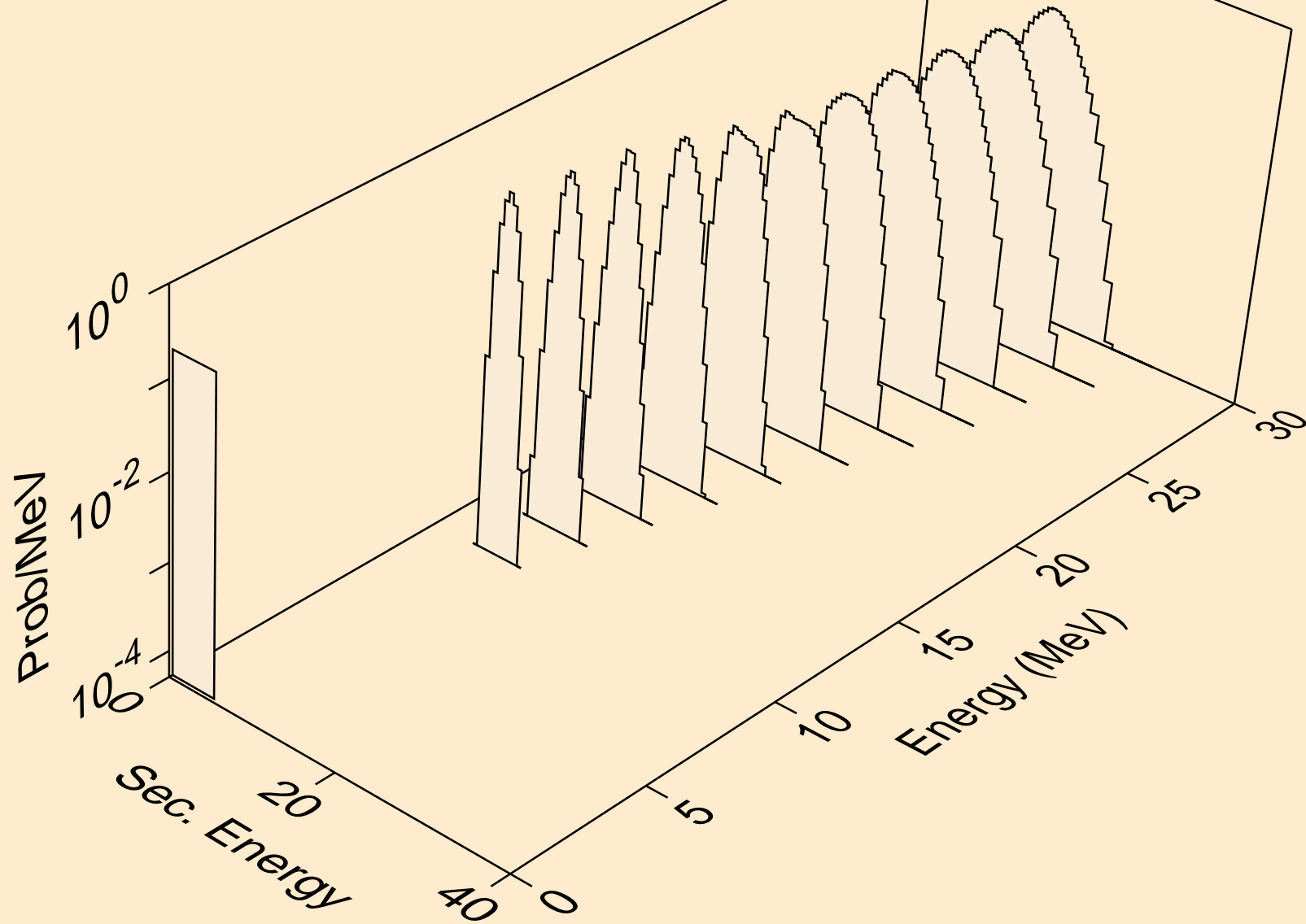

TM150 DEUTERON ACER TENDL-2021 LIBRARY; T=0.K  
alphas from (d,npa)

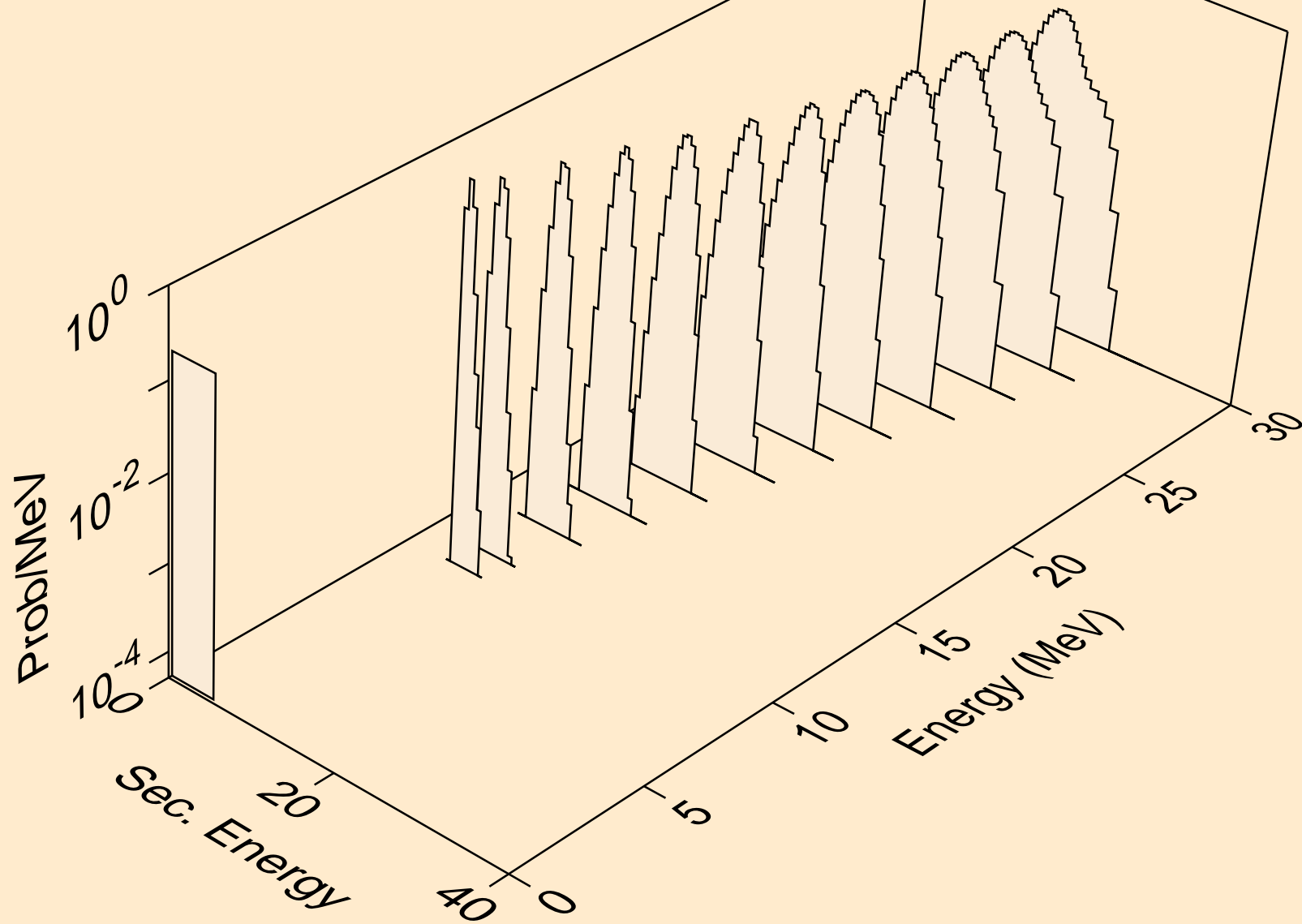

TM150 DEUTERON ACER TENDL-2021 LIBRARY; T=0.K  
alphas from (d,a)

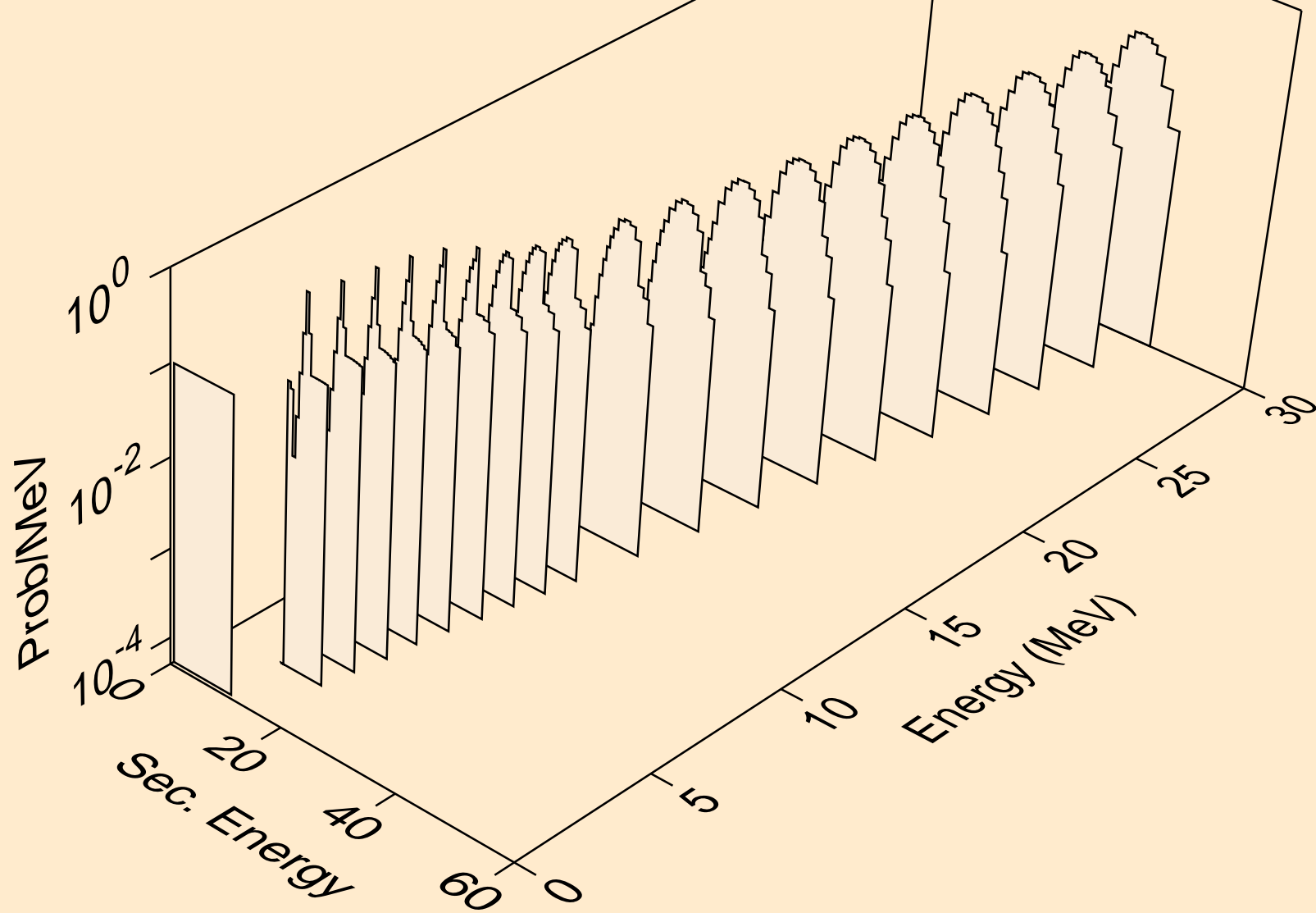

TM150 DEUTERON ACER TENDL-2021 LIBRARY; T=0.K  
alphas from (d,2a)

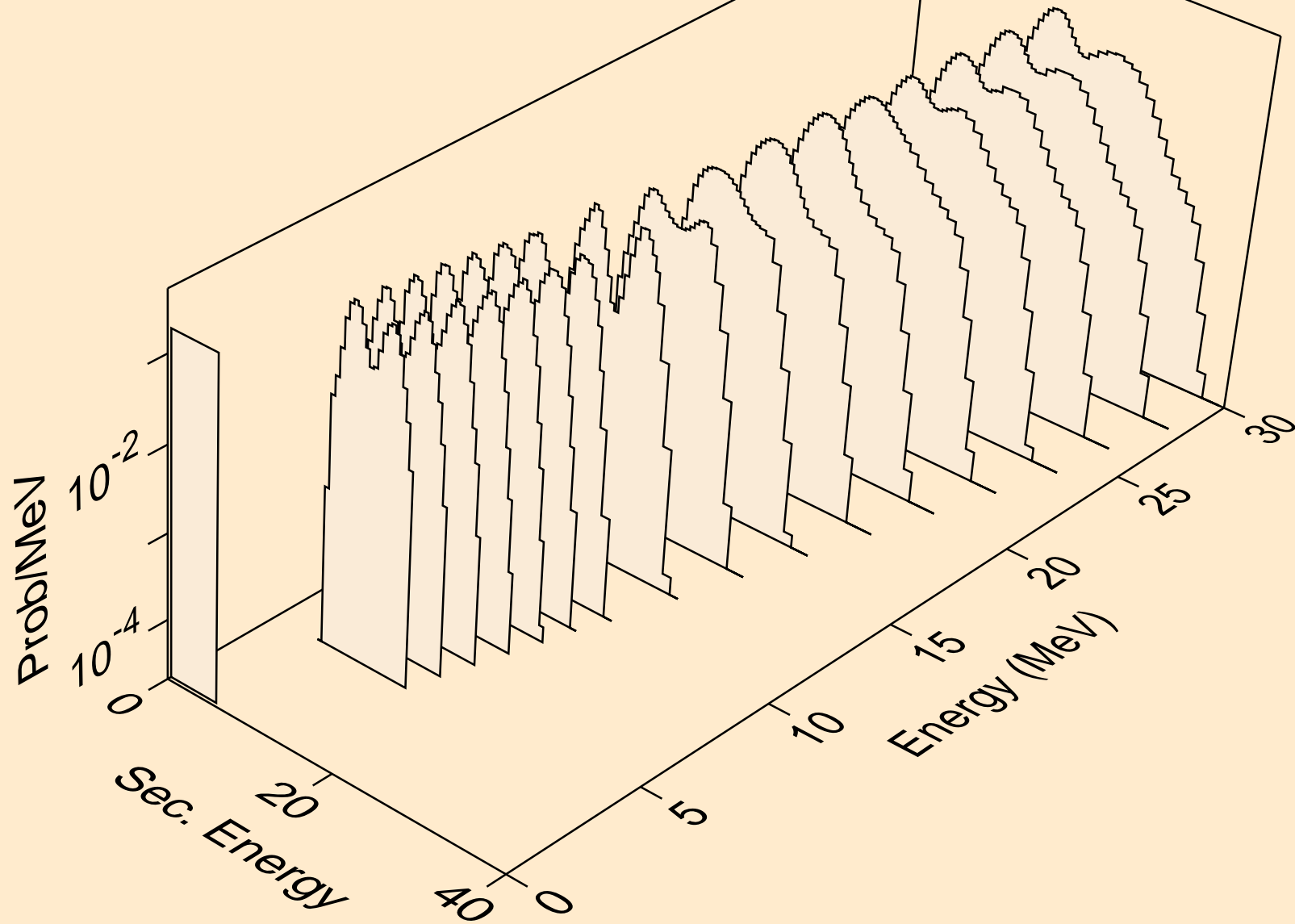



TM150 DEUTERON ACER TENDL-2021 LIBRARY; T=0.K  
alphas from (d,3a)

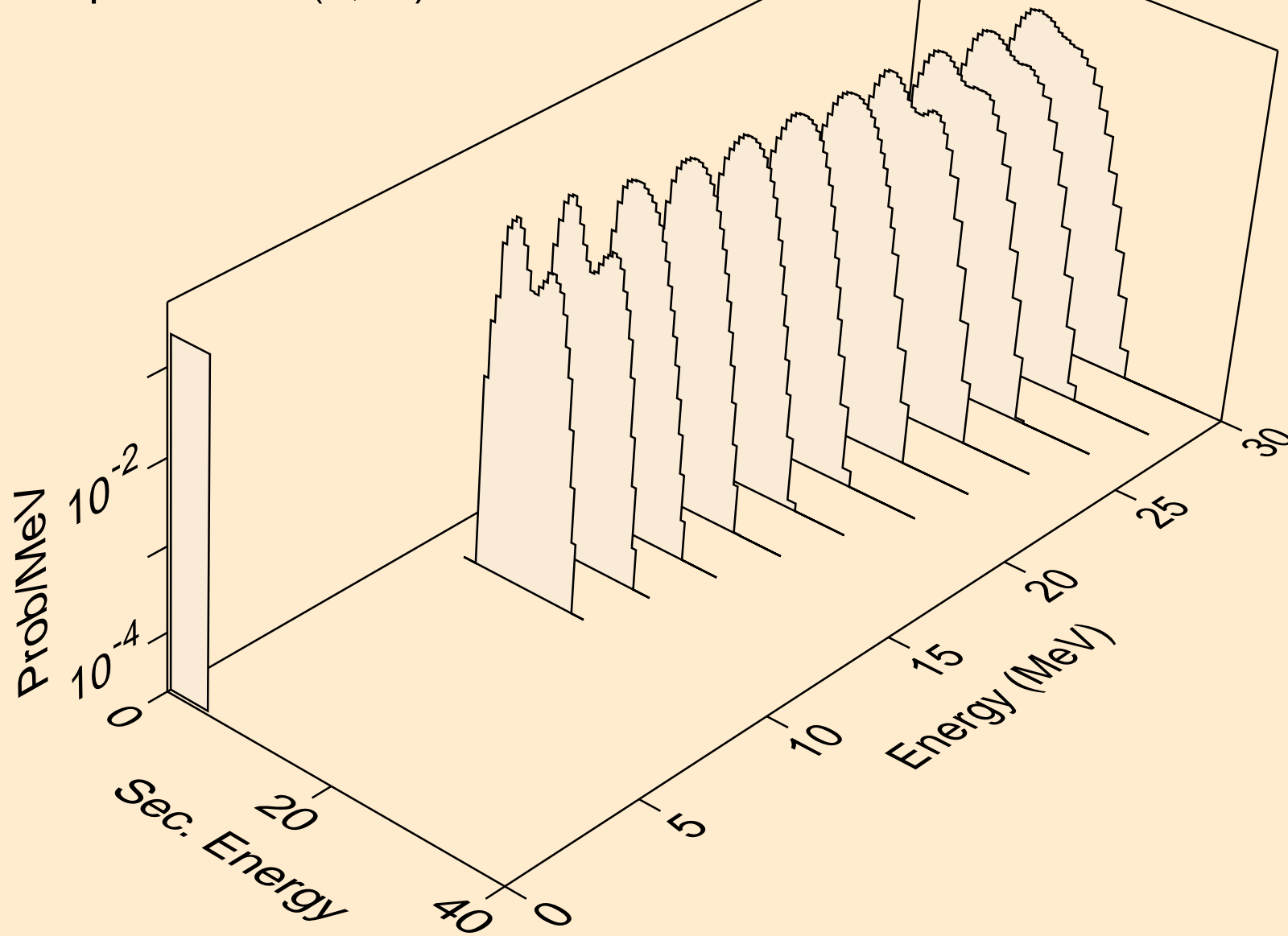

TM150 DEUTERON ACER TENDL-2021 LIBRARY; T=0.K  
alphas from (d,pa)

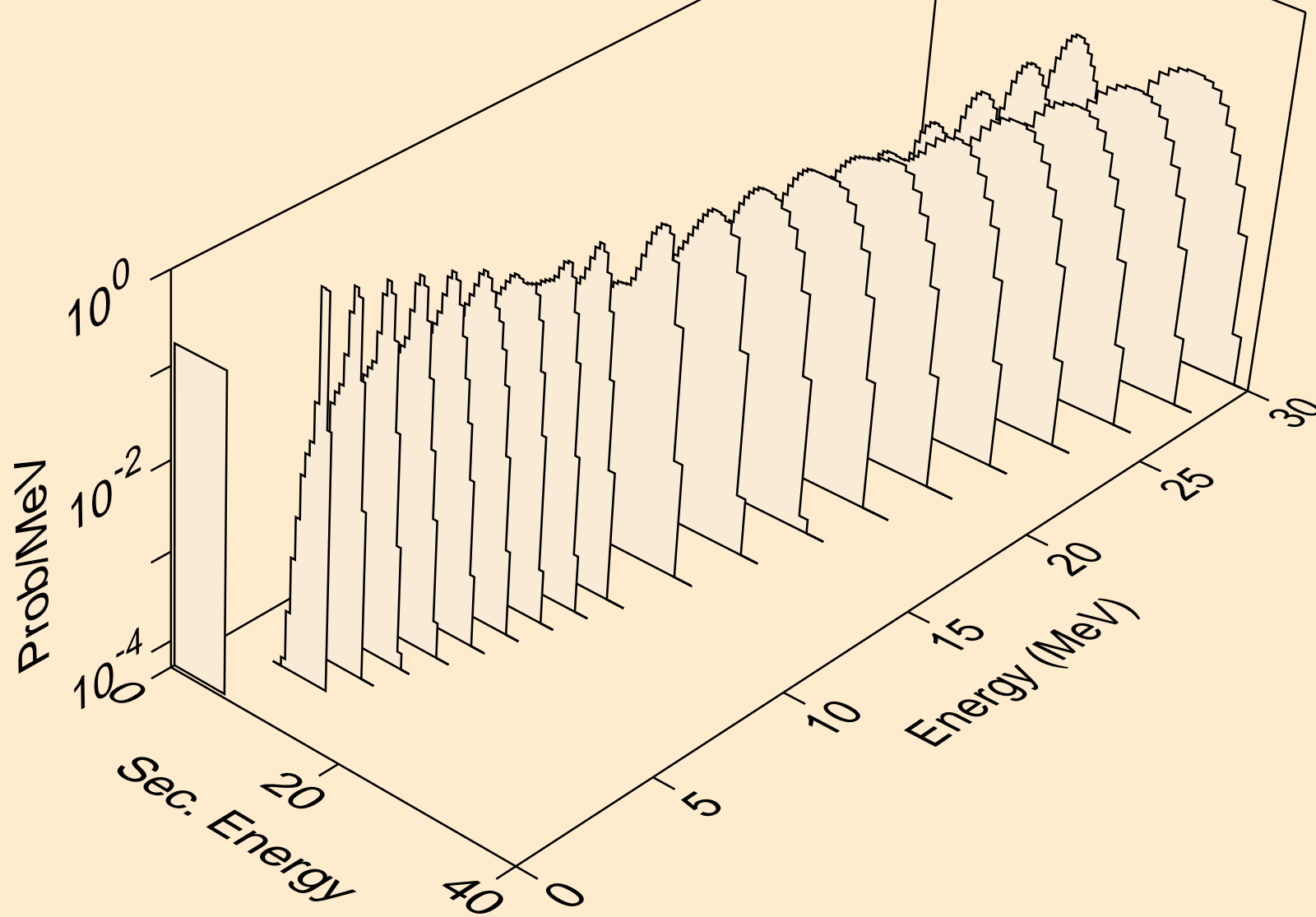

TM150 DEUTERON ACER TENDL-2021 LIBRARY; T=0.K  
alphas from (d,da)

