

W191 DEUTERON ACER TENDL-2021 LIBRARY; T=0.K

Principal cross sections

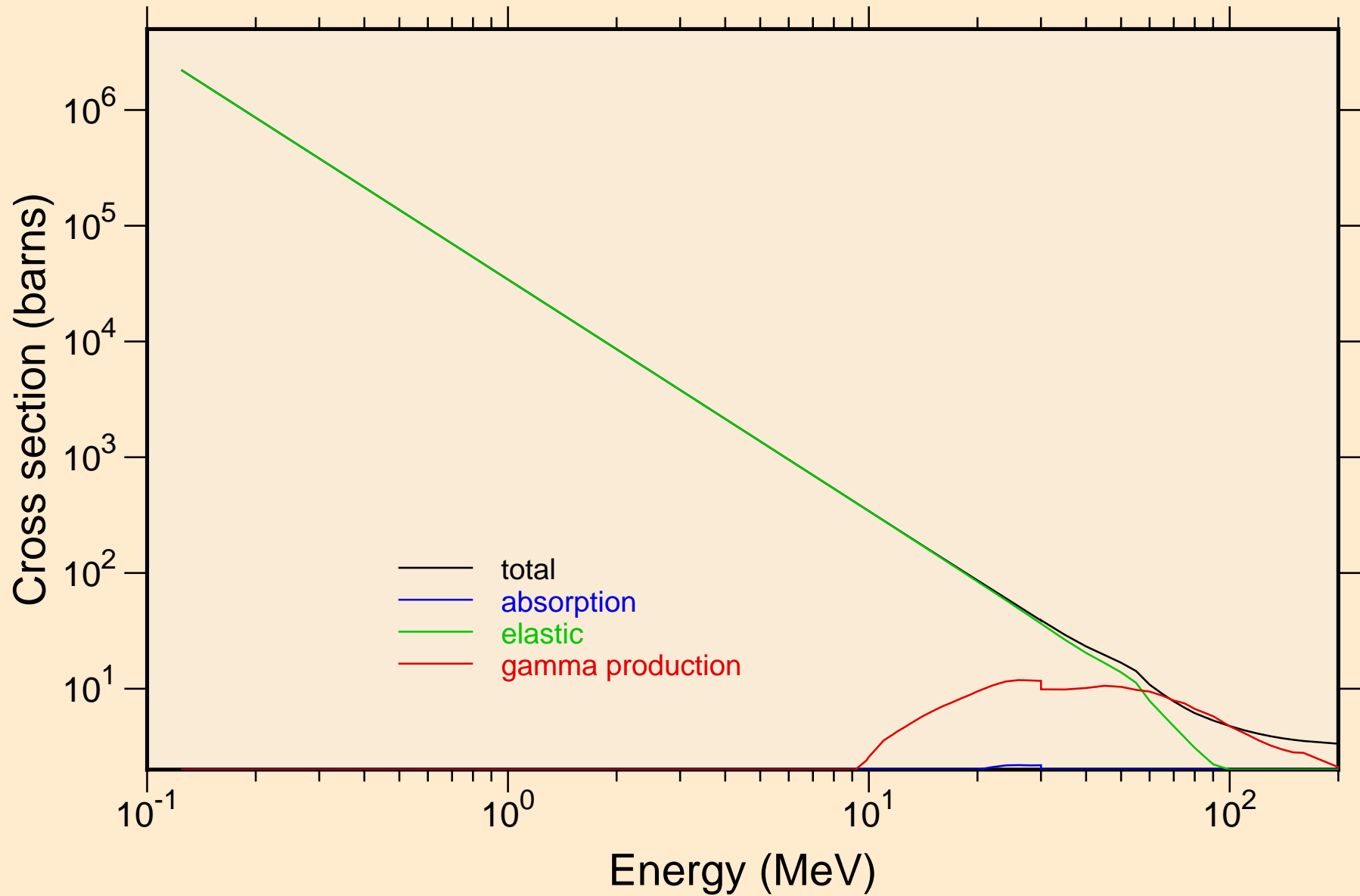

W191 DEUTERON ACER TENDL-2021 LIBRARY; T=0.K

Heating

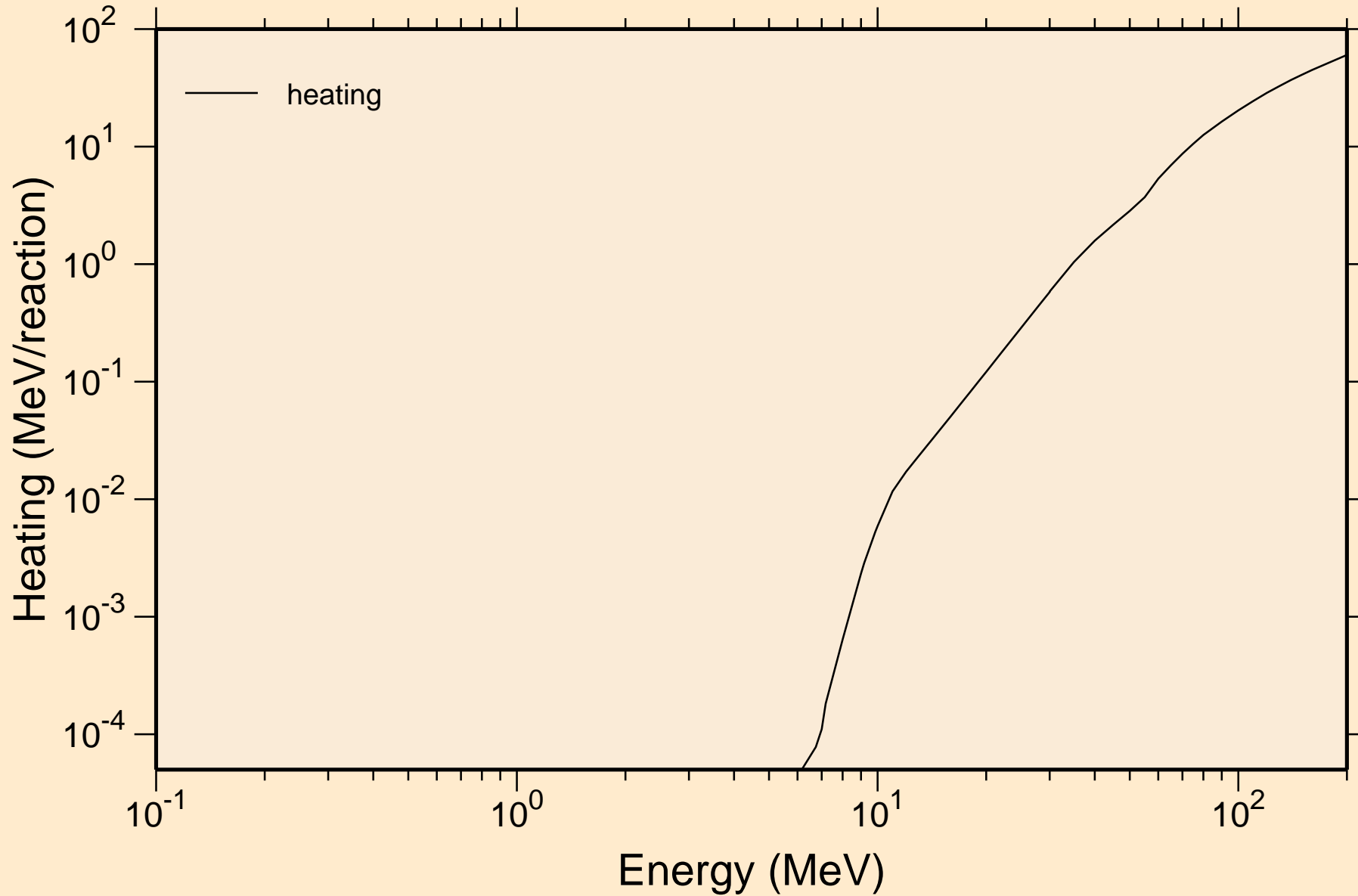

W191 DEUTERON ACER TENDL-2021 LIBRARY; T=0.K
Principal cross sections

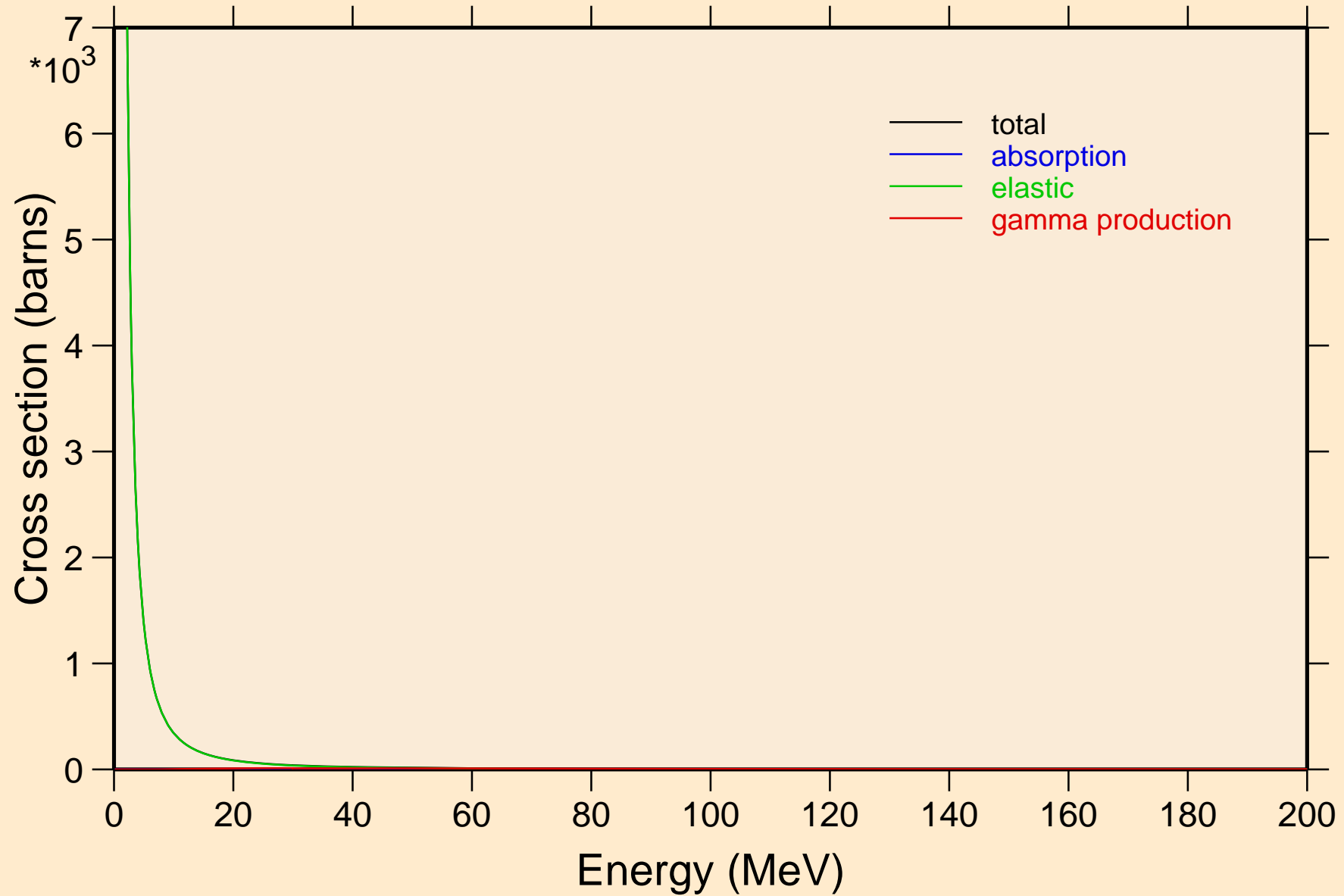

W191 DEUTERON ACER TENDL-2021 LIBRARY; T=0.K

Heating

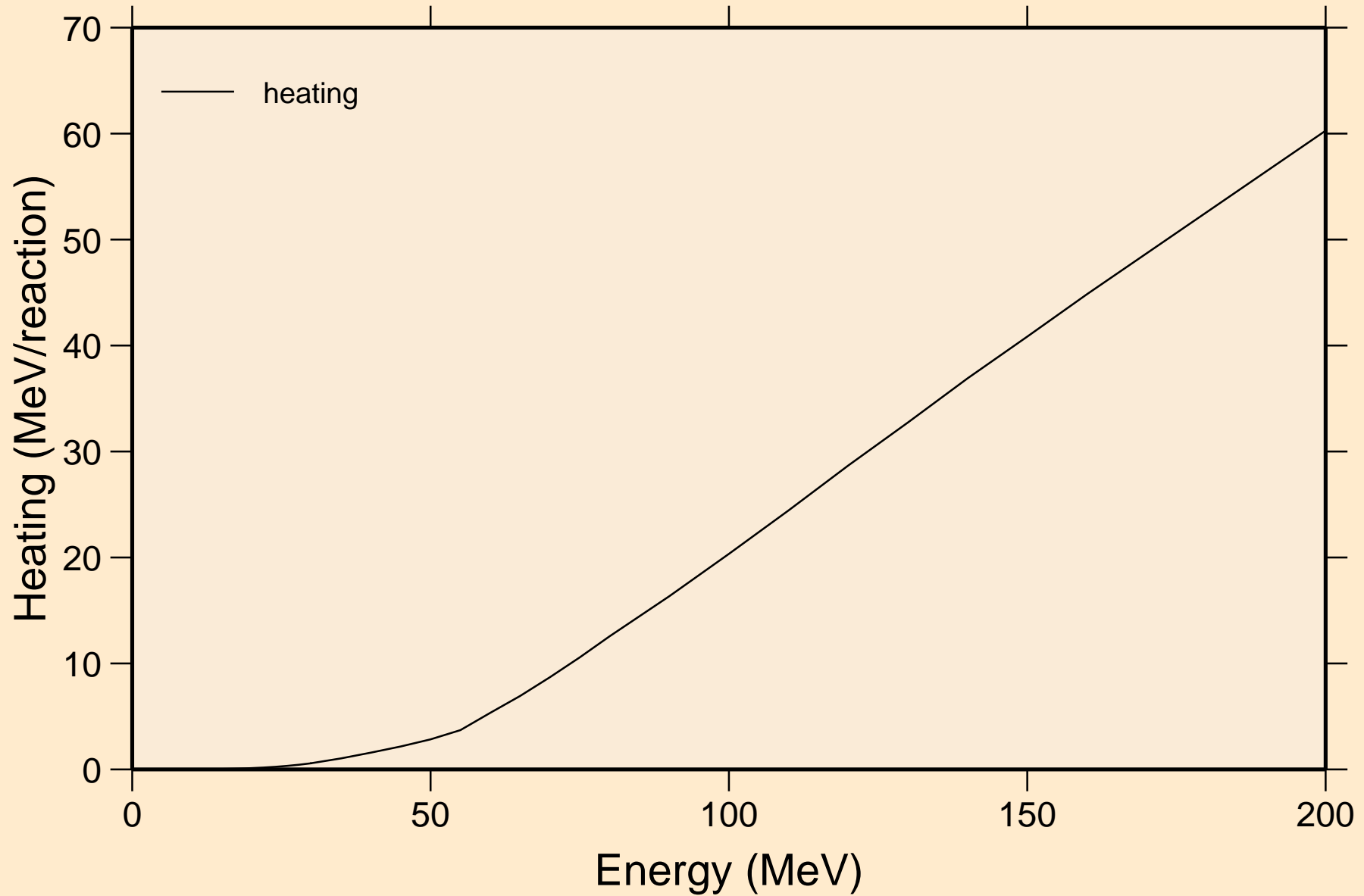

W191 DEUTERON ACER TENDL-2021 LIBRARY; T=0.K
Threshold reactions

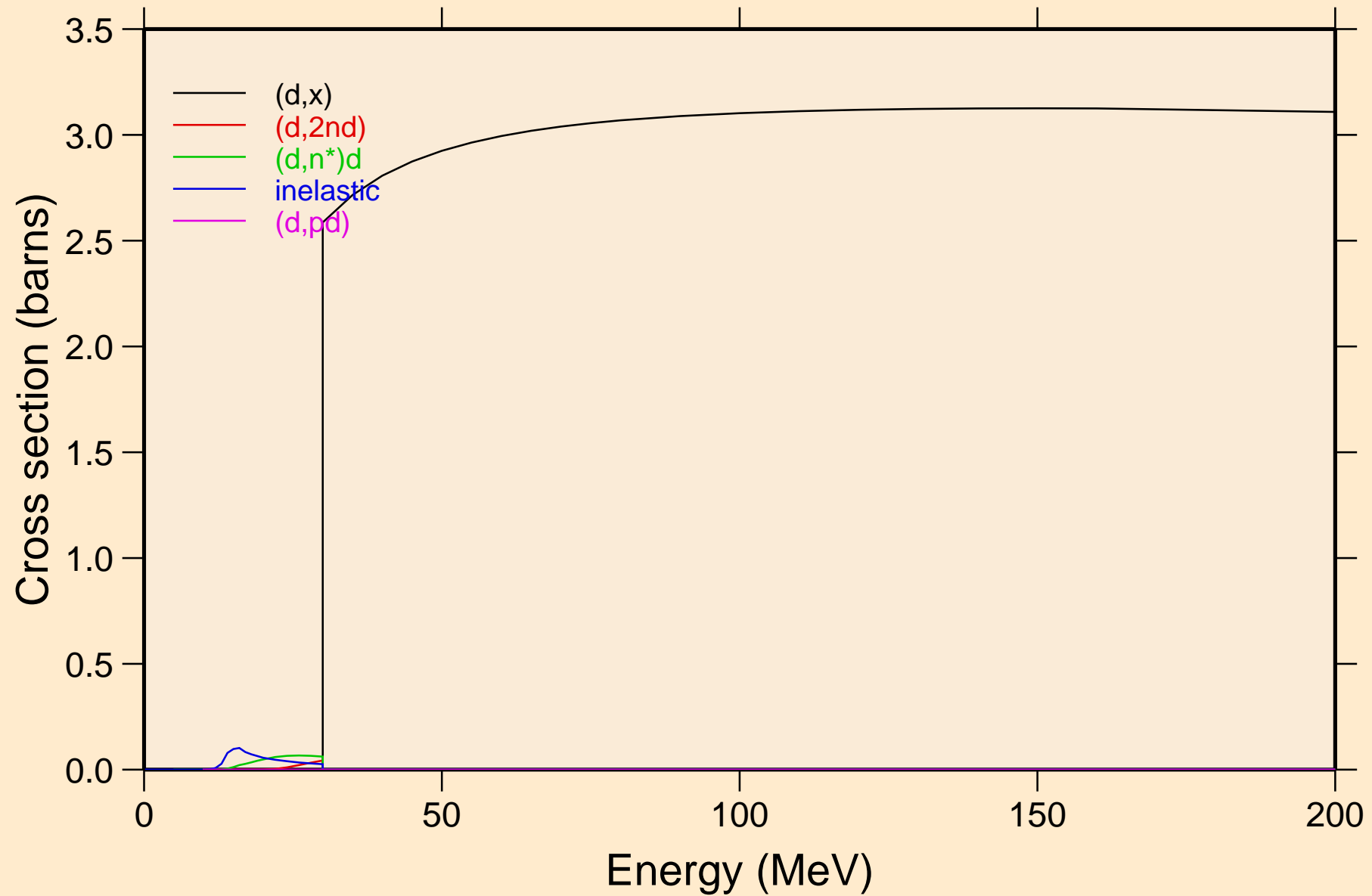

W191 DEUTERON ACER TENDL-2021 LIBRARY; T=0.K
angular distribution for elastic

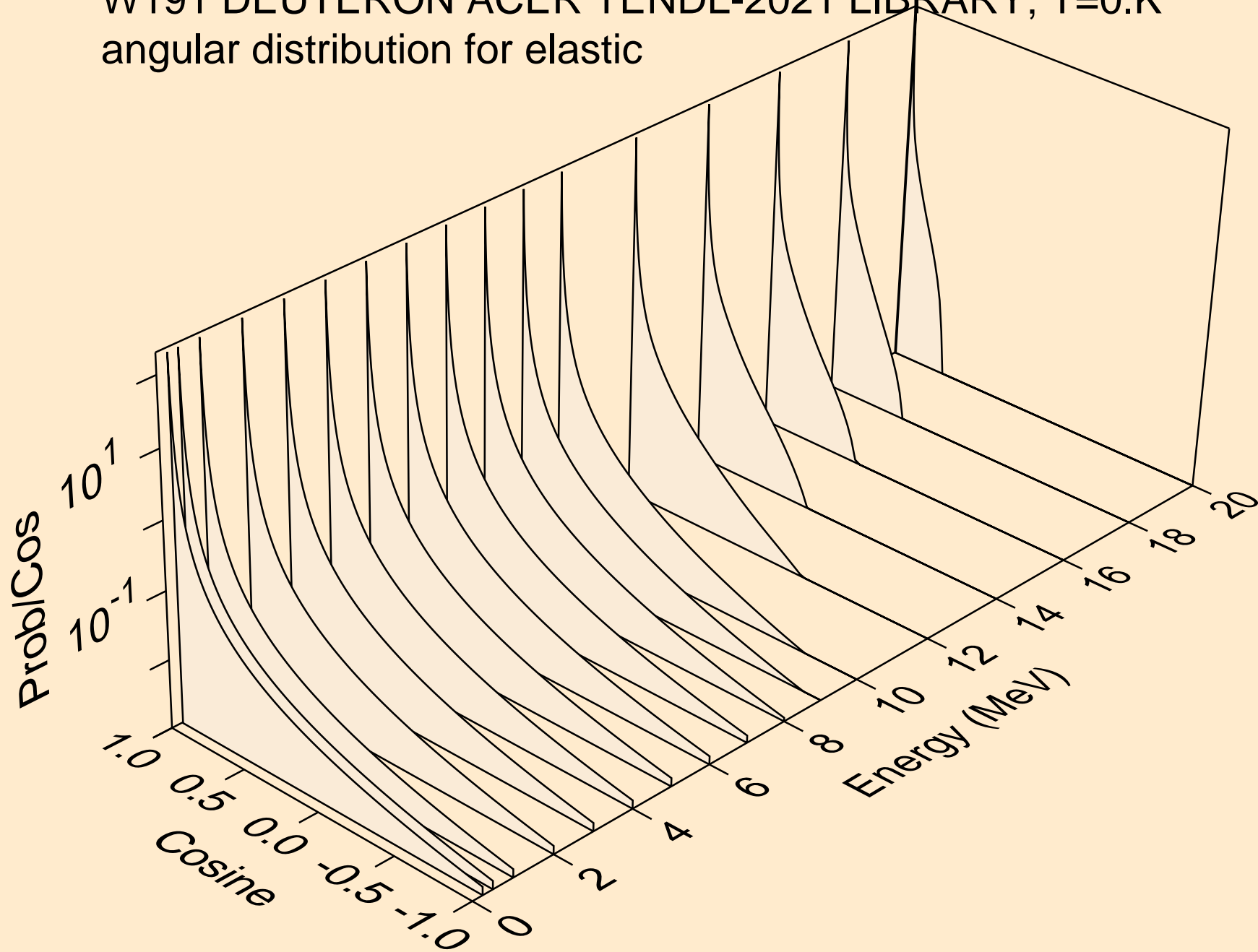

W191 DEUTERON ACER TENDL-2021 LIBRARY; T=0.K
angular distribution for elastic

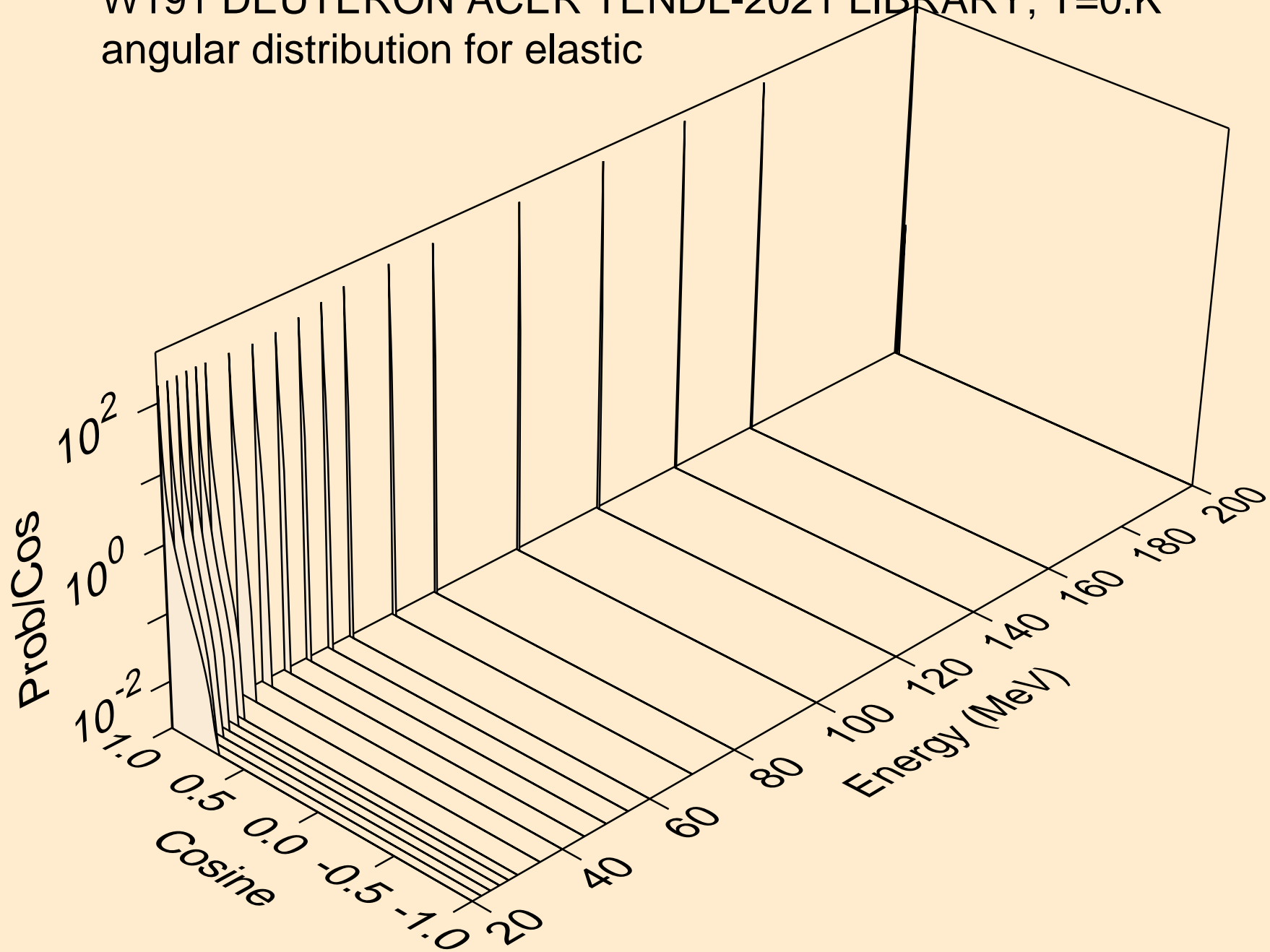

W191 DEUTERON ACER TENDL-2021 LIBRARY; T=0.K
Deuteron emission for (d,x)

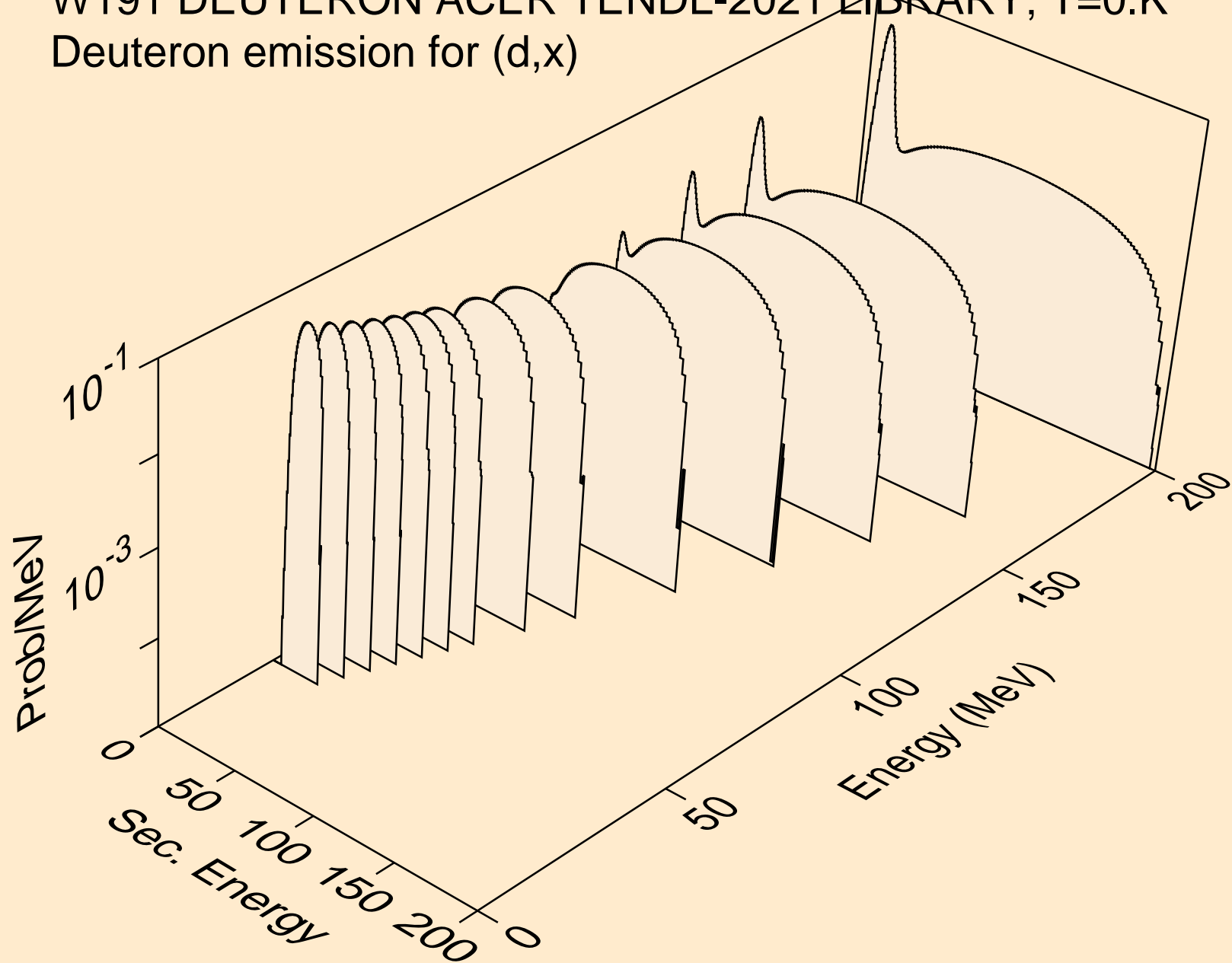

W191 DEUTERON ACER TENDL-2021 LIBRARY; T=0.K
Deuteron emission for (d,2nd)

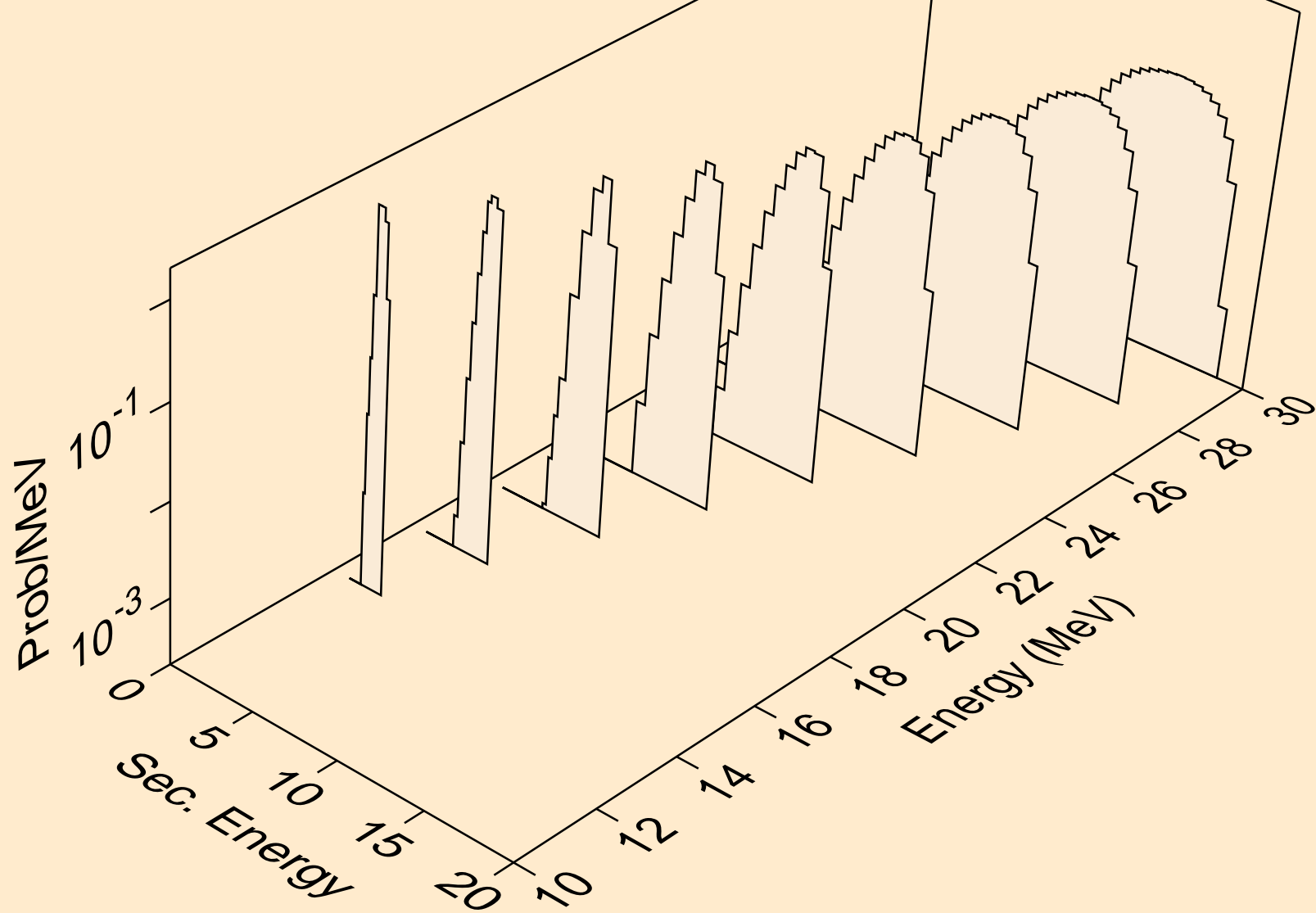

W191 DEUTERON ACER TENDL-2021 LIBRARY; T=0.K
Deuteron emission for (d,n*)d

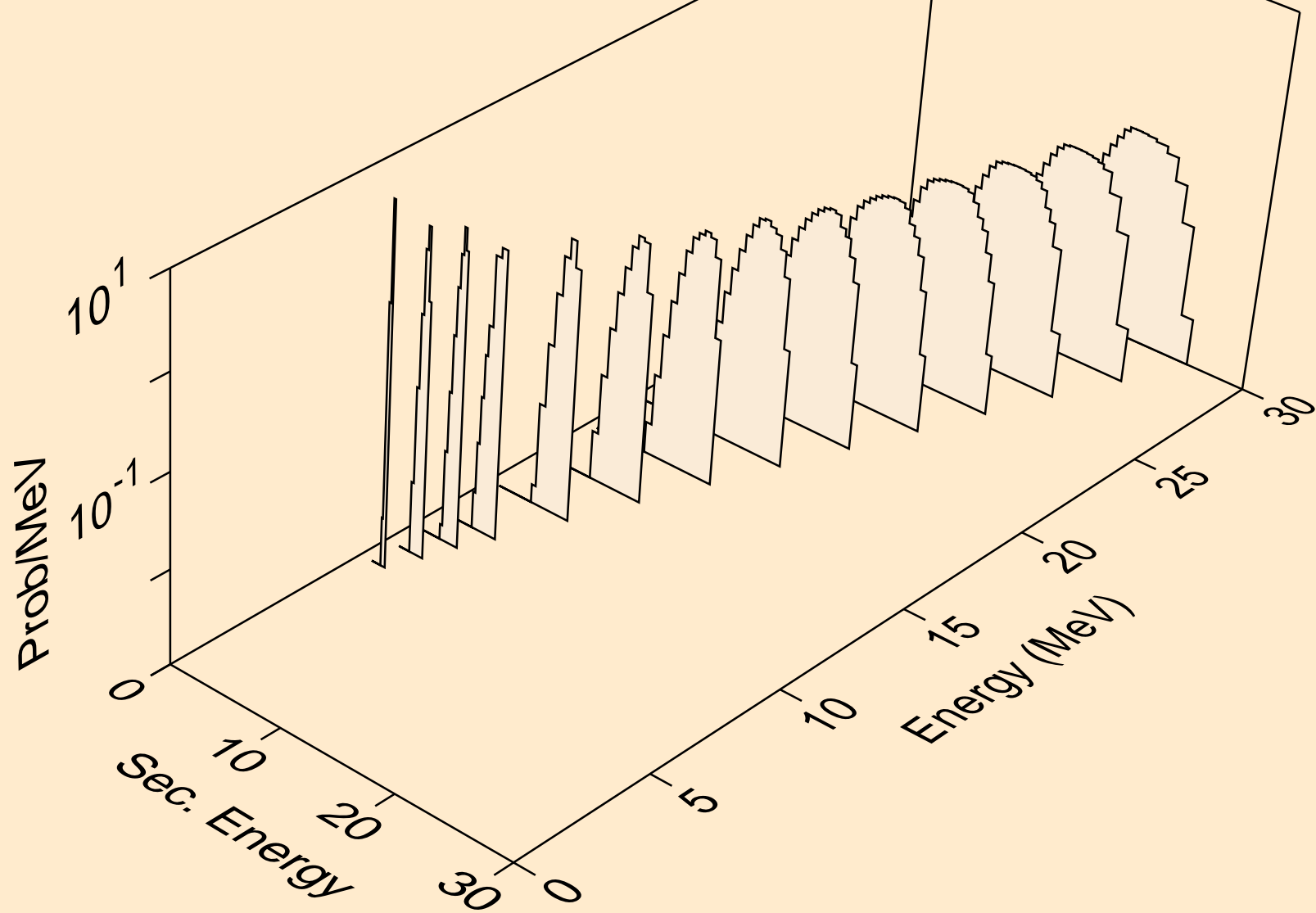

W191 DEUTERON ACER TENDL-2021 LIBRARY; T=0.K
Deuteron emission for inelastic

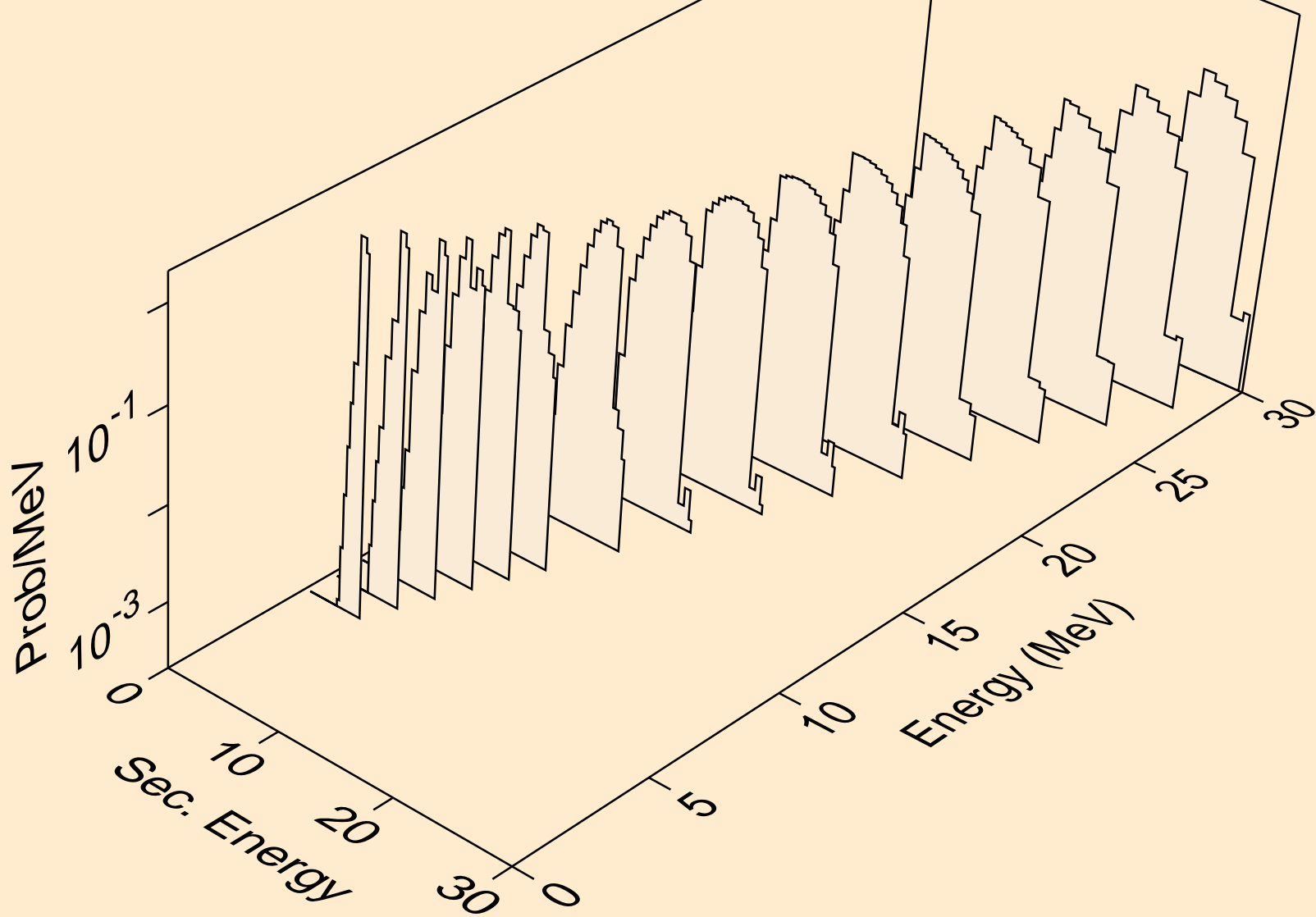

W191 DEUTERON ACER TENDL-2021 LIBRARY; T=0.K
Deuteron emission for (d,pd)

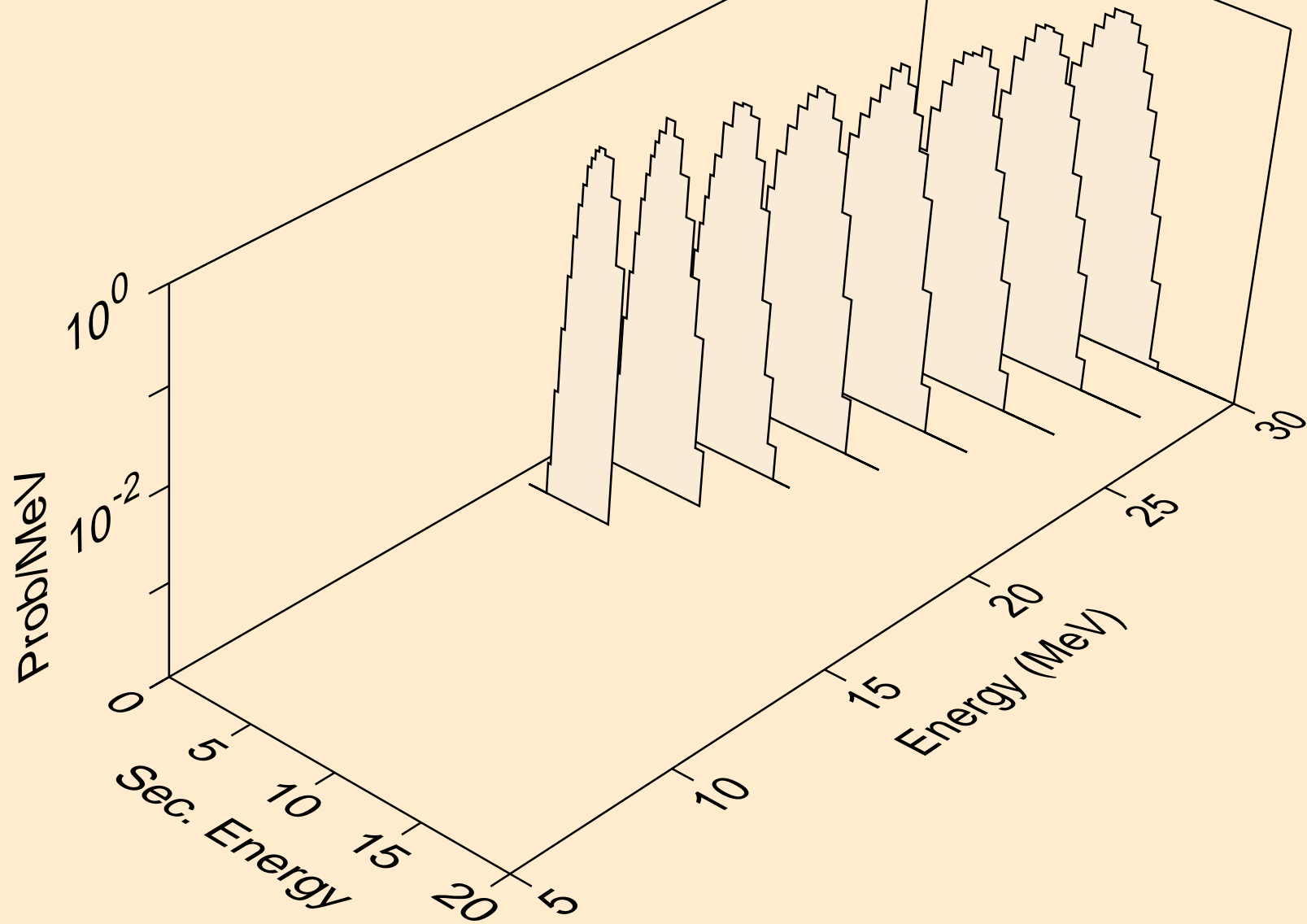

W191 DEUTERON ACER TENDL-2021 LIBRARY; T=0.K
Photon emission for (z,n)

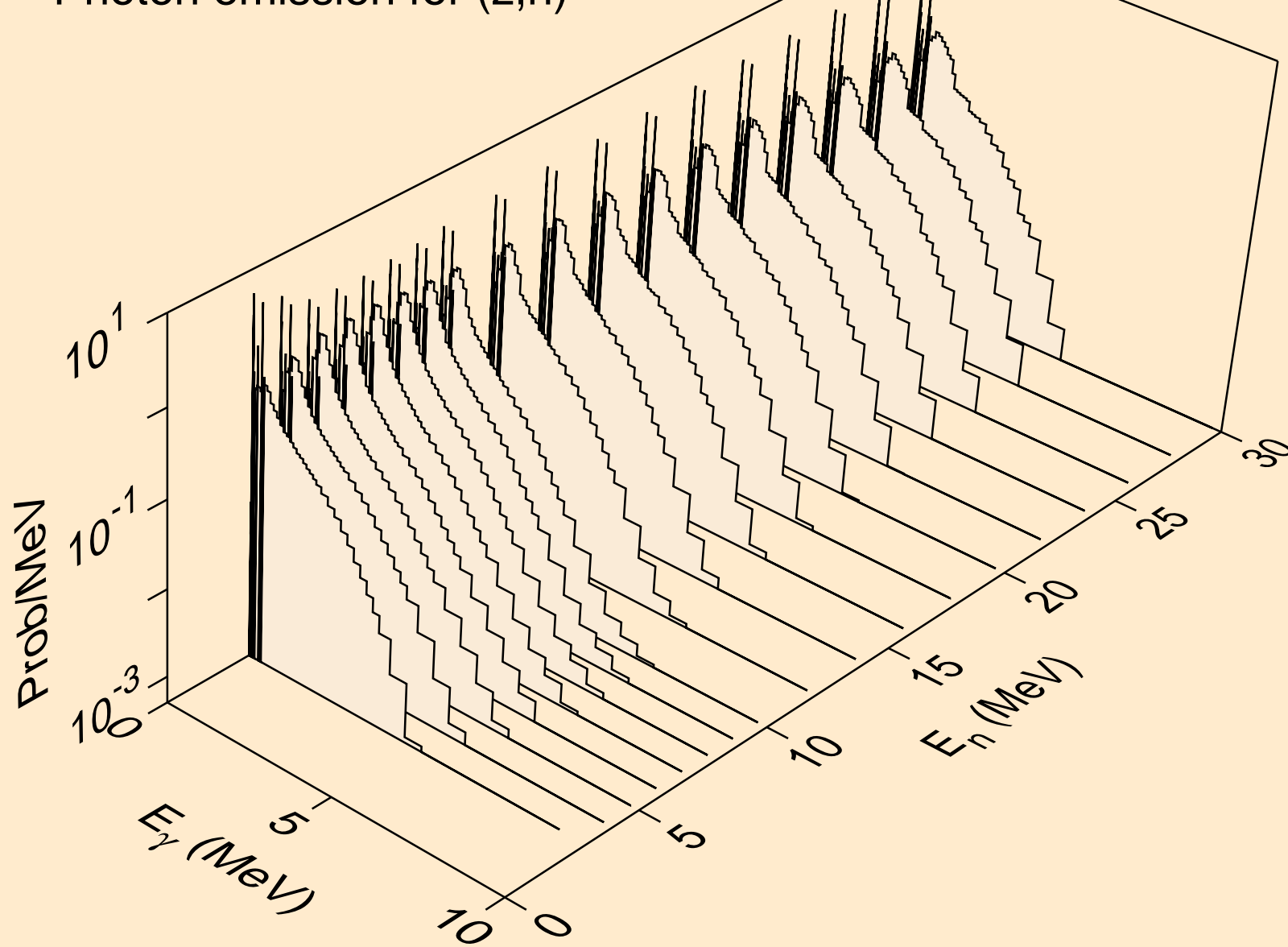

W191 DEUTERON ACER TENDL-2021 LIBRARY; T=0.K
Photon emission for (n,x)

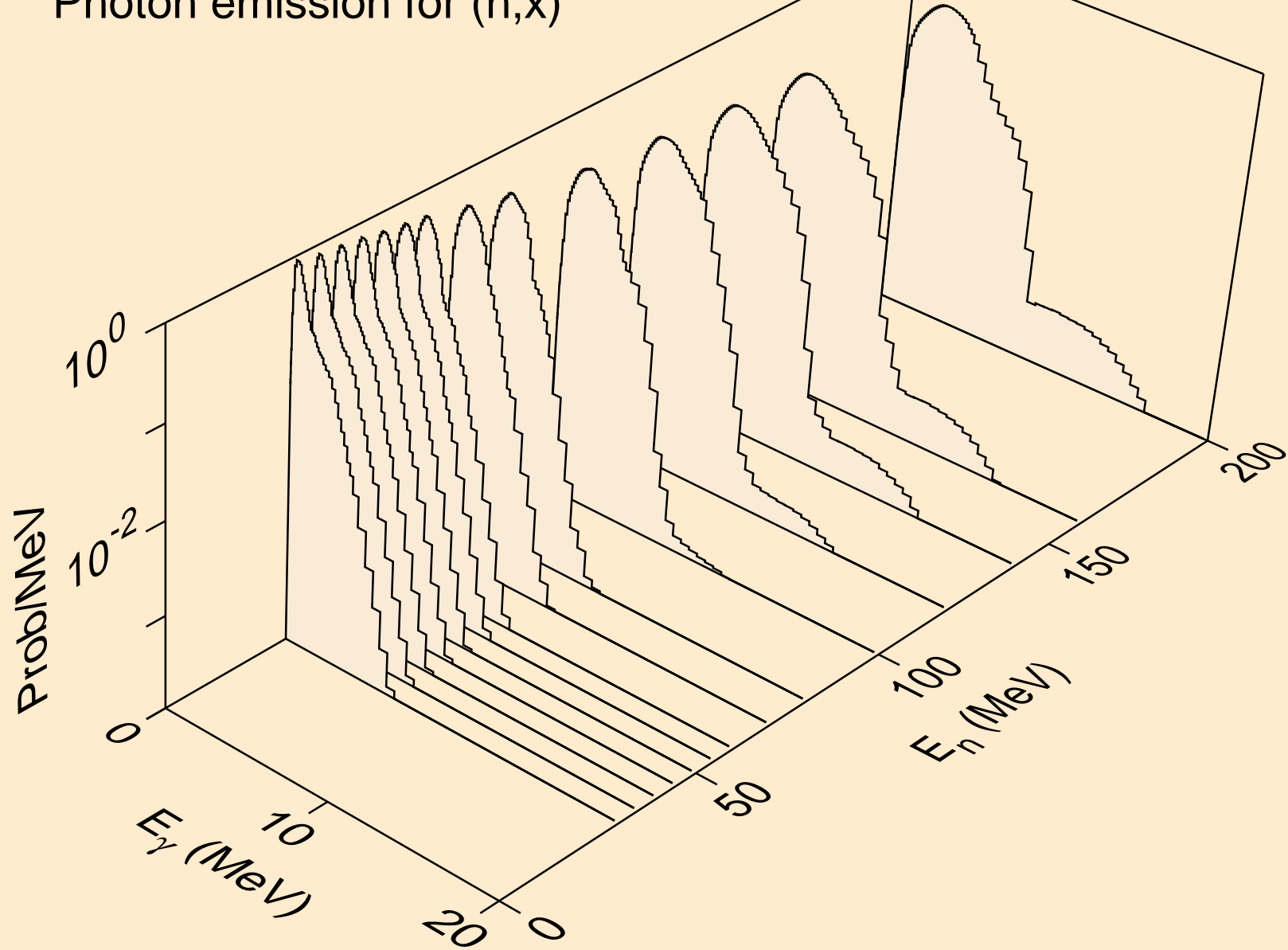

W191 DEUTERON ACER TENDL-2021 LIBRARY; T=0.K
Photon emission for (n,2nd)

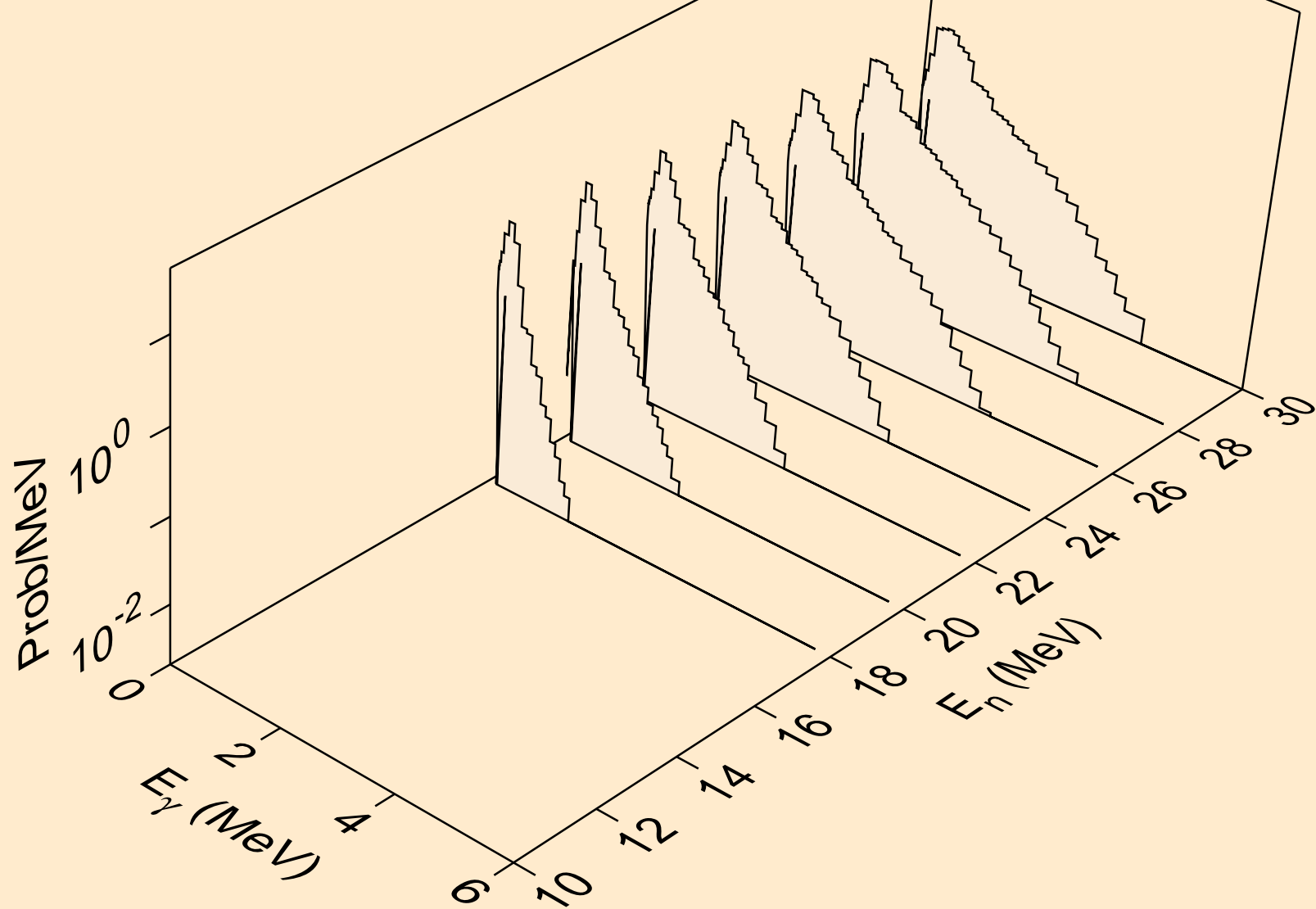

W191 DEUTERON ACER TENDL-2021 LIBRARY; T=0.K
Photon emission for (n,2n)

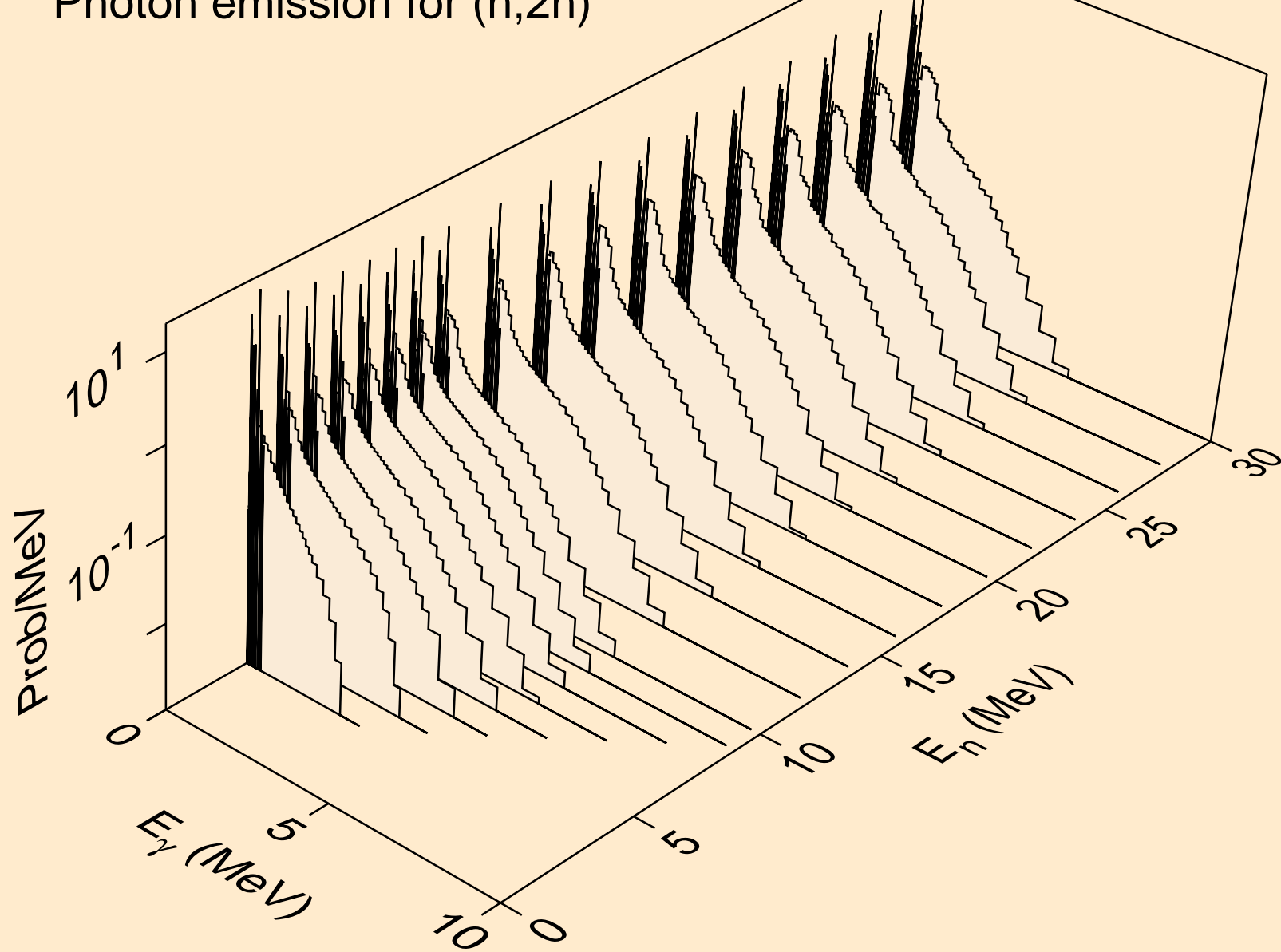

W191 DEUTERON ACER TENDL-2021 LIBRARY; T=0.K
Photon emission for (n,3n)

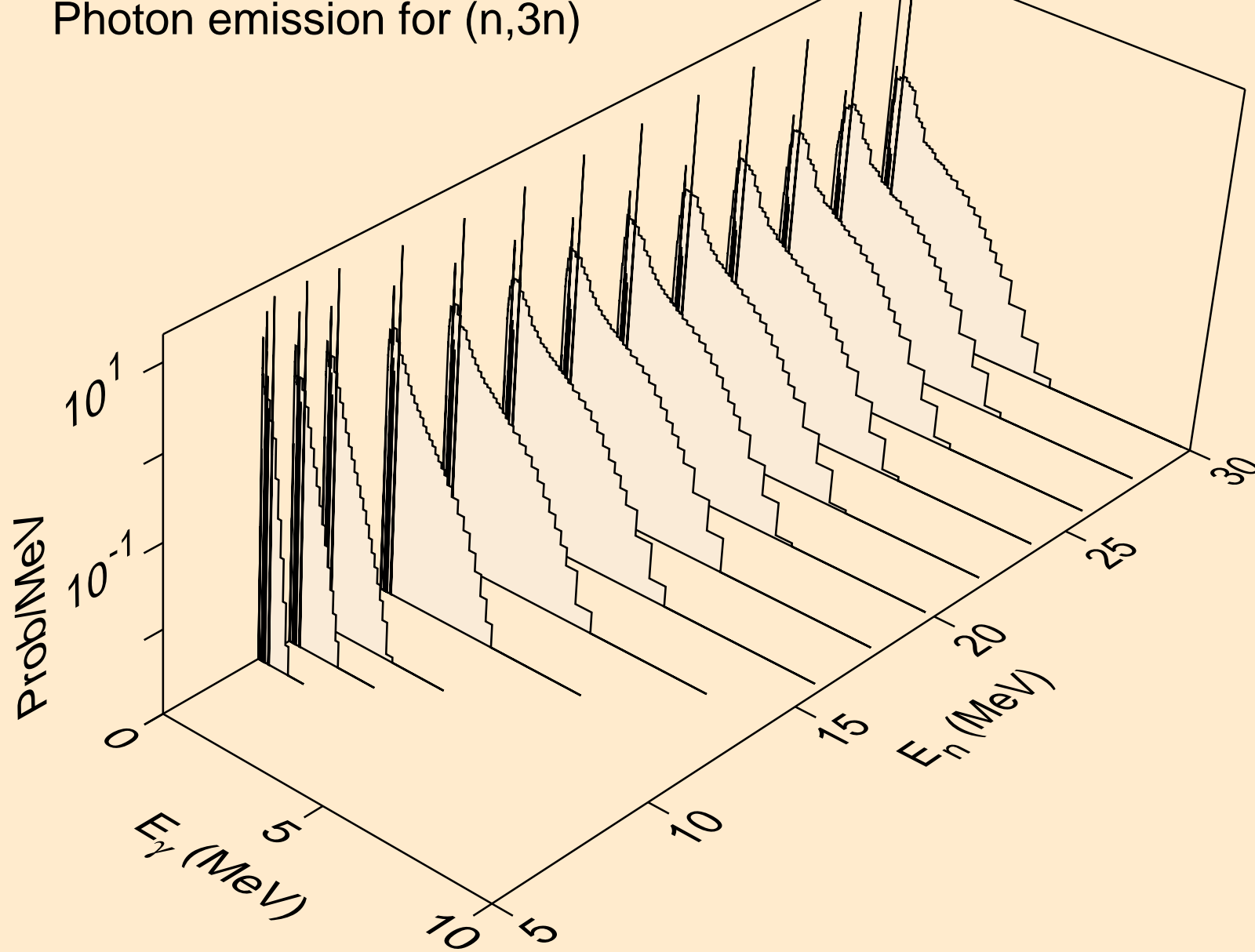

W191 DEUTERON ACER TENDL-2021 LIBRARY; T=0.K
Photon emission for (n,n*)a

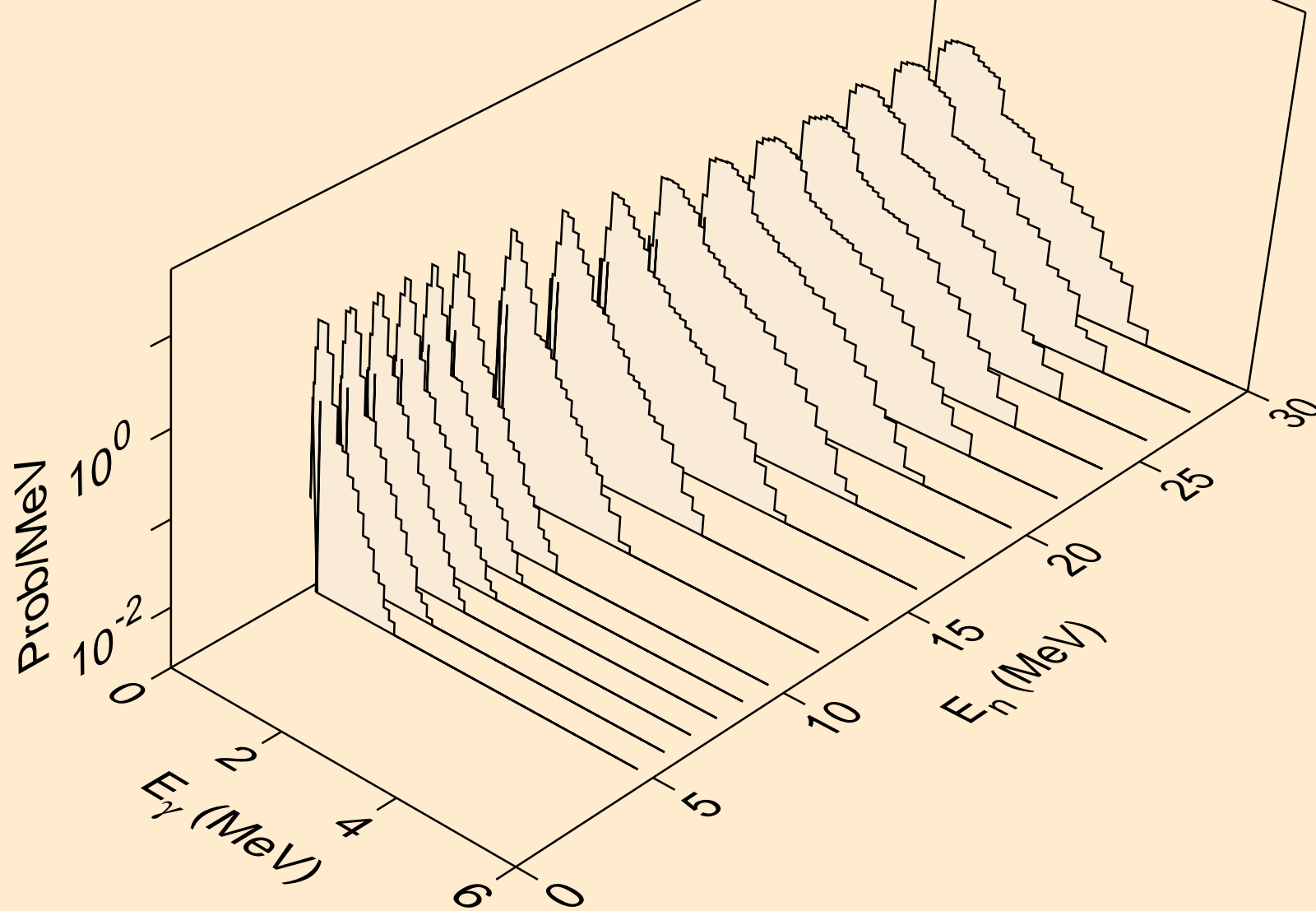

W191 DEUTERON ACER TENDL-2021 LIBRARY; T=0.K
Photon emission for (n,2n)a

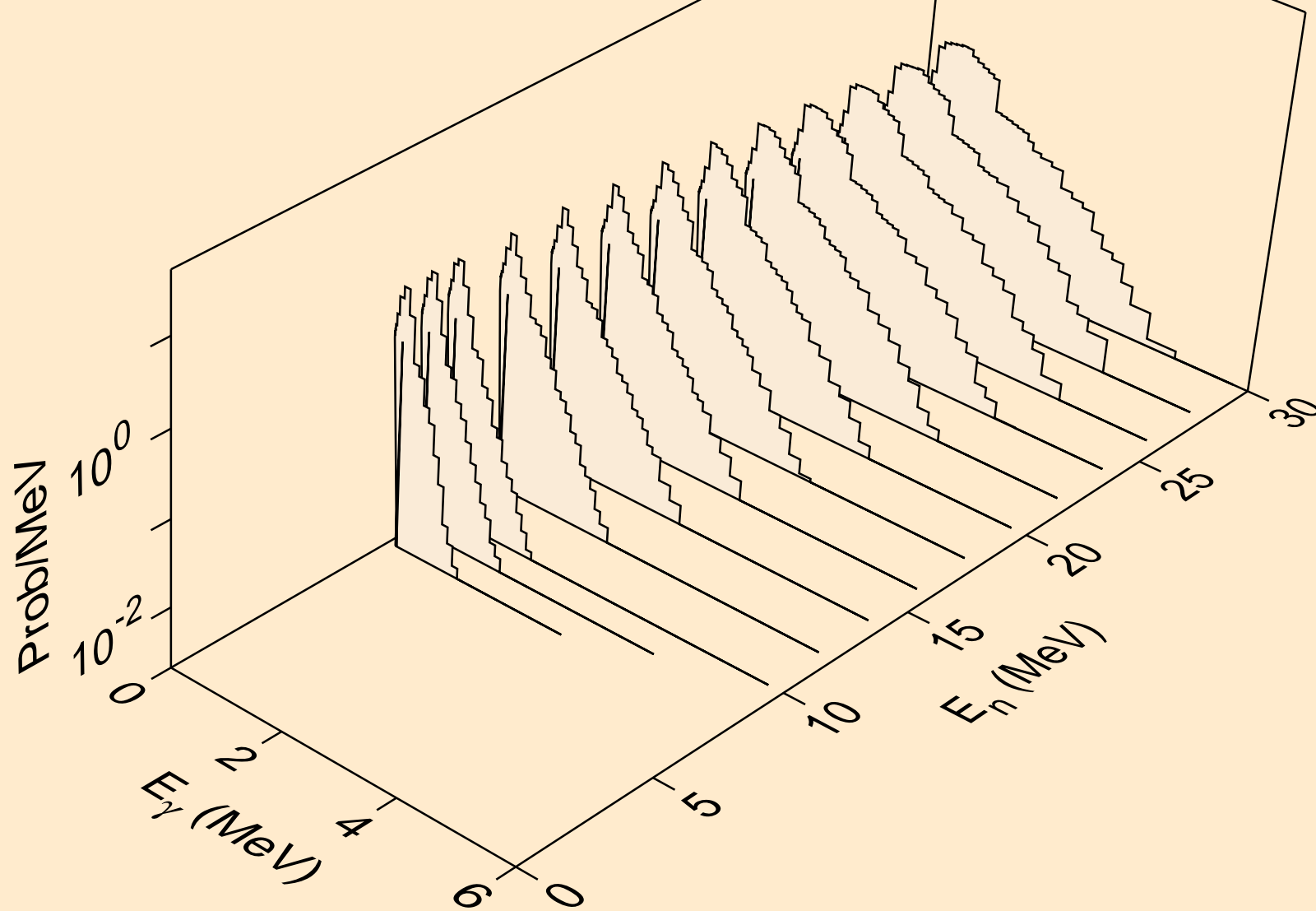

W191 DEUTERON ACER TENDL-2021 LIBRARY; T=0.K
Photon emission for (n,3n)a

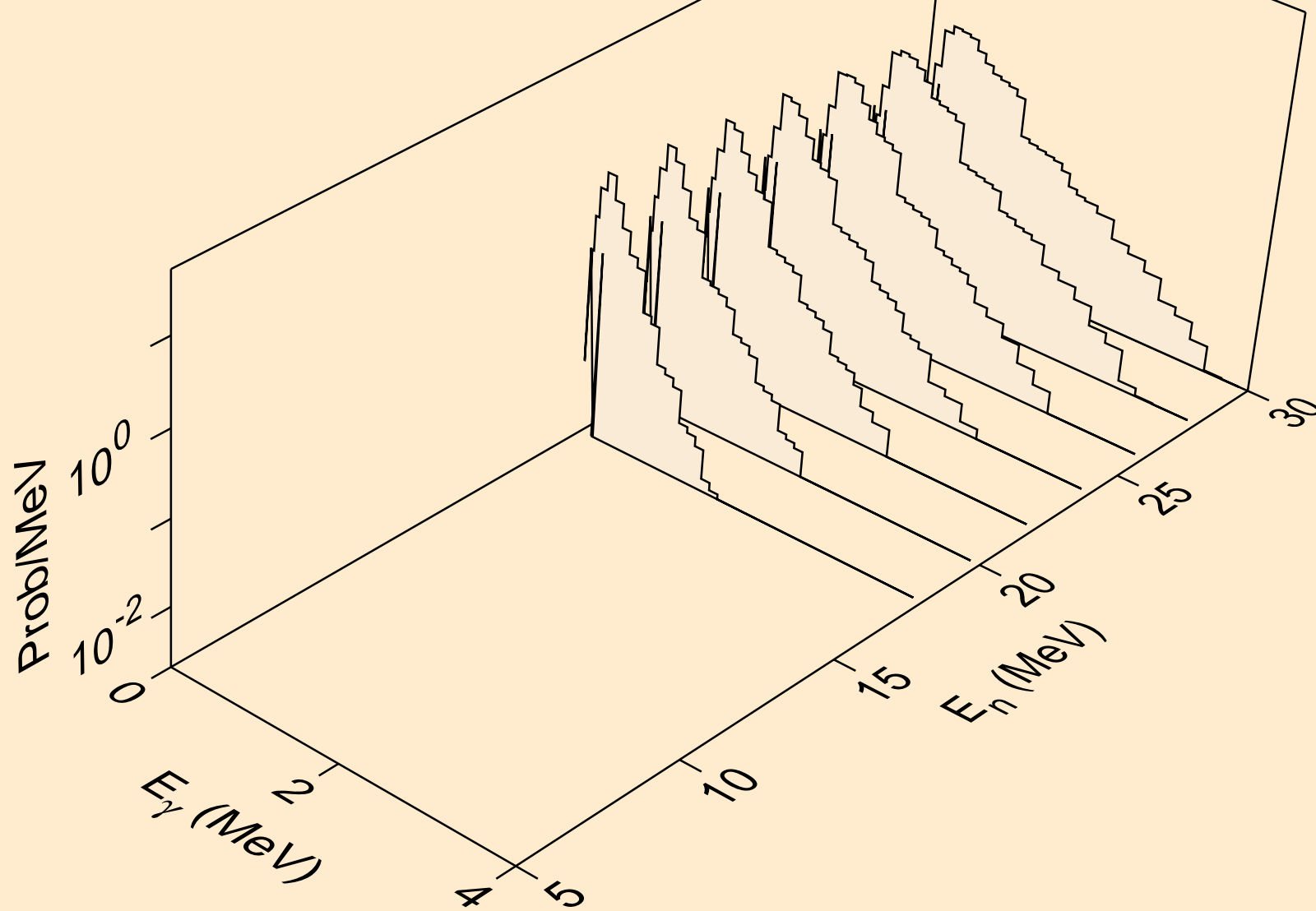

W191 DEUTERON ACER TENDL-2021 LIBRARY; T=0.K
Photon emission for (n,n*)p

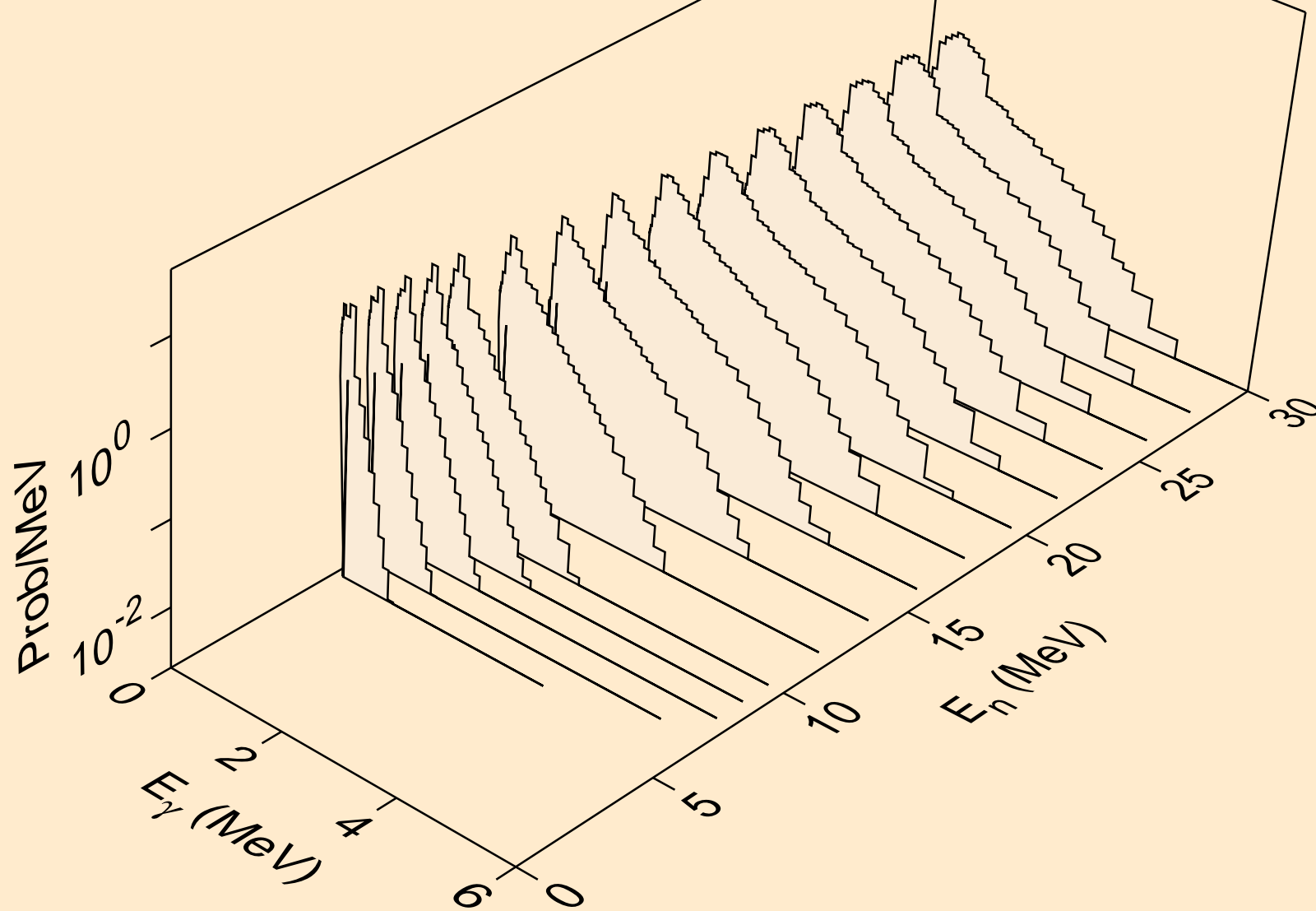

W191 DEUTERON ACER TENDL-2021 LIBRARY; T=0.K
Photon emission for (n,n*)d

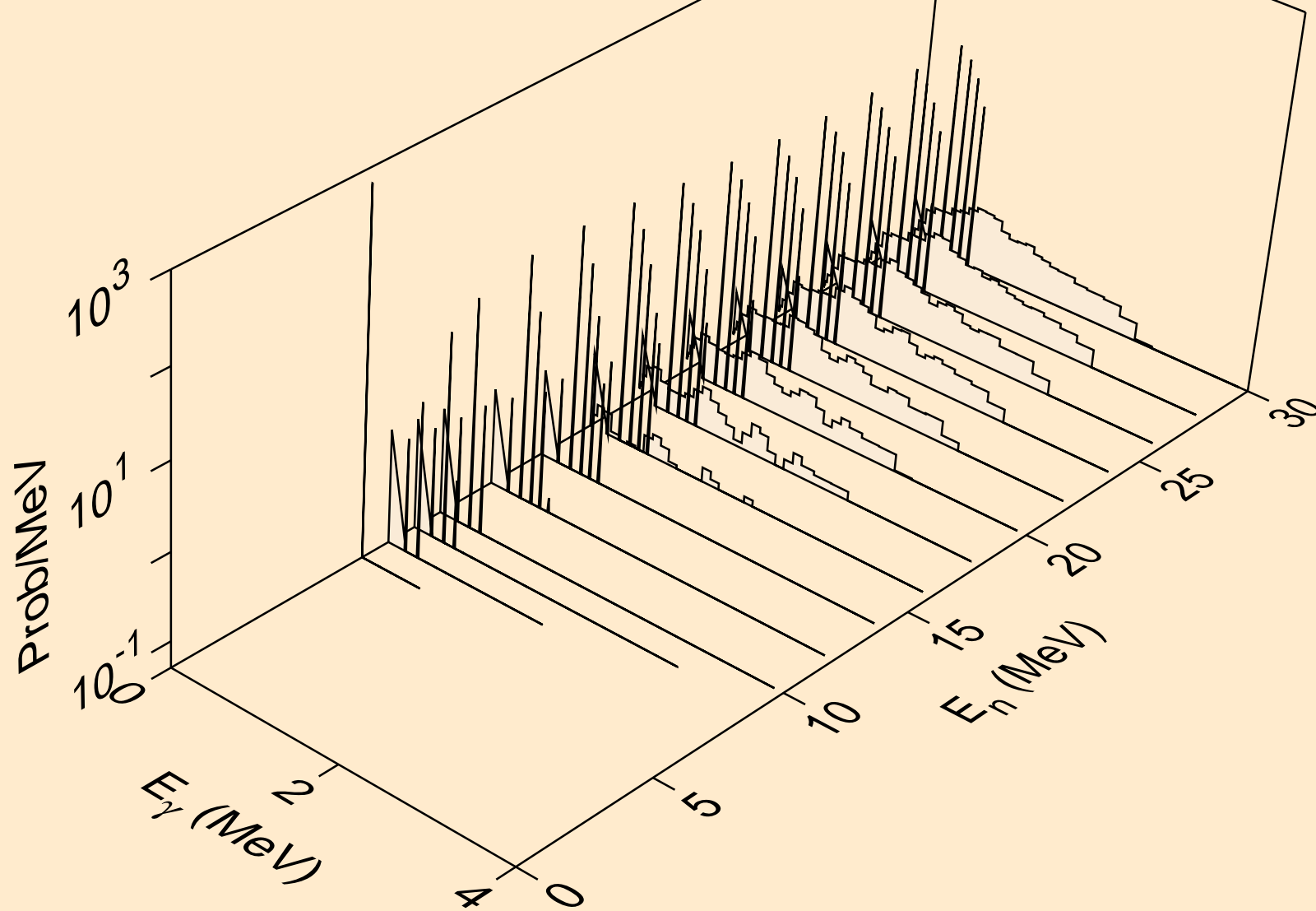

W191 DEUTERON ACER TENDL-2021 LIBRARY; T=0.K
Photon emission for (n,n*)t

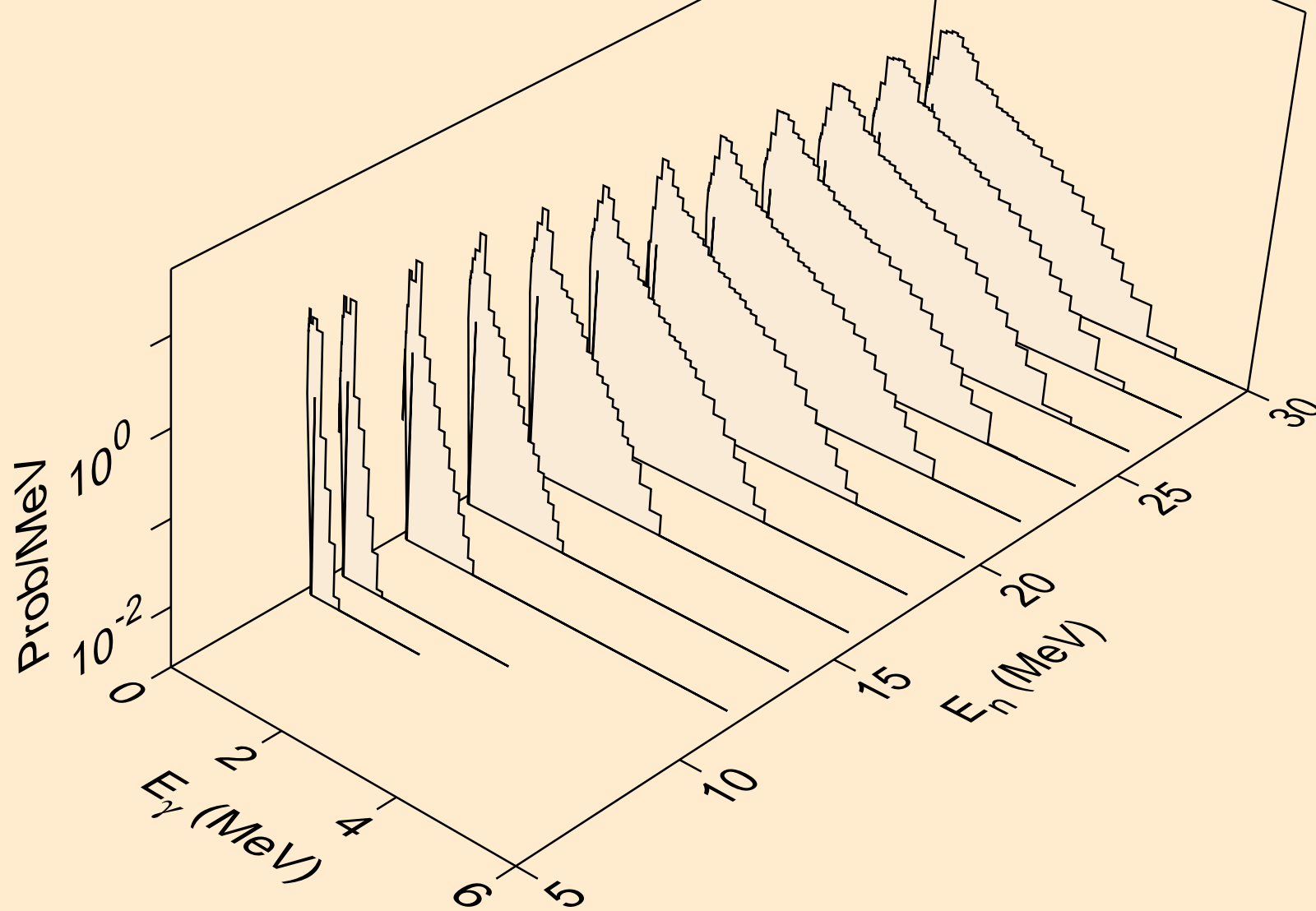

W191 DEUTERON ACER TENDL-2021 LIBRARY; T=0.K
Photon emission for (n,n*)he3

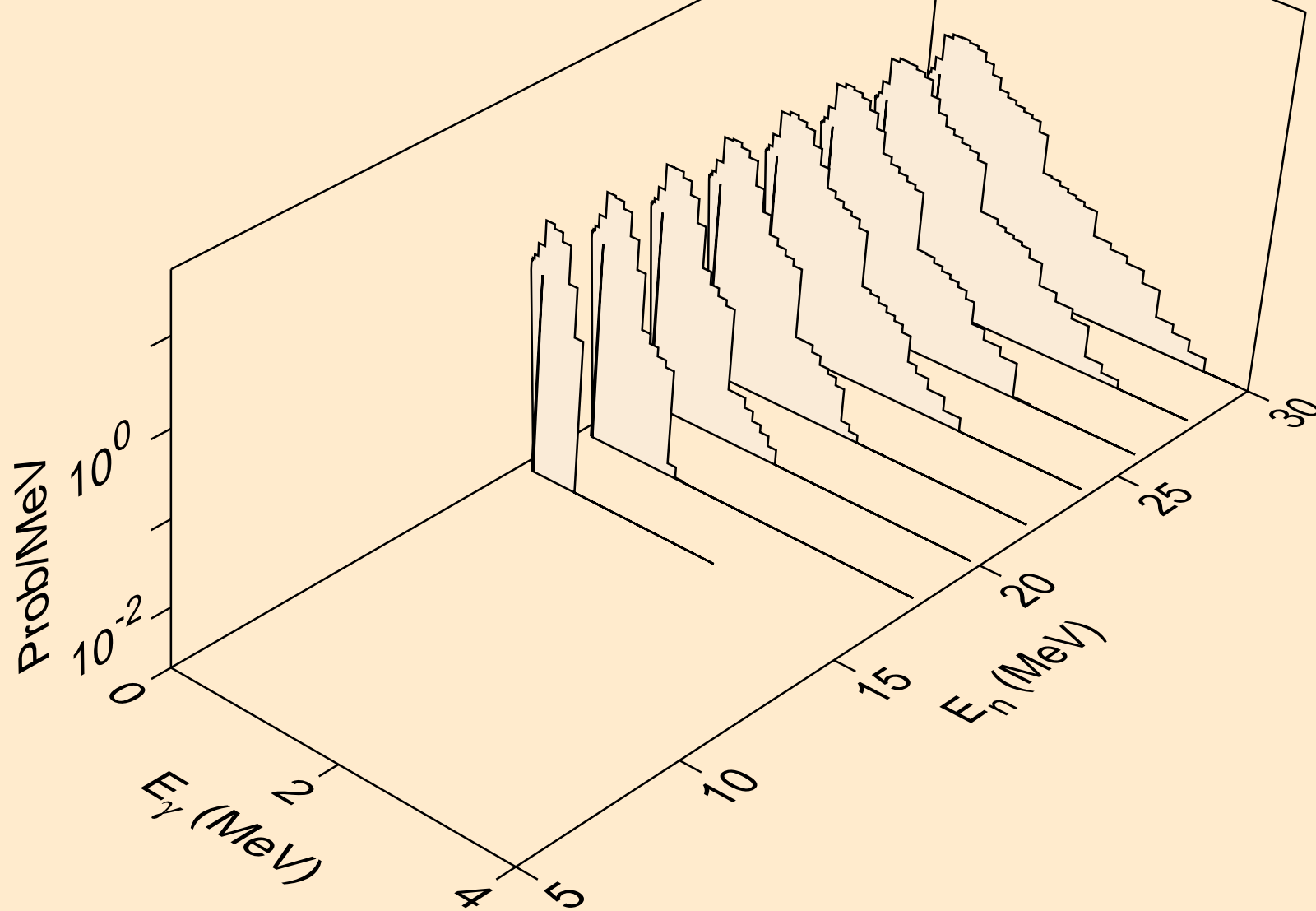

W191 DEUTERON ACER TENDL-2021 LIBRARY; T=0.K
Photon emission for (n,4n)

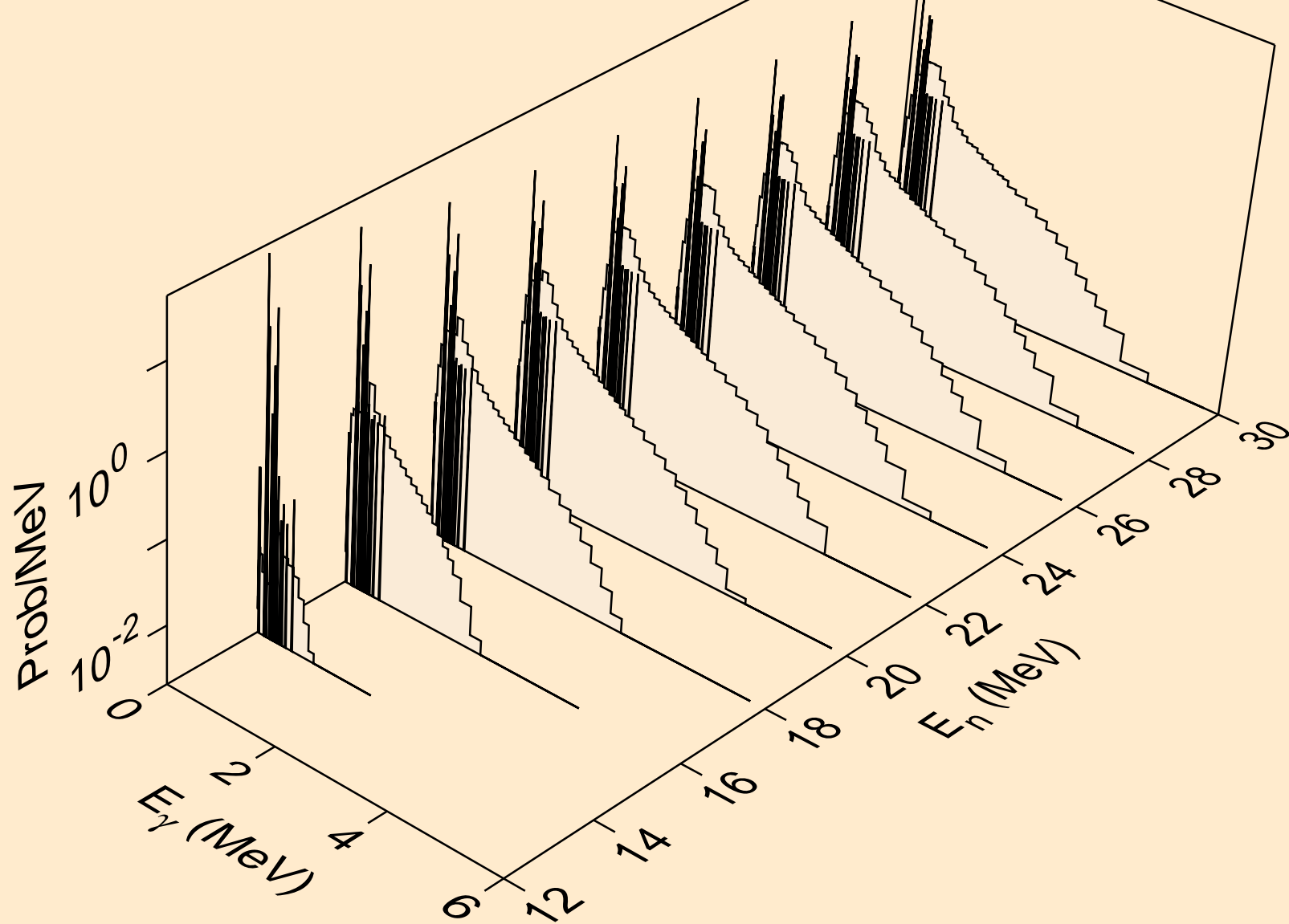

W191 DEUTERON ACER TENDL-2021 LIBRARY; T=0.K
Photon emission for (n,2np)

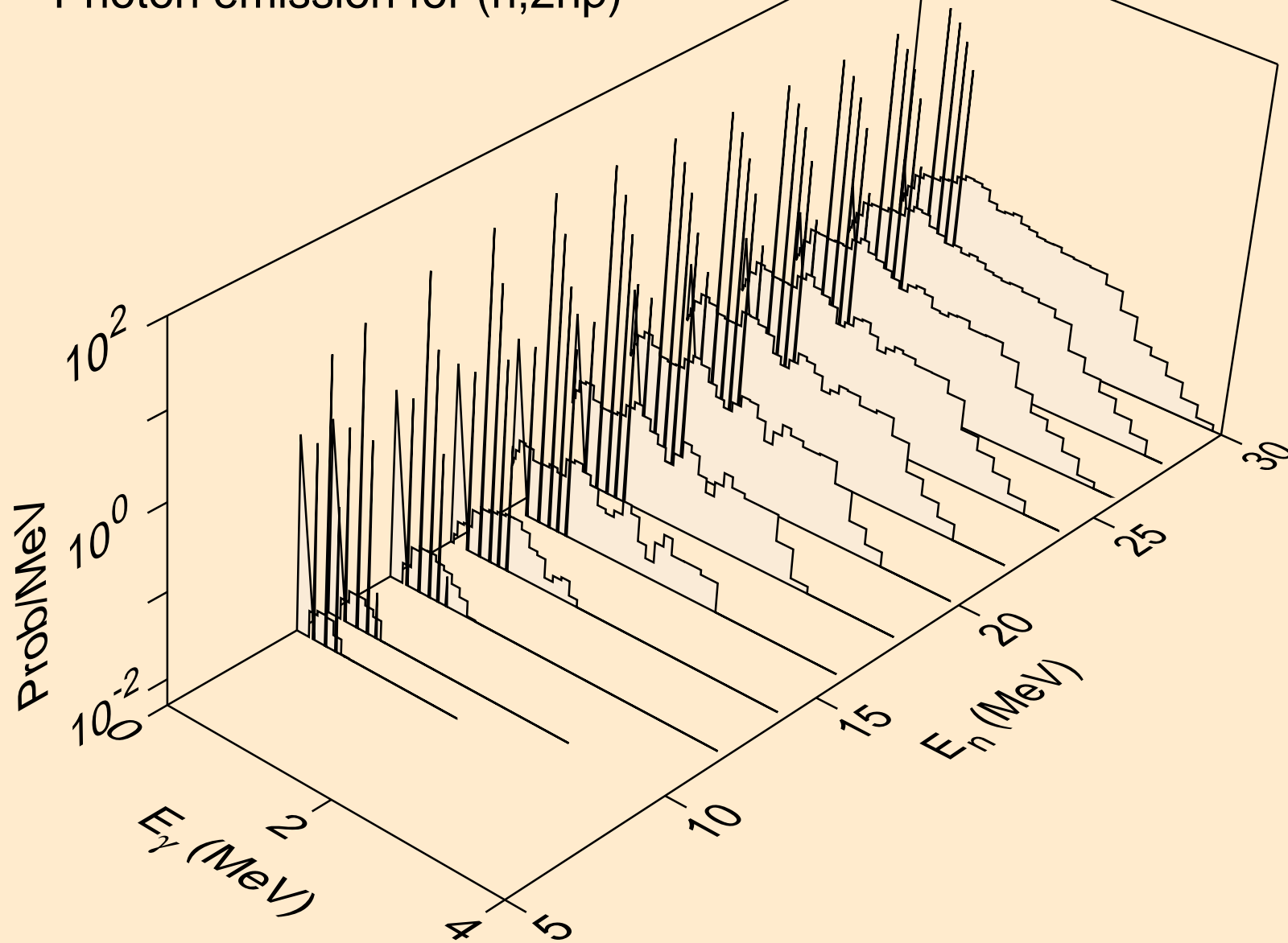

W191 DEUTERON ACER TENDL-2021 LIBRARY; T=0.K
Photon emission for (n,3np)

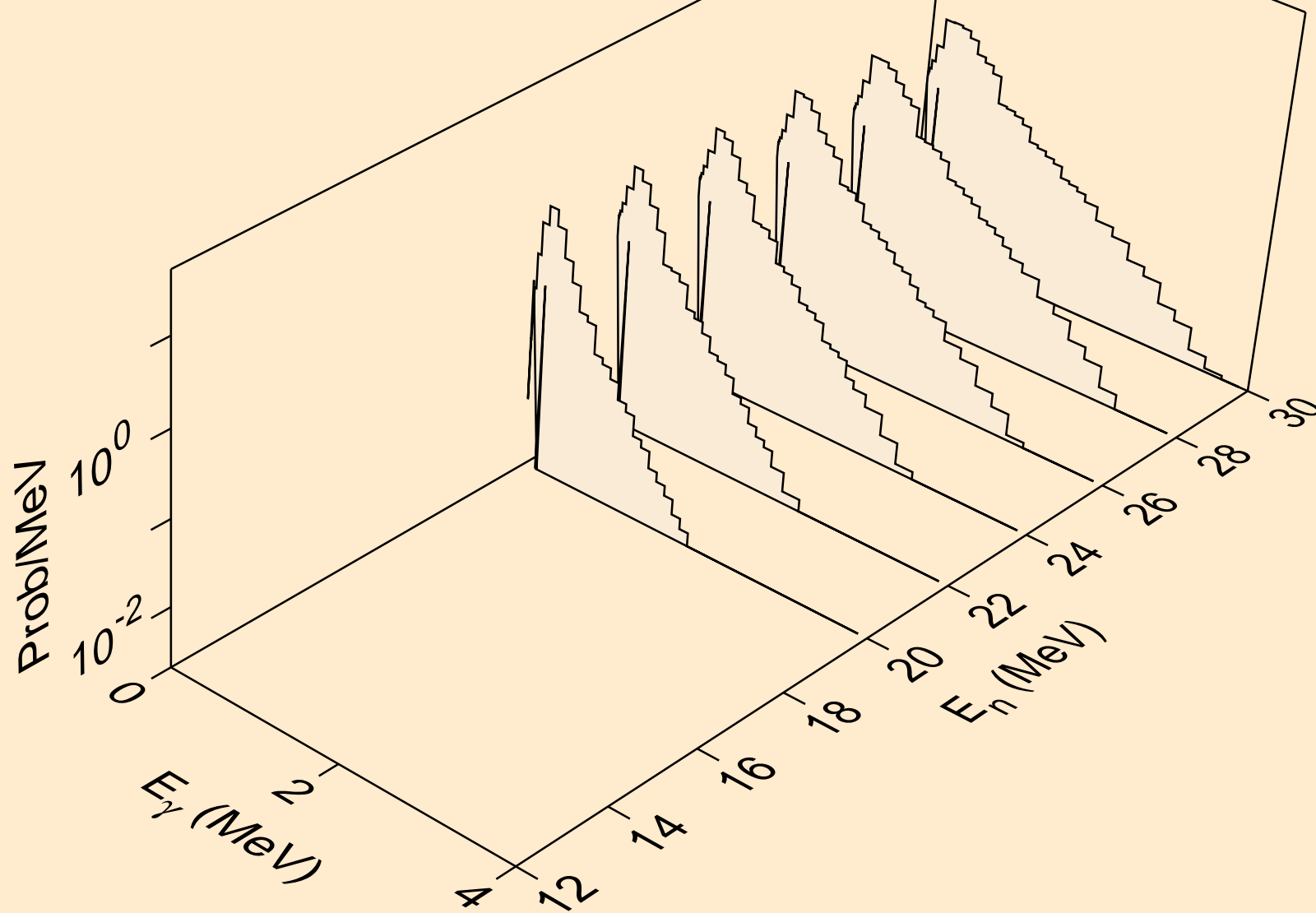

W191 DEUTERON ACER TENDL-2021 LIBRARY; T=0.K
Photon emission for (n,2np)

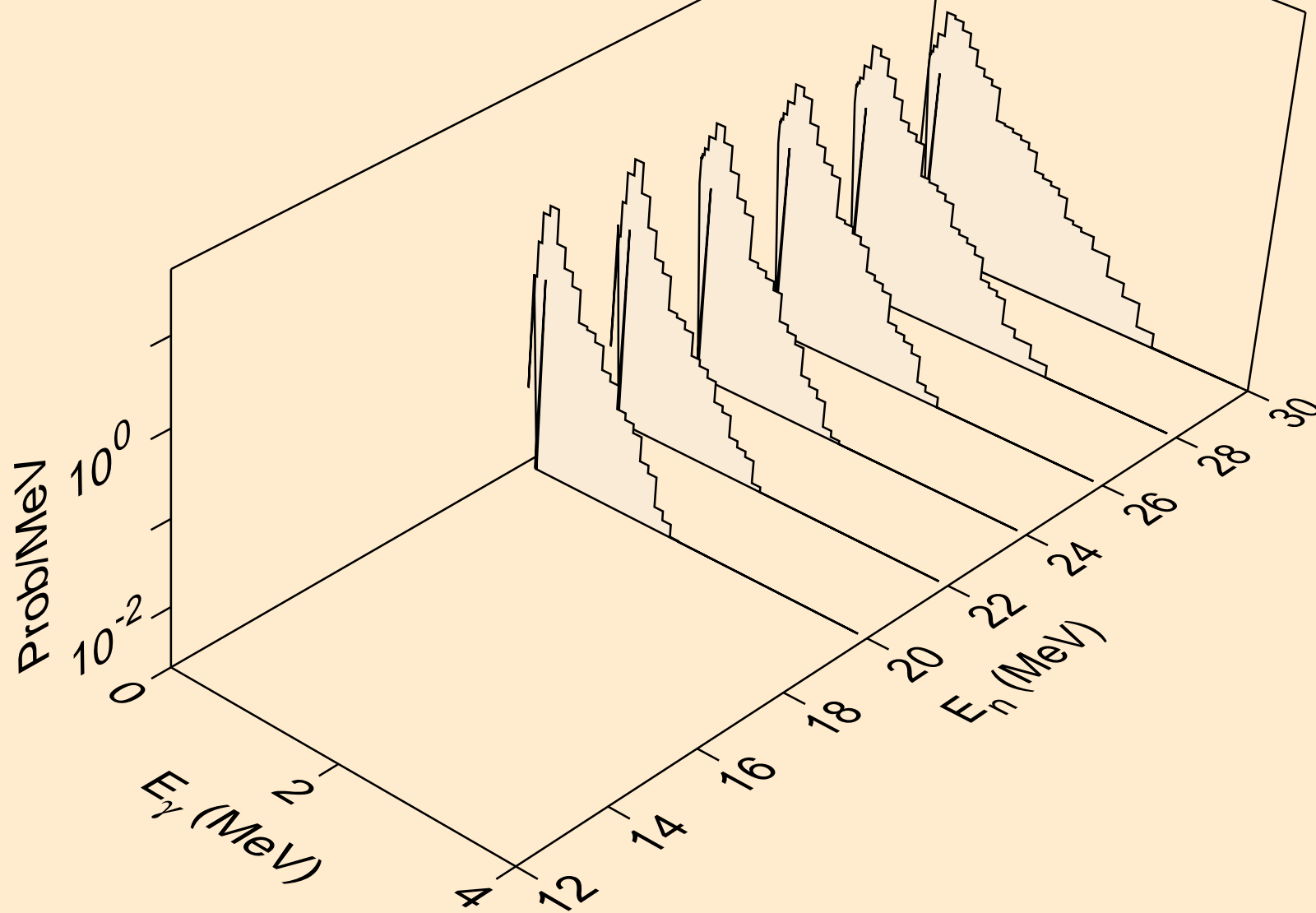

W191 DEUTERON ACER TENDL-2021 LIBRARY; T=0.K
Photon emission for (n,npa)

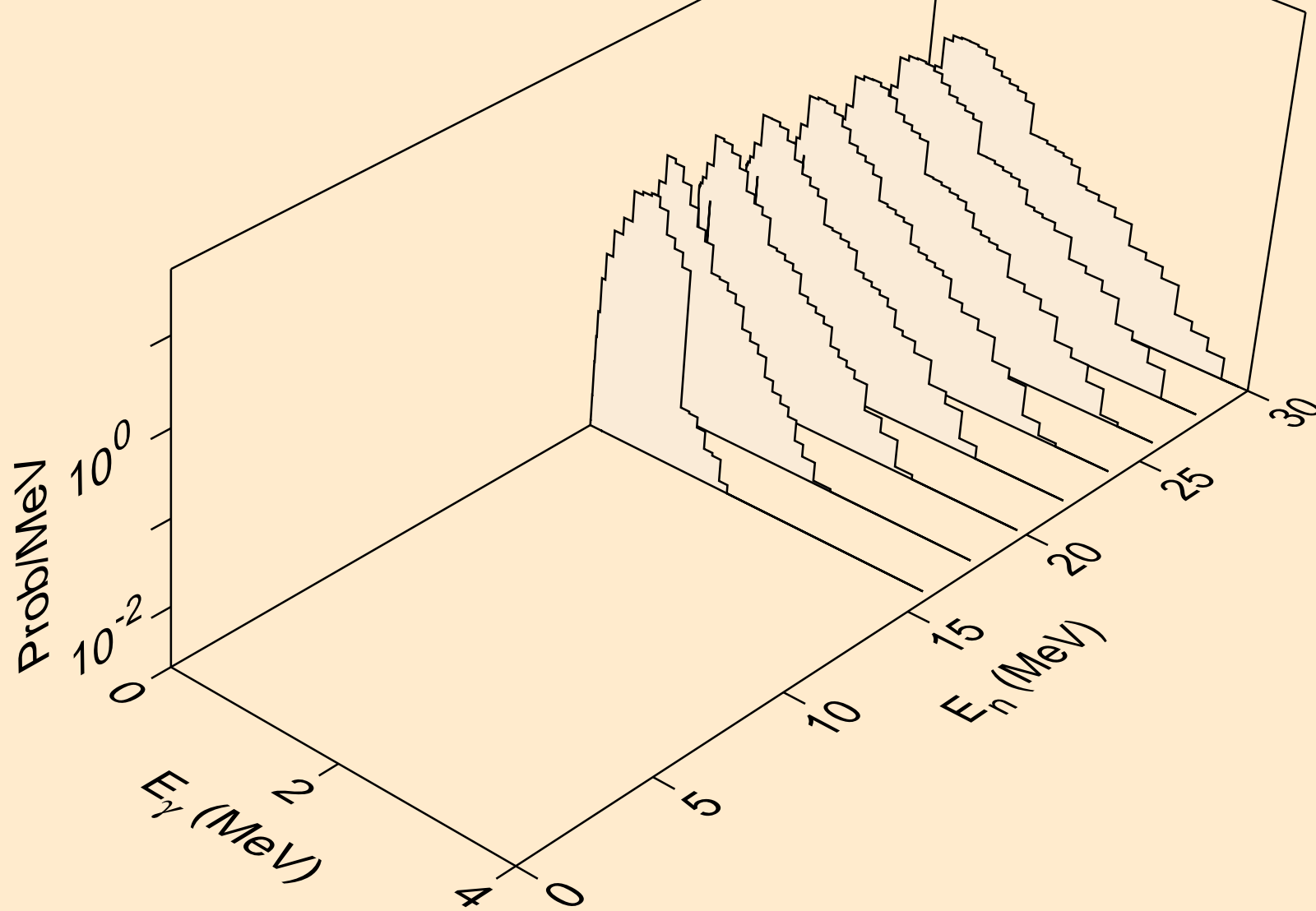

W191 DEUTERON ACER TENDL-2021 LIBRARY; T=0.K
Photon emission for (n,gma)

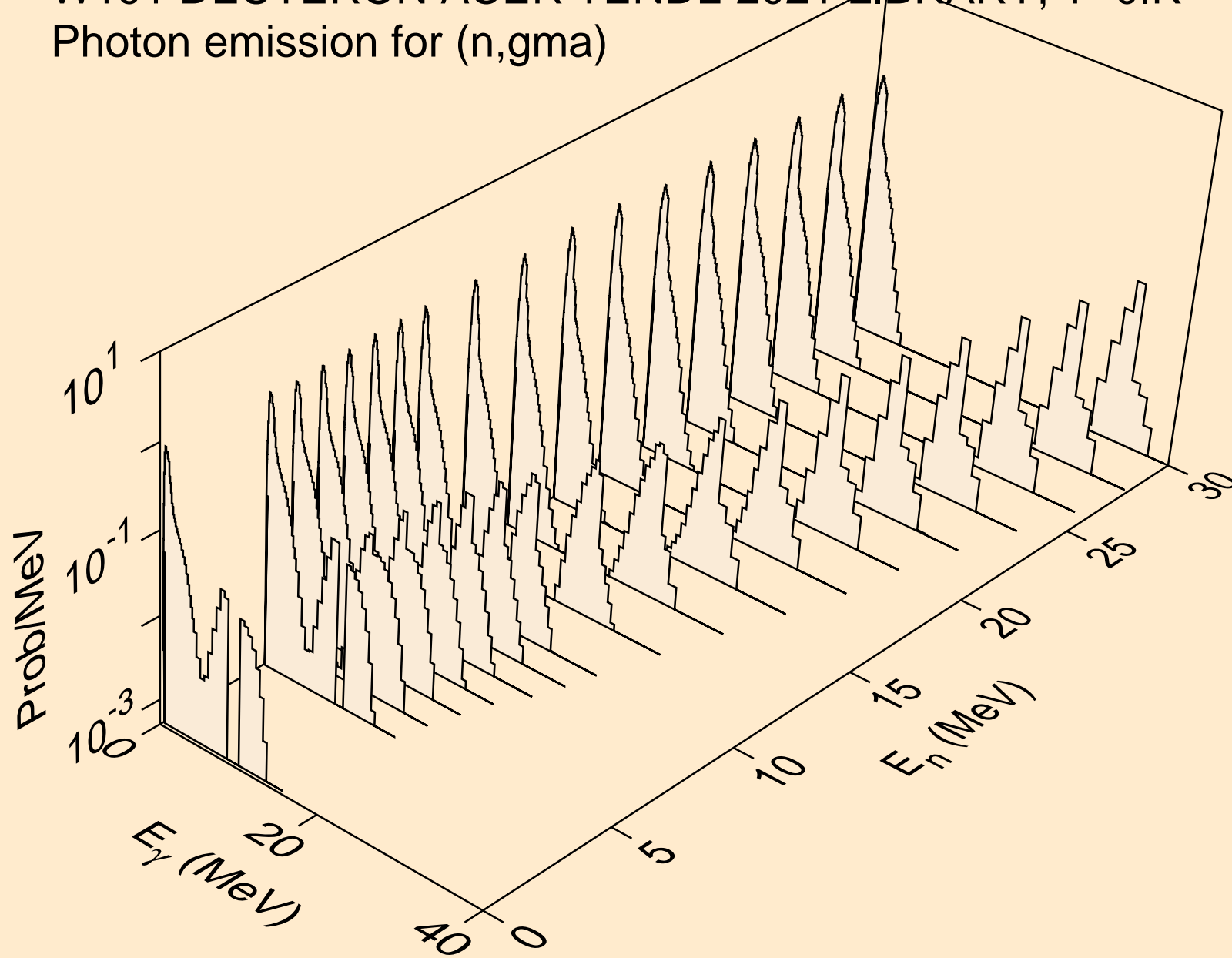

W191 DEUTERON ACER TENDL-2021 LIBRARY; T=0.K
Photon emission for (n,p)

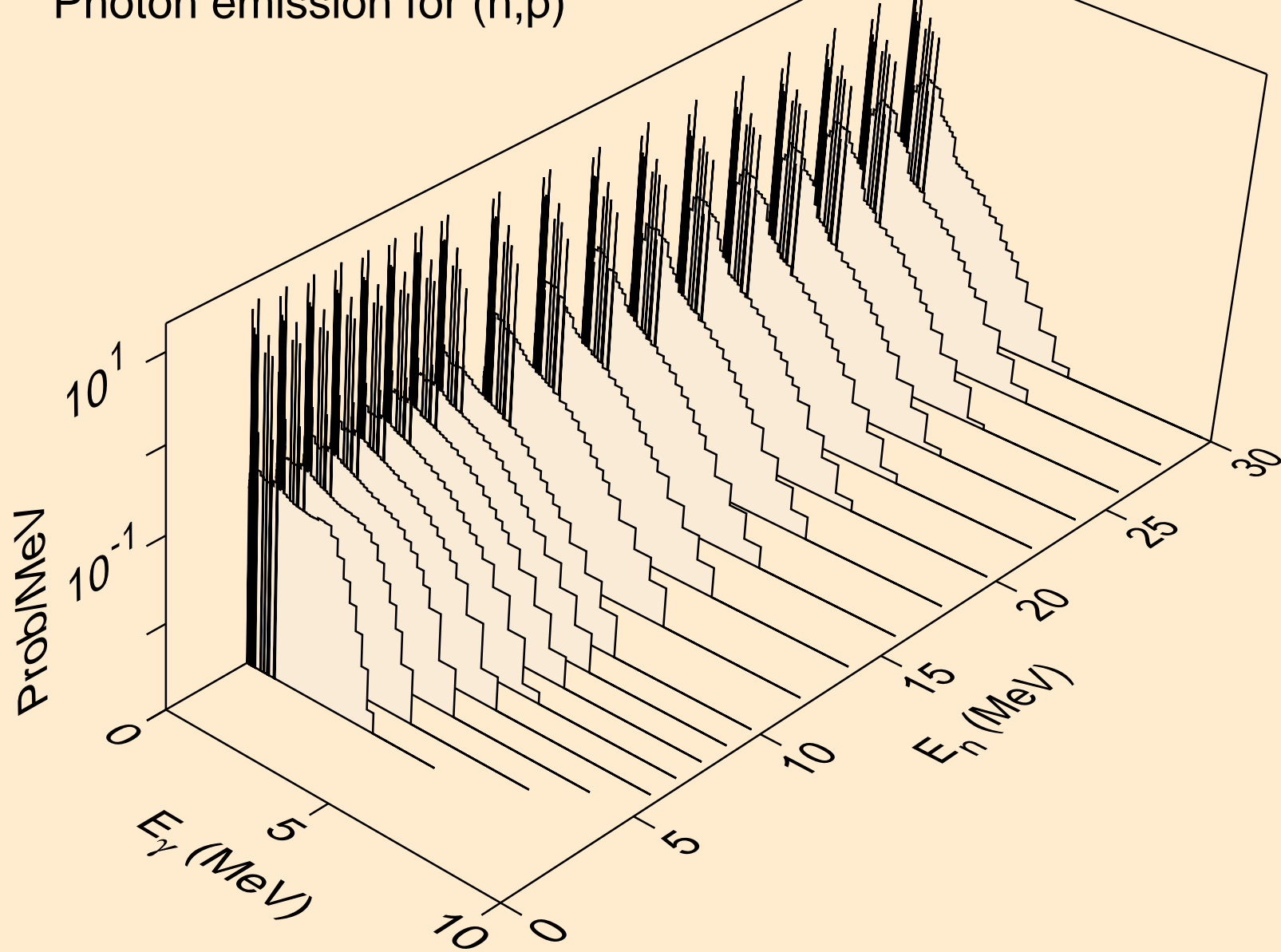

W191 DEUTERON ACER TENDL-2021 LIBRARY; T=0.K
Photon emission for inelastic

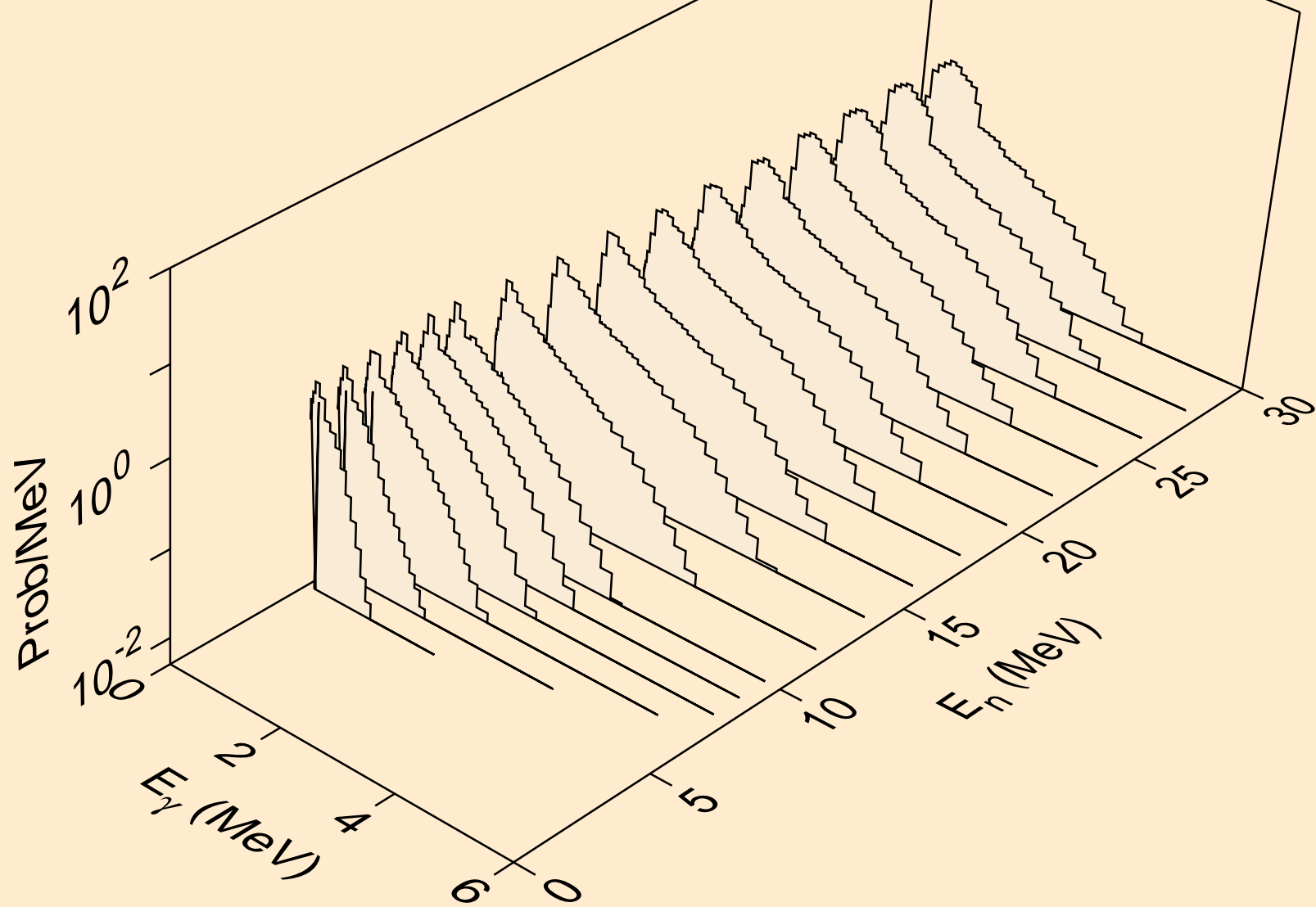

W191 DEUTERON ACER TENDL-2021 LIBRARY; T=0.K
Photon emission for (n,t)

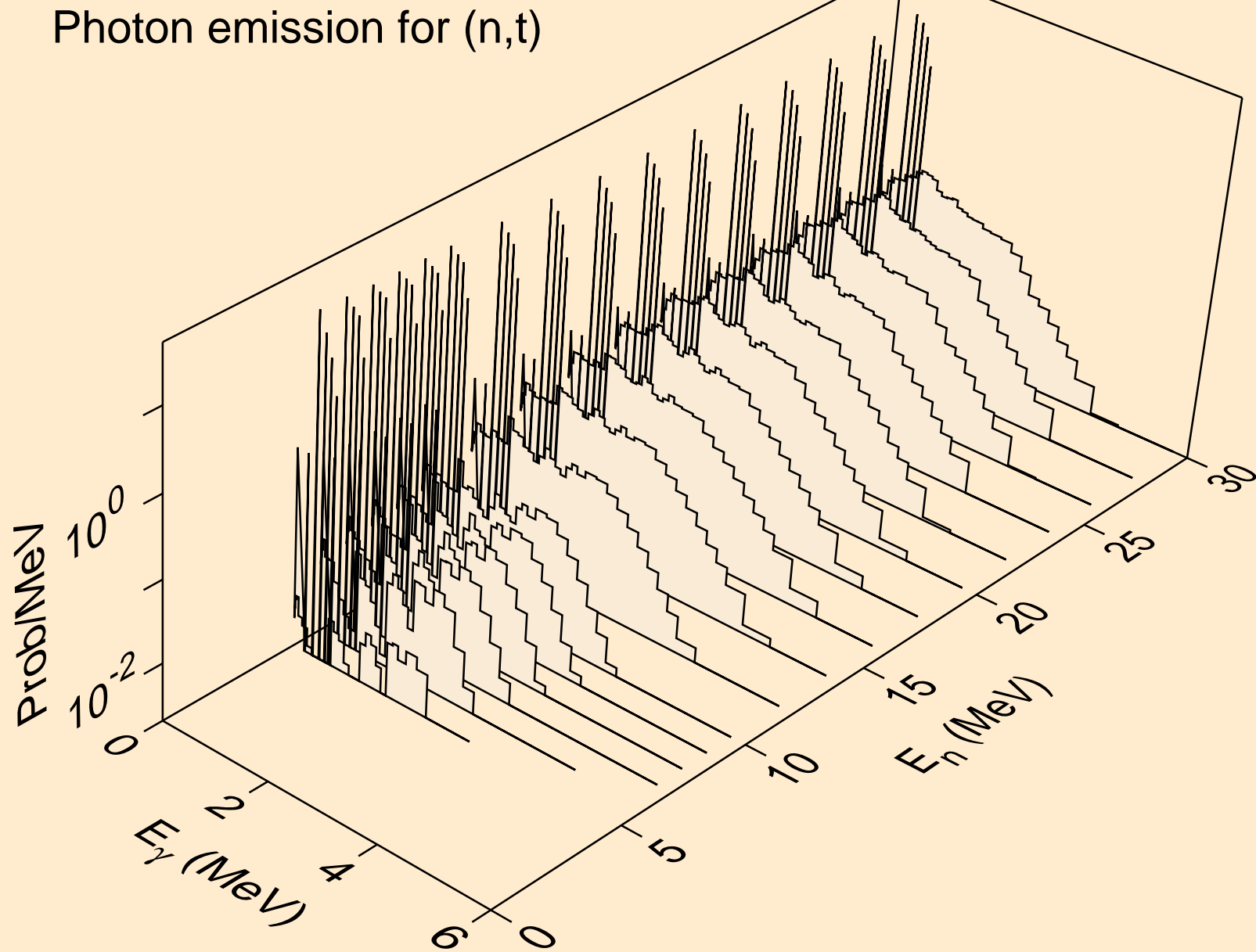

W191 DEUTERON ACER TENDL-2021 LIBRARY; T=0.K
Photon emission for (n,he3)

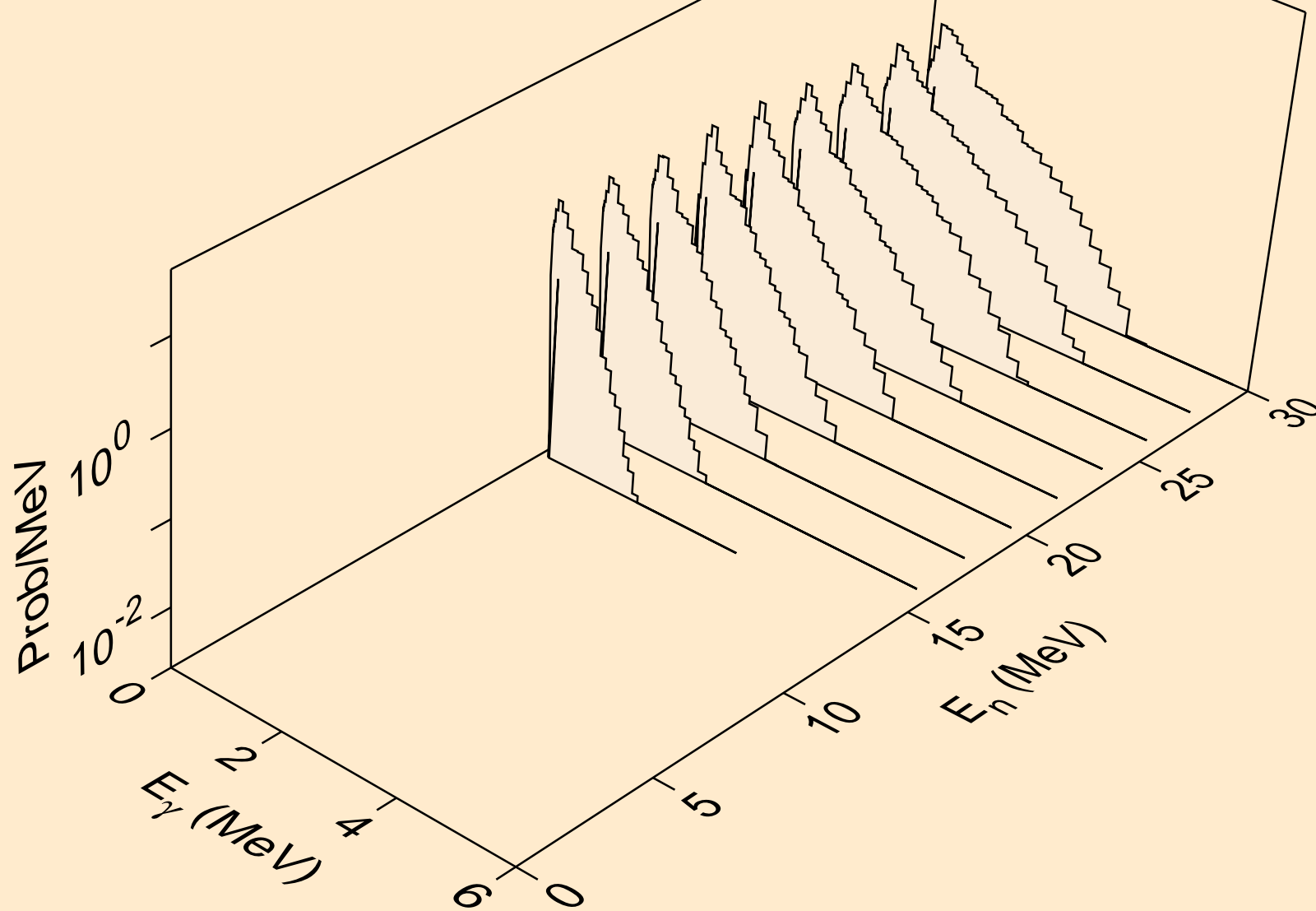

W191 DEUTERON ACER TENDL-2021 LIBRARY; T=0.K
Photon emission for (n,a)

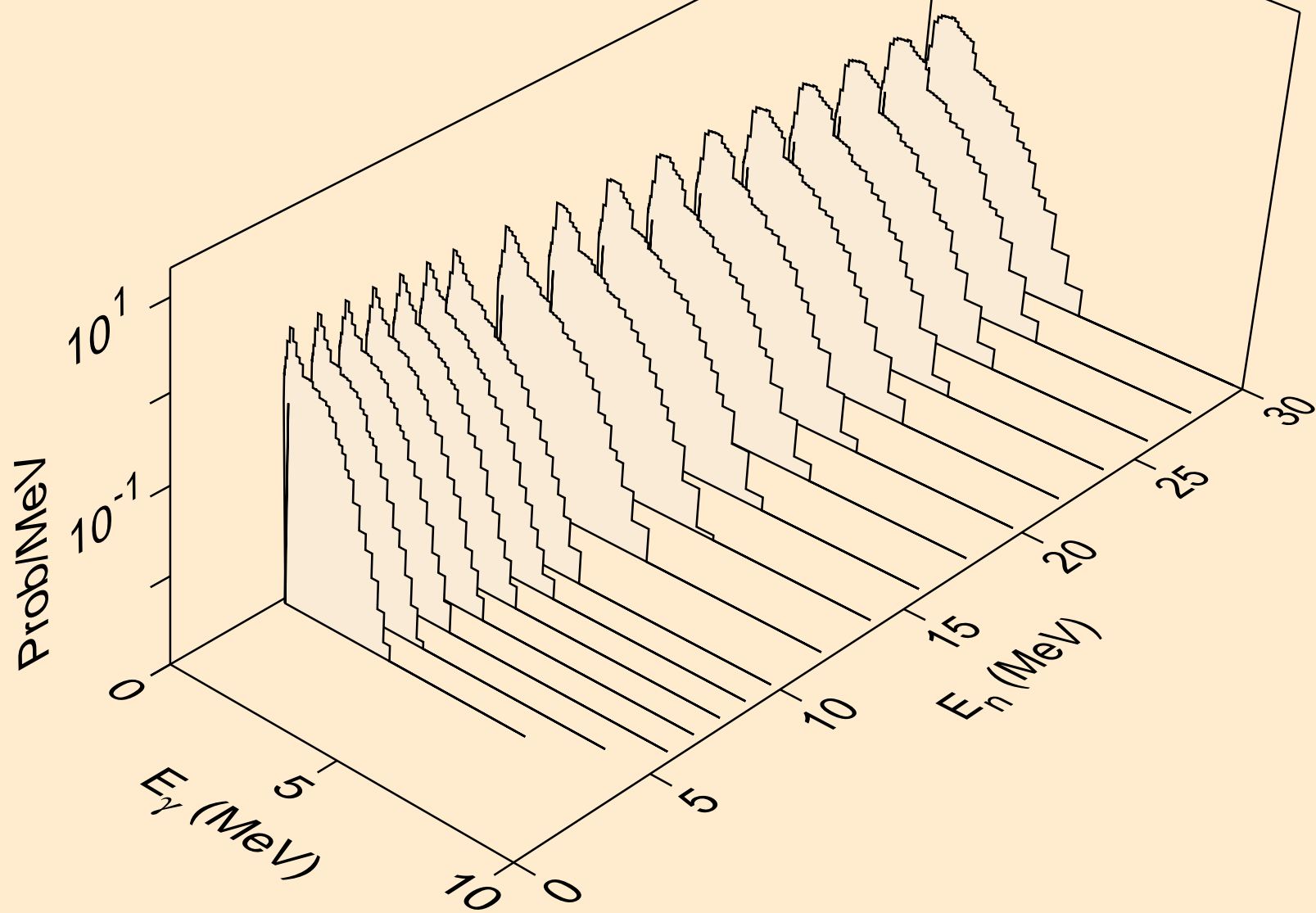

W191 DEUTERON ACER TENDL-2021 LIBRARY; T=0.K
Photon emission for (n,2p)

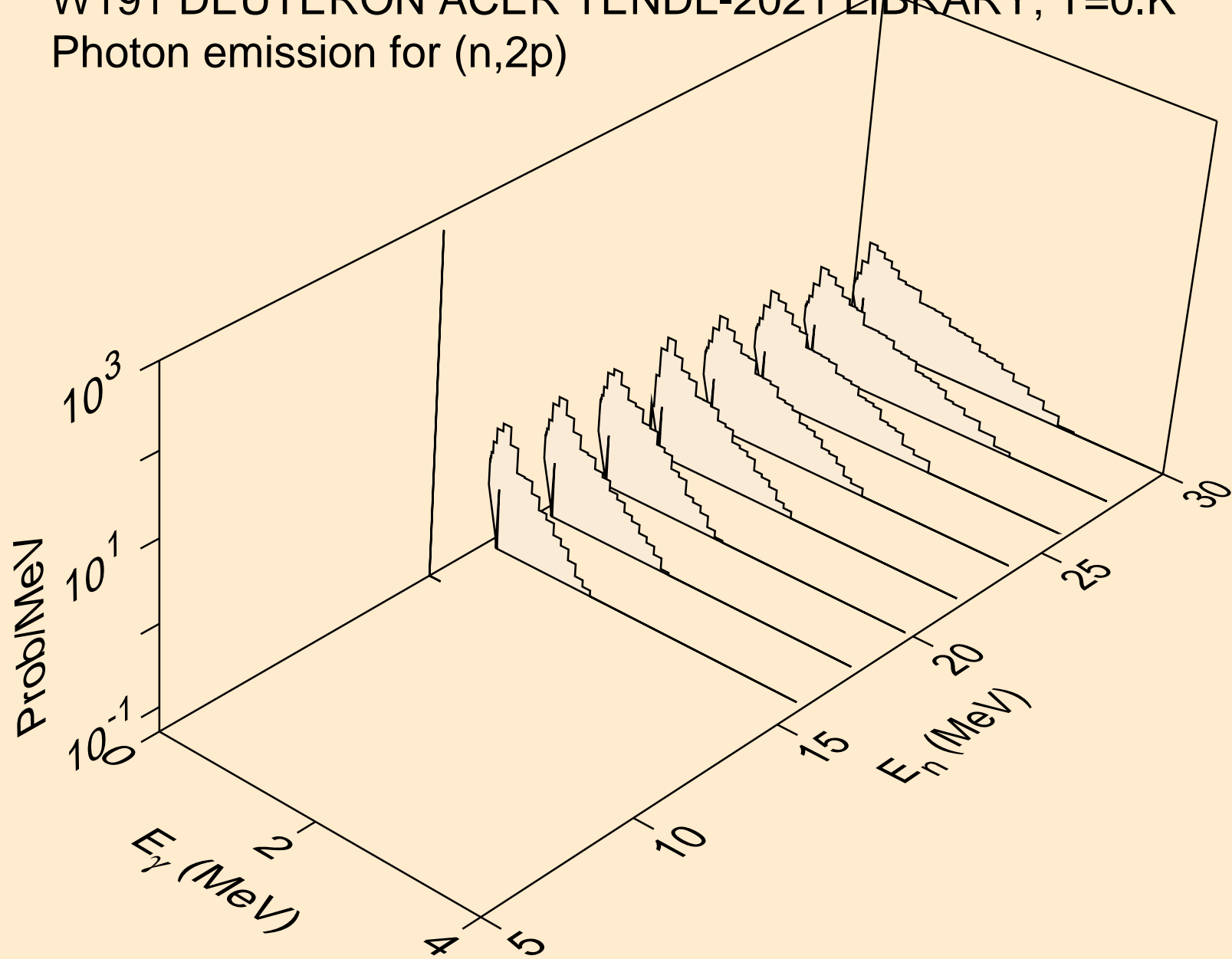

W191 DEUTERON ACER TENDL-2021 LIBRARY; T=0.K
Photon emission for (n,pd)

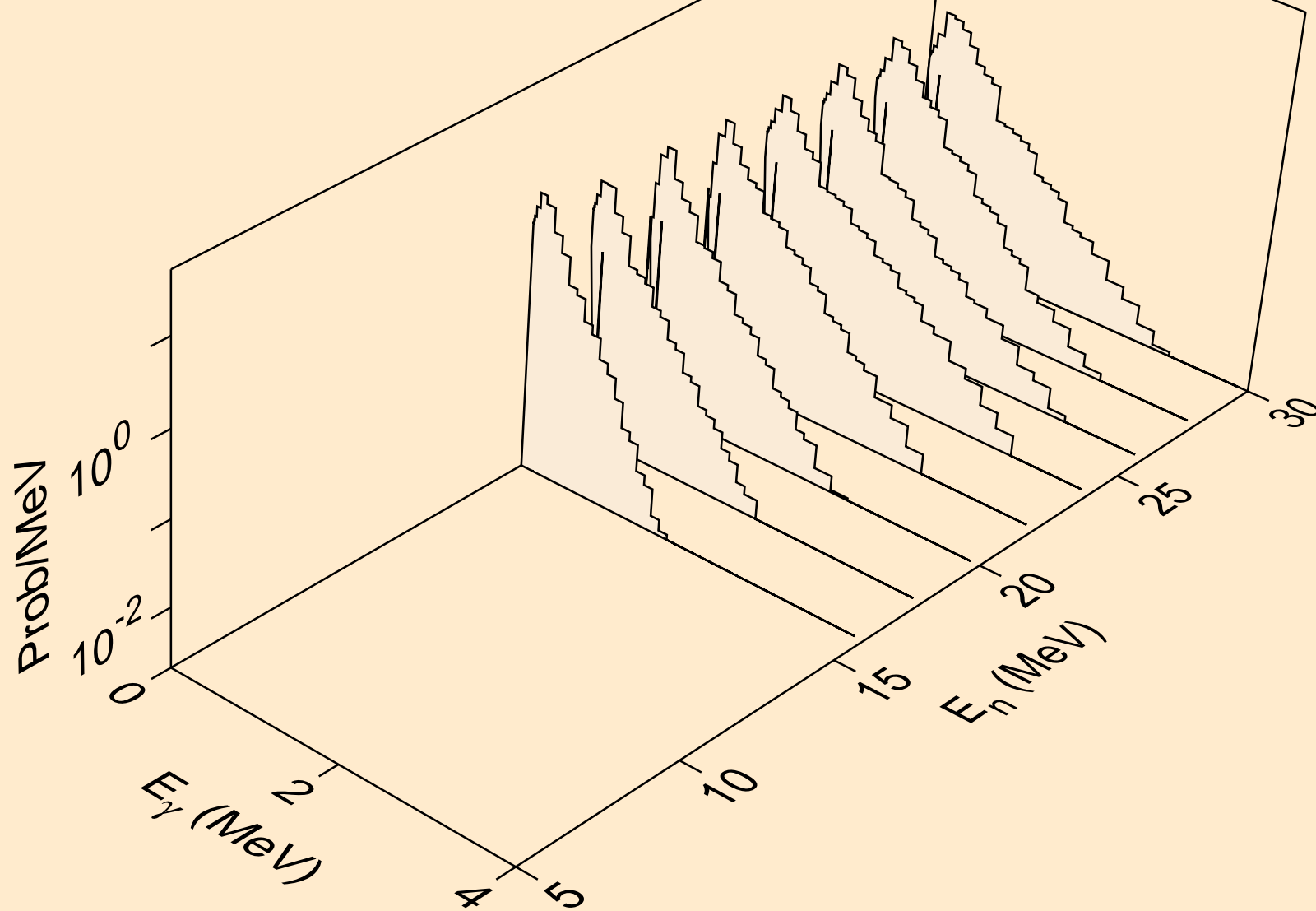

W191 DEUTERON ACER TENDL-2021 LIBRARY; T=0.K

Particle heating contributions

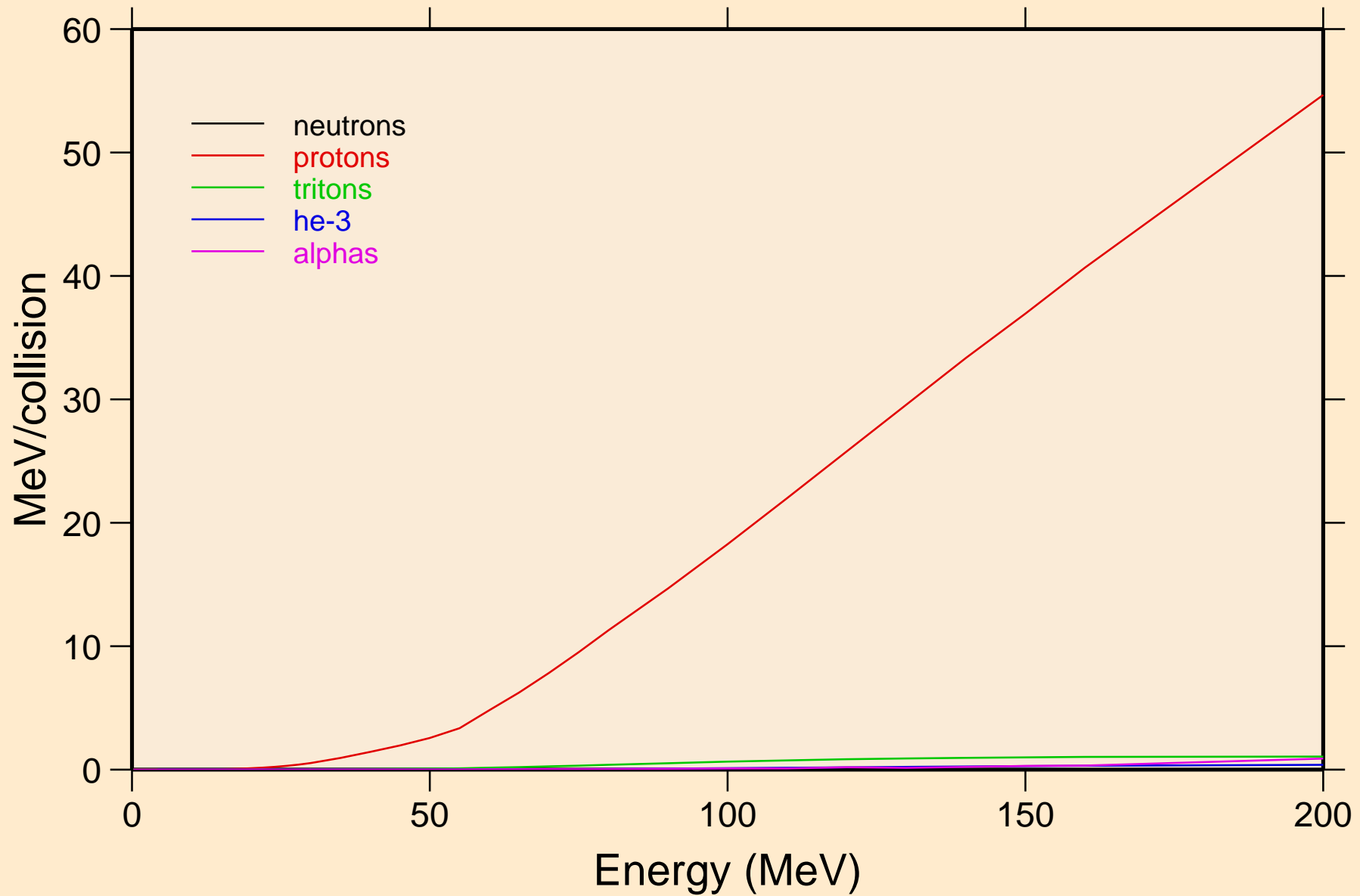

W191 DEUTERON ACER TENDL-2021 LIBRARY; T=0.K
Recoil Heating

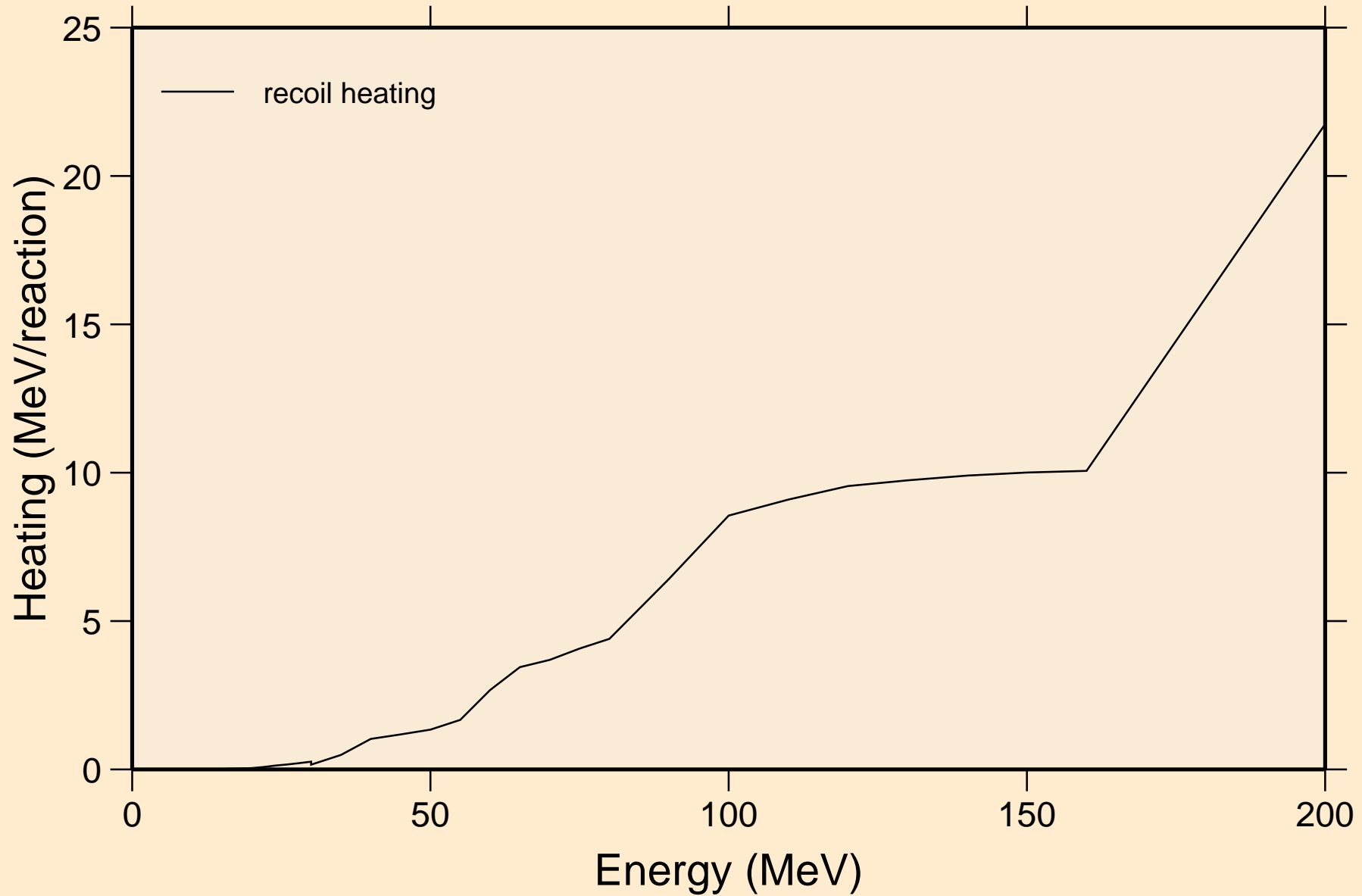

W191 DEUTERON ACER TENDL-2021 LIBRARY; T=0.K

Particle production cross sections

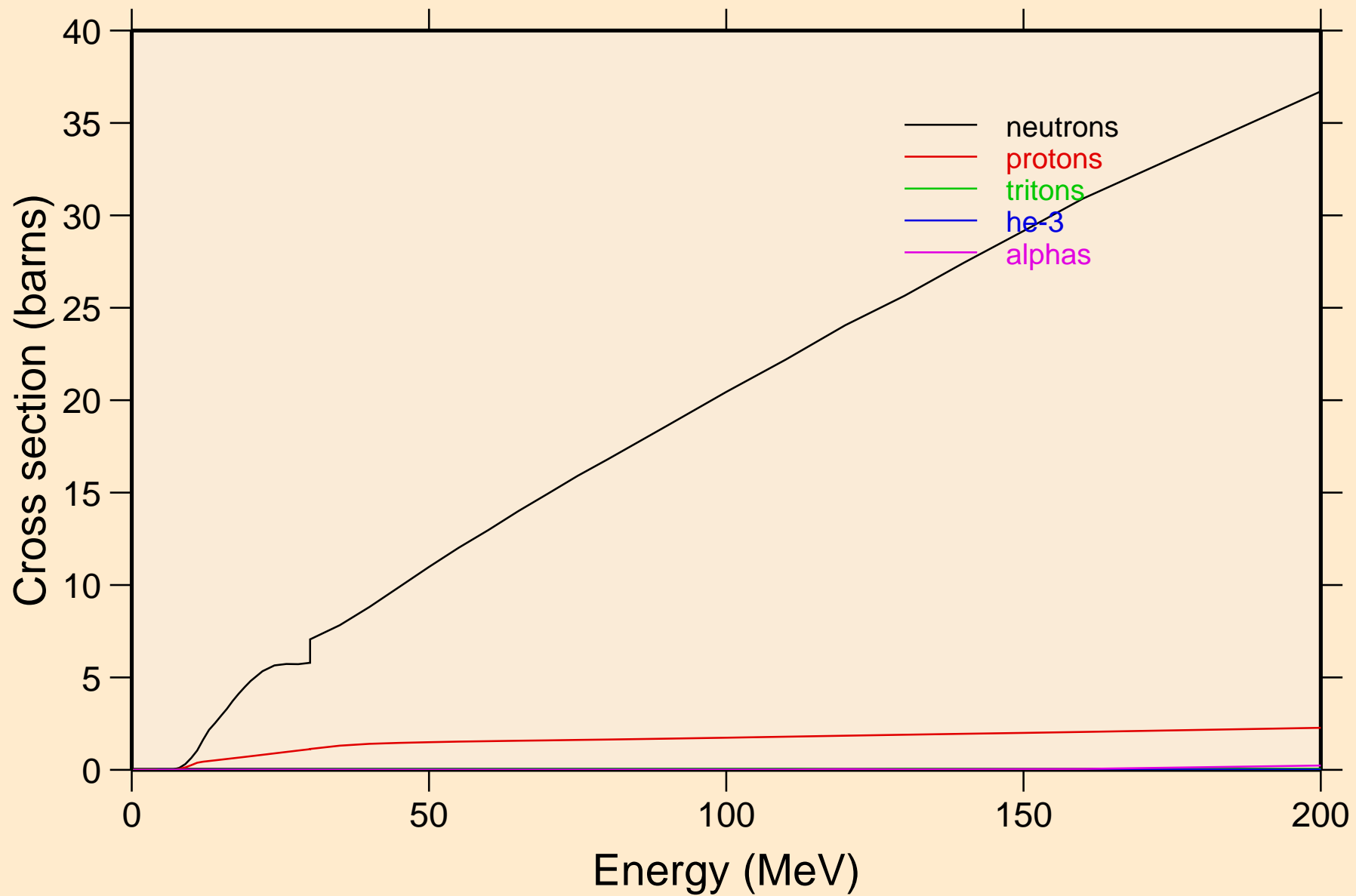

W191 DEUTERON ACER TENDL-2021 LIBRARY; T=0.K
neutrons from (d,n)

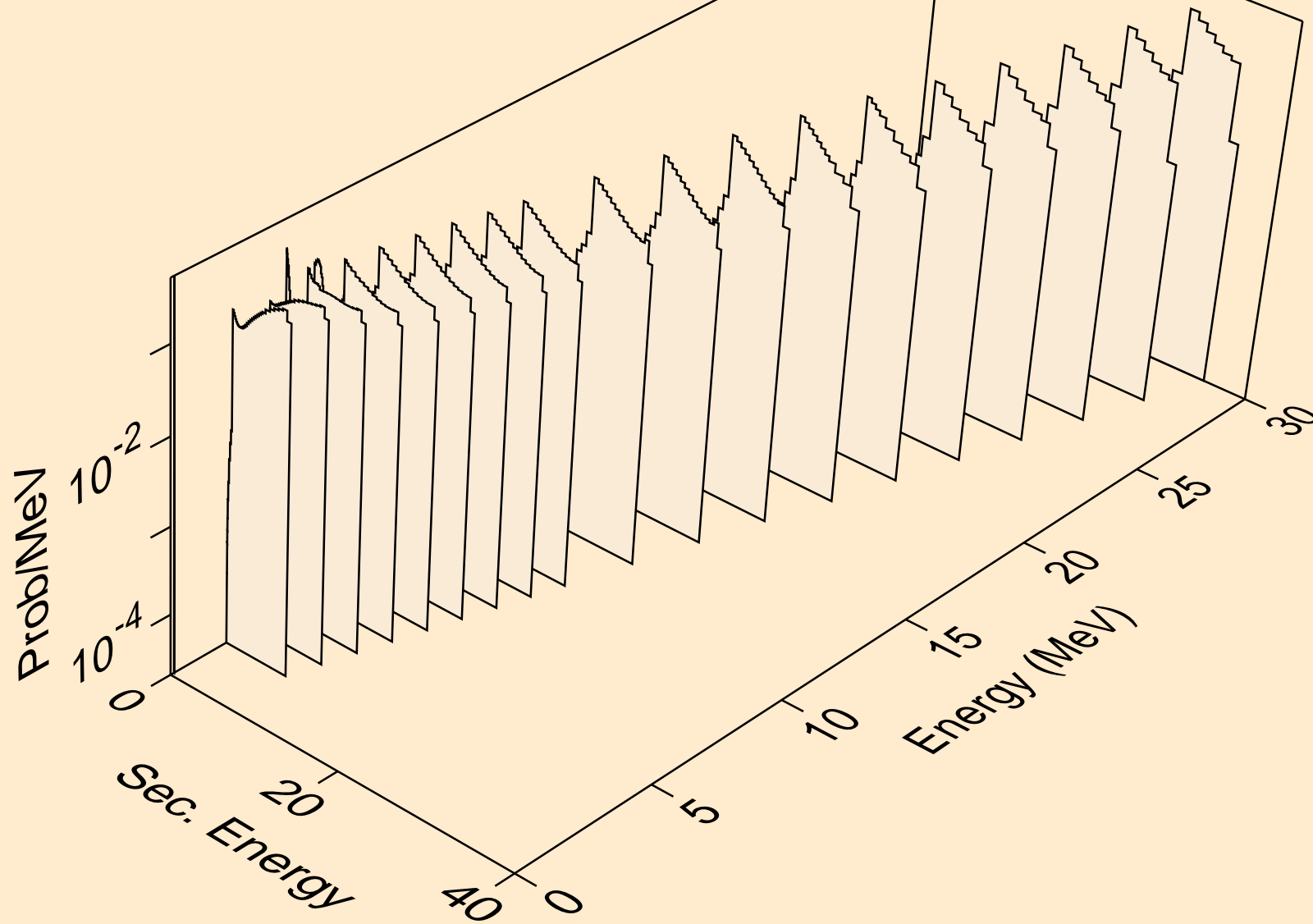

W191 DEUTERON ACER TENDL-2021 LIBRARY; T=0.K
neutrons from (d,x)

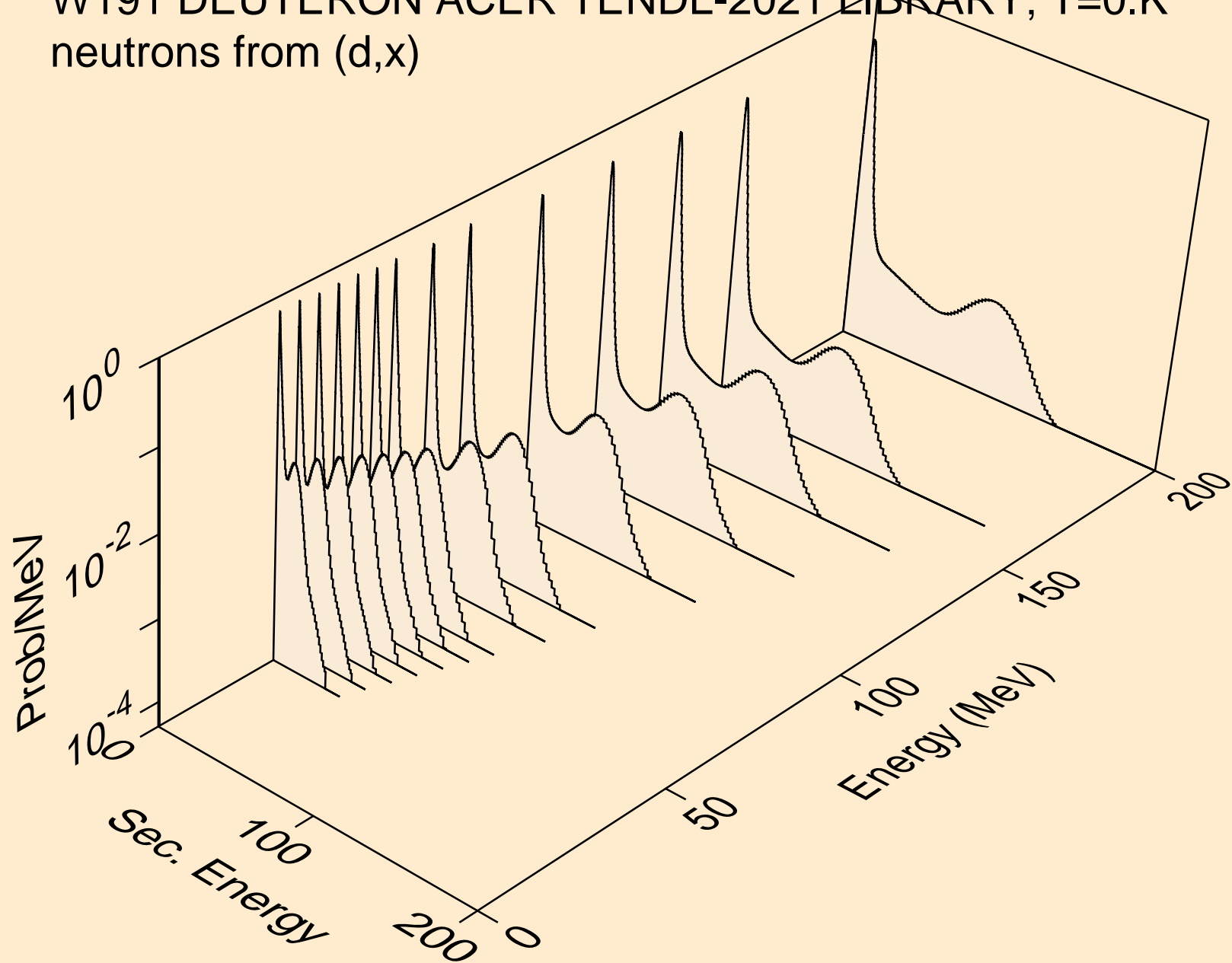

W191 DEUTERON ACER TENDL-2021 LIBRARY; T=0.K
neutrons from (d,2nd)

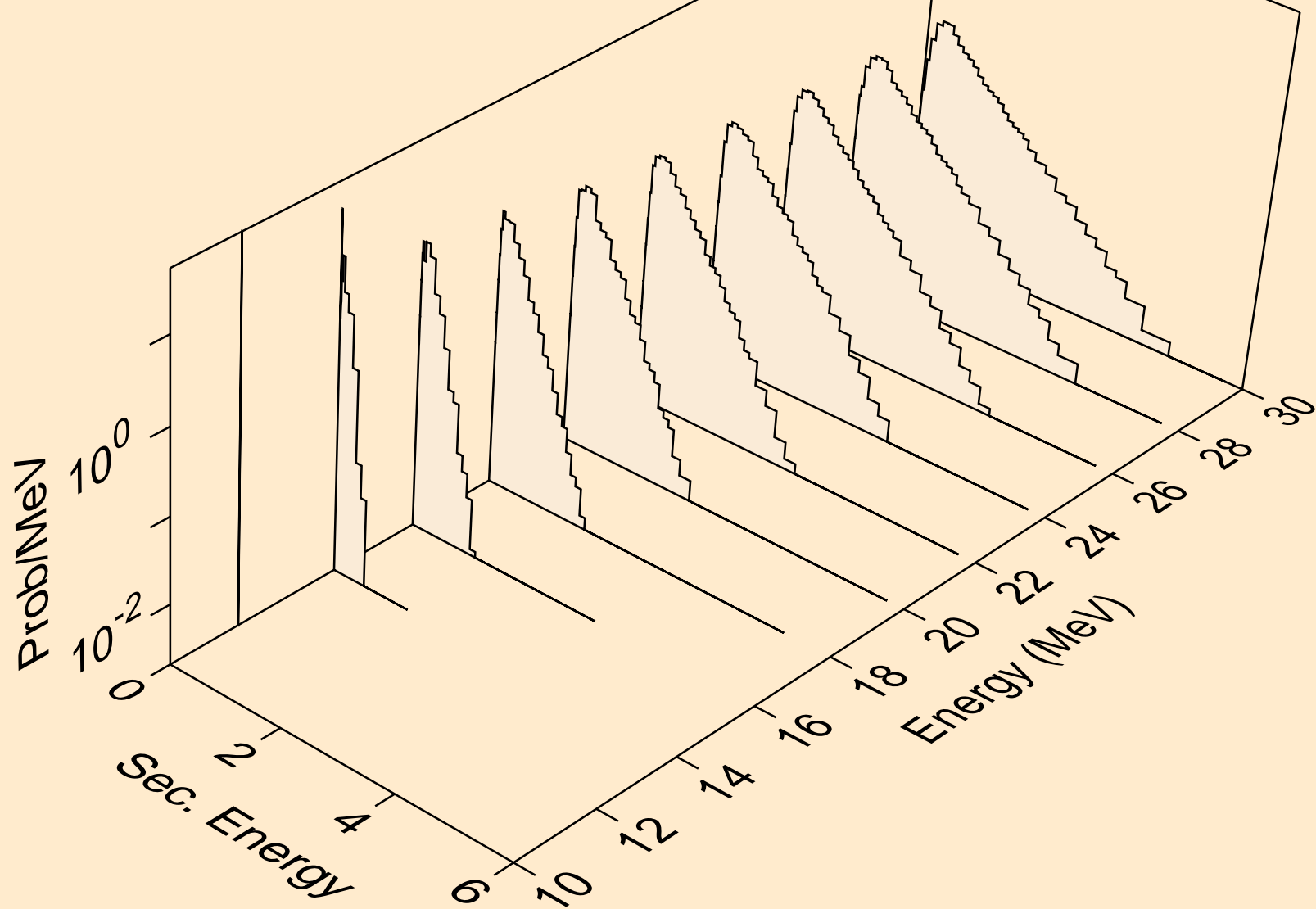

W191 DEUTERON ACER TENDL-2021 LIBRARY; T=0.K
neutrons from (d,2n)

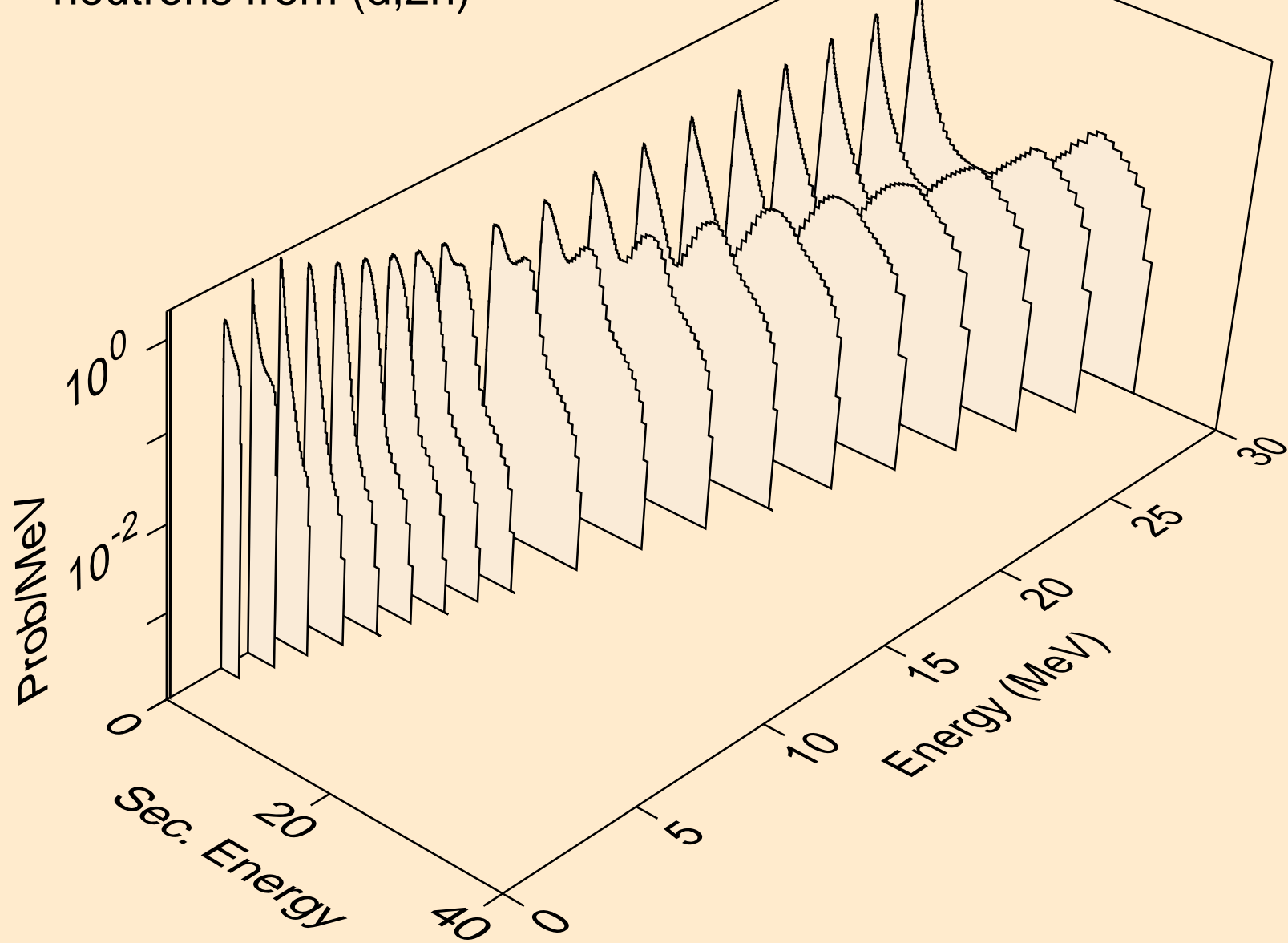

W191 DEUTERON ACER TENDL-2021 LIBRARY; T=0.K
neutrons from (d,3n)

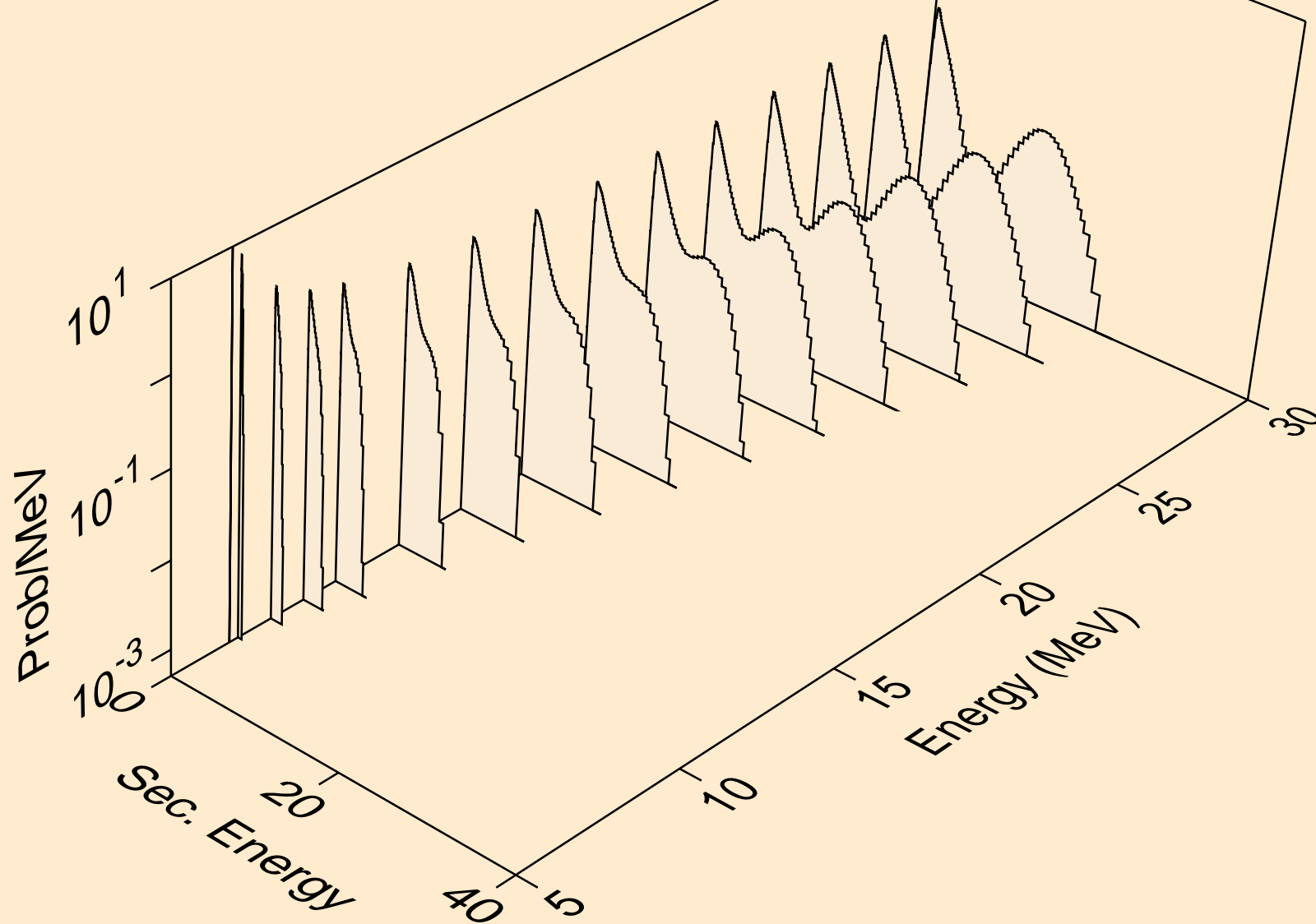

W191 DEUTERON ACER TENDL-2021 LIBRARY; T=0.K
neutrons from (d,n*)a

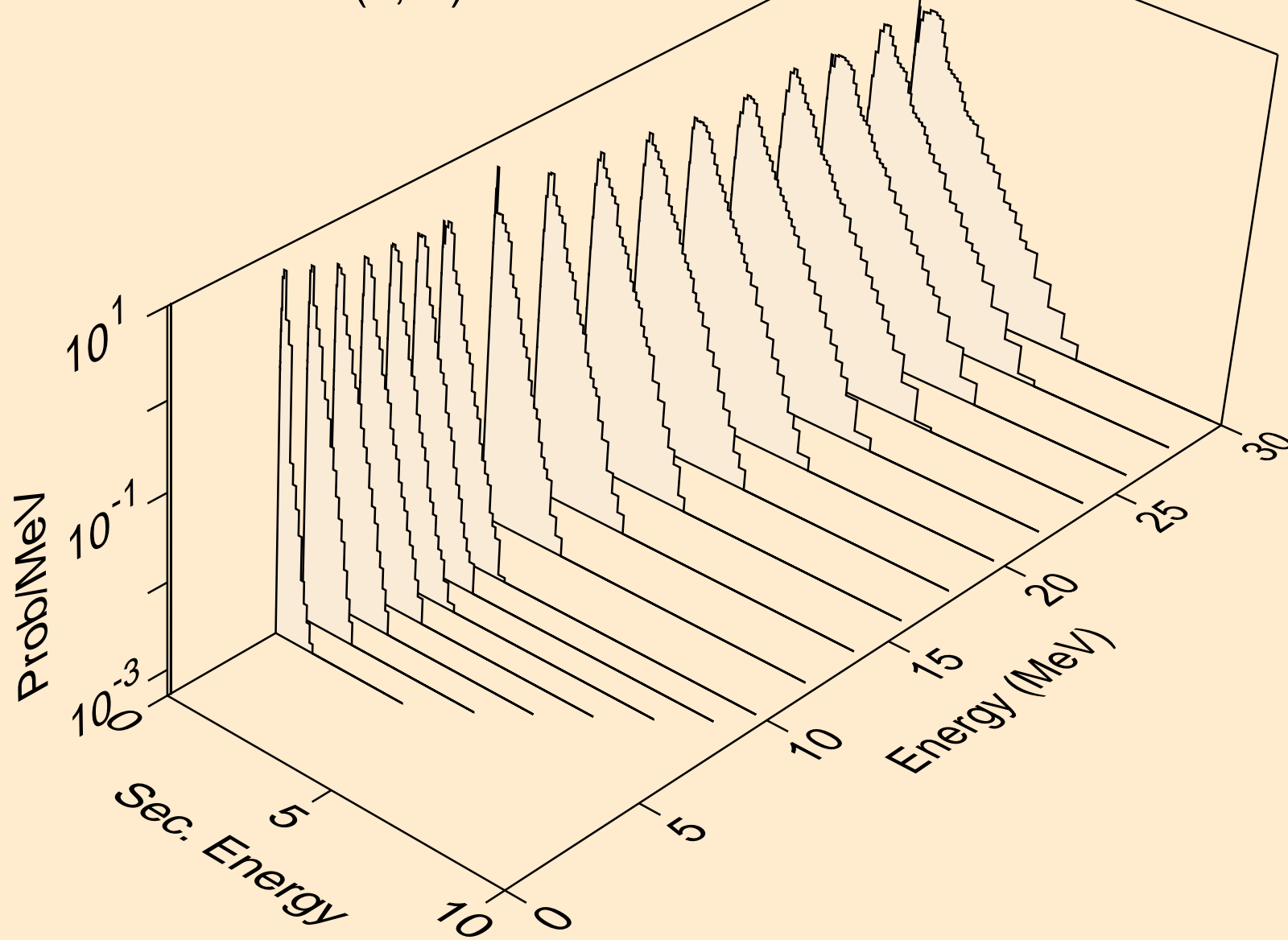

W191 DEUTERON ACER TENDL-2021 LIBRARY; T=0.K
neutrons from (d,2n)a

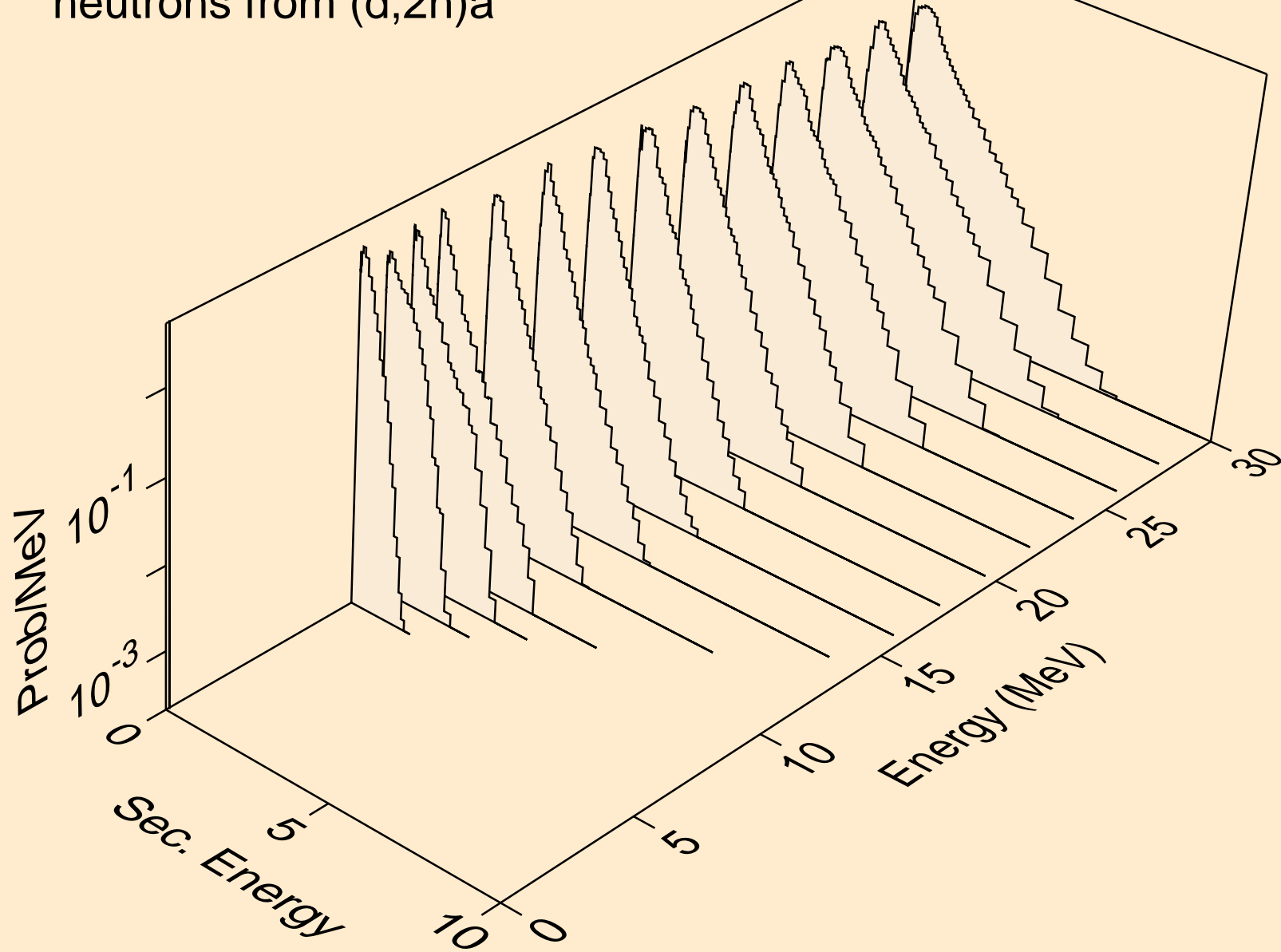

W191 DEUTERON ACER TENDL-2021 LIBRARY; T=0.K
neutrons from (d,3n)a

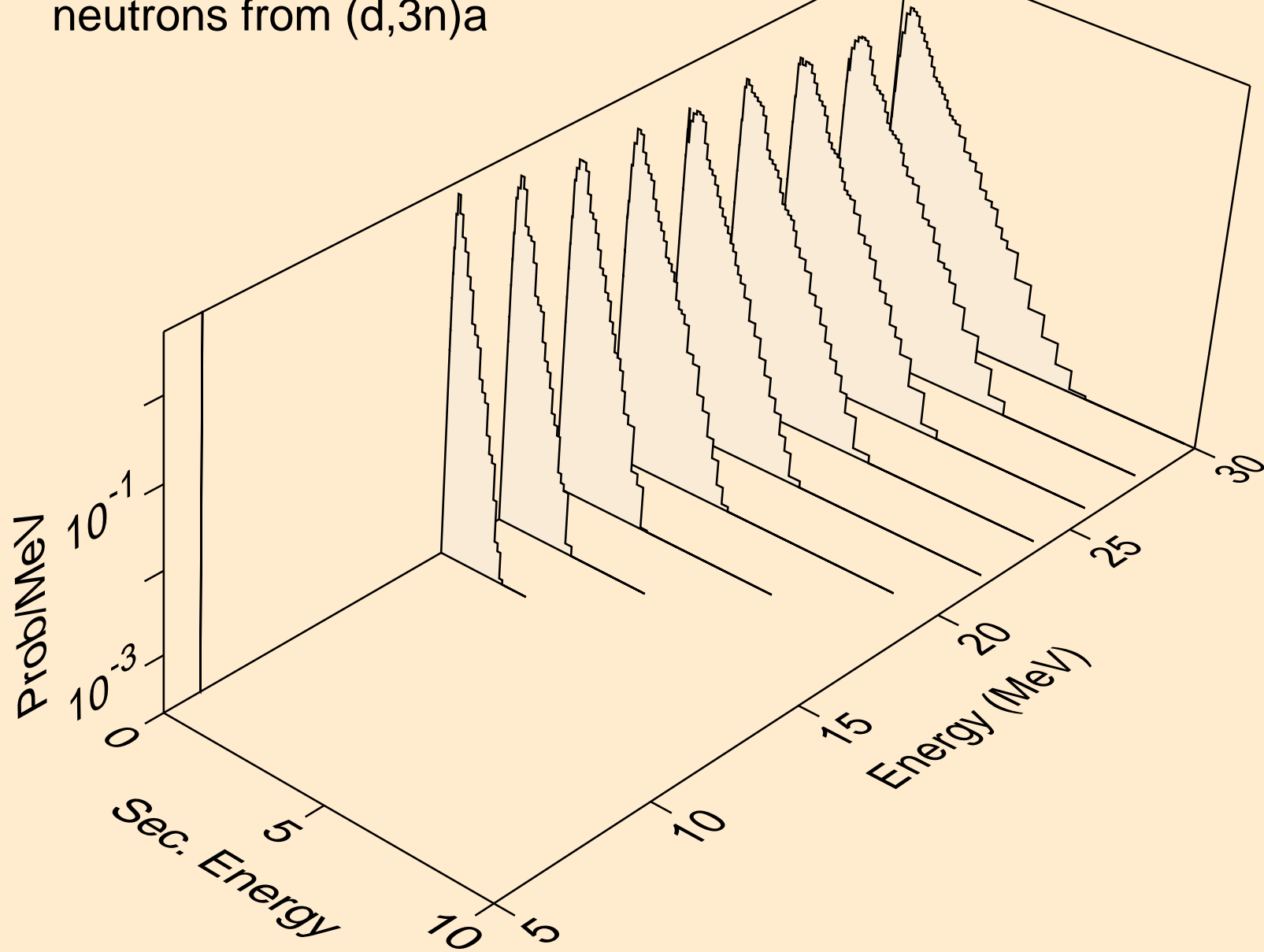

W191 DEUTERON ACER TENDL-2021 LIBRARY; T=0.K
neutrons from (d,n*)p

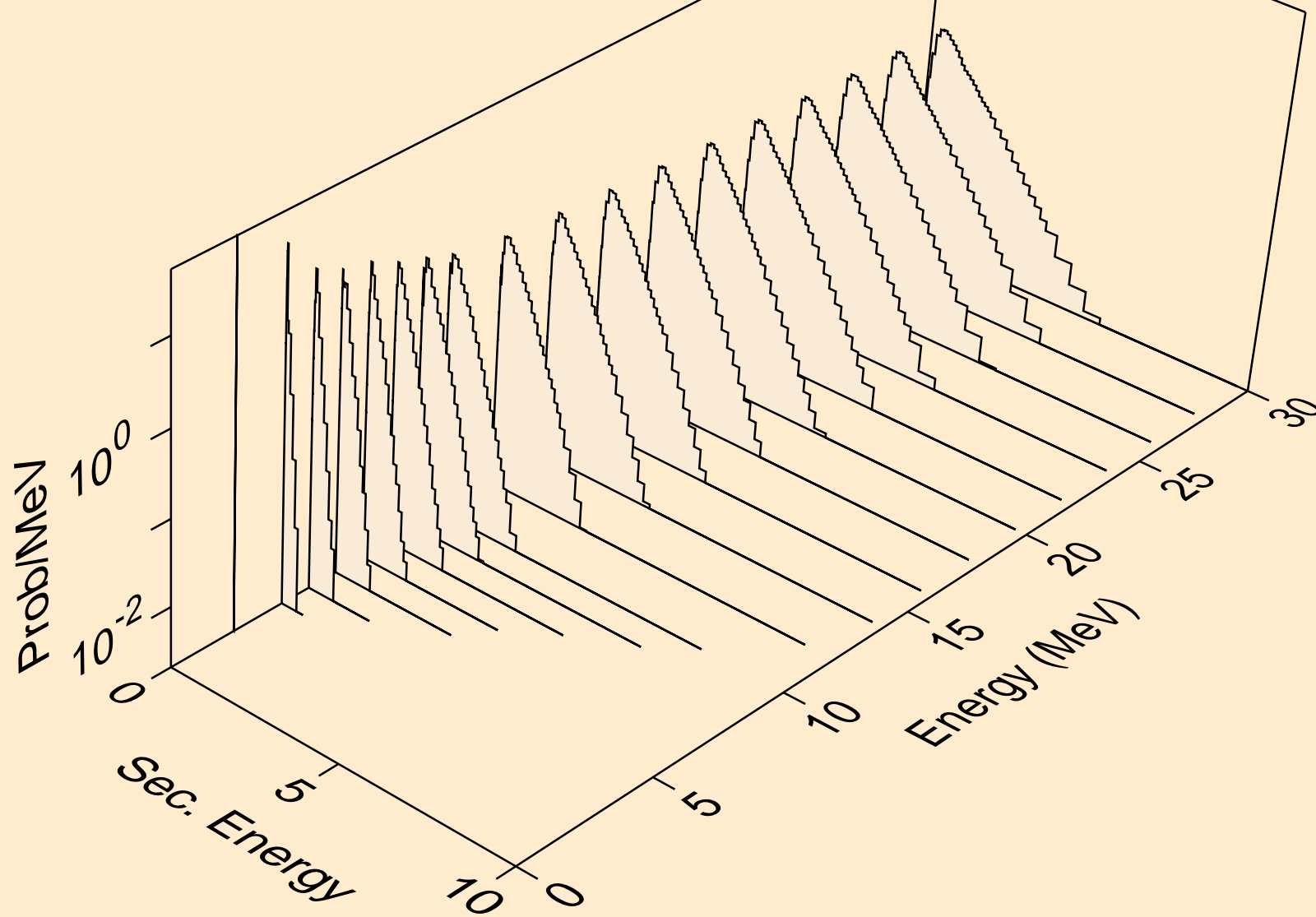

W191 DEUTERON ACER TENDL-2021 LIBRARY; T=0.K
neutrons from (d,n*)d

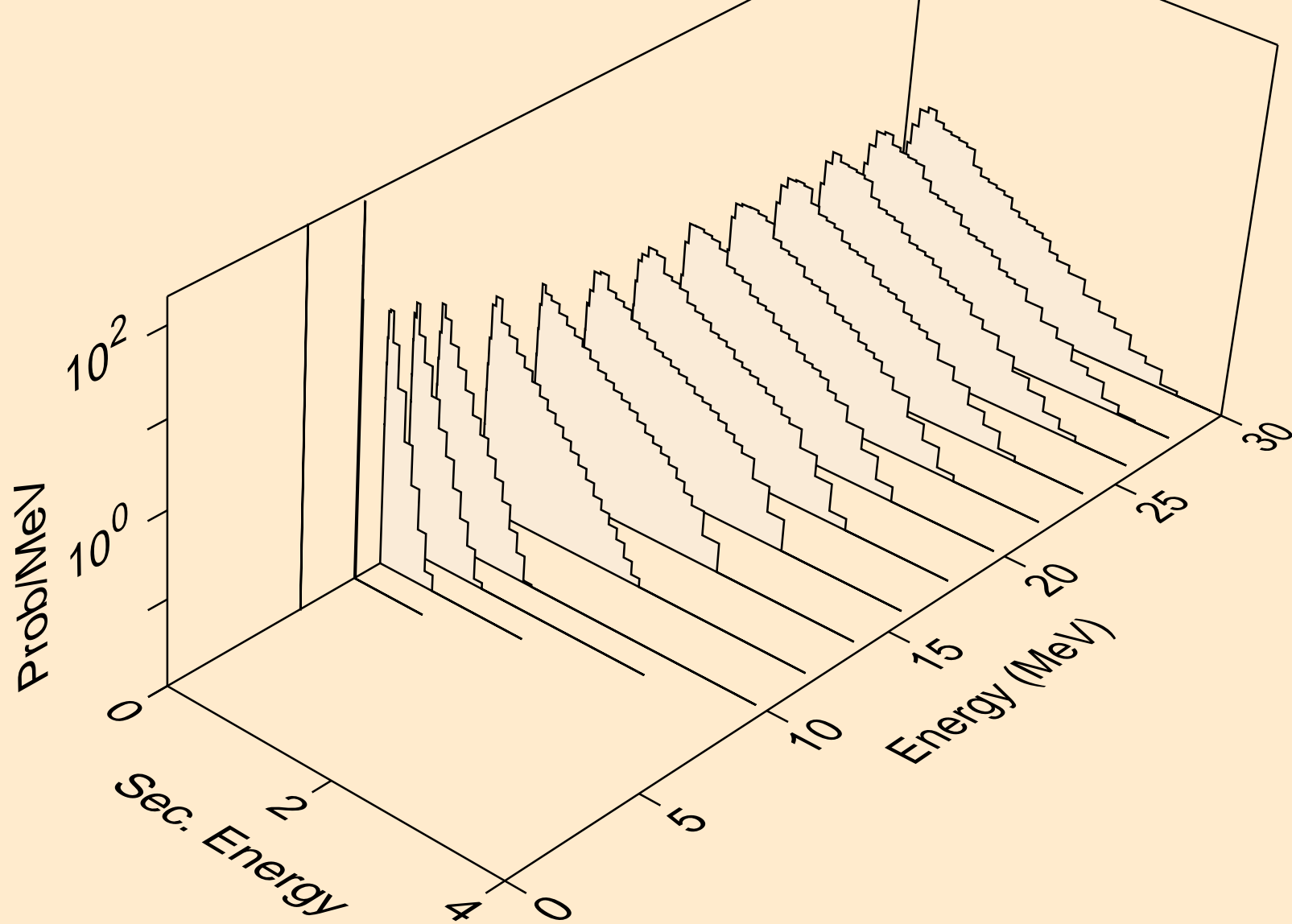

W191 DEUTERON ACER TENDL-2021 LIBRARY; T=0.K
neutrons from (d,n*)t

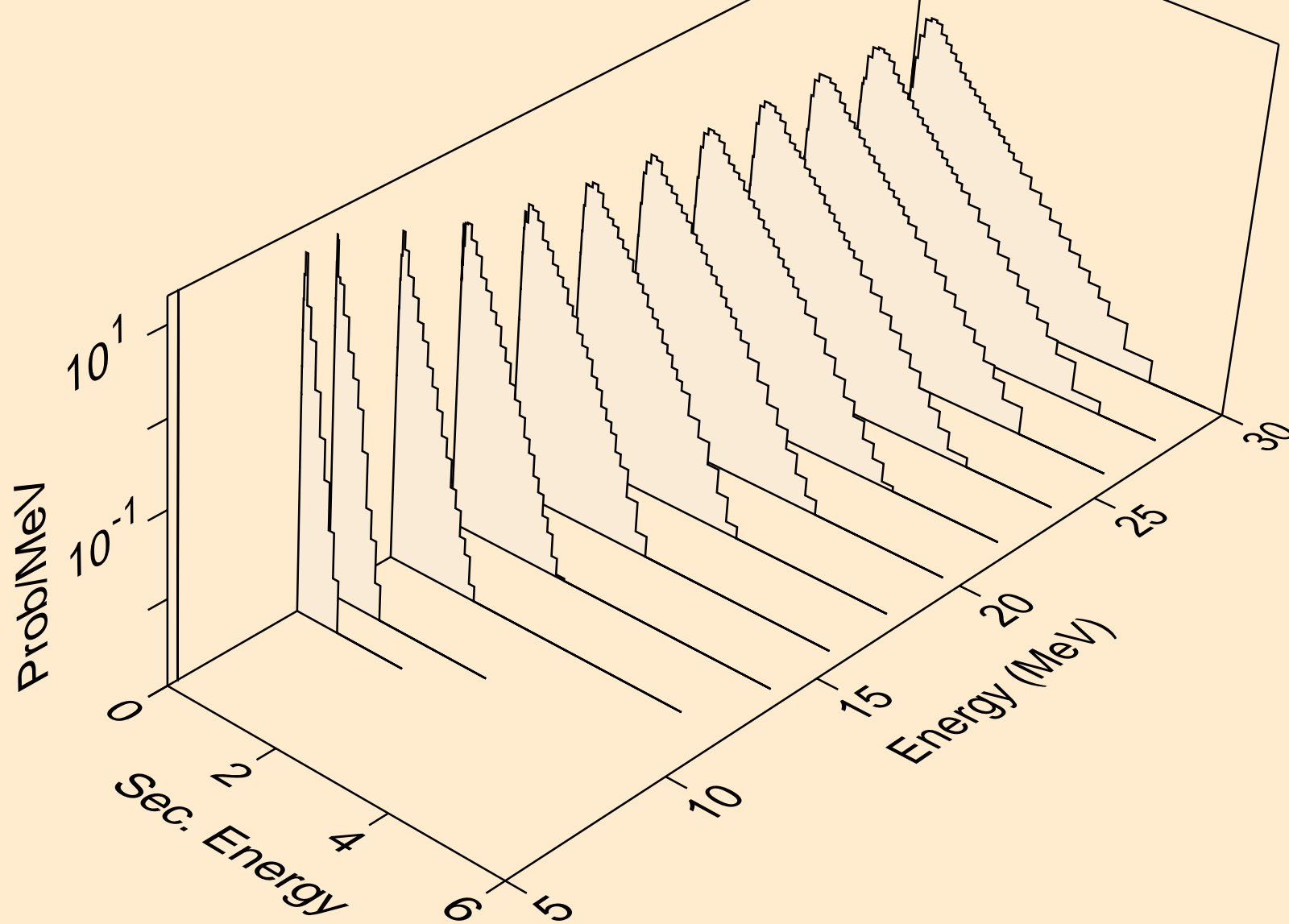

W191 DEUTERON ACER TENDL-2021 LIBRARY; T=0.K
neutrons from (d,n*)he3

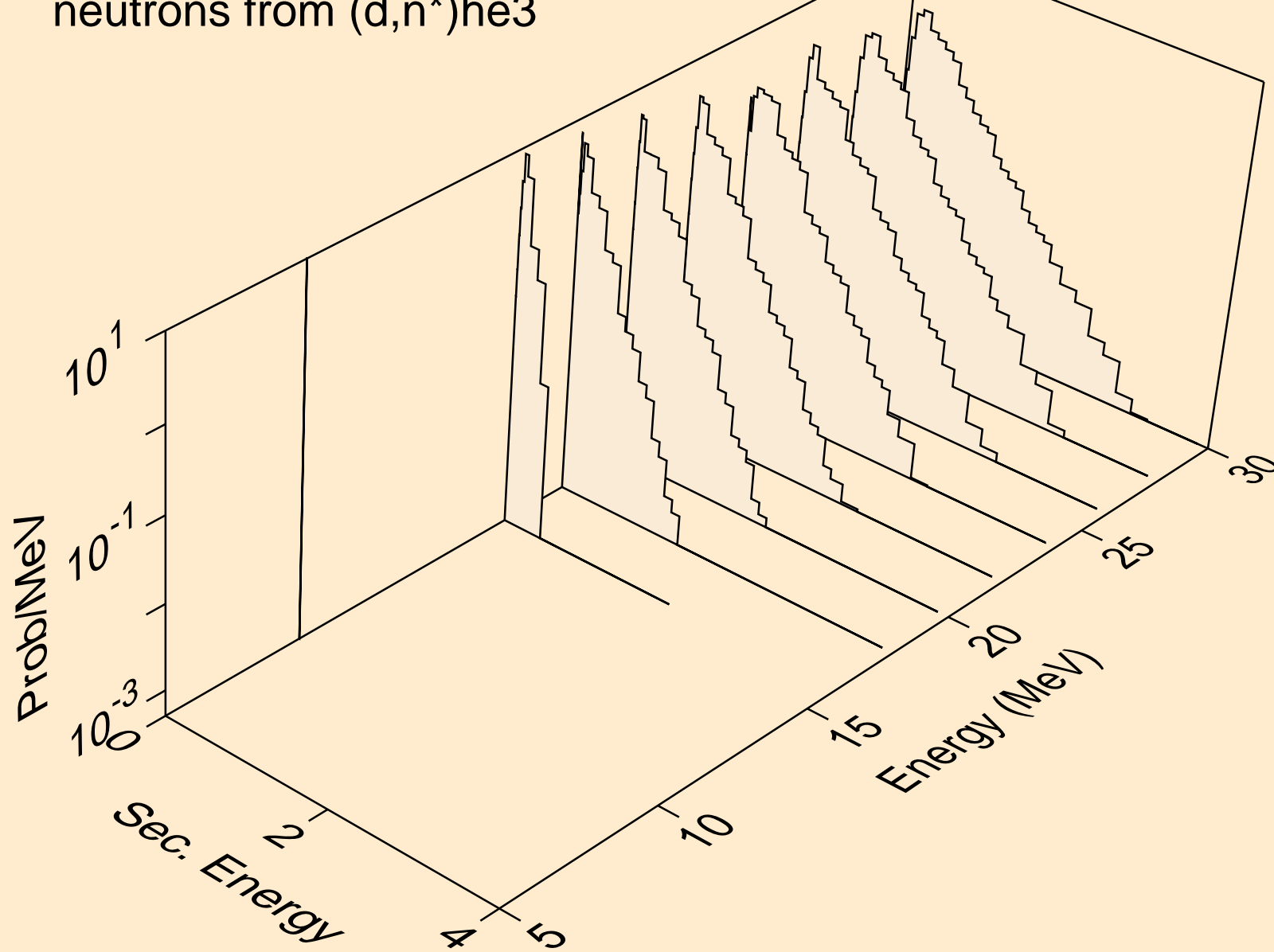

W191 DEUTERON ACER TENDL-2021 LIBRARY; T=0.K
neutrons from (d,4n)

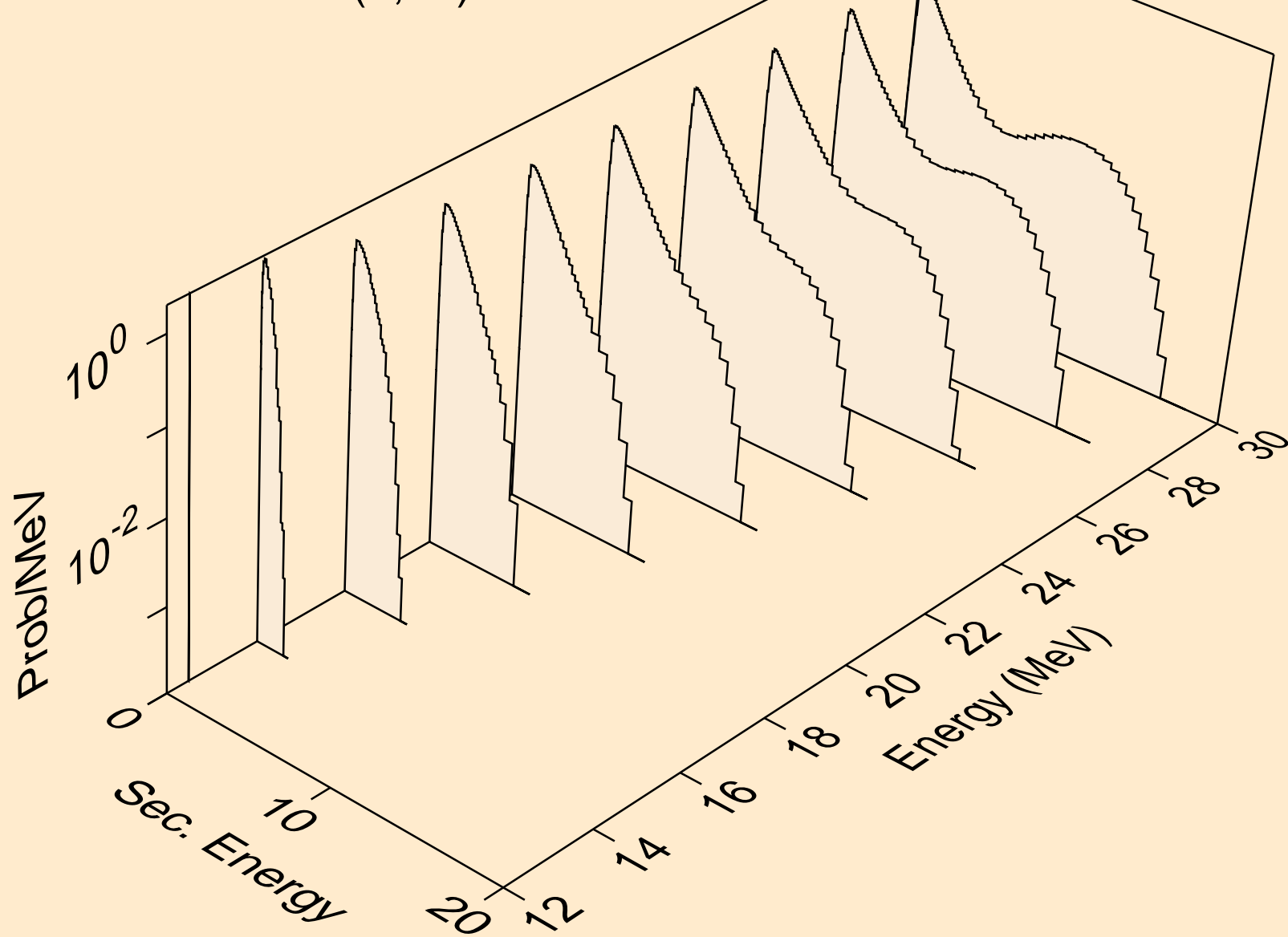

W191 DEUTERON ACER TENDL-2021 LIBRARY; T=0.K
neutrons from (d,2np)

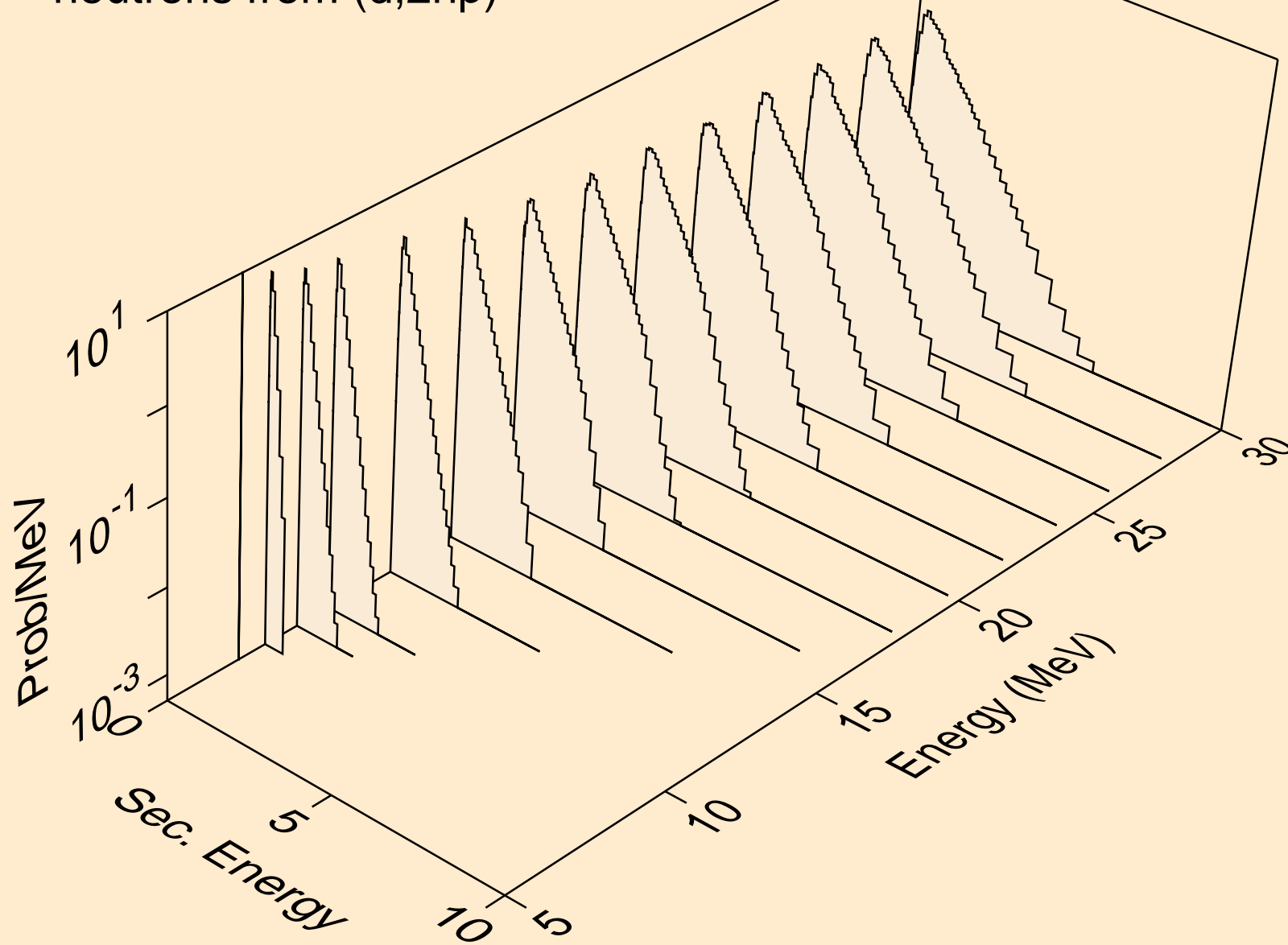

W191 DEUTERON ACER TENDL-2021 LIBRARY; T=0.K
neutrons from (d,3np)

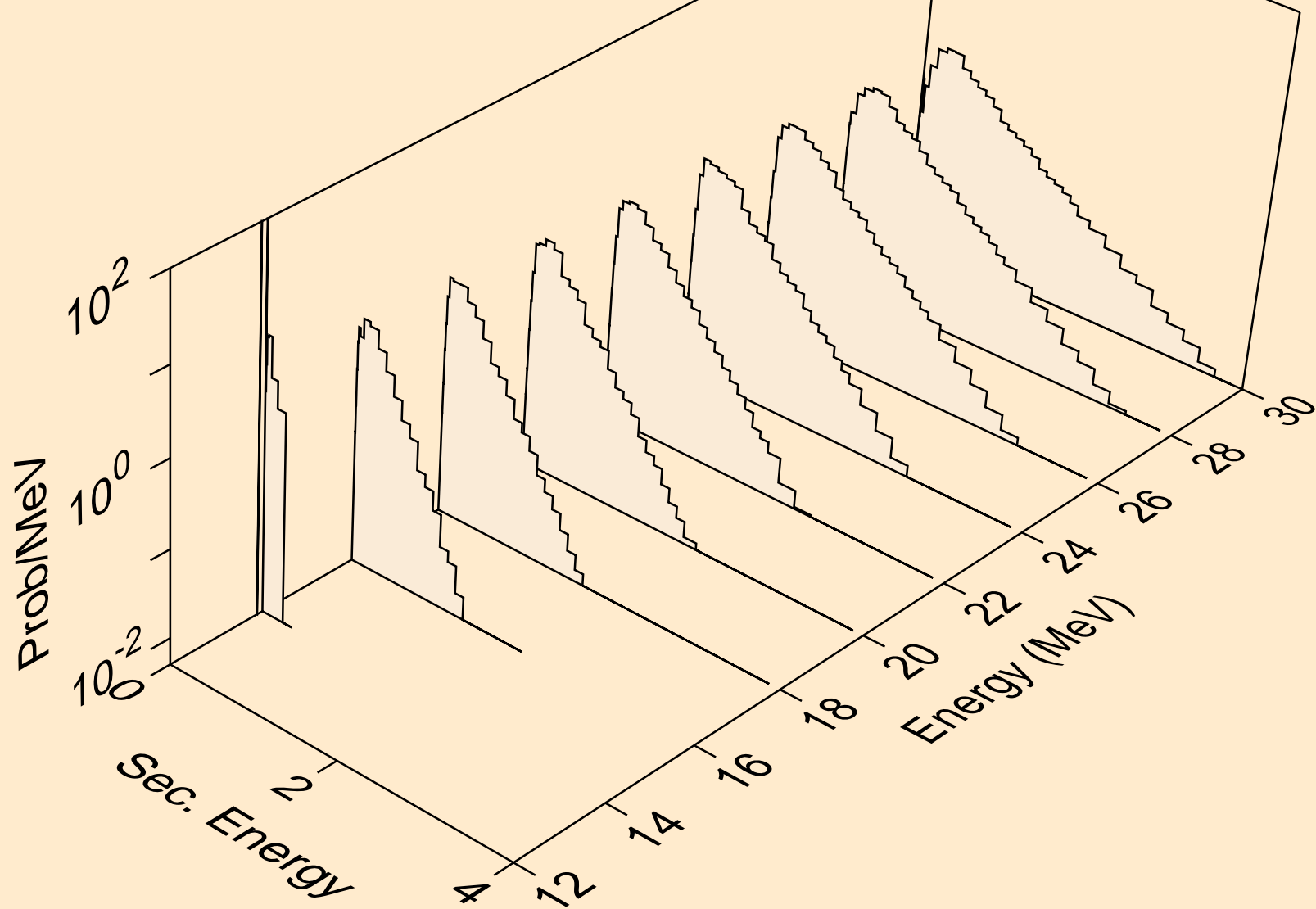

W191 DEUTERON ACER TENDL-2021 LIBRARY; T=0.K
neutrons from (d,2np)

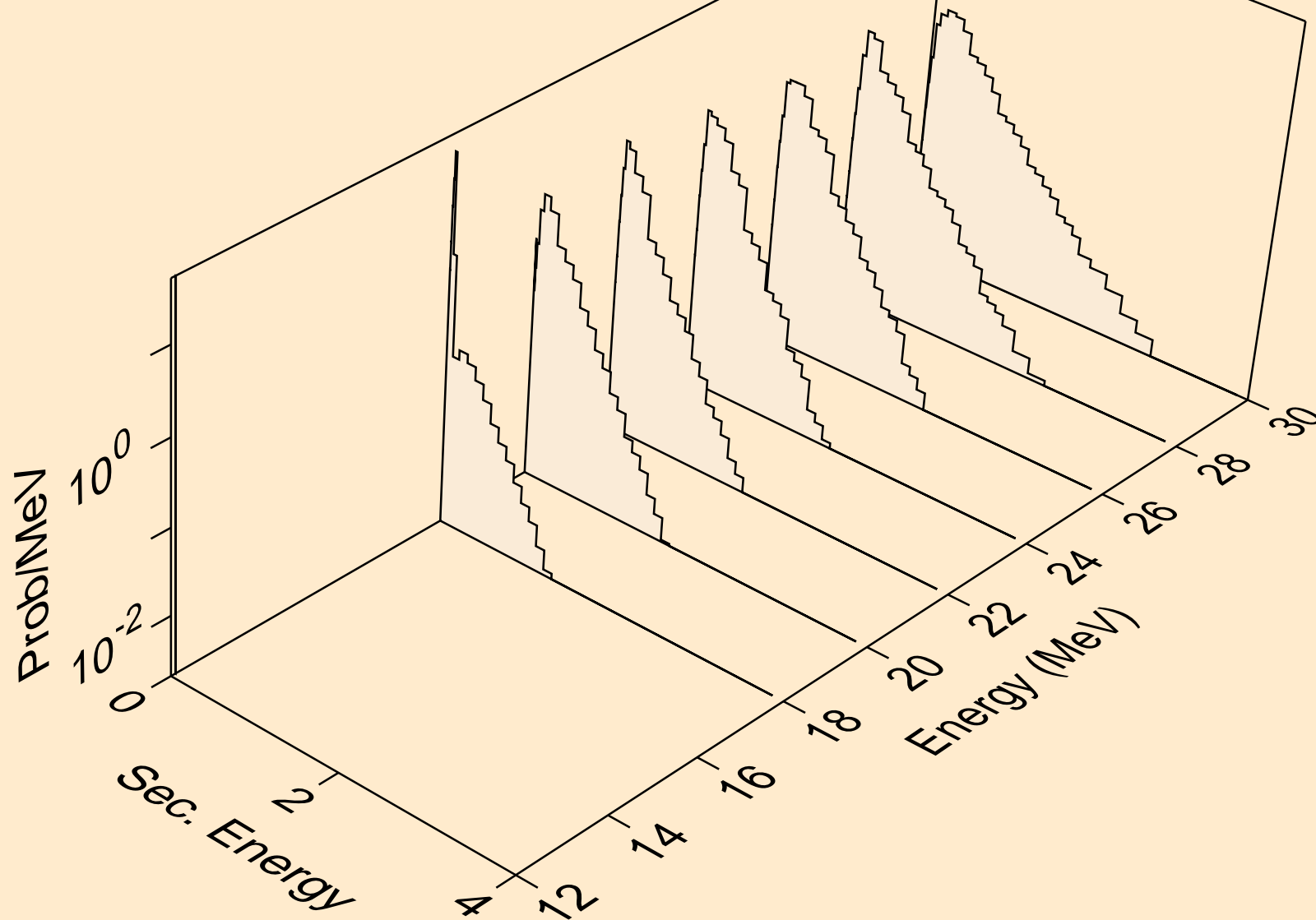

W191 DEUTERON ACER TENDL-2021 LIBRARY; T=0.K
neutrons from (d,npa)

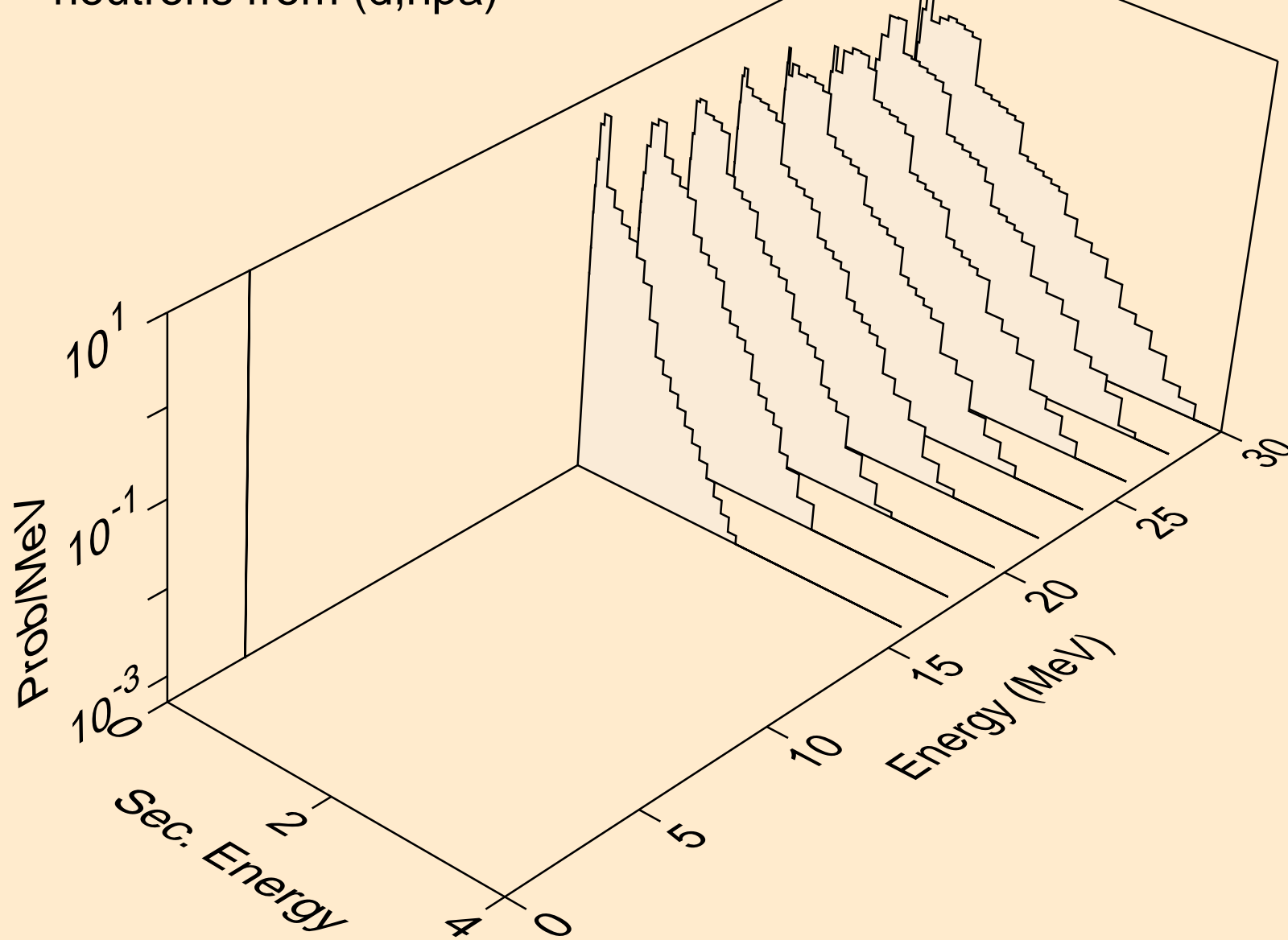

W191 DEUTERON ACER TENDL-2021 LIBRARY; T=0.K
protons from (d,x)

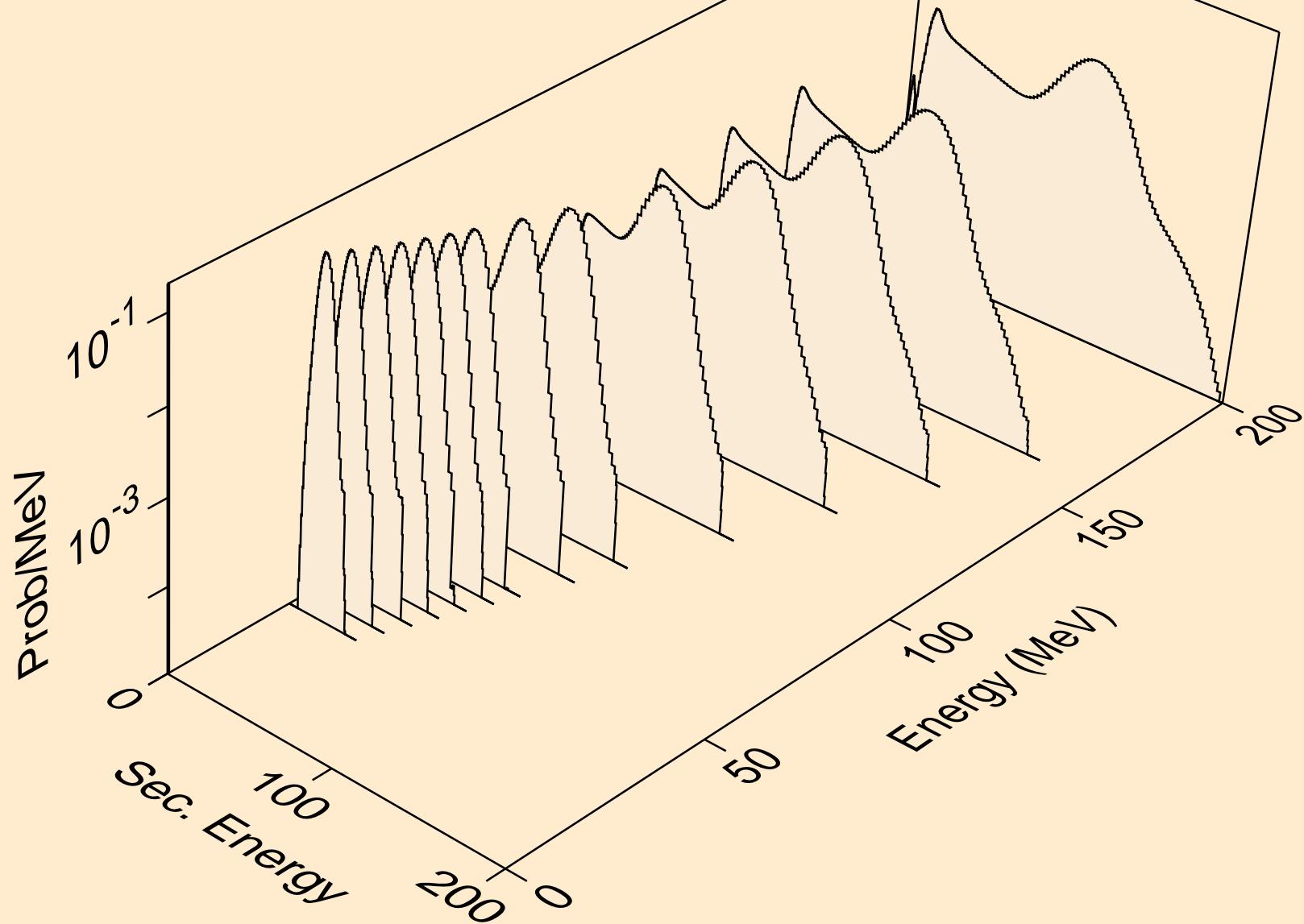

W191 DEUTERON ACER TENDL-2021 LIBRARY; T=0.K
protons from (d,n*)p

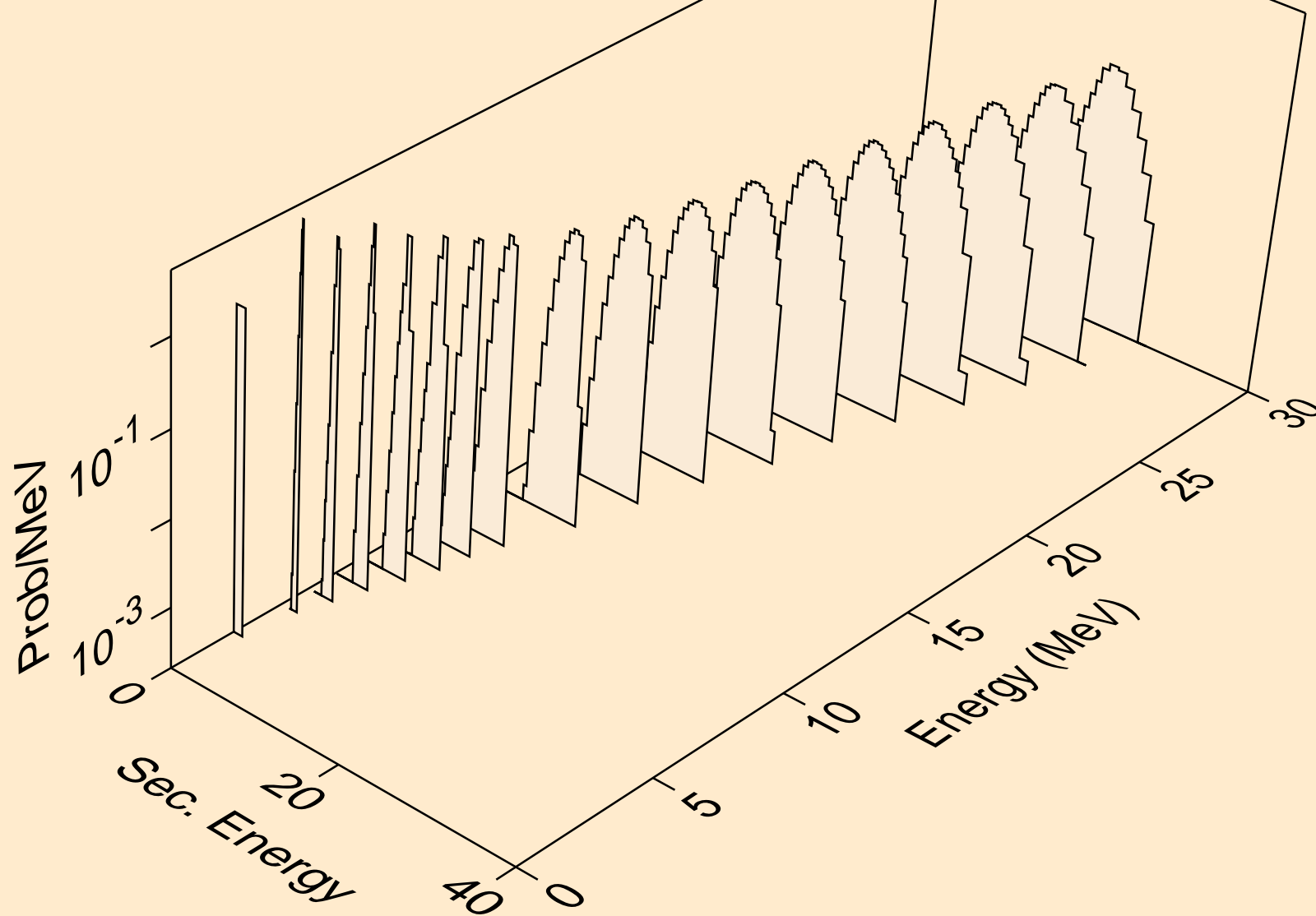

W191 DEUTERON ACER TENDL-2021 LIBRARY; T=0.K
protons from (d,2np)

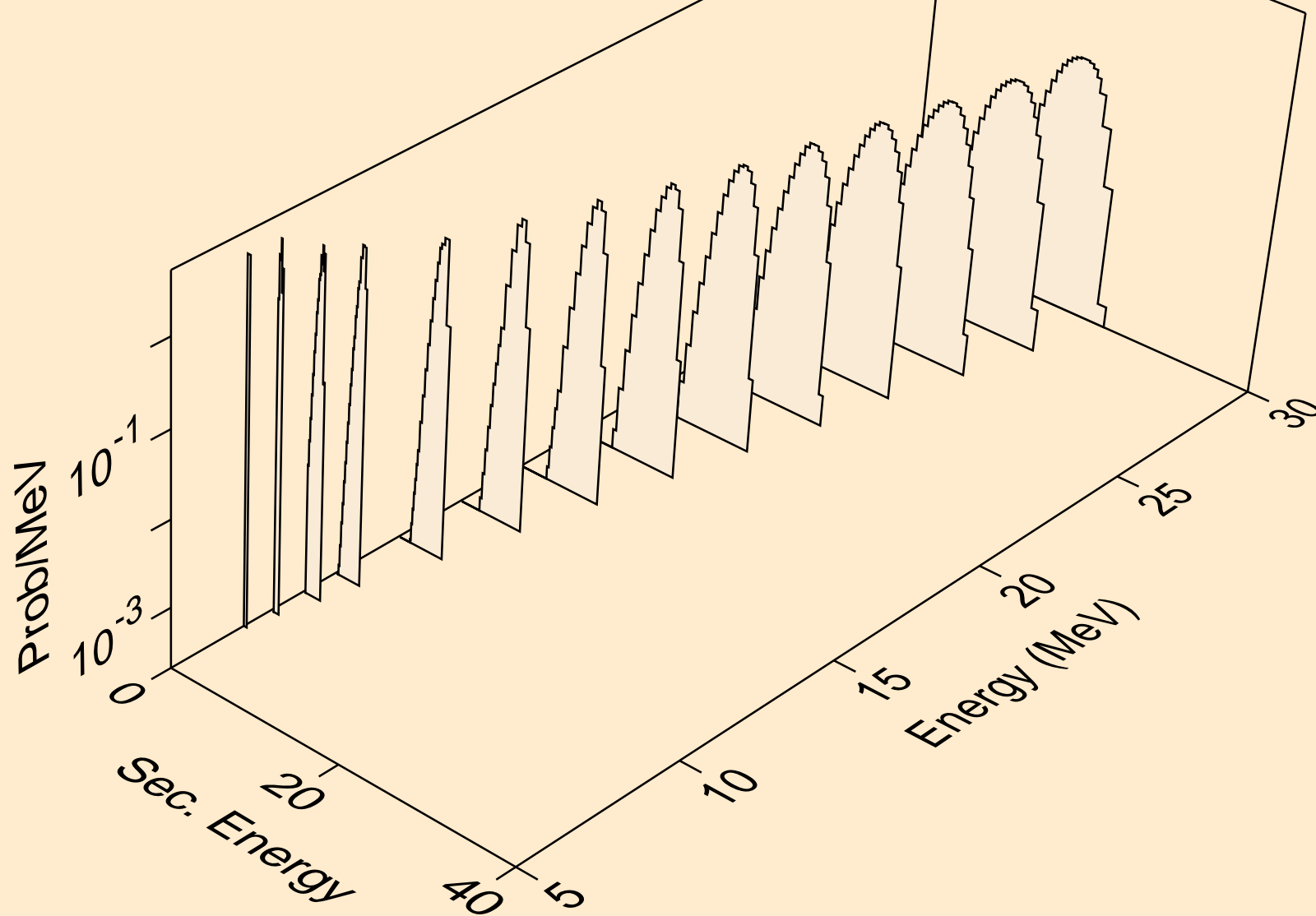

W191 DEUTERON ACER TENDL-2021 LIBRARY; T=0.K
protons from (d,3np)

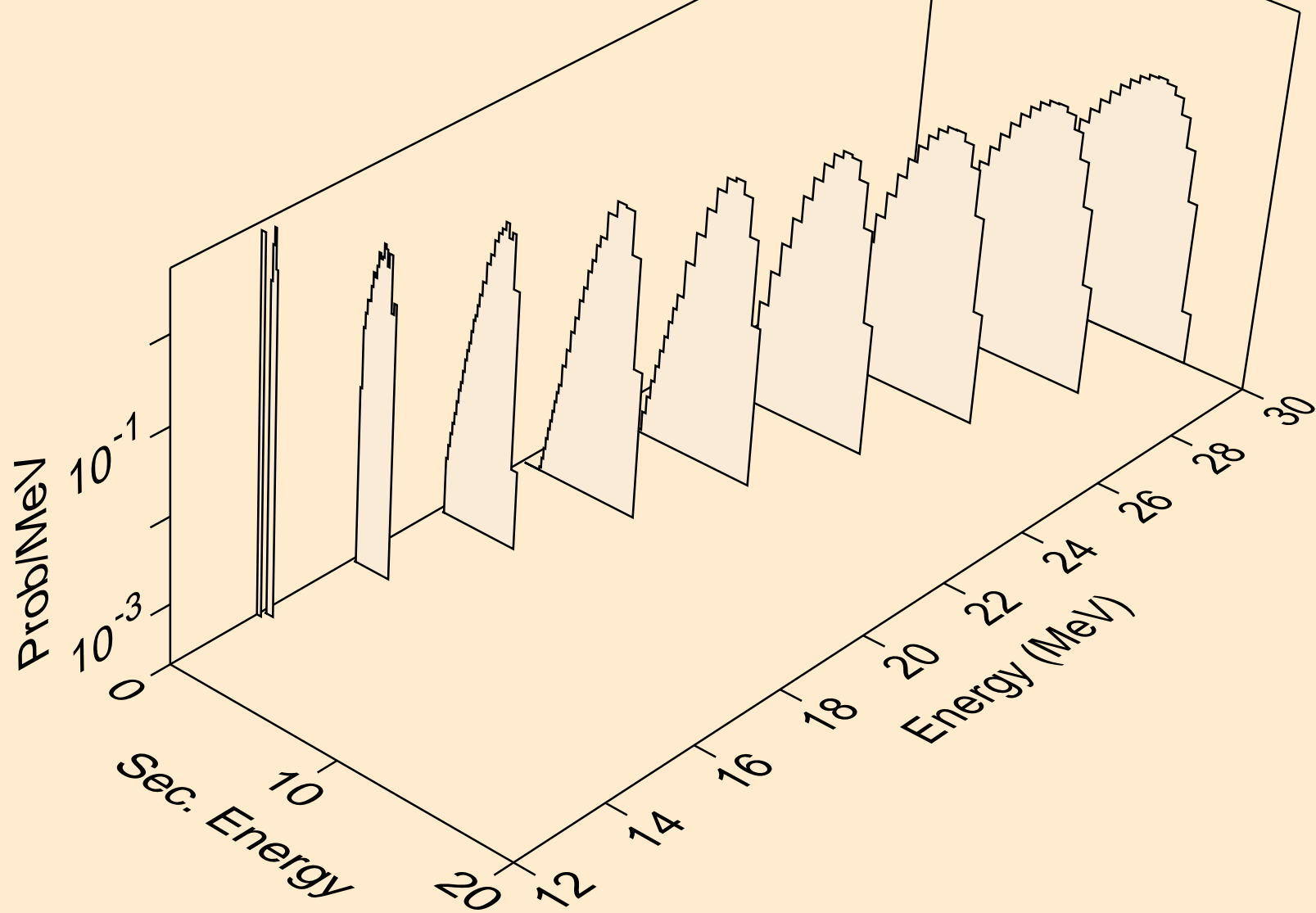

W191 DEUTERON ACER TENDL-2021 LIBRARY; T=0.K
protons from (d,2np)

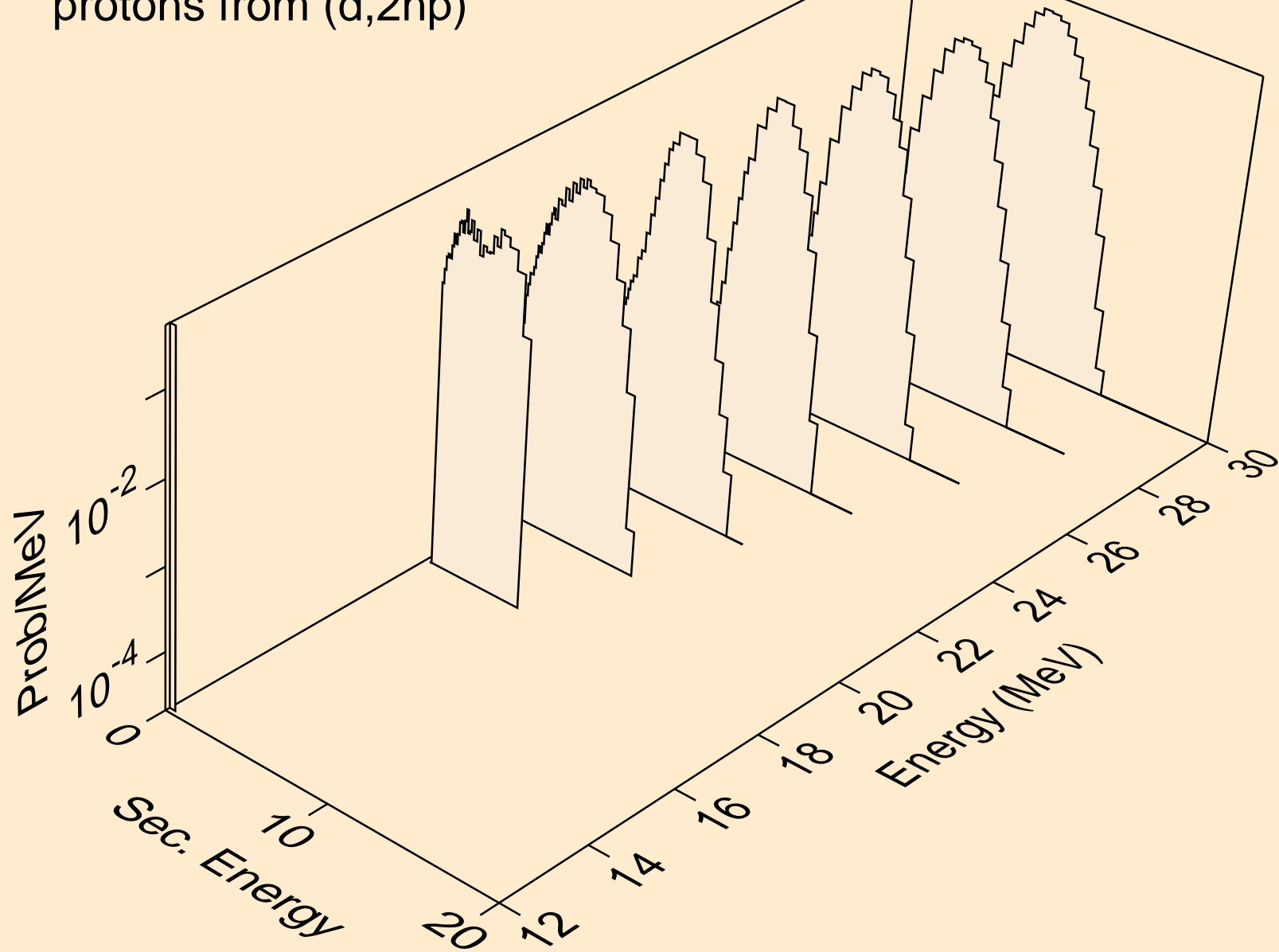

W191 DEUTERON ACER TENDL-2021 LIBRARY; T=0.K
protons from (d,npa)

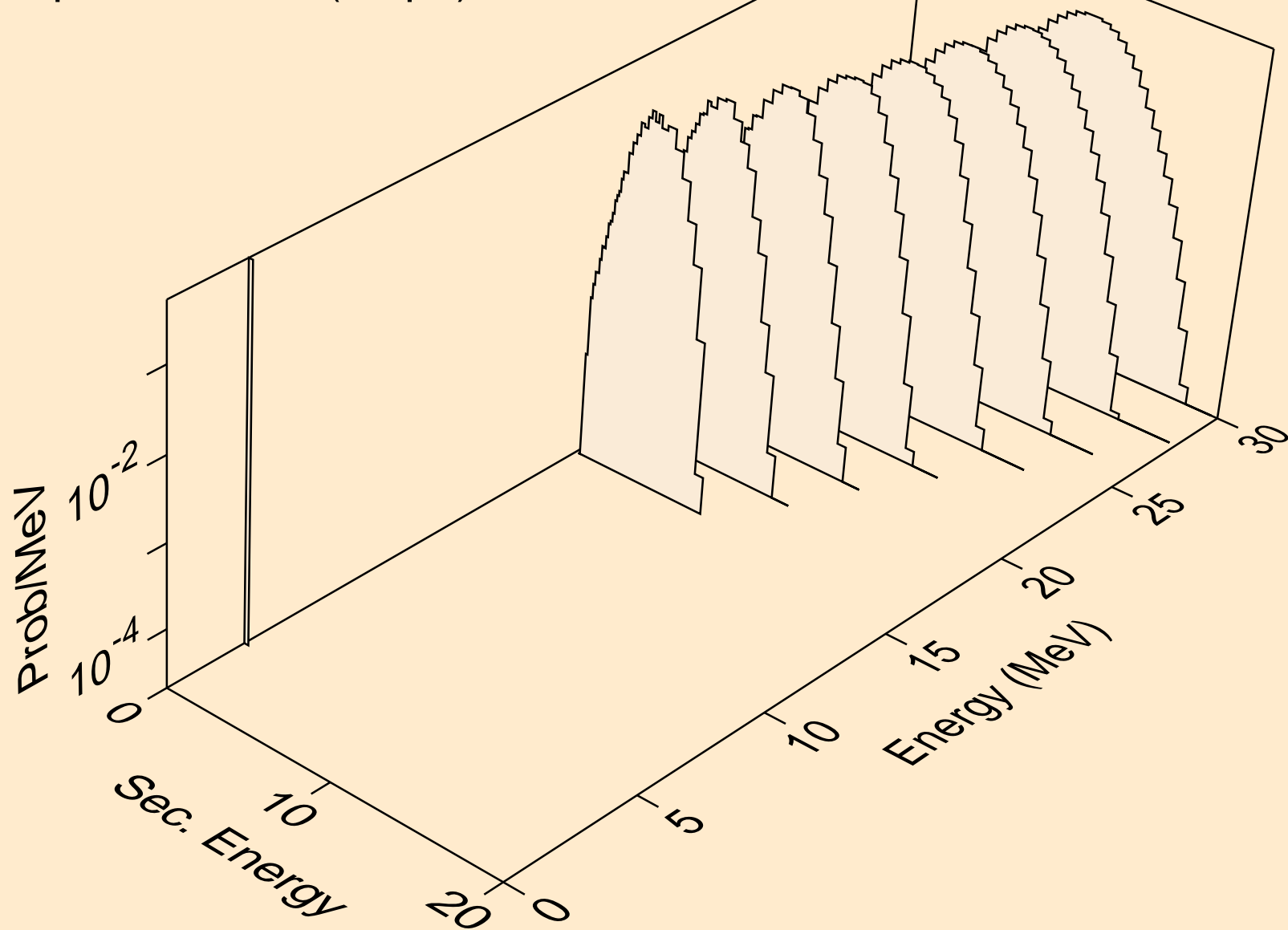

W191 DEUTERON ACER TENDL-2021 LIBRARY; T=0.K
protons from (d,p)

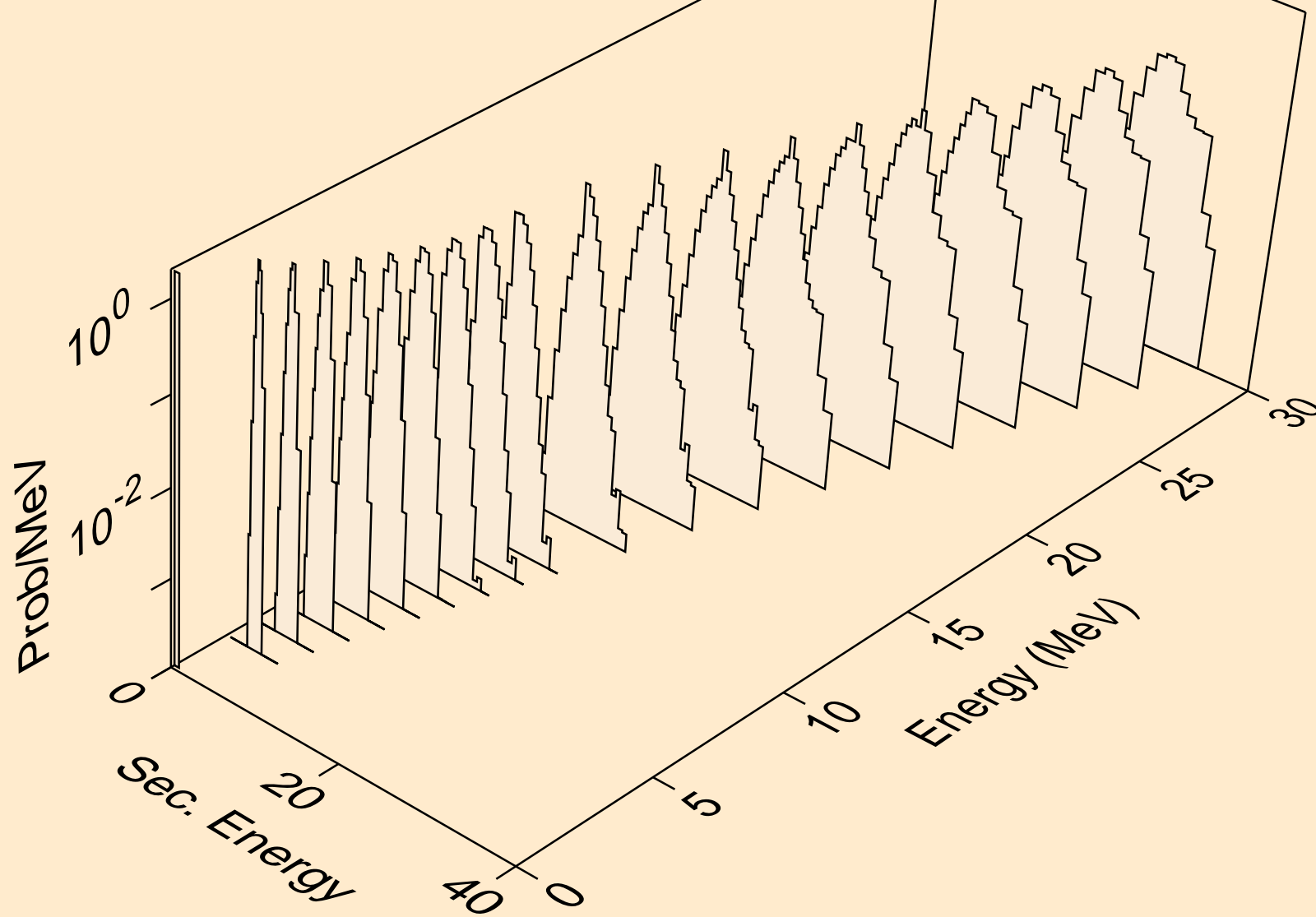

W191 DEUTERON ACER TENDL-2021 LIBRARY; T=0.K
protons from (d,2p)

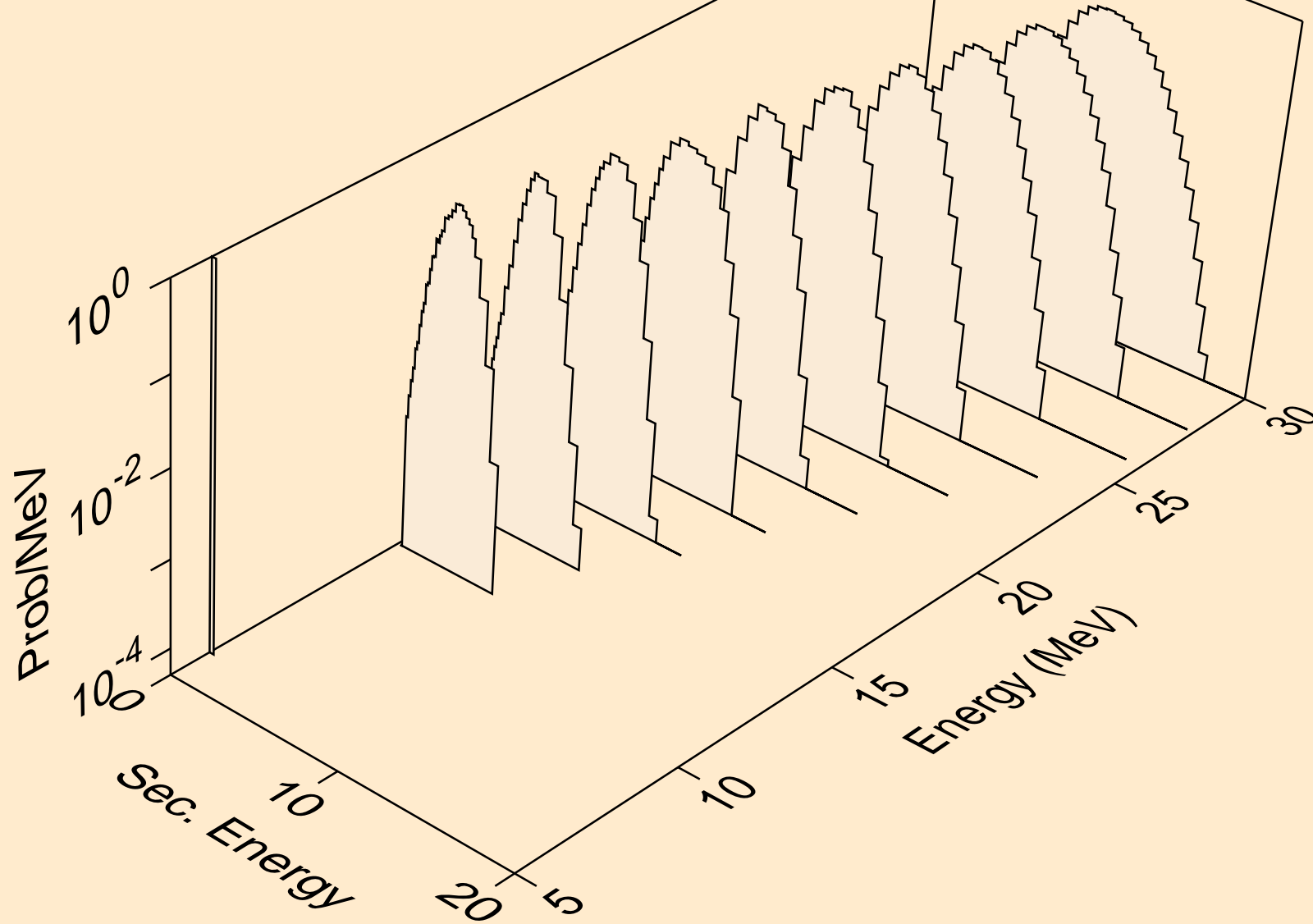

W191 DEUTERON ACER TENDL-2021 LIBRARY; T=0.K
protons from (d,pd)

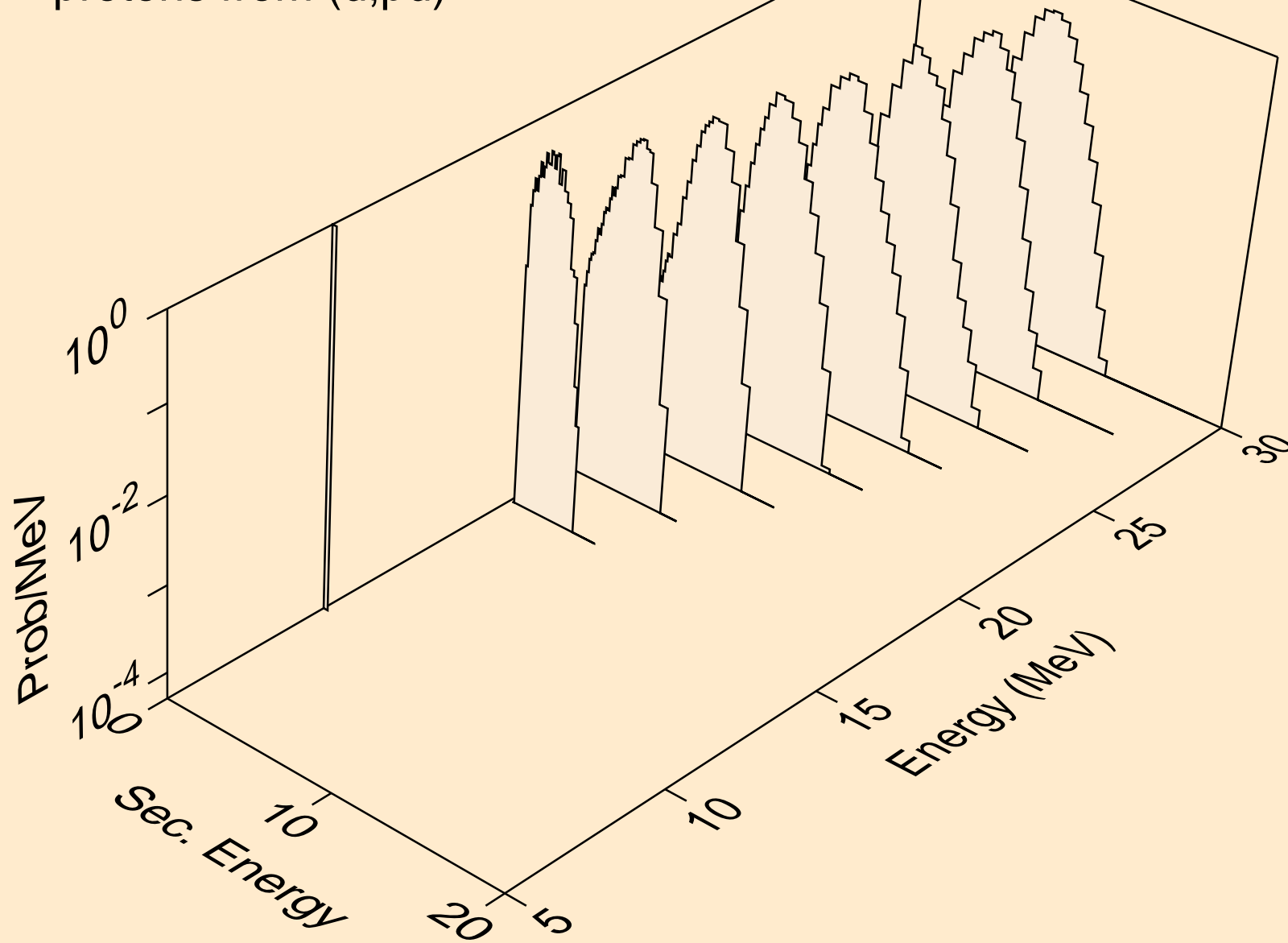

W191 DEUTERON ACER TENDL-2021 LIBRARY; T=0.K
tritons from (d,x)

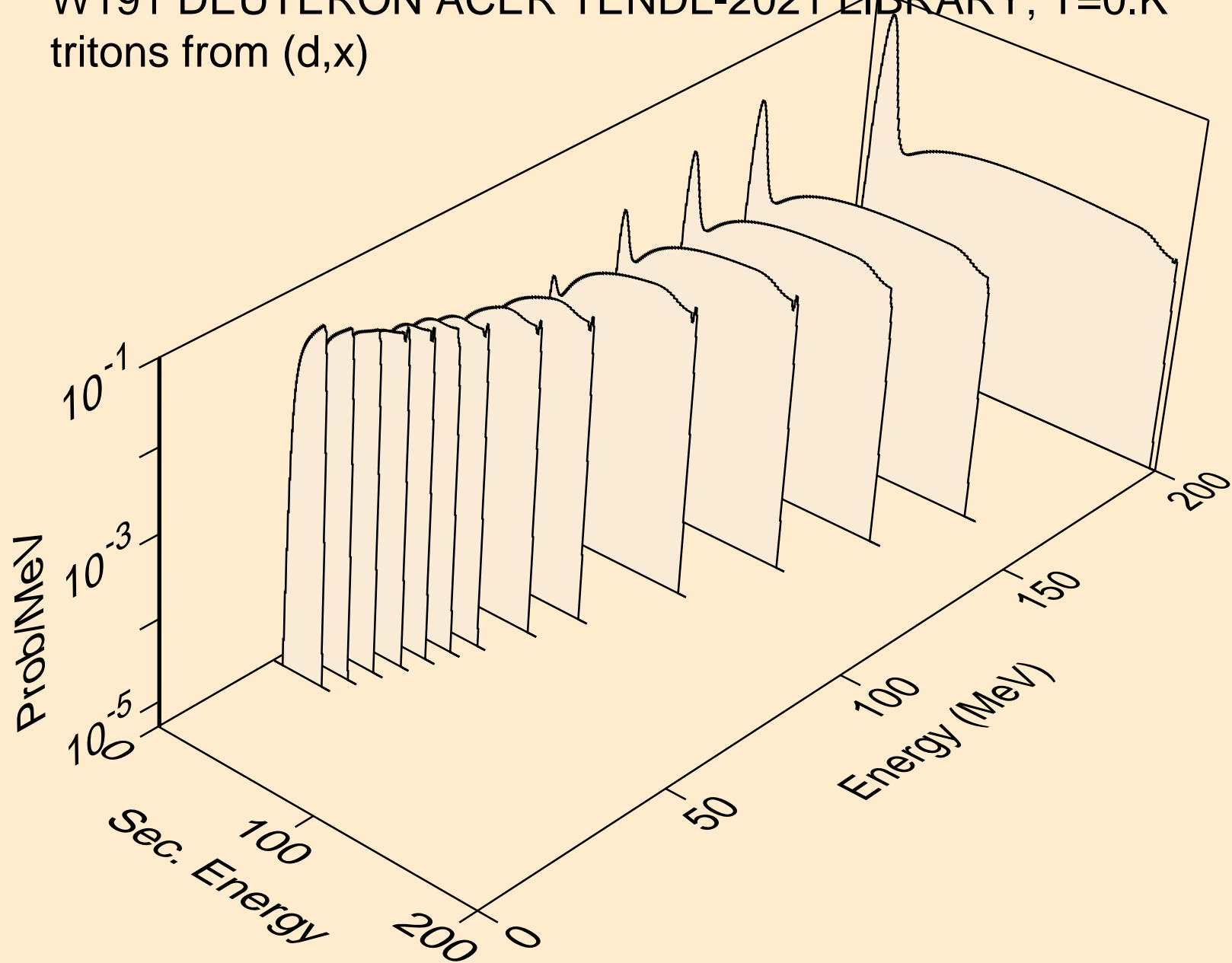

W191 DEUTERON ACER TENDL-2021 LIBRARY; T=0.K
tritons from (d,n*)t

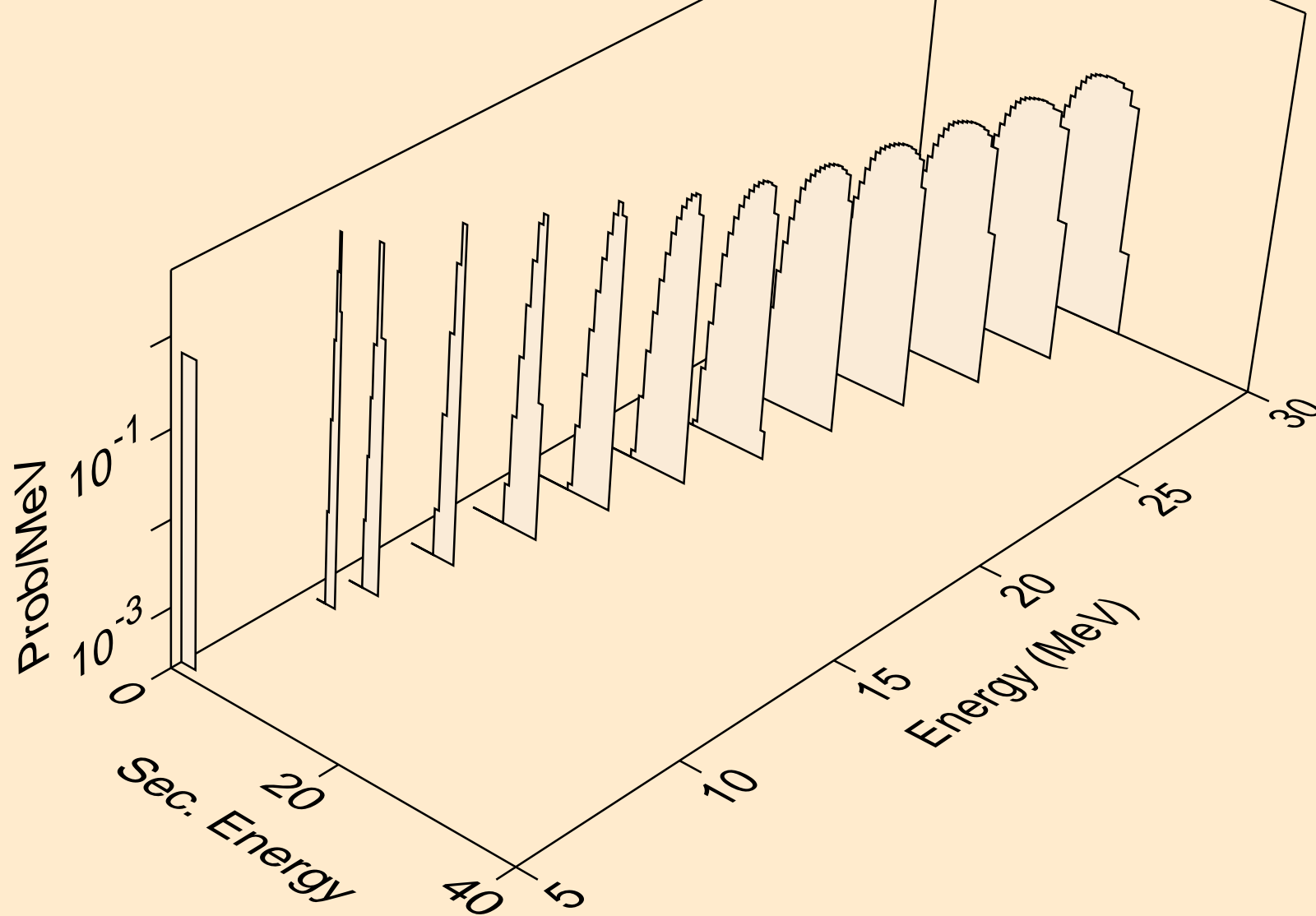

W191 DEUTERON ACER TENDL-2021 LIBRARY; T=0.K
tritons from (d,t)

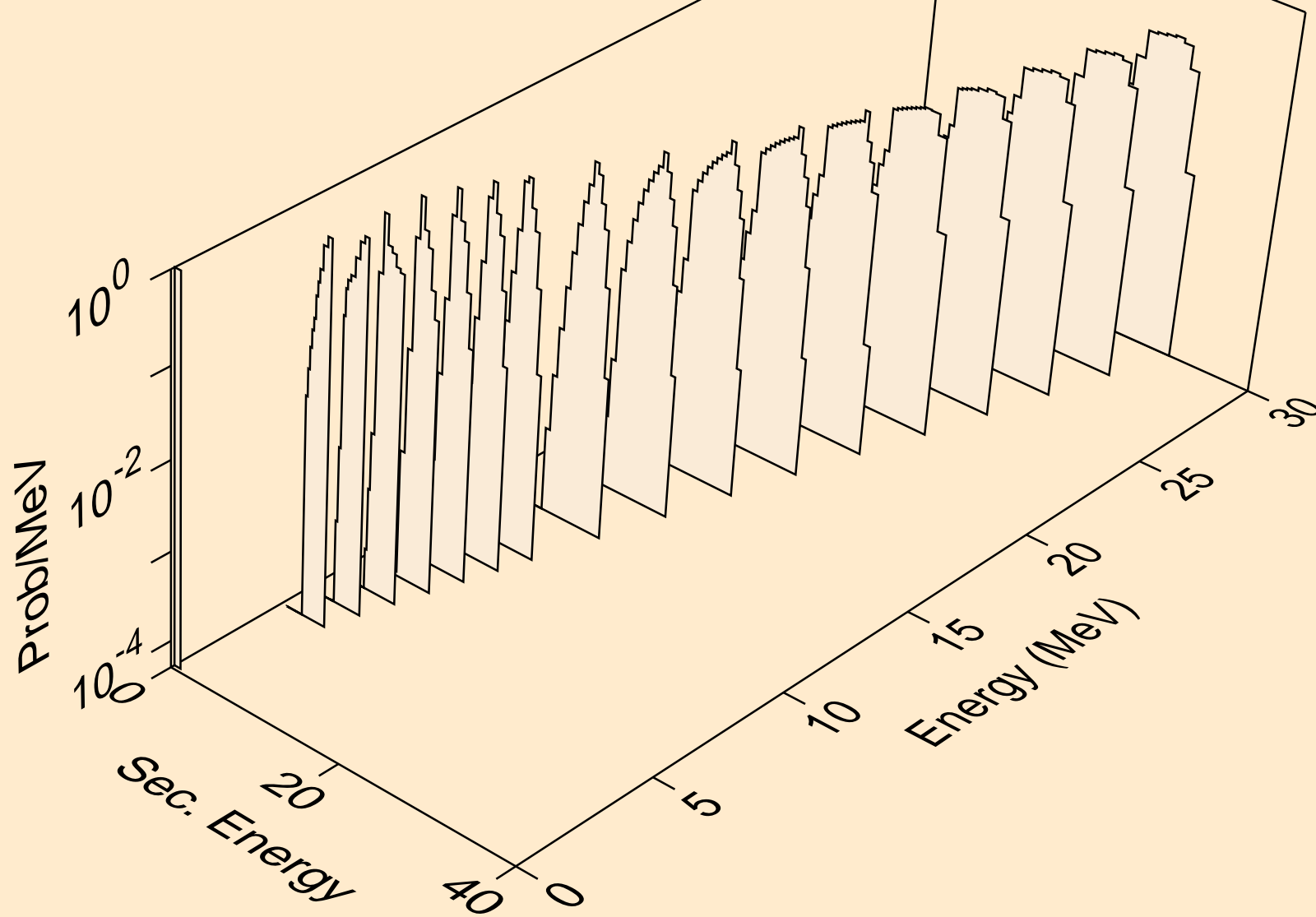

W191 DEUTERON ACER TENDL-2021 LIBRARY; T=0.K
he3s from (d,x)

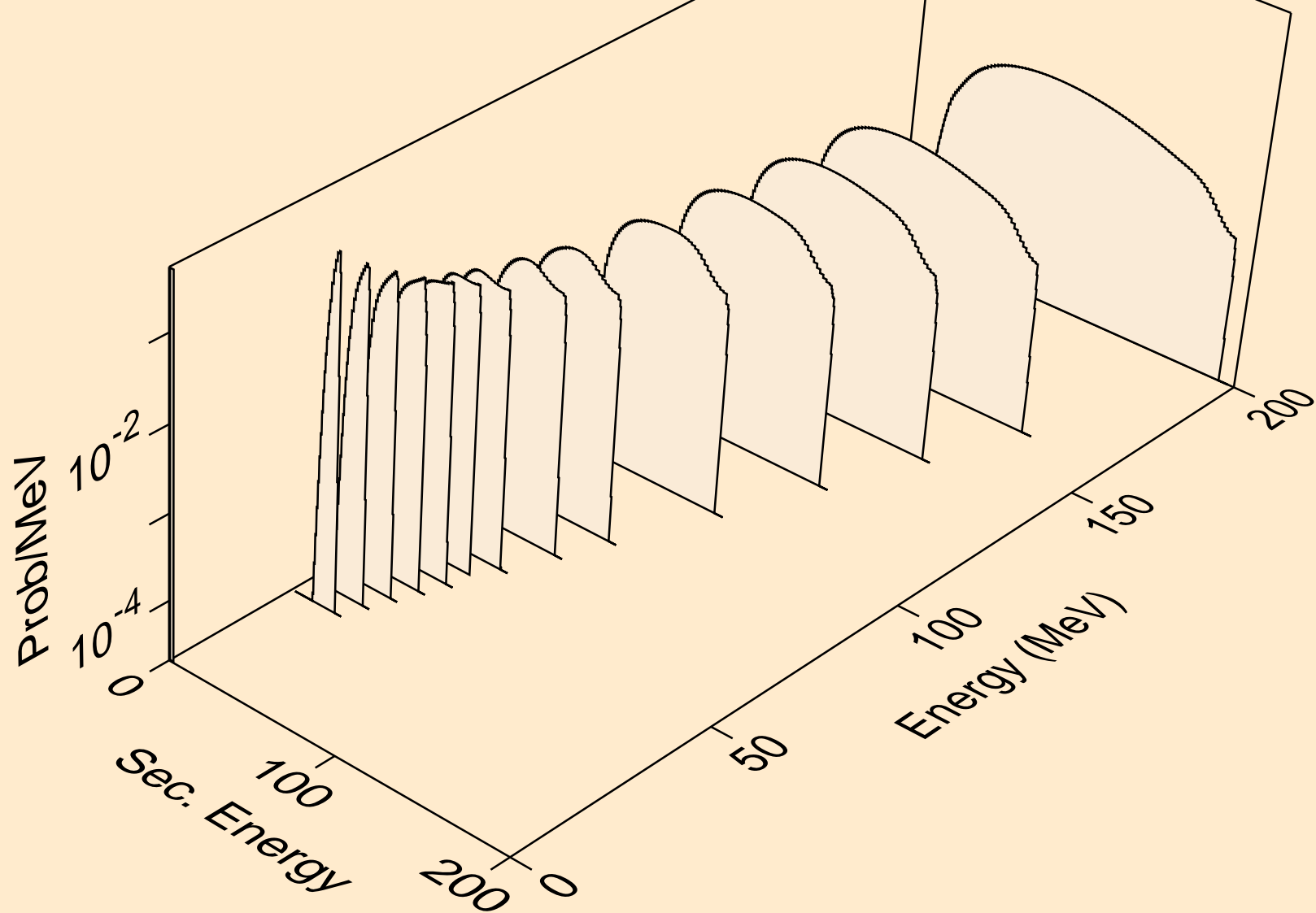

W191 DEUTERON ACER TENDL-2021 LIBRARY; T=0.K
he3s from (d,n*)he3

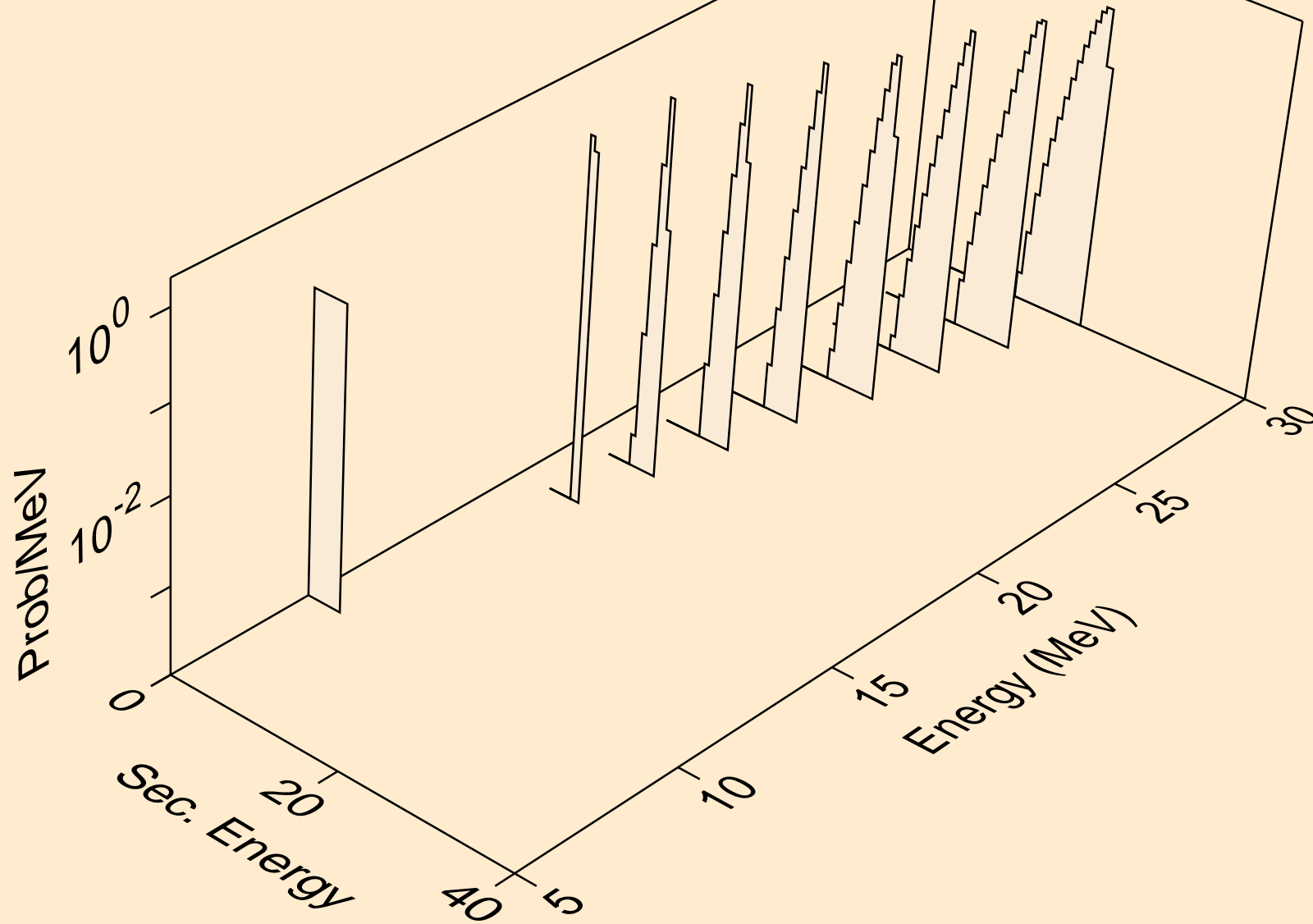

W191 DEUTERON ACER TENDL-2021 LIBRARY; T=0.K
he3s from (d,he3)

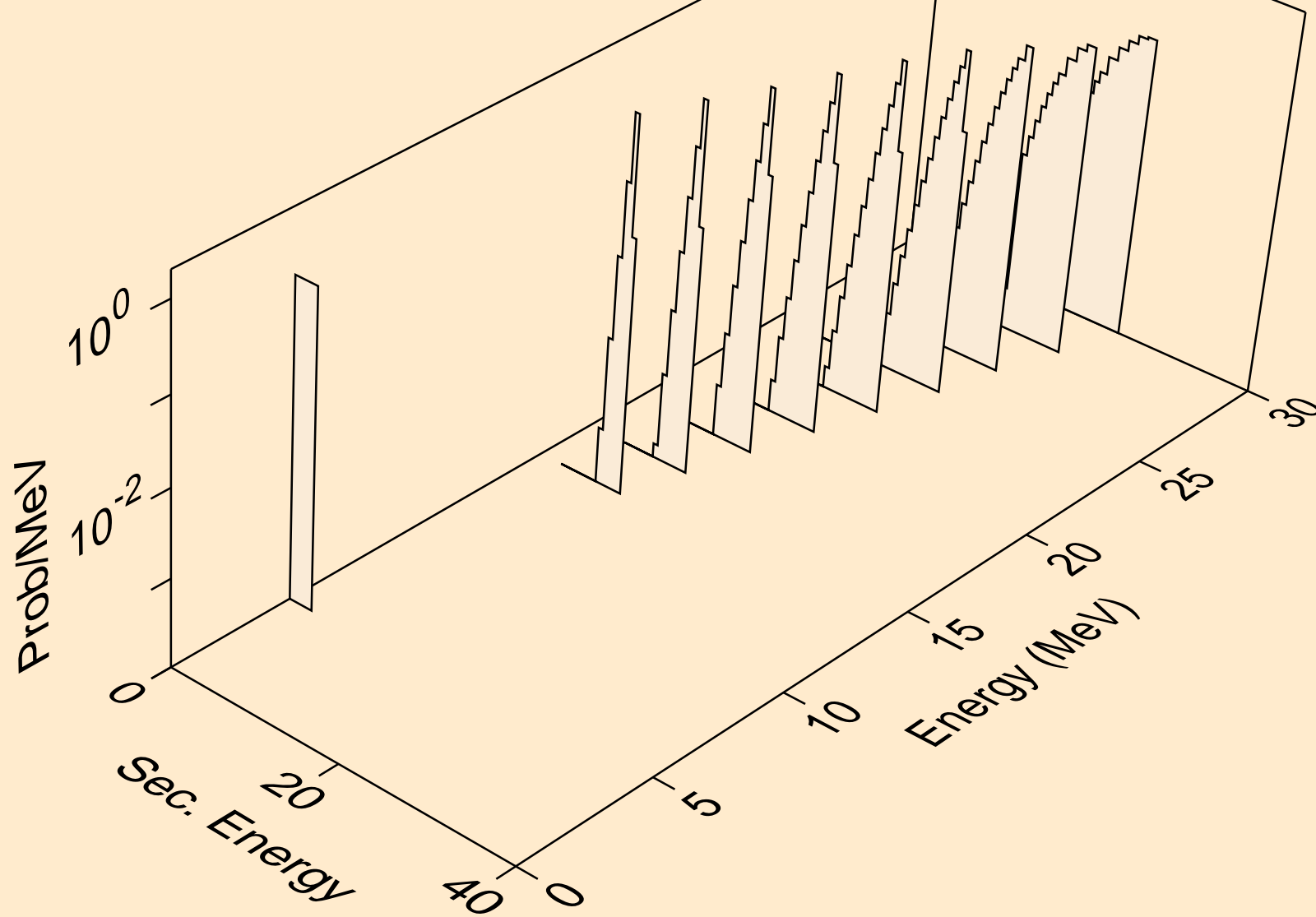

W191 DEUTERON ACER TENDL-2021 LIBRARY; T=0.K
alphas from (d,x)

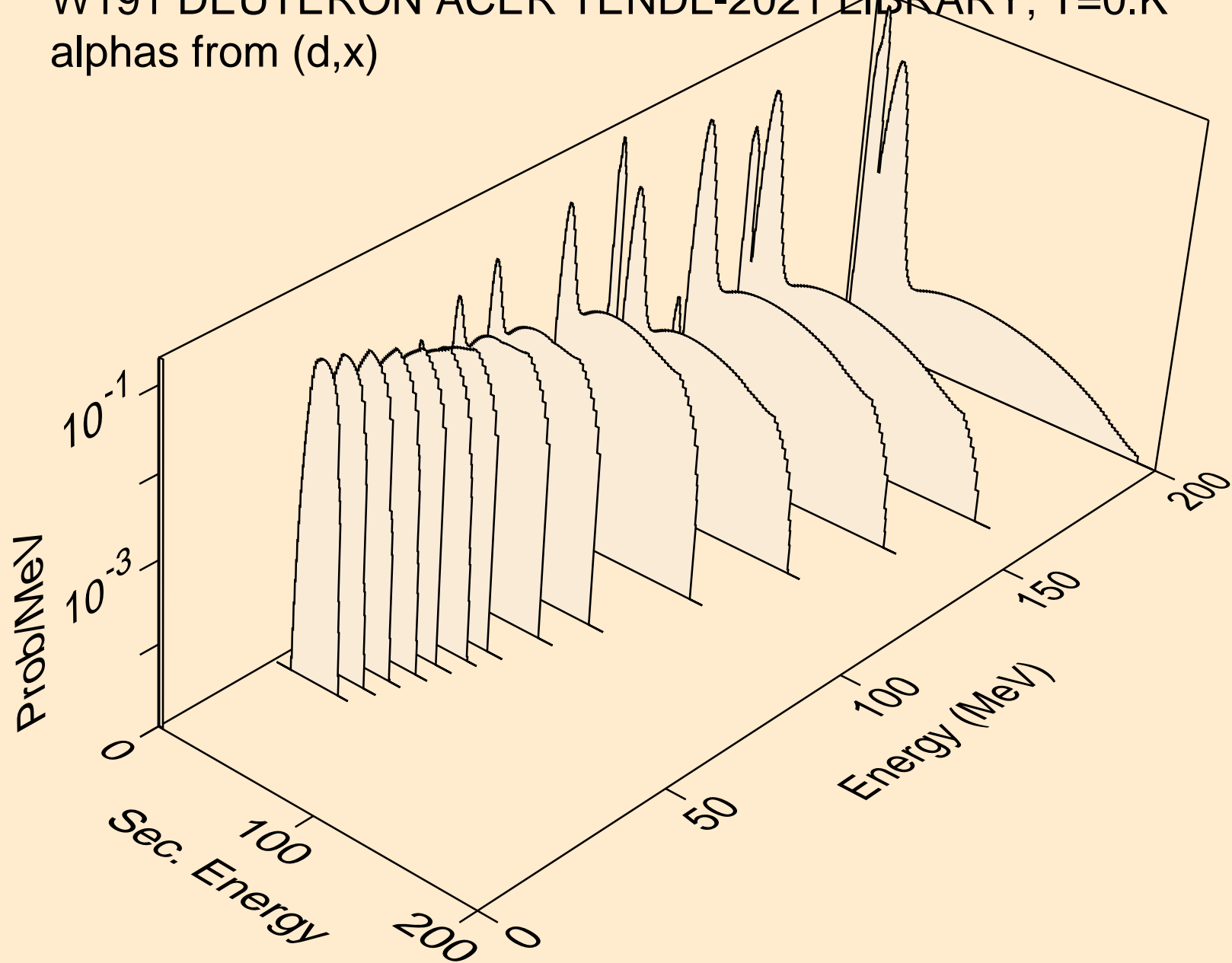

W191 DEUTERON ACER TENDL-2021 LIBRARY; T=0.K
alphas from (d,n*)a

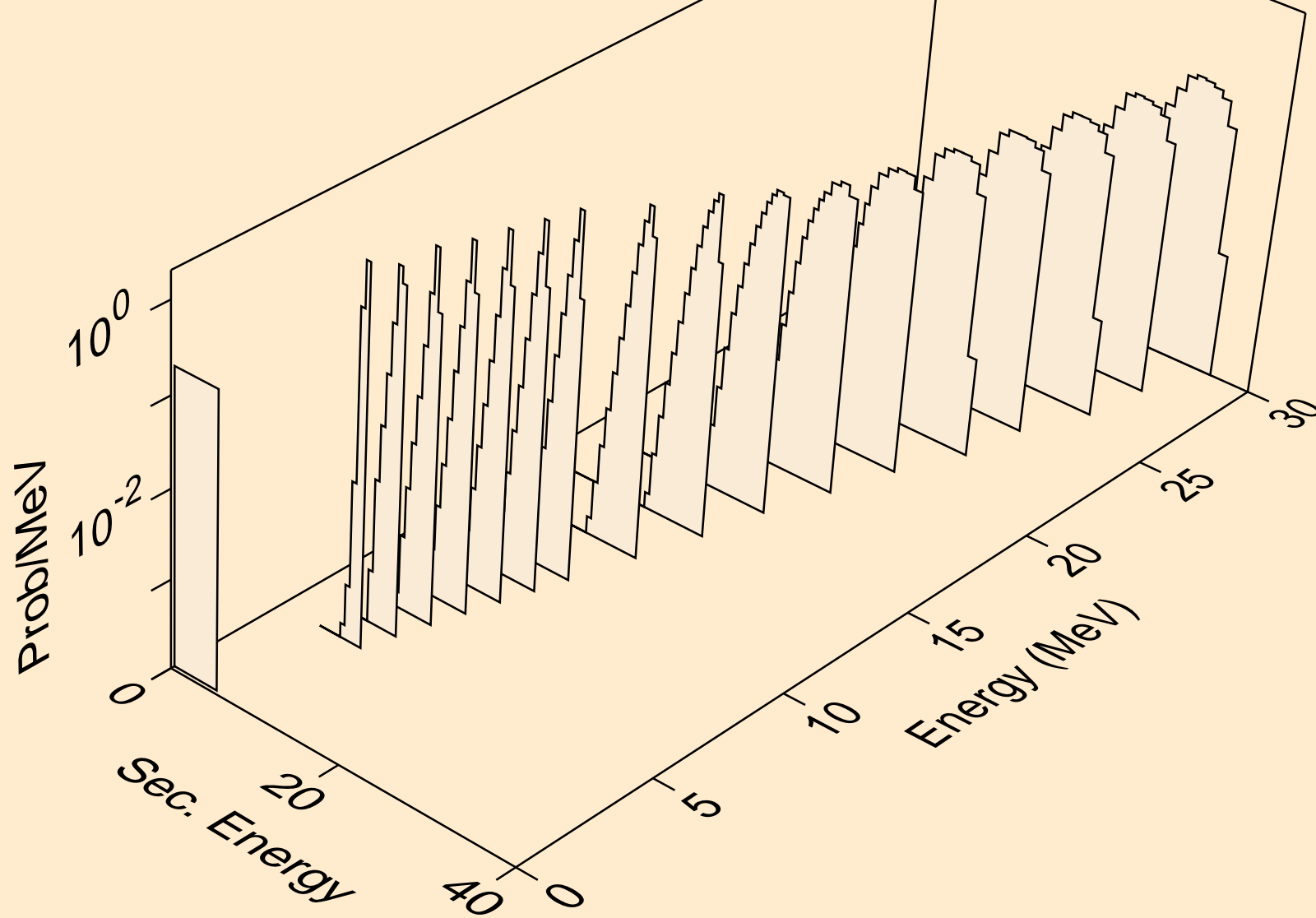

W191 DEUTERON ACER TENDL-2021 LIBRARY; T=0.K
alphas from (d,2n)a

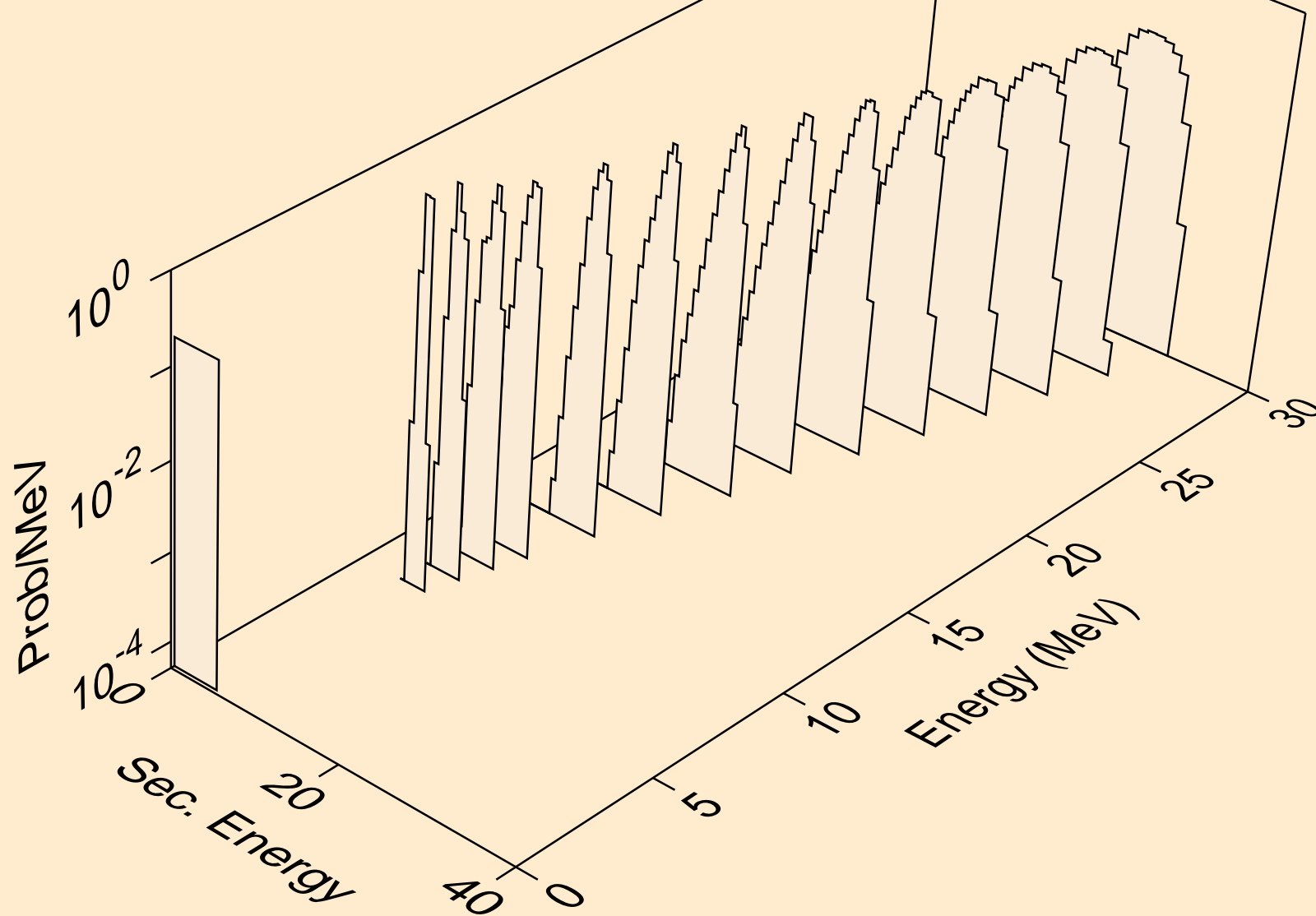

W191 DEUTERON ACER TENDL-2021 LIBRARY; T=0.K
alphas from (d,3n)a

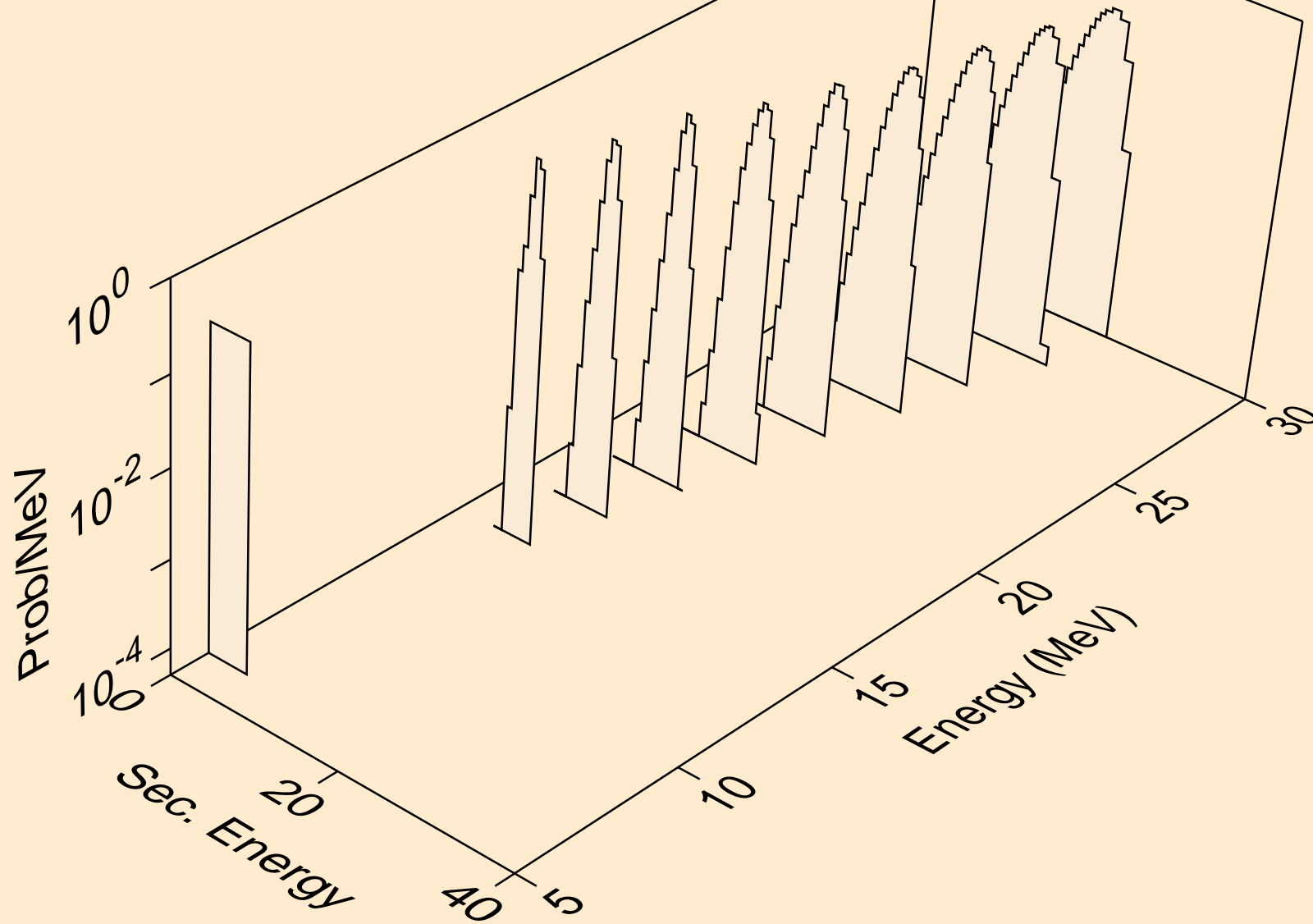

W191 DEUTERON ACER TENDL-2021 LIBRARY; T=0.K
alphas from (d,npa)

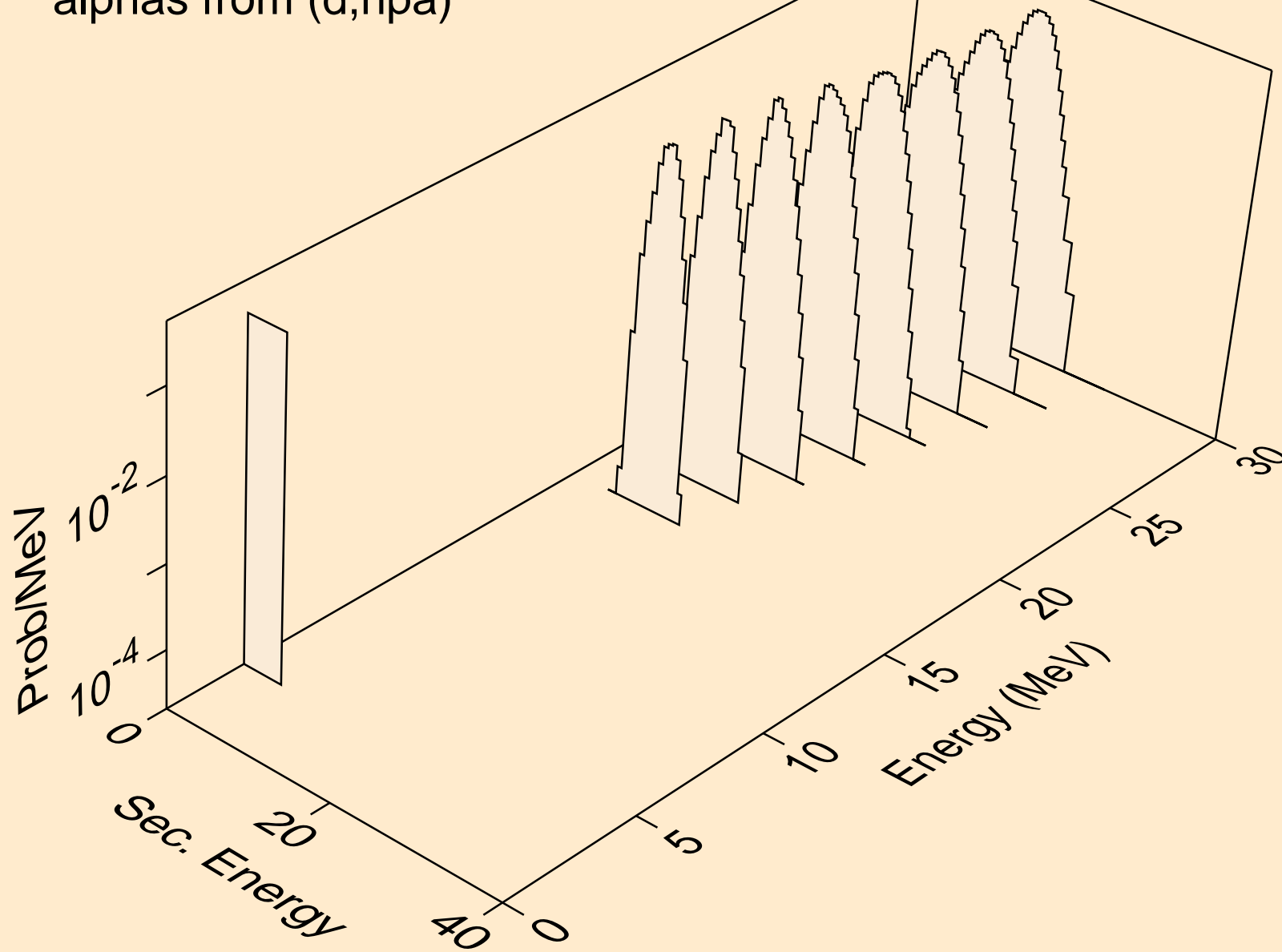

W191 DEUTERON ACER TENDL-2021 LIBRARY; T=0.K
alphas from (d,a)

