

CD110 PHOTON ACER TENDL-2021 LIBRARY; T=0.K
Principal cross sections

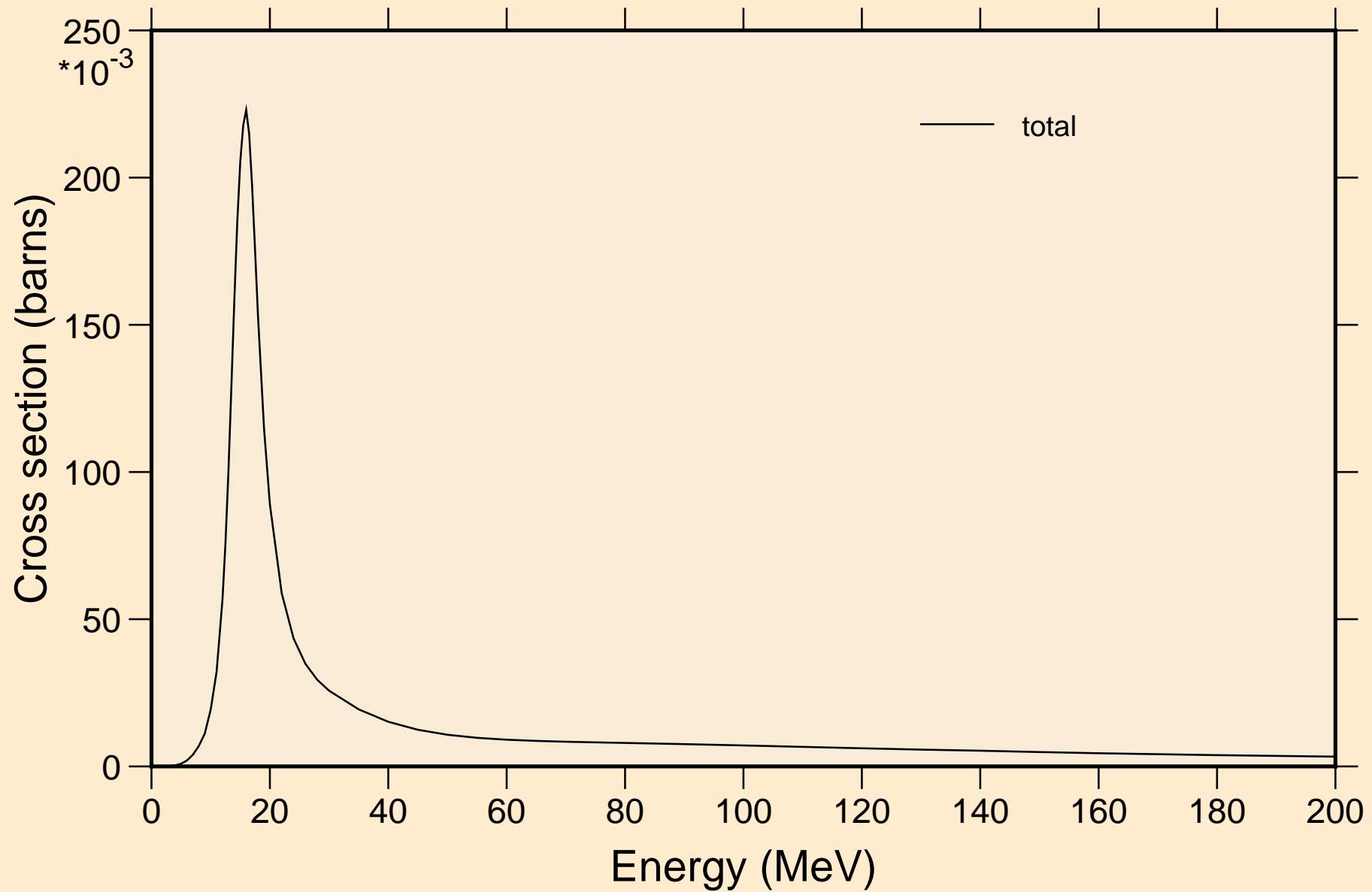

CD110 PHOTON ACER TENDL-2021 LIBRARY; T=0.K

Heating

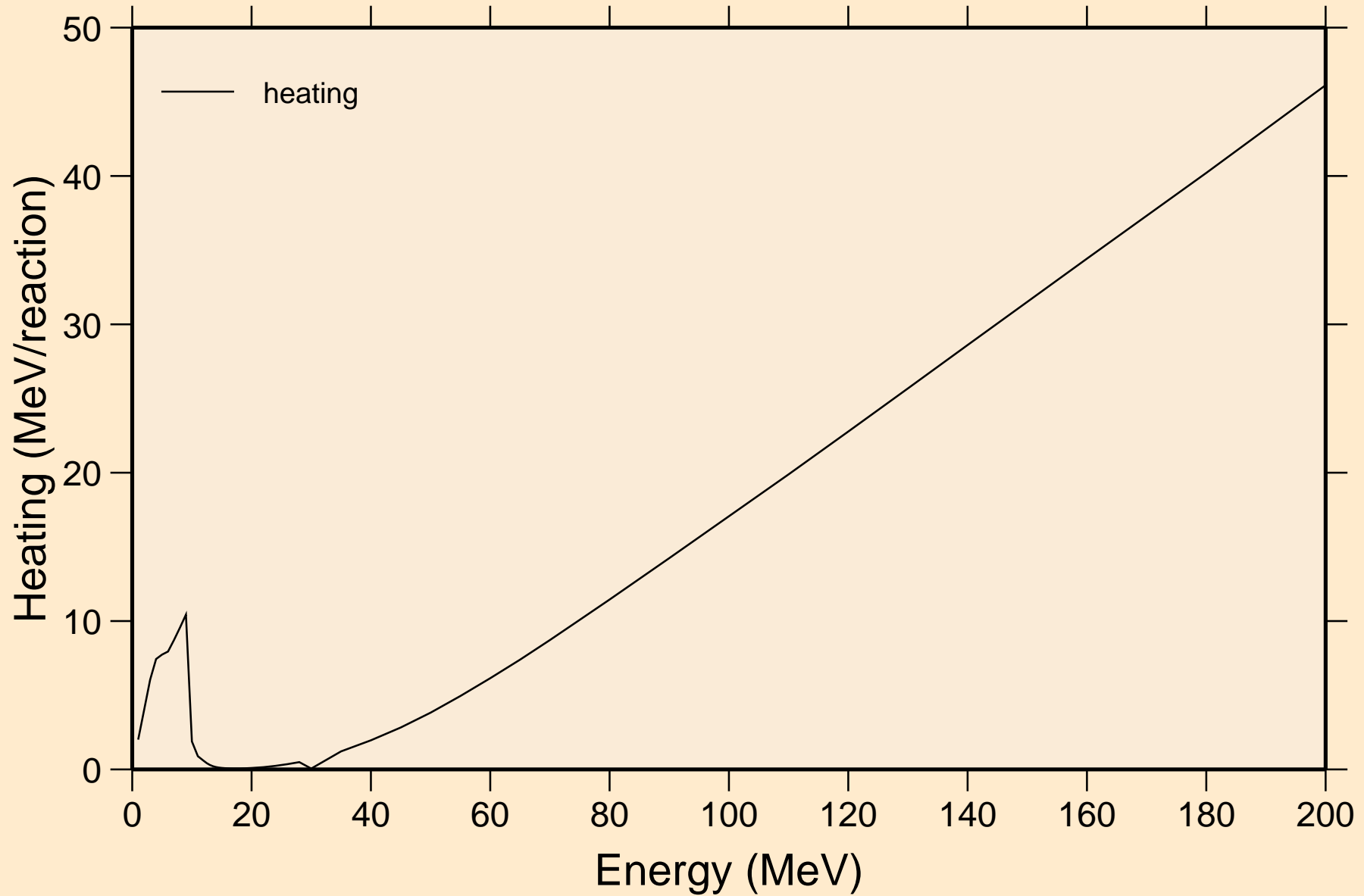

CD110 PHOTON ACER TENDL-2021 LIBRARY; T=0.K

Particle heating contributions

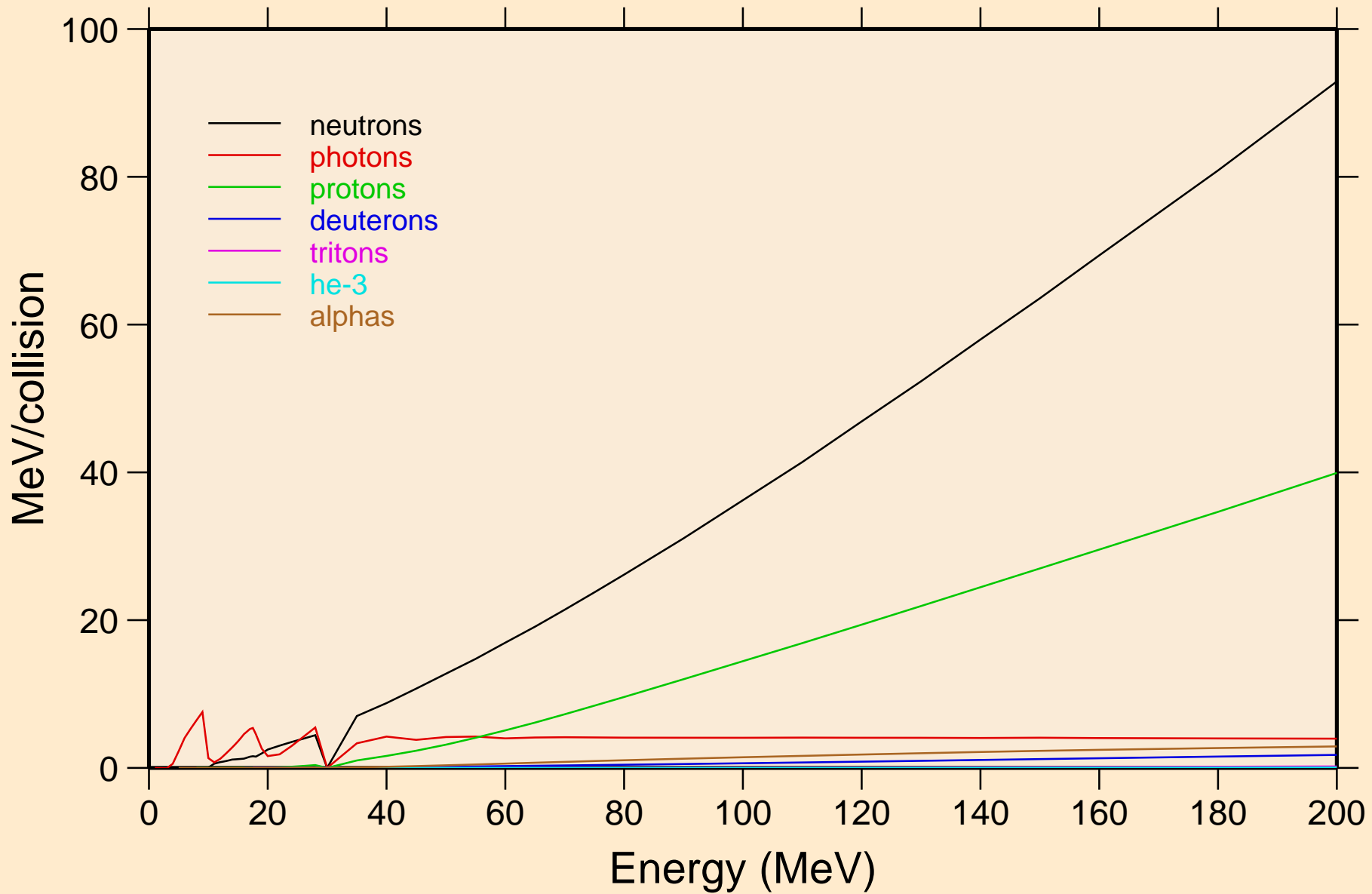

CD110 PHOTON ACER TENDL-2021 LIBRARY; T=0.K

Particle production cross sections

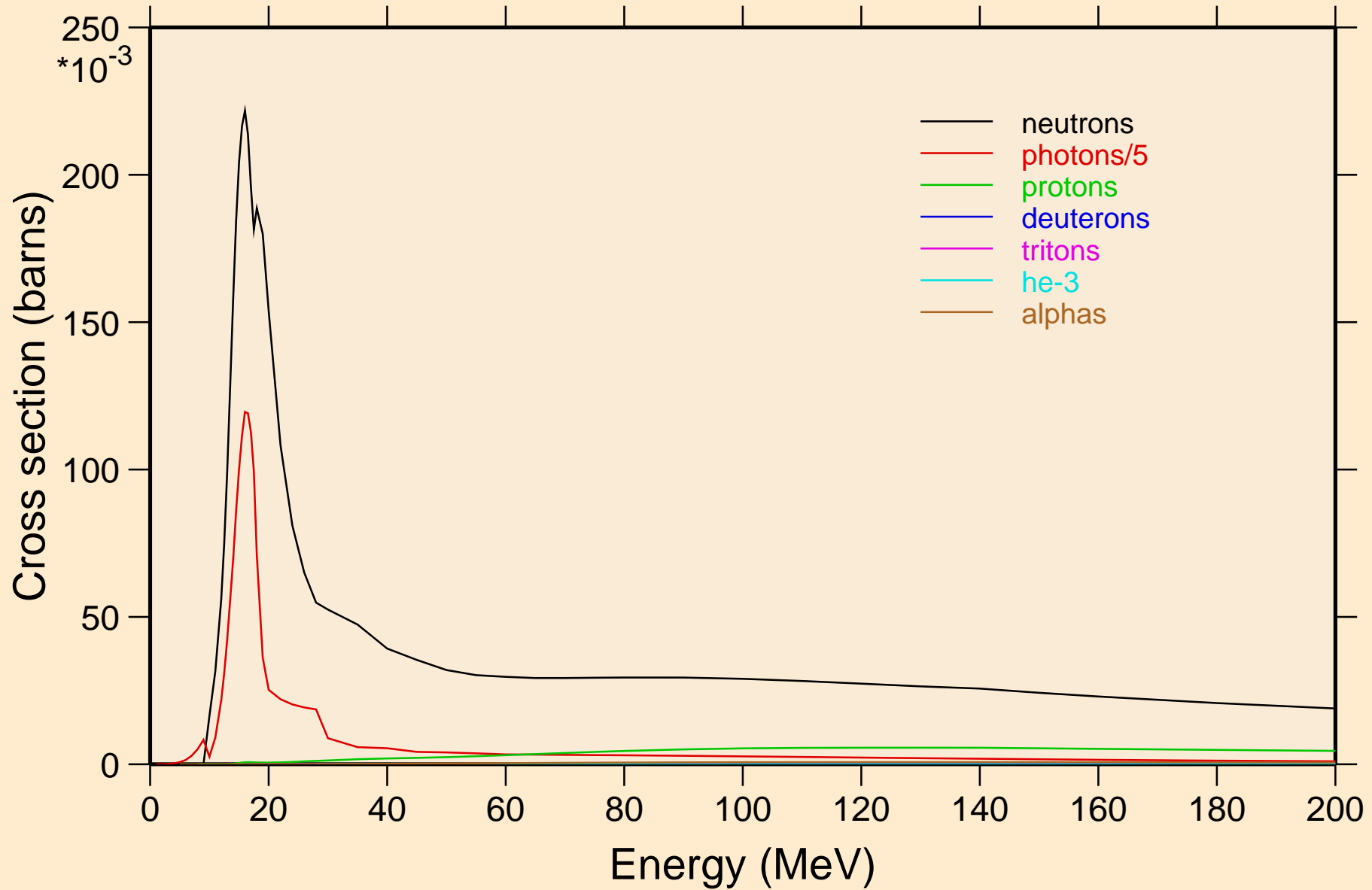

CD110 PHOTON ACER TENDL-2021 LIBRARY; T=0.K
neutrons from (g,x)

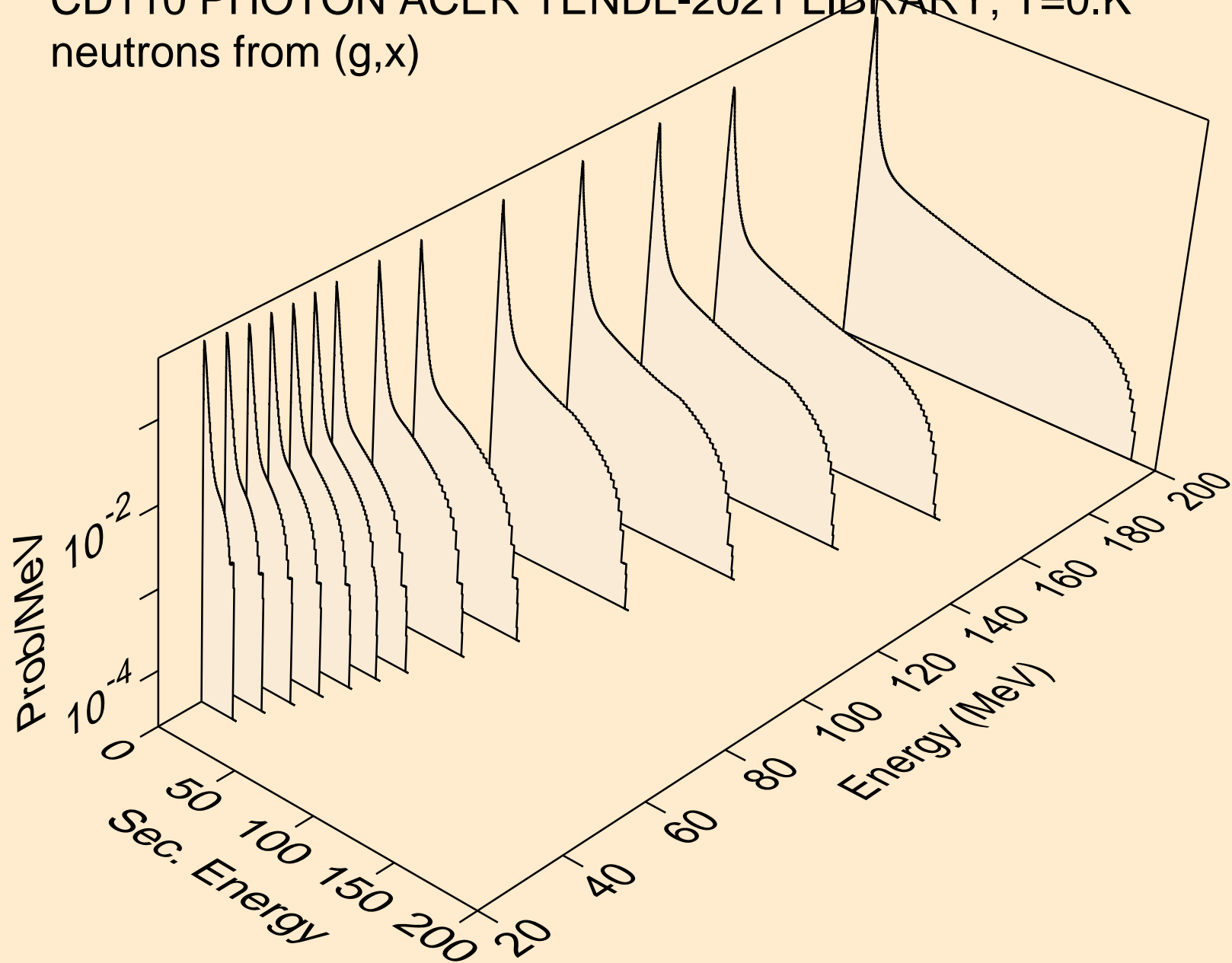

CD110 PHOTON ACER TENDL-2021 LIBRARY; T=0.K
neutrons from (g,2n)

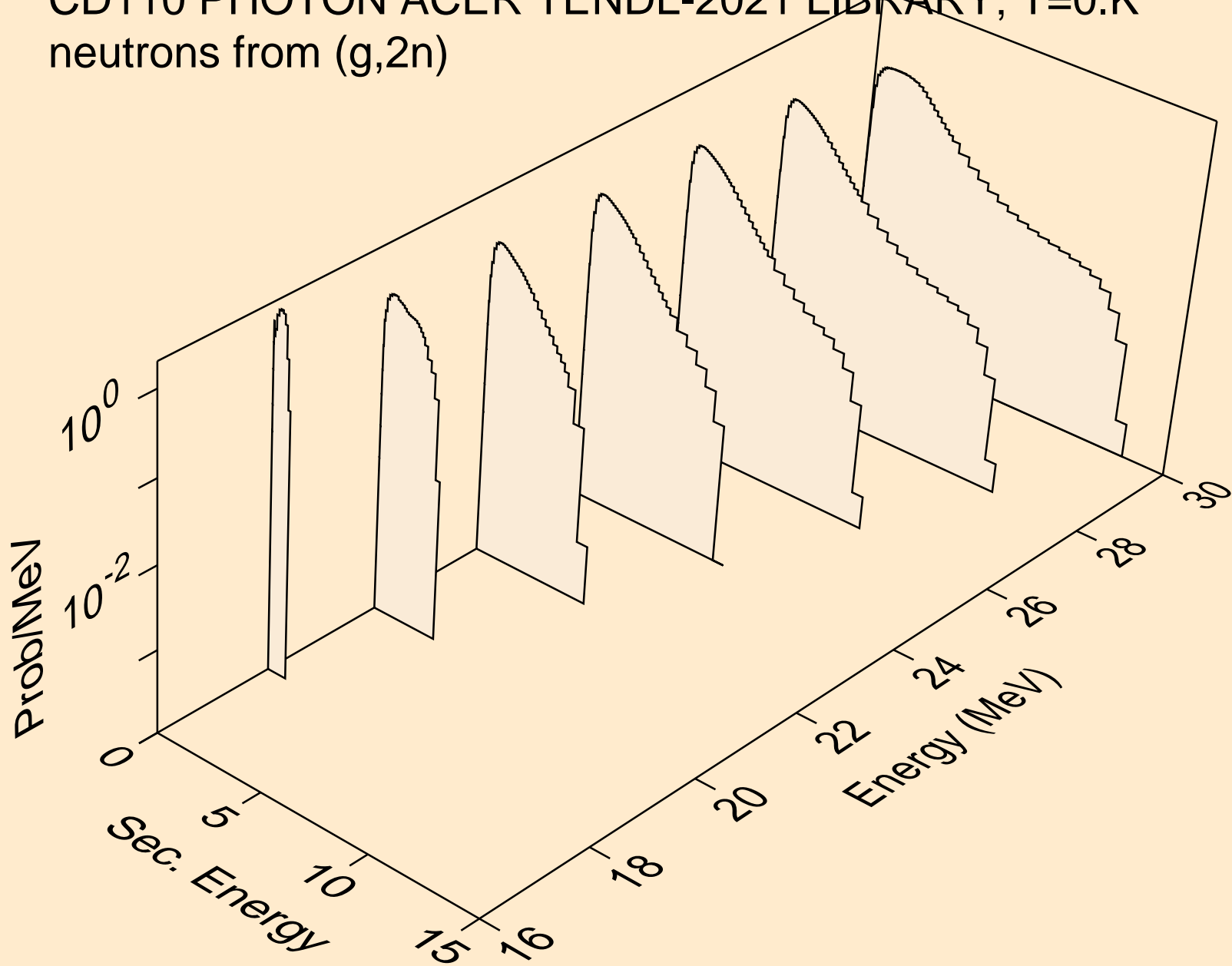

CD110 PHOTON ACER TENDL-2021 LIBRARY; T=0.K
neutrons from (g,3n)

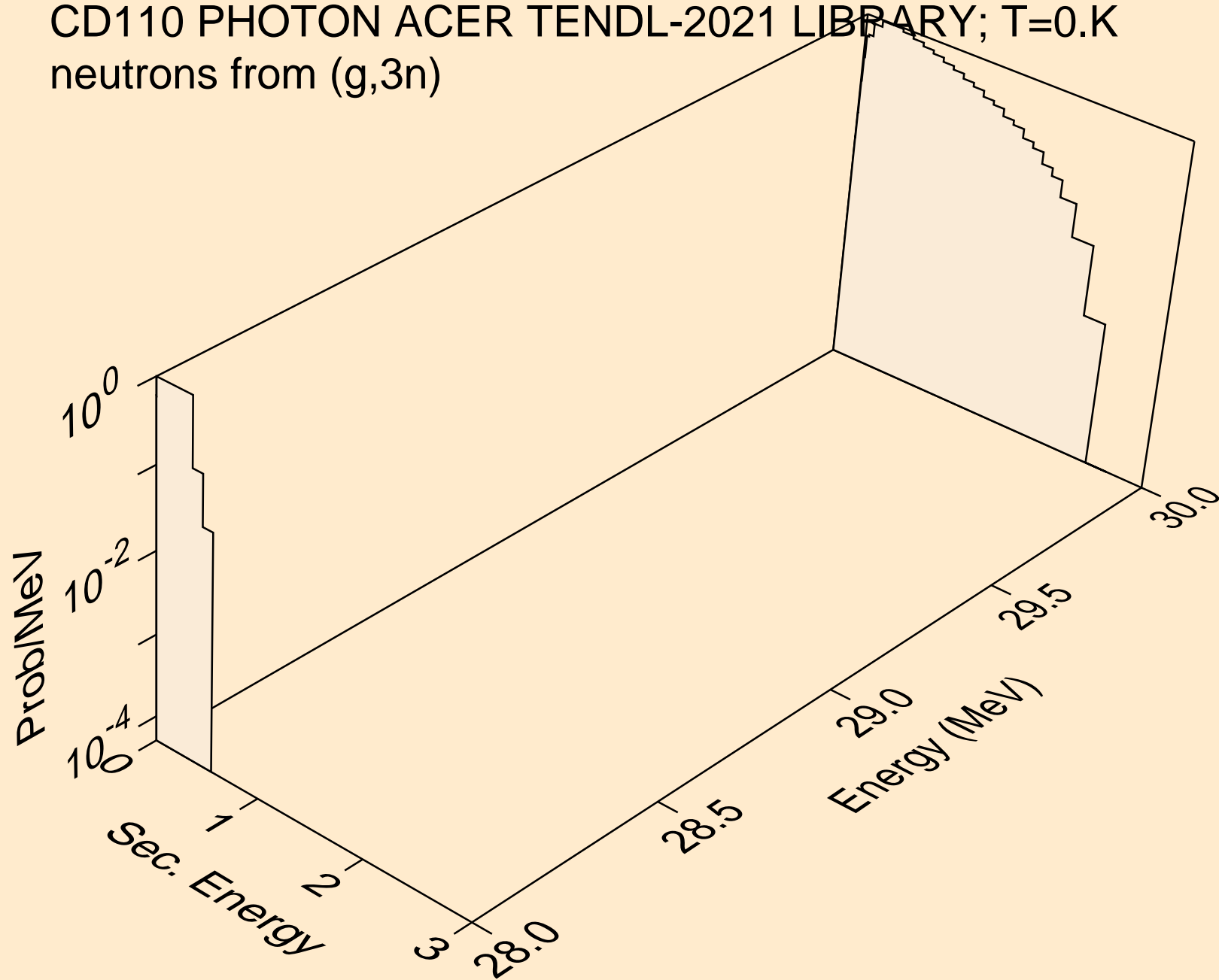

CD110 PHOTON ACER TENDL-2021 LIBRARY; T=0.K
neutrons from (g,n*)a

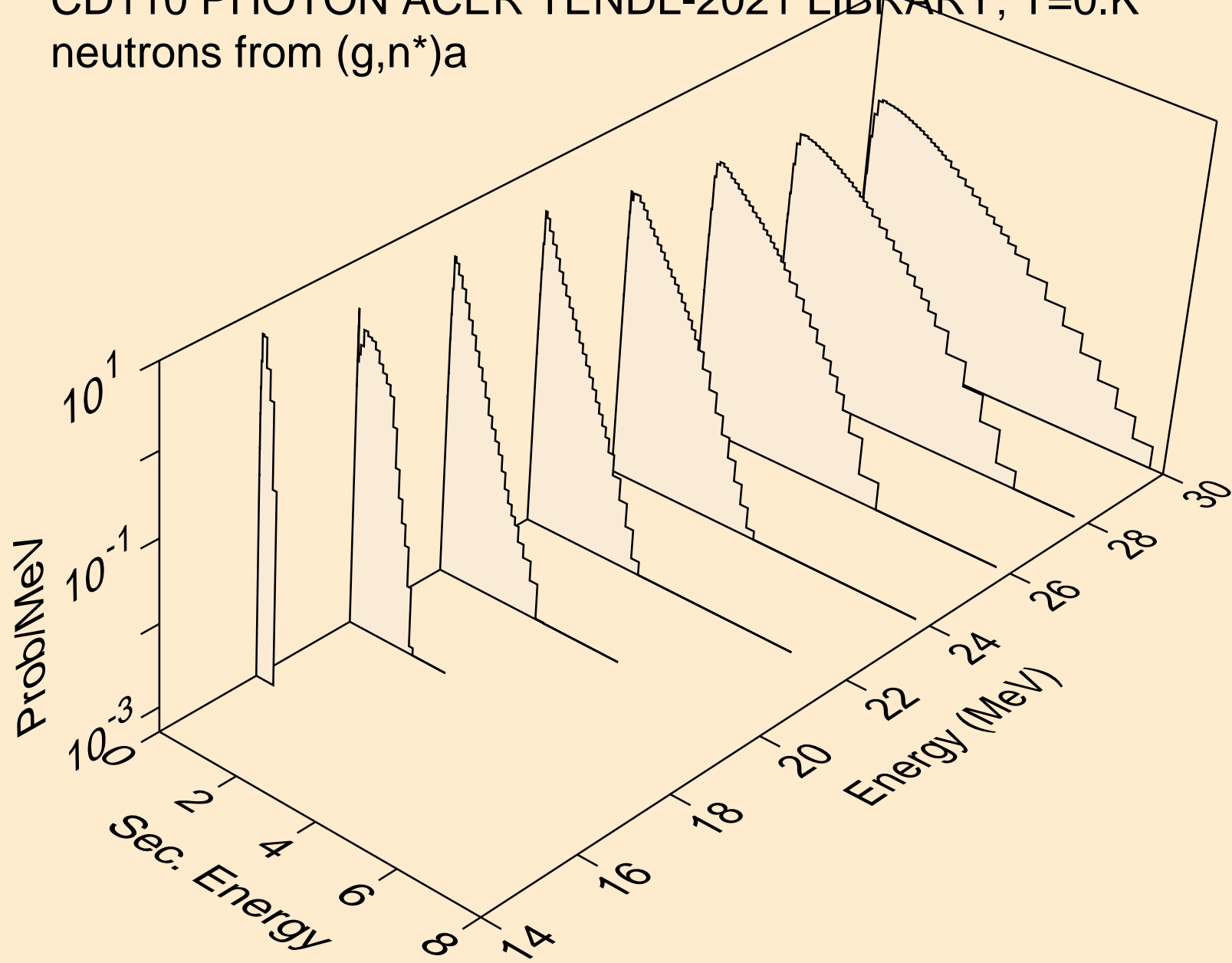

CD110 PHOTON ACER TENDL-2021 LIBRARY; T=0.K
neutrons from (g,2n)a

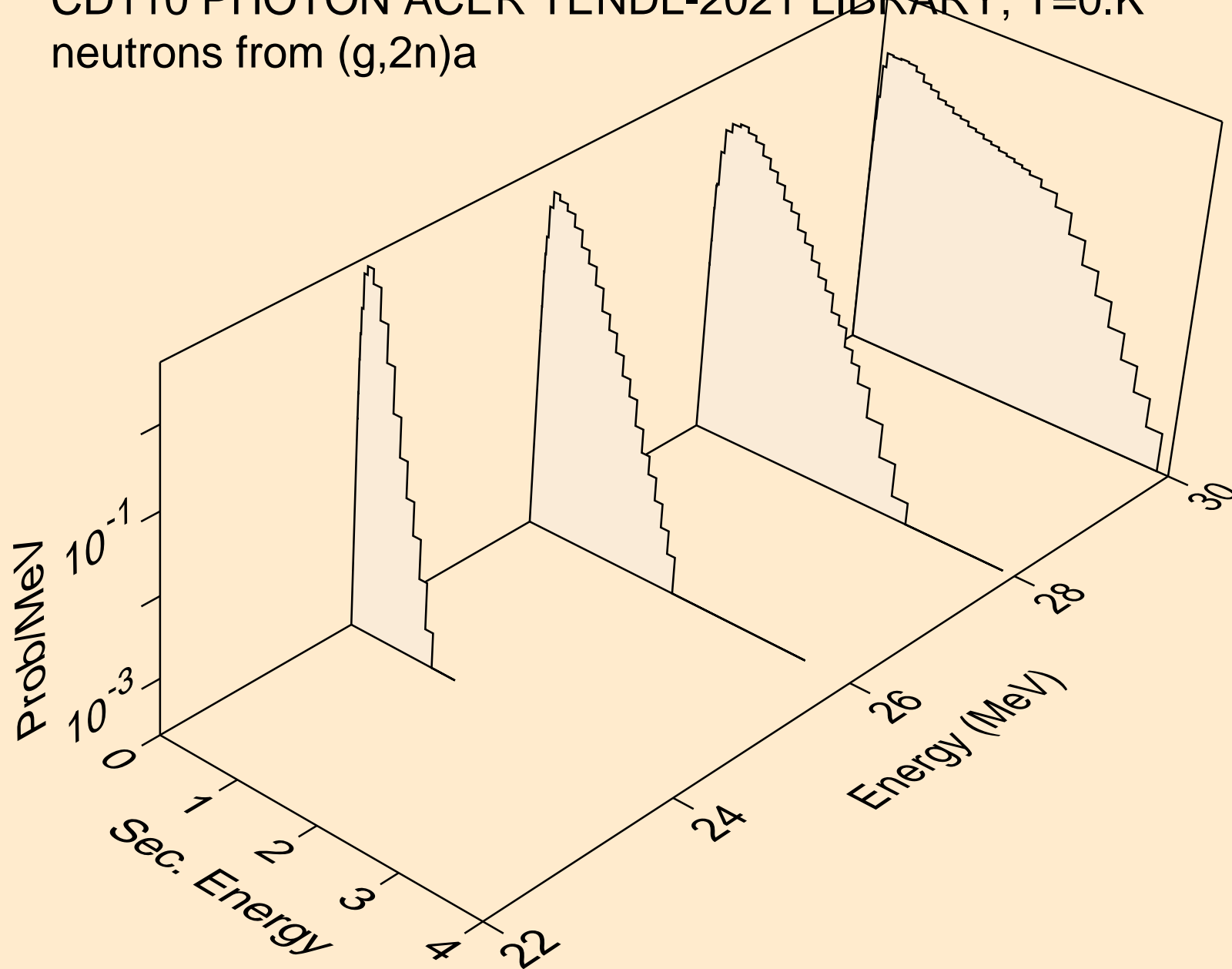

CD110 PHOTON ACER TENDL-2021 LIBRARY; T=0.K
neutrons from (g,n*)p

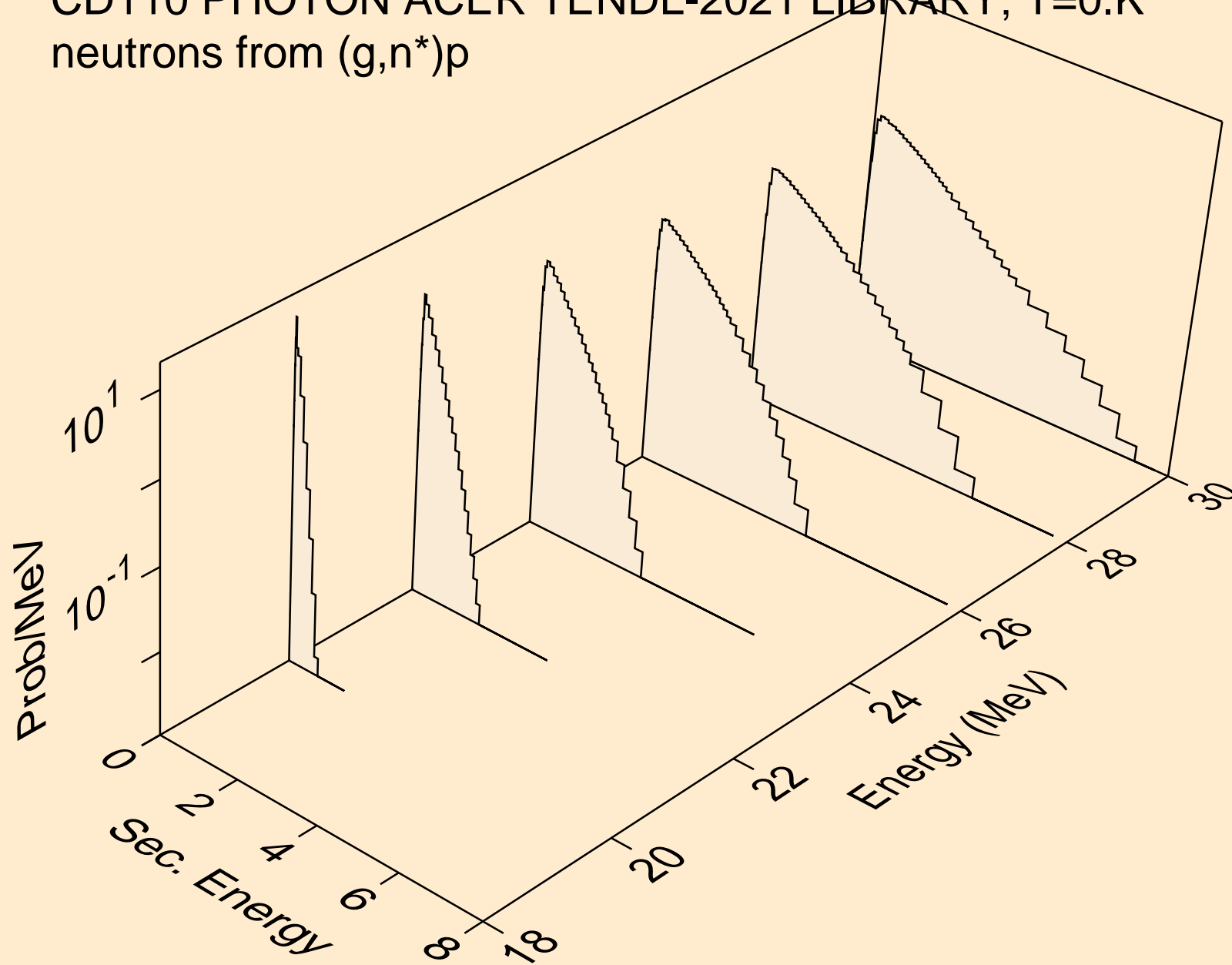

CD110 PHOTON ACER TENDL-2021 LIBRARY; T=0.K
neutrons from (g,n*)d

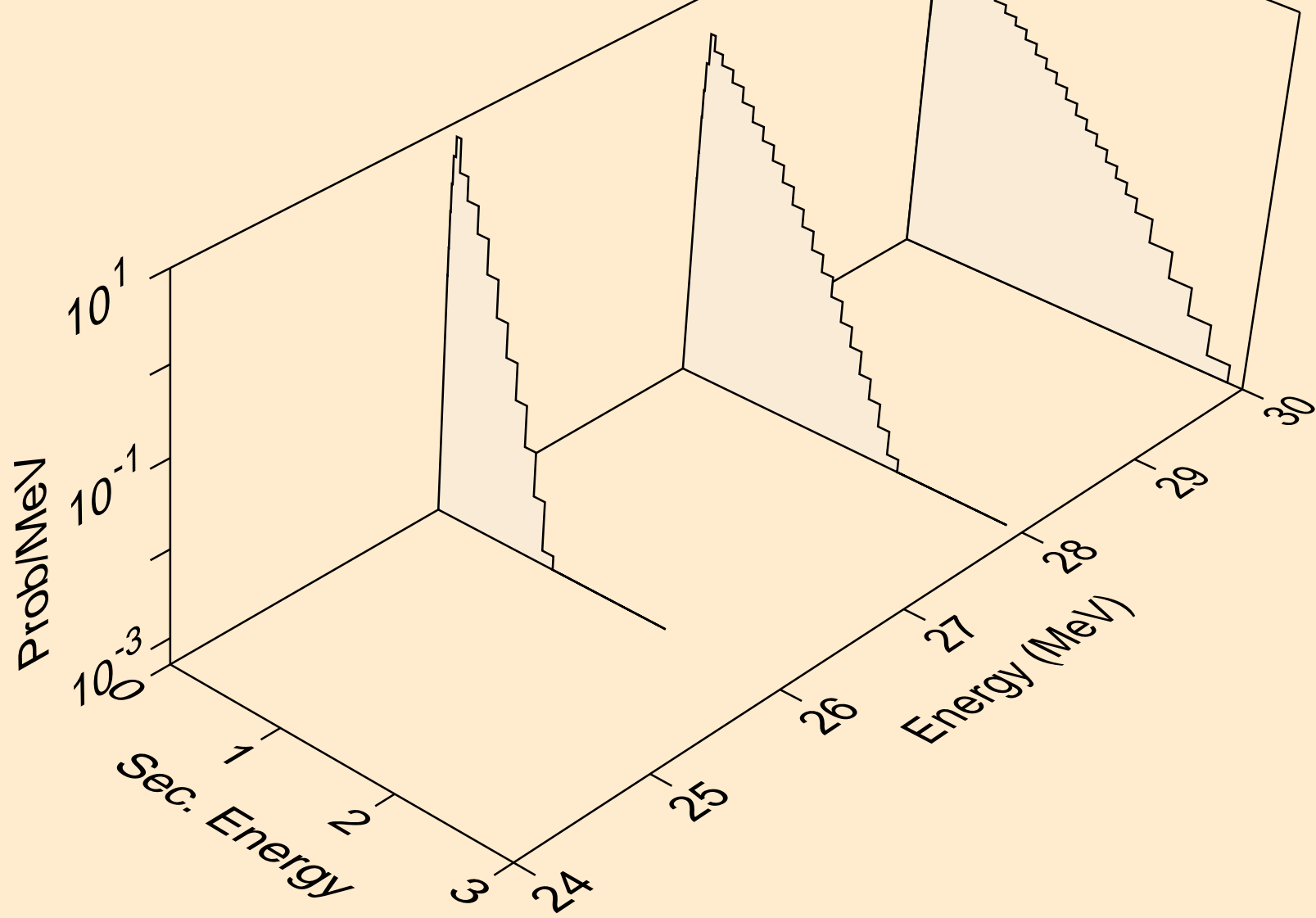

CD110 PHOTON ACER TENDL-2021 LIBRARY; T=0.K
neutrons from (g,2np)

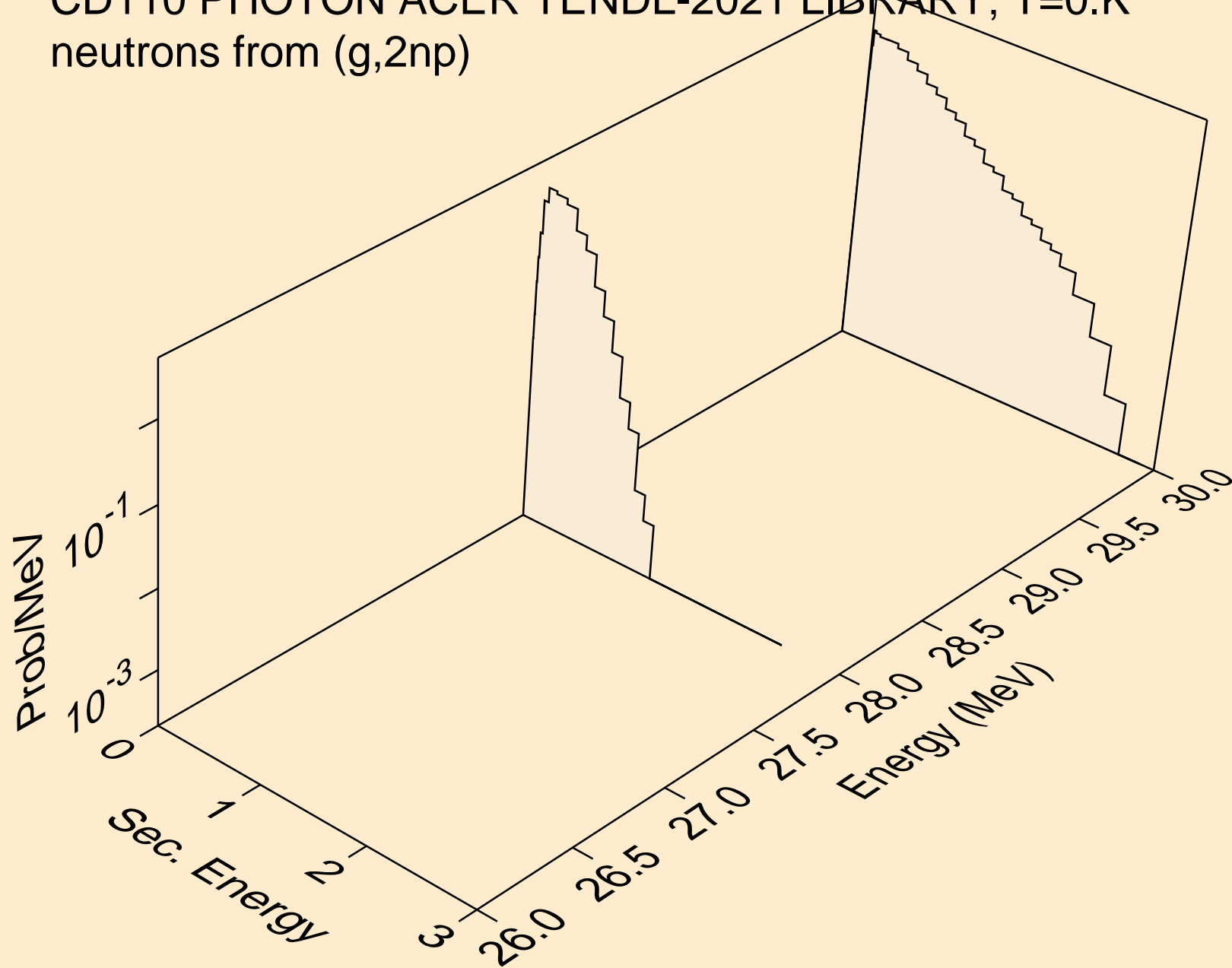

CD110 PHOTON ACER TENDL-2021 LIBRARY; T=0.K
angular distribution for (g,n*0) neutron

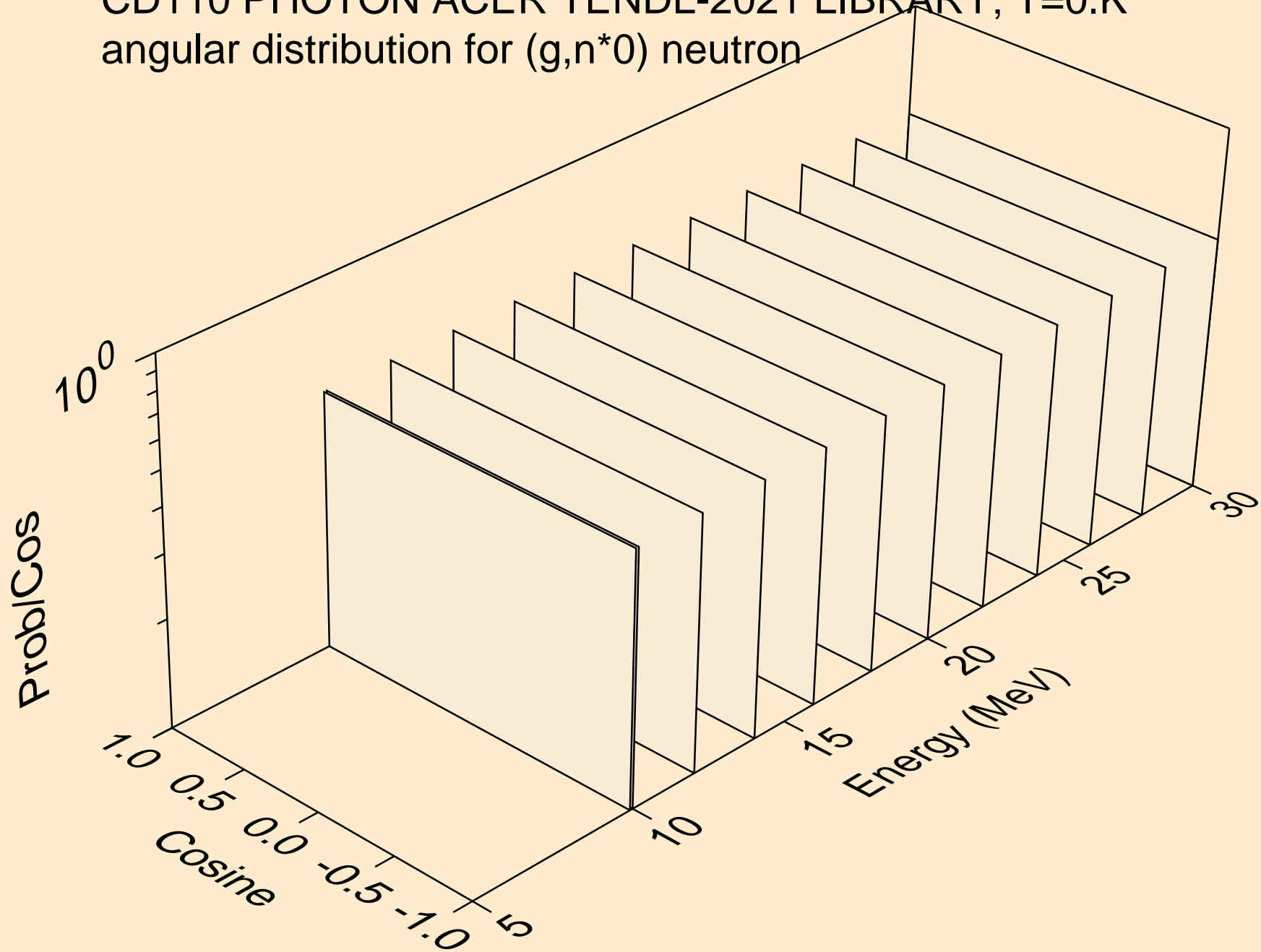

CD110 PHOTON ACER TENDL-2021 LIBRARY; T=0.K
angular distribution for (g,n*1) neutron

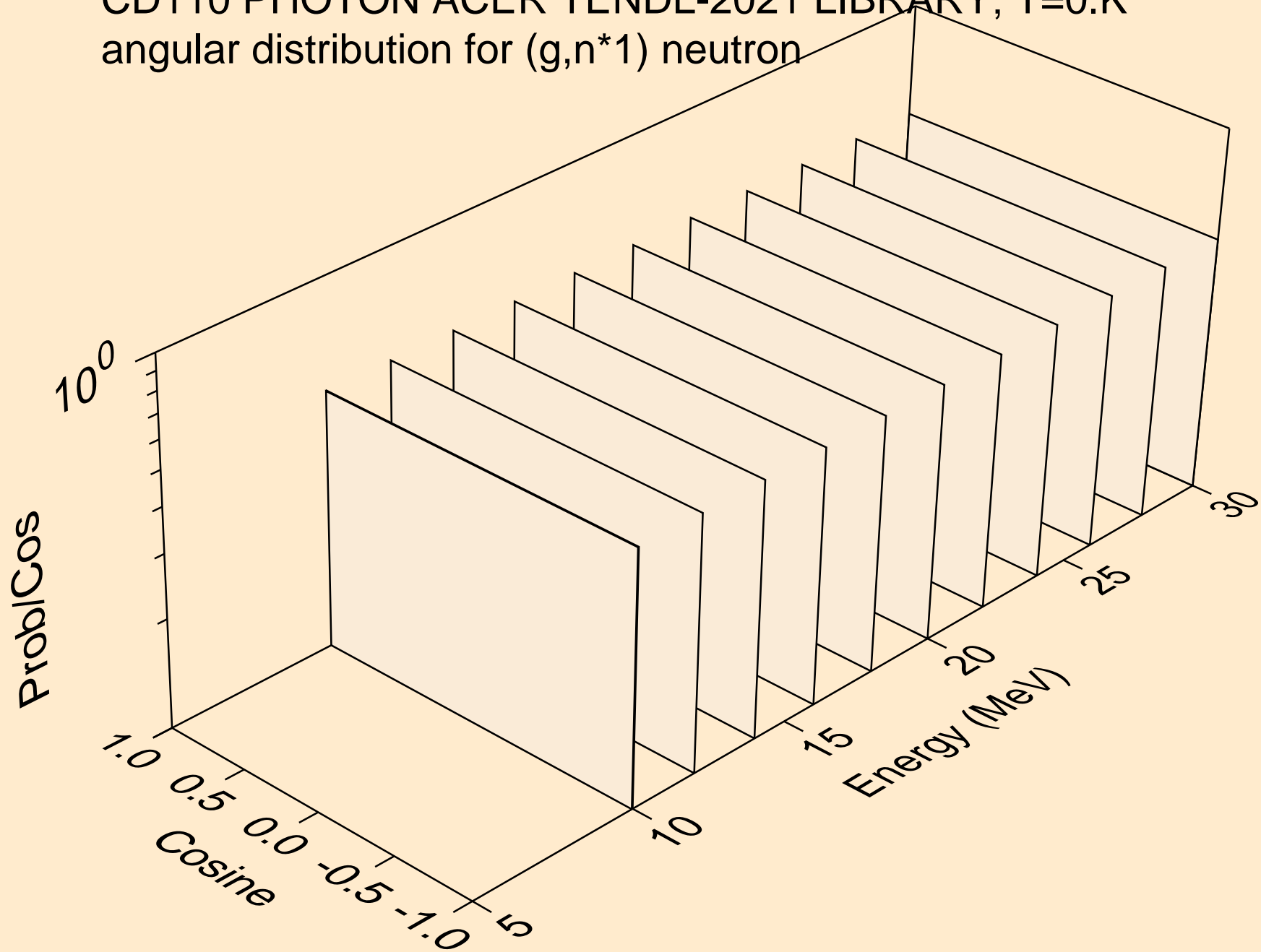

CD110 PHOTON ACER TENDL-2021 LIBRARY; T=0.K
neutrons from (g,n*c)

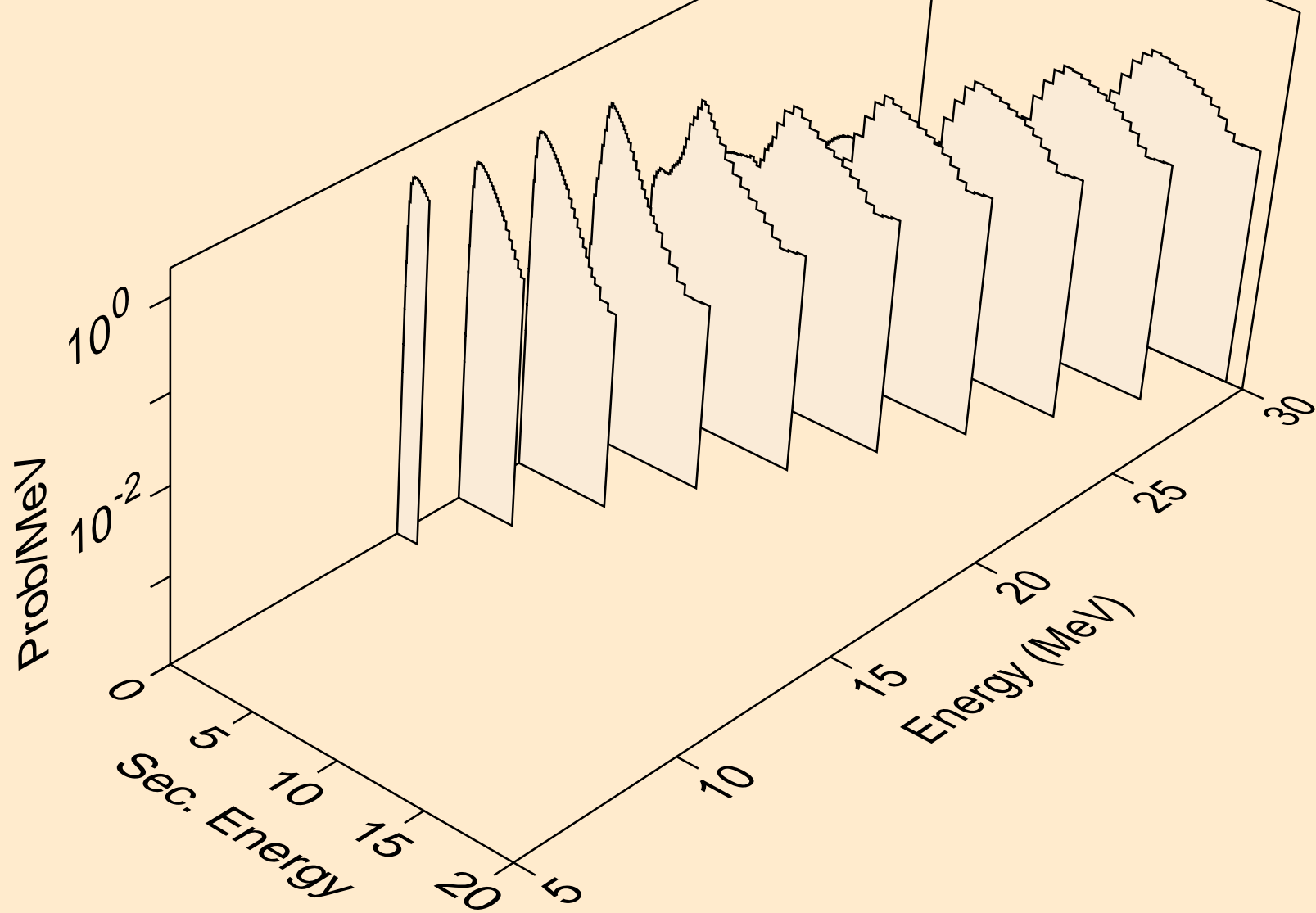

CD110 PHOTON ACER TENDL-2021 LIBRARY; T=0.K
photons from (g,2n)

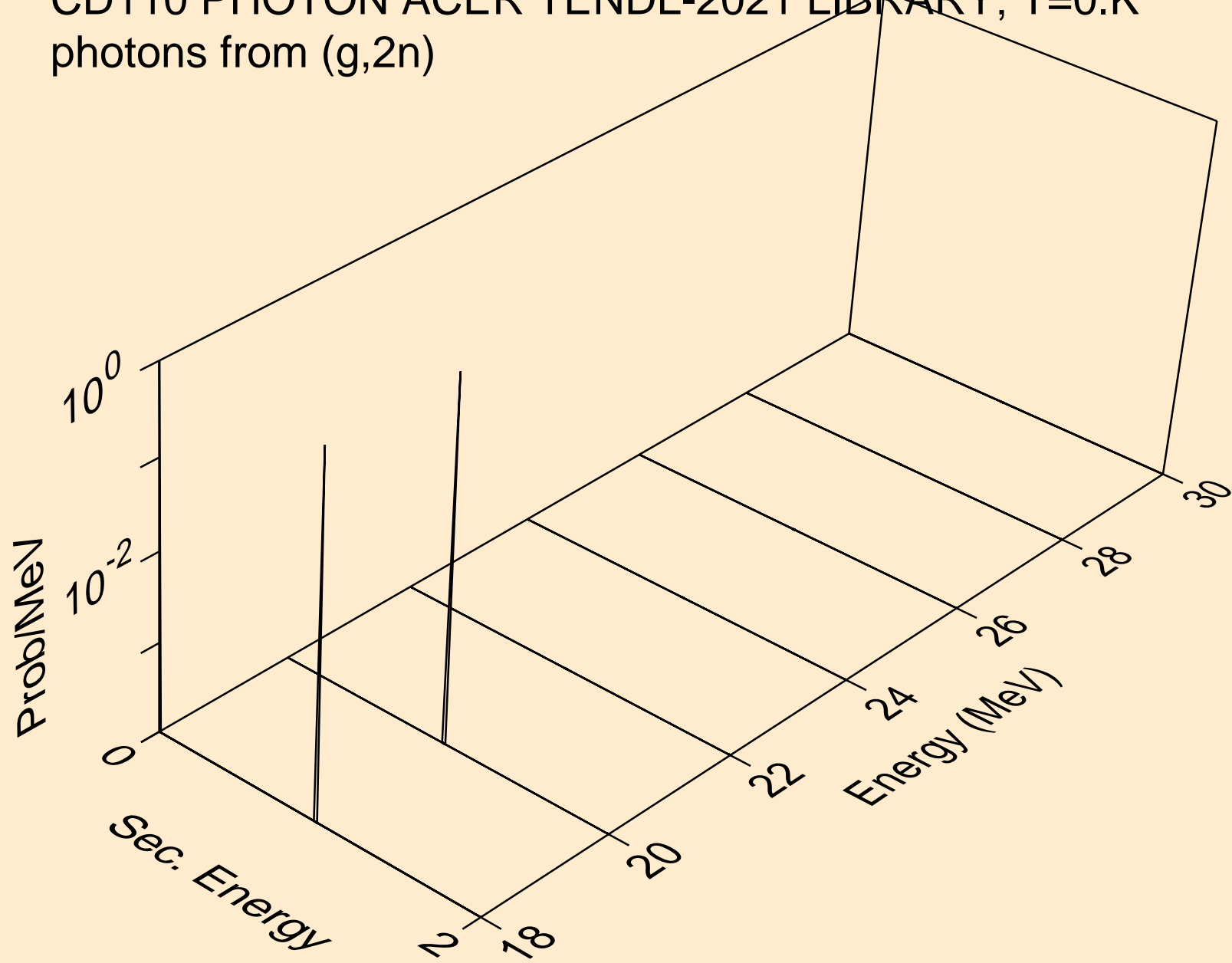

CD110 PHOTON ACER TENDL-2021 LIBRARY; T=0.K
photons from (g,n*)a

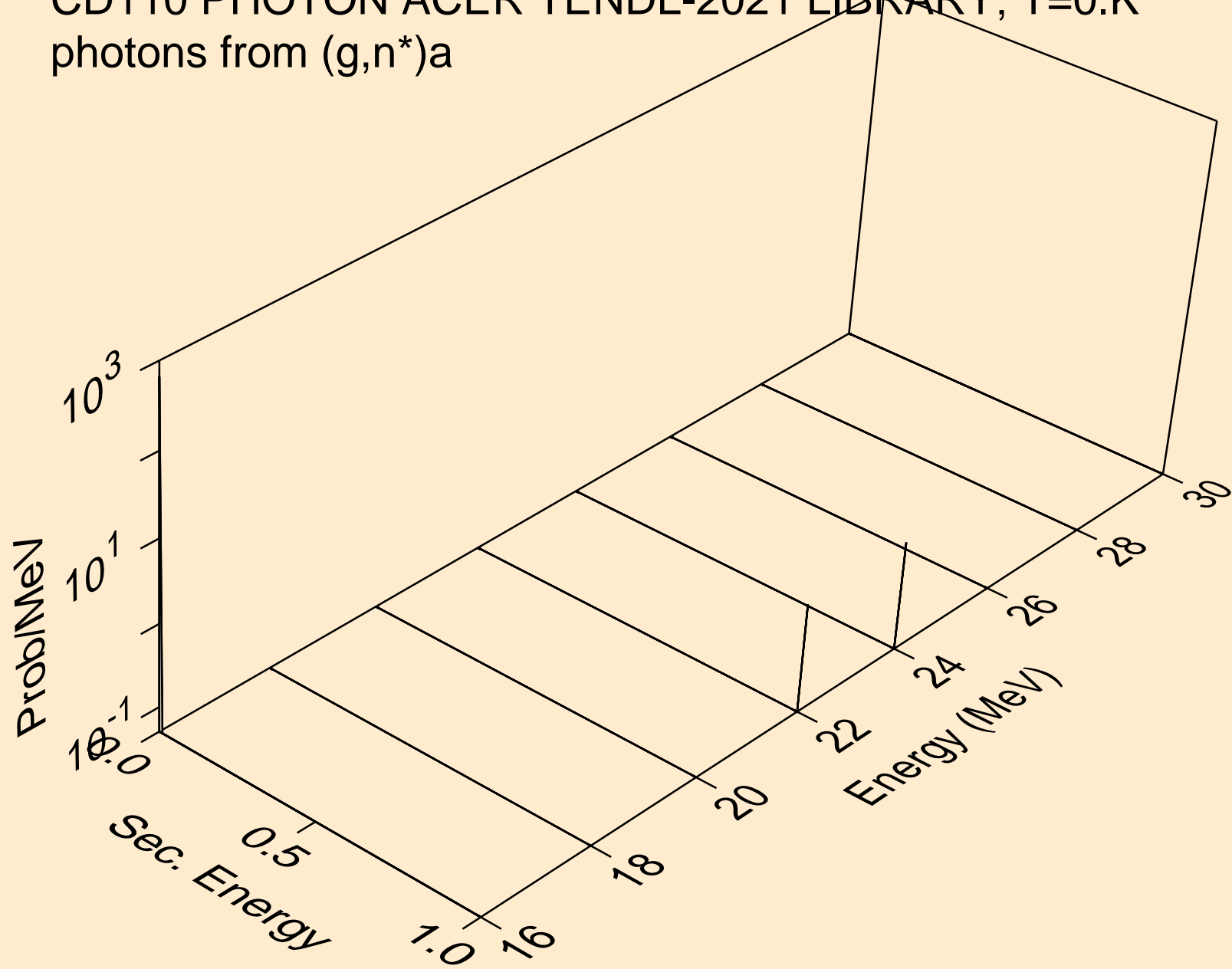

CD110 PHOTON ACER TENDL-2021 LIBRARY; T=0.K
photons from (g,2n)a

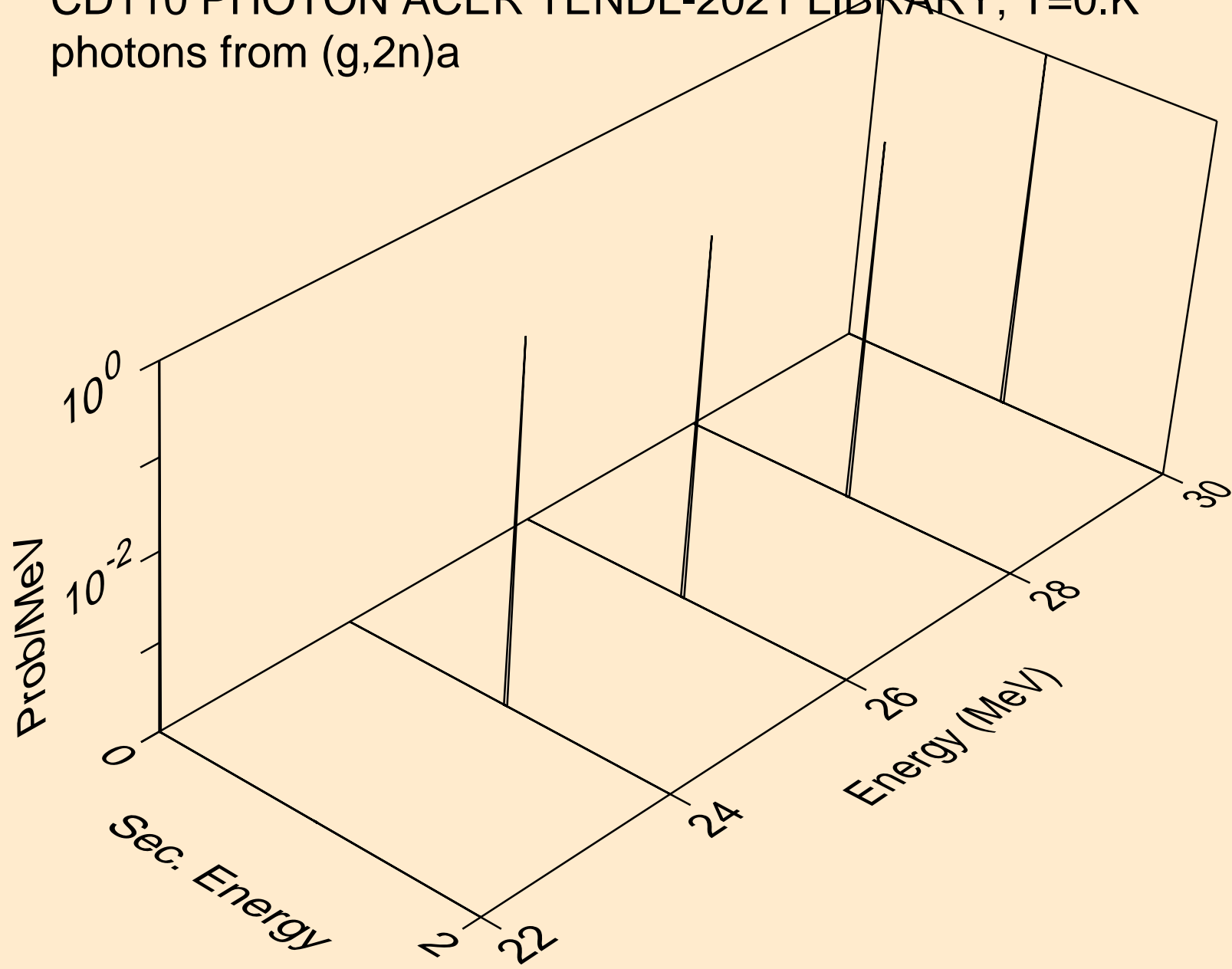

CD110 PHOTON ACER TENDL-2021 LIBRARY; T=0.K
photons from (g,n*)p

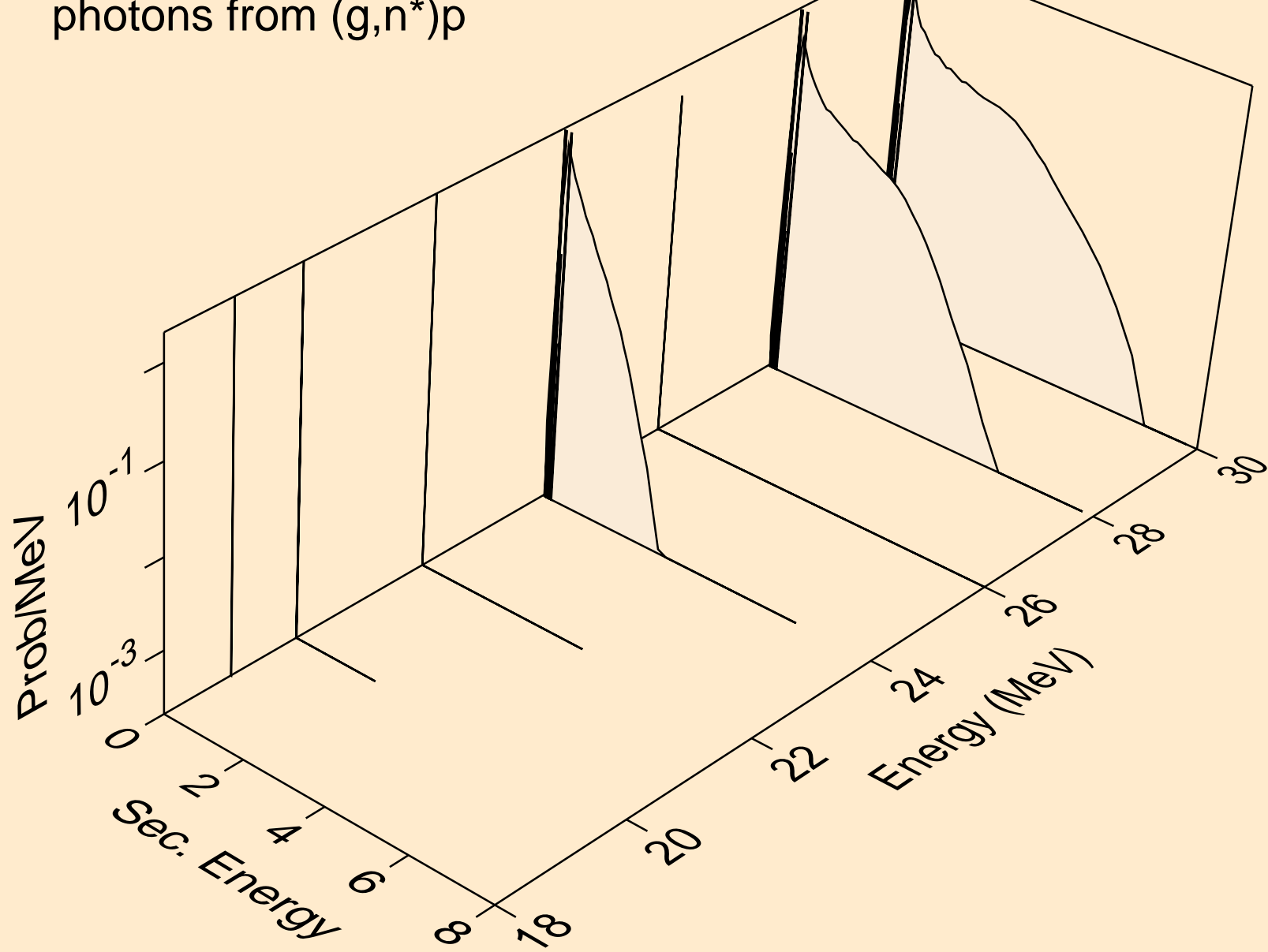

CD110 PHOTON ACER TENDL-2021 LIBRARY; T=0.K
photons from (g,n*)d

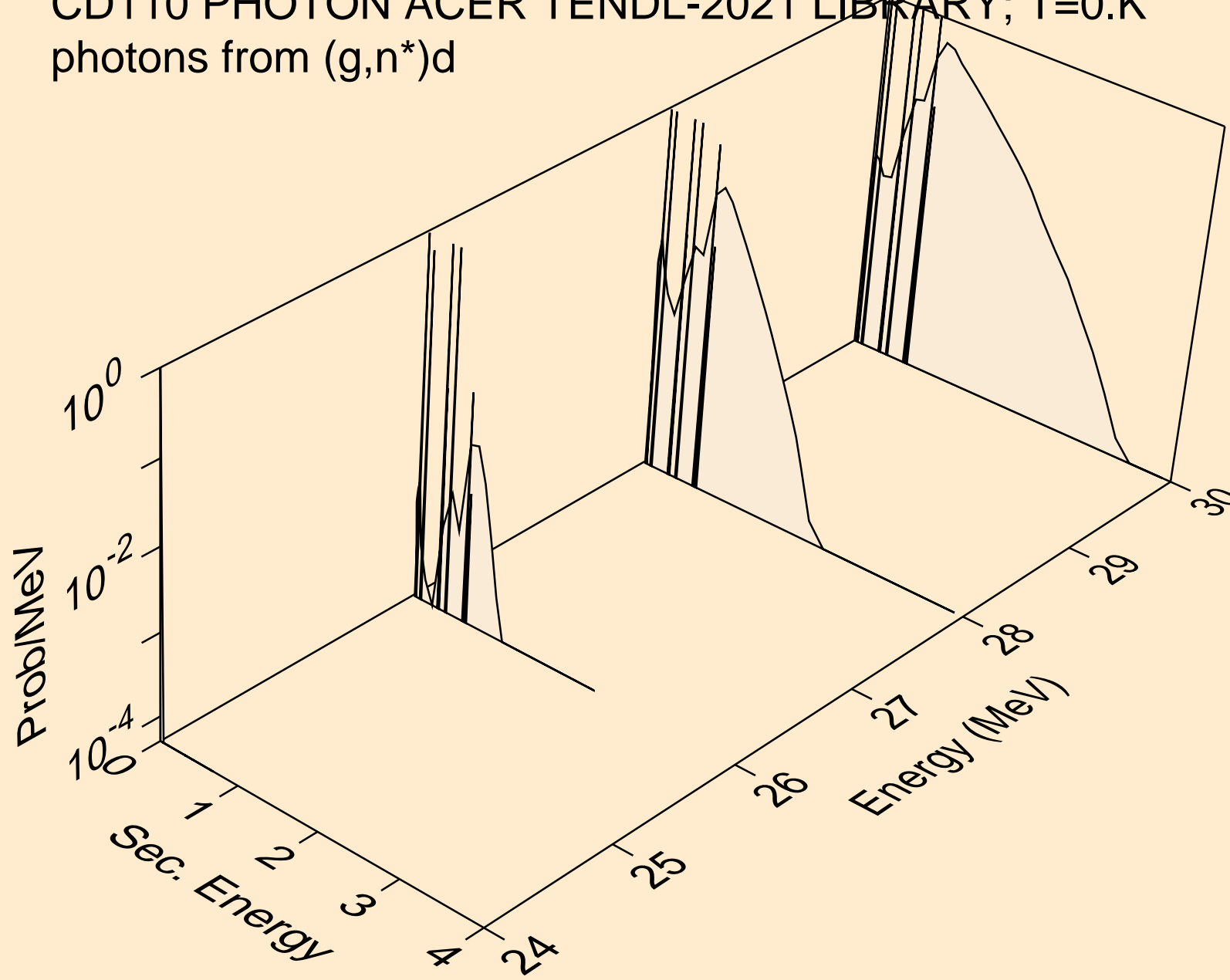

CD110 PHOTON ACER TENDL-2021 LIBRARY; T=0.K
photons from (g,2np)

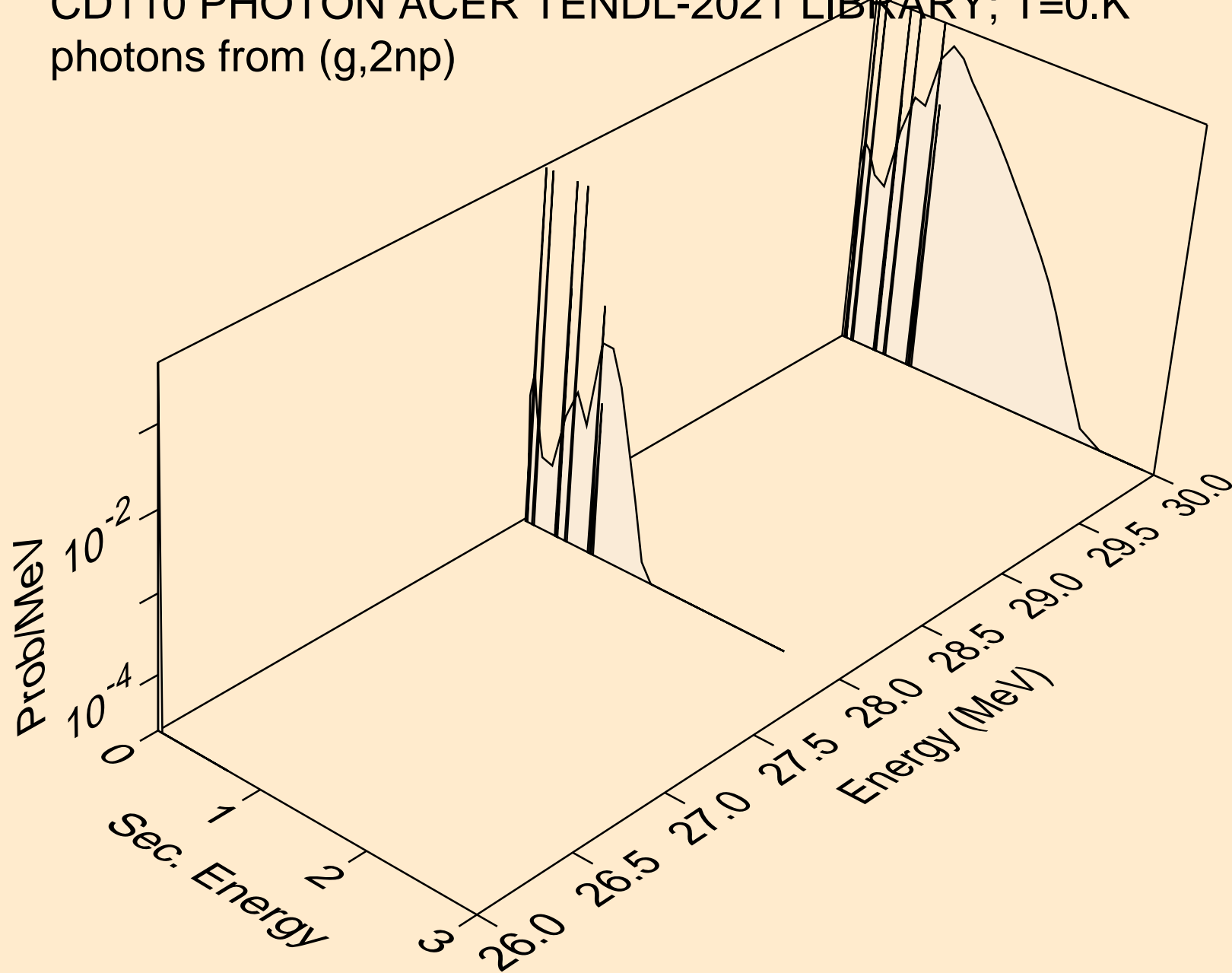

CD110 PHOTON ACER TENDL-2021 LIBRARY; T=0.K
photons from (g,n*c)

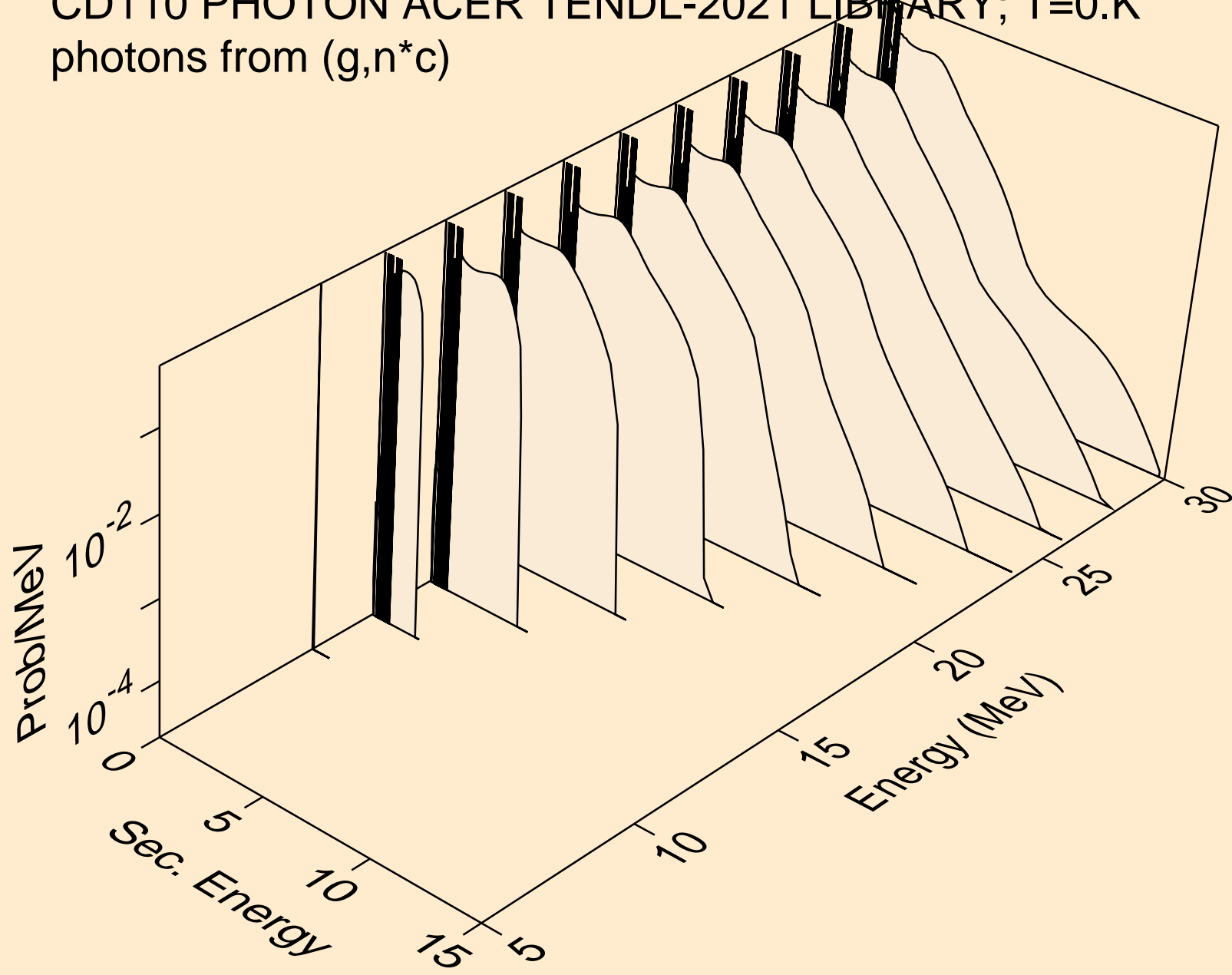

CD110 PHOTON ACER TENDL-2021 LIBRARY; T=0.K
photons from (g,gma)

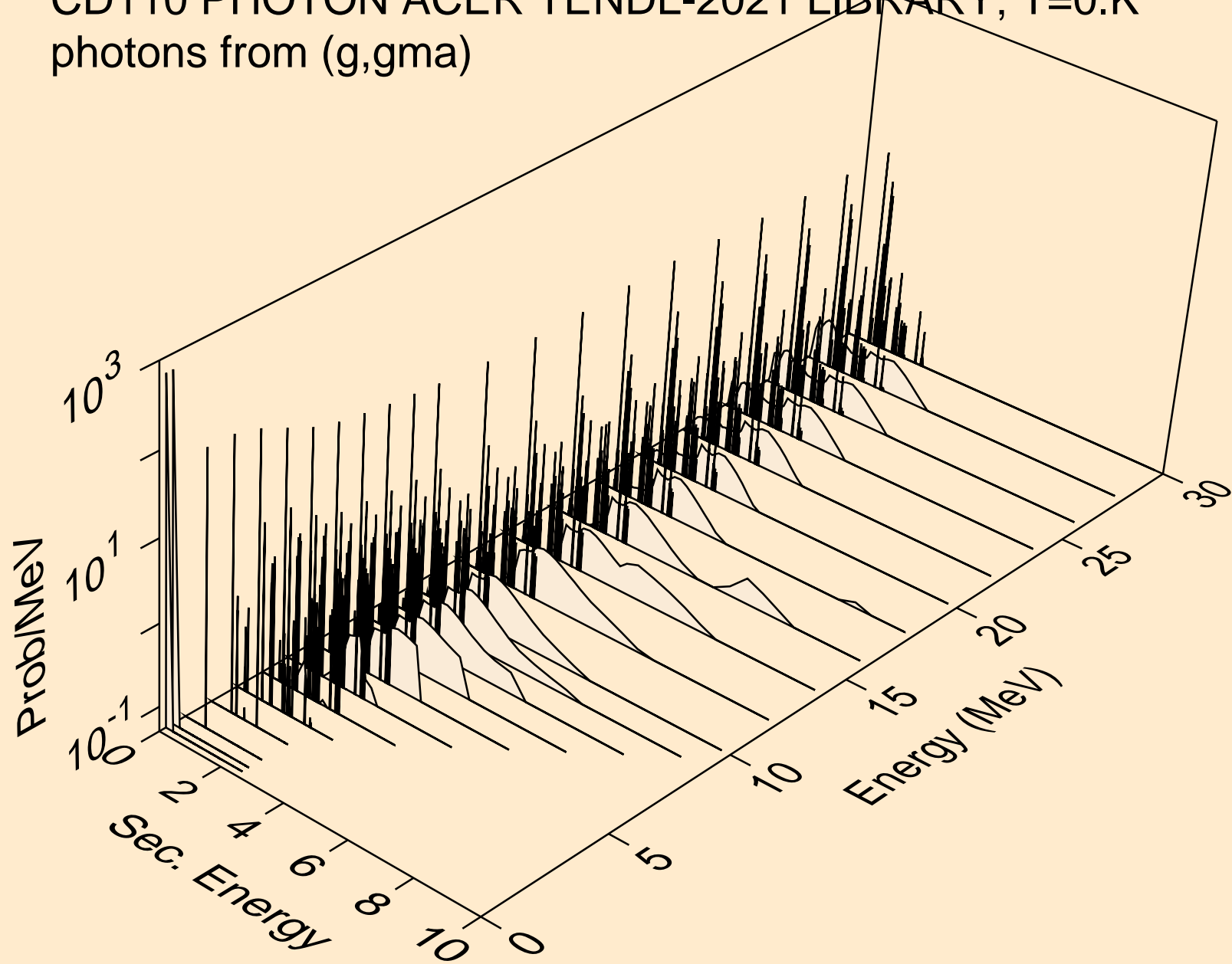

CD110 PHOTON ACER TENDL-2021 LIBRARY; T=0.K
photons from (g,p)

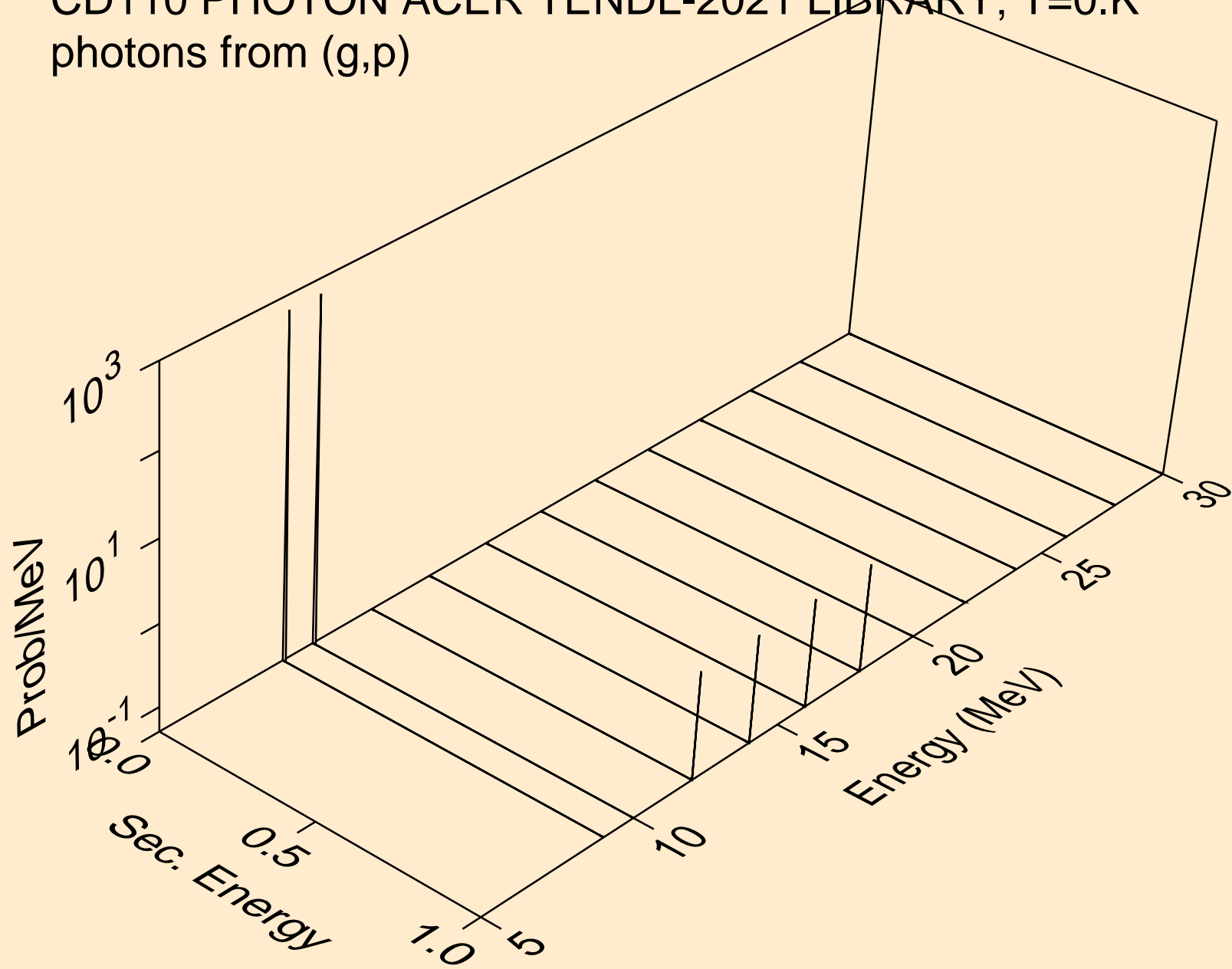

CD110 PHOTON ACER TENDL-2021 LIBRARY; T=0.K
photons from (g,d)

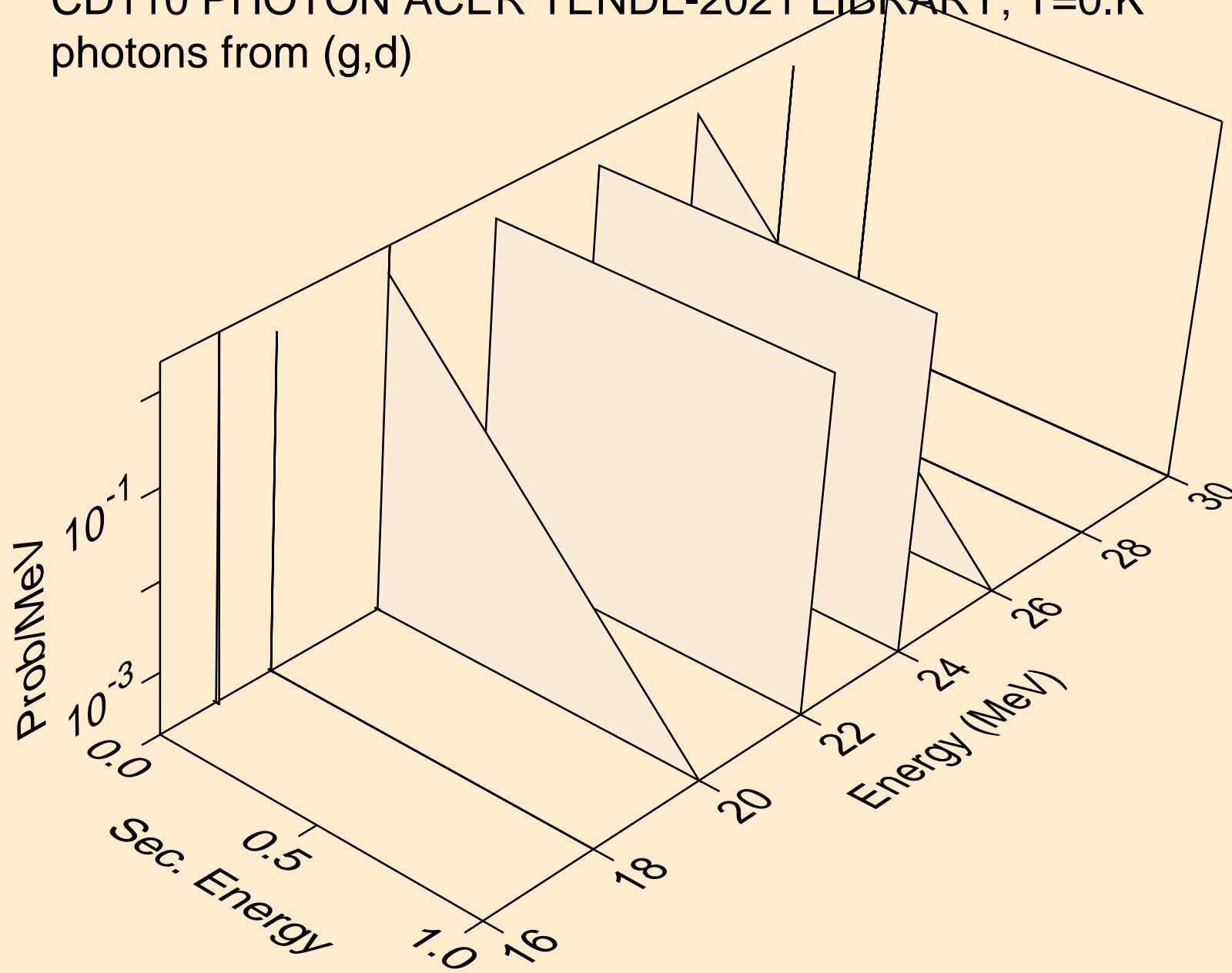

CD110 PHOTON ACER TENDL-2021 LIBRARY; T=0.K
photons from (g,t)

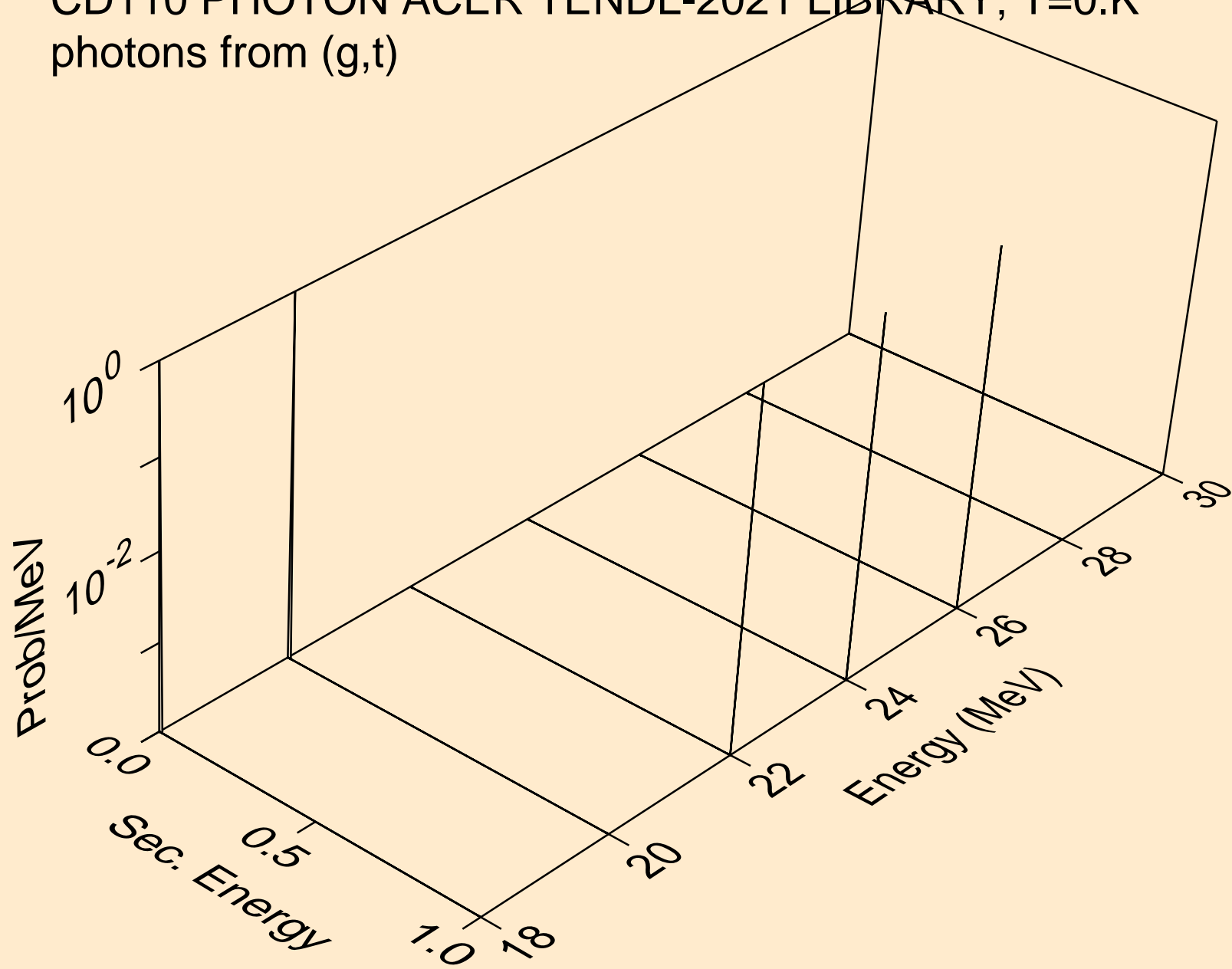

CD110 PHOTON ACER TENDL-2021 LIBRARY; T=0.K
photons from (g,a)

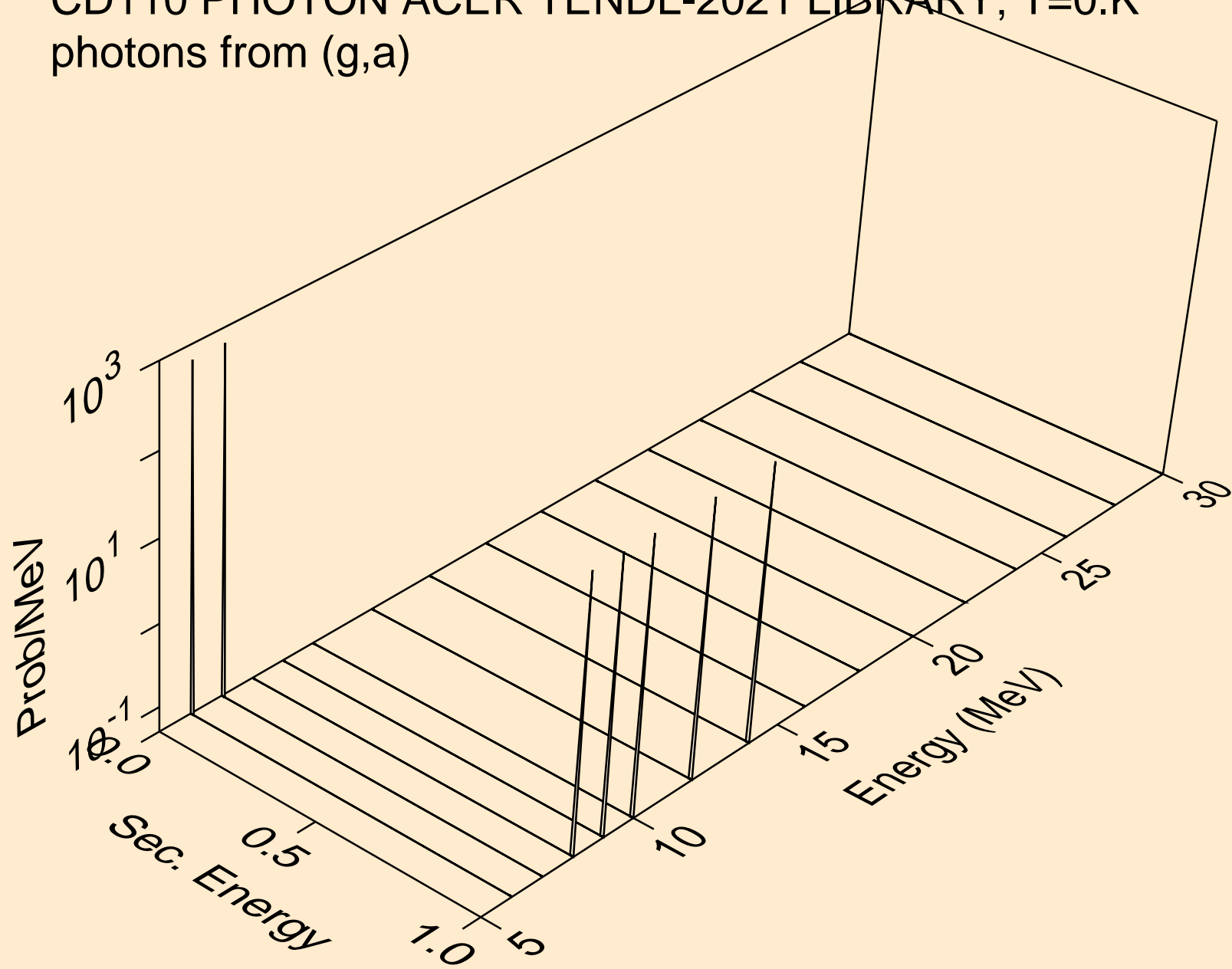

CD110 PHOTON ACER TENDL-2021 LIBRARY; T=0.K
photons from (g,2a)

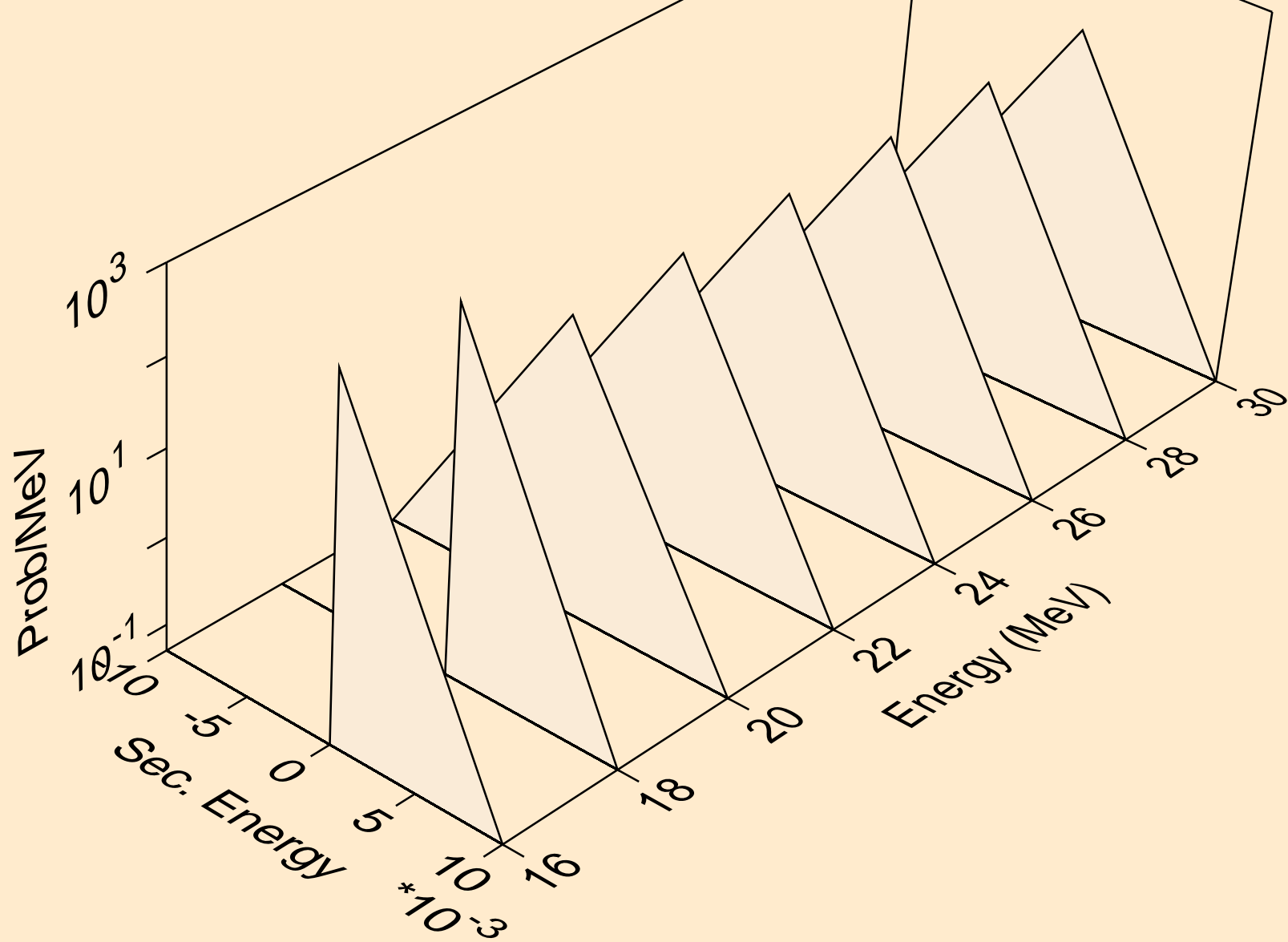

CD110 PHOTON ACER TENDL-2021 LIBRARY; T=0.K
photons from (g,2p)

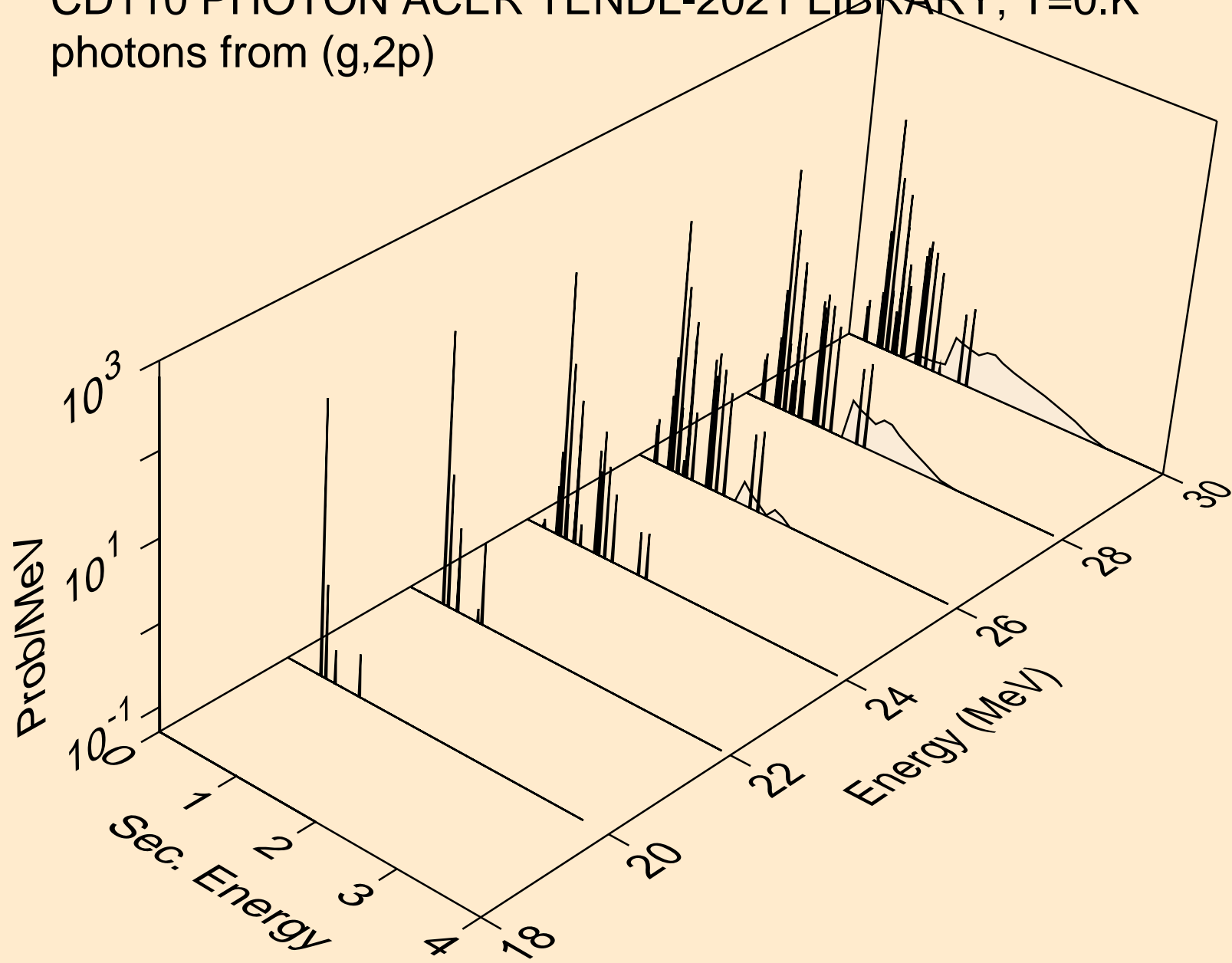

CD110 PHOTON ACER TENDL-2021 LIBRARY; T=0.K
protons from (g,x)

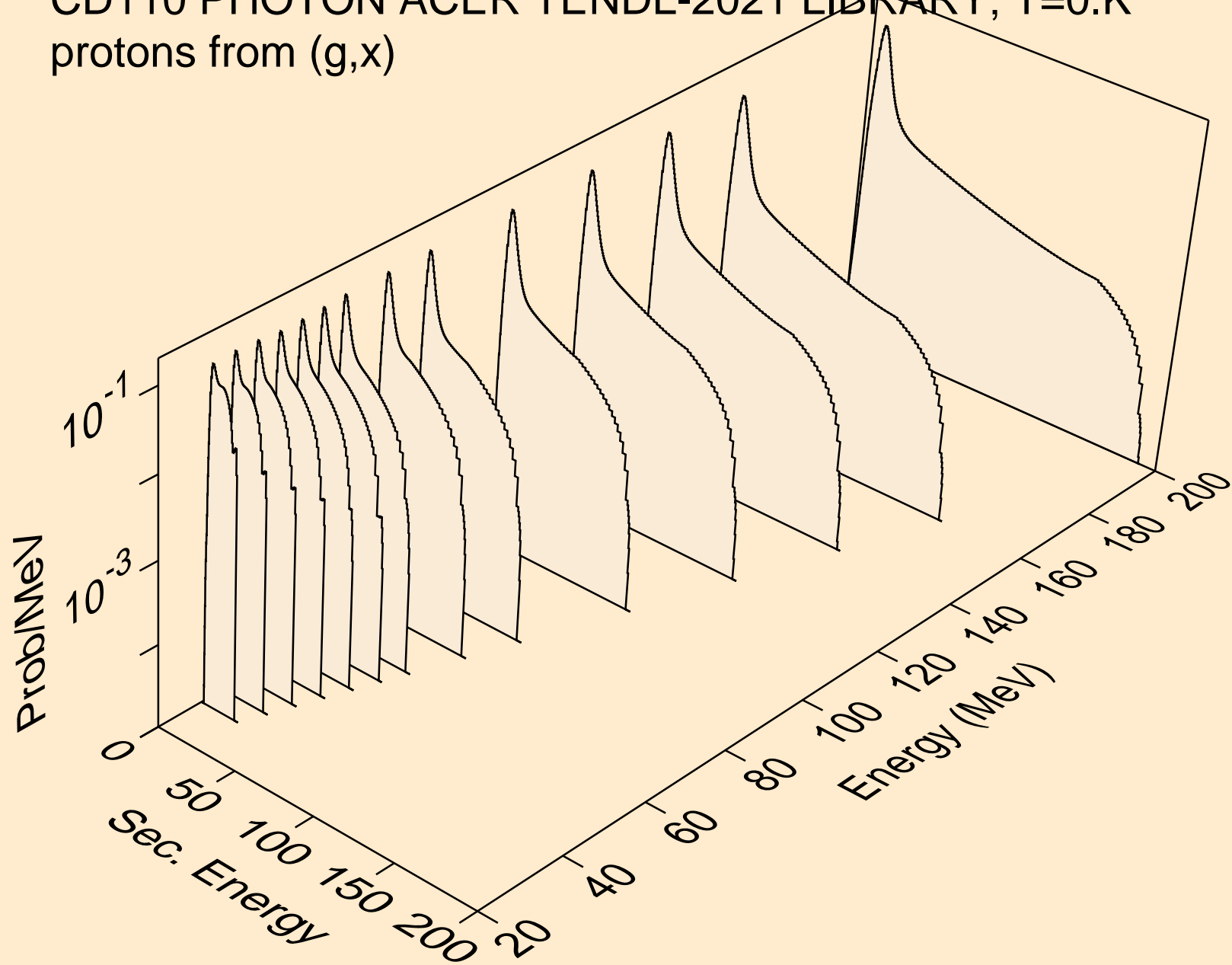

CD110 PHOTON ACER TENDL-2021 LIBRARY; T=0.K
protons from (g,n*)p

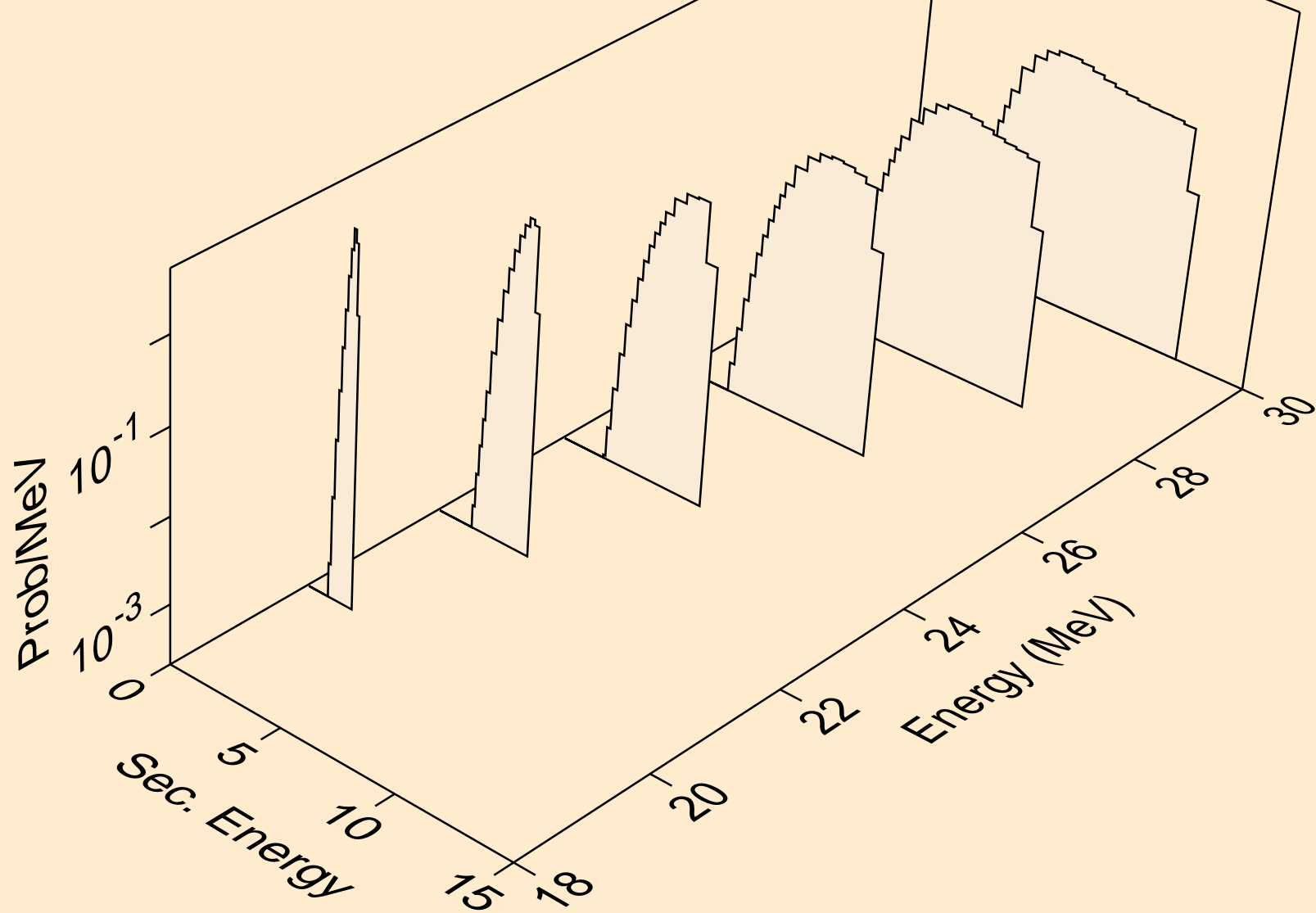

CD110 PHOTON ACER TENDL-2021 LIBRARY; T=0.K
protons from (g,2np)

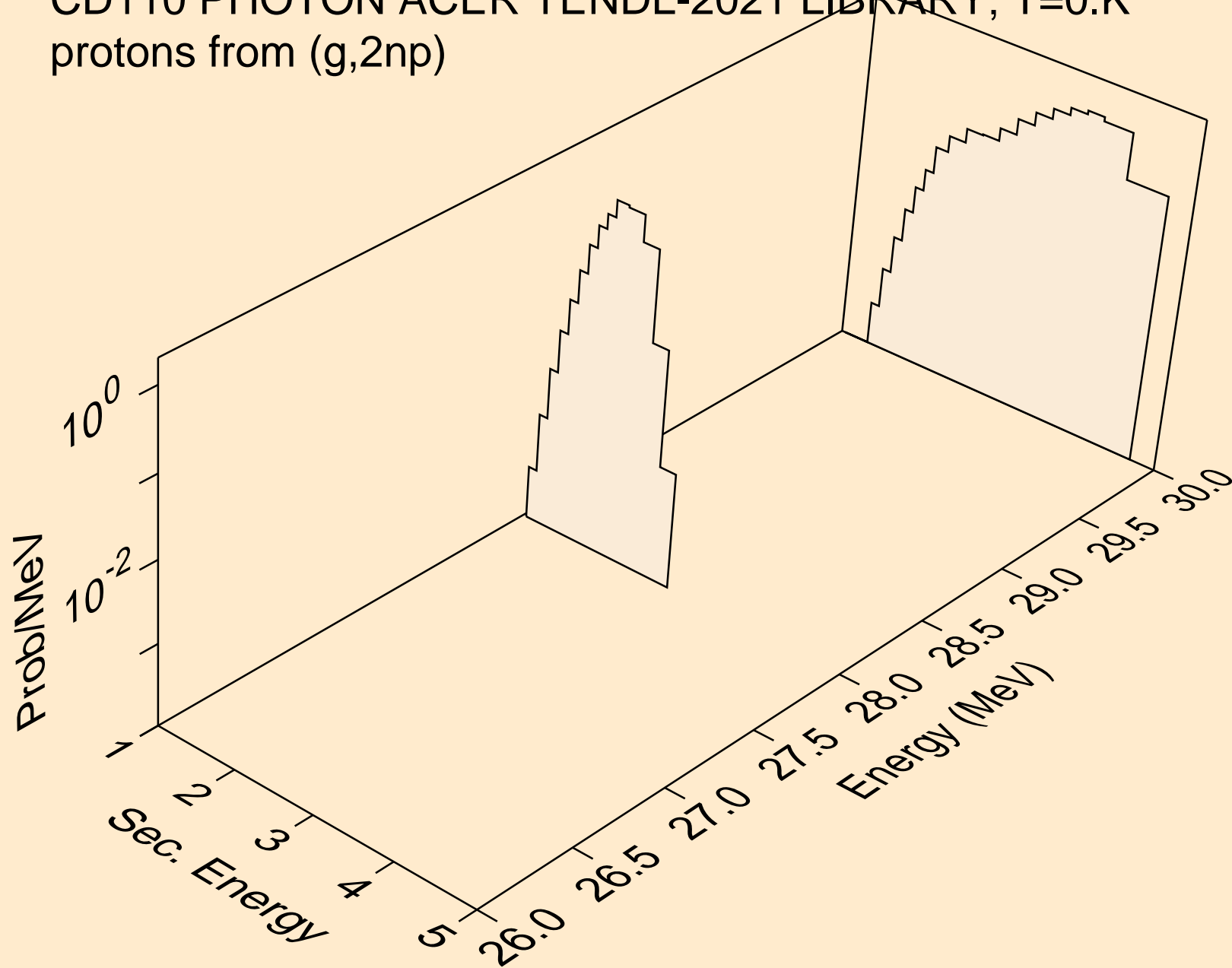

CD110 PHOTON ACER TENDL-2021 LIBRARY; T=0.K
protons from (g,p)

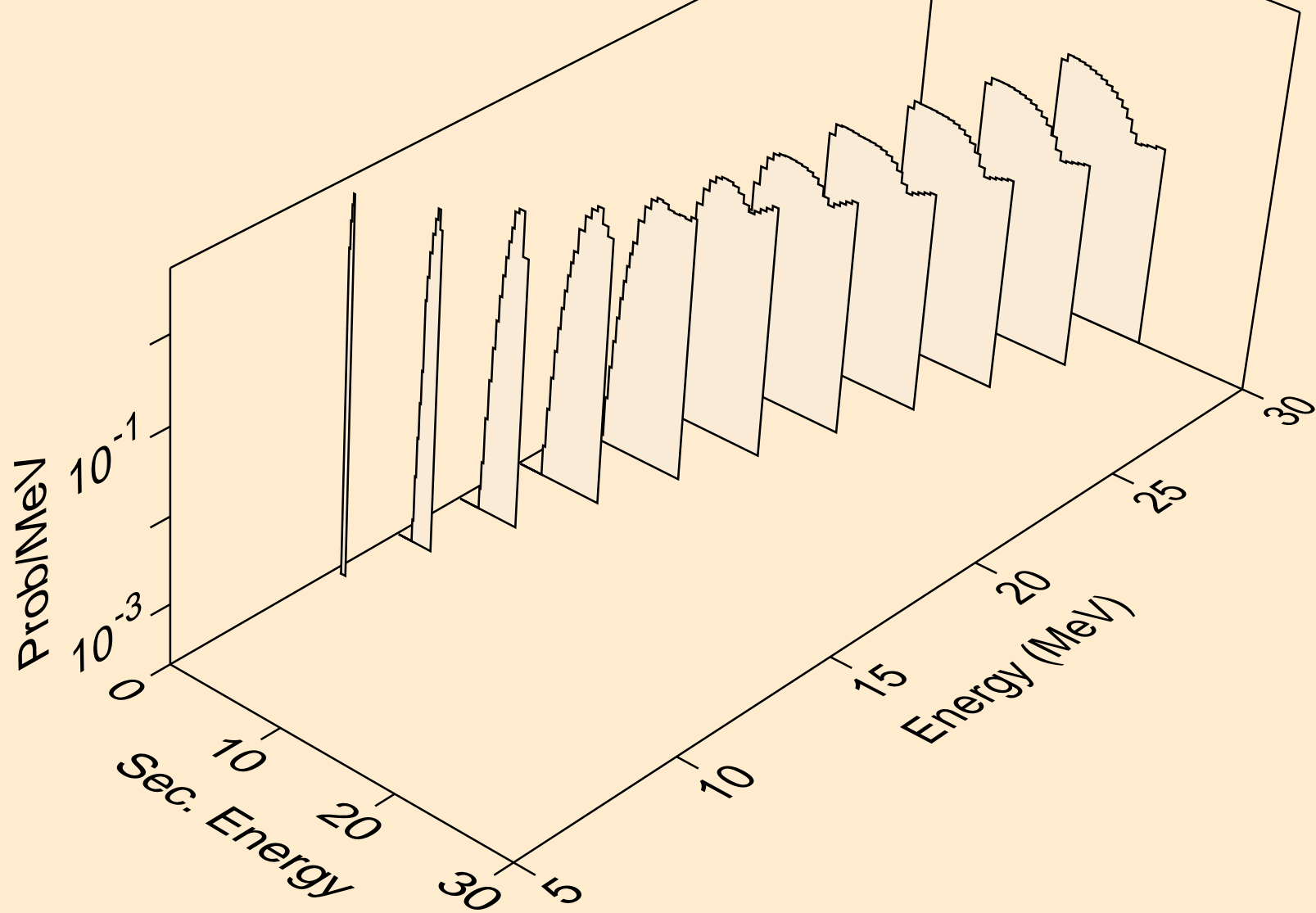

CD110 PHOTON ACER TENDL-2021 LIBRARY; T=0.K
protons from (g,2p)

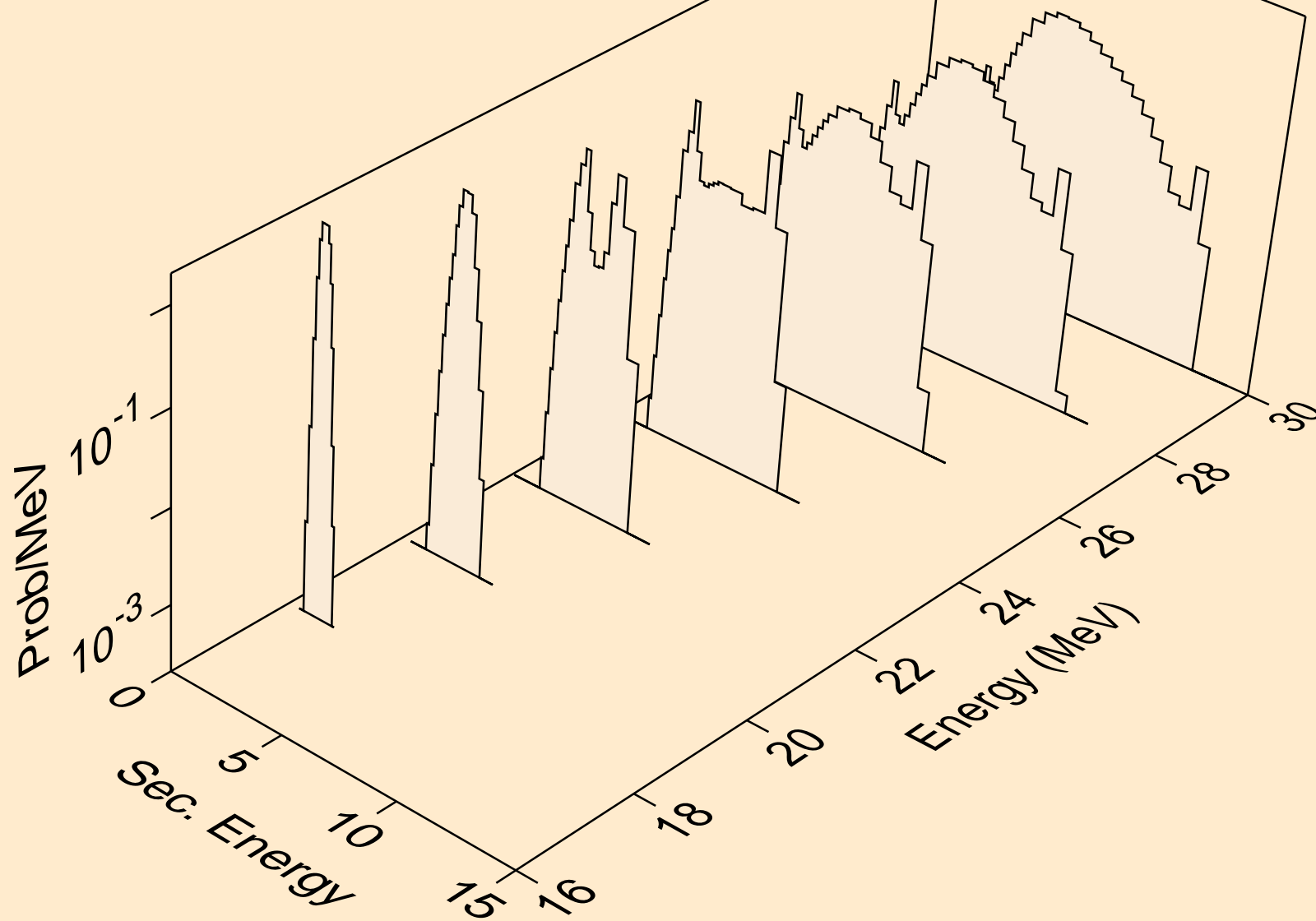

CD110 PHOTON ACER TENDL-2021 LIBRARY; T=0.K
protons from (g,pa)

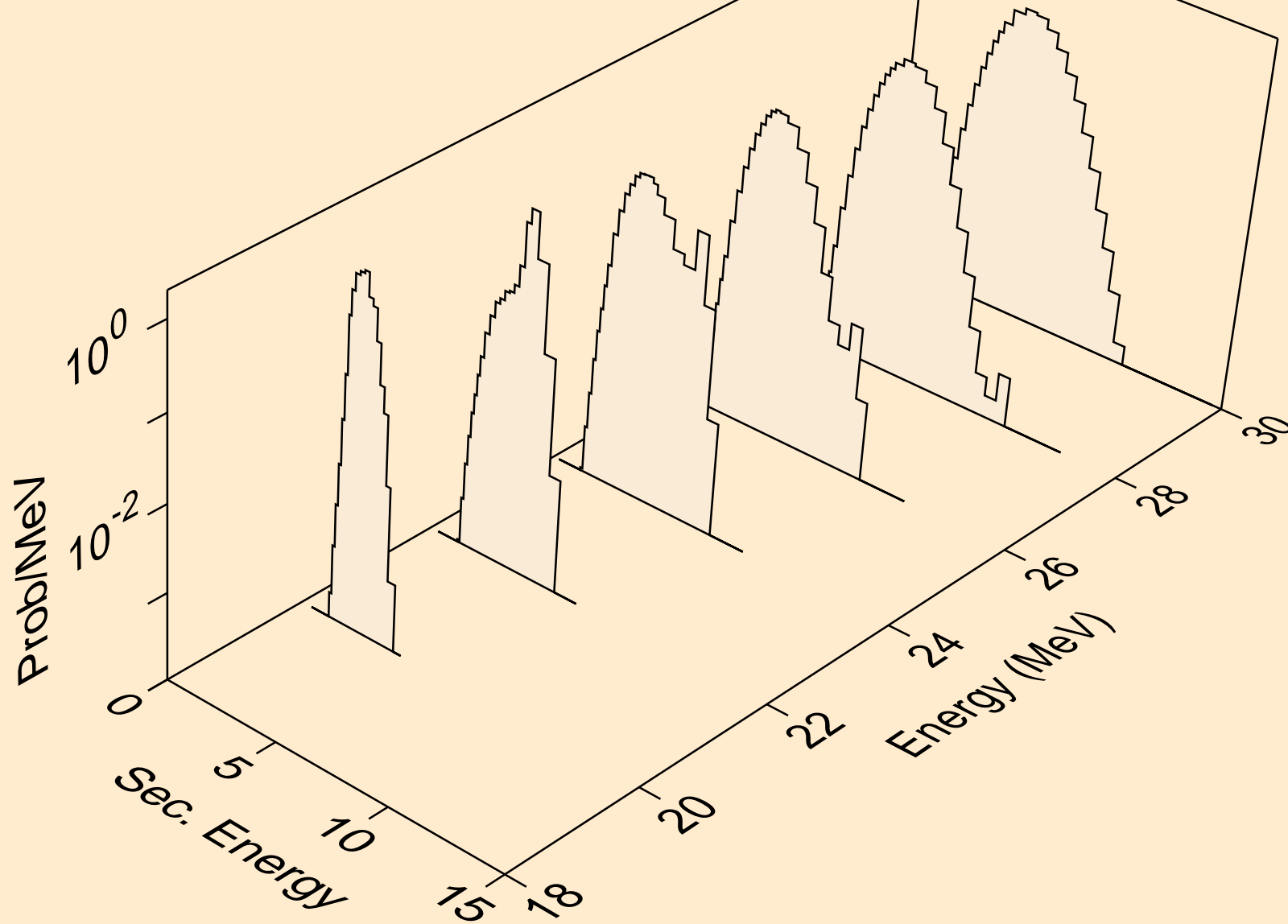

CD110 PHOTON ACER TENDL-2021 LIBRARY; T=0.K
deuterons from (g,x)

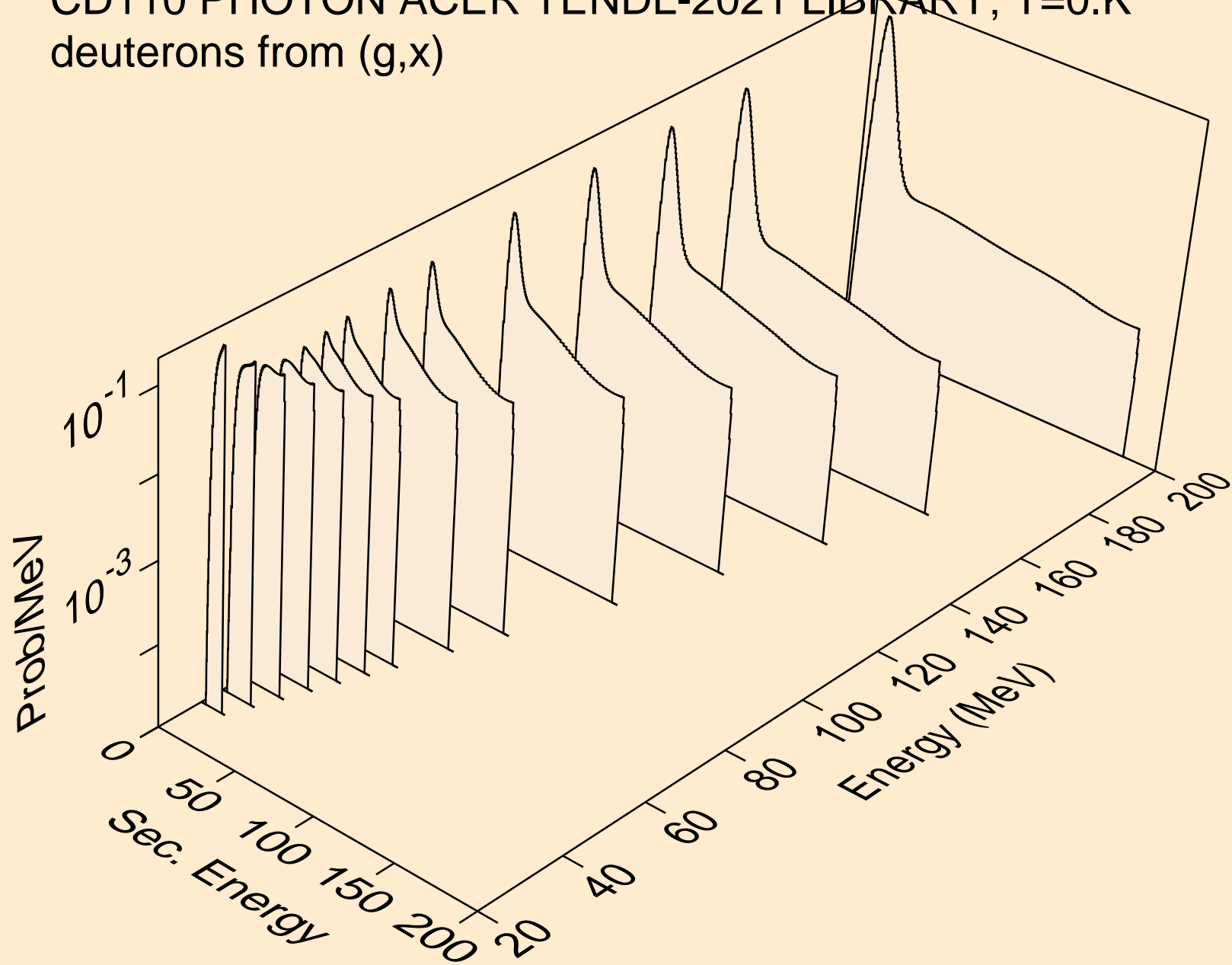

CD110 PHOTON ACER TENDL-2021 LIBRARY; T=0.K
deuterons from (g,n*)d

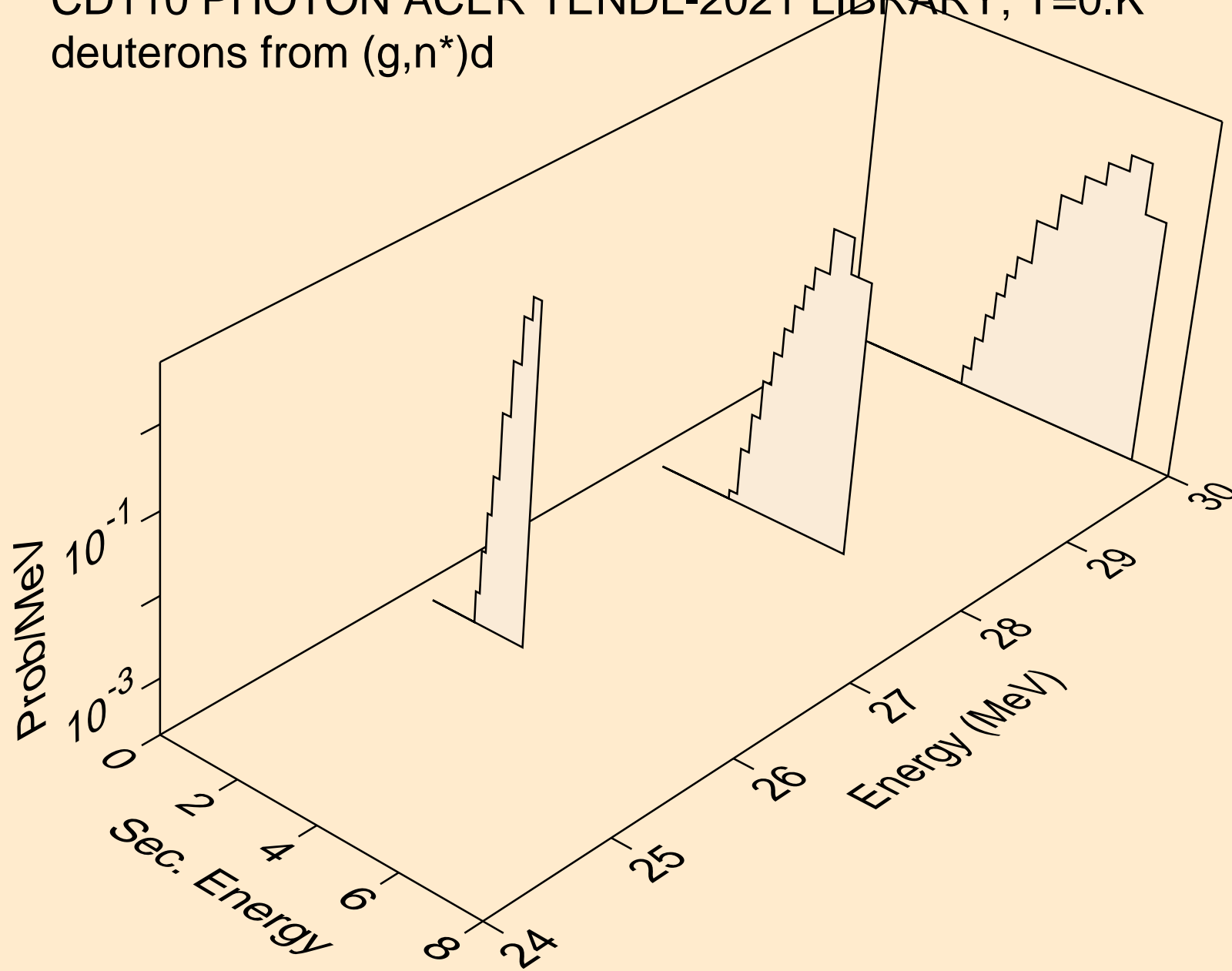

CD110 PHOTON ACER TENDL-2021 LIBRARY; T=0.K
deuterons from (g,d)

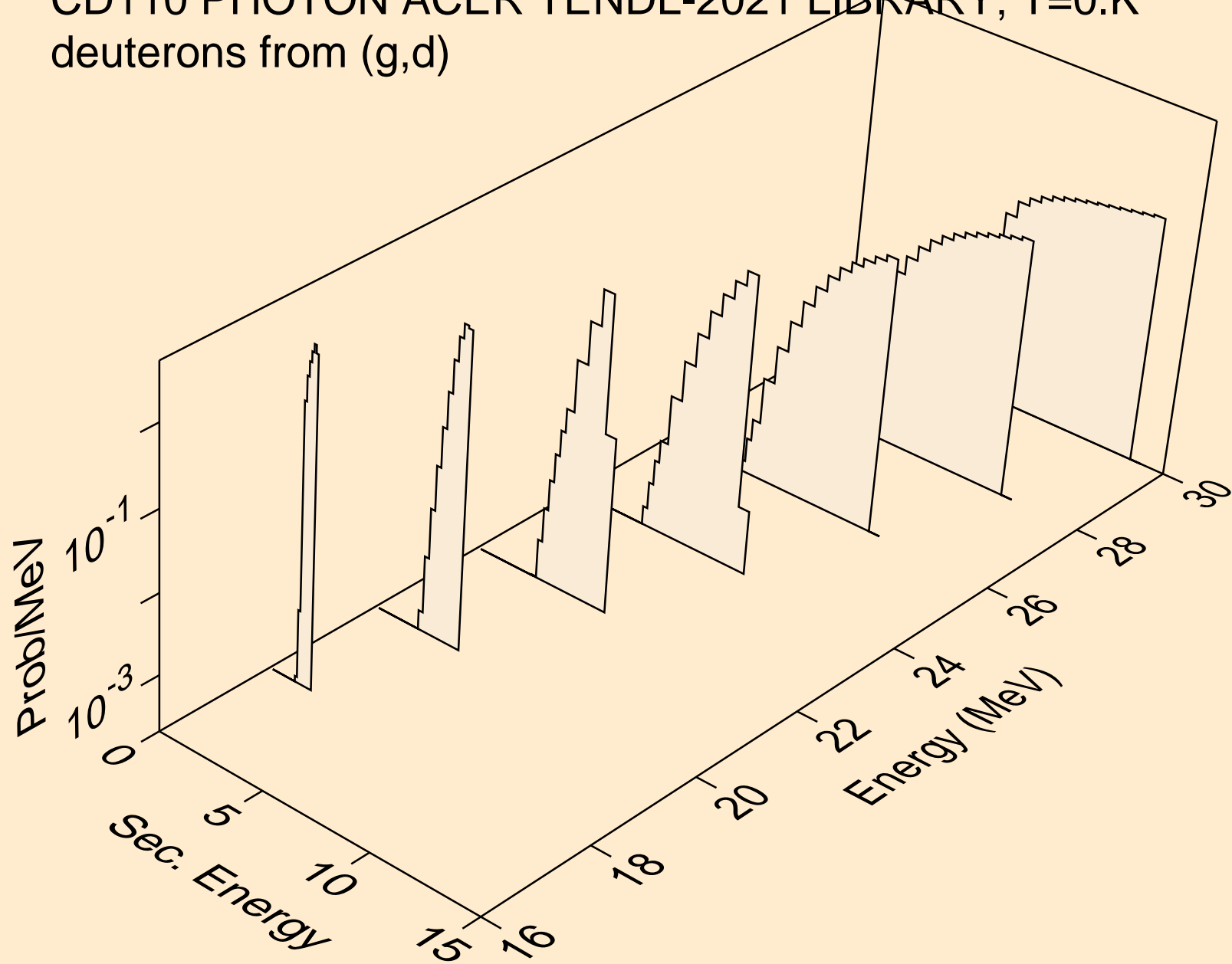

CD110 PHOTON ACER TENDL-2021 LIBRARY; T=0.K
tritons from (g,x)

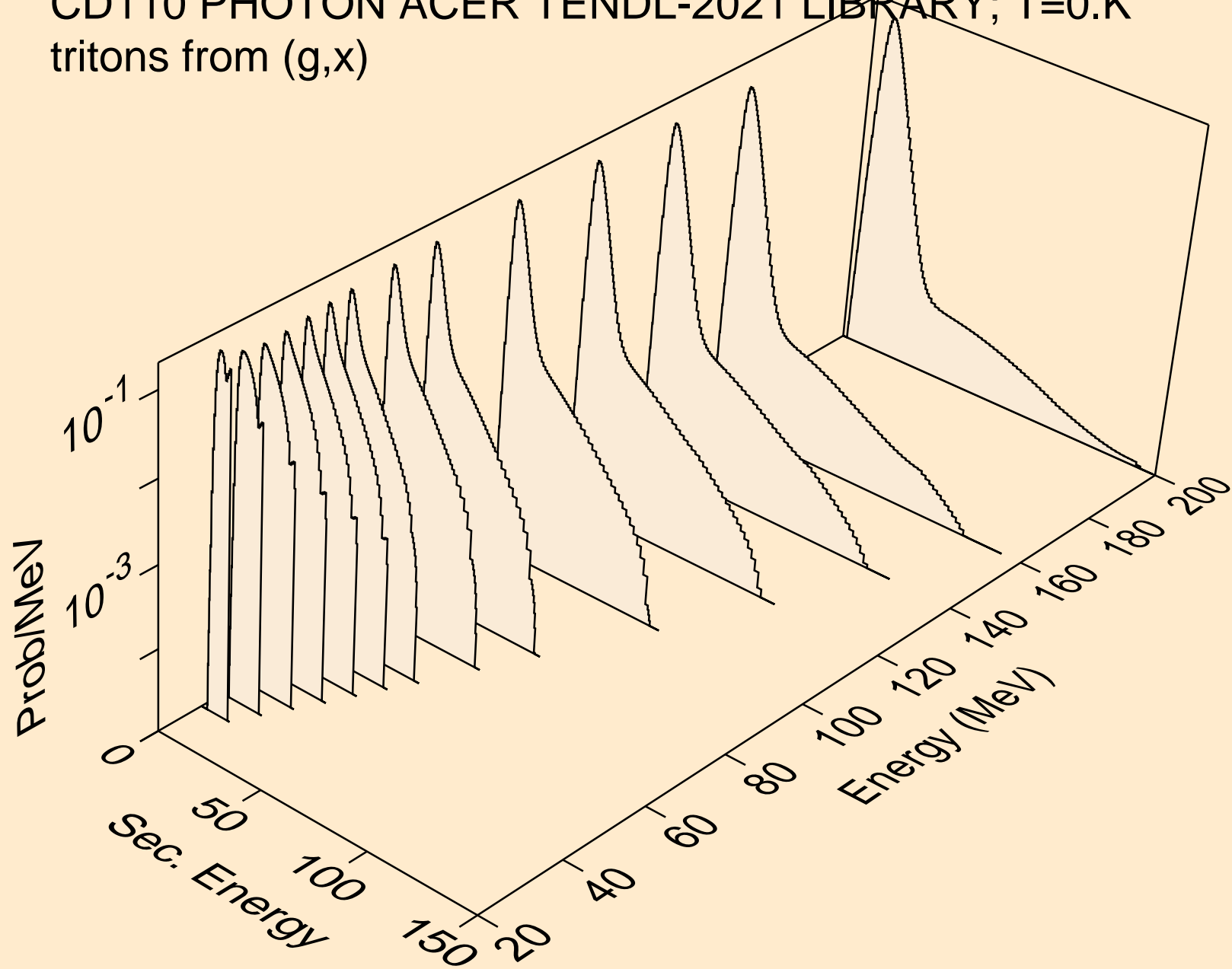

CD110 PHOTON ACER TENDL-2021 LIBRARY; T=0.K
tritons from (g,t)

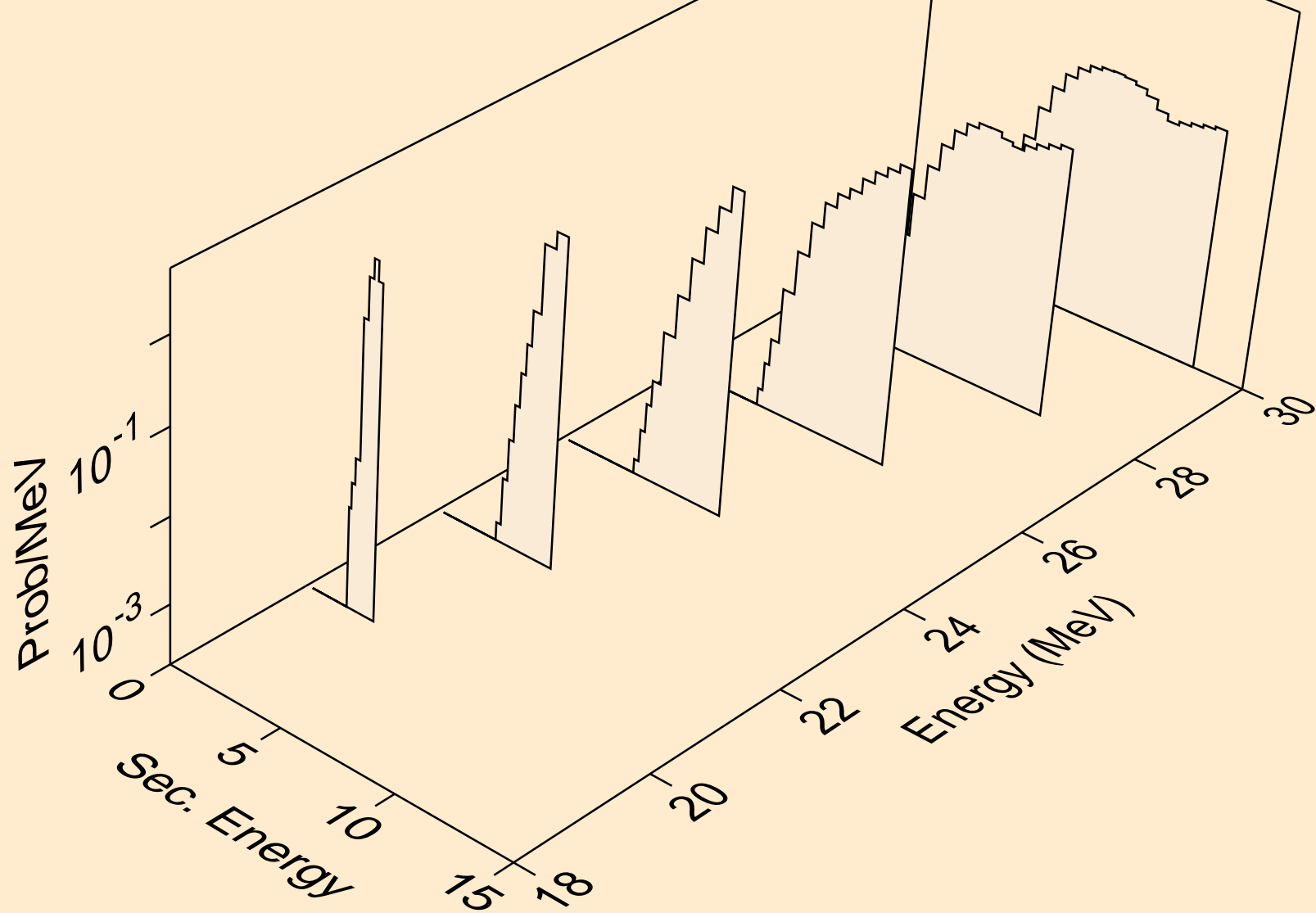

CD110 PHOTON ACER TENDL-2021 LIBRARY; T=0.K
he3s from (g,x)

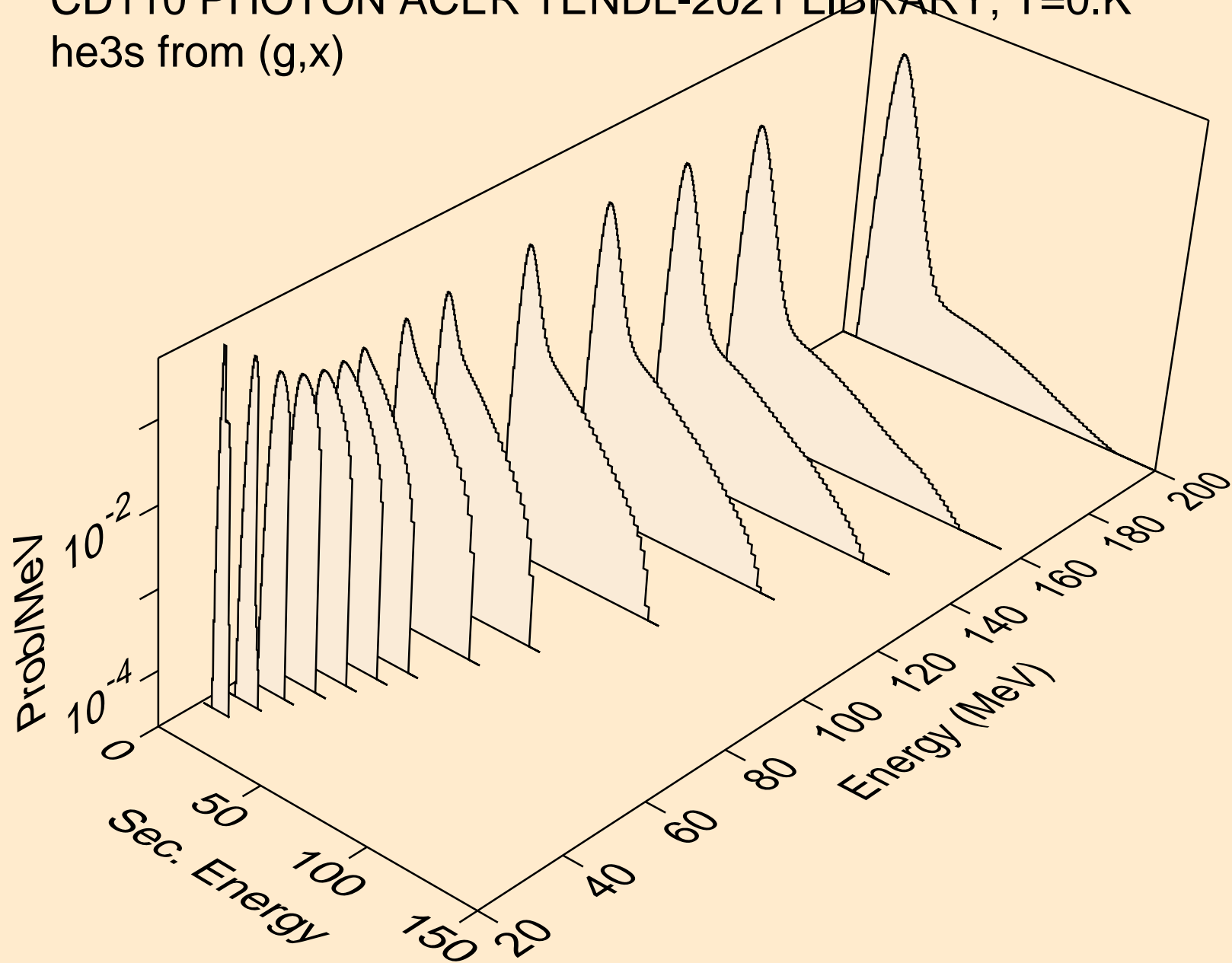

CD110 PHOTON ACER TENDL-2021 LIBRARY; T=0.K
alphas from (g,x)

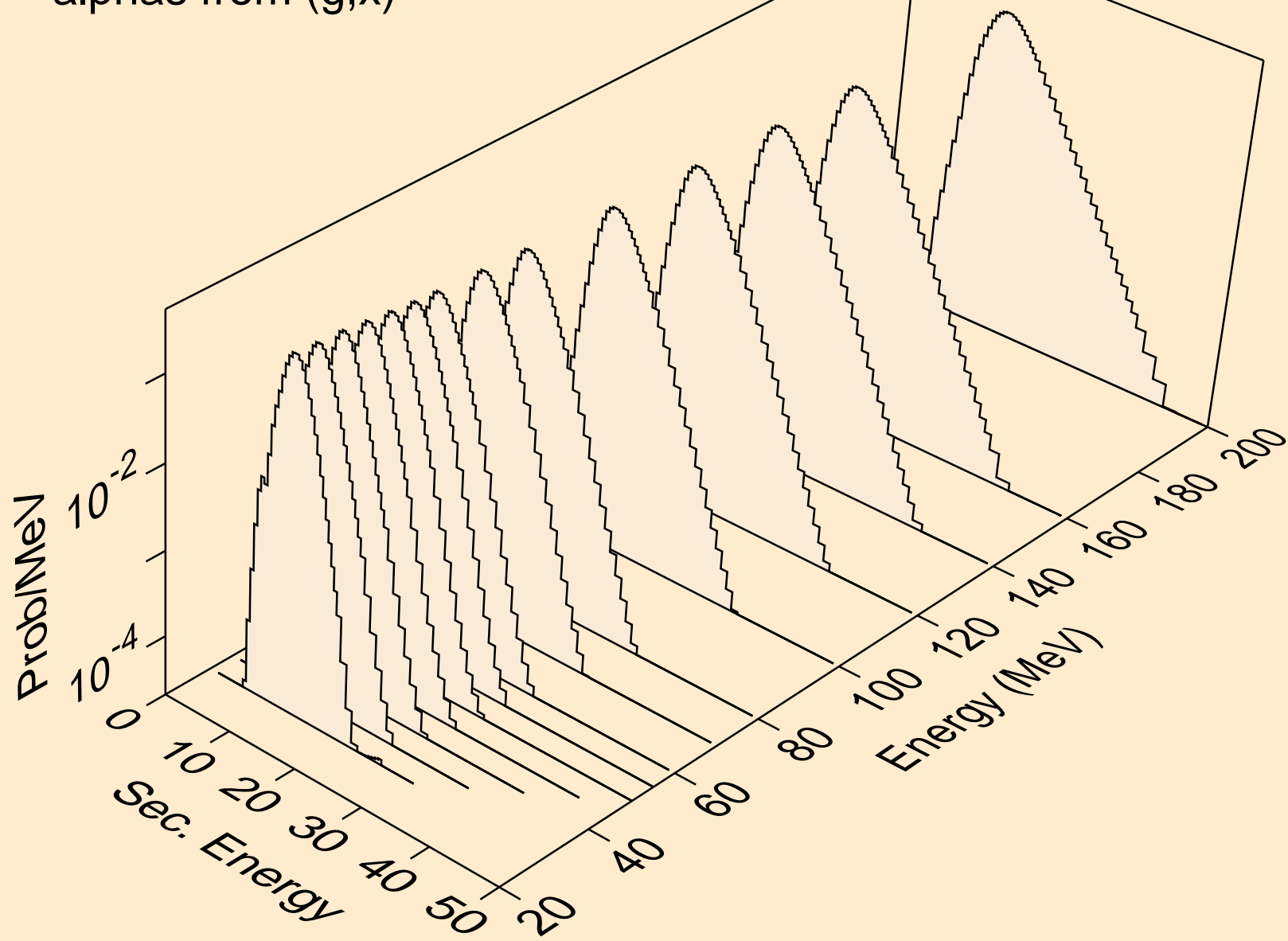

CD110 PHOTON ACER TENDL-2021 LIBRARY; T=0.K
alphas from (g,n*)a

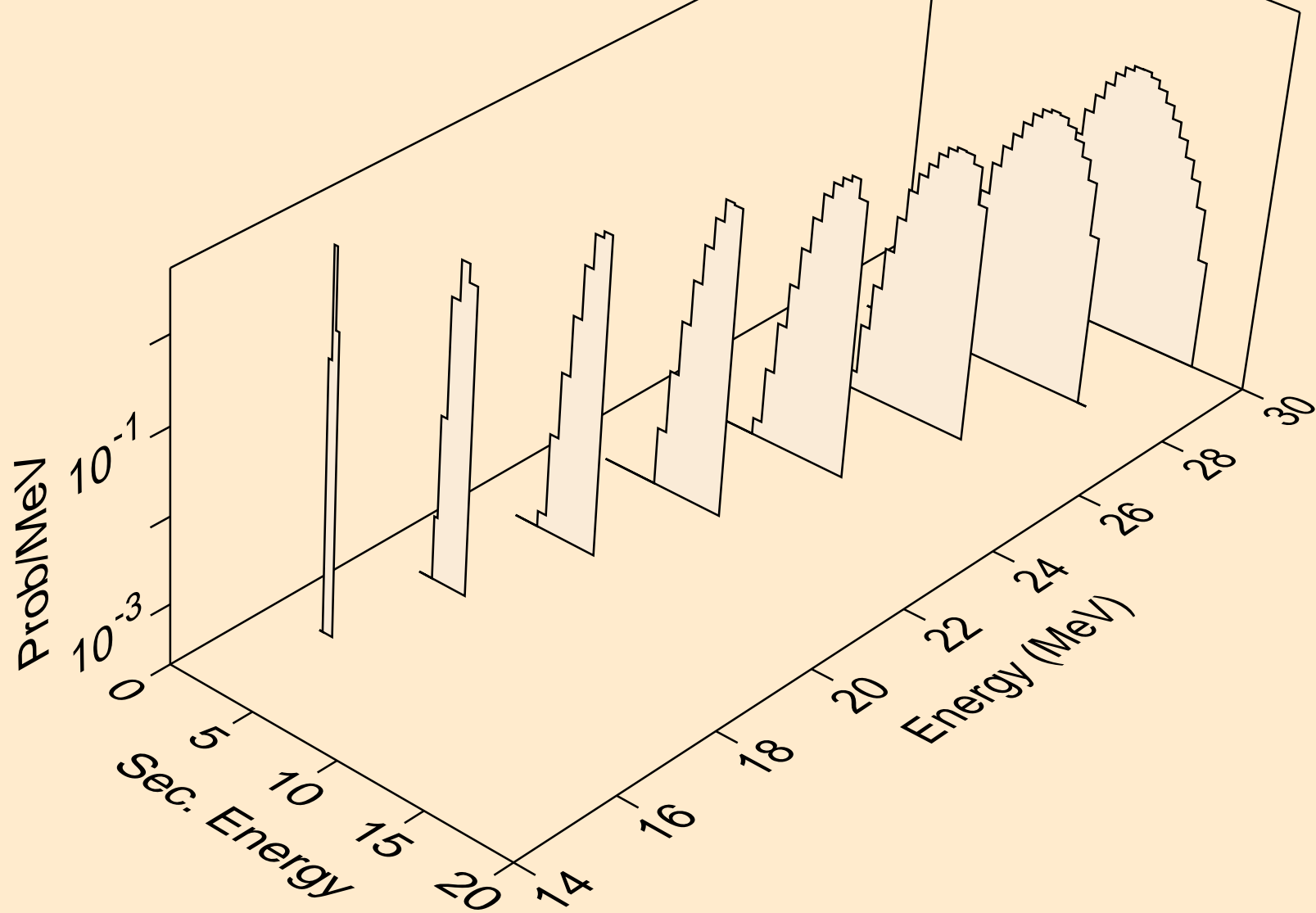

CD110 PHOTON ACER TENDL-2021 LIBRARY; T=0.K
alphas from (g,2n)a

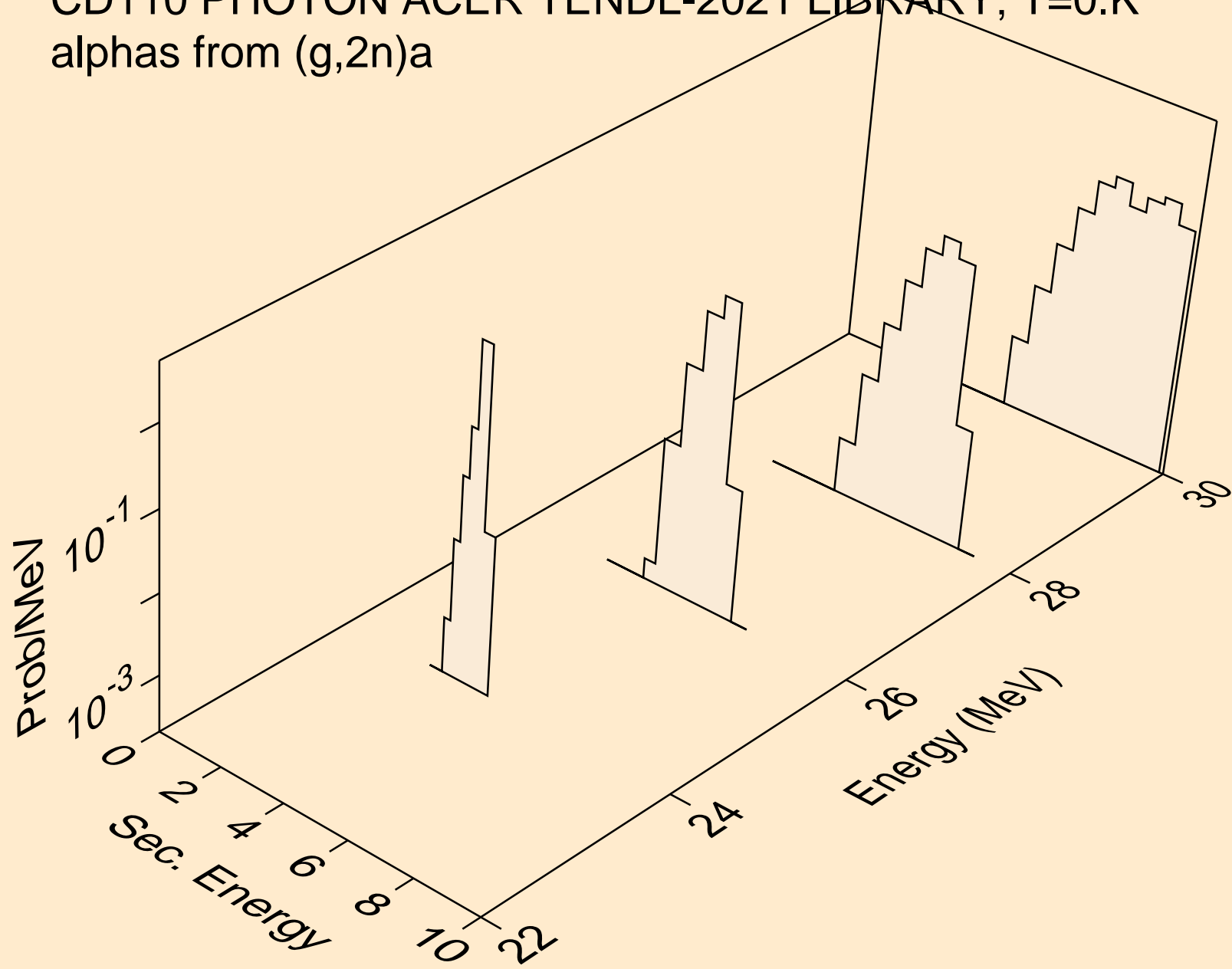

CD110 PHOTON ACER TENDL-2021 LIBRARY; T=0.K
alphas from (g,a)

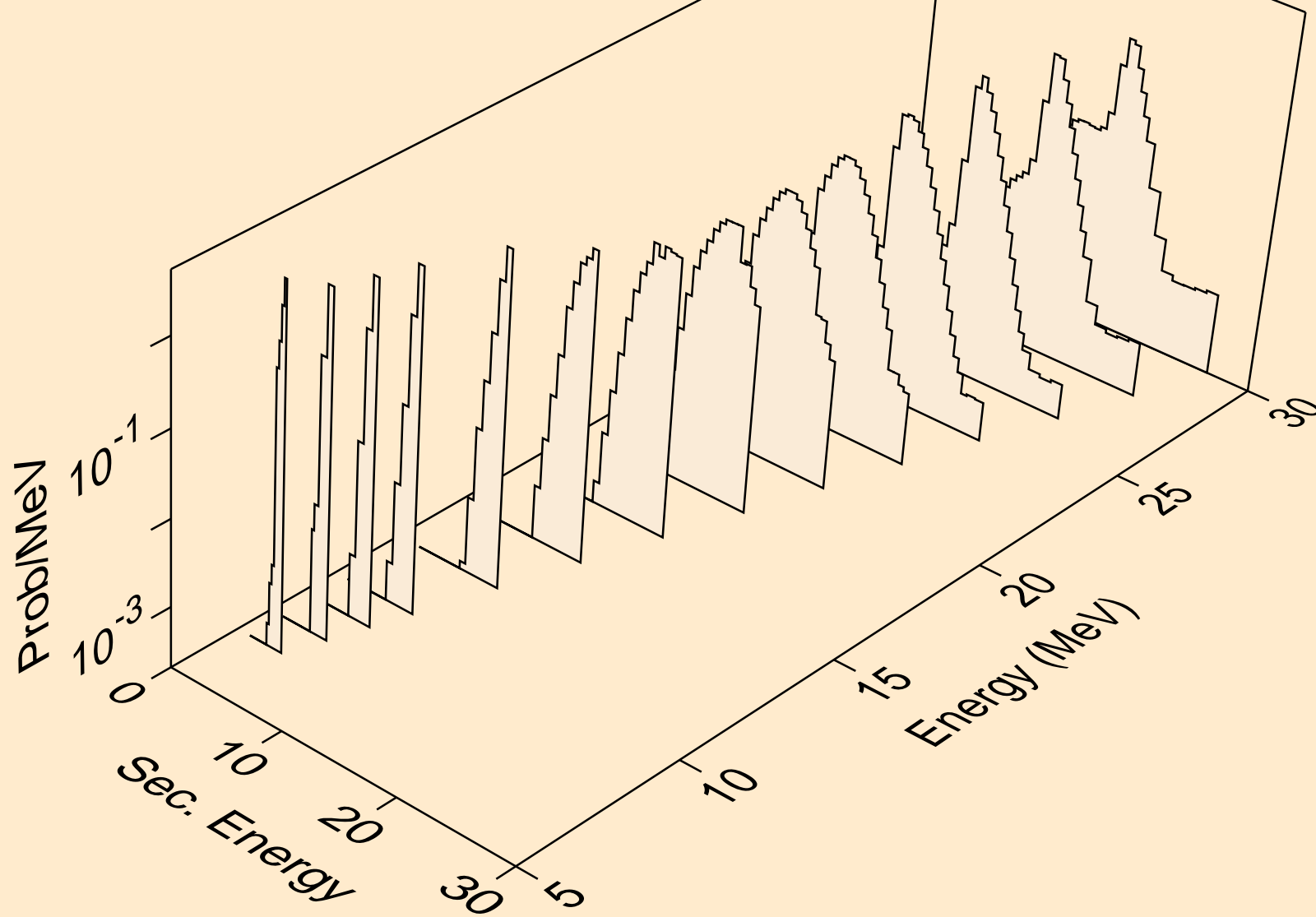

CD110 PHOTON ACER TENDL-2021 LIBRARY; T=0.K
alphas from (g,2a)

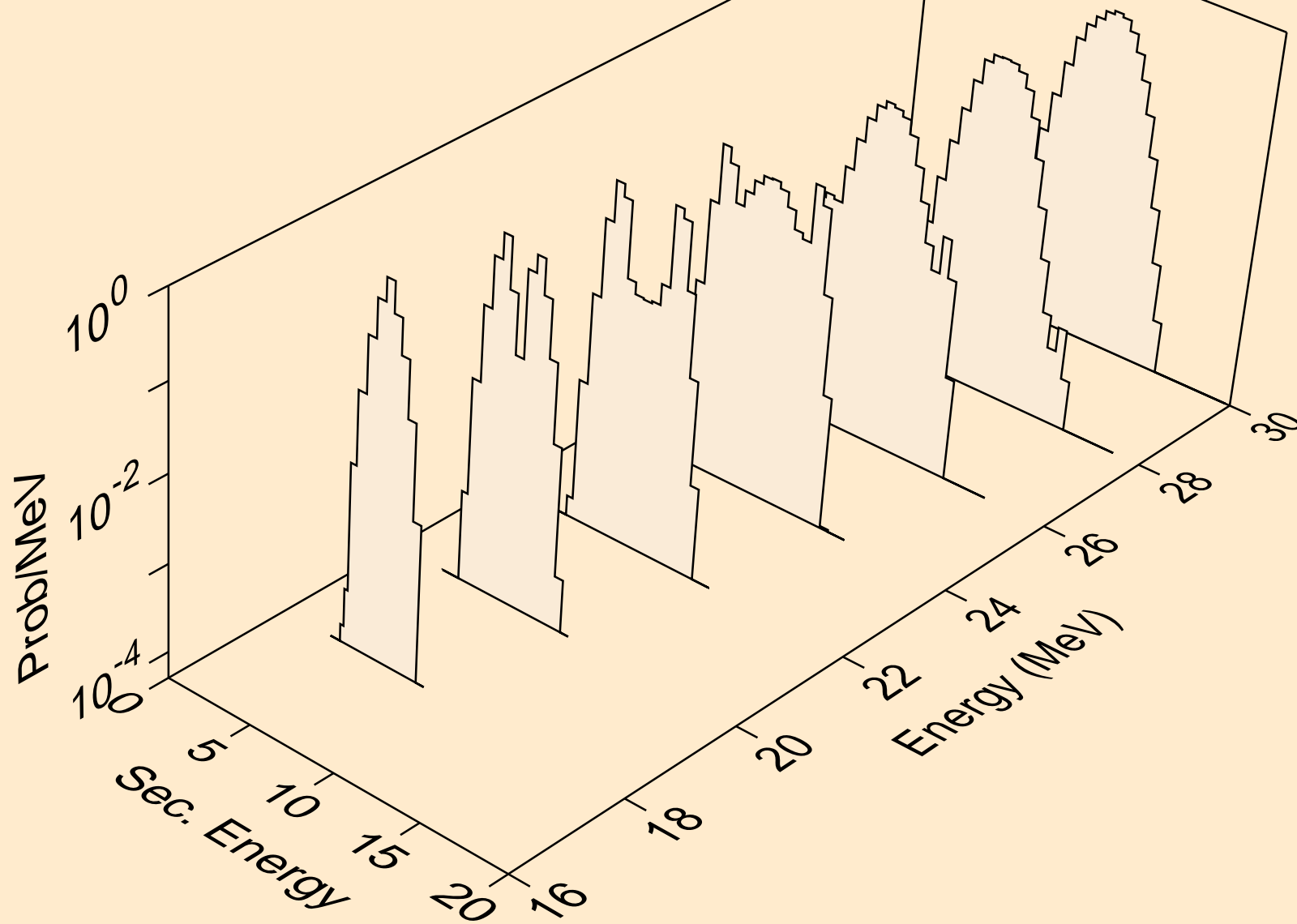

CD110 PHOTON ACER TENDL-2021 LIBRARY; T=0.K
alphas from (g,pa)

