

GD149 PHOTON ACER TENDL-2021 LIBRARY; T=0.K
Principal cross sections

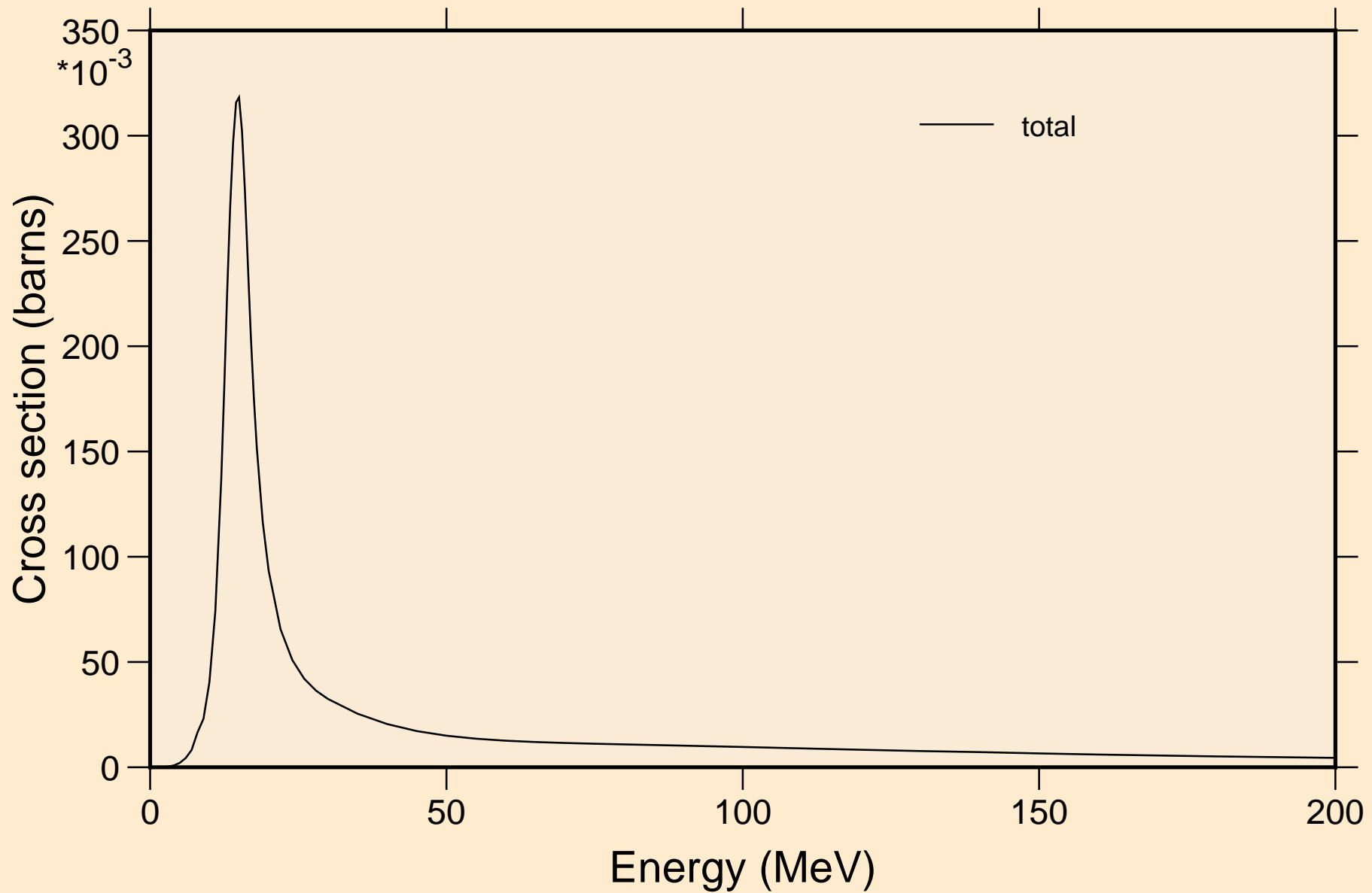

GD149 PHOTON ACER TENDL-2021 LIBRARY; T=0.K

Partial cross sections

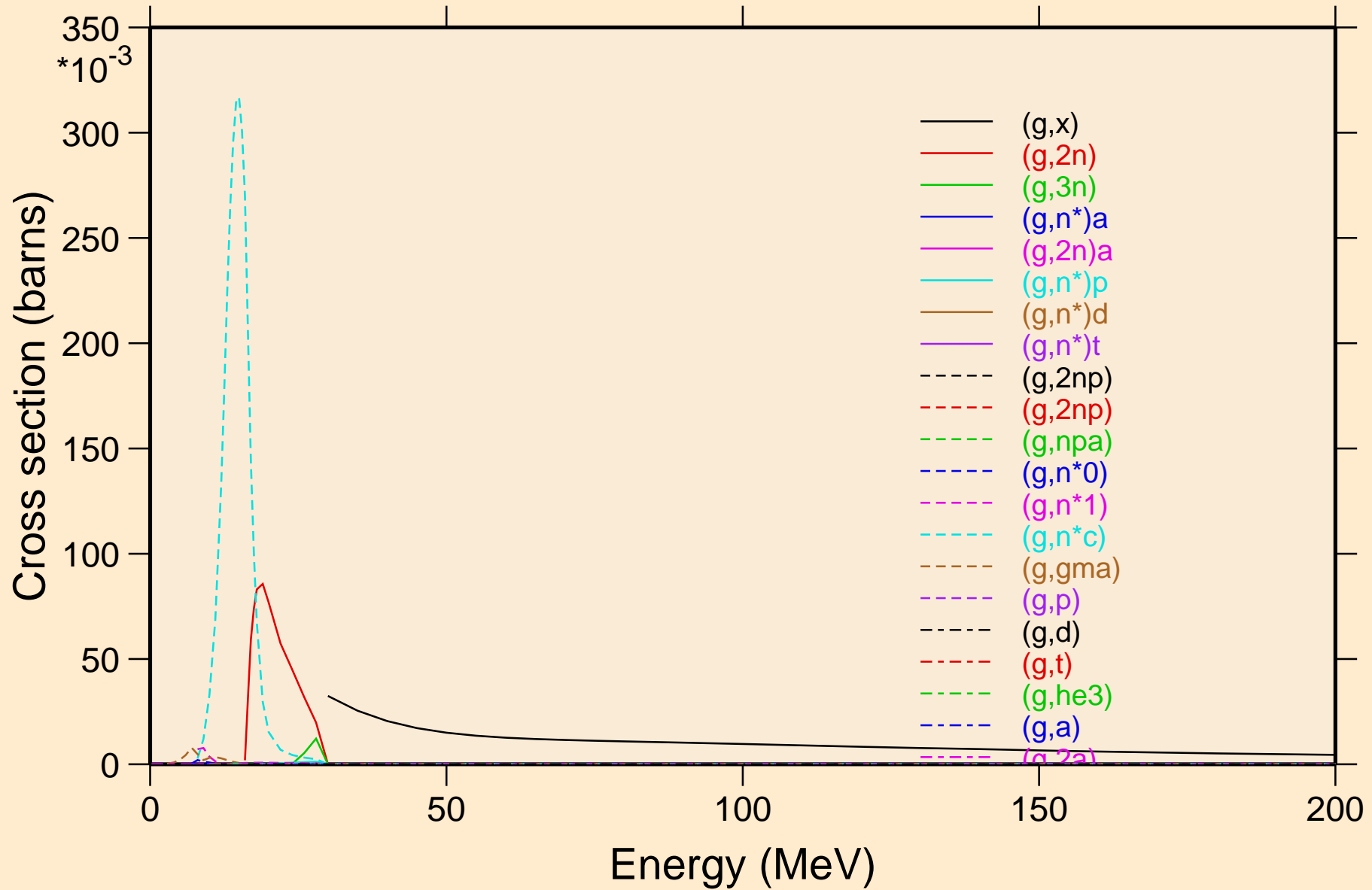

GD149 PHOTON ACER TENDL-2021 LIBRARY; T=0.K

Heating

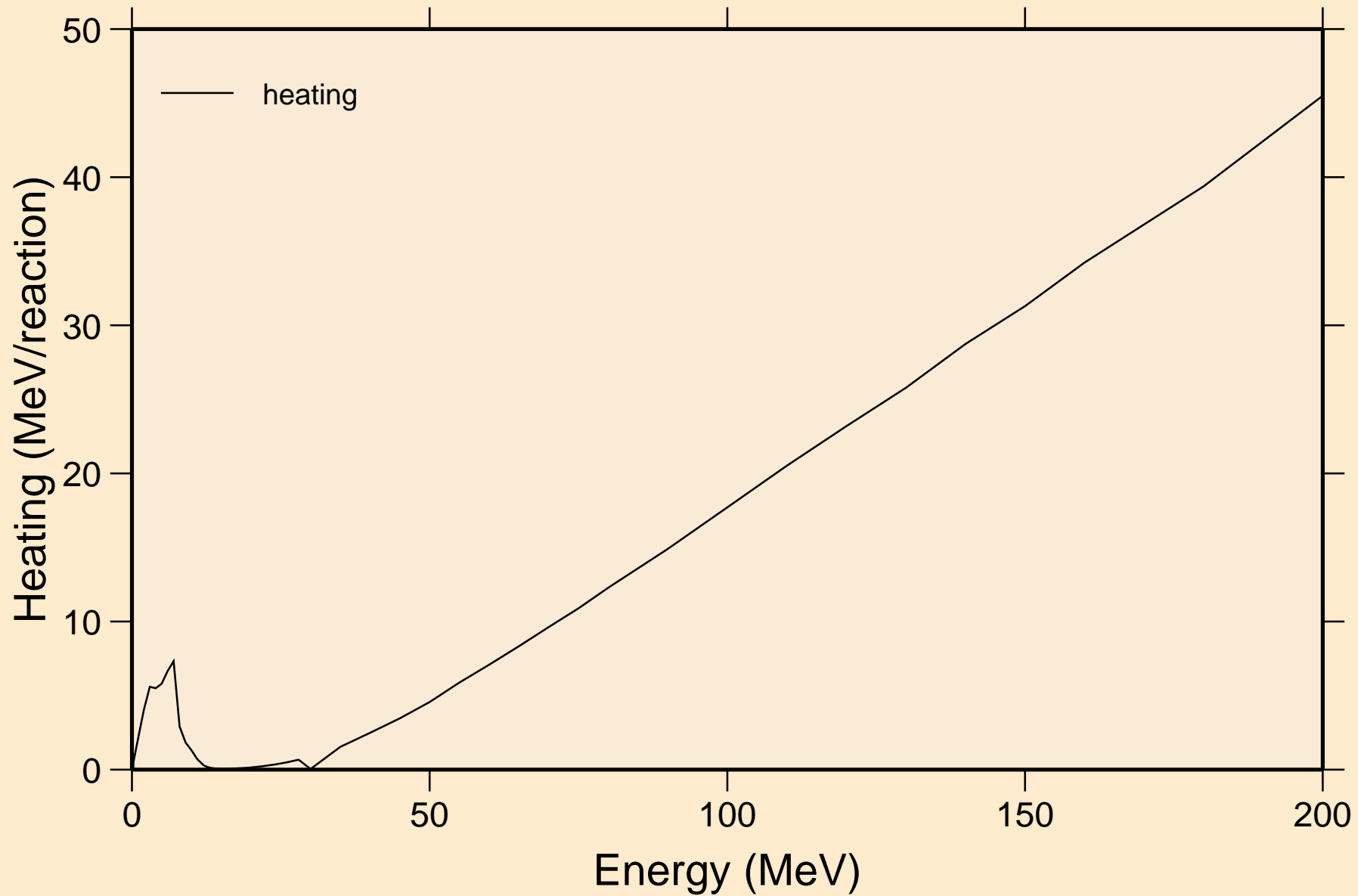

GD149 PHOTON ACER TENDL-2021 LIBRARY; T=0.K

Particle heating contributions

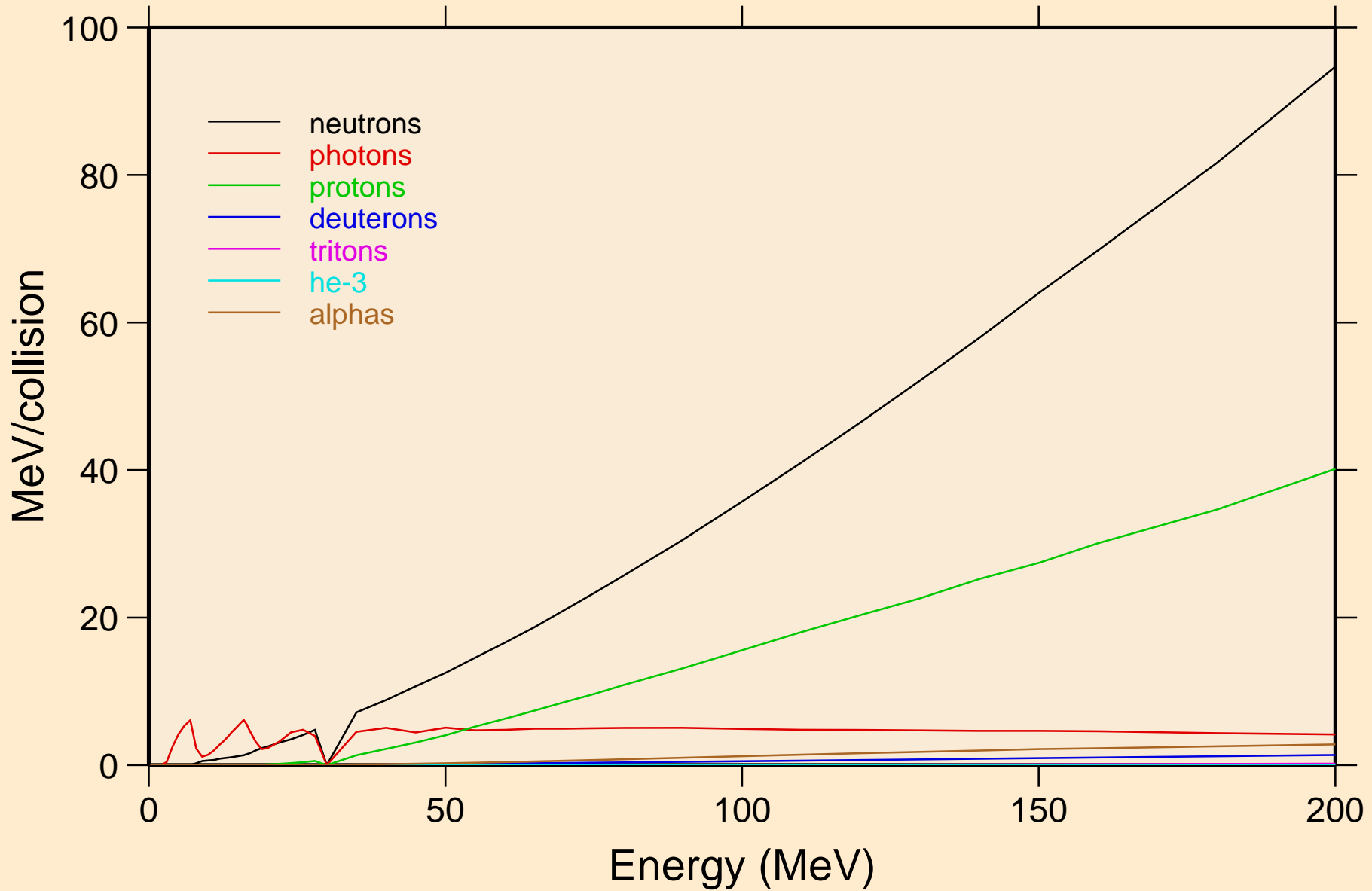

GD149 PHOTON ACER TENDL-2021 LIBRARY; T=0.K

Particle production cross sections

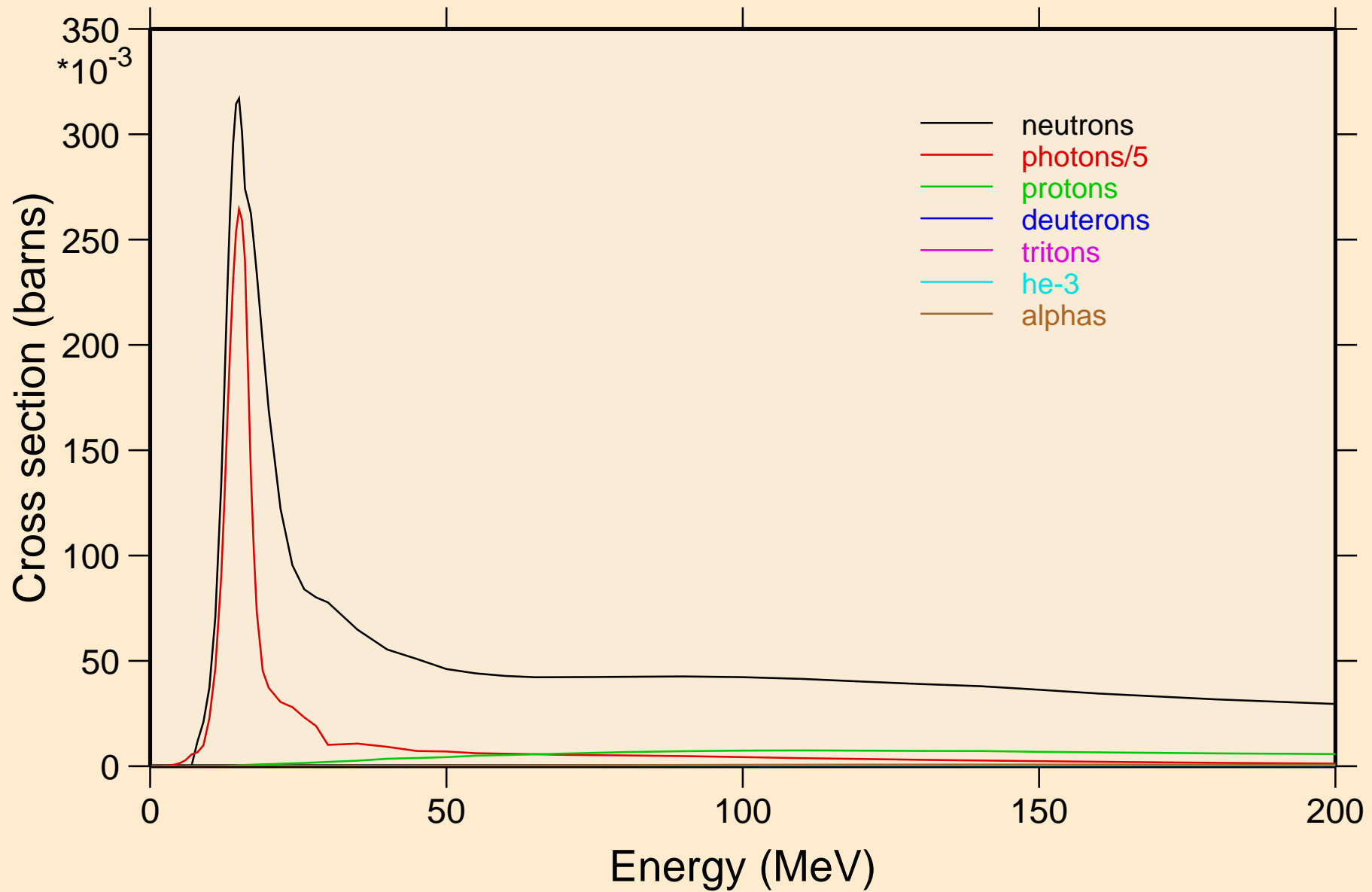

GD149 PHOTON ACER TENDL-2021 LIBRARY; T=0.K
neutrons from (g,x)

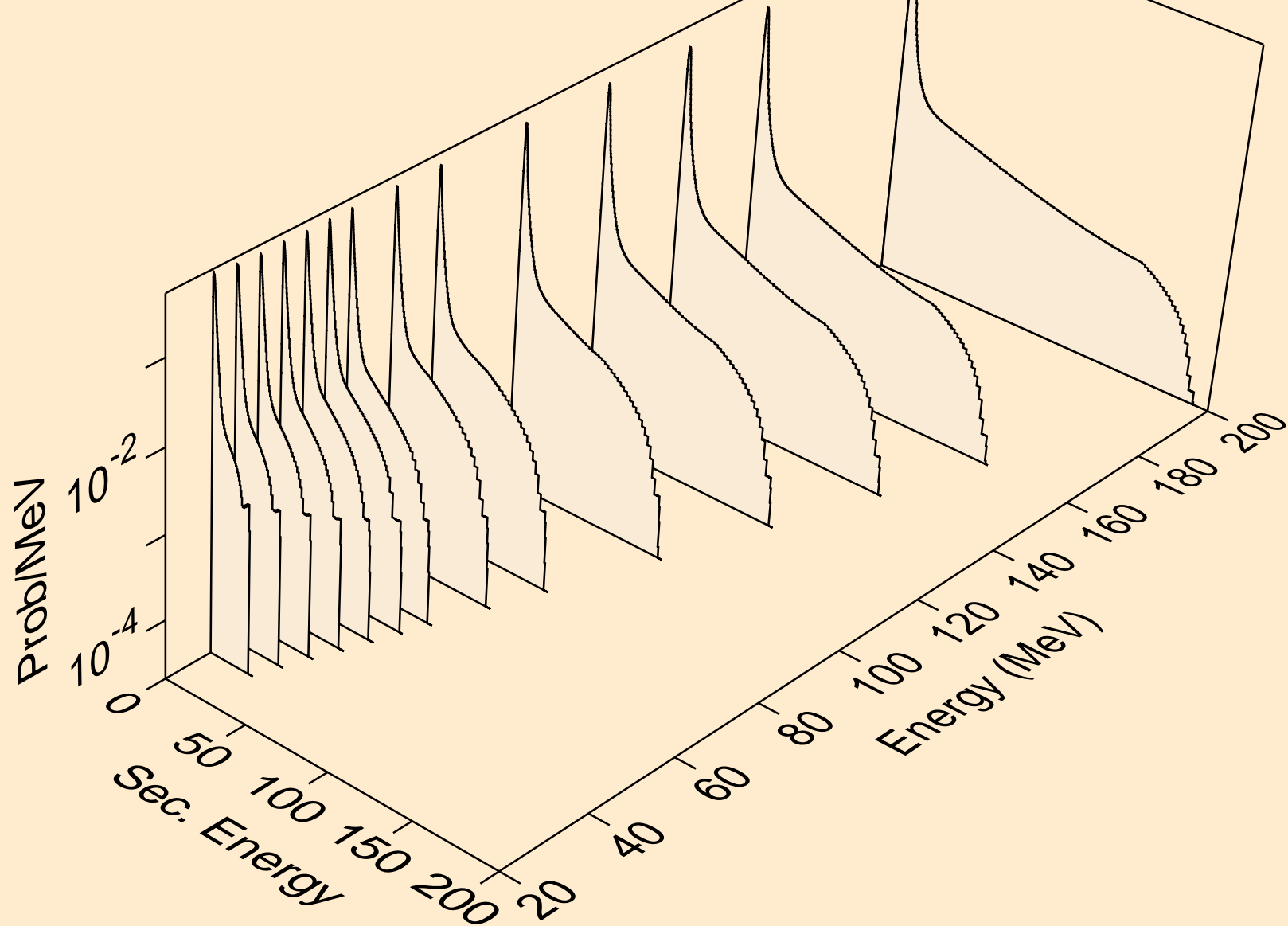

GD149 PHOTON ACER TENDL-2021 LIBRARY; T=0.K
neutrons from (g,2n)

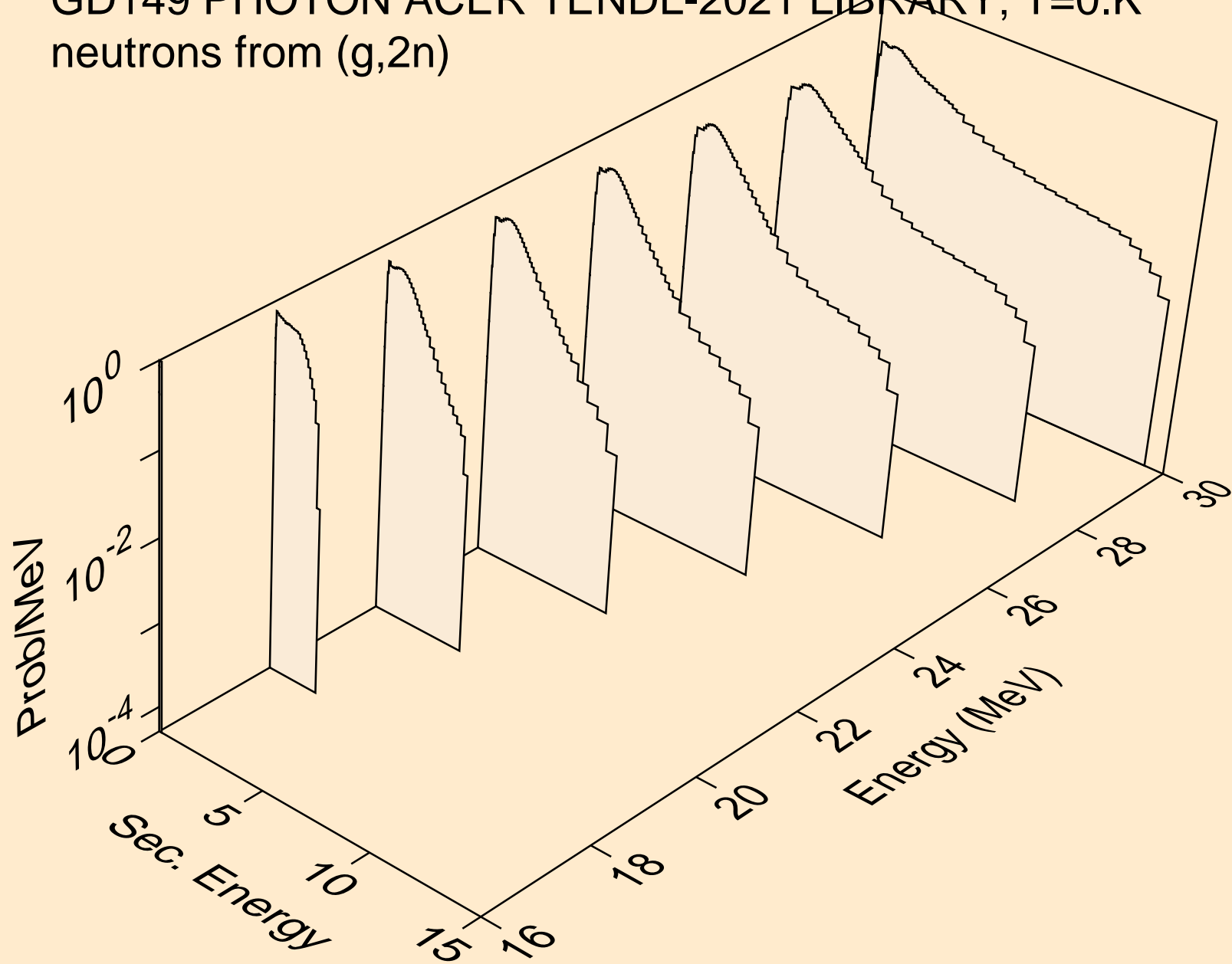

GD149 PHOTON ACER TENDL-2021 LIBRARY; T=0.K
neutrons from (g,3n)

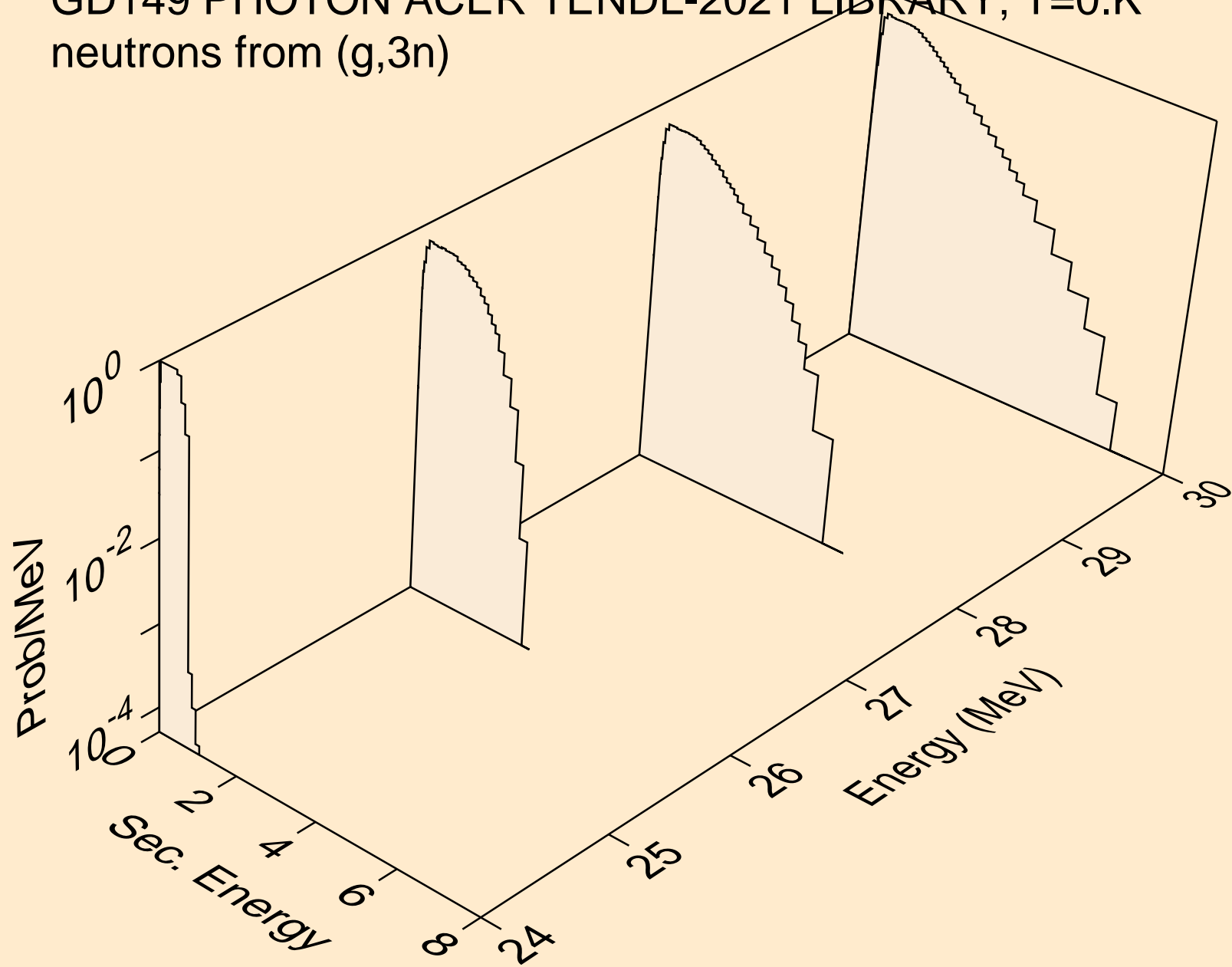

GD149 PHOTON ACER TENDL-2021 LIBRARY; T=0.K
neutrons from (g,n*)a

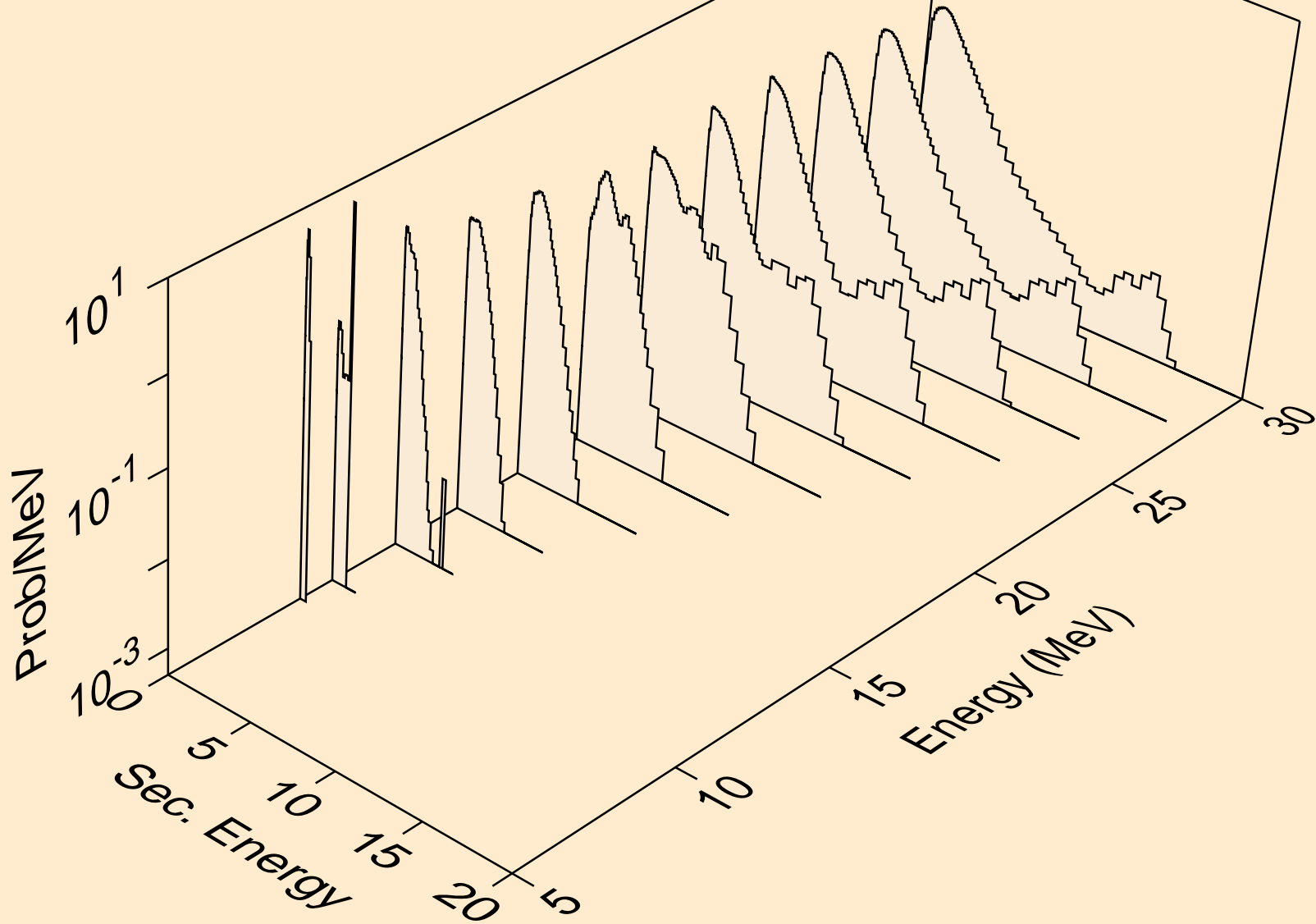

GD149 PHOTON ACER TENDL-2021 LIBRARY; T=0.K
neutrons from (g,2n)a

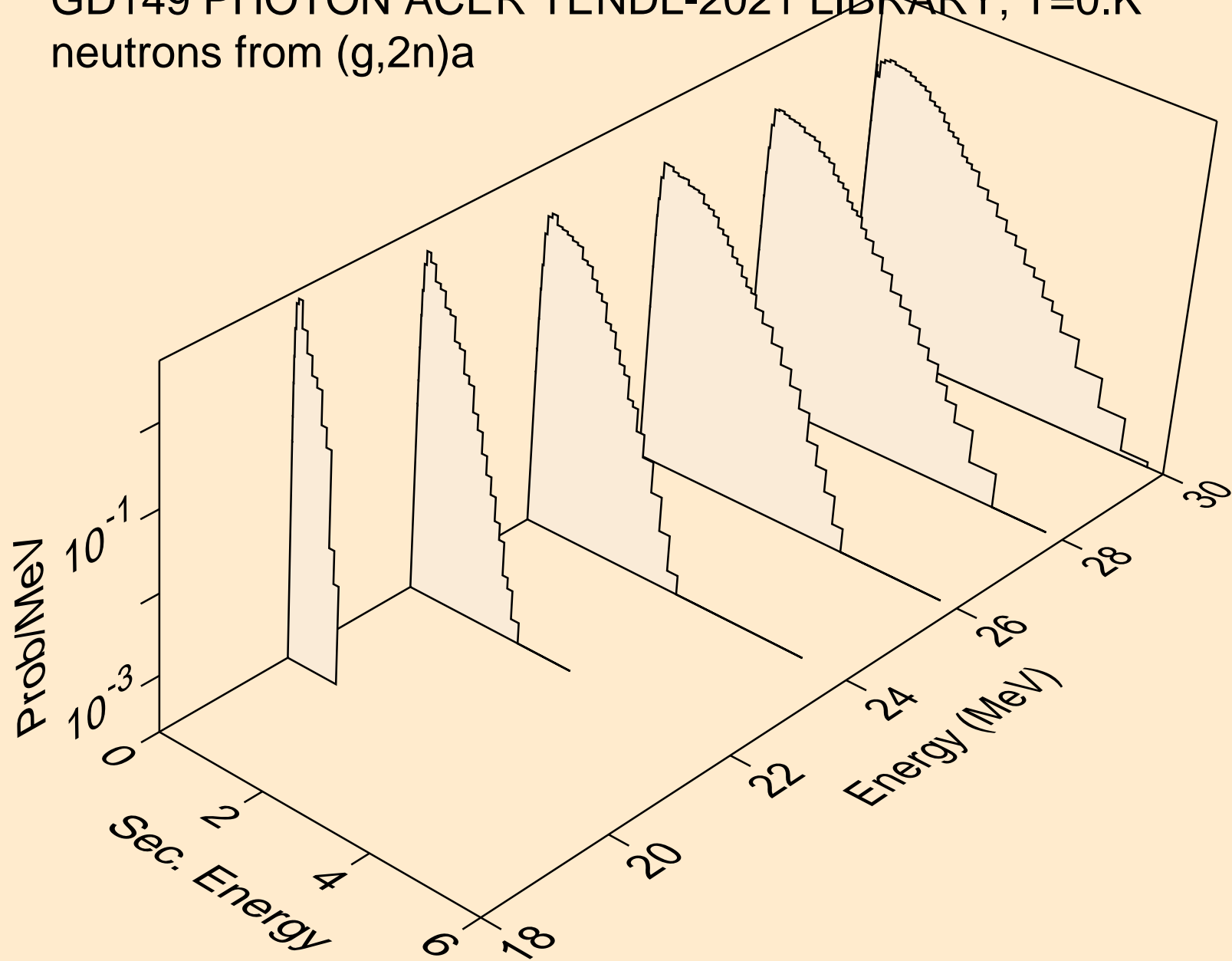

GD149 PHOTON ACER TENDL-2021 LIBRARY; T=0.K
neutrons from (g,n*)p

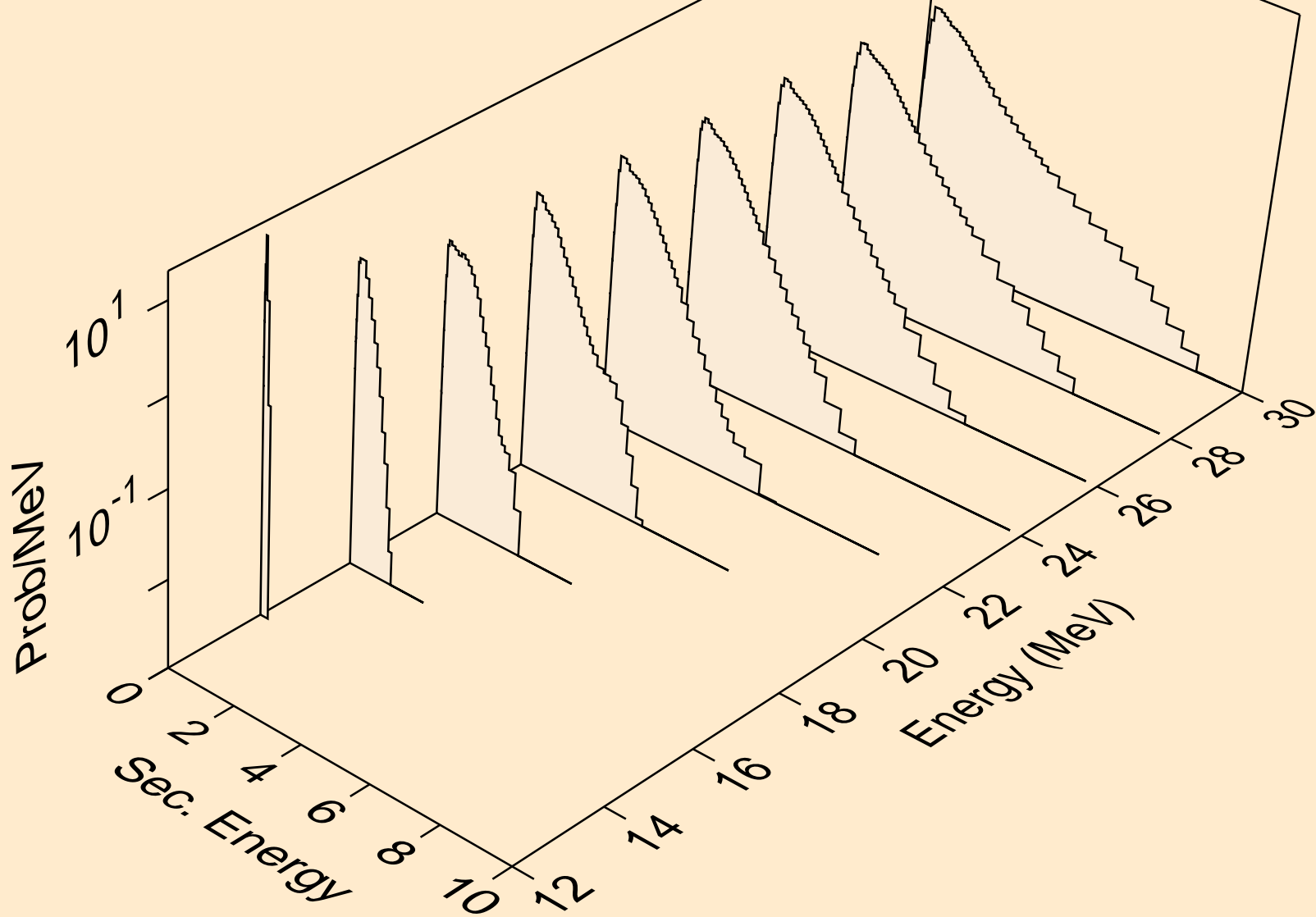

GD149 PHOTON ACER TENDL-2021 LIBRARY; T=0.K
neutrons from (g,n*)d

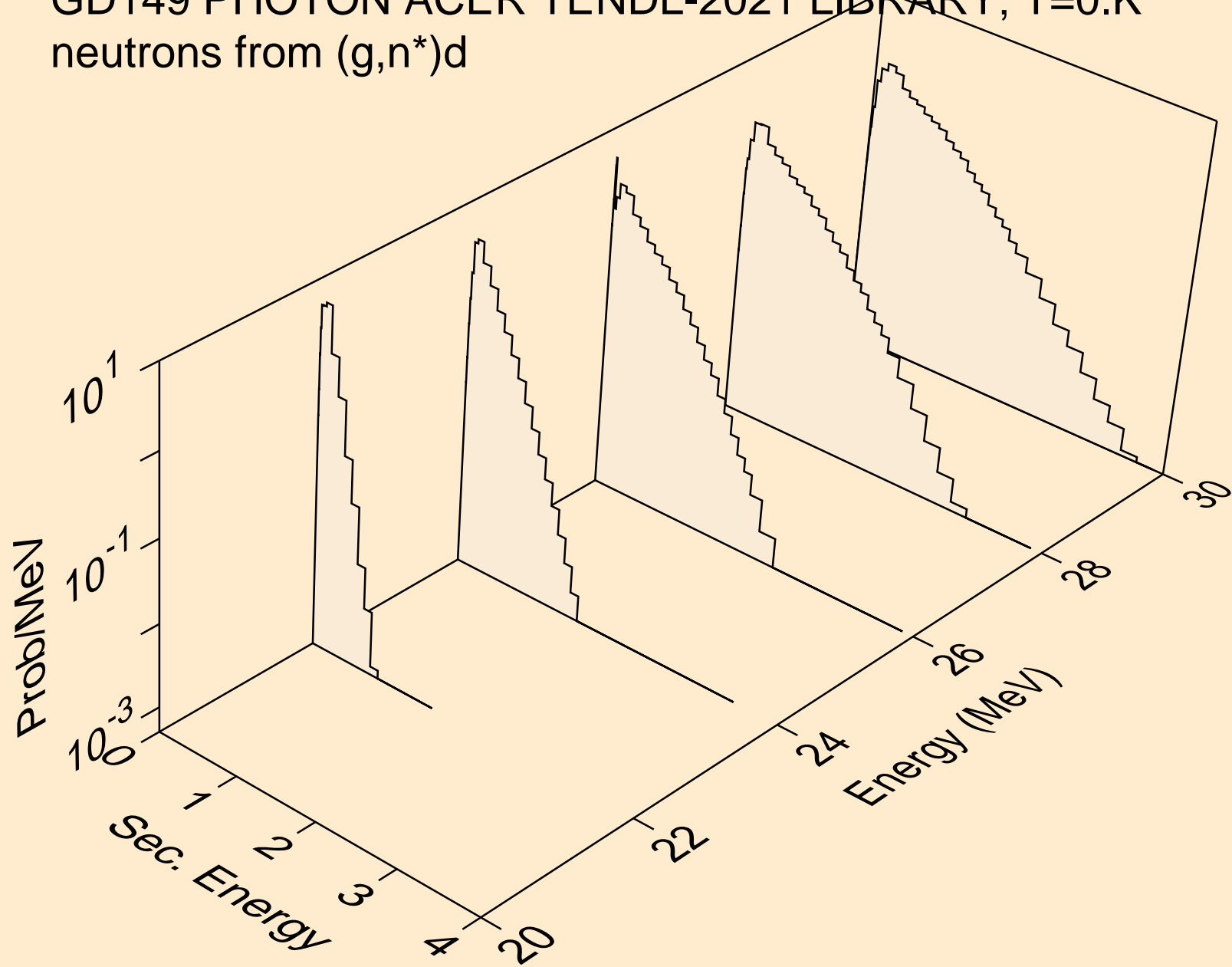

GD149 PHOTON ACER TENDL-2021 LIBRARY; T=0.K
neutrons from (g,n*)t

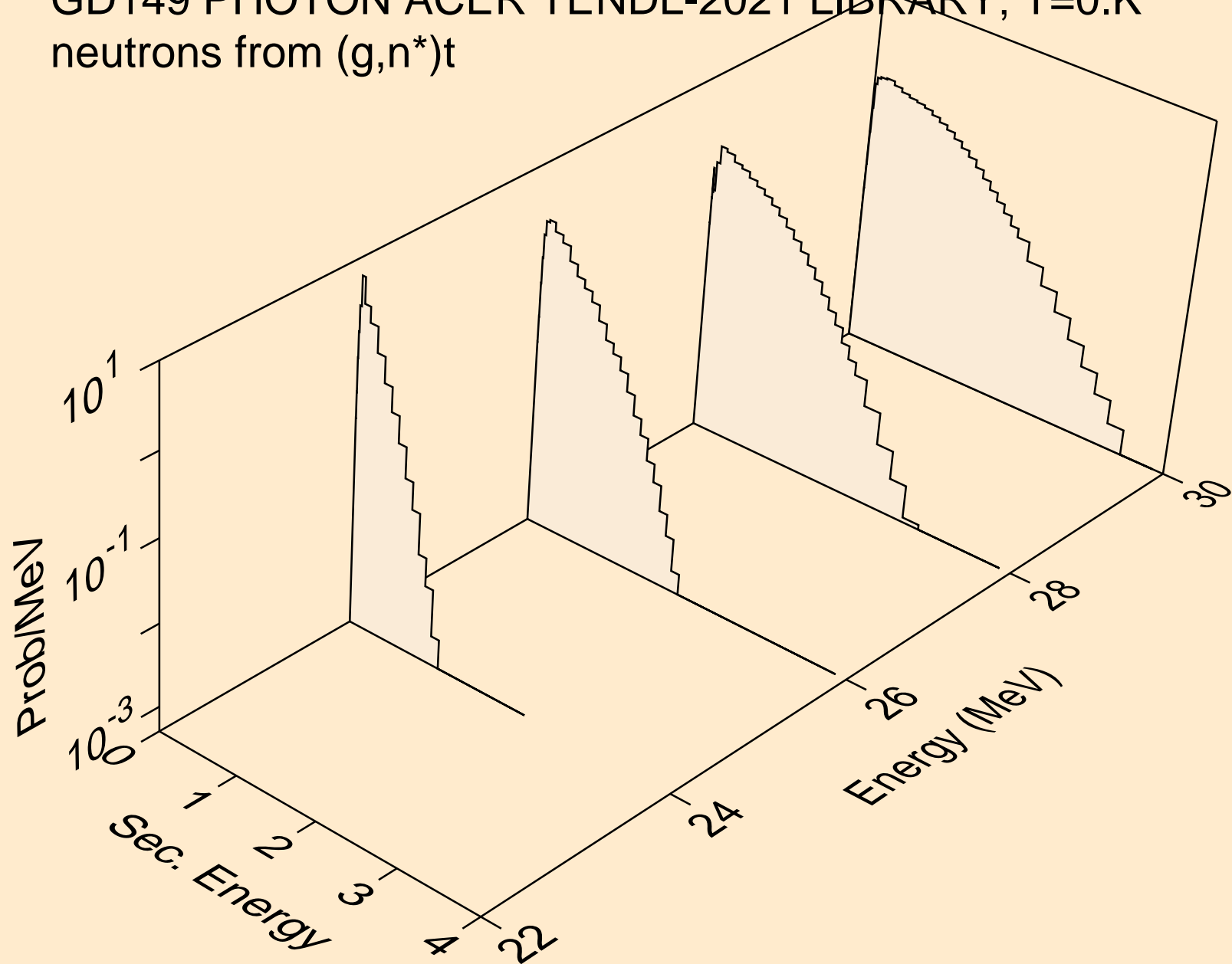

GD149 PHOTON ACER TENDL-2021 LIBRARY; T=0.K
neutrons from (g,2np)

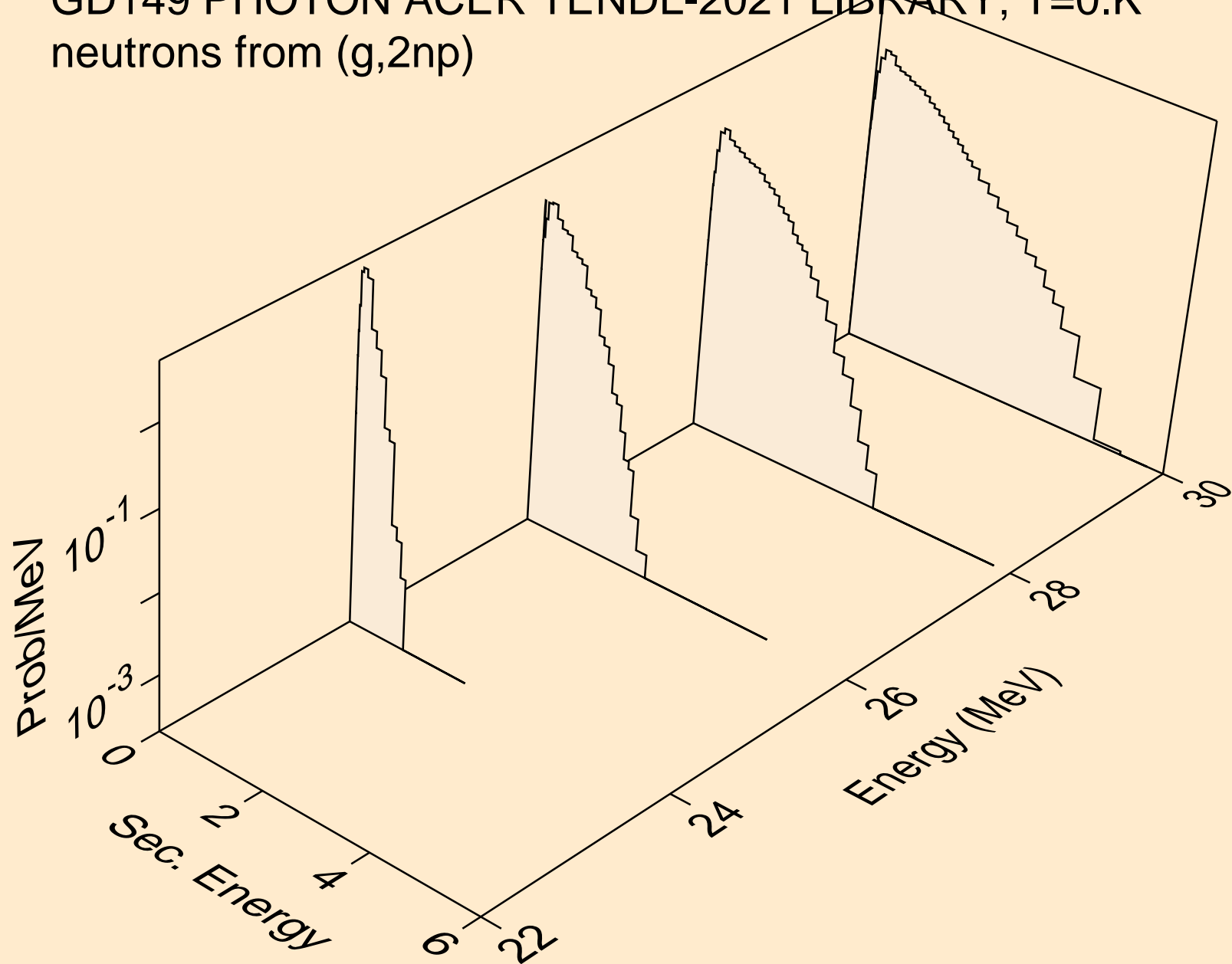

GD149 PHOTON ACER TENDL-2021 LIBRARY; T=0.K
neutrons from (g,2np)

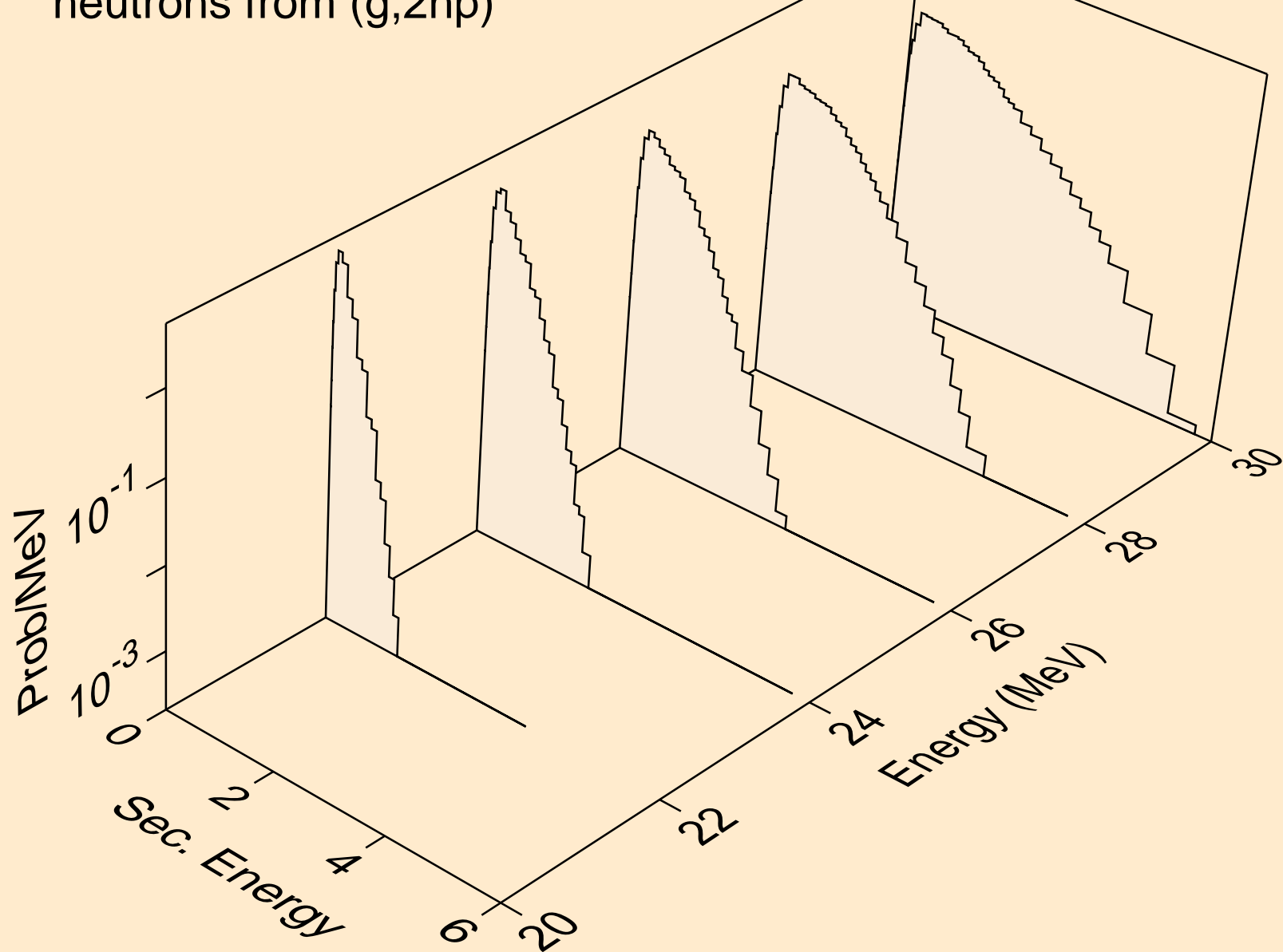

GD149 PHOTON ACER TENDL-2021 LIBRARY; T=0.K
neutrons from (g,npa)

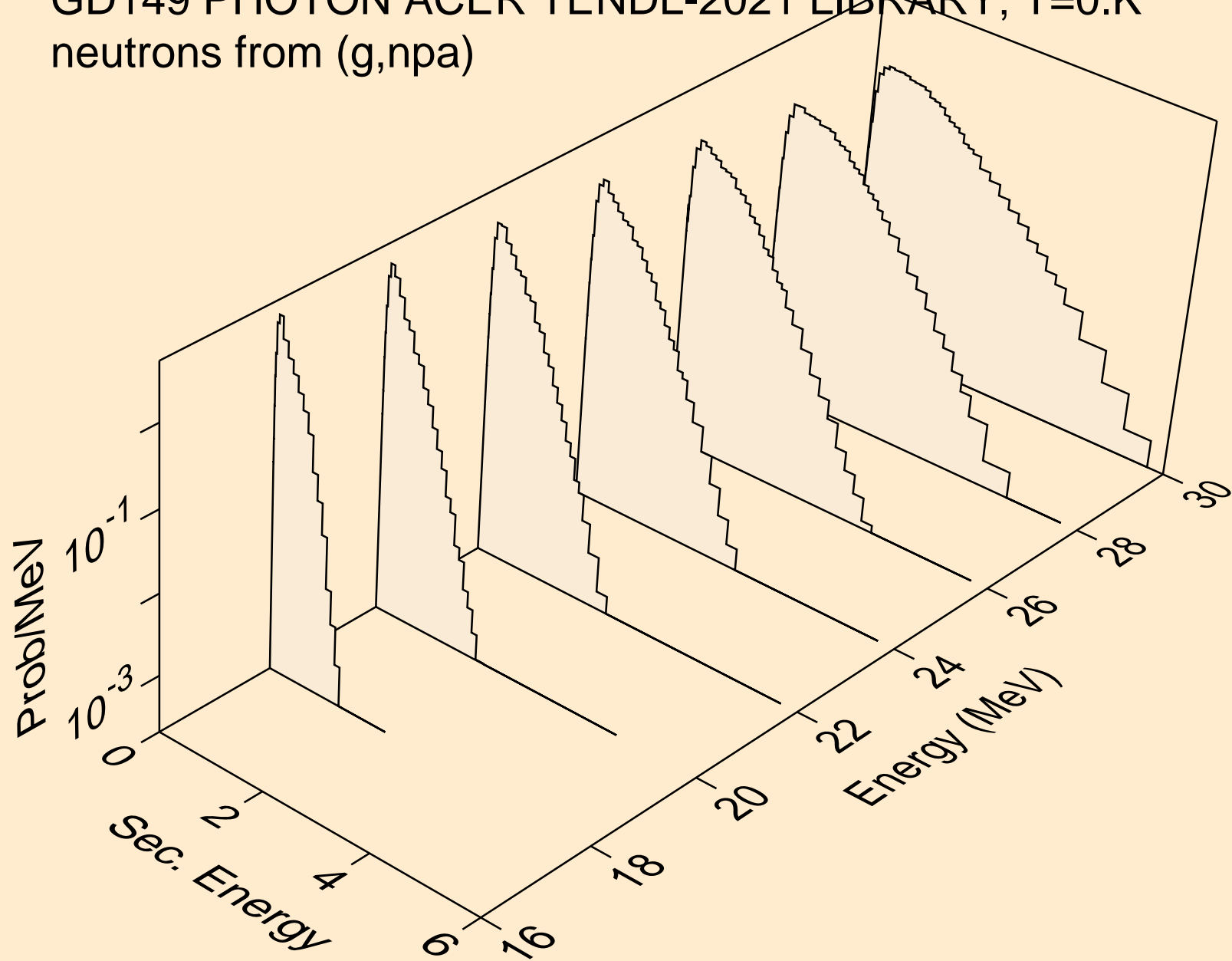

GD149 PHOTON ACER TENDL-2021 LIBRARY; T=0.K
angular distribution for (g,n*0) neutron

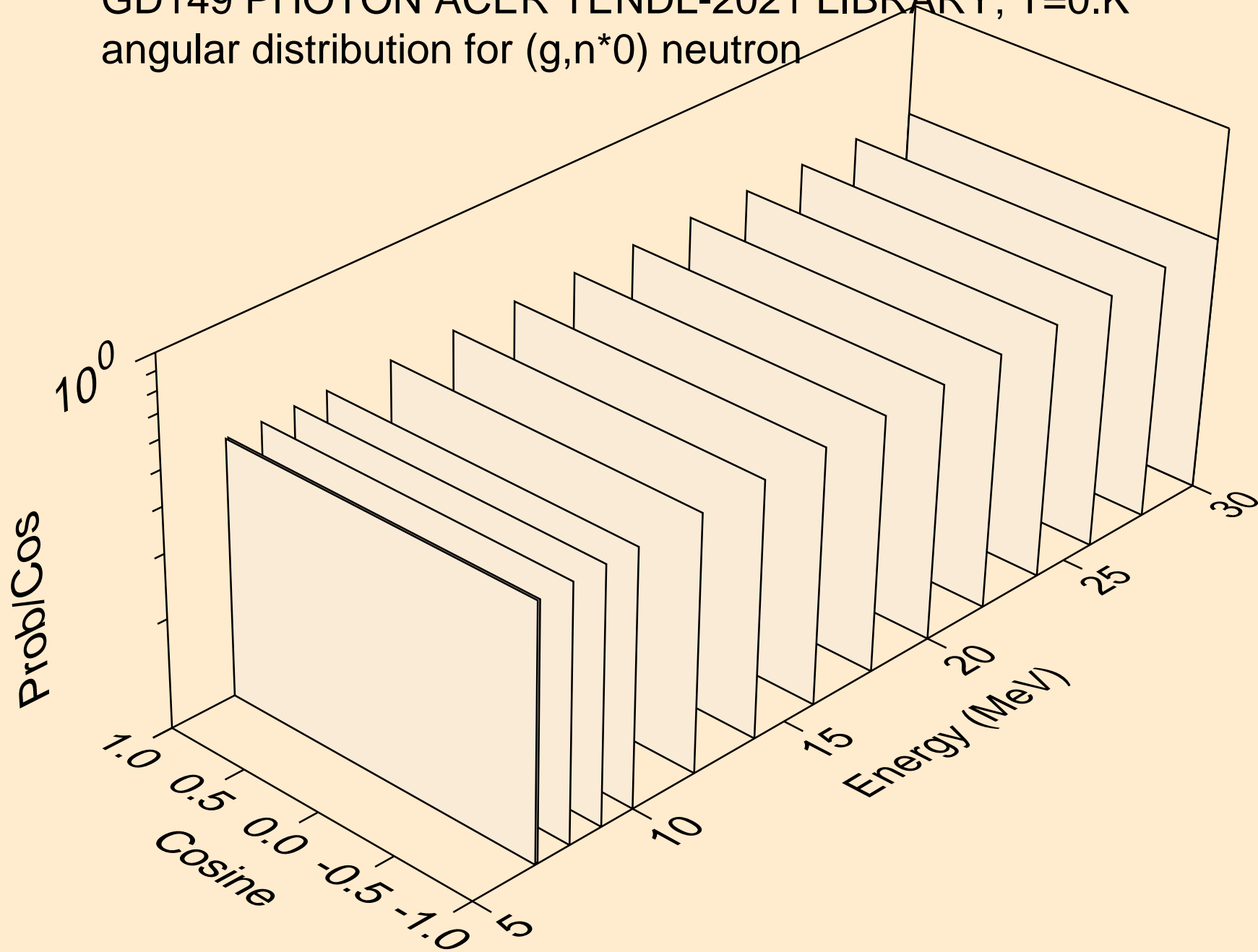

GD149 PHOTON ACER TENDL-2021 LIBRARY; T=0.K
angular distribution for (g,n*1) neutron

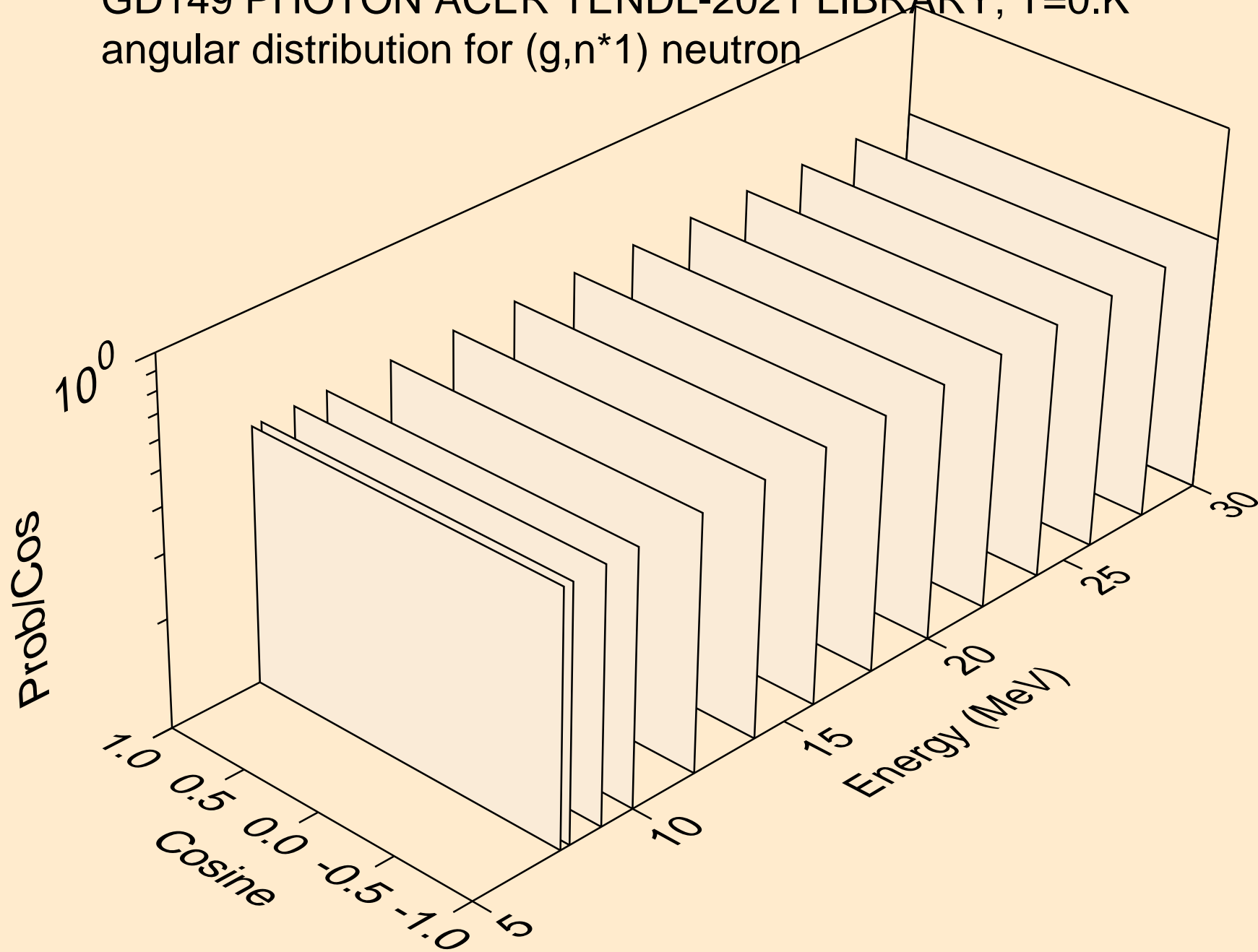

GD149 PHOTON ACER TENDL-2021 LIBRARY; T=0.K
neutrons from (g,n*c)

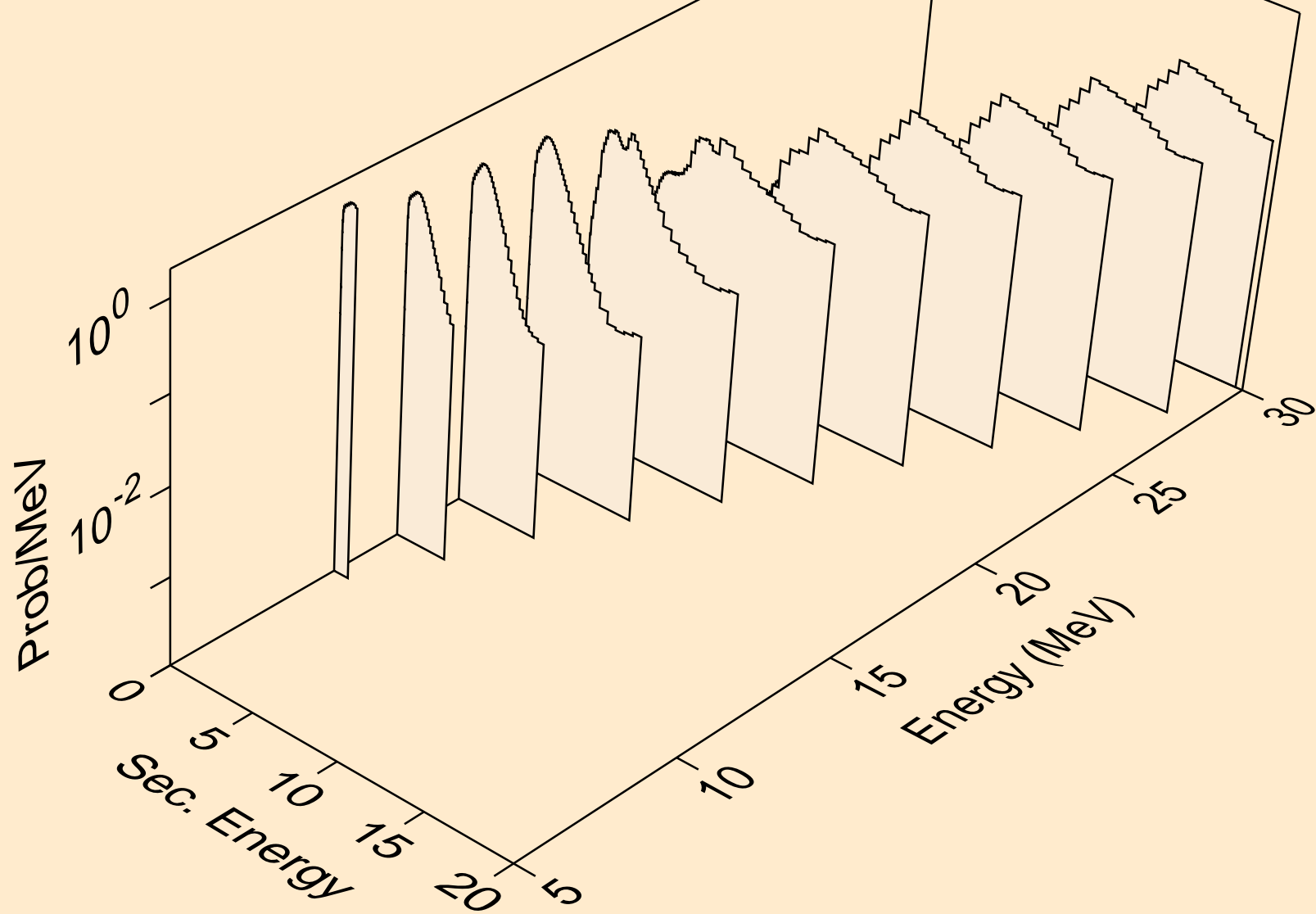

GD149 PHOTON ACER TENDL-2021 LIBRARY; T=0.K
photons from (g,2n)

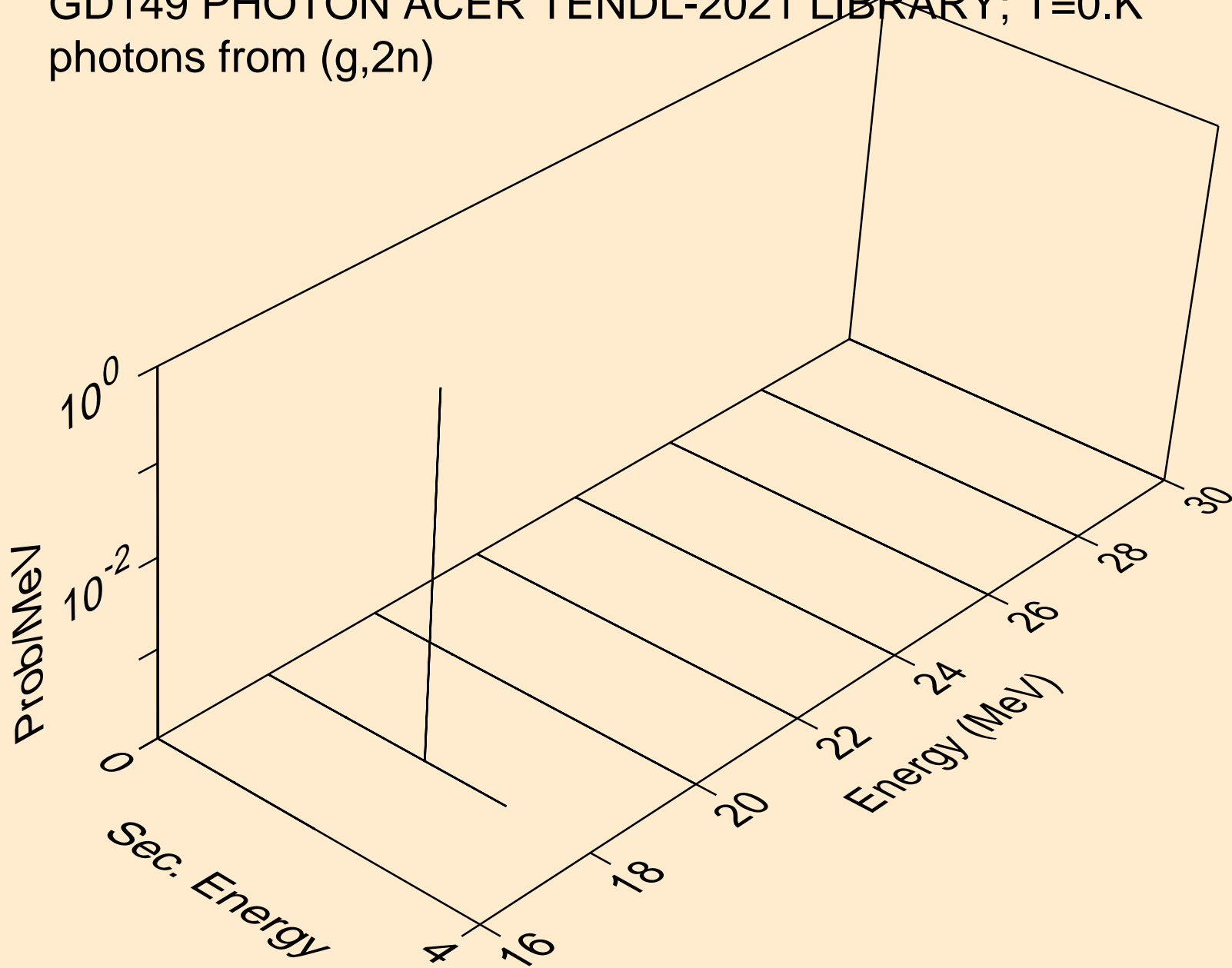

GD149 PHOTON ACER TENDL-2021 LIBRARY; T=0.K
photons from (g,3n)

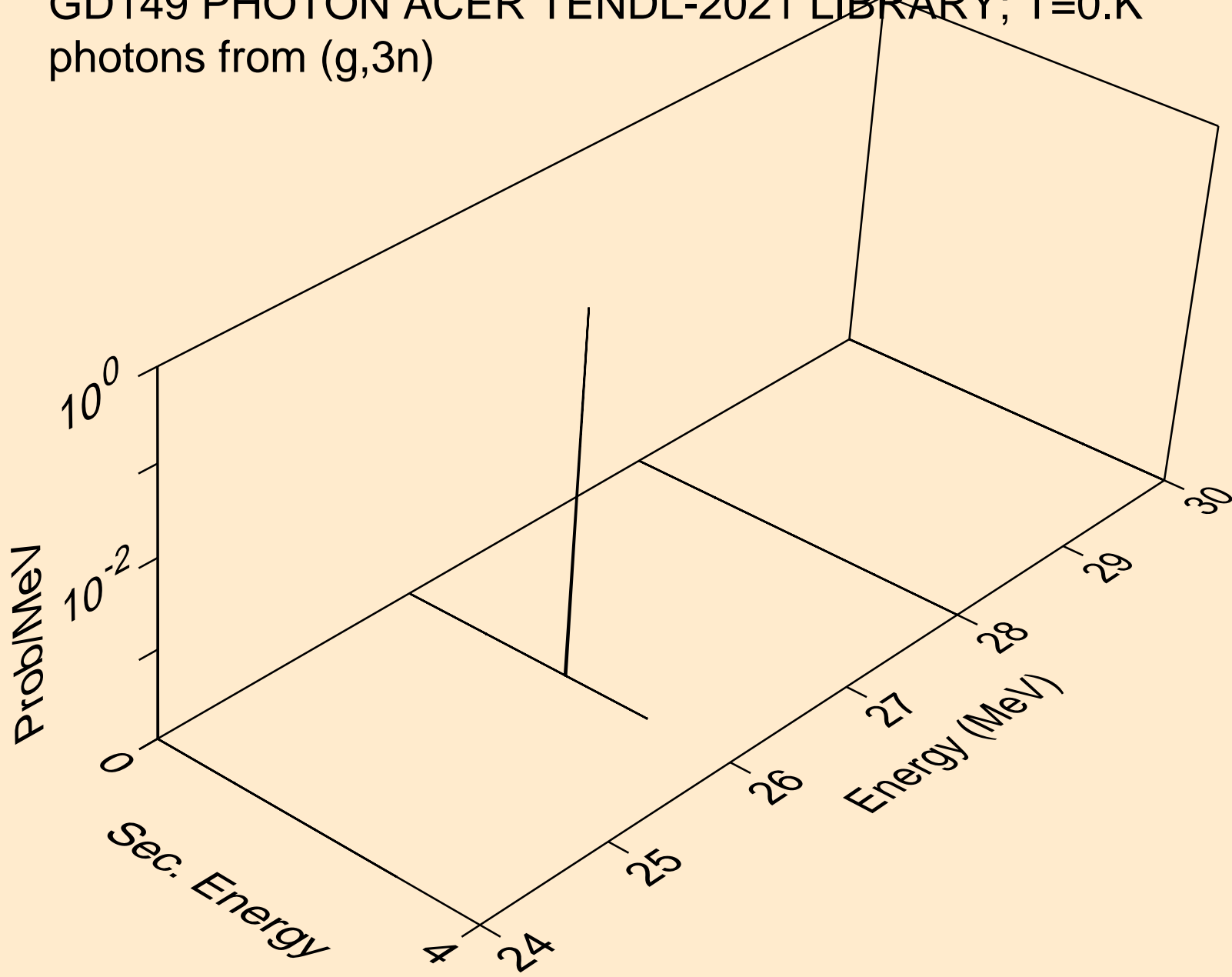

GD149 PHOTON ACER TENDL-2021 LIBRARY; T=0.K
photons from (g,n*)a

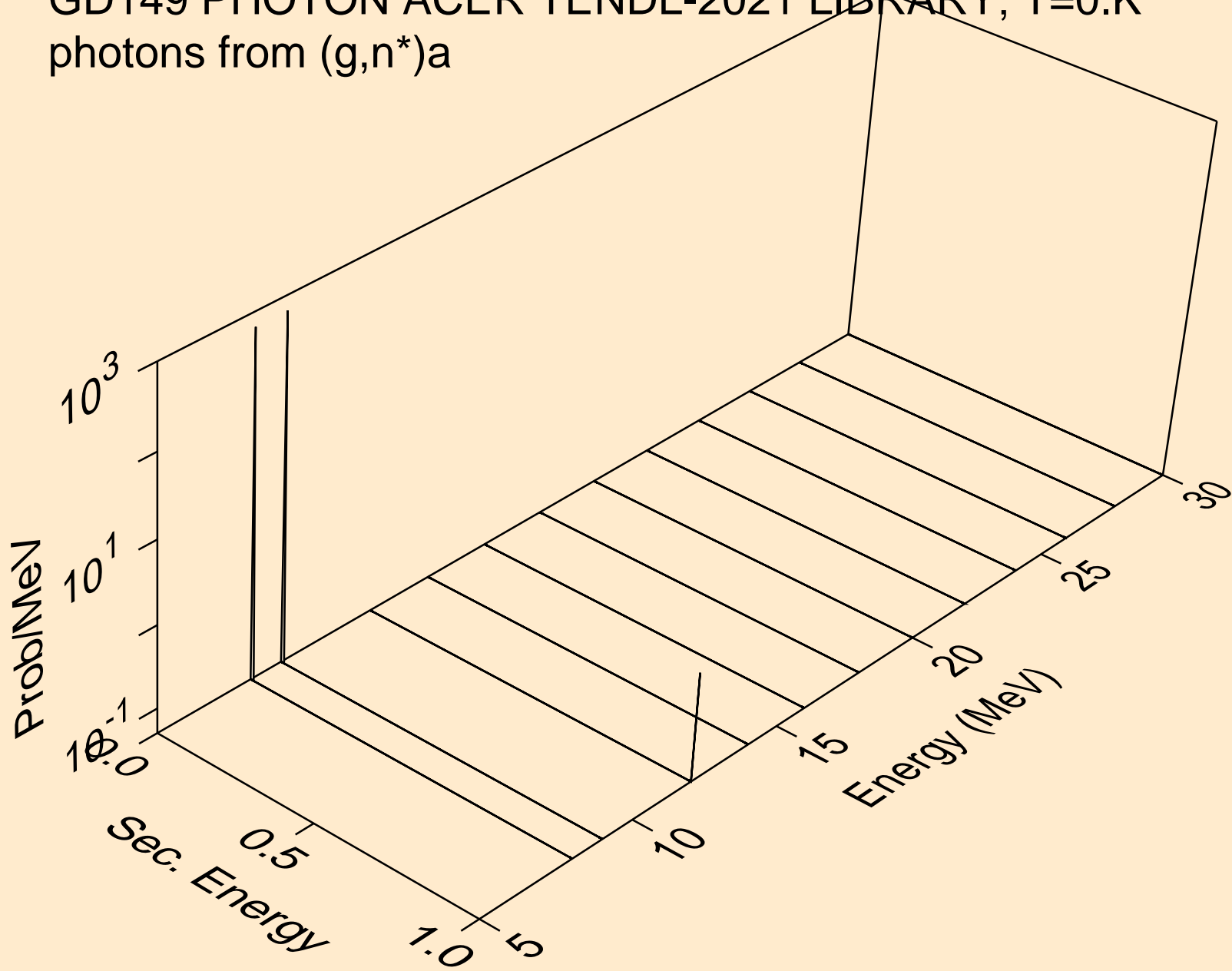

GD149 PHOTON ACER TENDL-2021 LIBRARY; T=0.K
photons from (g,2n)a

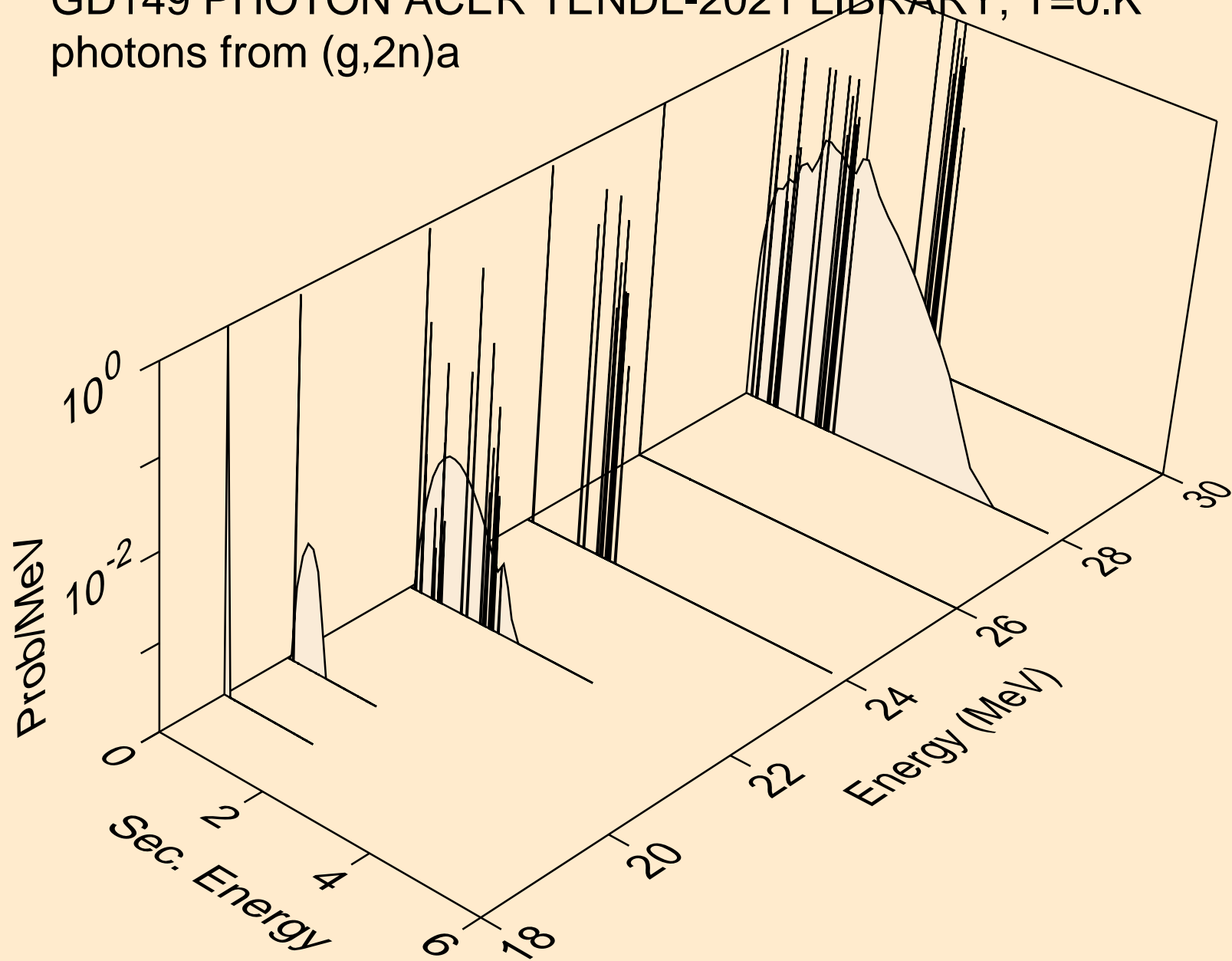

GD149 PHOTON ACER TENDL-2021 LIBRARY; T=0.K
photons from (g,n*)p

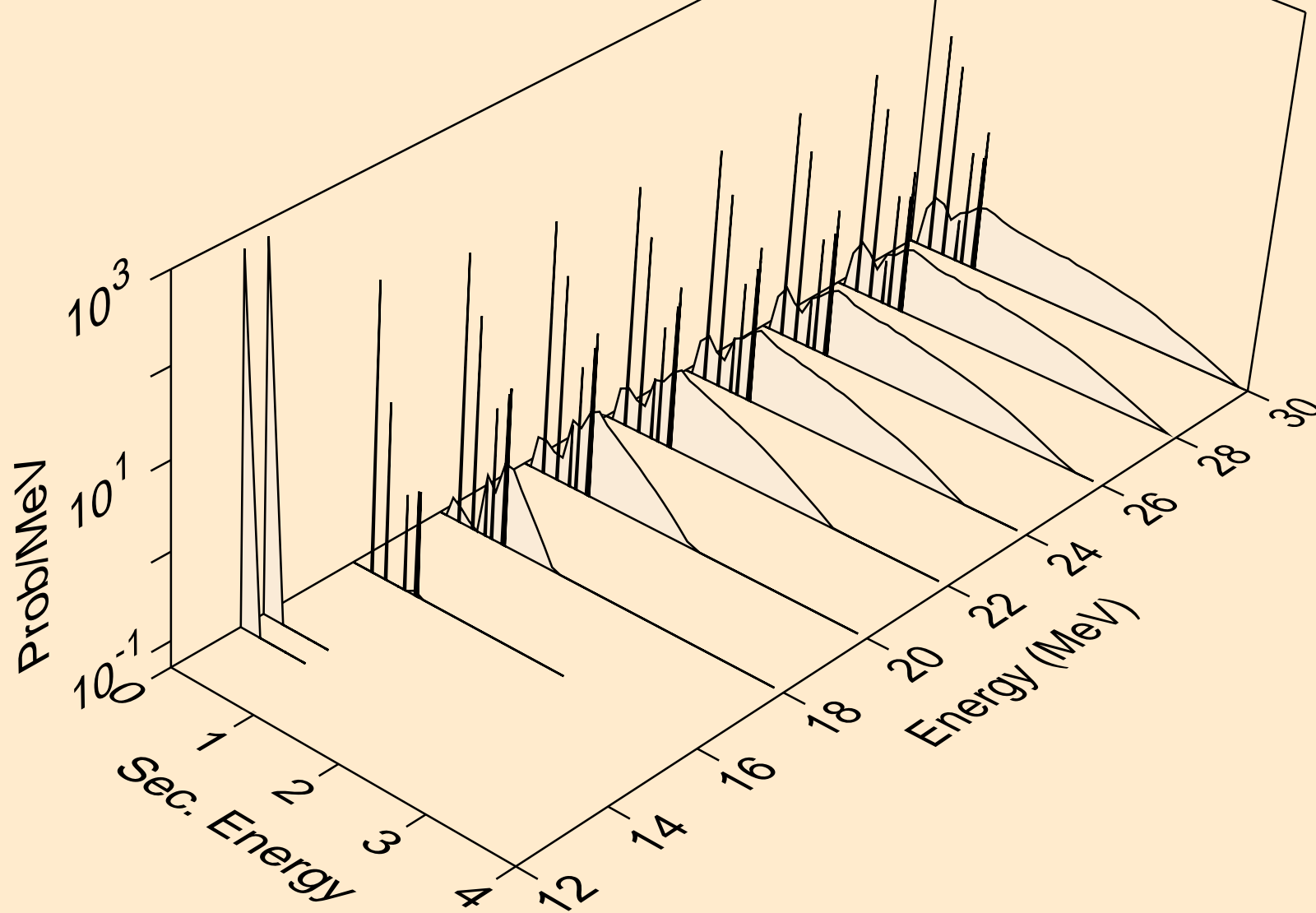

GD149 PHOTON ACER TENDL-2021 LIBRARY; T=0.K
photons from (g,n*)d

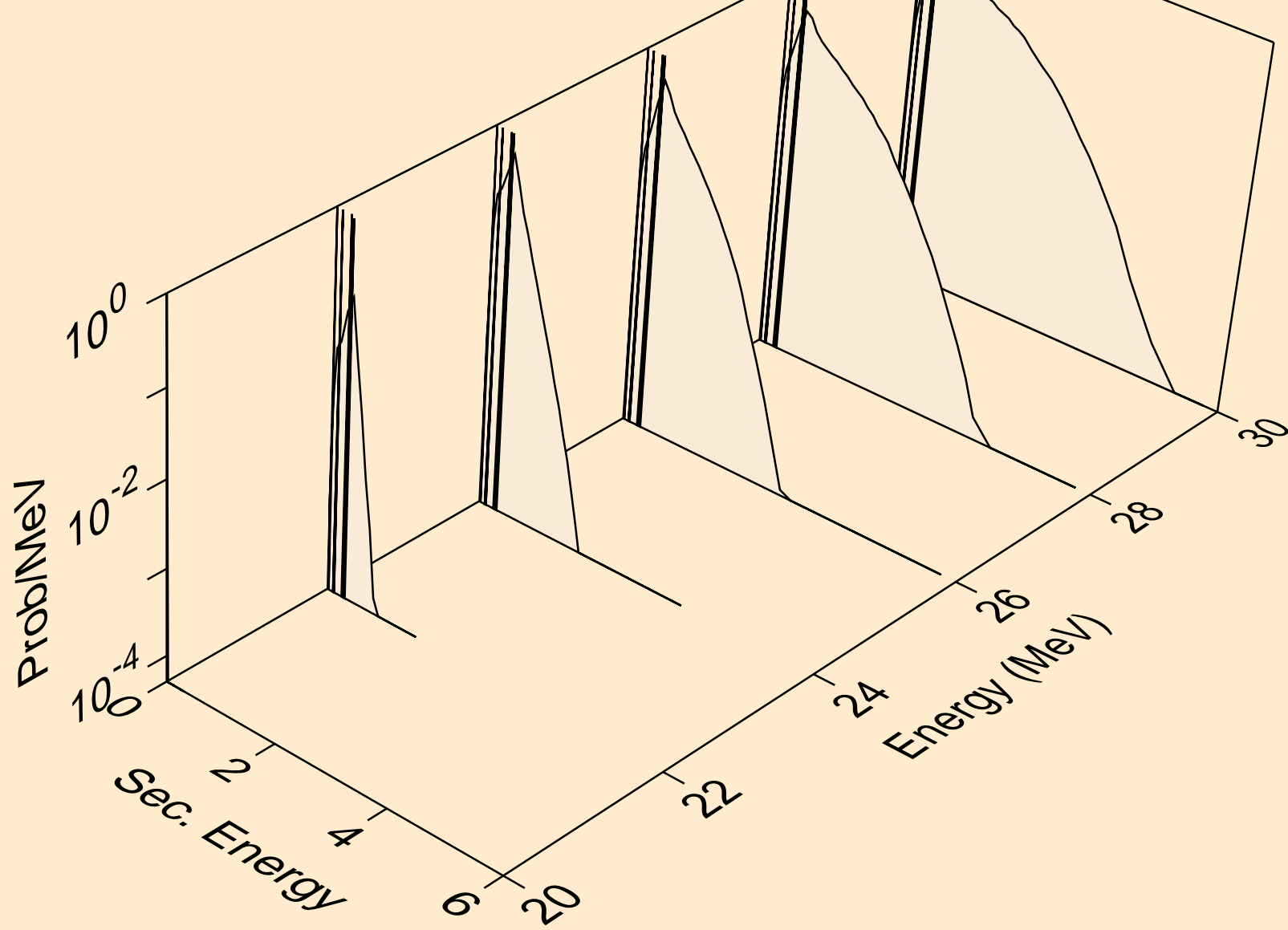

GD149 PHOTON ACER TENDL-2021 LIBRARY; T=0.K
photons from (g,n*)t

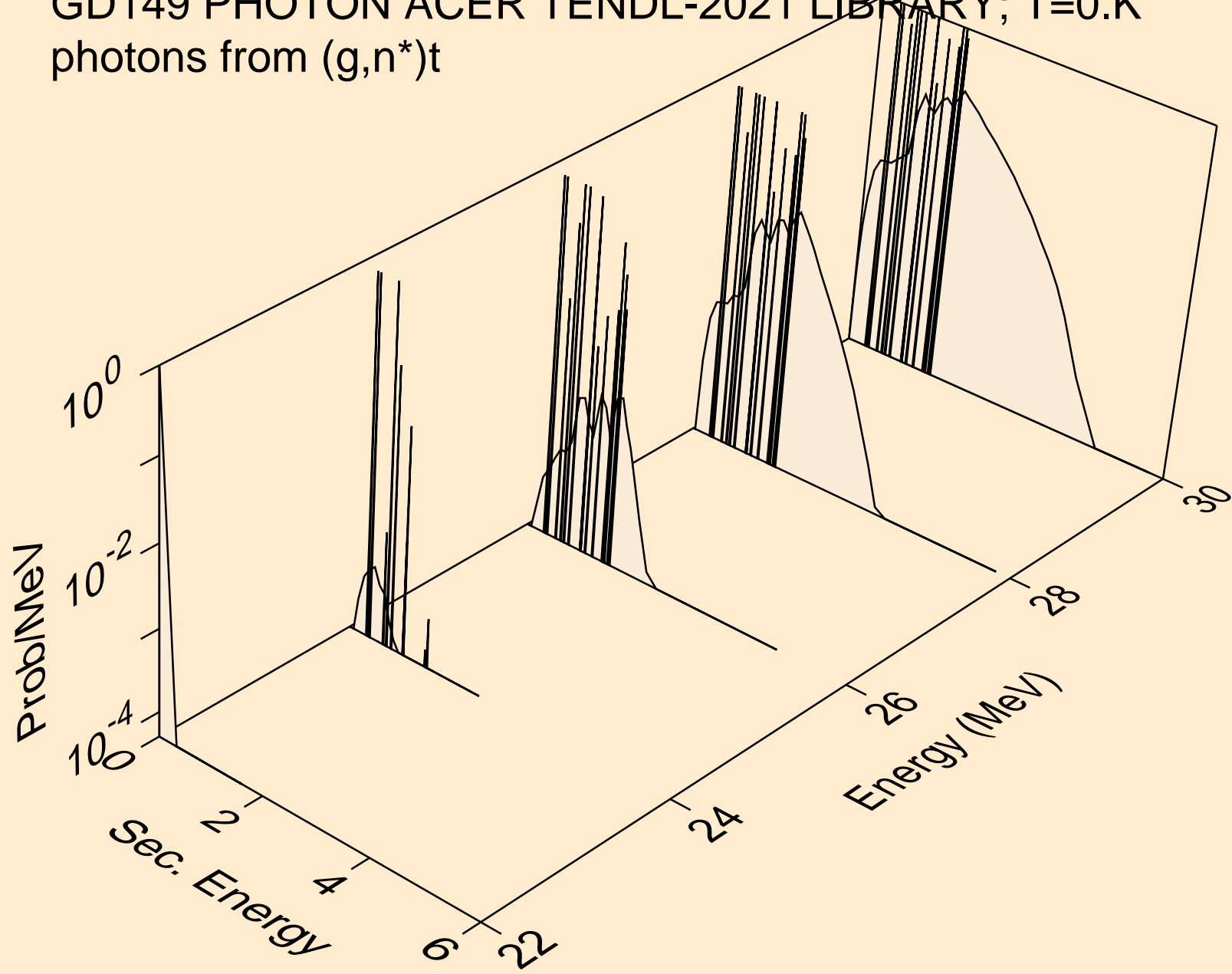

GD149 PHOTON ACER TENDL-2021 LIBRARY; T=0.K
photons from (g,2np)

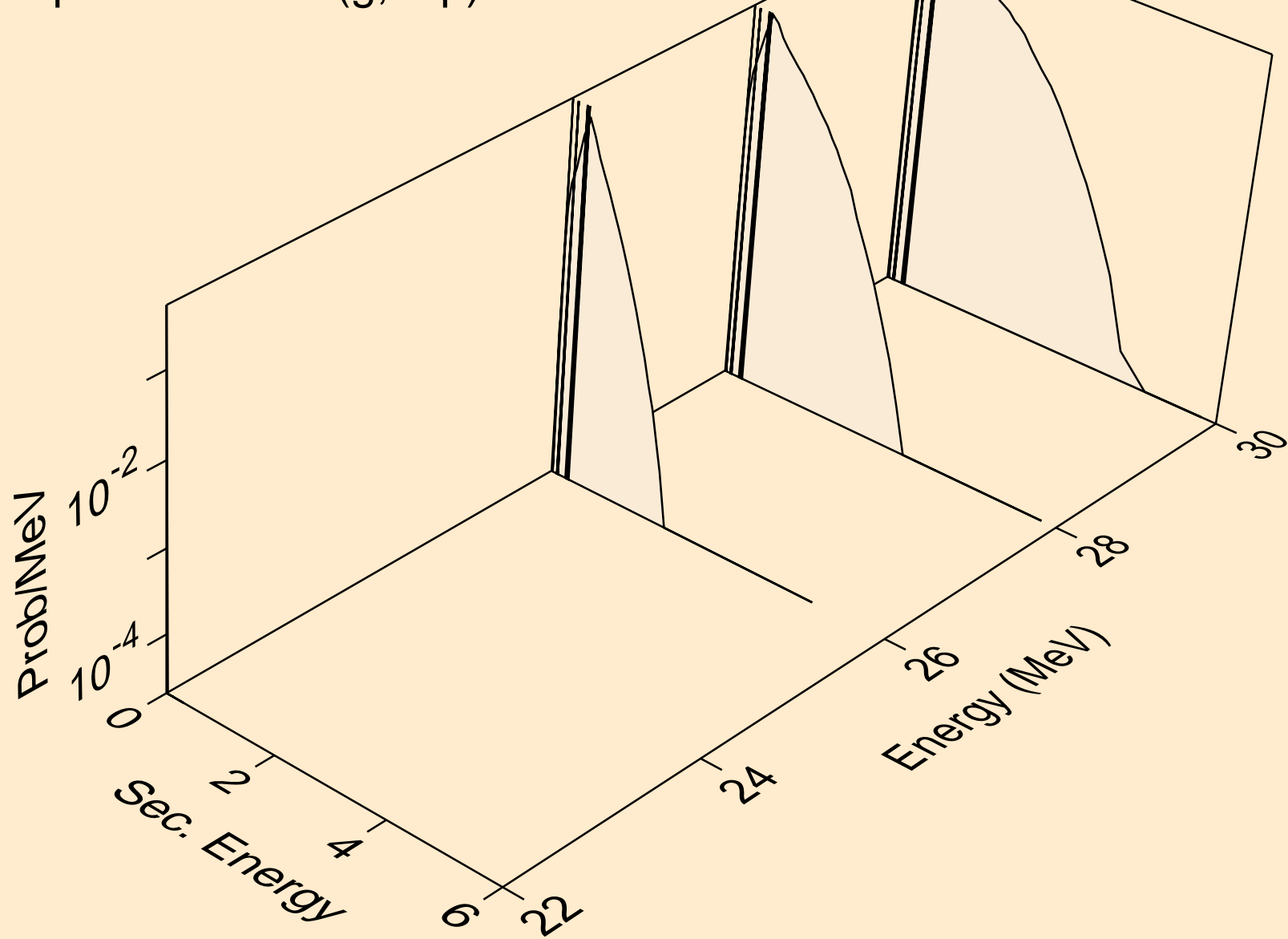

GD149 PHOTON ACER TENDL-2021 LIBRARY; T=0.K
photons from (g,2np)

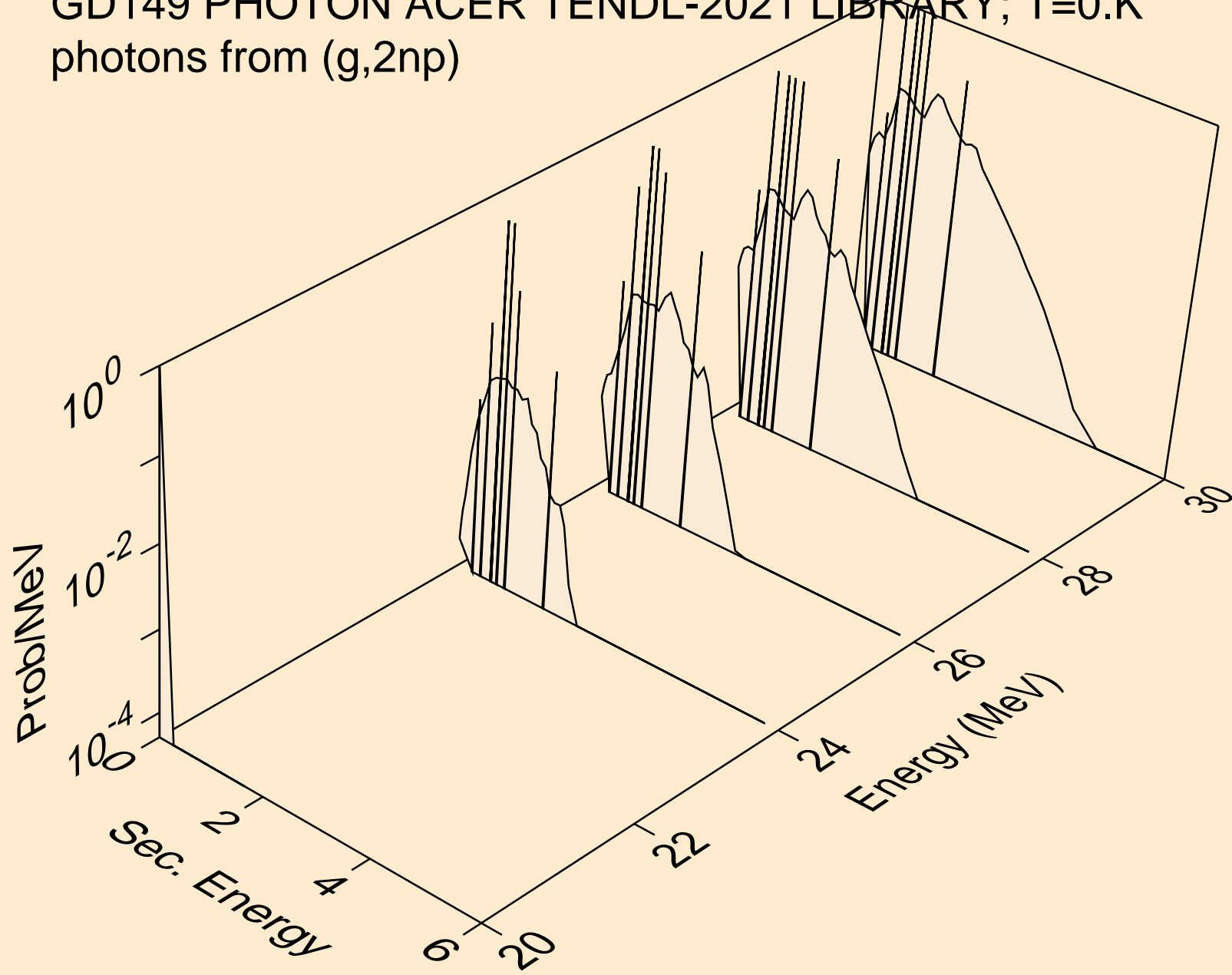

GD149 PHOTON ACER TENDL-2021 LIBRARY; T=0.K
photons from (g,npa)

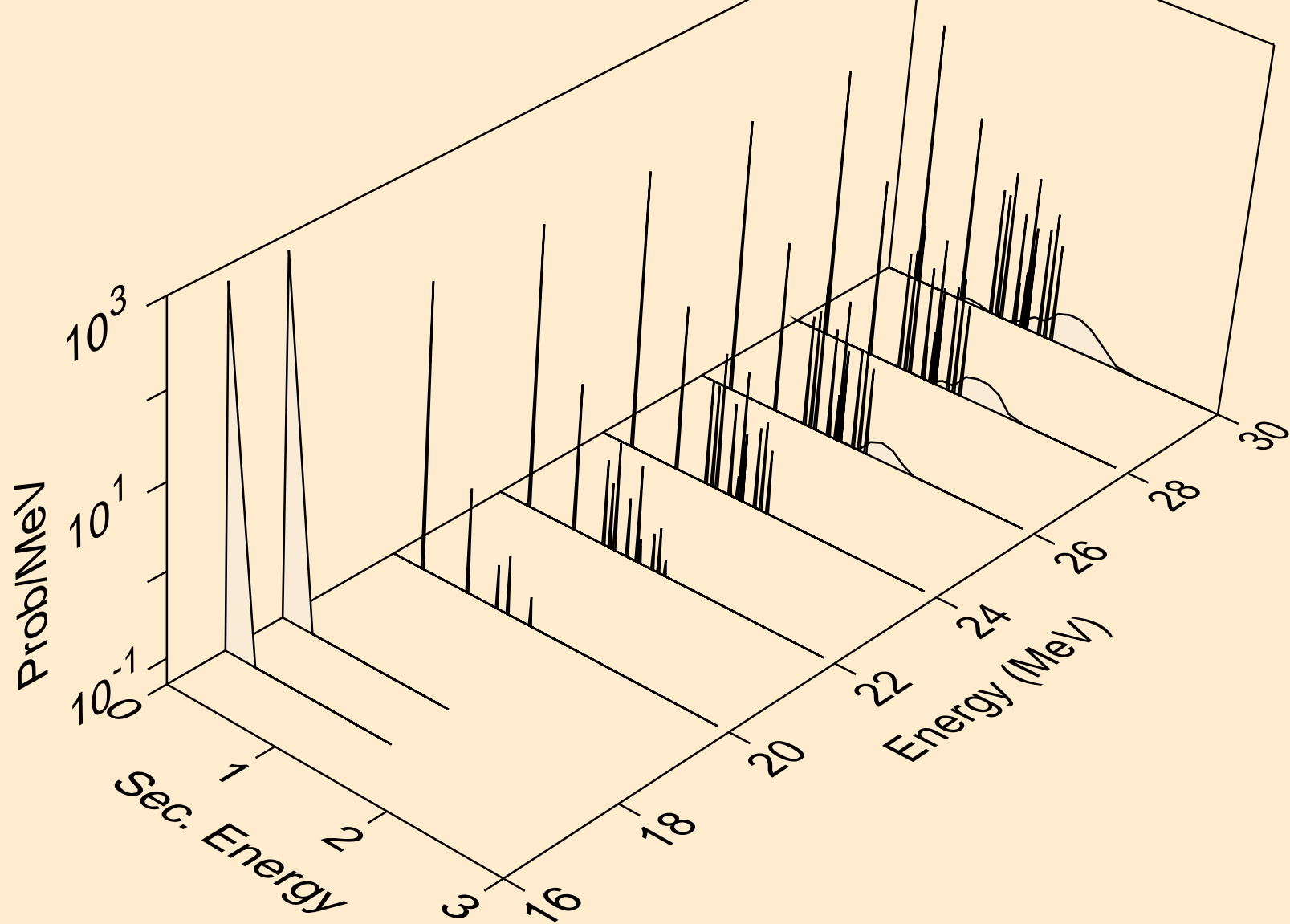

GD149 PHOTON ACER TENDL-2021 LIBRARY; T=0.K
photons from (g,n*c)

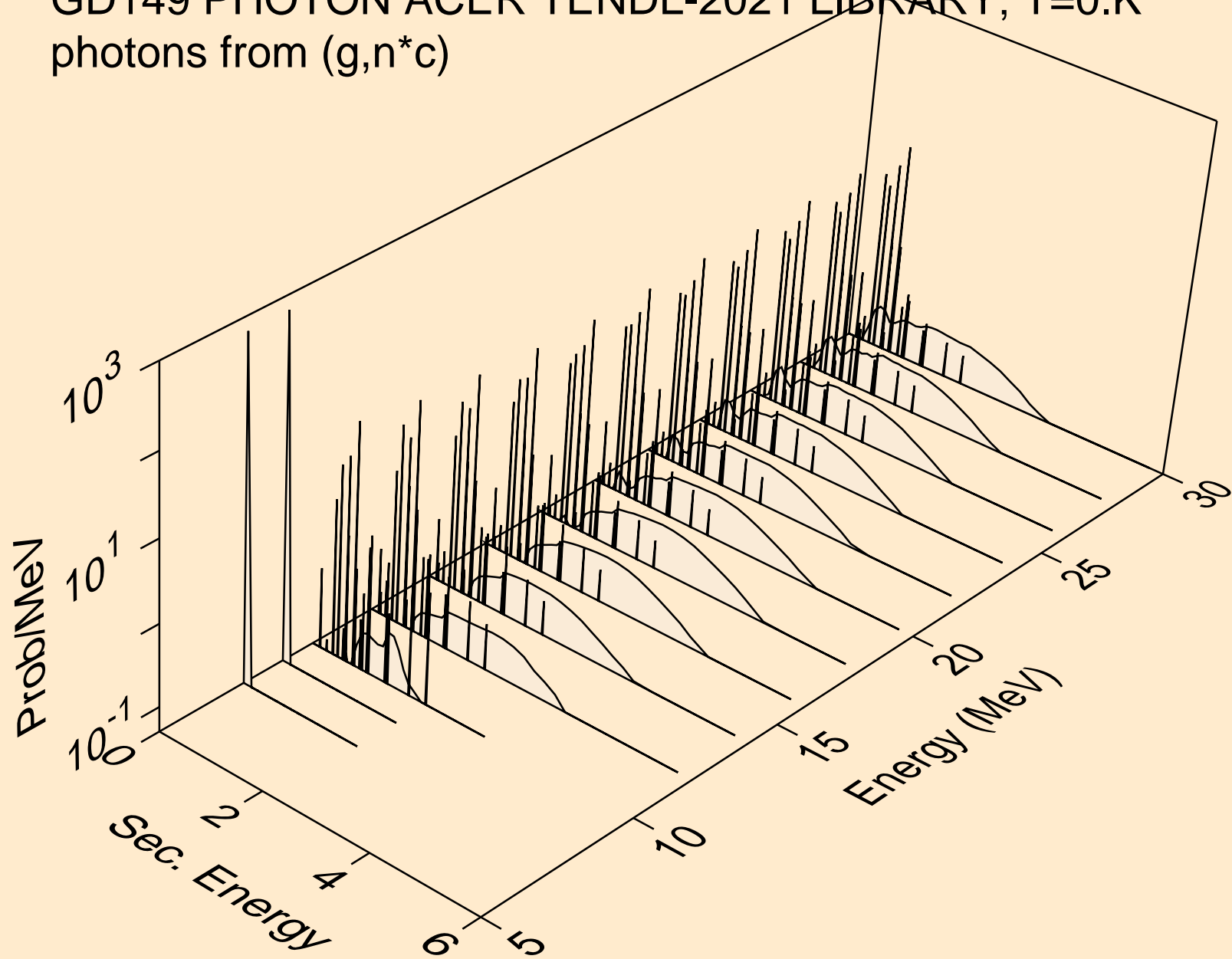

GD149 PHOTON ACER TENDL-2021 LIBRARY; T=0.K
photons from (g,gma)

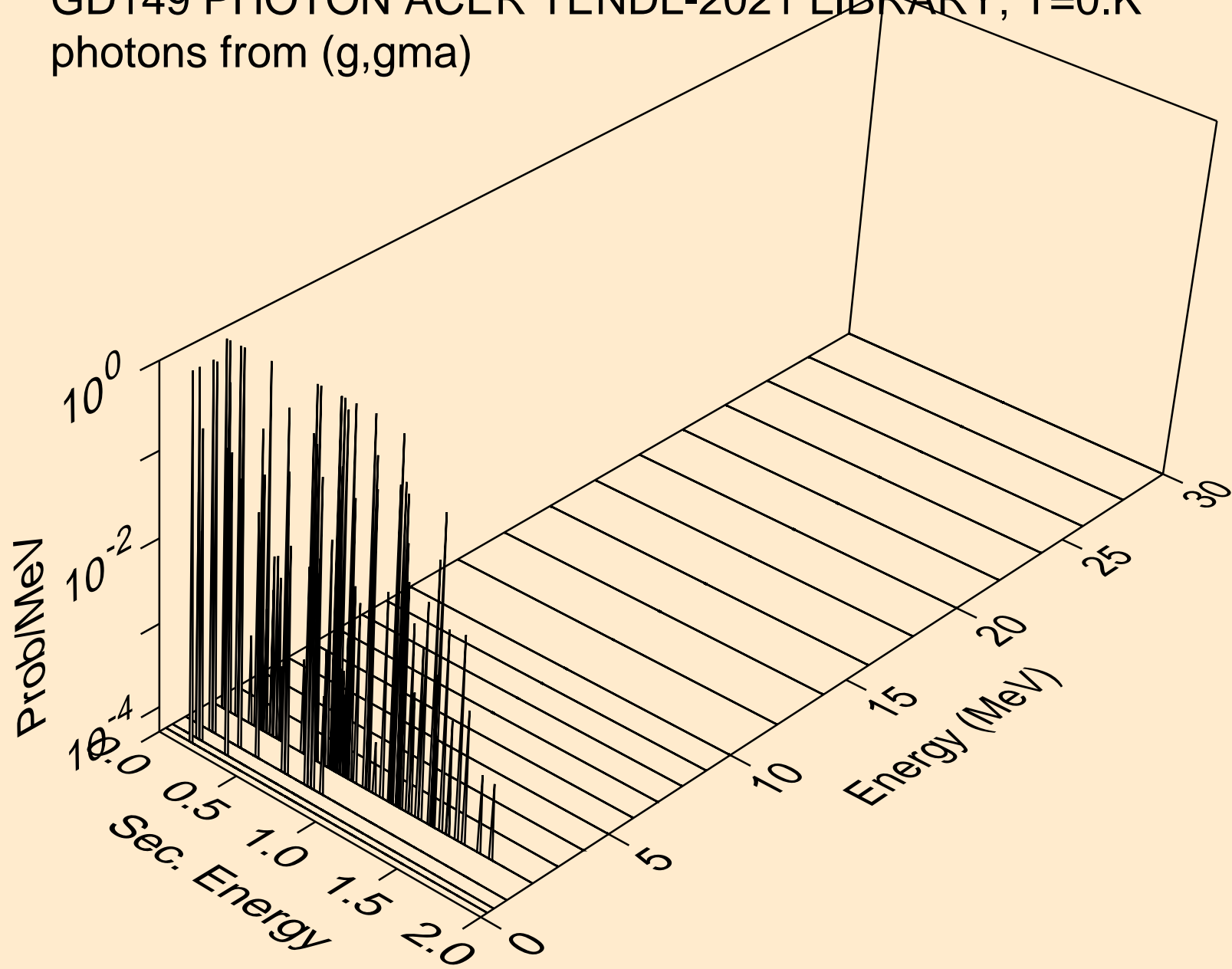

GD149 PHOTON ACER TENDL-2021 LIBRARY; T=0.K
photons from (g,p)

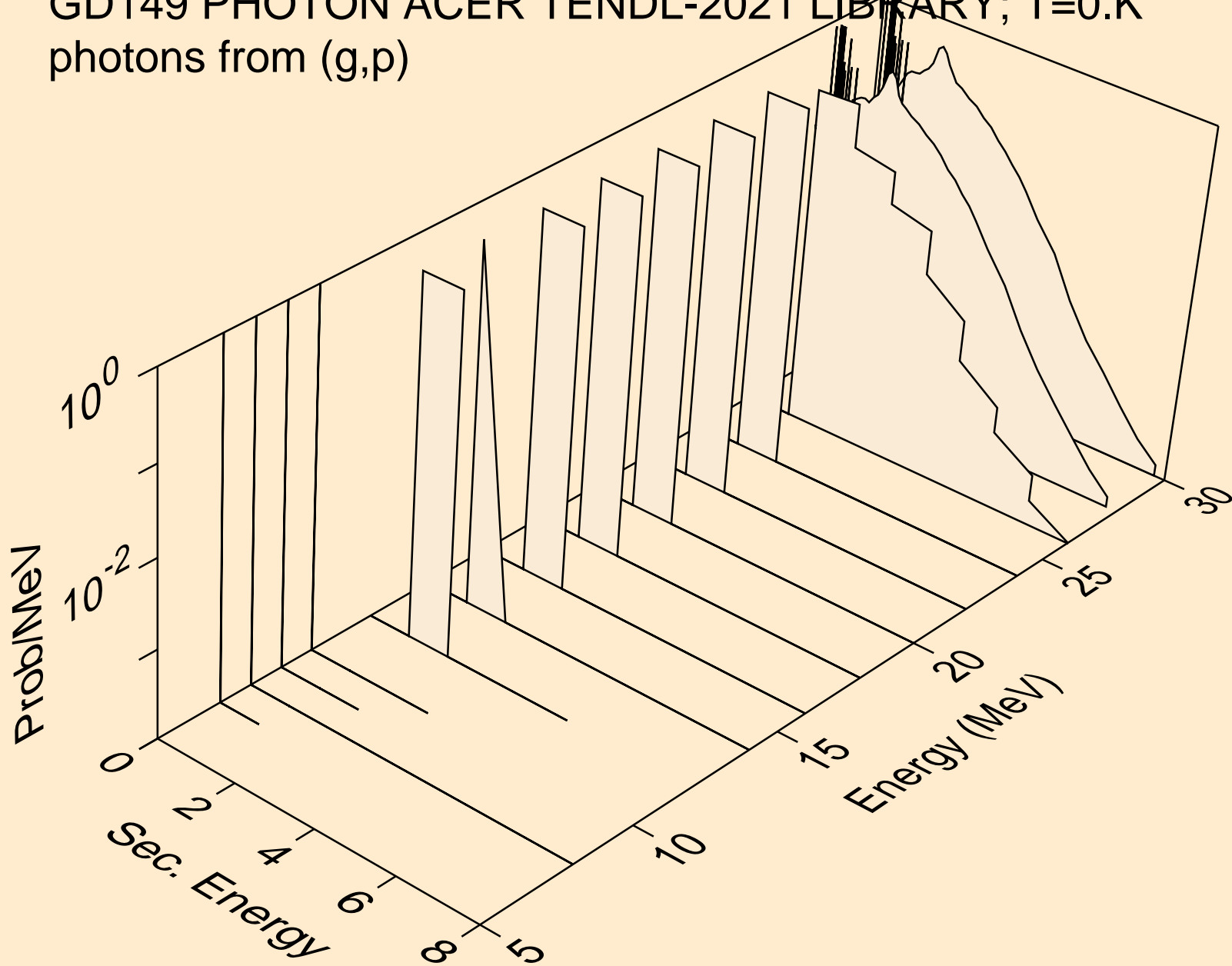

GD149 PHOTON ACER TENDL-2021 LIBRARY; T=0.K
photons from (g,d)

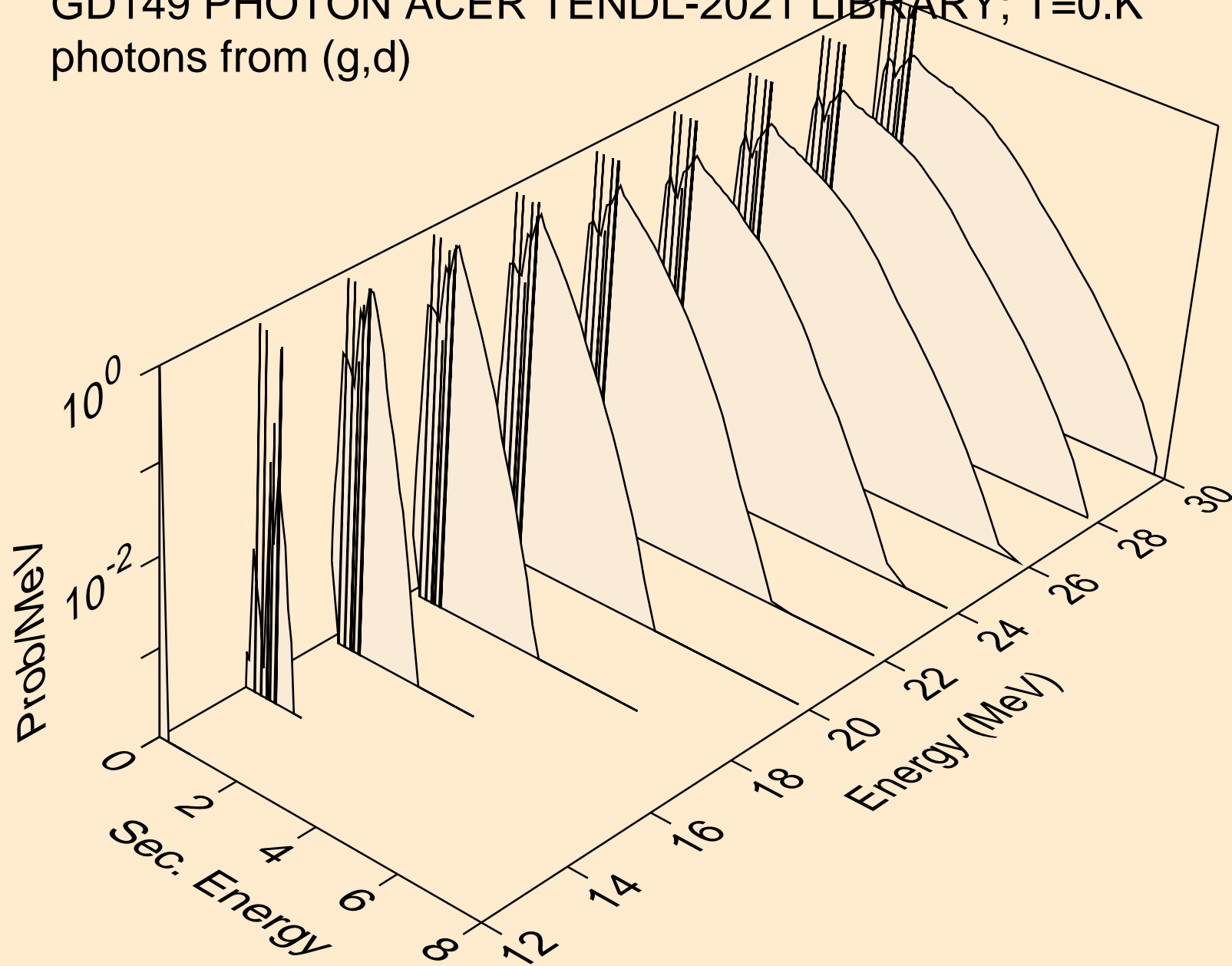

GD149 PHOTON ACER TENDL-2021 LIBRARY; T=0.K
photons from (g,t)

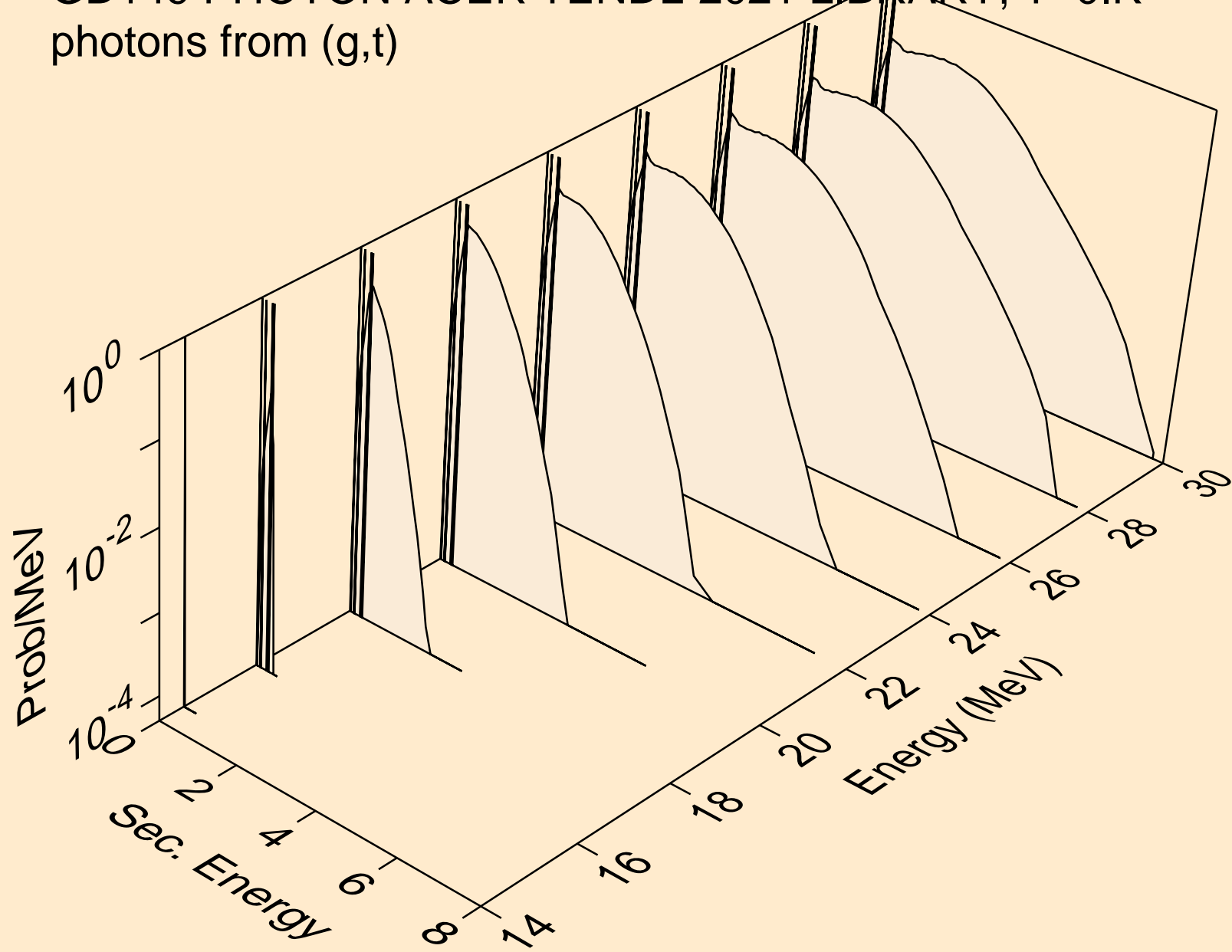

GD149 PHOTON ACER TENDL-2021 LIBRARY; T=0.K
photons from (g,he3)

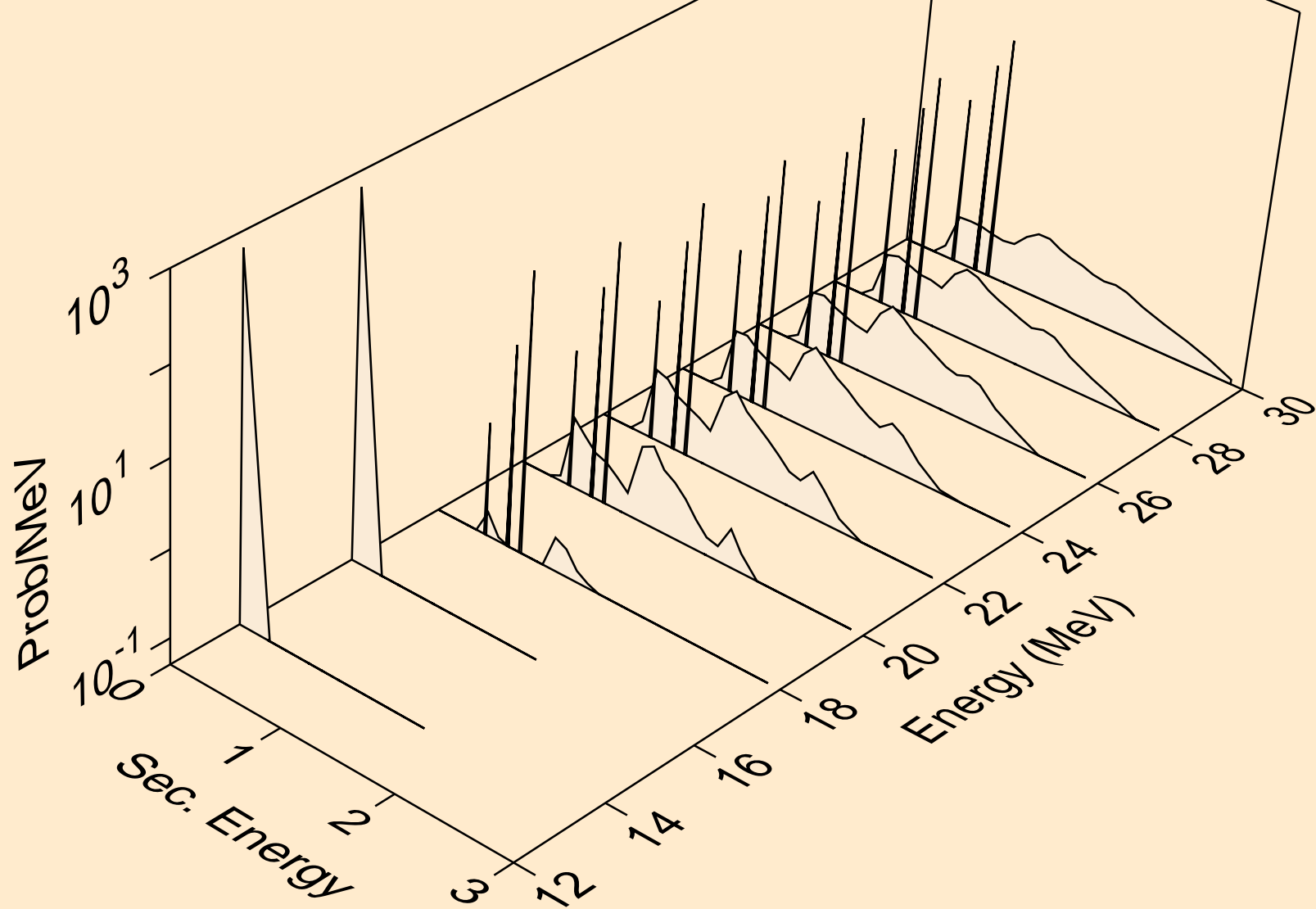

GD149 PHOTON ACER TENDL-2021 LIBRARY; T=0.K
photons from (g,a)

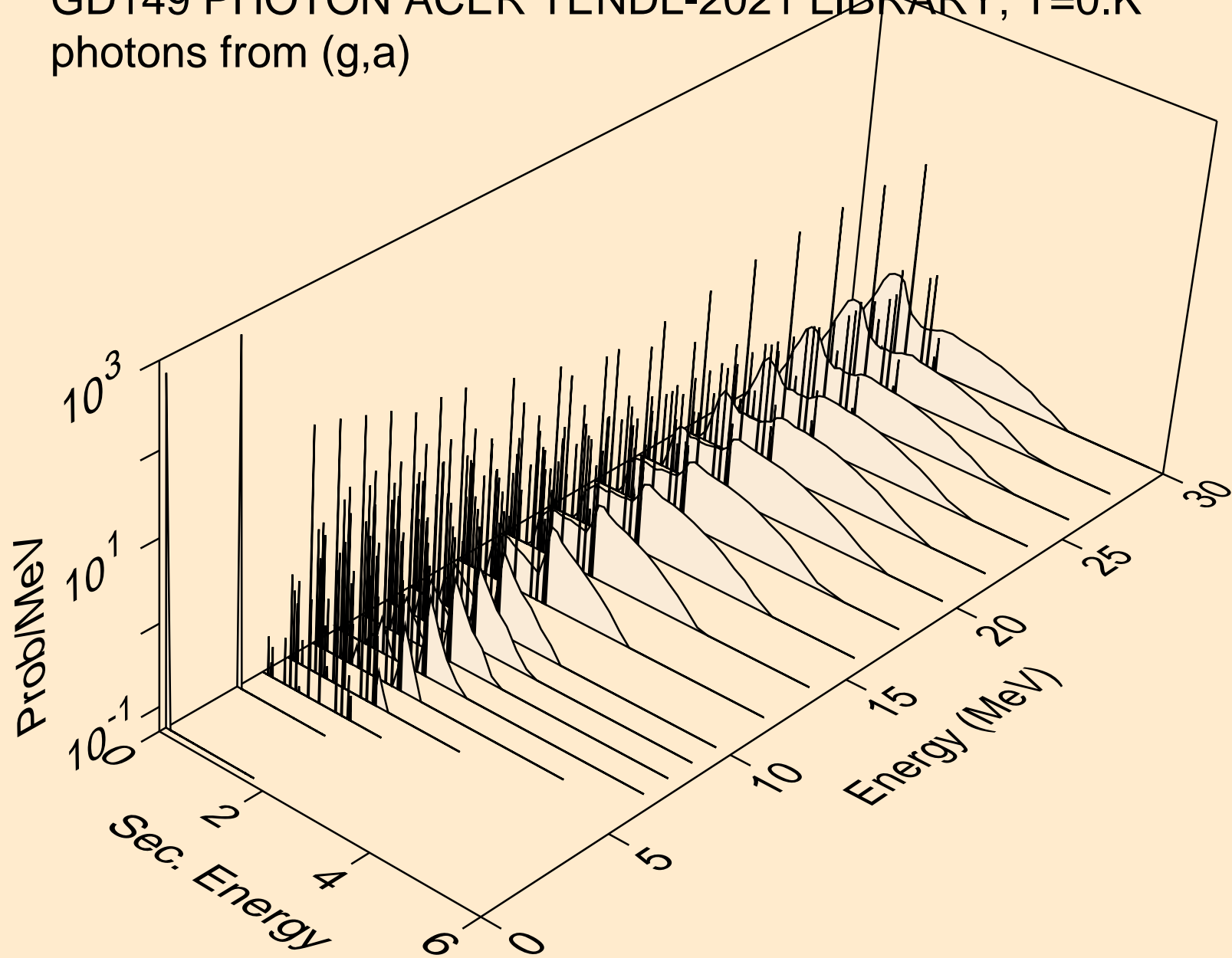

GD149 PHOTON ACER TENDL-2021 LIBRARY; T=0.K
photons from (g,2a)

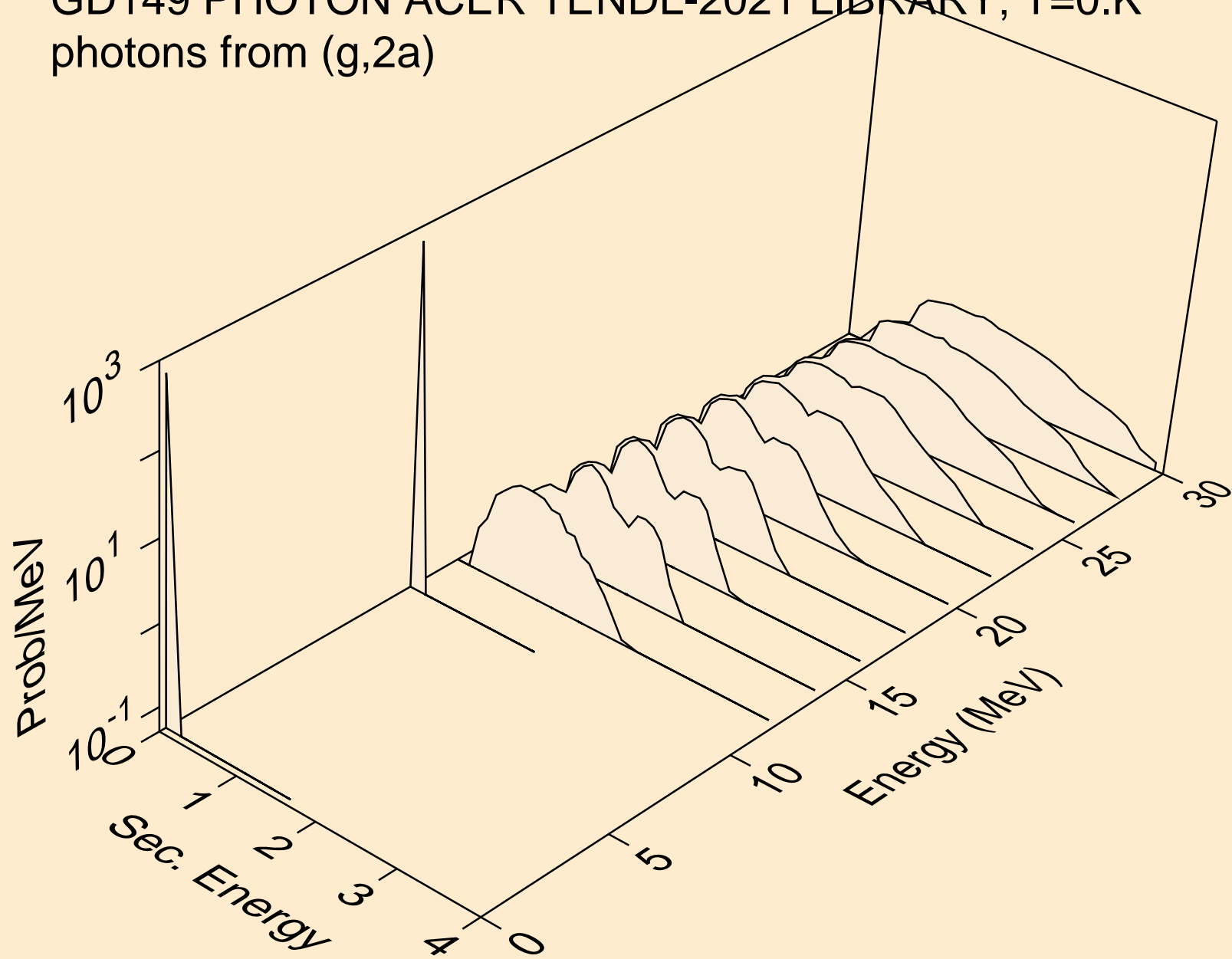

GD149 PHOTON ACER TENDL-2021 LIBRARY; T=0.K
photons from (g,2p)

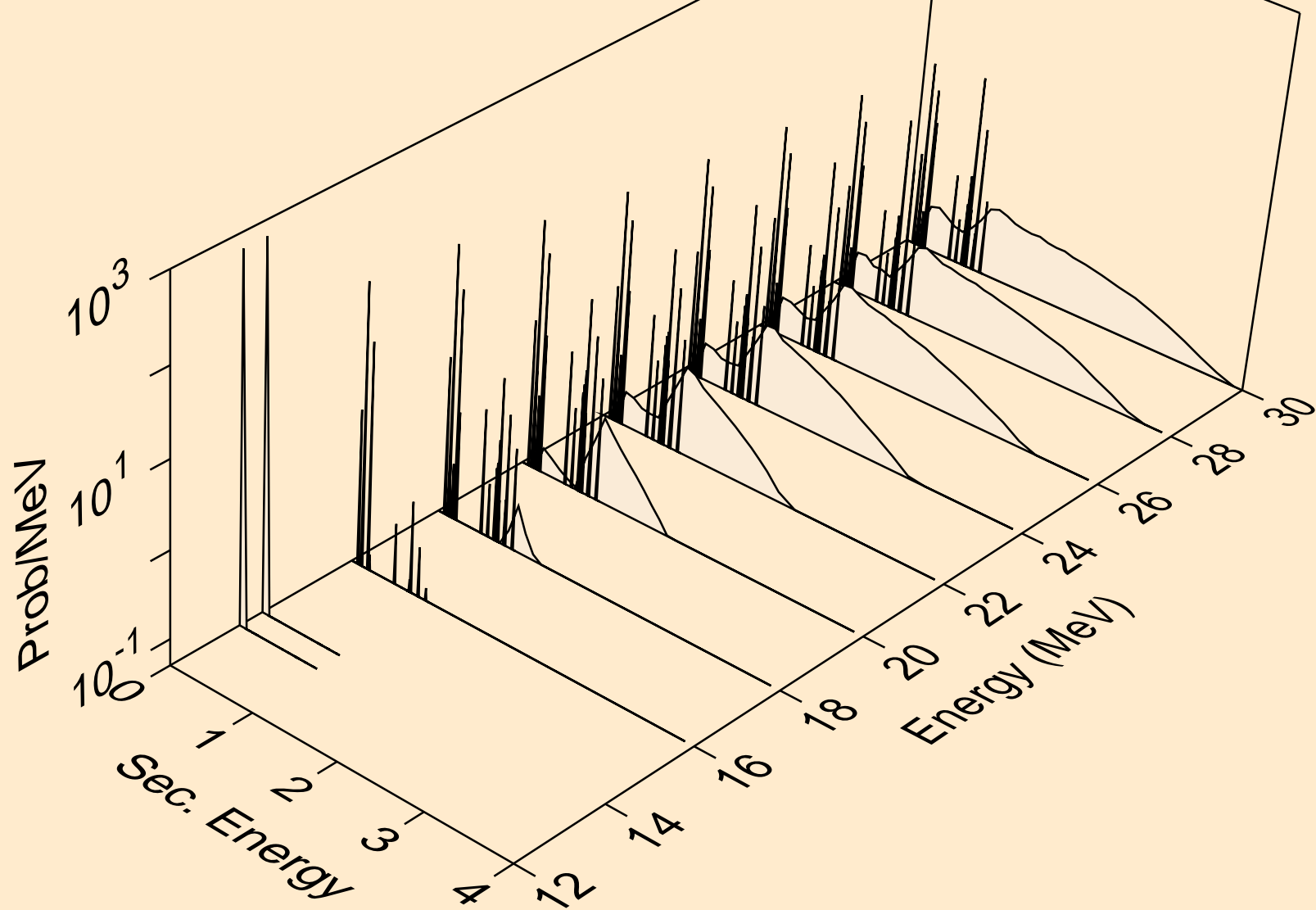

GD149 PHOTON ACER TENDL-2021 LIBRARY; T=0.K
photons from (g,pa)

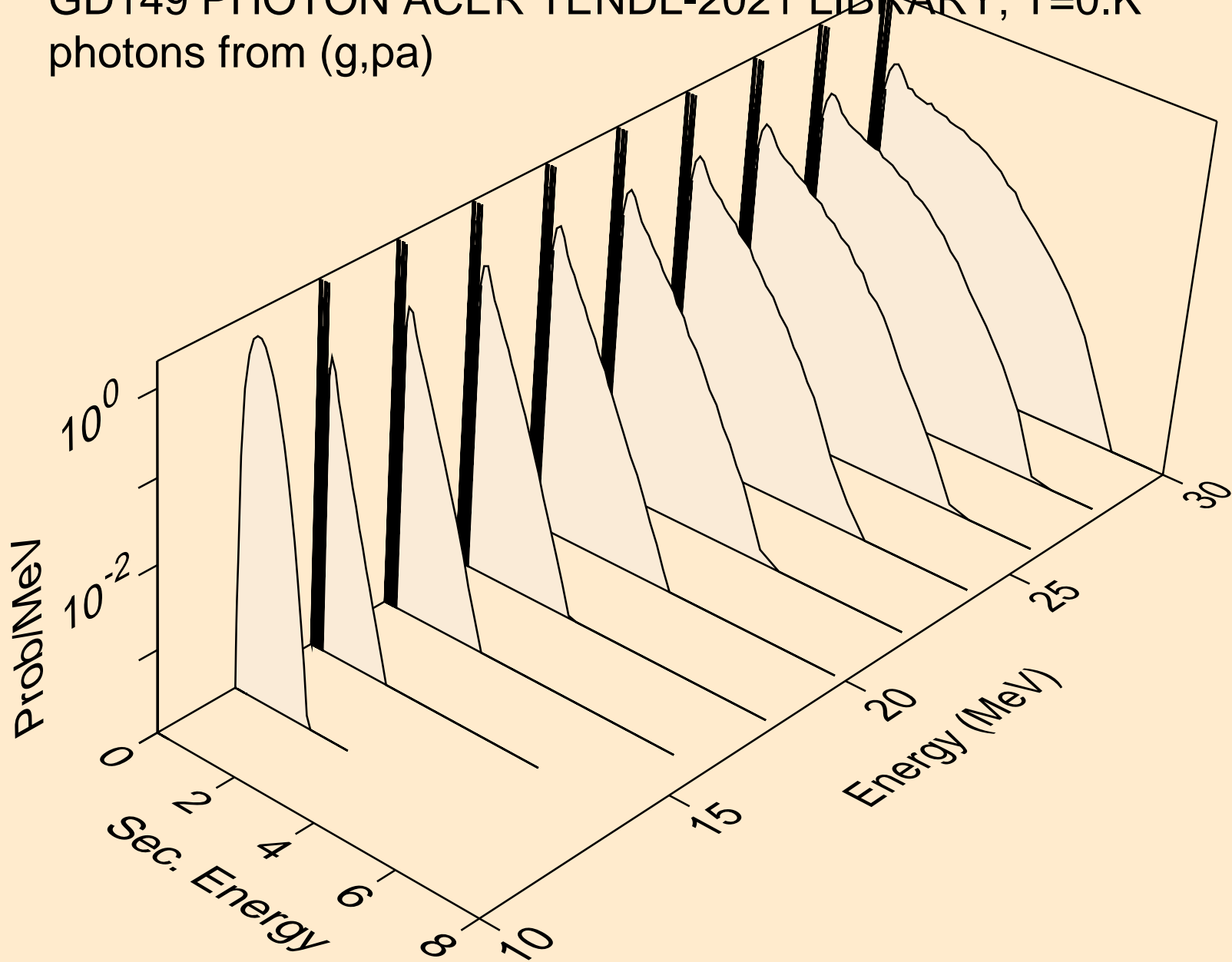

GD149 PHOTON ACER TENDL-2021 LIBRARY; T=0.K
photons from (g,pd)

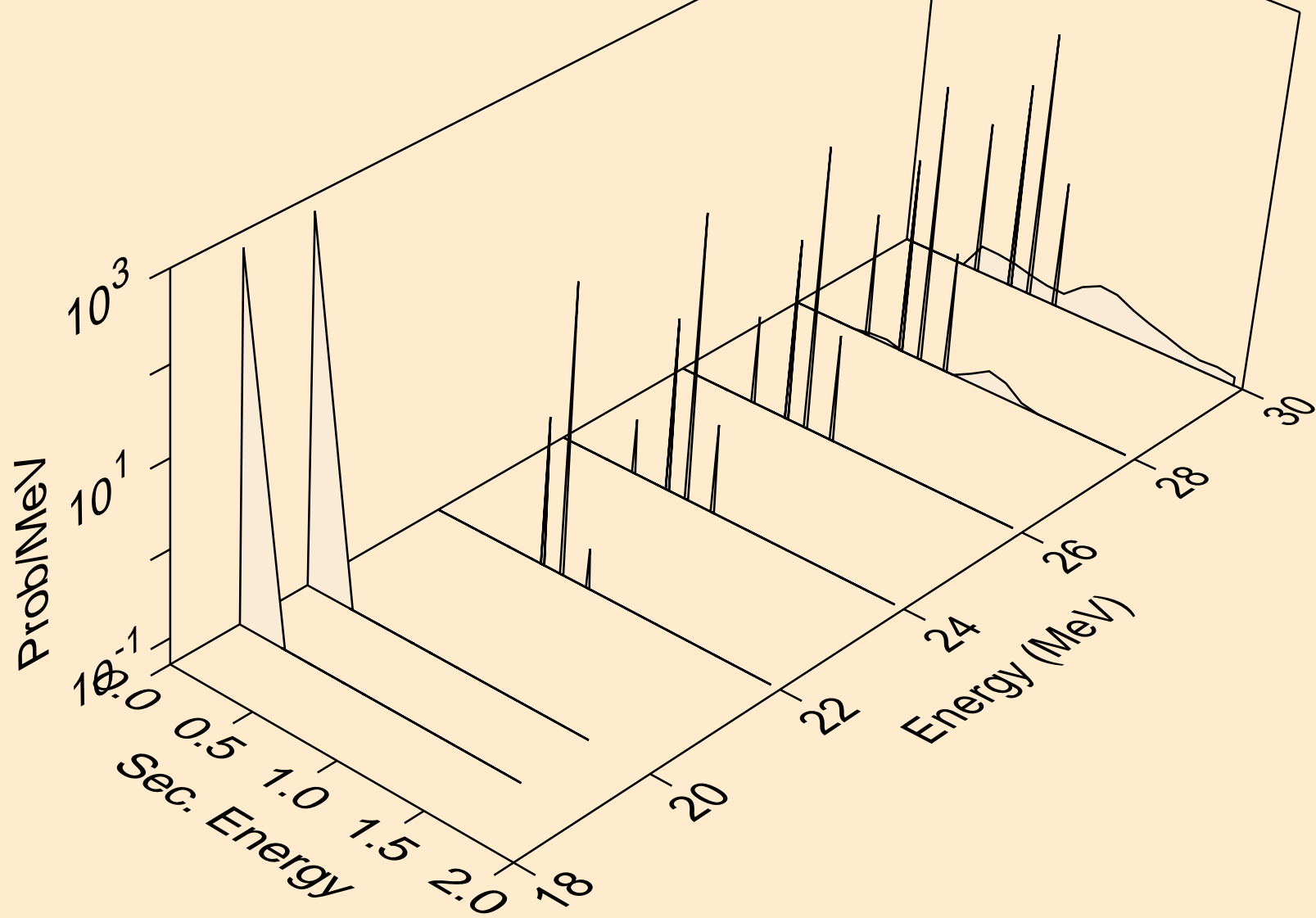

GD149 PHOTON ACER TENDL-2021 LIBRARY; T=0.K
protons from (g,x)

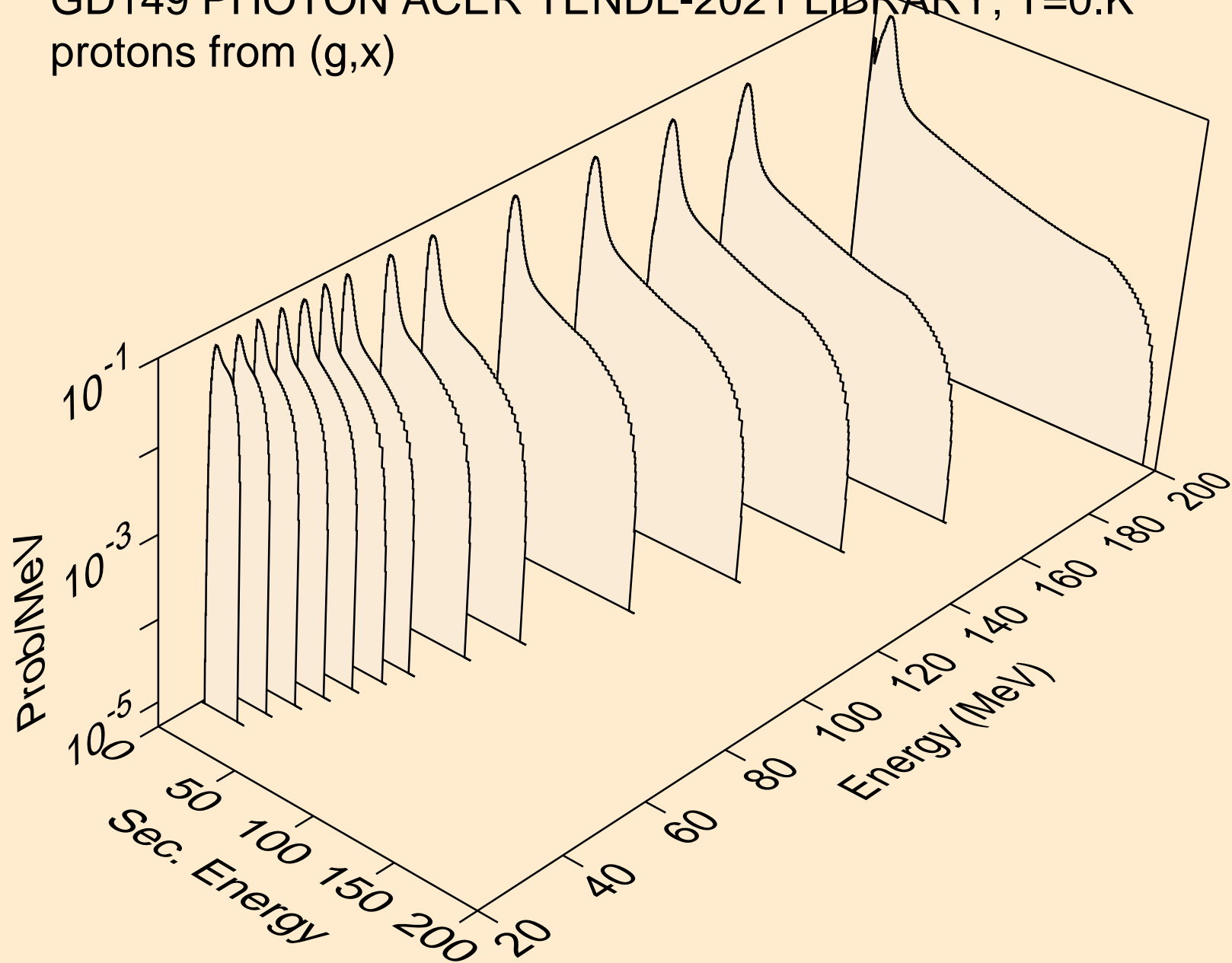

GD149 PHOTON ACER TENDL-2021 LIBRARY; T=0.K
protons from (g,n*)p

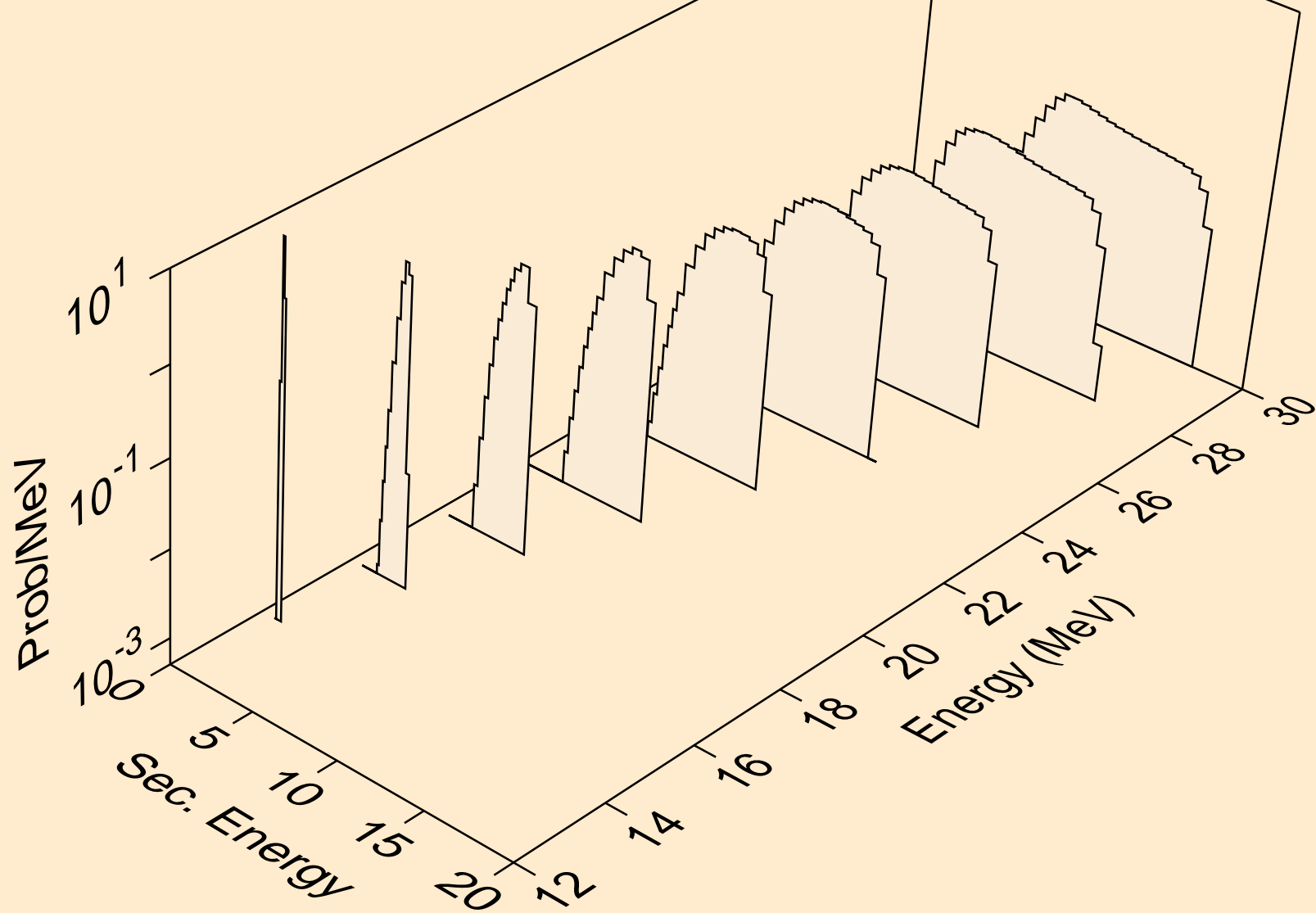

GD149 PHOTON ACER TENDL-2021 LIBRARY; T=0.K
protons from (g,2np)

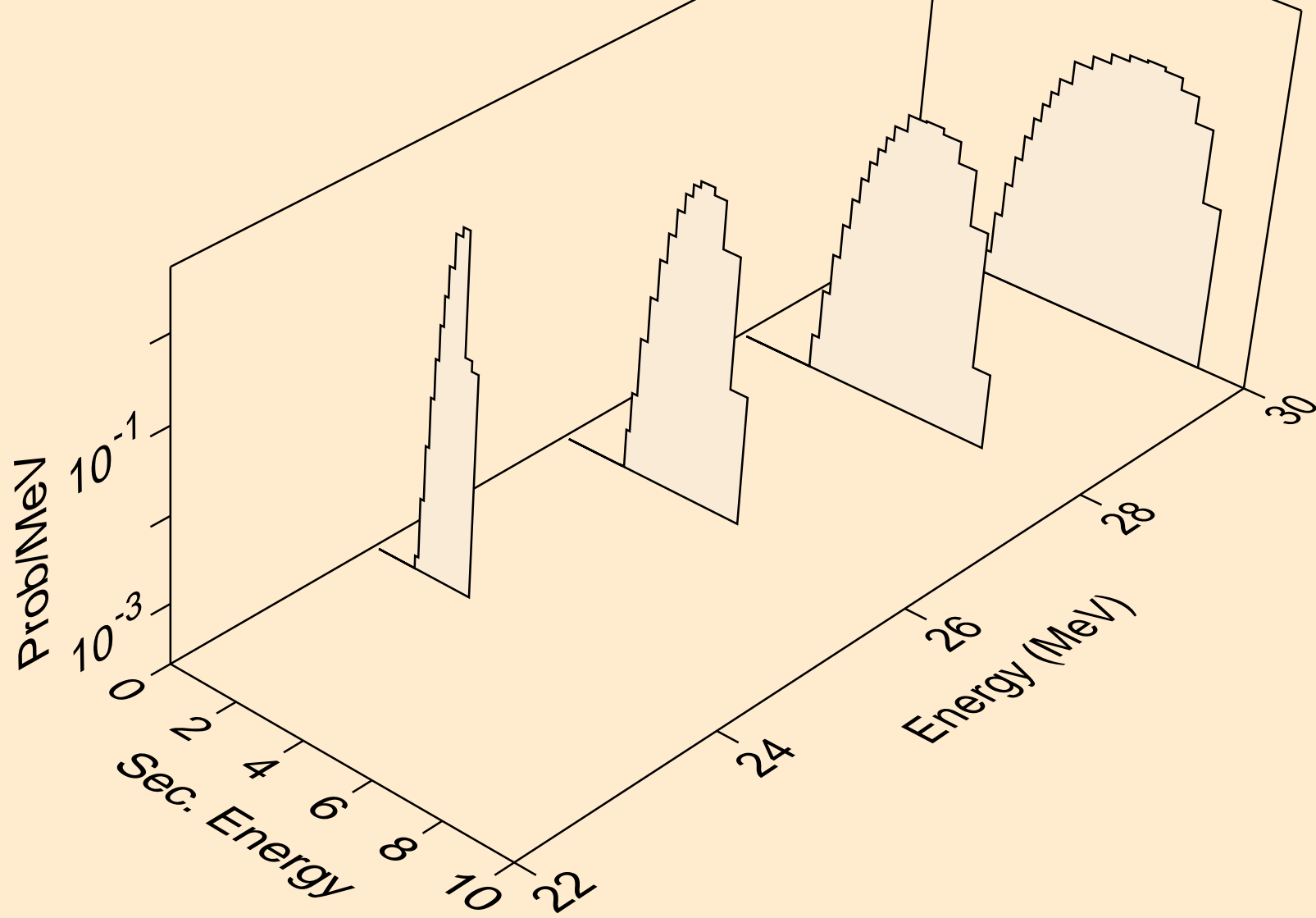

GD149 PHOTON ACER TENDL-2021 LIBRARY; T=0.K
protons from (g,2np)

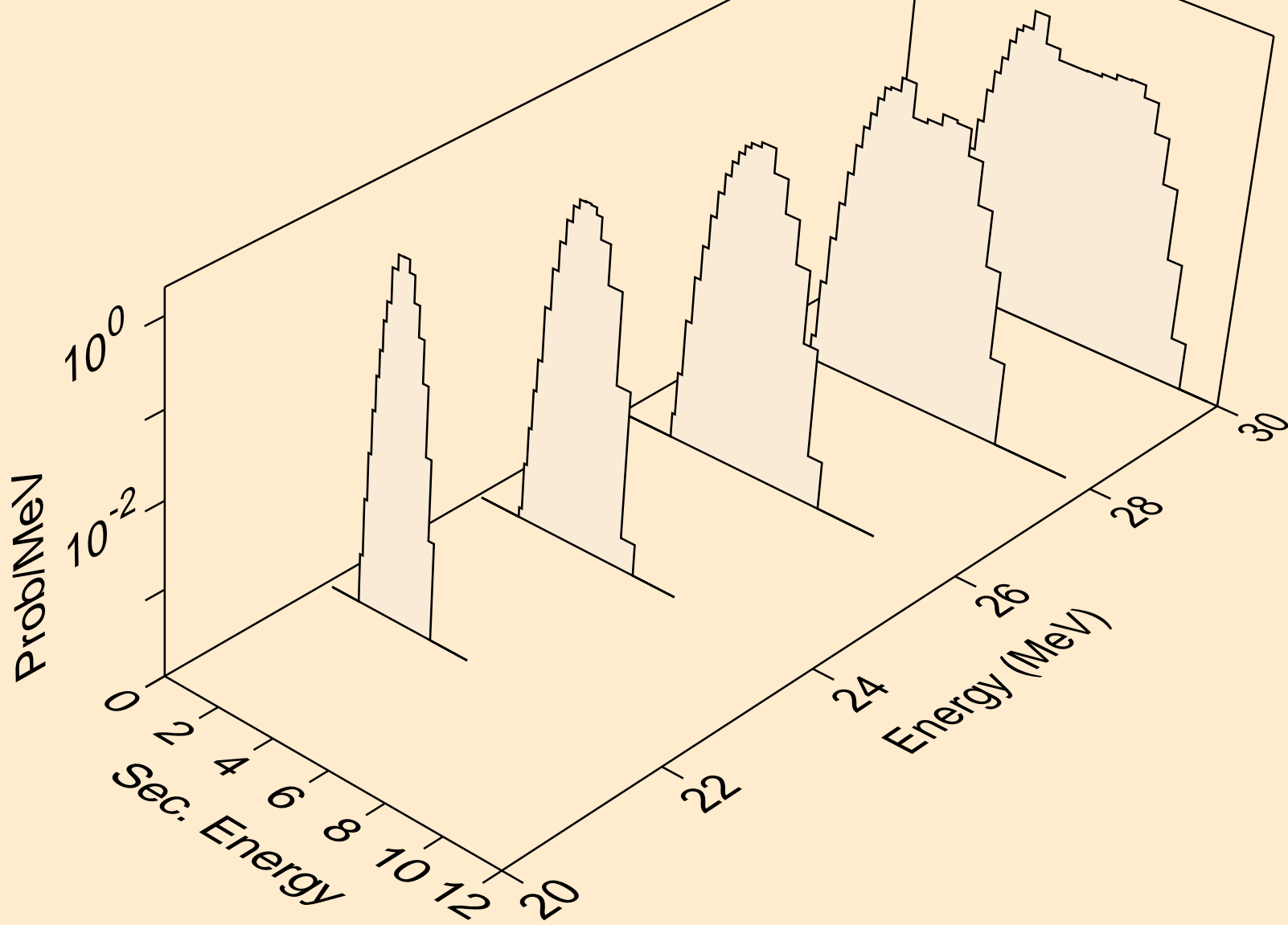

GD149 PHOTON ACER TENDL-2021 LIBRARY; T=0.K
protons from (g,npa)

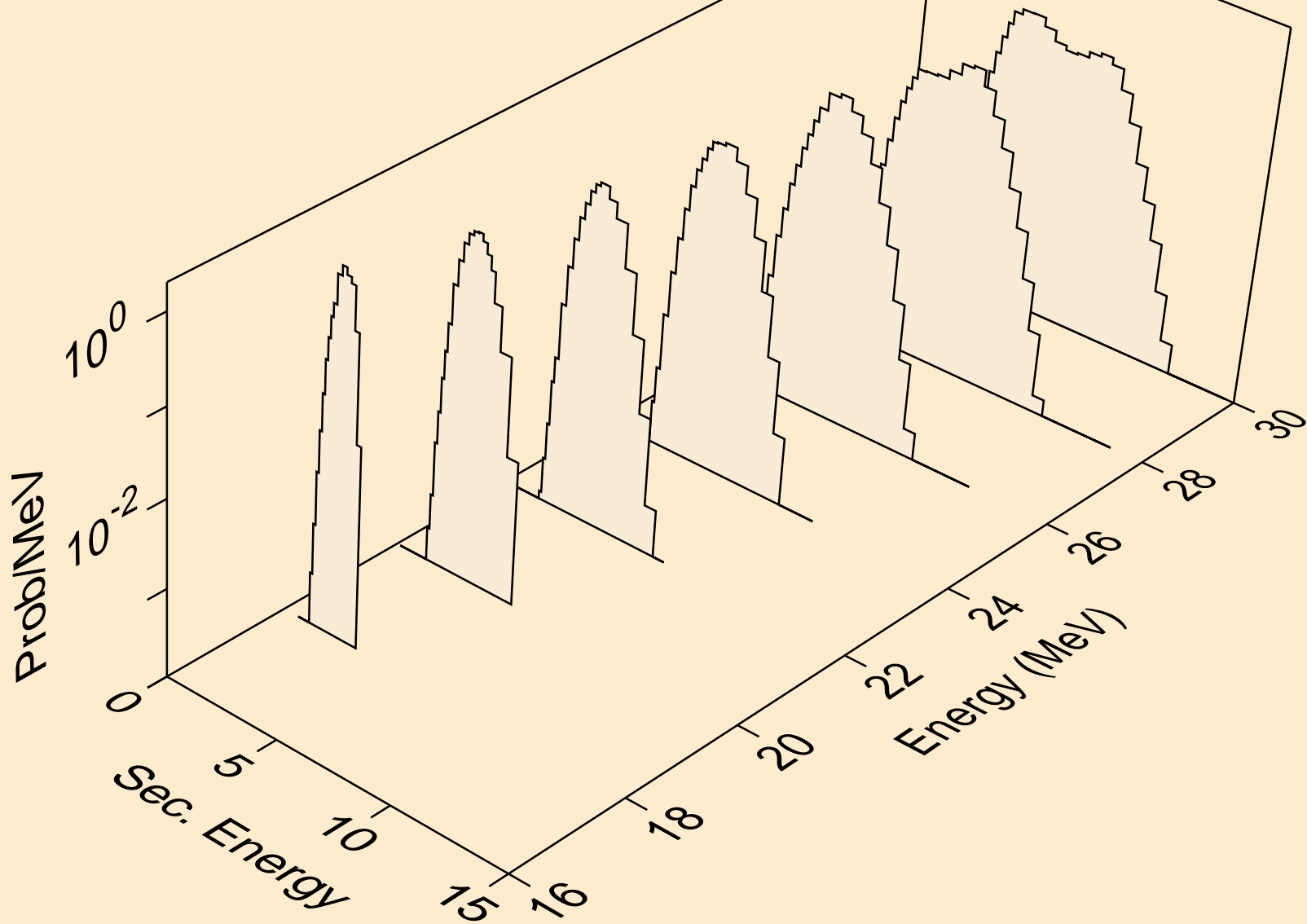

GD149 PHOTON ACER TENDL-2021 LIBRARY; T=0.K
protons from (g,p)

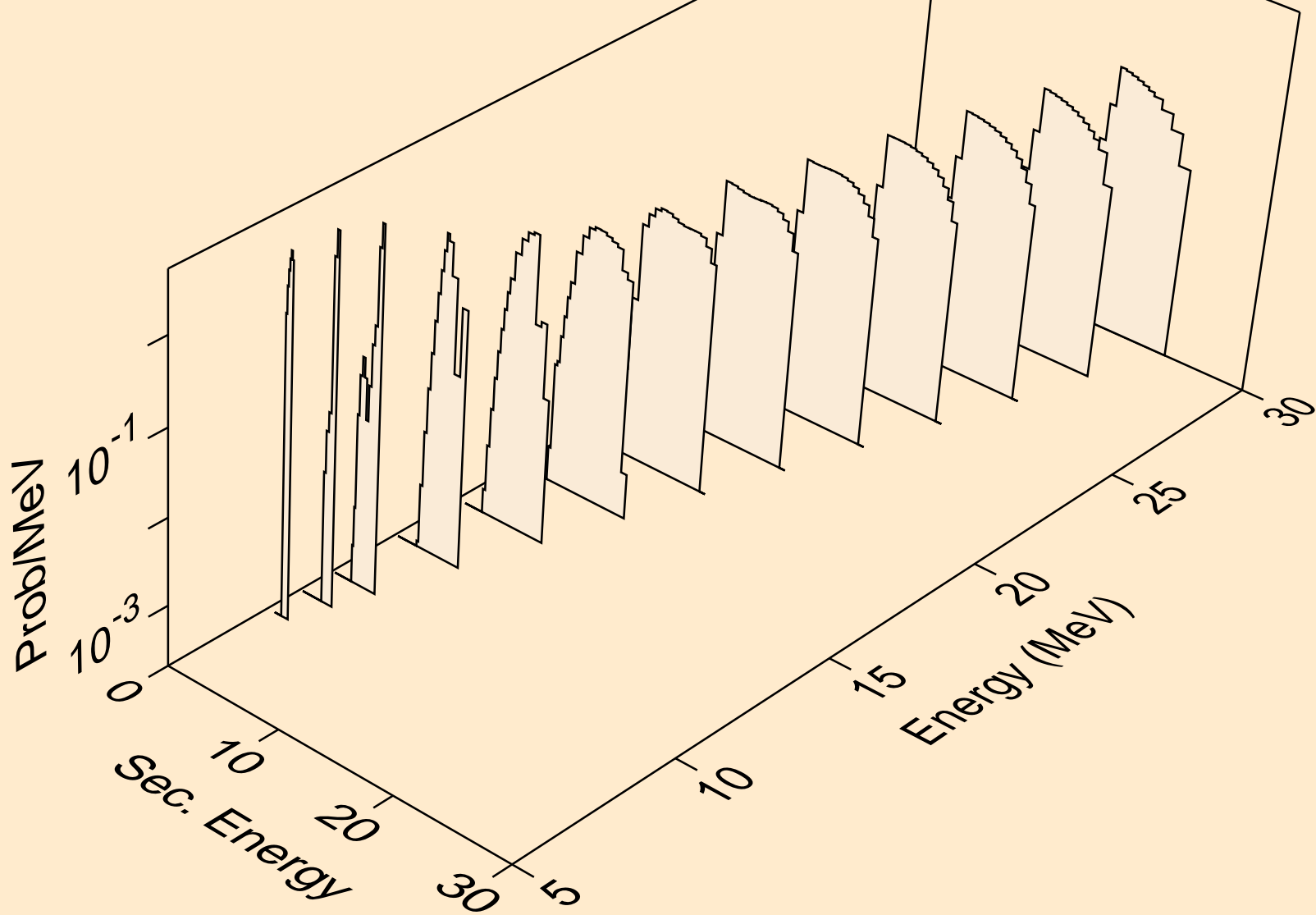

GD149 PHOTON ACER TENDL-2021 LIBRARY; T=0.K
protons from (g,2p)

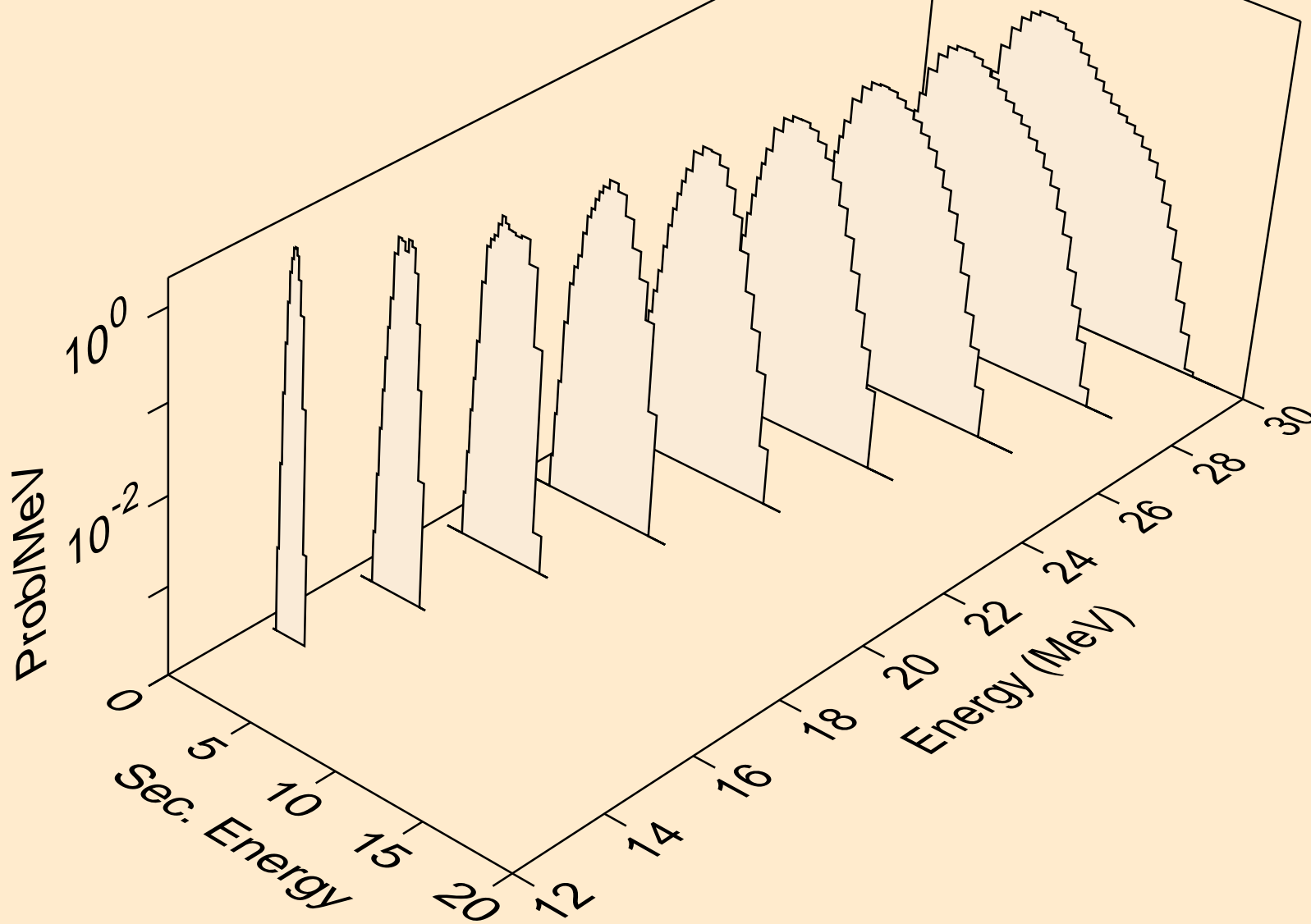

GD149 PHOTON ACER TENDL-2021 LIBRARY; T=0.K
protons from (g,pa)

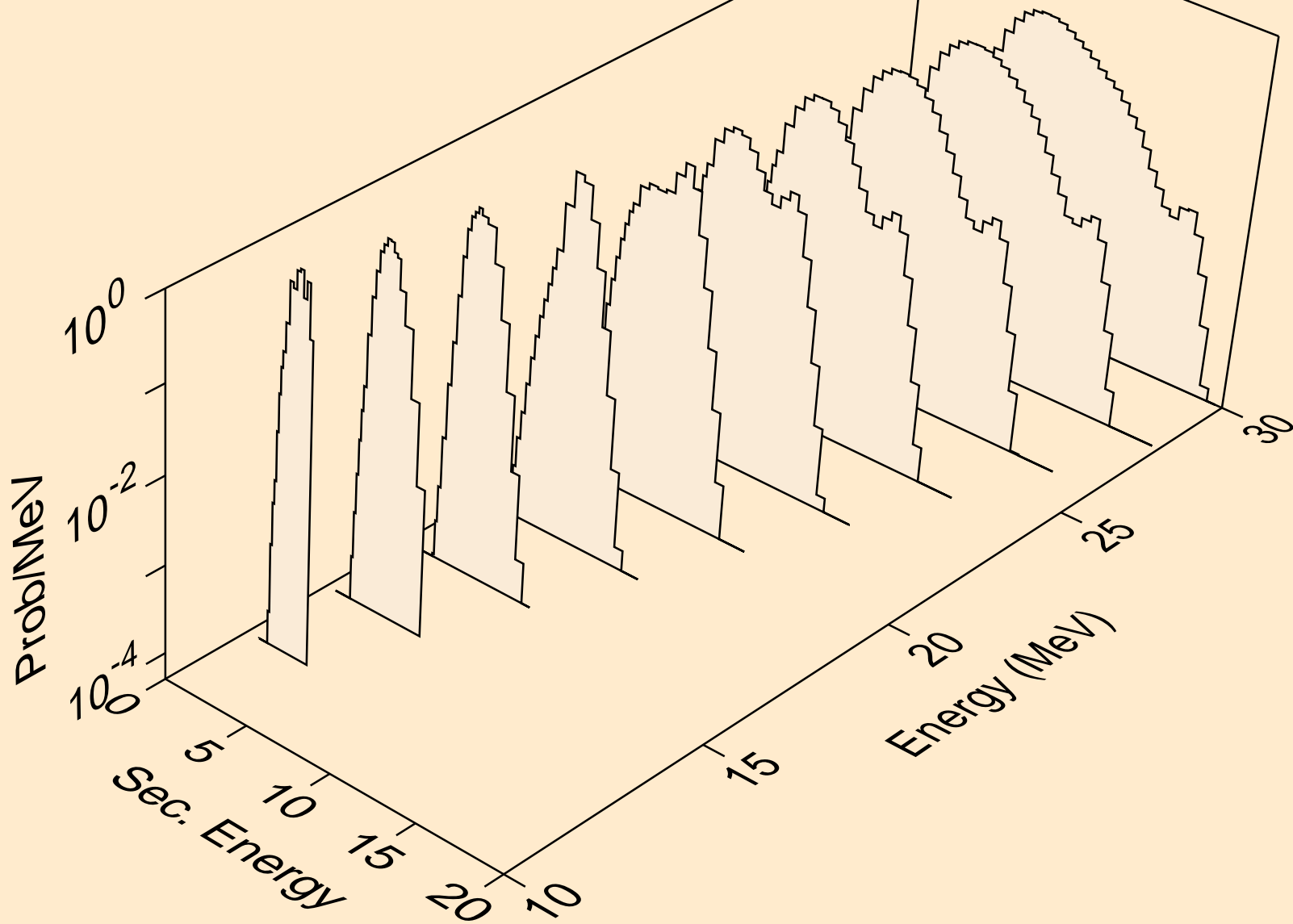

GD149 PHOTON ACER TENDL-2021 LIBRARY; T=0.K
protons from (g,pd)

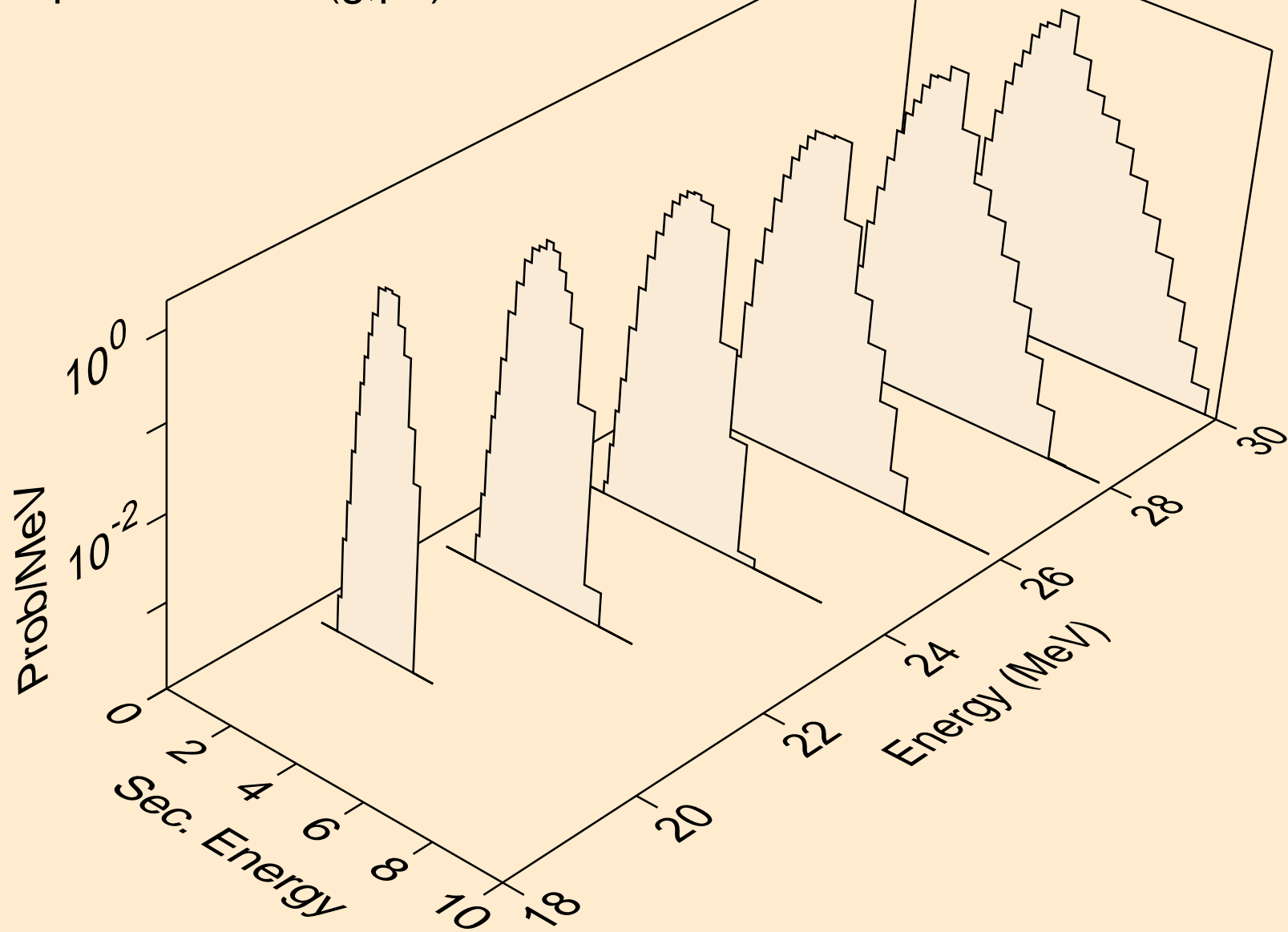

GD149 PHOTON ACER TENDL-2021 LIBRARY; T=0.K
deuterons from (g,x)

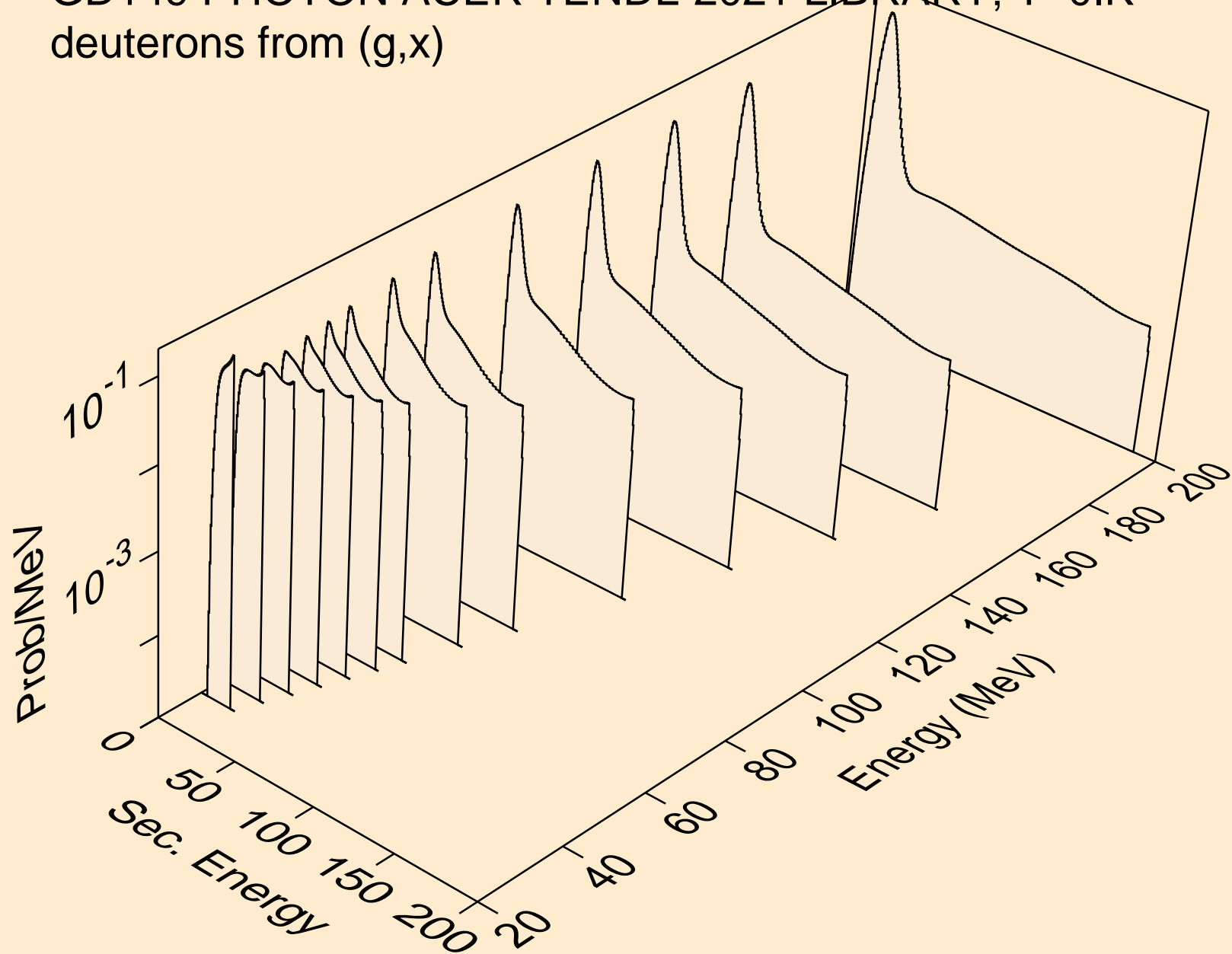

GD149 PHOTON ACER TENDL-2021 LIBRARY; T=0.K
deuterons from (g,n*)d

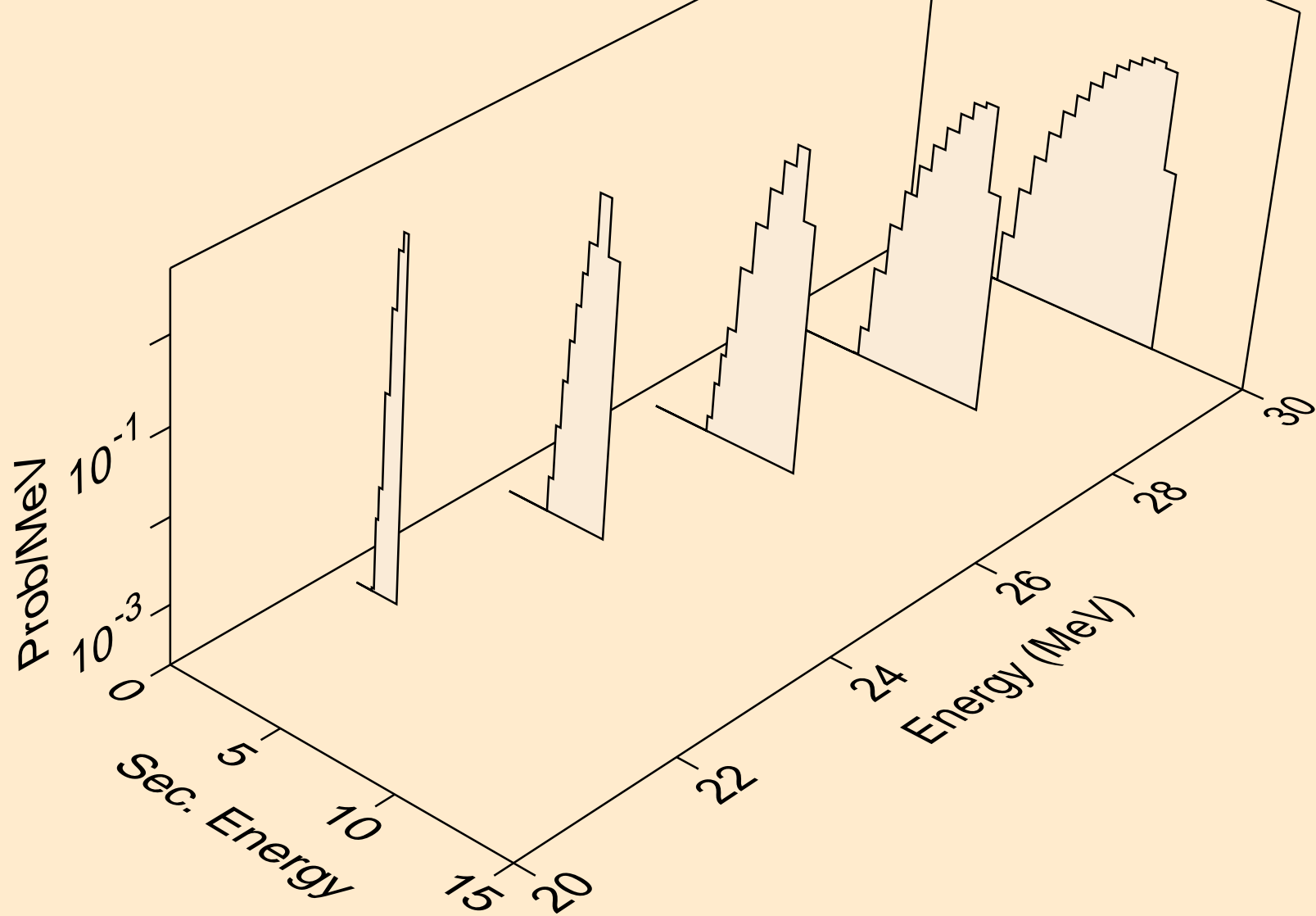

GD149 PHOTON ACER TENDL-2021 LIBRARY; T=0.K
deuterons from (g,d)

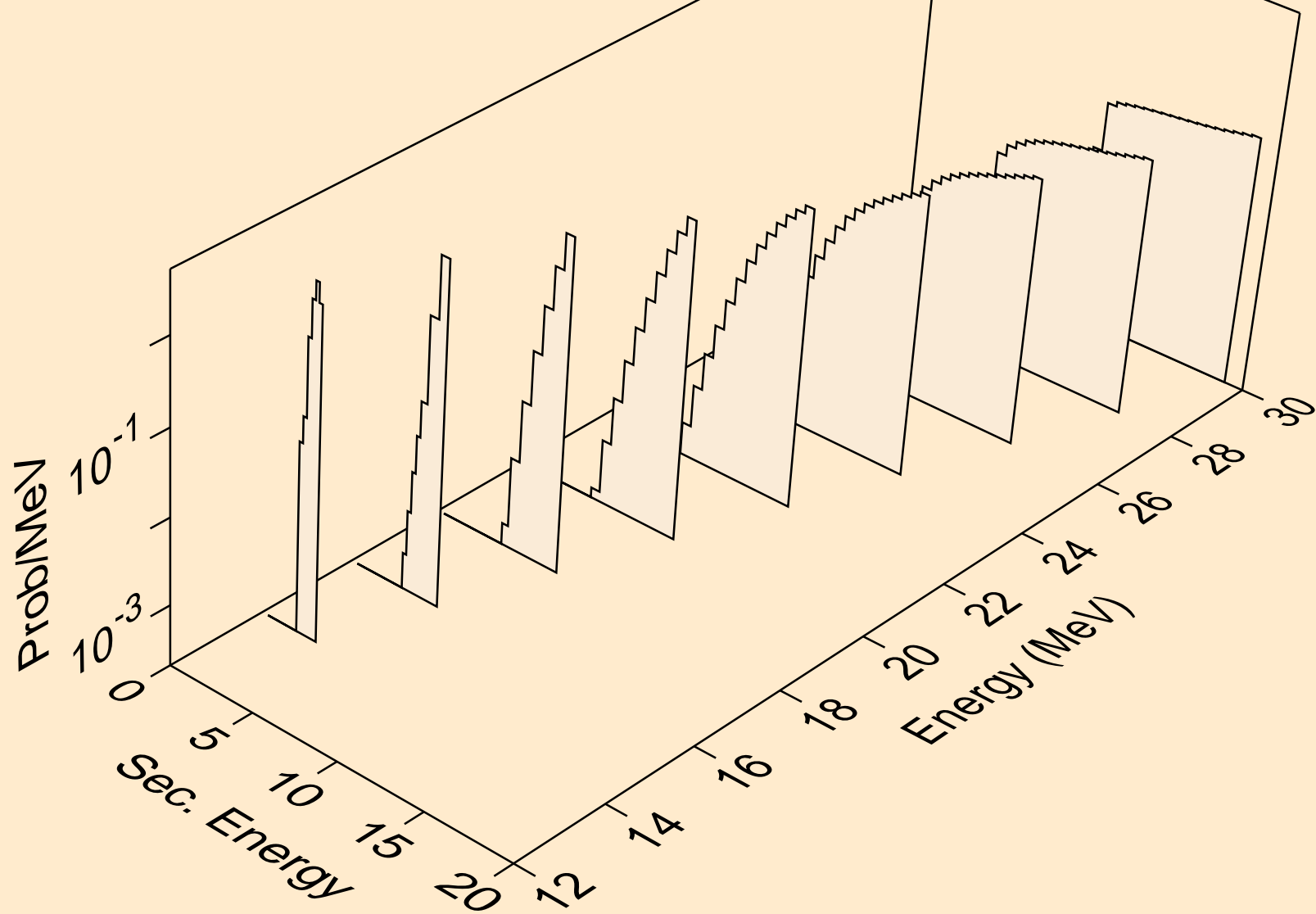

GD149 PHOTON ACER TENDL-2021 LIBRARY; T=0.K
deuterons from (g,pd)

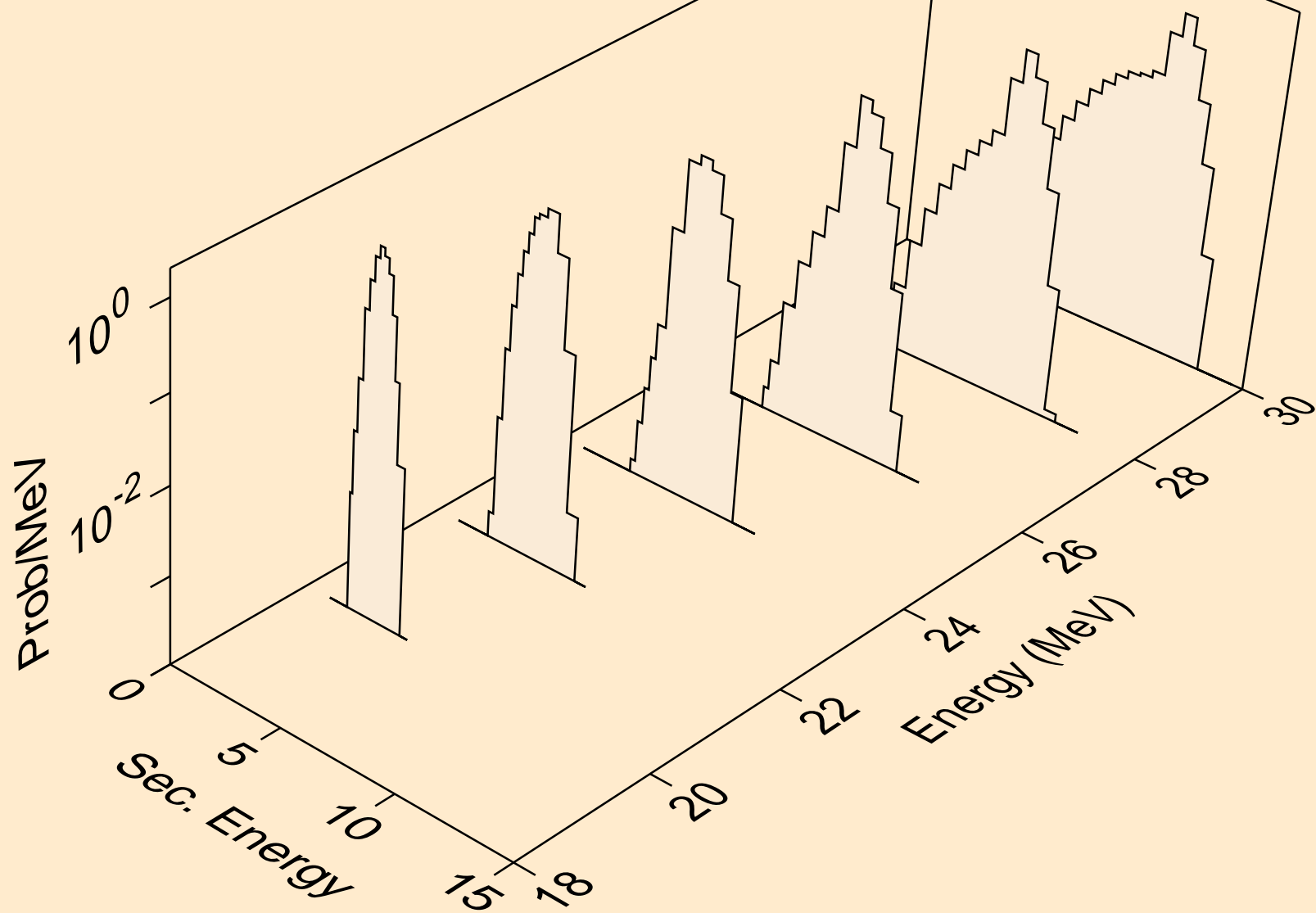

GD149 PHOTON ACER TENDL-2021 LIBRARY; T=0.K
deuterons from (g,da)

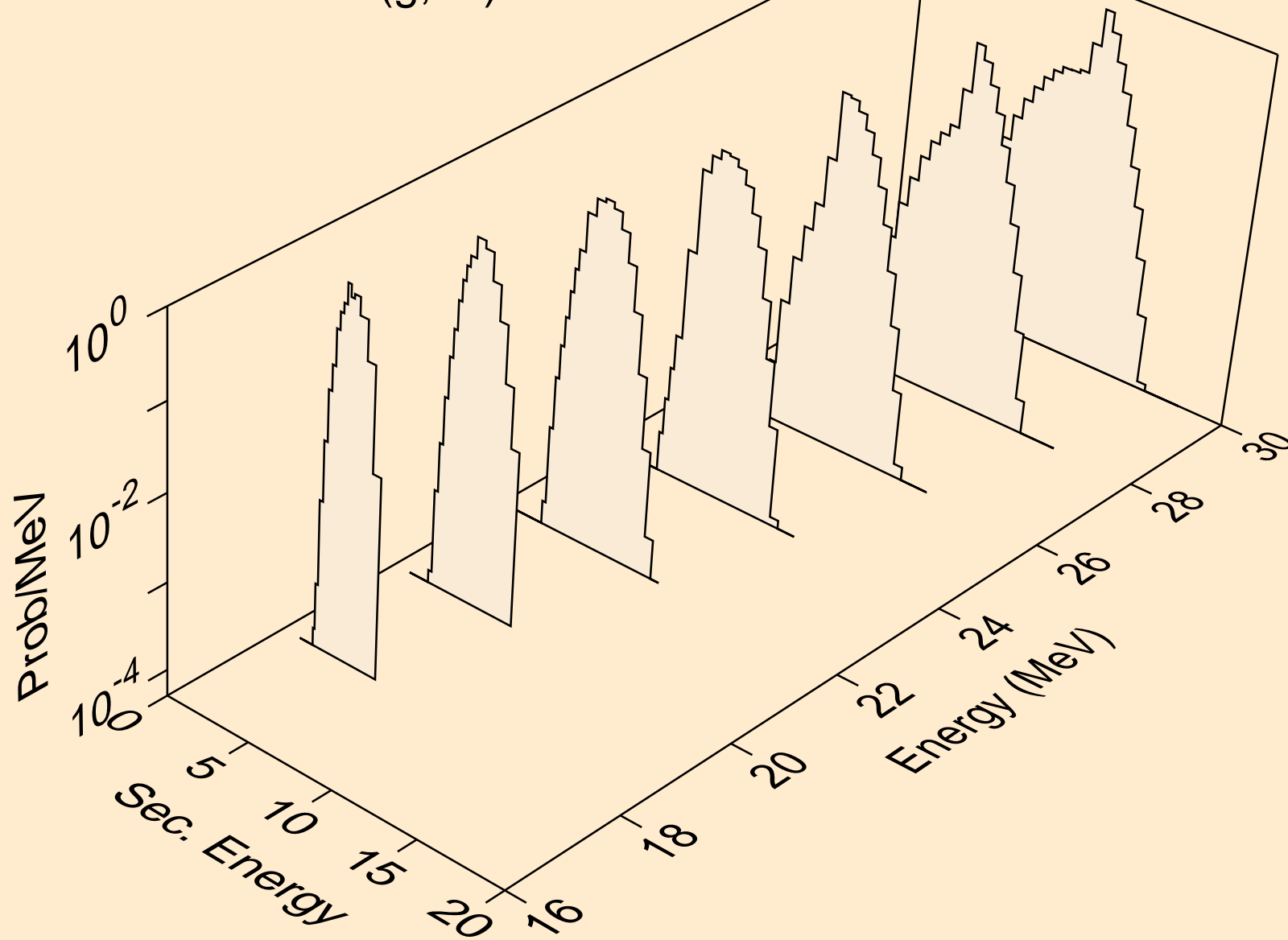

GD149 PHOTON ACER TENDL-2021 LIBRARY; T=0.K
tritons from (g,x)

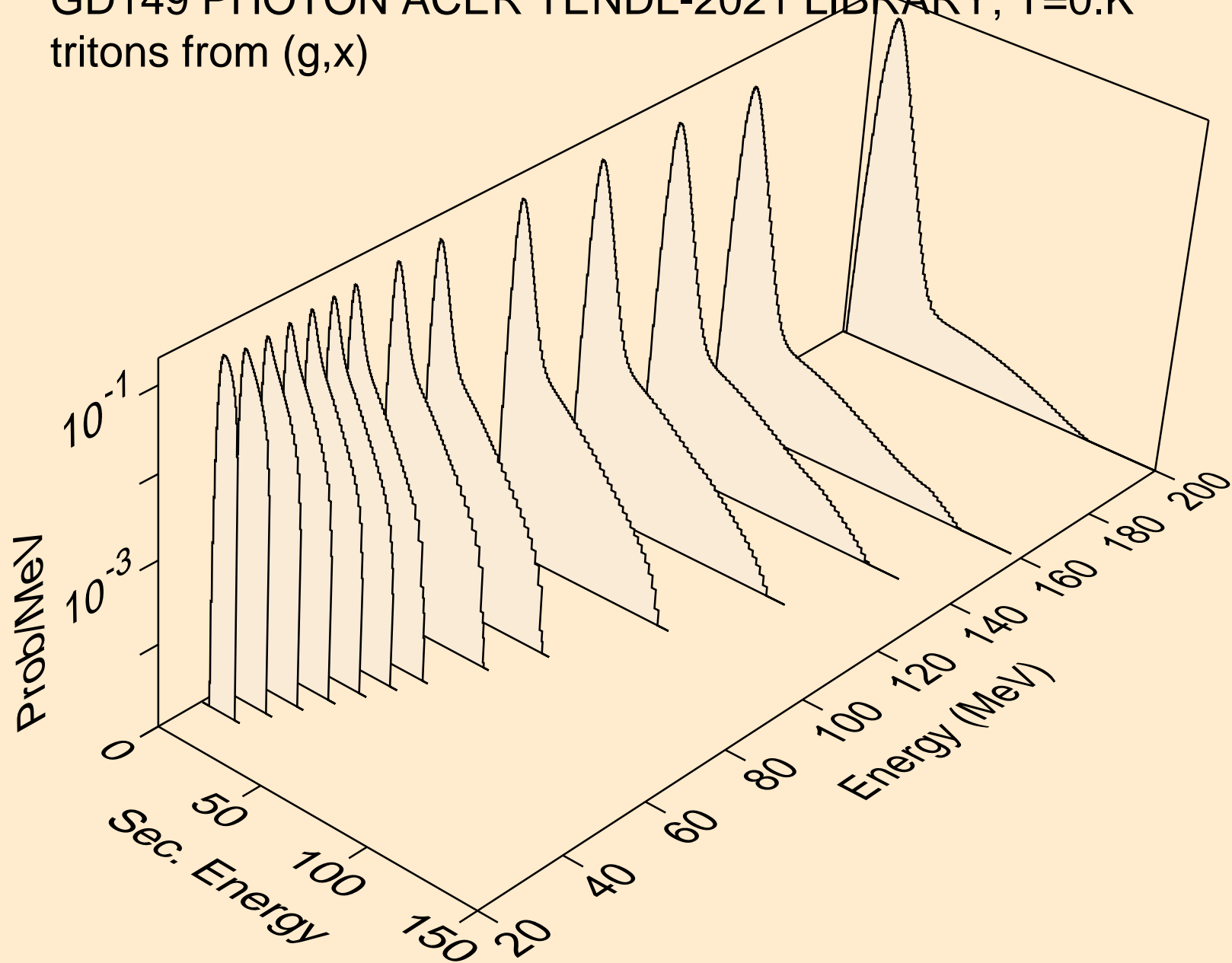

GD149 PHOTON ACER TENDL-2021 LIBRARY; T=0.K
tritons from (g,n*)t

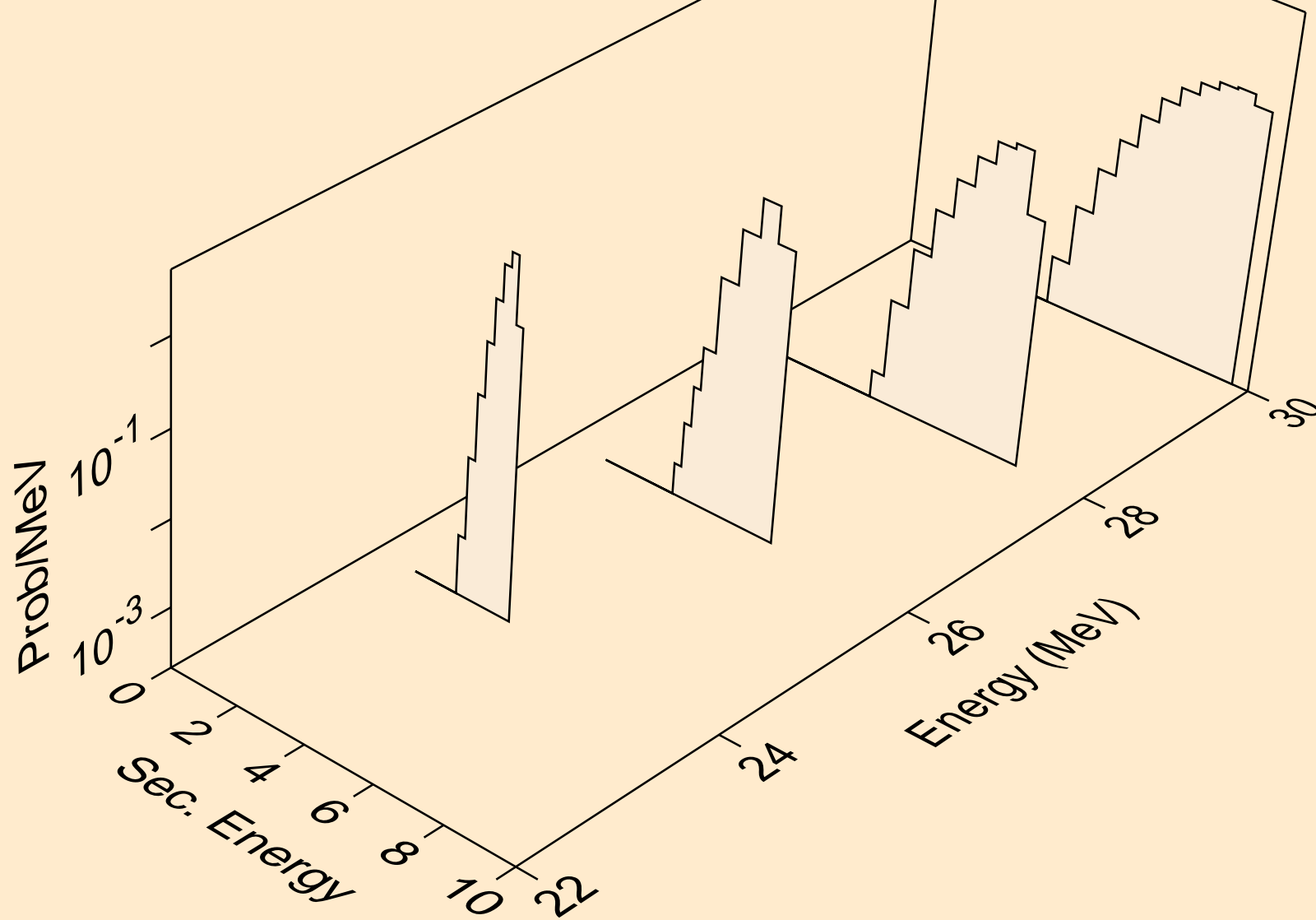

GD149 PHOTON ACER TENDL-2021 LIBRARY; T=0.K
tritons from (g,t)

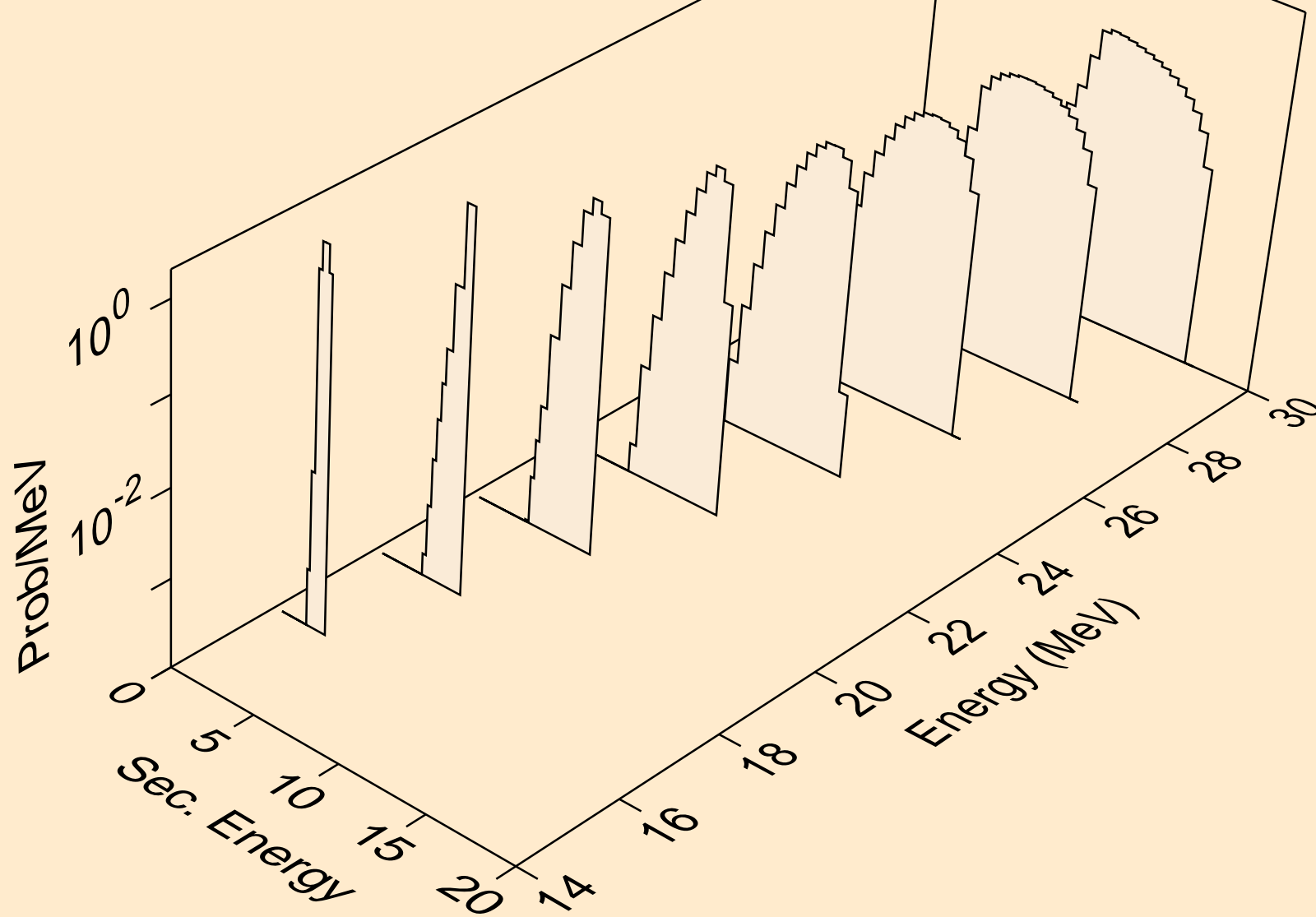

GD149 PHOTON ACER TENDL-2021 LIBRARY; T=0.K
he3s from (g,x)

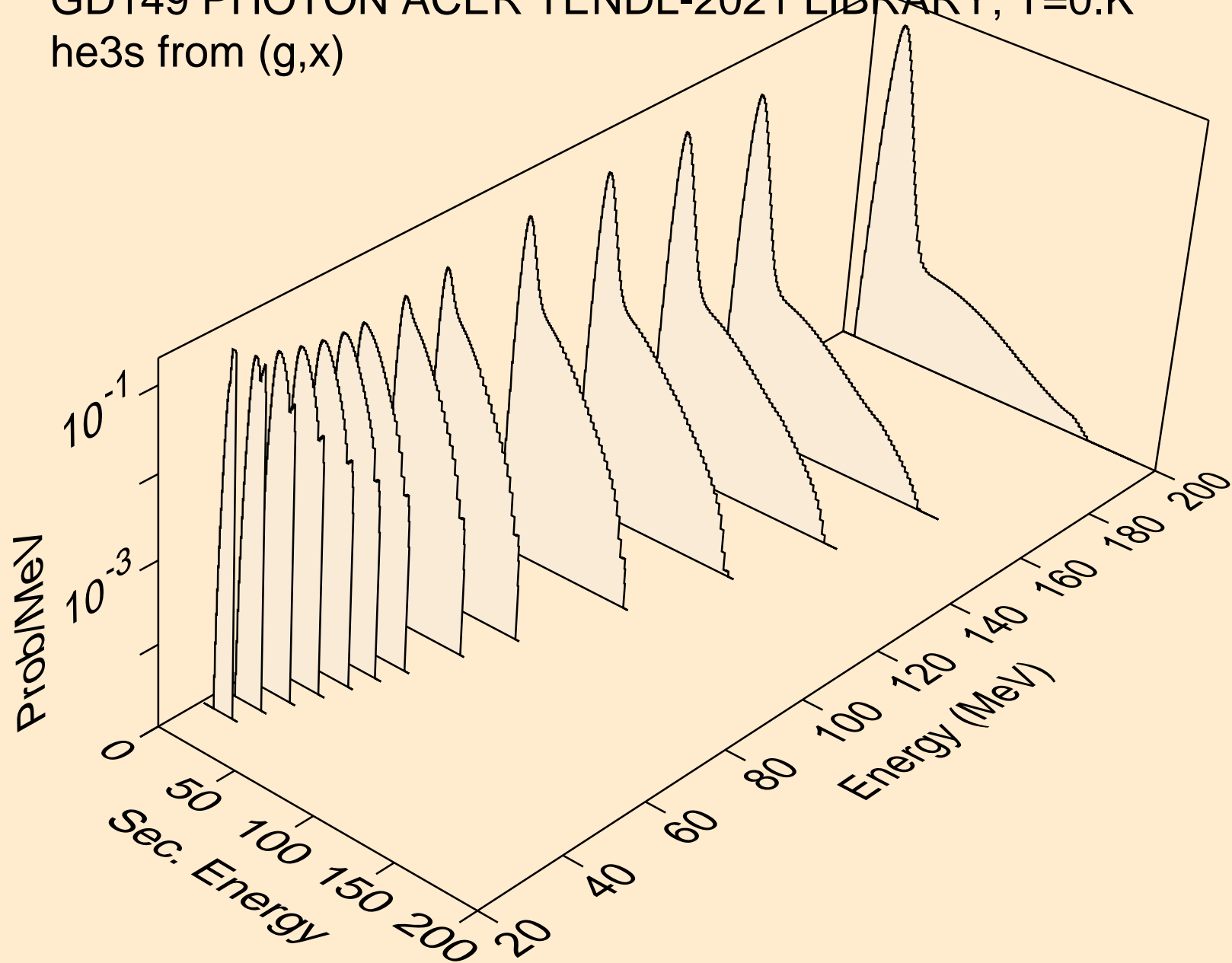

GD149 PHOTON ACER TENDL-2021 LIBRARY; T=0.K
he3s from (g,he3)

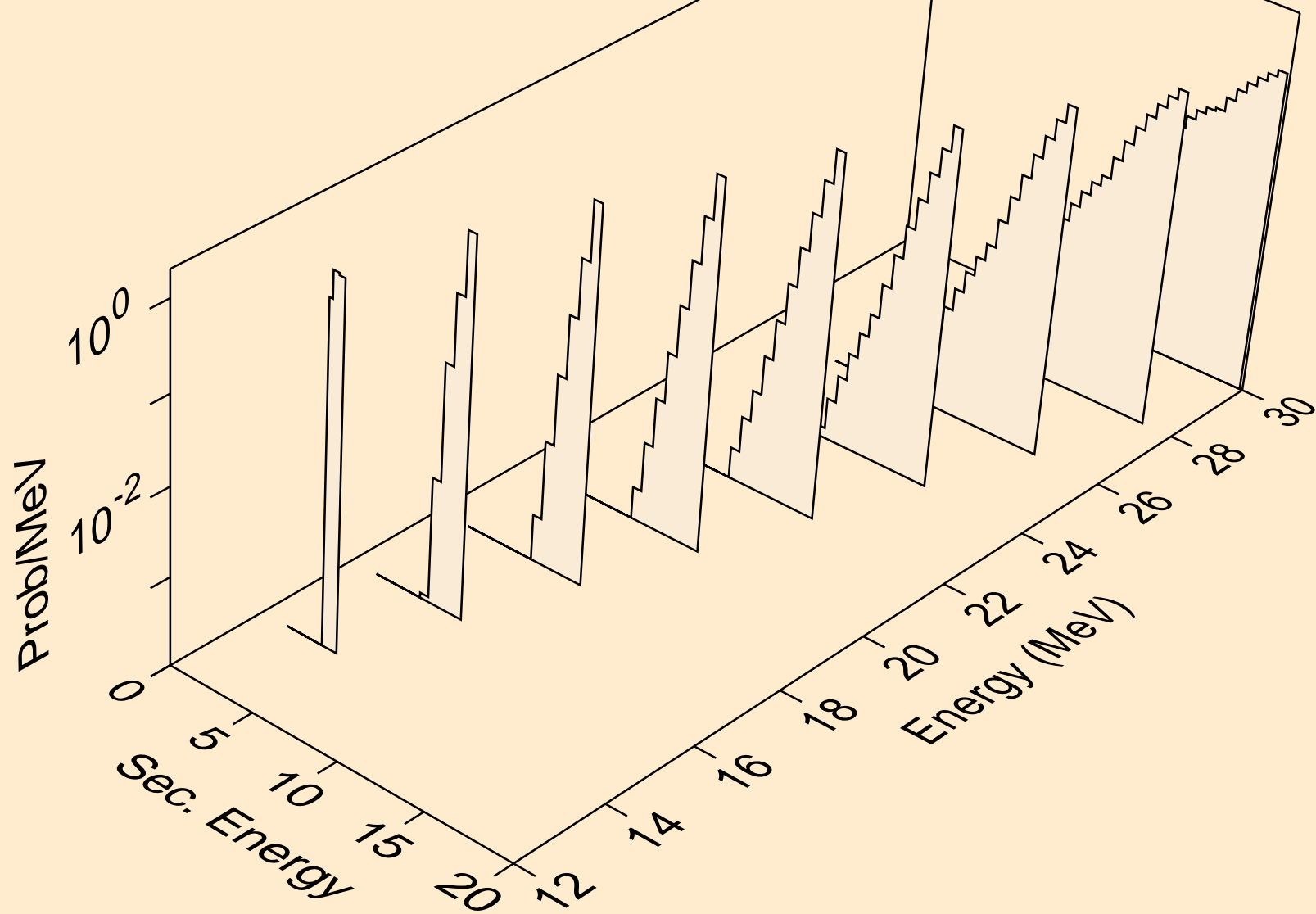

GD149 PHOTON ACER TENDL-2021 LIBRARY; T=0.K
alphas from (g,x)

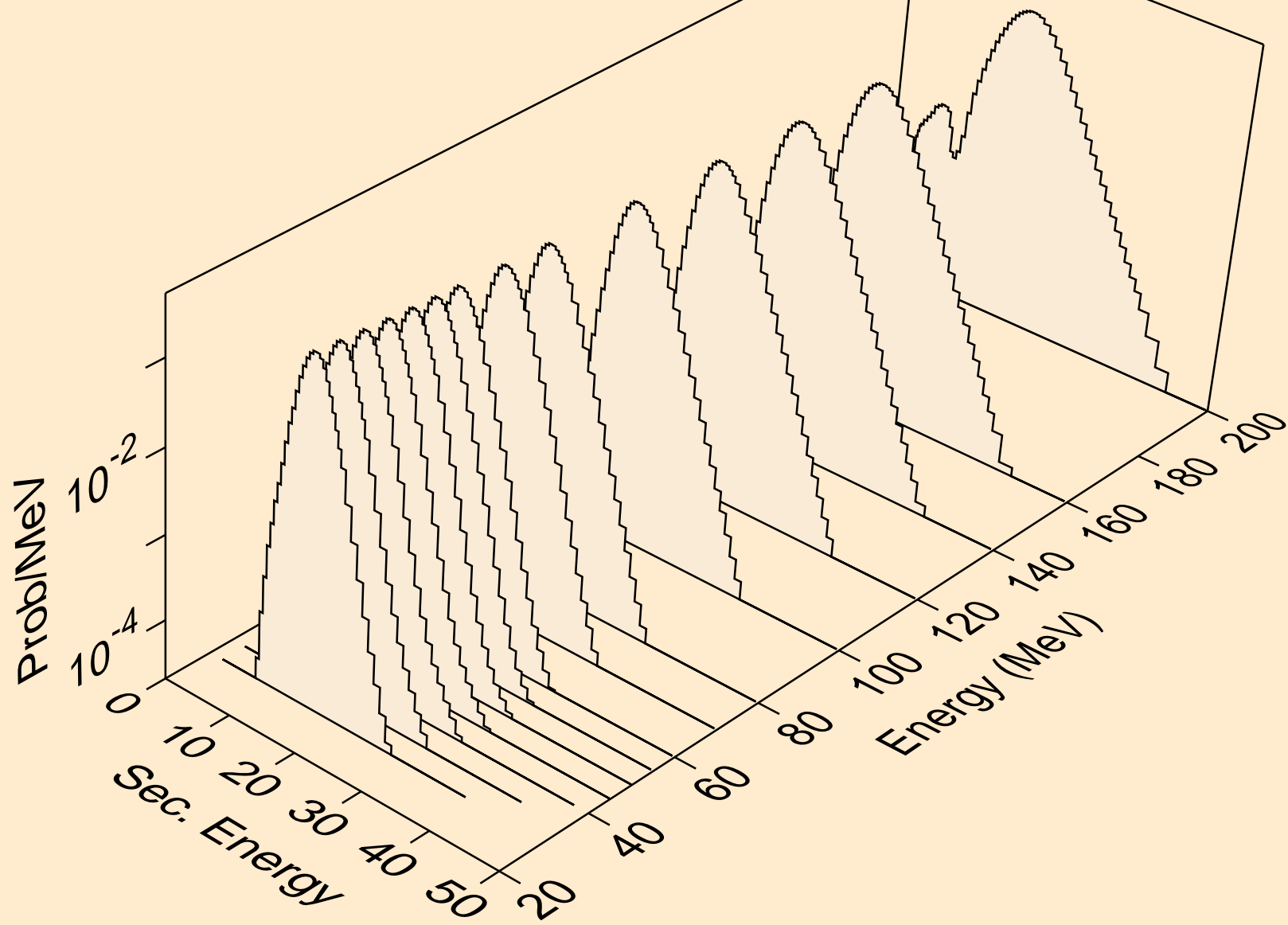

GD149 PHOTON ACER TENDL-2021 LIBRARY; T=0.K
alphas from (g,n*)a

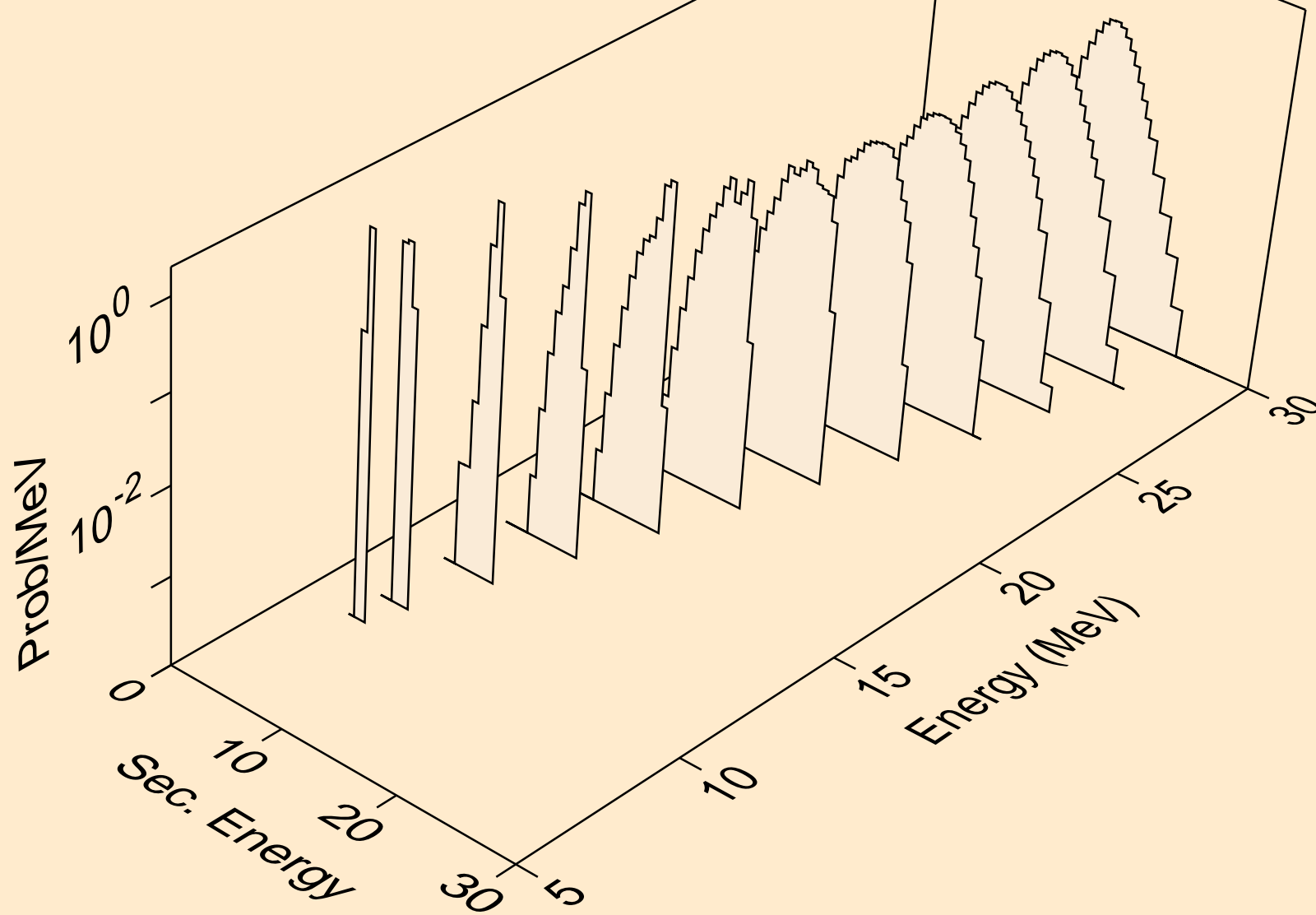

GD149 PHOTON ACER TENDL-2021 LIBRARY; T=0.K
alphas from (g,2n)a

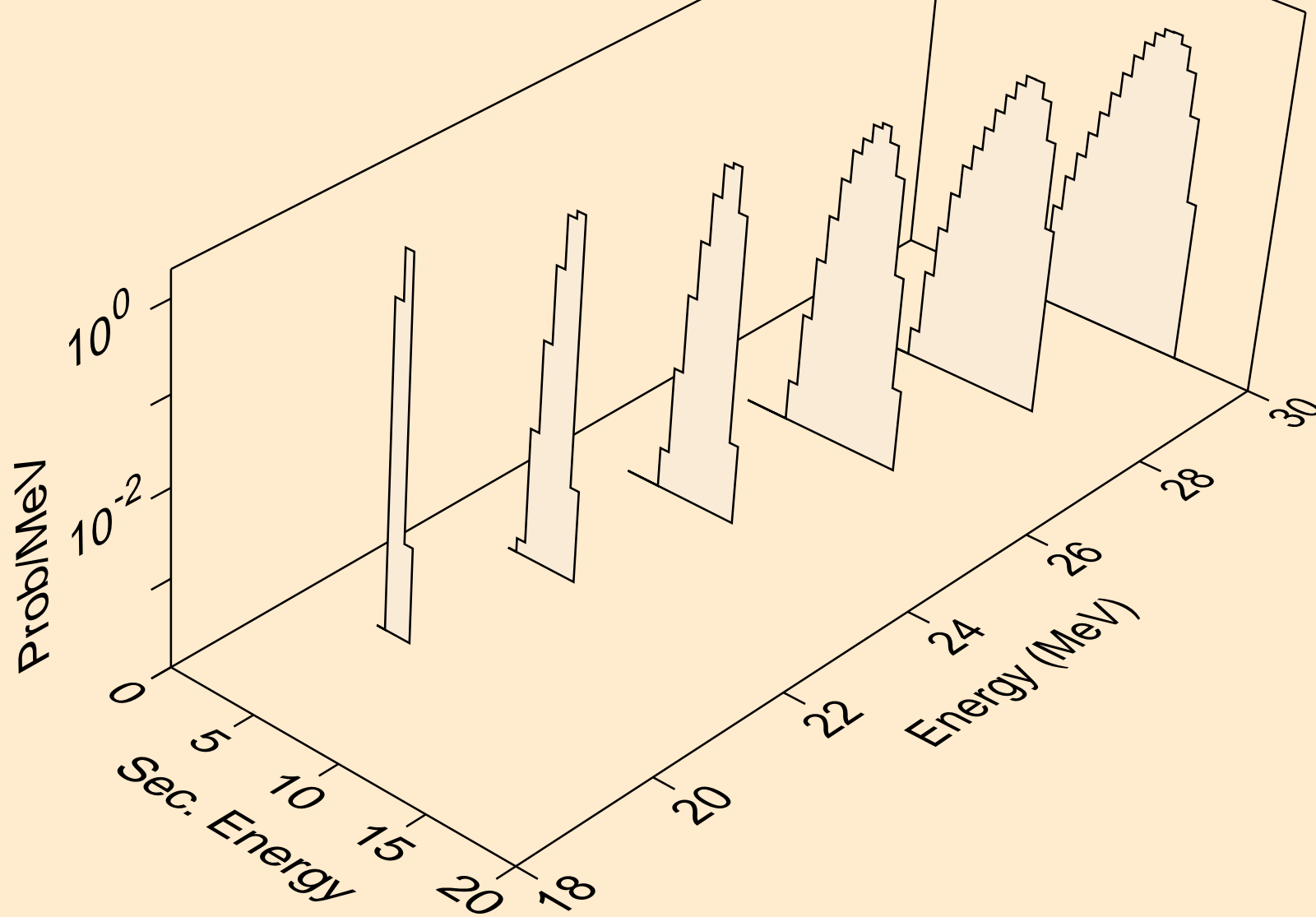

GD149 PHOTON ACER TENDL-2021 LIBRARY; T=0.K
alphas from (g,npa)

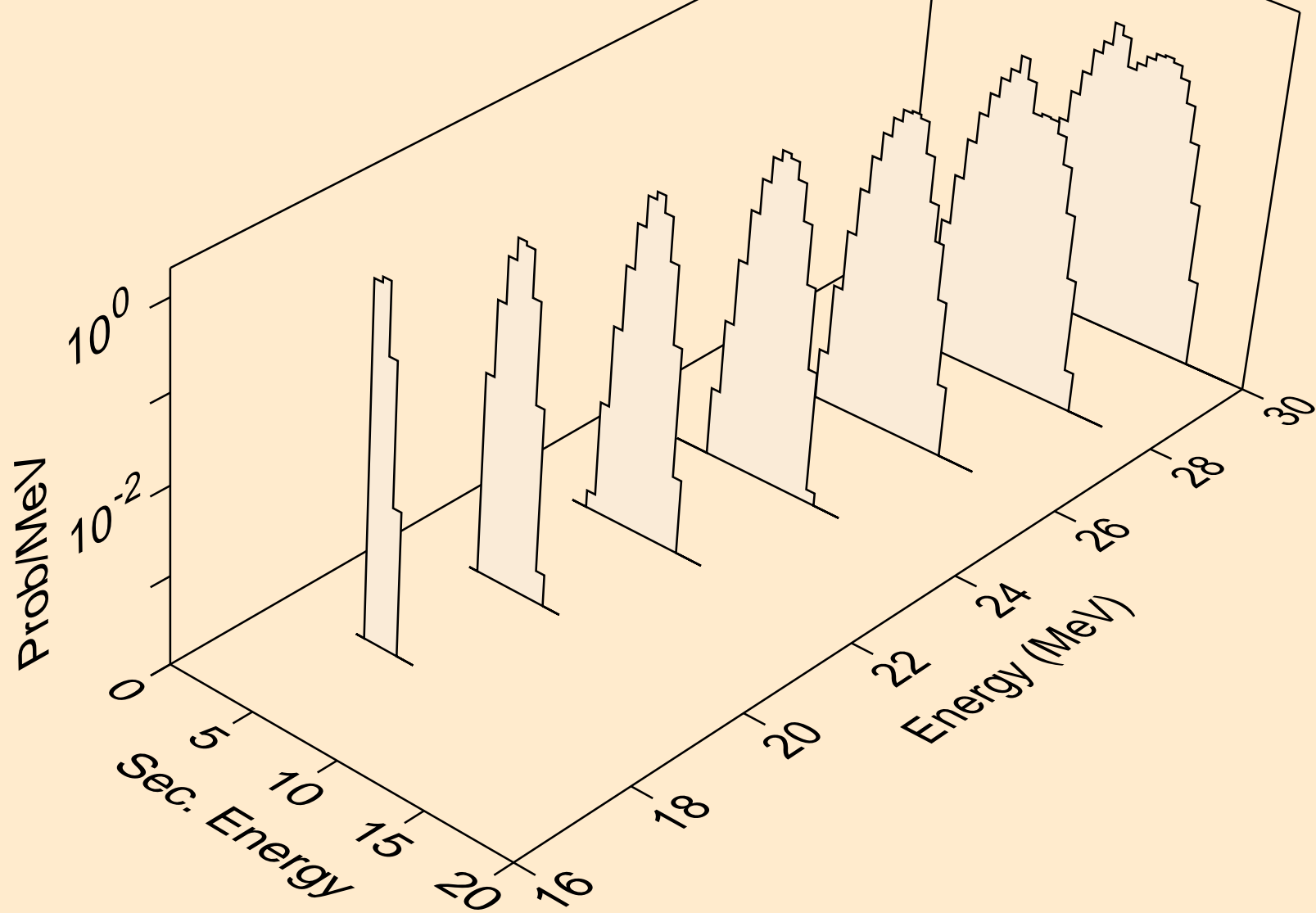

GD149 PHOTON ACER TENDL-2021 LIBRARY; T=0.K
alphas from (g,a)

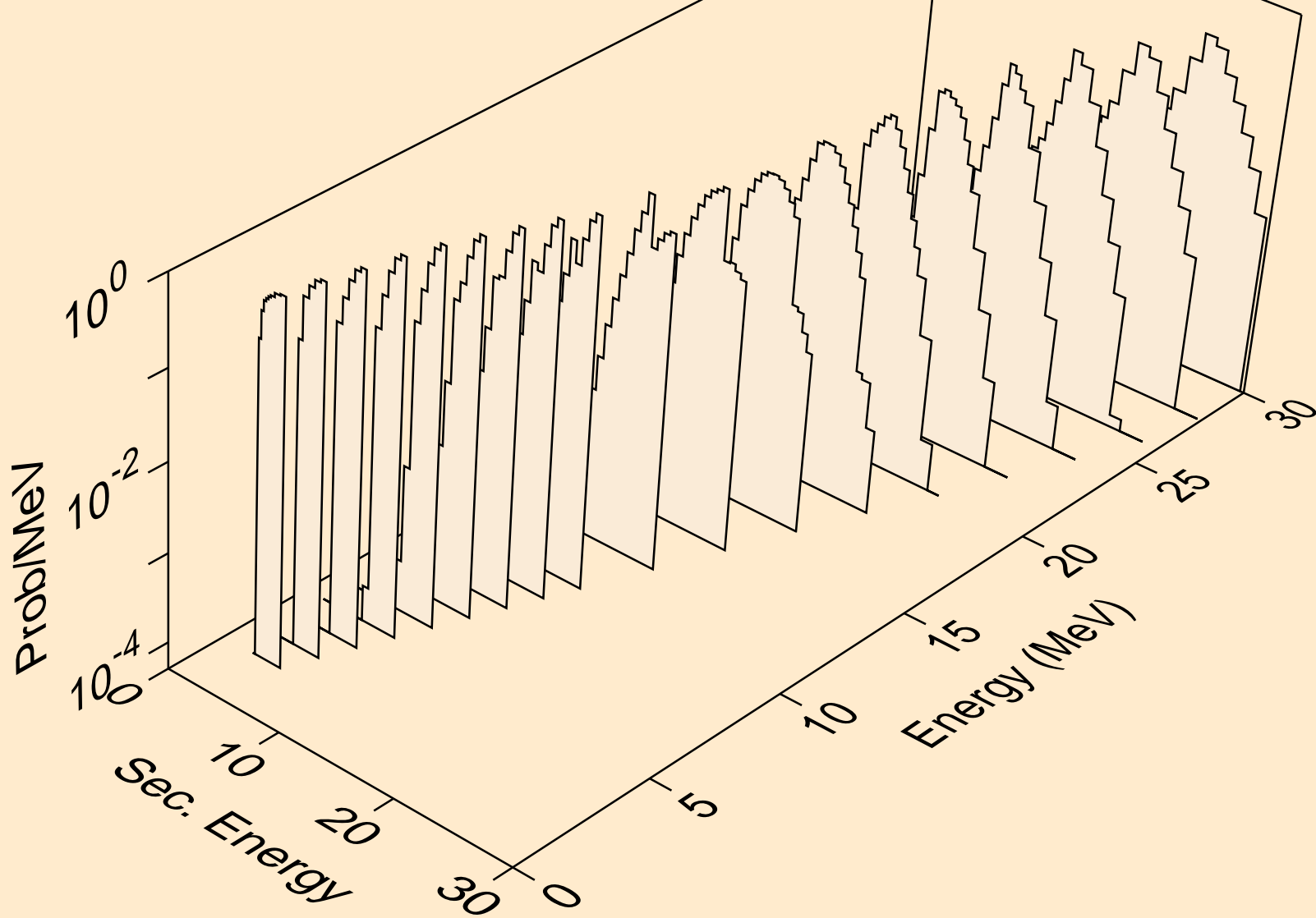

GD149 PHOTON ACER TENDL-2021 LIBRARY; T=0.K
alphas from (g,2a)

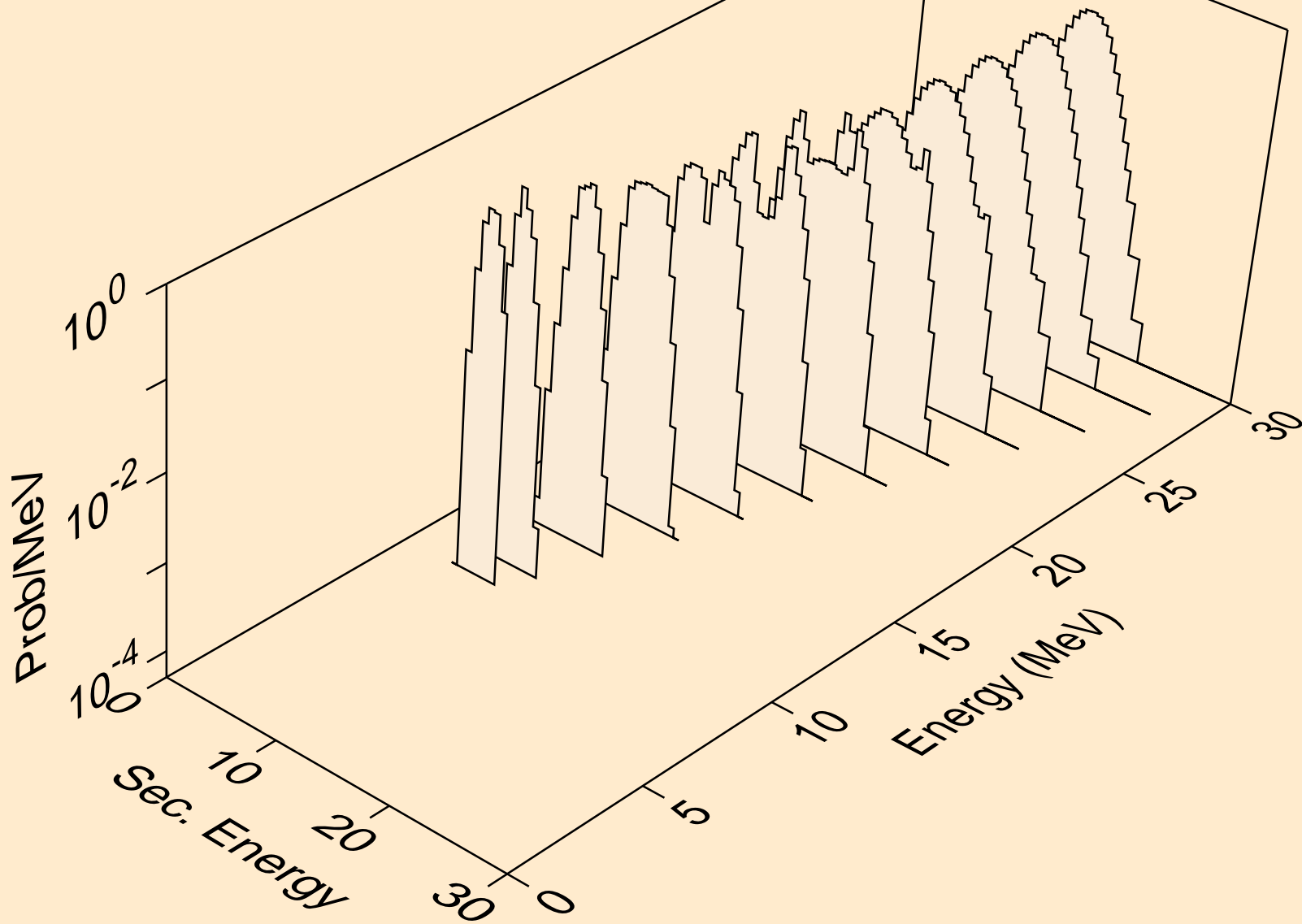

GD149 PHOTON ACER TENDL-2021 LIBRARY; T=0.K
alphas from (g,pa)

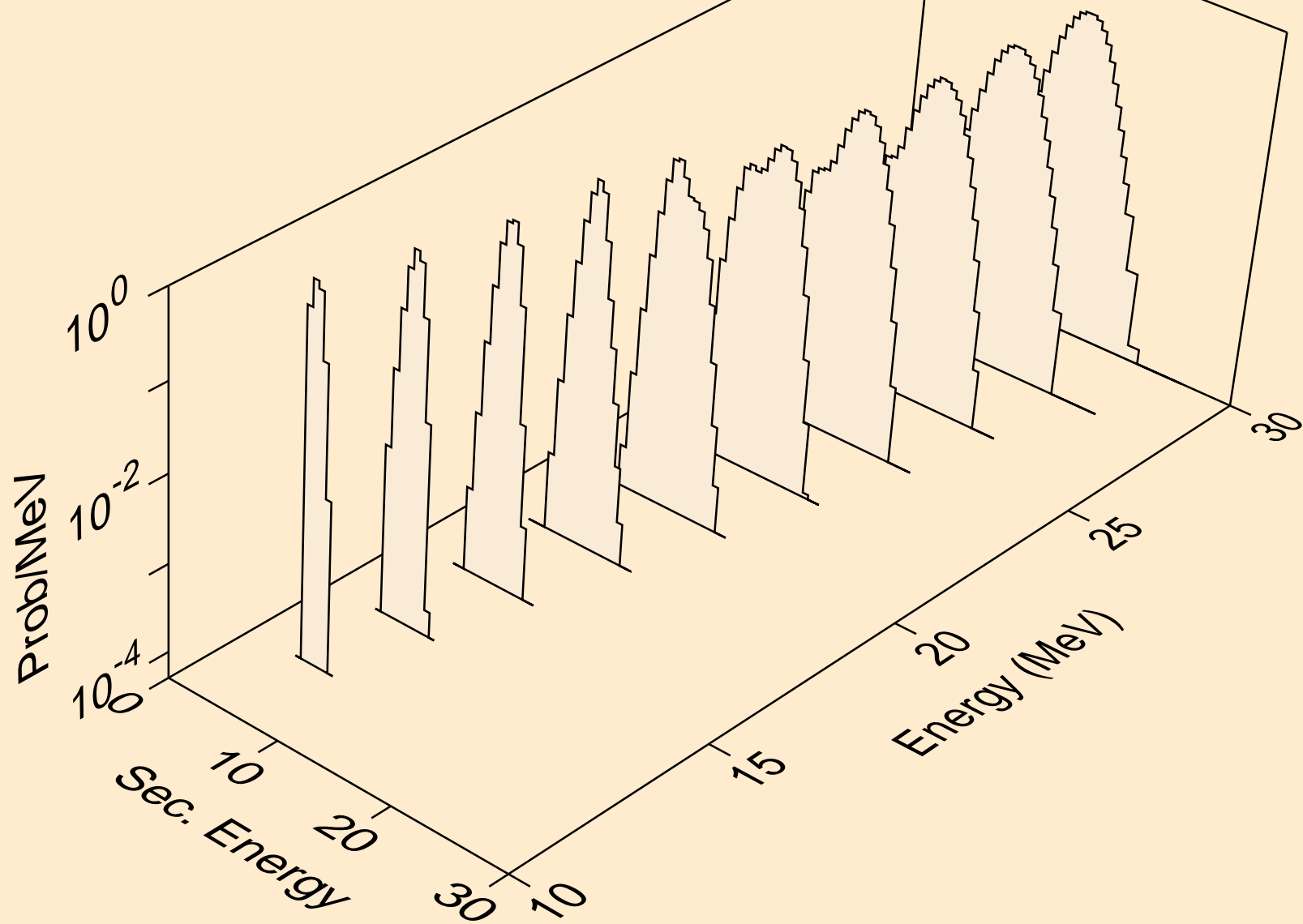

GD149 PHOTON ACER TENDL-2021 LIBRARY; T=0.K
alphas from (g,da)

