

# GD150 PHOTON ACER TENDL-2021 LIBRARY; T=0.K

## Principal cross sections

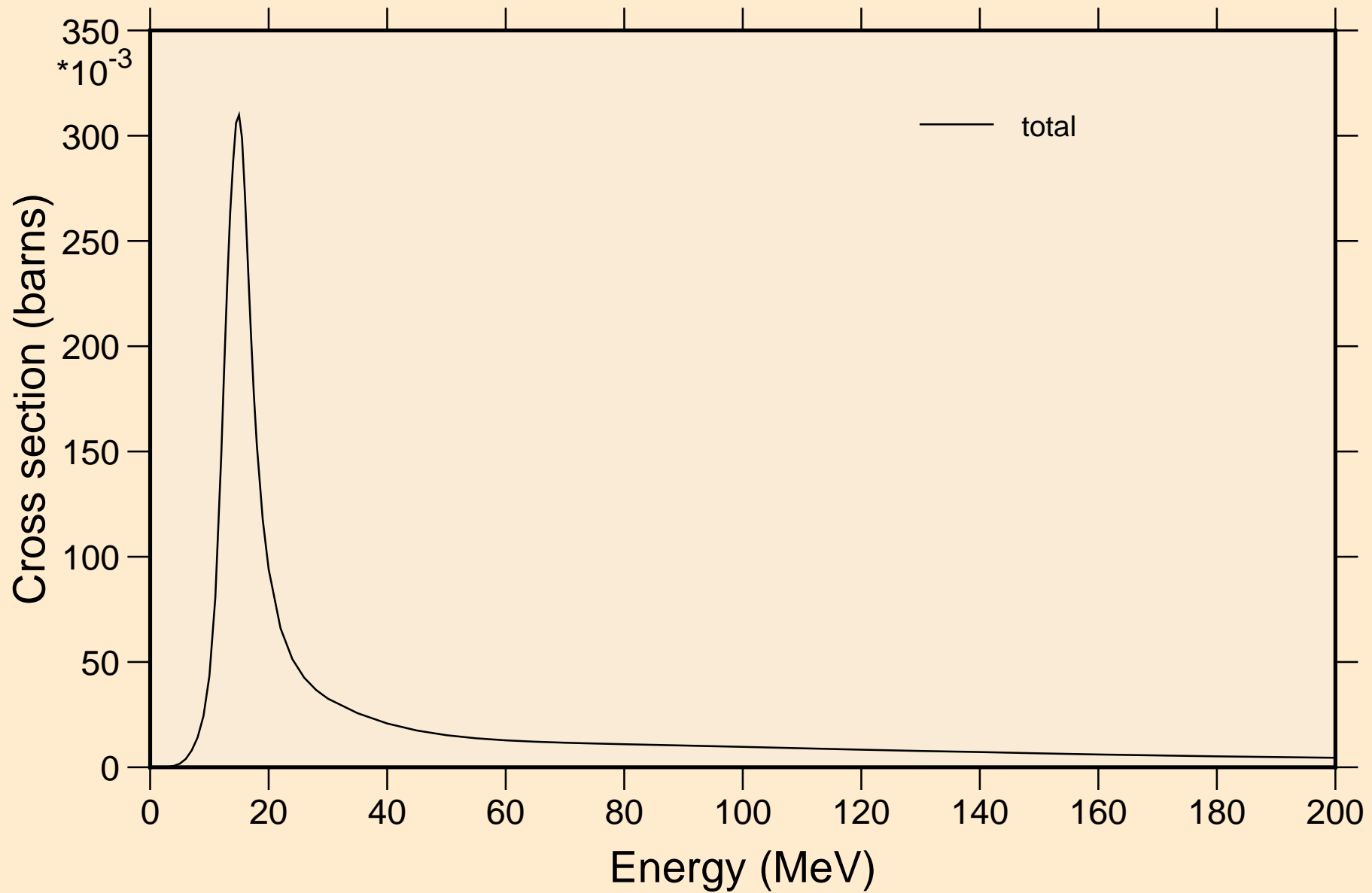

# GD150 PHOTON ACER TENDL-2021 LIBRARY; T=0.K

## Partial cross sections

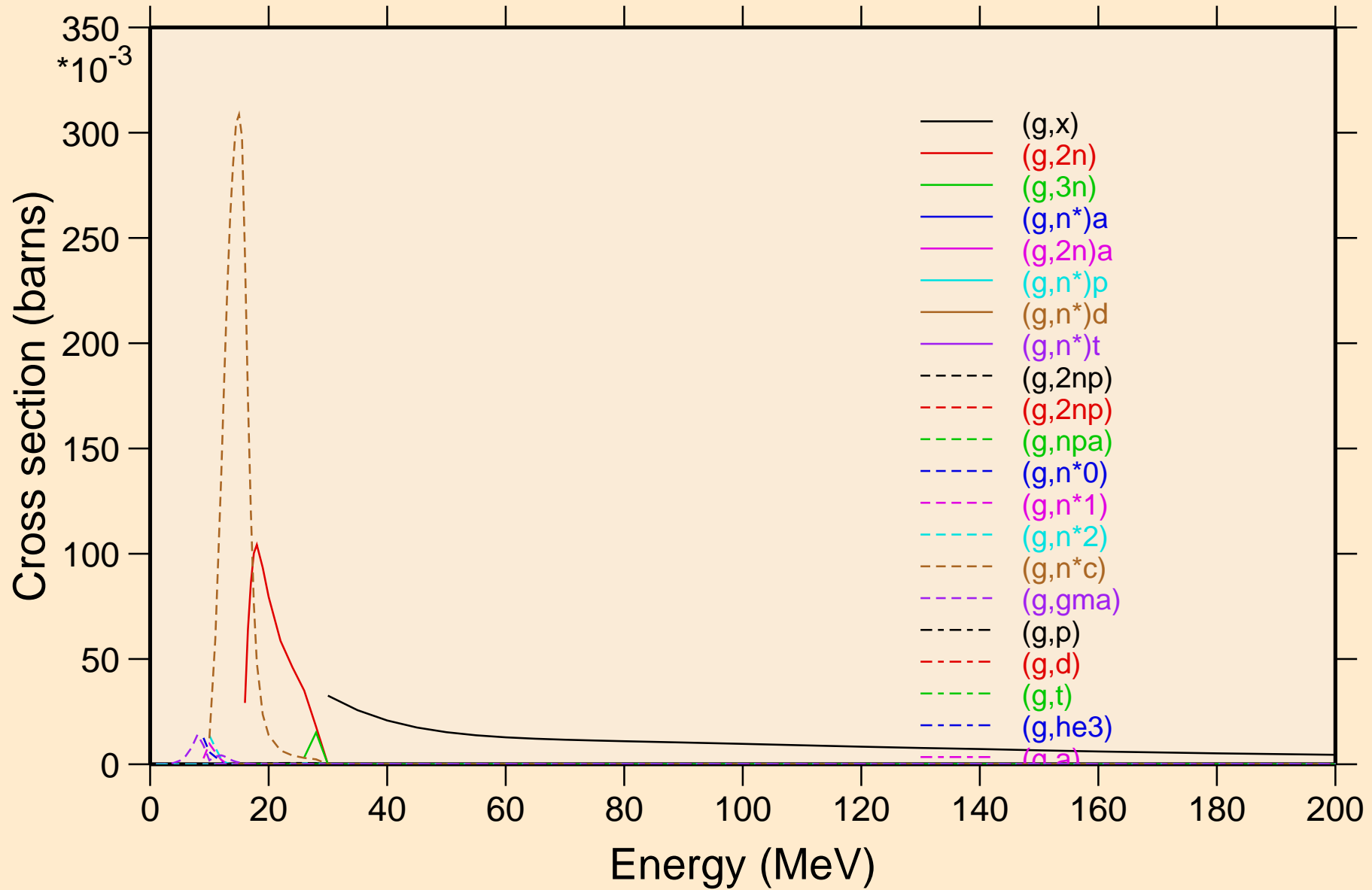

# GD150 PHOTON ACER TENDL-2021 LIBRARY; T=0.K

## Heating

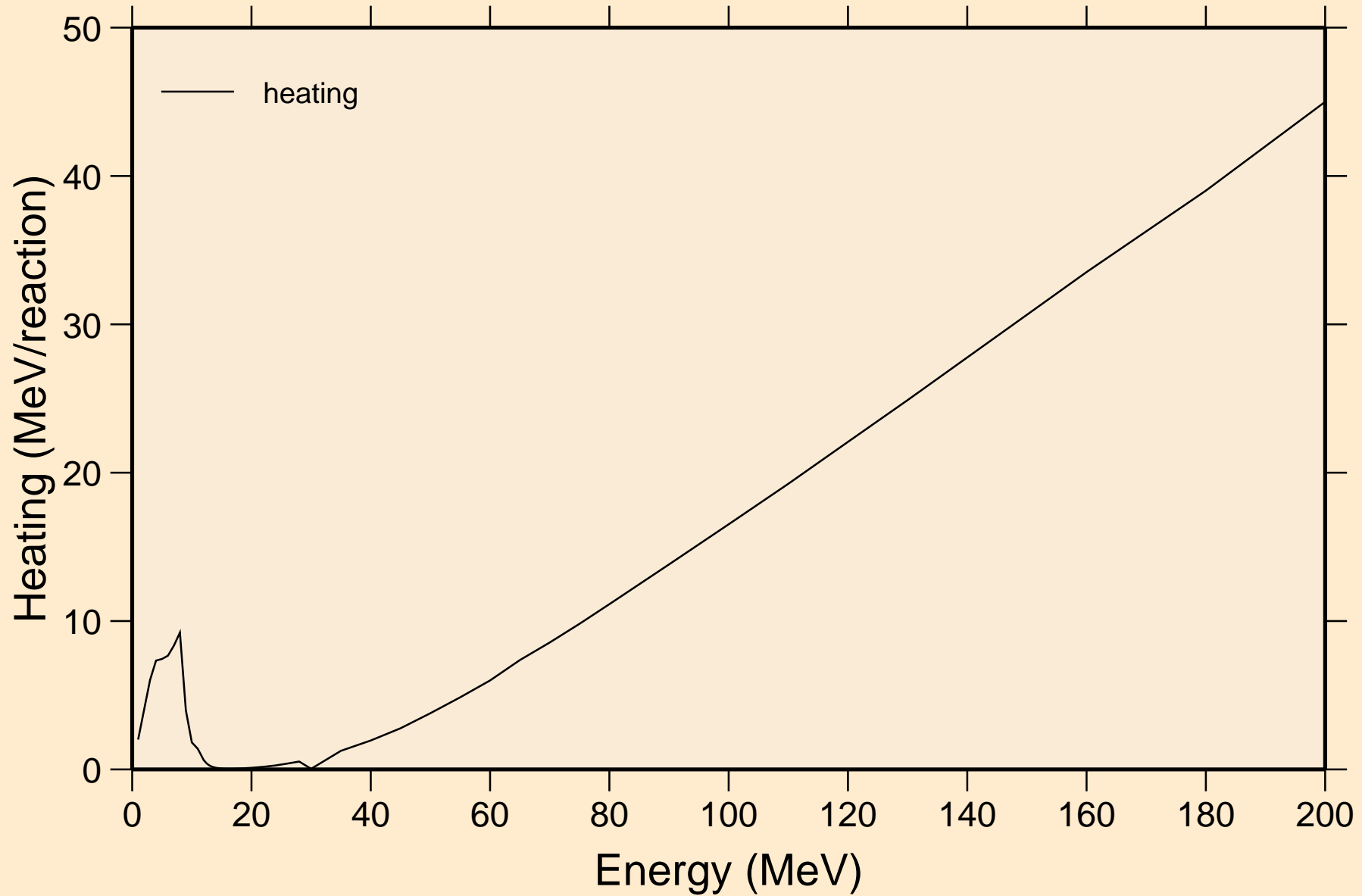

# GD150 PHOTON ACER TENDL-2021 LIBRARY; T=0.K

## Particle heating contributions

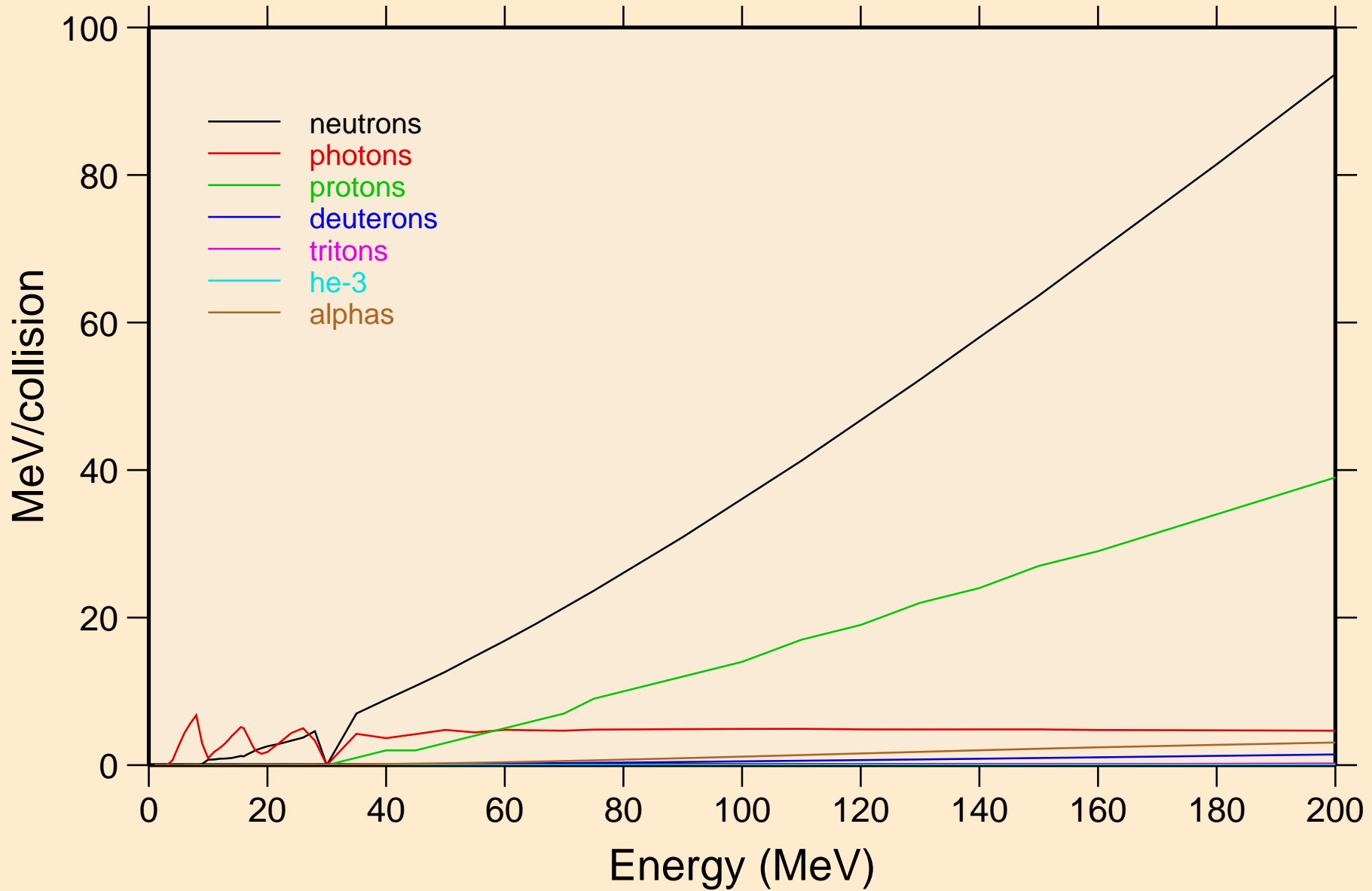

# GD150 PHOTON ACER TENDL-2021 LIBRARY; T=0.K

## Particle production cross sections

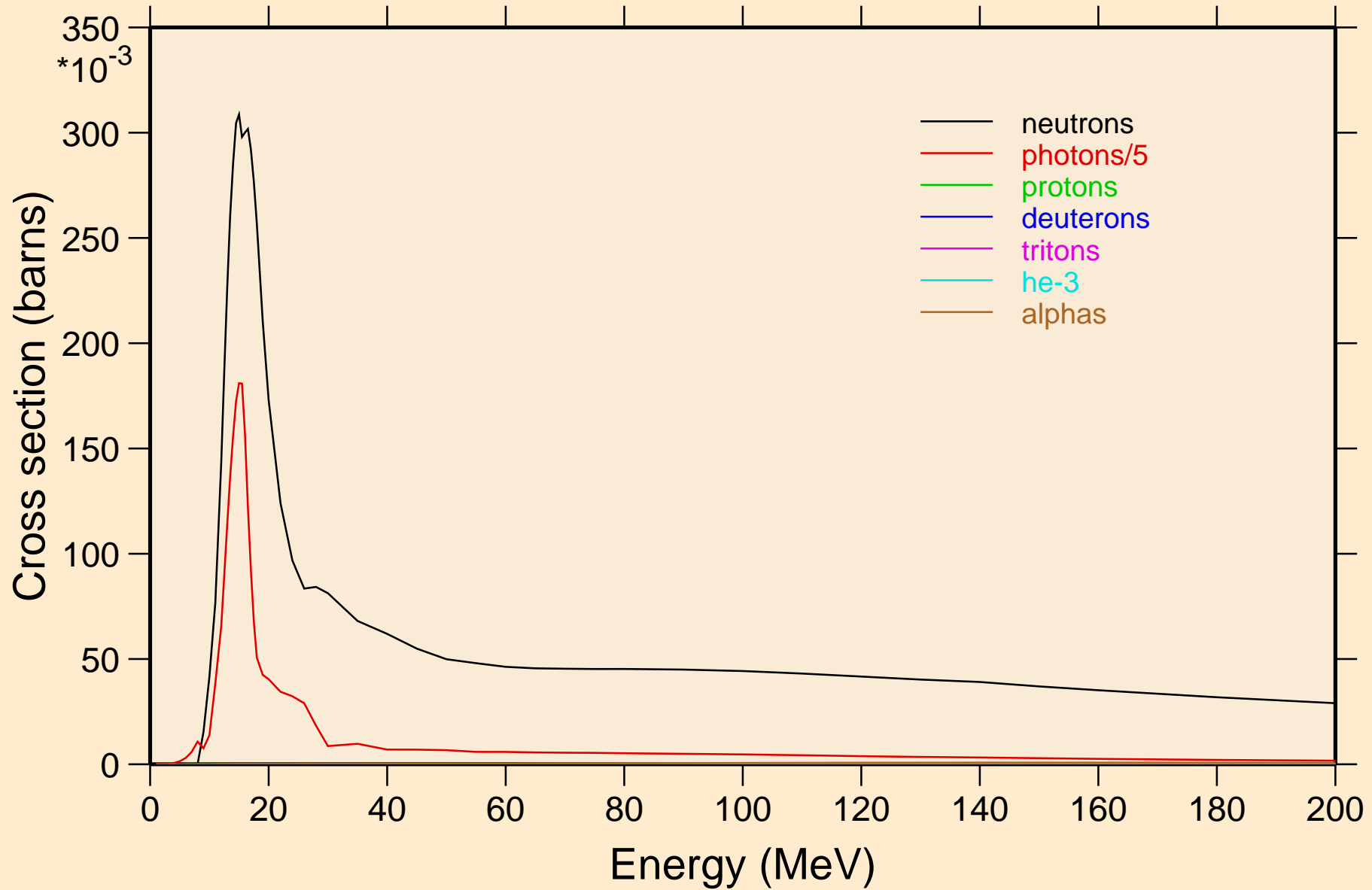

GD150 PHOTON ACER TENDL-2021 LIBRARY; T=0.K  
neutrons from (g,x)

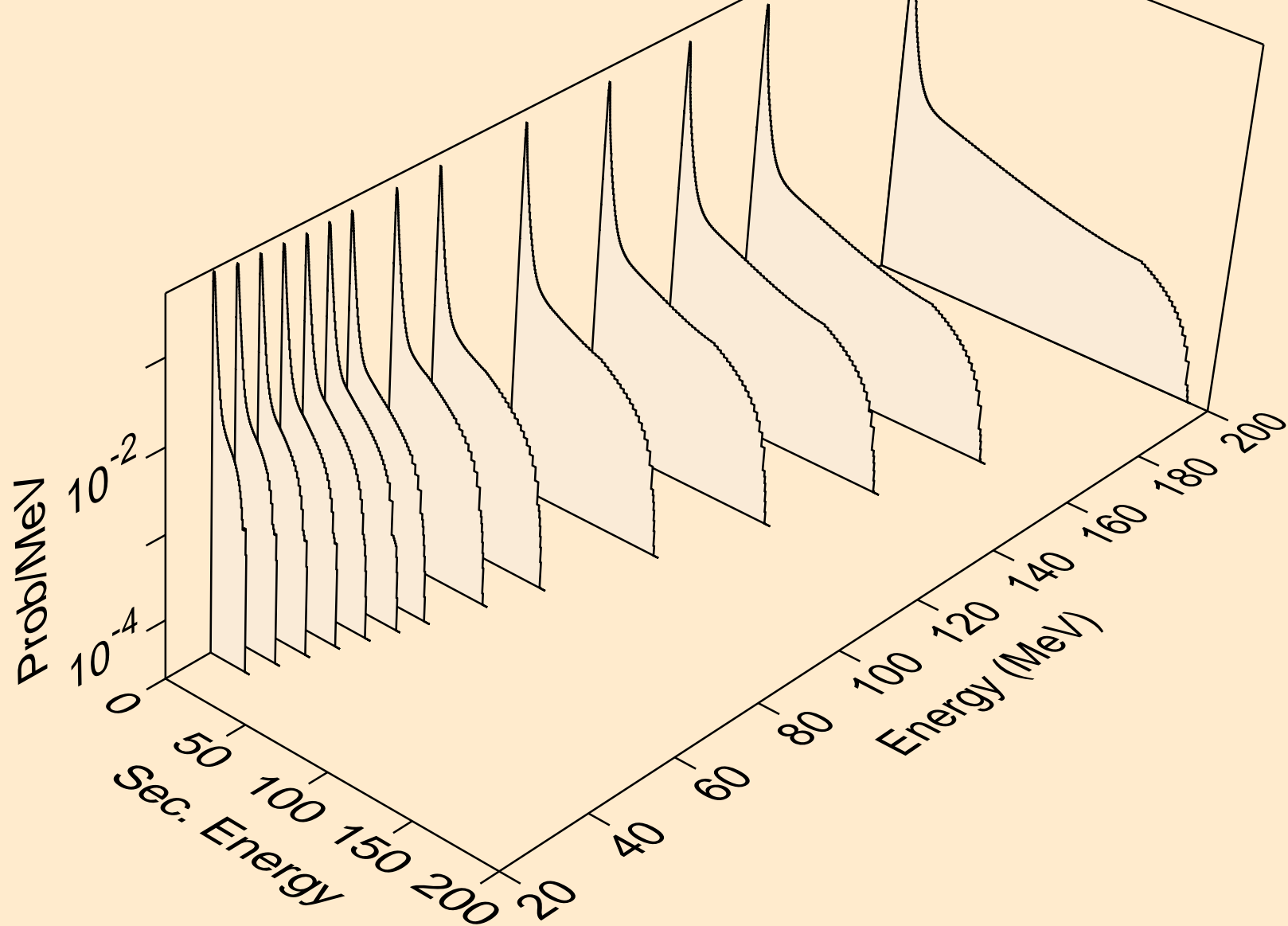

GD150 PHOTON ACER TENDL-2021 LIBRARY; T=0.K  
neutrons from (g,2n)

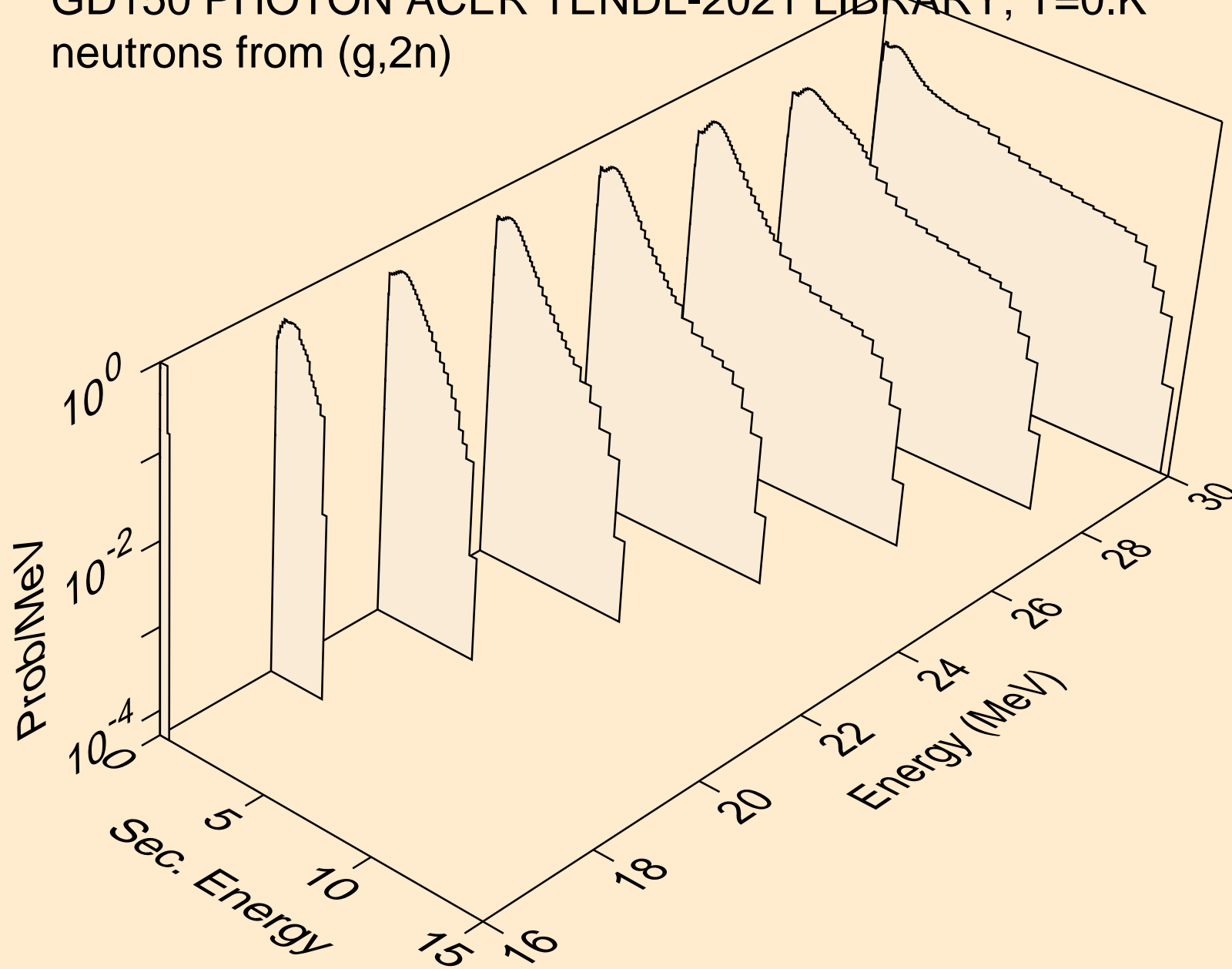

GD150 PHOTON ACER TENDL-2021 LIBRARY; T=0.K  
neutrons from (g,3n)

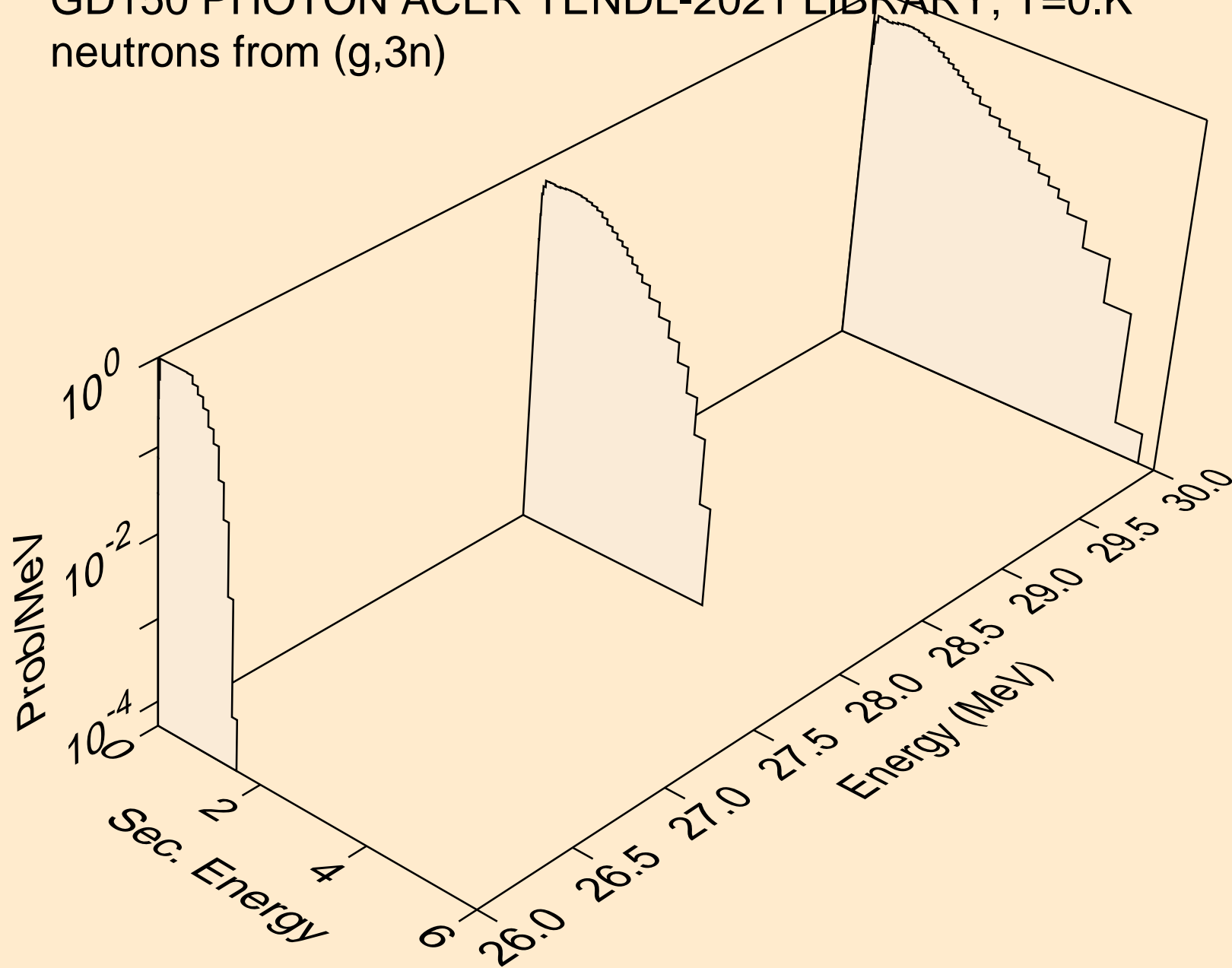



GD150 PHOTON ACER TENDL-2021 LIBRARY; T=0.K  
neutrons from (g,n\*)a

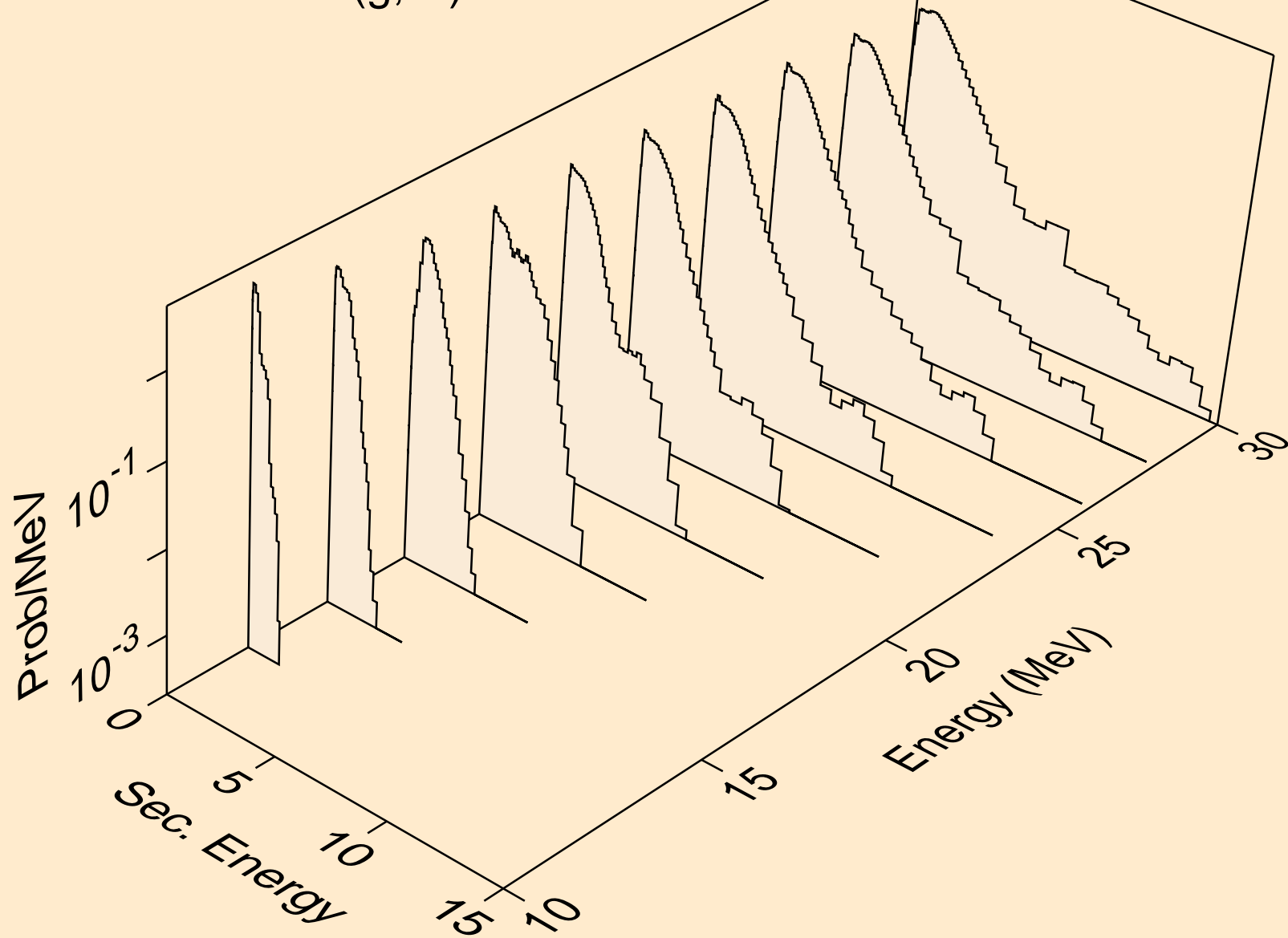

GD150 PHOTON ACER TENDL-2021 LIBRARY; T=0.K  
neutrons from (g,2n)a

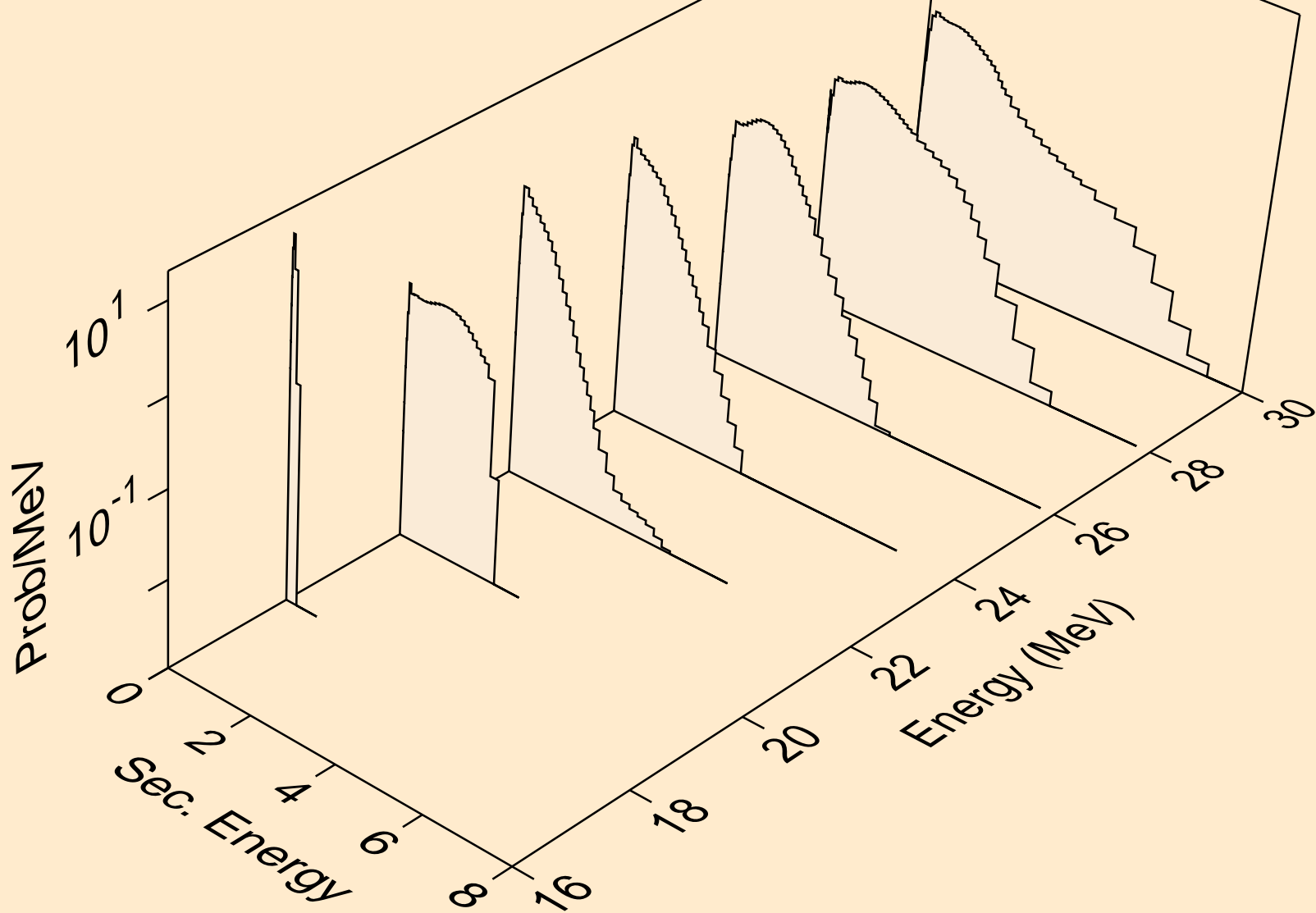

GD150 PHOTON ACER TENDL-2021 LIBRARY; T=0.K  
neutrons from (g,n\*)p

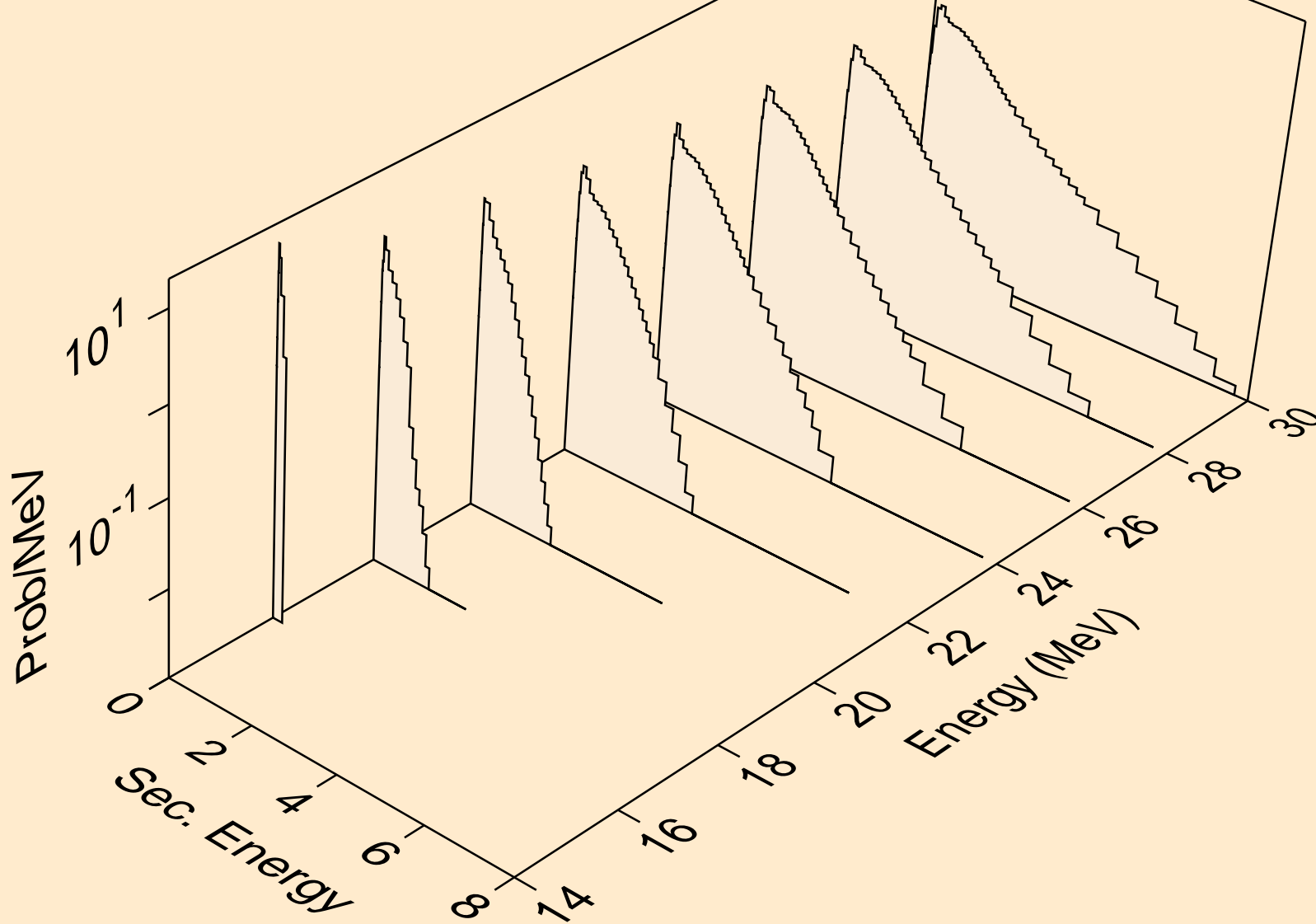

GD150 PHOTON ACER TENDL-2021 LIBRARY; T=0.K  
neutrons from (g,n\*)d

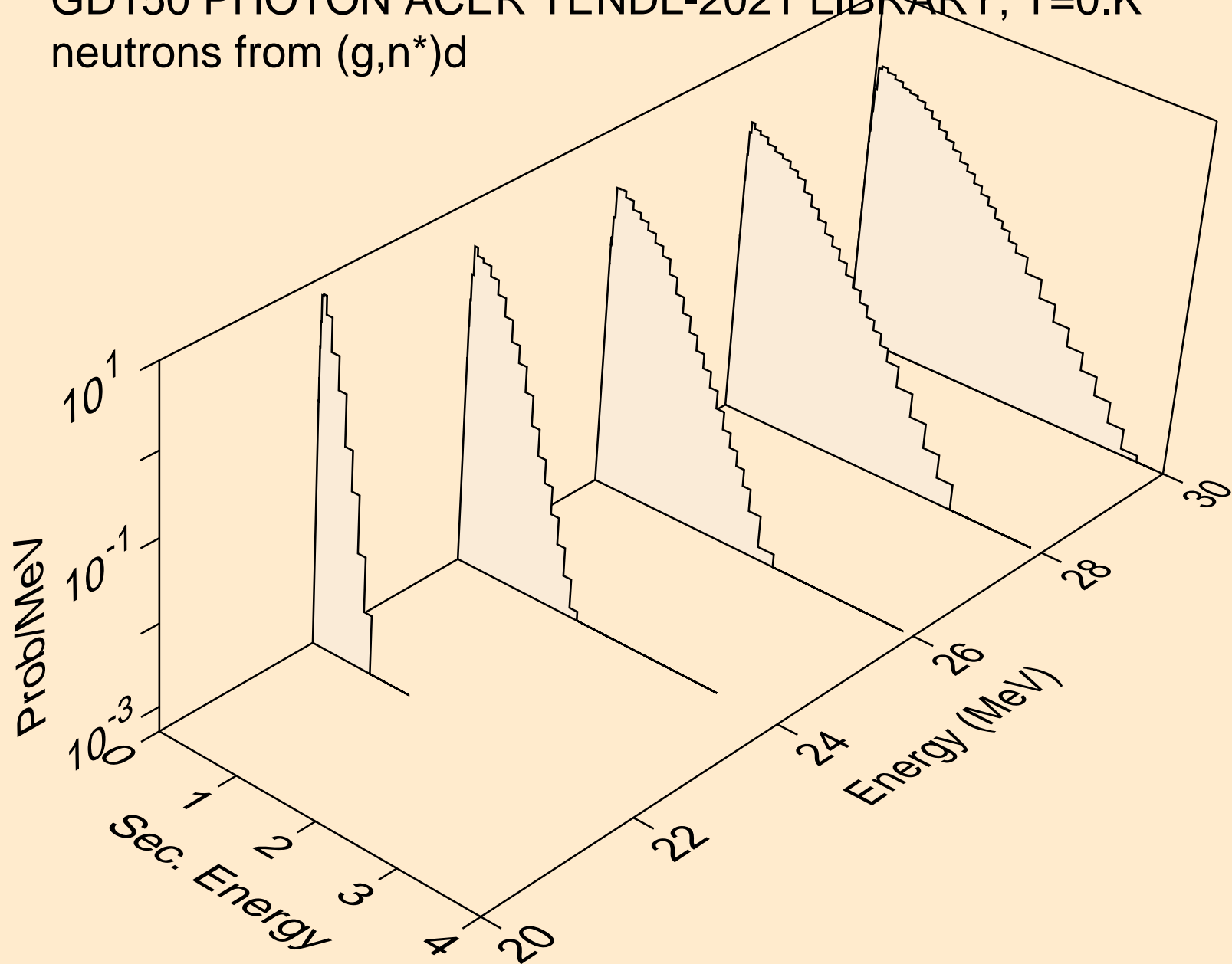

GD150 PHOTON ACER TENDL-2021 LIBRARY; T=0.K  
neutrons from (g,n\*)t

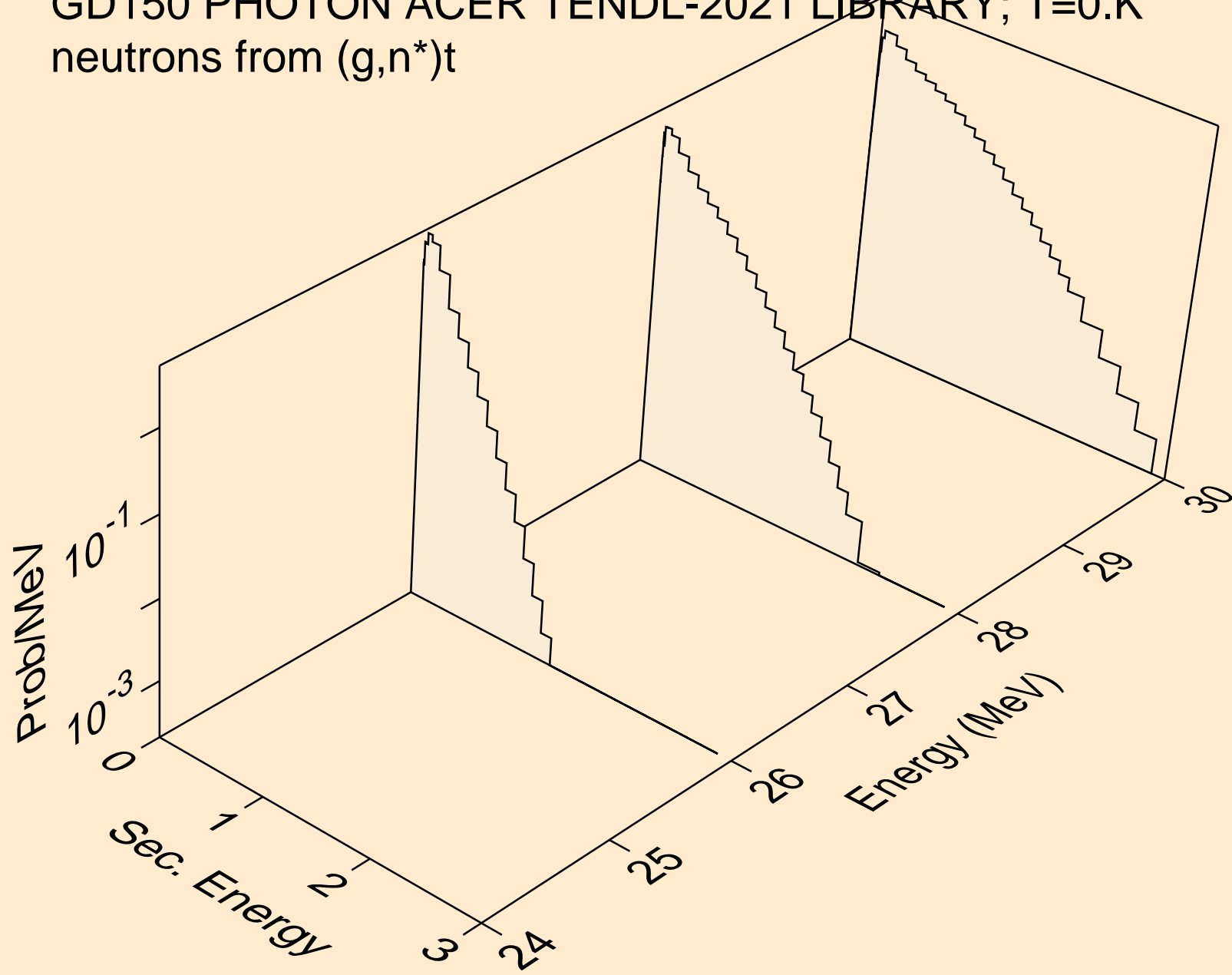

GD150 PHOTON ACER TENDL-2021 LIBRARY; T=0.K  
neutrons from (g,2np)

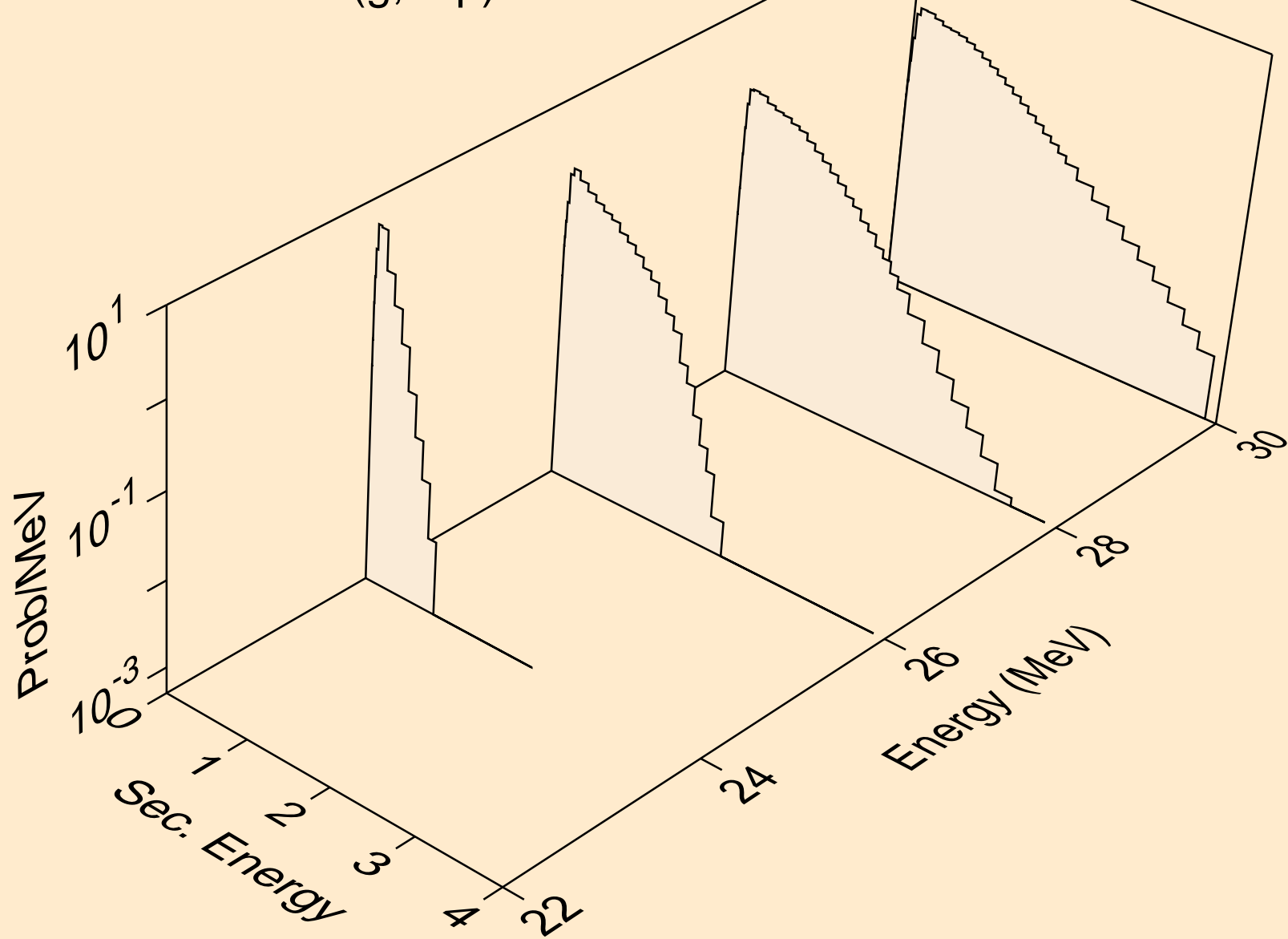

GD150 PHOTON ACER TENDL-2021 LIBRARY; T=0.K  
neutrons from (g,2np)

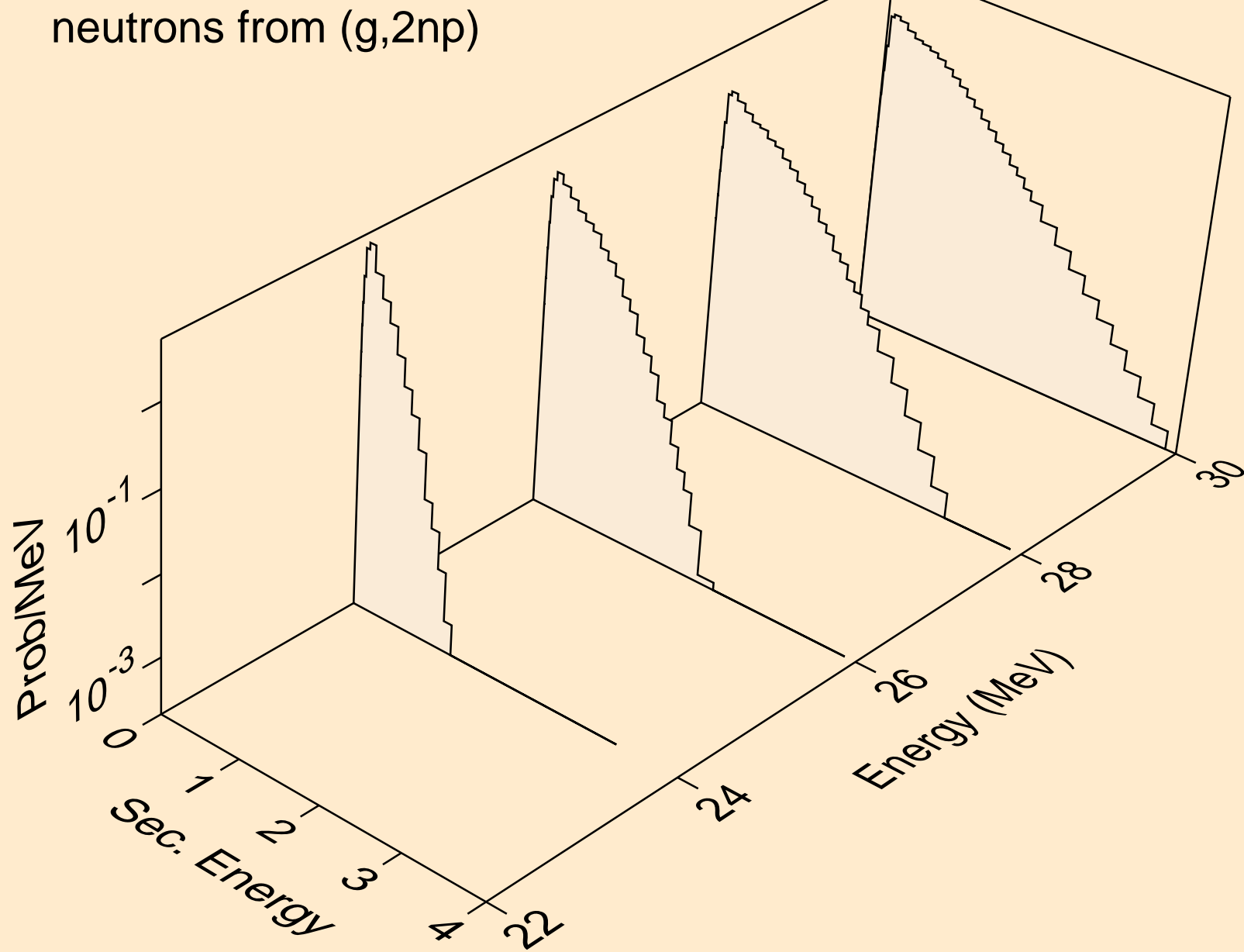

GD150 PHOTON ACER TENDL-2021 LIBRARY; T=0.K  
neutrons from (g,npa)

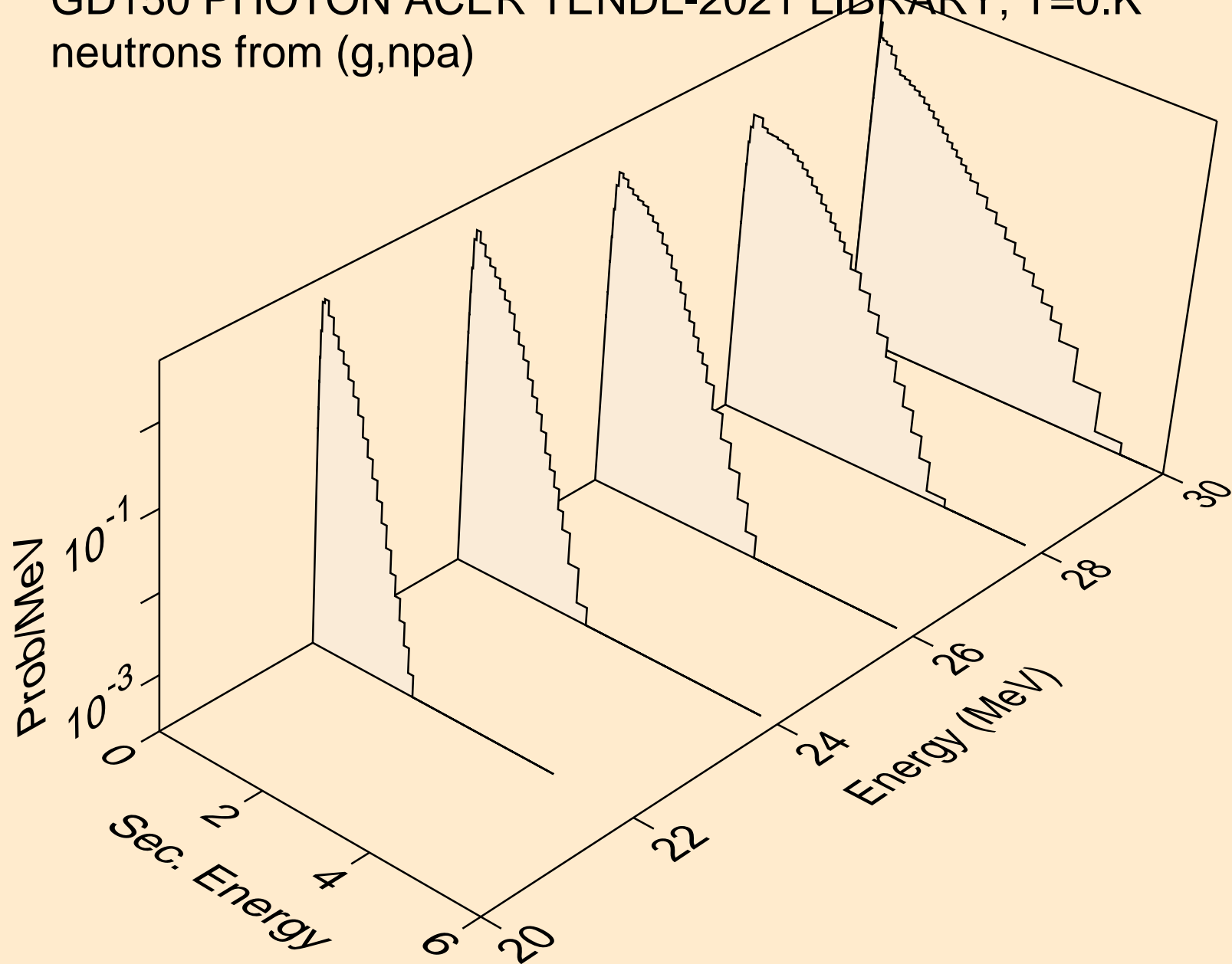



GD150 PHOTON ACER TENDL-2021 LIBRARY; T=0.K  
angular distribution for (g,n\*0) neutron

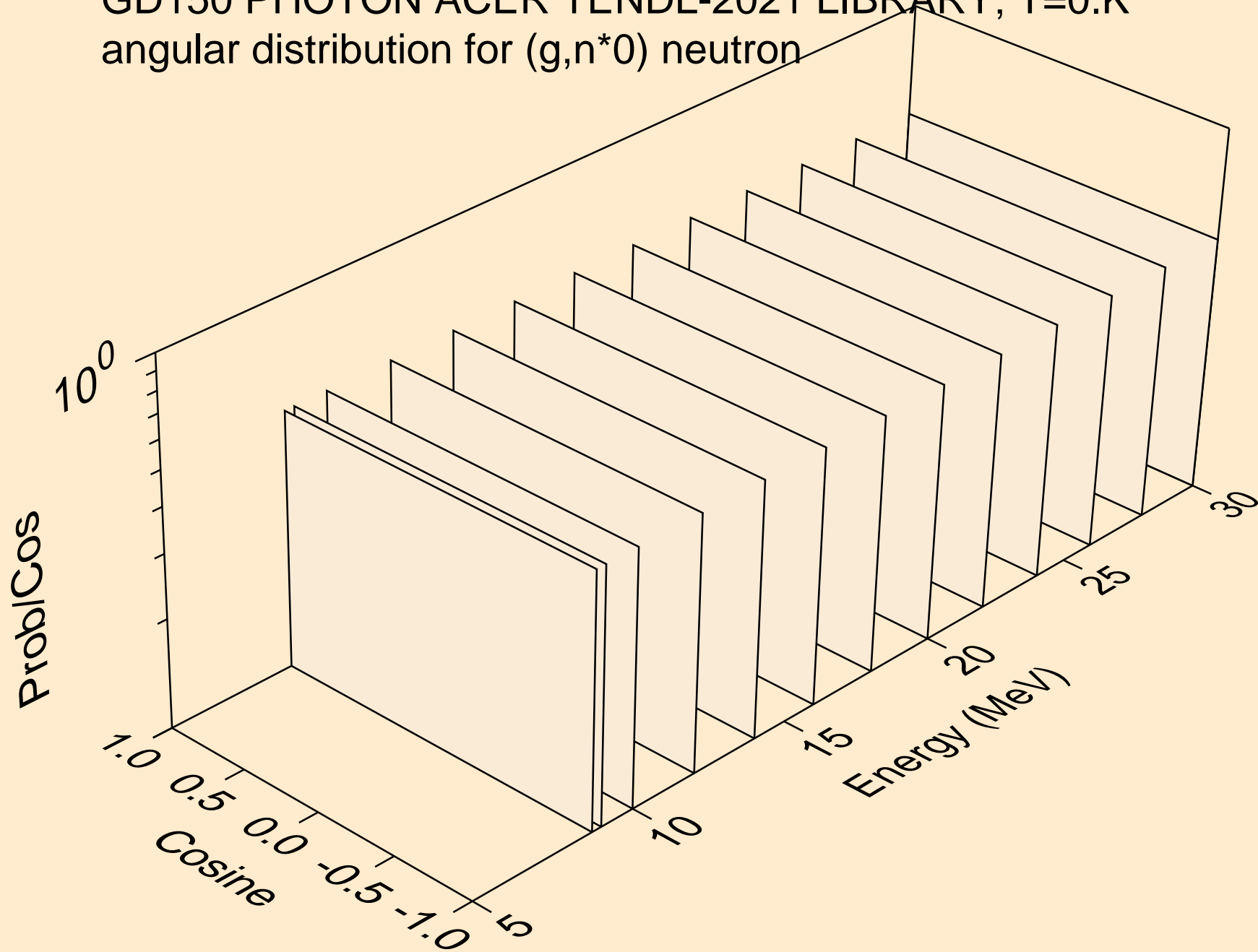

GD150 PHOTON ACER TENDL-2021 LIBRARY; T=0.K  
angular distribution for (g,n\*1) neutron

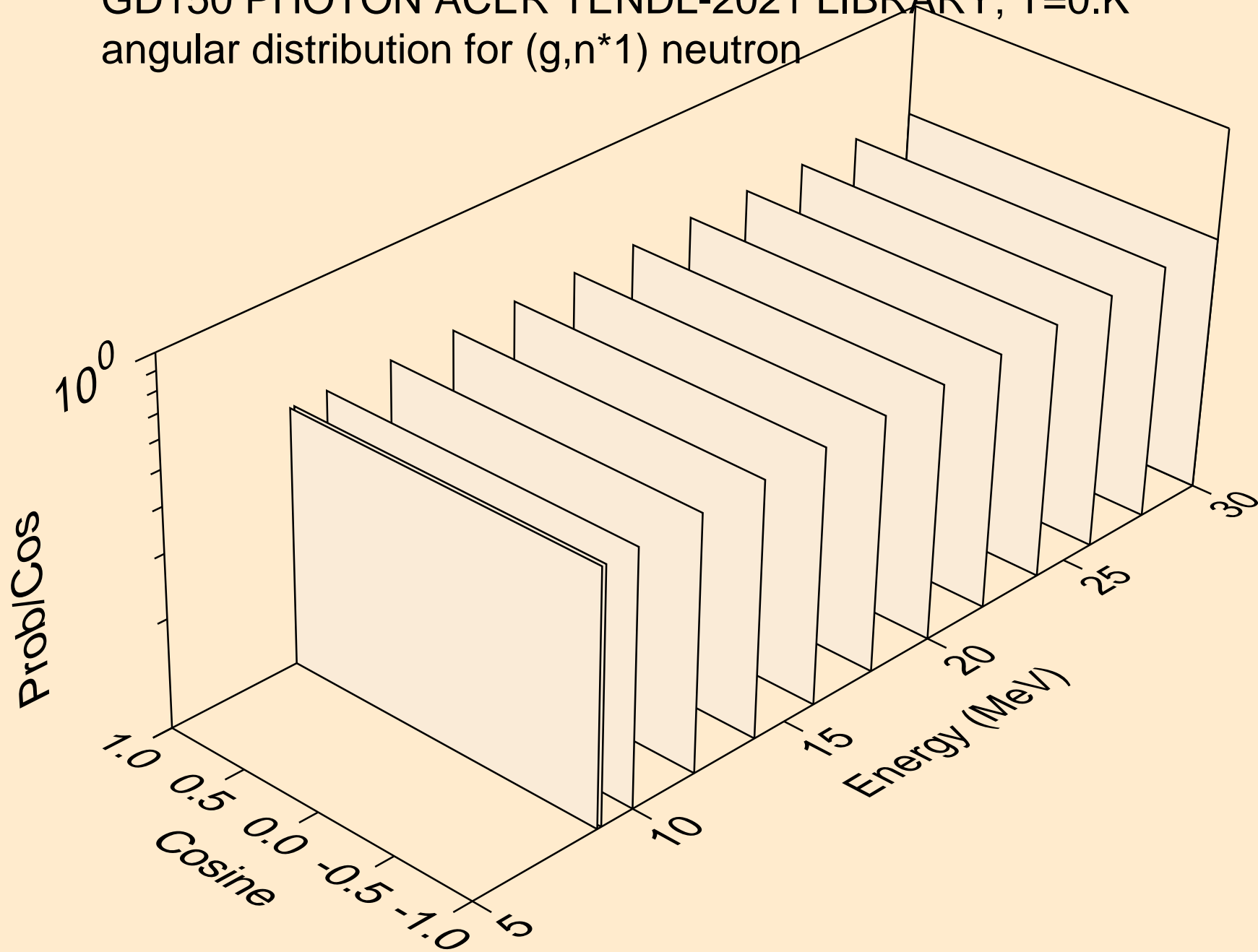

GD150 PHOTON ACER TENDL-2021 LIBRARY; T=0.K  
angular distribution for (g,n\*2) neutron

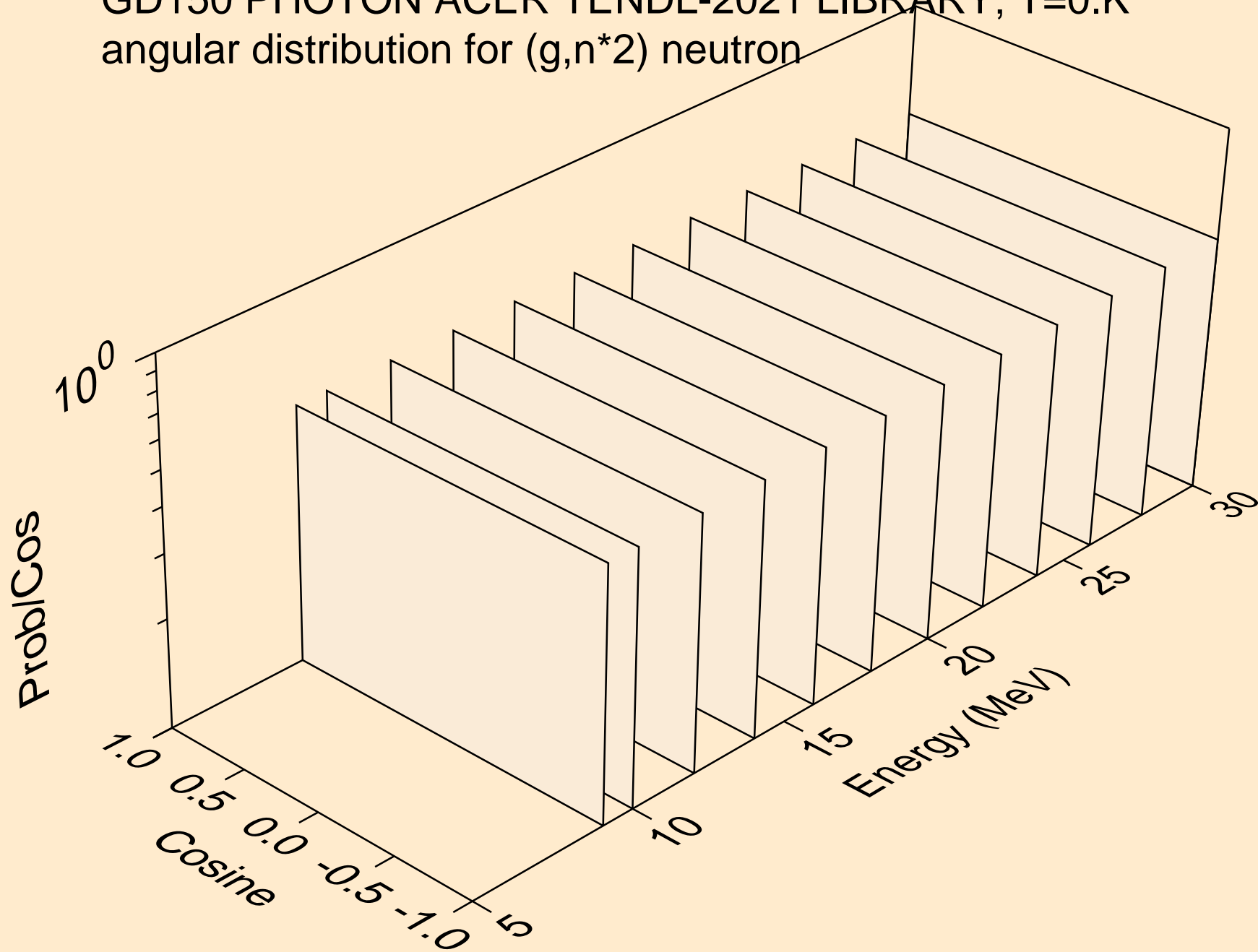

GD150 PHOTON ACER TENDL-2021 LIBRARY; T=0.K  
neutrons from (g,n\*c)

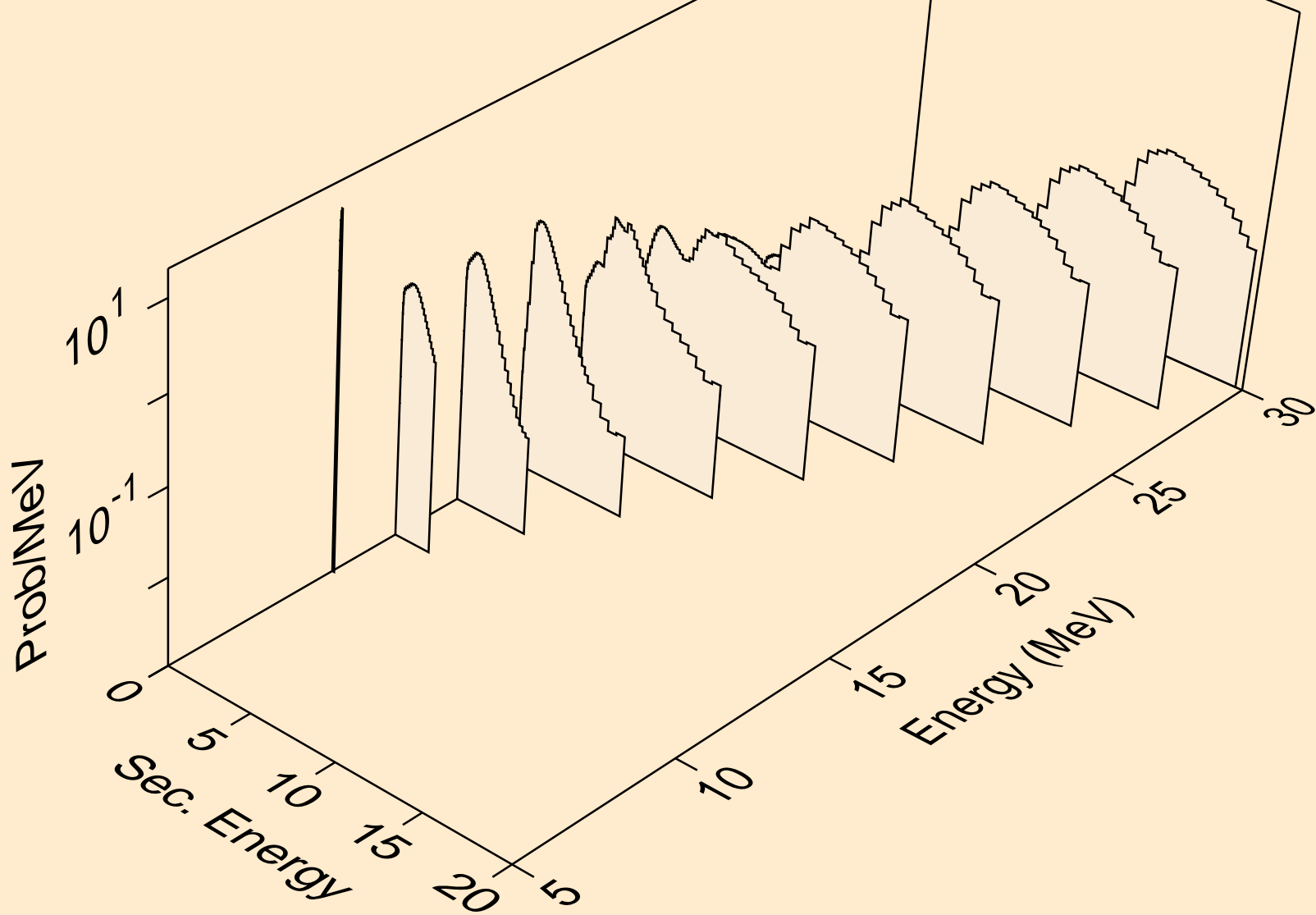

GD150 PHOTON ACER TENDL-2021 LIBRARY; T=0.K  
photons from (g,2n)

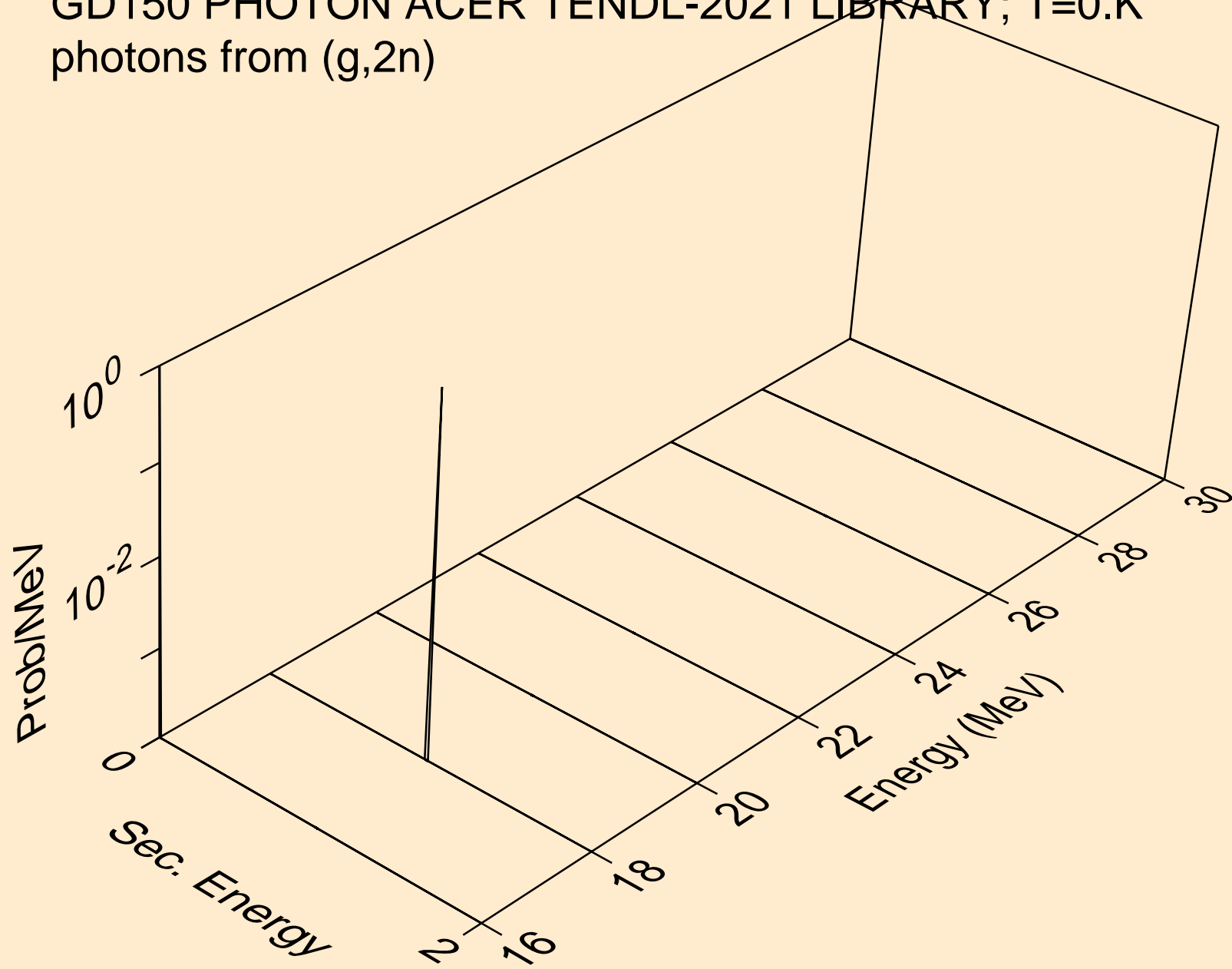

GD150 PHOTON ACER TENDL-2021 LIBRARY; T=0.K  
photons from (g,3n)

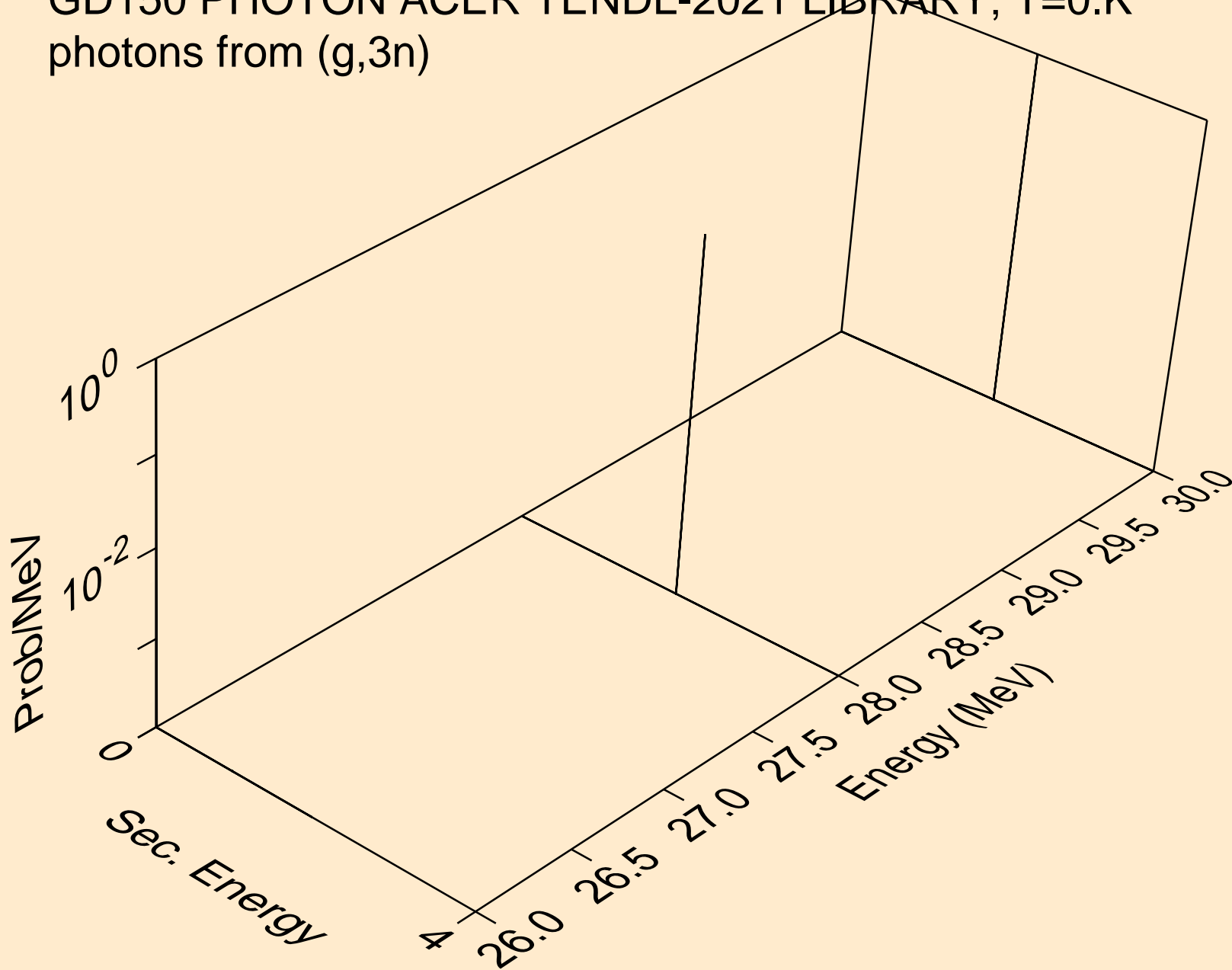

GD150 PHOTON ACER TENDL-2021 LIBRARY; T=0.K  
photons from (g,n\*)a

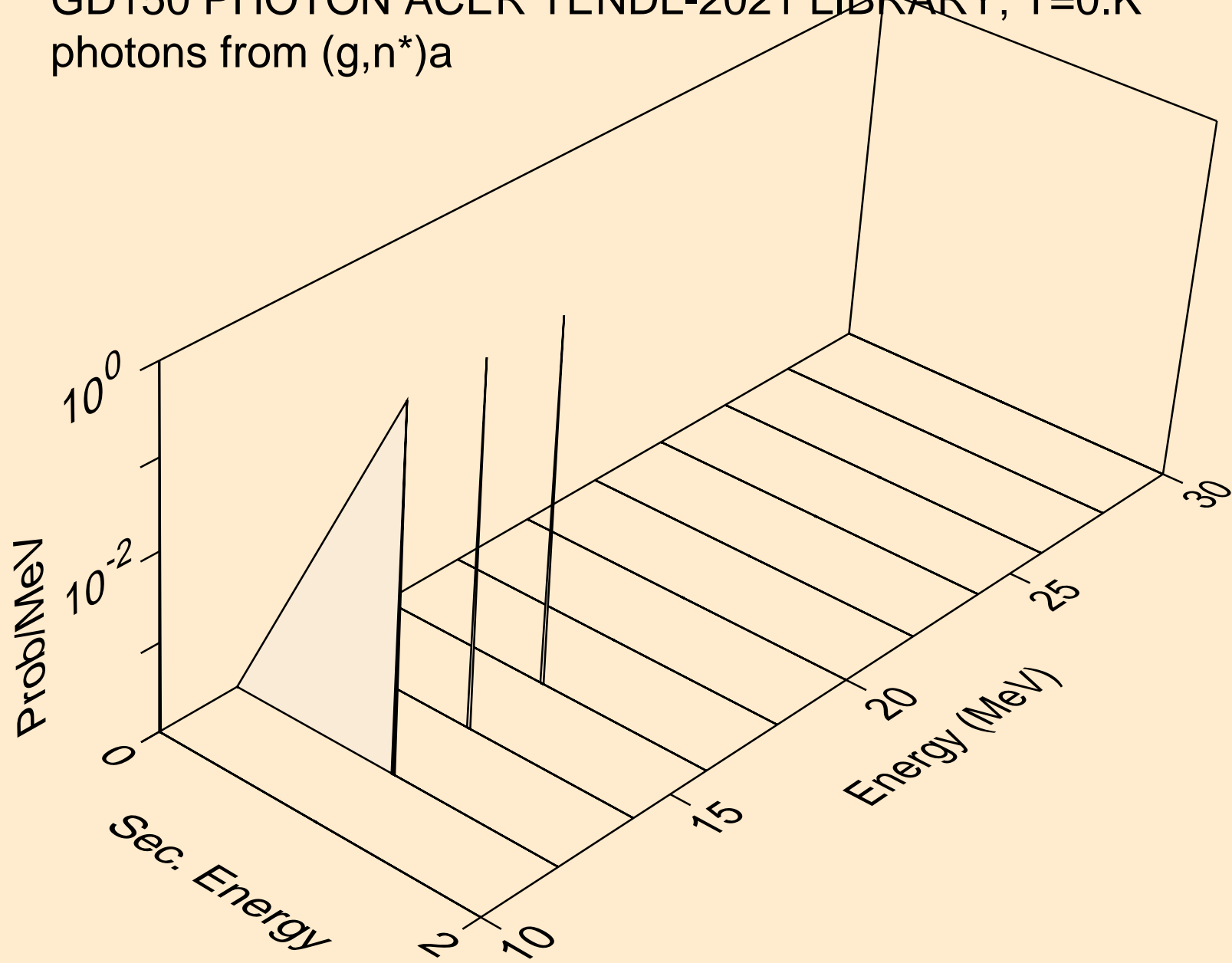

GD150 PHOTON ACER TENDL-2021 LIBRARY; T=0.K  
photons from (g,2n)a

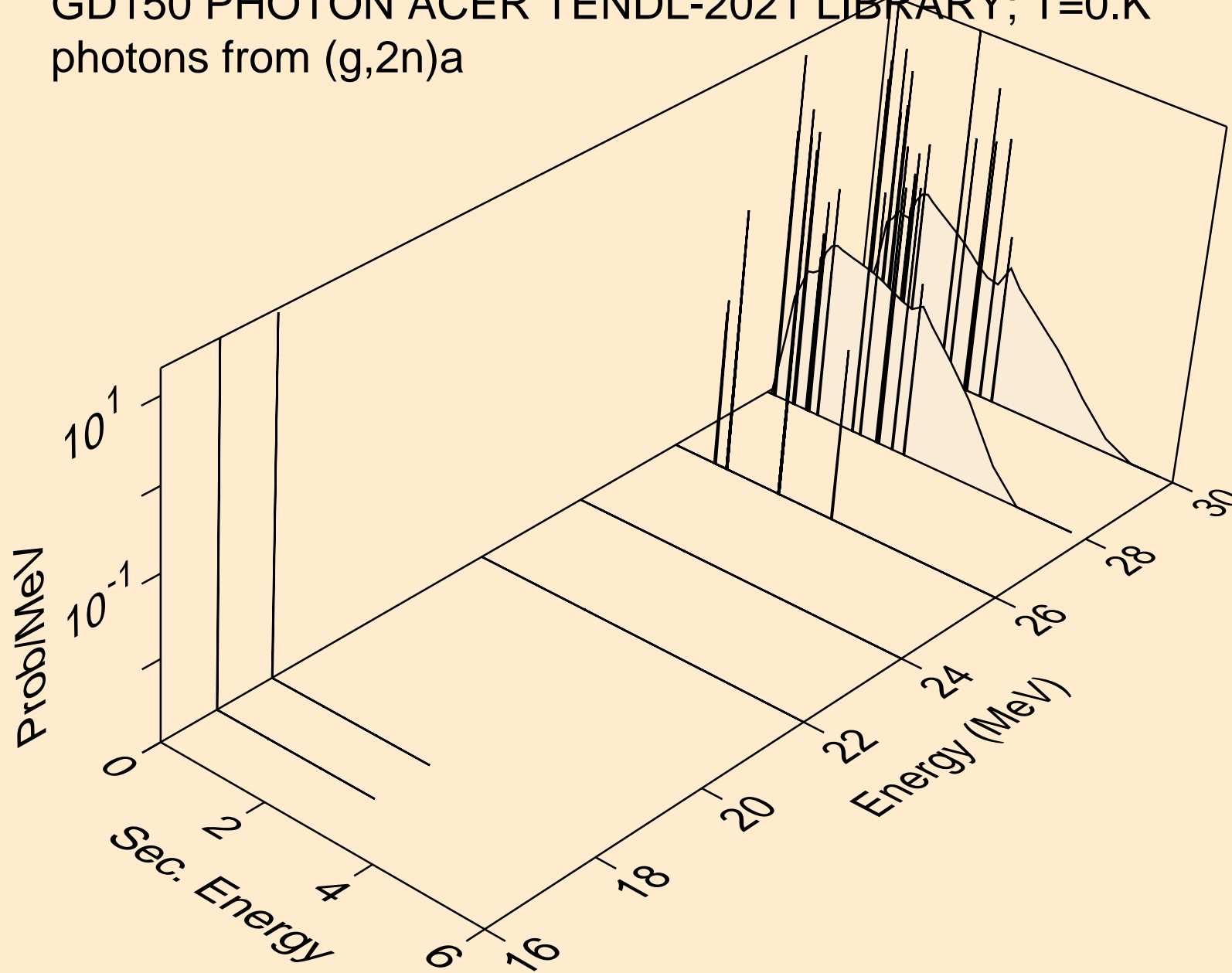



GD150 PHOTON ACER TENDL-2021 LIBRARY; T=0.K  
photons from (g,n\*)p

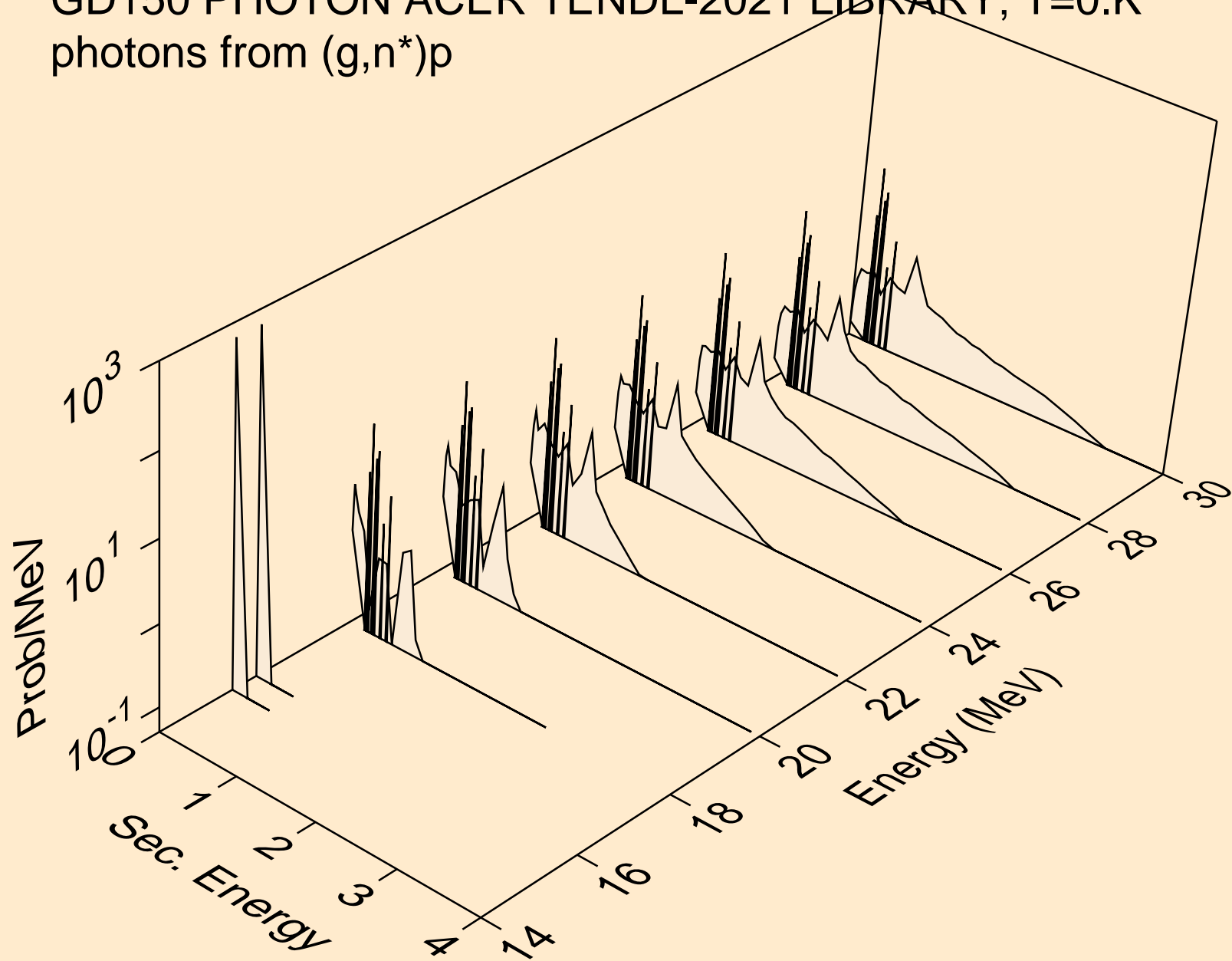

GD150 PHOTON ACER TENDL-2021 LIBRARY; T=0.K  
photons from (g,n\*)d

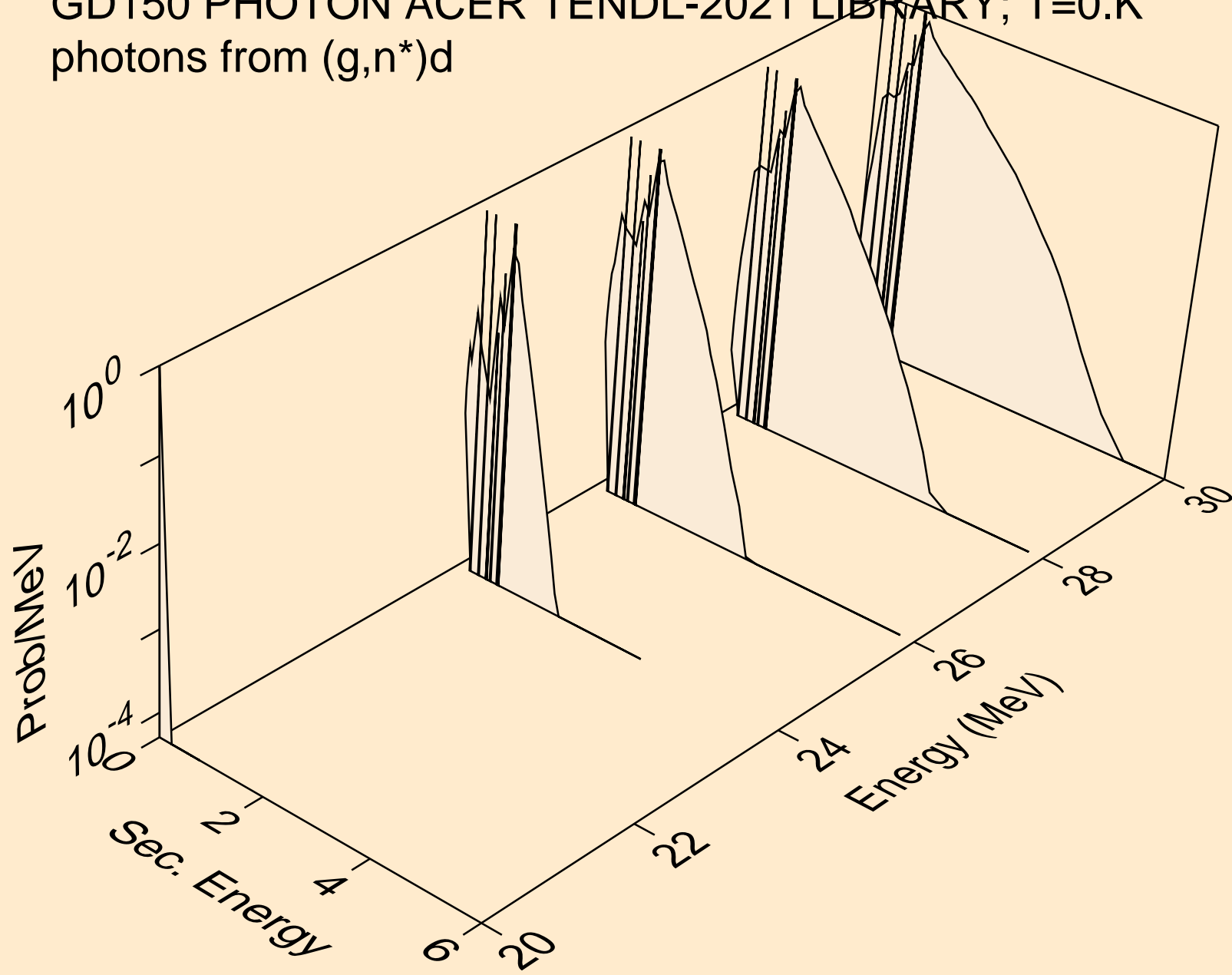

GD150 PHOTON ACER TENDL-2021 LIBRARY; T=0.K  
photons from (g,n\*)t

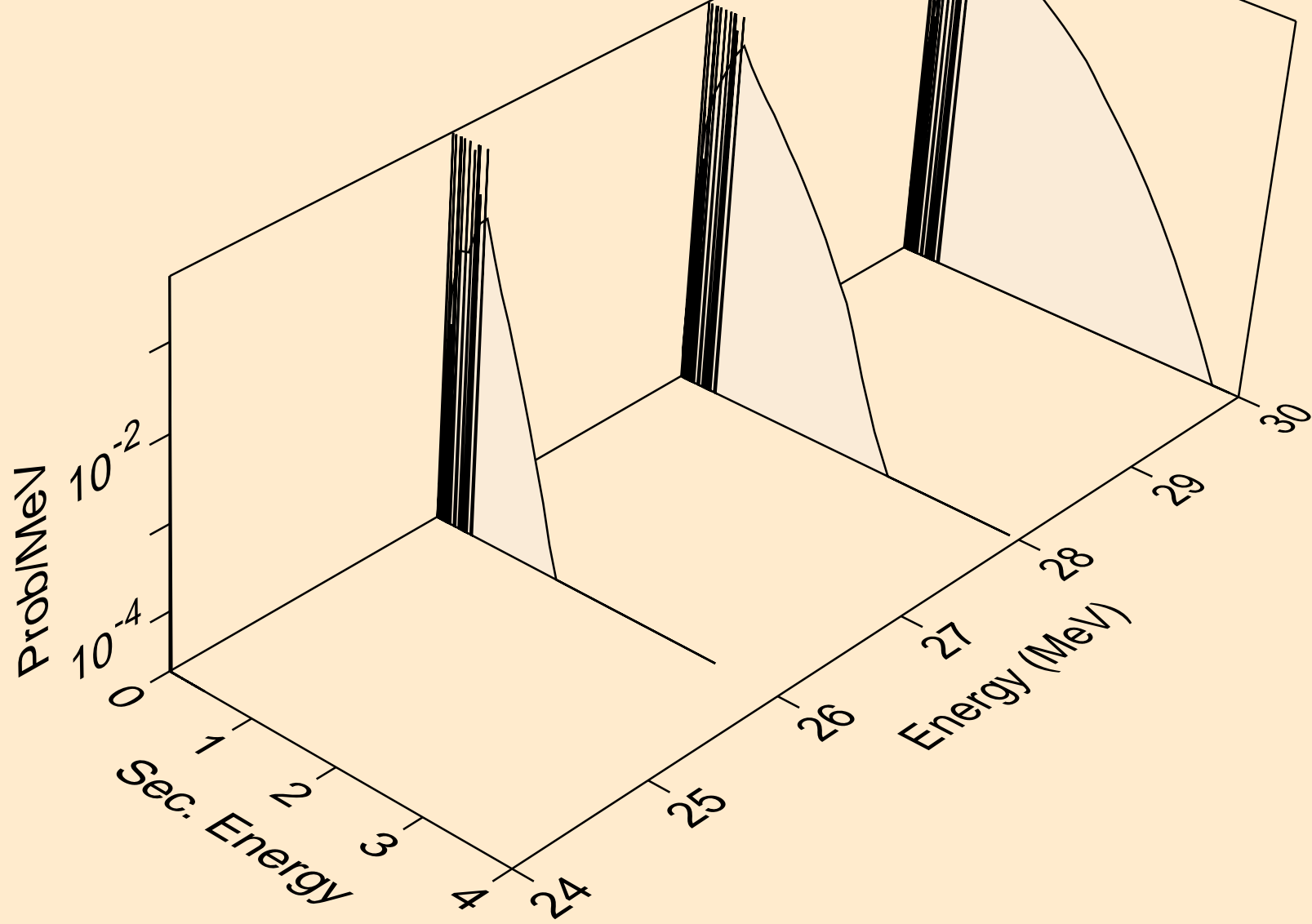

GD150 PHOTON ACER TENDL-2021 LIBRARY; T=0.K  
photons from (g,2np)

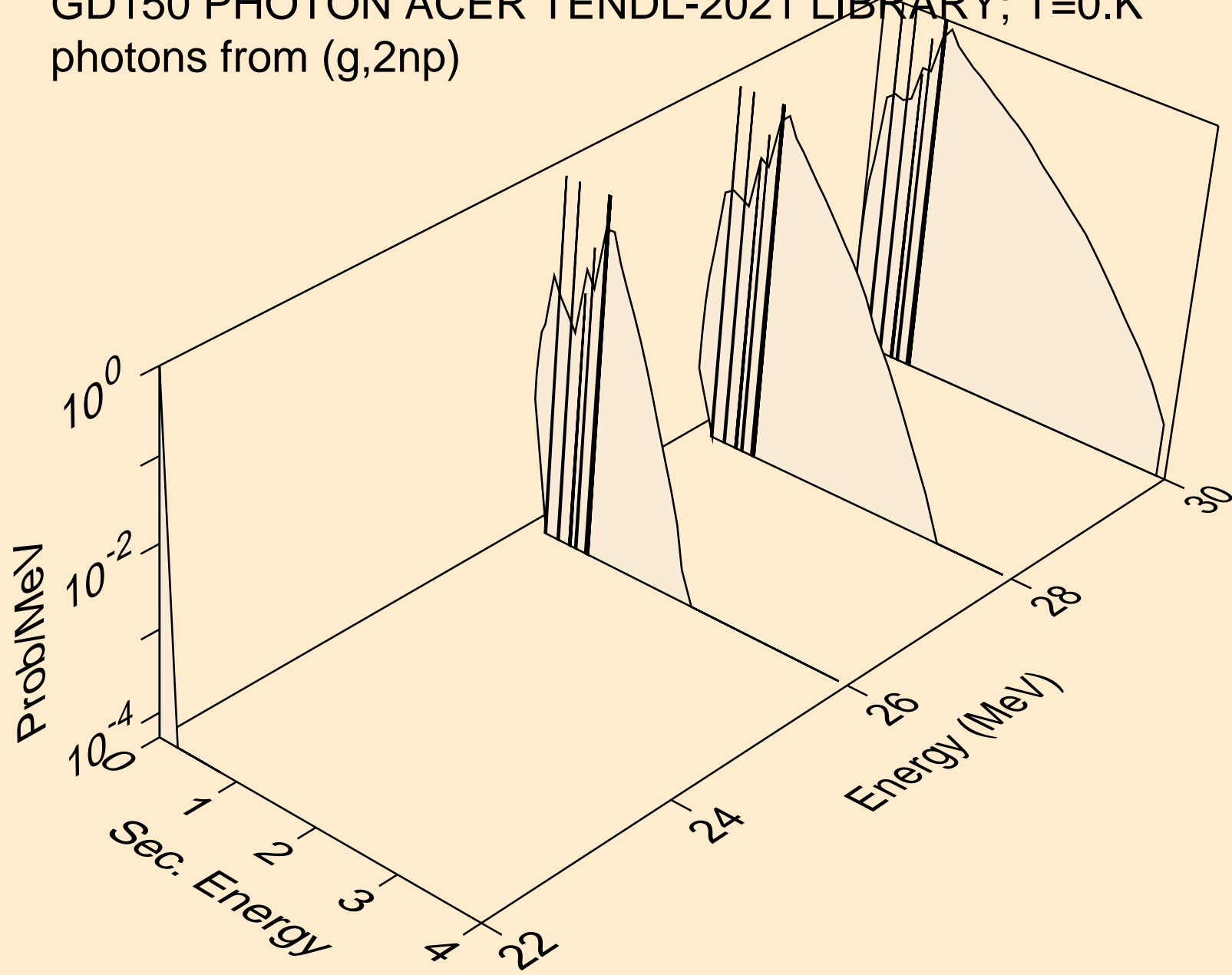

GD150 PHOTON ACER TENDL-2021 LIBRARY; T=0.K  
photons from (g,2np)

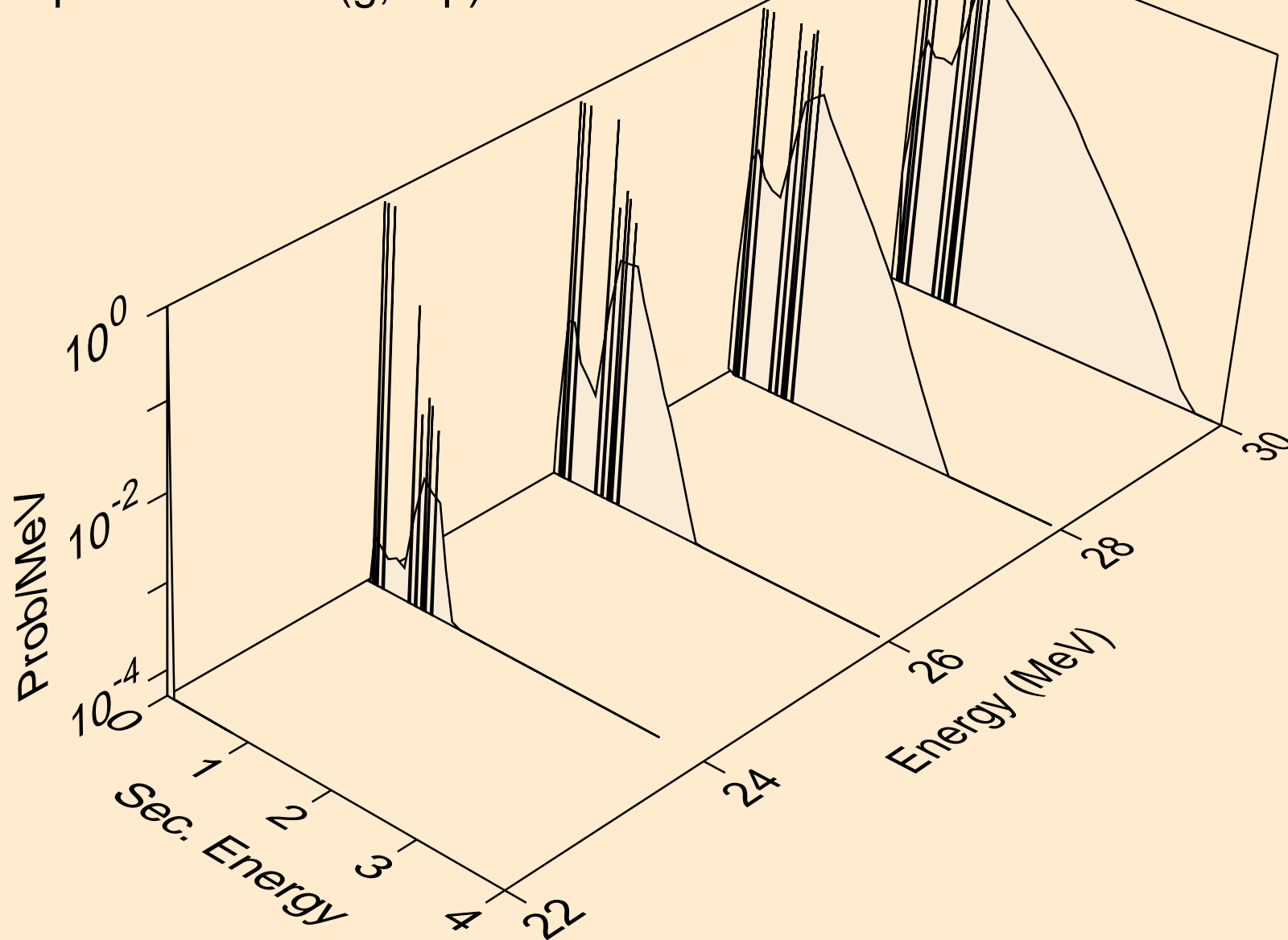

GD150 PHOTON ACER TENDL-2021 LIBRARY; T=0.K  
photons from (g,npa)

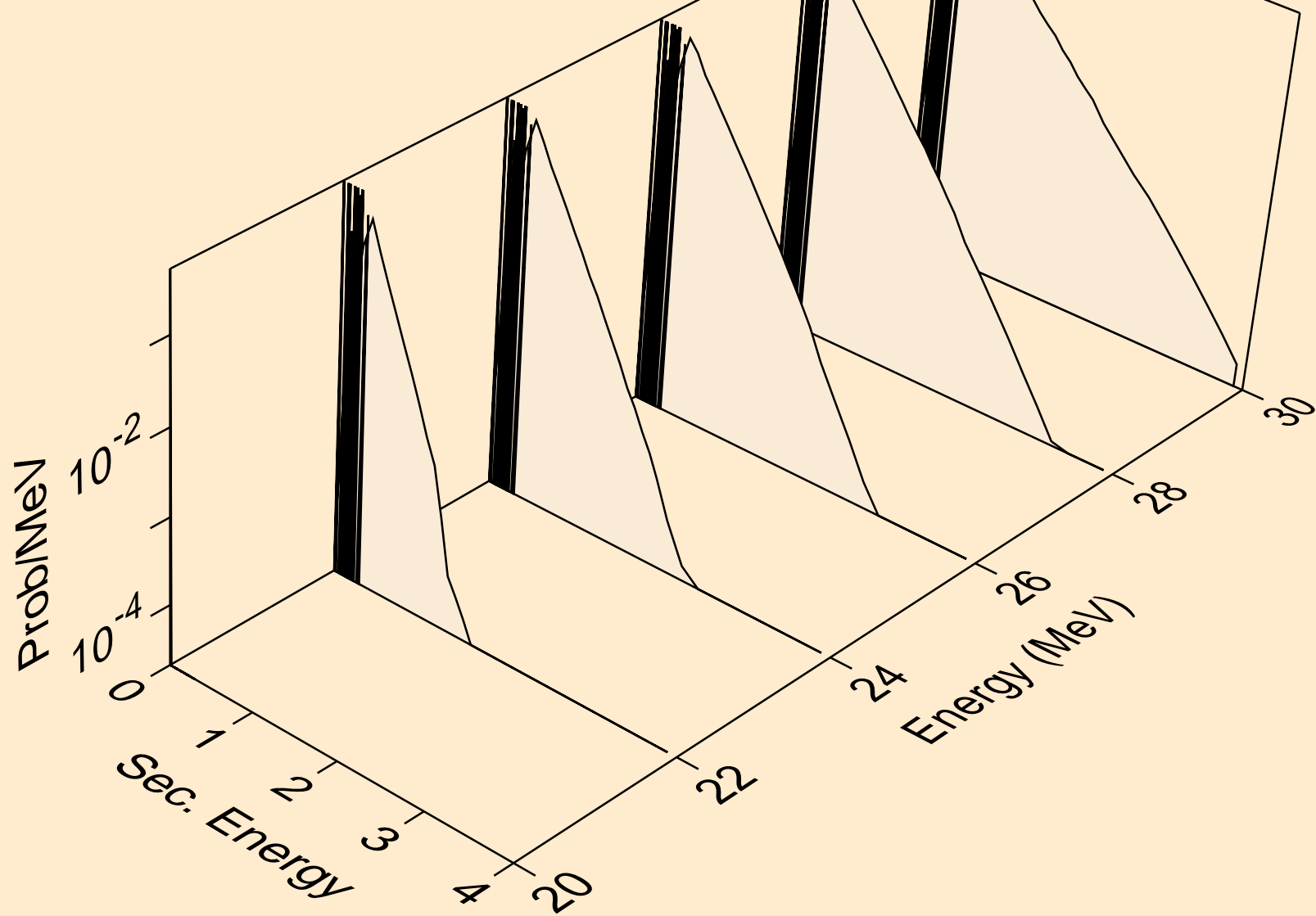

GD150 PHOTON ACER TENDL-2021 LIBRARY; T=0.K  
photons from (g,n\*c)

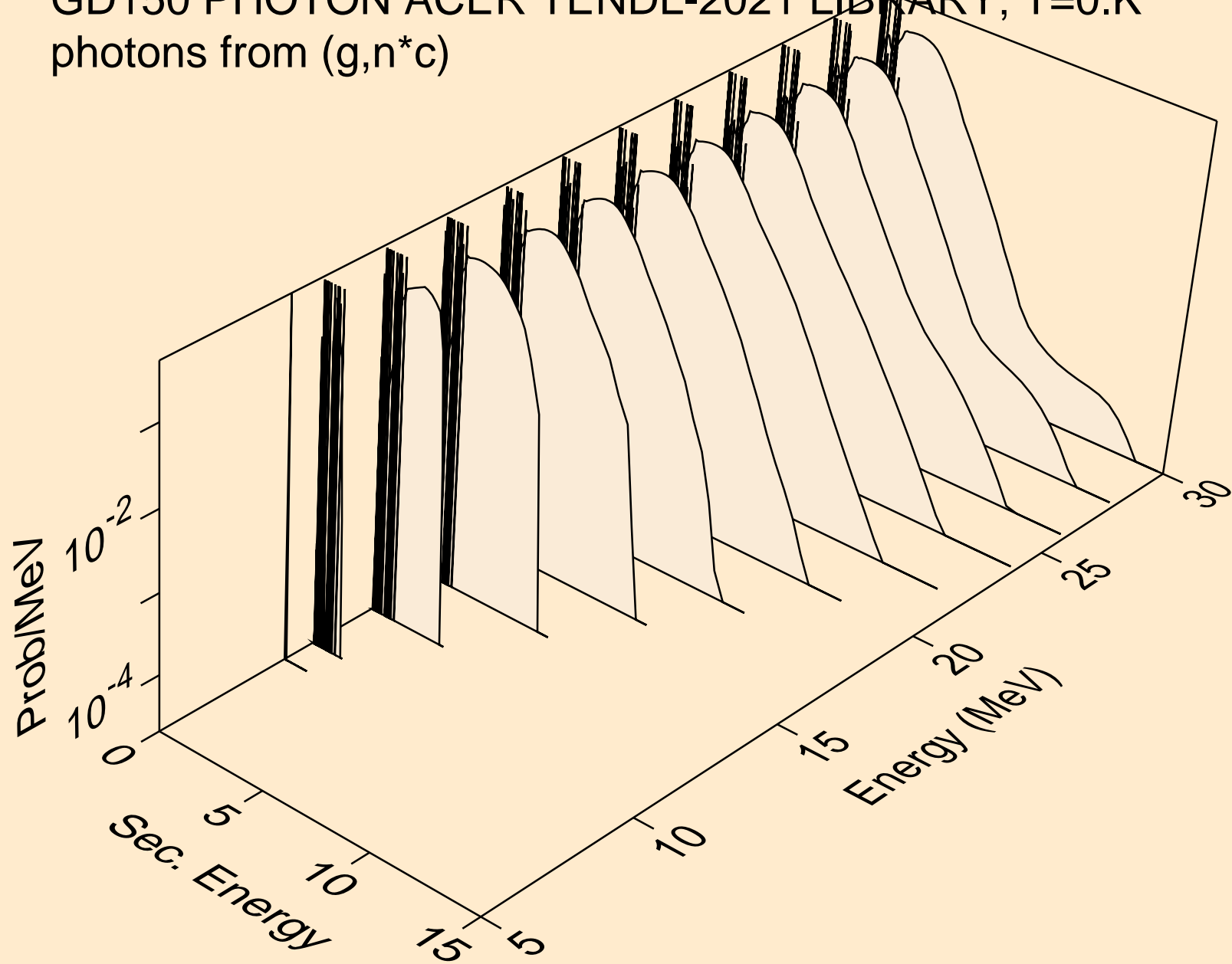

GD150 PHOTON ACER TENDL-2021 LIBRARY; T=0.K  
photons from (g,gma)

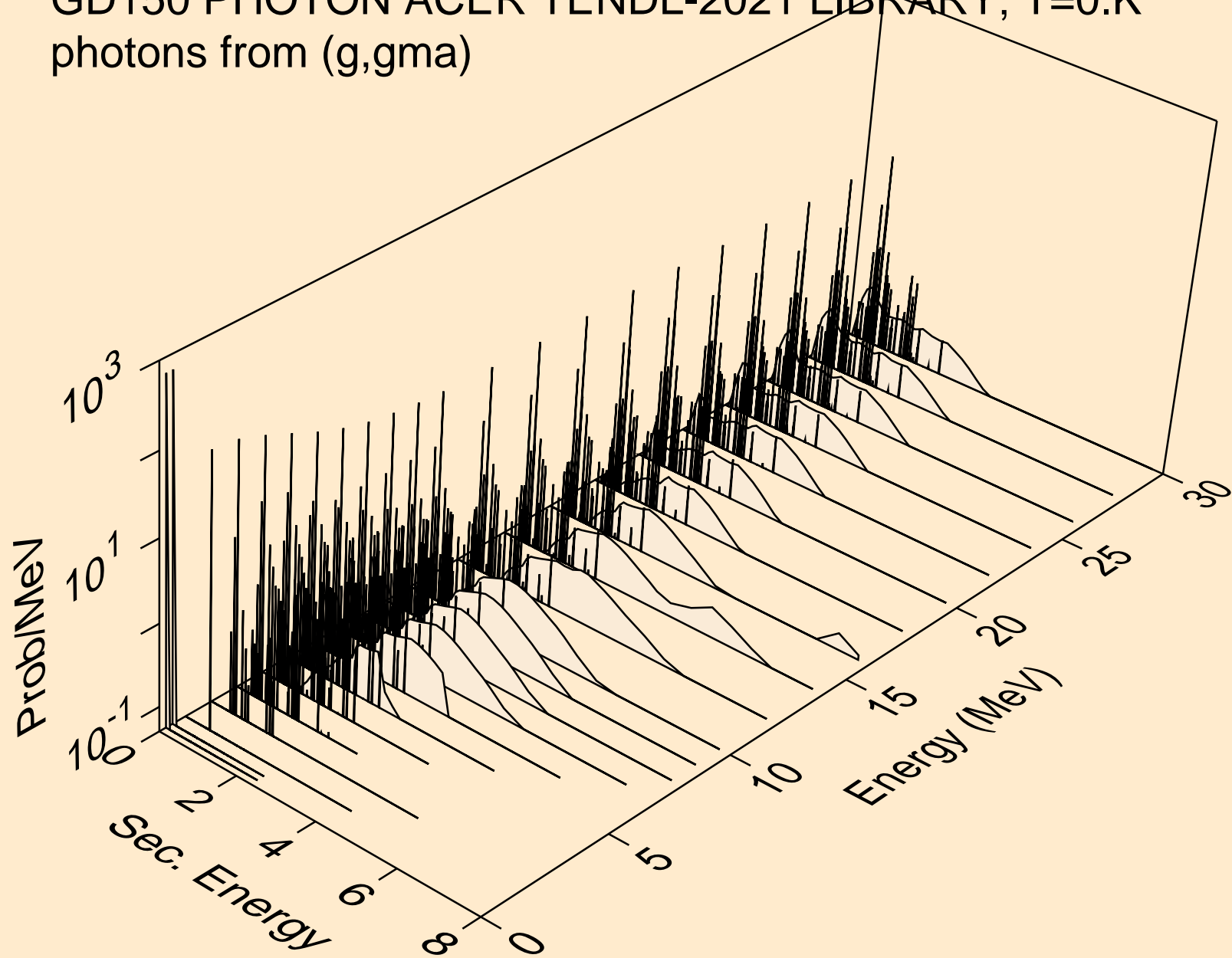



GD150 PHOTON ACER TENDL-2021 LIBRARY; T=0.K  
photons from (g,p)

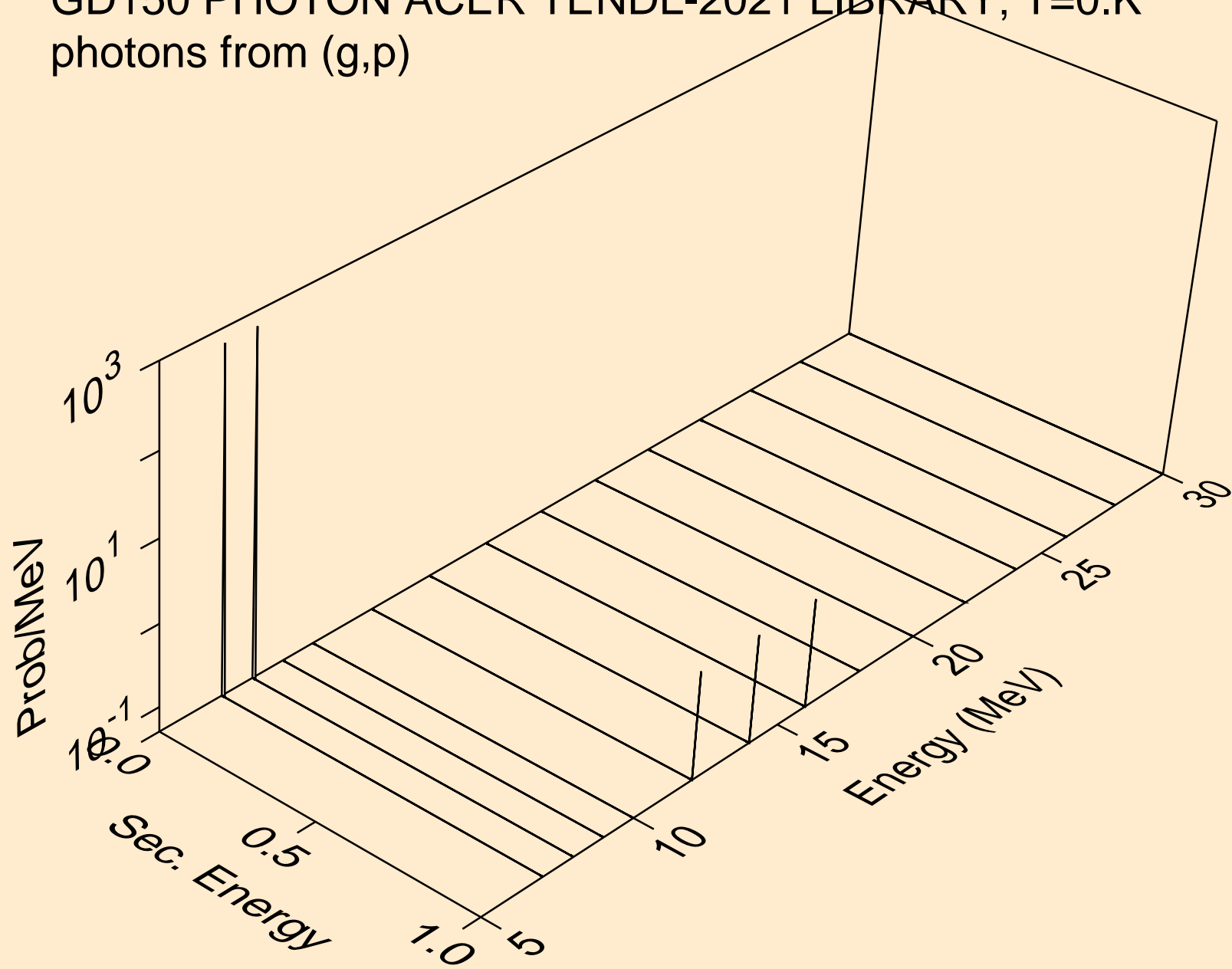

GD150 PHOTON ACER TENDL-2021 LIBRARY; T=0.K  
photons from (g,d)

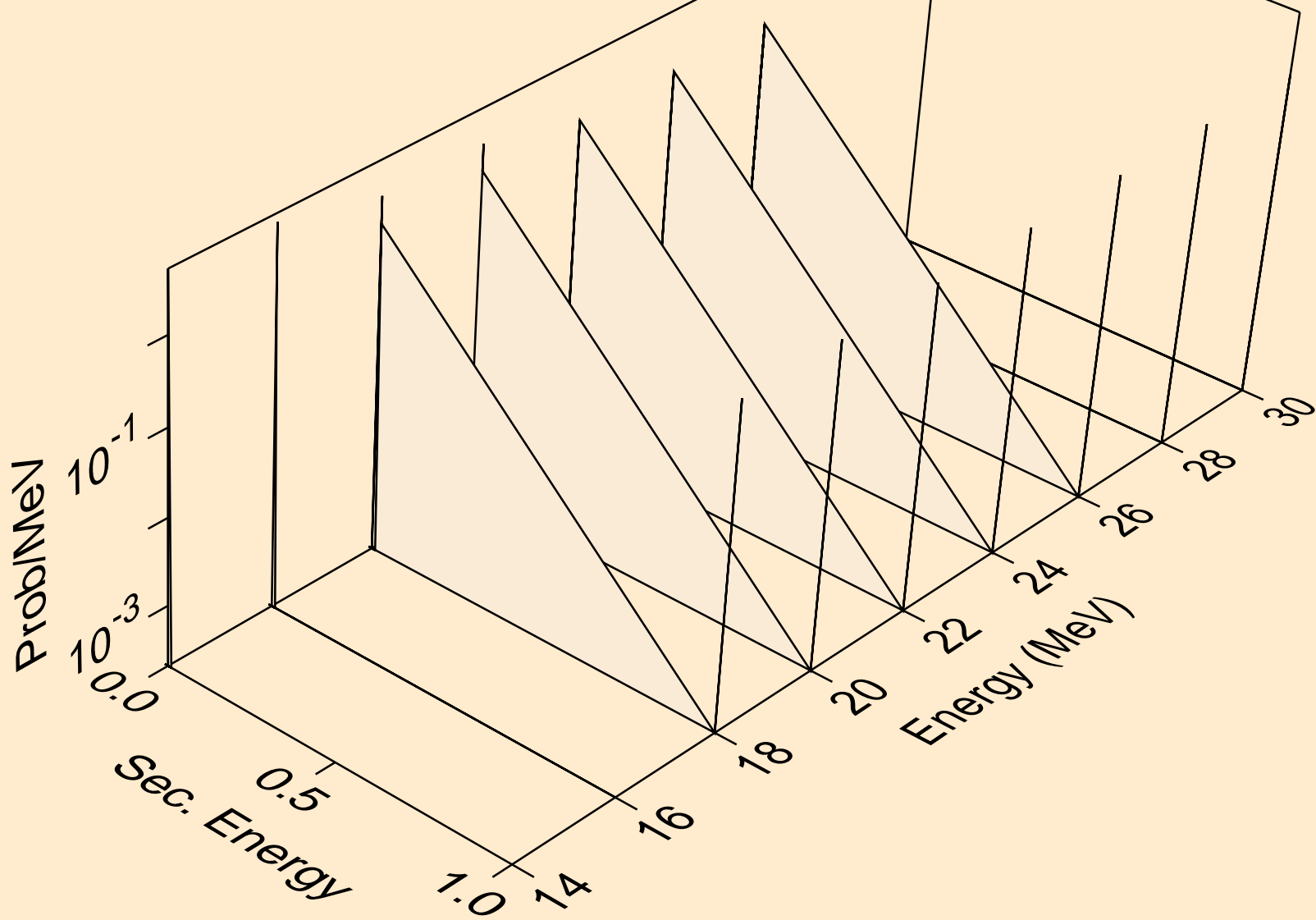

GD150 PHOTON ACER TENDL-2021 LIBRARY; T=0.K  
photons from (g,t)

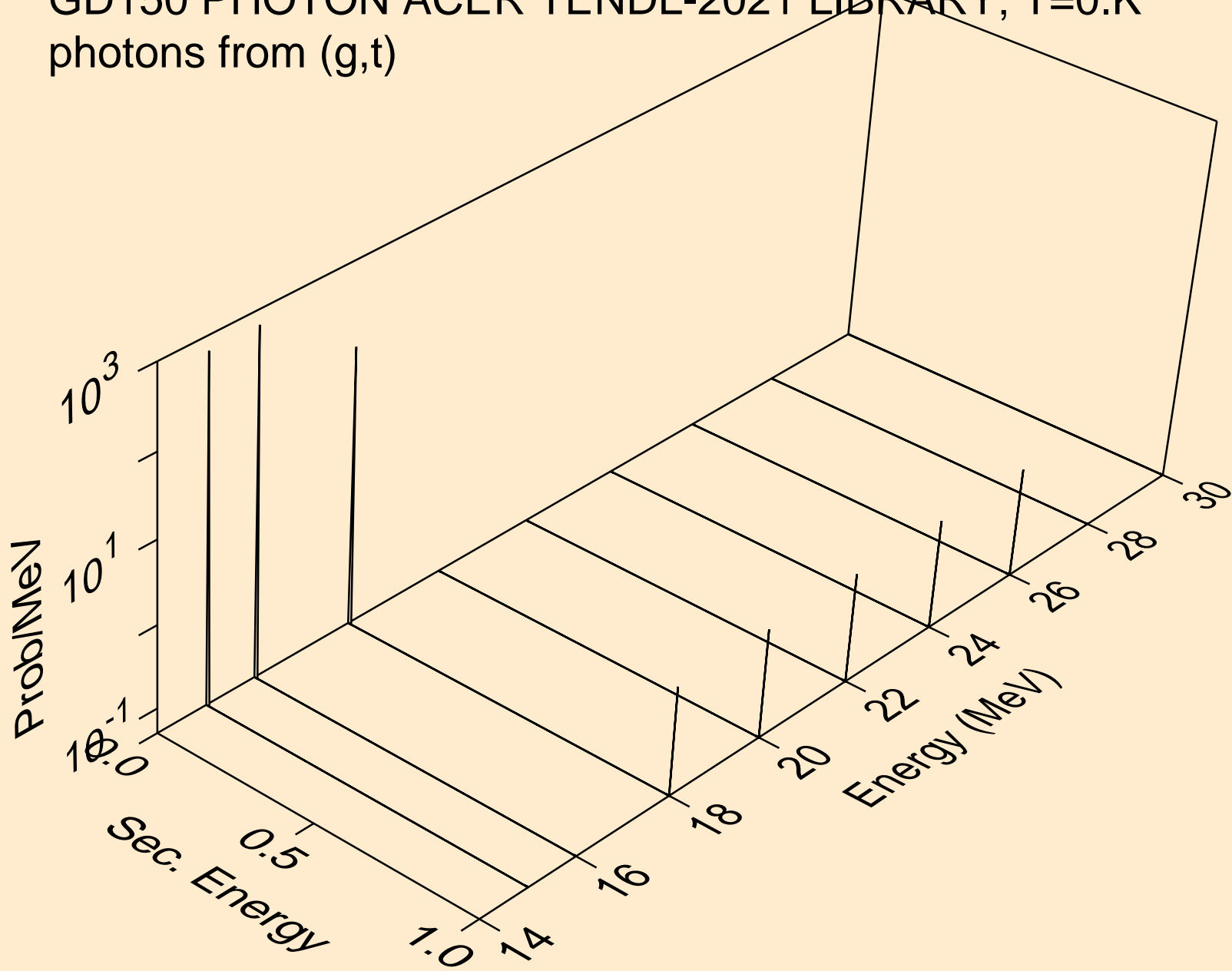

GD150 PHOTON ACER TENDL-2021 LIBRARY; T=0.K  
photons from (g,he3)

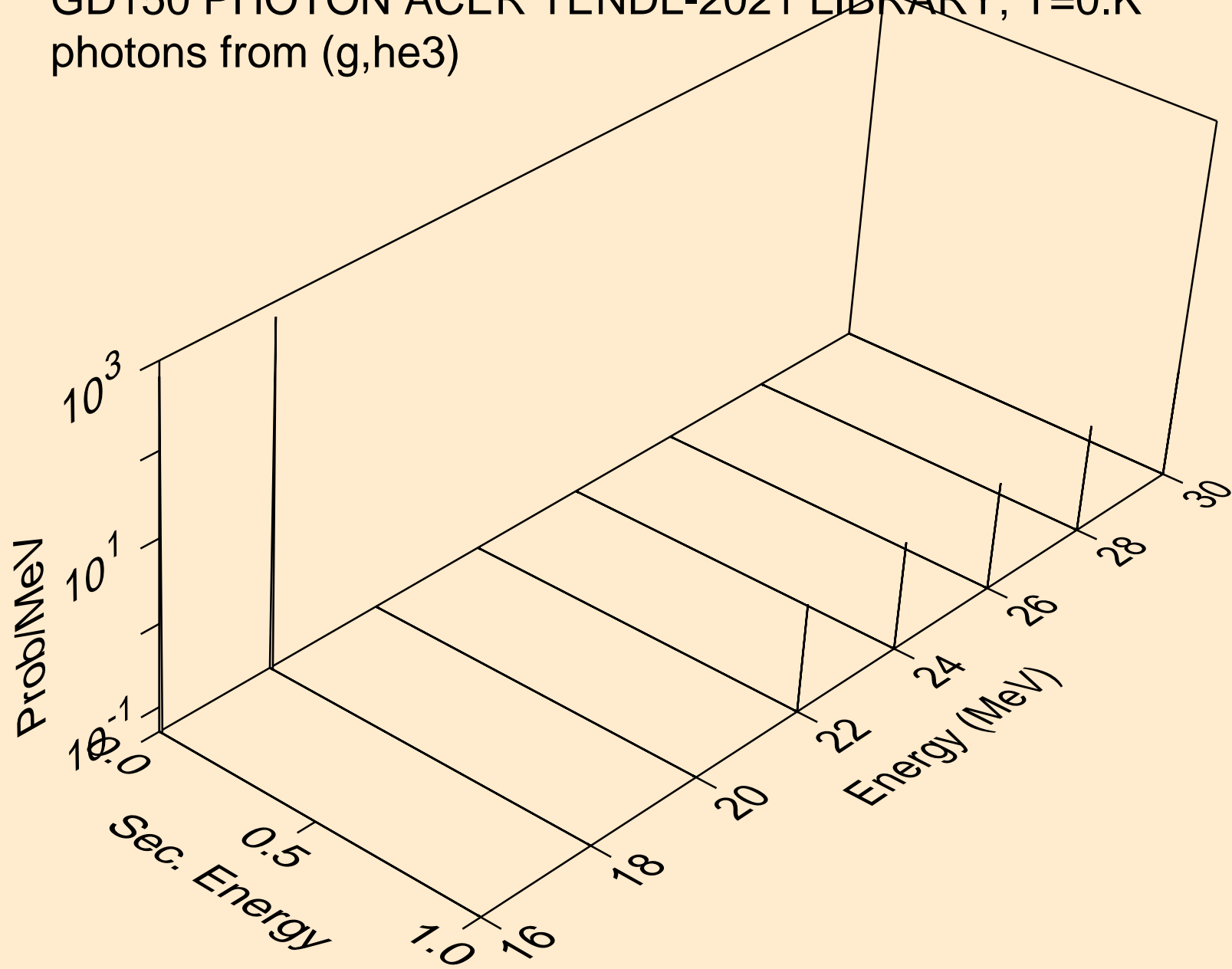

GD150 PHOTON ACER TENDL-2021 LIBRARY; T=0.K  
photons from (g,a)

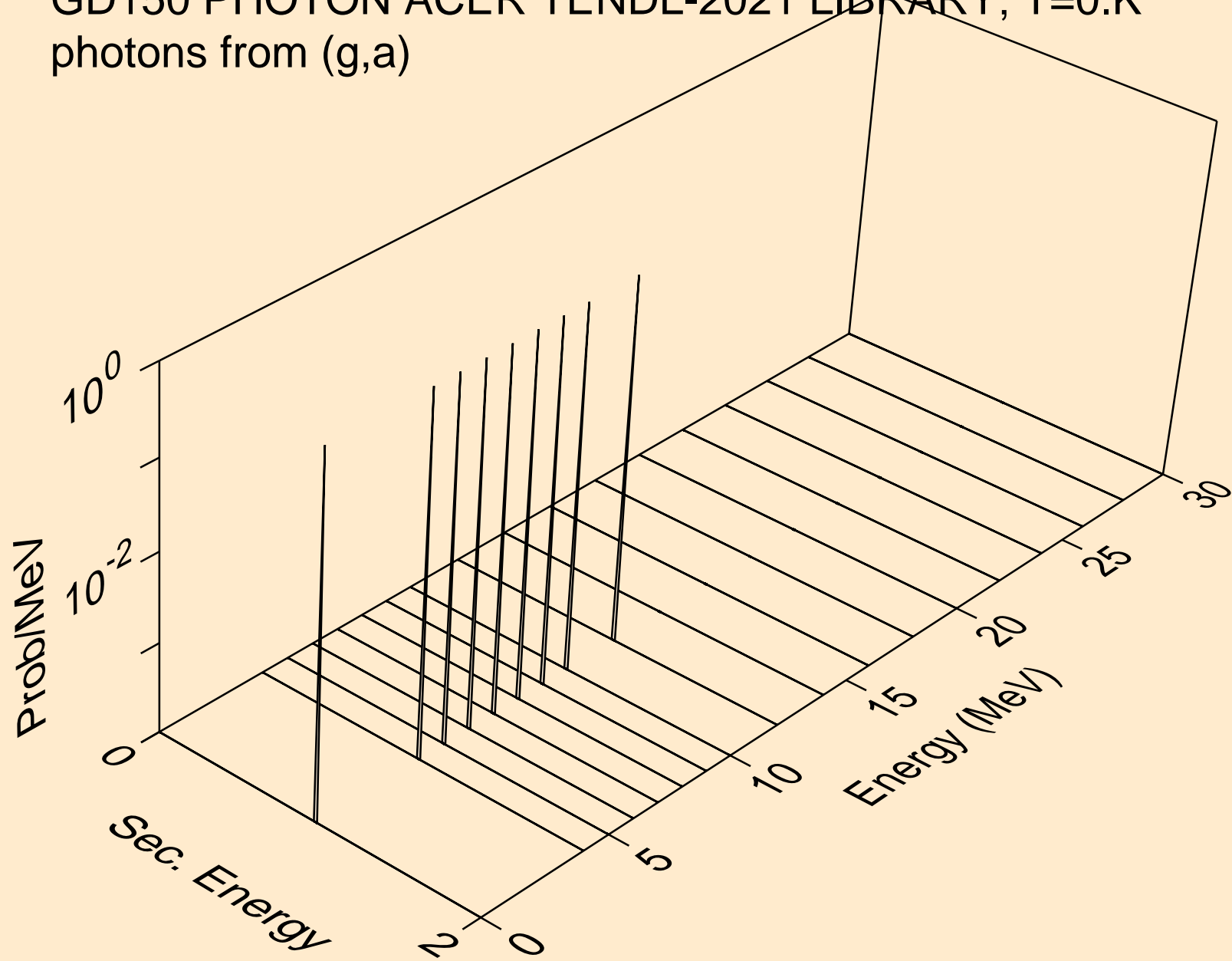

GD150 PHOTON ACER TENDL-2021 LIBRARY; T=0.K  
photons from (g,2a)

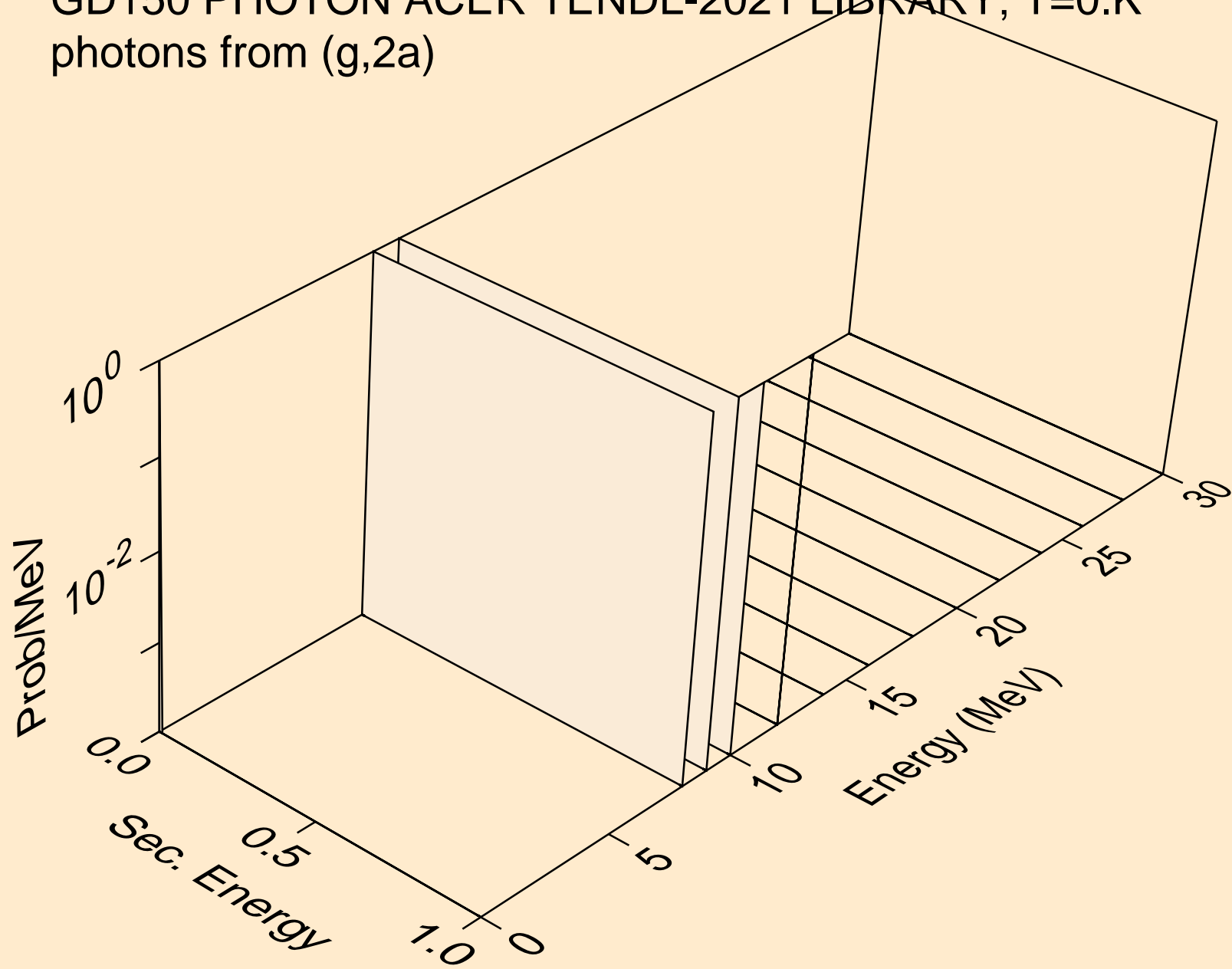

GD150 PHOTON ACER TENDL-2021 LIBRARY; T=0.K  
protons from (g,x)

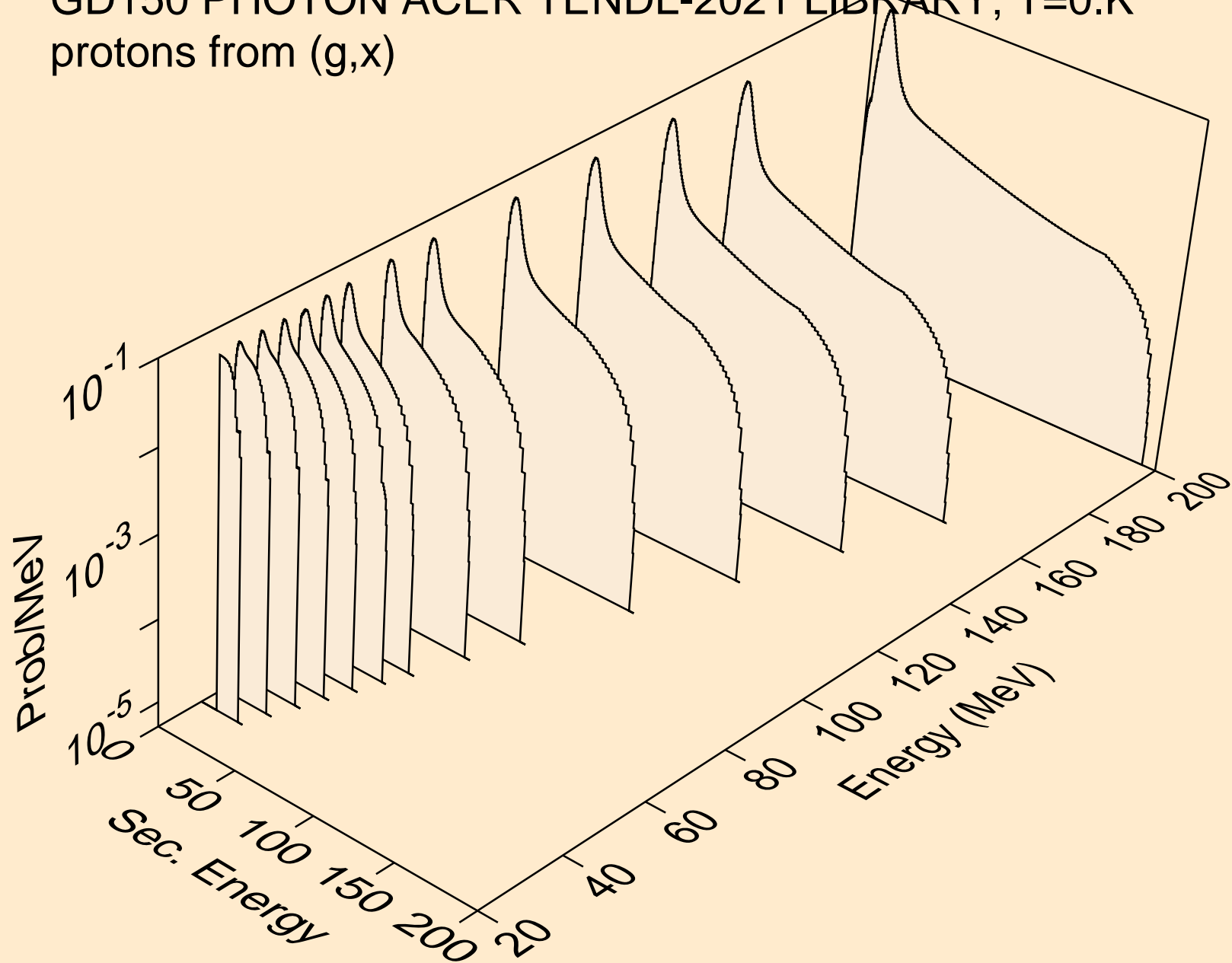

GD150 PHOTON ACER TENDL-2021 LIBRARY; T=0.K  
protons from (g,n\*)p

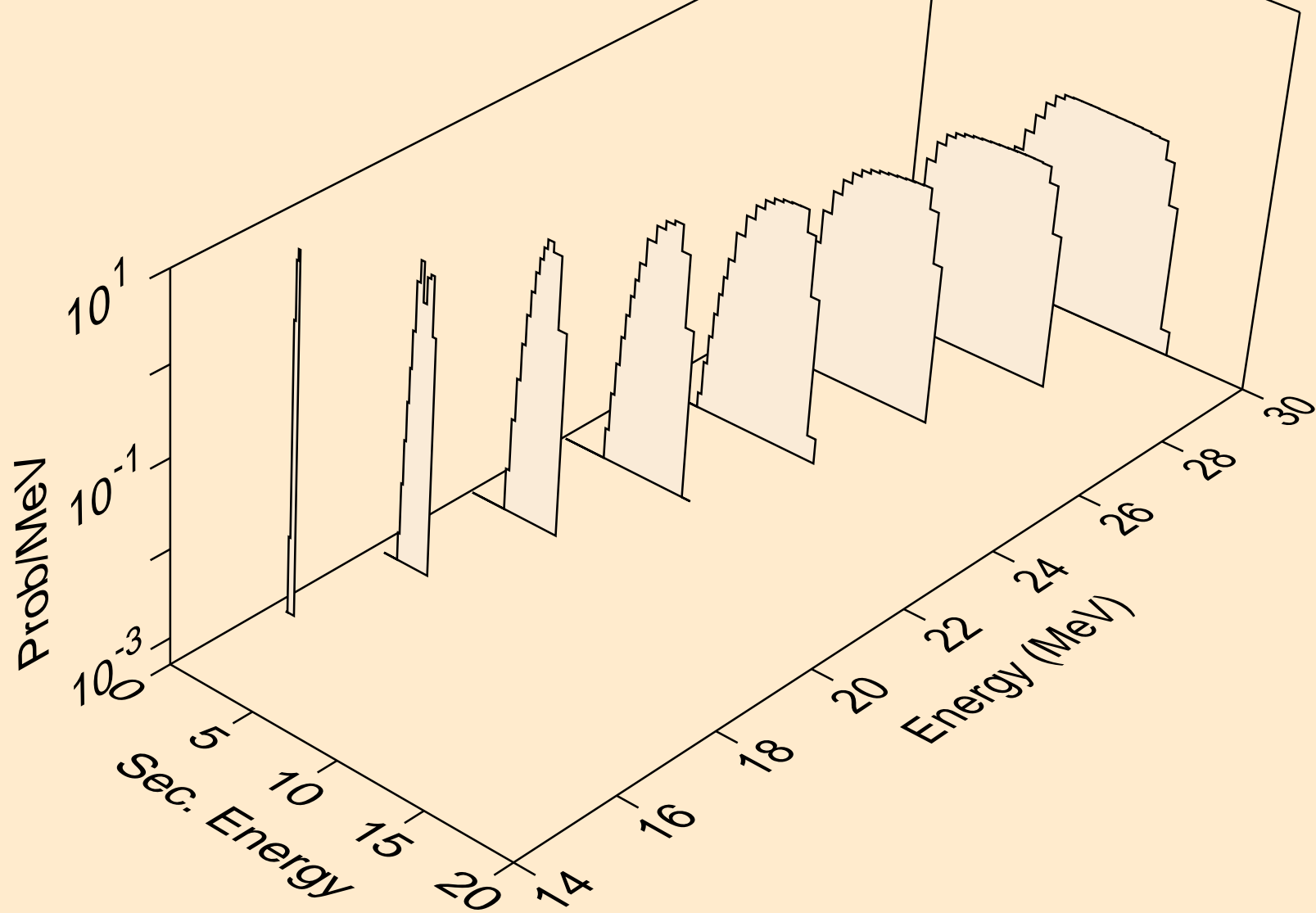



GD150 PHOTON ACER TENDL-2021 LIBRARY; T=0.K  
protons from (g,2np)

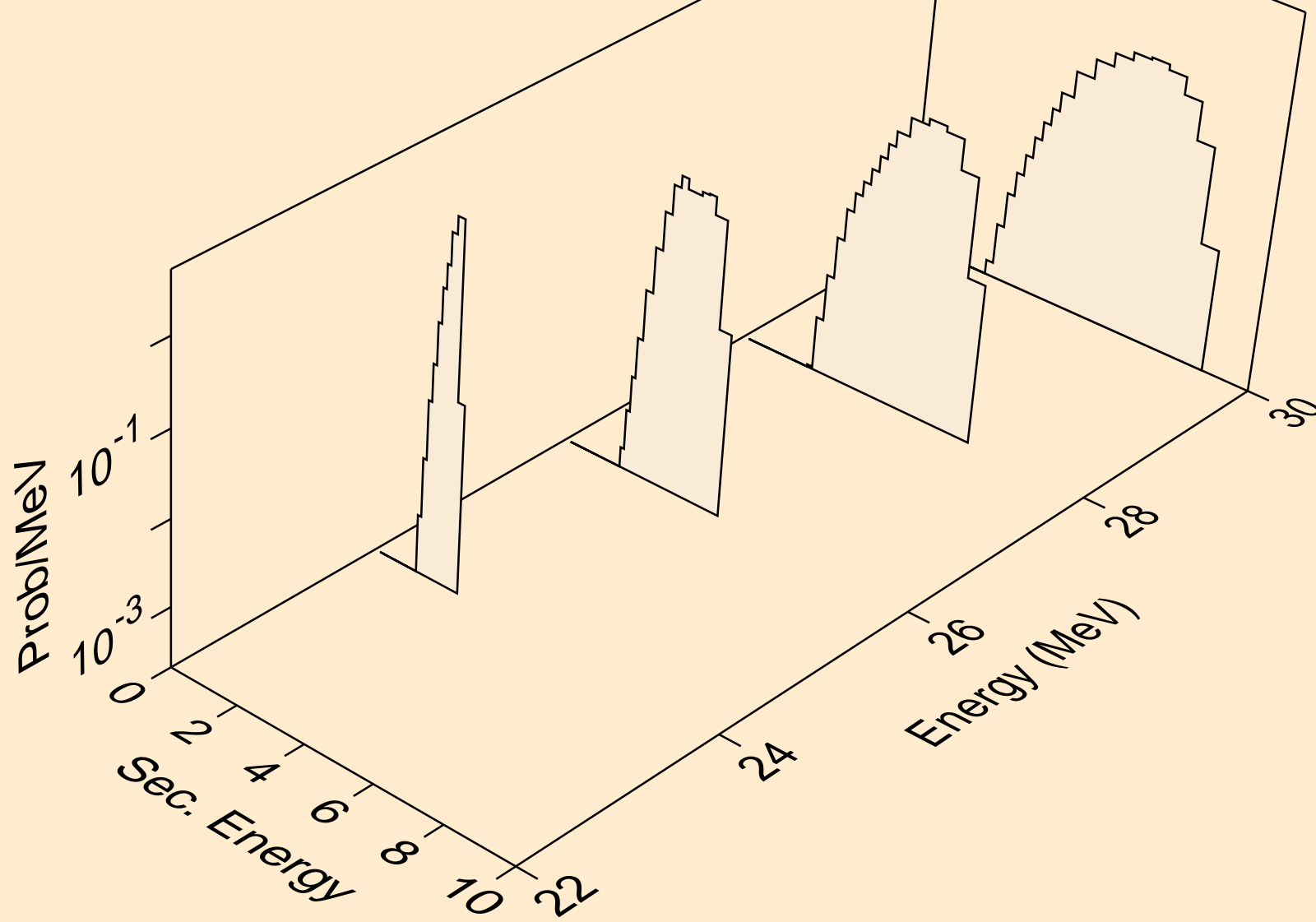

GD150 PHOTON ACER TENDL-2021 LIBRARY; T=0.K  
protons from (g,2np)

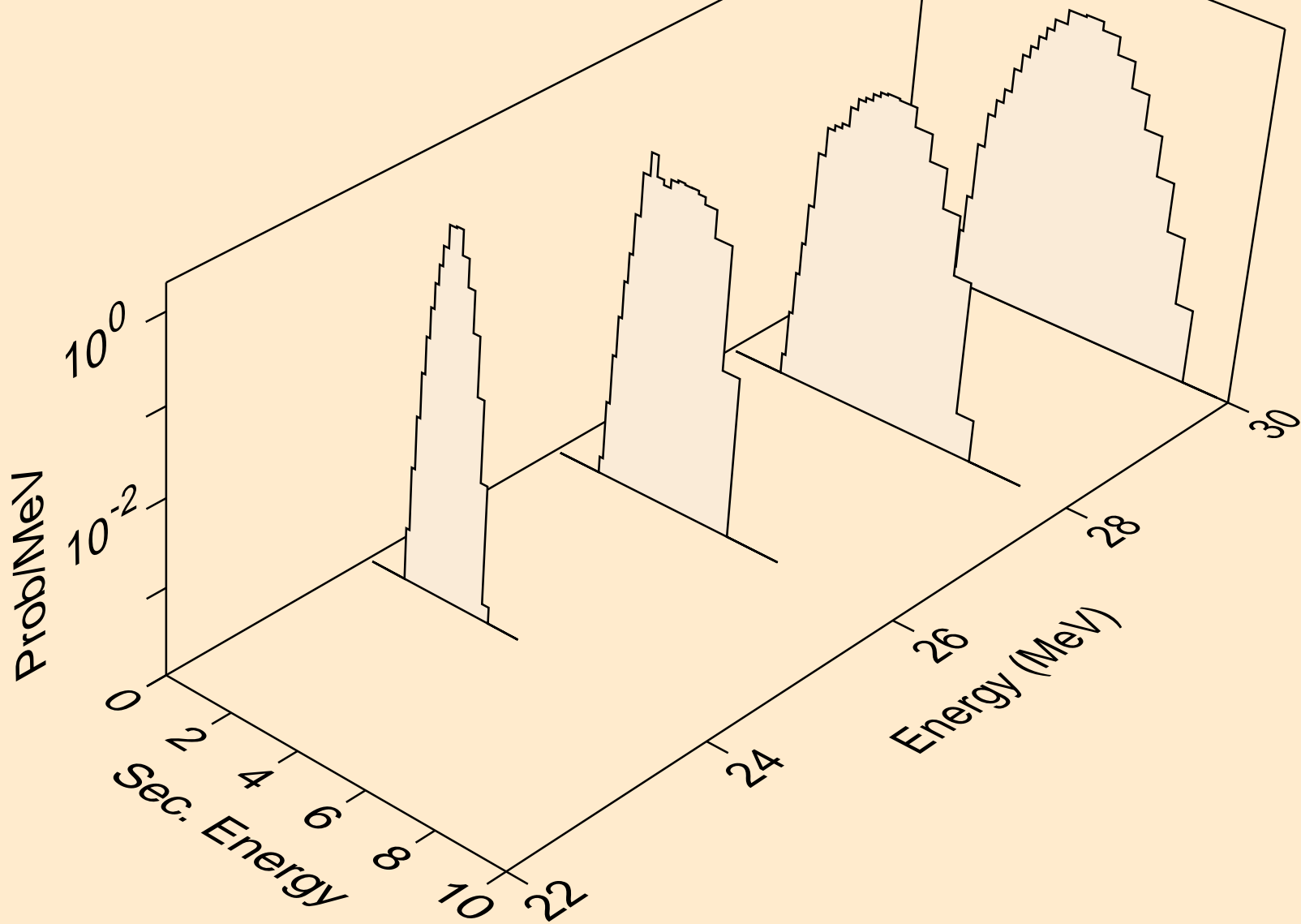

GD150 PHOTON ACER TENDL-2021 LIBRARY; T=0.K  
protons from (g,npa)

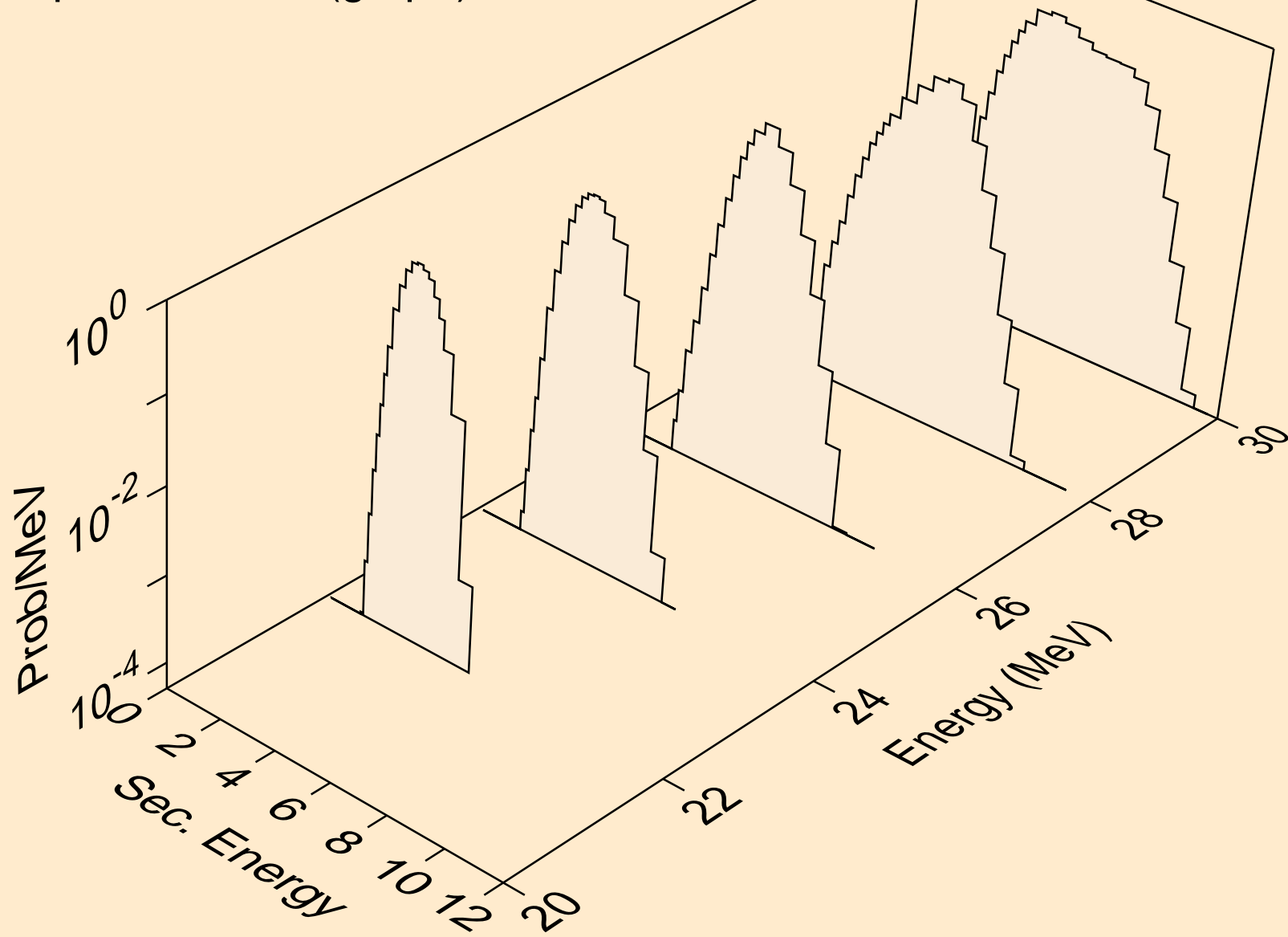

GD150 PHOTON ACER TENDL-2021 LIBRARY; T=0.K  
protons from (g,p)

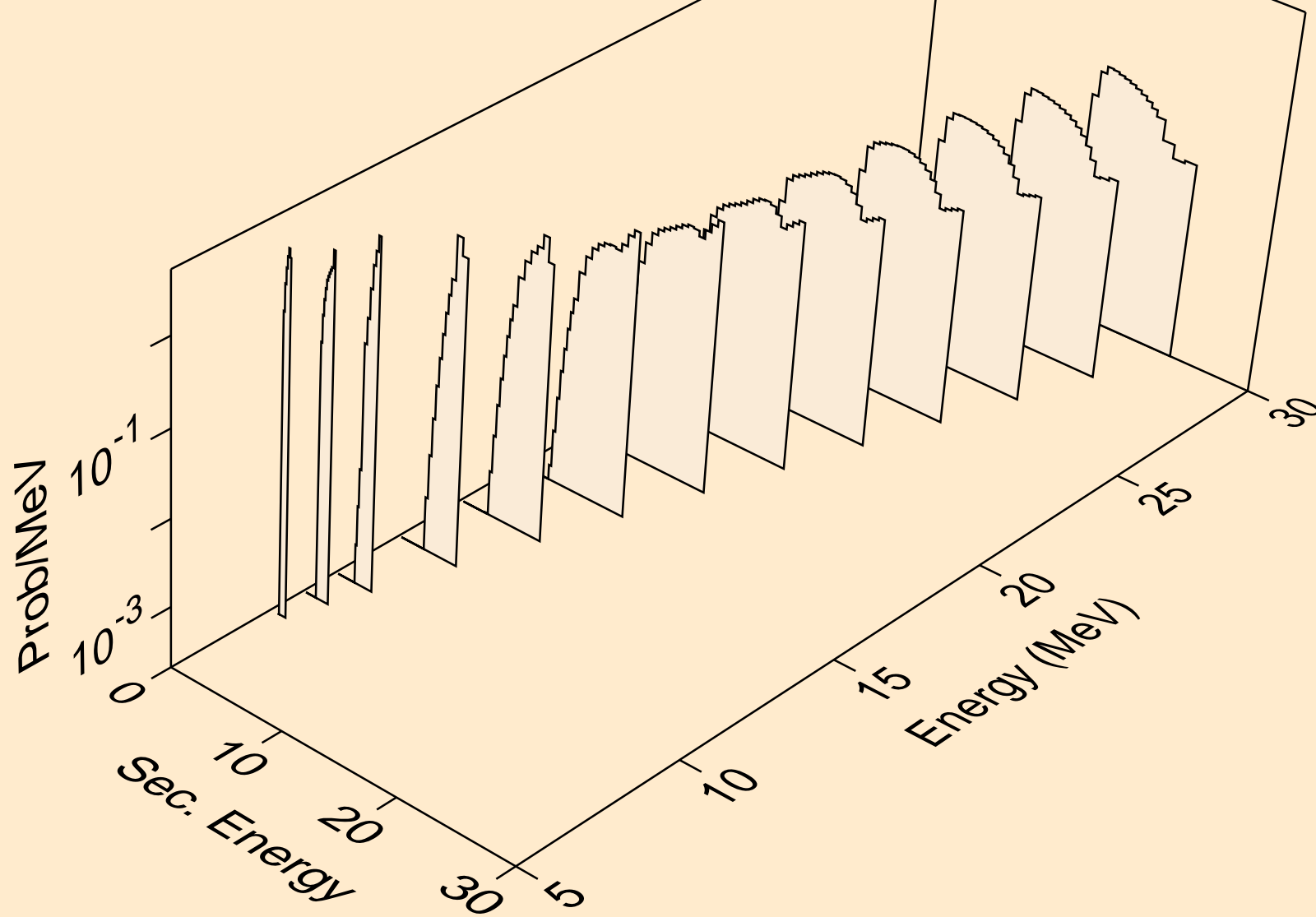

GD150 PHOTON ACER TENDL-2021 LIBRARY; T=0.K  
protons from (g,2p)

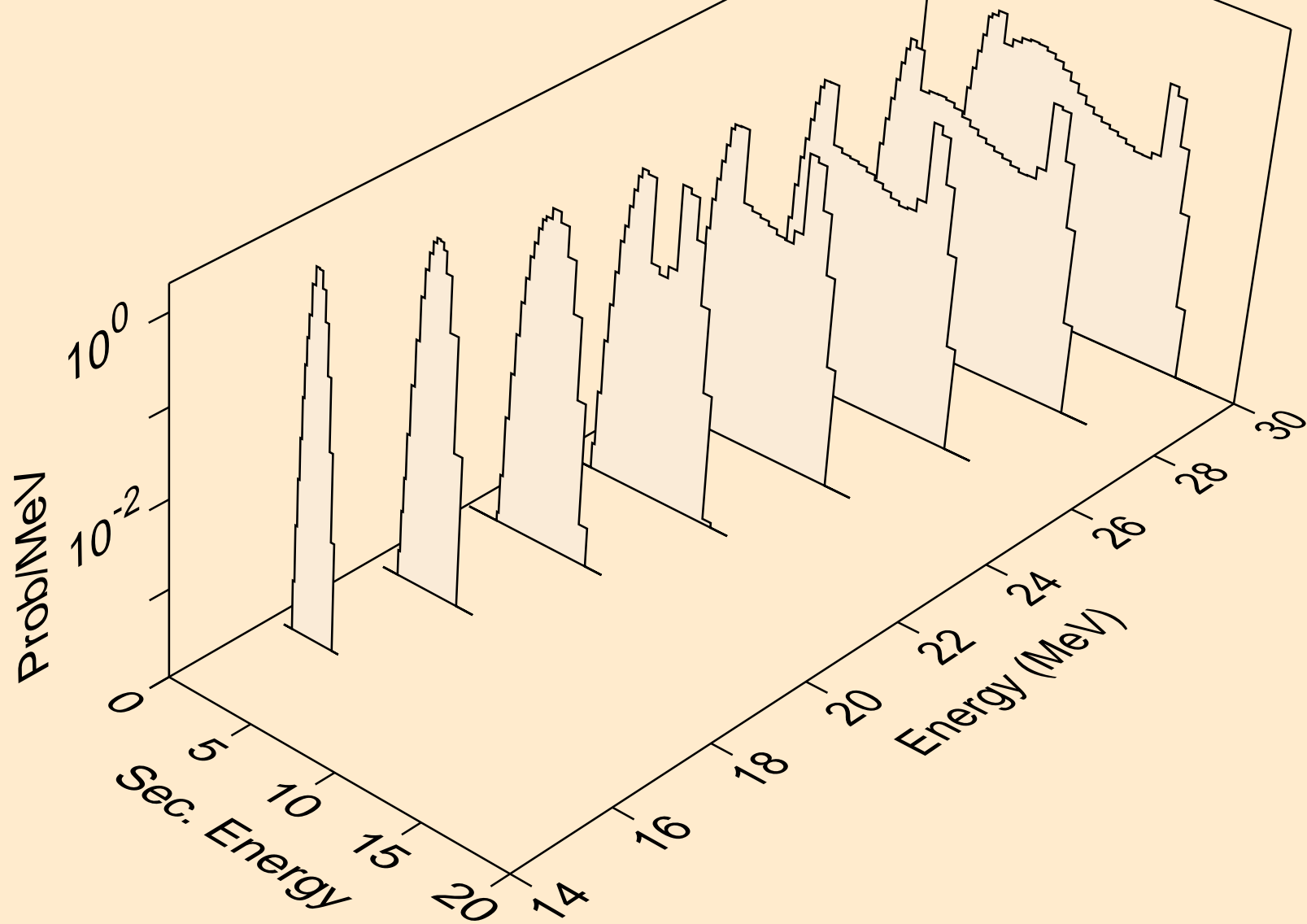

GD150 PHOTON ACER TENDL-2021 LIBRARY; T=0.K  
protons from (g,pa)

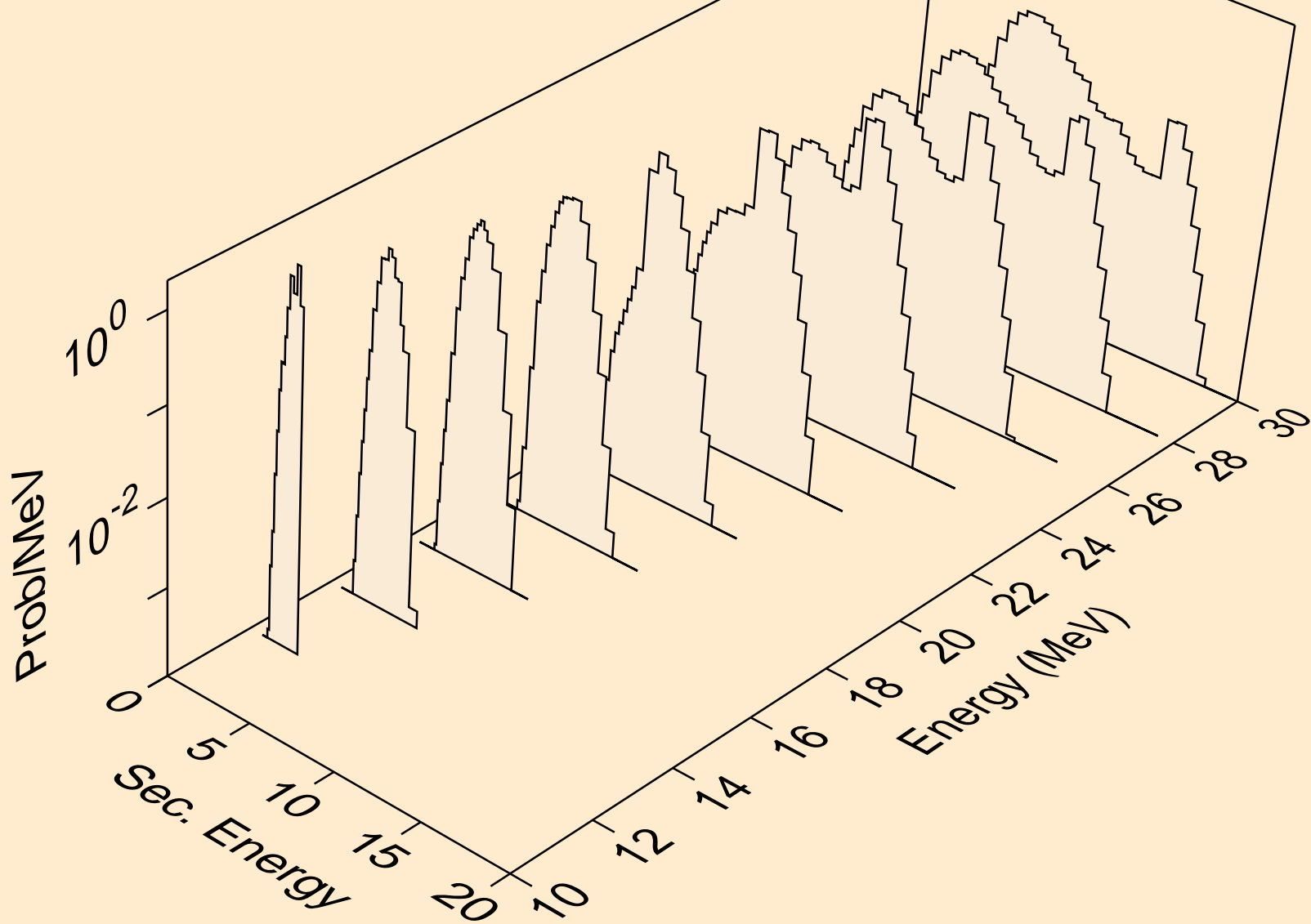

GD150 PHOTON ACER TENDL-2021 LIBRARY; T=0.K  
deuterons from (g,x)

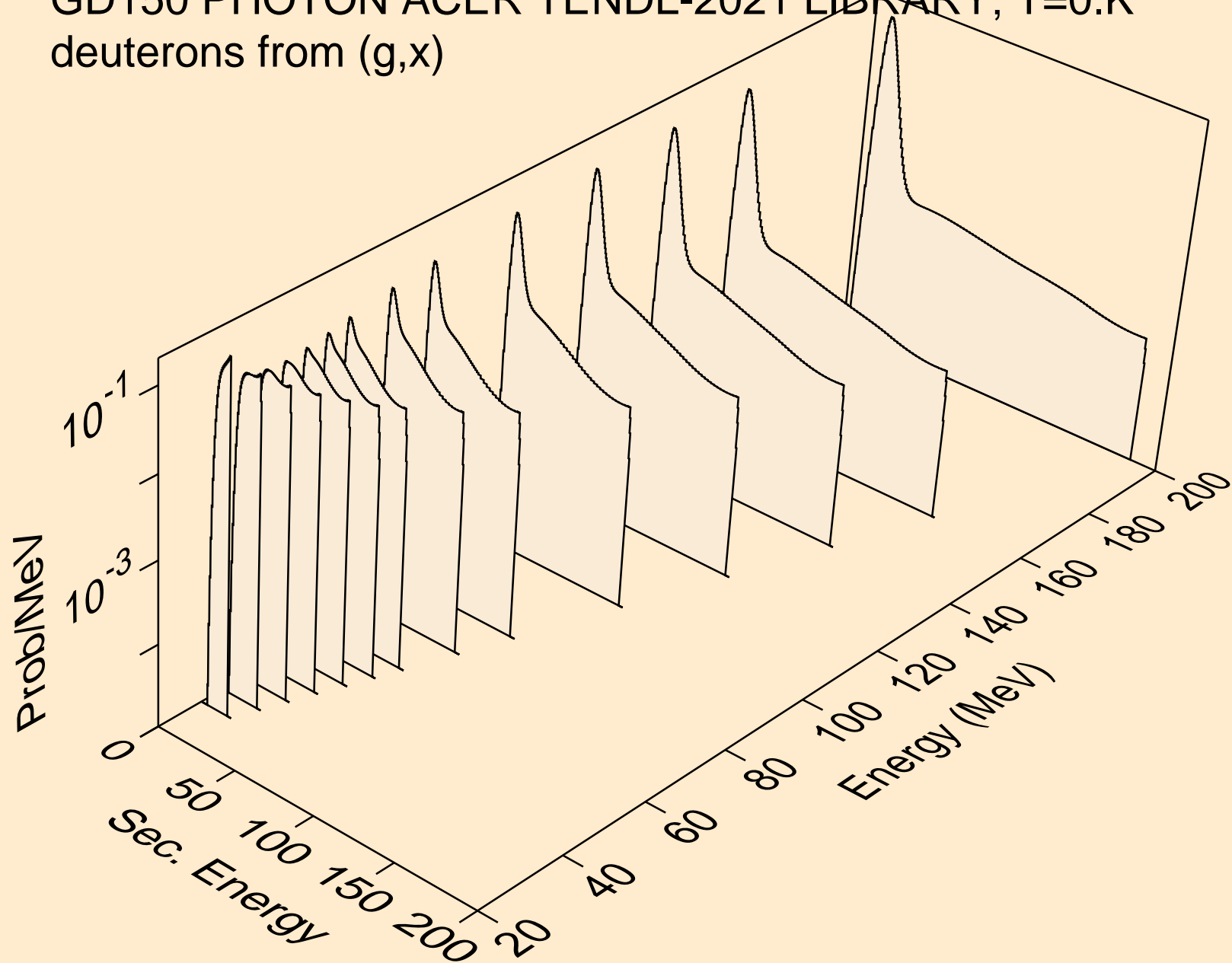

GD150 PHOTON ACER TENDL-2021 LIBRARY; T=0.K  
deuterons from (g,n\*)d

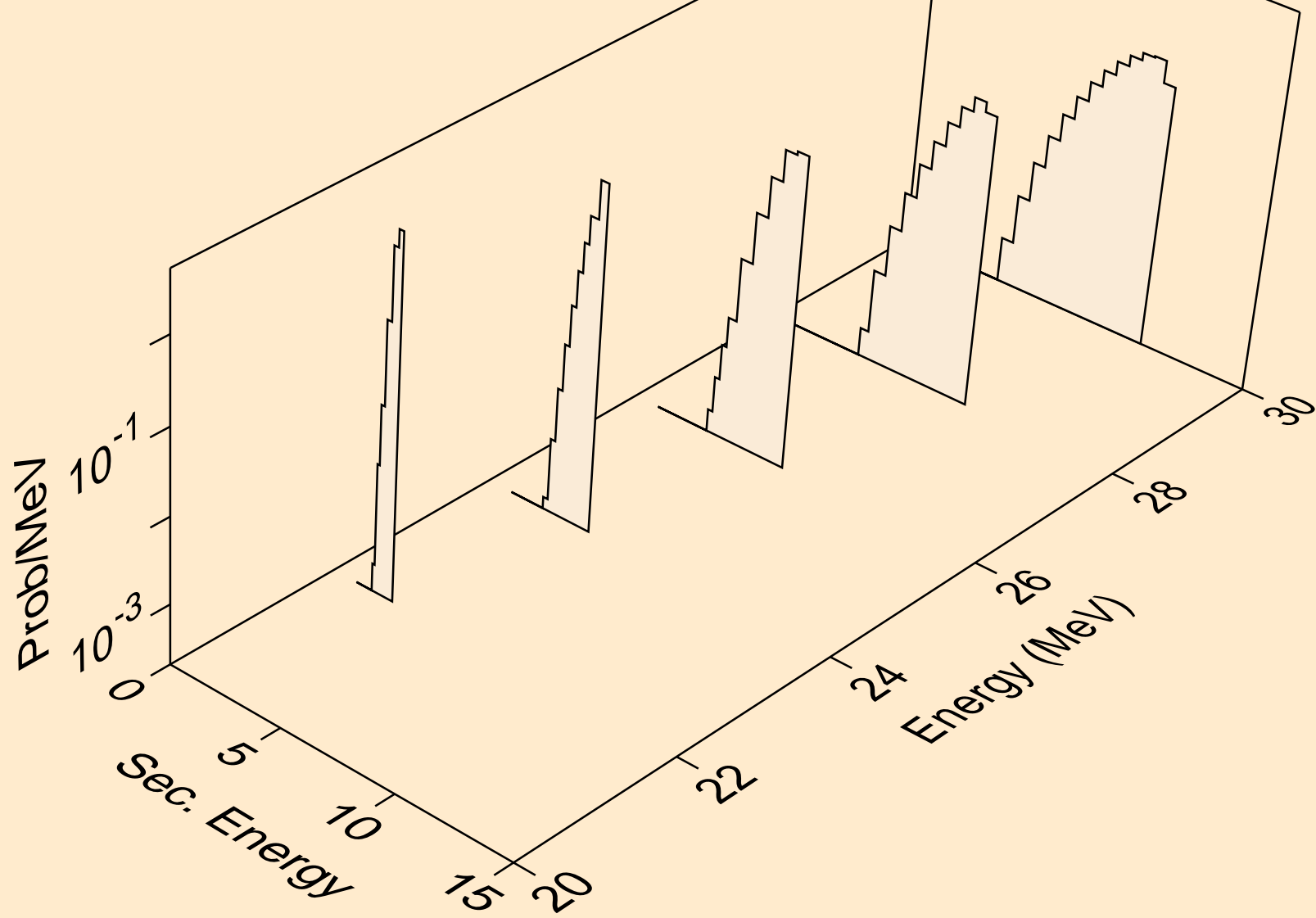



GD150 PHOTON ACER TENDL-2021 LIBRARY; T=0.K  
deuterons from (g,d)

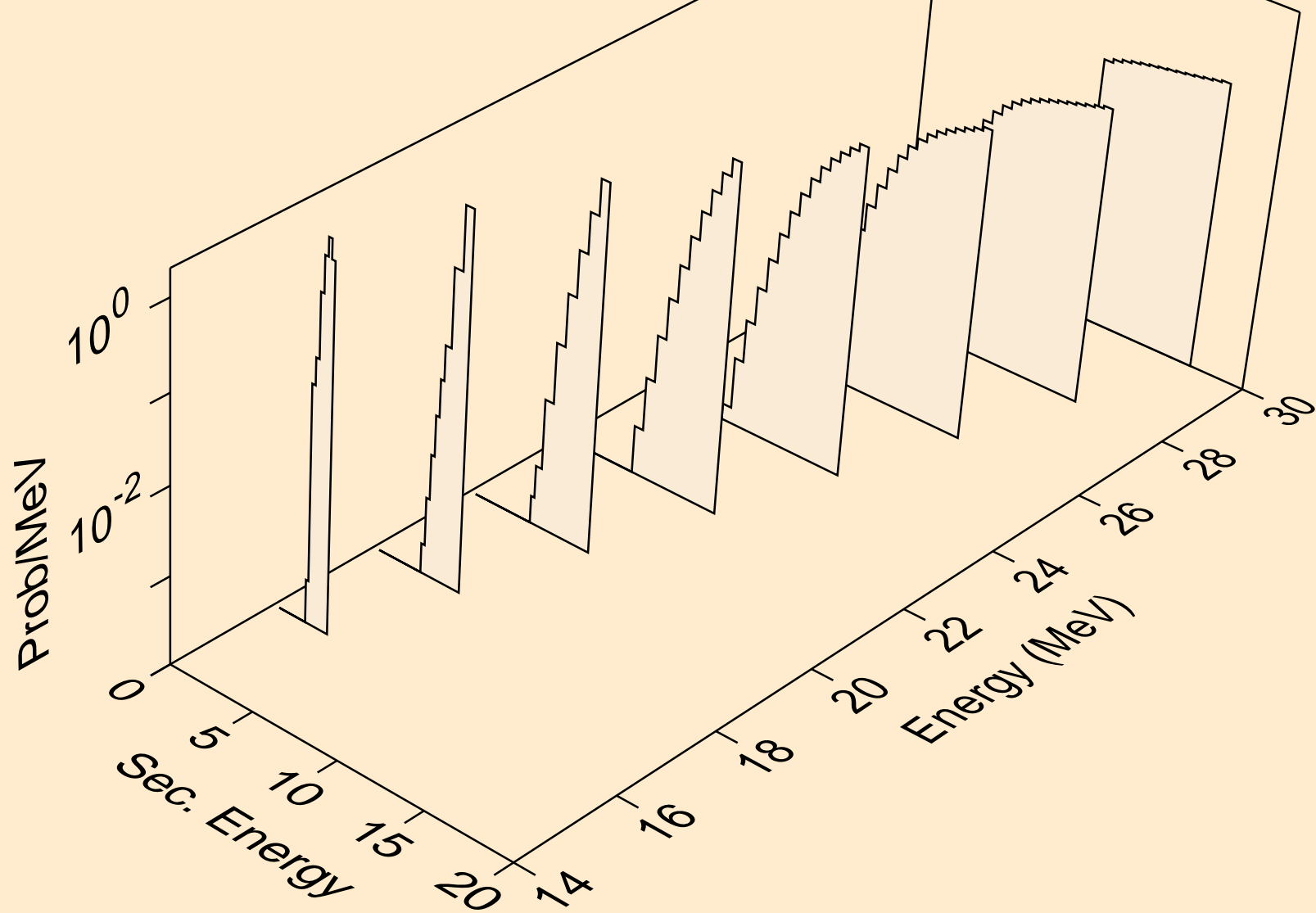

GD150 PHOTON ACER TENDL-2021 LIBRARY; T=0.K  
tritons from (g,x)

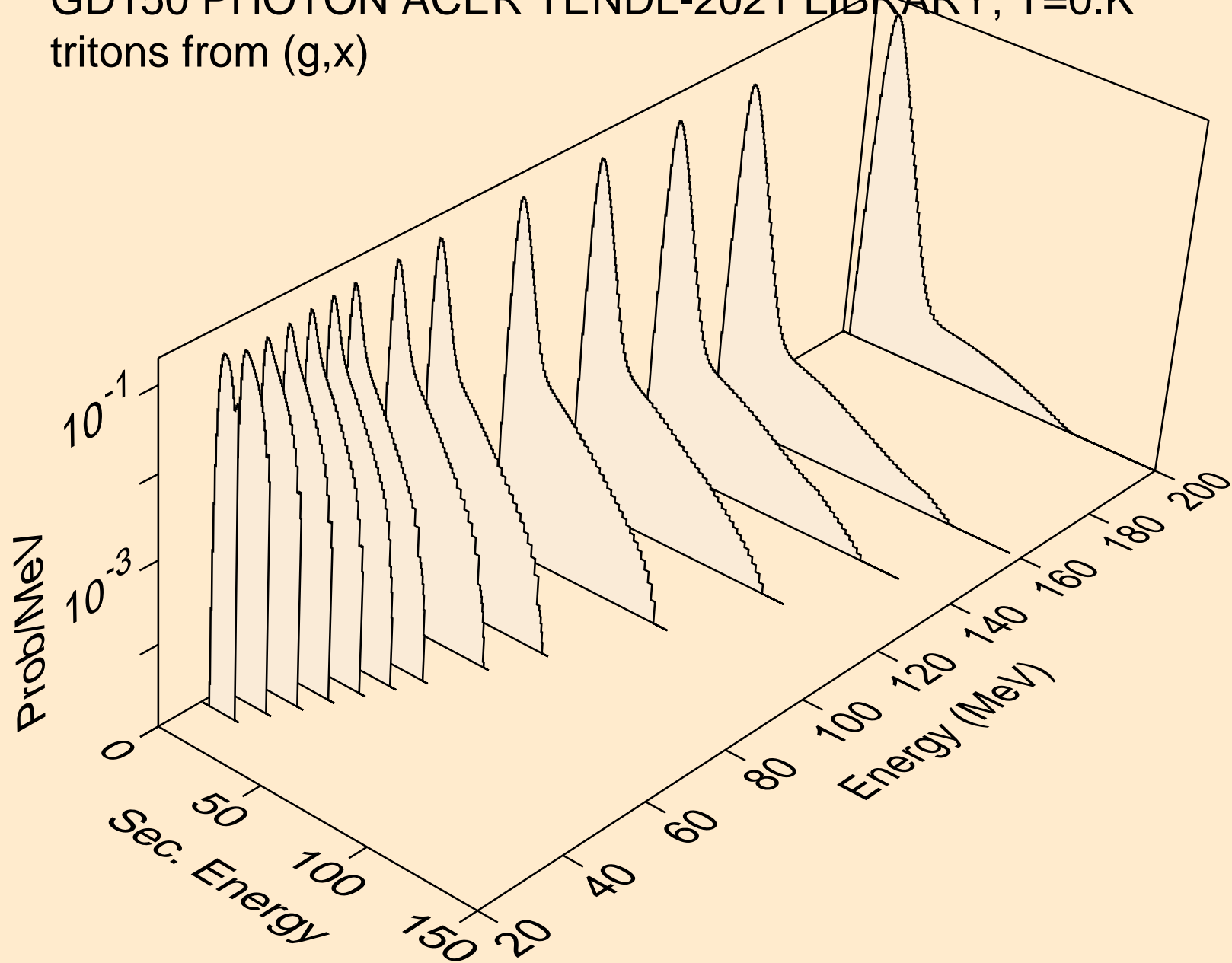

GD150 PHOTON ACER TENDL-2021 LIBRARY; T=0.K  
tritons from (g,n\*)t

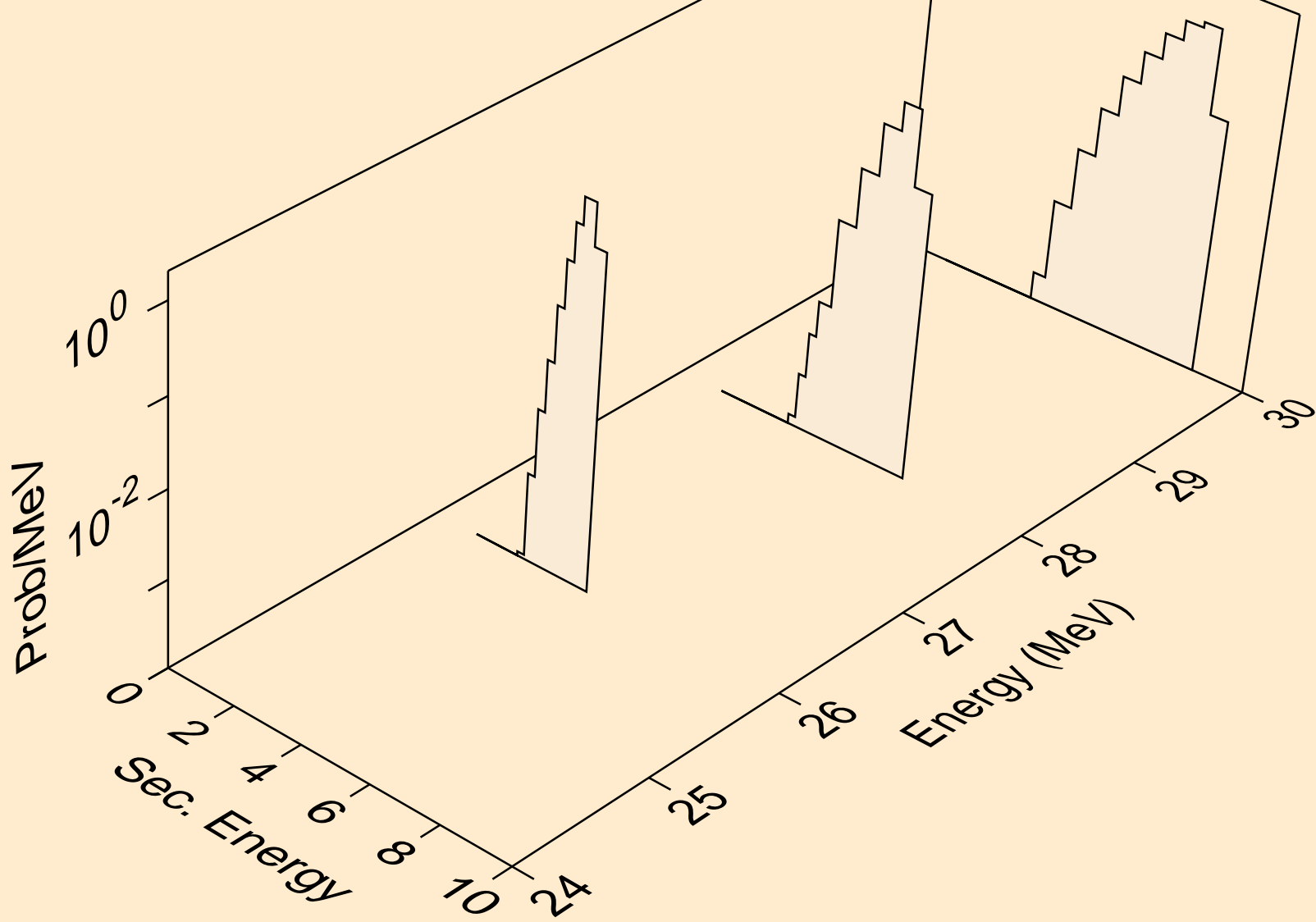

GD150 PHOTON ACER TENDL-2021 LIBRARY; T=0.K  
tritons from (g,t)

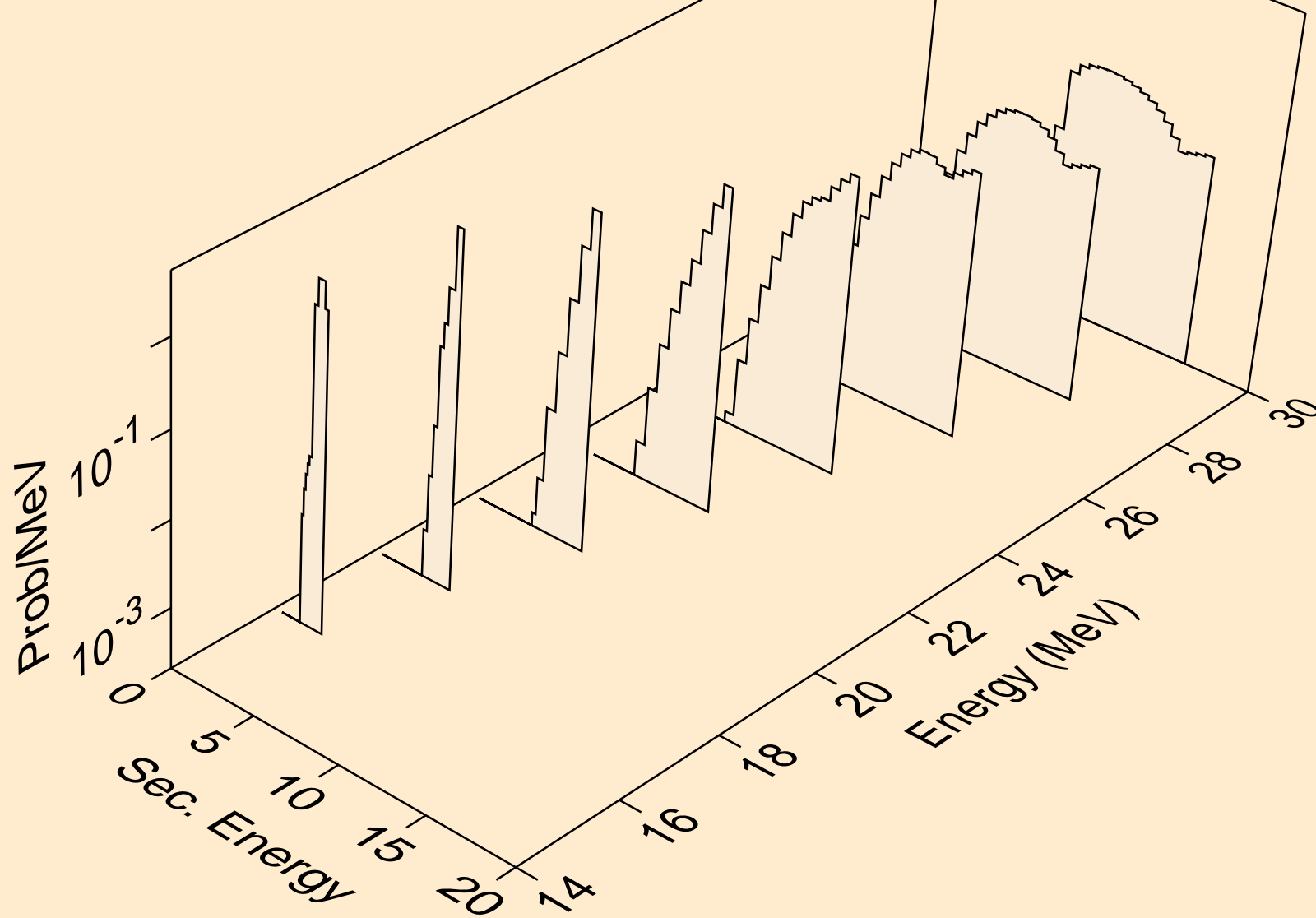

GD150 PHOTON ACER TENDL-2021 LIBRARY; T=0.K  
he3s from (g,x)

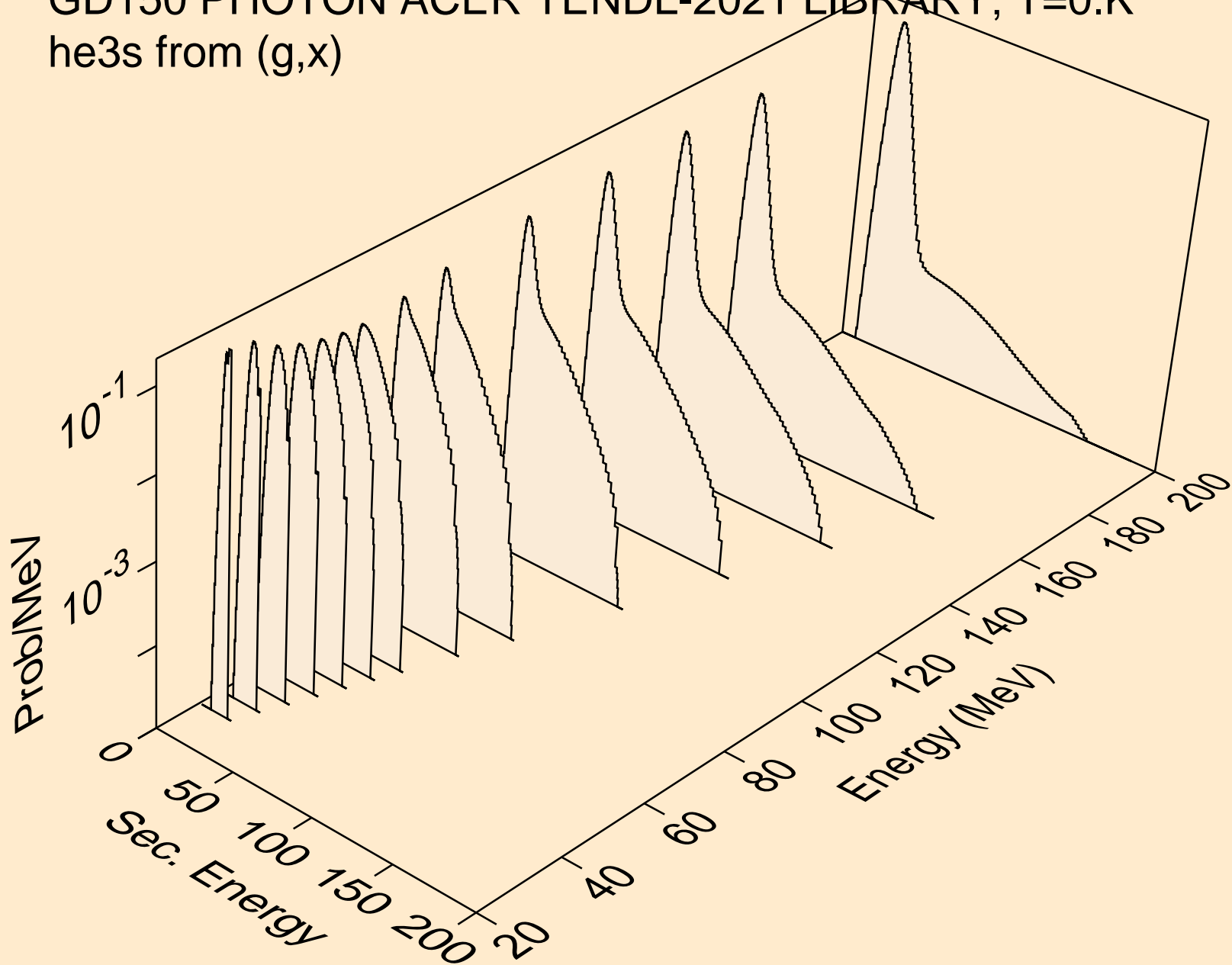

GD150 PHOTON ACER TENDL-2021 LIBRARY; T=0.K  
he3s from (g,he3)

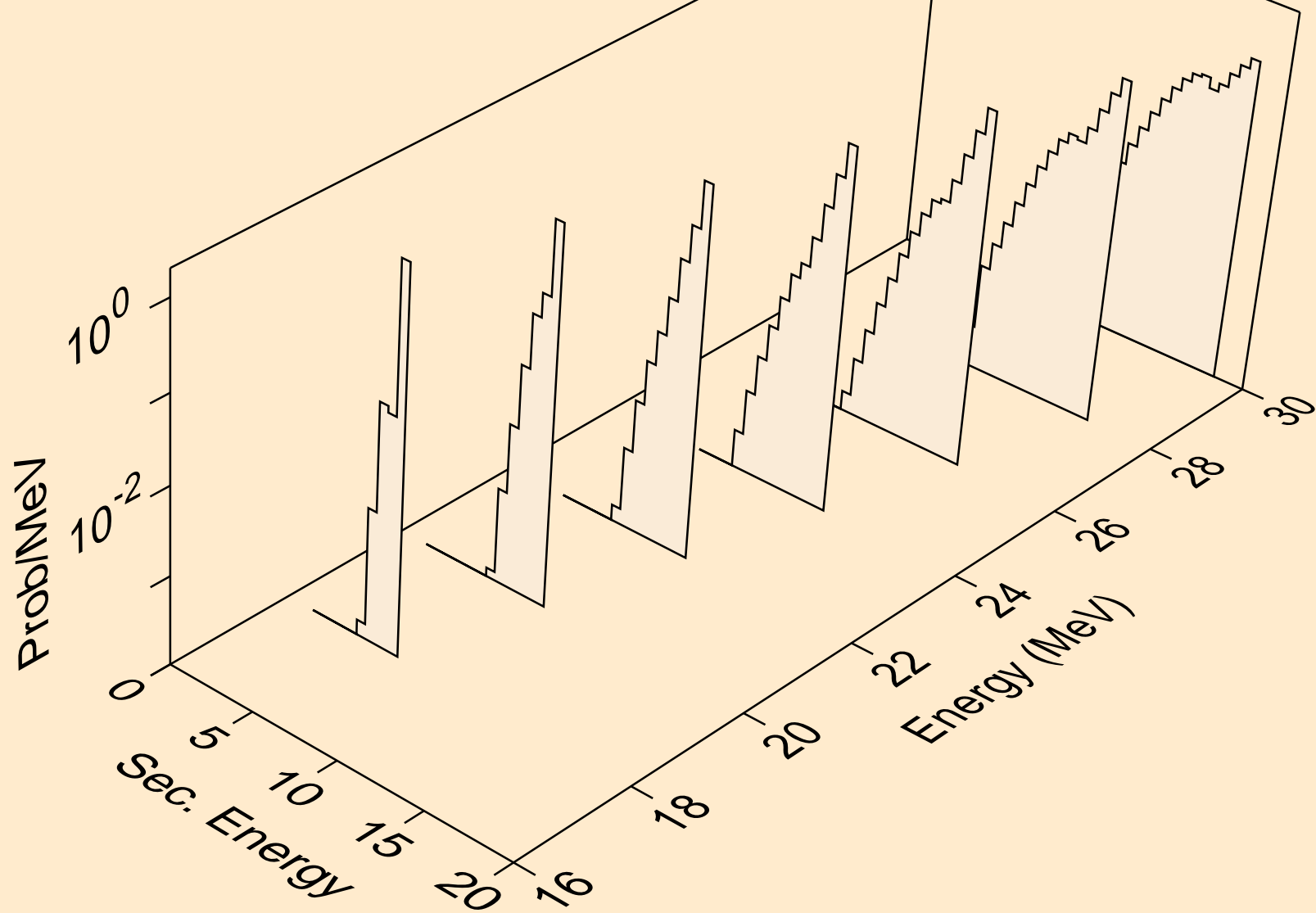

GD150 PHOTON ACER TENDL-2021 LIBRARY; T=0.K  
alphas from (g,x)

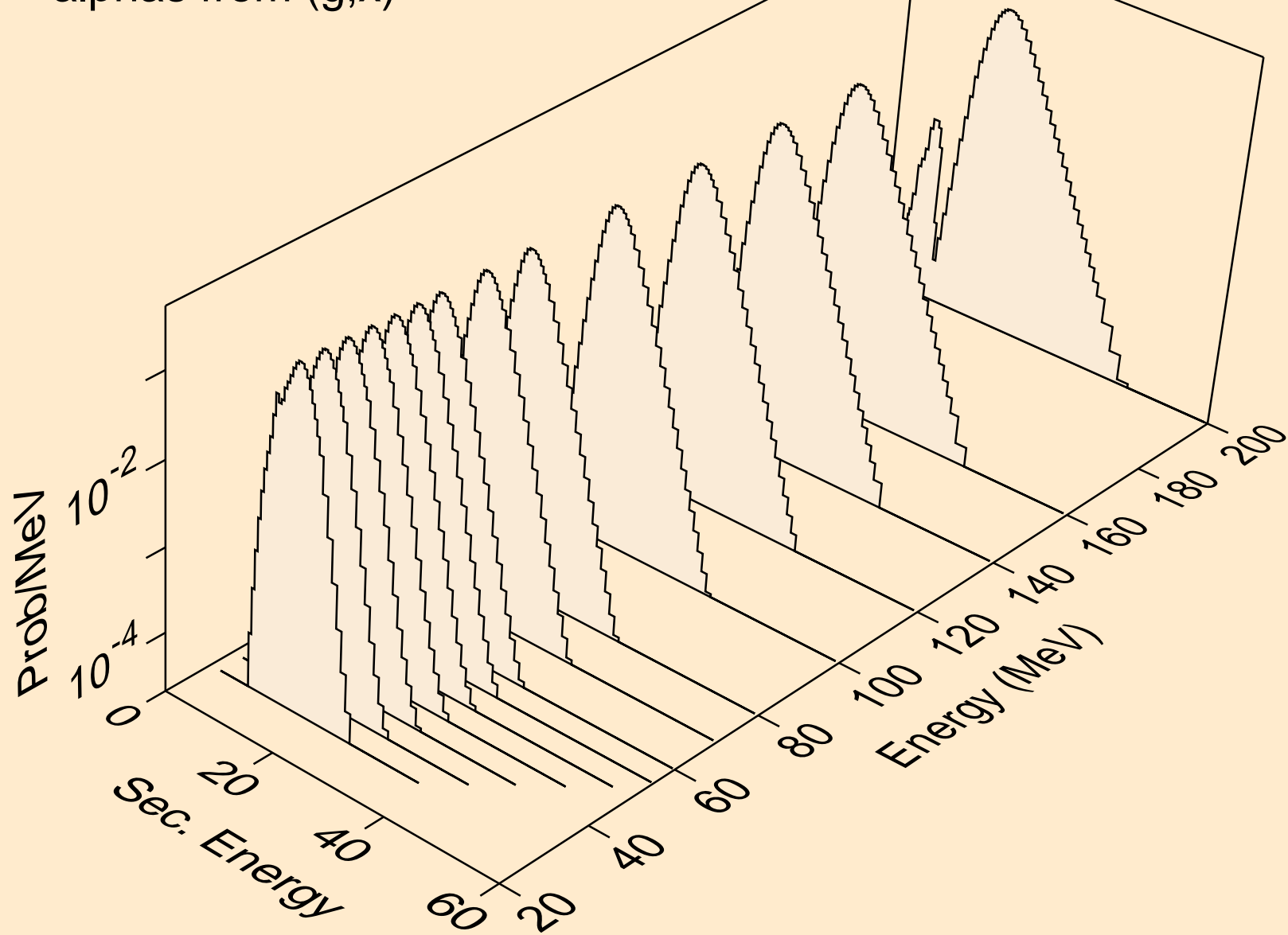

GD150 PHOTON ACER TENDL-2021 LIBRARY; T=0.K  
alphas from (g,n\*)a

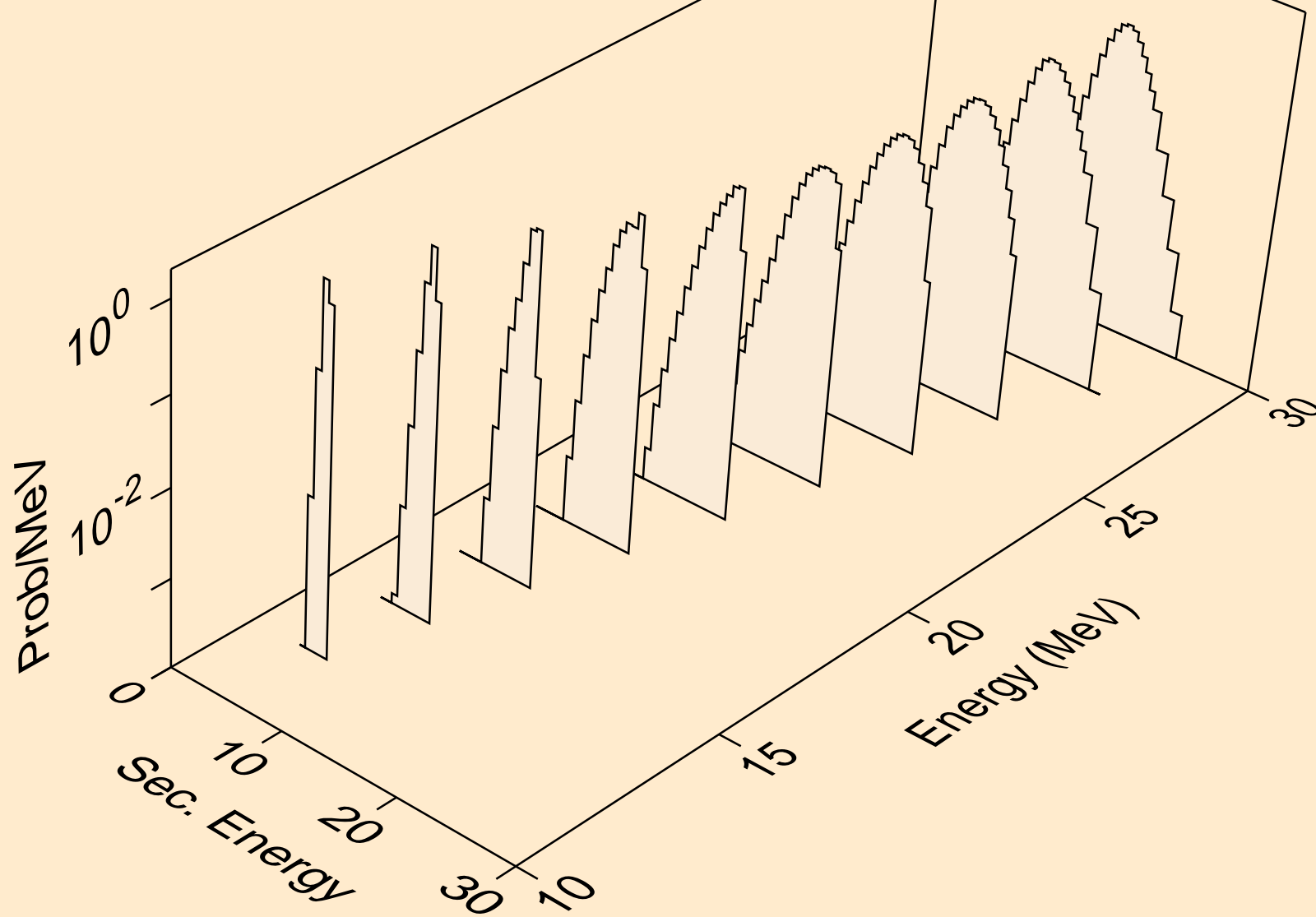



GD150 PHOTON ACER TENDL-2021 LIBRARY; T=0.K  
alphas from (g,2n)a

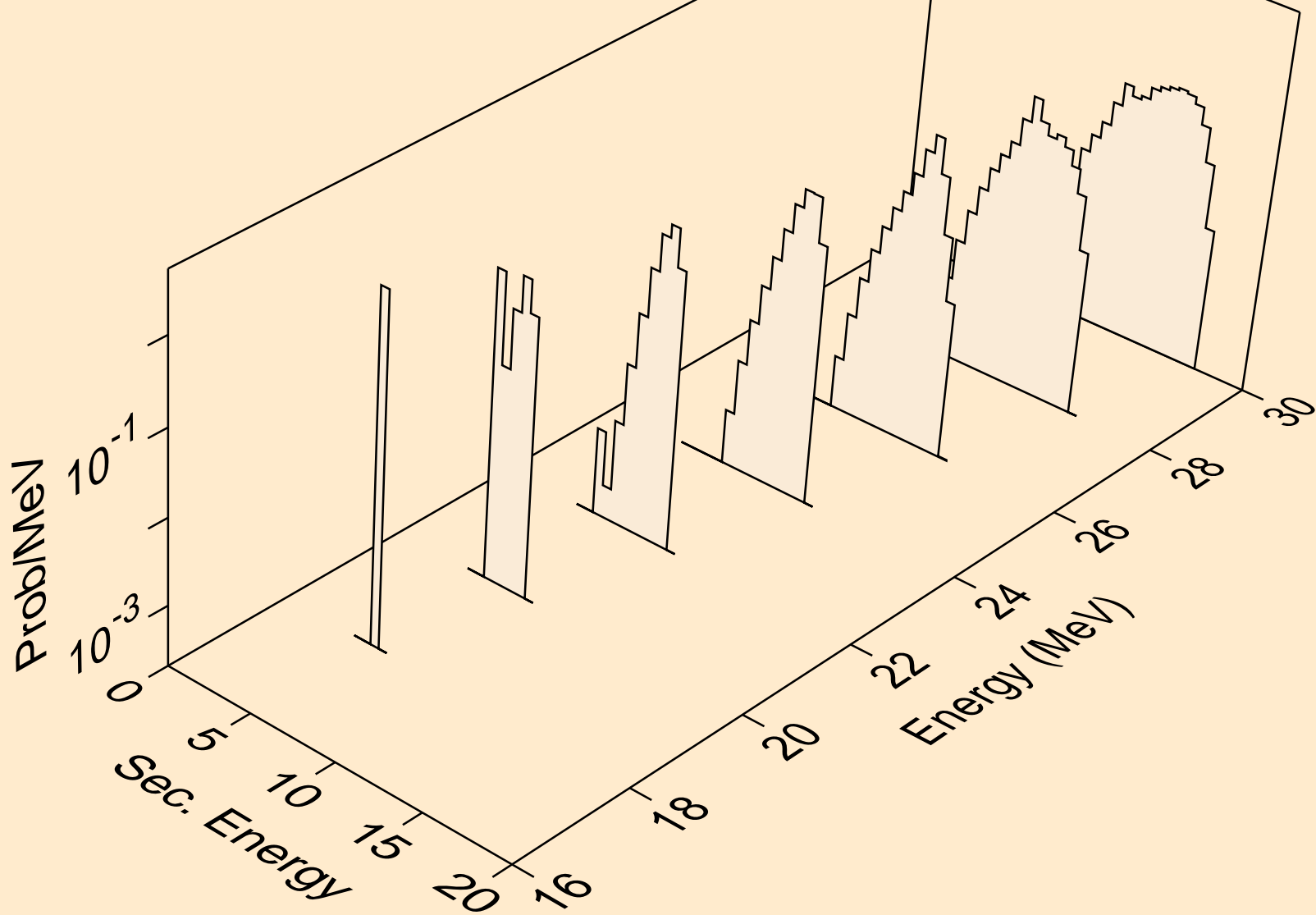

GD150 PHOTON ACER TENDL-2021 LIBRARY; T=0.K  
alphas from (g,npa)

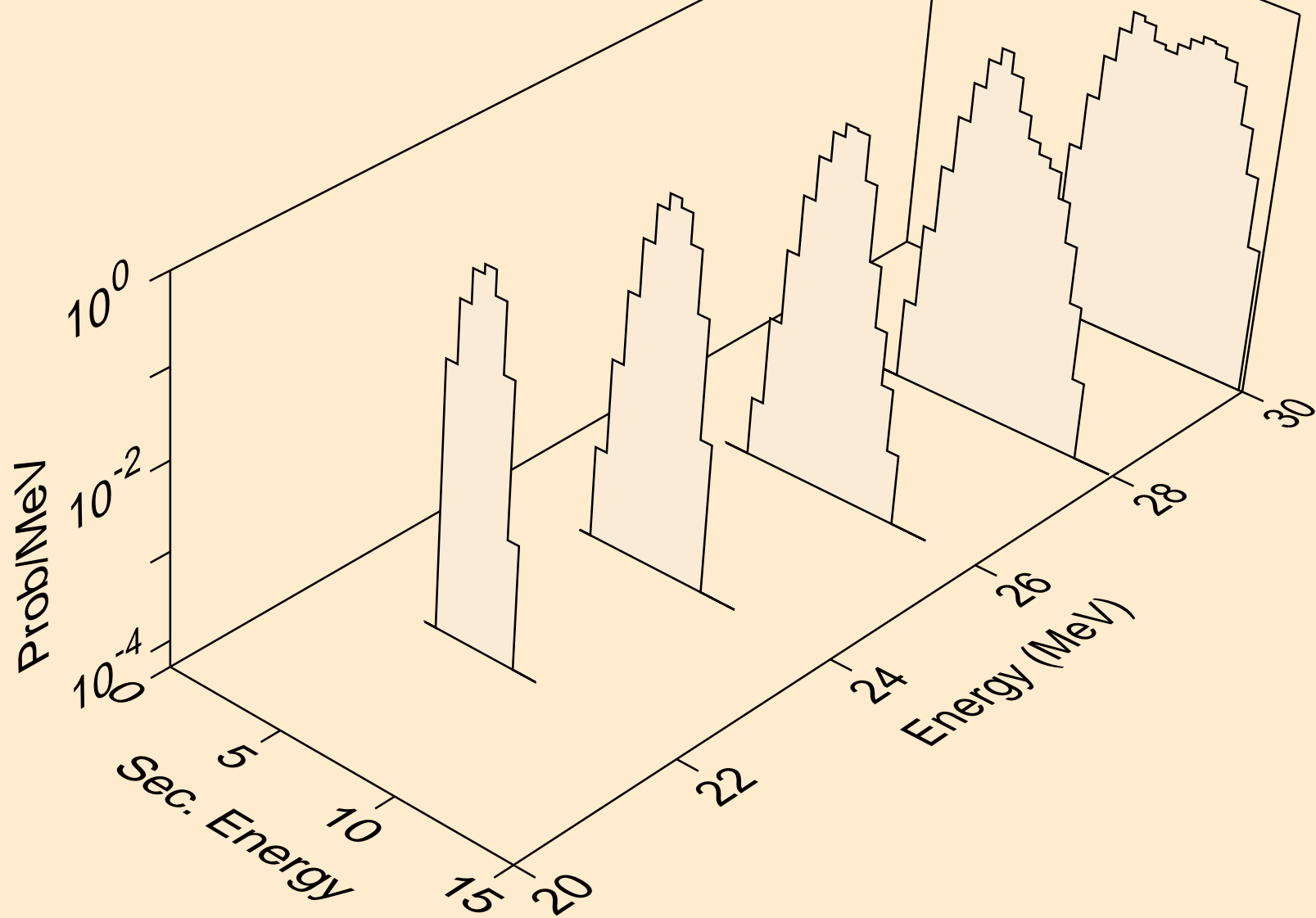

GD150 PHOTON ACER TENDL-2021 LIBRARY; T=0.K  
alphas from (g,a)

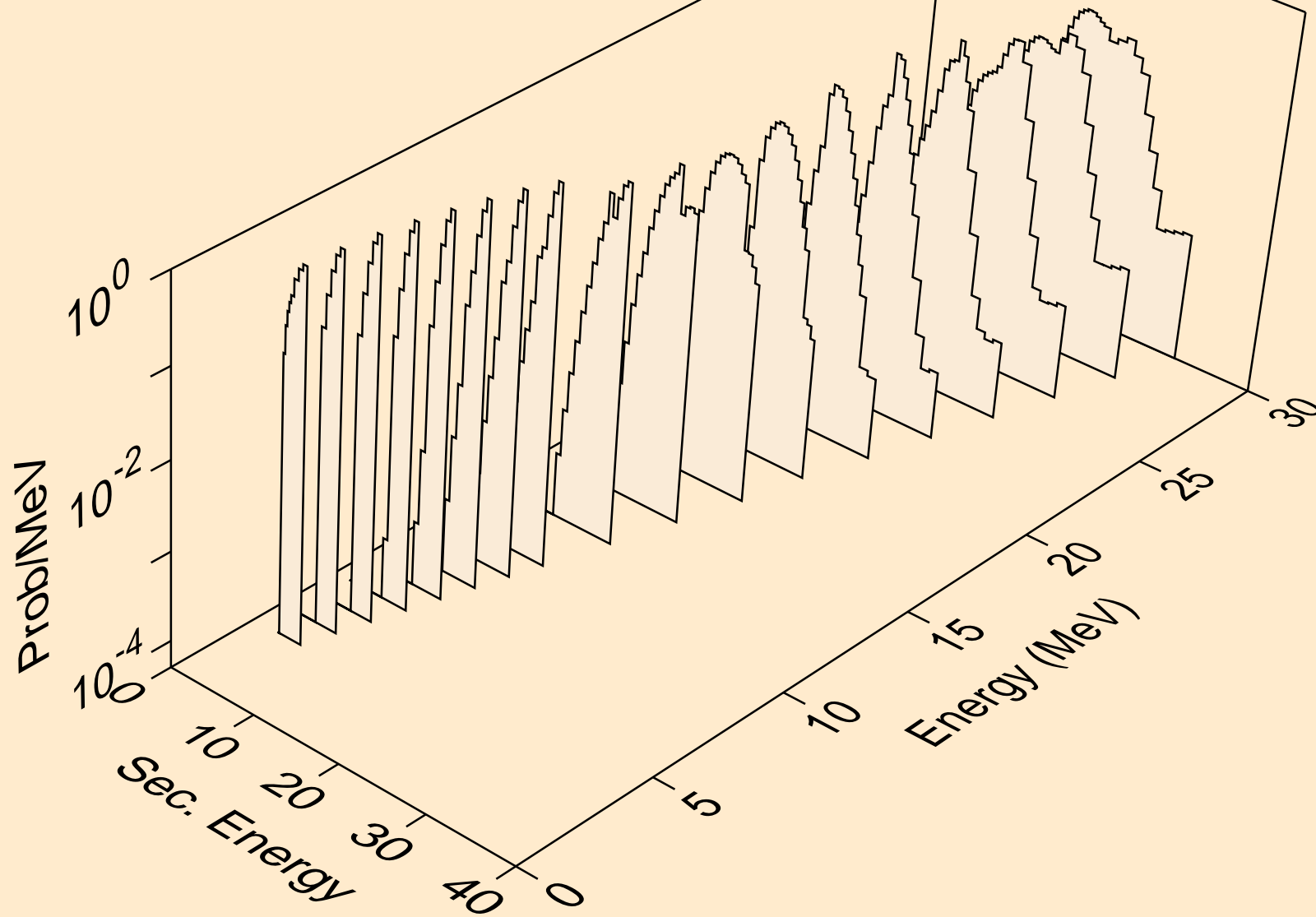

GD150 PHOTON ACER TENDL-2021 LIBRARY; T=0.K  
alphas from (g,2a)

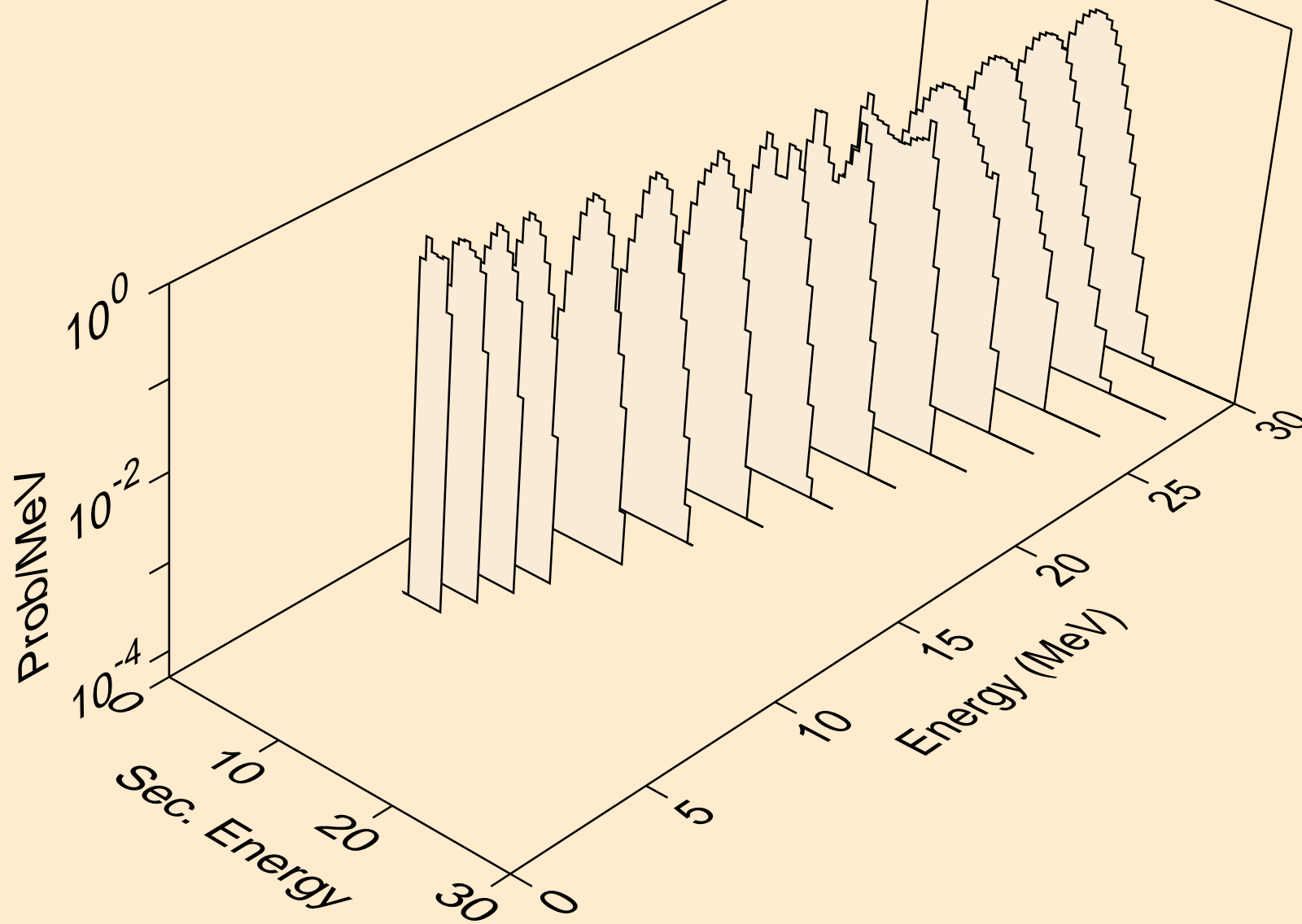

GD150 PHOTON ACER TENDL-2021 LIBRARY; T=0.K  
alphas from (g,pa)

