

PM156M PHOTON ACER TENDL-2021 LIBRARY; T=0.K
Principal cross sections

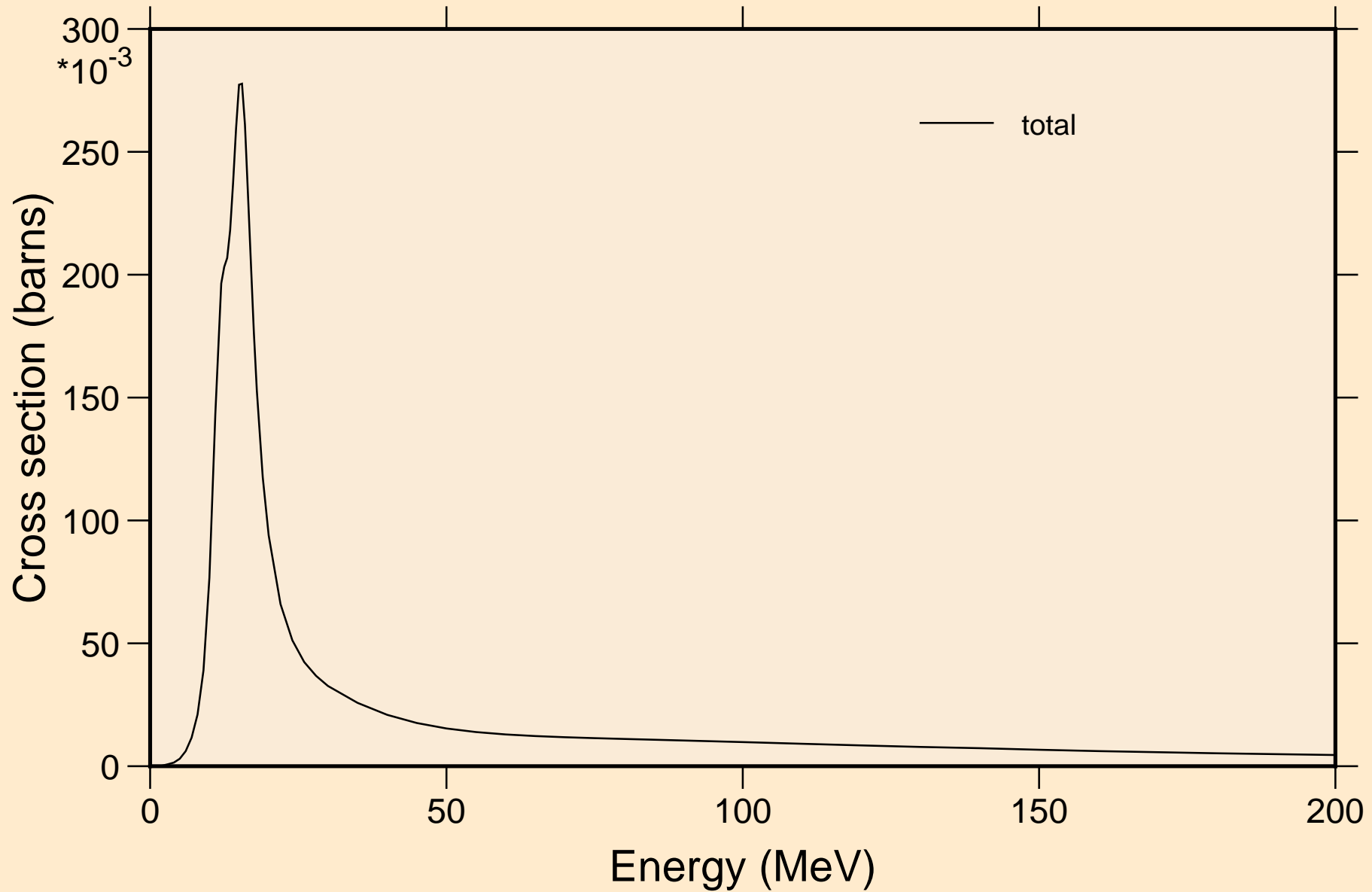

PM156M PHOTON ACER TENDL-2021 LIBRARY; T=0.K

Partial cross sections

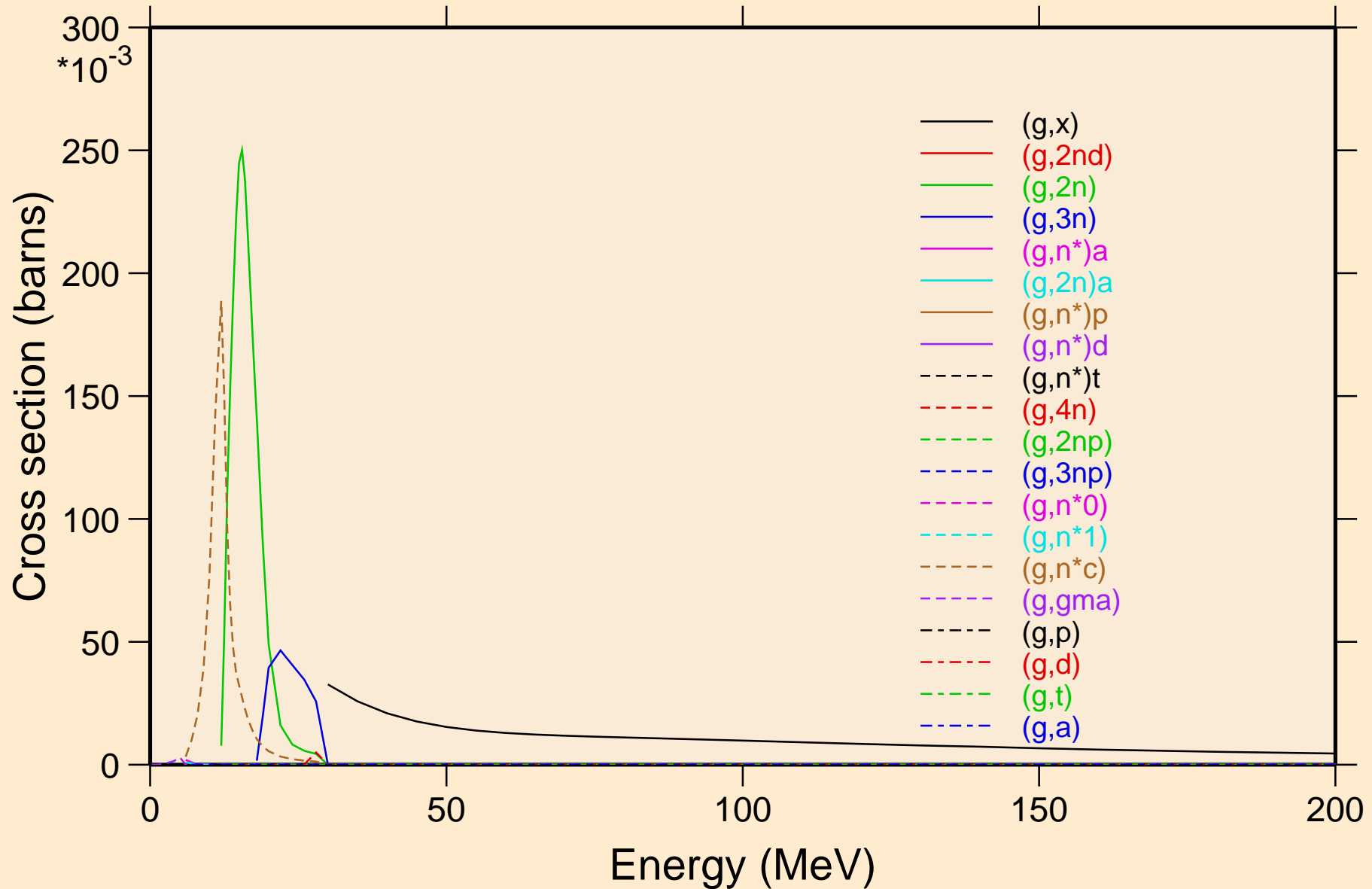

PM156M PHOTON ACER TENDL-2021 LIBRARY; T=0.K

Heating

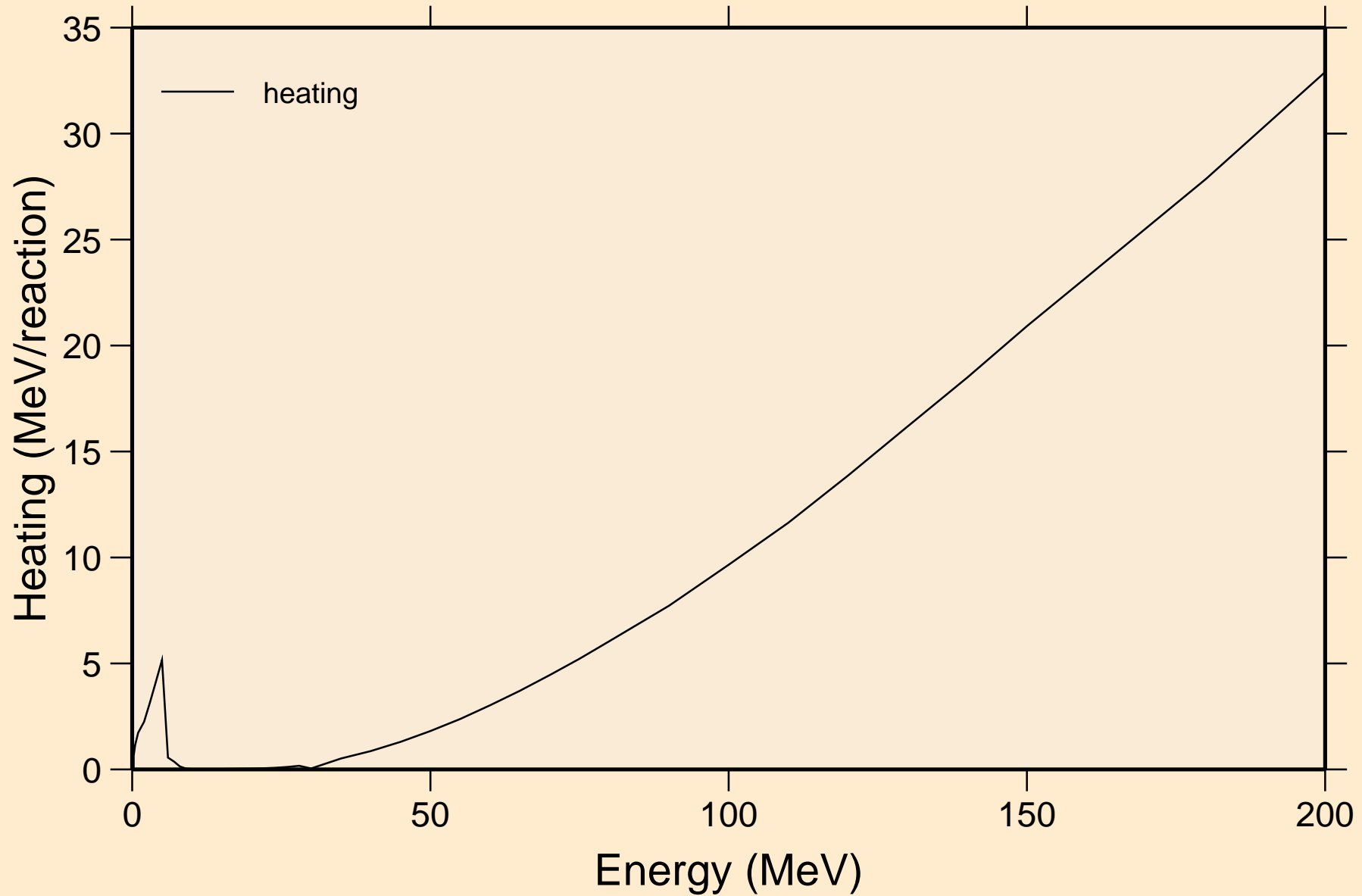

PM156M PHOTON ACER TENDL-2021 LIBRARY; T=0.K

Particle heating contributions

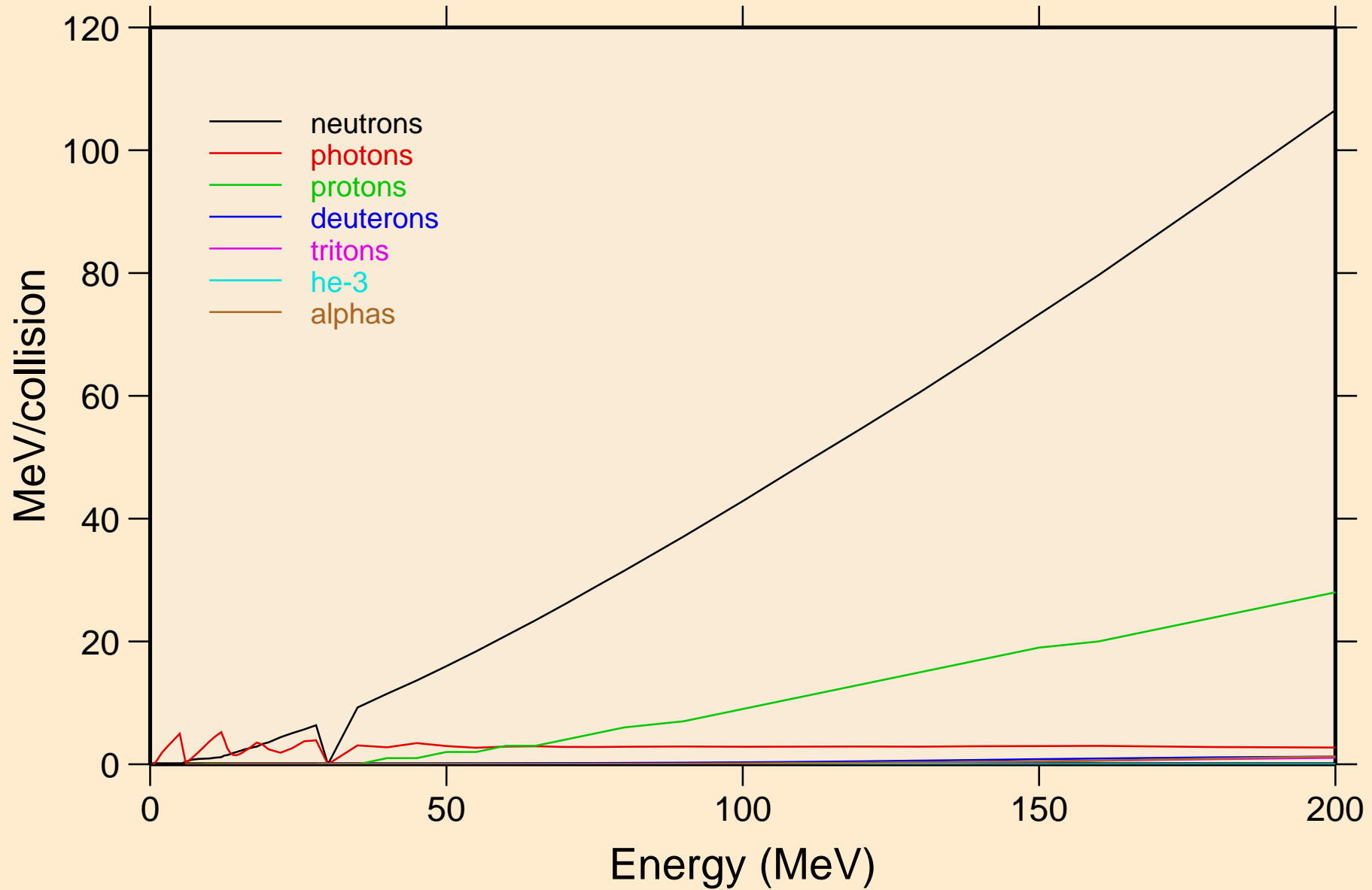

PM156M PHOTON ACER TENDL-2021 LIBRARY; T=0.K
Particle production cross sections

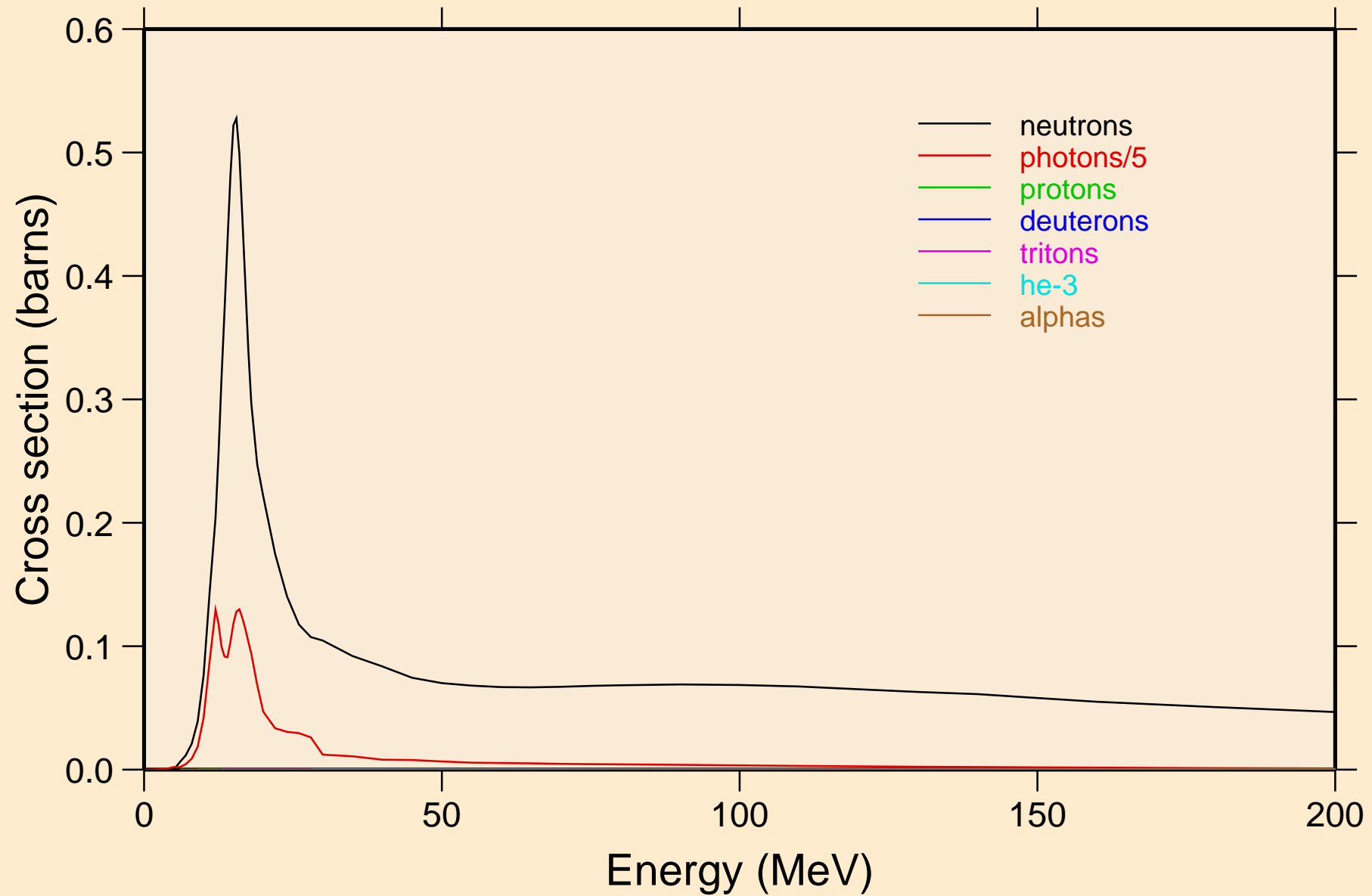

PM156M PHOTON ACER TENDL-2021 LIBRARY; T=0.K
neutrons from (g,x)

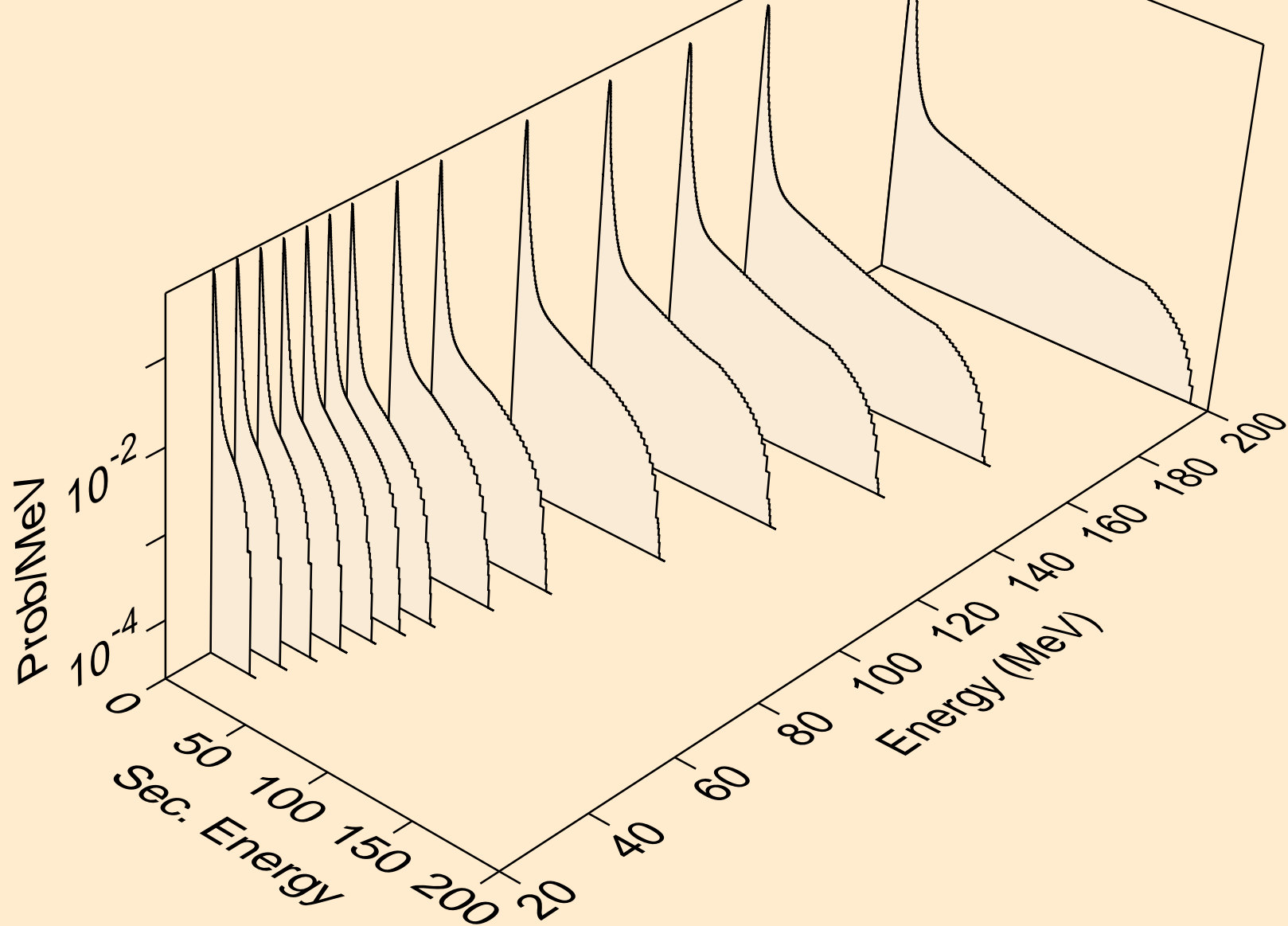

PM156M PHOTON ACER TENDL-2021 LIBRARY; T=0.K
neutrons from (g,2nd)

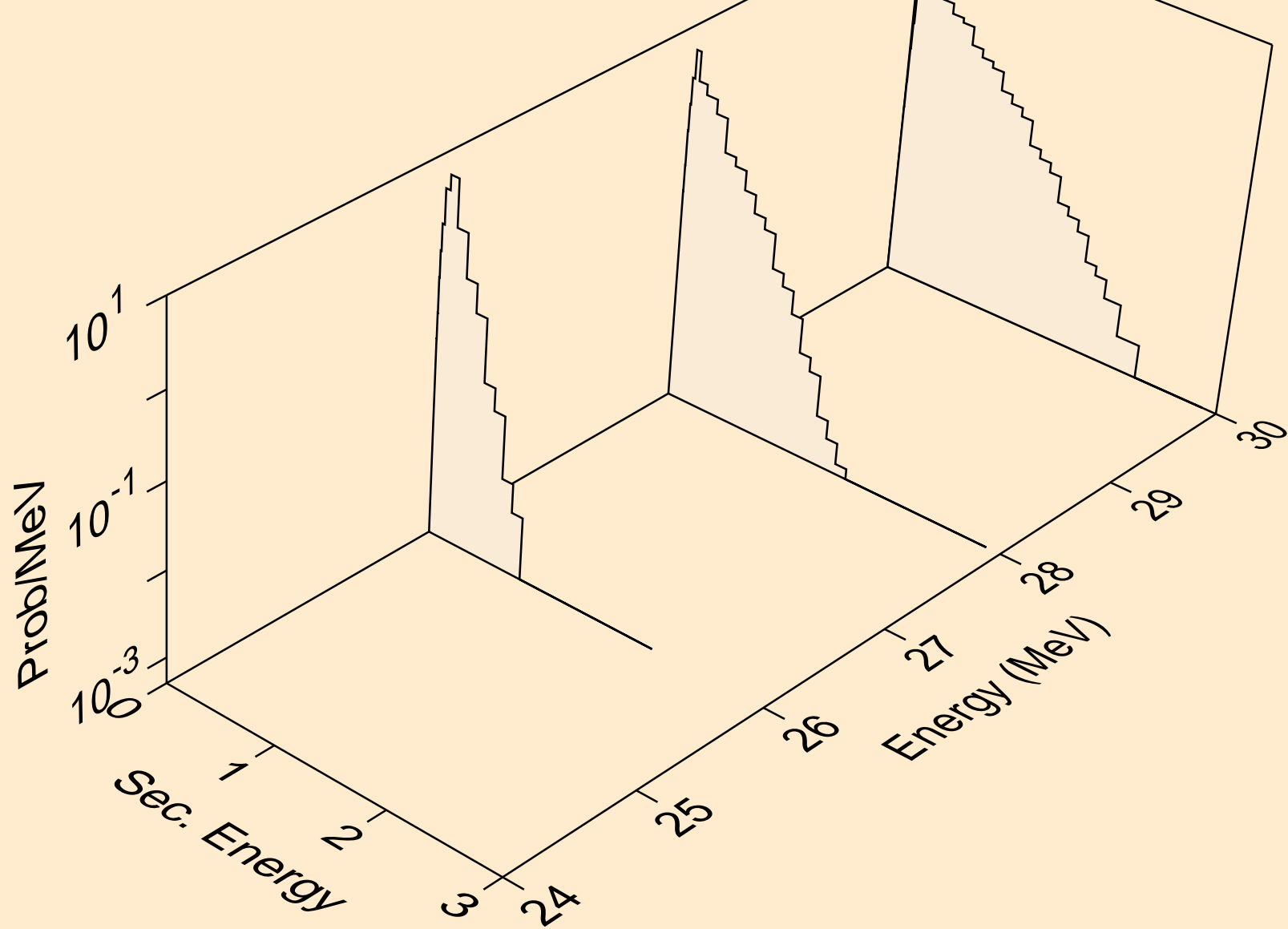

PM156M PHOTON ACER TENDL-2021 LIBRARY; T=0.K
neutrons from (g,2n)

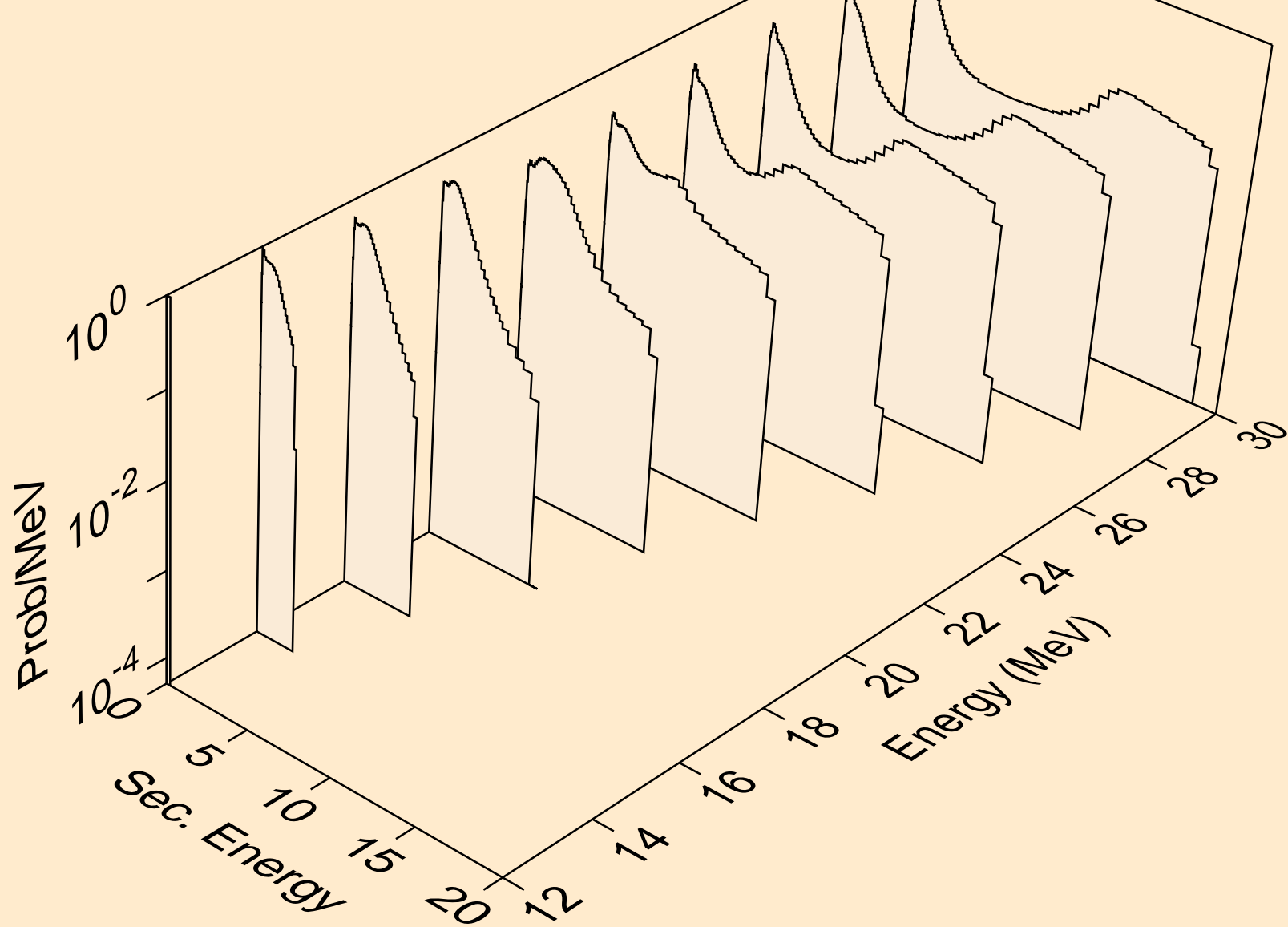

PM156M PHOTON ACER TENDL-2021 LIBRARY; T=0.K
neutrons from (g,3n)

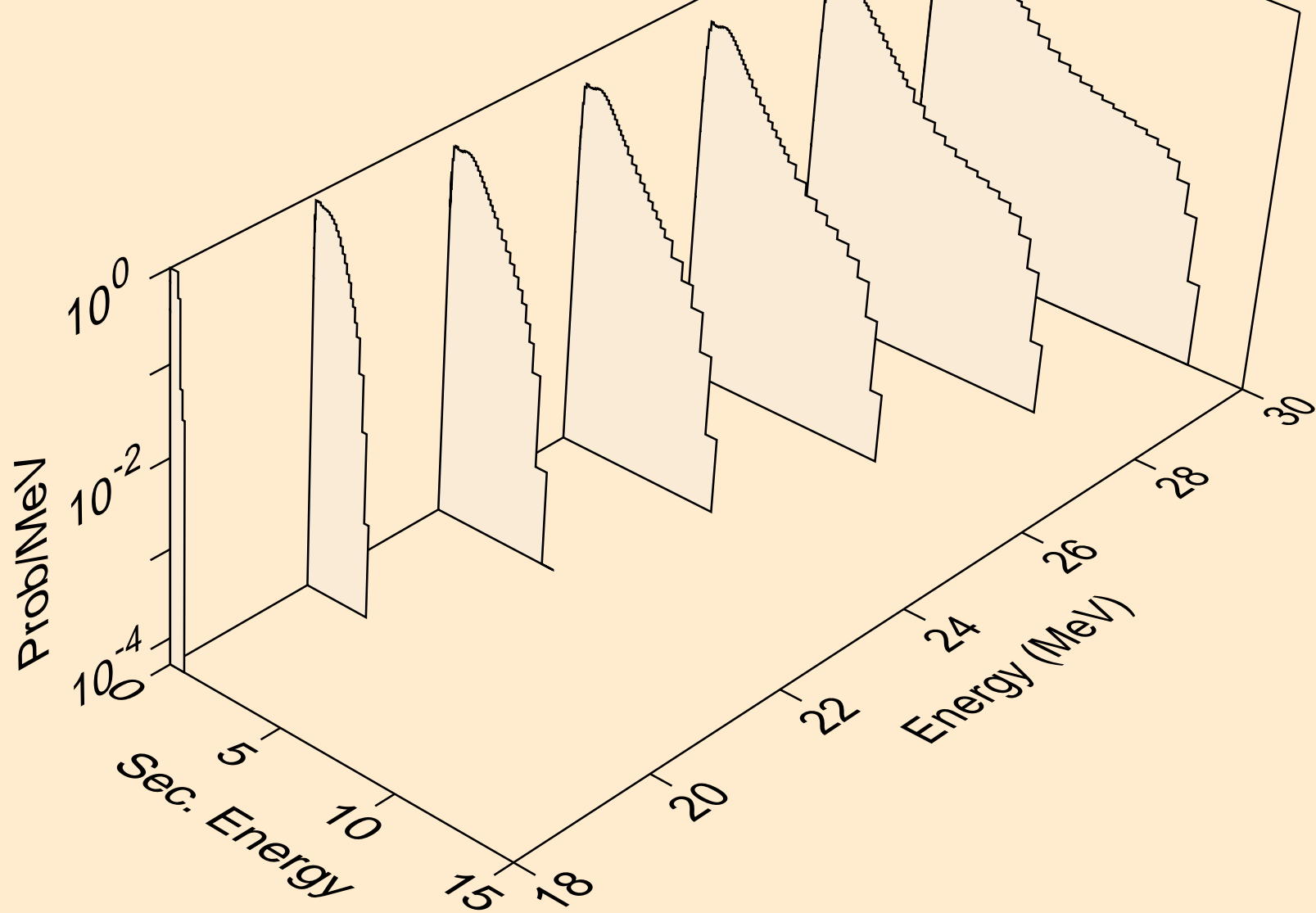

PM156M PHOTON ACER TENDL-2021 LIBRARY; T=0.K
neutrons from (g,n*)a

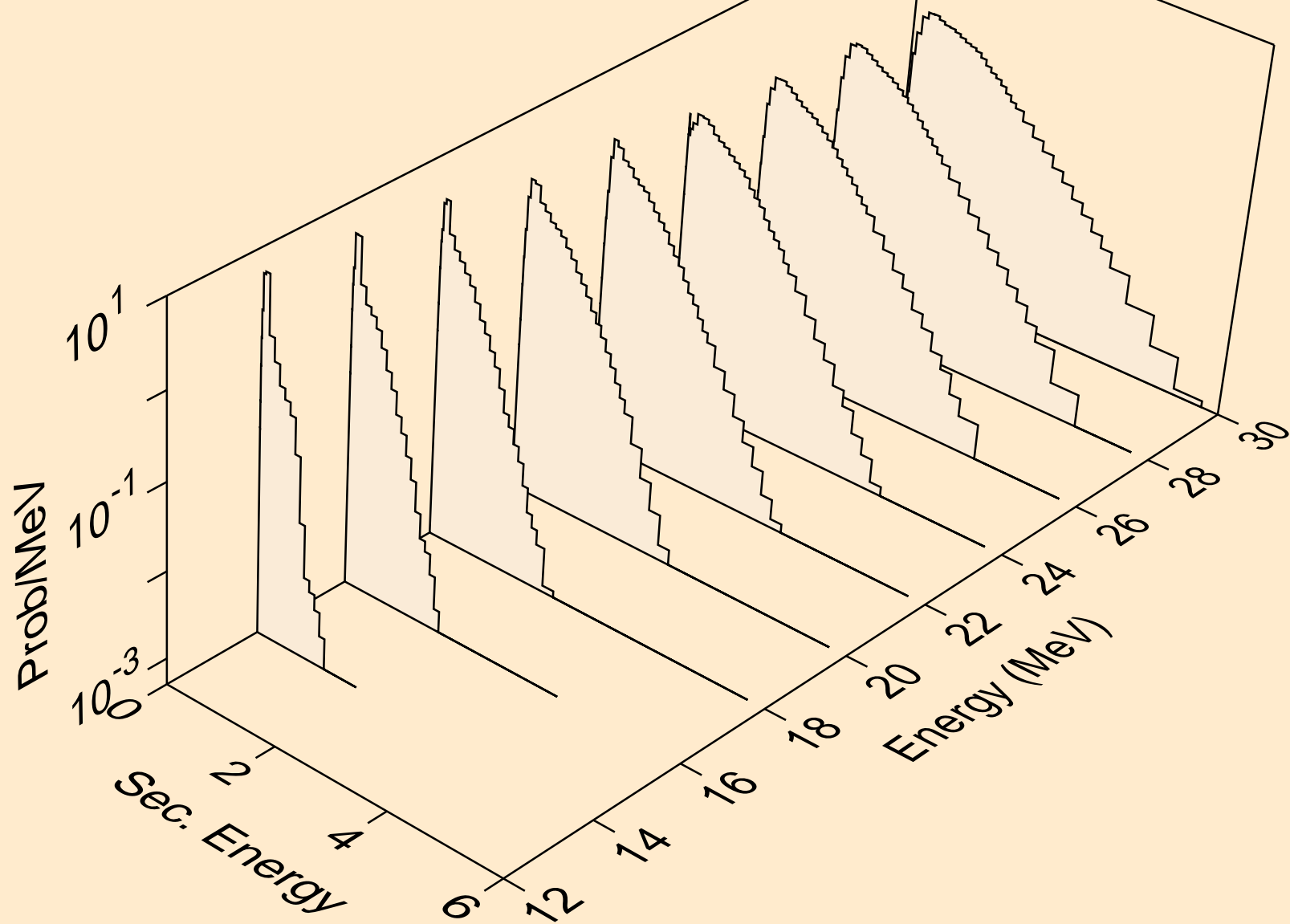

PM156M PHOTON ACER TENDL-2021 LIBRARY; T=0.K
neutrons from (g,2n)a

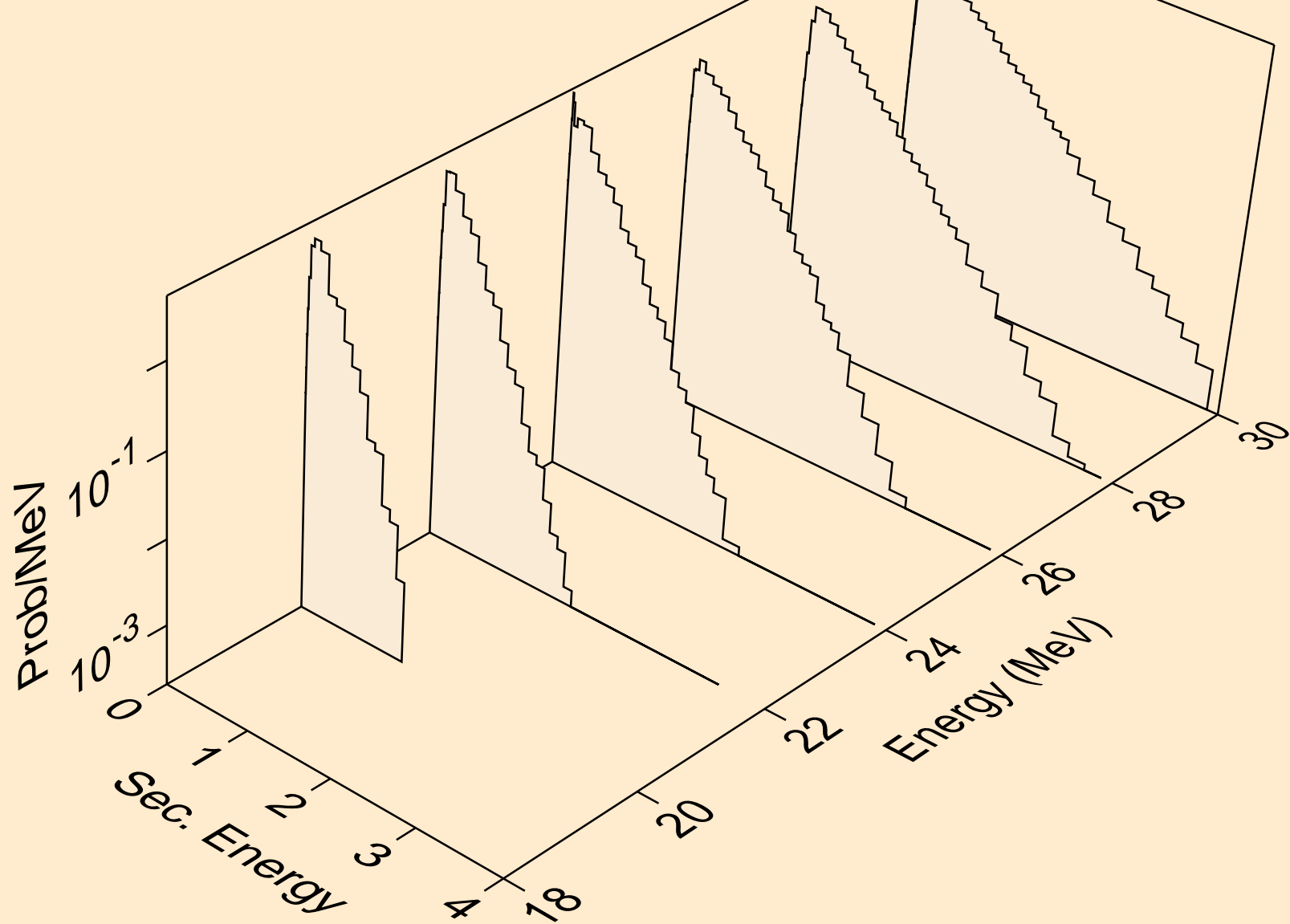

PM156M PHOTON ACER TENDL-2021 LIBRARY; T=0.K
neutrons from (g,n*)p

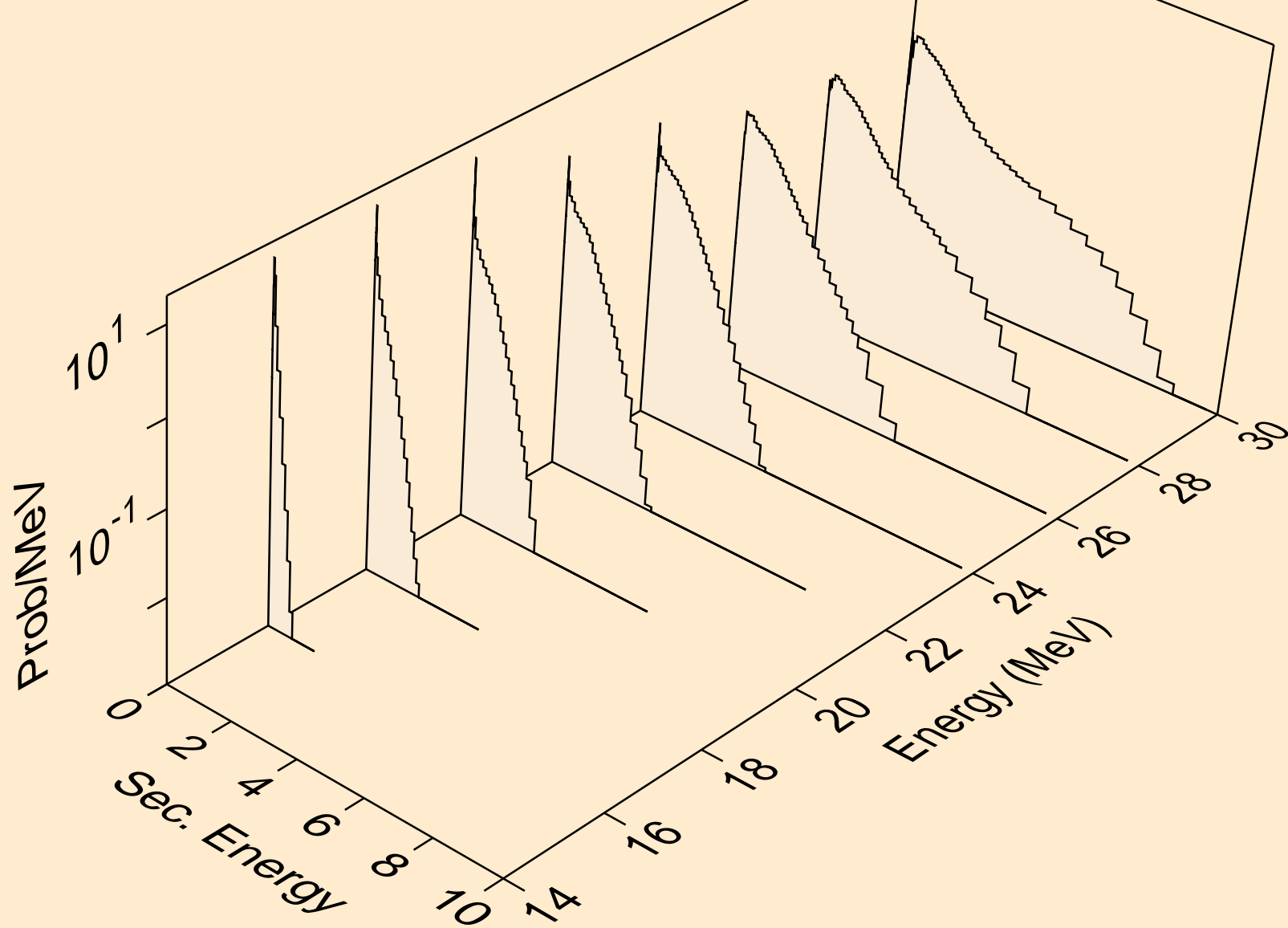

PM156M PHOTON ACER TENDL-2021 LIBRARY; T=0.K
neutrons from (g,n*)d

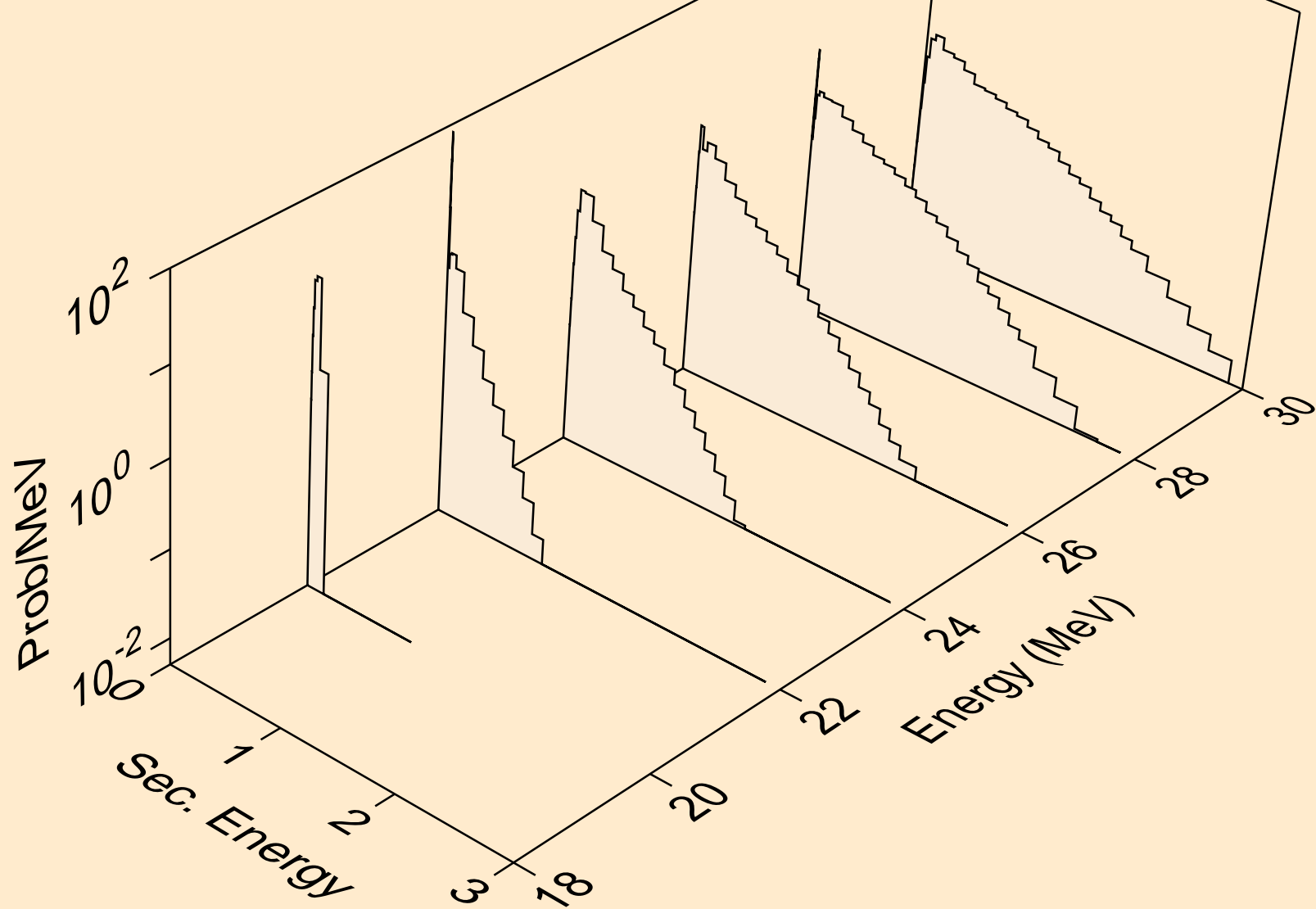

PM156M PHOTON ACER TENDL-2021 LIBRARY; T=0.K
neutrons from (g,n*)t

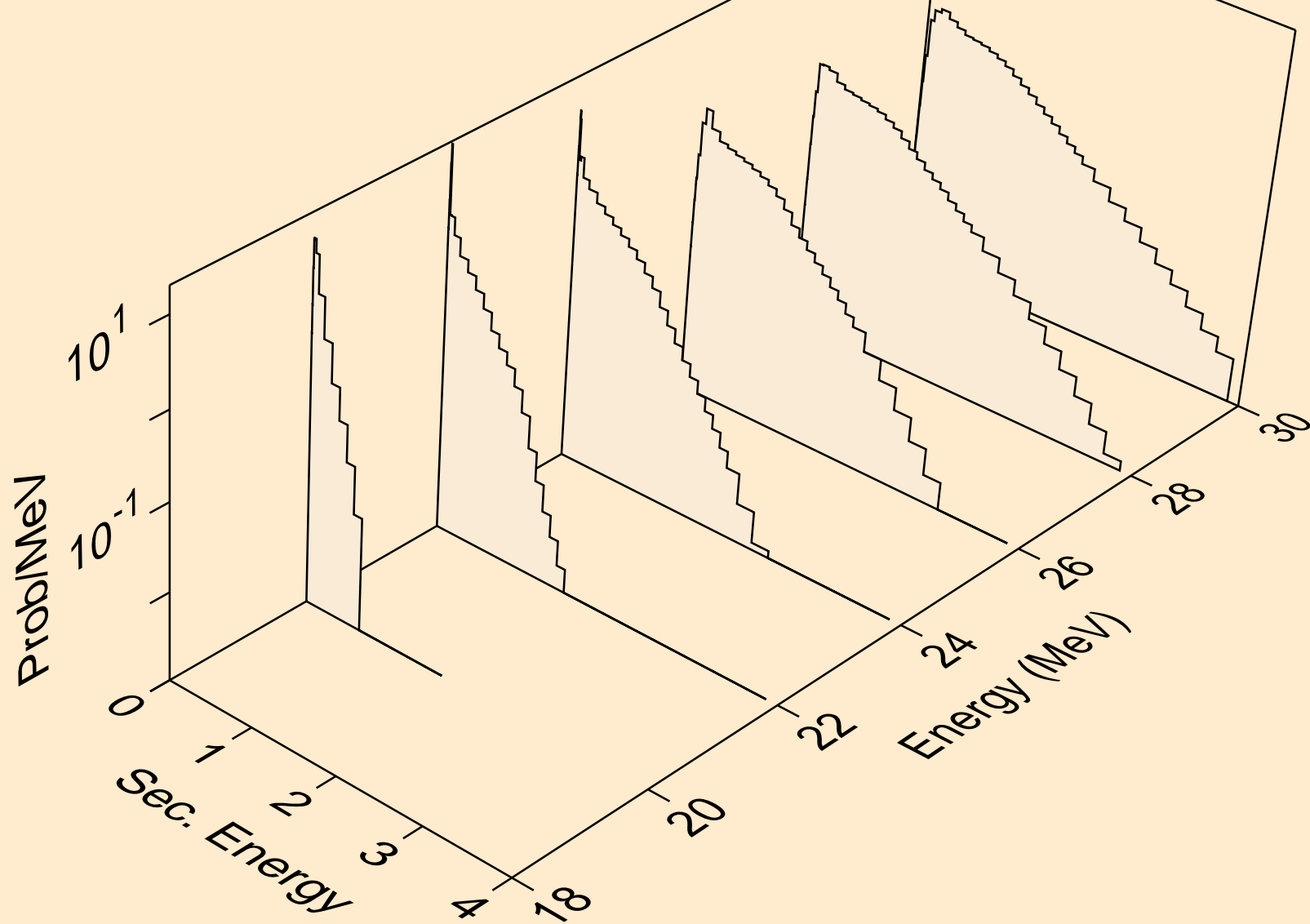

PM156M PHOTON ACER TENDL-2021 LIBRARY; T=0.K
neutrons from (g,4n)

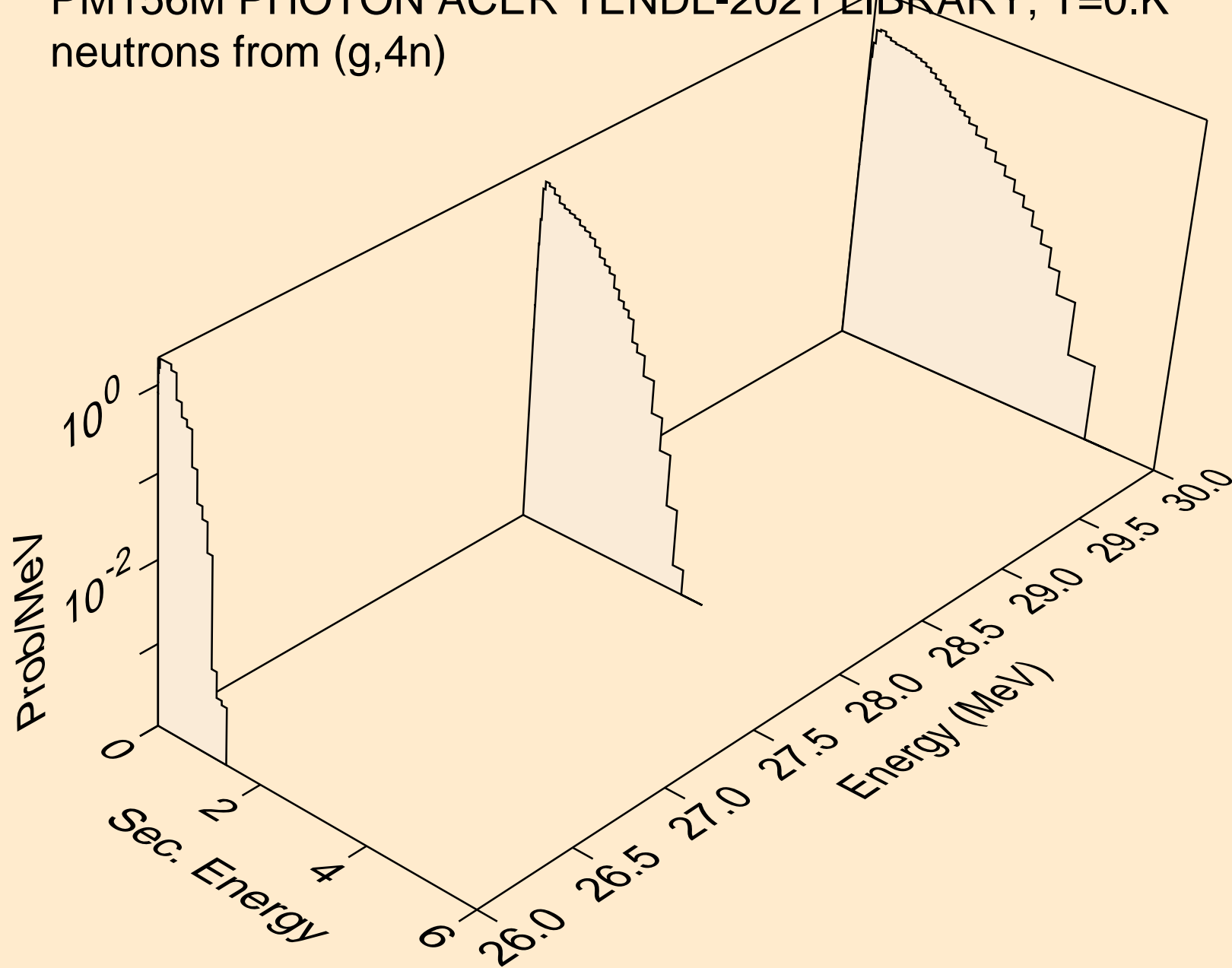

PM156M PHOTON ACER TENDL-2021 LIBRARY; T=0.K
neutrons from (g,2np)

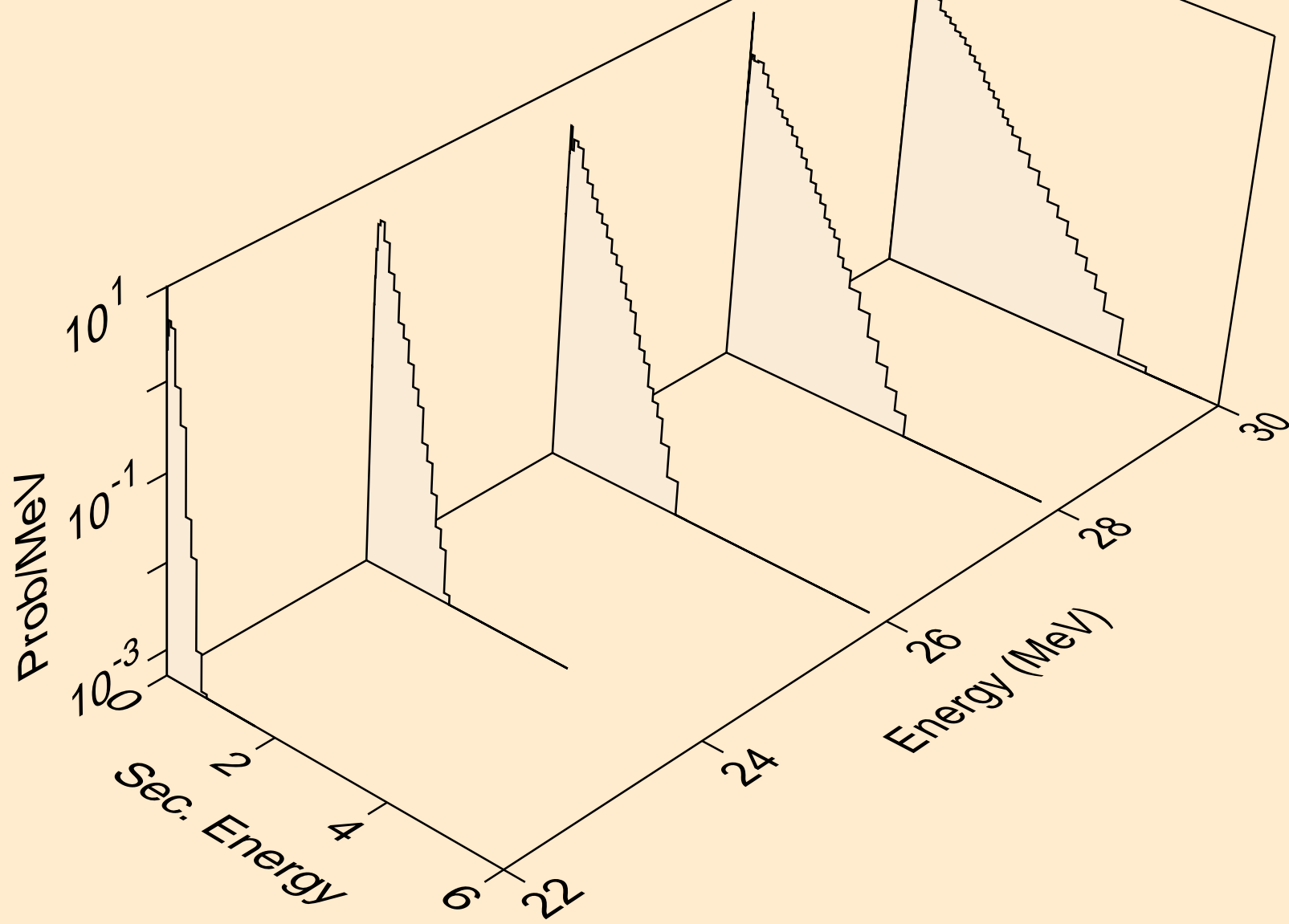

PM156M PHOTON ACER TENDL-2021 LIBRARY; T=0.K
neutrons from (g,3np)

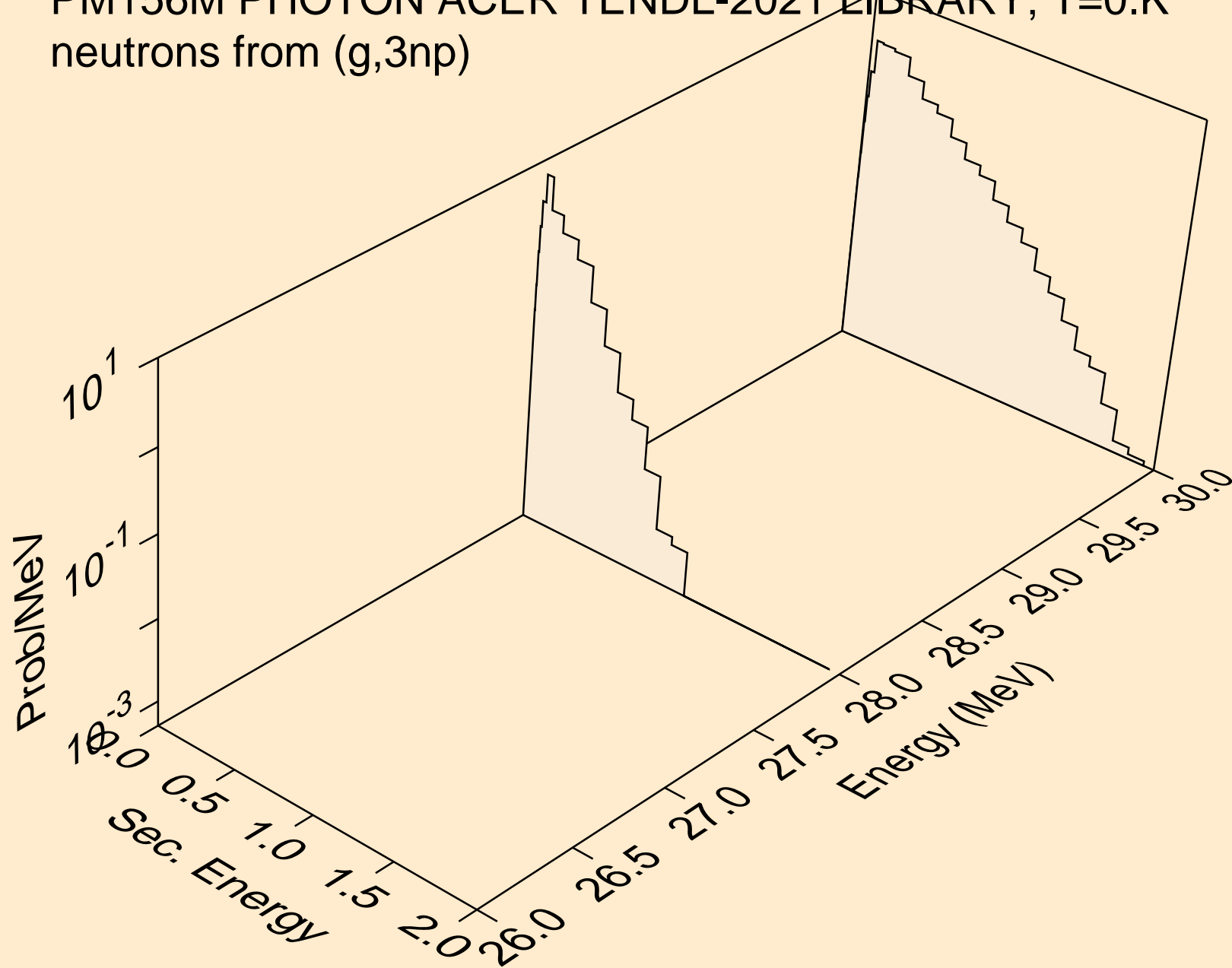

PM156M PHOTON ACER TENDL-2021 LIBRARY; T=0.K
angular distribution for (g,n*0) neutron

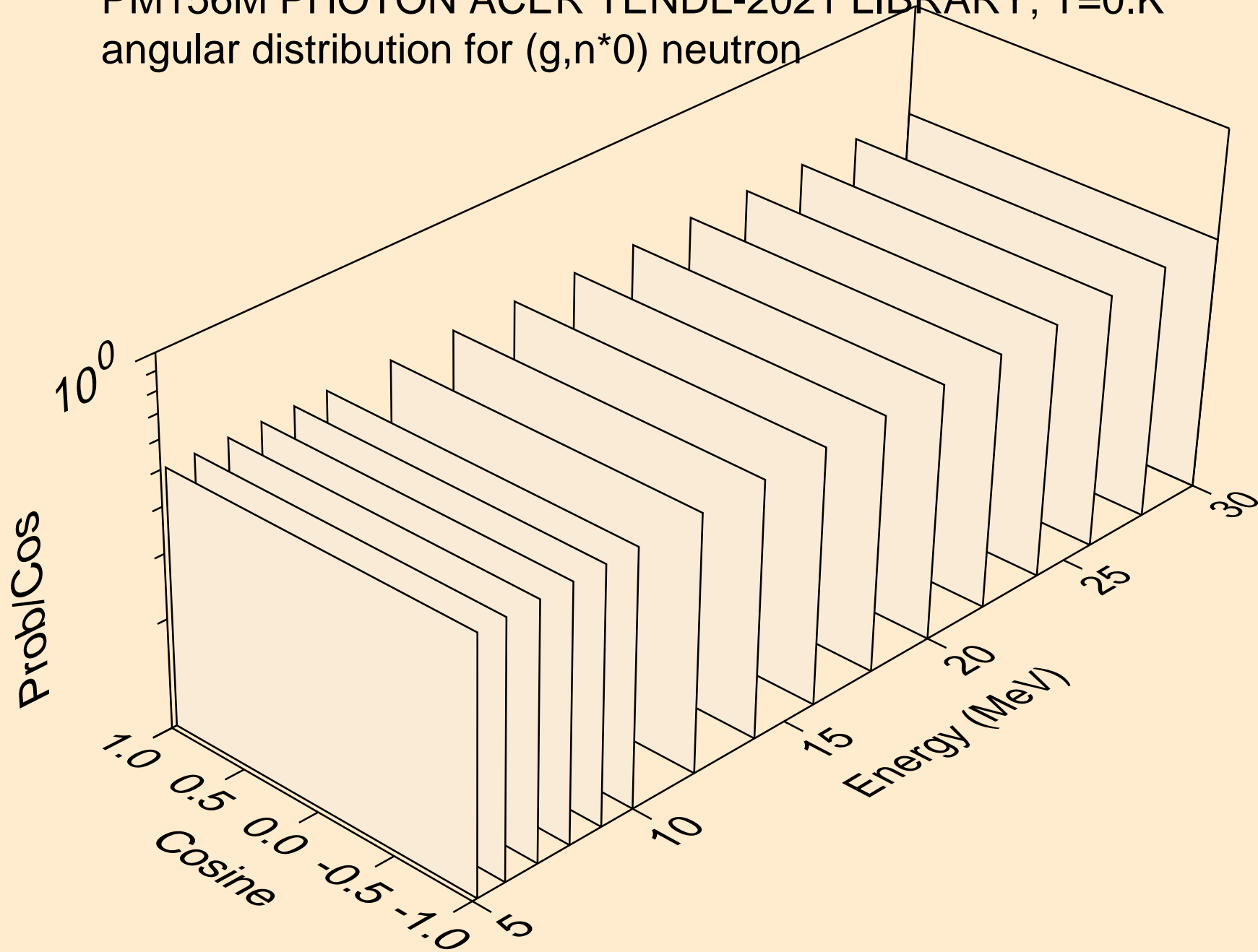

PM156M PHOTON ACER TENDL-2021 LIBRARY; T=0.K
angular distribution for (g,n*1) neutron

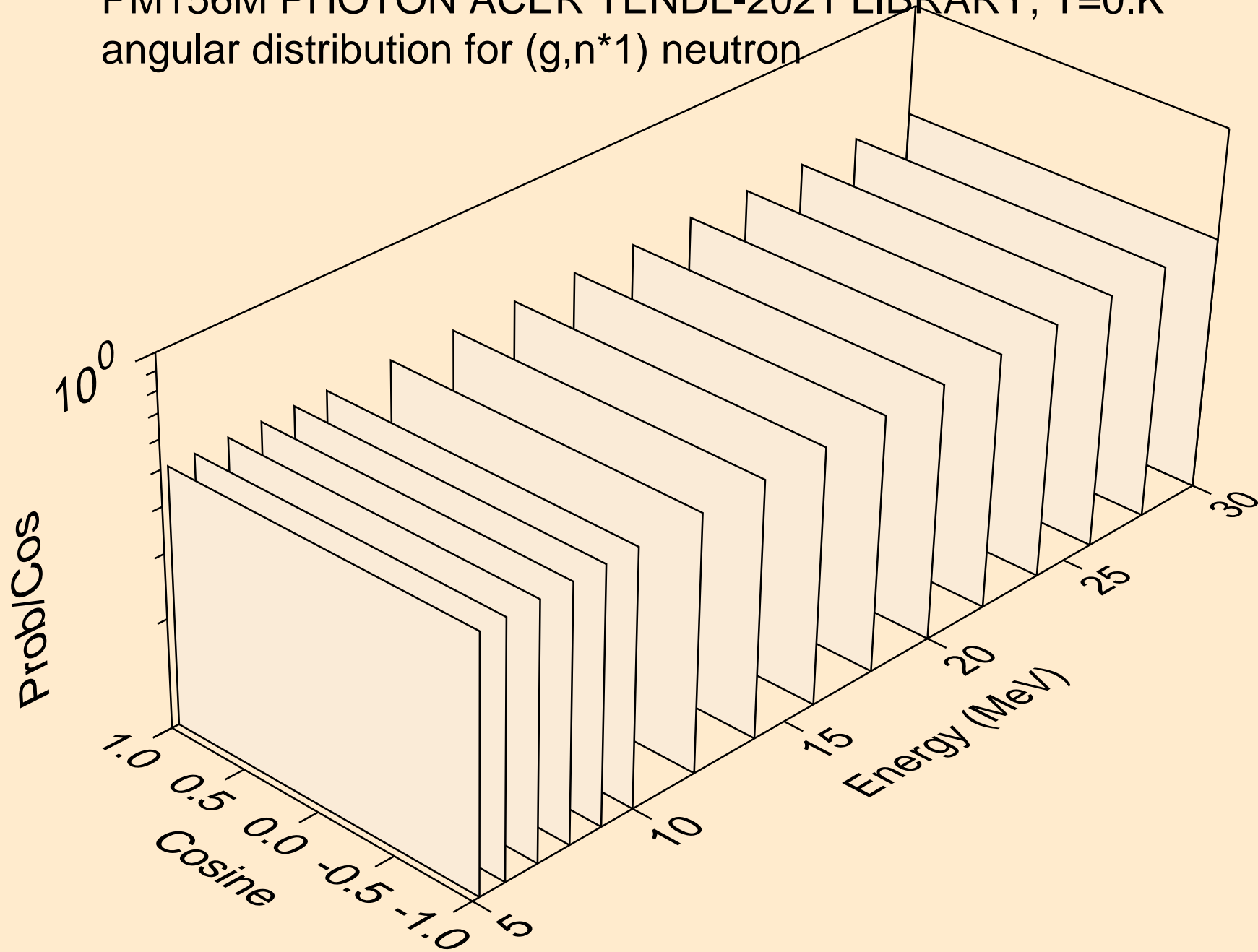

PM156M PHOTON ACER TENDL-2021 LIBRARY; T=0.K
neutrons from (g,n*c)

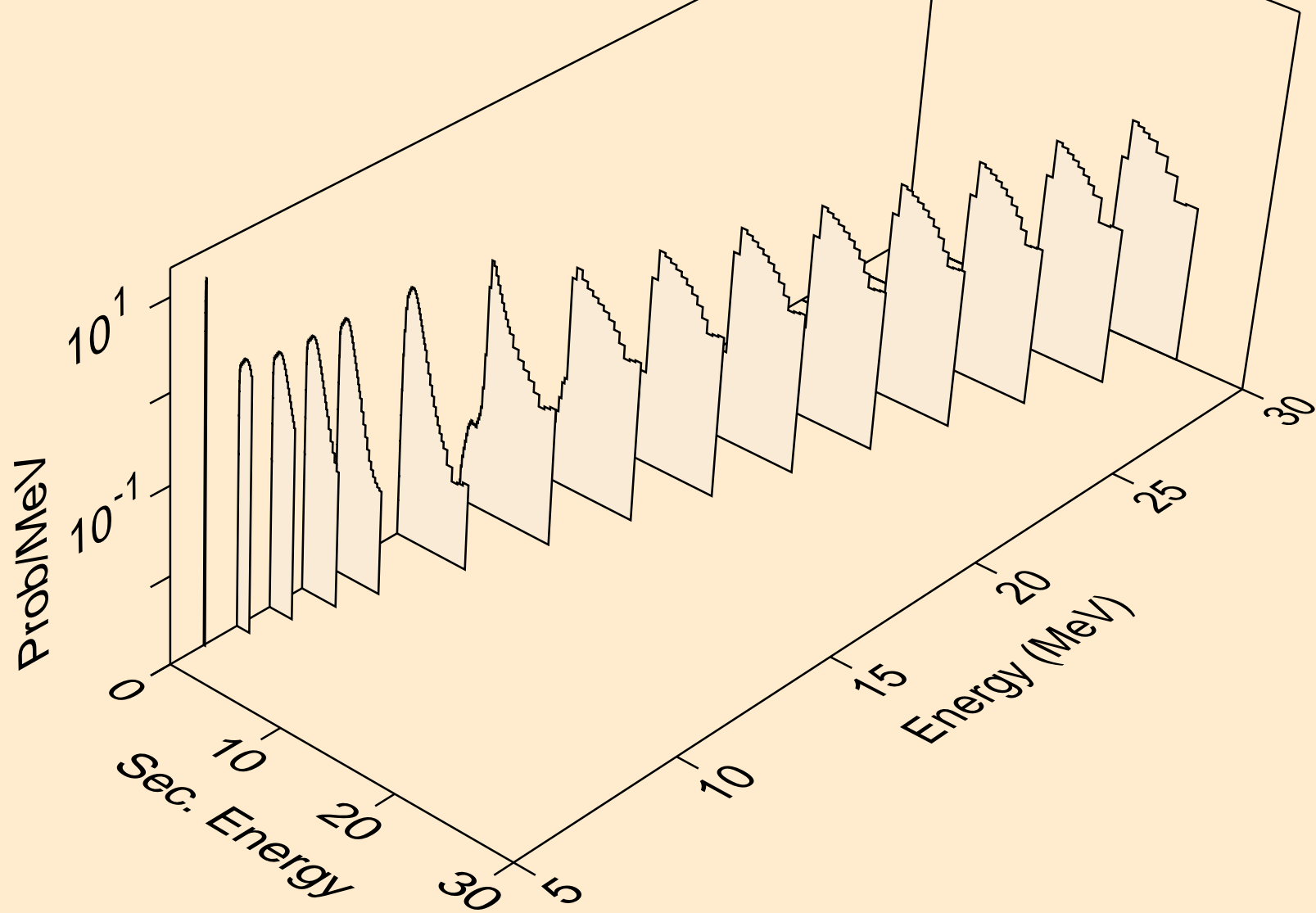

PM156M PHOTON ACER TENDL-2021 LIBRARY; T=0.K
photons from (g,x)

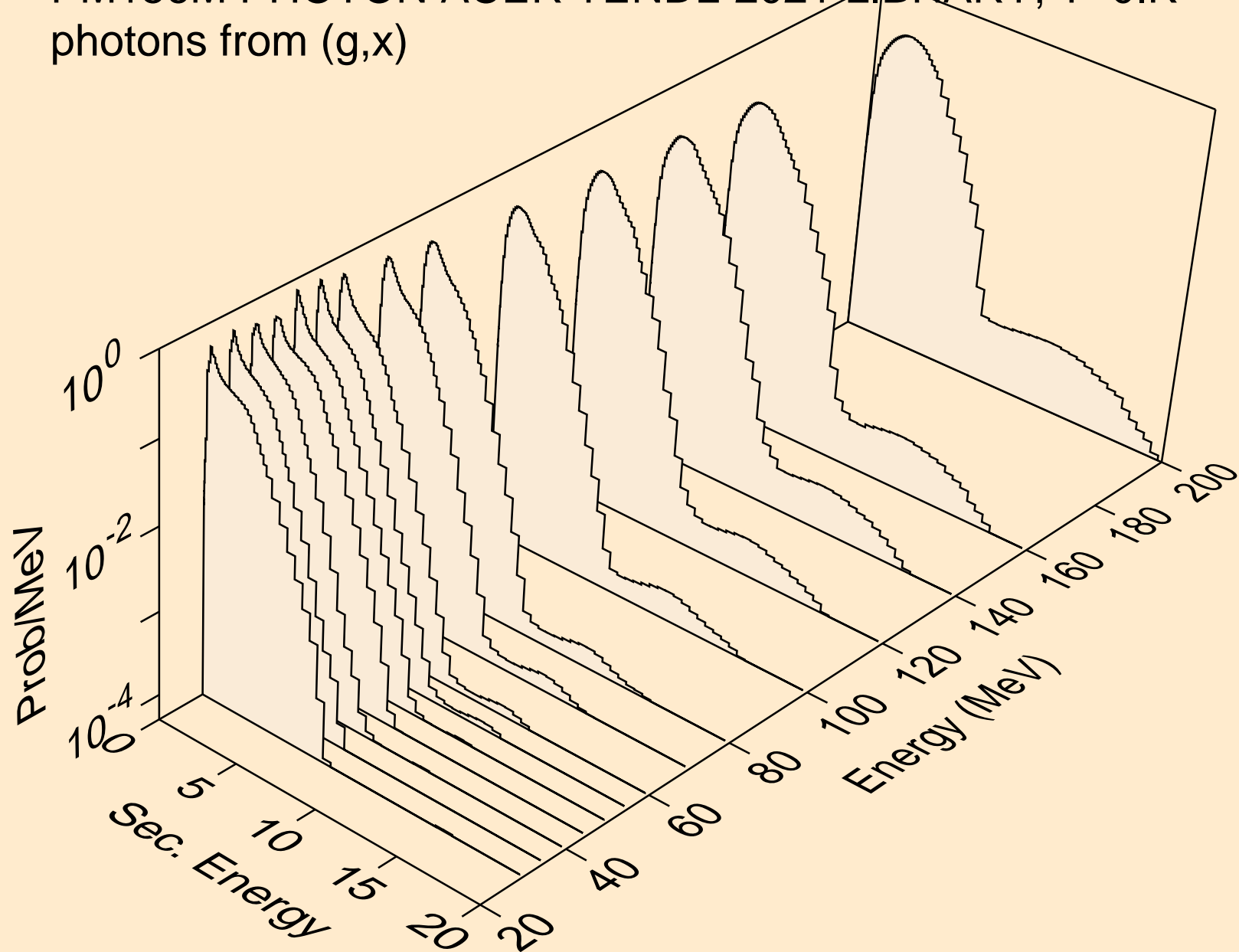

PM156M PHOTON ACER TENDL-2021 LIBRARY; T=0.K
photons from (g,2nd)

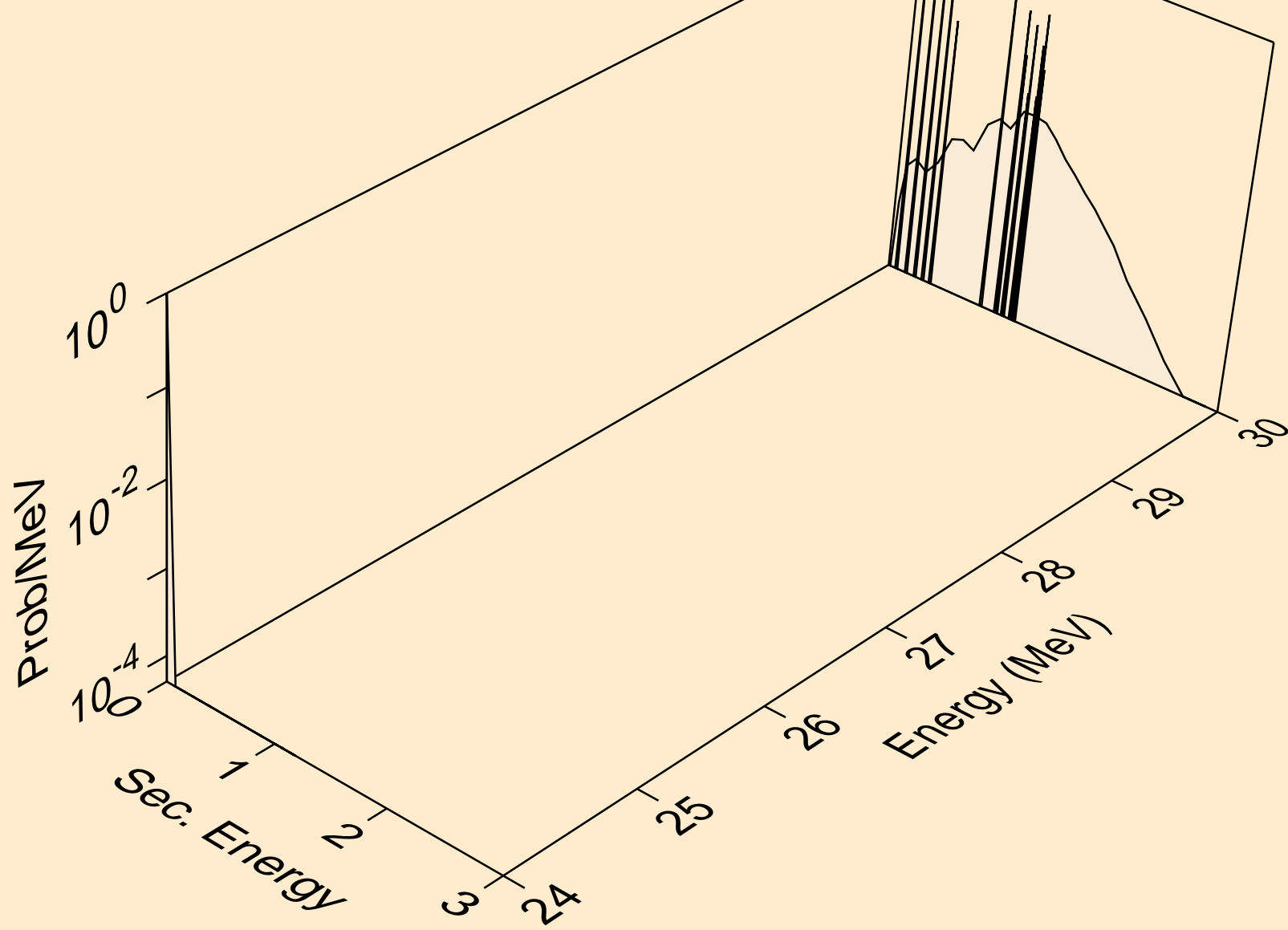

PM156M PHOTON ACER TENDL-2021 LIBRARY; T=0.K
photons from (g,2n)

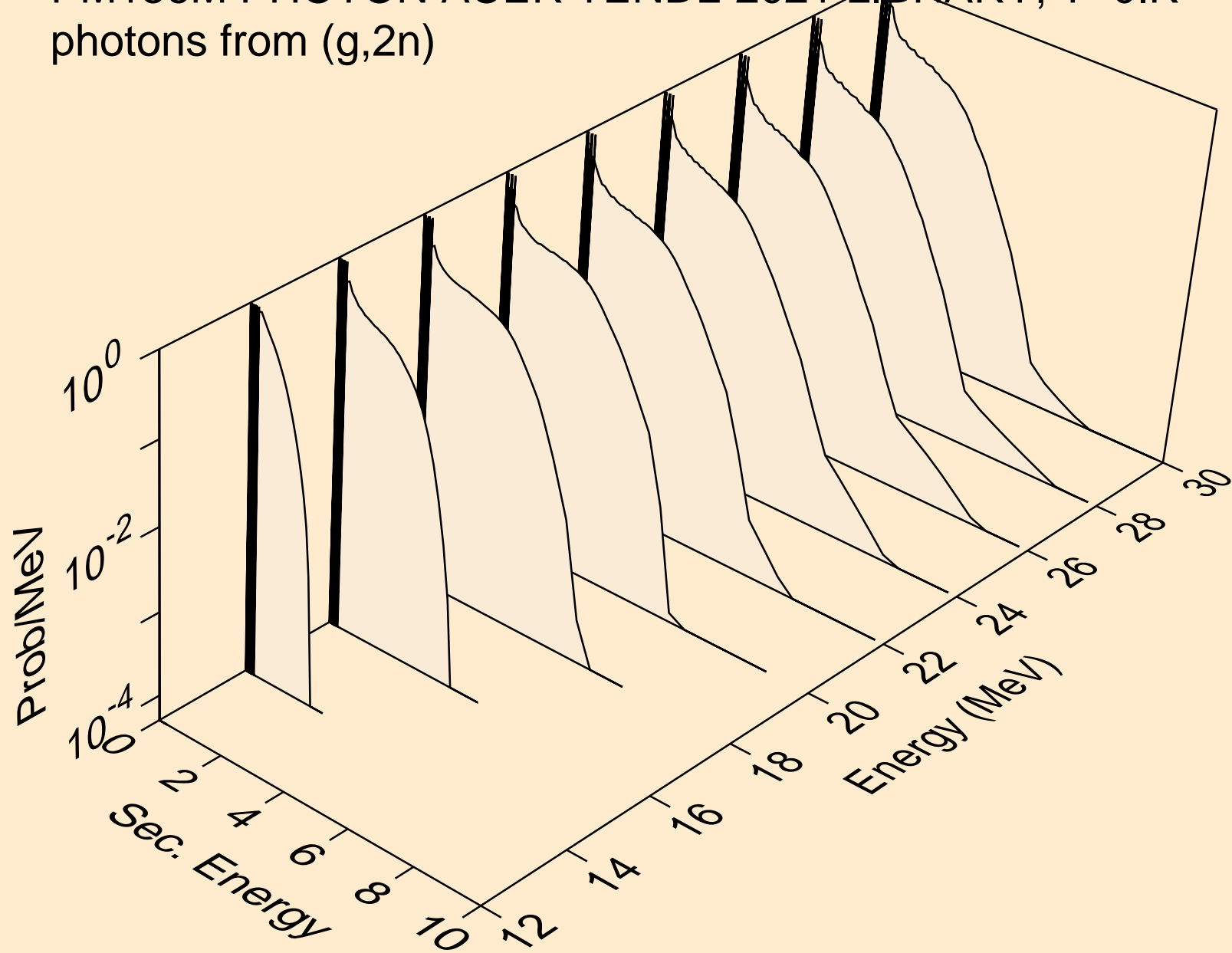

PM156M PHOTON ACER TENDL-2021 LIBRARY; T=0.K
photons from (g,3n)

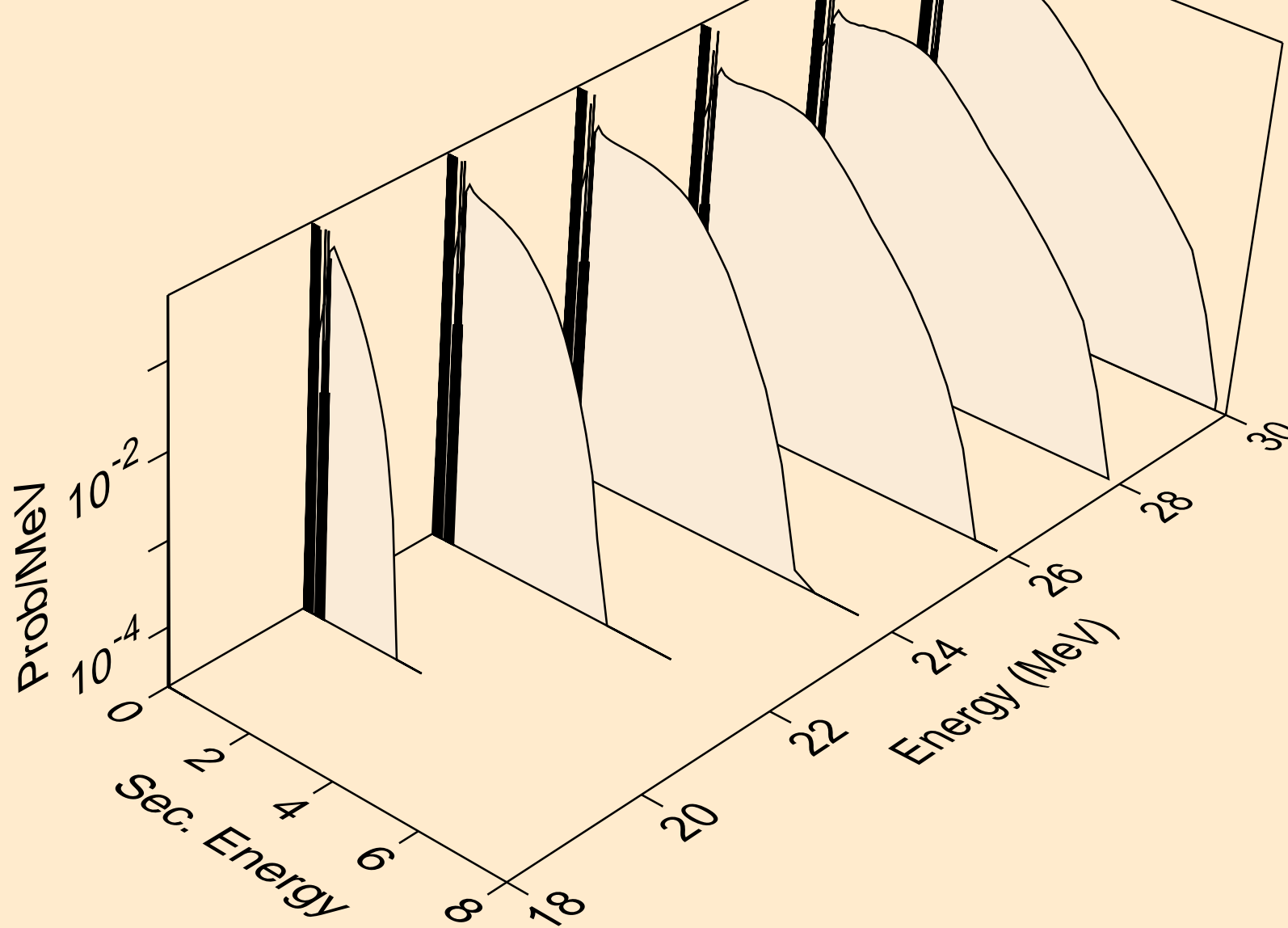

PM156M PHOTON ACER TENDL-2021 LIBRARY; T=0.K
photons from (g,n*)a

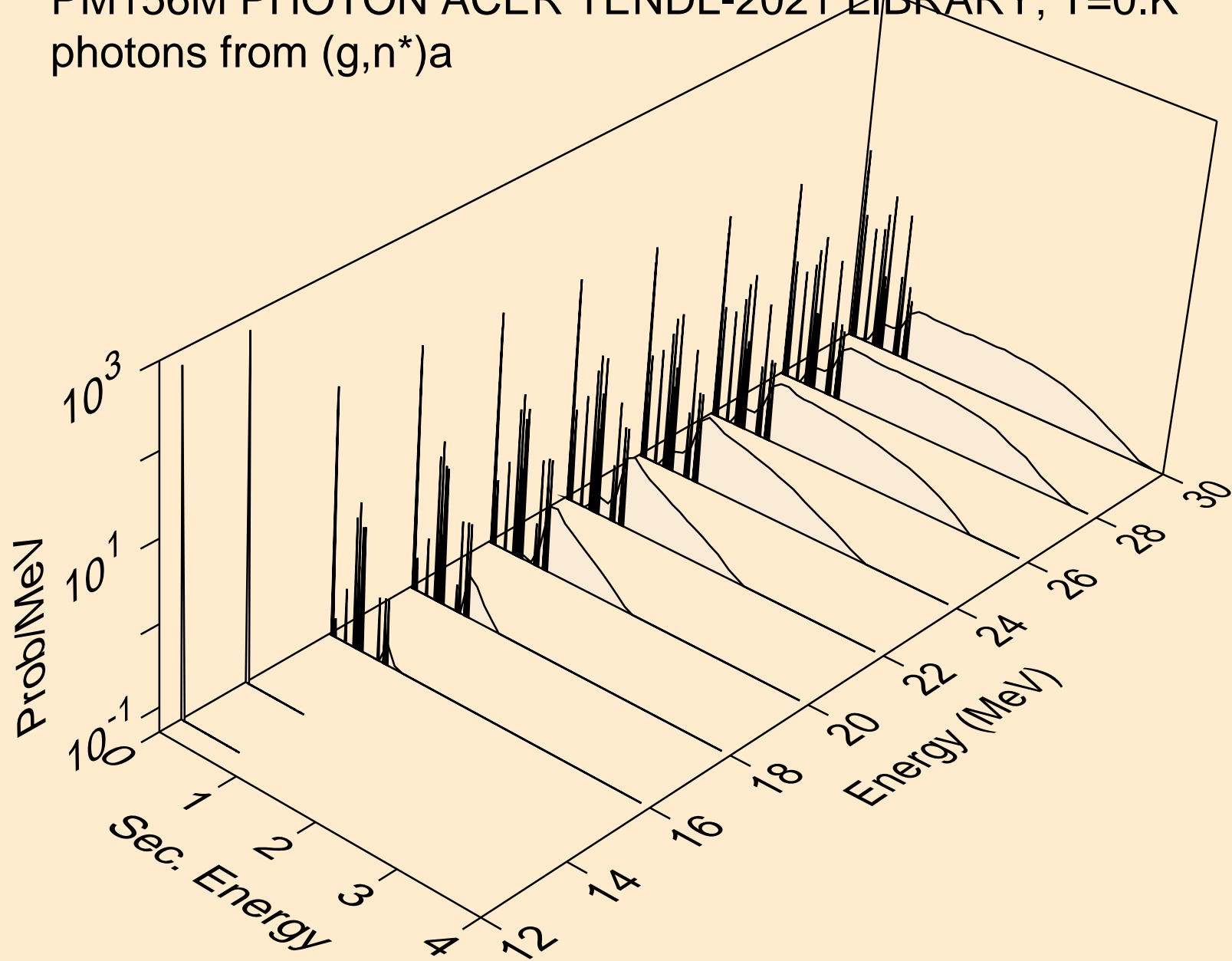

PM156M PHOTON ACER TENDL-2021 LIBRARY; T=0.K
photons from (g,2n)a

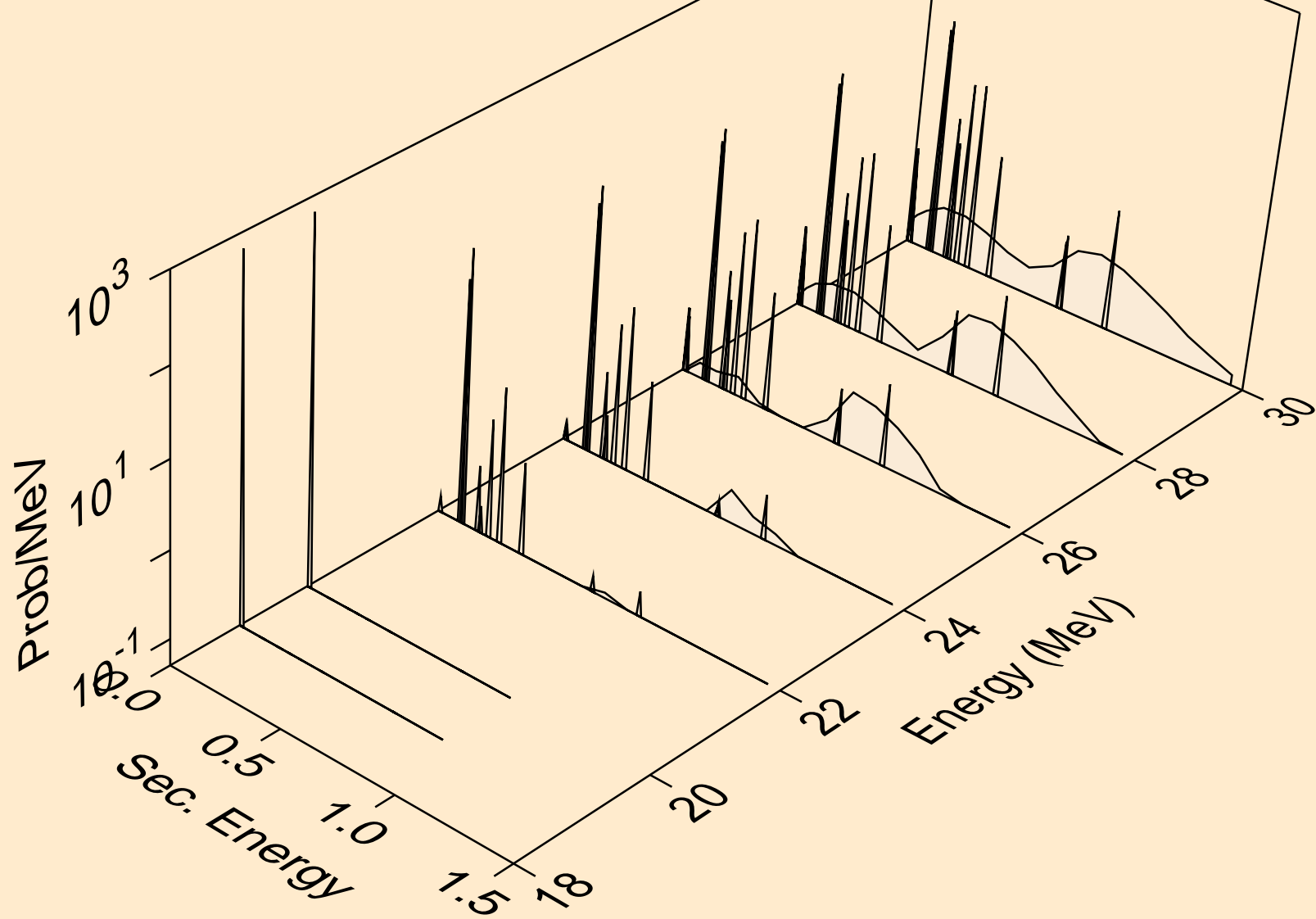

PM156M PHOTON ACER TENDL-2021 LIBRARY; T=0.K
photons from (g,n*)p

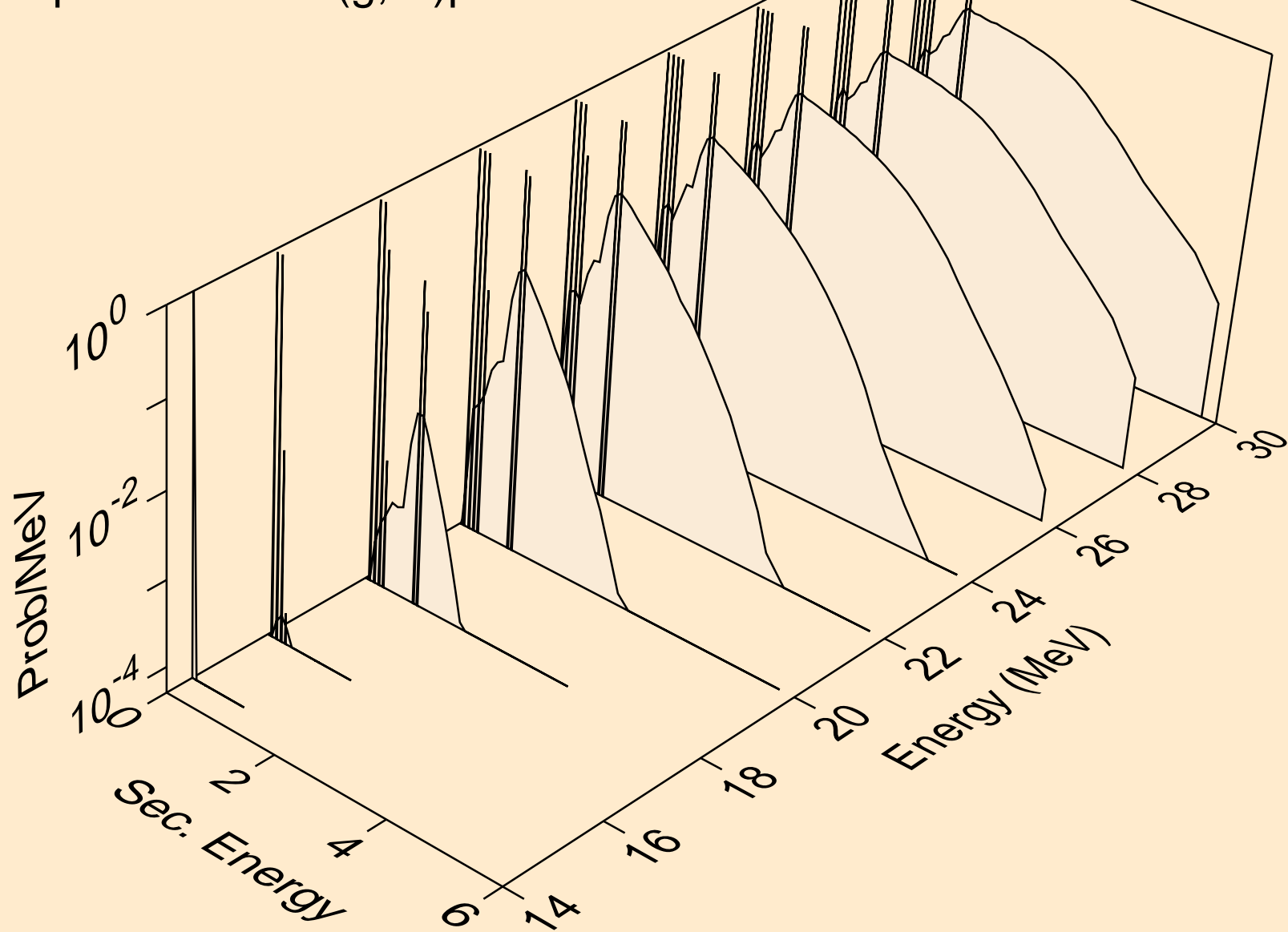

PM156M PHOTON ACER TENDL-2021 LIBRARY; T=0.K
photons from (g,n*)d

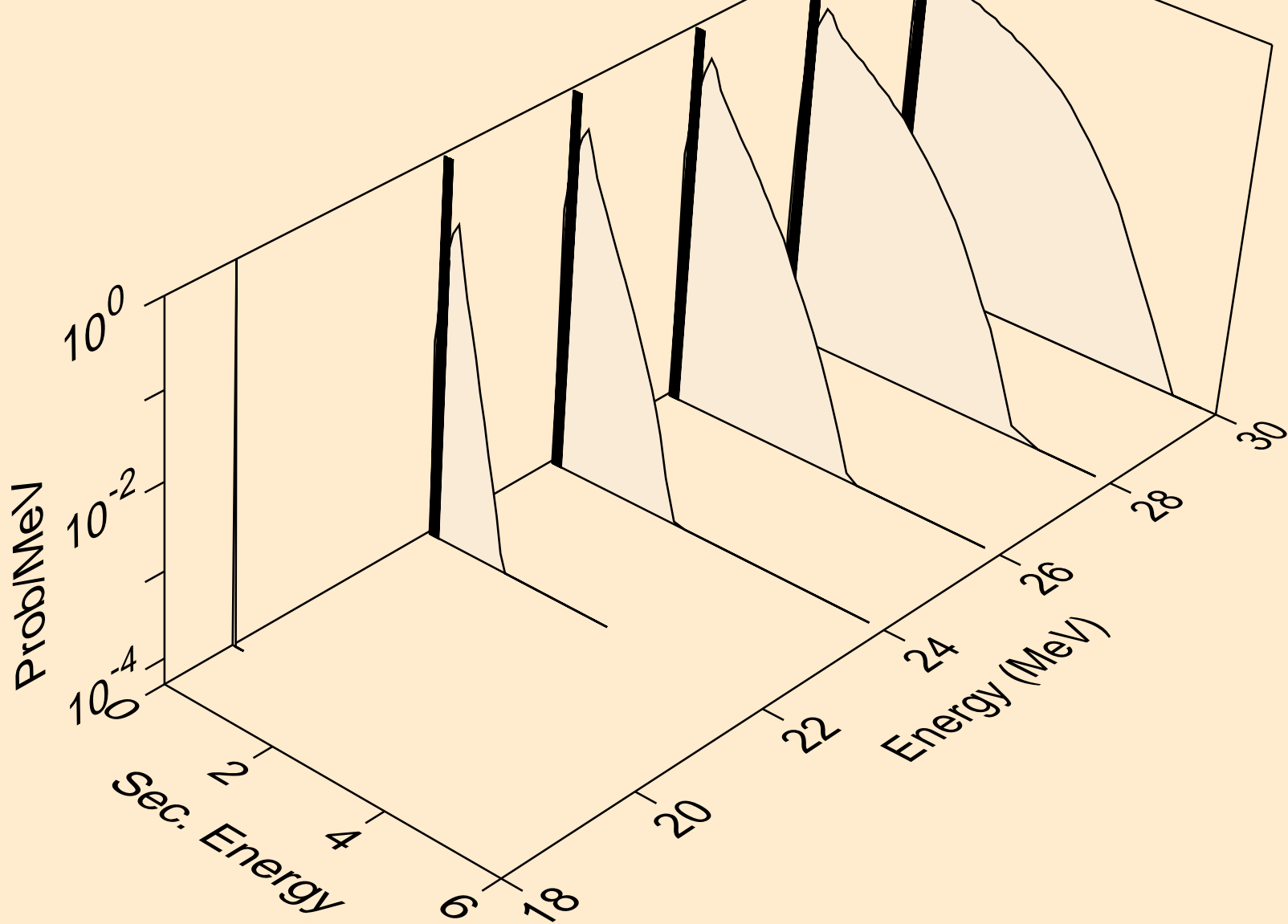

PM156M PHOTON ACER TENDL-2021 LIBRARY; T=0.K
photons from (g,n*)t

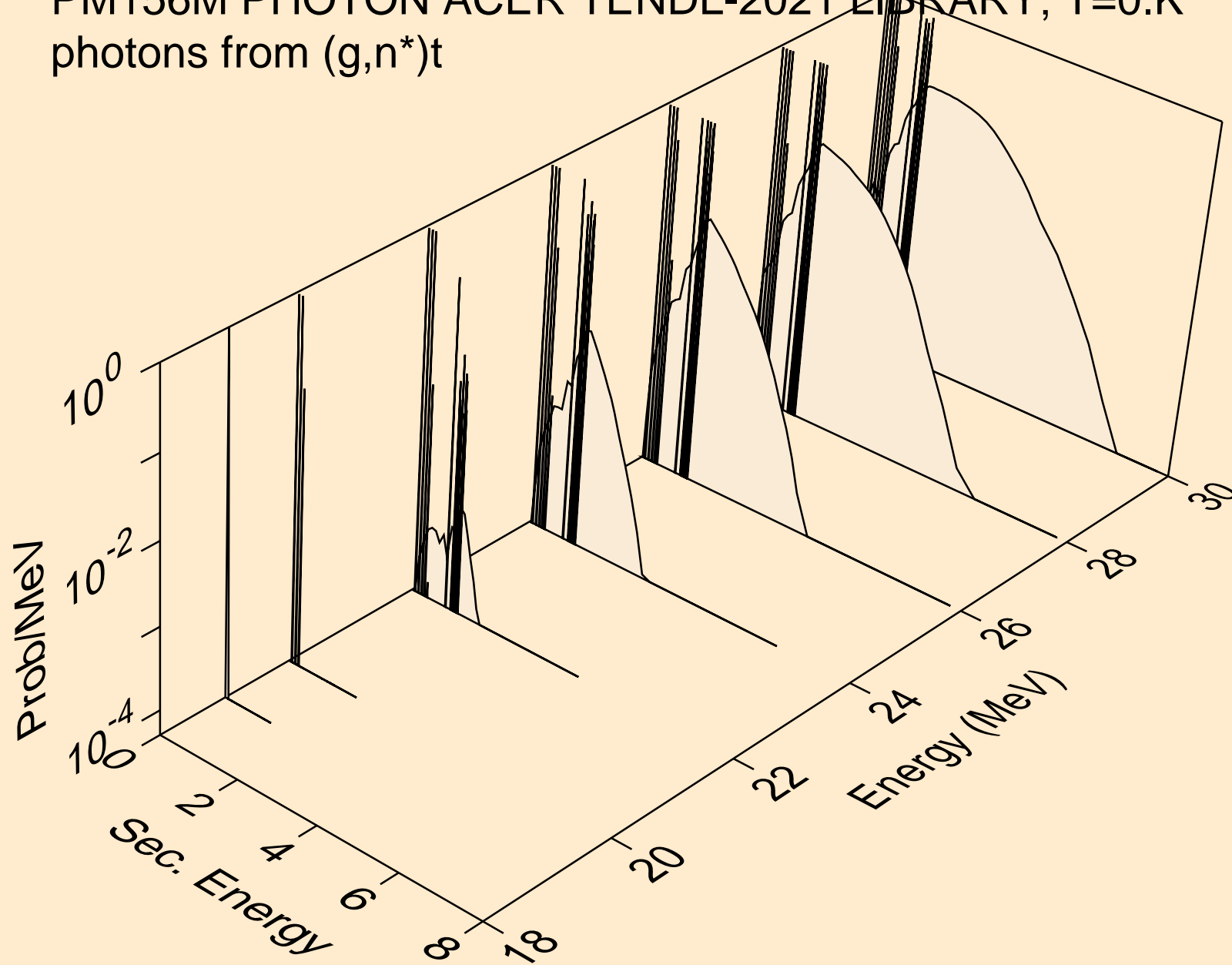

PM156M PHOTON ACER TENDL-2021 LIBRARY; T=0.K
photons from (g,4n)

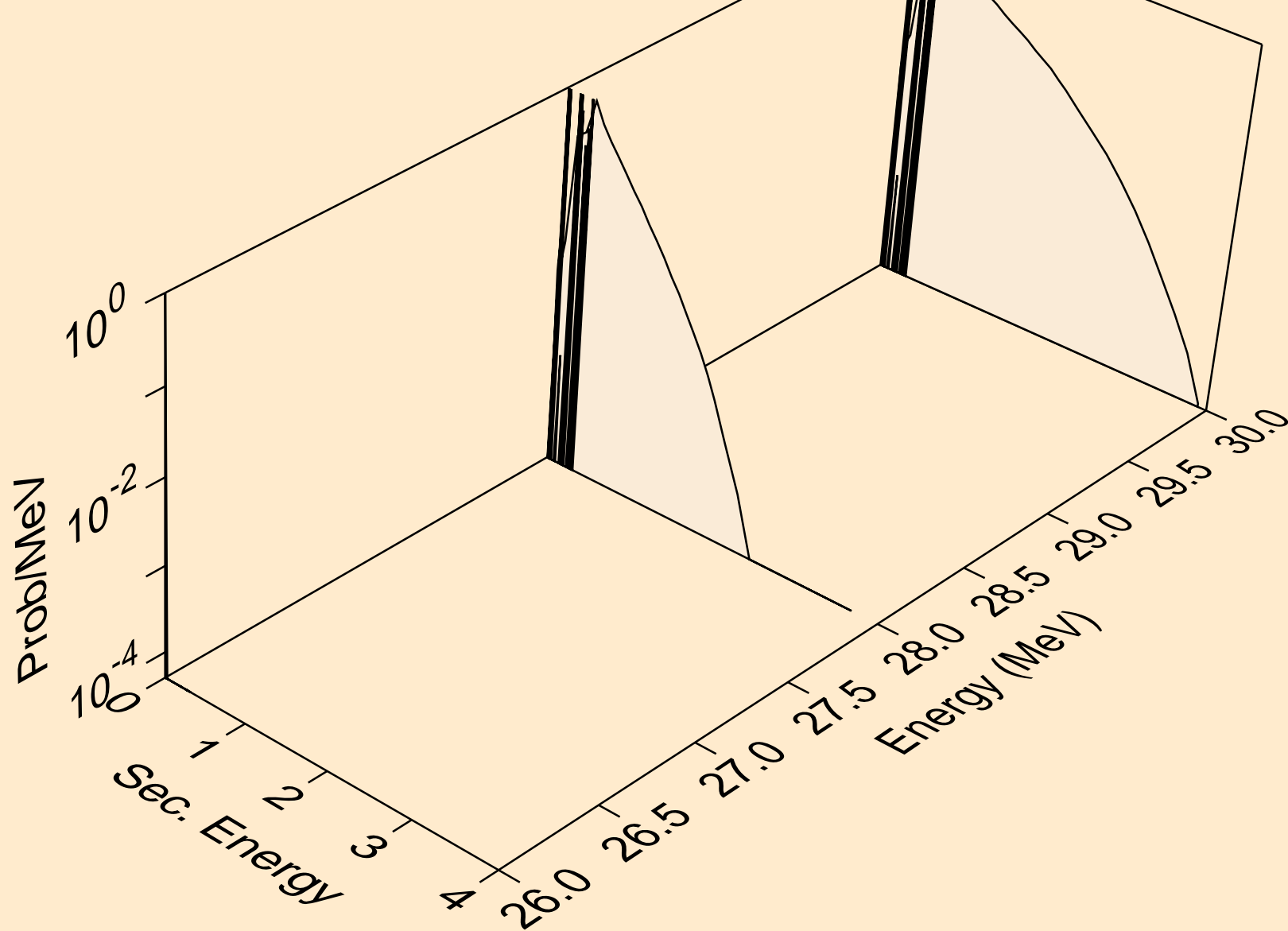

PM156M PHOTON ACER TENDL-2021 LIBRARY; T=0.K
photons from (g,2np)

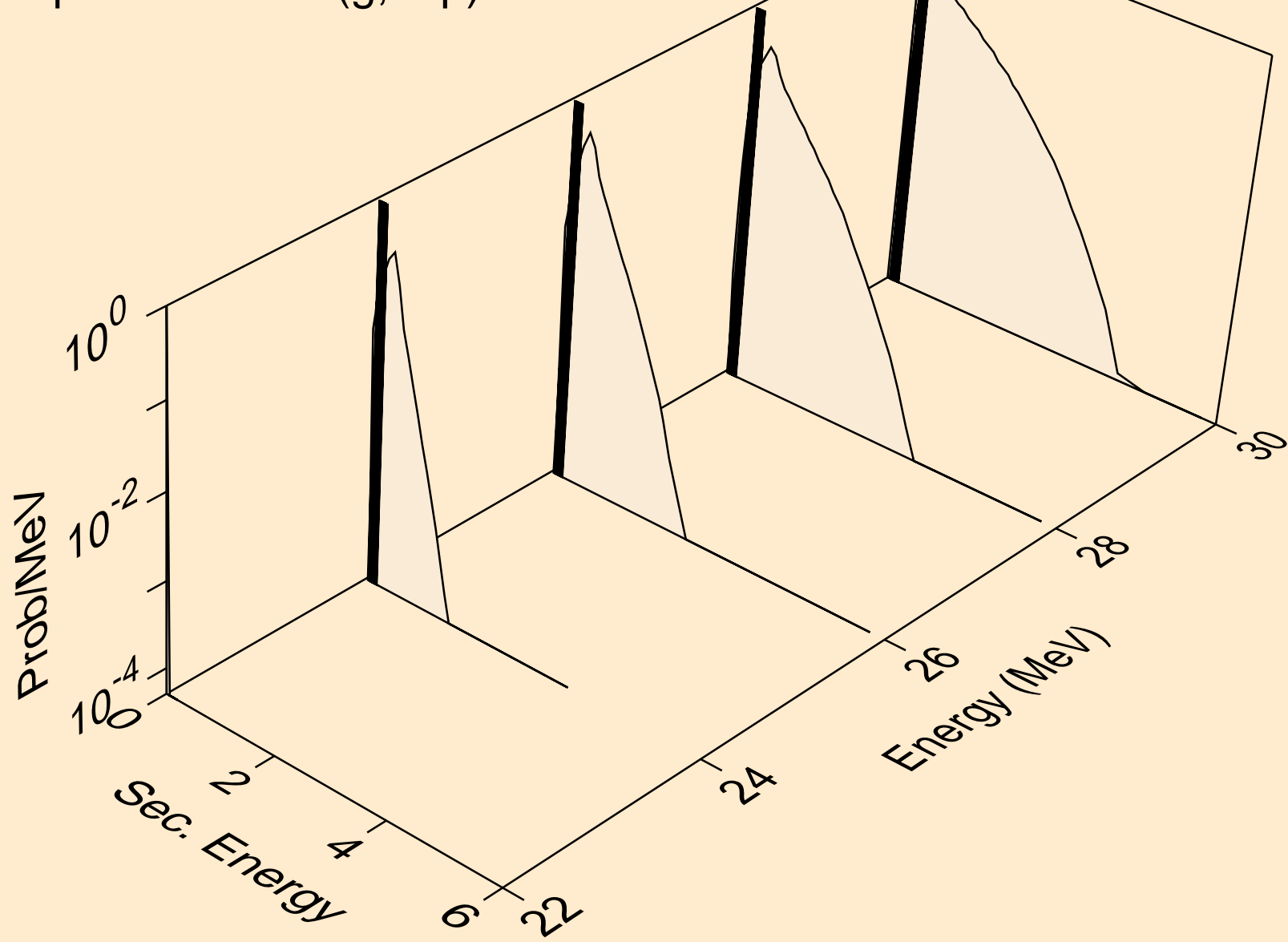

PM156M PHOTON ACER TENDL-2021 LIBRARY; T=0.K
photons from (g,n*c)

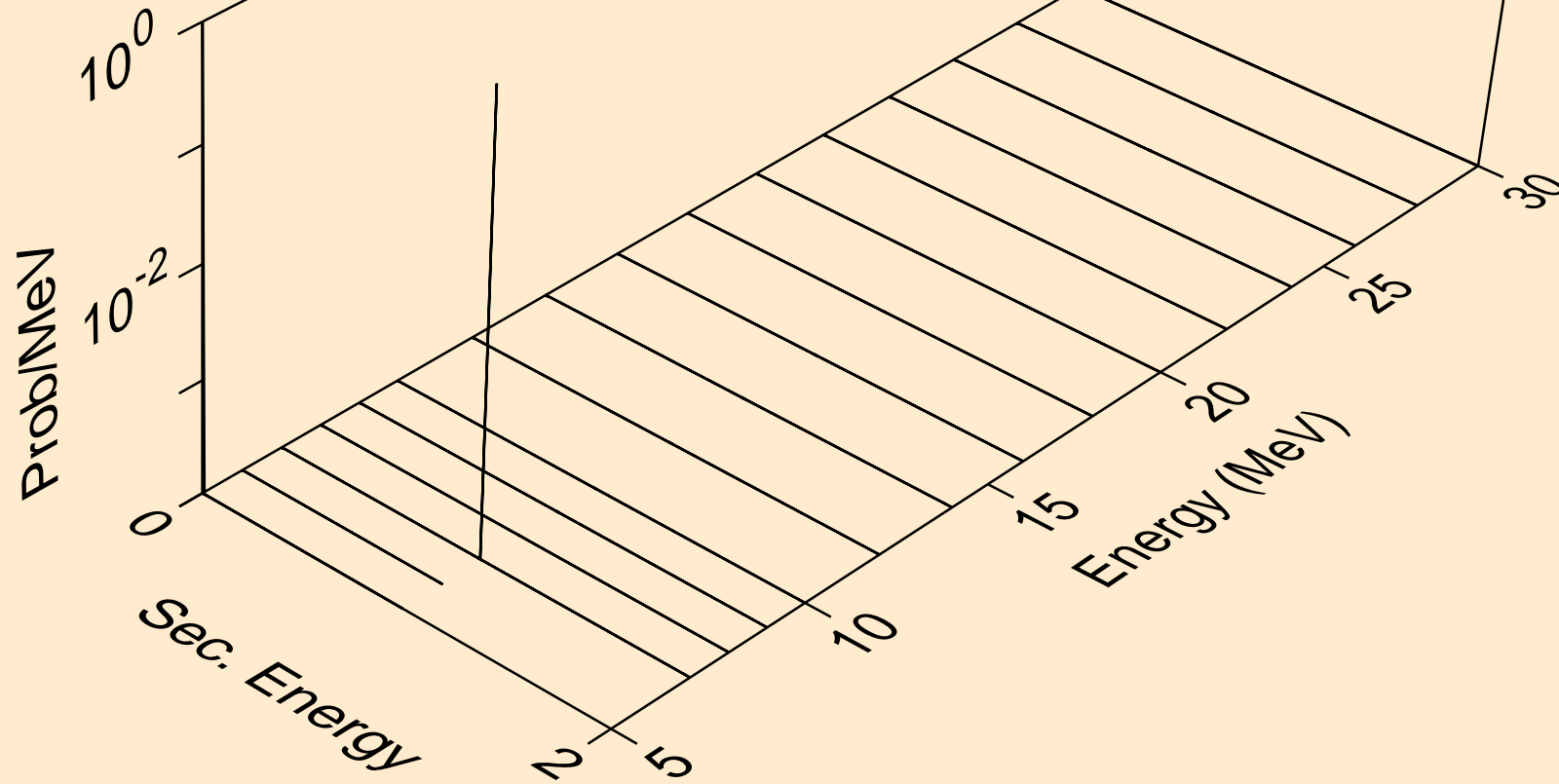

PM156M PHOTON ACER TENDL-2021 LIBRARY; T=0.K
photons from (g,gma)

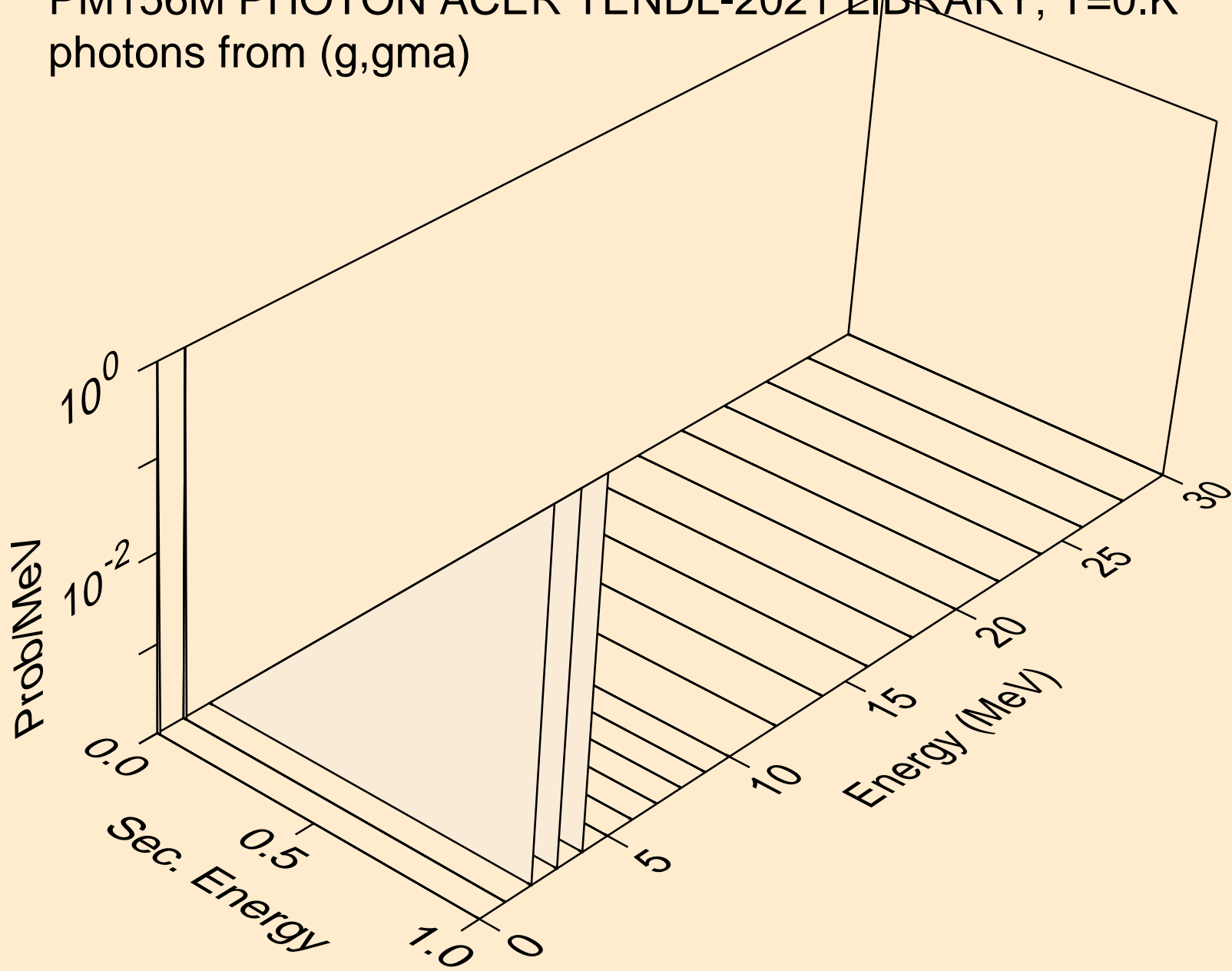

PM156M PHOTON ACER TENDL-2021 LIBRARY; T=0.K
photons from (g,p)

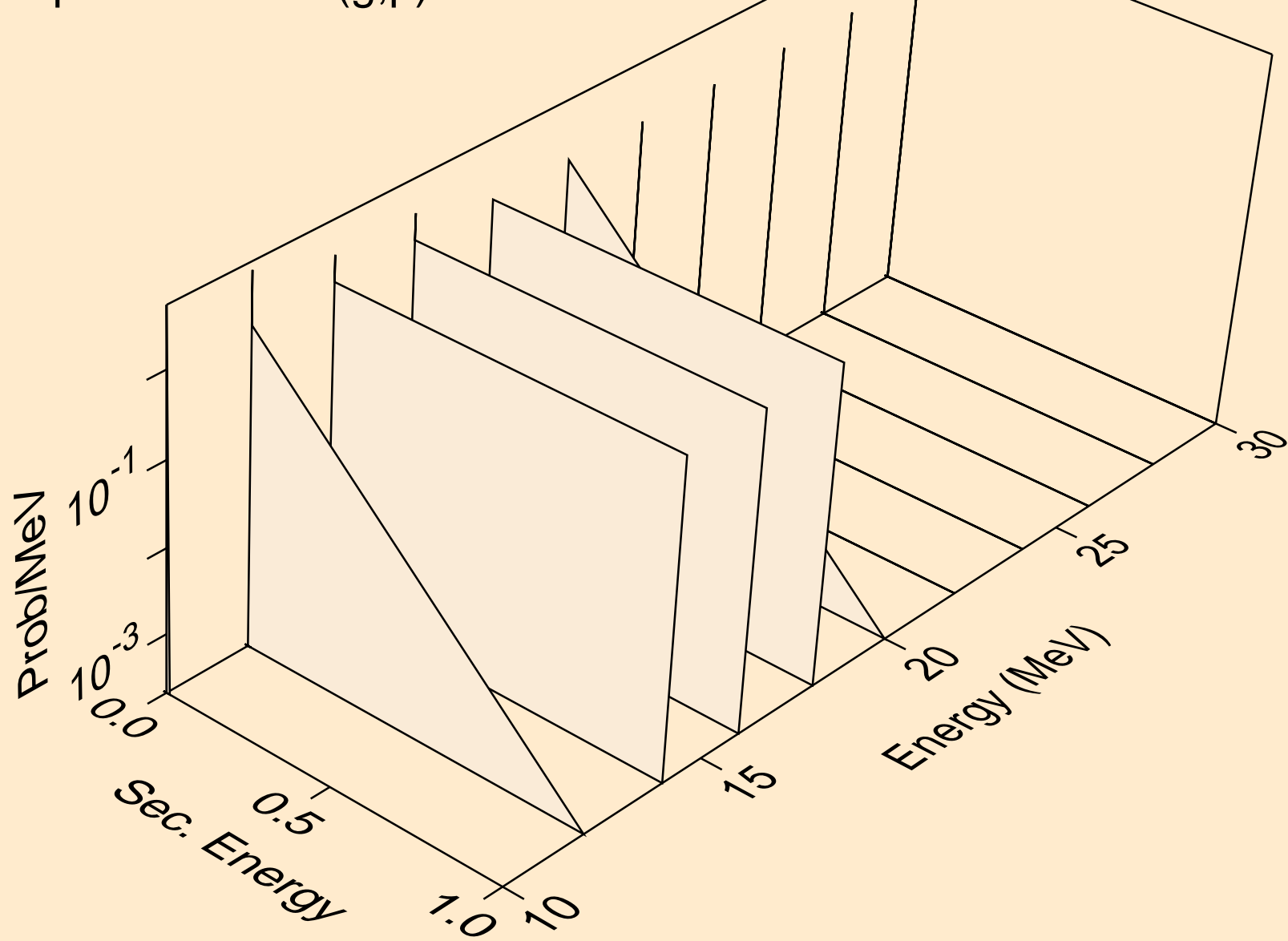

PM156M PHOTON ACER TENDL-2021 LIBRARY; T=0.K
photons from (g,d)

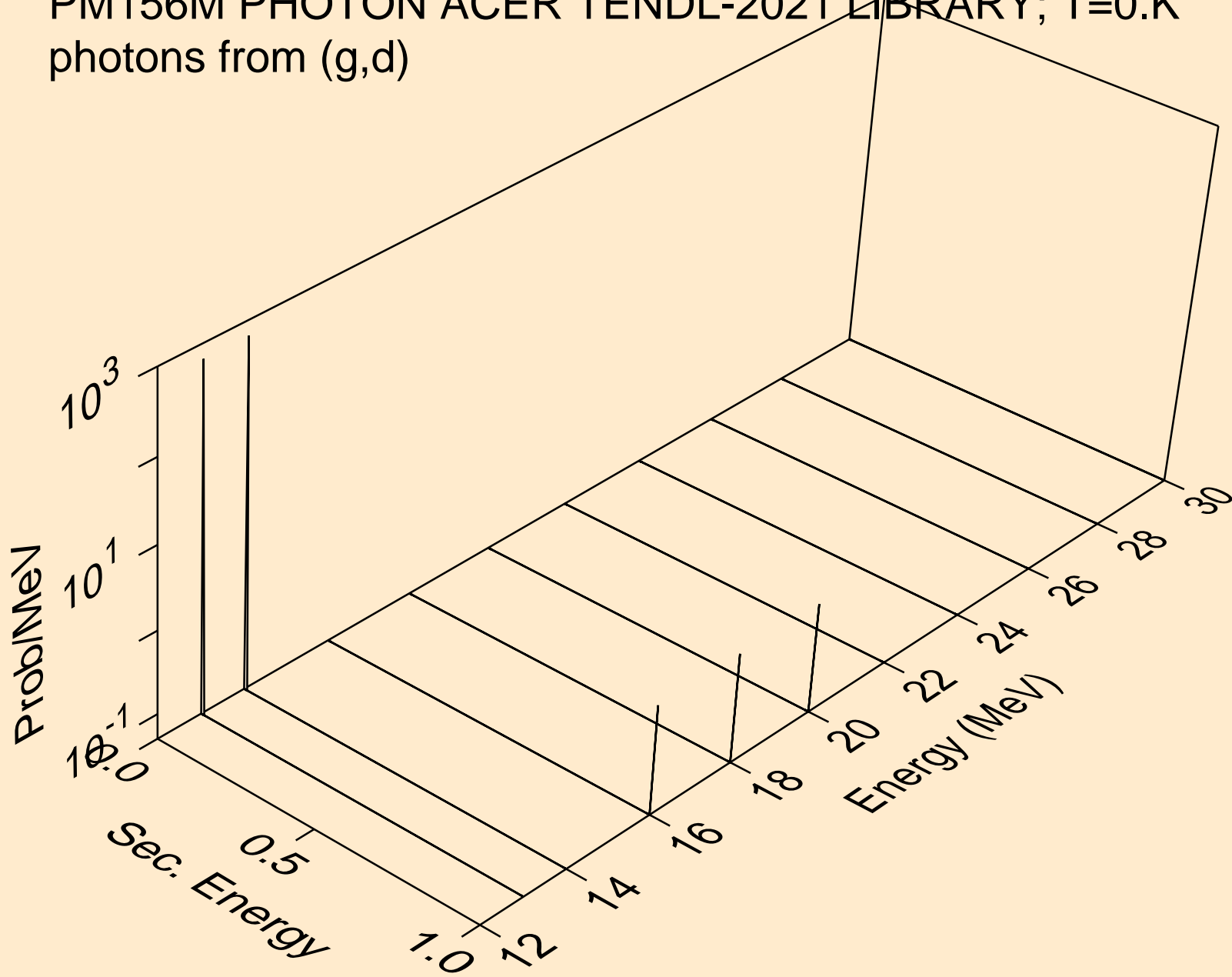

PM156M PHOTON ACER TENDL-2021 LIBRARY; T=0.K
photons from (g,t)

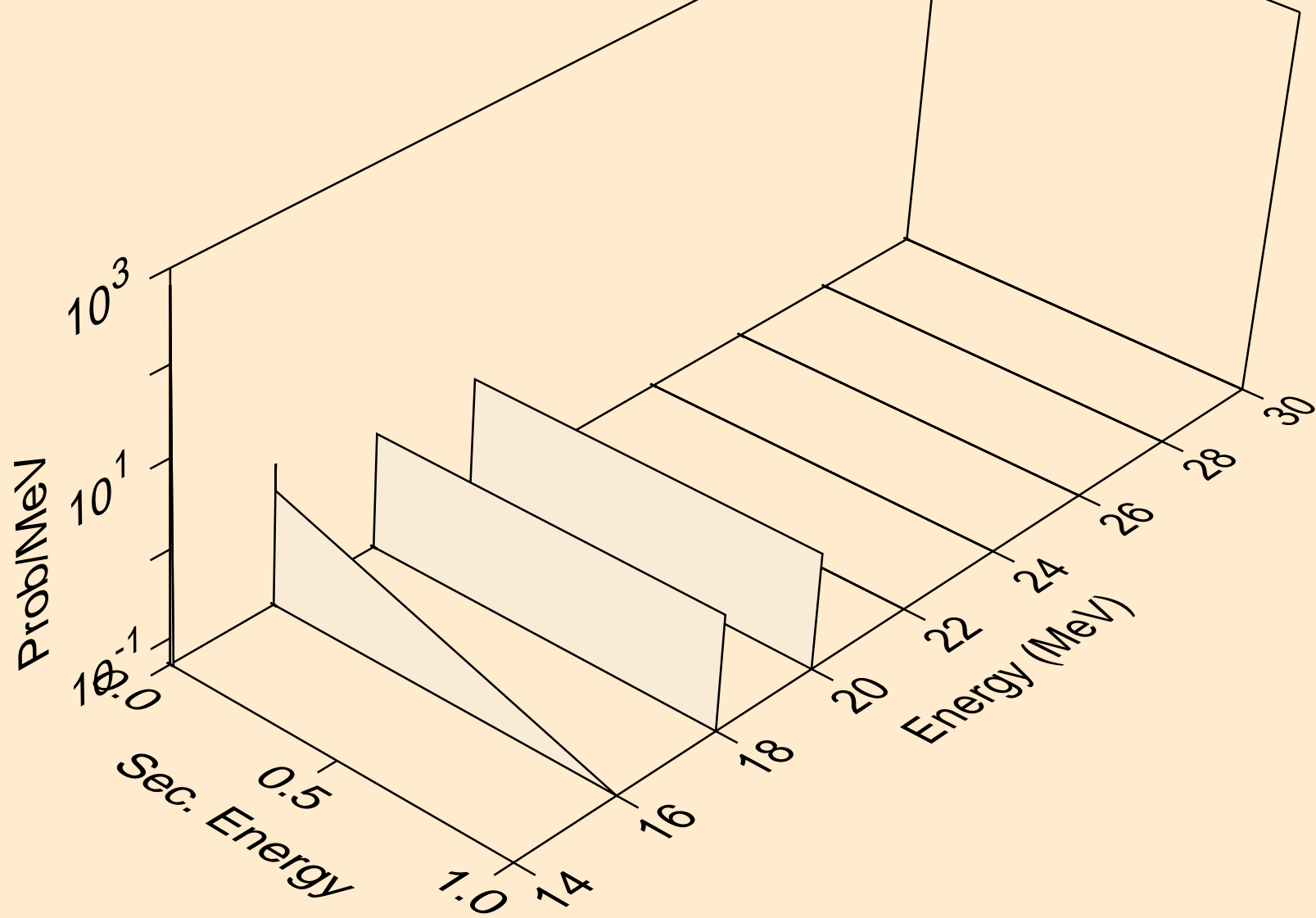

PM156M PHOTON ACER TENDL-2021 LIBRARY; T=0.K
protons from (g,x)

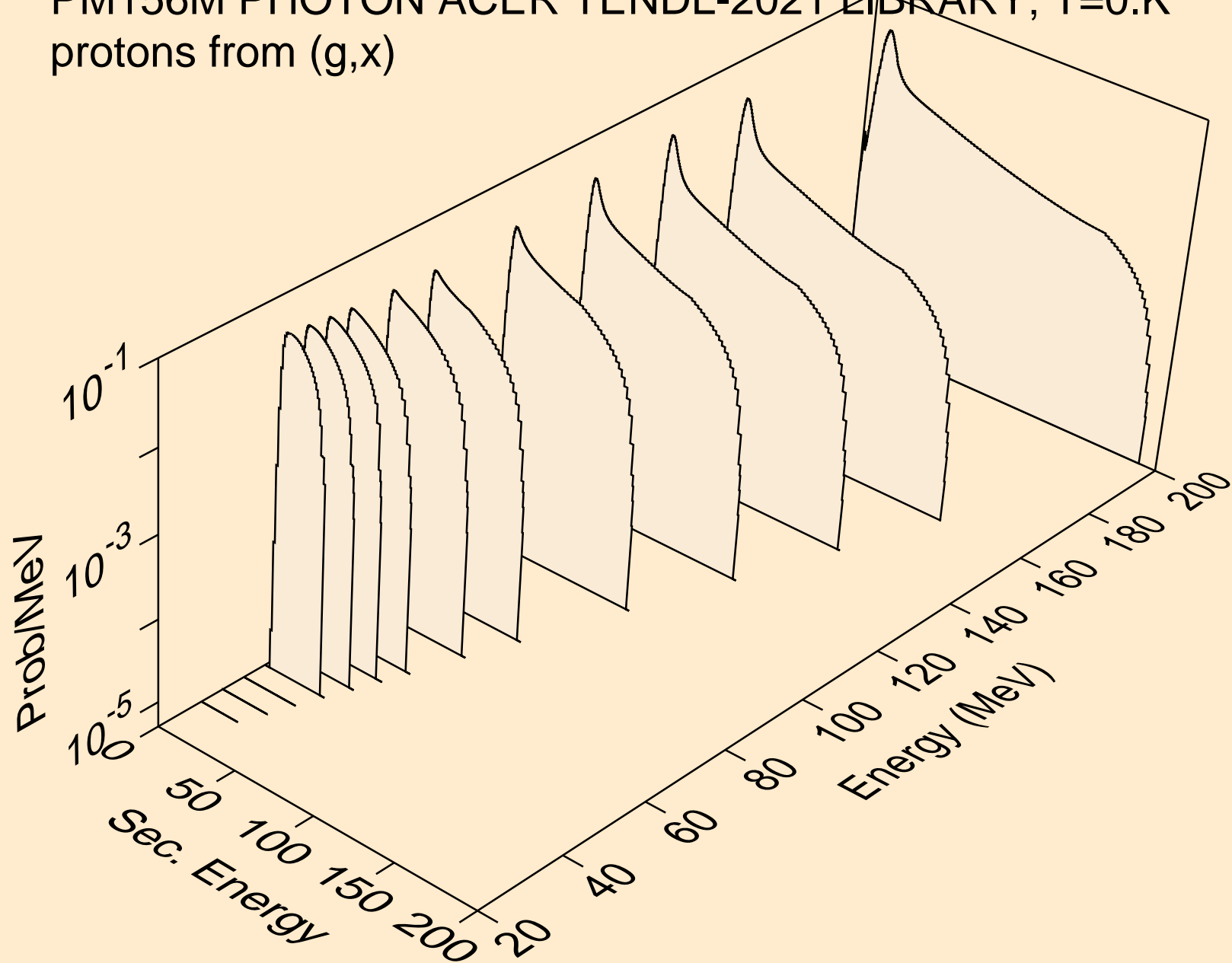

PM156M PHOTON ACER TENDL-2021 LIBRARY; T=0.K
protons from (g,n*)p

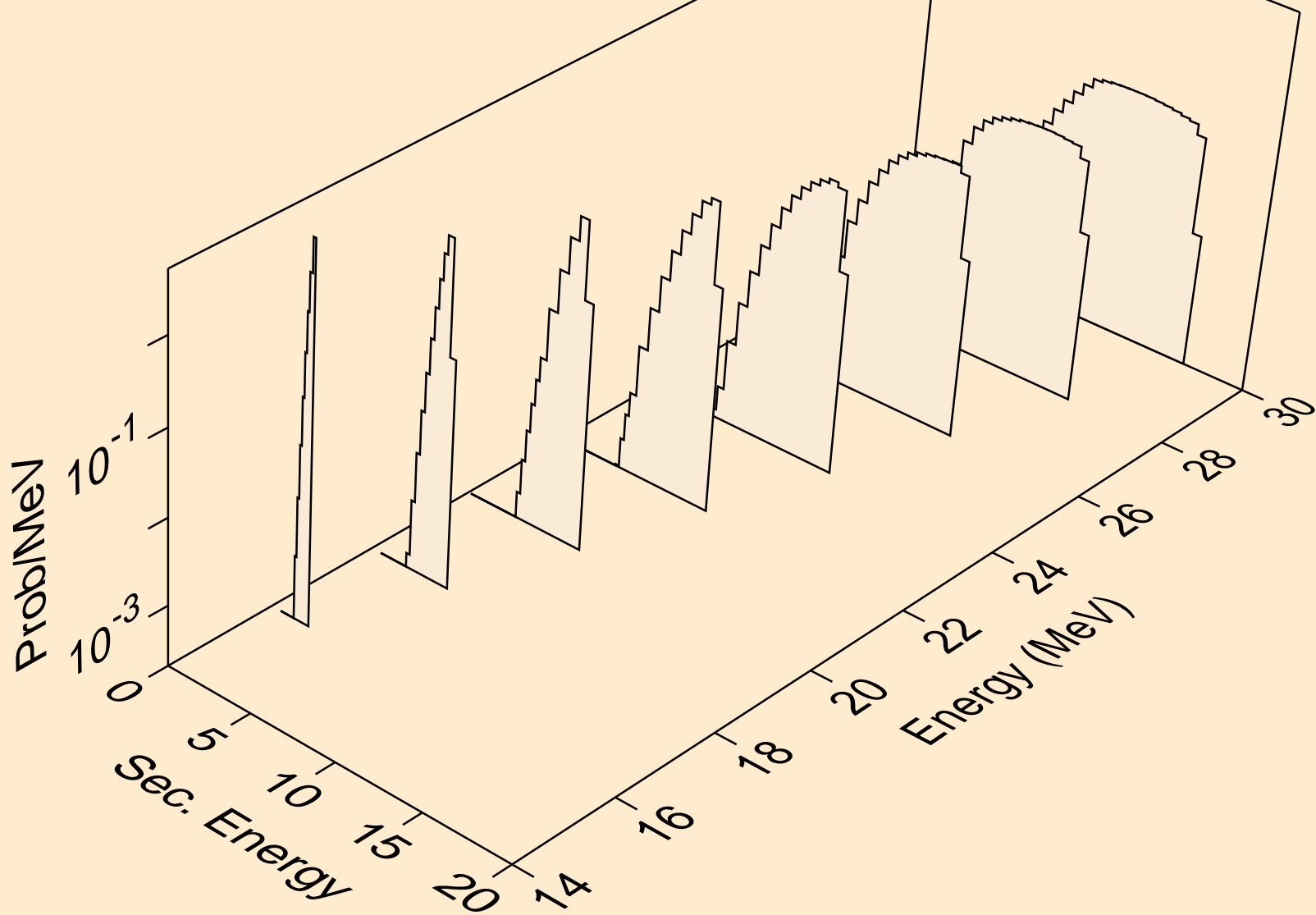

PM156M PHOTON ACER TENDL-2021 LIBRARY; T=0.K
protons from (g,2np)

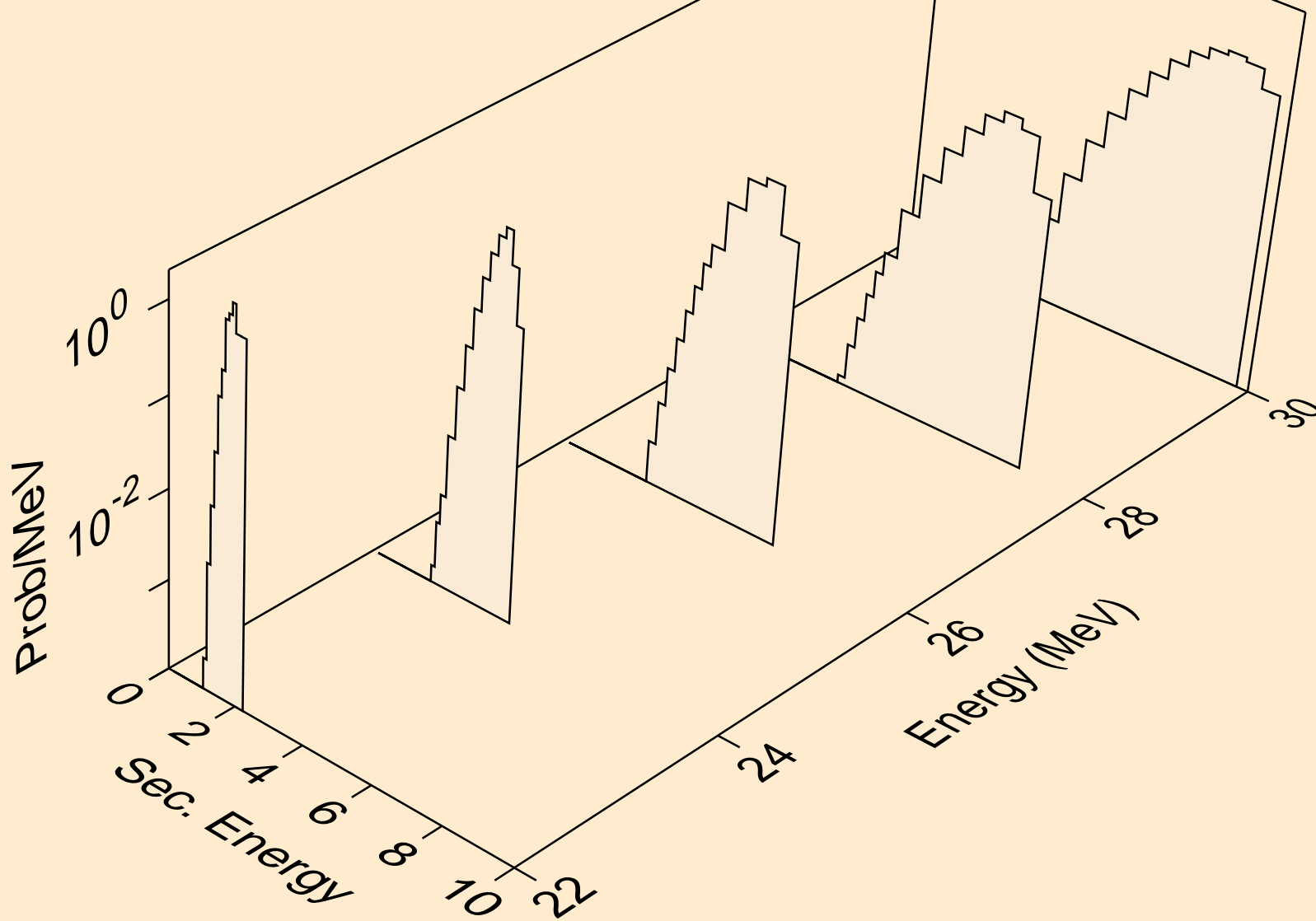

PM156M PHOTON ACER TENDL-2021 LIBRARY; T=0.K
protons from (g,3np)

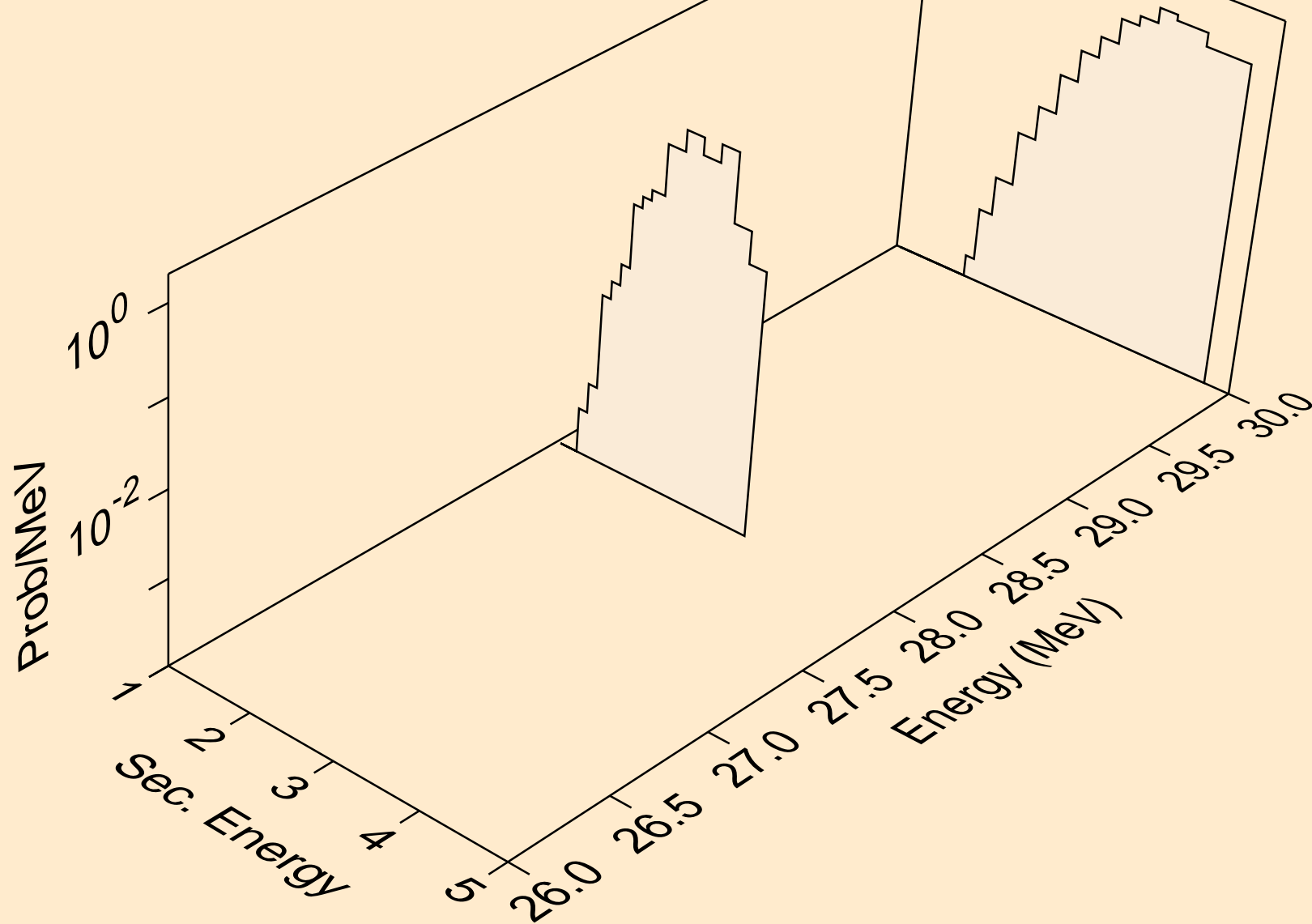

PM156M PHOTON ACER TENDL-2021 LIBRARY; T=0.K
protons from (g,p)

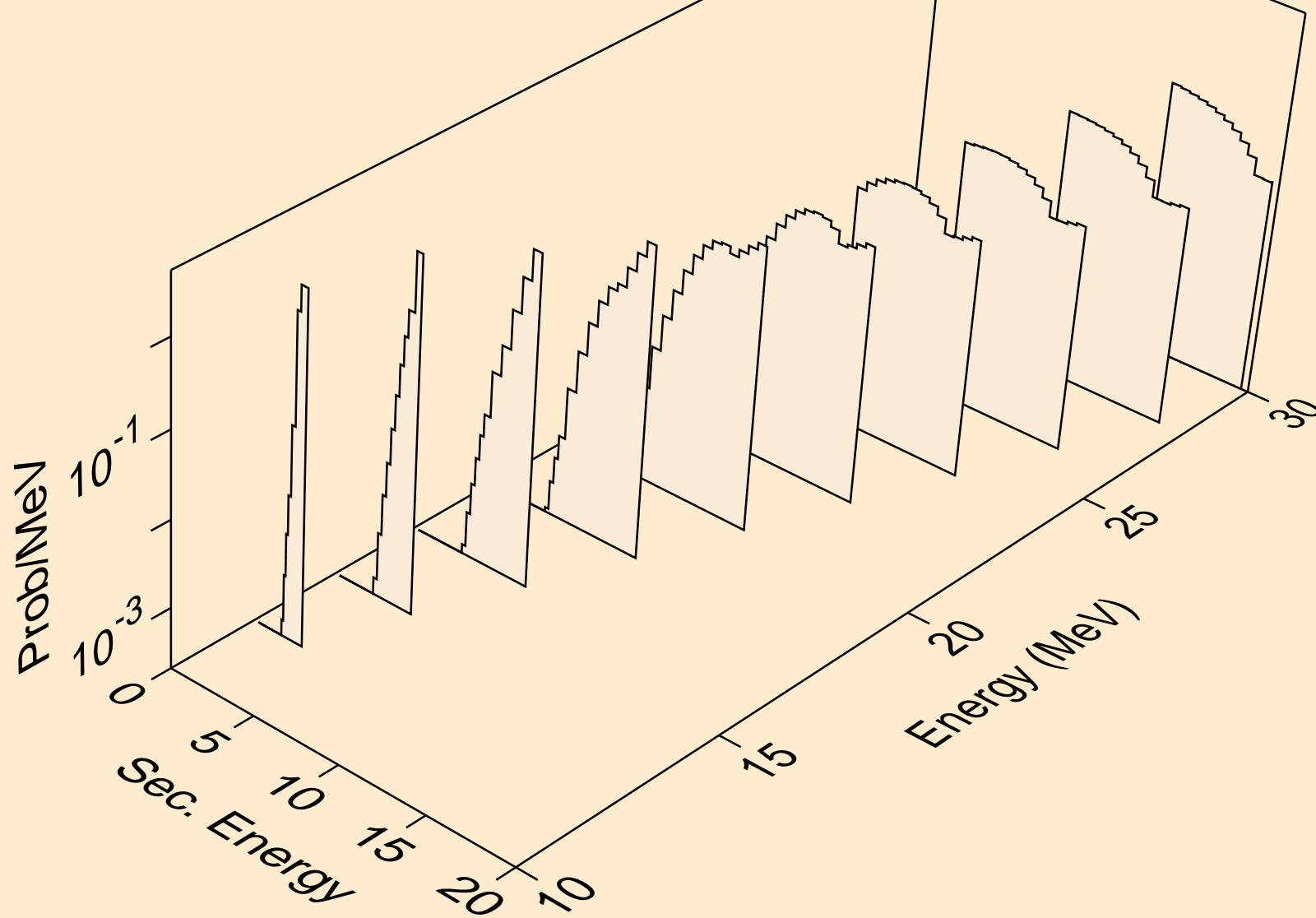

PM156M PHOTON ACER TENDL-2021 LIBRARY; T=0.K
deuterons from (g,x)

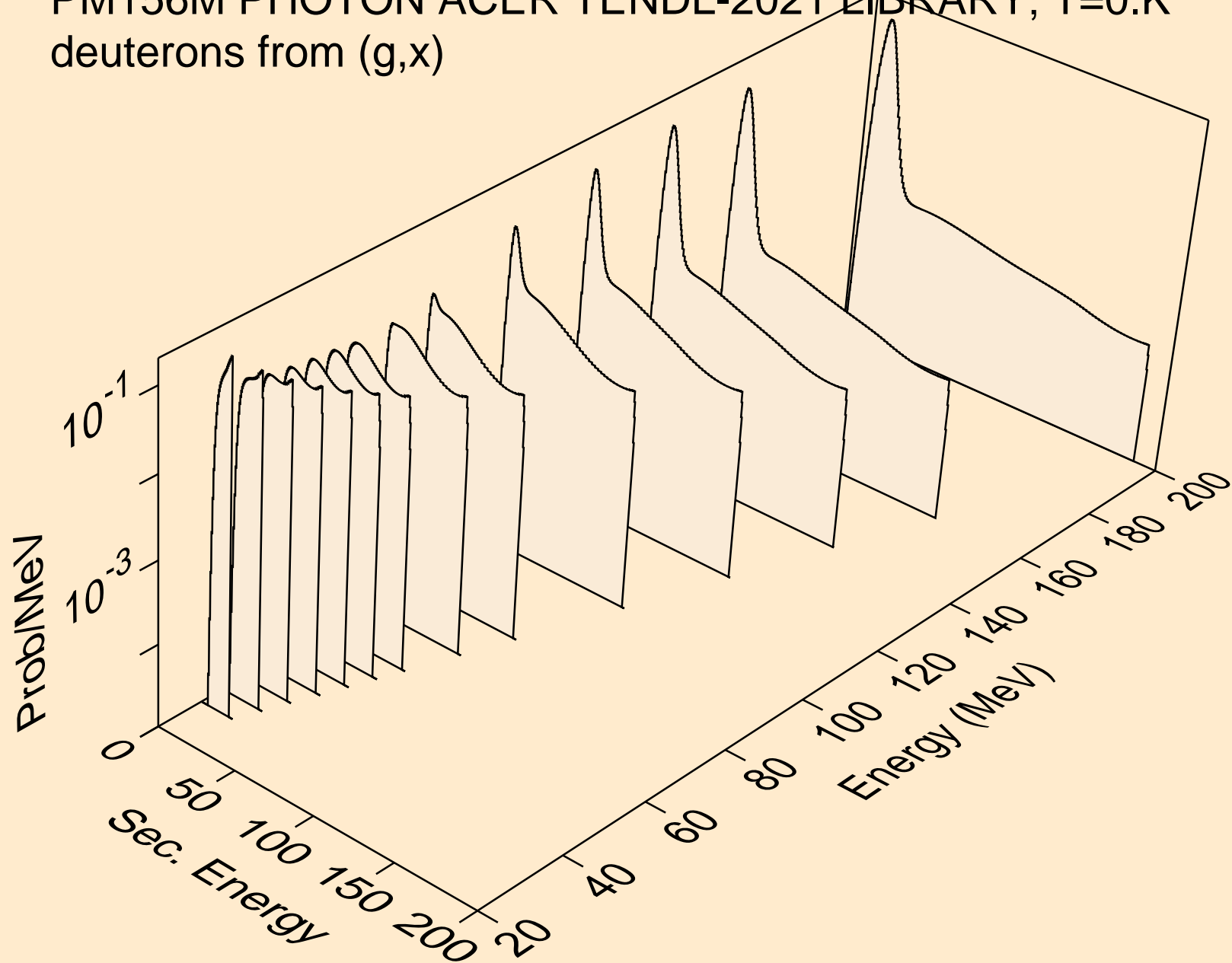

PM156M PHOTON ACER TENDL-2021 LIBRARY; T=0.K
deuterons from (g,2nd)

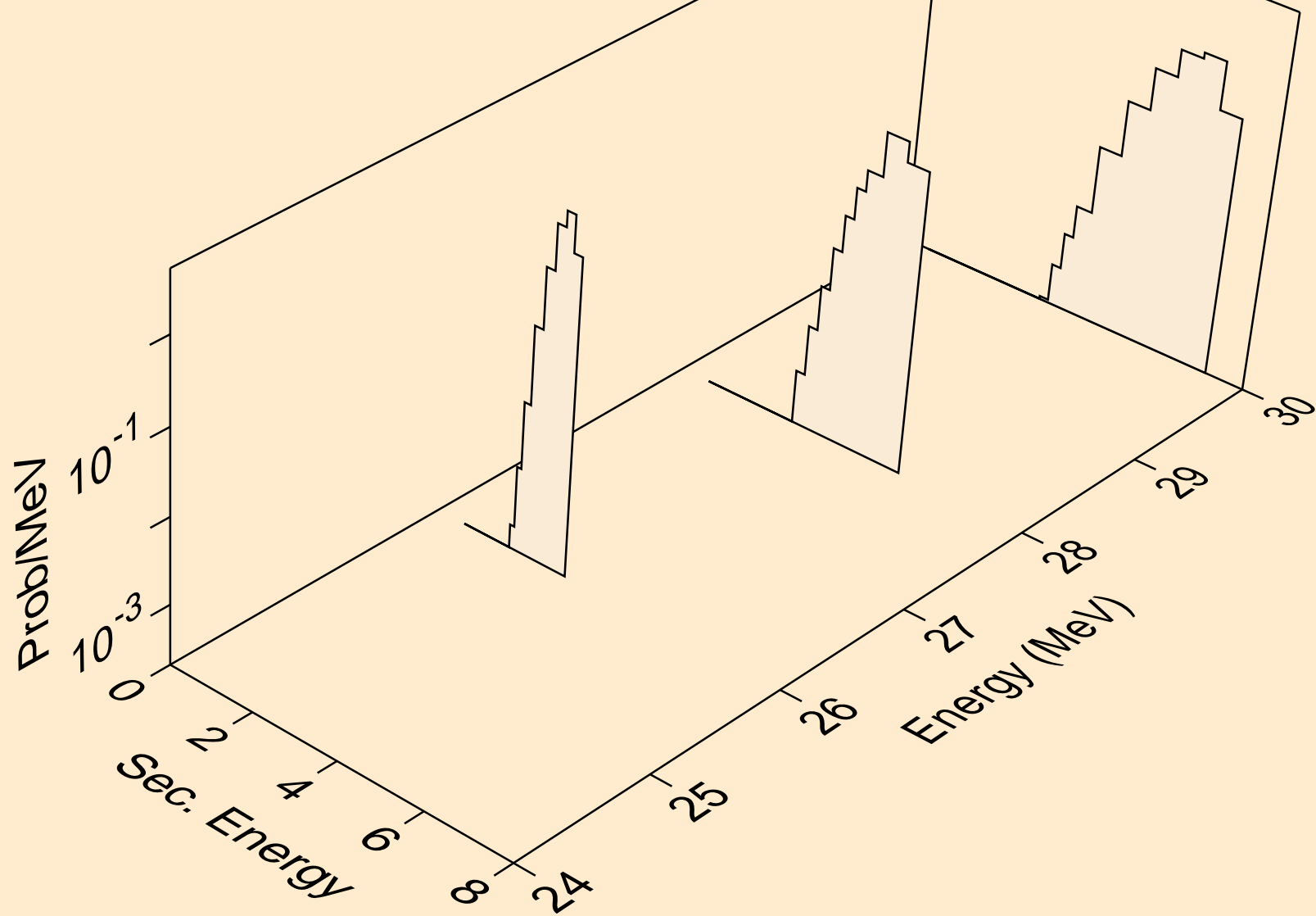

PM156M PHOTON ACER TENDL-2021 LIBRARY; T=0.K
deuterons from (g,n*)d

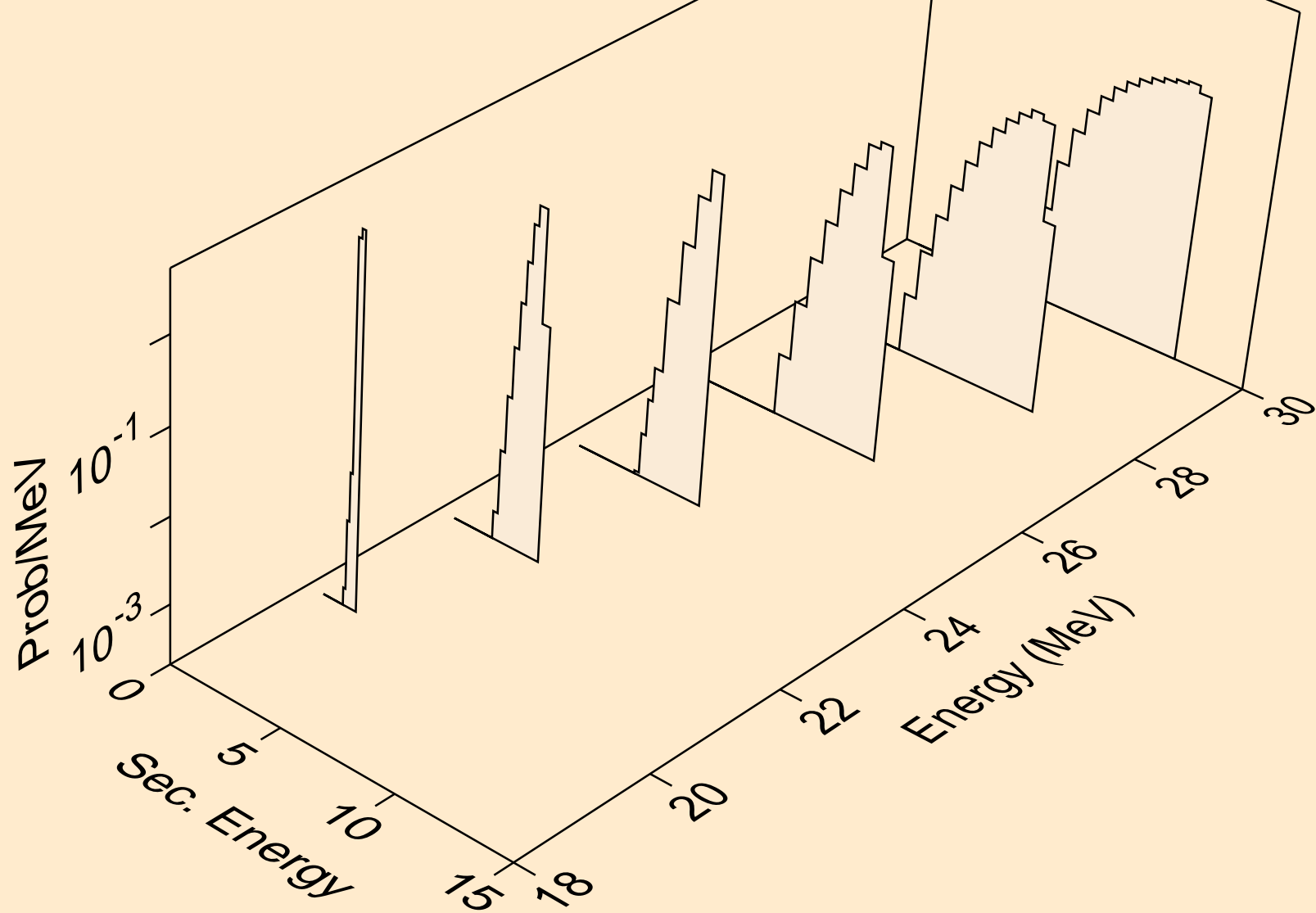

PM156M PHOTON ACER TENDL-2021 LIBRARY; T=0.K
deuterons from (g,d)

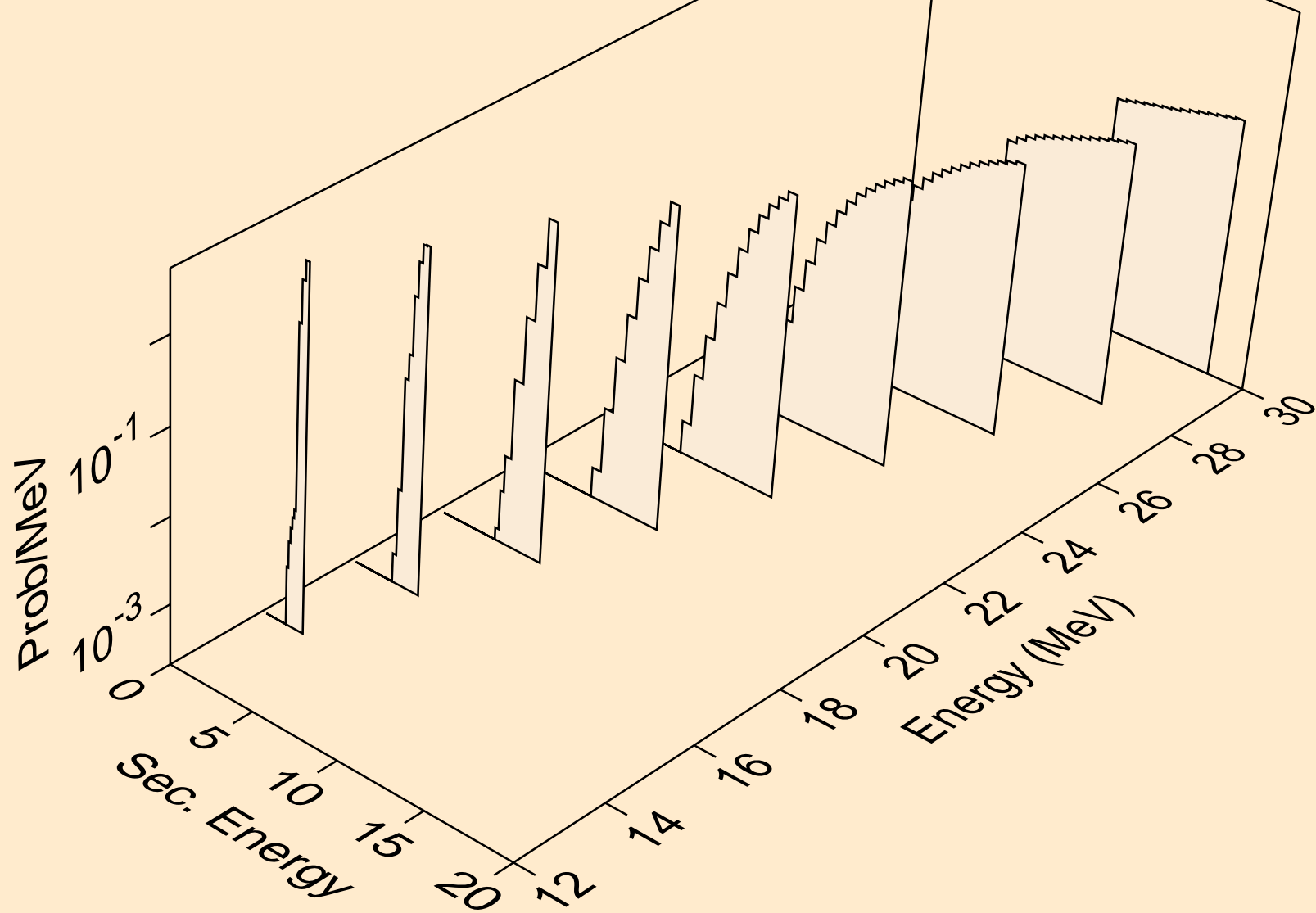

PM156M PHOTON ACER TENDL-2021 LIBRARY; T=0.K
tritons from (g,x)

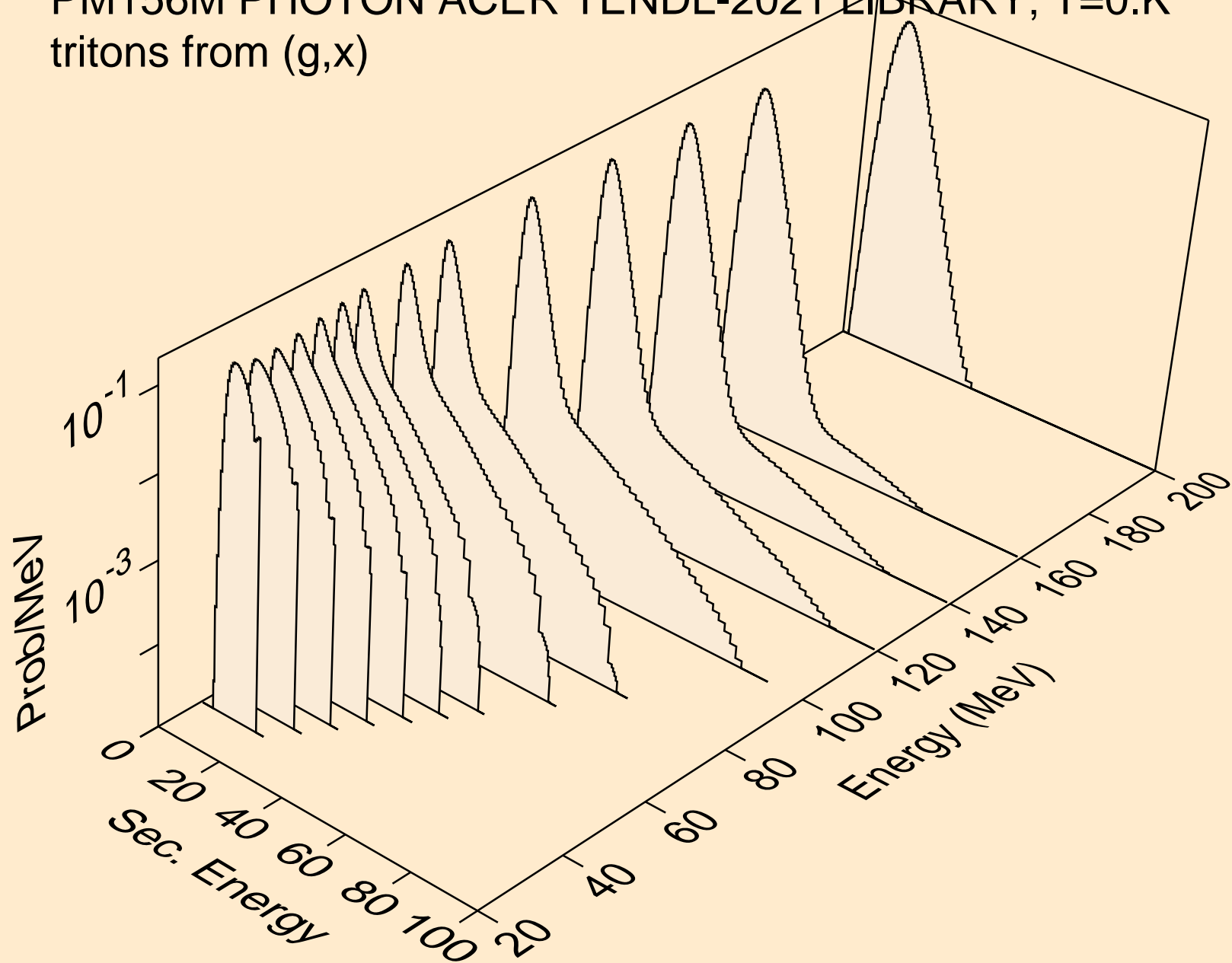

PM156M PHOTON ACER TENDL-2021 LIBRARY; T=0.K
tritons from (g,n*)t

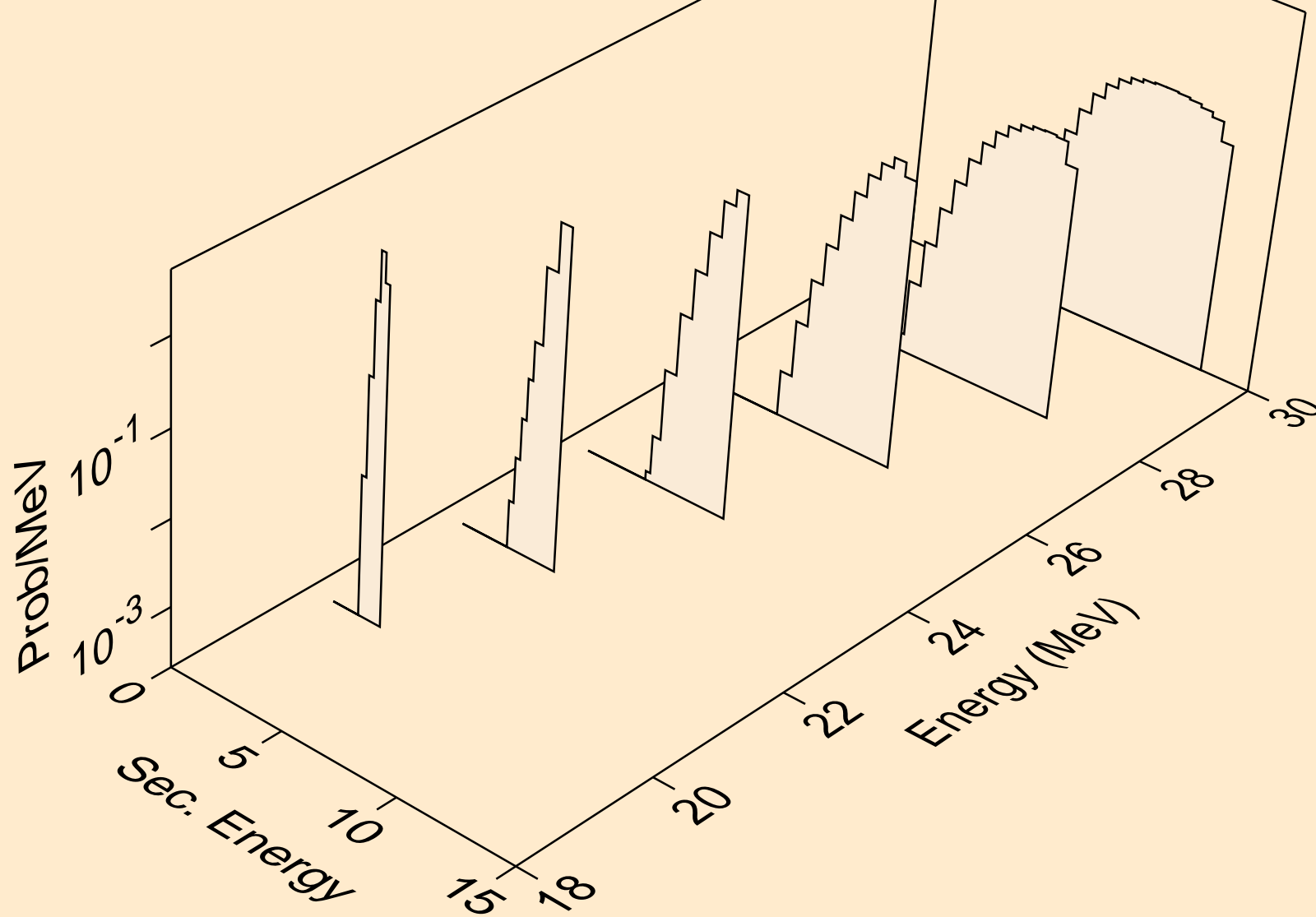

PM156M PHOTON ACER TENDL-2021 LIBRARY; T=0.K
tritons from (g,t)

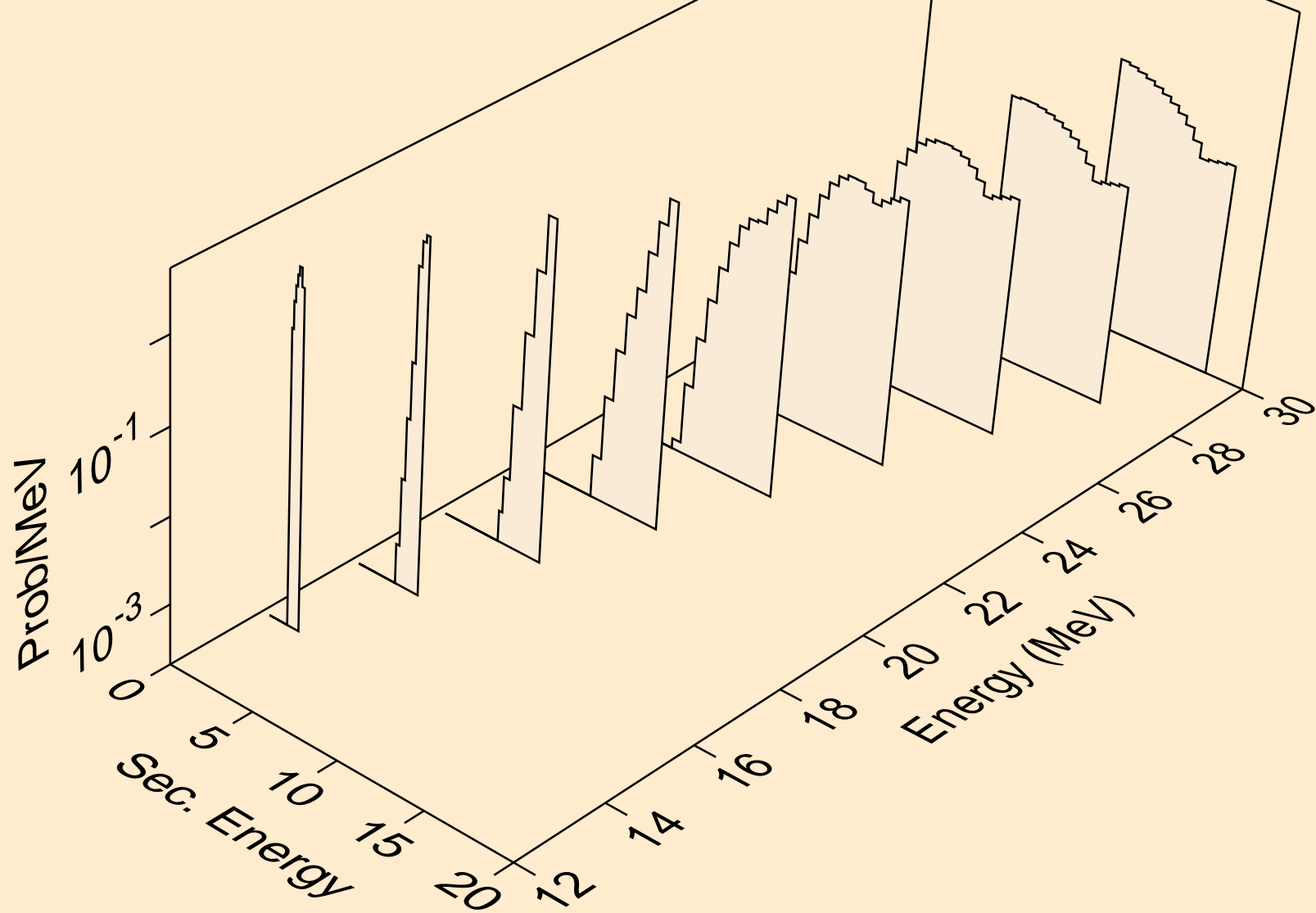

PM156M PHOTON ACER TENDL-2021 LIBRARY; T=0.K
he3s from (g,x)

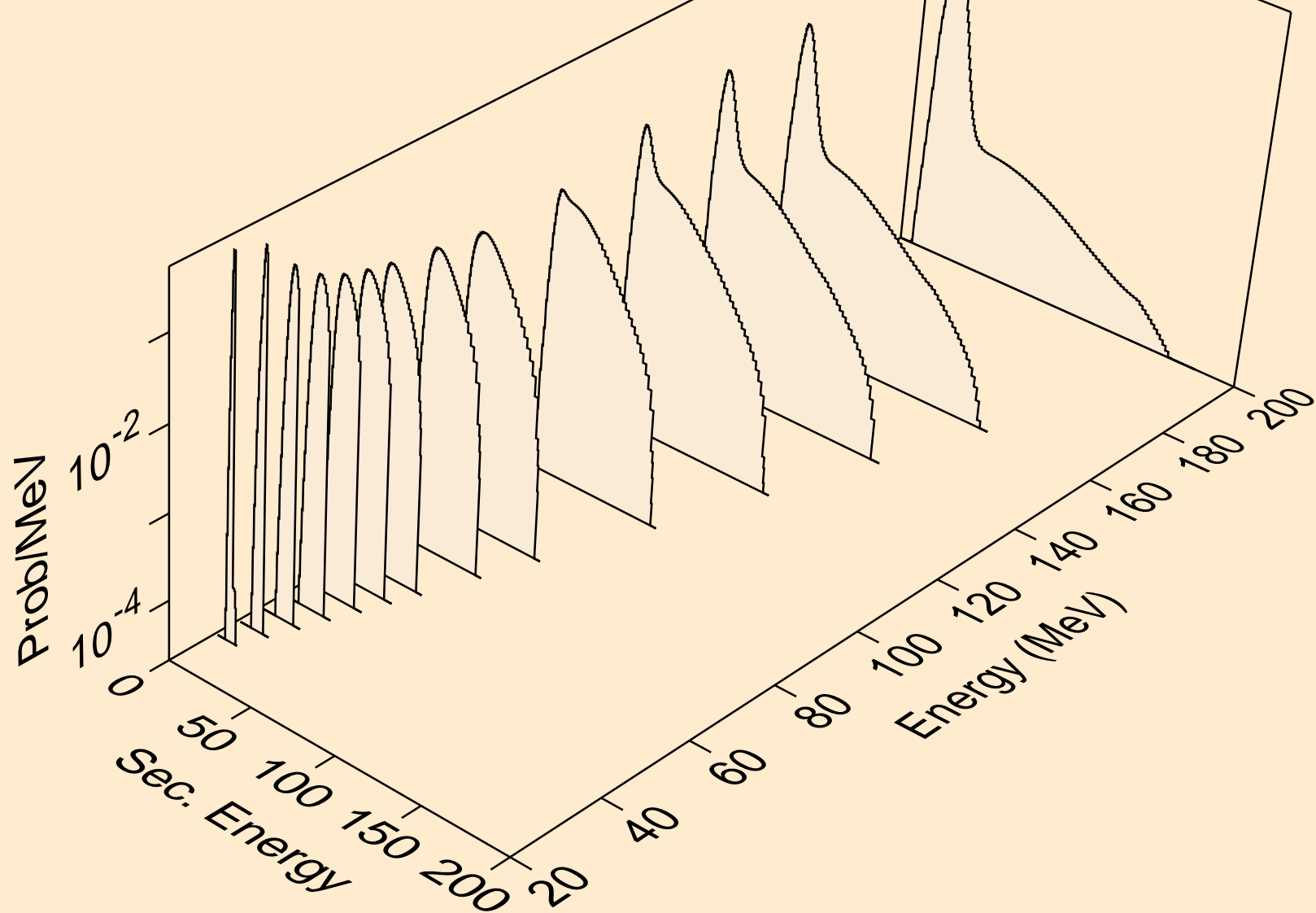

PM156M PHOTON ACER TENDL-2021 LIBRARY; T=0.K
alphas from (g,x)

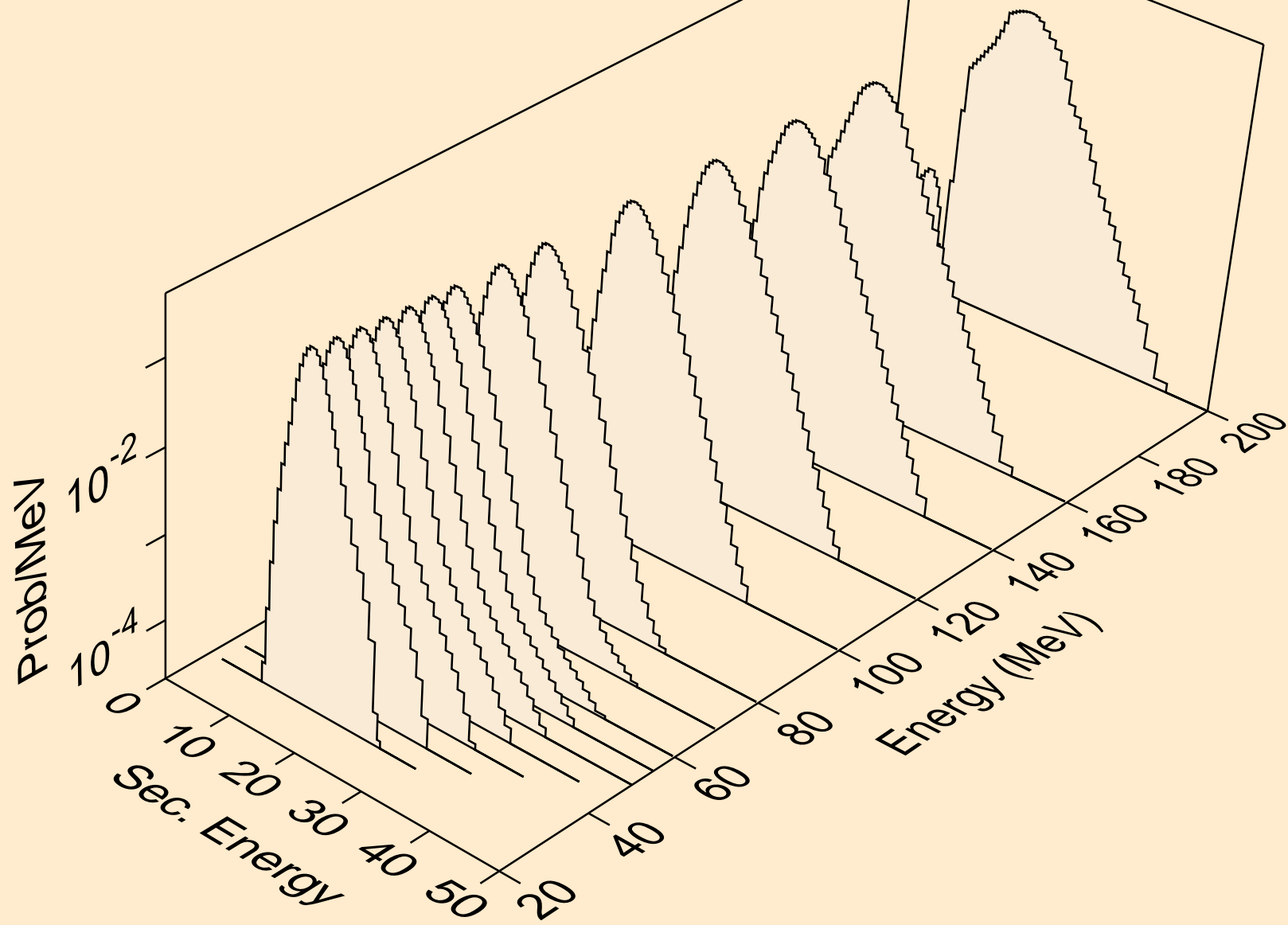

PM156M PHOTON ACER TENDL-2021 LIBRARY; T=0.K
alphas from (g,n*)a

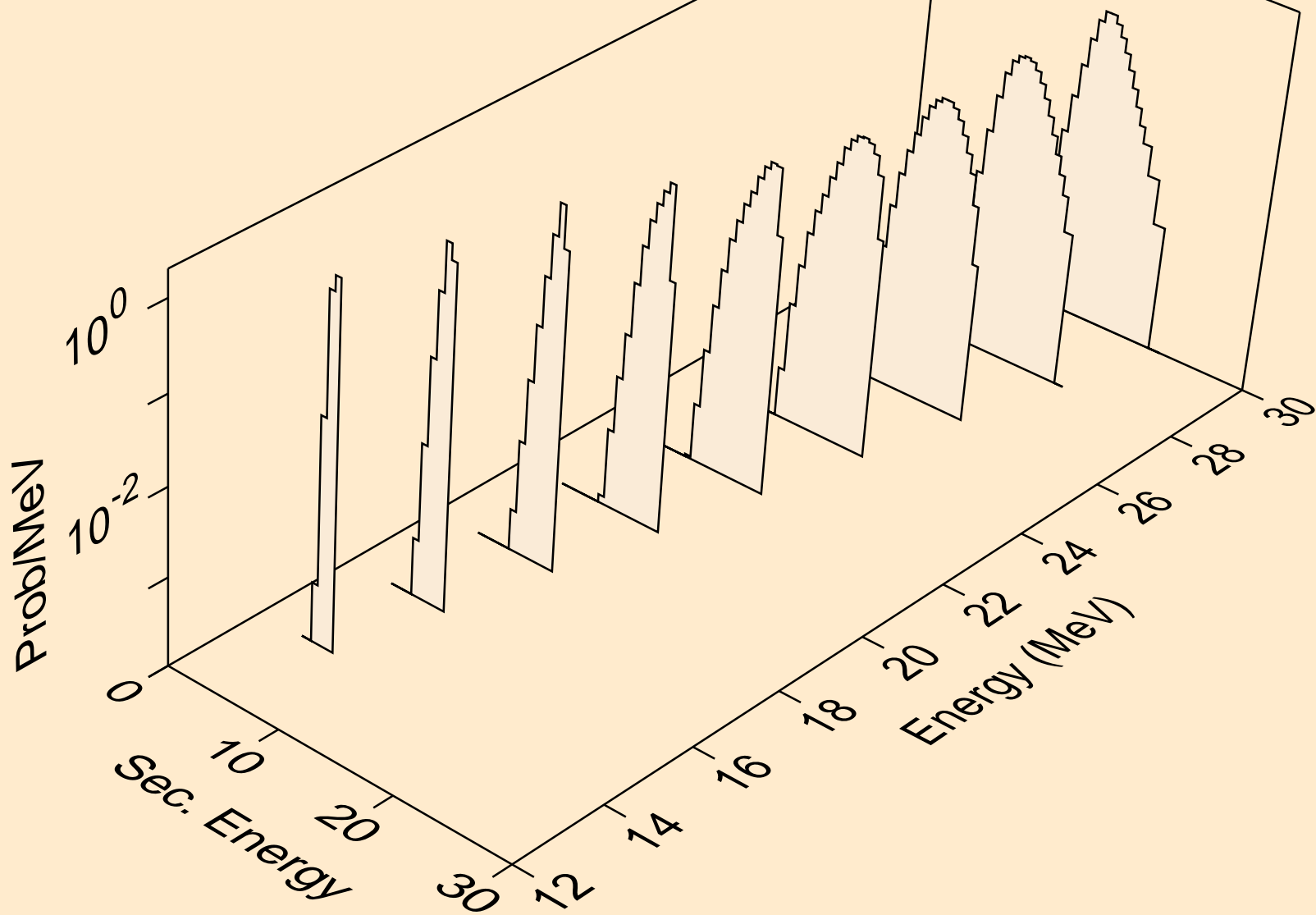

PM156M PHOTON ACER TENDL-2021 LIBRARY; T=0.K
alphas from (g,2n)a

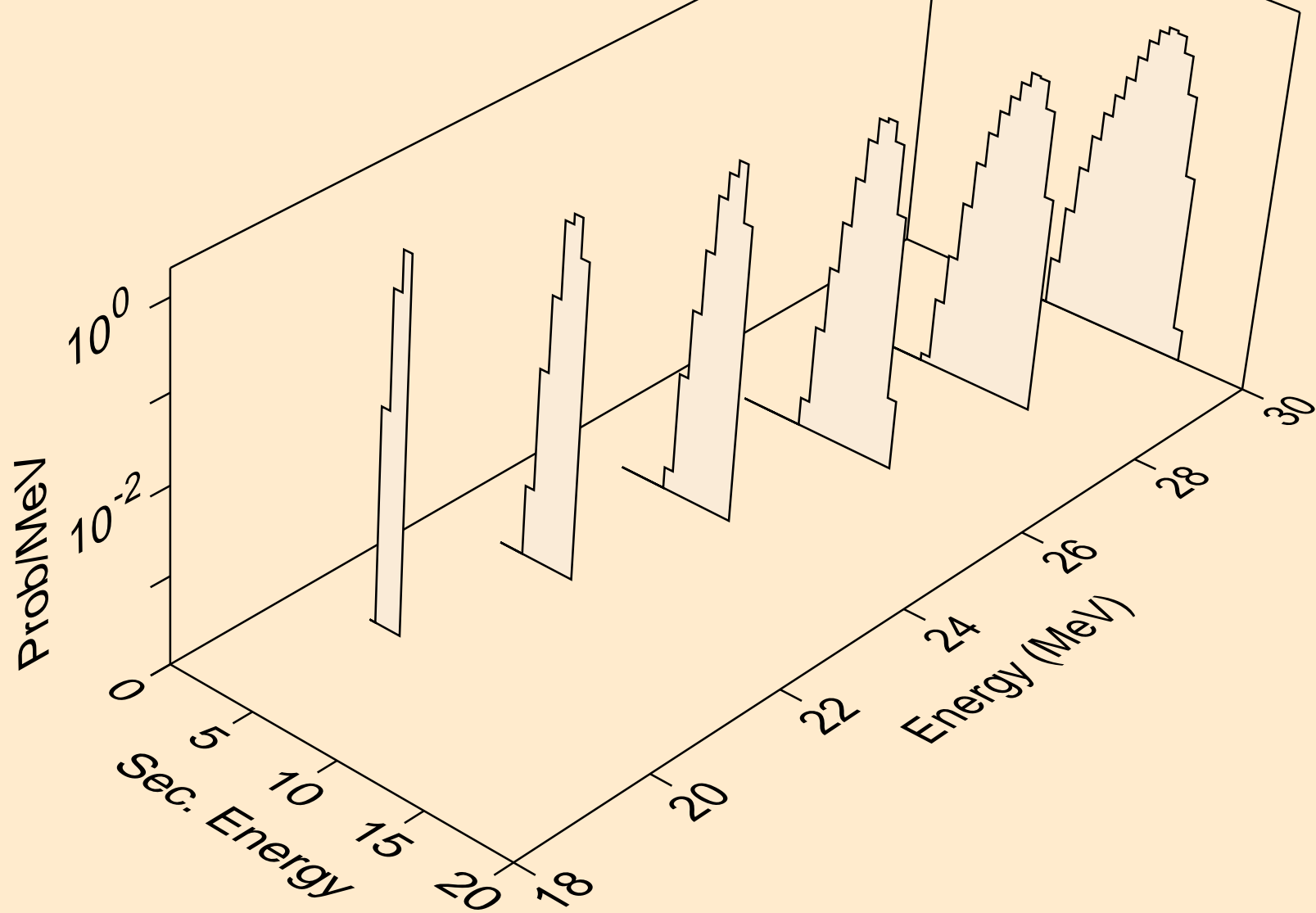

PM156M PHOTON ACER TENDL-2021 LIBRARY; T=0.K
alphas from (g,a)

